

Short Form Catalog

Relays

Electromechanical Relays

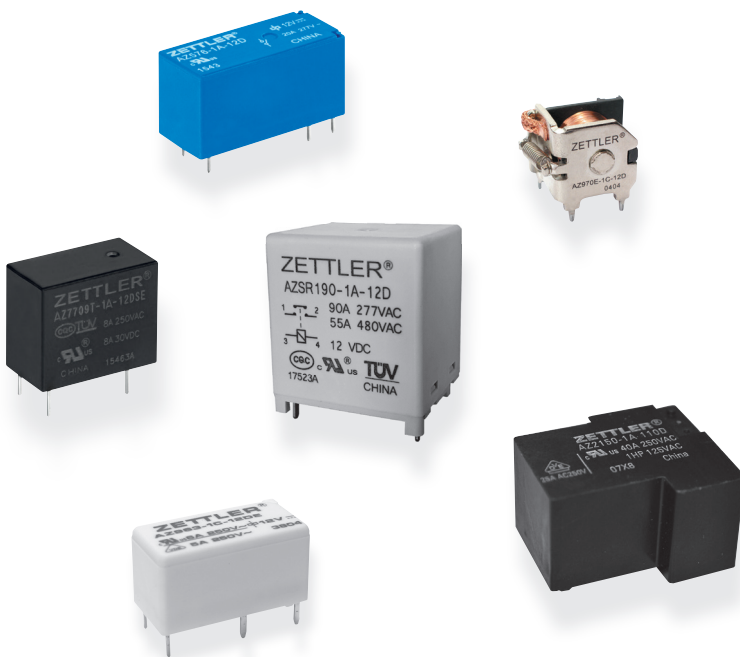

worldwide. competence in components.

Electromechanical Relays from ZETTLER

The name stands for certified quality. The products are the result of the strict international standardization and our longterm experience in developing and manufacturing of relays. No matter what application, ZETTLER relays are the sophisticated solution.

Our range of products will fully come to your expectations in terms of variety and technology. The wide product range includes Signal Relays for telecommunication, Power Relays for general purpose, Solar Relays for solar inverter applications, E-Mobility Relays for electric car charging equipment, High Power Relays for heavy loads, Automotive Relays for automotive applications as well as DC Relays for medium DC loads.

In addition to established components you will find a series of technical innovations like DC Relays in common design for medium DC loads and extremely small relays on the next pages.

ZETTLER electronics is a member of the worldwide operating ZETTLER Group. In addition to relays the group is manufacturing transformers, bimetal thermostats and LCD displays.

Not only components are our business. We offer competence in service and technology. Our engineers will always lead you to the best choice for your application. The ZETTLER engineering departments are working global to meet international standards.

A well assorted warehouse enables a fast and – upon request – delivery on a given day.

Signal Relays

Page 8

... for switching of small signals in communications, measurement and controls, automated test equipment (ATE). Signals will be connected with high precision.

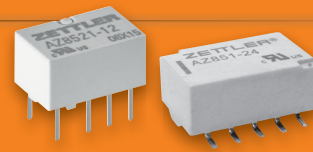

Power Relays

Page 10

... for general purpose. Most of the typical applications in industry, HVAC (Heating, Ventilation, Air Condition), lighting, building control, as well as other control equipments can be solved by using these relays. The special standards for appliances (White Goods) are achieved by many of these relays. They guarantee a safety space (high insulation) between the control unit and the power load. Available with AC and DC coils.

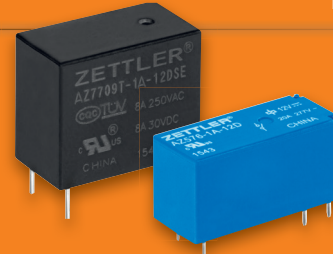

Solar Relays

Page 18

... are designed for the photovoltaic industry to fulfill the common requirements of applications like solar inverters.



E-Mobility Relays

Page 19

... are designed according common requirements for E-Mobility charging equipment.

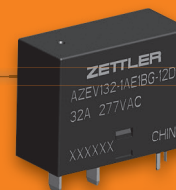

High Power Relays

Page 20

... for switching of high loads. Mainly used in heating, lighting, motor controls and micro wave ovens.

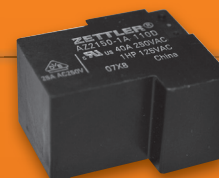

Automotive Relays

Page 21

... for automotive applications. These relays can be used for a huge variety of typical motor applications in cars like central locking, sun roof and window control, seat memory, mirror movement, as well as lights and blinkers.



DC Relays

Page 23

... for medium DC loads.



Important information

Page 25



Series	Contact Form	U _{max} (V)	Contact Ratings	
			I _{max} continuous (A)	P _{max} (VA / W)
AZ 8521 / 8521S	2C	250 AC	2	62,5 / 60
AZ 8462 / 8462S	2C	250 AC	2	62,5 / 60
AZ 850 / 851	2C	250 AC	2	62,5 / 30
AZ 951 / 952	1C	220 AC	5	62,5 / 150
AZ 9571	1C	125 AC	1	62,5 / 30
AZ 822	2C	250 AC	2	125 / 60
AZ 832	2C	250 AC	2	250 / 60
AZ 770	1A / 1C	400 AC	10	2500 / 150
AZ 7709	1A	250 AC	10	2500 / 300
AZ 770H	1A	400 AC	5	1250 / 150
AZ 963	1A / 1B / 1C	380 AC	6	1500 / 180
AZ 940	1A / 1C	400 AC	10	2770 / 150
AZ 9405	1A / 1C	277 AC	10	1400 / 150
AZ 921	1A	250 AC	5	1250 / 150
AZ 9371	1A	277 AC	10	2770 / 300
AZ 6951	1A	250 AC	5	1250 / 150
AZ 6991	1A / 1C	400 AC	8	2216 / 180
AZ 6960	1A / 1B / 1C	400 AC	8	2270 / 192
AZ 6962	1A / 1B / 1C	440 AC	10	2500 / 300
AZ 742	2A / 2C	400 AC	10	2500 / 240
AZ 743	2A / 2C	440 AC	10	2500 / 240
AZ 763	1A / 1C	400 AC	12	3000 / 360
AZ 761	1A / 1B / 1C	440 AC	12	3324 / 360
AZ 764	1A / 1C	400 AC	20	5000 / 480
AZ 762	1A / 1C	440 AC	16	5540 / 480
AZ 576	1A / 1C	480 AC	20	5540 / 510
AZ 764H	1A	400 AC	16	4000 / 480
AZ 762H	1A / 1C	440 AC	16	4000
AZ 762T	1A	440 AC	16	4000
AZ 762P	1A / 1C	350 AC	20	5000
AZ 7621P	1A / 1C	440 AC	16	4000
AZ 943	1A / 1C	300 AC	15	2770 / 300
AZ 943W	1A / 1C	277 AC	10	2770 / 300

Signal Relays

Power Relays

DC coil	AC coil	DC Coil Power at Pickup (mW)	Dielectric Strength Coil / Contact (VAC)	Size L x W x H (mm)	Flux proof	Case Epoxy sealed	open	Page
●		56...113	1600	10,0 x 6,5 x 5,4		●		8
●		56...152	2000	15,2 x 7,7 x 9,2		●		8
●		56...169	1000	14,0 x 9,0 x 5,0		●		8
●		113...253	1000	15,75 x 10,75 x 11,81		●		9
●		96...128	1000	12,5 x 7,5 x 10,0		●		9
●		73...174	1000	20,0 x 9,8 x 12,0		●		9
●		42...159	1500	20,2 x 10,0 x 10,65		●		9
●		113...256	5000	17,85 x 10,35 x 12,95	●	●		10
●		113...223	4000	18,9 x 10,7 x 15,7	●	●		10
●		113...116	5000	17,85 x 10,35 x 12,95	●	●		10
●		113	4000	20,3 x 10,2 x 10,7	●	●		11
●		113...265	4000	20,5 x 10,2 x 15,7	●	●		11
●		113...297	4000	20,0 x 10,0 x 15,2	●	●		11
●		59...88	3000	20,3 x 5,3 x 12,8		●		12
●		113	4000	20,5 x 7,2 x 15,3	●	●		12
●		100	3000	18,5 x 6,5 x 12,4		●		12
●		96...129	4000	28,0 x 5,0 x 15,0	●	●		13
●		120...126	5000	28,5 x 10,1 x 12,5	●	●		13
●		108...141	5000	28,5 x 10,1 x 12,5	●	●		13
●	●	196...235	5000	29,0 x 12,7 x 15,7	●	●		14
●	●	196...235	5000	29,0 x 12,7 x 15,7	●	●		14
●	●	196...235	5000	29,0 x 12,7 x 15,7	●	●		14
●	●	141...235	5000	29,3 x 13,0 x 16,0	●	●		15
●	●	196...235	5000	29,0 x 12,7 x 15,7	●	●		15
●	●	141...235	5000	29,0 x 12,7 x 15,7	●	●		15
●		196...226	5000	29,3 x 12,7 x 15,3	●	●		15
●		138...141	5000	29,0 x 12,7 x 15,7	●			16
●		140...235	5000	29,0 x 12,7 x 15,7	●	●		16
●		196...235	5000	29,0 x 12,7 x 15,7	●	●		16
●		256...416	4000	29,4 x 12,7 x 16,0	●	●		17
●		192...319	5000	29,0 x 12,7 x 15,9	●	●		17
●		203...206	1500	19,0 x 15,3 x 15,7	●	●		17
●		300...312	1500	19,0 x 15,3 x 16,0	●	●		17



	Series	Contact Form	U _{max} (V)	Contact Ratings	
				I _{max} continuous (A)	P _{max} (VA / W)
Solar Relays	AZ SR131	1A	277 AC	35	9695
	AZ SR235 / 250	1A / 2A	440 AC	50	13850 / 1500
	AZ SR165	1A	690 AC	65	43200
	AZ SR190	1A	800 AC	100	48000
	AZ SR1160	1A	690 AC	160	110400
E-Mobility Relays	AZ EV116 / 132	1A + 1B	440 AC	32	8864 / 960
High Power Relays	AZ 2150	1A / 1B / 1C	300 AC	40	10000 / 900
	AZ 2150W	1A	440 AC	30	8310 / 900
	AZ 21501	1A / 1B / 1C	300 AC	50	12000 / 1500
Automotive Relays	AZ 947	1A / 1C / 1U	42 DC	20	1250 / 280
	AZ 987-1 / 987-2	1A / 1C / 2A / 2C	16 DC	30	- / 480
	AZ 970E / 971E	1A / 1C	150 DC	40	- / 560
	AZ 983	1A / 1B / 1C	28 DC	80	- / 1120
	AZ 979 / 980	1A / 1B / 1C	28 DC	80	- / 1120
	AZ 9731	1A / 1C / 1U	28 DC	40	- / 560
	AZ 977	1A / 1C	150 DC	20	- / 280
DC Relays	AZ DC110	1A	420 DC	16	4800 / 3000
	AZ DC105	1A	60 DC	150	- / 9000

(1) Dust cover

DC coil	AC coil	DC Coil Power at Pickup (mW)	Dielectric Strength Coil / Contact (VAC)	Size L x W x H (mm)	Flux proof	Case Epoxy sealed	open	Page
●		681...792	4500	30,4 x 15,9 x 25,15	●			18
●		268...281	5000	40,0 x 25,0 x 49,2	●			18
●		1227...1246	4000	38,0 x 33,0 x 41,5	●			18
●		1077...1080	5000	38,0 x 33,0 x 43,0	●			19
●		1662...1687	4000	63,3 x 62,0 x 41,7	●			19
●		870	4000	35,0 x 16,0 x 27,9	●			19
●		470...523	2500	26,9 x 31,8 x 19,1	●	●		20
●		623...625	4000	26,9 x 31,8 x 19,1	●	●		20
●		842...843	4000	31,8 x 26,9 x 19,1	●	●		20
●		216...222	500	15,7 x 12,3 x 14,0	●	●		21
●		180...194	500	12,3 x 13,2 x 10,2	●			21
●		514...573	500 DC	18,8 x 23,0 x 18,0	●	●	●	21
●		761	500	29,0 x 29,0 x 26,0	● (1)	●		22
●	●	676...761	500	29,0 x 29,0 x 26,5	● (1)	●		22
●	●	676	750	26,5 x 26,5 x 24,5	● (1)	●		22
●	●	405...540	1000 DC	23,0 x 15,5 x 26,0	● (1)	●		23
●		224...225	5000	29,3 x 12,7 x 19,0	●			23
●		1800	4000	47,6 x 40,0 x 45,1	●			23

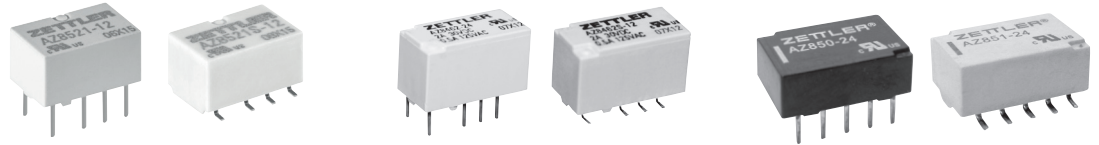

Relay Type	AZ 8521 / 8521S		AZ 8462 / 8462S		AZ 850 / 851	
	THT	SMT	THT	SMT	THT	SMT
Features	<ul style="list-style-type: none"> • Contact rating: 2 x 60 W / 2 x 62,5 VA • Microminiature size • Coil power at pickup 56...113 mW • Bifurcated cossbar contacts • Polarized coil • Epoxy sealed 		<ul style="list-style-type: none"> • Contact rating: 2 x 60 W / 2 x 62,5 VA • Microminiature size • Coil power at pickup 56...152 mW • Bifurcated cossbar contacts • Polarized coil • High temperature 105°C • Epoxy sealed 		<ul style="list-style-type: none"> • Contact rating: 2 x 30 W / 2 x 62,5 VA • Microminiature size • Coil power at pickup 56...169 mW • Bifurcated cossbar contacts • Polarized coil • Epoxy sealed 	
Size L x W x H	10,0 x 6,5 x 5,4 (SMT: 5,65) mm		15,2 x 7,7 x 9,2 (SMT: 9,7) mm		14,0 x 9,0 x 5,0 (SMT: 6,2) mm	
Other Versions	Latching version AZ 8521P SMT version		Latching version AZ 8462P SMT version		Latching version AZ 850P SMT version	
Contact Forms A = N.O. B = N.C. C = C.O.	2C		2C		2C	
Contact Material	AgNi+Au		AgNi+Au		AgPd+Au	
Contact Ratings (at resistive load)	max. max. max. max. max.	2 A 250 VAC 220 VDC 62,5 VA 60 W	max. max. max. max. max.	2 A 250 VAC 220 VDC 62,5 VA 60 W	1 A switching / 2 A continuous 250 VAC 220 VDC 62,5 VA 30 W	
Electrical Life Expectancy (at rated load)	1 x 10 ⁵		5 x 10 ⁵		2 x 10 ⁵	
Mechanical Life Expectancy	1 x 10 ⁸		1 x 10 ⁸		1 x 10 ⁸	
Standard Types (nominal coil voltage coil resistance)	VDC	Ω	VDC	Ω	VDC	Ω
	3	64,3	3	64,3	3	64
	4,5	145	4,5	145	5	178
	5	178	5	178	6	257
	6	257	6	257	12	1028
	9	579	9	579	24	2880
	12	1080	12	1080		
	24	2880	24	4114		
			48	8533		
Pickup / Dropout (% of V _{nom})	≤ 75% / ≥ 10%		≤ 75% / ≥ 10%		≤ 75% / ≥ 10%	
Ambient Temperature	-40°C...+85°C		-40°C...+105°C		THT: -40°C...+70°C SMT: -40°C...+85°C	
Dielectric Strength (coil to contacts)	1600 VAC		2000 VAC		1000 VAC	
Termination	PCB		PCB		PCB	
Operate / Release Time (typ. at V _{nom})	3 / 3 ms		4 / 4 ms		2 / 1 ms	
Approvals	UL, CUR		UL, CUR		UL, CUR	
Accessories	-		-		-	

Layout

(viewed toward terminals)

(dimensions in mm)
(grid: 2.54 mm)

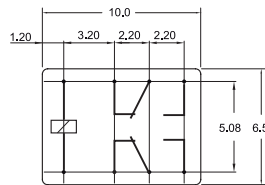

AZ 8521

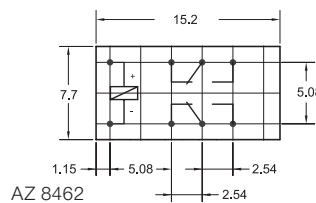

AZ 8462

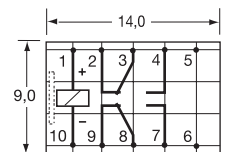

AZ 850

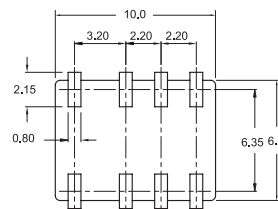

AZ 8521S

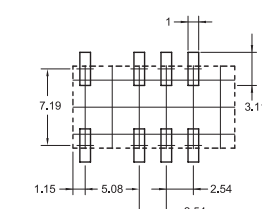

AZ 8462S

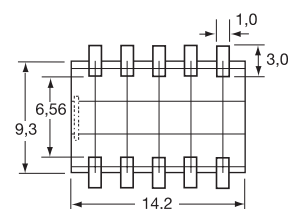

AZ 851

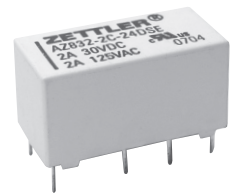
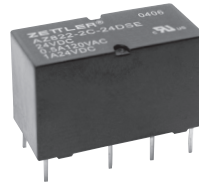

AZ 951 / 952		AZ 9571		AZ 822		AZ 832	
<ul style="list-style-type: none"> • Contact rating: 150 W / 625 VA • Small size • Coil power at pickup 113...253 mW • Non polarized coil 		<ul style="list-style-type: none"> • Contact rating: 30 W / 62,5 VA • Microminiature size • Coil power at pickup 96...128 mW • Non polarized coil • Epoxy sealed 		<ul style="list-style-type: none"> • Contact rating: 2 x 60 W / 2 x 125 VA • Coil power at pickup 73...174 mW • Bifurcated cossbar contacts • Non polarized coil • Epoxy sealed 		<ul style="list-style-type: none"> • Contact rating: 2 x 60 W / 2 x 250 VA • Max. switching 3 A • Coil power at pickup 42...159 mW • Bifurcated cossbar contacts • Polarized coil • Epoxy sealed 	
15,75 x 10,75 x 11,81 mm		12,5 x 7,5 x 10,0 mm		20,0 x 9,8 x 12,0 mm		20,2 x 10,0 x 10,65 mm	
Epoxy sealed version 2 pin configurations		Sensitive coil version		-		Latching version AZ 832P	
1C		1C		2C		2C	
AgNi+Au or Ag+Au		AgNi+Au		AgPd+Au		PdAg+Au against PdAg or Ag+Au against PdAg	
5 A 220 VAC 60 VDC 625 VA 150 W		1 A 125 VAC 60 VDC 62,5 VA 30 W		2 A 250 VAC 220 VDC 125 VA 60 W		3 A switching / 2 A continuous 250 VAC 220 VDC 250 VA 60 W	
1 x 10 ⁵ 1 x 10 ⁷		1 x 10 ⁵ 5 x 10 ⁶		5 x 10 ⁵ 1 x 10 ⁸		1 x 10 ⁵ 2 x 10 ⁷	
VDC	Ω std./sens.	VDC	Ω std./sens.	VDC	Ω	VDC	Ω std./sens.
3	20/45	3	45/60	3	60	3	45/-
5	56/125	5	125/167	5	167	5	125/167
6	80/180	6	180/240	6	240	6	180/240
9	-/405	9	405/540	9	540	9	405/540
12	320/720	12	720/960	12	960	12	720/960
18	720/1620	18	2880/3840	18	1620	18	2880/3840
24	1280/2880			24	2880	24	11520/-
				48	7680	48	
≤ 75% / ≥ 10%		≤ 80% / ≥ 10%		≤ 70% / ≥ 5%		std.: ≤ 80% / ≥ 10% sens.: ≤ 75% / ≥ 10%	
std.: -25°C...+55°C sens.: -25°C...+70°C		+30°C...+70°C		-55°C...+90°C		-40°C...+85°C	
1000 VAC		1000 VAC		1000 VAC		1500 VAC	
PCB		PCB		PCB		PCB	
5 / 1 ms		5 / 5 ms		5 / 2 ms		3 / 2 ms	
UL, CUR		UL, CUR		UL, CUR		UL, CUR	
-		-		-		-	

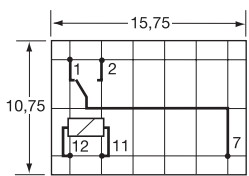

AZ 951

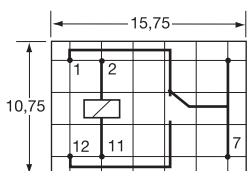
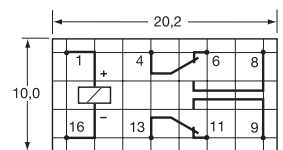
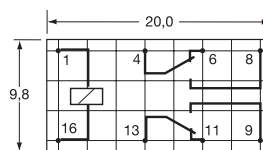
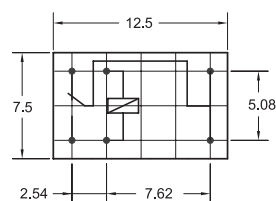

AZ 952

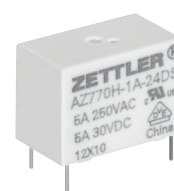
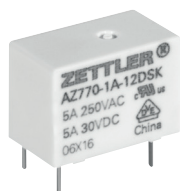

Relay Type	AZ 770	AZ 7709	AZ 770H																																																				
Features	<ul style="list-style-type: none"> Contact rating: 5 A / 250 VAC Low profile: 12,95 mm Coil power at pickup 113...256 mW Clearance / creepage \geq 8 mm Dielectric strength 5000 VAC Reinforced insulation VDE 0631 / 0700 10 A \rightarrow AZ 770T EN 60335-1 (GWT) version available 	<ul style="list-style-type: none"> Contact rating: 5 A / 250 VAC Coil power at pickup 113...223 mW Dielectric strength 4000 VAC 10 A \rightarrow AZ 7709T 	<ul style="list-style-type: none"> Contact rating: 5 A / 250 VAC Low profile: 12,95 mm Coil power at pickup 113...116 mW Clearance / creepage \geq 8 mm Dielectric strength 5000 VAC Reinforced insulation VDE 0631 / 0700 High temperature 105°C 																																																				
Size L x W x H	17,85 x 10,35 x 12,95 mm	18,9 x 10,7 x 15,7 mm	17,85 x 10,35 x 12,95 mm																																																				
Other Versions	Epoxy sealed version Sensitive coil version, 2 pin configurations	Epoxy sealed version Sensitive coil version	Epoxy sealed version																																																				
Contact Forms A = N.O. B = N.C. C = C.O.	1A / 1C	1A	1A																																																				
Contact Material	AgNi, AgNi+Au or AgSnO ₂	AgCdO, AgSnO ₂ , AgSnO ₂ In ₂ O ₃ or AgSnO ₂ +Au	AgNi, AgNi+Au																																																				
Contact Ratings (at resistive load)	max. 10 A max. 400 VAC max. 30 VDC max. 2500 VA max. 150 W	max. 10 A max. 250 VAC max. 30 VDC max. 2500 VA max. 300 W	max. 5 A max. 400 VAC max. 30 VDC max. 1250VA max. 150 W																																																				
Electrical Life Expectancy (at rated load)	1 x 10 ⁵	1 x 10 ⁵	1 x 10 ⁵																																																				
Mechanical Life Expectancy	1 x 10 ⁶	1 x 10 ⁷	1 x 10 ⁶																																																				
Standard Types (nominal coil voltage coil resistance)	<table border="1"> <thead> <tr> <th>VDC</th> <th>Ω std./sens.</th> </tr> </thead> <tbody> <tr><td>3</td><td>20/45</td></tr> <tr><td>5</td><td>55/25</td></tr> <tr><td>6</td><td>80/180</td></tr> <tr><td>9</td><td>180/400</td></tr> <tr><td>12</td><td>320/720</td></tr> <tr><td>18</td><td>720/1600</td></tr> <tr><td>24</td><td>1280/2800</td></tr> <tr><td>48</td><td>5120/-</td></tr> </tbody> </table>	VDC	Ω std./sens.	3	20/45	5	55/25	6	80/180	9	180/400	12	320/720	18	720/1600	24	1280/2800	48	5120/-	<table border="1"> <thead> <tr> <th>VDC</th> <th>Ω std./sens.</th> </tr> </thead> <tbody> <tr><td>3</td><td>20/45</td></tr> <tr><td>5</td><td>55/125</td></tr> <tr><td>6</td><td>80/180</td></tr> <tr><td>9</td><td>180/400</td></tr> <tr><td>12</td><td>320/720</td></tr> <tr><td>18</td><td>720/1600</td></tr> <tr><td>24</td><td>1280/2800</td></tr> <tr><td>48</td><td>5120/-</td></tr> </tbody> </table>	VDC	Ω std./sens.	3	20/45	5	55/125	6	80/180	9	180/400	12	320/720	18	720/1600	24	1280/2800	48	5120/-	<table border="1"> <thead> <tr> <th>VDC</th> <th>Ω</th> </tr> </thead> <tbody> <tr><td>3</td><td>45</td></tr> <tr><td>5</td><td>125</td></tr> <tr><td>6</td><td>180</td></tr> <tr><td>9</td><td>400</td></tr> <tr><td>12</td><td>720</td></tr> <tr><td>18</td><td>1600</td></tr> <tr><td>24</td><td>2800</td></tr> </tbody> </table>	VDC	Ω	3	45	5	125	6	180	9	400	12	720	18	1600	24	2800
VDC	Ω std./sens.																																																						
3	20/45																																																						
5	55/25																																																						
6	80/180																																																						
9	180/400																																																						
12	320/720																																																						
18	720/1600																																																						
24	1280/2800																																																						
48	5120/-																																																						
VDC	Ω std./sens.																																																						
3	20/45																																																						
5	55/125																																																						
6	80/180																																																						
9	180/400																																																						
12	320/720																																																						
18	720/1600																																																						
24	1280/2800																																																						
48	5120/-																																																						
VDC	Ω																																																						
3	45																																																						
5	125																																																						
6	180																																																						
9	400																																																						
12	720																																																						
18	1600																																																						
24	2800																																																						
Pickup / Dropout (% of V _{nom})	\leq 75% / \geq 5%	std.: \leq 70% / \geq 5% sens.: \leq 75% / \geq 5%	\leq 75% / \geq 5%																																																				
Ambient Temperature	-40°C...+85°C	-40°C...+85°C	-40°C...+105°C																																																				
Dielectric Strength (coil to contacts)	5000 VAC	4000 VAC	5000 VAC																																																				
Termination	PCB	PCB	PCB																																																				
Operate / Release Time (typ. at V _{nom})	8 / 4 ms	8 / 4 ms	8 / 4 ms																																																				
Approvals	VDE, UL, CUR	TÜV, UL, CUR	VDE, UL, CUR																																																				
Accessories	-	-	-																																																				

Layout
(viewed toward terminals)

(dimensions in mm)
(grid: 2.54 mm)

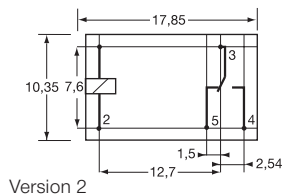
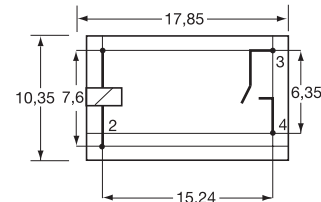
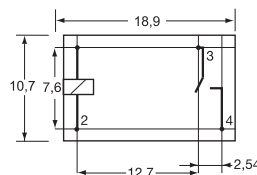
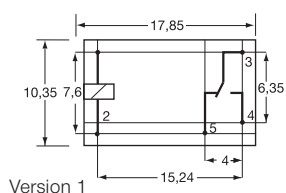

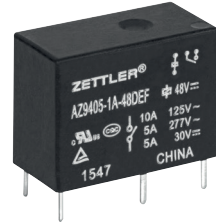

AZ 963		AZ 940		AZ 9405	
<ul style="list-style-type: none"> Contact rating: 6 A / 250 VAC Small size Coil power at pickup 113 mW Clearance / creepage $\geq 4,5 / 5,5$ mm Dielectric strength 4000 VAC Epoxy sealed 		<ul style="list-style-type: none"> Contact rating: 5 A / 250 VAC Small size Coil power at pickup 113...265 mW Dielectric strength 4000 VAC 		<ul style="list-style-type: none"> Contact rating: 5 A / 277 VAC Small size Coil power at pickup 113...297 mW Clearance / creepage 1A: $\geq 4 / 6$ mm Clearance / creepage 1C: $\geq 3 / 5$ mm Dielectric strength 4000 VAC 	
20,3 x 10,2 x 10,7 mm		20,5 x 10,2 x 15,7 mm		20,0 x 10,0 x 15,2 mm	
-		Epoxy sealed version		Epoxy sealed version	
1A / 1B / 1C		1A / 1C		1A / 1C	
AgNi or AgSnO ₂		AgCdO, AgNi, AgNi+Au or AgSnO ₂		AgSnO ₂	
6 A 380 VAC 220 VDC 1500 VA 180 W		10 A 400 VAC 150 VDC 2770 VA 150 W		10 A 277 VAC 30 VDC 1400 VA 150 W	
1 x 10 ⁵ 1 x 10 ⁷		1 x 10 ⁵ 1 x 10 ⁷		1 x 10 ⁵ 1 x 10 ⁷	
VDC	Ω	VDC	Ω std./sens.	VDC	Ω std./sens.
3	45	3	20/45	3	22,5/45
5	125	5	55/125	5	63/125
6	180	6	80/180	6	90/180
9	405	9	180/400	9	202,5/400
12	720	12	320/720	12	360/720
18	1620	18	720/1600	18	810/1620
24	2880	24	1280/2800	24	1440/2800
48	11520			48	5760/-
$\leq 75\% / \geq 10\%$		$\leq 75\% / \geq 5\%$		std.: $\leq 70\% / \geq 10\%$ sens.: $\leq 75\% / \geq 10\%$	
-40°C...+85°C		std.: -40°C...+70°C sens.: -40°C...+85°C		-40°C...+85°C	
4000 VAC		4000 VAC		4000 VAC	
PCB		PCB		PCB	
6 / 4 ms		8 / 5 ms		std.: 10 / 5 ms sens.: 15 / 5 ms	
VDE, UL, CUR		VDE, UL, CUR		TÜV, UL, CUR	
-		-		-	

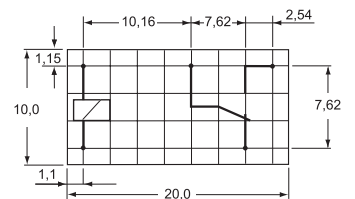
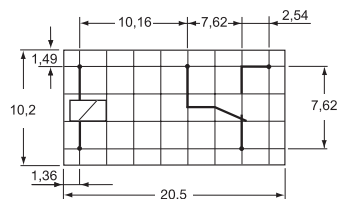
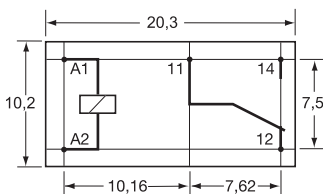

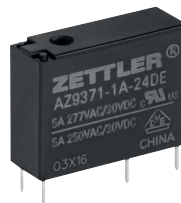

Relay Type	AZ 921	AZ 9371	AZ 6951
Features	<ul style="list-style-type: none"> Contact rating: 5 A / 250 VAC Extremely slim size: 5 mm Coil power at pickup 59...88 mW Clearance / creepage ≥ 3 mm Dielectric strength 3000 VAC Epoxy sealed version 	<ul style="list-style-type: none"> Contact rating: 5 A / 250 VAC Extremely slim size: 7 mm Coil power at pickup 113 mW Clearance / creepage $\geq 5,5$ mm Dielectric strength 4000 VAC 10 A \rightarrow AZ 9371T 	<ul style="list-style-type: none"> Contact rating: 5 A / 250 VAC Extremely slim size: 6,5 mm Coil power at pickup 100 mW Dielectric strength 3000 VAC Epoxy sealed version
Size L x W x H	20,3 x 5,3 x 12,8 mm	20,5 x 7,2 x 15,3 mm	18,5 x 6,5 x 12,4 mm
Other Versions	2 pin configurations Horizontal version available	Epoxy sealed version 2 pin configurations	-
Contact Forms A = N.O. B = N.C. C = C.O.	1A	1A	1A
Contact Material	AgNi, AgNi+Au or AgSnO ₂	AgNi, AgNi+Au or AgSnO ₂	AgSnO ₂ or AgSnO ₂ +Au
Contact Ratings (at resistive load)	max. 5 A max. 250 VAC max. 150 VDC max. 1250 VA max. 150 W	max. 10 A max. 277 VAC max. 30 VDC max. 2770 VA max. 300 W	max. 5 A max. 250 VAC max. 30 VDC max. 1250 VA max. 150 W
Electrical Life Expectancy (at rated load)	1 x 10 ⁵	1 x 10 ⁵	1 x 10 ⁵
Mechanical Life Expectancy	2 x 10 ⁷	5 x 10 ⁴	2 x 10 ⁷
Standard Types (nominal coil voltage coil resistance)	VDC Ω 5 208 6 300 9 675 12 1200 18 2700 24 3200	VDC Ω 3 45 5 125 6 180 9 405 12 720 18 1620 24 2880	VDC Ω 5 125 12 720 24 2880
Pickup / Dropout (% of V _{nom})	$\leq 70\%$ / $\geq 10\%$	$\leq 75\%$ / $\geq 5\%$	$\leq 70\%$ / $\geq 10\%$
Ambient Temperature	-40°C...+85°C	-40°C...+105°C	-25°C...+70°C
Dielectric Strength (coil to contacts)	3000 VAC	4000 VAC	3000 VAC
Termination	PCB	PCB	PCB
Operate / Release Time (typ. at V _{nom})	6 / 3 ms	6 / 3 ms	6 / 3 ms
Approvals	TÜV, UL, CUR	VDE, UL, CUR	TÜV, UL, CUR
Accessories	-	-	-

Layout

(viewed toward terminals)

(dimensions in mm)
(grid: 2.54 mm)

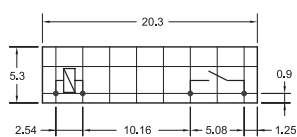

AZ 921

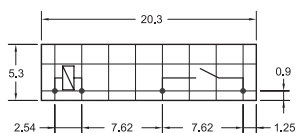

AZ 921 "K"-Version

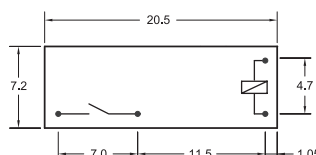

AZ 9371

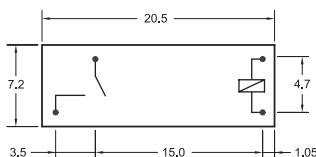

AZ 9371 "K"-Version

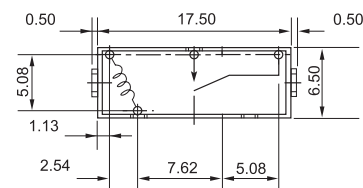

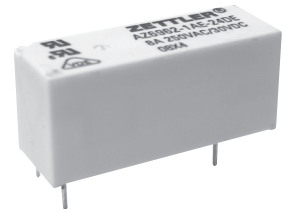

AZ 6991		AZ 6960		AZ 6962	
<ul style="list-style-type: none"> • Contact rating: 8 A / 277 VAC • Extremely slim size: 5 mm • Coil power at pickup 96...129 mW • Clearance / creepage $\geq 6 / 8$ mm • Dielectric strength 4000 VAC • Reinforced insulation VDE 0631 / 0700 		<ul style="list-style-type: none"> • Contact rating: 10 A / 250 VAC • Low profile: 12,5 mm • Coil power at pickup 120...126 mW • Clearance / creepage ≥ 8 mm • Dielectric strength 5000 VAC • Reinforced insulation VDE 0631 / 0700 • Materials according IEC 60335-1 		<ul style="list-style-type: none"> • Contact rating: 10 A / 250 VAC • Low profile: 12,5 mm • Coil power at pickup 108...141 mW • Clearance / creepage ≥ 10 mm • Dielectric strength 5000 VAC • Reinforced insulation VDE 0631 / 0700 	
28,0 x 5,0 x 15,0 mm		28,5 x 10,1 x 12,5 mm		28,5 x 10,1 x 12,5 mm	
Epoxy sealed version Horizontal version available		Epoxy sealed version		Epoxy sealed version	
1A / 1C		1A / 1B / 1C		1A / 1B / 1C	
AgNi, AgNi+Au or AgSnO ₂		AgNi, AgNi+Au, AgSnO ₂ , AgSnO ₂ +Au		AgNi, AgNi+Au or AgSnO ₂	
8 A 400 VAC 125 VDC 2216 VA 180 W		8 A 400 VAC 24 VDC 2000 VA 192 W		10 A 440 VAC 240 VDC 2500 VA 300 W	
1 x 10 ⁵ 1 x 10 ⁷		1 x 10 ⁶ 1 x 10 ⁷		1 x 10 ⁵ 1 x 10 ⁷	
VDC	Ω	VDC	Ω	VDC	Ω
5	147	5	102	5	113
12	848	6	144	6	164
24	3390	9	330	9	360
48	10600	12	580	12	620
60	16600	18	1300	18	1295
		24	2300	24	2350
		48	9340	48	8000
		60	14000	60	12500
$\leq 75\% / \geq 5\%$		$\leq 70\% / \geq 10\%$		$\leq 70\% / \geq 10\%$	
-40°C...+85°C		-40°C...+85°C		-40°C...+85°C	
4000 VAC		5000 VAC		5000 VAC	
PCB		PCB		PCB	
5 / 3 ms		10 / 5 ms		7 / 3 ms	
VDE, UL, CUR		VDE, UL, CUR		VDE, UL, CUR	
-		-		-	

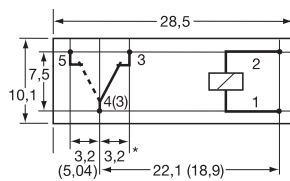
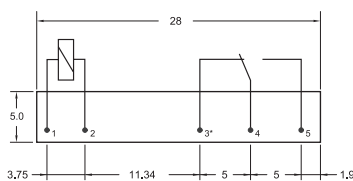

* not used on Form A and Form B

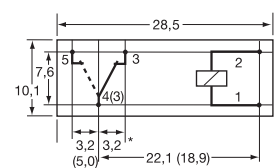

* not used on Form A and Form B

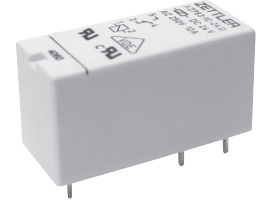
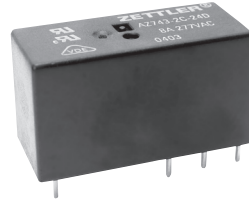
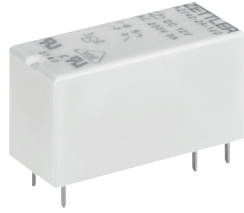

Relay Type	AZ 742	AZ 743	AZ 763																																																																																																												
Features	<ul style="list-style-type: none"> • Contact rating: 2 x 10 A / 250 VAC • Low profile: 15,7 mm • Coil power at pickup 196...235 mW • Clearance / creepage \geq 10 mm • Dielectric strength 5000 VAC • Reinforced insulation VDE 0631 / 0700 • AC and DC coils 	<ul style="list-style-type: none"> • Contact rating: 2 x 10 A / 250 VAC • Low profile: 15,7 mm • Coil power at pickup 196...235 mW • Clearance / creepage \geq 10 mm • Dielectric strength 5000 VAC • Reinforced insulation VDE 0631 / 0700 • AC and DC coils 	<ul style="list-style-type: none"> • Contact rating: 12 A / 250 VAC • Low profile: 15,7 mm • Coil power at pickup 196...235 mW • Clearance / creepage \geq 10 mm • Dielectric strength 5000 VAC • Reinforced insulation VDE 0631 / 0700 • AC and DC coils 																																																																																																												
Size L x W x H	29,0 x 12,7 x 15,7 mm	29,0 x 12,7 x 15,7 mm	29,0 x 12,7 x 15,7 mm																																																																																																												
Other Versions	Epoxy sealed version	Epoxy sealed version	Epoxy sealed version other Layouts AZ 763L, AZ763R																																																																																																												
Contact Forms A = N.O. B = N.C. C = C.O.	2A / 2C	2A / 2C	1A / 1C																																																																																																												
Contact Material	AgNi, AgNi+Au or AgSnO ₂	AgCdO, AgNi, AgNi+Au or AgSnO ₂	AgNi, AgNi+Au or AgSnO ₂																																																																																																												
Contact Ratings (at resistive load)	max. 10 A max. 400 VAC max. 300 VDC max. 2500 VA max. 240 W	max. 10 A max. 440 VAC max. 125 VDC max. 2500 VA max. 240 W	max. 12A max. 400 VAC max. 300 VDC max. 3000 VA max. 360 W																																																																																																												
Electrical Life Expectancy (at rated load)	1 x 10 ⁵	1 x 10 ⁵	1 x 10 ⁵																																																																																																												
Mechanical Life Expectancy	3 x 10 ⁷	1 x 10 ⁷	3 x 10 ⁷																																																																																																												
Standard Types (nominal coil voltage coil resistance)	<table border="1"> <thead> <tr> <th>VDC</th> <th>Ω</th> <th>VAC</th> <th>Ω/mA</th> </tr> </thead> <tbody> <tr><td>5</td><td>60</td><td>12</td><td>100/63,0</td></tr> <tr><td>6</td><td>90</td><td>24</td><td>400/31,3</td></tr> <tr><td>9</td><td>200</td><td>48</td><td>1150/15,6</td></tr> <tr><td>12</td><td>360</td><td>60</td><td>2600/12,5</td></tr> <tr><td>24</td><td>1440</td><td>110</td><td>8900/6,8</td></tr> <tr><td>48</td><td>5700</td><td>120</td><td>10200/6,3</td></tr> <tr><td>60</td><td>7500</td><td>230</td><td>38500/3,3</td></tr> <tr><td>110</td><td>25200</td><td>240</td><td>42500/3,1</td></tr> </tbody> </table>	VDC	Ω	VAC	Ω /mA	5	60	12	100/63,0	6	90	24	400/31,3	9	200	48	1150/15,6	12	360	60	2600/12,5	24	1440	110	8900/6,8	48	5700	120	10200/6,3	60	7500	230	38500/3,3	110	25200	240	42500/3,1	<table border="1"> <thead> <tr> <th>VDC</th> <th>Ω</th> <th>VAC</th> <th>Ω/mA</th> </tr> </thead> <tbody> <tr><td>5</td><td>60</td><td>24</td><td>350/31,6</td></tr> <tr><td>6</td><td>90</td><td>115</td><td>8100/6,6</td></tr> <tr><td>9</td><td>200</td><td>230</td><td>32500/3,2</td></tr> <tr><td>12</td><td>360</td><td></td><td></td></tr> <tr><td>24</td><td>1440</td><td></td><td></td></tr> <tr><td>48</td><td>5700</td><td></td><td></td></tr> <tr><td>60</td><td>7500</td><td></td><td></td></tr> <tr><td>110</td><td>25200</td><td></td><td></td></tr> </tbody> </table>	VDC	Ω	VAC	Ω /mA	5	60	24	350/31,6	6	90	115	8100/6,6	9	200	230	32500/3,2	12	360			24	1440			48	5700			60	7500			110	25200			<table border="1"> <thead> <tr> <th>VDC</th> <th>Ω</th> <th>VAC</th> <th>Ω/mA</th> </tr> </thead> <tbody> <tr><td>5</td><td>60</td><td>12</td><td>100/63,0</td></tr> <tr><td>6</td><td>90</td><td>24</td><td>400/31,3</td></tr> <tr><td>9</td><td>200</td><td>48</td><td>1150/15,6</td></tr> <tr><td>12</td><td>360</td><td>60</td><td>2600/12,5</td></tr> <tr><td>24</td><td>1440</td><td>110</td><td>8900/6,8</td></tr> <tr><td>48</td><td>5700</td><td>120</td><td>10200/6,3</td></tr> <tr><td>60</td><td>7500</td><td>230</td><td>38500/3,3</td></tr> <tr><td>110</td><td>25200</td><td>240</td><td>42500/3,1</td></tr> </tbody> </table>	VDC	Ω	VAC	Ω /mA	5	60	12	100/63,0	6	90	24	400/31,3	9	200	48	1150/15,6	12	360	60	2600/12,5	24	1440	110	8900/6,8	48	5700	120	10200/6,3	60	7500	230	38500/3,3	110	25200	240	42500/3,1
VDC	Ω	VAC	Ω /mA																																																																																																												
5	60	12	100/63,0																																																																																																												
6	90	24	400/31,3																																																																																																												
9	200	48	1150/15,6																																																																																																												
12	360	60	2600/12,5																																																																																																												
24	1440	110	8900/6,8																																																																																																												
48	5700	120	10200/6,3																																																																																																												
60	7500	230	38500/3,3																																																																																																												
110	25200	240	42500/3,1																																																																																																												
VDC	Ω	VAC	Ω /mA																																																																																																												
5	60	24	350/31,6																																																																																																												
6	90	115	8100/6,6																																																																																																												
9	200	230	32500/3,2																																																																																																												
12	360																																																																																																														
24	1440																																																																																																														
48	5700																																																																																																														
60	7500																																																																																																														
110	25200																																																																																																														
VDC	Ω	VAC	Ω /mA																																																																																																												
5	60	12	100/63,0																																																																																																												
6	90	24	400/31,3																																																																																																												
9	200	48	1150/15,6																																																																																																												
12	360	60	2600/12,5																																																																																																												
24	1440	110	8900/6,8																																																																																																												
48	5700	120	10200/6,3																																																																																																												
60	7500	230	38500/3,3																																																																																																												
110	25200	240	42500/3,1																																																																																																												
Pickup / Dropout (% of V _{nom})	DC: \leq 70% / \geq 10% AC: \leq 75% / \geq 15%	DC: \leq 70% / \geq 10% AC: \leq 75% / \geq 15%	DC: \leq 70% / \geq 10% AC: \leq 75% / \geq 15%																																																																																																												
Ambient Temperature	DC: -40°C...+85°C AC: -40°C...+70°C	DC: -40°C...+85°C AC: -40°C...+70°C	DC: -40°C...+85°C AC: -40°C...+70°C																																																																																																												
Dielectric Strength (coil to contacts)	5000 VAC	5000 VAC	5000 VAC																																																																																																												
Termination	PCB	PCB	PCB																																																																																																												
Operate / Release Time (typ. at V _{nom})	DC: 7 / 3 ms AC: 8 / 7 ms	DC: 7 / 4 ms AC: 10 / 4 ms	DC: 7 / 3 ms AC: 8 / 7 ms																																																																																																												
Approvals	VDE, UL, CUR	VDE, UL, CUR	VDE, UL, CUR																																																																																																												
Accessories	PCB-Socket: EC50 + MP16-2 / MH16-2 DIN rail: GZT80 + GZT80-0040	PCB-Socket: EC50 + MP16-2 / MH16-2 DIN rail: GZT80 + GZT80-0040	PCB-Socket: EC35 + MP16-2 / MH16-2 DIN rail: GZT92 + GZT80-0040																																																																																																												

Layout
(viewed toward terminals)

(dimensions in mm)
(grid: 2.54 mm)

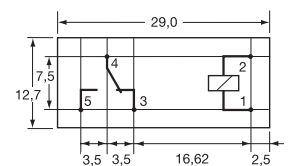
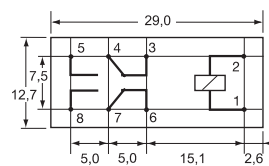
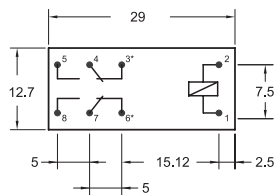

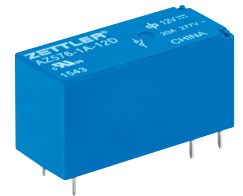
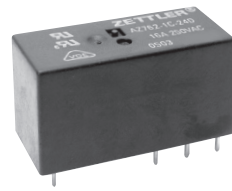
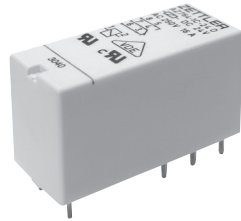

AZ 761		AZ 764		AZ 762		AZ 576	
<ul style="list-style-type: none"> Contact rating: 12 A / 250 VAC Low profile: 16,0 mm Coil power at pickup 141...235 mW Clearance / creepage \geq 10 mm Dielectric strength 5000 VAC Reinforced insulation VDE 0631 / 0700 AC and DC coils 		<ul style="list-style-type: none"> Contact rating: 16 A / 250 VAC Low profile: 15,7 mm Coil power at pickup 196...235 mW Clearance / creepage \geq 10 mm Dielectric strength 5000 VAC Reinforced insulation VDE 0631 / 0700 AC and DC coils 		<ul style="list-style-type: none"> Contact rating: 16 A / 250 VAC Low profile: 15,7 mm Coil power at pickup 141...235 mW Clearance / creepage \geq 10 mm Dielectric strength 5000 VAC Reinforced insulation VDE 0631 / 0700 AC and DC coils 		<ul style="list-style-type: none"> Contact rating: 20 A / 277 VAC Low profile: 15,3 mm Coil power at pickup 196...226 mW Dielectric strength 5000 VAC High temperature 105°C 	
29,3 x 13,0 x 16,0 mm		29,0 x 12,7 x 15,7 mm		29,0 x 12,7 x 15,7 mm		29,3 x 12,7 x 15,3 mm	
Epoxy sealed version Sensitive coil version		Epoxy sealed version High inrush version 80 A (1 Form A only)		Epoxy sealed version High inrush version 80 A (1 Form A only)		Epoxy sealed version	
1A / 1B / 1C		1A / 1C		1A / 1C		1A / 1C	
AgCdO, AgNi, AgNi+Au or AgSnO ₂		AgNi or AgSnO ₂		AgCdO, AgNi, AgNi+Au or AgSnO ₂		AgSnO ₂	
12 A 440 VAC 125 VDC 3324 VA 360 W		20 A 400 VAC 300 VDC 5000 VA 480 W		16 A 440 VAC 125 VDC 5540 VA 480 W		20 A 480 VAC 30 VDC 5540 VAC 510 W	
1 x 10 ⁵ 1 x 10 ⁷		7 x 10 ⁴ 3 x 10 ⁷		1 x 10 ⁵ 1 x 10 ⁷		1 x 10 ⁵ 1 x 10 ⁷	
VDC	Ω std./sens.	VDC	Ω	VAC	Ω /mA	VDC	Ω
5	62/100	5	60	12	100/63,0	5	62,5
6	90/144	6	90	24	400/31,3	6	90
9	200/576	9	200	48	1150/15,6	9	202,5
12	360/1296	12	360	60	2600/12,5	12	360
24	1440/2304	24	1440	110	8900/6,8	24	1440
48	5760/9216	48	5700	120	10200/6,3	48	5760
60	7500/12867	60	7500	230	38500/3,3	60	9000
110	25200/-	110	25200	240	42500/3,1	110	30250
std.: \leq 70% / \geq 10% sens.: \leq 75% / \geq 10%		DC: \leq 70% / \geq 10% AC: \leq 75% / \geq 15%		\leq 70% / \geq 10%		\leq 75% / \geq 10%	
std.: -40°C...+85°C sens.: -40°C...+105°C		DC: -40°C...+85°C AC: -40°C...+70°C		DC: -40°C...+85°C AC: -40°C...+70°C		-40°C...+105°C	
5000 VAC		5000 VAC		5000 VAC		5000 VAC	
PCB		PCB		PCB		PCB	
7 / 3 ms		DC: 7 / 3 ms AC: 8 / 7 ms		7 / 3 ms		8 / 4 ms	
VDE, UL, CUR		VDE, UL, CUR		VDE, UL, CUR		TÜV, UL, CUR	
PCB-Socket: EC35 + MP16-2 / MH16-2 DIN rail: GZT92 + GZT80-0040		PCB-Socket: EC50 + MP16-2 / MH16-2 DIN rail: GZT80 + GZT80-0040		PCB-Socket: EC50 + MP16-2 / MH16-2 DIN rail: GZT80 + GZT80-0040		PCB-Socket: EC50 + MP16-2 / MH16-2 DIN rail: GZT80 + GZT80-0040	

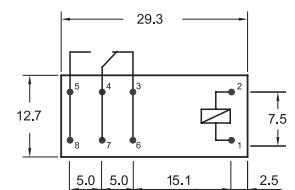
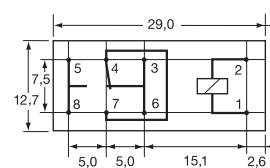
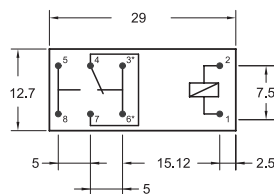
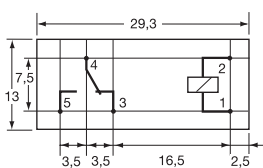

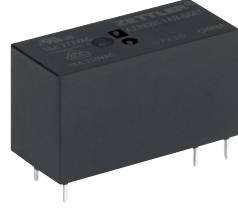

Relay Type	AZ 764H	AZ 762H	AZ 762T																																																						
Features	<ul style="list-style-type: none"> Contact rating: 16 A / 250 VAC Low profile: 15,7 mm Coil power at pickup 138...141 mW Clearance / creepage \geq 10 mm Dielectric strength 5000 VAC Reinforced insulation VDE 0631 / 0700 High temperature 105°C Flux proof 	<ul style="list-style-type: none"> Contact rating: 16 A / 277 VAC Low profile: 15,7 mm Coil power at pickup 140...235 mW Clearance / creepage \geq 10 mm Dielectric strength 5000 VAC Reinforced insulation VDE 0631 / 0700 High temperature 105°C 	<ul style="list-style-type: none"> Contact rating: 16 A / 250 VAC Inrush: 165 A, 20 ms / 800 A, 200 μs Tungsten premake contact Low profile: 15,7 mm Coil power at pickup 196...235 mW Clearance / creepage $>$ 10 mm Dielectric strength 5000 VAC 																																																						
Size L x W x H	29,0 x 12,7 x 15,7 mm	29,0 x 12,7 x 15,7 mm	29,0 x 12,7 x 15,7 mm																																																						
Other Versions	-	Epoxy sealed version Sensitive coil version	Epoxy sealed version																																																						
Contact Forms A = N.O. B = N.C. C = C.O.	1A / 1C	1A / 1C	1A																																																						
Contact Material	AgNi or AgSnO ₂	AgCdO, AgCdO+Au, AgNi or AgNi+Au	AgSnO ₂ + W																																																						
Contact Ratings (at resistive load)	max. 16 A max. 400 VAC max. 300 VDC max. 4432 VA max. 480 W	max. 16 A max. 440 VAC max. 125 VDC max. 4432 VA max. 480 W	max. 16 A max. 440 VAC max. 125 VDC max. 4432 VA max. 480 W																																																						
Electrical Life Expectancy (at rated load)	1,7 x 10 ⁵	1 x 10 ⁵	1 x 10 ⁵																																																						
Mechanical Life Expectancy	3 x 10 ⁷	1 x 10 ⁷	5 x 10 ⁶																																																						
Standard Types (nominal coil voltage coil resistance)	<table border="1"> <thead> <tr> <th>VDC</th> <th>Ω</th> </tr> </thead> <tbody> <tr><td>5</td><td>102</td></tr> <tr><td>6</td><td>144</td></tr> <tr><td>9</td><td>330</td></tr> <tr><td>10</td><td>400</td></tr> <tr><td>12</td><td>580</td></tr> <tr><td>18</td><td>1300</td></tr> <tr><td>24</td><td>2300</td></tr> <tr><td>48</td><td>9340</td></tr> </tbody> </table>	VDC	Ω	5	102	6	144	9	330	10	400	12	580	18	1300	24	2300	48	9340	<table border="1"> <thead> <tr> <th>VDC</th> <th>Ω std./sens.</th> </tr> </thead> <tbody> <tr><td>5</td><td>62/100</td></tr> <tr><td>6</td><td>90/145</td></tr> <tr><td>9</td><td>200/325</td></tr> <tr><td>12</td><td>360/580</td></tr> <tr><td>18</td><td>810/1300</td></tr> <tr><td>24</td><td>1440/2300</td></tr> <tr><td>48</td><td>5760/9220</td></tr> <tr><td>60</td><td>7500/12860</td></tr> </tbody> </table>	VDC	Ω std./sens.	5	62/100	6	90/145	9	200/325	12	360/580	18	810/1300	24	1440/2300	48	5760/9220	60	7500/12860	<table border="1"> <thead> <tr> <th>VDC</th> <th>Ω</th> </tr> </thead> <tbody> <tr><td>5</td><td>62</td></tr> <tr><td>6</td><td>90</td></tr> <tr><td>9</td><td>202</td></tr> <tr><td>12</td><td>360</td></tr> <tr><td>24</td><td>1440</td></tr> <tr><td>48</td><td>5760</td></tr> <tr><td>60</td><td>7500</td></tr> <tr><td>110</td><td>25200</td></tr> </tbody> </table>	VDC	Ω	5	62	6	90	9	202	12	360	24	1440	48	5760	60	7500	110	25200
VDC	Ω																																																								
5	102																																																								
6	144																																																								
9	330																																																								
10	400																																																								
12	580																																																								
18	1300																																																								
24	2300																																																								
48	9340																																																								
VDC	Ω std./sens.																																																								
5	62/100																																																								
6	90/145																																																								
9	200/325																																																								
12	360/580																																																								
18	810/1300																																																								
24	1440/2300																																																								
48	5760/9220																																																								
60	7500/12860																																																								
VDC	Ω																																																								
5	62																																																								
6	90																																																								
9	202																																																								
12	360																																																								
24	1440																																																								
48	5760																																																								
60	7500																																																								
110	25200																																																								
Pickup / Dropout (% of V _{nom})	\leq 75% / \geq 10%	\leq 75% / \geq 10%	\leq 70% / \geq 10%																																																						
Ambient Temperature	-40°C...+105°C	-40°C...+105°C	-40°C...+85°C																																																						
Dielectric Strength (coil to contacts)	5000 VAC	5000 VAC	5000 VAC																																																						
Termination	PCB	PCB	PCB																																																						
Operate / Release Time (typ. at V _{nom})	8 / 3 ms	7 / 3 ms	7 / 3 ms																																																						
Approvals	VDE, UL, CUR	VDE, UL, CUR	VDE, UL, CUR																																																						
Accessories	-	-	-																																																						

Layout
(viewed toward terminals)

(dimensions in mm)
(grid: 2.54 mm)

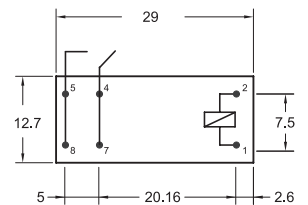
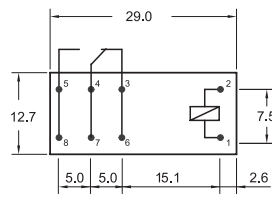
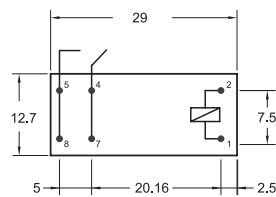



AZ 762P		AZ 7621P		AZ 943		AZ 943W	
<ul style="list-style-type: none"> • Contact rating: 20 A / 250 VAC • Single and dual coil latching • Inrush: 165 A, 20 ms / 800 A, 200 μs • Low profile: 15,7 mm • Coil power at pickup 256...416 mW • Dielectric strength 4000 VAC 		<ul style="list-style-type: none"> • Contact rating: 16 A / 250 VAC • Single and dual coil latching • Low profile: 15,7 mm • Coil power at pickup 192...319 mW • Dielectric strength 5000 VAC 		<ul style="list-style-type: none"> • Contact rating: 10 A / 277 VAC • Small size • Coil power at pickup 203...206 mW • Dielectric strength 1500 VAC 		<ul style="list-style-type: none"> • Contact rating: 10 A / 277 VAC • Small size • Coil power at pickup 300...312 mW • Dielectric strength 1500 VAC • Wide contact gap ≥ 0,8 mm 	
29,4 x 12,7 x 15,7 mm		29,0 x 12,7 x 15,9 mm		19,0 x 15,3 x 15,7 mm		19,0 x 15,3 x 16,0 mm	
Epoxy sealed version High inrush version 165 A (1 Form A only)		Epoxy sealed version		Epoxy sealed version		Epoxy sealed version	
1A / 1C		1A / 1C		1A / 1C		1A / 1C	
AgSnO ₂ or AgSnO ₂ +W		AgSnO ₂ or AgSnO ₂ +Au		AgSnO ₂		AgSnO ₂	
20 A 350 VAC 125 VDC 5000 VA 600 W		16 A 440 VAC 30 VDC 4000 VA 480 W		15 A 300 VAC 30 VDC 2770 VA 300 W		10 A 277 VAC 30 VDC 2770 VA 300 W	
1 x 10 ⁵ 1 x 10 ⁶		5 x 10 ⁴ 5 x 10 ⁶		1 x 10 ⁵ 1 x 10 ⁶		2 x 10 ⁴ 1 x 10 ⁶	
VDC	Ω	VDC	Ω	VDC	Ω	VDC	Ω
3	22,5	5	63	5	70	6	65
5	62,5	6	90	6	100	12	270
6	90	9	203	9	225	18	600
9	202	12	360	12	400	24	1070
12	360	24	1440	18	900		
24	1440			24	1600		
				36	3600		
				48	6400		
≤ 80% / ≥ 80%		≤ 70% / ≥ 70%		≤ 75% / ≥ 10%		≤ 75% / ≥ 10%	
-40°C...+85°C		-40°C...+85°C		-40°C...+85°C		-40°C...+70°C	
4000 VAC		5000 VAC		1500 VAC		1500 VAC	
PCB		PCB		PCB		PCB	
10 / 10 ms		10 / 10 ms		10 / 5 ms		10 / 5 ms	
UL, CUR		UL, CUR		VDE, TÜV, UL, CUR		-	
-		-		-		-	

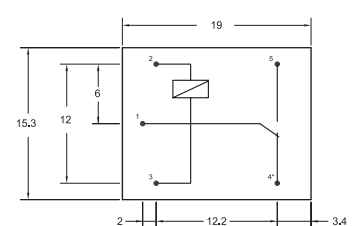
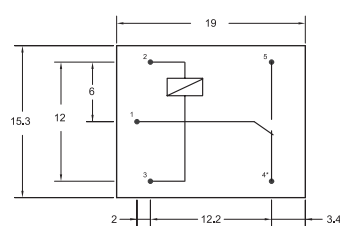
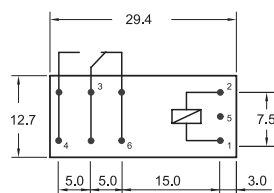
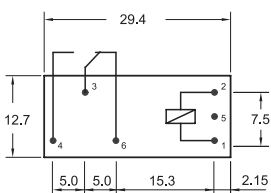



Relay Type	AZ SR131	AZ SR235 / 250	AZ SR165
Features	<ul style="list-style-type: none"> Contact rating: 35 A / 277 VAC Contact gap: $\geq 1,8$ mm Coil power at holding 170... ≥ 172 mW Dielectric strength 4500 VAC Flux proof 	<ul style="list-style-type: none"> Contact rating: 2 x 50 A / 250 VAC Contact gap: AZ SR235 \rightarrow 2 x 2,05 mm Contact gap: AZ SR250 \rightarrow 2 x 1,85 mm Coil power at holding 54...95 mW Clearance / creepage ≥ 10 mm Dielectric strength 5000 VAC Flux proof 	<ul style="list-style-type: none"> Contact rating: 80 A / 540 VAC Contact gap: $\geq 3,0$ mm Coil power at holding 351...355 mW Dielectric strength 4000 VAC Flux proof
Size L x W x H	30,4 x 15,9 x 25,15 mm	40,0 x 25,0 x 49,2 mm	38,0 x 33,0 x 41,5 mm
Other Versions	Contact gap (200) version: $\geq 2,3$ mm	AZ SR235 / AZ SR250: 2 x 35 A / 50 A AZ SR250 1-pole version available	-
Contact Forms A = N.O. B = N.C. C = C.O.	1A	1A / 2A	1A
Contact Material	AgSnO ₂	AgSnO ₂	AgNi
Contact Ratings (at resistive load)	max. 35 A max. 277 VAC max. 9695 VA	max. 50 A max. 440 VAC max. 150 VDC max. 13850 VA max. 1500 W	max. 80 A max. 690 VAC max. 43200 VA
Electrical Life Expectancy (at rated load)	3×10^4	5×10^4	1×10^3
Mechanical Life Expectancy	3×10^5	1×10^6	1×10^6
Standard Types (nominal coil voltage coil resistance)	VDC Ω 5 18 9 58 12 103 18 230 24 410 48 1650	VDC Ω 5 50 9 170 12 300 18 675 24 1200	VDC Ω 6 16,2 9 36,8 12 65 24 262
Pickup / Dropout (% of V_{nom})	$\leq 70\%$ / $\geq 5\%$	$\leq 75\%$ / $\geq 5\%$	$\leq 75\%$ / $\geq 5\%$
Ambient Temperature	-40°C...+85°C	-40°C...+85°C	-40°C...+85°C
Dielectric Strength (coil to contacts)	4500 VAC	5000 VAC	4000 VAC
Termination	PCB	PCB	PCB
Operate / Release Time (typ. at V_{nom})	20 / 10 ms	40 / 5 ms	40 / 10 ms
Approvals	TÜV, UL, CUR	VDE, UL, CUR	TÜV, UL, CUR
Accessories	-	-	-

Layout
(viewed toward terminals)

(dimensions in mm)
(grid: 2.54 mm)

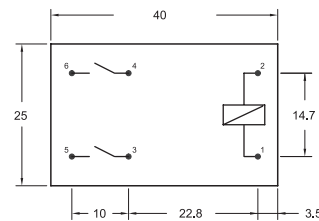
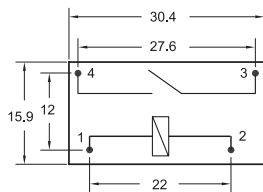

AZ SR 235 / 250

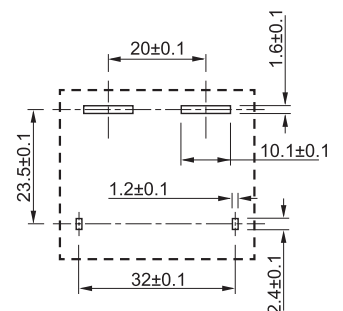

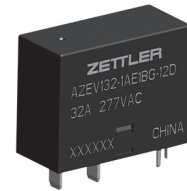

AZ SR190		AZ SR1160		AZ EV116 / 132	
<ul style="list-style-type: none"> Contact rating: 90 A / 480 VAC Contact gap: $\geq 3,6$ mm Coil power at holding 306...307 mW Dielectric strength 5000 VAC Flux proof 		<ul style="list-style-type: none"> Contact rating: 160 A / 690 VAC Contact gap: $\geq 3,15$ mm Coil power at holding 480 mW Dielectric strength 4000 VAC Flux proof 		<ul style="list-style-type: none"> Contact rating: 32 A / 440 VAC Contact gap: $\geq 2,25$ mm Coil power at pickup 190 mW Dielectric strength 4000 VAC Short circuit carrying capability 1500 A Flux proof 	
38,0 x 33,0 x 43,0 mm		63,3 x 62,0 x 41,7 mm		35,0 x 16,0 x 27,9 mm	
AZ SR190T: 100 A Low profile version available 41,5 mm height		Contact gap (200) version: $\geq 3,6$ mm		AZ EV116: 16 A version	
1A		1A		1A + 1B	
AgNi		AgNi, AgSnO ₂		AgSnO ₂ +AgSnO ₂ +Au	
100 A 800 VAC 44000 VA		160 A 690 VAC 110400 VA		32 A 440 VAC 30 VDC 8864 VA 960 W	
1 x 10 ³		1 x 10 ³		3 x 10 ⁴	
1 x 10 ⁶		1 x 10 ⁶		1 x 10 ⁵	
VDC	Ω	VDC	Ω	VDC	Ω
5	18,8	6	12	12	93
9	42,2	9	27		
12	75	12	48		
24	300	24	192		
$\leq 75\%$ / $\geq 10\%$		$\leq 75\%$ / $\geq 5\%$		$\leq 75\%$ / $\geq 5\%$	
-40°C...+85°C		-40°C...+85°C		-40°C...+85°C	
5000 VAC		4000 VAC		4000 VAC	
PCB		PCB		PCB	
40 / 10 ms		40 / 15 ms		30 / 10 ms	
TÜV, UL, CUR		-		-	
-		-		-	

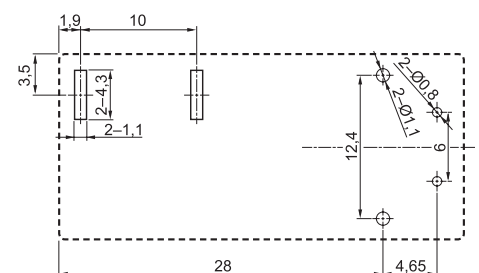
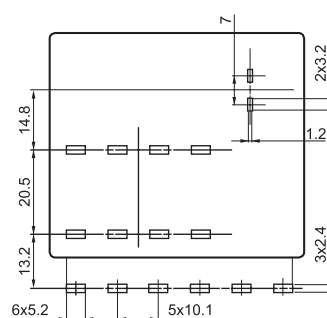
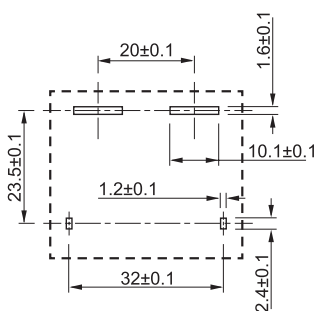

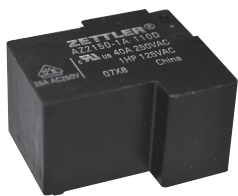

Relay Type	AZ 2150	AZ 2150W	AZ 21501																																																		
Features	<ul style="list-style-type: none"> Contact rating: 30 A / 240 VAC Coil power at holding 470...523 mW Dielectric strength 2500 VAC 	<ul style="list-style-type: none"> Contact rating: 30 A / 277 VAC Contact gap $\geq 1,75$ mm Coil power at holding 277 mW Clearance / creepage ≥ 3 mm Dielectric strength 4000 VAC 	<ul style="list-style-type: none"> Contact rating: 50 A / 250 VAC Coil power at holding 842...843 mW Dielectric strength 4000 VAC 																																																		
Size L x W x H	31,8 x 26,9 x 19,1 mm	31,8 x 26,9 x 19,1 mm	31,8 x 26,9 x 19,1 mm																																																		
Other Versions	Epoxy sealed version	Epoxy sealed version	Epoxy sealed version																																																		
Contact Forms A = N.O. B = N.C. C = C.O.	1A / 1B / 1C	1A	1A / 1B / 1C																																																		
Contact Material	AgCdO	AgSnO ₂	AgSnO ₂																																																		
Contact Ratings (at resistive load)	max. 40 A (N.O.), 30 A (N.C.) max. 300 VAC max. 30 VDC max. 10000 VA max. 900 W	30 A 440 VAC 250 VDC 8310 VA 900 W	50 A 300 VAC 30 VDC 12000 VA 1500 W																																																		
Electrical Life Expectancy (at rated load)	1 x 10 ⁵	3 x 10 ⁴	1 x 10 ⁴																																																		
Mechanical Life Expectancy	1 x 10 ⁷	2 x 10 ⁵	1 x 10 ⁷																																																		
Standard Types (nominal coil voltage coil resistance)	<table border="1"> <thead> <tr> <th>VDC</th> <th>Ω</th> </tr> </thead> <tbody> <tr><td>5</td><td>27</td></tr> <tr><td>6</td><td>40</td></tr> <tr><td>9</td><td>97</td></tr> <tr><td>12</td><td>155</td></tr> <tr><td>18</td><td>380</td></tr> <tr><td>24</td><td>660</td></tr> <tr><td>48</td><td>2560</td></tr> <tr><td>110</td><td>13450</td></tr> </tbody> </table>	VDC	Ω	5	27	6	40	9	97	12	155	18	380	24	660	48	2560	110	13450	<table border="1"> <thead> <tr> <th>VDC</th> <th>Ω</th> </tr> </thead> <tbody> <tr><td>5</td><td>22,5</td></tr> <tr><td>6</td><td>32,5</td></tr> <tr><td>9</td><td>73</td></tr> <tr><td>12</td><td>130</td></tr> <tr><td>24</td><td>520</td></tr> <tr><td>48</td><td>2080</td></tr> </tbody> </table>	VDC	Ω	5	22,5	6	32,5	9	73	12	130	24	520	48	2080	<table border="1"> <thead> <tr> <th>VDC</th> <th>Ω</th> </tr> </thead> <tbody> <tr><td>5</td><td>16,7</td></tr> <tr><td>6</td><td>24</td></tr> <tr><td>9</td><td>54</td></tr> <tr><td>12</td><td>96</td></tr> <tr><td>18</td><td>216</td></tr> <tr><td>24</td><td>384</td></tr> <tr><td>48</td><td>1536</td></tr> <tr><td>110</td><td>8067</td></tr> </tbody> </table>	VDC	Ω	5	16,7	6	24	9	54	12	96	18	216	24	384	48	1536	110	8067
VDC	Ω																																																				
5	27																																																				
6	40																																																				
9	97																																																				
12	155																																																				
18	380																																																				
24	660																																																				
48	2560																																																				
110	13450																																																				
VDC	Ω																																																				
5	22,5																																																				
6	32,5																																																				
9	73																																																				
12	130																																																				
24	520																																																				
48	2080																																																				
VDC	Ω																																																				
5	16,7																																																				
6	24																																																				
9	54																																																				
12	96																																																				
18	216																																																				
24	384																																																				
48	1536																																																				
110	8067																																																				
Pickup / Dropout (% of V _{nom})	$\leq 75\%$ / $\geq 10\%$	$\leq 75\%$ / $\geq 10\%$	$\leq 75\%$ / $\geq 10\%$																																																		
Ambient Temperature	-55°C...+85°C	-40°C...+85°C	-55°C...+85°C																																																		
Dielectric Strength (coil to contacts)	2500 VAC	4000 VAC	4000 VAC																																																		
Termination	PCB	PCB	PCB																																																		
Operate / Release Time (typ. at V _{nom})	8 / 3,5 ms	15 / 10 ms	15 / 10 ms																																																		
Approvals	VDE, UL, CUR	VDE, UL, CUR	UL, CUR																																																		
Accessories	-	-	-																																																		

Layout
(viewed toward terminals)

(dimensions in mm)
(grid: 2.54 mm)

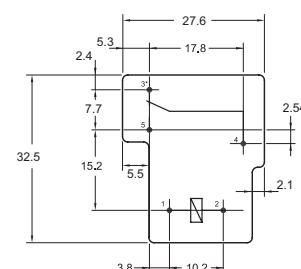
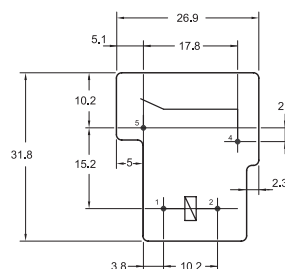
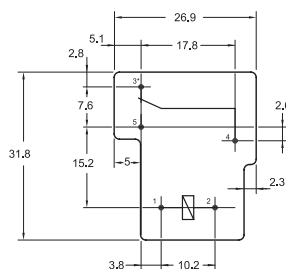

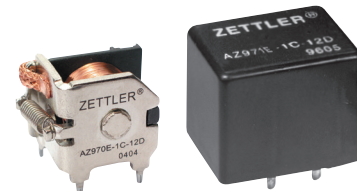
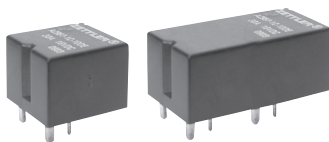

AZ 947		AZ 987-1 / 987-2 single relay double relay		AZ 970E / 971E open version covered version	
<ul style="list-style-type: none"> Contact rating: 20 A / 14 VDC Subminiature size Coil power at pickup 216...222 mW 		<ul style="list-style-type: none"> Contact rating: 30 A / 14 VDC Coil power at pickup 180...194 mW Single or double relay Epoxy sealed 		<ul style="list-style-type: none"> Contact rating: 40 A / 14 VDC Coil power at pickup 514...573 mW Open, covered or sealed European footprint 	
15,7 x 12,3 x 14,0 mm		13,2 x 12,3 x 10,2 / 13,2 x 24,0 x 10,2 mm		23,0 x 18,8 x 18,0 / 26,2 x 21,1 x 21,1 mm	
Epoxy sealed version		Single relay AZ 987-1 Double relay AZ 987-2		AZ 970E: open, AZ 971E: covered Epoxy sealed version	
1A / 1C / 1U		1A / 1C / 2A / 2C		1A / 1C	
AgSnO ₂		AgSnO ₂		AgSnO ₂	
20 A (N.O.) / 6 A (N.C.) 250 VAC 42 VDC 1250 VA 280 W		30 A 16 VDC 480 W		40 A (1 Form A) 30 A (1 Form C / B) 150 VDC 560 W (1 Form A) 420 W (1 Form C / B)	
1 x 10 ⁵ 1 x 10 ⁷		3 x 10 ⁵ 1 x 10 ⁶		1 x 10 ⁵ 5 x 10 ⁶	
VDC	Ω	VDC	Ω	VDC	Ω
6	60	6	63	6	19
9	135	10	181	9	50
12	240	12	254	12	90
24	960			24	362
≤ 60% / ≥ 5%		≤ 57% / ≥ 12%		≤ 57% / ≥ 6%	
-40°C...+85°C		-40°C...+105°C		-40°C...+105°C	
500 VAC		500 VAC		500 VDC	
PCB		PCB		PCB	
10 / 5 ms		3 / 1,5 ms		5 / 3 ms	
-		-		-	
-		-		-	

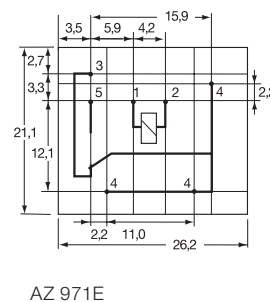
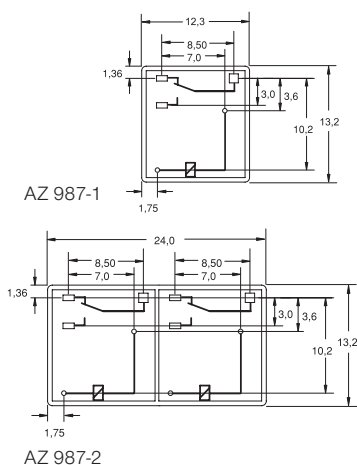
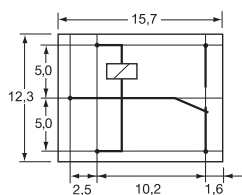



Relay Type	AZ 983	AZ 979 / 980 flange mounting plug in	AZ 9731
Features	<ul style="list-style-type: none"> • Contact rating: 80 A / 14 VDC • PCB version • Coil power at pickup 761 mW 	<ul style="list-style-type: none"> • Contact rating: 80 A / 14 VDC • Quick connect or plug in version • Coil power at pickup 676...761 mW 	<ul style="list-style-type: none"> • Contact rating: 40 A / 14 VDC • Quick connect or plug in version • Coil power at pickup 676 mW
Size L x W x H	29,0 x 29,0 x 26,5 mm	29,0 x 29,0 x 26,5 mm	26,5 x 26,5 x 36,0 mm
Other Versions	Diode or resistor across coil Epoxy sealed version	Diode or resistor across coil Epoxy sealed version	Diode or resistor across coil Epoxy sealed version (shrouded cover)
Contact Forms A = N.O. B = N.C. C = C.O.	1A / 1B / 1C	1A / 1B / C	1A / 1B / 1C / 1U
Contact Material	AgSnO ₂	AgSnO ₂	AgSnO ₂
Contact Ratings (at resistive load)	max. 80 A (1 Form A) max. 60 A (1 Form C / B) max. 28 VDC max. 1120 W (1 Form A) max. 840 W (1 Form C / B)	max. 80 A (1 Form A) max. 60 A (1 Form C / B) max. 28 VDC max. 1120 W (1 Form A) max. 840 W (1 Form C / B)	40 A 28 VDC 560 W
Electrical Life Expectancy (at rated load)	1 x 10 ⁵	1 x 10 ⁵	1 x 10 ⁵
Mechanical Life Expectancy	1 x 10 ⁷	1 x 10 ⁷	1 x 10 ⁷
Standard Types (nominal coil voltage coil resistance)	VDC Ω 6 20 12 80 24 320	VDC Ω 6 20 12 90 24 360	VDC Ω 6 22,5 12 90 24 360
Pickup / Dropout (% of V _{nom})	≤ 65% / ≥ 10%	≤ 65% / ≥ 10%	≤ 65% / ≥ 10%
Ambient Temperature	-40°C...+85°C	-40°C...+85°C	-40°C...+125°C
Dielectric Strength (coil to contacts)	500 VAC	500 VAC	750 VAC
Termination	PCB	Quick connect or plug in	Quick connect or plug in
Operate / Release Time (typ. at V _{nom})	7 / 5 ms	7 / 5 ms	7 / 5 ms
Approvals	-	-	-
Accessories	-	-	-

Layout
(viewed toward terminals)

(dimensions in mm)
(grid: 2.54 mm)

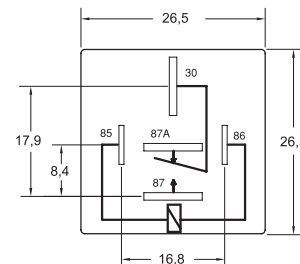
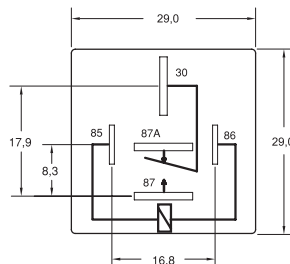
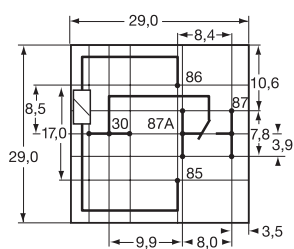

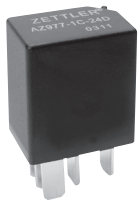

AZ 977		AZ DC110		AZ DC105	
<ul style="list-style-type: none"> • Contact rating: 20 A • Small size • Coil power at pickup 430...530 mW • Plug in relay • Dust cover 		<ul style="list-style-type: none"> • Contact rating: 16 A / 180 VDC 10 A / 300 VDC 5 A / 420 VDC 16 A / 300 VAC • Coil power at pickup 224...225 mW • Dielectric strength 5000 VAC • Flux proof 		<ul style="list-style-type: none"> • Contact rating: 150 A / 60 VDC • Contact gap: ≥ 3,0 mm • Coil power at pickup 224...225 mW • Dielectric strength 4000 VAC • Flux proof 	
23,0 x 15,5 x 26,0 mm		29,3 x 12,7 x 19,0 mm		38,0 x 33,0 x 43,0 mm	
Diode or resistor across coil Sensitive coil version		-		-	
1A / 1C		1A		1A	
AgSnO ₂		AgSnO ₂		AgSnO ₂	
20 A 150 VDC 280 W		16 A 300 VAC 420 VDC 4800 VA 3000 W		150 A 60 VDC 9000 W	
1 x 10 ⁵		3 x 10 ⁴		1 x 10 ³	
1 x 10 ⁶		3 x 10 ⁷		1 x 10 ⁶	
VDC	Ω std./sens.	VDC	Ω	VDC	Ω
6	25/32	5	62,5	12	45
12	97/123	6	90	24	180
24	384/483	9	203	48	720
		12	360		
		18	810		
		24	1440		
≤ 60% / ≥ 8%		≤ 70% / ≥ 5%		≤ 75% / ≥ 5%	
-40°C...+85°C		-40°C...+105°C		-40°C...+85°C	
1000 VDC		5000 VAC		4000 VAC	
Plug in		PCB		PCB	
10 / 7 ms		10 / 5 ms		30 / 10 ms	
-		TÜV, UL, CUR		TÜV, UL, CUR	
-		-		-	

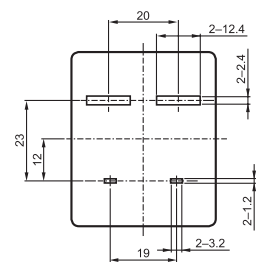
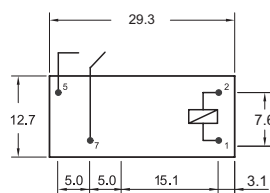
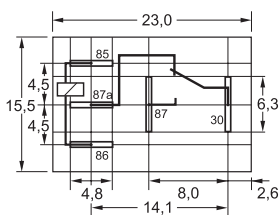

APPLICATION NOTES

This products specification
to be used only together with the application notes
which can be downloaded from our website
www.ZETTLERelectronics.com



Diese Produktspezifikation darf nur
zusammen mit den Anwendungshinweisen verwendet werden,
die von unserer Website heruntergeladen werden können
www.ZETTLERelectronics.com



ZETTLER GROUP

ZETTLER GROUP's diversified product lines are designed to provide complete solutions for component applications across a broad spectrum of industries.

ZETTLER RELAYS

ZETTLER Relays are used in a wide spectrum of applications, including Power, HVAC/R, Energy Management, Lighting, Metering, Automotive, Industrial, Tele-Communications, Security, Home Appliances, Medical, Solar, Electric Vehicle Charging and many other types of electric and electronic equipment. For decades, customers in these industries have embraced ZETTLER Relays for their quality and agree that "It's a better Relay".



ZETTLER MAGNETICS



A diversified range of MAGNETICS products has long been an integral part of ZETTLER Group's engineering and production competence. **ZETTLER Magnetics** offers a complete line of PCB and chassis-mounted Transformers, Toroids and Chokes as well as current sensors.

ZETTLER DISPLAYS

ZETTLER Displays manufactures and markets a broad line of TFT panels and LCD modules under the **AZ Displays** and **ZETTLER Displays** brands, and has established an industry leading reputation as a provider of top quality display solutions in a wide range of industry applications.



ZETTLER CONTROLS

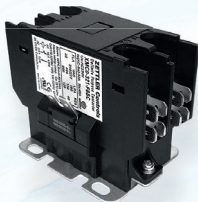

Within ZETTLER Group's portfolio, **ZETTLER Controls** is a prime example of our capacity to not only develop and market high quality electronic components, but also to provide focused industry specific engineering solutions. **ZETTLER Controls** offers industry leading and highly specialized support services to the HVAC/R market with a comprehensive product line of contactors, relays, transformers, heat sequencers, temperature sensors, and fan centers.

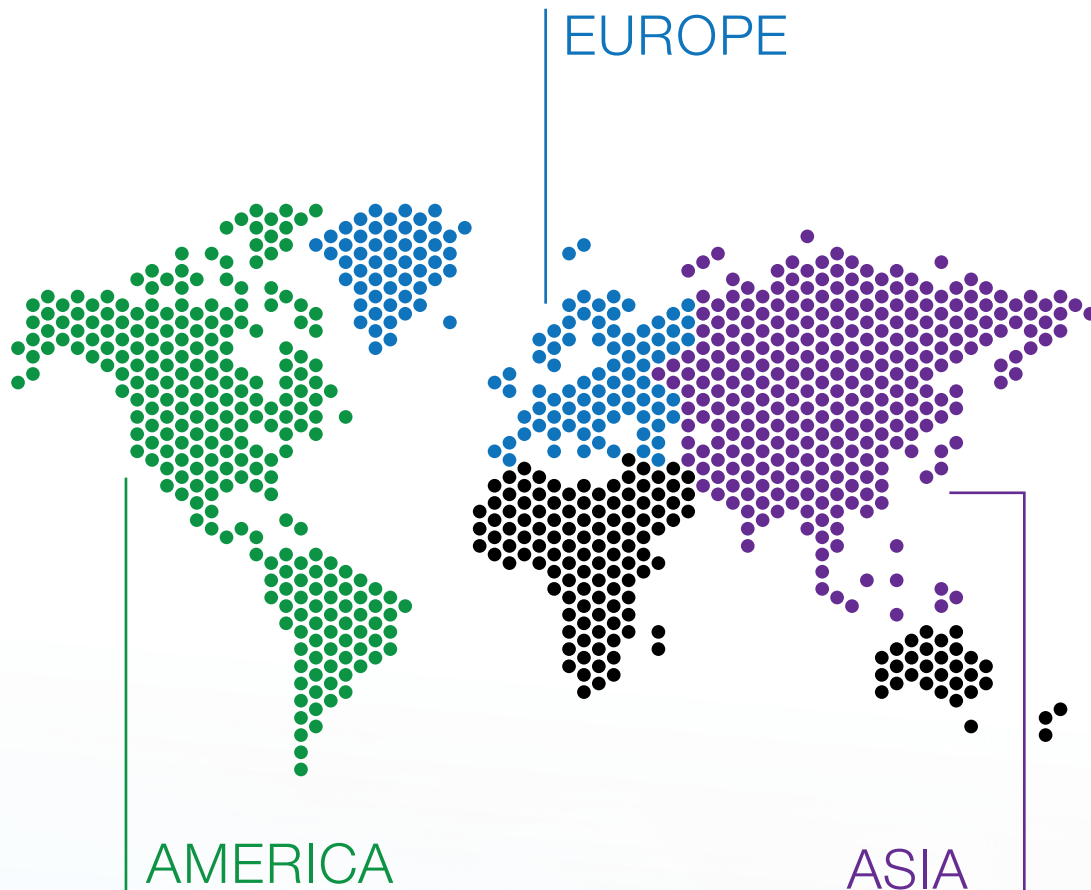

Enjoy the technical competence and the absolutely reliable service of a worldwide operating group!

- Global engineering departments with well experienced engineers and sophisticated measuring equipment
- Excellent guidance in choice of products
- Customer specific tests
- Additional securing the components quality by continuous incoming inspection
- New designs and modifications of existing parts according to European and international standards or according to customer specifications
- Well assorted warehouse of standard components
- Fast and upon request delivery on a given day

DIN EN ISO 9001:2015 certified



ZETTLER electronics GmbH

Junkersstr. 3
82178 Puchheim
GERMANY
Phone: +49 89 / 800 97-0
Fax: +49 89 / 800 97-200
office@ZETTLERelectronics.com
www.ZETTLERelectronics.com



Visit our website
www.ZETTLERelectronics.com

ZETTLER electronics Poland sp.z.o.o.

Ul. Witosa 29
86-200 Zary
POLAND
Phone: +48 68 / 479 1437
Fax: +48 68 / 479 1439
office@ZETTLERelectronics.pl
www.ZETTLERelectronics.pl

Companies of the ZETTLER Group

AMERICA:

AMERICAN ZETTLER Inc.

ASIA:

Xiamen ZETTLER Relay Co., Ltd.
ZETTLER electronics (HK), Ltd.

A member of the ZETTLER Group

www.ZETTLERelectronics.com
www.zettler-group.com