

3ARR3, 3ARR22 Type

MOTOR START POTENTIAL RELAY

General Description

A voltage sensitive, electromagnetic type motor starting relay with normally closed snap-action contacts used to disconnect the start capacitor on capacitor-start, induction-run and capacitor-start, capacitor-run motors. The relay has a protective cover which eliminates the need for additional electrical and mechanical protection. A variety of mounting brackets are available. Terminals may be either Quick Connect Tab Type or Screw Type.

Typical Applications

- Central air conditioner compressors
- Submersible pump motors
- Motors generally over 1/3 HP with start capacitors

Operation

The relay is energized by a magnet coil electrically connected across the start winding of the motor and responds to the increase in start winding voltage as the motor accelerates from zero to the normal running speed. The relay contacts are actuated by the armature of the relay to disconnect the start capacitor at a speed where the motor has sufficient torque to bring it up to normal running speed. The relay remains energized during the run operation of the motor, keeping the relay contacts open. When the motor is de-energized, the relay contacts re-close for the next motor start. Each relay is designed for a specific application which includes the coil rating for continuous run voltage and the pickup and dropout calibration for proper motor starting.

Terminals

- Quick Connect Type
0.250" x 0.032" (6.3 mm x 0.8 mm)
- Screw Type, Tin Plated Brass
#8-32 Thread

Electrical Ratings

- Contacts
35 Amperes max, 50/60 Hz, break only (3ARR3)
50 Amperes max, 50/60 Hz, break only (3ARR22)
- Continuous Coil Rating
60 Hz; 130 to 500 Volts
50 Hz; 117 to 470 Volts

See Appendix "B" for Coil Groups and Ratings.

Potential Motor Start Relay 35A and 50A Rating



Endurance

- 100,000 to 500,000 operations
(depending on load)

Mounting

- Mounting Bracket
Select from available brackets in Appendix "C".
- Mounting Position
Each relay is calibrated in the intended mounting position. Specify desired mounting position from Appendix "D".

Circuits

If there is a terminal in position #6, it must be the same polarity as terminals #1, #2, and #4 to prevent possible flashover. If there is no terminal in #6 position, #4 can be either polarity.



Common Coil Circuit

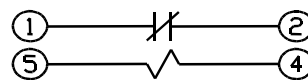

Isolated Coil Circuit

ZETTLER Controls, Inc.

www.zettlercontrols.com

75 COLUMBIA • ALISO VIEJO, CA 92656 • PHONE: (949) 360-5840 • FAX: (949) 360-5839 • E-MAIL: SALES@ZETTLERCONTROLS.COM

12/09/19

3ARR3, 3ARR22 Type

GENERAL OUTLINE DIMENSIONS

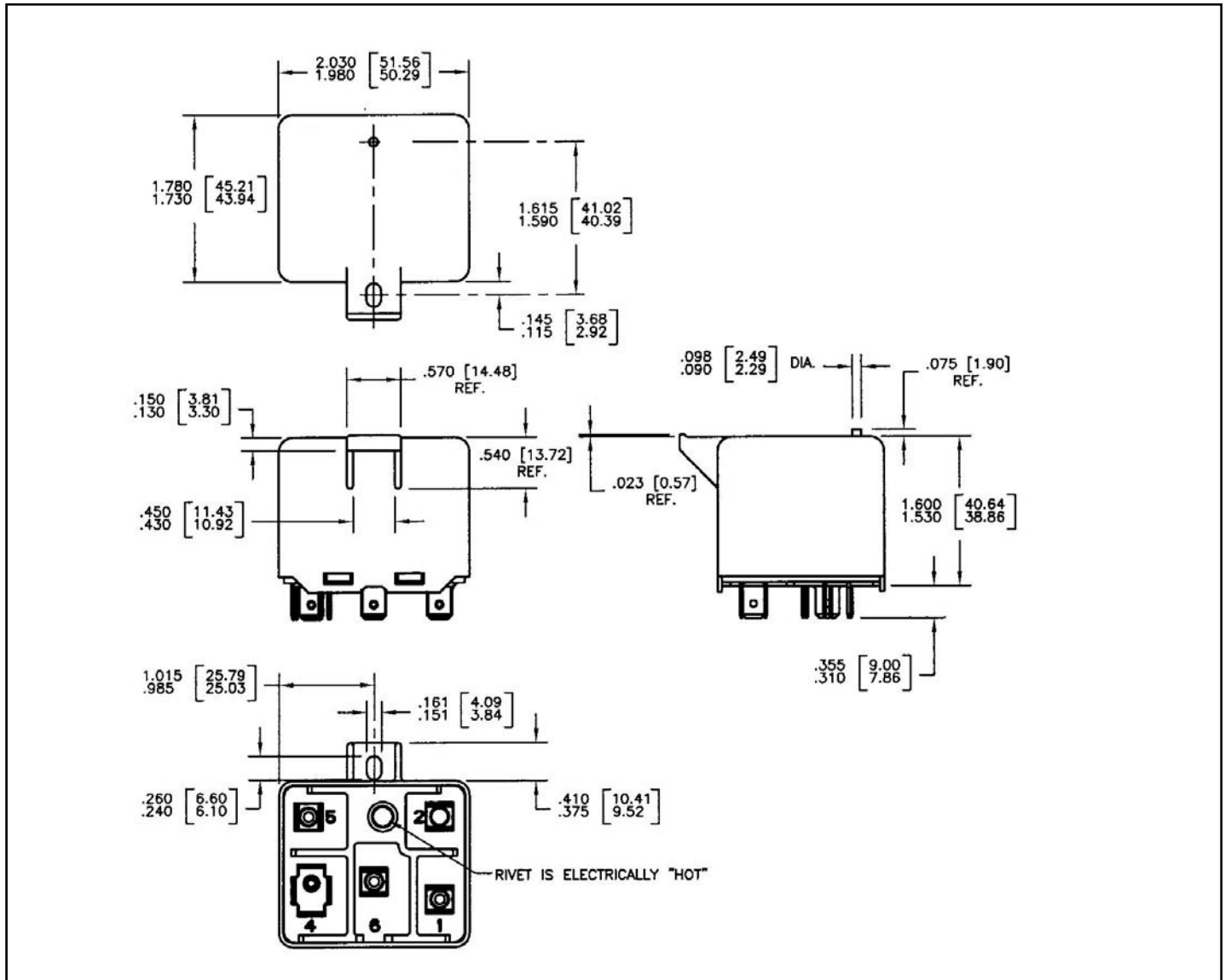

Application Procedure

Use the part number scheme from *Appendix "A"* to create part number requirements.

Agency Approvals

UL File #SA 44129
CSA included in UL

Calibration

Relay is factory calibrated for pickup and dropout voltages to match motor speed and torque curves for the specific application requirements. See *Appendix "B"* for calibrations available for each coil group.

ZETTLER Controls, Inc.

www.zettlercontrols.com

75 COLUMBIA • ALISO VIEJO, CA 92656 • PHONE: (949) 360-5840 • FAX: (949) 360-5839 • E-MAIL: SALES@ZETTLERCONTROLS.COM

3ARR3, 3ARR22 Type _____

APPENDIX A (Ordering Part Number)

Relay model number (Example: 3ARR3AA2A1)

3ARR

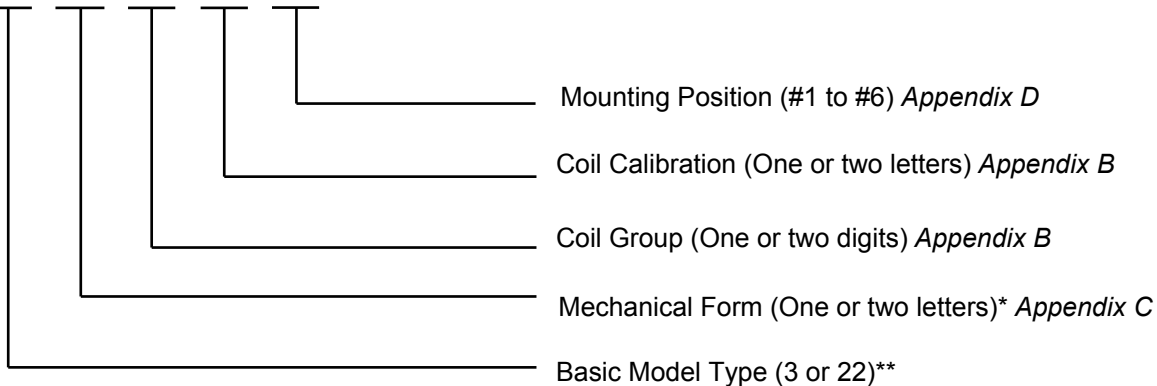

* Mechanical Form per appendix C or assigned by the ZC Application Engineer as required.

** Basic Model Type is selected based on capacitor disconnect current ("3" for 35A) ("22" for 50A).

ZETTLER Controls, Inc. www.zettlercontrols.com

75 COLUMBIA • ALISO VIEJO, CA 92656 • PHONE: (949) 360-5840 • FAX: (949) 360-5839 • E-MAIL: SALES@ZETTLERCONTROLS.COM

APPENDIX B

(Coil Group and Calibration)

THE CONTINUOUS DUTY VOLTAGE OF THE RELAY COIL MUST BE EQUAL TO OR GREATER THAN THE MAXIMUM VOLTAGE TO WHICH IT WILL BE EXPOSED. THIS VOLTAGE WILL BE THE VOLTAGE INDUCED IN THE MOTOR START WINDING WHEN THE MOTOR IS RUNNING AFTER THE START WINDING HAS BEEN DISCONNECTED. IT WILL BE THE GREATEST WHEN THE LINE VOLTAGE IS AT ITS MAXIMUM, WHEN THE MOTOR IS RUNNING AT ITS MAXIMUM SPEED (LIGHTLY LOADED), AND WHEN THE RUN CAPACITOR SIZE IS LARGEST.

THE EFFECT OF THE "EFFECTIVE AMBIENT TEMPERATURE" SURROUNDING THE RELAY MUST ALSO BE TAKEN INTO ACCOUNT.

THE EFFECTIVE AMBIENT TEMPERATURE IS NOT THE AMBIENT TEMPERATURE IN WHICH THE APPLIANCE OR EQUIPMENT IS INSTALLED, BUT IS THE AMBIENT TEMPERATURE SURROUNDING THE RELAY WHILE THE APPLIANCE IS OPERATING. OFTEN THE ENCLOSED CONTROL COMPARTMENT WILL BE SUBSTANTIALLY HIGHER IN TEMPERATURE THAN THE AREA AROUND THE APPLIANCE. IN SOME CASES OTHER HEAT SOURCES OR RADIANT EFFECTS ARE CONTRIBUTORS TO ITS TEMPERATURE.

THE MAXIMUM ALLOWABLE TEMPERATURE OF THE COIL WINDING IS 120° C, WHEN MEASURED BY CHANGE IN RESISTANCE METHOD.

THIS MEANS THAT THE COIL GROUP NUMBER SELECTED MUST NOT PRODUCE A HEAT RISE, WHICH WHEN ADDED TO THE EFFECTIVE AMBIENT TEMPERATURE, WILL RESULT IN THE COIL TEMPERATURE EXCEEDING THE MAXIMUM ALLOWABLE FOR THE SPECIFIC INSULATION CLASS.

IF THIS SHOULD OCCUR, A COIL GROUP SHOULD BE SELECTED WHICH WILL PRODUCE A LOWER HEAT RISE WITH THE MAXIMUM VOLTAGE APPLIED TO THE COIL. A GROUP WITH A HIGHER COIL RATING WILL PRODUCE A LOWER HEAT RISE AT A SPECIFIC APPLIED VOLTAGE.

IF THE COMPRESSOR/MOTOR MANUFACTURER IS NOT SURE OF THE ACTUAL EFFECTIVE AMBIENT IN THE APPLIANCE IN WHICH THE RELAY IS INSTALLED, A WORST CONDITION OF 40° C OR HIGHER SHOULD BE USED IN SELECTING THE PROPER COIL GROUP. FOR EXAMPLE, UNITS INSTALLED OUTDOORS OR IN TIGHTLY CONFINED SPACES.

TO PREDICT A HEAT RISE AT A NEW VOLTAGE, MULTIPLY THE KNOWN RISE AT A SPECIFIC VOLTAGE BY THE SQUARE OF THE RATIO OF THE NEW VOLTAGE OVER THE OLD.

TABLES OF COILS BY GROUP, ALONG WITH CALIBRATION IDENTIFICATION FOLLOW ON SHEETS 1 THRU 4. THE COIL RATINGS FOR SPECIFIC GROUPS FOR 50 HZ OPERATION ARE ON SEPARATE SHEETS. IT SHOULD BE NOTED THAT FOR A GIVEN COIL GROUP, THE VOLTAGE RATING AT 60 HZ IS HIGHER THAN FOR 50 HZ.

TITLE POTENTIAL RELAY APPLICATION
SELECTION OF THE PROPER
COIL VOLTAGE RATING

74-407791
SHEET NO. A
CONT ON SH. 1

74-407791
SHEET NO. A
CONT ON SH. 1

74-407791
SHEET NO. A
CONT ON SH. 1

PROPRIETARY AND CONFIDENTIAL

THIS DOCUMENT IS THE PROPERTY OF ZETTLER CONTROLS COMPANY AND CONTAINS PROPRIETARY AND CONFIDENTIAL INFORMATION OF ZETTLER CONTROLS COMPANY. THIS DOCUMENT IS LOANED ON THE EXPRESS CONDITION THAT NEITHER IT NOR THE INFORMATION CONTAINED THEREIN SHALL BE DISCLOSED TO OTHERS WITHOUT THE EXPRESS CONSENT OF ZETTLER CONTROLS AND THAT THE INFORMATION SHALL BE USED BY THE RECIPIENT ONLY AS APPROVED EXPRESSLY BY ZETTLER CONTROLS. ALSO, THIS DOCUMENT SHALL BE RETURNED TO THE COMPANY UPON ITS REQUEST.

REVISIONS		PRINTS TO
1		
2		
3		
APPROVAL		
MADE BY		
ISSUED		
TRANSFER REL 1-1-14		
ZETTLER CONTROLS, INC.		74-407791
		SHEET NO. A

ZC MOTOR START RELAY (3ARR3, 3ARR22) DATA

74-407791
SH.1

CUSTOMER COLD PICK-UP AND DROP-OUT FOR EACH COIL GROUP

CALIBRATION VALUES ARE BASED ON AVERAGE COIL COPPER TEMPERATURES OF: COLD 35°C HOT 95°C.

COIL GROUPS ARE U.L. CLASS B RATINGS AND VDE RECOGNIZED.

(U.L. FILE SA 44129)

CALIBRATION IDENTIFICATION	FREQUENCY (HERTZ)	HOT PICK-UP VOLTS	MAXIMUM COIL VOLTAGES FOR SPECIFIED MAXIMUM TEMPERATURE RISE																																			
			GROUP 2.12		GROUP 3.13		GROUP 4.14		GROUP 5.15		GROUP 6.16		GROUP 7.17		GROUP 8.18		GROUP 9.19		GROUP 10.20																			
			PICK-UP MIN	PICK-UP MAX	PICK-UP MIN	PICK-UP MAX	PICK-UP MIN	PICK-UP MAX	PICK-UP MIN	PICK-UP MAX	PICK-UP MIN	PICK-UP MAX	PICK-UP MIN	PICK-UP MAX	PICK-UP MIN	PICK-UP MAX	PICK-UP MIN	PICK-UP MAX	PICK-UP MIN	PICK-UP MAX	PICK-UP MIN	PICK-UP MAX																
A	60	260	280	243	271	40	90	239	266	60	135	240	269	35	77	242	272	60	121	238	266	25	65	243	271	40	90	239	270	50	110	375V-Δ 80°C	328V-Δ 60°C					
B	60	280	300	261	290	50	100	258	287	60	135	259	288	35	77	262	290	60	121	256	285	25	65	261	290	50	100	260	289	50	110							
C	60	300	320	280	309	55	100	277	305	60	135	278	306	35	77	280	310	60	121	275	303	25	65	280	309	55	100	279	308	50	110							
D	60	320	340	299	327	50	100	295	324	60	135	296	325	35	77	300	328	60	121	293	324	25	65	299	327	50	100	298	326	50	110							
E	60	340	360	317	345	50	100	314	342	60	135	315	343	35	77	318	347	60	121																			
F	60	350	370	326	354	50	100	323	352	60	135	323	352	35	77	328	356	60	121																			
G	60	360	380	335	364	50	100	332	361	60	135	333	363	35	77	337	366	60	121																			
H	60	365	395																																			
J	60	120	130	111	124	20	45																															
K	60	130	140	120	134	20	45																															
L	60	140	150	132	148	40	90																															
M	60	150	160	140	157	40	90																															
N	60	160	170	149	163	20	45																															
P	60	170	180	159	172	20	45																															
R	60	180	190	168	182	20	45																															
S	60	190	200	178	192	20	45																															
T	60	200	220	186	215	40	90																															
U	60	220	240	205	234	40	90																															
V	60	240	260	224	252	40	90																															
W	60	210	230	198	225	20	45																															
BD	60																																					
Y	60	70	80																																			
BE	60																																					
BA	60	290	310	268	298	50	100																															
BB	60	110	120																																			
TV	60	240	260																																			
TW	60	210	230																																			
TP	60	170	180	162	175	70	100																															
COIL RESISTANCE @ 25°C (OHMS) REFERENCE			1,620		6,050		14,820		4,080		11,500		830		2,600		5,550																		9,400			

PROPRIETARY AND CONFIDENTIAL

THIS DOCUMENT IS THE PROPERTY OF ZETTLER CONTROLS COMPANY AND CONTAINS PROPRIETARY AND CONFIDENTIAL INFORMATION OF ZETTLER CONTROLS COMPANY. THIS DOCUMENT IS LOANED ON THE EXPRESS CONDITION THAT NEITHER IT NOR THE INFORMATION CONTAINED THEREIN SHALL BE DISCLOSED TO OTHERS WITHOUT THE EXPRESS CONSENT OF ZETTLER CONTROLS AND THAT THE INFORMATION SHALL BE USED BY THE RECIPIENT ONLY AS APPROVED EXPRESSLY BY ZETTLER CONTROLS. ALSO, THIS DOCUMENT SHALL BE RETURNED TO THE COMPANY UPON ITS REQUEST.

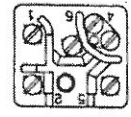

POS.6

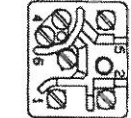

POS.5

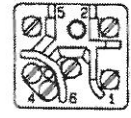

POS.4

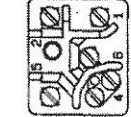

POS.3



POS.2



POS.1



MOUNTING POSITIONS

UP

74-407791
SHEET 1

ZC MOTOR START RELAY (3ARR3, 3ARR22) DATA

CUSTOMER COLD PICK-UP AND DROP-OUT FOR EACH COIL GROUP
COIL GROUPS ARE U.L. CLASS B RATINGS AND VDE RECOGNIZED.

CALIBRATION VALUES ARE BASED ON
AVERAGE COIL COPPER TEMPERATURES
OF: COLD 35°C
HOT 95°C.

CALIBRATION IDENTIFICATION	FREQUENCY (HERTZ)	HOT PICK-UP VOLTS	MAXIMUM COIL VOLTAGES FOR SPECIFIED MAXIMUM TEMPERATURE RISE																			
			GROUP 21.41		GROUP 22.42		GROUP 23.43		GROUP 24.44		GROUP 25.45		GROUP 26.46		GROUP 27.47		GROUP 28					
			PICK-UP MIN	PICK-UP MAX	DROP-OUT MIN	DROP-OUT MAX	PICK-UP MIN	PICK-UP MAX	DROP-OUT MIN	DROP-OUT MAX	PICK-UP MIN	DROP-OUT MAX	PICK-UP MIN	DROP-OUT MAX	PICK-UP MIN	DROP-OUT MAX	PICK-UP MIN	DROP-OUT MAX	PICK-UP MIN	DROP-OUT MAX		
A	60	260																				
B	60	280																				
C	60	300																				
D	60	320																				
E	60	340																				
F	60	360																				
G	60	380																				
H	60	365																				
J	60	120	111	125	20	50	111	124	30	65												
K	60	130	140	154	20	50	120	134	30	65												
L	60	140	150	164	20	55	130	144	30	65												
M	60	150	160	174	20	55	140	153	30	65	136	150	45	90								
N	60	160	170	184	20	55	149	163	30	65	150	163	45	90	153	165	55	115				
P	60	170	180				159	172	30	65	159	172	45	90	162	175	55	115				
R	60	180	190				168	182	30	65	168	182	45	95	171	185	55	115				
S	60	190	200				178	192	30	75	178	192	45	95	180	193	55	115	189	205	60	130
T	60	200	220								185	213	45	95	186	215	55	115	189	211	60	130
U	60	220	240								203	231	45	95	205	234	55	115	204	233	60	130
V	60	240	260								221	250	45	95	224	252	55	125	223	252	75	150
W	60	210	230																			
X	60																					
Y	60	70	80	62	76	20	45															
Z	60																					
BA	60	290	310								267	297	55	125								
BB	60	110	120	101	115	20	45															
BD	60			85	99	20	45															
BE	60			90	104	20	45															
COIL RESISTANCE @ 25°C (OHMS) REFERENCE			1,350		2,200		5,220		8,000		11,600		13,260		15,900		17,660					



PROPRIETARY AND CONFIDENTIAL
THIS DOCUMENT IS THE PROPERTY OF ZETTLER CONTROLS COMPANY AND CONTAINS PROPRIETARY AND CONFIDENTIAL INFORMATION OF ZETTLER CONTROLS COMPANY. THIS DOCUMENT IS LOANED ON THE EXPRESS CONDITION THAT NEITHER IT NOR THE INFORMATION CONTAINED THEREIN SHALL BE DISCLOSED TO OTHERS WITHOUT THE EXPRESS CONSENT OF ZETTLER CONTROLS AND THAT THE INFORMATION SHALL BE USED BY THE RECIPIENT ONLY AS APPROVED EXPRESSLY BY ZETTLER CONTROLS. ALSO, THIS DOCUMENT SHALL BE RETURNED TO THE COMPANY UPON ITS REQUEST.

ZC MOTOR START RELAY (3ARR3, 3ARR22) DATA

CUSTOMER COLD PICK-UP AND DROP-OUT FOR EACH COIL GROUP

CALIBRATION VALUES ARE BASED ON AVERAGE COIL COPPER TEMPERATURES OF:
 COLD 35°C
 HOT 95°C.

COIL GROUPS ARE U.L. CLASS B RATINGS AND VDE RECOGNIZED.

		MAXIMUM COIL VOLTAGES FOR SPECIFIED MAXIMUM TEMPERATURE RISE																											
CALIBRATION IDENTIFICATION	FREQUENCY (HERTZ)	GROUP 21.41		GROUP 22.42		GROUP 23.43		GROUP 24.44		GROUP 25.45		GROUP 26.46		GROUP 27.47		GROUP 28													
		193V - Δ 80°C 117V - Δ 60°C		174V - Δ 80°C 153V - Δ 60°C		262V - Δ 80°C 230V - Δ 60°C		344V - Δ 80°C 302V - Δ 60°C		406V - Δ 80°C 356V - Δ 60°C		415V - Δ 80°C 359V - Δ 60°C		470V - Δ 80°C 407V - Δ 60°C		530V - Δ 80°C 455V - Δ 60°C													
		PICK-UP VOLTS	DROP-OUT	PICK-UP	DROP-OUT	PICK-UP	DROP-OUT	PICK-UP	DROP-OUT	PICK-UP	DROP-OUT	PICK-UP	DROP-OUT	PICK-UP	DROP-OUT	PICK-UP	DROP-OUT												
AA	50	260	280			240	269	45	109	243	271	55	119	242	272	60	133	242	272	75	152	239	268	75	170				
AB	50	280	300			259	288	45	109	261	290	55	119	262	290	60	133	262	290	75	152	258	287	75	170				
AC	50	300	320			278	306	45	129	280	309	55	138	279	310	60	133	280	310	75	152	277	305	75	170				
AD	50	320	340							299	327	55	138	300	328	60	154	300	328	75	152	295	324	75	170				
AE	50	340	360							310	340	75	140	318	347	60	154	318	347	75	152	314	342	75	180				
AF	50	350	370																										
AG	50	360	380																										
AH	50	365	395																										
AJ	50	120	130	52	111	124	30	52																					
AK	50	130	140	52	120	134	30	62																					
AL	50	140	150	58	130	144	30	62																					
AM	50	150	160	140	153	30	71	136	150	45	90																		
AN	50	160	170	149	163	30	71	150	163	45	90																		
AP	50	170	180	159	172	30	71	159	172	45	90	162	175	55	119														
AQ	50	180	190	168	182	45	90	171	184	55	119																		
AR	50	180	190	178	192	45	90	180	193	55	119	180	195	60	133														
AS	50	190	200	185	213	45	90	186	215	55	119	186	214	60	133														
AT	50	200	220	203	231	45	109	205	234	55	119	204	233	60	133	204	233	75	120										
AU	50	220	240	221	250	45	109	224	252	55	119	223	252	60	133	223	252	75	152										
AV	50	240	260																										
AW	50	210	230																										
AX	50																												
AY	50	70	80	62	76	20	48																						
AZ	50																												
COIL RESISTANCE (e 25°C (OHMS) REFERENCE)		1, 350				2, 200				8, 000				11, 500				13, 260				15, 900				17, 550			



PROPRIETARY AND CONFIDENTIAL
 THIS DOCUMENT IS THE PROPERTY OF ZETTLER CONTROLS COMPANY AND CONTAINS PROPRIETARY AND CONFIDENTIAL INFORMATION OF ZETTLER CONTROLS COMPANY. THIS DOCUMENT IS LOANED ON THE EXPRESS CONDITION THAT NEITHER IT NOR THE INFORMATION CONTAINED THEREIN SHALL BE DISCLOSED TO OTHERS WITHOUT THE EXPRESS CONSENT OF ZETTLER CONTROLS AND THAT THE INFORMATION SHALL BE USED BY THE RECIPIENT ONLY AS APPROVED EXPRESSLY BY ZETTLER CONTROLS. ALSO, THIS DOCUMENT SHALL BE RETURNED TO THE COMPANY UPON ITS REQUEST.

3ARR3, 3ARR22 Type

APPENDIX C (Mechanical Form)

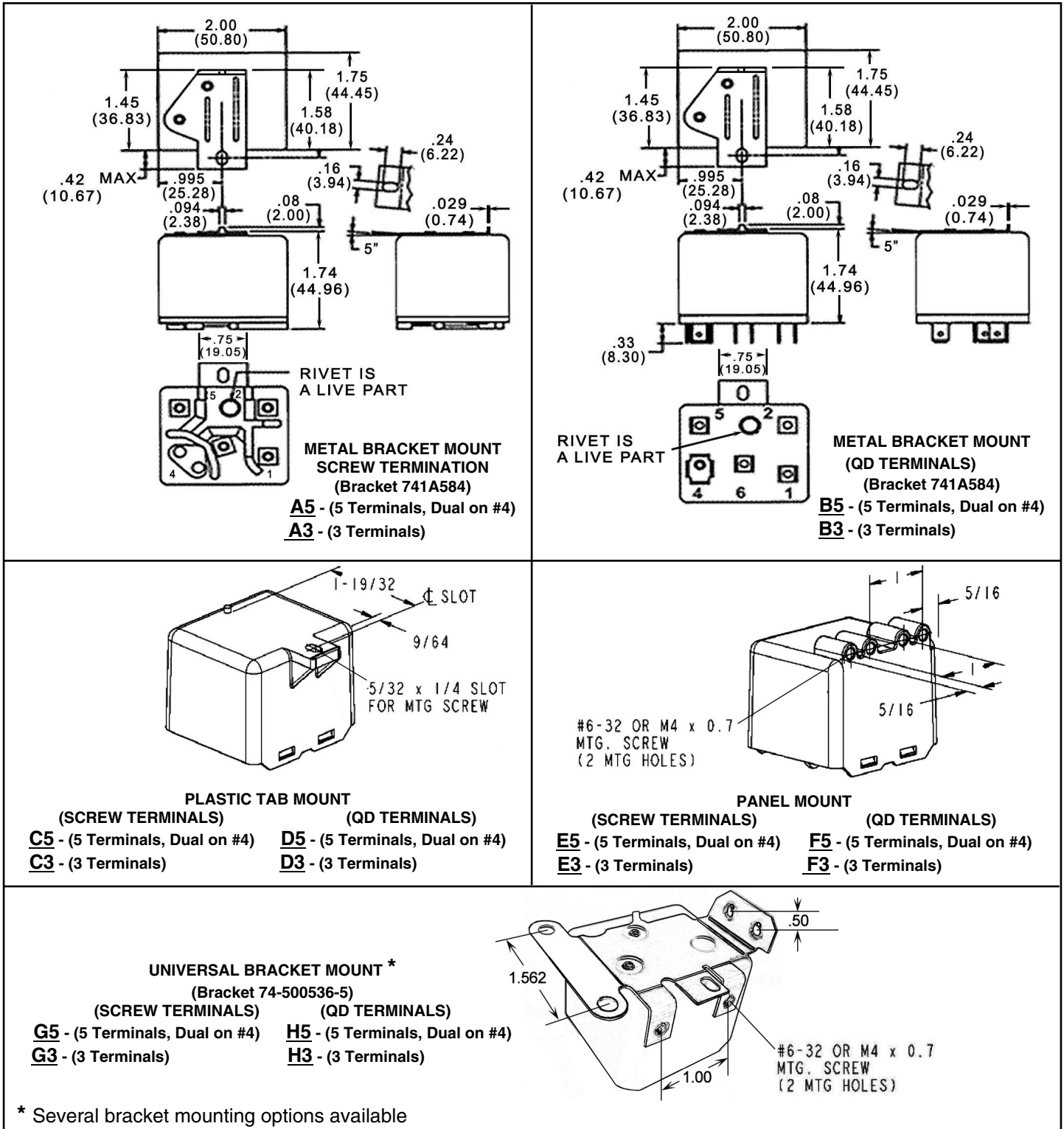

3ARR3, 3ARR22 Type

APPENDIX D (Mounting Positions)

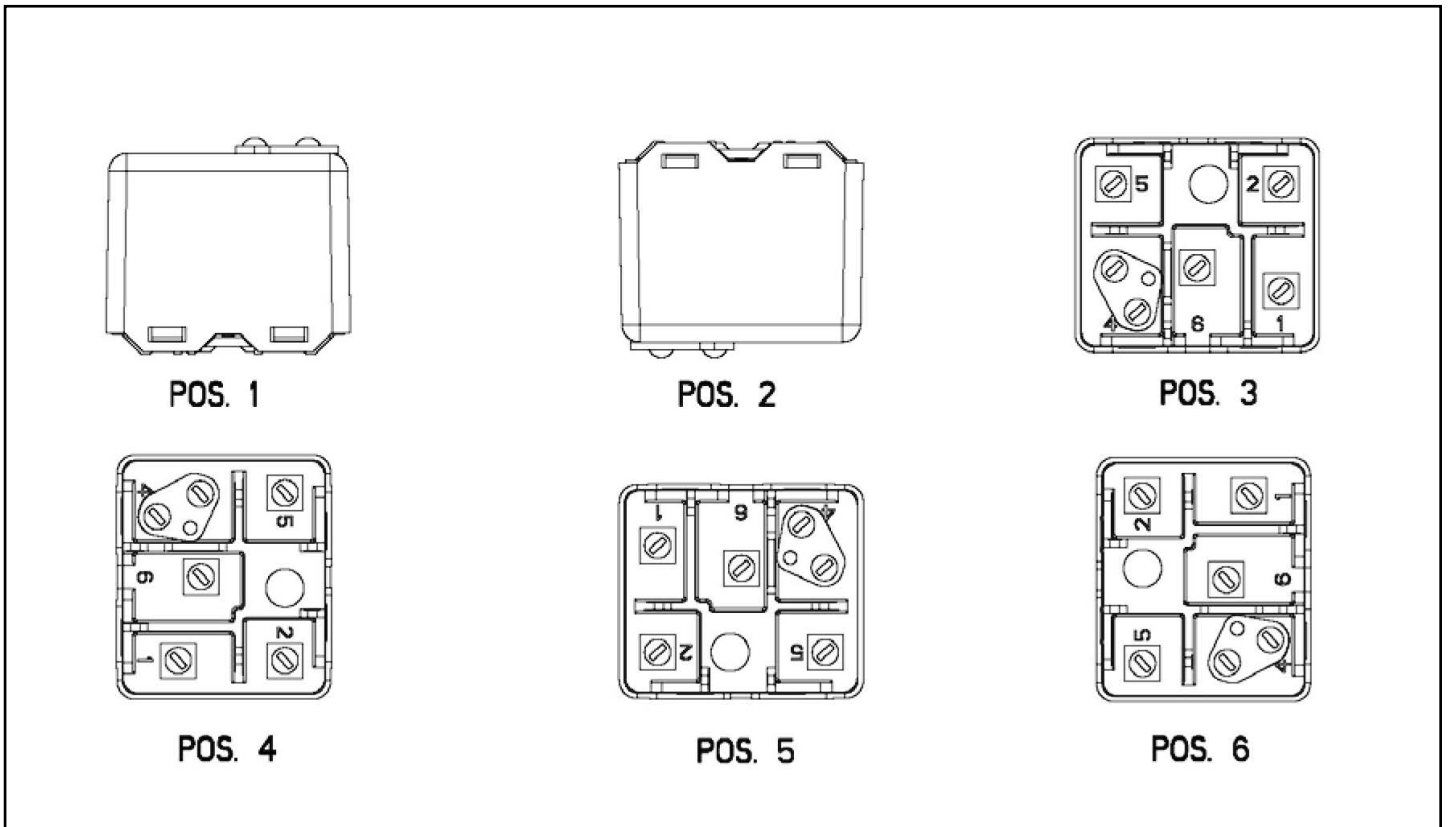

ZETTLER Controls, Inc.

www.zettlercontrols.com

75 COLUMBIA • ALISO VIEJO, CA 92656 • PHONE: (949) 360-5840 • FAX: (949) 360-5839 • E-MAIL: SALES@ZETTLERCONTROLS.COM