



YMW TAPS USA

2024-2025
Product Catalog



North America's oldest and largest importer of YAMAWA products.



Think threads with

YAMAWA

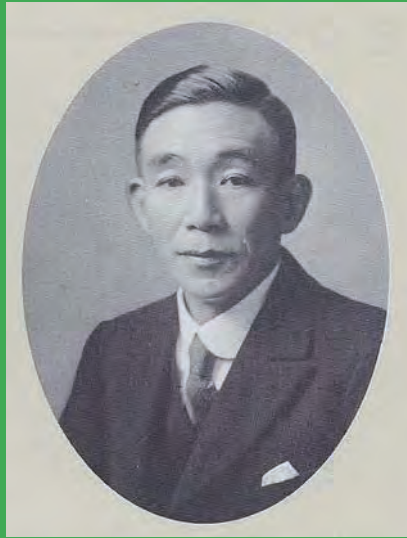

Mr. Jokichi Watanabe, founder of Yamawa Mfg. Co., Ltd., located his company in Shibuya-Ku, Tokyo during 1923. Since then, Yamawa continues a strong effort to evolve its manufacturing technology along with the progress of machine tool development worldwide. As a group, Yamawa responds to the customer's needs by continuously focusing on research and development of products, processes and quality improvements.

The definition of Yamawa is "greater prosperity, more united". In these words, Jokichi Watanabe had a Vision, as the company becomes prosperous, the harmony among its employees become more precious. From its inauguration in 1923, the Yamawa Group has continued to invest in the development and manufacturing of the highest quality cutting tools to meet the demanding needs of the worldwide technology industries.

The many users of Yamawa high quality taps and cutting tools include aerospace, defense, telecommunications, automotive, oil tool, wind generation, ship building, machine tools, electronic appliances, IT industries and others. Year after year, Yamawa branded products continue to receive the highest recognition for consistent reliance from the worldwide market.

Yamawa continues the investigation of excellence in development and manufacturing by seeking the best technology available in today's market. When there are no major improvements available in machine technology, Yamawa continues to manufacture its own pre-cise machinery to manufacture the highest quality cutting tools available in the worldwide market. It is with great pride that Yamawa was the first manufacturer in Japan to obtain ISO9001 not only through technology but quality control.

Yoshio Watanabe, current President of Yamawa states "The Yamawa spirit contributes to industries by producing the most Reliable Screw Threads. These reliable threads are indispensable as the basis of manufacturing. Yamawa realizes that a consistent supply of high quality and high performance products satisfies our customer's requirement and contributes to the technological evolution of industrial fields and advancement of society".

Realizing that enterprise gives influence to earthy environment, Yamawa contributes to our society by manufacturing the highest quality cutting tools, and proceeds with the continuous development of activities while protecting environment. All employees participate in the activities of protecting our environment.

We thank you for your continued support.

Yamawa's mission is to create high quality, high performance taps and cutting tools while supporting technical innovation in metal machining.

As rapid technical innovation unfolds in every field of industry, metal cutting and threading are faced with demands for higher quality and more efficient machining.

By developing and supplying more precise, high performance taps and center drills to meet these evolving needs, YAMAWA is contributing to the advancement of global machining.

Product Line

Precision Cutting Tools

•Taps •Center Drills •Gages •Dies

Regrind Fixtures

•Tap and Drill Sharpeners

Precision Pitch Diameter Measuring Machines

•Three-wire measuring machine for highly accurate pitch diameter measurement

YAMAWA products respond to a wide variety of technical demands, addressing a wide range of metal processing needs, including:

Industry demand for high production and higher quality screw threads

High-speed, high-precision, multi-function CNC machine tools in the field of metal machining, have provided the platforms for threading improvements. YAMAWA has been quick to respond to this emerging trend, leading and toughness of these materials accelerate the industry in the development and introduction of taps for CNC and high-speed and ultra high-speed machining. We continue to produce a steady stream of high-performance taps in response to today's increasingly high demand for quality threads at reduced tapping costs.

Environment protection and increased efficiency

YAMAWA is actively engaged in finding solutions for the increasing important problems of coolant management. Our proprietary oil-less thread forming taps have eliminated the need for cutting oil during tapping for popular sizes. This not only enables cleaner threading but also makes the entire process more efficient by eliminating chips during threading and reducing the clean-up step.

Tapping hard-to-machine materials

Technological advances in the aerospace industry and other fields have prompted the use of various new light weight, heat resistant materials such as titanium and nickel based alloys. The extreme hardness and toughness of these materials accelerate wear on cutting tools, making conventional taps inadequate. YAMAWA continues to develop specific high performance tap designs for such hard to machine materials. We supply a broad range of new products in response to evolving customer needs, supporting the cutting edge of the next generation of metal processing.

New tap innovation for aluminum

Yamawa has introduced new taps for high-performance threading of high-silicon aluminum and wrought aluminum.

YAMAWA is continuously updating tap design based on meeting and exceeding our customers' tapping needs for increased quality at higher production rates.

Our technical expertise continues to create high quality, high performance products while protecting the environment.

For more than 90 years, YAMAWA has continued to develop superior technical expertise as a pioneer in the taps and dies industry.

The Yamawa employees' technological know-how throughout its history has helped to produce many of the diverse products that have supported our growth over the years. We have established a flexible production system and a research and development system geared to the needs of our customers.

We remain committed to the development of high-quality, high-performance products, while continuing to refine and advance our technical capabilities.

YAMAWA's Unique Capabilities

Tap production involves the grinding of many features on a tap blank to produce a finished precision tool. For many years, YAMAWA has recognized the need to build these precision tap grinding machines "in house" as a means of achieving greater tool precision and higher quality tools. Today, YAMAWA makes more than 90% of its own production machines, thereby controlling tap quality from cut-off to final laser making and measurement. Machines manufactured include machine tools to thread, flute grind, chamfer, machine tap squares, OD grind, and machines to measure all of the tap's critical elements such as thread pitch diameter. The self-reliance at YAMAWA allows us to control product quality and production capabilities by custom engineering machines not readily available in the open market. At YAMAWA, we understand how to make taps, tap manufacturing machines and tap measuring equipment.

Research and Development

To achieve maximum tapping efficiency, we analyze materials to be tapped in detail. After carefully selecting a tap base material we thoroughly control heat treatment and design. This allows us to develop and supply taps that are ideally suited to specific application.

In addition to the basic tap research taking place at our technical research center, we also have a test center where we conduct performance and durability tests on the taps produced at Yamawa to evaluate tool performance with the goal of continuous improvement.

ISO9001

Equipped with many measuring machines manufactured in-house, YAMAWA maintains a rigorous quality system that includes inspection of both the machine stage and for finished goods. This quality control system has received widespread acclaim, along with numerous awards. In 1996, the Yonezawa Plant stepped ahead of our competitors by receiving ISO9001. The Fukushima Plant and Aizu Plant were ISO9001 certified in 2000. The Tsutsumi Plant were certified with ISO9001 in 2011. The head quarters were certified with ISO9001 in 2012.

ISO14001

Yamawa is proud to announce the certification of ISO14001 for all manufacturing facilities and operations. Our aim is to preserve the environment for future generation under the themes as an ecological friendly while producing the best screw threads available today. Yamawa recognizes that enterprise activities have a major influence on the earth's environments and as a large corporation we proceed with the protection and continuous improvement of the environment. Yamawa decreases the burden on environment, and respects the environmental rules as it continues to pursue an environment friendly enterprise.

**Yonezawa Plant (ISO9001L 1996)
(ISO14001: 2003)**



Yonezawa is the main manufacturing plant of the Yamawa Group, this location is equipped with production lines and is the Quality Control Center. The plant obtained ISO9001 certification in 1996. Of the four Yamawa plants, the Yonezawa location has the longest history of manufacturing and the highest production capacity. Products include roll taps, spiral pointed, pipe and hand taps.

The Yonezawa Plant stepped ahead of our competitors by receiving ISO9001 before any other cutting tool manufacturing in Japan.

**Fukushima Plant (ISO9001: 2000)
(ISO14001: 2002)**



The Fukushima Plant provides both tap production lines and in house facilities for the manufacturing of specialized production machine tools to produce the exceptional high quality cutting tools. This plant develops and manufactures special tap and die production equipment. It also supplies these machines to our other manufacturing sites. Products include spiral fluted taps, dies and combined drills/countersinks as well as production machinery.

**Aizu Plant (ISO9001" 2000)
(ISO14001: 2002)**



Equipped with the most sophisticated machine tools available, this plant is famous for its automation and robotized labor saving manufacturing processes. The plant is designed for mass production of the highest quality cutting tools and screw thread tools. Products include spiral fluted taps and carbide taps.

**Tsutsumi Plant (ISO9001: 2011)
(ISO14001: 2011)**



The Tsutsumi plant is the main tool blank manufacturing operation of Yamawa group. This location is also the testing center where Yamawa executes the innovation in metal machining and performance tests of the products for the Yamawa group.

**Head Office (ISO9001: 2012)
(ISO14001: 2003)**



Head office and export department
Address: Nakajima Gold Building,
No. 13-10,
Kyobashi 3chome, Chuoh-ku, Tokyo,
Japan 104-0031
TEL: +81-3-3561-2717
FAX: +81-3-3564-6838

Quality, Consistency, Performance and Product Development. All of the 800 Yamawa employees are committed to these principles and these are reflected in each tool we produce.

Origin of our Corporate name, "YA" "MA" "WA"

Mr. Jokichi Watanabe, the founder of the company, decided to use the shop name "YA" "MA" "WA", which he had been using in his family business instead of using his personal family name. He gave his company the name "YA" "MA" "WA" by adapting these lucky words and using the connotation "YAMAWA" from the ancient Japanese characters, MANYOGANA. The meaning of YAMAWA is "Greater prosperity, More united". In this phrase, he put his wish "as the company becomes prosperous, the harmony among employees becomes more precious".

90 years' experience in threading application

YAMAWA was founded in 1923. For more than 90 years, YAMAWA has been improving the quality of Taps and Dies in order to meet the customers needs. Our chief goal is to provide our customers with "Reliable Screw Threads".

90% of all the grinding machines are built in-house.

More than 90% of the grinding machines used in manufacturing at the YAMAWA factories are built in-house by YAMAWA. This enables YAMAWA to always maintain the highest level of accuracy with these in-house grinding machines and continue to supply our customers worldwide with the highest quality of taps. These machines lead to consistency of the taps performance.



100% quality inspection

Taps produce thousands of internal screw threads. One defective tap could produce thousands of defective parts. In order to prevent this from happening, YAMAWA conducts 100% final inspection of each single tap as well as intermediate inspection after each grinding process.





YAMAWA'S motto is "Reliable Screw Threads". We enrich the manufacturing industry by producing the highest quality taps. In addition to taps, we also manufacture threading dies, drills, countersinks, combined drill countersinks and a broad range of other centering type cutting tools. Since YAMAWA's founding in 1923, we have been putting a continuous effort into quality improvements and technical progress as a general cutting tool manufacturer for over 90 years.

YMW TAPS USA

The largest agent of
YAMAWA/YMW USA products



YMW TAPS USA provides all the customers in the US with the following services:

Customer Support



Inventory Operation



YMW TAPS USA is equipped with the Microtap TTT system that produces operational testing and is available to support our customers needs. Should you have any tapping problems or difficulties, please call 855-969-8721.

With high levels of inventory, we can meet your urgent delivery requests.

History of Yamawa Group

November 1923	Founded by Jokichi Watanabe in Shibuya-ku, Tokyo.
December 1937	Company Incorporated.
May 1945	Plant established in Yonezawa City in Yamagata prefecture.
January 1953	Spun off Yonezawa Plant into a separate company as Yamawa Tap Co., LTD.
June 1955	All products certified to Japanese Industrial Standards (JIS) categories.
October 1956	Award by the Department of Trade and Industry for superiority in industrial standardization of Yonezawa Plant.
April 1964	Newly constructed Fukushima Plant began operation.
November 1973	Award by the Department of Trade and Industry for superiority in industrial standardization of Fukushima Plant.
October 1983	Established YAMAWA ENGINEERING Co., LTD.
December 1984	New machine tool manufacturing facility constructed inside the Fukushima Plant.
October 1986	Newly completed Aizu Plant opened.
April 1991	Spun off Fukushima Plant and Aizu Plant into a separate company, YAMAWA PRECISION Co., LTD.
November 1995	Established TC (Total Cutting) CENTER Co., LTD.
June 1996	YAMAWA TAP Co., LTD. obtained ISO 9001 certification















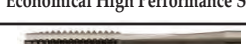

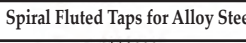
History of Yamawa Group



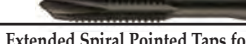
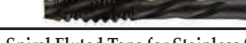



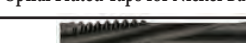
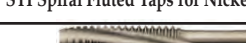









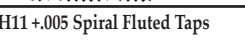

- | | |
|----------------|--|
| July 2000 | YAMAWA PRECISION Co., LTD. in Aizu obtained ISO 9001 certification |
| October 2000 | YAMAWA PRECISION Co, LTD. in Fukushima obtained ISO 9001 certification |
| August 2001 | Estbalish YAMAWA TC CENTER Co., LTD. |
| October 2002 | Obtain ISO 14001 certification in YAMWA PRECISION Co., LTD. at Fukushima Plant. |
| December 2002 | Obtain ISO 14001 certification in YAMAWA PRECISION Co., LTD. at Aizu Plant. |
| January 2003 | Obtain ISO 14001 certification in YAMAWA TAP Co., LTD. |
| October 2006 | Obtain ISO 14001 certification in YAMAWA MFG. Co., LTD. |
| October 2006 | Spun off overseas sales division into a separate company as YAMAWA INTERNATIONAL Company, LTD. |
| January 2007 | Spun off Taiwan office into a separate company as YAMAWA ASIA LTD. |
| September 2008 | YAMAWA ENGINEERING Co., LTD. and YAMAWA TC CENTER Co., LTD. obtain ISO 14001. |
| June 2012 | YAMAWA assigns a new importer, YMW Taps USA, for the U.S.A. and Canadian markets. |

Table of Contents

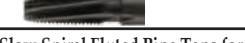
Tap Index	P10
Index By EDP Number	P12
Surface Treatment	P13
Icons	P14
Tap Selection By Material	P15
SFM to RPM	P19
Taps, Dies	P3
Drills	P118
Gages	P127
Technical Information	P140
Metal Cutting Safety	P185
Special Tap Request Form	P186

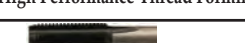
TAP INDEX

Z-PRO PO		P41
	Economical High Performance Spiral Point	
Z-PRO SP		P52
	Economical High Performance Spiral Flute	
Z-PRO HT		P63
	Economical High Performance Hand Taps	
Z-PRO STI-PO		P85
	Economical High Performance STI Spiral Pointed Taps	
Z-PRO STI-SP		P66
	Economical High Performance STI Spiral Fluted Taps	
Z-PRO STI-HT		P89
	Economical High Performance STI Hand Taps	
8 TPI SP		P95
	Spiral Fluted Taps for Alloy Steels	
8 TPI LO-SP		P95
	Spiral Fluted Taps for Alloy Steels	
IPO		P96
	I Series Spiral Pointed Taps	
ISP		P96
	I Series Spiral Fluted Taps	
ZELX SS		P3
	Spiral Pointed Taps for Stainless Steel	
ZELX SS 6"		P7
	Extended Spiral Pointed Taps for Stainless Steel	
ZELX SS		P8
	Spiral Fluted Taps for Stainless Steel	
ZELX SS 6"		P13
	Extended Spiral Fluted Taps for Stainless Steel	
ZELX NI		P15
	Spiral Pointed Taps for Nickel Base Alloys	
ZELX NI STI		P20
	STI Spiral Pointed Taps for Nickel Base Alloys	
ZELX NI		P19
	Spiral Fluted Taps for Nickel Base Alloys	
ZELX NI STI		P21
	STI Spiral Fluted Taps for Nickel Base Alloys	
ZELX TI		P23
	Left Hand Spiral Pointed Taps For Titanium Alloys	
ZELX TI		P25
	Spiral Fluted Taps for Titanium Alloys	
ZELX MOLD		P100
	Hand Taps for Hard-to-Machine Materials	
ZELX AL		P29
	Spiral Pointed Taps for Non-Ferrous Materials	

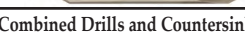
ZELX AL		P29
	Spiral Fluted Taps for Non-Ferrous Materials	
ZELX ALS		P30
	Spiral Fluted Taps for Non-Ferrous Materials	
ZEXL CARB CI		P103
	Carbide Taps for Cast Irons	
ZELX CARB AL		P103
	Carbide Taps for Non-Ferrous Materials	
MHSL		P128
	Metric SL Series	
AXE		P130
	Metric ST Series	
IHT		P98
	I Series HT	
MHRZ		P38
	MHRZ	
+0.05		P106
	H11 +.005 Spiral Fluted Taps	
N-RZ		P109
	Thread Forming Taps for Ferrous Materials	
N-RS		P112
	Thread Forming Taps for Non-Ferrous Materials	
ZELX HP-RZ		P115
	High Performance Thread Forming Taps for Dry Tapping	
ZELX SS PIPE		1268
	Slow Spiral Fluted Pipe Taps for Stainless Steel, for NPT and NPTF Threads	
ZELX MOLD PIPE		P100
	Pipe Taps for Mold Steels, for NPT Threads	
ZELX OL-RZ		P118
	High Performance Thread Forming Taps	
NPT		P113
	Pipe Taps for NPT Threads	
NPTF		P115
	Pipe Taps for NPTF Dryseal Threads	
NPS		P117
	Pipe Taps for NPS Threads	
NPSF		P117
	Pipe Taps for NPSF Dryseal Threads	
DRILLS		P160
	Combined Drills and Countersinks	
VU SERIES		#33
TECH.		P132
	Technical Section	

Product Offering Summary

Series	Tap Type	Style	Sizes	Tap Dimensions	Tap Material	Tap Application
3218 3228	Spiral Point	Plug	Machine Screw Fractional	ANSI	Vanadium HSS	Stainless & Alloy Steel, Ductile Irons
3318 3328	Spiral Flute	Modified Bottoming	Machine Screw Fractional	ANSI	Vanadium HSS	Stainless & Alloy Steel, Ductile Irons
3218T 3228T	Spiral Point, TiN	Plug	Machine Screw Fractional	ANSI	Vanadium HSS	Stainless & Alloy Steel, Ductile Irons
3318T 3328T	Spiral Flute, TiN	Modified Bottoming	Machine Screw Fractional	ANSI	Vanadium HSS	Stainless & Alloy Steel, Ductile Irons
3718 3728	Extended Spiral Point	Plug	Machine Screw Fractional	ANSI	Vanadium HSS	Stainless & Alloy Steel, Ductile Irons
3818 3828	Extended Spiral Flute	Modified Bottoming	Machine Screw Fractional	ANSI	Vanadium HSS	Stainless & Alloy Steel, Ductile Irons
3438 3448	Slow Spiral Flute	NPT NPTF	NPT Pipe NPTF Pipe	ANSI	Vanadium HSS	Stainless & Alloy Steel, Ductile Irons
3114 3124	Straight Flute	Plug	Machine Screw Fractional	ANSI	Cobalt HSS	Mold Steel & Alloy Steels >30RC
3434	Taper Pipe	Straight Flute	NPT Pipe	ANSI	Cobalt HSS	Mold Steel & Alloy Steels >30RC
3278 3278T	Spiral Point Spiral Point, TiN	Plug	Metric	ANSI	Vanadium HSS	Stainless & Alloy Steel, Ductile Irons
3378 3378T	Spiral Flute Spiral Flute, TiN	Modified Bottoming	Metric	ANSI	Vanadium HSS	Stainless & Alloy Steel, Ductile Irons
3613 3623	Spiral Point	Plug	Machine Screw Fractional	ANSI	Cobalt Vanadium Premium Steel	Titanium, Copper Alloys, Soft Plastics
3673	Spiral Point	Plug	Metric	ANSI	Cobalt Vanadium Premium Steel	Titanium, Copper Alloys, Soft Plastics
3616 3626 3676	Spiral Flute	Modified Bottoming	Machine Screw Fractional Metric	ANSI	Cobalt Vanadium Premium Steel	Titanium, Copper Alloys, Soft Plastics
3612 3622 3672	Spiral Point	Plug	Machine Screw Fractional Metric	ANSI	Cobalt Vanadium Premium Steel	Nickel Base & Exotic Alloy, Stainless >30RC
3615 3625 3675	Spiral Flute	Plug/Bottoming	Machine Screw Fractional Metric	ANSI	Cobalt Vanadium Premium Steel	Nickel Base & Exotic Alloy, Stainless >30RC
3619 3629	Spiral Point STI	Plug	Machine Screw Fractional	ANSI	Cobalt Vanadium Premium Steel	Nickel Base & Exotic Alloy, Stainless >30RC
3617 3627	Spiral Flute STI	Plug/ Bottoming	Machine Screw Fractional	ANSI	Cobalt Vanadium Premium Steel	Nickel Base & Exotic Alloy, Stainless >30RC
3814 3824 3884	Spiral Point	Plug	Machine Screw Fractional Metric	ANSI/DIN Length	Vanadium HSS	Cast Silicon Aluminum and Wrought Aluminum
3701 3711 3771	Spiral Flute, 45°	Modified Bottoming	Machine Screw Fractional Metric	ANSI/DIN Length	Vanadium HSS	Wrought Aluminum Alloys, Soft Plastics
3804 3834 3874	Slow Spiral Flute, 25°	Modified Bottoming	Machine Screw Fractional Metric	ANSI/DIN Length	Vanadium HSS	Cast Silicon, Aluminum Alloys
3570 3580	Roll Form, Dry	Plug	Metric Machine Screw Fractional	ANSI/DIN Length	Cobalt Vanadium Premium Steel	Stainless Steel and Other Soft Alloys
3502 3512 3572	Roll Form, Wet	Plug/Bottoming	Machine Screw Fractional Metric	ANSI/DIN Length	Cobalt Vanadium Premium Steel	Stainless Steel and Other Soft Alloys
3550 3552 3750	Roll Form	Plug/ Bottoming	Machine Screw Fractional Metric	ANSI/DIN Length	Vanadium HSS	Aluminum, Brass, Copper Alloys
3560 3565 3575	Roll Form	Plug/ Bottoming	Machine Screw Fractional Metric	ANSI/DIN Length	Vanadium HSS	Stainless Steel, Alloy Steels
3317 3327	RH Spiral Flute	Modified Bottoming	Machine Screw Fractional	ANSI	Vanadium HSS	Fast, Rigid, Synchronized Tapping
3315 3325	LH Spiral Flute	Plug	Machine Screw Fractional	ANSI	Vanadium HSS	Fast, Rigid, Synchronized Tapping

















Index by EDP Number

EDP No. Range	List	Page	EDP No. Range	List	Page
I Series		90	383810-383887	3927	95
I PO Series		90	384001-384690	3318	11
I SP Series		90	384013-384715	3328	11
Z-Pro Series		34	384500-384523	3910	13
Z-Pro PO Series		34	384513-384522	3920	13
Z-Pro SP Series		45	384800-384809	3318T	95
Z-Pro HT Series		56	384810-384879	3328T	95
Z-Pro STI Series		78	384901-384910	3318T	8
+005 H11 SP Spiral Flute		98	384913-384997	3328T	8
Check Pin Gages		128	385501-385570	3612	15
350000-350050	3800	118	385513-385586	3622	15
370000-370029	3977	96	385613-385678	3623	24
371000-371021	3970	96	385700-385712	3673	25
372615-372633	3278	3	386200-386206	3814	30
372915-372927	3278T	3	386207-386227	3824	30
374015-374633	3378	11	386228-386240	3884	30
374915-374927	3378T	8	386400-386406	3804	32
381409-387445	3617	22	386407-386427	3834	32
381508-387586	3625	18	386428-386440	3874	32
381556-387583	3615	18	386507-386527	3711	31
381608-387670	3616	27	386528-386540	3771	31
381629-387695	3626	27	386600-386609	3580	109
382500-382523	3718	13	386610-386615	3570	109
382513-382522	3728	13	386799-386823	3502	107
382590-382710	3228	3	386824-386863	3512	107
382600-382699	3218	3	386864-386889	3572	108
382901-382910	3218T	3	387058-387475	3627	21
382913-382997	3228T	3	387248-387275	3629	20
383100-383110	3430	111	387320-387332	3672	16
383125-383135	3440	113	387700-387712	3676	28
383151-383160	3435	112	388320-388332	3675	19
383201-383210	3437	112	388410-388469	3550	104
383226-383235	3447	112	388470-388511	3552	104
383301-383307	3450	115	388512-388535	3750	105
383326-383332	3460	115	389410-389469	3560	101
383640-383647	3438	116	389470-389511	3565	101
383660-383667	3448	116	389512-389535	3575	102
383806-383809	3917	95	389599-389607	3114	92
			389613-389628	3124	92
			389641-389646	3434	113

Surface Treatment

Material Class	Material Type	Material Examples	TiN	TiCN	TiALN	Nitride	Oxide	Oxide	CrN	Bright
Steel	Carbon Steel	1010, 1045	A	P	N	N	A	A	N	N
	Alloy Steels	4140, 8620	A	P	A	N	A	A	N	N
	Tool Steels	A2, D2, H13	A	P	A	N	A	A	N	N
	Martensitic Stainless	414, 440	A	P	A	N	A	A	N	N
	PH Stainless	15-5PH, 17-4PH	A	P	A	N	A	A	N	N
Stainless Steel	Austenitic Stainless	304, 316	A	P	A	N	A	A	N	N
Cast Iron	Cast Iron, Ductile		A	P	A	A	A	A	N	N
	Cast Iron, Gray	Class 20-50	A	P	A	A	A	A	N	N
Non-Ferrous	Aluminum, Wrought	2024, 6061, 7071	N	N	N	A	N	N	A	P
	Aluminum, Silicon, Cast	319, 360, 380	A	A	N	A	N	N	A	P
	Copper & Alloys		N	N	N	A	N	N	A	P
	Brass		N	N	N	P	N	N	A	A
	Bronze		N	N	N	P	N	N	A	A
	Zinc		N	N	N	A	N	N	A	P
High-Temp Alloy	Magnesium & Alloys		N	N	N	A	N	N	A	P
	Titanium, Pure	CP Ti	N	N	N	A	N	P	A	N
	Titanium, Alloys	Ti, 6Al4V	A	A	N	A	N	P	A	N
	Nickel Based Alloys	Monel, Inconel	A	P	A	A	A	A	A	N
	Iron Based Alloys	A286, Incoloy	A	P	A	A	A	A	N	N
Other	Cobalt Alloys	Haynes	A	P	A	A	A	A	N	N
	Plastic, Soft		P	A	N	N	N	N	A	A
	Plastic, Abrasive Graphite		A	P	N	N	N	N	A	N
Speed Increase Combined To Uncoa aps			+50%	+50%	+100%	Use Same Speed As Uncoat				
P= Preferred A= Acceptable N= Not Recommended										

Explanation of Icons

	High Speed Steel		Oxide Nitride Surface Toughening		Heli Angle of Spiral Flute
	Cobalt High Speed Steels		Titanium Nitride Coating		Heli Angle of Left-Hand Spiral Flute
	Powder High Speed Steels		Titanium Carbon Nitride Coating		For Left-Hand Screw Threads
	Ultra Micro Grain Tungsten Carbide		Oxide Surface Treatment		Number of Pitches for Chamfer Part of Tap
	Cemented Carbide		Nitride Surface Toughening Treatment		For Through Hole
			For Synchronized Tapping		For Blind Hole Tapping



BASED ON 65-75% THREADS, 1-2X DIAMETER, THROUGH HOLE

Material	Condition	Hardness		Speed SFFM	YMW ZELX								Forming Tap				
		BHN	HRC		SS	SS TiN	Mold	NI	TI	AL	ALS	HT CI	PO	HP-RZ	*OL-RZ	N-RS	N-RZ
Low Carbon Steel, Wrought																	
1005-1029, 1108-1211, 1212-1215, 1513-1522, 12L13-12L14	Normalized or Cold Drawn	< 175 < 276	< 9 < 30	50-75 40-60	●	●							○	○	○	●	●
Medium Carbon Steel, Wrought																	
1030-1055, 1525-1541, 41L30-41L50, 43L47, 51L32, 52L100, 86L20-86L40	Normalized Hardened	< 250 < 350	< 25 < 38	30-50 15-25	●	●							○	○	○	●	●
High Carbon Steel, Wrought																	
1060-1069, 1070-1078, 1080-1086, 1090-1095, 1547-1572	Annealed Hardened	< 275 < 350	< 30 < 38	30-50 15-25	●	●							○	○	○	●	●
Alloy Steel Low Carbon, Wrought																	
4012-4028, 4118, 4320, 4419-4427, 4615-4626, 5015-5120, 8115, 8615-27	Normalized Hardened	< 250 < 350	< 25 < 38	30-45 25-35	●	●							○	○	○	●	●
Alloy Steel Medium Carbon, Wrought																	
1330-1345, 4032-4047, 4130-4161, 4340, 50B40-50B60, 5046-5060, 5135-5160, 8630-8660, 8740-8742, 9254-9260	Normalized Hardened Hardened	< 250 < 350 < 425	< 25 < 38 < 40	25-35 15-20 10-12	●	●							○	○	○	●	●
Tool Steels, Wrought																	
H10, H11, H12, H13, H14, H19, H21, H24, H25, H26, H42, H43, D2, D3, D4, D5, D7, A7, A2-A10, O1-O7, S1-S7, P2, P4, P5, P6, P20, P21	Annealed Hardened Annealed Annealed Annealed	< 250 < 375 < 150 < 250 < 200	< 25 < 41 < 15 < 25 < 16	15-25 15-20 30-45 10-15 25-35	●	○	●		○				○	○	○		●
Armor Plate, Wrought																	
HY80, HY100, MIL-S-12560, MIL-S-16216	Annealed Hardened Hardened	< 250 < 300 < 350	< 25 < 33 < 38	25-35 18-30 15-25	●		○	●					○	○			●
High Strength Steels, Wrought																	
300M, 4330V, 4340, D6ac, H11, H13, 4340Si, 98BV40, HP9-4.20, HP9-4.25, HP9-4.30, HP9-4.45, HP25, HP30, HP45	Normalized Normalized Hardened Annealed Hardened	< 350 < 400 < 460 < 375 < 460	< 38 < 43 < 48 < 41 < 48	15-20 10-15 5-7 10-15 7-10	○	○	○	●									●
Maraging Steels, Wrought																	
200Grade, 250Grade, 300 Grade, 350Grade, HY230, 120Grade, 180Grade	Annealed Maraged	< 325 < 425	< 35 < 45	15-20 7-10	○		○	●									
Free Machining Stainless Steel																	
303, 430F, 430F Se, 416, 420, 440Se, 440	Annealed	< 195		50-70	●	●							○	○			●
Ferritic Stainless Steel, Wrought																	
405, 409, 430, 434, 436, 442, 446, 502	Annealed	< 185	< 12	25-40	●	●							○	○	○	○	●
Austenitic Stainless Steel, Wrought																	
201, 202, 301, 302, 304, 304L, 305, 308, 309, 310, 314, 316, 316L, 317, 321, 330, 347, 384, 385, Nitronic	Annealed Cold Drawn Annealed Cold Drawn	< 185 < 275 < 250 < 375	< 12 < 30 < 25 < 41	18-25 12-20 12-20 7-15	●	●		●					○	○	○	○	●
Martensitic Stainless Steel Wrought																	
403, 410, 420, 422, 501, 502, 414, 431, Greek Ascology, 440A, 440B, 440C	Annealed Annealed Hardened Hardened Annealed Hardened Hardened Hardened Hardened	< 175 < 225 < 325 < 425 < 275 < 325 < 425 < 275 < 325 < 425	< 9 < 21 < 35 < 45 < 30 < 35 < 45 < 30 < 35 < 45	25-40 18-30 18-25 10-18 18-25 12-20 7-15 12-20 10-18 7-15	●	●		○					○	○	○	○	●
Precipitation Hardening																	
Stainless Steel Wrought																	
PH13-8Mo, 15-5PH, 16-6PH, 17-4PH, 17-7PH, AF71, AFC-77, AM350, AM355, PH13-8MO, PH14-8MO, PH15-7MO, Custom 455, HNM, Stainless W	Annealed Hardened Hardened Hardened	< 200 < 325 < 375 < 440	< 16 < 35 < 41 < 47	18-30 15-25 12-20 6-12		○	●	●					○	○			
Aluminum Alloys, Wrought																	
10660-1100, 1145-1175, 2011-2025, 5050, 2011-2618, 5005-5657, 6061-6951, 7075, Aluminum Die Cast, X201.0, 208.0-295.0, 308.0-357.0, 514.0-535.0, 707.0-771.0, High Silicon Aluminum	Cold Drawn Treated As Cast Treated Si > 10%	< 80 < 150 < 100 < 125 < 125	- - - - -	95-125 75-100 100-150 70-100 25-40	O*	●							●	○	○	○	○
Brass, Cast																	
		-	-	50-70	O*	●		○					○	○	○	○	○
Bronze, Cast																	
		-	-	40-60	O*	●		○					○	○	○	○	○
Copper, Wrought																	
	Annealed	< 100Rs	-	40-100	O*	●		○	○	○	○	○	○	○	○	○	○
Copper, Beryllium																	
		-	-	35-80	O*	●		○					○	○	○	○	○
Magnesium Alloys, Wrought																	
	Treated & Aged	< 125	-	70-100	O*	●		○	○	○	○	○	○	○	○	○	○
Plastics, Thermosetting & Thermoplastic																	
		UP TO 125Rm		30 to 50	O*	●		○	○	○	○	○	○	○	○	○	○

● FIRST CHOICE ○ ALTERNATE * BRIGHT FINISH

* OL-RZ Designed to tap dry or with mist coolant - for 1 to 1-1/2 diameters in tapping depth.



BASED ON 65-75% THREADS, 1-2X DIAMETER, THROUGH HOLE

Material	Condition	Hardness		Speed SFFM	YMW ZELX						Forming Tap			
		BHN	HRC		SS	SS TIN	Mold	NI	TI	CI	PO	HP-RZ	*OL-RZ	N-RS
Cast Iron, Gray														
Ferritic ASTM A48: CL 20 SAE G1800	Annealed	120 to 150		50-80	●						○	○		
Pearlitic-Ferritic A48: CL25 SAE G2500	As Cast	160 to 200		40-60	●						○	○		
Pearlitic A48: CL30, 35 & 40 SAE G3000	As Cast	190 to 220		30-50	●						○	○		
Pearlitic + Free Carbides	As Cast	220 to 260			○			●			○	○		
Pearlitic or Acicular + Free Carbides	As Cast	250 to 320		15-20	○			●			○	○		
Austenitic (NI-RESIST) A436: 1, 1b, 5	As Cast	120 to 200			○			●			○	○		
A436: TYPE 2,3,6, 2b, 4		120 to 175		30-45	○			○						
Cast Iron, Ductile														
		BHN	HRC											
Ferritic, 60-40-18, 65-45-12	Annealed	140 to 190		40-60	●			○			○	○		○
Ferritic-Pearlitic, 80-55-06	As Cast	190 to 225		25-45	○			●			○	○		○
Pearlitic-Martensitic, 100-70-03	Normalized & Tempered	240 to 300		15-20	○			●			○	○		○
Martensitic, 120-90-02	Quenched & Tempered			15	○			●			○			
Austenitic (IN-RISIT Ductile)	Annealed	120 to 220		15-20	○			●						
ASTM A439: D-2, D-2C, D-5, D-3A, D-5. ASTM A571: D-2M														
Cast Iron, Malleable														
		BHN	HRC											
Ferritic 32510, 35018	Malleablized	110 to 160		40-60	●						○			○
Pearlitic 40010, 45008	Malleablized	160 to 200		30-50	●						○			○
43010, 48005, 45006, 50005	& Heat Treated	200 to 240		20-40	○			●			○			○
Martensitic 53004, 60003, 60004	Malleablized & Heat Treated	200 to 255		20-40	○			●			○			
70002, 70003	Malleablized & Heat Treated	220 to 260		15-35	○			●			○			
800002	Malleablized & Heat Treated	240 to 280		15-30				●						
900001	Malleablized & Heat Treated	250 to 320		15-25				●						
Nickel Alloys, Wrought and Cast														
		BHN	HRC											
Nickel 200 - Nickel 270	Annealed	< 170	< 7	15-25	●	●		○	○				●	
Monel 400, 401, 404, Monel R405	Annealed	< 240	< 23	15-20	○	○		●	○					
Monel 502, Monel K500	Treated	< 360	< 39	3-5				●	○					
Perma Nickel 300, Duranickel 301								●						
Inconel 625, 702, 706, 718, 721, 722	Annealed	< 300	< 33	7-10				●	○					
Inconel X-750, 751, 901, Haynes 263	Treated	< 400	< 43	4-7				●	○					
M252, Nimonic 75, 80, Waspaloy								●						
Astroloy, Inconel 700	Treated	< 300	< 33	5-8				●	○					
Nimonic 90, 95, Rene 41, 63	Treated	< 400	< 43	3-5				●	○					
Udimett 500, 700, 710								●						
AF2-1DA, Rene 77, Rene 95	Treated	< 390	< 43	4-7				●	○					
Unitemp 1753	Treated	< 475	< 49	3-5				●	○					
Hastelloy B, C, G, S, X	Annealed	< 220	< 20	7-10	○	○		●	○					
Incoloy 804, Incoloy 825	Cold Drawn	< 310	< 34	4-7				●	○					
Inconel 600, Inconel 601								●						
Udimet 630, Retractaloy 26								●						
M252, Rene 80, Rene 125	As cast or Cast/Aged	< 320	< 34	3-5				●	○					
B-1900, GMR-235, IN-100, IN-738								●						
MAR-M200, 426, 421, 432								●						
Inconel 718, Udimet 500, 700								●						
Cobalt Base Alloys, Wrought and Cast														
		BHN	HRC											
AiResist 13, 213, 215, V36, S-816	Treated	< 230	< 22	5-8	○			●					●	
Haynes 25(L-605), 25 & HS-31 (X-40)	Treated/Aged	< 320	< 34	3-5				●	○					
Haynes 188, MAR-M905, 918, V-36								●						
AiResist 13, 215, X45, HS-6, HS-21, HS-31 (X-40) Stellite, HS-151	Cast/Aged	< 290	< 32	3-5				●	○					
HOWMET 3, NASA-Co-W-Re								●						
MAR-M302, M322, M509, W1-52 X-45								●						
Iron Base Alloys, Wrought														
		BHN	HRC											
A-286, Discaloy, N-155	Treated	< 230	< 22	10-15	○	○		●					●	●
V57, VV-545, Incoloy 800, Incoloy 801, Incoloy 802, 16-25-6, 19-90L	Treated/Aged	< 320	< 34	7-10				○	●					
Titanium Alloys, Wrought														
		BHN	HRC											
Commercial Pure	Annealed	< 170	< 7	40-60	○	●			●					○
Commercial Pure	Annealed	< 200	< 16	30-50	○	○			●					○
Commercial Pure	Annealed	< 275	< 30	25-40		○			●					○
Ti- 3AL-2.5V	Annealed	< 340	< 37	15-25	○				●					○
Ti-5AL-2.5Sn	Annealed	< 340	< 37	15-25					●					○
Ti-6AL-4V	Annealed	< 350	< 38	15-20	○				●					○
Ti-6AL-6V-2Sn	Annealed	< 370	< 40	10-15	○				●					○
Ti-6AL-4V	Treated	< 380	< 41	7-10	○				●					○
Ti-6AL-6V-2Sn	Treated	< 440	< 46	5-7					●					○
Tungsten Alloys														
As Cast		< 320		15-25				●	●					
Molybdenum														
Relieved		< 290		30-50					●					

● FIRST CHOICE ○ ALTERNATE * BRIGHT FINISH

* OL-RZ Designed to tap dry or with mist coolant - for 1 to 1-1/2 diameters in tapping depth.

YMW TAPPING GUIDE THINK THREADS WITH YMW U.S.A.

YMW TAPS U.S.A. TAPPING GUIDE 855-YMW-USA1
BASED ON 65-75% THREAD HEIGHT, LENGTH OF THREAD 2 X DIAMETER, THROUGH HOLE.

Material	Condition	Hardness		Speed	Z-PRO TAP SERIES											
		BHN	HRC	SFPM	SP OX	PO OX	HT OX	SP TiN	PO TiN	HT TiN	SP TiCN	PO TiCN	HT TiCN	SP BR	PO BR	HT BR
Low Carbon Steel, Wrought																
1005-1029, 1513-1522	Normalized or	< 175	< 9	40-65	●	●	●	●	●							
	Cold Drawn	< 276	< 30	30-50	●	●	●	●	●							
Medium Carbon Steel, Wrought																
1030-1055, 1525-1522	Normalized	< 250	< 25	20-40	●	●	●	●	●							
High Carbon Steel, Wrought																
1060-1069, 1070-1078, 1089-1086, 1095	Annealed	< 275	<30	20-40	●	●	●	●	●							
Low Carbon Alloy Steel, Wrought																
4023, 4320, 5120, 8115, 8622	Normalized	< 250	< 25	20-35	●	●	●	●	●							
Medium Carbon Alloy Steel, Wrought																
4032, 4130, 5135, 8630	Normalized	< 250	< 25	15-25	●	●	●	●	●							
Tool Steels, Wrought																
H10, H11, H12, H13, H14, H19, H21, H26	Annealed	<250	<25	15-25	●	●	●	●	●							
D2, D3, D4, D5, D7, A7	Annealed	<150		20-35	●	●	●	●	●							
P2, P4, P5, P6	Annealed	<250	<25	10-15	●	●	●	●	●							
P20, P21	Annealed	<200	<16	15-25	●	●	●	●	●							
Ferritic Stainless Steel, Wrought																
405, 409, 430, 434, 436, 442, 446, 502	Annealed	< 185	<12	15-30	●	●	●					●	●			
Austenitic Stainless Steel, Wrought																
201, 202, 301, 302, 303, 304,	Annealed	< 185	<12	18-25	●	●	●					●	●			
305, 308, 309, 310, 314, 316,	Cold Drawn	< 275	< 30	12-20	●	●	●					●	●			
317, 321, 330, 347, 384, 385					●	●	●					●	●			
Martensitic Stainless Steel Wrought																
403, 410, 420, 422	Annealed	< 175	< 9	15-30	●	●	●					●	●			
501, 502	Annealed	< 225	< 21	15-25	●	●	●					●	●			
414, 431	Annealed	< 275	< 30	15-25	●	●	●					●	●			
440A, 440B, 440C	Annealed	< 275	< 30	10-20	●	●	●					●	●			
Precipitation Hardening Stainless Steel Wrought																
15-5PH, 16-6PH, 17-4PH	Annealed	< 200	< 16	12-25	●	●	●					●	●			
Aluminum Alloys, Wrought																
2011-2025, 5050	Cold Drawn	< 80	-	95-125										○	○	○
6061, 7075	Treated	< 150	-	75-100										○	○	○
Aluminum Die Cast	As Cast	< 100	-	100-150										○	○	○
Brass, Cast		-	-	40-60	●	●	●	●	●							
Bronze, Cast		-	-	30-50	●	●	●	●	●							
Copper, Wrought	Annealed	<100Rs	-	30-90										○	○	○
Magnesium Alloys, Wrought	Treated & Aged	< 125	-	60-90										○	○	○
Plastics, Therosetting & Thermoplastic		UP TO 125Rm		30 to 50										○	○	○
Cast Iron, Gray																
Ferritic	Annealed	120 to 150		40-70			●						●			
Pearlitic-Ferritic	As Cast	160 to 200		30-50			●						●			
Pearlitic	As Cast	190 to 220		20-40			●						●			
Pearlitic + Free Carbides	As Cast	220 to 260					●						●			
Cast Iron, Ductile																
Ferritic	Annealed	140 to 190		30-50	●	●	●	●	●							
Ferritic-Pearlitic	As Cast	190 to 225		15-35	●	●	●	●	●							
Pearlitic-Martensitic	Normalized & Tempered	240 to 300		15-20	●	●	●	●	●							
Martensitic	Quenched & Tempered	270 to 300		15	●	●	●	●	●							
Cast Iron, Malleable																
Ferritic 32510, 35018	Malleablized	110 to 160		30-50	●	●	●	●	●							
Pearlitic 40010, 45008	Malleablized	160 to 200		20-40	●	●	●	●	●							
43010, 48005, 45006, 50005	& Heat Treated	200 to 240		15-25	●	●	●	●	●							
Martensitic 53004, 60003, 60004	Malleablized & Heat Treated	200 to 255		14-25	●	●	●	●	●							

FIRST CHOICE ● ALTERNATE TiN ● ALTERNATE TiCN ● BRIGHT SURFACE ○



Hardness conversion table

■ Conversion table from Rockwell C hardness of steel. (Approximate)

Rockwell C Scale Hardness	Vickers Hardness	Brinell Hardness		Rockwell Hardness ^{*2}			Rockwell Superficial Hardness			Shore Hardness	Tensile Strength MPa ^{*1}	Rockwell C Scale Hardness ^{*2}
		Standard ball	Tungsten Carbide ball	A scale	B scale	D scale	15-N scale	30-N scale	45-N scale			
HRC	HV	HB		HRA	HRB	HRD	HS15N	HS30N	HS45N	HS	—	HRC
68	940	—	—	85.6	—	76.9	93.2	84.4	75.4	97	—	68
67	900	—	—	85.0	—	76.1	92.9	83.6	74.2	95	—	67
66	865	—	—	84.5	—	75.4	92.5	82.8	73.3	92	—	66
65	832	—	(739)	83.9	—	74.5	92.2	81.9	72.0	91	—	65
64	800	—	(722)	83.4	—	73.8	91.8	81.1	71.0	88	—	64
63	772	—	(705)	82.8	—	73.0	91.4	80.1	69.9	87	—	63
62	746	—	(688)	82.3	—	72.2	91.1	79.3	68.8	85	—	62
61	720	—	(670)	81.8	—	71.5	90.7	78.4	67.7	83	—	61
60	697	—	(654)	81.2	—	70.7	90.2	77.5	66.7	81	—	60
59	674	—	(634)	80.7	—	69.9	89.8	76.6	65.5	80	—	59
58	653	—	615	80.1	—	69.2	89.3	75.7	64.3	78	—	58
57	633	—	595	79.6	—	68.5	88.9	74.8	63.2	76	—	57
56	613	—	577	79.0	—	67.7	88.3	73.9	62.0	75	—	56
55	595	—	560	78.5	—	66.9	87.9	73.0	60.9	74	2075	55
54	577	—	543	78.0	—	66.1	87.4	72.0	59.8	72	2015	54
53	560	—	525	77.4	—	65.4	86.9	71.2	58.6	71	1950	53
52	544	(500)	512	76.8	—	64.6	86.4	70.2	57.4	69	1880	52
51	528	(487)	496	76.3	—	63.8	85.9	69.4	56.1	68	1820	51
50	513	(475)	481	75.9	—	63.1	85.5	68.5	55.0	67	1760	50
49	498	(464)	469	75.2	—	62.1	85.0	67.6	53.8	66	1695	49
48	484	451	455	74.7	—	61.4	84.5	66.7	52.5	64	1635	48
47	471	442	443	74.1	—	60.8	83.9	65.8	51.4	63	1580	47
46	458	432	432	73.6	—	60.0	83.5	64.8	50.3	62	1530	46
45	446	421	421	73.1	—	59.2	83.0	64.0	49.0	60	1480	45
44	434	409	409	72.5	—	58.5	82.5	63.1	47.8	58	1435	44
43	423	400	400	72.0	—	57.7	82.0	62.2	46.7	57	1385	43
42	412	390	390	71.5	—	56.9	81.5	61.3	45.5	56	1340	42
41	402	381	381	70.9	—	56.2	80.9	60.4	44.3	55	1295	41
40	392	371	371	70.4	—	55.4	80.4	59.5	43.1	54	1250	40
39	382	362	362	69.9	—	54.6	79.9	58.6	41.9	52	1215	39
38	372	353	353	69.4	—	53.8	79.4	57.7	40.8	51	1180	38
37	363	344	344	68.9	—	53.1	78.8	56.8	39.6	50	1160	37
36	354	336	336	68.4	(109.0)	52.3	78.3	55.9	38.4	49	1115	36
35	345	327	327	67.9	(108.5)	51.5	77.7	55.0	37.2	48	1080	35
34	336	319	319	67.4	(108.0)	50.8	77.2	54.2	36.1	47	1055	34
33	327	311	311	66.8	(107.5)	50.0	76.6	53.3	34.9	46	1025	33
32	318	301	301	66.3	(107.0)	49.2	76.1	52.1	33.7	44	1000	32
31	310	294	294	65.8	(106.0)	48.4	75.6	51.3	32.5	43	980	31
30	302	286	286	65.3	(105.5)	47.7	75.0	50.4	31.3	42	950	30
29	294	279	279	64.7	(104.5)	47.0	74.5	49.5	30.1	41	930	29
28	286	271	271	64.3	(104.0)	46.1	73.9	48.6	28.9	41	910	28
27	279	264	264	63.8	(103.0)	45.2	73.3	47.7	27.8	40	880	27
26	272	258	258	63.3	(102.5)	44.6	72.8	46.8	26.7	38	860	26
25	266	253	253	62.8	(101.5)	43.8	72.2	45.9	25.5	38	840	25
24	260	247	247	62.4	(101.0)	43.1	71.6	45.0	24.3	37	825	24
23	254	243	243	62.0	100.0	42.1	71.0	44.0	23.1	36	805	23
22	248	237	237	61.5	99.0	41.6	70.5	43.2	22.0	35	785	22
21	243	231	231	61.0	98.5	40.9	69.9	42.3	20.7	35	770	21
20	238	226	226	60.5	97.8	40.1	69.4	41.5	19.6	34	760	20
(18)	230	219	219	—	96.7	—	—	—	—	33	730	(18)
(16)	222	212	212	—	95.5	—	—	—	—	32	705	(16)
(14)	213	203	203	—	93.9	—	—	—	—	31	675	(14)
(12)	204	194	194	—	92.3	—	—	—	—	29	650	(12)
(10)	196	187	187	—	90.7	—	—	—	—	28	620	(10)
(8)	188	179	179	—	89.5	—	—	—	—	27	600	(8)
(6)	180	171	171	—	87.1	—	—	—	—	26	580	(6)
(4)	173	165	165	—	85.5	—	—	—	—	25	550	(4)
(2)	166	158	158	—	83.5	—	—	—	—	24	530	(2)
(0)	160	152	152	—	81.7	—	—	—	—	24	515	(0)

*1 : 1Mpa=1N/mm²

*2 : In above table, numbers in parenthesis are only for reference. This table is abstracted from SAE J 417.

SUGGESTED SFM TO RPM CONVERSION CHART BY SIZE

Tap Sizes	Surface Feet per Minute																		
	5'	10'	15'	20'	25'	30'	40'	50'	60'	70'	80'	90'	100'	110'	120'	130'	140'	150'	
	Revolutions per Minute																		
0	318	637	955	1273	1592	1910	2546	3183	3820	4456	5093	5729	6366	7003	7639	8276	8913	9549	
1	273	546	819	1046	1308	1570	2093	2617	3140	3663	4186	4710	5233	5756	6279	6805	7326	7849	
2	212	424	637	888	1110	1333	1777	2221	2665	3109	3554	3999	4442	4886	5330	5774	6218	6662	
3	191	382	573	772	964	1157	1543	1929	2315	2701	3086	3472	3858	4244	4629	5015	5401	5787	
4	174	347	521	682	853	1023	1364	1705	2046	2387	2728	3069	3411	3751	4092	4434	4775	5116	
5	147	294	441	611	764	917	1222	1528	1833	2139	2445	2750	3056	3361	3667	3973	4278	4584	
6	136	273	409	553	691	829	1106	1382	1659	1935	2212	2488	2766	3042	3318	3595	3871	4148	
8	119	239	358	466	583	699	932	1165	1398	1631	1864	2097	2330	2563	2796	3029	3262	3495	
10	101	201	302	402	502	603	804	1005	1205	1406	1607	1808	2009	2210	2411	2612	2813	3014	
12	87	174	260	354	442	531	707	884	1061	1238	1415	1592	1769	1945	2122	2300	2476	2653	
1/4	76	153	229	306	382	458	611	764	917	1070	1222	1375	1528	1681	1833	1986	2139	2292	
5/16	62	123	185	245	306	367	489	611	733	856	978	1100	1222	1345	1467	1589	1711	1833	
3/8	50	101	151	204	255	305	407	509	611	713	815	917	1019	1120	1222	1324	1426	1528	
7/16	43	87	130	175	219	262	349	437	524	611	698	786	873	960	1048	1135	1222	1310	
1/2	38	76	115	153	191	229	305	382	458	535	611	688	764	840	917	993	1070	1146	
9/16	34	68	102	137	172	206	274	342	410	478	547	616	683	752	820	888	952	1020	
5/8	32	64	96	122	153	183	244	306	367	428	489	550	611	672	733	794	856	917	
11/16	28	55	83	111	138	167	222	278	333	389	444	500	556	611	667	722	778	833	
3/4	25	51	76	102	128	153	203	255	305	357	407	458	509	560	611	662	713	764	
7/8	22	43	65	87	109	131	175	218	262	306	350	392	437	480	524	568	611	655	
1	19	38	57	76	96	115	153	191	230	268	305	344	382	420	458	497	535	573	
1-1/8	17	34	51	68	84	102	136	170	204	238	272	306	340	373	407	441	475	509	
1-1/4	15	31	46	61	76	92	122	153	183	214	244	275	305	336	367	397	428	458	
1-3/8	14	28	42	56	69	83	111	139	167	194	222	250	278	306	333	361	389	417	
1-1/2	13	25	38	51	63	76	102	127	153	178	204	229	255	280	305	331	356	382	
1-5/8	12	23	35	47	59	71	94	118	141	165	188	212	235	259	282	306	329	353	
1-3/4	11	22	33	44	55	65	87	109	131	153	175	196	218	240	262	284	306	327	
1-7/8	10	20	30	41	51	61	81	102	122	143	163	183	204	224	244	265	285	306	
2	9	19	29	38	48	57	76	96	115	134	153	172	191	210	229	248	267	287	
M1	490	979	1469	1959	2449	2938	3918	4897	5877	6856	7836	8815	9795	10774	11754	12733	13713	14692	
M2	242	484	725	967	1209	1451	1934	2418	2901	3385	3868	4352	4835	5319	5803	6286	6770	7253	
M3	162	324	486	647	829	971	1295	1619	1942	2266	2590	2914	3237	3561	3885	4208	4532	4856	
M3.5	138	277	415	557	692	830	1107	1384	1661	1938	2214	2491	2768	3045	3322	3599	3875	4152	
M4	122	243	365	487	608	730	973	1217	1460	1698	1946	2190	2433	2676	2920	3163	3406	3650	
M5	97	194	291	388	485	582	776	970	1163	1357	1551	1745	1939	2133	2327	2521	2715	2909	
M6	81	162	243	324	405	486	647	809	971	1133	1295	1457	1619	1781	1942	2104	2266	2428	
M7	69	138	208	277	346	415	554	692	830	969	1107	1246	1384	1522	1661	1799	1938	2076	
M8	61	121	182	243	303	364	485	606	728	849	970	1091	1213	1334	1455	1577	1698	1819	
M10	48	97	145	194	242	291	388	485	582	679	776	873	970	1067	1163	1260	1357	1454	
M12	40	81	121	162	202	243	324	405	486	567	647	728	809	890	971	1052	1133	1214	
M14	35	69	104	139	173	208	277	347	416	485	555	624	693	763	832	901	971	1040	
M16	30	61	91	121	152	182	243	303	364	424	485	546	606	667	728	788	849	910	
M18	27	54	81	108	135	162	216	269	323	377	431	485	539	593	647	700	754	808	
M20	24	49	73	97	121	146	194	243	291	340	388	437	485	534	582	631	680	728	
M22	22	44	66	88	110	132	176	221	265	309	353	397	441	485	529	573	618	662	
M24	20	40	61	81	101	121	162	202	243	283	323	364	404	445	485	526	566	606	
M27	18	36	54	72	90	108	144	180	216	252	287	323	359	395	431	467	503	539	
M30	16	32	49	65	81	97	129	162	194	226	259	291	323	356	388	420	453	485	



YMW TAPS USA

With over 35 years of tapping experience, YMW TAPS USA is North America's oldest and largest importer of YAMAWA products. Our knowledge in the threading industry and large inventories put us far above the rest.

2 Warehouses with over \$5 million in inventory for one day delivery 98% ship rate

Santa Ana, CA Mayfield, KY



Manufacturing Field Reps

Free test tools for standards & specials
ask for details

New Yamawa Mobile App



YAMAWA APP

Download Now !

- * Helps find the correct tool for any material
- * Find correct Bore size and speeds
- * For iOS and Android **FREE** download

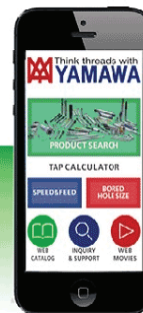

YMW-USA NEW PRODUCTS

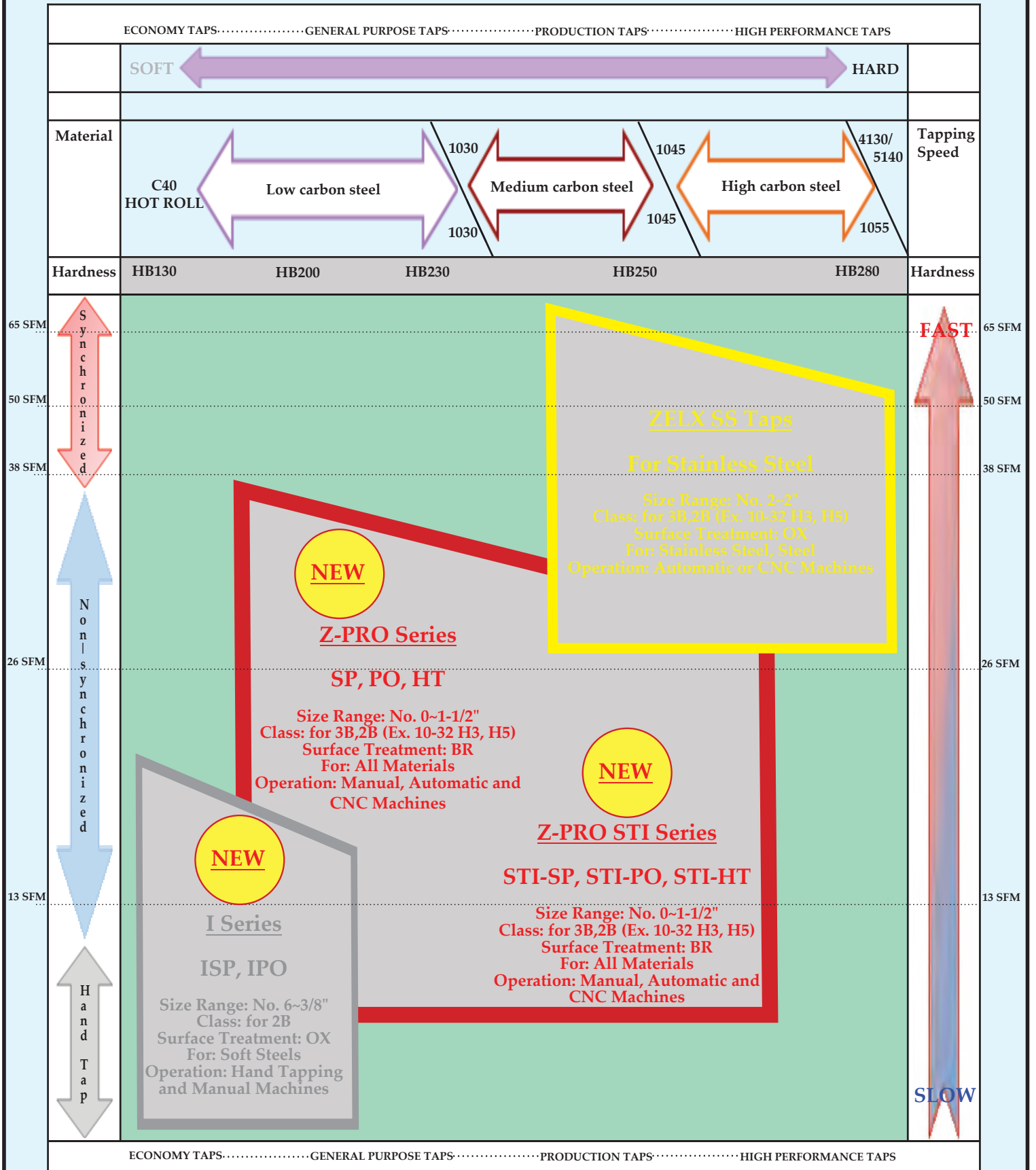

ZELX SERIES

SS NI TI

Tap series designed for threading stainless steels, titanium alloys and nickel-based alloys. Suitable for UNJ Aerospace internal threading applications.

The demands for tapping into heat resistant alloys and stainless steels are increasing rapidly in the Aerospace Industry. The most common heat resistant alloys are Nickel base alloys, such as A286, Inconel, Hastelloy, Waspalloy, and Titanium alloys. There are considerable difficulties in tapping these materials due to their material features which can easily cause severe damage to taps. YAMAWA has the best line of taps for such a severe tapping conditions.



ZELX[®]SS taps for Stainless steels

ZELX[®]TI taps for Titanium alloys

ZELX[®]NI taps for Nickel base alloys, A286, Inconel, Hastelloy, Waspalloy

YAMAWA Products Chart for AEROSPACE INDUSTRY

		Tapping speed				
		Slow		Fast		
		5m/min (17SFM)	10m/min (33SFM)	15m/min (50SFM)		
Workpiece Materials					Workpiece Materials	
Heat resistant alloys	Titanium alloys (Ti-6Al-4V)	ZELX TI SP ZELX TI LHSP			Titanium alloys (Ti-6Al-4V)	
	Nickel base alloys (INCONEL718, 750, Waspalloy, HASTELLOY)	ZELX NI SP ZELX NI PO			Area of full rigid lead feed	
	A286				A286	
Stainless steels	15-5PH				15-5PH	
	17-4PH (SUS630)	ZELX NI SP ZELX NI PO			17-4PH (SUS630)	
	SUS316				SUS316	
	SUS304				SUS304	
	SUS303	ZELX SS SP ZELX SS PO			SUS303	
Alloy steels	8740 (SNCM240)				8740 (SNCM240)	
		5m/min (17SFM)	10m/min (33SFM)	15m/min (50SFM)		

An image telling possible applications

ZELX SERIES

ZELX SS

High performance tap series designed for difficult jobs including the stainless steel family as well as alloy steels, high carbon steel and ductile irons. Suitable for UNJ Aerospace internal threading applications.

Features of ZELX SS Series

- Custom blended vanadium high speed steel for high wear resistance.
- Ideal cutting edge design to prevent welding.
- Suitable surface treatment to prevent welding.

◇For through hole◇

Spiral Pointed Taps for Stainless Steels

ZELX[®] SS

Size Ranges
UNJC...No.4~1"
UNJF...No.4~1"



List No.	
3218	Machine Screw sizes with oxide surface treatment
3228	Fractional sizes with oxide surface treatment
3218T	Machine Screw sizes with TiN (Titanium Nitride)
3228T	Fractional sizes with TiN (Titanium Nitride)

Suitable work materials
303 STAINLESS STEEL
304 STAINLESS STEEL
410 STAINLESS STEEL
8740 (SNCM240)

◇For blind hole◇

Spiral Fluted Taps for Stainless Steels

ZELX[®] SS

Size Ranges
UNJC...No.4~1"
UNJF...No.4~1"



List No.	
3318	Machine Screw sizes with oxide surface treatment
3328	Fractional sizes with oxide surface treatment
3318T	Machine Screw sizes with TiN (Titanium Nitride)
3328T	Fractional sizes with TiN (Titanium Nitride)

Suitable work materials
303 STAINLESS STEEL
304 STAINLESS STEEL
410 STAINLESS STEEL
8740 (SNCM240)



For Stainless Steels, Alloy Steels and Ductile Irons

Spiral Pointed Taps for Stainless Steels For Unified Threads

ZELX SS Spiral Pointed Taps are designed for difficult jobs including the stainless steel family of materials as well as alloy steels, high carbon steel and ductile irons. Our unique design ZELX SS taps increase productivity through longer tool life. The unique spiral point chamfer makes them ideally suited for the through hole of difficult to machine materials.

ZELX SS



ZELX SS have an Oxide Surface Treatment
Custom Blend High Vanadium HSS

ZELX SS taps are suitable for UNJ Aerospace internal threading applications.

Plug Style (3 to 5 threads chamfered) List 3218 Machine Screw sizes with oxide surface treatment
Fractional sizes with oxide surface treatment

TPI Nominal NC Size	NF UNC	NF UNF	No. of Flutes	Pitch Diameter Limit/ EDP Numbers						Dimensions		
				H2	H3	H4	H5	H6	H7	Length of Thread	Neck Length	Length Overall
2	56	—	2	382623	382624	—	—	—	—	.256	.181	1- 3/4
3	48	—	2	382600	—	—	—	—	—	.295	.205	1- 13/16
4	40	—	2	382601	382602	382612	382634	—	—	.335	.227	1- 7/8
4	—	48	2	382683	—	—	—	—	—	.335	.227	1- 7/8
5	—	40	3	382603	—	—	—	—	—	.374	.251	1- 15/16
6	32	—	3	382604	382605	382608	382635	382659	382665	.413	.274	2
6	—	40	3	382684	382642	—	—	—	—	.413	.274	2
8	32	—	3	382606	382607	382629	382637	382660	382667	.453	.297	2- 1/8
8	—	36	3	382686	—	—	—	—	—	.453	.297	2- 1/8
10	24	—	3	—	382609	—	382639	382690	382669	.531	.344	2- 3/8
10	—	32	3	382611	382610	382630	382640	382661	382670	.531	.344	2- 3/8
12	24	—	3	—	382688	—	—	—	—	.571	.366	2- 3/8
12	—	28	3	—	382689	—	—	—	—	.571	.366	2- 3/8
1/4	20	—	3	—	382613	—	382643	382590	382673	.591	.409	2- 1/2
1/4	—	28	3	—	382614	382631	382644	382662	382674	.591	.409	2- 1/2
5/16	18	—	3	—	382615	—	382645	—	382675	.669	.456	2- 23/32
5/16	—	24	3	—	382616	382632	382646	382663	382676	.669	.456	2- 23/32
3/8	16	—	3	—	382617	—	382647	—	382668	.748	.502	2- 15/16
3/8	—	24	3	—	382618	382633	382648	382664	382678	.748	.502	2- 15/16
7/16	14	—	3	—	382619	—	382649	—	—	.866	—	3- 5/32
7/16	—	20	3	—	382620	—	382650	382691	382680	.866	—	3- 5/32
1/2	13	—	3	—	382621	—	382651	—	382681	.984	—	3- 3/8
1/2	—	20	3	—	382622	—	382652	382692	382682	.984	—	3- 3/8
9/16	12	—	3	—	382653	—	—	—	—	.984	—	3- 19/32
9/16	—	18	3	—	382654	—	—	—	—	.984	—	3- 19/32
5/8	11	—	3	—	382625	—	382655	—	—	1.083	—	3- 13/16
5/8	—	18	3	—	382626	382636	382656	382694	382591	1.083	—	3- 13/16
3/4	10	—	3	—	382627	—	382657	—	—	1.201	—	4- 1/4
3/4	—	16	3	—	382628	—	382658	—	382592	1.201	—	4- 1/4

Necked design enhances flow of cutting fluid to cutting teeth and reduces surface contact between the tool and work-piece for more efficient threading.

CONTINUED ON NEXT PAGE

Spiral Pointed Taps for Stainless Steels

For Unified Threads

ZELX SS



ZELX SS have an Oxide Surface Treatment
Custom Blend High Vanadium HSS

For Stainless Steels, Alloy Steels and Ductile Irons

ZELX SS Spiral Pointed Taps are designed for difficult jobs including the stainless steel family of materials as well as alloy steels, high carbon steel and ductile irons. Our unique design ZELX SS taps increase productivity through longer tool life. The unique spiral pointed chamfer makes them ideally suited for the through hole of difficult to machine materials.

ZELX SS taps are suitable for UNJ Aerospace internal threading applications.

- | | | | |
|--|------|-------|--|
| Plug Style
(3 to 5 threads chamfered) | List | 3218 | Machine Screw sizes with oxide surface treatment |
| | | 3228 | Fractional sizes with oxide surface treatment |
| | | 3218T | Machine Screw sizes with TiN (Titanium Nitride) |
| | | 3228T | Fractional Screw sizes with TiN (Titanium Nitride) |

Nominal Size	TPI		No. of Flutes	Pitch Diameter Limit/ EDP Numbers					Dimensions		
	NC UNC	NF UNF		H4	H4 TIN	H5	H6	H7	Length of Thread	Neck Length	Length Overall
7/8	9	—	3	382695	382995	—	—	—	1.339	—	4- 11/16
7/8	—	14	3	382696	382996	—	382699	—	1.339	—	4- 11/16
1	8	—	3	382697	382997	—	—	—	1.496	—	5- 1/8
1	—	12	3	382679	—	—	—	—	1.496	—	5- 1/8
1- 1/8	7	—	4	—	—	—	382700	—	1.535	—	5- 7/16
1- 1/8	—	12	4	—	—	382701	—	—	1.535	—	5- 7/16
1- 1/4	7	—	4	—	—	—	382702	—	1.535	—	5- 3/4
1- 1/4	—	12	4	—	—	382703	—	—	1.535	—	5- 3/4
1- 3/8	6	—	4	—	—	—	382705	—	1.811	—	6- 1/16
1- 3/8	—	12	4	—	—	382706	—	—	1.811	—	6- 1/16
1- 1/2	6	—	4	—	—	—	382707	—	1.811	—	6- 3/8
1- 1/2	—	12	4	—	—	382708	—	—	1.811	—	6- 3/8
1- 3/4	5	—	4	—	—	—	—	382709	1.929	—	7
2	—	12	4	—	—	—	—	382710	1.929	—	7- 5/8



For Stainless Steels, Alloy Steels and Ductile Irons

Spiral Pointed Taps for Stainless Steels For Unified Threads

ZELX SS Spiral Pointed Taps are designed for difficult jobs including the stainless steel family of materials as well as alloy steels, high carbon steel and ductile irons. Our unique design ZELX SS taps increase productivity through longer tool life. The unique spiral point chamfer makes them ideally suited for the through hole of difficult to machine materials.

ZELX SS taps are suitable for UNJ Aerospace internal threading applications.

ZELX SS



ZELX SS have a TiN Surface Treatment
Custom Blend High Vanadium HSS
*AVAILABLE IN TICN UPON
REQUEST

Plug Style
(3 to 5 threads chamfered)

List 3218T 3228T Machine Screw sizes with TiN (Titanium Nitride)
Fractional sizes with TiN (Titanium Nitride)

Nominal Size	TPI		No. of Flutes	Pitch Diameter Limit/ EDP Numbers						Dimensions		
	NC UNC	NF UNF		H2 TIN	H3 TIN	H4 TIN	H5 TIN	H6 TIN	H7 TIN	Length of Thread	Neck Length	Length Overall
2	56	—	2	382923	—	—	—	—	—	.256	.181	1- 3/4
4	40	—	2	382901	382602TIN	—	382634TIN	—	—	.335	.227	1- 7/8
5	40	—	3	382903	—	—	—	—	—	.374	.251	1- 15/16
6	32	—	3	—	382905	—	382635TIN	—	—	.413	.274	2
8	32	—	3	—	382907	—	382637TIN	—	—	.453	.297	2- 1/8
10	24	—	3	—	382909	—	—	—	—	.531	.344	2- 3/8
10	—	32	3	—	382910	—	—	382661TIN	382670TIN	.531	.344	2- 3/8
1/4	20	—	3	—	382913	—	382643TIN	—	—	.591	.409	2- 1/2
1/4	—	28	3	—	382914	—	—	382662TIN	382674TIN	.591	.409	2- 1/2
5/16	18	—	3	—	382915	—	—	—	—	.669	.456	2- 23/32
5/16	—	24	3	—	382916	—	—	382663TIN	382676TIN	.669	.456	2- 23/32
3/8	16	—	3	—	382917	—	—	—	—	.748	.502	2- 15/16
3/8	—	24	3	—	382918	382633TIN	—	—	—	.748	.502	2- 15/16
7/16	14	—	3	—	382919	—	—	—	—	.866	—	3- 5/32
7/16	—	20	3	—	382920	—	382650TIN	382691TIN	382680TIN	.866	—	3- 5/32
1/2	13	—	3	—	382921	—	382651TIN	—	382681TIN	.984	—	3- 3/8
1/2	—	20	3	—	382922	—	382652TIN	382692TIN	—	.984	—	3- 3/8
9/16	12	—	3	—	382953	—	—	—	—	.984	—	3- 19/32
9/16	—	18	3	—	382954	—	—	—	—	.984	—	3- 19/32
5/8	11	—	3	—	382925	—	—	—	—	1.083	—	3- 13/16
5/8	—	18	3	—	382926	—	—	382694TIN	382591TIN	1.083	—	3- 13/16
3/4	10	—	3	—	382927	—	—	—	—	1.201	—	4- 1/4
3/4	—	16	3	—	382928	—	—	—	382592TIN	1.201	—	4- 1/4

Spiral Pointed Taps for Stainless Steels

For Metric Threads

For Stainless Steels, Alloy Steels and Ductile Irons

ZELX SS



ZELX SS have an Oxide Surface Treatment
Custom Blend High Vanadium HSS

ZELX SS Spiral Pointed Taps are designed for difficult jobs including the stainless steel family of materials as well as alloy steels, high carbon steel and ductile irons. Our unique design ZELX SS taps increase productivity through longer tool life. The unique spiral point chamfer makes them ideally suited for the through hole of difficult to machine materials.

Plug Style
(3 to 5 threads chamfered)

List 3278 With oxide surface treatment
3278T With TiN (Titanium Nitride)

Nominal Size	No. of Flutes	Pitch Diameter Limit/ EDP Numbers									Dimensions		
		D3	D3 TIN	D4	D4 TIN	D5	D5 TIN	D6	D6 TIN	D7	Length of Thread	Neck Length	Length Overall
M3 X 0.5	3	372615	372915	—	—	—	—	—	—	—	.374	.251	1- 15/16
M3.5 X 0.6	3	—	—	372616	—	—	—	—	—	—	.413	.274	2
M4 X 0.7	3	—	—	372617	372917	—	—	—	—	—	.453	.297	2- 1/8
M5 X 0.8	3	—	—	372619	372919	—	—	—	—	—	.531	.344	2- 3/8
M6 X 1	3	—	—	—	—	372620	372920	—	—	—	.591	.409	2- 1/2
M7 X 1	3	—	—	—	—	372621	—	—	—	—	.669	.456	2- 23/32
M8 X 1	3	—	—	—	—	372622	—	—	—	—	.669	.456	2- 23/32
M8 X 1.25	3	—	—	—	—	372623	372923	—	—	—	.669	.456	2- 23/32
M10 X 1.25	3	—	—	—	—	372624	—	—	—	—	.748	.502	2- 15/16
M10 X 1.5	3	—	—	—	—	—	—	372625	372925	—	.748	.502	2- 15/16
M12 X 1.25	3	—	—	—	—	372626	—	—	—	—	.984	—	3- 3/8
M12 X 1.75	3	—	—	—	—	—	—	372627	372927	—	.984	—	3- 3/8
M14 X 1.5	3	—	—	—	—	—	—	372628	—	—	.984	—	3- 19/32
M14 X 2	3	—	—	—	—	—	—	—	—	372629	.984	—	3- 19/32
M16 X 1.5	3	—	—	—	—	—	—	372630	—	—	1.083	—	3- 13/16
M16 X 2	3	—	—	—	—	—	—	—	—	372631	1.083	—	3- 13/16
M18 X 1.5	3	—	—	—	—	—	—	372632	—	—	1.083	—	4- 1/32
M18 X 2.5	3	—	—	—	—	—	—	—	—	372633	1.083	—	4- 1/32



6" Extended Spiral Pointed Taps for Stainless Steels For Unified Threads

ZELX SS

ZELX SS Spiral Pointed Taps are designed for difficult jobs including the stainless steel family of materials as well as alloy steels, high carbon steel and ductile irons. Our unique design ZELX SS taps increase productivity through longer tool life. The unique spiral point chamfer makes them ideally suited for the through hole of difficult to machine materials.



ZELX SS have an Oxide Surface Treatment
Custom Blend High Vanadium HSS

Plug Style (3 to 5 threads chamfered) List 3718 Machine Screw Sizes 3728 Fractional Sizes

Threads Per Inch Nominal Size	NC		No. of Flutes	Pitch Diameter Limit/ EDP Numbers		Dimensions Length Overall
	UNC	UNF		H2	H3	
2	56	—	2	382523	—	6"
3	48	—	2	382500	—	6"
4	40	—	2	382501	—	6"
6	32	—	3	—	382505	6"
8	32	—	3	—	382507	6"
10	24	—	3	—	382509	6"
10	—	32	3	—	382510	6"
1/4	20	—	3	—	382513	6"
1/4	—	28	3	—	382514	6"
5/16	18	—	3	—	382515	6"
5/16	—	24	3	—	382516	6"
3/8	16	—	3	—	382517	6"
3/8	—	24	3	—	382518	6"
7/16	14	—	3	—	382519	6"
7/16	—	20	3	—	382520	6"
1/2	13	—	3	—	382521	6"
1/2	—	20	3	—	382522	6"

6" extended taps have the same approximate thread lengths as corresponding non-extended taps.

Spiral Fluted Taps for Stainless Steels

For Unified Threads

ZELX SS



ZELX SS have an Oxide Surface Treatment
Custom Blend High Vanadium HSS

For Stainless Steels, Alloy Steels and Ductile Irons

ZELX SS Spiral Flute Taps are designed for difficult jobs including the stainless steel family of materials as well as alloy steels, high carbon steel and ductile irons. Our unique design ZELX SS taps increase productivity through longer tool life. The modified bottom chamfer makes them ideally suited to blind hole tapping.

ZELX Spiral Fluted Taps are oxide surface treated or Titanium Nitride (TiN) coated to reduce loading and galling of product material, improving tap wear life and thread quality.

ZELX SS taps are suitable for UNJ Aerospace internal threading applications.

- List 3218 Machine Screw sizes with oxide surface treatment
- 3228 Fractional sizes with oxide surface treatment
- 3218T Machine Screw sizes with TiN (Titanium Nitride)
- 3228T Fractional sizes with TiN (Titanium Nitride)

Modified Bottoming Style
(2- 1/2 to 3- 1/2 threads chamfered)

Nominal Size	TPI NC UNC	NF UNF	No. of Flutes	Pitch Diameter Limit/ EDP Numbers								Dimensions			
				H2	H2 TIN	H3	H3 TIN	H4	H5	H5 TIN	H6	H7	Length of Thread	Neck Length	Length Overall
2	56	—	2	384623	—	—	—	—	—	—	—	—	.157	.280	1- 3/4
3	48	—	2	384600	—	—	—	—	—	—	—	—	.197	.303	1- 13/16
4	40	—	2	384601	384901	384602	—	384629	384634	—	—	—	.236	.326	1- 7/8
4	—	48	2	384683	—	—	—	—	—	—	—	—	.236	.326	1- 7/8
5	—	40	3	384603	384903	—	—	—	—	—	—	—	.236	.389	1- 15/16
6	32	—	3	384604	—	384605	384905	384636	384635	—	384659	384665	.276	.411	2
6	—	40	3	384684	—	384685	—	—	—	—	—	—	.276	.411	2
8	32	—	3	384606	—	384607	384907	384638	384637	—	384660	384667	.276	.474	2- 1/8
8	—	36	3	—	—	384687	—	—	—	—	—	—	.276	.474	2- 1/8
10	24	—	3	384624	—	384609	384909	—	384639	—	384690	384669	.354	.521	2- 3/8
10	—	32	3	384611	—	384610	384910	384630	384640	384640TIN	384662	384670	.276	.599	2- 3/8
12	24	—	3	—	—	384688	—	—	—	—	—	—	.354	.583	2- 3/8
12	—	28	3	—	—	384689	—	—	—	—	—	—	.276	.661	2- 3/8
1/4	20	—	3	—	—	384613	384913	—	384643	384643TIN	—	384673	.433	.567	2- 1/2
1/4	—	28	3	—	—	384614	384914	384631	384644	384644TIN	384664	384674	.354	.646	2- 1/2
5/16	18	—	3	—	—	384615	384915	—	384645	384645TIN	—	384675	.472	.653	2- 23/32
5/16	—	24	3	—	—	384616	384916	384632	384646	—	—	384676	.394	.731	2- 23/32
3/8	16	—	3	—	—	384617	384917	—	384647	384647TIN	—	384677	.551	.699	2- 15/16
3/8	—	24	3	—	—	384618	384918	384633	384648	—	—	384678	.394	.856	2- 15/16
7/16	14	—	3	—	—	384619	384919	—	384649	—	—	384679	.591	—	3- 5/32
7/16	—	20	3	—	—	384620	384920	—	384650	—	384691	384680	.472	—	3- 5/32
1/2	13	—	3	—	—	384621	384921	—	384651	384651TIN	—	384681	.630	—	3- 3/8
1/2	—	20	3	—	—	384622	384922	—	384652	—	384692	384682	.472	—	3- 3/8
9/16	12	—	3	—	—	384653	384953	—	—	—	—	—	.709	—	3- 19/32
9/16	—	18	3	—	—	384654	384954	—	384698	—	—	—	.512	—	3- 19/32
5/8	11	—	3	—	—	384625	384925	—	384655	—	—	—	.748	—	3- 13/16
5/8	—	18	3	—	—	384626	384926	—	384656	—	—	384672	.512	—	3- 13/16
3/4	10	—	3	—	—	384627	384927	—	384657	—	—	—	.827	—	4- 1/4
3/4	—	16	3	—	—	384628	384928	—	384658	—	—	384686	.591	—	4- 1/4

Necked design enhances flow of cutting fluid to cutting teeth and reduces surface contact between the tool and work-piece for more efficient threading.

CONTINUED ON NEXT PAGE



For Stainless Steels, Alloy Steels and Ductile Irons

Spiral Fluted Taps for Stainless Steels For Unified Threads

ZELX SS Spiral Flute Taps are designed for difficult jobs including the stainless steel family of materials as well as alloy steels, high carbon steel and ductile irons. Our unique design ZELX SS taps increase productivity through longer tool life. The modified bottom chamfer makes them ideally suited to blind hole tapping.

ZELX Spiral Fluted Taps are oxide surface treated or Titanium Nitride (TiN) coated to reduce loading and galling of product material, improving tap wear life and thread quality.

ZELX SS taps are suitable for UNJ Aerospace internal threading applications.

ZELX SS



ZELX SS have an Oxide Surface Treatment
Custom Blend High Vanadium HSS

	List	3218	Machine Screw sizes with oxide surface treatment
		3228	Fractional sizes with oxide surface treatment
Modified Bottoming Style		3218T	Machine Screw sizes with TiN (Titanium Nitride)
(2- 1/2 to 3- 1/2 threads chamfered)		3228T	Fractional sizes with TiN (Titanium Nitride)

TPI Nominal Size	NC UNC	NF UNF	No. of Flutes	Pitch Diameter Limit/ EDP Numbers					Dimensions		
				H4	H4 TiN	H5	H6	H7	Length of Thread	Neck Length	Length Overall
7/8	9	—	4	384695	384995	—	—	—	.827	—	4- 11/16
7/8	—	14	4	384696	384996	—	—	—	.709	—	4- 11/16
1	8	—	4	384697	384997	—	—	—	.984	—	5- 1/8
1	—	12	4	384668	—	—	—	—	.709	—	5- 1/8
1- 1/8	7	—	4	—	—	—	384701	—	1.181	—	5- 7/16
1- 1/8	—	12	4	—	—	384702	—	—	.787	—	5- 7/16
1- 1/4	7	—	4	—	—	—	384703	—	1.181	—	5- 3/4
1- 1/4	—	12	4	—	—	384705	—	—	.787	—	5- 3/4
1- 3/8	6	—	4	—	—	—	384706	—	1.575	—	6- 1/16
1- 3/8	—	12	4	—	—	384707	—	—	.787	—	6- 1/16
1- 1/2	6	—	4	—	—	—	384709	—	1.575	—	6- 3/8
1- 1/2	—	12	4	—	—	384711	—	—	1.811	—	6- 3/8
1- 3/4	5	—	4	—	—	—	—	384714	.787	—	7
2	4- 1/2	—	4	—	—	—	—	384715	1.969	—	7- 5/8



Spiral Fluted Taps for Stainless Steels

For Metric Threads

ZELX SS



ZELX SS have an Oxide Surface Treatment
Custom Blend High Vanadium HSS

For Stainless Steels, Alloy Steels and Ductile Irons

ZELX SS Spiral Flute Taps are designed for difficult jobs including the stainless steel family of materials as well as alloy steels, high carbon steel and ductile irons. Our unique design ZELX SS taps increase productivity through longer tool life. The modified bottom chamfer makes them ideally suited to blind hole tapping.

Modified Bottoming Style
(2- 1/2 to 3- 1/2 threads chamfered)

List 3378 with oxide surface treatment
3378T with TiN (Titanium Nitride)

Nominal Size	No. of Flutes	Pitch Diameter Limit/ EDP Numbers									Dimensions		
		D3	D3 TIN	D4	D4 TIN	D5	D5 TIN	D6	D6 TIN	D7	Length of Thread	Neck Length	Length Overall
M3 X 0.5	3	374615	374915	—	—	—	—	—	—	—	.197	.428	1- 15/16
M3.5 X 0.6	3	—	—	374616	—	—	—	—	—	—	.276	.411	2
M4 X 0.7	3	—	—	374617	374917	—	—	—	—	—	.276	.474	2- 1/8
M5 X 0.8	3	—	—	374619	374919	—	—	—	—	—	.354	.521	2- 3/8
M6 X 1	3	—	—	—	—	374620	374920	—	—	—	.433	.567	2- 1/2
M7 X 1	3	—	—	—	—	374621	—	—	—	—	.433	.692	2- 23/32
M8 X 1	3	—	—	—	—	374622	—	—	—	—	.472	.653	2- 23/32
M8 X 1.25	3	—	—	—	—	374623	374923	—	—	—	.472	.653	2- 23/32
M10 X 1.25	3	—	—	—	—	374624	—	—	—	—	.472	.778	2- 15/16
M10 X 1.5	3	—	—	—	—	—	—	374625	374925	—	.512	.738	2- 15/16
M12 X 1.25	3	—	—	—	—	374626	374926	—	—	—	.551	—	3- 3/8
M12 X 1.75	3	—	—	—	—	—	—	374627	374927	—	.591	—	3- 3/8
M14 X 1.5	3	—	—	—	—	—	—	374628	—	—	.551	—	3- 19/32
M14 X 2	3	—	—	—	—	—	—	—	—	374629	.709	—	3- 19/32
M16 X 1.5	3	—	—	—	—	—	—	374630	—	—	.551	—	3- 13/16
M16 X 2	3	—	—	—	—	—	—	—	—	374631	.709	—	3- 13/16
M18 X 1.5	4	—	—	—	—	—	—	374632	—	—	.551	—	4- 1/32
M18 X 2.5	4	—	—	—	—	—	—	—	—	374633	.787	—	4- 1/32



For Stainless Steels, Alloy Steels and Ductile Irons

Spiral Fluted Taps for Stainless Steels For Unified Threads

ZELX SS Spiral Flute Taps are designed for difficult jobs including the stainless steel family of materials as well as alloy steels, high carbon steel and ductile irons. Our unique design ZELX SS taps increase productivity through longer tool life. The bottom chamfer makes them ideally suited to blind hole tapping.

ZELX SS taps are suitable for UNJ Aerospace internal threading applications.

ZELX SS



ZELX SS have an Oxide Surface Treatment
Custom Blend High Vanadium HSS

Z
E
L
X

S
S

Bottoming Style
(1 to 2 threads chamfered)

List 3318 3328 Machine Screw sizes
Fractional sizes

TPI Nominal NC Size	NF UNC	NF UNF	No. of Flutes	Pitch Diameter Limit/ EDP Numbers						Dimensions		
				H2	H3	H4	H5	H6	H7	Length of Thread	Neck Length	Length Overall
4	40	—	2	384001	384002	—	384034	—	—	.236	.326	1- 7/8
4	—	48	2	384083	—	—	—	—	—	.236	.326	1- 7/8
5	40	—	3	384003	—	—	—	—	—	.236	.389	1- 15/16
6	32	—	3	384004	384005	—	384035	—	—	.276	.411	2
6	—	40	3	384084	384085	—	—	—	—	.276	.411	2
8	32	—	3	384006	384007	—	384037	—	—	.276	.474	2- 1/8
10	24	—	3	—	384009	—	384039	—	—	.354	.521	2- 3/8
10	—	32	3	—	384010	—	384040	—	—	.276	.599	2- 3/8
1/4	20	—	3	—	384013	—	384043	—	—	.433	.567	2- 1/2
1/4	—	28	3	—	384014	—	384044	—	—	.354	.646	2-23/32
5/16	18	—	3	—	384015	—	384045	—	—	.472	.653	2- 23/32
5/16	—	24	3	—	384016	—	384046	—	—	.394	.731	2- 23/32
3/8	16	—	3	—	384017	—	384047	—	384077	.551	.699	2- 15/16
3/8	—	24	3	—	384018	384033	384048	—	—	.394	.856	2- 15/16
7/16	14	—	3	—	384019	—	384049	—	—	.591	—	3- 5/32
7/16	—	20	3	—	384020	—	384050	—	—	.472	—	3- 5/32
1/2	13	—	3	—	384021	—	384051	—	—	.630	—	3- 3/8
1/2	—	20	3	—	384022	—	384052	—	—	.472	—	3- 3/8
9/16	12	—	3	—	384053	—	—	—	—	.709	—	3- 19/32
9/16	—	18	3	—	384054	—	—	—	—	.512	—	3- 19/32
5/8	11	—	3	—	384025	—	384055	—	—	.748	—	3- 13/16
5/8	—	18	3	—	384026	—	384056	—	—	.512	—	3- 13/16
3/4	10	—	4	—	384027	—	—	—	—	.827	—	4- 1/4
3/4	—	16	4	—	384028	—	—	—	—	.591	—	4- 1/4



Spiral Fluted Taps for Stainless Steels

For Metric Threads

ZELX SS



ZELX SS have an Oxide Surface Treatment
Custom Blend High Vanadium HSS

For Stainless Steels, Alloy Steels and Ductile Irons

ZELX SS Spiral Flute Taps are designed for difficult jobs including the stainless steel family of materials as well as alloy steels, high carbon steel and ductile irons. Our unique design ZELX SS taps increase productivity through longer tool life. The bottom chamfer makes them ideally suited to blind hole tapping.

Bottoming Style
(1 to 2 threads chamfered) List 3378 with oxide surface treatment

Nominal Size	No. of Flutes	Pitch Diameter Limit/ EDP Numbers					Dimensions		
		D3	D4	D5	D6	D7	Length of Thread	Neck Length	Length Overall
M3 X 0.5	3	374015	—	—	—	—	.197	.428	1- 15/16
M3.5 X 0.6	3	—	374016	—	—	—	.276	.411	2
M4 X 0.7	3	—	374017	—	—	—	.276	.474	2- 1/8
M5 X 0.8	3	—	374019	—	—	—	.354	.521	2- 3/8
M6 X 1	3	—	—	374020	—	—	.433	.567	2- 1/2
M7 X 1	3	—	—	374021	—	—	.433	.692	2- 23/32
M8 X 1	3	—	—	374022	—	—	.472	.653	2- 23/32
M8 X 1.25	3	—	—	374023	—	—	.472	.653	2- 23/32
M10 X 1.25	3	—	—	374024	—	—	.472	.778	2- 15/16
M10 X 1.5	3	—	—	—	374025	—	.512	.738	3- 3/8
M12 X 1.25	3	—	—	374026	—	—	.551	—	3- 3/8
M12 X 1.75	3	—	—	—	3740627	—	.591	—	3- 19/32
M14 X 1.5	3	—	—	—	374028	—	.551	—	3- 19/32
M14 X 2	3	—	—	—	—	374029	.709	—	3- 13/16
M16 X 1.5	3	—	—	—	374030	—	.551	—	3- 13/16
M16 X 2	3	—	—	—	—	374031	.709	—	4- 1/32
M18 X 1.5	3	—	—	—	374032	—	.551	—	4- 1/32



6" Extended Spiral Fluted Taps for Stainless Steels For Unified Threads

For Stainless Steels, Alloy Steels and Ductile Irons

ZELX SS Spiral Flute Taps are designed for difficult jobs including the stainless steel family of materials as well as alloy steels, high carbon steel and ductile irons. Our unique design ZELX SS taps increase productivity through longer tool life.

ZELX SS taps are suitable for UNJ Aerospace internal threading applications.

ZELX SS



ZELX SS have an Oxide Surface Treatment
Custom Blend High Vanadium HSS

Modified Bottoming Style (2- 1/2 to 3- 1/2 threads chamfered)				List	3818 3828	Machine Screw Sizes Fractional Sizes
Threads Per Inch Nominal Size	NC UNC	NF UNF	No. of Flutes	Pitch Diameter Limit/ EDP Numbers		Dimensions
				H2	H3	Length Overall
2	56	—	2	384523	—	6"
3	48	—	2	384500	—	6"
4	40	—	2	384501	—	6"
6	32	—	3	—	384505	6"
8	32	—	3	—	384507	6"
10	24	—	3	—	384509	6"
10	—	32	3	—	384510	6"
1/4	20	—	3	—	384513	6"
1/4	—	28	3	—	384514	6"
5/16	18	—	3	—	384515	6"
5/16	—	24	3	—	384516	6"
3/8	16	—	3	—	384517	6"
3/8	—	24	3	—	384518	6"
7/16	14	—	3	—	384519	6"
7/16	—	20	3	—	384520	6"
1/2	13	—	3	—	384521	6"
1/2	—	20	3	—	384522	6"

6" extended taps have the same approximate thread lengths as corresponding non-extended taps.

ZELX SERIES

ZELX NI NI STI

Taps have been designed for extended tap life in cobalt, nickel and iron base exotic materials such as: inconel, hastelloy, waspalloy and harder stainless steels, molds and tool steels >30HRC.

Features of ZELX NI

- Stainless Steels>30RC
- Tools Steels and Mold Steels>30RC
- Nickel Based Alloys, Inconel 718, Inconel X-750, Inconel 625
- Monel, Rene, Hastalloy, Waspaloy
- Taps have an oxide and nitride surface toughening treatment.
- PM High Speed Steel



Features of ZELX NI STI

- STI taps are oversized to the extent that the internal thread which they produce will accommodate a helical coil wire screw thread insert, which at final assembly will accept a screw thread of the nominal size and pitch.
- PM High Speed Steel
- Taps have an oxide nitride surface toughening treatment.

Spiral Pointed Taps for Nickel Base Alloys

ZELX[®] NI



Size Ranges
UNJC...No.4~3/4
UNJF...No.6~3/4



List No.

3612 Machine Screw sizes
3622 Fractional sizes

Suitable work materials

INCONEL718, 750
Waspalloy
Hastelloy
A286
15-5PH
17-4PH (SUS630)
316 STAINLESS STEEL

Spiral Fluted Taps for Nickel Base Alloys

ZELX[®] NI



Size Ranges
UNJC...No.4~3/4
UNJF...No.4~5/8



List No.

3615 Machine Screw sizes
3625 Fractional sizes

Suitable work materials

INCONEL718, 750
Waspalloy
Hastelloy
A286
15-5PH
17-4PH (SUS630)
316 STAINLESS STEEL



Spiral Pointed Taps for Nickel Base Alloys For Unified Threads

ZELX NI Taps have been designed for extended tap life in Cobalt, Nickel, and Iron Base exotics materials such as: Inconel, Hatelloy, Waspalloy and harder stainless Steels, Mold and Tool Steels >30HRC.

ZELX NI Taps are suitable for UNJ Aerospace internal threading applications.

ZELX NI



ZELX NI have an Oxide and Nitride Surface Toughening Treatment
PM High Speed Steel

Plug Style
(3 to 5 threads chamfered)

List 3612 3622 Machine Screw Sizes Fractional Sizes

TPI Nominal NC Size	NF UNC	NF UNF	No. of Flutes	Pitch Diameter Limit/ EDP Numbers						Dimensions		
				H2	H3	H4	H5	H6	H7	Length of Thread	Neck Length	Length Overall
2	56	—	2	385523	—	—	—	—	—	.256	.181	1- 3/4
4	40	—	2	385501	385502	385504	—	—	—	.335	.227	1- 7/8
5	40	—	3	385503	—	—	—	—	—	.374	.251	1- 5/16
6	32	—	3	—	385505	385524	385535	—	—	.413	.274	2
6	—	40	3	385512	—	—	—	—	—	.413	.274	2
8	32	—	3	—	385507	385529	385537	385560	385567	.453	.297	2- 1/8
10	24	—	3	—	385509	—	385539	—	—	.531	.344	2- 3/8
10	—	32	3	—	385510	385530	385540	385561	385570	.531	.344	2- 3/8
1/4	20	—	3	—	385513	—	385543	—	—	.591	.409	2- 1/2
1/4	—	28	3	—	385514	385531	385544	385562	385574	.591	.409	2- 1/2
5/16	18	—	3	—	385515	—	385545	—	385553	.669	.456	2- 23/32
5/16	—	24	3	—	385516	385532	385546	385563	385576	.669	.456	2- 23/32
3/8	16	—	3	—	385517	—	385547	—	—	.748	.502	2- 15/16
3/8	—	24	3	—	385518	385533	385548	385564	385578	.748	.502	2- 15/16
7/16	14	—	3	—	385519	—	385549	—	—	.866	—	3- 5/32
7/16	—	20	3	—	385520	—	385550	—	—	.866	—	3- 5/32
1/2	13	—	3	—	385521	—	385551	—	385581	.984	—	3- 3/8
1/2	—	20	3	—	385522	—	385552	—	385582	.984	—	3- 3/8
5/8	11	—	3	—	385525	—	385555	—	385585	1.083	—	3- 13/16
5/8	—	18	3	—	385526	—	385556	—	385586	1.083	—	3- 13/16
3/4	10	—	3	—	385527	—	385557	—	—	1.201	—	4- 1/4
3/4	—	16	3	—	385528	—	385558	—	—	1.201	—	4- 1/4

Spiral Pointed Taps for Nickel Base Alloys

For Unified Threads

ZELX NI Taps have been designed for extended tap life in Cobalt, Nickel, and Iron Base exotics materials such as: Inconel, Hatelloy, Waspalloy and harder stainless Steels, Mold and Tool Steels >30HRC.

ZELX NI



ZELX NI have a TIN Surface Treatment
PM High Speed Steel

ZELX NI Taps are suitable for UNJ Aerospace internal threading applications.

Plug Style
(3 to 5 threads chamfered)

List 3612 3622 Machine Screw Sizes
Fractional Sizes

Nominal Size	TPI		No. of Flutes	Pitch Diameter Limit/ EDP Numbers				Dimensions		
	NC UNC	NF UNF		H4 TIN	H5 TIN	H6 TIN	H7 TIN	Length of Thread	Neck Length	Length Overall
6	32	—	3	—	385535TIN	—	—	.413	.274	2
8	32	—	3	385529TIN	385537TIN	385560TIN	385567TIN	.453	.297	2- 1/8
10	—	32	3	385530TIN	385540TIN	385561TIN	385570TIN	.531	.344	2- 3/8
1/4	—	28	3	385531TIN	385544TIN	385562TIN	385574TIN	.591	.409	2- 1/2
5/16	—	24	3	385532TIN	385546TIN	385563TIN	385576TIN	.669	.456	2- 23/32
3/8	—	24	3	—	385548TIN	385564TIN	385578TIN	.748	.502	2- 15/16
7/16	—	20	3	—	385550TIN	—	—	.866	—	3- 5/32
1/2	—	20	3	—	385552TIN	—	385582TIN	.984	—	3- 3/8

Spiral Pointed Taps for Nickel Base Alloys

For Metric Threads

ZELX NI

ZELX NI Taps are suitable for UNJ Aerospace internal threading applications.



ZELX NI have an Oxide and Nitride Surface Toughening Treatment
PM High Speed Steel

Plug Style
(3 to 5 threads chamfered)

List 3672 Metric Sizes

Nominal Size	No. of Flutes	Pitch Diameter Limit/ EDP Numbers				Dimensions		
		D3	D4	D5	D6	Length of Thread	Neck Length	Length Overall
M2.5 X 0.45	2	387320	—	—	—	.295	.205	1- 13/16
M3 X 0.5	3	387321	—	—	—	.374	.251	1- 15/16
M3.5 X 0.6	3	—	387322	—	—	.413	.274	2
M4 X 0.7	3	—	387323	—	—	.453	.297	2- 1/8
M5 X 0.8	3	—	387324	—	—	.531	.344	2- 3/8
M6 X 1	3	—	—	387325	—	.591	.409	2- 1/2
M7 X 1	3	—	—	387326	—	.669	.456	2- 23/32
M8 X 1	3	—	—	387327	—	.669	.456	2- 23/32
M8 X 1.25	3	—	—	387328	—	.669	.456	2- 23/32
M10 X 1.25	3	—	—	387329	—	.748	.502	2- 15/16
M10 X 1.5	3	—	—	—	387330	.748	.502	2- 15/16
M12 X 1.25	3	—	—	387331	—	.984	—	3- 3/8
M12 X 1.75	3	—	—	—	387332	.984	—	3- 3/8



Spiral Fluted Taps for Nickel Base Alloys For Unified Threads

ZELX NI Taps have been designed for extended tap life in Cobalt, Nickel, and Iron Base exotics materials such as: Inconel, Hatelloy, Waspalloy and harder stainless Steels, Mold and Tool Steels >30HRC.

ZELX NI Taps are suitable for UNJ Aerospace internal threading applications.

ZELX NI



ZELX NI have an Oxide and Nitride Surface Toughening Treatment
PM High Speed Steel

Z
E
L
X

N
I

Modified Bottoming Style
(3 to 4 threads chamfered)

List 3615 3625 Machine Screw Sizes Fractional Sizes

Nominal Size	TPI		No. of Flutes	Pitch Diameter Limit/ EDP Numbers							Dimensions		
	NC	NF		H2	H3	H4	H5	H5TIN	H6	H7	Length of Thread	Neck Length	Length Overall
2	56	—	3	387523	—	—	—	—	—	—	.157	.280	1- 3/4
4	40	—	3	387501	387502	387512	—	—	—	—	.236	.326	1- 7/8
5	40	—	3	387504	—	—	—	—	—	—	.236	.389	1- 5/16
6	32	—	3	—	387505	387508	387535	—	—	—	.276	.411	2
8	32	—	3	—	387507	—	—	—	—	—	.276	.474	2- 1/8
10	24	—	3	—	387509	—	387539	—	—	—	.354	.521	2- 3/8
10	—	32	3	—	387510	387530	387540	387540TIN	387561	387570	.276	.599	2- 3/8
1/4	20	—	3	—	387513	—	387543	—	—	—	.433	.567	2- 1/2
1/4	—	28	3	—	387514	387531	387544	—	387562	387574	.354	.646	2- 1/2
5/16	18	—	3	—	387515	—	387545	—	—	—	.472	.653	2- 23/32
5/16	—	24	3	—	387516	387532	387546	—	387563	387576	.394	.731	2- 23/32
3/8	16	—	3	—	387517	—	387547	—	—	—	.551	.699	2- 15/16
3/8	—	24	3	—	387518	387533	387548	—	387564	387578	.394	.856	2- 15/16
7/16	14	—	3	—	387519	—	387549	—	—	—	.591	—	3- 5/32
7/16	—	20	3	—	387520	—	387550	—	—	—	.472	—	3 -5/32
1/2	13	—	3	—	387521	—	387551	—	—	387581	.630	—	3- 3/8
1/2	—	20	3	—	387522	—	387552	—	—	387582	.472	—	3- 3/8
5/8	11	—	4	—	387525	—	387555	—	—	387585	.748	—	3- 13/16
5/8	—	18	4	—	387526	—	387556	—	—	387586	.512	—	3- 13/16
3/4	10	—	4	—	387527	—	387557	—	—	—	.827	—	4- 1/4
3/4	—	16	4	—	387528	—	387558	—	—	—	.591	—	4- 1/4



Spiral Fluted Taps for Nickel Base Alloys

For Unified Threads

ZELX NI Taps have been designed for extended tap life in Cobalt, Nickel, and Iron Base exotics materials such as: Inconel, Hatelloy, Waspalloy and harder stainless Steels, Mold and Tool Steels >30HRC.

ZELX NI



ZELX NI Taps are suitable for UNJ Aerospace internal threading applications.

ZELX NI have an Oxide and Nitride Surface Toughening Treatment
PM High Speed Steel

Bottoming Style (1 to 2 threads chamfered) List 3615 3625 Machine Screw Sizes Fractional Sizes

TPI Nominal NC Size	NF UNC	NF UNF	No. of Flutes	Pitch Diameter Limit/ EDP Numbers				Dimensions		
				H2	H3	H4	H5	Length of Thread	Neck Length	Length Overall
4	40	—	3	387583	387002	—	387072	.236	.326	1- 7/8
4	—	48	3	387003	—	—	—	.236	.326	1- 7/8
5	40	—	3	381501	—	—	—	.236	.389	1- 5/16
6	32	—	3	387006	387005	—	387035	.276	.411	2
6	—	40	3	387011	—	—	—	.276	.411	2
8	32	—	3	387024	387580	—	387037	.276	.474	2- 1/8
10	24	—	3	—	387009	—	387039	.354	.521	2- 3/8
10	—	32	3	—	381556	—	387040	.276	.599	2- 3/8
1/4	20	—	3	—	387013	—	387043	.433	.567	2- 1/2
1/4	—	28	3	—	387579	387031	387443	.354	.646	2- 1/2
5/16	18	—	3	—	387015	—	387045	.472	.653	2- 23/32
5/16	—	24	3	—	387577	387032	387046	.394	.731	2- 23/32
3/8	16	—	3	—	387017	—	387047	.551	.699	2- 15/16
3/8	—	24	3	—	387575	387033	387048	.394	.856	2- 15/16
7/16	14	—	3	—	387019	—	387049	.591	—	3- 5/32
7/16	—	20	3	—	387573	—	387050	.472	—	3- 5/32
1/2	13	—	3	—	387500	—	387051	.630	—	3- 3/8
1/2	—	20	3	—	387022	—	387052	.472	—	3- 3/8
5/8	11	—	4	—	387025	—	—	.748	—	3- 13/16
5/8	—	18	4	—	381508	—	—	.512	—	3- 13/16
3/4	10	—	4	—	387027	—	—	.827	—	4- 1/4



Spiral Fluted Taps for Nickel Base Alloys For Metric Threads

ZELX NI Taps have been designed for extended tap life in Cobalt, Nickel, and Iron Base exotics materials such as: Inconel, Hatelloy, Waspalloy and harder stainless Steels, Mold and Tool Steels >30HRC.

ZELX NI Taps are suitable for UNJ Aerospace internal threading applications.

ZELX NI



ZELX NI have an Oxide and Nitride Surface Toughening Treatment
PM High Speed Steel

Z
E
L
X

N
I

Modified Bottoming Style
(3 to 4 threads chamfered)

List 3675 Metric Sizes

Nominal Size	No. of Flutes	Pitch Diameter Limit/ EDP Numbers				Dimensions		
		D3	D4	D5	D6	Length of Thread	Neck Length	Length Overall
M2.5 X 0.45	2	388320	—	—	—	.295	.205	1- 13/16
M3 X 0.5	3	388321	—	—	—	.197	.428	1- 15/16
M3.5 X 0.6	3	—	388322	—	—	.276	.411	2
M4 X 0.7	3	—	388323	—	—	.276	.474	2- 1/8
M5 X 0.8	3	—	388324	—	—	.354	.521	2- 3/8
M6 X 1	3	—	—	388325	—	.433	.567	2- 1/2
M7 X 1	3	—	—	388326	—	.433	.692	2- 23/32
M8 X 1	3	—	—	388327	—	.472	.653	2- 23/32
M8 X 1.25	3	—	—	388328	—	.472	.653	2- 23/32
M10 X 1.25	3	—	—	388329	—	.472	.778	2- 15/16
M10 X 1.5	3	—	—	—	388330	.512	.738	2- 15/16
M12 X 1.25	3	—	—	388331	—	.551	—	3- 3/8
M12 X 1.75	3	—	—	—	388332	.591	—	3- 3/8

STI Spiral Pointed Taps For Nickel Base Alloys

For Unified Threads

ZELX NI Taps have been designed for extended tap life in Cobalt, Nickel, and Iron base exotic materials such as: Inconel, Hatelloy, Waspalloy and harder stainless Steels, Mold and Tool Steels >30HRC.

ZELX NI STI



ZELX NI STI have an Oxide and Nitride Surface Toughening Treatment
PM High Speed Steel

STI taps are oversize to the extent that the internal thread which they produce will accommodate a helical coil wire screw thread insert, which at final assembly will accept a screw thread of the nominal size and pitch.

Plug Style (3 to 5 threads chamfered)				List	3619 3629	Machine Screw Sizes Fractional Sizes				
Nominal Size	TPI NC UNC	NF UNF	No. of Flutes	Pitch Diameter Limit/ EDP Numbers				Dimensions		
				H1	H2	H3	H4	Length of Thread	Neck Length	Length Overall
2	56	—	2	—	387200	—	—	.335	.227	1- 7/8
4	40	—	3	387203	387204	—	—	.413	.274	2
6	32	—	3	—	387208	387224	—	.531	.344	2- 3/8
6	—	40	3	—	387209	—	—	.453	.297	2- 1/8
8	32	—	3	—	387210	387226	—	.571	.366	2- 3/8
10	24	—	3	—	387212	387228	—	.591	.409	2- 1/2
10	—	32	3	—	387213	387229	—	.591	.409	2- 1/2
1/4	20	—	3	—	387248	387258	—	.669	.456	2- 23/32
1/4	—	28	3	—	387249	387259	—	.669	.456	2- 23/32
5/16	18	—	3	—	—	387260	387272	.748	.502	2- 15/16
5/16	—	24	3	—	387251	387261	—	.748	.502	2- 15/16
3/8	16	—	3	—	—	387262	387270	.984	—	3- 3/8
3/8	—	24	3	—	387253	387263	—	.866	—	3- 5/32
7/16	14	—	3	—	—	387264	—	.984	—	3- 19/32
7/16	—	20	3	—	—	387265	387275	.984	—	3- 3/8
1/2	13	—	3	—	—	387266	—	1.083	—	3- 13/16
1/2	—	20	3	—	—	387267	—	.984	—	3- 19/32

Recommended Minor Diameters and Tap Drills for Inch Size STI

Nominal Size STI	Threads per Inch		Aluminum Recommended Drill		Plastic- Steel- Magnesium Recommended Drill	
	UNC	UNF	Nominal Size	Dec. Equiv.	Nominal Size	Dec. Equiv.
2	56	—	3/32	.0938	.41	.0960
4	40	—	31	.1200	31	.1200
6	32	—	26	.1470	25	.1495
8	32	—	17	.1730	16	.1770
10	24	—	13/64	.2031	5	.2055
10	—	32	7	.2010	13/64	.2031
1/4	20	—	H	.2660	H	.2660
1/4	—	28	G	.2610	6,7mm	.2638
5/16	18	—	Q	.3320	Q	.3320
5/16	—	24	21/64	.3281	21/64	.3281
3/8	16	—	X	.3970	X	.3970
3/8	—	24	25/64	.3906	25/64	.3906
7/16	14	—	29/64	.4531	29/64	.4531
7/16	—	20	29/64	.4531	29/64	.4531
1/2	13	—	33/64	.5156	17/32	.5312
1/2	—	20	33/64	.5156	17/32	.5312



STI Spiral Fluted Taps for Nickel Base Alloys For Unified Threads

For Nickel Base Alloys, Other Exotic Alloys, Mold and Stainless Steels >30HRC

ZELX NI STI



ZELX NI STI have an Oxide and Nitride Surface Toughening Treatment
PM High Speed Steel

ZELX NI Taps have been designed for extended tap life in Cobalt, Nickel, and Iron base exotic materials such as: Inconel, Hatelloy, Waspalloy and harder stainless Steels, Mold and Tool Steels

STI taps are oversize to the extent that the internal thread which they produce will accommodate a helical coil wire screw thread insert, which at final assembly will accept a screw thread of the nominal size and pitch.

Modified Bottoming Style
(3 to 4 threads chamfered)

List 3617
3627

Machine Screw Sizes
Fractional Sizes

Nominal Size	TPI		No. of Flutes	Pitch Diameter Limit/ EDP Numbers				Dimensions		
	NC	NF		H1	H2	H3	H4	Length of Thread	Neck Length	Length Overall
	UNC	UNF								
2	56	—	2	—	387400	—	—	.236	.326	1- 7/8
4	40	—	3	387403	387404	387420	—	.276	.411	2
6	32	—	3	—	387408	387424	—	.354	.521	2- 3/8
6	—	40	3	—	387409	—	—	.276	.474	2- 1/8
8	32	—	3	—	387410	387426	—	.354	.573	2- 3/8
10	24	—	3	—	387412	387428	—	.433	.567	2- 1/2
10	—	32	3	—	387413	387429	—	.354	.646	2- 1/2
1/4	20	—	3	—	387448	387458	—	.472	.653	2- 23/32
1/4	—	28	3	—	387449	387459	—	.394	.731	2- 23/32
5/16	18	—	3	—	—	387460	387470	.551	.699	2- 15/16
5/16	—	24	3	—	387451	387461	—	.394	.856	2- 15/16
3/8	16	—	3	—	—	387462	387472	.630	1.417	3- 3/8
3/8	—	24	3	—	387453	387463	—	.472	1.378	3- 5/32
7/16	14	—	3	—	—	387464	—	.709	1.338	3- 19/32
7/16	—	20	3	—	—	387465	387475	.472	1.575	3- 3/8
1/2	13	—	3	—	—	387466	—	.748	1.456	3- 13/16
1/2	—	20	3	—	—	387467	—	.512	1.535	3- 19/32



STI Spiral Fluted Taps For Nickel Base Alloys

For Unified Threads

ZELX NI STI



ZELX NI STI have an Oxide and Nitride Surface Toughening Treatment
PM High Speed Steel

ZELX NI Taps have been designed for extended tap life in Cobalt, Nickel, and Iron base exotic materials such as: Inconel, Hatelloy, Waspalloy and harder stainless Steels, Mold and Tool Steels

STI taps are oversize to the extent that the internal thread which they produce will accommodate a helical coil wire screw thread insert, which at final assembly will accept a screw thread of the nominal size and pitch.

For Nickel Base Alloys, Other Exotic Alloys, Mold and Stainless Steels >30HRC

Bottoming Style (1 to 2 threads chamfered) List 3617 3627 Machine Screw Sizes Fractional Sizes

Nominal Size	TPI NC UNC	NF UNF	No. of Flutes	Pitch Diameter Limit/ EDP Numbers					Dimensions		
				H1	H2	H3	H4	H5	Length of Thread	Neck Length	Length Overall
4	40	—	3	—	387004	387419	—	—	.276	.411	2
6	32	—	3	387008	387425	—	—	—	.354	.521	2- 3/8
8	32	—	3	381409	—	387026	—	—	.354	.583	2- 3/8
10	24	—	3	387012	—	387028	—	387445	.433	.567	2- 1/2
10	—	32	3	—	—	387029	—	387057	.354	.646	2- 1/2
1/4	20	—	3	—	—	387058	—	—	.472	.653	2- 23/32
1/4	—	28	3	—	—	387059	—	—	.394	.731	2- 23/32
5/16	18	—	3	—	—	387060	—	—	.551	.699	2- 15/16
5/16	—	24	3	—	—	387061	—	—	.394	.856	2- 15/16
3/8	16	—	3	—	—	387062	—	—	.630	1.417	3- 3/8
3/8	—	24	3	—	387063	—	—	—	.472	1.378	3- 5/32
7/16	14	—	3	—	—	387064	—	—	.709	1.338	3- 19/32
7/16	—	20	3	—	—	387065	—	—	.472	1.575	3- 3/8
1/2	13	—	3	—	—	387066	—	387088	.748	1.456	3- 13/16
1/2	—	20	3	—	—	387067	—	—	.512	1.535	3- 19/32

ZELX SERIES

ZELX TI

Taps have been designed for Titanium, Titanium Alloys, Magnesium and Beryllium Copper.

Features of ZELX TI

- Suitable surface treatment to prevent welding and enhance wear resistance.
- Optimum flute design to evacuate chips smoothly for each work material.
- Ideal cutting edge design and thread relief for high heat resistance.
- Premium PM High Speed Steel for high heat and wear resistance



Left Hand Spiral Fluted Taps for Titanium Alloys

ZELX[®] TI



Size Ranges
UNJC...No.4~1/2
UNJF...No.10~1/2



List No.
3613 Machine Screw sizes
3623 Fractional sizes

Suitable work materials

Titanium alloys
(Ti-6Al-4V)

Spiral Fluted Taps for Titanium Alloys

ZELX[®] TI



Size Ranges
UNJC...No.4~1/2
UNJF...No.10~1/2



List No.
3613 Machine Screw sizes
3623 Fractional sizes

Suitable work materials

Titanium alloys
(Ti-6Al-4V)

Left Hand Spiral Pointed Taps for Titanium Alloys

For Unified Threads

ZELX TI

For Titanium, Titanium Alloys, Magnesium and Beryllium Copper



ZELX TI have a Nitride Surface Toughening Treatment

PM High Speed Steel

ZELX TI Slow Spiral Flute Taps have a left hand spiral flute design specifically designed to tap R.H. Threads in Titanium and Titanium Alloys. The Left Hand Slow Spiral makes this series of taps ideal for through hole tapping of right hand threads. The ZELX TI Taps are made from a PM High Speed Steel material to provide increase productivity as well as increased tap life while tapping Titanium.

Plug Style
(4.5 to 6 threads chamfered)

List 3613 3623 Machine Screw Sizes Fractional Sizes

Nominal Size	TPI		No. of Flutes	Pitch Diameter Limit/ EDP Numbers						Dimensions		
	NC UNC	NF UNF		H2	H3	H4	H5	H6	H7	Length of Thread	Neck Length	Length Overall
2	56	—	3	385623	—	—	—	—	—	.256	.181	1- 3/4
4	40	—	3	385601	—	—	—	—	—	.335	.227	1- 7/8
5	40	—	3	385603	—	—	—	—	—	.374	.251	1- 5/16
6	32	—	3	—	385605	—	385635	—	—	.413	.274	2
8	32	—	3	—	385607	385629	385637	385660	385667	.453	.297	2- 1/8
10	24	—	3	—	385609	—	385639	—	—	.531	.344	2- 3/8
10	—	32	3	—	385610	385630	385640	385661	385670	.531	.344	2- 3/8
1/4	20	—	3	—	385613	—	385643	—	—	.591	.409	2- 1/2
1/4	—	28	3	—	385614	385631	385644	385662	385674	.591	.409	2- 1/2
5/16	18	—	3	—	385615	—	385645	—	—	.669	.456	2- 23/32
5/16	—	24	3	—	385616	385632	385646	385663	385676	.669	.456	2- 23/32
3/8	16	—	3	—	385617	—	385647	—	—	.748	.502	2- 15/16
3/8	—	24	3	—	385618	385633	385648	385664	385678	.748	.502	2- 15/16
7/16	14	—	3	—	385619	—	385649	—	—	.866	.984	—
7/16	—	20	3	—	385620	—	385650	—	—	.866	.984	—
1/2	13	—	3	—	385621	—	385651	—	—	.984	1.063	—
1/2	—	20	3	—	385622	—	385652	—	—	.984	1.063	—



Left Spiral Pointed Taps for Titanium Alloys For Metric Threads

For Titanium, Titanium Alloys, Magnesium and Beryllium Copper

ZELX TI

ZELX TI Slow Spiral Flute Taps have a left hand spiral flute design specifically designed to tap R.H. Threads in Titanium and Titanium Alloys. The Left Hand Slow Spiral makes this series of taps ideal for through hole tapping of right hand threads. The ZELX TI Taps are made from a PM High Speed Steel material to provide increased productivity as well as increased tap life while tapping Titanium.



ZELX TI have a Nitride Surface Toughening Treatment
PM High Speed Steel

Plug Style

(4.5 to 6 threads chamfered)

List 3673 Metric Sizes

Nominal Size	No. of Flutes	Pitch Diameter Limit/ EDP Numbers				Dimensions		
		D3	D4	D5	D6	Length of Thread	Neck Length	Length Overall
M2.5 X 0.45	2	385700	—	—	—	.295	.205	1- 13/16
M3 X 0.5	3	385701	—	—	—	.374	.251	1- 15/16
M3.5 X 0.6	3	—	385702	—	—	.413	.274	2
M4 X 0.7	3	—	385703	—	—	.453	.297	2- 1/8
M5 X 0.8	3	—	385704	—	—	.531	.344	2- 3/8
M6 X 1	3	—	—	385705	—	.591	.409	2- 1/2
M7 X 1	3	—	—	385706	—	.669	.456	2- 23/32
M8 X 1	3	—	—	385707	—	.669	.456	2- 23/32
M8 X 1.25	3	—	—	385708	—	.669	.456	2- 23/32
M10 X 1.25	3	—	—	385709	—	.748	.502	2- 15/16
M10 X 1.5	3	—	—	—	385710	.748	.502	2- 15/16
M12 X 1.25	3	—	—	385711	—	.984	—	3- 3/8
M12 X 1.75	3	—	—	—	385712	.984	—	3- 3/8



Spiral Fluted Taps for Titanium Alloys

For Unified Threads

ZELX TI

For Titanium, Titanium Alloys, Magnesium and Beryllium Copper



ZELX TI have a Nitride Surface Toughening Treatment
PM High Speed Steel

ZELX TI Slow Spiral Flute Taps have a right hand spiral flute design specifically designed to tap R.H. Threads in Titanium and Titanium Alloys. The ZELX TI Taps are made from a PM High Speed material to provide increased productivity as well as increased tap life while tapping Titanium.

Modified Bottoming Style
(3 to 4 threads chamfered)

List 3616 3626 Machine Screw Sizes Fractional Sizes

TPI Nominal Size	NC UNC	NF UNF	No. of Flutes	Pitch Diameter Limit/ EDP Numbers						Dimensions		
				H2	H3	H4	H5	H6	H7	Length of Thread	Neck Length	Length Overall
2	56	—	2	387623	—	—	—	—	—	.157	.280	1- 3/4
4	40	—	2	387601	—	387612	—	—	—	.236	.326	1- 7/8
6	32	—	3	—	387605	387608	387635	—	—	.276	.411	2
8	32	—	3	—	387607	387629	387637	387660	387667	.276	.474	2- 1/8
10	24	—	3	—	387609	—	—	—	—	.354	.521	2- 3/8
10	—	32	3	—	387610	387630	387640	387661	387670	.276	.599	2- 3/8
1/4	20	—	3	—	387613	—	—	—	—	.433	.567	2- 1/2
1/4	—	28	3	—	387614	387631	387644	387662	387674	.354	.646	2- 1/2
5/16	18	—	3	—	387615	—	—	—	—	.472	.653	2- 23/32
5/16	—	24	3	—	387616	387632	387646	387663	387676	.394	.731	2- 23/32
3/8	16	—	3	—	387617	—	—	—	—	.551	.699	2- 15/16
3/8	—	24	3	—	387618	387633	387648	387664	387678	.394	.856	2- 15/16
7/16	14	—	3	—	387619	—	—	—	—	.591	—	3 -5/32
7/16	—	20	3	—	387620	—	387650	—	—	.472	—	3- 5/32
1/2	13	—	3	—	387621	—	387626	—	—	.630	—	3- 3/8
1/2	—	20	3	—	387622	—	387652	—	—	.472	—	3- 3/8



Spiral Fluted Taps for Titanium Alloys For Unified Threads

For Titanium, Titanium Alloys, Magnesium and Beryllium Copper

ZELX TI

ZELX TI Slow Spiral Flute Taps have a right hand spiral flute design specifically designed to tap R.H. Threads in Titanium and Titanium Alloys. The ZELX TI Taps are made from a PM High Speed material to provide increased productivity as well as increased tap life while tapping Titanium.



ZELX TI have a Nitride Surface Toughening Treatment
PM High Speed Steel

Bottoming Style (1 to 2 threads chamfered)				List	3616 3626	Machine Screw Sizes Fractional Sizes			
Nominal Size	TPI		No. of Flutes	Pitch Diameter Limit/ EDP Numbers			Dimensions		
	NC UNC	NF UNF		H3	H4	H5	Length of Thread	Neck Length	Length Overall
4	40	—	2	—	387001	—	.236	.326	1- 7/8
6	32	—	3	387606	—	—	.276	.411	2
8	32	—	3	387007	—	—	.276	.474	2- 1/8
10	24	—	3	381608	—	—	.354	.521	2- 3/8
10	—	32	3	387010	—	—	.276	.599	2- 3/8
1/4	20	—	3	387628	—	387627	.433	.567	2- 1/2
1/4	—	28	3	387014	—	—	.354	.646	2- 1/2
5/16	18	—	3	387695	—	387079	.472	.653	2- 23/32
5/16	—	24	3	387016	—	—	.394	.731	2- 23/32
3/8	16	—	3	387611	—	387685	.551	.699	2- 15/16
3/8	—	24	3	387018	—	—	.394	.856	2- 15/16
7/16	14	—	3	381629	—	—	.591	—	3- 5/32
7/16	—	20	3	387020	—	387050	.472	—	3- 5/32
1/2	13	—	3	387021	—	—	.630	—	3- 3/8
1/2	—	20	3	387023	—	—	.472	—	3- 3/8

Z
E
L
X

T
I



Spiral Fluted Taps for Titanium Alloys

For Metric Threads

ZELX TI



ZELX TI have a Nitride Surface Toughening Treatment
PM High Speed Steel

For Titanium, Titanium Alloys, Magnesium and Beryllium Copper

ZELX TI Slow Spiral Flute Taps have a right hand spiral flute design specifically designed to tap R.H. Threads in Titanium and Titanium Alloys. The ZELX TI Taps are made from a PM High Speed material to provide increased productivity as well as increased tap life while tapping Titanium.

Modified Bottoming Style
(3 to 4 threads chamfered)

List 3676 Metric Sizes

Nominal Size	No. of Flutes	Pitch Diameter Limit/ EDP Numbers				Dimensions		
		D3	D4	D5	D6	Length of Thread	Neck Length	Length Overall
M2.5 X 0.45	2	387700	—	—	—	.295	.205	1- 13/16
M3 X 0.5	3	387701	—	—	—	.197	.428	1- 15/16
M3.5 X 0.6	3	—	387702	—	—	.276	.411	2
M4 X 0.7	3	—	387703	—	—	.276	.474	2- 1/8
M5 X 0.8	3	—	387704	—	—	.354	.521	2- 3/8
M6 X 1	3	—	—	387705	—	.433	.567	2- 1/2
M7 X 1	3	—	—	387706	—	.433	.692	2- 23/32
M8 X 1	3	—	—	387707	—	.472	.653	2- 23/32
M8 X 1.25	3	—	—	387708	—	.472	.653	2- 23/32
M10 X 1.25	3	—	—	387709	—	.472	.778	2- 15/16
M10 X 1.5	3	—	—	—	387710	.512	.738	2- 15/16
M12 X 1.25	3	—	—	387711	—	.551	—	3- 3/8
M12 X 1.75	3	—	—	—	387712	.591	—	3- 3/8

ZELX SERIES

ZELX AL & ALS HP Series - ALUMINUM

YMW custom blended high speed steel with nitride surface toughening treatment. Suitable for UNJ internal threading applications.

ZELX AL

For Silicon Die Cast, Copper, Zinc Alloys, Zinc Die Cast Aluminum, Magnesium Alloys and Wrought Aluminum Alloys

ZELX ALS

For Silicon Die Cast Aluminum Alloys, Soft Plastics and Copper Alloys



Features of ZELX AL

- 2 and 3 flute design
- Plug Chamfer, 3-5 Thread Chamfer
- Modified Bottoming, 2 1/2-3 Thread Chamfer
- Will also thread deep blind holes in Silicon Die Cast Aluminum



Features of ZELX ALS

- 25° Spiral Fluted Taps
- Plug Chamfer, 3-5 Thread Chamfer
- Modified Bottoming, 2 1/2-3 Thread Chamfer

#3814, #3701, #3804 Series machine screws #2-#10

#3824, #3711, #3834 Series Fractional 1/4"-1/2"

#3884, #3771, #3874 Metric M3 to M12

Spiral Pointed Taps for Non-Ferrous Materials

For Unified Threads

ZELX AL



For Silicon Die Cast, Zinc Die Cast
Aluminum and Wrought Aluminum Alloys

*ZELX AL have a Nitride Surface Toughening Treatment

Custom Blend High Vanadium HSS

Plug Style (4 to 5 threads chamfered)
DIN lengths with ANSI shank dimensions.

List 3814 Machine Screw Sizes
3824 Fractional Sizes

Nominal Size	TPI		No. of Flutes	Pitch Diameter Limit/ EDP Numbers				Dimensions		
	NC	NF		H2	H3	H4	H5	Length of Thread	Neck Length	Length Overall
	UNC	UNF								
2	56	—	2	386200	—	—	—	.276	.196	1.772
4	40	—	2	386201	—	—	—	.433	.276	2.205
5	40	—	3	386202	—	—	—	.433	.276	2.205
6	32	—	3	—	386203	—	—	.512	.275	2.205
8	32	—	3	—	386204	—	—	.512	.315	2.480
10	24	—	3	—	386205	—	—	.630	.354	2.756
10	—	32	3	—	386206	—	—	.630	.354	2.756
1/4	20	—	3	—	386207	—	386208	.748	.433	3.150
1/4	—	28	3	—	386209	386211	—	.748	.433	3.150
5/16	18	—	3	—	386212	—	386213	.866	.512	3.543
5/16	—	24	3	—	386214	386215	—	.866	.512	3.543
3/8	16	—	3	—	386216	—	386217	.945	.590	3.937
3/8	—	24	3	—	386218	386219	—	.787	.748	3.543
7/16	14	—	3	—	386220	—	386221	.945	—	3.937
7/16	—	20	3	—	386222	—	386223	.945	—	3.937
1/2	13	—	3	—	386224	—	386225	1.142	—	4.331
1/2	—	20	3	—	386226	—	386227	.866	—	3.937

ZELX AL taps are suitable for UNJ Aerospace internal threading applications.

Spiral Pointed Taps for Non-Ferrous Materials

For Metric Threads

ZELX AL

Plug Style (4 to 5 threads chamfered)
DIN lengths with ANSI shank dimensions.

List 3884 Metric Sizes

Nominal Size	No. of Flutes	Pitch Diameter Limit/ EDP Numbers				Dimensions		
		D3	D4	D5	D6	Length of Thread	Neck Length	Length Overall
M3 X 0.5	3	386228	—	—	—	.433	.276	2.205
M3.5 X 0.6	3	—	386229	—	—	.512	.275	2.205
M4 X 0.7	3	—	386230	—	—	.512	.315	2.480
M5 X 0.8	3	—	386231	—	—	.630	.354	2.756
M6 X 1	3	—	—	386232	—	.748	.433	3.150
M7 X 1	3	—	—	386233	—	.748	.433	3.150
M8 X 1	3	—	—	386234	—	.866	.512	3.543
M8 X 1.25	3	—	—	386235	—	.866	.512	3.543
M10 X 1.25	3	—	—	386236	—	.945	.590	3.937
M10 X 1.5	3	—	—	—	386237	.945	.590	3.937
M12 X 1.25	3	—	—	386238	—	.866	—	3.937
M12 X 1.5	3	—	—	386239	—	.866	—	3.937
M12 X 1.75	3	—	—	—	386240	1.142	—	4.331

ZELX AL taps are suitable for UNJ Aerospace internal threading applications.



Spiral Fluted Taps for Non-Ferrous Materials For Unified Threads

For Wrought Aluminum Alloys (6061-T6, 7075 type),
Copper, Zinc Alloys, Magnesium Alloys will also
thread deep blind holes in Silicon Die Cast
Aluminum >1-1/2 diameters in depth.

ZELX AL



*ZELX AL have a Nitride Surface Toughening Treatment
Custom Blend High Vanadium HSS

Modified Bottoming (2- 1/2 to 3 threads chamfered)
DIN lengths with ANSI shank dimensions.

List 3701 Machine Screw Sizes
3711 Fractional Sizes

TPI Nominal Size	NC UNC	NF UNF	No. of Flutes	Pitch Diameter Limit/ EDP Numbers				Dimensions		
				H2	H3	H4	H5	Length of Thread	Neck Length	Length Overall
2	56	—	2	386500	—	—	—	.314	—	1.772
4	40	—	2	386501	—	—	—	.433	.276	2.205
5	40	—	3	386502	—	—	—	.433	.276	2.205
6	32	—	3	—	386503	—	—	.512	.275	2.205
8	32	—	3	—	386504	—	—	.512	.315	2.480
10	24	—	3	—	386505	—	—	.630	.354	2.756
10	—	32	3	—	386506	—	—	.630	.354	2.756
1/4	20	—	3	—	386507	—	386508	.748	.433	3.150
1/4	—	28	3	—	386509	386511	—	.748	.433	3.150
5/16	18	—	3	—	386512	—	386513	.866	.512	3.543
5/16	—	24	3	—	386514	386515	—	.866	.512	3.543
3/8	16	—	3	—	386516	—	386517	.945	.590	3.937
3/8	—	24	3	—	386518	386519	—	.787	.748	3.543
7/16	14	—	3	—	386520	—	386521	.945	—	3.937
7/16	—	20	3	—	386522	—	386523	.945	—	3.937
1/2	13	—	3	—	386524	—	386525	1.142	—	4.331
1/2	—	20	3	—	386526	—	386527	.866	—	3.937

ZELX AL taps are suitable for UNJ Aerospace internal threading applications.

Spiral Fluted Taps for Non-Ferrous Materials For Metric Threads

ZELX AL

Modified Bottoming (2- 1/2 to 3 threads chamfered)
DIN lengths with ANSI shank dimensions.

List 3771 Metric Sizes

Nominal Size	No. of Flutes	Pitch Diameter Limit/ EDP Numbers				Dimensions		
		D3	D4	D5	D6	Length of Thread	Neck Length	Length Overall
M3 X 0.5	3	386528	—	—	—	.433	.276	2.205
M3.5 X 0.6	3	—	386529	—	—	.512	.275	2.205
M4 X 0.7	3	—	386530	—	—	.512	.315	2.480
M5 X 0.8	3	—	386531	—	—	.630	.354	2.756
M6 X 1	3	—	—	386532	—	.748	.433	3.150
M7 X 1	3	—	—	386533	—	.748	.433	3.150
M8 X 1	3	—	—	386534	—	.866	.512	3.543
M8 X 1.25	3	—	—	386535	—	.866	.512	3.543
M10 X 1.25	3	—	—	386536	—	.945	.590	3.937
M10 X 1.5	3	—	—	—	386537	.945	.590	3.937
M12 X 1.25	3	—	—	386538	—	.866	—	3.937
M12 X 1.5	3	—	—	386539	—	.866	—	3.937
M12 X 1.75	3	—	—	—	386540	1.142	—	4.331

ZELX AL taps are suitable for UNJ Aerospace internal threading applications.



Spiral Fluted Taps for Non-Ferrous Materials

For Unified Threads

ZELX ALS



*ZELX ALS have a Nitride Surface Toughening Treatment
Custom Blend High Vanadium HSS

For Silicon Die Cast Aluminum Alloys, Soft
Plastics and Copper Alloys.

25° Spiral Fluted Taps

Modified Bottoming (2- 1/2 to 3 threads chamfered)
DIN lengths with ANSI shank dimensions.

List 3804 Machine Screw Sizes
3834 Fractional Sizes

TPI Nominal Size	NC UNC	NF UNF	No. of Flutes	Pitch Diameter Limit/ EDP Numbers				Dimensions		
				H2	H3	H4	H5	Length of Thread	Neck Length	Length Overall
2	56	—	2	386400	—	—	—	.276	.196	1.772
4	40	—	2	386401	—	—	—	.433	.276	2.205
5	40	—	3	386402	—	—	—	.433	.276	2.205
6	32	—	3	—	386403	—	—	.512	.275	2.205
8	32	—	3	—	386404	—	—	.512	.315	2.480
10	24	—	3	—	386405	—	—	.630	.354	2.756
10	—	32	3	—	386406	—	—	.630	.354	2.756
1/4	20	—	3	—	386407	—	386408	.748	.433	3.150
1/4	—	28	3	—	386409	386411	—	.748	.433	3.150
5/16	18	—	3	—	386412	—	386413	.866	.512	3.543
5/16	—	24	3	—	386414	386415	—	.866	.512	3.543
3/8	16	—	3	—	386416	—	386417	.945	.590	3.937
3/8	—	24	3	—	386418	386419	—	.787	.748	3.543
7/16	14	—	3	—	386420	—	386421	.945	—	3.937
7/16	—	20	3	—	386422	—	386423	.945	—	3.937
1/2	13	—	3	—	386424	—	386425	1.142	—	4.331
1/2	—	20	3	—	386426	—	386427	.866	—	3.937

ZELX ALS taps are suitable for UNJ Aerospace internal threading applications.

Spiral Fluted Taps for Non-Ferrous Materials

For Metric Threads

ZELX ALS

Modified Bottoming (2- 1/2 to 3 threads chamfered)
DIN lengths with ANSI shank dimensions.

List 3874 Metric Sizes

Nominal Size	No. of Flutes	Pitch Diameter Limit/ EDP Numbers				Dimensions		
		D3	D4	D5	D6	Length of Thread	Neck Length	Length Overall
M3 X 0.5	3	386428	—	—	—	.433	.276	2.205
M3.5 X 0.6	3	—	386429	—	—	.512	.275	2.205
M4 X 0.7	3	—	386430	—	—	.512	.315	2.480
M5 X 0.8	3	—	386431	—	—	.630	.354	2.756
M6 X 1	3	—	—	386432	—	.748	.433	3.150
M7 X 1	3	—	—	386433	—	.748	.433	3.150
M8 X 1	3	—	—	386434	—	.866	.512	3.543
M8 X 1.25	3	—	—	386435	—	.866	.512	3.543
M10 X 1.25	3	—	—	386436	—	.945	.590	3.937
M10 X 1.5	3	—	—	—	386437	.945	.590	3.937
M12 X 1.25	3	—	—	386438	—	.866	—	3.937
M12 X 1.5	3	—	—	386439	—	.866	—	3.937
M12 X 1.75	3	—	—	—	386440	1.142	—	4.331

ZELX ALS taps are suitable for UNJ Aerospace internal threading applications.

VU SERIES

VUPO VUSP

VUSP

- Optimum taps for tapping on High Performance M/C with water soluble fluids.
- The VUSP has a longer neck length to avoid chips interfering with the holder.
- The VUSP has a special Flute Design for better chip evacuation.
- Made of Premium Powder High Speed Steel.
- Special coating for longer tool life.

VUPO

- Optimum tool for tapping on High Performance Machining Centers with water soluble fluids.
- Longer overall length enables better flow of lubricant.
- Special Flute Design for better chip evacuation.
- Made of Premium Powder High Speed Steel.
- Special coating for longer tool life.





Z-Pro PM VUPO offers improved tool life from using a high grade of powder high speed steel with a special coating. Improved chip evacuation and cutting resistance from a unique flute shape to produce excellent internal threads. The Z-Pro PM VUPO allows a longer projected length out of the holder for better application of cutting fluids. It is designed for use with water-soluble fluid where there is a good coolant supply.

Spiral Pointed Tap VUPO



For metric threads

Size	Class	EDP	Chamfer	L (inch)	ℓ (inch)	ℓ _n (inch)	ℓ _s (inch)	D _s (inch)	No. of flutes	Type
M2 X 0.4	D4	392645	5P	1.772	0.314	-	1.161	0.141	2	1
M2.2 X 0.45	D4	392646	5P	1.772	0.314	-	1.161	0.141	2	1
M2.3 X 0.4	D4	392647	5P	1.772	0.314	-	1.161	0.141	2	1
M2.5 X 0.45	D4	392648	5P	2.205	0.354	0.693	1.28	0.141	2	2
M2.6 X 0.45	D4	392649	5P	2.205	0.354	0.709	1.28	0.141	2	2
M3 X 0.5	D4	392615	5P	2.205	0.433	0.736	1.339	0.141	3	2
M3 X 0.35	D4	392644	5P	2.205	0.256	0.736	1.339	0.141	3	2
M4 X 0.7	D5	392617	5P	2.48	0.512	0.815	1.535	0.168	3	2
M4 X 0.5	D4	392643	5P	2.48	0.354	0.815	1.535	0.168	3	2
M5 X 0.8	D5	392619	5P	2.756	0.551	0.984	1.654	0.194	3	2
M5 X 0.5	D4	392642	5P	2.756	0.354	0.984	1.654	0.194	3	2
M6 X 1	D6	392620	5P	3.15	0.591	1.181	1.713	0.255	3	2
M6 X 0.75	D6	392641	5P	3.15	0.591	1.181	1.713	0.255	3	2
M6 X 0.5	D4	392635	5P	3.15	0.354	1.181	1.713	0.255	3	2
M8 X 1.25	D7	392623	5P	3.543	0.748	1.378	1.831	0.318	3	3
M8 X 1	D6	392622	5P	3.543	0.748	1.378	1.831	0.318	3	3
M10 X 1.5	D8	392625	5P	3.937	0.906	1.535	2.126	0.381	3	3
M10 X 1.25	D7	392624	5P	3.937	0.906	1.535	2.126	0.381	3	3
M10 X 1	D6	392601	5P	3.937	0.906	1.535	2.126	0.381	3	3
M12 X 1.75	D8	392627	5P	4.331	1.024	-	2.205	0.367	3	4
M12 X 1.5	D8	392650	5P	4.331	1.024	-	2.205	0.367	3	4
M12 X 1.25	D7	392626	5P	4.331	1.024	-	2.205	0.367	3	4
M14 X 2	D9	392629	5P	4.331	1.024	-	2.205	0.429	3	4
M14 X 1.5	D8	392628	5P	4.331	1.024	-	2.205	0.429	3	4
M16 X 2	D9	392631	5P	4.331	1.024	-	2.205	0.48	3	4
M16 X 1.5	D8	392630	5P	4.331	1.024	-	2.205	0.48	3	4
M18 X 2.5	D9	392633	5P	4.921	1.299	-	2.52	0.542	3	4
M18 X 1.5	D8	392632	5P	4.921	0.945	-	2.52	0.542	3	4
M20 X 2.5	D9	392636	5P	5.512	1.299	-	2.795	0.652	3	4
M20 X 1.5	D8	392637	5P	5.512	0.945	-	2.795	0.652	3	4
M22 X 2.5	D9	392638	5P	5.512	1.299	-	2.795	0.697	3	4
M22 X 1.5	D8	392639	5P	5.512	0.945	-	2.795	0.697	3	4
M24 X 3	D10	392640	5P	6.299	1.457	-	3.228	0.76	3	4
M24 X 1.5	D8	382651	5P	6.299	1.063	-	3.228	0.76	3	4



Z-Pro PM VUPO offers improved tool life from using a high grade of powder high speed steel with a special coating. Improved chip evacuation and cutting resistance from a unique flute shape to produce excellent internal threads. The Z-Pro PM VUPO allows a longer projected length out of the holder for better application of cutting fluids. It is designed for use with water-soluble fluid where there is a good coolant supply.

Spiral Pointed Tap VUPO



V
U
P
O

Size	Class	EDP	Chamfer	L (inch)	ℓ (inch)	ℓ _n (inch)	ℓ _s (inch)	D _s (inch)	No. of flutes	Type
5-40UNC	GH2	392703	5P	2.205	0.433	0.736	1.339	0.141	2	1
5-44UNF	GH2	392792	5P	2.205	0.433	0.736	1.339	0.141	2	1
6-32UNC	GH3	392704	5P	2.205	0.433	0.748	1.339	0.141	2	1
6-40UNF	GH2	392784	5P	2.205	0.433	0.748	1.339	0.141	2	1
8-32UNC	GH3	392706	5P	2.48	0.512	0.827	1.535	0.168	2	1
8-36UNF	GH2	392786	5P	2.48	0.512	0.827	1.535	0.168	2	1
10-24UNC	GH3	392709	5P	2.756	0.551	0.945	1.654	0.194	2	1
10-32UNF	GH3	392710	5P	2.756	0.551	0.945	1.654	0.194	2	1
12-24UNC	GH3	392788	5P	3.15	0.591	0.984	1.953	0.22	2	1
12-28UNF	GH3	392789	5P	3.15	0.591	0.984	1.953	0.22	2	1
1/4-20UNC	GH5	392744	5P	3.15	0.591	1.181	1.713	0.255	3	1
1/4-28UNF	GH4	392731	5P	3.15	0.591	1.181	1.713	0.255	3	1
5/16-18UNC	GH5	392745	5P	3.543	0.748	1.378	1.831	0.318	3	2
5/16-24UNF	GH4	392732	5P	3.543	0.748	1.378	1.831	0.318	3	2
3/8-16UNC	GH5	392747	5P	3.937	0.906	1.535	2.028	0.381	3	2
3/8-24UNF	GH4	392733	5P	3.937	0.906	1.535	2.028	0.381	3	2
7/16-14UNC	GH5	392749	5P	3.937	0.906	-	2.008	0.323	3	3
7/16-20UNF	GH5	392750	5P	3.937	0.906	-	2.008	0.323	3	3
1/2-13UNC	GH5	392751	5P	4.331	1.024	-	2.205	0.367	3	3
1/2-20UNF	GH5	392752	5P	4.331	1.024	-	2.205	0.367	3	3
9/16-12UNC	GH5	392753	5P	4.331	1.024	-	2.205	0.429	3	3
9/16-18UNF	GH5	392754	5P	4.331	1.024	-	2.205	0.429	3	3
5/8-11UNC	GH5	392755	5P	4.331	1.024	-	2.205	0.48	3	3
5/8-18UNF	GH5	392756	5P	4.331	1.024	-	2.205	0.48	3	3
3/4-10UNC	GH5	392757	5P	4.921	1.299	-	2.52	0.59	3	3
3/4-16UNF	GH5	392758	5P	4.921	1.299	-	2.52	0.59	3	3
7/8-9UNC	GH6	392795	5P	5.512	1.299	-	2.795	0.697	3	3
7/8-14UNF	GH6	392799	5P	5.512	1.299	-	2.795	0.697	3	3



Spiral Fluted Tap VUSP



Z-Pro PM VUSP offers improved tool life from using a high speed steel with a special coating. Improved chip evacuation and cutting resistance from a unique flute shape excellent internal threads. The Z-Pro OM VUSP utilizes a longer overall length to avoid the chips interfering with the holder. It is designed for use with water-soluble cutting fluid where there is a good coolant supply.

For unified threads

Size	Class	EDP	Chamfer	L (inch)	ℓ (inch)	ℓ _n (inch)	ℓ _s (inch)	D _s (inch)	No. of flutes	Type
5-40UNC	GH2	394703	2.5P	2.205	0.197	0.736	1.339	0.141	2	1
5-44UNF	GH2	394792	2.5P	2.205	0.197	0.736	1.339	0.141	2	1
6-32UNC	GH2	394604	2.5P	2.205	0.276	0.748	1.339	0.141	2	1
6-40UNF	GH2	394784	2.5P	2.205	0.276	0.748	1.339	0.141	2	1
8-32UNC	GH3	394707	2.5P	2.48	0.276	0.827	1.535	0.168	2	1
8-36UNF	GH3	394787	2.5P	2.48	0.276	0.827	1.535	0.168	2	1
10-24UNC	GH3	394709	2.5P	2.756	0.354	0.945	1.654	0.194	2	1
10-32UNF	GH3	394710	2.5P	2.756	0.354	0.945	1.654	0.194	2	1
12-24UNC	GH3	394788	2.5P	3.15	0.354	0.984	1.953	0.22	2	1
12-28UNF	GH3	394789	2.5P	3.15	0.354	0.984	1.953	0.22	2	1
1/4-20UNC	GH3	394713	2.5P	3.15	0.433	1.181	1.713	0.255	2	1
1/4-20UNF	GH5	394744	2.5P	3.15	0.433	1.181	1.713	0.255	2	1
1/4-28UNF	GH3	394714	2.5P	3.15	0.433	1.181	1.713	0.255	2	1
1/4-28UNF	GH5	394764	2.5P	3.15	0.433	1.181	1.713	0.255	2	1
5/16-18UNC	GH5	394745	2.5P	3.543	0.472	1.378	1.831	0.318	3	2
3/8-16UNC	GH5	394747	2.5P	3.937	0.512	1.535	2.028	0.381	3	2
7/16-14UNC	GH5	394749	2.5P	3.937	0.512	-	2.008	0.323	3	3
1/2-13UNC	GH5	397451	2.5P	4.331	0.591	-	2.205	0.367	3	3
9/16-12UNC	GH5	394780	2.5P	4.331	0.709	-	2.205	0.429	3	3
5/8-11UNC	GH5	394755	2.5P	4.331	0.709	-	2.205	0.48	3	3

For metric threads

Size	Class	EDP	Chamfer	L (inch)	ℓ (inch)	ℓ _n (inch)	ℓ _s (inch)	D _s (inch)	No. of flutes	Type
M3 X 0.5	D4	394615	2.5P	2.205	0.196	0.736	1.339	0.141	3	1
M3 X 0.35	D4	394644	2.5P	2.205	0.196	0.736	1.339	0.141	3	1
M4 X 0.7	D5	394617	2.5P	2.48	0.275	0.815	1.535	0.168	3	1
M4 X 0.5	D4	394643	2.5P	2.48	0.196	0.815	1.535	0.168	3	1
M5 X 0.8	D5	394619	2.5P	2.756	0.354	0.984	1.654	0.194	3	1
M5 X 0.5	D4	394642	2.5P	2.756	0.236	0.984	1.654	0.194	3	1
M6 X 1	D6	394620	2.5P	3.15	0.433	1.181	1.713	0.255	3	1
M6 X 0.75	D6	394735	2.5P	3.15	0.315	1.181	1.713	0.255	3	1
M6 X 0.5	D4	394641	2.5P	3.15	0.315	1.181	1.713	0.255	3	1
M8 X 1.25	D7	394623	2.5P	3.543	0.472	1.378	1.831	0.318	3	2
M8 X 1	D6	394622	2.5P	3.543	0.472	1.378	1.831	0.318	3	2
M10 X 1.5	D8	394625	2.5P	3.937	0.512	1.535	2.126	0.381	3	2
M10 X 1.25	D6	394624	2.5P	3.937	0.512	1.535	2.126	0.381	3	2
M10 X 1	D6	394601	2.5P	3.937	0.512	1.535	2.126	0.381	3	2
M12 X 1.75	D8	394627	2.5P	4.331	0.591	-	2.205	0.367	3	3
M12 X 1.5	D7	394626	2.5P	4.331	0.591	-	2.205	0.367	3	3
M12 X 1.25	D7	394636	2.5P	4.331	0.591	-	2.205	0.367	3	3
M14 X 2	D9	394629	2.5P	4.331	0.709	-	2.205	0.429	3	3
M14 X 1.5	D8	394628	2.5P	4.331	0.551	-	2.205	0.429	3	3
M16 X 2	D9	394630	2.5P	4.331	0.709	-	2.205	0.48	3	3
M16 X 1.5	D8	394631	2.5P	4.331	0.551	-	2.205	0.48	3	3
M18 X 2.5	D9	394633	2.5P	4.921	0.787	-	2.52	0.542	4	3
M18 X 1.5	D8	394632	2.5P	4.921	0.551	-	2.52	0.542	3	3
M20 X 2.5	D9	394634	2.5P	5.512	0.787	-	2.795	0.652	4	3
M20 X 1.5	D8	394635	2.5P	5.512	0.551	-	2.795	0.652	3	3
M22 X 2.5	D9	394640	2.5P	5.512	0.787	-	2.795	0.697	4	3
M22 X 1.5	D8	394637	2.5P	5.512	0.551	-	2.795	0.697	3	3
M24 X 3	D10	394638	2.5P	6.299	0.984	-	3.228	0.76	4	3
M24 X 1.5	D8	394639	2.5P	6.299	0.984	-	3.228	0.76	3	3



Spiral Fluted Tap VUSP

Z-Pro PM VUSP offers improved tool life from using a high speed steel with a special coating. Improved chip evacuation and cutting resistance from a unique flute shape excellent internal threads. The Z-Pro OM VUSP utilizes a longer overall length to avoid the chips interfering with the holder. It is designed for use with water-soluble cutting fluid where there is a good coolant supply.



Coated Spiral Fluted Taps 1.5P VUSP 1.5P

V
U
S
P

For metric threads

Size	Class	EDP	Chamfer	L (inch)	ℓ (inch)	ℓ _n (inch)	ℓ _s (inch)	D _s (inch)	No. of flutes	Type
M3 X 0.5	D4	394015	1.5P	2.205	0.197	0.736	1.339	0.141	3	1
M3 X 0.35	D4	394016	1.5P	2.205	0.197	0.736	1.339	0.141	3	1
M4 X 0.7	D5	394017	1.5P	2.48	0.276	0.815	1.535	0.168	3	1
M4 X 0.5	D4	394018	1.5P	2.48	0.197	0.815	1.535	0.168	3	1
M5 X 0.8	D5	394019	1.5P	2.756	0.354	0.984	1.654	0.194	3	1
M5 X 0.5	D4	394021	1.5P	2.756	0.236	0.984	1.654	0.194	3	1
M6 X 1	D6	394020	1.5P	3.15	0.433	1.181	1.713	0.255	3	1
M6 X 0.75	D6	394035	1.5P	3.15	0.315	1.181	1.713	0.255	3	1
M6 X 0.5	D4	394036	1.5P	3.15	0.315	1.181	1.713	0.255	3	1
M8 X 1.25	D7	394023	1.5P	3.543	0.472	1.378	1.831	0.318	3	2
M8 X 1	D6	394022	1.5P	3.543	0.472	1.378	1.831	0.318	3	2
M10 X 1.5	D8	394025	1.5P	3.937	0.512	1.535	2.126	0.381	3	2
M10 X 1.25	D6	394024	1.5P	3.937	0.512	1.535	2.126	0.381	3	2
M10 X 1	D6	394037	1.5P	3.937	0.512	1.535	2.126	0.381	3	2
M12 X 1.75	D8	394027	1.5P	4.331	0.591	-	2.205	0.367	3	3
M12 X 1.5	D7	394038	1.5P	4.331	0.591	-	2.205	0.367	3	3
M12 X 1.25	D7	394026	1.5P	4.331	0.591	-	2.205	0.367	3	3
M14 X 2	D9	394029	1.5P	4.331	0.709	-	2.205	0.429	3	3
M14 X 1.5	D8	394039	1.5P	4.331	0.551	-	2.205	0.429	3	3
M16 X 2	D9	394031	1.5P	4.331	0.709	-	2.205	0.48	3	3
M16X1.5	D8	394030	1.5P	4.331	0.551	-	2.205	0.48	3	3

Coated Spiral Fluted Taps with Coolant Through Hole VUSP CH

Tapping Data

For unified threads

Size	Class	EDP	Chamfer	L (inch)	ℓ (inch)	ℓ _n (inch)	ℓ _s (inch)	D _s (inch)	No. of flutes	Type
5/16-18UNC	GH5	394845	2.5P	3.543	0.472	1.378	1.831	0.318	3	1
3/8-16UNC	GH5	394847	2.5P	3.937	0.512	1.535	2.028	0.381	3	1
1/2-13UNC	GH5	394851	2.5P	4.331	0.591	-	2.205	0.367	3	2

MHRZ Series

•Features

- We realized a reduction of tapping torque by introducing our original specifications and design.
- Made from excellent wear-resistant material and special coating techniques have dramatically improved the durability of the tool.
- Consistent tapping on thermal refined materials with hardness up to 35HRC is achieved
- Water soluble tapping fluid is recommended when using MHRZ roll taps.

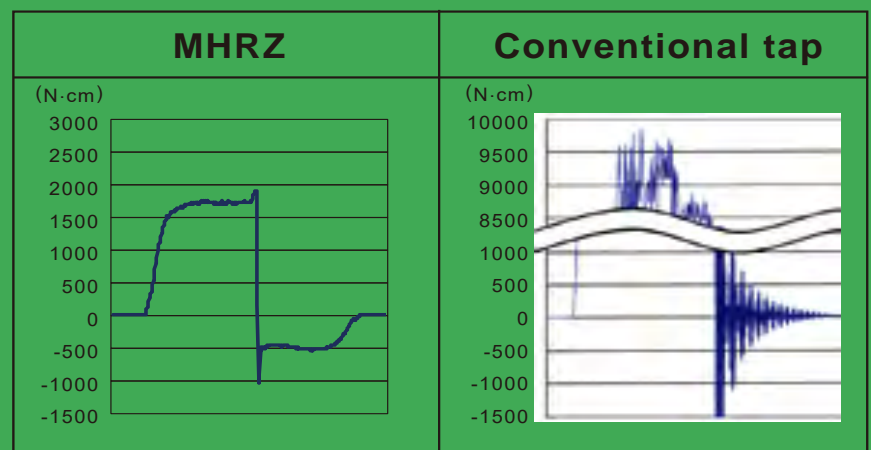
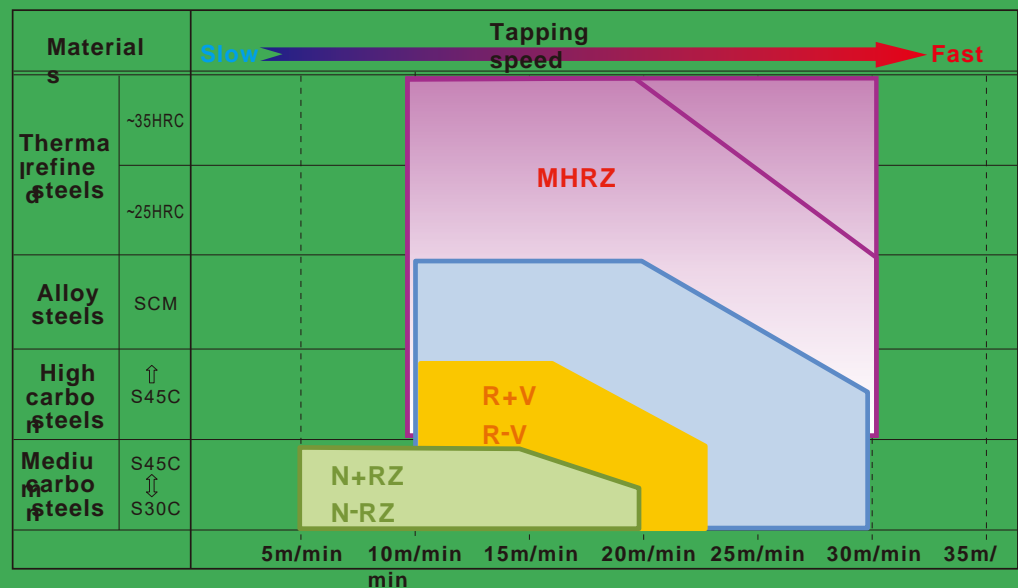

Our MHRZ taps have made it possible to tap 4140 material with hardness of 35HRC. This material was considered difficult to be processed with roll taps because of the high tapping torque.



Roll Taps for Carbon Steels

MHRZ

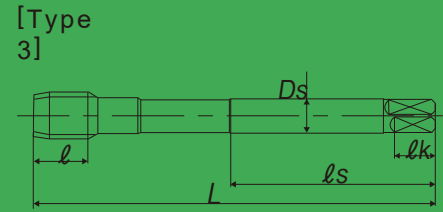
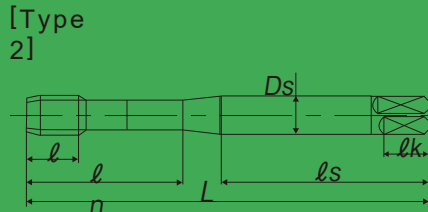
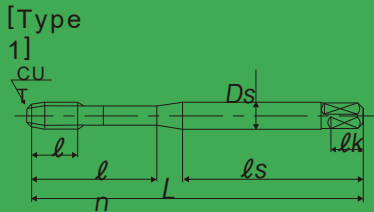

Size	Class	EDP Number	Number of chamfer threads	L (inch)	l (inch)	ln (inch)	ls (inch)	Ds (inch)	Lobe	Type
No.10-24UNC	H6	387817	2P	2.756	0.354	0.945	1.654	0.194	5	1
No.10-32UNF	H6	387821	2P	2.756	0.354	0.945	1.654	0.194	5	1
1/4-20UNC	H7	387873	2P	3.150	0.433	1.181	1.713	0.255	5	1
5/16-18UNC	H8	387834	2P	3.543	0.472	1.378	1.831	0.318	6	2
3/8-16UNC	H8	387842	2P	3.937	0.512	1.535	2.028	0.381	8	2
7/16-14UNC	H9	387850	2P	3.937	0.512	-	2.008	0.323	8	3
1/2-13UNC	H9	387858	2P	4.331	0.591	-	2.205	0.367	8	3

Z-PRO

Economical High Performance Taps

SP PO HT STI STI-HT

Tap series designed for general purpose applications in small to large batch quantity jobs that require the most economical tap cost to tool life.

Features of Z-Pro Series

- Made from a custom blended High Vanadium HSS.
- Available in Inch, Inch STI and Metric Thread
- Offered in Spiral Flute, Spiral Point and Hand Taps.
- Produces lower torque and longer tool life than conventional HP or GP taps.

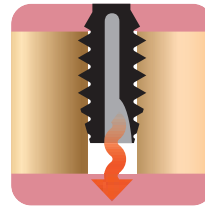

PO

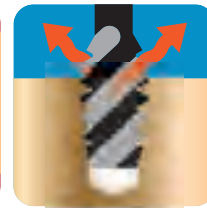

SP

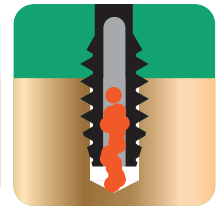

HT



Z-PRO HAND TAP IN
MILD STEEL



Z-PRO SPIRAL
FLUTE TAP FOR
BLIND HOLE
IN STEEL



Z-PRO SPIRAL
POINT TAP FOR
THROUGH
HOLE IN MILD
STEELS



Z-PRO SPIRAL FLUTE
TAP FOR BLIND HOLE
IN ALUMINUM



Economical High Performance Taps

For Unified Threads

PO



*Z-PRO PO have a Bright Surface Finish

*AVAILABLE IN TIN AND TICN UPON REQUEST

Custom Blend High Vanadium HSS

The Z-PRO Series is designed for carbon steels, alloyed steels, irons, brass and free machining materials, including stainless steel that requires the most economical tool life, They are ideal for materials that produce stringy chips, such as steels, stainless steels and plastics.

Spiral Pointed taps are recommended for tapping through holes.

Plug Style (5 threads chamfered)
DIN lengths with ANSI shank dimensions.

Z-PRO Series PO

Machine Screw Sizes
Fractional Sizes

TPI Nominal Size	NC UNC	NF UNF	No. of Flutes	Pitch Diameter Limit/ EDP Numbers					Dimensions		
				H1	H2	H3	H4	H5	Length of Thread	Neck Length	Length Overall
0	80	—	2	PSUN0B1NEB	PSUN0B2NEB	—	—	—	.236	—	1.772
1	64	—	2	PSUN1D1NEB	PSUN1D2NEB	—	—	—	.275	—	1.772
1	—	72	2	PSUN1C1NEB	PSUN1C2NEB	—	—	—	.375	—	1.772
2	56	—	2	PSUN2E1NEB	PSUN2E2NEB	—	—	—	.314	—	1.772
2	—	64	2	PSUN2D1NEB	PSUN2D2NEB	—	—	—	.314	—	2.205
3	48	—	2	PSUN3F1NEB	PSUN3F2NEB	—	—	—	.314	.669	2.205
3	—	56	2	PSUN3E1NEB	PSUN3E2NEB	—	—	—	.354	.669	2.205
4	40	—	2	—	PSUN4H2NEB	PSUN4H3NEB	—	—	.354	.709	2.205
4	—	48	2	PSUN4F1NEB	PSUN4F2NEB	—	—	—	.354	.709	2.205
5	40	—	2	—	PSUN5H2NEB	PSUN5H3NEB	—	—	.433	.768	2.205
5	—	44	2	—	PSUN5G2NEB	PSUN5G3NEB	—	—	.433	.768	2.205
6	32	—	2	—	PSUN6J2NEB	PSUN6J3NEB	—	—	.433	.768	2.205
6	—	40	2	—	PSUN6H2NEB	PSUN6H3NEB	—	—	.433	.768	2.205
8	32	—	2	—	PSUN8J2NEB	PSUN8J3NEB	—	—	.512	.827	2.480
8	—	36	2	—	PSUN8I2NEB	PSUN8I3NEB	—	—	.512	.827	2.480
10	24	—	2	—	PSUNAM2NEB	PSUNAM3NEB	—	—	.551	.984	2.756
10	—	32	2	—	PSUNAJ2NEB	PSUNAJ3NEB	—	—	.551	.984	2.756
12	24	—	2	—	PSUNCM2NEB	PSUNCM3NEB	—	—	.591	.984	3.150
12	—	28	2	—	PSUNC2NEB	PSUNC3NEB	—	—	.591	.984	3.150
1/4	20	—	3	—	—	PSU04N3NEB	PSU04N4NEB	—	.591	1.181	3.150
1/4	—	28	3	—	PSU04K2NEB	PSU04K3NEB	—	—	.591	1.181	3.150
5/16	18	—	3	—	—	PSU05O3NEB	PSU05O4NEB	—	.748	1.378	3.543
5/16	—	24	3	—	—	PSU05M3NEB	PSU05M4NEB	—	.748	1.378	3.543
3/8	16	—	3	—	—	PSU06P3NEB	—	PSU06P5NEB	.906	1.535	3.937
3/8	—	24	3	—	—	PSU06M3NEB	PSU06M4NEB	—	.906	1.535	3.937
7/16	14	—	3	—	—	—	PSU07Q4NEB	PSU07Q5NEB	.906	—	3.937
7/16	—	20	3	—	—	PSU07N3NEB	PSU07N4NEB	—	.906	—	3.937
1/2	13	—	3	—	—	—	PSU08R4NEB	PSU08R5NEB	1.024	—	4.331
1/2	—	20	3	—	—	PSU08N3NEB	PSU08N4NEB	—	1.024	—	4.331
9/16	12	—	3	—	—	—	PSU09S4NEB	PSU09S5NEB	1.024	—	4.331
9/16	—	18	3	—	—	—	PSU09O4NEB	PSU09O5NEB	1.024	—	4.331

CONTINUED ON NEXT PAGE



Z-PRO

Z
P
R
O

P
O

The Z-PRO Series is designed for carbon steels, alloyed steels, irons, brass and free machining materials, including stainless steel that requires the most economical tool life. They are ideal for materials that produce stringy chips, such as steels, stainless steels and plastics.

Spiral Pointed taps are recommended for tapping through holes.

Economical High Performance Taps For Unified Threads



*Z-PRO PO have a Bright Surface Finish
*AVAILABLE IN TIN AND TICN UPON REQUEST
Custom Blend High Vanadium HSS

Plug Style (5 threads chamfered)
DIN lengths with ANSI shank dimensions.

Z-PRO Series PO

Machine Screw Sizes
Fractional Sizes

Nominal Size	TPI NC UNC	NF UNF	No. of Flutes	Pitch Diameter Limit/ EDP Numbers					Dimensions		
				H4	H5	H6	H7	H8	Length of Thread	Neck Length	Length Overall
5/8	11	—	3	PSU10U4NEB	—	PSU10U6NEB	—	—	1.024	—	4.331
5/8	—	18	3	PSU10O4NEB	PSU10O5NEB	—	—	—	1.024	—	4.331
3/4	10	—	3	—	PSU12V5NEB	PSU12V6NEB	—	—	1.299	—	4.921
3/4	—	16	3	PSU12P4NEB	PSU12P5NEB	—	—	—	1.299	—	4.921
7/8	9	—	3	—	PSU14W5NEB	PSU14W6NEB	—	—	1.299	—	5.512
7/8	—	14	3	PSU14Q4NEB	—	PSU14Q6NEB	—	—	1.299	—	5.512
1	8	—	3	—	PSU16X5NEB	—	PSU16X7NEB	—	1.457	—	6.299
1	—	12	3	—	PSU16S5NEB	PSU16S6NEB	—	—	1.457	—	6.299
1 1/8	7	—	4	—	—	PSU18Y6NEB	PSU18Y7NEB	—	1.732	—	7.087
1 1/8	—	12	4	—	PSU18S5NEB	PSU18S6NEB	—	—	1.732	—	7.087
1 1/4	7	—	4	—	—	PSU20Y6NEB	—	PSU20Y8NEB	1.929	—	7.087
1 1/4	—	12	4	—	PSU20S5NEB	PSU20S6NEB	—	—	1.929	—	7.087
1 3/8	6	—	4	—	—	PSU22Z6NEB	—	PS822Z8NEB	2.165	—	7.874
1 3/8	—	12	4	—	PSU22S5NEB	PSU22S6NEB	—	—	2.165	—	7.874
1 1/2	6	—	4	—	—	PSU24Z6NEB	—	PSU24Z8NEB	2.323	—	7.874
1 1/2	—	12	4	—	PSU24S5NEB	—	PSU24S7NEB	—	2.323	—	7.874



Economical High Performance Taps

For Unified Threads

PO-OX



*Z-PRO PO-OX have an Oxide Surface Finish
Custom Blend High Vanadium HSS

The Z-PRO Series is designed for carbon steels, alloyed steels, irons, brass and free machining materials, including stainless steel that requires the most economical tool life, They are ideal for materials that produce stringy chips, such as steels, stainless steels and plastics.

Spiral Pointed taps are recommended for tapping through holes.

Plug Style (5 threads chamfered)
DIN lengths with ANSI shank dimensions.

Z-PRO Series PO-OX

Machine Screw Sizes
Fractional Sizes

TPI Nominal Size	NC UNC	NF UNF	No. of Flutes	Pitch Diameter Limit/ EDP Numbers					Dimensions		
				H2	H3	H4	H5	H6	Length of Thread	Neck Length	Length Overall
2	56	—	2	PSUN2E2NEX	—	—	—	—	.314	—	1.772
4	40	—	2	—	PSUN4H3NEX	—	—	—	.354	.709	2.205
5	40	—	2	—	PSUN5H3NEX	—	—	—	.433	.768	2.205
6	32	—	2	—	PSUN6J3NEX	—	—	—	.433	.768	2.205
6	—	40	2	—	PSUN6H3NEX	—	—	—	.433	.768	2.205
8	32	—	2	—	PSUN8J3NEX	—	—	—	.512	.768	2.480
10	24	—	2	—	PSUNAM3NEX	—	—	—	.551	.827	2.756
10	—	32	2	—	PSUNAJ3NEX	—	—	—	.551	.984	2.756
12	24	—	2	—	PSUNCM3NEX	—	—	—	.591	.984	3.150
1/4	20	—	3	—	—	PSU04N4NEX	—	—	.591	1.181	3.150
1/4	—	28	3	—	PSU04K3NEX	—	—	—	.591	1.181	3.150
5/16	18	—	3	—	—	PSU05O4NEX	—	—	.748	1.378	3.543
5/16	—	24	3	—	—	PSU05M4NEX	—	—	.748	1.378	3.543
3/8	16	—	3	—	—	—	PSU06P5NEX	—	.906	1.535	3.937
3/8	—	24	3	—	—	PSU06M4NEX	—	—	.906	1.535	3.937
7/16	14	—	3	—	—	—	PSU07Q5NEX	—	.906	—	3.937
7/16	—	20	3	—	—	PSU07N4NEX	—	—	.906	—	3.937
1/2	13	—	3	—	—	—	PSU08R5NEX	—	1.024	—	4.331
1/2	—	20	3	—	—	PSU08N4NEX	—	—	1.024	—	4.331
9/16	12	—	3	—	—	—	PSU09S5NEX	—	1.024	—	4.331
9/16	—	18	3	—	—	—	PSU09O5NEX	—	1.024	—	4.331
5/8	11	—	3	—	—	—	—	PSU10U6NEX	1.024	—	4.331
5/8	—	18	3	—	—	—	PSU10O5NEX	—	1.024	—	4.331
3/4	10	—	3	—	—	—	—	PSU12V6NEX	1.299	—	4.921
3/4	—	16	3	—	—	PSU12P4NEX	—	—	1.299	—	4.921
7/8	9	—	3	—	—	—	PSU14W5NEX	—	1.299	—	5.512
7/8	—	14	3	—	—	PSU14Q4NEX	—	—	1.299	—	5.512
1	8	—	3	—	—	—	PSU16X5NEX	—	1.457	—	6.299
1	—	12	3	—	—	—	PSU16S5NEX	—	1.457	—	6.299
1 1/8	7	—	4	—	—	—	—	PSU18Y6NEX	1.732	—	7.087
1 1/8	—	12	4	—	—	—	PSU18S5NEX	—	1.732	—	7.087
1 1/4	7	—	4	—	—	—	—	PSU20Y6NEX	1.929	—	7.087
1 1/4	—	12	4	—	—	—	PSU20S5NEX	—	1.929	—	7.087
1 3/8	6	—	4	—	—	—	—	PSU22Z6NEX	2.165	—	7.874
1 3/8	—	12	4	—	—	—	PSU22S5NEX	—	2.165	—	7.874
1 1/2	6	—	4	—	—	—	—	PSU24Z6NEX	2.323	—	7.874
1 1/2	—	12	4	—	—	—	PSU24S5NEX	—	2.323	—	7.874



Z-PRO

The Z-PRO Series is designed for carbon steels, alloyed steels, irons, brass and free machining materials, including stainless steel that requires the most economical tool life. They are ideal for materials that produce stringy chips, such as steels, stainless steels and plastics.

Spiral Pointed taps are recommended for tapping through holes.

Economical High Performance Taps For Metric Threads

PO



*Z-PRO PO have a Bright Surface Finish
*AVAILABLE IN TIN AND TICN UPON REQUEST
Custom Blend High Vanadium HSS

Plug Style (3 to 5 threads chamfered) DIN lengths with ANSI shank dimensions.

Z-PRO Series PO

Machine Screw Sizes
Fractional Sizes

TPI Nominal Size	No. of Flutes	Pitch Diameter Limit/ EDP Numbers				Dimensions		
		D3	D4	D5	D6	Length of Thread	Neck Length	Length Overall
M2 X 0.4	3	PS2.0E3NEB	—	—	—	.314	.382	1.772
M2.2 X 0.45	3	PS2.2F3NEB	—	—	—	.314	.382	1.772
M2.5 X 0.45	3	PS2.5F3NEB	—	—	—	.354	.693	2.205
M2.6 X 0.45*	3	PS2.6F3NEB	—	—	—	.354	.693	2.205
M3 X 0.5	3	PS3.0G3NEB	—	—	—	.433	.768	2.205
M3.5 X 0.6	3	—	PS3.5H4NEB	—	—	.433	.787	2.205
M4 X 0.7	3	—	PS4.0I4NEB	—	—	.512	.827	2.48
M5 X 0.8	3	—	PS5.0K4NEB	—	—	.591	.984	3.15
M6 X 1	3	—	—	PS6.0M5NEB	—	.591	1.181	3.15
M7 X 0.5*	3	—	PS7.0G4NEB	—	—	.394	1.315	3.543
M7 X 0.75*	3	—	PS7.0J4NEB	—	—	.748	1.315	3.543
M7 X 1	3	—	—	PS7.0M5NEB	—	.748	1.315	3.543
M8 X 0.5*	3	—	PS8.0G4NEB	—	—	.394	1.382	3.543
M8 X 0.75*	3	—	PS8.0J4NEB	—	—	.748	1.382	3.543
M8 X 1	3	—	—	PS8.0M5NEB	—	.748	1.382	3.543
M8 X 1.25	3	—	—	PS8.0N5NEB	—	.748	1.382	3.543
M9 X 1*	3	—	—	PS9.0M5NEB	—	.748	1.382	3.543
M9 X 1.25*	3	—	—	PS9.0N5NEB	—	.748	1.382	3.543
M10 X 0.75*	3	—	PS010J4NEB	—	—	.512	1.929	3.937
M10 X 1*	3	—	—	PS010M5NEB	—	.906	1.929	3.937
M10 X 1.25	3	—	—	PS010N5NEB	—	.906	1.929	3.937
M10 X 1.5	3	—	—	—	PS010O6NEB	.906	1.929	3.937
M11 X 1.5*	3	—	—	—	PS011O6NEB	.906	1.929	3.937
M12 X 1*	3	—	—	PS012M5NEB	—	1.024	2.126	4.331
M12 X 1.25	3	—	—	—	PS012N6NEB	1.024	2.126	4.331
M12 X 1.5*	3	—	—	—	PS012O6NEB	1.024	2.126	4.331
M 12 X 1.75	3	—	—	—	PS012P6NEB	1.024	2.126	4.331

*Semi Standard

CONTINUED ON NEXT PAGE



Economical High Performance Taps

For Metric Threads

PO



*Z-PRO PO have a Bright Surface Finish

*AVAILABLE IN TIN AND TICN UPON REQUEST

Custom Blend High Vanadium HSS

The Z-PRO Series is designed for carbon steels, alloyed steels, irons, brass and free machining materials, including stainless steel that requires the most economical tool life. They are ideal for materials that produce stringy chips, such as steels, stainless steels and plastics.

Spiral Pointed taps are recommended for tapping through holes.

Plug Style (3 to 5 threads chamfered) DIN lengths with ANSI shank dimensions.

Z-PRO Series PO

Machine Screw Sizes
Fractional Sizes

TPI Nominal Size	No. of Flutes	Pitch Diameter Limit/ EDP Numbers				Dimensions		
		D5	D6	D7	D8	Length of Thread	Neck Length	Length Overall
M14 X 1*	3	PS014M5NEB	—	—	—	1.024	2.126	4.331
M14 X 1.25	3	—	PS014N6NEB	—	—	1.024	2.126	4.331
M14 X 1.5*	3	—	PS014O6NEB	—	—	1.024	2.126	4.331
M14 X 2	3	—	—	PS014Q7NEB	—	1.024	2.126	4.331
M16 X 1*	3	PS016M5NEB	—	—	—	1.024	2.126	4.331
M16 X 1.5	3	—	PS016O6NEB	—	—	1.024	2.126	4.331
M16 X 2	3	—	—	PS016Q7NEB	—	1.024	2.126	4.331
M18 X 1*	4	PS018M5NEB	—	—	—	.945	2.402	4.921
M18 X 1.5*	3	—	PS018O6NEB	—	—	.945	2.402	4.921
M18 X 2*	3	—	—	PS018Q7NEB	—	1.299	2.402	4.921
M18 X 2.5	3	—	—	PS018R7NEB	—	1.299	2.402	4.921
M20 X 1*	3	PS020M5NEB	—	—	—	.945	2.717	5.512
M20 X 1.5	3	—	PS020O6NEB	—	—	.945	2.717	5.512
M20 X 2*	3	—	—	PS020Q7NEB	—	1.299	2.717	5.512
M20 X 2.5	3	—	—	PS020R7NEB	—	1.299	2.717	5.512
M22 X 1*	3	PS022M5NEB	—	—	—	.945	2.717	5.512
M22 X 1.5	3	—	PS022O6NEB	—	—	.945	2.717	5.512
M22 X 2*	3	—	—	PS022Q7NEB	—	1.299	2.717	5.512
M22 X 2.5	3	—	—	PS022R7NEB	—	1.299	2.717	5.512
M24 X 1*	4	PS024M5NEB	—	—	—	1.063	3.071	6.299
M24 X 1.5*	3	—	PS024O6NEB	—	—	1.063	3.071	6.299
M24 X 2	3	—	—	PS024Q7NEB	—	1.063	3.071	6.299
M24 X 3	3	—	—	—	PS024S8NEB	1.457	3.071	6.299
M25 X 1.5*	3	—	PS025O6NEB	—	—	1.063	3.071	6.299
M26 X 1.5*	4	—	PS026O6NEB	—	—	1.063	3.465	7.087
M27 X 1*	4	PS027M5NEB	—	—	—	1.063	3.465	7.087

*Semi Standard

CONTINUED ON NEXT PAGE



Z-PRO

Z
P
R
O

P
O

The Z-PRO Series is designed for carbon steels, alloyed steels, irons, brass and free machining materials, including stainless steel that requires the most economical tool life, They are ideal for materials that produce stringy chips, such as steels, stainless steels and plastics.

Spiral Pointed taps are recommended for tapping through holes.

Economical High Performance Taps For Metric Threads



*Z-PRO PO have a Bright Surface Finish
*AVAILABLE IN TIN AND TICN UPON REQUEST
Custom Blend High Vanadium HSS

Plug Style (3 to 5 threads chamfered)
DIN lengths with ANSI shank dimensions.

Z-PRO Series PO
Machine Screw Sizes
Fractional Sizes

TPI Nominal Size	No. of Flutes	Pitch Diameter Limit/ EDP Numbers					Dimensions		
		D5	D6	D7	D8	D9	Length of Thread	Neck Length	Length Overall
M27 X 1.5*	4	—	PS027O6NEB	—	—	—	1.063	3.465	7.087
M27 X 2	4	—	—	PS027Q7NEB	—	—	1.063	3.465	7.087
M27 X 3	4	—	—	—	PS027S8NEB	—	1.732	3.465	7.087
M28 X 1*	4	PS028M5NEB	—	—	—	—	1.063	3.465	7.087
M28 X 1.5*	4	—	PS028O6NEB	—	—	—	1.063	3.465	7.087
M28 X 2*	4	—	—	PS028Q7NEB	—	—	1.063	3.465	7.087
M30 X 1*	4	PS030M5NEB	—	—	—	—	1.063	3.465	7.087
M30 X 1.5*	4	—	PS030O6NEB	—	—	—	1.063	3.465	7.087
M30 X 2	4	—	—	PS030Q7NEB	—	—	1.063	3.465	7.087
M30 X 3.5	4	—	—	—	—	PS030T9NEB	1.732	3.465	7.087
M32 X 1*	4	PS032M5NEB	—	—	—	—	1.063	3.465	7.087
M32 X 1.5*	4	—	PS032O6NEB	—	—	—	1.063	3.465	7.087
M32 X 2*	4	—	—	PS032Q7NEB	—	—	1.063	3.465	7.087
M33 X 1*	4	PS033M5NEB	—	—	—	—	1.142	3.465	7.087
M33 X 1.5*	4	—	PS033O6NEB	—	—	—	1.142	3.465	7.087
M33 X 2	4	—	—	PS033Q7NEB	—	—	1.142	3.465	7.087
M33 X 3.5	4	—	—	—	—	PS033T9NEB	1.181	3.465	7.087
M36 X 1*	4	PS036M5NEB	—	—	—	—	1.142	3.858	7.784
M36 X 1.5*	4	—	PS036O6NEB	—	—	—	1.142	3.858	7.874
M36 X 2*	4	—	—	PS036Q7NEB	—	—	1.142	3.858	7.874
M36 X 3	4	—	—	—	PS036S8NEB	—	2.047	3.858	7.874
M36 X 4	4	—	—	—	—	PS036U9NEB	2.047	3.858	7.874
M39 X 1*	4	PS039M5NEB	—	—	—	—	1.142	3.858	7.874
M39 X 1.5*	4	—	PS039O6NEB	—	—	—	1.142	3.858	7.874
M39 X 2*	4	—	—	PS039Q7NEB	—	—	1.142	3.858	7.874
M39 X 3	4	—	—	—	PS039S8NEB	—	2.047	3.858	7.874

*Semi Standard

CONTINUED ON NEXT PAGE

Z-PRO



Economical High Performance Taps

For Metric Threads

PO



*Z-PRO PO have a Bright Surface Finish

*AVAILABLE IN TIN AND TICN UPON REQUEST

Custom Blend High Vanadium HSS

The Z-PRO Series is designed for carbon steels, alloyed steels, irons, brass and free machining materials, including stainless steel that requires the most economical tool life. They are ideal for materials that produce stringy chips, such as steels, stainless steels and plastics.

Spiral Pointed taps are recommended for tapping through holes.

Plug Style (3 to 5 threads chamfered)
DIN lengths with ANSI shank dimensions.

Z-PRO Series PO

Machine Screw Sizes
Fractional Sizes

TPI Nominal Size	No. of Flutes	Pitch Diameter Limit/ EDP Numbers							Dimensions		
		D5	D6	D7	D8	D9	D10	D11	Length of Thread	Neck Length	Length Overall
M39 X 4	4	—	—	—	—	PS039U9NEB	—	—	2.047	3.858	7.874
M42 X 1*	4	PS042M5NEB	—	—	—	—	—	—	1.142	3.858	7.874
M42 X 1.5*	4	—	PS042O6NEB	—	—	—	—	—	1.142	3.858	7.874
M42 X 2	4	—	—	PS042Q7NEB	—	—	—	—	1.142	3.858	7.874
M42 X 4.5	4	—	—	—	—	—	PS042VONEB	—	2.323	3.858	7.874
M45 X 1*	4	PS045M5NEB	—	—	—	—	—	—	1.22	4.252	8.661
M45 X 1.5*	4	—	PS045O6NEB	—	—	—	—	—	1.22	4.252	8.661
M45 X 2*	4	—	—	PS045Q7NEB	—	—	—	—	1.22	4.252	8.661
M45 X 3	4	—	—	—	PS045S8NEB	—	—	—	2.323	4.252	8.661
M45 X 4.5	4	—	—	—	—	—	PS045VONEB	—	2.323	4.252	8.661
M48 X 1*	4	—	PS048M6NEB	—	—	—	—	—	1.22	4.803	9.843
M48 X 1.5*	4	—	—	PS048O7NEB	—	—	—	—	1.22	4.803	9.843
M48 X 2*	4	—	—	PS048Q7NEB	—	—	—	—	1.22	4.803	9.843
M48 X 3	4	—	—	—	—	PS048S9NEB	—	—	2.559	4.803	9.843
M48 X 5	4	—	—	—	—	—	—	PS048W-NEB	2.559	4.803	9.843

*Semi Standard



Z-PRO

The Z-PRO Series is designed for carbon steels, alloyed steels, irons, brass and free machining materials, including stainless steel that requires the most economical tool life. They are ideal for materials that produce stringy chips, such as steels, stainless steels and plastics.

Spiral Pointed taps are recommended for tapping through holes.

Economical High Performance Taps For Metric Threads

PO-OX



*Z-PRO PO-OX have an Oxide Surface Finish
Custom Blend High Vanadium HSS

Plug Style (3 to 5 threads chamfered)
DIN lengths with ANSI shank dimensions.

Z-PRO Series PO-OX

Machine Screw Sizes
Fractional Sizes

TPI Nominal Size	No. of Flutes	Pitch Diameter Limit/ EDP Numbers				Dimensions		
		D3	D4	D5	D6	Length of Thread	Neck Length	Length Overall
M2 X 0.4	3	PS2.0E3NEX	—	—	—	.314	.382	1.772
M2.2 X 0.45	3	PS2.2F3NEX	—	—	—	.314	.382	1.772
M2.5 X 0.45	3	PS2.5F3NEX	—	—	—	.354	.693	2.205
M2.6 X 0.45*	3	PS2.6F3NEX	—	—	—	.354	.693	2.205
M3 X 0.5	3	PS3.0G3NEX	—	—	—	.433	.768	2.205
M3.5 X 0.6	3	—	PS3.5H4NEX	—	—	.433	.787	2.205
M4 X 0.7	3	—	PS4.0I4NEX	—	—	.512	.827	2.48
M5 X 0.8	3	—	PS5.0K4NEX	—	—	.591	.984	3.15
M6 X 1	3	—	—	PS6.0M5NEX	—	.591	1.181	3.15
M7 X 0.5*	3	—	PS7.0G4NEX	—	—	.394	1.315	3.543
M7 X 0.75*	3	—	PS7.0J4NEX	—	—	.748	1.315	3.543
M7 X 1	3	—	—	PS7.0M5NEX	—	.748	1.315	3.543
M8 X 0.5*	3	—	PS8.0G4NEX	—	—	.394	1.382	3.543
M8 X 0.75*	3	—	PS8.0J4NEX	—	—	.748	1.382	3.543
M8 X 1	3	—	—	PS8.0M5NEX	—	.748	1.382	3.543
M8 X 1.25	3	—	—	PS8.0N5NEX	—	.748	1.382	3.543
M9 X 1*	3	—	—	PS9.0M5NEX	—	.748	1.382	3.543
M9 X 1.25*	3	—	—	PS9.0N5NEX	—	.748	1.382	3.543
M10 X 0.75*	3	—	PS010J4NEX	—	—	.512	1.929	3.937
M10 X 1*	3	—	—	PS010M5NEX	—	.906	1.929	3.937
M10 X 1.25	3	—	—	PS010N5NEX	—	.906	1.929	3.937
M10 X 1.5	3	—	—	—	PS010O6NEX	.906	1.929	3.937
M11 X 1.5*	3	—	—	—	PS011O6NEX	.906	1.929	3.937
M12 X 1*	3	—	—	PS012M5NEX	—	1.024	2.126	4.331
M12 X 1.25	3	—	—	—	PS012N6NEX	1.024	2.126	4.331
M12 X 1.5*	3	—	—	—	PS012O6NEX	1.024	2.126	4.331
M 12 X 1.75	3	—	—	—	PS012P6NEX	1.024	2.126	4.331

*Semi Standard

CONTINUED ON NEXT PAGE



Economical High Performance Taps

For Metric Threads

PO-OX



*Z-PRO PO-OX have an Oxide Surface Finish
Custom Blend High Vanadium HSS

The Z-PRO Series is designed for carbon steels, alloyed steels, irons, brass and free machining materials, including stainless steel that requires the most economical tool life. They are ideal for materials that produce stringy chips, such as steels, stainless steels and plastics.

Spiral Pointed taps are recommended for tapping through holes.

Plug Style (3 to 5 threads chamfered)
DIN lengths with ANSI shank dimensions.

Z-PRO Series PO-OX

Machine Screw Sizes
Fractional Sizes

TPI Nominal Size	No. of Flutes	Pitch Diameter Limit/ EDP Numbers				Dimensions		
		D5	D6	D7	D8	Length of Thread	Neck Length	Length Overall
M14 X 1*	3	PS014M5NEX	—	—	—	1.024	2.126	4.331
M14 X 1.25	3	—	PS014N6NEX	—	—	1.024	2.126	4.331
M14 X 1.5*	3	—	PS014O6NEX	—	—	1.024	2.126	4.331
M14 X 2	3	—	—	PS014Q7NEX	—	1.024	2.126	4.331
M16 X 1*	3	PS016M5NEX	—	—	—	1.024	2.126	4.331
M16 X 1.5	3	—	PS016O6NEX	—	—	1.024	2.126	4.331
M16 X 2	3	—	—	PS016Q7NEX	—	1.024	2.126	4.331
M18 X 1*	4	PS018M5NEX	—	—	—	.945	2.402	4.921
M18 X 1.5*	3	—	PS018O6NEX	—	—	.945	2.402	4.921
M18 X 2*	3	—	—	PS018Q7NEX	—	1.299	2.402	4.921
M18 X 2.5	3	—	—	PS018R7NEX	—	1.299	2.402	4.921
M20 X 1*	3	PS020M5NEX	—	—	—	.945	2.717	5.512
M20 X 1.5	3	—	PS020O6NEX	—	—	.945	2.717	5.512
M20 X 2*	3	—	—	PS020Q7NEX	—	1.299	2.717	5.512
M20 X 2.5	3	—	—	PS020R7NEX	—	1.299	2.717	5.512
M22 X 1*	3	PS022M5NEX	—	—	—	.945	2.717	5.512
M22 X 1.5	3	—	PS022O6NEX	—	—	.945	2.717	5.512
M22 X 2	3	—	—	PS022Q7NEX	—	1.299	2.717	5.512
M22 X 2.5	3	—	—	PS022R7NEX	—	1.299	2.717	5.512
M24 X 1*	4	PS024M5NEX	—	—	—	1.063	3.071	6.299
M24 X 1.5*	3	—	PS024O6NEX	—	—	1.063	3.071	6.299
M24 X 2	3	—	—	PS024Q7NEX	—	1.063	3.071	6.299
M24 X 3	3	—	—	—	PS024S8NEX	1.457	3.071	6.299
M25 X 1.5*	3	—	PS025O6NEX	—	—	1.063	3.071	6.299
M26 X 1.5*	4	—	PS026O6NEX	—	—	1.063	3.465	7.087
M27 X 1*	4	PS027M5NEX	—	—	—	1.063	3.465	7.087

*Semi Standard

CONTINUED ON NEXT PAGE



Z-PRO

The Z-PRO Series is designed for carbon steels, alloyed steels, irons, brass and free machining materials, including stainless steel that requires the most economical tool life. They are ideal for materials that produce stringy chips, such as steels, stainless steels and plastics.

Spiral Pointed taps are recommended for tapping through holes.

Economical High Performance Taps For Metric Threads

PO-OX



*Z-PRO PO-OX have an Oxide Surface Finish
Custom Blend High Vanadium HSS

Plug Style (3 to 5 threads chamfered)
DIN lengths with ANSI shank dimensions.

Z-PRO Series PO-OX

Machine Screw Sizes
Fractional Sizes

TPI Nominal Size	No. of Flutes	Pitch Diameter Limit/ EDP Numbers					Dimensions		
		D5	D6	D7	D8	D9	Length of Thread	Neck Length	Length Overall
M27 X 1.5*	4	—	PS027O6NEX	—	—	—	1.063	3.465	7.087
M27 X 2	4	—	—	PS027Q7NEX	—	—	1.063	3.465	7.087
M27 X 3	4	—	—	—	PS027S8NEX	—	1.732	3.465	7.087
M28 X 1*	4	PS028M5NEX	—	—	—	—	1.063	3.465	7.087
M28 X 1.5*	4	—	PS028O6NEX	—	—	—	1.063	3.465	7.087
M28 X 2*	4	—	—	PS028Q7NEX	—	—	1.063	3.465	7.087
M30 X 1*	4	PS030M5NEX	—	—	—	—	1.063	3.465	7.087
M30 X 1.5*	4	—	PS030O6NEX	—	—	—	1.063	3.465	7.087
M30 X 2	4	—	—	PS030Q7NEX	—	—	1.063	3.465	7.087
M30 X 3.5	4	—	—	—	—	PS030T9NEX	1.732	3.465	7.087
M32 X 1*	4	PS032M5NEX	—	—	—	—	1.063	3.465	7.087
M32 X 1.5*	4	—	PS032O6NEX	—	—	—	1.063	3.465	7.087
M32 X 2*	4	—	—	PS032Q7NEX	—	—	1.063	3.465	7.087
M33 X 1*	4	PS033M5NEX	—	—	—	—	1.142	3.465	7.087
M33 X 1.5*	4	—	PS033O6NEX	—	—	—	1.142	3.465	7.087
M33 X 2	4	—	—	PS033Q7NEX	—	—	1.142	3.465	7.087
M33 X 3.5	4	—	—	—	—	PS033T9NEX	1.181	3.465	7.087
M36 X 1*	4	PS036M5NEX	—	—	—	—	1.142	3.858	7.874
M36 X 1.5*	4	—	PS036O6NEX	—	—	—	1.142	3.858	7.874
M36 X 2*	4	—	—	PS036Q7NEX	—	—	1.142	3.858	7.874
M36 X 3	4	—	—	—	PS036S8NEX	—	2.047	3.858	7.874
M36 X 4	4	—	—	—	—	PS036U9NEX	2.047	3.858	7.874
M39 X 1*	4	PS039M5NEX	—	—	—	—	1.142	3.858	7.874
M39 X 1.5*	4	—	PS039O6NEX	—	—	—	1.142	3.858	7.874
M39 X 2*	4	—	—	PS039Q7NEX	—	—	1.142	3.858	7.874
M39 X 3	4	—	—	—	PS039S8NEX	—	2.047	3.858	7.874

*Semi Standard

CONTINUED ON NEXT PAGE



Z-PRO

Economical High Performance Taps

For Metric Threads

PO-OX



*Z-PRO PO-OX have an Oxide Surface Finish
Custom Blend High Vanadium HSS

The Z-PRO Series is designed for carbon steels, alloyed steels, irons, brass and free machining materials, including stainless steel that requires the most economical tool life. They are ideal for materials that produce stringy chips, such as steels, stainless steels and plastics.

Spiral Pointed taps are recommended for tapping through holes.

Plug Style (3 to 5 threads chamfered)
DIN lengths with ANSI shank dimensions.

Z-PRO Series PO-OX

Machine Screw Sizes
Fractional Sizes

TPI Nominal Size	No. of Flutes	Pitch Diameter Limit/ EDP Numbers							Dimensions		
		D5	D6	D7	D8	D9	D10	D11	Length of Thread	Neck Length	Length Overall
M39 X 4	4	—	—	—	—	PS039U9NEX	—	—	2.047	3.858	7.874
M42 X 1*	4	PS042M5NEX	—	—	—	—	—	—	1.142	3.858	7.874
M42 X 1.5*	4	—	PS042O6NEX	—	—	—	—	—	1.142	3.858	7.874
M42 X 2	4	—	—	PS042Q7NEX	—	—	—	—	1.142	3.858	7.874
M42 X 4.5	4	—	—	—	—	—	PS042VONEX	—	2.323	3.858	7.874
M45 X 1*	4	PS045M5NEX	—	—	—	—	—	—	1.22	4.252	8.661
M45 X 1.5*	4	—	PS045O6NEX	—	—	—	—	—	1.22	4.252	8.661
M45 X 2*	4	—	—	PS045Q7NEX	—	—	—	—	1.22	4.252	8.661
M45 X 3	4	—	—	—	PS045S8NEX	—	—	—	2.323	4.252	8.661
M45 X 4.5	4	—	—	—	—	—	PS045VONEX	—	2.323	4.252	8.661
M48 X 1*	4	—	PS048M6NEX	—	—	—	—	—	1.22	4.803	9.843
M48 X 1.5*	4	—	—	PS048O7NEX	—	—	—	—	1.22	4.803	9.843
M48 X 2*	4	—	—	PS048Q7NEX	—	—	—	—	1.22	4.803	9.843
M48 X 3	4	—	—	—	—	PS048S9NEX	—	—	2.559	4.803	9.843
M48 X 5	4	—	—	—	—	—	PS048W-NEX	—	2.559	4.803	9.843

*Semi Standard



Z-PRO

The Z-PRO Series is designed for carbon steels, alloyed steels, irons, brass and free machining materials, including stainless steel that requires the most economical tool life, They are ideal for materials that produce stringy chips, such as steels, stainless steels and plastics.

Spiral Fluted Bottoming taps are recommended for tapping blind holes where the chips are pulled out of the hole towards the tap shank instead of pushing them to the bottom of the hole.

Economical High Performance Taps For Unified Threads

SP



*Z-PRO SP have a Bright Surface Finish
*AVAILABLE IN TIN AND TICN UPON REQUEST
Custom Blend High Vanadium HSS

Bottoming Style (2.5 threads chamfered)
DIN lengths with ANSI shank dimensions.

Z-PRO Series SP

Machine Screw Sizes
Fractional Sizes

Nominal Size	TPI NC UNC	NF UNF	No. of Flutes	Pitch Diameter Limit/ EDP Numbers				Dimensions		
				H1	H2	H3	H4	Length of Thread	Neck Length	Length Overall
2	56	—	2	SSUN2E1NEB	SSUN2E2NEB	—	—	.314	—	1.772
2	—	64	2	SSUN2D1NEB	SSUN2D2NEB	—	—	.314	—	1.772
3	48	—	2	SSUN3F1NEB	SSUN3F2NEB	—	—	.354	.669	2.205
3	—	56	2	SSUN3E1NEB	SSUN3E2NEB	—	—	.354	.669	2.205
4	40	—	2	SSUN4H1NEB	SSUN4H2NEB	—	—	.354	.709	2.205
4	—	48	2	SSUN4F1NEB	SSUN4F2NEB	—	—	.354	.709	2.205
5	40	—	2	SSUN5H1NEB	SSUN5H2NEB	—	—	.433	.768	2.205
5	—	44	2	SSUN5G1NEB	SSUN5G2NEB	—	—	.433	.768	2.205
6	32	—	3	SSUN6J1NEB	SSUN6J2NEB	—	—	.433	.768	2.205
6	—	40	3	SSUN6H1NEB	SSUN6H2NEB	SSUN6H3NEB	—	.433	.768	2.205
8	32	—	3	—	SSUN8J2NEB	SSUN8J3NEB	—	.512	.827	2.480
8	—	36	3	—	SSUN8I2NEB	SSUN8I3NEB	—	.512	.827	2.480
10	24	—	3	—	SSUNAM2NEB	SSUNAM3NEB	—	.551	.984	2.756
10	—	32	3	—	SSUNAJ2NEB	SSUNAJ3NEB	—	.551	.984	2.756
12	24	—	3	—	SSUNCM2NEB	SSUNCM3NEB	—	.591	.984	3.150
12	—	28	3	—	SSUNCK2NEB	SSUNCK3NEB	—	.591	.984	3.150
1/4	20	—	3	—	SSU04N2NEB	SSU04N3NEB	—	.591	1.181	3.150
1/4	—	28	3	—	SSU04K2NEB	SSU04K3NEB	—	.591	1.181	3.150
5/16	18	—	3	—	SSU05O2NEB	SSU05O3NEB	—	.748	1.378	3.543
5/16	—	24	3	—	SSU05M2NEB	SSU05M3NEB	—	.748	1.378	3.543
3/8	16	—	3	—	—	SSU06P3NEB	SSU06P4NEB	.906	1.535	3.937
3/8	—	24	3	—	SSU06M2NEB	SSU06M3NEB	—	.906	1.535	3.937
7/16	14	—	3	—	—	SSU07Q3NEB	SSU07Q4NEB	.906	—	3.937
7/16	—	20	3	—	SSU07N2NEB	SSU07N3NEB	—	.906	—	3.937
1/2	13	—	3	—	—	SSU08R3NEB	SSU08R4NEB	1.024	—	4.331
1/2	—	20	3	—	SSU08N2NEB	SSU08N3NEB	—	1.024	—	4.331
9/16	12	—	3	—	—	SSU09S3NEB	SSU09S4NEB	1.024	—	4.331
9/16	—	18	3	—	—	SSU09O3NEB	SSU09O4NEB	1.024	—	4.331

CONTINUED ON NEXT PAGE



Economical High Performance Taps

For Unified Threads

SP



*Z-PRO SP have a Bright Surface Finish
 *AVAILABLE IN TIN AND TICN UPON REQUEST
 Custom Blend High Vanadium HSS

The Z-PRO Series is designed for carbon steels, alloyed steels, irons, brass and free machining materials, including stainless steel that requires the most economical tool life, They are ideal for materials that produce stringy chips, such as steels, stainless steels and plastics.

Spiral Fluted Bottoming taps are recommended for tapping blind holes where the chips are pulled out of the hole towards the tap shank instead of pushing them to the bottom of the hole.

Bottoming Style (2.5 threads chamfered)
 DIN lengths with ANSI shank dimensions.

Z-PRO Series SP

Machine Screw Sizes
 Fractional Sizes

TPI Nominal Size	NC UNC	NF UNF	No. of Flutes	Pitch Diameter Limit/ EDP Numbers				Dimensions		
				H3	H4	H5	H6	Length of Thread	Neck Length	Length Overall
5/8	11	—	3	SSU10U3NEB	SSU10U4NEB	—	—	1.024	—	4.331
5/8	—	18	3	SSU10O3NEB	SSU10O4NEB	—	—	1.024	—	4.331
3/4	10	—	4	SSU12V3NEB	—	SSU12V5NEB	—	1.299	—	4.921
3/4	—	16	4	SSU12P3NEB	SSU12P4NEB	—	—	1.299	—	4.921
7/8	9	—	4	—	SSU14W4NEB	SSU14W5NEB	—	1.299	—	5.512
7/8	—	14	4	SSU14Q3NEB	SSU14Q4NEB	—	—	1.299	—	5.512
1	8	—	4	—	SSU16X4NEB	SSU16X5NEB	—	1.457	—	6.299
1	—	12	3	SSU16S3NEB	—	SSU16S5NEB	—	1.457	—	6.299
1 1/8	7	—	4	—	SSU18Y4NEB	—	SSU18Y6NEB	1.732	—	7.087
1 1/8	—	12	4	—	SSU18S4NEB	SSU18S5NEB	—	1.732	—	7.087
1 1/4	7	—	4	—	SSU20Y4NEB	—	SSU20Y6NEB	1.929	—	7.087
1 1/4	—	12	4	—	SSU20S4NEB	SSU20S5NEB	—	1.929	—	7.087
1 3/8	6	—	4	—	—	SSU22Z5NEB	SS822Z6NEB	2.165	—	7.874
1 3/8	—	12	4	—	SSU22S4NEB	SSU22S5NEB	—	2.165	—	7.874
1 1/2	6	—	4	—	—	SSU24Z5NEB	SSU24Z6NEB	2.323	—	7.874
1 1/2	—	12	4	—	SSU24S4NEB	SSU24S5NEB	—	2.323	—	7.874



Z-PRO

The Z-PRO Series is designed for carbon steels, alloyed steels, irons, brass and free machining materials, including stainless steel that requires the most economical tool life, They are ideal for materials that produce stringy chips, such as steels, stainless steels and plastics.

Economical High Performance Taps For Unified Threads

SP-OX



*Z-PRO SP-OX have an Oxide Surface Finish
Custom Blend High Vanadium HSS

Spiral Fluted Bottoming taps are recommended for tapping blind holes where the chips are pulled out of the hole towards the tap shank instead of pushing them to the bottom of the hole.

Bottoming Style (2.5 threads chamfered)
DIN lengths with ANSI shank dimensions.

Z-PRO Series SP-OX

Machine Screw Sizes
Fractional Sizes

Nominal Size	TPI NC UNC	NF UNF	No. of Flutes	Pitch Diameter Limit/ EDP Numbers				Dimensions		
				H2	H3	H4	H5	Length of Thread	Neck Length	Length Overall
2	56	—	2	SSUN2E2NEX	—	—	—	.314	—	1.772
4	40	—	2	SSUN4H2NEX	—	—	—	.354	.709	2.205
5	40	—	2	SSUN5H2NEX	—	—	—	.433	.768	2.205
6	32	—	3	SSUN6J2NEX	—	—	—	.433	.768	2.205
6	—	40	3	SSUN6H2NEX	—	—	—	.433	.768	2.205
8	32	—	3	SSUN8J2NEX	SSUN8J3NEX	—	—	.512	.827	2.480
10	24	—	3	—	SSUNAM3NEX	—	—	.551	.984	2.756
10	—	32	3	—	SSUNAJ3NEX	—	—	.551	.984	2.756
12	24	—	3	—	SSUNCM3NEX	—	—	.591	.984	3.150
1/4	20	—	3	—	SSU04N3NEX	—	—	.591	1.181	3.150
1/4	—	28	3	—	SSU04K3NEX	—	—	.591	1.181	3.150
5/16	18	—	3	—	SSU05O3NEX	—	—	.748	1.378	3.543
5/16	—	24	3	—	SSU05M3NEX	SSU05M4NEX	—	.748	1.378	3.543
3/8	16	—	3	—	—	SSU06P4NEX	—	.906	1.535	3.937
3/8	—	24	3	—	SSU06M3NEX	—	—	.906	1.535	3.937
7/16	14	—	3	—	—	SSU07Q4NEX	—	.906	—	3.937
7/16	—	20	3	—	SSU07N3NEX	—	—	.906	—	3.937
1/2	13	—	3	—	—	SSU08R4NEX	—	1.024	—	4.331
1/2	—	20	3	—	SSU08N3NEX	—	—	1.024	—	4.331
9/16	12	—	3	—	SSU09S3NEX	—	—	1.024	—	4.331
9/16	—	18	3	—	SSU09O3NEX	—	—	1.024	—	4.331
5/8	11	—	3	—	—	SSU10U4NEX	—	1.024	—	4.331
5/8	—	18	3	—	SSU10O3NEX	—	—	1.024	—	4.331
3/4	10	—	4	—	—	—	SSU12V5NEX	1.299	—	4.921
3/4	—	16	4	—	—	SSU12P4NEX	—	1.299	—	4.921
7/8	9	—	4	—	—	SSU14W4NEX	—	1.299	—	5.512
7/8	—	14	4	—	SSU14Q3NEX	—	—	1.299	—	5.512
1	8	—	4	—	—	SSU16X4NEX	—	1.457	—	6.299
1	—	12	3	—	SSU16S3NEX	—	—	1.457	—	6.299
1 1/8	7	—	4	—	—	SSU18Y4NEX	—	1.732	—	7.087
1 1/8	—	12	4	—	—	SSU18S4NEX	—	1.732	—	7.087
1 1/4	7	—	4	—	—	SSU20Y4NEX	—	1.929	—	7.087
1 1/4	—	12	4	—	—	SSU20S4NEX	—	1.929	—	7.087
1 3/8	6	—	4	—	—	—	SSU22Z5NEX	2.165	—	7.874
1 3/8	—	12	4	—	—	SSU22S4NEX	—	2.165	—	7.874
1 1/2	6	—	4	—	—	—	SSU24Z5NEX	2.323	—	7.874
1 1/2	—	12	4	—	—	SSU24S4NEX	—	2.323	—	7.874



Economical High Performance Taps

For Metric Threads

SP



*Z-PRO SP have a Bright Surface Finish

*AVAILABLE IN TIN AND TICN UPON REQUEST

Custom Blend High Vanadium HSS

The Z-PRO Series is designed for carbon steels, alloyed steels, irons, brass and free machining materials, including stainless steel that requires the most economical tool life. They are ideal for materials that produce stringy chips, such as steels, stainless steels and plastics.

Spiral Fluted taps are recommended for tapping blind holes where the chips are pulled out of the hole towards the tap shank instead of pushing them to the bottom of the hole.

Bottoming Style (2.5 threads chamfered)
DIN lengths with ANSI shank dimensions.

Z-PRO Series SP
Machine Screw Sizes
Fractional Sizes

TPI Nominal Size	No. of Flutes	Pitch Diameter Limit/ EDP Numbers				Dimensions		
		D3	D4	D5	D6	Length of Thread	Neck Length	Length Overall
M2 X 0.4	2	SS2.0E3NEB	—	—	—	.314	.382	1.772
M2.2 X 0.45	2	SS2.2F3NEB	—	—	—	.314	.382	1.772
M2.5 X 0.45	2	SS2.5F3NEB	—	—	—	.354	.693	2.205
M2.6 X 0.45*	2	SS2.6F3NEB	—	—	—	.354	.693	2.205
M3 X 0.5	3	SS3.0G3NEB	—	—	—	.433	.768	2.205
M3.5 X 0.6	3	—	SS3.5H4NEB	—	—	.433	.787	2.205
M4 X 0.7	3	—	SS4.0I4NEB	—	—	.512	.827	2.48
M5 X 0.8	3	—	SS5.0K4NEB	—	—	.591	.984	3.15
M6 X 1	3	—	—	SS6.0M5NEB	—	.591	1.181	3.15
M7 X 0.5*	3	—	SS7.0G4NEB	—	—	.394	1.315	3.543
M7 X 0.75*	3	—	SS7.0J4NEB	—	—	.748	1.315	3.543
M7 X 1	3	—	—	SS7.0M5NEB	—	.748	1.315	3.543
M8 X 0.5*	3	—	SS8.0G4NEB	—	—	.394	1.382	3.543
M8 X 0.75*	3	—	SS8.0J4NEB	—	—	.748	1.382	3.543
M8 X 1	3	—	—	SS8.0M5NEB	—	.748	1.382	3.543
M8 X 1.25	3	—	—	SS8.0N5NEB	—	.748	1.382	3.543
M9 X 1*	3	—	—	SS9.0M5NEB	—	.748	1.382	3.543
M9 X 1.25*	3	—	—	SS9.0N5NEB	—	.748	1.382	3.543
M10 X 0.75*	3	—	SS010J4NEB	—	—	.512	1.929	3.937
M10 X 1*	3	—	—	SS010M5NEB	—	.906	1.929	3.937
M10 X 1.25	3	—	—	SS010N5NEB	—	.906	1.929	3.937
M10 X 1.5	3	—	—	—	SS010O6NEB	.906	1.929	3.937
M11 X 1.5*	3	—	—	—	SS011O6NEB	.906	1.929	3.937
M12 X 1*	3	—	—	SS012M5NEB	—	1.024	2.126	4.331
M12 X 1.25	3	—	—	—	SS012N6NEB	1.024	2.126	4.331
M12 X 1.5*	3	—	—	—	SS012O6NEB	1.024	2.126	4.331
M 12 X 1.75	3	—	—	—	SS012P6NEB	1.024	2.126	4.331

*Semi Standard

CONTINUED ON NEXT PAGE



Z-PRO

The Z-PRO Series is designed for carbon steels, alloyed steels, irons, brass and free machining materials, including stainless steel that requires the most economical tool life. They are ideal for materials that produce stringy chips, such as steels, stainless steels and plastics.

Spiral Fluted taps are recommended for tapping blind holes where the chips are pulled out of the hole towards the tap shank instead of pushing them to the bottom of the hole.

Economical High Performance Taps For Metric Threads

SP



*Z-PRO SP have a Bright Surface Finish
*AVAILABLE IN TIN AND TICN UPON REQUEST
Custom Blend High Vanadium HSS

Bottoming Style (2.5 threads chamfered)
DIN lengths with ANSI shank dimensions.

Z-PRO Series SP

Machine Screw Sizes
Fractional Sizes

TPI Nominal Size	No. of Flutes	Pitch Diameter Limit/ EDP Numbers				Dimensions		
		D5	D6	D7	D8	Length of Thread	Neck Length	Length Overall
M14 X 1*	3	SS014M5NEB	—	—	—	1.024	2.126	4.331
M14 X 1.25	4	—	SS014N6NEB	—	—	1.024	2.126	4.331
M14 X 1.5*	3	—	SS014O6NEB	—	—	1.024	2.126	4.331
M14 X 2	3	—	—	SS014Q7NEB	—	1.024	2.126	4.331
M16 X 1*	4	SS016M5NEB	—	—	—	1.024	2.126	4.331
M16 X 1.5	3	—	SS016O6NEB	—	—	1.024	2.126	4.331
M16 X 2	3	—	—	SS016Q7NEB	—	1.024	2.126	4.331
M18 X 1*	4	SS018M5NEB	—	—	—	.945	2.402	4.921
M18 X 1.5*	4	—	SS018O6NEB	—	—	.945	2.402	4.921
M18 X 2*	4	—	—	SS018Q7NEB	—	1.299	2.402	4.921
M18 X 2.5	4	—	—	SS018R7NEB	—	1.299	2.402	4.921
M20 X 1*	4	SS020M5NEB	—	—	—	.945	2.717	5.512
M20 X 1.5	4	—	SS020O6NEB	—	—	.945	2.717	5.512
M20 X 2*	4	—	—	SS020Q7NEB	—	1.299	2.717	5.512
M20 X 2.5	4	—	—	SS020R7NEB	—	1.299	2.717	5.512
M22 X 1*	4	SS022M5NEB	—	—	—	.945	2.717	5.512
M22 X 1.5	4	—	SS022O6NEB	—	—	.945	2.717	5.512
M22 X 2*	4	—	—	SS022Q7NEB	—	1.299	2.717	5.512
M22 X 2.5	4	—	—	SS022R7NEB	—	1.299	2.717	5.512
M24 X 1*	4	SS024M5NEB	—	—	—	1.063	3.071	6.299
M24 X 1.5*	4	—	SS024O6NEB	—	—	1.063	3.071	6.299
M24 X 2	4	—	—	SS024Q7NEB	—	1.063	3.071	6.299
M24 X 3	4	—	—	—	SS024S8NEB	1.457	3.071	6.299
M25 X 1.5*	4	—	SS025O6NEB	—	—	1.063	3.071	6.299
M26 X 1.5*	4	—	SS026O6NEB	—	—	1.063	3.465	7.087
M27 X 1*	4	SS027M5NEB	—	—	—	1.063	3.465	7.087

*Semi Standard

CONTINUED ON NEXT PAGE



Economical High Performance Taps

For Metric Threads

SP



*Z-PRO SP have a Bright Surface Finish
 *AVAILABLE IN TIN AND TICN UPON REQUEST
 Custom Blend High Vanadium HSS

The Z-PRO Series is designed for carbon steels, alloyed steels, irons, brass and free machining materials, including stainless steel that requires the most economical tool life. They are ideal for materials that produce stringy chips, such as steels, stainless steels and plastics.

Spiral Fluted taps are recommended for tapping blind holes where the chips are pulled out of the hole towards the tap shank instead of pushing them to the bottom of the hole.

Bottoming Style (2.5 threads chamfered)
 DIN lengths with ANSI shank dimensions.

Z-PRO Series SP
 Machine Screw Sizes
 Fractional Sizes

TPI Nominal Size	No. of Flutes	Pitch Diameter Limit/ EDP Numbers					Dimensions		
		D5	D6	D7	D8	D9	Length of Thread	Neck Length	Length Overall
M27 X 1.5*	4	—	SS027O6NEB	—	—	—	1.063	3.465	7.087
M27 X 2	4	—	—	SS027Q7NEB	—	—	1.063	3.465	7.087
M27 X 3	4	—	—	—	SS027S8NEB	—	1.732	3.465	7.087
M28 X 1*	4	SS028M5NEB	—	—	—	—	1.063	3.465	7.087
M28 X 1.5*	4	—	SS028O6NEB	—	—	—	1.063	3.465	7.087
M28 X 2*	4	—	—	SS028Q7NEB	—	—	1.063	3.465	7.087
M30 X 1*	4	SS030M5NEB	—	—	—	—	1.063	3.465	7.087
M30 X 1.5*	4	—	SS030O6NEB	—	—	—	1.063	3.465	7.087
M30 X 2	4	—	—	SS030Q7NEB	—	—	1.063	3.465	7.087
M30 X 3.5	4	—	—	—	—	SS030T9NEB	1.732	3.465	7.087
M32 X 1*	4	SS032M5NEB	—	—	—	—	1.063	3.465	7.087
M32 X 1.5*	4	—	SS032O6NEB	—	—	—	1.063	3.465	7.087
M32 X 2*	4	—	—	SS032Q7NEB	—	—	1.063	3.465	7.087
M33 X 1*	4	SS033M5NEB	—	—	—	—	1.142	3.465	7.087
M33 X 1.5*	4	—	SS033O6NEB	—	—	—	1.142	3.465	7.087
M33 X 2	4	—	—	SS033Q7NEB	—	—	1.142	3.465	7.087
M33 X 3.5	4	—	—	—	—	SS033T9NEB	1.181	3.465	7.087
M36 X 1*	4	SS036M5NEB	—	—	—	—	1.142	3.858	7.784
M36 X 1.5*	4	—	SS036O6NEB	—	—	—	1.142	3.858	7.874
M36 X 2*	4	—	—	SS036Q7NEB	—	—	1.142	3.858	7.874
M36 X 3	4	—	—	—	SS036S8NEB	—	2.047	3.858	7.874
M36 X 4	4	—	—	—	—	SS036U9NEB	2.047	3.858	7.874
M39 X 1*	4	SS039M5NEB	—	—	—	—	1.142	3.858	7.874
M39 X 1.5*	4	—	SS039O6NEB	—	—	—	1.142	3.858	7.874
M39 X 2*	4	—	—	SS039Q7NEB	—	—	1.142	3.858	7.874
M39 X 3	4	—	—	—	SS039S8NEB	—	2.047	3.858	7.874

*Semi Standard

CONTINUED ON NEXT PAGE



Z-PRO

Z
P
R
O

S
P

The Z-PRO Series is designed for carbon steels, alloyed steels, irons, brass and free machining materials, including stainless steel that requires the most economical tool life. They are ideal for materials that produce stringy chips, such as steels, stainless steels and plastics.

Spiral Fluted taps are recommended for tapping blind holes where the chips are pulled out of the hole towards the tap shank instead of pushing them to the bottom of the hole.

Economical High Performance Taps For Metric Threads

SP



*Z-PRO SP have a Bright Surface Finish
*AVAILABLE IN TIN AND TICN UPON REQUEST
Custom Blend High Vanadium HSS

Bottoming Style (2.5 threads chamfered)
DIN lengths with ANSI shank dimensions.

Z-PRO Series SP

Machine Screw Sizes
Fractional Sizes

TPI Nominal Size	No. of Flutes	Pitch Diameter Limit/ EDP Numbers							Dimensions		
		D5	D6	D7	D8	D9	D10	D11	Length of Thread	Neck Length	Length Overall
M39 X 4	4	—	—	—	—	SS039U9NEB	—	—	2.047	3.858	7.874
M42 X 1*	4	SS042M5NEB	—	—	—	—	—	—	1.142	3.858	7.874
M42 X 1.5*	4	—	SS042O6NEB	—	—	—	—	—	1.142	3.858	7.874
M42 X 2	4	—	—	SS042Q7NEB	—	—	—	—	1.142	3.858	7.874
M42 X 4.5	4	—	—	—	—	—	SS042VONEB	—	2.323	3.858	7.874
M45 X 1*	4	SS045M5NEB	—	—	—	—	—	—	1.22	4.252	8.661
M45 X 1.5*	4	—	SS045O6NEB	—	—	—	—	—	1.22	4.252	8.661
M45 X 2*	4	—	—	SS045Q7NEB	—	—	—	—	1.22	4.252	8.661
M45 X 3	4	—	—	—	SS045S8NEB	—	—	—	2.323	4.252	8.661
M45 X 4.5	4	—	—	—	—	—	SS045VONEB	—	2.323	4.252	8.661
M48 X 1*	4	—	SS048M6NEB	—	—	—	—	—	1.22	4.803	9.843
M48 X 1.5*	4	—	—	SS048O7NEB	—	—	—	—	1.22	4.803	9.843
M48 X 2*	4	—	—	SS048Q7NEB	—	—	—	—	1.22	4.803	9.843
M48 X 3	4	—	—	—	—	SS048S9NEB	—	—	2.559	4.803	9.843
M48 X 5	4	—	—	—	—	—	SS048W-NEB	—	2.559	4.803	9.843

*Semi Standard



Economical High Performance Taps

For Metric Threads

SP-OX



*Z-PRO SP-OX have an Oxide Surface Finish
Custom Blend High Vanadium HSS

The Z-PRO Series is designed for carbon steels, alloyed steels, irons, brass and free machining materials, including stainless steel that requires the most economical tool life. They are ideal for materials that produce stringy chips, such as steels, stainless steels and plastics.

Spiral Fluted taps are recommended for tapping blind holes where the chips are pulled out of the hole towards the tap shank instead of pushing them to the bottom of the hole.

Bottoming Style (2.5 threads chamfered) DIN lengths with ANSI shank dimensions.		Z-PRO Series SP-OX				Machine Screw Sizes Fractional Sizes		
TPI Nominal Size	No. of Flutes	Pitch Diameter Limit/ EDP Numbers				Dimensions		
		D3	D4	D5	D6	Length of Thread	Neck Length	Length Overall
M2 X 0.4	2	SS2.0E3NEX	—	—	—	.314	.382	1.772
M2.2 X 0.45	2	SS2.2F3NEX	—	—	—	.314	.382	1.772
M2.5 X 0.45	2	SS2.5F3NEX	—	—	—	.354	.693	2.205
M2.6 X 0.45*	2	SS2.6F3NEX	—	—	—	.354	.693	2.205
M3 X 0.5	3	SS3.0G3NEX	—	—	—	.433	.768	2.205
M3.5 X 0.6	3	—	SS3.5H4NEX	—	—	.433	.787	2.205
M4 X 0.7	3	—	SS4.0I4NEX	—	—	.512	.827	2.48
M5 X 0.8	3	—	SS5.0K4NEX	—	—	.591	.984	3.15
M6 X 1	3	—	—	SS6.0M5NEX	—	.591	1.181	3.15
M7 X 0.5*	3	—	SS7.0G4NEX	—	—	.394	1.315	3.543
M7 X 0.75*	3	—	SS7.0J4NEX	—	—	.748	1.315	3.543
M7 X 1	3	—	—	SS7.0M5NEX	—	.748	1.315	3.543
M8 X 0.5*	3	—	SS8.0G4NEX	—	—	.394	1.382	3.543
M8 X 0.75*	3	—	SS8.0J4NEX	—	—	.748	1.382	3.543
M8 X 1	3	—	—	SS8.0M5NEX	—	.748	1.382	3.543
M8 X 1.25	3	—	—	SS8.0N5NEX	—	.748	1.382	3.543
M9 X 1*	3	—	—	SS9.0M5NEX	—	.748	1.382	3.543
M9 X 1.25*	3	—	—	SS9.0N5NEX	—	.748	1.382	3.543
M10 X 0.75*	3	—	SS10J4NEX	—	—	.512	1.929	3.937
M10 X 1*	3	—	—	SS10M5NEX	—	.906	1.929	3.937
M10 X 1.25	3	—	—	SS10N5NEX	—	.906	1.929	3.937
M10 X 1.5	3	—	—	—	SS010O6NEX	.906	1.929	3.937
M11 X 1.5*	3	—	—	—	SS011O6NEX	.906	1.929	3.937
M12 X 1*	3	—	—	SS012M5NEX	—	1.024	2.126	4.331
M12 X 1.25	3	—	—	—	SS012N6NEX	1.024	2.126	4.331
M12 X 1.5*	3	—	—	—	SS012O6NEX	1.024	2.126	4.331
M 12 X 1.75	3	—	—	—	SS012P6NEX	1.024	2.126	4.331

*Semi Standard

CONTINUED ON NEXT PAGE



Z-PRO

Z
P
R
O

S
P

The Z-PRO Series is designed for carbon steels, alloyed steels, irons, brass and free machining materials, including stainless steel that requires the most economical tool life. They are ideal for materials that produce stringy chips, such as steels, stainless steels and plastics.

Spiral Fluted taps are recommended for tapping blind holes where the chips are pulled out of the hole towards the tap shank instead of pushing them to the bottom of the hole.

Economical High Performance Taps
For Metric Threads

SP-OX



*Z-PRO SP-OX have an Oxide Surface Finish
Custom Blend High Vanadium HSS

Bottoming Style (2.5 threads chamfered)
DIN lengths with ANSI shank dimensions.

Z-PRO Series SP-OX

Machine Screw Sizes
Fractional Sizes

TPI Nominal Size	No. of Flutes	Pitch Diameter Limit/ EDP Numbers				Dimensions		
		D5	D6	D7	D8	Length of Thread	Neck Length	Length Overall
M14 X 1*	3	SS014M5NEX	—	—	—	1.024	2.126	4.331
M14 X 1.25	4	—	SS014N6NEX	—	—	1.024	2.126	4.331
M14 X 1.5*	3	—	SS014O6NEX	—	—	1.024	2.126	4.331
M14 X 2	3	—	—	SS014Q7NEX	—	1.024	2.126	4.331
M16 X 1*	4	SS016M5NEX	—	—	—	1.024	2.126	4.331
M16 X 1.5	3	—	SS016O6NEX	—	—	1.024	2.126	4.331
M16 X 2	4	—	—	SS016Q7NEX	—	1.024	2.126	4.331
M18 X 1*	4	SS018M5NEX	—	—	—	.945	2.402	4.921
M18 X 1.5*	4	—	SS018O6NEX	—	—	.945	2.402	4.921
M18 X 2*	4	—	—	SS018Q7NEX	—	1.299	2.402	4.921
M18 X 2.5	4	—	—	SS018R7NEX	—	1.299	2.402	4.921
M20 X 1*	4	SS020M5NEX	—	—	—	.945	2.717	5.512
M20 X 1.5	4	—	SS020O6NEX	—	—	.945	2.717	5.512
M20 X 2*	4	—	—	SS020Q7NEX	—	1.299	2.717	5.512
M20 X 2.5	4	—	—	SS020R7NEX	—	1.299	2.717	5.512
M22 X 1*	4	SS022M5NEX	—	—	—	.945	2.717	5.512
M22 X 1.5	4	—	SS022O6NEX	—	—	.945	2.717	5.512
M22 X 2*	4	—	—	SS022Q7NEX	—	1.299	2.717	5.512
M22 X 2.5	4	—	—	SS022R7NEX	—	1.299	2.717	5.512
M24 X 1*	4	SS024M5NEX	—	—	—	1.063	3.071	6.299
M24 X 1.5*	4	—	SS024O6NEX	—	—	1.063	3.071	6.299
M24 X 2	4	—	—	SS024Q7NEX	—	1.063	3.071	6.299
M24 X 3	4	—	—	—	SS024S8NEX	1.457	3.071	6.299
M25 X 1.5*	4	—	SS025O6NEX	—	—	1.063	3.071	6.299
M26 X 1.5*	4	—	SS026O6NEX	—	—	1.063	3.465	7.087
M27 X 1*	4	SS027M5NEX	—	—	—	1.063	3.465	7.087

*Semi Standard

CONTINUED ON NEXT PAGE



Economical High Performance Taps

For Metric Threads

SP-OX



*Z-PRO SP-OX have an Oxide Surface Finish
Custom Blend High Vanadium HSS

The Z-PRO Series is designed for carbon steels, alloyed steels, irons, brass and free machining materials, including stainless steel that requires the most economical tool life. They are ideal for materials that produce stringy chips, such as steels, stainless steels and plastics.

Spiral Fluted taps are recommended for tapping blind holes where the chips are pulled out of the hole towards the tap shank instead of pushing them to the bottom of the hole.

Bottoming Style (2.5 threads chamfered)
DIN lengths with ANSI shank dimensions.

Z-PRO Series SP-OX

Machine Screw Sizes
Fractional Sizes

TPI Nominal Size	No. of Flutes	Pitch Diameter Limit/ EDP Numbers					Dimensions		
		D5	D6	D7	D8	D9	Length of Thread	Neck Length	Length Overall
M27 X 1.5*	4	—	SS027O6NEX	—	—	—	1.063	3.465	7.087
M27 X 2	4	—	—	SS027Q7NEX	—	—	1.063	3.465	7.087
M27 X 3	4	—	—	—	SS027S8NEX	—	1.732	3.465	7.087
M28 X 1*	4	SS028M5NEX	—	—	—	—	1.063	3.465	7.087
M28 X 1.5*	4	—	SS028O6NEX	—	—	—	1.063	3.465	7.087
M28 X 2*	4	—	—	SS028Q7NEX	—	—	1.063	3.465	7.087
M30 X 1*	4	SS030M5NEX	—	—	—	—	1.063	3.465	7.087
M30 X 1.5*	4	—	SS030O6NEX	—	—	—	1.063	3.465	7.087
M30 X 2	4	—	—	SS030Q7NEX	—	—	1.063	3.465	7.087
M30 X 3.5	4	—	—	—	—	SS030T9NEX	1.732	3.465	7.087
M32 X 1*	4	SS032M5NEX	—	—	—	—	1.063	3.465	7.087
M32 X 1.5*	4	—	SS032O6NEX	—	—	—	1.063	3.465	7.087
M32 X 2*	4	—	—	SS032Q7NEX	—	—	1.063	3.465	7.087
M33 X 1*	4	SS033M5NEX	—	—	—	—	1.142	3.465	7.087
M33 X 1.5*	4	—	SS033O6NEX	—	—	—	1.142	3.465	7.087
M33 X 2	4	—	—	SS033Q7NEX	—	—	1.142	3.465	7.087
M33 X 3.5	4	—	—	—	—	SS033T9NEX	1.181	3.465	7.087
M36 X 1*	4	SS036M5NEX	—	—	—	—	1.142	3.858	7.784
M36 X 1.5*	4	—	SS036O6NEX	—	—	—	1.142	3.858	7.774
M36 X 2*	4	—	—	SS036Q7NEX	—	—	1.142	3.858	7.774
M36 X 3	4	—	—	—	SS036S8NEX	—	2.047	3.858	7.774
M36 X 4	4	—	—	—	—	SS036U9NEX	2.047	3.858	7.774
M39 X 1*	4	SS039M5NEX	—	—	—	—	1.142	3.858	7.774
M39 X 1.5*	4	—	SS039O6NEX	—	—	—	1.142	3.858	7.774
M39 X 2*	4	—	—	SS039Q7NEX	—	—	1.142	3.858	7.774
M39 X 3	4	—	—	—	SS039S8NEX	—	2.047	3.858	7.774

*Semi Standard

CONTINUED ON NEXT PAGE



Z-PRO

The Z-PRO Series is designed for carbon steels, alloyed steels, irons, brass and free machining materials, including stainless steel that requires the most economical tool life. They are ideal for materials that produce stringy chips, such as steels, stainless steels and plastics.

Spiral Fluted taps are recommended for tapping blind holes where the chips are pulled out of the hole towards the tap shank instead of pushing them to the bottom of the hole.

Economical High Performance Taps For Metric Threads

SP-OX



*Z-PRO SP-OX have an Oxide Surface Finish
Custom Blend High Vanadium HSS

Bottoming Style (2.5 threads chamfered)
DIN lengths with ANSI shank dimensions.

Z-PRO Series SP-OX

Machine Screw Sizes
Fractional Sizes

TPI Nominal Size	No. of Flutes	Pitch Diameter Limit/ EDP Numbers							Dimensions		
		D5	D6	D7	D8	D9	D10	D11	Length of Thread	Neck Length	Length Overall
M39 X 4	4	—	—	—	—	SS039U9NEX	—	—	2.047	3.858	7.874
M42 X 1*	4	SS042M5NEX	—	—	—	—	—	—	1.142	3.858	7.874
M42 X 1.5*	4	—	SS042O6NEX	—	—	—	—	—	1.142	3.858	7.874
M42 X 2	4	—	—	SS042Q7NEX	—	—	—	—	1.142	3.858	7.874
M42 X 4.5	4	—	—	—	—	—	SS042VONEX	—	2.323	3.858	7.874
M45 X 1*	4	SS045M5NEX	—	—	—	—	—	—	1.22	4.252	8.661
M45 X 1.5*	4	—	SS045O6NEX	—	—	—	—	—	1.22	4.252	8.661
M45 X 2*	4	—	—	SS045Q7NEX	—	—	—	—	1.22	4.252	8.661
M45 X 3	4	—	—	—	SS045S8NEX	—	—	—	2.323	4.252	8.661
M45 X 4.5	4	—	—	—	—	—	SS045VONEX	—	2.323	4.252	8.661
M48 X 1*	4	—	SS048M6NEX	—	—	—	—	—	1.22	4.803	9.843
M48 X 1.5*	4	—	—	SS048O7NEX	—	—	—	—	1.22	4.803	9.843
M48 X 2*	4	—	—	SS048Q7NEX	—	—	—	—	1.22	4.803	9.843
M48 X 3	4	—	—	—	—	SS048S9NEX	—	—	2.559	4.803	9.843
M48 X 5	4	—	—	—	—	—	—	SS048W-NEX	2.559	4.803	9.843

*Semi Standard



Economical High Performance Taps

For Unified Threads

Z-PRO HT



*Z-PRO HT have a Bright Surface Finish
 *AVAILABLE IN TIN AND TICN UPON REQUEST
 Custom Blend High Vanadium HSS

For Tapping Steels, Irons, Brass and Plastics

Z-PRO HT are manufactured from YMW's own high speed steel for maximum toughness and wear life.

Z-PRO HT are the most popular style of general purpose taps for tapping under power or by hand.

Plug Style (5 threads chamfered)
 DIN lengths with ANSI shank dimensions.

Z-PRO Series HT

Machine Screw Sizes
 Fractional Sizes

Nominal Size	TPI NC UNC	NF UNF	No. of Flutes	Pitch Diameter Limit/ EDP Numbers					Dimensions		
				H1	H2	H3	H4	H5	Length of Thread	Neck Length	Length Overall
0	80	—	2	TSUN0B1NEB5	TSUN0B2NEB5	—	—	—	.236	—	1.772
1	64	—	2	TSUN1D1NEB5	TSUN1D2NEB5	—	—	—	.275	—	1.772
1	—	72	2	TSUN1C1NEB5	TSUN1C2NEB5	—	—	—	.375	—	1.772
2	56	—	3	TSUN2E1NEB5	TSUN2E2NEB4	—	—	—	.314	—	1.772
2	—	64	3	TSUN2D1NEB5	TSUN2D2NEB5	—	—	—	.314	—	2.205
3	48	—	3	TSUN3F1NEB5	TSUN3F2NEB5	—	—	—	.314	.669	2.205
3	—	56	3	TSUN3E1NEB5	TSUN3E2NEB5	—	—	—	.354	.669	2.205
4	40	—	3	—	TSUN4H2NEB5	TSUN4H3NEB4	—	—	.354	.709	2.205
4	—	48	3	TSUN4F1NEB5	TSUN4F2NEB5	—	—	—	.354	.709	2.205
5	40	—	3	—	TSUN5H2NEB5	TSUN5H3NEB4	—	—	.433	.768	2.205
5	—	44	3	—	TSUN5G2NEB5	TSUN5G3NEB5	—	—	.433	.768	2.205
6	32	—	3	—	TSUN6J2NEB5	TSUN6J3NEB4	—	—	.433	.768	2.205
6	—	40	3	—	TSUN6H2NEB5	TSUN6H3NEB4	—	—	.433	.768	2.205
8	32	—	4	—	TSUN8J2NEB5	TSUN8J3NEB4	—	—	.512	.827	2.480
8	—	36	4	—	TSUN8I2NEB5	TSUN8I3NEB5	—	—	.512	.827	2.480
10	24	—	4	—	TSUNAM2NEB5	TSUNAM3NEB4	—	—	.551	.984	2.756
10	—	32	4	—	TSUNAJ2NEB5	TSUNAJ3NEB4	—	—	.551	.984	2.756
12	24	—	4	—	TSUNCM2NEB5	TSUNCM3NEB4	—	—	.591	.984	3.150
12	—	28	4	—	TSUNCK2NEB5	TSUNCK3NEB5	—	—	.591	.984	3.150
1/4	20	—	4	—	—	TSU04N3NEB5	TSU04N4NEB4	—	.591	1.181	3.150
1/4	—	28	4	—	TSU04K2NEB5	TSU04K3NEB5	—	—	.591	1.181	3.150
5/16	18	—	4	—	—	TSU05O3NEB5	TSU05O4NEB4	—	.748	1.378	3.543
5/16	—	24	4	—	—	TSU05M3NEB5	TSU05M4NEB4	—	.748	1.378	3.543
3/8	16	—	4	—	—	TSU06P3NEB5	—	TSU06P5NEB4	.906	1.535	3.937
3/8	—	24	4	—	—	TSU06M3NEB5	TSU06M4NEB4	—	.906	1.535	3.937
7/16	14	—	4	—	—	—	TSU07Q4NEB5	TSU07Q5NEB4	.906	—	3.937
7/16	—	20	4	—	—	TSU07N3NEB5	TSU07N4NEB4	—	.906	—	3.937
1/2	13	—	4	—	—	—	TSU08R4NEB5	TSU08R5NEB4	1.024	—	4.331
1/2	—	20	4	—	—	TSU08N3NEB5	TSU08N4NEB4	—	1.024	—	4.331
9/16	12	—	4	—	—	—	TSU09S4NEB5	TSU09S5NEB4	1.024	—	4.331
9/16	—	18	4	—	—	—	TSU09O4NEB5	TSU09O5NEB4	1.024	—	4.331



Z-PRO

Z
P
R
O

H
T

For Tapping Steels, Iron, Brass and Plastics

Z-PRO HT are manufactured from YMW's own high speed steel for maximum toughness and wear life.

Z-PRO HT are the most popular style of general purpose taps for tapping under power by hand.

Economical High Performance Taps
For Unified Threads

Z-PRO HT



*Z-PRO HT have a Bright Surface Finish
*AVAILABLE IN TIN AND TICN UPON REQUEST
Custom Blend High Vanadium HSS

Plug Style (5 threads chamfered)
DIN lengths with ANSI shank dimensions.

Z-PRO Series HT

Machine Screw Sizes
Fractional Sizes

TPI Nominal Size	NC UNC	NF UNF	No. of Flutes	Pitch Diameter Limit/ EDP Numbers					Dimensions			
				H4	H5	H6	H7	H8	Length of Thread	Neck Length	Length Overall	
5/8	11	—	4	TSU10U4NEB5	—	TSU10U6NEB4	—	—	—	1.024	—	4.331
5/8	—	18	4	TSU10O4NEB5	TSU10O5NEB4	—	—	—	—	1.024	—	4.331
3/4	10	—	4	—	TSU12V5NEB5	TSU12V6NEB4	—	—	—	1.299	—	4.921
3/4	—	16	4	TSU12P4NEB5	TSU12P5NEB4	—	—	—	—	1.299	—	4.921
7/8	9	—	4	—	TSU14W5NEB5	TSU14W6NEB4	—	—	—	1.299	—	5.512
7/8	—	14	4	TSU14Q4NEB5	—	TSU14Q6NEB5	—	—	—	1.299	—	5.512
1	8	—	4	—	TSU16X5NEB5	—	TSU16X7NEB5	—	—	1.457	—	6.299
1	—	12	4	—	TSU16S5NEB5	TSU16S6NEB5	—	—	—	1.457	—	6.299
1 1/8	7	—	4	—	—	TSU18Y6NEB5	TSU18Y7NEB5	—	—	1.732	—	7.087
1 1/8	—	12	4	—	TSU18S5NEB5	TSU18S6NEB5	—	—	—	1.732	—	7.087
1 1/4	7	—	4	—	—	TSU20Y6NEB5	—	TSU20Y8NEB5	—	1.929	—	7.087
1 1/4	—	12	4	—	TSU20S5NEB5	TSU20S6NEB5	—	—	—	1.929	—	7.087
1 3/8	6	—	4	—	—	TSU22Z6NEB5	—	TSU22Z8NEB5	—	2.165	—	7.874
1 3/8	—	12	6	—	TSU22S5NEB5	TSU22S6NEB5	—	—	—	2.165	—	7.874
1 1/2	6	—	4	—	—	TSU24Z6NEB5	—	TSU24Z8NEB5	—	2.323	—	7.874
1 1/2	—	12	6	—	TSU24S5NEB5	—	TSU24S7NEB5	—	—	2.323	—	7.874



Economical High Performance Taps

For Unified Threads

Z-PRO HT-OX



*Z-PRO HT-OX have an Oxide Surface Treatment
Custom Blend High Vanadium HSS

For Tapping Steels, Irons, Brass and Plastics

Z-PRO HT are manufactured from YMW's own high speed steel for maximum toughness and wear life.

Z-PRO HT are the most popular style of general purpose taps for tapping under power or by hand.

Plug Style (5 threads chamfered)
DIN lengths with ANSI shank dimensions.

Z-PRO Series HT-OX

Machine Screw Sizes
Fractional Sizes

Nominal Size	TPI		No. of Flutes	Pitch Diameter Limit/ EDP Numbers						Dimensions		
	NC	NF		H2	H3	H4	H5	H6	Length of Thread	Neck Length	Length Overall	
	UNC	UNF										
2	56	—	3	TSUN2E2NEX5	—	—	—	—	.314	—	1.772	
4	40	—	3	—	TSUN4H3NEX5	—	—	—	.354	.709	2.205	
5	40	—	3	—	TSUN5H3NEX5	—	—	—	.433	.768	2.205	
6	32	—	3	—	TSUN6J3NEX5	—	—	—	.433	.787	2.205	
6	—	40	3	—	TSUN6H3NEX5	—	—	—	.433	.787	2.205	
8	32	—	4	—	TSUN8J3NEX5	—	—	—	.512	.827	2.480	
10	24	—	4	—	TSUNAM3NEX5	—	—	—	.551	.984	2.756	
10	—	32	4	—	TSUNAJ3NEX5	—	—	—	.551	.984	2.756	
12	24	—	4	—	TSUNCM3NEX5	—	—	—	.591	.984	3.150	
1/4	20	—	4	—	—	TSU04N4NEX5	—	—	.591	1.181	3.150	
1/4	—	28	4	—	TSU04K3NEX5	—	—	—	.591	1.181	3.150	
5/16	18	—	4	—	—	TSU05O4NEX5	—	—	.748	1.378	3.543	
5/16	—	24	4	—	—	TSU05M4NEX5	—	—	.748	1.378	3.543	
3/8	16	—	4	—	—	—	TSU06P5NEX5	—	.906	1.535	3.937	
3/8	—	24	4	—	—	TSU06M4NEX5	—	—	.906	1.535	3.937	
7/16	14	—	4	—	—	—	TSU07Q5NEX5	—	.906	—	3.937	
7/16	—	20	4	—	—	TSU07N4NEX5	—	—	.906	—	3.937	
1/2	13	—	4	—	—	—	TSU08R5NEX5	—	1.024	—	4.331	
1/2	—	20	4	—	—	TSU08N4NEX5	—	—	1.024	—	4.331	
9/16	12	—	4	—	—	—	TSU09S5NEX5	—	1.024	—	4.331	
9/16	—	18	4	—	—	—	TSU09O5NEX5	—	1.024	—	4.331	
5/8	11	—	4	—	—	—	—	TSU10U6NEX5	1.024	—	4.331	
5/8	—	18	4	—	—	—	TSU10O5NEX5	—	1.024	—	4.331	
3/4	10	—	4	—	—	—	TSU12V5NEX5	TSU12V6NEX5	1.299	—	4.921	
3/4	—	16	4	—	—	—	TSU12P5NEX5	—	1.299	—	4.921	
7/8	9	—	4	—	—	—	—	TSU14W6NEX5	1.299	—	5.512	
1	8	—	4	—	—	—	—	TSU16X7NEX5	1.457	—	6.299	



Z-PRO

For Tapping Steels, Irons, Brass and Plastics

Z-PRO HT are manufactured from YMW's own high speed steel for maximum toughness and wear life.

Z-PRO HT are the most popular style of general purpose taps for tapping under power or by hand.

Economical High Performance Taps
For Metric Threads

Z-PRO HT



*Z-PRO HT have a Bright Surface Finish
*AVAILABLE IN TIN AND TICN UPON REQUEST

Custom Blend High Vanadium HSS

Plug Style (5 threads chamfered)
DIN lengths with ANSI shank dimensions.

Z-PRO Series HT

Metric Sizes

TPI Nominal Size	No. of Flutes	Pitch Diameter Limit/ EDP Numbers				Dimensions		
		D3	D4	D5	D6	Length of Thread	Neck Length	Length Overall
M2 X 0.4	3	TS2.0E3NEB5	—	—	—	.314	.382	1.772
M2.2 X 0.45	3	TS2.2F3NEB5	—	—	—	.314	.382	1.772
M2.5 X 0.45	3	TS2.5F3NEB5	—	—	—	.354	.693	2.205
M2.6 X 0.45*	3	TS2.6F3NEB5	—	—	—	.354	.693	2.205
M3 X 0.5	3	TS3.0G3NEB5	—	—	—	.433	.768	2.205
M3.5 X 0.6	3	—	TS3.5H4NEB5	—	—	.433	.787	2.205
M4 X 0.7	3	—	TS4.0I4NEB5	—	—	.512	.827	2.48
M5 X 0.8	3	—	TS5.0K4NEB5	—	—	.591	.984	3.15
M6 X 1	3	—	—	TS6.0M5NEB5	—	.591	1.181	3.15
M7 X 0.5*	4	—	TS7.0G4NEB5	—	—	.394	1.315	3.543
M7 X 0.75*	4	—	TS7.0J4NEB5	—	—	.748	1.315	3.543
M7 X 1	4	—	—	TS7.0M5NEB5	—	.748	1.315	3.543
M8 X 0.5*	4	—	TS8.0G4NEB5	—	—	.394	1.382	3.543
M8 X 0.75*	4	—	TS8.0J4NEB5	—	—	.748	1.382	3.543
M8 X 1	4	—	—	TS8.0M5NEB5	—	.748	1.382	3.543
M8 X 1.25	3	—	—	TS8.0N5NEB5	—	.748	1.382	3.543
M9 X 1*	4	—	—	TS9.0M5NEB5	—	.748	1.382	3.543
M9 X 1.25*	4	—	—	TS9.0N5NEB5	—	.748	1.382	3.543
M10 X 0.75*	4	—	TS010J4NEB5	—	—	.512	1.929	3.937
M10 X 1*	4	—	—	TS010M5NEB5	—	.906	1.929	3.937
M10 X 1.25	4	—	—	TS010N5NEB5	—	.906	1.929	3.937
M10 X 1.5	4	—	—	—	TS010O6NEB5	.906	1.929	3.937
M11 X 1.5*	4	—	—	—	TS011O6NEB5	.906	1.929	3.937
M12 X 1*	4	—	—	TS012M5NEB5	—	1.024	2.126	4.331
M12 X 1.25	4	—	—	—	TS012N6NEB5	1.024	2.126	4.331
M12 X 1.5*	4	—	—	—	TS012O6NEB5	1.024	2.126	4.331
M 12 X 1.75	4	—	—	—	TS012P6NEB5	1.024	2.126	4.331

*Semi Standard

CONTINUED ON NEXT PAGE



Economical High Performance Taps For Metric Threads

Z-PRO HT



*Z-PRO HT have a Bright Surface Finish
*AVAILABLE IN TIN AND TICN UPON REQUEST
Custom Blend High Vanadium HSS

For Tapping Steels, Irons, Brass and Plastics

Z-PRO HT are manufactured from YMW'S own high speed steel for maximum toughness and wear life.

Z-PRO HT are the most popular style of general purpose taps for tapping under power or by hand.

Plug Style (5 threads chamfered)
DIN lengths with ANSI shank dimensions.

TPI Nominal Size	No. of Flutes	Pitch Diameter Limit/ EDP Numbers				Dimensions		
		D5	D6	D7	D8	Length of Thread	Neck Length	Length Overall
M14 X 1*	4	TS014M5NEB5	—	—	—	1.024	2.126	4.331
M14 X 1.25	4	—	TS014N6NEB5	—	—	1.024	2.126	4.331
M14 X 1.5*	4	—	TS014O6NEB5	—	—	1.024	2.126	4.331
M14 X 2	4	—	—	TS014Q7NEB5	—	1.024	2.126	4.331
M16 X 1*	4	TS016M5NEB5	—	—	—	1.024	2.126	4.331
M16 X 1.5	4	—	TS016O6NEB5	—	—	1.024	2.126	4.331
M16 X 2	4	—	—	TS016Q7NEB5	—	1.024	2.126	4.331
M18 X 1*	4	TS018M5NEB5	—	—	—	.945	2.402	4.921
M18 X 1.5*	4	—	TS018O6NEB5	—	—	.945	2.402	4.921
M18 X 2*	4	—	—	TS018Q7NEB5	—	1.299	2.402	4.921
M18 X 2.5	4	—	—	TS018R7NEB5	—	1.299	2.402	4.921
M20 X 1*	4	TS020M5NEB5	—	—	—	.945	2.717	5.512
M20 X 1.5	4	—	TS020O6NEB5	—	—	.945	2.717	5.512
M20 X 2*	4	—	—	TS020Q7NEB5	—	1.299	2.717	5.512
M20 X 2.5	4	—	—	TS020R7NEB5	—	1.299	2.717	5.512
M22 X 1*	4	TS022M5NEB5	—	—	—	.945	2.717	5.512
M22 X 1.5	4	—	TS022O6NEB5	—	—	.945	2.717	5.512
M22 X 2*	4	—	—	TS022Q7NEB5	—	1.299	2.717	5.512
M22 X 2.5	4	—	—	TS022R7NEB5	—	1.299	2.717	5.512
M24 X 1*	4	TS024M5NEB5	—	—	—	1.063	3.071	6.299
M24 X 1.5*	4	—	TS024O6NEB5	—	—	1.063	3.071	6.299
M24 X 2	4	—	—	TS024Q7NEB5	—	1.063	3.071	6.299
M24 X 3	4	—	—	—	TS024S8NEB5	1.457	3.071	6.299
M25 X 1.5*	4	—	TS025O6NEB5	—	—	1.063	3.071	6.299
M26 X 1.5*	4	—	TS026O6NEB5	—	—	1.063	3.465	7.087
M27 X 1*	4	TS027M5NEB5	—	—	—	1.063	3.465	7.087

*Semi Standard

CONTINUED ON NEXT PAGE



Z-PRO

For Tapping Steels, Irons, Brass and Plastics

Z-PRO HT are manufactured from YMW'S own high speed steel for maximum toughness and wear life.

Z-PRO HT are the most popular style of general purpose taps for tapping under power or by hand.

Economical High Performance Taps
For Metric Threads

Z-PRO HT



*Z-PRO HT have a Bright Surface Finish
*AVAILABLE IN TIN AND TICN UPON REQUEST
Custom Blend High Vanadium HSS

Plug Style (5 threads chamfered)
DIN lengths with ANSI shank dimensions.

Z-PRO Series HT

Metric Sizes

TPI Nominal Size	No. of Flutes	Pitch Diameter Limit/ EDP Numbers					Dimensions		
		D5	D6	D7	D8	D9	Length of Thread	Neck Length	Length Overall
M27 X 1.5*	4	—	TS027O6NEB5	—	—	—	1.063	3.465	7.087
M27 X 2	4	—	—	TS027Q7NEB5	—	—	1.063	3.465	7.087
M27 X 3	4	—	—	—	TS027S8NEB5	—	1.732	3.465	7.087
M28 X 1*	4	TS028M5NEB5	—	—	—	—	1.063	3.465	7.087
M28 X 1.5*	4	—	TS028O6NEB5	—	—	—	1.063	3.465	7.087
M28 X 2*	4	—	—	TS028Q7NEB5	—	—	1.063	3.465	7.087
M30 X 1*	4	TS030M5NEB5	—	—	—	—	1.063	3.465	7.087
M30 X 1.5*	4	—	TS030O6NEB5	—	—	—	1.063	3.465	7.087
M30 X 2	4	—	—	TS030Q7NEB5	—	—	1.063	3.465	7.087
M30 X 3.5	4	—	—	—	—	TS030T9NEB5	1.732	3.465	7.087
M32 X 1*	4	TS032M5NEB5	—	—	—	—	1.063	3.465	7.087
M32 X 1.5*	4	—	TS032O6NEB5	—	—	—	1.063	3.465	7.087
M32 X 2*	4	—	—	TS032Q7NEB5	—	—	1.063	3.465	7.087
M33 X 1*	4	TS033M5NEB5	—	—	—	—	1.142	3.465	7.087
M33 X 1.5*	4	—	TS033O6NEB5	—	—	—	1.142	3.465	7.087
M33 X 2	4	—	—	TS033Q7NEB5	—	—	1.142	3.465	7.087
M33 X 3.5	4	—	—	—	—	TS033T9NEB5	1.181	3.465	7.087
M36 X 1*	4	TS036M5NEB5	—	—	—	—	1.142	3.858	7.784
M36 X 1.5*	4	—	TS036O6NEB5	—	—	—	1.142	3.858	7.874
M36 X 2*	4	—	—	SS036Q7NEB5	—	—	1.142	3.858	7.874
M36 X 3	4	—	—	—	TS036S8NEB5	—	2.047	3.858	7.874
M36 X 4	4	—	—	—	—	TS036U9NEB5	2.047	3.858	7.874
M39 X 1*	4	TS039M5NEB5	—	—	—	—	1.142	3.858	7.874
M39 X 1.5*	4	—	TS039O6NEB5	—	—	—	1.142	3.858	7.874
M39 X 2*	4	—	—	TS039Q7NEB5	—	—	1.142	3.858	7.874
M39 X 3	4	—	—	—	TS039S8NEB5	—	2.047	3.858	7.874

*Semi Standard

CONTINUED ON NEXT PAGE



Economical High Performance Taps

For Metric Threads

Z-PRO HT



*Z-PRO HT have a Bright Surface Finish
 *AVAILABLE IN TIN AND TICN UPON REQUEST
 Custom Blend High Vanadium HSS

For Tapping Steels, Irons, Brass and Plastics

Z-PRO HT are manufactured from YMW's own high speed steel for maximum toughness and wear life.

Z-PRO HT are the most popular style of general purpose taps for tapping under power or by hand.

Plug Style (5 threads chamfered)
 DIN lengths with ANSI shank dimensions.

Z-PRO Series HT

Metric Sizes

TPI Nominal Size	No. of Flutes	Pitch Diameter Limit/ EDP Numbers							Dimensions		
		D5	D6	D7	D8	D9	D10	D11	Length of Thread	Neck Length	Length Overall
M39 X 4	4	—	—	—	—	TS039U9NEB5	—	—	2.047	3.858	7.874
M42 X 1*	4	TS042M5NEB5	—	—	—	—	—	—	1.142	3.858	7.874
M42 X 1.5*	4	—	TS042O6NEB5	—	—	—	—	—	1.142	3.858	7.874
M42 X 2	4	—	—	TS042Q7NEB5	—	—	—	—	1.142	3.858	7.874
M42 X 4.5	4	—	—	—	—	—	TS042VONEB5	—	2.323	3.858	7.874
M45 X 1*	4	TS045M5NEB5	—	—	—	—	—	—	1.22	4.252	8.661
M45 X 1.5*	4	—	TS045O6NEB5	—	—	—	—	—	1.22	4.252	8.661
M45 X 2*	4	—	—	TS045Q7NEB5	—	—	—	—	1.22	4.252	8.661
M45 X 3	4	—	—	—	TS045S8NEB5	—	—	—	2.323	4.252	8.661
M45 X 4.5	4	—	—	—	—	—	TS045VONEB5	—	2.323	4.252	8.661
M48 X 1*	4	—	TS048M6NEB5	—	—	—	—	—	1.22	4.803	9.843
M48 X 1.5*	4	—	—	TS048O7NEB5	—	—	—	—	1.22	4.803	9.843
M48 X 2*	4	—	—	TS048Q7NEB5	—	—	—	—	1.22	4.803	9.843
M48 X 3	4	—	—	—	—	TS048S9NEB5	—	—	2.559	4.803	9.843
M48 X 5	4	—	—	—	—	—	—	TS048W-NEB5	2.559	4.803	9.843

*Semi Standard



Z-PRO

For Tapping Steels, Irons, Brass and Plastics

Z-PRO HT are manufactured from YMW's own high speed steel for maximum toughness and wear life.

Z-PRO HT are the most popular style of general purpose taps for tapping under power or by hand.

Economical High Performance Taps
For Metric Threads

Z-PRO HT-OX



*Z-PRO HT-OX have an Oxide Surface Finish
Custom Blend High Vanadium HSS

Plug Style (5 threads chamfered)
DIN lengths with ANSI shank dimensions.

Z-PRO Series Z-PRO HT-OX

Metric Sizes

TPI Nominal Size	No. of Flutes	Pitch Diameter Limit/ EDP Numbers				Dimensions		
		D3	D4	D5	D6	Length of Thread	Neck Length	Length Overall
M2 X 0.4	3	TS2.0E3NEX5	—	—	—	.314	.382	1.772
M2.2 X 0.45	3	TS2.2F3NEX5	—	—	—	.314	.382	1.772
M2.5 X 0.45	3	TS2.5F3NEX5	—	—	—	.354	.693	2.205
M2.6 X 0.45*	3	TS2.6F3NEX5	—	—	—	.354	.693	2.205
M3 X 0.5	3	TS3.0G3NEX5	—	—	—	.433	.768	2.205
M3.5 X 0.6	3	—	TS3.5H4NEX5	—	—	.433	.787	2.205
M4 X 0.7	3	—	TS4.0I4NEX5	—	—	.512	.827	2.48
M5 X 0.8	3	—	TS5.0K4NEX5	—	—	.591	.984	3.15
M6 X 1	3	—	—	TS6.0M5NEX5	—	.591	1.181	3.15
M7 X 0.5*	4	—	TS7.0G4NEX5	—	—	.394	1.315	3.543
M7 X 0.75*	4	—	TS7.0J4NEX5	—	—	.748	1.315	3.543
M7 X 1	4	—	—	TS7.0M5NEX5	—	.748	1.315	3.543
M8 X 0.5*	4	—	TS8.0G4NEX5	—	—	.394	1.382	3.543
M8 X 0.75*	4	—	TS8.0J4NEX5	—	—	.748	1.382	3.543
M8 X 1	4	—	—	TS8.0M5NEX5	—	.748	1.382	3.543
M8 X 1.25	3	—	—	TS8.0N5NEX5	—	.748	1.382	3.543
M9 X 1*	4	—	—	TS9.0M5NEX5	—	.748	1.382	3.543
M9 X 1.25*	4	—	—	TS9.0N5NEX5	—	.748	1.382	3.543
M10 X 0.75*	4	—	TS010J4NEX5	—	—	.512	1.929	3.937
M10 X 1*	4	—	—	TS010M5NEX5	—	.906	1.929	3.937
M10 X 1.25	4	—	—	TS010N5NEX5	—	.906	1.929	3.937
M10 X 1.5	4	—	—	—	TS010O6NEX5	.906	1.929	3.937
M11 X 1.5*	4	—	—	—	TS011O6NEX5	.906	1.929	3.937
M12 X 1*	4	—	—	TS012M5NEX5	—	1.024	2.126	4.331
M12 X 1.25	4	—	—	—	TS012N6NEX5	1.024	2.126	4.331
M12 X 1.5*	4	—	—	—	TS012O6NEX5	1.024	2.126	4.331
M 12 X 1.75	4	—	—	—	TS012P6NEX5	1.024	2.126	4.331

*Semi Standard

CONTINUED ON NEXT PAGE



Economical High Performance Taps

For Metric Threads

Z-PRO HT-OX



*Z-PRO HT-OX have an Oxide Surface Finish
Custom Blend High Vanadium HSS

For Tapping Steel, Irons, Brass and Plastics

Z-PRO HT are manufactured from YMW's own high speed steel for maximum toughness and wear life.

Z-PRO HT are the most popular style of general purpose taps for tapping under power or by hand.

Plug Style (5 threads chamfered)

DIN lengths with ANSI shank dimensions.

Z-PRO Series HT-OX

Metric Sizes

TPI Nominal Size	No. of Flutes	Pitch Diameter Limit/ EDP Numbers				Dimensions		
		D5	D6	D7	D8	Length of Thread	Neck Length	Length Overall
M14 X 1*	4	TS014M5NEX5	—	—	—	1.024	2.126	4.331
M14 X 1.25	4	—	TS014N6NEX5	—	—	1.024	2.126	4.331
M14 X 1.5*	4	—	TS014O6NEX5	—	—	1.024	2.126	4.331
M14 X 2	4	—	—	TS014Q7NEX5	—	1.024	2.126	4.331
M16 X 1*	4	TS016M5NEX5	—	—	—	1.024	2.126	4.331
M16 X 1.5	4	—	TS016O6NEX5	—	—	1.024	2.126	4.331
M16 X 2	4	—	—	TS016Q7NEX5	—	1.024	2.126	4.331
M18 X 1*	4	TS018M5NEX5	—	—	—	.945	2.402	4.921
M18 X 1.5*	4	—	TS018O6NEX5	—	—	.945	2.402	4.921
M18 X 2*	4	—	—	TS018Q7NEX5	—	1.299	2.402	4.921
M18 X 2.5	4	—	—	TS018R7NEX5	—	1.299	2.402	4.921
M20 X 1*	4	TS020M5NEX5	—	—	—	.945	2.717	5.512
M20 X 1.5	4	—	TS020O6NEX5	—	—	.945	2.717	5.512
M20 X 2*	4	—	—	TS020Q7NEX5	—	1.299	2.717	5.512
M20 X 2.5	4	—	—	TS020R7NEX5	—	1.299	2.717	5.512
M22 X 1*	4	TS022M5NEX5	—	—	—	.945	2.717	5.512
M22 X 1.5	4	—	TS022O6NEX5	—	—	.945	2.717	5.512
M22 X 2*	4	—	—	TS022Q7NEX5	—	1.299	2.717	5.512
M22 X 2.5	4	—	—	TS022R7NEX5	—	1.299	2.717	5.512
M24 X 1*	4	TS024M5NEX5	—	—	—	1.063	3.071	6.299
M24 X 1.5*	4	—	TS024O6NEX5	—	—	1.063	3.071	6.299
M24 X 2	4	—	—	TS024Q7NEX5	—	1.063	3.071	6.299
M24 X 3	4	—	—	—	TS024S8NEX5	1.457	3.071	6.299
M25 X 1.5*	4	—	TS025O6NEX5	—	—	1.063	3.071	6.299
M26 X 1.5*	4	—	TS026O6NEX5	—	—	1.063	3.465	7.087
M27 X 1*	4	TS027M5NEX5	—	—	—	1.063	3.465	7.087

*Semi Standard

CONTINUED ON NEXT PAGE



Z-PRO

For Tapping Steels, Irons, Brass and Plastics

Z-PRO HT are manufactured from YMW's own high speed steel for maximum toughness and wear life.

Z-PRO HT are the most popular style of general purpose taps for tapping under power or by hand.

Economical High Performance Taps
For Metric Threads

Z-PRO HT-OX



*Z-PRO HT-OX have an Oxide Surface Finish
Custom Blend High Vanadium HSS

Plug Style (5 threads chamfered)
DIN lengths with ANSI shank dimensions.

TPI Nominal Size	No. of Flutes	Pitch Diameter Limit/ EDP Numbers					Dimensions		
		Z-PRO Series HT-OX					Length of Thread	Neck Length	Length Overall
		D5	D6	D7	D8	D9			
M27 X 1.5*	4	—	TS027O6NEX5	—	—	—	1.063	3.465	7.087
M27 X 2	4	—	—	TS027Q7NEX5	—	—	1.063	3.465	7.087
M27 X 3	4	—	—	—	TS027S8NEX5	—	1.732	3.465	7.087
M28 X 1*	4	TS028M5NEX5	—	—	—	—	1.063	3.465	7.087
M28 X 1.5*	4	—	TS028O6NEX5	—	—	—	1.063	3.465	7.087
M28 X 2*	4	—	—	TS028Q7NEX5	—	—	1.063	3.465	7.087
M30 X 1*	4	TS030M5NEX5	—	—	—	—	1.063	3.465	7.087
M30 X 1.5*	4	—	TS030O6NEX5	—	—	—	1.063	3.465	7.087
M30 X 2	4	—	—	TS030Q7NEX5	—	—	1.063	3.465	7.087
M30 X 3.5	4	—	—	—	—	TS030T9NEX5	1.732	3.465	7.087
M32 X 1*	4	TS032M5NEX5	—	—	—	—	1.063	3.465	7.087
M32 X 1.5*	4	—	TS032O6NEX5	—	—	—	1.063	3.465	7.087
M32 X 2*	4	—	—	TS032Q7NEX5	—	—	1.063	3.465	7.087
M33 X 1*	4	TS033M5NEX5	—	—	—	—	1.142	3.465	7.087
M33 X 1.5*	4	—	TS033O6NEX5	—	—	—	1.142	3.465	7.087
M33 X 2	4	—	—	TS033Q7NEX5	—	—	1.142	3.465	7.087
M33 X 3.5	4	—	—	—	—	TS033T9NEX5	1.181	3.465	7.087
M36 X 1*	4	TS036M5NEX5	—	—	—	—	1.142	3.858	7.784
M36 X 1.5*	4	—	TS036O6NEX5	—	—	—	1.142	3.858	7.874
M36 X 2*	4	—	—	TS036Q7NEX5	—	—	1.142	3.858	7.874
M36 X 3	4	—	—	—	TS036S8NEX5	—	2.047	3.858	7.874
M36 X 4	4	—	—	—	—	TS036U9NEX5	2.047	3.858	7.874
M39 X 1*	4	TS039M5NEX5	—	—	—	—	1.142	3.858	7.874
M39 X 1.5*	4	—	TS039O6NEX5	—	—	—	1.142	3.858	7.874
M39 X 2*	4	—	—	TS039Q7NEX5	—	—	1.142	3.858	7.874
M39 X 3	4	—	—	—	TS039S8NEX5	—	2.047	3.858	7.874

*Semi Standard

CONTINUED ON NEXT PAGE



Economical High Performance Taps For Metric Threads

Z-PRO HT-OX



*Z-PRO HT-OX have an Oxide Surface Finish
Custom Blend High Vanadium HSS

For Tapping Steels, Irons, Brass, and Plastics

Z-PRO HT are manufactured from YMW's own high speed steel for maximum toughness and wear life.

Z-PRO HT are the most popular style of general purpose taps for tapping under power or by hand.

Plug Style (5 threads chamfered)
DIN lengths with ANSI shank dimensions.

Z-PRO Series HT-OX

Metric Sizes

TPI Nominal Size	No. of Flutes	Pitch Diameter Limit/ EDP Numbers							Dimensions		
		D5	D6	D7	D8	D9	D10	D11	Length of Thread	Neck Length	Length Overall
M39 X 4	4	—	—	—	—	TS039U9NEX5	—	—	2.047	3.858	7.874
M42 X 1*	4	TS042M5NEX5	—	—	—	—	—	—	1.142	3.858	7.874
M42 X 1.5*	4	—	TS042O6NEX5	—	—	—	—	—	1.142	3.858	7.874
M42 X 2	4	—	—	TS042Q7NEX5	—	—	—	—	1.142	3.858	7.874
M42 X 4.5	4	—	—	—	—	—	TS042VONEX5	—	2.323	3.858	7.874
M45 X 1*	4	TS045M5NEX5	—	—	—	—	—	—	1.22	4.252	8.661
M45 X 1.5*	4	—	TS045O6NEX5	—	—	—	—	—	1.22	4.252	8.661
M45 X 2*	4	—	—	TS045Q7NEX5	—	—	—	—	1.22	4.252	8.661
M45 X 3	4	—	—	—	TS045S8NEX5	—	—	—	2.323	4.252	8.661
M45 X 4.5	4	—	—	—	—	—	TS045VONEX5	—	2.323	4.252	8.661
M48 X 1*	4	—	TS048M6NEX5	—	—	—	—	—	1.22	4.803	9.843
M48 X 1.5*	4	—	—	TS048O7NEX5	—	—	—	—	1.22	4.803	9.843
M48 X 2*	4	—	—	TS048Q7NEX5	—	—	—	—	1.22	4.803	9.843
M48 X 3	4	—	—	—	—	TS048S9NEX5	—	—	2.559	4.803	9.843
M48 X 5	4	—	—	—	—	—	—	TS048W-NEX5	2.559	4.803	9.843

*Semi Standard



Z-PRO

For Tapping Steels, Irons, Brass and Plastics

Z-PRO HT are manufactured from YMW's own high speed steel for maximum toughness and wear life.

Z-PRO HT are the most popular style of general purpose taps for tapping under power or by hand.

Economical High Performance Taps
For Metric Threads

Z-PRO HT



*Z-PRO HT have a Bright Surface Finish
*AVAILABLE IN TIN AND TICN UPON REQUEST
Custom Blend High Vanadium HSS

Bottoming Style (1.5 threads chamfered)
DIN lengths with ANSI shank dimensions.

Z-PRO Series HT

Metric Sizes

TPI Nominal Size	NC UNC	NF UNF	No. of Flutes	Pitch Diameter Limit/ EDP Numbers					Dimensions		
				H1	H2	H3	H4	H5	Length of Thread	Neck Length	Length Overall
0	80	—	2	TSUN0B1NEBA	TSUN0B2NEBA	—	—	—	.236	—	1.772
1	64	—	2	TSUN1D1NEBA	TSUN1D2NEBA	—	—	—	.275	—	1.772
1	—	72	2	TSUN1C1NEBA	TSUN1C2NEBA	—	—	—	.275	—	1.772
2	56	—	3	TSUN2E1NEBA	TSUN2E2NEBA	—	—	—	.314	—	1.772
2	—	64	3	TSUN2D1NEBA	TSUN2D2NEBA	—	—	—	.314	—	1.772
3	48	—	3	TSUN3F1NEBA	TSUN3F2NEBA	—	—	—	.354	.669	2.205
3	—	56	3	TSUN3E1NEBA	TSUN3E2NEBA	—	—	—	.354	.669	2.205
4	40	—	3	—	TSUN4H2NEBA	TSUN4H3NEBA	—	—	.354	.709	2.205
4	—	48	3	TSUN4F1NEBA	TSUN4F2NEB5A	—	—	—	.354	.709	2.205
5	40	—	3	—	TSUN5H2NEBA	TSUN5H3NEBA	—	—	.433	.768	2.205
5	—	44	3	—	TSUN5G2NEBA	TSUN5G3NEBA	—	—	.433	.768	2.205
6	32	—	3	—	TSUN6J2NEBA	TSUN6J3NEBA	—	—	.433	.787	2.205
6	—	40	3	—	TSUN6H2NEBA	TSUN6H3NEBA	—	—	.433	.787	2.205
8	32	—	4	—	TSUN8J2NEBA	TSUN8J3NEBA	—	—	.512	.827	2.480
8	—	36	4	—	TSUN8I2NEBA	TSUN8I3NEBA	—	—	.512	.827	2.480
10	24	—	4	—	TSUNAM2NEBA	TSUNAM3NEBA	—	—	.551	.984	2.756
10	—	32	4	—	TSUNAJ2NEBA	TSUNAJ3NEBA	—	—	.551	.984	2.756
12	24	—	4	—	TSUNCM2NEBA	TSUNCM3NEBA	—	—	.591	.984	3.150
12	—	28	4	—	TSUNCK2NEBA	TSUNCK3NEBA	—	—	.591	.984	3.150
1/4	20	—	4	—	—	TSU04N3NEBA	TSU04N4NEBA	—	.591	1.181	3.150
1/4	—	28	4	—	TSU04K2NEBA	TSU04K3NEBA	—	—	.591	1.181	3.150
5/16	18	—	4	—	—	TSU05O3NEBA	TSU05O4NEBA	—	.748	1.378	3.543
5/16	—	24	4	—	—	TSU05M3NEBA	TSU05M4NEBA	—	.748	1.378	3.543
3/8	16	—	4	—	—	TSU06P3NEBA	—	TSU06P5NEBA	.906	1.535	3.937
3/8	—	24	4	—	—	TSU06M3NEBA	TSU06M4NEBA	—	.906	1.535	3.937
7/16	14	—	4	—	—	—	TSU07Q4NEBA	TSU07Q5NEBA	.906	—	3.937
7/16	—	20	4	—	—	TSU07N3NEBA	TSU07N4NEBA	—	.906	—	3.937
1/2	13	—	4	—	—	—	TSU08R4NEBA	TSU08R5NEBA	1.024	—	4.331
1/2	—	20	4	—	—	TSU08N3NEBA	TSU08N4NEBA	—	1.024	—	4.331
9/16	12	—	4	—	—	—	TSU09S4NEBA	TSU09S5NEBA	1.024	—	4.331
9/16	—	18	4	—	—	—	TSU09O4NEBA	TSU09O5NEBA	1.024	—	4.331



Economical High Performance Taps

For Unified Threads

Z-PRO HT



*Z-PRO HT have a Bright Surface Finish

*AVAILABLE IN TIN AND TICN UPON REQUEST

Custom Blend High Vanadium HSS

For Tapping Steels, Irons, Brass and Plastics

Z-PRO HT are manufactured from YMW's own high speed steel for maximum toughness and wear life.

Z-PRO HT are the most popular style of general purpose taps for tapping under power or by hand.

Bottoming Style (1.5 threads chamfered)
DIN lengths with ANSI shank dimensions.

Z-PRO Series HT

Machine Screw Sizes
Fractional Sizes

Nominal Size	TPI		No. of Flutes	Pitch Diameter Limit/ EDP Numbers					Dimensions		
	NC	NF		H4	H5	H6	H7	H8	Length of Thread	Neck Length	Length Overall
	UNC	UNF									
5/8	11	—	4	TSU10U4NEBA	—	TSU10U6NEBA	—	—	1.024	—	4.331
5/8	—	18	4	TSU10O4NEBA	TSU10O5NEBA	—	—	—	1.024	—	4.331
3/4	10	—	4	—	TSU12V5NEBA	TSU12V6NEBA	—	—	1.299	—	4.921
3/4	—	16	4	TSU12P4NEBA	TSU12P5NEBA	—	—	—	1.299	—	4.921
7/8	9	—	4	—	TSU14W5NEBA	TSU14W6NEBA	—	—	1.299	—	5.512
7/8	—	14	4	TSU14Q4NEBA	—	TSU14Q6NEBA	—	—	1.299	—	5.512
1	8	—	4	—	TSU16X5NEBA	—	TSU16X7NEBA	—	1.457	—	6.299
1	—	12	4	—	TSU16S5NEBA	TSU16S6NEBA	—	—	1.457	—	6.299
1 1/8	7	—	4	—	—	TSU18Y6NEBA	TSU18Y7NEBA	—	1.732	—	7.087
1 1/8	—	12	4	—	TSU18S5NEBA	TSU18S6NEBA	—	—	1.732	—	7.087
1 1/4	7	—	4	—	—	TSU20Y6NEBA	—	TSU20Y8NEBA	1.929	—	7.087
1 1/4	—	12	4	—	TSU20S5NEBA	TSU20S6NEBA	—	—	1.929	—	7.087
1 3/8	6	—	4	—	—	TSU22Z6NEBA	—	TSU22Z8NEBA	2.165	—	7.874
1 3/8	—	12	6	—	TSU22S5NEBA	TSU22S6NEBA	—	—	2.165	—	7.874
1 1/2	6	—	4	—	—	TSU24Z6NEBA	—	TSU24Z8NEBA	2.323	—	7.874
1 1/2	—	12	6	—	TSU24S5NEBA	—	TSU24S7NEBA	—	2.323	—	7.874



Z-PRO

For Tapping Steels, Irons, Brass and Plastics

Z-PRO HT are manufactured from YMW's own high speed steel for maximum toughness and wear life.

Z-PRO HT are the most popular style of general purpose taps for tapping under power or by hand.

Economical High Performance Taps
For Unified Threads

Z-PRO HT-OX



*Z-PRO HT-OX have an Oxide Surface Treatment
Custom Blend High Vanadium HSS

Bottoming Style (1.5 threads chamfered)
DIN lengths with ANSI shank dimensions.

Z-PRO Series HT

Machine Screw Sizes
Fractional Sizes

Nominal Size	TPI NC UNC	NF UNF	No. of Flutes	Pitch Diameter Limit/ EDP Numbers						Dimensions		
				H2	H3	H4	H5	H6	H7	Length of Thread	Neck Length	Length Overall
2	56	—	3	TSUN2E2NEXA	—	—	—	—	—	.314	—	1.772
4	40	—	3	—	TSUN4H3NEXA	—	—	—	—	.354	.709	2.205
5	40	—	3	—	TSUN5H3NEXA	—	—	—	—	.433	.768	2.205
6	32	—	3	—	TSUN6J3NEXA	—	—	—	—	.433	.787	2.205
6	—	40	3	—	TSUN6H3NEXA	—	—	—	—	.433	.787	2.205
8	32	—	4	—	TSUN8J3NEXA	—	—	—	—	.512	.827	2.480
10	24	—	4	—	TSUNAM3NEXA	—	—	—	—	.551	.984	2.756
10	—	32	4	—	TSUNAJ3NEXA	—	—	—	—	.551	.984	2.756
12	24	—	4	—	TSUNCM3NEXA	—	—	—	—	.591	.984	3.150
1/4	20	—	4	—	—	TSU04N4NEXA	—	—	—	.591	1.181	3.150
1/4	—	28	4	—	TSU04K3NEXA	—	—	—	—	.591	1.181	3.150
5/16	18	—	4	—	—	TSU05O4NEXA	—	—	—	.748	1.378	3.543
5/16	—	24	4	—	TSU05M3NEXA	TSU05M4NEXA	—	—	—	.748	1.378	3.543
3/8	16	—	4	—	TSU06P3NEXA	—	TSU06P5NEXA	—	—	.906	1.535	3.937
3/8	—	24	4	—	—	TSU06M4NEXA	—	—	—	.906	1.535	3.937
7/16	14	—	4	—	—	TSU07Q4NEXA	TSU07Q5NEXA	—	—	.906	—	3.937
7/16	—	20	4	—	—	TSU07N4NEXA	—	—	—	.906	—	3.937
1/2	13	—	4	—	—	—	TSU08R5NEXA	—	—	1.024	—	4.331
1/2	—	20	4	—	—	TSU08N4NEXA	—	—	—	1.024	—	4.331
9/16	12	—	4	—	—	—	TSU09S5NEXA	—	—	1.024	—	4.331
9/16	—	18	4	—	—	—	TSU09O5NEXA	—	—	1.024	—	4.331
5/8	11	—	4	—	—	—	—	TSU10U6NEXA	—	1.024	—	4.331
5/8	—	18	4	—	—	—	TSU10O5NEXA	—	—	1.024	—	4.331
3/4	10	—	4	—	—	—	—	TSU12V6NEXA	—	1.299	—	4.921
3/4	—	16	4	—	—	—	TSU12P5NEXA	—	—	1.299	—	4.921
7/8	9	—	4	—	—	—	—	TSU14W6NEXA	—	1.299	—	5.512
1	8	—	4	—	—	—	—	—	TSU16X7NEXA	1.457	—	6.299



Economical High Performance Taps

For Metric Threads

Z-PRO HT



*Z-PRO HT have a Bright Surface Finish
*AVAILABLE IN TIN AND TICN UPON REQUEST
Custom Blend High Vanadium HSS

For Tapping Steels, Irons, Brass and Plastics

Z-PRO HT are manufactured from YMW's own high speed steel for maximum toughness and wear life.

Z-PRO HT are the most popular style of general purpose taps for tapping under power or by hand.

Bottoming Style (1.5 threads chamfered)
DIN lengths with ANSI shank dimensions.

TPI Nominal Size	No. of Flutes	Pitch Diameter Limit/ EDP Numbers				Dimensions		
						Length of Thread	Neck Length	Length Overall
		D3	D4	D5	D6			
M2 X 0.4	3	TS2.0E3NEBA	—	—	—	.314	.382	1.772
M2.2 X 0.45	3	TS2.2F3NEBA	—	—	—	.314	.382	1.772
M2.5 X 0.45	3	TS2.5F3NEBA	—	—	—	.354	.693	2.205
M2.6 X 0.45*	3	TS2.6F3NEBA	—	—	—	.354	.693	2.205
M3 X 0.5	3	TS3.0G3NEBA	—	—	—	.433	.768	2.205
M3.5 X 0.6	3	—	TS3.5H4NEBA	—	—	.433	.787	2.205
M4 X 0.7	3	—	TS4.0I4NEBA	—	—	.512	.827	2.48
M5 X 0.8	3	—	TS5.0K4NEBA	—	—	.591	.984	3.15
M6 X 1	3	—	—	TS6.0M5NEBA	—	.591	1.181	3.15
M7 X 0.5*	4	—	TS7.0G4NEBA	—	—	.394	1.315	3.543
M7 X 0.75*	4	—	TS7.0J4NEBA	—	—	.748	1.315	3.543
M7 X 1	4	—	—	TS7.0M5NEBA	—	.748	1.315	3.543
M8 X 0.5*	4	—	TS8.0G4NEBA	—	—	.394	1.382	3.543
M8 X 0.75*	4	—	TS8.0J4NEBA	—	—	.748	1.382	3.543
M8 X 1	4	—	—	TS8.0M5NEBA	—	.748	1.382	3.543
M8 X 1.25	3	—	—	TS8.0N5NEBA	—	.748	1.382	3.543
M9 X 1*	4	—	—	TS9.0M5NEBA	—	.748	1.382	3.543
M9 X 1.25*	4	—	—	TS9.0N5NEBA	—	.748	1.382	3.543
M10 X 0.75*	4	—	TS010J4NEBA	—	—	.512	1.929	3.937
M10 X 1*	4	—	—	TS010M5NEBA	—	.906	1.929	3.937
M10 X 1.25	4	—	—	TS010N5NEBA	—	.906	1.929	3.937
M10 X 1.5	4	—	—	—	TS010O6NEBA	.906	1.929	3.937
M11 X 1.5*	4	—	—	—	TS011O6NEBA	.906	1.929	3.937
M12 X 1*	4	—	—	TS012M5NEBA	—	1.024	2.126	4.331
M12 X 1.25	4	—	—	—	TS012N6NEBA	1.024	2.126	4.331
M12 X 1.5*	4	—	—	—	TS012O6NEBA	1.024	2.126	4.331
M 12 X 1.75	4	—	—	—	TS012P6NEBA	1.024	2.126	4.331

*Semi Standard

CONTINUED ON NEXT PAGE



Z-PRO

For Tapping Steels, Irons, Brass and Plastics

Z-PRO HT are manufactured from YMW's own high speed steel for maximum toughness and wear life.

Z-PRO HT are the most popular style general purpose taps for tapping under power or by hand.

Economical High Performance Taps
For Metric Threads

Z-PRO HT



*Z-PRO HT have a Bright Surface Finish
*AVAILABLE IN TIN AND TICN UPON REQUEST
Custom Blend High Vanadium HSS

Bottoming Style (1.5 threads chamfered)
DIN lengths with ANSI shank dimensions.

Z-PRO Series HT

Metric Sizes

TPI Nominal Size	No. of Flutes	Pitch Diameter Limit/ EDP Numbers				Dimensions		
		D5	D6	D7	D8	Length of Thread	Neck Length	Length Overall
M14 X 1*	4	TS014M5NEBA	—	—	—	1.024	2.126	4.331
M14 X 1.25	4	—	TS014N6NEBA	—	—	1.024	2.126	4.331
M14 X 1.5*	4	—	TS014O6NEBA	—	—	1.024	2.126	4.331
M14 X 2	4	—	—	TS014Q7NEBA	—	1.024	2.126	4.331
M16 X 1*	4	TS016M5NEBA	—	—	—	1.024	2.126	4.331
M16 X 1.5	4	—	TS016O6NEBA	—	—	1.024	2.126	4.331
M16 X 2	4	—	—	TS016Q7NEBA	—	1.024	2.126	4.331
M18 X 1*	4	TS018M5NEBA	—	—	—	.945	2.402	4.921
M18 X 1.5*	4	—	TS018O6NEBA	—	—	.945	2.402	4.921
M18 X 2*	4	—	—	TS018Q7NEBA	—	1.299	2.402	4.921
M18 X 2.5	4	—	—	TS018R7NEBA	—	1.299	2.402	4.921
M20 X 1*	4	TS020M5NEBA	—	—	—	.945	2.717	5.512
M20 X 1.5	4	—	TS020O6NEBA	—	—	.945	2.717	5.512
M20 X 2*	4	—	—	TS020Q7NEBA	—	1.299	2.717	5.512
M20 X 2.5	4	—	—	TS020R7NEBA	—	1.299	2.717	5.512
M22 X 1*	4	TS022M5NEBA	—	—	—	.945	2.717	5.512
M22 X 1.5	4	—	TS022O6NEBA	—	—	.945	2.717	5.512
M22 X 2*	4	—	—	TS022Q7NEBA	—	1.299	2.717	5.512
M22 X 2.5	4	—	—	TS022R7NEBA	—	1.299	2.717	5.512
M24 X 1*	4	TS024M5NEBA	—	—	—	1.063	3.071	6.299
M24 X 1.5*	4	—	TS024O6NEBA	—	—	1.063	3.071	6.299
M24 X 2	4	—	—	TS024Q7NEBA	—	1.063	3.071	6.299
M24 X 3	4	—	—	—	TS024S8NEBA	1.457	3.071	6.299
M25 X 1.5*	4	—	TS025O6NEBA	—	—	1.063	3.071	6.299
M26 X 1.5*	4	—	TS026O6NEBA	—	—	1.063	3.465	7.087
M27 X 1*	4	TS027M5NEBA	—	—	—	1.063	3.465	7.087

*Semi Standard

CONTINUED ON NEXT PAGE



Economical High Performance Taps

For Metric Threads

Z-PRO HT



*Z-PRO HT have a Bright Surface Finish
 *AVAILABLE IN TIN AND TICN UPON REQUEST
 Custom Blend High Vanadium HSS

For Tapping Steels, Irons, Brass and Plastics

Z-PRO HT are manufactured from YMW's own high speed steel for maximum toughness and wear life.

Z-PRO HT are the most popular style of general purpose for tapping under power or by hand.

Bottoming Style (1.5 threads chamfered)
 DIN lengths with ANSI shank dimensions.

Z-PRO Series HT

Metric Sizes

TPI Nominal Size	No. of Flutes	Pitch Diameter Limit/ EDP Numbers					Dimensions		
		D5	D6	D7	D8	D9	Length of Thread	Neck Length	Length Overall
M27 X 1.5*	4	—	TS027O6NEBA	—	—	—	1.063	3.465	7.087
M27 X 2	4	—	—	TS027Q7NEBA	—	—	1.063	3.465	7.087
M27 X 3	4	—	—	—	TS027S8NEBA	—	1.732	3.465	7.087
M28 X 1*	4	TS028M5NEBA	—	—	—	—	1.063	3.465	7.087
M28 X 1.5*	4	—	TS028O6NEBA	—	—	—	1.063	3.465	7.087
M28 X 2*	4	—	—	TS028Q7NEBA	—	—	1.063	3.465	7.087
M30 X 1*	4	TS030M5NEBA	—	—	—	—	1.063	3.465	7.087
M30 X 1.5*	4	—	TS030O6NEBA	—	—	—	1.063	3.465	7.087
M30 X 2	4	—	—	TS030Q7NEBA	—	—	1.063	3.465	7.087
M30 X 3.5	4	—	—	—	—	TS030T9NEBA	1.732	3.465	7.087
M32 X 1*	4	TS032M5NEBA	—	—	—	—	1.063	3.465	7.087
M32 X 1.5*	4	—	TS032O6NEBA	—	—	—	1.063	3.465	7.087
M32 X 2*	4	—	—	TS032Q7NEBA	—	—	1.063	3.465	7.087
M33 X 1*	4	TS033M5NEBA	—	—	—	—	1.142	3.465	7.087
M33 X 1.5*	4	—	TS033O6NEBA	—	—	—	1.142	3.465	7.087
M33 X 2	4	—	—	TS033Q7NEBA	—	—	1.142	3.465	7.087
M33 X 3.5	4	—	—	—	—	TS033T9NEBA	1.181	3.465	7.087
M36 X 1*	4	TS036M5NEBA	—	—	—	—	1.142	3.858	7.784
M36 X 1.5*	4	—	TS036O6NEBA	—	—	—	1.142	3.858	7.874
M36 X 2*	4	—	—	TS036Q7NEBA	—	—	1.142	3.858	7.874
M36 X 3	4	—	—	—	TS036S8NEBA	—	2.047	3.858	7.874
M36 X 4	4	—	—	—	—	TS036U9NEBA	2.047	3.858	7.874
M39 X 1*	4	TS039M5NEBA	—	—	—	—	1.142	3.858	7.874
M39 X 1.5*	4	—	TS039O6NEBA	—	—	—	1.142	3.858	7.874
M39 X 2*	4	—	—	TS039Q7NEBA	—	—	1.142	3.858	7.874
M39 X 3	4	—	—	—	TS039S8NEBA	—	2.047	3.858	7.874

*Semi Standard

CONTINUED ON NEXT PAGE



Z-PRO

Z
P
R
O

H
T

For Tapping Steels, Irons, Brass and Plastics

Z-PRO HT are manufactured from YMW's own high speed steel for maximum toughness and wear life.

Z-PRO HT are the most popular style general purpose taps for tapping under power or by hand.

Economical High Performance Taps For Metric Threads

Z-PRO HT



*Z-PRO HT have a Bright Surface Finish
*AVAILABLE IN TIN AND TICN UPON REQUEST

Custom Blend High Vanadium HSS

Bottoming Style (1.5 threads chamfered)
DIN lengths with ANSI shank dimensions.

Z-PRO Series HT

Metric Sizes

TPI Nominal Size	No. of Flutes	Pitch Diameter Limit/ EDP Numbers							Dimensions		
		D5	D6	D7	D8	D9	D10	D11	Length of Thread	Neck Length	Length Overall
M39 X 4	4	—	—	—	—	TS039U9NEBA	—	—	2.047	3.858	7.874
M42 X 1*	4	TS042M5NEBA	—	—	—	—	—	—	1.142	3.858	7.874
M42 X 1.5*	4	—	TS042O6NEBA	—	—	—	—	—	1.142	3.858	7.874
M42 X 2	4	—	—	TS042Q7NEBA	—	—	—	—	1.142	3.858	7.874
M42 X 4.5	4	—	—	—	—	—	TS042VONEBA	—	2.323	3.858	7.874
M45 X 1*	4	TS045M5NEBA	—	—	—	—	—	—	1.22	4.252	8.661
M45 X 1.5*	4	—	TS045O6NEBA	—	—	—	—	—	1.22	4.252	8.661
M45 X 2*	4	—	—	TS045Q7NEBA	—	—	—	—	1.22	4.252	8.661
M45 X 3	4	—	—	—	TS045S8NEBA	—	—	—	2.323	4.252	8.661
M45 X 4.5	4	—	—	—	—	—	TS045VONEBA	—	2.323	4.252	8.661
M48 X 1*	4	—	TS048M6NEBA	—	—	—	—	—	1.22	4.803	9.843
M48 X 1.5*	4	—	—	TS048O7NEBA	—	—	—	—	1.22	4.803	9.843
M48 X 2*	4	—	—	TS048Q7NEBA	—	—	—	—	1.22	4.803	9.843
M48 X 3	4	—	—	—	—	TS048S9NEBA	—	—	2.559	4.803	9.843
M48 X 5	4	—	—	—	—	—	—	TS048W-NEBA	2.559	4.803	9.843

*Semi Standard



Economical High Performance Taps

For Metric Threads

Z-PRO HT-OX



*Z-PRO HT-OX have an Oxide Surface Treatment
Custom Blend High Vanadium HSS

For Tapping Steels, Irons, Brass and Plastics

Z-PRO HT are manufactured from YMW's own high speed steel for maximum toughness and wear life.

Z-PRO HT are the most popular style of general purpose taps for tapping under power or by hand.

Bottoming Style (1.5 threads chamfered)
DIN lengths with ANSI shank dimensions.

Z-PRO Series HT-OX

Metric Sizes

TPI Nominal Size	No. of Flutes	Pitch Diameter Limit/ EDP Numbers				Dimensions		
		D3	D4	D5	D6	Length of Thread	Neck Length	Length Overall
M2 X 0.4	3	TS2.0E3NEXA	—	—	—	.314	.382	1.772
M2.2 X 0.45	3	TS2.2F3NEXA	—	—	—	.314	.382	1.772
M2.5 X 0.45	3	TS2.5F3NEXA	—	—	—	.354	.693	2.205
M2.6 X 0.45*	3	TS2.6F3NEXA	—	—	—	.354	.693	2.205
M3 X 0.5	3	TS3.0G3NEXA	—	—	—	.433	.768	2.205
M3.5 X 0.6	3	—	TS3.5H4NEXA	—	—	.433	.787	2.205
M4 X 0.7	3	—	TS4.0I4NEXA	—	—	.512	.827	2.48
M5 X 0.8	3	—	TS5.0K4NEXA	—	—	.591	.984	3.15
M6 X 1	3	—	—	TS6.0M5NEXA	—	.591	1.181	3.15
M7 X 0.5*	4	—	TS7.0G4NEXA	—	—	.394	1.315	3.543
M7 X 0.75*	4	—	TS7.0J4NEXA	—	—	.748	1.315	3.543
M7 X 1	4	—	—	TS7.0M5NEXA	—	.748	1.315	3.543
M8 X 0.5*	4	—	TS8.0G4NEXA	—	—	.394	1.382	3.543
M8 X 0.75*	4	—	TS8.0J4NEXA	—	—	.748	1.382	3.543
M8 X 1	4	—	—	TS8.0M5NEXA	—	.748	1.382	3.543
M8 X 1.25	3	—	—	TS8.0N5NEXA	—	.748	1.382	3.543
M9 X 1*	4	—	—	TS9.0M5NEXA	—	.748	1.382	3.543
M9 X 1.25*	4	—	—	TS9.0N5NEXA	—	.748	1.382	3.543
M10 X 0.75*	4	—	TS10J4NEXA	—	—	.512	1.929	3.937
M10 X 1*	4	—	—	TS10M5NEXA	—	.906	1.929	3.937
M10 X 1.25	4	—	—	TS10N5NEXA	—	.906	1.929	3.937
M10 X 1.5	4	—	—	—	TS10O6NEXA	.906	1.929	3.937
M11 X 1.5*	4	—	—	—	TS11O6NEXA	.906	1.929	3.937
M12 X 1*	4	—	—	TS12M5NEXA	—	1.024	2.126	4.331
M12 X 1.25	4	—	—	—	TS12N6NEXA	1.024	2.126	4.331
M12 X 1.5*	4	—	—	—	TS12O6NEXA	1.024	2.126	4.331
M 12 X 1.75	4	—	—	—	TS12P6NEXA	1.024	2.126	4.331

*Semi Standard

CONTINUED ON NEXT PAGE



Z-PRO

For Tapping Steels, Irons, Brass, and Plastics

Economical High Performance Taps
For Metric Threads

Z-PRO HT are manufactured from YMW's own high speed steel for maximum toughness and wear life.

Z-PRO HT-OX

Z-PRO HT are the most popular style of general purpose taps under power or by hand.



*Z-PRO HT-OX have an Oxide Surface Treatment Custom Blend High Vanadium HSS

Bottoming Style (1.5 threads chamfered)
DIN lengths with ANSI shank dimensions.

Z-PRO Series HT-OX

Metric Sizes

TPI Nominal Size	No. of Flutes	Pitch Diameter Limit/ EDP Numbers				Dimensions		
		D5	D6	D7	D8	Length of Thread	Neck Length	Length Overall
M14 X 1*	4	TS014M5NEXA	—	—	—	1.024	2.126	4.331
M14 X 1.25	4	—	TS014N6NEXA	—	—	1.024	2.126	4.331
M14 X 1.5*	4	—	TS014O6NEXA	—	—	1.024	2.126	4.331
M14 X 2	4	—	—	TS014Q7NEXA	—	1.024	2.126	4.331
M16 X 1*	4	TS016M5NEXA	—	—	—	1.024	2.126	4.331
M16 X 1.5	4	—	TS016O6NEXA	—	—	1.024	2.126	4.331
M16 X 2	4	—	—	TS016Q7NEXA	—	1.024	2.126	4.331
M18 X 1*	4	TS018M5NEXA	—	—	—	.945	2.402	4.921
M18 X 1.5*	4	—	TS018O6NEXA	—	—	.945	2.402	4.921
M18 X 2*	4	—	—	TS018Q7NEXA	—	1.299	2.402	4.921
M18 X 2.5	4	—	—	TS018R7NEXA	—	1.299	2.402	4.921
M20 X 1*	4	TS020M5NEXA	—	—	—	.945	2.717	5.512
M20 X 1.5	4	—	TS020O6NEXA	—	—	.945	2.717	5.512
M20 X 2*	4	—	—	TS020Q7NEXA	—	1.299	2.717	5.512
M20 X 2.5	4	—	—	TS020R7NEXA	—	1.299	2.717	5.512
M22 X 1*	4	TS022M5NEXA	—	—	—	.945	2.717	5.512
M22 X 1.5	4	—	TS022O6NEXA	—	—	.945	2.717	5.512
M22 X 2*	4	—	—	TS022Q7NEXA	—	1.299	2.717	5.512
M22 X 2.5	4	—	—	TS022R7NEXA	—	1.299	2.717	5.512
M24 X 1*	4	TS024M5NEXA	—	—	—	1.063	3.071	6.299
M24 X 1.5*	4	—	TS024O6NEXA	—	—	1.063	3.071	6.299
M24 X 2	4	—	—	TS024Q7NEXA	—	1.063	3.071	6.299
M24 X 3	4	—	—	—	TS024S8NEXA	1.457	3.071	6.299
M25 X 1.5*	4	—	TS025O6NEXA	—	—	1.063	3.071	6.299
M26 X 1.5*	4	—	TS026O6NEXA	—	—	1.063	3.465	7.087
M27 X 1*	4	TS027M5NEXA	—	—	—	1.063	3.465	7.087

*Semi Standard

CONTINUED ON NEXT PAGE



Economical High Performance Taps

For Metric Threads

Z-PRO HT-OX



*Z-PRO HT-OX have an Oxide Surface Treatment
Custom Blend High Vanadium HSS

For Tapping Steels, Irons, Brass and Plastics

Z-PRO HT are manufacture from YMW's own high speed steel for maximum toughness and wear life.

Z-PRO HT are the most popular style general purpose taps for tapping under power or by hand.

Bottoming Style (1.5 threads chamfered)
DIN lengths with ANSI shank dimensions.

Z-PRO Series HT-OX

Metric Sizes

TPI Nominal Size	No. of Flutes	Pitch Diameter Limit/ EDP Numbers					Dimensions		
		D5	D6	D7	D8	D9	Length of Thread	Neck Length	Length Overall
M27 X 1.5*	4	—	TS027O6NEXA	—	—	—	1.063	3.465	7.087
M27 X 2	4	—	—	TS027Q7NEXA	—	—	1.063	3.465	7.087
M27 X 3	4	—	—	—	TS027S8NEXA	—	1.732	3.465	7.087
M28 X 1*	4	TS028M5NEXA	—	—	—	—	1.063	3.465	7.087
M28 X 1.5*	4	—	TS028O6NEXA	—	—	—	1.063	3.465	7.087
M28 X 2*	4	—	—	TS028Q7NEXA	—	—	1.063	3.465	7.087
M30 X 1*	4	TS030M5NEXA	—	—	—	—	1.063	3.465	7.087
M30 X 1.5*	4	—	TS030O6NEXA	—	—	—	1.063	3.465	7.087
M30 X 2	4	—	—	TS030Q7NEXA	—	—	1.063	3.465	7.087
M30 X 3.5	4	—	—	—	—	TS030T9NEXA	1.732	3.465	7.087
M32 X 1*	4	TS032M5NEXA	—	—	—	—	1.063	3.465	7.087
M32 X 1.5*	4	—	TS032O6NEXA	—	—	—	1.063	3.465	7.087
M32 X 2*	4	—	—	TS032Q7NEXA	—	—	1.063	3.465	7.087
M33 X 1*	4	TS033M5NEXA	—	—	—	—	1.142	3.465	7.087
M33 X 1.5*	4	—	TS033O6NEXA	—	—	—	1.142	3.465	7.087
M33 X 2	4	—	—	TS033Q7NEXA	—	—	1.142	3.465	7.087
M33 X 3.5	4	—	—	—	—	TS033T9NEXA	1.181	3.465	7.087
M36 X 1*	4	TS036M5NEXA	—	—	—	—	1.142	3.858	7.784
M36 X 1.5*	4	—	TS036O6NEXA	—	—	—	1.142	3.858	7.874
M36 X 2*	4	—	—	TS036Q7NEXA	—	—	1.142	3.858	7.874
M36 X 3	4	—	—	—	TS036S8NEXA	—	2.047	3.858	7.874
M36 X 4	4	—	—	—	—	TS036U9NEXA	2.047	3.858	7.874
M39 X 1*	4	TS039M5NEXA	—	—	—	—	1.142	3.858	7.874
M39 X 1.5*	4	—	TS039O6NEXA	—	—	—	1.142	3.858	7.874
M39 X 2*	4	—	—	TS039Q7NEXA	—	—	1.142	3.858	7.874
M39 X 3	4	—	—	—	TS039S8NEXA	—	2.047	3.858	7.874

*Semi Standard

CONTINUED ON NEXT PAGE



Z-PRO

Z
P
R
O

H
T

For Tapping Steels, Irons, Brass and Plastics

Z-PRO HT are manufactured from YMW's own high speed steel for maximum toughness and wear life.

Z-PRO HT are the most popular style general purpose taps for tapping under power or by hand.

Economical High Performance Taps
For Metric Threads

Z-PRO HT-OX



*Z-PRO SP-OX have an Oxide Surface Treatment
Custom Blend High Vanadium HSS

Bottoming Style (1.5 threads chamfered)
DIN lengths with ANSI shank dimensions.

Z-PRO Series HT-OX

Metric Sizes

TPI Nominal Size	No. of Flutes	Pitch Diameter Limit/ EDP Numbers							Dimensions		
		D5	D6	D7	D8	D9	D10	D11	Length of Thread	Neck Length	Length Overall
M39 X 4	4	—	—	—	—	TS039U9NEXA	—	—	2.047	3.858	7.874
M42 X 1*	4	TS042M5NEXA	—	—	—	—	—	—	1.142	3.858	7.874
M42 X 1.5*	4	—	TS042O6NEXA	—	—	—	—	—	1.142	3.858	7.874
M42 X 2	4	—	—	TS042Q7NEXA	—	—	—	—	1.142	3.858	7.874
M42 X 4.5	4	—	—	—	—	—	TS042VONEXA	—	2.323	3.858	7.874
M45 X 1*	4	TS045M5NEXA	—	—	—	—	—	—	1.22	4.252	8.661
M45 X 1.5*	4	—	TS045O6NEXA	—	—	—	—	—	1.22	4.252	8.661
M45 X 2*	4	—	—	TS045Q7NEXA	—	—	—	—	1.22	4.252	8.661
M45 X 3	4	—	—	—	TS045S8NEXA	—	—	—	2.323	4.252	8.661
M45 X 4.5	4	—	—	—	—	—	TS045VONEXA	—	2.323	4.252	8.661
M48 X 1*	4	—	TS048M6NEXA	—	—	—	—	—	1.22	4.803	9.843
M48 X 1.5*	4	—	—	TS048O7NEXA	—	—	—	—	1.22	4.803	9.843
M48 X 2*	4	—	—	TS048Q7NEXA	—	—	—	—	1.22	4.803	9.843
M48 X 3	4	—	—	—	—	TS048S9NEXA	—	—	2.559	4.803	9.843
M48 X 5	4	—	—	—	—	—	—	TS048W-NEXA	2.559	4.803	9.843

*Semi Standard



Economical High Performance Taps

For Unified Threads

STI-PO



*Z-PRO STI-PO have a Bright Surface Finish
 *AVAILABLE IN TIN AND TICN UPON REQUEST
 Custom Blend High Vanadium HSS

The Z-PRO Series taps are designed for general purpose usage in small and large batch quantity jobs that require the most economical tool life. These taps are designed to thread steels and ferrous materials that produce stringy chips. They are also ideal for brass, plastics in through hole applications.

Plug Style (5 threads chamfered)
 DIN lengths with ANSI shank dimensions.

Z-PRO Series STI-PO

Machine Screw Sizes
 Fractional Sizes

TPI Nominal Size	NC UNC	NF UNF	No. of Flutes	Pitch Diameter Limit/ EDP Numbers				Dimensions		
				H1	H2	H3	H4	Length of Thread	Neck Length	Length Overall
2	—	56	2	PUUN2E1NEB	PUUN2E2NEB	—	—	.354	.709	2.205
4	40	—	2	PUUN4H1NEB	PUUN4H2NEB	—	—	.512	.827	2.480
6	32	—	2	PUUN6J1NEB	PUUN6J2NEB	—	—	.551	.945	2.756
8	32	—	2	PUUN8J1NEB	PUUN8J2NEB	—	—	.591	.984	3.150
10	24	—	2	—	PUUNAM2NEB	PUUNAM3NEB	—	.591	1.181	3.150
10	—	32	2	—	PUUNAJ2NEB	PUUNAJ3NEB	—	.591	1.181	3.150
1/4	20	—	2	—	PUU04N2NEB	PUU04N3NEB	—	.748	1.378	3.543
1/4	—	28	2	—	PUU04K2NEB	PUU04K3NEB	—	.748	1.378	3.543
5/16	18	—	2	—	PUU05O2NEB	PUU05O3NEB	—	.906	1.535	3.937
5/16	—	24	2	—	PUU05M2NEB	PUU05M3NEB	—	.906	1.535	3.937
3/8	16	—	3	—	—	PUU06P3NEB	PUU06P4NEB	1.024	—	4.331
3/8	—	24	3	—	PUU06M2NEB	PUU06M3NEB	—	.906	—	3.937
7/16	14	—	3	—	—	PUU07Q3NEB	PUU07Q4NEB	1.024	—	4.331
7/16	—	20	3	—	—	PUU07N3NEB	PUU07N4NEB	1.024	—	4.331
1/2	13	—	3	—	—	PUU08R3NEB	PUU08R4NEB	1.024	—	4.331
1/2	—	20	3	—	—	PUU08N3NEB	PUU08N4NEB	1.024	—	4.331



Z-PRO

The Z-PRO Series taps are designed for general purpose usage in small and large batch quantity jobs that require the most economical tool life. These taps are designed to thread steels and ferrous materials that produce stringy chips. They are also ideal for brass, plastics in blind hole applications.

Economical High Performance Taps For Unified Threads

STI-SP



*Z-PRO STI-SP have a Bright Surface Finish
*AVAILABLE IN TIN AND TICN UPON REQUEST
Custom Blend High Vanadium HSS

Bottoming Style (2 threads chamfered)
DIN lengths with ANSI shank dimensions.

Z-PRO Series STI-SP

Machine Screw Sizes
Fractional Sizes

Nominal Size	TPI		No. of Flutes	Pitch Diameter Limit/ EDP Numbers			Dimensions		
	NC UNC	NF UNF		H1	H2	H3	Length of Thread	Neck Length	Length Overall
2	—	56	2	SUUN2E1NEB	SUUN2E2NEB	—	.354	.709	2.205
4	40	—	2	SUUN4H1NEB	SUUN4H2NEB	—	.512	.827	2.480
6	32	—	3	SUUN6J1NEB	SUUN6J2NEB	—	.551	.945	2.756
8	32	—	3	SUUN8J1NEB	SUUN8J2NEB	—	.591	.984	3.150
10	24	—	3	—	SUUNAM2NEB	SUUNAM3NEB	.591	1.181	3.150
10	—	32	3	—	SUUNAJ2NEB	SUUNAJ3NEB	.591	1.181	3.150
1/4	20	—	3	—	SUU04N2NEB	SUU04N3NEB	.748	1.378	3.543
1/4	—	28	3	—	SUU04K2NEB	SUU04K3NEB	.748	1.378	3.543
5/16	18	—	3	—	SUU05O2NEB	SUU05O3NEB	.906	1.535	3.937
5/16	—	24	3	—	SUU05M2NEB	SUU05M3NEB	.906	1.535	3.937
3/8	16	—	3	—	SUU06P2NEB	SUU06P3NEB	1.024	—	4.331
3/8	—	24	3	—	SUU06M2NEB	SUU06M3NEB	.906	—	3.937
7/16	14	—	3	—	SUU07Q2NEB	SUU07Q3NEB	1.024	—	4.331
7/16	—	20	3	—	SUU07N2NEB	SUU07N3NEB	1.024	—	4.331
1/2	13	—	3	—	SUU08R2NEB	SUU08R3NEB	1.024	—	4.331
1/2	—	20	3	—	SUU08N2NEB	SUU08N3NEB	1.024	—	4.331



Economical High Performance Taps

For Unified Threads

STI-PO-OX



*Z-PRO STI-PO-OX have an Oxide Surface Treatment
Custom Blend High Vanadium HSS

The Z-PRO Series taps are designed for general purpose usage in small and large batch quantity jobs that require the most economical tool life. These taps are designed to thread steels and ferrous materials that produce stringy chips. They are also ideal for brass, plastics in through hole applications.

Plug Style (5 threads chamfered)

DIN lengths with ANSI shank dimensions.

Z-PRO Series STI-PO-OX

Machine Screw Sizes
Fractional Sizes

Nominal Size	TPI		No. of Flutes	Pitch Diameter Limit/ EDP Numbers				Dimensions		
	NC	NF		H1	H2	H3	H4	Length of Thread	Neck Length	Length Overall
	UNC	UNF								
2	—	56	2	—	PUUN2E2NEX	—	—	.354	.709	2.205
4	40	—	2	—	PUUN4H2NEX	—	—	.512	.827	2.480
6	32	—	2	—	PUUN6J2NEX	—	—	.551	.945	2.756
8	32	—	2	—	PUUN8J2NEX	—	—	.591	.984	3.150
10	24	—	2	—	—	PUUNAM3NEX	—	.591	1.181	3.150
10	—	32	2	—	PUUNAJ2NEX	PUUNAJ3NEX	—	.591	1.181	3.150
1/4	20	—	2	—	—	PUU04N3NEX	—	.748	1.378	3.543
1/4	—	28	2	—	—	PUU04K3NEX	—	.748	1.378	3.543
5/16	18	—	2	—	—	PUU05O3NEX	—	.906	1.535	3.937
5/16	—	24	2	—	—	PUU05M3NEX	—	.906	1.535	3.937
3/8	16	—	3	—	—	—	PUU06P4NEX	1.024	—	4.331
3/8	—	24	3	—	—	PUU06M3NEX	—	.906	—	3.937
7/16	14	—	3	—	—	—	PUU07Q4NEX	1.024	—	4.331
7/16	—	20	3	—	—	—	PUU07N4NEX	1.024	—	4.331
1/2	13	—	3	—	—	—	PUU08R4NEX	1.024	—	4.331
1/2	—	20	3	—	—	—	PUU08N4NEX	1.024	—	4.331



Z-PRO

The Z-PRO Series are designed for general purpose usage in small and large batch quantity jobs that require the most economical tool life. These taps are designed to thread steels and ferrous materials that produce stringy chips. They are also ideal for brass, plastics in blind hole applications.

Economical High Performance Taps
For Unified Threads

STI-SP-OX



*Z-PRO ST-SP-OX have an Oxide Surface Treatment
Custom Blend High Vanadium HSS

Bottoming Style (2 threads chamfered)
DIN lengths with ANSI shank dimensions.

Z-PRO Series STI-SP-OX

Machine Screw Sizes
Fractional Sizes

Nominal Size	TPI		No. of Flutes	Pitch Diameter Limit/ EDP Numbers			Dimensions		
	NC	NF		H1	H2	H3	Length of Thread	Neck Length	Length Overall
	UNC	UNF							
2	—	56	2	—	SUUN2E2NEX	—	.354	.709	2.205
4	40	—	2	—	SUUN4H2NEX	—	.512	.827	2.480
6	32	—	3	—	SUUN6J2NEX	—	.551	.945	2.756
8	32	—	3	—	SUUN8J2NEX	—	.591	.984	3.150
10	24	—	3	—	—	SUUNAM3NEX	.591	1.181	3.150
10	—	32	3	—	—	SUUNAJ3NEX	.591	1.181	3.150
1/4	20	—	3	—	—	SUU04N3NEX	.748	1.378	3.543
1/4	—	28	3	—	SUU04K2NEX	SUU04K3NEX	.748	1.378	3.543
5/16	18	—	3	—	—	SUU05O3NEX	.906	1.535	3.937
5/16	—	24	3	—	SUU05M2NEX	SUU05M3NEX	.906	1.535	3.937
3/8	16	—	3	—	—	SUU06P3NEX	1.024	—	4.331
3/8	—	24	3	—	—	SUU06M3NEX	.906	—	3.937
7/16	14	—	3	—	—	SUU07Q3NEX	1.024	—	4.331
7/16	—	20	3	—	—	SUU07N3NEX	1.024	—	4.331
1/2	13	—	3	—	—	SUU08R3NEX	1.024	—	4.331
1/2	—	20	3	—	—	SUU08N3NEX	1.024	—	4.331

Z
P
R
O

S
T
I

S
P
O
X



Economical High Performance Taps

For Unified Threads

STI-HT



*Z-PRO STI-HT have a Bright Surface Finish
*AVAILABLE IN TIN AND TICN UPON REQUEST
Custom Blend High Vanadium HSS

The Z-PRO STI HAND taps are designed for general purpose usage in small and large batch quantity jobs that require the most economical tool life. These taps are designed to thread steels and ferrous materials that produce stringy chips. They are also ideal for brass and plastics.

Z-PRO STI-HT taps are recommended for tapping through holes or blind bottoming holes where the hole depth is great enough to allow chip accumulation at bottom of the hole.

Plug Style (5 threads chamfered)
DIN lengths with ANSI shank dimensions.

Z-PRO Series STI-HT

Machine Screw Sizes
Fractional Sizes

Nominal Size	TPI		No. of Flutes	Pitch Diameter Limit/ EDP Numbers				Dimensions		
	NC	NF		H1	H2	H3	H4	Length of Thread	Neck Length	Length Overall
	UNC	UNF								
2	—	56	3	TUUN2E1NEB5	TUUN2E2NEB4	—	—	.354	.709	2.205
4	40	—	3	TUUN4H1NEB5	TUUN4H2NEB4	—	—	.512	.827	2.480
6	32	—	3	TUUN6J1NEB5	TUUN6J2NEB4	—	—	.551	.945	2.756
8	32	—	3	TUUN8J1NEB5	TUUN8J2NEB4	—	—	.591	.984	3.150
10	24	—	3	—	TUUNAM2NEB5	TUUNAM3NEB4	—	.591	1.181	3.150
10	—	32	3	—	TUUNAJ2NEB5	TUUNAJ3NEB4	—	.591	1.181	3.150
1/4	20	—	3	—	TUU04N2NEB5	TUU04N3NEB4	—	.748	1.378	3.543
1/4	—	28	3	—	TUU04K2NEB5	TUU04K3NEB4	—	.748	1.378	3.543
5/16	18	—	4	—	TUU05O2NEB5	TUU05O3NEB4	—	.906	1.535	3.937
5/16	—	24	4	—	TUU05M2NEB5	TUU05M3NEB4	—	.906	1.535	3.937
3/8	16	—	4	—	—	TUU06P3NEB5	TUU06P4NEB4	1.024	—	4.331
3/8	—	24	4	—	TUU06M2NEB5	TUU06M3NEB4	—	.906	—	3.937
7/16	14	—	4	—	—	TUU07Q3NEB5	TUU07Q4NEB4	1.024	—	4.331
7/16	—	20	4	—	—	TUU07N3NEB5	TUU07N4NEB4	1.024	—	4.331
1/2	13	—	4	—	—	TUU08R3NEB5	TUU08R4NEB4	1.024	—	4.331
1/2	—	20	4	—	—	TUU08N3NEB5	TUU08N4NEB4	1.024	—	4.331



Z-PRO

The Z-PRO STI HAND taps are designed for general purpose usage in small and large batch quantity jobs that require the most economical tool life. These taps are designed to thread steels and ferrous materials that produce stringy chips. They are also ideal for brass and plastics.

Z-PRO STI-HT taps are recommended for tapping through holes or blind bottoming holes where the hole depth is great enough to allow chip accumulation at bottom of the hole.

Economical High Performance Taps For Unified Threads

STI-HT



*Z-PRO STI-HT have a Bright Surface Finish
*AVAILABLE IN TIN AND TICN UPON REQUEST
Custom Blend High Vanadium HSS

Bottoming Style (2 threads chamfered)
DIN lengths with ANSI shank dimensions.

Z-PRO Series STI-HT

Machine Screw Sizes
Fractional Sizes

Nominal Size	TPI		No. of Flutes	Pitch Diameter Limit/ EDP Numbers				Dimensions		
	NC	NF		H1	H2	H3	H4	Length of Thread	Neck Length	Length Overall
	UNC	UNF								
2	—	56	3	TUUN2E1NEBA	TUUN2E2NEBA	—	—	.354	.709	2.205
4	40	—	3	TUUN4H1NEBA	TUUN4H2NEBA	—	—	.512	.827	2.480
6	32	—	3	TUUN6J1NEBA	TUUN6J2NEBA	—	—	.551	.945	2.756
8	32	—	3	TUUN8J1NEBA	TUUN8J2NEBA	—	—	.591	.984	3.150
10	24	—	3	—	TUUNAM2NEBA	TUUNAM3NEBA	—	.591	1.181	3.150
10	—	32	3	—	TUUNAJ2NEBA	TUUNAJ3NEBA	—	.591	1.181	3.150
1/4	20	—	3	—	TUU04N2NEBA	TUU04N3NEBA	—	.748	1.378	3.543
1/4	—	28	3	—	TUU04K2NEBA	TUU04K3NEBA	—	.748	1.378	3.543
5/16	18	—	4	—	TUU05O2NEBA	TUU05O3NEBA	—	.906	1.535	3.937
5/16	—	24	4	—	TUU05M2NEBA	TUU05M3NEBA	—	.906	1.535	3.937
3/8	16	—	4	—	—	TUU06P3NEBA	TUU06P4NEBA	1.024	—	4.331
3/8	—	24	4	—	TUU06M2NEBA	TUU06M3NEBA	—	.906	—	3.937
7/16	14	—	4	—	—	TUU07Q3NEBA	TUU07Q4NEBA	1.024	—	4.331
7/16	—	20	4	—	—	TUU07N3NEBA	TUU07N4NEBA	1.024	—	4.331
1/2	13	—	4	—	—	TUU08R3NEBA	TUU08R4NEBA	1.024	—	4.331
1/2	—	20	4	—	—	TUU08N3NEBA	TUU08N4NEBA	1.024	—	4.331



Economical High Performance Taps

For Unified Threads

STI-HT-OX



*Z-PRO STI-HT-OX have an Oxide Surface Treatment
Custom Blend High Vanadium HSS

The Z-PRO STI HAND taps are designed for general purpose usage in small and large batch quantity jobs that require the most economical tool life. These taps are designed to thread steels and ferrous materials that produce stringy chips. They are also ideal for brass and plastics.

Z-PRO STI-HT taps are recommended for tapping through holes or blind bottoming holes where the hole depth is great enough to allow chip accumulation at bottom of the hole.

Plug Style (5 threads chamfered)
DIN lengths with ANSI shank dimensions.

Z-PRO Series STI-HT-OX

Machine Screw Sizes
Fractional Sizes

TPI Nominal Size	NC UNC	NF UNF	No. of Flutes	Pitch Diameter Limit/ EDP Numbers				Dimensions		
				H1	H2	H3	H4	Length of Thread	Neck Length	Length Overall
2	—	56	3	—	TUUN2E2NEX5	—	—	.354	.709	2.205
4	40	—	3	—	TUUN4H2NEX5	—	—	.512	.827	2.480
6	32	—	3	—	TUUN6J2NEX5	—	—	.551	.945	2.756
8	32	—	3	—	TUUN8J2NEX5	—	—	.591	.984	3.150
10	24	—	3	—	—	TUUNAM3NEX5	—	.591	1.181	3.150
10	—	32	3	—	TUUNAJ2NEX5	TUUNAJ3NEX5	—	.591	1.181	3.150
1/4	20	—	3	—	—	TUU04N3NEX5	—	.748	1.378	3.543
1/4	—	28	3	—	—	TUU04K3NEX5	—	.748	1.378	3.543
5/16	18	—	4	—	TUU05O2NEX5	TUU05O3NEX5	—	.906	1.535	3.937
5/16	—	24	4	—	—	TUU05M3NEX5	—	.906	1.535	3.937
3/8	16	—	4	—	—	—	TUU06P4NEX5	1.024	—	4.331
3/8	—	24	4	—	—	TUU06M3NEX5	—	.906	—	3.937
7/16	14	—	4	—	—	—	TUU07Q4NEX5	1.024	—	4.331
7/16	—	20	4	—	—	—	TUU07N4NEX5	1.024	—	4.331
1/2	13	—	4	—	—	—	TUU08R4NEX5	1.024	—	4.331
1/2	—	20	4	—	—	—	TUU08N4NEX5	1.024	—	4.331



Z-PRO

The Z-PRO STI HAND taps are designed for general purpose usage in small and large batch quantity jobs that require the most economical tool life. These taps are designed to thread steels and ferrous materials that produce stringy chips. They are also ideal for brass and plastics.

Z-PRO STI-HT taps are recommended for tapping through holes or blind bottoming holes where the hole depth is great enough to allow chip accumulation at bottom of the hole.

Economical High Performance Taps For Unified Threads

STI-HT-OX



*Z-PRO STI-HT-OX have an Oxide Surface Treatment Custom Blend High Vanadium HSS

Bottoming Style (2 threads chamfered)
DIN lengths with ANSI shank dimensions.

Z-PRO Series STI-HT-OX
Machine Screw Sizes
Fractional Sizes

Nominal Size	TPI		No. of Flutes	Pitch Diameter Limit/ EDP Numbers				Dimensions		
	NC	NF		H1	H2	H3	H4	Length of Thread	Neck Length	Length Overall
	UNC	UNF								
2	—	56	3	—	TUUN2E2NEXA	—	—	.354	.709	2.205
4	40	—	3	—	TUUN4H2NEXA	—	—	.512	.827	2.480
6	32	—	3	—	TUUN6J2NEXA	—	—	.551	.945	2.756
8	32	—	3	—	TUUN8J2NEXA	—	—	.591	.984	3.150
10	24	—	3	—	—	TUUNAM3NEXA	—	.591	1.181	3.150
10	—	32	3	—	—	TUUNAJ3NEXA	—	.591	1.181	3.150
1/4	20	—	3	—	—	TUU04N3NEXA	—	.748	1.378	3.543
1/4	—	28	3	—	—	TUU04K3NEXA	—	.748	1.378	3.543
5/16	18	—	4	—	—	TUU05O3NEXA	—	.906	1.535	3.937
5/16	—	24	4	—	—	TUU05M3NEXA	—	.906	1.535	3.937
3/8	16	—	4	—	—	—	TUU06P4NEXA	1.024	—	4.331
3/8	—	24	4	—	—	TUU06M3NEXA	—	.906	—	3.937
7/16	14	—	4	—	—	—	TUU07Q4NEXA	1.024	—	4.331
7/16	—	20	4	—	—	—	TUU07N4NEXA	1.024	—	4.331
1/2	13	—	4	—	—	—	TUU08R4NEXA	1.024	—	4.331
1/2	—	20	4	—	—	—	TUU08N4NEXA	1.024	—	4.331

SP

For Vertical use

LO-SP

For Horizontal use

SP/LO-SP

Spiral Fluted Taps for Alloy Steels



Feature of products

Spiral Fluted Taps for Alloy Steels

SP/LO-SP 1"-8UNC~1 1/2-8UN

SP for Vertical use



LO-SP for Horizontal use



Features

- Recommended for tapping alloy steels and high carbon steels
- Custom blended vanadium High Speed Steel with high wear resistance
- Ideal flute design for larger thread sizes produces smooth chip ejection and improved tool life
- DIN overall length/ANSI shank diameter creates smooth chip ejection and better application of coolant for more stable tapping
- Rear section of the thread part is specially ground off in order to improve the chip ejection and reduce friction resistance during tapping which lead to lower tapping torque, more accurate internal threads with better surface finish
- Recommendable tapping condition Tapping speed :
Up to 24SFM (~8m/min)
Coolant : Non soluble oil
Tapping length : Up to 2D

Table of dimensions and sizes

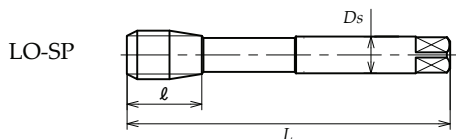
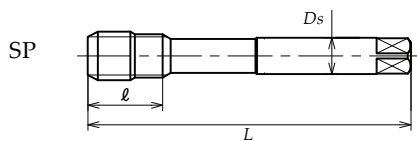

Size	Class	Chamfer	L	l	Ds	Number of flutes	Code
1"-8UNC	2BX	2.5P	6.30	1.457	0.800	4	SSU16XYEEXJ
1 1/8-8UN	2BX	2.5P	7.09	1.732	0.896	4	SSU18XYEEXJ
1 1/4-8UN	2BX	2.5P	7.09	1.929	1.021	4	SSU20XYEEXJ
1 3/8-8UN	2BX	2.5P	7.87	2.165	1.108	4	SSU22XYEEXJ
1 1/2-8UN	2BX	2.5P	7.87	2.323	1.233	4	SSU24XYEEXJ

Size	Class	Chamfer	L	l	Ds	Number of flutes	Code
1"-8UNC	2BX	2.5P	6.30	1.457	0.800	4	SSU16XYEEXHT
1 1/8-8UN	2BX	2.5P	7.09	1.732	0.896	4	SSU18XYEEXHT
1 1/4-8UN	2BX	2.5P	7.09	1.929	1.021	4	SSU20XYEEXHT
1 3/8-8UN	2BX	2.5P	7.87	2.165	1.108	4	SSU22XYEEXHT
1 1/2-8UN	2BX	2.5P	7.87	2.323	1.233	4	SSU24XYEEXHT

Tapping data

As a result of the taps' features shown above, the "SP" tap showed far better results for tapping into large diameter threads in alloy steel than a conventional "HISP" tap without causing damage to the cutting edge. The surface finish of internal thread produced by "SP" is excellent.

Tapping condition

Tap size	1"-8UNC
Work material	AISI 4140 (SCM440)
Tapping speed	22.6 SFM (6.9 m/min)
Hole shape	Blind hole
Hole diameter	0.878" (22.3 mm)
Tapping length	1.50" (38 mm)
Machine	Radial drilling machine
Coolant	Non-soluble oil

SP

Cutting edge



Internal thread

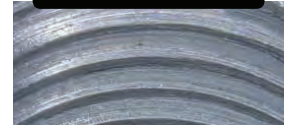

HISP

Cutting edge

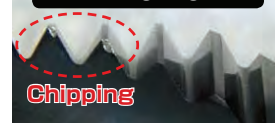

Internal thread



Warning

- ◆ Tools may shatter. Wear safety glass to avoid eye injury during tapping.
- ◆ Tools may be shatter. Use tools under the proper tapping condition.
- ◆ Never wear gloves during turning operations as the gloves may get caught with the tools.
- ◆ Wear safety shoes to avoid injury from falling tools.

- ◆ On attaching tools to the machine, fasten firmly to avoid chattering and run-out.
- ◆ Fasten the workpieces firmly so there is no movement during operation. Never use worn tools or damaged tools with chipping.
- ◆ Take special care to avoid fire. High temperature during machining may cause fire.

Please note that specification may change without advance notice.

YAMAWA Mfg. CO., Ltd.

Website : <http://www.yamawa.com>

YMW TAPS U.S.A.
Customer Service
855-YMW-USA1
855-969-8721
Fax 714-380-6324
www.ymw-tapsusa.com



8 TPI SP



SP Series Spiral Fluted Taps

For Unified Threads

8 Pitch Series SP-OX



SP-OX have an Oxide Surface Treatment
Custom Blend High Vanadium HSS

Recommended for tapping alloy steels and high carbon steels. Ideal flute design for larger thread sizes produces smooth chip ejection and improved tool life. The rear section of the thread part is specially ground off in order to improve the chip ejection and reduce friction resistance during tapping which lead to lower tapping torque, more accurate internal threads with better surface finish.

Modified Bottoming (2.5 threads chamfered) DIN lengths with ANSI shank dimensions				SP Series	Machine Screw Sizes Fractional Sizes	
Nominal Size	TPI		No. of Flutes	EDP Numbers	Dimensions	
	NC	NF		2B Class of Fit	Length of Thread	Length Overall
1	8	—	4	SSU16XYEEXJ	1.457	6.30
1" 1/8	8	—	4	SSU18XYEEXJ	1.732	7.09
1" 1/4	8	—	4	SSU20XYEEXJ	1.929	7.09
1" 3/8	8	—	4	SSU22XYEEXJ	2.165	7.09
1" 1/2	8	—	4	SSU24XYEEXJ	2.323	7.87



LO-SP Spiral Fluted Taps

For Unified Threads

8 Pitch Series LO-SP-OX



LO-SP-OX have an Oxide Surface Treatment
Custom Blend High Vanadium HSS

Bottoming (2.5 threads chamfered) DIN lengths with ANSI shank dimensions				LO-SP Series	Machine Screw Sizes Fractional Sizes	
Nominal Size	TPI		No. of Flutes	EDP Numbers	Dimensions	
	NC	NF		2B Class of Fit	Length of Thread	Length Overall
1	8	—	4	SSU16XYEEXHT	1.457	6.30
1" 1/8	8	—	4	SSU18XYEEXHT	1.732	7.09
1" 1/4	8	—	4	SSU20XYEEXHT	1.929	7.09
1" 3/8	8	—	4	SSU22XYEEXHT	2.165	7.09
1" 1/2	8	—	4	SSU24XYEEXHT	2.323	7.87

I SERIES

ISP IPO

New tap series especially designed for manual tapping and for drilling machine tapping.

Features of I series

- Designed specially for simple tapping operations such as manual tapping and drilling machine tapping.
- Surface treated (Oxidization Treatment) is mostly suitable for tapping SPC and soft steel.
- Recommendable for smaller quantity tapping such as tapping of test pieces.

material	SPC	SS400	low carbon steel	high carbon steel	alloy steel
suitable	◎	◎	◎	○	△



Flute shape of taps and chip injection

SP= Spiral	PO= Spiral point	HT= Straight
Ejection backwards	Ejection forward	Broken chips stored in flutes

Area of application

Basic concept of new products system for steels

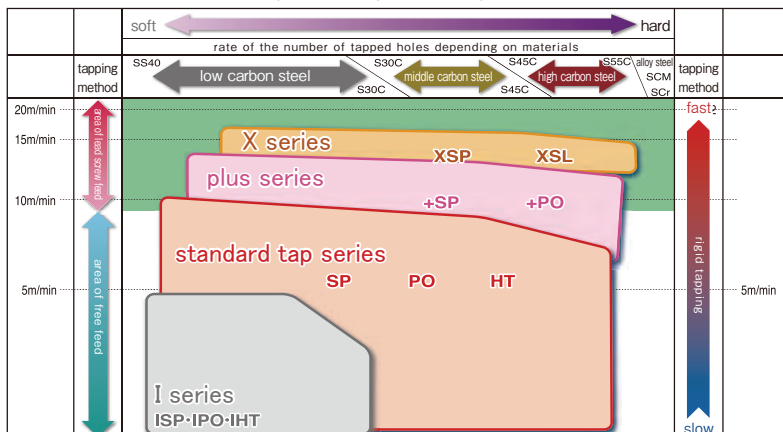

chart of application area



I Series Spiral Pointed Taps

For Unified Threads

Ideal for Steels, Irons, Brass and Plastics in blind hole applications

IPO



IPO have an Oxide Surface Treatment
Custom Blend High Vanadium HSS

Designed for small batch quantity jobs that require the most economical tap. These taps are designed to tap steels and ferrous materials that produce stringy chips. They are also deal for brass, plastics in through hole applications.

Spiral Pointed taps are recommended for tapping through holes.

Plug Style (3 to 5 threads chamfered)				I SERIES PO		Machine Screw sizes Fractional sizes	
Threads Per Inch			No. of Flutes	EDP NUMBERS	Dimensions		
Nominal Size	NC UNC	NF UNF		2B CLASS OF FIT	Length of Thread	Length Overall	
6	32	—	3	VAUN6JXHEX	.374	2	
8	32	—	3	VAUN8JXHEX	.374	2- 1/8	
10	24	—	3	VAUNAMXHEX	.512	2- 3/8	
1/4	20	—	3	VAU04NXHEX	.591	2- 1/2	
5/16	18	—	3	VAU05OXHEX	.669	2- 23/32	
3/8	16	—	3	VAU06PXHEX	.748	2- 15/16	



I Series Spiral Fluted Taps

For Unified Threads

ISP

Ideal for Steels, Irons, Brass and Plastics in blind hole applications

These taps are designed to tap steels and ferrous materials that produce stringy chips.

Spiral Fluted taps are recommended for tapping blind hole where chips are pulled out of the hole toward the tap shank instead of pushing them to the bottom of the hole.



ISP have an Oxide Surface Treatment
Custom Blend High Vanadium HSS

Bottom Style (2.5 threads chamfered)				I SERIES SP		Machine Screw sizes Fractional sizes	
Threads Per Inch			No. of Flutes	EDP NUMBERS	Dimensions		
Nominal Size	NC UNC	NF UNF		2B CLASS OF FIT	Length of Thread	Length Overall	
6	32	—	3	UAUN6JXHEX	.374	2	
8	32	—	3	UAUN8JXHEX	.374	2- 1/8	
10	24	—	3	UAUNAMXHEX	.512	2- 3/8	
1/4	20	—	3	UAU04NXHEX	.591	2- 1/2	
5/16	18	—	3	UAU05OXHEX	.669	2- 23/32	
3/8	16	—	3	UAU06PXHEX	.748	2- 15/16	

IHT SERIES

Features of I series

- Designed specially for simple tapping operations such as manual tapping and drilling machine tapping.
- Surface treated (Oxidation Treatment) is mostly suitable for tapping SPC and soft steel.
- Recommendable for smaller quantity tapping such as tapping of test pieces.

material	SPC	SS400	low carbon steel	high carbon steel	alloy steel
suitable	◎	◎	◎	○	△

Area of application

Basic concept of new products system for steels

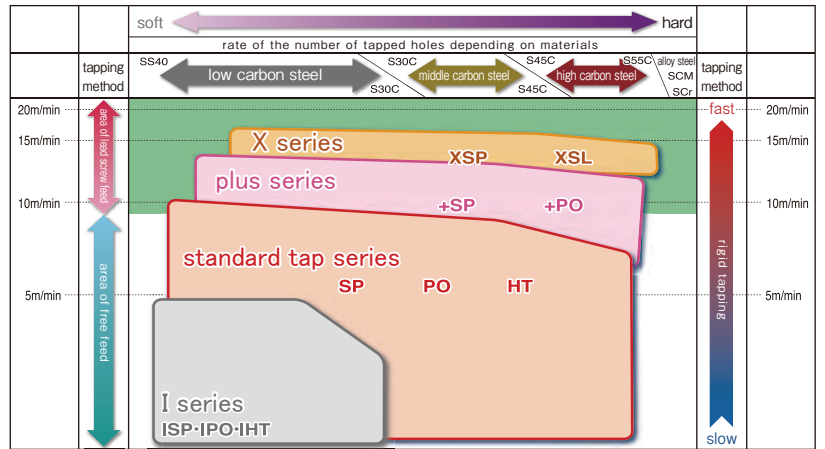

chart of application area

IHT

size	overall length	thread length	neck length	shank diameter	s(ref.)	code
M3X0.5	46	9	14	4	26	HI73.0G ()
M4X0.7	52	11	17	5	40	HI74.0I ()
M5X0.8	60	13	22	5.5	33	HI75.0K ()
M6X1	62	15	26	6	33	HI76.0M ()
M8X1.25	70	19	34	6.2	36	HI78.0N ()
M10X1.5	75	23	37	7	38	HI70100 ()

(ref.)=M2.6 and smaller 5P=5, 1.5P=1

M3 and larger

Tapping operation



Manual tapping by using tap wrench



Tapping with drilling machine

Products related to I series

Shank adjuster By one touch, attaching and detaching to I series tap (IHT/ISP/IPO) become possible.

M3~M



size	L	D	Ds	ℓ	ℓ ₁	k	ℓ _k	code
M3-150	150	11	4	127	45	3.2	6	SA3.0M
M4-150	150	12	5	122	45	4	7	SA4.0M
M5-150	150	12.5	5.5	114	45	4.5	7	SA5.0M
M6-150	150	13	6	115	45	4.5	7	SA6.0M

M8,M1



(unit:mm)

size	L	D	Ds	ℓ	ℓ ₁	k	ℓ _k	code
M8-150	150	13	6.2	108	45	5	8	SA8.0M
M10-150	150	14	7	103	45	5.5	8	SA010M



I Series HT
For Unified Threads

IHT

I
S
E
R
I
E
S
H
T



Designed for small batch quantity jobs that require the most economical tap. These taps are designed to tap steels and ferrous materials that produce stringy chips. They are also ideal for brass, plastics in through hole applications.

I Series HT available in blister packs.

Taps have oxide surface treatment.

Plug Style (5 threads chamfer)
DIN lengths with ANSI shank dimensions.

I Series HT Machine Screw sizes
Fractional Size

Nominal Size	Threads Per Inch		No. of Flutes	EDP NUMBERS		Dimensions	
	NC UNC	NF UNF		Plug	Bottoming	Length of Thread	Length Overall
6	32	—	3	IAUN6JXHEX5R	IAUN6JXHEX2R	.374	2
8	32	—	3	IAUN8JXHEX5R	IAUN8JXHEX2R	.374	2- 1/8
10	24	—	3	IAUNAMXHEX5R	IAUNAMXHEX2R	.512	2- 3/8
1/4	20	—	3	IAU04NXHEX5R	IAU04NXHEX2R	.591	2- 1/2
5/16	18	—	3	IAU05OXHEX5R	IAU05OXHEX2R	.669	2- 23/32
3/8	16	—	3	IAU06PXHEX5R	IAU06PXHEX2R	.748	2- 15/16

ZELX MOLD SERIES

MOLD STEELS

For materials from 35-45RC. Designed for tool steels, alloy steels >275 BRN, gray irons and hardened steel.



Features of Zelx Mold Series

- Available in a "Hand" tap style.
- Low cutting face, straight flute only.
- USC TI & ANSI STD. dimensions, table
- 302 M42 Cobalt HSS

Also available in NPT





Mold Hand Taps

Hand Taps for Hard-to-Machine Materials

For Unified Threads

ZELX MOLD



ZELX Mold have a Bright Finish Coating

Cobalt High Speed Steels

First Choice for Tapping Mold Steels

Ideal for tapping mold steels, tool steels and gray cast irons, YMW offers this series of ZELX Mold Taps made of Cobalt High Speed Steel, ZELX Mold Hand Taps and Mold Pipe Taps.

Combined with specially designed geometry, Cobalt High Speed Steel improves the toughness of ZELX Taps for use in Prehardened Mold Steels. Furnished bright without surface treatment, taps can be surfaced treated upon request.

Ideal for tapping mold steels, tool steels and gray cast irons. (35 to 45HRC) YMW offers this series of ZELX Mold Taps made of Cobalt High Speed Steel.

Plug Style (4 to 6 threads chamfered)				List		Machine Screw sizes	
				3114	3124	Fractional sizes	
Nominal Size	TPI NC UNC	NF UNF	No. of Flutes	Pitch Diameter Limit/ EDP Numbers		Dimensions	
				H2	H3	Length of Thread	Length Overall
4	40	—	3	389599	—	9/16	1- 7/8
5	40	—	3	389601	—	5/8	1- 15/16
6	32	—	3	—	389602	11/16	2
8	32	—	3	—	389604	3/4	2- 1/8
10	24	—	3	—	389606	7/8	2- 3/8
10	—	32	3	—	389607	7/8	2- 3/8
1/4	20	—	3	—	389613	1	2- 1/2
1/4	—	28	3	—	389614	1	2- 1/2
5/16	18	—	4	—	389615	1- 1/8	2- 23/32
5/16	—	24	4	—	389616	1- 1/8	2- 23/32
3/8	16	—	4	—	389617	1- 1/4	2- 15/16
3/8	—	24	4	—	389618	1- 1/4	2- 15/16
7/16	14	—	4	—	389619	1- 7/16	3- 5/32
7/16	—	20	4	—	389620	1- 7/16	3- 5/32
1/2	13	—	4	—	389621	1- 21/32	3- 3/8
1/2	—	20	4	—	389622	1- 21/32	3- 3/8
5/8	11	—	4	—	389625	1- 13/16	3- 13/16
5/8	—	18	4	—	389626	1- 13/16	3- 13/16
3/4	10	—	4	—	389627	2	4- 1/4
3/4	—	16	4	—	389628	2	4- 1/4



Mold Hand Taps

Hand Taps for Hard-to-Machine Materials For Metric Threads

Ideal for tapping mold steels, tool steels, and gray cast irons, YMW offers this series of ZELX Mold Taps made of Cobalt High Speed Steel, ZELX Mold Hand Taps and Mold Pipe Taps.

ZELX MOLD



ZELX Mold have a Bright Finish Coating

Cobalt High Speed Steels

First Choice for Tapping Mold Steels

ZELX MOLD

Plug Style
(4 to 6 threads chamfered)

List 3114 Metric sizes

Nominal Size	No. of Flutes	Pitch Diameter Limit/ EDP Numbers			Dimensions		
		D5	D6	D7	Length of Thread	Neck Length	Length Overall
M5 X 0.8	3	TS5.0K5DCB5	—	—	.591	.984	3.15
M6 X 1	3	—	TS6.0M6DCB5	—	.591	1.181	3.15
M8 X 1	4	—	TS8.0M6DCB5	—	.748	1.382	3.543
M8 X 1.25	4	—	TS8.0N6DCB5	—	.748	1.382	3.543
M10 X 1.25	4	—	TS010N6DCB5	—	.906	—	3.937
M10 X 1.5	4	—	—	TS010O7DCB5	.906	—	3.937
M12 X 1.75	4	—	—	TS012P7DCB5	1.024	—	4.331

ZELX SERIES

CARBIDE HAND TAPS

YMW solid ultra fine grain carbide taps are manufactured from the finest micro grain carbide for exceptional wear life and reduced chipping.

ZELX CARB CI CARBIDE HAND TAPS

For Cast Irons, Hard Plastics, Fiberglass, Cast Brass, Cobalt and Chrome Alloys Steels.

ZELX CARB AL CARBIDE HAND TAPS

For Aluminum Alloys, Zinc Die Castings, Copper Alloys and Soft Plastics.



Features of Zelx Carbide Hand Taps

- Ideal for long production runs where reduced tool changes mean improved production efficiency.
- Also proven to be an excellent choice for threading very abrasive materials below 40HRC .
- For the longest tool life available from any tap, YMW offers two carbide tap designs-one for tapping cast irons and another for aluminums.
- Plug and Bottoming chamfer available.

#3917/3927: 4 Flute for Cast Iron, Cobalt Chrome, Fiberglass and other hard short chipping materials.

Low Hook Cutting Face

#3910/3920: 3 Flute for Aluminum, Copper, Plastics and other soft easy to machine materials.

High Hook Cutting Face for Aluminum

#3977 Series for Cast Iron from #10 to 5/8" plus M3-M12

#3970 Series for Aluminum from #5 to 1/2" plus M3-M12



ZELX Carbide Hand Taps

For Unified Threads

Ideal for long production runs where reduced tool changes mean improved production efficiency.

YMW carbide taps have also proven to be an excellent choice for threading very abrasive materials below 40HRC.

YMW solid ultra fine grain carbide taps are manufactured from the finest micro grain carbide for exceptional wear life and reduced chipping.

For the longest tool life available from any tap, YMW offers two carbide tap designs --- one for tapping cast irons and another for aluminums.

ZELX CARB CI CARBIDE HAND TAPS

For Cast Irons, Hard Plastics, Fiberglass, Cast Brass, Cobalt, Chrome Alloys Steels



ZELX CARB AL CARBIDE HAND TAPS

For Aluminum Alloys, Zinc Die Castings, Copper Alloys and Soft Plastics

Straight Flute
 Plug (3 to 5 threads chamfered) for through hole tapping. List 3910 & 3817 Machine Screw sizes
 Bottoming (1 to 2 threads chamfered) for blind hole tapping. List 3920 & 3927 Fractional sizes

TPI Nominal Size	NC UNC	NF UNF	Ground Thread Limits	EDP Numbers				Dimensions	
				FOR CAST IRONS 4 Flutes		FOR ALUM. ALLOYS 3 Flutes		Length of Thread	Length Overall
			Plug	Bottoming	Plug	Bottoming			
				LIST 3917		LIST 3910			
5	40	—	H3	—	—	384800	384801	5/8	1- 5/16
6	32	—	H3	—	—	384802	384803	11/16	2
8	32	—	H3	—	—	384804	384805	3/4	2- 1/8
10	24	—	H3	383806	383807	384806	384807	7/8	2- 3/8
10	—	32	H5	383808	383809	384808	384809	7/8	2- 3/8
				LIST 3927		LIST 3920			
1/4	20	—	H3	383810	383811	384810	384811	1	2- 1/2
1/4	20	—	H5	383860	383861	384860	384861	1	2- 1/2
1/4	—	28	H3	383812	383813	384812	384813	1	2- 1/2
1/4	—	28	H5	383862	383863	384862	384863	1	2- 1/2
5/16	18	—	H3	383814	383815	384814	384815	1- 1/8	2- 23/32
5/16	18	—	H5	383864	383865	384864	384865	1- 1/8	2- 23/32
5/16	—	24	H3	383816	383817	384816	384817	1- 1/8	2- 23/32
5/16	—	24	H5	383866	383867	384866	384867	1- 1/8	2- 23/32
3/8	16	—	H3	383818	383819	384818	384819	1- 1/4	2- 15/16
3/8	16	—	H5	383868	383869	384868	384869	1- 1/4	2- 15/16
3/8	—	24	H3	383820	383821	384820	384821	1- 1/4	2- 15/16
3/8	—	24	H5	383870	383871	384870	384871	1- 1/4	2- 15/16
7/16	14	—	H3	383822	383823	384822	384823	1- 7/16	3- 5/32
7/16	14	—	H5	383572	383873	384872	384873	1- 7/16	3- 5/32
7/16	—	24	H3	383824	383825	384824	384825	1- 7/16	3- 5/32
7/16	—	24	H5	383874	383875	384874	384875	1- 7/16	3- 5/32
1/2	13	—	H3	383826	383827	384826	384827	1- 21/32	3- 3/8
1/2	13	—	H5	383876	383877	384876	384877	1- 21/32	3- 3/8
1/2	—	20	H3	383828	383829	384828	384829	1- 21/32	3- 3/8
1/2	—	20	H5	383878	383879	384878	384879	1- 21/32	3- 3/8
5/8	11	—	H3	383834	383835	—	—	1- 13/16	3- 13/16
5/8	11	—	H5	383884	383885	—	—	1- 13/16	3- 13/16
5/8	—	18	H3	383836	383837	—	—	1- 13/16	3- 13/16
5/8	—	18	H5	383886	383887	—	—	1- 13/16	3- 13/16



ZELX Carbide Hand Taps

For Metric Threads

YMW solid ultra fine grain carbide taps are manufactured from the finest micro grain carbide for exceptional wear life and reduced chipping.

For the longest tool life available from any tap, YMW offers two carbide tap designs --- one for tapping cast irons and another for aluminums.

Ideal for long production runs where reduced tool changes mean improved production efficiency.

YMW carbide taps have also proven to be an excellent choice for threading very abrasive materials below 40HRC.



ZELX CARB CI CARBIDE HAND TAPS

For Cast Irons, Hard Plastics, Fiberglass, Cast Brass, Cobalt, Chrome Alloys Steels

ZELX CARB AL CARBIDE HAND TAPS

For Aluminum Alloys, Zinc Die Castings, Copper Alloys and Soft Plastics

Straight Flute

Plug (3 to 5 threads chamfered) for through hole tapping
 Bottoming (1 to 2 threads chamfered) for blind hole tapping

List 3977 Cast Iron Metric sizes

List 3970 Aluminum Metric sizes

Nominal Size	Ground Thread Limits	EDP Numbers				Dimensions	
		FOR CAST IRONS 4 Flutes		FOR ALUM. ALLOYS 3 Flutes		Length of Thread	Length Overall
		Plug	Bottoming	Plug	Bottoming		
		LIST 3977		LIST 3970			
M3 X 0.5	D3	370000	370001	371000	371001	5/8	1- 5/16
M4 X 0.7	D4	370002	370003	371002	371003	3/4	2- 1/8
M5 X 0.8	D4	370004	370005	371004	371005	7/8	2- 3/8
M6 X 1	D5	370006	370007	371006	371007	1	2- 1/2
M8 X 1	D5	370008	370009	371008	371009	1- 1/8	2- 23/32
M8 X 1.25	D5	370010	370011	371010	371011	1- 1/8	2- 23/32
M10 X 1.25	D5	370012	370013	371012	371013	1- 1-4	2- 15/16
M10 X 1.5	D6	370014	370015	371014	371015	1- 1/4	2- 15/16
M12 X 1.25	D5	370016	370017	371016	371017	1- 21/32	3- 3/8
M12 X 1.5	D6	370018	370019	371018	371019	1- 21/32	3- 3/8
M12 X 1.75	D6	370020	370021	371020	371021	1- 21/32	3- 3/8
M14 X 1.5	D6	370022	370023	---	---	1- 21/32	3- 19/32
M14 X 2	D7	370024	370025	---	---	1- 21/32	3- 19/32
M16 X 1.5	D6	370026	370027	---	---	1- 13/16	3- 13/16
M16 X 2	D7	370028	370029	---	---	1- 13/16	3- 13/16

OVERSIZE TAPS

+0.005 H11 OVERSIZE

Oversize taps are +.005 larger than the basic pitch diameter (the equivalent of an H11). Vanadium High Speed Steel Taps.

Oversize taps are supplied in the popular bottoming chamfer with a 2 1/2 to 3 pitch length. Available as spiral flute taps for ferrous and non ferrous materials.



+0.005" Oversize Spiral Flute Taps for Ferrous Materials

+0.005" H11 Oversize Taps



*Taps have TICN coating Surface Treatment
Custom Blend High Vanadium HSS

Oversize taps are +.005" larger than basic pitch diameter (equivalent to an H11).

Oversize taps are supplied in the popular bottoming chamfer which is 2 pitches in length.

Bottoming Style (2 threads chamfered)
DIN lengths with ANSI shank dimensions.

Fractional Sizes

TPI Nominal Size	NC UNC	NF UNF	No. of Flutes	Pitch Diameter Limit/ EDP Numbers	Dimensions	
				H11	Length of Thread	Length Overall
1/4	20	—	3	SSU04N11-TICN	.591	3.150
1/4	—	28	3	SSU04K11-TICN	.591	3.150
5/16	18	—	3	SSU05O11-TICN	.748	3.543
5/16	—	24	3	SSU05M11-TICN	.748	3.543
3/8	16	—	3	SSU06P11-TICN	.906	3.937
3/8	—	24	3	SSU06M11-TICN	.906	3.937
1/2	13	—	3	SSU08R11-TICN	1.024	4.331
1/2	—	20	3	SSU08N11-TICN	1.024	4.331
5/8	11	—	3	SSU10U11-TICN	1.024	4.331
5/8	—	18	3	SSU10O11-TICN	1.024	4.331
3/4	10	—	3	SSU12V11-TICN	1.299	4.921
3/4	—	16	3	SSU12P11-TICN	1.299	4.921

Available in bright finish by changing suffix to NEB, example 1/2"-13 GH11 SSU08R11NEB
 Available in oxide finish by changing suffix to NEX, example 1/2"-13 GH11 SSU08R11NEX
 Available in TIN coating by changing suffix to TIN, example 1/2"-13 GH11 SSU08R11-TIN

ROLL TAP SERIES

N-RZ N-RS HP-RZ OL-RZ

Features of N-RZ Series

- Custom blended vanadium high speed steel for stainless steels and alloy steels.
- Taps are DIN length with ANSI shank dimensions.
- Steam Oxide for improved roll tapping in steels and stainless steels.
- N-RZ taps should be ran 1 1/2 faster than the recommended speed for a cutting tap.



Features of N-RS Series

- Custom blended vanadium high speed steel for aluminum, brass and copper alloys.
- Taps are DIN length with ANSI shank dimensions.
- Nitride surface for toughening treatment.
- N-RS taps should be ran 1 1/2 faster than the recommended speed for a cutting tap.



Features of HP-RZ Series

- Custom blended powder metals roll taps for stainless steels, medium and high carbon steels.
- Taps are DIN length with ANSI shank dimensions.
- TiCN coating for tapping with coolant.
- HP-RZ taps should be ran 2 faster than the recommended speed for a cutting tap.

Features of OL-RZ Series

- Custom blended powder metals roll taps for stainless steels, soft low and high carbon steels.
- Taps are DIN length with ANSI shank dimensions.
- TiCN coating for COOLANT FREE threading.
- OL-RZ taps should be ran 2 faster than the recommended speed for a cutting tap.



Thread Forming Taps for Ferrous Materials

For Unified Threads

N-RZ



N-RZ have an Oxide Surface Finish
Custom Blend High Vanadium HSS

Stainless Steels & Alloy Steels
(for Ferrous Materials)

Improved performance, new tap design.

Plug Style (3 to 5 threads chamfered)
DIN lengths with ANSI shank dimensions.

List 3560 Machine Screw Sizes
3565 Fractional Sizes

TPI Nominal Size	UNC UNJC	UNF UNJF	No. of Lobe Grooves	Pitch Diameter Limit/ EDP Numbers						Dimensions		
				H2	H3	H4	H5	H6	H7	Length of Thread	Neck Length	Length Overall
4	40	—	0	—	389423	—	389424	—	—	.433	.276	2.205
4	—	48	0	—	389427	—	389428	—	—	.433	.276	2.205
5	40	—	4	—	389431	—	389432	—	—	.433	.276	2.205
5	—	44	4	—	389435	—	389436	—	—	.433	.276	2.205
6	32	—	4	—	389440	—	389441	—	—	.512	.276	2.205
6	—	40	4	—	389444	—	389445	—	—	.512	.276	2.205
8	32	—	4	—	389448	—	389449	—	—	.512	.315	2.480
8	—	36	4	—	389452	—	389453	—	—	.512	.315	2.480
10	24	—	4	—	—	389456	—	389457	—	.630	.354	2.756
10	—	32	4	—	—	389460	—	389461	—	.630	.354	2.756
12	24	—	4	—	—	389464	—	389465	—	.630	.354	3.150
12	—	28	4	—	—	389468	—	389469	—	.630	.354	3.150
1/4	20	—	4	—	—	389472	—	389473	—	.748	.433	3.150
1/4	—	28	4	—	—	389476	—	389477	—	.748	.433	3.150
5/16	18	—	3	—	—	—	389480	—	389481	.866	.512	3.543
5/16	—	24	3	—	—	—	389484	—	389485	.866	.512	3.543
3/8	16	—	3	—	—	—	389488	—	389489	.945	.597	3.937
3/8	—	24	3	—	—	—	389492	—	389493	.787	.748	3.543
7/16	14	—	4	—	—	—	389496	—	389497	.945	—	3.937
7/16	—	20	4	—	—	—	389502	—	389503	.945	—	3.937
1/2	13	—	4	—	—	—	389506	—	389507	1.142	—	4.331
1/2	—	20	4	—	—	—	389510	—	389511	.866	—	3.937



Thread Forming Taps for Ferrous Materials For Unified Threads

N-RZ



N-RZ have an Oxide Surface Finish
Custom Blend High Vanadium HSS

**Stainless Steels & Alloy Steels
(for Ferrous Materials)**

Improved performance, new tap design.

Bottoming Style (2 to 2- 1/2 threads chamfered)
DIN lengths with ANSI shank dimensions.

List 3560 Machine Screw Sizes
3565 Fractional Sizes

Nominal Size	TPI		No. of Lobe Grooves	Pitch Diameter Limit/ EDP Numbers						Dimensions		
	UNC UNJC	UNF UNJF		H2	H3	H4	H5	H6	H7	Length of Thread	Neck Length	Length Overall
0	—	80	0	389410	—	—	—	—	—	.315	—	1.575
1	64	—	0	389411	—	—	—	—	—	.315	—	1.575
1	—	72	0	389412	—	—	—	—	—	.315	—	1.575
2	56	—	0	389413	389414	—	—	—	—	.354	—	1.772
2	—	64	0	389415	389416	—	—	—	—	.354	—	1.772
3	48	—	0	389417	389418	—	—	—	—	.276	.217	1.969
3	—	56	0	389419	389420	—	—	—	—	.276	.217	1.969
4	40	—	0	—	389421	—	389422	—	—	.433	.276	2.205
4	—	48	0	—	389425	—	389426	—	—	.433	.276	2.205
5	40	—	4	—	389429	—	389430	—	—	.433	.276	2.205
5	—	44	4	—	389433	—	389434	—	—	.433	.276	2.205
6	32	—	4	—	389437	—	389438	—	—	.512	.276	2.205
6	—	40	4	—	389442	—	389443	—	—	.512	.276	2.205
8	32	—	4	—	389446	—	389447	—	—	.512	.315	2.480
8	—	36	4	—	389450	—	389451	—	—	.512	.315	2.480
10	24	—	4	—	—	389454	—	389455	—	.630	.354	2.756
10	—	32	4	—	—	389458	—	389459	—	.630	.354	2.756
12	24	—	4	—	—	389462	—	389463	—	.630	.354	3.150
12	—	28	4	—	—	389466	—	389467	—	.630	.354	3.150
1/4	20	—	4	—	—	389470	—	389471	—	.748	.433	3.150
1/4	—	28	4	—	—	389474	—	389475	—	.748	.433	3.150
5/16	18	—	3	—	—	—	389478	—	389479	.866	.512	3.543
5/16	—	24	3	—	—	—	389482	—	389483	.866	.512	3.543
3/8	16	—	3	—	—	—	389486	—	389487	.945	.597	3.937
3/8	—	24	3	—	—	—	389490	—	389491	.787	.748	3.543
7/16	14	—	4	—	—	—	389494	—	389495	.945	—	3.937
7/16	—	20	4	—	—	—	389498	—	389499	.945	—	3.937
1/2	13	—	4	—	—	—	389504	—	389505	1.142	—	4.331
1/2	—	20	4	—	—	—	389508	—	389509	.866	—	3.937

N-RZ Roll taps can be run 1.5 times faster than the tapping speeds recommended for thread cutting taps



Thread Forming Taps for Ferrous Materials

For Metric Threads

N-RZ



N-RZ have an Oxide Surface Finish
Custom Blend High Vanadium HSS

**Stainless Steels & Alloy Steels
(for Ferrous Materials)**

Improved performance, new tap design.
Replaces #3510 and #3520 Roll Taps styles.

Plug Style (3 to 5 threads chamfered)
Bottoming Style (2 to 2- 1/2 threads chamfered)
DIN lengths with USCTI shank dimensions.

List 3575 Metric Sizes

Nominal Size	Ground Thread Limits	No. of Lobe Grooves	Pitch Diameter Limit/EDP Numbers		Dimensions		
			Plug	Bottoming	Length of Thread	Neck Length	Length Overall
M3 X 0.5	D5	4	389513	389512	.433	.276	2.205
M3.5 X 0.6	D6	4	389515	389514	.512	.276	2.205
M4 X 0.7	D6	4	389517	389516	.512	.315	2.480
M5 X 0.8	D7	4	389519	389518	.630	.354	2.756
M6 X 1	D8	4	389521	389520	.748	.433	3.150
M7 X 1	D9	4	389523	389522	.748	.433	3.150
M8 X 1	D9	3	389525	389524	.866	.512	3.543
M8 X 1.25	D9	3	389527	389526	.866	.512	3.543
M10 X 1.25	D9	4	389529	389528	.945	.591	3.937
M10 X 1.5	D10	4	389531	389530	.945	.591	3.937
M12 X 1.25	D9	4	389533	389532	.866	—	3.937
M12 X 1.75	D11	4	389535	389534	1.142	—	4.331



Thread Forming Taps for Non-Ferrous Materials For Unified Threads

N-RS



N-RS have a Nitride Surface Toughening Treatment
Custom Blend High Vanadium HSS

For Aluminums, Brass, Copper Alloys
(Non-Ferrous Materials).

Improved performance, new tap design.

Plug Style (3 to 5 threads chamfered)
DIN lengths with ANSI shank dimensions.

List 3550 Machine Screw Sizes
3552 Fractional Sizes

Nominal Size	TPI		No. of Lobe Grooves	Pitch Diameter Limit/ EDP Numbers						Dimensions		
	UNC UNJC	UNF UNJF		H2	H3	H4	H5	H6	H7	Length of Thread	Neck Length	Length Overall
4	40	—	0	—	388423	—	388424	—	—	.433	.276	2.205
4	—	48	0	—	388427	—	388428	—	—	.433	.276	2.205
5	40	—	1	—	388431	—	388432	—	—	.433	.276	2.205
5	—	44	1	—	388435	—	388436	—	—	.433	.276	2.205
6	32	—	1	—	388440	—	388441	—	—	.512	.276	2.205
6	—	40	1	—	388444	—	388445	—	—	.512	.276	2.205
8	32	—	1	—	388448	—	388449	—	—	.512	.315	2.480
8	—	36	1	—	388452	—	388453	—	—	.512	.315	2.480
10	24	—	1	—	—	388456	—	388457	—	.630	.354	2.756
10	—	32	1	—	—	388460	—	388461	—	.630	.354	2.756
12	24	—	1	—	—	388464	—	388465	—	.630	.354	3.150
12	—	28	1	—	—	388468	—	388469	—	.630	.354	3.150
1/4	20	—	1	—	—	388472	—	388473	—	.748	.433	3.150
1/4	—	28	1	—	—	388476	—	388477	—	.748	.433	3.150
5/16	18	—	1	—	—	—	388480	—	388481	.866	.512	3.543
5/16	—	24	1	—	—	—	388484	—	388485	.866	.512	3.543
3/8	16	—	1	—	—	—	388488	—	388489	.945	.590	3.937
3/8	—	24	1	—	—	—	388492	—	388493	.787	.748	3.543
7/16	14	—	1	—	—	—	388496	—	388497	.945	—	3.937
7/16	—	20	1	—	—	—	388502	—	388503	.945	—	3.937
1/2	13	—	1	—	—	—	388506	—	388507	1.142	—	4.331
1/2	—	20	1	—	—	—	388510	—	388511	.866	—	3.937



Thread Forming Taps for Non-Ferrous Materials

For Unified Threads

N-RS



N-RS have a Nitride Surface Toughening Treatment
Custom Blend High Vanadium HSS

For Aluminums, Brass, Copper Alloys
(Non-Ferrous Materials).

Improved performance, new tap design.

Bottoming Style (2 to 2-1/2 threads chamfered)
DIN lengths with ANSI shank dimensions.

List 3550 Machine Screw Sizes
3552 Fractional Sizes

Nominal Size	TPI		No. of Lobe Grooves	Pitch Diameter Limit/ EDP Numbers						Dimensions		
	UNC UNJC	UNF UNJF		H2	H3	H4	H5	H6	H7	Length of Thread	Neck Length	Length Overall
0	—	80	0	388410	—	—	—	—	—	.315	—	1.575
1	64	—	0	388411	—	—	—	—	—	.315	—	1.575
1	—	72	0	388412	—	—	—	—	—	.315	—	1.575
2	56	—	0	388413	388414	—	—	—	—	.354	—	1.772
2	—	64	0	388415	388416	—	—	—	—	.354	—	1.772
3	48	—	0	388417	388418	—	—	—	—	.276	.217	1.969
3	—	56	0	388419	388420	—	—	—	—	.276	.217	1.969
4	40	—	0	—	388421	—	388422	—	—	.433	.276	2.205
4	—	48	0	—	388425	—	388426	—	—	.433	.276	2.205
5	40	—	1	—	388429	—	388430	—	—	.433	.276	2.205
5	—	44	1	—	388433	—	388434	—	—	.433	.276	2.205
6	32	—	1	—	388437	—	388438	—	—	.512	.276	2.205
6	—	40	1	—	388442	—	388443	—	—	.512	.276	2.205
8	32	—	1	—	388446	—	388447	—	—	.512	.315	2.480
8	—	36	1	—	388450	—	388451	—	—	.512	.315	2.480
10	24	—	1	—	—	388454	—	388455	—	.630	.354	2.756
10	—	32	1	—	—	388458	—	388459	—	.630	.354	2.756
12	24	—	1	—	—	388462	—	388463	—	.630	.354	3.150
12	—	28	1	—	—	388466	—	388467	—	.630	.354	3.150
1/4	20	—	1	—	—	388470	—	388471	—	.748	.433	3.150
1/4	—	28	1	—	—	388474	—	388475	—	.748	.433	3.150
5/16	18	—	1	—	—	—	388478	—	388479	.866	.512	3.543
5/16	—	24	1	—	—	—	388482	—	388483	.866	.512	3.543
3/8	16	—	1	—	—	—	388486	—	388487	.945	.591	3.937
3/8	—	24	1	—	—	—	388490	—	388491	.787	.748	3.543
7/16	14	—	1	—	—	—	388494	—	388495	.945	—	3.937
7/16	—	20	1	—	—	—	388498	—	388499	.945	—	3.937
1/2	13	—	1	—	—	—	388504	—	388505	1.142	—	4.331
1/2	—	20	1	—	—	—	388508	—	388509	.866	—	3.937

N-RS Roll taps can be run 1.5 times faster than the tapping speeds recommended for thread cutting taps



Thread Forming Taps for Non-Ferrous Materials For Metric Threads

For Aluminums, Brass, Copper
Alloys (Non-Ferrous Materials).

Improved performance, new tap design.

N-RS



*N-RS have a Nitride Surface Toughening Treatment
Custom Blend High Vanadium HSS

Plug Style (3 to 5 threads chamfered)
Bottoming Style (2 to 2-1/2 threads chamfered)
DIN lengths with ANSI shank dimensions.

List 3750 Metric Sizes

Nominal Size	Ground Thread Limits	No. of Lobe Grooves	Pitch Diameter Limit/ EDP Numbers		Dimensions		
			Plug	Bottoming	Length of Thread	Neck Length	Length Overall
M3 X 0.5	D5	1	388513	388512	.433	.276	2.205
M3.5 X 0.6	D6	1	388515	388514	.512	.276	2.205
M4 X 0.7	D6	1	388517	388516	.512	.315	2.480
M5 X 0.8	D7	1	388519	388518	.630	.354	2.756
M6 X 1	D8	1	388521	388520	.748	.433	3.150
M7 X 1	D9	1	388523	388522	.748	.433	3.150
M8 X 1	D9	1	388525	388524	.866	.512	3.543
M8 X 1.25	D9	1	388527	388526	.866	.512	3.543
M10 X 1.25	D9	1	388529	388528	.945	.591	3.937
M10 X 1.5	D10	1	388531	388530	.945	.591	3.937
M12 X 1.25	D9	1	388533	388532	.866	—	3.937
M12 X 1.75	D11	1	388535	388534	1.142	—	4.331

N-RS Roll taps can be run 1.5 times faster than the tapping speeds recommended for thread cutting taps



High Performance Thread Forming Taps For Unified Threads

ZELX HP-RZ



HP-RZ have a TiCN Surface Treatment
PM High Speed Steel

For Stainless Steels, Low, Medium, High Carbon
Steels <35HRC.

HP-RZ Roll taps can be run 2 times faster than the tapping
speeds recommended for thread cutting taps. Taps have a
TiCN coating for tapping with coolant.

Plug Style (3 to 5 threads chamfered)
DIN lengths with ANSI shank dimensions.

List 3502 Machine Screw Sizes
3512 Fractional Sizes

Nominal Size	TPI		No. of Lobe Grooves	Pitch Diameter Limit/ EDP Numbers						Dimensions		
	UNC UNJC	UNF UNJF		H2	H3	H4	H5	H6	H7	Length of Thread	Neck Length	Length Overall
6	32	—	2	—	386810	—	386811	—	—	.512	.276	2.205
8	32	—	2	—	386814	—	386815	—	—	.512	.375	2.480
10	24	—	2	—	—	386818	—	386819	—	.630	.354	2.756
10	—	32	2	—	—	386822	—	386823	—	.630	.354	2.756
1/4	20	—	2	—	—	386826	—	386827	—	.748	.433	3.150
1/4	—	28	2	—	—	386830	—	386831	—	.748	.433	3.150
5/16	18	—	3	—	—	—	386834	—	386835	.866	.512	3.543
5/16	—	24	3	—	—	—	386838	—	386839	.866	.512	3.543
3/8	16	—	3	—	—	—	386842	—	386843	.945	.591	3.937
3/8	—	24	3	—	—	—	386846	—	386847	.787	.748	3.543
7/16	14	—	4	—	—	—	386850	—	386851	.945	—	3.937
7/16	—	20	4	—	—	—	386854	—	386855	.945	—	3.937
1/2	13	—	4	—	—	—	386858	—	386859	1.142	—	4.331
1/2	—	20	4	—	—	—	386862	—	386863	.866	—	3.937



High Performance Thread Forming Taps For Unified Threads

For Stainless Steels, Low, Medium, High Carbon Steels <35HRC.

ZELX HP-RZ



HP-RZ have a TiCN Surface Treatment
PM High Speed Steel

HP-RZ Roll taps can be run 2 times faster than the tapping speeds recommended for thread cutting taps. Taps have a TiCN coating for tapping with coolant.

Bottoming Style (2 to 2-1/2 threads chamfered)
DIN lengths with ANSI shank dimensions.

List 3502 Machine Screw Sizes
3512 Fractional Sizes

TPI Nominal Size	UNC UNJC	UNF UNJF	No. of Lobe Grooves	Pitch Diameter Limit/ EDP Numbers						Dimensions		
				H2	H3	H4	H5	H6	H7	Length of Thread	Neck Length	Length Overall
0	—	80	0	386800	—	—	—	—	—	.315	—	1.575
2	56	—	0	—	386801	—	—	—	—	.354	—	1.772
3	48	—	0	—	386802	—	—	—	—	.276	.217	1.969
3	—	56	0	—	386803	—	—	—	—	.276	.217	1.969
4	40	—	0	—	386804	—	386805	—	—	.433	.276	2.205
4	—	48	0	—	386806	—	386807	—	—	.433	.276	2.205
5	40	—	2	—	—	—	386799	—	—	.433	.276	2.205
6	32	—	2	—	386808	—	386809	—	—	.512	.276	2.205
8	32	—	2	—	386812	—	386813	—	—	.512	.315	2.480
10	24	—	2	—	—	386816	—	386817	—	.630	.354	2.756
10	—	32	2	—	—	386820	—	386821	—	.630	.354	2.756
1/4	20	—	2	—	—	386824	—	386825	—	.748	.433	3.150
1/4	—	28	2	—	—	386828	—	386829	—	.748	.433	3.150
5/16	18	—	3	—	—	—	386832	—	386833	.866	.512	3.543
5/16	—	24	3	—	—	—	386836	—	386837	.866	.512	3.543
3/8	16	—	3	—	—	—	386840	—	386841	.945	.597	3.937
3/8	—	24	3	—	—	—	386844	—	386845	.787	.748	3.543
7/16	14	—	4	—	—	—	386848	—	386849	.945	—	3.937
7/16	—	20	4	—	—	—	386852	—	386853	.945	—	3.937
1/2	13	—	4	—	—	—	386856	—	386857	1.142	—	4.331
1/2	—	20	4	—	—	—	386860	—	386861	.866	—	3.937



High Performance Thread Forming Taps

For Unified Threads

ZELX HP-RZ



HP-RZ have a TiCN Surface Treatment
PM High Speed Steel

For Stainless Steels, Low, Medium, High Carbon Steels <35HRC.

HP-RZ Roll taps can be run 2 times faster than the tapping speeds recommended for thread cutting taps. Taps have a TiCN coating for tapping with coolant.

Plug Style (3 to 5 threads chamfered)
Bottoming Style (1 to 2 threads chamfered)
DIN lengths with ANSI shank dimensions.

List 3750 Metric Sizes

Nominal Size	Ground Thread Limits	No. of Lobe Grooves	Pitch Diameter Limit/EDP Numbers		Dimensions		
			Plug	Bottoming	Length of Thread	Neck Length	Length Overall
M3 X 0.5	D5	2	386885	386864	.433	.276	2.205
M3.5 X 0.6	D6	2	386886	386865	.512	.275	2.205
M4 X 0.7	D6	2	386887	386866	.512	.315	2.480
M5 X 0.8	D7	2	386888	386867	.630	.354	2.756
M6 X 1	D8	2	386889	386868	.748	.433	3.150
M7 X 1	D9	2	386870	386869	.748	.433	3.150
M8 X 1	D9	3	386872	386871	.866	.512	3.543
M8 X 1.25	D9	3	386874	386873	.866	.512	3.543
M10 X 1.25	D9	4	386876	386875	.945	.590	3.937
M10 X 1.5	D10	4	386878	386877	.945	.590	3.937
M12 X 1.25	D9	4	386880	386879	.866	—	3.937
M12 X 1.5	D9	4	386882	386881	.866	—	3.937
M12 X 1.75	D11	4	386884	386883	1.142	—	4.331



High Performance Thread Forming Taps for Dry Tapping For Unified Threads

ZELX OL-RZ



OL-RZ have a TiCN Surface Treatment
PM High Speed Steel

For Stainless Steels, and Other Soft, Low and Carbon Steels

OL-RZ Roll Taps can be run 1.5 to 2 times faster than the tapping speeds recommended for thread cutting taps. Taps can be run dry or with mist coolant. Taps have TiCN coating for coolant free roll tapping.

Designed for shallow hole tapping < 1-1/2 diameters in depth

Plug Style (3 to 5 threads chamfered)
DIN lengths with ANSI shank dimensions.

List 3502 Machine Screw Sizes
3512 Fractional Sizes

TPI Nominal Size	UNC UNJC	UNF UNJF	No. of Lobe Grooves	Pitch Diameter Limit/ EDP Numbers					Dimensions			
				H2	H3	H4	H5	H6	Length of Thread	Neck Length	Length Overall	
2	56	—	0	—	386600	—	—	—	—	.354	—	1.772
4	40	—	0	—	—	—	386601	—	—	.433	.276	2.205
4	—	48	0	—	—	—	386602	—	—	.433	.276	2.205
5	40	—	0	—	—	—	386603	—	—	.433	.276	2.205
6	32	—	0	—	—	—	386604	—	—	.512	.275	2.205
8	32	—	0	—	—	—	386605	—	—	.512	.315	2.480
10	24	—	0	—	—	—	—	386606	—	.630	.354	2.756
10	—	32	0	—	—	—	—	386607	—	.630	.354	2.756
1/4	20	—	0	—	—	—	—	386608	—	.748	.433	3.150
1/4	—	28	0	—	—	—	—	386609	—	.748	.433	3.150



High Performance Thread Forming Taps for Dry Tapping For Metric Threads

ZELX OL-RZ



OL-RZ have a TiCN Surface Treatment
PM High Speed Steel

For Stainless Steels, and Other Soft, Low and Carbon Steels

OL-RZ Roll Taps can be run 1.5 to 2 times faster than the tapping speeds recommended for thread cutting taps. Taps can be run dry or with mist coolant. Taps have TiCN coating for coolant free roll tapping.

Plug Style (3 to 5 threads chamfered)
DIN lengths with ANSI shank dimensions.

List 3570 Metric Sizes

Nominal Size	No. of Lobe Grooves	Pitch Diameter Limit/ EDP Numbers				Dimensions		
		D5	D6	D7	D8	Length of Thread	Neck Length	Length Overall
M3 X 0.5	0	386610	—	—	—	.433	.276	2.205
M3.5 X 0.6	0	—	386611	—	—	.512	.275	2.205
M4 X 0.7	0	—	386612	—	—	.512	.315	2.480
M5 X 0.8	0	—	—	386614	—	.630	.354	2.756
M6 X 1	0	—	—	—	386615	.748	.433	3.150

PIPE TAPS

NPT

NPTF

ZELX MOLD

NPT

NPS

NPSF

ZELX SS

Features of NPT Taper

- General Purpose ideal for threading a wide variety of materials, such as steels and Irons and can be used for non ferrous and non metallic materials
- American Standard Pipe Form (NPT)
- The nominal size of a pipe tsp is that of the pipe fitting to be tapped, not the actual size of the tap. The thread tapers 3/4 of an inch per foot.

Features of Interrupted Taper

- Balance of the threads are interrupted to reduce drag while threading
- American Standard Pipe Form (NPT)
- The nominal size of a pipe tsp is that of the pipe fitting to be tapped, not the actual size of the tap. The thread tapers 3/4 of an inch per foot.

Features of NPT/NPTF

- Geometry suited for tapping gray irons and irons that produce broken chips
- Appropriate for some non metallics such as Bakelite and Cast Brass

Features of NPTF Taper

- General Purpose ideal for threading a wide variety of materials, such as steels and Irons and can be used for non ferrous and non metallic materials
- For American Taper Pipe Dryseal Threads

Features of NPS Straight

- General purpose
- For American Straight Pipe
- Threads Oxide Surface Treatment

Features of NPSF Straight

- General purpose
- For American Straight Pipe Dryseal
- Threads Oxide Surface Treatment

Features of ZELX MOLD NPT

- First choice for tapping mold steels
- Ideal for tapping mold steels, tool steels and gray cast irons (35 to 45 HRC)
- YMW offers this series of ZELX MOLD Taps made of Cobalt High Speed Steel



NPT Taper Pipe Taps. These general purpose taper pipe taps are ideal for threading a wide variety of materials, such as steels and irons, can also be used for nonferrous and nonmetallic materials.

Ground thread taper pipe taps are standard in American Standard Pipe Form (NPT).

The nominal size of a pipe taps is that of the pipe fitting to be tapped, not the actual size of the tap. The thread tapers 3/4 of an inch per foot.

Taper Pipe Taps- General Purpose

NPT



NPT taps have an Oxide Surface Treatment Custom Blend High Vanadium HSS

List 3430 NPT ANPT

All pipe taps have a chamfer of 2-1/2 to 3-1/2 threads

Nominal Size	Threads per Inch	No. of Flutes	EDP Numbers NPT or ANPT	Dimensions	
				Length of Thread	Length Overall
1/16	27	4	383100	11/16	2- 1/8
1/8 (Lg. Shank)	27	4	383101	3/4	2- 1/8
1/8 (Sm. Shank)	27	4	383102	3/4	2- 1/8
1/4	18	4	383103	1- 1/16	2- 7/16
3/8	18	4	383104	1- 1/16	2- 9/16
1/2	14	4	383105	1- 3/8	3- 1/8
3/4	14	5	383106	1- 3/8	3- 1/4
1	11- 1/2	5	383107	1- 3/4	3- 3/4
1- 1/4	11- 1/2	5	383108	1- 3/4	4
1- 1/2	11- 1/2	7	383109	1- 3/4	4- 1/4
2	11- 1/2	7	383110	1- 3/4	4- 1/2

Troubleshooting

Problem	Causes	Solutions
Chipping	Excessive Tapping Speed Misalignment Hole Size is Too Small Poor Tapping Fluid	Increase Tapping Speed to 15-18 SFM Adjust or Use Radial Float Tapping Head Check Hole Size Use a Heavy Duty Lubricant
Poor Finish (Chatter Mark)	Excessive Tapping Speed Excessive Hook Angle Poor Tapping Fluid	Reduce Tapping Speed to 10-15 SFM Adjust Hook Angle During Re grind Use Cutting Oil or tapping Lubricant
Stop Mark	Excessive Tapping Speed Poor Tapping Head Poor Setup	Reduce Tapping Speeds to 10-15 SFM Use Floating Tapping Head Use Special Design Taps or Thread Mill



Economical High Performance Taps

For American Taper Pipe Threads

NPT



NPT taps have an Oxide Surface Treatment
Custom Blend Vanadium HSS

The tap chamfer and for the first few threads. The balance of the threads are interrupted to reduce drag while threading. These pipe taps are standard having an odd number of flutes, 5 or 7.

Ground thread taper pipe taps are standard in American Standard Pipe Form (NPT).

The nominal size of a pipe tap is that of the pipe fitting to be tapped, not the actual size of the tap. The thread tapers 3/4 of an inch per foot.

All pipe taps have a chamfer of 2-1/2 to 3-1/2 threads List 3435 Interrupted NPT

Nominal Size	Threads per Inch	No. of Flutes	EDP Numbers NPT or ANPT	Dimensions	
				Length of Thread	Length Overall
1/16	27	—	—	11/16	2- 1/8
1/8 (Lg. Shank)		5	383151	3/4	2- 1/8
1/8 (Sm. Shank)		5	383152	3/4	2- 1/8
1/4	18	5	383153	1- 1/16	2- 7/16
3/8	18	5	383154	1- 1/16	2- 9/16
1/2	14	5	383155	1- 3/8	3- 1/8
3/4	14	5	383156	1- 3/8	3- 1/4
1	11- 1/2	5	383157	1- 3/4	3- 3/4
1- 1/4	11- 1/2	5	383158	1- 3/4	4
1- 1/2	11- 1/2	7	383159	1- 3/4	4- 1/4
2	11- 1/2	7	383160	1- 3/4	4- 1/2

Taper Pipe Taps for Cast Iron

For American Taper Pipe Threads

NPT / NPTF



NPT/NPTF taps have a Nitride Surface Toughening Treatment
Custom Blend High Vanadium HSS



These taps have a geometry suited for tapping gray irons and irons that produce broken chips. This design is also appropriate for some non-metallics such as Bakelite and Cast Brass.

Straight Flute (2-1/2 to 3-1/2 threads chamfered) List 3437 NPT 3447 NPTF Dryseal

Nominal Size	Threads per Inch	No. of Flutes	EDP Numbers		Dimensions	
			NPT	NPTF	Length of Thread	Length Overall
1/8 (Lg. Shank)		4	383201	383226	3/4	2- 1/8
1/8 (Sm. Shank)		4	383202	383227	3/4	2- 1/8
1/4	18	4	383203	383228	1- 1/16	2- 7/16
3/8	18	4	383204	383229	1- 1/16	2- 9/16
1/2	14	4	383205	383230	1- 3/8	3- 1/8
3/4	14	5	383206	383231	1- 3/8	3- 1/4
1	11- 1/2	5	383207	383232	1- 3/4	3- 3/4
1- 1/4	11- 1/2	5	383208	383233	1- 3/4	4
1- 1/2	11- 1/2	7	383209	383234	1- 3/4	4- 1/4
2	11- 1/2	7	383210	383235	1- 3/4	4- 1/2



First choice for Tapping Mold Steels.

Ideal for tapping mold steels, tool steels and gray cast iron. (35 to 45 HRC)

Taper Pipe Taps for Mold Steels

For American Taper Pipe Threads

ZELX MOLD NPT



ZELX Mold NPT taps have a Bright Surface Finish
Cobalt High Speed Steel

Straight Flute Style

Pipe Taps are standard with (2-1/2 to 3-1/2 threads chamfered)

List 3434 NPT

Nominal Size	Threads per Inch	No. of Flutes	EDP Numbers NPT or ANPT	Dimensions	
				Length of Thread	Length Overall
1/8 (Lg. Shank)	27	4	389641	11/16	2- 1/8
1/4	18	4	389643	3/4	2- 1/8
3/8	18	4	389644	3/4	2- 1/8
1/2	14	4	389645	1- 1/16	2- 7/16
3/4	14	5	389646	1- 1/16	2- 9/16



Taper Pipe Taps- General Purpose

For American Taper Pipe Dryseal Threads

NPTF



NPTF taps have an Oxide Surface Treatment
Custom Blend High Vanadium HSS

All pipe taps have a chamfer of 2-1/2 to 3-1/2 threads

List 3440 NPTF

Nominal Size	Threads per Inch	No. of Flutes	EDP Numbers NPTF	Dimensions	
				Length of Thread	Length Overall
1/16	27	4	383125	11/16	2- 1/8
1/8 (Lg. Shank)	27	4	383126	3/4	2- 1/8
1/8 (Sm. Shank)	27	4	383127	3/4	2- 1/8
1/4	18	4	383128	1- 1/16	2- 7/16
3/8	18	4	383129	1- 1/16	2- 9/16
1/2	14	4	383130	1- 3/8	3- 1/8
3/4	14	5	383131	1- 3/8	3- 1/4
1	11- 1/2	5	383132	1- 3/4	3- 3/4
1- 1/4	11- 1/2	5	383133	1- 3/4	4
1- 1/2	11- 1/2	7	383134	1- 3/4	4- 1/4
2	11- 1/2	7	383135	1- 3/4	4- 1/2

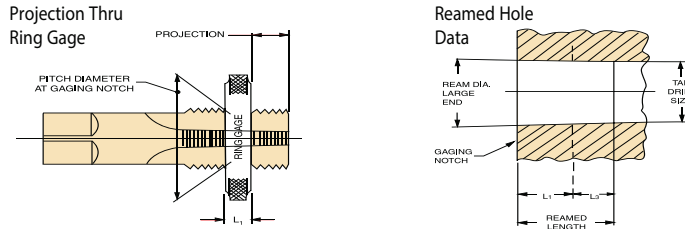

NPT/NPTF THREAD LIMITS

Nominal Size (inch)	Threads per inch NPT	*Gage Measurement (inch)		Tapper per Foot (inch)	
		Projection	Tolerance(+/-)	Min.	Max.
1/16	27	0.312	1/16	23/32	25/32
1/8	*27	0.312	1/16	23/32	25/32
1/4	18	0.459	1/16	23/32	25/32
3/8	18	0.454	1/16	23/32	25/32
1/2	14	0.579	1/16	23/32	25/32
3/4	14	0.565	1/16	23/32	25/32
1	11- 1/2	0.678	3/32	23/32	25/32
1- 1/4	11- 1/2	0.686	3/32	23/32	25/32
1- 1/2	11- 1/2	0.699	3/32	23/32	25/32
2	11- 1/2	0.667	3/32	23/32	25/32
2- 1/2	8	0.925	3/32	47/64	25/32
3	8	0.925	3/32	47/64	25/32
3- 1/2	8	0.938	1/8	47/64	25/32
4	8	0.950	1/8	47/64	25/32

*The distance small end of tap projects through an L1 American Standard Taper Pipe Thread Ring Gage.

Measurement of Taper Pipe Taps, Reaming Data and Tap Drill Sizes

Size	Projection				Ream Dia. Large End	Gage Width L1	Reamed Length L1 + L3	Tap Drill for use w/ Reaming	Tap Drill for use w/o Reaming
	NPT & NPTF		SAE-SHORT						
	Min.	Max.	Min.	Max.					
1/16- 27	0.250	0.375	0.222	0.259	0.2515	0.2515	0.2711	15/64	C
1/8- 27	0.250	0.375	0.222	0.259	0.3340	0.1615	0.2726	21/64	Q
1/4- 18	0.397	0.521	0.333	0.389	0.4472	0.2278	0.3945	27/64	7/16
3/8- 18	0.392	0.516	0.333	0.389	0.5826	0.240	0.4067	9/16	9/16
1/2- 14	0.517	0.641	0.429	0.500	0.7213	0.320	0.5343	11/16	45/64
3/4- 14	0.503	0.627	0.429	0.500	0.9317	0.339	0.5533	57/64	29/32
1- 11 1/2	0.584	0.772	—	—	1.1691	0.400	0.6609	1- 1/8	1- 9/64
1 1/4- 11 1/2	0.592	0.780	—	—	1.1538	0.420	0.6809	1- 15/32	1- 31/64
1 1/2- 11 1/2	0.606	0.792	—	—	1.7528	0.420	0.6809	1- 45/64	1- 23/32
2- 11 1/2	0.574	0.760	—	—	2.2267	0.436	0.6969	2- 3/16	2- 3/16



Straight Pipe Taps- General Purpose For American Straight Pipe Threads

NPS



NPS taps have an Oxide Surface Treatment
Custom Blend High Vanadium HSS

All pipe taps have a chamfer of 2-1/2 to 3-1/2 threads List 3450 NPS

Nominal Size	Threads per Inch	No. of Flutes	EDP Numbers NPS	Dimensions	
				Length of Thread	Length Overall
1/8 (Lg. Shank)	27	4	383301	3/4	2- 1/8
1/8 (Sm. Shank)	27	4	383302	3/4	2- 1/8
1/4	18	4	383303	1- 1/16	2- 7/16
3/8	18	4	383304	1- 1/16	2- 9/16
1/2	14	4	383305	1- 3/8	3- 1/8
3/4	14	5	383306	1- 3/8	3- 1/4
1	11- 1/2	5	383307	1- 3/4	3- 3/4



Straight Pipe Taps- General Purpose For American Straight Pipe Dryseal Threads

NPSF



NPSF taps have an Oxide Surface Treatment
Custom Blend High Vanadium HSS

All pipe taps have a chamfer of 2-1/2 to 3-1/2 threads List 3460 NPSF Dryseal

Nominal Size	Threads per Inch	No. of Flutes	EDP Numbers NPSF	Dimensions	
				Length of Thread	Length Overall
1/8 (Lg. Shank)	27	4	383326	3/4	2- 1/8
1/8 (Sm. Shank)	27	4	383327	3/4	2- 1/8
1/4	18	4	383328	1- 1/16	2- 7/16
3/8	18	4	383329	1- 1/16	2- 9/16
1/2	14	4	383330	1- 3/8	3- 1/8
3/4	14	5	383331	1- 3/8	3- 1/4
1	11- 1/2	5	383332	1- 3/4	3- 3/4



Slow Spiral Fluted Pipe Taps for Stainless Steels, for NPT and NPTF Threads

For American Taper Pipe Threads

ZELX SS PIPE



NPSF taps have an Oxide Surface Treatment
Custom Blend High Vanadium HSS

For Stainless Steels, Alloy Steels and Ductile Irons.

Pipe taps are standard with 2-1/2 to 3-1/2 threads chamfered

List 3438 NPT Pipe Tap
3448 NPTF Pipe Tap Dryseal Taper

Nominal Size	Threads per Inch	No. of Flutes	EDP Numbers		Dimensions	
			NPT	NPTF	Length of Thread	Length Overall
1/16	27	4	383640	383660	11/16	2- 1/8
1/8 (Lg. Shank)	27	4	383641	383661	3/4	2- 1/8
1/8 (Sm. Shank)	27	4	383642	383662	3/4	2- 1/8
1/4	18	4	383643*	383663	1- 1/16	2- 7/16
3/8	18	4	383644*	383664	1- 1/16	3- 9/16
1/2	14	4	383645*	383665	1- 3/8	3- 1/8
3/4	14	4	383646*	383666	1- 3/8	3- 1/4
1	11- 1/2	4	383647	383667	1- 3/4	3- 3/4

The nominal size of a Pipe Taps is that of the pipe fitting to be tapped, not the actual size of the tap. The thread tapers 3/4 of an inch per foot.

*AVAILABLE IN BRIGHT FINISH COATING. ALSO AVAILABLE IN TIN AND TICN COATING UPON REQUEST.

ZELX SS Spiral Fluted Pipe Taps are designed for difficult jobs including the Stainless Steel family of materials as well as Alloy Steels, High Carbon Steel and Ductile Irons. Our unique design ZELX SS Pipe taps increase productivity through longer tool life.

Taper Pipe Tap Standard Projection

ZELX Pipe Taps are designed for difficult jobs including stainless steels, alloy steels and ductile irons.

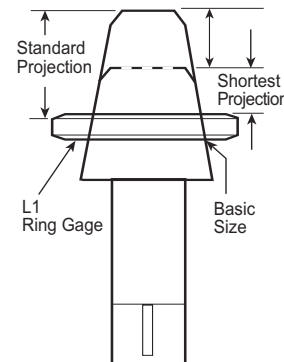

TAPER PIPE TAPS- General Dimensions- Inches

Nominal Pipe Size	Length Overall		Length of Thread		Length of Square		Diameter of Shank		Size of Square		Gage Measurement		Taper per Foot		Tap Drill Sizes First 2 or 3 Threads (full)
	Length	Tol.	Length	Tol.	Length	Tol.	Dia.	Tol.	Size	Tol.	Projection	Tol.	Min.	Max.	
1/16	2- 1/8	±1/32	11/16	±1/16	3/8	±1/32	.3125	-.0015	.234	-.004	.312	±1/16	23/32	25/32	C
1/8	2- 1/8	±1/32	3/4	±1/16	3/8	±1/32	.3125	-.0015	.234	-.004	.312	±1/16	23/32	25/32	Q
1/8	2- 1/8	±1/32	3/4	±1/16	3/8	±1/32	.4375	-.0015	.328	-.004	.312	±1/16	23/32	25/32	Q
1/4	2- 7/16	±1/32	1- 1/16	±1/16	7/16	±1/32	.5625	-.002	.421	-.006	.459	±1/16	23/32	25/32	7/16
3/8	2- 9/16	±1/32	1- 1/16	±1/16	1/2	±1/32	.7000	-.002	.531	-.006	.454	±1/16	23/32	25/32	9/16
1/2	3- 1/8	±1/32	1- 3/8	±1/16	5/8	±1/32	.6875	-.002	.515	-.006	.579	±1/16	23/32	25/32	45/65
3/4	3- 1/4	±1/32	1- 3/8	±1/16	11/16	±1/32	.9063	-.002	.679	-.006	.565	±1/16	23/32	25/32	29/32
1	3- 3/4	±1/16	1- 3/4	±3/32	13/16	±1/16	1.1250	-.002	.843	-.008	.678	±3/32	23/32	25/32	1- 9/64
1- 1/4	4	±1/16	1- 3/4	±3/32	15/16	±1/16	1.3125	-.003	.984	-.008	.686	±3/32	23/32	25/32	1- 31/64
1- 1/2	4- 1/4	±1/16	1- 3/4	±1/8	1	±1/16	1.5000	-.003	1.125	-.008	.699	±3/32	23/32	25/32	1- 23/32
2	4- 1/2	±1/16	1- 3/4	±1/8	1- 1/8	±1/16	1.8750	-.003	1.406	-.008	.667	±3/32	23/32	25/32	2- 3/16

Taper Pipe tap standard projection is the distance the small end of the tap projects through an American National Standard Pipe Thread Ring Gage.

ZELX SS SERIES

DRILLS & COUNTERSINKS

For Stainless Steels, Alloy Steels, Aluminums and Ductile Irons.



Features of Zelx Drills/Countersinks

- Custom Blended Vanadium HSS .
- Combined drills & countersinks w/60° included angle are ideal for CNC and general machining applications.
- Designed and manufactured for high efficiency and good wear life.

PERFORMANCE COMBINED DRILL AND COUNTERSINK

For Stainless Steels, Alloy Steels, Aluminums and Ductile Irons

ZELX SS Drills & Countersinks



*ZELX SS Drills & Countersinks have a Bright Surface Finish

*AVAILABLE IN TIN AND TICN COATING ON REQUEST

Custom Blend High Vanadium HSS

YMW combined drills and countersinks with a 60° included angle are ideal for CNC and general machining applications. They are designed and manufactured for high efficiency and good wear life.

Performance Combined Drill and Countersink

List	3800	Plain Type	Dimensions				
			Size	EDP Numbers	Body Diameter	Drill Diameter	Overall Length
			00	350000	1/8	1/4	1- 7/32
			0	350001	1/8	1/32	1- 7/32
			1	350010	1/8	3/64	1- 1/4
			2	350020	3/16	5/64	1- 7/8
			3	350030	1/4	7/64	2
			4	350040	5/16	1/8	2- 1/8
			5	350050	7/16	3/16	2- 3/4

MHSL SERIES

Feature of products

For carbon steel of middle class hardness, for through hole tapping **MHSL** M6~M16×1.5

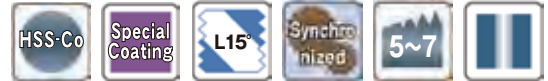

Features

- **Long tool life**...Combination of CO-HSS (featuring wear resistance) and special coating realizes high durability.
- **Improved chip ejection**...Having Yamawa's special flute design, MHSL accomplishes splendid chip ejection performance.
- **Good surface roughness**...Superior cutting performance results in preferable surface roughness.

【Example of tapping】



MHSL has attained very high durability in through hole tapings of steel product of middle hardness class, such as automobile component-Hub bearings.

Table of dimensions and sizes

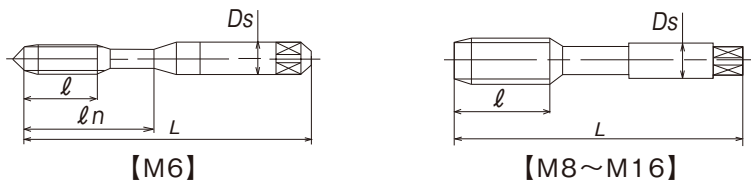

size	class	L	l	ln	Ds	number of flutes	code
M6 X1	P3	62	15	26	6	3	MHSLR6.0M5
M8 X1.25	P4	70	19	-	6.2	3	MHSLS8.0N5
M10X1.25	P4	75	23	-	7	3	MHSLS010N5
M12X1.25	P5	82	26	-	8.5	4	MHSLT012N7
M14X1.5	P5	88	26	-	10.5	4	MHSLT014O7
M16X1.5	P5	95	26	-	12.5	4	MHSLT016O7



Flute Form

To improve chip ejection, MHSL have 2-step-flute taper.



2-step-flute taper pushes out chips smoothly.
Cross section of 2-step-flute taper.

Tapping data

Improved wear resistance feature

Due to wear, tap having old design caused noise at 1239 tapping.



SL +TICN
1239 holes
NG

tapping condition

size	M12×1.25
material	S53C (25HRC)
thread length	13mm
tapping speed	30m/min
machine	machining center
cutting oil	water soluble (external)

Good!

MHSL 2800 holes still running



Improved surface roughness



PO no surface treatment first tapping internal screw thread



SL + TIN coating first tapping internal screw thread

Good!

MHSL first tapping internal screw thread

As a result of high cutting performance, MHSL produces far better internal screws with good surface roughness.

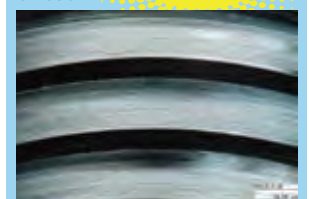



MHSL Series

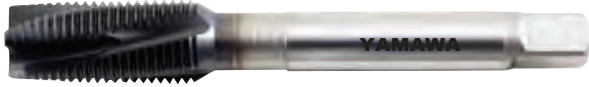

MHSL Series has a Special Coating Surface Finish
Cobalt High Speed Steel

MHSL has attained a very high durability in through hole tapping for steel products of mid range hardness used in the automotive industry.

The MHSL Series taps are designed for Carbon Steels of mid range hardness and through hole applications.

A combination of HSS-CO (featuring wear resistance) and Yamawa's special coating, resulting in a highly durable tap.

Yamawa's MHSL special flute design results in excellent forward chip ejection.

MHSL superior cutting results in excellent surface finishes.

DIN lengths with ANSI shank dimensions.

Nominal Size	No. of Flutes	Pitch Diameter Limit/ EDP Numbers			Dimensions		
		D5	D6	D7	Length of Thread	Neck Length	Length Overall
M6 X 1	3	LS6.0M5FCL5	—	—	.591	1.181	3.150
M8 X 1.25	3	LS8.0N5FCL5	—	—	.748	1.382	3.543
M10 X 1.25	3	—	LS010N6FCL5	—	.906	1.929	3.937
M12 X 1.25	4	—	LS012N6FCL7	—	1.024	2.126	4.331
M14 X 1.5	4	—	—	LS014O7FCL7	1.024	2.126	4.331
M16 X 1.5	4	—	—	LS016O7FCL7	1.024	2.126	4.331

AXE-HT SERIES

Feature of products

AXE-HT AXE tap



- **long tool life**...Special cutting edge design results in little damage on the cutting edge. Combination of premium powder HSS(featuring high wear resistance and heat resistance) and TiN coating brings out 5 times longer tool life than previous taps designed for aluminum.
 - **Reliable screw threads**...Cutting edge with little damage restricts both the size change of internal threads and the reduction of surface roughness.
 - **Wider range of application, from middle speed tapping to high speed tapping**...Most preferable combination of negative rake angle and eccentric relief enables AXE taps to be applicable in wider range, from middle speed to high speed.
- Most preferable combination of negative rake angle and eccentric relief realizes the long tool life.
 - AXE taps adopt premium powder HSS (featuring high wear resistance and heat resistance)and TiN coating.
 - AXE taps are applicable to wider machines, from transfer machines to machining centers.
 - Due to parted small chips, tapping operation becomes quite stable.

Table of dimensions and sizes

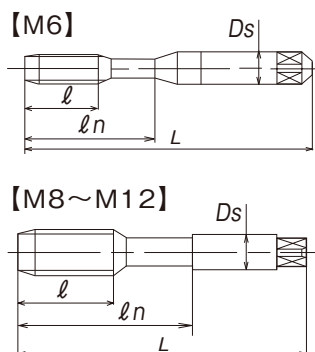

size	class	L	ℓ	ℓn	Ds	number of flutes	code
M6 X1	P3	62	19	28	6	3	TAXER6.0M1
M8 X1.25	P3	70	22	—	6.2	4	TAXER8.0N1
M10X1.5	P3	75	24	—	7	4	TAXER01001
M10X1.25	P3	75	24	—	7	4	TAXER010N1
M10X1	P3	75	24	—	7	4	TAXER010M1
M12X1.75	P3	82	29	—	8.5	4	TAXER012P1
M12X1.5	P3	82	29	—	8.5	4	TAXER012O1
M12X1.25	P3	82	29	—	8.5	4	TAXER012N1

Tap's accuracy classes do not always ensure the accuracy of internal screws.

Tapping data

Comparison of tool life between AXE-HT and LA-O (previous product)

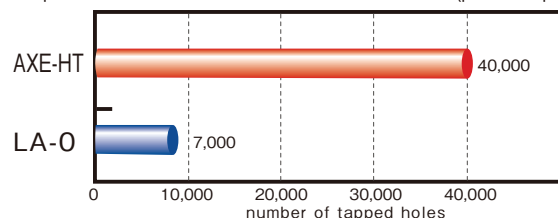

Change of pitch diameter of internal threads

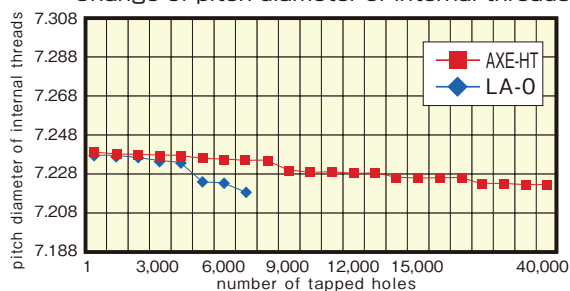

tap M8×1.25

AXE-HT : HSS-P TiN

LA-O : HSS-E Ni

- material : AC4A- T6 treated
- thread length : 13 mm (blind hole)
- tapping speed : 10m/min
- machine : transfer machine
- feed : lead screw feed
- bored hole : $\phi 6.8$
- cutting oil : water soluble (x30)

Damage at cutting edge after 7,000 hole tapping

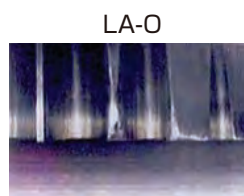

AXE-HT Series

For Cast Aluminum



AXE-HT has a TiN Surface Treatment
Powdered High Speed Steel

The AXE-HT Series are manufactured from premium HSS powder metals that feature high wear resistance and high heat durability properties along with a new cutting edge design, resulting in extended tool life.

The AXE-HT Series have a special TiN coating resulting in five times longer tool life compared to previous taps designed for Cast Aluminum.

AXE-HT taps offer a wider range of application, from mid range to high speed tapping.



DIN lengths with ANSI shank dimensions.

Nominal Size	No. of Flutes	Pitch Diameter Limit/ EDP Numbers		Dimensions		
		D5	D6	Length of Thread	Neck Length	Length Overall
M6 X 1	3	TS6.0M5LPVA	—	.591	1.181	3.150
M8 X 1.25	4	TS8.0N5LPVA	—	.748	1.382	3.543
M10 X 1	4	—	TS010M6LPVA	.906	1.929	3.937
M10 X 1.25	4	—	TS010N6LPVA	.906	1.929	3.937
M10 X 1.5	4	—	TS010O6LPVA	.906	1.929	3.937
M12 X 1.25	4	—	TS012N6LPVA	1.024	2.126	4.331
M12 X 1.5	4	—	TS012O6LPVA	1.024	2.126	4.331
M12 X 1.75	4	—	TS012P6LPVA	1.024	2.126	4.331

Dimensions Table 302 (*USCTI)

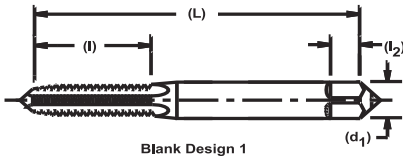

Blank Design 1

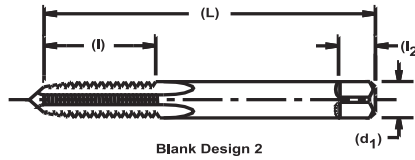

Blank Design 2

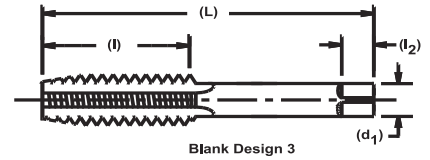

Blank Design 3

General Dimensions

Nominal Diameter Range Inches		Machine Screw Size No.	Nominal Fractional Diameter Inches		Nominal Metric Diameter Millimeters		Style Per Illustration Above	Overall Length L	Tap Dimensions — Inches			
Over	To (Incl)								Thread Length l ₁	Square Length l ₂	Shank Diameter d ₁	Size of Square a
.052	.065	0 (.0600)			M 1.6 (.0630)		1	1.63	.31	.19	.1410	.110
.065	.078	1 (.0730)			M1.8 (.0709)		1	1.69	.38	.19	.1410	.110
.078	.091	2 (.0860)			M2 (0787), M2.2 (.0866)		1	1.75	.44	.19	.1410	.110
.091	.104	3 (.0990)			M2.5 (.0984)		1	1.81	.50	.19	.1410	.110
.104	.117	4 (.1120)					1	1.88	.56	.19	.1410	.110
.117	.130	5 (.1250)			M3 (.1181)		1	1.94	.63	.19	.1410	.110
.130	.145	6 (.1380)			M3.5 (.1378)		1	2.00	.69	.19	.1410	.110
.145	.171	8 (.1640)			M4 (.1575)		1	2.13	.75	.25	.1680	.131
.171	.197	10 (.1900)			M4.5 (.1772), M5 (.1969)		1	2.38	.88	.25	.1940	.152
.197	.223	12 (.2160)					1	2.38	.94	.28	.2200	.165
.223	.260		1/4 (.2500)		M6 (.2362)		2	2.50	1.00	.31	.2550	.191
.260	.323		5/16 (.3125)		M7 (.2756), M8 (.3150)		2	2.72	1.13	.38	.3180	.238
.323	.395		3/8 (.3750)		M10 (.3937)		2	2.94	1.25	.44	.3810	.286
.395	.448		7/16 (.4375)				3	3.16	1.44	.41	.3230	.242
.448	.510		1/2 (.5000)		M12 (.4724)		3	3.38	1.66	.44	.3670	.275
.510	.573		9/16 (.5625)		M14 (.5512)		3	3.59	1.66	.50	.4290	.322
.573	.635		5/8 (.6250)		M16 (.6299)		3	3.81	1.81	.56	.4800	.360
.635	.709		11/16 (.6875)		M18 (.7087)		3	4.03	1.81	.63	.5420	.406
.709	.760		3/4 (.7500)				3	4.25	2.00	.69	.5900	.442
.760	.823		13/16 (.8125)		M20 (.7874)		3	4.47	2.00	.69	.6520	.489
.823	.885		7/8 (.8750)		M22 (.8661)		3	4.69	2.22	.75	.6970	.523
.885	.948		15/16 (.9375)		M24 (.9449)		3	4.91	2.22	.75	.7600	.570
.948	1.010		1 (1.0000)		M25 (.9843)		3	5.13	2.50	.81	.8000	.600
1.010	1.073		1-1/16 (1.0625)		M27 (1.0630)		3	5.13	2.50	.88	.8960	.672
1.073	1.135		1-1/8 (1.1250)				3	5.44	2.56	.88	.8960	.672
1.135	1.198		1-3/16 (1.1875)		M30 (1.1811)		3	5.44	2.56	1.00	1.0210	.766
1.198	1.260		1-1/4 (1.2500)				3	5.75	2.56	1.00	1.0210	.766
1.260	1.323		1-5/16 (1.3125)		M33 (1.2992)		3	5.75	2.56	1.06	1.1080	.831
1.323	1.385		1-3/8 (1.3750)				3	6.06	3.00	1.06	1.1080	.831
1.358	1.448		1-7/16 (1.4375)		M36 (1.4173)		3	6.06	3.00	1.13	1.2330	.925
1.448	1.510		1-1/2 (1.5000)				3	6.38	3.00	1.13	1.2330	.925
1.510	1.635		1-5/8 (1.6250)		M39 (1.5354)		3	6.69	3.19	1.13	1.3050	.979
1.635	1.760		1-3/4 (1.7500)		M42 (1.6535)		3	7.00	3.19	1.25	1.4300	1.072
1.760	1.885		1-7/8 (1.8750)				3	7.31	3.56	1.25	1.5190	1.139
1.885	2.010		2 (2.0000)		M48 (1.8898)		3	7.63	3.56	1.38	1.6440	1.233
2.010	2.135		2 1/8 (2.1250)				3	8.00	3.56	1.38	1.7690	1.327
2.135	2.260		2 1/4 (2.2500)		M56 (2.2047)		3	8.25	3.56	1.44	1.8940	1.420
2.260	2.385		2 3/8 (2.3750)				3	8.50	4.00	1.44	2.0190	1.514
2.385	2.510		2 1/2 (2.5000)				3	8.75	4.00	1.50	2.1000	1.575
2.510	2.635		2 5/8 (2.6250)		M64 (2.5197)		3	8.75	4.00	1.50	2.2250	1.669
2.635	2.760		2 3/4 (2.7500)				3	9.25	4.00	1.56	2.3500	1.762
2.760	2.885		2 7/8 (2.8750)		M72 (2.8346)		3	9.25	4.00	1.56	2.4750	1.856
2.885	3.010		3 (3.0000)				3	9.75	4.56	1.63	2.5430	1.907
3.010	3.135		3 1/8 (3.1250)				3	9.75	4.56	1.63	2.6680	2.001
3.135	3.260		3 1/4 (3.2500)		M80 (3.1496)		3	10.00	4.56	1.75	2.7930	2.095
3.260	3.385		3 3/8 (3.3750)				3	10.00	4.56	1.75	2.8830	2.162
3.385	3.510		3 1/2 (3.5000)				3	10.25	4.94	2.00	3.0080	2.256
3.510	3.635		3 5/8 (3.6250)		M90 (3.5433)		3	10.25	4.94	2.00	3.1330	2.350
3.635	3.760		3 3/4 (3.7500)				3	10.50	5.31	2.13	3.2170	2.413
3.760	3.885		3 7/8 (3.8750)				3	10.50	5.31	2.13	3.3420	2.506
3.885	4.010		4 (4.0000)		M100 (3.9370)		3	10.75	5.31	2.25	3.4670	2.600

*United States Cutting Tool Institute (USCTI) governs tap dimensions for the United States

Dimensions

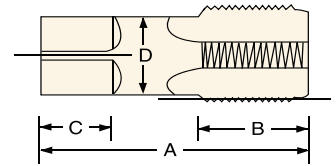

USCTI Table 302 Tap Tolerance

Element	Nominal Diameter Range – Inches		Direction	Tolerance (Inches)
	Over	To (Inc.)		
Length Overall - A	.0520	1.0100	Plus or Minus	.031
	1.0100	4.0100	Plus or Minus	.063
Length of Thread -B	.0520	.2230	Plus or Minus	.047
	.2230	.5100	Plus or Minus	.063
	.5100	1.5100	Plus or Minus	.094
	1.5100	4.0100	Plus or Minus	.125
Length of square - C	.0520	1.0100	Plus or Minus	.031
	1.0100	4.0100	Plus or Minus	.063
Diameter of shank -D	.0520	.2230	Minus	.0015
	.2230	.6350	Minus	.0015
	.6350	1.0100	Minus	.0020
	1.0100	1.5100	Minus	.0020
	1.5100	2.0100	Minus	.0030
	2.0100	4.0100	Minus	.0030
Size of square	.0520	.5100	Minus	.004
	.5100	1.0100	Minus	.006
	1.0100	2.0100	Minus	.008
	2.0100	4.0100	Minus	.010

Special Fine Pitch Taps – Short Series, Ground Thread USCTI TABLE 303

Unless otherwise specified, special taps 1.010" to 1.510" diameter inclusive having 14 or more threads per inch or 1.75 millimeter pitch and finer, and sizes over 1.510"

diameter with 10 or more threads per inch, or 2.5 millimeter pitch and finer, will be made to the general dimensions shown below:

Nominal Diameter Range Inches		Nominal Fractional Diameter Inches	Nominal Metric Diameter Millimeters	General Tap Dimensions - Inches				
				Overall Length A	Thread Length B	Square Length C	Shank Diameter D	Size of Square
1.010	1.073	1-1/	M27	4.00	1.50	.88	.8960	.672
1.073	1.135	1- 1/8		4.00	1.50	.88	.8960	.672
1.135	1.198	1-3/	M30	4.00	1.50	1.00	1.0210	.766
1.198	1.260	1-1/4		4.00	1.50	1.00	1.0210	.766
1.260	1.323	1-5/	M33	4.00	1.50	1.00	1.1080	.831
1.323	1.385	1-3/8		4.00	1.50	1.00	1.1080	.831
1.385	1.448	1-7/	M36	4.00	1.50	1.00	1.2330	.925
1.448	1.510	1-1/2		4.00	1.50	1.00	1.2330	.925
1.510	1.635	1-5/8	M39	5.00	2.00	1.13	1.3050	.979
1.635	1.760	1-3/4	M42	5.00	2.00	1.25	1.4300	1.072
1.760	1.885	1-7/8		5.00	2.00	1.25	1.5190	1.139
1.885	2.010	2	M48	5.00	2.00	1.38	1.6440	1.233
2.010	2.135	2-1/8		5.25	2.00	1.38	1.7690	1.327
2.135	2.260	2-1/4	M56	5.25	2.00	1.44	1.8940	1.420
2.260	2.385	2-3/8		5.25	2.00	1.44	2.0190	1.514
2.385	2.510	2-1/2		5.25	2.00	1.50	2.1000	1.575
2.510	2.635	2-5/8	M64	5.50	2.00	1.50	2.1000	1.575
2.635	2.760	2-3/4		5.50	2.00	1.50	2.1000	1.575
2.760	2.885	2-7/8	M72	5.50	2.00	1.50	2.1000	1.575
2.885	3.010	3		5.50	2.00	1.50	2.1000	1.575
3.010	3.135	3-1/8		5.75	2.00	1.50	2.1000	1.575
3.135	3.260	3-1/4	M80	5.75	2.00	1.50	2.1000	1.575
3.260	3.385	3-3/8		5.75	2.00	1.50	2.1000	1.575
3.385	3.510	3-1/2		5.75	2.00	1.50	2.1000	1.575
3.510	3.635	3-5/8	M90	6.00	2.00	1.75	2.1000	1.575
3.635	3.760	3-3/8		6.00	2.00	1.75	2.1000	1.575
3.760	3.885	3-7/8		6.00	2.00	1.75	2.1000	1.575
3.885	4.010	4	M100	6.00	2.00	1.75	2.1000	1.575

United States Cutting Tool Institute (USCTI) governs tap dimensions for the United States

Dimensions

JIS Spiral Pointed and Spiral Fluted Taps STANDARD DIMENSIONS

Diameter	Pitch	General Dimensions - Metric					Ground Thread Limits Class	Pitch Diameter Limit		
		Overall Length A	Length of Thread B	Length of Square C	Shank Diam. D	Size of Square E		Basic	Minimum	Maximum
M2	0.4	40	15	5	3	2.5	2	1.740	1.750	1.770
M2.3	0.4	42	15	5	3	2.5	2	2.040	2.050	2.070
M2.6	0.45	44	16	5	3	2.5	2	2.308	2.318	2.333
M3	0.5	46	18	6	4	3.2	2	2.675	2.685	2.700
M3.5	0.6	48	18	6	4	3.2	2	3.110	3.120	3.135
M4	0.7	52	20	7	5	4	2	3.545	3.555	3.575
M4.5	0.75	55	20	7	5	4	2	4.013	4.023	4.043
M5	0.8	60	22	7	5.5	4.5	2	4.480	4.490	4.510
M6	0.75	62	20	7	6	4.5	2	5.513	5.523	5.543
M6	1	62	24	7	6	4.5	2	5.350	5.360	5.380
M7	1	65	6	8	6.2	5	2	6.350	6.360	6.380
M7	0.75	62	20	8	6.2	5	2	7.513	7.525	7.550
M8	1	70	30	8	6.2	5	2	7.350	7.360	7.380
M8	1.25	70	30	8	6.2	5	2	7.188	7.198	7.223
M9	1.25	72	30	8	7	5.5	2	8.188	8.198	8.223
M9	1	70	30	8	7	5.5	2	9.350	9.362	9.387
M10	1.25	75	32	8	7	5.5	2	9.188	9.198	9.223
M10	1.5	75	32	8	7	5.5	2	9.026	9.041	9.066
M11	1.5	80	38	9	8	6	2	10.026	10.041	10.066
M11	1	70	30	9	8.5	6.5	2	11.350	11.365	11.395
M12	1.25	80	38	9	8.5	6.5	2	11.188	11.203	11.233
M12	1.5	82	38	9	8.5	6.5	2	11.026	11.041	11.071
M12	1.75	82	38	9	8.5	6.5	2	10.863	10.878	10.908
M12	1.25	80	38	11	10.5	8	2	13.188	13.203	13.233
M14	1.5	88	42	11	10.5	8	2	13.026	13.041	13.071
M14	2	88	42	11	10.5	8	2	12.701	12.716	12.746
M14	1	75	30	13	12.5	10	2	15.350	15.365	15.395
M16	1.5	95	45	13	12.5	10	2	15.026	15.041	15.071
M16	2	95	45	13	12.5	10	2	14.701	14.716	14.746
M16	1.5	95	45	14	14	11	2	17.026	17.041	17.071
M18	2	95	45	14	14	11	2	16.701	16.716	16.751
M18	2.5	100	48	14	14	11	2	16.376	16.396	16.431
M20	1.5	95	45	15	15	12	2	19.026	19.041	19.076
M20	2.5	100	48	15	15	12	2	18.376	18.396	18.431
M22	1.5	95	45	16	17	13	2	21.026	21.041	21.076
M22	2.5	115	55	16	17	13	2	20.376	20.396	20.431
M24	1.5	95	45	18	19	15	2	23.026	23.041	23.076
M24	3	120	58	18	19	15	2	22.051	22.071	22.111
M26	1.5	95	45	18	20	15	2	25.026	25.041	25.076
M26	3	130	62	18	20	15	2	24.051	24.071	24.076
M28	1.5	105	45	8	21	17	2	27.026	27.041	27.076
M28	1.5	105	45	20	23	17	2	29.026	29.041	29.076
M30	3.5	135	65	20	23	17	2	27.727	27.747	27.787
M32	1.5	105	45	22	24	19	2	31.026	31.041	31.076
M33	1.5	110	45	22	25	19	2	32.026	32.041	32.076
M34	1.5	110	45	24	26	21	2	33.026	33.041	33.076
M36	1.5	110	45	24	28	21	2	35.026	35.041	35.076

Dimensions are in millimeters

NPT/NPTF THREAD LIMITS

Nominal Size (inch)	Threa per Inch NPT	*Gage Measurement (inch)		Taper per Foot (inch)	
		Projection	Tolerance (+/-)	Min.	Max.
1/16	27	0.312	1/16	23/32	25/32
1/8	*27	0.312	1/16	23/32	25/32
1/4	18	0.459	1/16	23/32	25/32
3/8	18	0.454	1/16	23/32	25/32
1/2	14	0.579	1/16	23/32	25/32
3/4	14	0.565	1/16	23/32	25/32
1	11-1/2	0.678	3/32	23/32	25/32
1 1/4	11-1/2	0.686	3/32	23/32	25/32
1 1/2	11-1/2	0.699	3/32	23/32	25/32
2	11-1/2	0.667	3/32	23/32	25/32
2 1/2	8	0.925	3/32	47/64	25/32
3	8	0.925	3/32	47/64	25/32
3 1/2	8	0.938	1/8	47/64	25/32
4	8	0.950	1/8	47/64	25/32

*The distance small end of the tap projects through an L1 American Standard Pipe Thread Ring Gage.

WIDTH OF FLATS—TAPS

Threads Per Inch	Element	Width of Flats at Tap Crest and Roots			
		NPT		NPTF	
		Min.	Max.	Min.	Max.
27	Major Dia.	0.0014	.0041	0.0040	.0055
	Minor Dia.		.0041		.0040
18	Major Dia.	0.0021	.0057	0.0050	.0065
	Minor Dia.		.0057		.0050
14	Major Dia.	0.0027	.0064	0.0050	.0065
	Minor Dia.		.0064		.0050
11 1/2	Major Dia.	0.0033	.0073	0.0060	.0083
	Minor Dia.		.0073		.0060
8	Major Dia.	0.0048	.0090	0.0080	.0103
	Minor Dia.		.0090		.0080

Minimum minor diameter flats are not specified. May be as sharp as practicable. Ground Thread Taps marked NPTF may be used for NPT and ANPT applications.

Measurement of Taper Pipe Taps, Reaming Data and Tap Drill Sizes

Size	Projection				Ream Dia. Large End	Gage Width L1	Reamed Length L1 + L3	Tap Drill for Use w/ Reaming	Tap Drill for Use w/o Reaming
	NPT & NTF		SAE-SHORT						
	Min.	Max.	Min.	Max.					
1/16-27	0.250	0.375	0.222	0.259	0.2515	0.1600	0.2711	15/64	C
1/8-27	0.250	0.375	0.222	0.259	0.3340	0.1615	0.2726	21/64	Q
1/4-18	0.397	0.521	0.333	0.389	0.4472	0.2278	0.3945	27/64	7/16
3/8-18	0.392	0.516	0.333	0.389	0.5826	0.240	0.4067	9/16	9/16
1/2-14	0.517	0.641	0.429	0.500	0.7213	0.320	0.5343	11/16	45/64
3/4-14	0.503	0.627	0.429	0.500	0.9317	0.339	0.5533	57/64	29/32
1-11-1/2	0.584	0.772	-	-	1.1691	0.400	0.6609	1-1/8	1-9/64
1-1/4-11-1/2	0.592	0.780	-	-	1.1538	0.420	0.6809	1-15/32	1-31/64
1-1/2-11-1/2	0.606	0.792	-	-	1.7528	0.420	0.6809	1-45/64	1-23/32
2-11-1/2	0.574	0.760	-	-	2.2267	0.436	0.6969	2-3/16	2-3/16

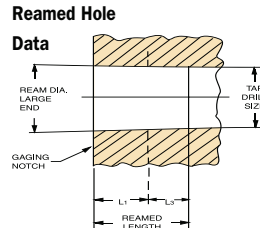
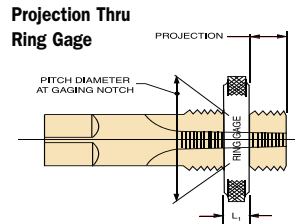

Straight Pipe Taps — General Dimensions — Inches

Nominal Pipe Size	L Overall Len		l Length of Thread		l2 Length of Square		d1 Shank Diameter			a Size of Square		Tap Drill Sizes
	Length	Tol.	Length	Tol.	Length	Tol.	Dia.	Thread Tol.	Ground Thread Tol.	Size	Tol.	
1/8	2-1/8	±1/32	3/4	±1/16	3/8	±1/32	.3125	-.007	-.0015	.234	-.004	11/32
1/8	2-1/8	±1/32	3/4	±1/16	3/8	±1/32	.4375	-.007	-.0015	.328	-.004	11/32
1/4	2-7/16	±1/32	1-1/16	±1/16	7/16	±1/32	.5625	-.007	-.0020	.421	-.006	7/16
3/8	2-9/16	±1/32	1-1/16	±1/16	1/2	±1/32	.7000	-.007	-.0020	.531	-.006	37/64
1/2	3-1/8	±1/32	1-3/8	±1/16	5/8	±1/32	.6875	-.007	-.0020	.515	-.006	23/32
3/4	3-1/4	±1/32	1-3/8	±1/16	11/16	±1/32	.9063	-.009	-.0020	.679	-.006	59/64
1	3-3/4	±1/16	1-3/4	±3/32	13/16	±1/16	1.1250	-.009	-.0020	.843	-.008	1-5/32

Straight Pipe Taps — Standard Sizes and Limits — H.S. Steel Ground Threads

Nominal Pipe Size	Threads Per I NPS NPSF		No. of Flutes	American Standard Pipe Form (NPS, NPSC and NPSM)				American Standard Dryseal Pipe Form (NPSF)				*Minor Dia. Of Flat Max
				Major Diameter		Pitch Diameter		Major Diameter		Pitch Diameter		
				Min	Max	Min	Max	Min	Max	Min	Max	
1/8	27	27	4	.4022	.4032	.3746	.3751	.3932	.3942	.3696	.3701	.004
1/4	18	18	4	.5347	.5357	.4933	.4938	.5239	.5249	.4859	.4864	.005
3/8	18	18	4	.6701	.6711	.6287	.6292	.6593	.6603	.6213	.6218	.005
1/2	14	14	4	.8347	.8357	.7806	.7811	.8230	.8240	.7712	.7717	.005
3/4	14	14	5	1.0447	1.0457	.9906	.9916	1.0335	1.0345	.9817	.9822	.005
1	11-1/2	11-1/2	5	1.3062	1.3077	1.2402	1.2412	1.2933	1.2943	1.2295	1.2305	.006

American Pipe Thread Taps

American standard pipe thread has various types. We show their symbols and engagement of threads as follows.

■ Pair groups of external thread and internal thread.

Standard	Symbol	Internal Thread	Mating Thread	External Thread	Mating Thread
Pipe Threads, General Purpose (ANSI/ASME B1.20.1)	American Standard Taper Pipe Thread for General Use	NPT	NPT	NPT	NPT NPSC
	American Standard Straight Pipe Thread in Pipe Couplings	NPSC	NPT	—	—
	American Standard Taper Pipe Threads for Railing Joints	NPTR	NPTR	NPTR	NPTR
	American Standard Straight Pipe Thread for Free-Fitting Mechanical Joints for Fixtures	NPSM	NPSM	NPSM	NPSM
	American Standard Straight Pipe Thread for Loose-Fitting Mechanical Joints with Locknuts	NPSL	NPSL	NPSL	NPSL
	American Standard Straight Pipe Threads for Loose-Fitting Mechanical Joints for Hose Couplings	NPSH	NPSH	NPSH	NPSH
Dryseal Pipe Threads (ANSI B1.20.3)	Dryseal American Standard Taper Pipe Thread	NPTF	NPTF PTF-SAE-SHORT	NPTF	NPTF,NPSF,NPSI PTF-SAE-SHORT
	Dryseal SAE Short Taper Pipe Thread	PTF-SAE-SHORT	NPTF	PTF-SAE-SHORT	NPTF NPSI
	Dryseal American Standard Fuel Internal Straight Pipe Thread	NPSF	NPTF	—	—
	Dryseal American Standard Intermediate Internal Straight Pipe Thread	NPSI	NPTF PTF-SAE-SHORT	—	—

Note : These symbols correspond to the name of American pipe thread.

These threads are

- (1) Thread angle is 60°
- (2) Taper of Taper Thread is 3/4" per foot.
- (3) Fundamental height of triangle : H=Height of triangle thread profile H=0.866025P
- (4) The difference between American Standard Pipe Thread for general use and Dryseal American Standard Pipe
 - Crests and roots truncation of thread is different.
 - The length of engagement for pipe thread is different by types.
 - With regard to standard, Dryseal American Standard Pipe Thread is available in right hand.

In accordance with ANSI B 94.9, 4 types of pipe thread are specified in American Pipe Thread Standard. Please refer to next page about the relation between taps and threads and about thread tolerance.

UNIFIED AND AMERICAN NATIONAL SCREW THREADS

Size	Threads Per Inch		Recommended Tap Limits and for Internal Thread Pitch Diameter Limits								
	NC UNC	NF UNF	Class 2	Class 3	Class 2B	Class 3B	Min/All Classes (Basic)	Max Class 2	Max Class 3	Max Class 2B	Max Class 3B
0		80	G H1	G H1	G H2	G H1	.0519	.0536	.0532	.0542	.0536
1	64		G H1	G H1	G H2	G H1	.0629	.0648	.0643	.0655	.0648
1		72	G H1	G H1	G H2	G H1	.0640	.0658	.0653	.0665	.0659
2			G H1	G H1	G H2	G H1	.0744	.0764	.0759	.0772	.0765
2	56		G H1	G H1	G H2	G H1	.0759	.0778	.0773	.0786	.0779
3			G H1	G H1	G H2	G H1	.0855	.0877	.0871	.0885	.0877
3	48		G H1	G H1	G H2	G H1	.0874	.0894	.0889	.0902	.0895
4			G H2	G H1	G H2	G H2	.0958	.0982	.0975	.0991	.0982
4	40		G H1	G H1	G H2	G H1	.0985	.1007	.1001	.1016	.1008
5			G H2	G H1	G H2	G H2	.1088	.1112	.1105	.1121	.1113
5	40		G H1	G H1	G H2	G H2	.1102	.1125	.1118	.1134	.1126
6			G H2	G H1	G H3	G H2	.1177	.1204	.1196	.1214	.1204
6	32		G H2	G H1	G H2	G H2	.1218	.1242	.1235	.1252	.1243
8			G H2	G H1	G H3	G H3	.1437	.1464	.1456	.1475	.1465
8	32		G H2	G H1	G H2	G H2	.1460	.1485	.1478	.1496	.1487
10			G H3	G H1	G H3	G H3	.1629	.1662	.1653	.1672	.1661
10	24		G H2	G H1	G H3	G H2	.1697	.1724	.1716	.1736	.1726
12			G H3	G H1	G H3	G H3	.1889	.1922	.1913	.1933	.1922
12	24		G H3	G H1	G H3	G H3	.1928	.1959	.1950	.1970	.1959
1/4			G H3	G H2	G H5	G H3	.2175	.2211	.2201	.2223	.2211
1/4	20		G H3	G H1	G H4	G H3	.2268	.2299	.2290	.2311	.2300
5/16			G H3	G H2	G H5	G H3	.2764	.2805	.2794	.2817	.2803
5/16	18		G H3	G H1	G H4	G H3	.2854	.2887	.2878	.2902	.2890
3/8			G H3	G H2	G H5	G H3	.3344	.3389	.3376	.3401	.3387
3/8	16		G H3	G H1	G H4	G H3	.3479	.3512	.3503	.3528	.3516
7/16			G H5	G H3	G H5	G H3	.3911	.3960	.3947	.3972	.3957
7/16	14		G H3	G H1	G H5	G H3	.4050	.4086	.4076	.4104	.4091
1/2			G H5	G H3	G H5	G H3	.4500	.4552	.4537	.4565	.4548
1/2	13		G H3	G H1	G H5	G H3	.4675	.4711	.4701	.4731	.4717
9/16			G H5	G H3	G H5	G H3	.5084	.5140	.5124	.5152	.5135
9/16	12		G H3	G H2	G H5	G H3	.5264	.5305	.5294	.5323	.5308
5/8			G H5	G H3	G H5	G H3	.5660	.5719	.5702	.5732	.5714
5/8	11		G H3	G H2	G H5	G H3	.5889	.5930	.5919	.5949	.5934
3/4			G H5	G H3	G H5	G H5	.6850	.6914	.6895	.6927	.6907
3/4	10		G H3	G H2	G H4	G H3	.7094	.7139	.7126	.7159	.7143
7/8			G H6	G H4	G H6	G H4	.8028	.8098	.8077	.8110	.8089
7/8	9		G H4	G H2	G H6	G H4	.8286	.8335	.8322	.8356	.8339
1			G H6	G H4	G H6	G H4	.9188	.9264	.9242	.9276	.9254
1	8		G H4	G H2	G H6	G H4	.9459	.9515	.9499	.9535	.9516
1		12 14 NS	G H4	G H2	G H6	G H4	.9536	.9585	.9572	.9609	.9590
1-1/8			G H8	G H4	G H8	G H4	1.0322	1.0407	1.0381	1.0416	1.0393
1-1/8	7		G H4	G H4	G H6	G H4	1.0709	1.0765	1.0749	1.0787	1.0768
1-1/4			G H8	G H4	G H8	G H4	1.1572	1.1657	1.1631	1.1668	1.1644
1-1/4	7		G H4	G H4	G H6	G H4	1.1959	1.2015	1.1999	1.2039	1.2019
1-3/8			G H8	G H4	G H8	G H4	1.2667	1.2768	1.2738	1.2771	1.2745
1-3/8	6		G H4	G H4	G H6	G H4	1.3209	1.3265	1.3249	1.3291	1.3270
1-1/2			G H8	G H4	G H8	G H4	1.3917	1.4018	1.3988	1.4022	1.3996
1-1/2	6		G H4	G H4	G H6	G H4	1.4459	1.4515	1.4499	1.4542	1.4522

The above recommended taps normally produce the class of thread indicated in average materials when used with reasonable care. However, if the tap specified does not give a satisfactory gage fit in the work, a choice of some other limit tap will be necessary.

**Sizes through 1" diameter:
 H1= Basic PD to Basic PD + 0.0005"
 H2= Basic PD + 0.0005" to Basic PD + 0.0010"
 H3= Basic PD + 0.0010" to Basic PD + 0.0015"
 H4= Basic PD + 0.0015" to Basic PD + 0.0020"
 H5= Basic PD + 0.0020" to Basic PD + 0.0025"
 H6= Basic PD + 0.0025" to Basic PD + 0.0030"
 Sizes larger than 1" diameter through 1-1/2"
 H4= Basic PD + 0.0010" to Basic PD + 0.0020"

Ground Thread Tap Limits

In addition to the nominal size and pitch of a tap, there is another important dimensional factor to be considered in selecting a ground thread tap for a given job. This factor is the "H" and "L" pitch diameter tap limits. "H" represents (high) above basic pitch diameter; "L" (low) is below basic pitch diameter. Tap limits have been established to provide a choice in the selection of the tap size best suited to produce the class of thread desired.

Figure 1 illustrates the numbering system and the .0005" diameter increment separation between successive limits. Since the starting point is basic pitch diameter, dividing the limit number by two establishes in thousandths of an inch, the amount the maximum tap pitch diameter is above basic in the "H" series and the amount the minimum tap pitch diameter is under basic in the "L" series.

Figure 2 illustrates the positioning of the tap limits in relation to the various classes of threads for a 1/4-20 size.

Figure 1

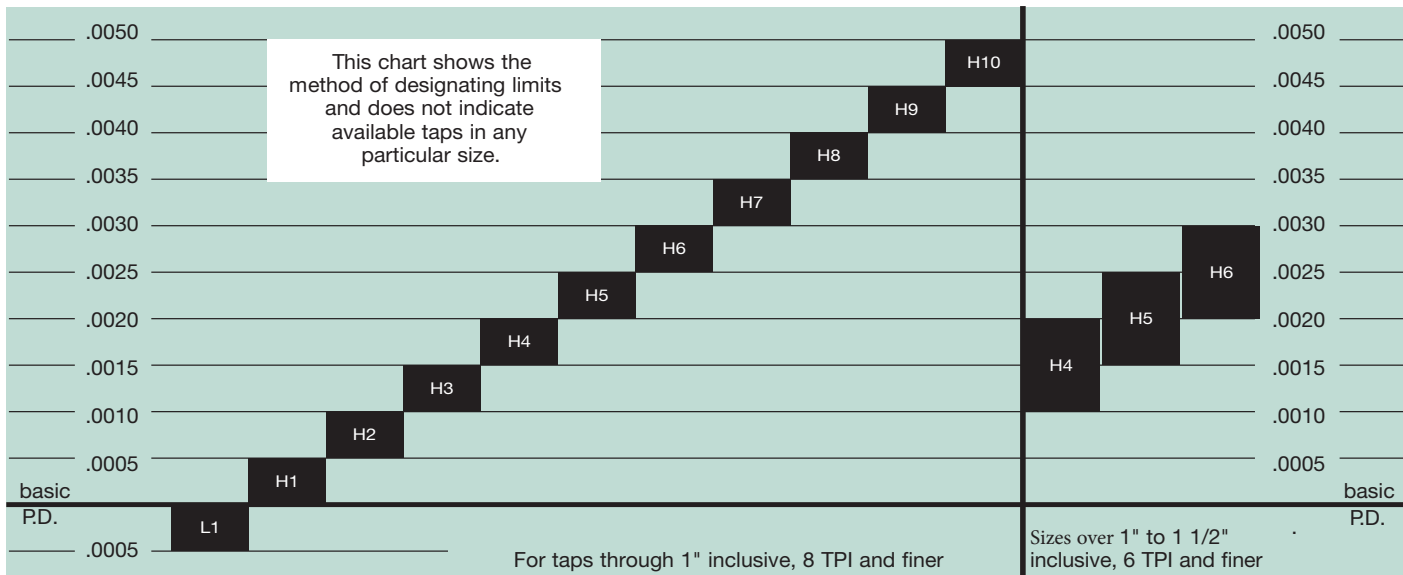
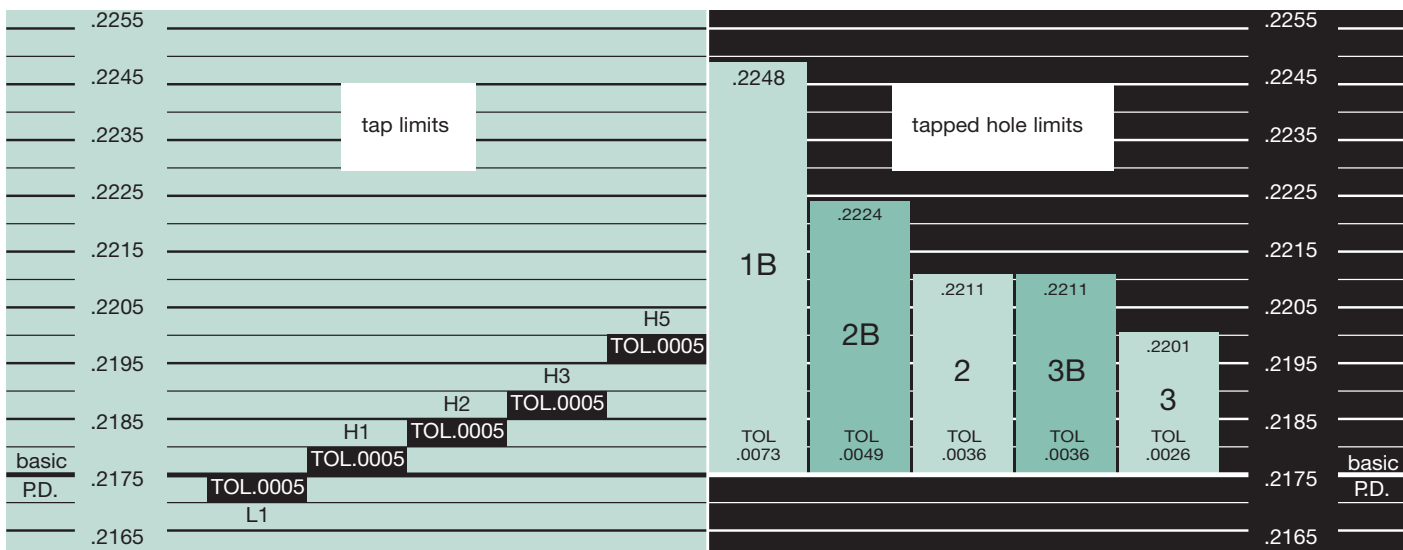

Figure 2

Class of Thread – 1/4 -20 UNC and NC



YMW U.S.A.

Comparison of PD tolerance for tap classes for American market, for Yamawa P classes and for unified internal thread classes.

CLASSES OF INTERNAL THREADS AND CLASSES OF TAPS

Technical Information

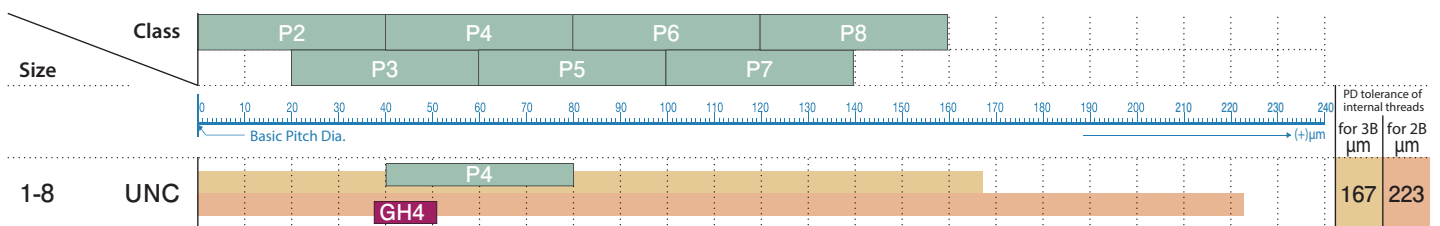
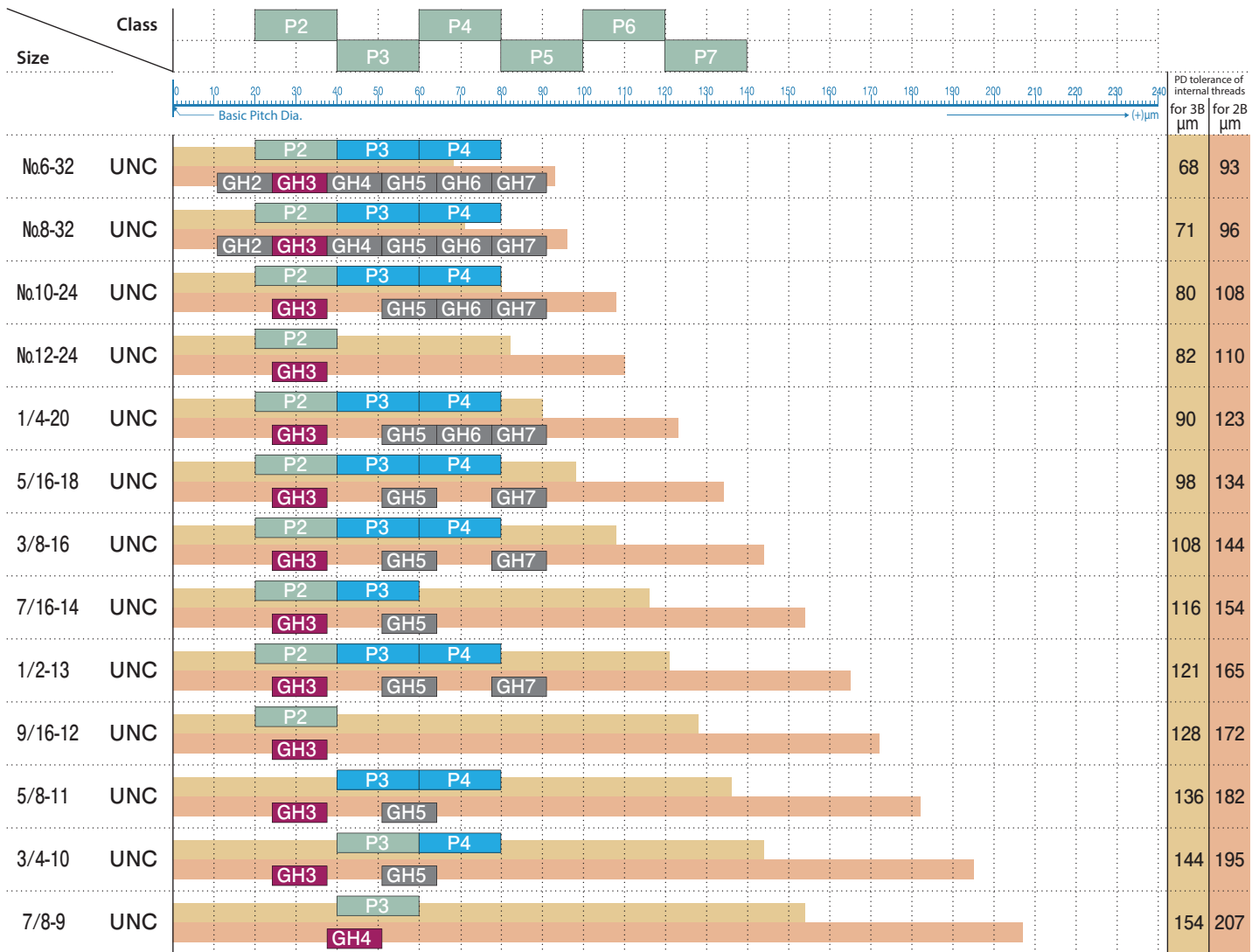
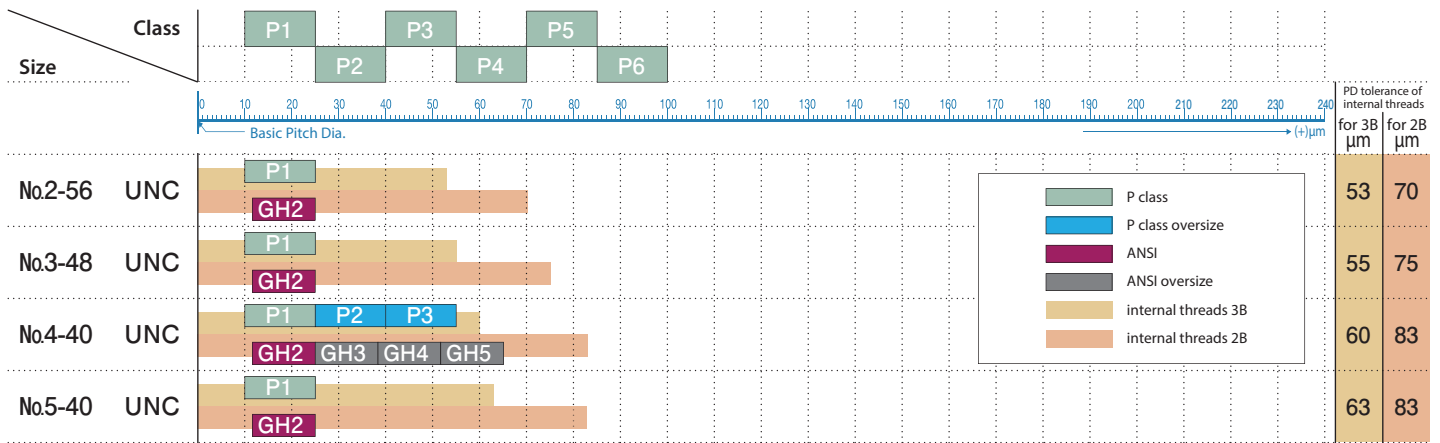

Tap Drill Size Selection

Recommended Percentage of Full Thread in Tapped Holes

To reduce tapping problems and improve tool life use the largest drill possible for the minor diameter. Select the percentage of thread height from the chart below to find the appropriate drill size of each size thread.

A minor diameter that provides a 55% to 65% thread is sufficient for good strength in most applications. In some cases it may be necessary to produce a thread with a higher percentage of thread height to meet minor diameter limits of thread class specified or for added strength.

Material		>2D to L Tapping	Average Commercial Work	Thin Sheet Stock or Stamping
Free machining	Aluminum, Brass, Bronze, Cast Iron, Copper, Mild Steel, Tool Steel	60% - 70%	65% - 70%	75% - 85%
Harder materials or tougher machining	Cast Steel, Drop Forging, Monel Metal, Nickel Steel, Stainless Steel	55% - 65%	60% - 70%	

Tap Size	Threads Per Inch		Minor Diameter		80% Thread	Tap Drill Diameter			65% Thread	60% Thread
	UNC	UNF	Min. 2B	Max. 2B		75% Thread	70% Thread	65% Thread		
0	-	80	0.0465	0.0514	0.0470	0.0478	0.0486	0.0494	0.0503	
1	64	-	0.0561	0.0623	0.0568	0.0578	0.0588	0.0598	0.0608	
	-	72	0.0580	0.0635	0.0586	0.0595	0.0604	0.0613	0.0622	
2	56	-	0.0667	0.0737	0.0674	0.0686	0.0698	0.0709	0.0721	
	-	64	0.0691	0.0752	0.0698	0.0708	0.0718	0.0728	0.0738	
3	48	-	0.0764	0.0845	0.0774	0.0787	0.0801	0.0814	0.0828	
	-	56	0.0797	0.0865	0.0804	0.0816	0.0828	0.0839	0.0851	
4	40	-	0.0849	0.0939	0.0860	0.0876	0.0893	0.0909	0.0925	
	-	48	0.0894	0.0968	0.0904	0.0917	0.0931	0.0944	0.0958	
5	40	-	0.0979	0.1062	0.0990	0.1006	0.1023	0.1039	0.1055	
	-	44	0.1004	0.1079	0.1014	0.1029	0.1043	0.1058	0.1073	
6	32	-	0.1040	0.1140	0.1055	0.1076	0.1096	0.1116	0.1136	
	-	40	0.1110	0.1190	0.1120	0.1136	0.1153	0.1169	0.1185	
8	32	-	0.1300	0.1390	0.1315	0.1336	0.1356	0.1376	0.1396	
	-	36	0.1340	0.1420	0.1351	0.1369	0.1387	0.1405	0.1424	
10	24	-	0.1450	0.1560	0.1467	0.1494	0.1521	0.1548	0.1575	
	-	32	0.1560	0.1640	0.1575	0.1596	0.1616	0.1636	0.1656	
12	24	-	0.1710	0.1810	0.1727	0.1754	0.1781	0.1808	0.1835	
	-	28	0.1770	0.1860	0.1789	0.1812	0.1835	0.1858	0.1882	
1/4	20	-	0.1960	0.2070	0.1980	0.2013	0.2045	0.2078	0.2110	
	-	28	0.2110	0.2200	0.2129	0.2152	0.2175	0.2198	0.2222	
5/16	18	-	0.2520	0.2650	0.2548	0.2584	0.2620	0.2656	0.2692	
	-	24	0.2670	0.2770	0.2692	0.2719	0.2746	0.2773	0.2800	
3/8	16	-	0.3070	0.3210	0.3101	0.3141	0.3182	0.3222	0.3263	
	-	24	0.3300	0.3400	0.3317	0.3344	0.3371	0.3398	0.3425	
7/16	14	-	0.3600	0.3760	0.3633	0.3679	0.3726	0.3772	0.3818	
	-	20	0.3830	0.3950	0.3855	0.3888	0.3920	0.3953	0.3985	
1/2	13	-	0.4170	0.4340	0.4201	0.4251	0.4301	0.4351	0.4400	
	-	20	0.4460	0.4570	0.4480	0.4513	0.4545	0.4578	0.4610	
9/16	12	-	0.4720	0.4900	0.4759	0.4813	0.4867	0.4921	0.4976	
	-	18	0.5020	0.5150	0.5048	0.5084	0.5120	0.5156	0.5192	
5/8	11	-	0.5270	0.5460	0.5305	0.5364	0.5423	0.5482	0.5541	
	-	18	0.5650	0.5780	0.5673	0.5709	0.5745	0.5781	0.5817	
3/4	10	-	0.6420	0.6630	0.6461	0.6526	0.6591	0.6656	0.6721	
	-	16	0.6820	0.6960	0.6851	0.6891	0.6932	0.6972	0.7013	
7/8	9	-	0.7550	0.7780	0.7595	0.7668	0.7740	0.7812	0.7884	
	-	14	0.7980	0.8140	0.8008	0.8054	0.8101	0.8147	0.8193	
1	8	-	0.8650	0.8900	0.8701	0.8782	0.8863	0.8945	0.9026	
	-	12	0.9100	0.9280	0.9134	0.9188	0.9242	0.9296	0.9351	
1-1/8	7	-	0.9700	0.9980	0.9765	0.9858	0.9951	1.0044	1.0137	
	-	12	1.0350	1.0530	1.0384	1.0438	1.0492	1.0546	1.0601	
1-1/4	7	-	1.0950	1.1230	1.1015	1.1108	1.1201	1.1294	1.1387	
	-	12	1.1600	1.1780	1.1634	1.1688	1.1742	1.1796	1.1851	
1-3/8	6	-	1.1950	1.2250	1.2018	1.2126	1.2235	1.2343	1.2451	
	-	12	1.2850	1.3030	1.2884	1.2938	1.2992	1.3046	1.3101	
1-1/2	6	-	1.3200	1.3500	1.3268	1.3376	1.3485	1.3593	1.3701	
	-	12	1.4100	1.4280	1.4134	1.4188	1.4242	1.4296	1.4351	
1-3/4	5	-	1.5330	1.5670	1.5422	1.5551	1.5681	1.5811	1.5941	
2	4-1/2	-	1.7590	1.7950	1.7691	1.7835	1.7979	1.8124	1.8268	

TAP DRILL SIZE FORMULA	PERCENTAGE OF FULL THREAD FORMULA
$\text{Drill Size} = \frac{\text{Tap Major Dia} \times 0.01299 \times \% \text{ of Full Thread}}{\# \text{ of Threads Per Inch}}$	$\% \text{ of Full Thread} = \text{Threads Per Inch} \times \frac{\text{Major Dia} - \text{Drill}}{0.01299}$
<p>Example : To determine Drill Size for 3/4"—10 Tap,70% Full Thread Basic Major Diameter of Tap = .750" $0.01299 \times 70 = 0.9093$ $0.9093 \div 10 = 0.09093$ Drill size = .750" - 0.09093 = .6591"</p>	<p>Example : To determine the % of Full Thread for 3/4"—10 Tap, using .6656" Drill. Threads Per Inch = $10 \div (.750 - .6656) = 0.0844$ $0.0844 \div 0.01299 = 6.497$ Percentage of Full Threads = $10 \times 6.497 = 65\%$</p>

Guide to Thread Forming Taps (Roll Taps)

YMW U.S.A.

Thread Forming Taps are the tools used for producing internal threads by a thread forming process. Currently, YAMAWA's Thread Forming Taps have a good reputation by being used in large area. They are widely used along with the diversity of workpieces and with the change into miniaturization of workpieces. Followings are the characteristics and features of Thread Forming Taps (Roll Tap) which cutting type taps do not have.

<Features of Roll Taps>

- Tapping without producing chips. They are suitable for blind hole tapping. In producing internal threads with no chips, they save you a time for chip disposal.
- Roll taps are stronger than cutting taps due to their design. The effect of fluteless design gives a large cross-section area to the tap, and there is no worry of chip jamming, which makes Roll taps very tough against breakage.
- Roll taps produce excellent pitch diameter well within pitch diameter tolerances. Material deformation process produces the internal threads with good surface finish as well as precise pitch diameter.
- High efficiency and tool life. The configuration of the lobes at the crests of the tap threads makes high speed tapping possible and extends tool life compared with cutting type taps. The addition of a supplemental tap surface treatment, such as Oxidizing, Nitriding, TiN, and TiCN can extend tool life 2 to 20 times over an uncoated (bright) tap performance.

<Points to note during a Roll tapping operation>

- Tapping torque is 2 to 3 times larger than that of cutting type taps.
- Roll tapping is only applicable to stringy materials.
- The deviation of hole size before tapping should be about 5% of pitch. The control of hole size before tapping should be more severe than that of cutting type taps.
- The selection of lubricants is important to prevent sticking or welding.
- Burrs at the face of an internal thread are larger than those produced by cutting type taps. In some cases it is necessary to take additional counter-sink processing at the top of hole.
- On the minor diameter of internal thread, U-shape form (Tine form) at the hole entrance can be seen. U-shape form is never seen when using cutting type taps.

<Selection of YAMAWA Roll Taps>

- Types of Roll Taps. YAMAWA produces various types of Roll Taps which include General purpose taps, Special purpose taps for non-ferrous and steel, as well as special purpose taps with surface treatment for the specified applications. To provide for longer tool life, specially developed premium materials are also used together with physical vapor deposition (PVD) such as TiN and TiCN. In particular, OL-RZ is superior product developed for dry machining with good regards to tapping environment and performance.
- Tap Materials. YAMAWA's standard tap material is SKH58 designed for improving torque, superior anti-friction properties as well as toughness. To extend tool life, we use SKH56, or SKH10 (Powder HSS) which is the best tap material for antifriction.
- Tolerance Class. Using the datum 12.7 μ m in a step form, in accordance with ANSI standard GH class, we made up YAMAWA's G class system. The differences in materials being Roll tapped, as well as hole size, contribute to differences in thread forming. YAMAWA offers 2 to 3 oversized tap tolerance classes in order to achieve the most suitable internal thread pitch diameter size.
- Chamfer length. Chamfer lengths : 2 pitches for blind hole use and 4 pitches for through hole use. Basically 4 pitches have longer tool life than 2 pitches because force applied on one blade at 4 pitch chamfer is smaller than that at 2 pitch chamfer. However, it is difficult to say about tool life in a few words because each different tapping condition influences the tool life.

<Shape of internal threads and the ratio of thread engagement affected by bored hole diameter>

Compared with the basic height of thread engagement, the actual height of the thread engagement is called "thread engagement ratio" in percentage.

Depending on the bored hole diameter, internal threads and thread engagement ratio will change.

In tapping, the tapping condition must be chosen by referring to the thread engagement ratio.

In tapping, it can reduce cutting space and forming space to make bored hole diameters as large as possible. This, through reducing the load on taps, can restrict tap's wear and damage.

S50C, minor diameter of threads cut M24x3 minor dia tolerance of internal threads $\varphi 20.752\text{--}\varphi 21.252$		Aluminum, minor diameter of threads formed M25x2 minor dia tolerance of internal threads $\varphi 22.835\text{--}\varphi 23.210$	
<p>【S50C internal threads cut ①】 M24x3 bored hole size : $\varphi 20.652$ minor dia tolerance of internal threads NG thread engagement ratio : 103.1%</p>		<p>【Aluminum, internal threads formed ①】 M25x2 bored hole size : $\varphi 23.903$ minor diameter of finished internal threads : 22.723mm minor dia tolerance of internal threads NG thread engagement ratio : 105.2%</p>	
<p>【S50C internal threads cut ③】 M24x3 bored hole size : $\varphi 21.000$ minor dia tolerance of internal threads: Middle thread engagement ratio : 92.4%</p>		<p>【Aluminum, internal threads formed ③】 M25x2 bored hole size : $\varphi 24.042\text{mm}$ minor diameter of finished internal threads : 23.067mm minor dia tolerance of internal threads : Middle thread engagement ratio : 89.3%</p>	
<p>【S50C internal threads cut ⑤】 M24x3 bored hole size : $\varphi 21.352$ minor dia tolerance of internal threads NG thread engagement ratio : 81.5%</p>		<p>【Aluminum, internal threads formed ⑤】 M25x2 bored hole size : $\varphi 24.240\text{mm}$ minor diameter of finished internal threads : 23.462mm minor dia tolerance of internal threads NG thread engagement ratio : 71.0%</p>	

Form Tap Drill Sizes Chart

To reduce tapping problems and improve tool life use the largest drill possible for the minor diameter. Select the percentage of thread height from the chart below to find the appropriate drill size of each size thread.

A minor diameter that provides a 55% to 65% thread is sufficient for good strength in most applications. In some cases it may be necessary to produce a thread with a higher percentage of thread height to meet minor diameter limits of thread class specified or for added strength.

Suggested Percentage of Full Thread in Tapped Holes

Material		* Deep Hole Tapping	Average Commercial Work	Thin Sheet Stock or Stamping
Free Cutting	Aluminum, Brass, Bronze, Cast Iron, Copper, Mild Steel, Tool Steel	60% - 70%	65% - 70%	75% - 85%
Hard or Tough Cutting	Cast Steel, Drop Forging, Monel Metal, Nickel Steel, Stainless Steel	55% - 65%	60% - 70%	

Tap Size	Threads Per Inch			Minor Diameter		Tap Drill Diameter- Form Taps				
	UNC	UNF	8-Pitch	Min. 2B	Max. 2B	75% Thread	70% Thread	65% Thread	60% Thread	55% Thread
						(in)	(in)	(in)	(in)	(in)
0	-	80	-	0.0465	0.0514	0.0536	0.0540	0.0545	0.0549	0.0554
1	64	-	-	0.0561	0.0623	0.0650	0.0655	0.0661	0.0666	0.0672
	-	72	-	0.0580	0.0635	0.0659	0.0663	0.0669	0.0673	0.0679
2	56	-	-	0.0667	0.0737	0.0769	0.0774	0.0781	0.0787	0.0794
	-	64	-	0.0691	0.0752	0.0780	0.0785	0.0791	0.0796	0.0802
3	48	-	-	0.0764	0.0845	0.0884	0.0890	0.0898	0.0905	0.0913
	-	56	-	0.0797	0.0865	0.0899	0.0904	0.0911	0.0917	0.0924
4	40	-	-	0.0849	0.0939	0.0993	0.1000	0.1010	0.1018	0.1028
	-	48	-	0.0894	0.0968	0.1014	0.1020	0.1028	0.1035	0.1043
5	40	-	-	0.0979	0.1062	0.1123	0.1130	0.1140	0.1148	0.1158
	-	44	-	0.1004	0.1079	0.1134	0.1141	0.1150	0.1157	0.1166
6	32	-	-	0.1040	0.1140	0.1221	0.1230	0.1243	0.1252	0.1264
	-	40	-	0.1110	0.1190	0.1253	0.1260	0.1270	0.1278	0.1288
8	32	-	-	0.1300	0.1390	0.1481	0.1490	0.1503	0.1512	0.1524
	-	36	-	0.1340	0.1420	0.1498	0.1507	0.1518	0.1526	0.1537
10	24	-	-	0.1450	0.1560	0.1688	0.1700	0.1716	0.1729	0.1746
	-	32	-	0.1560	0.1640	0.1741	0.1750	0.1762	0.1772	0.1784
12	24	-	-	0.1710	0.1810	0.1948	0.1960	0.1976	0.1989	0.2006
	-	28	-	0.1770	0.1860	0.1978	0.1990	0.2002	0.2014	0.2028
1/4	20	-	-	0.1960	0.2070	0.2245	0.2260	0.2279	0.2295	0.2315
	-	28	-	0.2110	0.2200	0.2318	0.2329	0.2342	0.2354	0.2389
5/16	18	-	-	0.2520	0.2650	0.2842	0.2861	0.2879	0.2898	0.2917
	-	24	-	0.2670	0.2770	0.2912	0.2927	0.2941	0.2955	0.2969
3/8	16	-	-	0.3070	0.3210	0.3431	0.3452	0.3474	0.3495	0.3516
	-	24	-	0.3300	0.3400	0.3537	0.3552	0.3566	0.3580	0.3594
7/16	14	-	-	0.3600	0.3760	0.4011	0.4035	0.4059	0.4084	0.4108
	-	20	-	0.3830	0.3950	0.4120	0.4137	0.4154	0.4171	0.4188
1/2	13	-	-	0.4170	0.4340	0.4608	0.4634	0.4660	0.4686	0.4712
	-	20	-	0.4460	0.4570	0.4745	0.4762	0.4779	0.4796	0.4813
9/16	12	-	-	0.4720	0.4900	0.5200	0.5229	0.5257	0.5285	0.5313
	-	18	-	0.5020	0.5150	0.5342	0.5361	0.5379	0.5398	0.5417
5/8	11	-	-	0.5270	0.5460	0.5787	0.5817	0.5848	0.5879	0.5910
	-	18	-	0.5650	0.5780	0.5967	0.5986	0.6004	0.6023	0.6042
3/4	10	-	-	0.6420	0.6630	0.6990	0.7024	0.7058	0.7092	0.7126
	-	16	-	0.6820	0.6960	0.7181	0.7202	0.7224	0.7245	0.7266
7/8	9	-	-	0.7550	0.7780	0.8183	0.8221	0.8259	0.8297	0.8334
	-	14	-	0.7980	0.8140	0.8386	0.8410	0.8434	0.8459	0.8483
1	8	-	-	0.8650	0.8900	0.9363	0.9405	0.9448	0.9490	0.9533
	-	12	-	0.9100	0.9280	0.9575	0.9603	0.9632	0.9660	0.9866

FORM TAP DRILL SIZE FORMULA

$$\text{Drill Size} = \text{Tap Major Dia} - \frac{0.0068 \times \% \text{ of Full Thread}}{\# \text{ of Threads Per Inch}}$$

Example: Determine Drill Size for 3/4"-10 Tap, 70% Full Thread.
 Basic Major Diameter of Tap = .7500"
 $0.0068 \times 70 = 0.4760$
 $0.4760 \div 10 = 0.0476$ "
 Drill Size = .750" - 0.0476 = .7024"

PERCENTAGE OF FULL THREAD FORMULA

$$\% \text{ of Full Thread} = \text{Threads Per Inch} \times \frac{\text{Tap Major Dia} - \text{Drill Dia}}{0.0068}$$

Example: Determine the % of Full Thread for 3/4"-10 Tap, using .7058" Drill.
 Threads Per Inch = 10
 $.750 - .7058 = 0.0442$
 $0.0442 \div 0.0068 = 6.5$
 Percentage of Full Threads = 10 x 6.5 = 65%

Suggested Percentage of Full Thread in Tapped Holes

Material		>2D to L Tapping	Average Commercial Work	Thin Sheet Stock or Stamping
Free Machining	Aluminum, Brass, Bronze, Cast Iron, Copper, Mild Steel, Tool Steel	60% - 70%	65% - 70%	75% - 85%
Harder Materials or Tough Machining	Cast Steel, Drop Forging, Monel Metal, Nickel Steel, Stainless Steel	55% - 65%	60% - 70%	

To reduce tapping problems and improve tool life use the largest drill possible for the minor diameter. Select the percentage of thread height from the chart below to find the appropriate drill size of each size thread.

A minor diameter that provides a 55% to 65% thread is sufficient for good strength in most applications. In some cases it may be necessary to produce a thread with a higher percentage of thread height to meet minor diameter limits of thread class specified or for added strength.

Tap Size	Pitch		Minor Diameter (mm)		Metric Tap Drill Diameter									
	M	MF	Min. 6H	Max. 6H	80% Thread		75% Thread		70% Thread		65% Thread		60% Thread	
					(mm)	(in)	(mm)	(in)	(mm)	(in)	(mm)	(in)	(mm)	(in)
M1.6	0.35	-	1.221	1.321	1.24	0.0488	1.26	0.0496	1.28	0.0504	1.30	0.0512	1.33	0.0524
M1.7	0.35	-	1.321	1.421	1.33	0.0524	1.36	0.0535	1.38	0.0543	1.40	0.0551	1.42	0.0559
M1.8	0.35	-	1.422	1.519	1.44	0.0567	1.46	0.0575	1.48	0.0583	1.50	0.0591	1.53	0.0602
M2	0.4	-	1.567	1.679	1.58	0.0622	1.61	0.0634	1.64	0.0646	1.66	0.0654	1.69	0.0665
M2.2	0.45	-	1.715	1.836	1.73	0.0681	1.76	0.0693	1.79	0.0705	1.82	0.0717	1.85	0.0728
M2.5	0.45	-	2.013	2.138	2.03	0.0799	2.06	0.0811	2.09	0.0823	2.12	0.0835	2.15	0.0846
M2.6	0.45	-	2.113	2.238	2.13	0.0839	2.16	0.0850	2.19	0.0862	2.22	0.0874	2.25	0.0886
M3	0.5	-	2.459	2.599	2.48	0.0976	2.51	0.0988	2.55	0.1004	2.58	0.1016	2.61	0.1028
M3.5	0.6	0.35	2.621	2.721	2.63	0.1035	2.66	0.1047	2.68	0.1055	2.70	0.1063	2.72	0.1071
M3.5	0.6	-	2.850	3.010	2.88	0.1134	2.92	0.1150	2.95	0.1161	2.99	0.1177	3.03	0.1193
M4	0.7	-	3.242	3.422	3.27	0.1287	3.32	0.1307	3.36	0.1323	3.41	0.1343	3.45	0.1358
M4	0.7	0.5	3.459	3.599	3.48	0.1370	3.51	0.1382	3.54	0.1394	3.58	0.1409	3.61	0.1421
M4.5	0.75	-	3.688	3.876	3.72	0.1465	3.77	0.1484	3.82	0.1504	3.87	0.1524	3.92	0.1543
M5	0.8	-	4.134	4.334	4.17	0.1642	4.22	0.1661	4.27	0.1681	4.32	0.1701	4.38	0.1724
M5	0.8	0.5	4.458	4.600	4.48	0.1764	4.51	0.1776	4.54	0.1787	4.58	0.1803	4.61	0.1815
M6	1	-	4.917	5.153	4.96	0.1953	5.03	0.1980	5.09	0.2004	5.16	0.2031	5.22	0.2055
M6	1	0.75	5.187	5.377	5.22	0.2055	5.27	0.2075	5.32	0.2094	5.37	0.2114	5.41	0.2130
M7	1	-	5.918	6.152	5.96	0.2346	6.03	0.2374	6.09	0.2398	6.16	0.2425	6.22	0.2449
M7	1	0.75	6.647	6.912	6.70	0.2638	6.78	0.2669	6.86	0.2701	6.94	0.2732	7.03	0.2768
M8	1	-	6.917	7.153	6.96	0.2740	7.03	0.2768	7.09	0.2791	7.16	0.2819	7.22	0.2843
M8	1	0.75	7.187	7.377	7.22	0.2843	7.27	0.2862	7.32	0.2882	7.37	0.2902	7.41	0.2917
M8	1	1.25	8.376	8.676	8.44	0.3323	8.54	0.3362	8.64	0.3402	8.73	0.3437	8.83	0.3476
M10	1.25	-	8.647	8.942	8.70	0.3425	8.78	0.3457	8.86	0.3488	8.94	0.3520	9.03	0.3555
M10	1.25	0.75	8.917	9.153	8.96	0.3528	9.03	0.3555	9.09	0.3579	9.16	0.3606	9.22	0.3630
M10	1.25	1.5	9.188	9.378	9.22	0.3630	9.27	0.3650	9.32	0.3669	9.37	0.3689	9.41	0.3705
M10	1.25	1.75	10.106	10.441	10.18	0.4008	10.30	0.4055	10.41	0.4098	10.52	0.4142	10.64	0.4189
M12	1.5	-	10.376	10.676	10.44	0.4110	10.54	0.4150	10.64	0.4189	10.73	0.4224	10.83	0.4264
M12	1.5	1.25	10.647	10.912	10.70	0.4213	10.78	0.4244	10.86	0.4276	10.94	0.4307	11.03	0.4343
M12	1.5	1.5	10.917	11.153	10.96	0.4315	11.03	0.4343	11.09	0.4366	11.16	0.4394	11.22	0.4417
M14	2	-	11.835	12.210	11.92	0.4693	12.05	0.4744	12.18	0.4795	12.31	0.4846	12.44	0.4898
M14	2	1.5	12.376	12.676	12.44	0.4898	12.54	0.4937	12.64	0.4976	12.73	0.5012	12.83	0.5051
M16	2	-	13.835	14.210	13.92	0.5480	14.05	0.5531	14.18	0.5583	14.31	0.5634	14.44	0.5685
M16	2	1.5	14.376	14.676	14.44	0.5685	14.54	0.5724	14.64	0.5764	14.73	0.5799	14.83	0.5839
M18	2.5	-	15.296	15.743	15.40	0.6063	15.56	0.6126	15.73	0.6193	15.89	0.6256	16.05	0.6319
M18	2.5	1.5	16.376	16.676	16.44	0.6472	16.54	0.6512	16.64	0.6551	16.73	0.6587	16.83	0.6626
M20	2.5	-	17.294	17.744	17.40	0.6850	17.56	0.6913	17.73	0.6980	17.89	0.7043	18.05	0.7106
M20	2.5	1.5	18.376	18.676	18.44	0.7260	18.54	0.7299	18.64	0.7339	18.73	0.7374	18.83	0.7413
M20	2.5	1.75	18.917	19.153	18.96	0.7465	19.03	0.7492	19.09	0.7516	19.16	0.7543	19.22	0.7567
M22	3	-	19.294	19.744	19.40	0.7638	19.56	0.7701	19.73	0.7768	19.89	0.7831	20.05	0.7894
M22	3	1.5	19.835	20.210	19.92	0.7843	20.05	0.7894	20.18	0.7945	20.31	0.7996	20.44	0.8047
M22	3	1.75	20.376	20.676	20.44	0.8047	20.54	0.8087	20.64	0.8126	20.73	0.8161	20.83	0.8201
M24	3	-	20.752	21.252	20.88	0.8220	21.08	0.8299	21.27	0.8374	21.47	0.8453	21.66	0.8528
M24	3	1.5	21.835	22.210	21.92	0.8630	22.05	0.8681	22.18	0.8732	22.31	0.8783	22.44	0.8835
M24	3	1.75	22.376	22.676	22.44	0.8835	22.54	0.8874	22.64	0.8913	22.73	0.8949	22.83	0.8988
M27	3	-	23.752	24.252	23.88	0.9402	24.08	0.9480	24.27	0.9555	24.47	0.9634	24.66	0.9709
M27	3	1.5	24.835	25.210	24.92	0.9811	25.05	0.9862	25.18	0.9913	25.31	0.9965	25.44	1.0016
M27	3	1.75	25.376	25.676	25.44	1.0016	25.54	1.0055	25.64	1.0094	25.73	1.0130	25.83	1.0169
M30	3.5	-	26.211	26.711	26.36	1.0378	26.59	1.0469	26.82	1.0559	27.04	1.0646	27.27	1.0736
M30	3.5	1.5	27.835	28.210	27.92	1.0992	28.05	1.1043	28.18	1.1094	28.31	1.1146	28.44	1.1197
M30	3.5	1.75	28.376	28.676	28.44	1.1197	28.54	1.1236	28.64	1.1276	28.73	1.1311	28.83	1.1350
M33	4	-	29.211	29.711	29.36	1.1559	29.59	1.1650	29.82	1.1740	30.04	1.1827	30.27	1.1917
M33	4	1.5	30.835	31.210	30.92	1.2173	31.05	1.2224	31.18	1.2276	31.31	1.2327	31.44	1.2378
M33	4	1.75	31.670	32.270	31.84	1.2535	32.10	1.2638	32.36	1.2740	32.62	1.2843	32.88	1.2945
M36	4	-	32.752	33.252	32.88	1.2945	33.08	1.3024	33.27	1.3098	33.47	1.3177	33.66	1.3252
M36	4	1.5	33.835	34.210	33.92	1.3354	34.05	1.3406	34.18	1.3457	34.31	1.3508	34.44	1.3559
M36	4	1.75	34.670	35.270	34.84	1.3717	35.10	1.3819	35.36	1.3921	35.62	1.4024	35.88	1.4126
M39	4.5	-	36.835	37.210	36.92	1.4535	37.05	1.4587	37.18	1.4638	37.31	1.4689	37.44	1.4740
M39	4.5	1.5	37.129	37.799	37.32	1.4693	37.62	1.4811	37.91	1.4925	38.20	1.5039	38.49	1.5154
M42	5	-	38.752	39.252	38.88	1.5307	39.08	1.5386	39.27	1.5461	39.47	1.5539	39.66	1.5614
M42	5	1.5	39.835	40.210	39.92	1.5717	40.05	1.5768	40.18	1.5819	40.31	1.5870	40.44	1.5921

TAP DRILL SIZE FO

Drill Size = Tap Major Dia - $\frac{\text{Pitch} \times \% \text{ of Full Thread}}{76.980}$

Example: Determine Drill Size for M12 x 1.75 Tap, 70% Full Thread.

Tap Major Diameter = 12

$1.75 \times 70 = 122.5$, $122.5 \div 76.980 = 1.59$

Drill Size = 12 - 1.59 = 10.41mm

PERCENTAGE OF FULL THREAD FORMULA FOR MATRIC THREADS

$\% \text{ of Full Thread} = (\text{Tap Major Dia.} - \text{Drill Dia.}) \times \frac{76.980}{\text{Pitch}}$

Example: Determine the % of Full Thread for M12 x 1.75 Tap, using 10.41mm Drill.

Pitch = 1.75

$12 - 10.41 = 1.59$

$76.980 \div 1.75 = 44$

Percentage of Full Thread = $1.59 \times 44 = 70\%$

Bored hole size before tapping (for thread cutting)

for Metric Threads

Size	Minor diameter of internal threads (D ₁)		Bored hole size (ref.)
	Max.	Min.	
M1 ×0.25	(0.785)	(0.729)	0.77
M1 ×0.2	(0.821)	(0.783)	0.81
M1.1×0.25	(0.885)	(0.829)	0.87
M1.1×0.2	(0.921)	(0.883)	0.91
M1.2×0.25	(0.985)	(0.929)	0.97
M1.2×0.2	(1.021)	(0.983)	1.01
M1.4×0.3	(1.142)	(1.075)	1.13
M1.4×0.2	(1.221)	(1.183)	1.21
M1.6×0.35	1.321	1.221	1.30
M1.6×0.2	(1.421)	(1.383)	1.41
※ M1.7×0.35	1.421	1.321	1.40
※ M1.7×0.2	1.521	1.483	1.51
M1.8×0.35	1.521	1.421	1.50
M1.8×0.2	(1.621)	(1.583)	1.61
M2 ×0.4	1.679	1.567	1.65
M2 ×0.25	(1.785)	(1.729)	1.77
M2.2×0.45	1.838	1.713	1.81
M2.2×0.25	(1.985)	(1.929)	1.97
※ M2.3×0.4	1.979	1.867	1.95
※ M2.3×0.25	2.085	2.029	2.07
M2.5×0.45	2.138	2.013	2.11
M2.5×0.35	2.221	2.121	2.20
※ M2.6×0.45	2.238	2.113	2.21
※ M2.6×0.35	2.321	2.221	2.30
M3 ×0.5	2.599	2.459	2.56
M3 ×0.35	2.721	2.621	2.70
M3.5×0.6	3.010	2.850	2.97
M3.5×0.35	3.221	3.121	3.20
M4 ×0.7	3.422	3.242	3.38
M4 ×0.5	3.599	3.459	3.56
M4.5×0.75	3.878	3.688	3.83
M4.5×0.5	4.099	3.959	4.06
M5 ×0.8	4.334	4.134	4.28
M5 ×0.5	4.599	4.459	4.56
M5.5×0.5	5.099	4.959	5.06
M6 ×1	5.153	4.917	5.09
M6 ×0.75	5.378	5.188	5.33
※ M6 ×0.5	5.599	5.459	5.56
M7 ×1	6.153	5.917	6.09

Unit : mm

Size	Minor diameter of internal threads (D ₁)		Bored hole size (ref.)
	Max.	Min.	
M7 ×0.75	6.378	6.188	6.33
※ M7 ×0.5	6.599	6.459	6.56
M8 ×1.25	6.912	6.647	6.85
M8 ×1	7.153	6.917	7.09
M 8×0.75	7.378	7.188	7.33
※ M 8×0.5	7.599	7.459	7.56
M 9×1.25	7.912	7.647	7.85
M 9×1	8.153	7.917	8.09
M 9×0.75	8.378	8.188	8.33
M10×1.5	8.676	8.376	8.60
M10×1.25	8.912	8.647	8.85
M10×1	9.153	8.917	9.09
M10×0.75	9.378	9.188	9.33
※ M10×0.5	9.599	9.459	9.56
M11×1.5	9.676	9.376	9.60
M11×1	10.153	9.917	10.10
M11×0.75	10.378	10.188	10.33
※ M11×0.5	10.599	10.459	10.56
M12×1.75	10.441	10.106	10.4
M12×1.5	10.676	10.376	10.6
M12×1.25	10.912	10.647	10.85
M12×1	11.153	10.917	11.09
※ M12×0.5	11.599	11.459	11.56
M14×2	12.210	11.835	12.1
M14×1.5	12.676	12.376	12.6
M14×1	13.153	12.917	13.09
M15×1.5	13.676	13.376	13.60
M15×1	14.153	13.917	14.09
M16×2	14.210	13.835	14.1
M16×1.5	14.676	14.376	14.6
M16×1	15.153	14.917	15.09
M17×1.5	15.676	15.376	15.60
M17×1	16.153	15.917	16.09
M18×2.5	15.744	15.294	15.6
M18×2	16.210	15.835	16.1
M18×1.5	16.676	16.376	16.6
M18×1	17.153	16.917	17.09
M20×2.5	17.744	17.294	17.6

The recommended tap drill sizes indicated above are for JIS 6H (Class 2) Metric Threads.

- D1: Minor diameter of JIS 6H (Class 2) internal thread. The Minor diameters D1 shown in () are of 5H (Class 2) for coarse threads and of 4H • 5H (Class 1) for fine threads.
- ※Marked sizes have been eliminated from JIS.

Bored hole size before tapping (for thread cutting)

Unit : mm

Size	Minor diameter of internal threads (D _i)		Bored hole size (ref.)
	Max.	Min.	
M20×2	18.210	17.835	18.1
M20×1.5	18.676	18.376	18.6
M20×1	19.153	18.917	19.09
M22×2.5	19.744	19.294	19.6
M22×2	20.210	19.835	20.1
M22×1.5	20.676	20.376	20.6
M22×1	21.153	20.917	21.09
M24×3	21.252	20.752	21.1
M24×2	22.210	21.835	22.1
M24×1.5	22.676	22.376	22.6
M24×1	23.153	22.917	23.09
M25×2	23.210	22.835	23.1
M25×1.5	23.676	23.376	23.6
M25×1	24.153	23.917	24.09
M26×1.5	24.676	24.376	24.6
M27×3	24.252	23.752	24.1
M27×2	25.210	24.835	25.1
M27×1.5	25.676	25.376	25.6
M27×1	26.153	25.917	26.09
M28×2	26.210	25.835	26.1
M28×1.5	26.676	26.376	26.6
M28×1	27.153	26.917	27.09
M30×3.5	26.771	26.211	26.6
M30×3	27.252	26.752	27.1
M30×2	28.210	27.835	28.1
M30×1.5	28.676	28.376	28.6
M30×1	29.153	28.917	29.09
M32×2	30.210	29.835	30.1
M32×1.5	30.676	30.376	30.6
M33×3.5	29.771	29.211	29.6
M33×3	30.252	29.752	30.1
M33×2	31.210	30.835	31.1
M33×1.5	31.676	31.376	31.6
M35×1.5	33.676	33.376	33.6
M36×4	32.270	31.670	32.1
M36×3	33.252	32.752	33.1
M36×2	34.210	33.835	34.1
M36×1.5	34.676	34.376	34.6

• D_i: Minor diameter of JIS 6H (Class 2) internal thread.

Size	Minor diameter of internal threads (D _i)		Bored hole size (ref.)
	Max.	Min.	
M38×1.5	36.676	36.376	36.6
M39×4	35.270	34.670	35.1
M39×3	36.252	35.752	36.1
M39×2	37.210	36.835	37.1
M39×1.5	37.676	37.376	37.6
M40×3	37.252	36.752	37.1
M40×2	38.210	37.835	38.1
M40×1.5	38.676	38.376	38.6
M42×4.5	37.799	37.129	37.6
M42×4	38.270	37.670	38.1
M42×3	39.252	38.752	39.1
M42×2	40.210	39.835	40.1
M42×1.5	40.676	40.376	40.6
M45×4.5	40.799	40.129	40.6
M45×4	41.270	40.670	41.1
M45×3	42.252	41.752	42.1
M45×2	43.210	42.835	43.1
M45×1.5	43.676	43.376	43.6
M48×5	43.297	42.587	43.1
M48×4	44.270	43.670	44.1
M48×3	45.252	44.752	45.1
M48×2	46.210	45.835	46.1
M48×1.5	46.676	46.376	46.6
M50×3	47.252	46.752	47.1
M50×2	48.210	47.835	48.1
M50×1.5	48.676	48.376	48.6
M52×5	47.297	46.587	47.1
M52×4	48.270	47.670	48.1
M52×3	49.252	48.752	49.1
M52×2	50.210	49.835	50.1
M52×1.5	50.676	50.376	50.6
M55×4	51.270	50.670	51.1
M55×3	52.252	51.752	52.1
M55×2	53.210	52.835	53.1
M55×1.5	53.676	53.376	53.6
M56×5.5	50.796	50.046	50.6
M56×4	52.270	51.670	52.1
M56×3	53.252	52.752	53.1
M56×2	54.210	53.835	54.1
M56×1.5	54.676	54.376	54.6

Bored hole size before tapping (for thread cutting)

■ for Metric Threads

Size	Class	Hole size depending on percentage of thread engagement			ref. Minor diameter of internal threads (5H/6H)	
		100%	90%	80%	Max.	Min.
		M1 × 0.25	G4	0.89	0.90	0.92
	G5	0.90	0.91	0.93		
M1.2 × 0.25	G4	1.09	1.10	1.11	0.983	0.929
	G5	1.10	1.11	1.13		
M1.4 × 0.3	G4	1.26	1.28	1.30	1.142	1.075
	G5	1.28	1.29	1.31		
M1.6 × 0.35	G4	1.43	1.44	1.46	1.321	1.221
	G5	1.44	1.46	1.48		
※ M1.7 × 0.35	G4	1.52	1.54	1.56	1.421	1.321
	G5	1.54	1.56	1.58		
	G6	1.55	1.57	1.59		
M1.8 × 0.35	G4	1.62	1.64	1.66	1.521	1.421
	G5	1.64	1.66	1.68		
M2 × 0.4	G4	1.79	1.81	1.83	1.679	1.567
	G5	1.80	1.82	1.84		
	G6	1.81	1.83	1.86		
M2 × 0.25	G4	1.89	1.90	1.91	1.785	1.729
	G5	1.90	1.91	1.93		
M2.2 × 0.45	G5	1.98	2.00	2.02	1.838	1.713
※ M2.3 × 0.4	G4	2.09	2.11	2.13	1.979	1.867
	G5	2.10	2.12	2.14		
	G6	2.11	2.13	2.16		
M2.5 × 0.45	G5	2.27	2.30	2.32	2.138	2.013
	G6	2.29	2.31	2.44		
M2.5 × 0.35	G5	2.34	2.36	2.37	2.221	2.121
※ M2.6 × 0.45	G5	2.37	2.40	2.42	2.238	2.113
	G6	2.39	2.41	2.44		
※ M2.6 × 0.35	G5	2.44	2.45	2.47	2.321	2.221
M3 × 0.5	G5	2.75	2.78	2.80	2.599	2.459
	G6	2.76	2.79	2.82		
	G7	2.77	2.80	2.83		
	G8	2.79	2.81	2.84		
M3 × 0.35	G5	2.79	2.84	2.86	2.721	2.621
M3.5 × 0.6	G5	3.19	3.22	3.25	3.010	2.850
	G6	3.20	3.23	3.26		
	G7	3.21	3.24	3.28		
M3.5 × 0.35	G5	3.32	3.34	3.36	3.221	3.121
	G6	3.33	3.35	3.37		
M4 × 0.7	G5	3.65	3.67	3.71	3.422	3.242
	G6	3.65	3.69	3.72		
	G7	3.66	3.70	3.74		
	G8	3.67	3.71	3.75		
M4 × 0.5	G5	3.75	3.77	3.80	3.599	3.459
	G6	3.76	3.79	3.81		

unit: mm

Size	Class	Hole size depending on percentage of thread engagement			ref. Minor diameter of internal threads (5H/6H)	
		100%	90%	80%	Max.	Min.
		M5 × 0.8	G5	4.57	4.62	4.66
G6	4.59		4.63	4.67		
G7	4.60		4.64	4.68		
G8	4.61		4.65	4.70		
M5 × 0.5	G7	4.77	4.80	4.82	4.599	4.459
M6 × 1	G5	5.46	5.51	5.57	5.153	4.917
	G6	5.47	5.53	5.58		
	G7	5.49	5.54	5.59		
	G8	5.50	5.55	5.61		
M6 × 0.75	G6	5.61	5.65	5.69	5.378	5.188
	G7	5.62	5.66	5.70		
※ M6 × 0.5	G6	5.76	5.78	5.81	5.599	5.459
M7 × 1	G6	6.47	6.52	6.58	6.153	5.917
	G7	6.48	6.54	6.59		
M7 × 0.75	G7	6.62	6.66	6.70	6.378	6.188
M8 × 1.25	G7	7.36	7.43	7.49	6.912	6.647
	G8	7.37	7.44	7.51		
M8 × 1	G7	7.48	7.54	7.59	7.153	6.917
M8 × 0.75	G7	7.62	7.66	7.70	7.378	7.188
M10 × 1.5	G7	9.22	9.30	9.38	8.676	8.376
	G8	9.23	9.31	9.39		
M10 × 1.25	G7	9.35	9.42	9.49	8.912	8.647
	G8	9.37	9.43	9.50		
M10 × 1	G7	9.48	9.53	9.59	9.153	8.917
M12 × 1.75	G8	11.09	11.19	11.28	10.441	10.106
	G9	11.11	11.20	11.29		
M12 × 1.5	G8	11.22	11.30	11.38	10.676	10.376
	G9	11.23	11.31	11.39		
	G8	11.35	11.42	11.49		
M12 × 1.25	G8	11.35	11.42	11.49	10.912	10.647
	G9	11.36	11.43	11.50		
M12 × 1	G7	11.47	11.53	11.58	11.153	10.917
M14 × 2	G9	12.97	13.07	13.18	12.210	11.835
	G10	12.98	13.09	13.19		
M14 × 1.5	G9	13.22	13.31	13.39	12.676	12.376
M14 × 1	G8	13.48	13.54	13.59	13.153	12.917
M16 × 2	G9	14.96	15.07	15.18	14.210	13.835
	G10	14.97	15.08	15.19		
M16 × 1.5	G9	15.22	15.30	15.38	14.676	14.376
M16 × 1	G8	15.48	15.53	15.59	15.153	14.917
M18 × 1.5	G9	17.22	17.30	17.38	16.676	16.376
M20 × 2.5	G11	18.72	18.86	18.99	17.744	17.294
M20 × 1.5	G9	19.21	19.29	19.37	18.676	18.376
	G10	19.22	19.31	19.39		

Sizes with * mark are deleted from JIS.

■ for Unified Threads

Size	Class	Hole size depending on percentage of thread engagement			ref. Minor diameter of internal threads (2B)	
		100%	90%	80%	Max.	Min.
No. 0 - 80UNF	G5	1.39	1.41	1.42	1.305	1.182
No. 1 - 64UNC	G5	1.68	1.70	1.72	1.582	1.425
No. 1 - 72UNF	G5	1.70	1.72	1.74	1.612	1.474
No. 2 - 56UNC	G4	1.96	1.98	2.01	1.871	1.695
	G5	1.97	1.99	2.02		
	G6	1.98	2.01	2.03		
	G7	2.00	2.02	2.04		
No. 2 - 64UNF	G4	1.98	2.01	2.03	1.912	1.756
	G5	2.00	2.02	2.04		
No. 3 - 48UNC	G4	2.25	2.28	2.31	2.146	1.941
	G5	2.26	2.29	2.32		
No. 3 - 56UNF	G4	2.29	2.31	2.34	2.197	2.025
	G5	2.30	2.32	2.35		
No. 4 - 40UNC	G5	2.54	2.57	2.61	2.385	2.157
	G6	2.55	2.59	2.62		
	G7	2.57	2.60	2.63		
No. 4 - 48UNF	G5	2.59	2.62	2.65	2.458	2.271
	G6	2.61	2.63	2.66		
No. 5 - 40UNC	G5	2.87	2.90	2.94	2.697	2.487
	G6	2.88	2.92	2.95		
No. 5 - 44UNC	G5	2.90	2.93	2.96	2.740	2.551
	G6	2.91	2.94	2.97		
No. 6 - 32UNC	G5	3.11	3.15	3.19	2.895	2.642
	G6	3.12	3.16	3.21		
	G7	3.13	3.18	3.22		
No. 6 - 40UNF	G5	3.19	3.22	3.26	3.022	2.820
	G6	3.20	3.23	3.27		
	G7	3.21	3.25	3.28		

unit: mm

Size	Class	Hole size depending on percentage of thread engagement			ref. Minor diameter of internal threads (2B)	
		100%	90%	80%	Max.	Min.
No. 8 - 32UNC	G6	3.78	3.82	3.87	3.530	3.302
	G7	3.79	3.84	3.88		
	G8	3.81	3.85	3.89		
No. 8 - 36UNF	G5	3.81	3.85	3.89	3.606	3.404
	G6	3.82	3.86	3.90		
No. 10 - 24UNC	G6	4.30	4.35	4.41	3.962	3.683
	G7	4.31	4.37	4.42		
No. 10 - 32UNF	G6	4.44	4.48	4.53	4.165	3.963
	G7	4.45	4.50	4.54		
No. 12 - 24UNC	G6	4.96	5.01	5.07	4.597	4.344
	G7	4.97	5.03	5.08		
No. 12 - 28UNF	G6	5.03	5.08	5.13	4.724	4.496
	G7	5.04	5.09	5.14		
1/4 - 20UNC	G6	5.71	5.78	5.85	5.257	4.979
	G7	5.73	5.80	5.86		
	G8	5.74	5.81	5.88		
1/4 - 28UNF	G6	5.89	5.94	5.99	5.588	5.360
	G7	5.91	5.95	6.00		
5/16 - 18UNC	G7	7.23	7.31	7.38	6.731	6.401
5/16 - 24UNF	G7	7.42	7.47	7.53	7.035	6.782
3/8 - 16UNC	G7	8.72	8.80	8.89	8.153	7.798
	G8	8.73	8.81	8.90		
3/8 - 24UNF	G7	8.99	9.04	9.10	8.636	8.382
	G8	9.00	9.06	9.11		
7/16 - 14UNC	G8	10.20	10.30	10.40	9.550	9.144
7/16 - 20UNF	G8	10.48	10.55	10.62	10.033	9.729
1/2 - 13UNC	G8	11.70	11.81	11.92	11.023	10.592
1/2 - 20UNF	G8	12.06	12.13	12.20	11.607	11.329

■ for Helical Coil Wire Screw Thread Inserts

unit: mm

Size	Class	Hole size depending on percentage of thread engagement			
		Min.		Max.	
STI M3 × 0.5	G3	3.40	100%	3.45	80%
STI M4 × 0.7	G4	4.56	100%	4.61	85%
STI M5 × 0.8	G4	5.63	100%	5.70	85%
STI M6 × 1	G4	6.82	100%	6.90	85%
STI M8 × 1.25	G4	9.00	100%	9.11	85%
STI M10 × 1.5	G5	11.21	100%	11.30	90%
STI M12 × 1.75	G6	13.42	100%	13.57	85%

■ for Miniature Screw Threads

unit: mm

Size	Class	Max.	Min.
S0.6 × 0.15	GS2	0.55	0.54
S0.7 × 0.175	GS3	0.64	0.62
S0.8 × 0.2	GS3	0.73	0.71
S0.9 × 0.225	GS4	0.82	0.80

Concerning bored hole sizes for metric extra fine screw series, please contact Yamawa or The Japan Research Institute for Screw Thread and Fastener.

■ SURZ SURZ adopts special design on the thread root of tap and is applicable to the control of minor diameter of internal threads and seams of thread crests.

unit: mm

Size	Class	Recommended bored hole sizes	Size	Class	Recommended bored hole sizes
M1 × 0.25	G4	0.90	M2.3 × 0.4	G4	2.12
M1.2 × 0.25	G4	1.10	M2.5 × 0.45	G4	2.30
M1.4 × 0.3	G4	1.28	M2.6 × 0.45	G5	2.40
M1.6 × 0.35	G4	1.46	M3 × 0.5	G5	2.77
M1.6 × 0.2	G3	1.52	No. 2 - 56UNC	G4	1.98
M1.7 × 0.35	G4	1.56	No. 4 - 40UNC	G5	2.55
M2 × 0.4	G4	1.82	No. 6 - 32UNC	G5	3.14

*Recommended bored hole sizes shown above aim at 90% percentage of thread engagement, and are decided by paying attention to tap breakage possibility based on our test results.

*Material deformation can slightly change depending on material, hardness and shape of workpiece and cutting condition, and hole sizes should be changed accordingly.

Please choose the suitable bored hole size.

Differences between UN and UNJ threads

The minor diameter of both the external and internal screw threads of a UNJ are larger than that of a UN thread. This design is to enhance the bending and shearing strength of an external thread as per the diagrams below.

The standards for a UNJ screw thread (MIL-S-8879, AS 8879 and ISO 3161) are one of the Unified screw threads and were established for fastening parts of commercial and military aircrafts with threaded components called "Air-fastener". UNJ threads have only one combination of 3A class external threads and 3B class internal threads per size and both are the smallest tolerance for unified threads to insure that air-fasteners are securely fastened for excessive loads.

The external screw threads of a UNJ have a rounded root radii to specific tolerances for added strength. Yamawa (YMW) taps manufactured for UN threads can be used to produce internal UNJ threads per (MIL-S-8879, AS 8879 and ISO 3161).

Internal threads require producing a larger minor diameter bore than those recommended for UN threads. This larger minor diameter prevents interference of external and internal threads within the tolerance for UNJ standards.

Tapping conditions must be highly accurate to produce an internal screw thread within a 3B class of thread. Thread results can be effected by tapping conditions such as feed mechanism of tapping machine, etc.

Tapping machines with synchronized tapping attachments are strongly recommended.

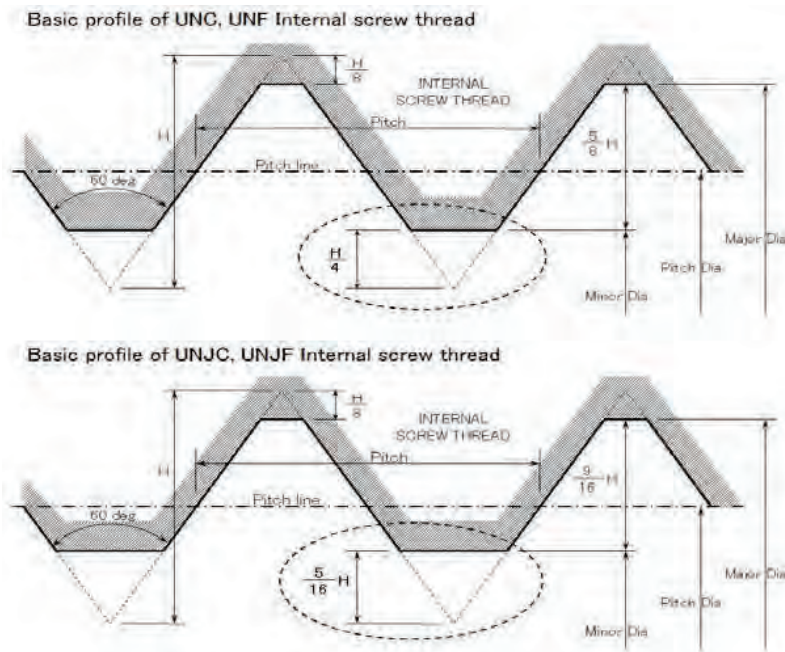

(1) Feature of UNJ threads:

Larger minor diameter (larger core diameter) and rounded root radii make the external screw threads of a UNJ stronger than a UN thread. Internal UNJ threads require producing a larger minor diameter bore than those recommended for UN threads while staying within the tolerance of the minor diameter for UNJ standards.

(2) Example:

Limit size for minor diameter of Unified internal threads

1/4-20UNC (2B)	Min: 0.1960" (or 4.979mm) - Max: 0.2070" (or 5.257mm)
1/4-20UNJC (3B)	Min: 0.2013" (or 5.114mm) - Max: 0.2121" (or 5.387mm)

UNJ Threads are Unified Threads used for Aircrafts.

<Features of UNJ Threads>

In order to protect the breakage from thread bottom of external threads, UNJ thread defines the minor diameter larger than Unified thread and the range of root bottom R.

And accuracy of threads is only defined in highest classes of unified threads, 3A of external threads and 3B of internal threads. UNJ Threads were initially defined as a MIL Standard (American Military Standard). It is now superseded by American SAE Standard (Automobile Engineers Association).

Standard Numbers are as follows:

- SAE AS8879D Screw Threads - UNJ Profile, Inch
- Controlled Radius Root with Increased Minor Diameter

<Basic Profile of UNJ Thread>

Basic profile of UNJ thread is shown in the drawing below. Truncation on thread root of external threads is $5H/16$, that is, $H/16$ larger than $H/4$ of normal Unified Thread's truncation.

And radius of thread root is $0.18042P \sim 0.15011P$.

■ Basic Profile of UNJ Thread

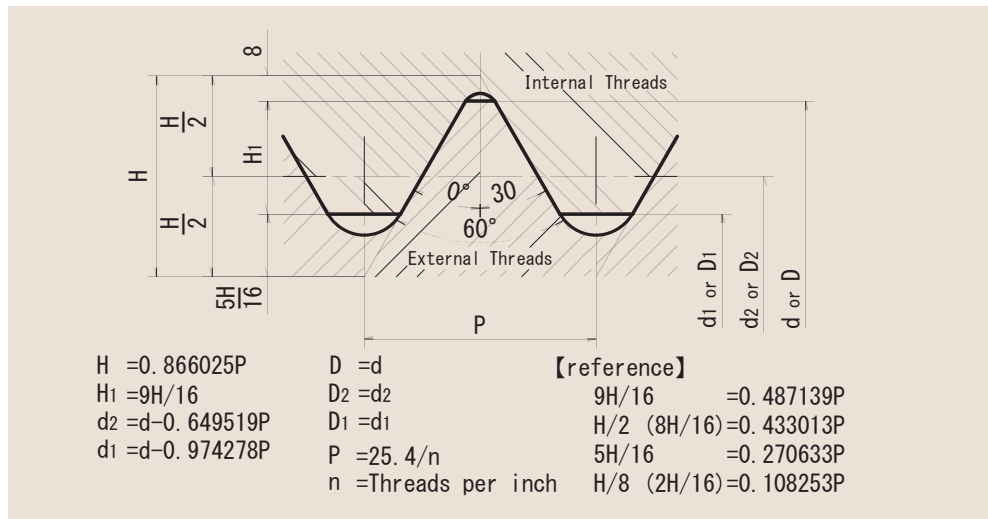

<Bored hole size>

Bored hole size is recommended to be a little larger than that for normal unified threads considering that the minor diameter of UNJ series is larger than that of normal Unified Threads. unit: mm

Size	Minor Diameter		Bored Hole Size
	Maximum	Minimum	
No.6 - 32 UNJC	2.938	2.734	2.89
No.6 - 40 UNJF	3.053	2.888	3.01
No.8 - 32 UNJC	3.599	3.394	3.55
No.8 - 36 UNJF	3.662	3.480	3.62
No.10 - 24 UNJC	4.064	3.795	4.00
No.10 - 32 UNJF	4.254	4.054	4.20
No.12 - 24 UNJC	4.704	4.456	4.64
No.12 - 28 UNJF	4.815	4.603	4.76
1/4 - 20 UNJC	5.387	5.114	5.32
1/4 - 28 UNJF	5.661	5.467	5.61
5/16 - 18 UNJC	6.832	6.564	6.76
5/16 - 24 UNJF	7.109	6.907	7.06
3/8 - 16 UNJC	8.255	7.979	8.19
3/8 - 24 UNJF	8.679	8.494	8.63
7/16 - 14 UNJC	9.639	9.348	9.57
7/16 - 20 UNJF	10.083	9.876	10.03
1/2 - 13 UNJC	11.094	10.798	11.02
1/2 - 20 UNJF	11.661	11.464	11.61

Surface Treatment

Surface treatments are selected and applied to each tap depending on the material being tapped. An explanation of each type of surface treatment is shown below.

Nitriding

In Nitriding, Nitrogen and Carbon are allowed to soak into the surface of HSS tools, which reacts with the chemical composition of the HSS material to produce a hard nitride surface. There are 3 methods in the treatment, a composition gas method, a salt bath nitride method and an ion nitride method. Salt bath nitride treatment has been changed into a gas nitride treatment method because of cyanic environmental pollution.

The Nitriding temperature of treatment is 500 to 550 degree. Hardness and depth of the treatment can be controlled by active nitrogen concentration and the reaction time.

The high hardness of the tool surface minimize the chemical attraction to the tap material and results in less welding and it lowers the resulting friction resistance. A major improvement can be expected in tool's performance. Yamawa have found the best combinations of hardness and toughness through it's treatment technology.

The nitriding treatment is widely applicable to workpiece materials like gray cast irons, special cast irons, aluminum diecastings with higher silicone content, copper, alloys, and resinoids (plastics). These materials produce small segmental chips and are very abrasive.

Yamawa recommends nitriding and oxidizing for comparatively sticky material such as high carbon steel and refined alloy steel. This double treatment improves the chipping resistance and has a proven benefit in machining ferrous materials.

Depth and hardness of Nitride Surface Treatment

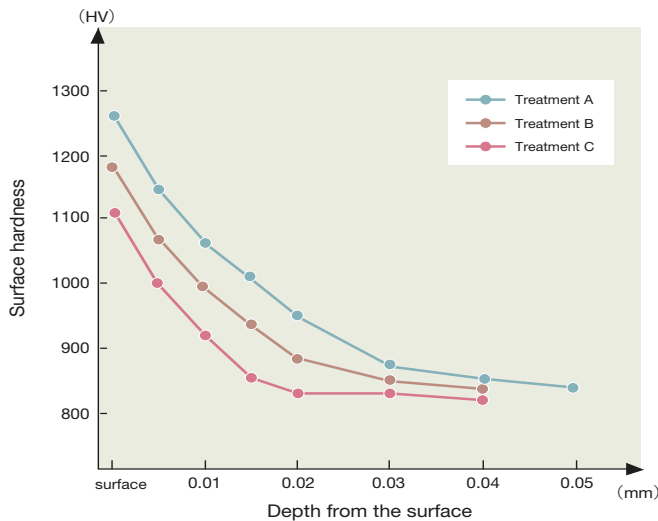

Efficiency of Nitride Treatment

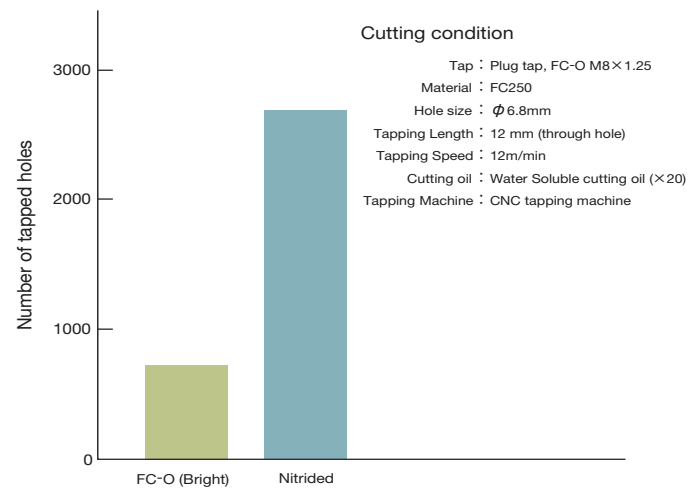

Each tap has the best surface treatment applied depending on the tapping purpose. Characteristics and effectiveness of surface treatment are introduced below.

Oxidizing

The first offering of this treatment was created using a HOMO furnace of LEED AND NORTHUP Company in the USA around 1938. It is called HOMO treatment. This treatment is also called vapor treatment and steam treatment. Through this treatment, a Fe3O4 layer of blue black color is produced over the tool surface.

The oxidization treatment produces a porous layer on the tool's surface. This porous layer works as a series of oil pocket to hold the oil on the tap surface. The oxidization helps to reduce friction, to avoid welding and to improve the surface roughness of internal screw. Moreover, longer tool life is experienced because the treatment reduces the remaining stress of HSS tools.

Thickness of oxide layer and the time of treatment

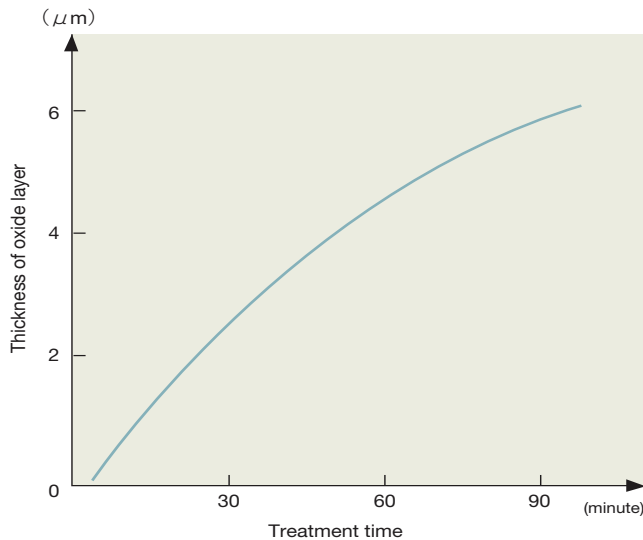

The oxidization treatment does not increase the hardness on tool surface. Using the furnace of YAMAWA original design and choosing the proper treatment surface treatment time, we have been very good resesu of oxidizing for YAMAWA HSS tools.

Stainless steel and low carbon steel are materials that easily weld the chip to the tap. Yamawa applies this treatment to the special purpose taps as well for better tool life in these materials. Because of the reduction of frictional resistance, this treatment has a wide range of application in steel and stainless steel material for better tool life.

Yamawa combines oxidizing with nitriding for taps designed for steels, alloyed steel, tool steels and stainless steels. This double treatment improves tool life in all types of ferrous materials.

Efficiency of oxide treatment

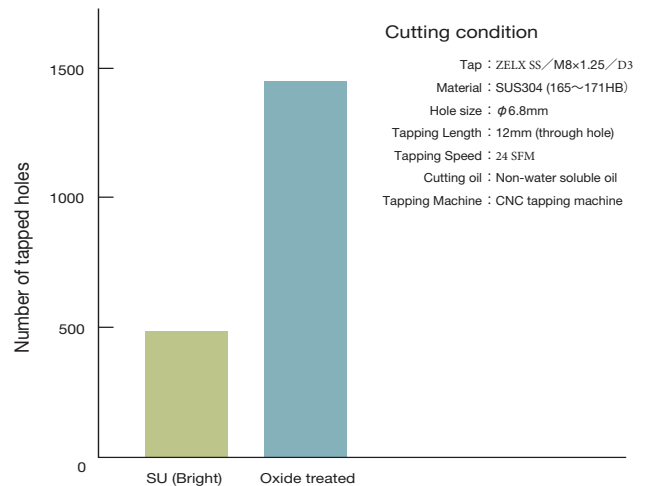

Surface Treatment

Each tap has the best surface treatment applied, depending on the tapping purpose. Characteristics and effectiveness of surface treatment are introduced in following.

High speed cutting and hard-to-machine cutting are more popular in recent technology. To meet this tendency, a hard layer coating applied by vapor deposition over tool's surface has proven to increase tool life. There are two coating method, CVD and PVD. The lower heat PVD process is mainly used for tap.

Physical Vapor Deposition

A vacuum chamber container of low heat and vapor deposition material are used to deposit the thin film coating by electric discharge on the surface of each tap.

Due to its low reaction temperature (lower than 500°C), PVD makes little change of shape and hardness of HSS tools.

Yamawa has adopted an ion plating method, which coats a thin layer (1-4um) over our HSS and carbide tools. This layer processed by this method is very high in its adherence and its wear resistance.

The features and classification of coating

Classification	Titanium nitride (TiN)	Titanium carbonitride (TiCN)	Titanium nitride aluminum (TiAlN)	Hard chromium plating (CrN)
Features				
Vickers Hardness	2000~2400	3000~3500	2300~2700	1800~2200
Wear resistance	Good	Excellent	Excellent	Normal
Welding resistance	Good	Good	Good	Excellent
Heat resistance	Good	Normal	Excellent	Excellent
Acid resistance	Good	Normal	Excellent	Good
Slippery	Good	Excellent	Good	Excellent
Color	Gold	Blue Gray Violet	Violet	Silver
Workpiece materials	Carbon Steels Aluminum forging	Carbon Steels Hard Steels Stainless Steels Aluminum forging Cast Irons Brass · Bronze	Stainless Steels Cast Irons	Copper

Note: Evaluation (tri-level) of characteristic features is just comparative of these four coatings, TiN, TiCN, TiAlN, and CrN, in the table. These coatings have great advantages of wear resistance, welding resistance, and reduced friction resistance. Hardness of each coating is higher than those treated HSS products and of Nitride treated products.

The efficiency of TiN coating

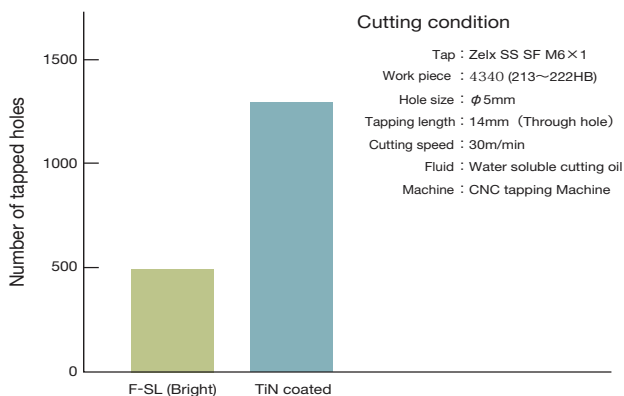

The efficiency of TiCN coating

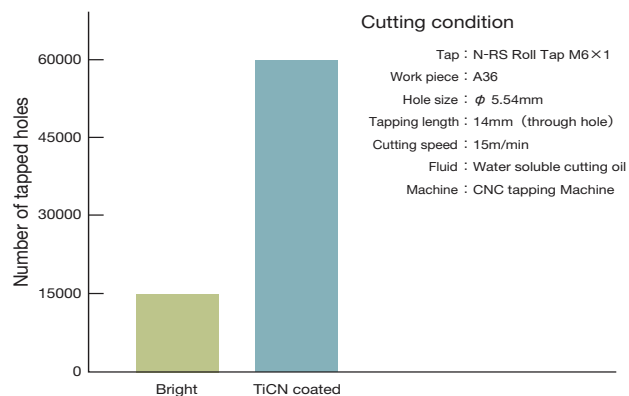

How to determine which tap holder to use each machines type.

The function and aspect of machine feed system

Fully synchronous feed (Rigid) system

Spindle revolution and feed are synchronized, a perfect thread lead and feed per revolution are expected.

A better-feed condition is expected because the tap is fed by a master lead screw shaft that has the same pitch as this tap.

The tap is fed at the same pitch by combinations of gears. This creates better-feed condition.

Asynchronous feed system by approximation

Use when the values of spindle rotation and the feed are set independently, especially, if the machine feed value cannot be accurately predicted to be that of the tap lead.

Hydraulic or Pneumatic pressure feed system

Feed is controlled by a pressure regulation system which normally results in an inaccurate feed per revolution compared to the tap.

Manual feed

Feed is controlled by worker which is difficult to keep a stable amount of feed per revolution.

How to combine the use of machines, holders, and taps

HOLDERS aspects

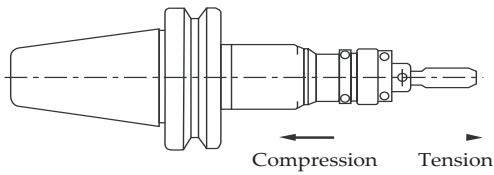

Spring direction

Completely fixed holder type

The tap is completely mounted with no axial or radial adjustment in the collet and holder.

Adjustable spring floating holder (Tension & Compression)

Machine feed and tap's pitch errors are corrected by two types of spring system, axial tap's tensional direction and axial tap's compressional direction.

Characteristics of self-guidance behavior in tapping

Eccentric thread relief (no width of margin)

Tap; with high cutting performance and machining performance, but with little self-guidance
Operation; A fully synchronous machining system with fixing holder is needed.
Example: "High speed tapping" and "fully synchronous tapping."

Con-eccentric thread relief (margin and thread relief)

Tap; High level of self-guidance due to suitable margin and thread relief.

Concentric (No relief)

Tap; Full land touches the material because of its no thread relief design, resulting in high level of self-guidance even under a little unbalanced feeding.

Common reasons for over size-cutting of internal thread and its mechanism

1. Run out, misalignment, inclined hole/cutting at inclined hole → Over-cutting at radial direction

Run out during tapping

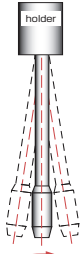

Run out

Chuck needs to be adjusted. Tapping with run out can be observed and checked by idle running.

Misalignment during tapping



Lateral force

misalignment

Axis of tapping process and bored hole should be lined up correctly. Solutions: The use of adjustable holder with floating features will reduce this problem.

Inclined hole/Cutting at inclined hole

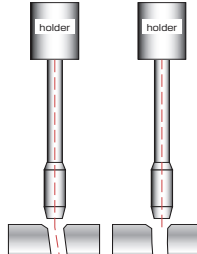

Verification of prepared hole condition.

Over-cutting is caused by extra cutting of workpiece at rotational direction. This process is followed along bored hole, which small amount of over-cutting would be observed at bored hole bottom, and over-cutting would be observed at bored hole entrance.

Excessive-cutting at radial direction



Over sized internal threads

Not Go gauge

Normal internal threads



Normal internal threads

Not Go gauge

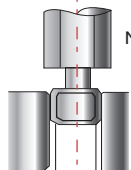

Not Go gauge

Internal threads

2. Using a tap not suitable for the operation or a tap with a dull cutting edge may cause galling and over-cutting. → Over-cutting caused by galling and excess cutting

Tapping process with incorrect tap for workpiece

Tap

- Straight fluted tap
- Spiral fluted tap
- Spiral pointed tap
- Roll tap

Selection of correct taps are strongly recommended.

Tapping process with dull edge

Abrasion

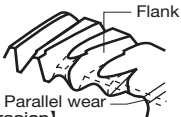

Flank

Parallel wear [Abrasion]

Welding



[Welding]

Chipping



[Breakage of Chamfer/chipping]

Proper use of cutting oil, confirmed value to establish tool life constant

A torn thread is observed at the surface of internal thread. When this situation is continued, over-cutting of internal thread, deformed threads, interrupted threads, and finally it leads to over-cutting of internal thread.

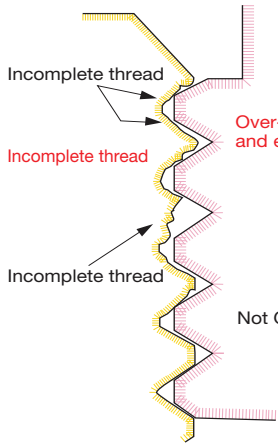

Incomplete thread

Incomplete thread

Incomplete thread

Over-cutting caused by galling and excess feeding

Not Go gauge

The reasons for over-cutting of internal thread lead and its mechanism

3. Tapping with improper feed condition → over-cutting at axial direction

The mechanism producing an incorrect thread;

① At cutting edge b1, cutting chamfer

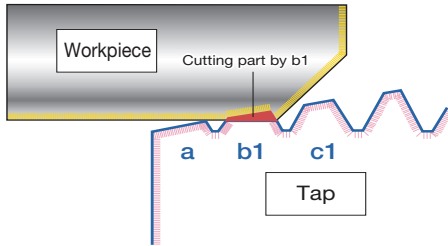

② Position after the tap rotates 1 turn. Cutting trace(b1) and thread phase of cutting face(c2) are misaligned creating the distance of excessive feeding A.

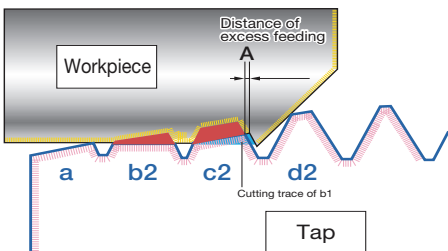

③ Position after the tap rotates 2 turns. Cutting chamfer(c3) is misaligned until the distance of excess feeding B and cutting chamfer (d3) is misaligned until the distance of over feeding A+B.

Cutting situation

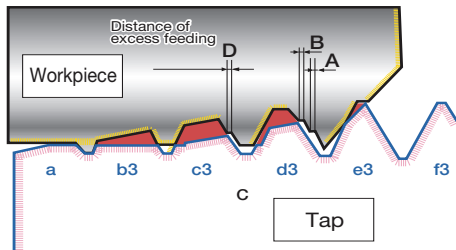

④ Position of thread after 3 rotations of tap. The thread continues to misalign until the distance of the thread lead is in error from excessive feeding C.

Cutting situation

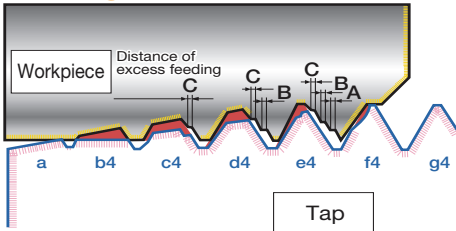

- Feed adjustment is strongly recommended.**
- * (Use of fully synchronous feed system and fixing holder)
 - Cutting machine that do not have the functions listed, such as drilling machine.
 - * The correct balance of main spindle adjustment is strongly recommended
 - * Use an axial/radial floating holder for its adjustment.

Solutions

Excessive-cutting of the thread by excessive feeding. A clearance gap is created at the back flank of thread. An additional amount of material is a cut at front flank, creating an incomplete threads.

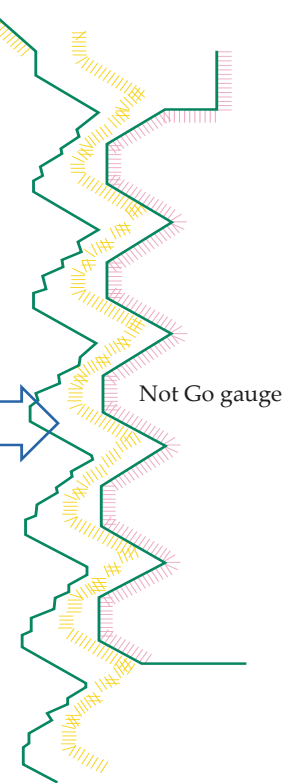

over-cutting thread by too slow feeding; This mechanism creates a the opposite of excess feeding or over-cutting internal thread. A clearance gap is created at the front flank and extra material is cut at back flank.

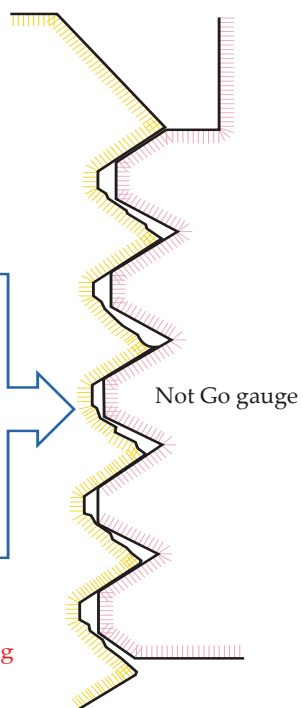

Reasons for over-cutting during tapping process (overview)

- ① The tap mounting condition in the holder.
- ② The condition of bored hole.
- ③ The cutting oil selection.
- ④ Incorrect adjustment of feed balance.
- ⑤ Selecting the correct tap from the tap selection section.

THE REASONS FOR OVERCUTTING OF INTERNAL THREAD AND ITS MECHANISM

Technical Information

Trouble Shooting

Troubles		Breakage			Excessive wear	
Check point		Prevent excessive cutting torque	Prevent clogging of chips	Tap	Work material	Tap
Segments						
Workpiece	Hardness	● Use work material which has even structure and hardness.			○ Use work material which has even structure and hardness.	
	Shape	● Pay attention to tapping position and material thickness.			● Pay attention to tapping position and material thickness.	
	Bored hole	○ Provide bigger bored holes. ● Prevent work hardening.			○ Provide bigger bored holes. ● Provide countersinking on hole entrance. ○ Prevent work hardening.	
		○ Provide deeper tapping hole. ● Prevent slanting of hole.				
Machine		● Avoid inconsistent feed. ● Adjust feed stroke.				
Jigs, Holders		● Use tap holder of floating type. ○ Use tap holder with torque limiter.				
Cutting condition		○ Reduce cutting speed.			○ Reduce cutting speed.	
Lubricant		● Use the other cutting oil which prevents cold welding. ● Use non soluble type cutting oil.			● Provide proper timing for changing or filling-up of cutting oil. ● Prevent mixing of other oil into cutting oil. ● Use other cutting oil which prevents cold welding. ● Use cutting oil of non soluble type. ● Adjust flow of cutting oil and method of lubrication.	
On process			● Remove unnecessary chips during tapping. ● Provide bigger space for chips disposal.			
Tap	Selection			● Use PO tap(through hole). ● Use SP tap(blind hole). ● Use Roll tap.		
	Design		● Provide bigger chip room.	● Change material of taps. ● Provide proper hardness on taps.		● Use set tap. ● Change material of taps. ● Provide proper hardness on taps.
		● Reconsider length of cutting chamfer. ● Use set tap.				● Reconsider length of cutting chamfer. ● Provide nitride on taps.
	Re-grind	● Be careful about burning during re-sharpening. ● Provide proper land.			● Be careful about burning during re-sharpening. ● Increase re-sharpening frequency.	

Trouble Shooting

Undersize cutting of internal thread			Bad surface, surface damaged		
Improve cutting performance	Selection and design of tap	Work material	Improve cutting performance	Prevent welding	Check cutting condition
		● Check work material.			hardness on work material.
		tapping position and material thickness.			tapping position and material thickness.
hardening of material.					
			hardening of material.		
					● Use the tap holder of floating type. ● Prevent vibrating of axis of tap work piece.
			● Reduce cutting speed.		
			<ul style="list-style-type: none"> ● Prevent mixing of other oil into cutting oil. ● Use other cutting oil which prevents cold welding. ● Use cutting oil with non soluble type. ● Adjust flow of cutting oil and method of lubrication. 		
	◎ Use oversize taps.		taps (for through hole).	coating on taps.	◎ Use oil hole taps.
	○ Provide thread relief.		◎ Provide larger cutting angle. ● Adjust relief angle on cutting chamfer. ○ Provide more narrow margin.	● Change of no. of flutes on taps.	
		● Increase re-sharpening frequency.	● Increase re-sharpening frequency.	● Provide better surface finishing on flutes.	
			<ul style="list-style-type: none"> ● Provide precise re-sharpening. ● Be careful about burning during re-sharpening. 		

Trouble Shooting

Troubles		Over-cutting of internal thread				
Check point		Prevent unevenness in feed of tap	Prevent over cutting on thread	Prevent welding	Check cutting condition	Prevent unbalance on entering
Segments						
Workpiece	Hardness	● Use workpiece which has even structure and hardness.				
	Shape					
	Bored hole			● Provide bigger hole.	● Prevent slanting of hole.	● Provide countersinking on the hole entrance.
Machine		● Adjust a feed. ○ Feed according to pitch.				
Jigs, Holders					○ Use tap holder of floating type.	○ Prevent vibrating of axis of tap. ○ Prevent centering-off with work piece. ● Use tap holder of floating type.
Cutting condition				● Reduce cutting speed.		
Lubricant				● Use other cutting lubricant which prevents cold welding. ● Check the viscosity.		
On process						
Tap	Selection			○ Provide oxide surface treatment. ○ Use tap with oil hole.		
	Design		○ Provide small cutting angle. ● Adjust chamfer relief angle. ○ Check the width of thread margin.	● Provide short thread length.	● Reconsider number of flutes of tap.	● Reconsider number of flutes of tap.
	Re-grind		● Remove burrs on teeth after re-grinding. ● Provide proper land.		● Provide precise re-sharpening.	○ Care for vibration.

◎ : Most suitable solution ○ : Second most suitable solution

Trouble Shooting

Chipping				Tapping operation	
Prevent clogging of chips	Prevent excessive cutting torque	Improve tapping method	Tap	Prevent clogging of chips	Tap
	material which has even structure and hardness.				
		○Pay attention to tapping position and material thickness.		●If possible, use finer pitch tap or shorter tapping length.	
Provide deeper tapping hole(Blind hole).	●Prevent work hardening.	●Prevent slanting of holes.		○Reduce cutting speed. tapping hole(Blind hole).	
●Provide countersinking on hole the entrance.					
	●Avoid inconsistent feed.				
		●Prevent centering-off with workpiece. ●Prevent vibration of axis of tap. ●Use the tap holder of floating type.			●Use the tap holder of floating type. ●Prevent vibrating of axis of tap. ●Prevent centering -off with workpiece.
●Reduce cutting speed.				●Reduce cutting speed.	
	●Use the other cutting oil which prevents cold welding.			●Check the viscosity.	
				●Remove unnecessary chips during tapping. ●Provide bigger space for chip disposal.	
			●Use PO taps (Through hole). ●Use SP taps (Blind hole). ●Use Roll tap.		●Use PO taps (Through hole). ●Use SP taps (Blind hole). ●Use Roll tap.
			●Change material of tap. ●Provide smaller cutting angle. ●Provide proper hardness.	●Provide bigger chip room. ●Reconsider length of cutting chamfer.	
●Reduce cutting speed. ●Reduce cutting speed. ●Adjust relief angle on cutting chamfer.				○Use oil hole tap. ●Provide shorter thread length to tap.	
●Be careful about burning during re-sharpening.					

Thread Series

Unified Threads

Unit : mm

Size		Nominal Dia.		Threads per inch													
Column 1	Column 2	inch	mm	Coarse	Fine	Extra Fine	Constant pitch series										
				UNC	UNF	UNEF	4UN	6UN	8UN	12UN	16UN	20UN	28UN	32UN			
No. 0	No. 1	0.0600	1.524		80												
		0.0730	1.854	64	72												
No. 2		0.0860	2.184	56	64												
No. 4	No. 3	0.0990	2.515	48	56												
		0.1120	2.845	40	48												
No. 5		0.1250	3.175	40	44												
No. 6		0.1380	3.505	32	40												UNC
No. 8		0.1640	4.166	32	36												UNC
No.10		0.1900	4.826	24	32												UNF
	No.12	0.2160	5.486	24	28	32											UNEF
1/4		0.2500	6.350	20	28	32								UNC	UNF	UNEF	
5/16		0.3125	7.938	18	24	32								UNC	28	28	UNEF
3/8		0.3750	9.525	16	24	32								UNC	20	28	UNEF
7/16		0.4375	11.112	14	20	28								16	UNF	UNEF	32
1/2		0.5000	12.700	13	20	28								UNC	16	UNF	UNEF
9/16		0.5625	14.288	12	18	24								12	16	20	28
5/8		0.6250	15.875	11	18	24								12	16	20	28
	11/16	0.6875	17.462		24									12	16	20	28
		0.7500	19.050	10	16	20								12	UNF	UNEF	28
	13/16	0.8125	20.638		20									12	UNF	UNEF	28
		0.8750	22.225	9	14	20								12	16	UNEF	28
		0.9375	23.812		20									12	16	UNEF	28
1	15/16	1.0000	25.400	8	12	20			UNC	UNF	16			16	UNEF	UNEF	28
		1.0625	26.988		18			8	12	16	20	28					
1 1/8	1 1/16	1.1250	28.575	7	12	18		8	UNF	16	20	28					
	1 3/16	1.1875	30.162		18			8	12	16	20	28					
		1.2500	31.750	7	12	18		8	UNF	16	20	28					
1 1/4	1 5/16	1.3125	33.338		18			8	12	16	20	28					
		1.3750	34.925	6	12	18		8	UNF	16	20	28					
	1 7/16	1.4375	36.512		18			6	8	12	16	20	28				
1 1/2	1 9/16	1.5000	38.100	6	12	18		UNC	8	UNF	16	20	28				
		1.5625	39.688		18			6	8	12	16	20	28				
1 5/8	1 11/16	1.6250	41.275		18			6	8	12	16	20					
		1.6875	42.862		18			6	8	12	16	20					
1 3/4	1 13/16	1.7500	44.450	5				6	8	12	16	20					
		1.8125	46.038					6	8	12	16	20					
1 7/8	1 15/16	1.8750	47.625					6	8	12	16	20					
		1.9375	49.212					6	8	12	16	20					
2	2 1/8	2.0000	50.800	4 1/2				6	8	12	16	20					
		2.1250	53.975					6	8	12	16	20					
2 1/4	2 1/4	2.2500	57.150	4 1/2				6	8	12	16	20					
		2.3750	60.325					6	8	12	16	20					
2 1/2	2 3/8	2.5000	63.500	4			UNC	6	8	12	16	20					
		2.6250	66.675				4	6	8	12	16	20					
2 3/4	2 5/8	2.7500	69.850	4			UNC	6	8	12	16	20					
		2.8750	73.025				4	6	8	12	16	20					
3	2 7/8	3.0000	76.200	4			UNC	6	8	12	16	20					
		3.1250	79.375				4	6	8	12	16	20					
3 1/4	3 1/8	3.2500	82.550	4			UNC	6	8	12	16	20					
		3.3750	85.725				4	6	8	12	16	20					
3 1/2	3 3/8	3.5000	88.900	4			UNC	6	8	12	16	20					
		3.6250	92.075				4	6	8	12	16	20					
3 3/4	3 5/8	3.7500	95.250	4			UNC	6	8	12	16	20					
		3.8750	98.425				4	6	8	12	16	20					
4	3 7/8	4.0000	101.600	4			UNC	6	8	12	16	20					
		4.1250	104.775				4	6	8	12	16	20					
4 1/4	4 1/8	4.2500	107.950				4	6	8	12	16	20					
		4.3750	111.125				4	6	8	12	16	20					
4 1/2	4 3/8	4.5000	114.300				4	6	8	12	16	20					
		4.6250	117.475				4	6	8	12	16	20					
4 3/4	4 5/8	4.7500	120.650				4	6	8	12	16	20					
		4.8750	123.825				4	6	8	12	16	20					
5	4 7/8	5.0000	127.000				4	6	8	12	16	20					
		5.1250	130.175				4	6	8	12	16	20					
5 1/4	5 1/8	5.2500	133.350				4	6	8	12	16	20					
		5.3750	136.52				4	6	8	12	16	20					
5 1/2	5 3/8	5.5000	139.700				4	6	8	12	16	20					
		5.6250	142.875				4	6	8	12	16	20					
5 3/4	5 5/8	5.7500	146.050				4	6	8	12	16	20					
		5.8750	149.225				4	6	8	12	16	20					
6	5 7/8	6.0000	152.400				4	6	8	12	16	20					

※ : Please select the first column by priority. And select second column if necessary.

Conversion Table

Threads per inch	Pitch
100	0.2540
80	0.3175
72	0.3528
64	0.3969
60	0.4233
56	0.4536
48	0.5292
44	0.5773
40	0.6350
36	0.7056
32	0.7938
28	0.9071
27	0.9407
24	1.0583
20	1.2700
19	1.3368
18	1.4111
16	1.5875
14	1.8143
13	1.9538
12	2.1167
11 1/2	2.2087
11	2.3091
10	2.5400
9	2.8222
8	3.1750
7	3.6286
6	4.2333
5	5.0800
4 1/2	5.6444
4	6.3500

Dimension table for Metric threads

Dimension table for Metric threads

Unit:mm

nominal size	pitch	0.2	0.25	0.3	0.35	0.4	0.45	0.5	0.6	0.7	0.75	0.8	1	1.25	1.5	1.75	2	2.5	3	3.5	4	4.5	5	
1	0.2	0.25																						
1.1	0.2	0.25																						
1.2	0.2	0.25																						
1.4	0.2		0.3																					
1.6	0.2			0.35																				
1.7	0.2			0.35																				
1.8	0.2			0.35																				
2		0.25			0.4																			
2.2		0.25				0.45																		
2.3		0.25			0.4																			
2.5				0.35		0.45																		
2.6				0.35		0.45																		
3				0.35			0.5	0.6																
3.5				0.35				0.6																
4							0.5		0.7	0.75														
4.5							0.5			0.75														
5							0.5			0.75	0.8													
5.5							0.5			0.75		1												
6							0.5			0.75		1												
7							0.5			0.75		1												
8							0.5			0.75		1	1.25											
9							0.5			0.75		1	1.25											
10							0.5			0.75		1	1.25	1.5										
11							0.5			0.75		1	1.25	1.5										
12							0.5			0.75		1	1.25	1.5	1.75									
13							0.5			0.75		1	1.25	1.5	1.75									
14							0.5			0.75		1	1.25	1.5	1.75	2								
15							0.5			0.75		1	1.25	1.5		2								
16							0.5			0.75		1	1.25	1.5		2								
17							0.5			0.75		1	1.25	1.5		2								
18							0.5			0.75		1	1.25	1.5		2	2.5							
19							0.5			0.75		1	1.25	1.5		2	2.5							
20							0.5			0.75		1	1.25	1.5		2	2.5							
22							0.5			0.75		1	1.25	1.5		2	2.5							
24							0.5			0.75		1	1.25	1.5		2		3						
25												1		1.5		2		3						
26												1		1.5		2		3						
27												1		1.5		2		3						
28												1		1.5		2		3						
30												1		1.5		2		3	3.5					
32												1		1.5		2		3	3.5					
33												1		1.5		2		3	3.5					
34												1		1.5		2		3						
35												1		1.5		2		3						
36												1		1.5		2		3			4			
37														1.5										
38												1		1.5		2		3						
39														1.5		2		3			4			
40														1.5		2		3			4			
42														1.5		2		3			4	4.5		
44														1.5		2		3			4			
45														1.5		2		3			4	4.5		
46														1.5		2		3			4			
48														1.5		2		3			4			5

※Letters in red mean Coarse screw threads.

※Please refer to PRAD system page 2 when you'd like to use PRAD system.

※Please contact our sales staff if you require the thread shown in above table, but not listed in this catalog.

Screw Thread Terms and Definitions

Major Diameter- The largest diameter of a straight thread.

Minor Diameter- The smallest diameter of a straight head.

Angle of Thread- The angle included between the flanks of the thread measured in an axial plane.

Half Angle of Thread- The angle included between a flank of thread and the normal (90°) to the axis, measured in an axial plane.

Pitch- The distance from a point on a screw thread to a corresponding point on the next thread measured parallel to the axis.

Metric- The pitch in inches = $\frac{\text{Pitch in Millimeters}}{25.4}$

Inches- The Pitch in inches = $\frac{1}{\text{Number of threads per inch}}$

Lead of Thread- The distance a screw thread advances axially in one turn. On a single-thread screw the lead and pitch are identical. On a double-thread, the lead is 2 x the pitch. On a triple-thread, the lead is 3 x pitch, etc.

Lead Angle- The angle made by the helix of a thread at the pitch diameter with a line perpendicular to the axis.

Tolerance- The total amount of variation permitted from a specified dimension. Tolerance may be expressed between mating threads.

Allowance- The intentional minimum clearance between mating threads.

Length of Engagement- The length that is engaged measured parallel to the axis, when mating parts are fully assembled.

Pitch Diameter- On a straight screw thread, the diameter of an imaginary cylinder, the surface of which would pass through the threads at such points as to make equal the width of the threads and the width of the spaces cut by the surface of the cylinder.

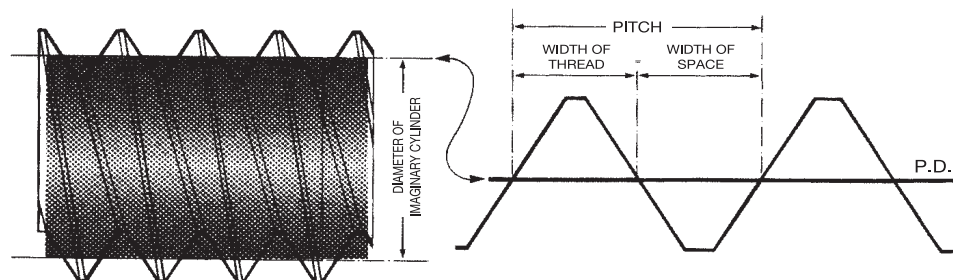
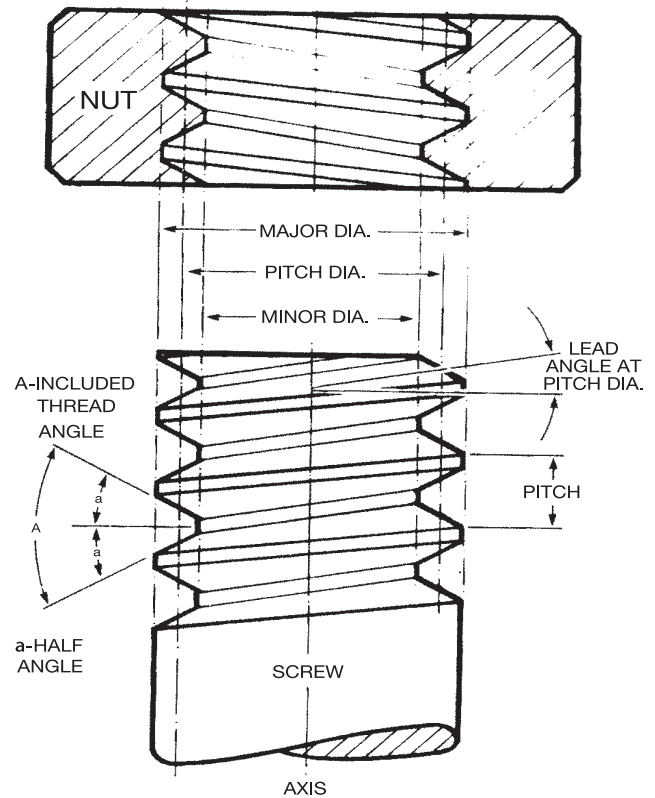

Basic profile of threads

Metric Screw Threads (M)

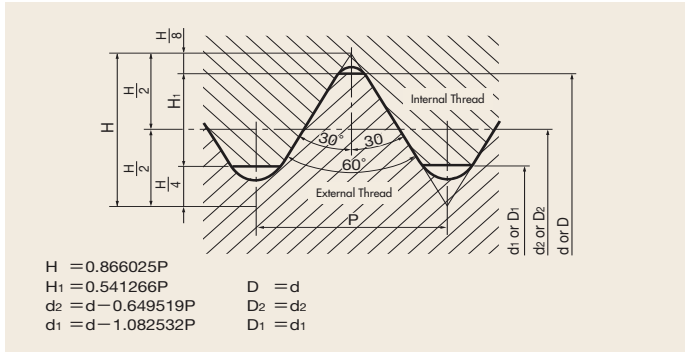

Unified Screw Threads (UNC, UNF, etc.)

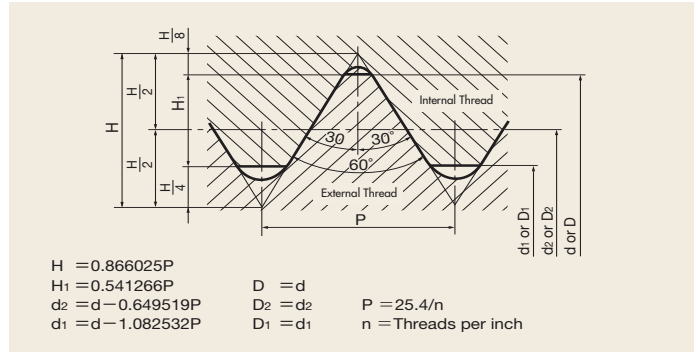

Whitworth Screw Threads (W)

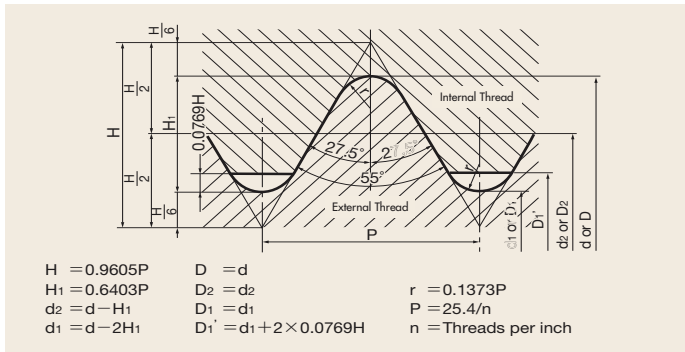

Screw Threads for Sewing Machine (SM)

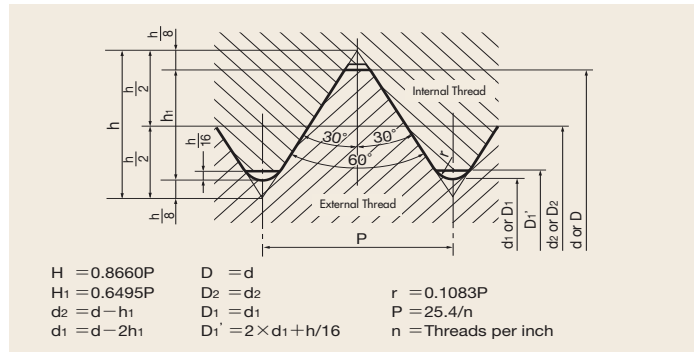

Miniature Screw Threads (S)

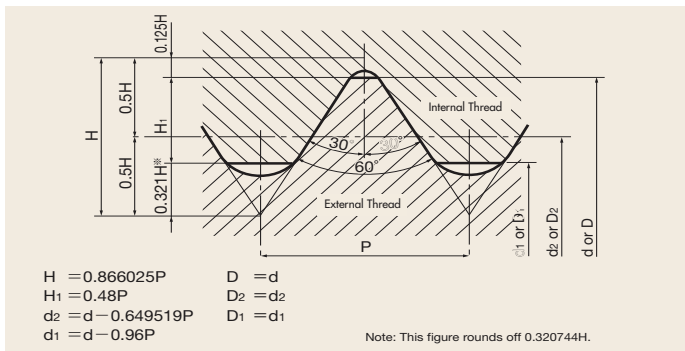

Parallel Pipe Threads (G, PF)

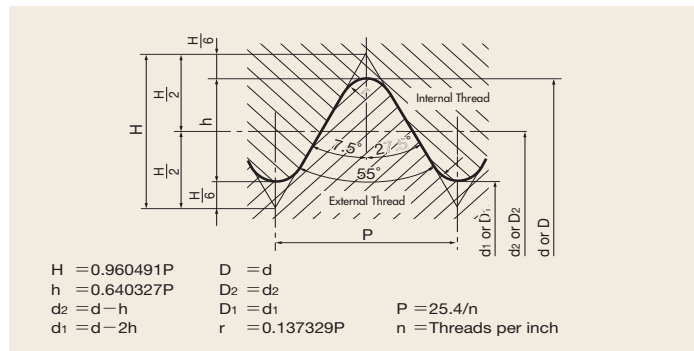

Taper Pipe Threads (R, Rc, PT)

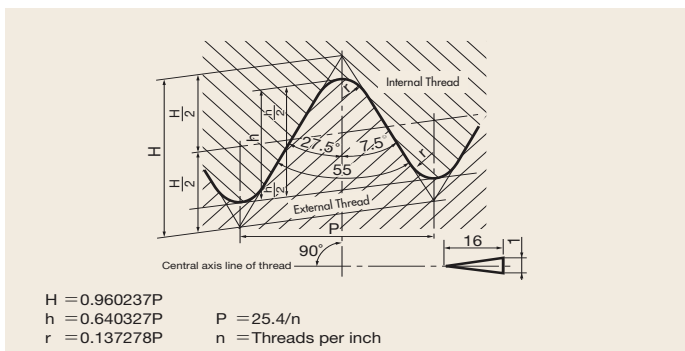

Taper Pipe Threads (Parallel) (Rp, PS)

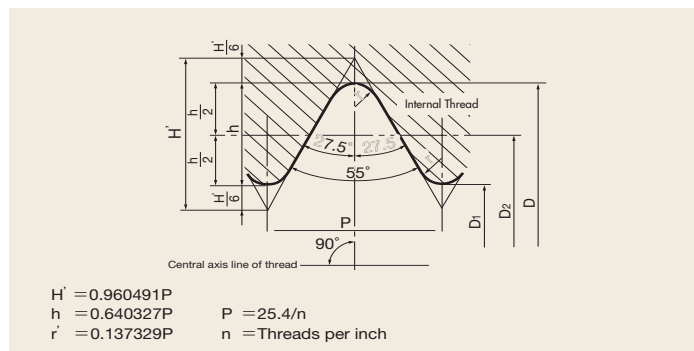

Basic profile of threads

American Standard Taper Pipe Threads (NPT)

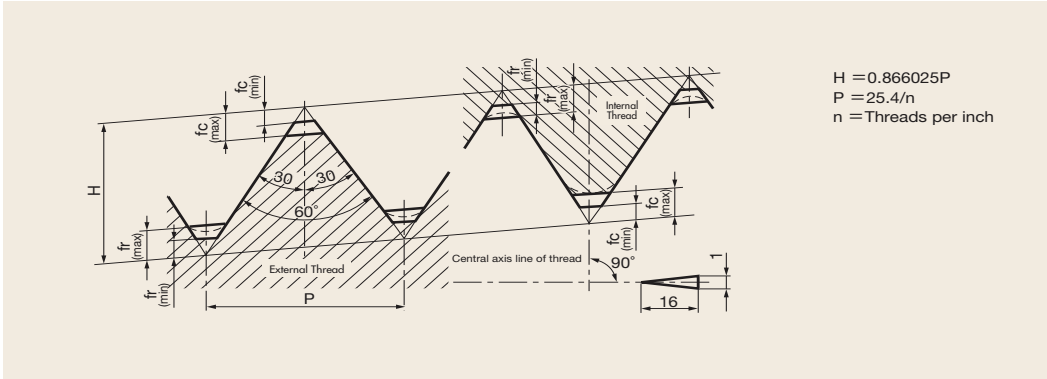

Truncation Unit : mm

Threads per inch	Section	$f_c = f_r$
27	Max.	0.096P
	Min.	0.033P
18	Max.	0.088P
	Min.	0.033P
14	Max.	0.078P
	Min.	0.033P
11.5	Max.	0.073P
	Min.	0.033P
8	Max.	0.062P
	Min.	0.033P

Dryseal American Standard Taper Pipe Threads (NPTF)

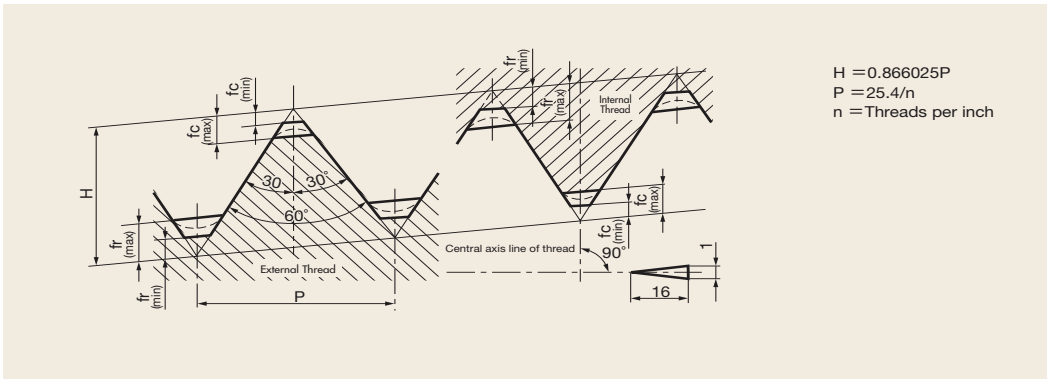

Truncation Unit : mm

Threads per inch	Section	f_c	f_r
27	Max.	0.094P	0.140P
	Min.	0.047P	0.094P
18	Max.	0.078P	0.109P
	Min.	0.047P	0.078P
14	Max.	0.060P	0.085P
	Min.	0.036P	0.060P
11.5	Max.	0.060P	0.090P
	Min.	0.040P	0.060P
8	Max.	0.055P	0.076P
	Min.	0.042P	0.055P

Metric Trapezoidal Screw Threads (Tr)

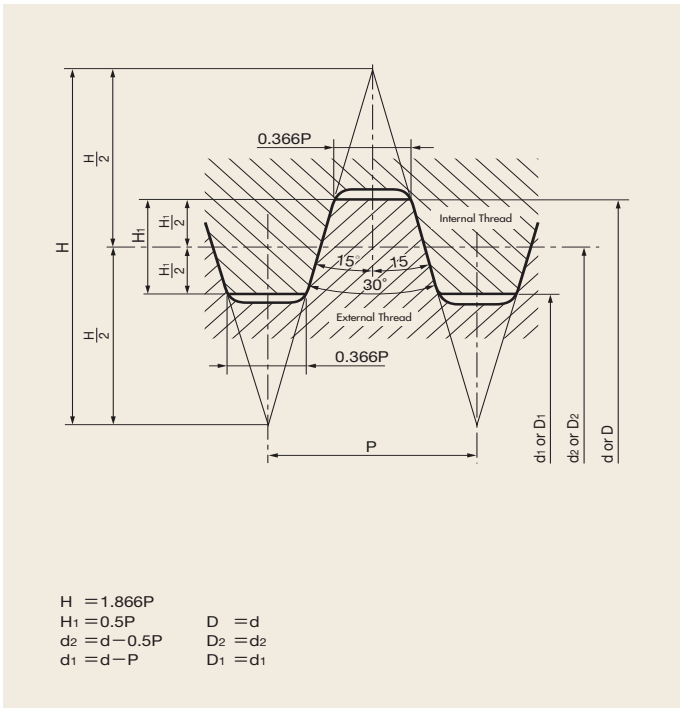

29Trapezoidal Screw Threads (Tw)

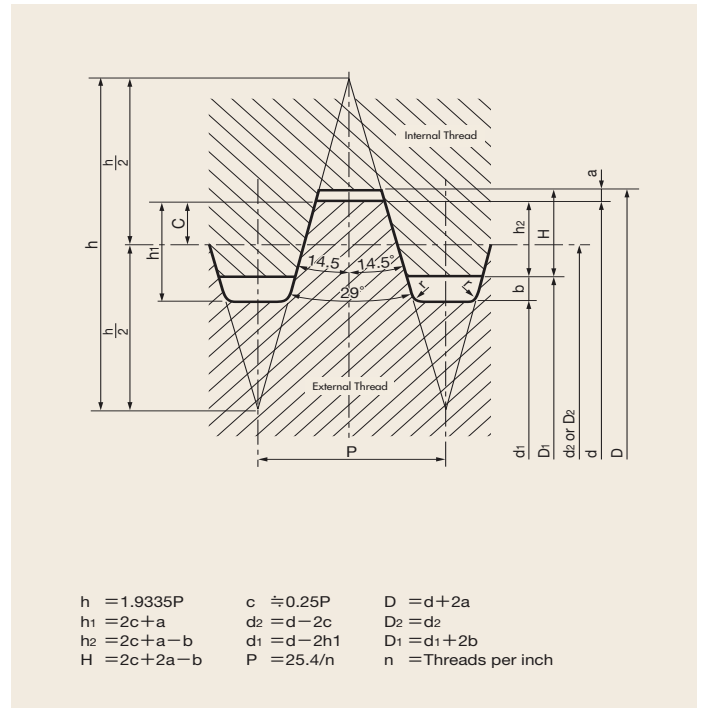

USCTI SPECIFICATION

The following tables and formula are used in determining the limits and tolerances for ground thread taps having a thread lead angle not in excess of 5°, unless otherwise specified.

LEAD TOLERANCE

A maximum lead deviation of ±0.0005", within any two threads not farther apart than 1" is permitted.

ANGLE TOLERANCE

Threads Per Inch	Deviation in Half Angle
4 to 5-1/2 incl.	±20'
6 to 9 incl.	±25'
10 to 80 incl.	±30'

FORMULA

Max. Major Dia. = Basic + A

Max. Pitch Dia. = Min. + D

Min. Major Dia. = Basic + B

Min. Pitch Dia. = Basic + C

In the above formula:

A = Constant to add = 0.130P for all Pitches

B = Major Diameter Tolerance = 0.087P for 48 Through 80 TPI

= 0.076P for 36 Through 47 TPI

= 0.065P for 4 Through 35 TPI

C = Amount over basic for minimum pitch diameter

D = Pitch diameter tolerance

Note: When the tap major diameter must be determined from a specified tap pitch diameter, the maximum major diameter equals the minimum specified pitch diameter minus Constant C, plus 0.64952P, plus Constant A.

Thread Per Inch	A	B	C			D			
			To 5/8" Incl.	Over 5/8" to 2 1/2" Incl.	Over 2 1/2"	To 1" Incl.	Over 1" to 1 1/2" Incl.	Over 1 1/2" to 2 1/2" Incl.	Over 2 1/2"
80	0.0016	0.0011	0.0005	0.0010	0.0015	0.0005	0.0010	0.0010	0.0015
72	0.0018	0.0012	0.0005	0.0010	0.0015	0.0005	0.0010	0.0010	0.0015
64	0.0020	0.0014	0.0005	0.0010	0.0015	0.0005	0.0010	0.0010	0.0015
56	0.0023	0.0016	0.0005	0.0010	0.0015	0.0005	0.0010	0.0010	0.0015
48	0.0027	0.0018	0.0005	0.0010	0.0015	0.0005	0.0010	0.0010	0.0015
44	0.0030	0.0017	0.0005	0.0010	0.0015	0.0005	0.0010	0.0010	0.0015
40	0.0032	0.0019	0.0005	0.0010	0.0015	0.0005	0.0010	0.0010	0.0015
36	0.0036	0.0021	0.0005	0.0010	0.0015	0.0005	0.0010	0.0010	0.0015
32	0.0041	0.0020	0.0010	0.0010	0.0015	0.0005	0.0010	0.0010	0.0015
28	0.0046	0.0023	0.0010	0.0010	0.0015	0.0005	0.0010	0.0010	0.0015
24	0.0054	0.0027	0.0010	0.0010	0.0015	0.0005	0.0010	0.0015	0.0015
20	0.0065	0.0032	0.0010	0.0010	0.0015	0.0005	0.0010	0.0015	0.0015
18	0.0072	0.0036	0.0010	0.0010	0.0015	0.0005	0.0010	0.0015	0.0015
16	0.0081	0.0041	0.0010	0.0010	0.0015	0.0005	0.0010	0.0015	0.0020
14	0.0093	0.0046	0.0010	0.0015	0.0015	0.0005	0.0010	0.0015	0.0020
13	0.0100	0.0050	0.0010	0.0015	0.0015	0.0005	0.0010	0.0015	0.0020
12	0.0108	0.0054	0.0010	0.0015	0.0015	0.0005	0.0010	0.0015	0.0020
11	0.0118	0.0059	0.0010	0.0015	0.0020	0.0005	0.0010	0.0015	0.0020
10	0.0130	0.0065	-	0.0015	0.0020	0.0005	0.0010	0.0015	0.0020
9	0.0144	0.0072	-	0.0015	0.0020	0.0005	0.0010	0.0015	0.0020
8	0.0162	0.0081	-	0.0015	0.0020	0.0005	0.0010	0.0015	0.0020
7	0.0186	0.0093	-	0.0015	0.0020	0.0010	0.0010	0.0020	0.0025
6	0.0217	0.0108	-	0.0015	0.0020	0.0010	0.0010	0.0020	0.0025
5 1/2	0.0236	0.0118	-	0.0015	0.0020	0.0010	0.0015	0.0020	0.0025
5	0.0260	0.0130	-	0.0015	0.0020	0.0010	0.0015	0.0020	0.0025
4 1/2	0.0289	0.0144	-	0.0015	0.0020	0.0010	0.0015	0.0020	0.0025
4	0.0325	0.0162	-	0.0015	0.0020	0.0010	0.0015	0.0020	0.0025

For intermediate pitches, use values for next coarser pitch for C and D, but use formulas for A and B.

Symbols for Standard Threads

■ USA

Thread symbols	Kinds of threads	Related Standards
UN	Unified inch screw threads	ANSI B 1.1
UNC/UNRC	Unified coarse thread series	ANSI B 1.1
UNF/UNRF	Unified fine thread series	ANSI B 1.1
UNEF/UNREF	Unified extra-fine thread series	ANSI B 1.1
4UN/4UNR	Unified constant-pitch series with 4-threads	ANSI B 1.1
6UN/6UNR	Unified constant-pitch series with 6-threads	ANSI B 1.1
8UN/8UNR	Unified constant-pitch series with 8-threads	ANSI B 1.1
12UN/12UNR	Unified constant-pitch series with 12-threads	ANSI B 1.1
16UN/16UNR	Unified constant-pitch series with 16-threads	ANSI B 1.1
20UN/20UNR	Unified constant-pitch series with 20-threads	ANSI B 1.1
28UN/28UNR	Unified constant-pitch series with 28-threads	ANSI B 1.1
32UN/32UNR	Unified constant-pitch series with 32-threads	ANSI B 1.1
UN/UNRS	Unified threads of special diameters, pitches and lengths of engagement	ANSI B 1.1
NR	American National thread with a0.108p to 0.144p controlled root radius	MIL-B-7838
Acme	Acme screw threads	ANSI B 1.5
Stub-Acme	Stub Acme screw threads	ANSI B 1.8
Butt	Buttress inch screw threads	ANSI B 1.9
UNM	Unified miniature thread series	ANSI B 1.10
NC5	Class 5 interference-fit thread	ANSI B 1.12
NPT	American Standard taper pipe threads for general use	ANSI/ASME B 1.20.1
NPTR	American Standard taper pipe threads for railing joints	ANSI/ASME B 1.20.1
NPSC	American Standard straight pipe thread in pipe couplings	ANSI/ASME B 1.20.1
NPSL	American standard straight pipe threads for loose-fitting mechanical joints with locknuts	ANSI/ASME B 1.20.1
NPSM	American Standard straight pipe threads for free-fitting mechanical joints for fixture	ANSI/ASME B 1.20.1
NPSH	American Standard straight pipe threads for loose-fitting mechanical joints for hose couplings	ANSI/ASME B 1.20.1
NPTF	Dryseal American Standard taper pipe threads	ANSI B 1.20.3, 1.20.4
F-PTF	Dryseal fine taper pipe thread series	ANSI B 1.20.3, 1.20.4
PTF-SAE SHORT	Dryseal SAE short taper pipe threads	ANSI B 1.20.3, 1.20.4
PTF-SPL SHORT	Dryseal special short taper pipe threads	ANSI B 1.20.3, 1.20.4
PTF-SPL EXTRA SHORT	Dryseal special extra short taper pipe threads	ANSI B 1.20.3, 1.20.4
SPL-PTF	Dryseal special taper pipe threads	ANSI B 1.20.3, 1.20.4
NPSI	Dryseal American Standard intermediate internal straight pipe threads	ANSI B 1.20.3, 1.20.4
NPSF	Dryseal American Standard fuel internal straight pipe threads	ANSI B 1.20.3, 1.20.4
ANPT	Aeronautical National Form taper pipe threads	MIL-P-7150
NGO	National gas outlet threads	ANSI B 57.1
NGS	National gas straight threads	ANSI B 57.1
NGT	National gas taper threads	ANSI B 57.1
SGT	Special gas taper threads	ANSI B 57.1
NH	Hose coupling and firehose coupling threads	USAS B 2.4
NHR	Hose coupling and firehose coupling threads	USAS B 2.4
NPSH	Hose coupling and firehose coupling threads	USAS B 2.4
AMO	American standard microscope objective threads	ANSI B 1.11

Symbols for Standard Threads

■ Japan

Thread symbols	Kinds of threads	Related Standards
M	Metric screw threads, Coarse series	JIS B 0205-1~0205-4
M	Metric screw threads, Fine series	JIS B 0205-1~0205-4
S	Miniature screw threads	JIS B 0201
UNC	Unified threads, Coarse series	JIS B 0206
UNF	Unified threads, Fine series	JIS B 0208
Tr	Metric Trapezoidal screw threads	JIS B 0216
R	Taper external pipe threads	JIS B 0203 (JIS main book)
Rc	Taper internal pipe threads	JIS B 0203 (JIS main book)
Rp	Parallel internal pipe threads	JIS B 0203 (JIS main book)
G	Parallel pipe threads	JIS B 0202 (JIS main book)
PF	Parallel pipe threads	JIS B 0202 (JIS Appendix)
PT	Taper pipe threads	JIS B 0203 (JIS Appendix)
PS	Taper pipe threads (Parallel)	JIS B 0203 (JIS Appendix)
CTC	Screw threads for rigid metal thin-walled conduit and fitting	JIS C 8305
CTG	Screw threads for rigid metal thick-walled conduit and fitting	JIS C 8305
BC	Cycle threads	JIS B 0225
SM	Screw threads for sewing machine	JIS B 0226(2001.2.20repeal)
E	Electric socket and lamp-base threads	JIS C 7709
V	Tire valve threads of automobile	JIS D 4207
CTV	Tire valve threads of cycle	JIS D 9422

SO

Thread symbols	Kinds of threads	Related Standards
M	ISO Metric threads	ISO 261
S	ISO Miniature screw threads	ISO R 1501
Tr	ISO Metric trapezoidal screw threads	ISO 2902
UNC	ISO Unified threads, coarse series	ISO 263
UNF	ISO Unified threads, fine series	ISO 263
UNEF	ISO Unified threads, extra fine series	ISO 263
UN	ISO Unified threads, constant pitch series	ISO 263
UNJC	Unified threads (MIL Standard) coarse	ISO 3161
UNJF	Unified threads (MIL Standard) fine	ISO 3161
UNJEF	Unified threads (MIL Standard) extra fine	ISO 3161
UNJ	Unified threads (MIL Standard) constant pitch series	ISO 3161
MJ	Metric threads, MIL Standard	ISO 5855
R	Taper external pipe threads	ISO 7/1
Rc	Taper internal pipe threads	ISO 7/1
Rp	Parallel internal pipe threads	ISO 7/1
G	Parallel pipe threads	ISO 228/1
GL	Glass container threads	ISO R 1115
V	Tire valve threads	ISO 4570/1~3

Symbols for Standard Threads

British*

Thread symbols	Kinds of threads	Related Standards
UNS	Unified special series	BS 1580
B.S.W.	British Standard Whitworth coarse threads	BS 84
B.S.F.	British Standard fine threads	BS 84
BSP	British Standard pipe thread (corresponding to R, Rc, Rp and G of ISO standard)	BS 21,2779
B.A.	B.A.-Screw threads	BS 93
Acme	General purpose, Acme screw threads	BS 1104
Buttress	Buttress threads	BS 1657
BSC	Cycle threads	BS 811
BSMO	Microscope objective threads	BS 3569
E	Edison screw threads	BS 5042
R.S.M	Rolled sheet metal screw threads and threads for molded plastics and die-cast materials	BS 2038

* : We left out the symbols after ISO standard was adopted.

German*

Thread symbols	Kinds of threads	Related Standards
GL	Glass containers thread.	DIN 168
S	Buttress thread.	DIN 513,2781,20401
Rd	Knuckle thread.	DIN 405,262,264,3182,7273,15403,20400
W	Whitworth-gewinde.	DIN 168,477,6630,4668,49301
KS,KT	Screw seal for package made of plastics.	DIN 6063
E	Edison screw thread.	DIN 40400
Pg	Steel conduit thread.	DIN 40430
Glasg	Thread for cover glasses, porcelain and cast iron caps.	DIN 40450
Vg	Automobile tire valve thread.	DIN 7756
Gf	Thread for freezing pipes.	DIN 4930
Gg	Threads for drill pipe.	DIN 4941,20314
HA	Thread for bone screws and nuts.	DIN 58810
RMS	Thread connection for microscope objectives.	DIN 58888
FG	Bicycle threads.	DIN 79012

* : We left out the symbols after ISO standard was adopted.

Cross chart of thread cutting tool standard

Tap and Die names	JIS	TAS	ISO	ANSI	BS	DIN
General specification		4051				
Measuring method		4053				
Technical requirement			8830			2197
Thread limit (Metric)		4052	2857			
Thread limit (Pipe)			5969			
Hand taps (Metric coarse)	B4430	4105	529	B94.9	949	352
Hand taps (Metric fine)	B4430	4106	529	B94.9	949	2181
Hand taps (Unified coarse)	B4432	4107	529	B94.9	949	
Hand taps (Unified fine)	B4438		529	B94.9	949	
Hand taps (Parallel pipe thread)	B4445		2284	B94.9	949	
Hand taps (Taper pipe thread)	B4446		2284	B94.9	949	
Hand taps (American parallel pipe thread)		4113		B94.9		
Hand taps (American taper pipe thread)		4114		B94.9		
Hand taps (American dryseal parallel pipe thread)		4115		B94.9		
Hand taps (American dryseal taper pipe thread)		4116		B94.9		
Nut taps (Metric coarse)	B4433	4109			357	
Nut taps (Metric fine)		4110				
Nut taps (Unified coarse)		4111		B94.9		
Nut taps (Unified fine)		4112				
Machine taps (Metric coarse)						371,376
Machine taps (Metric fine)						374
Bent shank taps (Metric coarse)		4101				
Bent shank taps (Metric fine)		4102				
Bent shank taps (Unified coarse)		4103				
Bent shank taps (Unified fine)		4104				
Long shank machine taps (Metric thread)		4153	2283			
Long shank machine taps (Inch thread)		4153	2283			
Spiral pointed taps		4155		B94.9		
Spiral fluted taps		4154		B94.9		
Shell taps (Metric thread)		4117				
Pulley taps				B94.9		
Thread Forming taps				B94.9		
Blanks for carbide taps				B94.1		
Thread cutting round dies (Metric coarse, Adjustable)	B4451					223
Thread cutting round dies (Metric fine, Adjustable)	B4451					223
Thread cutting round dies (Metric, Solid)	B4451		2568		1127	223
Thread cutting round dies (Unified coarse adjustable)	B4451					
Thread cutting round dies (Unified fine adjustable)	B4451					
Thread cutting round dies (Unified thread)	B4451		2568		1127	
Thread cutting round dies (Parallel pipe thread)	B4455		4231		1127	5158
Thread cutting round dies (Taper pipe thread)	B4456		4230			5159
Hexagon dies			7226		1127	382

: We left out the symbols after ISO standard was adopted

Symbols: Organization names

- ISO: International Organization for Standardization
- JIS: Japanese Industrial Standards Committee
- TAS: Japan Small Tool Makers' Association
- ANSI: American National Standards Institute
- BS: British Standards Institution, UK
- DIN: Deutsches Institut für Normung

Hardness conversion table

■ Conversion table from Rockwell C hardness of steel.*1 (Approximate)

Rockwell C Scale Hardness	Vickers Hardness	Brinell Hardness		Rockwell Hardness*3			Rockwell Superficial Hardness			Shore Hardness	MPa*2 Tensile Strength	Rockwell C Scale Hardness*3
		Standard ball	Tungsten Carbide ball	A scale	B scale	D scale	15-N scale	30-N scale	45-N scale			
68	940	—	—	85.6	—	76.9	93.2	84.4	75.4	97	—	68
67	900	—	—	85.0	—	76.1	92.9	83.6	74.2	95	—	67
66	865	—	—	84.5	—	75.4	92.5	82.8	73.3	92	—	66
65	832	—	(739)	83.9	—	74.5	92.2	81.9	72.0	91	—	65
64	800	—	(722)	83.4	—	73.8	91.8	81.1	71.0	88	—	64
63	772	—	(705)	82.8	—	73.0	91.4	80.1	69.9	87	—	63
62	746	—	(688)	82.3	—	72.2	91.1	79.3	68.8	85	—	62
61	720	—	(670)	81.8	—	71.5	90.7	78.4	67.7	83	—	61
60	697	—	(654)	81.2	—	70.7	90.2	77.5	66.7	81	—	60
59	674	—	(634)	80.7	—	69.9	89.8	76.6	65.5	80	—	59
58	653	—	615	80.1	—	69.2	89.3	75.7	64.3	78	—	58
57	633	—	595	79.6	—	68.5	88.9	74.8	63.2	76	—	57
56	613	—	577	79.0	—	67.7	88.3	73.9	62.0	75	—	56
55	595	—	560	78.5	—	66.9	87.9	73.0	60.9	74	2075	55
54	577	—	543	78.0	—	66.1	87.4	72.0	59.8	72	2015	54
53	560	—	525	77.4	—	65.4	86.9	71.2	58.6	71	1950	53
52	544	(500)	512	76.8	—	64.6	86.4	70.2	57.4	69	1880	52
51	528	(487)	496	76.3	—	63.8	85.9	69.4	56.1	68	1820	51
50	513	(475)	481	75.9	—	63.1	85.5	68.5	55.0	67	1760	50
49	498	(464)	469	75.2	—	62.1	85.0	67.6	53.8	66	1695	49
48	484	451	455	74.7	—	61.4	84.5	66.7	52.5	64	1635	48
47	471	442	443	74.1	—	60.8	83.9	65.8	51.4	63	1580	47
46	458	432	432	73.6	—	60.0	83.5	64.8	50.3	62	1530	46
45	446	421	421	73.1	—	59.2	83.0	64.0	49.0	60	1480	45
44	434	409	409	72.5	—	58.5	82.5	63.1	47.8	58	1435	44
43	423	400	400	72.0	—	57.7	82.0	62.2	46.7	57	1385	43
42	412	390	390	71.5	—	56.9	81.5	61.3	45.5	56	1340	42
41	402	381	381	70.9	—	56.2	80.9	60.4	44.3	55	1295	41
40	392	371	371	70.4	—	55.4	80.4	59.5	43.1	54	1250	40
39	382	362	362	69.9	—	54.6	79.9	58.6	41.9	52	1215	39
38	372	353	353	69.4	—	53.8	79.4	57.7	40.8	51	1180	38
37	363	344	344	68.9	—	53.1	78.8	56.8	39.6	50	1160	37
36	354	336	336	68.4	(109.0)	52.3	78.3	55.9	38.4	49	1115	36
35	345	327	327	67.9	(108.5)	51.5	77.7	55.0	37.2	48	1080	35
34	336	319	319	67.4	(108.0)	50.8	77.2	54.2	36.1	47	1055	34
33	327	311	311	66.8	(107.5)	50.0	76.6	53.3	34.9	46	1025	33
32	318	301	301	66.3	(107.0)	49.2	76.1	52.1	33.7	44	1000	32
31	310	294	294	65.8	(106.0)	48.4	75.6	51.3	32.5	43	980	31
30	302	286	286	65.3	(105.5)	47.7	75.0	50.4	31.3	42	950	30
29	294	279	279	64.7	(104.5)	47.0	74.5	49.5	30.1	41	930	29
28	286	271	271	64.3	(104.0)	46.1	73.9	48.6	28.9	41	910	28
27	279	264	264	63.8	(103.0)	45.2	73.3	47.7	27.8	40	880	27
26	272	258	258	63.3	(102.5)	44.6	72.8	46.8	26.7	38	860	26
25	266	253	253	62.8	(101.5)	43.8	72.2	45.9	25.5	38	840	25
24	260	247	247	62.4	(101.0)	43.1	71.6	45.0	24.3	37	825	24
23	254	243	243	62.0	100.0	42.1	71.0	44.0	23.1	36	805	23
22	248	237	237	61.5	99.0	41.6	70.5	43.2	22.0	35	785	22
21	243	231	231	61.0	98.5	40.9	69.9	42.3	20.7	35	770	21
20	238	226	226	60.5	97.8	40.1	69.4	41.5	19.6	34	760	20
(18)	230	219	219	—	96.7	—	—	—	—	33	730	(18)
(16)	222	212	212	—	95.5	—	—	—	—	32	705	(16)
(14)	213	203	203	—	93.9	—	—	—	—	31	675	(14)
(12)	204	194	194	—	92.3	—	—	—	—	29	650	(12)
(10)	196	187	187	—	90.7	—	—	—	—	28	620	(10)
(8)	188	179	179	—	89.5	—	—	—	—	27	600	(8)
(6)	180	171	171	—	87.1	—	—	—	—	26	580	(6)
(4)	173	165	165	—	85.5	—	—	—	—	25	550	(4)
(2)	166	158	158	—	83.5	—	—	—	—	24	530	(2)
(0)	160	152	152	—	81.7	—	—	—	—	24	515	(0)

*1 : Bold-faced numbers are based on the table of ASTM E 140

*2 : 1 Mpa=1N/mm²

*3 : In above table, numbers in parenthesis are only for reference. This table is abstracted from SAE J 417.

YMW STYLES OF TAPS



Straight Fluted Hand Taps

These are general purpose taps used for a wide variety of hand and machine tapping applications. They are available, in most cases, in taper, plug and bottoming chamfers and in various numbers of flutes.



Spiral Pointed Taps

These taps have a special angular grind at the point which shears chips and drives them ahead of the tap. Advantages are reduced tapping torque and increased speed in through hole tapping.



Spiral Fluted Taps

These taps are manufactured with spiral flutes for increased chip clearing efficiency in soft materials in which stringy chips are generated. Especially useful in tapping deep or blind holes, and in bridging keyways, these taps are available with regular or high helix flutes.



Roll Forming Taps

Roll forming taps generate threads by displacing rather than cutting metal, thereby eliminating or greatly reducing chips. They are especially useful for applications in which chips cannot be tolerated. YMW-USA Roll taps are designed to allow tapping and tougher materials than have been successfully tapped with other forming taps.



Extra Length Taps

YMW-USA produces, as standard and special, two different types of taps with extra long shanks that permit tapping in deep or obstructed areas. These are extension taps being offered in spiral point and spiral flute.



Pipe Taps

Taps for internal threading of pipe, pipe fittings, or holes in which threaded pipe is to be assembled are pipe taps. The types of pipe taps manufactured by YAMAWA for YMW-USA as standard include: Zelx SS Taper Pipe Taps, NPT Taper Pipe Taps in regular or interrupted thread; Zelx Mold NPT Taper Pipe Taps for hardened steels, Hand Tap design NPT Taper Pipe Taps, and Straight Pipe Taps.



Interrupted Pipe Taps

Interrupted thread pipe taps are manufactured with alternate teeth removed on adjacent lands (with the exception of the first few threads at the point). Designed for tapping certain tough metals or those which tend to tear or load the cutting teeth, these taps are to be used only when regular full thread taps fail.

Taper taps have 7 to 10 threads chamfered and are designed for threading through holes.

Plug taps have 3 to 5 threads chamfered and are most widely used in through holes and in blind holes that do not have to be threaded all the way to the bottom. Although most hand taps are available in taper, plug, and bottoming styles, some taps, such as pipe taps, are available only in the plug chamfer.

Semi-bottoming taps have 2 to 2-1/2 threads chamfered and are designed for both through and blind hole tapping.

Bottoming taps have 1 to 2 threads chamfered, and are de-signed to thread blind holes close to the bottom.

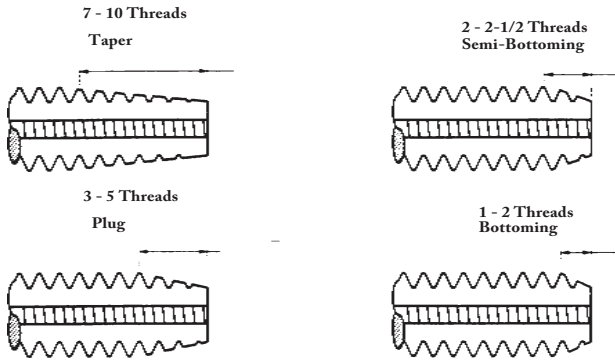

Types of Tapped Holes

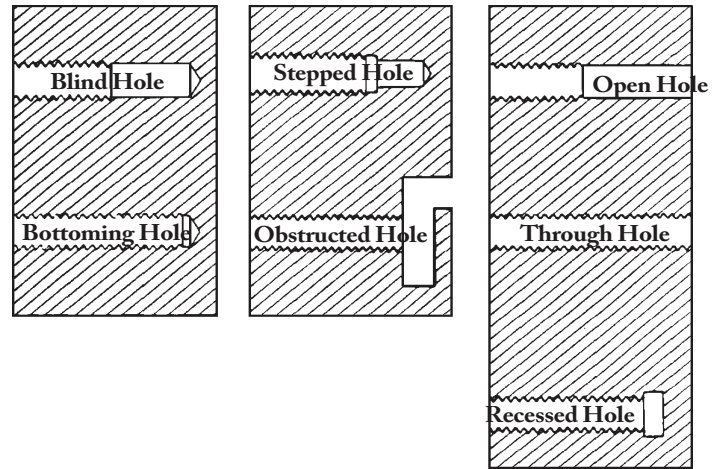

Clearance Relief Styles

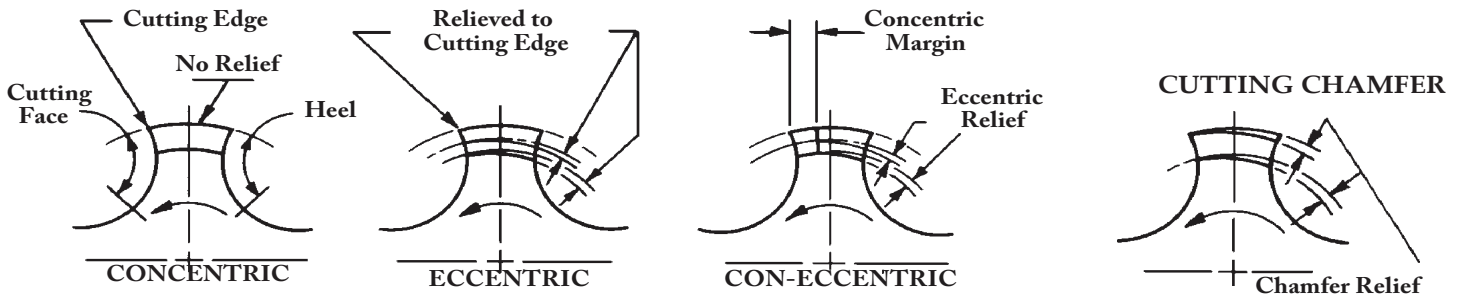

ADDED RELIEF FOR DIFFICULT MATERIALS

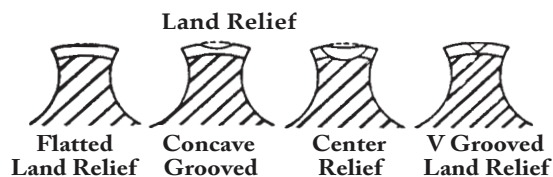

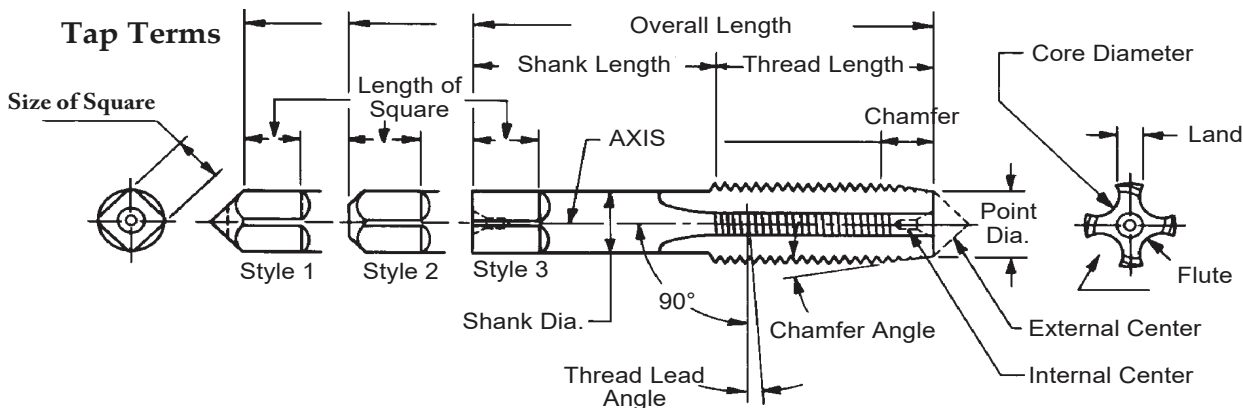

ALLOWANCE . An allowance is an intentional difference in cor-related dimensions of mating parts. It is the minimum clearance (positive allowance) or maximum interference (negative allowance) between such parts.

ANGLE OF THREAD. The angle included between the flanks of the thread, measured in an axial plane.

AXIS. The longitudinal central line through the screw or tap.

BACK TAPER. A slight axial relief on the thread of the tap which makes the pitch diameter of the thread near the shank somewhat smaller than that at the chamfered end. (See RELIEF)

BASIC. The theoretical or nominal standard size from which all variations are made. (See SIZE)

CHAMFER. The tapering of the end of the thread on a tap by cutting away and relieving the crest of the first few teeth to distribute the cutting action over several teeth. It also acts as a guide in starting the tap. When the tapering amounts to 7 to 10 threads, the tap is called a "taper" tap; 3 to 5 threads, a "plug" tap; and 1 to 2 threads chamfer, a "bottoming" tap.

Chamfer Dimensions

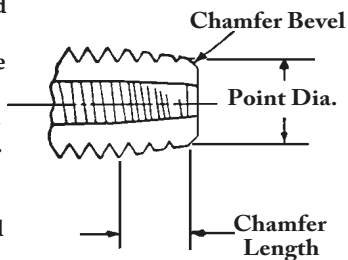

CORE DIAMETER. The diameter of an imaginary cylinder tangent to the deepest part of the flute.

CREST. The top surface joining the two flanks of a thread. The crest of an external thread is at its major diameter, while the crest of an internal thread is at its minor diameter.

CREST CLEARANCE. The space between the crest of a thread and the root of its component.

CUTTING EDGE. The leading side of the land in the direction of rotation for cutting and which does the actual cutting.

DEPTH OF THREAD. The distance between the crest and the base of the thread, measured normal to the axis.

DRYSEAL. A pipe-threaded connection for both external and internal application designed for use where the assembled product must withstand high fluid or gas pressures without the use of a sealing compound, or where a sealer is functionally objectionable.

FLANK. The surface of the thread, sometimes referred to as side of thread, which connects the crest with the root.

FLUTES. The longitudinal channels formed in a tap to create cutting edges on the thread profile and to provide chip spaces and cutting-fluid passages.

FLUTE LEAD. The axial advance of a helical or spiral cutting edge in one turn around the tool axis.

HEEL. The face of the tap land trailing the cutting edge during forward rotation.

HEIGHT OF THREAD. The distance between the crest and the root of a thread measured normal to the axis.

HELIX ANGLE—FLUTE. Flutes of taps are sometimes cut helically instead of straight. This helix angle is the angle made by the flute with the axis of the tap. (Helical flutes are sometimes called spiral flutes.)

HELIX ANGLE—THREAD. The angle made by the helix of a thread at the pitch diameter with a plane perpendicular to the axis.

HOOK. The concave cutting face of a tap land between the crest and the root of thread.

INTERRUPTED THREAD. A tap having an odd number of lands, with every other tooth along the thread helix removed.

LAND. One of the threaded sections between the flutes on a tap.

LEAD. The distance a screw thread advances axially in one complete turn. On a single-lead screw or tap, the lead and the pitch are identical. On a double-lead screw or tap, the lead is twice the pitch, etc.

LEAD ERROR. The amount the actual lead of the screw thread differs from the specified lead.

LEAD—DRUNKEN. Irregular advance of the thread helix or lead. Usually called "drunken thread."

LENGTH OF ENGAGEMENT. The length of contact between two mating threaded parts measured axially.

LIMITS. The maximum and minimum sizes permissible for a spe-cific dimension. (See ALLOWANCE AND TOLERANCE)

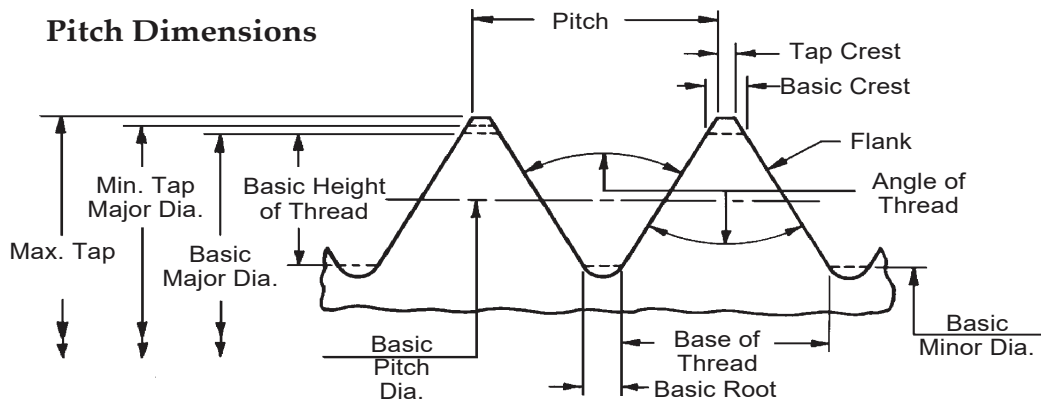

MAJOR DIAMETER. The largest diameter of a straight thread. On a taper thread, the largest diameter at any given plane normal to the axis. The term "major diameter" replaces the term "outside diameter" as applied to the thread of a screw or tap and also the term "full diameter" as applied to the thread of a nut or die.

MINOR DIAMETER. The smallest diameter of a straight thread. On a taper thread, the smallest diameter at any given plane normal to the axis. The term "minor diameter" replaces the terms "root diameter" and "core diameter" as applied to the thread of a screw or tap and also the term "inside diameter" as applied to the thread of a nut or die.

PERCENT OF THREAD. One-half the difference between the basic major diameter and the actual minor diameter or an internal thread, divided by the basic thread height, expressed as percentage.

PITCH. The distance from a point on a screw thread to a corresponding point on the next thread, measured parallel to the axis and on the same side of the axis. The pitch equals one divided by the number of threads per inch.

PITCH DIAMETER. On a straight screw thread, the diameter of an imaginary cylinder, the surface of which would pass through the threads at such points as to make equal the width of the threads and the width of the spaces cut by a given distance from a reference plane perpendicular to the axis of an imaginary cone, the surface of which would pass through the threads at such points as to make equal the width of the threads and the width of the spaces cut by the surface of the cone.

PITCH LINE. A generator of the imaginary cylinder or cone specified in the definition of PITCH DIAMETER.

Rake Angles

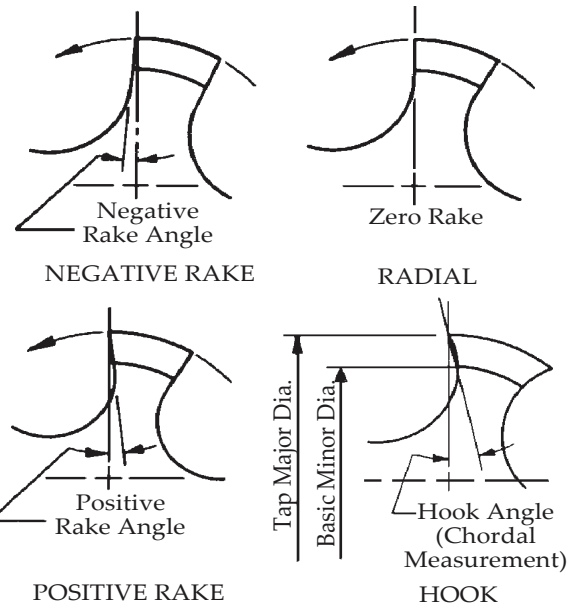

RAKE. On a tap, any deviation of a straight cutting face of the tooth from a radial line. Positive rake means that the crest of the cutting face is angularly advanced ahead of the balance of the face of the tooth. Negative rake means that the same point is angularly behind the balance of the cutting face of the tooth. Zero rake means that the cutting face is directly on the center line.

RELIEF-RADIAL. The clearance produced by removal of metal from behind the cutting edge. Taps should have the chamfer relieved and should have back taper, but may or may not have relief in the angle and on the major diameter of the threads. When the thread angle is relieved from heel to cutting edge, the tap is said to have "eccentric" relief. If relieved from heel for only a portion of land width (usually 2/3) the tap is said to have "concentric" relief. (see BACK TAPER)

Metalcutting Safety (read this before using YMW products)

Modern metalcutting operations involve high energy, high spindle or cutter speeds, and high temperatures and cutting forces. Hot, flying chips may be projected from the workpiece during metalcutting. Although advanced cutting tool materials are designed and manufactured to withstand the high cutting forces and temperatures that normally occur in these operations, they are susceptible to fragmenting in service, particularly if they are subjected to overstress, severe impact or otherwise abused. Therefore, precautions should be taken to adequately protect workers, observers and equipment against hot, flying chips, fragmented cutting tools, broken workpieces or other similar projectiles. Machines should be fully guarded and personal protective equipment should be used at all times.

When grinding advanced cutting tool materials, a suitable means for collection and disposal of dust, mist or sludge should be provided. Overexposure to dust or mist containing metallic particles can be hazardous to health particularly if exposure continues over an extended period of time and may cause eye, skin and mucous membrane irritation and temporary or permanent respiratory disease. Certain existing pulmonary and skin conditions may be aggravated by exposure to dust or mist. Adequate ventilation, respiratory protection and eye protection should be provided when grinding and workers should avoid breathing of and prolonged skin contact with dust or mist.

General Industry Safety and Health Regulations, Part 1910. U.S. Department of Labor, published in Title 29 of the Code of Federal Regulations should be consulted. Obtain from YMW and read the applicable Material Safety Data Sheet before grinding.

Cutting tools are only one part of the worker-machine tool system. Many variables exist in machining operations, including the metal removal rate; the workpiece size, shape, strength and rigidity; the chucking and fixturing; the load carrying capability of centers; the cutter and spindle speed and torque limitations; the holder and boring bar overhang; the available power; and the condition of the tooling and the machine. A safe metalcutting operation must take all of these variables, and others, into consideration.

YMW has no control over the end use of its products or the environment into which those products are placed. YMW urges that its customers adhere to the recommended standards of use of their metalcutting machines and tools, and that they follow procedures that ensure safe metalcutting operations. The information included throughout this catalog under the heading "Technical Data" and other recommendations on machining practices referred to herein are only advisory in nature and do not constitute representations or warranties and are not necessarily appropriate for any particular work environment or application.

SPECIAL TAP REQUEST FORM

Please fill in the blanks and send it to us by e-mail or FAX

e-mail: jeff@ymwtaps.com FAX: 714-437-1712

●Company name			
●Department		●Name	
●TEL		●FAX	
●e-mail address			

Customer's request

●Thread type	· Metric · Unified · Whitworth · Special()		
●Size and pitch	() X ()	●Rotative direction	· Right hand · Left hand
●Tap Type	· Spiral Flute · Spiral Point · Hand Tap · ROLL · Other item()		
●Overall length	· YMW standard () or special length () ·		
●Tap material	HSS-E (M42) · HSS (M7) · HSS-P (T15)		
●Tolerance	CLASS · GH () ISO · Request class ()		
●Thread length	· YMW standard () · Request length ()	●Shank dia.	· YMW standard · Request dia. ()
●Chamfer length	· YMW standard · Taper · Plug · Bottoming · 4P(P) · 2P(B) · Request chamfer ()		
●Surface treatment	· Oxide · Nitride · Nitride-Oxide · TiN · TiCN · CrN · Bright finished		

Condition of Work-piece material

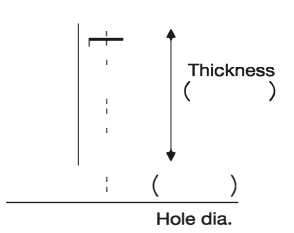
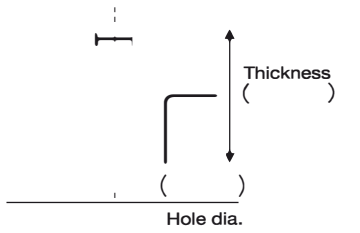
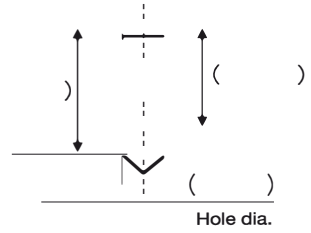
●Tapping part	() · Unclear	●Hardness	() HB () HC Rc · Unclear	
●Work material	· Cast iron () · Low carbon steel () · Medium carbon steel () · High carbon steel () · Stainless steel () · Alloy steel () · Die-cast aluminum () · Bronze casting () · Brass () · Synthetic resin () · Other () · Unclear			
●Parts shape				●Direction · Vertical · Horizontal
●How to make hole	· Drill · Press · Reamer · Molding · Other () · Unclear			
●Gauge	· GP () · NP (WP) () · No check · Unclear			

Machine, cutting condition

●Tapping machine	· Drill press · Automatic lathe · Special machine · Tapping machine · Machining Center · Other
●Holder	· Drill chuck type · Tapping holder (with spring) type · Complete fixed holder type · Other
●Feed	· Manual feed · Gear feed system · Master lead screw feed system · Asynchronous feed system by approximation · Fully synchronous feed system · Other
●Cutting speed	() SFM or Revolution () rpm · Unclear
●Cutting oil	· Oil · Water soluble oil · Paste · Other () · Unclear



YMW TAPS USA

1507 E. McFadden Ave

Santa Ana, CA 92705

Customer Service

855-YMW-USA1

Phone: 714-782-0960

Fax: 714-380-6324

www.ymwtapsusa.com

Copyright 2012-2024

2024-2025