

# Machine Controller MP900/MP2000 Series

## New Ladder Editor

### PROGRAMMING MANUAL

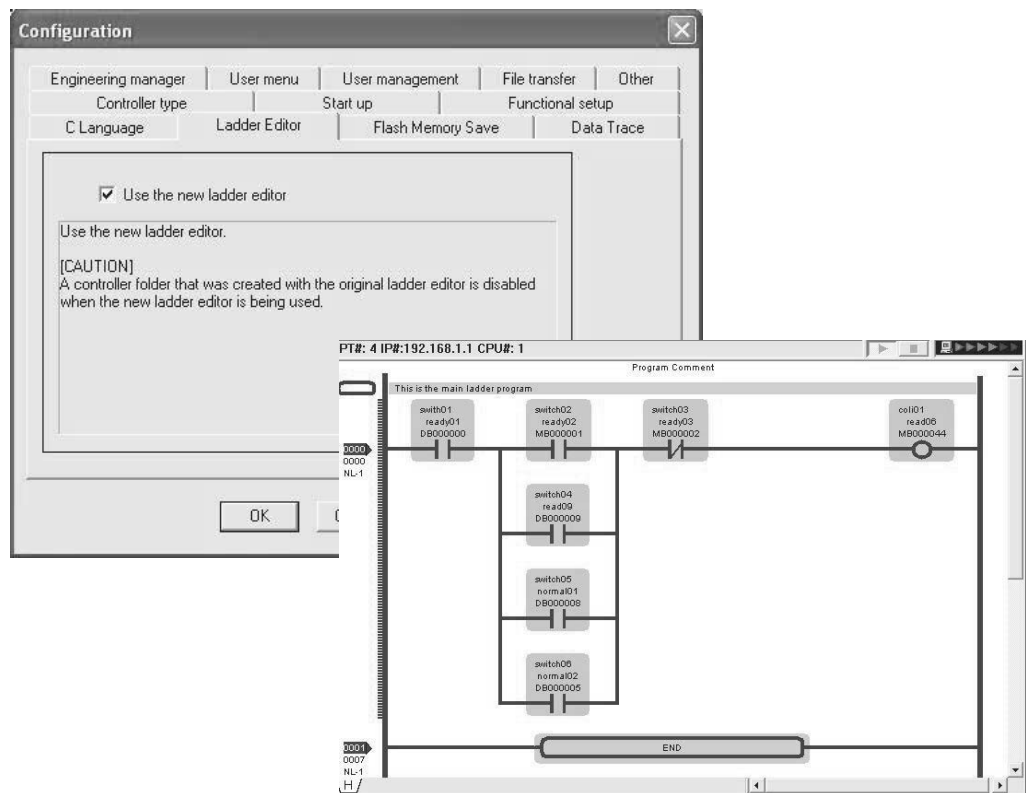

Copyright © 2001 YASKAWA ELECTRIC CORPORATION

---

All rights reserved. No part of this publication may be reproduced, stored in a retrieval system, or transmitted, in any form, or by any means, mechanical, electronic, photocopying, recording, or otherwise, without the prior written permission of Yaskawa. No patent liability is assumed with respect to the use of the information contained herein. Moreover, because Yaskawa is constantly striving to improve its high-quality products, the information contained in this manual is subject to change without notice. Every precaution has been taken in the preparation of this manual. Nevertheless, Yaskawa assumes no responsibility for errors or omissions. Neither is any liability assumed for damages resulting from the use of the information contained in this publication.

---

## About This Manual

- This manual describes the programming instructions of the New Ladder Editor, a programming software application that aids in the design and maintenance of MP900-series and MP2000-series Machine Controllers.
- This manual is written for readers with a working knowledge of Microsoft Windows 95/98/2000/NT. Refer to Windows documentation provided with your computer for information on basic operations, such as opening and closing windows and mouse operations.

- **Intended Audience**

This manual is intended for the following users.

- Those responsible for designing the MP900 and MP2000 System
- Those responsible for writing MP900 and MP2000 motion programs
- Those responsible for writing MP900 and MP2000 ladder logic programs

- **Description of Technical Terms**

In this manual, the terms are defined as follows:

- PLC = Machine Controller
- MPE720 = MPE720 Engineering Tool

- Read this manual carefully to ensure the proper use of the New Ladder Editor. Also, keep this manual in a safe place so that it can be referred to whenever necessary.

## About The Software

- **Precautions**

- This software is to be installed on one and only one computer. You must purchase another copy of the software to install it on another computer.
- This software is not to be copied for any reason other than when installing it on the computer.
- Store the floppy disks containing the software in a safe place.
- This software is not to be decompiled, disassembled, or reverse engineered.
- This software is not to be given to, rent to, exchanged with, or otherwise released to a third party without the prior permission of Yaskawa Corporation.

- **Trademarks**

- Windows and Windows 95/98/2000/NT are registered trademarks of Microsoft Corporation.
- Pentium is a registered trademark of Intel Corporation.
- Ethernet is a registered trademark of Xerox Corporation.

---

## Visual Aids

The following aids are used to indicate certain types of information for easier reference.

**IMPORTANT**

Indicates important information that should be memorized. Also indicates low-level precautions that, if not heeded, may cause an alarm to sound but will not result in the device being damaged.

◀ EXAMPLE ▶

Indicates application examples.



Indicates supplemental information.

## Related Manuals

The MP900 series Machine Controllers consists of four models, the MP910, MP920, MP930, and MP940.

The MP2000 series Machine Controllers consists of two models, the MP2100 and MP2300. Manuals have been produced on these products line.

The following table shows related manuals for the MP900 and MP2000 series.

Refer to the following related manuals as required.

Manual Name	Manual Number	Applicable Model					
		MP910	MP920	MP930	MP940	MP2100	MP2300
Machine Controller MP930 User's Manual: Design and Maintenance	SIEZ-C887-1.1			√			
Machine Controller MP900/MP2000 Series User's Manual: Ladder Programming	SIEZ-C887-1.2	√	√	√	√	√	√
Machine Controller MP900/MP2000 Series User's Manual: Motion Programming	SIEZ-C887-1.3	√	√	√	√	√	√
Machine Controller MP900 Series Teach Pendant User's Manual	SIEZ-C887-1.6		√	√			
Machine Controller MP920 User's Manual: Design and Maintenance	SIEZ-C887-2.1		√				
Machine Controller MP900 Series Programming Panel Software User's Manual for Simple Operation	SIEZ-C887-2.3	√	√	√	√		
Machine Controller MP920 User's Manual: Motion Module	SIEZ-C887-2.5		√				
Machine Controller MP920 User's Manual: Communications Module	SIEZ-C887-2.6		√				
Machine Controller MP920 Installation Manual	SIEZ-C887-2.50		√				
Machine Controller MP910 User's Manual: Design and Maintenance	SIEZ-C887-3.1	√					
Machine Controller MP940 User's Manual: Design and Maintenance	SIEZ-C887-4.1				√		
Machine Controller MP940 Installation Manual	SIEZ-C887-4.50				√		
Machine Controller MP900/MP2000 Series MECHATROLINK System User's Manual	SIEZ-C887-5.1	√	√	√	√		
Machine Controller MP900 Series 260IF DeviceNet System User's Manual	SIEZ-C887-5.2		√		√		
Machine Controller MP900 Series MPLoader (Server) User's Manual for Server	SIEZ-C887-12.1		√	√	√		
Machine Controller MP900 Series MPLoader (Client) User's Manual for Client	SIEZ-C887-12.2		√	√	√		

(cont'd)

Manual Name	Manual Number	Applicable Model					
		MP910	MP920	MP930	MP940	MP2100	MP2300
Machine Controller MP900/MP2000 Series New Ladder Editor Programming Manual	SIEZ-C887-13.1	√	√	√	√	√	√
Machine Controller MP900/MP2000 Series New Ladder Editor User's Manual	SIEZ-C887-13.2	√	√	√	√	√	√
Machine Controller MP2100/MP2100M User's Manual: Design and Maintenance	SIEPC88070001					√	
Machine Controller MP2300 Basic Module User's Manual	SIEPC88070003						√
Machine Controller MP2300 User's Manual: Communications Module	SIEPC88070004						√
Machine Controller MP900/2000 Series MPE720 Software for Programming Device User's Manual	SIEPC88070005	√	√	√	√	√	√

---

# CONTENTS

About This Manual	iii
About The Software	iii
Visual Aids	iv
Related Manuals	v

## 1 Ladder Program Instructions

1.1 Relay Circuit Instructions	1-4
1.1.1 N.O. Contact Instruction (NOC)	1-4
1.1.2 N.C. Contact Instruction (NCC)	1-5
1.1.3 10-MS ON-DELAY TIMER Instruction (TON [10ms])	1-6
1.1.4 10-MS OFF-DELAY TIMER Instruction (TOFF [10ms])	1-7
1.1.5 1-S ON-DELAY TIMER Instruction (TON [1s])	1-8
1.1.6 1-S OFF-DELAY TIMER Instruction (TOFF [1s])	1-10
1.1.7 RISING PULSE Instruction (ON-PLS)	1-11
1.1.8 FALLING PULSE Instruction (OFF-PLS)	1-13
1.1.9 COIL Instruction (COIL)	1-14
1.1.10 SET COIL Instruction (S-COIL)	1-15
1.1.11 RESET COIL Instruction (R-COIL)	1-17
1.2 Numeric Operation Instructions	1-19
1.2.1 STORE Instruction (STORE)	1-19
1.2.2 ADDITION Instruction (ADD)	1-21
1.2.3 EXTENDED ADDITION Instruction (ADDX)	1-23
1.2.4 SUBTRACTION Instruction (SUB)	1-24
1.2.5 EXTENDED SUBTRACTION Instruction (SUBX)	1-27
1.2.6 MULTIPLICATION Instruction (MUL)	1-28
1.2.7 DIVISION Instruction (DIV)	1-31
1.2.8 MOD Instruction (MOD)	1-33
1.2.9 REM Instruction (REM)	1-34
1.2.10 INC Instruction (INC)	1-35
1.2.11 DEC Instruction (DEC)	1-36
1.2.12 ADD TIME Instruction (TMADD)	1-38
1.2.13 SUBTRACT TIME Instruction (TMSUB)	1-39
1.2.14 SPEND TIME Instruction (SPEND)	1-41
1.2.15 SIGN INVERSION Instruction (INV)	1-43
1.2.16 1'S COMPLEMENT Instruction (COM)	1-44
1.2.17 ABSOLUTE VALUE CONVERSION Instruction (ABS)	1-45
1.2.18 BINARY CONVERSION Instruction (BIN)	1-46
1.2.19 BCD CONVERSION Instruction (BCD)	1-48
1.2.20 PARITY CONVERSION Instruction (PARITY)	1-50
1.2.21 ASCII CONVERSION Instruction (ASCII)	1-51
1.2.22 ASCII CONVERSION 2 Instruction (BINASC)	1-52
1.2.23 ASCII CONVERSION 3 Instruction (ASCBIN)	1-53

1.3	Logical Operation/Comparison Instructions	1-55
1.3.1	AND Instruction (AND)	1-55
1.3.2	OR Instruction (OR)	1-56
1.3.3	XOR Instruction (XOR)	1-57
1.3.4	Comparison Instruction (<)	1-59
1.3.5	Comparison Instruction (<=)	1-60
1.3.6	Comparison Instruction (=)	1-61
1.3.7	Comparison Instruction (!=)	1-62
1.3.8	Comparison Instruction (>=)	1-63
1.3.9	Comparison Instruction (>)	1-64
1.3.10	RANGE CHECK Instruction (RCHK)	1-65
1.4	Program Control Instructions	1-68
1.4.1	SUB-DRAWING CALL Instruction (SEE)	1-68
1.4.2	MOTION PROGRAM CALL Instruction (MSEE)	1-69
1.4.3	FUNCTION CALL Instruction (FUNC)	1-70
1.4.4	DIRECT INPUT STRING Instruction (INS)	1-72
1.4.5	DIRECT OUTPUT STRING Instruction (OUTS)	1-74
1.4.6	EXTENSION PROGRAM CALL Instruction (XCALL)	1-76
1.4.7	WHILE Instruction (WHILE, END_WHILE)	1-77
1.4.8	IF Instruction (IF, END_IF)	1-79
1.4.9	IF Instruction (IF, ELSE, END_IF)	1-80
1.4.10	FOR Instruction (FOR, END_FOR)	1-82
1.4.11	EXPRESSION Instruction (EXPRESSION)	1-84
1.5	Basic Function Instructions	1-85
1.5.1	SQUARE ROOT Instruction (SQRT)	1-85
1.5.2	SINE Instruction (SIN)	1-87
1.5.3	COSINE Instruction (COS)	1-88
1.5.4	TANGENT Instruction (TAN)	1-90
1.5.5	ARC SINE Instruction (ASIN)	1-91
1.5.6	ARC COSINE Instruction (ACOS)	1-92
1.5.7	ARC TANGENT Instruction (ATAN)	1-93
1.5.8	EXPONENT Instruction (EXP)	1-94
1.5.9	NATURAL LOGARITHM Instruction (LN)	1-95
1.5.10	COMMON LOGARITHM Instruction (LOG)	1-96
1.6	Data Manipulation Instructions	1-98
1.6.1	BIT ROTATION LEFT Instruction (ROTL)	1-98
1.6.2	BIT ROTATION RIGHT Instruction (ROTR)	1-99
1.6.3	MOVE BITS Instruction (MOV B)	1-101
1.6.4	MOVE WORD Instruction (MOV W)	1-103
1.6.5	EXCHANGE Instruction (XCHG)	1-105
1.6.6	SET WORDS Instruction (SET W)	1-106
1.6.7	BYTE-TO-WORD EXPANSION Instruction (BEXTD)	1-108
1.6.8	WORD-TO-WORD COMPRESSION Instruction (BPRESS)	1-110
1.6.9	BINARY SEARCH Instruction (BSRCH)	1-111
1.6.10	SORT Instruction (SORT)	1-113
1.6.11	BIT SHIFT LEFT Instruction (SHFTL)	1-114
1.6.12	BIT SHIFT RIGHT Instruction (SHFTR)	1-115
1.6.13	COPY WORD Instruction (COPY W)	1-116
1.6.14	BYTE SWAP Instruction (BSWAP)	1-118



<b>1.7 DDC Instructions</b>	<b>1-120</b>
1.7.1 DEAD ZONE A Instruction (DZA)	1-120
1.7.2 DEAD ZONE B Instruction (DZB)	1-122
1.7.3 UPPER/LOWER LIMIT Instruction (LIMIT)	1-124
1.7.4 PI CONTROL Instruction (PI)	1-127
1.7.5 PD CONTROL Instruction (PD)	1-131
1.7.6 PID CONTROL Instruction (PID)	1-135
1.7.7 FIRST-ORDER LAG Instruction (LAG)	1-139
1.7.8 PHASE LEAD/LAG Instruction (LLAG)	1-142
1.7.9 FUNCTION GENERATOR Instruction (FGN)	1-144
1.7.10 INVERSE FUNCTION GENERATOR Instruction (IFGN)	1-147
1.7.11 LINEAR ACCELERATOR/DECELERATOR 1 Instruction (LAU)	1-151
1.7.12 LINEAR ACCELERATOR/DECELERATOR 2 Instruction (SLAU)	1-155
1.7.13 PULSE WIDTH MODULATION Instruction (PWM)	1-163
<b>1.8 Table Data Manipulation Instructions</b>	<b>1-166</b>
1.8.1 BLOCK READ Instruction (TBLBR)	1-166
1.8.2 BLOCK WRITE Instruction (TBLBW)	1-168
1.8.3 ROW SEARCH Instruction (TBL SRL)	1-170
1.8.4 COLUMN SEARCH Instruction (TBL SRC)	1-171
1.8.5 BLOCK CLEAR Instruction (TBL CL)	1-173
1.8.6 BLOCK MOVE Instruction (TBL MV)	1-175
1.8.7 QUEUE TABLE READ Instructions (QTBL R, QTBL RI)	1-177
1.8.8 QUEUE TABLE WRITE Instructions (QTBL W, QTBL WI)	1-179
1.8.9 QUEUE POINTER CLEAR Instruction (QTBL CL)	1-182

## 2 Standard System Function

<b>2.1 Message Functions</b>	<b>2-2</b>
2.1.1 Send Message Function (MSG-SND)	2-2
2.1.2 Receive Message Function (MSG-RCV)	2-13
<b>2.2 Trace Functions</b>	<b>2-22</b>
2.2.1 Trace Function (TRACE)	2-22
2.2.2 Data Trace Read Function (DTRC-RD)	2-23
2.2.3 Failure Trace Read Function (FTRC-RD)	2-26
2.2.4 Inverter Trace Read Function (ITRC-RD)	2-31
<b>2.3 Inverter Functions</b>	<b>2-34</b>
2.3.1 Inverter Constant Write Function (ICNS-WR)	2-34
2.3.2 Inverter Constant Read Function (ICNS-RD)	2-39
<b>2.4 Other Functions</b>	<b>2-42</b>
2.4.1 Counter Function (COUNTER)	2-42
2.4.2 First-in First-out Function (FINFOUT)	2-44

---

## Appendix A Expression

A.1 Expression	A-2
A.1.1 Operator	A-2
A.1.2 Operand	A-4
A.1.3 Instructions Available in EXPRESSION Instruction	A-5
A.2 Recognizable Expression	A-6
A.2.1 Arithmetic Operator	A-6
A.2.2 Comparison Operator	A-6
A.2.3 Logic Operator	A-6
A.2.4 Substitution Operator	A-7
A.2.5 Function	A-7
A.2.6 Others	A-7
A.3 Application to Ladder Program	A-9
A.3.1 Conditional Expression of IF Instruction	A-9
A.3.2 Conditional Expression of WHILE Instruction	A-9
A.3.3 Operational Expression of EXPRESSION Instruction	A-10

## Revision History

# Ladder Program Instructions

This chapter describes in the instructions for relay circuits, numeric operations, logical operations and comparisons, program controls, basic functions, data manipulation, DDC, and table data a manipulation.

<b>1.1 Relay Circuit Instructions</b>	<b>1-4</b>
1.1.1 N.O. Contact Instruction (NOC)	1-4
1.1.2 N.C. Contact Instruction (NCC)	1-5
1.1.3 10-MS ON-DELAY TIMER Instruction (TON [10ms])	1-6
1.1.4 10-MS OFF-DELAY TIMER Instruction (TOFF [10ms])	1-7
1.1.5 1-S ON-DELAY TIMER Instruction (TON [1s])	1-8
1.1.6 1-S OFF-DELAY TIMER Instruction (TOFF [1s])	1-10
1.1.7 RISING PULSE Instruction (ON-PLS)	1-11
1.1.8 FALLING PULSE Instruction (OFF-PLS)	1-13
1.1.9 COIL Instruction (COIL)	1-14
1.1.10 SET COIL Instruction (S-COIL)	1-15
1.1.11 RESET COIL Instruction (R-COIL)	1-17
<b>1.2 Numeric Operation Instructions</b>	<b>1-19</b>
1.2.1 STORE Instruction (STORE)	1-19
1.2.2 ADDITION Instruction (ADD)	1-21
1.2.3 EXTENDED ADDITION Instruction (ADDX)	1-23
1.2.4 SUBTRACTION Instruction (SUB)	1-24
1.2.5 EXTENDED SUBTRACTION Instruction (SUBX)	1-27
1.2.6 MULTIPLICATION Instruction (MUL)	1-28
1.2.7 DIVISION Instruction (DIV)	1-31
1.2.8 MOD Instruction (MOD)	1-33
1.2.9 REM Instruction (REM)	1-34
1.2.10 INC Instruction (INC)	1-35
1.2.11 DEC Instruction (DEC)	1-36
1.2.12 ADD TIME Instruction (TMADD)	1-38
1.2.13 SUBTRACT TIME Instruction (TMSUB)	1-39
1.2.14 SPEND TIME Instruction (SPEND)	1-41
1.2.15 SIGN INVERSION Instruction (INV)	1-43
1.2.16 1'S COMPLEMENT Instruction (COM)	1-44

1.2.17 ABSOLUTE VALUE CONVERSION Instruction (ABS)	1-45
1.2.18 BINARY CONVERSION Instruction (BIN)	1-46
1.2.19 BCD CONVERSION Instruction (BCD)	1-48
1.2.20 PARITY CONVERSION Instruction (PARITY)	1-50
1.2.21 ASCII CONVERSION Instruction (ASCII)	1-51
1.2.22 ASCII CONVERSION 2 Instruction (BINASC)	1-52
1.2.23 ASCII CONVERSION 3 Instruction (ASCBIN)	1-53
<b>1.3 Logical Operation/Comparison Instructions</b>	<b>1-55</b>
1.3.1 AND Instruction (AND)	1-55
1.3.2 OR Instruction (OR)	1-56
1.3.3 XOR Instruction (XOR)	1-57
1.3.4 Comparison Instruction (<)	1-59
1.3.5 Comparison Instruction (<=)	1-60
1.3.6 Comparison Instruction (=)	1-61
1.3.7 Comparison Instruction (!=)	1-62
1.3.8 Comparison Instruction (>=)	1-63
1.3.9 Comparison Instruction (>)	1-64
1.3.10 RANGE CHECK Instruction (RCHK)	1-65
<b>1.4 Program Control Instructions</b>	<b>1-68</b>
1.4.1 SUB-DRAWING CALL Instruction (SEE)	1-68
1.4.2 MOTION PROGRAM CALL Instruction (MSEE)	1-69
1.4.3 FUNCTION CALL Instruction (FUNC)	1-70
1.4.4 DIRECT INPUT STRING Instruction (INS)	1-72
1.4.5 DIRECT OUTPUT STRING Instruction (OUTS)	1-74
1.4.6 EXTENSION PROGRAM CALL Instruction (XCALL)	1-76
1.4.7 WHILE Instruction (WHILE, END_WHILE)	1-77
1.4.8 IF Instruction (IF, END_IF)	1-79
1.4.9 IF Instruction (IF, ELSE, END_IF)	1-80
1.4.10 FOR Instruction (FOR, END_FOR)	1-82
1.4.11 EXPRESSION Instruction (EXPRESSION)	1-84
<b>1.5 Basic Function Instructions</b>	<b>1-85</b>
1.5.1 SQUARE ROOT Instruction (SQRT)	1-85
1.5.2 SINE Instruction (SIN)	1-87
1.5.3 COSINE Instruction (COS)	1-88
1.5.4 TANGENT Instruction (TAN)	1-90
1.5.5 ARC SINE Instruction (ASIN)	1-91
1.5.6 ARC COSINE Instruction (ACOS)	1-92
1.5.7 ARC TANGENT Instruction (ATAN)	1-93
1.5.8 EXPONENT Instruction (EXP)	1-94
1.5.9 NATURAL LOGARITHM Instruction (LN)	1-95
1.5.10 COMMON LOGARITHM Instruction (LOG)	1-96
<b>1.6 Data Manipulation Instructions</b>	<b>1-98</b>
1.6.1 BIT ROTATION LEFT Instruction (ROTL)	1-98
1.6.2 BIT ROTATION RIGHT Instruction (ROTR)	1-99
1.6.3 MOVE BITS Instruction (MOVB)	1-101
1.6.4 MOVE WORD Instruction (MOVW)	1-103
1.6.5 EXCHANGE Instruction (XCHG)	1-105
1.6.6 SET WORDS Instruction (SETW)	1-106
1.6.7 BYTE-TO-WORD EXPANSION Instruction (BEXTD)	1-108

---

1.6.8 WORD-TO-WORD COMPRESSION Instruction (BPRESS)	1-110
1.6.9 BINARY SEARCH Instruction (BSRCH)	1-111
1.6.10 SORT Instruction (SORT)	1-113
1.6.11 BIT SHIFT LEFT Instruction (SHFTL)	1-114
1.6.12 BIT SHIFT RIGHT Instruction (SHFTR)	1-115
1.6.13 COPY WORD Instruction (COPYW)	1-116
1.6.14 BYTE SWAP Instruction (BSWAP)	1-118
<b>1.7 DDC Instructions</b>	<b>1-120</b>
1.7.1 DEAD ZONE A Instruction (DZA)	1-120
1.7.2 DEAD ZONE B Instruction (DZB)	1-122
1.7.3 UPPER/LOWER LIMIT Instruction (LIMIT)	1-124
1.7.4 PI CONTROL Instruction (PI)	1-127
1.7.5 PD CONTROL Instruction (PD)	1-131
1.7.6 PID CONTROL Instruction (PID)	1-135
1.7.7 FIRST-ORDER LAG Instruction (LAG)	1-139
1.7.8 PHASE LEAD/LAG Instruction (LLAG)	1-142
1.7.9 FUNCTION GENERATOR Instruction (FGN)	1-144
1.7.10 INVERSE FUNCTION GENERATOR Instruction (IFGN)	1-147
1.7.11 LINEAR ACCELERATOR/DECELERATOR 1 Instruction (LAU)	1-151
1.7.12 LINEAR ACCELERATOR/DECELERATOR 2 Instruction (SLAU)	1-155
1.7.13 PULSE WIDTH MODULATION Instruction (PWM)	1-163
<b>1.8 Table Data Manipulation Instructions</b>	<b>1-166</b>
1.8.1 BLOCK READ Instruction (TBLBR)	1-166
1.8.2 BLOCK WRITE Instruction (TBLBW)	1-168
1.8.3 ROW SEARCH Instruction (TBL SRL)	1-170
1.8.4 COLUMN SEARCH Instruction (TBL SRC)	1-171
1.8.5 BLOCK CLEAR Instruction (TBL CL)	1-173
1.8.6 BLOCK MOVE Instruction (TBL MV)	1-175
1.8.7 QUEUE TABLE READ Instructions (QTBLR, QTBLRI)	1-177
1.8.8 QUEUE TABLE WRITE Instructions (QTBLW, QTBLWI)	1-179
1.8.9 QUEUE POINTER CLEAR Instruction (QTBL CL)	1-182

## 1.1 Relay Circuit Instructions

### 1.1.1 N.O. Contact Instruction (NOC)

#### ■ Outline

The NOC sets the value of the bit output to ON if the value of the referenced register is 1 (ON), and to OFF if the value of the referenced register is 0 (OFF).

#### ■ Format

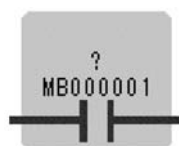

Symbol: NOC  
 Full Name: NO Contact  
 Category: RELAY  
 Icon:

#### ■ Parameter

Parameter Name	Setting
Relay No.	<ul style="list-style-type: none"> <li>• Any bit type register</li> <li>• Any bit type register with subscript</li> </ul>

#### ■ Program Example

When MW000100 becomes ON, MB000101 becomes ON.

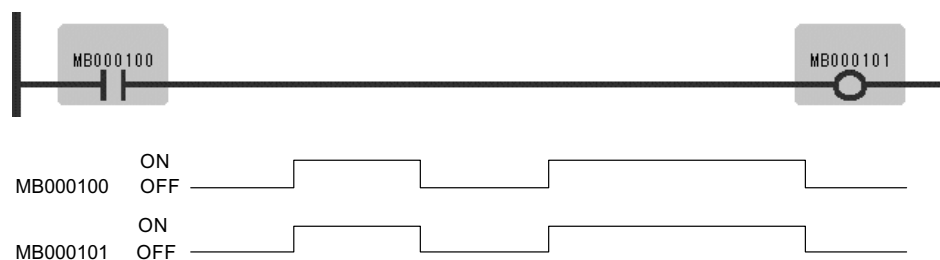

### 1.1.2 N.C. Contact Instruction (NCC)

#### ■ Outline

The NCC sets the value of the bit output to OFF when the value of the referenced register is 1 (ON), and to ON when the value of the referenced register is 0 (OFF).

#### ■ Format

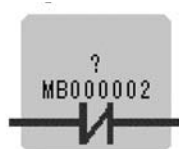

Symbol: NCC  
 Full Name: NC Contact  
 Category: RELAY  
 Icon:

1

#### ■ Parameter

Parameter Name	Setting
Relay No.	<ul style="list-style-type: none"> <li>• Any bit type register</li> <li>• Any bit type register with subscript</li> </ul>

#### ■ Program Example

When MB000100 becomes ON, MB000101 becomes OFF.

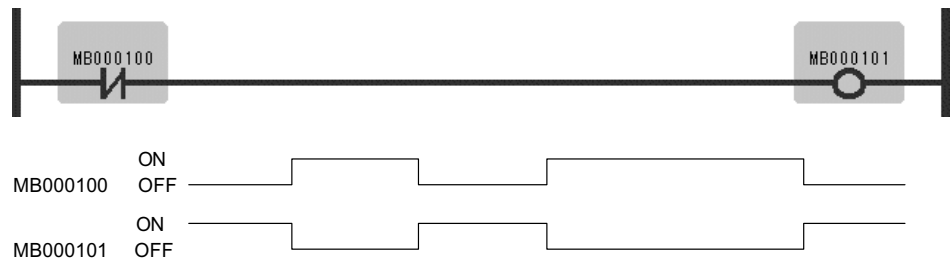



### 1.1.3 10-MS ON-DELAY TIMER Instruction (TON [10ms])

#### ■ Outline

The TON [10ms] is executed while the immediately-preceding value of the bit input is ON. The value of the bit output is set to ON when the timer value reaches the set value. The timer stops when the immediately-preceding value of the bit input is set to OFF during timing. When the bit input is set to ON again, timing restarts from the beginning (0). A value equal to the actual timed time (10 ms Unit) is stored in the timer value register. The maximum error of the count is 10 ms or less.

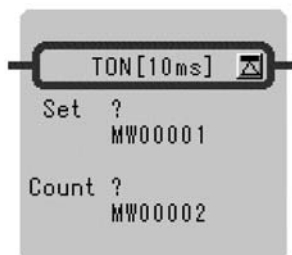
#### ■ Format



Symbol: TON [10ms]  
 Full Name: On-Delay Timer [10ms]  
 Category: RELAY  
 Icon: 

#### ■ Parameter

Parameter Name	Setting
Set (set value)	<ul style="list-style-type: none"> <li>Any integer type register</li> <li>Any integer type register with subscript (0 to 65535: in 0.01 sec unit)</li> <li>Constant</li> </ul>
Count (timer value)	<ul style="list-style-type: none"> <li>Any integer type register (except for # and C registers)</li> <li>Any integer type register with subscript (except for # and C registers)</li> </ul>



## ■ Program Example

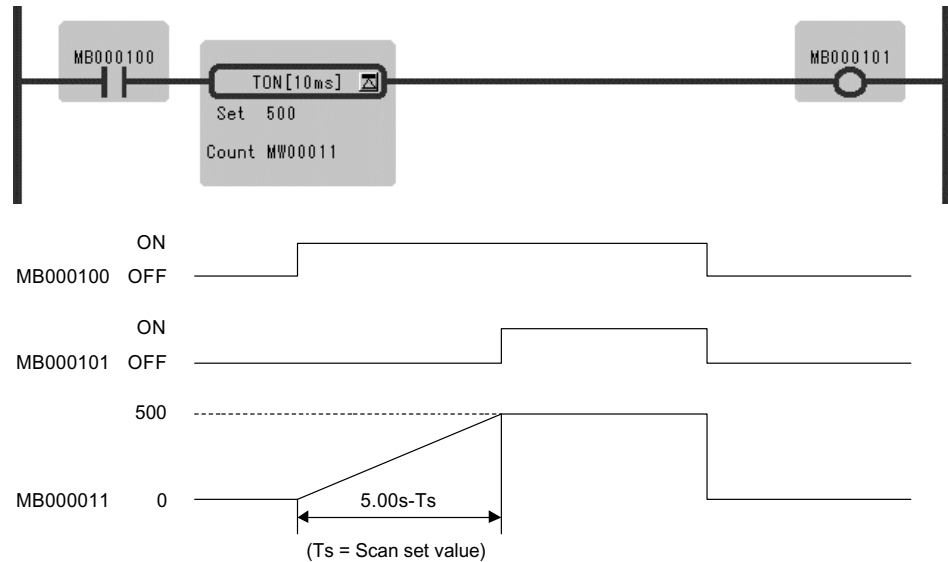

### IMPORTANT

MW00011 works as timer count register. Thus, it is essential that there is no overlap. Set an unused register.

## 1.1.4 10-MS OFF-DELAY TIMER Instruction (TOFF [10ms])

### ■ Outline

The TOFF [10ms] is executed while the immediately-preceding value of the bit input is OFF. The value of the bit output is set to OFF when the timer value reaches the set value. The timer stops when the immediately-preceding value of the bit input is set to ON during timing. When the bit input is set to OFF again, timing restarts from the beginning (0). A value equal to the actual timed time (10 ms Unit) is stored in the timer value register. The maximum error of the count is 10 ms or less.

### ■ Format

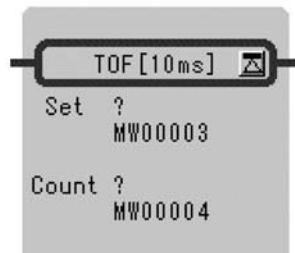

Symbol: TOFF [10ms]  
 Full Name: Off-Delay Timer [10 ms]  
 Category: RELAY  
 Icon: 

■ Parameter

Parameter Name	Setting
Set (set value)	<ul style="list-style-type: none"> <li>Any integer type register</li> <li>Any integer type register with subscript (0 to 65535: 0.01 sec unit)</li> <li>Constant</li> </ul>
Count (timer value)	<ul style="list-style-type: none"> <li>Any integer type register (except for # and C registers)</li> <li>Any integer type register with subscript (except for # and C registers)</li> </ul>

■ Program Example

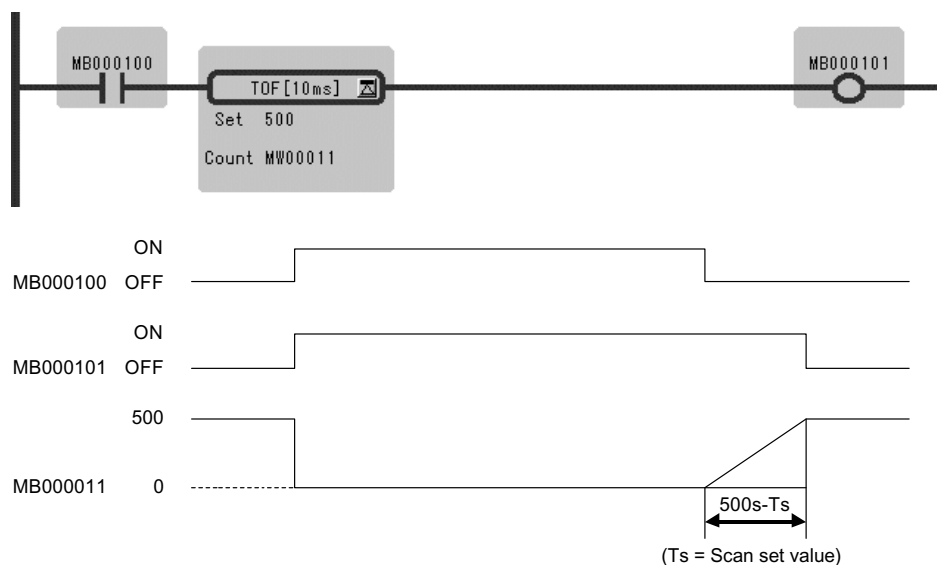

**IMPORTANT**

MW00011 works as timer count register. Thus, it is essential that there is no overlap. Set an unused register.

1.1.5 1-S ON-DELAY TIMER Instruction (TON [1s])

■ Outline

The TON [1s] times while the immediately-preceding value of the bit input is ON. The value of the bit output is set to ON when the timer value reaches the set value. The timer stops when the immediately-preceding value of the bit input is set to ON during timing. When the bit input is set to OFF again, timing restarts from the beginning (0). A value equal to the actual timed time (1 s Unit) is stored in the timer value register. The maximum error of the count is 1 s or less.

■ Format

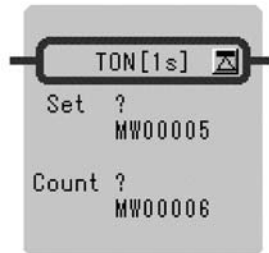

Symbol: TON [1s]  
 Full Name: On-Delay Timer [1s]  
 Category: RELAY  
 Icon:

1

■ Parameter

Parameter Name	Setting
Set (set value)	<ul style="list-style-type: none"> <li>Any integer type register</li> <li>Any integer type register with subscript (0 to 65535: 1 sec unit)</li> <li>Constant</li> </ul>
Count (timer value)	<ul style="list-style-type: none"> <li>Any integer type register (except for # and C registers)</li> <li>Any integer type register with subscript (except for # and C registers)</li> </ul>

■ Program Example

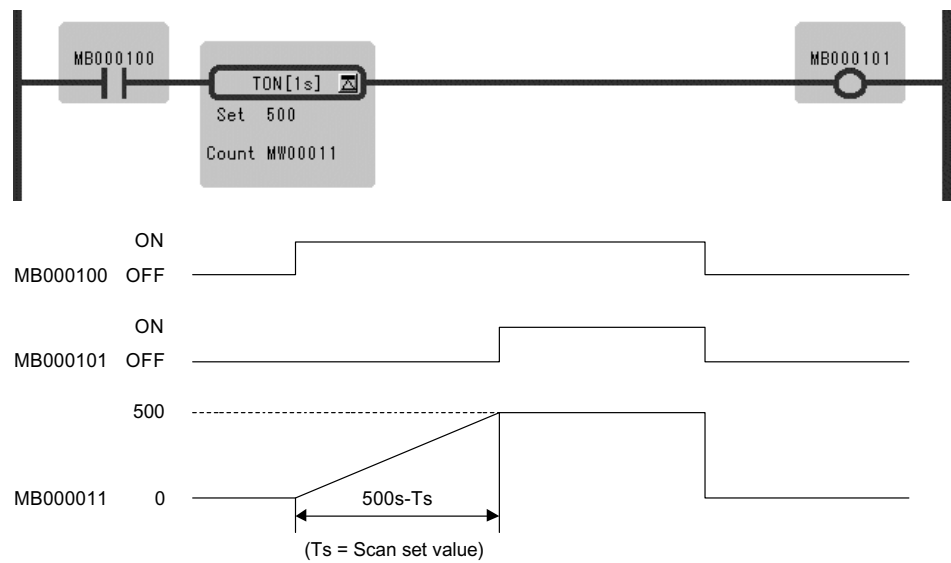

**IMPORTANT**

MW00011 works as timer count register. Thus, it is essential that there is no overlap. Set an unused register.

## 1.1.6 1-S OFF-DELAY TIMER Instruction (TOFF [1s])

### ■ Outline

The TOFF [1s] times while the immediately-preceding value of the bit input is OFF. The value of the bit output is set to OFF when the timer value reaches the set value. The timer stops when the immediately-preceding value of the bit input is set to ON during timing.

When the bit input is set to OFF again, timing restarts from the beginning (0). A value equal to the actual timed time (1 s Unit) is stored in the timer value register.

The maximum error of the count is 1 s or less.

### ■ Format

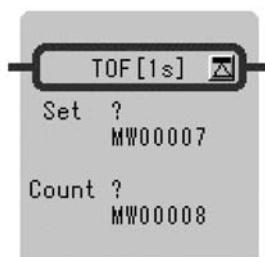

Symbol: TOFF [1s]  
Full Name: Off-Delay Timer [1s]  
Category: RELAY

Icon: 

### ■ Parameter

Parameter Name	Setting
Set (set value)	<ul style="list-style-type: none"> <li>Any integer type register</li> <li>Any integer type register with subscript (0 to 65535: 1 sec unit)</li> <li>Constant</li> </ul>
Count (timer value)	<ul style="list-style-type: none"> <li>Any integer type register (except for # and C registers)</li> <li>Any integer type register with subscript (except for # and C registers)</li> </ul>

■ Program Example

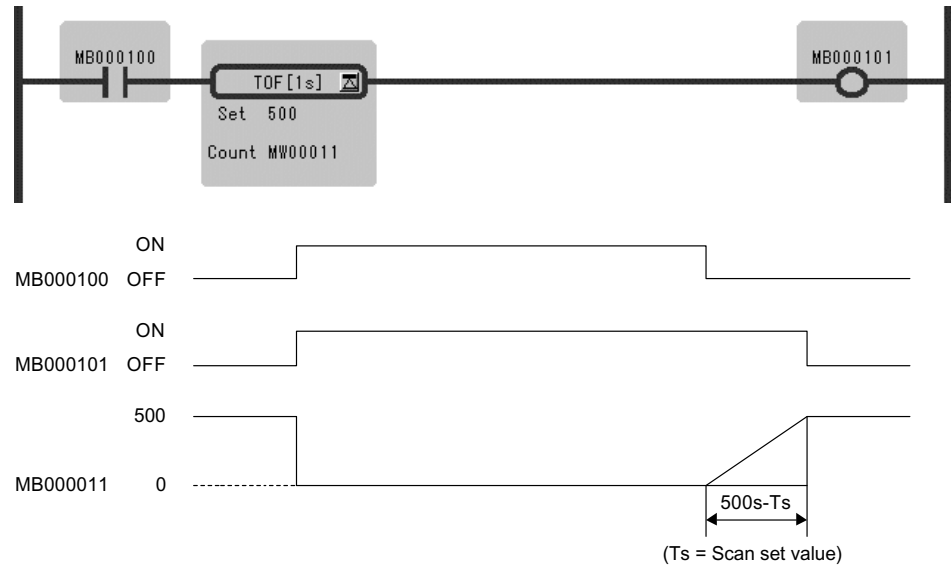

1

**IMPORTANT**

MW00011 works as timer count register. Thus, it is essential that there is no overlap. Set an unused register.

1.1.7 RISING PULSE Instruction (ON-PLS)

■ Outline

The ON-PLS sets the value of the bit input to ON during one scan when the immediately-preceding value of the bit output changes from OFF to ON. The designated register is used to store the previous value of the bit output.

■ Format



Symbol: ON-PLS  
 Full Name: Rise Pulse  
 Category: RELAY  
 Icon: 

■ Parameter

Parameter Name	Setting
Register No.	<ul style="list-style-type: none"> <li>Any bit type register (except for # and C register)</li> <li>Any bit type register with subscript (except for # and C registers)</li> </ul>

■ Program Example

When IB00001 turns ON from OFF, MB000101 turns ON and stays ON during 1 scan. MB000100 is used to store the previous value of IB00001.

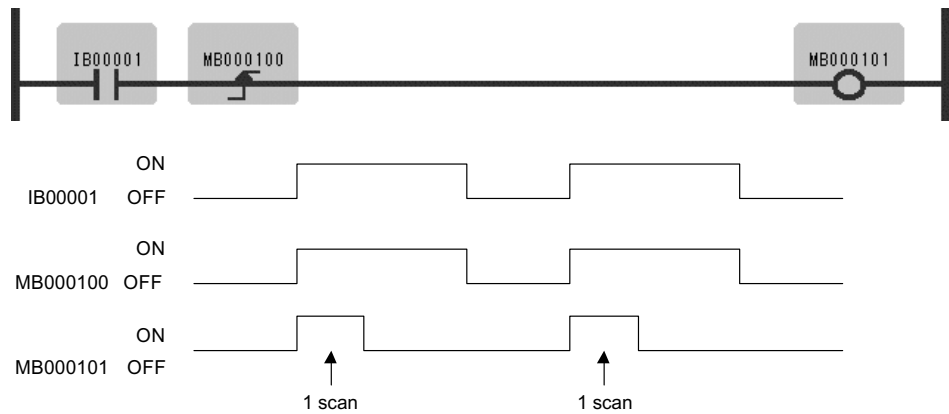

Register status of Rising pulse instruction is shown in Table 1.1.

Table 1.1 Register Status with Rising Pulse Instruction

Input		Result	
IB00001	MB000100 (Previous value of IB00001)	MB000100 (IB00001 stored)	MB000101
OFF	OFF	OFF	OFF
OFF	ON	OFF	OFF
ON	OFF	ON	ON
ON	ON	ON	OFF

Note: Case of Program Example, the instruction is used not for rise detection of MB000100 but is used for rise detection of IB00001. MB000100 is used only for storing the previous value of IB00001.

## 1.1.8 FALLING PULSE Instruction (OFF-PLS)

### ■ Outline

The OFF-PLS sets the value of the bit input to ON for one scan when the immediately-preceding value of the bit output changes from ON to OFF. The designated register is used to store the previous value of the bit output.

### ■ Format



Symbol: OFF-PLS  
 Full Name: Fall Pulse  
 Category: RELAY  
 Icon:

### ■ Parameter

Parameter Name	Setting
Register No.	<ul style="list-style-type: none"> <li>• Any bit type register (except for # and C register)</li> <li>• Any bit type register with subscript (except for # and C registers)</li> </ul>

### ■ Program Example

When IB00001 turns OFF, MB000101 turns ON and stays ON during 1 scan. MB000100 is used to store the previous value of IB00001.

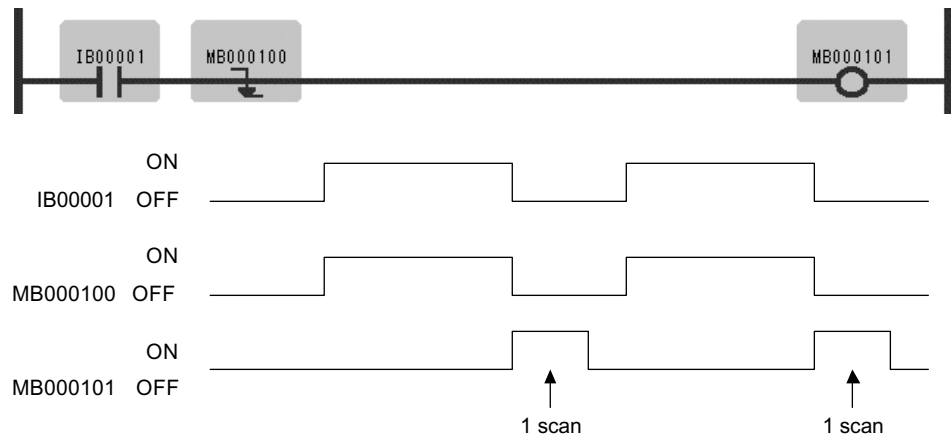

Register status of Falling pulse instruction is shown in Table 1.2.

Table 1.2 Register Status with Falling Pulse Instruction

Input		Result	
IB00001	MB000100 (Previous value of IB00001)	MB000100 (IB00001 stored)	MB000101
OFF	OFF	OFF	OFF
OFF	ON	OFF	ON
ON	OFF	ON	OFF
ON	ON	ON	OFF

Note: Case of Program Example, the instruction is used not for fall detection of MB000100 but is used for fall detection of IB00001. MB000100 is used only for storing the previous value of IB00001.

### 1.1.9 COIL Instruction (COIL)

#### ■ Outline

The COIL sets the value of the referenced register to 1 (ON) when the immediately-preceding value of the bit input is ON, and to 0 (OFF) when the immediately-preceding value of the bit input is OFF.

#### ■ Format



Symbol: COIL  
Full Name: Coil  
Category: RELAY  
Icon: 

#### ■ Parameter

Parameter Name	Setting
Coil No.	<ul style="list-style-type: none"> <li>Any bit type register (except for # and C register)</li> <li>Any bit type register with subscript (except # and C registers)</li> </ul>



■ Program Example

When MB000100 becomes ON, MB000101 becomes ON.

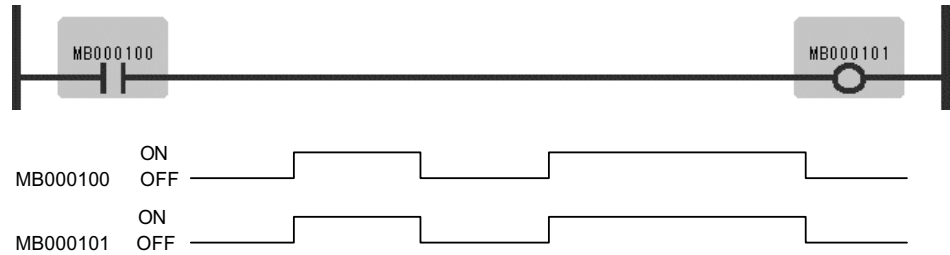

1

1.1.10 SET COIL Instruction (S-COIL)

■ Outline

The S-COIL turns ON the output when the execution condition is satisfied, and maintains the ON state.

■ Format



Symbol: S-COIL  
 Full Name: Set Coil  
 Category: RELAY  
 Icon:

■ Parameter

Parameter Name	Setting
Coil No.	<ul style="list-style-type: none"> <li>Any bit type register (except for # and C register)</li> <li>Any bit type register with subscript (except for # and C registers)</li> </ul>

### ■ Program Example

Case where the same output destination is designated multiple times.

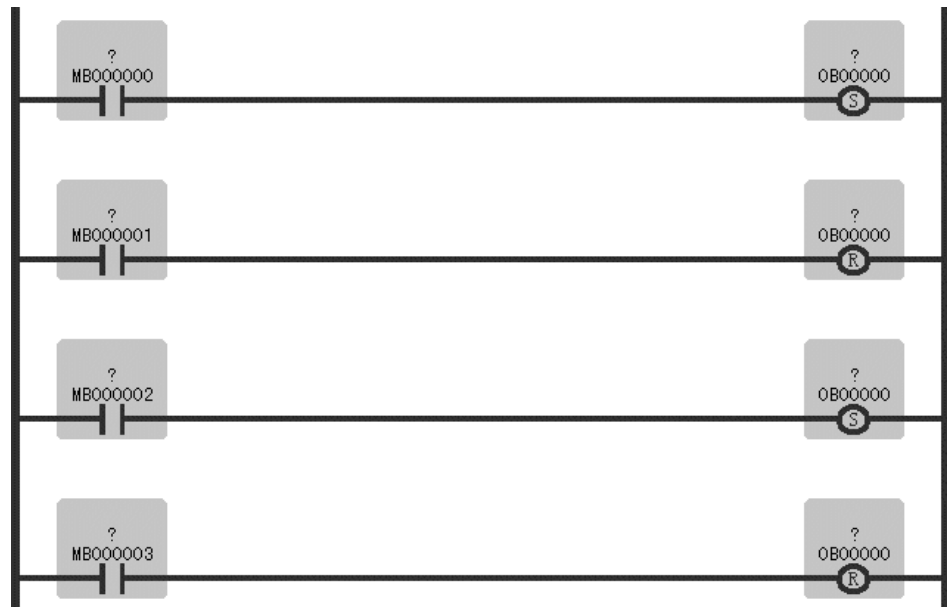

The above example acts as in the graph below.

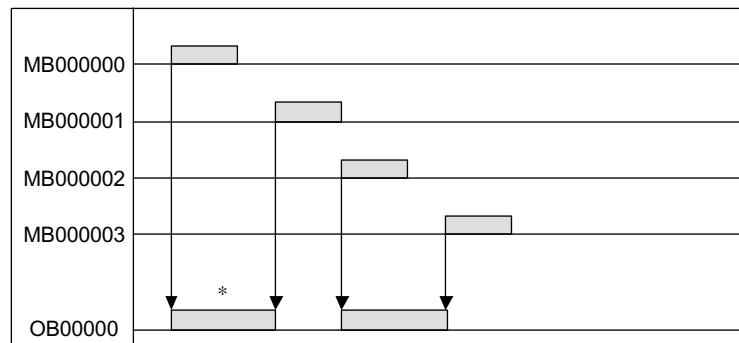

\* When OB000000 is OFF, with the "set coil" instruction, OB000000 turns ON.

### 1.1.11 RESET COIL Instruction (R-COIL)

#### ■ Outline

The R-COIL turns OFF the output when the execution condition is satisfied, and maintains the OFF state.

#### ■ Format



Symbol: R-COIL  
 Full Name: Reset Coil  
 Category: RELAY  
 Icon:

#### ■ Parameter

Parameter Name	Setting
Coil No.	<ul style="list-style-type: none"> <li>Any bit type register (except for # and C register)</li> <li>Any bit type register with subscript (except for # and C registers)</li> </ul>

#### ■ Program Example

Case where the same output destination is designated multiple times.

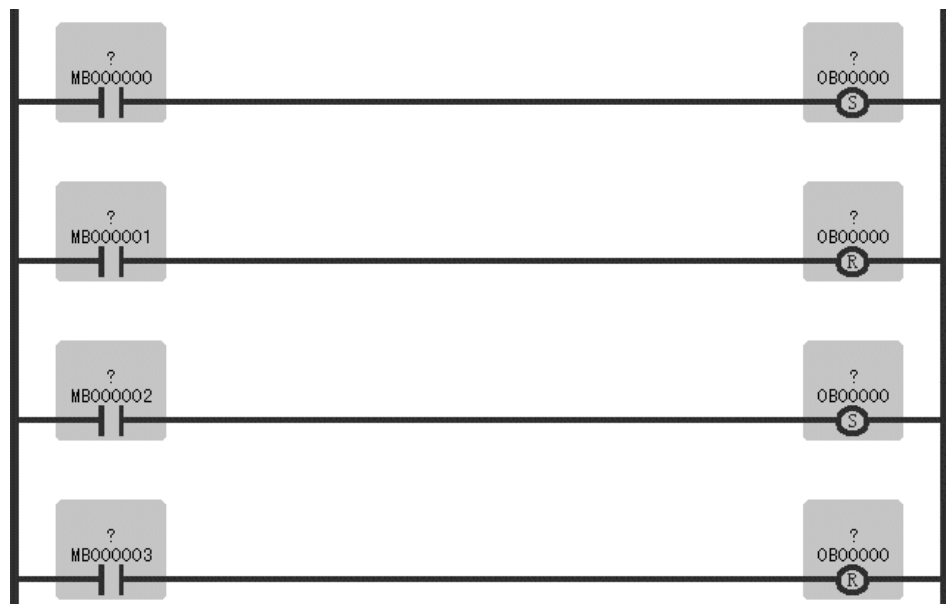

The above example acts as in the graph below.

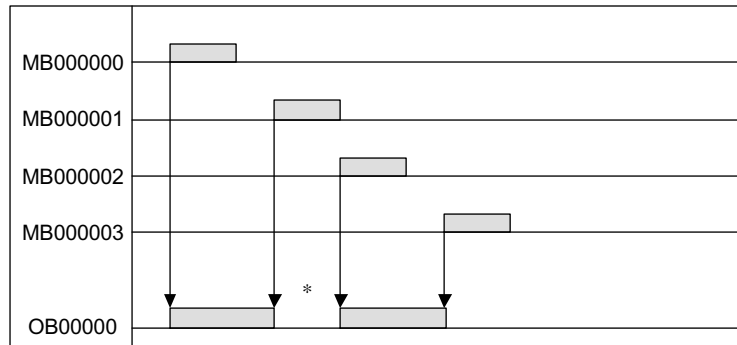

\* When OB000000 is ON, with the "reset coil" instruction, OB000000 turns OFF.

## 1.2 Numeric Operation Instructions

### 1.2.1 STORE Instruction (STORE)

#### ■ Outline

The STORE instruction stores the contents of *Source* in the *Dest*.

#### ■ Format



Symbol: STORE  
 Full Name: Store  
 Category: MATH  
 Icon: 

#### ■ Parameter

Parameter Name	Setting
Source	<ul style="list-style-type: none"> <li>• Any integer type, double-length integer type and real number type register</li> <li>• Any integer type, double-length integer type and real number type register with subscript</li> <li>• Subscript register</li> <li>• Constant</li> </ul>
Dest	<ul style="list-style-type: none"> <li>• Any integer type, double-length integer type and real number type register (except for # and C registers)</li> <li>• Any integer type, double-length integer type and real number type register with subscript (except for # and C registers)</li> <li>• Subscript register</li> </ul>

## ■ Program Example

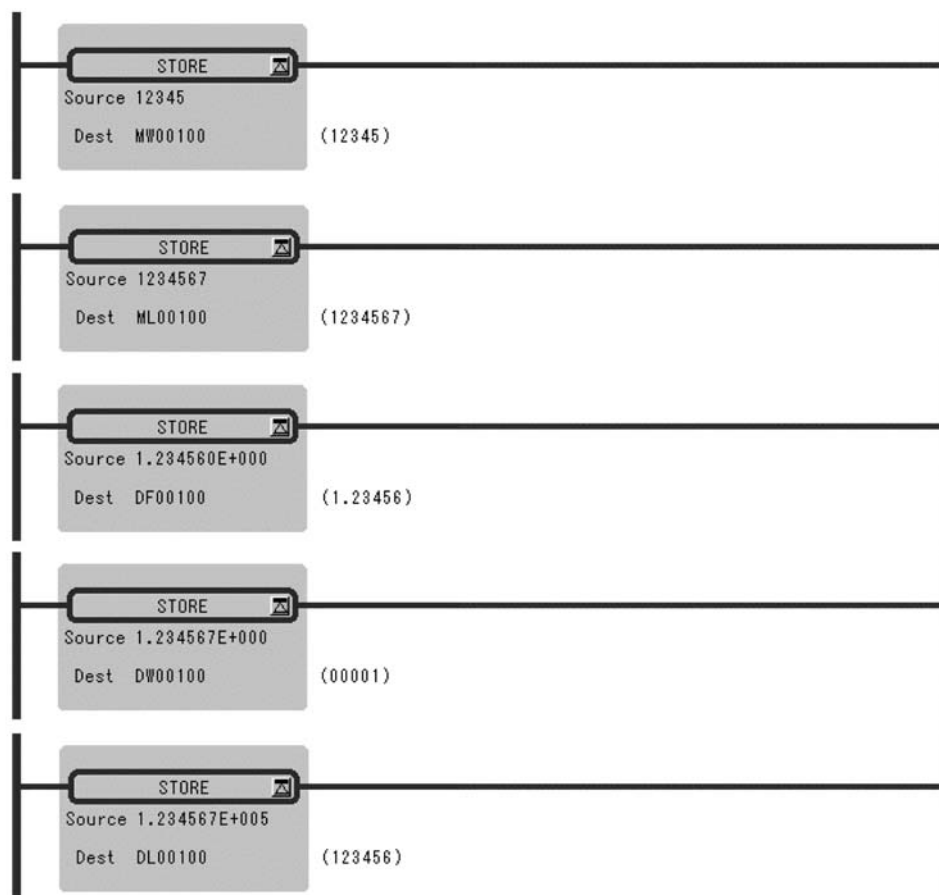

When a double-length integer type data is stored in an integer type register, the lower 16 bits are stored as they are. Be careful since an operation error will not occur even if the data to be stored exceeds the integer range (-32768 to 32767).

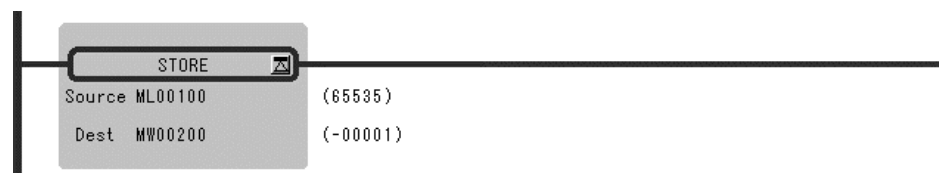



## 1.2.2 ADDITION Instruction (ADD)

### ■ Outline

The ADD instruction adds integer, double-length integer, and real number values. *Source B* is added to *Source A* and stored in the *Dest*. If the result of adding integer values is greater than 32767, an overflow error occurs. If the result of adding double-length integer values is greater than 2147483647, an overflow error occurs.

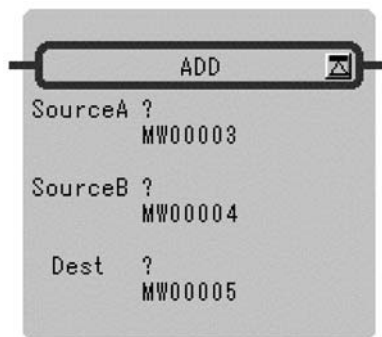
### ■ Format



Symbol: ADD  
 Full Name: Add  
 Category: MATH  
 Icon: 

### ■ Parameter

Parameter Name	Setting
Source A	<ul style="list-style-type: none"> <li>Any integer type, double-length integer type and real number type register</li> <li>Any integer type, double-length integer type and real number type register with subscript</li> <li>Subscript register</li> <li>Constant</li> </ul>
Source B	<ul style="list-style-type: none"> <li>Any integer type, double-length integer type and real number type register</li> <li>Any integer type, double-length integer type and real number type register with subscript</li> <li>Subscript register</li> <li>Constant</li> </ul>
Dest	<ul style="list-style-type: none"> <li>Any integer type, double-length integer type and real number type register (except for # and C registers)</li> <li>Any integer type, double-length integer type and real number type register with subscript (except for # and C registers)</li> <li>Subscript register</li> </ul>

## ■ Program Example

### Addition of Integer Type Values



### Addition of Real Number Type Values

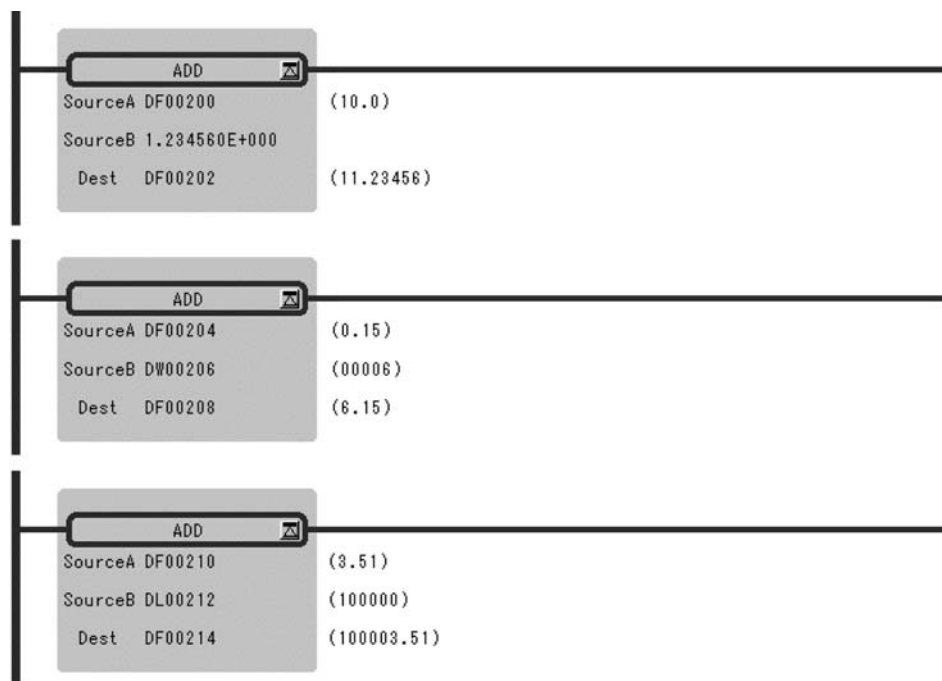

In the case of double-length integer type values, an operation using addition and subtraction instructions (+, -, ++, --) will be a 32-bit operation. However, when an addition or subtraction instruction is used in a remainder correction operation (where a multiplication instruction (×) is the immediately preceding instruction and a division instruction (/) is the immediately subsequent instruction), the operation will be a 64-bit operation.



### 1.2.3 EXTENDED ADDITION Instruction (ADDX)

#### ■ Outline

The ADDX instruction adds integer values. *Source B* is added to *Source A* and stored in the *Dest*. No operation error occurs, even if the operation results in an overflow. Otherwise, the ADDX is much the same as the ADD.

#### ■ Format

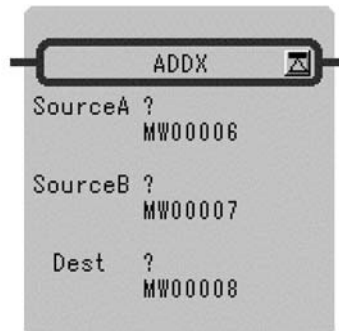

Symbol: ADDX  
 Full Name: Expanded Add  
 Category: MATH  
 Icon:

#### ■ Parameter

Parameter Name	Setting
Source A	<ul style="list-style-type: none"> <li>• Any integer type and double-length integer type register</li> <li>• Any integer type and double-length integer type register with subscript</li> <li>• Subscript register</li> <li>• Constant</li> </ul>
Source B	<ul style="list-style-type: none"> <li>• Any integer type and double-length integer type register</li> <li>• Any integer type and double-length integer type register with subscript</li> <li>• Subscript register</li> <li>• Constant</li> </ul>
Dest	<ul style="list-style-type: none"> <li>• Any integer type and double-length integer type register (except for # and C registers)</li> <li>• Any integer type and double-length integer type register with subscript (except for # and C registers)</li> <li>• Subscript register</li> </ul>

### ■ Program Example

This instruction is used in cases where it is desirable that operation errors do not occur in the addition of integer type values.

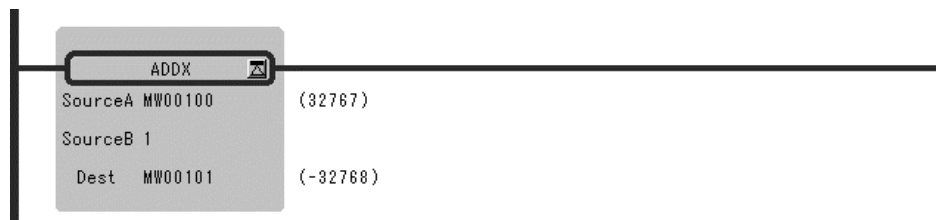

In the case of double-length integer type values, an operation using addition and subtraction instructions (+, -, ++, --) will be a 32-bit operation. However, when an addition or subtraction instruction is used in a remainder correction operation (where a multiplication instruction (×) is the immediately preceding instruction and a division instruction (÷) is the immediately subsequent instruction), the operation will be a 64-bit operation.

## 1.2.4 SUBTRACTION Instruction (SUB)

### ■ Outline

The SUB instruction subtracts integer, double-length integer, and real number values. *Source B* is subtracted to *Source A* and stored in the *Dest*. If the result of subtracting integer values is smaller than -32768, an underflow error occurs. If the result of subtracting double-length integer values is smaller than -2147483648, an underflow error occurs.

### ■ Format

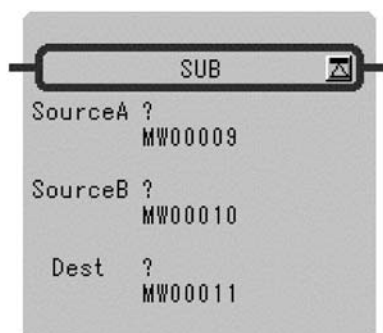

Symbol: SUB  
 Full Name: Subtract  
 Category: MATH  
 Icon: 

## ■ Parameter

Parameter Name	Setting
Source A	<ul style="list-style-type: none"> <li>• Any integer type, double-length integer type and real number type register</li> <li>• Any integer type, double-length integer type and real number type register with subscript</li> <li>• Subscript register</li> <li>• Constant</li> </ul>
Source B	<ul style="list-style-type: none"> <li>• Any integer type, double-length integer type and real number type register</li> <li>• Any integer type, double-length integer type and real number type register with subscript</li> <li>• Subscript register</li> <li>• Constant</li> </ul>
Dest	<ul style="list-style-type: none"> <li>• Any integer type, double-length integer type and real number type register (except for # and C registers)</li> <li>• Any integer type, double-length integer type and real number type register with subscript (except for # and C registers)</li> <li>• Subscript register</li> </ul>

1

## ■ Program Example

### Subtraction of Integer Type Values

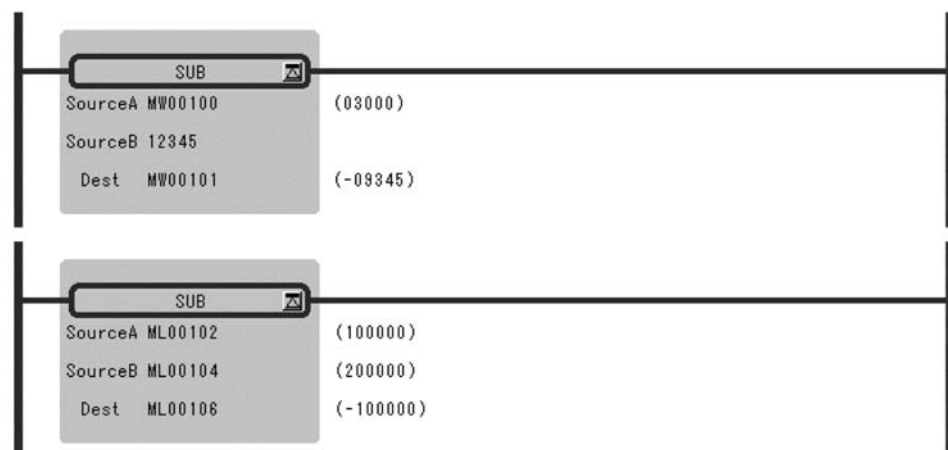

## Subtraction of Real Number Type Values

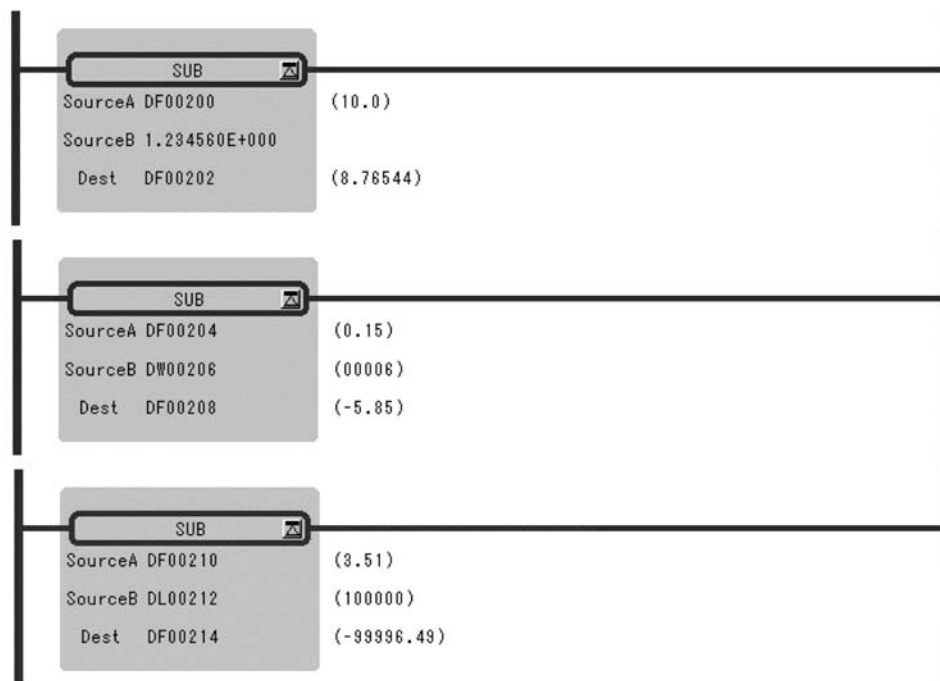

In the case of double-length integer type values, an operation using addition and subtraction instructions (+, -, ++, --) will be a 32-bit operation. However, when an addition or subtraction instruction is used in a remainder operation (where a multiplication instruction (×) is the immediately preceding instruction and a division instruction (÷) is the immediately subsequent instruction), the operation will be a 64-bit operation.

## 1.2.5 EXTENDED SUBTRACTION Instruction (SUBX)

### ■ Outline

The SUBX instruction subtracts integer values. No operation error occurs, even if the operation results in an underflow.

### ■ Format

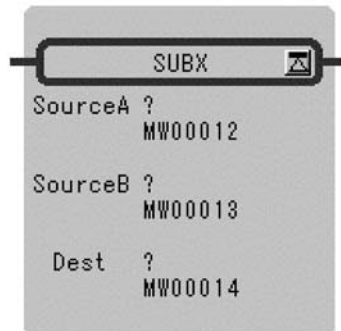

Symbol: SUBX  
 Full Name: Expanded Subtract  
 Category: MATH  
 Icon: 

1

### ■ Parameter

Parameter Name	Setting
Source A	<ul style="list-style-type: none"> <li>• Any integer type and double-length integer type register</li> <li>• Any integer type and double-length integer type register with subscript</li> <li>• Subscript register</li> <li>• Constant</li> </ul>
Source B	<ul style="list-style-type: none"> <li>• Any integer type and double-length integer type register</li> <li>• Any integer type and double-length integer type register with subscript</li> <li>• Subscript register</li> <li>• Constant</li> </ul>
Dest	<ul style="list-style-type: none"> <li>• Any integer type and double-length integer type register (except for # and C registers)</li> <li>• Any integer type and double-length integer type register with subscript (except for # and C registers)</li> <li>• Subscript register</li> </ul>

### ■ Program Example

This instruction is used in cases where it is desirable that operation errors do not occur in the subtraction of integer type values.

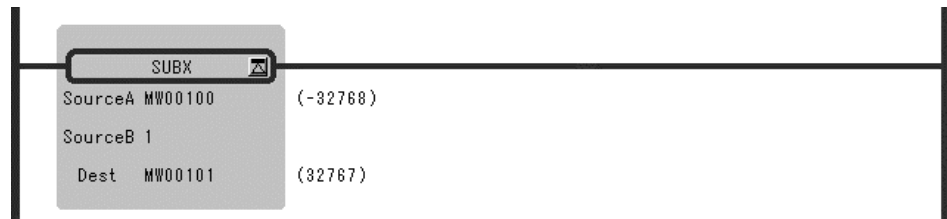

In the case of double-length integer type values, an operation using addition and subtraction instructions (+, -, ++, --) will be a 32-bit operation. However, when an addition or subtraction instruction is used in a remainder correction operation (where a multiplication instruction (×) is the immediately preceding instruction and a division instruction (÷) is the immediately subsequent instruction), the operation will be a 64-bit operation.

## 1.2.6 MULTIPLICATION Instruction (MUL)

### ■ Outline

The MUL instruction multiplies integer, double-length integer, and real number values. *Source B* is multiplied to *Source A* and stored in the *Dest*.

### ■ Format

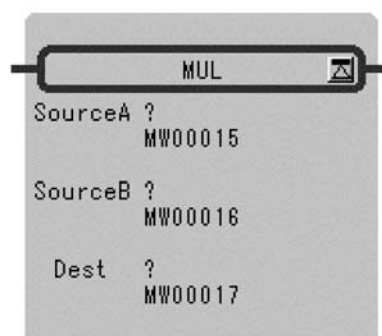

Symbol: MUL  
 Full Name: Multiply  
 Category: MATH  
 Icon:

## ■ Parameter

Parameter Name	Setting
Source A	<ul style="list-style-type: none"> <li>• Any integer type, double-length integer type and real number type register</li> <li>• Any integer type, double-length integer type and real number type register with subscript</li> <li>• Subscript register</li> <li>• Constant</li> </ul>
Source B	<ul style="list-style-type: none"> <li>• Any integer type, double-length integer type and real number type register</li> <li>• Any integer type, double-length integer type and real number type register with subscript</li> <li>• Subscript register</li> <li>• Constant</li> </ul>
Dest	<ul style="list-style-type: none"> <li>• Any integer type, double-length integer type and real number type register (except for # and C registers)</li> <li>• Any integer type, double-length integer type and real number type register with subscript (except for # and C registers)</li> <li>• Subscript register</li> </ul>

1

## ■ Program Example

### Multiplication of Integer Type Values

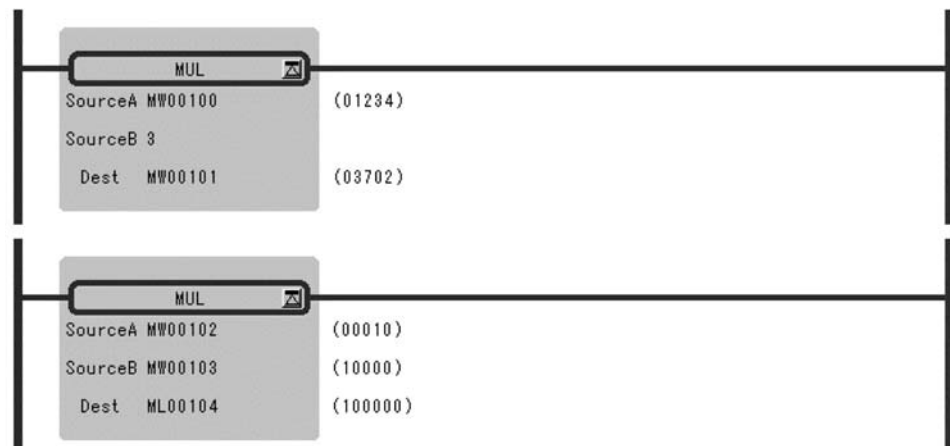

### Multiplication of Double-length Integer Type Values

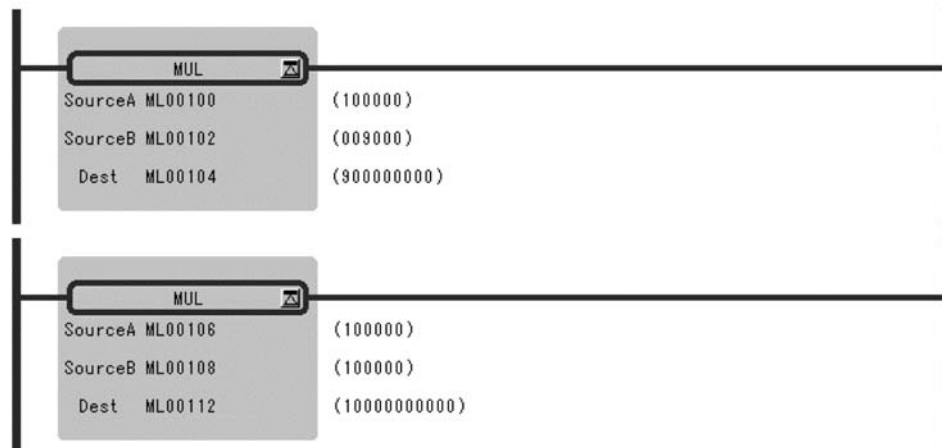

### Multiplication of Real Number Type Values

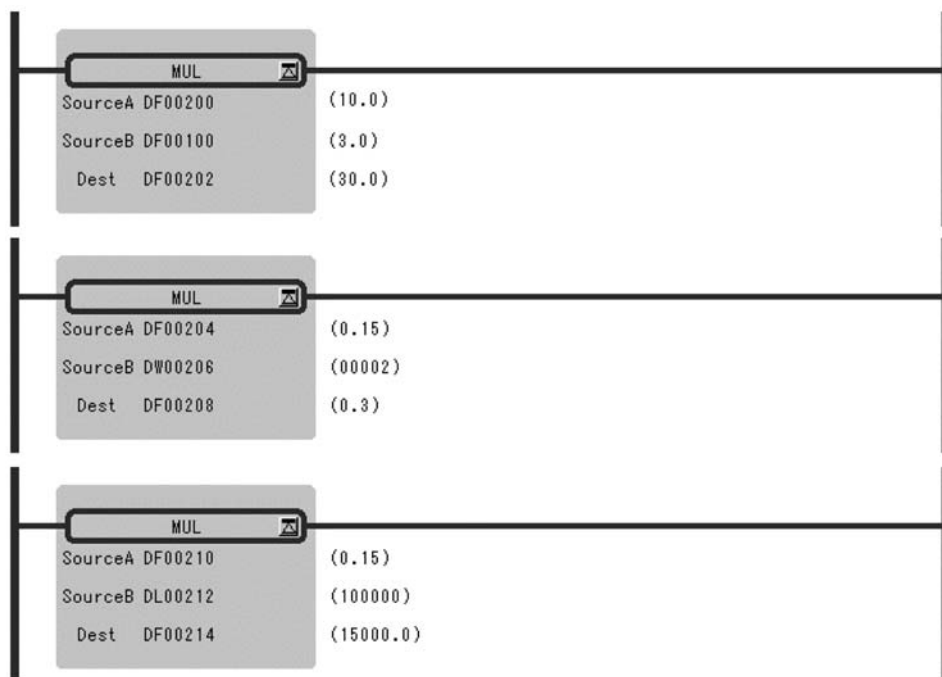

In the case of double-length integer type values, an operation using addition and subtraction instructions (+, -, ++, --) will be a 32-bit operation. However, when an addition or subtraction instruction is used in a remainder correction operation (where a multiplication instruction (×) is the immediately preceding instruction and a division instruction (÷) is the immediately subsequent instruction), the operation will be a 64-bit operation.



## 1.2.7 DIVISION Instruction (DIV)

### ■ Outline

The DIV instruction divides integer, double-length integer, and real number values. *Source A* is divided by *Source B* and stored in the *Dest*.

### ■ Format



Symbol: DIV  
 Full Name: Divide  
 Category: MATH  
 Icon: 

1

### ■ Parameter

Parameter Name	Setting
Source A	<ul style="list-style-type: none"> <li>• Any integer type, double-length integer type and real number type register</li> <li>• Any integer type, double-length integer type and real number type register with subscript</li> <li>• Subscript register</li> <li>• Constant</li> </ul>
Source B	<ul style="list-style-type: none"> <li>• Any integer type, double-length integer type and real number type register</li> <li>• Any integer type, double-length integer type and real number type register with subscript</li> <li>• Subscript register</li> <li>• Constant</li> </ul>
Dest	<ul style="list-style-type: none"> <li>• Any integer type, double-length integer type and real number type register (except for # and C registers)</li> <li>• Any integer type, double-length integer type and real number type register with subscript (except for # and C registers)</li> <li>• Subscript register</li> </ul>

■ Program Example

Division of Real Number Type Values

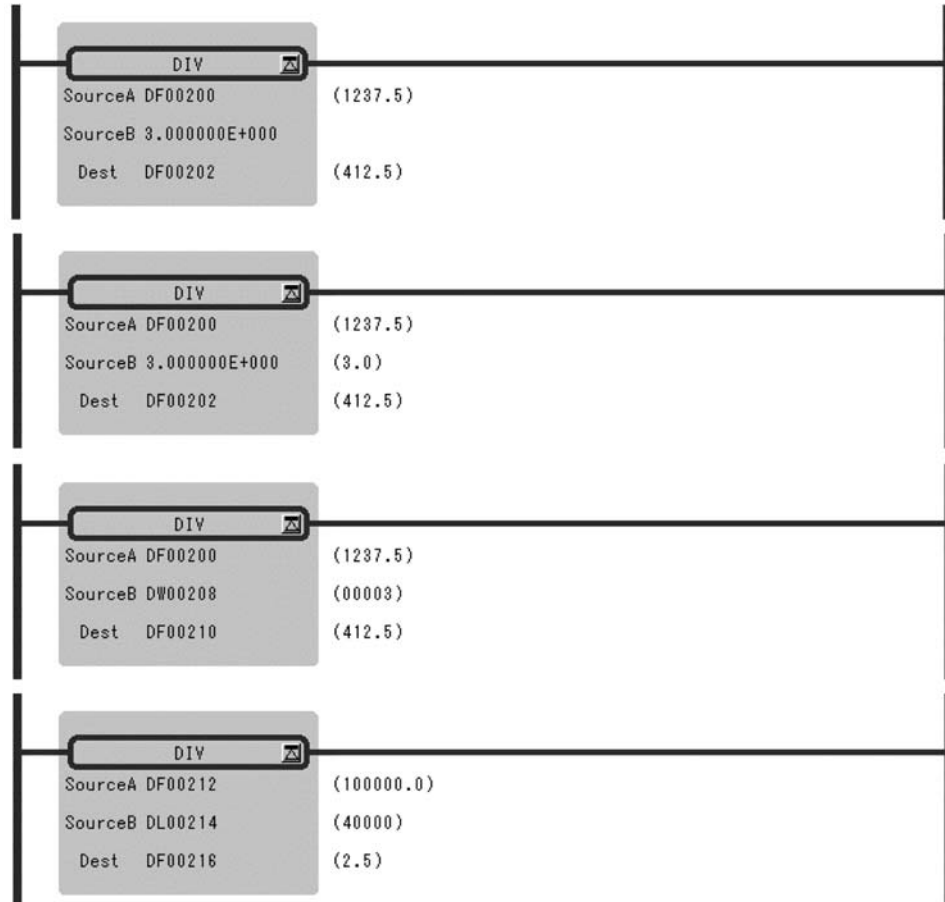



## 1.2.8 MOD Instruction (MOD)

### ■ Outline

The MOD instruction outputs the remainder of integer or double-length integer division to the *Dest*. Always execute the MOD immediately after the division instruction. If the MOD is executed somewhere else, the operation results obtained before the next entry instruction cannot be guaranteed.

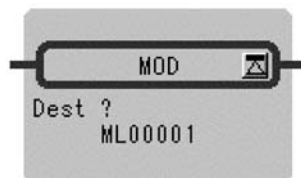
### ■ Format



Symbol: MOD  
 Full Name: Integer Remainder  
 Category: MATH  
 Icon: 

### ■ Parameter

Parameter Name	Setting
Dest	<ul style="list-style-type: none"> <li>• Any integer type and double-length integer type register (except for # and C registers)</li> <li>• Any integer type and double-length integer type register with subscript (except for # and C registers)</li> <li>• Subscript register</li> </ul>

### ■ Program Example

The quotient of an integer type division is stoned in MW00101 and the remainder is stored in MW00102.

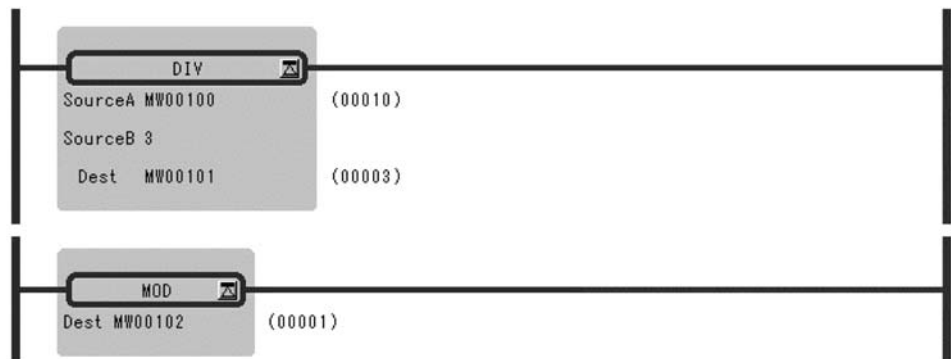

## 1.2.9 REM Instruction (REM)

### ■ Outline

The REM instruction outputs the remainder of real number division to the *Dest*. Here, the remainder refers to the remainder obtained by repeatedly subtracting the Base designated by the *Source*. Thus, the n is the number of times subtraction is repeated.

$$\text{Dest} = \text{Source} - (\text{Base} \times n) \quad (0 \leq \text{Dest} < \text{Base})$$

### ■ Format

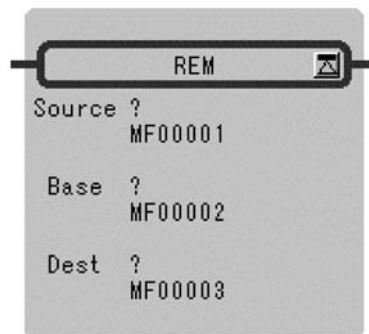

Symbol: REM  
 Full Name: Real Remainder  
 Category: MATH  
 Icon: 

### ■ Parameter

Parameter Name	Setting
Source	<ul style="list-style-type: none"> <li>Any real number type register</li> <li>Any real number type register with subscript</li> <li>Constant</li> </ul>
Base	<ul style="list-style-type: none"> <li>Any real number type register</li> <li>Any real number type register with subscript</li> <li>Constant</li> </ul>
Dest	<ul style="list-style-type: none"> <li>Any real number type register (except for # and C register)</li> <li>Any real number type register with subscript (except for # and C register)</li> </ul>

### ■ Program Example

The remainder of the division of the real number variable MF00200 by the constant value, 1.5, is determined and stored in DF00202.

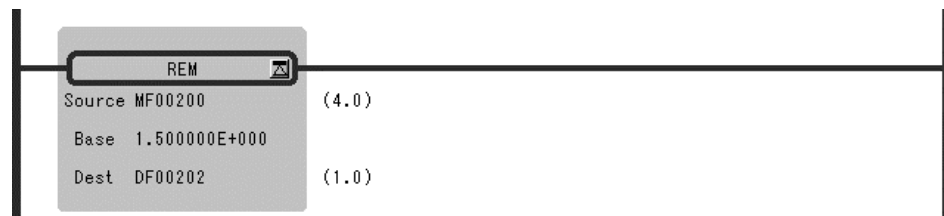

### 1.2.10 INC Instruction (INC)

■ Outline

The INC instruction adds 1 to the designated integer or double-length integer register. For integer registers, no overflow error occurs even if the result of addition exceeds 32767. Likewise, no overflow error occurs for double-length integer registers.

■ Format

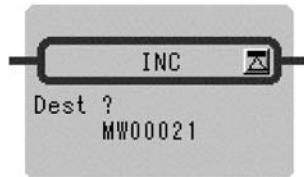

Symbol: INC  
 Full Name: Increment  
 Category: MATH  
 Icon:

■ Parameter

Parameter Name	Setting
Dest	<ul style="list-style-type: none"> <li>• Any integer type and double-length integer type register (except for # and C registers)</li> <li>• Any integer type and double-length integer type register with subscript (except for # and C registers)</li> <li>• Subscript register</li> </ul>

■ Program Example

Integer Type

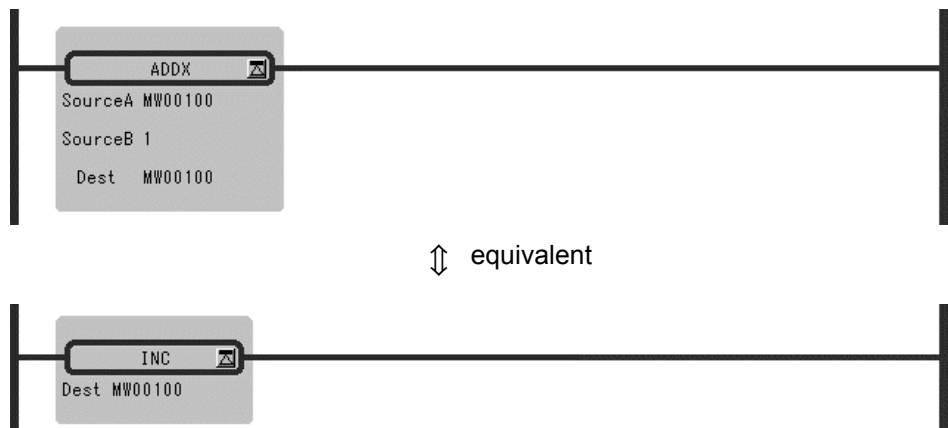

### Double-length Integer Type

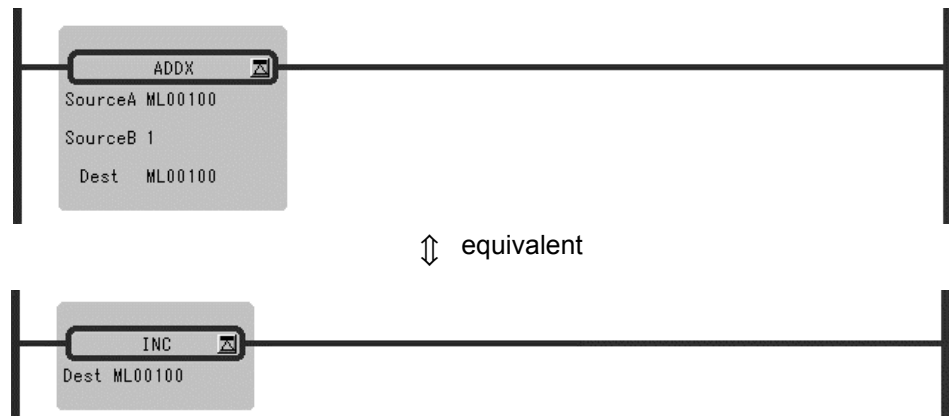



## 1.2.11 DEC Instruction (DEC)

### ■ Outline

The DEC instruction subtracts 1 from the designated integer or double-length integer register. For integer registers, no underflow error occurs even if the result of subtraction is less than -32768. Likewise, no underflow error occurs for double-length integer registers.

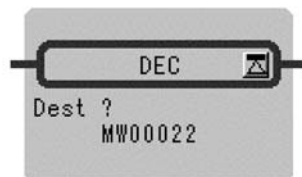
### ■ Format



Symbol: DEC  
 Full Name: Decrement  
 Category: MATH  
 Icon: 

### ■ Parameter

Parameter Name	Setting
Dest	<ul style="list-style-type: none"> <li>Any integer type and double-length integer type register (except for # and C registers)</li> <li>Any integer type and double-length integer type register with subscript (except for # and C registers)</li> <li>Subscript register</li> </ul>

## ■ Program Example

### Integer Type

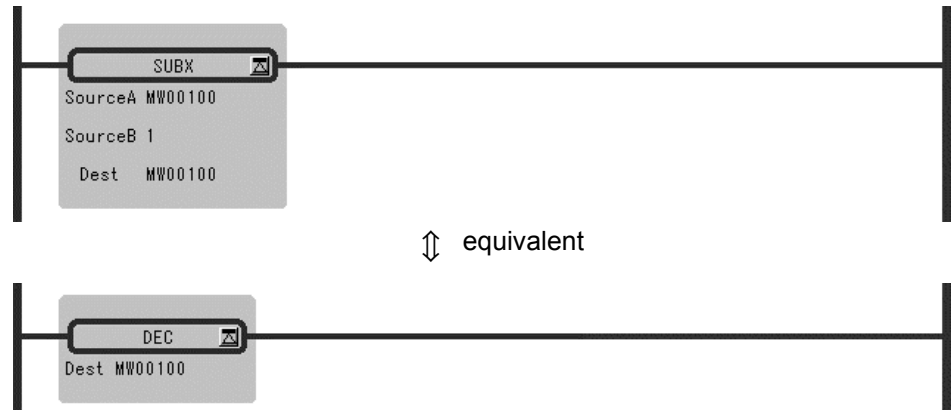

### Double-length Integer Type

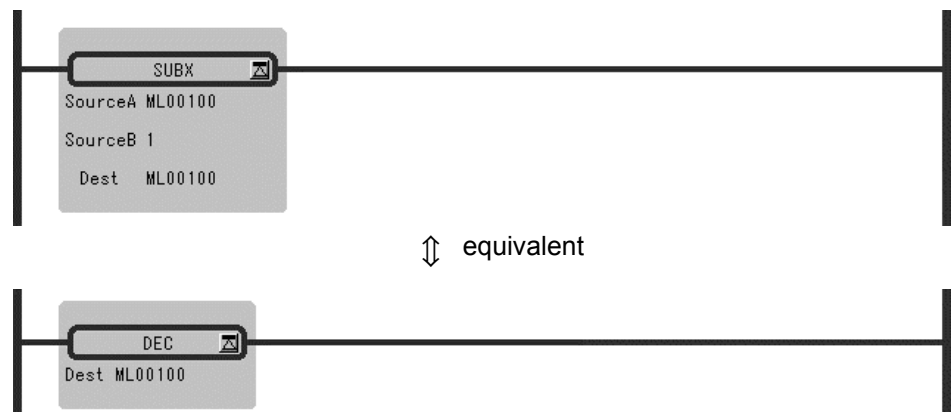

## 1.2.12 ADD TIME Instruction (TMADD)

### ■ Outline

The TMADD instruction adds one time (hours/minutes/seconds) to another time. The *Source* is added to the *Dest* and the result is stored in the *Dest*. The formats of *Source* and *Dest* are as follows.

Table 1.3 Data Format

Register Offset	Data Contents	Data Range (BCD)
0	Hours/minutes	Upper byte (hours) : 0 to 23 Lower byte (minutes) : 0 to 59
1	Seconds	0000 to 0059

If the contents of the *Dest* and *Source* and the operation result are with the appropriate ranges, the operation will be performed normally. After the operation is completed, the *[Status]* is turned OFF. If the contents of the *Dest* and *Source* are outside the data ranges, the operation is not performed. In this case, 9999H is stored in the column "second" of the *Dest*, and the *[Status]* is turned ON.

### ■ Format

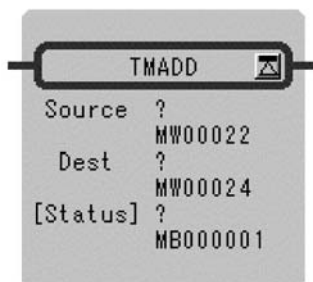

Symbol: TMADD  
Full Name: Time Add  
Category: MATH  
Icon:

### ■ Parameter

Parameter Name	Setting
Source	<ul style="list-style-type: none"> <li>Any integer type register</li> <li>Any integer type register with subscript</li> </ul>
Dest	<ul style="list-style-type: none"> <li>Any integer type register (except for # and C register)</li> <li>Any integer type register with subscript (except for # and C register)</li> </ul>
[Status]*	<ul style="list-style-type: none"> <li>Any bit type register (except for # and C register)</li> <li>Any bit type register with subscript (except for # and C register)</li> </ul>

\* Possible to omit.



## ■ Program Example

The time data in DW0000 to DW00101 is added to the time data in MW00100 to MW00101.



8 hrs 40 min 32 sec + 1 hrs 22 min 16 sec = 10 hrs 2 min 48 sec  
 (MW00100) (MW00101) (DW00000) (DW00001) (MW00100) (MW00101)

Time Data	Before Execution	After Execution
MW00100	0840H	1002H
MW00101	0032H	0048H
DW00000	0122H	0122H
DW00001	0016H	0016H

### 1.2.13 SUBTRACT TIME Instruction (TMSUB)

#### ■ Outline

The TMSUB instruction subtracts one time (hours/minutes/seconds) from another time. The *Source* is subtracted from the *Dest* and the result is stored in the *Dest*. The formats of *Source* and *Dest* are as follows.

Table 1.4 Data Format

Register Offset	Data Contents	Data Range (BCD)
0	Hours/minutes	Upper byte (hours) : 0 to 23 Lower byte (minutes) : 0 to 59
1	Seconds	0000 to 0059

If the contents of the *Dest* and *Source* are with the appropriate ranges, the operation will be performed normally. After the operation is completed, the *[Status]* is turned OFF. If the contents of the *Dest* and *Source* are outside the data ranges, the operation is not performed. In this case, 9999H is stored in the column "second" of the *Dest*, and the *[Status]* is turned ON.

■ Format



Symbol: TMSUB  
 Full Name: Time Sub  
 Category: MATH  
 Icon:

■ Parameter

Parameter Name	Setting
Source	<ul style="list-style-type: none"> <li>Any integer type register</li> <li>Any integer type register with subscript</li> </ul>
Dest	<ul style="list-style-type: none"> <li>Any integer type register (except for # and C register)</li> <li>Any integer type register with subscript (except for # and C register)</li> </ul>
[Status]*	<ul style="list-style-type: none"> <li>Any bit type register (except for # and C register)</li> <li>Any bit type register with subscript (except for # and C register)</li> </ul>

\* Possible to omit.

■ Program Example

The time data in DW0000 to DW0001 is subtracted to the time data in MW00100 to MW00101.



8 hrs 40 min 32sec + 1 hrs 22 min 16 sec = 7 hrs 18 min 16 sec  
 (MW00100) (MW00101) (DW00000) (DW00001) (MW00100) (MW00101)

Time Data	Before Execution	After Execution
MW00100	0840H	0718H
MW00101	0032H	0016H
DW00000	0122H	0122H
DW00001	0016H	0016H

## 1.2.14 SPEND TIME Instruction (SPEND)

### ■ Outline

The SPEND instruction subtracts one time (year/month/day/hours/minutes/seconds) from another time data and calculates the elapsed time. *Source* is subtracted from the *Dest* and the result is stored in the *Dest*. The formats of *Source* and *Dest* are as follows.

Table 1.5 Source Format

Register Offset	Data Contents	Data Range (BCD)	I/O
0	Year (BCD)	0000 to 0099	IN
1	Month/Day (BCD)	Upper byte (month) : 1 to 12 Lower byte (day) : 1 to 31	IN
2	Hours/minutes (BCD)	Upper byte (hours) : 0 to 23 Lower byte (minutes) : 0 to 59	IN
3	Seconds (BCD)	0000 to 0059	IN

Table 1.6 Dest Format

Register Offset	Data Contents	Data Range (BCD)	I/O
0	Year (BCD)	0000 to 0099	IN/OUT
1	Month/Day (BCD)	Upper byte (month) : 1 to 12 Lower byte (day) : 1 to 31	IN/OUT
2	Hours/minutes (BCD)	Upper byte (hours) : 0 to 23 Lower byte (minutes) : 0 to 59	IN/OUT
3	Seconds (BCD)	0000 to 0059	IN/OUT
4	Total number of seconds	This is the number of records which is obtained by converting Year/Month/Day/Hour/Minutes/Seconds, which is the results of operations, to seconds. (Double-length integer)	IN/OUT
5			

If the contents of the *Dest*, *Source* and the operation result are with the appropriate ranges, the operation will be performed normally. After the operation is completed, *[Status]* is turned OFF. If the contents of the *Dest* and *Source* are outside the data ranges, the operation is not performed. In this case, 9999H is stored in the column "second" of the *Dest*, and the *[Status]* is turned ON.

### ■ Format



Symbol: SPEND  
 Full Name: Time Spend  
 Category: MATH  
 Icon:

■ Parameter

Parameter Name	Setting
Source	<ul style="list-style-type: none"> <li>Any integer type register</li> <li>Any integer type register with subscript</li> </ul>
Dest	<ul style="list-style-type: none"> <li>Any integer type register (except for # and C register)</li> <li>Any integer type register with subscript (except for # and C register)</li> </ul>
[Status]*	<ul style="list-style-type: none"> <li>Any bit type register (except for # and C register)</li> <li>Any bit type register with subscript (except for # and C register)</li> </ul>

\* Possible to omit.

■ Program Example

The time elapsed from the time data in MW00100 to MW00103 to the time data in DW00000 to DW00003 is stored to MW00100 - MW00105.



98 yrs 5 mos 11 days 15 hrs 4 min 47 sec - 98 yrs 4 mos 2 days 8 hrs 13 min 8 sec  
 (MW00100) (MW00101) (MW00102) (MW00103) (DW00000) (DW00101) (DW00102) (DW00103)  
 = 0 yrs 39 days 6 hrs 51 min 39 sec  
 (MW00100) (MW00101) (MW00102) (MW00103)

Time Data	Before Execution	After Execution
MW00100	H0098	H0000
MW00101	H0511	H0039
MW00102	H1504	H0651
MW00103	H0047	H0039
MW00104	-	3394299 (Decimal)
MW00105	-	
DW00000	H0098	H0098
DW00001	H0402	H0402
DW00002	H0813	H0813
DW00003	H0008	H0008

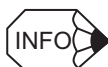

In the operation results, the year is counted as 365 days and a leap year is not taken into consideration. Also, the number of months is not counted. It is counted in days.

## 1.2.15 SIGN INVERSION Instruction (INV)

### ■ Outline

The INV instruction inverts the sign of the contents of the *Source*, and the result is stored in the *Dest*.

### ■ Format

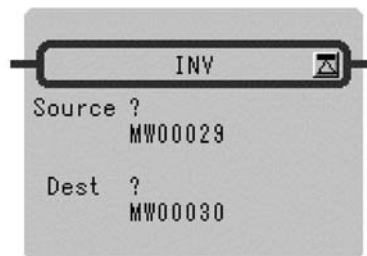

Symbol: INV  
 Full Name: Inverse  
 Category: MATH  
 Icon: 

1

### ■ Parameter

Parameter Name	Setting
Source	<ul style="list-style-type: none"> <li>• Any integer type, double-length integer type and real number type register</li> <li>• Any integer type, double-length integer type and real number type register with subscript</li> <li>• Subscript register</li> <li>• Constant</li> </ul>
Dest	<ul style="list-style-type: none"> <li>• Any integer type, double-length integer type and real number type register (except for # and C registers)</li> <li>• Any integer type, double-length integer type and real number type register with subscript (except for # and C registers)</li> <li>• Subscript register</li> </ul>

### ■ Program Example

#### Integer Type Data

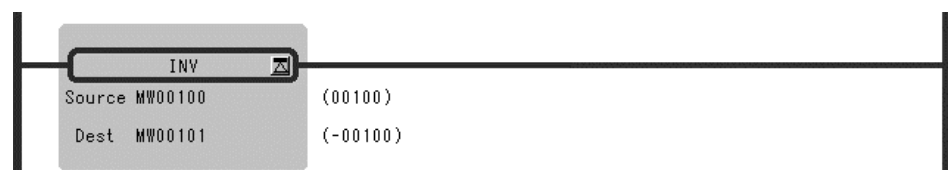

### Double-length Integer Type Data

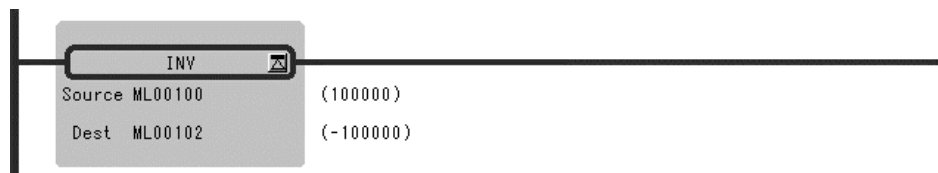

### Real Number Type Data



## 1.2.16 1'S COMPLEMENT Instruction (COM)

### ■ Outline

The COM instruction determines the 1's complement of the contents of the *Source* and the result is stored in the *Dest*.

### ■ Format

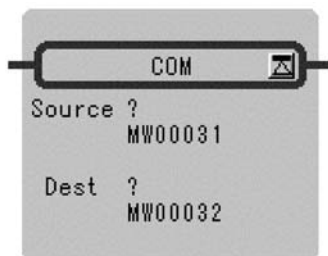

Symbol: COM  
 Full Name: Complement  
 Category: MATH  
 Icon:

### ■ Parameter

Parameter Name	Setting
Source	<ul style="list-style-type: none"> <li>Any integer type and double-length integer type register</li> <li>Any integer type and double-length integer type register with subscript</li> <li>Subscript register</li> </ul>
Dest	<ul style="list-style-type: none"> <li>Any integer type and double-length integer type register (except for # and C registers)</li> <li>Any integer type and double-length integer type register with subscript (except for # and C registers)</li> <li>Subscript register</li> </ul>

■ Program Example

Integer Type Data



1

Double-length Integer Type Data

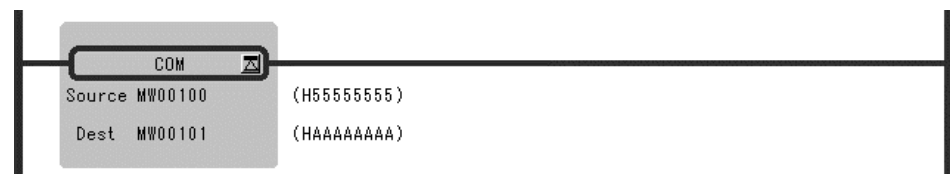

1.2.17 ABSOLUTE VALUE CONVERSION Instruction (ABS)

■ Outline

The ABS instruction determines the absolute value of the contents of the *Source* and the result is stored in the *Dest*.

■ Format

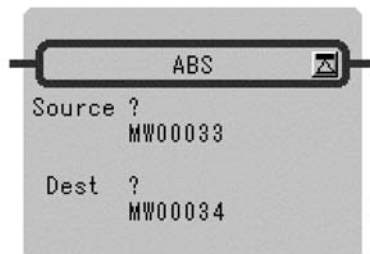

Symbol: ABS  
 Full Name: Absolute  
 Category: MATH  
 Icon:

■ Parameter

Parameter Name	Setting
Source	<ul style="list-style-type: none"> <li>Any integer type, double-length integer type and real number type register</li> <li>Any integer type, double-length integer type and real number type register with subscript</li> <li>Subscript register</li> </ul>
Dest	<ul style="list-style-type: none"> <li>Any integer type, double-length integer type and real number type register (except for # and C registers)</li> <li>Any integer type, double-length integer type and real number type register with subscript (except for # and C registers)</li> <li>Subscript register</li> </ul>

### ■ Program Example

#### Integer Type Data

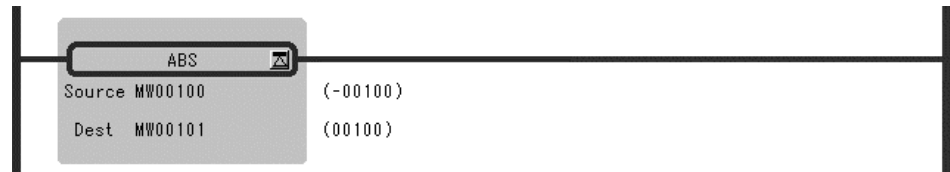

#### Double-length Integer Type Data

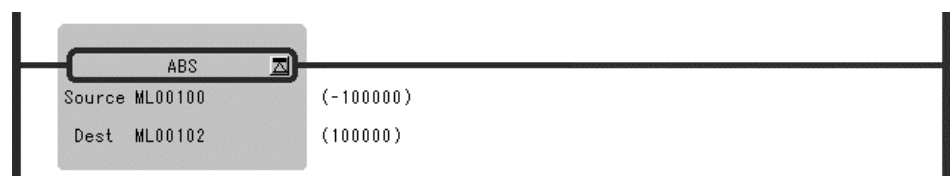

#### Real Number Type Data



## 1.2.18 BINARY CONVERSION Instruction (BIN)

### ■ Outline

The BIN instruction converts a binary coded decimal (BCD) value in the *Source* and into a binary value (binary conversion) and the result is stored in the *Dest*. If the 4-digit BCD value in the integer is *abcd*, the output value (*Dest*) of the BIN instruction can be determined by the following formula:

$$\text{Dest} = (a \times 1000) + (b \times 100) + (c \times 10) + d$$

Although the above formula is applicable even if the value in the *Source* is not in BCD notation (e.g. 123FH), correct results are obtained in such cases.



■ Format

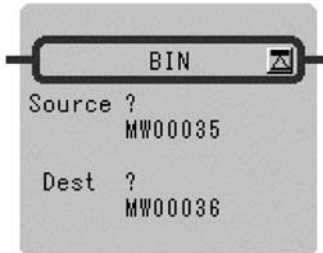

Symbol: BIN  
 Full Name: Convert to Binary  
 Category: MATH  
 Icon: 

1

■ Parameter

Parameter Name	Setting
Source	<ul style="list-style-type: none"> <li>Any integer type and double-length integer type register</li> <li>Any integer type and double-length integer type register with subscript</li> <li>Subscript register</li> </ul>
Dest	<ul style="list-style-type: none"> <li>Any integer type and double-length integer type register (except for # and C registers)</li> <li>Any integer type and double-length integer type register with subscript (except for # and C registers)</li> <li>Subscript register</li> </ul>

■ Program Example

Integer Type Data



Double-length Integer Data

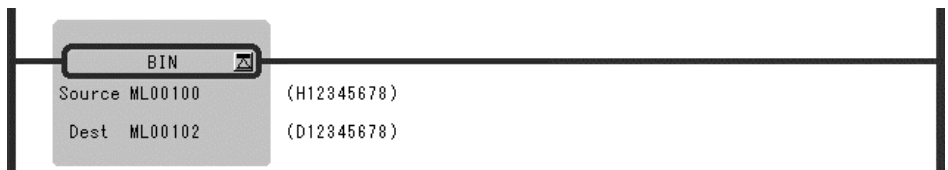

## 1.2.19 BCD CONVERSION Instruction (BCD)

### ■ Outline

The BCD instruction converts a binary value in the *Source* into a BCD value (BCD conversion) and the result is stored in the *Dest*. If the 4 - digit decimal value in the *Source* is abcd, the output value (*Dest*) of the BCD instruction can be determined by the following formula:

$$\text{Dest} = (a \times 4096) + (b \times 256) + (c \times 16) + d$$

Although the above formula is applicable even if the value in the *Source* cannot be expressed in BCD notation (e.g. numbers greater than 9999 or negative numbers), correct results are obtained in such cases.

### ■ Format

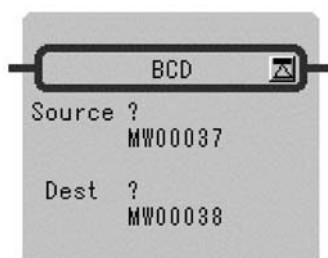

Symbol: BCD

Full Name: Convert to BCD

Category: MATH

Icon: 

### ■ Parameter

Parameter Name	Setting
Source	<ul style="list-style-type: none"> <li>• Any integer type and double-length integer type register</li> <li>• Any integer type and double-length integer type register with subscript</li> <li>• Subscript register</li> </ul>
Dest	<ul style="list-style-type: none"> <li>• Any integer type and double-length integer type register (except for # and C registers)</li> <li>• Any integer type and double-length integer type register with subscript (except for # and C registers)</li> <li>• Subscript register</li> </ul>

## ■ Program Example

### Integer Type Data



1

### Double-length Integer Type Data

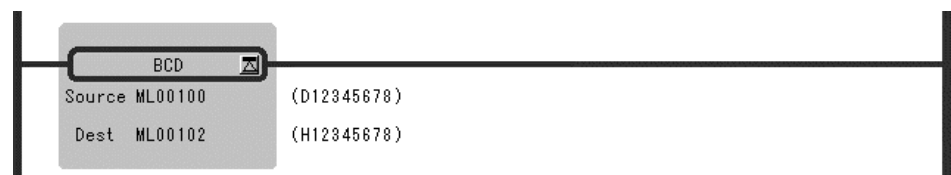

## 1.2.20 PARITY CONVERSION Instruction (PARITY)

### ■ Outline

The PARITY instruction counts the number of bits in the *Source* that are set to ON (or 1) and the result is stored in the *Dest*.

### ■ Format



Symbol: PARITY  
 Full Name: Count ON Bit  
 Category: MATH  
 Icon: 

### ■ Parameter

Parameter Name	Setting
Source	<ul style="list-style-type: none"> <li>Any integer type and double-length integer type register</li> <li>Any integer type and double-length integer type register with subscript</li> <li>Subscript register</li> </ul>
Dest	<ul style="list-style-type: none"> <li>Any integer type and double-length integer type register (except for # and C registers)</li> <li>Any integer type and double-length integer type register with subscript (except for # and C registers)</li> <li>Subscript register</li> </ul>

### ■ Program Example

#### Integer Type Data



#### Double-length Integer Type Data

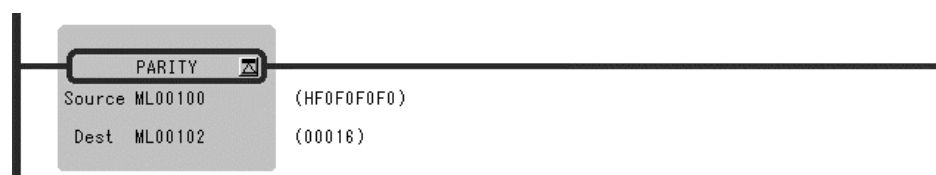

## 1.2.21 ASCII CONVERSION Instruction (ASCII)

### ■ Outline

The ASCII instruction converts the specified characters (character string in *Source*) to the corresponding ASCII character codes and stores them in the designated *Dest*. It recognizes uppercase and lowercase characters separately.

The first character is stored in the lower-place byte of the first word and the second character is stored in the higher-place byte of the first word. Other characters are stored in the same way. If the number of characters is odd, the higher-place byte of the last word in the storage register is set to 0. Up to 32 characters can be entered.

### ■ Format

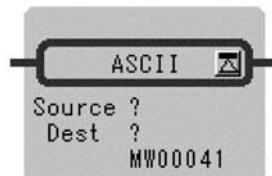

Symbol: ASCII  
 Full Name: Convert Character to ASCII  
 Category: MATH  
 Icon:

### ■ Parameter

Parameter Name	Setting
Source	• ASCII characters
Dest	• Any integer type register (except for # and C register) • Any integer type register with subscript (except for # and C register)

### ■ Program Example

The character string "ABCD" is stored in MW00100 to MW00101.



	Upper	Lower	
MW00100	42H ('B')	41H ('A')	MW00100 = 4241H
MW00101	44H ('D')	43H ('C')	MW00101 = 4443H

1.2.22 ASCII CONVERSION 2 Instruction (BINASC)

The character string "ABCDEFGG" is stored in MW00100 to MW00103.

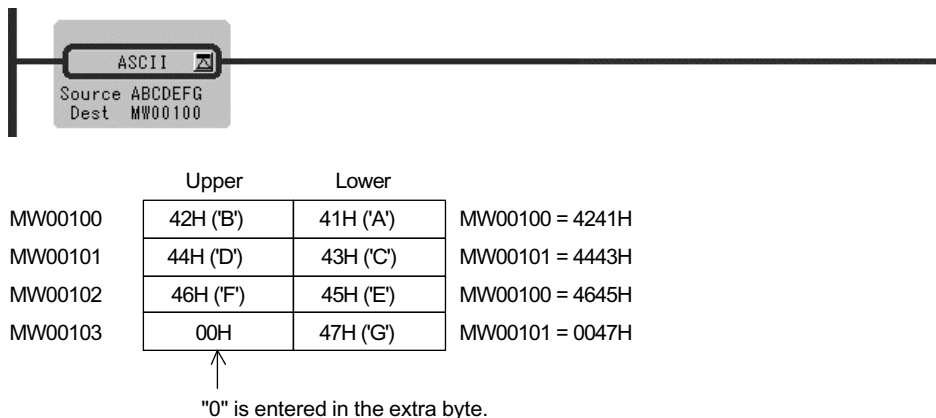

1.2.22 ASCII CONVERSION 2 Instruction (BINASC)

■ Outline

The BINASC instruction converts the 16-bit binary data stored in the *Source* into four-digit hexadecimal ASCII character codes and stores them in the designated *Dest* (two words).

■ Format



Symbol: BINASC  
 Full Name: Convert Binary to ASCII  
 Category: MATH  
 Icon:

■ Parameter

Parameter Name	Setting
Source	<ul style="list-style-type: none"> <li>Any integer type register</li> <li>Any integer type register with subscript</li> <li>Constant</li> </ul>
Dest	<ul style="list-style-type: none"> <li>Any integer type register (except for # and C register)</li> <li>Any integer type register with subscript (except for # and C register)</li> </ul>

■ Program Example

The "1234H" binary stored in MW00200 is converted to a for digit hexadecimal ASCII code and stored in MW00100 to MW00101.

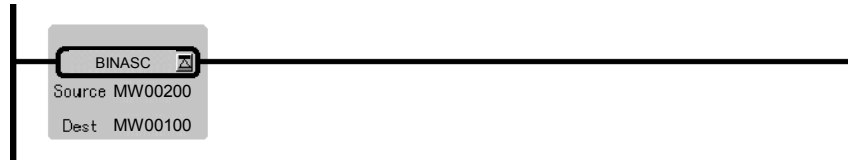

1

	Upper	Lower	
MW00100	32H ('2')	31H ('1')	MW00100 = 3231H
MW00101	34H ('4')	33H ('3')	MW00101 = 3433H

1.2.23 ASCII CONVERSION 3 Instruction (ASCBIN)

■ Outline

The ASCBIN instruction converts four-digit hexadecimal ASCII character codes in the *Source* into 16-bit binary data and stores it in the *Dest*.

■ Format



Symbol : ASCBIN  
 Full Name : Convert ASCII to Binary  
 Category : MATH  
 Icon : 

■ Parameter

Parameter Name	Setting
Source	<ul style="list-style-type: none"> <li>Any integer type register</li> <li>Any integer type register with subscript</li> </ul>
Dest	<ul style="list-style-type: none"> <li>Any integer type register (except for # and C register)</li> <li>Any integer type register with subscript (except for # and C register)</li> </ul>

■ Program Example

The four-byte ASCII code stored in MW00100 to MW00101 is converted to two-byte binary data, and the result is stored in MW00200.

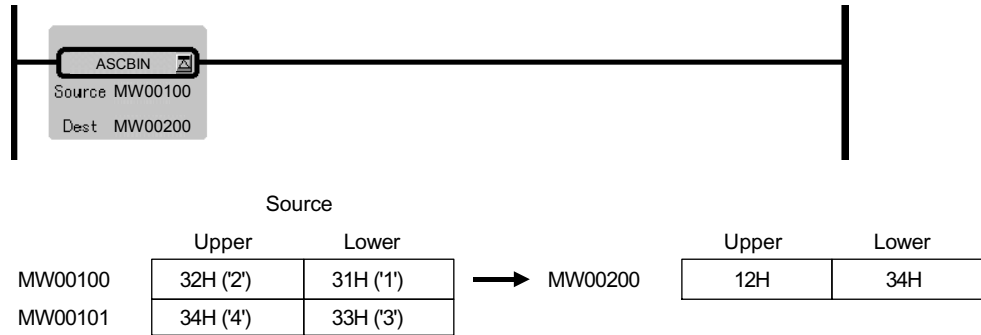



## 1.3 Logical Operation/Comparison Instructions

### 1.3.1 AND Instruction (AND)

#### ■ Outline

The AND instruction outputs the logical product (AND) of *Source A* and *Source B* to the *Dest*.

Table 1.7 1 bit Truth Table for the Logical Product

Source A	Source B	Dest
0	0	0
0	1	0
1	0	0
1	1	1

#### ■ Format

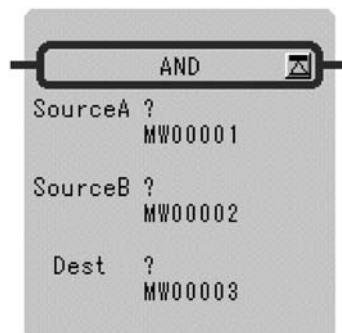

Symbol: AND  
 Full Name: AND  
 Category: LOGIC  
 Icon: 

#### ■ Parameter

Parameter Name	Setting
Source A	<ul style="list-style-type: none"> <li>• Any integer type and double-length integer type register</li> <li>• Any integer type and double-length integer type register with subscript</li> <li>• Subscript register</li> <li>• Constant</li> </ul>
Source B	<ul style="list-style-type: none"> <li>• Any integer type and double-length integer type register</li> <li>• Any integer type and double-length integer type register with subscript</li> <li>• Subscript register</li> <li>• Constant</li> </ul>
Dest	<ul style="list-style-type: none"> <li>• Any integer type and double-length integer type register (except for # and C register)</li> <li>• Any integer type and double-length integer type register with subscript (except for # and C register)</li> <li>• Subscript register</li> </ul>

■ Program Example

The logical product of MW000100 and a constant is stored in MW000101.

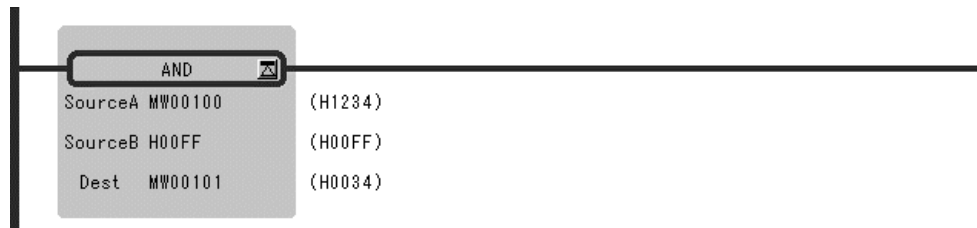

1.3.2 OR Instruction (OR)

■ Outline

The OR instruction outputs the logical sum (OR) of *Source A* and *Source B* to the *Dest*.

Table 1.8 1 bit Truth Table for the Logical Sum

Source A	Source B	Dest
0	0	0
0	1	1
1	0	1
1	1	1

■ Format

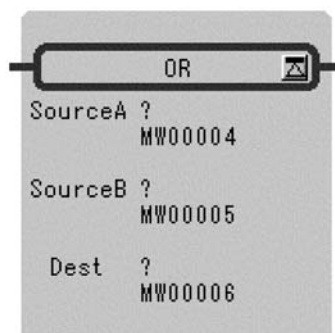

Symbol: OR  
 Full Name: Inclusive OR  
 Category: LOGIC  
 Icon: 

## Parameter

Parameter Name	Setting
Source A	<ul style="list-style-type: none"> <li>Any integer type and double-length integer type register</li> <li>Any integer type and double-length integer type register with subscript</li> <li>Subscript register</li> <li>Constant</li> </ul>
Source B	<ul style="list-style-type: none"> <li>Any integer type and double-length integer type register</li> <li>Any integer type and double-length integer type register with subscript</li> <li>Subscript register</li> <li>Constant</li> </ul>
Dest	<ul style="list-style-type: none"> <li>Any integer type and double-length integer type register (except for # and C register)</li> <li>Any integer type and double-length integer type register with subscript (except for # and C register)</li> <li>Subscript register</li> </ul>

1

## Program Example

The logical sum of MW00100 and a constant is stored in MW00101.



### 1.3.3 XOR Instruction (XOR)

#### Outline

The XOR instruction outputs the exclusive logical sum (XOR) of *Source A* and *Source B* to the *Dest*.

Table 1.9 1 bit Truth Table for the Exclusive Logical Sum

Source A	Source B	Dest
0	0	0
0	1	1
1	0	1
1	1	0

■ Format

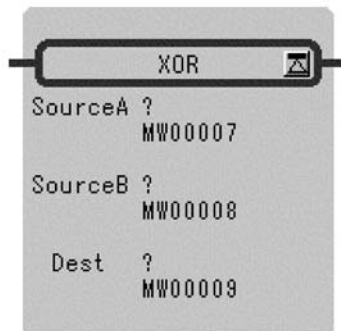

Symbol: XOR  
 Full Name: Exclusive OR  
 Category: LOGIC  
 Icon:

■ Parameter

Parameter Name	Setting
Source A	<ul style="list-style-type: none"> <li>• Any integer type and double-length integer type register</li> <li>• Any integer type and double-length integer type register with subscript</li> <li>• Subscript register</li> <li>• Constant</li> </ul>
Source B	<ul style="list-style-type: none"> <li>• Any integer type and double-length integer type register</li> <li>• Any integer type and double-length integer type register with subscript</li> <li>• Subscript register</li> <li>• Constant</li> </ul>
Dest	<ul style="list-style-type: none"> <li>• Any integer type and double-length integer type register (except for # and C register)</li> <li>• Any integer type and double-length integer type register with subscript (except for # and C register)</li> <li>• Subscript register</li> </ul>

■ Program Example

The exclusive logical sum of MW00100 and a constant is stored in MW00101.

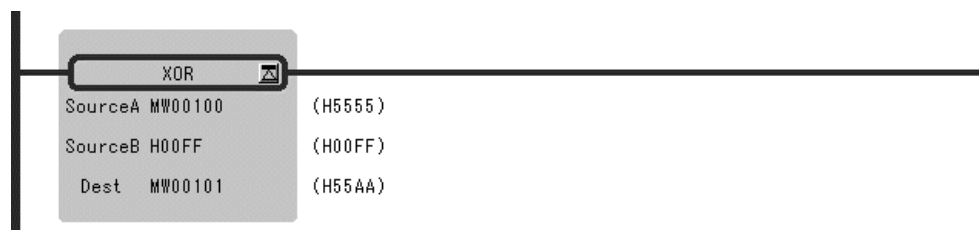

### 1.3.4 Comparison Instruction (<)

#### ■ Outline

This instruction compare *Source A* with *Source B* and stores the comparison result in the bit output (the result is ON when true).

#### ■ Format

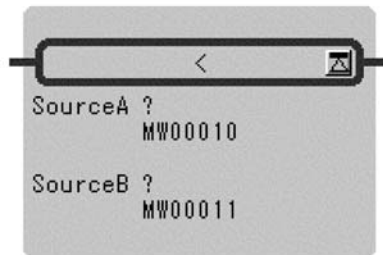

Symbol: <  
 Full Name: Less Than (A < B)  
 Category: LOGIC  
 Icon:

#### ■ Parameter

Parameter Name	Setting
Source A	<ul style="list-style-type: none"> <li>• Any integer type, double-length integer type and real number type register</li> <li>• Any integer type, double-length integer type and real number type register with subscript</li> <li>• Subscript register</li> <li>• Constant</li> </ul>
Source B	<ul style="list-style-type: none"> <li>• Any integer type, double-length integer type and real number type register</li> <li>• Any integer type, double-length integer type and real number type register with subscript</li> <li>• Subscript register</li> <li>• Constant</li> </ul>

#### ■ Program Example

If the value of MW00100 is smaller than 100, after the instructions operation are executed.

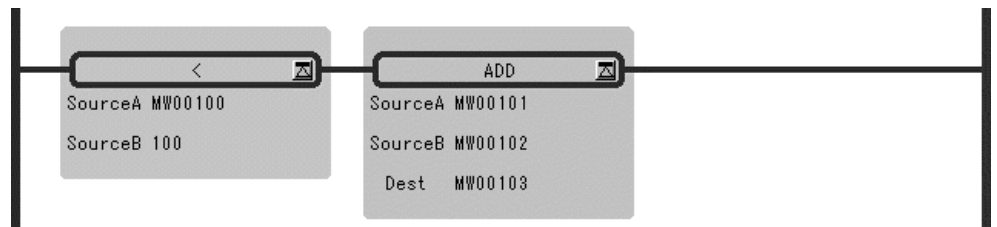

### 1.3.5 Comparison Instruction (<=)

#### ■ Outline

This instruction compare *Source A* with *Source B* and stores the comparison result in the bit output (the result is ON when true).

#### ■ Format

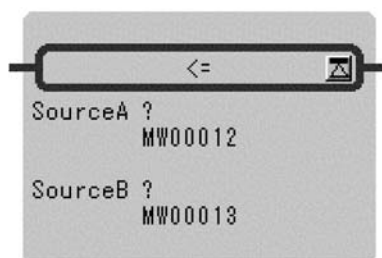

Symbol: <=  
 Full Name: Less Than or Equal (A <= B)  
 Category: LOGIC  
 Icon:

#### ■ Parameter

Parameter Name	Setting
Source A	<ul style="list-style-type: none"> <li>Any integer type, double-length integer type and real number type register</li> <li>Any integer type, double-length integer type and real number type register with subscript</li> <li>Subscript register</li> <li>Constant</li> </ul>
Source B	<ul style="list-style-type: none"> <li>Any integer type, double-length integer type and real number type register</li> <li>Any integer type, double-length integer type and real number type register with subscript</li> <li>Subscript register</li> <li>Constant</li> </ul>

#### ■ Program Example

If the value of MW00100 is under 100, after the instructions operation are executed.

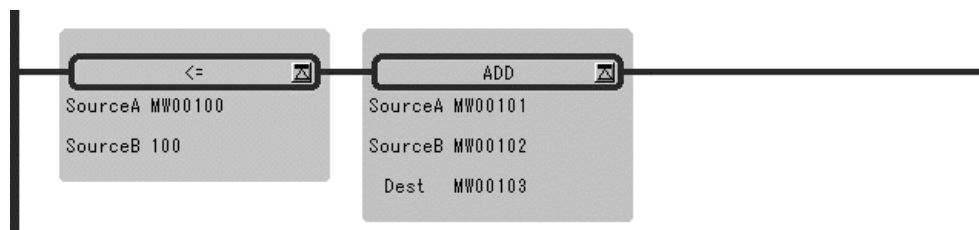

### 1.3.6 Comparison Instruction (=)

#### ■ Outline

This instruction compare *Source A* with *Source B* and stores the comparison result in the bit output (the result is ON when true).

#### ■ Format

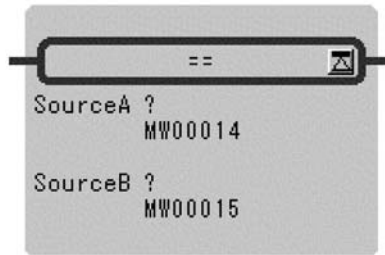

Symbol: =  
 Full Name: Equal (A = B)  
 Category: LOGIC  
 Icon:

1

#### ■ Parameter

Parameter Name	Setting
Source A	<ul style="list-style-type: none"> <li>• Any integer type, double-length integer type and real number type register</li> <li>• Any integer type, double-length integer type and real number type register with subscript</li> <li>• Subscript register</li> <li>• Constant</li> </ul>
Source B	<ul style="list-style-type: none"> <li>• Any integer type, double-length integer type and real number type register</li> <li>• Any integer type, double-length integer type and real number type register with subscript</li> <li>• Subscript register</li> <li>• Constant</li> </ul>

#### ■ Program Example

If the value of MW00100 is equal to 100, after the instructions operation are executed.

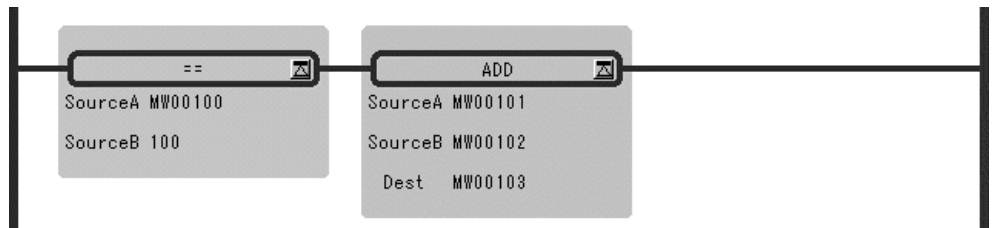

### 1.3.7 Comparison Instruction (!=)

#### ■ Outline

This instruction compare *Source A* with *Source B* and stores the comparison result in the bit output (the result is ON when true).

#### ■ Format

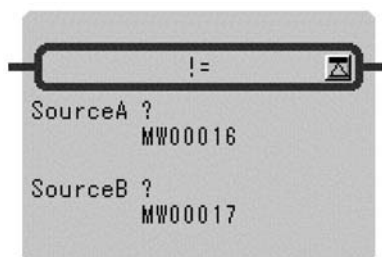

Symbol: !=  
 Full Name: Not Equal (A! = B)  
 Category: LOGIC  
 Icon:

#### ■ Parameter

Parameter Name	Setting
Source A	<ul style="list-style-type: none"> <li>Any integer type, double-length integer type and real number type register</li> <li>Any integer type, double-length integer type and real number type register with subscript</li> <li>Subscript register</li> <li>Constant</li> </ul>
Source B	<ul style="list-style-type: none"> <li>Any integer type, double-length integer type and real number type register</li> <li>Any integer type, double-length integer type and real number type register with subscript</li> <li>Subscript register</li> <li>Constant</li> </ul>

#### ■ Program Example

If the value of MW00100 is not equal to 100, after the instructions operation are executed.

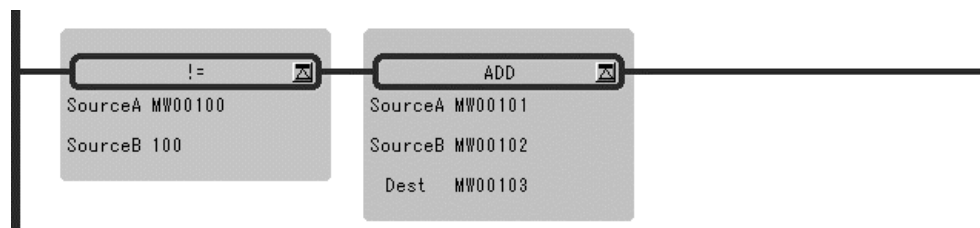



### 1.3.8 Comparison Instruction (>=)

#### ■ Outline

This instruction compare *Source A* with *Source B* and stores the comparison result in the bit output (the result is ON when true).

#### ■ Format

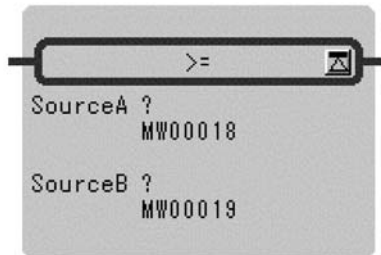

Symbol: >=  
 Full Name: Greater Than or Equal (A >= B)  
 Category: LOGIC  
 Icon:

1

#### ■ Parameter

Parameter Name	Setting
Source A	<ul style="list-style-type: none"> <li>• Any integer type, double-length integer type and real number type register</li> <li>• Any integer type, double-length integer type and real number type register with subscript</li> <li>• Subscript register</li> <li>• Constant</li> </ul>
Source B	<ul style="list-style-type: none"> <li>• Any integer type, double-length integer type and real number type register</li> <li>• Any integer type, double-length integer type and real number type register with subscript</li> <li>• Subscript register</li> <li>• Constant</li> </ul>

#### ■ Program Example

If the value of MW00100 is above 100, after the instructions operation are executed.

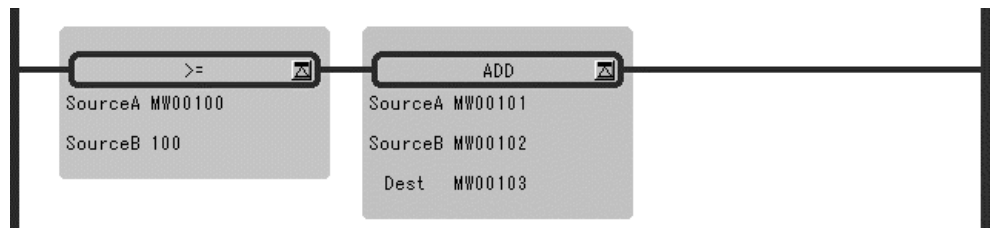

## 1.3.9 Comparison Instruction (>)

### ■ Outline

This instruction compare *Source A* with *Source B* and stores the comparison result in the bit output (the result is ON when true).

### ■ Format

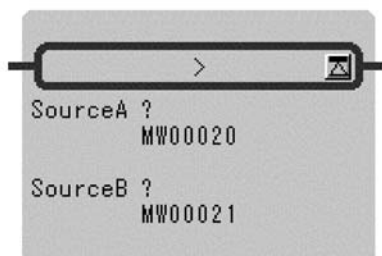

Symbol: >

Full Name: Greater Than (A > B)

Category: LOGIC

Icon:

### ■ Parameter

Parameter Name	Setting
Source A	<ul style="list-style-type: none"> <li>• Any integer type, double-length integer type and real number type register</li> <li>• Any integer type, double-length integer type and real number type register with subscript</li> <li>• Subscript register</li> <li>• Constant</li> </ul>
Source B	<ul style="list-style-type: none"> <li>• Any integer type, double-length integer type and real number type register</li> <li>• Any integer type, double-length integer type and real number type register with subscript</li> <li>• Subscript register</li> <li>• Constant</li> </ul>

### ■ Program Example

If the value of MW00100 is bigger than 100, after the instructions operation are executed.

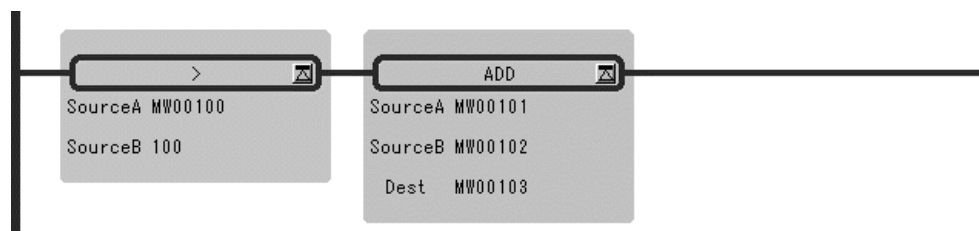

### 1.3.10 RANGE CHECK Instruction (RCHK)

#### ■ Outline

The RCHK instruction checks whether the input value in the *Input* is within the *Lower Limit* and *Upper Limit*, and then outputs the result to the bit output. The contents of the *Input* are retained.

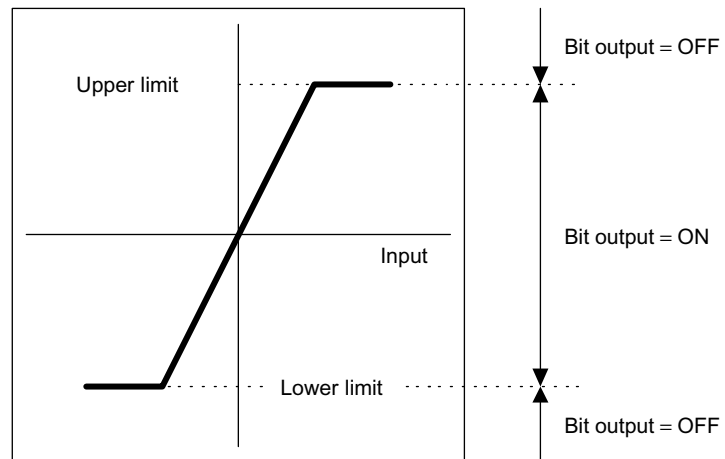

- If the Input value (*Input*) is greater than the *Lower Limit* and less than the *Upper Limit*, the result (Bit Output) = ON.
- In the cases other than the above, the result (Bit Output) = OFF.

#### ■ Format

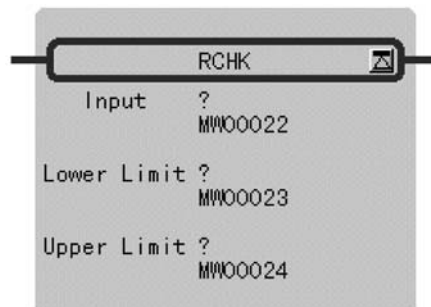

Symbol: RCHK  
 Full Name: Range Check  
 Category: LOGIC  
 Icon:

■ Parameter

Parameter Name	Setting
Input	<ul style="list-style-type: none"> <li>• Any integer type, double-length integer type and real number type register</li> <li>• Any integer type, double-length integer type and real number type register with subscript</li> <li>• Subscript register</li> <li>• Constant</li> </ul>
Lower Limit	<ul style="list-style-type: none"> <li>• Any integer type, double-length integer type and real number type register</li> <li>• Any integer type, double-length integer type and real number type register with subscript</li> <li>• Subscript register</li> <li>• Constant</li> </ul>
Upper Limit	<ul style="list-style-type: none"> <li>• Any integer type, double-length integer type and real number type register</li> <li>• Any integer type, double-length integer type and real number type register with subscript</li> <li>• Subscript register</li> <li>• Constant</li> </ul>

■ Program Example

Integer Type Data



Input (MW00100)	Output (DB000000)
-1000 > MW00100	OFF
-1000 <= MW00100 <= 1000	ON
MW00100 >1000	OFF

## Double-length Integer Type Data

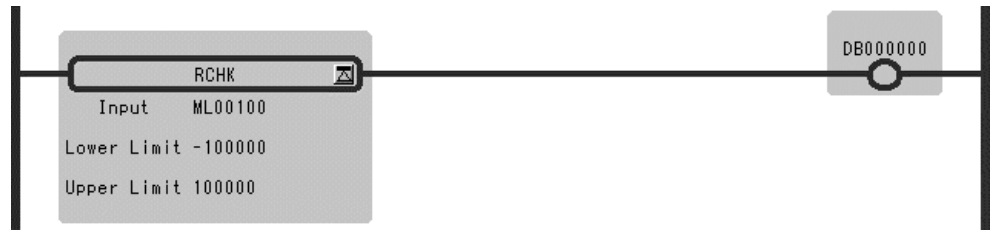

Input (ML00100)	Output (DB000000)
$-100000 > \text{ML00100}$	OFF
$-100000 \leq \text{ML00100} \leq 100000$	ON
$\text{ML00100} > 100000$	OFF

## Real Number Type Data



Input (DF00100)	Output (DB000000)
$-10.5 > \text{DF00100}$	OFF
$-10.5 \leq \text{DF00100} \leq 10.5$	ON
$\text{DF00100} > 10.5$	OFF

## 1.4 Program Control Instructions

### 1.4.1 SUB-DRAWING CALL Instruction (SEE)

#### ■ Outline

The SEE instruction is used to call a sub-drawing from a drawing or to call a sub-sub-drawing from a sub-drawing. Calling is not possible between drawings of different types. For example, SEE H01 cannot be specified in DWG.L.

#### ■ Format



Symbol: SEE  
 Full Name: Call Program  
 Category: CONTROL  
 Icon: 

#### ■ Parameter

Parameter Name	Setting
Name	Program Name

#### ■ Program Example

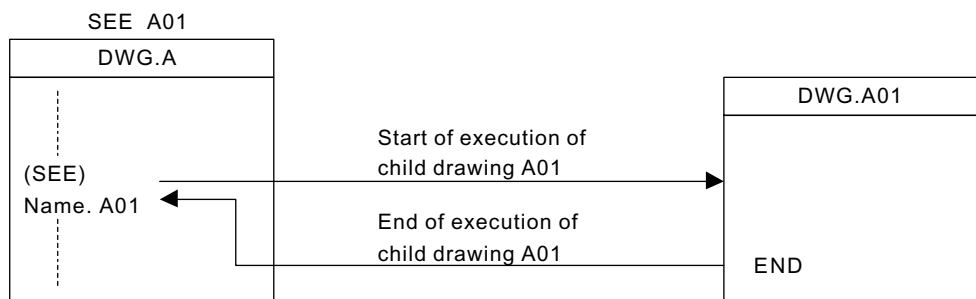



## 1.4.2 MOTION PROGRAM CALL Instruction (MSEE)

### ■ Outline

MSEE instruction is used in referring to the motion program.  
 This instruction can be referred only from DWGH.  
 It is not possible to refer from DWGA and DWGL.

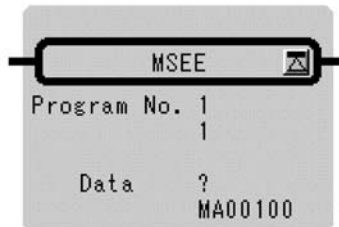
### ■ Format



Symbol: MSEE  
 Full Name: Call Motion Program  
 Category: MOTION  
 Icon: 

### ■ Parameter

Parameter Name	Setting
Program No. (Motion Program No.)	<ul style="list-style-type: none"> <li>• Direct specification: Numerical value of 1-256</li> <li>• Indirect specification: Register of integer type</li> </ul>
Dest (Work Register)	<ul style="list-style-type: none"> <li>• Register address (except for # and C registers)</li> </ul>

### ■ Program Example

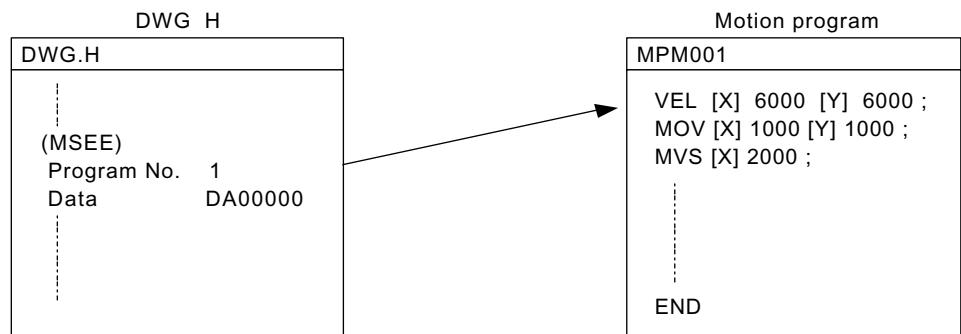



### 1.4.3 FUNCTION CALL Instruction (FUNC)

#### ■ Outline

The FUNC instruction is used to call a user function or system function from a drawing, sub-drawing, or user function. The user function to be called must be defined in advance. (System functions do not have to be defined by the user because they are already defined by the system.)

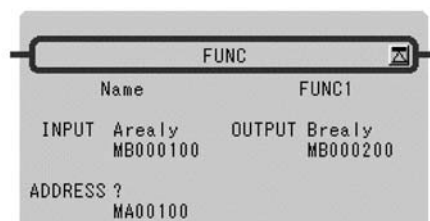
#### ■ Format



Symbol: FUNC  
 Full Name: User Function  
 Category: CONTROL  
 Icon: 

#### ■ Parameter

Parameter Name	Setting
Name	Program name
INPUT	Input parameter (the data type depends on function definition)
ADRESS	Address parameter (Address type register)
OUTPUT	Output parameter (the data type depends on function definition)



The forms of parameter input and output are shown below.

Input Data Form	Input Designation	Description
Bit Input	B-VAL	Designates the output to be of a bit type. The bit type data become the input to the function.
Integer Type Input	I-VAL	Designates the input to be of an integer type. The contents (integer data) of the register with the designated number become the input to the function.
	I-REG	Designates the input to be the contents of an integer type register. The number of the integer type register is designated when referencing the function. The contents (integer data) of the register with the designated number become the input to the function.
Double-length Integer Type Input	L-VAL	Designates the input to be of a double-length integer type register. When reference the function, the contents (double-length integer data) of the register with the designated number become the input to the function.
	L-REG	Designates the input to be the contents of a double-length integer type register. When reference the function, the contents (double-length integer data) of the register with the designated number become the input to the function.
Real Number Type Input	F-VAL	Designates the input to be of a real number type. The contents (real number data) of the register with the designated number become the input to the function.
	F-REG	Designates the input to be the contents of a real number type register. The number of the real number type register is designated when referencing the function. The contents (real number data) of the register with the designated number become the input to the function.
Address Input	–	Hands over the address of the designated register (an arbitrary integer register) to the function. Only 1 input is allowed in the case of a user function.

### ■ Program Example

Name		F30	
INPUT1	MB000000	OUTPUT1	OB000000
INPUT2	IW0010	OUTPUT2	MW00020
INPUT3	MB000001	OUTPUT3	MB000021
INPUT4	ML00011	OUTPUT4	ML00201
ADRESS	MA00100		

### 1.4.4 DIRECT INPUT STRING Instruction (INS)

#### ■ Outline

The INS instruction continuously performs direct input to a single module according to the contents of a previously-set parameter table. INS can only be used for LIO modules.

#### ■ Format

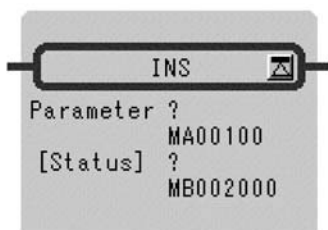

Symbol : INS  
 Full Name : Direct Input String  
 Category : CONTROL  
 Icon :

#### ■ Parameter

Parameter Name	Setting
Parameter	<ul style="list-style-type: none"> <li>• Register address (except for # and C registers)</li> <li>• Register address with subscript</li> </ul>
[Status]*	<ul style="list-style-type: none"> <li>• Any bit type register (except for # and C registers)</li> <li>• Any bit type register with subscript</li> </ul>

\* Possible to omit.

Table 1.10 INS Instruction Parameter/Data

ADR	Type	Symbol	Name	Specifications	Input or Output
0	W	RSSEL	Module designation 1	Designation of module for performing input<For details refer to (1) and (2) below>	IN
1	W	MDSEL	Module designation 2		IN
2	W	STS	Status	Output of a bit equivalence of the status for each word input	OUT
3	W	N	Number of words	Designation of number of continuous input words	IN
4	W	ID1	Input data 1	If there is an error in the output of input data, 0 is stored	OUT
⋮	⋮	⋮	⋮		⋮
N+3	W	IDN	Input data N		OUT

#### Method of Setting RSSEL

Designates the rack/slot where the target module is mounted.

Hexadecimal expression: xxyyH

xx = rack number (01H ≤ xx ≤ 04H)

yy = slot number (00H ≤ yy ≤ 0DH)



The rack number = 1, slot number = 3 with fixation in MP930

### Method of Setting MDSEL

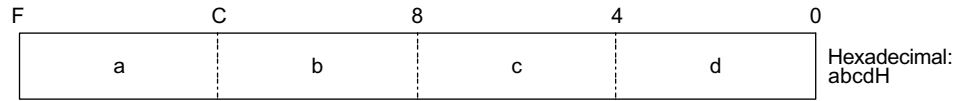

- a: Input module type
- b: Rack number ( $1 \leq b \leq 4$ )
- c: Slot number ( $1 \leq c \leq 9$ )
- d: Data offset ( $0 \leq d \leq 7$ )
- 0: Discrete input module
- 1: Register input module

1



The input module type = 0, rack number = 1, slot number = 3, data offset = 0 with fixation in MP930

### ■ Program Example

Data input from LIO mounted at rack 2, slot 4.

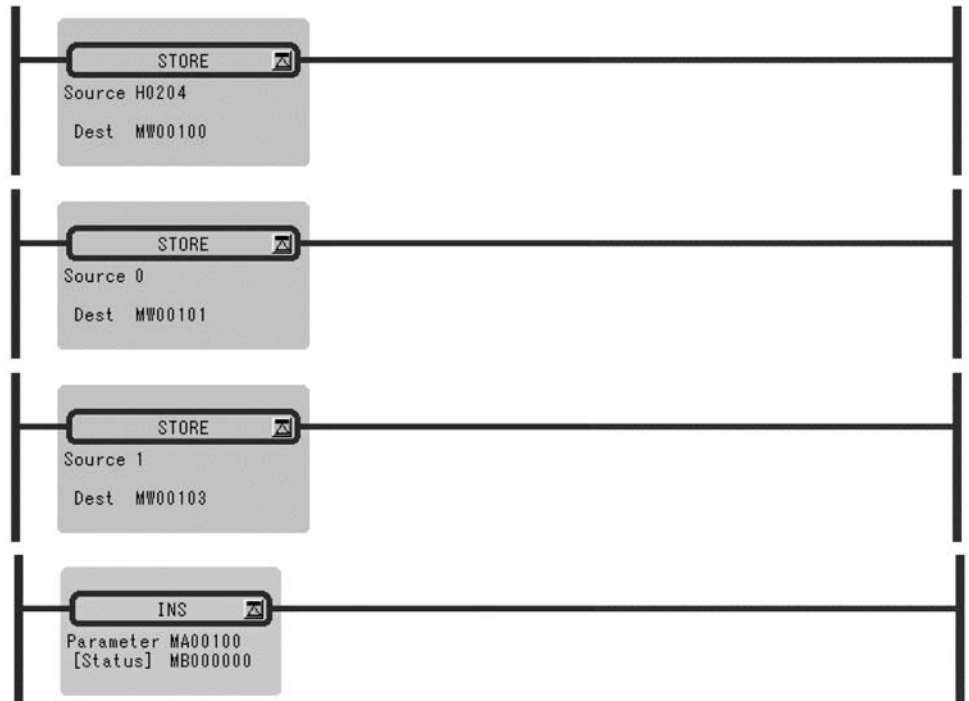

### 1.4.5 DIRECT OUTPUT STRING Instruction (OUTS)

■ Outline

The OUTS instruction continuously performs direct output to a single module according to the contents of a previously-set parameter table. OUTS can only be used for LIO modules.

■ Format

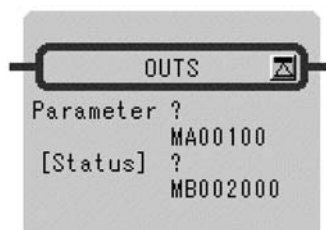

Symbol: OUTS  
 Full Name: Direct Output String  
 Category: CONTROL  
 Icon:

■ Parameter

Parameter Name	Setting
Parameter	<ul style="list-style-type: none"> <li>• Register address (except for # and C registers)</li> <li>• Register address with subscript</li> </ul>
[Status]*	<ul style="list-style-type: none"> <li>• Any bit type register (except for # and C registers)</li> <li>• Any bit type register with subscript</li> </ul>

\* Possible to omit.

Table 1.11 OUTS Instruction Parameter/Data

ADR	Type	Symbol	Name	Specifications	Input or Output
0	W	RSSEL	Module designation 1	Designation of module for performing output*	IN
1	W	MDSEL	Module designation 2		IN
2	W	STS	Status	Output of a bit equivalence of the status for each word output	OUT
3	W	N	Number of words	Designation of number of words output continuously	IN
4	W	OD1	Output data 1	Setting output data	IN
•	•	•	•		•
•	•	•	•		•
N+3	W	ODN	Output data N		IN

\* Method of setting RSSEL and N (number of words) is the same as for INS.

## ■ Program Example

Two words output to LIO-01 mounted at rack 3, slot 10.

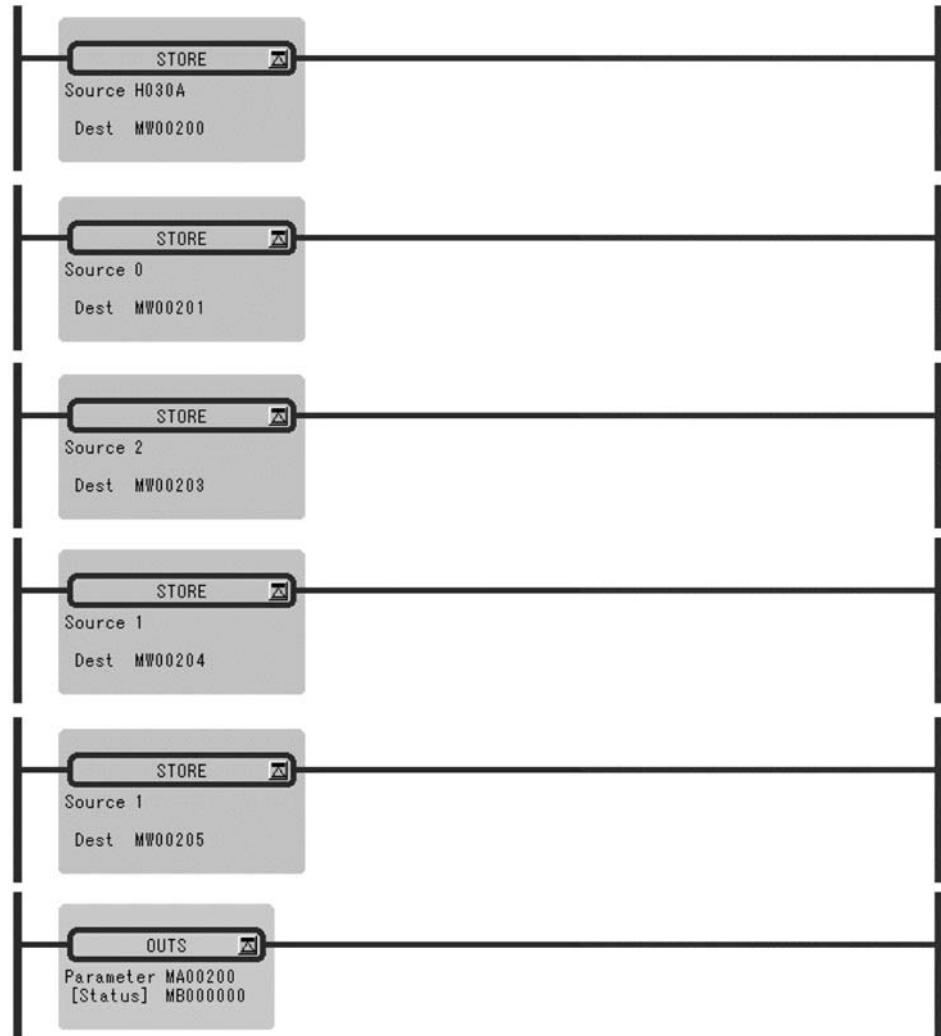

Two outputs will be done by using the OUTS instruction because local I/O is allocated by default for MP930.

## 1.4.6 EXTENSION PROGRAM CALL Instruction (XCALL)

### ■ Outline

The XCALL instruction is used to call an extension program. Extension programs are table format programs. Although a plurality of XCALL instructions may be used in one drawing, the same extension program cannot be called more than once.

### ■ Format

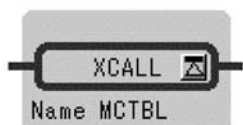

Symbol: XCALL  
 Full Name: Call Extended Program  
 Category: CONTROL  
 Icon: 

### ■ Parameter

Parameter Name	Setting
Name	MCTBL: Constant table (M register) IOTBL: I/O conversion table ILKTBL: Interlock table ASMTBL: Parts composition table

### ■ Program Example

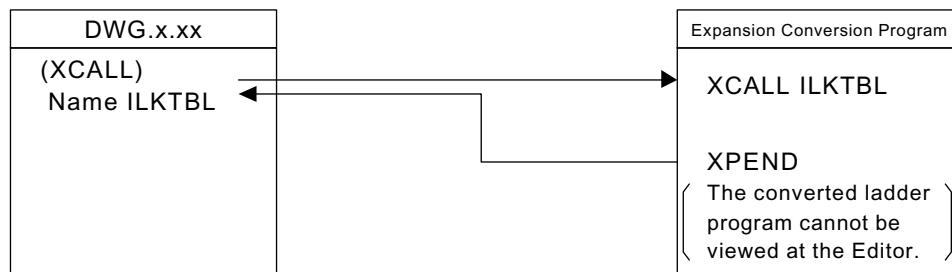

## 1.4.7 WHILE Instruction (WHILE, END\_WHILE)



### ■ Outline

Instruction between WHILE and END\_WHILE is repeatedly executed as long as the condition specified by WHILE instruction is satisfied. When the condition is no longer satisfied, instruction sequence is not executed and the program proceeds with the instruction immediately after END\_WHILE.

### ■ Format

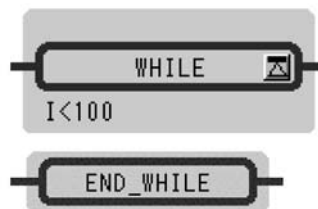
- At instruction development display ON



Symbol: WHILE  
END\_WHILE  
Full Name: While Do  
End of While  
Category: CONTROL  
Icon: , 

- At instruction development display OFF

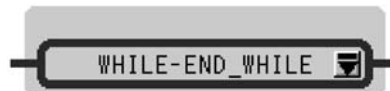

Symbol: WHILE-END\_WHILE  
Full Name: While Do and  
End of While  
Category: CONTROL  
Icon: 

### ■ Parameter

Parameter Name	Setting
Conditional Expression	Description by Expression

### ■ Program Example

The total for 100 registers, from MW00100 to MW00199, is stored in MW00200.

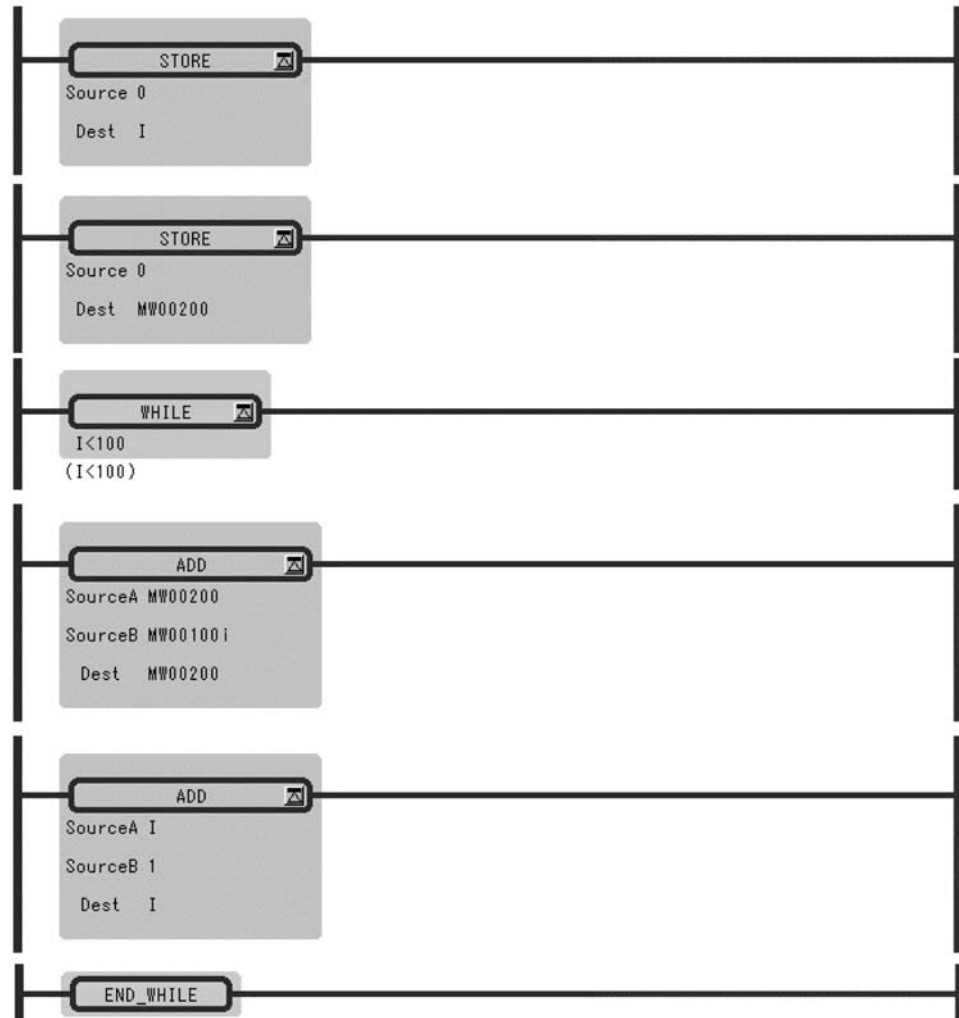



## 1.4.8 IF Instruction (IF, END\_IF)

### ■ Outline

If the conditional expression in the IF instruction is approved, the instruction sequence between IF and END\_IF is executed. If the conditional expression in the IF instruction is not approved, the instruction sequence between IF and END\_IF is not executed.

### ■ Format

- At instruction development display ON

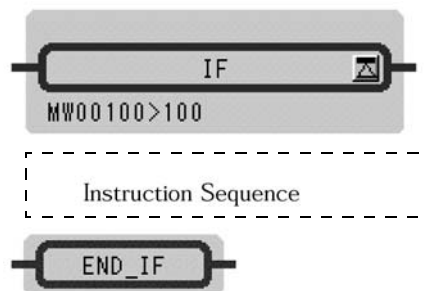

Symbol: IF  
 END\_IF  
 Full Name: If Then  
 End of If  
 Category: CONTROL  
 Icon: IF, END\_IF

- At instruction development display OFF



Symbol: IF-END\_IF  
 Full Name: IF Then and  
 End of If  
 Category: CONTROL  
 Icon: IF /END

### ■ Parameter

Parameter Name	Setting
Conditional Expression	Description by Expression

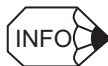

1. Eight IF instructions can be nested.
2. If an instruction is defined after a contact, this instruction is regarded as an IF instruction and included in the nest.

■ Program Example

If MB000108 is ON, MW00201 is added to MW00200, and MW00201 is incremented.

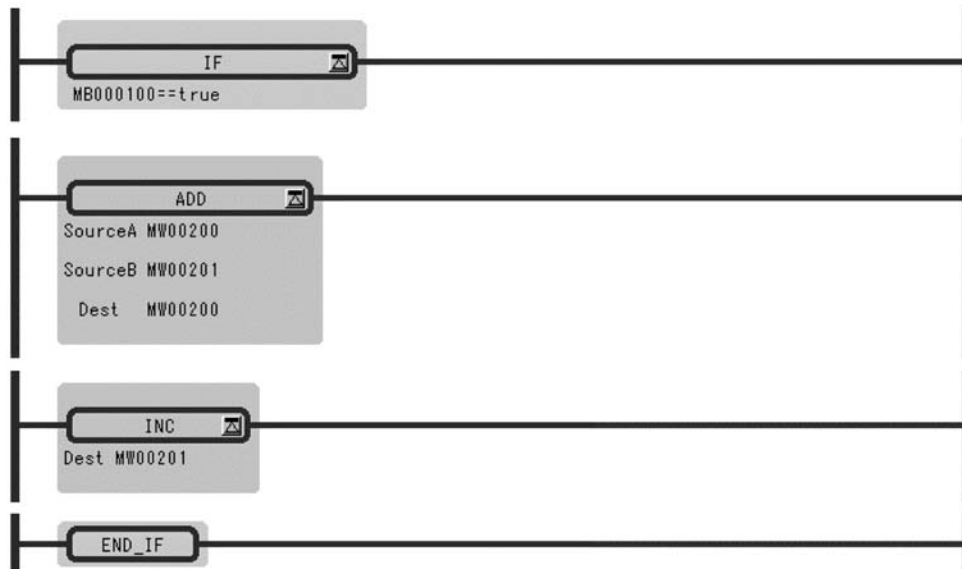

1.4.9 IF Instruction (IF, ELSE, END\_IF)

■ Outline

If the conditional expression in the IF instruction is approved, the instruction sequence 1 between IF and ELSE is executed. If the conditional expression in the IF instruction is not approved, the instruction sequence 2 between ELSE and END\_IF is executed.

■ Format

- At instruction development display ON

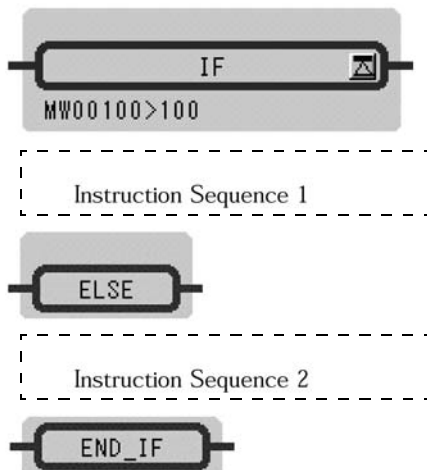

Symbol: IF  
 ELSE  
 END\_IF  
 Full Name: If Then  
 Else  
 End of If  
 Category: CONTROL  
 Icon: IF, ELSE, END\_IF

- At instruction development display OFF



Symbol: IF-ELSE-  
END\_IF  
Full Name: IF Then and  
Else and  
End of If  
Category: CONTROL  
Icon: 

■ Parameter

Parameter Name	Setting
Conditional Expression	Description by Expression



1. Eight IF instructions can be nested.
2. If an instruction is defined after a contact, this instruction is regarded as an IF instruction and included in the nest.

■ Program Example

MW00011 is set to 0 if MW00010 is positive number, and set to 1 if MW00010 is negative number.

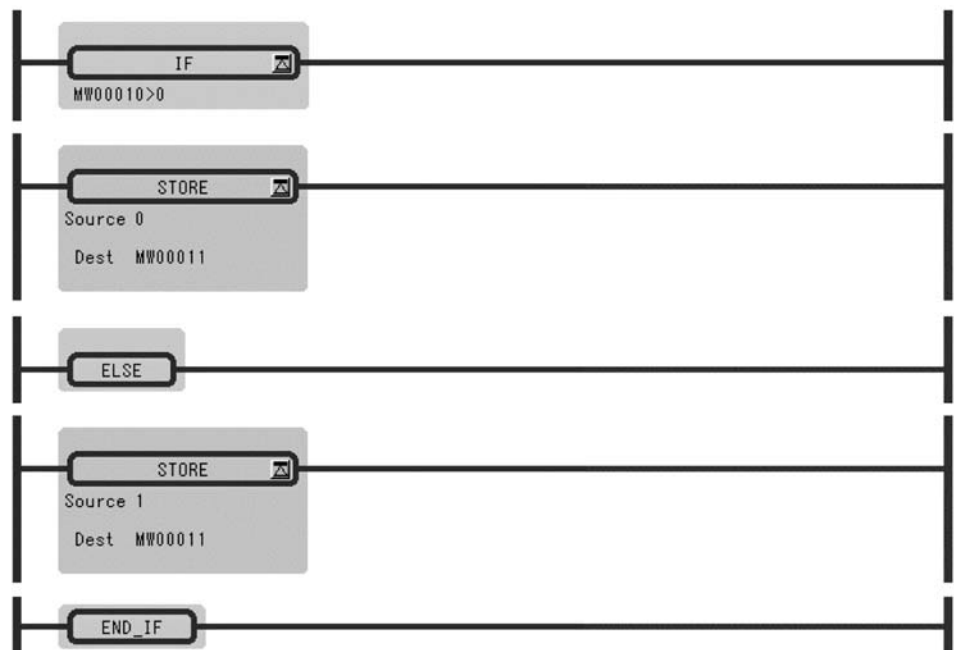

## 1.4.10 FOR Instruction (FOR, END\_FOR)



### ■ Outline

The instruction sequence surrounded by the FOR instruction and the corresponding END\_FOR instruction are executed the specified number of times:  $N = (Max - Init + 1) / Step$ . *Variable* starts from initial value (*Init*) and is incremented by *Step* on each execution. The instruction sequence is ended when *Variable* > *Max*.

### ■ Format

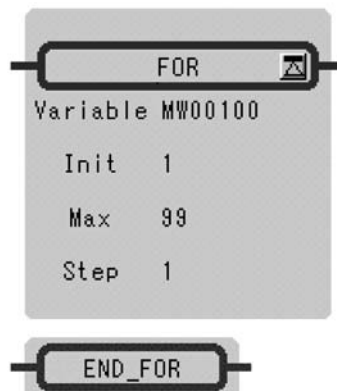
- At instruction development display ON



Symbol: FOR  
 END\_FOR  
 Full Name: For  
 End of For  
 Category: CONTROL  
 Icon: , 

- At instruction development display OFF



Symbol: FOR-END\_FOR  
 Full Name: For and  
 End of For  
 Category: CONTROL  
 Icon: 

## ■ Parameter

Parameter Name	Setting
Variable	<ul style="list-style-type: none"> <li>• Any integer type register</li> <li>• Any integer type register with subscript</li> <li>• Subscript register (I and J registers)</li> </ul>
Init	<ul style="list-style-type: none"> <li>• Any integer type register</li> <li>• Any integer type register with subscript</li> <li>• Subscript register</li> <li>• Constant</li> </ul>
Max	<ul style="list-style-type: none"> <li>• Any integer type register</li> <li>• Any integer type register with subscript</li> <li>• Subscript register</li> <li>• Constant</li> </ul>
Step	<ul style="list-style-type: none"> <li>• Any integer type register</li> <li>• Any integer type register with subscript</li> <li>• Subscript register</li> <li>• Constant</li> </ul>

1

## ■ Program Example

The high byte and low byte, from MW00100 to MW00102, are exchanged.

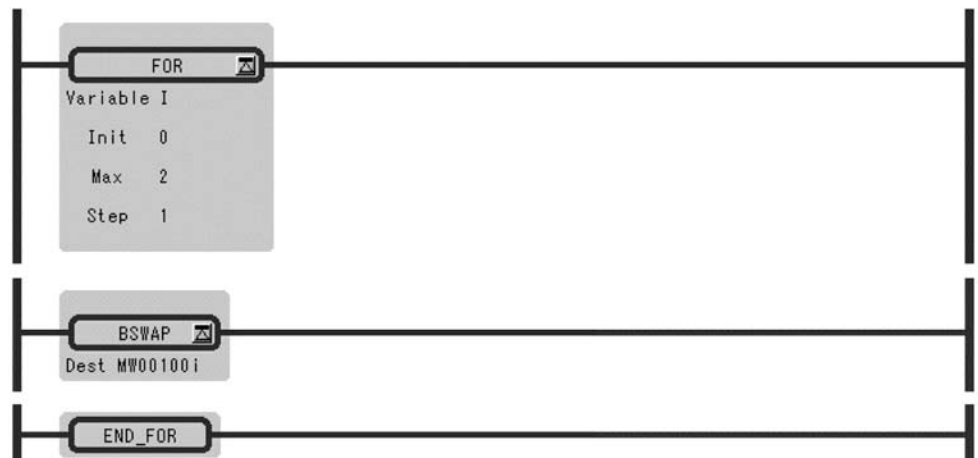

### 1.4.11 EXPRESSION Instruction (EXPRESSION)

■ Outline

EXPRESSION instruction is composed by one block. It considers on a par with a coil type component, and an input line has the Instruction of Enable/Disable command. In the block, Expression box for an operation formula description is prepared, and the description of the operation formula to 1000 lines is possible.

■ Format



Symbol: EXPRESSION  
 Full Name: Expression  
 Category: CONTROL  
 Icon:

■ Parameter

Parameter Name	Setting
Conditional Expression	Description by Expression

■ Program Example



## 1.5 Basic Function Instructions

### 1.5.1 SQUARE ROOT Instruction (SQRT)

#### ■ Outline

The SQRT instruction calculates the square root of an integer or real number value as the operation result. The input units and output results for integer and real number values are different. This instruction cannot be used for double-length integer data.

#### Integer Type Data

The square root of *Source* is stored in *Dest*. The operation result of the SQRT instruction slightly differs from the square root in mathematical terms. To be more precise, the operation result is expressed by the following formula:

$$32768 * \text{sign}(A) * \text{SQRT}(|A| / 32768)$$

sign (A): sign of the Source

|A| : absolute value of the Source

In other words, the operation result is equal to the mathematical square root multiplied by approximately 181.02. If the input is a negative value, the square root of the absolute value is calculated first and then the negative value of the square root is output as the operation result.

The maximum error of the output value is +/-2.

#### Real Number Type Data

The square root of *Source* is stored in *Dest*. If the input is a negative value, the square root of the absolute value is calculated first and then the negative value of the square root is output as the operation result. This instruction can be used in a real number operation.

#### ■ Format

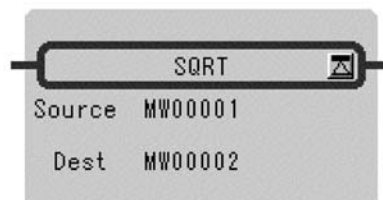

Symbol: SQRT  
 Full Name: Square Root  
 Category: FUNCTION  
 Icon: 

■ Parameter

Parameter Name	Setting
Source (Input)	<ul style="list-style-type: none"> <li>• Any integer type and real number type register</li> <li>• Any integer type and real number type register with subscript</li> <li>• Subscript register</li> <li>• Constant</li> </ul>
Dest (Output)	<ul style="list-style-type: none"> <li>• Any integer type and real number type register (except for # and C registers)</li> <li>• Any integer type and real number type register with subscript (except for # and C registers)</li> <li>• Subscript register</li> </ul>

■ Program Example

Integer Type Data

- When the input is a positive number

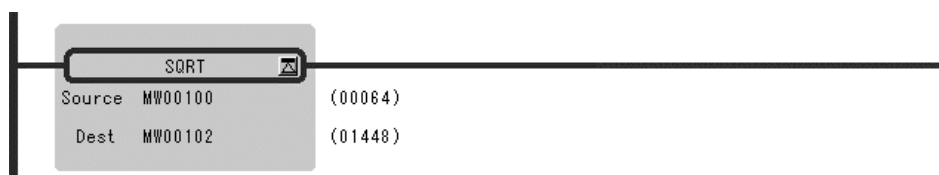

- When the input is a negative number

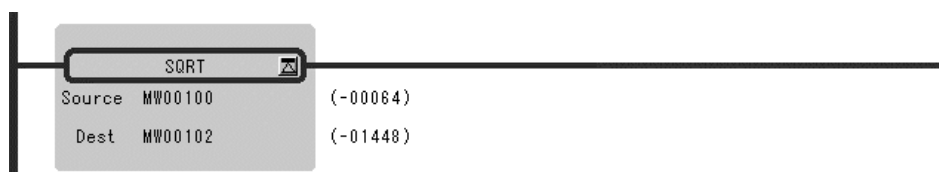

Real Number Type Data

- When the input is a positive number

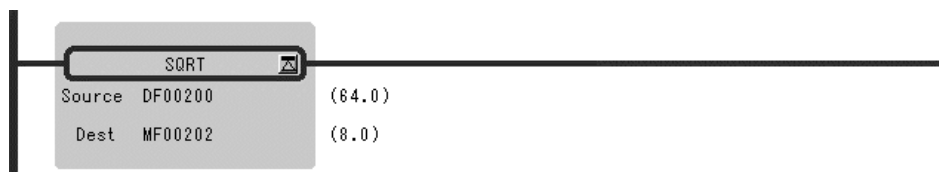

- When the input is a negative number

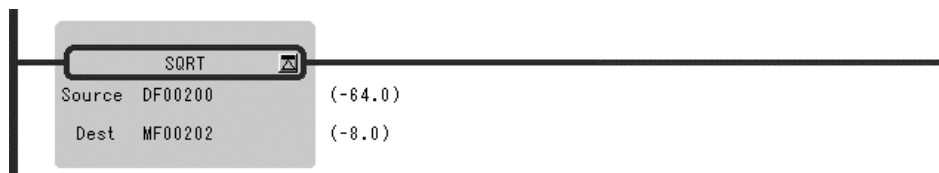



## 1.5.2 SINE Instruction (SIN)

### ■ Outline

The SIN instruction calculates the sine of an integer or real number value as the operation result. The input units and output results for integer and real number values are different. This instruction cannot be used for double-length integer data.

### Integer Type Data

This instruction can be used between -327.68 and 327.67 degrees. The *Source* is used as the input (1 = 0.01 degree) and the operation result is stored in the *Dest*. Upon output, the operation result is multiplied by 10,000.

If a value outside the range of -327.68 to 327.67 is entered, the correct result cannot be obtained. For example, if 360.00 is entered, -295.36 degrees will be output as the result.

### Real Number Type Data

The *Source* is used as the input (unit = degrees) and the sine of the input is stored in the *Dest*.

### ■ Format

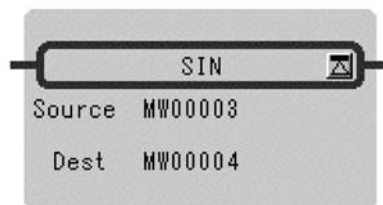

Symbol: SIN  
 Full Name: Sine  
 Category: FUNCTION  
 Icon: 

### ■ Parameter

Parameter Name	Setting
Source (Input)	<ul style="list-style-type: none"> <li>• Any integer type and real number type register</li> <li>• Any integer type and real number type register with subscript</li> <li>• Subscript register</li> <li>• Constant</li> </ul>
Dest (Output)	<ul style="list-style-type: none"> <li>• Any integer type and real number type register (except for # and C registers)</li> <li>• Any integer type and real number type register with subscript (except for # and C registers)</li> <li>• Subscript register</li> </ul>

### ■ Program Example

#### Integer Type Data

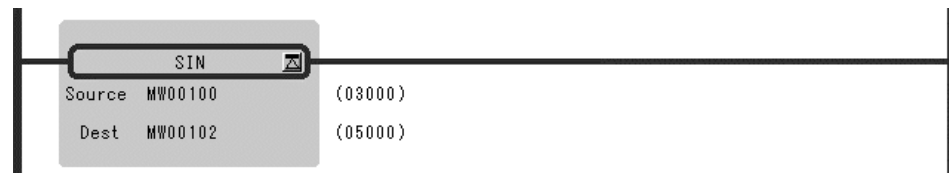

Input  $X = 30$  degrees ( $MW00100 = 30 * 100 = 3000$ )

Output  $SIN(X) = 0.50$  ( $MW00102 = 0.50 * 10000 = 5000$ )

#### Real Number Type Data

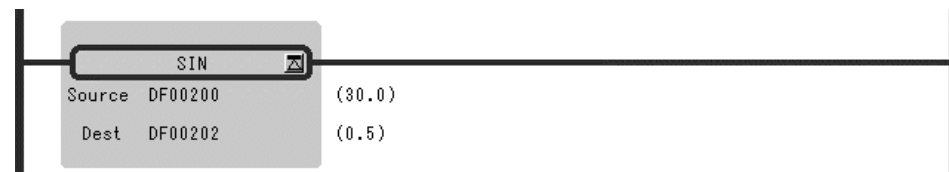

### 1.5.3 COSINE Instruction (COS)

#### ■ Outline

The COS instruction calculates the cosine of integer or real number values as the operation result.

The input units and output results for integer and real number values are different. This instruction cannot be used for double-length integer data.

#### Integer Type Data

This instruction can be used between  $-327.68$  and  $327.67$  degrees. The Source is used as the input ( $1 = 0.01$  degrees) and the operation result is stored in the Dest. Upon output, the operation result is multiplied by 10,000. If a value outside the range of  $-327.68$  to  $327.67$  is entered, the correct result is obtained. For example, if 360.00 is entered,  $-295.36$  degrees is output as a result.

#### Real Number Type Data

The *Source* is used as the input (unit = degrees) and the cosine of the input is stored in the *Dest*.

■ Format

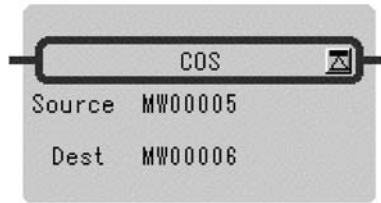

Symbol: COS  
 Full Name: Cosine  
 Category: FUNCTION  
 Icon: 

1

■ Parameter

Parameter Name	Setting
Source (Input)	<ul style="list-style-type: none"> <li>• Any integer type and real number type register</li> <li>• Any integer type and real number type register with subscript</li> <li>• Subscript register</li> <li>• Constant</li> </ul>
Dest (Output)	<ul style="list-style-type: none"> <li>• Any integer type and real number type register (except for # and C registers)</li> <li>• Any integer type and real number type register with subscript (except for # and C registers)</li> <li>• Subscript register</li> </ul>

■ Program Example

Integer Type Data

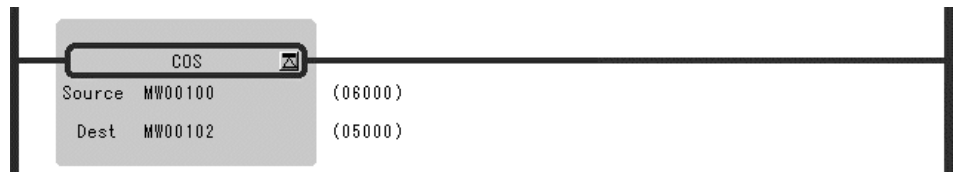

Input X = 60 degrees (MW00100 = 60\*100 = 6000)

Output COS (X) = 0.50 (MW00102 = 0.50\*10000 = 500)

Real Number Type Data





## 1.5.4 TANGENT Instruction (TAN)

### ■ Outline

The TAN instruction uses the *Source* as the input (unit = degrees) and stores the tangent of the input in the *Dest*. This instruction can be used in a real number operation.

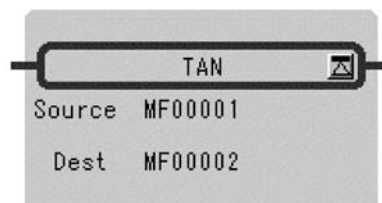
### ■ Format



Symbol: TAN  
 Full Name: Tangent  
 Category: FUNCTION  
 Icon: 

### ■ Parameter

Parameter Name	Setting
Source (Input)	<ul style="list-style-type: none"> <li>• Any real number type register</li> <li>• Any real number type register with subscript</li> <li>• Constant</li> </ul>
Dest (Output)	<ul style="list-style-type: none"> <li>• Any real number type register (except for # and C register)</li> <li>• Any real number type register with subscript (except for # and C register)</li> </ul>

### ■ Program Example

The tangent of the input value ( $X = 45.0$  degrees) [ $TAN(X) = 1.0$ ] is calculated.

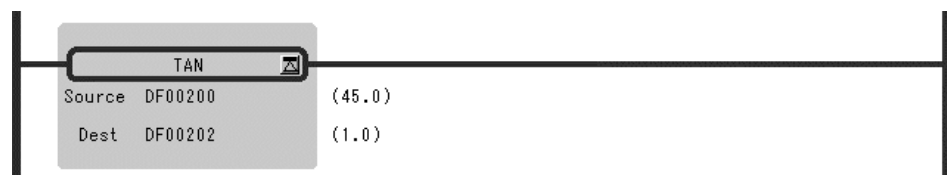

TANGENT Instruction cannot be used for integer type and double-length integer type data.

## 1.5.5 ARC SINE Instruction (ASIN)

### ■ Outline

The ASIN instruction uses the *Source* as the input and stores the arc sine (unit = degrees) of the input in the *Dest*. This instruction can be used in a real number operation.

### ■ Format

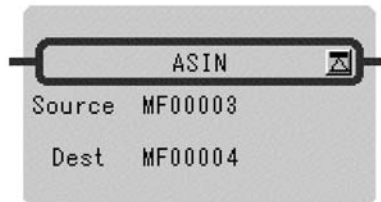

Symbol: ASIN  
 Full Name: Arc Sine  
 Category: FUNCTION  
 Icon:

1

### ■ Parameter

Parameter Name	Setting
Source (Input)	<ul style="list-style-type: none"> <li>• Any real number type register</li> <li>• Any real number type register with subscript</li> <li>• Constant</li> </ul>
Dest (Output)	<ul style="list-style-type: none"> <li>• Any real number type register (except for # and C register)</li> <li>• Any real number type register with subscript (except for # and C register)</li> </ul>

### ■ Program Example

The arc sine of the input value (0.5) [ $\text{ASIN}(0.5) = \theta = 30.0$  degrees] is calculated.



ARC SINE Instruction cannot be used for integer type and double-length integer type data.

## 1.5.6 ARC COSINE Instruction (ACOS)

### ■ Outline

The ACOS instruction uses the *Source* as the input and stores the arc cosine (unit = degrees) of the input in the *Dest*. This instruction can be used in a real number operation.

### ■ Format

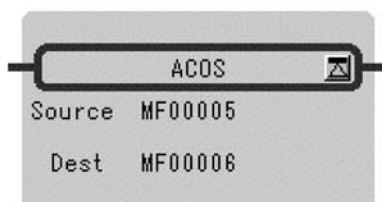

Symbol: ACOS  
 Full Name: Arc Cosine  
 Category: FUNCTION  
 Icon:

### ■ Parameter

Parameter Name	Setting
Source (Input)	<ul style="list-style-type: none"> <li>Any real number type register</li> <li>Any real number type register with subscript</li> <li>Constant</li> </ul>
Dest (Output)	<ul style="list-style-type: none"> <li>Any real number type register (except for # and C register)</li> <li>Any real number type register with subscript (except for # and C register)</li> </ul>

### ■ Program Example

The arc cosine of the input value (0.5) [ACOS (0.5) = X = 60.0 degrees] is calculated.

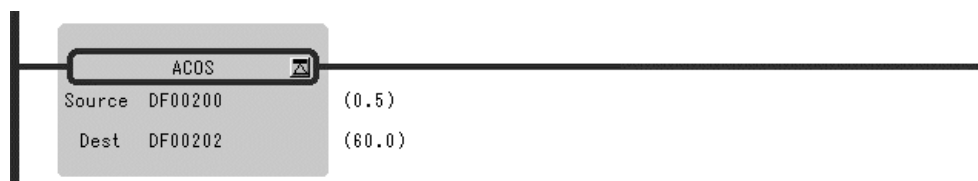

ARC COSINE Instruction cannot be used for integer type and double-length integer type data.

## 1.5.7 ARC TANGENT Instruction (ATAN)

### ■ Outline

The ATAN instruction calculates the arc tangent of integer or real number data as the operation result.

The input units and output results for integer and real number data are different. This instruction cannot be used for double-length integer data.

### Integer Type Data

This instruction can be used between  $-327.68$  and  $327.67$  degrees. The *Source* is used as the input ( $1 = 0.01$  degrees) and the operation result is stored in the *Dest*. Upon output, the operation result is multiplied by 100.

### Real Number Type Data

The *Source* is used as the input (unit = degrees) and the arc tangent of the input is stored in the *Dest*.

This instruction cannot be used for integer type and double-length integer data.

### ■ Format

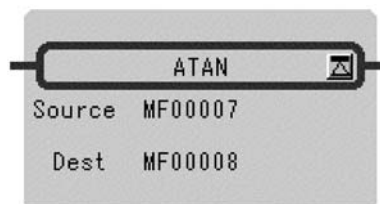

Symbol: ATAN  
 Full Name: Arc Tangent  
 Category: FUNCTION  
 Icon: 

### ■ Parameter

Parameter Name	Setting
Source (Input)	<ul style="list-style-type: none"> <li>• Any integer type and real number type register</li> <li>• Any integer type and real number type register with subscript</li> <li>• Subscript register</li> <li>• Constant</li> </ul>
Dest (Output)	<ul style="list-style-type: none"> <li>• Any integer type and real number type register (except for # and C registers)</li> <li>• Any integer type and real number type register with subscript (except for # and C registers)</li> <li>• Subscript register</li> </ul>

### ■ Program Example

#### Integer Type Data

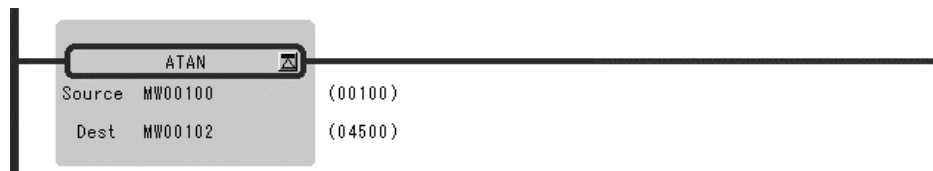

Input X = 1.00 (MW00100 = 1.00\*100 = 100)

Output X = 45 degrees (MW00102 = 45\*100 = 4500)

#### Real Number Type Data

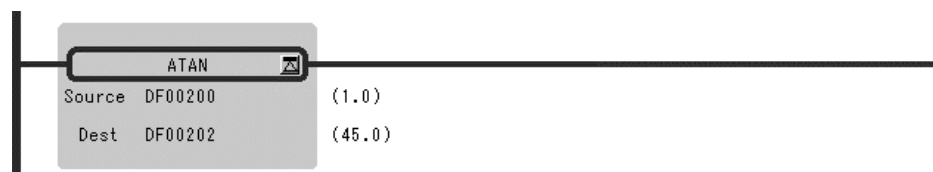

## 1.5.8 EXPONENT Instruction (EXP)

### ■ Outline

The EXP instruction uses the *Source* as the input (x) and stores the natural logarithmic base (e) to the power of the input ( $e^x$ ) in the *Dest* as the operation result. This instruction can be used only in a real number operation.

### ■ Format

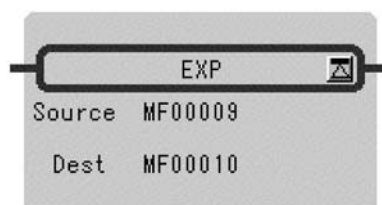

Symbol: EXP

Full Name: Exponential

Category: FUNCTION

Icon:



## ■ Parameter

Parameter Name	Setting
Source (Input)	<ul style="list-style-type: none"> <li>Any real number type register</li> <li>Any real number type register with subscript</li> <li>Constant</li> </ul>
Dest (Output)	<ul style="list-style-type: none"> <li>Any real number type register (except for # and C register)</li> <li>Any real number type register with subscript (except for # and C register)</li> </ul>

1

## ■ Program Example

$e$  (= 2.7183) to the power of the input value ( $x = 1.0$ ) is calculated.

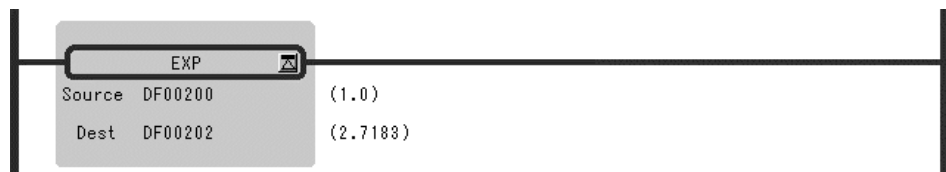

Maximum value ( $3.4 \cdots E + 38$ ) is stored and an operation error will not occur even if the operation results of EXP instruction in an overflow.

## 1.5.9 NATURAL LOGARITHM Instruction (LN)

### ■ Outline

The LN instruction uses the *Source* as the input ( $x$ ) and stores the natural logarithm ( $\text{Log}_e^x$ ) of the input in the *Dest* as the operation result. This instruction can be used only in a real number operation.

### ■ Format

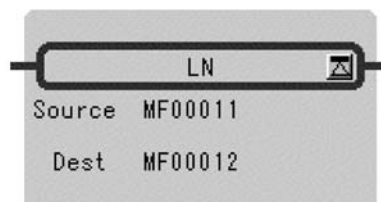

Symbol: LN  
 Full Name: Natural Logarithm  
 Category: FUNCTION  
 Icon:

### ■ Parameter

Parameter Name	Setting
Source (Input)	<ul style="list-style-type: none"> <li>Any real number type register</li> <li>Any real number type register with subscript</li> <li>Constant</li> </ul>
Dest (Output)	<ul style="list-style-type: none"> <li>Any real number type register (except for # and C register)</li> <li>Any real number type register with subscript (except for # and C register)</li> </ul>

### ■ Program Example

The natural logarithm of the input value ( $x = 10.0$ ) [ $\text{Log}_e(x) = 2.3026$ ] is calculated.

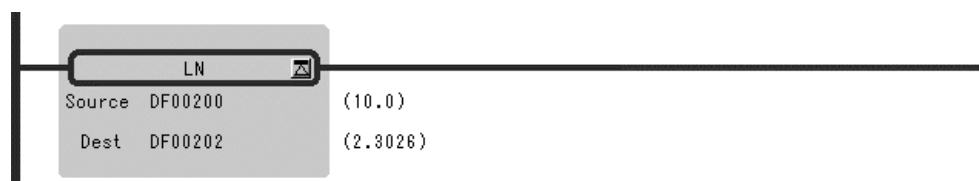

LN instruction is input (x) value is checked, execute the following handling.

- When the input is minus LN (-1), calculate an absolute value.
- When the input is zero LN (0), take  $-\infty$  for solution.

## 1.5.10 COMMON LOGARITHM Instruction (LOG)

### ■ Outline

The LOG instruction uses the *Source* as the input (x) and stores the common logarithm ( $\text{Log}_{10}^x$ ) of the input in the *Dest* as the operation result. This instruction can be used only in a real number operation.

### ■ Format

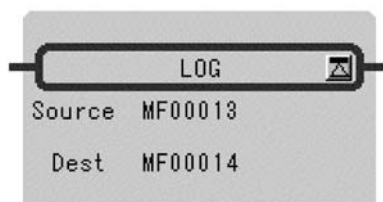

Symbol: LOG  
 Full Name: Logarithm Base 10  
 Category: FUNCTION  
 Icon:

## ■ Parameter

Parameter Name	Setting
Source (Input)	<ul style="list-style-type: none"> <li>• Any real number type register</li> <li>• Any real number type register with subscript</li> <li>• Constant</li> </ul>
Dest (Output)	<ul style="list-style-type: none"> <li>• Any real number type register (except for # and C register)</li> <li>• Any real number type register with subscript (except for # and C register)</li> </ul>

1

## ■ Program Example

The common logarithm of the input value ( $x = 10.$ ) [ $\text{Log}_{10}(x) = 1.0$ ] is calculated.



LOG instruction is input (x) value is checked, execute the following handling.

- When the input is minus LOG (-1), calculate an absolute value.
- When the input is zero LOG (0), take  $-\infty$  for solution.

## 1.6 Data Manipulation Instructions

### 1.6.1 BIT ROTATION LEFT Instruction (ROTL)

#### ■ Outline

The ROTL instruction is used to rotate bits to the left the number of times designated in the bit table designated by the leading bit address and bit width.

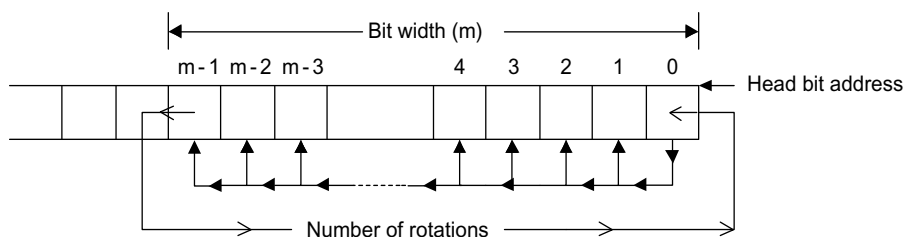

#### ■ Format

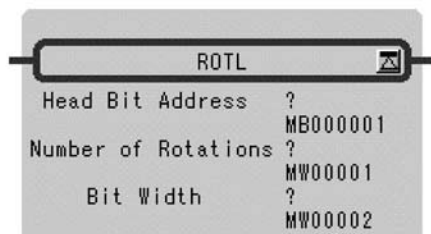

Symbol: ROTL  
 Full Name: Bit Rotate Left  
 Category: MOVE  
 Icon:

#### ■ Parameter

Parameter Name	Setting
Head Bit Address	<ul style="list-style-type: none"> <li>Any bit type register (except for # and C registers)</li> <li>Any bit type register with subscript (except for # and C registers)</li> </ul>
Number of Rotations	<ul style="list-style-type: none"> <li>Any integer type register</li> <li>Any integer type register with subscript</li> <li>Constant</li> </ul>
Bit Width	<ul style="list-style-type: none"> <li>Any integer type register</li> <li>Any integer type register with subscript</li> <li>Constant</li> </ul>

■ Program Example

The data having MB00000A (bit A of MW00000) as the head address and a bit width of 10 are rotated five times to the left.



1

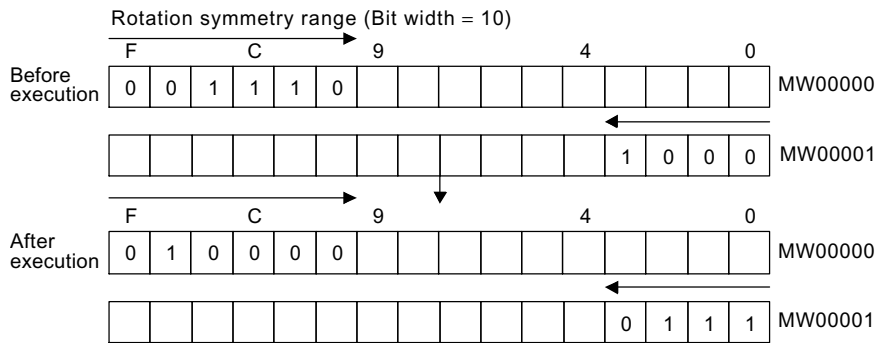

1.6.2 BIT ROTATION RIGHT Instruction (ROTR)

■ Outline

The ROTR instruction is used to rotate bits to the right the number of times designated in the bit table designated by the leading bit address and bit width.

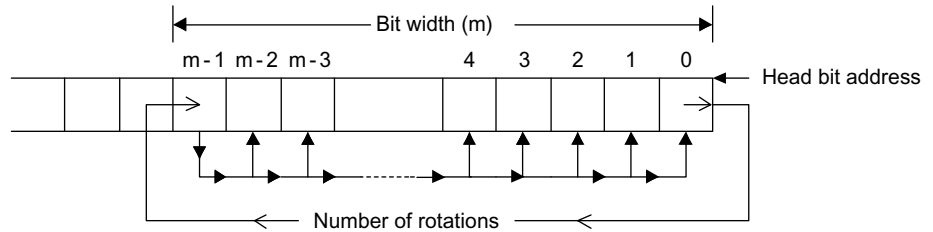

■ Format

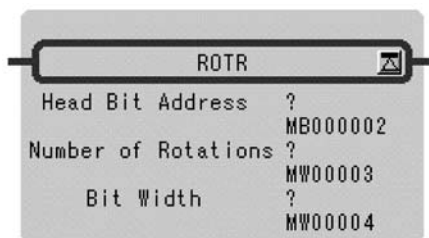

Symbol: ROTR  
 Full Name: Bit Rotate Right  
 Category: MOVE  
 Icon:

■ Parameter

Parameter Name	Setting
Head Bit Address	<ul style="list-style-type: none"> <li>Any bit type register (except for # and C registers)</li> <li>Any bit type register with subscript (except for # and C registers)</li> </ul>
Number of Rotations	<ul style="list-style-type: none"> <li>Any integer type register</li> <li>Any integer type register with subscript</li> <li>Constant</li> </ul>
Bit Width	<ul style="list-style-type: none"> <li>Any integer type register</li> <li>Any integer type register with subscript</li> <li>Constant</li> </ul>

■ Program Example

The data having MB00000 (bit 0 of MW00000) as the head address and a bit width of 10 are rotated once to the right.

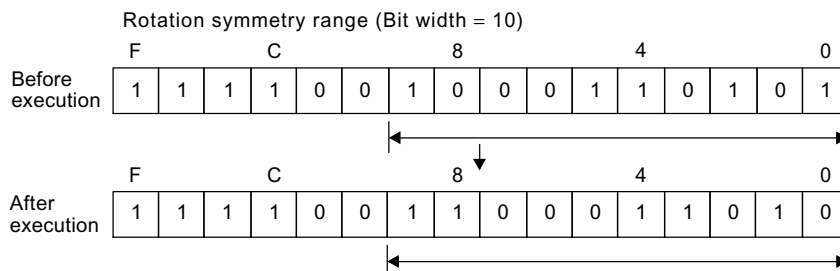

### 1.6.3 MOVE BITS Instruction (MOVB)

#### ■ Outline

The MOVB instruction moves the designated number of bits (*Width*) from the beginning of the move source bits (*Source*) to the beginning of the move destination bits (*Dest*). The move process is performed one bit at a time in the direction in which the relay number increases.

Unless the move source bits overlap with the move destination bits, the move source bit table is stored. If there is overlap between them, the move source bit table may not be stored.

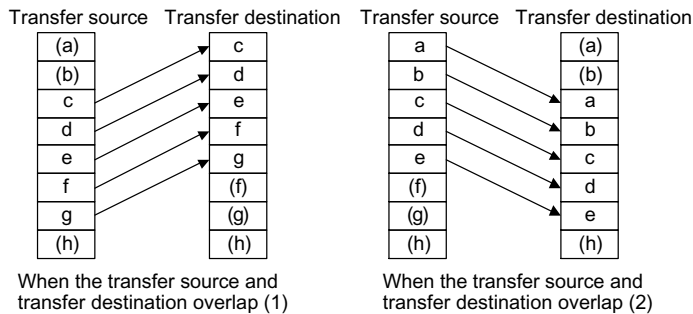
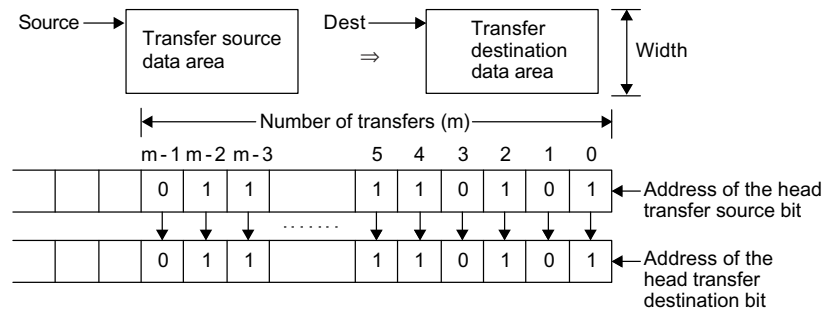

#### ■ Format

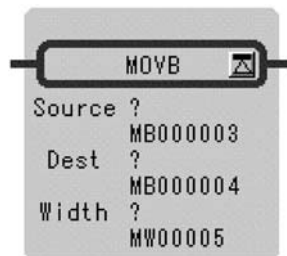

Symbol: MOVB  
 Full Name: Move Bit  
 Category: MOVE  
 Icon: 

■ Parameter

Parameter Name	Setting
Source	<ul style="list-style-type: none"> <li>Any bit type register</li> <li>Any bit type register with subscript</li> </ul>
Dest	<ul style="list-style-type: none"> <li>Any bit type register (except for # and C registers)</li> <li>Any bit type register with subscript (except for # and C registers)</li> </ul>
Width	<ul style="list-style-type: none"> <li>Any integer type register</li> <li>Any integer type register with subscript</li> <li>Constant</li> </ul>

■ Program Example

The 10 bits of data starting from MB000000 (bit 0 of MW00000) are transferred to MB000010 ( bit 0 of MW0000).

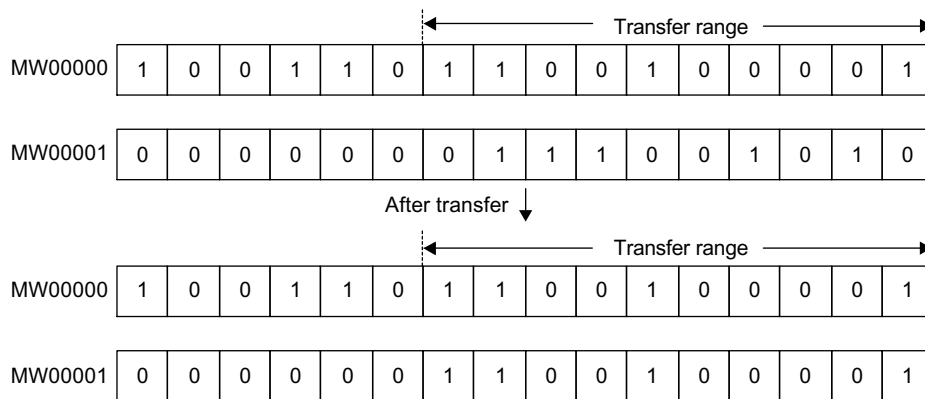



## 1.6.4 MOVE WORD Instruction (MOVW)

### ■ Outline

The MOVW instruction moves the designated number of words (*Width*) from the beginning of the move source registers (*Source*) to the beginning of the move destination registers (*Dest*). The move process is performed one word at a time in the direction in which the register number increases.

Unless the move source registers overlap with the move destination registers, the move source word table is stored. If there is overlap between them, the move source bit table may not be stored.

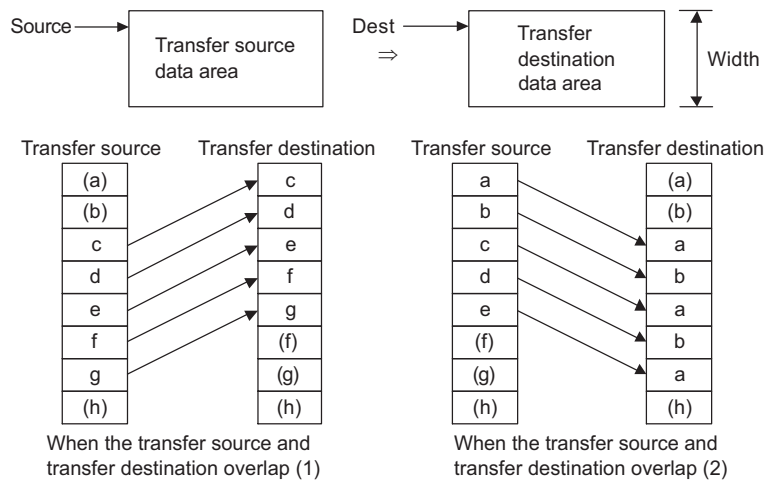

### ■ Format

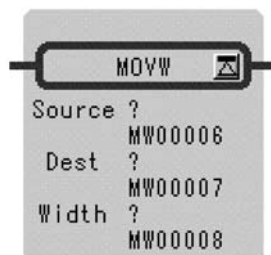

Symbol: MOVW  
 Full Name: Move Word  
 Category: MOVE  
 Icon: 

### Parameter

Parameter Name	Setting
Source	<ul style="list-style-type: none"> <li>Any integer type register</li> <li>Any integer type register with subscript</li> </ul>
Dest	<ul style="list-style-type: none"> <li>Any integer type register (except for # and C registers)</li> <li>Any integer type register with subscript (except for # and C registers)</li> </ul>
Width	<ul style="list-style-type: none"> <li>Any integer type register</li> <li>Any integer type register with subscript</li> <li>Constant</li> </ul>

### Program Example

The word data MW00000 to MW00009 are transferred to MW00100 to MW00109.

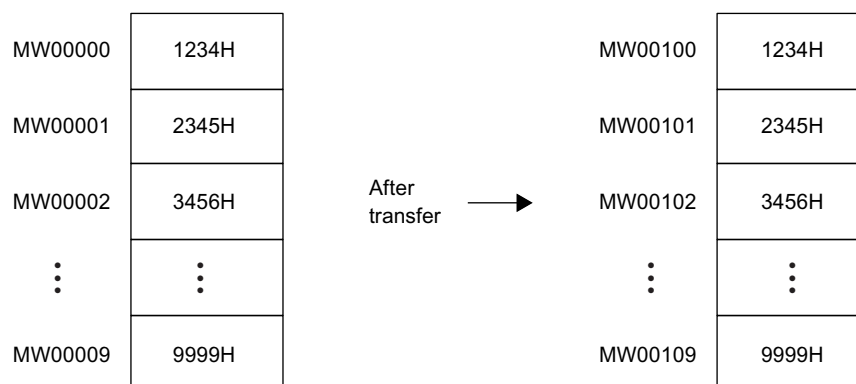

## 1.6.5 EXCHANGE Instruction (XCHG)

### ■ Outline

The XCHG instruction is used to exchange data between data tables 1 (*Data Table1*) and 2 (*Data Table2*).

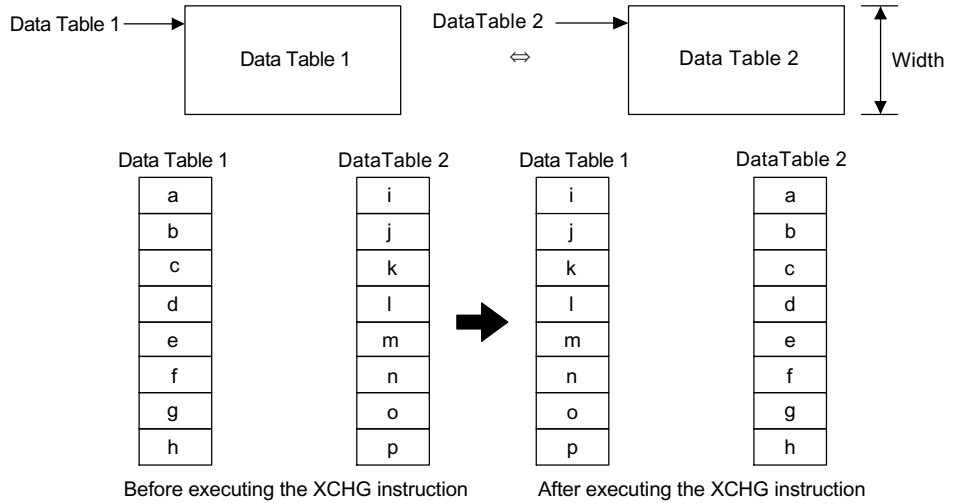

### ■ Format

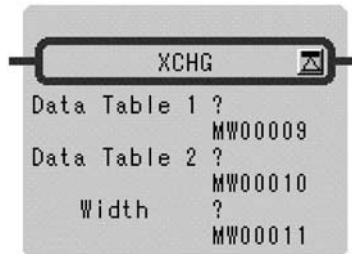

Symbol: XCHG  
 Full Name: Exchange  
 Category: MOVE  
 Icon:

### ■ Parameter

Parameter Name	Setting
Data Table 1	<ul style="list-style-type: none"> <li>Any integer type register (except for # and C registers)</li> <li>Any integer type register with subscript (except for # and C registers)</li> </ul>
Data Table 2	<ul style="list-style-type: none"> <li>Any integer type register (except for # and C registers)</li> <li>Any integer type register with subscript (except for # and C registers)</li> </ul>
Width	<ul style="list-style-type: none"> <li>Any integer type register</li> <li>Any integer type register with subscript</li> <li>Constant</li> </ul>

■ Program Example

The contents of MW00000 to MW00009 are exchanged to MW00100 to MW00109.



MW00000	1031H	MW00100	2050H	MW00000	2050H	MW00100	1031H
MW00001	1032H	MW00101	2051H	MW00001	2051H	MW00101	1032H
MW00002	1033H	MW00102	2052H	MW00002	2052H	MW00102	1033H
MW00003	1034H	MW00103	2053H	MW00003	2053H	MW00103	1034H
MW00004	1035H	MW00104	2054H	MW00004	2054H	MW00104	1035H
MW00005	1036H	MW00105	2055H	MW00005	2055H	MW00105	1036H
MW00006	1037H	MW00106	2056H	MW00006	2056H	MW00106	1037H
MW00007	1038H	MW00107	2057H	MW00007	2057H	MW00107	1038H
MW00008	1039H	MW00108	2058H	MW00008	2058H	MW00108	1039H
MW00009	1030H	MW00109	2059H	MW00009	2059H	MW00109	1030H

After transfer →

1.6.6 SET WORDS Instruction (SETW)

■ Outline

The SETW instruction stores the designated data (*Set Data*) in all registers designated by the transfer destination register number (*Dest*) and the number of destination registers (*Width*). The storage process is performed one word at a time in the direction in which the register number increases.

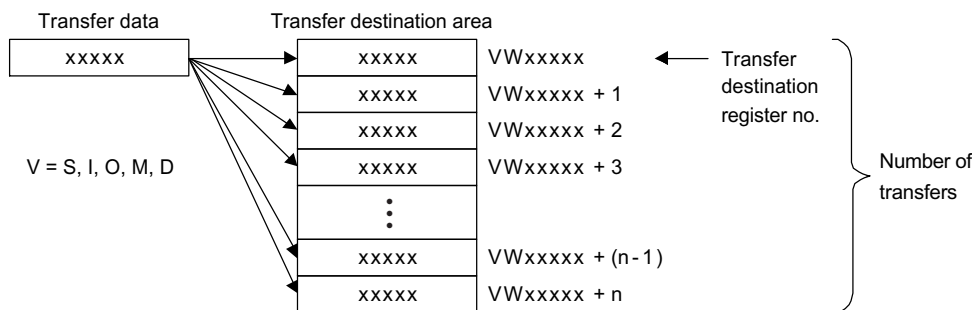

■ Format



Symbol: SETW  
 Full Name: Set Word  
 Category: MOVE  
 Icon:

1

■ Parameter

Parameter Name	Setting
Dest	<ul style="list-style-type: none"> <li>Any integer type register (except for # and C registers)</li> <li>Any integer type register with subscript (except for # and C registers)</li> </ul>
Set Data	<ul style="list-style-type: none"> <li>Any integer type register (except for # and C registers)</li> <li>Any integer type register with subscript (except for # and C registers)</li> </ul>
Width	<ul style="list-style-type: none"> <li>Any integer type register</li> <li>Any integer type register with subscript</li> <li>Constant</li> </ul>

■ Program Example

The contents of MW00100 to MW00119 are set to 0.

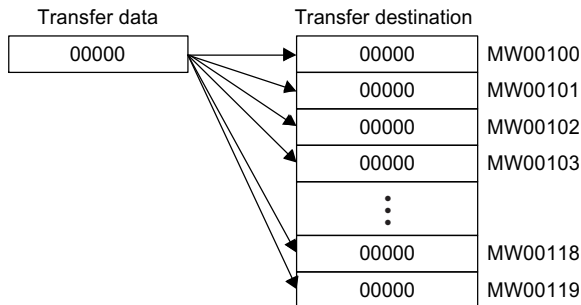

## 1.6.7 BYTE-TO-WORD EXPANSION Instruction (BEXTD)

### ■ Outline

The BEXTD instruction stores the byte sequence stored in the transfer source registers (*Source*) one byte at a time in the word sequence in the transfer destination registers (*Dest*). The higher-place bytes of the transfer destination registers are set to 0.

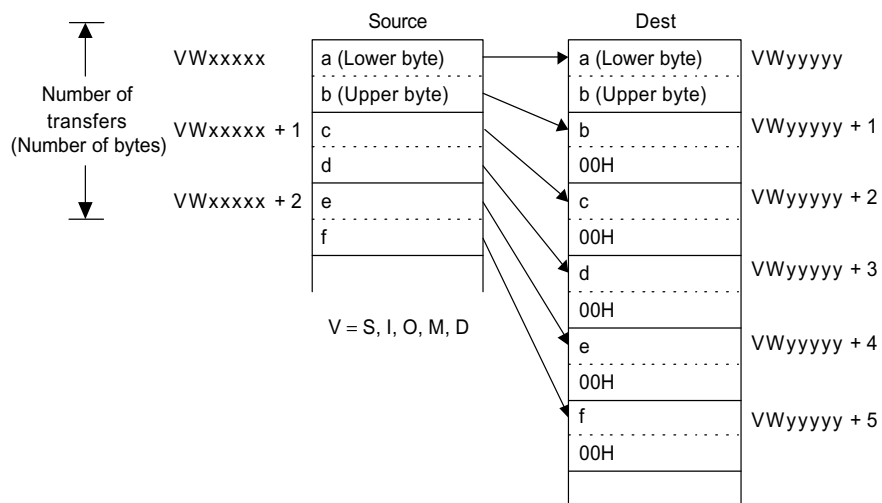

### ■ Format



Symbol: BEXTD  
 Full Name: Extend Byte to Word  
 Category: MOVE  
 Icon:

■ Parameter

Parameter Name	Setting
Source	<ul style="list-style-type: none"> <li>Any integer type register</li> <li>Any integer type register with subscript</li> </ul>
Dest	<ul style="list-style-type: none"> <li>Any integer type register (except for # and C registers)</li> <li>Any integer type register with subscript (except for # and C registers)</li> </ul>
Byte Width	<ul style="list-style-type: none"> <li>Any integer type register</li> <li>Any integer type register with subscript</li> <li>Constant</li> </ul>

1

■ Program Example

The 5 bytes beginning with MW00100 are expanded into five words beginning with MW00200.

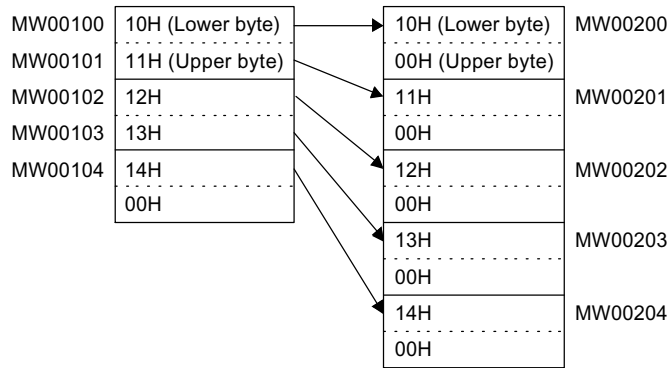

### 1.6.8 WORD-TO-WORD COMPRESSION Instruction (BPRESS)

#### ■ Outline

The BPRESS instruction stores the lower-place bytes of the word sequence stored in the transfer source registers (*Source*) in the byte sequence of the transfer destination registers (*Dest*). The higher-place bytes of the transfer source registers are ignored. This function is the reverse of that of the BEXTD instruction.

- In the case of BPRESS VWxxxxx to VWyyyyy B = N

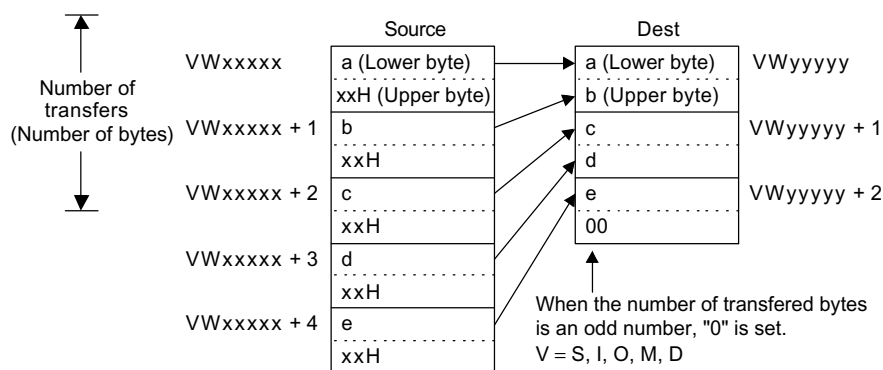

#### ■ Format



Symbol: BPRESS  
 Full Name: Compress Word to Byte  
 Category: MOVE  
 Icon: 

#### ■ Parameter

Parameter Name	Setting
Source	<ul style="list-style-type: none"> <li>• Any integer type register</li> <li>• Any integer type register with subscript</li> </ul>
Dest	<ul style="list-style-type: none"> <li>• Any integer type register (except for # and C registers)</li> <li>• Any integer type register with subscript (except for # and C registers)</li> </ul>
Byte Width	<ul style="list-style-type: none"> <li>• Any integer type register</li> <li>• Any integer type register with subscript</li> <li>• Constant</li> </ul>



■ Program Example

The five words beginning with MW00100 are compressed into 5 bytes beginning with MW00200.

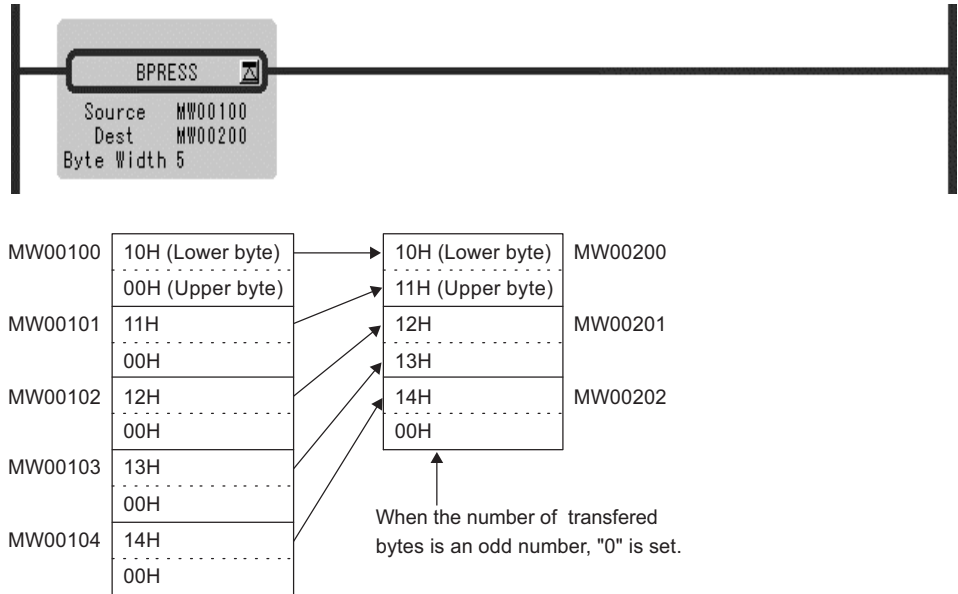

1

1.6.9 BINARY SEARCH Instruction (BSRCH)

■ Outline

The BSRCH instruction uses a binary search method to search the designated data (*Search Data*) within the designated search range (*Source*). The search result (offset from the leading register number of the search range for the matching data) is stored in the designated register (*Result*).

- Note:
1. Before executing the BSRCH instruction, sort the data within the search range in ascending order.
  2. If there are two or more words with identical data, the first register number that matches the data will be stored.
  3. If no matching data is found, -1 will be stored.

■ Format



Symbol: BSRCH  
 Full Name: Binary Data Search  
 Category: MOVE  
 Icon:

■ Parameter

Parameter Name	Setting
Source	<ul style="list-style-type: none"> <li>Any integer type and double-length integer type register</li> <li>Any integer type and double-length type register with subscript</li> </ul>
Width	<ul style="list-style-type: none"> <li>Any integer type and double-length integer type register</li> <li>Any integer type and double-length type register with subscript</li> </ul>
Search Data	<ul style="list-style-type: none"> <li>Any integer type and double-length integer type register</li> <li>Any integer type and double-length type register with subscript</li> <li>Constant</li> </ul>
Result	<ul style="list-style-type: none"> <li>Any integer type register (except for # and C registers)</li> <li>Any integer type register with subscript (except for # and C registers)</li> </ul>

■ Program Example

Data matching with 01234 are searched for in registers MW00100 to MW00199, and the result is stored in register DW00000.

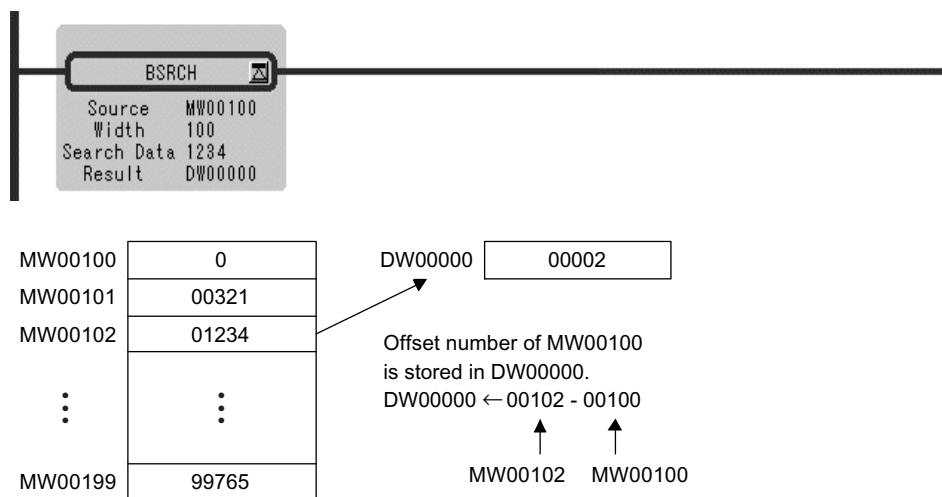



## 1.6.10 SORT Instruction (SORT)

### ■ Outline

The SORT instruction sorts data within the designated register range (*Data Table, Width*) in ascending order.

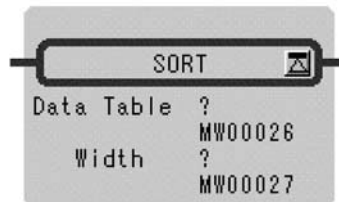
### ■ Format



Symbol: SORT  
 Full Name: Sort  
 Category: MOVE  
 Icon: 

1

### ■ Parameter

Parameter Name	Setting
Data Table	<ul style="list-style-type: none"> <li>• Any integer type and double-length integer type register (except for # and C registers)</li> <li>• Any integer type and double-length integer type register with subscript (except for # and C registers)</li> </ul>
Width	<ul style="list-style-type: none"> <li>• Any integer type register (except for # and C registers)</li> <li>• Any integer type register with subscript (except for # and C registers)</li> <li>• Constant</li> </ul>

### ■ Program Example

The data in registers MW00100 to MW00119 are sorted in ascending order.



### 1.6.11 BIT SHIFT LEFT Instruction (SHFTL)

#### ■ Outline

The SHFTL instruction shifts the bit sequence designated by the leading bit address (*Head Bit Address*) and bit width (*Bit Width*) to the left the designated number of bits (*Number of Shifts*).

#### ■ Format

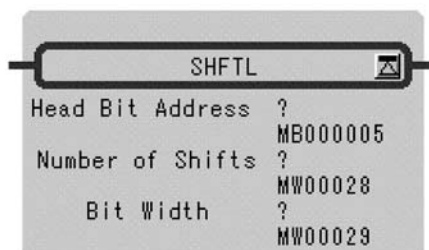

Symbol: SHFTL  
 Full Name: Bit Shift Left  
 Category: MOVE  
 Icon:

#### ■ Parameter

Parameter Name	Setting
Head Bit Address	<ul style="list-style-type: none"> <li>Any bit type register (except for # and C registers)</li> <li>Any bit type register with subscript (except for # and C registers)</li> </ul>
Number of Shifts	<ul style="list-style-type: none"> <li>Any integer type register</li> <li>Any integer type register with subscript</li> <li>Constant</li> </ul>
Bit Width	<ul style="list-style-type: none"> <li>Any integer type register</li> <li>Any integer type register with subscript</li> <li>Constant</li> </ul>

#### ■ Program Example

A ten-bit wide section of data with MB0000A (bit A of MW00000) as the head is shifted five bits to the left.



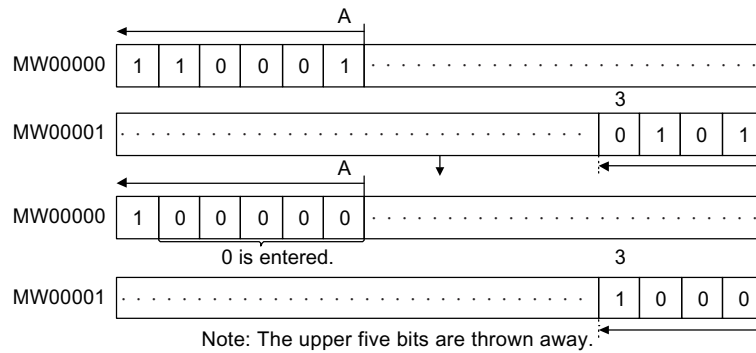

### 1.6.12 BIT SHIFT RIGHT Instruction (SHFTR)

■ Outline

The SHFTR instruction shifts the bit sequence designated by the leading bit address (*Head Bit Address*) and bit width to (*Bit Width*) the right the designated number of bits (*Number of Shifts*).

■ Format

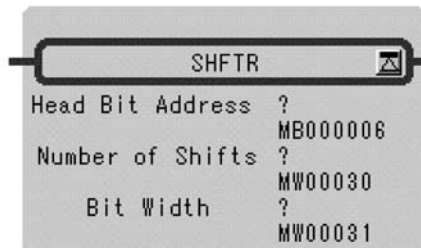

Symbol: SHFTR  
 Full Name: Bit Shift Right  
 Category: MOVE  
 Icon:

■ Parameter

Parameter Name	Setting
Head Bit Address	<ul style="list-style-type: none"> <li>Any bit type register (except for # and C registers)</li> <li>Any bit type register with subscript (except for # and C registers)</li> </ul>
Number of Shifts	<ul style="list-style-type: none"> <li>Any integer type register</li> <li>Any integer type register with subscript</li> <li>Constant</li> </ul>
Bit Width	<ul style="list-style-type: none"> <li>Any integer type register</li> <li>Any integer type register with subscript</li> <li>Constant</li> </ul>

■ Program Example

A five-bit wide section of data with MB000005 (bit A of MW00000) as the head is shifted three bits to the right.

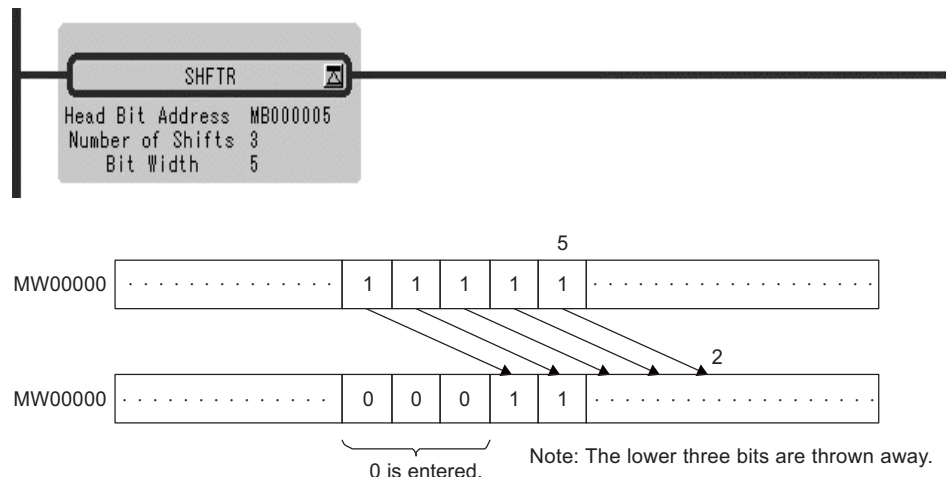

1.6.13 COPY WORD Instruction (COPYW)

■ Outline

The COPYW instruction copies the designated number of words (*Width*) from the beginning of the copy source register (*Source*) to the beginning of the copy destination register (*Dest*). The copy process copies the entire block of data from the copy source to the copy destination. Even if there is overlap between the copy source and the copy destination, the full copy data block is copied to the copy destination.

■ Format



Symbol: COPYW  
 Full Name: Copy Word  
 Category: MOVE  
 Icon: 

## ■ Parameter

Parameter Name	Setting
Source	<ul style="list-style-type: none"> <li>Any integer type register</li> <li>Any integer type register with subscript</li> </ul>
Dest	<ul style="list-style-type: none"> <li>Any integer type register (except for # and C registers)</li> <li>Any integer type register with subscript (except for # and C registers)</li> </ul>
Width	<ul style="list-style-type: none"> <li>Any integer type register</li> <li>Any integer type register with subscript</li> <li>Constant</li> </ul>

1

## ■ Program Example

The word data of MW00000 to MW00009 are transferred to MW00100 to MW00109.

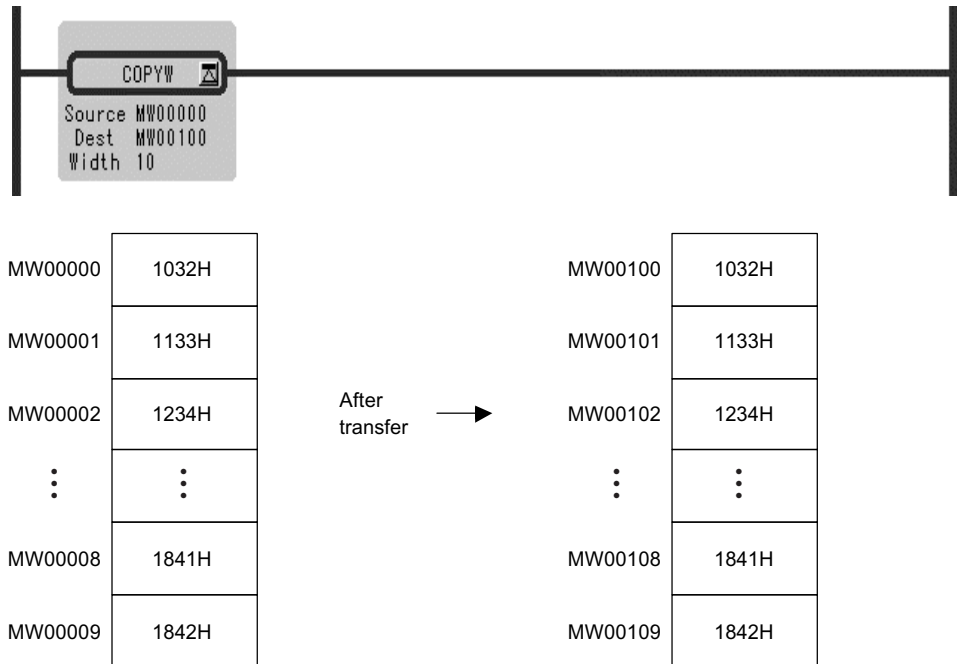

### 1.6.14 BYTE SWAP Instruction (BSWAP)

■ Outline

The BSWAP instruction swaps the higher-place and lower-place bytes of the designated register (*Dest*).

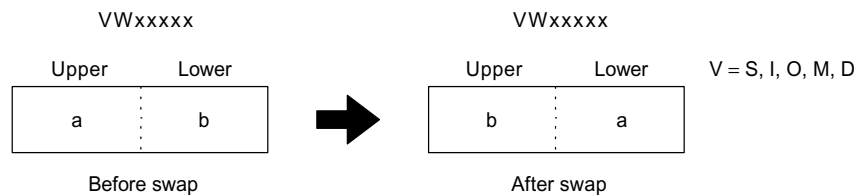

■ Format



Symbol: BSWAP  
 Full Name: Byte Swap  
 Category: MOVE  
 Icon:

■ Parameter

Parameter Name	Setting
Dest	<ul style="list-style-type: none"> <li>• Any integer type register (except for # and C registers)</li> <li>• Any integer type register with subscript (except for # and C registers)</li> </ul>



## ■ Program Example

The upper and lower bytes of MW00100 to MW00102 are swapped.

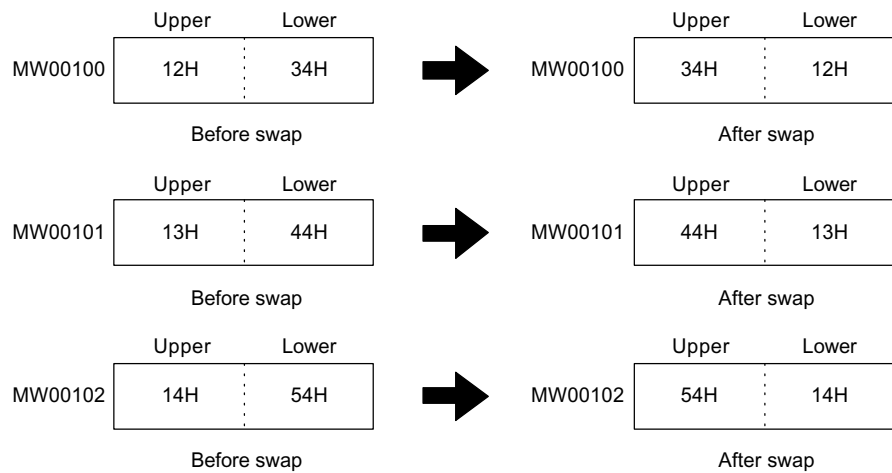
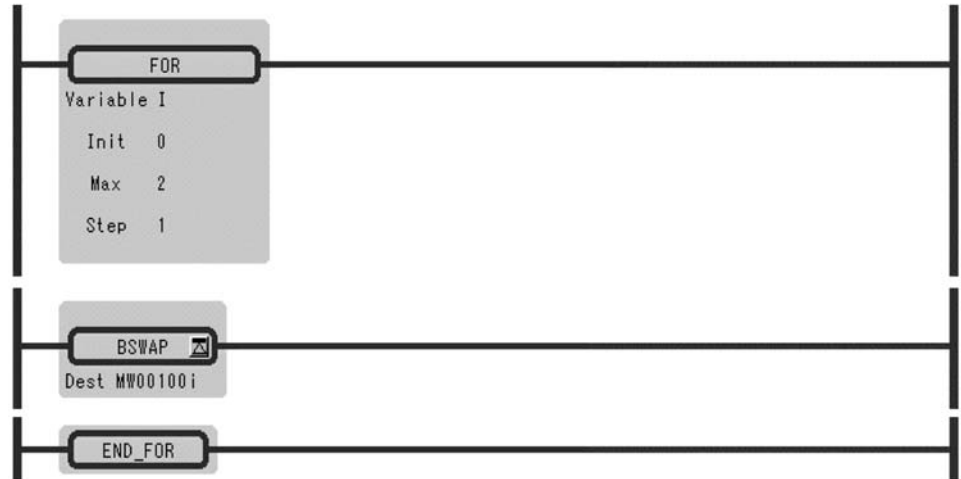

## 1.7 DDC Instructions

### 1.7.1 DEAD ZONE A Instruction (DZA)

#### ■ Outline

The DZA instruction executes a dead zone operation on integer, double-length integer or real number data.

The following operation is performed, where *Input* is the input value, *Zone* is the designated dead zone value, and *Output* is the output value:

- $Output = Input$  (absolute value of *Input* is greater than or equal to the absolute value of *Zone*)
- $Output = 0$  (absolute value of *Input* is less than the absolute value of *Zone*)

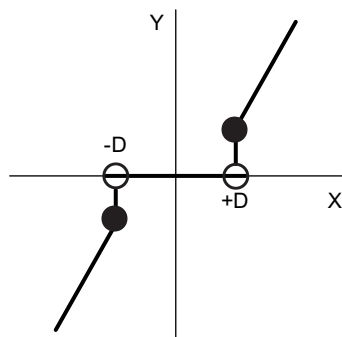

#### ■ Format

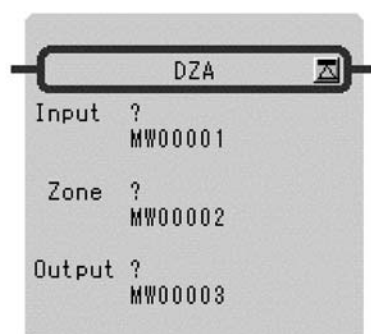

Symbol: DZA  
 Full Name: Dead Zone A  
 Category: DDC  
 Icon: 

■ Parameter

Parameter Name	Setting
Input	<ul style="list-style-type: none"> <li>• Any integer type, double-length integer type and real number type register</li> <li>• Any integer type, double-length integer type and real number type register with subscript</li> <li>• Subscript register</li> <li>• Constant</li> </ul>
Zone	<ul style="list-style-type: none"> <li>• Any integer type, double-length integer type and real number type register</li> <li>• Any integer type, double-length integer type and real number type register with subscript</li> <li>• Subscript register</li> <li>• Constant</li> </ul>
Output	<ul style="list-style-type: none"> <li>• Any integer type, double-length integer type and real number type register (except for # and C registers)</li> <li>• Any integer type, double-length integer type and real number type register with subscript (except for # and C registers)</li> <li>• Subscript register</li> </ul>

■ Program Example

Integer Type Operation

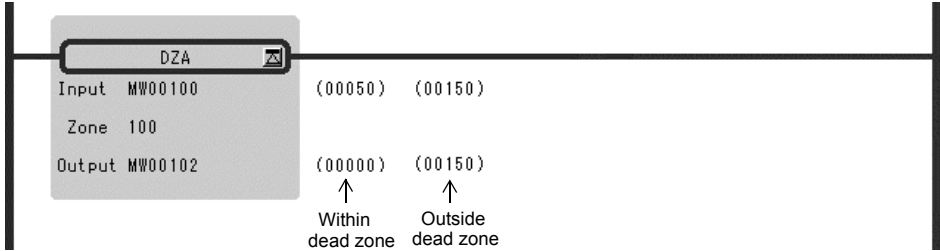

Double-length Integer Type Operation

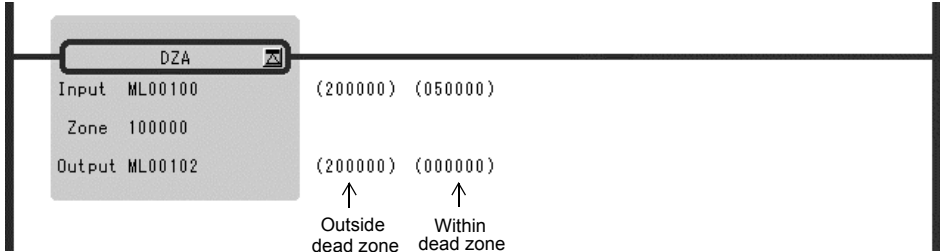

## Real Number Type Operation

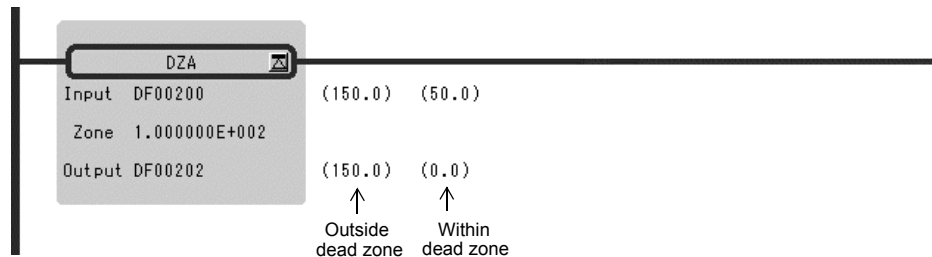

## 1.7.2 DEAD ZONE B Instruction (DZB)

### ■ Outline

The DZB instruction executes a dead zone operation on integer, double-length integer or real number data.

The following operation is performed, where *Input* is the input value, *Zone* is the designated dead zone value, and *Output* is the output value:

- $Output = Input - \text{the absolute value of } Zone$  (the absolute value of *Input* is greater than or equal to the absolute value of *Zone*; *Input* is greater than or equal to 0)
- $Output = Input + \text{the absolute value of } Zone$  (the absolute value of *Input* is greater than or equal to the absolute value of *Zone*; *Input* is less than or equal to 0)
- $Output = 0$  (the absolute value of *Input* is less than the absolute value of *Zone*)

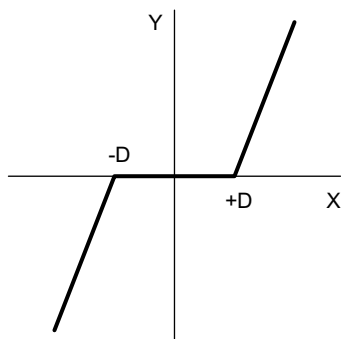

■ Format



Symbol: DZB  
 Full Name: Dead Zone B  
 Category: DDC  
 Icon:

1

■ Parameter

Parameter Name	Setting
Input	<ul style="list-style-type: none"> <li>• Any integer type, double-length integer type and real number type register</li> <li>• Any integer type, double-length integer type and real number type register with subscript</li> <li>• Subscript register</li> <li>• Constant</li> </ul>
Zone	<ul style="list-style-type: none"> <li>• Any integer type, double-length integer type and real number type register</li> <li>• Any integer type, double-length integer type and real number type register with subscript</li> <li>• Subscript register</li> <li>• Constant</li> </ul>
Output	<ul style="list-style-type: none"> <li>• Any integer type, double-length integer type and real number type register (except for # and C registers)</li> <li>• Any integer type, double-length integer type and real number type register with subscript (except for # and C registers)</li> <li>• Subscript register</li> </ul>

■ Program Example

Integer Type Operation



### Double-length Integer Type Operation

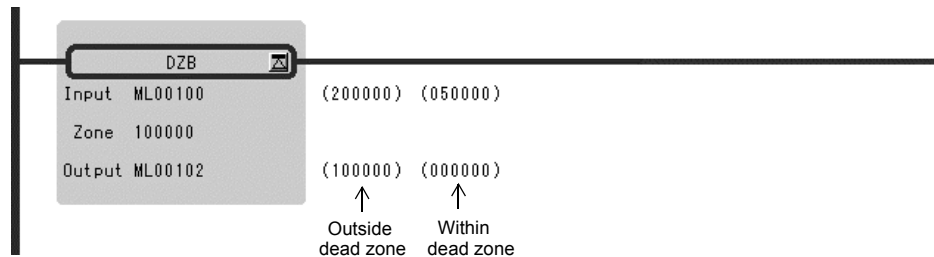

### Real Number Type Operation

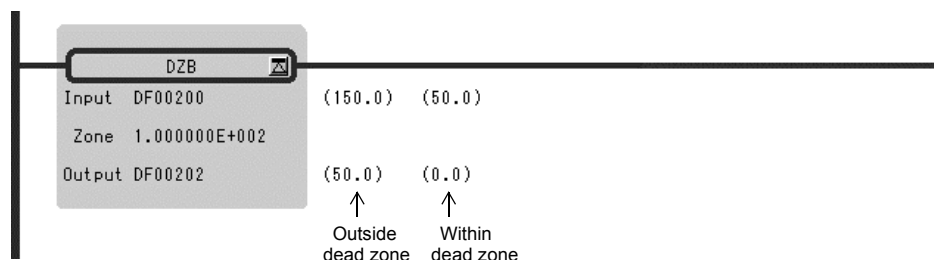

## 1.7.3 UPPER/LOWER LIMIT Instruction (LIMIT)

### ■ Outline

The LIMIT instruction executes an upper/lower limit operation on integer, double-length integer, or real number data. The following operation is performed, where *Input* is the input value, *Lower Limit* is the lower limit, *Upper Limit* is the upper limit, and *Output* is the output value:

- $Output = Lower\ Limit$  (*Input* is less than *Lower Limit*)
- $Output = Input$  (*Lower Limit* is less than or equal to *Input* which is less than or equal to *Upper Limit*)
- $Output = Upper\ Limit$  (*Upper Limit* is less than *Input*)

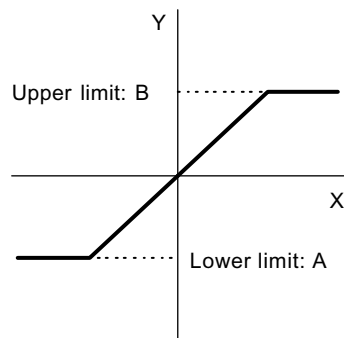

■ Format

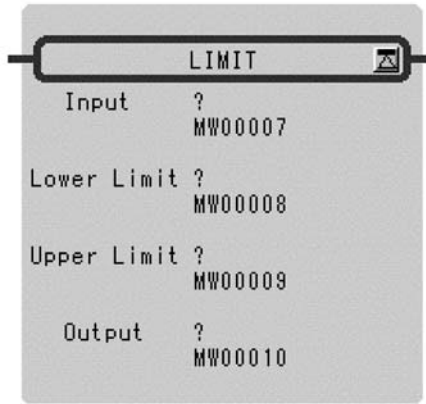

Symbol: LIMIT  
 Full Name: Limit  
 Category: DDC  
 Icon: 

1

■ Parameter

Parameter Name	Setting
Input	<ul style="list-style-type: none"> <li>• Any integer type, double-length integer type and real number type register</li> <li>• Any integer type, double-length integer type and real number type register with subscript</li> <li>• Subscript register</li> <li>• Constant</li> </ul>
Lower Limit	<ul style="list-style-type: none"> <li>• Any integer type, double-length integer type and real number type register</li> <li>• Any integer type, double-length integer type and real number type register with subscript</li> <li>• Subscript register</li> <li>• Constant</li> </ul>
Upper Limit	<ul style="list-style-type: none"> <li>• Any integer type, double-length integer type and real number type register</li> <li>• Any integer type, double-length integer type and real number type register with subscript</li> <li>• Subscript register</li> <li>• Constant</li> </ul>
Output	<ul style="list-style-type: none"> <li>• Any integer type and double-length integer register (except for # and C registers)</li> <li>• Any integer type and double-length integer register with subscript (except for # and C registers) (except for # and C registers)</li> <li>• Subscript register</li> </ul>

## ■ Program Example

### Integer Type Operation

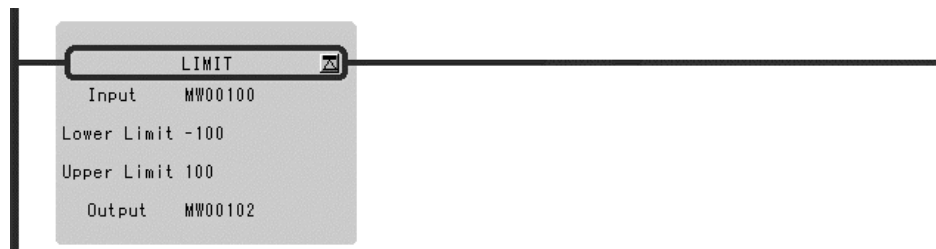

Input (MW00100)	Output (MW0010)
$-100 > \text{MW00100}$	-00100 (under the lower limit)
$-100 \leq \text{MW00100} \leq 100$	Value of MW00100 (within the upper and lower limit)
$\text{MW00100} > 100$	00100 (above the upper limit)

### Double-length Integer Type Operation

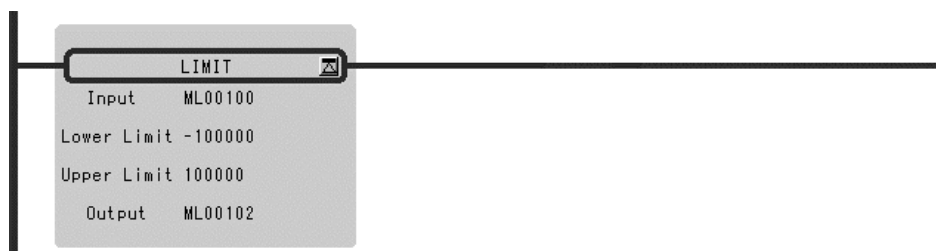

Input (ML00100)	Output (ML00102)
$-100000 > \text{ML00100}$	-100000 (under the lower limit)
$-100000 \leq \text{ML00100} \leq 100000$	Value of ML00100 (within the upper and lower limit)
$\text{ML00100} > 100000$	100000 (above the upper limit)



### Real Number Type Operation



1

Input (MF00200)	Output (MF00202)
$-100.0 > MF00200$	-100.0 (under the lower limit)
$-100.0 \leq MF00200 \leq 100.0$	Value of MF00200 (within the upper and lower limit)
$MF00200 > 100.0$	100.0 (above the upper limit)

### 1.7.4 PI CONTROL Instruction (PI)

■ Outline

The PI instruction executes a PI control operation according to the contents of a previously set parameter table. The input (*Input*) to the PI operation must be integer or real number data. Double-length integer data cannot be used. The configurations of the parameter tables for integer and real number data are different. Operations are performed by processing each parameter as an integer consisting of the lower-place 16 bits.

Table 1.12 Integer Type PI Instruction Parameters

ADR	Type	Symbol	Name	Specifications	I/O
0	W	RLY	Relay I/O	Relay input, relay output *	IN/OUT
1	W	Kp	P gain	Gain of the P offset (a gain of 1 is set to 100)	IN
2	W	Ki	Integration adjustment gain	Gain of the integration circuit input (a gain of 1 is set to 100)	IN
3	W	Ti	Integration time	Integration time (ms)	IN
4	W	IUL	Upper integration limit	Upper limit for the I offset	IN
5	W	ILL	Lower integration limit	Lower limit for the I offset	IN
6	W	UL	Upper PI limit	Upper limit for the P + I offset	IN
7	W	LL	Lower PI limit	Lower limit for the P + I offset	IN
8	W	DB	PI output dead band	Width of the dead band for the P + I offset	IN
9	W	Y	PI output	PI offset output (also output to the A register)	OUT
10	W	Yi	I offset	Storage of the I offset	OUT
11	W	I REM	I remainder	Storage of the I remainder	OUT

\* Relay I/O Bit Assignment

BIT	Symbol	Name	Specifications	I/O
0	IRST	Integration reset	"ON" is input when integration is reset	IN
1 to 7	–	(Reserved)	Reserved relay for input	IN
8 to F	–	(Reserved)	Reserved relay for output	OUT

Table 1.13 Real Number Type PI Instruction Parameters

ADR	Type	Symbol	Name	Specifications	I/O
0	W	RLY	Relay I/O	Relay input, relay output *	IN/OUT
1	W	–	(Reserved)	Reserved register	–
2	F	Kp	P gain	Gain of the P offset	IN
4	F	Ki	Integration adjustment gain	Gain of the integration circuit input	IN
6	F	Ti	Integration time	Integration time (s)	IN
8	F	IUL	Upper integration limit	Upper limit for the I offset	IN
10	F	ILL	Lower integration limit	Lower limit for the I offset	IN
12	F	UL	Upper PI limit	Upper limit for the P + I offset	IN
14	F	LL	Lower PI limit	Lower limit for the P + I offset	IN
16	F	DB	PI output dead band	Width of the dead band for the P + I offset	IN
18	F	Y	PI output	PI offset output (also output to the A register)	OUT
20	F	Yi	I offset	I stored	OUT

\* Relay I/O Bit Assignment

BIT	Symbol	Name	Specifications	I/O
0	IRST	Integration reset	"ON" is input when integration is reset	IN
1 to 7	–	(Reserved)	Reserved relay for input	IN
8 to F	–	(Reserved)	Reserved relay for output	OUT

Here, the PI operation is expressed as follows:

$$\frac{Y}{X} = Kp + Ki \times \frac{1}{Ti \times S}$$

X: deviation input value

Y: output value

The following operation is performed within the PI instruction:

$$Y = Kp \times X + \{(Ki \times X + IREM) / \frac{Ti}{Ts} + Yi\}$$

Yi: previous output value

Ts: scan time setting

Block Diagram

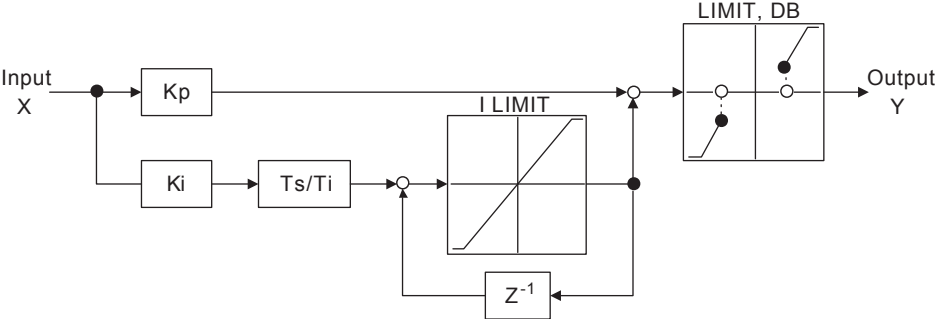

1

- **When the P + I offset reaches the upper or lower PI limit (UL, LL) or the PI dead band (DB)**  
 When the present P offset and the I offset are the same in sign (diverging), the I offset is not renewed but is kept at the previous value. Oppositely, if the P and I offsets are opposite in sign (converging towards 0), the I offset is renewed by the present value.
- **When the integration reset (IRST) is "ON"**  
 $Y_i = 0$  and  $IREM = 0$  are output.

■ Format

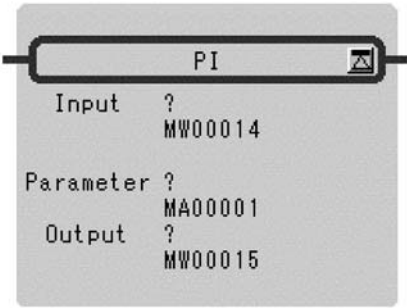

Symbol: PI  
 Full Name: PI Control  
 Category: DDC  
 Icon: 

■ Parameter

Parameter Name	Setting
Input	<ul style="list-style-type: none"> <li>• Any integer type and real number type register</li> <li>• Any integer type and real number type register with subscript</li> <li>• Subscript register</li> <li>• Constant</li> </ul>
Parameter	<ul style="list-style-type: none"> <li>• Register address (except for # and C registers)</li> <li>• Register address with subscript (except for # and C registers)</li> </ul>
Output	<ul style="list-style-type: none"> <li>• Any integer type and real number type register (except for # and C registers)</li> <li>• Any integer type and real number type register with subscript (except for # and C registers)</li> <li>• Subscript register</li> </ul>

■ Program Example

Integer Type Operation

MW00100 to MW00111 are used for the parameter table.

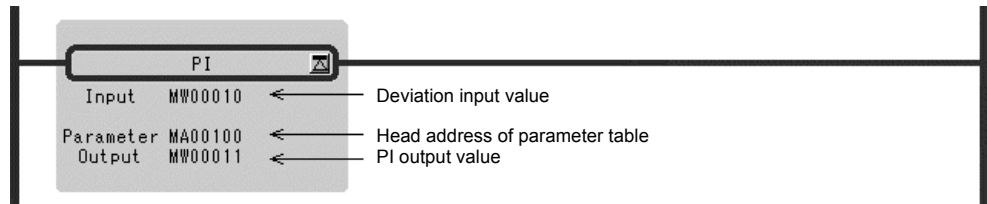

Real Number Type Operation

MF00200 to MF00220 are used for the parameter table.

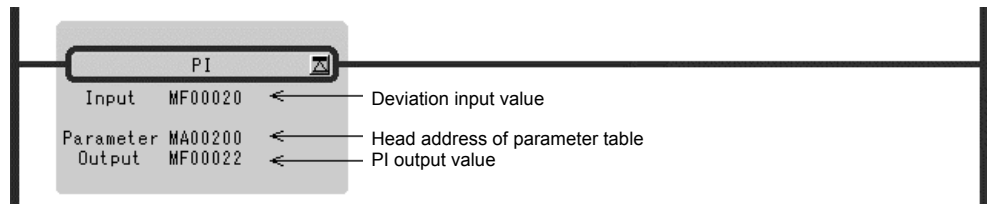

### 1.7.5 PD CONTROL Instruction (PD)

■ Outline

The PD instruction executes a PD control operation according to the contents of a previously set parameter table. The input (*Input*) to the PD operation must be integer or real number data.

Double-length integer data cannot be used. The configurations of the parameter tables for integer and real number data are different. Operations are performed by processing each parameter as an integer consisting of the lower-place 16 bits.

1

Table 1.14 Integer Type PD Instruction Parameters

ADR	Type	Symbol	Name	Specifications	I/O
0	W	RLY	Relay I/O	Relay input, relay output *	IN/OUT
1	W	Kp	P gain	Gain of the P offset (a gain of 1 is set to 100)	IN
2	W	Kd	D gain	Gain of the differential circuit input (a gain of 1 is set to 100)	IN
3	W	Td1	Divergence differential time	The differential time (ms) used in the case of diverging input.	IN
4	W	Td2	Convergence differential time	The differential time (ms) used in the case of converging input.	IN
5	W	UL	Upper PD limit	Upper limit for the P + D offset	IN
6	W	LL	Lower PD limit	Lower limit for the P + D offset	IN
7	W	DB	PD output dead band	Width of the dead band for the P + D offset	IN
8	W	Y	PD output	PD offset output (also output to the A register)	OUT
9	W	X	Input value storage	Storage of the present deviation input value	OUT

\* Relay I/O Bit Assignment

BIT	Symbol	Name	Specifications	I/O
0 to 7	–	(Reserved)	Reserved relay for input	IN
8 to F	–	(Reserved)	Reserved relay for output	OUT

Table 1.15 Real Number Type PD Instruction Parameters

ADR	Type	Symbol	Name	Specifications	I/O
0	W	RLY	Relay I/O	Relay input, relay output *	IN/OUT
1	W	–	(Reserved)	Reserved register	–
2	F	Kp	P gain	Gain of the P correction	IN
4	F	Kd	D gain	Gain of the differential circuit input	IN
6	F	Td1	Divergence differential time	The differential time (s) used in the case of diverging input.	IN
8	F	Td2	Convergence differential time	The differential time (s) used in the case of converging input.	IN
10	F	UL	Upper PD limit	Upper limit for the P + D offset	IN
12	F	LL	Lower PD limit	Lower limit for the P + D offset	IN
14	F	DB	PD output dead band	Width of the dead band for the P + D offset	IN
16	F	Y	PD output	PD offset output (also output to the A register)	OUT
18	F	X	Input stored	Present deviation input value stored	OUT

\* Relay I/O Bit Assignment

BIT	Symbol	Name	Specifications	I/O
0 to 7	–	(Reserved)	Reserved relay for input	IN
8 to F	–	(Reserved)	Reserved relay for output	OUT

Here, the PD operation is expressed as follows:

$$\frac{Y}{X} = Kp + Kd \times Td \times S$$

X: deviation input value

Y: output value

The following operation is performed within the PD instruction:

$$Y = Kp \times X + Kd \times (X - X') \times \frac{Td}{Ts}$$

X': previous input value

Ts: scan time setting

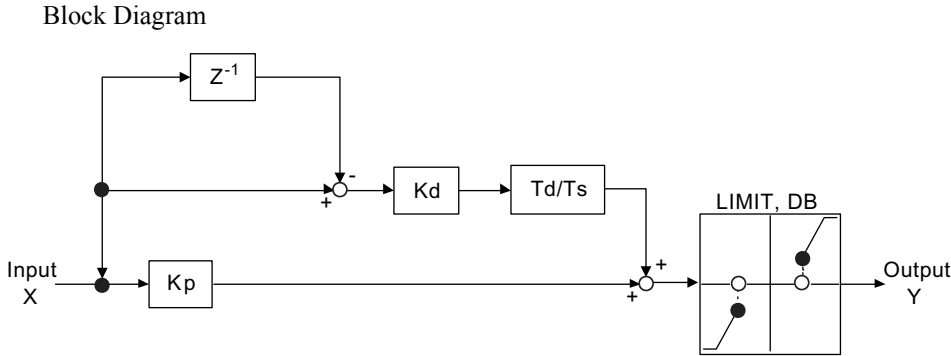

1

- **When the change in deviation output (X-X') and the previous deviation input (X') are the same in sign (diverging) in the differential (D) operation**  
The divergence differential time (Td1) is used as the differential time.
- **When the change in deviation output (X-X') and the previous deviation input (X') are opposite in sign (converging) in the differential (D) operation**  
The convergence differential time (Td2) is used as the differential time.

■ Format

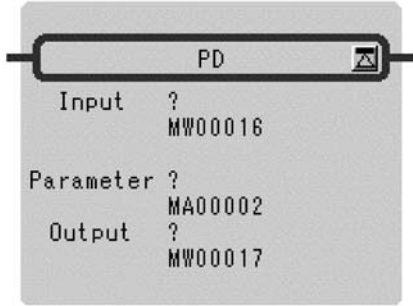

Symbol: PD  
 Full Name: PD Control  
 Category: DDC  
 Icon: 

■ Parameter

Parameter Name	Setting
Input	<ul style="list-style-type: none"> <li>• Any integer type and real number type register</li> <li>• Any integer type and real number type register with subscript</li> <li>• Subscript register</li> <li>• Constant</li> </ul>
Parameter	<ul style="list-style-type: none"> <li>• Register address (except for # and C registers)</li> <li>• Register address with subscript (except for # and C registers)</li> </ul>
Output	<ul style="list-style-type: none"> <li>• Any integer type and real number type register (except for # and C registers)</li> <li>• Any integer type and real number type register with subscript (except for # and C registers)</li> <li>• Subscript register</li> </ul>

■ Program Example

Integer Type Operation

MW00100 to MW00109 are used for the parameter table.

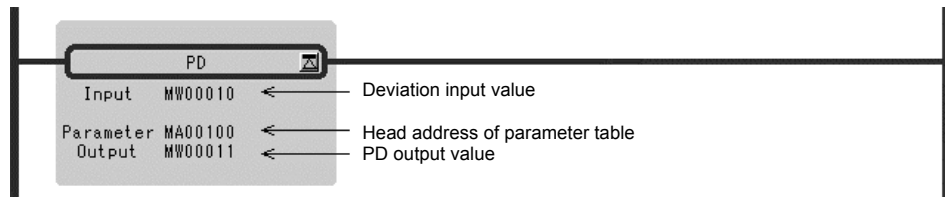

Real Number Integer Type Operation

MF00200 to MF00218 are used for the parameter table.

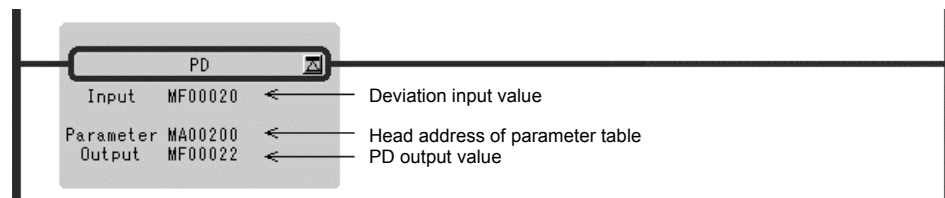



## 1.7.6 PID CONTROL Instruction (PID)

### ■ Outline

The PID instruction executes a PID control operation according to the contents of a previously set parameter table. The input (*Input*) to the PID operation must be integer or real number data.

Double-length integer data cannot be used. The configurations of the parameter tables for integer and real number data are different. Operations are performed by processing each parameter as an integer consisting of the lower-place 16 bits.

Table 1.16 Integer Type PID Instruction Parameters

ADR	Type	Symbol	Name	Specifications	I/O
0	W	RLY	Relay I/O	Relay input, relay output *	IN/OUT
1	W	Kp	P gain	Gain of the P correction (a gain of 1 is set to 100)	IN
2	W	Ki	I gain	Gain of the integration circuit input (a gain of 1 is set to 100)	IN
3	W	Kd	D gain	Gain of the differentiation circuit input (a gain of 1 is set to 100)	IN
4	W	Ti	Integration time	Integration time (ms)	IN
5	W	Td1	Divergence differential time	The differential time (ms) used in the case of diverging input.	IN
6	W	Td2	Convergence differential time	The differential time (ms) used in the case of converging input.	IN
7	W	IUL	Upper integration limit	Upper limit for the I correction value	IN
8	W	ILL	Lower integration limit	Lower limit for the I correction value	IN
9	W	UL	Upper PID limit	Upper limit for the P + I + D offset	IN
10	W	LL	Lower PID limit	Lower limit for the P + I + D offset	IN
11	W	DB	PID output dead band	Width of the dead band for the P + I + D offset	IN
12	W	Y	PID output	PID offset output (also output to the A register)	OUT
13	W	Ti	I offset	I offset stored	OUT
14	W	I REM	I remainder	I remainder stored	OUT
15	W	X	Input value storage	Present deviation input value stored	OUT

\* Relay I/O Bit Assignment.

BIT	Symbol	Name	Specifications	I/O
0	IRST	Integration reset	"ON" is input when integration is reset.	IN
1 to 7	–	(Reserved)	Reserved relay for input	IN
8 to F	–	(Reserved)	Reserved relay for output	OUT

Table 1.17 Real Number Type PID Instruction Parameters

ADR	Type	Symbol	Name	Specifications	I/O
0	W	RLY	Relay I/O	Relay input, relay output *	IN/OUT
1	W	–	(Reserved)	Reserved register	–
2	F	Kp	P gain	Gain of the P offset	IN
4	F	Ki	I gain	Gain of the integration circuit	IN
6	F	Kd	D gain	Gain of the differentiation circuit input	IN
8	F	Ti	Integration time	Integration time (ms)	IN
10	F	Td1	Divergence differential time	The differential time (s) used in the case of diverging input.	IN
12	F	Td2	Convergence differential time	The differential time (s) used in the case of converging input.	IN
14	F	IUL	Upper integration limit	Upper limit for the I offset	IN
16	F	ILL	Lower integration limit	Lower limit for the I offset	IN
18	F	UL	Upper PID limit	Upper limit for the P + I + D offset	IN
20	F	LL	Lower PID limit	Lower limit for the P + I + D offset	IN
22	F	DB	PID output dead band	Width of the dead band for the P + I + D offset	IN
24	F	Y	PID output	PID offset output (also output to the A register)	OUT
26	F	Ti	I offset	I offset stored	OUT
28	F	X	Input value storage	Present deviation input value stored	OUT

\* Relay I/O Bit Assignment

BIT	Symbol	Name	Specifications	I/O
0	IRST	Integration reset	"ON" is input when integration is reset.	IN
1 to 7	–	(Reserved)	Reserved relay for input	IN
8 to F	–	(Reserved)	Reserved relay for output	OUT

Here, the PID operation is expressed as follows:

$$\frac{Y}{X} = Kp + Ki \times \frac{1}{Ti \times S} + Kd \times Td \times S$$

X: deviation input value

Y: output value

The following operation is performed within the PID instruction:

$$Y = Kp \times X + \{ (Ki \times X + IREM) / \frac{Ti}{Ts} + Yi' \} + Kd \times (X - X') \times \frac{Td}{Ts}$$

X': previous input value

Yi': previous I output value

Ts: scan time setting

Block Diagram

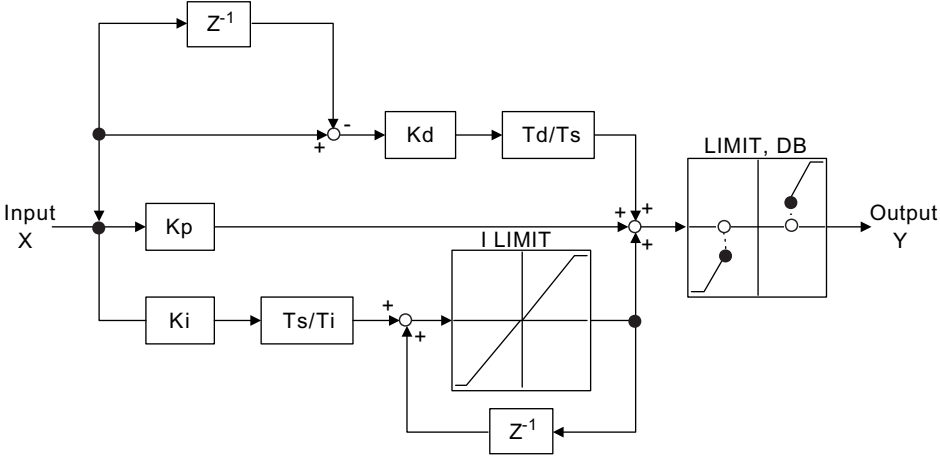

1

- **When the P + I + D offset reaches the upper or lower PID limit (UL, LL) or the PID dead band (DB)**  
When the present P offset and the I offset are the same in sign (diverging), the I offset is not renewed but is kept at the previous value. Oppositely, if the P and I offsets are opposite in sign (converging towards 0), the I offset is renewed with the present value.
- **When the change in deviation output (X-X') and the previous deviation input X' are the same in sign (diverging) in the differential (D) operation**  
The divergence differential time (Td1) is used as the differential time.
- **When the change in deviation output (X-X') and the previous deviation input X' are opposite in sign (converging) in the differential (D) operation**  
The convergence differential time (Td2) is used as the differential time.
- **When the integration reset (IRST) is "ON"**  
Yi = 0 and IREM = 0 are output.

■ Format

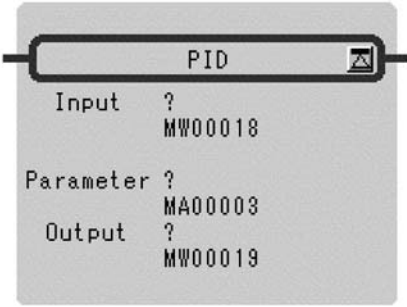

Symbol: PID  
 Full Name: PID Control  
 Category: DDC  
 Icon: 

■ Parameter

Parameter Name	Setting
Input	<ul style="list-style-type: none"> <li>• Any integer type and real number type register</li> <li>• Any integer type and real number type register with subscript</li> <li>• Subscript register</li> <li>• Constant</li> </ul>
Parameter	<ul style="list-style-type: none"> <li>• Register address (except for # and C registers)</li> <li>• Register address with subscript (except for # and C registers)</li> </ul>
Output	<ul style="list-style-type: none"> <li>• Any integer type and real number type register (except for # and C registers)</li> <li>• Any integer type and real number type register with subscript (except for # and C registers)</li> <li>• Subscript register</li> </ul>

■ Program Example

Integer Type Operation

MW00100 to MW00115 are used for the parameter table.

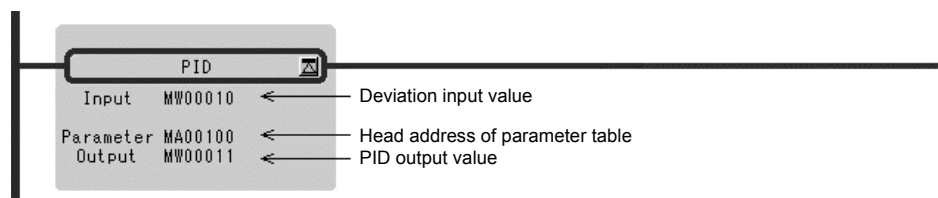

Real Number Type Operation

MF00200 to MF00228 are used for the parameter table.

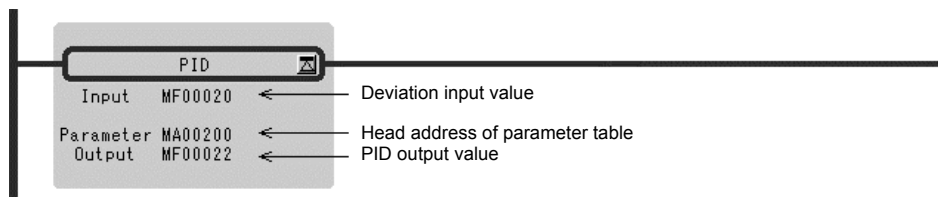

### 1.7.7 FIRST-ORDER LAG Instruction (LAG)

■ Outline

The LAG instruction calculates the first-order lag according to the contents of a previously set parameter table. The input (*Input*) to the LAG operation must be integer or real number data.

Double-length integer data cannot be used. The configurations of the parameter tables for integer and real number data are different. Operations are performed by processing each parameter as an integer consisting of the lower-place 16 bits.



Table 1.18 Integer Type LAG Instruction Parameters

ADR	Type	Symbol	Name	Specifications	I/O
0	W	RLY	Relay I/O	Relay input, relay output *	IN/OUT
1	W	T	First-order lag time constant	First-order lag time constant (ms)	IN
2	W	Y	LAG output	LAG output (also output to the A register)	OUT
3	W	REM	Remainder	Remainder stored	OUT

\* Relay I/O Bit Assignment.

BIT	Symbol	Name	Specifications	I/O
0	IRST	LAG reset	"ON" is input when LAG is reset.	IN
1 to 7	–	(Reserved)	Reserved relay for input	IN
8 to F	–	(Reserved)	Reserved relay for output	OUT

Table 1.19 Real Type LAG Instruction Parameters

ADR	Type	Symbol	Name	Specifications	I/O
0	W	RLY	Relay I/O	Relay input, relay output *	IN/OUT
1	W	–	(Reserved)	Reserved register	–
2	F	T	First-order lag time constant	First-order lag time constant (s)	IN
4	F	Y	LAG output	LAG output (also output to the F register)	OUT

\* Relay I/O Bit Assignment

BIT	Symbol	Name	Specifications	I/O
0	IRST	LAG reset	"ON" is input when LAG is reset.	IN
1 to 7	–	(Reserved)	Reserved relay for input	IN
8 to F	–	(Reserved)	Reserved relay for output	OUT

Here, the LAG operation is expressed as follows:

$$\frac{Y}{X} = \frac{1}{1+T \times S} ; \text{ie. } T \times (dY/dt) + Y = X$$

The following operation is performed within the LAG instruction with  $dt = T_s$  and  $dY = Y - Y'$ :

$$Y = \frac{T \times Y' + T_s \times X + REM}{T + T_s}$$

- X: input value
- Y: output value
- Y': previous output value
- Ts: scan time setting

$Y = 0$  and  $REM = 0$  are output when the LAG reset (RST) is "ON".

■ Format

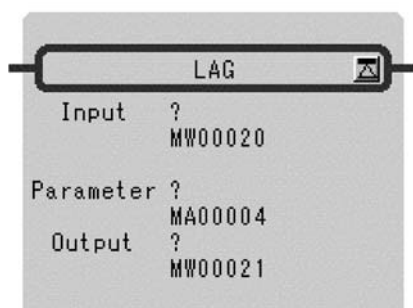

Symbol: LAG  
 Full Name: First Order Lag  
 Category: DDC  
 Icon: 

■ Parameter

Parameter Name	Setting
Input	<ul style="list-style-type: none"> <li>• Any integer type and real number type register</li> <li>• Any integer type and real number type register with subscript</li> <li>• Subscript register</li> <li>• Constant</li> </ul>
Parameter	<ul style="list-style-type: none"> <li>• Register address (except for # and C registers)</li> <li>• Register address with subscript (except for # and C registers)</li> </ul>
Output	<ul style="list-style-type: none"> <li>• Any integer type and real number type register (except for # and C registers)</li> <li>• Any integer type and real number type register with subscript (except for # and C registers)</li> <li>• Subscript register</li> </ul>

■ Program Example

Integer Type Operation

MW00100 to MW00103 are used for the parameter table.

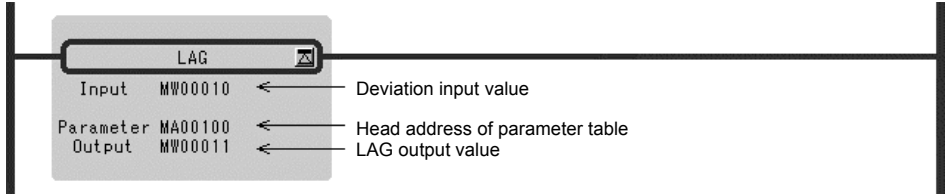

1

Real Number Type Operation

MF00200 to MF00204 are used for the parameter table.

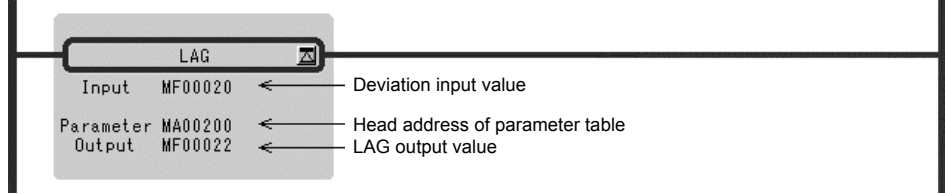

## 1.7.8 PHASE LEAD/LAG Instruction (LLAG)

### ■ Outline

The LLAG instruction calculates the phase lead/lag according to the contents of a previously set parameter table. The input (*Input*) to the LLAG operation must be integer or real number data.

Double-length integer data cannot be used. The configurations of the parameter tables for integer and real number data are different. Operations are performed by processing each parameter as an integer consisting of the lower-place 16 bits.

Table 1.20 Integer Type LLAG Instruction Parameters

ADR	Type	Symbol	Name	Specifications	I/O
0	W	RLY	Relay I/O	Relay input, relay output *	IN/OUT
1	W	T2	Phase lead time constant	Phase lead time constant (ms)	IN
2	W	T1	Phase lag time constant	Phase lag time constant (ms)	IN
3	W	Y	LLAG output	LLAG output (may also be output to the A register)	OUT
4	W	REM	Remainder	Remainder stored	OUT
5	W	X	Input stored	Input value stored	OUT

\* Relay I/O Bit Assignment

BIT	Symbol	Name	Specifications	I/O
0	IRST	LLAG reset	"ON" is input when LLAG is reset.	IN
1 to 7	–	(Reserved)	Reserved relay for input	IN
8 to F	–	(Reserved)	Reserved relay for output	OUT

Table 1.21 Real Number Type LLAG Instruction Parameters

ADR	Type	Symbol	Name	Specifications	I/O
0	W	RLY	Relay I/O	Relay input, relay output *	IN/OUT
1	W	–	(Reserved)	Reserved register	–
2	W	T2	Phase lead time constant	Phase lead time constant (s)	IN
4	W	T1	Phase lag time constant	Phase lag time constant (s)	IN
6	W	Y	LLAG output	LLAG output (may also be output to the F register)	OUT
8	W	X	Input preservation	Input value stored	OUT

\* Relay I/O Bit Assignment

BIT	Symbol	Name	Specifications	I/O
0	IRST	LLAG reset	"ON" is input when LLAG is reset.	IN
1 to 7	–	(Reserved)	Reserved relay for input	IN
8 to F	–	(Reserved)	Reserved relay for output	OUT



Here, the LLAG operation is expressed as follows:

$$\frac{Y}{X} = \frac{1 + T2 \times S}{1 + T1 \times S} ; \text{ie. } T \times (dY/dt) + Y = T2 \times (dX/dt) + X$$

The following operation is performed within the LLAG instruction with dt = Ts, dY = Y-Y', and dX = X-X'

$$Y = \frac{T1 \times Y' + (T2 + Ts) \times X - T2 \times X' + REM}{T1 + Ts}$$

- X: input value
- Y: output value
- X': previous input value
- Y': previous output value
- Ts: scan time setting

Y = 0, REM = 0, X = 0, are output when the LLAG reset (RST) is "ON".

■ Format

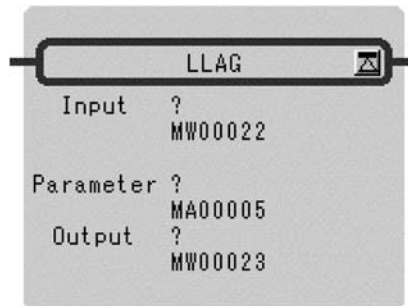

Symbol: LLAG  
 Full Name: Phase Lead Lag  
 Category: DDC  
 Icon: 

■ Parameter

Parameter Name	Setting
Input	<ul style="list-style-type: none"> <li>• Any integer type and real number type register</li> <li>• Any integer type and real number type register with subscript</li> <li>• Subscript register</li> <li>• Constant</li> </ul>
Parameter	<ul style="list-style-type: none"> <li>• Register address (except for # and C registers)</li> <li>• Register address with subscript (except for # and C registers)</li> </ul>
Output	<ul style="list-style-type: none"> <li>• Any integer type and real number type register (except for # and C registers)</li> <li>• Any integer type and real number type register with subscript (except for # and C registers)</li> <li>• Subscript register</li> </ul>

## ■ Program Example

### Integer Type Operation

MW00100 to MW00105 are used for the parameter table.

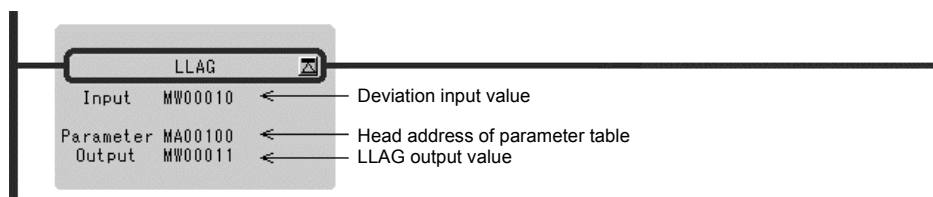

### Real Number Type Operation

MF00200 to MF00208 are used for the parameter table.

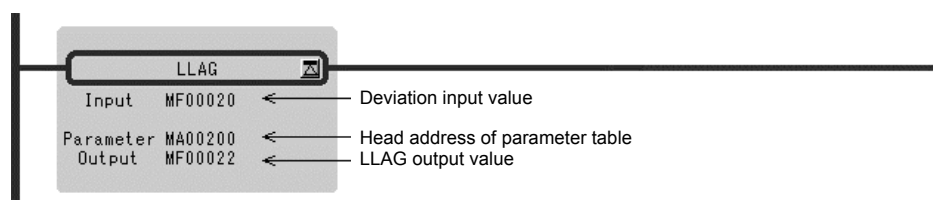

## 1.7.9 FUNCTION GENERATOR Instruction (FGN)

### ■ Outline

The FGN instruction generates a function curve according to the contents of a previously set parameter table. The input to the FGN instruction can be integer, double-length integer, or real number data. The configuration of the parameter table differs according to the type of data.

Table 1.22 Integer Type FGN Instruction Parameters

ADR	Type	Symbol	Name	Specifications	I/O
0	W	N	Number of data	Number of pairs of X and Y	IN
1	W	X1	Data 1		IN
2	W	Y1	Data 1		IN
3	W	X2	Data 2		IN
4	W	Y2	Data 2		IN
...	...	...	...	...	...
2N-1	W	XN	Data N		IN
2N	W	YN	Data N		IN

Table 1.23 Double-length Integer or Real Type FGN Instruction Parameters

ADR	Type	Symbol	Name	Specifications	I/O
0	W	N	Number of data	Number of pairs of X and Y	IN
1	W	-	(Reserved)	Reserved register	IN
2	L/F	X1	Data 1		IN
4	L/F	Y1	Data 1		IN
6	L/F	X2	Data 2		IN
8	L/F	Y2	Data 2		IN
...	...	...	...	...	...
4N-2	L/F	XN	Data N		IN
4N	L/F	YN	Data N		IN

1

If the data set in the parameter table for the FGN instruction are  $X_n$  and  $Y_n$ , the data must be set so that  $X_n \leq Y_{n+1}$ . The FGN instruction searches for an  $X_n/ Y_n$  pair within the parameter table for which  $X_n \leq X \leq Y_{n+1}$  and computes the output value  $Y$  according to the following formula:

$$Y = Y_n + \frac{Y_{n+1} - Y_n}{X_{n+1} - X_n} \times (X - X_n) \quad (1 \leq n \leq N - 1)$$

If the  $X_n/ Y_n$  pair, which satisfies  $X_n \leq X \leq Y_{n+1}$  for an input value  $X$ , does not exist in the parameter table, the result will be as follows:

- IF  $X < X_1$

$$Y = Y_1 + \frac{Y_2 - Y_1}{X_2 - X_1} (X - X_1)$$

- IF  $X > X_4$

$$Y = Y_{n+1} + \frac{Y_n - Y_{n+1}}{X_n - X_{n+1}} (X - X_{n+1})$$

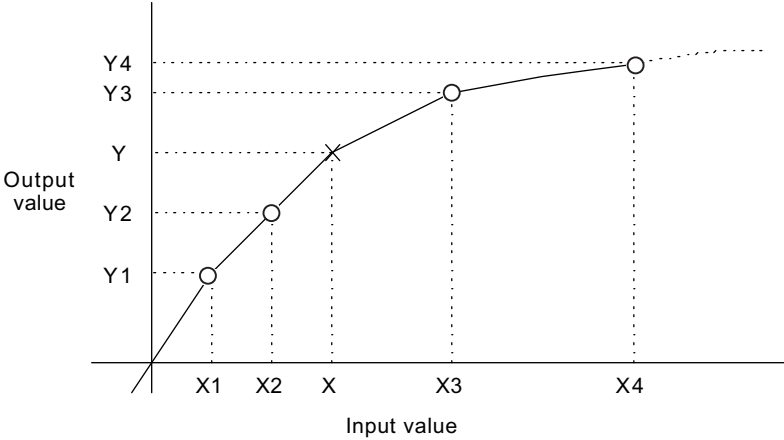

■ Format

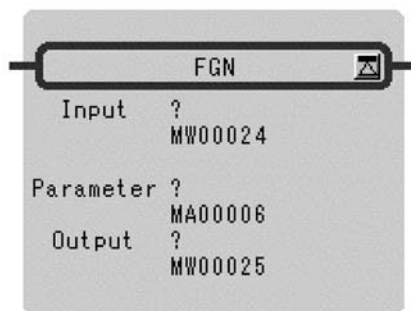

Symbol: FGN  
 Full Name: Function Generator  
 Category: DDC  
 Icon: 

■ Parameter

Parameter Name	Setting
Input	<ul style="list-style-type: none"> <li>• Any integer type, double-length integer and real number type register</li> <li>• Any integer type register with subscript</li> <li>• Any integer type, double-length integer and real number type register with subscript</li> <li>• Subscript register</li> <li>• Constant</li> </ul>
Parameter	<ul style="list-style-type: none"> <li>• Register address (except for # and C registers)</li> <li>• Register address with subscript (except for # and C registers)</li> </ul>
Output	<ul style="list-style-type: none"> <li>• Any integer type, double-length integer and real number type register (except for # and C registers)</li> <li>• Any integer type, double-length integer and real number type register with subscript (except for # and C registers)</li> <li>• Subscript register</li> </ul>

■ Program Example

Integer Type Operation (Number of Data: N = 20)

#W00000 to #W00040 are used for the parameter table.

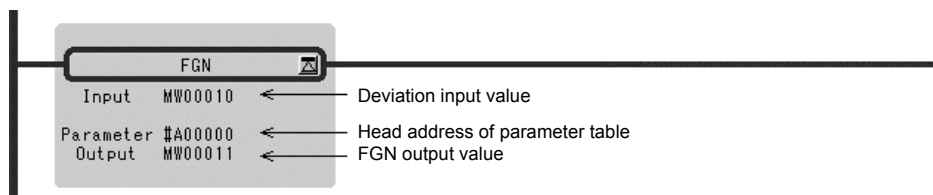

Double-length Integer Type Operation (Number of Data: N = 20)

#L00000 to #L00080 are used for the parameter table.

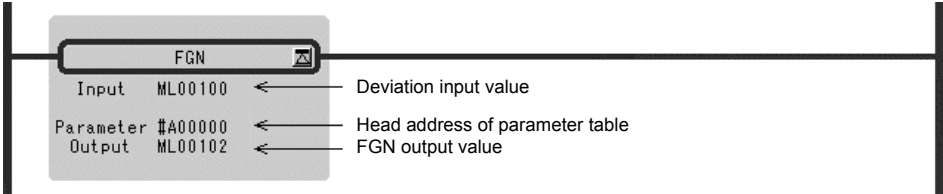

1

Real Number Type Operation (Number of Data: N = 20)

#F00000 to #F00080 are used for the parameter table.

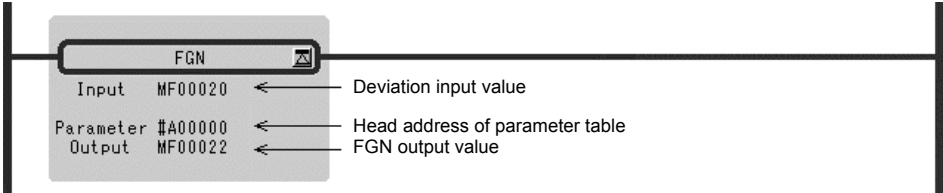

1.7.10 INVERSE FUNCTION GENERATOR Instruction (IFGN)

■ Outline

The IFGN instruction generates a function curve according to the contents of a previously set parameter table. The input to the IFGN instruction can be integer, double-length integer, or real number data.

The configuration of the parameter table differs according to the type of data.

If the data set in the parameter table for the IFGN instruction are  $X_n$  and  $Y_n$ , the data must be set so that  $Y_n$  is less than or equal to  $Y_{n+1}$ . The IFGN instruction searches for an  $X_n/Y_n$  pair within the parameter table in which  $Y_n$  is less than or equal to  $Y$  which is less than or equal to  $Y_{n+1}$  from input value  $Y$  and calculates the output value  $X$ .

Table 1.24 Integer Type IFGN Instruction Parameters

ADR	Type	Symbol	Name	Specifications	I/O
0	W	N	Number of data	Number of pairs of X and Y	IN
1	W	X1	Data 1		IN
2	W	Y1	Data 1		IN
3	W	X2	Data 2		IN
4	W	Y2	Data 2		IN
...	...	...	...	...	...
2N-1	W	XN	Data N		IN
2N	W	YN	Data N		IN

Table 1.25 Double-length Integer or Real Type IFGN Instruction Parameters

ADR	Type	Symbol	Name	Specifications	I/O
0	W	N	Number of data	Number of pairs of X and Y	IN
1	W	-	(Reserved)	Reserved register	IN
2	L/F	X1	Data 1		IN
4	L/F	Y1	Data 1		IN
6	L/F	X2	Data 2		IN
8	L/F	Y2	Data 2		IN
...	...	...	...	...	...
4N-2	L/F	XN	Data N		IN
4N	L/F	YN	Data N		IN

If the data set in the parameter table for the IFGN instruction are  $X_n$  and  $Y_n$ , the data must be set so that  $X_n \leq Y_{n+1}$ . The IFGN instruction searches for an  $X_n / Y_n$  pair within the parameter table for which  $Y_n \leq Y \leq Y_{n+1}$  and computes the output value  $Y$  according to the following formula:

$$X = X_n + \frac{X_{n+1} - X_n}{Y_{n+1} - Y_n} \times (Y - Y_n)$$

If the  $X_n / Y_n$  pair, which satisfies  $Y_n \leq Y \leq Y_{n+1}$  for an input value  $Y$ , does not exist in the parameter table, the result will be as follows:

- IF  $X < Y_1$

$$X = X_1 + \frac{X_2 - X_1}{Y_2 - Y_1} (Y - Y_1)$$

- IF  $Y > Y_1$

$$X = X_{n+1} + \frac{X_n - X_{n-1}}{Y_n - Y_{n-1}} (Y - Y_1)$$

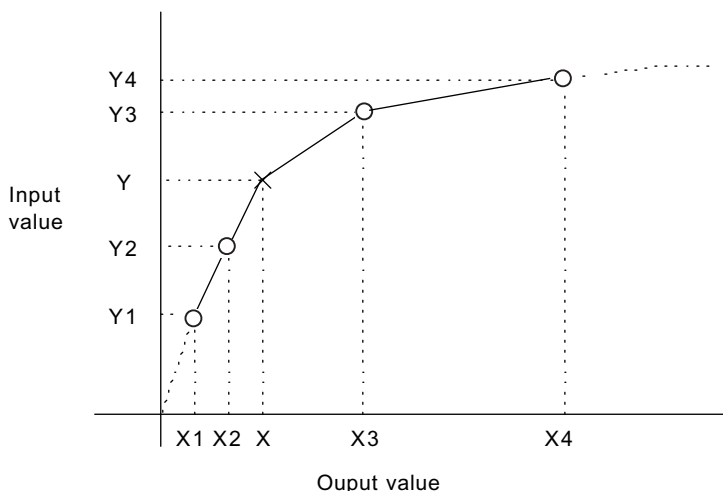

■ Format

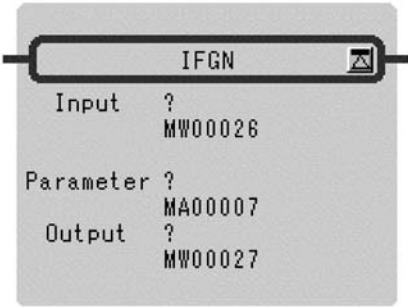

Symbol: IFGN  
 Full Name: Inverse Function Generator  
 Category: DDC  
 Icon: 

1

■ Parameter

Parameter Name	Setting
Input	<ul style="list-style-type: none"> <li>• Any integer type, double-length integer and real number type register</li> <li>• Any integer type register with subscript</li> <li>• Any integer type, double-length integer and real number type register with subscript</li> <li>• Subscript register</li> <li>• Constant</li> </ul>
Parameter	<ul style="list-style-type: none"> <li>• Register address (except for # and C registers)</li> <li>• Register address with subscript (except for # and C registers)</li> </ul>
Output	<ul style="list-style-type: none"> <li>• Any integer type, double-length integer and real number type register (except for # and C registers)</li> <li>• Any integer type, double-length integer and real number type register with subscript (except for # and C registers)</li> <li>• Subscript register</li> </ul>

■ Program Example

Integer Type Operation (Number of Data: N = 20)

#W00000 to #W00040 are used for the parameter table.

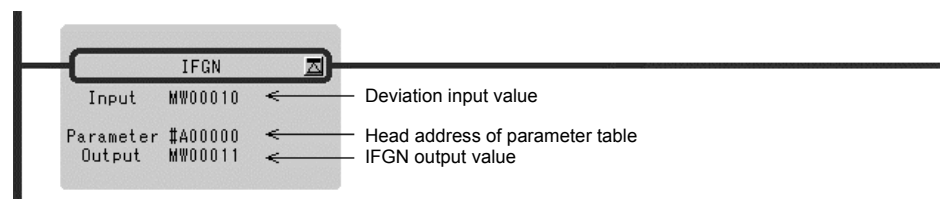

Double-length Integer Type Operation (Number of Data: N = 20)

#L00000 to #L00080 are used for the parameter table.

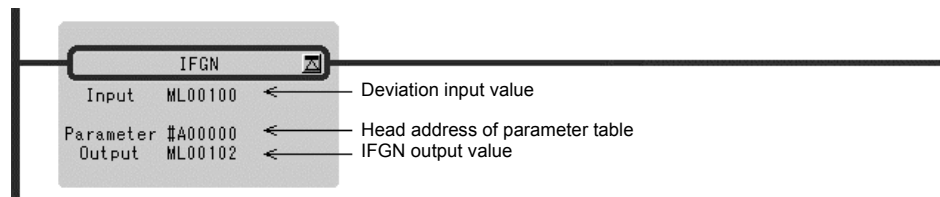

Real Number Type Operation (Number of Data: N = 20)

#F00000 to #F00080 are used for the parameter table.

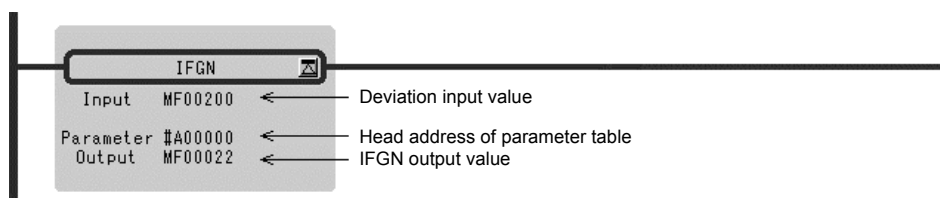



## 1.7.11 LINEAR ACCELERATOR/DECELERATOR 1 Instruction (LAU)

### ■ Outline

The LAU instruction performs acceleration and deceleration at a fixed acceleration/deceleration rate upon input of a speed reference (*Input*). The operation is performed according to the contents of a previously set parameter table.

The input to the LAU operation must be integer or real number data. Double-length data cannot be used. The configurations of the parameter tables for integer and real number data are different. Operations are performed by processing each parameter as an integer consisting of the lower-place 16 bits.

Table 1.26 Integer Type LAU Instruction Parameters

ADR	Type	Symbol	Name	Specifications	I/O
0	W	RLY	Relay I/O	Relay input, relay output *	IN/OUT
1	W	LV	100% input level	Scale of the 100% input value	IN
2	W	AT	Acceleration time	Time for acceleration from 0% to 100% (0.1 s)	IN
3	W	BT	Deceleration time	Time for deceleration from 0% to 100% (0.1 s)	IN
4	W	QT	Quick stop time	Time for quick stop from 100% to 0% (0.1 s)	IN
5	W	V	Current speed	LAU output (also output to the A register)	OUT
6	W	DVDT	Current acceleration/deceleration speed	Scale with the normal acceleration rate being set to 5000.	OUT
7	W	–	(Reserved)	Reserved register	–
8	W	VIM	Previous speed instruction	For storage of the previous value of the speed instruction input	OUT
9	W	DVDTK	DVDT coefficient	Scaling coefficient of the current acceleration (DVDT) (-32768 to 32767)	IN
10	L	REM	Remainder	Remainder of the acceleration/deceleration rate	OUT

\* Relay I/O Bit Assignment

BIT	Symbol	Name	Specifications	I/O
0	RN	Line is running	"ON" is input while the line is running.	IN
1	QS	Quick stop	"OFF" is input upon quick stop. *	IN
2	DVDTF	DVDT operation non-execution	"Closed" entered in DVDT operation non-execution	IN
3	DVDTS	DVDT operation selection	Selection DVDT operation method	IN
4 to 7	–	(Reserved)	Reserved relay for input	IN
8	ARY	In acceleration	"ON" is output during acceleration.	OUT
9	BRY	In deceleration	"ON" is output during deceleration.	OUT
A	LSP	Zero speed	"ON" is output upon attainment of a speed of 0.	OUT
B	EQU	Coincidence	"ON" is output when input value = output value.	OUT
C to F	–	(Reserved)	Reserved relay for input	OUT

\* When the quick stop (QS) is "OFF", the quick stop time (QT) is used as acceleration/deceleration time.

Table 1.27 Real Type LAU Instruction Parameters

ADR	Type	Symbol	Name	Specifications	I/O
0	W	RLY	Relay I/O	Relay input, relay output *	IN/OUT
1	W	–	(Reserved)	Reserved register	–
2	F	LV	100% input level	Scale of the 100% input value	IN
4	F	AT	Acceleration time	Time for acceleration from 0% to 100% (s)	IN
6	F	BT	Deceleration time	Time for deceleration from 0% to 100% (s)	IN
8	F	QT	Quick stop time	Time for quick stop from 100% to 0% (s)	IN
10	F	V	Current speed	LAU output (also output to the F register)	OUT
12	F	DVDT	Current acceleration/deceleration speed	Scaled with the normal acceleration rate being set to 5000.	OUT

\* Relay I/O Bit Assignment

BIT	Symbol	Name	Specifications	I/O
0	RN	Line is running	"ON" is input while the line is running.	IN
1	QS	Quick stop	"OFF" is input upon quick stop.*	IN
2 to 7	–	(Reserved)	Reserved relay for input	IN
8	ARY	In acceleration	"ON" is output during acceleration.	OUT
9	BRY	In deceleration	"ON" is output during deceleration.	OUT
A	LSP	Zero speed	"ON" is output upon attainment of a speed of 0.	OUT
B	EQU	Coincidence	"ON" is output when input value = output value.	OUT
C to F	–	(Reserved)	Reserved relay for input	OUT

\* When the quick stop (QS) is "OFF", the quick stop time (QT) is used as acceleration/deceleration time.

The following operations are performed inside integer type LAU instructions.

### Integer Type LAU Instruction

$$\text{Acceleration rate (ADV)} = \frac{\text{LV} \times \text{Ts} (0.1 \text{ ms}) + \text{REM}}{\text{AT} (0.1 \text{ s}) \times 1000}$$

When  $V_I > V'$  ( $V' \geq 0$ ),  
 $V = V' + \text{ADV}$ : In acceleration (ARY)  
 ON  
 When  $V_I < V'$  ( $V' \leq 0$ ),  
 $V = V' - \text{ADV}$ : In acceleration (ARY)  
 ON

$$\text{Deceleration rate (BDV)} = \frac{\text{LV} \times \text{Ts} (0.1 \text{ ms}) + \text{REM}}{\text{BT} (0.1 \text{ s}) \times 1000}$$

When  $V_I > V'$  ( $V' < 0$ )  
 $V = V' + \text{BDV}$ : In deceleration (BRY)  
 ON  
 When  $V_I < V'$  ( $V' > 0$ )  
 $V = V' - \text{BDV}$ : In deceleration (BRY)  
 ON

$$\text{Quick stop rate (QDV)} = \frac{LV \times Ts (0.1 \text{ ms}) + \text{REM}}{QT (0.1 \text{ s}) \times 1000}$$

When QS = ON (VI > V'),  
V = V' + QDV: In deceleration (BRY) ON  
At QS=ON(VI < V'; V' > 0)  
V = V' - QDV: In deceleration (BRY) ON

V': previous speed output value

VI: Speed designated input

Ts: scan time setting

- If the DVDT operation instruction (DVDTF) is ON, a current acceleration/deceleration operation (DVDT) is performed.
- If DVDTF is OFF, DVDT = 0 is output. If DVDTF is ON, a current acceleration/deceleration operation (DVDT) is output after one of the following operations has been performed through DVDT operation selection (DVDTs).

After (\*S) operates (\*O) of either as follows, the operation of addition-subtraction speed (DVDT) is output by DVDT operation selection (DVDTs) now when DVDTF is turning on.

$$\text{If DVDTs is ON: } DVDT = \frac{V - V'}{ADV} \times 5000$$

$$\text{If DVDTs is OFF: } DVDT = (V \times DVDTK) - (V' \times DVDTK)$$

At V = 0, the zero velocity (LSP) is ON, at VI = V equality (EQU) turns ON.

- When the "line is running" signal (RN) is "OFF", V = 0 and DVDT = 0 are output.

## Real Type LAU Instruction

$$\text{Acceleration rate (ADV)} = \frac{LV \times Ts (0.1 \text{ ms})}{AT(s) \times 10000}$$

When VI > V (V' > 0) ,  
V = V' + ADV: ARY (in acceleration) is ON  
When VI < V'(V' < 0) ,  
V = V' - ADV: ARY (in acceleration) is ON

$$\text{Deceleration rate (BDV)} = \frac{-LV \times Ts (0.1 \text{ ms})}{BT(s) \times 10000}$$

When VI < V' (V' > 0)  
V = V' + BDV: BRY (in deceleration) is ON  
At VI > V' (V' < 0)  
V = V' - BDV: BRY (in deceleration) is ON

$$\text{Quick stop rate (QDV)} = \frac{-LV \times Ts (0.1 \text{ ms})}{QT(s) \times 10000}$$

When QS = ON (V' > VI),  
V = V' + QDV: BRY (in deceleration) is ON  
When QS = ON (V' < VI)  
V = V' - QDV: BRY (in deceleration) is ON

V': previous speed output value

VI: Speed designated input

Ts: scan time setting (ms)

The current acceleration/deceleration (DVDT) is output after the following operation is carried out:

$$DVDT = \frac{V - V'}{ADV} \times 5000$$

When the "line is running" signal (RN) is "OFF",  $V = 0$  and  $DVDT = 0$  are output.

### ■ Format

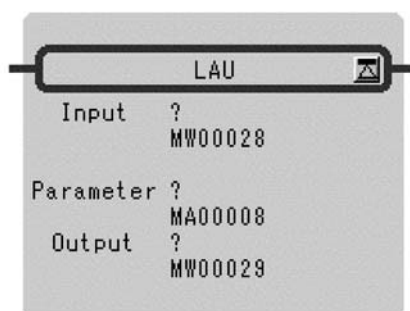

Symbol: LAU  
 Full Name: Linear Accelerator  
 Category: DDC  
 Icon: 

### ■ Parameter

Parameter Name	Setting
Input	<ul style="list-style-type: none"> <li>• Any integer and real number type register</li> <li>• Any integer and real number type register with subscript</li> <li>• Subscript register</li> <li>• Constant</li> </ul>
Parameter	<ul style="list-style-type: none"> <li>• Register address (except for # and C registers)</li> <li>• Register address with subscript (except for # and C registers)</li> </ul>
Output	<ul style="list-style-type: none"> <li>• Any integer and real number type register (except for # and C registers)</li> <li>• Any integer and real number type register with subscript (except for # and C registers)</li> <li>• Subscript register</li> </ul>

■ Program Example

Integer Type Operation

MW00100 to MW00111 are used for the parameter table.

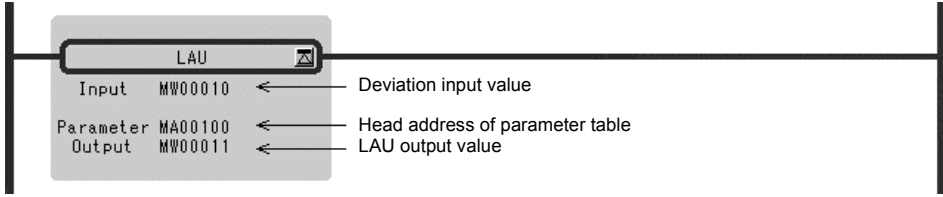

1

Real Number Type Operation

MF00200 to MF00212 are used for the parameter table.

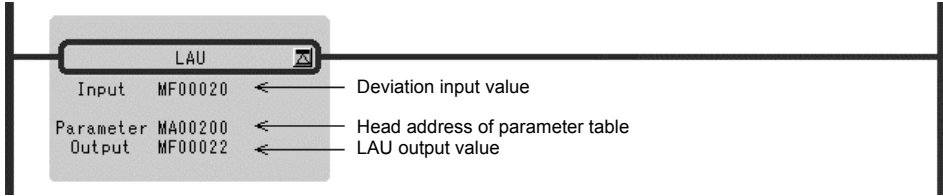

1.7.12 LINEAR ACCELERATOR/DECELERATOR 2 Instruction (SLAU)

■ Outline

The SLAU instruction performs acceleration and deceleration at a variable acceleration/ deceleration rate upon input of a speed reference (*Input*). The operation is performed according to the contents of the previously set parameter table.

Positive and negative values can be entered for speed reference input. Always set a value so that the linear acceleration or deceleration time (AT or BT) is greater than or equal to the S-curve acceleration or deceleration time (AAT or BBT).

The input to the SLAU operation must be integer or real number data. Double-length integer data cannot be used. The configurations of the parameter tables for integer and real number data are different

Table 1.28 Integer Type SLAU Instruction Parameters

ADR	Type	Symbol	Name	Specifications	I/O
0	W	RLY	Relay I/O	Relay input, relay output *	IN/OUT
1	W	LV	100% input level	Scale of the 100% input	IN
2	W	AT	Acceleration time	Time for acceleration from 0% to 100% (0.1 s)	IN
3	W	BT	Deceleration time	Time for deceleration from 0% to 100% (0.1 s)	IN
4	W	QT	Quick stop time	Time for quick stop from 100% to 0% (0.1 s)	IN
5	W	AAT	S-curve acceleration time	Time spent in the S-curve area during acceleration (0.01 s)	IN
6	W	BBT	S-curve deceleration time	Time spent in the S-curve area during deceleration (0.01 s)	IN
7	W	V	Current speed	SLAU output (also output to the A register)	OUT
8	W	DVDT1	Current acceleration/ deceleration speed1 (DVDT1)	Scaled with the normal acceleration rate being set to 5000.	OUT
9	W	–	(Reserved)	Reserved register	–
10	W	ABMD	Speed increase upon holding	Amount of change in speed after hold instruction and until stabilization.	OUT
11	W	REM1	Remainder	Remainder of acceleration/deceleration rate	OUT
12	W	–	(Reserved)	Reserved register	–
13	W	VIM	Remainder	For storage of the previous value of the speed designation input	OUT
14	L	DVDT2	Current acceleration/ deceleration speed2 (DVDT2)	1000 times of actual acceleration/deceleration	OUT
16	L	DVDT3	Current acceleration/ deceleration speed3 (DVDT3)	Current acceleration/deceleration (= DCDT2/1000)	OUT
18	L	REM2	Remainder	Remainder of S-curve area acceleration/deceleration rate	OUT
20	W	REM3	Remainder	Remainder of the current speed	OUT
21	W	DVDTK	DVDT1 coefficient	Scaling coefficient (-32768 to 32767) of current acceleration/deceleration (DVDT1)	IN

## \* Relay I/O Bit Assignment

BIT	Symbol	Name	Specifications	I/O
0	RN	Line is running	"ON" is input while the line is running.	IN
1	QS	Quick stop	"OFF" is input upon quick stop*	IN
2	DVDTF	Non-execution of DVDT1 operation	Input of "OFF" into non-execution of DVDT1 operation.	IN
3	DVDTS	DVDT1 operation selection	Selection DVDT1 operation method	IN
4 to 7	–	(Reserved)	Reserved relay for input	IN
8	ARY	In acceleration	"ON" is output during acceleration.	OUT
9	BRY	In deceleration	"ON" is output during deceleration.	OUT
A	LSP	Zero speed	"ON" is output upon attainment of a speed of 0.	OUT
B	EQU	Coincidence	"ON" is output when input value = output value.	OUT
C	EQU	(Reserved)	Reserved relay for output	OUT
D	CCF	Work relay	System internal work relay	OUT
E	BBF	Work relay	System internal work relay	OUT
F	AAF	Work relay	System internal work relay	OUT

\* When the quick stop (QS) is "OFF", the quick stop time is used for the acceleration/deceleration time.

Table 1.29 Real Type SLAU Instruction Parameters

ADR	Type	Symbol	Name	Specifications	I/O
0	W	RLY	Relay I/O	Relay input, relay output *	IN/OUT
1	W	–	(Reserved)	Reserved register	–
2	F	LV	100% input level	Scale of the 100% input	IN
4	F	AT	Acceleration time	Time for acceleration from 0% to 100% (s)	IN
6	F	BT	Deceleration time	Time for deceleration from 100% to 0% (s)	IN
8	F	QT	Quick stop time	Time for quick stop from 100% to 0% (s)	IN
10	F	AAT	S-curve acceleration time	Time spent in the S-curve area during acceleration (s)	IN
12	F	BBT	S-curve deceleration time	Time spent in the S-curve area during deceleration (s)	IN
14	F	V	Current speed	SLAU output (also output to the F register)	OUT
16	F	DVDT	Current acceleration/deceleration	Scaled with the normal acceleration rate being set.	OUT
18	F	ABMD	Speed increase upon holding	Amount of change in speed after hold instruction until stabilization.	OUT

\* Relay I/O Bit Assignment

BIT	Symbol	Name	Specifications	I/O
0	RN	Line is running	"ON" is input while the line is running.	IN
1	QS	Quick stop	"OFF" is input upon quick stop.	IN
2 to 7	–	(Reserved)	Reserved relay for input	IN
8	ARY	In acceleration	"ON" is output during acceleration.	OUT
9	BRY	In deceleration	"ON" is output during deceleration.	OUT
A	LSP	Zero speed	"ON" is output upon attainment of a speed of 0.	OUT
B	EQU	Coincidence	"ON" is output when input value = output value.	OUT
C to F	–	(Reserved)	Reserved relay for output	OUT

The following operations are performed inside integer type SLAU instructions.

### Integer Type SLAU Instruction

Acceleration rate (ADV) =  $\frac{LV \times Ts (0.1 \text{ ms}) + REM1}{AT(0.1s) \times 1000}$  Outside S-curve area (ADVS > ADV)  
 When VI > V' (V' ≥ 0)  
 V = V' + ADV: In acceleration (ARY)  
 ON  
 When VI < V' (V' ≤ 0)  
 V = V' - ADV: In acceleration (ARY)  
 ON

Deceleration rate (BDV) =  $\frac{LV \times Ts (0.1 \text{ ms}) + REM1}{BT (0.1s) \times 1000}$  Outside S-curve area (BDVS > BDV)  
 At VI > V' (V' < 0)  
 V = V' + BDV: In deceleration (BRY)  
 ON  
 When VI < V' (V' > 0)  
 V = V' - BDV: In deceleration (BRY)  
 ON

Quick stop rate (QDV) =  $\frac{LV \times Ts (0.1 \text{ ms}) + REM1}{QT (0.1 \text{ s}) \times 1000}$  When QS = ON (VI > V'),  
 V = V' + QDV: In deceleration (BRY)  
 ON  
 When QS = ON (VI < V'),  
 V = V' - QDV: In deceleration (BRY)  
 ON  
 (NOTE) The quick stop rate is not S-curve movement, but linear movement (same as the quick stop rate of SLAU).



Acceleration rate in the S-curve area (ADVS) = ADVS' ± AADVS

$$AADVS = \frac{ADV \times Ts (0.1 \text{ ms}) + REM2}{AAT (0.01 \text{ s}) \times 100}$$

ADVS': previous value of ADVS  
 Inside the S-curve area (BDVS < BDV)  
 When VI > V' (V' ≥ 0),  
 V = V' + ADVS: In acceleration (ARY)  
 ON  
 When VI < V' (V' ≤ 0),  
 V = V' - ADVS: In acceleration (ARY)  
 ON

S character section moderation rate (BDVS) = BDVS' ± BBDVS

$$BBDVS = \frac{BDV \times Ts(0.1 \text{ ms}) + REM2}{BBT (0.01 \text{ s}) \times 100}$$

In (BDVS < BDV) in S character section  
 At VI > V' (V' < 0)  
 V = V' + BDVS; Moderation inside (BRY)  
 turning on  
 At VI < V' (V' > 0)  
 V = V' - BDVS; (BRY) turning on when  
 being accelerating

V': Speed output value last time  
 VI: Speed instruction input  
 Ts: Scanning time setting

- Addition-subtraction speed 1 (DVDT1) is operated now when DVDT1 operation instruction (DVDTF) is turning on.
- When DVDTF is turning off, DVDT1 = 0 is output.  
 After (\*S) operates (\*O) of either as follows, the operation of addition-subtraction speed 1 (DVDT1) is output by DVDT1 operation selection (DVDTTS) now when DVDTF is turning on.

When DVDTTS is turning on:  $DVDT1 = \frac{(V - V')}{ADV} \times 5000$

When DVDTTS is turning off:  $DVDT = (V \times DVDTK) - (V' \times DVDTK)$ ; DVDTK: DVDT coefficient

- Addition-subtraction speed 2 (DVDT2) is output as follows now.  
 (\*S) is accelerating: In S character section: DVDT2 = ±ADVS.  
 Outside S character section: DVDT2 = ±ADV  
 The moderation inside: In S character section: DVDT2 = ±BDVS.  
 Outside S character section: DVDT2 = ±BDV
- It was output to operate (\*O) as follows maintenance per hour degree rise (ABMD).

$$ABMD = \frac{DVDT2' \times DVDT2'}{2 \times AADVS (BBDVS)}$$

Present value last time of addition-subtraction speed 2 (DVDT2)

- 0 velocities (LSP) turn on in turning on with V = 0 and agreement (EQU) is turned on by VI = V.
- When line in operation (RN) is "Open", V = 0, DVDT1 = 0, DVDT2 = 0, DVDT3 = 0, ABMD = 0, REM1 = 0, REM2 = 0, and REM3 = 0 are output.

## Real Type SLAU Instruction

$$\text{Acceleration rate (ADV)} = \frac{LV \times Ts (0.1 \text{ ms})}{AT (s) \times 10000}$$

Outside S character section  
(ADVS > ADV)  
VI > V' (V' > 0):  
V = V' + ADV

$$\text{Moderation rate (BDV)} = \frac{LV \times Ts (0.1 \text{ ms})}{BT(s) \times 10000}$$

Outside S character section  
(BDVS < BDV)  
VI < V' (V' > 0):  
V = V' + BDV

$$\text{Rapid stop rate (QDV)} = \frac{LV \times Ts (0.1 \text{ ms})}{QT(s) \times 10000}$$

QS = ON (V' > VI):  
V = V' + QDV

S character section acceleration rate (ADVS) = ADVS' ± AADVS

$$\text{AADVS} = \frac{ADV \times Ts (0.1 \text{ ms})}{AAT(s) \times 10000}$$

: Value last time of ADVS' = ADVS  
In (ADVS < ADV) in S character section  
VI > V' (V' > 0):  
V = V' + ADVS

S character section moderation rate (BDVS) = BDVS' ± BBDVS

$$\text{BBDVS} = \frac{BDV \times Ts (0.1 \text{ ms})}{BBT(s) \times 10000}$$

: Value last time of BDVS' = BDVS  
Outside S character section  
(BDVS > BDV)  
VI < V' (V' > 0):  
V = V' + BDVS

V': Speed output value last time

VI: Speed instruction input

Ts: Scanning time setting value

- After (\*S) operates (\*O) as follows, addition-subtraction speed (DVDT) is output now.

(\*S) is accelerating: In S character section: DVDT = ADVS.

Outside S character section: DVDT = ADV

Moderation inside : In S character section: DVDT = BDVS.

Outside S character section: DVDT = BDV

- It was output to operate (\*O) as follows maintenance per hour degree rise (ABMD).

$$\text{ABMD} = \frac{DVDT \times DVDT}{2 \times \text{AADVS (BBDVS)}}$$

- When line in operation (RN) is "Open", V = 0, DVDT = 0, and ABMD = 0 are output.

■ Format

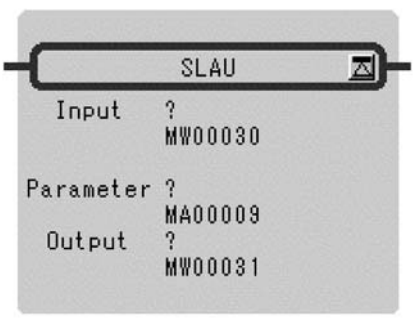

Symbol: SLAU  
 Full Name: S-Curve Linear Accelerator  
 Category: DDC  
 Icon: 

1

■ Parameter

Parameter Name	Setting
Input	<ul style="list-style-type: none"> <li>Any integer and real number type register</li> <li>Any integer and real number type register with subscript</li> <li>Subscript register</li> <li>Constant</li> </ul>
Parameter	<ul style="list-style-type: none"> <li>Register address (except for # and C registers)</li> <li>Register address with subscript (except for # and C registers)</li> </ul>
Output	<ul style="list-style-type: none"> <li>Any integer and real number type register (except for # and C registers)</li> <li>Any integer and real number type register with subscript (except for # and C registers)</li> <li>Subscript register</li> </ul>

■ Program Example

Integer Type Operation

MW00100 to MW000121 are used for the parameter table.

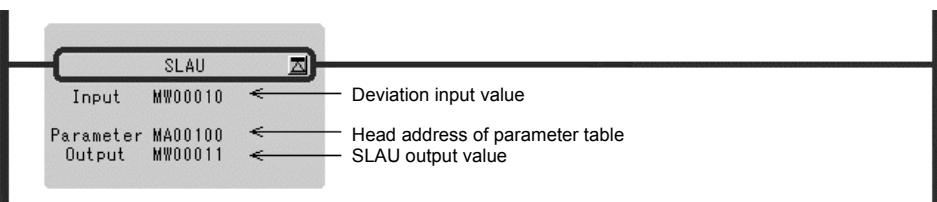

## Real Number Type Operation

MF00200 to MF00218 are used for the parameter table.

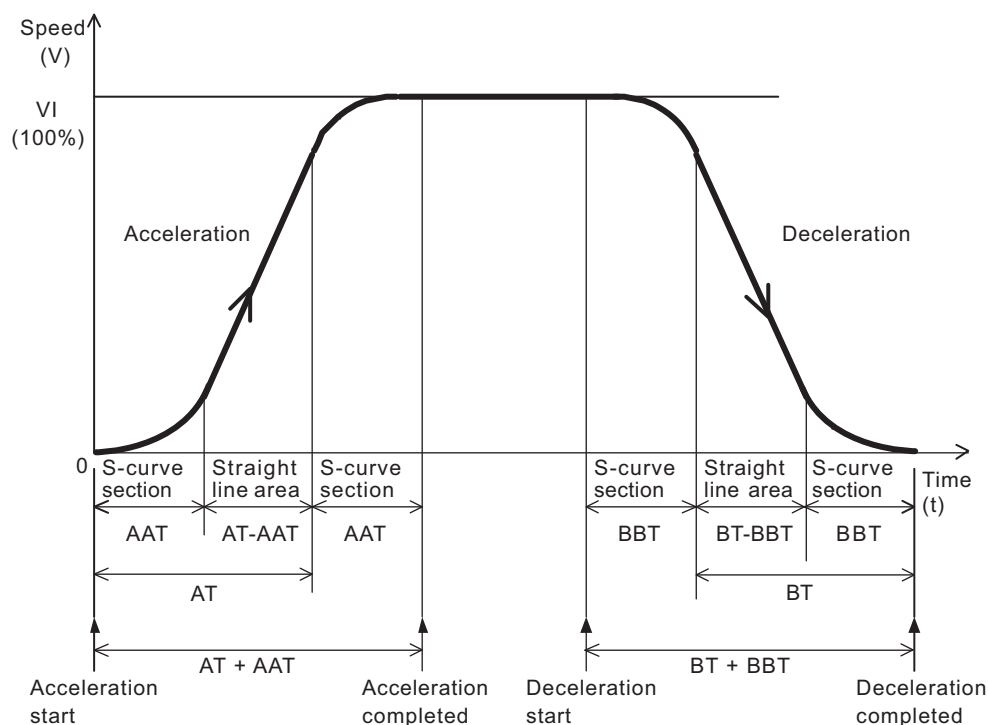
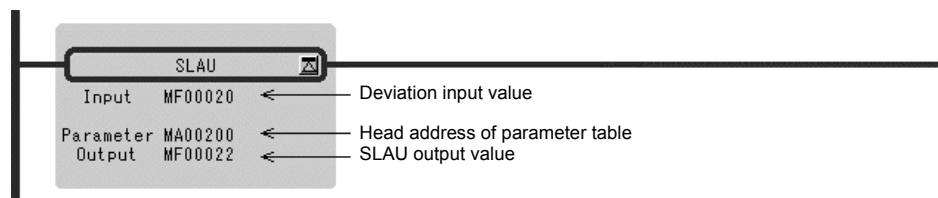

Note: Please note the following when you use integer type SLAU instruction.

Please do not change input value (VI) before reaching input value (VI) (de-and acceleration inside).

When input value (VI) is changed in the de-and acceleration, overshooting/undershoot might be generated. (Refer to the figure below)

Please make the application program when you change input value (VI) in the de-and acceleration by either the undermentioned.

- Please use real type SLAU instruction.
- Please use the LIMIT instruction together when you use integer SLAU instruction. The output value of integer type SLAU instruction is limited, and that is, please assume the output value of the LIMIT instruction to be a input value of the LIMIT instruction, and limit overshooting/undershoot.

I will encourage the use of one real type SLAU instruction from the easiness of making the application program.

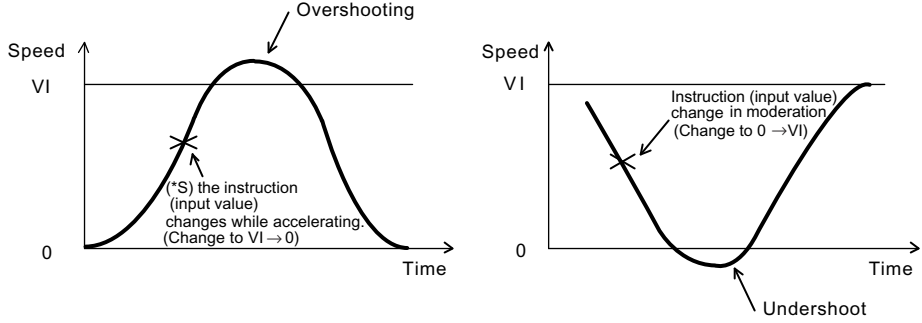

### 1.7.13 PULSE WIDTH MODULATION Instruction (PWM)

■ Outline

The PWM instruction converts the value of the *Input* to PWM as an input value (between -100.00 and 100.00%, with increments of 0.01%) and outputs the result to the *Output* and the parameter table.

Double-length integer and real number operations are not allowed.

$$\text{Time of ON output} = \frac{\text{PWMT} ( X + 10000 )}{20000}$$

$$\text{Number of ON outputs} = \frac{\text{PWMT} ( X + 10000 )}{T_s \times 20000}$$

- X: input value
- Ts: scan time set value (ms)
- When 100.00% is input: all ON
- When 0% is input: 50% duty (50% ON)
- When -100.00% is input: all OFF

When the PWM reset (PWMRST) is ON, all internal operations are reset and PWM operations are performed with that instant as the starting point. After turning the power ON, set PWMRST to ON to clear all internal operations, then use the PWM instruction.

Table 1.30 Integer Type PWM Instruction Parameters

ADR	Type	Symbol	Name	Specifications	I/O
0	W	RLY	Relay I/O	Relay input, relay output *	IN/OUT
1	W	PWMT	PWM cycle	PWM cycle (1 ms) (1 to 32767 ms)	IN
2	W	ONCNT	ON output set timer	Set timer for ON output (1 ms)	OUT
3	W	CVON	ON output counting timer	Counting timer for ON output (1 ms)	OUT
4	W	CVON REM	ON output counting timer remainder	ON output counting timer remainder (0.1 ms)	OUT
5	W	OFFCNT	OFF output set timer	Set timer for OFF output (1 ms)	OUT
6	W	CVOFF	OFF output counting timer	Counting timer for OFF output (1 ms)	OUT
7	W	CVOFF REM	OFF output counting timer remainder	OFF output counting timer remainder (0.1 ms)	OUT

\* Relay I/O Bit Assignment

BIT	Symbol	Name	Specifications	I/O
0	PWM RST	PWM reset	"ON" is input when PWM is reset	IN
2 to 7	-	(Reserved)	Reserved relay for input	IN
8	PWM OUT	PWM output	PWM is output (2 value output: ON = 1, OFF = 0)	OUT
9 to F	-	(Reserved)	Reserved relay for output	OUT

■ Format

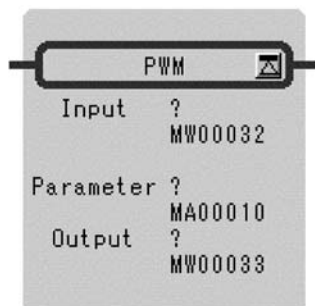

Symbol: PWM  
 Full Name: Pulse Width Modulation  
 Category: DDC  
 Icon: 

■ Parameter

Parameter Name	Setting
Input	<ul style="list-style-type: none"> <li>• Any integer type register</li> <li>• Any integer type register with subscript</li> <li>• Subscript register</li> <li>• Constant</li> </ul>
Parameter	<ul style="list-style-type: none"> <li>• Register address (except for # and C registers)</li> <li>• Register address with subscript (except for # and C registers)</li> </ul>
Output	<ul style="list-style-type: none"> <li>• Any integer type register (except for # and C registers)</li> <li>• Any integer type register with subscript (except for # and C registers)</li> <li>• Subscript register</li> <li>• Constant</li> </ul>

1

■ Program Example

MW00100 is used as PWM input and MW00200 to MW00207 as a parameter table.

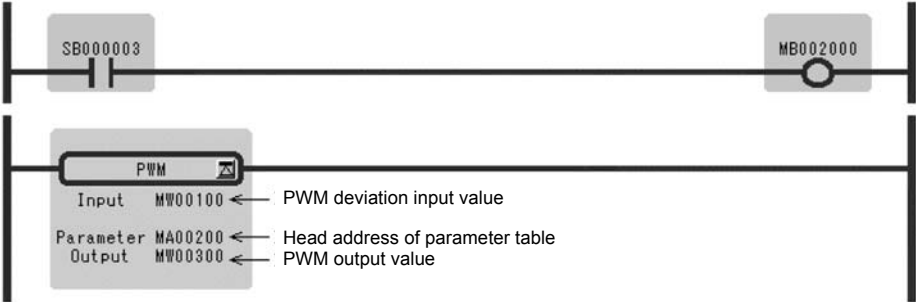

PWM reset with the first scan of DWGL. (SB000001 when used with DWG.H)

## 1.8 Table Data Manipulation Instructions

### 1.8.1 BLOCK READ Instruction (TBLBR)

#### ■ Outline

The TBLBR instruction consecutively reads file register table elements in block format that are specified by table name (*Table Name*), row number, and column number. It then stores the elements in a continuous region starting with the specified register (*Read Data*). The type of the element being read is automatically determined according to the specified table. The type of the storage destination register is ignored and the read data is stored according to the table element type without converting the data type.

If errors such as invalid table names, invalid row numbers, invalid column numbers, or insufficient storage register data length are found, they are reported and the contents of the storage destination register is retained without reading the data.

Upon normal termination, the number of words transferred is set in the *[Output]*, and the *[Status]* is turned OFF.

When an error occurs, the corresponding error code is set in the *[Output]*, and the *[Status]* is turned ON.

Table 1.31 List of Error Codes

Error Code	Error Name	Content
0001H	Referenced table undefined	The target table is not defined.
0002H	Outside row number range	The row number of the table element is not within the range of the target table.
0003H	Outside column number range	The column number of the table element is not within the range of the target table.
0004H	Number of elements incorrect	The number of elements of the target is invalid.
0005H	Insufficient space in storage destination	There is not enough space for storing.
0006H	Incorrect element type	The type of the specified element is a malfunction.
0007H	Cue buffer error	An attempt is made to read the cue buffer when it is empty, or the buffer is written to by pointer advance when it is full.
0008H	Cue table error	The specified table is not a table of the cue type.
0009H	System error	An unexpected error is detected internally in the system during instruction execution.



Table 1.32 Block Read PI Instruction Parameters

ADR	Type	Symbol	Name	Specifications	I/O
0	L	ROW1	Table element beginning row number	Beginning row number of the target table element (1 to 65535)	IN
2	L	COL1	Table element beginning column number	Beginning column number of the target table element (1 to 32767)	IN
4	W	RLEN	Number of row elements	Number of row elements (1 to 32767)	IN
5	W	CLEN	Number of column elements	Number of column elements (1 to 32767)	IN

### ■ Format

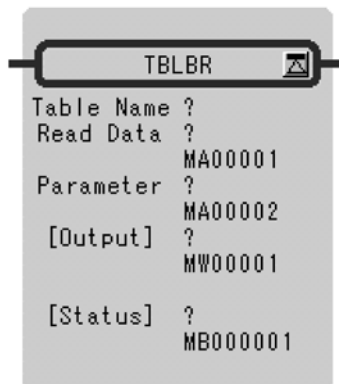

Symbol: TBLBR  
 Full Name: Table Block Read  
 Category: TABLE

Icon:

### ■ Parameter

Parameter Name	Setting
Table Name	Table name
Read Data	<ul style="list-style-type: none"> <li>• Register address (except for # and C registers)</li> <li>• Register address with subscript</li> </ul>
Parameter	<ul style="list-style-type: none"> <li>• Register address</li> <li>• Register address with subscript</li> </ul>
[Output]*	<ul style="list-style-type: none"> <li>• Any integer type register (except for # and C registers)</li> <li>• Any integer type register with subscript</li> <li>• Subscript register</li> </ul>
[Status]*	<ul style="list-style-type: none"> <li>• Any bit type register (except for # and C registers)</li> <li>• Any bit type register with subscript</li> </ul>

\* Possible to omit.

### ■ Program Example

From the table defined as TABLE1, with DW00010 to DW00015 as a parameter table, data (element type is integer type) from the starting table element position to the end position are stored in block form in the area starting from MW00100.



## 1.8.2 BLOCK WRITE Instruction (TBLBW)

### ■ Outline

The TBLBW instruction writes the contents of a continuous region starting with the specified register (*Write Data*) to the file register table elements in block format that are specified by table name (*Table Name*), row number, and column number. The data is processed assuming that the type of the table elements in the storage destination register is the same as that of the table elements in the storage source register.

If errors such as invalid table names, invalid row numbers, invalid column numbers, or insufficient storage register data length are found, they are reported and the contents of the storage destination register is retained without writing the data.

Upon normal termination, the number of words transferred is set in the *[Output]* and the *[Status]* is turned OFF.

When an error occurs, the corresponding error code is set in the *[Output]* and the *[Status]* is turned ON.

Table 1.33 Block Write Instruction Parameters

ADR	Type	Symbol	Name	Specifications	I/O
0	L	ROW1	Table element beginning row number	Beginning row number of the target table element (1 to 65535)	IN
2	L	COL1	Table element beginning column number	Beginning column number of the target table element (1 to 32767)	IN
4	W	RLEN	Number of row elements	Number of row elements (1 to 32767)	IN
5	W	CLEN	Number of column elements	Number of column elements (1 to 32767)	IN

■ Format

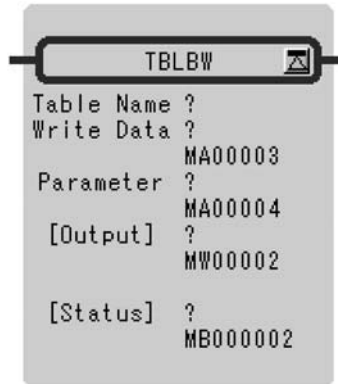

Symbol: TBLBW  
 Full Name: Table Block Write  
 Category: TABLE  
 Icon: 

1

■ Parameter

Parameter Name	Setting
Table Name	Table name
Write Data	<ul style="list-style-type: none"> <li>• Register address (except for # and C registers)</li> <li>• Register address with subscript</li> </ul>
Parameter	<ul style="list-style-type: none"> <li>• Register address</li> <li>• Register address with subscript</li> </ul>
[Output]*	<ul style="list-style-type: none"> <li>• Any integer type register (except for # and C registers)</li> <li>• Any integer type register with subscript</li> <li>• Subscript register</li> </ul>
[Status]*	<ul style="list-style-type: none"> <li>• Any bit type register (except for # and C registers)</li> <li>• Any bit type register with subscript</li> </ul>

\* Possible to omit.

■ Program Example

From the table defined as TABLE1, with DW00010 to DW00015 as a parameter table, area (element type is integer type) from the starting table element position to the end position are stored in block form in the data from MW00100.



### 1.8.3 ROW SEARCH Instruction (TBSRL)

#### ■ Outline

The TBSRL instruction searches for the column element of the file register table specified by the table name (*Table Name*), row number, and column number. If there is data that matches the data in the specified register (*Search Data*), the instruction reports that row number. The type of the data to be searched is automatically determined according to the specified table.

If errors such as invalid table names, invalid row numbers, invalid column numbers, or insufficient storage register data length are found, they are reported.

Upon normal termination, if a matching column element is found, 1 is set in the search result, the row number is set in the *[Output]*, and the *[Status]* is turned OFF. If no matching column element is found, 0 is set in the search result.

When an error occurs, the corresponding error code is set in the *[Output]*, and the *[Status]* is turned ON.

Table 1.34 Row Search Instruction Parameters

ADR	Type	Symbol	Name	Specifications	I/O
0	L	ROW1	Table element head row number	Head row number of the target table element (1 to 65535)	IN
2	L	ROW2	Table element last row number	Last row number of the target table element (1 to 65535)	IN
4	L	COL-UMN	Table element column number	Column number of the target table element (1 to 32767)	IN
6	W	FIND	Search result	Search results 0: No matching row 1: Matching row exists	OUT

#### ■ Format

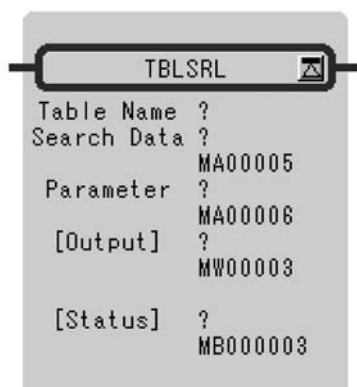

Symbol: TBSRL  
 Full Name: Table Row Search  
 Category: TABLE  
 Icon: 

## ■ Parameter

Parameter Name	Setting
Table Name	Table name
Search Data	<ul style="list-style-type: none"> <li>• Register address</li> <li>• Register address with subscript</li> </ul>
Parameter	<ul style="list-style-type: none"> <li>• Register address</li> <li>• Register address with subscript</li> </ul>
[Output]*	<ul style="list-style-type: none"> <li>• Any integer type register (except for # and C registers)</li> <li>• Any integer type register with subscript</li> <li>• Subscript register</li> </ul>
[Status]*	<ul style="list-style-type: none"> <li>• Any bit type register (except for # and C registers)</li> <li>• Any bit type register with subscript</li> </ul>

\* Possible to omit.

## ■ Program Example

The table defined as TABLE1 is searched for data which matches MW00100 (when the type of the searched table is integer) with DW00010 to DW00014 as a parameter table.



### 1.8.4 COLUMN SEARCH Instruction (TBL SRC)

#### ■ Outline

The TBL SRC instruction searches for the row element of the file register table specified by a table name (*Table Name*), row number, and column number. If there is data that matches the data of the specified register (*Search Data*), the instruction reports that column number. The type of the data to searched is automatically determined according to the specified table.

If errors such as invalid table names, invalid row numbers, invalid column numbers, or insufficient storage register data length are found, they are reported.

Upon normal termination, if a matching row element is found, 1 is set in the search result, the row number is set in the *[Output]*, and the *[Status]* is turned OFF. If no matching column element is found, 0 is set in the search result.

When an error occurs, the corresponding error code is set in the *[Output]* and the *[Status]* is turned ON.

Table 1.35 Column Search Instruction Parameters

ADR	Type	Symbol	Name	Specifications	I/O
0	L	ROW1	Table element row number	Row number of the target table element (1 to 65535)	IN
2	L	COL-UMN1	Table element head column number	Head column number of the target table element (1 to 32767)	IN
4	L	COL-UMN2	Table element last column number	Last column number of the target table element (1 to 32767)	IN
6	W	FIND	Search result	Search results 0: No matching column 1: Matching column exists	OUT

■ Format

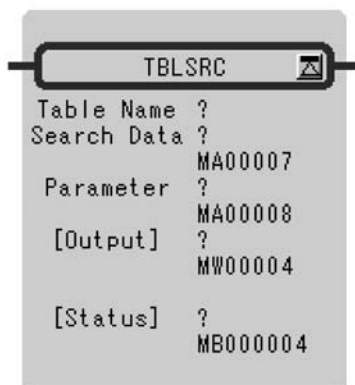

Symbol: TBSLRC  
 Full Name: Table Column Search  
 Category: TABLE  
 Icon:

■ Parameter

Parameter Name	Setting
Table Name	Table name
Search Data	<ul style="list-style-type: none"> <li>• Register address</li> <li>• Register address with subscript</li> </ul>
Parameter	<ul style="list-style-type: none"> <li>• Register address</li> <li>• Register address with subscript</li> </ul>
[Output]*	<ul style="list-style-type: none"> <li>• Any integer type register (except for # and C registers)</li> <li>• Any integer type register with subscript</li> <li>• Subscript register</li> </ul>
[Status]*	<ul style="list-style-type: none"> <li>• Any bit type register (except for # and C registers)</li> <li>• Any bit type register with subscript</li> </ul>

\* Possible to omit.

## ■ Program Example

The table defined as TABLE1 is searched for data which matches MW00100 (when the type of the searched table is integer) with DW00010 to DW00014 as a parameter table.



### 1.8.5 BLOCK CLEAR Instruction (TBLCL)

#### ■ Outline

The TBLCL instruction clears the data of the block element of the file register table specified by a table name (*Table Name*), row number, and column number. If the element type is a character string, space is written. If the element type is a numeric value, 0 is written.

If both the table element leading row number and the table element leading column number are 0, the entire table is cleared.

If errors such as invalid table names, invalid row numbers, invalid column numbers, or insufficient storage register data length are found, they are reported and data is not written. Upon normal termination, the number of words cleared is set in the *[Output]*, and the *[Status]* is turned OFF.

When an error occurs, the corresponding error code is set in the *[Output]*, and the *[Status]* is turned ON.

Table 1.36 Block Clear Instruction Parameters

ADR	Type	Symbol	Name	Specifications	I/O
0	L	ROW	Table element head row number	Head row number of the target table element (0 to 65535)	IN
2	L	COL-UMN	Target table element head column number	Head column number of the target table element (10 to 32767)	IN
4	W	RLEN	Number of row elements	Number of row elements (1 to 32767)	IN
5	W	CLEN	Number of column elements	Number of column elements (1 to 32767)	IN

■ Format

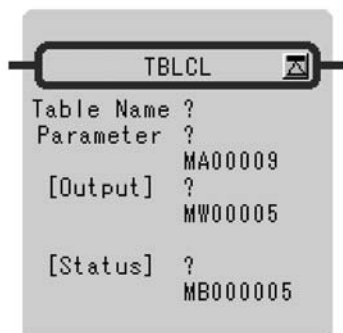

Symbol: TBLCL  
 Full Name: Table Block Clear  
 Category: TABLE  
 Icon: 

■ Parameter

Parameter Name	Setting
Table Name	Table name
Parameter	<ul style="list-style-type: none"> <li>• Register address</li> <li>• Register address with subscript</li> </ul>
[Output]*	<ul style="list-style-type: none"> <li>• Any integer type register (except for # and C registers)</li> <li>• Any integer type register with subscript</li> <li>• Subscript register</li> </ul>
[Status]*	<ul style="list-style-type: none"> <li>• Any bit type register (except for # and C registers)</li> <li>• Any bit type register with subscript</li> </ul>

\* Possible to omit.

■ Program Example

The designated block in the table defined as TABLE1 is cleared using DW00010 to DW00015 as a parameter table.





## 1.8.6 BLOCK MOVE Instruction (TBLMV)

### ■ Outline

The TBLMV instruction transfers the data of the block elements of the file register table specified by the table name (*Table Name*), row number, and column number to another block. Block transfer between different tables and data transfer within the same table are both possible. If the column element types of the source and destination blocks are different, an error is reported and data is not written.

If errors such as invalid table names, invalid row numbers, invalid column numbers, or unmatched storage destination element type are found, they are reported and data is not written.

Upon normal termination, the number of words transferred is set in the *[Output]*, and the *[Status]* is turned OFF.

When an error occurs, the corresponding error code is set in the *[Output]*, and the *[Status]* is turned ON.

Table 1.37 Inter Table Block Transfer Instruction Parameters

ADR	Type	Symbol	Name	Specifications	I/O
0	L	ROW1	Table element head row number	Head row number of the transfer source table element (1 to 65535)	IN
2	L	COL - UMN1	Table element head column number	Head column number of the transfer source table element (1 to 32767)	IN
4	W	RLEN	Number of row elements	Number of transfer row elements to be transferred (1 to 32767)	IN
5	W	CLEN	Number of column elements	Number of transfer column elements to be transferred (1 to 32767)	IN
6	L	ROW2	Table element head row number	Head row number of the transfer destination table element (1 to 65535)	IN
8	L	COL - UMN2	Table element head column number	Head column number of the transfer destination table element (1 to 32767)	IN

■ Format



Symbol: TBLMV  
 Full Name: Table Block Move  
 Category: TABLE  
 Icon:

■ Parameter

Parameter Name	Setting
Src Table Name	Table name
Dest Table Name	Table name
Parameter	<ul style="list-style-type: none"> <li>• Register address</li> <li>• Register address with subscript</li> </ul>
[Output]*	<ul style="list-style-type: none"> <li>• Any integer type register (except for # and C registers)</li> <li>• Any integer type register with subscript</li> <li>• Subscript register</li> </ul>
[Status]*	<ul style="list-style-type: none"> <li>• Any bit type register (except for # and C registers)</li> <li>• Any bit type register with subscript</li> </ul>

\* Possible to omit.

■ Program Example

There are tables defined as TABLE1 and TABLE2. The designated block in TABLE1 is transferred to the designated block in TABLE2 using DW00010 to DW00019 as a parameter table.



## 1.8.7 QUEUE TABLE READ Instructions (QTBLR, QTBLRI)

### ■ Outline

The QTBLR/QTBLRI instruction consecutively reads file register table column elements specified by table name (*Table Name*), row numbers, and column numbers and stores the elements in the continuous region starting with the specified register (*Read Data*). The type of the element being read is automatically determined according to the specified table. The type of the storage destination register is ignored and the read data is stored according to the table element type without converting the data type.

The QTBLR instruction does not change the queue table read pointer. The QTBLRI instruction advances the queue table read pointer by one row.

If errors such as invalid table names, invalid row numbers, invalid column numbers, insufficient storage register data length, or empty queue buffers are found, they are reported, data is not read, and the queue table read pointer does not advance. The contents of the storage destination register are retained.

Upon normal termination, the number of words transferred is set in the *[Output]*, and the *[Status]* is turned OFF.

When an error occurs, the corresponding error code is set in the *[Output]*, and the *[Status]* is turned ON. The pointer value does not change.

Table 1.38 Queue Table Read Instruction Parameters

ADR	Type	Symbol	Name	Specifications	I/O
0	L	ROW	Table element corresponding row number	Corresponding row number of the target table element (0 to 65535)	IN
2	L	COL-UMN	Table element beginning column number	Beginning column number of the target table element (1 to 32767)	IN
4	W	CLEN	Number of column elements	Number of column elements continuously read out (1 to 32767)	IN
5	W	Reserved			
6	L	RPTR	Read pointer	Read pointer of the queue after execution	OUT
8	L	WPTR	Write pointer	Write pointer of the queue after execution	OUT

■ Format

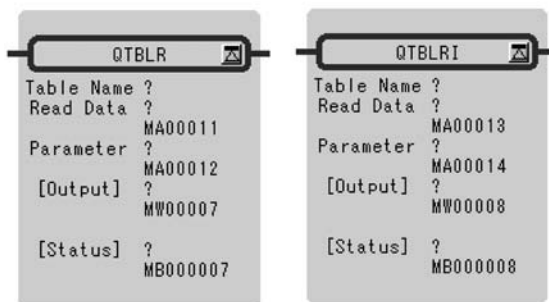

Symbol: QTBLR  
 QTBLRI  
 Full Name: Queue Table Read  
 Queue Table Read  
 Category: TABLE  
 Icon:

■ Parameter

Parameter Name	Setting
Table Name	Table name
Read Data	<ul style="list-style-type: none"> <li>• Register address (except for # and C registers)</li> <li>• Register address with subscript</li> </ul>
Parameter	<ul style="list-style-type: none"> <li>• Register address</li> <li>• Register address with subscript</li> </ul>
[Output]*	<ul style="list-style-type: none"> <li>• Any integer type register (except for # and C registers)</li> <li>• Any integer type register with subscript</li> <li>• Subscript register</li> </ul>
[Status]*	<ul style="list-style-type: none"> <li>• Any bit type register (except for # and C registers)</li> <li>• Any bit type register with subscript</li> </ul>

\* Possible to omit.

## ■ Program Example

Column element data (element format assumed to be integer) from the table defined as TABLE1 is stored for the number of column elements beginning with MW00100 using DW00010 to DW00014 as a parameter table.

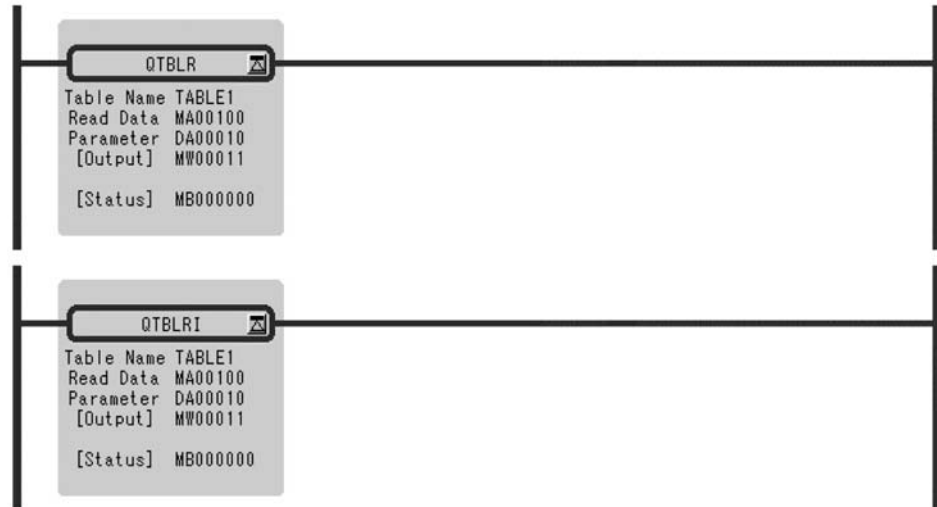

1

### 1.8.8 QUEUE TABLE WRITE Instructions (QTBLW, QTBLWI)

#### ■ Outline

The QTBLW/QTBLWI instruction writes the contents of the continuous region starting with the specified register (*Write Data*) to the file register table column elements specified by table name (*Table Name*), row numbers, and column numbers. The data is processed assuming that the type of the table elements in the storage destination register is the same as that of the table elements in the storage source register.

The QTBLW instruction does not change the queue table write pointer. The QTBLWI instruction advances the queue table write pointer by one row.

If errors such as invalid table names, invalid row numbers, invalid column numbers, insufficient storage register data length, or full queue buffers are found, they are reported, data is not written, and the queue table write pointer does not advance.

Upon normal termination, the number of words transferred is set in the *[Output]*, and the *[Status]* is turned OFF.

When an error occurs, the corresponding error code is set in the *[Output]*, and the *[Status]* is turned ON. The pointer value does not change.

Table 1.39 Queue Table Write Instruction Parameters

ADR	Type	Symbol	Name	Specifications	I/O
0	L	ROW	Table element corresponding row number	Corresponding row number of the target table element (0 to 65535)	IN
2	L	COL-UMN	Table element beginning column number	Beginning column number of the target table element (1 to 32767)	IN
4	W	CLEN	Number of column elements	Number of column elements to be continuously write (1 to 32767)	IN
5	W	Reserved			
6	L	RPTR	Read pointer	Read pointer of the queue after execution	OUT
8	L	WPTR	Write pointer	Write pointer of the queue after execution	OUT

■ Format

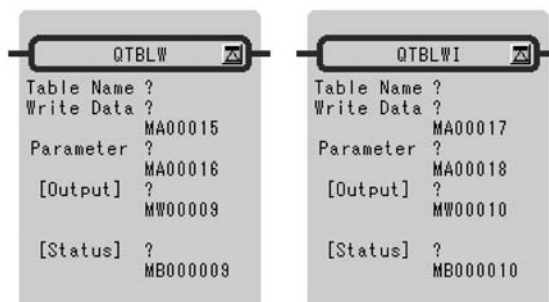

Symbol: QTBLW  
 QTBLWI  
 Full Name: Queue Table White  
 Queue Table Pointer  
 Clear  
 Category : TABLE  
 Icon:

## ■ Parameter

Parameter Name	Setting
Table Name	Table name
Write Data	<ul style="list-style-type: none"> <li>• Register address (except for # and C registers)</li> <li>• Register address with subscript</li> </ul>
Parameter	<ul style="list-style-type: none"> <li>• Register address</li> <li>• Register address with subscript</li> </ul>
[Output]*	<ul style="list-style-type: none"> <li>• Any integer type register (except for # and C registers)</li> <li>• Any integer type register with subscript</li> <li>• Subscript register</li> </ul>
[Status]*	<ul style="list-style-type: none"> <li>• Any bit type register (except for # and C registers)</li> <li>• Any bit type register with subscript</li> </ul>

\* Possible to omit.

## ■ Program Example

Integer form consecutive data for the number of column elements beginning with MW00100 is written in column element data in the table defined as TABLE1 using DW00010 to DW00014 as a parameter table.

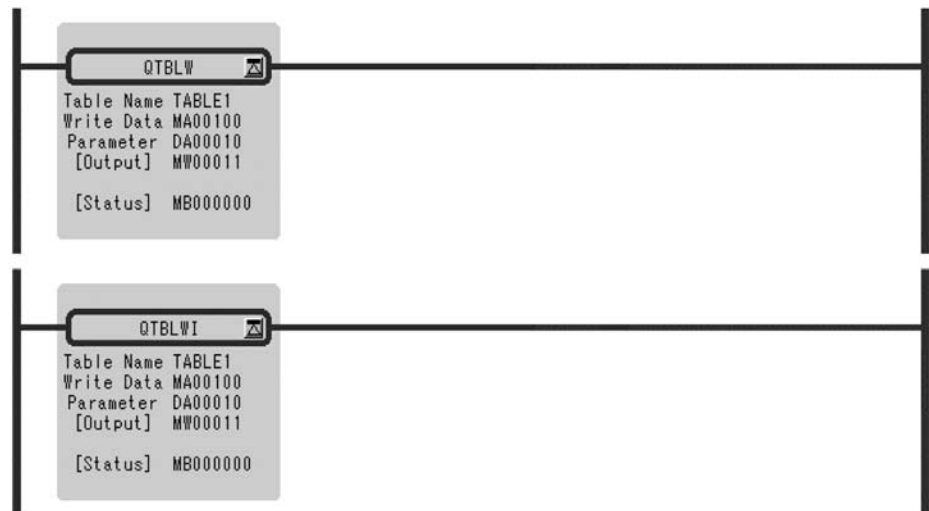

## 1.8.9 QUEUE POINTER CLEAR Instruction (QTBLCL)

### ■ Outline

The QTBLCL instruction returns the queue read and queue write pointers of the file register table specified by a table name (*Table Name*) to their initial state (first row).

Upon normal termination, 0 is set in the *[Output]*, and the *[Status]* is turned OFF.

When an error occurs, the corresponding error code is set in the *[Output]*, and the *[Status]* is turned ON.

### ■ Format



Symbol: QTBLCL

Full Name: Queue Table Pointer  
Clear

Category: TABLE

Icon: 



## ■ Parameter

Parameter Name	Setting
Table Name	Table name
[Output]*	<ul style="list-style-type: none"> <li>• Any integer type register (except for # and C registers)</li> <li>• Any integer type register with subscript</li> <li>• Subscript register</li> </ul>
[Status]*	<ul style="list-style-type: none"> <li>• Any bit type register (except for # and C registers)</li> <li>• Any bit type register with subscript</li> </ul>

\* Possible to omit.

## ■ Program Example

The cue read and cue write pointer of TABLE1 are reset to initial status.

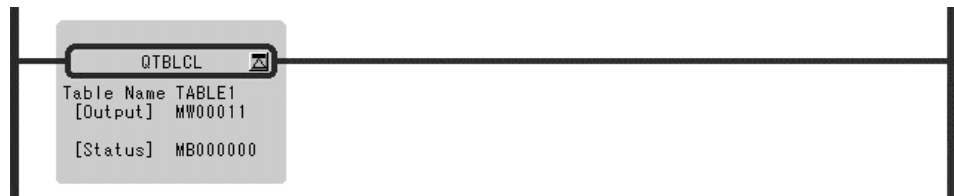

## Standard System Function

This chapter describes the details of standard system functions.

<b>2.1 Message Functions</b>	<b>2-2</b>
2.1.1 Send Message Function (MSG-SND)	2-2
2.1.2 Receive Message Function (MSG-RCV)	2-13
<b>2.2 Trace Functions</b>	<b>2-22</b>
2.2.1 Trace Function (TRACE)	2-22
2.2.2 Data Trace Read Function (DTRC-RD)	2-23
2.2.3 Failure Trace Read Function (FTRC-RD)	2-26
2.2.4 Inverter Trace Read Function (ITRC-RD)	2-31
<b>2.3 Inverter Functions</b>	<b>2-34</b>
2.3.1 Inverter Constant Write Function (ICNS-WR)	2-34
2.3.2 Inverter Constant Read Function (ICNS-RD)	2-39
<b>2.4 Other Functions</b>	<b>2-42</b>
2.4.1 Counter Function (COUNTER)	2-42
2.4.2 First-in First-out Function (FINFOUT)	2-44

## 2.1 Message Functions

### 2.1.1 Send Message Function (MSG-SND)

#### ■ Outline

Sends a message to the called station which is on the line and which is designated by the transmission device type. Supports a plurality of protocol types.

The execution command (*Execute*) must be held until *Complete* or *Error* becomes ON.

[Transmission Devices] CPU Module, 215IF, 217IF, 218IF, SVB-01 for MP920

[Protocols] MEMOBUS communication, non-procedural

#### ■ Format

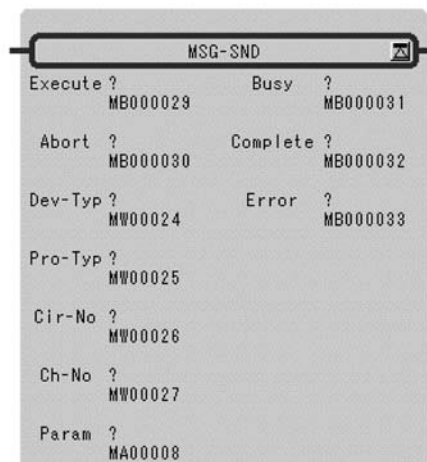

Symbol: MSG-SND  
 Full Name: Message Send  
 Category: SYSTEM  
 Icon: 

## ■ Parameter

I/O Definition	Parameter Name	I/O Designation	Setting
Input	Execute	B-VAL	Send message instruction
	Abort	B-VAL	Send message forced interruption instruction
	Dev-Typ	I-REG	Type of transmission device CPU module = 8      215IF = 1      217IF = 5 218IF = 6      218-02 = 16      SVB-01 = 11
	Pro-Typ	I-REG	Transmission protocol MEMOBUS = 1 non-procedural = 2
	Cir-No	I-REG	Line No. CPU module = 1, 2      215IF = 1 to 8      217IF = 1 to 24 218IF = 1 to 8      SVB-01 = 1 to 16
	Ch-No	I-REG	Transmission buffer channel No. CPU module = 1, 2      215IF = 1 to 13      217IF = 1 218IF = 1 to 10      SVB-01 = 1 to 8
	Param	Address input	Head address of set data (MW, DW, #W)
Output	Busy	B-VAL	Message is being sent.
	Complete	B-VAL	The sending of the message has been completed.
	Error	B-VAL	Occurrence of error

2

## ■ Parameter Details

They adhere to contents-functions and so on and are collected into parameter numerical order.

Table 2.1 is Parameter List.

Table 2.1 Parameter List

Parameter No.	IN/OUT	Contents	
		MEMOBUS	Non-procedural
PARAM 00	OUT	Process result	Process result
PARAM 01	OUT	Status	Status
PARAM 02	IN	Called station number	Called station number
PARAM 03	SYS	System reserved	System reserved
PARAM 04	IN	Function code	
PARAM 05	IN	Data address	Data address
PARAM 06	IN	Data size	Data size
PARAM 07	IN	Called CPU number	Called CPU number
PARAM 08	IN	Coil offset	
PARAM 09	IN	Input relay offset	
PARAM 10	IN	Input register offset	
PARAM 11	IN	Holding register offset	Register offset
PARAM 12	SYS	For system use	For system use

Table 2.1 Parameter List (cont'd)

Parameter No.	IN/OUT	Contents	
		MEMOBUS	Non-procedural
PARAM 13	SYS	System reserved	System reserved
PARAM 14	SYS	System reserved	System reserved
PARAM 15	SYS	System reserved	System reserved
PARAM 16	SYS	System reserved	System reserved

## Process Result (PARAM00)

The process result is output to the upper byte. The lower byte is for system analysis.

- 00xx: In process (BUSY)
- 10xx: End of process (COMPLETE)
- 8xxx: Occurrence of error (ERROR)

### Error Classification

- 81xx: Function code error  
The sending of an unused function code was attempted. Or, an unused function code was received.
- 82xx: Address setting error  
The data address, coil offset, input relay offset, input register offset, or holding register offset setting is out of range.
- 83xx: Data size error  
The size of the sent or received data is out of range.
- 84xx: Line No. setting error  
The line No. setting is out of range.
- 85xx: Channel No. Setting error  
The channel No. setting error.
- 86xx: Station address error  
The station No. setting is out of range.
- 88xx: Transmission unit error  
An error response was returned from the transmission unit.
- 89xx: Device selection error  
A non-applicable device is selected.

## Status (PARAM01)

Output the status of the transmission unit.

- Bit Assignment

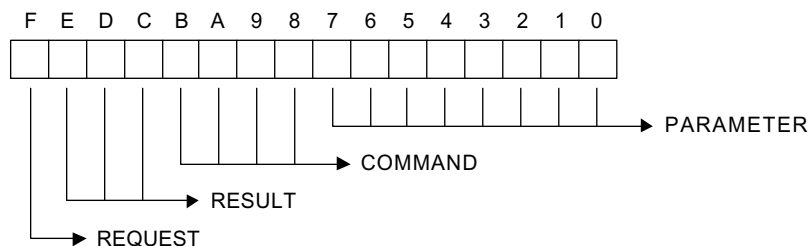

- COMMAND

Command list is described below.

Code	Symbol	Meaning
1	U_SEND	Send generic message
2	U_REC	Receive generic message
3	ABORT	Forced interruption
8	M_SEND	Send MEMOBUS command ... completed upon receipt of response.
9	M_REC	Receive MEMOBUS command ... accompanies sending of response.
C	MR_SEND	Send MEMOBUS response.

- RESULT

Symbol and Meaning of the Result list is described in Table 2.2.

Table 2.2 Result List

Code	Symbol	Meaning
0	–	Executing
1	SEND_OK	Sending has been completed correctly.
2	REC_OK	Receiving has been completed correctly.
3	ABORT_OK	Completion of forced interruption
4	FMT_NG	Parameter format error
5	SEQ_NG, or INIT_NG	Command sequence error The token has not been received yet. Not connected to a transmission system.
6	RESET_NG, or O_RING_NG	Reset state Out-of-ring. The token could not be received even when the token monitor time was exceeded.
7	REC_NG	Data receive error (error detected by a program of a lower rank)

- **PARAMETER**

One of the error codes of Table 2.3 is indicated if RESULT = 4 (FMT\_NG). Otherwise, this indicates the address of the called station.

Table 2.3 Error Codes List

Code	Error
00	No errors
01	Station address is out of range.
02	Monitored MEMOBUS response receiving time error
03	Resending count setting error
04	Cyclic area setting error
05	Message signal CPU No. error
06	Message signal register No. error
07	Message signal word count error

- **REQUEST**

1 = Request

0 = Completion of receipt report

### Called Station Number (PARAM02)

Serial

1 to 254: Message is sent to the station of designated device address.

## Function Code (PARAM04)

The MEMOBUS function code to be sent is set. Refer to Table 2.4.

Table 2.4 Function Codes

Function Code		Setting
00H	Unused	–
01H	Read coil status	OK
02H	Read input relay status	OK
03H	Read contents of holding register	OK
04H	Read contents of input register	OK
05H	Change status of single coil	OK
06H	Write into a single holding register	OK
07H	Unused	–
08H	Loop-back test	OK
09H	Read contents of holding register (expanded)	OK
0AH	Read contents of input register (expanded)	OK
0BH	Write into holding register (expanded)	OK
0CH	Unused	–
0DH	Discontinuous readout of holding register (expanded)	OK
0EH	Discontinuous write into holding register (expanded)	OK
0FH	Change status of a multiple coil	OK
10H	Write into a plurality of holding register	OK
11H to 20H	Unused	–
21H to 3FH	System reserved	–
40H to 4FH	System reserved	–
50H to	Unused	–

Note: 1. –: cannot be set, OK: can be set

2. Only MW (MB) can be used as the sending/receiving register during master operation. The MB, MW, IB, and IW registers can be used respectively as the coil, holding register, input relay, and input registers during slave operation.



## Data Address

The set contents will differ according to the function code as Table 2.5.

Table 2.5 Address Setting Range

Function Code		Data Address Setting Range
00H	Unused	Ineffective
01H	Read coil status	0 to 65535 (0 to FFFFH) *1
02H	Read input relay status	0 to 65535 (0 to FFFFH) *1
03H	Read contents of holding register	0 to 32767 (0 to 7FFFH) *2
04H	Read contents of input register	0 to 32767 (0 to 7FFFH) *2
05H	Change status of single coil	0 to 65535 (0 to FFFFH) *1
06H	Write into a single holding register	0 to 32767 (0 to 7FFFH) *2
07H	Unused	Ineffective
08H	Loop-back test	Ineffective
09H	Read contents of holding register (expanded)	0 to 32767 (0 to 7FFFH) *2
0AH	Read contents of input register (expanded)	0 to 32767 (0 to 7FFFH) *2
0BH	Write into holding register (expanded)	0 to 32767 (0 to 7FFFH) *2
0CH	Unused	Ineffective
0DH	Discontinuous readout of holding register (expanded)	0 to 32767 (0 to 7FFFH) *3
0EH	Discontinuous write into holding register (expanded)	0 to 32767 (0 to 7FFFH) *3
0FH	Change status of a multiple coil	0 to 65535 (0 to FFFFH) *1
10H	Write into a plurality of holding register	0 to 32767 (0 to 7FFFH) *2

- \* 1. Request for readout from/write-in to coil or relay: Set the head bit address of the data.
- \* 2. Request for continuous readout from/write-in to a register: Set head word address of the data.
- \* 3. Request for discontinuous readout from/write-in to a register: Set head word address of the data.

## ■ Data Size (PARAM06)

Set the size (in number of bits or number of words) of the data that is requested for readout or write-in. The setting range will differ according to the transmission module and the function code to be used. Refer to Table 2.6.

Table 2.6 Serial Data Size Setting Range

Function Code		Data Address Setting Range	
		215IF/218IF	CPU Module/ 217IF/SVB-01
00H	Unused	Ineffective	
01H	Read coil status	1 to 2000 (1 to 07D0H) bits	
02H	Read input relay status	1 to 2000 (1 to 07D0H) bits	
03H	Read contents of holding register	1 to 125 (1 to 007DH) words	
04H	Read contents of input register	1 to 125 (1 to 007DH) words	
05H	Change status of single coil	Ineffective	
06H	Write into a single holding register	Ineffective	
07H1	Unused	Ineffective	
08H	Loop-back test	Ineffective	
09H	Read contents of holding register (expanded)	1 to 508 (1 to 01FCH) words	1 to 252 (1 to 00FCH) words
0AH	Read contents of input register (expanded)	1 to 508 (1 to 01FCH) words	1 to 252 (1 to 00FCH) words
0BH	Write into holding register (expanded)	1 to 507 (1 to 01FBH) words	1 to 252 (1 to 00FBH) words
0CH	Unused	Ineffective	
0DH	Discontinuous readout of holding register (expanded)	1 to 508 (1 to 01FCH) words	1 to 252 (1 to 00FCH) words
0EH	Discontinuous write into holding register (expanded)	1 to 254 (1 to 00FEH) words	1 to 126 (1 to 007EH) words
0FH	Change status of a multiple coil	1 to 800 (1 to 0320H) bits	
10H	Write into a plurality of holding register	1 to 100 (1 to 0064H) words	

## Called CPU Number (PARAM07)

PARAM07 sets the called CPU number.

Set the called CPU number to 1 if the called device is an MP2000 Series Machine Controller.

If the called device is a Yaskawa Controller, but not in the MP2000 Series and it consists of more than one CPU Module, set the destination CPU number.

In all other cases, set 0.

### Coil Offset (PARAM08)

Set the offset word address of the coil. This is valid in the case of function codes 01H, 05H, and 0FH.

### Input Relay Offset (PARAM09)

Set the offset word address of the input relay. This is valid in the case of function code 02H.

### Input Register Offset (PARAM10)

Set the offset word address of the input register. This is valid in the case of function codes 04H and 0AH.

### Holding Register Offset (PARAM11)

Set the offset word address of the holding register. This is valid in the case of function codes 03H, 06H, 09H, 0BH, 0DH, 0EH, and 10H.

### For System Use (PARAM12)

The channel No. being used is stored. Make sure that this will be set to 0000H by the user program on the first scan after turning on the power. This parameter must not be changed by the user program thereafter since this parameter will then be used by the system.

### Relationship between the Data Address, Size and Offset

Relationship between the data address, size and offset are described in Figure 2.1.

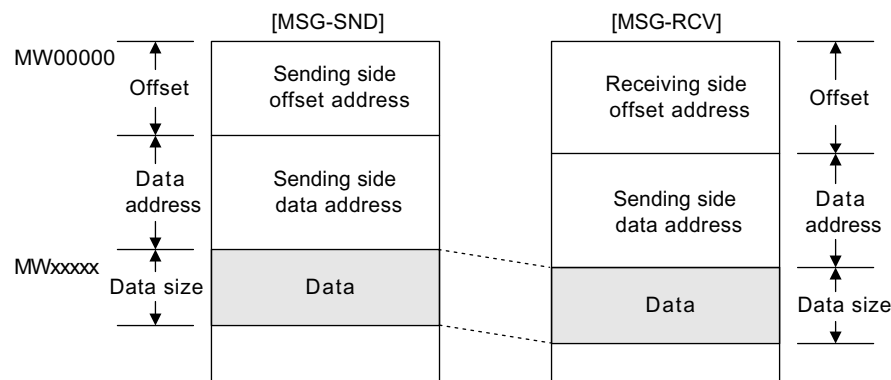

Fig. 2.1 Relationship between the Data Address, Size and Offset

### When transmission protocol is set to non-procedural

The setting of PARAM04, PARAM08, PARAM09, and PARAM10 are not necessary.

Transmission enabled register is only MW.

## ■ Input

### EXECUTE (Send Message Execution Command)

When the command becomes "ON", the message is sent.

### ABORT (Send Message Forced Interruption Command)

This command forcibly interrupts the sending of the message. This has priority over EXECUTE (send message forced interruption command).

### DEV-TYP (Transmission Device Type)

Designates transmission device type.

CPU Module = 8, 215IF = 1, 217IF = 5, 218IF = 6, SVB-01 = 11

### PRO-TYP (Transmission Protocol)

Designates transmission protocol. In non-procedural transmission, a response is not received from the other station.

MEMOBUS : Setting = 1

Non-procedural : Setting = 2

### CIR-NO (Circuit No.)

Designate the Circuit No.

CPU Module = 1, 2, 215IF = 1 to 8, 217IF = 1 to 24, 218IF = 1 to 8, SVB-01 = 1 to 16

### CH-NO (Channel No.)

Designate the channel No. of the transmission unit. However, the channel number should be set so as not to be duplicated on a single line.

CPU Module = 1, 215IF = 1 to 13, 217IF = 1, 218IF = 1 to 10, SVB-01 = 1 to 8

### PARAM (Set Data Head Address)

The head address of the set data is designated. For details of the set data, refer to "■ Parameter Details" (on page 2-3).

### BUSY (In Process)

Indicates that the process is being executed. Keep EXECUTE set to "ON".

### COMPLETE (Completion of Process)

Becomes "ON" for only 1 scan upon normal completion.

### ERROR (Occurrence of Error)

Becomes "ON" for only 1 scan upon occurrence of error. Refer to PARAM00 and PARAM 01 of "■ Parameter Details" (on page 2-3).

#### ■ Program Example

Program example is described in Figure 2.2.

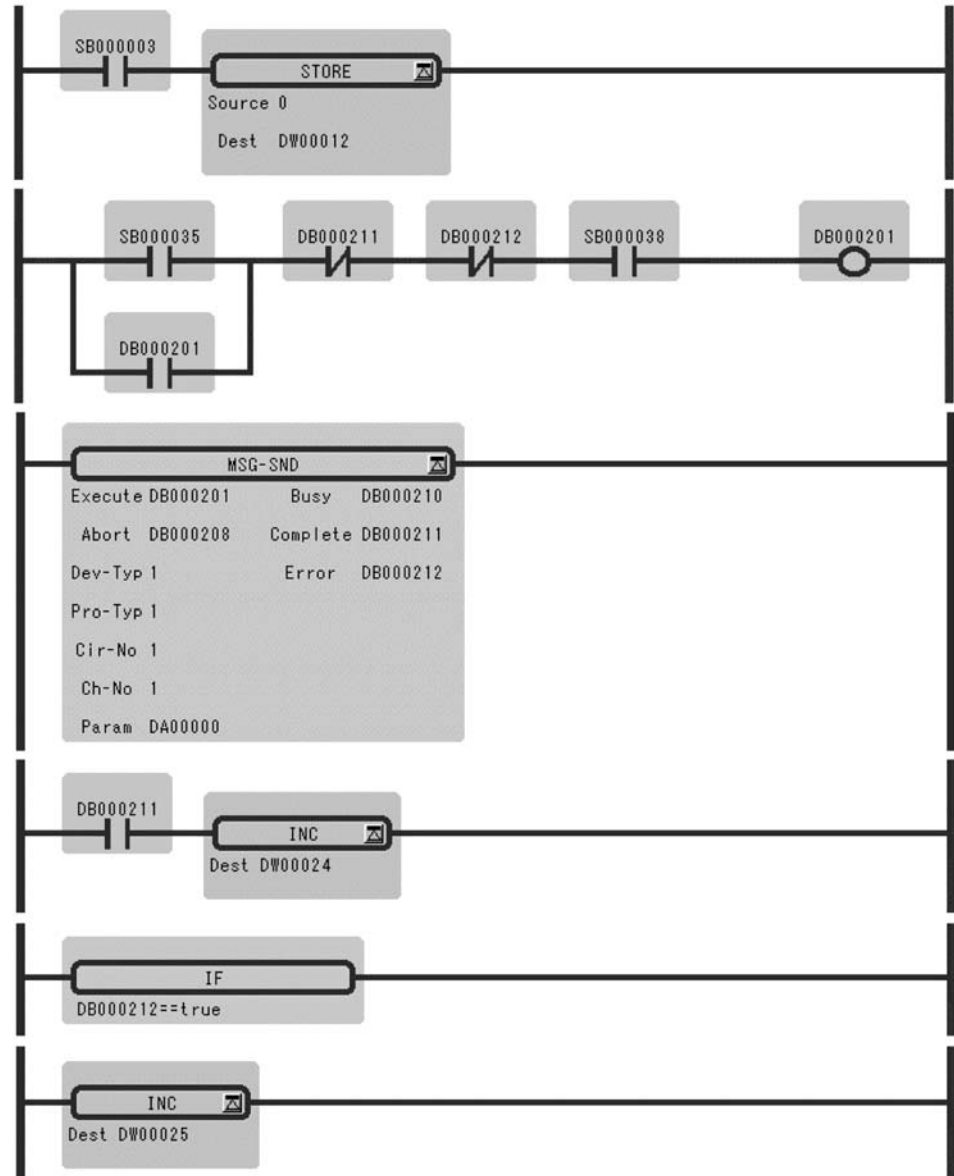

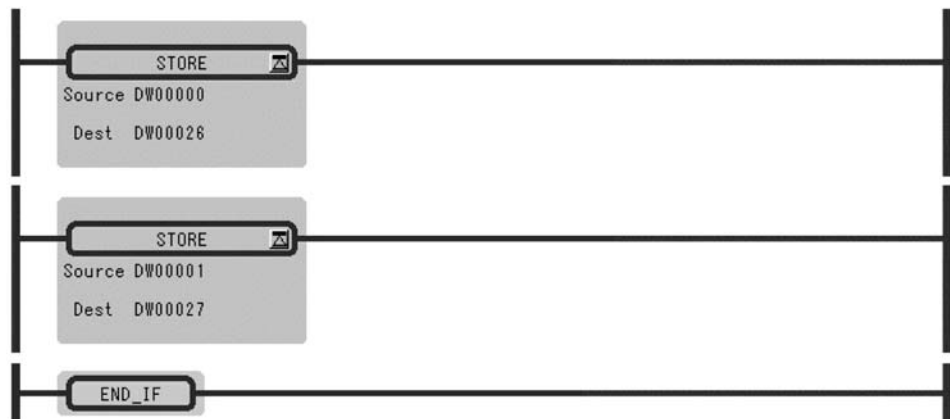

Fig. 2.2 Program Sample

2

## 2.1.2 Receive Message Function (MSG-RCV)

### ■ Outline

Receives a message from a calling station which is on the line and which is designated by the transmission device type. Supports a plurality of protocol types.

The execution command (*Execute*) must be held until *Complete* or *Error* becomes ON.

[Transmission Devices] CPU module, 215IF, 217IF, 218IF, SVB-01 for MP920

[Protocols] MEMOBUS, non-procedural

### ■ Format

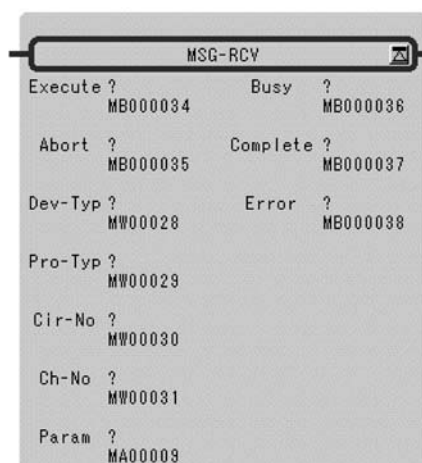

Symbol: MSG-RCV

Full Name: Message Receive

Category: SYSTEM

Icon:

### ■ Parameter

I/O Definition	Parameter Name	I/O Designation	Setting
Input	Execute	B-VAL	Receive message instruction
	Abort	B-VAL	Receive message forced interruption instruction
	Dev-Typ	I-REG	Type of transmission device CPU module = 8      215IF = 1      217IF = 5 218IF = 6      218-02 = 16      SVB-01 = 11
	Pro-Typ	I-REG	Transmission protocol (Set up of RTU and ASCII is module configuration definition.) MEMOBUS = 1 non-procedural = 2
	Cir-No	I-REG	Line No. CPU module = 1      215IF = 1 to 8      217IF = 1 to 24 218IF = 1 to 8      SVB-01 = 1 to 16
	Ch-No	I-REG	Transmission buffer channel No. CPU module = 1      215IF = 1 to 13      217IF = 1 218IF = 1 to 10      SVB-01 = 1 to 8
	Param	Address input	Head address of set data (MW, DW, #W)
Output	Busy	B-VAL	Message is being received.
	Complete	B-VAL	The receiving of the message has been completed.
	Error	B-VAL	Occurrence of error

### ■ Parameter Details

They adhere to contents-functions and so on and are collected into parameter numerical order.

Table 2.7 is Parameter List.

Table 2.7 Parameter List

Parameter No.	IN/OUT	Contents	
		MEMOBUS	Non-procedural
PARAM 00	OUT	Process result	Process result
PARAM 01	OUT	Status	Status
PARAM 02	OUT IN*	Called station number	Called station number
PARAM 03	SYS	System reserved	System reserved
PARAM 04	OUT	Function code	
PARAM 05	OUT	Data address	Data address
PARAM 06	OUT	Data size	Data size
PARAM 07	OUT	Called CPU number	Called CPU number
PARAM 08	IN	Coil offset	
PARAM 09	IN	Input relay offset	
PARAM 10	IN	Input register offset	

Table 2.7 Parameter List (cont'd)

Parameter No.	IN/OUT	Contents	
		MEMOBUS	Non-procedural
PARAM 11	IN	Holding register offset	Register offset
PARAM 12	IN	Write-in range LO	Register offset
PARAM 13	IN	Write-in range HI	Register offset
PARAM 14	SYS	For system use	For system use
PARAM 15	SYS	System reserved	System reserved
PARAM 16	SYS	System reserved	System reserved

\* Applicable only for 218IF.

## Process Result (PARAM00)

The process result is output to the upper byte. The lower byte is for system analysis.

- 00xx: In process (BUSY)
- 10xx: End of process (COMPLETE)
- 8xxx: Occurrence of error (ERROR)

### Error Classification

- 81xx: Function cord error  
The sending of an unused function code was attempted. Or, an unused function code was received.
- 82xx: Address setting error  
The data address, coil offset, input relay offset, input register offset, or holding register offset setting is out of range.
- 83xx: Data size error  
The size of the sent or received data is out of range.
- 84xx: Line No. setting error  
The line No. setting is out of range.
- 85xx: Channel No. Setting error  
The channel No. setting error.
- 86xx: Station address error  
The station No. setting is out of range.
- 88xx: Transmission unit error  
An error response was returned from the transmission unit. (Refer to "■ Parameter Details" (on page 2-14)).
- 89xx: Device selection error  
A non-applicable device is selected.



### Status (PARAM01)

Output the status of the transmission unit. See "Status (PARAM01)" (on page 2-5) for details.

### Called Station Number (PARAM02)

The station number of sending side is output.

### Function Code (PARAM04)

Output the MEMOBUS function code received. Refer to Table 2.8.

Table 2.8 Function Codes

Function Code		Setting
00H	Unused	–
01H	Read coil status	OK
02H	Read input relay status	OK
03H	Read contents of holding register	OK
04H	Read contents of input register	OK
05H	Change status of single coil	OK
06H	Write into a single holding register	OK
07H	Unused	–
08H	Loop-back test	OK
09H	Read contents of holding register (expanded)	OK
0AH	Read contents of input register (expanded)	OK
0BH	Write into holding register (expanded)	OK
0CH	Unused	–
0DH	Discontinuous readout of holding register (expanded)	OK
0EH	Discontinuous write into holding register (expanded)	OK
0FH	Change status of a multiple coil	OK
10H	Write into a plurality of holding register	OK
11H to 20H	Unused	–
21H to 3FH	System reserved	–
40H to 4FH	System reserved	–
50H to	Unused	–

Note: 1. –: cannot be output, OK: can be output

2. The MB, MW, IB, and IW registers can be used respectively as the coil, holding register, input relay, and input registers during slave operation.

### Data Address (PARAM05)

The data address requested by the sending side is output.

### Data Size (PARAM06)

The data size (number of bits or number of words) of the requested read or write is output.

### Called CPU Number (PARAM07)

PARAM07 outputs the called CPU number.

If the called device is an MP2000 Series Machine Controller, 1 is output.

If the called device is a Yaskawa Controller, but not in the MP2000 Series and it consists of more than one CPU Module, the called CPU number is output.

In all other cases, 0 is output.

### Coil Offset (PARAM08)

Set the offset word address of the coil. This is valid in the case of function codes 01H, 05H, and 0FH.

### Input Relay Offset (PARAM09)

Set the offset word address of the input relay. This is valid in the case of function code 02H.

### Input Register Offset (PARAM10)

Set the offset word address of the input register. This is valid in the case of function codes 04H and 0AH.

### Holding Register Offset (PARAM11)

Set the offset word address of the holding register. This is valid in the case of function codes 03H, 06H, 09H, 0BH, 0DH, 0EH, and 10H.

### Write-in Range LO (PARAM12), Write-in Range HI (PARAM13)

Set the write allowable range for the request for write-in. A request which is outside of this range will cause an error. This is valid in the case of function code 0BH, 0EH, 0FH, and 10H.

$0 \leq \text{Write-in Range LO} \leq \text{Write-in Range HI} \leq \text{Maximum value of MW Address}$

### For System Use (PARAM14)

The channel No. being used is stored. Make sure that this will be set to 0000H by the user program on the first scan after turning on the power. This parameter must not be changed by the user program thereafter since this parameter will then be used by the system.

## When Non-procedural is set for Transmission Protocol

PARAM04 has no function. The settings of PARAM08, PARAM09, and PARAM10 are not necessary. The message receivable register is only MW.

### ■ Input

#### EXECUTE (Receive Message Execution Command)

When the command becomes "ON", the message is received. This must be held until COMPLETE (completion of process) or ERROR (occurrence of error) becomes "ON".

#### ABORT (Receive Message Forced Interruption Command)

This command forcibly interrupts the receiving of the message. This has priority over EXECUTE (receive message execution command).

#### DEV-TYP (Transmission Device Type)

Designates transmission device type.

CPU Module = 8, 215IF = 1, 217IF = 5, 218IF = 6, 218-02 = 16, SVB-01 = 11

#### PRO-TYP (Transmission Protocol)

Designates transmission protocol. In non-procedural transmission, a response is not sent to the called station.

MEMOBUS : Setting = 1

Non-procedural : Setting = 2

#### CIR-NO (Circuit No.)

Designate the circuit No.

CPU Module = 1, 2, 215IF = 1 to 8, 217IF = 1 to 24, 218IF = 1 to 8, SVB-01 = 1 to 16

#### CH-NO (Channel No.)

Designate the channel No. of the transmission unit. However, the channel number should be set so as not to be duplicated on a single line.

CPU Module = 1, 215IF = 1 to 13, 217IF = 1, 218IF = 1 to 10, SVB-01 = 1 to 8

#### PARAM (Setting Data Head Address)

The head address of the set data is designated. For details of the set data refer to "■ Parameter Details" (on page 2-14).

## ■ Output

### BUSY (In Process)

Indicates that the process is being executed. Keep EXECUTE set to "ON".

### COMPLETE (Completion of Process)

Becomes "ON" for only 1 scan upon normal completion.

### ERROR (Occurrence of Error)

Becomes "ON" for only 1 scan upon occurrence of error. Refer to PARAM00 and PARAM01 of "■ Parameter Details" (on page 2-14).

■ Program Example

Program example is described in Figure 2.3.

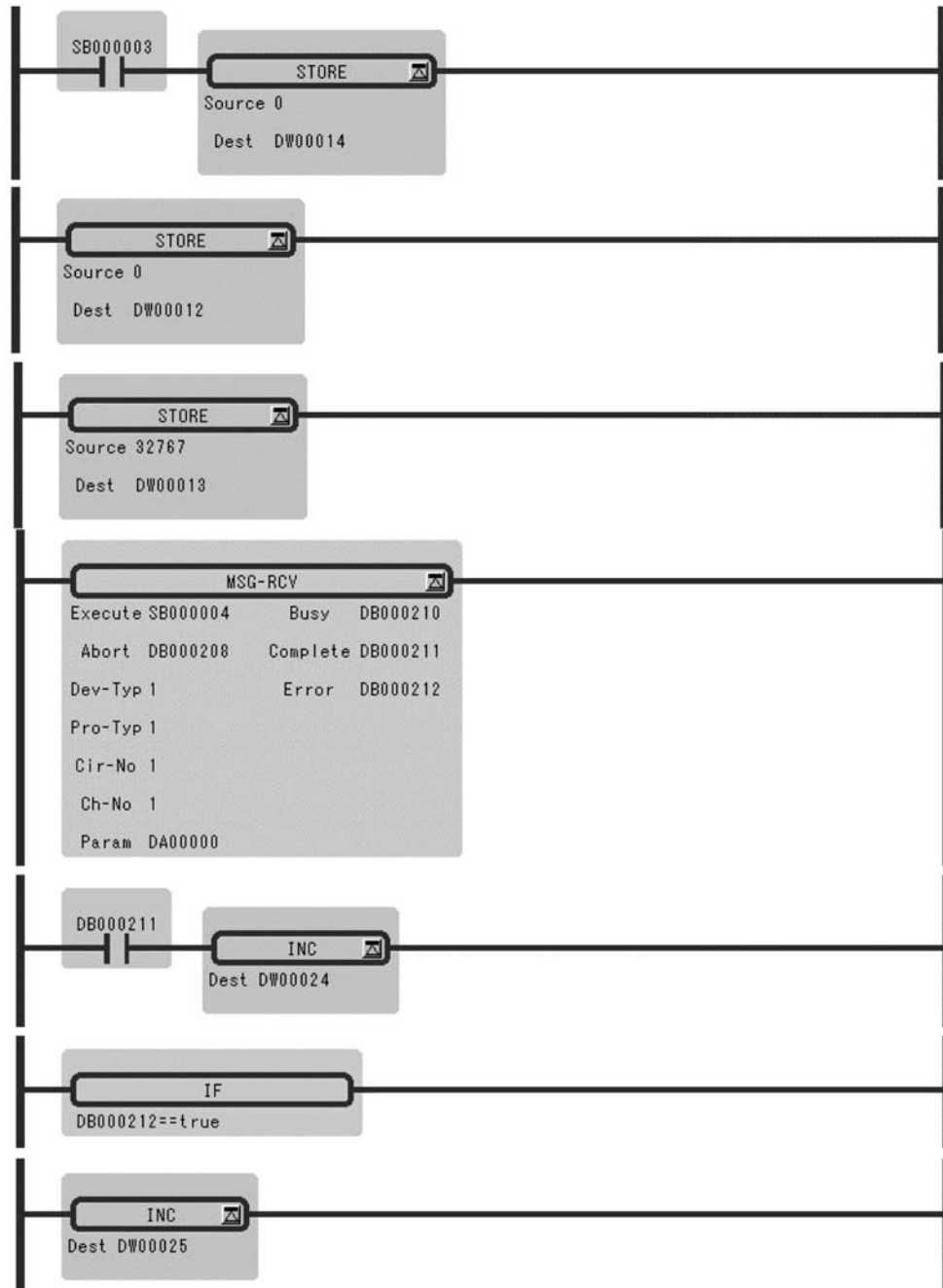

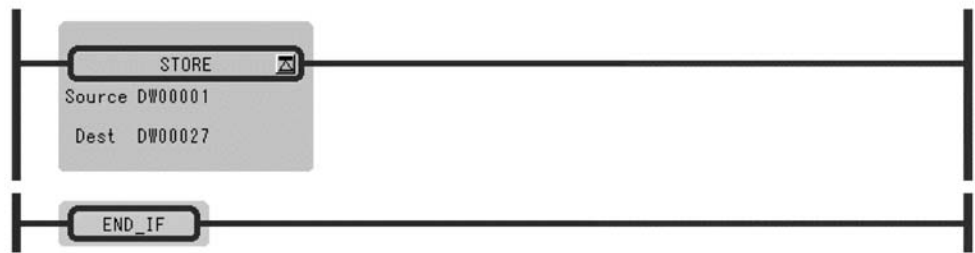

Fig. 2.3 Program Sample

## 2.2 Trace Functions

### 2.2.1 Trace Function (TRACE)

#### ■ Outline

Performs execution control of the traces of the trace data designated by the trace group No. The trace is defined as "Data Trace Definition" screen.

- Tracing is executed when the trace execution command (*Execute*) is set to ON.
- The trace counter is reset when the trace reset command (*Reset*) is set to ON.  
The trace end (*Trc-End*) output is also reset at this time.
- The trace end (*Trc-End*) output is set to ON when the trace execution count becomes equal to the set count (set as Trace Definition).

#### ■ Format

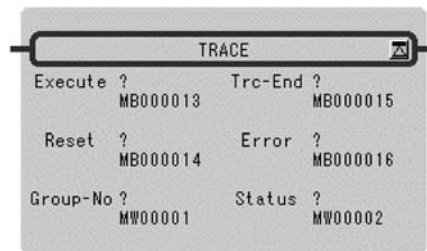

Symbol: TRACE  
Full Name: Trace  
Category: SYSTEM  
Icon: 

#### ■ Parameter

I/O Definition	Parameter Name	I/O Designation	Setting
Input	Execute	B-VAL	Trace execution command
	Reset	B-VAL	Trace reset command
	Group-No	I-REG	Designation of the trace group
Output	Trc-End	B-VAL	End of Trace
	Error	B-VAL	Occurrence of error
	Status	I-REG	Trace execution status

Configuration of the trace execution status (STATUS) is described below.

Table 2.9 Configuration of the Trace Execution Status

Name	Bit No.	Remarks
Trace data full	bit 0	This becomes ON after one round of reading of the contents in the data trace memory of the designated group has been completed.
System reserved	bit 1 to bit 7	
No trace definition	bit8	The function will not be executed.
Designated group No. error	bit9	The function will not be executed.
System reserved	bit 10 to bit 12	
Execution timing error	bit13	The function will not be executed.
System reserved	bit14	
System reserved	bit15	

2

## 2.2.2 Data Trace Read Function (DTRC-RD)

### ■ Outline

Reads out the trace data of the main controller unit and stores this data in the user registers.

The data in the trace memory can be read out upon designating the record number and the number of records. The readout can be performed by designating just the necessary items in the record.

### ■ Format

DTRC-RD	
Execute ? MB000017	Complete ? MB000018
Group-No ? MW000003	Error ? MB000019
Rec-No ? MW000004	Status ? MW000007
Rec-Size ? MW000005	Rec-Size ? MW000008
Select ? MW000006	Rec-Len ? MW000009
Dat-Adr ? MA000005	

Symbol: DTRC-RD  
 Full Name: Data-Trace Read  
 Category: SYSTEM  
 Icon: 



### ■ Parameter

I/O Definition	Parameter Name	I/O Designation	Setting
Input	Execute	B-VAL	Designation of the execution of data trace read
	Group-No	I-REG	Designation of the data trace group No. (1 to 4)
	Rec-No	I-REG	Designation of the head record No. for readout (0 to maximum number of records-1)
	Rec-Size	I-REG	Designation of the number of records requested for readout (1 to maximum number of records)
	Select	I-REG	Item to be read out (0001H to FFFFH) Bits 0 to F correspond to data designations 1 to 16 of the trace definition.
	Dat-Adr	Address input	Designation of the No. of the head register for readout (address of MW or DW)
Output	Complete	B-VAL	Completion of trace read
	Error	B-VAL	Occurrence of error
	Status	I-REG	Data trace read execution status
	Rec-Size	I-REG	Number of records read
	Rec-Len	I-REG	Length (in words) of 1 record that is read

Table 2.10 Configuration of the Data Trace Read Execution Status (STATUS)

Name	Bit No.	Note
System reserved	bit0 to bit7	
No trace definition	bit8	The function is not executed.
Group No. error	bit9	The function is not executed.
Designated record No. error	bit10	
Error in the designated number of records read	bit11	The function is not executed.
Data storage error	bit12	The function is not executed.
System reserved	bit13	
System reserved	bit14	
Address input error	bit15	The function is not executed.

### ■ Readout of Data

Readout of Data is described in Figure 2.4.

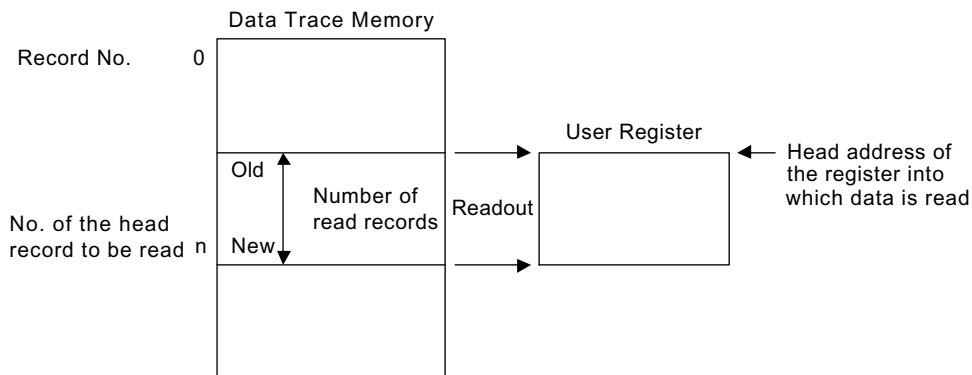

Fig. 2.4 Data Read

The most recent record No. of trace groups are each stored in SW00100 to SW00103.

Table 2.11 Newest Records Number

System Register Number	Data Trace Definition
SW00100	For group 1
SW00101	For group 2
SW00102	For group 3
SW00103	For group 4
SW00104	—
SW00105	—
SW00106	—
SW00107	—

### ■ Configuration of the Read Data

Configuration of the read data is described in Figure 2.5.

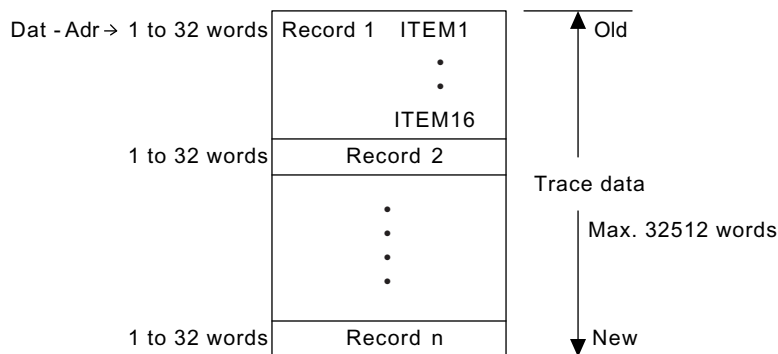

Fig. 2.5 Configuration of the Read Data

### Record Length

A Record is composed of the data for the selected items.

Word length of 1 record =  $B_n \times 1 \text{ word} + W_n \times 1 \text{ word} + L_n \times 2 \text{ words} + F_n \times 2 \text{ words}$

$B_n$ : Number of bit type register selected points

$W_n$ : Number of word type register selected points

$L_n$ : Number of double-length integer type register selected points

$F_n$ : Number of real number type register selected points

Maximum of record length = 32 words (e.g. when there are 16 double-length integer type or real number type registers)

Minimum of record length = 1 words (e.g. when there is one bit type or integer type register)

### Number of Records

The Number of Records is the following.

Maximum Number of Records	32512/ Record Length
Number of records when the record length is the maximum	0 to 1015
Number of records when the record length is the minimum	0 to 32511

## 2.2.3 Failure Trace Read Function (FTRC-RD)

### ■ Outline

Reads the failure trace data and stores them in the user register. The data in the trace buffer can be read out upon designating the number of records needed. Either the failure occurrence data or the restoration data are designated for readout. Enables the reset (initialization) of the failure trace buffer.

### ■ Format

FTRC-RD	
Execute ? MB000020	Complete ? MB000022
Reset ? MB000021	Error ? MB000023
Type ? MW00010	Status ? MW00012
Rec-Size ? MW00011	Rec-Size ? MW00013
Dat-Adr ? MA00006	Rec-Len ? MW00014

Symbol: FTRC-RD  
 Full Name: Failure-Trace Read  
 Category: SYSTEM  
 Icon: 

■ Parameter

I/O Definition	Parameter Name	I/O Designation	Setting
Input	Execute	B-VAL	Failure trace readout instruction
	Reset	B-VAL	Failure trace buffer reset instruction
	Type	I-REG	Type of data read 1: Occurrence data 2: Restoration data
	Rec-Size	I-REG	Number of read record Occurrence data: 1 to 64 Restoration data: 450
	Dat-Adr	Address input	Head register address for reading (address of MW or DW)
Output	Complete	B-VAL	Completion of failure trace read
	Error	B-VAL	Occurrence of error
	Status	I-REG	Failure trace read execution status
	Rec-Size	I-REG	Number of records read
	Rec-Len	I-REG	Length of record read

2

Table 2.12 Failure Trace Reading Execution Status (STATUS)

Name	Bit No.	Remarks
System reserved	bit0 to bit7	
No trace definition	bit8	The function will not be executed.
Designated type No. error	bit9	The function will not be executed.
System reserved	bit10	
Error in the designated number of records	bit11	The function will not be executed.
Data storage error	bit12	The function will not be executed.
System reserved	bit13	
System reserved	bit14	
System reserved	bit15	The function will not be executed.

■ Failure Occurrence Data Readout

Failure occurrence data readout is described in Figure 2.6. The readout will always be started from the most recent record.

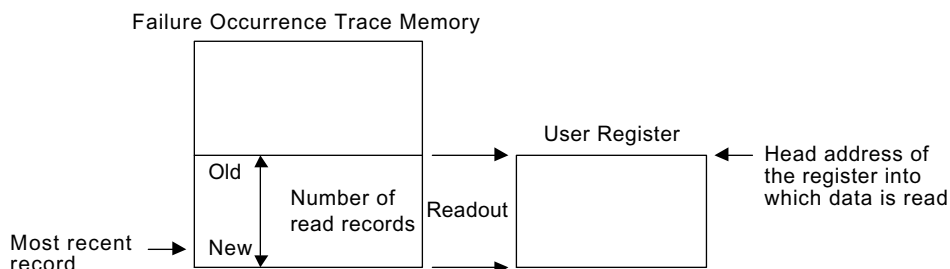

Fig. 2.6 Failure Occurrence Data Readout

■ Readout Data Configuration (Failure Occurrence Data)

Data Configuration

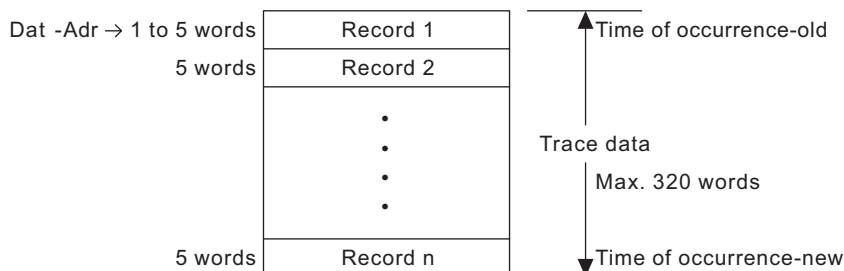

Fig. 2.7 Data Configuration

Record Configuration

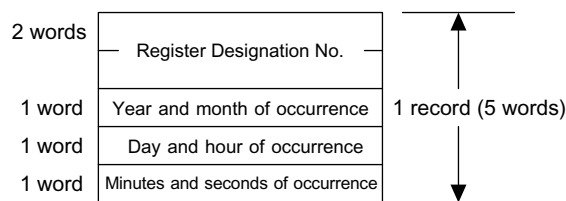

Fig. 2.8 Record Configuration

Structure of Register Designation No. (2 words)

Contain the failure detection relay information.

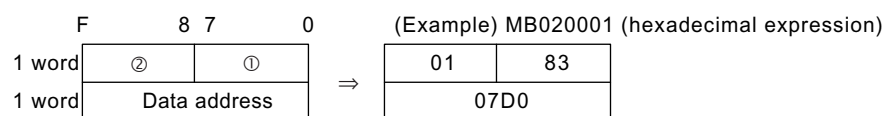

Fig. 2.9 Structure of Register Designation No.

Table 2.13 Bit Configuration

No.	Bit Configuration of ①	Bit Configuration of ②
7	Defined flag (1 = defined, 0 = undefined)	System reserved (= 0)
6	System reserved (= 0)	Data Type Bit = 0, Integer = 1, Double-length integer = 2, Real Number = 3
5		
4	0 = NO contact designation, 1 = NC contact designation	
3	Type of register	Bit Address 0 to F
2	S = 0,	
1	I = 1,	
0	O = 2, M = 3	

### Number of Records

The Number of Records is the following.

Minimum number of records	0 (no failure restoration data)
Maximum number of records	64

### Failure Restoration Data

Failure restoration data is described in Figure 2.10. The number (amount) of restoration data is stored in SW00093 (ring counter for 1 to 9999).

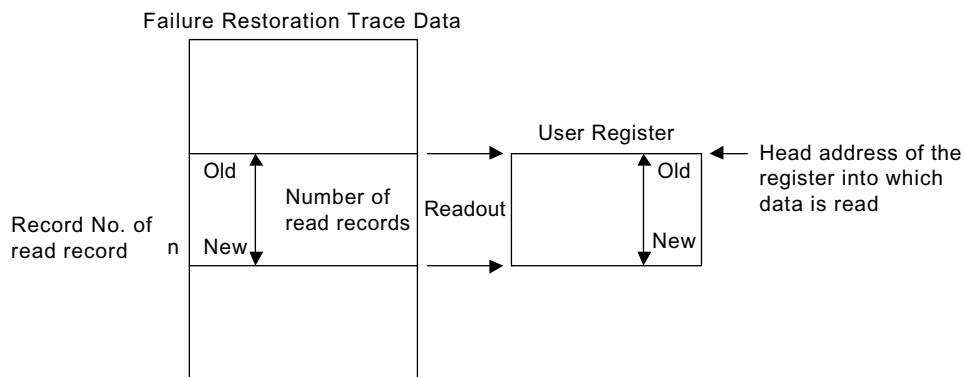

Fig. 2.10 Failure Restoration Data

### Readout Data Configuration (Failure Restoration Data)

Data configuration is described in Figure 2.11.



Fig. 2.11 Data Configuration

### Record Configuration

Record composition is shown in Figure 2.12.

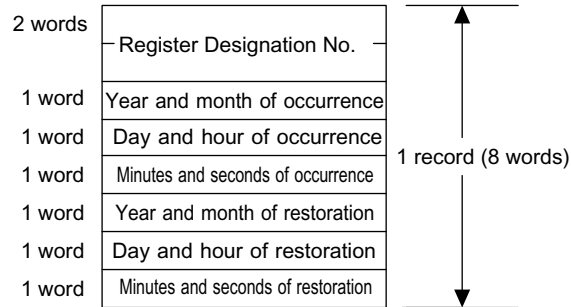

Fig. 2.12 Record Configuration

### Number of Record

The Number of Records is the following.

Minimum number of records	0 (no failure restoration data)
Maximum number of records	450

## 2.2.4 Inverter Trace Read Function (ITRC-RD)

### ■ Outline

Reads out the trace data of the inverter and stores this data in the user registers. The data in the trace buffer can be read out upon designating the number of records needed. The readout can be performed upon designating just the necessary items in the record.

### Applicable inverters

- Connected MP930 via 216
- Connected SVB-01 for MP920 via 216
- Connected 215IF for MP920 and MP2000 series via 215

### ■ Format

ITRC-RD	
Execute ? MB000024	Busy ? MB000026
Abort ? MB000025	Complete ? MB000027
Dev-Typ ? MW00015	Error ? MB000028
Cir-No ? MW00016	Status ? MW00021
St-No ? MW00017	Rec-Size ? MW00022
Ch-No ? MW00018	Rec-Len ? MW00023
Rec-Size ? MW00019	
Select ? MW00020	
Dat-Adr ? MA00007	

Symbol: ITRC-RD  
 Full Name: Inverter-Trace Read  
 Category: SYSTEM  
 Icon : 



### ■ Parameter

I/O Definition	Parameter Name	I/O Designation	Setting
Input	Execute	B-VAL	Inverter trace read instruction
	Abort	B-VAL	Inverter trace read forced interruption instruction
	Dev-Typ	I-REG	Type of transmission device 215IF = 1                      MP930 = 4                      SVB-01 = 11
	Cir-No	I-REG	Line No. 215IF = 1                      MP930 = 1                      SVB-01 = 1 to 16
	St-No	I-REG	Slave station No. 215IF = 1 to 64                      MP930 = 1 to 14                      SVB-01 = 1 to 14
	Ch-No	I-REG	Transmission buffer channel No. (No designation) 215IF = 1 to 3                      MP930 = 1                      SVB-01 = 1 to 8
	Rec-Size	I-REG	Number of records to be read (1 to 64)
	Select	I-REG	Items to be read (0001H to FFFFH) Bits 0 to F correspond to trace data items 1 to 26
	Dat-Adr	Address input	Head address of data buffer register (address of MW or DW)
Output	Busy	B-VAL	The reading of inverter trace data is in progress.
	Complete	B-VAL	Completion of inverter trace read
	Error	B-VAL	Occurrence of error
	Status	I-REG	Inverter trace read execution status
	Rec-Size	I-REG	Number of read records
	Rec-Len	I-REG	Length of read record (for 1 record)

Table 2.14 Configuration of the Inverter Trace Read Execution Status (STATUS)

Name	Bit No.	Remarks
System reserved	bit0 to bit8	
Transmission parameter error	bit9	The function will not be executed.
System reserved	bit10	
Error in the designated number of records	bit11	The function will not be executed.
Data storage error	bit12	The function will not be executed.
Transmission error	bit13	The function will not be executed.
System reserved	bit14	
Address input error	bit15	The function will not be executed.

## ■ Readout of Inverter Trace Data

The readout will always be started from the most recent record.

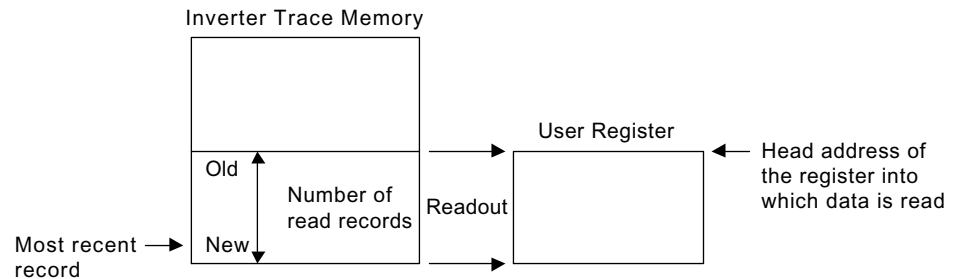

## ■ Readout Data Configuration

### Data Configuration

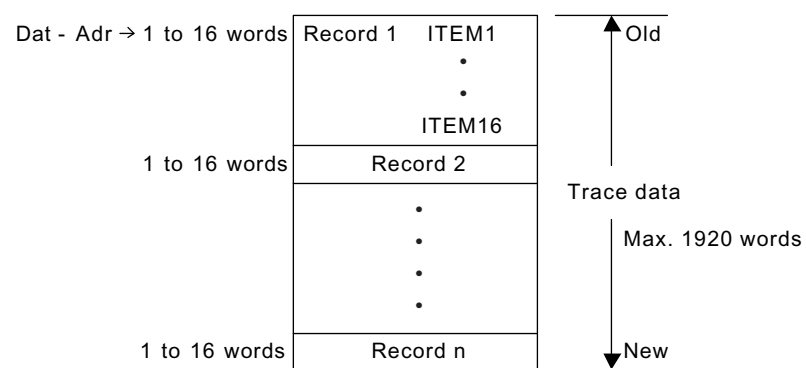

### Record Length

A record is composed of the data of the selected items.

Word length of 1 record = 1 to 16 words

### Number of Records

Maximum number of records = 120

## 2.3 Inverter Functions

### 2.3.1 Inverter Constant Write Function (ICNS-WR)

#### ■ Outline

Writes the inverter constants.

The types and ranges of the inverter constants to be written can be designated.

#### Applicable inverters

- Connected MP930 via 216
- Connected SVB-01 for MP920 via 216
- Connected 215IF for MP920 and MP2000 series via 215

#### ■ Format

ICNS-WR			
Execute ?	MB000039	Busy ?	MB000041
Abort ?	MB000040	Complete ?	MB000042
Dev-Typ ?	MW000032	Error ?	MB000043
Cir-No ?	MW000033	Status ?	MW000039
St-No ?	MW000034		
Ch-No ?	MW000035		
Cns-Typ ?	MW000036		
Cns-No ?	MW000037		
Cns-Size ?	MW000038		
Dat-Adr ?	MA000010		

Symbol: ICNS-WR

Full Name: Inverter-Constant Write

Category: SYSTEM

Icon: 

## ■ Parameter

I/O Definition	Parameter Name	I/O Designation	Setting
Input	Execute	B-VAL	Inverter constant write instruction
	Abort	B-VAL	Inverter constant write forced interruption instruction
	Dev-Typ	I-REG	Type of transmission device 215IF = 1                      MP930 = 4                      SVB-01 = 11
	Cir-No	I-REG	Line No. 215IF = 1, 2                      MP930 = 1                      SVB-01 = 1 to 16
	St-No	I-REG	Slave station No. 215IF = 1 to 64                      MP930 = 1 to 14                      SVB-01 = 1 to 14
	Ch-No	I-REG	Transmission buffer channel No. 215IF = 1 to 3                      MP930 = 1                      SVB-01 = 1 to 8
	Cns-Typ	I-REG	Type of inverter constant 0 = direct designation of reference No. 1 = An, 2 = Bn, 3 = Cn, 4 = Dn, 5 = En, 6 = Fn, 7 = Hn, 8 = Ln, 9 = On, 10 = Tn
	Cns-No	I-REG	Inverter constant No. (1 to 99) The upper limit will differ according to the type of inverter. If Cns-Typ = 0, designate the reference No.
	Cns-Size	I-REG	Number of inverter constants (number of data to be written)1 to 100
	Dat-Adr	Address input	Register address of set data (address of MW, DW, or #W)
Output	Busy	B-VAL	Inverter constants are being written in.
	Complete	B-VAL	The write-in of inverter constants has been completed.
	Error	B-VAL	Occurrence of error
	Status	I-REG	Inverter constant write execution status

Table 2.15 Configuration of Inverter Constant Write Execution Status (STATUS)

Name	Bit No.	Remarks
System reserved	bit0 to bit7	
Execution sequence error	bit8	The function will not be executed.
Transmission parameter error	bit9	The function will not be executed.
Designated type error	bit10	The function will not be executed.
Designated No. error	bit11	The function will not be executed.
Error in number (amount) of the designated data	bit12	The function will not be executed.
Transmission error	bit13	The function will not be executed.
Inverter response error	bit14	The function will not be executed.
Address input error	bit15	The function will not be executed.

Note: In the case of an inverter response error, the error codes from the inverter are indicated in bit 0 to bit 7.

- 01H(1) : function code error
  - 02H(2) : reference No. error
  - 03H(3) : write-in count error
  - 21H(33) : write-in data upper/lower limit error
  - 22H(34) : write-in error (during running, during UV)
- Numbers in ( ) are of decimal expressions.

■ Configuration of the Write-in Data

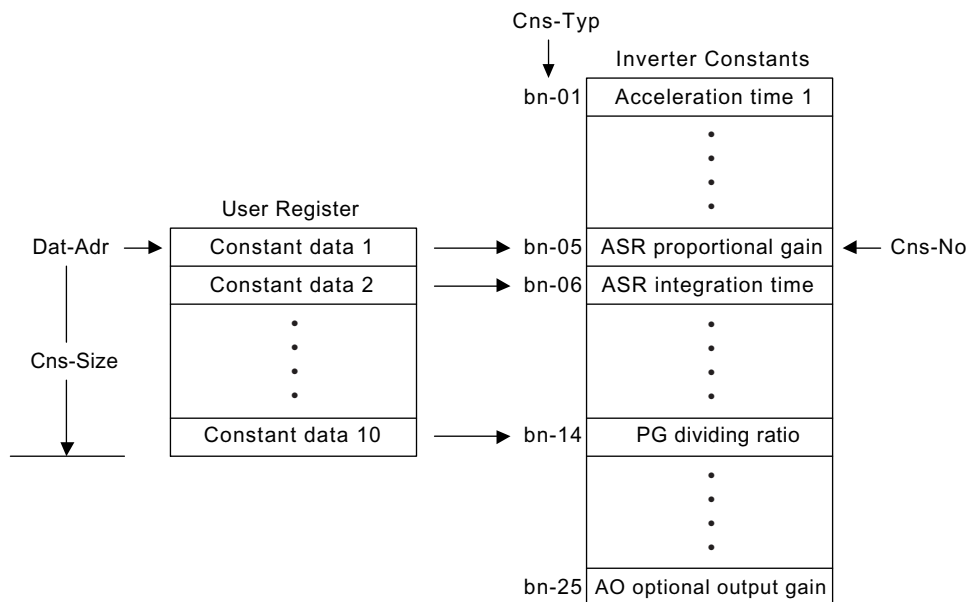

## ■ Method of Writing to an EEPROM

Procedures for writing constants to an EEPROM (inverter internal constant storage memory) are shown in below.

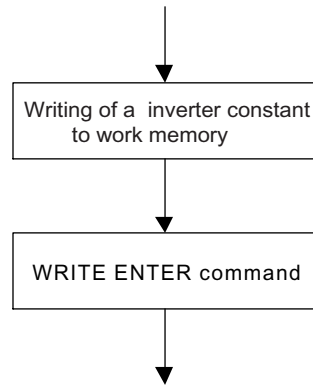

Constants written with the system function "ICNS-WR" are once entered in work memory. In order to actually store these in EEPROM, it is necessary to bring up the WRITE ENTER command as shown in below.

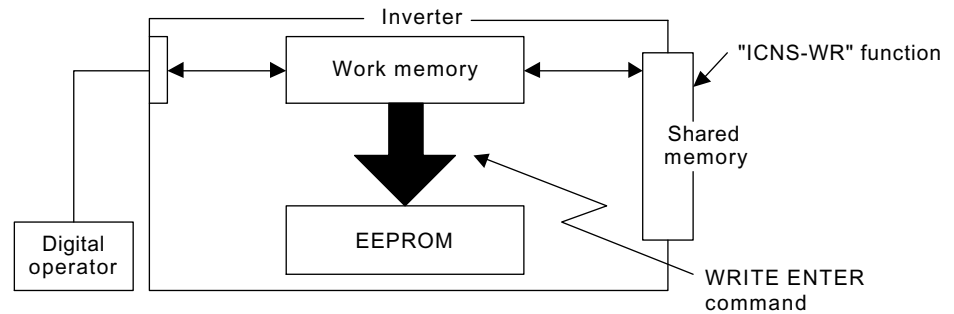

### WRITE ENTER Command

Using the "ICNS-WR" function, by writing the data "0" in the reference number "FFFD" the WRITE ENTER command is entered for the inverter.

■ Program Example

An example of a program (if MP930) that writes "200" in the constant "C1-01" is shown below.

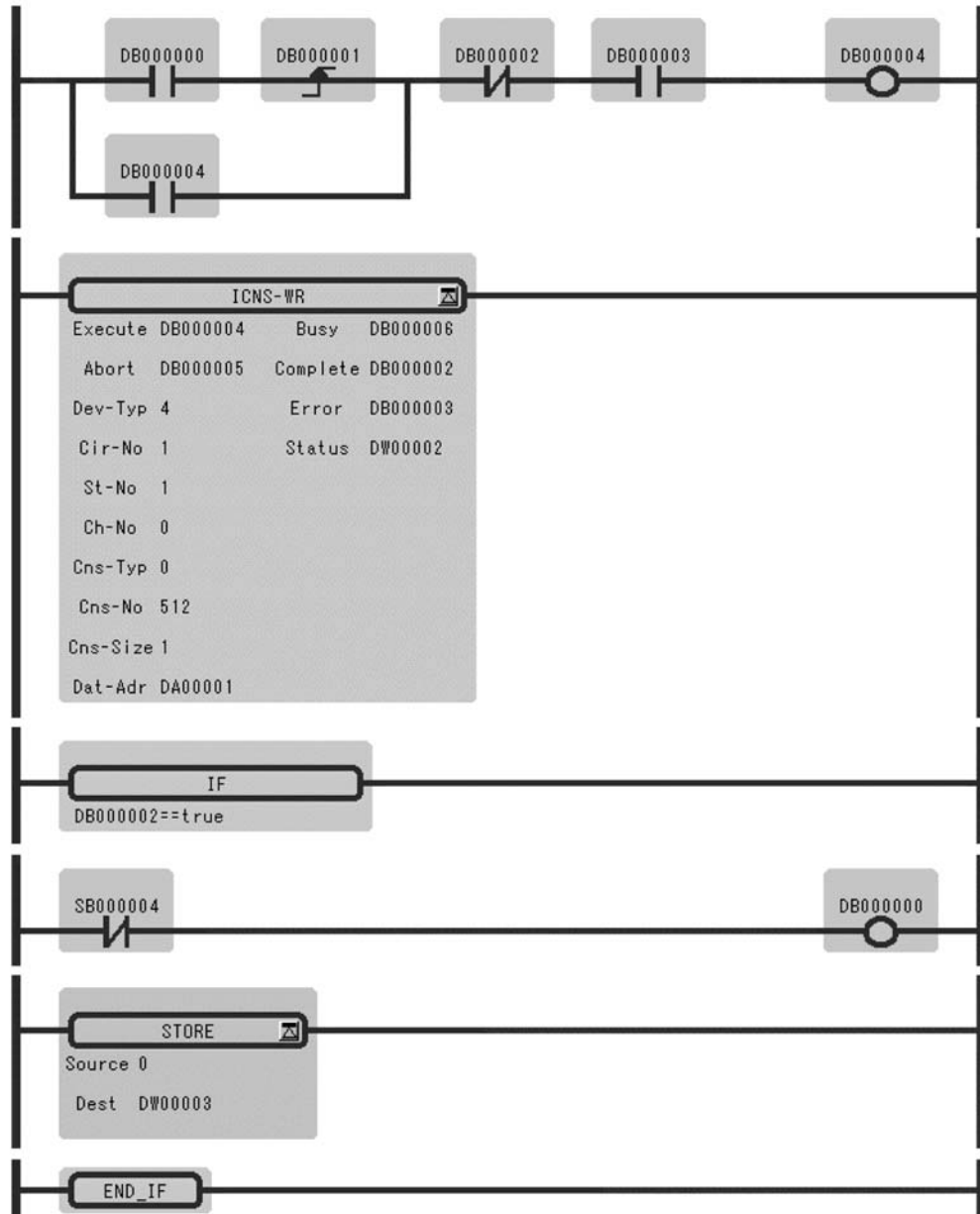

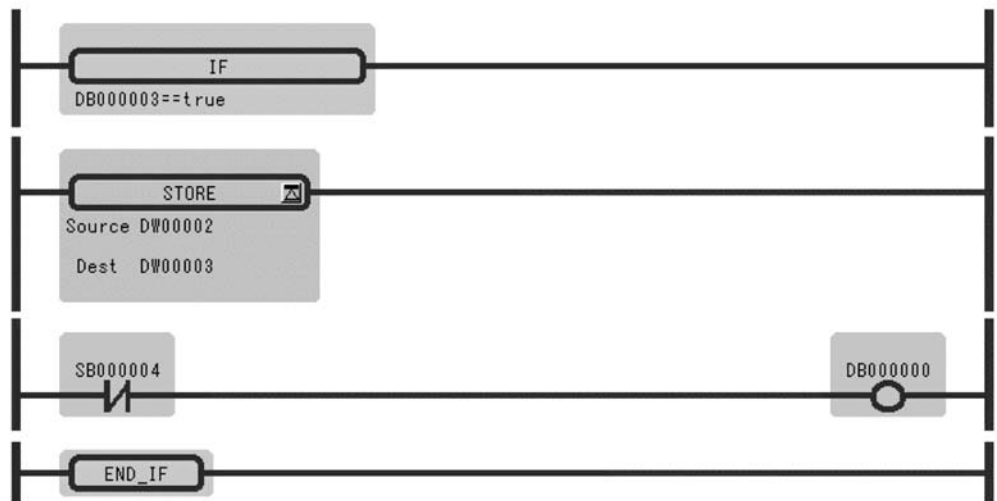

2

### 2.3.2 Inverter Constant Read Function (ICNS-RD)

#### ■ Outline

Reads the inverter constants.

The types and ranges of the inverter constants to be read can be designated.

#### Applicable inverters

- Connected MP930 via 216
- Connected SVB-01 for MP920 via 216
- Connected 215IF for MP920 and MP2000 series via 215

#### ■ Format

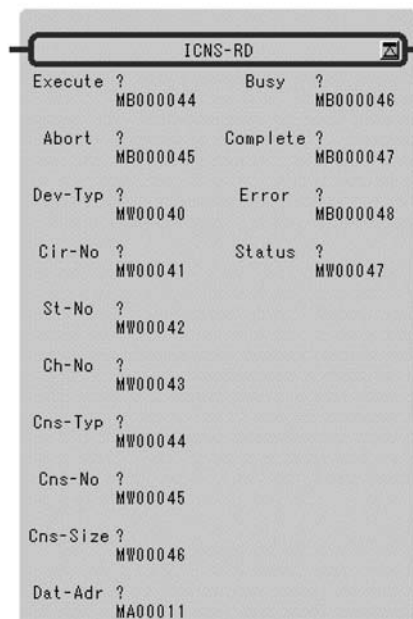

Symbol: ICNS-RD  
 Full Name: Inverter-Constant Read  
 Category: SYSTEM  
 Icon: 



### ■ Parameter

I/O Definition	Parameter Name	I/O Designation	Setting
Input	Execute	B-VAL	Inverter constant read execution instruction
	Abort	B-VAL	Inverter constant read forced interruption instruction
	Dev-Typ	I-REG	Type of transmission device 215IF = 1                      MP930 = 4                      SVB-01 = 11
	Cir-No	I-REG	Line No. 215IF = 1, 2                      MP930 = 1                      SVB-01 = 1 to 16
	St-No	I-REG	Slave station No. 215IF = 1 to 64                      MP930 = 1 to 14                      SVB-01 = 1 to 14
	Ch-No	I-REG	Transmission buffer channel No. 215IF = 1 to 3                      MP930 = 1                      SVB-01 = 1 to 8
	Cns-Typ	I-REG	Type of inverter constant 0 = direct designation of reference No. 1 = An, 2 = Bn, 3 = Cn, 4 = Dn, 5 = En, 6 = Fn, 7 = Hn, 8 = Ln, 9 = On, 10 = Tn
	Cns-No	I-REG	Inverter constant No. (1 to 99) The upper limit will differ according to the type of inverter. If Cns-Typ = 0, designate the reference No.
	Cns-Size	I-REG	Number of inverter constants (number of data to be read) 1 to 100
	Dat-Adr	Address input	Register address of read-out destination (address of MW or DW)
Output	Busy	B-VAL	Inverter constants are being read.
	Complete	B-VAL	The reading of inverter constants has been completed.
	Error	B-VAL	Occurrence of error
	Status	I-REG	Inverter constant read execution status

Table 2.16 Configuration of Inverter Constant Read Execution Status (STATUS)

Name	Bit No.	Remarks
System reserved	bit0 to bit7	
Execution sequence error	bit8	The function will not be executed.
Transmission parameter error	bit9	The function will not be executed.
Designated type error	bit10	The function will not be executed.
Designated No. error	bit11	The function will not be executed.
Error in number (amount) of the designated data	bit12	The function will not be executed.
Transmission error	bit13	The function will not be executed.
Inverter response error	bit14	The function will not be executed.
Address input error	bit15	The function will not be executed.

Note: In the case of an inverter response error, the error codes from the inverter are indicated in bit0 to bit7.

01H(1): function code error

02H(2): reference No. error

Numbers in ( ) are of decimal expressions.

■ Configuration of the Data Readout

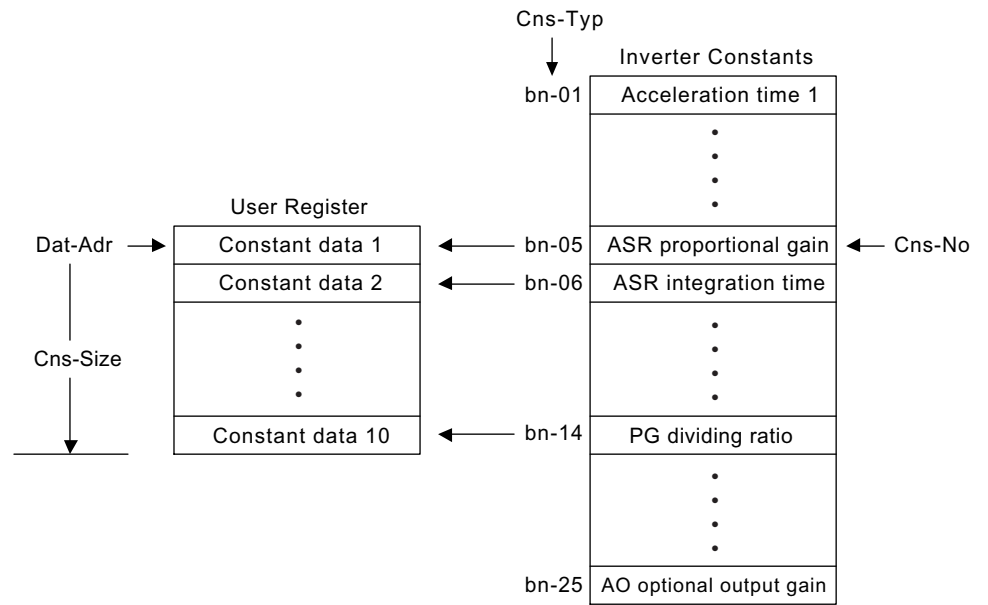

2

## 2.4 Other Functions

### 2.4.1 Counter Function (COUNTER)

#### ■ Outline

Increments or decrements the current value when the count up/down command (*Up-Cmd*, *Down-Cmd*) changes from OFF to ON.

When the counter reset command (*Reset*) becomes ON, the current counter value is set to 0. Also, the current counter value and the set value are compared and the comparison result is output.

\* The current value will not be incremented neither decremented if a counter error (current value > set value) occurs.

#### ■ Format

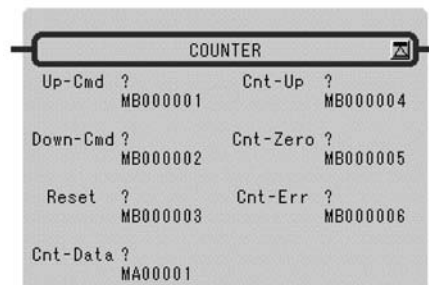

Symbol: COUNTER

Full Name: Counter

Category: SYSTEM

Icon: 

#### ■ Parameter

I/O Definition	Parameter Name	I/O Designation	Setting	
Input	Up-Cmd	B-VAL	Count up command (OFF→ON)	Data area for counter process 1: Set value 2: Current value 3: Work flag
	Down-Cmd	B-VAL	Count down command (OFF→ON)	
	Reset	B-VAL	Counter reset command	
	Cnt-Data	Address input	Head address of data area for counter process (MW or DW register)	
Output	Cnt-Up	B-VAL	Becomes ON when current counter value = set value.	
	Cnt-Zero	B-VAL	Becomes ON when current counter value = 0.	
	Cnt-Err	B-VAL	Becomes ON when current counter value > set value.	

The forms of parameter input and output are shown in below.

Input Data Form	Input Designation	Description
Bit Input	B-VAL	Designates the output to be of a bit type. The bit type data become the input to the function.
Integer Type Input	I-VAL	Designates the input to be of an integer type. The contents (integer data) of the register with the designated number become the input to the function.
	I-REG	Designates the input to be the contents of an integer type register. The number of the integer type register is designated when referencing the function. The contents (integer data) of the register with the designated number become the input to the function.
Double-length Integer Type Input	L-VAL	Designates the input to be of a double-length integer type. When reference the function, the contents (double-length integer data) of the register with the designated number become the input to the function.
	L-REG	Designates the input to be the contents of a double-length integer type register. When reference the function, the contents (double-length integer data) of the register with the designated number become the input to the function.
Real Number Type Input	F-VAL	Designates the input to be of a real number type. The contents (real number data) of the register with the designated number become the input to the function.
	F-REG	Designates the input to be the contents of a real number type register. The number of the real number type register is designated when referencing the function. The contents (real number data) of the register with the designated number become the input to the function.
Address Input	—	Hands over the address of the designated register (an arbitrary integer register) to the function. Only 1 input is allowed in the case of a user function.

## 2.4.2 First-in First-out Function (FINFOUT)

### ■ Outline

This is a first-in first-out type block data transfer function. The FIFO data table is composed of a 4-word header part and a data buffer. 3 words of the header part (data size, input size, output size) must be set before this function is referenced.

- When the data input command (*In-Cmd*) becomes ON, the designated number of data is sequentially stored from the designated input data area to the data area of the FIFO table.
- When the data output command (*Out-Cmd*) becomes ON, the designated number of data are transferred from the head of the data area of the FIFO table to the designated output data area.
- When the reset command (*Reset*) becomes ON, the number (amount) of data stored is set to zero and the FIFO table empty output (*Tbl-Emp*) becomes ON.
- If "size of available space for data (empty size) < input size" or if "data size < output size," the FIFO table error (*Tbl-Err*) becomes ON.

### ■ Format

FINFOUT			
In-Cmd ?	MB000007	Tbl-Full ?	MB000010
Out-Cmd ?	MB000008	Tbl-Emp ?	MB000011
Reset ?	MB000009	Tbl-Err ?	MB000012
FIFO-Tbl ?	MA00002		
In-Data ?	MA00003		
Out-Data ?	MA00004		

Symbol: FINFOUT  
 Full Name: First-in First-out  
 Category: SYSTEM  
 Icon: 

### ■ Parameter

I/O Definition	Parameter Name	I/O Designation	Setting	
Input	In-Cmd	B-VAL	Data input command (IN-CMD)	FIFO Table Configuration 0: data size 1: input size 2: output size 3: number of data stored 4: data
	Out-Cmd	B-VAL	Data output command (OUT-CMD)	
	Reset	B-VAL	Reset command	
	FIFO-Tbl	Address input	Head address of FIFO table (MW or DW address)	
	In-Data	Address input	Head address of input data (MW or DW address)	
	Out-Data	Address input	Head address of output data (MW or DW address)	
Output	Tbl-Full	B-VAL	FIFO table is full.	
	Tbl-Emp	B-VAL	FIFO table is empty.	
	Tbl-Err	B-VAL	FIFO table error.	

# Appendix A

## Expression

It is necessary to describe the conditional expression and the operational expression in IF, WHILE, and the EXPRESSION instruction in the ladder instruction. Those expressions can be described by using "Expression". This appendix describes the use rule of the Expression.

A.1 Expression	A-2
A.1.1 Operator	A-2
A.1.2 Operand	A-4
A.1.3 Instructions Available in EXPRESSION Instruction	A-5
A.2 Recognizable Expression	A-6
A.2.1 Arithmetic Operator	A-6
A.2.2 Comparison Operator	A-6
A.2.3 Logic Operator	A-6
A.2.4 Substitution Operator	A-7
A.2.5 Function	A-7
A.2.6 Others	A-7
A.3 Application to Ladder Program	A-9
A.3.1 Conditional Expression of IF Instruction	A-9
A.3.2 Conditional Expression of WHILE Instruction	A-9
A.3.3 Operational Expression of EXPRESSION Instruction	A-10

## A.1 Expression

The Expression is composed of the operator, the operand (constant and variable), and functions. The end of one Expression is shown by the semicolon “;”. The expressions can be united by using parentheses “(”, “)”.

Each component of the Expression is explained here.

### A.1.1 Operator

#### ■ Usable Operator

There is the following kinds of usable operators.

##### Arithmetic Operator

+	Addition
-	Subtraction
*	Multiplication
/	Division
%	Surplus
&	AND of each bit
	OR of each bit

##### Logic Operator (Only for the Bit Type)

&&	Logical product
	Logical add
!	Logical denial

##### Comparison Operator

==	Equal to a right value
!=	Not equal to a right value
>	Greater than a right value
>=	Greater than or equal to a right value
<	Less than a right value
<=	Less than or equal to a right value



## Substitution Operator

= A right value is substituted for a left value

## Reserved Word

true/false Value to logical expression

## ■ Priority Level and Uniting Rule

There is a priority level in the operator, and the uniting rule is applied.

The priority level and the uniting rule (order from which the operand is evaluated) of the operator are settled in the next table. The table is sequentially shown from the operator with a high priority level. The operator of the same line has the same priority level, and is evaluated according to the uniting rule.

Operator	Explanation	Uniting Rule
[ ] ( )	expression	right from left
- !	monadic	left from right
* / %	multiplication, division, surplus	right from left
+ -	addition, subtraction	right from left
< > <= >=	relation	right from left
== !=	relation (value)	right from left
&	AND of each bit	right from left
	OR of each bit	right from left
&&	logical AND	right from left
	logical OR	right from left



When using IF, WHILE and EXPRESSION instruction by hexadecimal, describe 0x□□□□. Description of H□□□□ is error.

When using the others instruction, describe H□□□□.

## A.1.2 Operand

### ■ Constant

The constant is either the integer or the real number.

#### Integer

The integer can use the value within the range which can be expressed by 32 bit integer value. (-2147483648 to 2147483647)

#### Real number

The real number can use the value within the range which can be expressed by 32 bit float type.  $\pm$  (1.175494351e-38F to 3.402823466e+38F)

### ■ Variable

In Expression, it is possible to describe by associating the arbitrary variable name permitted by C language with controller's register.

Controller's bit type register is handled as bool type though the bool type variable does not exist in C language. The bool type variable takes only either of value of true or false. It can be used only for the logical expression.

The following limitations are installed in the variable name which can be used.

- It is started from characters other than the numerical value.
- The character which can be used is alphabet and underscore “\_”, and figures among ASCII characters.
- The same variable name as the following function names cannot be used.

#### ◀ EXAMPLE ▶

Abc	OK
get_input0	OK
lab	NG
Sin	NG

## A.1.3 Instructions Available in EXPRESSION Instruction

Instruction	Contents	Example	Reserved Word
+	Addition	MW00001 = MW00002 + MW00003	○
-	Subtraction	MW00001 = MW00002 - MW00003	○
*	Multiplication	MW00001 = MW00002 * MW00003	○
/	Division	MW00001 = MW00002 / MW00003	○
%	Surplus	MW00001 = MW00002 % MW00003	○
&	AND of each bit	MW00001 = MW00002 & 4096	○
	OR of each bit	MW00001 = MW00002   4096	○
&&	Logical product	MB000010 = MB000011 && MB000012	○
	Logical add	MB000010 = MB000011    MB000012	○
!	Logical denial	MB000010 = !MB000011	○
==	Equal to a right value	MB000010 = MB000011 == true	○
>=	Greater than or equal to a right value	MB000010 = MW00020 >= MW00021	○
>	Greater than a right value	MB000010 = MW00020 > MW00021	○
<	Less than a right value	MB000010 = MW00020 < MW00021	○
<=	Less than or equal to a right value	MB000010 = MW00020 <= MW00021	○
=	A right value is substituted for a left value	MW00001 = MW00002	○
true	true	MB000010 = MB000011 == true	○
false	false	MB000010 = MB000011 == false	○
sin()	SIN	MW00001 = sin(MW00002)	○
cos()	COS	MF00002 = cos(MF00004)	○
atan()	ARCTAN	MW00001 = atan(MF00002)	○
tan()	TAN	MW00001 = tan(MW00002)	○
()	Parentheses	MW00001 = (MW00002 + MW00003) / MW00004	○
asin()	ARCSIN	MW00001 = asin(MW00002)	○
acos()	ARCCOS	MW00001 = acos(MW00002)	○
sqrt()	AQRT	MW00001 = sqrt(MW00002)	○
abs()	ABS	MW00001 = abs(MW00002)	○
exp()	EXP	MW00001 = exp(MW00002)	○
log()	LOG Natural logarithm	MW00001 = log(MW00002)	○
log10()	LOG10 Common logarithm	MW00001 = log10(MW00002)	○

A

## A.2 Recognizable Expression

The Expression is described by combining the operand and the operator. There are some restrictions in the description method. The restriction is explained as follows.

### A.2.1 Arithmetic Operator

This operator can be used for the operand of the integer type and the real type.

The monadic minus can be used only once. The bit operation can use only the integer type.

The arithmetic operation cannot be used for the operand of the bit type.

Even if the calculation value exceeds the range of the register, the type conversion is not automatically done. Therefore, the user should allocate an appropriate type in the variable.

◀ <b>EXAMPLE</b> ▶	MW00001 = MW00002 + MW00003	OK
	MW00001 = MW00002 / 345	OK
	MF00002 = (MW00004 + MF00002) / (ML00018 + MW00008)	OK
	MW00001 = MW00002 & 4096	OK
	MB000010 = MB000011 – MB000012	NG
	MW00001 = MB000011 * MW00001	NG

### A.2.2 Comparison Operator

This operator can be used for the operand of the integer type and the real type.

The register of the bit type should come left. In the case to do the comparison which uses “= ” or “ != ” for the operand of the integer bit type, the comparison object should be an expression of true/false.

◀ <b>EXAMPLE</b> ▶	MB000010 = MW00002 != MW00003	OK
	MB000010 = MF00002 < 99.99	OK
	MB000010 = MW00002 >= MW00003	OK
	MB000010 = MB000011 == true	OK
	MB000010 = MB000011 != 0	NG
	MB000010 = MB000011 == 1	NG

### A.2.3 Logic Operator

This operator can be used only for the operand of the bit type.

◀ <b>EXAMPLE</b> ▶	MB000010 = MB000011 && MB000012	OK
	MB000010 = !MB000011	OK
	MB000010 = (MW000020 >= 50) && MB000011	OK
	MB000010 = MW00001    MW00002	NG
	MB000010 = !MW00001	NG

## A.2.4 Substitution Operator

If it is a difference of the real type or the integer type even if a right, left type is different, substitution is possible. However, the rounding error is caused when substituting from the real type to the integer type.

Substitution for the bit type register can do only a logical value (bit type register or true/false). In the case to substitute the values other than a logical value for the bit type register, the values are compared with 0 (Or, 0.0), and the truth is converted into the substituted code. The substitution of the bit type excluding the bit type register is assumed to be impossible.

◀ <u>EXAMPLE</u> ▶	MW00001 = MW00002	OK
	ML00003 = MW00002	OK
	MF00006 = MW00002 * 343	OK
	MB000010 = MB000011	OK
	MW00001 = MF00012	OK
	MB000102 = MW00010	OK
	MB000102 = true	OK
	MW00010 = MB000101	NG
	MW00010 = true	NG

## A.2.5 Function

The argument and the return value to the function depend on the specification of controller's function. That is, the output value is returned by the integer when the register of the integer and the integer type is input to sin (), cos (), and atan (), and when the register of the real number and the real type is input, the output value is returned by the real number. When the register of the integer type is input because the argument of tan () is a real number, is treated as a real type.

◀ <u>EXAMPLE</u> ▶	MW00001 = sin (MW00002)	OK
	MF00001 = cos (MF00002 * 3.14)	OK
	MW00001 = - atan(MF00002)	OK

## A.2.6 Others

### ■ Parentheses

Two or more expressions can be united by using “(” and “)”.

◀ <u>EXAMPLE</u> ▶	MW00001 = - ((MW00002 - MW00003) / (MW00004 + MW00005))	OK
--------------------	---	----

**■ Array**

The array can be specified by using “[” and “]” B as well as C language.

**◀ EXAMPLE ▶**

MW00001 = MW00002 [100] OK

MW00001 = MW00002 [MW00100] OK

MB00001 = MB000020 [0] OK

## A.3 Application to Ladder Program

The use of Expression in the ladder program is divided into three kinds of the following.

- Conditional expression of IF instruction
- Conditional expression of WHILE instruction
- Operational expression of EXPRESSION instruction

The use example is explained as follows.

### A.3.1 Conditional Expression of IF Instruction

The Expression is described in the conditional expression description area of the IF instruction and the ELSE instruction. However, only Expression which outputs the result of the bool type can be described. Therefore, the description of the Expression which includes the substitution operator is not recognized.

◀ <u>EXAMPLE</u> ▶	MB000001 == true	OK
	MW00002 < 100	OK
	MW00003 != MW00004	OK
	MB000005 = false	NG
	MW00007 = MW00010	NG

### A.3.2 Conditional Expression of WHILE Instruction

The Expression is described in the conditional expression description area of the WHILE instruction. However, only Expression which outputs the result of the bool type can be described. Therefore, the description of the Expression which includes the substitution operator is not recognized.

◀ EXAMPLE ▶ Refer to the example of A.3.1 "Conditional Expression of IF Instruction".

### A.3.3 Operational Expression of EXPRESSION Instruction

The Expression is described in the conditional expression description area of the EXPRESSION instruction. The operational expression can be described according to the description rule of Expression. However, Expression which outputs the result of the bool type cannot be described.

◀ <b>EXAMPLE</b> ▶	MB000010 = MB000001 && MB000005;	OK
	MB000011 = MB000010 == true;	OK
	MW00000 = (MW00001 + MW00005) / MW00004;	OK
	MW00003 = MW00000/50;	OK
	MW00002 = MW00001 & 300;	OK
	MW00010 = MW00003 – MW00002;	OK
	MB000001 == true;	NG
	MW00006 >= 100;	NG
	MW00007 != MW00009;	NG



## Revision History

The revision dates and numbers of the revised manuals are given on the bottom of the back cover.

MANUAL NO. SIEZ-C887-13.1B

Published in Japan January 2008 01-12  $\diamond$ -1

└─ WEB revision number  
└─ Revision number  
└─ Date of original publication  
└─ Date of publication

Date of Publication	Rev. No.	WEB Rev. No.	Section	Revised Content
July 2013	$\diamond$	2	1.6.4	Revision: Description of Outline of MOVE WORD Instruction (MOVW)
			Back cover	Revision: Address
January 2013		1	1.7.4, 1.7.5, 1.7.6	Revision: Information on P, D, I, and Integration adjustment gains of PI, PD and PID CONTROL instructions
			Back cover	Revision: Address
January 2012		0	–	SIEZ-C887-13.1B<4>-6, available on the web.
			1.7.11	Revision: Description of integer type operation of program example
			Back cover	Revision: Address
October 2011	$\diamond$	6	2.1.2	Revision: Information on IN/OUT of the parameter (PARAM02)
July 2011		5	1.6.9	Addition: Notes for binary search instruction (BSRCH)
March 2011		4	1.4.10	Revision: Outline
			1.7.11	Revision: Units of acceleration/deceleration/quick stop time in real type LAU instruction parameters
			1.7.11, 1.7.12	Revision: Setting of parameter
December 2010		3	Front cover	Revision: Format
			2.1.1, 2.1.2	Revision: Called station # → Called station number, Called CPU # → Called CPU number, Description of called CPU number (PARAM07)
			Back cover	Revision: Address, format
March 2010		2	1.1.3, 1.1.4, 1.1.5, 1.1.6	Addition: Description of error of the count
			1.7.4, 1.7.5, 1.7.6	Revision: Information on P, I and D gains of PI, PD and PID CONTROL instructions
	1.7.12		Revision: S-curve acceleration/deceleration time	
	Chapter2		Partly revised	
	2.1.1		Addition: Type of transmission device in Dev-Type: 218-02 = 16	
	A.1.1		Addition: INFO	
	A.1.3		Revision: Instructions Available in EXPRESSION instruction	
Back cover	Revision: Address			
January 2008	1	1.2.22, 1.2.23	Revision: Program example	
		1.4.8, 1.4.9	Addition: Information on the nesting of IF instructions	
		A.2.5	Revision: arctan() → atan()	
		Back cover	Revision: Address	
August 2005		0	Back cover	Revision: Address
March 2005	$\diamond$	–	All chapters	Addition: MP2000-series Revision: CP-717 to MPE720 Windows 95 to Windows 95/98/2000/NT
		Back cover	Revision: Address	
July 2003	$\diamond$	–	Back cover	Revision: Address
November 2002	$\diamond$	–	Back cover	Revision: Address
December 2001	–	–	–	First edition

# Machine Controller MP900/MP2000 Series

# New Ladder Editor

# PROGRAMMING MANUAL

---

**IRUMA BUSINESS CENTER (SOLUTION CENTER)**

480, Kamifujisawa, Iruma, Saitama 358-8555, Japan  
Phone 81-4-2962-5151 Fax 81-4-2962-6138  
<http://www.yaskawa.co.jp>

**YASKAWA AMERICA, INC.**

2121 Norman Drive South, Waukegan, IL 60085, U.S.A.  
Phone 1-800-YASKAWA (927-5292) or 1-847-887-7000 Fax 1-847-887-7310  
<http://www.yaskawa.com>

**YASKAWA ELÉTRICO DO BRASIL LTDA.**

Avenida Piraporinha 777, Diadema, São Paulo, 09950-000, Brasil  
Phone 55-11-3585-1100 Fax 55-11-3585-1187  
<http://www.yaskawa.com.br>

**YASKAWA EUROPE GmbH**

Hauptstraße 185, Eschborn 65760, Germany  
Phone 49-6196-569-300 Fax 49-6196-569-398  
<http://www.yaskawa.eu.com>

**YASKAWA ELECTRIC KOREA CORPORATION**

9F, Kyobo Securities Bldg. 26-4, Yeouido-dong, Yeongdeungpo-gu, Seoul, 150-737, Korea  
Phone 82-2-784-7844 Fax 82-2-784-8495  
<http://www.yaskawa.co.kr>

**YASKAWA ELECTRIC (SINGAPORE) PTE. LTD.**

151 Lorong Chuan, #04-02A, New Tech Park 556741, Singapore  
Phone 65-6282-3003 Fax 65-6289-3003  
<http://www.yaskawa.com.sg>

**YASKAWA ELECTRIC (CHINA) CO., LTD.**

12F, Carlton Bld., No.21 HuangHe Road, HuangPu District, Shanghai 200003, China  
Phone 86-21-5385-2200 Fax 86-21-5385-3299  
<http://www.yaskawa.com.cn>

**YASKAWA ELECTRIC (CHINA) CO., LTD. BEIJING OFFICE**

Room 1011, Tower W3 Oriental Plaza, No.1 East Chang An Ave.,  
Dong Cheng District, Beijing 100738, China  
Phone 86-10-8518-4086 Fax 86-10-8518-4082

**YASKAWA ELECTRIC TAIWAN CORPORATION**

9F, 16, Nanking E. Rd., Sec. 3, Taipei 104, Taiwan  
Phone 886-2-2502-5003 Fax 886-2-2505-1280



YASKAWA ELECTRIC CORPORATION

In the event that the end user of this product is to be the military and said product is to be employed in any weapons systems or the manufacture thereof, the export will fall under the relevant regulations as stipulated in the Foreign Exchange and Foreign Trade Regulations. Therefore, be sure to follow all procedures and submit all relevant documentation according to any and all rules, regulations and laws that may apply.

Specifications are subject to change without notice for ongoing product modifications and improvements.

© 2001-2013 YASKAWA ELECTRIC CORPORATION. All rights reserved.

MANUAL NO. SIEZ-C887-13.1C

Published in Japan July 2013 01-12 -2  
13-6-9