

ELECTRONICS & WIRELESS WORLD

MAY 1987

£1.95

**Logic
analysers and
analysis**

**Experimental
high-voltage
generator**

**Very low
frequency
measurement**

**Coprocessors
for the 68020**

**Comparing
power mos
and bipolar
devices**

**Morse – the
American
Leonardo**

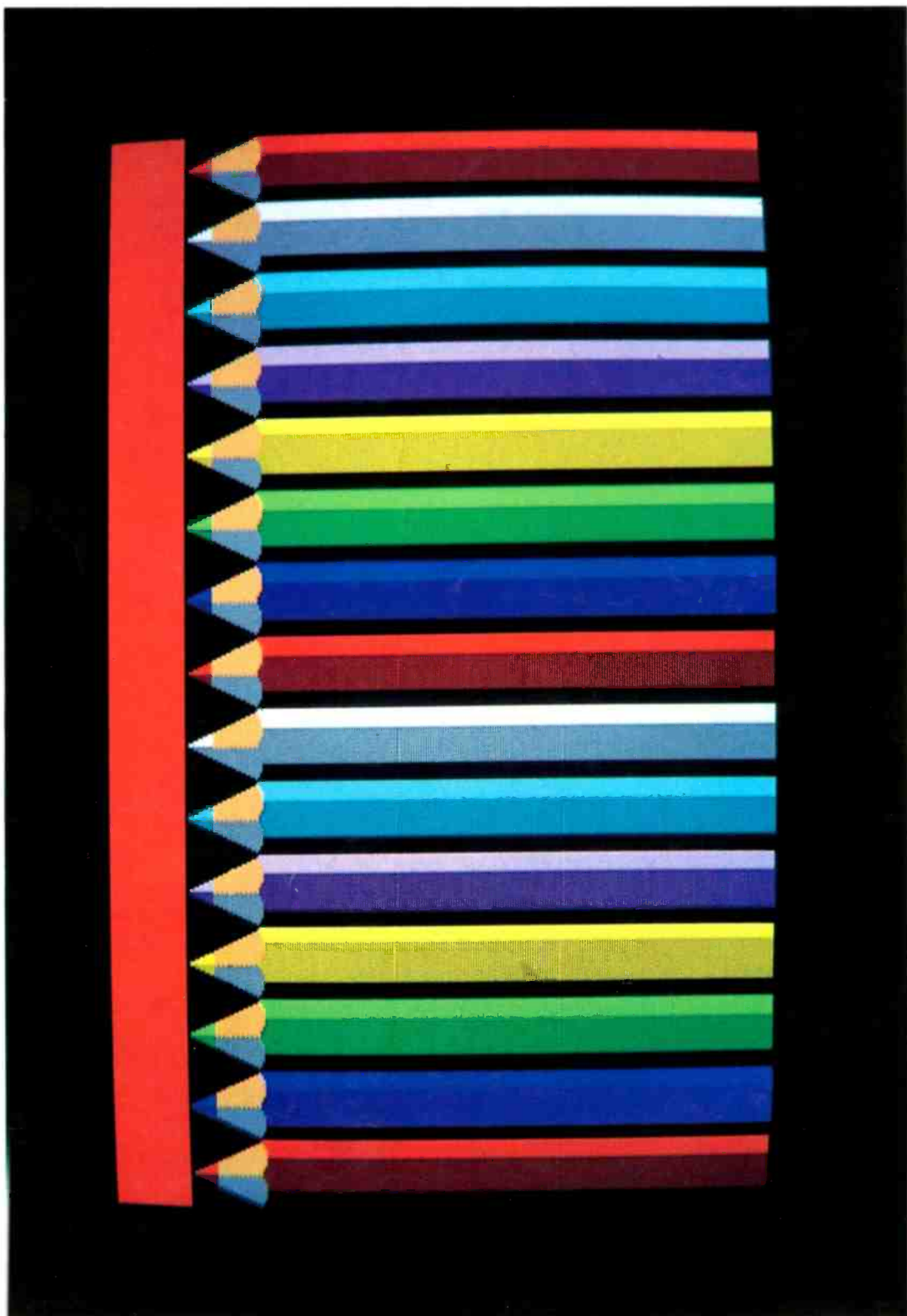

EW TRONIX 2225 ST £750

FOR FURTHER INFORMATION
DIAL 100 AND ASK FOR
FREEPHONE TEK-SCOPE

beam finder
Screen signals, even
if intensity is turned down.

Sweep speeds to 5 ns/div are fast enough for making accurate pulse and timing measurements on most digital logic families, with good resolution.

Proven design and rugged construction offer reliability at its best. And the Tektronix reputation for meeting rigid environmental requirements means confidence in your measurements – and in knowing that this scope is built to last.

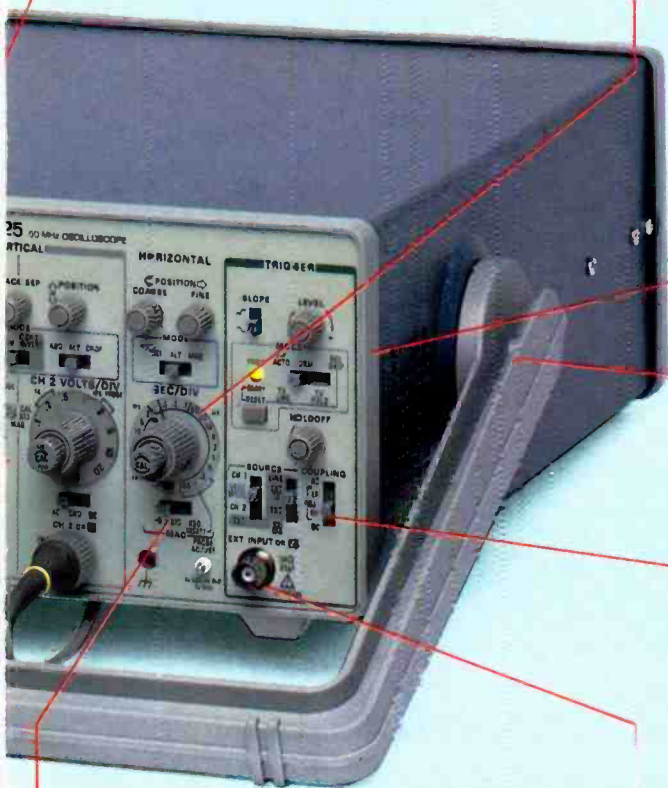

Light weight makes the 2225 easy to carry even to remote servicing sites.

Alternate magnification lets you choose any of three levels to magnify any normal waveform including the trigger and end of sweep.

Now for the first time! Two vertical-channel inputs and an external Z-axis input all on the front panel. An excellent combination for manufacturing test stations and rackmount applications. And at the simple flip of a switch you can trigger on the Z-axis signal.

Versatile, easy-to-use triggering functions let you solidly trigger the sweep on either channel. Included are asynchronous triggering capability; flexible coupling via DC, AC, HF and LF reject filtering; hands-free triggering from virtually any signal; plus independent selection of either TV line or TV field triggering regardless of time-base setting.

Get the performance you expect from Tektronix . . . at an unexpected price:

PROBES AND 3 YEAR WARRANTY

price and value. It's the easy, economical answer to oscilloscope needs for bench and field sites, call Tektronix to order or for application assistance.

AVAILABLE FROM

01201 Electroplan – 0763 45145

ON REPLY CARD

Tektronix
COMMITTED TO EXCELLENCE

N TEKT AT JUST

Fully segmented graticule lines ease the way for quick, accurate voltage and time measurements.

Bright, full-size CRT with minimal geometric distortion and crisp, small spot size delivers sharp trace definition.

One-button locates off-scale when intensity is

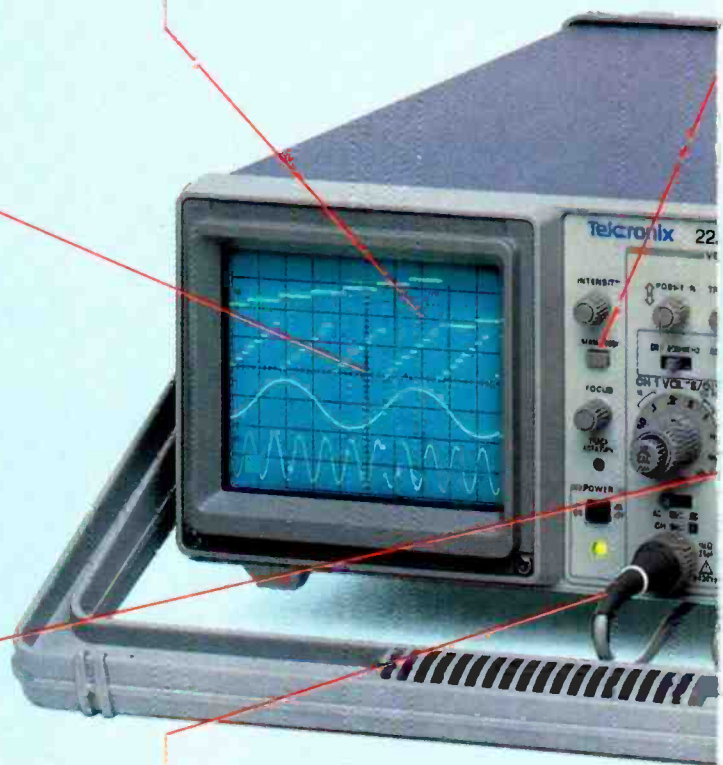

Two independent channels with 50 MHz bandwidth and independent bandwidth limiting on each channel to 5 MHz. 500 μ V/div sensitivity for low-level signal measurements and differential applications.

New low-cost probes (with nearly unbreakable tips) complement the rugged scope design. Compensation adjustments in the probe body itself eliminate the bulky compensation box at the front panel. Scope and probes are a perfect match.

Fast, accurate horizontal measurements you choose. Expansion part of the no display - inc point and en

Now, the professional quality and performance

£750 FOR OSCILLOSCOPE

No portable in its class can match the Tektronix 2225 for features, versatility, convenience in manufacturing and in the classroom. Call

ALSO
R.S. Components - 05362

ENTER 1

Tektronix
COMMITTED TO EXCELLENCE

MADE IN
ENGLAND

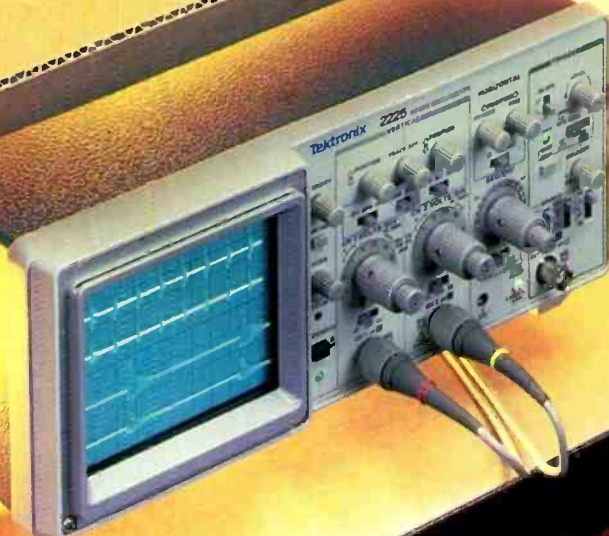

BOX CLEVER!
TURN OVER TO
TEK

CONTENTS

MAY 1987 VOLUME 93 NUMBER 1615

FEATURES

COVER

A screen photograph of a display produced by John Adams' colour graphics controller.

LOGIC ANALYSIS

465

As digital circuitry increases in speed and complexity, logic analysers have to keep in step

WARC-87 – A FEW STEPS ON

470

A cut-off date for d.s.b. a.m. radio is proposed at Geneva
by D.P. Leggatt

HIGH PERFORMANCE COLOUR GRAPHICS CONTROLLER

472

Versatile display controller for high resolution graphics
by John Adams

VOLTAGE OR CURRENT?

477

J.W. enlarges on amplification, which is neither pure nor simple
by Joules Watt

MEASURING LOW FREQUENCIES

479

A look-up table in rom avoids long measurement intervals
by N.C. de Mattos-Shipley

PIONEERS – 5

481

Samuel Morse – the American Leonardo
by W.A. Atherton



Thurlby Electronics 6809 microprocessor dis-assembler option for use with Thurlby LA-160 logic analyser.

BUILDING BLOCKS FOR ACTIVE OP-AMP COMPENSATION

486

Actively compensated op-amps improve the performance of filters. Professor Soliman surveys first-order, two op-amp blocks to formulate a systematic design procedure.
by Ahmed M. Soliman

A COMPARISON OF POWER MOS AND BIPOLAR POWER TRANSISTORS

499

Power mos may replace bipolar power devices in many applications
by Sue Cain and Ray Ambrose

SCIENTIFIC INTERFACE FOR THE AMSTRAD PCW

508

Circuit details and software
by Brian J Frost

THE INCREDIBLE SCOPHONY RECEIVER

515

A fresh look at an ingenious, mechanically scanned projection tv
by T. Voore

MARX GENERATOR FOR HIGH-VOLTAGE EXPERIMENTS

519

A simple device to generate pulses of up to several hundred kilovolts
by E.A. Richley

IMAGE ACQUISITION SYSTEM

531

Solid-state vision for any computer with an RS232 serial interface
by G.J. Awcock, F.S. Stone and R. Thomas

USING 68020 COPROCESSORS

535

Using a 68020 with a floating-point coprocessor can give polar-to-Cartesian translation in 29 microseconds
by David Burns and David Jones

REGULARS

COMMENT 459

UPDATE 491

TELECOMMS TOPICS 495

FEEDBACK 501

APPLICATION NOTES 506

SATELLITE SYSTEMS 527

NEW PRODUCTS 538, 541

TELEVISION BROADCAST
546

RADIO BROADCAST 548

RADIO COMMUNICATIONS
550

RESEARCH NOTES 554

ELECTRONIC BROKERS

This is just a sample of our huge inventory – contact us with your requirements.

OSCILLOSCOPES

Hewlett Packard

180 TR 100MHz Scope Mainframe (Mint) **£950**

Philips

PM3266 100MHz Storage Scope **£3950**
PM3305P 35MHz Digital Storage **£1925**
PM3540 Logic Anal/Scope **£950**

Tektronix

465B/DM44 100MHz Scope/DMM **£1595**
465B 100MHz Scope **£1450**
475A/DM44 200MHz Scope/DMM **£2500**
485 350MHz Scope **£3950**
608 Monitor **£1250**

634 opt 1, 20 Display Monitor **£395**

5223 Scope M/F (Mint) **£3600**

7104 1GHz Scope M/F **£16000**

7603 100MHz M/F **£1750**

7704A 200MHz Mainframe **£2850**

7834 Fast Storage Scope M/F **£7500**

R7603 100 MHz Rack MINT M/F **£1750**

7904 500 MHz Scope M/F **£5500**

A large selection of 7000 series plug-ins available at up to 60% saving on list. Please call for quotations.

ANALYSERS

Hewlett Packard

141T Display Mainframe **£2000**

3582A Spectrum Analyser **£7500**

4193A Impedance Analyser **£5250**

8552B IF Section **£2500**

8553B RF Section, 110MHz **£2650**

Marconi

TF 2300A Mod Meter **£495**

TF 2370 110MHz Spectrum Analyser **£7250**

TF 2371 200MHz Spectrum Analyser **£6500**

Tektronix

7L14 Spectrum Analyser P.In **£9250**

308 Data Analyser **£600**

SIGNAL SOURCES

Hewlett Packard

4204A Digital Oscillator **£200**

8007B Pulse Generator **£750**

8011A-001 Pulse Generator 20MHz **£400**

8601A Sweep Generator **£1000**

8614A Signal Generator **£3950**

86260A Sweep Gen. Plug-in 12.4-18GHz **£1500**

Marconi

2015-1 AM/FM Signal Generator **£675**

TF 2002B AM/FM Signal Generator **£500**

Philips

PM5134 Function Generator **£1300**
PM55191TV Pattern Generator **£595**

Wavetek

184 5MHz Sweep Generator **£425**
1080 1GHz Sweeper **£1500**

HEWLETT PACKARD COMPUTERS

9816S Personal Computer **£2400**

9825A opt 001-002 Desk Top Computer **£700**

98256A 256K RAM board, series 200 **£250**

9862A Plotter **£500**

9872C 8-pen flat bed plotter **£995**

9915A Computer **£600**

GENERAL PURPOSE T & M

Farnell

SSG 520 + TTS 520 Transmission Test Set **£4275**

Fluke

7220A Comms. Freq. Counter **£350**

Hewlett Packard

436A Power Meter **£1050**

467A Amplifier **£600**

3403C True RMS Voltmeter **£1850**

3406A Sampling Voltmeter **£1250**

3465A 4½ Digit D.M.M. **£100**

4271A 1MHz Digital LCR meter **£2500**

4271B Digital LCR Meter **£2500**

5300B + 5305B 1300 MHz Counter **£495**

5381A 80 MHz Counter **£225**

8447A Amplifier **£400**

8447D Amplifier **£600**

Marconi

TF 1246 Oscillator **£500**

TF 1313A LCR Bridge 0.1% **£750**

TF 2173 Synchroniser for 2016 **£450**

TF 2304 Modulation Meter **£450**

TF 2603 RF Millivoltmeter **£495**

TF 2604 Voltmeter **£425**

TF 2702 Inductor Analyser **£950**

TF 2905/8 TV Pulse Generator **£750**

TF 2915 Data Monitor **£1200**

TF 2950/5 Mobile Radio T.S. **£1350**

Philips

PM5580 IF Modulator **£3000**

PM5581 RF Converter **£1000**

PM5582 RF Converter **£1000**

Tektronix

520A Vectorscope (NTSC) **£3750**

521A PAL Vectorscope **£4500**

S1 Sampling Head **£850**

S.3A Sampling Head **£1250**

1411C opt 03 TV Signal Generator **£5500**

A6901 Isolation Monitor **£275**

4041 System Controller **£4650**

PM 102 Personality Module **£500**

PM 107 Personality Module **£675**

PM 108 Personality Module **£650**

SEND NOW FOR OUR LATEST BROCHURE



85A Microcomputer **£995**

110 (45710BU) The Portable' **£950**

150B Touchscreen **£550**

2673A Thermal Printer **£425**

6940B Multiprogrammer **£950**

7470A opt 001/002 A4 2-pen plotter **£600**

7475A opt 001/002 A3/A4 6-pen plotter **£1050**

7910H opt 015 Disk Drive **£200**

82913A 12 inch Monitor **£75**

82937A HPIB Interface **£150**

82938A HPIB Interface **£150**

82939A Serial Interface **£200**

82940A GPIO Interface **£350**

86B Microcomputer **£650**

9111A Graphics Tablet **£825**

9121D Single-sided Disc Drive **£550**

9122D Dual Double-sided Disc Drive **£875**

All prices are exclusive of VAT and correct at time of going to press • Carriage and packing charges extra • A copy of our trading conditions is available on request

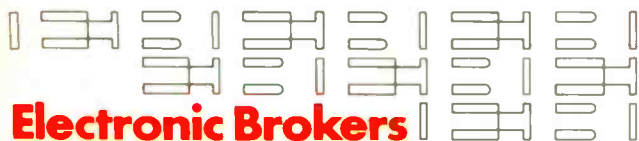

Electronic Brokers

140-146 Camden Street, London NW1 9PB
Fax: 01-267 7363. Telex: 298694. Tel: 01-267 7070

ENTER 72 ON REPLY CARD

Science education

EDITOR
Philip Darrington

DEPUTY EDITOR
Geoffrey Shorter, B.Sc.
01-661 8639

TECHNICAL EDITOR
Martin Eccles
01-661 8638

PROJECTS EDITOR
Richard Lambley
01-661 3039 or 8637 (lab.)

NEWS EDITOR
David Scobie
01-661 8632

ART EDITOR
Alan Kerr

DRAWING OFFICE
Roger Goodman
01-661 8690

ADVERTISEMENT MANAGER
Ashley Wallis
01-661 3130
Michael Downing
01-661 8640

CLASSIFIED EXECUTIVE
Susan Platts
01-661 3033

ADVERTISING PRODUCTION
Brian Bannister
(Make-up and copy)
01-661 8648

PUBLISHER
Shobhan Gajjar



After over a century of technology, science and engineering still possess a disreputable image, and it is costing this country dear. Furthermore, it is possible that it is already too late to do anything about it.

There is a profound, but seldom defined feeling in this country that engineering, together with any occupation concerned with selling, comes slightly below house-breaking as a career that one might recommend to a high-flying school-leaver.

Further, although teaching is (or was) considerably more respectable as a profession than any kind of engineering, a teacher forced to confess to being of the scientific persuasion immediately loses several points in the upwardly mobile section of society. Even if this is unimportant to a dedicated impartor of knowledge, what is important is that the equipment needed to teach science or engineering properly is in extremely short supply. Books are scarce, money (both for supplies and for salaries) is short and, if it were not for the shower of computers recently and inexplicably rained on astonished teachers, the feeling of being in the wrong century must be overpowering.

The problem is a circular one – it possesses positive feedback, which is dangerously close to locking the whole system up. Starting anywhere in the system, it goes like this: low status and lack of facilities and low salaries drive science teachers away from the profession; the number of university entrants reading science or engineering is falling; fewer graduates in these subjects are available to teach the next generation; fewer university entrants... And all the time, of course, there are fewer good graduates going into industry, for precisely the same reasons.

There is probably only one feasible way to break the spiral. A good grounding in maths and science is obviously of first importance in any approach to a career in our field. If the teaching of these subjects is to be made attractive, there must be no more attempts at it by unqualified people, pressed into it by a lack of anyone more able. The requirements for new teachers should be brought back up to the proper level and salaries made to compare reasonably well with those in industry, perhaps with assistance from that industry.

"Cut-backs" have been made the scapegoat for shortcomings in virtually every sector of education, but this stage of teaching – GCSE science and mathematics – is possibly a more sensitive part of the system than any other, where available resources must be applied in a responsible manner. If it is thought necessary to provide computers for all, well and good; but they should not displace more conventional aids to education, like teachers, books and apparatus.

Electronics & Wireless World is published monthly USPS 687540 Current issue price £1.95, back issues (if available) £2.10 at Retail and Trade Counter, Units 1&2, Bankside Industrial Centre, Hopton Street, London SE1 Telephone: 01-928 3567. By post, current issue £2.25, back issues (if available) £2.50. Order and payments to 301 *Electronics and Wireless World*, Quadrant House, The Quadrant, Sutton, Surrey SM2 5AS. Cheques should be payable to Reed Business Publishing Ltd. Editorial & Advertising offices: EWW Quadrant House, The Quadrant, Sutton, Surrey SM2 5AS. Telephones: Editorial 01-661 3614 Advertising 01-661 3130 01-661 8469 Telex: 892084 BHSRSG (EEP). Facsimile: 01-661 2071 (Groups II & III). Beeline: 01-661 8978 or 01-661 8986 300 baud, 7 data bits, even parity, one stop-bit. Send ctrl-Q, then EWW to start. NNNN to sign off. Subscription rates: 1 year (normal

rate) £27.40 UK and £28.50 outside UK. Distribution: Quadrant House, The Quadrant, Sutton, Surrey SM2 5AS. Telephone: 01-661 3248. Subscriptions: Oakfield House, Perrymount Road, Haywards Heath, Sussex RH16 3DH. Telephone: 04444 59188. Please notify a change of address. USA: \$49.40 surface mail, \$102.60 airmail. Reed Business Publishing (USA), Subscriptions Office, 205 E. 42nd Street, NY 10117. Overseas advertising agents: France and Belgium: Pierre Mussard, 18-20 Place de la Madeleine, Paris 75008. United States of America: Jay Feinman, Reed Business Publishing Ltd, 205 East 42nd Street, New York, NY 10017. Telephone (212) 867-2080 Telex 23827. USA mailing agents: Mercury Airfreight International Ltd, Inc., 100b Englehard Ave, Avenel N.J. 07001. 2nd class postage paid at Rahway N.J. Postmaster – send address to the above. © Reed Business Publishing Ltd 1987. ISBN 0043 6062.

ADCOLA

THE ALL BRITISH SOLDERING EQUIPMENT
MANUFACTURERS

K 4000 3/16" · 4.75mm
**DUAL TEMPERATURE
SOLDERING INSTRUMENT**
(PERFECT FOR THE OCCASIONAL LARGE TERMINATION)

- 350°C to 500°C
- 3/16" · 4.75mm ADIRON TIP fitted standard
- full supporting tip range
- available in 24v or 240v AC

Scottish
Show –
Stand 712

- FOR FULL DETAILS on all ADCOLA equipment contact Sales Department



ADCOLA PRODUCTS LIMITED Gauden Road London SW4 6LH
Telephone Sales (01) 622 0291 Telex 21851 Adcola G
Sales Offices also at Bristol · Bournemouth · Preston · Glasgow

ENTER 9 ON REPLY CARD

ICOM Communications



ICOM introduces the IC-R7000, advanced technology, continuous coverage communications receiver. With 99 programmable memories the IC-R7000 covers aircraft marine FM broadcast, Amateur radio, television and weather satellite bands. For simplified operation and quick tuning the IC-R7000 features direct keyboard entry. Precise frequencies can be selected by pushing the digit keys in sequence of the frequency or by turning the main tuning knob. FM wide/FM narrow/AM upper and lower SSB modes with 6 tuning speeds: 0.1, 1.0, 5, 10, 12.5 and 25kHz. A sophisticated scanning system provides instant access to the most used frequencies. By depressing the Auto-M switch the IC-R7000 automatically memorises frequencies that are in use whilst it is in the scan mode, this allows you to recall frequencies that were in use. Readout is clearly shown on a dual-colour fluorescent display. Options include the RC-12 infra-red remote controller, voice synthesizer and HP-1 headphones.

Please rush me details of the IC-R7000 and my nearest ICOM dealer.

Name _____

Address _____

Tel. _____

Post to: ICOM (UK) LIMITED, Dept W W, FREEPOST,
Herne Bay, Kent CT6 8BR. (no stamp). Tel. 0227 363859.

ENTER 62 ON REPLY CARD

Microkit 0536 743439 24 hr 7 days/week

74TTL LS	HC	40% OFF LINEAR	SAVE OVER 40% ON OUR EX-EQUIPMENT MEMORIES AND EPROMS	PRICES SMASHED ON OUR MEMORIES
00 .20	.25	7812 .30	1000's of delighted customers	DYNAMIC RAM 5V NMOS
02 .20	.25	78M12 .30	1000's of delighted customers	4164-15ns 64Kx1 .99
04 .20	.25	75154 .90	GUARANTEED UV ERASED AND TESTED	memory upgrade AMSTRAD 8512
05 .20	.25	LM308 .40	4116 16Kx8 .75	41256-15ns 256Kx1 2.29
08 .20	.25	LM332A .40	2716 2Kx8 1.50	41256-10ns 256Kx1 4.42
11 .20	.25	LM337 1.20	2732 4Kx8 1.50	41464-15ns 16Kx4 3.30
14 .20	.29	LM348 .55	2764 8Kx8 1.50	41464-12ns 16Kx4 3.30
20 .20	.29	LM358 .45	27128 16Kx8 1.75	TCS11000-12 1M BIT CMOS 32.00
21 .20	.29	LM3900 .40	All taken from working boards. Try some. You will save POUNDS!!!!	TCS11000-10 1M BIT CMOS 35.00
27 .20	.27	OP07/CP .65	EPROMS	STATIC RAM 5V NMOS
30 .20		NE555 .18	2716 2Kx8 1.50	2114p-30ns 1Kx4 1.50
32 .20	.35	TL074 .90	2732 4Kx8 1.50	2114p-20ns 1Kx4 1.80
42 .20	.49	TL072 .50	2764 8Kx8 1.50	STATIC RAM 5V CMOS
51 .20	.25	TL082 .45	27128 16Kx8 1.75	6116p-12ns 2Kx8 1.40
73 .20	.29	TL084 .45		6116p-15ns 2Kx8 1.70
74 .20	.39	ULN2004 .70	FLOPPY DISC CONTROLLERS	6264p-15ns 8Kx8 2.40
85 .20	.59		WD2797 19.00	6264p-10ns 8Kx8 2.75
86 .20	.49	4000 SERIES	WD2797 19.00	6264p-10ns 8Kx8 2.90
93 .45		4000 .18	WD9216 14.26	62256p-12ns 32Kx8 14.50
107 .49		4002 .18		62256p-10ns 32Kx8 17.50
109 .47		4006 .33	PROCESSORS	EPROMS 5V NMOS
113 .49		4007 .18	2128 2.50	2716-35ns 2Kx8 2.70
123 .60	.55	4008 .33	UM2128 1.50	2732A-30ns 4Kx8 2.65
132 .49		4009 .21	UPD812C 3.75	2732S-25ns 4Kx8 5.00
138 .40	.49	4010 .21	IC SOCKETS	2764-25ns 8Kx8 2.45
139 .40	.49	4011 .18	14PIN .10	2764-20ns suit BBC 2.70
153 .45	.59	4012 .18	16PIN .12	27128-20ns 12.5V 16Kx8 2.70
154 .85		4014 .33	18PIN .16	27128A-20ns 21V 16Kx8 2.49
157 .40	.55	4016 .22	MICROPROCESSORS	27256-25ns 32Kx8 3.75
158 .40	.55	4017 .32	Z80 CPU 1.60	27512-25ns 512Kx8 8.20
161 .55	.55	4018 .32	Z80A CTC 5.00	27512-20ns 512Kx8 8.40
163 .55	.55	4019 .26	Z80A PIO 2.60	EPROMS 5V CMOS
164 .55	.55	4020 .34	Z80A DMA 6.90	27C32A-25ns 4Kx8 6.50
165 .60	.75	4024 .28	Z80A SIO2 6.80	27C64-20ns 8Kx8 4.60
166 .60	.60	4025 .18	Z80A DART 5.50	27C128-25ns 16Kx8 5.00
174 .40	.55	4032 .85	Z80B CPU 4.90	27C256-20ns 32Kx8 5.20
175 .55	.55	4040 .35	Z80B PIO 4.90	27C128-25ns 512Kx8 9.70
193 .60	.75	4049 .38	Z80B CTC 4.90	
194 .50		4049 .36	Z80B DART 7.90	
240 .65	.89	4052 .18	Z80B SIO/O 6.50	
244 .65	.89	4069 .18		
245 .80	.95	4070 .18		
257 .50	.55	4081 .18		
273 .65	.89	4093 .21		
365 .40	.59	4512 .39		
367 .40		4518 .39		
373 .65	.95	4528 .39		
374 .65	.95	4532 .63		
393 .60	.60	4538 .47		
540 .65	.65	4539 .47		
643 1.25		45555 .43		

FREE POSTAGE

Orders over £25
Orders under £25 add £1 p&p
Add 15% VAT
Export welcome £3 p&p

FREE CATALOGUE
WITH FIRST ORDER

ORDERS DESPATCHED SAME DAY BEFORE 3.30pm
DEPT (W5), 18 COLDERMEADOW AVENUE, CORBY,
NORTHANTS NN 18 9AJ.

ENTER 10 ON REPLY CARD

Carston

USED TEST & COMPUTER EQUIPMENT

FULL PERFORMANCE TO ORIGINAL SPECIFICATION
*** ALL ITEMS ARE COVERED BY OUR COMPREHENSIVE PARTS & LABOUR GUARANTEE ***

LOGIC ANALYSERS & DIGITAL TEST EQUIPMENT

HEWLETT PACKARD
1615A Logic State &
timing analyser. 20MHz
clock...£2950

1630G Logic state &
timing. 65ch. 100MHz
clock...£7950

4951A/1/100 Portable
Protocol Analyser for
serial data..£2500

TEKTRONIX
834 Datacom/Protocol
Analyser...£1550

OSCILLOSCOPES

PHILIPS
PM3266 100MHz Fast
storage. Dual trace
dual timebase...£2950

TEKTRONIX
2215 60MHz dual trace
with delay...£575

2445 150MHz four
trace. Dual timebase.
£2550

2465 300MHz four
trace with
delay..£3500

7623A/7A18/7B53A
75MHz Fast
storage. Dual trace.
Dual t/base..£1500

SPECTRUM ANALYSERS

HEWLETT PACKARD
141T/8552B/8555A
System 0.01-18GHz
.£7500 or with
model 8445 pre-
selector..£9000

MARCONI
TF2370 110MHz
analyser with tracking
generator....£6850

SOLARTRON
1200 Dual channel L.F.
Signal
Processor/Analyser.
£7250

SIGNAL SOURCES

MARCONI
2019 1GHz AM/FM phase
locked. HP-IB..£2950

PHILIPS
FM5190 1mHz-2MHz
phase locked. HP-IB
£1050

MICRO DEVELOPMENT SYSTEMS

INTEL
Series 2
Series 3
Series 4 & PDS series
systems are all
available.
**CHECK NOW FOR BEST
PRICES:**

HEWLETT PACKARD
64100A/041 Logic
development station.
...£5900

64600 Logic Timing
Analyser...£2500

A WIDE RANGE OF THIS
SERIES EQUIPMENT IS
AVAILABLE. CALL US FOR
THE LATEST
INFORMATION!

COMPUTERS AND PERIPHERALS

CENTRONICS
353 200cps dot matrix
printer. Centr. &
RS232 I/F. +NLQ mode
..£350

HEWLETT PACKARD
7475A/2 Eight pen
plotter HP-IB..£800

82901A Dual Disc Drive
HP-IB..£150

9121D Dual Disc Drive
HP-IB ...£175

9817 Modular computer
workstation....£1800

9826A Technical
computer / controller.
Internal disc...£1500

FULL SPECIFICATIONS OF
THESE ITEMS ARE
AVAILABLE ON REQUEST !

Prices exclude
delivery & V.A.T.

SPECIAL OFFERS

HEWLETT PACKARD 1630D LOGIC ANALYSER



State/Timing/Glitch
43ch. 100MHz clock mux
..£4250

WATANABE MC6601-6Z CHART RECORDER



6ch. flatbed.
Overlapping pens. I/P
voltages 1mV-500V
..£500.

ATLANTIC RESEARCH Interview 4600 PROTOCOL ANALYSER



Int. memory + data
tape. Up to 19.2kbps
..£3250

THE ABOVE EQUIPMENT IS JUST A SMALL SELECTION FROM OUR CURRENT STOCK !

Stocks are always changing: If your requirement is not listed then
please phone: WE MAY WELL BE ABLE TO HELP YOU !

WE ALSO BUY TOP QUALITY
UNDER UTILISED EQUIPMENT

Carston **Carston**buy

☎ 01-943 4477

RF LINEAR POWER AMPLIFIERS

WIDEBAND AMPLIFIERS

Ideal for laboratory work where large instantaneous bandwidths are required at high power output. Suitable also for increasing power output of signal generators etc quickly and easily without tuning or adjustment. RF output levels of 4, 20 or 40 watts. 24V + DC supply. 100 KHz-100 MHz: **Type 9046** 4 watts, Gain 13 dB ($\times 20$) ... £98 + £4 p&p. **Type 9176** 4 watts, Gain 26dB ($\times 400$) ... £231 + £6 p&p. 15-225 MHz: **Type 9051** 4 watts, Gain 13dB ($\times 20$) ... £98 + £4 p&p. **Type 9177** 4 watts, Gain 26dB ($\times 400$) ... £231 + £6 p&p. **Type 9174** 20 watts, Gain 13dB ... £280 + £20 p&p. **Type 9172** 40 watts, Gain 10dB ($\times 10$) ... £560 + £25 p&p.

HIGH GAIN TUNED FREQUENCY AMPLIFIERS

Aligned to your specified frequency in the range 10-300 MHz. Provide higher power gains and spurious rejection over limited bandwidths. 24V + DC supply.

Type 9105 10 mW input, 1 watt output ... £209 + £12 p&p. **Type 9106** 100 mW input, 10 watts output ... £258 + £15 p&p. **Type 9155** 1 watt input, 30 watts output ... £297 + £15 p&p. **Type 9158** 5 watts input, 70 watts output ... £407 + £20 p&p.

TELEVISION LINEAR POWER AMPLIFIERS

Tuned to your specified channels in bands IV or V (or in the range 400-950MHz) 24V + DC supply.

Type 9261 100 MV input, 10mW output ... £198 + £10 p&p. **Type 9252** 10 mW input, 500 mW output ... £231 + £10 p&p. **Type 9259** 500 mW input, 3 watts output ... £264 + £10 p&p. **Type 9263** 2/3 watts input, 15 watts output ... £363 + £12 p&p.

MAINS POWER SUPPLY UNIT

Capable of providing power for one or more of any of the above amplifiers up to a current consumption of 5 amps. Fully protected.

Type 9235. £149 + £12 p&p.

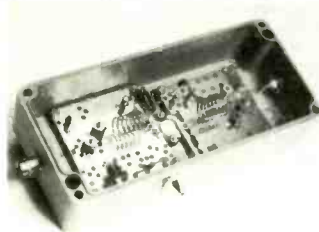

TYPE 9105



TYPE 9158/9235

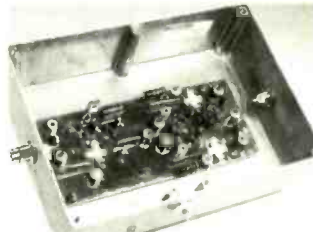

TYPE 9252

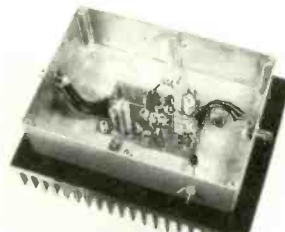

TYPE 9263

Comprehensive range of Gasfet RF preamplifiers, frequency converters, signal sources. FM exciters and FM transmitters also available. Complete amplifier and retransmission systems supplied with connectors.

Full technical information available on request.

Please add 15% VAT on total for UK sales. Please contact sales office for overseas post and packing rates.

RESEARCH COMMUNICATIONS LTD

UNIT 3, DANE JOHN WORKS, GORDON ROAD, CANTERBURY, KENT CT1 3PP.
TELEPHONE: CANTERBURY (0227) 456489

DESIGN, DEVELOPMENT AND
MANUFACTURE OF RF
COMMUNICATIONS EQUIPMENT

EMS Power Systems



EMS manufactures DC Power Supplies and Battery Chargers both linear and switch mode in a range from 5 VA to 3.2 KVA.

Also a complete range of Standby, UPS and Mains Stabilizer Systems 35 VA to 1 KVA. EMS specialises in the manufacture of customised products and has a full design and development facility.

EMS (Manufacturing) Limited,
Chairborough Road,
High Wycombe,
Bucks HP12 3HH.
Tel: (0494) 448484

ENTER 34 ON REPLY CARD

RUGBY TIME?

MSF CLOCK IS EXACT

8 DIGIT display of Date, Hours, Minutes and Seconds.

SELF SETTING at switch-on, never gains or loses, automatic GMT/BST and leap year, and leap seconds.

EXPANDABLE to Years, Months, Weekday and Milliseconds and use as a STOPCLOCK to show event time.

COMPUTER or **ALARM** output also, parallel BCD (including Weekday) and audio to record and show time on playback.

DECODES Rugby 60KHz atomic time signals, superhet receiver (available separately), built-in antenna, 1000Km range.

LOW COST, fun-to-build kit (ready-made to order) with receiver

ONLY £89.80 includes ALL parts, pcb, 5x8x15 cm case, by-return postage etc and list of other kits. Get the **TIME RIGHT**.

CAMBRIDGE KITS

45(WS) Old School Lane, Milton, Cambridge, Tel 860150

PROGRAMME and DEVIATION CHART RECORDERS

Single and two channel versions chart audio to IEC/BS PPM standards and true peak deviation.

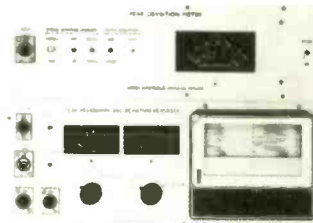

Broadcast Monitor Receiver
150kHz-30MHz • Stereo Disc
Amplifier 3 and 5 • Moving Coil
Preamplifier • 10 Outlet
Distribution Amplifier 4 • Stabilizer
• Fixed Shift Circuit Boards •
Illuminated PPM Boxes • PPM 7
and PPM3 Drive Circuits • PPM5 20
Pin DIL Hybrid and *Ernest Turner*
Movements • Stereo Microphone
Amplifier • Advanced Active Aerial
• Stereo Coders.

Surrey Electronics Ltd,
The Forge, Lucks Green,
Cranleigh, Surrey GU6 7BG.
Tel: 0483 275997

IMAGE-10

HIGH PERFORMANCE SINGLE BOARD GRAPHICS COMPUTER

High performance? they all say that.
Ah yes, but...

Image-10 has three 16 bit processors working concurrently for
dazzling speed
and

Image-10 has a resolution of 736 by 576 pixels for intricate detail
and

Image-10 has 256 on-screen colours giving photographic quality.
Image-10 has all of the refinements asked of graphics
intensive applications. Like hardware window, hardware
drawing, hardware zoom and plot, hardware character generation
and hardware back-moves. The only thing that you has to do is to
run your applications.

Price £1295

Image-10 includes:

- ★ 68010 cpu ★ 82780 gdc ★ 512K dram ★ 64K sram ★ 256K
- ★ Floppy disc controller ★ Winchester disc controller eprom
- ★ Dual RS232 ★ Centronics ★ Mouse ★ transputer ports
- ★ Battery backed clock ★ Stereo sound generator

SOFTWARE DEVELOPMENT SYSTEMS

Versatile, low cost, development systems based on Micro
Concepts' single board computer, Microbox 3.
A choice of powerful disc operating systems is available
including Os-9/68K, TRIPOS, and CP/M-68K

Features include:

- 68000 microprocessor, 8MHz clock.
- 512K dynamic ram, 64K static ram, 128K eprom
- On-board graphics controller offers:
- 80 column, 24 row, 16 colour text.
- 640 by 480, 4 colour graphics.
- 320 by 480, 16 colour graphics.
- Floppy disc controller.
- Winchester disc controller.
- Dual serial RS232 ports.
- Centronics printer port.
- Up to 48 lines of parallel input/output.
- Battery backed clock/calendar.
- I/O expansion capability.
- Double eurocard board format.

Hardware prices:

Fully built and tested Microbox 3 single board computer	£650
System with dual 1M byte floppy disc drives	£1195
System with 20M byte Winchester and single floppy drive	£1895



All prices
shown
exclusive
of VAT
and
carriage

UNIVERSAL CROSS ASSEMBLERS for all MSDOS OS-9 FLEX computers

Supports the following devices

1802	1805	6301	6303
6502	6800	6801	6802
6803	6804	6805	68HC05
6808	6809	68HC11	8020
8021	8022	8031	8035
80C35	8039	80C39	8040
8048	80C48	8049	80C49
8050	8051	8080	8085
8748	8749	8751	Z8
Z80	68000		

Extensive directives support modular,
conditional and structured program-
ming. Powerful Macro Pre-processor,
xref generator and output conversion
utilities provided.

COMPLETE SUITE.....£295
INCLUDES FULL 'C' SOURCE CODES
(NOT 68000)

MICROPROCESSOR CONTROLLED EPROM EEPROM and SINGLE CHIP MICRO PROGRAMMER

Programs the following devices:

2508	2516	2532
2564	27(C)16	27(C)32
2732A	27(C)64	2764A
27(C)128	27128A	27(C)256
57(C)256	27(C)512	27513
2758	27011	2816A
2817A	2864A	28256
48Z02	52B13	52B23
52B33	68732	68764
68766	8741	8742
8744	8748	8749
8748H	8749H	8751
8755	9761	CY7C282
CY7C292		DS1225
AT-ROM	PC-ROM	XT-ROM

No Personality Modules required.

Controlled via RS232 interface.

Accepts Intel, Motorola, Ascii-hex and
binary data. Ultra-fast, fast and
standard programming modes.

Low and high byte programming
supported.

Completely self contained but
uncased.

Price £295

Micro Concepts

2 St. Stephens Road, Cheltenham, Gloucestershire GL51 5AA
Telephone (0242) 510525

MONOCHROME CATHODE RAY TUBES FOR MONITOR AND DISPLAY APPLICATIONS

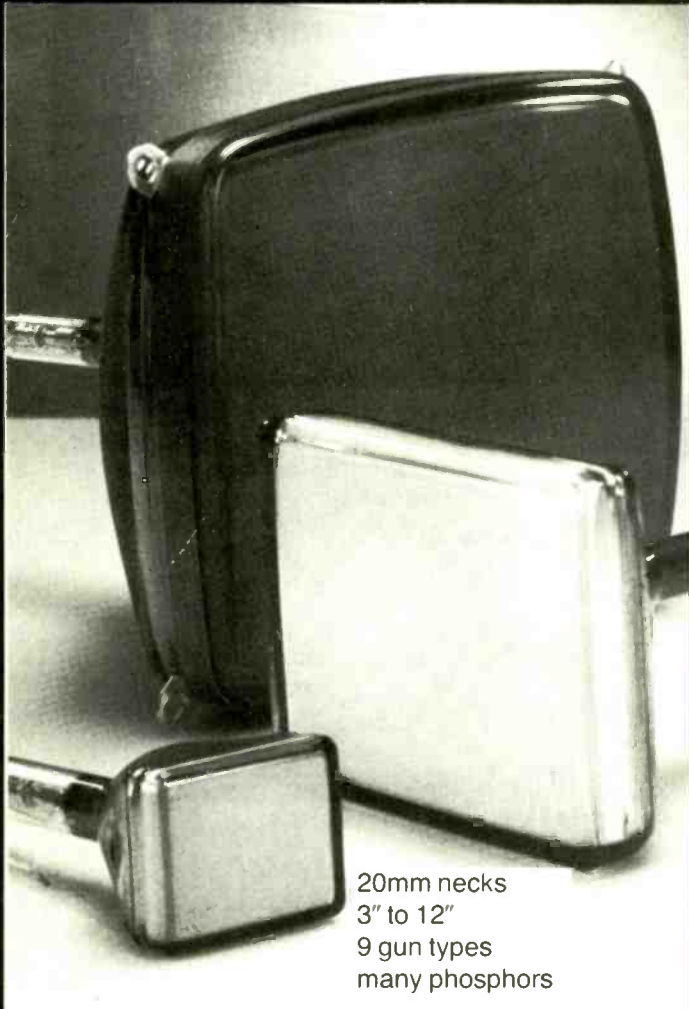

20mm necks
3" to 12"
9 gun types
many phosphors

SPECIAL VIDEO

G. A. STANLEY PALMER LIMITED

Elmbridge Works
Island Farm Avenue
West Molesey Trading Estate
Surrey KT8 0UR England

TELEPHONE: 01-979 7254/5/6
TELEX: 917069

ENTER 59 ON REPLY CARD



FORTH INSTRUMENTATION COMPUTER

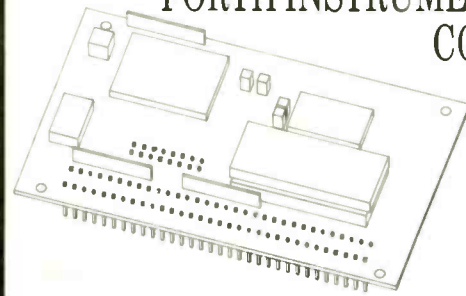

TDS 9090

A powerful control computer based on the new Hitachi 6303Y and high level language Forth. 100mm x 72mm. 30K bytes RAM, 16K dictionary RAM/PROM, 256 bytes EEPROM, 16K Forth. You can attach 64 key keyboard, LCD and I²C bus peripherals. Built in are interrupts, multitasking, time of day clock, watchdog timer, full screen editor and symbolic assembler. 32 parallel and two serial ports. Single power supply and low power 3mA operational mode.

1 off £194.95 including manual and non-volatile RAM.

Triangle Digital Services Ltd
100a Wood Street, London E17 3HX

Telephone 01-520-0442 Telex 262284 (quote M0775)

ENTER 30 ON REPLY CARD

Used equipment - with 30 days guarantee. Manuals supplied if possible. This is a very small sample of stock. SAE or telephone for LISTS. Please check availability before ordering. Carriage all units £16. VAT to be added to total on Goods and Carriage.

Tektronix 2215 Oscilloscope		SPECIAL OFFERS	
60MHz Dual Trace Delay Sweep With Manual ONLY £475 each		B & K Precision CRT Restorer/Analyser Model 467 Supplied with 2 bases and manual. p&p £7 ONLY £125 each	
OSCILLOSCOPES		Labgear Colour Bar Generator KG1 8 Test Patterns p&p £4 ONLY £40 each	
TEKTRONIX 577 Curve Tracer £2,500		COMMUNICATION RECEIVERS	
TEKTRONIX 475 Dual Trace 200MHz Delay Sweep £1,500		RACAL RA 17L 500kHz-30MHz with manual ONLY £140 each	
TEKTRONIX 465B Dual Trace 100MHz Delay Sweep £1,200		EDDYSTONE 730 4 430kHz-30MHz with manual ONLY £110 each	
HP 1715A Dual Trace 200MHz Delay Sweep £1,200		MULTIMETERS	
TEKTRONIX 465 Dual Trace 100MHz Delay Sweep £900		AVO 8 Mhz Complete 4h batteries & leads £45	
TEKTRONIX 454 Dual Trace 150MHz Delay Sweep £950		Above items in GOOD WORKING ORDER - appearance not AI hence the price	
TELEQUIPMENT DPA Dual Trace 50MHz Delay Sweep £325		AVO TEST SET No. 1 (Military version of AVO 8) Complete with batteries, leads & carrying case £65	
HP 180A Dual Trace 50MHz Delay Sweep £325		TEST LEADS supplied for AVOMETERS Red & Black with 2 Croc Clips and 2 Prods (p&p £2) £5	
TELEQUIPMENT D67 Dual Trace 25MHz Delay Sweep £250		ANALOGUE POCKET MULTIMETERS Philips/Taylor/Avo etc Complete with Batteries & Leads from £10	
COSSER COU150 Dual Trace 35MHz Delay Sweep £150		BRUEL & KJOER EQUIPMENT	
S.E. LABS SE111 Dual Trace 18MHz AC or External DC Operation £140		High Resolution Signal Analyser Type 2033 £3,500	
TEKTRONIX 547 Dual Trace 50MHz Delay TB Delay Sweep £140		Portable Level Recorder Type 2306 £1,000	
SOLARTRON CD1 400 Dual Trace 15MHz with manual £85		Real Time Third Octave Analyser Type 3347 £2,000	
TELEQUIPMENT D43 Dual Trace 45MHz £100		Heterodyne Analyser Type 2010 £1,750	
TELEQUIPMENT S54A Single Trace 10MHz Solid State PHILIPS PM32 12 STORAGE Dual Beam 10MHz £500		Level Recorder Type 2307 £1,400	
TELEQUIPMENT DM4 STORAGE Dual Trace 10MHz £225		Beat Frequency Indicator Type 1022 £400	
GENERATORS		DISK DRIVE PSU 240V in 5V 1.6A & 12V 1.5A Out Size WZMIN QWERTY KEYBOARD (as in LYNX MICRO) Push to make Card £10 ea ONLY £5 ea	
MARCONI TF2950 Mobile Radio Test Set £1,400		AVO TRANSISTOR TESTER TT169 Handheld DC/AC/NOV in in situ testing. Complete with batteries, leads and instructions NOW ONLY £12 (p&p £3)	
MARCONI TF2006 FM 10-100MHz £1,400		NEW EQUIPMENT	
MARCONI TF2006 AM/FM 4-500MHz £950		HAMEG OSCILLOSCOPE 605 Dual Trace 60MHz Delay Sweep Component Tester £583	
MARCONI TF2008 AM/FM 10kHz-510MHz £1,200		HAMEG OSCILLOSCOPE 203 6 Dual Trace 20MHz Component Tester with ten probes. All other models available £314	
MARCONI TF2015 AM/FM 10MHz-520MHz with TF2171 Synthesizer £1,000		BLACK STAR COUNTER TIMERS (p&p £5)	
MARCONI TF2002B with Synthesizer TF2170B 10Hz-88MHz AM FM £500		APOLLO 10-100MHz Ratio/Period Time interval etc £219	
MARCONI TF1066B AM FM 10MHz-470MHz £350		APOLLO 100-1000MHz (As above with more functions) £285	
MARCONI TF995A 1.5-2.0MHz Narrow Deviation ADVANCE Type SGR2B AM FM 4-30MHz £100		BLACK STAR FREQUENCY COUNTERS (p&p £4) Meteor 100-100MHz £99	
ADVANCE Type SGR2B AM FM 4-30MHz £45		Meteor 600-600MHz £126	
MARCONI Q Meter TF1245 with TF1246 or TF1247 £500		Meteor 1000-1GHz £175	
HP Power METER 431C with Thermistor Mount 10MHz-10GHz or 12-18GHz £200		BLACK STAR BUPTOR 500 FUNCTION GENERATOR Saw/Square/Triangle 0.1Hz-500kHz (p&p £4) £110	
MARCONI RF MILLIVOLTMETER TF2503 50kHz-1.500MHz £150		ORION COLOUR BAR GENERATOR Pal TV Video £199	
MARCONI VALVE VOLTMETER TF2600 10Hz-10MHz 1mV-300V FSD £40		HUNG CHANG DMM R031 3 1/2 digit Hand held 28 ranges including 10 Amp AC/DC 0.1% Complete with battery and leads (p&p £4) £39.50	
MARCONI UNIVERSAL BRIDGE TF2701 £45		As above DMM R010 0.5% £33.50	
MARCONI UNIVERSAL BRIDGE TF2730 Battery Operated £150		OSCILLOSCOPES PROBES Switched x1 x10 (p&p £2) £11	
MARCONI TF313 Universal Bridge £110			
HP RF MILLIVOLTMETER 411A 500kHz-500MHz £60			
KEITHLEY ELECTROMETER Type 611B with Adaptor 610B £500			
SOLARTRON TRUE RMS VOLTMETER M1484 £50			
HP TRUE RMS VOLTMETER 3408 10Hz-10MHz £400			
TEXCAN AL608 SPECTRUM ANALYSER 0-3GHz £3,000			
THANIDAR LOGIC ANALYSER TF2160 16 Channels 20MHz £1,750			
THANIDAR LOGIC ANALYSER TAP080 (Unused) 8 Channels 20MHz £850			
ISOLATING TRANSFORMERS			
240V input 240V output			
100VA £15 each p&p £5	100VA £6 each p&p £2		

STEWART OF READING Telephone: 0734 68041

110 WYKEHAM ROAD, READING, BERKS RG6 1PL

Callers welcome 9am to 5.30pm. MON-FRI. (UNTIL 8pm. THURS)

ENTER 68 ON REPLY CARD

Logic analysis – an introduction

Logic analysers are basic tools for the development of microprocessor applications. As processors become more complex and fast it is necessary for the analysers to keep up with them. We explore some of the facilities available on analysers.

The introduction of the microprocessor brought along with it a complexity that needed new tools for development and test applications; specifically, logic analysers, in-circuit emulators, word pattern generators and memory and other device programmers. Since then more complexity has been packed into less chip space and there is a constant challenge for instrument manufacturers to keep up with the latest devices.

The increasing complexity of integrated circuitry needs to be reflected in the increasing complexity of the tools. At the same time they should be easy to use so there is also a trend towards concealing the complexity in interfaces that make them more friendly and avoid the appearance of complexity.

As micro electronic components get cheaper it is necessary for the tools also to be low-cost for the user to gain any advantage in their use, which tends to divide the

market between the high-end devices that can cope with the latest micro-technology and the low-cost instruments for normal day-to-day applications. This has led to the 'personal' logic analyser which is low enough in cost to be used by one operator, compared with a costly high-end instruments used by the whole lab.

The analyser is itself a computer, so it is possible to simulate the functions of an analyser as a computer program. Such programs are available for running on many of the computers found in laboratories. Some of the functions can be delegated to a 'front-end' analyser, whose output is relayed to a computer for storage and display.

All analysers need a probe to physically contact the device under test and this is designed to be specific to the device – a 'personality' probe. This is so that the signals on the pins coincide with the expected signals by the analyser. The probe can

include some processing power on internal i.c.s (in the jargon, a 'smart' or 'intelligent' probe) or just re-route the signals to the analysers' inputs. The logic analyser has many functions. All digital signals have an on-off condition and the analyser can act like a multi-channel oscilloscope, displaying the sequences of ons and offs coming from the pins of an integrated circuit. By displaying a number of sequences on a screen it is possible to compare the time relationships of signals and discover any glitches that may be present.

What the device under examination is actually doing is determined by sequences of 1s and 0s entering and leaving it, so another function of the analyser is to display these as columns of 'words', indicating the logic state of the device. These words can be disassembled into computer instructions understandable by the operator so disassembly is often included in logic analysers' repertoire.

Thandar are tackling both high and low ends of the spectrum of analysers. The TA2000 is a low-cost instrument offering 32 channels of 25MHz or eight channels at 100MHz. It features multi-level triggering, 5ns glitch capture and glitch trigger. Three external clocks have independent thresholds. RS232, GPIB and Genronics links are provided, as is non-volatile storage of data and set-ups. TA3000 interactively combines 8 or 16 channels or 100MHz timing with 32, 64, or 96 channels of 20MHz state analysis. Cross triggering of the timing channels by the state sequencer allow a 'snapshot' to be taken of the hardware activity at a specific point in the operation of the circuit under test. The instrument has full CP/M+ computing facilities.



This needs to be specific to the device under test and may be stored internally on a rom or download from a disc. Such facilities have the additional advantage of being able to test software or firmware, at the assembly-language or machine-code level, while it is actually running.

Thus the principal differences in logic analysers are between the numbers of channels capable of being probed at one time, and the speeds of instruments, which needs to exceed by about three times the speed of the device being tested. Other differences include the complexity of the analyser which gives it additional analysis functions, perhaps the comparison of the output pattern of a device with a stored pattern for routine checking, or communication with a computer for further data storage and analysis, or in a computer-controlled test and measurement system.

SERIAL ANALYSIS

A serial logic analyser acquires serial data one bit at a time on its single channel. By using a matching decoder, and synchronization, it can change the serial data into parallel for storage and word recognition. Once the data is converted into parallel, word recognition for triggering can take place in a similar way to that in a parallel logic analyser. Two consecutive words can have a special meaning in some protocols, so the triggering operation often includes word recognition in pairs. The software in the analyser is used to recognise various aspects of data protocol: such as number of bits/character, parity selection, sync word etc. Specialized versions of serial logic analyser are called protocol analysers.

SIGNATURE ANALYSIS

The flow of data through a digital circuit means that at certain nodes a specific pattern should appear regularly, this is known as a signature. A single probe can be moved from node to node sensing the signatures. These can be compared with pre-recorded signatures to detect any malfunction in the circuit under test. Some logic analyser are dedicated to this use and are called signature analysers.

WORD GENERATION

As a further tool for testing, analysers can include the ability to generate pre-set word

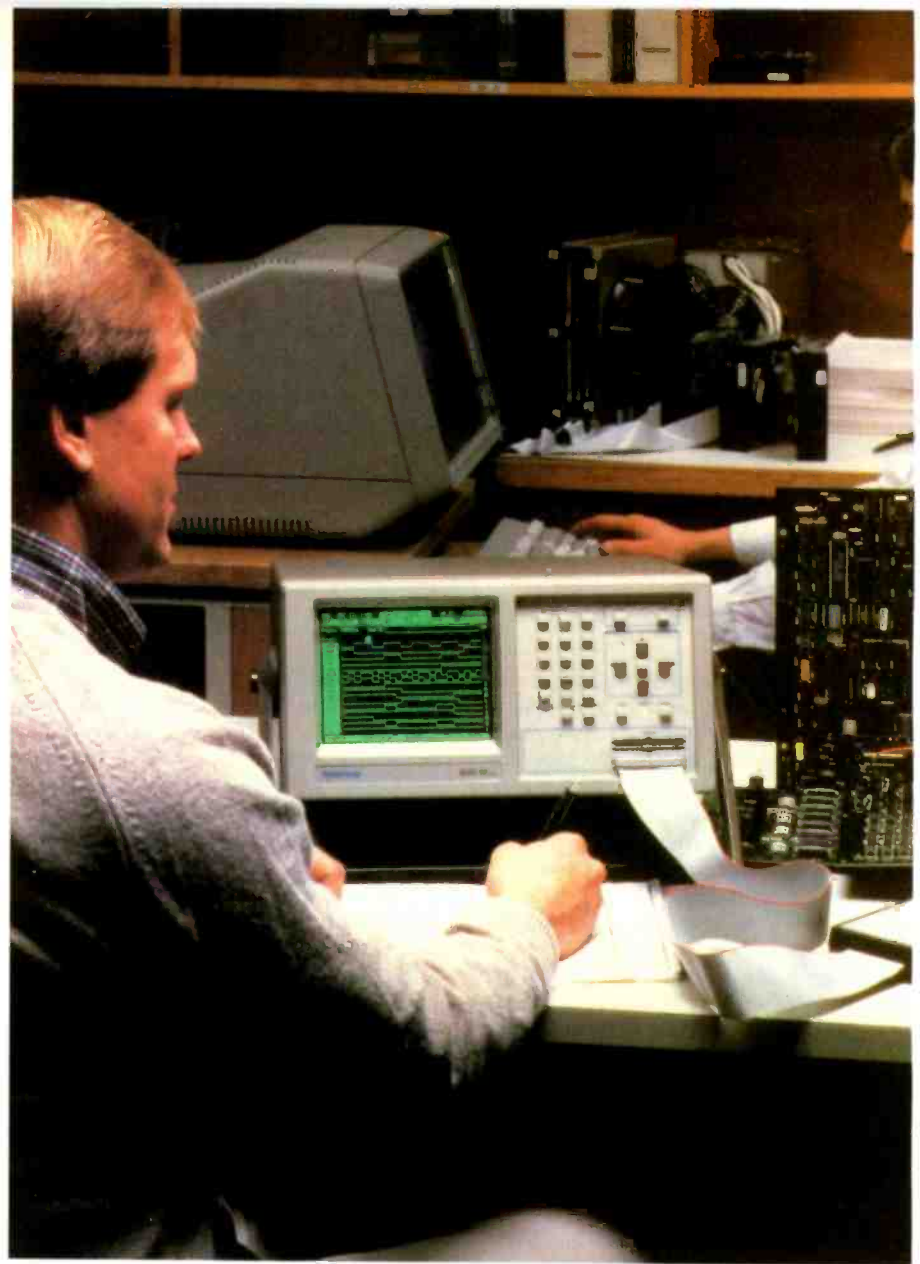

The 1220 logic analyser from Tekronix can display 16 channels at a time. Sample rates are up to 100MHz. There are many trigger options, a non-volatile set-up memory, real-time clock and glitch detection. This is one of a range of analysers intended to cover the whole field of logic analysis.

patterns which can be introduced into the test circuit to excite expected patterns in the circuit.

WIDTH BY DEPTH

The trend to ever higher numbers of channels for logic analysers is easily explained by the bus widths of the tested devices. A short

time ago 16-bit processors were 'state-of-the-art' but now 32-bit c.p.us take that place. Falling prices and rising density of memory chips, as well as the ability to analyse larger parts of the processes running on the target system are the chief reason for the increase in memory depth. This last-mentioned feature is often requested to hide a certain fear of having to define a proper trigger sequence. Without a good trigger sequence, however excessive time may be needed to evaluate the data acquired.

Disregarding 'transitional timing' or 'transition recording' as offered by some logic analysers – memory depth becomes much more critical on timing analysis, because with increasing sample rate and resolution in time, the 'window' or length of the maximum time during which data can be recorded decreases. But in the software domain, deep memory may also be useful for the statistical evaluation of certain system activities with the purpose of program optimization, software performance analysis for example.

Fig.1. Trigger condition with verification of time intervals. The same principal can be applied to verify nominal values of handshake, set-up and hold times, and allows easy identification (detection, verification and determination) of exceptions.

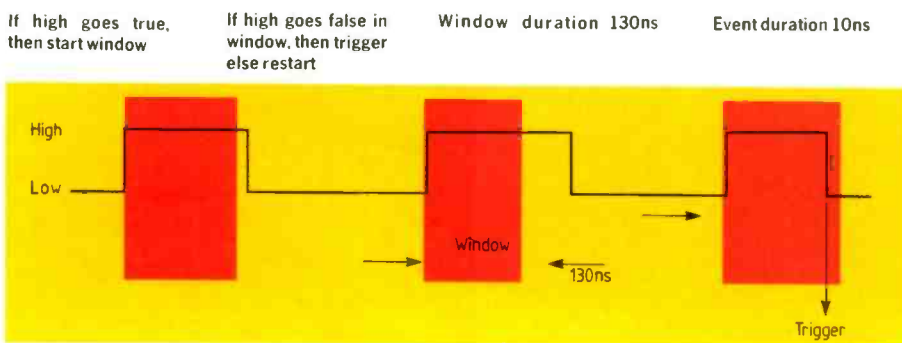

ELECTRONIC BROKERS

UK's No.1 Test Equipment Distribution Company:

TOP VALUE IN LOGIC ANALYSERS

THANDAR TA 2000



High performance, low-cost, portable logic analyser for development, production and field service. Can capture data across 32 channels (at 25MHz) and up to 100MHz (8 channels), displaying data in both timing and list formats.
Features: Multilevel triggering, 5ns glitch capture and glitch triggering, high impedance input pods (8 channels per pod), 3 external clocks. All functions accessed through soft key controlled display.

£2,950

THURLBY LA160B



20MHz, 16 channels, LED display, DC to 20MHz external clock, 2.5KHz internal clock in 16 steps, 1,999 x 16 bit word acquisition memory.

£495

THANDAR TA 3000 32/8



A flexible high performance logic analyser, easy to learn and use, readily expandable, and interactively combines up to 16 channels of 100MHz timing analysis with up to 96 channels of state analysis.

£6,795

DIGITAL STORAGE OSCILLOSCOPES

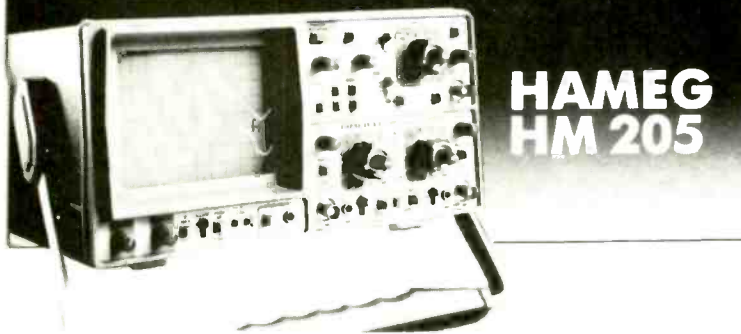

**HAMEG
HM 205**

Real time to 20MHz, digital storage to 10KHz, resolution of 1024 x 256 points on X and Y axes, re-fresh mode shows changes in waveform, amplitude and frequency, built in component tester for non-destructive testing of semi-conductors and passive components, active video trigger, switch selectable 1KHz-1MHz calibrator with 3ns rise time, dual channel, add and invert, mode and X-Y operation. **£498**

ARRIVING SOON

To be announced at the British Electronics Week, a new low cost storage scope with 5MHz clock rate and dot-joining facility, plus optional plot output.

SEE US ON STAND
1381/1380, ATE SHOW,
NATIONAL HALL OLYMPIA

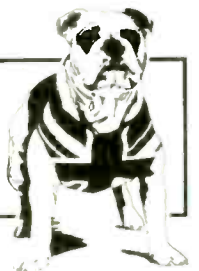

**NEW 1987 COLOUR
CATALOGUE - CONTACT US
FOR YOUR FREE COPY**

All prices exclude VAT and carriage, and are correct at time of going to press.

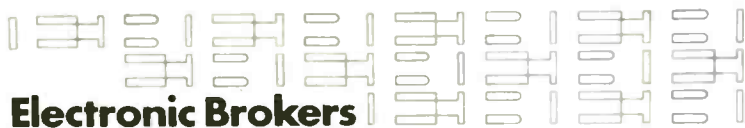

Electronic Brokers

140/146 Camden Street, London NW1 9PB
Fax: 01-267 7363. Telex: 298694. Tel: 01-267 7070

ENTER 74 ON REPLY CARD

150ns. However, such a filter is used more frequently to avoid interpretation of bit-patterns which occur as short unstable intermediate states in the data stream, as regular trigger events. Checking for 'greater than', as needed in this case, corresponds to the function of the usual trigger filter.

Checking distances, as shown in the panel example serves an entirely different purpose in software analysis, which must unambiguously identify certain locations in a program flow or data stream. Polling for A and then B is often insufficient because A and B may occur several times. However, if their distance (in samples of processor cycles) is included in the trigger condition, the desired determination can often be obtained from a two-level trigger sequence. In other words, checking the distance is the easiest way to define precise trigger conditions with little effort.

The capacity for triggering a state analyser is not so much determined by its maximum number of trigger levels but more by how few levels are required to trigger unambiguously. Sometimes, more levels will be an advantage; within a longer program run, program sections may need to be identified but only certain activities within these sections should be recorded. To achieve this, the sections in question have to be identified by a suitable trigger sequence, while specifying which particular activities should be recorded until the next section is found. This allows a trace of all activities, none at all or selective recording of only certain activities like i/o for example. The procedure for repetitively recording only a single segment of the program from address A to address B is shown with the example of Fig.2.

OPERATIONAL CONVENIENCE

Besides the purely quantitative properties such as clock rate, number of channels and memory depth, triggering and record control are among the most important functions of a logic analyser. As decisive criteria on the software side, post processing such as disassembly and, not least, the operating concept contribute much to the usefulness of an analyser. In one new instrument, all functions are selected with a 'scroll knob' within pop-up menus. The course of such entries are described with "touch - turn - release." Touching a key brings a menu to the screen, showing the possible settings for the parameter selected in the main menu at a glance. The scroll knob then moves a pointer to the desired setting within the pop-up menu. This setting is then entered into the main menu by releasing the select key.

Speed and clarity are important properties in this concept of operation. With all types of post-processing and data evaluations, the importance of processing speed is increasing with the number of channels and the depth of the memory. In one case, a 112-channel configuration has 64 bytes for evaluation, substantially more than the usual 2 to 16 bytes acquisition memory. A powerful 16-bit c.p.u. with megabytes of memory results in extremely short display up-date times, as well as horizontal and vertical scrolling of the timing diagram.

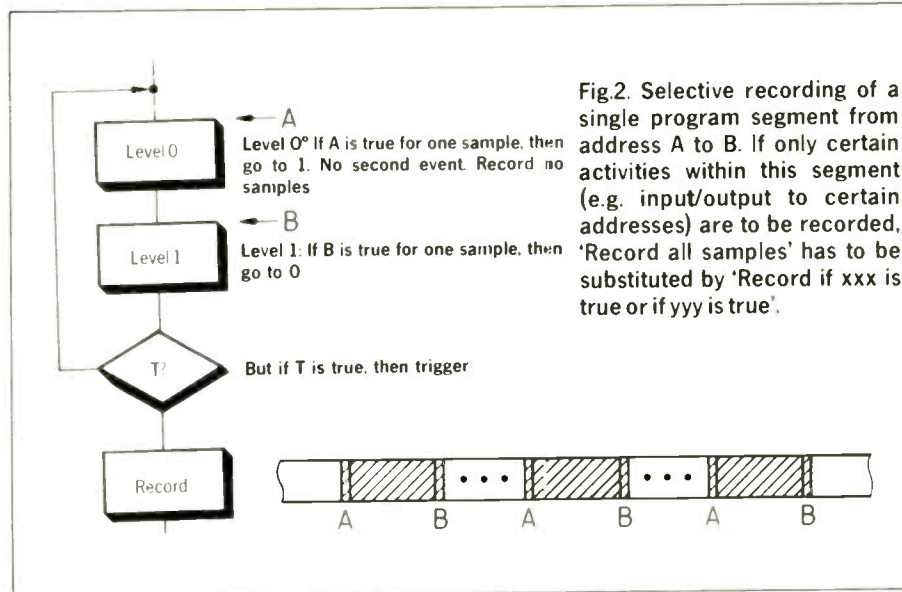

Fig.2. Selective recording of a single program segment from address A to B. If only certain activities within this segment (e.g. input/output to certain addresses) are to be recorded, 'Record all samples' has to be substituted by 'Record if xxx is true or if yyy is true'.

HOST COMPUTER

A computer built-in to a powerful logic analyser can obviously be used to run the owners specific data evaluation programs. Extensive possibilities, reaching far beyond logic analysis, arise if the computer is built to an industrial standard. Compatibility with the IBM-AT, for example, would give access to a comprehensive library of user software and bus-compatible hardware.

In addition to the pure processing power, this suggests further benefits for the logic analyser. Complete analyser setups, along with a data recorded by the analyser, may be stored to disc; interfaces would allow printing of screen content such as timing diagram and disassembler. And as the analysers operating software can be loaded from disc, software updates or retrofitting options are no problem.

80286 DISASSEMBLY

Logic analyser disassembler support for the 16-bit 80286 microprocessor can be used

with the entire Philips high-end logic analyser line, including the PM3551A, the PM3565 and the PM3570 (115 channel/400MHz). Hardware consists of a front-end unit which ensures proper connection of the logic analyser channels to the 60-pin, pin-grid-array package of the 80286. The multi-clock state analyser architecture avoids the need for external 'personality' probe hardware. This allows small and cost-effective personality adaptors to be used. The software support consists of a prom-based disassembler package, fitted to the option board of the analyser. Up to four different packages can reside inside the instrument at all times and are available from power-up. Thus there is no need for down-loading of disassembler software from disc.

This package adds to the collection of over 40 different 8 and 16-bit processors supported by Philips' system. The analysers on which run incorporate separate analysers for logic-state and timing. They range from 35-channel state analysers to 83 channels at 20MHz timing, and eight channels of 50MHz timing to 32-channels of 400MHz timing.

LOGIC ANALYSER MANUFACTURERS

Advantest (formerly TakedaRiken) instruments available from Chase Electronics Ltd, London SW14 7LY. Tel: 01-878 7748

Anritsu Europe Ltd, Thistle Road, Windmill Trading Estate, Luton, Beds LU1 3XJ. Tel: 0582 418853.

Dolch Logic Instruments Ltd, Foresters House, 4 London Street, Andover, Hants SP10 2PA. Tel: 0264 50944

Fieldtech Heathrow Ltd, Huntavia House, Bath Road, Longford, Middlesex UB7 0LL. Tel: 0897 6446.

Global Specialities Ltd, Shire Hill Ind. Estate, Saffron Walden, Essex CB11 3AQ. Tel: 0799 21682.

Gould Electronics Ltd, Roebuck Road, Hainault, Ilford Essex IG6 3UE. Tel: 01-500 1000.

Hewlett-Packard Ltd, Nine Mile Ride, Easthampton, Wokingham, Berks RG11 3LL. Tel: 03448 773100.

Iwatsu instruments are available through STC Instrument Services, Harlow, Essex. Tel: 0279 29522.

Kikusui instruments through Telonic Instruments Ltd, Maidenhead, Berks. Tel: 0628 73933.

Kontron Electronics Ltd, Blackmoor Lane, Croxley Centre, Watford, Herts WD1 8XQ. Tel: 0923 45991.

Marconi Instruments Ltd, Longacres, St Albans, Herts AL4 0JN. Tel: 0727 59292

Nicolet Instruments Ltd, Budbrooke Road, Warwick CV34 5XH. Tel: 0926 494 111.

Philips Test & Measurement, Pye Unicam Ltd, York Street, Cambridge CB1 2PX. Tel: 0223 358866.

Racal-Dana Instruments Ltd, Duke Street, Windsor, Berks SL4 1SB. Tel: 0735 368101.

Rohde & Schwartz UK Ltd, Roebuck Road, Chessington, Surrey KT9 1LP. Tel: 01-397 8771.

Tektronix UK Ltd, Fourth Ave, Globe Park, Marlow, Bucks SL7 1YD. Tel: 06284 6000.

Thandar Electronics Ltd, London Road, St. Ives, Huntingdon, Cambridge PE17 4HJ. Tel: 0480 64646.

Thorn EMI Instruments Ltd, Archcliffe Road, Dover, Kent CT17 9EN. Tel: 0304 202620.

Thurlby Electronics Ltd, New Road, St. Ives, Huntingdon, Cambridge PE17 4BG. Tel: 0480 63570.

Zicon Instruments Ltd, 23 Meteor Close, Airport Ind. Est, Norwich. Tel: 0603 400083.

British Electronics Week

Olympia, London, 28 to 30 April 1987



No less than seven exhibitions are combined to make up British Electronics Week. The senior event is the **12th All-electronics/ECIF Show**, for electronics components and systems. **Circuit Technology** specializes in the design and manufacture of p.c.bs. A large number of semiconductor manufacturers will be exhibiting in the **Electronics Product Design** show. **Fibre Optics** has its own show. Introduced this year are two new sections: **Power Sources and Supplies**; and the **Electronic Subcontract Show**, where some 40 providers of design and manufacturing services will be on show. The final section, zone 16 on the map, is devoted to the **Automatic Test Equipment** show.

There are conferences and/or seminars being run in conjunction with the Fibre Optics and Automatic Test Equipment shows.

Olympia is on Hammersmith Road, Kensington, and has its own Underground station. The show is open between 10.00 and 18.00h except on April 30th, when it closes an hour earlier. Tickets cost £2 at the door or from the organizers: Evan Steadman Services Ltd, The Hub, Emson Close, Saffron Walden, Essex CB10 1HL. Telephone: 0799 26699.

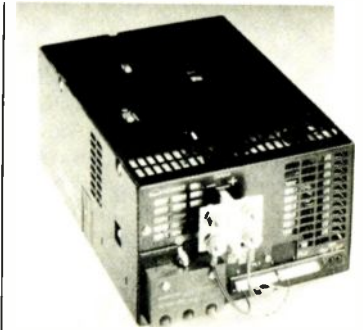

How the shows are distributed about Olympia.

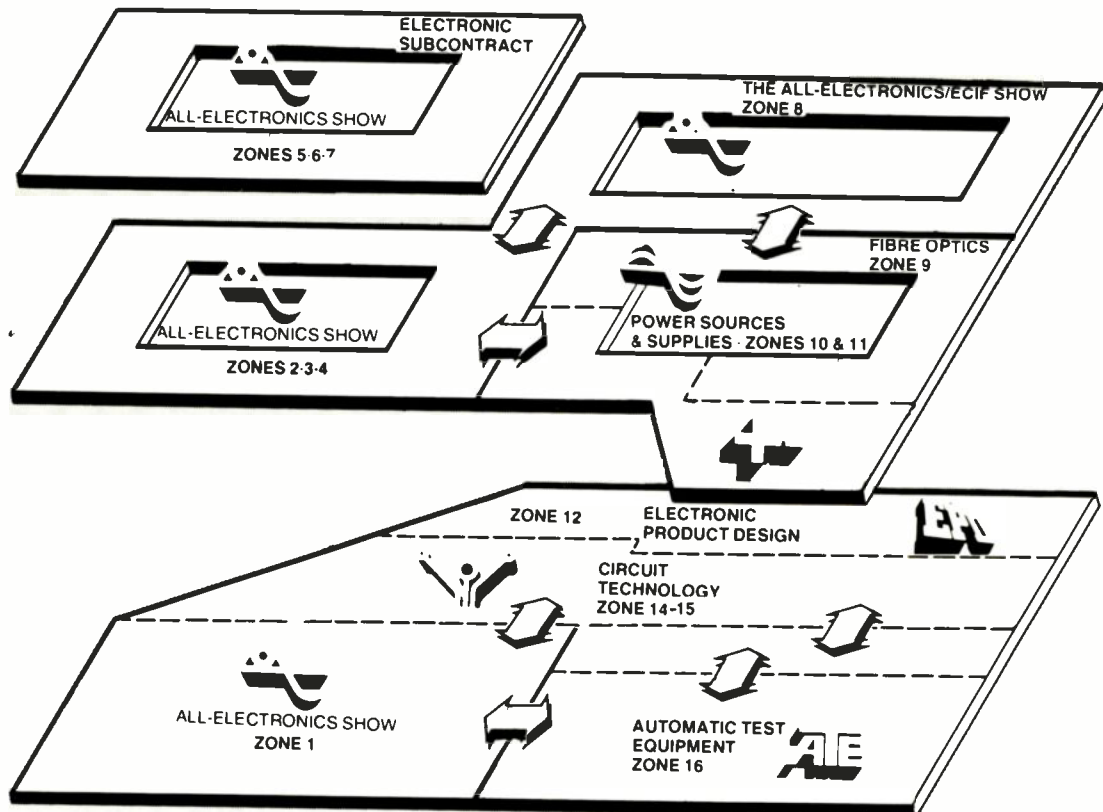

A POWERFUL BUSINESS MICRO FOR AN UNBELIEVABLE

£149.95



- Twin 5¼" 250 K disk drives
- On-board auto-dial modem
- Built-in amber high resolution screen
- Full 67-key Qwerty keyboard
- CP/M plus operating system
- RS232 and centronic printer ports
- 64K of RAM ● Real time clock
- Winchester and joystick ports

FREE CARRYING CASE
AVAILABLE WHILE STOCKS LAST.

Access/Visa accepted



FOR FULL DETAILS RING
HELEN WILKES ON

0737 65080

ENTER 19 ON REPLY CARD

Fibre-Optics EDUCATOR

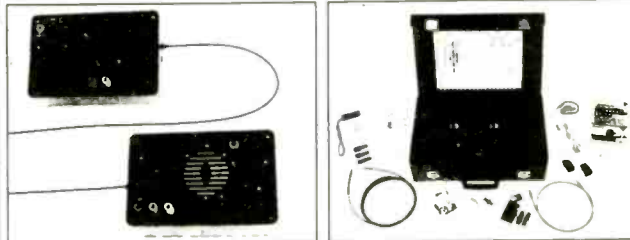

For teaching fibre-optics and telecommunications in schools, colleges, universities and technology training centres.

Transmits **analogue** and **digital** data over **free-space** and **optical fibres** using red light.

Plus **many** other applications, including numerous measurement experiments.

Designed and Manufactured in the U.K.

For further details contact:

ELLMAX ELECTRONICS LTD.,
Unit 29, Leyton Business Centre,
Etloe Road, Leyton,
London E10 7BT.
Telephone: 01-539 0136

**ELLMAX
ELECTRONICS**

ENTER 48 ON REPLY CARD

LOGIC ANALYSERS



TA3000

from £4795 + VAT

Up to 112 channels.
100MHz Timing; 20MHz State.
Multilevel conditional triggering.
State/Timing cross-triggering and correlation.
Easy to use soft-key control.
Optional disassemblers for 68000, 8086/8088, Z80, 8085, 6502, 6809.



TA2000

£2950 + VAT

32 data channels; 100MHz maximum sampling rate.
5ns glitch capture; glitch triggering.
4 level trigger sequencer with event count and delay.
Non-Volatile memory for data and set-ups.
Easy to use soft-key control.
Optional disassemblers for 68000, 8086/8088, Z80, 8085, 6502, 6809.



thandar
ELECTRONICS LIMITED

ENTER 22 ON REPLY CARD

Thandar Electronics Limited,
London Road, St. Ives, Huntingdon,
Cambridgeshire PE17 4HJ, England
Telephone (0480) 64646 Telex 32250 Test

THE LOGICAL CHOICE

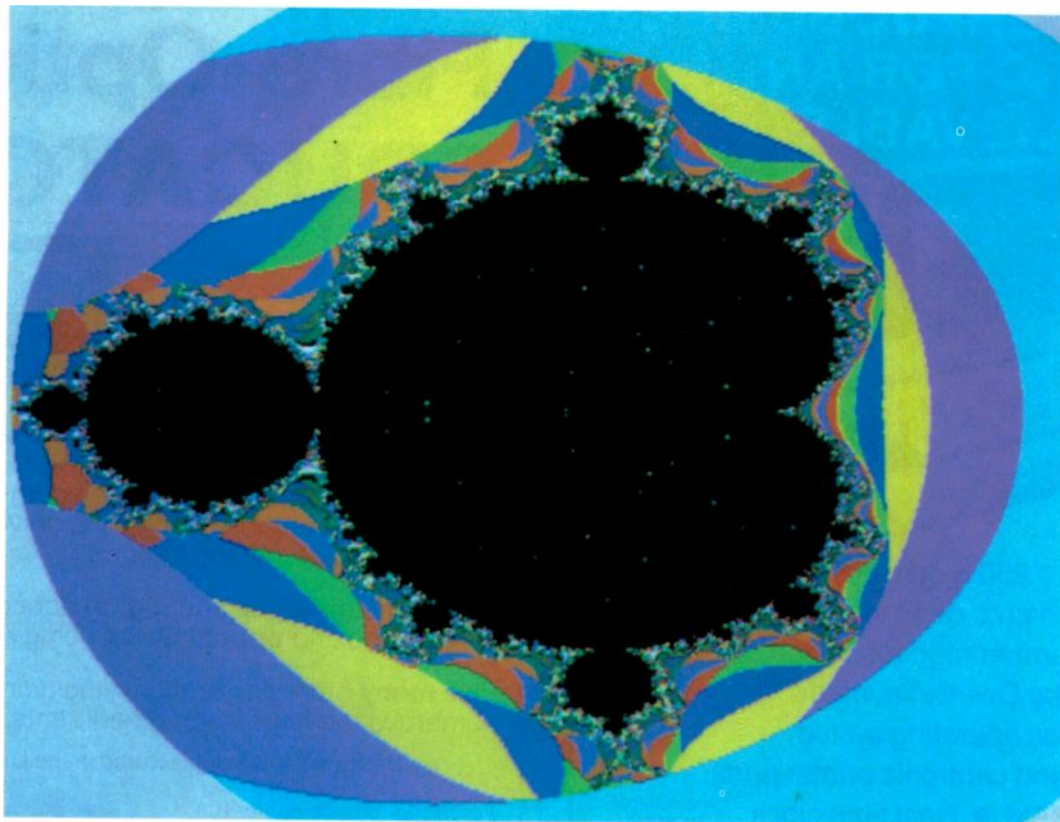

High-performance colour graphics controller

With little more than a few memory and interface i.cs this versatile display controller makes high-resolution colour graphics with up to 640 by 512 pels.

JOHN ADAMS

Bus control signals on the VSDD are intended for an 8086 or 8051 bus interface. The design shown in Fig. 6 is in two parts, the second consisting of an interface to an HD64180 processor such as is used in the SC84 computer.

VSDD can work with two independent clocks Fig. 7. The video-display clock drives high-speed logic for generating video and synchronizing signals while the video-system clock operates the system parts of the chip. Video system sections include the bus interface, video memory interface and construction processor. In a minimum system only one clock is used and that signal can be generated using an internal clock oscillator by connecting a crystal between the pins XTALIN and XTALOUT. Provision is made for the use of two external clocks as it is possible to clock the video section at a higher rate than the system, thereby achieving higher pel rates.

Two versions of the VSDD are available; the '-3' version has maximum system and video clocking rates of 10MHz and 15MHz respectively. When using separate clocks

connect the system clock to XTALIN and the video clock to CKIO.

Two 640-by-4-bit line-construction buffers are built into the VSDD: one of these is loaded with data from memory while the other is outputting display data. When working in the two or four-bits-per-pel bit-mapped mode, this buffer is treated as being 640 pels long, the difference being that in the two bits per pel mode only two bits are valid, the other two being obtained from the object's descriptor table. When working in eight bits-per-pel mode the buffer is treated as being 320 pels long.

For character objects the buffer is always used in the 640-by-4 mode. Figure 8 shows how the state, *i*, of a character dot selects the colour. In limited mode, two colours are available whereas in full attribute mode the full range of colour is available through the values stored in the FCND and BCND fields within the object descriptor.

At the beginning of every frame period the VSDD reads the colour look-up table from memory. This table consists of sixteen 12-bit words and is initialized by the host processor

writing sixteen 16-bit values to the colour look-up table area of memory. Each written word consists of four 4-bit fields. Three of the fields are values corresponding to the three primary colour intensities required. The fourth field is the colour's address in the table. During output, the four bits of data (the lower four for 8-bit mode) are used as the address pointer into the colour table. The three 4-bit values drive three of the four digital-to-analogue converters which in turn drive the RGB pins.

Seventeen analogue levels can be output by the system, the seventeenth, which is approximately one level below the lowest colour value, being output during blanking periods. External buffering to 50Ω is provided for the four analogue output signals as is a common, adjustable, reference voltage for the digital-to-analogue converters. Colour two is used as the background colour, i.e. it is displayed when a scan line contains no objects and during display of the programmable margin.

A colour defined as one unit of each of red, green and blue activates the I (insert) pin.

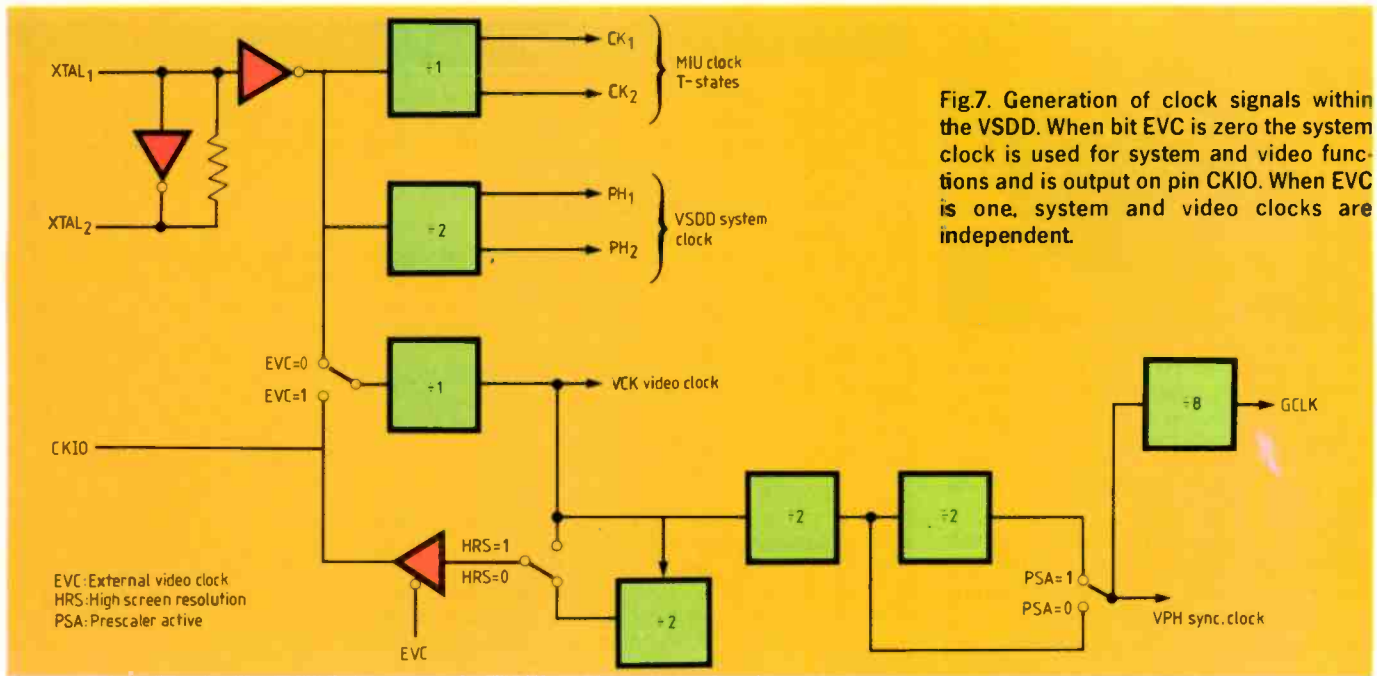
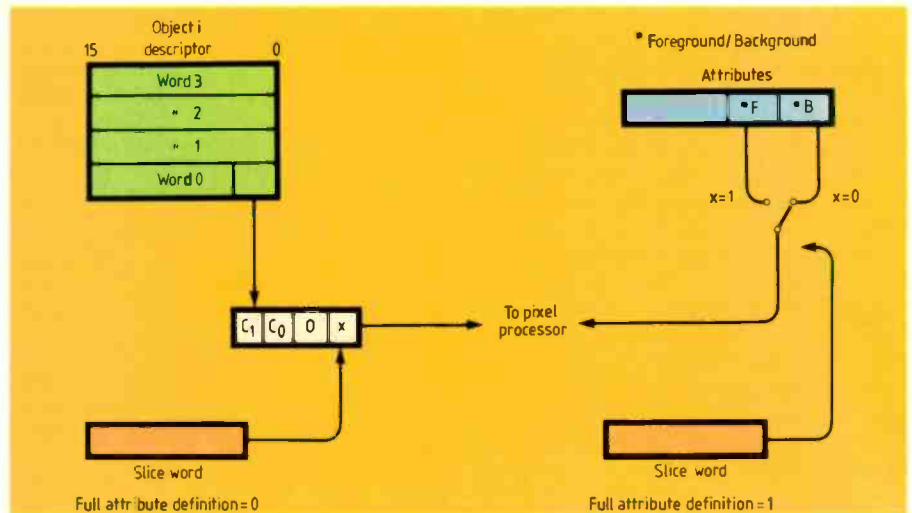

Fig.7. Generation of clock signals within the VSDD. When bit EVC is zero the system clock is used for system and video functions and is output on pin CK10. When EVC is one, system and video clocks are independent.

Fig.8. Colour selection for the two text modes. Each bit of the slice word fetched from the character generator is expanded to a 4-bit pel code. When FAD is zero the slice word bit is directly combined with two from the object descriptor to select one of two colours across the whole object. When FAD is one the slice word bit selects between two, three or four bit words held within that character's own attribute word – giving individual foreground and background colours for individual characters.



This pin is like the other analogue pins except that it only gives out two values, those corresponding to the colour digital values 0 and 15. Fifteen is the norm but the specific colour code 111 switches it to the zero value. It is possible to program this colour as the background colour in which case the \bar{r} pin can act as a 'data insert' to overlay graphic data on a conventional video display.

This mode can be very effective when the VSDD is used in slave mode, under control of the conventional system's sync. signals. Under these conditions a phase-locked loop circuit in the VSDD can be used to synchronize the crystal clock to the main system clock allowing superimposition onto an off-air image.

By programming certain control bits, the four analogue lines, \bar{r} CB \bar{r} , can be made to act as a four-bit digital bus sending either the four-bit input to the colour table or one of the three (software selected) colour table outputs. Direct output of the colour-table input code, i.e. the construction buffer output, is used during eight bits-per-pixel mode. In this mode the VSDD multiplexes pairs of four-bit nibbles onto the pins which can be captured by external circuitry and used to produce up to 256 colours. The mode in which the colour table digital values are output could be used where a colour separation print was required.

Positive and negative synchronizing signals are available. Separate or combined

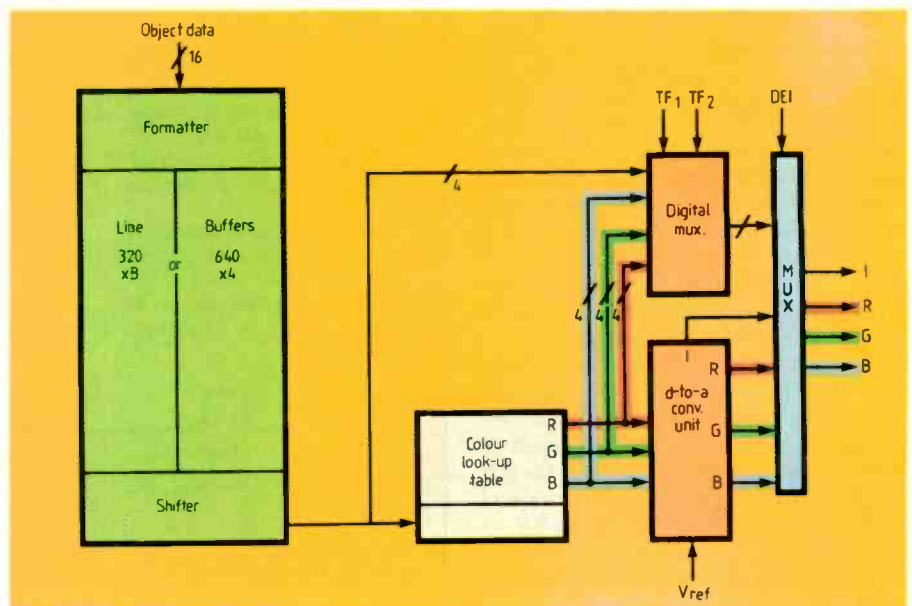
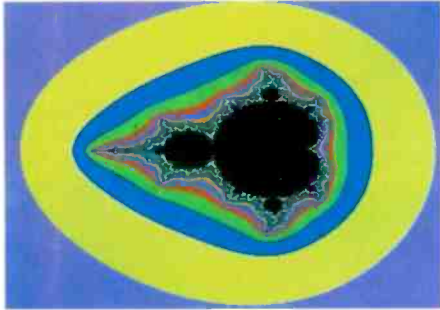

Fig.9. Pel formation within the VSDD. Control bits TF1, TF2 and DEI select the format of the data output on pins RGBI.



Listings for a 9-by-6 character generator in VSDD format and for an HD64180 program to generate the Mandelbrot plot shown in less than four minutes are available from John at 5 The Close, Radlett, Hertfordshire for three loose 18p stamps.

sync. signals may be selected by a bit in one of the control registers.

Bus buffering converts HD64180 signals to 8086 form. Signal \overline{ME} is a 64180 line indicating that a memory cycle is occurring. As it goes active once the address lines are stable it can act as \overline{ALE} . Paging line $\overline{PAGE\ 5}$ is a chip-select signal produced by the SC84 c.p.u. board using address lines A_{16-18} . It acts as the most-significant address line of the VSDD, A_{16} . It is possible to think of this pin as a programmable chip select. By gating line $\overline{PAGE\ 5}$ with the data bus enable signal \overline{E} , a signal indicating that a bus transaction is taking place in memory page five is available. This signal is used to select between the eight-bit data bus and the 16-bit address lines, producing the multiplexed 8086-like bus.

The only other timing requirement is for a delayed read signal which is produced by gating the relatively early 64180 \overline{RD} signal with the bus-transaction signal. Other requirements are for an active high \overline{RESET} and open-collector buffering on the \overline{RDY} and \overline{CRO} signals, the former being used directly as the 64180 \overline{WAIT} signal and the latter, once inverted, as an interrupt.

After a hardware reset the VSDD is configured in 'single' mode with analogue colour selected but with the display disabled and the sync. outputs in a high-impedance state. Access to video memory and the priority access system are disabled, the \overline{RDY} pin is configured as a \overline{WAIT} generator and the \overline{CKIO} pin is in a high-impedance state, the system clock acting as both system and video clocks. The register window is accessible and is mapped to appear at byte locations 400-41F in the main-processor memory map. Immediately after reset is released the VSDD performs eight very fast refresh cycles in order to 'power-up' the substrate generators in external dynamic video memory and is then, 10 μ s after the reset, ready for use.

The first write to the VSDD should be to the first location in the register window. This write is unique in that the VSDD acts on the lower eight bits of this word as it passes it on to the video memory. Specifically the bits \overline{DOF} , $\overline{DF_1}$ and $\overline{DS_2}$ describe the configuration of the video memory to the VSDD and the \overline{UCF} bit, when clear, instructs the processor to store but not to act upon the other control words being written until the \overline{UCF} bit is set.

Following this procedure is very important as the device may act oddly if the control registers are accessed by the VSDD before

VSDD REGISTERS

These register descriptions illustrate flexibility of the video display and storage i.c. Almost all functions are programmable. In the tables, the column headed Cond. describes the condition of the bit for which the function description is true. Complementing the bit makes the function false.

Video configuration register R0

Bit	Mnem.	Cond.	Function.
0	UCF	Clear	Locks out updating of all registers except $\overline{VCR_0}$ and ATBA.
1	DEI	Set	Enables digital data o/p (rather than analogue).
2	SAB	Set	Memory access 3 clock cycles (slow).
		Clear	Memory access 2 clock cycles.
3	DEN	Set	Enables display.
4	HRS	Set	Permits lines of 321 to 640 pels.
5	DOF	Set	Selects 4bit 16K d-rams
		Clear	Selects 1bit 16K d-rams.
6	DS ₁	Set	Selects 64Kbit d-rams
7	DS ₂	Set	Selects 256K-bit d-rams.
8-12	BR	-	Blink rate in multiples of 8 frames.
13-15	DC	-	Blink duty cycle in 1/8ths of blink period.

Video configuration register R1

Bit	Mnem.	Cond.	Function.
0	PRE	Set	Selects pipeline access mode.
1	PSA	Set	Halves sync. generator clock rate.
2	RE	Set	Allows system to read from video memory.
3	F AE	Set	Converts \overline{RDY} pin to FREE ACCESS indicator.
4	PCE	Set	Enable priority-access mode (used only with \overline{RDY}).
5	EVC	Set	\overline{CKIO} acts as input for separate video clock.
6	VP	Set	Selects European interlace vertical sync.
7	TMS	Set	Configures VSDD as slave in twin mode.
8	TMM	Set	Configures VSDD as master in twin mode.
9	SM	Set	Combined sync. signal produced at HSYNC pin.
10	MAS	Set	VSDD generates sync.
		Clear	VSDD inputs sync.
11	INL	Set	VSDD generates interlaced display.
12-15	CH	-	Char. height in display lines (0 implies 16).

Register-window base address R2

Bit	Mnem.	Cond.	Function.
0	ME	Set	Enables margin of background col. around image.
1,2	TF	-	Selects red, green, blue or pel code digital o/p (DEI set).
3	PLL	Set	PLL o/p only active during hor. sync.
4-15	RWBA	-	Upper 12 bits of reg. window word address.

Data-window base address R3

Bit	Mnem.	Cond.	Function.
3-9	SB	-	Upper 7 bits of 10bit coordinate of r.h. display edge. By specifying SB, no time is wasted in constructing non-displayable data.
11-15	DWBA	-	Upper 5 bits of data-window word address in host memory.

Data-length mask R4

Bits 11-15 of this register are DLM and form the upper five bits of a mask used to qualify which bits of a processor address must match those in the DWBA for the address to be accepted as being in the data window. For example, 11100 represents a 16Kbyte window 11000 a 32Kbyte window and 10000 a 64Kbyte window.

Data-segment base address R5

Bank bits 7 and 8, whose mnemonic is BNK, form the word address of the data window in VSDD ram. Character objects must be in bank zero. Bits 11-15 are the next 5 bits of the data-window word address in VSDD and have the mnemonic DSBA.

Priority-access quantity R6

The number of priority accesses permitted per scan line is defined by bits 0-3 of this register. Their mnemonic is PAQ.

Object-descriptor table base R7

Bits 6-15, ODTBA, are the upper 10 bits of the object-descriptor word address in ram bank zero.

Access-table base address R8

The word address of the access table in ram bank zero is formed by bits 0-15 of this register. These have the mnemonic ATBA.

Colour-table base address R9

Bits 0-15 have the mnemonic CTBA and define the word address of the colour table in ram bank zero.

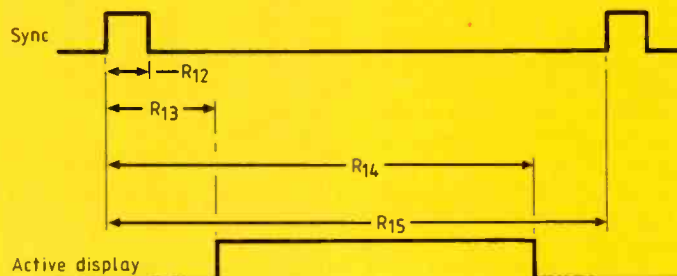

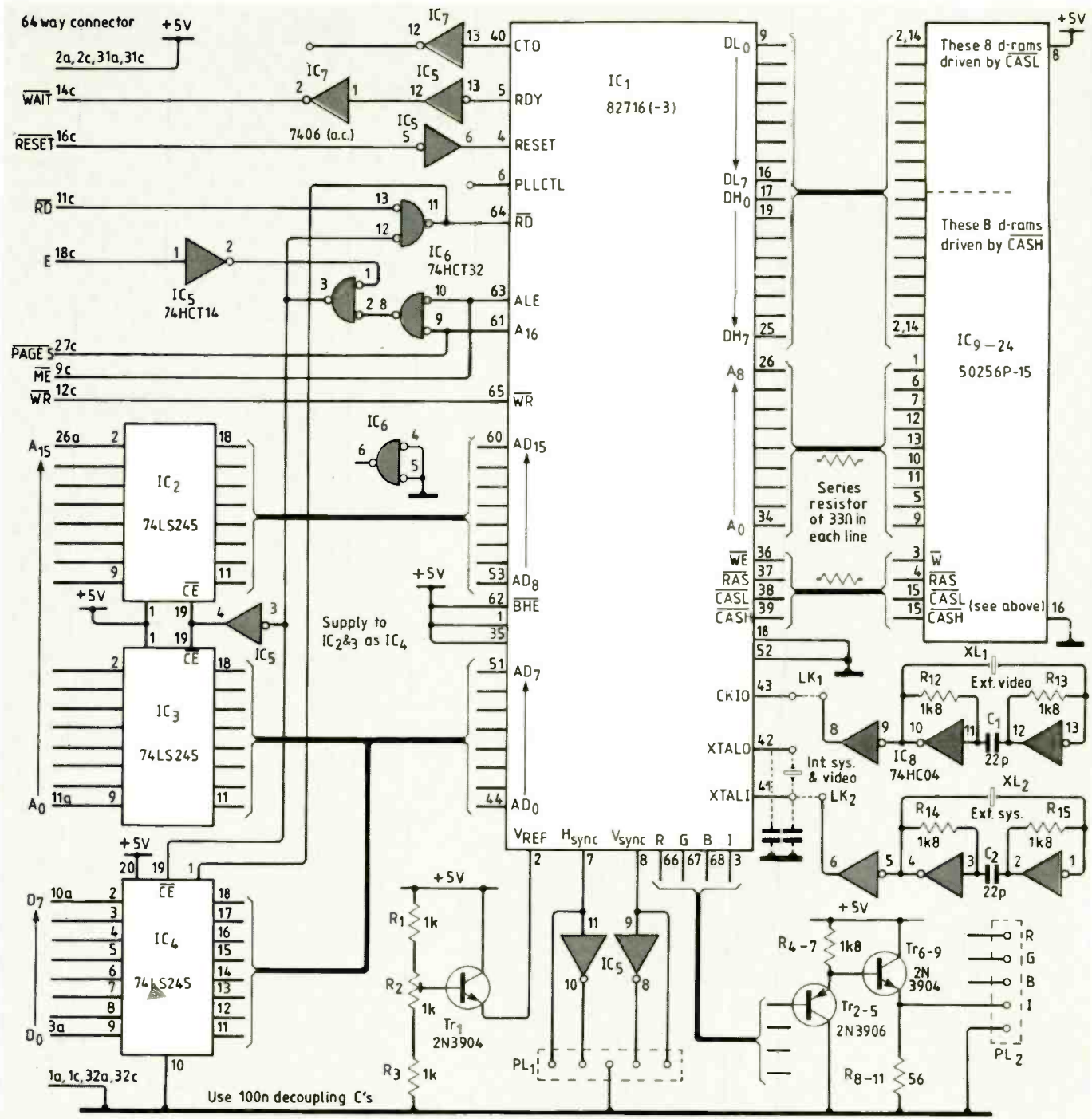

Character-generator base address R10

Here, bit groups 0-3 and 4-7 form the upper 4 bits of character generators two and one respectively. These groups are CGBA2 and CGBA1.

Access-table address counter R11

Bits 0-15 are a pointer to the next line's access word and are maintained by the VSDD.

Timing constants R12-15

In each of these registers, the lower 10 bits represent a vertical parameter measured in scan lines and the upper 6 bits form a matching horizontal parameter measured in GCLK clock cycles. In each case the value written is the intended value +1.

Object descriptors

Word 0

Bit	Mnem.	Cond.	Function
0-1	CO-1	-	Used to complete 2-bit/pixel and plain Ascii colour codes.
2	TDE	Set	Colour 0 is redefined to mean 'transparent'.
3	HCR	-	When FAD is set, HCR selects extra colour capability on text.
4	BLA	Set	Inhibits object display.
5	OBL	Set	Object blinks.
6	FAD	Set	Full-attribute mode (character only).
7	PSE	Set	Enable proportional character display (character only).
6-7	-	-	Upper 2 (i.e. bank) bits of object base address (bit-map only).

Two versions of the VSDD are available, one for maximum system and video clocking rates of 10 and 15MHz respectively and the other for clocks of up to 14.5 and 25MHz respectively. When using separate clocks, connect the system clock to XTALIN and the video clock to CKIO.

being initialized. The resulting mayhem may put the computer into a permanent wait state, causing loss of all computer data, or cause random output of display synchronizing signals with the risk of damage to the display itself.

There are two prime reasons for this unpredictable activity. Firstly, one of the control words specifies the address in processor memory at which the register window will be mapped. If the VSDD acts on this parameter before the entire register window has been updated then the remaining regis-

SPECIAL OFFER

A limited number of VSDD display controllers is being made available to EWW readers at a special fully-inclusive price of £39.86 ; the normal one-off price is around £64.

These 12MHz devices in p.l.c.c. form with the full part number S82716-3, can be obtained by sending a cheque made payable to Thame Components to Jacqueline Cole, Thame Components Ltd, Thame Park Road, Thame, Oxon OX9 3XD. The G82716-3 in a pin-grid-array package is also available at £45.80 fully inclusive. This offer is limited to one device per reader.

Combe Martin Electronics of King Street, Combe Martin, North Devon EX34 0AD is in the process of making a Eurocard p.c.b. for this design which is to cost £18, fully inclusive. This board has two 41612 connector positions, one at either end. One of these is wired for the backplane of John's 64180-based SC84 computer and the board can be wired to suit other backplanes.

Cards for the SC84 now include a 64180 processor with 256Kbyte memory, a monochrome v.d.u. controller, a floppy-disc interface with i/o, a hard disc interface, a half-megabyte silicon disc and a p.s.u. Boards for these designs and the original Z80 card are still available at the original prices. All software including SC84's CP/M-compatible operating system is available from John Adams.

- 8 CRS Set When FAD is set, CRS allows use of conceal/reveal. When FAO is clear, CRS selects which character generator is used (character only).
- 9-10 R0-1 - Resolution: used in conjunction with HRS (in VCRO) as in table below.
- 11 CBS Set Character mode.
- Clear Bit-map mode.
- 12-15 - Character starting dot row for display (allows smooth scrolling).

Word 1

Bits 0-9 are a two's complement number representing position of the leftmost pel of the object relative to the leftmost display pel. Their mnemonic is X. If HRS is zero, X is in pels and the object may be scrolled left or right in the range -512 to +511 pels in one pel steps. When HRS is one, X is in pairs of pels and the object may be scrolled left or right in the range -1024 to +1023 pels in two pixels steps.

Remaining bits 10-15, whose mnemonic is W, describe width of the object in units of 64 video-memory bits, i.e.

Mode	Width units (pels)
2 bit/pel	32
4 bit/pel	16
8 bit/pel	8
Normal	8
Full attrib	8

*provided that W is always a multiple of three.

Word 2

All 16 bits of this register are used to describe the object-base word address in video memory. Bank bits from Word 0 are appended when in bit-map mode. For these bits, the mnemonic is O.

Word 3

Here, bits 0-15 are used to maintain data on current scanning status of the object.

Character modes

In both character modes, pairs of sequential characters are stored in sequential words of video memory with the first character in the word's lower byte. When FAD is zero, this pattern repeats. When FAD is one, the next two words after each character word contain the attributes for the two characters. Within those words, the bits have these meanings.

Bit	Mnem.	Cond.	Function.
0-2	BC	-	Background colour.
3	UL	-	Extra background colour if HCR is set. If HCR is clear, UL indicates which half of a double-height character is being displayed at this position (0 implies lower half).
4-6	FC	-	Foreground colour.
7	DH	-	Extra foreground colour if HCR set, otherwise double height.
8	UND	Set	Enables underline attribute.
9	BLI	Set	Blinks foreground between foreground and background characters.
10	INV	Set	Swaps foreground and background colours.
11	MSK	Set	Forces foreground colour to be the background colour, used in conjunction with HRS.
12	DW	Set	Causes the character to be displayed at double width and next character to be ignored.
13	TBG	Set	Causes background to be transparent.
14	TFG	Set	Causes foreground (i.e. the character itself) to be transparent.
15	CGB	-	Selects between two banks of character generators.

Character generators

Characters n dots high require n×256 words of video memory. Each block of 256 words represents a given dot row for each of 256 characters. In each word the least-significant bit is the first pel displayed.

When using uniform spacing, bits higher than the specified character width are ignored. When using proportional spacing (PSE=1), individual characters may be programmed to be any even number of pels wide between 2 and 14 using the top three bits of the word; 000 implies two-bit width, 001 implies four bits, 101 implies 12 bits and 110 and 111 both imply 14-bit width.

When using plain Ascii (FAD=0) the CRS bit selects which character generator is used for the entire object, limiting the number of possible generated characters to 256. When using full attribute mode, the CGB bit selects the character generator used for each character and hence 512 different characters may be generated.

Colour look-up table

Structure of each of the 16 words in the colour look-up table is as follows.

Bit	Function.
0-3	Colour address.
4-7	Blue value.
8-11	Green value.
12-15	Red value.

The order in which the words appear is irrelevant. At the beginning of each display frame the table is read into a 16-by-12-bit ram within the VSDD using the colour address rather than the table position to locate the values read in the correct ram locations. This look-up table is then made from the internal memory (for speed).

Note that plain Ascii characters only use colours 0, 4, 8 and 12 for background and colours 1, 5, 9 and 13 for foreground colours. Colour codes for these characters are constructed as C1 C0 00 x where C1 and C0 come from the object descriptor and x is fixed as zero for background and one for foreground. In full-colour attribute mode, only the first eight colours are available when the double-height attribute is in use.

ter writes will be to where the register window was, not is. Secondly, one control word is the base address of an object descriptor table, every fourth word of which may be used as scratch memory by the VSDD. If the VSDD acts on this parameter before it is correctly set - possibly as a result of the remapping of the register window as described above - then random memory will be corrupted by the VSDD.

As the register bank is stored at the bottom of the video memory and dynamic memory has the tendency to 'power-up' with blocks of all zeros, this will direct the VSDD to treat the very area being used for the register window as the scratch area. As chance would have it, one of the four control words which will be altered by the VSDD's scratch activities is the base address of the object descriptor table and so, once corrupted the object tables are relocated by the corruption and the mayhem continues.

When writing to the registers it is important to remember that most parameters are only updated at the end of each display frame.

A sample of the data which should be written to this window is shown separately. Once these sixteen words are written to the device, the first word should be rewritten with ucr and den set. This will ensure that no spurious operation occurs until all registers are initialized. This data is for a system using a single 10MHz clock which is to produce a non-interlaced near-standard CCIR 626 display. Such data can be used directly with standard monitors or with modified colour televisions.

John Adams, M.Sc. is with Graseby Ionics in Watford. An example of VSDD initialization values can be obtained by sending a s.a.e. marked VSDD to E&WW's editorial offices in Quadrant House, The Quadrant, Sutton, Surrey SM2 5AS.

Voltage or current?

J.W. enlarges on amplification, which is neither pure nor simple

JOULES WATT

Of course, to get a job of work done in a reasonable time, *power* (in the physical sense) is required. Some might say it helps if power is available in the other sense too, but then the situation gets a bit messy because politics becomes involved, and it might be best to repudiate that sort of power for the moment.

Yet, if we return to amplifiers in our sense of using watts of power, it appears that this signal power is only one of the quantities that arises. In addition, engineers talk about *voltage* amplification or *current* gain. The confusion does not stop there, as you might very well come across someone talking about *transconductance* amplification. And the transistor itself is said to be a shortened name for *transresistance* amplifier.

Like most things, nothing is pure and simple and voltage amplifiers often appear to amplify signals as well as voltage. Conductance is the reciprocal of resistance; is a transconductance amplifier a kind of reciprocal transresistance amplifier? I would answer no, but in earlier articles carried by *Wireless World*, Cathode Ray would have argued, I'm sure, that each was the electrical *dual* of the other. One might ask if there is any real difference in practice between amplifiers, as surely it is true that you put a signal into them and get a bigger one out?

As in many attempts to build a picture of what does occur in practice, it is best to take the ideal, or as some might say, the extreme example for each amplifier concept. At the same time, we realise that real life will probably offer a mixture of these results, with some merging into the others as the parameters change. So, as an engineer directs his or her thoughts along these lines, often the situation might be indeterminate. Nevertheless, the answer to the question is that there are different amplifiers and it is useful to examine the pure or ideal cases.

IDEAL SIGNAL SOURCES

From the beginning of the subject, people have separated from the a.c. signal paths¹ the d.c. bias arrangements that supply the power to drive amplifier circuits. Engineers and designers tend to draw a.c. equivalent circuits in which the d.c. supplies have mysteriously disappeared. To make up the 'loss' of the power supply by crossing off the d.c. sources, the active devices (the transistors and formerly valves) are redrawn as fictitious a.c. generators of voltage and current to account for the signal power observed. We all know that this signal power actually comes from the conversion of some of the d.c. bias power in the real amplifier circuits, but everyone goes along with the deception, because it gives correct results and is so useful. This *equivalent generator* method makes the analysis of the signal performance of the circuit a much easier

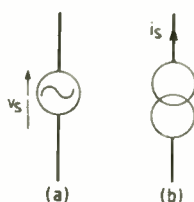

Fig. 1. The voltage generator shown in (a) supplies a terminal voltage v_s . In the general case this is an instantaneous alternating quality. Nevertheless, a "direction" is assigned, which is important to avoid errors in, for example, the application of Kirchhoff's Voltage or Mesh Law. Likewise the current generator in (b) has an instantaneous direction, thereby assisting in getting signal phase correct, or in applying the current, or Node Law.

task. It also simplifies the d.c. design calculations, which can be carried out separately. The design and performance of the whole amplifier is the sum of these two separate solutions, because nearly all circuits are designed for linear operation and the Law of Superposition applies.

A particular active device might look like an ideal voltage generator when operating. Or another device might approach the ideal current generator. One traditional set of symbols for these generators is shown in Fig. 1(a) and 1(b). The symbols have the peculiar properties of possessing, in the voltage generator case, a zero internal resistance

and, in the current generator case, infinite internal resistance. Of course, no real life generators, equivalent or otherwise, have such extremes of internal resistance, but those with low resistances approximate most conveniently to voltage sources – those with high values to current sources.

What makes the generators in amplifier equivalent circuits special is that they are *controlled generators*². A voltage across a separate pair of terminals, or alternatively a current in the separate circuit, can control the voltage or current generated elsewhere via a *transfer parameter* which determines how sensitive the cross control is allowed to be.

A little thought shows that there are four possibilities. Figure 2(a), (b), (c) and (d) illustrates these possibilities and Table 1 lists the properties. The parameters μ , r_m , g_m and α are often written as partial derivatives, where the input terminal quantities act as independent variables and the output quantities follow as dependent variables.

$$\text{Thus } \mu = \frac{\partial V_o}{\partial V_i}, \quad r_m = \frac{\partial V_o}{\partial I_i}$$

and so on.

AMPLIFIERS

Figure 2 shows the ideal or extreme versions of what can be defined as the four possible types of electronic amplifier. In type (a), the first departure from the ideal is the existence

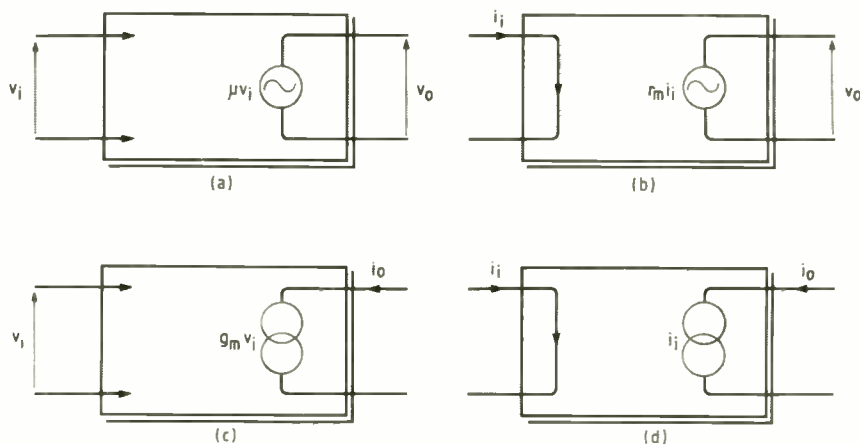

Fig. 2. The ideal voltage amplifier (a), is a controlled voltage generator operated by an input voltage v_i across the open circuit. The ideal transresistance case (b) has the voltage generator operated by an input current flowing in a short circuit. Similar definitions apply to the transconductance (c), and current (d) amplifiers.

TABLE 1

Circuit	Type of generator	Transfer parameter	r_i	r_o
Fig. 2(a)	voltage generator, voltage controlled	μ , voltage transfer ratio (dimensionless)	∞	
Fig. 2(b)	voltage generator, current controlled	r_m , transfer resistance (ohms)		
Fig. 2(c)	current generator, voltage controlled	g_m , transfer conductance (siemens)	∞	∞
Fig. 2(d)	current generator, current controlled	α , current transfer ratio (dimensionless)		∞

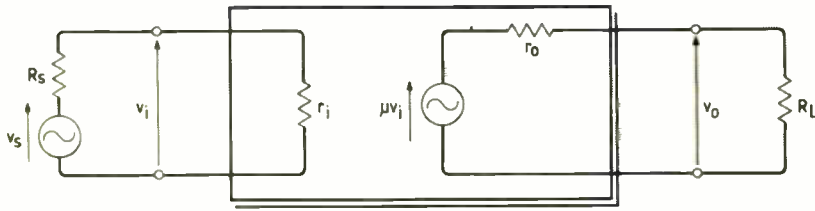

Fig.3. A 'real' voltage amplifier offers a finite input resistance r_i and output resistance r_o . The designer has to keep a weather eye on these, or the gain might be much less than expected – if the external load and source resistances are not suitable.

of finite input and output resistances. Figure 2(a) is then modified as shown in Fig.3. You might recognize this much more familiar block with its input resistance r_i , output resistance r_o , together with source signal generator (with its own internal resistance, R_s), and the load resistor, R_L .

This familiar voltage amplifier equivalent circuit enables a quick analysis to be carried out for its voltage amplification. This is defined as the ratio of the output voltage to the input voltage, and is found by noting the input and output voltage dividers (R_s working with r_i and r_o in conjunction with R_L) together with the transfer parameter μ . But one not so obvious question, and one that is not often answered very well in the books, immediately arises. Which voltage amplification are we talking about? Is it v_o/v_s or v_o/v_i , because these ratios will be different in general. I have plumped for defining the ratio v_o/v_s as A_v – the external voltage amplification, and V_o/V_i as A_v – the internal voltage amplification.

The main point, though, is to see how to arrange the design for closest approach to ideality. Clear requirements for this include the conditions $r_i \gg R_s$ and $r_o \ll R_L$. If the first condition obtains, then the external and internal amplifications, as I have defined them, become equal. If the second condition is true also, then the loss of voltage at the output potential divider disappears so that the overall gain is the absolute maximum value μ . The best voltage amplifiers must therefore have a very high input resistance, a low output resistance and a constant voltage ratio transfer function, i.e. they approximate to the conditions of Fig.2(a), in particular, it is no use connecting, say, a pH meter probe whose R_s might be $\approx 10^{10}$ ohms to a bipolar transistor amplifier whose r_i is usually about 1.5 k Ω . You won't see anything on the meter...

TRANSISTORS

Field-effect transistors yield a good approximation at the input to the conditions for amplification. They have a rather high output resistance, similar indeed to the charac-

teristics of the pentode valve stage – for those readers who can still remember them. For example, they would be appropriate for the pH probe requirement. Bipolar transistors were conceived as current driven devices, operating more or less exclusively in the common-base circuit. This circuit yields a very low input resistance looking into the emitter and a very high resistance looking back into the collector at the output. The equivalent circuit in Fig.4 shows that Fig. 2(d) is appropriate.

This would indicate that the common-base transistor circuit makes a good current amplifier. Unfortunately, the current "gain" α is less than 1, even though only slightly. This means a current loss occurs, which is a little embarrassing.

Like all good stories, there is often a messy – if not confusing part. Ours is the mode of operation that gave the transistor its name. It is the current amplifier just described that was appropriate at the time, although the actual current gain itself – or lack of it, was of secondary importance. The significant action was that the input current flowing in the low r_i could be transferred to flow (via the effect of the current-gain factor α) in a different circuit mesh containing the high resistance, r_o . So the device became known as a 'transfer resistor' or transistor for short because of this action. But this is not the same argument as that for the example illustrated in Fig. 2(b), which is a true transresistance amplifier, possessing a transfer resistance parameter, r_m . The output resistances and the type of controlled generator differ in the two cases. This could be very confusing as the same term (transfer resistor) is used in both.

SIGNAL CONVERTERS

A voltage amplifier has a gain which is dimensionless. Of course, nearly all the tiny voltages from transducers and sensors designed to respond to the enormous range of physical variations we run around detecting in the work, home and natural environment these days, need boosting to reach working levels. Some signals are produced as tiny

currents and simple current amplifiers can be used to boost these via the amplifier's dimensionless gain ratio, together with appropriate consideration of the input and output current dividers and, as in voltage amplifiers, care whether we are using the external or internal current gain.

The possibility of converting one kind of signal to another would also be very useful. The 'amplifier' then operates not only to give gain, but also *signal conditioning*. This is another way of looking at transresistance and transconductance amplifiers, namely, as current-to-voltage and voltage-to-current converters. As seen earlier, the gain parameters describing either of these amplifiers are not dimensionless, and are therefore not ratios. The quantities are *rates* and measure either the rate at which the output current changes for input voltage variations, or how the output voltage varies for input current changes.

Finally on this point, the actual transfer rates or ratios may themselves vary – in other words, they may not be constants or even simple parameters¹ any more. Tone controls in audio amplifiers carry out this kind of function. (In this case the transfer ratios or rates are functions of frequency.) Another simple application of 'doctoring' the rates or ratios in this way is to make them depend on the logarithm of the signal quality. (This time they become functions of amplitude). In this operation, direct decibel-scale outputs can be obtained⁴. This kind of functional designing-in broadens the concept of signal conditioning even more. In this last example, the amplifiers are no longer operating in the linear mode, which now therefore requires more careful thought.

So there is more in the simple idea of amplification than meets the eye. The subject could be amplified (!) further and if your appetite has been whetted, then an hour or two with a good book⁵ will expand on the design principles of particular applications. I have said nothing about negative feedback. It is well known that the use of the various methods of connecting feedback into the input terminals and of deriving the fraction sampled at the output, has a strong effect on the input and output impedance levels of the amplifier.

Current amplifiers and transconductance circuits are really inherent power amplifiers. Plenty of amperes are required to dissipate the watts required to drive most output transducers such as loudspeakers, or electric motors for that matter. But although *power* amplification was where we came in, it must now become another story – and is a subject strewn with even more pitfalls.

References

1. Cathode Ray, That Other Valve Equivalent *Wireless World* April 1951.
2. Hakim, S. S., *Feedback Circuit Analysis*, Chapter 1, (Hilfe, London, 1966).
3. Joules Watt, *Parameters, Parameters...* *E&W* February, 1987.
4. 'Non-linear Circuit Handbook' (Analog Devices Inc. USA, 1976).
5. Bapat, Y.N., 'Electronic Devices and Circuits', Chapter 4, (Tata McGraw-Hill, 1979)

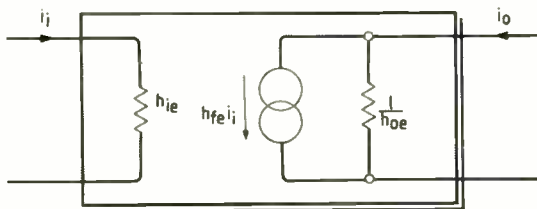

Fig.4. If h_{ie} is small and $1/h_{oe}$ large (at least compared to the source and load that is connected to the respective terminals), then this block approximates to the ideal current amplifier and fits the common-emitter transistor well.

Measuring low frequencies

Long measurement intervals in very-low-frequency measurement can be avoided by the use of a look-up table residing in rom.

H.G. DE MATTOS-SHIPLEY

A digital meter measuring the frequency of an h.f. signal is theoretically simple. One simply counts the number of signal cycles during a convenient time interval to obtain a measure of the signal's frequency. The same principle could be applied to low-frequency signals, but because everything happens so slowly, counting the cycles can be a slow business. It takes 100 seconds to tell the difference between 49.99 Hz and 50.00 Hz, and that does not take into account the possibility of rounding errors, which can arise if the time interval starts or stops at an inopportune moment.

It is, of course, possible to use a frequency-multiplying circuit, using a divider in the feedback circuit of a phase-lock loop to obtain a higher-frequency input signal. Even then, there is the problem of the time it takes for the loop to lock, not to mention tracking problems if the low-frequency signal suddenly changes frequency.

Of course, with a low-frequency signal there is nothing to prevent one measuring its period. Since that period is inversely proportional to the frequency, the latter can be calculated and the answer is available within one or two cycles of the input waveform. The meter described in this article does operate by measuring the period of the incoming waveform. What is of interest is the manner in which the frequency is obtained therefrom.

Obtaining the reciprocal of a number can be obtained by going through the mathematics, either in software if a computer is available for the task or even in hardware, although the latter requires a fairly complicated design. Another method is to use look-up tables stored in rom.

Look-up tables have the advantage that you can provide more than one "frequency" for each cycle period. A frequency meter can be used, for example, as a car speedometer taking its input from a suitable transducer. With a multiple look-up table, at the flick of a switch, the speed is available in miles/h or km/h or ft/s or even knots. It merely requires a few address bits to a rom to be changed and a different "calculation" results.

Of course, if a separate entry were provided in the look-up table for every possible time period likely to be encountered, the table could become uncomfortably large. Using a 16-bit counter for measuring the time period would require 65,536 entries for each item of frequency information to be recovered. This, however, is not necessary.

The look-up table can be arranged so as to contain not merely frequency information, but period information as well. Having measured the period of an input waveform, one can then scan the period information until

one finds in the look-up table the largest period not greater than the period measured. Stored with that value will be the corresponding frequency.

This method has the advantage that the frequencies for which there are entries in the look-up table need not be equally spaced. The meter can be arranged to have different resolutions at different points of its scale. A meter for measuring the mains frequency could have (say) a resolution of 0.01 Hz in the region round 50 Hz (or 60 Hz or both) while having a resolution dropping to only 1 Hz below 40 Hz or above 70 Hz.

Further, the meter can operate quickly, for there is no reason why the look-up table scanning should not proceed while the period is being measured. This is a simple matter. One simply arranges the entries in the look-up table in order of size of period.

The meter then operates as follows. At the start of an input signal cycle, a timing counter is zeroed, as is a counter used as a pointer into the look-up table. The timing counter is then incremented at regular intervals to measure the length of the period.

As this counter is incremented, its value is compared with the first timing period obtained from the look-up table. This first value corresponds to the period representing the transition between the highest frequency (which would correspond also to frequency overflow) and the next highest frequency. If the values are equal, then the look-up table pointer is incremented to point to the next transition period.

The process is continued until the end of the input cycle. Since the look-up table pointer points to that part of the look-up table corresponding to the detected frequency, it can be used to extract from the look-up table the frequency information which is to be the output.

The only other requirements of a practical circuit are suitable input signal conditioning, data steering to take into account the liking of cheap roms (that is to say eproms) to deal in data which is eight bits wide, and some means of detecting frequency underflow.

The principles of operation have been outlined, but the circuit can be varied to suit particular requirements.

In this circuit, I have assumed a maximum of 256 different period transitions. The circuit will accordingly only output 256 different frequencies, but these can of course be distributed in such manner as is desired. Again, it is merely a case of programming the eprom with the appropriate data. For each frequency, up to 16 bits of output information may be required. What form

this data takes is arbitrary: It could be binary code, b.c.d. code or even direct output for seven-segment devices. If b.c.d. coding is used, the output data could contain code to blank the less significant digits of the display to indicate the resolution of the meter in the area of the frequency detected.

There is also provision for four different sets of transition periods and corresponding output data to be available. This is implemented by switching two bits of the eprom's address data. A mains frequency meter can have its area of maximum resolution switchable between 50 Hz and 60 Hz, with two more "spreads" available.

In the circuit shown, the input signal period is measured using a 16-bit counter driven at 1 MHz (Counter 1). This will measure a maximum period of 65.535 ms, corresponding to a minimum measurable frequency of about 15.26 Hz.

Exactly how the 16-bit counter is constructed does not matter. Synchronous counters clocking on the rising edge of the input signal can be used with signal *a*, while asynchronous counters clocking on the falling edge of the input signal would use signal *b*. Likewise, signals *c* and *d* are used for active high and active low "clear" or "reset" signals. (Resetting should be asynchronous.)

The clock is derived from a 2MHz oscillator of standard design (Oscillator 1), and the flip-flop FF₁ provides the two phase signals *a* and *b*.

No signal conditioning circuitry is shown, but will be present if necessary. On the falling edge of the input signal, flip-flop FF₂ is reset. On the next rising edge of signal *a*, this is detected and stored in flip-flop FF₃ (which also resets FF₂). Flip-flop FF₄ provides signals *e* and *f*, indicating that the falling edge of the input signal has been detected, but this is information is delayed for one cycle of signals *a* and *b*.

If the start of an input cycle has not been detected, and the timing counter has not overflowed (detected by flip-flop FF₅), then the circuit undertakes the following tasks. At the start of Phase A, the timing counter (Counter 1) is incremented. Meanwhile the least significant byte of the current timing transition period is fetched from the eprom and is tested for equality with the least significant byte of the timing counter. At the end of Phase A (which is the beginning of Phase B), the results of this comparison are latched in FF₆.

Multiplexer 1 is an octal 2-to-1 multiplexer, which may be constructed in any convenient manner. Signals *a* and *b* are both available, which means that quad And-Or gates could be used. CF₁ is an octal comparator which produces an active low of the

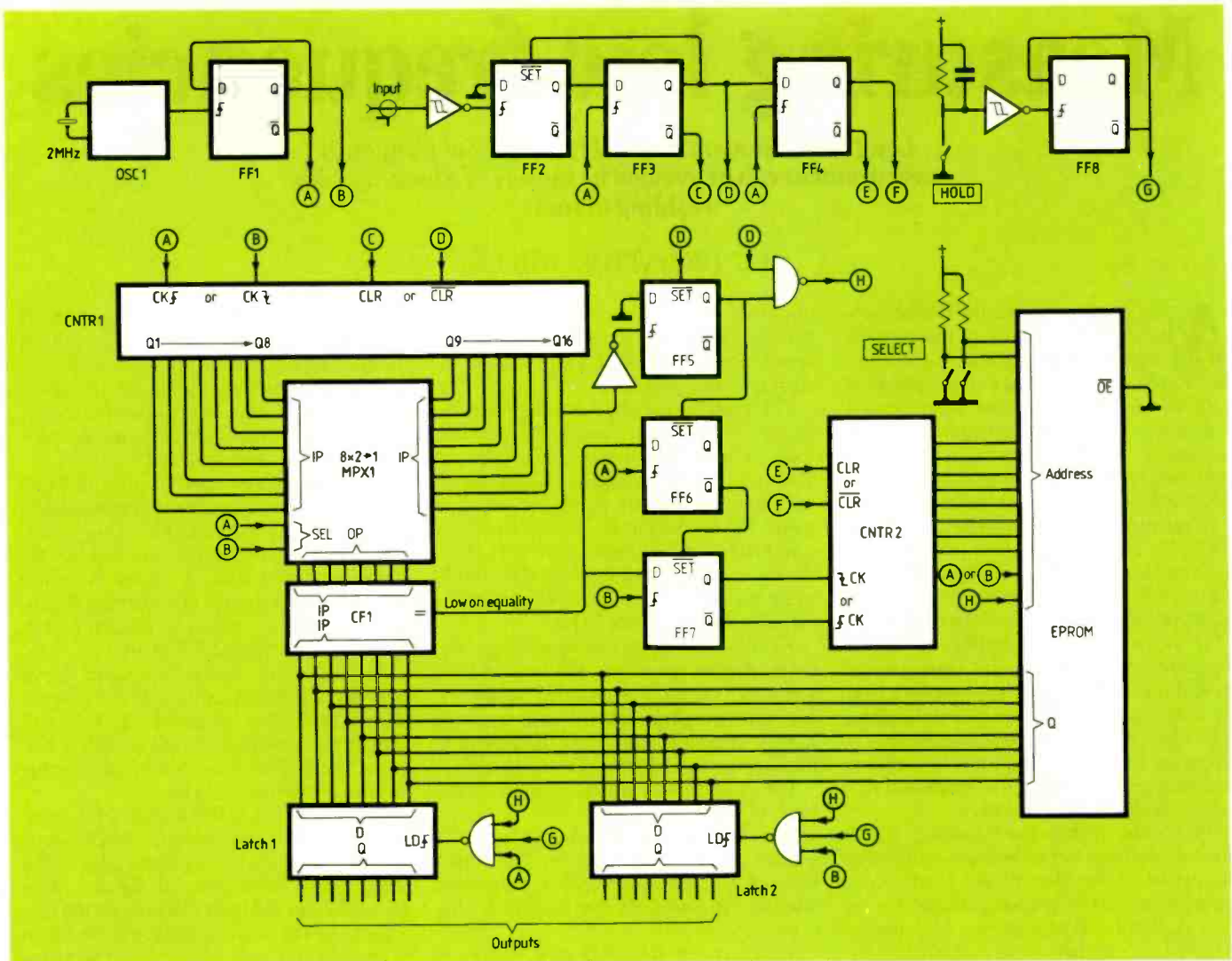

Fig.1. Complete theoretical circuit diagram of low-frequency meter. Device types are not specific and circuit functions can be carried out by available i.cs.

output when the two inputs are equal.

During Phase B, the most significant byte of the current transition timing period is fetched from the eeprom and is now compared with the most significant byte of the counter. At the end of Phase B, the result of this comparison is latched into FF7.

The SET input of FF6 and FF7 are used to ensure that the output of FF7 will only go low if both comparisons led to the relevant bytes being found to be equal and then only if the counter has not overflowed (detected by FF5).

The output of FF7 is used to increment the look-up table pointer counter. Counter 2. Again this could be constructed using synchronous or asynchronous counters with an active high or active low "clear" input. The "clear" input should be asynchronous.

As has been described, the end of an input cycle (and hence the start of the next) is detected by FF2, FF3 and FF4. Various things now happen. Signal C or D is used to reset Counter 1. Meanwhile Latch 1 and Latch 2 are loaded with the recovered output data, and when all that has been accomplished, signal E and F is used to reset Counter 2.

The choice of latches is essentially arbitrary. In the circuit described, the latches are loaded either on the LD input being taken low (as with the LE input of a 4511 c-mos latch/decoder/driver) or on the rising edge of

the LD input (as with a 74C374 or 74HC374 octal D-type flip-flop). An active-high load input latch could be used if the appropriate Nand gates are replaced by And gates, or the outputs of the Nand gates are inverted.

If the timing counter overflows, this is detected by FF5 since if the input had been disconnected (thereby stopping the flow of input signal cycle starts), the output information would not otherwise be updated. With no signal applied some "frequency underflow" indication is needed. Accordingly, after FF5 detects counter overflow, signal H is generated to cause the output information to be latched on the appropriate phases of signals A and B. When the next input cycle start is detected, then FF5 is reset, and normal operation resumes.

Finally, flip-flop FF8 is used to provide a "hold display" facility. Since the data output changes with each cycle of the input waveform, a display output may be difficult to read if it is jittering between adjacent values. The output signal G of FF8 is used to prevent the output latches being updated, thereby freezing the display.

The Eeprom is permanently enabled, and is shown with its data output driving CF1 and the two latches directly. If any of these devices are (say) LS T.T.L. rather than c-mos input devices then some buffering may be required.

Further, although this circuit has been described as a frequency meter, the output information is essentially arbitrary - what is put into the eeproms comes out.

With the circuit shown, the signal H used as an address bit must distinguish between data corresponding to transition periods (H low) and output information (H high). The address bit corresponding to signal A or B will distinguish between the bytes that go to make up the transition period data (H low) or the output data (H high).

With two "select function" address bits and an 8-bit counter for Counter 2, the eeprom is of 4K-byte size. Like the rest of the circuit this may be varied.

The only critical point about the information stored in the eeprom relates to the transition period data. This must be organized to be output in increasing order as Counter 2 counts up, because CF1 only detects equality and, if it misses a comparison, then Counter 2 will not be incremented.

Further, in order to ensure that Counter 2 does count, FF7 must be set between transition periods. This can be achieved if all adjacent transition periods differ by two or more counts of Count 1. Otherwise, the circuit must be re-arranged with the output of FF7 being used as a "clock enable" input to Counter 2, the clock being derived from signal A or B.

Pioneers

5. Samuel Finley Breese Morse (1791–1872) – the American Leonardo

A good Trivial Pursuit question might be, "Who invented the Morse Code?" Not very taxing, you might think: but the answer is less obvious than it seems.

Morse was an artist, painting his great love. He was a founder and the first President of the US National Academy of Design. When he took up a second career as an engineer-inventor he left his art unwillingly and grieved over the loss for years.

Samuel Finley Breese Morse – the American Leonardo, according to an enthusiastic biographer – was born on 27th April, 1791 in Charlestown, Massachusetts, a sixth-generation American. Named after his mother's parents, taking their surnames as his Christian names, he was called Finley by his family. He and two brothers were the only survivors through birth and infancy of eleven children. Later he fathered eight of his own.

Whilst a student at Yale his reputation as an artist began to grow, especially for his ivory miniatures. But his father dissuaded him from art as a career and, for a time, Morse became a clerk in a bookshop.

His talent was not to be restrained, though. On 13th July 1811, aged 20, and with his parents blessing, he sailed for England where he studied art for the next four years, mainly at the Royal Academy in London. Among his works were at least three of outstanding merit. One, 'The Dying Hercules', was exhibited at the Royal Academy; another, a statuette of Hercules, won a gold medal from the Society of Arts.

On his return home his hopes of reviving the splendour of the fifteenth century crashed. Though admired, his historical paintings were not bought and for income he turned to portraiture, seemingly the only form of painting Americans would buy. At this he excelled.

His personality brought him social respect; his art scratched him a living, though at times meagre. Best known of his works are probably two portraits of Lafayette, painted in Washington in 1825, and the slightly earlier 'The Old House of Representatives' which includes 86 portraits.

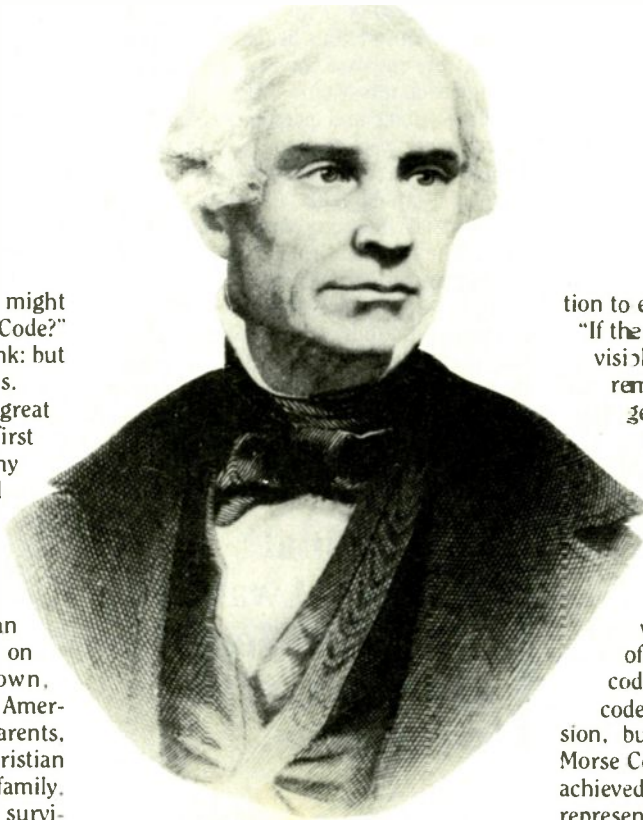

Institution of Electrical Engineers.

“If the presence of electricity can be made visible... I see no reason why intelligence may not be transmitted instantaneously.”

Even in those early years Morse appears to have been something of an experimenter. For a portrait of his wife and children he ground the pigments in milk. Another time he used beer!

The mid-1820s brought change for Morse. In four short years his wife, father and mother all died. In 1829 he again sailed for Europe and spent the next three years mostly in France and Italy.

On the return voyage in 1832 a fellow passenger drew the dinner-time conversa-

tion to electricity. Soon Morse was hooked. "If the presence of electricity can be made visible in any part of the circuit," he remarked, "I see no reason why intelligence may not be transmitted instantaneously by electricity." By the end of the voyage his notebook was crammed with sketches and ideas. The next dozen years transformed his life – and the world.

He devised a system in which words were represented by groups of numbers and he began work on a code book. Each numeral was further coded into dots and dashes for transmission, but this was not the now famous Morse Code. Speedy transmission was to be achieved with lead 'types' which had teeth representing the dots and dashes of the numerals. Assembled on a bar, they were pulled across contacts so that the teeth switched a battery in and out of a two-wire circuit. From the beginning he wanted a receiver that would give a permanent record of the message. The earliest model had an electromagnet which moved a pencil to mark the dots and dashes on to paper tape driven along by clockwork.

Evidently Morse's proposals owed little to the rush of European ideas for magnetic needle telegraphs. His thoughts were his own, and for years he found it difficult to believe that anyone had considered electric telegraphy before him.

After landing at New York he tinkered with telegraphy until necessity forced itself upon him. He had children to support, paintings to finish, and very little money.

By the end of 1835 he was at the University of the City of New York (now New York University) as professor of painting and sculpture (later as professor of literature of the arts of design). Apart from teaching and painting, both of which brought in a little money and took most of his time, he was once again working on the telegraph.

A friend who saw this early telegraph was Leonard D. Gale, a professor of science, and in him Morse found a partner. In particular

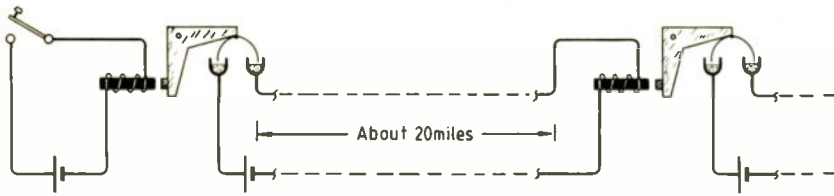

Morse relay system, as published in 1867. An electromagnet closed a mercury switch which activated the next battery and a further 20 miles or so of wire.

he learned from Gale of Henry's achievements with electromagnetism. Henry had pointed the way to telegraphy in 1831 when he signalled through more than a mile of wire to cause an electromagnet to strike a bell – the first electric bell!

Gale's contributions included recognizing the need for a large number of turns of fine wire (hundreds instead of tens) at the receiving electromagnet, and a multiple-cell rather than single-cell battery at the transmitter (so as to give a much higher voltage). This knowledge Gale had learned from Henry, and with such help Morse increased his range from a meagre 40 feet to a respectable 10 miles. On a number of occasions later Henry gave direct advice and encouragement.

Meanwhile the US Government had begun to consider whether some form of telegraph system would be of use to America. Amongst others, Morse responded with his proposals on 27th September, 1837. In October he began his application for a patent, which was granted on 20th June, 1840. His bid for a British patent was foiled by objections from Cooke and Wheatstone who had already patented their own telegraph system.

A third man, Alfred Vail, who had been a student only a year before, joined the partnership in September 1837, bringing much-needed financial backing as well as great mechanical skill. In Morse's own words, the original equipment was made up of "an old picture or canvas frame fastened to a table, the wheels of an old wooden clock moved by a weight to carry the paper forward" and "three wooden drums". It was so crude he was reluctant to have it seen.

Morse and Vail set to work to improve it. The lead types at the transmitter were soon replaced by a key and keyboard. At the receiver, pencils, fountain pens and embossers were tried, and the number-coded words and code book were thrown out in favour of a dots-and-dashes code for each letter. It is likely that this 'Morse' code, which underwent a number of changes, was actually designed by Alfred Vail. Morse who was very protective of his own inventions, did not refute the suggestion.

F.O.J. Smith, a fourth partner, joined in March 1838. As a lawyer his job was to steer the telegraph through the labyrinths of Washington. Here Morse made a dreadful mistake. Smith has been described by many adjectives of which perhaps the gentlest is unscrupulous. In his attempts to further the telegraph, of which he was now part owner, he is said to have abused his position as a congressman. Much later he harried Morse for a share of 400 000 francs which European countries had given to Morse as an honorary

gratuity. Morse was at times close to despair.

In 1838, with the improved equipment, public demonstrations began. The dots and dashes were embossed on to paper and gave a transmission rate of ten words per minute.

Morse's long and personal struggle for government recognition was finally rewarded in 1843 when Congress, by a narrow margin, granted \$30 000 (£6000) for a 40-mile trial line from Washington to Baltimore. The long and frustrating delays had once again brought Morse to the brink of financial ruin, with even Vail's family, who had provided funds, refusing more support. The years from 1837 to 1844 were hard, Morse preferring poverty and hunger to debt. It was his tenacity in the face of rejection which brought him eventual success.

The original equipment was so crude that Morse was reluctant to have it seen.

The twin 40-mile lengths of iron wire were tested before laying. Then, with a specially designed 'plough', the wires were encased in hot lead and speedily buried. When it was discovered that the line no longer worked (the insulation having been damaged by the heat) all was discreetly recovered (Government money was involved) and the line strung up on chestnut poles using glass doorknobs as insulators.

As the two-wire line reached out from Washington it was regularly checked by sending messages both ways. At last on 24th May 1844, soon after his 53rd birthday, Morse opened his telegraph with the famous first message, "What hath God wrought!"

That year's Democratic Convention in Baltimore brought further publicity. The vote for the presidential nomination ran to nine ballots. The result of each was telegraphed immediately to Washington where Morse had cunningly established his office in the Chamber of the Supreme Court. As the excitement grew politicians flocked to Morse's room in such numbers that the Senate was adjourned. The Morse telegraph had arrived.

By 1845 the line had been extended to New York and Boston, using one wire and an earth return. The paper embossers were eventually replaced by inkers. In turn these gave way to the sounder, perfected by Vail

after it was realized that operators could recognise messages from the clicks of the receivers.

Rarely can anything so novel have caught on so quickly. After only four years there were 6000 miles of wire in use in America and after eight years the figure was over 16 000 miles, about 70% of the world total. Morse had hoped that the Government would take up and run the telegraph as a national asset but this was not to be. Instead licences were granted and private companies set up. The first big merger took place in 1851 and produced the Mississippi Valley Printing Telegraph Company, better known later as Western Union.

At 57, after 23 years as a widower, Morse remarried. Later, as he grew rich from the exploitation of his system he became a philanthropist and again supported the furtherance of art, though his own skills were never really recovered. In 1836 he had tried his hand at politics when he ran for mayor of New York. Aged 63, he had another go, this time attempting to become a Democratic Congressman. Again he was defeated.

As the Morse telegraph spread, only memories remained of the early system over which the artist had laboured in New York. Gone were the lead types, code book, pencil or embosser and buried line. In their place was a simple system of Morse key, overhead wire, and sounder. Gone too was a public naivety which prompted one Washingtonian to ask the cost of sending a parcel to Baltimore by telegraph.

Tony Atherton works at the Independent Broadcasting Authority's engineering training college in Devon. His book, From Compass to Computer. A History of Electrical and Electronics Engineering, was published by Macmillan in 1984.

Next in this series of pioneers of electrical communication will be William Thomson (Lord Kelvin).

The distinguished group below comes from a photograph in the collection of Mr Peter Mallett.

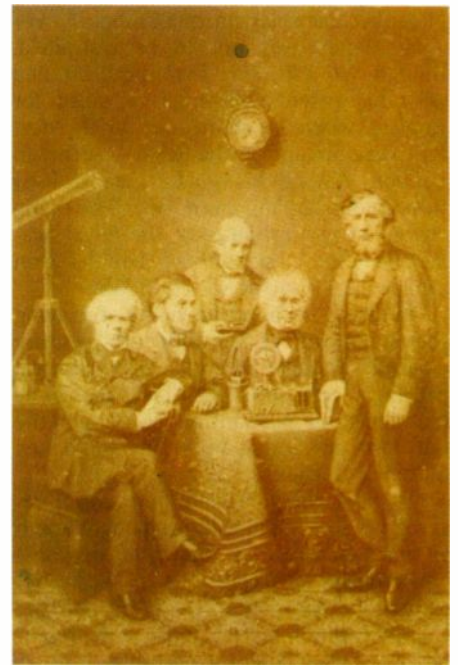

Versatower:

A range of telescopic towers in static and mobile models from 7.5 to 36 metres with tilt-over facility enabling all maintenance to be at ground level.

Designed in accordance with CP3 Chapter V; part 2; 1972 for a minimum wind speed of 140 kph in conditions of maximum exposure and specified by professional world-wide where hostile environments demand the ultimate in design, quality and reliability.

Suitable for mounting equipment in the fields of:

Communications

Security surveillance - CCTV

Meteorology

Environmental monitoring

Geographical survey

Defence range-finding

Marine and aero navigation

Floodlighting

Airport approach lighting

Further details available on request.



STRUMECH ENGINEERING LIMITED

Portland House, Coppice Side, Brownhills
Walsall, West Midlands WS8 7EX, England
Telephone: Brownhills (0543) 452321
Telex: 335243 SEL G.

ENTER 52 ON REPLY CARD

Don't Let Your Image Sensor Slow You Down

For industrial inspection and document scanning, you want an image sensor that has everything.

And above all, you want speed. With output taps every 128 diodes, EG&G Reticon's D Series Tapped High-speed CCDs™ can operate at effective sampling rates of up to 240 MHz - the highest speed of any standard commercial image sensor.

The D Series devices not only have the low noise and high dynamic range (5000:1) you'd expect from CCD's but they also have several unique features: smooth spectral response, anti-blooming circuitry, and diode reset capability, allowing you to synchronize scanning with a strobe light or other event.

To get complete information on the D Series and many other image sensing products we have to offer - for non-contact inspection, page and character scanning, robotics, or spectroscopy - contact EG&G Reticon.

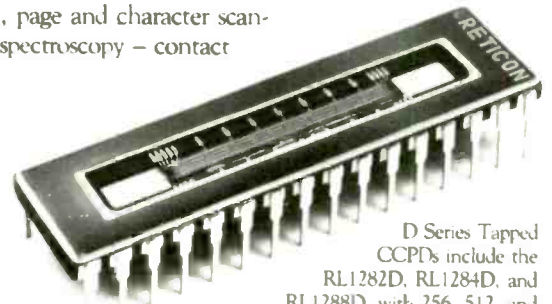

D Series Tapped CCDs include the RL1282D, RL1284D, and RL1288D, with 256, 512, and 1024 photosites, respectively. D Series Linear CCDs include the RL0256D, RL0512D, RL1024D, and RL2048D, with 256, 512, 1024, and 2048 photosites, respectively.

EG&G Reticon 345 Potrero Ave., Sunnyvale, CA 94086 (408) 738-4266 TWX 910-339-9343 or Boston (617) 745-7400; Japan 03-343-4411; England (0734) 788666; Germany (089) 92692-666.



34/35 MARKET PLACE, WOKINGHAM, BERKSHIRE RG11 1AT
Telephone: Wokingham (0734) 788666 Telex: 847510 EGGUK

ENTER 60 ON REPLY CARD

FIELD ELECTRIC LTD.

3 Shenley Road, Borehamwood, Herts WD6 1AA. 01-953 6009

Official Orders/Overseas Enquiries Welcome/Order by phone or post. Open 6 days, half day Thursday. Please ring for C/P details not shown. Postal rates apply U.K. mainland only. All test equipment carries warranty. All prices incl. 15% VAT & c/p unless stated

Power supplies all 240V AC input 5V 20A s/mode £18.00 5V 40A s/mode £28.00 5V 60A £15.95 PMA47 12V 3A Linear £16.95 Farnell 0V 40A £28.95 10.5V 30A £24.95 Farnell s/mode - 5V 10A - 24V 4A - 12V 500 mA - 5V 1A new equip data £27.75 Farnell s/mode G6 5M 10A £22.00 Farnell fan cooled s/mode - 5V 10A - 5V 1A - 12V 3A - 12V 1A £32.00 Gould 379 5V 40A 12V 4A 15V 11A s/mode £60.00 Gould 24V 15A Simult-N boxed data £60.00 5V 1A PC card regulate £48.00 40 watt s/mode PC card psi 100 - 160 - 5V 2.5A - 12V 2A - 12V 1A new £10.50 Kingshill metered 0.40V 0.2A £80.00 Metered 0.40V G2A £80.00 Metered 0.40V G2A - 2 £125.00 Metered 0.50V 0.1A £46.00 Metered 0.50V 0.3A £75.00 Metered PSU auto zero rated voltage and current	Marcon Sanders 6600A 1 micro wave sweep oscillator mainframe c. with 26.5 400Hz RF Osc unit £3,450.00 r/p please ring.
Bulgin Bender 250V 6A IF, Filter Plug Units chassis mount, integral mains filter £3.50	Hewlett Packard 3330B frequency synthesizer 0.1Hz to 1MHz digitally sweeps amplitude and frequency £2,400.00 c/p please ring.
PCB 16+ 2716 Fproms new £13.95	Hewlett Packard 1611A 1 meg. State analyzer c. with option A85 for 8085 microprocessor option A80 for 8080 microprocessor various probes etc. £1,500.00 clock probe 6 bit data probe etc. r/p please ring.
Sonnetcen A200 DVM 8bits, new and boxed 12V DC 57Ah charging volts 1.38 maximum ABS case £16.95	Hewlett Packard 675A sweep Signal Gen. 10kHz to 37MHz in-line range £460.00 c/p please ring.
Papst DC Brushless Fans 2V 2.4W £8.50 c/p 1.00	Hewlett Packard 431A Distribution Analyzer any fundamental frequency 5Hz to 600kHz £345.00 c/p please ring.
12-0 12V 2A per winding, 140V Prim new transformer £3.50 c/p 50p	Si Surface NSG 100 means interference smooth mainframe c. with NSG 100 high energy pulse generator £1,000.00 c/p please ring.
6-0-6V 20A 240V Prim £25.00 new 15.00 Larr pack	Tektronix 451 150MHz c/scope opt dual trace delay sweep £460.00 c/p please ring.
Dot Matrix Printers c. with all electronics data via 240V 80MA line about rly £22.45 1422 - 1422 - 422	Tektronix 413 oscilloscope mainframe 75MHz storage £575.00 c/p please ring. No guarantee.
SPECIAL OFFER Full height disk drives 5 1/4" 80 track double side, double density 1/2 meg. S-D rec. 1 meg. D-D rec. new and boxed £57.50	ACCS Source level meter c. calculator 12V 0.1A £115.00 c/p £4.75
12V DC 7.0 amp 1.2W Permanent Magnet DC geared motor £6.00	Hewlett Packard 181A D scope mainframe c. 1801A 5MHz, D channel amp 18-1A 100MHz time base £425.00 c/p please ring.
Plastic boxes 115 - 95 - 45 6 for £5.00 All Die Cast box 114 x 64 - 30 £22.50 each	Tektronix 720 D scope mainframe 150MHz to 450MHz. No guarantees.
Fluke DVM 8100A 8100B £19.50 no guarantee	Tektronix 4051 Desktop Computer high resolution graphics and auto memory s. 8K bytes standard full 1.38 ASCII keyboard c. a. 4.00 £650.00
Winchester disk drives, random access storage device using 1 non-removable 8 rigid platter storage capacity of 10 meg, complete with data control electronics £75.00 new and boxed	Bygones 26700 high speed XY recorder A3 amplifiers 6116 76116 external paper feed. Main frame base 3630 £375.00
Winchester disk drives same as above but no equipment taken out of working equipment we cannot offer guarantee supplied with data £39.50	
Archive Sidewriter 20 meg 1/4" streaming cartridge tape drive new eqpt all electronics data £100.00 cartridge supplied	
12" Green screen monitor 754 high res. raster case single details	

ALL OUR PRICES INCLUDE 15% VAT & CARR/PACKING UNLESS STATED. SAVE TIME PHONE YOUR ORDER FOR QUICK DELIVERY WITH ACCESS OR VISA CARDS

ENTER 24 ON REPLY CARD

LOW COST HIGH SPEC

The best specifications at the best prices. Just look at the superior features.

GOS-522 20MHz DUAL BEAM OSCILLOSCOPE

- Large 6 inch rectangular screen
- Internal grid cuts
- Chop/Alternate Timebase Function
- High Sensitivity 1mV/div < 3% accuracy
- TV Triggering
- Wide Timebase Range 0.5s to 0.2 μ s
- Ch. 1 Output on rear
- Hold-off Timebase Function

ONLY £295.00

GPR-3020 BENCH POWER SUPPLY

The GPR-3020 bench power supply provides a single stabilised output variable from zero to 30 volts at 2 amps. Not only can the voltage be accurately set by use of the 'FINE' control but there is a current limit control with a 'HI' and 'LO' setting for accurate control.

The unit is supplied with the necessary lead set, 4mm plugs to croc. clips, a spare 3A fuse and comprehensive manual.

- Fully floating outputs
- Push button selection of ranges
- Clear analogue displays of Voltage and Current
- LED indicators of Constant Voltage and Current
- Fine/coarse voltage and current controls
- Series/parallel functions on multiple outputs
- Dual tracking
- Overload and short circuit protection
- All necessary leads
- Safety: BS4151EC 348

ONLY £99.00

GFG-8015F FUNCTION GENERATOR

The GFG-8015F function generator is a high specification low cost instrument, designed for applications extending from educational to the broad general purpose area. It is an extremely versatile instrument with many features. The unit gives sine, square, triangle, pulse and ramp waveforms with a frequency range from 0.2Hz to 2MHz, selected via 7 pushbuttons on overlapping frequency ranges, also giving a variable or fixed voltage TTL output.

The unit is short circuit proof and good ergonomic design makes the operation simple, while the instrument occupies minimal bench space.

The unit is supplied with two lead sets, two spare fuses, and an instruction manual.

ONLY £139.50

GAG-808B AUDIO GENERATOR

A superior audio generator providing sine and square waves from 10Hz to 1MHz in 5 ranges. Low distortion \pm 3% accuracy and fast rise times. Supplied complete with test lead, power lead and full instructions.

ONLY £99.00

SEND FOR OUR FULL
INSTRUMENTATION CATALOGUE
TODAY!



FLIGHT ELECTRONICS LTD.

Flight Electronics Ltd., Flight House, Ascupart St., Southampton SO1 1LU. Telex: 477389 FLIGHT G. Fax: (0703) 330039.

TELEPHONE NOW FOR FULL DETAILS! (0703) 227721 -6 LINES

DM 105 - Pocket DVM from Cirkit

A meter to literally suit all pockets - including the one that holds the wallet!

Its small size offers easy one hand operation, with large, clear, wide-angle display. But small does not mean delicate: the DM105 can withstand a 12 inch drop without damage, due to its glass epoxy PC boards, shock mounted display and through thermoplastic case. Overloads are handled with similar certainty: the resistance range is protected up to 500 dc, AC voltage range to 800V rms and DC voltage ranges up to 1000V.

Battery life is typically 2000 hours and a L.O BATT indicator signals 20% battery life remaining.

Ranges

DC Volts: 2V, 20V, 200V, 1kV

AC Volts: 200V, 750V

Freq Range: 45Hz - 450Hz

DC Current: 2 mA, 20 mA,

200 mA, 2A

Resistance: 2K, 20K, 200K, 2M

DC Accuracy:

± (0.5% reading + 2 digits)

Size: 130 x 75 x 28mm

Weight: 195g

Accessories: Battery, test leads

and manual.



Price **£24.75** inc VAT

Please add 70p for post and packing.

This is just one of our range of quality Analogue and Digital multimeters.

Full details and specifications from:

Cirkit Distribution Ltd

Park Lane, Broxbourne, Herts EN10 7NQ

Telephone (0992) 441111 Telex: 22478

TRADE ENQUIRIES WELCOME



ENTER 69 ON REPLY CARD

IEEE 488 CONTROLLERS FROM M A INSTRUMENTS LTD

IBM PC and clones including Amstrad PC1512.

Hall length interface card, software including Turbo Pascal, IEEE 488 cable and comprehensive operating manual. £270

Acorn 'B' and Master

Interface in separate case, software in PROM, IEEE 488 cable and comprehensive operating manual. £250

New software for existing owners of Acorn GPIB controllers which offers compatibility with the new IEEE 488.2 standard. £28

All controllers offer a command structure which follows the IEEE 488.2 standard. This simplifies the control of existing GPIB devices, reducing the number of commands needed and is compatible with new devices using IEEE 488.2 format commands.

Designed, manufactured and supported in Great Britain.

For more information contact:

M A INSTRUMENTS LIMITED
Moordene, Axtown Lane, Yelverton, Devon PL20 6BU.
Tel: (0822) 853585

Prices exclude V.A.I. and delivery

ENTER 29 ON REPLY CARD

Editorial Feature List

JUNE 1987

Batteries. Recent developments in battery design mean that an investigation into the new types available is needed. We discuss design and applications and characterize the types on the market.

JULY 1987

Computer-aided design. There is a great deal of hardware and software dedicated to the design of electronic equipment, from printed circuit boards to integrated circuits. We examine what is now available.

For further advertising details please ring Ashley Wallis on: 661 8641

INSTRUMENTS COMPONENTS EQUIPMENT ACCESSORIES

Official orders welcomed.
Export supplied.
Please add 15% VAT (UK orders only)
UK FREE DELIVERY

OSCILLOSCOPES

HAMEG with component testers	
203/6 Dual 20 MHz (with probes)	£314.00
204 With sweep delay	£418.00
205 Digital storage dual 20MHz	P.O.A.
605 Dual 60 MHz plus sweep delay	£583.00
CROTECH with component tester	
3031 Single 20 MHz, 9.5cm CRT	£199.00
HITACHI V212 Dual trace 20 MHz	
8 x 10cm	£320.00
GENERAL 0ST5m single trace 5 MHz	
3 CRT	£139.09
HUNG CHANG Dual trace with probes	
620 Dual 20MHz + component test	£295.00
635 Dual 30MHz Sweep delay	£399.00
615 Dual 15MHz bal/Mains	£399.00
650 Dual 50MHz Sweep delay	£579.00

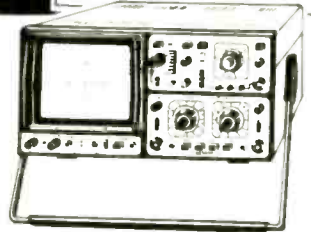

COUNTERS AND TIMERS

FUNCTION sine, sq, triangle, TTL O/P	
J500 0.1Hz to 500KHz	£110.00
TG101 0.02Hz to 200KHz	£110.00
TG102 0.2Hz to 2MHz	£160.00
PULSE Square, Complement, TTL O/P	
TG105 5Hz to 5MHz	£105.00
TV-VIDEO PAL VHF/UHF 5.5, 6, 6.5MHz	
sound carriers RGB and SYNC O/P's AM/FM sound mod.	
Colour, etc	£199.00

220/240V AC mains, 8 digit LED	
Counters 0.1Hz resolution, 5mV sensitivity	£99.00
100MHz 2 ranges	£126.00
600MHz 3 ranges	£175.00
1000MHz 3 ranges	£199.00
1500MHz 3 ranges	£199.00
Timers 0.001Hz Resolution 100MHz 5mV sensitivity	
OP10 Standard model	£219.00
OP100 Incl display hold, etc stopwatch/ RPM etc	£285.00



DC POWER SUPPLIES	
240V AC input, Stabilised variable output voltages	
Direct meter reading volts and amps.	
243 0/24 volts 0/3 amps DC	£43.26
245 0/24 volts 0/5 amps DC	£56.26
154 5/15 volts 0/4 amps DC	£33.26
Also 13.8V DC, 3 amps max. Fixed (no meter)	£13.00
0/30V 1.5A DC with volt meter	£29.95
0/30V 0/2 amps DC LCD display	£150.00

DIGITAL MULTIMETERS

3 1/2 digit LCD displays	
508 15 range, 200mA DC, 2MEG	£19.96
105 14 Range 2A DC	£21.50
528T 13 range, plus Hfe test	£26.04
55C 28 range 10A AC/DC	£35.65
6010 28 range, 10A AC/DC, 20 MEG	£33.50
7030 0.1% version of above	£39.50
578 20 range auto-memory - hold 10A AC/DC	£34.50
615 19 range, plus Hfe test, 20MEG 10A DC	£30.39
5010 31 range 10A AC/DC - buzz 20mA AC/DC	£36.50
TM357 30 range 10A AC/DC - buzz	£39.00
5010 EC as 5010 - cap - Hfe - cond.	£52.13

SWITCH MODE PSU's

Open Frame Models I/P 100/240V AC	
SX 510 to 5w (adjustable) 10amp	£7.78
65W - 5V 3A - 12V 2.9A - 18V 1A - 5V 0.2A	£13.00

Enclosed Model

85/97W - 5V 6A - 12V 4.75A 12V 0.5A	£19.95
-------------------------------------	--------

BENCH DMM'S

3 1/2 Digit LCD 10A AC/DC 20 meg, Buzzer etc.	
322 0.25%	£ 89.00
3210 0.1% True RMS	£119.00

STOCKISTS FOR:

Logic Analysers • Insulation Testers • Temperature meters • Security Systems • Public Address • Communications • Tools • Computer Equipment • TV/Video Accessories • (See Catalogue)

ORDER BY POST OR PHONE. OPEN 6 DAYS A WEEK FOR CALLERS.

HENRY'S ELECTRONICS
301 Edgware Road, London W2 1BN. 01-724 3564
404 Edgware Road, London W2 1ED. 01-724 0323
TELEX 298102 TRANS G

FREE CATALOGUE
Ref TG/W
SEND S A E
(Min 12" x 9")
with £1 stamp UK
(Export send £1.00)

EDUCATION AND ACCOUNT ENQUIRIES 01-258 1831

ENTER 25 ON REPLY CARD

Building blocks for active op-amp compensation

Actively compensated op-amps offer significant improvement to the h.f. performance of active filters. Here Professor Soliman surveys first-order circuits using two op-amps to formulate a systematic design procedure.

AHMED M. SOLIMAN

The characteristics of most active filters using operational amplifiers change significantly at high frequencies due to h.f. roll-off of the op-amp gain. Several actively compensated finite-gain amplifiers and integrators have recently been introduced in the literature (see bibliographic references) that offer significant improvements in the h.f. performance of filters employing them. This article is a wide-ranging survey of actively compensated finite-gain amplifiers and integrators.

To formulate a systematic procedure for the realization of the compensated amplifiers and integrators, five first-order building blocks are considered together with their transfer functions. Most of the actively compensated amplifiers and integrators are generated using one of these building blocks. The actively compensated amplifiers and integrators considered in this paper are limited to those employing two op-amps only.

GENERALIZED FIRST-ORDER BUILDING BLOCK

Figure 1(a) represents the generalized first-order building block employing a single op-amp, for which the basic equation is

$$\frac{V_o}{A} = aV_i + bV_o \quad (1)$$

where a and b are real coefficients having magnitudes ≤ 1 . Let the open-loop gain of the op-amp be represented by the single-pole model:

$$A(s) \approx \frac{\omega_1}{s}$$

where ω_1 is the gain-bandwidth product of the op-amp. Substituting this into (1), the transfer function of the generalized block can be shown to be

$$\frac{V_o}{V_i} = -\frac{a}{b} \frac{1}{1 - \frac{s}{b\omega_1}}$$

and the d.c. gain is $= -a/b$. For the stability of the block, coefficient b must be negative. For a non-inverting block coefficient a must be positive, and for an inverting one it must be negative.

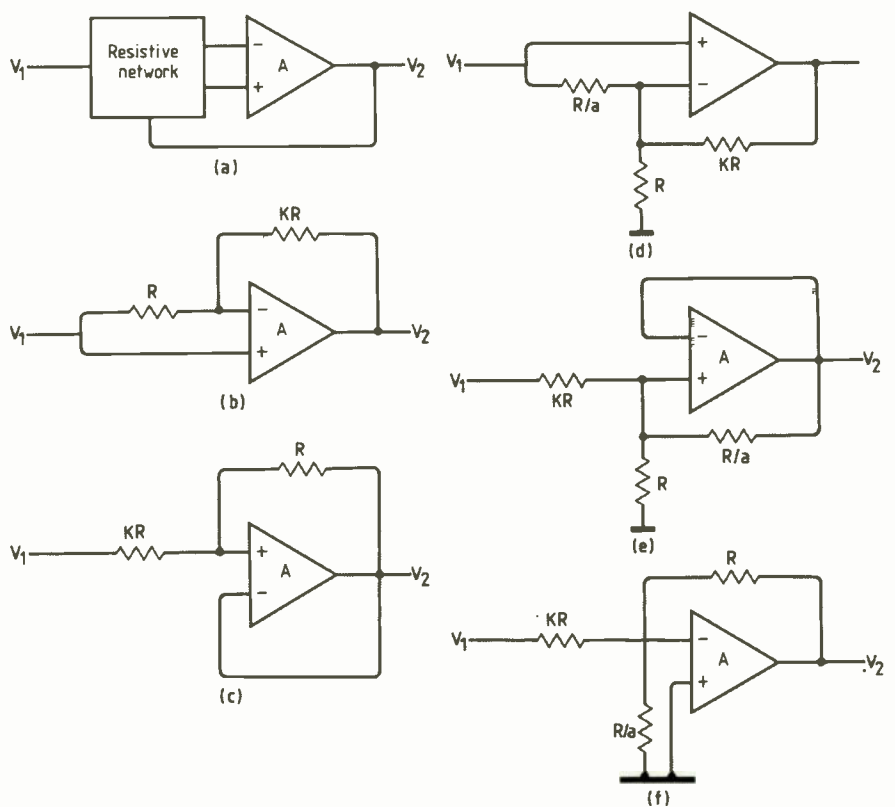

Fig.1. Generalized first-order building block (BB) employing a single op-amp (a) and two equivalent non-inverting first-order blocks BB1 (b,c) with unity d.c. gain. BB2 (d) has a d.c. gain > 1 and BB3 (e) has a d.c. gain < 1 , while the fourth BB4 (f) is an inverting block.

In the next section, five building blocks are given, where it is assumed that the single-pole model is used to represent op-amp gain characteristics.

BUILDING BLOCK 1

The transfer function of the first building block, Fig.1(b) is

$$\frac{V_o}{V_i} = \frac{1}{1 + \frac{K+1}{\omega_1} s}$$

and an equivalent building block is shown at (c). These two equivalent blocks have been employed widely in the field of active compensation. The first application is in the phase-compensated three-port v.c.v.s.

network¹ shown in Fig.2, whose general compensated expression for v_o is

$$V_o = [(K_1 + 1)V_p - K_1 V_n] E(s)$$

where
$$E(s) = \frac{1 + sT}{1 + sT_1 + s^2 T T_1}$$

$$T = \frac{K+1}{\omega_1} \quad \text{and} \quad T_1 = \frac{K_1+1}{\omega_{11}}$$

To reduce the phase error to a negligible limit it is necessary that $T = T_1$, so that if matched op-amps are used, the design equation for phase compensation simplifies to $K = K_1$. This compensation technique has been applied to realise compensated all-pass filters, and experimental results were given in ref. 1.

Actively-compensated three-port v.c.v.s. using BB1, Fig.2, with a non-inverting d.c. gain K_1+1 and an inverting d.c. gain $-K_1$, yields a negligible phase error assuming matched op-amps are used and $K=K_1$. Fig.3 is a variable-phase inverting integrator using BB1. In the improved Kerwin-Huelsman-Newcomb biquad filter using BB1, Fig.4, resistor KR in BB1 should be tuned to $K=3$ for phase correction around the loop. In the variable-phase non-inverting amplifier using BB3, Fig.6, resistor KR in BB3 controls the d.c. gain of the v.c.v.s. which equals to $K+1$. Resistor R/a controls phase. If matched op-amps are used, the condition for phase compensation is $a=K+1$. The phase-compensated three-port v.c.v.s. network of Fig.7 uses either BB2 or BB3.

The second application is in the variable phase-inverting integrator² shown in Fig.3. If matched op-amps are used, the integrator phase is controlled by the parameter K and is approximately

$$\phi \approx K \frac{\omega}{\omega_1} \quad \omega \ll \omega_1$$

Many applications for this phase-lead inverting integrator in realizing two-integrator loop filters suitable for high Q and high frequency are given in reference 3.

The three-port v.c.v.s. of Fig.2 can also be adjusted to realize a phase-lead three-port v.c.v.s. which has an important application in the phase correction of the Kerwin-Huelsman-Newcomb KHN filter. Fig.4 represents the improved KHN biquad filter. Fig.5 shows the improvement in the performance of the filter with BB1 included and adjusted so that $K=3$ to provide the necessary phase lead of $2\omega/\omega_1$ to cancel the phase lag of the two integrators (ref.4).

Building blocks 2 and 3 are generalizations of each of the first blocks. Block 2 has very limited application; on the other hand block 3 has many useful applications, as given next.

BUILDING BLOCK 3

An important application of BB3 is in the variable-phase non-inverting amplifier⁵ shown in Fig.6. If matched op-amps are used, the phase for this amplifier is

$$\phi \approx K \left[\frac{a}{K+1} - 1 \right] \frac{\omega}{\omega_1} \quad \omega \ll \omega_1 \quad (2)$$

Figure 7 is a generalization of Fig.2 using blocks 2 or 3 (see ref.6). The phase-lead inverting integrator⁷ shown in Fig.8, introduced in 1980, has excess phase given in eqn 2. Its application in the Tow-Thomas (TT) biquad and the KHN biquad is shown in Figs 9 and 10 respectively where parameters K and a for BB3 are adjusted so that $K=1$ and $a=8$ to yield the phase lead of $3\omega/\omega_1$, which is the necessary amount for phase correction at ω_{10} .

Another application for BB3 is in the realization of the variable-phase non-inverting integrator⁷ shown in Fig.11, where the phase for this grounded-capacitor integrator has the form given by (2). An improved two-integrator loop filter using this integrator has parameters adjusted so that $K=1$ and $a=4$, Fig.12.

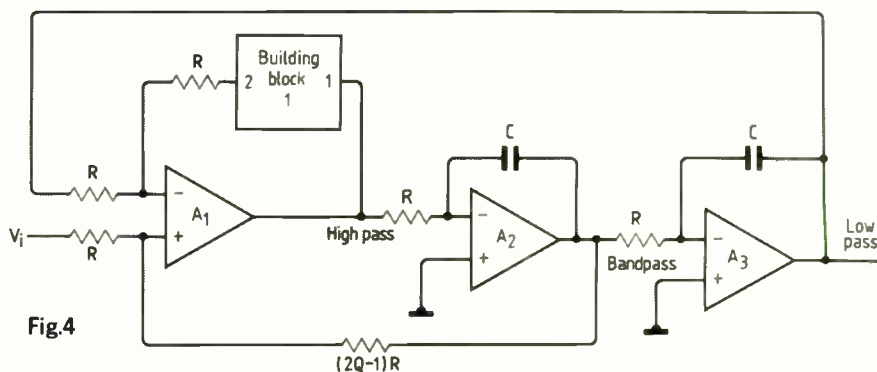

Fig.4

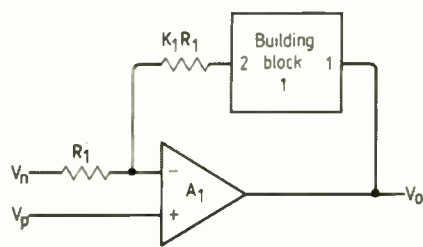

Fig.2

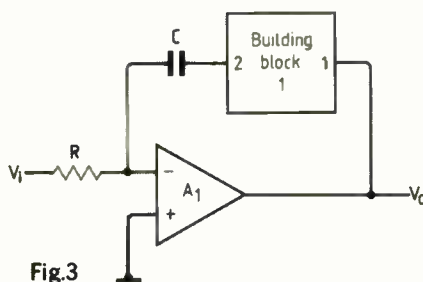

Fig.3

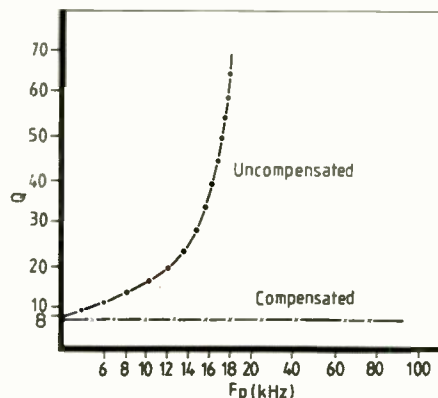

Fig.5. Graph shows measured Q versus f_p at $Q_0=8$ of the KHN filter (from ref.4).

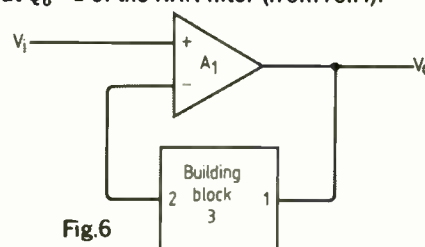

Fig.6

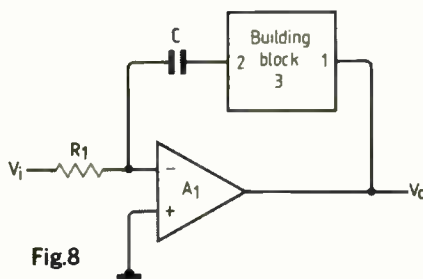

Fig.8

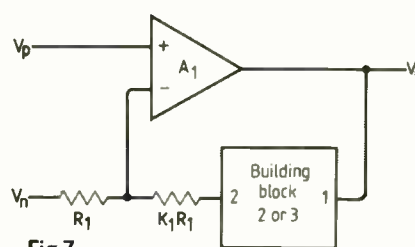

Fig.7

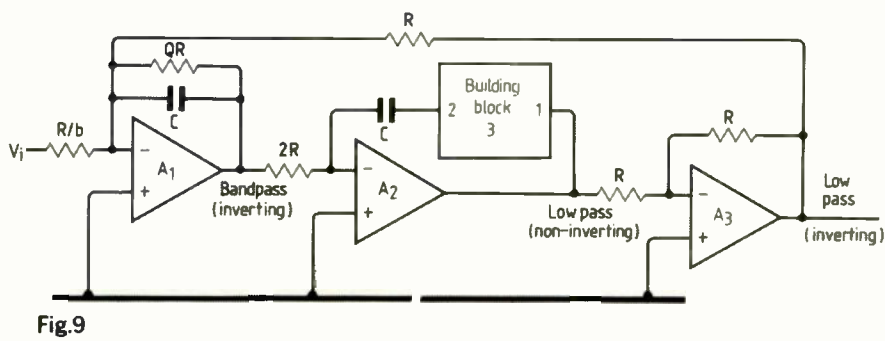

Fig.9

BUILDING BLOCK 4

The inverting building block of Fig.1(f) has the transfer function

$$\frac{V_2}{V_1} = -\frac{1}{K + \frac{K(a+1)+1}{\omega_1}}$$

Figure 13 represents the variable-phase inverting amplifier⁸ using block 4, in which the phase is

$$\phi \approx \left[a + 1 + \frac{1}{K} - K \right] \frac{\omega}{\omega_1} \quad \omega \ll \omega_1.$$

Block 4 can also be used to realise a phase-compensated three-port v.c.v.s. as shown in Fig.14. And finally, an improved TT biquad using block 4 is given in Fig.15.

References

1. A.M. Soliman and M. Ismail. Active compensation of op-amps. *IEEE Trans. on Circuits and Syst.*, vol.CAS-26, Feb. 1979, pp.112-117.
2. P.O. Brackett and A.S. Sedra. Active compensation for high frequency effects in op-amp with applications to active RC filters. *IEEE Trans. Circuits and Syst.*, vol.CAS-23, Feb. 1976 pp.68-72.
3. A.M. Soliman. Novel generalized differential integrator with controlled phase lead. *Proc. IEEE*, vol.67, October 1979, pp.1449-1451.
4. A.M. Soliman. Novel variable phase-inverting integrator. *Frequenz*, vol.36, October 1982, pp.272-274.
5. M.A. Reddy. Operational amplifier circuits with variable phase shift and their applications to high-Q active RC-filters and RC-oscillators. *IEEE Trans. circuits and Syst.*, vol.CAS-23, June 1976, pp.384-389.
6. S. Natarajan and B.B. Bhattacharyya. Design and some applications of extended bandwidth finite gain amplifiers. *J. of Franklin Institute*, vol.305, June 1978, pp.321-341.
7. A.M. Soliman and M. Ismail. Universal variable-phase 3-port v.c.v.s and its application in two-integrator loop filters. *IEEE International Symposium on Circuits and Systems*, April 1980, pp.83-86.
8. A.M. Soliman. Classification and generation of active compensated non-inverting v.c.v.s. building blocks. *International Journal of Circuit Theory and Applications*, vol.8, October 1980, pp.395-405.
9. A.M. Soliman. Novel phase-lead inverting integrator and its application in two-integrator loop filters. *Electronics Letters*, vol.16, June 1980, pp.475-476.
10. A.M. Soliman. Design of high frequency three port v.c.v.s. structures. *Frequenz*, vol.35, No.8, August 1981, pp.202-210.
11. A.M. Soliman. Two-integrator loop filters with stable Q factor. *Frequenz*, vol.35, January 1981, pp.19-22.
12. A.M. Soliman. Novel two op amps three resistor variable phase inverting amplifier. *Electronics Letters*, vol.6, no.8, April 1980, pp.294-295.

Professor Soliman is head of the electrical engineering department of the United Emirates University, Al-Ain, United Arab Republic.

In Fig.14, the condition for phase compensation is $K^2(K_1+1)=K(a+1)+1$, the non-inverting d.c. gain $P=KK_1$ and the magnitude of the inverting d.c. gain $N=K(K_1+1)$. Improved TT biquad filter, Fig.15, is suitable for high Q and high frequency using BB4. Assuming matched op-amps are used and taking $K=1$ in BB4, the condition for phase correction around the loop is $a=1$.

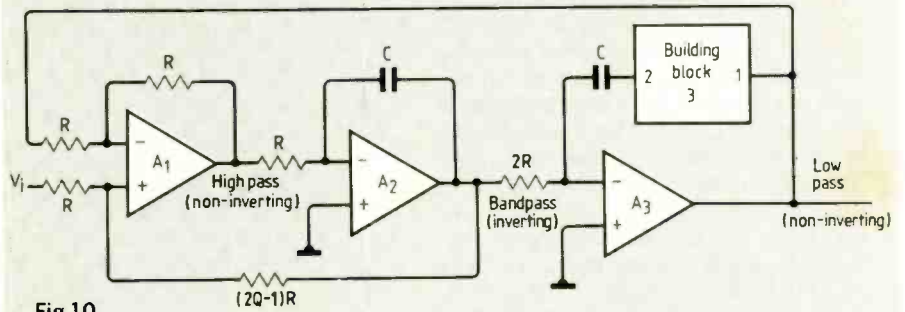

Fig.10.

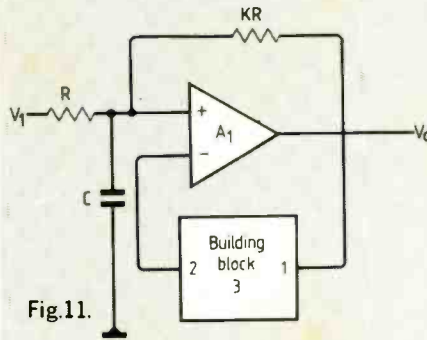

Fig.11.

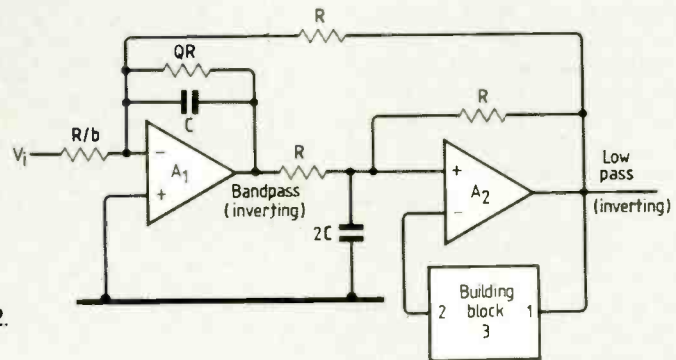

Fig.12.

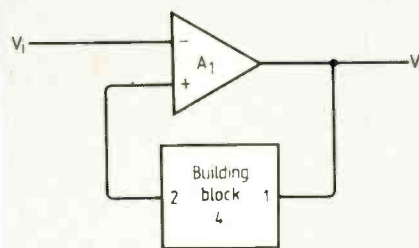

Fig.13.

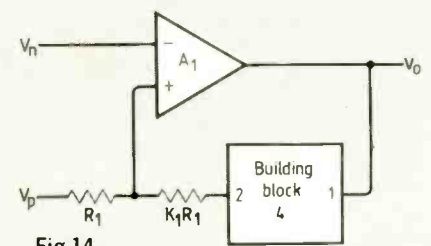

Fig.14.

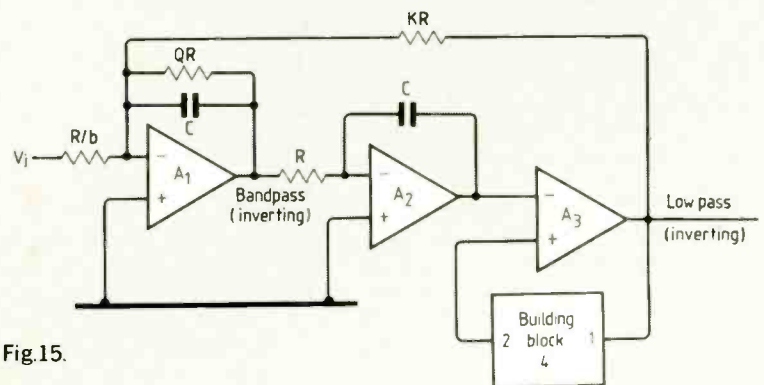
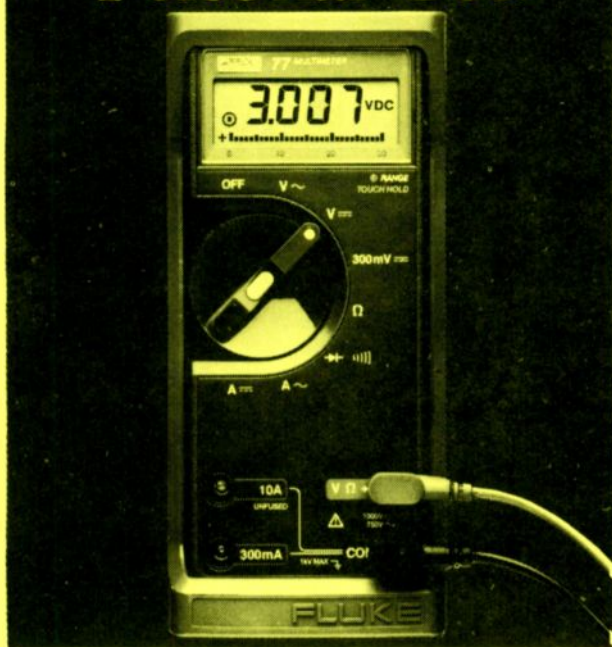

Fig.15.

Improved Kerwin-Heulsman-Newcomb biquad (above) and high frequency using BB3, with $a=8$ as in Fig.9, and $K=1$ (Fig.10). Grounded-C variable-phase non-inverting integrator using BB3 is shown left (Fig.11), while Fig.12 (below) is the improved two-integrator loop filter. The non-inverting integrator is adjusted to provide a phase lead at resonance equal to ω_o/ω_1 . In this case the design values for the BB3 parameters are $K=1$, $a=4$. In the variable-phase inverting amplifier using BB4, Fig.13, the design value for a that provides phase compensation is $K-1-K^{-1}$, assuming matched op-amps are used.

The Professional Meter for Personal Use.



The standard of the industry is setting a new standard for home use as well.

The Fluke 77 multimeter is ideal to test and repair anything electrical: home wiring, appliances... even your car. It's inexpensive, simple to operate and filled with professional features. Made in the U.S.A. and backed by a 3-year warranty, the new Fluke 77 is the world's first handheld meter to combine analog and digital displays.

For a free brochure or the distributor nearest you, call **0923-40511**. Or write Fluke (G.B.) Ltd., Colonial Way, WATFORD Herts WD2 4TT, United Kingdom.

FROM THE WORLD LEADER IN DIGITAL MULTIMETERS.

FLUKE 73

Analog/digital display
Volts, ohms, 10A, diode test
Autorange
0.7% basic dc accuracy
2000+ hour battery life
3-year warranty

FLUKE 75

Analog/digital display
Volts, ohms, 10 A, mA, diode test
Audible continuity
Autorange/range hold
0.5% basic dc accuracy
2000+ hour battery life
3-year warranty

FLUKE 77

Analog/digital display
Volts, ohms, 10A, mA, diode test
Audible continuity
"Touch Hold" function*
Autorange/range hold
0.3% basic dc accuracy
2000+ hour battery life
3-year warranty
Multipurpose holster

* Patent Pending

FLUKE[®]

ENTER 4 ON REPLY CARD

Fluke also presents:



New Fluke 37 3 1/2 digit bench/portable DMM

- Analogue/bar graph
- High resolution/ 3200 count display
- Min./max. storage
- Relative mode
- Superior overload protection
- Excellent EMI shielding
- 2-year warranty



New Fluke 8060A 4 1/2 digit DMM with frequency

- A world standard
- Frequency 12 Hz - 200 KHz
 - dB measurement
 - Relative/relative dB
 - Fast continuity test
 - True RMS up to 100 KHz
 - 2-year warranty



New Fluke 8842A 5 1/2 digit system DMM

- 0.003 % basic dc accuracy (1 year)
- 0.08 % basic ac accuracy (1 year)
- 0.008 % basic ohms accuracy (1 year)
- Resolution to 100 nV dc, 1µA dc, 100µΩ
- 2-year specification & warranty

**FLUKE THE WORLDLEADER
IN DIGITAL MULTIMETERS**



Fluke (G.B.) Ltd.
Colonial Way, WATFORD Herts WD2 4TT
United Kingdom
Tel.: (0923) 40511
Telex: 93 4583

Link up with your industry

To link up with the latest and best in the cable and satellite broadcasting industry just take a trip to Brighton this summer.

Because this June will see the leading operators, programmers and equipment and service suppliers from throughout the UK and Europe converging on the Metropole for their annual industry event – CableSat TV '87.

The exhibition halls will be filled with the latest in cables, fibre optics, switching systems, receiving equipment, programmes and on-screen services. And the Satellite Dish Farm, just along the promenade from the Metropole, will be bringing live feed directly to the show. What's more there's a top-level business conference running alongside the exhibition – in fact, all the ingredients that have made Online's previous 'Cable' events so successful.

As any one of the thousands of visitors to last year's Cable '86 event will testify, this event is more than just an opportunity to catch up with what's new on the market. It's also a time when all sectors of the industry get together – to make new contacts and renew old ones... to review the past year and make plans for the future.

To get your free tickets to the industry's premier event – and the full conference programme – ring Pam Howard on 01-868 4466, or clip your business card to this advertisement and send it to Online International at the address below.

Just some of the people you'll see at CableSat TV '87...

Aquapipes · Armstrong Electronics · Avitel Spacenet · BCS · Bishopsgate Terminals · Bravo-Cablevision · Broadcast · Cable TV Supply Co · Communications Technology Publications · Confederation of Aerial Industries · Deloitte Haskins & Sells · Electrostatic · Eupen Cable · Ferranti · Fuba · Home Video Channel · Intercomm · Kathrein · Multipoint Communications · Micro X · NKF · National Satellite Communications · Nexus Engineering · Oakbury Components · PFJ · Paytel · Reuters · Rhode & Schwarz · Richard Hirschmann · SES · Satcom · Satellite TV Antenna Systems · SelecTV · Skyscan · Teldis · Triax · White Rose Satellite Systems

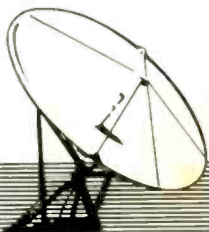

CABLE SAT·TV 87

2 - 4 June 1987 The Brighton Metropole



Online International Ltd
Pinner Green House, Pinner, Middlesex HA5 2AE, UK

ENTER 32 ON REPLY CARD

TAYLOR

VESTIGIAL SIDEBAND TELEVISION MODULATOR C.C.I.R/3

CRYSTAL CONTROLLED OSCILLATOR
19" RACK MOUNTING, 1u HIGH, 205mm DEEP



C.C.I.R/3 SPECIFICATION

Power Requirement	240V 8 Watt (available in other voltages)
Video Input	TV Pk. Pk 75 Ohm
Audio Input	-8V 600 Ohm
F.M. Sound Sub-Carrier Modulation	6MHz (available 5.5MHz) Negative
I.F. Vision	38.9MHz
I.F. Sound	32.9MHz (available 33.4MHz)
Sound Pre Emphasis	50us
Ripple on I.F. Saw Filter	-6dB
Output (any channel 47-860MHz)	+6dBmV (2mV) 75 Ohm
Vision to Sound Power Ratio	5 to 1
Intermodulation	Equal or less than 60dB
Spurious Harmonic Output	40dB (80dB if fitted with TCFL1 Filter or combined via TCFL4 Combiner/Leveler)

C.C.I.R/3.1

Specification as above but output level 60dBmV 1000mV

CHANNEL COMBINER/FILTER/LEVELLER to combine outputs of modulators

TCFL2	2 Channel Filter/Combiner/Leveler. Insertion Loss 3.5dB
TCFL4	4 Channel Filter/Combiner/Leveler. Insertion Loss 3.5dB
TSKO	Enables up to 4 x TCFL2 or TCFL4 to be combined.

TAYLOR BROS (OLDHAM) LTD
BISLEY STREET WORKS, LEE STREET,
OLDHAM, ENGLAND.
TELEPHONE: 061 652 3221 TELEX: 669911

ENTER 16 ON REPLY CARD

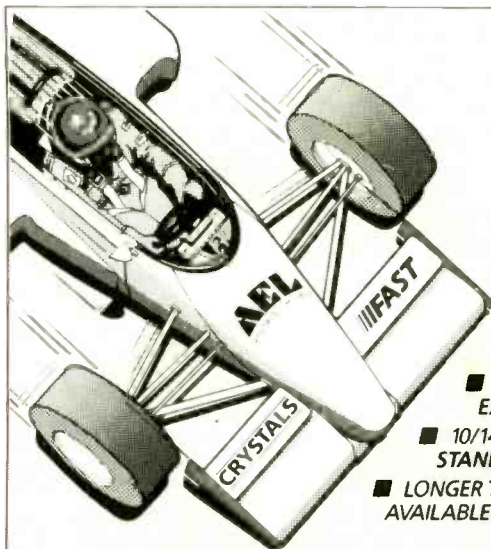

- 3 WORKING DAYS EXPRESS SERVICE.
- 10/14 WORKING DAYS STANDARD SERVICE.
- LONGER TERM SCHEDULES AVAILABLE.

CRYSTALS // FAST



AEL Crystals carry full specifications for most Communications Equipment used today.

For further details contact the Sales Office.

AEL
CRYSTALS LIMITED

GATWICK HOUSE · HORLEY · SURREY · ENGLAND RH6 9SU · TEL: HORLEY (0293) 785353
TELEX: 87116 & 87180 AERO G · CABLES: AEROCON TELEX HORLEY · FAX: 0293 774658

ENTER 35 ON REPLY CARD

SMALL SELECTION ONLY LISTED - RING US FOR YOUR REQUIREMENTS WHICH MAY BE IN STOCK

Racal Solid State Communication Receivers - RA1217 - Mechanical digit readout 1 - 30MC/S - £300. Racal RA17L Communication Receivers 500KC/S to 30MC/S in 30 bands 1MC/S Wide - £175 - All receivers are air tested and calibrated in our workshop - supplied with dust cover - operation instructions - circuit - in fair used condition.

Racal Synthesizers (Decade frequency generators) MA250 - 1.6MC/S to 31.6 MC/S - £100 MA1350 for use with RA17 receiver - £100 MA259G - precision frequency standard 5MC/S - 1MC/S - 100KHz - £100 to £150 RA137 and RA37 - LF converters 10 to 980KC/S - £40 to £75 RA98 SSE-ISB converter - £50. RA121 SSB-ISB converter - £75. Plessey PR155G Solid State receivers - 60KC/S - 30MC/S - £300.

Transtel Matrix Printers AF11R - 5 level baudot code - up to 300 bauds - for print out on plain teleprinter paper - £50 Army Field

Telephone sets type F L and J - large quantity in stock - £6 to £15 depending on type and quantity. P.O.R Don 10 Telephone Cable - half mile canvas containers - £20. **Night Viewing infra-red periscopes** twin eyepiece - 24 volt DC supply - £100. EA. Original cost to Government over £11,000. EA. **Static Inverters** - 12 or 24 volt input - 240 volt AC sine wave output - various wattages. P.O.R. **XY Plotters and pen recorders** - various - P.O.R. **Signal Generators** - various - P.O.R. **TF 893A** Power meter - £50. **Racal frequency counter** type 836 - £50. **Tektronic plug-ins** - 1A1 £50. 1A2 £40. 1A4 £100. M £50. All items are bought direct from H.M. Government being surplus equipment. Price is ex works. S.A.E. for enquiries. Phone for appointment for demonstration of any items; also availability or price change. VAT and carriage extra.

EXPORT TRADE AND QUANTITY DISCOUNTS
JOHNS RADIO, WHITEHALL WORKS,
84 WHITEHALL ROAD EAST, BIRKENSHAW,
BRADFORD BD11 2ER. TEL NO: (0274) 684007
WANTED: REDUNDANT TEST EQUIPMENT - VALVES - PLUGS - SOCKETS, SYNCHROS ETC. RECEIVING AND TRANSMITTING EQUIPMENT

19" RACK MOUNTING CASES

A range of lightweight aluminium 19" rackmounting cases at competitive prices, available in the following sizes.



Height	Depth	Price
1RU	89mm	28.00
1RU	153mm	28.50
1RU	254mm	29.00
2RU	89mm	30.90
2RU	153mm	31.75
2RU	254mm	32.60
3RU	89mm	34.50
3RU	153mm	35.25
3RU	254mm	36.35

Front panel, 3mm extrusion finished in dawn grey, all other panels 16 SWG clear anodised aluminium. It should be noted that no constructional fixings are visible on the front panel.

For finishes or sizes different from above, or for details of our range of blank panels, vent panels, audio and video jackfields, panel punching and prototype manufacturing services, please call.

Please add 3.00 P&P +15% VAT

Ian P. Kinloch & CO. Ltd
3 Darwin Close, Reading, Berkshire RG2 0TB.
Tel: (0734) 311030

ENTER 38 ON REPLY CARD

Band III mobile radio

August is the date chosen for the London launch of a national private mobile radio network. The licence has been granted to Band Three Radio Ltd, a consortium consisting of Pye, Racal, Securicor and Digital Mobile Communications. Band III is the frequency band vacated when the 405-line tv services ceased operation.

Mobile radio requirements are continuously expanding and there has been congestion on the permitted channels. The new allocation will add some 400 further channels to the existing 1300 private mobile radio and 600 cellular radio channels.

The Band Three network is intended to cover the whole country, with 60% of the population covered by mid-1988.

The system will incorporate long-distance trunking of shared circuits and frequencies. It will offer call queueing so that it will return an engaged tone. Privacy of conversations is ensured by varying the allocated channel from call to call. The system will have the capacity for 60 000 subscribers when fully operational. This compares with over 350 000 mobile radios currently in use outside the emergency services, and 130 000 cellular subscribers.

Users will be offered a choice of service from local to national coverage. The costs will be around 60% of those for cellular radio and will be more predictable because there is no use of the telephone network; although it will be possible to link with a PSTN call. Band Three Ltd will set up and run the network. Service providers will supply equipment and give access to the end users.

Advanced robotics centre

A government proposal to found an advanced robotics research centre has been met with enthusiasm by a number of institutions wishing to host the centre. The DTI has invited five applicants to make firm proposals. These are The Turing Institute, Glasgow, Harwell (UKAEA)

Laboratory, Salford University, RSRE, Malvern combined with the Royal Armament Research and Development Establishment, Chertsey, and ERA Technology Ltd. The aim of the centre is to consolidate the UK's position in the field by developing a greater awareness of the market potential of robotics. Cooperation between industry and educational establishments will help to avoid wasteful duplication of effort and assist the formulation of collaboration projects. It is intended that the centre should combine the efforts of over 20 industrial partners.

The centre will be dedicated to the development, evaluation and integration of robotics technologies among which are: manipulators, including artificial limbs; sensors; navigation systems and mobility; and systems, software and control, including artificial intelligence. A particular emphasis will be placed on the development of robots for use in hostile environments.

Software ghost in the machine

One of the 1987 British Design Awards has gone to Direct Technology Ltd, of Isleworth, Middlesex, for a system that can copy the actions of an operator of a personal computer and then copy them. It's called a 'software robot' or ghost operator. 'Automator mi' is a program that is incorporated into the personal computer's systems disc so that it is always available.

One of the most frequent uses is to access a mainframe computer from the p.c. to obtain information from a database. This can be a tedious and error-prone operation; requiring the user to enter long strings of characters to call up the mainframe, set the transmission standards, enter passcodes and the like. Any error or a busy or faulty telephone link requires the whole operation to be repeated. The 'robot' can do the whole job automatically, repeating the operation or trying alternative numbers until the connection is made. In addition, because it can store the link drivers to a number of mainframes, it can even enable a link between incompatible main-

frames through a p.c. running the program.

The robot can be set into action in a number of ways. An operator can press a pre-set key; it can respond to an incoming message; or it can operate automatically at a specific preset time. Thus it can be used to transfer files during the night or access a mainframe at a specific time each week. It can automatically reject unwanted electronic mail from blacklisted sources. Priorities can be built in so that it will interrupt a program already running if a more important task is detected. It can also be used to train operators by offering easy-to-use guides to running a program and telling the operator what they have done wrong.

The software comes in two parts, a "teaching" package to programme the robot and the normal user software.

Software design tool

The second of the two Design Awards for software goes to Yard Software Systems, of Chippenham, Wilts. It is designed specifically for the production of software used to run complex control systems, such as air-traffic control, or reactor systems where applications are critical. Lifespan, as it is called, was developed in Glasgow by Yard. It runs on a DEC Vax computer and imposes an organized environment on the development of the constituent modules that go into a complex control program. Each labelled module is 'signed out' to an engineer and carries its own history, such as version number, date, nature of modification, whether it has passed quality control, and its relationship to other modules. The modules are also provided with security checks so that only authorized users can use or change them. It keeps an 'overview' of the project and can provide progress reports.

More than 40 Lifespan systems are in operation, including exports to Switzerland and Holland. The system is under continuous development and has recently been extended to incorporate computer-aided design, and facilities leading towards integrated manufacturing control.



Don Yeates, Datasolve education director and Janet Larcher of The Spastics Society demonstrate a 'touch-painting' computer to Adam King, a pupil at the Society's Thomas Delarue School, Tonbridge, during the February launch of Datasolve's Award Scheme to further development of new technologies to help cerebral palsy children.

Electronics for peace

Electronics for Peace is an organization set up to unite those engineers in electronics and computing who did not want their resources used in a military context. The organization has now expanded by setting up a company, Exchange Resources, which will act as an employment agency, connecting engineers with like-minded companies and also as a business consultancy, offering business-to-business contacts, organisational and project help. Career and ethical counselling for individuals can be provided along with staff/management awareness seminars. Further details from Tony Wilson, a founder of Electronics for Peace, at EIP Ltd, 28 Milsom Street, Bath, BA1 1DP.

Electronic mail protocols

The X400 system of message-handling protocols has "moved from the laboratory to the world of commercial reality" says a report that follows demonstrations of equipment at the Han-

over computer exhibition CeBIT '87. Two national telecommunications administrations, BT and Deutsches Bundespost, combined with twelve manufacturers of electronic mail computers to demonstrate how their proprietary services and equipment communicated with each other. They were using the trial message-handling services being run by both authorities. BT has been running engineering trials since October and expects to launch a full commercial service in "late spring". The X400 protocol was developed by BT's subsidiary, Dialcom, in the USA. The system is available under franchise in 15 countries and can offer access to a world-wide business network. It can be used to link computers and terminals, telex, teletex and facsimile machines.

Electronic drums

A new range of electronic drum-kits with a number of new technical features was launched in Europe by Simmons Electronics Ltd at Musikmesse – the International musical instruments trade fair held at Frankfurt, West Germany.

The drum kits, in the SDX range, have been developed by Simmons with British Technology Group (BTG) support in the form of joint-venture funding for the project.

SDX embodies a number of significant advances and incorporates an 8Mbyte random-access memory controlled by a semi-custom integrated circuit so as to make optimum use of memory capacity to store the output signals. Up to 16 different voices are available on the top-of-the-range model. One facility enables the performer to manipulate digital samples of real drum and cymbal sounds. Sample resolution is 16-bit at 44.1 kHz, the processing format for compact disc digital audio.

An electronic drum-kit consists of a number of pads with electrical sensors instead of the drumheads of a traditional kit. Signals from the pads activate electronic signal generators which provide the audible output via conventional power amplifiers and loudspeakers. Advantage of electronic drum-kits in-

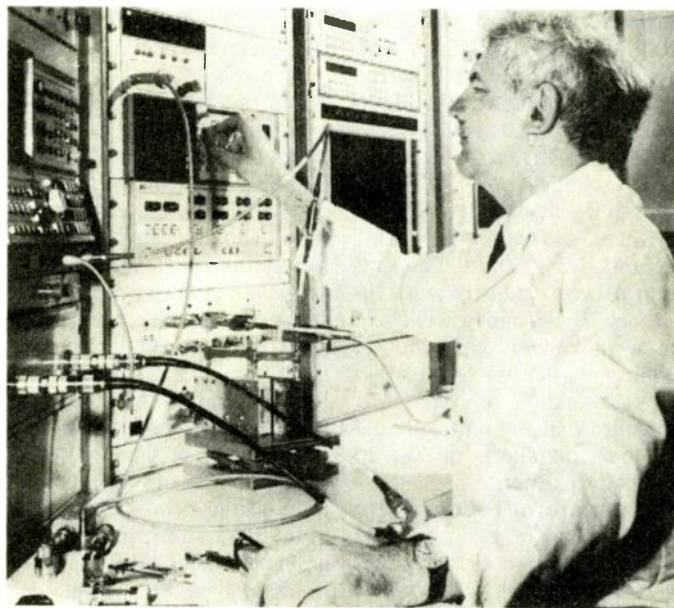

Ferranti Defence Systems Limited has installed a computer-controlled microwave test system for the measurement and calibration of microwave and hybrid r.f. radar components. The test system is the result of a three-year joint development project with Hewlett-Packard, representing one of the most sophisticated automatic test installations to be commissioned by Hewlett-Packard.

clude the ability to create remarkable effects and 'silent' practice using headphones. Hitherto the pads in electronic drum-kits have used piezoelectric transducers to sensor how hard the pad has been struck. The SDX range uses a resistor pattern printed on to a surface inside the drum pad so that the output sound depends on the position of the striking point within the pad as well as the force with which the drumstick hits the pad, as is the case with a traditional acoustic drumhead. The technique derives from pads designed for computer graphics applications. Each voice can be manipulated electronically by the performer using five programmable envelope generators for detailed control of sample playback frequency (to pitch the sound), filter cut-off frequency, noise amount, amplitude and output mix. Pitching is achieved by a second semicustom gate array, while a third array deals with rapid digital-to-analogue conversion.

The company, started by David Simmons and two colleagues, produced the world's first electronic drum kit. It has expanded rapidly in five years and has become the market leader in these instruments, despite competition from Japanese and European manufacturers.

In brief

Decisions on the exact nature and application of an h.f. planning system have effectively been postponed for some years until a proposed future WARC. In the meantime, h.f. broadcasting is to continue under the existing Article 17 regime. Recommendations of the 1987 WARC – held last February and March and reported elsewhere in this issue – will be put to the ITU's Administrative Council in June but a decision when to convene the proposed WARC will rest with the 1989 Plenipotentiary Conference.

The IBA are completing engineering test transmissions for their radio teletext service using the Telerate data system, these have been broadcast on the IBA LBC 97.3MHz transmitter in London. The system uses techniques developed in the USA and works rather like tv teletext, needing an adaptor to feed the data into a display terminal or computer. The service will offer up-to-date financial information. A similar service is to be offered on the Capital Radio transmitter (95.8MHz) run by Telemet (UK) Ltd.

The system can be used in parallel with the forthcoming Radio Data Service.

IEE and IEEIE lectures and meetings

12–15 May 1987

Automat: 4th European Automated Manufacturing systems exhibition and conference. NEC, Birmingham.

17–20 May 1987

CES – Consumer Electronics and Technology Show. Earls Court, London. Organised by Montbuild Ltd, Tel: 01-486 1951.

19–21 May 1987

Sound-Comm 87: Exhibition of the Association of Sound and Communication Engineers, Business Design Centre (formerly Royal Agricultural Hall), Liverpool Road, Islington, London N1. Batiste Exhibitions. Tel: 01-340 3291.

16–18 June 1987

Scottish Technology Week: including the Scottish Electronics Technology Show and Conference; the Scottish Factory Efficiency Show and Conference and OEM Scotland show and conference. Scottish Exhibition Centre, Glasgow. Cahners Exhibitions. Tel: 01-891 5051.

18–20 June 1987

Television measurements: Third international IERE conference. Montreux, Switzerland. IERE. Tel: 01-388 3071.

22–26 June 1987

Laser 87 Opto-electronics, microwaves. 8th International congress and exhibition. Munich Trade Fair Centre, F.R. Germany. MMA, Messsegelände, Postfach 12 10 09, D-8000 München, FRG.

26–30 June 1987

BKSTS 87. 10th international film and tv technology conference and Exhibition. Metropole Hotel, Brighton. BKSTS. Tel: 01-242 8400.

7 July 1987

World final of the Mice-mouse competition. Maze-solving, self propelled computers will be running around the IEE, Savoy Place, London E1 at 17.30h. Further details, and rules and entry forms, from Andrew Wilson at the Institution. Tel: 01-240 1871 Ext. 260.

IT'S YOUR CHOICE ...

AMCAD
The Amstrad based PCB
design workstation
from £1495.00 + VAT

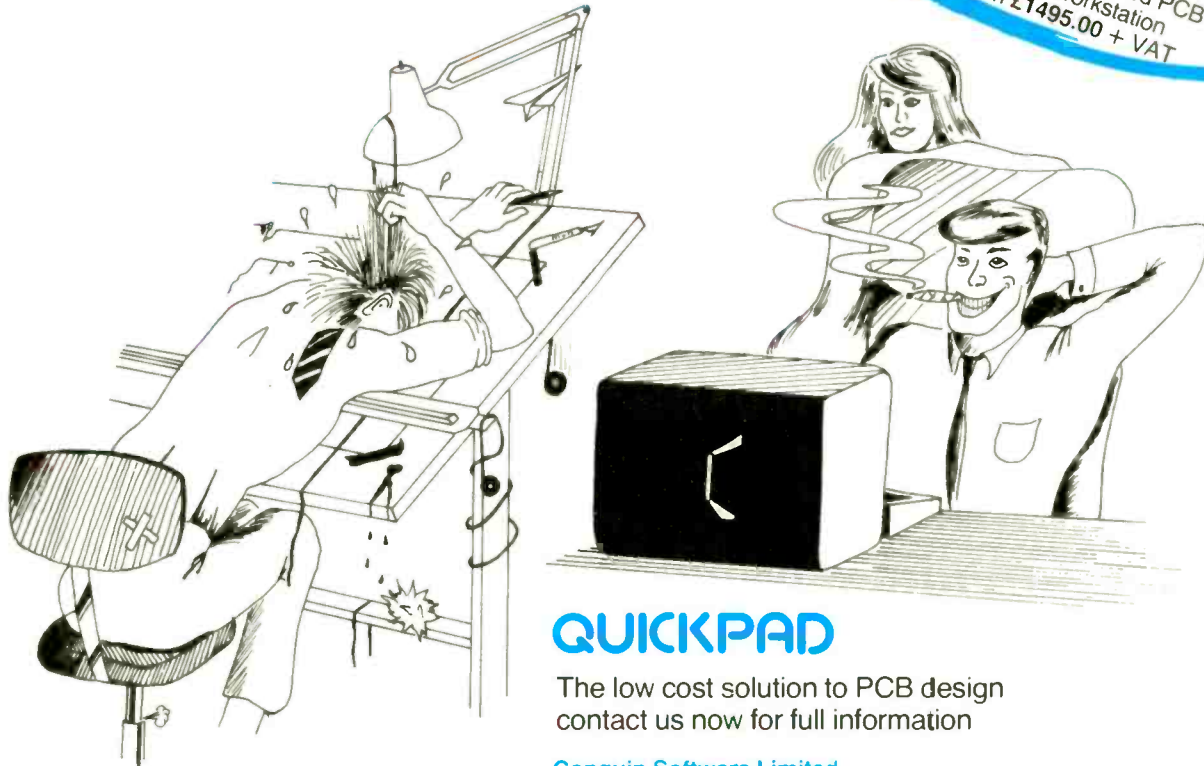

QUICKPAD

The low cost solution to PCB design
contact us now for full information

Conguin Software Limited

Freepost, Morden, Surrey SM4 1BR Telephone: 01-640 9130

ENTER 41 ON REPLY CARD

ANALOGUE METERS

LEVELL AC MICROVOLTMETERS TM3A/B £159/179
16 ranges 15 μ Vfs/500Vfs, accuracy 1% + 1%fs + 1 μ V
-20dB/+6dB scale \pm 3dB 1Hz-3MHz 150mVfs output.
TM3A: 83mm scale. **TM3B**: 123mm scale and LF filter.

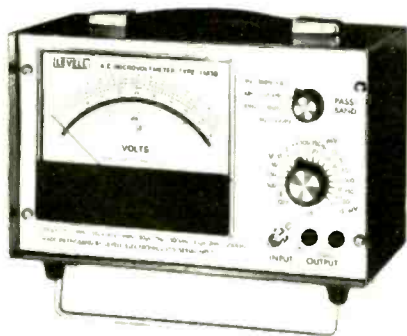

LEVELL BROADBAND VOLTMETERS TM6A/B £249/279
16 LF ranges as TM3A/B + 8 HF ranges 1mVfs 3Vfs,
accuracy 4% + 1%fs at 30MHz \pm 3dB 300kHz-400MHz

LEVELL DC MICROVOLTMETER TM8 £135
28 linear ranges \pm 3 μ V/ \pm 300V and \pm 3pA/ \pm 300nA plus 2
log ranges for nulling. Output \pm 300mV at fs.

LEVELL MULTITESTER TM11 £179
50 μ V/500Vfs ac, 50pA/500mAfs ac, 150 μ V/500Vfs dc,
150pA/500mAfs dc, 0.2 Ω to 100G Ω , lin/log null,
Diode/LED test Optional RF, HV and Temperature.

LEVELL

for INSTRUMENTS

LEVELL TRANSISTOR TESTER TM12 £199
Transistor, diode and zener leakage to 0.5nA at 2V 150V.
Breakdown to 100V at 10 μ A, 100 μ A, 1mA. Gain at
1 μ A-100mA. V_{sat} and V_{be} at 1mA-100mA

LEVELL INSULATION TESTER TM14 £210
Log scale covers 6 decades 10M Ω 10T Ω at 250V, 500V,
750V, 1kV; 1M-1T Ω at 25V 100V; 100k 100G Ω at
2.5V 10V; 10k 10G Ω at 1V. Current 100pA-100 μ A

BENCH POWER SUPPLIES

THURLBY SINGLES PL154/310/320 £159/125/155
0.5" LED digit meters, acc 0.1%, resoln. 10mV, 1mA.
<0.01% change for 50% load change. Remote sense.
154: 0-15V 0-4A, 310: 0-30V 0-1A, 320: 0-30V 0-2A.

THURLBY DUALS PL310QMD/320QMD £269/339
Two 0-30V 0-1A (2A on 320) with isolated, series
tracking, series or parallel modes of operation.

THURLBY TRIPLES PL310K/320K £275/345
310K: 0-30V at 0-1A, 0-30V at 1/2A & 4V-6V at 3 1/2A.
320K: 0-30V at 0-2A, 0-30V at 1A & 4V-6V at 7A.

LEVELL DECADE BOXES

C410 10pF to 111, 110pF, acc 1% \pm 2pF £49
R401/410 4 decs. 1 Ω or 10 Ω steps, acc 1%, 2.5W £49
R601/610 6 decs 1 Ω or 10 Ω steps, acc 1%, 2.5W £63
R601S 6 decades. 1 Ω steps, acc 0.3%, 2.5W £75
R701 7 decades. 1 Ω steps, acc 1%, 2.5W £72

DIGITAL METERS

LEVELL DIGITAL THERMOMETER DT1K £44
120 $^{\circ}$ C/+820 $^{\circ}$ C, acc 0.2% \pm 1 $^{\circ}$ C. 3 digit 8.5mm LCD.
A standard Type K thermocouple socket is fitted. Bead
couple is supplied. Battery life >3000 hrs.

LEVELL DIGITAL CAPACITANCE METER 7705 £49
0.1pF-2000 μ F, acc 0.5% 3 1/2 digit 12.7mm LCD

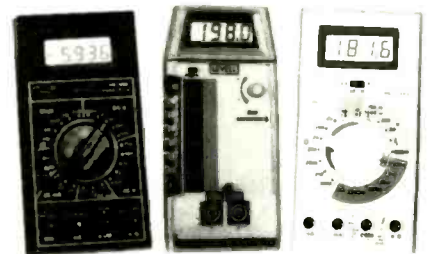

HC DIGITAL MULTIMETER HC4510 £69
4 1/2 digit 11mm LCD. Up to 1kVdc, 750Vac, 10A, 20M Ω .
Resoln. 10 μ V, 100nA, 10m Ω . Buzzer. dcV 0.05%.

HC DIGITAL MULTIMETERS HC5040/5040T £37/39
3 1/2 digit 12.7mm LCD. Up to 1kVdc, 750Vac,
10A, 20M Ω . Resolution 100 μ V, 100nA, 10m Ω
(5040T: 100m Ω). Buzzer. dcV 0.25%. Battery life
2000hrs. 5040T: has a TR test.

THURLBY DMMs 1503/1503HA/1504 £169/185/199
4 1/2 digit 9mm LCD. Up to 1.2kVdc, 750Vac, 10A, 32M Ω ,
4MHz. Resoln. 10 μ V, 10nA, 10m Ω . Mains battery.
1503: dcV 0.05%. 1503HA: 0.03%. 1504: True rms ac.

THURLBY INTELLIGENT MULTIMETER 1905a £349
5 1/2 digit 13mm LED. Up to 1.1kVdc, 750Vac, 5A, 21M Ω .
Resoln. 1 μ V, 1nA, 1m Ω . dcV 0.015%. Computing and
storage functions. RS232C/IEEE interface options.

OTHER INSTRUMENTS AVAILABLE - FREE DELIVERY MAINLAND UK - QUANTITY DISCOUNTS - VAT EXTRA

LEVELL ELECTRONICS LTD.

Moxon Street, Barnet, Herts., EN5 5SD, England
Telephone: 01-440 8686 & 01-449 5028

ENTER 21 ON REPLY CARD

LANGREX SUPPLIES LTD

Climax House, Fallsbrook Rd., Streatham, London SW16 6ED

RST Tel: 01-677 2424 Telex: 946708 RST

SEMICONDUCTORS		SEMICONDUCTORS		SEMICONDUCTORS		SEMICONDUCTORS		SEMICONDUCTORS		SEMICONDUCTORS		SEMICONDUCTORS		SEMICONDUCTORS	
AA19	0.10	AN216	2.00	BC182	0.11	BD183	0.75	BE908	0.30	MJ1340	0.29	OC26	1.50	1IC26AD	1.20
AA370	0.17	AN217	2.00	BC183	0.09	BD237	0.35	BE910	1.04	MJ1370	0.73	OC28	5.50	1IC29D	0.29
AAZ13	0.30	AN230	1.50	BC212	0.15	BD238	0.35	BE911	1.04	MJ1371	1.05	OC29	3.40	1IP29A	0.35
AAZ15	0.30	AN231	1.50	BC213	0.11	BD239	2.00	BE912	0.28	MJ1372	0.75	OC35	4.00	1IP30A	0.36
AAZ17	0.30	AN232	1.50	BC214	0.11	BD240	2.00	BE913	0.28	MJ1373	0.75	OC36	4.00	1IP31A	0.25
AC107	0.55	BA115	0.13	BC237	0.09	BDY20	1.50	BE914	0.28	MJ1374	0.75	OC41	1.20	1IP32A	0.25
AC125	0.35	BA148	0.15	BC238	0.09	BDY60	1.50	BE915	0.28	MJ1375	0.75	OC42	1.50	1IP33A	0.53
AC127	0.40	BA155	0.11	BC307	0.09	BI115	0.30	BE916	0.28	MJ1376	0.75	OC43	1.50	1IP34A	0.60
AC128	0.35	BA156	0.06	BC308	0.09	BI152	0.16	BE917	0.28	MJ1377	0.75	OC44	1.25	1IP35A	0.48
AC141	0.35	BA162	0.05	BC327	0.09	BI173	0.15	BE918	0.28	MJ1378	0.75	OC45	0.65	1IP36A	0.48
AC148	0.45	BA163	0.05	BC328	0.09	BI174	0.15	BE919	0.28	MJ1379	0.75	OC46	0.65	1IP37A	0.48
AC152	0.40	BA164	0.06	BC329	0.09	BI175	0.15	BE920	0.28	MJ1380	0.75	OC47	0.65	1IP38A	0.48
AC158	0.45	BA165	0.06	BC330	0.09	BI176	0.15	BE921	0.28	MJ1381	0.75	OC48	0.65	1IP39A	0.48
AC167	0.35	BA166	0.06	BC331	0.09	BI177	0.15	BE922	0.28	MJ1382	0.75	OC49	0.65	1IP40A	0.48
AC168	0.35	BA167	0.06	BC332	0.09	BI178	0.15	BE923	0.28	MJ1383	0.75	OC50	0.65	1IP41A	0.48
AC171	0.35	BA168	0.06	BC333	0.09	BI179	0.15	BE924	0.28	MJ1384	0.75	OC51	0.65	1IP42A	0.48
AC172	0.35	BA169	0.06	BC334	0.09	BI180	0.15	BE925	0.28	MJ1385	0.75	OC52	0.65	1IP43A	0.48
AC173	0.35	BA170	0.06	BC335	0.09	BI181	0.15	BE926	0.28	MJ1386	0.75	OC53	0.65	1IP44A	0.48
AC174	0.35	BA171	0.06	BC336	0.09	BI182	0.15	BE927	0.28	MJ1387	0.75	OC54	0.65	1IP45A	0.48
AC175	0.35	BA172	0.06	BC337	0.09	BI183	0.15	BE928	0.28	MJ1388	0.75	OC55	0.65	1IP46A	0.48
AC176	0.35	BA173	0.06	BC338	0.09	BI184	0.15	BE929	0.28	MJ1389	0.75	OC56	0.65	1IP47A	0.48
AC177	0.35	BA174	0.06	BC339	0.09	BI185	0.15	BE930	0.28	MJ1390	0.75	OC57	0.65	1IP48A	0.48
AC178	0.35	BA175	0.06	BC340	0.09	BI186	0.15	BE931	0.28	MJ1391	0.75	OC58	0.65	1IP49A	0.48
AC179	0.35	BA176	0.06	BC341	0.09	BI187	0.15	BE932	0.28	MJ1392	0.75	OC59	0.65	1IP50A	0.48
AC180	0.35	BA177	0.06	BC342	0.09	BI188	0.15	BE933	0.28	MJ1393	0.75	OC60	0.65	1IP51A	0.48
AC181	0.35	BA178	0.06	BC343	0.09	BI189	0.15	BE934	0.28	MJ1394	0.75	OC61	0.65	1IP52A	0.48
AC182	0.35	BA179	0.06	BC344	0.09	BI190	0.15	BE935	0.28	MJ1395	0.75	OC62	0.65	1IP53A	0.48
AC183	0.35	BA180	0.06	BC345	0.09	BI191	0.15	BE936	0.28	MJ1396	0.75	OC63	0.65	1IP54A	0.48
AC184	0.35	BA181	0.06	BC346	0.09	BI192	0.15	BE937	0.28	MJ1397	0.75	OC64	0.65	1IP55A	0.48
AC185	0.35	BA182	0.06	BC347	0.09	BI193	0.15	BE938	0.28	MJ1398	0.75	OC65	0.65	1IP56A	0.48
AC186	0.35	BA183	0.06	BC348	0.09	BI194	0.15	BE939	0.28	MJ1399	0.75	OC66	0.65	1IP57A	0.48
AC187	0.35	BA184	0.06	BC349	0.09	BI195	0.15	BE940	0.28	MJ1400	0.75	OC67	0.65	1IP58A	0.48
AC188	0.35	BA185	0.06	BC350	0.09	BI196	0.15	BE941	0.28	MJ1401	0.75	OC68	0.65	1IP59A	0.48
AC189	0.35	BA186	0.06	BC351	0.09	BI197	0.15	BE942	0.28	MJ1402	0.75	OC69	0.65	1IP60A	0.48
AC190	0.35	BA187	0.06	BC352	0.09	BI198	0.15	BE943	0.28	MJ1403	0.75	OC70	0.65	1IP61A	0.48
AC191	0.35	BA188	0.06	BC353	0.09	BI199	0.15	BE944	0.28	MJ1404	0.75	OC71	0.65	1IP62A	0.48
AC192	0.35	BA189	0.06	BC354	0.09	BI200	0.15	BE945	0.28	MJ1405	0.75	OC72	0.65	1IP63A	0.48
AC193	0.35	BA190	0.06	BC355	0.09	BI201	0.15	BE946	0.28	MJ1406	0.75	OC73	0.65	1IP64A	0.48
AC194	0.35	BA191	0.06	BC356	0.09	BI202	0.15	BE947	0.28	MJ1407	0.75	OC74	0.65	1IP65A	0.48
AC195	0.35	BA192	0.06	BC357	0.09	BI203	0.15	BE948	0.28	MJ1408	0.75	OC75	0.65	1IP66A	0.48
AC196	0.35	BA193	0.06	BC358	0.09	BI204	0.15	BE949	0.28	MJ1409	0.75	OC76	0.65	1IP67A	0.48
AC197	0.35	BA194	0.06	BC359	0.09	BI205	0.15	BE950	0.28	MJ1410	0.75	OC77	0.65	1IP68A	0.48
AC198	0.35	BA195	0.06	BC360	0.09	BI206	0.15	BE951	0.28	MJ1411	0.75	OC78	0.65	1IP69A	0.48
AC199	0.35	BA196	0.06	BC361	0.09	BI207	0.15	BE952	0.28	MJ1412	0.75	OC79	0.65	1IP70A	0.48
AC200	0.35	BA197	0.06	BC362	0.09	BI208	0.15	BE953	0.28	MJ1413	0.75	OC80	0.65	1IP71A	0.48
AC201	0.35	BA198	0.06	BC363	0.09	BI209	0.15	BE954	0.28	MJ1414	0.75	OC81	0.65	1IP72A	0.48
AC202	0.35	BA199	0.06	BC364	0.09	BI210	0.15	BE955	0.28	MJ1415	0.75	OC82	0.65	1IP73A	0.48
AC203	0.35	BA200	0.06	BC365	0.09	BI211	0.15	BE956	0.28	MJ1416	0.75	OC83	0.65	1IP74A	0.48
AC204	0.35	BA201	0.06	BC366	0.09	BI212	0.15	BE957	0.28	MJ1417	0.75	OC84	0.65	1IP75A	0.48
AC205	0.35	BA202	0.06	BC367	0.09	BI213	0.15	BE958	0.28	MJ1418	0.75	OC85	0.65	1IP76A	0.48
AC206	0.35	BA203	0.06	BC368	0.09	BI214	0.15	BE959	0.28	MJ1419	0.75	OC86	0.65	1IP77A	0.48
AC207	0.35	BA204	0.06	BC369	0.09	BI215	0.15	BE960	0.28	MJ1420	0.75	OC87	0.65	1IP78A	0.48
AC208	0.35	BA205	0.06	BC370	0.09	BI216	0.15	BE961	0.28	MJ1421	0.75	OC88	0.65	1IP79A	0.48
AC209	0.35	BA206	0.06	BC371	0.09	BI217	0.15	BE962	0.28	MJ1422	0.75	OC89	0.65	1IP80A	0.48
AC210	0.35	BA207	0.06	BC372	0.09	BI218	0.15	BE963	0.28	MJ1423	0.75	OC90	0.65	1IP81A	0.48
AC211	0.35	BA208	0.06	BC373	0.09	BI219	0.15	BE964	0.28	MJ1424	0.75	OC91	0.65	1IP82A	0.48
AC212	0.35	BA209	0.06	BC374	0.09	BI220	0.15	BE965	0.28	MJ1425	0.75	OC92	0.65	1IP83A	0.48
AC213	0.35	BA210	0.06	BC375	0.09	BI221	0.15	BE966	0.28	MJ1426	0.75	OC93	0.65	1IP84A	0.48
AC214	0.35	BA211	0.06	BC376	0.09	BI222	0.15	BE967	0.28	MJ1427	0.75	OC94	0.65	1IP85A	0.48
AC215	0.35	BA212	0.06	BC377	0.09	BI223	0.15	BE968	0.28	MJ1428	0.75	OC95	0.65	1IP86A	0.48
AC216	0.35	BA213	0.06	BC378	0.09	BI224	0.15	BE969	0.28	MJ1429	0.75	OC96	0.65	1IP87A	0.48
AC217	0.35	BA214	0.06	BC379	0.09	BI225	0.15	BE970	0.28	MJ1430	0.75	OC97	0.65	1IP88A	0.48
AC218	0.35	BA215	0.06	BC380	0.09	BI226	0.15	BE971	0.28	MJ1431	0.75	OC98	0.65	1IP89A	0.48
AC219	0.35	BA216	0.06	BC381	0.09	BI227	0.15	BE972	0.28	MJ1432	0.75	OC99	0.65	1IP90A	0.48
AC220	0.35	BA217	0.06	BC382	0.09	BI228	0.15	BE973	0.28	MJ1433	0.75	OC100	0.65	1IP91A	0.48
AC221	0.35	BA218	0.06	BC383	0.09	BI229	0.15	BE974	0.28	MJ1434	0.75	OC101	0.65	1IP92A	0.48
AC222	0.35	BA219	0.06	BC384	0.09	BI230	0.15	BE975	0.28	MJ1435	0.75	OC102	0.65	1IP93A	0.48
AC223	0.35	BA220	0.06	BC385	0.09	BI231	0.15	BE976	0.28	MJ1436	0.75	OC103	0.65	1IP94A	0.48
AC224	0.35	BA221	0.06	BC386	0.09	BI232	0.15	BE977	0.28	MJ1437	0.75	OC104	0.65	1IP95A	0.48
AC225	0.35	BA222	0.06	BC387	0.09	BI233	0.15	BE978	0.28	MJ1438	0.75	OC105	0.65	1IP96A	0.48
AC226	0.35	BA223	0.06	BC388	0.09	BI234	0.15	BE979	0.28	MJ1439	0.75	OC106	0.65	1IP97A	0.48
AC227	0.35	BA224	0.06	BC389	0.09	BI235	0.15	BE980	0.28	MJ1440	0.75	OC107	0.65	1IP98A	0.48
AC228	0.35	BA225	0.06	BC390	0.09	BI236	0.15	BE981	0.28	MJ1441	0.75	OC108	0.65	1IP99A	0.48
AC229	0.35	BA226	0.06	BC391	0.09	BI237	0.15	BE982	0.28	MJ1442	0.75	OC109	0.65	1IP100A	0.48
AC230	0.35	BA227	0.06	BC392	0.09	BI238	0.15	BE983	0.28	MJ1443	0.75	OC110	0.65	1IP101A	0.48
AC231	0.35	BA228	0.06	BC393	0.09	BI239	0.15	BE984	0.28	MJ1444	0.75	OC111	0.65	1IP102A	0.48
AC232	0.35	BA229	0.06	BC394	0.09	BI240	0.15	BE985	0.28	MJ1445	0.75	OC112	0.65	1IP103A	0.48
AC233	0.35	BA230	0.06	BC395	0.09	BI241	0.15	BE986	0.28	MJ1446	0.75	OC113	0.65	1IP104A	0.48
AC234	0.35	BA231	0.06	BC396	0.09	BI242	0.15	BE987	0.28	MJ1447	0.75				

TELECOMMS TOPICS

Alcatel wins 2.4Gbit/s opto

Alcatel CIT has been awarded a contract by the Belgium Telephone and Telegraph Administration for a 2.4Gbit/s optical transmission system. It will provide a 50km link between the cities of Brussels, Mechelen and Antwerp and is believed to be the first in the world to operate at such a high speed. Having 16 times the capacity of the most widely used 140Mbit/s systems, it will ease the strain on the heavily used route between Brussels and Antwerp.

Alcatel CIT is the French public telecommunications subsidiary of Alcatel NV, the company formed at the end of last year to bring together, under the management of CGE, the telecommunications activities of ITT worldwide and all the activities of French companies Alcatel CIT, Alcatel Electronique and Cables de Lyon.

Philips for private ISDN in China

Philips Sopho-S PABXs are to be used to establish a private ISDN network in China under a £500,000 contract with the Beijing Application Information Institute of Technology (BAITT). The network will link up all the government research organizations in the main cities of each province in China.

The first phase of the project involves eight Sopho-S systems having a total of 2,800 lines. A further 14 sets of systems are expected to be ordered for the second phase.

Discussions between Philips and the Chinese began in 1984, the order for optical fibre and transmission equipment for the Beijing ISDN trial being placed with AT&T and Philips Telecommunications (APT) in early 1986. Following evaluation of PABXs from suppliers, the Chinese then visited Europe, mainly Holland and Belgium. The purpose of this visit was to choose a long-term partner and to gain an understanding of the supplier company and product.

APT is the joint venture be-

tween AT&T of the USA and Philips Telecommunications Industries, with headquarters in The Netherlands.

Packets for Irish Distilleries

Irish Distilleries, one of the countries largest companies, has set up a packet-switched network to link its headquarters with seven remote locations. These sites are engaged in a range of activities ranging from distilling to distribution of finished products. Links are through a combination of leased lines and the Eirpac packet switched service based on X.25.

All locations have the back-up necessary to maintain network integrity through the public switched telephone network (PSTN). The network management system automatically monitors the state of the lines and controls the network as well as providing management information. It is based on a Motorola 6740 distributed communications processor and an IXP network management system. All eight sites are equipped with either 6001 or 6002 statistical multipliers or 625 PADs (packet assembler/disassembler) and a total of 13 2345 modems under a contract worth £100,000.

British Telecom looks towards Pacific

British Telecom marked the recent opening of its new San Francisco office with a teleconferencing link-up to London. When speaking over the satellite link to customers in San Francisco, BT chief executive Iain Vallance stressed BT's commitment to its overseas customers in its aim of becoming the world's best telecommunications company. He went on to add that BT opened its first office in the USA in New York in mid-1984 and that this office is "...the next step in our plans to establish offices in key business areas throughout North America." He pointed out that San Francisco, as well as

servicing the West Coast, also looks westwards towards the Pacific countries such as Japan, Singapore, and Hong Kong, all of which have tremendous potential in the telecommunications marketplace.

At the office opening Anthony J. Booth, managing director of British Telecom International (BTI), said that "Transatlantic digital satellite and cable technologies will soon be extended to the West Coast. With a single, direct satellite hop between the western seaboard and the UK now a reality, the additional West Coast satellite earth stations coming on stream shortly, and with the advent in 1988 of the optical-fibre TAT-8 service and growing availability of optical-fibre cables on US domestic routes, the West Coast is entering a whole new era of low-cost, efficient communications with Europe."

Dictaphone shows the Connexions

At a press conference mainly devoted to voice recorders and dictating systems, Dictaphone gave a preview of its Connexions communications terminal. According to the company's sales director, Les Goff, "This is a preview of the next barrier that Dictaphone will break in the business communications market. How long it will be to the UK launch we cannot say at present but we are not embargoing information about it - it is too important for that."

In addition to incorporating those functions expected in a feature phone, it incorporates call logging, personal electronic calendar with reminder alarm for appointments, electronic mail facilities to and from other computers plus, as one would expect from Dictaphone, a dictating machine recording onto an integral cassette tape.

Goff went on to say that "this is the kind of integration to which the end user must be led. No-one can expect users to demand technology which has not yet been previewed to them. They are not inventors - we are. There has to be a four-way integration of voice and data, communication and



recording. He continued by stressing the need to integrate these functions to meet user needs. "Or more simply, we have telephones on their way now which allow you to see who you're talking to. What more natural need than to record the voice and the vision parts, along with the text of the document or computer file you are discussing? That development at Dictaphone is a little further off than our Connexions unit but not much further."

CICI goes for Gold

Telecom Gold, British Telecom's electronic mail service, has been chosen by the Confederation of Information Communication Industries (CICI) to provide electronic communications tailored specifically to the needs of the information industry.

CICI decided that, in order to improve communications to its members and to increase the industry's awareness of electronic information services, it should establish an online network, CICIInet.

Members will be invited to register for a Gold mailbox within the CICIInet closed user group so as to access an online version of CICI's newsletter and diary of events. A private noticeboard will also be available to give users the opportunity to exchange ideas with other members and to ask them for information.

CICI is essentially a confederation of associations, public bodies and leading companies in the information industry. Members include the BBC, the British Library, the British Council and the Publishers Association. The larger bodies within CICI will be encouraged to become corporate members of Telecom Gold. They

TELECOMMS TOPICS

can then have an unlimited number of mailboxes for one corporate registration fee, while still benefitting from all the extra CICNet services.

Mercury Link 7500 – the new Easylink

For the past year the Easylink service has been managed on behalf of Cable and Wireless Easylink Ltd by Mercury Communications Ltd. The relaunch of the service as Mercury Link 7500 enables it to be integrated in marketing terms within the developing portfolio of business communications services being offered under the Mercury banner.

The first of a programme of service enhancements is the 'personal telex number' for users of the Mercury Link 7500 telex access service. All users are allocated their own number which will be quoted on all outgoing telex messages and may be used as a regular telex address for all return messages.

Cable pressure monitors for British Telecom

British Telecom has placed an order for Condic 100 systems designed to continuously monitor telephone cable pressurization. The order, worth £250,000, was placed with Vaisala (UK) Ltd., the British subsidiary of a Finnish meteorological and industrial measurement company. The first network, comprising 3-4 central monitoring points and 11 sub-stations, will be installed in North Wales this year.

Many telephone cable systems are pressurized with compressed air to protect the inner cores from damage by water. Currently the normal BT procedure for locating a leak involves the repair team checking the cable pressure at a number of man-holes along a cable run. They can then establish the pressure profile along the cable and thus find the leak.

The new system is said to represent an important increase in technical sophistication over

existing methods and will lead to the more rapid location of leaks in the cable pressurization systems. It employs independently addressable sensors which are interrogated via telephone lines. The system's computer collects the data and reassembles it into groups each of which relate to a single cable. Cable pressure values can be presented in various forms and the system can generate out-of-tolerance alarms.

The system can also, if necessary, be equipped with additional sensors to monitor water level in manholes, humidity in cable connection cabinets and the status of alarms in exchange buildings.

Direct link to USA

Mercury Communications Ltd, together with FTC Communications Inc. are offering high-quality, dedicated, private, leased voice service between the US and UK. The voice service will be provided using 32Kbit/s a.d.p.c.m. digital transmission techniques.

The channel will be provided on a full 24 hour availability at what are claimed to be extremely competitive tariffs. The FTCC tariff for the US terminal is 1500 US dollars per month and the Mercury tariff for the UK one is 1350 pounds. FTCC's previous published tariff only covered the higher speeds from 56/64 Kbit/s through to 2.048 Mbit/s.

PC to fax service from Lydiastar

Lydiastar Telecommunications, providers of a personal computer-to-telex message delivery service is launching a PC-to-facsimile delivery service. The new service, which the company believes will be the first of its kind in the world, will be added to the existing telex service at no extra charge.

As with Lydiastar's existing telex service, the new fax capability will offer a number of other user benefits including simplicity and the flexibility to allow

access by most types of communicating PC.

By taking advantage of differences in international messages transmission costs, it is claimed that the new service will offer customers savings of 20 per cent against conventional fax-to-fax transmission costs.

Philips Radio/E.F. Johnson agreement

Philips Radio Communications Systems Ltd. (PRCS) of Cambridge and E.F. Johnson Company, Waseca, Minnesota, USA have reached a collaborative working relationship.

The joint agreement permits the latter to distribute certain Philips mobile radio communications products in the United States as well as allowing Philips to distribute certain Johnson products in various other countries around the world. In addition, the agreement allows for the potential exchange of technology and combined R & D activities.

According to Ian McKenzie, managing director of PRCS "With the recent establishment of PRCS as the Philips corporate centre for international mobile radio activities, it is only natural that we, more actively, participate in the US market. Our business is international in scope and we are very pleased to establish this new relationship with the E.F. Johnson Company which has considerable mutual benefit for both organisations.

Dowty cooperates with Dorset police

Dowty Information Systems has signed an exclusive agreement with Dorset Police under which it will undertake further development and market Dorset Police's new command, control and management information system.

Dowty already has 12 years experience of developing and marketing emergency services command and control systems and has installed eighteen systems worldwide. The £2 million

Dorset Police system comprises two DEC 8300s to run the system, 18 DEC Micro PSP11/23 terminal concentrators at various locations around the Force, and 109 v.d.us and keyboards, customized for police use, and a DEC VAX 11/750 for training and development. It has been specifically designed "to meet the needs of the Force until the mid-1990s" according to Brian Weight, Dorset's Chief Constable. "It puts the Dorset Police light years ahead of any other force in the British Isles."

Review of Telecommunications Standards

Prof. Bryan Carsberg, Director General of Telecommunications, has published the findings of the Report of the Telecommunications Standards Review Committee together with a covering statement.

The Committee was formed because of the concern that apparatus approvals were taking too long and were too expensive. Its task was to determine what improvements could be achieved by simplifying standards.

Because of the complexities involved, the Committee was unable to reach full agreement on all the issues considered. Minority reports were submitted by TEMA, the Telecommunications and Engineering and Manufacturing Association; Mercury Communications Ltd; Hull Telephone Department; and British Telecom.

Prof. Carsberg emphasized that although the integrity of the network must be maintained, the system should also allow suppliers rapid access to their markets. He said that he could see considerable possibilities for suppliers to commission their own test reports through approved test laboratories, and to submit findings to BABT (the British Approvals Board for Telecommunications). He would be looking to BABT to play an enhanced role both in setting standards and establishing technical policies.

Telecomms Topics was written by Adrian Morant.

LOW COST ELECTRONICS C.A.D.

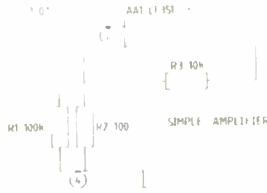
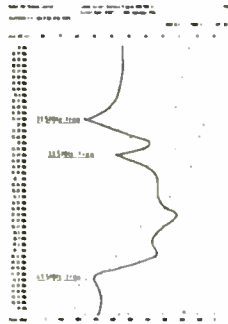
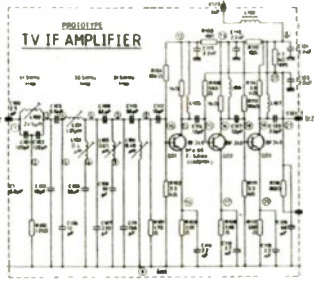

IBM PC (and compatibles), RM NIMBUS, BBC MODEL B, B+ and MASTER, AMSTRAD CPC and SPECTRUM 48K

"ANALYSER" I and II compute the A.C. FREQUENCY RESPONSE of linear (analogue) circuits. GAIN and PHASE INPUT IMPEDANCE, OUTPUT IMPEDANCE and GROUP DELAY (except Spectrum version) are calculated over any frequency range required. The programs are in use regularly for frequencies between 0.1Hz to 1.2GHz. The effects on performance of MODIFICATIONS to both circuit and component values can be speedily evaluated.

Circuits containing any combination of RESISTORS, CAPACITORS, INDUCTORS, TRANSFORMERS, BIPOLAR and FIELD EFFECT TRANSISTORS and OPERATIONAL AMPLIFIERS can be simulated - up to 60 nodes and 180 components (IBM version).

Ideal for the analysis of ACTIVE and PASSIVE FILTER CIRCUITS, AUDIO AMPLIFIERS, LOUDSPEAKER CROSS-OVER NETWORKS, WIDE-BAND AMPLIFIERS, TUNED R F AMPLIFIERS, AERIAL MATCHING NETWORKS, TV IF and CHROMA FILTER CIRCUITS, LINEAR INTEGRATED CIRCUITS etc

STABILITY CRITERIA AND OSCILLATOR CIRCUITS can be evaluated by "breaking the loop"

Tabular output on Analyser I Full graphical output, increased circuit size and active component library facilities on Analyser II.

Check out your new designs in minutes rather than days

ANALYSER can greatly reduce or even eliminate the need to breadboard new designs.

Used by INDUSTRIAL, GOVERNMENT and UNIVERSITY R & D DEPARTMENTS worldwide. IDEAL FOR TRAINING COURSES, VERY EASY TO USE. Prices from £20 to £195

Full AFTER SALES SERVICE with TELEPHONE QUERY HOT LINE and FREE update service. For illustrated leaflets and ordering information please contact Ref: WW

Number One Systems Ltd 1

Crown Street, St Ives, Huntingdon, Cambs. PE17 4EB.

Telephone: St Ives (0480) 61778

ENTER 49 ON REPLY CARD

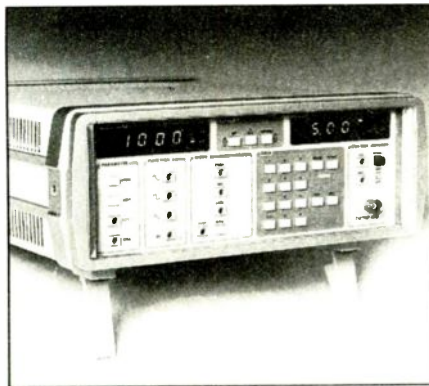
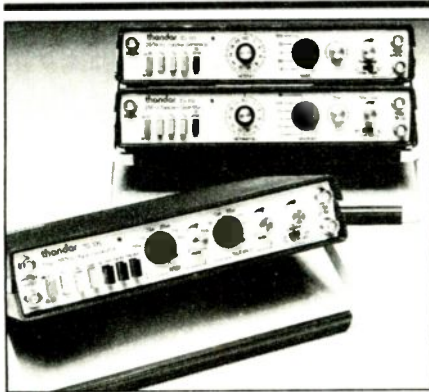

GENERATORS

TG101 £110 + VAT

0.02Hz to 200kHz Function Generator. Sine, square, triangle DC offset. 600Ω and TTL outputs; ext. sweep input.

TG102 £160 + VAT

0.2Hz to 2MHz Function Generator. Sine, square, triangle, DC offset. 50Ω and TTL outputs; ext. sweep input.

TG105 £105 + VAT

5Hz to 5MHz Pulse Generator. Free-run, gated and triggered modes; squarewave, complement. 50Ω, TTL and sync outputs.

TG401 £1290 + VAT

0.004Hz to 4MHz Programmable Function Generator. Sine, square, triangle, DC offset. Continuous, triggered or gated modes. Internal and external sweep. 50Ω and TTL outputs. All functions GPIB programmable.

TG501 £325 + VAT

0.005Hz to 5MHz Function Generator. Sine, square, triangle, ramp, pulse, haversine and DC offset. Continuous, triggered or gated modes. Variable start/stop phase; 19.1 symmetry range, ext sweep 50Ω and TTL outputs.

TG502 £545 + VAT

All TG501 features plus 1000:1 lin, 10,000:1 log sweep with adjustable sweep rate and marker.

TG503 £545 + VAT

All TG501 features plus variable width pulse mode. Normal, double, or delayed pulses; 10MHz in double mode.

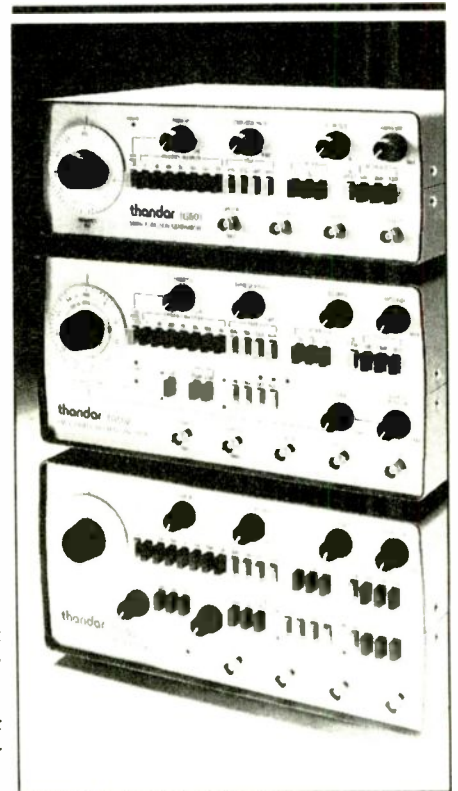

thandar
ELECTRONICS LIMITED
ENTER 23 ON REPLY CARD

Thandar Electronics Limited
London Road, St Ives, Huntingdon
Cambridgeshire PE17 4HJ, England
Telephone (0480) 64646 Telex 32250 Test

THE LOGICAL CHOICE

MATURE, FRIENDLY EPROM PROGRAMMER

GANG-OF-EIGHT BY DATAMAN

Redesigned to Your Specification

GANG-OF-EIGHT is a successful product, because of its performance and unbeatable price. Since the launch we have taken careful note of comments made by engineers who have called us. This gave us a wish-list of extra features and revisions to work by. The result is an improved G8 which should suit you even better — it is just what you asked for.

25 and 27 Series to 512K
G8 will handle 2516, 2532 and 2564 EPROMS, as well as all 27 series from 2716 to 27512.

FAST and SLOW Programming Method

You can use a FAST, intelligent algorithm to program larger EPROMS, which speeds up the programming operation by a factor of five, at least. G8 will also program the old-fashioned way, with 50ms pulses.

Voltage Selection

There are three different voltages selectable (by switches) and these are each resettable (by potentiometers) over a wide range. The factory-setting is 25 volts, 21 volts and 12.5 volts.

Liquid Crystal Display

G8 shows the EPROM type, the Program-Method and the Program-Voltage and changes the display when you reset the switches. You always know what is happening with G8.

Two Key operation

G8 has only two keys — START and RESET — simple to operate, yet it does all the useful things you need. Before every programming cycle it checks that you have not programmed any of the EPROMS already, reporting any which match the master. Then G8 tells you if any are not blank, so that you can erase them. Only if the EPROMS pass these tests does G8 start programming (but G8 will try to program un erased EPROMS, if you ignore the ERASE message and press START again — something else you asked for).

Checksum Facility

G8 will calculate and display a 6-digit checksum of your master EPROM, when you press START and RESET at the same time. This helps you to identify EPROMS which are unlabelled, and provides a simple check on the integrity of your data.

Tuneful, too

G8 provides audible feedback, to avoid the necessity for constant monitoring — that is, it makes noises so you don't need to watch it: rising and falling arpeggios as the program starts and finishes; occasional tones to remind you that your EPROMS are ready. Data is audible when uploading and downloading.

Option — Steel Case

G8 normally comes in a plastic case, which is light and durable. However, some of you want your G8 in a steel case, and this option is available now.

Option — Bidirectional RS232 Serial Interface

G8 was intended as a fast, low-cost production copier, but frequent enquiries made us think again and design a version which could be used for development purposes, capable of uploading and downloading in a variety of serial formats: INTELHEX, MOTOROLA S, TEKHEX, ASCIIHEX and BINARY. Links on your serial cable select the format.

Quick delivery

We know you don't want to wait, so we keep lots of Gang-of-Eight programmers in stock. If you are in a real hurry telephone us — we will save your time and arrange the fastest delivery possible.

No Risk Trial: Refund Guaranteed

Without any questions asked, you get your money back if you do not get along with your G8, provided you return the product within 14 days. (we subtract only carriage expenses).

Terms

Cheque with order or credit-card.

Dataman

Lombard House, Cornwall Road,
Dorchester, Dorset DT1 1RX
England

Telephone: (0305) 68066

Telex: 418442 DATAMN G

add for RS232 option £50.00

add for steel case option £35.00

to basic
GANG-OF-EIGHT **£395.00**

postage is free BUT please add VAT in U.K.

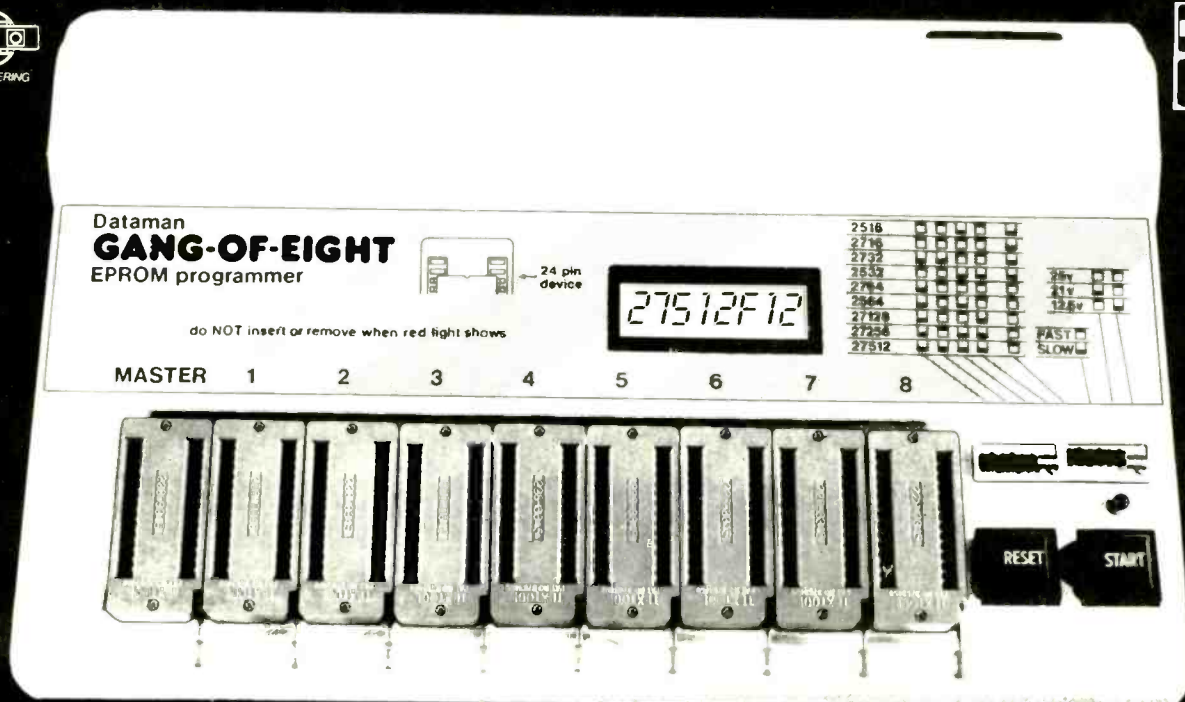

A comparison of power mos and bipolar power transistors

It is very likely that in the near future power mos will gradually replace power bipolar devices in many applications.

SUE CAIN AND RAY AMBROSE

Table 1 lists the principal differences between mos and bipolar transistors. In addition to their inherent high switching speed resulting from the lack of minority carrier injection during operation, mos with its insulated gates requires negligible input gate-drive current. Other advantages are related to the negative temperature coefficient of the current, which prevents the formation of thermal instabilities and makes the paralleling of devices much more reliable. In contrast, bipolar transistors require ballasting or careful device matching to prevent thermal runaway.

Only in high-voltage cases is mos on-resistance higher than in bipolar transistors; this leads to slightly larger steady-state power dissipation and could offset the advantages. The prospects for mos appear bright in many high-frequency applications, where switching losses become very high for bipolar devices.

PERFORMANCE COMPARISON

A comparison of the switching speeds of power mos and bipolar devices gives an indication of the energy consumption during transitions and their different values of $V_{DS(ON)}$ and $V_{CE(SAT)}$ related to energy consumption during the on state.

The two devices used in the comparison are
 SGSP565 : SGS MOS; 400V; 6A
 $R_{DS(ON)} = 1\Omega$
 SGSD00036 : SGS; 400V; 6A
 (very fast switching)

$$V_{DI}/V_{CC} = 200V$$

$$I_L = 5A \text{ (average value)}$$

Since the input losses were neglected the bipolar devices have an advantage in this comparison.

Figure 1 shows E_{TOT} (the energy losses per cycle) as a function of the operation frequency for different values of the duty cycle. For a bipolar device, the energy used during the on phase has only a slight influence with frequency variation. Mos, however, is influenced by these variations and as a result two curves, relative to the same duty cycle, are obtained. The intersecting points of these curves can be considered as a guideline to the use of devices.

In other words, if both the duty cycle and

the power to be switched are fixed, there is a frequency value above which the dissipated energy per cycle for a mos transistor is less than for a bipolar device. This means the higher the frequency the more advantageous it is to use a mos.

Under relatively low frequency conditions the value of the duty cycle (d) is fundamental in determining the advantages of both bipolar and mos technologies. From the graph in Fig.2, the best working conditions for both devices can be seen. A mos is most suited to high-frequency conditions ($> 100kHz$) for any given value of d . Maximum frequency limitations are of a thermal nature only and depend on the die size.

For the mos under consideration, the maximum power dissipated is 100W when $R_{th \text{ case}} = 1^\circ C/W$ and $T_{max} = 150^\circ C$. By plotting the power dissipated as a function of the frequency, when $d = 50\%$, the actual limits of the two technologies can be seen (Fig.3).

THERMAL STABILITY

The greater thermal stability of mos with respect to bipolar devices is essentially due to the different responses that the two devices exhibit when they are subjected to external power pulses.

In a bipolar device, an external power pulse results in an increase in the junction temperature (T_j) which causes V_{BE} to decrease and h_{FE} to increase. Both cause the collector current to increase and this, consequently, further increases T_j . This positive feedback is compensated only by the base widening effect at high currents (that is a higher recombination of the minority carriers). At high voltages, the base widening effect is not present, so that any hot spots lead to thermal runaway. These effects, if not controlled, could seriously damage a bipolar device.

A power pulse in a mos device would cause an increase in temperature of the device and a decrease in the threshold voltage.

$$V_{GS(0)} = V_{GS(0)25^\circ C} \times [1 - \alpha(T_j - 25^\circ C)]$$

where alpha is a positive coefficient of temperature ($\alpha = 2.10^{-3} C^{-1}$). This is a positive feedback, similar to a decrease of

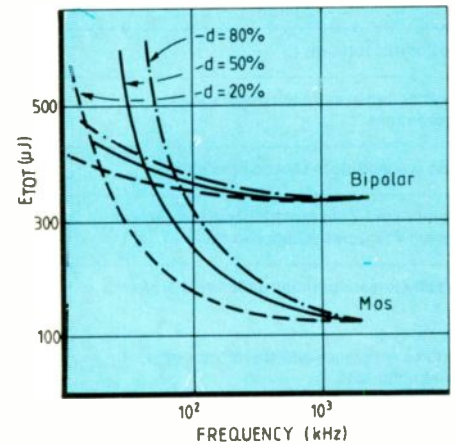

Fig.1. E_{TOT} versus frequency (kHz)

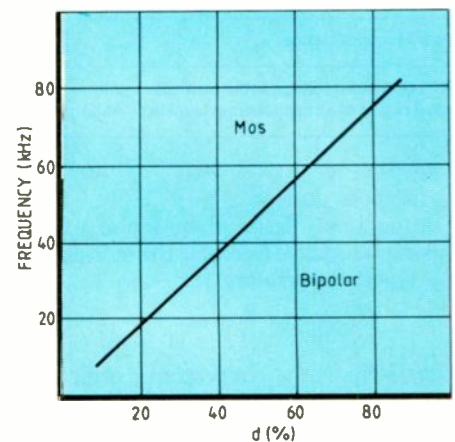

Fig.2. Best working conditions for power mos and bipolar devices

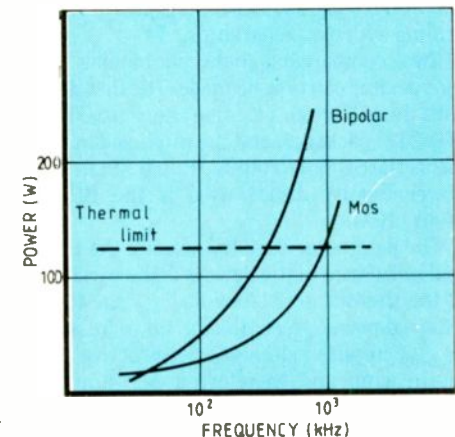

Fig.3. Thermal limits of bipolar and power mos devices

Table 1 – Comparison of MOS and bipolar power transistors

MOS	BIPOLAR
Majority-carrier device	Minority-carrier device
No charge-storage effects	Charge stored in the base and collector
High switching speed; less temperature sensitive than bipolar devices	Low switching speed; temperature sensitive
Drift current (fast process)	Diffusion current (slow process)
Voltage driven	Current driven
Purely capacitive input impedance; no d.c. current required	Low input impedance; d.c. current required
Simple drive circuitry	Complex drive circuitry (resulting from high base-current requirements)
Predominantly negative temperature coefficient of drain current	Positive temperature coefficient of collector current
No thermal runaway	Thermal runaway
Devices can be paralleled with some precautions	Devices cannot be easily paralleled because of V_{BE} matching problems and local current concentration
Less susceptible to second breakdown	Susceptible to second breakdown
Square-law I-V characteristics at low current; linear I-V features at high current	Exponential I-V characteristics
Greater linear operation and fewer harmonics	More intermodulation and cross-modulation products
High on-resistance and, therefore, larger conduction loss	Low on-resistance (low saturation voltage) because of conductivity modulation of high resistivity drift region
Drain current proportional to channel width	Collector current approximately proportional to emitter stripe length and area
Low transconductance	High transconductance
High breakdown voltage as the result of a lightly doped region of a channel-drain blocking junction	High breakdown voltage as the result of a lightly doped region of a base collector blocking junction.

V_{BE} in bipolar devices.

But in a mos device, there is also a very important negative feedback; the increase of $R_{DS(on)}$ with temperature.

$$R_{DS(on)(T)} = R_{DS(on)(25^{\circ}C)} \times [1 + \alpha (T - 25^{\circ}C)]$$

where alpha is the temperature coefficient ($\alpha = 8.10^{-3} \text{ }^{\circ}\text{C}^{-1}$). The effect of an increase in $R_{DS(on)}$ is greater than the variation in $V_{GS(th)}$. As a result, mos devices are thermally stable and the difference in behaviour of the two devices is even more exaggerated when dealing with paralleled chips.

Two comparisons between bipolar and mos devices can now be made. The first deals with the behaviour of single chips in SOT-93 (TO-218) packages, and the mos used in this test is the SGSP475 (400V, 12A, 0.55 Ω). The power bipolar device used is the BUV48 (400V, 10A).

The parameter used to measure the thermal unbalance of the devices is the variation of the thermal resistance $R_{thj-case}$ due to an external power pulse. In fact, an increase of $R_{thj-case}$ implies a decrease of the active area of the chip and therefore a non-uniform spreading of the heat, with a creation of hot spots and thermal and electrical unbalancing. The devices have been tested under several conditions, with respect to the power

dissipation and the voltage across them (V_{DS} for SGSP471, V_{CE} for BUV48). Results are shown in Fig.4 and Fig.5). SGSP475 shows optimum thermal stability under all conditions, while bipolars, with $V_{CE} = 45V$ and $P > 45W$, show a degrading of the thermal performances.

The second thermal comparison was made between mos and bipolar devices in multiple chips mounted in a parallel configuration.

The mos device under test was SGS30MA050D1 : four mos chips paralleled in a TO-240 package with $I_{D(MAX)} = 30A$, $V_{DSS} = 500V$ and $R_{DS(on)} = 0.250\Omega$. The bipolar device was SGS40TA045D : four bipolar chips paralleled in a TO-240 package with $I_C = 40A$ and $V_{CEO} = 450V$. The results are shown in Fig.6 and reveal a much better thermal stability for the mos than for the bipolar device.

Sue Cain is Product Marketing Engineer with BA Electronics, with responsibility for SGS. She has been with BA Electronics for 18 months, having joined from R.R. Electronics where she worked for five years. Ray Ambrose is UK Marketing Manager of SGS. He has been at the company for five years and joined from Mostek, where he was European Marketing Manager.

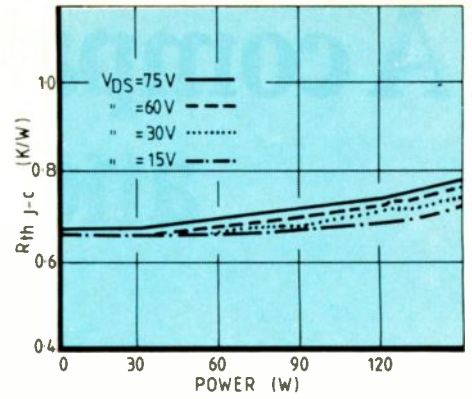

Fig.4. Variation of $R_{thj-case}$ vs. P (power mos) SGS475 SOT-93

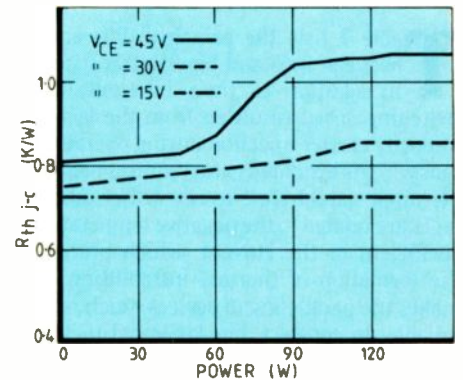

Fig.5. Variation of $R_{thj-case}$ vs. P (bipolar) BUV48 SOT-93

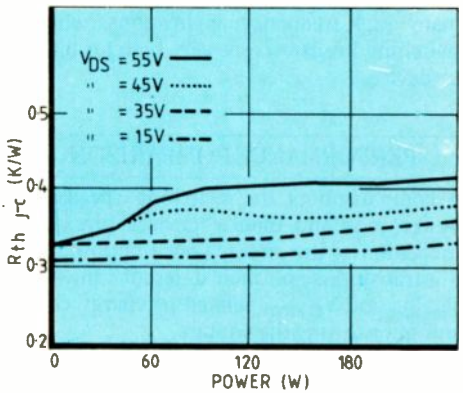

Fig.6. Variation of $R_{thj-case}$ vs. P (power mos) SGS30MA050D TO-240

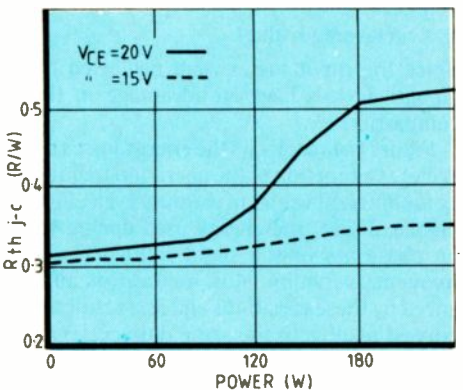

Fig.7. Variation of $R_{thj-case}$ vs. P (bipolar) SGS40TA045D TO-240

FEEDBACK

Roberts Radio

We are currently considering publishing the history of our company, Roberts Radio Company Limited.

The company was formed in 1932 at 7 Hills Place, London W1 and shortly after moved to 41 Rathbone Place, London W1, prior to moving to Molesey in 1940. We would be pleased to hear from any of your readers who may have historical information of any kind on Roberts Radio. We are particularly interested in any photographs, product information and former employees who may have memories of the early days.

I would be most grateful if anyone who has any such information or material available would contact me at the address below.

R. Roberts
Managing Director
Roberts Radio Company Ltd
Molesey Avenue
West Molesey, Surrey KT8 0RL
Telephone: 01-979 7474

Where does the bus stop?

There's plenty of information on terminating unidirectional digital buses but I cannot find anything on terminating or loading bidirectional buses.

It probably doesn't make any difference whether the load is placed on the middle of the bus or shared at each end but is there an argument for placing the loading at the most important receiving end? Any advice on this matter would be greatly appreciated.

L.J. Silver
Belmont
Surrey

S5/8

I would like to thank Mr Hardie for his suggestion and invitation (March).

On his suggestion, I telephoned the sales department of Amstrad, and enquired as to what serial interface was used with their latest computer. The predictable answer was: RS232. Had they considered using S5/8? The salesperson had not heard of it. Amstrad declined to comment

on their marketing policy, so I was unable to get the "forthright answer" referred to by Mr Hardie, but from the appearance of the product, I would suggest that Amstrad manufacture up to a standard, rather than down to a price.

I think that this illustrates one point that I made earlier, namely that there is little point in proposing this standard in isolation from the rest of the world. We can argue the technical niceties *ad nauseam*, but the real problem with British Standards lies not with technical matters, but with politics. Surely a system can be devised where a much wider canvassing of users is undertaken, to find out (a) if a new standard is required at all, and (b) what features it should employ well *before* any technical work is begun. Such users should include major importers of affected equipment.

Until such a radical change is introduced, I must regretfully decline Mr Hardie's kind invitation to participate.

Les Hayward
Eastpoint Ltd
Corfe Castle
Dorset

Andrew Hardie is incorrect when he says in his letter (March 87) that the pull-up resistor at the end of a cable driven by an open-collector driver is not a proper terminator. In fact it is, because the wave is only travelling in one direction, towards the pull-up. The driven end is, however, not properly terminated, but this only matters if there is a reflection from the other end of the cable, which there won't be because it is properly terminated.

In the case of a floppy disc drive the termination may not be perfect because the impedance of the interface ribbon cable is usually fairly arbitrary, and as Mr Hardie says, various pull-up values are used in the drives.

Alun Morris
Cambridge

Planck

Ove Tedenstig (Feedback, February 1987) represents the equation

$$h = 2\pi m_e r_e c \alpha (a-1)$$

as demonstrating a "deep relation" between h and α .

Not so, I fear.

$$E = h\nu_e = \frac{hc}{\lambda_e} = m_e c^2$$

where λ_e = equivalent wavelength of electron and ν_e = equivalent frequency of electron

$$\therefore m_e = \frac{hc}{c^2 \lambda_e} = \frac{h}{c \lambda_e}$$

Substituting in Tedenstig's equation

$$h = \frac{2\pi h r_e c (a-1)}{\lambda_e}$$

— in other words, h has been craftily hidden in the r.h.s. For h may be substituted, with equal validity, the price of kippers or the mass of a distant galaxy.

Removing h

$$\frac{2\pi r_e c (a-1)}{\lambda_e} = 1$$

an expression relating the circumference of a resting electron to its equivalent wavelength.

T.H. Brindlea
Isle of Luing
Oban, Argyll

Mathematics

I was delighted to read Messrs Coleman and Ridley's (March) confirmation that if one removes every vestige of energy from a system (a catastrophic procedure) one ends up with nothing (0) which is what the "proof" is all about and lay behind what I said. I did use inverted commas round the word.

The stage $(a + b) = b$ is an entirely fresh start following the nothing (0) which is left after several catastrophes, this being the essential part of my logic, missed by Mr Ridley, hence his long rigmarole. No proof can have a fresh start in the middle of it — it becomes a presumptive statement as I said.

I suggest, Mr Ridley, that one should be sure of the logic before attempting to discredit anything. That is in line with my second point, and I return your compliment in thanking you for demonstrating it so clearly.

Mathematicians may claim that maths are a dynamic logic, but in the final analysis maths are no more than a universal analogy to the physical systems

from or into which they may be translated. No driving energy, dead system. No constitutional energy, no system at all. Thus maths are not a dynamic logic, and must be supported by one, as I said.

As a schoolboy, I was also taught the fallacy of the so-called "proof", and thus the fallacies which *can* lie behind mathematics: I would expect the process to be normal — it should be, to keep maths pushers under control.

Thank you, gentlemen. I now suggest that you both look more carefully into the logic of removing energy, more especially in the Einsteinian context as outlined in my letter, because that is the precise procedure which modern science has followed, leading to the claimed warping of space and time, which is a technological impossibility even for Brits, however clever they may think they are.

James A. MacHarg
Wooler
Northumberland

Notwithstanding Mr Ridley's comments in the March issue of *E&W*, perhaps Mr MacHarg needed only to select a different approach in order to demonstrate "the lack of value of mathematics..." (January 1987 issue).

If one takes, as first axiom, that mathematics is a form of communication and, as second, that all communications can be represented as Markov processes, then the subject becomes entirely out of probability. This is also to say that the "active dynamic logic" of which he speaks is entirely that of words. Such an approach should appeal to specialists in the field of communications since an adequate definition of probability is "average frequency of occurrence". In other words, all mathematics is expressible as average frequencies. But what of the associated arithmetic?

Conventionally, number theory is based on sets of objects and Peano's postulates. However, if one takes a single bacterial cell (representing a primitive object), places it in nutrient medium on a microscope slide, and keeps it under observation for twenty minutes or so, then it will normally *divide*. Clearly, this violates Peano's first postulate

that "one is a positive integer". With the right conditions, the cells will continue to divide. This violates the postulate that "no positive integer has one as its successor". Only replication, not multiplication or addition, is found in nature. Why, then do we humans make computers in which $1 + 1 = 0$, carry 1? Can we really expect to understand the physical universe on this basis?
B.E.P. Clement
Crickhowell
Powys

Wide-area binary paging

Mr Kirby's article gave a very interesting introduction to practical wide-area radiopaging. Some amplification of his comparison of the two codes (POCSAG and Golay) might be helpful.

Firstly, there is a body called the Consultative Committee for International Radio (CCIR) appointed by the United Nations to create world-wide standards in radio matters. The experts of CCIR, drawn from all over the world, considered various radiopaging codes (including POCSAG, Golay and NEC). In 1982 they adopted the POCSAG code as their first world standard paging code. The POCSAG code has been renamed the "CCIR Radio-Paging Code No.1" (here called RPC1). The Post Office Code Standardisation Advisory Group (POCSAG) which developed the code is discontinued and any future development of RPC1 will be within the CCIR. In 1986 Golay was proposed as a second standard but not adopted.

In the CCIR studies it was noted that initially, by using conventional "hard-decision" decoding, RPC1 pagers offered 2-bit error correction in the address codeword and 1-bit correction in message codewords. However, it was also noted that the code could be used with a variety of error correction algorithms, e.g. by using "soft-decision" decoding up to 5 random errors or a single error burst up to 11 bits long can be corrected in any (address or message) codeword. At 512 bit/s the potential maximum signal drop-out tolerance of RPC1 thus is 21 ms (compare Kirby, Table 2).

Clearly the potential of RPC1 was under-utilized, largely because of lack of available low-voltage, miniature processing power.

An important point is that RPC1 pagers are made by a growing number of competing manufacturers. Consequently there is considerable drive to achieve a competitive edge by employing more of the potential of the code. Already RPC1 pagers using hard-decision decoding have advanced beyond the initial error correction algorithms and performance mentioned in Mr. Kirby's article. Improvements in low-power processing technology will allow this advancement to continue rapidly towards the full potential of the code. Whilst the other codes studied by CCIR also possess potential greater than their current implementation, they are proprietary and so lack the multiplicity of competitive developments which are being applied to RPC1.

This point illustrates a major advantage of a standard over a proprietary code. New standard-code pagers, from whatever source, can be deployed immediately alongside existing standard pagers. Users can always be given access to the very latest technology, and have a variety of styles and prices of pager to select from.

RPC1 (or POCSAG) was designed to be very flexible and work alongside other code formats. British Telecoms Radiopaging used three codes, including RPC1 and Golay, for several years on its channels. BT now are turning over completely to RPC1 because of its many advantages. Regarding voice on the same channel, RPC1 certainly could be used since each batch lasts 1.06 second at 512 bit/s (or 453 ms at 1200 bit/s), which is a negligible delay for voice. However, there is little call now for speech paging because of the much greater air-time efficiency of digital message paging compared to speech. Additionally digital message paging is not affected by poor quality speech or loud noises, does not demand immediate attention and each message can be read many times, and is discreet.

Another advantage of RPC1 is that for alpha-numeric messages the 7-bit alphabet used is the international standard CCITT No.5 (also known as ASCII or ISO

7-bit). RPC1 alpha-message paging offers the potential of being connected directly to any briefcase or other processor since all such machines inherently cater for this alphabet. In contrast, the Golay code uses a special 6-bit limited-facility alphabet, not inherent in any common processor.

References

CCIR Recommendation 584, titled "Standard Codes and Formats for International Radio Paging"

"The Book of the CCIR Radiopaging Code No.1" available from Multitone Communications Systems Ltd. and some other radiopager manufacturers, or BT Radiopaging.

R.H. Tridgell
Formerly chairman of POCSAG and BT delegate to CCIR
Welwyn Garden City
Hertfordshire

Magnetism

I am fascinated by P.J. Ratcliffe's experiments with high-flux pulsed magnetic fields (Feb. 1987). He says his stream of projectiles simulate "magneto-hydrostatic phenomena". Surely the phenomena are magneto-hydrodynamic effects caused by the motion of flux of a fluid medium, an ether wind or current.

I am even more fascinated by Lee Coe's letter (Jan. 1987). If the relative velocity of an electromagnetic wave in the linear accelerator is increased by a magnetic flux flowing in the same direction as the wave, a reversal of the direction of flow of the magnetic flux would surely cause an equivalent reduction of the wave's velocity relative to the accelerator. This would seem to indicate that the magnetic flux is a flow of the wave's medium, a Newtonian ether wind.

It is possible to make a simple mechanical model to simulate the Newtonian actions and reactions of two magnets or Amperian magnetic shells by suspending two electric fans facing each other. When the two atmospheric winds flow through both fans in the same direction, the two fans attract each other at a distance. When one fan is turned through 180 degrees so that the two winds flow in opposite directions, the fans repel each other at a distance. These actions are

effects caused by pressures due to fluxes of the surrounding fluid medium moving at a finite velocity, not by two central forces attracting or repelling each other instantaneously at a distance.

A tissue paper streamer glued to the end of a plastic knitting needle simulates a magnetic needle, and traces the direction and strength of the lines of atmospheric flux or Faraday's lines of magnetic force in the vicinity of the simulated magnets. Each simulated line of magnetic force is, as Faraday insisted in para. 3117 of his *Experimental Researches* "... a closed circuit, passing in some part of its course through the magnet...", Faraday's first explicit rejection of magnetic poles as centres of instantaneous attraction or repulsion at a distance, and the source of Maxwell's equation of magnetic continuity, $\text{div } B = 0$. In Maxwell's Newtonian mathematical model of an electromagnetic medium in space, B is an element of the medium's magnetic flux or ether wind flowing in closed circuits at a finite velocity.

In Lorentz's non-Newtonian mathematical model of the electron, two stationary electrons mutually repel each other with a Coulomb force acting instantaneously at a distance, and when set in motion begin to mutually attract each other with an Ampere force which depends on their absolute velocity, an action strictly forbidden by the law of the conservation of energy. The energy of any system of central forces depends only on their relative position.

The mutual effect of the central forces acting between two fans, or the Sun and the Earth, is caused by an action which depends on their relative position, not on their velocity. In other words, on their mutual potential energy, or atmospheric or gravitational pressure, never on their kinetic energy. Maxwell's quantity M is the mutual potential energy of two circuits, a system of central forces, and depends only on the relative position of the central forces. In Lorentz's model, M , if it exists at all, depends on the absolute velocities of the electron's central forces.

M.G. Wellard
Kenley
Surrey

OLSON

Small Enclosures

Boxes in Steel Aluminium and Plastic

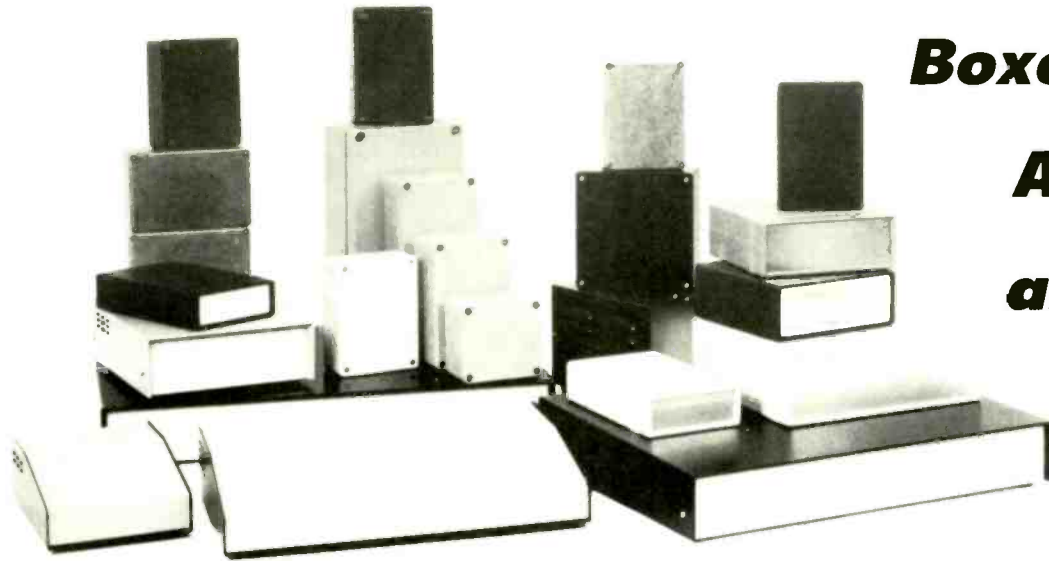

OLSON Electronics Ltd.

UNIT 3, FOUNTAYNE HOUSE
ROUNTAYNE ROAD, LONDON N15 4QL
Tel: 01-885 2884 Telex: 296797

ENTER 81 ON REPLY CARD

GET TUNED TO TELEVISION

Follow developments in VCRs and TV month by month in this unique magazine. Coverage includes teletext/viewdata, satellite TV and microcomputer servicing.

* SERVICING THE SHARP VC9300

Fault-finding guidance on this popular machine.

* SURFACE-MOUNTED TECHNOLOGY

How boards using surface-mounted components are produced, plus hints on servicing.

* VIDEO 8 SIGNAL PROCESSING

Record/playback chroma and luminance signal processing arrangements.

* TV AND VCR SERVICING

Reports from contributors on TV and VCR faults.

TELEVISION

May issue OUT NOW



FOR THE BEST CIRCUIT SIMULATION C.A.D.

BBC USERS
PLEASE SEE OUR
ADVERT ON
PAGE 545

Designers are turning to 'THOSE ENGINEERS' software. They keep ahead by knowing what is going on while free to experiment without the costs, delays and uncertainties of physical testing. Those Engineers software which creates a net list removes the chores and errors in documenting. Ask us too for schematic layout software.

ECA-2 is an example of one of our circuit simulators

Features:

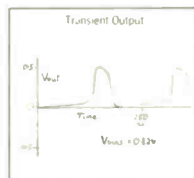
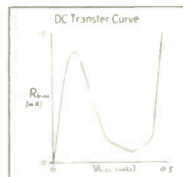
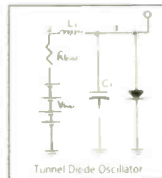

- Transient analysis – timing diagrams plotted.
- DC analysis – DC transfer curves plotted.
- AC analysis – Bode curves (gain and phase) plotted, also phase and group delay output.
- Fourier analysis – transients output in frequency domain
- Tolerancing – Monte Carlo and Worst Case.
- Temperature – Components temperature effects supported
- Non-linear simulation – Breakpoints and polynomials supported
- Full diode model – $I = I_0 \cdot (\exp\{v/q/(n \cdot k \cdot T)\} - 1)$.
- Complex components – Resistors may have inductance etc. etc.
- Varlants – Component characteristics can be made to vary with both time and frequency according to any function. Offset currents may be imposed.
- Macro models – Up to 64 connections per model to main circuit, no limit on number or size.
- Probe – Signals may be sampled or injected anywhere.
- Dual mode – Interactive mode has powerful editing and interrupting facilities. Batch mode for heavy work allows you to come back
- High capacity – Sparse matrix technique allows typically over 500 modes in 512K memory. 8087 (or 80287) coprocessors supported.
- High Speed – A ring-bound reference manual of over 200 pages is an integral part of ECA-2.
- Reference Manual – If you need more convincing, ring us for details of money-back trial.
- No risk trial – ECA-2 costs just £675 + VAT. ECA-2 compares favourably with well-known mainframe simulators and is more powerful than any other we know available on PC's.
- Low price –

THOSE ENGINEERS software which is available from £99 supports IBM PC's and compatibles and the range of BBC microcomputers. As engineers in electronic and mechanical product and process design, we welcome enquiries for other requirements.



THOSE ENGINEERS LTD. Sales: 106a Fortune Green Road, West Hampstead, London NW6 1DS.
Tel 01-435 2771, Telex 8950511 mark for mailbox 23332001.

ENTER 45 ON REPLY CARD

PHONE
0474 60521
4 LINES

P. M. COMPONENTS LTD
SELECTRON HOUSE, SPRINGHEAD ENTERPRISE PARK
SPRINGHEAD RD, GRAVESEND, KENT DA11 8HD

TELEX
966371
TOS-PM



A SELECTION FROM OUR STOCK OF BRANDED VALVES

1714 24.50	EFB83 0.95	EL519 6.95	M8225 3.95	OS1208 0.90	W77 5.00	4832 35.00	6CD6GA 1.00	29C1 19.50	1927 25.00
1834 7.50	EFB99 0.70	EL802 3.65	ME1401 29.50	OS1209 3.15	W729 1.00	4BO7A 1.75	6Y6G 1.95	29K06 6.50	4687A 9.50
1998 11.50	EFB93 0.95	EL821 8.50	ME1402 29.50	OS1210 1.50	W739 1.50	4B26 1.95	6X2N 1.00	30C17 0.40	4212E 250.00
2087 11.50	EBL1 2.50	EL822 12.95	ME1501 24.00	OS1211 1.50	X24 4.50	4C27 25.00	6CH6 6.95	30C18 1.48	4313C 4.00
2134 14.95	EBL21 2.00	EL820 22.50	M4 3.50	OS1212 3.20	X66X65 4.95	4C28 25.00	6CL3 3.95	30C19 1.00	4328D 9.00
2293 6.50	EC52 0.75	EM1 9.00	M4.6 4.00	OS1213 3.00	X76M 1.95	4C35 145.00	6CL6 1.50	30F1 1.00	5626 9.50
2426 35.00	EC70 1.75	EM4 9.00	M4.6 4.50	OS1215 2.10	X76M 1.95	4CX1000A 425.00	6CL8A 1.50	30F1.2 1.35	5642 9.50
2599 37.50	EC81 7.95	EM80 0.70	MP25 195.00	OS1218 1.50	XK24 1.50	4CX4000A 1100.00	6CN5 1.60	30F1.2 0.95	5651 2.50
2792 27.50	EC86 1.00	EM81 0.70	MS4B 5.50	OS1218 1.50	XK24 1.50	4CX250B EIMAC 49.00	6CM7 2.95	30F1.3 1.10	5654 1.95
2900 11.50	EC88 1.00	EM84 1.65	MU14 3.50	OS1218 1.50	XK24 1.50	4CX250B EIMAC 49.00	6C87 0.95	30F1.4 1.25	5653 1.95
3042 24.00	EC90 1.10	EM85 3.95	MU21 4.50	OS1218 1.50	XK24 1.50	4CX250B EIMAC 49.00	6C87 0.95	30F1.4 0.45	5670 3.25
3283 24.00	EC91 5.50	EM87 2.50	MU21-100 125.00	OS1218 1.50	XK24 1.50	4CX250B EIMAC 49.00	6C87 0.95	30L15 0.60	5672 4.50
CT4DD 4.00	EC92 1.50	EM88 1.50	N57 12.50	OS1218 1.50	XK24 1.50	4CX250B EIMAC 49.00	6C87 0.95	30L17 0.60	5675 28.00
CT4H 4.00	EC93 1.50	EM89 1.50	N78 12.50	OS1218 1.50	XK24 1.50	4CX250B EIMAC 49.00	6C87 0.95	30P4MR 1.00	5678 7.50
CT12 59.75	EC95 7.00	EN92 4.50	OA2 1.15	OS1218 1.50	XK24 1.50	4CX250B EIMAC 49.00	6C87 0.95	30P18 1.00	5687 4.50
H221 39.00	EC97 1.10	EX35 235.00	OA2WA 2.50	OS1218 1.50	XK24 1.50	4CX250B EIMAC 49.00	6C87 0.95	30P19 1.00	5692 7.50
H238 39.00	EC98 1.00	EM84 1.65	OA3 2.50	OS1218 1.50	XK24 1.50	4CX250B EIMAC 49.00	6C87 0.95	30P18 1.00	5696 4.50
N0 6.00	EC99 1.10	EM85 3.95	OB2 1.15	OS1218 1.50	XK24 1.50	4CX250B EIMAC 49.00	6C87 0.95	30P1.1 2.50	5704 3.50
N1 14.00	EC99 1.10	EM87 2.50	OB2WA 2.50	OS1218 1.50	XK24 1.50	4CX250B EIMAC 49.00	6C87 0.95	30P1.3 0.60	5718 6.15
RF12 0.70	EC99 1.10	EM88 1.50	OB2WA 2.50	OS1218 1.50	XK24 1.50	4CX250B EIMAC 49.00	6C87 0.95	30P1.4 1.75	5725 2.50
RP34 1.25	EC99 1.10	EM89 1.50	OC3 1.50	OS1218 1.50	XK24 1.50	4CX250B EIMAC 49.00	6C87 0.95	31J56C 5.50	5726 2.50
RP35 2.50	EC99 1.10	EM90 0.70	OC3 1.50	OS1218 1.50	XK24 1.50	4CX250B EIMAC 49.00	6C87 0.95	33A158M 19.50	5727 2.50
Z11 4.50	EC99 1.10	EM91 1.50	OC3 1.50	OS1218 1.50	XK24 1.50	4CX250B EIMAC 49.00	6C87 0.95	35A5 4.50	5749 2.50
Z13 4.50	EC99 1.10	EM92 4.50	OC3 1.50	OS1218 1.50	XK24 1.50	4CX250B EIMAC 49.00	6C87 0.95	35L6GT 2.00	5750 1.85
L63 2.00	EC99 1.10	EM93 0.75	OC3 1.50	OS1218 1.50	XK24 1.50	4CX250B EIMAC 49.00	6C87 0.95	35Z3 1.85	5751 2.95
SB14 55.00	EC99 1.10	EM94 0.75	OC3 1.50	OS1218 1.50	XK24 1.50	4CX250B EIMAC 49.00	6C87 0.95	30F114 0.45	5753 9.75
T17 25.00	EC99 1.10	EM95 0.75	OC3 1.50	OS1218 1.50	XK24 1.50	4CX250B EIMAC 49.00	6C87 0.95	30K17 0.45	5758 3.25
IK 27.50	EC99 1.10	EM96 0.75	OC3 1.50	OS1218 1.50	XK24 1.50	4CX250B EIMAC 49.00	6C87 0.95	40K06 5.50	5814A 3.25
3E 27.50	EC99 1.10	EM97 0.75	OC3 1.50	OS1218 1.50	XK24 1.50	4CX250B EIMAC 49.00	6C87 0.95	50C5 0.95	5823 9.50
3A 20.00	EC99 1.10	EM98 0.75	OC3 1.50	OS1218 1.50	XK24 1.50	4CX250B EIMAC 49.00	6C87 0.95	50C5 0.95	5829WA 6.50
6A 20.00	EC99 1.10	EM99 0.75	OC3 1.50	OS1218 1.50	XK24 1.50	4CX250B EIMAC 49.00	6C87 0.95	50C5 0.95	5840 11.00
1108 65.00	EC99 1.10	EM100 0.75	OC3 1.50	OS1218 1.50	XK24 1.50	4CX250B EIMAC 49.00	6C87 0.95	50C5 0.95	5847 10.95
1134 32.00	EC99 1.10	EM101 0.75	OC3 1.50	OS1218 1.50	XK24 1.50	4CX250B EIMAC 49.00	6C87 0.95	50C5 0.95	5879 5.50
1148A 115.00	EC99 1.10	EM102 0.75	OC3 1.50	OS1218 1.50	XK24 1.50	4CX250B EIMAC 49.00	6C87 0.95	50C5 0.95	5886 13.95
1149 195.00	EC99 1.10	EM103 0.75	OC3 1.50	OS1218 1.50	XK24 1.50	4CX250B EIMAC 49.00	6C87 0.95	50C5 0.95	5894 39.50
1150 135.00	EC99 1.10	EM104 0.75	OC3 1.50	OS1218 1.50	XK24 1.50	4CX250B EIMAC 49.00	6C87 0.95	50C5 0.95	5899 6.50
1534 32.00	EC99 1.10	EM105 0.75	OC3 1.50	OS1218 1.50	XK24 1.50	4CX250B EIMAC 49.00	6C87 0.95	50C5 0.95	5963 1.75
3E 29.50	EC99 1.10	EM106 0.75	OC3 1.50	OS1218 1.50	XK24 1.50	4CX250B EIMAC 49.00	6C87 0.95	50C5 0.95	5965 2.25
C3L 0.90	EC99 1.10	EM107 0.75	OC3 1.50	OS1218 1.50	XK24 1.50	4CX250B EIMAC 49.00	6C87 0.95	50C5 0.95	6005 1.85
K1006 3.50	EC99 1.10	EM108 0.75	OC3 1.50	OS1218 1.50	XK24 1.50	4CX250B EIMAC 49.00	6C87 0.95	50C5 0.95	6012 16.00
on request	EC99 1.10	EM109 0.75	OC3 1.50	OS1218 1.50	XK24 1.50	4CX250B EIMAC 49.00	6C87 0.95	50C5 0.95	6021 8.50
3A 27.50	EC99 1.10	EM110 0.75	OC3 1.50	OS1218 1.50	XK24 1.50	4CX250B EIMAC 49.00	6C87 0.95	50C5 0.95	6057 3.75
63 11.50	EC99 1.10	EM111 0.75	OC3 1.50	OS1218 1.50	XK24 1.50	4CX250B EIMAC 49.00	6C87 0.95	50C5 0.95	6058 3.95
AA 22.50	EC99 1.10	EM112 0.75	OC3 1.50	OS1218 1.50	XK24 1.50	4CX250B EIMAC 49.00	6C87 0.95	50C5 0.95	6059 3.75
AA2 17.50	EC99 1.10	EM113 0.75	OC3 1.50	OS1218 1.50	XK24 1.50	4CX250B EIMAC 49.00	6C87 0.95	50C5 0.95	6060 2.25
480 4.50	EC99 1.10	EM114 0.75	OC3 1.50	OS1218 1.50	XK24 1.50	4CX250B EIMAC 49.00	6C87 0.95	50C5 0.95	6062 4.50
A100 125.00	EC99 1.10	EM115 0.75	OC3 1.50	OS1218 1.50	XK24 1.50	4CX250B EIMAC 49.00	6C87 0.95	50C5 0.95	6063 2.00
AF91 0.70	EC99 1.10	EM116 0.75	OC3 1.50	OS1218 1.50	XK24 1.50	4CX250B EIMAC 49.00	6C87 0.95	50C5 0.95	6064 3.25
AF96 0.65	EC99 1.10	EM117 0.75	OC3 1.50	OS1218 1.50	XK24 1.50	4CX250B EIMAC 49.00	6C87 0.95	50C5 0.95	6067 7.00
C70 1.75	EC99 1.10	EM118 0.75	OC3 1.50	OS1218 1.50	XK24 1.50	4CX250B EIMAC 49.00	6C87 0.95	50C5 0.95	6072 4.20
CR0 3.50	EC99 1.10	EM119 0.75	OC3 1.50	OS1218 1.50	XK24 1.50	4CX250B EIMAC 49.00	6C87 0.95	50C5 0.95	6074 6.50
CK4-5000 25.00	EC99 1.10	EM120 0.75	OC3 1.50	OS1218 1.50	XK24 1.50	4CX250B EIMAC 49.00	6C87 0.95	50C5 0.95	6080 8.50
ET16 28.50	EC99 1.10	EM121 0.75	OC3 1.50	OS1218 1.50	XK24 1.50	4CX250B EIMAC 49.00	6C87 0.95	50C5 0.95	6082 4.50
ET18 28.50	EC99 1.10	EM122 0.75	OC3 1.50	OS1218 1.50	XK24 1.50	4CX250B EIMAC 49.00	6C87 0.95	50C5 0.95	6083 8.50
ET22 35.00	EC99 1.10	EM123 0.75	OC3 1.50	OS1218 1.50	XK24 1.50	4CX250B EIMAC 49.00	6C87 0.95	50C5 0.95	6084 8.50
ET23 35.00	EC99 1.10	EM124 0.75	OC3 1.50	OS1218 1.50	XK24 1.50	4CX250B EIMAC 49.00	6C87 0.95	50C5 0.95	6085 8.50
ET24 35.00	EC99 1.10	EM125 0.75	OC3 1.50	OS1218 1.50	XK24 1.50	4CX250B EIMAC 49.00	6C87 0.95	50C5 0.95	6086 8.50
ET25 22.00	EC99 1.10	EM126 0.75	OC3 1.50	OS1218 1.50	XK24 1.50	4CX250B EIMAC 49.00	6C87 0.95	50C5 0.95	6087 8.50
ET29 32.00	EC99 1.10	EM127 0.75	OC3 1.50	OS1218 1.50	XK24 1.50	4CX250B EIMAC 49.00	6C87 0.95	50C5 0.95	6088 8.50
IF91 1.00	EC99 1.10	EM128 0.75	OC3 1.50	OS1218 1.50	XK24 1.50	4CX250B EIMAC 49.00	6C87 0.95	50C5 0.95	6089 8.50
IF92 0.60	EC99 1.10	EM129 0.75	OC3 1.50	OS1218 1.50	XK24 1.50	4CX250B EIMAC 49.00	6C87 0.95	50C5 0.95	6090 8.50
IF96 1.25	EC99 1.10	EM130 0.75	OC3 1.50	OS1218 1.50	XK24 1.50	4CX250B EIMAC 49.00	6C87 0.95	50C5 0.95	6091 8.50
IF97 1.25	EC99 1.10	EM131 0.75	OC3 1.50	OS1218 1.50	XK24 1.50	4CX250B EIMAC 49.00	6C87 0.95	50C5 0.95	6092 8.50
IF98 1.25	EC99 1.10	EM132 0.75	OC3 1.50	OS1218 1.50	XK24 1.50	4CX250B EIMAC 49.00	6C87 0.95	50C5 0.95	6093 8.50
IF99 1.25	EC99 1.10	EM133 0.75	OC3 1.50	OS1218 1.50	XK24 1.50	4CX250B EIMAC 49.00	6C87 0.95	50C5 0.95	6094 8.50
IF100 1.25	EC99 1.10	EM134 0.75	OC3 1.50	OS1218 1.50	XK24 1.50	4CX250B EIMAC 49.00	6C87 0.95	50C5 0.95	6095 8.50
IF101 1.25	EC99 1.10	EM135 0.75	OC3 1.50	OS1218 1.50	XK24 1.50	4CX250B EIMAC 49.00	6C87 0.95	50C5 0.95	6096 8.50
IF102 1.25	EC99 1.10	EM136 0.75	OC3 1.50	OS1218 1.50	XK24 1.50	4CX250B EIMAC 49.00	6C87 0.95	50C5 0.95	6097 8.50
IF103 1.25	EC99 1.10	EM137 0.75	OC3 1.50	OS1218 1.50	XK24 1.50	4CX250B EIMAC 49.00	6C87 0.95	50C5 0.95	6098 8.50
IF104 1.25	EC99 1.10	EM138 0.75	OC3 1.50	OS1218 1.50	XK24 1.50	4CX250B EIMAC 49.00	6C87 0.95	50C5 0.95	6099 8.50
IF105 1.25	EC99 1.10	EM139 0.75	OC3 1.50	OS1218 1.50	XK24 1.50	4CX250B EIMAC 49.00	6C87 0.95	50C5 0.95	6100 8.50
IF106 1.25	EC99 1.10	EM140 0.75	OC3 1.50	OS1218 1.50	XK24 1.50	4CX250B EIMAC 49.00	6C87 0.95	50C5 0.95	6101 8.50
IF107 1.25	EC99 1.10	EM141 0.75	OC3 1.50	OS1218 1.50	XK24 1.50	4CX250B EIMAC 49.00	6C87 0.95	50C5 0.95	6102 8.50
IF108 1.25	EC99 1.10	EM142 0.75	OC3 1.50	OS1218 1.50	XK24 1.50	4CX250B EIMAC 49.00	6C87 0.95	50C5 0.95	6103 8.50
IF109 1.25	EC99 1.10	EM143 0.75	OC3 1.50	OS1218 1.50	XK24 1.50	4CX250B EIMAC 49.00	6C87 0.95	50C5 0.95	6104 8.50
IF110 1.25	EC99 1.10	EM144 0.75	OC3 1.50	OS1218					

APPLICATIONS SUMMARY

Radio navigation system

Design, testing and implementation of a Loran navigation system using a 16bit Transputer are described in two notes from Immos.

Because the Transputer is capable of servicing a repetitive event every 10µs, it can receive Loran C 100kHz transmissions directly without demodulation, saving a lot of hardware. Using averaging, the system described in the notes can give a resolution of around 300m.

Circuit diagrams are not given but each module is well described. Software too is only outlined. Elements of the design are a high-gain narrow-band amplifier to capture the incoming signal, a counter to measure phase, a Transputer to perform signal processing and trigonometric calculation, a keyboard and a display. Since the incoming signal is only short bursts of r.f., energy-storing LC circuits are avoided. The processor also provides system control signals.

At 100kHz, the events must be trapped at a 10µs cycle rate. The Immos Transputer has an inherent response time to external stimuli of 1-3µs and has an internal resolution of 1µs. Theoretically, it could resolve r.f. information to an accuracy of 3µs, which at the speed of light would give a resolution of around 1km in a navigation system. In practice, this figure can be reduced to 300m using averaging techniques.

During the implementation phase of the project, several improvements were made over the design described in Technical Note 0. First, the external 10MHz counter was found to be unnecessary since, due to noise, the incoming r.f. signal had much more than 100ns jitter. Software handled the jitter and regained the accuracy by averaging over many incoming signals. Thus the link adaptor was only needed to connect to keyboard and screen, which are slow devices and do not justify such a high-performance chip.

Secondly, the M212 disc-control Transputer became available. In addition to its disc hardware, it has 16 general-purpose i/o pins. Thus the final design uses just a narrow-band amplifier, the M212 Transputer, a keyboard and an l.c.d.

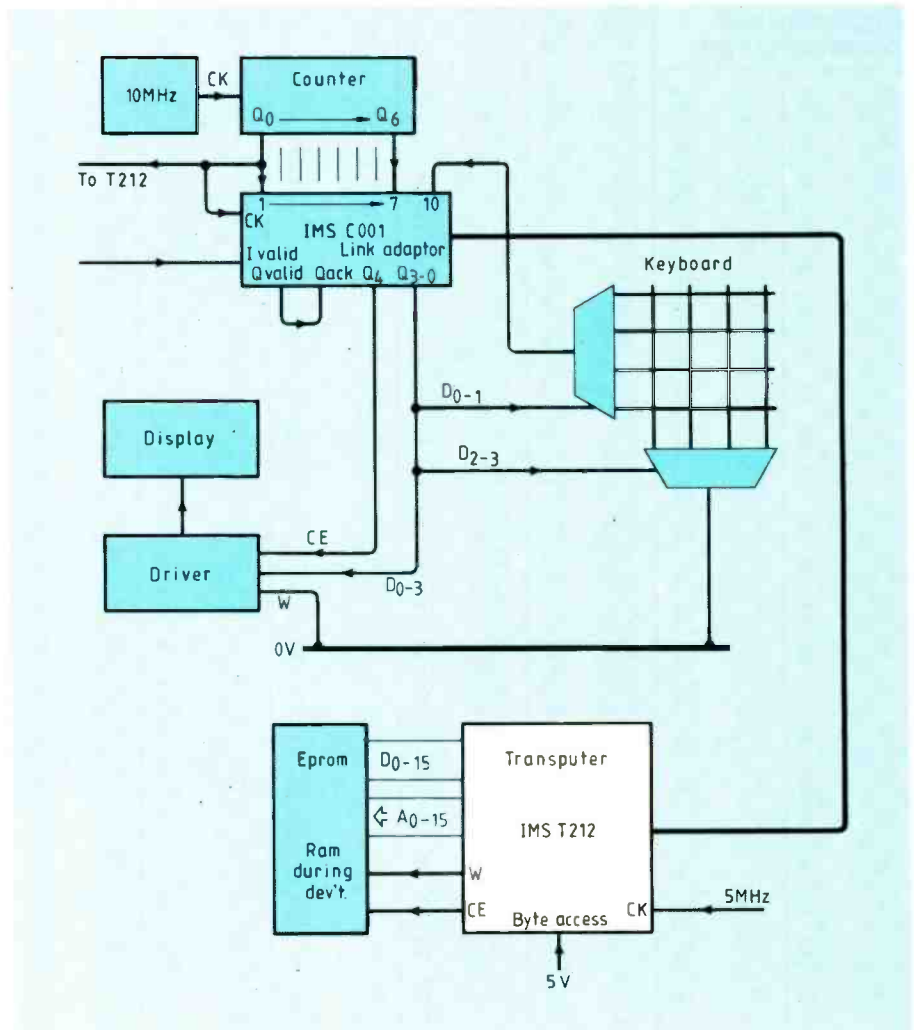

Loran

Author of the note, Philip Mattos, adds that the Loran system does not cover south England adequately and although there were some tests of an additional transmitter chain in France and Germany, to make it work correctly would need a further transmitter in Ireland, which no one appears willing to fund.

The system will run until at least 1995, when it should be replaced by satellite navigation. He is currently designing a Transputer-based navigation system

based on the American Global Positioning System (GPS) satellites. This will require a down converter and a-to-d converter, with the Transputer taking raw data at two megasamples per second and correlating to extract the signal, which is transmitted in spread-spectrum form.

The GPS system is partially available but, due to the Challenger accident, launch of the satellites is behind schedule and 24-hour coverage is not yet available.

Siliconix
Semiconductor Specialists Carrol House
159 High Street Weylesley West Drayton
Middlesex UB7 7BX Tel. 0895 445522

Motorola
ITT Multicomponents 346 Edinburgh
Avenue Slough Berkshire SL1 4TU Tel.
0753 824131

Inmos
1000 Aztec West Amondsbury Bristol
BS12 4SQ Tel. 0454 616616

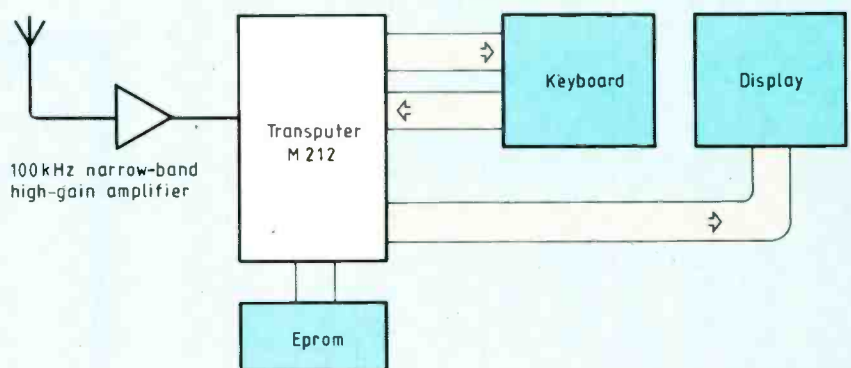

APPLICATIONS SUMMARY

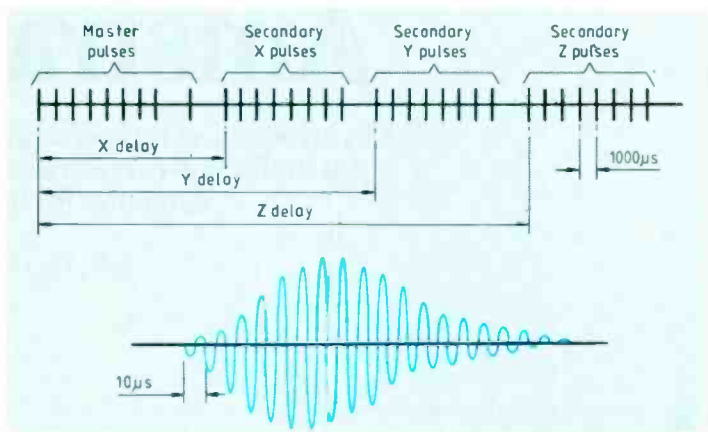
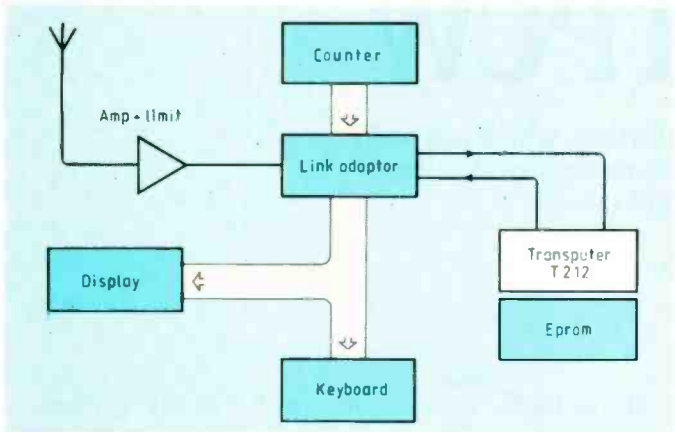

-64-channel shared p.c.m. codec

Fast analogue multiplexers with low channel-to-channel crosstalk and high-off/low-on resistance are used in this 64-channel shared p.c.m. coder/decoder. This design is part of Siliconix Applications No.3.

For a 64-channel system, each channel has to be accessed every 2μ ($125 \div 64$). Connecting four drains together increases output-node capacitance, but the multiplexer sampling time of 125μ (8kHz) is easily attained.

Digital switching matrixes like the one shown normally use e.c.l. or t.t.l. devices; the 536 switch saves power. Also, using analogue devices for the p.c.m. switching matrix makes code converters and regeneration stages unnecessary.

After transmission, the digital p.c.m. trunk is converted back to analogue form and demultiplexed to provide the analogue output channels.

Crosstalk of the Siliconix DG536 multi-

plexer is -92dB at 5MHz, off isolation is $>100\text{dB}$ at 5MHz and on resistance is 90Ω . The device switches on in 300ns and off in 150ns.

Other applications in the brochure include a multiplexed a-to-d converter for 8085 interfacing, a low-power two-phase clock and a data acquisition system for aircraft. There are also notes on using fet voltage-controlled resistors, source followers and synchronous rectifiers.

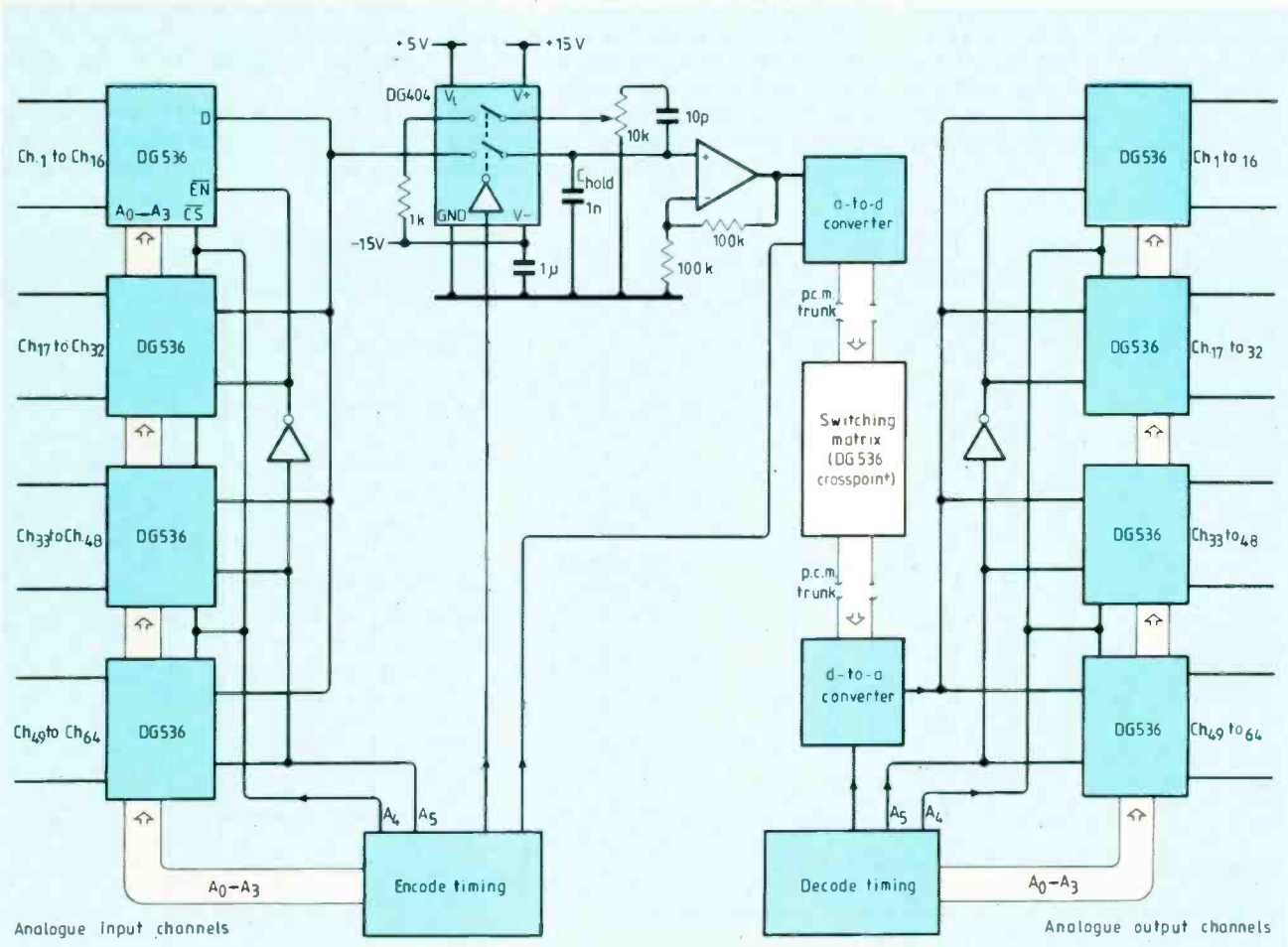

Scientific interface for the Amstrad PCW

Circuit details of this versatile interface, which can make Amstrad's low-cost word-processor into an excellent computer for the laboratory.

BRIAN J. FROST

An important requirement was that the interface be kept modular so that sections could be easily omitted or added later. Figures 5 to 9 show optional circuitry that may be included as required. In addition, extra address decoding has been provided to reserve a total of eight 8-bit port addresses, allowing four for the present circuitry and another four for adding later a serial interface and eprom programmer.

Address lines from the expansion connector are taken to decoders IC₂₀₁ and IC₂₀₂ (Fig.2, April issue, page 455) which provide a separate read and write select line for each of the four ports on the card. Port addresses and their hardware assignments (Fig.4) have been chosen in consultation with Amstrad to ensure future upgrade capability.

Any address access to the card triggers IC₂₀₃, a monostable which drives an 'access' led. This has proved useful during the construction of both hardware. Data bus transceiver IC₂₀₇ is enabled by any card access and provides additional protection and fanout.

Figure 5 shows the eight-bit digital output. A single octal latch IC₃₀₁ latches data written to port address A₁. The data output is displayed on leds but no attempt has been made to add extra output buffering. This is the only external connection to the interface where protection is not available since it adds significant complexity if speed or other compromises are to be avoided. Data written to this address remains latched until changed.

Figure 6 shows the eight-way input circuitry. Input signals are pulled down by R₅₀₁ and the Schmitt triggers are fed via R₅₀₂. This arrangement is highly recommended since it provides very low loading and can be connected directly to 15V c-mos or arbitrary logic levels, so long as the threshold of around 2V is accommodated.

The level of protection is very high: and although it is to be discouraged, an input can be connected to the mains without damage other than increased heating of the input resistors. A speed degradation of 1µs or so is due to R₅₀₂, but this is small compared with

the obtainable processor i/o rate of around 20µs.

The digital to analogue converter circuit (Fig.7) can be added to the address decoding of Fig.2 to form a powerful waveform synthesizer.

The eight-bit converter is a bus-orientated device that latches data written to port address A₂ and provides an output voltage controlled from zero to its 2.55V internal reference. This is fed to the optional circuitry of Fig.10 which provides scale and offset adjustment as well as i/o protection.

Figure 8 shows the high-speed eight-bit successive approximation a-to-d converter IC₇₀₁ with its sample and hold buffer amplifier. A minimum system would comprise the address decoding (Fig.2), the d.a.c. (Fig.7), a simple inverter to derive a negative supply and this circuit to provide almost all of the waveform recording, replay and plotting facilities.

This circuit will digitize an input waveform via software at up to 25kHz, although the a-to-d conversion time is set by the clock

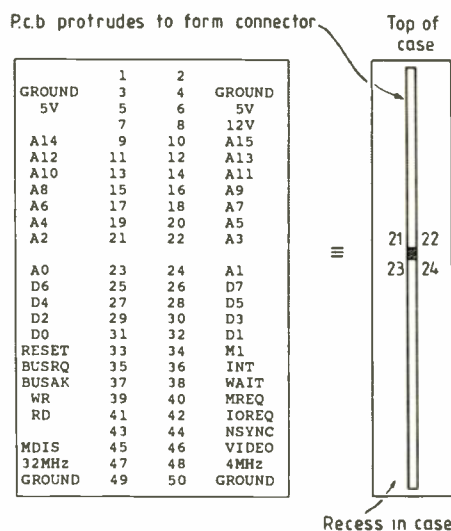

Fig.3. Details of the Amstrad PCW connector.

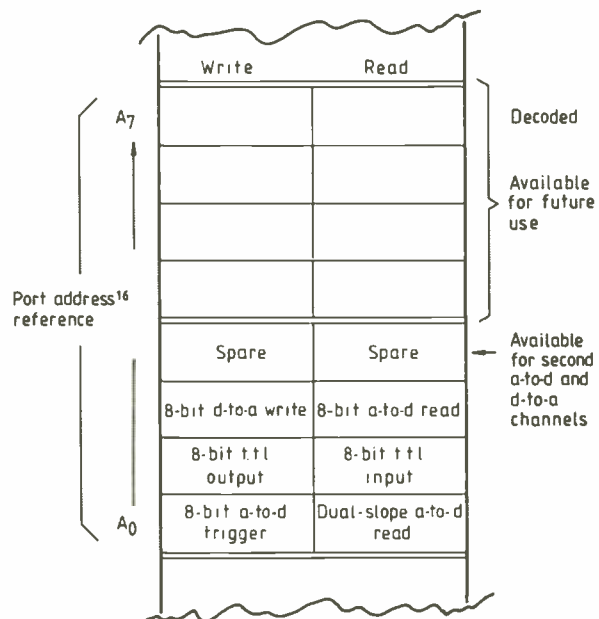

Fig.4 (right). Port address map: assignments for the interface have been chosen in consultation with Amstrad.

generator IC₇₀₂ to around 10 μ s (100k samples per second). During conversion the Busy output is used to force a Hold condition on IC₇₀₃ to ensure no input change. This allows the fastest sampling of dynamic waveforms without external filtering.

Conversion is started by a write to port address A_0 . Internal circuitry then performs the conversion and data is available for reading at port A_2 . The fixed, short conversion time eliminates the need to take the Busy signal to the processor.

For more precise but slower measurements, a dual-slope a-to-d converter is available (Fig.9). This is an auto-zeroing, b.c.d. output device which accepts an input voltage of either polarity in the range +2.000V to -2.000V and provides four 4-bit b.c.d. words at Q_0 Q_3 together with strobe signals DS_0 DS_3 which identify their significance.

The device is ratiometric and requires an external 2V reference. The d-to-a converter reference is slightly higher at a nominal 2.55V and for accurate reading of the applied voltage this reference may be adjusted to 2.000 volts by VR₅₀₁. The adjustment is only needed if the analogue signal conditioning is omitted, since a variable gain factor is inherent in that section. In this case VR₅₀₁ can be replaced by a link, and 100k Ω fitted instead of the 82k Ω shown.

The processor reads each b.c.d. digit and its strobe via IC₅₀₂ (timing diagram Fig.10).

A read cycle begins with the end-of-conversion signal E_{OC} which is stretched by IC₅₀₄ to ensure its visibility to the processor read loop. The processor then loops waiting for the first strobe (DS_0) to read the most significant b.c.d. digit, followed by strobes for the other three digits. Strobes DS_1 and DS_3 are combined since there is no timing ambiguity.

Extra information is available coded into the m.s.d. (inset in Fig.10). The accompanying software extracts the half-digit and polarity and stores overrange and under-range in memory undecoded.

SIGNAL CONDITIONING

A quad op-amp IC₅₀₁ (not shown) buffers and conditions the analogue signals both inward and outward. The circuits allow a scale factor

COMPONENTS

The interface is available fully assembled and tested at £139, or in the following kit stages:

Kit A: printed circuit board with connector for address decoding circuitry of Fig.2, £16.50.

Kit B: address decoding circuitry of Fig.2, including p.c.b. connector, and all components fully assembled and tested, £31.50.

Kit C: complete interface including case, p.c.bs, components, connectors, switches and interconnecting cable, £117.50.

Prices include postage and packing but please add v.a.t. at 15%. Orders or enquiries should be addressed to Placepower Ltd, Unit 24, Longs Industrial Estate, Englands Lane, Gorleston, Norfolk NR31 6BE; telephone 0493 603771.

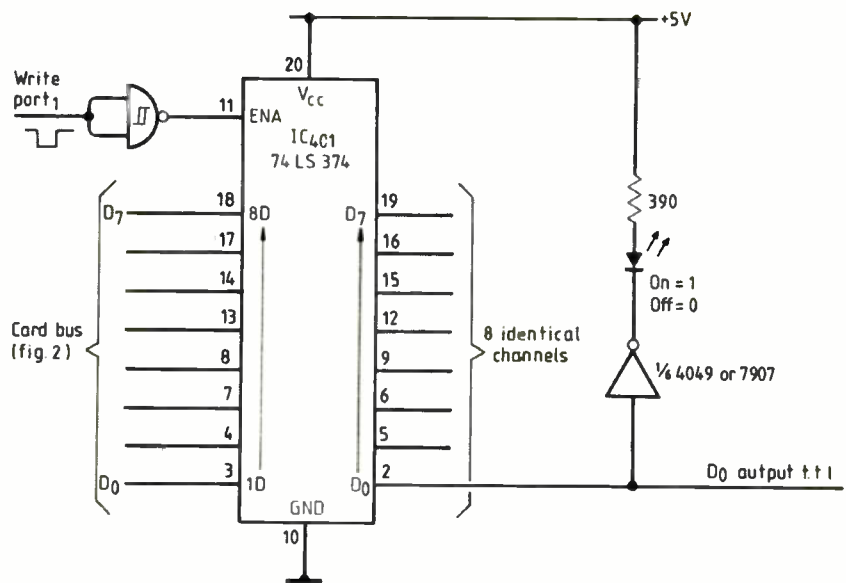

Fig.5. Eight-bit t.t.l.-level output. Further buffering may be needed.

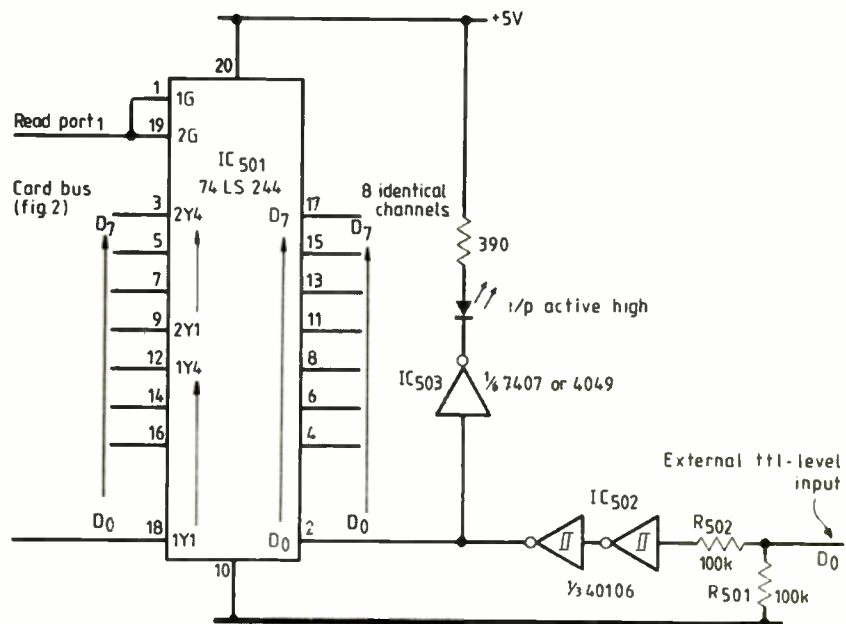

Fig.6. Eight-bit t.t.l.-level input: loading of the external circuit is very low.

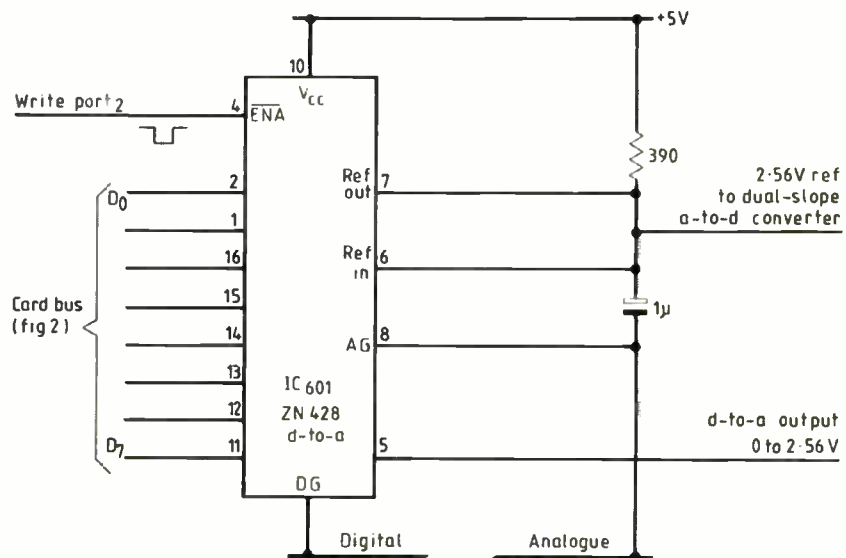

Fig.7. Digital-to-analogue converter: applications include waveform synthesis.

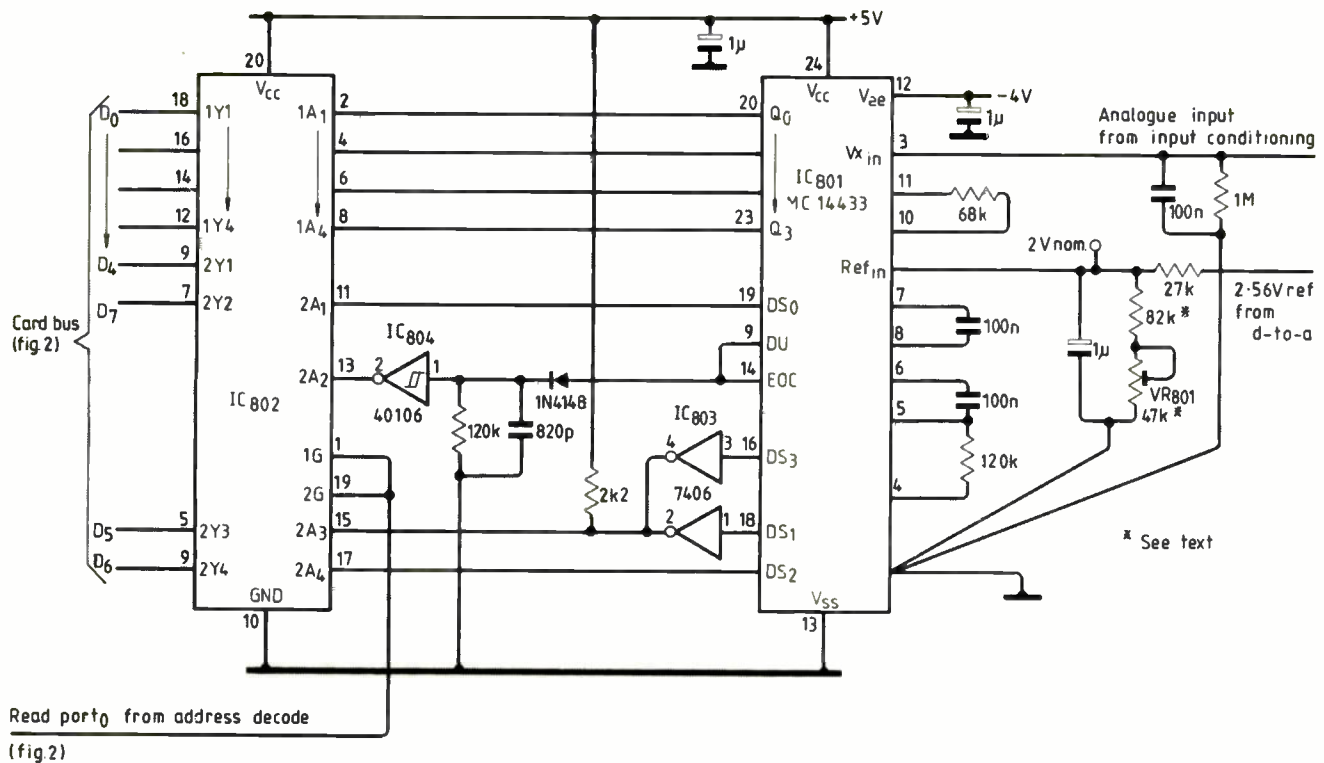

Fig.9 (above). For more precise measurements, the interface includes this eight-bit dual-slope converter. IC₈₀₂ is an LS244.

connector may become a permanent feature of the computer! Wiping the Amstrad connector with a silicone-based preparation such as WD-40 will prevent stray epoxy from adhering.

Begin testing with the address decoding circuit of Fig.2. Having checked it, fit it to the computer and run the program `PORT`. This asks for the selection of a read-data or write-data fast software loop, allowing an ordinary oscilloscope to be triggered from TP₂₀₁ (the card enable line) and so probe any address or data line.

If there has been an error in construction, it may be that no trigger pulse appears at TP₂₀₁. In this case, trigger the scope from `IOREQ` (i/o request) using the `PORT` program and examine the inputs and outputs of the address decoders to establish why the required port address is not being correctly decoded. On the prototype the +5V rail takes around 200mA and the +12V a few mA.

After one or more of the interface functions has been added it can be tested fully using another supplied test program `SIX`.

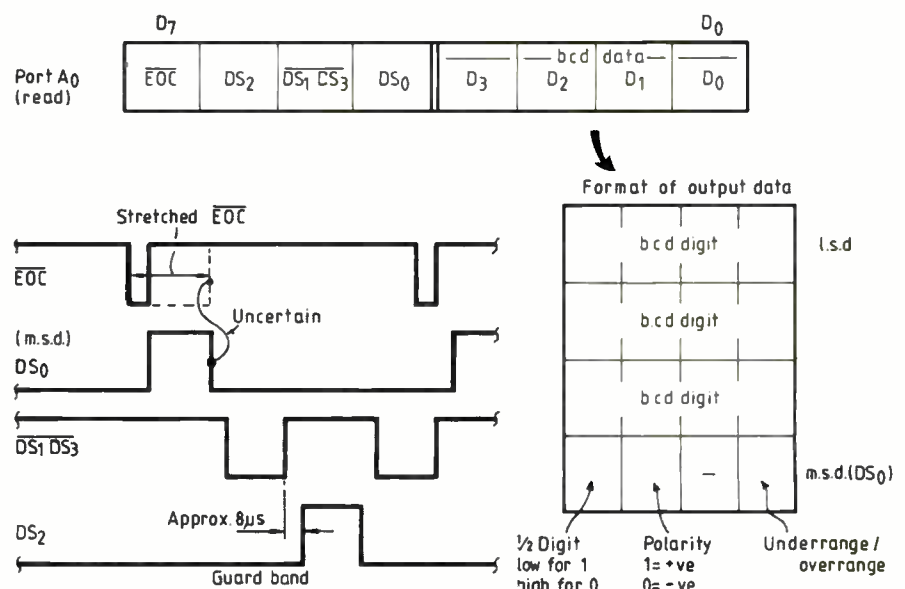
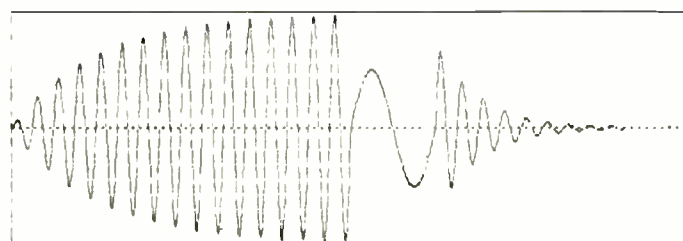

Fig.10. Timing diagram and data format of the a-to-d converter in Fig.9.

AVOIDING PROBLEMS

- Do not unplug the interface with the computer switched on.
- Avoid connecting an oscilloscope to the interface whilst the computer is running. Applying the scope ground so close to the processor ground can inject a noise pulse causing the computer to crash.
- Be careful when probing with an oscilloscope directly on the processor output lines. These are connected to large gate array which is not in a socket and would be awkward to replace. When the interface is functioning, all processor lines are buffered by the address decoding circuitry.



- Data -
 Plot start address: 136B
 Plot data length: 0000
 Cursor at address: 176B
 Data at cursor is: 80

- Options -
 'C exit from plot
 { plot cursor }
 Z zoom in (x2 magnify)
 P pan in (x2 expand)
 R r.marg from curs (moves left)
 L l.marg from curs (moves right)
 D redraw plot centre cursor

Using the interface: this waveform was synthesized numerically using the design program. The waveform may be output through the d-to-a to a 'real-world' application at a variety of timebase rates, but equally it could have been recorded from the real world.



RAEDEK ELECTRONICS

Tel: 021-474 6000

Telex No: 312242

SERVING THE COMMUNICATIONS AND ELECTRONICS INDUSTRIES

MIDLTX G.

102 PRIORY ROAD, SCRIBERS LANE, HALL GREEN, BIRMINGHAM B28 0TB. ENGLAND.

TRANSISTORS:

TYPE:	LIST: £	TYPE:	LIST: £
2N3375	11.25	2SC1978	6.40
2N3553	1.90	2SC2053	0.80
2N3632	12.95	2SC2237	11.50
2N3733	12.95	2SC2287	9.60
2N3866	1.50	2SC2290	20.00
2N4416	0.75	MRF237	3.50
2N4427	1.75	MRF238	11.90
2N5090	10.90	MRF240	20.70
2N5109	1.95	MRF245	33.00
2N5160	3.00	MRF247	33.30
2N5589	8.00	MRF433	9.00
2N5590	8.25	MRF449A	10.15
2N5591	10.00	MRF450	14.50
2N5641	7.50	MRF450A	14.50
2N5642	10.20	MRF454	17.25
2N5643	11.85	MRF454A	17.25
2N5913	2.50	MRF455	16.50
2N5944	8.20	MRF458	17.20
2N5945	10.60	MRF475	2.30
2N5946	11.50	MRF476	2.15
2N6080	7.00	MRF644	22.50
2N6081	8.75	MRF646	27.00
2N6082	10.90	MRF648	32.70
2N6083	11.95	MRF901	2.75
2N6084	12.50	SD1013	9.75
2SC1729	14.50	SD1019-STUD	23.10
2SC1945	3.45	SD1019-5	22.80
2SC1946A	16.00	SD1127	3.10
2SC1947	8.50	SD1134-1	2.25
2SC1969	1.80	SD1136	11.90
2SC1970	1.40	SD1143	9.40
2SC1971	3.50	SD1219	14.70
2SC1972	6.00	SD1272	10.95
		SD1278	14.25

VALVES:

TYPE:	LIST: £	TYPE:	LIST: £	TYPE:	LIST: £	TYPE:	LIST: £	TYPE:	LIST: £	TYPE:	LIST: £	TYPE:	LIST: £
AH211A	137.50	EF94	2.00	OA3	2.50	6AU5GT	3.70	813	30.00				
AH2511	90.00	EF95	1.60	OB2	2.50	6AZ8	3.80	934	18.00				
AH2532	31.50	EF183	1.90	OB3	2.50	6BA6	1.70	935	41.20				
BT5	52.50	EF184	1.80	OC3	2.50	6BE6	1.95	2050	4.80				
BT5B	52.50	EK90	1.40	2C39A	39.90	6BH6	2.15	2050A	4.80				
BT17	142.00	EL34	3.90	2C39WA	42.00	6BQ6	2.00	5544	81.00				
BT17A	130.00	EL36	2.30	2E21	2.90	6BKAC	4.50	5545	95.00				
BT95	125.00	EL84	3.00	2E26	7.50	6BN8	3.50	5557	24.50				
C3J	30.00	EL86	2.10	2K25	114.00	6BZ6	2.50	5559	52.50				
C3JA	30.00	EL519	7.70	3-400ZEIM	99.00	6C4	1.95	5727	2.95				
E55L	56.00	EL803S	9.95	3-500ZEIM	99.00	6CB6A	1.80	5867A	140.00				
E80CC	14.00	EL821	13.75	3B28	15.00	6CJ3	2.30	5879	6.15				
E80L	21.00	EN32	16.25	3C45	24.50	6CW4	8.00	5965	6.20				
E88CC	3.90	EN91	2.00	3CX100A5	70.00	6DC6	2.45	5991	32.00				
E90CC	7.50	EZ80	1.90	4-65A	52.50	6E5	4.20	6130	24.50				
E130L	21.25	EZ81	1.50	4-125A	60.00	6EA8	2.25	6146A	9.50				
EB91	1.35	EZ90	1.50	4-250A	76.00	6GK6	2.50	6146B	9.50				
EBC91	1.10	FG17	24.50	4-400A	110.00	6HK6	4.25	6360A	4.95				
EBF89	1.35	FG105	160.00	4-400B	110.00	6HF5	4.25	6550A	7.90				
EC90	1.25	GXU1	15.00	4-400C	110.00	6HJ6	3.95	6883B	6.70				
ECC32	3.25	GXU4	45.00	4B32	30.50	6JEC	4.50	6973	3.95				
ECC81	1.90	GZ34	5.35	4C35A	135.00	6JSC	6.65	7027A	6.50				
ECC82	1.90	KT66	9.00	4CX250B		6K7	2.50	7199	4.20				
ECC83	1.90	KT77	8.75	EIM AMP	55.00	6K11	2.25	7247	3.20				
ECC85	3.80	KT88	24.95	4CX250B		6KD6	6.40	7262A	26.00				
ECC88	2.00	ML8536	275.00	NAT	48.00	6KD8	2.00	7586	11.50				
ECC91	2.00	ML8741	265.00	4CX350A	87.00	6L6GC	4.10	7587	35.00				
ECC189	2.00	NL SERIES		4X150A	33.70	6LQ6	6.25	7591A	4.65				
ECF80	1.50	QOV02-6	22.00	5AR4	5.35	6Q11	2.25	7815AL-GE	48.00				
ECF86	1.65	QOV03-10	5.30	5A54A	2.10	6SL7GT	2.25	7815R	53.00				
ECF801	1.80	QV03-12	7.00	5R4GYA-B	3.50	6SN7GTB	3.05	8122	120.00				
ECH81	2.30	QY3-65	57.50	5U4G	2.10	6UB8	2.00	8906AL	55.00				
ECL82	1.90	QY3-125	63.00	5V4G	2.50	7591A	2.00	150B2	6.50				
ECL86	1.60	QY4-250	69.80	6AH6	2.30	12A16	1.90	572B CETRON	55.00				
EF80	1.70	RG1-240A	10.00	6AK5W-	2.50	12AV6	2.00	807	2.90				
EF85	3.00	RG4-3000	90.00	6AK6	1.95	12BA6	1.95	810	82.00				
EF86	3.00	XG1-2500	52.50	6AL5W	1.80	12BA7	2.35	812A	36.85				
EF89	2.30	XG5-500	24.50	6A05A	1.75	12BE6	2.00						
EF91	2.95	XR1-3200	72.50	6A05W	1.80	12BY7A	2.70						
EF92	2.20	XR1-6400	120.00	6A56	2.40	12BZ6	3.70						
EF93	1.50	OA2	2.00	6A57G	4.30	12DW7	3.75						

INDUCTION AND DIELECTRIC HEATING SPARES

INCL	SOLID STATE RECTIFIERS
CERAMIC CAPACITORS	RECTIFIER VALVES
VACUUM CAPACITORS	OSCILLATOR VALVES
GRID LAMPS	COOLING FANS/FILTERS
CARBON FREE HOSE	etc etc.
WATER FLOW SWITCHES	

1000's of VALVES TRANSISTORS/IC's IN STOCK. PLEASE ENQUIRE ON TYPES NOT LISTED.

BACKWARD WAVE OSCILL	KLYSTRONS	SOLID STATE REPLACEMENTS
CRT's	MAGNETRONS	THYRATRONS
IGNITRONS	RECEIVING TUBES	TRANSMITTING TUBES

WE ALSO SUPPLY EIMAC TUBES AND ACCESSORIES

PRICES - CORRECT AT TIME OF GOING TO PRESS
TERMS - PLEASE ADD £1.00 P&P AND VAT @ 15% to orders

ENTER 54 ON REPLY CARD

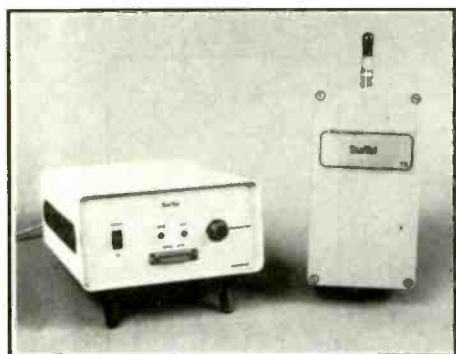

SURTTEL UHF VHF RADIO TELEMETRY

Scientific Instrumentation - Automatic Guided Vehicles - Machine Control Systems - Data Buoys - Plant Control - Mobile Terminals/Displays - Environmental & Meteorological Systems - Strain Gauge - Monitoring - Survey Instrumentation

- UHF - Digital Communications at 1200 Baud over one or two way line of sight conditions (458 MHz nom.)
 - VHF - As for UHF but available at 173 MHz working.
 - INTELLIGENCE - Microprocessor based radio telemetry providing error checking and data formatting etc. Outputs for VDU's, Printers, Computers, Terminals.
- Features: DTI Home Office approved to MPT 1309 - weatherproof housings (IP65) - portable - rugged - high/low power selectable - standby operation reduces battery drain - 12 volts D.C. - low power consumption - visual monitoring of operation.

Overseas customers may specify higher power options or alternative frequency of operation - OEM enquiries welcome

MICROMAKE ELECTRONICS

1 THE HOLT · HARE HATCH · UPPER WARGRAVE · READING · RG10 9TG

TEL: 073522 3255 TLX: 946240 Ref 19023890

ENTER 33 ON REPLY CARD

NEW! AFFORDABLE PCB CAD

FROM CHANNEL MICRO PRODUCTS LTD

- Maximum circuit board size greater than 2' x 2'.
- Powerful zoom facility and fast screen re-draw.
- Full off-screen editing. Mouse & Trackball compatible.
- Hard copy at 1:1, 2:1 & 4:1 from Epson FX or RX printer.
- Plotter drivers for most popular plotters available.
- Low cost BBC Micro hardware keeps system cost below £1500. Software only £240.

Please write or telephone for full details.

227 Canterbury Street, Gillingham Kent ME7 5XB. Tel: 0634 570256

ENTER 11 ON REPLY CARD

Toroidal & E.I. Transformers

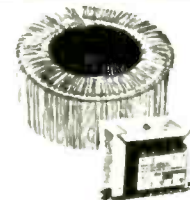

As manufacturers we are able to offer a range of quality toroidal and laminated transformers at highly competitive prices

Toroidal Mail Order Price List

prices inclusive of VAT & Postage
15va 7.95, 30va 9.18, 50va 10.16, 80va 11.36, 120va 12.07, 160va 14.20, 225va 15.21, 300va 17.04, 500va 22.10, 625va 24.66, 750va 28.75, 1000va 44.82.
Also available 1k2, 1k5, 2k, 2k5, 3k. Prices on request.

Available from stock in the following voltages: 6-0-6, 9-0-9, 12-0-12, 15-0-15, 18-0-18, 22-0-22, 25-0-25, 30-0-30, 35-0-35, 40-0-40, 45-0-45, 50-0-50, 110, 220, 240. Primary 240 volt.

Quantity prices and delivery on request



Air Link Transformers

Unit 6, The Maltings, Station Road, Sawbridgeworth, Herts. Tel: 0279 724425

ENTER 12 ON REPLY CARD

THE PREMIER ELECTRONICS EXHIBITION IN THE NORTH

LEEDS ELECTRONICS EXHIBITION

Leetronex 87

**30 JUNE
- 2 JULY 87**

**Venue: The Department of Electrical
and Electronic Engineering
University of Leeds
Leeds LS2 9JT**

Telephone (0532) 431751 Ext. 328

THE PREMIER ELECTRONICS EXHIBITION IN THE NORTH

ENTER 75 ON REPLY CARD

HAMEG Ltd, 70 - 78 Collingdon Street,
Luton, Bedfordshire LU1 1RX.
Telephone: (0582) 413174.
Telex: 825484.

Designed and manufactured in West Germany by HAMEG, one of the World's leading oscilloscope manufacturers - the range of Industry's unsurpassed Price/Performance oscilloscopes.

Quality, Performance, Value... Oscilloscope Range



- Dual Trace 20MHz, 2mV/cm, Algebraic Add, Component Tester, incl. 2 probes HZ36.
£314.00 HM203-6
- Dual Trace 20MHz, 1mV/cm, Sweep Delay, Component Tester.
£418.00 HM204-2
- Dual Trace 60MHz, 1mV/cm, Delay Line, 1MHz Cal. Generator.
£583.00 HM605
- Dual Trace 20MHz, Digital Storage Oscilloscope incl. 2 probes Type HZ37.
£498.00 HM205
- Dual Trace 20MHz, 4 x 1k memory, plotter output, incl. 2 probes Type HZ37
£1460.00 HM208
- IEEE-488 Interface Version, incl. 2 probes Type HZ37.
£1735.00 HM208

Price U.K. List ex. VAT
2 Years Warranty, Parts & Labour

ENTER 8 ON REPLY CARD

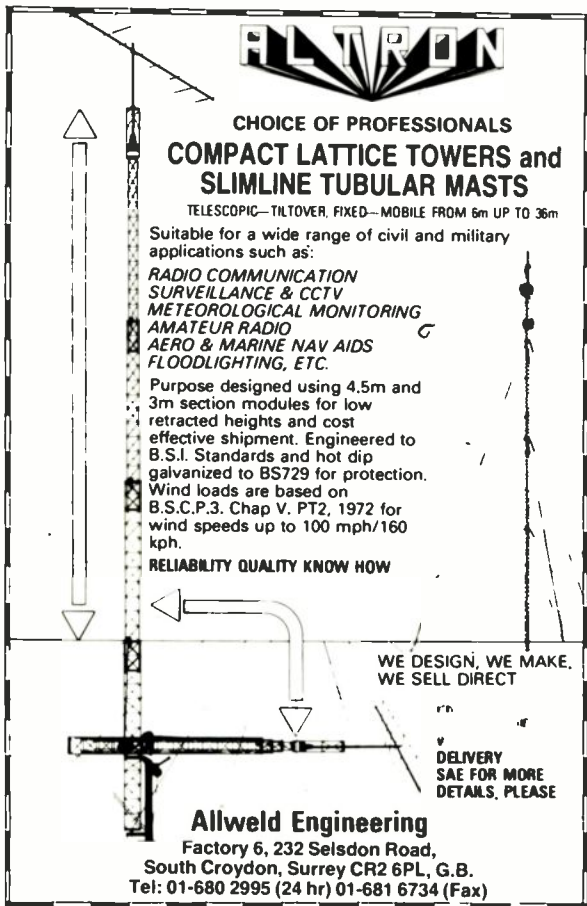

ALTRON

CHOICE OF PROFESSIONALS
COMPACT LATTICE TOWERS and
SLIMLINE TUBULAR MASTS

TELESCOPIC—TILTOVER, FIXED—MOBILE FROM 6m UP TO 36m

Suitable for a wide range of civil and military applications such as:

RADIO COMMUNICATION
SURVEILLANCE & CCTV
METEOROLOGICAL MONITORING
AMATEUR RADIO
AERO & MARINE NAV AIDS
FLOODLIGHTING, ETC.

Purpose designed using 4.5m and 3m section modules for low retracted heights and cost effective shipment. Engineered to B.S.I. Standards and hot dip galvanized to BS729 for protection. Wind loads are based on B.S.C.P.3, Chap V, PT2, 1972 for wind speeds up to 100 mph/160 kph.

RELIABILITY QUALITY KNOW HOW

WE DESIGN, WE MAKE,
WE SELL DIRECT

DELIVERY
SAE FOR MORE
DETAILS, PLEASE

Allweld Engineering
Factory 6, 232 Selsdon Road,
South Croydon, Surrey CR2 6PL, G.B.
Tel: 01-680 2995 (24 hr) 01-681 6734 (Fax)

ENTER 7 ON REPLY CARD

Happy Memories

Part type	1 off	25-99	100 up
4164 150ns Not Texas.....	.95	.90	.87
41256 150ns.....	2.15	1.95	1.85
41464 120ns.....	3.35	2.99	2.79
2114 200ns Low Power	1.75	1.60	1.55
6116 150ns Low Power	1.25	1.10	1.05
6264 150ns Low Power	2.25	2.05	1.99
62256 120ns Low Power	8.75	8.50	8.25
2716 450ns 5 volt.....	2.95	2.85	2.70
2532 450ns.....	5.40	4.85	4.50
2732 450ns.....	2.60	2.40	2.25
2732A 250ns.....	3.30	2.85	2.75
2764 250ns Suit BBC.....	2.60	2.40	2.25
27128 250ns Suit BBC.....	2.95	2.75	2.60
27256 250ns.....	3.70	3.45	3.30
27512 250ns.....	7.95	7.40	6.85

Low profile IC sockets: Pins 8 14 16 18 20 24 28 40
Pence 5 9 10 11 12 15 17 24

Please ask for quote on higher quantities or items not shown.
Data free on memories purchased, enquire cost for other.

Write or 'phone for list of other items including our 74LS series and a DISCOUNT ORDER FORM.

Please add 50p post & packing to orders under £15 and VAT to total. Access orders by 'phone or mail welcome.

Non-Military Government & Educational orders welcome for minimum invoice value of £15 net.

HAPPY MEMORIES (WW),
FREEPOST, Kington,
Herefordshire HR5 3BR.
Tel: (054 422) 618
(No stamp required)

ENTER 63 ON REPLY CARD

The incredible Scophony receiver

With interest in projection sets for HDTV on the increase, the time may be right for a reassessment of Scophony's ingenious mechanical receiver.

T.VOORE



Being prepared for the 1938 Television and Radio Show at Olympia: Scophony's mechanically-scanned television set, at £231 the dearest in the show (BBC Hulton Picture Library).

It is a widely held belief that serious development of mechanical television receivers ceased with the ending of 30-line transmissions in 1935; and that after the adoption of the 405-line system as the UK standard in February 1937, the cathode ray tube reigned supreme. Nothing could be further from the truth.

Engineers concerned with the development of low-definition receivers realized that three major problems had to be solved if mechanical systems were to have any real future.

To give a large, bright high-definition picture a projection system using a video-modulated light beam would be needed; and this would require a suitable light-valve.

The light-valve that showed most promise was the Kerr cell. To vary its light transmission, this made use of the principle of voltage-controlled rotation of the plane of polarization of light as it passed through a liquid.

Despite intensive development, the fundamental drawbacks of the Kerr cell – its high capacitance and its high drive and bias voltage requirements – were never overcome.

The second problem was in obtaining sufficient light energy in the small spot size essential for high-definition pictures.

Finally, synchronization of the received pictures would have to be reliable. None of the synchronization methods (some of them quite elaborate) in use with low-

definition systems was really satisfactory.

Success in overcoming all these problems and applying the solutions to the production of a 405-line receiver for sale to the public was achieved by Scophony Ltd.

No other company in the mechanical television field was more deserving of success. Scophony had always set its sights on the development of a large-screen projection system of high definition and had spent many years researching scanning systems.

THE SCOPHONY LIGHT VALVE

In 1934, J.H. Jeffree of the Scophony company demonstrated how the diffraction of light by ultrasonic waves could be used as the basis of a light control. This brilliant invention was the main reason why Scophony was able to make the leap forward

from low to high definition.

This light valve gave adequate bandwidth at acceptable drive levels; and because of its action as a storage device it also solved the problem of supplying adequate light output.

Jeffree's light control consisted of a glass-sided container filled with a transparent liquid of the paraffin group. Immersed in the liquid and mounted on one wall of the cell was a piezoelectric crystal transducer. The opposite wall of the cell contained an absorbent material. A high-frequency carrier drove the crystal transducer, approximately at its resonant frequency. Video information was amplitude-modulated on to the carrier.

Mechanical vibrations in the crystal were then transferred to the liquid as a series of compressions and rarefactions which moved forward from the crystal at the speed of sound in the liquid. This train of ultrasonic waves was completely absorbed at the far end of the cell. The density and thus the refractive index of the cell therefore varied periodically in the direction of the wavetrain.

Light passing through the cell perpendicular to the motion of the waves would be retarded by compressed half-waves and speeded up by rarefied ones. And since the wavelengths were small, interference of the emergent light would take place, producing diffraction spectra. The intensity of the light deflected from the normal beam into the diffraction spectra was proportional to

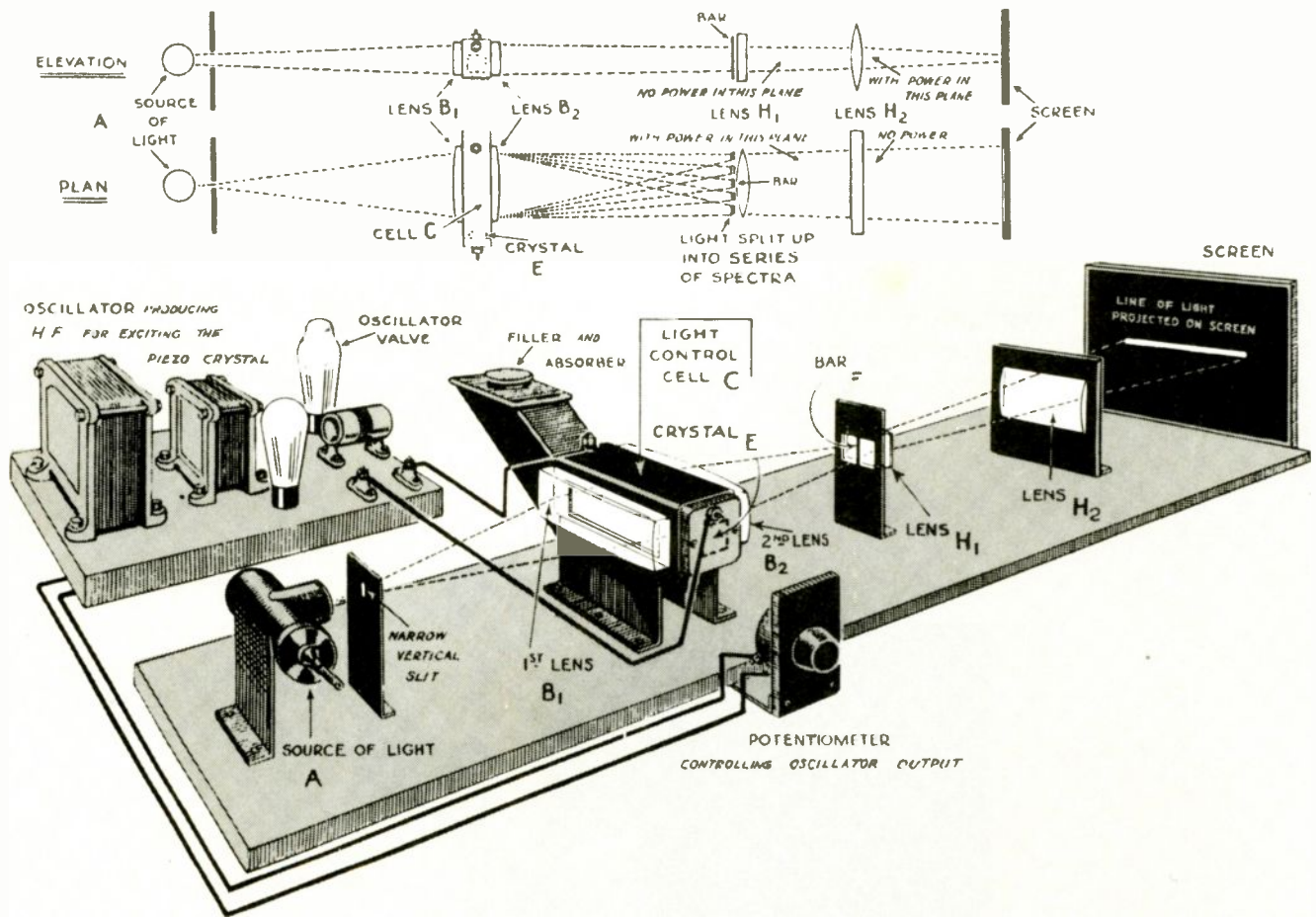

the amplitude of the h.f. carrier driving the crystal. It was a simple matter to stop out the normal beam and to direct light from the side images to the screen (after suitable spectral correction), giving an intensity proportional to the received vision signal (Fig.1). A bandwidth of 5MHz could be obtained by stagger tuning and the drive required was about 10 watts at 18MHz.

Maximum length of the cell was limited by attenuation of the ultrasonic wavetrain to about 5cm. The wavetrain travelled this distance in about 50 microseconds, forming an information store about half a 405 line long. This meant that the input light beam did not have to be reduced to elemental size as it now contained half a line of information, thus overcoming a major disadvantage of light-beam projection systems.

As the stored information propagated through the cell, line-rate scanning in the opposite direction was needed to produce a stationary image.

SCOPHONY'S HOME RECEIVER

By September 1938, development had reached an advanced stage and a receiver was on sale (Fig.2). This set used back-projection to produce a 24 by 22 inch picture (note the strange aspect ratio) with a 300W mercury vapour lamp as its light source. Figure 3 gives an idea of the layout of the optical components.

The low-speed mirror-drum frame scanner was driven at 250 rev/min by a 1500 rev/min four-pole motor via a single spur reduction gear. Motor drive, from two 6L6 output valves, was provided by filtering and

amplifying the separated field synchronization pulses. As the frame scan had two possible lock-up positions (in-frame and displaced by half a frame), correct framing could be achieved by switching a resistor in series with the motor windings, reducing its drive current and so producing frame-slip. When the picture was positioned correctly the resistor was shorted out.

With a 12-mirror drum, 250 rev/min gave a scan rate of $(250 \times 12) \div 60$, or 50 frames per second.

Line scan was produced by a 20-facet stainless steel polygon. For the 405-line system this reflector had to rotate at $(10125 \times 60) \div 20$, or 30 375 rev/min.

Fig.1. How Jeffree's light-valve worked. A fluid-filled cell was excited mechanically by an ultrasonic transducer modulated with the vision signal. When a light beam passed transversely through the cell, compression and rarefaction of the liquid created diffraction spectra corresponding to the intensity of modulation (*Television and Short-wave World*, August 1937 – reproduced here by permission of *Electronic Engineering*).

Fig.3. Vertical scanning in the Scophony receiver was achieved by a mirror-drum (by permission of *Electronic Engineering*).

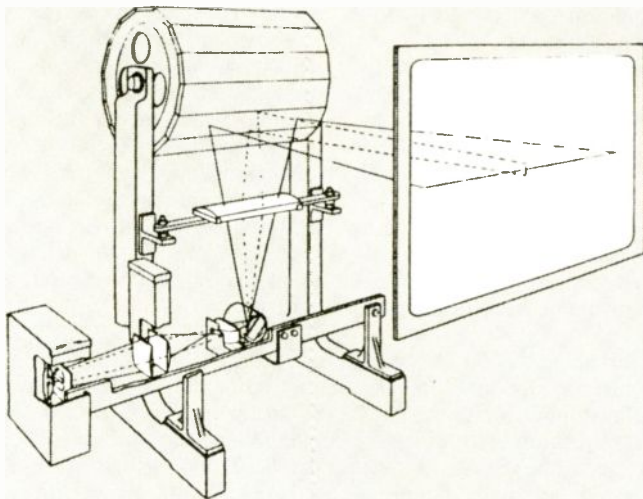

Fig.2 (right). Rear view of the Scophony mechanical-optical 405-line domestic receiver (*Television and Short-Wave World*, December 1938 – by permission of *Electronic Engineering*).

Fig. 4 (below right). Chief parts of the Scophony high-speed line-scan motor (*Electronics and Television & Short-Wave World*, November 1939 – by permission of *Electronic Engineering*).

The design of the high-speed line scan motor was a miracle of mechanical and electrical engineering (Fig.4.) It had to operate safely and continuously at this very high speed, which called for special bearings and very accurate dynamic balancing of the rotating components. To ensure rapid and accurate synchronization, the motor was in fact two motor systems on a common shaft. The first was an asynchronous motor which ran the system up to speed, driven by a 500-550Hz oscillator through a 6L6 push-pull output stage. Synchronization was achieved via the other motor (a synchronous phonic wheel motor) run resonant at line frequency, driven by amplified and filtered line sync pulses.

WHERE ARE THEY NOW?

By the time that the television service was closed on the outbreak of war, Scophony mechanical receivers had been installed in several cinemas of the Odeon group.

But little was known of the history of the Scophony system after the ending of hostilities. Research ought to be undertaken as soon as possible, while the people who designed, installed, sold and used these marvellous receivers are still with us and can give a first-hand account of their experience.

It is sad to record that not a single example of any Scophony receiver has survived.

Or has it? Perhaps, forgotten in some dusty corner, one still awaits discovery. Let us hope so.

Tim Voore is an television engineer working in broadcasting.

Further reading

D.M. Robinson. The supersonic light control and its application to television with special reference to the Scophony Television Receiver. *Proc. IRE*, August 1939.

J. Sieger. the design and development of television receivers using the Scophony optical scanning system. *Proc. IRE*, August 1939.

G. Wikkenhauser. Synchronization of Scophony television receivers. *Proc. IRE*, August 1939.

H.W. Lee. Some factors involved in the optical design of a modern television receiver using moving scanners. *Proc. IRE*, August 1939.

J. Sieger. The Scophony television system. IEE Conference Proceedings no.271, International Conference on the History of Television from Early Days to the Present (November 1986).

A romance of television: Scophony has arrived. *Television: Journal of the Royal Television Society* (December 1986).

Numerous articles describing the Scophony system appeared between 1936 and 1939 in *Television and Short-Wave World* (from 1939, *Electronics and Television & Short-Wave World*); among these was one in April 1936 covering J.H. Jeffrey's patent description (patent no. 439236).

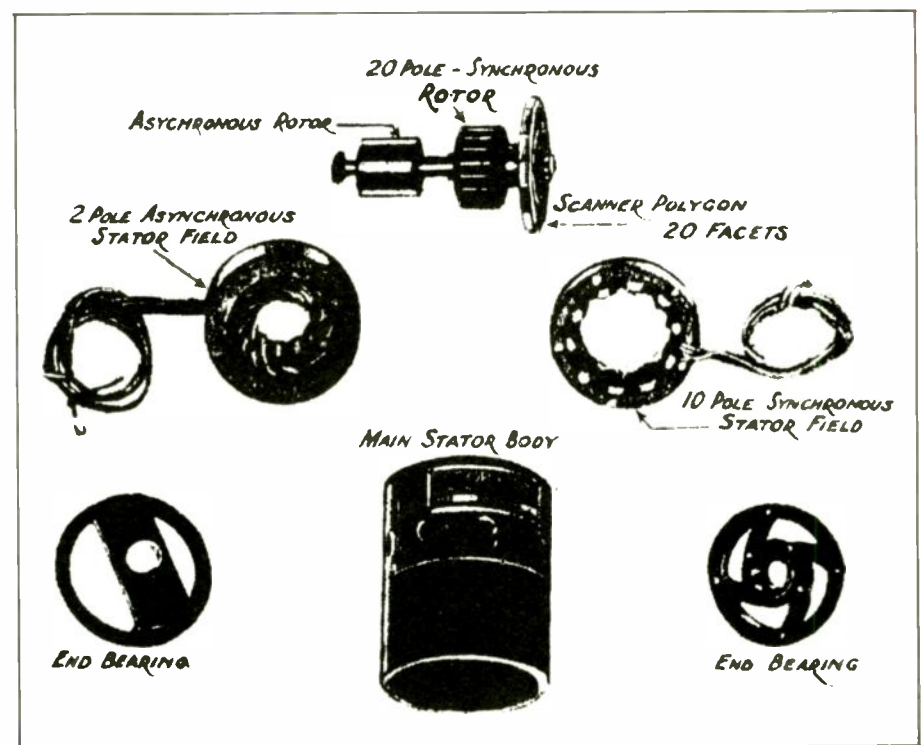
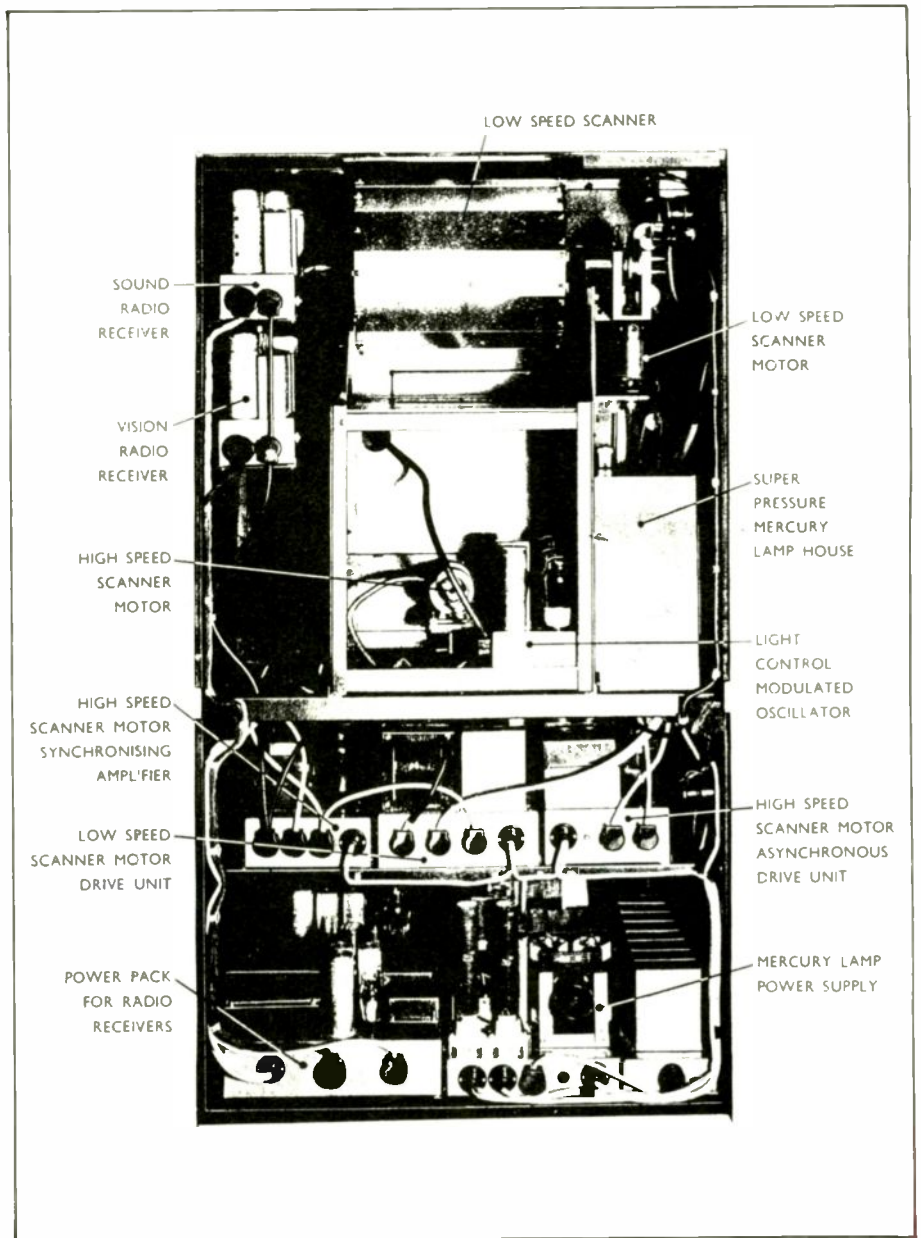

OASIS VIRTUAL INSTRUMENT SYSTEM

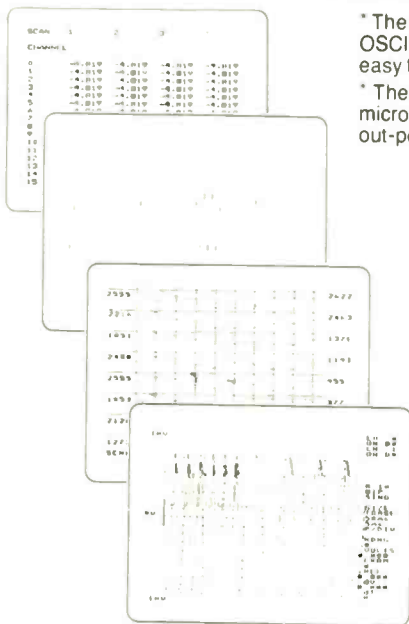

* The OASIS Virtual Instrument System (VIS) emulates conventional DVM, OSCILLOSCOPE, CHART RECORDER, X/Y PLOTTER and DATA LOGGER in one easy to use package and also provides sophisticated data analysis tools.

* The VIS data acquisition module and instrument emulation software turns the BBC micro directly into a versatile and flexible laboratory measurement system which can out-perform and is easier to implement than IEEE 488 linked systems.

* VIS professional, ready-to-use instrument emulations include:

Multi-channel DVM with real time numeric and graphic displays, storage SCOPE with on-screen measurement and waveform zoom, DATA LOGGER with logged data compression algorithm and X/Y PLOTTER with programmable integration periods.

HARDWARE

VIS is based on a precision computer controlled 16 channel A-D converter, with six programmable ranges and read rates of 50k samples per second at 8 bit resolution, 25k at 12 bit.

This simply installed unit has proven long term stability and reliability.

SOFTWARE

The menu-driven acquisition, analysis and display programs combine on screen set up of measurement parameters, SPREADSHEET data manipulation and a range of data display formats, including 8 trace CHART RECORDER and oscillogram.

Total data mobility from measured information to memory, disk, screen and HARD COPY output.

The OASIS VIS carries full documentation to allow the beginner or professional programmer to create new interface applications or personalised instrument emulations.

PRICE

At £399 (ex VAT), the price of the complete VIS system is less than any one of the instruments it replaces. Performance enhanced versions also available, e.g. higher acquisition speeds.

For fast delivery, phone your order on 0603 747887. Technical queries answered and requests for further data on this number.

The Street, Old Costessey, Norwich NR8 5DF. Tel: 0603 747887

Design Consultancy

ENTER 58 ON REPLY CARD

HART – The Firm for QUALITY

LINSLEY-HOOD 300 SERIES AMPLIFIER KITS

Superb integrated MosFet amplifier kits with an unbeatable pedigree: circuit design by John Linsley-Hood and engineering by HART. Ultra easy assembly and set-up with sound quality to please the most discerning listener. Ideal basis for any domestic sound systems if quality matters to you. Buy the complete kit and save pounds off the individual component price.

K300-35, 35 Watt. Discount price for Complete Kit £98.79
K300-45, 45 Watt. Discount price for Complete Kit £102.36
RLH4&5. Reprints of Original Articles from HiFiNews £1.05 no VAT

LINSLEY-HOOD SYNCHRODYNE AM RECEIVER

Very high quality kit for this recent design featured in Wireless World. Advanced construction system, approved by the Author, uses 3 double sided PCBs in a stacked layout for total stability, ease of construction and minimal wiring. This module will form the AM section of an ultra high quality AM/FM switched bandwidth tuner to match our 300 series amplifiers. Power supply and tuning gang will be included with the FM section.

K450 JLH Synchrondyne Kit. Special Price £59.95

LINSLEY-HOOD SUPER QUALITY FM TUNER

The long awaited ultra high quality FM companion to the Synchrondyne AM receiver. Novel circuit features ready built pre-aligned front end, phase locked loop demodulator and advanced sample and hold stereo decoder. Circuits featured in Electronics Today International magazine February and March 1987. Complete kits for FM only or combined with the Synchrondyne are cased to match our 300 Series amplifiers. Send for details.

Special Introductory Prices. FM only version £111.69. Version to add Synchrondyne £118.13. Both prices inc VAT & post. Send for details.

HIGH QUALITY REPLACEMENT CASSETTE HEADS

Do your tapes lack treble? A worn head could be the problem. Tape heads are constantly improving and fitting one of our latest replacement heads could restore performance to better than new! Standard mountings fit most decks and our TC1 Test Cassette will make it easy to set the azimuth spot on. As we are the actual importers you get prime parts at lowest prices. All our heads are suitable for Dolby machines.

HC20 Permalloy Stereo Head. Good quality standard head fitted as original equipment on many decks. £7.66
HS16 Sendust Alloy Super Head. Quite simply the best. Longer life than permalloy, higher output than ferrite, fantastic frequency response. £14.86
HQ551 4-Track head for auto-reverse or quadrophonic use. Full specification record and play head. £14.60
Special Offer Stereo R P Heads £2.49
4-Track Auto-Reverse Play Head £3.50
HS9510 2/4 Stereo DC Erase Head £6.70
HQ751E 4/4 Erase compatible with HQ551 £39.70

Full data on these and other heads in our range are contained in our free list.

HART TRIPLE-PURPOSE TEST CASSETTE TC1

One inexpensive test cassette enables you to set up VU (Dolby) level, head azimuth and tape speed without test equipment. Vital when fitting new heads. Complete with instructions. £4.66

JLH QUALITY AM RADIO

Sets of Parts available now, including Short Wave coils. Full kits ready later. Send for list.

Send for your FREE copy of our lists with full details of our complete range of Kits, Components, PCBs, Cassette Heads and Decks: - Overseas please send 5 IRCs for Airmail Post.

Please add VAT to all prices. Postage on orders up to £10 - 50p. £10 to £49 - £1. Over £50 - £1.50.

HART ELECTRONIC KITS LTD
1, Penylan Mill, Oswestry, Shropshire SY10 9AF
24 hr SALES LINE (0691) 652894 Please add VAT

R. WITHERS COMMUNICATIONS LTD

Manufacturers, importers and suppliers of world famous communications products
584 HAGLEY ROAD WEST OLDBURY, WARLEY, BIRMINGHAM B68 0BS
021-421 8201/2/3. CELLNET 0860 323056. PRESTEL MBX 214218216 FAX 0215614074
Amateur Radio, Business Radio, Radio Telephones, Sales, Service Accessories and antenna systems.



THE TECHNICALLY ORIENTATED
RADIO COMMUNICATIONS
SPECIALISTS.

AGENT TO THE STARS!

Heard about RWC LTD yet? Looking for someone who speaks your language? When it's radio we have something for everyone! We supply Companies and Government Departments Worldwide with Communications related systems and equipment. Some of our specialities include:

- All mode Scanning Receivers and antennas 25 MHz - 2 GHz. A choice of model and option modified by RWC to suit your exacting needs and requirements.
- Custom designed Communication systems. UK MPT Type Approved equipment designed to meet your requirements, including Broadcast industry talkback systems, Handhelds, UHF/VHF repeater systems, Marine Radio, HF point to point links, Radiotelephones and Cellular telephones.
- Quality UK made Raycom hybrid modular VHF/UHF RF power Amplifiers. 1-5w input all mode or class C units (RF switched) up to 45W output.
- UK made Raycom Cost Effective Regulated 13.8 Volt power supplies. A choice of units 3A to 12A with metered options.
- Raycom UK made Land mobile VHF/UHF antennas. A choice of 5/8 whips, UHF colinears and 1/4 wave whips in the range 50-950MHz with a choice of base's and magnetic mounts to suit modern requirements.
- New and second user Amateur and Business Radio Main brand HF/VHF/UHF transceivers, receivers and accessories. We produce modification kits to improve and expand facilities and offer guaranteed used equipment checked to original specification. As for our bi-weekly used list.
- RF semiconductors and RF Power Modules for HF/VHF/UHF. A range imported and European made specialist devices for OEM and the service industry. Try us for fast service and delivery.
- We offer the largest selection of Radio allied services under one roof.

Call us by Telephone, Telex or FAX for more details, or send us a detailed specification of your needs for a fast written Quotation.

Export enquiries invited.

Tel: 021 421 8201 (24hr answerphone)
Telex: 334303 G TXAGWM



ENTER 6 ON REPLY CARD

Marx generator for high voltage experiments

This simple device delivers unipolar pulses of up to several hundred kilovolts at very high currents.

E.A. RICHLEY

Generating high voltages for laboratory experiments has always been a challenging task, from both a technical and an economic standpoint. High voltage generators are used in many practical and experimental applications, such as accelerating for sub-atomic experiments, generating ionizing radiation and producing ion beams from a variety of plasma diode configurations.

Research applications of high voltage supplies include the study of dielectric breakdown, vacuum breakdown and a wide variety of gaseous conduction phenomena. Furthermore, there is much interest in protecting electronic equipment from high-voltage atmospheric phenomena such as lightning and, of increasing interest, electromagnetic pulse (e.m.p.).

Many readers are familiar with construction techniques for Tesla coils and Van de Graaff generators and the difficulties and limitations of these. A moderate size Tesla coil, for example, requires a large and expensive high-voltage transmitting-type capacitor, a hard-to-find neon sign transformer (which inevitably burns up), and several thousand feet of magnet wire. The output of such a device is in the form of bursts of high-frequency alternating current which, although fine for producing large sparks, has few practical applications.

A Van de Graaff generator, while capable of generating direct current, has a capacity limited to a few milliamperes at best. Corona losses and surface leakage are critical and must be carefully minimized. A large metal sphere must be provided as a capacitor for the output voltage.

Most significant Van de Graaff generators use an insulating system other than air to improve the dielectric strength of the environment. Thus they require a gas system, usually employing an electronegative gas such as sulphur hexafluoride.

Ironically, very little has been written about construction of Marx generators. These devices, originally described by Erwin Marx, provide unipolar pulses of very high voltage (commonly up to several million volts) and very high available currents (several thousand amperes is common). In addition, voltage rise times are extremely fast (about $1\mu\text{s}$). Either polarity of pulse can be generated and pulse timing can be easily

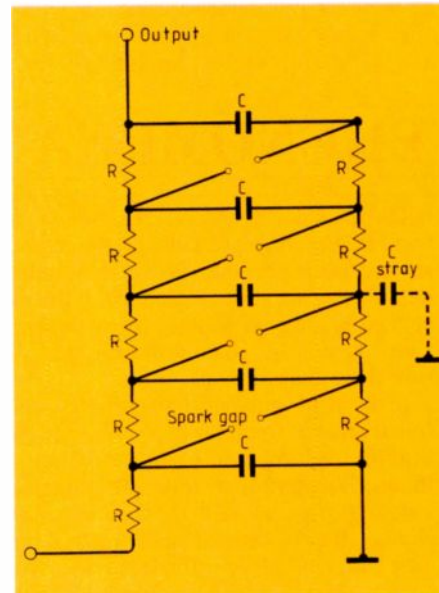
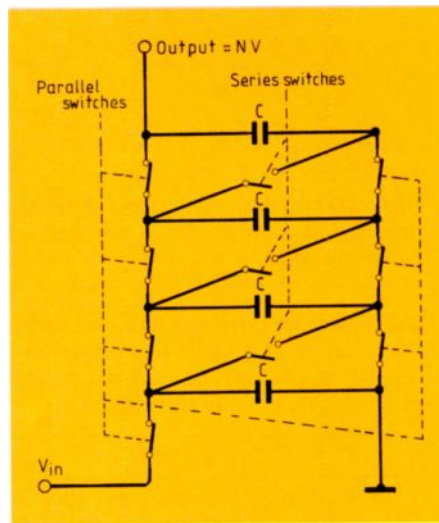

Fig.1 (top). Basic Marx generator with switches shown in charging positions.

Fig.2. Practical Marx generator. Stray capacitance is present at all nodes.

controlled. Best of all, a Marx generator requires no exotic parts and can be very inexpensive.

GENERATOR DESIGN

A Marx generator can be thought of as a system for charging a bank of capacitors to a high voltage and suddenly switching them

into a series configuration (Fig.1). The voltage source is designed to supply as high a voltage as can be conveniently produced. Each capacitor is charged to voltage V with the parallel switches closed and the series switches open. The switch positions are then reversed, and an output pulse of voltage NV is delivered to the output.

This description, of course, is highly idealized and impracticable. The switching arrangement presents a mechanical nightmare. Switching would have to take place very quickly to avoid self-discharging of the capacitors, and without arcing.

Figure 2 shows a general Marx generator. Here the series switches have been replaced by spark gaps and the parallel switches by resistors. Its operation is very simple. The primary requirement is that the time constant RC greatly exceeds the breakdown time of the gaps. As long as all gaps have a breakdown voltage in excess of the power supply voltage V , but not quite as great as $2V$, the capacitors all charge to V through the resistors.

If the lowest gap can be induced to break down, an amazing process takes place. When the first gap breaks down, the voltage at point A suddenly rises to $2V$. Point B, however, has remained at earth potential because there is a minute stray capacitance to which no current has flowed. Thus, the second gap sees a potential of $2V$ and breaks down. The stray capacitance is trivial compared to C and is charged instantly. In a similar manner, the third, fourth and all other gaps fire in succession. Since these gaps break down in times of the order of $1\mu\text{s}$, all gaps appear to fire simultaneously. The output voltage then rises to NV .

When the gaps fire, the capacitors self-discharge through the fired gaps and nearby resistors (Fig.3). For this reason, the RC time constant must be kept large in comparison to the gap firing time. This ensures that little self-discharging will occur before the total potential appears at the output. Of course, by making the time constant larger, the time required to charge the Marx generator between pulses is increased.

The available power supply may also play a part in determining resistor size. As charging time is increased by making the resistor larger, the current which must be drawn from the supply is reduced. Thus a com-

promise must be made between efficiency, firing rate and power supply capabilities.

In general, the energy storage requirements of the generator determine the size of the capacitors. Resistors are then chosen to provide a sufficient firing rate with sufficiently small self-discharge.

PRACTICAL MARX GENERATOR

A simple Marx generator can easily be built from ordinary p.v.c. pipe fittings and a modified television high voltage system.

The input voltage to this generator will be slightly in excess of 30kV. Although the output impedance of the power supply is very high and the continuous current available is only of the order of 1mA, capacitors charged to this voltage can deliver quite a jolt.

For this reason it is important to keep a grounding stick nearby when testing. A grounding stick is a long insulating stick (with absolutely no metal parts) to which is taped a length of wire connected to ground. The wire must be routed far from the handle end of the stick. Use this stick to discharge all high voltage components before handling the system.

Furthermore, when operating any of the high voltage apparatus, stay a safe distance away. Instantaneous currents from the top of this generator can easily reach several tens of amperes and would be quite painful and very possibly dangerous.

It is very tempting to get close, especially while looking for corona leaks. The author has more than once felt the tiny hairs on the surface of his nose stand up from the electric

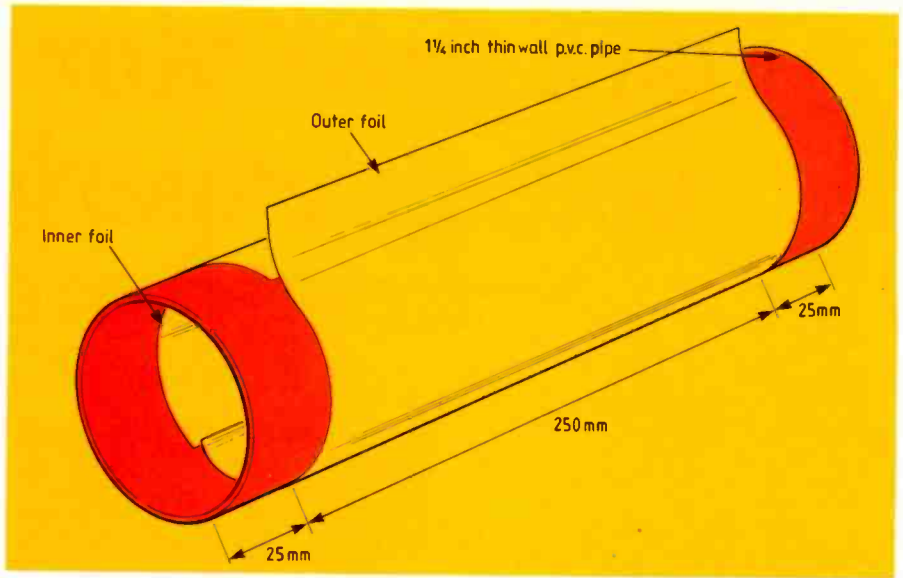

Fig.4. Making the p.v.c. pipe capacitors. Ordinary aluminium foil is secured with thin glue or tape.

field. This is an extremely hazardous situation as an arc can easily jump from a hot electrode to a person's face or metal eyeglasses. It is best to avoid all such dangers.

CAPACITORS

Commercial high voltage capacitors are quite hard to find and very expensive. For example, a 1nF ceramic capacitor with a 15kV breakdown voltage costs between \$10 and \$20. This cost is prohibitive for a

generator of five to 10 stages. Furthermore, the capacitors must be able to withstand 30kV or more since such a driving voltage can easily be produced.

Capacitors for this design can be made for less than \$1 apiece and are more than adequate (Fig.4). A 300mm section of 1 1/4 inch diameter (36mm nominal) thin-

HIGH VOLTAGE PHENOMENA

It might seem at first that a vacuum would provide the ideal dielectric for a high voltage system. There is simply no source of current carriers (electrons or ions) in a perfect vacuum. The dielectric properties of a vacuum gap are very good and, as a result, vacuum interrupters are made for both a.c. and d.c. applications. However, vacuum breakdown does occur and is the subject of much current research. The electrodes, as it turns out, can provide an ample supply of current carriers for the gap.

Several mechanisms exist for the formation of an arc plasma in a vacuum gap¹. Although the dominating mechanism will depend on gap length and applied voltage, a brief outline of typical mechanisms can be given here.

The onset of gap current generally depends on some sort of imperfection in the electrode surface. These imperfections can consist of small, filamentary protrusions of electrode material or deposits of impurities on the electrode surfaces.

Electron current can start to flow from the cathode by field emission. Field emission is a tunnelling process by which electrons are drawn out of the cathode surface, despite the work function barrier, and subsequently traverse the gap. Current densities are generally extremely small and are strongly

field-dependent. However, field-enhancement occurs at irregularities on the cathode surface making the local field at these points many times the average gap field. If the gap voltage is sufficiently high, these electrons gain a significant amount of energy by the time they reach an anode.

If the field emission current is concentrated at an irregularity on the anode, heating, melting, and even evaporation of the anode material may result. This liberated vapour can be ionized by incoming electrons, can cross the gap and liberate secondary electrons at the cathode surface. Thus an avalanche is created, leading to complete breakdown of the gap.

Under some conditions, microparticles can be generated as small pieces of electrode material are torn free from the electrodes. These microparticles can then liberate vapour upon impact at the opposite electrode. At that point, the gap is no longer a vacuum but contains a low pressure gas of electrode material. Any free electrons may then lead to breakdown by ionization of vapour atoms in the gap itself.

GASEOUS BREAKDOWN

When the voltage across a gas-filled gap is increased, a voltage-current relationship

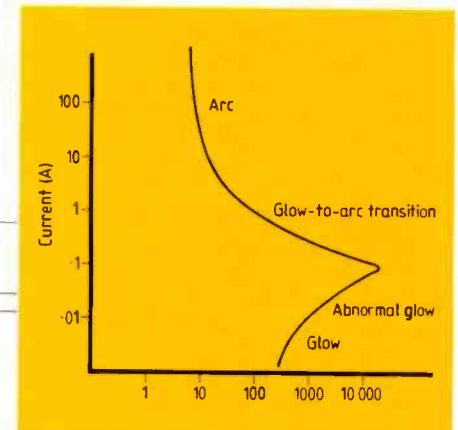

Fig.3. Characteristics of a gas-filled gap: current plotted against voltage.

similar to the one shown in Fig.1 will be obtained. The general form of this curve will be the same regardless of the gas pressure. However, the scales of voltage and current will depend very much on the particular gas, gas pressure, and electrode shape.

It is convenient to think of a gas discharge as either low-pressure or high-pressure. The distinction is generally made at a pressure of about one atmosphere. At pressures far below one atmosphere different mechanisms will predominate at a given voltage. The following discussion concentrates on high-pressure phenomena, which include discharges in atmospheric air.

Three principal regions are of interest in arc breakdown: corona, glow, and arc (Fig.3). A fourth, called the Townsend region, is apparent only at much lower currents and is all but unobservable at high pressures.

Corona is the first region of self-sustained discharge where no external ionizing

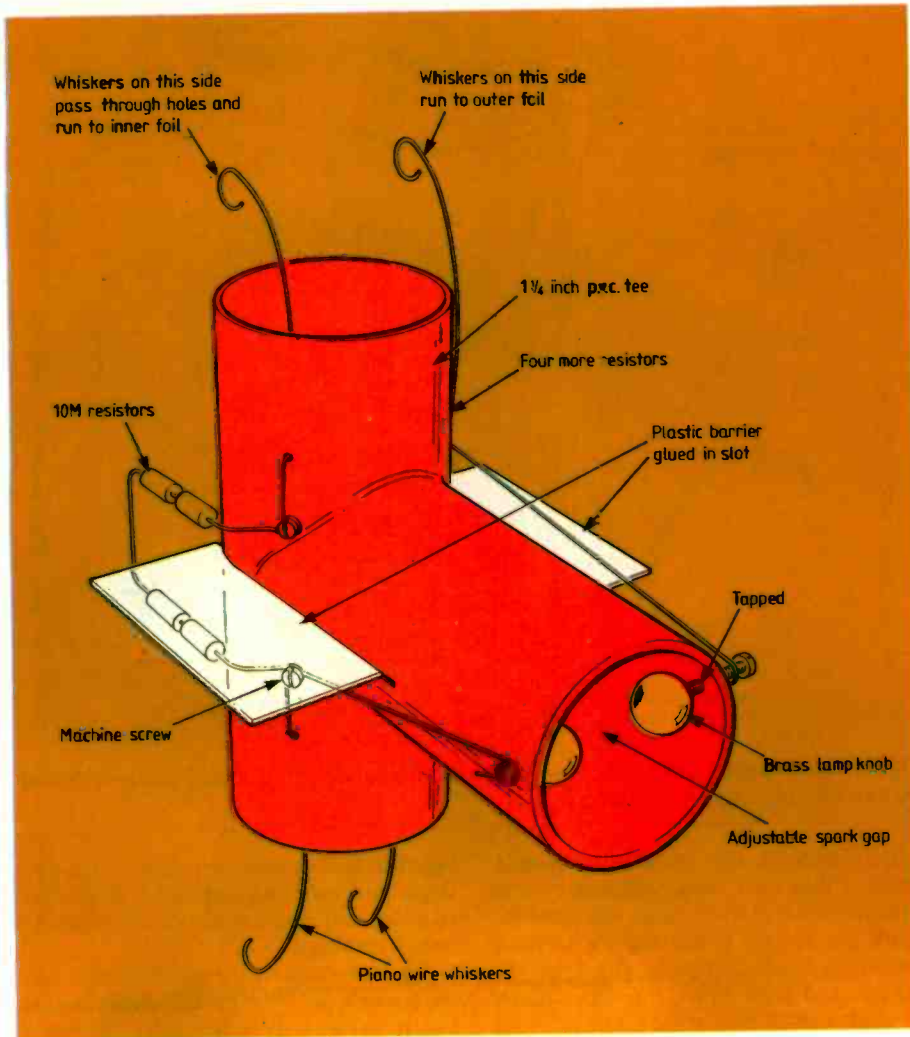

walled p.v.c. pipe is covered to within 25mm of its ends with aluminium foil, inside and out. For such a cylindrical capacitor,

$$C = \frac{55.6\epsilon_r l}{\ln(b/a)} \text{pF}$$

where b and a are the outer and inner diameters, respectively, l is the length in meters, and ϵ_r is the relative dielectric constant of the material. The relative dielectric constant for p.v.c.³ is about 3.2. Thus the capacitor should have a capacitance in excess of 200pF (more than adequate for the Marx generator) and it should be capable of withstanding about 50kV.

The ends of each length of pipe should be de-burred to allow them to fit freely into the couplers to be described later. Each capacitor corresponds to one stage of the Marx generator. For the 200kV generator, seven capacitors will be required.

When forming the plates, keep the foil very smooth to make it close to the dielectric and so maximize the capacitance. This can be quite difficult, but a few tricks will help. Small wrinkles can be removed by pushing a fingernail across the foil. With large wrinkles, it may be better to start again. Thin, clear tape can be used to start the outer foil on the pipe. Roll the pipe section over the foil piece until the ends overlap and secure the foil with clear tape or a thin layer of glue.

For the inner plate, begin by forming a tube of foil on the outside of a blank piece of pipe. This curled piece can then be encour-

Fig.5. Interstage couplers are made from standard plastics waste-pipe fittings.

mechanism is needed to maintain the carriers of discharge current. Typically, corona exists in regions of high non-uniformity of electric field and it can carry currents of up to the order of a milliamper. Thus, sharp edges and fine wires are often causes of corona leakage and can be quite annoying when they draw current away from a desired place.

Corona shows as a faint glow around the electrodes. In air, corona is purple and can actually make an audible hiss. Far away from the electrodes the discharge is very diffuse. Electron density is too low to provide much light from recombination.

The glow discharge is what is commonly seen in neon signs, although such signs operate at low pressure. Glow discharges occurs in regions of uniform field but remain quite diffuse in nature. A glow discharge represents a situation of extreme non-equilibrium in which electrons become much 'hotter' than ions and neutrals owing to the inefficiency of energy transfer between electrons and the heavier species. As long as the available power is limited and the situation remains diffuse, the glow will be maintained.

At high pressures, such a density of heavy species exists that the inefficiency of energy transfer is partially compensated for by an

extremely high frequency of interactions. Thus, at high pressure, glow discharges are very difficult to maintain. A high pressure glow can be thought of as a highly advanced corona just before the onset of an arc.

An arc discharge occurs as the conduction region collapses into a narrow region. As more power is made available to the discharge, a slight, random concentration of that power will occur and will cause enough heating to increase the ionization in that region.

Increased ionization liberates more electrons which carry more current and cause further heating and ionization. Soon a narrow conducting channel forms and complete breakdown occurs.

This is somewhat analogous to thermal runaway of bipolar transistors connected in parallel. The hotter transistor draws more current and so gets even hotter. Eventually, one device is drawing virtually all of the current. In a similar manner, the hot conducting channel draws all the current away from the other regions of the diffuse discharge and the glow makes the transition to an arc.

A fully developed arc has a high degree of ionization and is nearly in thermal equilibrium as the ions and neutrals become as hot as the electrons. Arc temperatures can easily

reach 20 000K. An arc can carry many thousands of amperes and typically exhibits a very low voltage drop (tens of volts).

The mechanism by which breakdown occurs in high pressure gaps is not obvious. Undoubtedly, some positive ion bombardment of the cathode occurs releasing secondary electrons in what is considered a Townsend process. But the speed of breakdown cannot always be theoretically explained by this cathode process. Breakdown typically takes place in less than a microsecond. A Townsend process would depend on ion transit times and so would take much longer.

Fortunately, another effect originating at the anode has been observed - streamer formation. Streamers are luminous filaments moving from the anode to the cathode and are thought to be columns of positive ions generated by electron impact.

As an ionized region is formed, the field in that region is enhanced by the presence of positive space charge and further electron impact is thus encouraged. Although the ions themselves need not move, this ionization front propagates like a wave toward the cathode at a very high speed. Theoretical investigations of these processes are very complicated and much has yet to be determined.

aged to fit inside by gently compressing it inward while sliding it down the pipe. If it crumples, start again. Secure the inner plate with clear tape or a thin layer of glue anywhere it tries to pull away from the wall.

In general, avoid all sharp edges on any electrically conducting surface. Smooth any rough edges on the foil plates and, if necessary, cover them with a thin layer of silicone sealant. Rough edges are prone to emit corona. Such losses should be minimized as they lower the system operating voltage. Silicone sealant is an excellent high voltage insulating material and is very useful for suppressing corona leaks. It is available in small toothpaste-type tubes or larger rigid tubes for a caulking gun.

INTERSTAGE COUPLERS

The resistors and spark gaps are built into coupling units placed between the capacitors. Six such couplers will be needed for the seven stage generator. In addition, a top cap and bottom feeder will be needed. The couplers have been designed to keep the outer foil of the capacitors at ground potential except while firing, both to minimize corona losses by confining the high voltage conducting surfaces and as a safety precaution.

Figure 5 shows the general layout of an interstage coupler. Spark gaps are adjustable and are made by threading holes in the leg of the tee fitting to accept 6-32 bolts. The ends of these bolts are fitted with small brass spheres of the type sold as knobs for lamp switches or pull chains. These are ideal spark gap electrodes. It is important to use perfectly round, smooth knobs to minimize corona losses. Screw threads and bolt heads give off

Fig.7. Top cap is made from a p.v.c. end cap. The brass lamp knob is secured with a bolt from underneath which also holds the whisker in place.

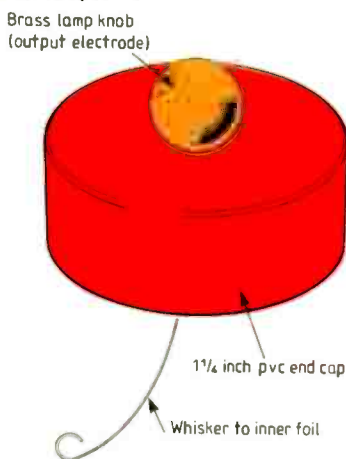

large amounts of corona and are not suitable.

High voltage resistors must be carefully constructed. Although much lower values could be used for higher repetition rates, each resistor is made from four 10 megohm carbon resistors. This is primarily a precaution to keep the continuous current available at any point at a harmless level. A single carbon resistor of 10M Ω would easily break down during operation.

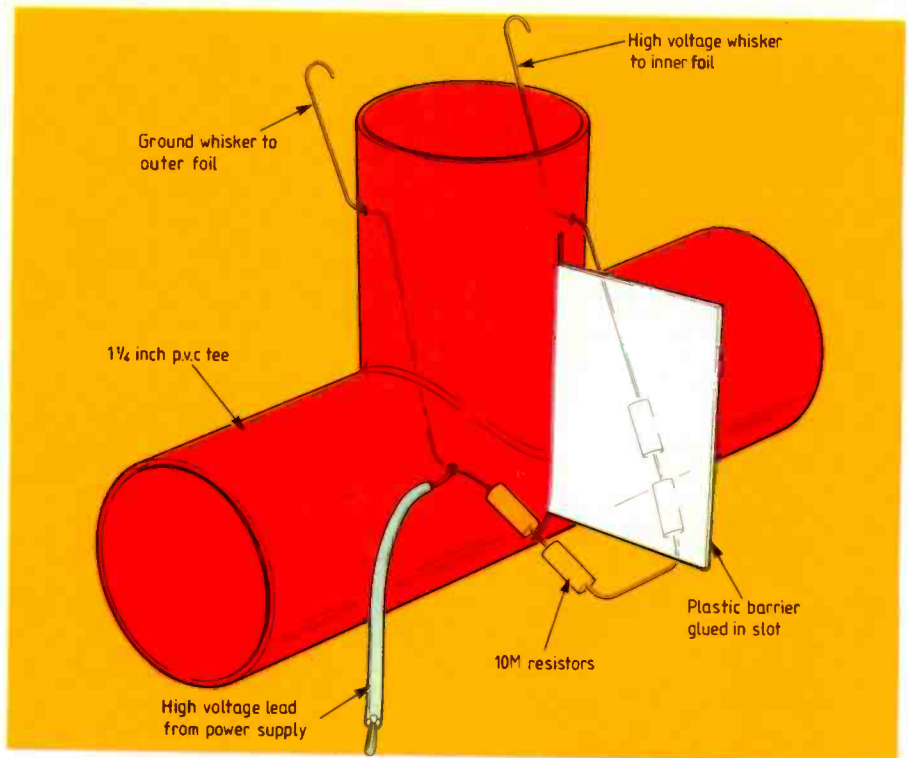

Fig.6. Bottom feeder: only one is required. To avoid troublesome corona leakage it should be carefully insulated from the floor.

Connections to the capacitors are made by forming thin steel piano wire into contact whiskers. Two of these wires run from the spark gap screws, over a resistor terminal and off to a capacitor plate. One is on the outside and runs down, the other passes through a small hole to the inside and runs up to the inner foil. The opposite two run only from the resistor terminals to the capacitors as shown. Care must be taken to ensure that enough curvature and spring tension are provided to make contact with the foil surfaces. Tiny air gaps can appear as mysterious voltage drops and cause problems later.

Resistors, bolt heads, and even some of the piano wire surfaces must be covered with silicone glue to prevent corona and suppress arcs. Especially important are the inside ends of the resistor terminal screws. Care must be taken not to get glue on the foil contact loops. When properly constructed, these couplers will fit nicely between two capacitors. There is no need to glue them

together as they will fit tightly. Since the stages pull apart, any number of stages can be added and maintenance or development work is very easy.

A bottom feeder is needed to connect to the power supply (Fig.6). The earth connection passes directly to the outer foil, while another resistor is provided for the inner foil connection. It is again important to cover all sharp surfaces with silicone sealant.

The top cap carries the output electrode for the Marx generator (Fig.7). A single brass sphere of the type used in the adjustable spark gaps is bolted to a p.v.c. end cap from the inside and a piano wire whisker makes contact with the inner foil of the top capacitor.

BASE

A base for the Marx generator can be made from more p.v.c. pipe and fittings. These are formed into an H arrangement built around the bottom coupler. The base can be glued together with p.v.c. cement for rigidity. To allow the generator to tilt over, it is a good

Fig.8. Electromechanical remote trigger.

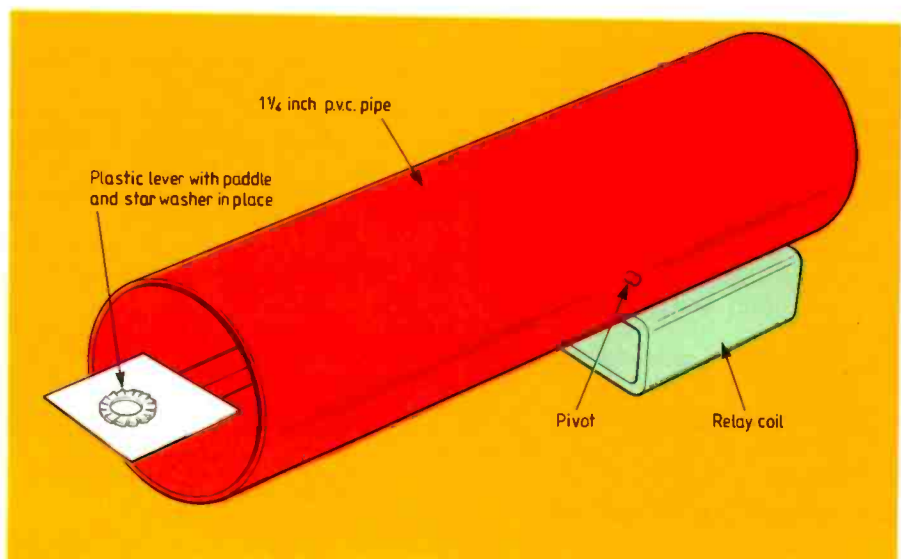

idea not to glue the connections to the bottom coupler. This will also allow the generator to be stored more conveniently when dismantled.

REMOTE TRIGGER

A remote trigger device is especially useful for photography. A very simple electro-mechanical trigger is reliable and quite satisfactory for most applications.

The basic idea of the trigger is to set the first gap too wide to break down from the power supply voltage. A long plastic lever then brings a metal star washer into the gap. The increased field strength in the gap allows breakdown to occur and fires the generator.

Figure 8 shows the trigger built into a section of p.v.c. pipe. The lever just protrudes from the far end to place the washer into the gap. A relay coil at the other end actuates the lever. A long cord with a push-button built into a plastic film canister serves as the remote switch. The design of the trigger will depend on the coil or solenoid available. It is important to maintain a lever length of several inches to keep high voltage away from the coil. The trigger is then press-fit into the leg of the first interstage coupler.

POWER SUPPLY

The power supply should deliver slightly more than 30kV to the Marx generator. The design is based on a modified television flyback transformer, which will yield about 10kV of alternating current at about 15kHz. A voltage tripler produces the final output. Any common unit intended for large colour televisions will do.

Unfortunately, these modules produce only positive output voltages. If applied to the inner side of the Marx generator these will deliver positive pulses at the top. If the input leads are reversed, negative pulses can be obtained, but at the risk of placing high voltage on the outside of the generator. Otherwise, negative pulses can be produced only by making a negative-output tripler and applying power to the inner side.

The circuit diagram for the power supply is shown in Fig.9. The primary of the flyback transformer must be removed and insulating tape should be applied to the core for winding a new one. The new primary winding is formed with five bifilar turns of no.18 (1mm diameter, 19s.w.g.) magnet wire with the ends joined in a centre-tapped arrangement. The tickler coil is made from five turns of no.24 (0.5mm diameter, 25s.w.g.) or larger magnet wire. It is essential to connect the windings in proper phase.

The tripler and high-voltage side of the transformer should be kept as far away as possible from the low voltage connections to prevent corona leakage and even breakdown in the power supply itself.

The output lead of the power supply should produce some corona and a grounded lead will draw small discharges continuously from it. Since the tripler contains capacitors, take care never to touch the output directly. Discharges of the order of an inch long should be possible.

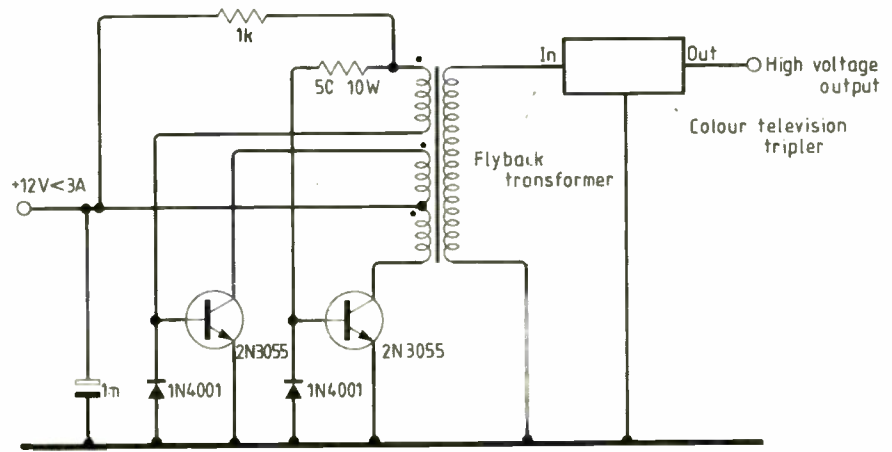

Fig.9. High voltage power supply. Both transistors must be secured to a heat sink with insulating hardware. The 12V unregulated source should be able to provide up to 3A.

TESTING

Begin testing the generator with two capacitors and one coupler on the base. Set the spark gaps to greater than one inch. Carefully apply power and look for any corona leaks in the generator itself or from the connecting leads. If the gap breaks down, make it wider. Having noted any leaks, remove power and discharge the inner side of the Marx generator.

Discharging can be accomplished by bringing the grounding stick in contact with the 'hot' end of the spark gap. Always do this before handling the Marx generator.

Dismantle the capacitor column and treat the corona leaks with silicone sealant or by removing sharp edges. Re-assemble and test for more leakage. When the first stages have been perfected, add the next ones and repeat the procedure.

When the entire column has been purged of corona leaks, the remote control trigger can be installed. Actuating the trigger while

Assembled Marx generator. Note the remote trigger in place in the lowest gap.



power is applied to the Marx generator should break down the first gap. If it doesn't, adjust the first gap (after discharging the column) until it does. Other gaps should follow at the same time as the first. If they do not, look for bad connections between the whisker contacts and the foil and adjust the gaps down until they fire synchronously with the triggered gap.

An earthed wire can be dangled from the ceiling to within a few inches of the top cap of the column. This wire will allow arcs to be drawn when the Marx generator is triggered. The difference between corona and arc will become apparent as the gap discharges charge from faint purple filament to a hotter white spark.

Arcs of up to six or seven inches are easily obtained. This indicates that output voltages of 200kV are available. Charging times of two or three seconds are required between firings.

IMPROVEMENT

For an improved generator, the resistors on the interstage couplers could be reduced to 1M Ω or so (four 250k Ω resistors in series). This would greatly increase the firing rate if a more powerful power supply could be found. A 30mA 30kV supply could possibly be made from a 15kV power transformer and a specially constructed voltage multiplier using large transmitting capacitors or, possibly, large p.v.c. pipe capacitors.

Furthermore, a completely re-designed unit with two or three-inch pipe could be built to increase the available current.

References

1. Howatson, A.M. An Introduction to Gas Discharges. Pergamon, 1976.
2. Maller, V.N. and Naidu, M.S. Advances in High Voltage Insulation and Arc Interruption in SF₆ and Vacuum. Pergamon, 1981.
3. Reference Data for Radio Engineers. Howard W. Sams Inc., 1981.

Edward Richley attended Carnegie-Mellon University in Pittsburgh, Pennsylvania from 1975 to 1984. He gained a B.S. in 1979, an M.S. in 1980, and in 1984, a Ph.D. with a thesis on non-equilibrium effects in high-pressure electric arcs. He now works for Xerox Corporation at their Palo Alto Research Center in California. He also holds an advanced-class amateur radio licence, KD8KZ.

COMPUTER WAREHOUSE

1000's OF BARGAINS FOR CALLERS

THE "ALLADINS" CAVE OF COMPUTER AND ELECTRONIC EQUIPMENT

HOT LINE DATA BASE

DISTEL

The ORIGINAL FREE OF CHARGE dial up data base. Buy, browse or place YOUR OWN AD for goods or services to sell. 1000's of stock items, spares and one off bargains. Updated daily. ON LINE NOW. CCITT, 8 bit word, no parity. For 300 baud modems call 01-679 1888. For 1200-75 baud modems call 01-679 6183.

FREE

Your monitor from its computer!! For only £29.95 it becomes a SUPERB HIGH QUALITY * COLOUR * TV SET

The fabulous TELEBOX, an INVALUABLE MUST for the owner of ANY video monitor with a composite input, colour or monochrome. Made by a major UK Co. as a TOP QUALITY stand alone UHF tuner and costing OVER £75 to manufacture. This opportunity to give your monitor a DUAL FUNCTION must not be missed!! The TELEBOX consists of a compact, stylish two tone charcoal moulded case, containing ALL electronics tuner, power supply etc. to simply plug in and convert your previously dedicated computer monitor into a HIGH QUALITY COLOUR * TV SET, giving a real benefit to ALL the family! Don't worry if your monitor doesn't have sound - THE TELEBOX even has an integral 4 watt audio amplifier for driving an external speaker. PLUS an auxiliary output for superb quality television sound via your headphones or Hi-Fi system etc. Other features include: Compact dimensions of only 15.75" w x 7.5" d x 3.5" h, latest technology, BRITISH manufacture, fully tuneable 7 channel push button tuner, Auto AGC circuit, SAW filter, LED status indicator, fully isolated 240v AC power supply for total safety. Mains ON-OFF switch etc. Many other uses.

LIMITED QUANTITY - DON'T MISS THIS OFFER!!

ONLY £29.95 OR £24.95 if purchased with ANY of our video monitors. Supplied BRAND NEW with full instructions and 2 YEAR warranty. Post and packing £3.50. *When used with colour crt.

COLOUR & MONOCHROME MONITOR SPECIALS

'SYSTEM ALPHA' 14 COLOUR MULTI INPUT MONITOR

Made by the famous REDIFFUSION Co. for their own professional computer system this monitor has all the features to suit your immediate and future requirements. Two video inputs: RGB and PAL Composite Video, allow direct connection to BBC/IBM and most other makes of micro computers or VCR's, including our very own TELEBOX. An internal speaker and audio amp may be connected to computer or VCR for superior sound quality. Many other features: PIL tube. Matching BBC case colour. Major controls on front panel. Separate Contrast and Brightness - even in RGB mode. Separate Colour and audio controls for Composite Video input. BNC plug for composite input. 15 way D plug for RGB input, modular construction etc.

This Must Be ONE OF THE YEAR'S BEST BUYS. PC USER

Supplied BRAND NEW and BOXED, complete with DATA and 90 day guarantee ONLY £159.00 as above OR IBM PC Version £165.00. 15 Day 'D' sct £1.00. BNC sct 75p BNC interface cable £5.50.

DECCA 80 16 COLOUR monitor, RGB input.

Little or hardly used manufacturer's surplus enables us to offer this special converted DECCA RGB Colour Video TV Monitor at a super low price of only £99.00, a price for a colour monitor as yet unheard of! Our own interface, safety modification and special 16" high definition PIL tube, coupled with the DECCA 80 series TV chassis give 80 column definition and quality found only on monitors costing 3 TIMES OUR PRICE. The quality for the price has to be seen to be believed!! Supplied complete and ready to plug direct to a BBC MICRO computer or any other system with a TTL RGB output. Other features are: internal speaker, modular construction, auto degaussing circuit, attractive TEAK CASE, compact dimensions only 52cm W x 34 H x 24 D, 90 day guarantee. Although used units are supplied in EXCELLENT condition. ONLY £99.00 + Carriage.

DECCA 80, 16 COLOUR monitor, Composite video Input. Same as above model but fitted with Composite Video input and audio amp for COMPUTER, VCR or AUDIO VISUAL use ONLY £99.00 + Car.

REDIFFUSION MARK 3, 20 COLOUR monitor. Fitted with standard 75 ohm composite video input and sound amp. This large screen colour display is ideal for SCHOOLS, SHOPS, DISCOS, CLUBS and other AUDIO VISUAL applications. Supplied in AS NEW or little used condition ONLY £145.00 + Car.

BUDGET RANGE EX EQUIPMENT MONOCHROME video monitors.

All units are fully cased and set for 240v standard working with composite video inputs. Units are pre tested and set up for up to 80 column use. Even when MINOR screen burns exist - normal data displays are unaffected 30 day guarantee.

12 KGM 320-1 B/W bandwidth input, will display up to 132 x 25 lines. £32.95
12 GREEN SCREEN version of KGM 320-1. Only £39.95
9 KGM 324 GREEN SCREEN fully cased very compact unit. Only £49.00

Carriage and insurance on all monitors £10.00

DC POWER SUPPLY SPECIALS

GOULD OF443 enclosed, compact switch mode supply with DC regulated outputs of +5v @ 55a, +12v @ 0.5a, -12v @ 0.1a and -23v @ 0.02a Dim 18 x 11 x 6 cm. 110 or 240v input. BRAND NEW only £16.95

GOULD G6-40A 5v 40 amp switch mode supply NEW £130.00
AC-DC Linear PSU for DISK drive and SYSTEM applications. Constructed on a rugged ALLOY chassis to continuously supply fully regulated DC outputs of +5v @ 3 amps, -5v @ 0.6 amps and +24v @ 5 amps. Short circuit and overvoltage protected 100 or 240v AC input. Dim 28 x 12.5 x 7 cm. NEW £49.94

Carriage on all PSU's £3.00

KEYBOARDS

Manufacturer's BRAND NEW surplus.

DEC LA34 Uncoded keyboard with 67 quality gold plated switches on X-Y matrix - ideal micro conversions etc. £24.95

AMKEY MPNK 114 Superb word processor chassis keyboard on single PCB with 116 keys. Many features such as On board Micro, Single 5v rail full ASCII coded character set with 31 function keys, numeric keypad, cursor pad and 9600 baud SERIAL TTL ASCII OUTPUT! Less than half price. ONLY £69.00 with data. Carriage on Keyboards £3.50



DON'T MISS THE CPM Deal OF THE CENTURY

The FABULOUS CPM TATUNG PC2000 Professional Business System

A cancelled export order and months of negotiation enables us to offer this professional PC CPM system, recently on sale at OVER £1400, at a SCOOP price just over the cost of the two internal disk drives! Or less than the price of a dumb terminal!!

Not a toy, the BIG BROTHER of the EINSTIEN computer, the DUAL PROCESSOR PC2000 comprises a modern stylish three piece system with ALL the necessities for the SMALL BUSINESS, INDUSTRIAL, EDUCATIONAL or HOBBYIST USER. Used with the THOUSANDS of proven, tested and available CPM software packages such as WORDSTAR, FAST, DBASE2 etc. the PC2000 specification, at our prices CANNOT BE BEATEN!!

The central processor plinth contains the 64K, Z80A processor, DUAL TEAC 55F 5 1/4 CENTRONICS and system expansion ports, and if that's not enough a ready to plug into STANDARD 8 DRIVE port for up to FOUR 8 disk drives, either in double density or IBM format. The ultra slim 92 key, detachable keyboard features 32 user definable keys, numeric keypad and text editing keys, even its own integral microprocessor which allows the main Z80A to devote ALL its time to USER programs, eliminating "lost character" problems found on other machines. The attractive, detachable 12" monitor combines a green, anti-glare etched screen, with full swivel and tilt movement for maximum user comfort. Supplied BRAND NEW with CPM 2.2, user manuals and full 90 day guarantee. Full data sheet and info on request.

PC2000 System with CPM Etc. COST OVER £1400

PC2000 Business System with CPM and 'Ready to Run' FAST Sales and Purchase ledger, supports up to 9000 Accounts, VAT etc. COST OVER £1700

PC2000 Wordprocessor System with CPM and TEC FP25 daisywheel printer. COST OVER £1700

NOW only £399

NOW only £499
Carriage & Insurance £12.00

NOW only £799

MODEMS

Join the communications revolution with our super range of DATA MODEMS, prices and specifications to suit all applications and budgets.

BRAND NEW State of the art products.
DACOM DSSL2123 Multistandard 300-300, 1200-75 Auto answer etc. £268.00
DACOM DSSL2123AQ Auto dial, smart modem with multi standard AUTO SPEED detect and data buffer with flow control etc. £365.00
DACOM DSSL2123GT The CREAM of the intelligent modems, auto dial, auto call, index, buffer etc. £498.00
Steebeck SB1212 V22 1200 baud FULL DUPLEX sync or async optional auto dial. £465.00
TRANSDATA 307A Acoustic coupler 300 baud full duplex, originate only, RS232 interface. £49.00

EX BRITISH TELECOM full spec. CCITT, ruggedised, bargain offers. Sold TESTED with data. Will work on any MICRO or system with RS232 interface.
MODEM 13A 300 baud unit, only 2" high fits under phone CALL mode only. £45.00
MODEM 20-1, 75-1200 baud. Compact unit for use as subscriber end to PRESTEL, TELECOM GOLD, MICRONET etc. £39.95 + pp £6.50
MODEM 20-2 1200-75 baud. Same as 20-1 but for computer end. £65.00 + pp £6.50
DATEL 2412. Made by SE Labs for BT this two part unit is for synchronous data links at 1200 or 2400 baud using 2780/3780 protocol etc. Many features include 2 or 4 wire working, self test, auto answer etc. COST OVER £800. Our price ONLY £199 + pp £8.00
DATEL 4800, RACAL MPS4800 baud modem. EX BT good working order. ONLY £295.00 + pp £8.00

SPECIAL OFFER

MODEM TG2393. Ex BT, up to 1200 baud, full duplex 4 wire or half duplex over 2 wire line. ONLY £85.00 PER PAIR + pp £10.00

For more information contact our Sales Office.

MATRIX PRINTERS

SPECIAL BULK PURCHASE of these compact, high speed matrix printers. Built in Japan for the Hazeltine Corporation this unit features quality construction giving 100cps bidirectional, full pin addressable graphics, 6 type fonts, up to 95 single sheet or tractor paper handling, RS232 and CENTRONICS parallel interface. Many other features. BRAND NEW and BOXED. COST £420. Our price ONLY £199.00

RECHARGEABLE BATTERIES

Dry Fit MAINTENANCE FREE by Sonnenschein & Yuasa.

A300 07191315 12v 3Ah NEW £13.95
A300 07191312 6v 3Ah NEW £9.95
A300 07191202 6-0-6v 1.8Ah TESTED Ex Equip £5.99

VDU TERMINALS

Standard VDU data entry terminals

at give away prices!!

QUME QVT108. Current product, state of the art terminal with detachable keyboard, 12" Green screen, 2 page RAM, TVI 925, Hazeltine, ADMSA emulations, software setup, 25 x 80, Clock, Swivel and tilt base, Printer port, Function keys etc. BRAND NEW and BOXED at ALMOST HALF PRICE ONLY £425.00
AJ510 - EX RENTAL, Z80 controlled, 15 green screen 24 x 80 display, graphics, cursor addressing, printer port etc. Very good condition TESTED complete with manual only £225.00
ADDS 520 - Dumb terminal, used, 12" b/w screen RS232 interface and printer port. TESTED. ONLY £125.00. Carriage on terminals £10.00. 100's of other terminals in stock. CALL for more details.

SURPLUS SPECIALS ON PRESTEL - VIEWDATA - TELEX

PLESSEL VUTEL, ultra compact unit, slightly larger than a telephone features A STANDARD DTMF TELEPHONE (tone dial) with 5 CRT monitor and integral modem etc. for direct connection to PRESTEL VIEWDATA etc. Designed to sell to the EXECUTIVE at over £600. Our price BRAND NEW AND BOXED at only £99.00

DECCAFAX VPI complete Professional PRESTEL system in slimline desk top unit containing Modem, Numeric keypad, CPU, PSU etc. Connects direct to standard RGB colour monitor. Many other features include: Printer output, Full keyboard input, Cassette port etc. BRAND NEW with DATA. A FRACTION OF COST only £55.00

ALPHATANTEL, Very compact unit with integral FULL ALPHA NUMERIC keyboard. Just add a domestic TV receiver and you have a superb PRESTEL system and via PRESTEL the cheapest TELEX service to be found. Many features: CENTRONICS Printer output, Memory dialling etc. Supplied complete with data and DIY mod for RGB or Composite video outputs. AS NEW only £125.00

EX-STOCK INTEGRATED CIRCUITS

4164 200 ns D RAMS 9 for £11 4116 ns £11 50 2112 £10.00 2114 £2.50 2102 £2.00 6116 £2.50 EPROMS 2716 £2.50 2732 £3.00 2764 £4.95 27128 £5.50 6800 £2.50 6821 £1 68A09 £8 68B09 £10 80B5A £5.50 8086 £15 8088 £8 NEC765 £8 WD2793 £28 8202A £22 B251 £7 8748 £15 Z80A DART £6.50 Z80A CPU £2.00 Thousands of IC's EX STOCK send SAE for list

DISK DRIVES

Japanese 5 1/4" half height, 80 track double sided disk drives by TEAC, CANON, TOSHIBA etc. Sold as NEW with 90 day guarantee ONLY £85.00
TEC FB-503 Double sided HH 40 TRK NEW £75.00
SUGART SA400 SS FH 35 TRK £55.00
SIEMENS FDD100 SS FH 40 TRK £65.00 carriage on 5 1/4" drives £5.50

Brand NEW metal 5 1/4" DISK CASES with internal PSU.
DSKC1 for 2 HH or 1 FH drive £29.95 + pp £4.00
DSKC 2 for 1 HH drive £22.95 + pp £3.50
DKSC 3 AS DSK1 LESS PSU £12.95 + pp £2.50
DKSC 4 AS DSK2 LESS PSU £10.95 + pp £2.00

8" IBM format TESTED EX EQUIPMENT
SHUGART 800/801 SS £175.00 + pp £8.50
SHUGART 851 DS £250.00 + pp £8.50
TWIN SHUGART 851 s2 1.2 Mb total capacity in smart case, complete with PSU etc. £595.00

MITSUBISHI M2894-63 8" DS 1 Mb equiv to SHUGART SA850R. BRAND NEW at £275.00 + pp £8.50
DYSAN 8 Alignment disk £29.00 + pp £1.00

Various disk drive PSU's Ex Stock SEE PSU section.
HARD DISK DRIVES
DRE/DIABLO Series 30 2.5 Mb front load £525.00
Exchangeable version £295.00. ME3029 PSU £75.00

DIABLO 44/DRE4000A, B 5 + 5 Mb £199.00
CDC HAWK 5 + 5 Mb £795.00. CDC 9782 80 Mb RMO3 etc. £2500.00
PERTEC D3422 5+5 Mb £495.00
RODIME 5 1/4" Winchester ex-stock from £150 CALL Clearance items - Sold as seen - No guarantee
ICL 2314 BRAND NEW 14" Mb Removable pack hard disk drive, cost over £2000 with data ONLY £99.00
BASF 6172 B 23Mb Winchester £199.00

Unless stated all drives are refurbished with 90 day guarantee. Many other drives and spares in stock - call sales office for details.

All prices quoted are for U.K. Mainland, paid cash with order in Pounds Sterling PLUS VAT. Minimum order value £2.00. Minimum Credit Card order £10.00. Minimum BONA FIDE account orders from Government Depts., Schools, Universities and established companies £20.00. Where post and packing not indicated please ADD £1.00 + VAT. Warehouse open Mon-Fri 9.30-5.30. Sat 10.30-5.30. We reserve the right to change prices and specifications without notice. Trade, Bulk and Export

32 Biggin Way, Upper Norwood, London SE19 3XF
Telephone 01-679 4414 Telex 894502 Data 01-679 1888

ERS — PRINTERS — PRINTERS — PRINTERS

SUPER DEAL? NO — SUPER STEAL THE FABULOUS 25 CPS "TEC STARWRITER"

Made to the very highest spec the **TEC STARWRITER FP1500-25** features a very heavy duty die cast chassis and **DIABLO** type print mechanism giving superb registration and print quality. Micro-processor electronics offer full **DIABLO/QUEM** command compatibility and full control via **CPM WORDSTAR ETC.** Many other features include bi-directional printing, switchable 10 or 12 pitch, full width 381mm paper handling with up to 163 characters per line, friction feed rollers for single sheet or continuous paper, internal buffer, standard **RS232** serial interface with handshake. Supplied absolutely **BRAND NEW** with 90 day guarantee and **FREE** daisy wheel and dust cover. Order **NOW** or contact sales office for more information. Optional extras **RS232** data cable £10.00 Tech manual £7.50 Tractor Feed £140.00 Spare daisy wheel £3.50 Carriage & Ins (UK Mainland) £10.00



NOW ONLY £499 + VAT

DIY PRINTER MECH

Brand New surplus of this professional printer chassis gives an outstanding opportunity for the **Student, Hobbyist or Robotics** constructor to build a **printer - plotter - digitiser** etc, entirely to their own specification. The printer mechanism is supplied ready built, aligned and pre tested but **WITHOUT** electronics. Many features include all metal chassis, phosphor bronze bearings, 132 character optical shaft position encoder, **NINE** needle head, 2 x two phase 12V stepper motors for carriage and paper control, 9.5" Paper platen etc, etc. Even a manufacturer's print sample to show the unit's capabilities!! Overall dimensions 40 cm x 12 cm x 21 cm.
Sold **BRAND NEW** at a **FRACTION** of cost **ONLY £49.50 + pp £4.50.**

TELETYPE ASR33 DATA I/O TERMINALS

Industry standard, combined ASCII 110 baud printer, keyboard and 8 hole paper tape punch and reader. Standard **RS232** serial interface. Ideal as cheap hard copy unit or tape prep. for CNC and NC machines. **TESTED** and in good condition. Only £250.00 floor stand £10.00. Carr & Ins. £15.00.

EX NEWS SERVICE PRINTERS

Compact ultra reliable quality built unit made by the **USA EXTEL Corporation**. Often seen in major Hotels printing up to the minute News and Financial information. The unit operates on 5 UNIT **BAUDOT CODE** from a Current loop, **RS232** or **TTL** serial interface. May be connected to your micro as a low cost printer or via a simple interface and filter to any communications receiver to enable printing of worldwide **NEWS, TELEX and RTTY** services.
Supplied **TESTED** in second hand condition complete with **DATA, 50 and 75 baud xtals** and large paper roll.

TYPE AE11
50 Column **ONLY £49.95**
Spare paper roll for AE11 **£4.50**
TYPE AF11R 72 Col.
+ Ribbon **£65.00**
TYPE AH11R 80 Col.
ASCII/BAUDOT **£185.00**
Carriage and Insurance £7 50

GE TERMIPRINTER

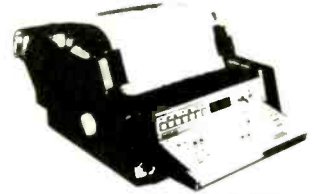

A massive purchase of these desk top printer terminals enables us to offer you these quality 30 or 120 cps printers at a **SUPER LOW PRICE** against their original cost of over £1000. Unit comprises of full **QWERTY** electronic keyboard and printer mech with print face similar to correspondence quality typewriter. Variable forms tractor unit enables full width - up to 135 120 column paper, upper - lower case, standard **RS232** serial interface, internal vertical and horizontal tab settings, standard ribbon, adjustable baud rates, quiet operation plus many other features. Supplied complete with manual. Guaranteed working **GE30 £130.00. GE1200 120 cps £175.00.** Untested **GE30 £65.00** Optional floor stand £12.50 Carr & Ins £10.00.

SEMICONDUCTOR 'GRAB BAGS'

Mixed Semis amazing value contents include transistors digital linear ICs, triacs, diodes, bridge recs, etc etc. All devices guaranteed brand new full spec with manufacturer's markings, fully guaranteed.
50+ £2.95 100+ £5.15
TTL 74 Series A gigantic purchase of an "across the board" range of **74 TTL** series ICs enables us to offer **100+ mixed "mostly TTL" grab bags** at a price which two or three chips in the bag would normally cost to buy. Fully guaranteed all IC's full spec. **100+ £6.90. 200+ £12.30. 300+ £19.50.**

MAINS FILTERS

CURE those unnerving hang ups and data glitches caused by mains interference with professional quality filters **SD5A** match-box size up to 1000 watt 240 V Load **ONLY £5.95. L12127** compact completely cased unit with 3 pin fitted socket up to 750 watts **ONLY £9.99.**

EPROM COPIERS

The amazing **SOFTY 2** The "Complete Toolkit" for copying, writing, modifying and listing **EPROMS** of the **2516, 2716, 2532, 2732** range. Many other functions include integral keyboard, cassette interface, serial and parallel i/o UHF modulator ZIF socket etc.
ONLY £195.00 + pp £25.00
"GANG OF EIGHT" intelligent Z80 controlled 8 gang programmer for ALL single 5v rail EPROMS up to 27128. Will copy 8 27128 in **ONLY 3 MINUTES**. Internal LCD display and checking routines for **IDOT PROOF** operation. Only **£395.00 + pp £30.00**
"GANG OF EIGHT PLUS" Same spec as above but with additional **RS232** serial interface for down line loading data from computer etc. **ONLY £445.00 + pp £3.00**
Data sheets on request

COOLING FANS

Keep your hot parts **COOL** and **RELIABLE** with our range of **COOLING FANS** **ETRI 126/F21** 240v 5 blade equipment fan Dim 80 x 80 x 38mm **£9.95** **ETRI 99XU/OI** 240v Slimline Dim. 92 x 92 x 25mm equipment fan **NEW £9.95** **GOULD JB-3AR** Dim. 3" x 3" x 2.5" compact very quiet running 240v operation **NEW £6.95** **MUFFIN CENTAUR BOXER** standard 120 x 120 x 38mm fans Order 110v OR 240v, 3 or 5 blade **NEW at £10.50** or tested **EX EQUIPMENT** £5.50. Low Voltage DC Fans **BUHLER 69.11.22** 8 16v DC micro miniature reversible. Uses brushless servo motor almost silent running, guaranteed 10,000 hr life. Measures only 62 x 62 x 22mm. Current cost **£35.00 OUR PRICE** **ONLY £13.95** complete with data. 120 x 120 38mm (4 DC fans) **PANSONIC FB 12C12H** 12v DC 5 blade £18.00 **PAPST 4124X 24** 28v DC 5 blade £18.00.
100's of other Fans Ex Stock.
Call for Details Post & Packing on all Fans £2.00

20,000 FEET OF ELECTRONIC AND COMPUTER GOODIES ENGLAND'S LARGEST SURPLUS STORE — SEEING IS BELIEVING!!

DEC CORNER

PDP 1140 System comprising of CPU, 124k memory & MMU 15 line **RS232** interface. **RP02** 40 MB hard disk drive. **TU10** 9 track 800 BPI Mag tape drive, dual track system. **VT52** VDU, etc. etc. Tested and running. **£3,750.00**
BA11-MB 3.5" Box, PSU, LTC **£395.00**
DH11-AD 16" x RS232 DMA interface **£1,900.00**
DLV11-J4 x EIA Interface **£350.00**
DLV11-E Serial, Modem support **£190.00**
DUP11 Synchron. Serial data i/o **£650.00**
DQ200 Dialog - multi RK controller **£495.00**
DZ11-B 8 line RS232 mux board **£650.00**
KDF11-B M8189 PDP 1123 PLUS **£1,100.00**
LA30 Printer and Keyboard **£80.00**
LA36 Decwriter EIA or 20 mA loop **£270.00**
MS11-JP Unibus 32kb Ram **£80.00**
MS11-LB Unibus 128kb Ram **£450.00**
MS11-LD Unibus 256kb Ram **£850.00**
PDP11/05 Cpu Ram, i/o etc **£450.00**
PDP11/40 Cpu, 124k MMU **£1,850.00**
RT11 ver 3B documentation kit **£70.00**
RK05-J 2.5 Mb disk drives **£650.00**
KL8 JA PDP 8 async i/o **£175.00**
M18E PDP 8 Bootstrap option **£75.00**
VT50 VDU and Keyboard **£175.00**
-20 mA **£175.00**
VT52 VDU and RS232 interface **£250.00**

MAG TAPE DRIVES

Many **EX STOCK** computer tape drives and spares by **PERTEC, CIPHER, WANGO, DIGIDATA, KENNEDY** etc. Special offer this month on **DEI Cartridge** tape drives **ONLY £450.00 each.**

CALL FOR DETAILS

COMPUTER/SYSTEM CABINET & PSU

All in one quality computer cabinet with integral switched mode PSU, mains filtering, and twin fan cooling. Originally made for the famous **DEC PDP8** computer system costing thousands of pounds. Made to run 24 hours per day the psu is fully screened and will deliver a massive **+5v DC at 17 amps, +15v DC at 1 amp and -15v DC at 5 amps.** The complete unit is fully enclosed with removable top lid, filtering, trip switch, power and run leds mounted on all front panel, rear cable entries, etc. etc. Units are in good but used condition - supplied for 240v operation complete with full circuit and tech. man. Give your system that professional finish for only **£49.95 + carr. 19" wide 16" deep 10.5" high.** Useable area 16" w 10.5" h 11.5" d.

Also available less psu, with fans etc. Internal dim. 19" w, 16" d, 10.5" h. **£19.95. Carriage £8.75**

66% DISCOUNT ON ELECTRONIC COMPONENTS EQUIPMENT

Due to our massive bulk purchasing programme, which enables us to bring you the best possible bargains, we have thousands of ICs, Transistors, Relays, Caps, PCBs, Sub-assemblies, Switches etc. surplus to OUR requirements. Because we don't have sufficient stocks of any one item to include in our ads we are packing all these items into the **BARGAIN OF A LIFETIME**. Thousands of components at giveaway prices. Guaranteed to be worth at least 3 times what you pay. Unbeatable value and perhaps one of the most consistently useful items you will ever buy!! Sold by weight.

2.5kIs £5.25 + pp £1.25
10kIs £11.25 + pp £2.25

5 kIs £6.90 + £1.80
20kIs £19.50 + pp £4.75



Give your **VT100** a Birthday!!

Brand New **VT100** Keyboards only **£85.00**

1000's of **EX STOCK** spares for **PDP8, PDP8A, PDP11, PD P1134** etc. SAE, for list, or CALL sales office for details.

ALL TYPES OF COMPUTER EQUIPMENT AND SPARES WANTED FOR PROMPT CASH PAYMENT.

1000's of other **EX STOCK** items including **POWER SUPPLIES, RACKS, RELAYS, TRANSFORMERS, TEST EQUIPMENT, CABLE, CONNECTORS, HARDWARE, MODEMS, TELEPHONES, VARIACS, VDU'S, PRINTERS, POWER SUPPLIES, OPTICS, KEYBOARDS** etc. etc. Give us a call for your spare part requirements. Stock changes almost daily.

Don't forget, **ALL TYPES** and **QUANTITIES** of electronic surplus purchased for **CASH**

ENTER 55 ON REPLY CARD

"Go on...

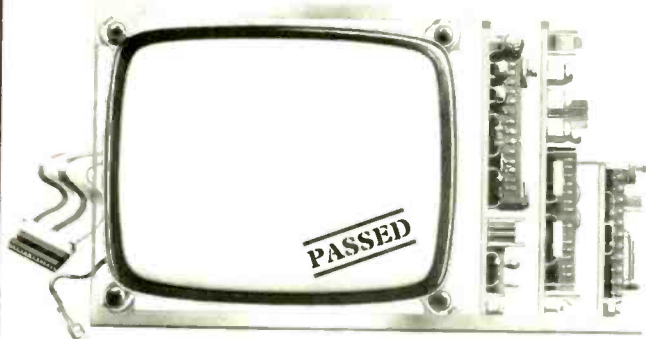

now stuff it in a tin box"

OK, so you only want twenty five to start with. That doesn't mean you have to devalue the whole project because you feel you can't afford a professional enclosure. Beechcraft will design your very own case. Then mould it in good looking rigid P.U. - putting in all the slots, holes and mountings you need - and finishing it perfectly in the livery you specify. All for a price which will pleasantly surprise you.

Impressed? - then get in touch with David Beech and let him prove it.

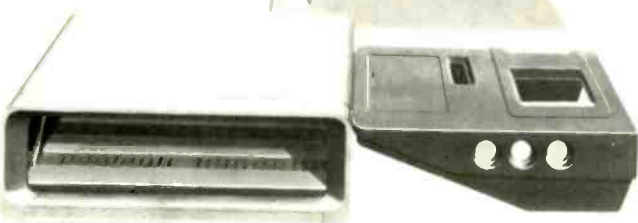

High specification enclosures on low level budgets Beechcraft

Beechcraft Ltd., Westfield Industrial Estate, Midsomer Norton, Bath, Avon BA3 4BS. Telephone: (0761) 416642 Tlx: 44627

ENTER 64 ON REPLY CARD

SOWTER AUDIO FREQUENCY TRANSFORMERS

You name it! We make it!

For the past 45 years we have concentrated on the design and manufacture of high grade audio transformers during which period our total sold exceeds half a million. We continually take full advantage of all the improvements in magnetic and insulating materials and in measuring techniques utilising the most up to date instrumentation.

We have a very large number of original designs made for clients all over the world but naturally there are certain types of Sowter Transformers which are in constant demand. These have taken into account the tendency towards small size without sacrifice of performance, particularly for PCB mounting, and a few of these are listed below. They can be supplied with or without mumetal shielding cans. Performance requirements can be modified on request (utilising our readily available questionnaire) and generally without alteration in price.

We specialise in **LOW COST AND QUICK DELIVERY** which means a few days only or ex-stock.

TYPICAL PERFORMANCES

Sowter Type No	3575	4652	3678	6499	4079	6471	6469
Description	Miniature bridging transformer	Line output	Multi primary microphone transformer	Line output high level low distortion toroidal core	Splitter combiner transformer	Widged mic transformer for BT private systems	Very high quality microphone transformer
Impedances	10k Ω - 10k Ω can be fed from 50 600 Ω	600 or 150 Ω inputs or outputs	Phys 60 200 or 600 Ω ; 5y 5k Ω down to 1k Ω	600 Ω 600 Ω	200 Ω Bal Py Two 200 Ω Secondaries	Py 600 Ω Py 60k Ω	200 Ω Py for 1k Ω loading (Bifilar) 8:1 step up
Frequency range	20Hz 20kHz	20Hz 20kHz	30Hz 20kHz	20Hz 20kHz	20Hz 20kHz	300Hz 3k4kHz	20Hz 20kHz
Performance	+0 dB over above range	+0.25dB over above range	+0.5dB over above range	+0.3dB 40Hz 15kHz +0.5dB 20Hz 20kHz	+0.5dB over above range	+0.5dB over above range	+0.2dB over above range
Maximum Level	7.75V r.m.s. on secondary	7.75V r.m.s. on 600 Ω	on 5k Ω load 3.4V r.m.s. at 30Hz	26dBm at 30Hz	2.3V r.m.s. at 30Hz	0.6V p.p. on Primary	2.0V r.m.s. on Py at 30Hz
Maximum Distortion	With 10V r.m.s. at 40Hz only 0.12%	On 600 Ω low source Z 0.1%	Less than 0.1% at 1kHz	0.1% at 30Hz at 26dBm	negligible 0.1% at 1kHz	negligible	0.1% at 20Hz
Shielding	Electrostatic screens and mumetal can	Mumetal can if desired at extra cost	Mumetal can	Toroidal can	Mumetal can rigid fixing bolts	PCB mounting	Mumetal can
Dimensions	33mm diam 22mm high	36mm high 43mm - 33mm	33mm diam 22mm high	50mm diam 36mm high	33mm diam 37mm high	11mm high 19mm 17mm	33mm diam 22mm high
Prices each at works	1 £10.83 50 £9.77 100 £9.27	1 £9.67 50 £8.89 100 £8.69	1 £9.67 50 £8.67 100 £8.41	1 £17.12 50 £15.69 100 £13.35	1 £14.59 50 £13.37 100 £13.08	1 £3.89 50 £3.55 100 £3.29	1 £11.38 50 £10.12 100 £9.92

E. A. SOWTER LTD. (Established 1941) Reg. No. England 303990
The Boat Yard, Cullingham Road, Ipswich IP1 2EG, Suffolk, PO Box 36, Ipswich IP1 2EL.
England. Phone: 0473 52794 & 0473 219390 - Telex: 987703G SOWTER

ENTER 47 ON REPLY CARD

QUALITY QUARTZ CRYSTALS QUICKLY

Our frequency ranges are:



We also supply quartz crystal filters, oscillators of all types and communication antennae.



Webster Electronics

ILMINSTER, SOMERSET TA19 9QA, ENGLAND
TEL: (046 05) 5166 TELEX: 46571 FRONCY G
FAX (046 05) 5865

ENTER 44 ON REPLY CARD

IN VIEW OF THE EXTREMELY RAPID CHANGE TAKING PLACE IN THE ELECTRONICS INDUSTRY, LARGE QUANTITIES OF COMPONENTS BECOME REDUNDANT. WE ARE CASH PURCHASERS OF SUCH MATERIALS AND WOULD APPRECIATE A TELEPHONE CALL OR A LIST IF AVAILABLE. WE PAY TOP PRICES AND COLLECT.

R. Henson Ltd.

21 Lodge Lane, N. Finchley, London, N12 8JG.
5 mins. from Tally Ho Corner

Telephone: 01-445 2713/0749

ENTER 40 ON REPLY CARD

SATELLITE SYSTEMS

Skynet-4 military comsat

Britain's Skynet-4 military comsat system is almost ready to go into operation. One spacecraft has already been built by British Aerospace, with Marconi Space Systems providing the communications payload. The second is still being constructed (see photo). The first of these was due to be launched by the US space shuttle in June 1986, but the Challenger disaster and its aftermath put paid to this plan. It was to have been placed in geostationary orbit at 1°W over the Atlantic Ocean, above a point just south of Accra on the African coastline. From here, when it eventually arrives, the comsat will have an east-west coverage roughly from Iran to the West Indies – the region in which UK military forces are mainly deployed.

The Skynet-4 system will have a much greater communication performance than Skynet-2, which was based on a single satellite launched in 1974. (Systems 1 and 3 did not come into being). First, it will use larger comsats than Skynet-2: spacecraft similar to the ECS (European Communications Satellite) with solar-cell 'paddles' and three-axis stabilization, rather than a cylindrical (1.9m diameter) construction. Their power supplies will provide 1200 watts.

Secondly the communications payload will give higher transponder powers, with e.i.r.p.s in different channels ranging from 26 dBW to 39 dBW. Thirdly the new comsat will have a greater communications capacity than Skynet-2. In addition to the extra r.f. power, the transponder bandwidths are wider, allowing high traffic densities and handling a variety of data rates from 50 bit/s upwards into the Mbit/s region.

Communication frequencies to be used range from u.h.f. to e.h.f. There are two 40-W u.h.f. transponders, each serving a channel of 25 kHz bandwidth. Here the receiving band is 305-315 MHz and the transmitting band 250-260 MHz. The u.h.f. antenna is a helical type intended to give overall coverage of the military area (approximately 120° of longitude). In the form of a flat spiral, it is only extended to

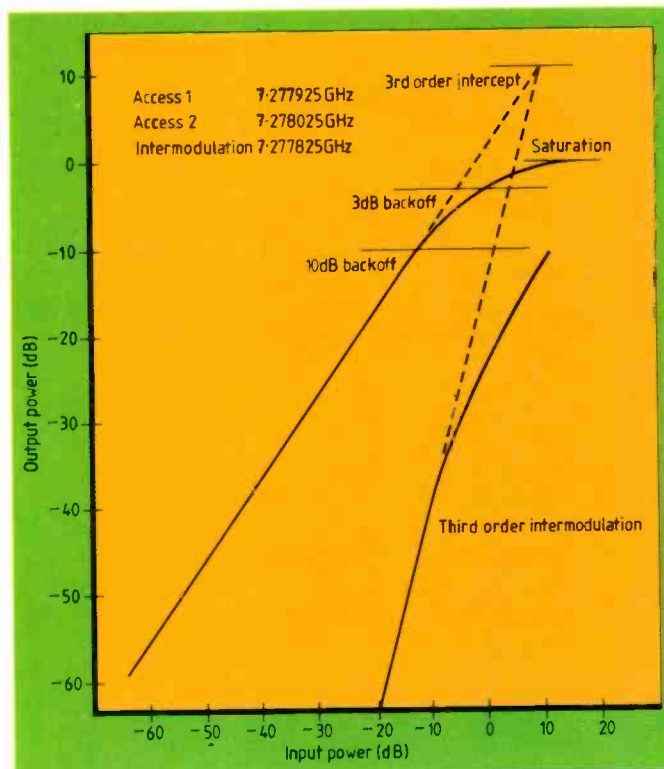

Fig.1. Transfer characteristic of prototype Channel 1 transponder for Skynet-4 comsat. (Courtesy JIERE)

its full height of 2.4m when the spacecraft arrives on station.

A very large part of the communications capacity is provided by four s.h.f. channels. Channel 1 receives at frequencies from 7975 to 8110 MHz and downconverts these by 725 MHz to the band 7250 – 7385 MHz for transmission (bandwidth 135 MHz). Channel 4 receives at 8340 – 8400 MHz and downconverts to 7615 – 7675 MHz for transmission (bandwidth 60 MHz). Between these, Channel 2 has a bandwidth of 85 MHz and Channel 3 a bandwidth of 60 MHz. There is a guard band of 35 MHz between Channels 1 and 2 and one of 25 MHz between the other channels.

In the s.h.f. repeater the total receiving frequency range of 7975 – 8400 MHz is first selected by bandpass filter then all signals in this are amplified by a broadband amplifier. Next, four input-channel filters separate the broadband signal output into four channels. These channel signals pass through four amplifiers with programmable gain and on to four downconverters. A combiner feeds Channels 2 and 4 to one of three 40-W travelling wave tube amplifiers (t.w.t.as), while Channels 1 and 3 are each

handled by a separate 40-W t.w.t.a. in the group of three. Other, spare t.w.t.as are also carried in the spacecraft.

Finally the outputs of the t.w.t.as pass through filters to the s.h.f. antennas. These provide various radiation patterns: full area coverage from a horn, and wide, narrow and spot beams from dishes.

One of the problems which had to be faced in the design of the s.h.f. repeater was the high density of the communications traffic to be carried by Skynet-4. Broadly this consists of data transmission at various rates on various carriers. When a given transponder carries a number of such signals, called 'accesses', mutual interference could occur as a result of intermodulation if the transponder had a non-linear transfer characteristic.

C.H. Jones of the Royal Signals & Radar Establishment explained this problem last year in an IERE paper describing a traffic simulator for Skynet-4 (IERE, vol. 56, No. 2, Feb. 1986). Skynet-2 used hard-limiting transponders and these required considerable skill in the planning of frequency spacing and the positioning of the various accesses to avoid inter-

modulation interference. The Skynet-4 transponder is mainly linear, but with "the wider bandwidths, higher traffic densities at diverse data rates and programmable channel gains within the satellite up to saturation condition for the output travelling-wave amplifiers, the inherent non-linearity of the system is still an important factor."

The Channel 1 transponder transfer characteristic in Fig. 1 (from the IERE paper) illustrates this problem. This shows the frequencies of two accesses to Channel 1 and a 3rd-order intermodulation frequency. The transfer characteristic is on the left and the 3rd-order intermodulation product curve on the right. Where the linear projections of these two curves meet (shown by broken lines) is called the 3rd-order intercept, a parameter used in design. It is a theoretical point where the signal and the intermodulation product are of equal amplitude.

In using a t.w.t. the design aim is to get the highest possible output power for the highest possible intercept point for the

Bringing together the communications and service modules of a Skynet-4 communications satellite at British Aerospace, Stevenage, Hertfordshire.

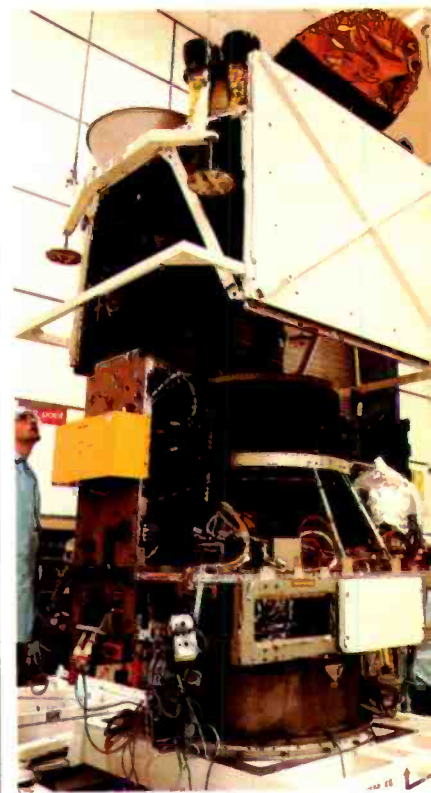

SATELLITE SYSTEMS

lowest possible d.c. power going into the tube. But as can be seen from the transfer characteristic the t.w.t.a. gain and power fall off sharply towards saturation. If the t.w.t.a. is over-driven into this non-linear region various intermodulation products result. Mr Jones mentioned that with two frequency accesses of equal amplitude, giving a total power just saturating the transponder, the 3rd-order product is only 12dB below the main access levels. Larger numbers of accesses give a complexity of intermodulation levels.

Thus the t.w.t.a. has to be backed off so that it is not driven into this region, as indicated by the 3-dB and 10-dB back-off levels. In practice the semiconductor amplifier driving the t.w.t.a. does this: it is arranged to limit at a level that ensures that the t.w.t.a. is not over-driven.

Military satellites, of course, are subject to jamming. One precaution taken against this in Skynet-4 is the use of spread-spectrum technique in the telemetry and telecommand system. In general the spread-spectrum principle embraces such things as frequency hopping and time hopping, but the technique hitherto used in military satellites (e.g. GPS/Navstar and Skynet-2) is the direct sequence method. Here the data signal is directly modulated (multiple) by a fast-random code sequence from a synthesizer with a rate typically in the range 1 – 10 MHz. This takes place prior to phase modulation at i.f., then the i.f. is upconverted to the microwave carrier frequency. At the receiving end the signal is multiplied by the same pseudo-random sequence to recover the original data by correlation.

The IERE paper mentioned above refers briefly to e.h.f. transponders, though the use of these has not yet been confirmed by BAe/Marconi. Of course, e.h.f. means frequencies of 30 GHz upwards, or millimetre waves. Such short wavelength transmissions are subject to heavy absorption in the Earth's atmosphere and water vapour, but they can be used to advantage for inter-satellite radio links directly through space, where there is no such absorption. So inter-satellite links between Skynet-4 and other spacecraft appear to be a possibility.

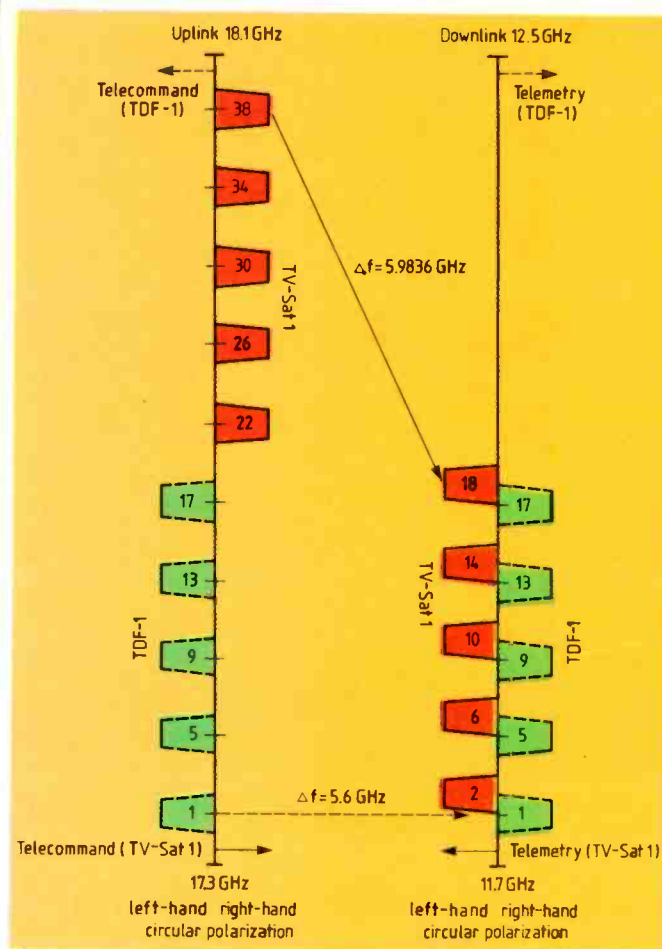

Frequency assignments and relative channel and polarization arrangements for TV-Sat 1 and TDF-1 direct broadcasting satellites.

More on Franco-German d.b.s.

The April issue included a brief description of Eurosatellite's common spacecraft design for the French TDF-1 and German TV-Sat 1 direct-broadcasting satellites, but did not give details of frequencies and channels or explain how these are handled in the repeater.

Accompanying this item is a diagram showing the uplink and downlink frequency assignments to the two satellites. In common with other ITU Region 1 countries, France and W. Germany were each given five d.b.s. channels at WARC 77. In the downlink (transmitting) frequency band of 11.7 – 12.1 GHz the German satellite TV-Sat 1 has the five channels, 2, 6, 10, 14 and 18, while the French TDF-1 has 1, 5, 9, 13 and 17.

There is likely to be a particu-

larly critical mutual interference situation at the 19°C W orbital position of the two spacecraft. Because of this the uplink groups of channels for the two satellites are kept well apart, as can be seen. TV-Sat 1 uses the upper half of this 17.3 – 18.1 GHz uplink band (channels 22, 26, 30, 34, 38) while TDF-1 uses the lower half (channels 1, 5, 9, 13, 17).

Further protection against possible interference is given by the two satellites' having opposite directions of circular polarization, in both uplinks and downlinks. Also, the telemetry and telecommand frequencies are kept widely separated. Those for TV-Sat 1 lie in the lower guard bands at 11.7 GHz and 17.3 GHz, while those for TDF-1 are in the upper guard bands at 12.5 and 18.1 GHz.

The repeater used in both spacecraft is manufactured by two members of the Euro-satellite consortium, ANT

Nachrichtentechnik of W. Germany and Alcatel-Thomson Espace of France. In this equipment the received uplink signals, in a power range of –68 to –46 dBm, pass into a common broadband receiver. Here they are frequency converted to the transmission band and amplified. Circuitry at this point takes the form of integrated fets.

A demultiplexer separates the broadband group of signals into the five individual channels. In each channel the group delay distortion is compensated by equalizers. Each channel chain also has an a.g.c. system to compensate for variations in received signal power caused by changes in atmospheric attenuation. These fluctuations cannot be corrected in the broadband receiver because of the presence there of relatively high level unwanted signals unavoidably picked up by the satellite. This channel a.g.c. is provided by p-i-n diode attenuators between fet amplifier stages.

For the transmitting part of the repeater, 230-W travelling-wave tubes are used. The t.w.t. amplifier (ANT type TL12260) with all related assemblies including the output multiplexer, has been designed with special attention to heat dissipation. Such a t.w.t.a., with an efficiency of about 40% and losses of typically 1.2 dB up to the repeater output, requires a power dissipation of over 400 watts to achieve the high radiated power for a d.b.s. channel. So the tube collector has been designed as a self-radiating unit which send the greater part of the dissipated power directly into space. You might say it re-cycles a bit of the energy which the spacecraft takes from the sun.

Finally the r.f. outputs of the transmitters in the five channels are combined in an output multiplexer. Insertion loss of this multiplexer has been kept low by making use of the H_{112} resonance.

Apart from an extra, switchable t.w.t.a. in one channel, the repeater has no redundancy within its channels. The satellite relies on the 'frequency redundancy' principle in the sense that it provides five channels for an actual broadcasting requirement of only up to three of these.

Satellite Systems is written by Tom Ival.

LOW COST DESIGN TOOLS FOR ENGINEERS

At last! The complete solution to computer aided circuit design on the IBM PC at a sensible price.

SCHEMA £499

Design professional quality circuit diagrams right on the screen with this widely used schematic drawing package.

- extensive schematic symbol library
- 3 zoom levels
- bill of materials
- wire and net lists
- print and plot hard copy

PROTEL £799

Fast establishing itself as the world's leading low cost printed circuit board design package, PROTEL-PCB enables you to create professional multi-layer PCBs from concept to camera-ready artwork.

- up to six track layers
- variety of track widths and pad sizes
- multi-coloured check plots
- NC drill support
- Gerber photoplotter compatibility

Who buys software without evaluating it first? Try out SCHEMA and PROTEL on your own PC with our well-documented evaluation disks — £25 each. Visa/Access welcome.

Schema: Enter 45 on Reply Card

Protel: Enter 46 on Reply Card



Engineering Solutions Limited, King's House,
18 King Street, Maidenhead, Berks. SL6 1EF
Telephone (0628) 36052 Telex 84962 Fax (0628) 74928

ENTER 77 ON REPLY CARD

MARCONI INSTRUMENTS

MARCONI TF2371 200MHz SPECTRUM ANALYSER



30Hz-200MHz frequency range. 0.1db & 5Hz resolution 100db displayed dynamic range In-built tracking gen & counter MINT condition Un-used since recent calibration to N.S. £7500

MARCONI 2019 SIGNAL GENERATORS

The synthesized signal generators Avucres model 1.5-1040MHz with following options: 1. Extended FM bandwidth 2. VOR/ILS capability. 8 Pulse modulator. Plus GPIB (MLP with options £6,000). Our price as new condition with full guarantee. £2500



TF2006 AM/FM Signal generator 10-1000MHz	£950
TF2011 FM Signal generator 130-180MHz	£325
TF2008 AM/FM Signal generator 10KHz-520MHz	£850
TF2015A/1 AM/FM Signal generator 10-520MHz	£650
TF2171 Digital synchronizer for above	£450
TF2016A VHF AM/FM Signal generator with 2173 lock-box	£195
TF995A 5 AM/FM signal generator 1.5-220MHz	£195
2017 AM/FM signal generator 0.01-1024MHz Superb spec	£8,000
TF2170 digital synchronizer (for 2002 series)	£400
TF2300S modulation meter 35-1000MHz AM/FM	£495
TF2303 Modulation meter 2.5-520MHz AM/FM	£325
TF2330 wave analyser audio	£295
TF1313 1/8% RCL Universal Component Bridge	£250
TF1245 Q-Meter with oscillators 1246 and 1247	£500
TF1245A/1 Q-Meter 1246 & 1247	£550/£250/£150
TM4520 Standa'd inductor set	£250
TF893A Audio power meter 1mW-10W 1st	£75
TF1020A 100W 250MHz RF power meter	£75
TF1152A 1.25W 250MHz RF power meter	£75
TF2604 Electronic multi-function meter	£175
TF2430 80MHz Frequency counter	£95
TF2807A PCM multiplex tester	£600
2829 PCM digital analyser	£850
2833 PCM digital line monitor	£500
2828A Digital simulator	£1250
TF2356 20MHz level oscillator	£1100
TF2167 RF amplifier 0.05-80MHz 47db gain	£450
TF1263S 1GHz attenuator 142db 1db steps	£250
TF2092C noise receiver	£450
TF2910A non-linear distortion analyser	£750
TF2162 MF Attenuator 0-111db in 0.1db steps	£100
2437 100MHz frequency counter & timer	£250

RALFE · ELECTRONICS

10 CHAPEL STREET, LONDON, NW1
TEL: 01-723 8753/724 8074



EST. 35 YEARS



EXTENDED WARRANTY SCHEME

is now available for all items of equipment costing £1000 or more. For an additional 10% of purchase price we can offer a comprehensive parts and labour warranty for a full year, and we still guarantee to under-cut our closest competitor! Certificates of calibration to national standards traceability are available upon request for certain items. Please let us quote you. *Different rates available on cheaper equipment.

TEST & MEASUREMENT EQUIPMENT

TEKTRONIX 576

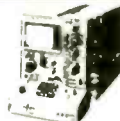

Crude Tracer
Mint
£3950

TELEQUIPMENT D83 Oscilloscopes 50MHz	£350
TELEQUIPMENT DM64 Storage scopes	from £250
GOULD Digital storage scope type 1425 with 125 unit 20MHz	£1250
OSCILLOSCOPE - stock phone for best quote	
BIRYANS 2020 XYT Plotter A3	£175
BPL Wheatstone comparator bridge	£150
BRUEL & KJAER 1402 Random noise gen	£250
DYMAR 785 modulation meters 30-400MHz AM/FM	£125
DYMAR 781/5 RF power meter 1-30W	£75
GPW 7620 Telegraph & Data generator	£195
AVO VCM163 Valve characteristic meter	£400
RACAL 9301 RF Voltmeter 1-5GHz	£450
RACAL 383 4-Trace display oscilloscope	£175
RADFORD LDO2 Low distortion oscillator	£150
PHILIPS PM2454B AC millivoltmeter 10Hz-12MHz 1mV-300V	£195
FLUKE 871A Differential Voltmeter	£195

★ MAINS INVERTERS ★

VALRADIO 24V DC input to 230V 50Hz output 120W Sine Wave
150W Square wave £75 (used) £185 (new); £125 (used) £45

ALL OUR EQUIPMENT IS SOLD IN EXCELLENT, FULLY FUNCTIONAL CONDITION AND GUARANTEED FOR 90 DAYS. MAIL ORDERS AND EXPORT ENQUIRIES WELCOMED PLEASE TELEPHONE FOR CARRIAGE QUOTE. ALL INSTRUMENTS ARE AVAILABLE EX-STOCK AS AT COPY DATE. GOOD QUALITY TEST EQUIPMENT ALWAYS WANTED FOR STOCK PRICES QUOTED ARE SUBJECT TO ADDITIONAL VAT.

HEWLETT PACKARD

8007B Pulse generator	£500
8555A Spectrum analyser unit to 40GHz	£3950
400F Voltmeter 100uV-300V 4MHz	£225
741B AC/DC Ditt V Meter/DC Standard	£275
738BR Calibrator	£195
4800A Vector impedance meter	£1250
11602B Transistor fixture for 8745A	£450
11600B As above	
8004 pulse generator	£225
1827/8558B spectrum analyser	£5000
7045A XY Plotter Opt 001 (Time-base)	£750
355E Programmable attenuator 1GHz 0-12db	£95
355F As above but 0-120db in 10db steps	£95
3490A Digital Multi-meter	£450
8733A Pn modulator	£450
8701A,2A,3A Microwave link analyser	£450
431C with 478A Microwave power meter	£250
8553B Spectrum analyser plug-in 110MHz	£1500

★ HP141T SPECTRUM ANALYSER SYSTEM to 40GHz ★



SYSTEM Comprises of type 141T Storage main-frame, 8552B I.F. plug-in unit and 8556A 10MHz-18GHz (40GHz with external mixers) R.F. plug-in. Excellent throughput, calibration certificate. £7000

110MHz SPECTRUM ANALYSER

HEWLETT-PACKARD 110MHz system 141T 8552 8553B	£4250
HEWLETT-PACKARD 110MHz system 141S/8552A 8553L	£2250
HEWLETT-PACKARD 21GHz system 182 with 8559A	£8250

NETWORK ANALYSER



HP 8407A

With types 8412A Phase-Magnitude and 8414A Polar display units 110MHz Recent calibration £2500

ENTER 57 ON REPLY CARD

TIME ELECTRONICS LIMITED

1030 Microcal (Combined Voltage and Current Source)



- ★ 3 Voltage Ranges
- ★ 2 Current Ranges
- ★ 0.1% Accuracy
- ★ Extremely Compact

1071 Decade Capacitance Box



- ★ 100uf Max with 10pf Setting Resolution
- ★ In Line Readout with Colour Coded Digits
- ★ Bi-Polar Working
- ★ Small Physical Size

8000 Decade Resistance Box



- ★ High Accuracy 0.1%
- ★ Wide Resistance Range 1 Ohm-100M Ohm
- ★ Low Temperature Coefficient 50 PPM
- ★ Colour Coded Decade Switches 8 Decades
- ★ Power Rating 1 Watt Per Resistor

1042 Precision Low Ohm Resistance Box



- ★ 0.01 Ohm to 1K Ohm
- ★ 10 Milliohm Resolution
- ★ Clear Visual Indication with Colour Coded Digits
- ★ High Stability and Low Temperature Coefficient
- ★ Platinum Resistance Thermometer Simulation

Full catalogue of calibration equipment available, which includes:

Inductance, Resistance, Capacitance Standards, Decade Boxes, Voltage References, DVM and Multifunction Calibrators plus IEEE Programmable Instruments.

MOD STD 05-24, 05-26 NATO APPROVED AQAP4



Time Electronics Limited

Botany Industrial Estate, Tonbridge, Kent TN9 1RH, England. Telephone: (0732) 355993. Telex 95481

ENTER 53 ON REPLY CARD

Z80 ■ CONTROL ■ Z80

CARDMASTER CPU

- 4/6 MHz Z80 CPU
- CP/M compatible
- User transparent MULTI-TASKING
- Up to 32K EPROM & 16K RAM
- Watchdog crash protection
- RS232 & RS422 Comms
- 2 * Z80a PIO (one uncommitted)
- On board bus buffering
- Power-on jump hardware
- Euro-card construction

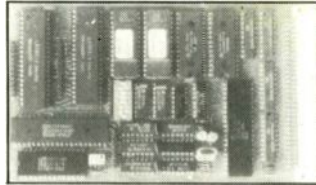

NOW FROM £124 + VAT

CUB MICROCONTROLLER

- Z80 CPU
- 4 x Z80a PIO's (64 I/O lines)
- Z80a CTC
- 4K Battery backed RAM (2K sup.)
- 4K EPROM (2K MCV2.0 sup.)
- Powerful monitor (MCV2.0)
- Eurocard construction

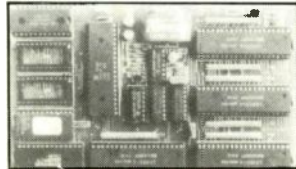

NOW FROM £108 + VAT

STARBURST V1.31

A CROSS ASSEMBLER FOR CP/M80 covers four major families of single chip uP's and uC's

- ★ 8048 inc. 8741/2 8748/9/50
- ★ 8051 inc. 8031/2 8751 8744
- ★ 6801 inc. 6800/1/2/3 68701
- ★ 6805 inc. 68705 63705

Supplied with a complete set of demonstration files.

STARBURST V1.31 £95.00
+ VAT
Requires Z80 CPU

CMR16 NOW FROM £199.00

Bare PCB's Available

	1+	10+
C/M CPU	28.50	25.65
C/M I/O	28.50	25.65
CUB	23.50	21.15
CMR16	40.00	36.00

Manuals on request

GNC ELECTRONICS
Little Lodge, Hopton Road,
Theinetham, DISS IP22 1JN.
Tel: 0379 898313

ENTER 13 ON REPLY CARD

CARSTON ELECTRONICS

We sell all types of test equipment from the simplest to the most sophisticated and specialised.

All of the high quality second user equipment we supply is fully calibrated and meets the manufacturers original specification. All equipment is fully guaranteed.

We also buy good quality under utilised equipment.

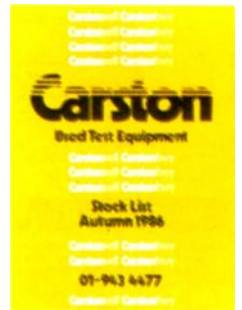

ENTER 66 ON REPLY CARD

SURPLUS/REDUNDANT STOCKS ELECTRONIC COMPONENTS

We offer cash for your surplus components including integrated circuits, transistors, memories, microprocessors, I/C sockets, connectors, caps etc, etc. Top prices paid, collection no problem. Please contact us today with your lists by telex, telephone or letter to:

MARLOW MARKETING

Mackenzie House, 221-241 Beckenham Road,
Beckenham, Kent BR3 4UF.

Telex: 946336 MICRO G. Tel: 01-676 0800

ALSO: COMPLETE FACTORY CLEARANCES UNDERTAKEN

ENTER 39 ON REPLY CARD

Image acquisition system

This hardware adds vision to any computer with an RS232 serial interface.

G.J. AWCOCK, F.W. STONE AND R. THOMAS

A main aim of the design was to produce a hardware interface that would be able to support the IS32 fully and be controlled by a few simple commands from the host computer via a serial link (Fig.8, April article). In this way the host can be relieved of the routine interface task and problems associated with it: it merely issues commands to select the required sensor quadrant and then requests execution of one of the major macro-tasks, Scan or Read.

The scan command serves to initialize, expose and interrogate the whole of the selected sensor quadrant. In doing so, it packs the image data into bytes and stores them in an on-board 2K×8 static ram chip. On receipt of the read command, the packed data is transmitted to the host as a continuous stream of 2048 words on the RS232 link. The host is then responsible for processing the received data by applying algorithms to perform the second stage of linearization.

The initialize-expose-interrogate cycle chosen for this array operates by setting a column address and then performing a write cycle to each of 128 cells whilst incrementing the row addresses. This scheme is known as row fast addressing. It is also used for reading the cells: it prevents reading of one cell in the column from causing refresh of any of the other 127.

After initialization, the array is deactivated for the chosen exposure time to allow the photosites to discharge under the influence of incident light. When this period has elapsed, the column of cells is read in the same order as it was written and the resulting data stream is packed into sixteen bytes and stored in consecutive locations of the static ram.

This method has the advantage that each cell receives precisely the same exposure (the exposure delay time plus 128 memory access cycles) without the need to expose them individually, and without anti-refresh complications. It is not the fastest method of scanning such an array, since 128 exposure periods are required to acquire all the data in a 128 column array; but it does provide a suitable compromise when combined with the RS232 serial link to the host. It takes a little over one second to transmit the image data, even at 19 200 baud, and this limits the image update rate.

HARDWARE

In the prototype, a double Eurocard was used for the control hardware. A separate p.c.b. about 60mm square holds the sensor,

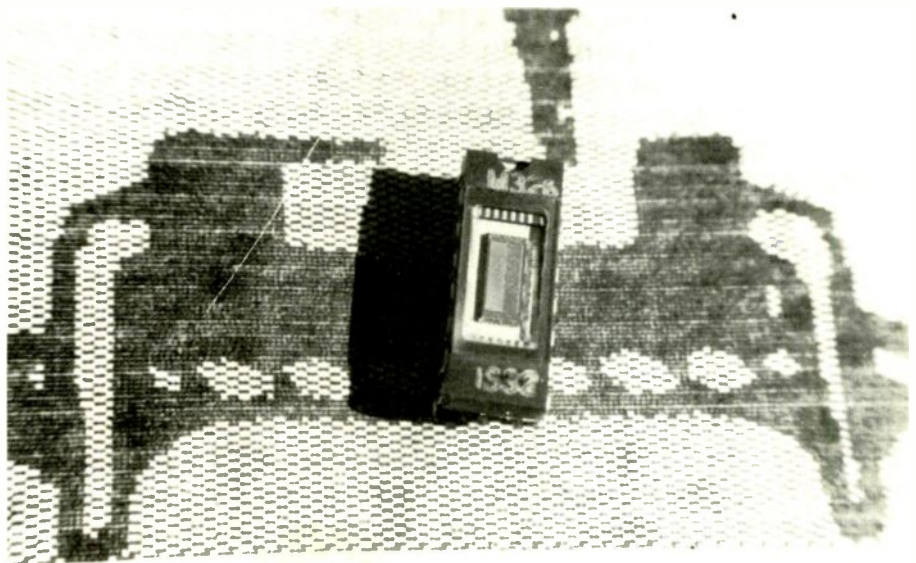

Beneath this sensor device is a profile of itself captured by the system.

Table 2. Command list for the interface.

Command word	Function
00	SCAN: initiates the sequence to scan the IS32. CTS is negated during this activity.
01	ROWL: sets the m.s.b. of the row address low, selecting the 'upper' array.
02	ROWU: sets the m.s.b. of the row address high, selecting the 'lower' array.
03	COLL: sets the m.s.b. of the column address low, selecting the lower column addresses.
04	COLU: sets the m.s.b. of the column address high, selecting the upper column addresses.
05	MR: resets the uart
06	READ: initiates the sequence to send image data back to the host computer. CTS is negated during this activity.

to simplify its integration into the optical system. The two boards are linked by a ribbon cable, which carries the d-ram signals and therefore must not be too long. However, experience has shown that the system operates successfully with several feet of cable.

At the heart of the serial system is a 6402 uart which is interfaced to the RS232 standard voltage levels by line drivers and receivers. The serial protocol may be selected by means of a switch-bank S_1 and the data rate by S_2 .

Command decoder IC₈ is capable of accepting eight commands, although only seven are implemented in this design (Table

2). The decoder produces transient pulses because the receive latch of the uart is reset by a delayed version of the Data Ready status flag. Decoded commands are registered by S_R latches implemented in IC₁₈ and IC₁₉. The outputs of the Scan and Read latches are combined in IC_{17d} and buffered by IC₁ to implement a serial control protocol by negating the clear-to-send (CTS) signal when the board is busy and thus unable to respond to further commands from the host. In this design the ready-to-send signal is not used, but the necessary hardware is present and may be selected with Lk₁ on the board.

The clock controller consists of an S_R latch, IC_{20a} and IC_{20b}, to control the enabl-

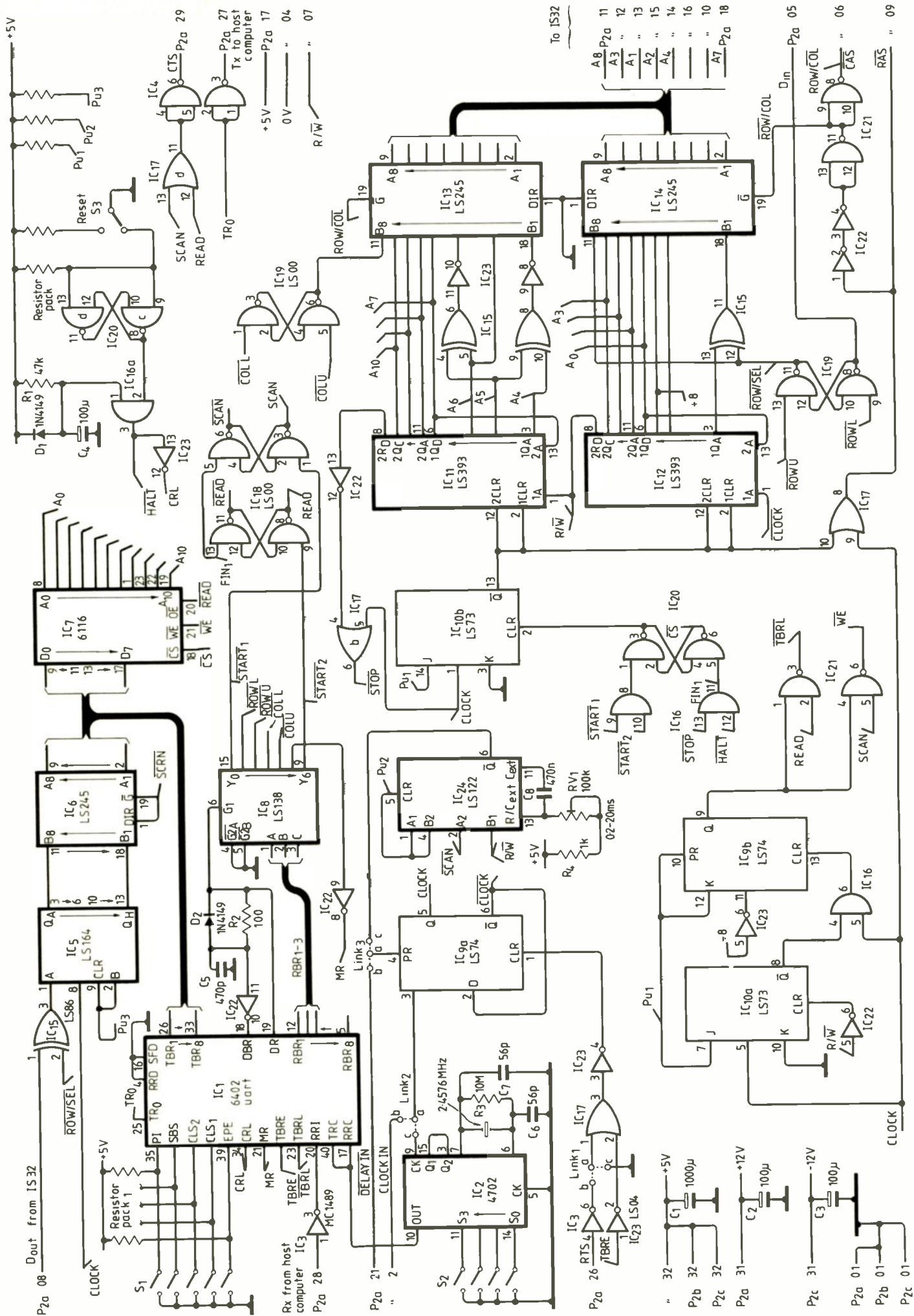
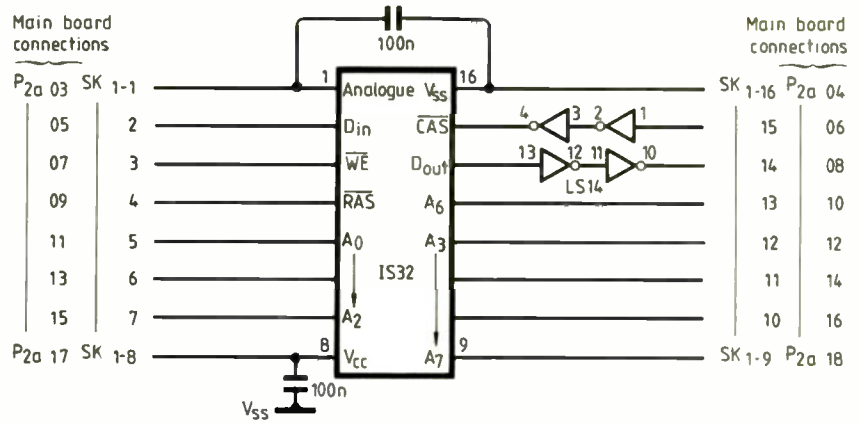

Fig.9 (left). The control circuit accepts commands from the host computer via an RS232 serial link. It returns image data for further processing.

Fig.10 (right). The sensor i.c. is mounted on a separate small p.c.b. which can be accommodated in the optical system.



ing of the address counters and the RAS/CAS generator; the latter is synchronized to the falling edge of the clock by flip-flop IC10b. The RAS and CAS signals are derived from the clock by making use of delays in the associated gates of IC21, IC22 and the buffer package on the sensor p.c.b.; they are used by the IS32 to strobe in the row and column addresses respectively. This circuit also produces row and column select signals to control the enable inputs of the octal three-state buffers IC13 and IC14, so that they behave as an address multiplexer/buffer.

Row and column addresses for the IS32 are furnished by the two dual four-bit counters IC12 and IC11, which are also jointly responsible for providing addresses for the on-board static memory IC7. Note that the most significant output of each of the counters is not used to provide an address bit to the d-ram, since the m.s.b. of IC12 is used as the R \bar{W} signal. The m.s.b. of IC11 is synchronized to the clock by means of IC7b and it then becomes the \bar{STOP} signal, responsible for terminating the scan or read macro-tasks. M.s.bs of the addresses are derived from the row and column select latches, IC19, rather than the counters, to allow quadrant selection by means of the command decoder. Gating by IC15 and IC23 performs the first stage linearization of the IS32 addresses.

Data retrieved from the sensor during a scan sequence is in the form of a serial bit-stream, whose polarity with respect to dark or light pels at the sensor will depend upon which bank of pels is selected. The exclusive-or gate IC15a in conjunction with ROWSEL compensates for this automatically: but it is also necessary to feed ROWSEL to the D_{IN} pin of the IS32 to ensure that the photosites are appropriately initialized. The bit-stream is then formatted in bytes by shift register IC5, whose parallel outputs are presented to the data bus of the byte-wide static ram IC7, after buffering by IC6, which is enabled only during the scan sequence to avoid bus clashes with the memory output drivers. A transceiver device was chosen for IC6 rather than a three-state buffer merely because its straightforward pinout simplified the p.c.b. design.

Since the capacity of the static ram is 2K-bytes, i.e. 16 384 bits, it is capable of storing data from one whole quadrant of the sensor when packed in this manner, which also gives a convenient word length for transmission back to the host during the read sequence.

The delay required for exposing each column of 128 pels is generated by IC21. This monostable is enabled only during the scan sequence, and is triggered by the R \bar{W} signal which is asserted when the row counter exceeds 127, and which is also used to determine whether initialize (write) or interrogate (read) cycles are performed by the sensor. The output of the monostable is used to inhibit the clock by holding flip-flop IC9a in its preset condition for the duration of the delay. This halts all activity on the board, allowing the photosites to be exposed for a period controlled by the monostable time constant.

Circuitry associated with IC9b and IC10a is required to provide pulses to be used as a byte write-enable (\bar{WE}) for the static ram during scan sequences, and as a transmit buffer register load (\bar{TBRL}) for the uart during real sequences. These pulses are generated by extracting half a clock pulse after every eight row address counts, and are designated as \bar{TBRL} or \bar{WE} by the gates IC21b and IC21a and IC1b, under the control of the Read and Scan outputs respectively of IC18. The role of IC10a is to prevent the generation of either of these signals when the R \bar{W} signal is low, and so to avoid both writing to the static ram whilst the IS32 is being initialized and double transmission to the host of each column of pel data.

It is necessary to provide a reset pulse on power-up and under certain other conditions such as a change of status of the uart control register. This signal is generated by

the circuitry associated with the manual reset button, S3; IC20c and IC20d are responsible for de-bouncing the switch. These sources are combined in IC16a whose direct output, called \bar{HALT} , is used to initialize the board so that it is awaiting commands from the host, whilst the inverted output \bar{CRI} is used to load the control register of the uart, thus establishing the protocol in use.

SCAN COMMAND

When a valid Scan command is received via the serial link, and decoded and latched, a number of operations take place.

The CTS signal is negated and the address counters, RAS/CAS generator, exposure delay generator, data-packing shift register, byte-wide buffer and \bar{WE} signal are all enabled. The address counters increment from a cleared state and thus R \bar{W} is low for the first 128 counts, making the IS32 perform a write cycle to each of 128 logically consecutive rows. This ensures that a column-initialize operation is executed at the currently-addressed column of the sensor bank. When, after 128 states, the row address count returns to zero R \bar{W} is set high, triggering the exposure delay generator and stopping the clock.

After the delay, the clock is re-started and counting begins once again with the row addresses at zero. However, these addresses are issued to the column of cells which has just been initialized, because the column

Image quality is good enough for many practical applications.

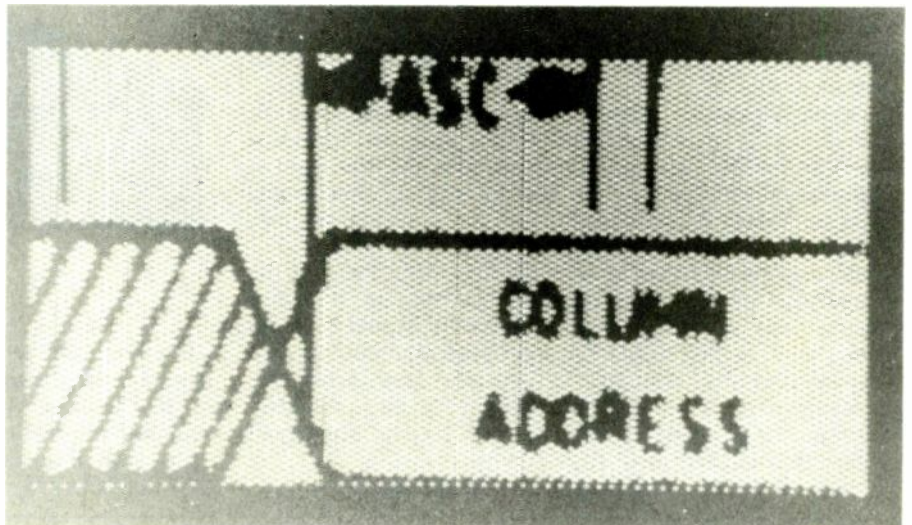

counter has yet to be incremented; but on this pass the IS32 performs read cycles in response to the high state of the $\overline{R\overline{W}}$ line. Image data retrieved from the sensor in this way is formatted into bytes by the shift register and loaded into the static ram by the \overline{WE} pulse.

When the row counter is clocked back to zero the column-interrogate operation is complete, $\overline{R\overline{W}}$ returns to zero (i.e. Write) and the column counter is incremented, ready for the entire initialize-expose-interrogate sequence to begin again at the next column of the sensor-bank. This action continues until 128 logically consecutive columns have been accessed. Completion of the last column causes the m.s.b. of IC₁₁ to be set, initiating the generation of the Stop signal. This signal terminates the Scan macro-task by resetting the clock-control and command latches, and so asserting CTS and disabling the relevant functional blocks to ensure a tidy exit.

READ COMMAND

On receipt of a valid Read command the CTS signal is once again negated. The address counters are enabled, but this time the data outputs of the static ram are enabled together with $\overline{T\overline{B\overline{R\overline{E}}}}$. However, the row address counter increments through 128 states without generating $\overline{T\overline{B\overline{R\overline{E}}}}$ signals because of the inhibiting action of the low $\overline{R\overline{W}}$ line.

During the next 128 counts $\overline{R\overline{W}}$ is high and a $\overline{T\overline{B\overline{R\overline{E}}}}$ pulse is produced after every eight counts, when a new address has been set up for the static ram. This pulse causes data from the ram to be loaded into the transmit buffer register of the uart, which responds by negating its transmit buffer register empty ($\overline{C\overline{T\overline{B\overline{R\overline{E}}}}$) signal to prevent another byte being loaded before transmission of the current one is complete. The negated $\overline{T\overline{B\overline{R\overline{E}}}}$ inhibits the clock until the uart is ready to send more data, which it will indicate by asserting $\overline{T\overline{B\overline{R\overline{E}}}}$, thus allowing the clock to re-start. Eight

clock periods later the next static ram address will be set up, $\overline{T\overline{B\overline{R\overline{E}}}}$ will be generated and the next byte of data transmitted. In this way each 256-count pass of the row address counter, which is actually now being used to provide the four low-order bits of the static ram address, causes sixteen bytes of image data to be transmitted back to the host. Thus all 2048 bytes will have been transferred when the column address counter has been through its 128 states. As before, the m.s.b. of IC₁₁ initiates the Stop signal to terminate the Read macro-task and ensure an orderly exit.

To be continued with a description of driver software for the interface.

Hugh Pocock

We are sad to report the breaking of a personal link with the earliest days of this journal. Hugh S. Pocock, editor of *The Wireless World* from 1920 to 1941, then managing editor of its publishing company, died in March this year at the age of 92. He had retired in 1962.

As a later editor once commented, "To him, more than any other one person, must go the credit for the development of *Wireless World*, both in its formative years and in its later growth." He became fascinated by radio from the very beginning, while still in his 'teens and not yet launched in a career. He was born in 1894, only six years after Hertz demonstrated the existence of electromagnetic waves and three years before Thomson discovered the fundamental properties of the electron. It was a time when, for example, Lodge and Marconi were developing Branly's coherer as a detector for receivers.

Pocock's long career in radio journalism started in 1913, when, already the holder of an Experimental Wireless licence, he joined *The Wireless World* as an editorial assistant. The journal was then owned by the Marconi Company and had just been broadened in scope and re-named after its previous existence as *The Marconigraph*. But war broke out in 1914 and Pocock became an officer in the Royal Engineers, with wireless and intelligence duties at home and overseas. He was mentioned in despatches. In 1920, while stationed in Baghdad, he received an invitation to re-join the journal as editor and promptly accepted.

During the early 'twenties he was very active in organizing the first short-wave transatlantic tests, both amateur and broadcasting. Then in 1924 he guided the journal into the new world of independent publishing, when Marconi sold its troublesome offspring (which had been attacking one of the firm's own customers, the Post Office) to Iliffe & Sons Ltd.

As a result of his experience with the short-wave trials, and the pioneering work of the amateur Gerald Marcuse on 30 metres, Pocock proposed that short-wave broadcasting should be set up throughout the then British Empire. Initially the BBC opposed the idea, but he managed to persuade John Reith, the director-general, and in 1932 the Empire Service was started. Subsequently it became the BBC's General Overseas Service and is now the World Service.

Hugh Shellshear Pocock was liked and respected by everyone.



He was reticent by nature but had a most charming smile and always radiated a quiet courtesy. One felt he somehow belonged to that era when publishing was being accepted as 'a career suitable for a gentleman.' But Hugh's good manners came from deep down in his nature, and he was a gentleman in the truest sense of that word.

Using 68020 coprocessors

In robotics applications using a 68020 with a floating-point coprocessor can result in a polar-to-Cartesian translation in just three instructions.

DAVID BURNS AND DAVID JONES

Coprocessors are intelligent peripheral devices that are coupled to the main processor to give added functions. There are currently three 68000 family coprocessors; the 68851 paged memory-management unit, the 68881 floating-point unit and a newly announced 68882 enhanced floating-point unit. These coprocessors are easily interfaced to all 68000 family processors.

Having the 68020 as the main processor is a considerable advantage since the coprocessor interface protocol is used to transfer instructions and data between devices. As far as the programmer is concerned adding coprocessors just increases the processor's programming register set.

FLOATING-POINT COPROCESSOR

The 68881 floating-point coprocessor fully complies with IEEE P754 floating-point specifications and handles a range of trigonometric and transcendental functions. This coprocessor is tightly coupled with the 68020 and the programmer need not be aware that the devices are separate chips.

Internally the μ COS 68881 has eight general purpose registers for 32bit single, 64bit double and 80bit extended precision values.

The coprocessor concept means that the instruction set, data types, and addressing modes of the 68881 are a logical extension of the 68000 family architecture, Fig.1. The coprocessor interface allows the 68020 and 68881 to share tasks; for example the 68020 will perform effective-address calculations and then fetch the data and pass it to the 68881. This means that the 68881 can make full use of all 68020 addressing modes.

Standard bus cycles are used for the coprocessor interface so the 68881 can be interfaced as a standard peripheral (68000 systems) or used in a 68020 system with multiple coprocessors. Because of the standard interface, coprocessors are not tied to any particular processor; a new processor will not require a new coprocessor and a new coprocessor will not require a new processor.

Seven data types can be used with the 68881; byte integer, word integer, long-word integer (32bit), single-precision binary real (32bit), double-precision binary real (64bit) extended-precision binary real

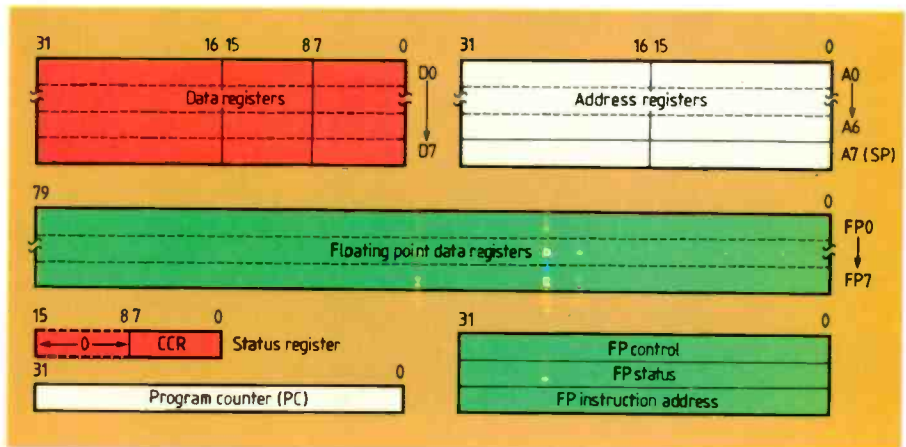

Fig.1. Combining the 68020 and 68881 over the coprocessor interface gives the programmer a larger register set to program with. Software is written as though the registers are all part of one device.

Fig.2. The 68881 floating-point coprocessor handles seven data types in a variety of data forms and floating-point standards.

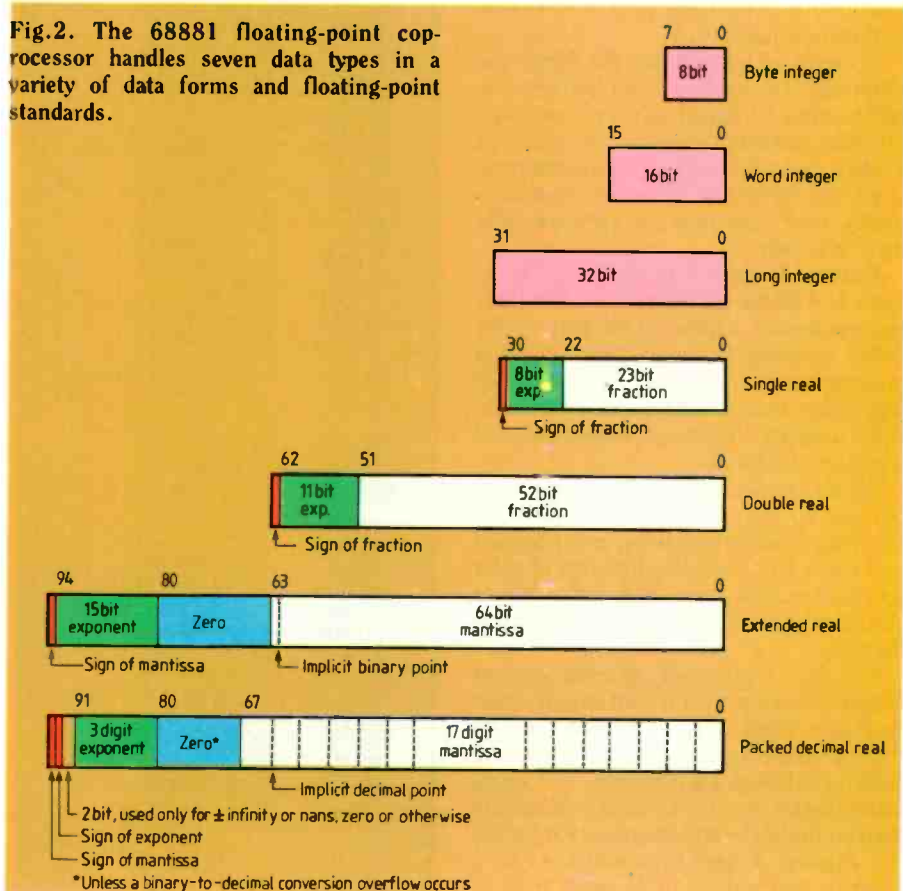
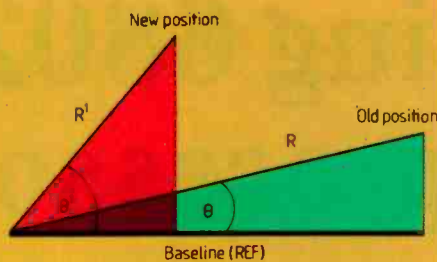

Fig.3. Robot control involves calculating positions using trigonometrical functions. This example shows how to determine angular difference between current elbow position and required position, then instruct the robot to move the elbow. Polar to Cartesian translation takes 29 μ sec. (Three instructions) and Cartesian to polar translation takes 39 μ sec. (six instructions).



Polar to coordinate:
 $X=R \cos \theta$
 $Y=R \sin \theta$

Coordinate to polar:
 $R=\sqrt{X^2+Y^2}$
 $\theta=\arctan(Y/X)$

Calculating movement:
 $\Delta \text{Angle}=\theta'-\theta$
 $\Delta \text{Extension}=R'-R$

GET POSITION	FSINCOS.S	RBOT-THETA,FP0,FP1	Calculate X/Y coordinates
	FMUL.S	RBOT-R,FP0	
	FMUL.S	RBOT-R,FP1	
	•		
	•		
	•		
	FMUL.X	FP2,FP2	Calculate new R
	FMUL.X	FP3,FP3	($R=\sqrt{X^2+Y^2}$)
	FADD.X	FP2,FP3	
	FSQRT.X	FP3	
	FDIV.X	FP0,FP1	Calculate new θ
	FATAN	FP1	($\theta=\arctan(Y/X)$)
	FSUB.S	RBOT-R,FP3	Calculate ΔR
	FSUB.S	RBOT-THETA,FP1	Calculate $\Delta \theta$

(80bit), and packed-decimal real string (96bit), Fig.2. All internal operations are performed in full extended precision, signed integer operands being converted to extended precision values before the specified operation is performed. Thus mixed-mode arithmetic is possible.

In terms of instructions the 68881 has arithmetic, trigonometric and transcendental functions. All functions operate to 80-bit precision internally which is equivalent to a 17-digit decimal mantissa. An internal constant rom contains some of the more commonly used mathematical constants like $\ln(2)$, e , π , zero.

Transcendental functions are shown in Table 1. With the coprocessor concept these transcendentals appear to be part of the 68020 assembly language. This simplifies programming at assembly-language level and makes mathematics routines in high-level languages easier to implement and much more efficient.

Figure 3 shows how useful 68881 instruction set is. The aim of the example is to calculate the difference between the old and new robot-arm positions, in terms of polar coordinates, and then change that into a change of angle and change of extension on the arm.

The first three lines of code convert coordinates from polar to Cartesian in order to display them. This conversion requires the sine and cosine of the arm's old angle; these calculations are performed in a single instruction - FSINCOS. Obtained values are then multiplied by arm extension R to obtain the existing X and Y coordinates. In a robot-control system, these would then be

displayed as a prompt for a new set of Cartesian coordinates.

When these new coordinates are obtained they are changed into polar form so that the change in angle and change in arm extension can be derived. Conversion involves squaring the X and Y coordinate inputs and then taking the square root of the sum. Obtaining the square simply involves multiplying the register value by itself (FMUL.X FP2,FP2); the square root of the sum can be obtained by using the square root instruction. This value is now the new arm extension and is contained in floating point register FP3.

The arctangent of ratio X/Y gives the new arm angle which is contained in floating-point register FP1. Differences between the old angle and extension (RBOT-THETA and RBOT-R) and the new ones (FP1 and FP3) can now be obtained by subtraction in order to determine the changes required in the arm to reach the new X, Y coordinates. Using these techniques, complex calculations and control systems can be implemented.

REMOVING BOTTLENECKS

Analysis of code written for the MC68881 showed that a number of bottlenecks occur with the coprocessor dialogue. It was found that the 68881 would be busy for a large portion of the time, often performing tasks which did not use the full power of the 67bit arithmetic and logic unit (a.l.u.).

An example of this is conversion of single or double-precision numbers to extended-precision real numbers (all internal operations on data are performed with extended-precision real numbers). The 68882 was designed to alleviate these bottlenecks and so obtain a noticeable performance improvement over the 68881.

To gain this improvement three hardware features were added to the 68882. Firstly special hardware conversion logic was included to allow conversions between single/double-precision real numbers and extended precision real numbers without using the main a.l.u. A finite state machine (the communication-dialogue sequencer) was also added to sequence instructions. This allows the processor to transfer the next opcode before the previous instruction has finished execution. Finally, the existing 80bit internal registers were given dual ports to allow simultaneous access to registers from both the new conversion hardware and the existing execution unit.

Figure 4 shows that the coprocessor divides into four main sections. The bus-interface-unit contains all the logic and coprocessor-interface registers required for communication with an external processor. Associated with the response interface register is a response program-logic array containing all coprocessor response primitives required for dialogue with the main processor. When the 68020 is the main processor, coprocessor dialogue is transparent to the user. The bus-interface unit also contains select logic for the coprocessor interface registers and DSACK control logic.

Operation of the whole 68882 is controlled by the microcode control unit. The clock

Table 1. Operations performed by the 68881 floating-point coprocessor

Transcendental instructions

Mnemonic	Function
FSIN	Sine
FASIN	Arc sine
FSINH	Hyperbolic sine
FCOS	Cosine
FACOS	Arc cosine
FCOSH	Hyperbolic cosine
FSINCOS	Simultaneous sine/cosine
FTAN	Tangent
FTANH	Hyperbolic tangent
FATAN	Arc tangent
FATANH	Hyprbolic arc tangent
FETOX	e to the power x
FETOXM1	e to the power x-1
FTENTOX	10 to the power x
FTWOTOX	2 to the power x
FLOG10	Logarithm base 10
FLOG2	Logarithm base 2
FLOGN	Logarithm base e
FLOGNP1	Logarithm base e of x+1

Main arithmetic instructions

Mnemonic	Function
FADD	Add
FSUB	Subtract
FINT	Take integer part
FNEG	Negate
FNOP	No operation (sync.)
FSQRT	Square root
FGETMAN	Return mantissa
FTST	Test the operand
FGETEXP	Return exponent
FCMP	Compare
FMUL	Multiply
FDIV	Divide
FMOD	Modulo
FREM	Remainder
FSCALE	Scale exponent
FSGLMUL	Single prec. multiply
FSGLDIV	Single prec. divide

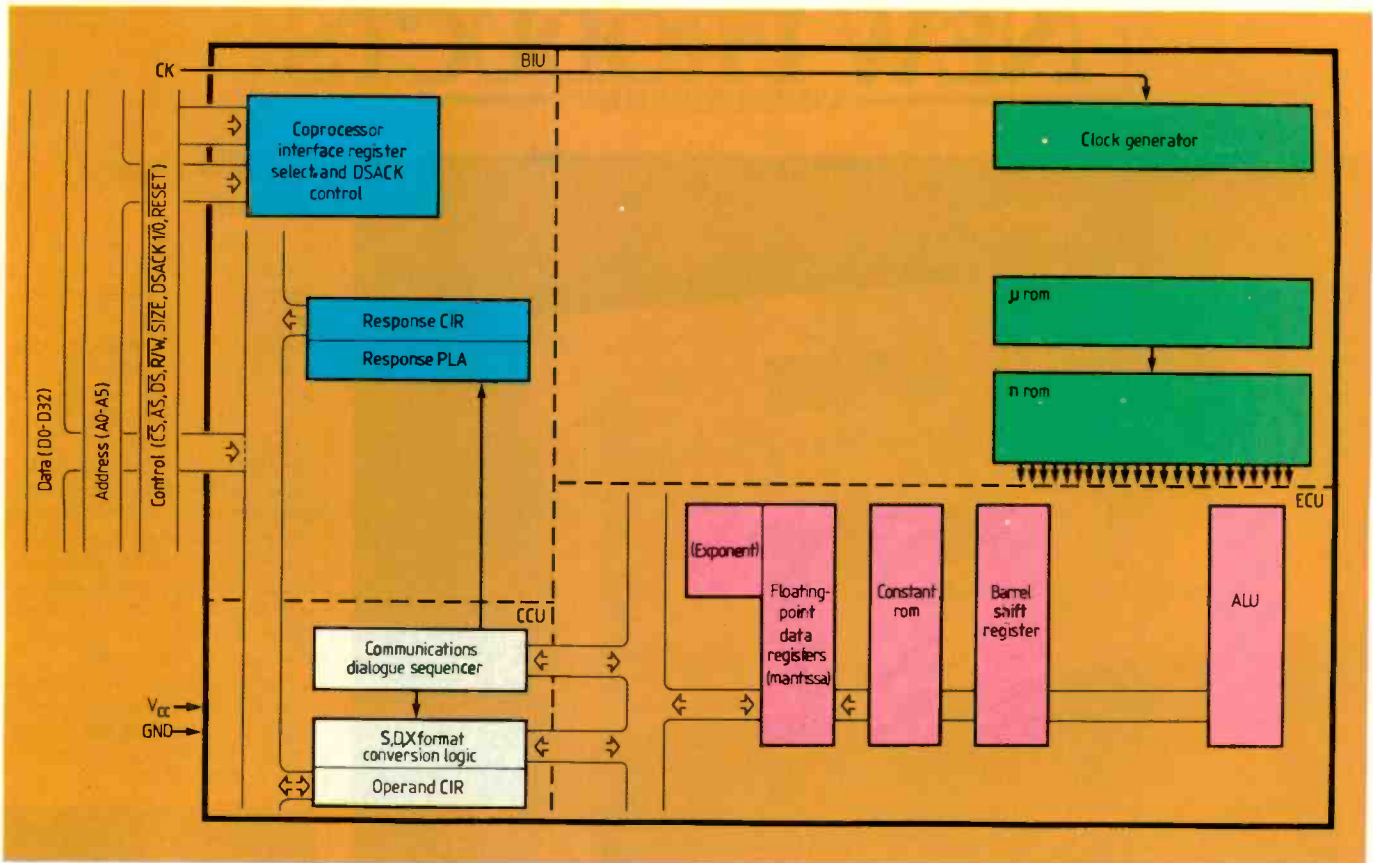

Fig. 4. The MC68882 can be considered as being made up of four separate units; the bus-interface unit, the microcode-control unit, the execution-control unit and the conversion-control unit.

signal is fed into this section and control signals are generated from the microrom and nanorom* to control data movements throughout the various sections.

All the floating-point calculations are performed by the execution control unit. It contains the 67bit a.l.u., a 67bit barrel shift register, a scientific and mathematical constant rom and the eight floating point registers.

A new section of logic called the conversion-control unit has been added to the 68882. Logic required to do simple conversion between single/double-precision real numbers and extended real numbers is contained in this control unit as are the operand interface register and communication dialogue sequencer.

To understand how each of these features improves performance consider this code sequence:

```
FMUL.D <EA>,FP4
```

```
FMOVE.X FP1,FP2
```

EA = effective address and

FP1,FP2,FP3 = floating-point registers
1, 2 and 3

This code performs a floating-point multiplication between the double-precision value contained at effective address <EA> and the contents of floating-point register FP4 and puts the result in FP4. Next is a

* For each microcode instruction there is a nanorom output which feeds the execution unit. Nanorom contains information relating to the configuration of the execution unit for the microcode instruction currently under execution.

$$X(i) = (A \cdot B(i)) + (C \cdot D(i)) + (E \cdot F(i)) + (G \cdot H(i))$$

		Clocks	
		'881	'882
FMOVE.D	<eaA>,FP0		
FMOVE.D	<eaC>,FP1		
FMOVE.D	<eaE>,FP2		
FMOVE.D	<eaG>,FP3		
LOOPST	FMOVE.X FP0,FP4	33	21
	FMUL.D <eaB>,FP4	102	100
	FMOVE.X FP1,FP5	33	0
	FMUL.D <eaD>,FP5	102	72
	FADD.X FP4,FP5	53	40
	FMOVE.X FP2,FP6	33	0
	FMUL.D <eaF>,FP6	102	92
	FADD.X FP5,FP6	53	40
	FMOVE.X FP3,FP7	33	0
	FMUL.D <eaH>,FP7	102	92
	FADD.X FP6,FP7	53	40
	FMOVE.D FP7,<eaX>	86	55
	BRA LOOPST		
Total Clocks:		785	552
Performance Ratio		1.0	1.4

Fig.5. Due to the new 68882 hardware features all instructions execute slightly faster. In addition, FMOVE X, FPX and FP instructions execute instantaneously as they are now completely hidden by the execution time of the floating-point multiplication instructions.

floating-point move instruction carried out on an extended-precision data value which moves a floating point value from FP1 to FP2.

In the 68882 the operand is written to the operand interface registers and immediately a data conversion is performed by the conversion-control unit to transform the double precision value into an extended-precision number. With the earlier 68881 the processor is told to wait while this operand is routed through the execution-control unit and the a.l.u. performs the conversion. Next the 68882 performs the actual floating-point multiplication.

The communication dialogue sequencer can request the next opcode (input into the response interface registers causes a repeat primitive to be sent to the processor) so the FMOVE.X instruction is fetched. The 68881 does not have this capability and informs the processor to wait until the FMUL has executed (a busy primitive is sent from the response interface registers to the processor).

Since the register set has dual ports and the move instruction is executed on registers that are not being used by the multiply instruction, the move instruction can execute at the same time as the multiply instruction. Multiply instructions take a lot longer to execute than move instructions hence fetching and execution of the move instruction are hidden by the multiply instruction. This was a bottleneck with the 68881 as the registers are not dual ported.

Code sequence in Fig.5 shows the performance gain by plugging in a 68882 into a 68881 system. The example shows hidden execution time of the FMOVE instruction for this iterative calculation. Improvements of greater than twice that of the 68881 can be achieved if the code is optimized to take full advantage of the 68882 conversion-control unit.

Memory-management coprocessing is discussed in the next article.

David Burns and David Jones are applications engineers at Motorola's East Kilbride plant.

NEW PRODUCTS

COMMUNICATIONS



Communications monitor

An RS232 breakout box and asynchronous data monitor is provided by the Miniscope from Compedex. When inserted into a communications line it can monitor and capture all the data present.

The instrument has a 32-character l.c.d. to review the data: half each for the transmit and receive lines. An additional display will indicate the state of the sixteen RS232 signals, show the floating and negative lines and indicate 'pulse' or 'glitch'. All control characters are displayed as symbols.

Patching is provided by 24

switches and there are sockets for all 25 signals. Believed to be the world's smallest communications monitor, the Miniscope is claimed to provide easier access to asynchronous protocol analysis. Compedex Ltd, 21 Alston Drive, Bradwell Abbey, Milton Keynes MK13 9HA. Tel: 0908 322177.

Cellular radio antenna

A roof-mounted car antenna for cellular radio telephones has won its designer a British Design Award. Only 89mm long, the Cellmaster antenna offers a 70MHz bandwidth, from 890 to 960MHz. It is machined from solid aluminium and brass and is anodized to a black finish. Although intended for roof mounting, Cellmaster is so small that it could be incorporated into a wing mirror. The screw fitting can be replaced by magnetic mount for portability. Les Wallen, the designer, was a marine engineer and radio ham who became interested in antennas when CB radio became legal and now runs his own company, manufacturing antenna for all types of mobile radio communications. Les Wallen Manufacturing Ltd, Unit 1, Trinity Place, Ramsgate, Kent CT11 7HJ. Tel: 0843 582864.

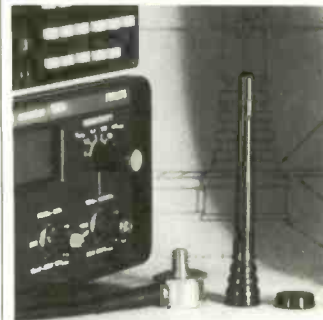

NEXT MONTH

Document management system, based on an optical disc, offers powerful indexing to link any number of documents, as well as giving near instant access to the equivalent of many hundreds of filing cabinets.

Image processing algorithms suitable for many applications in security, character recognition and robotics form the concluding part of the series describing a low-cost alternative to a tv camera.

Pioneers takes up Lord Kelvin: 'When you can measure what you're talking about and express it in numbers, you know something about it.'

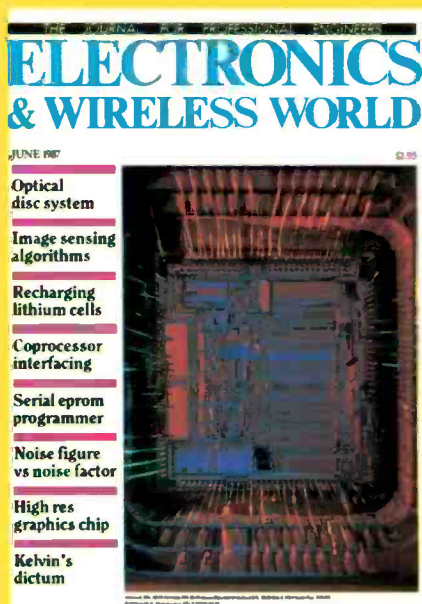

Noise factor or noise figure? 'Joules Watt' explains the difference, and shows why h.f. operation is 'environment-limited' and v.h.f. is 'equipment-limited'.

Serial eeprom programmer. How to design an eeprom programmer that requires no processor, no firmware, and no memory.

High resolution graphics: programming the new 82716 display chip that can produce pictures like that on our front cover.

Rechargeable lithium cells – a report on one of the most exciting recent developments from the world of electrochemical power sources.

NEW PRODUCTS

TEST & MEASUREMENT

Pulse generator with 125MHz

Particularly suitable for high-speed t.t.l. and e.c.l. circuit testing, the Philips PM5786 is a dual-output, variable rise and fall-time pulse generator. With a bipolar output mode and a four-range output attenuator, the generator is also useful in testing analogue circuits. The generator offers bipolar, positive or negative pulses in a complementary or simultaneous pair of outputs. Easy selection of pulse type eliminates the need for adjustments of the offset and inverter controls. A switch reverses the

polarity of the pulses, allowing a change in logic level without having to change cables.

Other features of the PM5786 include an external input which provides a number of external control facilities such as triggering, gate, burst, duration, and square wave. The external control signal defines the start and duration of the various control facilities. Start/stop conditions can be adjusted with the positive or negative-going slope selection and the $\pm 3V$ trigger level controls. Available from Electronic Brokers Ltd, 140-146 Camden Street, London NW1 9PB. Tel: 01-267 7070.

Millivoltmeter for high frequencies

Signals over the frequency range 10kHz to 1.2GHz are measured in eight ranges from 1mV to 3V (full-scale) on the Ballantine 3440A r.f. millivoltmeter. The instrument is suitable for field or lab. measurement and is designed to withstand hostile r.f. environments, vibration and shock. Reliability is enhanced by using a solid-state, chopper-stabilized amplifier which reduces audible noise to zero. The probe incorporates a self-regulating heater

to keep the detector diodes at a constant temperature, eliminating calibration errors caused by variations in temperatures.

Up to 30mV, response is true-r.m.s., permitting accurate calibration of non-sinusoidal waves. Above that, peak-to-peak linear readings are taken, though an analogue 'curve matching' circuit ensures a linear meter response in the higher ranges. The instrument's ranges can be programmed by t.t.l. or through an optional GPIB link. PPM Instruments Ltd, Hermitage Road, St. Johns, Woking, Surrey GU21 1TZ. Tel: 04867 80111.

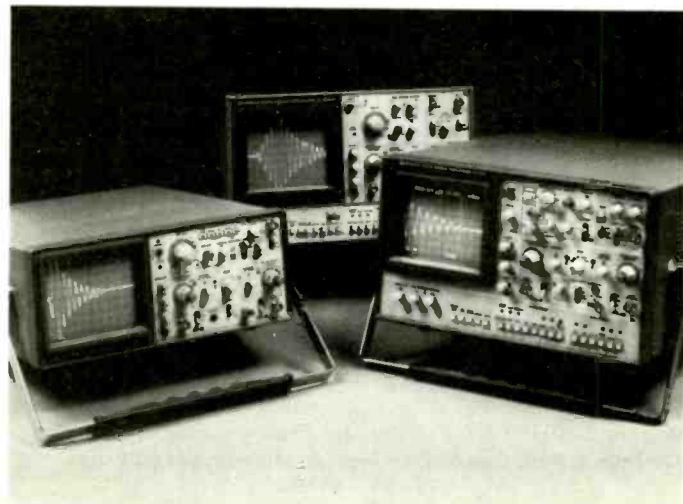
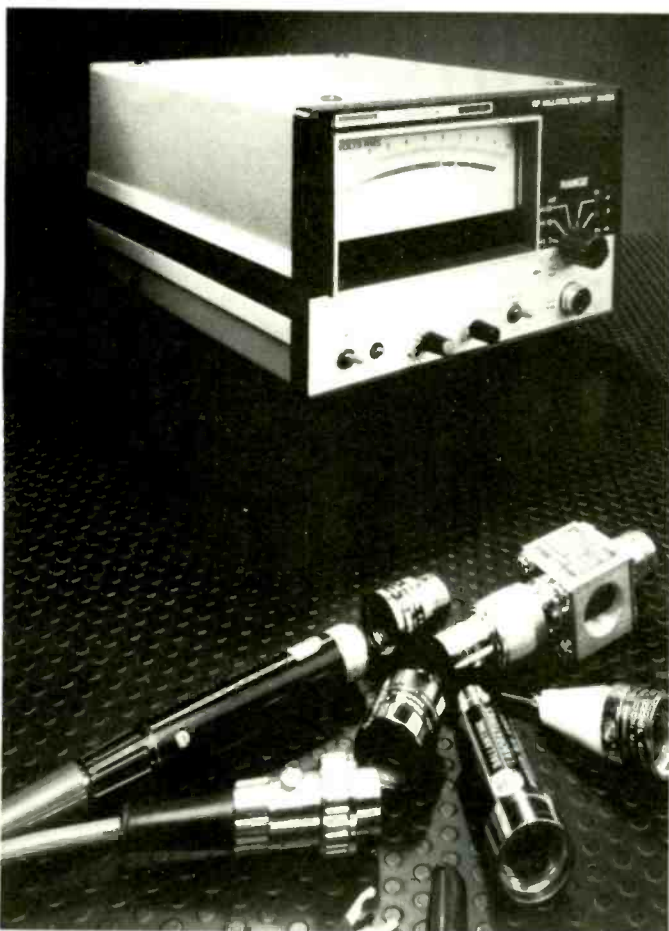

GPIB digital oscilloscopes

The newly-expanded range of Hitachi digital storage oscilloscopes features GPIB interfaces on every model.

The range starts with the VC6020 which has a real-time bandwidth of 20MHz and includes two 1MHz a-to-d converters to provide simultaneous, dual-channel storage of single-shot or repetitive waveforms. For very low speed events a 'roll' mode is provided which makes the screen act like a chart recorder, with new data being written onto the right-hand side of the screen while the old data scrolls off the left. An analogue plotter output allows stored data to be plotted using an x-y or y-t pen plotter. The GPIB interface enables waveform data to be transferred to or from a computer, enabling its use in a.t.e. systems.

The VC6041Z has a maximum sampling speed of 40MHz and a memory length of 4K words per channel. For single-shot events the

VC6041Z can capture waveforms up to 10MHz (at 4 samples per cycle), whilst repetitive waveforms of up to 40MHz can be captured with a resolution of 0.25ns (100 samples per cycle). Two separate 4K word stores are available as reference memories independently of the acquisition memories, enabling four waveforms to be held simultaneously. Other features include fully variable pre-trigger, digital averaging, and waveform magnification up to one hundred times.

The new VC6050 adds to the features of the VC6041Z, full dual timebases and a cursor measurement system that gives on-screen readout of voltage, time and equivalent frequency. Repetitive waveforms of up to 60MHz can be captured via the high-speed sample-and-hold digitizers which provide an equivalent sampling speed of 8GHz. Available through Thurlby Electronics Ltd, New Road, St. Ives, Huntingdon, Cambs. PE17 4BG. Tel: 0480 63570.

Data acquisition and control

A larger version of their ADU range of measurement and control modules has been produced by Mowlem Microsystems. The ADU 800 can accept up to 128 analogue or 256 digital inputs, and has a networking capability allowing up to 72 units to work together, giving access to a virtually unlimited number of channels.

The units have a choice of plug-in modules to provide direct input from a variety of transducers, including strain gauges, thermocouples and pressure sensors. The outputs are similarly varied and include closed-loop servo and stepper motor controls, as well as analogue and digital signal outputs.

Onboard processing allows the unit to monitor all logging or control

operations itself, with readings stored in a battery-backed memory. A host computer is used to set up an operation, but is then free for any other use. Systems can be configured to commence their tasks automatically without intervention from a computer or even an operator.

The ADU800 can work any computer that has RS232 or GPIB interfaces. Software, called Dialog, allows full use of the system without any need for programming. It provides all the facilities necessary to configure logging and control sequences, as well as displaying or plotting real-time graphs, data processing and links into standard computer data management packages such as Lotus 1-2-3, Supercalc etc. Mowlem Microsystems Ltd, Eastman Way, Hemel Hempstead, Herts HP2 7HB. Tel: 0442 218444.



Attn J. Smith
HYBRID ELECTRONICS LIMITED

Reference: 3359
Your Ref: RD 2326

VA Rating: 120VA
Regulation: Approx 11%
E/S Screen: No

Lead Type: Solid
Lead Length: Standard 20cm

Primary Windings: 2x0-120V @ 50/60Hz for Series/Parallel operation

Secondary Windings: 0-9V at 8.33A RMS
15-0 - 15V at 1.5A RMS

Other Requirements: None
Approx Weight: 1.28Kg
Approx Dimensions: 90x45mm

Mounting Method: 1 Steel + 2 Neoprene washers + Nut + Bolt

Prices: Prototype cost for first transformer: £41.80 Then:

10 - 24 = £11.80
25 - 99 = £7.76
100+ = £6.87

Quoted prices exclude V.A.T. and delivery charges.

We reserve the right to amend prices in accordance with current market conditions.

Minimum production batch = 10 pieces.

Minimum call off = 25 off to qualify for discount price.

Despatch: Prototype Order: 7 - 10 days
(21 days for non standard core)
Quantity Orders: 3 weeks
Gold Service: 7 working days
(standard cores only)

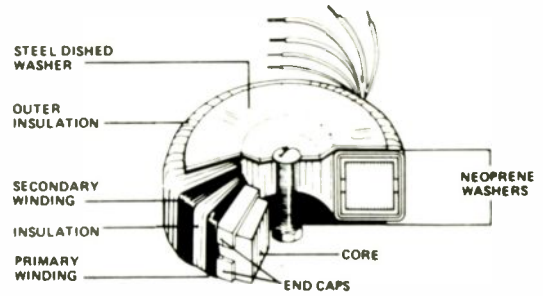

Within the last 10 years ILP Transformers has become the largest manufacturer of toroidal power transformers in the UK.

Opposite we are displaying a typical quotation for a custom design transformer, in the months to come other examples will be shown. If you wish us to quote for an existing transformer or perhaps one for the future, our CAD assisted design team will be pleased to quote.

We have a large standard range from 15VA-625VA with primaries of 120/240V which are available ex-stock (up to quantities of 25) from our distributor Jaytee Electronic Services, 143 Relculver Road, Beltinge, Herne Bay, Kent CT16 6PL - Telephone: (0227) 375254 - Telex: 2951551 TXLINK G Quote MBX 022735254.

All standard transformers are supplied with a full mounting kit comprising of 1 metal washer, 2 neoprene washers and nut, bolt + washer. On custom designs a variety of mounting methods are available including centre potting, threaded inserts etc.

Our design department offers a speedy quotation and prototype design service with full engineering support including field calls if required. Our manufacturing range is from 5VA to 5kVA with multiple primaries and/or secondaries, to U.K. and International standards.

Price stability:

Our current policy is that prices are fixed for one year commencing 1st January 1987.

We also have expertise in designing for low acoustic noise, low stray fields and low temperature rise etc.

ILP ELECTRONICS LIMITED,
Cotton Road, Wincheap Industrial Estate, Canterbury,
Kent CT1 3RB
Telephone: (0227) 454778 - Fax: (0227) 450507
Telex: 965780 ILPAMP.

ENTER 31 ON REPLY CARD



U-Matic
VHS
Betamax

RESPONSIVE-ACCURATE-INEXPENSIVE

The new Interactive Tape Control System
from **The Soft Option.**

Full details available from:

The Soft Option Limited,
Osbourne House, Lower Teddington Road,
Hampton Wick, Surrey KT1 4ER.
Telephone: 01-977 7670

ENTER 18 ON REPLY CARD

IEEE488

TECHNOLOGY THAT HITS THE MARK

- Interface system for IBM-PC/XT/AT/IC and all compatible equipment
- Interface system for PHILIPS PC :YES
- HP control commands (ENTER, CLEAR... etc.) implemented
- SRQ interrupt software implemented
- DMA and INTERRUPT activated by simple commands
- 64 kByte memory management for processing large volumes of data
- Integrated control interpreter, HELP screen and HELP functions in decoded text
- Support for BASIC, BASIC (compiled), (TURBO-)PASCAL, MODULA 2, FORTRAN, C and ASSEMBLER
- Software and manual available in English, French and German



DEALERS WANTED!

INES GmbH, Neuenhöfer Allee 45,
5000 Köln 41, West-Germany
PHONE: -49 221 438659
TELEX: -2627 17 221 4237 gizkln
TELEFAX: -49 221 4972078

ENTER 17 ON REPLY CARD

NEW PRODUCTS

COMPUTING

Overhead computer view

A means of allowing several people at once to view a computer screen is provided by the Davis Transview, a thin transparent liquid crystal display which will fit onto an overhead projector and allow the image to be projected onto a screen. The l.c.d. module replaces the monitor and graphics adaptor in an IBM XT or AT (or clone) and offers the same resolution when displaying word processors, spreadsheets, pictures and the like. Further information from Engberg (UK) Ltd, PO Box 33, Basingstoke, RG21 3JB. Tel: 0256 24299.

Programmable logic

An integrated circuit from Mullard can be configured to be pin-compatible with 19 different standard logic devices. PLS153 has 42 AND-gates and 10 OR-gates with fusible link connections for programming signal direction and polarity. The device can be programmed using standard equipment, but those without a programmer can have it done for them by the distributor. Gothic Crellon, who can also offer design and application support. The i.c. is one of a number of programmable logic devices and can be used as a function generator, fault detector, code converter or in such applications as address mapping, random logic and multiplexing. Gothic Crellon Ltd, 3 The Business Centre, Molly Millars Lane, Wokingham, Berks RG11 2EY. Tel: 0734 788878.

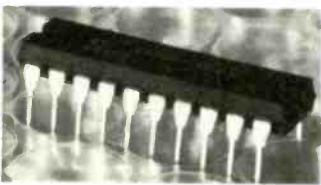

Eeprom and eeprom combined

A high-density, non-volatile, electrically erasable, programmable read-only memory has the additional ability to be completely erased in 20s. This makes the Seeq 48128 especially suitable for applications with infrequent updates, such as program storage. The read cycle is 200ns, and the write time of 2ms/byte is claimed to be five times faster than in other eeproms. The 28-pin d.i.l. package is pin-compatible with the 27128 eeprom. Available from ITT MULTICOMPONENTS Ltd, 346 Edinburgh Avenue, Slough, Berks. SL1 4TU. Tel: 0753 824212.

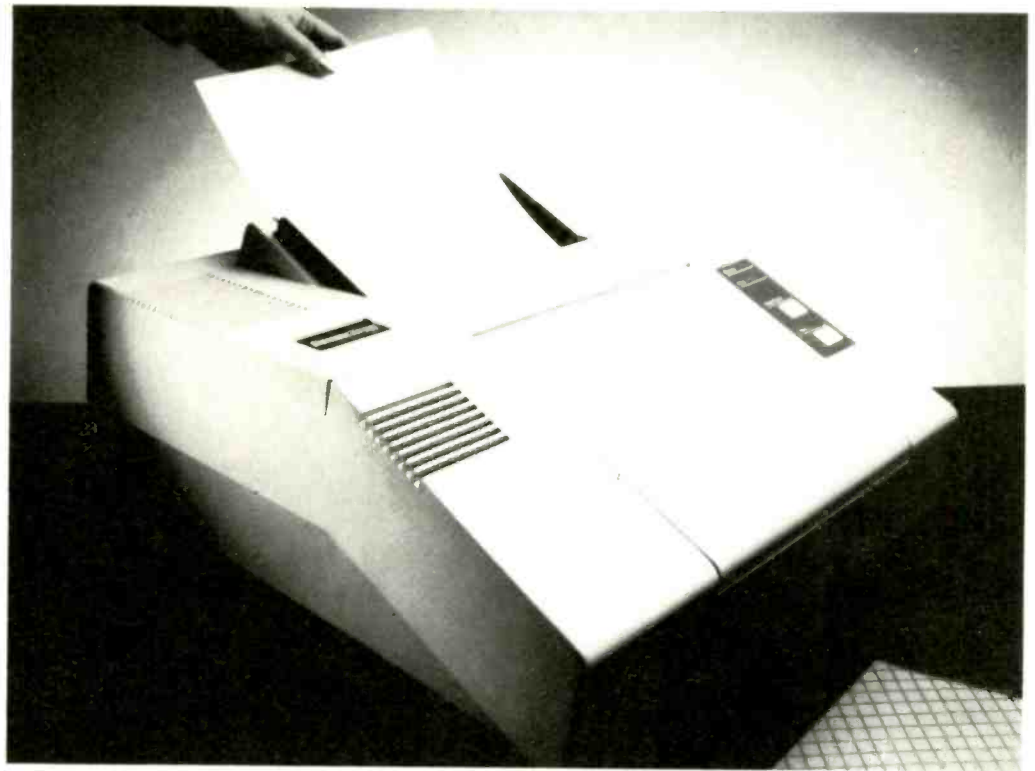

Document scanner

An optical character reader can enter text into a computer at up to 600 words per minute. Pages can be stacked into the loading tray and the scanner will read them at the rate of about a page every 30 seconds. It is thought to be especially useful for

communications by telex or electronic mail and for typesetting. The Compuscan PCS can recognise all popular type faces and it can automatically accommodate different page sizes, margins, type styles and line spacing as well as justified or unjustified text. The scanner communicates through

an RS232 interface and is available in three versions for use with dedicated word processors or IBM-compatible PCs. The third version adds image scanning to the IBM-compatible device. Kendata Peripherals, Nutsey Lane, Totton, Southampton SO4 3NB. Tel: 0702 869922.

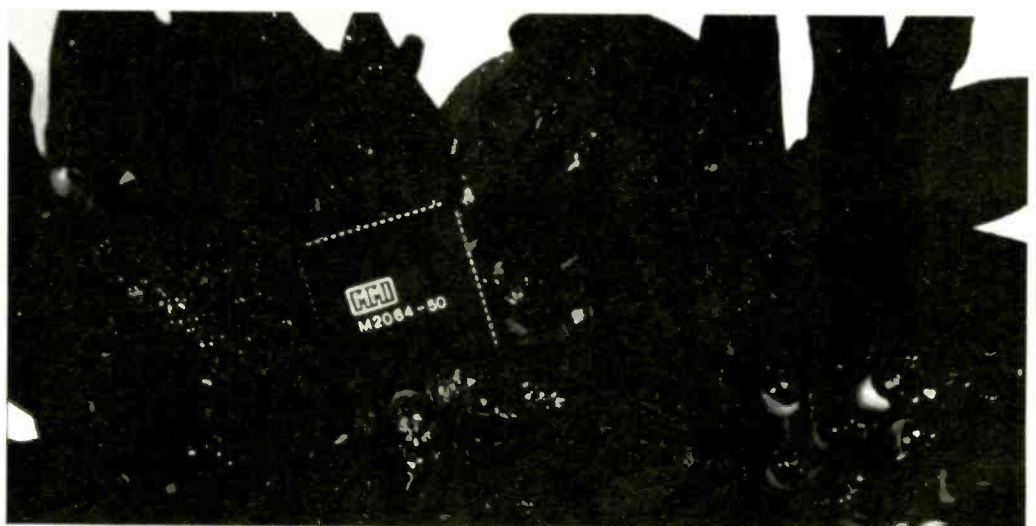

Logic cell array

Claimed to bridge the gap between field-programmable logic and gate-array i.c.s, the M2064 from Monolithic Memories offers user-programming with the gate density usually associated with gate arrays.

The cell array has an internal structure similar to that of a gate array with a matrix of 64

configurable logic blocks surrounded by a ring of i/o interface circuits. An interconnect program is used to define the overall device.

The M2064 is the first of a family of such devices which will have different switching speeds, up to 50MHz. It incorporates several features to monitor its configuration including a verification program and the reading back or complete

resetting of its register contents. Monolithic can also provide a comprehensive software development package which includes a configuration development system, simulation, in-circuit simulation and an in-circuit emulation pod for connecting to a target system. Monolithic Memories Ltd, 1 Queens Road, Farnborough, Hants GU14 6DJ. Tel: 0252 517431.

Xen-Electronics

Specialised Electronic Component Supplies
Just a small selection from 100's of thousands of stock items

4000 SERIES	74LS SERIES	MICRO & LSI	IR REMOTE IC'S	ZENER DIODES	TIP146	163	CAPACITORS ELECTROLYTIC	POLYESTER	RESISTORS CARBON FILM
4001UB 0.16	74LS00 0.20	MC3448AP 3.90	SL486DP 2.20	BZY88C2V7 0.05	2N2646 0.95	2N3055 0.50	A - AXIAL	0.01µF 250V 0.05	0.25W 5% 1R - 10M 0.02
4011B 0.16	74LS04 0.20	MC68488P 8.04	SL490DP 1.92	BZY88C4V3 0.06	2N3074 0.10	2N3819 0.40	10µF 35V 0.05	0.022µF 250V 0.06	0.5W 5% 10R - 10M 0.03
4011UB 0.16	74LS13 0.28	Z80A-CPU 1.80	ML926DP 2.73	BZY88C5V1 0.06	2N3819 0.40	2N5307 0.20	100µF 25V 0.07	0.047µF 250V 0.06	10R - 10M 0.04
4012B 0.21	74LS14 0.42	Z80A-DART 4.28	ML928DP 2.73	BZY88C7V5 0.06	2N5307 0.20	2N5308 0.20	100µF 50V 0.17	0.068µF 250V 0.06	NETAL FILM 0.4W 1% 10R - 1M 0.04
4013B 0.30	74LS20 0.20	Z80A-P10 1.68	VOLTAGE REG'S	BZY88C10 0.06	IC SOCKETS TURNED PIN	IC SOCKETS PLAIN	1000µF 10V 0.15	0.1µF 250V 0.08	10R - 10M 0.04
4017B 0.28	74LS32 0.20	Z80A-S10 0.46	LM317L 0.72	BZY88C11 0.06	8 PIN 0.21	8 PIN 0.26	1000µF 40V 0.32	0.1µF 250V 0.08	10R - 10M 0.04
4019B 0.50	74LS37 0.20	UPD41256-15 2.65	7805 0.40	BZY88C15 0.06	14 PIN 0.26	16 PIN 0.29	2200µF 16V 0.30	0.47µF 250V 0.14	10R - 10M 0.04
4020B 0.66	74LS42 0.42	TC5516APL-2 3.00	7812 0.45	BRIDGE REC'S	18 PIN 0.33	20 PIN 0.37	33µF 16V 0.05	0.47µF 250V 0.14	10R - 10M 0.04
4023B 0.25	74LS85 0.62	ICM7217PI 4.21	7815 0.45	KBPC808 1.42	24 PIN 0.46	28 PIN 0.54	33µF 16V 0.05	0.47µF 250V 0.14	10R - 10M 0.04
4024B 0.40	74LS123 0.67	AD & DA CONVERTERS	7824 0.45	SKB202L5A 0.43	28 PIN 0.46	32 PIN 0.54	33µF 16V 0.05	0.47µF 250V 0.14	10R - 10M 0.04
4025B 0.20	74LS132 0.54	AD7525LN 19.25	78L05 0.24	W005 0.26	32 PIN 0.54	36 PIN 0.62	33µF 16V 0.05	0.47µF 250V 0.14	10R - 10M 0.04
4028B 0.26	74LS139 0.46	DAC80N-CBI-V 19.50	78L08 0.25	KBU4C 0.95	36 PIN 0.62	40 PIN 0.70	33µF 16V 0.05	0.47µF 250V 0.14	10R - 10M 0.04
4030B 0.29	74LS193 0.98	ADC12110HCD 45.55	78L12 0.25	TRANSISTORS	40 PIN 0.70	44 PIN 0.78	33µF 16V 0.05	0.47µF 250V 0.14	10R - 10M 0.04
4040B 0.50	74LS240 0.67	ACL12111HCD 39.96	DIODES	BC107 0.09	44 PIN 0.78	48 PIN 0.86	33µF 16V 0.05	0.47µF 250V 0.14	10R - 10M 0.04
4042B 0.41	74LS244 0.58	DAC0800LCN 2.45	1N4001 0.03	BC108 0.08	48 PIN 0.86	52 PIN 0.94	33µF 16V 0.05	0.47µF 250V 0.14	10R - 10M 0.04
4050B 0.29	74LS245 0.75	DAC1200HCD 18.84	1N4148 0.02	BC118 0.08	52 PIN 0.94	56 PIN 1.02	33µF 16V 0.05	0.47µF 250V 0.14	10R - 10M 0.04
4053B 0.50	74LS365 0.42	DAC1201HCD 15.15	1N4933 0.25	BC212 0.09	56 PIN 1.02	60 PIN 1.10	33µF 16V 0.05	0.47µF 250V 0.14	10R - 10M 0.04
4063B 0.70	74LS373 0.58	ICL7109CP 8.40	1N3891 0.89	BC327B 0.08	60 PIN 1.10	64 PIN 1.18	33µF 16V 0.05	0.47µF 250V 0.14	10R - 10M 0.04
4066B 0.20	74HC SERIES	AD7542KN 18.94	1N5339B 0.36	BC546B 0.09	64 PIN 1.18	68 PIN 1.26	33µF 16V 0.05	0.47µF 250V 0.14	10R - 10M 0.04
4068B 0.21	74HC00 0.33	LINEAR	1N5401 0.12	BC556A 0.08	68 PIN 1.26	72 PIN 1.34	33µF 16V 0.05	0.47µF 250V 0.14	10R - 10M 0.04
4069B 0.20	74HC02 0.73	LF398N 3.95	31D003 0.64	BD131 0.40	72 PIN 1.34	76 PIN 1.42	33µF 16V 0.05	0.47µF 250V 0.14	10R - 10M 0.04
4070B 0.20	74HC04 0.33	LM311N 0.44	LM324N 0.41	BD233 0.33	76 PIN 1.42	80 PIN 1.50	33µF 16V 0.05	0.47µF 250V 0.14	10R - 10M 0.04
4071B 0.20	74HC11 0.33	LM308N 0.65	BYV32-100 1.24	BF259 0.26	80 PIN 1.50	84 PIN 1.58	33µF 16V 0.05	0.47µF 250V 0.14	10R - 10M 0.04
4078B 0.21	74HC85 0.83	LM741CN 0.32	BYV956 0.18	BSR50 0.44	84 PIN 1.58	88 PIN 1.66	33µF 16V 0.05	0.47µF 250V 0.14	10R - 10M 0.04
4081B 0.16	74HC139 0.58	MC1458CP1 0.41	BYV95C 0.20	BUS48P 2.65	88 PIN 1.66	92 PIN 1.74	33µF 16V 0.05	0.47µF 250V 0.14	10R - 10M 0.04
4510B 0.46	74HC200 1.01	MC3340P 1.30	BYX71 600 1.10	BUS98 5.70	92 PIN 1.74	96 PIN 1.82	33µF 16V 0.05	0.47µF 250V 0.14	10R - 10M 0.04
4511B 0.46	74HC240 0.58	ICL7660CPA 1.76	BY206 1.76	IRF520 1.75	96 PIN 1.82	100 PIN 1.90	33µF 16V 0.05	0.47µF 250V 0.14	10R - 10M 0.04
4514B 0.91	74HC244 0.95	SG3526J 4.92	40HF20 0.16	IRF840 7.59	100 PIN 1.90	104 PIN 1.98	33µF 16V 0.05	0.47µF 250V 0.14	10R - 10M 0.04
4518B 0.40	74HC245 0.92	SG3526N 4.92	40HF20 0.16	MTP8N10 1.85	104 PIN 1.98	108 PIN 2.06	33µF 16V 0.05	0.47µF 250V 0.14	10R - 10M 0.04
4543B 0.58	74HC251 0.43	TL072CP 0.65	M16-100R 0.93	MJ3001 1.46	108 PIN 2.06	112 PIN 2.14	33µF 16V 0.05	0.47µF 250V 0.14	10R - 10M 0.04
4547B 1.23	74HC273 0.83	TL074CN 0.66	M25-100 1.27	MJ2501 1.52	112 PIN 2.14	116 PIN 2.22	33µF 16V 0.05	0.47µF 250V 0.14	10R - 10M 0.04
40174B 0.48	74HC354 0.51	TL072CP 0.65	M25-100R 0.93	TIP110 0.36	116 PIN 2.22	120 PIN 2.30	33µF 16V 0.05	0.47µF 250V 0.14	10R - 10M 0.04
40192B 0.56	74HC373 0.79	TL074CN 0.66	M25-100R 0.93	TIP115 0.39	120 PIN 2.30	124 PIN 2.38	33µF 16V 0.05	0.47µF 250V 0.14	10R - 10M 0.04
40193B 0.56	74HC374 0.79	UA714HC 4.48	I.R. OPTO	TIP121 0.39	124 PIN 2.38	128 PIN 2.46	33µF 16V 0.05	0.47µF 250V 0.14	10R - 10M 0.04
40194B 0.65	74HC4002 0.54	OP07DP 1.43	TPS703A 1.25	TIP126 0.39	128 PIN 2.46	132 PIN 2.54	33µF 16V 0.05	0.47µF 250V 0.14	10R - 10M 0.04
40195B 0.83	74HC4022 0.54	UA759U1C 2.72	TLN105A 0.44	TIP141 1.59	132 PIN 2.54	136 PIN 2.62	33µF 16V 0.05	0.47µF 250V 0.14	10R - 10M 0.04
40374B 1.10	74HC4040 0.56	MC14366G 5.70	TLN105 0.40		136 PIN 2.62	140 PIN 2.70	33µF 16V 0.05	0.47µF 250V 0.14	10R - 10M 0.04
40374 1.10	74HC4060 0.56	UGN3020T 2.58			140 PIN 2.70	144 PIN 2.78	33µF 16V 0.05	0.47µF 250V 0.14	10R - 10M 0.04

ORDERS TO:-
Xen-Electronics
UNIT 4
SAMUEL WHITES EST
BRIDGE RD
COWES
ISLE OF WIGHT
PO31 7LP

PLEASE ADD £1.00 p&p & 15% VAT.
Orders over £20 Post and Packing Free
Minimum Order Value £2. No Export orders please.
Stock Items normally by return of post.
Ask for details of items not listed and pricing.
*Coil Winding Facility Available
Part Numbers are exact or near equivalents.
Prices correct at time of going to printers.

ENTER 56 ON REPLY CARD

Computer Appreciation 111 Northgate, Canterbury, Kent CT1 1BH

Tel: Canterbury (0227) 470512. Telex: 966134 COMPAP G

APPLE IIe COMPUTER SYSTEM with twin APPLE disc drives, monitor, 2xRS-232 interfaces, PROFILE 5MB Winchester disc drive, SYNTAURI music system software (including waveform generator with display and sequencer) with MOUNTAIN music cards and 5 octave, 6 voice keyboard. Other software includes PRODOS, PILOT, etc. All as new £995.00

TEKTRONIX Model 4051 DESKTOP GRAPHICS TERMINAL. With integral tape cartridge drive and 4000 Series ultra high resolution storage display (1,024x780). With local processing capacity and BASIC in ROM. With RS232 and IEEE interfaces £385.00

DEC Model BA11MF 8-slot box, backplane and psu for Q-bus devices. NEW £195.00

ADAC Model 1822 128k CMOS memory for DEC Q-bus with battery back-up £190.00

RICHO Model GP11 graph plotter. Intelligent drum/type incremental graph plotter with RS232 interface. Features include: 4 size character plotting; continuous or broken line vector plot; arc or circle plot; triangle and rectangle plot; plotting in any one of four directions. Plotting speed is 667 increments/s; incremental distance (X and Y) is 0.09525mm. Takes 9 inch wide sprocketed roll fed paper and pressurised ball point pen. BRAND NEW £49.00

CALCOMP Model 563 A0 drum plotter. With drive electronics, but without intelligence or interface. Takes full range of Rotring pens etc. £325.00

TEKTRONIX Model 577 SEMICONDUCTOR CURVE TRACER with 5 heads for various transistors and diodes £2,500.00

TEKTRONIX Type 7403N 60MHz OSCILLOSCOPE MAINFRAME £550.00

TEKTRONIX Type 7A18 75MHz 5mV dual trace amplifier £450.00

TEKTRONIX Type 7A18N. As above, but without CRT readout. £390.00

TEKTRONIX Type 7BS3A 100MHz dual timbase £490.00

TEKTRONIX Type 7D12 A/D converter with M2 sample/hold module £675.00

HATFIELD INSTRUMENTS Type 2105 500hm attenuator £50.00

TEKTRONIX Model 851 digital tester. One knob lets you dial 22 functions... 11 functions measure timing, two register plus and minus peak voltages, three carry out DMM measurements... and one reads line voltage at the outlet... the 851 measures its 4 input thresholds to adjust to the logic levels of the equipment being serviced, 5 1/2 digit readout, 35MHz frequency/timing, autorangeing etc. £250.00

BRYAN Model 45000 UV recorder with 6x45001 amplifiers 1mV/cm - 50V/cm and chart speeds from 1mm/min - 500mm/s. Timing line interval is adjustable from 0.002s-10s and Record Duration 0.5s-20s. With remote control facility. £195.00

HEWLETT PACKARD 20MHz pulse generator Model 8011A with Opt 001 burst mode (preselected no. of pulses delivered on trigger). Pulse width: 25ns-100ms in 4 ranges £375.00

HEWLETT PACKARD Model 59307A dual VHF switch. DC to 500MHz 50 Ohm switch for HP-1B/IEEE interface £285.00

HEWLETT PACKARD Model 5045A digital IC tester with CONTROL handler. With IEEE interface and print out of test results (either pass/fail or diagnostic). Complete with substantial library of magnetic card test programs including 74 series TTL. CONTROL handler allows automated testing with ICs sorted into pass/fail. A second HP 5045A (with 6 pin driver cards) is included in the price. £2,650.00

TIME ELECTRONICS Model 9810 programmable power supply £250.00

TIME ELECTRONICS Model 505 DC current source, 0.05% £150.00

PLEASE NOTE
*All prices plus VAT and carriage.

ENTER 43 ON REPLY CARD

HIGH QUALITY - LOW PRICES

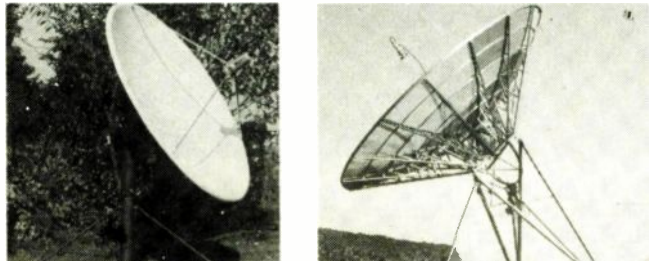

4+11GHz SATELLITE TV RECEIVING EQUIPMENT
RECEIVERS, LNB's, LNC's, FEED HORNS,
ANTENNAS, ANTENNA POSITIONERS,
POLOROTORS, LINE AMPLIFIERS, ETC.

For further details contact
HARRISON ELECTRONICS
Century Way, March, Cambs PE15 8QW Tel (0354) 51289

KESTREL ELECTRONIC COMPONENTS LTD.



All items guaranteed to manufacturers spec.
Many other items available.
Exclusive of V.A.T. and Post and Package

	1+	50-		1+	50-		1+	50-
74LS00	0.13	0.10	6821	1.40	1.00	2764-25	2.70	2.60
74LS04	0.13	0.10	6502	3.30	2.80	27128A-25	2.70	2.50
74LS08	0.13	0.10	6522	3.30	2.80	27128-25	2.75	2.60
74LS21	0.15	0.12	74S00	0.20	0.15	27256-25	3.35	3.25
74LS37	0.13	0.10	74S04	0.35	0.30	6116L-P-3	1.50	1.40
74LS74	0.13	0.10	74S138	0.30	0.25	6264L-P-15	2.40	2.15
74LS86	0.13	0.10	74S240	0.40	0.35	62256-12	12.00	9.00
74LS122	0.20	0.18	8085A	1.40	1.20	4164-15	0.90	0.80
74LS244	0.40	0.32	8255-5	1.80	1.65	41256-15	2.00	1.80
74LS245	0.44	0.32	4 meg Crystal	0.30	0.25	Z80ACPU	1.40	1.00
74LS367	0.23	0.17	LM324	0.25	0.20	Z80ACTC	1.40	1.00
74LS373	0.40	0.30	LM339	0.25	0.20	Z80AP10	1.40	1.10
74LS374	0.40	0.34	LM386	0.70	0.60	8253	1.40	1.25
74LS399	0.30	0.20	LM556	0.35	0.25	6815	1.90	1.30

All memory prices are fluctuating daily, please phone to confirm prices.

178 Brighton Road,
Purley, Surrey CR2 4HA
Tel: 01-668 7522

ENTER 42 ON REPLY CARD

WARC-87: a few steps on

A cut-off date for d.s.b. is among the proposals agreed by the Geneva h.f. broadcasting conference

D.P. LEGGATT

The second session of WARC-11FBC occupied five weeks during February and March 1987. It was held in the International Conference Centre in Geneva and 131 International Telecommunication Union member states participated. Very few delegations comprised fewer than two people and most were a good deal larger, so the total attendance was over 500.

Seven committees were formed to progress the work, the most significant being Committee 4 (technical), Committee 5 (planning method and associated procedures) and Committee 6 (regulatory matters).

Technical matters, although often quite complex, were dealt with in timely fashion and Committee 4 finished its work according to schedule. But agreement on planning matters was far more difficult to achieve and Committee 5 ran seriously late, to the extent that the conference finishing date had to be delayed from the intended March 6th to Sunday March 8th. Only by working until around midnight during most of the final week (and to 2 a.m. on the last night) was the conference able to finish with Final Acts to show for its five weeks of work.

MAIN RESULTS

Technical criteria were agreed in a number of important areas including transmitting antennas; propagation prediction procedures; measures of reception quality and interference protection ratios; double sideband and single sideband transmission parameters; and the technical standards to be used in further development of the IFRB planning systems.

Not many countries favoured the IFRB's proposed planning system*. It was soon agreed that no system could be accepted which left any broadcasting requirements without an assigned frequency, or which involved frequency changes or time breaks within a requirement, or which offered an interference protection ratio less than the accepted minimum usable value of 17dB.

Accordingly, much discussion was devoted to how the system could be improved. Agreement was not easy to achieve. In broad terms, some Arab and African countries, with India and Pakistan, favoured immediate application of an improved planning system; the South Americans were anxious to exclude their domestic h.f. broadcasting services from any planning limitations; and the larger international broadcasters wished to ensure that any revised system would be thoroughly tested and proved acceptable before being put into effect. Largely through the energetic chairmanship of Committee 5 by the representative of Senegal, a compromise package was finally agreed.

A future WARC would consider implementing an improved planning system (i.e. with frequency assignments produced by the IFRB computer system), to be applied in specified parts of the h.f. broadcasting bands.

- There would be no frequency changes or time breaks within a given requirement, apart from any frequency changes necessitated by prop-

agation considerations.

- Interference protection ratios should be progressively reduced in congested hours, as necessary, down to a value of 17dB.
- If congestion still persists, some of the erstwhile 'suspension rules' should be applied as 'transfer rules' to move a number of requirements to the parts of the h.f. bands subject to consultation procedures under the improved Article 17. Requirements would be transferred in this way to the point where each country had at least one requirement left in the parts of the bands covered by the planning system, irrespective of the extent to which interference protection ratios had had to be reduced to achieve this. However any country whose requirement were offered protection less than 17dB might request that their requirements be transferred for treatment under the improved Article 17.
- When initially registering its requirements, a country might nominate those which it wished to have dealt with under this planning system and those which were to be included *ab initio* in the improved Article 17 procedures.

AN IMPROVED ARTICLE 17

Consultation procedures currently set out in Article 17 are to be improved. The main improvement will stem from application of the recently developed computer programs, so that the IFRB will be able to give each country a more precise indication of incompatibilities between its requirements and those of other countries; and to offer more specific advice as to what changes could be made to the requirements to reduce or eliminate the incompatibilities.

It is proposed that the improved planning system be applied to the extension bands agreed by a WARC in 1979 plus some parts of the currently-used h.f. broadcasting bands. These extensions are being vacated by existing non-broadcasting users and were intended to come into use for broadcasting in 1989, or 1994 in the case of the 9MHz band.

The improved planning system will require thorough testing and will be brought into use only when accepted as satisfactory by a future WARC. The IFRB will need two to three years to develop and test this new system, and it is therefore recommended that a further WARC be convened not later 1992 to consider the results and, if they are found satisfactory, to set a date for introduction of the system together with the improved Article 17 consultation procedures.

To avoid premature establishment of unplanned broadcasting services in the extension bands, it was resolved that they shall become available for broadcasting only from a date to be set by the future WARC, rather than from 1989 or 1994 as suggested hitherto.

OTHER IMPROVEMENTS

The conference recognized that improved planning and consultation procedures may lessen congestion but cannot be expected to eliminate it. Several other improvements were accordingly agreed:

- It was recommended that a future WARC be empowered to consider the possibility of further extending the h.f. spectrum allocated to broadcasting.
- The conference recommended an immediate start to the transition from d.s.b. to s.s.b. broadcast transmissions. The date for final cessation of d.s.b. broadcasts is set as the year 2015 subject to review by a future WARC.
- Continuing study of the development of low cost s.s.b. receivers is recommended, as is the provision of sets with digital frequency display.
- All countries are urged to avoid "causing harmful interference" [jamming]. The conference recommended periodic monitoring of such interference and publication of the results.

DOMESTIC SERVICES ON I.F.

Countries using h.f. for domestic broadcasting, notably in South America, require uninterrupted use of specific frequencies year in and year out. These countries strongly resisted any constraints that a planning system might imply and made representations throughout the Conference that domestic h.f. broadcasting be excluded from the planning system.

It proved impossible to secure general agreement on this point, many delegates citing one of the planning principles agreed at the 1984 first session, that 'all the broadcasting requirements, national and international, shall be treated on an equal basis, with due consideration of the differences between two kinds of broadcasting requirements'. Finally it was decided that the question must be left for the future WARC to settle.

The conference urged that broadcasting stations operating in the 7000-7100kHz amateur band cease such operation immediately.

THE FUTURE

Decisions on the exact nature and application of an h.f. planning system have effectively been postponed for some years until the proposed future WARC; in the meantime h.f. broadcasting is to continue under the existing regime.

Recommendations of 1987's WARC will be considered by the ITU Administration Council meeting in June; and decisions as to whether and when to convene the proposed WARC (and perhaps another to consider re-allocation of h.f. spectrum) will rest with the ITU Plenipotentiary Conference in 1989. An important question will be the availability of finance for these future WARC's and for the very costly redevelopment and operation of an improved planning system by the IFRB.

The crystal ball is clouded. Will ITU member states contribute the necessary funds? And will a future WARC be able to agree that the revised planning system has been sufficiently improved and tested to be acceptable for h.f. broadcasting into the 21st century?

Pat Leggatt is the BBC's chief engineer, external relations.

* Deciding h.f. radio's future, by D.P. Leggatt, *Electronics & Wireless World*, February 1987.



Hitachi Oscilloscopes leading the way from £299 in performance and pricing! +VAT

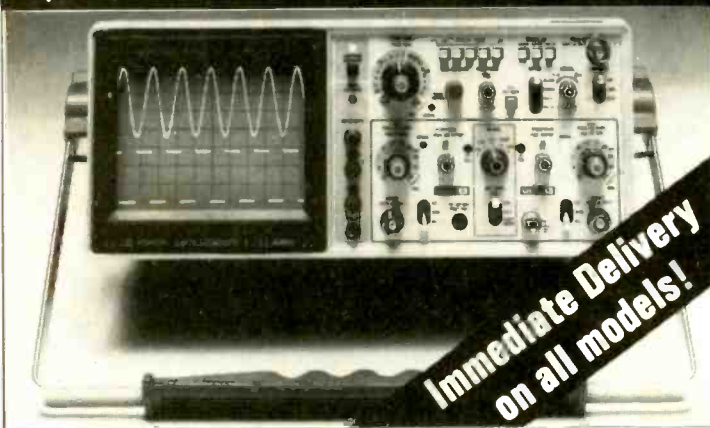

Immediate Delivery on all models!

The highest quality
The Hitachi name is synonymous with quality and reliability and is backed by a 2 year or 3 year warranty on every oscilloscope.

The keenest pricing
With prices starting at only £299 for a 20MHz dual-trace model Hitachi's price-performance ratio can not be bettered.

The largest range
Now totalling 18 models the Hitachi range covers bandwidths from 20MHz to 150MHz and digital storage models to 60MHz.

The fastest service
We can supply any Hitachi 'scope immediately from stock and we back it with full calibration and after-sales service.

For colour brochure giving specifications and prices ring (0480) 63570
Thurlby Electronics Ltd., New Road, St. Ives, Cambs. PE17 4BG

ENTER 50 ON REPLY CARD



low-cost logic analysis

Today's digital circuitry can't be debugged with just a logic probe and oscilloscope. A logic analyser has become an essential tool. The Thurlby LA160 system puts logic analysis within the reach of every engineer with a wide range of options to suit many different applications.

- Prices from £395 plus vat
- 16 or 32 data channels
- IBM-PC interface options
- Data pods for random logic
- Personality modules for uPs
- Microprocessor disassemblers

No other logic analyser system approaches the value for money of the Thurlby LA160. Contact us now for full technical data.



Thurlby Electronics Ltd
New Road, St. Ives, Huntingdon, Cambs.
PE17 4BG, England. Tel: (0480) 63570

ENTER 51 ON REPLY CARD

PINEAPPLE SOFTWARE

Programs for the BBC models 'B' with disc drive with FREE updating service on all software

DIAGRAM

Still the only drawing program available for the BBC micro which gives you the ability to draw really large diagrams and scroll them smoothly around the screen stopping to edit them at any time if required.

Pineapple's unique method of storing the diagram information on disc means that the size of diagrams is limited only by the free space on disc, and not the amount of computer memory you have available. (A blank 80 track disc will allow up to 39 mode 0 screens of diagram).

The superb print routines supplied with the program enable large areas of the diagram to be printed in a single print run in a number of different sizes and rotated through 90 deg. if required. Full use can also be made of printers which have a wider than normal carriage available.

The program is fully compatible with the Marconi Tracker ball described below.

PLEASE STATE 40 or 80 TRACK DISC & WHETHER STANDARD BBC or MASTER VERSION IS REQUIRED

PRICE £25.00 + VAT

DIAGRAM UTILITIES

A suite of six utility programs which add additional features to the 'Diagram' drawing program. The utilities include the saving and loading of areas of diagram to and from disc. The ability to display the whole of your large diagram on the screen at one time (in either 4*4 or 8*8 screen format). The addition of borders and screen indents to diagrams, and the ability to shift a whole diagram in any direction.

PRICE £10.00 + VAT

MARCONI TRACKER BALL

This high quality device comes with it's own Icon Artmaster drawing program and utilities to enable it to be used in place of keyboard keys, joysticks, or with your own programs.

PRICE £60.00 + VAT p&p £1.75

PRICE INCLUDING 'DIAGRAM' SOFTWARE £79.00 + VAT p&p £1.75

TRACKER BALL for MASTER series

The Pointer ROM is supplied instead of the Icon Artmaster disc and enables the Tracker ball to work directly with the MASTER series computers. (e.g. to use with TIMPAINT etc.). Prices are the same as for the standard tracker ball.

POINTER

The Pointer Rom is available separately for people already owning tracker balls, and comes with instructions for use with the MASTER computer.

PRICE £12.50 + VAT

PCB

This new release from Pineapple is a printed circuit board draughting aid which is aimed at producing complex double sided PCB's very rapidly using a standard BBC micro and any FX compatible dot-matrix printer.

The program is supplied on EPROM and will run with any 32k BBC micro (including Master series). Also supplied is a disc containing a sample PCB layout to demonstrate the programs features.

By using an EPROM for the program code the maximum amount of RAM is available for storing component location and ASCII identification files etc. (Up to 500 components and 500 ASCII component descriptions may be stored for a given layout). These is no limit to the number of tracks for a given PCB, although the maximum size of board is restricted to 8" x 5.6".

Using a mode 1 screen, tracks on the top side of the board are shown in red, while those on the underside are blue. Each side of the board may be shown individually or superimposed. A component placement screen allows component outlines to be drawn for silk screen purposes and component numbers entered on this screen may be displayed during track routing to aid identification of roundels.

The print routines allow separate printouts of each side of the PCB in a very accurate expanded definition 1:1 or 2:1 scale, enabling direct contact printing to be used on resist covered copper clad board.

This program has too many superb features to describe adequately here, so please write or phone for more information and sample printouts.

PRICE £85.00 + VAT

CONVERTER LEADS

Converter leads to enable the Trackerball to run mouse software and the mouse to run trackerball software (inc. DIAGRAM). Please state which way round when ordering.

PRICE £8.00 + VAT

MICROSPICE

A new addition to our range of engineering software. Microspice is a very powerful DC and AC analogue circuit simulator package for any model BBC computer.

As well as all the usual facilities available with this type of program, non-linear effects, small signal, noise measurements and sweeps may be performed. Component values may be swept, allowing component tolerances to be investigated as well as thermal performance etc. Comprehensive transistor modelling is incorporated using a 20 parameter Ebers Moll description. The program is supplied on disc with a very comprehensive 49 page manual. Please write or phone for more information.

PRICE £99.00 + VAT P&P FREE

ALL ORDERS SENT BY RETURN OF POST

39 Brownlea Gardens, Seven Kings, Ilford, Essex IG3 9NL. Tel: 01-599 1476

ENTER 76 ON REPLY CARD

SUBSCRIPTION ORDER FORM.

ELECTRONICS & WIRELESS WORLD

Take advantage of our offer of 10% off the annual subscription to *Electronics & Wireless World*. A year's copies would normally cost £23.40: by subscribing now, you can have them delivered to your door for £21 per year (this offer applies to the UK only). To subscribe, just fill in the form opposite.

Please send me *Electronics & Wireless World* each month for 12 months.

I enclose a cheque/PO to the value of £21 UK (£28.50 outside UK), made payable to Reed Business Publishing Ltd. Airmail rates available on request. 8765

Please debit my credit card account: Expiry date

--	--	--	--	--	--	--	--	--	--	--	--	--	--	--	--	--	--	--	--

Tick relevant box

Access Barclaycard/Visa Diners Club American Express

Signed _____ Date _____

Name _____

Job Title _____

Address _____

Telephone _____ Telex _____

FREE PRODUCT INFORMATION

For further details of the coded items mentioned at the foot of advertisements please complete the attached cards and enter the relevant numbers in the boxes provided.

To obtain free information about items in this issue enter the relevant numbers in the boxes below.

Do you have an annual subscription to *Electronics & Wireless World*?

YES NO

No. of employees at your address

ELECTRONICS & WIRELESS WORLD Reader Enquiry Service

Please complete all sections in block capitals.

Name _____

Job Title _____

Company _____

Type of Business _____

Address _____

Tel: _____ Telex: _____

8765 MAY 1987 VALID 6 MONTHS

FREE PRODUCT INFORMATION

For further details of the coded items mentioned at the foot of advertisements please complete the attached cards and enter the relevant numbers in the boxes provided.

To obtain free information about items in this issue enter the relevant numbers in the boxes below.

Do you have an annual subscription to *Electronics & Wireless World*?

YES NO

No. of employees at your address

ELECTRONICS & WIRELESS WORLD Reader Enquiry Service

Please complete all sections in block capitals.

Name _____

Job Title _____

Company _____

Type of Business _____

Address _____

Tel: _____ Telex: _____

8765 MAY 1987 VALID 6 MONTHS

**Electronics & Wireless World
Room 316,
Quadrant House,
The Quadrant,
Sutton,
Surrey SM2 5AS**

Postage
will be
paid by
Licensee

Do not affix Postage Stamps if posted in
Gt Britain, Channel Islands, N Ireland
or the Isle of Man



BUSINESS REPLY SERVICE
Licence No. CYO 258

2

Reader Enquiry Service
Oakfield House
Perrymount Road
Haywards Heath
Sussex RH16 3DH

Postage
will be
paid by
Licensee

Do not affix Postage Stamps if posted in
Gt Britain, Channel Islands, N Ireland
or the Isle of Man



BUSINESS REPLY SERVICE
Licence No. CYO 258

2

Reader Enquiry Service
Oakfield House
Perrymount Road
Haywards Heath
Sussex RH16 3DH

The Archer Z80 SBC

The **SDS ARCHER** – The Z80 based single board computer chosen by professionals and OEM users.

- ★ Top quality board with 4 parallel and 2 serial ports, counter-timers, power-fail interrupt, watchdog timer, EPROM & battery backed RAM.
- ★ **OPTIONS:** on board power supply, smart case, ROMable BASIC, Debug Monitor, wide range of I/O & memory extension cards.

from £185 + VAT.

ENTER 14 ON REPLY CARD

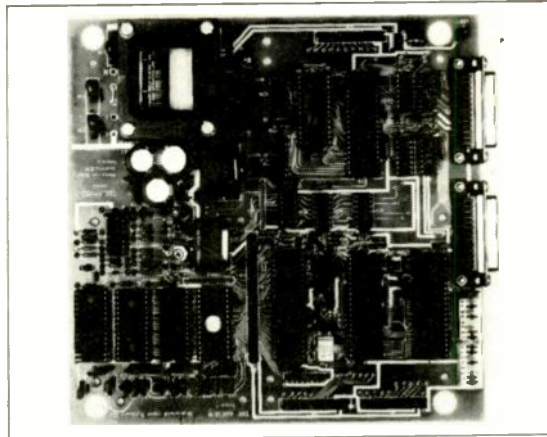

The Bowman 68000 SBC

The **SDS BOWMAN** – The 68000 based single board computer for advanced high speed applications.

- ★ Extended double Eurocard with 2 parallel & 2 serial ports, battery backed CMOS RAM, EPROM, 2 counter-timers, watchdog timer, powerfail interrupt, & an optional zero wait state half megabyte D-RAM.
- ★ Extended width versions with on board power supply and case.

from £295 + VAT.

ENTER 15 ON REPLY CARD



Sherwood Data Systems Ltd

Sherwood House, The Avenue, Farnham Common, Slough SL2 3JX. Tel. 02814-5067

REPRINTS

a ready made sales aid

THE JOURNAL FOR PROFESSIONAL ENGINEERS ELECTRONICS & WIRELESS WORLD

MARCH 1987

Industrial soldering technology

Orthogonality and Walsh functions

Testing surface-mounted devices

Measuring micro-ohms

Designing toroidal transformers

Scientific interface for PCW8256/8512

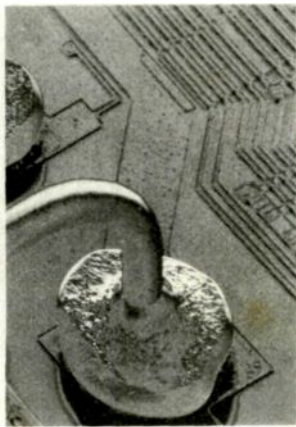

If you are interested in a particular article or advertisement in this publication why not take advantage of our reprint service.

We offer an excellent, reasonably priced service.

For further details and a quotation.

Ring Kaye Locke on 01-661 3779

ELECTRONIC ENGINEERS

serious CAD at lighthearted prices

Those Engineers – really useful people

IBM Users For PC software please see our advert on page 503

Probe around Miteyspice's computer model of your circuit. More informative, more fun and faster than a breadboard. Plot the AC & DC characteristics, quantify bandwidth with the digitising cursor, sweep components, investigate temperature and noise (20 param Ebers Moll model) and when perfect, lay it out and etch it accurately with PCB using an ordinary DM printer. These programs have too many superb features to cover here, please send for details.

★ Just released ★

MITEYSPICE

incorporating the unbeatable Microspice circuit simulator (£119 + VAT)

P.C.B.

Pineapple's acclaimed "a utility I thoroughly recommend" Julian Rogers *Micro User* March '87 circuit board drafting program (£85 + VAT)

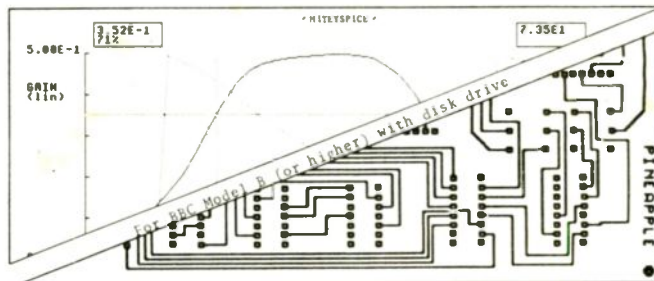

Postal address, callers by appointment

Tel: 01-435 2771

106a Fortune Green Road
West Hampstead
London NW6 1DS

Tlx: 8950511

Mark for mailbox 23332001



THOSE ENGINEERS Ltd
(also at Fair Oaks Airport, Chobham)

ENTER 46 ON REPLY CARD

TELEVISION BROADCAST

How good is good enough?

The European delegates to the CCIR meeting at Dubrovnik in May 1986 played a major role in ensuring that a decision on adopting the Japanese 1125-line, 60-Hz wide-screen high-definition television system as a world "production" standard for h.d.tv was postponed at least until 1988 or to the next full plenary meeting in 1990. This has led to intensive efforts to come up with alternative production and transmission standards that would be compatible with 50-Hz MAC, yet conform to the loose definition of h.d.tv as representing a system having about twice the horizontal and twice the vertical resolution of existing systems. Many European organizations are taking part in Eureka projects or within EBU committee work.

It will clearly take time to reach consensus views but some of the early work was aired recently at an IEE colloquium "HDTV bandwidth reduction" and in an issue of *EBU Review-Technical* (No 219) devoted almost entirely to this subject. What emerges clearly is the difficulty of squeezing more information into the planned 12 GHz satellite frequencies without introducing compromises.

On the other hand, there is support for using 1250-lines as a production standard, converting this down to 625 lines for transmission, and then, where required, using digital processing in the receiver to provide, say, a 100 Hz display. Intercarrier techniques introduce degradations, yet remain an unrivalled method of limiting transmission bandwidth. A major requirement for 1250 or 1125-line studio production would be an electronic camera with adequate performance on a system having a luminance bandwidth of the order of 25 to 30 MHz, still a difficult undertaking.

Some engineers believe that countries in ITU Region 1 (Europe and Africa) should think instead of putting "true" h.d.tv on to 22 GHz, leaving the possibility of "enhanced" systems on 12 GHz. At present there is no 22 GHz allocation for satellite broadcasting in Region 1 and it would require renegotiation of

the WARC 1979 table of frequency allocations. Region 1 does have broadcasting bands at 42 and 84 GHz but both are regarded as likely to remain beyond the boundaries of the technology for more than the 10-15 years assumed for the introduction of h.d.tv services.

While there are proven methods of bandwidth compression, most appear to involve compromises that would take away part of the attraction of h.d.tv. There are indeed those who would argue that by accepting "component" rather than "composite" colour systems, 625 lines can achieve a resolution entirely sufficient for present home display devices; that the next step should be the elimination of flicker and interline twitter and changing the aspect ratio to 16:9 or 5:3 by means of digital processing in the receiver. It has not been lost on some observers that MAC (multiplexed analogue components) is essentially a bandwidth-expansion rather than a bandwidth-reduction technique.

Most of the UK and European projects draw upon the NHK research which started in 1968 in respect of human vision, but even here the conclusions drawn are not always the same. P.E. Wilcock (ITCA), for example, believes that an 861/50 system with a luminance bandwidth of about 20 MHz could provide subjectively identical image quality to 1125/60.

Bandwidth reduction by spectrum folding, shuffling or sub-sampling techniques has the result of trading dynamic versus static resolution. The BBC digitally-assisted (DATV) system eliminates the need for motion detection in the receiver but requires substantial digital capacity (up to about 2 Mbit/s) to obtain optimum benefit and it might be difficult to provide both this and wide-screen pictures with MAC within a 1 GHz channel. DATV uses motion vector techniques not unlike those in the high-quality Japanese h.d.tv standards converter. The Japanese MUSE system, which can pack a 1125/60 system into a single d.b.s. channel, is regarded as resulting in "a most objectional 'blow focus' effect where picture resolution varies with picture dynamics".

There are still doubts as to the

commercial viability of h.d.tv, transmission and whether viewers would regard the better quality picture as having sufficient "perceived value" to compensate for what is bound to be a high-priced receiver.

In particular, the absence of any firm indication of what form future display devices may take is seen as a continuing problem. At present back-projection and direct-view picture tubes limit picture size to a width of between 30 to 50 inches. The Eduard Rhein Foundation (West Germany) is offering a prize of £1-million to the first development team to design a large-format, flat-screen colour tv set that can be easily mass produced. The high-resolution display should have a minimum resolution of 1200 lines, at least a 22-inch diagonal, and be not more than 2 inches deep. To qualify, designers need to come up with their design within the next four years.



WELL, BROADLY SPEAKING THATS IT IT NEEDS A LITTLE MORE WORK TO WEATHER-PROOF IT WHEN CAN I EXPECT THE CHEQUE?

Meanwhile most of us would be happy if all the pictures transmitted on 625 lines were closer to the standard possible with live or recorded programmes from well-lit studios.

C.c.d. cameras

Although the future of solid state display devices for colour television remains obscure, the other end of the chain has already begun to move away, it only for limited applications, from thermionic pick-up tubes.

BBC Television News has announced that in future it will buy only solid-state c.c.d. cameras for its 27 news teams, and is in process of equipping seven teams with Sony BVP-5 c.c.d. cameras.

The drive towards the elimination of one of the last two sub-systems based on thermionic devices (pick-up tubes and cathode-ray tubes) began in the

mid-1970s when it was often suggested that solid-state charge-coupled-device arrays would be adopted for studio and portable cameras within a year or two. In practice it took over a decade before they began to challenge pick-up tubes for e.g. and even now there is some way to go before c.c.d. arrays are used in studio operation.

BBC News are convinced that the advantages of c.c.d. arrays more than compensate for the slightly higher centre resolution of units based on modern pick-up tubes. C.c.d. units can give better performance at low light levels and suffer no permanent damage if pointed at the sun.

In 1975 Bell Laboratories produced a c.c.d. black-and-white camera with about a quarter-of-a-million sensing elements, RCA at Montreux 1975 showed a colour camera that concealed its profound insensitivity to blue by a carefully arranged demonstration. It was not until 1983 that RCA began to demonstrate portable c.c.d. camera using a frame-transfer arrangement and a resolution of roughly 200,000 pixels. A 625-line prototype was shown at IBC84 and gave an impressive performance in respect of registration, lag, absence of burn-out and low power consumption, and with a resolution only slightly down on most $\frac{2}{3}$ -in pick-up tubes. Indeed it seemed to maintain resolution better at low light levels or on moving objects.

But the RCA prototype camera, which had been originally funded by c.c.d. work for defence electronics, never went into production and the project lapsed when General Electric took over. It has been left to the Japanese to bring such cameras to the market place and to convince broadcasters that this is a technique whose time has come.

There would seem no immediate prospects of high-grade solid-state studio cameras entering service, although these should appear in the course of time. But beyond that is the even more demanding requirements of h.d.tv with its need for over 400,000 pixels, good signal-to-noise performance and reasonable depth of focus despite the very large luminance bandwidth.

Television Broadcast is written by PAT HAWKER.

SOAR SERIES 4000 DMM'S WITH BAR GRAPH DISPLAYS

*PERFORMANCE, QUALITY, DESIGN,
ACCURACY, RELIABILITY, VALUE.*

*Advanced Japanese Technology at an
amazing low unit cost.*

Soar's exciting 4000 Series range of DMM's with analogue displays incorporate the most advanced Japanese technology currently available. New custom designed chips and circuitry have produced DMM's with features only expected on models which are twice the cost.

The 4000 Series is manufactured at Soar's main complex, located at the foot of the Japanese Alps, just northwest of Tokyo. This area and its people are renowned for their ability to produce precision instruments.

A comprehensive range of five models enables you to select exactly the functions you need for every possible application. All models come with a no quibble three year guarantee and are available at prices starting from as low as £69.00.

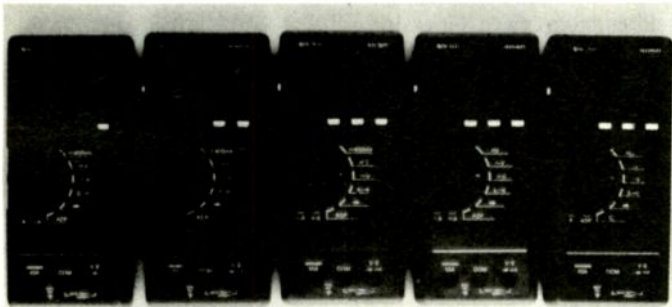

- ★ 40 Segment Analog Bargraph
- ★ Soar's exclusive custom 4000 count A/D Converter allows readings of 400.0mV for superior resolution.
- ★ Ruggedised cases make each unit vibration, dust, grime and splash proof. Also each unit is designed to withstand accidental dropping.
- ★ All models are auto and manual ranging with continuity beeper, diode test and more.
- ★ Selectable models feature illuminated LCD, frequency test, relative test, memory, temperature and min/max, hold, data old.
- ★ Optional adaptors expand functionality to include capacitance test, high AC/DC clamp current, transistor, hfe/loss plus temperature.
- ★ Full overload protection include two fuses plus transient noise to 6000V.
- ★ 1500 hours battery life is typical with 2 AA size alkaline cells and auto-power down.
- ★ 3 years limited warranty.
- ★ Calibration accuracy guaranteed for 1 year.

For further details of the Soar range of Test & Measuring Equipment contact:

SOLEX
INTERNATIONAL

44 MAIN STREET, BROUGHTON ASTLEY,
LEICS LE9 6RD.

Telephone: (0455) 283486

Telex: 378353

Fax: (0533) 544248

ENTER 73 ON REPLY CARD

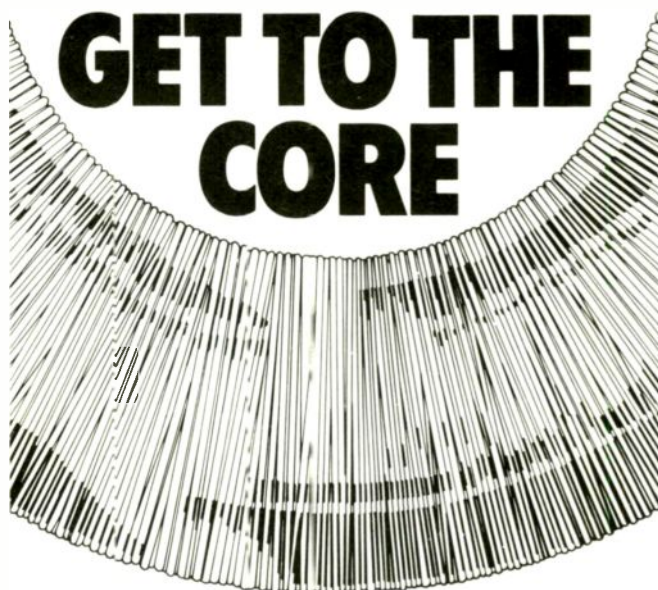

OF COMPACT POWER SUPPLY

NUVOTEM

CUSTOM-DESIGNED TOROIDAL COMPONENTS

Their compact size and low magnetic interference make Nuvotem's toroidal transformers ideal for today's types of power supply and power requirements in a wide variety of electronic applications. The benefits are clear:

- Significant savings in weight and volume over conventional transformers.
- Competitive price.
- No air gaps — hum almost completely eliminated.
- Nuvotem design and advisory service — customised components for specific applications.
- Highest standards of quality assurance — 100% tested.
- Also available — a standard range — 15VA-500VA plus a range of filter chokes.

GET TO THE CORE OF THINGS -

for further information complete and return the coupon or telephone Nuvotem today.

Name _____

Position _____

Company _____

Address _____

Telephone _____

Nuvotem Teoranta
Crolly, Co. Donegal
Ireland

Tel: Int. +353+75+21177/48139

Telex: 42*23 NUVO E*

A member of the International Talema group of companies



ENTER 61 ON REPLY CARD

RADIO BROADCAST

Green Paper and "simulcasting"

The Home Office's consultative document "Radio: Choices and Opportunities" (HMSO, Cm 92, 1987, £5) has certainly thrown into the arena an enormous number of discussion points that could profoundly influence the future of radio broadcasting in the UK. Whilst most of those concerned professionally have welcomed the document as a basis for discussion, one suspects that many of the proposals will be opposed strongly, if only behind closed doors.

The 44-page document has little to say on the long-term effects on radio audiences of the continuing extension of television broadcasting hours, although this seems bound to increase still further the percentage of radio listening on car or walk-about radios. Nor does it go very far into the very different costs, on the technical, programming and administration sides, between running local and national-network stations or whether it is realistic to suppose that there could be enough advertising to support three national, some 60 local and "hundreds" of community services funded solely by advertising and sponsorship, particularly in view of the growth in recent years of the "free-sheet" local newspapers, no matter how "loosely" the commercial radio services might be regulated.

But the Green Paper does consider in some detail the question of what it calls "simulcasting" (more usually known as "duplication"): the transmission of the same programmes on both medium- or long-waves and on v.h.f./f.m. with the extended Band 2, which will eventually span from 87.5 to 108 MHz. In paragraph 4.17, the Home Office expresses the view that "with increasing availability of and public familiarity with v.h.f./f.m. services, there is a good case for ending simulcasting altogether... If the BBC retained v.h.f./f.m. networks, m.f./l.f. networks would then be available to provide new commercial services... It would be sensible to set a target date now for the ending

of simulcasting, so that the necessary planning can be put in hand and the public prepared for what will be a large change in listening habits and expectations. The target might be 1995, after which (more) v.h.f./f.m. frequencies will be available for local (community) use."

At present the BBC has four national m.f./l.f. networks, plus the high-power External Services m.f. channel which attracts about a 4 per cent share of the UK audience. The 1987 BBC Handbook lists 26 Radio 1, 23 Radio 2, 21 Radio 3, 12 Radio 4, 6 Radio Wales, 5 Radio Scotland and 3 Radio Ulster m.f./l.f. transmitters, many forming parts of synchronized chains. And it is from these transmitters, despite the gradually increasing use of v.h.f./f.m. transmissions, that a significant majority of home listening and the great majority of car listening is done. This is despite the promotion for over 30 years of v.h.f./f.m. as usually providing better quality reception much freer of interference than is possible on m.f., particularly during the hours of dusk and darkness.

For the failure to convert most listeners to the benefits of v.h.f./f.m. and stereo, some blame the policy of duplication, arguing that if v.h.f./f.m. had been treated as the "main" way of broadcasting, listeners would have been forced to change. Others blame the lack of sustained promotion and pressure by broadcasters, the difficulty of receiving "noise-free" stereo without a good external aerial from transmitters located well outside the centres of population, the poor sensitivity and poor selectivity of many low-cost and some high-cost receivers, etc.

The Green Paper does show that, unlike the situation in the USA, younger listeners in the UK have never become committed to v.h.f./f.m. listening, undoubtedly influenced by the absence of a dedicated v.h.f./f.m. channel for Radio 1, although this is planned for the fairly near future.

There is little doubt that if simulcasting ends by 1995 and BBC "public service" broadcasting is confined to v.h.f./f.m., the Corporation could be faced with the loss of over half of its audience from this cause alone, un-

less it embarks on an all-out campaign to persuade listeners to change to v.h.f./f.m. Such a campaign would be bound to be very unpopular to the many who still find, despite the drawbacks, that m.f./l.f. transmissions give them adequate reception.

Then again there are an increasing number of professional broadcast engineers who believe that the real future for national coverage radio lies in satellite broadcasting on about 1 to 1.5 GHz from highly-elliptical orbits. Such satellites can hover almost directly overhead for about eight hours at a time so that continuous coverage could be provided by three synchronized satellites and received, for example, in moving vehicles by means of a simple planar antenna on the roof. Ideas for such radio satellites are currently being studied by EBU working parties with the object of presenting a case for a frequency allocation at the next World Administrative Radio Conference. Such systems are technically very attractive though they face the problem of the enormous cost of getting a series of satellites into orbit and then persuading listeners to buy suitable receivers.

The only form of satellite radio considered in the Green Paper is the possibility of carrying radio channels on 12 GHz MAC-family satellite transponders basically providing d.b.s. television services to fixed locations and unlikely ever to be suitable for reception in cars or on portable radios.

Cellular growth

The rapid build-up of the coverage and use of the 900 MHz Cellnet and Vodafone cellular radio networks with now over 150,000 subscribers has run ahead of most predictions. Their growth is proving a near match to the Scandinavian experience where cellular systems have been in operation for over five years. The systems have perhaps been fortunate in establishing the technology ahead of the 200 MHz national private mobile networks licensed to GEC and Band Three Radio, the first of which (Band Three) is expected to open in the London area this autumn.

Vodafone has issued some illuminating statistics on its operations. At the beginning of March, with 430 cells representing 3,700 voice channels, it is handling over 2 million calls per week through four "exchanges" and 235 base stations. Some 64 per cent of the traffic is now outside the London orbital ring area where frequency congestion has been a considerable problem.

An interesting figure is the 15 per cent "churn", the rate of disconnections from the network, based on operations since about the beginning of 1985. This rate of churn is comparable to that of some of the cable-television systems and is perhaps not unduly high for new, energetically-sold services, but it does seem to reflect the feeling of some observers that what with equipment costs, installation charges, standing charges and connection fees, plus the actual call charges, it can prove to be a costly, if useful, service.

Then, not all subscribers are tolerant of the basic fallibilities of 900 MHz radio propagation and expect the system to function as reliably as their desk telephones. In practice, calls get lost when hills intervene between the vehicles and the base station and there can be a good deal of "popping" due to the rapid fading brought about by the standing wave patterns resulting from multipath propagation.

The safety aspects of mobile radio attracted attention in the media with the publication, early March, of the new edition of the Highway Code with its specific warning against the use of hand microphones and handsets while driving. Surveys have shown that over half of mobile radio users expect to receive calls without stopping and many make outgoing calls on the move.

It seems odd, incidentally, that the RSGB, which has for many years included similar warning in its own safety code for radio amateur mobile operation, should feel aggrieved that it was not fully consulted by the Department of Transport and claims to be unaware of any accidents resulting from the use of hand-held microphones.

Radio Broadcast was written by PATHAWKER.



£1 BAKERS DOZEN PACKS

Price per pack is £1.00. *Order 12 you may choose another free. Items marked (sh) are not new but guaranteed ok

- 1 5 - 13 amp ring main junction boxes
- 2 5 - 13 amp ring main spur boxes
- 4 5 - surface mounting
- 5 electrical switching, white flush mounting
- 7 4 - in flex line switches with neons
- 9 2 - mains transformers with 6V 1A secondaries
- 10 2 - mains transformers with 12V 1/2A secondaries
- 11 1 - extension speaker cabinet for 6 1/2" speaker
- 13 12 - glass reed switches
- 17 2 - ultrasonic transmitters receivers with circuit
- 19 2 - light dependent resistors
- 25 4 - wafer switches - 6p 2 way, 4p 3 way, 2p 6 way, 2p 5 way, 1p 12 way small one hold fixing and good length 1/2" spindle your choice
- 28 1 - 6 digit counter mains voltage
- 30 2 - Nicad battery chargers
- 31 1 - key switch with key
- 33 2 - aerosol cans of ICI Dry Lubricant
- 34 96 - 1 metre lengths colour-coded connecting wire
- 39 1 - long and medium wave tuner kit
- 41 8 - rocker switch 10 amp mains SPST
- 45 1 - 24 hour time switch mains operated (s b)
- 49 10 - neon valves - make good night lights
- 50 2 - 12V DC or 24V AC, 3 CO relays
- 51 1 - 12V 2 CO miniature relay very sensitive
- 52 1 - 12V 4 CO miniature relay
- 54 10 - rows of 32 gold plated IC sockets (total 320 sockets)
- 55 1 - locking mechanism with 2 keys
- 56 1 - miniature unselector with circuit for electric pgsaw puzzle
- 60 5 - ferrite rods 4" x 5/16" diameter aereals
- 61 4 - ferrite slab aereals with L & M wave coils
- 63 1 - Mullard thyristor trigger module
- 66 1 - magnetic brake - stops rotation instantly
- 67 1 - low pressure 3 level switch can be mouth operated
- 70 2 - 25 watt pots 8000 ohm
- 71 4 - wire wound pots - 18, 33, 50 and 100 ohm your choice
- 77 1 - time reminder adjustable 1.60 mins clockwork
- 85 1 - mains shaded pole motor 1/2" stack - 1 shaft
- 89 1 - mains motor with gear box 1 rev per 24 hours
- 91 2 - mains motors with gear box 16 rpm
- 96 1 - thermostat for fridge
- 98 1 - motorised stud switch (s.h.)
- 101 1 - 2 1/2 hours delay switch
- 103 1 - mains power supply unit - 6V DC
- 104 1 - mains power supply unit - 4 1/2 V DC
- 107 1 - 5" speaker size radio cabinet with handle
- 112 1 - heating pad 200 watts mains
- 114 1 - 1W amplifier Mullard 1172
- 115 1 - wall mounting thermostat 24V
- 118 1 - teak effect extension 5" speaker cabinet
- 120 2 - p.c boards with 2 amp full wave and 17 other recs
- 121 4 - push push switches for table lamps etc
- 122 10 - mtrs twin screened flex white p.v.c outer
- 124 25 - clear plastic lenses 1 1/2 diameter
- 127 4 - pilot bulb lamp metal clip on type
- 128 10 - very fine drills for pcbs etc.
- 129 4 - extra thin screw drivers for instruments
- 132 2 - plastic boxes with windows, ideal for interrupted beam switch
- 134 10 - model aircraft motor - require no on/off switch, just spin to start
- 137 1 - 6 1/2" 4 ohm 10 watt speaker
- 142 10 - 4 BA spanners 1 end open, other end closed
- 145 2 - 4 reed relay kits 3V coil normally open c/o if magnets added
- 146 20 - pilot bulbs 6.5V 3A Philips
- 154 1 - 12V drip proof relay - ideal for car jobs
- 155 3 - varicap push button tuners with knobs
- 169 4 - short wave air spaced trimmers 2-30f
- 172 10 - 12V 6W bulbs Philips m.e.s.
- 178 3 - oblong amber indicators with lilliputs 12V
- 180 6 - round amber indicators with neons 240V
- 181 100 - p.v.c grommets 1/2 hole size
- 182 1 - short wave tuning condenser 50 pf with 1 1/2" spindle
- 184 1 - three gang tuning condenser each section 500 pf with trimmers and good length 1/2" spindle
- 188 1 - plastic box sloping metal front, 16 x 95mm average depth 45mm
- 193 6 - 5 amp 3 pin flush sockets brown
- 195 5 - B.C. lampholders brown bakelite threaded entry
- 196 1 - in flex summerstat for electric blanket soldering iron etc.
- 197 2 - thermostats, spindle setting - adjustable range for ovens etc.
- 199 1 - mains operated solenoid with plunger 1" travel
- 200 1 - 10 digit switch pad for telephones etc.
- 201 8 - computer keyboard switches with knobs, pcb or vero mounting
- 206 20 - mtrs 80 ohm, standard type co-ax off white
- 211 1 - electric clock mains driven, always right time - not cased
- 216 1 - stereo pre-amp Mullard EP9001
- 232 2 - 12V solenoids, small with plunger
- 236 1 - mains transformer 9V 1 amp secondary C core construction
- 241 1 - car door speaker (very flat) 6 1/2" 15 ohm made for Radiomobile
- 242 2 - speakers 5" x 4" 4 ohm 3 watt made for Radiomobile
- 243 2 - speakers 6" x 4" 16 ohm 5 watt made for Radiomobile
- 244 1 - mains motor with gear box very small, toothed output 1 rpm
- 245 4 - standard size pots, 1 meg with do switch
- 249 1 - 13A switched socket on double plate with fused spur
- 266 2 - mains transformers 9V 1/2A secondary
- 267 1 - mains transformers 15V 1A secondary p.c.b. mounting
- 291 1 - ten turns 3 watt pot 1/2" spindle 100 ohm
- 296 3 - car cigar lighter socket plugs
- 298 2 - 15 amp round pin plugs brown bakelite
- 300 1 - mains solenoid with plunger compact type
- 301 10 - ceramic magnets Mullard 1" x 3/8 x 5/16
- 303 1 - 12 pole 3 way ceramic wave charge switch
- 305 1 - tubular dynamic microphone with desk rest
- 308 1 - T.V. turret tuner (black & white T.V.)
- 310 2 - oven thermostats
- 313 5 - sub miniature micro switches
- 316 1 - round pin kettle plug with moulded on lead
- 453 2 - 2 1/2 in. 80hm loudspeakers
- 454 2 - 2 1/2 in. 80hm loudspeakers
- 463 1 - mains operated relay with 2 sets c/o contacts
- 464 2 - packets resin filler/sealer with cures
- 465 3 - 5A round 3 pin plugs will fit item 193
- 466 4 - 7 segment l.e.d. displays
- 470 4 - pc boards for stripping, lots of valuable parts
- 473 1 - 5" 4ohm speaker with built in tweeter Radio mobil
- 480 1 - 3A double pole magnetic trip, saves repairing fuses
- 498 4 - 1000uf 25V axial electrolytic capacitors

FROZEN PIPES Can be avoided by winding our heating cable around them, 15 mtrs connected to mains cost only about 10p per week to run. Hundreds of other uses as it is waterproof and very flexible. Resistance 60ohms/metre. Price 28p/metre or 15m for £3.95.

CAR STARTER/CHARGER KIT

Flat Battery! Don't worry you will start your car in a few minutes with this unit - 250 watt transformer 20 amp rectifiers, case and all parts with data £17.50 post £2



Ex-Electricity Board. Guaranteed 12 months

VENNER TIME SWITCH

Mains operated with 24 hrs switch, one on and one off per 24 hrs - repeats daily automatically correcting for the lengthening or shortening day. An expensive time switch but you can have it for only £2.95 without case, metal case - £2.95, adaptor kit to convert this into a normal 24hr time switch but with the added advantage of up to 12 on/off's per 24hrs. This makes an ideal controller for the immersion heater. Price of adaptor kit is £2.30.

SOUND TO LIGHT UNIT

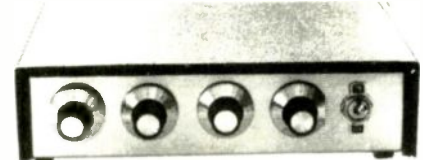

Complete kit of parts of a three channel sound to light unit controlling over 2000 watts of lighting. Use this at home if you wish but it is plenty rugged enough for disco work. The unit is housed in an attractive two tone metal case and has controls for each channel, and a master on/off. The audio input and output are by 1/2" sockets and three panel mounting vice holders provide thyristor protection. A four pin plug and socket facilitate ease of connecting lamps. Special price is £14.95 in kit form

12 volt MOTOR BY SMITHS

Made for use in cars, etc. these are very powerful and easily reversible. Size 3 1/2" long by 3 1/2" dia. They have a good length of 1 1/2" spindle - 1/10 hp £3.45, 1/8 hp £5.75, 1/6 hp £7.50

25A ELECTRICAL PROGRAMMER

Learn in your sleep. Have radio playing and kettle boiling as you wake - switch on lights to ward off intruders - have a warm house to come home to. You can do all these and more. By a famous maker with 25 amp on/off switch. A beautiful unit at £2.50

THIS MONTH'S SNIP

3" floppy disc drive unit plug in and with all electronics. Japanese made, brand new. We are told that this is a standard replacement in many Amstrad and other popular computers, and we supply with technical information. Special snip price £29.50 including post and VAT.

12V BATTERY OPERATED SIREN

(Or you can work this off a 24V transformer). Makes a shocking noise, will frighten away any intruder. Japanese made one 50p each, 2 for £1, ref. RD221. Storage sealed but unused and guaranteed perfect, only 20p each, 5 for £1, ref. RD221

WONDERFUL BREAKDOWN VALUE - HAND HELD STEREO UNIT

Contains two beautiful miniature moving coil loud speakers. These could also be used as microphones, also contains many other useful parts including mini stereo amp, transistors, condensers, rocker switches etc. To use this as a personal amplifier simply add a stethoseth, only £1, ref. BD29

SPIT MOTOR

Powerful mains operated induction motor with gearbox attached. Shaft has square hole which gives very easy coupling and quick release if required. Shaft speed 5rpm. Price £5, ref. 5P54

PUSH SWITCH REF 14DM

Double pole c/o switch, able to handle 10A at mains voltage. Mounts through an oblong hole like a rocker switch. Has its own push rod, so does not require a knob. Change over occurs when switch is depressed and returns to normal when pressure removed. 3 for £1, ref. BD489

20V-0-20V 1A MAINS TRANSFORMER

Upright mounting. Primary thermal cutout to interrupt the supply if transformer overheats. Price £2, ref. 2P138

4 BOOKS FOR £1

Book 1 describes the Mullard Unilex amplifier and gives details of a suitable cabinet. Book 2 describes several useful pieces of test equipment which could be quite easily constructed. Book 3 is electronic projects. Book 4 describes short wave receivers which can be easily constructed and is intended for mainly beginners. Our ref. BD400

TRANSFORMER IN WATERPROOF METAL CASE

24V 5A output. Ideal for garden lighting or to operate pond pump etc. Case has cable glands for mains in and low voltage output leads. Price £5 plus £1 post, ref. 5P88

MAINS RELAY

With transparent plastic cover. Could be pcb or clip mounted, has angle 8-10A c/o contact. Real bargain 2 for £1, ref. BD488

PANEL METERS

Engraved vu, approximately 1 1/2" square. Luminates these from behind and you will have a really superb looking panel. Real bargain 2 for £1, ref. BD386

TRANSISTOR TUNING CONDENSOR

180pf made for a very famous RAF transmitter, only £1 each. Unused but mounting brackets will need a bit of cleaning up due to storage. Our ref. BD424

MAGNETIC READ/WRITE UNIT

A read/write head mounted on a thumb operated lever is used to traverse magnetisable paper. The paper is held between top and bottom rollers which can be spun for localisation of the written message - new and unused only £1 each, BD381

IONISER KIT

Refresh your home, office, shop, work room, etc. with a negative ION generator. Makes you feel better and work harder - a complete mains operated kit, case included. £9.50 plus £2.00 post.

TELEPHONE BITS

Master socket (has surge arrester - ringing condenser etc) and takes B.T. plug £3.95
Extension socket £2.95
Dual adaptors (2 from one socket) £3.95
Co-terminating with B.T. plug 3 metres £2.95
Kit for converting old entry terminal box to new B.T. master socket, complete with 4 core cable, cable clips and 2 BT extension sockets £11.50
100 mtrs 4 core telephone cable £8.50

J & N BULL ELECTRICAL

Dept EWW, 250 PORTLAND ROAD, HOVE, BRIGHTON, SUSSEX BN3 5QT.

MAIL ORDER TERMS: Cash, P.O. or cheque with order. Orders under £20 add £1 service charge. Monthly account orders accepted from schools and public companies. Access & B/card orders accepted. Brighton 0273 734648. Bulk orders: write for quote.

£2 POUNDERS*

- 2P2 - Wall mounting thermostat, high precision with mercury switch and thermometer
- 2P3 - Variable and reversible 8-12v psu for model control
- 2P4 - 24 volt psu with separate channels for stereo made for Mullard UNILEX
- 2P6 - 100W mains to 115V auto-transformer with voltage tapping
- 2P8 - Mains motor with gear box and variable speed selector. Series wound so suitable for further speed control
- 2P9 - Time and set switch. Boxed, glass fronted and with knobs. Controls up to 15 amps. Ideal to program electric heaters
- 2P10 - 12 volt 5 amp mains transformer
- 2P12 - Disk or Tape precision motor - has balanced rotor and is reversible 230v mains operated 1500 rpm
- 2P14 - Mug Stop kit - when thrown emits piercing squeak
- 2P15 - Interrupted Beam kit for burglar alarms, counters, etc.
- 2P17 - 2 rev per minute mains driven motor, ideal to operate mirror ball
- 2P18 - Liquid/gas shut off valve mains solenoid operated
- 2P19 - Discs switch-motor drives 8 or more 10 amp change over micro switches supplied ready for mains operation
- 2P20 - 20 metres extension lead, 2 core - ideal most Black and Decker garden tools etc.
- 2P21 - 10 watt amplifier, Mullard module reference 1173
- 2P22 - Motor driven switch 20 secs on or off after push
- 2P26 - Counter resettable mains operated 3 digit
- 2P27 - Goodmans Speaker 8 inch round Bohm 12 watt
- 2P28 - Drill Pump - always useful couples to any make portable drill
- 2P31 - 4 metres 98 way interconnecting wire easy to strip
- 2P32 - Hot Wire amp meter - 4 1/2" round surface mounting 0-10A - old but working and definitely a bit of history
- 2P34 - Solenoid Air Valve mains operated
- 2P38 - 200 R.P.M. Gearbox Mains Motor 1" stack quite powerful, definitely large enough to drive a rotating aerial or a tumbler for polishing stones etc.
- 2P43 - Small type blower or extractor fan, motor inset so very compact, 230V
- 2P46 - Our famous drill control kit complete and with prepared case
- 2P49 - Fire Alarm break glass switch in heavy cast case
- 2P51 - Stereo amplifier, 3w per channel
- 2P55 - Mains motor, extra powerful has 1 1/2" stack and good length of spindle
- 2P62 - 1 pair Goodmans 15 ohm speakers for Unilex
- 2P64 - 1 five bladed fan 8 1/2" with mains motor
- 2P66 - 1 2Kw tangential heater 115v easily convertible for 230V
- 2P67 - 1 12v-0-12v 2 amp mains transformer
- 2P68 - 1 15v-0-15v 2 amp mains transformer
- 2P69 - 1 250v-0-250v 60 mA & 88.3v 5A mains transformer + 50p post
- 2P70 - 1 E.M.I. tape motor two speed and reversible
- 2P72 - 1 115v Muffin fan 4" x 4" approx. (s.h.)
- 2P75 - 1 2 hour timer, plugs into 13A socket
- 2P82 - 9v-0-9v 2 amp mains transformer
- 2P84 - Modem board with press keys for telephone radialler
- 2P85 - 20v-0-20v 1A Mains transformer
- 2P88 - Sangamo 24 hr time switch 20 amp (s.h.)
- 2P89 - 120 min. time switch with knob
- 2P90 - 90 min. time switch with edgewise engraved controller
- 2P94 - Telephone handset for EE home telephone circuit
- 2P95 - 13A socket on satin chrome plate
- 2P97 - mains transformer 24V 2A upright mounting
- 2P98 - 20m 4 core telephone cable, white outer
- 2P99 - 500 hardened pin type staples for telephone cable
- 2P101 - 15V mains transformer 4A upright mounting
- 2P105 - capillary type thermostat for air temperature with c/o switch
- 2P108 - mains motor with gear box giving 110rpm
- 2P109 - 5" wide black adhesive pvc tape 33m, add £1 post if not collecting

OVER 400 GIFTS YOU CAN CHOOSE FROM

There is a total of over 400 packs in our Baker's dozen range and you become entitled to a free gift with each dozen pounds you spend on these packs.

A classified list of these packs and our latest "News Letter" will be enclosed with your goods, and you will automatically receive our next news letter.



£5 POUNDERS*

- 5P1 12 volt submersible pump complete with a tap and switch, an ideal caravan unit.
- 5P2 Sound to light kit complete in case suitable for up to 750 watts.
- 5P8 12V alarm bell with heavy 6" gong, suitable for outside if protected from direct rainfall. Ex GPO but in perfect order.
- 5P12 Equipment cooling fan - mini small type mains operated.
- 5P13 Ping pong ball blower - or for any job that requires a powerful stream of air - ex computer. Collect or add £2 post.
- 5P15 - Unselector 4 pole, 25 way 50 volt coil
- 5P18 - motor driven water pump as fitted to many washing machines
- 5P20 - 2 kits, matchbox size, surveillance transmitter and FM receiver
- 5P23 - miniature (appr. 2 1/2" wide) tangential blow heater, 1-2kw
- 5P24 - 1/2 hp motor, ex computer, 230V, mains operation 1450rpm. If not collect add £3 post
- 5P25 - special effects lighting switch. Up to 8 channels of lamps can be on or off for varying time periods
- 5P27 - cartridge player 12V, has high quality stereo amplifier
- 5P34 - 24V 5A toroidal mains transformer
- 5P35 - modem board from telephone auto dealer, complete with keypad and all ICs
- 5P37 - 24 hour time switch, 2 on/off's and clockwork reserve, ex Elec. Board loading up to 50A. Add £1 post
- 5P41 - 5" extractor fan, very quiet runner (s.h.), grid 12 mths.
- 5P48 - telephone extension bell in black case, ex-GPO
- 5P52 - mains transformer 26V 10A upright mounting, add £2 post
- 5P54 - mains motor with gear box, final speed 5rpm
- 5P58 - Amstrad stereo tuner FM and LM. AM
- 5P60 - DC Muffin type fan 18 to 27v, only 3W
- 5P61 - drill pump mounted on frame, coupled to mains motor
- 5P62 - 2 1/2 kw tangential blow heater, add £1.50 post if not collecting
- 5P73C high pressure mains operated gas or water valve with tube connection suitable soldering
- 5P74 8rpm 60W mains motor and gearbox with instant stop
- 5P79 30rpm 60 watt mains driven motor with gearbox
- 5P82 1 25rpm mains 80w motor with gearbox
- 5P84 1 delay time switch, adjust 0-20 seconds
- 5P89 1 light box size 14" x 12" for circuit tracing pcb's. Add £3 for postage and packing
- 5P72 1 turntable for vdu or scope
- 5P81 1 stepper motor bi-directional, 7.5" steps 12-14V coil
- 5P86 1 mains transformer with 2 x 100V 1A secondaries. Add £1.50 post
- 5P88 1 24V 5A mains transformer in waterproof case, ideal for garden lighting, pond pump etc.

LIGHT CHASER KIT motor driven switch bank with connection diagram, used in connection with 4 sets of xmas lights makes a very eye catching display for home, shop or disco, only £5 ref 5P56.

RADIO COMMUNICATIONS

Ageing enthusiasts

The number of UK licensed radio amateurs increased spectacularly in the early 1980s, partly because of the ready availability of effective medium-priced transceivers, partly as a result of the publicity surrounding the introduction of Citizen's Band radio into the UK and the subsequent realization that legal c.b. was primarily a short-range service more suited to base/car, base/handheld or handheld/handheld communications than talking to people in other countries. This became more evident with the decline of sunspot cycle 21, with 27 MHz suitable for ionospheric reflection only for limited periods and seasons, mainly by means of unpredictable Sporadic E reflection.

The number of valid c.b. licences has fallen to about one-third of the number reached during the first year of 1982-83. But there has also been a significant decline in the number of new amateur radio licences being issued, although the total of valid licences (not necessarily all active) has remained relatively steady during the past couple of years. Importers of amateur radio equipment report sales roughly about half of the peak reached in the early 1980s, although the unit-cost of equipment has risen significantly with the continuing strengthening of the Yen exchange-rate. Equipment costs except for those prepared to buy secondhand or build simple equipment is proving a barrier for youngsters and indeed the hobby itself now seems

to be losing much of its appeal to teenagers. One result is that the average age of those still active on the amateur bands or attending local club meetings seems to be rising.

This trend seems likely to be increased still further by the recent (welcome) policy changes introduced by the Department of Trade & Industry as the licensing authority. During 1986, it was agreed that a pass in the 12 words per minute Morse Test for Class A licences remains valid for life. Since the beginning of this year it has similarly been agreed for anyone who can prove conclusively that they have ever held a UK amateur licence, including all pre-war amateurs who never had to take the Radio Amateurs Examination and also the immediate post-war licences issued to those with Service or civilian qualifications that exempted them from the written RAE and/or the Morse test. There must be many thousands of such lapsed amateurs still retaining an interest in the hobby (or at least in the hobby as it was in the days before the dominance of the factory-built black boxes).

It has always been the case that many who obtain licences while young tend to find their hobby activities restricted by increasing family or business responsibilities and let their licences lapse, but have been put off re-applying in later life by the prospect of having to retake one or both of the examinations. Now, by applying in writing, fully supported by firm documentary evidence of their having previously held a licence, the call sign then held, and all changes of address notified to the licensing

authority while the licence remained valid, date of original issue of the licence, proof of identity etc., it is possible to have the licence and usually the original call sign re-issued.

Applications have to be made in writing, with the necessary documentation, to DTI Radiocommunications Division, Amateur Radio Section, Room 613, Waterloo Bridge House, Waterloo Road, London SE1 8UA.

Data privacy

Legislative procedures in one's own country always seem tortuous and opaque – those of other countries just plain unfathomable. This is my excuse for having suggested (*Radio Communications*, March 1987) that President Reagan had failed to ratify the "Electronic Communication Privacy Act". In fact, although the Senate Bill S-2575 did lapse, a parallel House of Representatives Bill was duly ratified and became US law last October. As it now stands, the Act makes it illegal to access an electronic mailbox without authorization, including protection against government access without a court order. At least in theory, it gives all persons and organizations using electronic mail and data communications a similar right to privacy as already exists for telephones and the US mails, protecting data and on-line computers from industrial espionage, "private eyes" and amateur "hackers". But, as noted in the March issue, the original intention of restricting casual listening even to "readily accessible" radio transmissions appears to have been much watered down.

The high cost of government "security" equipment, a term that generally includes surveillance, cryptanalysis as well as cryptographic systems and secure communications equipment, and the practice in many countries of burying the costs in general government defence budgets, was underlined by the Project Zircon row. In the USA, it has been estimated that the federal market for security equipment required by some 28 US government agencies has already climbed to over £1-

billion per annum and will double in the next few years, without counting the cost of shielding equipment in order to conform with "Tempest" requirements, or the classified projects whose costs, like Zircon, are hidden in various budgets.

World of radio data

Both "radio teletext" based on American SCA technology and the European "radio data system (RDS)" are due to be operational in the UK before long, with radio teletext using the Telerate data system due to start in the London area any day now. It is clear that radio teletext, offering subscription services of financial information, will function primarily as a business and professional aid based on compact pocket special-purpose v.h.f. receivers. The initial purpose of the more sophisticated RDS will be for automatic switching and control of car radios, and then for positive station identification.

A specialist group of the European Broadcasting Union is currently preparing "Guidelines for the implementation of the RDS system" due to be published this year. The group is also collaborating with European set makers and the transport ministries in considering the possibilities of using the system for the transmission of comprehensive information to motorists. This could be done, for example, by the transmission of coded and/or uncoded digital data based on international vocabularies with the messages conveyed by a speech synthesizer or possibly using a compact printer. The driver would simply select the appropriate language channel. Such a service would require set makers to fit a suitable interface connector on all new receivers incorporating an RDS decoder in order to allow peripheral devices to be plugged in.

Work has also started with a view to providing some of the features of RDS on medium- and long-wave a.m. transmissions to support automatic tuning and station identification.

Radio Broadcast was compiled by PAT HAWKER.



RESEARCH NOTES

Speed record for digital gallium arsenide

Scientists at GMHE/Hughes Aircraft Co. have reported a divide-by-two counter chip that will run at just over 18 GHz without the need for cryogenics. This comfortably exceeds the previous record for digital GaAs chips of 13 GHz, established in 1984 by AT&T Bell Laboratories.

The Hughes chip achieves its performance by means of a number of advances, both in circuit configuration and fabrication techniques. Metal-semiconductor (mesfet) technology avoids the cryogenic requirement of high electron mobility transistors (hemts); and buffered fet logic, based on depletion mode active devices, contributes to the high speed of operation. As for fabrication, the use of direct-write electron beam lithography allows for minimum chip dimensions as small as 0.2µm. Active regions down to 700Å are formed by molecular beam epitaxy using a technique being developed for the US Navy.

At the moment, the mesfet logic requires level-shifting circuitry, which demands a high power consumption – 657mW per divider – but work is in progress to bring this within more acceptable limits.

Electronic vehicle testing

Electronic devices in modern vehicles now feature in engine and transmission management systems, door locks, brakes, air conditioning, instrumentation and even mirror adjustment. Suspension, steering and navigation are now following. The problem is that some of these devices may be sensitive to external electromagnetic interference. At the same time, the devices themselves may also have an effect on other vehicles or interfere with radios, radio telephones and televisions.

To find out more about the problems and also to develop ways in which car electronics can be protected from interference, an £800,000 test chamber has been built by Gaydon Technol-

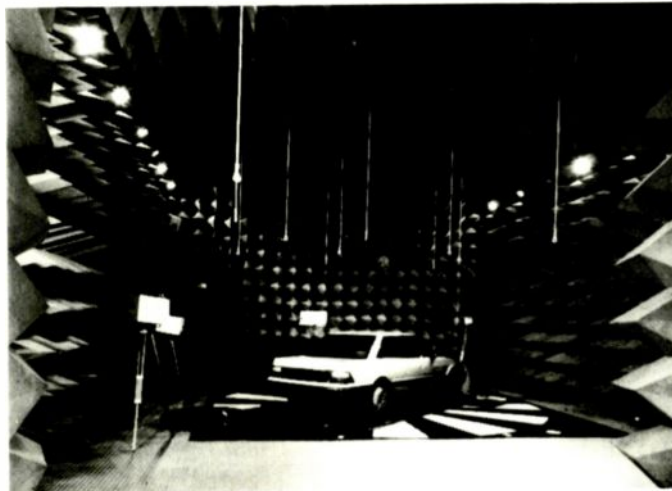

ogy at its proving ground in Warwickshire.

Gaydon Technology is a subsidiary of the Rover Group and is one of the UK motor industry's major research and development companies. Its latest facility comprises a completely closed room, screened to prevent outside interference, in which whole vehicles or components are bombarded with radio signals across a well-defined frequency range to test their proper functioning under running conditions. Within the chamber is a complete motorized turntable assembly and vehicle chassis dynamometer. This unique combination allows the test vehicle to 'drive' under simulated road conditions at any position. It can rotate a full 360 degrees in either direction.

Until now, there has been no special automotive test chamber in the UK, equipped with a chassis dynamometer, allowing vehicles to be tested for malfunction under load. It is believed that the Gaydon installation is the first dedicated vehicle chamber of this type in Europe.

Quantum chips?

A healthy sign that industry and fundamental research are not so far apart comes with news of some progress in quantum mechanics from Hitachi. What they've done is adapt a technique called electron holography to demonstrate the validity of a concept known as the Aharanov-Bohm effect. This effect, postulated in 1959, predicts on the basis of quantum theory that

electron beams passing either side of a magnetic field will be influenced by the field, even though they don't actually pass through it. This, of course, contradicts classical physics which says that electrons are only influenced by the direct effects of electric or magnetic fields.

Until now, it hasn't been possible to demonstrate the Aharanov-Bohm effect because of the sheer practical difficulties of limiting the extent of a magnetic field. Another difficulty is that of measuring the very tiny effect predicted.

The Hitachi engineers modified an electron holography system in which a split beam of electrons follows separate paths before being combined to produce an image on a target. Any disturbance to one beam – however tiny – produces a significant change in the image.

The really ingenious part of the exercise, however, consisted of creating a magnet with no external field. This was done by surrounding a magnetic alloy with a layer of superconducting niobium at the temperature of liquid helium (-270°C). Just to make sure that there were no residual electric fields, the whole assembly was sheathed in copper.

When this shielded magnet was brought near one of the electron beams in the holography apparatus it was found that the beam was indeed perturbed. Of course others will want to repeat the experiment just to be sure. But if such quantum effects do exist, then they aren't entirely without practical application. As chip etching techniques improves it will soon be possible to create details of micron size

where quantum effects could make a significant difference. Unless such effects are understood and controlled, they could well lead to unexplained performance anomalies.

Battery on a chip

Work undertaken by Dr Brian Nevett of the Department of Physical Sciences at Brighton Polytechnic together with Dr Peter Foot, now at Thames Polytechnic, is likely to lead to a commercially viable solid-state rechargeable lithium battery. Although many lithium couples have been tested with polymer electrolytes, there have been problems either with mechanical or electrical stability of the whole system, especially the cathode.

One ideal re-chargeable cathode is nickel phosphorus trisulphide (NiPS₃), though up till now it has proved impractically expensive to produce. The standard method is to heat the raw elements in a vacuum at over 800°C for a week or more.

Drs Nevett and Foot, with the help of the British Technology Group, have now developed a method of producing amorphous NiPS₃ at room temperature and then modifying this for cathode use by a relatively short process of heat treatment. This method not only works well but the NiPS₃ can easily be painted on to a nickel surface to make a practical cathode.

A NiPS₃ cathode, together with a solid polymer electrolyte and lithium anode, forms a system with between three and five times the energy density of a lead acid accumulator. It can also be constructed in a fashion more akin to that of chip manufacture by depositing successive layers of material on a substrate. This in turn has given the Brighton group the idea of combining a battery with a memory chip. Either the chip could be printed on the battery surface or the battery materials incorporated into the chip structure. Such a chip would then for all practical purposes be non-volatile.

Enquiries have already come from a number of interested companies.

Research Notes is written by John Wilson.

BBC Computer & Econet Referral Centre

AMB15 BBC MASTER £385 (a)		AMB12 BBC MASTER Econet £315 (a)	
AMC06 Turbo (65C - 02) Expansion Module..... £99 (b)			
ADC08	512 Processor..... £195 (b)	ADJ24	Advanced Ref Manual..... £19.50 (c)
ADF14	Rom Cartridge..... £13 (b)	ADF10	Econet Module..... £41 (c)
ADJ22	Ref Manual Part 1..... £14 (c)	ADJ23	Ref Manual Part II..... £14 (c)
			BBC Master Dust Cover..... £4.75 (d)
BBC MASTER COMPACT			
A free packet of ten 3.5" DS discs with each Compact			
SYSTEM 1 128K Single 640K Drive and bundled software £385 (a)			
SYSTEM 2 System 1 with a 12" Hi Res RGB Monitor £469 (a)			
SYSTEM 3 System 1 with a 14" Med Res RGB Monitor £599 (a)			
Second Drive Kit £99 (c) Extension Cable for ext 5.25" drive £12.50 (d)			
View 3.0 User Guide £10 (d)		Viewsheet User Guide £10 (d)	
BBC Dust Cover £4.50 (d)		1770 DFS Upgrade for Model B £43.50 (d)	
ADFS ROM (for B with 1770 DFS & B Plus) £26 (d)		1.2 OS ROM £15 (d)	
ACORN Z80 2nd Processor £329 (a)		Universal 2nd Processor £75 (b)	
MULTIFORM Z80 2nd Processor £289 (b)		ACORN IEEE Interface £265 (a)	
TORCH Z80 2nd Processor ZEP 100..... £229 (a)			
TZDP 240 ZEP 100 with Technomatic PD800P dual drive with built-in monitor stand..... £439 (a)			

META Version III - The only package available in the micro market that will assemble 27 different processors at the price offered. Supplied on two 16K roms and two discs and fully compatible with all BBC models. Please phone for comprehensive leaflet £145 (b).

We stock the full range of ACORN hardware and firmware and a very wide range of other peripherals for the BBC. For detailed specifications and pricing please send for our leaflet.

PRINTERS & PLOTTERS

EPSON		STAR NL10 (Parallel Interface)..... £209 (a)
EPSON LX-86..... £199 (a)		STAR NL10 (Serial Interface)..... £279 (a)
Optional Tractor Feed LX80/86..... £20 (c)		STAR Power Type
Sheet Feeder LX80/86..... £49 (c)		(Daisy Wheel)..... £229 (a)
FX800..... £329 (a)		BROTHER HR20..... £329 (a)
FX1000..... £449 (a)		COLOUR PRINTERS
EX800..... £409 (a)		Integrex Jet Printer..... £549 (a)
LQ800 (80 col)..... £439 (a)		Dotprint Plus NLO Rom for
LQ1000..... £589 (a)		Epson versions for FX, RX, MX and GLP..... £28 (d)
TAXAN		PLOTTERS
KP815 (160 cps)..... £269 (a)		Taxan A3 (6 col. flat bed)..... £679 (a)
KP915 (180 cps)..... £369 (a)		Hitachi 672..... £459 (a)
JUKI		Graphics Workstation (A3 Plotter)..... £599 (a)
6100 (Daisy Wheel)..... £259 (a)		Piomatic A4SM..... £450 (a)
NATIONAL PANASONIC		
KX P1080 (80 col)..... £159 (a)		
KX P 3132 (32K buffer)..... £249 (a)		

PRINTER ACCESSORIES

We hold a wide range of printer attachments (sheet feeders, tractor feeds etc) in stock. Serial, parallel, IEEE and other interfaces also available. Ribbons available for all above plotters. Pens with a variety of tips and colours also available. Please phone for details and prices.

Plain Fanfold Paper with extra fine perforation (Clean Edge):
 2000 sheets 9.5" x 11" £13(b) 2000 sheets 14.5" x 11" £18.50(b)
 Labels per 1000s: Single Row 3" x 1 7/16" £5.25(d) Triple Row 2-7/16" x 1 7/16" £5.00(d)

MODEMS

All modems carry a full BT approval

MIRACLE TECHNOLOGY WS Range

WS4000 V21/23 (Hayes Compatible, Intelligent, Auto Dial/Auto Answer)..... £169 (b)

WS3000 V21/23 Professional As WS4000 and with BELL standards and battery back up for memory..... £295 (b)

WS3000 V22 Professional As WS3000 V21/23 but with 1200 baud full duplex..... £495 (a)

WS3000 V22 bis Professional As V22 and 2400 baud full duplex..... £650 (a)

WS3022 V22 Professional As WS3000 but with only 1200/1200..... £395 (a)

WS3024 V22 Professional As WS3000 but with only 2400/2400..... £570 (b)

WS2000 V21/V23 Manual Modem..... £95 (b)

DATA Cable for WS series/PC or XT..... £10 (d)

DATATALK Comms Package
 * If purchased with any of the above modems *..... £70 (c)

PACE Nightingale Modem V21/V23 Manual..... £75 (b)
 (Offer limited to current stocks)

SOFTY II

This low cost intelligent eeprom programmer can program 2716, 2516, 2532, 2732, and with an adaptor, 2564 and 2764. Displays 512 byte page on TV has a serial and parallel I/O routines. Can be used as an emulator, cassette interface. Softy II..... £195.00(b)
 Adaptor for 2764/2564..... £25.00

SPECIAL OFFER

2764-25 £2.50 (d);
 27128-25 £2.75 (d);
 6264 LP-15 £2.80 (d);

RT256 3 PORT SWITCHOVER SERIAL INTERFACE
 3 input/1 output or 1 input/3 output manual channel selection. Input/output baud rates, independently selectable 7 bit/8 bit, odd/even/none parity. Hardware or software handshake. 256K buffer, mains powered..... £375 (b)

PB BUFFER
 Internal buffer for most Epson printers. Easy to install, Inst. supplied..... £99 (c)

PB128 128K..... £99 (c)

I.D. CONNECTORS

(Speedblock Type)			
Header	Recep	Edge Conn	
Plug	Jack	Conn	
90p	85p	120p	
145p	125p	195p	
175p	150p	240p	
200p	160p	320p	
220p	190p	340p	
235p	200p	390p	

D CONNECTORS

No of Ways				
	9	15	25	37
MALE:				
Ang Pins	120	180	230	350
Solder	60	85	125	170
IDC	175	275	325	-
FEMALE:				
St Pin	100	140	210	380
Ang Pins	160	210	275	440
Solder	90	130	195	290
IDC	195	325	375	-
St Hood	90	95	100	120
Screw	130	150	175	-
Lock				

TEXT TOOL ZIF

SOCKETS	24-pin £7.50
28-pin £9.10	40-pin £12.10

DISC DRIVES

5.25" Single Drives 40/50 switchable:	
TS400 400K/640K.....	£114 (b)
PS400 400K/640K with integral mains power supply.....	£129 (b)
5.25" Dual Drives 40/80 switchable:	
TD800 800K/1280K.....	£199 (a)
PD800 800K/1280K with integral mains power supply.....	£229 (a)
PD800P 800K/1280K with integral mains power supply and monitor stand.....	£249 (a)
3.5" 80T DS Drives:	
TS351 Single 400K/640K.....	£75 (b)
PS351 Single 400K/640K with integral mains power supply.....	£119 (b)
TD352 Dual 800K/1280K.....	£135 (b)
PD352 Dual 800K/1280K with integral mains power supply.....	£187 (b)
PD853 Combo Dual 5.25"/3.5" drive with p.s.u.....	£229 (a)

3M FLOPPY DISCS

Industry Standard floppy discs with a lifetime guarantee. Discs in packs of 10

5 1/4" Discs		3 1/2" Discs	
40 T SS DD..... £10.00 (d)	40 T DS DD..... £12.00 (d)	80 T SS DD..... £20.00 (d)	
80 T SS DD..... £14.50 (d)	80 T DS DD..... £15.50 (d)	80 T DS DD..... £25.00 (d)	

FLOPPICLENE DRIVEHEAD CLEANING KIT

FLOPPICLENE Disc Head Cleaning Kit with 28 disposable cleaning discs ensures continued optimum performance of the drives. 5 1/4" £12.50 (d) 3 1/2" £14.00 (d)

DRIVE ACCESSORIES

Single Disc Cable £6 (d)	Dual Disc Cable £8.50 (d)
10 Disc Library Case £1.80 (d)	30 x 5 1/2" Disc Storage Box £6 (c)
50 x 5 1/2" Disc Lockable Box £9.00 (c)	100 x 5 1/2" Disc Lockable Box £13 (c)

MONITORS

RGB 14"		MONOCHROME
1431 Std Res..... £179 (a)		TAXAN 12" HI-RES
1451 Med Res..... £225 (a)		KX1201G green screen..... £85 (a)
1441 Hi Res..... £365 (a)		KX1203A amber screen..... £95 (a)
MICROVITEC 14" RGB/PAL/Audio		PHILIPS 12" HI-RES
1431AP Std Res..... £199 (a)		BM7502 green screen..... £75 (a)
1451AP Std Res..... £259 (a)		BM7522 amber screen..... £79 (a)
All above monitors available in plastic or metal case.		8501 RGB Std Res..... £139 (a)
TAXAN SUPERVISION 620		ACCESSORIES
12" Hi Res with amber/green options.		Microvitec Swivel Base..... £20 (c)
IBM compatible..... £279 (a)		Taxan Mono Swivel Base with clock..... £22 (c)
Taxan Supervision 625..... £329 (a)		Philips Swivel Base..... £14 (c)
MITSUBISHI		BBC RGB Cable..... £5 (d)
XC1404 14" Med Res RGB, IBM & BBC compatible..... £219 (a)		Microvitec..... £3.50 (d)
		Taxan £5 (d) Monochrome £3.50 (d)
		Touchtec - 501..... £239 (b)

ERASERS

UV1T Eraser with built-in timer and mains indicator. Built-in safety interlock to avoid accidental exposure to the harmful UV rays. It can handle up to 5 erasings at a time with an average erasing time of about 20 mins. £59 + £2 p&p. UV1 as above but without the timer. £47 + £2 p&p. For Industrial Users, we offer UV140 & UV141 erasers with handling capacity of 14 erasings. UV141 has a built in timer. Both offer full built in safety features UV140 £69, UV141 £85, p&p £2.50.

EXT SERIAL/PARALLEL CONVERTERS

Mains powered converters
 Serial to Parallel..... £48 (c)
 Parallel to Serial..... £48 (c)
 Bidirectional Converter..... £105 (b)

Serial Test Cable

Serial Cable switchable at both ends allowing pin options to be re-routed or linked at either end - making it possible to produce almost any cable configuration on site. Available as M/M or M/F..... £24.75 (d)

Serial Mini Patch Box

Allows an easy method to reconfigure pin functions without rewiring the cable assay. Jumpers can be used and reused..... £22 (d)

Serial Mini Test

Monitors RS232C and CCITT V24 Transmissions, indicating status with dual colour LEDs on 7 most significant lines. Connects in Line..... £22.50 (d)

CONNECTOR SYSTEMS

I.D. CONNECTORS

(Speedblock Type)			
Header	Recep	Edge Conn	
Plug	Jack	Conn	
90p	85p	120p	
145p	125p	195p	
175p	150p	240p	
200p	160p	320p	
220p	190p	340p	
235p	200p	390p	

D CONNECTORS

No of Ways				
	9	15	25	37
MALE:				
Ang Pins	120	180	230	350
Solder	60	85	125	170
IDC	175	275	325	-
FEMALE:				
St Pin	100	140	210	380
Ang Pins	160	210	275	440
Solder	90	130	195	290
IDC	195	325	375	-
St Hood	90	95	100	120
Screw	130	150	175	-
Lock				

TEXT TOOL ZIF

SOCKETS	24-pin £7.50
28-pin £9.10	40-pin £12.10

EDGE CONNECTORS

	01	0156
2 x 6-way (commadore)	-	300p
2 x 10-way	150p	-
2 x 12-way (vic 20)	-	350p
2 x 18-way	-	140p
2 x 23-way (ZX81)	175p	220p
2 x 25-way	225p	220p
2 x 28-way (Spectrum)	200p	-
2 x 36-way	250p	-
1 x 43-way	260p	-
2 x 22-way	190p	-
2 x 43-way	395p	-
1 x 77-way	400p	500p
2 x 50-way (S100conn)	600p	-

EURO CONNECTORS

DIN	Plug	Skt
41612	230p	275p
2 x 32 way St Pin	275p	320p
3 x 32 way St Pin	260p	300p
3 x 32 way Ang Pin	375p	400p
IDC Skt A + B	400p	-
IDC Skt A + C	400p	-

For 2 x 32 way please specify spacing (A + B, A + C).

AMPHENOL CONNECTORS

36 way plug Centronics (solder) 500p (IDC) 475p
36 way skt Centronics (solder) 550p (IDC) 500p
24 way plug IEEE (solder) 475p (IDC) 475p
24 way skt IEEE (solder) 500p (IDC) 500p
PCB Mtg Skt Ang Pin
24 way 700p 36 way 750p

GENDER CHANGERS
 25 way D type

Male to Male..... £10
Male to Female..... £10
Female to Female..... £10

RS 232 JUMPERS

(25 way D)	
24 Single end Male.....	£5.00
24 Single end Female.....	£5.25
24 Female Female.....	£10.00
24 Male Male.....	£9.50
24 Male Female.....	£9.50

DIL SWITCHES

4-way 90p	6-way 105p
8-way 120p	10-way 150p

RIBBON CABLE

(grey/metre)			
10-way	40p	34-way	160p
16-way	60p	40-way	180p
20-way	85p	50-way	200p
26-way	120p	64-way	280p

DIL HEADERS

Solder			IDC		
14 pin	40p	100p	14 pin	40p	100p
16 pin	50p	110p	16 pin	50p	110p
18 pin	60p	-	18 pin	60p	-
20 pin	75p	-	20 pin	75p	-
24 pin	100p	150p	24 pin	100p	150p
28 pin	160p	200p	28 pin	160p	200p
40 pin	200p	225p	40 pin	200p	225p

ATTENTION
 All prices in this double page advertisement are subject to change without notice. ALL PRICES EXCLUDE VAT Please add carriage 50p unless indicated as follows: (a) £8 (b) £2.50 (c) £1.50 (d) £1.00

74 SERIES		74C SERIES		4076 0.65		LINEAR ICs		COMPUTER COMPONENTS	
7400 0.30	74273 2.00	74LS273 1.25	74C00 0.70	4076 0.25	AD7581 12.00	LM710 0.48	TA8231 1.80	1802CE 6.50	TMS4500 14.00
7401 0.30	74276 1.40	74LS279 0.70	74C04 0.50	4077 0.25	ADC0808 11.00	LM711 1.00	TBA800 1.20	2550A 6.50	TMS9901 5.00
7402 0.30	74279 0.90	74LS280 1.90	74C08 0.50	4081 0.24	AN1030C 25.00	LM723 0.60	TBA810 0.80	6502 4.50	TMS9902 5.00
7403 0.30	74283 1.05	74LS283 0.80	74C10 0.70	4082 0.25	AN1703 20.00	LM725 0.60	TBA820 0.90	65C02-2MHZ 12.00	TMS9911 8.00
7404 0.30	74287 1.30	74LS290 0.80	74C14 0.50	4086 1.75	AV-1-3550 3.50	LM733 0.65	TBA820M 0.75	Z8001A 14.00	TMS9912 8.00
7405 0.30	74290 0.90	74LS291 0.80	74C20 0.70	4093 0.35	AV-3-8910 4.80	LM747 0.70	TBA820M 0.75	Z8002 2.00	Z8001A 14.00
7406 0.40	74298 1.80	74LS292 1.40	74C32 1.00	4095 0.95	CA3012 5.00	LM749 0.70	TBA820M 0.75	Z8003 2.00	Z8001A 14.00
7407 0.40	74301 2.00	74LS298 1.00	74C42 1.50	4096 0.95	CA3019 5.00	LM749 0.70	TBA820M 0.75	Z8004 2.00	Z8001A 14.00
7408 0.30	74365A 0.80	74LS299 2.20	74C48 1.50	4097 2.70	CA3020 3.50	LM749 0.70	TBA820M 0.75	Z8005 2.00	Z8001A 14.00
7409 0.30	74366A 0.80	74LS321 3.70	74C73 1.00	4098 0.75	CA3028A 1.10	LM749 0.70	TBA820M 0.75	Z8006 2.00	Z8001A 14.00
7410 0.30	74367A 0.80	74LS323 3.00	74C74 1.20	4099 0.99	CA3046 0.70	LM749 0.70	TBA820M 0.75	Z8007 2.00	Z8001A 14.00
7411 0.30	74376 1.60	74LS324 3.20	74C76 1.00	4101 1.25	CA3059 3.25	LM749 0.70	TBA820M 0.75	Z8008 2.00	Z8001A 14.00
7412 0.30	74390 1.10	74LS328 2.00	74C83 2.00	4102 0.80	CA3060 0.90	LM749 0.70	TBA820M 0.75	Z8009 2.00	Z8001A 14.00
7413 0.50	74393 1.20	74LS352 1.20	74C86 2.25	4103 0.80	CA3085 1.50	LM749 0.70	TBA820M 0.75	Z8010 2.00	Z8001A 14.00
7414 0.70	74490 1.40	74LS353 1.20	74C90 1.90	4104 0.60	CA3086 0.60	LM749 0.70	TBA820M 0.75	Z8011 2.00	Z8001A 14.00
7415 0.36		74LS355 2.10	74C93 1.50	4105 1.00	CA3086 0.60	LM749 0.70	TBA820M 0.75	Z8012 2.00	Z8001A 14.00
7416 0.36		74LS355 2.10	74C95 1.00	4106 0.80	CA3086 0.60	LM749 0.70	TBA820M 0.75	Z8013 2.00	Z8001A 14.00
7417 0.40		74LS355 2.10	74C95 1.00	4107 0.55	CA3086 0.60	LM749 0.70	TBA820M 0.75	Z8014 2.00	Z8001A 14.00
7418 0.30		74LS355 2.10	74C95 1.00	4108 0.80	CA3086 0.60	LM749 0.70	TBA820M 0.75	Z8015 2.00	Z8001A 14.00
7419 0.30		74LS355 2.10	74C95 1.00	4109 0.80	CA3086 0.60	LM749 0.70	TBA820M 0.75	Z8016 2.00	Z8001A 14.00
7420 0.30		74LS355 2.10	74C95 1.00	4110 2.25	CA3086 0.60	LM749 0.70	TBA820M 0.75	Z8017 2.00	Z8001A 14.00
7421 0.60		74LS355 2.10	74C95 1.00	4111 2.25	CA3086 0.60	LM749 0.70	TBA820M 0.75	Z8018 2.00	Z8001A 14.00
7422 0.36		74LS355 2.10	74C95 1.00	4112 2.80	CA3086 0.60	LM749 0.70	TBA820M 0.75	Z8019 2.00	Z8001A 14.00
7423 0.36		74LS355 2.10	74C95 1.00	4113 2.80	CA3086 0.60	LM749 0.70	TBA820M 0.75	Z8020 2.00	Z8001A 14.00
7424 0.36		74LS355 2.10	74C95 1.00	4114 2.80	CA3086 0.60	LM749 0.70	TBA820M 0.75	Z8021 2.00	Z8001A 14.00
7425 0.40		74LS355 2.10	74C95 1.00	4115 2.80	CA3086 0.60	LM749 0.70	TBA820M 0.75	Z8022 2.00	Z8001A 14.00
7426 0.40		74LS355 2.10	74C95 1.00	4116 2.80	CA3086 0.60	LM749 0.70	TBA820M 0.75	Z8023 2.00	Z8001A 14.00
7427 0.32		74LS355 2.10	74C95 1.00	4117 2.80	CA3086 0.60	LM749 0.70	TBA820M 0.75	Z8024 2.00	Z8001A 14.00
7428 0.43		74LS355 2.10	74C95 1.00	4118 2.80	CA3086 0.60	LM749 0.70	TBA820M 0.75	Z8025 2.00	Z8001A 14.00
7429 0.30		74LS355 2.10	74C95 1.00	4119 2.80	CA3086 0.60	LM749 0.70	TBA820M 0.75	Z8026 2.00	Z8001A 14.00
7430 0.30		74LS355 2.10	74C95 1.00	4120 2.80	CA3086 0.60	LM749 0.70	TBA820M 0.75	Z8027 2.00	Z8001A 14.00
7431 0.30		74LS355 2.10	74C95 1.00	4121 2.80	CA3086 0.60	LM749 0.70	TBA820M 0.75	Z8028 2.00	Z8001A 14.00
7432 0.36		74LS355 2.10	74C95 1.00	4122 2.80	CA3086 0.60	LM749 0.70	TBA820M 0.75	Z8029 2.00	Z8001A 14.00
7433 0.30		74LS355 2.10	74C95 1.00	4123 2.80	CA3086 0.60	LM749 0.70	TBA820M 0.75	Z8030 2.00	Z8001A 14.00
7434 0.30		74LS355 2.10	74C95 1.00	4124 2.80	CA3086 0.60	LM749 0.70	TBA820M 0.75	Z8031 2.00	Z8001A 14.00
7435 0.30		74LS355 2.10	74C95 1.00	4125 2.80	CA3086 0.60	LM749 0.70	TBA820M 0.75	Z8032 2.00	Z8001A 14.00
7436 0.30		74LS355 2.10	74C95 1.00	4126 2.80	CA3086 0.60	LM749 0.70	TBA820M 0.75	Z8033 2.00	Z8001A 14.00
7437 0.30		74LS355 2.10	74C95 1.00	4127 2.80	CA3086 0.60	LM749 0.70	TBA820M 0.75	Z8034 2.00	Z8001A 14.00
7438 0.40		74LS355 2.10	74C95 1.00	4128 2.80	CA3086 0.60	LM749 0.70	TBA820M 0.75	Z8035 2.00	Z8001A 14.00
7439 0.40		74LS355 2.10	74C95 1.00	4129 2.80	CA3086 0.60	LM749 0.70	TBA820M 0.75	Z8036 2.00	Z8001A 14.00
7440 0.40		74LS355 2.10	74C95 1.00	4130 2.80	CA3086 0.60	LM749 0.70	TBA820M 0.75	Z8037 2.00	Z8001A 14.00
7441 0.90		74LS355 2.10	74C95 1.00	4131 2.80	CA3086 0.60	LM749 0.70	TBA820M 0.75	Z8038 2.00	Z8001A 14.00
7442 0.70		74LS355 2.10	74C95 1.00	4132 2.80	CA3086 0.60	LM749 0.70	TBA820M 0.75	Z8039 2.00	Z8001A 14.00
7443 0.30		74LS355 2.10	74C95 1.00	4133 2.80	CA3086 0.60	LM749 0.70	TBA820M 0.75	Z8040 2.00	Z8001A 14.00
7444 0.30		74LS355 2.10	74C95 1.00	4134 2.80	CA3086 0.60	LM749 0.70	TBA820M 0.75	Z8041 2.00	Z8001A 14.00
7445 0.30		74LS355 2.10	74C95 1.00	4135 2.80	CA3086 0.60	LM749 0.70	TBA820M 0.75	Z8042 2.00	Z8001A 14.00
7446 0.30		74LS355 2.10	74C95 1.00	4136 2.80	CA3086 0.60	LM749 0.70	TBA820M 0.75	Z8043 2.00	Z8001A 14.00
7447 0.30		74LS355 2.10	74C95 1.00	4137 2.80	CA3086 0.60	LM749 0.70	TBA820M 0.75	Z8044 2.00	Z8001A 14.00
7448 0.30		74LS355 2.10	74C95 1.00	4138 2.80	CA3086 0.60	LM749 0.70	TBA820M 0.75	Z8045 2.00	Z8001A 14.00
7449 0.30		74LS355 2.10	74C95 1.00	4139 2.80	CA3086 0.60	LM749 0.70	TBA820M 0.75	Z8046 2.00	Z8001A 14.00
7450 0.36		74LS355 2.10	74C95 1.00	4140 2.80	CA3086 0.60	LM749 0.70	TBA820M 0.75	Z8047 2.00	Z8001A 14.00
7451 0.35		74LS355 2.10	74C95 1.00	4141 2.80	CA3086 0.60	LM749 0.70	TBA820M 0.75	Z8048 2.00	Z8001A 14.00
7452 0.36		74LS355 2.10	74C95 1.00	4142 2.80	CA3086 0.60	LM749 0.70	TBA820M 0.75	Z8049 2.00	Z8001A 14.00
7453 0.38		74LS355 2.10	74C95 1.00	4143 2.80	CA3086 0.60	LM749 0.70	TBA820M 0.75	Z8050 2.00	Z8001A 14.00
7454 0.38		74LS355 2.10	74C95 1.00	4144 2.80	CA3086 0.60	LM749 0.70	TBA820M 0.75	Z8051 2.00	Z8001A 14.00
7455 0.55		74LS355 2.10	74C95 1.00	4145 2.80	CA3086 0.60	LM749 0.70	TBA820M 0.75	Z8052 2.00	Z8001A 14.00
7456 0.55		74LS355 2.10	74C95 1.00	4146 2.80	CA3086 0.60	LM749 0.70	TBA820M 0.75	Z8053 2.00	Z8001A 14.00
7457 0.55		74LS355 2.10	74C95 1.00	4147 2.80	CA3086 0.60	LM749 0.70	TBA820M 0.75	Z8054 2.00	Z8001A 14.00
7458 0.55		74LS355 2.10	74C95 1.00	4148 2.80	CA3086 0.60	LM749 0.70	TBA820M 0.75	Z8055 2.00	Z8001A 14.00
7459 0.80		74LS355 2.10	74C95 1.00	4149 2.80	CA3086 0.60	LM749 0.70	TBA820M 0.75	Z8056 2.00	Z8001A 14.00
7460 0.55		74LS355 2.10	74C95 1.00	4150 2.80	CA3086 0.60	LM749 0.70	TBA820M 0.75	Z8057 2.00	Z8001A 14.00
7461 0.55		74LS355 2.10	74C95 1.00	4151 2.80	CA3086 0.60	LM749 0.70	TBA820M 0.75	Z8058 2.00	Z8001A 14.00
7462 0.55		74LS355 2.10	74C95 1.00	4152 2.80	CA3086 0.60	LM749 0.70	TBA820M 0.75	Z8059 2.00	Z8001A 14.00
7463 0.55		74LS355 2.10	74C95 1.00	4153 2.80	CA3086 0.60	LM749 0.70	TBA820M 0.75	Z8060 2.00	Z8001A 14.00
7464 0.55		74LS355 2.10	74C95 1.00	4154 2.80	CA3086 0.60	LM749 0.70	TBA820M 0.75	Z8061 2.00	Z8001A 14.00
7465 0.55		74LS355 2.10	74C95 1.00	4155 2.80	CA3086 0.60	LM749 0.70	TBA820M 0.75	Z8062 2.00	Z8001A 14.00
7466 0.55		74LS355 2.10	74C95 1.00	4156 2.80	CA3086 0.60	LM749 0.70	TBA820M 0.75	Z8063 2.00	Z8001A 14.00
7467 0.55		74LS355 2.10	74C95 1.00	4157 2.80	CA3086 0.60	LM749 0.70	TBA820M 0.75	Z8064 2.00	Z8001A 14.00
7468 0.55		74LS355 2.10	74C95 1.00	4158 2.80	CA3086 0.60	LM749 0.70	TBA820M 0.75	Z8065 2.00	Z8001A 14.00
7469 0.80		74LS355 2.10	74C95 1.00	4159 2.80	CA3086 0.60	LM749 0.70	TBA820M 0.75	Z8066 2.00	Z8001A 14.00
7470 0.55		74LS355 2.10	74C95 1.00	4160 2.80	CA3086 0.60	LM749 0.70	TBA820M 0.75	Z8067 2.00	Z8001A 14.00
7471 0.55		74LS355 2.10	74C95 1.00	4161 2.80	CA3086 0.60	LM749 0.70	TBA820M 0.75	Z8068 2.00	Z8001A 14.00
7472 0.45		74LS355 2.10	74C95 1.00	4162 2.80	CA3086 0.60	LM749 0.70	TBA820M 0.75	Z8069 2.00	Z8001A 14.00
7473 0.45		74LS355 2.10	74C95 1.00	4163 2.80	CA3086 0.60	LM749 0.70	TBA820M 0.75	Z8070 2.00	Z8001A 14.00
7474 0.50		74LS355 2.10	74C95 1.00	4164 2.80	CA3086 0.60	LM749 0.70	TBA820M 0.75	Z8071 2.00	Z8001A 14.00
7475 0.60		74LS355 2.10	74C95 1.00	4165 2.80	CA3086 0.60	LM749 0.70	TBA820M 0.75	Z8072 2.00	Z8001A 14.00
7476 0.45		74LS355 2.10	74C95 1.00	4166 2.80	CA3086 0.60	LM749 0.70	TBA820M 0.75	Z8073 2.00	Z8001A 14.00
7477 0.45		74LS355 2.10	74C95 1.00	4167 2.80	CA3086 0.60	LM749 0.70	TBA820M 0.75	Z8074 2.00	Z8001A 14.00
7478 0.65		74LS355 2.10	74C95 1.00	4168 2.80					

APPOINTMENTS

Advertisements
accepted up to
12 noon April 30
for June issue

DISPLAYED APPOINTMENTS VACANT: £23 per single col. centimetre (min. 3cm).
LINE advertisements (run on): £5 per line, minimum £40 (prepayable).
BOX NUMBERS: £11 extra. (Replies should be addressed to the Box Number in the advertisement, c/o Quadrant House, The Quadrant, Sutton, Surrey SM2 5AS).
PHONE: SUSAN PLATTS, 01-661 3033 (DIRECT LINE)

Cheques and Postal Orders payable to REED BUSINESS PUBLISHING and crossed.

Supervisory Engineers c£23,000

Channel Four is breaking
new ground in broadcasting

Channel Four broadcasts a wide range of programmes from its London transmission centre using the most sophisticated, computer-aided equipment.

We are looking for engineers who can identify with a progressive TV company committed to advanced technology.

You will direct a small team on a shift basis. Candidates should have extensive knowledge of video tape and telecine operations/maintenance supported by first class management ability. Engineering qualifications, although useful, will be less important than relevant experience.

This is a career opportunity in a forward-looking company.

Please apply with full C.V. including current salary to Personnel Department, Channel Four Television, 60 Charlotte Street, London W1P 2AX quoting the reference EG20.



Channel Four is an equal opportunities employer.

CHANNEL FOUR TELEVISION

COMMUNICATIONS MANAGER

£11,952 – £13,653

Devon Fire and Rescue Service has recently commissioned a £750,000 computer aided command and control system, consisting of live database linking through to fire station turnout on three communications bearers. The Service communication network extends through main scheme radio, hand-held radios, radio paging systems, administrative telephone networks and automatic fire alarm connections. Microwave links and data to and from mobiles are future developments.

The Service is seeking a self motivated, suitably experienced and qualified person to be responsible for the management of the communications system involving liaison with British Telecom and the Home Office Directorate of Telecommunications as principal suppliers (ONC/HNC Electrical and Electronic Engineering or C and G Telecommunications of MI Electrical and Electronic Incorporated Engineers etc).

Technical details, application form and job description from the Chief Fire Officer, Devon Fire and Rescue Service HQ, Clyst St George, Exeter EX3 0NW.

Closing date 30 April 1987

DEVON

AN EQUAL
OPPORTUNITIES
EMPLOYER



436

CAPITAL APPOINTMENTS LTD

THE UK's No. 1 ELECTRONICS AGENCY

If you have HNC/TEC or higher qualifications and are looking for a job in design, test, customer service, technical sales or similar fields:

Telephone now for our free jobs list
We have vacancies in all areas of the UK
Salaries to £15,000 pa

01 808 3050
(24 hours)

CAPITAL APPOINTMENTS LTD
76 WILLOUGHBY LANE, LONDON N17 0SF

(291)

Hardware/Software/Systems

£9,000 – £25,000

As a leading recruitment consultancy we have a wide selection of opportunities for high calibre Design, Development, Systems and supporting staff throughout the UK. If you have experience in any of the following then you should be talking to us for your next career move.

**ARTIFICIAL INTELLIGENCE * IMAGE PROCESSING * ANALOGUE DESIGN
MICRO HARDWARE & SOFTWARE * GUIDED WEAPONS * C * PASCAL
ADA * RF & MICROWAVE * ELECTRO-OPTICS * SIMULATION * C++
REAL TIME PROGRAMMING * SYSTEMS ENGINEERING * ACOUSTICS
SONAR * RADAR * SATELLITES * AVIONICS * CONTROL * ANTENNA
VLSI DESIGN**

Opportunities exist with National, International and consultancy companies offering excellent salaries and career advancement.

To be considered for these and other requirements contact John Spencer or Stephen Morley or forward a detailed CV in complete confidence quoting Ref. WW/66.



STS Recruitment, 85 High Street, Winchester,
Hants SO23 9AP. Tel: (0962) 69478 (24 hrs).

Radio & Telecoms Technicians Seeking a more simple lifestyle overseas?

The Overseas Development Administration provides a wide variety of assistance to countries in the developing world. Radio and Telecommunications skills are at a particularly high premium, and we can now offer opportunities for appropriately experienced professionals to take up important and rewarding roles overseas. Kiribati and the Solomon Islands will appeal to independent and self-reliant individuals who are keen to establish a simple and relaxed lifestyle.

Senior Radio Technician & Switching Technician Kiribati

Kiribati, formerly the Gilbert Islands, became independent within the Commonwealth in 1979. The 33 Islands within the group enjoy a pleasant climate with trade winds holding the temperature to a steady 80°F-88°F. There is a small expatriate community and several social clubs, but you should be able to organise your own entertainment and intellectual stimulation.

Senior Radio Technician - Reporting to the Director of Telecoms and the Commissioner of Police you will be responsible for the operation of the police radio network which consists of Pye Telecoms VHF and UHF fixed and mobile equipment. This will involve installation and maintenance of HF communications equipment and servicing solar powered non-directional beacons on outer islands, and training of local staff.

Aged 25-50 you should hold a C&G final Telecoms Certificate and have servicing experience of HF, VHF and UHF radio equipment, terminal and voice frequency telegraphic AQR equipment, transmitters of up to 10 kw and aerial systems. Some time spent at technical middle management level is essential. Local salary is in the range Australian Dollars 4,954-6,447 pa, plus a tax free supplement, payable by ODA, in the range £12,804-£15,888 pa.

Switching Technician - You will be responsible for installing and maintaining public manual and automatic exchanges including power supplies (50V rectifiers and 7.5 KVA diesel standby generators and control systems). You will also supervise and train local staff on installing and maintaining the exchanges and subscribers' telephones and PABX Switchboards.

Aged 25-50 you should hold a fourth year C&G or equivalent certificate and have at least five years experience of digital switching equipment.

Local salary is in the range Australian Dollars 3,598-4,809 pa, plus a tax free supplement, payable by ODA, in the range £11,784-£14,868 pa.

Senior Telephony Training Officer Solomon Islands

The Solomon Islands, which became independent in 1978, comprises a double row of mountainous islands covering 249,000 square nautical miles. Situated in the South Pacific, they offer a warm and temperate climate. Population is around 219,000 and the capital, Honiara, is located on the Island of Guadalcanal.

You will be in charge of the Islands' Telephony Training School which is part of the Telecommunications Training Centre. This will involve you in formal practical and theoretical classroom training of trainee and qualified technicians on telecommunications and specialised equipment courses; producing syllabus timetables; assessing students for employment and promotion; day to day administration of the school; and the design of training literature and course materials.

A recognised certificate/apprenticeship in telephony is essential as is a supervisory/management qualification or proven ability and three years experience as a Technical Officer in Telephony Training.

Local salary is in the range Solomon Island Dollars 8,316-9,126 pa, plus a tax free supplement, payable by ODA, in the range £11,424-£14,268 pa.

Applicants for all posts should be British Citizens. The first two appointments are on contract to the Government of Kiribati for periods of 21 to 27 months. The third appointment is on contract to the Solomon Islands Government for a period of 2 years.

For all posts terminal gratuities of 25% of local salaries are payable and other benefits normally include free passages, children's education allowances and subsidised accommodation.

For an application form, please write, quoting ref. AH369/RA/EWW, stating post concerned, to: Appointments Officer, Overseas Development Administration, Room 351, Abercrombie House, Eaglesham Road, EAST KILBRIDE, Glasgow G75 8EA.

Or telephone 03552 41199, extension 3273 for the Solomon Islands post or extension 3530 for the Kiribati posts.



**OVERSEAS
DEVELOPMENT**

Britain helping nations to help themselves

CLIVEDEN

MEDICAL SYSTEMS

Repair of analogue and digital instrumentation.

£9,000 + Car Hants

BROADCAST EQUIPMENT

Test and service of multi-processor video systems.

£9,000 Middlesex

CELLULAR RADIO

Repair of R.F. Communications equipment. Analogue experience useful.

£11,000 Camberley

RADIOCOMMS

Develop and support a wide range of digital communications.

£12,000 Middlesex

RADAR SYSTEMS

Repair of microwave communication links.

£10,000 Essex

SECURITY SYSTEMS

Repair of analogue and digital signalling systems.

£9,000 Berks

Hundreds of other Electronic and Computer vacancies to £15,000.

Phone or write:

Roger Howard C.Eng. M.I.E.E. M.I.E.R.E.

CLIVEDEN RECRUITMENT

92 Broadway, Bracknell,
Berkshire RG12 1AR

Tel: 0344 489489

TEST/PRODUCTION VACANCIES

TracSystems is a leading company in the manufacture of special cassette machines. As part of our coming expansion plans we require beginners, technicians, and engineers at all levels in production. Qualifications are not as important as enthusiasm and interest in audio tape technology, please phone or write to Kathy Chapman

TracSystems

G08/157 Marlborough Road,

London N19 4NF

Tel: 01-281 4955

439

UNIVERSITY OF OXFORD DEPARTMENT OF NUCLEAR PHYSICS

ELECTRONIC/ELECTRICAL TECHNICIAN GRADE 5

A vacancy exists for a technician to work on the design, construction, testing and installation of electrical/electronic equipment associated with particle detectors which will operate at overseas laboratories.

Applicants should have a primary interest in linear and digital circuits and printed circuits; an experience of high voltage techniques would be an advantage. Minimum qualifications are ONC or equivalent, with 7 years relevant experience (including training). Salary will depend on age and experience, and will be within the range £7,274-£8,588 per annum. The post will be for a 3 year contract in the first instance. Written applications, giving age, experience and qualifications together with the names and addresses of two referees should be sent to the General Administrator, Department of Nuclear Physics, Keble Road, Oxford, OX1 3RH to reach him by Wednesday 13th May 1987.

442

Design Engineer-Electronics

Location: Melbourne, Australia

Salary Package: \$A40,000

Our clients are involved in advanced communications design and development.

They are seeking to employ an Engineer with a degree/diploma in communications engineering who has significant experience in original design and development work at microwave frequencies up to 10 GHz, with practical experience in stripline technology and the use of CAD. It is essential that applicants prefer and are self motivated towards producing timely results without supervision.

The expansion programme within the organisation is both exciting and real. An excellent rapid career development opportunity like this does not arise very often. Interested? Then please forward your details as follows:



Noel J. Ray and Associates Pty. Ltd.

Management Consultants

18 Bank Place, Melbourne, Vic. 3000.

Tel. Weekdays (03) 67-3702. Sat. & Sun. (053) 68-9511.

07182

Electronics Technicians, Electricians

YOU CAN'T CHANGE THE WORLD.

But you can make a world of difference.

Skills taken for granted in this country are vital to members of poorer Third World communities.

In a world which by and large does nothing about poverty and injustice (let alone hunger), VSO volunteers work directly with those seeking to become more self-reliant:

No one can change the world. But as a VSO volunteer, you could make a world of difference.

We have over a dozen jobs in electronics and electrical work. Most of the electronics jobs are in the repair and maintenance of a variety of control systems. The electrical jobs are principally in the training of school leavers in basic electrical installation in domestic and light industrial work. All the jobs require people who enjoy working with others and passing on their skills. If you have a relevant skill and qualification please apply now.

You should be without dependants and willing to work for the local rate of pay. Postings are for two years - although many choose to stay longer - and most U.K. employers should be prepared to grant leave of absence.

For more information please complete and return.

I'm interested. I have the following training/experience:



Charity no. 313757

Name _____

Address _____

EWV/SIB7

Post to: Enquiries Unit, Voluntary Service Overseas,
9 Belgrave Square, London SW1X 8PW. (24p S.A.E. appreciated)

Abekas Cox

Abekas Cox Limited is part of the Carlton Communications plc Group and specialises in the research, development and manufacture of high-performance analogue and digital video products for the broadcast television industry.

Due to increased sales we urgently require young, enthusiastic engineers, preferably with Broadcast Television experience:

TEST ENGINEERS: VISION MIXING

to work on our 8, 16 and 24 channel T series vision mixers.

TEST ENGINEERS: VIDEO PROCESSING:

to test and align the following products:

Colour Correctors Encoders/Transcoders

Computer Video Processors Colour Synthesisers

VT Clocks Keyers

Source Ident and Cue Dot Generators Instrumentation

Equipment for the accurate measurement of Broadcast TV waveforms.

PRODUCTION ENGINEER:

to liaise with development on future projects. Hi-tech electronics background and management experience essential.

Abekas Cox Limited is an equal opportunities employer: We offer a comprehensive training programme and attractive salaries and benefits package.

For further details and an application form contact:
John Petherick, Personnel Manager, Abekas Cox Limited, Hanworth Trading Estate, Hampton Road West, Feltham, Middlesex TW13 6DH (or telephone 01-894 5622 quoting ref: EWVO 1).

443

HUNTINGDON HEALTH AUTHORITY

Papworth Hospital

Technical Support Services

Medical Electronics Technician

Grade: MPT IV or Student MPT

The successful applicant will be based at Papworth - the leading Cardio-thoracic Hospital, and will be part of a small team which provides medical technical support throughout the Huntingdon Health District.

The Technician will undertake or be trained to undertake the repair and maintenance of a wide range of electronic/electro-medical equipment.

Applicants for the MPT IV should have two passes at Advance level in the General Certificate of Education in appropriate scientific subjects and relevant technical experience.

The applicants for the grade of Student MPT should hold/expect to obtain at least four G.C.E. 'O' levels or equivalent, including Mathematics, English and a Science subject.

The successful applicant will be expected to attend Technical College to gain further relevant qualifications.

Application forms and job description from:
Miss R Whiting, Unit Personnel Officer, Papworth Hospital, Papworth Everard, Cambridge CB3 8RE.
Tel: (0480) 830541 ext: 334

Closing date: Friday, 8th May 1987

440

UNIVERSITY OF WARWICK
AN EQUAL OPPORTUNITIES EMPLOYER
PSYCHOLOGY DEPARTMENT

Electronics Technician

Candidates should have a sound working knowledge of the video techniques and systems used in a small recording studio. Some knowledge of hardware and software aspects of microprocessors would be an advantage. Duties will include design, construction and maintenance of a wide variety of standard and specialized electronic equipment.

Experience and an active interest in the fields indicated above are felt to be important and lack of formal qualifications need not disbar an application.

Salary on the Technician Grade 5 scale: £7,274 - £8,588 p.a.

Further details and informal enquiries to Mr. G. Wales (0203 523611)

Application forms from the Personnel Office, University of Warwick, Coventry CV4 7AL (0203 523685) quoting Ref. No. 36/T/86. Closing date 4th June 1987.

437

ELECTRONICS TEST/SERVICE TECHNICIAN required by professional audio importers. Qualifications - preferably O.N.C. Electronics. At least 2 years experience in the service/test of audio related electronics. This is more important than formal qualifications provided it can be substantiated. Quality control experience an asset due to expanding company policy. Salary negotiable £8-10K. For further details & interview, please contact: Mr S.P. Smith on 01-871 0966.

435

Senior Telecommunications Engineer - Kenya

The Kenya Port Authority is seeking to improve and modernise its telecommunications and radar surveillance systems. To meet these aims a Senior Telecommunications Engineer is required to act as Project Leader, reporting to the Managing Director of the Ports Authority in Mombasa.

The successful applicant will investigate the project and formulate logical actions and then carry out detailed planning for its execution. Close liaison with the Kenya Posts and Telecommunications is essential.

Specifically your duties will include updating the telephone cable network; rationalisation of the ship to shore and shore-based radio communication system; establishment of data communications system for logistic control of container and other goods, through a modern PABX; the installation of a Radar Surveillance system to manage shipping in the harbour entrance and port area which is of prime importance; and the formation of a Telecommunications Maintenance Unit.

Applicants should be British citizens aged 35-55 who are already Senior Professional Telecommunications Engineers with a degree in Telecommunication Engineering or equivalent and should be IEE members with wide experience in the planning, design and execution of telecommunications projects. A knowledge of telephone networks, exchanges, cable, ship to shore radio and radar is required.

The appointment is on contract to ODA, on loan to the Government of Kenya, for a period of two years. Salary (UK taxable) is in the range £18,550 to £24,600 pa depending on qualifications and experience and will include an element in lieu of superannuation. A tax free Foreign Service Allowance, currently in the range £540 to £2,445 pa, is also payable.

The post is wholly financed by the British Government under Britain's programme of Aid to the developing countries. Other benefits normally include paid leave, free family passages, children's education allowances, free accommodation and medical attention.

For an application form, please write, quoting ref. AH367/SL/EWW, stating post concerned, to: Appointments Officer, Overseas Development Administration, Room 351, Abercrombie House, Eaglesham Road, EAST KILBRIDE, Glasgow G75 8EA.

Or telephone
03582 41199,
extension 3375.



OVERSEAS DEVELOPMENT

Britain helping nations to help themselves



Vision Maintenance Engineer

We require an engineer with substantial experience of maintaining television receivers and VCR's, who is looking to broaden their experience to a broadcast environment. The applicant needs to be enthusiastic and versatile as there may be occasional operational duties to undertake.

Applications to:

Stephen Fox, Chief Engineer, Limehouse Studios, Canary Wharf, West India Docks, London E14 9SJ.

432

SERVICE ENGINEER required for 4-6 months contract in Switzerland on self-employed basis. Must be fully experienced in all aspects electro-mechanical servicing on pin tables, video machines, stage lighting and sound, and audio-animatronics. Position possibly permanent for right applicant. Please write with full career history and salary required to box no 428 Electronics and Wireless World. 428

ELECTRONICS NUTTER WANTED now by small firm in West London to design, build, programme, test and install wide variety of electronic systems. Hours long. Salary by haggling. Phone Bob 01-940 4910 daytime or 01-949 2229 late evenings.

426

When replying to
classified advertisements,
readers are recommended
to take steps to protect
their interest before
sending money

ARTICLES FOR SALE

TEST EQUIPMENT

FOR SALE & WANTED

Buyers and Disposal Officers contact:

COOKE INTERNATIONAL
Unit 4, Fordingbridge Site
Main Road, Barnham
Bognor Regis
West Sussex PO22 0EB
Tel: 0243 685111/2

Stock list available, send 50p to cover p&p.

179

GOLLEDGE

ELECTRONICS

QUARTZ CRYSTALS OSCILLATORS AND FILTERS of all types. Large stocks of standard items. Specials supplied to order. Personal and export orders welcomed - SAE for lists please. OEM support thru: design advice, prototype quantities, production schedules. Golledge Electronics, Merriott, Somerset YA16 5NS. Tel: 0460 73718. (2472)

TO MANUFACTURERS, WHOLESALERS BULK BUYERS. ETC.

LARGE QUANTITIES OF RADIO, TV AND ELECTRONIC COMPONENTS FOR DISPOSAL

SEMICONDUCTORS, all types, INTEGRATED CIRCUITS, TRANSISTORS, DIODES, RECTIFIERS, THYRISTORS, etc. RESISTORS, C/F, M/F, W/W, etc. CAPACITORS, SILVER MICA, POLYSTYRENE, C280, C296, DISC CERAMICS, PLATE CERAMICS, etc. ELECTROLYTIC CONDENSERS, SPEAKERS, CONNECTING WIRE, CABLES, SCREENED WIRE, SCREWS, NUTS, CHOKES, TRANSFORMERS, etc.

ALL AT KNOCKOUT PRICES - Come and pay us a visit ALADDIN'S CAVE

TELEPHONE: 445 0749/445 2713

R. HENSON LTD.

21 Lodge Lane, North Finchley, London, N.12
(5 minutes from Tally Ho Corner)

(1613)

Electronics Engineer

Precision Optical Measurement Systems Stuttgart

UBM, a leader in its field, is a small, fast growing Company which develops and manufactures a range of highly sophisticated optical measuring instruments.

We have vacancies for *electronics engineers* to join the research and development team.

You will be a graduate, probably with a Ph.D, and a good working knowledge of analogue and digital electronics. You must be able to demonstrate the initiative to assist with further product development.

We offer the chance to grow with a young Company and real job satisfaction. Salaries will be dependent on age and experience from £20,000 considerably more for candidates with proven achievements in a relevant field.

The offices are located on the outskirts of Stuttgart in a pleasant area of Southern Germany.

Please write with a full c.v., showing how you meet the job requirements to:



**Ulrich Breitmeier Messtechnik
GmbH**
Nobelstr. 15, Tel. 07 11/6 87 46 61
7000 Stuttgart 80

Interviews will take place in Central London.

WANTED

STEWART OF READING
110 WYKEHAM ROAD,
READING RG6 1PL.
TEL: 0734 68041

**TOP PRICES PAID FOR ALL
TYPES OF SURPLUS TEST
EQUIPMENT, COMPUTER
EQUIPMENT, COMPONENTS
etc. ANY QUANTITY**

PLATINUM, GOLD, SILVER
SCRAP, melted assayed and paid for
within 24 hours. Relay contacts, p.c.b.s,
thermocouples, crucibles, plugus,
connectors, etc. Totally free sampling
service. Send samples or parcels
(registered post) or contact Eric
Henderson, 0773 760661. Steinbeck
Refineries (UK) Ltd, Anchor House,
Anchor Road, Eastwood, Notts. 406

ARTICLES WANTED

WANTED

Test equipment, receivers,
valves, transmitters, com-
ponents, cable and
electronic scrap and quan-
tity. Prompt service and
cash. Member of A.R.R.A.

M & B RADIO
86 Bishopsgate Street
Leeds LS1 4BB
0532 435649

TV-2 is the acknowledged world leader in the design and development of miniature TV camera systems.

We urgently need an:

Electronics Engineer

to help us maintain this position.

The ideal candidate must be of a practical nature, with experience of digital and analogue design a necessity.

Familiarity of PAL colour TV systems an advantage.
Salary would be in line with ability.

Applications in writing before 24 May 1987 to:

TV-2 Communications
The Old Brewhouse, Castle Ashby
NORTHAMPTON NN7 1LF



434

SWINDON RALLY

OAKFIELD SCHOOL, MARLOWE AVE., SWINDON

Sunday 10th May, open 10.30 am, adm. 50p.

Radio & Electronic Equipment, Components,
Computer Equipment & Software. Refreshments,
Entertainment for the Whole Family.

DETAILS: G8SFM QTHR.

TEL. 066689-307

TEST EQUIPMENT FOR SALE

All equipment in perfect condition includes:

B&K 2010/1902 superhet analyser.
B&K 2305 level recorder with 4 pots.
B&K 4440 gating system
B&K 2971 phasemeter.
B&K 2206 precision sound level meter with capsule.
B&K 2426 auto range millivoltmeter.
Enquire for full list of B&K.
HP86, 3.25 disc drive, biodata microlink III,
HP7475A 6 pen plotter, other accessories.
Tektronics computer 31, 152 and 2 x DM501
multimeters HP3580A spectrum analyser.
Sound technology 1700A distortion
measurement system, Philips 6652
programmable high res. timer counter, Datron
1085 autocal DMM Sennheiser universal UDM
550 AC/dB meter. Kemo VBF/14 band pass/stop
filter. Technon I.M.D. analyser. Wayne Kerr B221
universal bridge.

Please call Angus McKenzie for full list -
01-349 0511 strictly 9.30am-5.00pm.

422

COMMUNICATIONS CONSULTANT/ ENGINEER

HF/VHF/UHF/RTTY
BASE AND MOBILE PABX/
PAGERS

Widely experienced Africa and
Middle East.

If you need communications
you need reliability whether
its installation, maintenance
or advice, get an expert.

Contact:
FREMAR
CONSULTANTS ON
TEL (0722) 742284 or
TLX 477019 ASR-G
ATTN FREMAR CONSUL

382

INVERTERS

DC-AC High Power
Gardners sq. wave type GR75108
I/P: 50V DC 85A
O/P: 240V 50Hz 4kVA £300
Also 2kVA £200 - 1kVA £150

H&D Sinewave 600W
I/P: 24V DC
O/P: 230V 50Hz 600VA £240

CVT's: Cetronic Reguvolt 6kVA £290;
5kVA £250; 4kVA £220; 2kVA £160.

GREENWELD ELECTRONICS LTD
443 Millbrook Road, Southampton,
SO1 0XH. Tel: (0703) 772501/783740

BOX Nos

*Box number replies
should be addressed to:*

Box No.....
**c/o Electronics &
Wireless World
Quadrant House,
The Quadrant,
Sutton,
Surrey SM2 5AS**

SURPLUS COMPUTER HARDWARE

ITT SCRIBE III WORD PROCESSING SYSTEM.

Professional system originally selling at around £6000 without printer. Now offered with software included & a variety of different options available. This system is available from us **ALL BRAND NEW** at the cost of current budget systems, but with office-quality performance & features.

SOFTWARE INCLUDED:

- *DATABASE — allows information storage & retrieval by user-selectable criteria.
- *EDITING — including easy reformatting, global search & replace, save & move, cursor control etc.
- *AUTOMATIC LETTERWRITING — with merge, glossary file for much used phrases etc.
- *MATHS FUNCTIONS — screen maths allows addition of rows, columns & complete tables.
- *PROGRAMMABLE COMMANDS — allows format changes, accessing record block files, prompts etc.
- *HELP FILES — quicker to use than the comprehensive manual supplied.
- *BASIC COMPILER.

HARDWARE INCLUDED:

- *SCREEN/WORKSTATION — dual processor (16 bit T19995 & Z80H) with 128K memory, 12" green screen 25 x 80 character display with slow scrolling, QUME printer interface.
- *KEYBOARD — low-profile keyboard additionally has 43 clearly marked dedicated function keys.
- *DISC DRIVES — dual SHUGART 5 1/4" DSDD drives each 430K capacity formatted.

£295.00

OPTIONS:

- *10mbyte MiniScribe WINCHESTER disc drive (£195).
- *NEC Model 3500 35cps daisy wheel printer (£295).
- *NEC Model 7700 55cps daisy wheel printer (£395).
- *128K additional memory with spelling check software (£40).

*Communications hardware & software (£95).

COLOUR LEAFLET AVAILABLE

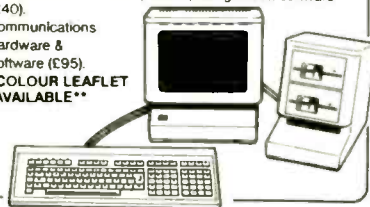

HITACHI Model 3055 3" disc drives. With SHUGART compatible Interface (34 way edge connector) & suitable for BBC with DFS, AMSTRAD 664/6128, TATUNG EINSTEIN & many others. 250K (double density unformatted) per side reversible; 40 track; standard power connector for 12V & 5V, overall power consumption typically 3.7W. Supplied **BRAND NEW** with connector pin-out details etc. but uncased. Data cables only are available for AMSTRAD & BBC (£7.50) and TATUNG (£10.00).

£29.95

HITACHI Model 305D double sided 3" disc drives. As above, but double sided (500KB unformatted accessible without turning disc over). Not suitable for AMSTRAD 664/6128.

*Over 2000 Model 305 drives already sold by us

£39.95



MATMOS PC. Available without disc drives only. 64KB Z80A based keyboard sized machine with RGB, composite video outputs & UHF modulator. Serial, parallel, cassette & peripheral bus interfaces are provided, together with a ROM port. MICROSOFT BASIC is in ROM. Office quality machine originally sold at £350 by its big-name manufacturer. **BRAND NEW.**

*Over 1000 already sold by us

£49.00

MATMOS TERMINAL. MATMOS PC as above but with additional plug-in menu driven terminal emulation ROM offering RS-232 communications up to 9600 Baud. (ROM is available separately at £20.)

£69.00



TOSHIBA Model T300 IBM compatible PC system.

With 6MHz 8088 processor, 256KB RAM, single half-height 5 1/4" floppy disc drive (640KB), high resolution green display, serial & parallel interfaces. Included are MS-DOS Ver. 2, MICROSOFT T-BASIC & comprehensive diagnostic disc. Available options include a high resolution colour monitor, graphics cards etc.

BRAND NEW £325.00

AS ABOVE but with dual floppy disc drives

£395.00

TOSHIBA Model T100 CP/M system. With 64KB RAM, dual 500K 5 1/4" floppy disc drives, serial & parallel interfaces & high resolution green display.

BRAND NEW. £199.00

DEC PDP 11/73 system. With 1MB RAM, twin 20MB WINCHESTER disc drives, single 8" floppy disc drive & DLV11-J quad serial interface.

£4500.00

DEC PDP 11/23 system. With 256KB RAM, single 20MB WINCHESTER disc drive, single 8" floppy disc drive & XENIX operating system.

£1800.00

ITT Model 3500 FACSIMILE machine. Very compact Group II machine allows document transmission & reception over phone line. EX DEMO.

£299.00

Please note:

*VAT & CARRIAGE must be added to all items. Carriage is £3.00 + VAT for 3" disc drives, and £10.00 + VAT for most other items.

*SAE please, for further details of any item and complete stock list.

MATMOS Ltd., 1 Church Street, Cuckfield, W. Sussex RH17 5JZ. (0444) 414484/454377
COMPUTER APPRECIATION, 111 Northgate, Canterbury, Kent CT1 1BH. (0227) 470512. TELEX 966134 COMPAP

matmos & COMPUTER APPRECIATION

ENTER 20 ON REPLY CARD

INDEX TO ADVERTISERS

Appointments Vacant Advertisements appear on pages 555-559

PAGE	PAGE	PAGE	PAGE
Adcola Products Ltd.....460	Ellmax Electronics.....471	Kantom Ingram Ltd.....542	Reticon, EG&G.....483
AEL Crystals Ltd.....490	EMS Manufacturing Ltd.....462	Kestrel Electronic Components Ltd.....542	Sherwood Data Systems.....545
Airlink Transformers.....512	Engineering Solutions.....529	Langrex Supplies Ltd.....494	Soft Option.....540
Allweld Engineering.....514	EWV Features List.....485	Leetronex 87.....513	Solex International.....547
Alpha Electronics..... Loose Insert	EWV Wall Chart.....551	Levell Electronics Ltd.....493	Sowter, E.A. Ltd.....526
Antex Electronics Ltd..... Inside Back Cover	Field Electric.....483	Marlow Marketing.....530	Stanley Palmer, G.A. Ltd.....464
Beechcraft Ltd.....526	Flight Electronics.....484	Micro Concepts.....463	Stewart of Reading.....464
Bull, J & N Electrical.....549	Fluke (GB) Ltd..... Advert Card	Microkrit Ltd.....460	Strumech Engineering.....483
Cable and Satellite 87 Exhib.....489	GNC Electronics.....530	Micronake Ltd.....512	Surrey Electronics.....462
Cambridge Kits.....462	Hameg Oscilloscopes.....514	Moordene Assoc.....485	Taylor Bros (Oldham).....490
Carston Electronics Ltd.....461,530	Happy Memories.....514	Number One Systems.....497	Technomatic Ltd.....552/553
Channel Micro Products Ltd.....512	Harrison Electronics.....542	Nuvotem Teo.....547	Tektronix (UK) Ltd..... Inside Front Cover
Cirkit Holdings.....485	Hart Electronic Kits.....518	Olson Electronics Ltd.....503	Television Magazine.....503
Computer Appreciation.....542,560	Henry's Audio Electronics.....485	Opus Supplies.....471	Thandar Electronics.....471,497
Conquin Software.....493	Henson, R. Ltd.....526	Pineapple Software.....544	Those Engineers.....503,545
Dataman Design.....498	Ian P Kinloch.....490	P M Components Ltd.....504,505	Thurlby Electronics.....544
Design Consultancy.....518	ICOM (UK) Ltd.....460	Raedek Electronics.....512	Time Electronics.....529
Display Electronics Ltd.....524/525	ILP Electronics.....540	Ralfe Electronics.....530	Triangle Digital Services Ltd.....464
Electronic Brokers Ltd.....458,467 Outside Back Cover	Ines GmbH.....540	Reprints.....545	Webster Electronics.....526
	John's Radio.....490	Research Communication.....462	Withers, R. Communication.....518

OVERSEAS ADVERTISEMENT AGENTS

France and Belgium: Pierre Mussard, 18-20 Place de la Madelaine, Paris 75008.

United States of America: Jay Feinman, Business Press International Ltd, 205 East 42nd Street, New York, NY 10017 - Telephone (212) 867 2080 - Telex 23827.

Printed in Great Britain by E.T. Heron (Print) Ltd, Crittall Factory, Braintree Road, Witham, Essex CM8 3QO, and typeset by Graphac Typesetting, 181/191 Garth Road, Morden, Surrey SM4 4LL, for the proprietors, Reed Business Publishing Ltd, Quadrant House, The Quadrant, Sutton, Surrey SM2 5AS. © Reed Business Publishing Ltd 1987. Electronics and Wireless World can be obtained from the following: AUSTRALIA and NEW ZEALAND: Gordon & Gotch Ltd, INDIA, A. J. Wheeler & Co. CANADA: The Wm. Dawson Subscription Service Ltd, Gordon & Gotch Ltd. SOUTH AFRICA: Central News Agency Ltd, William Dawson & Sons (S.A.) Ltd. UNITED STATES: Eastern News Distribution Inc., 14th Floor, 111 Eighth Avenue, New York, N.Y. 10011.

ANTEX a world of soldering

Professional Precision for the Amateur Enthusiast.

ANTEX has a worldwide reputation for quality & service & for many years has been one of the best known & most popular names in soldering. Always at the forefront of technology, ANTEX is continually researching new and better ways of achieving more accurate, reliable, and cost effective soldering. On ANTEX Soldering Irons, the advanced design of the interface between the element & the bit allows more efficient heat transfer to the bit and improved stability of the temperature at the point of contact with the work. Indeed, experiments have shown that an XS25 watt iron can be used for tasks where a 40 watt iron would normally have been required.

ANTEX Soldering Irons exhibit exceptionally low leakage currents & hence are suitable for use on Static Sensitive Devices. Sophisticated temperature controlled soldering units have recently been added to the ANTEX range.



SK5 Soldering Kit

Model XS

Model CS

Model C

TCSU-D Temperature-Controlled Soldering Unit

ST4 Stand

TCSU1 Soldering Unit

Model C
- 15 Watts. Available for 250, 220, 115, 100, 50 or 24 volts.

Model XS
- 25 Watts. Available for 240, 220, 115, 100, 50, 24 or 12 volts.

Model XS-BP
- 25 Watts. 240 volts, fitted with British Plug.

ST4 Stand
- To suit all irons.

SK5 Soldering Kit. Contains model CS 240v Iron, an ST4 Stand and solder.

SK6 Soldering Kit. Contains model XS240v Iron, an ST4 Stand and solder.

SK5-BP and SK6-BP
Soldering Kits as above with British Plug.

Model CS
- 17 Watts. Available for 240, 220, 115, 100, 50, 24 or 12 volts.

Model CS-BP
- 17 Watts. 240 volts, fitted with British Plug.

TCSU1
- Very robust temperature controlled Soldering Unit, with a choice of 30 Watt (CSTC) or 40 Watt (XSTC) miniature irons. Range 65°C to 420°C. Accuracy 2%.

TCSU-D
Elegant Temperature Controlled Soldering Unit with 50 W Iron (XSD) and built around FERRANTI custom-made ULA. Range Ambient to 450°C. Accuracy $\pm 5^\circ\text{C}$. Zero crossing switching. Detachable sponge tray.

ANTEX Made in England

ANTEX (Electronics) Ltd.
Mayflower House, Plymouth, Devon. Tel: 0752 667377 Telex: 45296

Please send literature, price list and my nearest stockist to:

Name _____

Address _____

Telephone _____

ENTER 28 ON REPLY CARD

MARCONI INSTRUMENTS

The last word in test instrumentation



**2955 Radio Communications
Test Set £5,750**

- 11 test functions, including full duplex radio test
- Revolutionary design: fast and easy to use
- High clarity CRT shows all settings plus measurements in digital or analog forms
- Tones encode/decode facilities
- 38 instrument settings in non-volatile memory
- Spin-wheel frequency/level control in addition to front panel buttons
- Single and two-port operation.



**2382/80 Spectrum Analyser £13,470
and Display £5,480**

- Audio to UHF coverage: 100Hz-400MHz
- Outstanding resolution, with 3Hz minimum resolution filter bandwidth
- 0.025dB amplitude resolution
- Superb level accuracy ± 1 dB, with auto calibration
- Frequency response better than ± 0.4 dB
- Fully GPIB programmable capability
- Two steerable markers for levels and frequencies
- Self calibration for repeatability of measurements.



**2022 AM/FM Signal Generator
10kHz to 1GHz £2,950**

- Wide frequency cover: 10kHz to 1000MHz
- Compact, rugged and lightweight
- Comprehensive modulation: AM/FM/PhM
- Simple push-button operation, large LCD display
- Non-volatile memory for 100 settings
- The perfect service/maintenance tool.



**2305 Modulation Meter 500kHz
to 2GHz £5,418**

- 500kHz to 2GHz frequency range
- Outstanding 0.5% basic accuracy
- Exceptionally fast auto-tuning, with low noise
- Modulation analysis including frequency and power
- Non-volatile memory to store user settings
- Excellent stereo separation
- Automatic self-calibration, advanced diagnostics.



**6960 Option 001 Digital RF
Power Meter £1,900**

- Simple push-button or systems application
- Unparalleled accuracy through sensor correction
- Non-volatile storage of frequently-used settings
- W or dB readings, plus offset capability
- Single-key auto-zero operation
- Average factor selection to reduce noise or improve resolution, advanced GPIB facilities.



**2440 Microwave Counter 20GHz
£3,650**

- Wide frequency coverage: 10Hz to 20GHz
- High sensitivity and resolution
- Fast acquisition time: only 200ms typical
- High-stability oven-controlled crystal oscillator
- Overload capability up to 27dBm
- High AM/FM tolerance
- Built-in GPIB.

ENTER 3 ON REPLY CARD

through ELECTRONIC BROKERS

The first name in test equipment distribution

Electronic Brokers

**Electronic Brokers 140-146 Camden Street, London, NW1 9PB
Fax: 01-2677363 Telex: 298694 Tel: 01-267 7070**

All prices exclusive of VAT. Prices correct at time of going to press (UK only). Trading conditions available on request.

Electronic Brokers are now distributors for a full range of Marconi Test Instruments including Signal Generators, Microwave Counters, Power Meters, Modulation Meters,

Spectrum Analysers, Radio Communication Test Sets and other general test and measuring equipment. For further information and a colour brochure please contact our Sales Office.