

# ELECTRONICS & Wireless World

JUNE 1985 85p

۱۳۵ / ۰۰  
 کازیندار  
 KHAZINDAR CO  
 8R 15:00

**70cm helical antenna design**

**Switched-mode power supplies**

**Improving BBC data recording**

**Look after your nicad batteries**

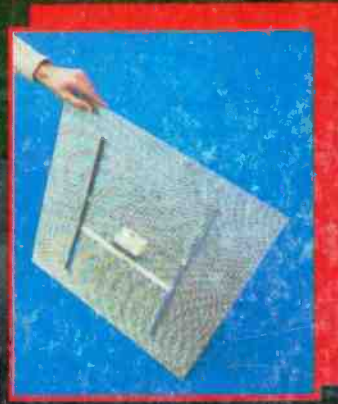

Australia	AS	2.95	Italy	L	4.20
Denmark	DKK	36.00	Spain	Pts	370.00
Germany	DM	7.00	Switzerland	Sfr	8.00
Greece	Dra	24.00	Singapore	M\$	7.00
Holland	DEG	8.00	U.S.A.	\$	4.00

# CONGUIN SOFTWARE

---

## Low Cost IBM PC Based CAD Systems

### smARTWORK

An Electronic LIGHT-BOX allowing layout of component pads with auto or interactive tracking. Artwork can be printed on Epson dot matrix printer or plotted on Houston Instrument or Hewlett Packard plotters.

smARTWORK Software only **£895.00**.  
Complete systems from **£3500.00**.

### AUTOCAD

General 2D drafting package with auto-dimensioning. Will support a variety of graphic displays and output devices.

Software from **£1000.00**.  
Systems from **£3495.00**.

### CEDS

A full PCB design system allowing the design of boards from schematic diagrams. System expandable from basic manual placing and routing to auto-tracking and schematic capture. Also available with technical drawing facilities and auto dimensioning.

Software from **£1200.00**.  
High resolution colour systems from **£6000.00**.

### SAM 2001 — XT

An IBM compatible with 10Mbyte hard disk, will run all IBM software. Can be upgraded to run as fast as an AT.

From **£1995.00**.

*Note: All prices exclude VAT and are subject to change without notice.*

*Terms: Strictly CASH WITH ORDER.*

### PSPICE

Circuit simulation package allowing simulation of upto 120 transistors with unlimited number of nodes. Performs AC, DC and transient analysis. Can use CEDS schematic capture as input.

Software from **£950.00**.



---

**Conguin Software, Freepost, Lancaster LA1 1BR.**

**Phone: 0524 381423**

CIRCLE 1 FOR FURTHER INFORMATION



# ELECTRONICS & Wirelessworld

over 70 years in independent electronics publishing

## CONTENTS

June 1985

Volume 91 number 1592

**Editor**  
PHILIP DARRINGTON

**Deputy Editor**  
GEOFFREY SHORTER, B.Sc.  
01-661 8639

**Technical Editor**  
MARTIN ECCLES  
01-661 8638

**Projects Editor**  
RICHARD LAMBLEY  
01-661 3039 OR 8637

**News Editor**  
DAVID SCOBIE  
01-661 8632

**Drawing Office**  
ROGER GOODMAN  
01-661 8690

BETTY PALMER

**Advertisement Manager**  
BOB NIBBS, A.C.I.I.  
01-661 3130

MICHAEL DOWNING  
01-661 8640

ASHLEY WALLIS  
01-661 8641

**Northern Sales**  
HARRY AIKEN  
061-872 8861

**Midland Sales**  
BASIL MCGOWAN  
021-356 4838

**Classified Manager**  
BRIAN DURRANT  
01-661 3106

IAN FAUX  
01-661 3033

**Production**  
BRIAN BANNISTER  
(Make-up and copy)  
01-661 8648

Current issue price 85p, back issues (if available) £1.06, at Retail and Trade Counter, Units 1 & 2, Bankside Industrial Centre, Hopton Street, London SE1. Available on microfilm; please contact editor.

By post, current issue £1.30, back issues (if available) £1.40, order and payments to EEP Sundry Sales Dept., Quadrant House, The Quadrant, Sutton, Surrey SM2 5AS. Tel.: 01-661 3378.

**Editorial & Advertising offices:**  
Quadrant House, The Quadrant, Sutton, Surrey SM2 5AD.

**Telephones:** Editorial 01-661 3614. Advertising 01-661 3130. See leader page.

**Telex:** 892084 BISPRS G (EEP)

**Subscription rates:** 1 year £15 UK and £21 outside UK.

**Student rates:** 1 year £10 UK and £14 outside UK.

**Distribution:** Quadrant House, The Quadrant, Sutton, Surrey SM2 5AS.

Telephone 01-661 3248.

**Subscriptions:** Oakfield House, Perrymount Road, Haywards Heath, Sussex RH16 3DH. telephone: 04444 459188. Please notify a change of address.

USA: \$102.70 airmail. Business Press International (USA). Subscriptions Office, 205 E. 42nd Street, NY 10017.

USA mailing agents: Expeditors of the Printed World Ltd, 527 Madison Avenue, Suite 1217, New York, NY 10022, 2nd class postage paid at New York.

© Business Press International Ltd 1983.

ISBN 0043 6062.

### FEATURES

<b>Fast camera interface</b> by Safa S. Omran Taking one pixel from each line of a video camera signal to feed a micro is a solution to the speed problem. This method uses eight.	<b>17</b>	<b>Look after your nickel cadmium cells</b> by Rod Cooper NiCd cells are expensive to buy yet are often thrown away for lack of a few drops of water. Rod Cooper discusses more failure modes and suggests how to avoid them.	<b>60</b>
<b>Sampled-data servos — a new analysis</b> by D.M. Taub Fourth instalment in this new tutorial series derives the response of a servo system to sinusoidal input.	<b>34</b>	<b>Cassette recording with the BBC micro</b> by David Stonebanks Improved performance with conventional recorders and an alternative digital method.	<b>64</b>
<b>Managing research and development</b> by R.E. Young In which the 'small-team' approach to R & D contrasts with the hierarchical style of management.	<b>39</b>	<b>Valve disc preamplifier</b> by Richard Brice Simple design without overall feedback, using passive RIAA equalization.	<b>73</b>
<b>Helical antennas for 435 MHz</b> by James Miller Simple-to-make design having true circular polarization. Intended for satellite working, but excellent also for local and long distance operations.	<b>43</b>	<b>Power '85</b> List of exhibitors	<b>75</b>
<b>Switched-mode power supplies</b> by K.L. Smith This part of the d.c. supplies series explains the theory, practice and design of switchers.	<b>49</b>	<b>Two-dimensional digital filter design</b> by R.N. Gorgui-Naguib, K.M. Henein and R.A. King This detailed comparison of current design techniques follows the authors' earlier article on one-dimensional filters.	<b>76</b>
<b>Reactivating Band III</b> A report from the Mobile Radio Users' Association conference which discussed trunked repeater networks and worsening interference problems.	<b>57</b>	<b>Channel code and disc format</b> by John Watkinson Part of our definitive Compact Disc series, this continuation shows how the information is organised on the disc surface.	<b>80</b>

### REGULARS

<b>News Commentary</b> New blood End of ATS-1 Towards a thinking computer Sending text to <i>Wireless World</i> Coming to this screen shortly. . .	<b>6</b>	<b>Circuit ideas</b> Trip for power switches Two-i.c. shortwave calibrator Fast converter for repetitive signals Centronics-to-RS232 converter	<b>29</b>
<b>Books</b>	<b>20</b>	<b>Feedback</b> D.c. supplies Electro reductionism Relativity Energy transfer	<b>69</b>
<b>Communications</b> Costly DEF V.h.f. changes Radar up-date JAS-1 in 1986	<b>23</b>	<b>New Products</b> Fast tape storage 256K s.ram Circuit diagrams on a micro	<b>84</b>



Front cover shows the 70cm aerial made by James Miller for the RSGB's headquarters station at Potters Bar. Photography by Grahame Richardson.

# META

A · S · S · E · M · B · L · E · R

META is both an Editor and a very special Assembler. Most of META resides on a 16K EPROM, but the tables defining the language the Assembler is to translate Assembler for ANY instruction set — you specify which you want to use in your source code.

The large box on the right details all the instruction sets that have been coded for META right now: all these are supplied free with META. The other 4 instruction sets will be supplied as soon as they are written and tested as A FREE UPGRADE. We're on Freepost, so you won't even have to pay postage.

META contains a fully integrated Editor. This follows Wordwise as closely as possible in its philosophy (ie cursor keys used to move text — quickly — up and down about central editing line etc), and includes Global/Selective Search/Replace, Markers (copy, save, delete, find marked text), load text to cursor, character count and heaps of other features.

If an error is detected during assembly, the Editor is right there: on the bad line with a plain English error message describing the fault.

Complex expressions are allowed by the Assembler, including brackets to 8 levels (!). All calculations are to 32 bits.

Macros and IF/ELSE/ENDIF Conditional Assembly are fully supported, and both are nestable. Macros may also pass parameters, and contain local labels. There's also a range of EQU pseudo-ops for data setup, all of which may have a list of arguments separated by a comma. Disc datafiles can also be inserted into the object code. A complex integrated Macro Library system is also included — you can invoke a routine and pass parameters by just giving its name.

Source code is Assembled in two fast passes (we don't use the groaning slow BPUT & BGET as do some inferior Assemblers. Instead portions of the source code are effectively \*LOADED in at top speed.) The resultant object code may be sent to disc files, sideways RAM, the user or printer port (full details and examples in manual), or down the RS423.

Remember that all instructions sets supported by META have access to all the above features (Macros, the Library etc)

META comes complete with a comprehensive manual and function key strip. 16K of source code for a 6502 BBC game is included free and the META system disc, which demonstrates many of the features of this assembler. (as well as being a neat game!)

- Comes in a 16K EPROM and 40tk disc for the BBC
- Complete Wordwise style integrated editor with special debugging aids
- Assembles for 7 different MPU families right now — FREE updates take this up to 11
- Nestable Macros (with parameters), Nestable IF/ELSE/ENDIF conditional assembly
- Specially integrated Macro Library facilities

FREE UPDATES INCLUDED IN PRICE

Meta can Assemble all these instruction sets right now:

65xx series incl. cmos	
68xx/63xx series incl. 00,01,02,03,05	
6809	65816
8048 series	
8080/8085	
Z8	
Z80	
And Free updates ("Real Soon Now") include:	
68000	8088/8086
Z8000	Micro Nova

**CRASH BARRIER  
FREEPOST  
FLITWICK  
BEDFORD  
MK45 1YP**

No stamp required



**META £69.95**

A · S · S · E · M · B · L · E · R

All inclusive. Free updates included in price — updates expected to be available early July. META is available right now. Dealer enquiries, as the saying goes, are welcome. Generous discounts to educational institutions.

CIRCLE 83 FOR FURTHER DETAILS.

## COMPUTER APPRECIATION

16 Walton Street, Oxford OX1 2HQ  
Tel: Oxford (0865) 55163 Telex: 838750

UNITRON Model 2200 Microcomputer. Apple 11/E and CP/M compatible machine with 6502 and Z80 processors, 64 Kbyte memory, detached keyboard with numeric pad and floppy disc interface. BRAND NEW AND BOXED £325.00

ROCKWELL AIM 65/40 single board 6502 development system with display, keyboard, power supply and cassette recorder £350.00

MANNESMANN/ITALY Model M80MC Matrix Printer with microprocessor control 200CPS bidirectional printing with u/I case, self test. Compact but heavy duty machine. BRAND NEW AND BOXED £95.00

CENTRONICS Model 702 Matrix Printer, 132 col., 165cps. bidirectional printing with self test. In good ex-demo condition £150.00

CENTRONICS Model 150-2 printer, NEW £325.00

DIABLO HYTYPE II DAISY WHEEL PRINTER (45CPS) £125.00

OLYMPIA SCRIPITA, Daisy wheel printer with centronics interface. Two available. both less processor chip and prom but otherwise complete. The pair £120.00

PERTEC Model FD 514 8" Floppy disc drives. AS NEW £50.00

SHUGART SA400 5 1/4" Floppy disc drives £50.00

DEC boxes and power supplies. Various models available (BA11MF SB11AA, BA11LX) all with 22 bit addressing or easily modified and various optional processors etc. P.O.A.

ITT Model 3510 telefax facsimile transmitter/receiver. Micro-processor controlled (8085) CCIT group 2 machine for transmitting documents over an ordinary phone line. BRAND NEW AND BOXED £295.00

TEKTRONIX Model 4601 harda copy unit for 400 series graphic terminals £50.00

TEKTRONIX Model 611 Graphics storage display. For use with any DAC computer output £75.00

FACIT Model 4020 High speed paper and tape reader. Parallel TTL interface £225.00

FACIT Model 4070 Paper tape punch £250.00

CALCOMP Model 563 AO drum plotter. 0.1mm step size £425.00

CALCOMP Model 763. As above, but high speed P.O.A.

CALCOMP Model 1036 AO Graph plotter. High speed 3 colour plotter with type 915 magnetic tape unit for optional off. line use, and selectable for 7/9 track, 800/1600 B P.I. etc P.O.A.

C.I.L. Model 6000, 2 Pen AO high speed graph plotter P.O.A.

HEWLETT—PACKARD Model 75C portable computer £250.00

HEWLETT—PACKARD Model 85 desk top computer with integral graphics display, printer and tape drive £690.00

GENERAL DATACOMM (IAL) Model LDM-1 private line modem £150.00

GENERAL DATACOMM Model TDM 1240 4 line statistical multiplexer as used with above modem. 280 controlled. Manufactured 1981. £150.00

DECLS1-11/23 processor with MMU £500.00

NEC Model 5510 spinwriter, 55cps daisy-wheel printer with RS232 interface. As new, and sold with tractor unit, manual and complete set of mechanical spares £650.00

Please note: VAT & CARRIAGE extra on all items \* Visitors by appointment, please. \* Technical manuals are available from us for many items stocked.

CIRCLE 85 FOR FURTHER DETAILS.

**BIRD** Electronic Corporation

**THRULINE**® Directional Wattmeters  
**TERMALINE**® RF Coaxial Load Resistors  
**TENULINE**® Attenuators and accessories from stock

**Aspen Electronics Limited**

The exclusive UK representative for Bird Electronic

2/3 Kildare Close, Eastcote, Ruislip  
Middlesex HA4 9UR  
Tel: 01-868 1188 Tlx: 8812727

CIRCLE 52 FOR FURTHER DETAILS.

**RADFORD**

Audio Measuring Instruments,  
Audio Amplifiers, Loudspeakers and  
Loudspeaker Components for the  
professional and enthusiast

**RADFORD AUDIO LTD.**

10 BEACH ROAD  
WESTON-S-MARE, AVON BS23 1AU  
TEL. 0934 416033

CIRCLE 55 FOR FURTHER DETAILS.

ELECTRONICS & WIRELESS WORLD JUNE 1985



# LEVELL

## OFFER AN EVEN BETTER DEAL

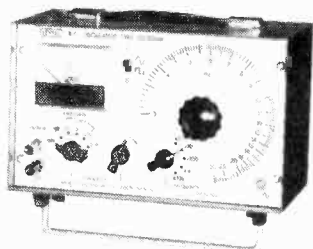

LEVELL OSCILLATORS, FUNCTION GENERATORS, AC/DC VOLTMETERS, FREQUENCY COUNTERS, DECADE R/C BOXES, TRANSISTOR and INSULATION TESTERS.

CROTECH OSCILLOSCOPES  
HAMEG OSCILLOSCOPES  
HITACHI OSCILLOSCOPES

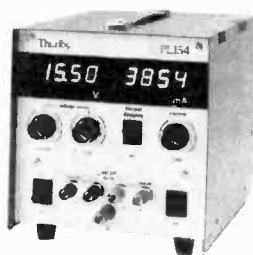
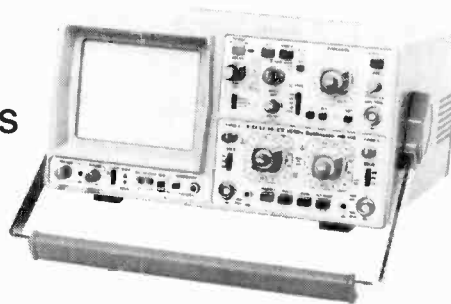

THURLBY POWER SUPPLIES, MULTIPLEXERS, DIGITAL MULTIMETERS, CAPACITANCE METERS and LOGIC ANALYSERS.

LEVELL DELIVER FREE IN THE UK.  
CATALOGUE, PRICE LIST and QUANTITY DISCOUNTS ON REQUEST

LEVELL ELECTRONICS LTD. Moxon Street, Barnet, Herts., EN5 5SD, England  
Telephone: 01-440 8686 & 01-449 5028

CIRCLE 77 FOR FURTHER DETAILS.

# COLOURJET 132

36 COLOUR INK JET PRINTER.

Logic seeking in dot address mode

132 Column Compressed Mode

Cash price **£569** + VAT

Centronics parallel interface with full Viewdata and free BBC Micro dump listing.

also: prints OVERHEAD TRANSPARENCIES

Options available

- Buffered RS232/Viewdata interface
- Apple II & IIe interface
- IBM pc dump

Specifications:

1280 dots/line in double res. mode  
37cps in full colour  
Friction feed roll paper and single sheet feed A4  
Ink cartridges 4 million character life

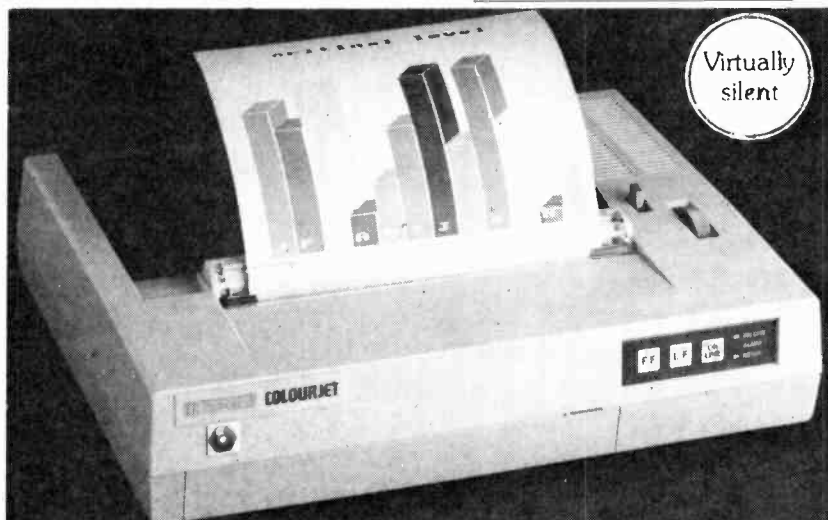

## INTEGREX LIMITED

Portwood Industrial Estate, Church Gresley  
Burton-on-Trent, Staffs DE11 9PT  
Burton-on-Trent (0283) 215432. Telex: 377106



CIRCLE 78 FOR FURTHER DETAILS.

★ ★ NI-CAD BARGAINS ★ ★

Ex-equipment but little-used, re-chargeable Nickel-cadmium batteries at fraction of L.P.  
 DEAC Type 1000DK 6 Cell Button-stack (7.2V) Measures 2 1/2" Diam. Capacity 1AH. Price each £3.50 inc vat (pp 25p)  
 DEAC Type 6000K2 3 Cell Button-stack (3.6V) Measures 1 1/2" Diam. Capacity 600mAh. Price each £1.50 inc vat (pp 25p)



★ ★ STEPPER MOTORS ★ ★

Brand new stock of 'ASTROSYN' Type 20PM-AU55 stepper motors. 28V DC. 24 steps per rev. 15 oz-in torque @ 100PPS. Body length 2 1/2" diameter 2" shaft 1/4" diam x 4 1/4" spirally threaded. Weight 16oz. Price each £11.50 (p&p 50p). Connections supplied. INC. VAT

!!! NEW STOCK !!! ★ STEPPER MOTORS ★

In stock — used, but excellent condition. 4-phase steppers. 50 steps/rev motor with (removable) gearbox giving a 300:1 reduction. 6V DC operated. Complete with a driver board requiring just a single 6V rail and pulse input. Motor measures 1" x 2" diameter, gearbox 3/4" x 2 1/2" output shaft 3/16" Sold complete with connections, CCT diagram of motor, CCT details of half-stepping etc. And pulse generator. Complete £8.50 inc. vat. (pp 50p)



ESCAP DC MOTORS.

Swiss-made precision 6V DC motors with 70:1 reduction gearbox giving final drive speed of 16rpm @ 6V. Diameter 2 1/2 cms x 4cms long. PRICE INC. VAT & CARRIAGE. £5.25. (Ex-equip., tested & guaranteed)

DATRON Model 1051 DIGITAL VM



1051 Multi-function digital voltmeter (DC) with Options fitted for AC Volts and Resistance. Total list is over £2200. Little used condition. £750.

★ ★ CROSS-HATCH GENERATORS ★ ★

**LABGEAR COLOURMATCH CM6804PG.** UHF television pattern generators giving cross-hatch, dot and grey scale patterns. Fully tested and guaranteed NOW JUST £20 inc VAT & p&p.  
**LABGEAR COLOURMATCH CM6010RG** Gated Rainbow colour pattern generators. Cross-hatch/dot & gated rainbow (RGB) colour bar patterns. £65 inc  
**UNADHM E0684 PAL** Colour-bar & pattern gen. £275-  
**KORTING 82512PAL/NTSC** Colour & pattern gen. 275-  
 Mail Order customers please add £2.50 postage each item



**RALFE · ELECTRONICS**  
 10 CHAPEL STREET, LONDON, NW1 TEL: 01-723 8753

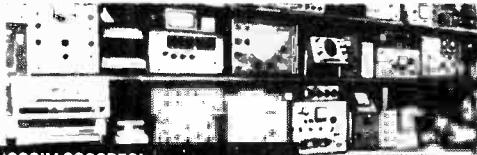

'OSCILLOSCOPES'

TEKTRONIX 454 Dual-trace 150MHz sweep delay £650  
 TEKTRONIX 453 Dual-trace 50MHz sweep-delay £500  
 TELEQUIPMENT D75 Dual-trace 50MHz. Delay £400  
 TELEQUIPMENT D63 15MHz Dual & Differential. £300  
 TELEQUIPMENT DM63 as above + STORAGE £500  
 TELEQUIPMENT D63 50MHz Dual-trace £450.  
 CDSQR C0U150 35MHz Dual-trace  
 HEWLETT-PACKARD 141A 20MHz Storage £350

1000 WATT AUDIO AMPLIFIERS

H & H PROFESSIONAL AUDIO POWER AMPLIFIER MODEL S500-D available ex-stock in superb, little-used condition at vastly reduced price. Specification includes: Dual-Channel 500+500W. THD 0.005%, IMD 0.02% Output impedance 2.5-16ohms. Frequency response ±1db 10Hz-20KHz (NB. For industrial applications these amps' can be configured to DC response) Forced air cooled dissipators for reliability and cool operation. Size 19" Rack mount x 3.5" Ht. PRICE JUST £275 inc vat & handbook. Carriage + £5. (NB. List price over £700.)

★ 125W MAINS INVERTERS ★

12V DC Battery input to 230V AC. Output @ 125 watts crystal-controlled 50Hz time-base oscillator. Fully enclosed in blue-steel cases with integral 13A socket. Dimensions approx. 4x6x10" BRAND NEW. £60 inc VAT & Carriage.

MAINS CONDITIONERS

TRANSVERTER 240V 50Hz Input to 110V 60Hz Out @ 250W. £350.  
 ADVANCE MT14DA. 230V 150W £20 + vat (pp £2)  
 GOULD 'ECVN' 220V 250W £45 + vat (pp £3)  
 GOULD 'TCVN' 220V 1500W £95 + vat (pp £5)  
 CETRONIC REGULVOLT 220V 3KW £350 - vat (pp £10)

COMPANIES PLEASE NOTE That we would be very pleased to receive your invitation to tender for your surplus or redundant equipment. Contracts offered for factory contents removals on regular basis

★ COMPUTER PERIPHERALS ★

1.6MB 8" FLOPPY DISC DRIVES — New Stock

BRAND NEW AT a surplus price. Fully Shugart compatible 'MFE CORPORATION' Model M-700 DOUBLE-SIDED industry standard 8" Floppy disc drives. Double-density, up to 1.5MBytes. Power requirements ±5V and +24V @ 1.1A. 240V AC 50Hz. LOWEST PRICE EVER. £160 — INC. VAT, CARRIAGE & HANDBOOK.

DRE 4000A DRIVES

Data Recording Equipment Model 4000A 5 + 5 MB Top-loading disc drives in stock. Brand new including full technical manual. Few remaining £250 each + VAT. SHUGART 8" Flexible disc drives Model SA800 Condition as new £150 + VAT (including postage and handbook copy).

★ MULTI-RAIL LINEAR PSU's ★

Recent stock of brand new COUTANT ESM-Series Power Supplies at surplus prices. Model ESM15.2 giving regulated, stabilised DC outputs 5V @ 15A and ±12V to ±15V @ 1.5A each and an un-stabilised 24V @ 2A. 240V AC input. Measures 5x8x11". Fully enclosed. In original cartons with handbooks. £45 each + VAT (+ carriage £5)

COUTANT LINE SUPPLIES:

MODEL ASA2000 5V 20A £35  
 MODEL ASC300 24V 2A £20  
 (inc vat, pp £4 & £2 respectively)

★ PHILLIPS TEST EQUIPMENT ★

Brand new, surplus to requirement stock NOT to be repeated. One-offs only.  
 PM2554 MILLI-VOLTMETER  
 PM6661 FREQUENCY COUNTER  
 PM6307 WOW & FLUTTER METER.

★ CENTRIFUGAL BLOWERS ★

'TORIN' Type U62B1. 230V Cap Start (supplied), very powerful (200W, 3,000 rpm) centrifugal fans for large rack cooling or enclosure extraction applications. Overall dimensions 20x12 cms. outlet 6x4 cms. BRAND NEW. Surplus stock £15 each inc. VAT, p&p £1.50.

★ INSTRUMENT COOLING FANS ★

All fans available ex-stock and GUARANTEED  
 230V 10W 5-Blade 3x3x1 1/2" NEW £7  
 115V 13W 5-Blade 3x3x1 1/2" NEW £6  
 115V 4x4x1 1/2" 5-Blade NEW £6  
 115V 7W 4 1/2" 3-Blade SHIPER £3  
 230V 40W Papst 350M/Hr. Ex-equip. £13  
 All prices include VAT (pp + 50p)

CIRCLE 67 FOR FURTHER DETAILS.

**FORTH = TOTAL CONTROL**

FORTH programs are instantly portable across the most popular microprocessors.

FORTH is interactive and very fast.

FORTH programs are structured, modular, and easy to maintain.

FORTH gives control of all interrupts, memory locations, and i/o ports.

FORTH gives full access to DOS files and functions.

FORTH application programs can be converted to turnkey programs.

FORTH Cross Compilers can generate ROMmable code for: 6502, 6809, 68000, 8080, Z80, 8086, 6800, 6801/3, 1802, Z8, 8070, Z8000, 99xxx, LSI-11

Application Development Systems include FORTH with virtual memory, multi-tasking, assembler, full-screen editor, decompiler, utilities, and full documentation.

**LMI Z80 FORTH — CPM 2.2 £95**  
**LMI 8086 FORTH — CPM-86, MSDOS £110**  
**LMI PC/FORTH — PC/DOS £110**  
**MPE-FORTH 6809 — FLEX, OS9 £175**  
**LMI 68000 FORTH — CPM 68K £225**

FORTH+ has 32-bit stacks and directly accesses the whole address space of the processor.

**PC FORTH+ £225**  
**8086 FORTH+ £225**  
**68000 FORTH+ £225**

Extension Packages include floating point, cross compilers, 8087 support, colour graphics, interactive deluggers

We are the FORTH specialists, we also stock a large range of books, listings, and implementations for machines ranging from Spectrums to Macintosh to VAX.

**mpe MicroProcessor Engineering Ltd**  
 21 Hanley Road, Shirley  
 Southampton SO1 5AP  
 Tel: 0703 780084



CIRCLE 73 FOR FURTHER DETAILS.

**FIELD ELECTRIC LTD**

3 SHENLEY RD, BOREHAMWOOD, HERTS.

TELEPHONE 01-953-6009

OFFICIAL ORDERS / OVERSEAS ENQUIRIES WELCOME

OPEN 6 DAY'S A WEEK 9.00am/5.00pm THUR. 9.00am/1.00pm

FARNELL FAN COOLED MULTI-RAIL SWITCH MODE + 12V

AT 15AMP-5V AT 1AMP + 12V AT 4AMP -12V AT 1AMP

£28.00.

GOULD PMA47 12V 3AMP D.C. LINEAR £16.95.

115 V.A.C. 4" FANS NEW & BOXED £4.95.

230 V.A.C. 4 FANS EX-EQUIP: NEW CONDITION £5.00.

G.E. PANEL METER 0-5A A.C. £7.00.

NOT SCALED NEW & BOXED.

M.P.I. 1/2 HEIGHT DISK DRIVE 5 1/4".

40 TRACK SINGLE SIDED NEW £65.00.

ALL PRICES INCLUDE 15% VAT UNLESS STATED.

CIRCLE 82 FOR FURTHER DETAILS.

**SATELLITE TELEVISION RECEPTION EQUIPMENT**

**ANTENNA**  
 1.8m dia aluminum petal dish complete with polar mount 45.4 dB gain at 11.45 GHz £609 + VAT (carriage included)

**SATELLITE TELEVISION RECEIVERS —**  
 suitable for 4GHz and 12GHz I.F. input 430—930MHz £399 + VAT (carriage included)

Get to know more about the latest technology by reading 'Tomorrows Television Today' by Michael J Stone. This well illustrated book is a comprehensive guide and covers all aspects including the fundamental theory of satellite television reception. Price: £9.95 inc p+p



**SATELLITE TECHNOLOGY SYSTEMS LTD**  
 3 Thicket Road, Staple Hill Bristol BS16 4LW

Telephone: 0272 573878 Telex: 449752 CHACOM G ATTN: STS

CIRCLE 90 FOR FURTHER DETAILS.

ELECTRONICS & WIRELESS WORLD JUNE 1985

# Sowter Transformers

With 42 years' experience in the design and manufacture of several hundred thousand transformers we can supply

## AUDIO FREQUENCY TRANSFORMERS OF EVERY TYPE

YOU NAME IT! WE MAKE IT!

### OUR RANGE INCLUDES:

Microphone transformers (all types), Microphone Splitter/Combiner transformers, Input and Output transformers, Direct Injection transformers for Guitars, Multi-Secondary output transformers, Bridging transformers, Line transformers, Line transformers to G.P.O. Isolating Test Specification, Tapped impedance matching transformers, Gramophone Pickup transformers, Audio Mixing Desk transformers (all types), Miniature transformers, Microminiature transformers for PCB mounting, Experimental transformers, Ultra low frequency transformers, Ultra linear and other transformers for Transistor and Valve Amplifiers up to 500 watts, Inductive Loop transformers, Smoothing Chokes, Filter, Inductors, Amplifier to 100 volt line transformers (from a few watts up to 1,000 watts), 100 volt line transformers to speakers, Speaker matching

transformers (all powers), Column Loudspeaker transformers up to 300 watts or more.

We can design for RECORDING QUALITY, STUDIO QUALITY, HI-FI QUALITY OR P.A. QUALITY. OUR PRICES ARE HIGHLY COMPETITIVE AND WE SUPPLY LARGE OR SMALL QUANTITIES AND EVEN SINGLE TRANSFORMERS. Many standard types are in stock and normal despatch times are short and sensible. OUR CLIENTS COVER A LARGE NUMBER OF BROADCASTING AUTHORITIES, MIXING DESK MANUFACTURERS, RECORDING STUDIOS, HI-FI ENTHUSIASTS, BAND GROUPS AND PUBLIC ADDRESS FIRMS. Export is a speciality and we have overseas clients in the COMMONWEALTH, EEC, USA, MIDDLE EAST, etc. Send for our questionnaire which, when completed, enables us to post quotations by return.

## E. A. Sowter Ltd.

Manufacturers and Designers

E. A. SOWTER LTD. (Established 1941), Reg. No. England 303990

The Boat Yard, Cullingham Road, Ipswich, IP1 2EG, Suffolk, P.O. Box 36, Ipswich, IP1 2EL, England

Phone: 0473 52794 & 0473 219390 : Telex: 987703G SOWTER

CIRCLE 69 FOR FURTHER DETAILS.

## The LJ Robotic Work- Cell System

Based around the popular LJ ATLAS Robot, this work-cell provides an automatic parts-selection system running under full microcomputer control.

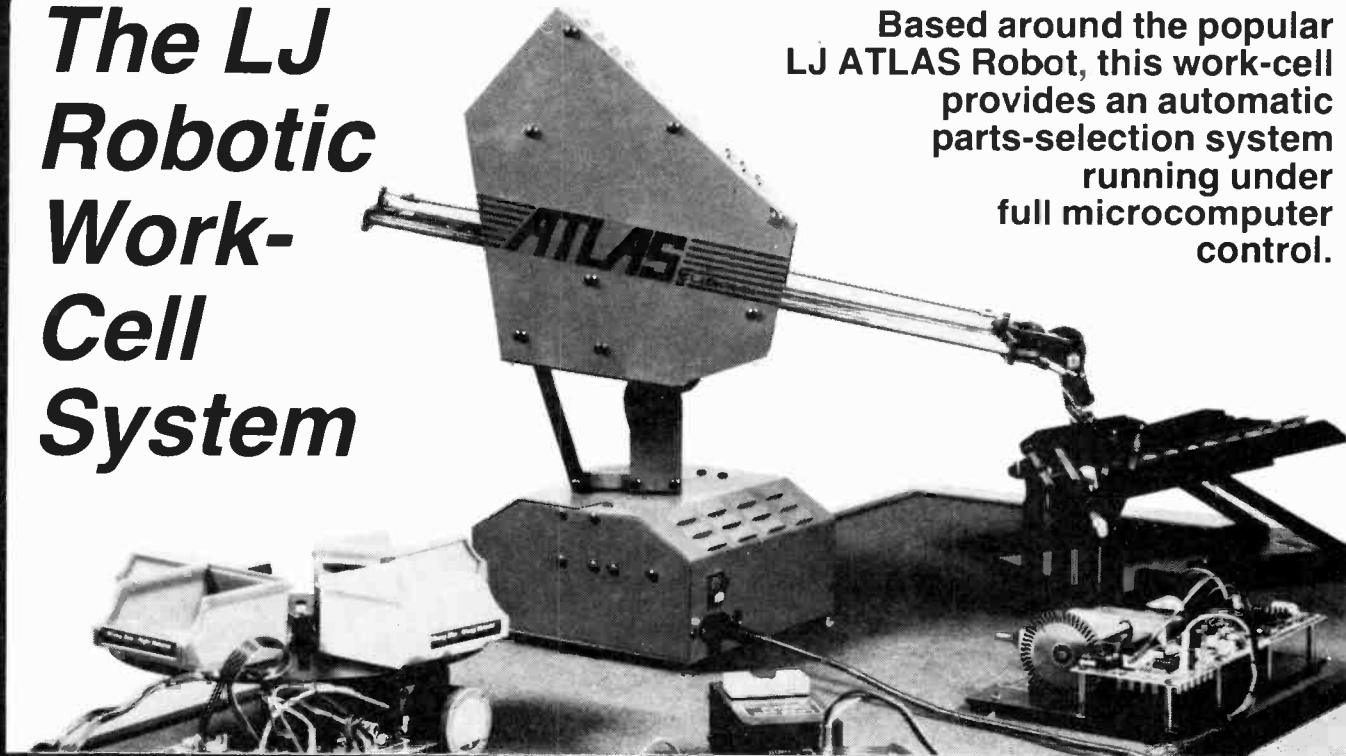

LJ Electronics Ltd  
Technical Teaching Systems  
for Microelectronics,  
Microprocessors  
and Robotics

Francis Way  
Bowthorpe Industrial Estate  
Norwich, NR5 9JA, England  
Tel:(0603) 748001. Telex: 975504

CIRCLE 64 FOR FURTHER DETAILS.



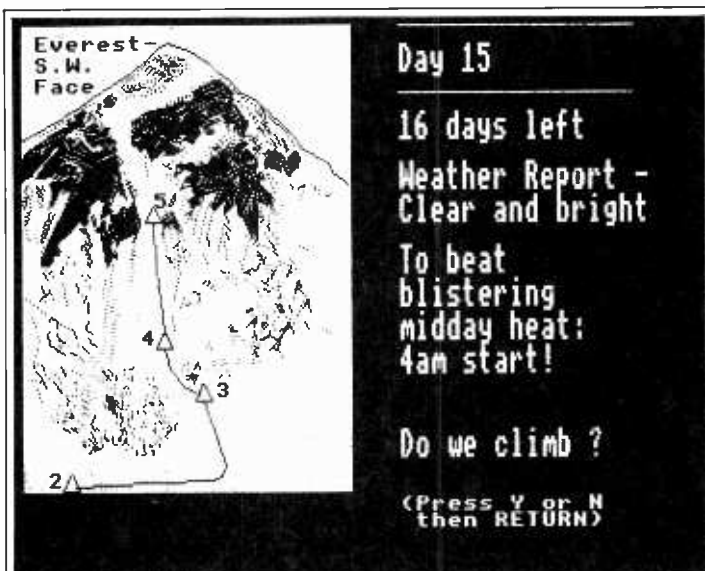

Can your computer climb Mount Everest? The challenge is posed by Summit, one of four entertaining games of strategy for young geographers in a new software pack from BBC Publications. The others include an exploration game designed to give an understanding of contour maps and an intercontinental airliner simulation in which the pilot must navigate his way safely to his destination. The games tie in with a BBC radio series for schools, but can be used independently in the classroom or at home. *Introducing Geography* is available for the BBC Micro on three well-filled discs at £20 and there is an accompanying book for £4.95.

From the same source comes *Maths with a Story*, which with subtlety and imagination introduces children of primary school age to elementary probability, the four-colour map problem, graphical co-ordinates and the concept of symmetry. A cassette for the BBC Micro (transferrable to disc) costs £10.95 and versions for the Acorn Electron, Spectrum and Commodore computers are in preparation. The associated book for parents will be published on May 23.

## End of ATS- 1 after 18 years

After more than 18 years of service, NASA's first Applications Technology Satellite, ATS-1 has failed to respond to commands to correct its eastward drift and will lose its useful orbital position in about six months.

Launched in 1966, with an expected life of three years, the satellite has provided voice and data communications to wide area around the Pacific Basin. During its service it has scored several significant achievements:

It was the first to transmit a full-earth, cloud cover picture from geosynchronous orbit.

It transmitted real-time tv pictures from the Apollo 4 splashdown in the Pacific.

It was used between 1967 and 1968 for two-way communications tests between aircraft to determine

navigational effects of satellite communications.

In 1971 it was used for the link between us and Soviet scientists during an atmosphere, sea and ice conditions experiment in the Bering Sea.

It has been employed in several medical connections including the transmission of cardiographs from Hawaii to New Zealand and from Alaska to the University of Washington; for a link-up between 12 nations for medical conferences with the University of Hawaii and as a link to paramedics in remote parts of Alaska.

ATS-3, launched in 1967 is still in operation and covers the US and most of the Atlantic as well as the eastern Pacific including Hawaii.

## Cellular data

A method of reliably transferring data by cellular telephone network from and to a mobile subscriber has been developed. Racial Vodata has worked with Racial Research to develop a protocol named CDLC (Cellular Data Link Control) which is specifically designed to overcome the problems of data transmission encountered on a cellular radio network, particularly when switching between cells which are subject to fading and hand-off. The first

CDLC products will be add-on modems for cellular phones which will provide 1200/s pseudo-full-duplex transmission. Any digital equipment with RS232 interfacing may be connected to the system. These include personal computers, printers, v.d.us and other terminals. Racial-Vodafone believes that this is at the forefront of world cellular technology and will be a major factor in persuading customers to use their system.

## Tape makers slam levy

The Government proposed levy on blank recording tape is condemned as unworkable, unnecessary and punitive by the Tape Manufacturers Group. Under the plans levies would be imposed of 10% on the price of audio and 5% on video tapes. Each cassette would carry a levy stamp and manufacturers and retailers selling tapes without stamps could be fined. Those caught using unstamped tapes could also be prosecuted. Christopher Hobbs, Chairman of the TMG likened the levy to "the Government adding £50 to the price of cars sold to allow for offences that the owners might commit." He also said that the scheme would be an "administrative nightmare, full of loopholes for the unscrupulous to exploit the public."

The proposals of the percentage levies are for the manufacturers' prices. By the

time the distributors and retailers have added their mark-up and v.a.t. is added, the levy could be doubled. The scheme could be circumvented by the import of tape from overseas undercutting the local product. "The incentives to counterfeit the levy stamp would be enormous."

The Group also maintains that the need for levies has not been proven. In an independent survey of video recorder use, less than 1% of recorded material is kept for repeat viewings. The vast majority of video usage is for time-shifting; recording programmes for viewing at a more convenient time. In audio, another survey has shown that less than 22% of the population buy blank tape for any purpose; almost 70% of record taping is from the user's own records and 25% do it to maintain their records in good condition.

## Powerful exchange

Claimed to be the world's most powerful exchange, the international telephone exchange at Keybridge House, Vauxhall, London, can handle 800 000 call attempts an hour. The digital exchange can cope with data, text, facsimile and graphics as well as telephone speech. It is supplied by Thorn Ericsson and is based on the Ericsson AXE10 design with an APZ212 processor. At present it has capacity for 13800 circuits and this is to be expanded to 50 000 circuits on

completion next year.

The exchange has been upgraded over the past nine months and all the operations including replacing the central processor have been carried out without disrupting the service. It is used primarily for international direct dialling calls and it is linked to BT's other international exchanges. It also handles transit calls (from one country to another through the UK) and operator-connected calls.

# Here is the news. . . without interference

A 14GHz satellite terminal made by the British company GEC McMichael will soon be helping to bring American television audiences live pictures of new events which until now would have been impossible to cover.

The CBS network has ordered GEC McMichael's Newshawk satellite terminal, which is the first transportable Ku-band earth station to meet the Federal Communication

Commission's exacting technical specifications.

The orbital positions of satellites used by American broadcasters for temporary links are so close together that off-axis radiation by ground stations using them must be strictly controlled. Newshawk meets the requirements easily by virtue of its unique one-piece antenna design. An offset-fed Gregorian configuration provides an r.f. path

unobstructed by mounting struts and hardware which in other designs lead to side-lobes.

GEC McMichael designed the antenna using specially-developed computer software. They say there is no simple mathematical expression to represent the curvature of the dish; but its overall shape is elliptical, combining a large radiating area with compactness, transportability and low wind-loading.

Two versions of the terminal are available: the 3m-high trailer-mounted model shown in the photograph, or the version bought by CBS which packs away so small that it can be

taken as luggage on scheduled air services. A two-man crew can have it up and running in as little as 15 minutes.

A special feature of the package is a video compression codec which makes it possible to transmit the video and sound signals in digital form at a choice of data rates ranging from 1.5Mbit/s to 8Mbit/s. The rate can be selected to suit the operating conditions: with the slower ones, the clarity of the picture is reduced in areas where movement occurs.

GEC McMichael Ltd., Sefton Park, Bells Hill, Stoke Poges, Slough SL2 4HD, tel 02816-2777.

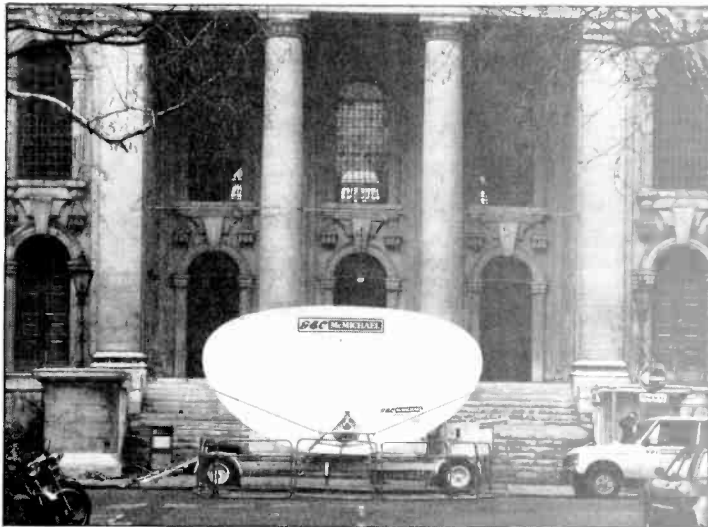

## Sending text to us

Business Press International, our parent company, has installed a Case Beeline System which can be used by those with a microcomputer and a modem to send text. The modem needs to be set up to 300Baud, even parity with 10bits/character. To use the system dial 01-661-8978, wait for a response tone from our modem, connect your modem.

Transmit in capitals EWW, the system will respond with +++STF GO; Then type the destination, e.g. "For the attention of the editor"; your details and the message, in upper and lower case. Sign off with NNNN, in capitals. Terminate call. At the receiving end the message is treated like a Telex and rushed straight to us.

# Coming to this screen shortly. . .

Now that negotiations for the BBC's tv licence fee are over, it is worth looking at what the opposition is up to. And by that we don't mean ITV. Or even radio.

The cable tv industry has been in the doldrums lately. The euphoria brought on by the Government's initial announcements a couple of years ago soon evaporated. And as disillusion with British prospects for the new medium set in, several powerful Anglo-American engineering marriages formed to exploit it found themselves on the rocks. But now things are looking up once more; and on council estates in Croydon and elsewhere a few brave spirits are hard at work pushing cables down holes.

But, these sporadic ventures apart, the British cable tv industry is far from booming. It still consists for the most part

not of engineers or programme-makers but of dark-suited businessmen whose instinct tells them that there is money to be made out of cable, without so far having revealed precisely how.

The whole affair turns on money, of course, and it is interesting to note that there is no general agreement that there is no prospect of supporting cable tv entirely through advertising income. The tv audience of the future will be fragmented into ten, twenty or more minority groups watching ten or twenty different channels. How could any programme deliver enough viewers to attract the advertisers? It would scarcely be worth the expense of producing the commercials.

So most of the money for cable programmes will have to come from viewers' subscriptions. In other words,

while Westminster and *The Times* try to steer us away from the licence fee system, the cable tv industry is doing the exact opposite; the difference being that the monthly 'licence fee' for a cable tv connection now works out at two to four times as costly as the ordinary broadcast one (which cable subscribers have to pay as well).

Television costs money, and good programmes generally cost big money. From that point of view, signs from the cable tv business are not encouraging. Burdened by the heavy cost of setting up their networks without the government aid enjoyed by operators abroad, the new stations must get their programmes from the cheapest possible sources.

The cheapest network tv programmes now cost

something like £50 000 an hour. Cable tv hopes to get by on £5000 an hour or less. Certainly, part of the difference can be accounted for by the broadcasters' organizational structure and high labour costs. But how can cable possibly compete? Even the rubbish from the BBC and ITV is usually good quality rubbish.

The inevitable conclusion must be that there is only one way cable can get anywhere in Britain. And that is by lobbying; by so demoralizing the existing broadcasters and undermining them financially that they lose the will to survive. If that happens, then cable tv's endless pop promo compilations, low-budget talking heads and wall-to-wall 'I Love Lucy' shows may just begin to look good by comparison.

## New blood

Looking at higher education as a whole, the effect of cuts in spending continues to bite ever more deeply. The Chancellor's Budget allocation of £43M to provide additional places in engineering and technology at selected higher education institution has to be seen against the overall picture, which still looks very grey indeed.

Nevertheless, the Engineering Council's campaign over the last year for more engineering education resources has been remarkably successful and is to have an immediate

effect: 475 new places in the first phase of the programme will be available this coming October. Dr Kenneth Miller, Director-General of the Engineering Council, expresses himself as "extremely gratified" with the outcome of the campaign. He points out that "the squeeze could affect engineering education disproportionately" and that the new money will help to avoid this effect.

Those concerned with engineering will, no doubt, rejoice at this evidence that the Government's heart is in the right place, but it seems less

than likely that the arts people are quite so overcome with euphoria. They may, however, derive some solace from the stated belief of the Council that "a broad education to a late stage is vital" for the provision of "numerate arts graduates and articulate science graduates". The intention is that pupils will not have to decide at, or before the age of 16 whether to be scientists or 'artists'. This has been said before, by the Council of Engineering Institutions in 1980, when the 'breadth' of proposed new courses was to be dealt with by the inclusion of "supplementary subjects as desired". A sideways glance at literature or history is mere lip-service to

the concept of a broad education, and it is to be hoped that this time the Council means what it says.

However vital it is for the nation's economic growth that there should be a flow of well-trained scientists and engineers coming out of universities and polytechnics, it is equally as important in the longer term that they should be as "articulate" as the products of the other faculties and no less appreciative of those facets of life which have little commercial value. Education is not, or ought not to be, a meal ticket; nor is it a factory process to produce a generation of single-minded technocrats to bolster the economy.

## Towards a thinking computer

Intelligent knowledge-based systems is one of the major research areas of the Alvey project; part of the quest for the next generation of super computers. Fifty projects, costing about £20M, have been announced which are aimed to establish the necessary technology upon which subsequent industrial and commercial applications of i.k.b.s. can be based. The researches into 'artificial intelligence' include projects on novel computer architecture, logic programming languages, expert systems, the understanding of natural language and image interpretation.

Each project is a collaboration between companies and/or academic research establishments and in all, 28 different firms and 26 universities, polytechnics and research establishments are involved.

The research is intended to develop systems which can reason and even guess the answer to a problem. They would need to be able to handle logical relationships and such trial-and-error based knowledge to be found in codes of practice, rules of thumb or 'hunches'. In effect they are trying to emulate the human reasoning process which often involves little actual

mathematics but uses logical inference, comparison with previous situations using extrapolation and interpolation, and estimating. A start has been made in the development of symbolic processing languages such as Prolog and Lisp, but the development of much larger and more powerful expert systems is a long-term aim, likely to take decades.

Demonstration projects under way include a system to monitor the performance of machinery and to permit automatic adjustment to give optimum performance. Another is the formulation of mixtures in chemical works, such as a lubricating oil for a specific application.

The main research programme is carried out under a number of specific research themes and cover an enormous range with thirteen projects related to expert systems, two on intelligent front-end

interfaces, seven are exploring natural language, three for image interpretation and the development of robot vision. Other areas are inference and knowledge representation, intelligent computer-aided instruction, and declarative systems architecture.

There is also a support infrastructure for the programme and include community clubs where companies with common interests and problems can jointly commission the development of an expert system. One such club has been formed to produce software to demonstrate the use of expert systems in the real-time process control of chemical plants; another for the development of a system for use in civil engineering, particularly quantity surveying. The third club is to set up a financial advisor on the performance and health of small business companies. Several more are planned or are being set up.



This liquid level sensor, developed by the RNIB, vibrates when liquid bridges the metal probes in the cup and may be felt by those who are deaf as well as blind. Two sets of probes indicate

low and high levels. The contact sets into motion a miniature Portescap motor with an eccentric load weight, producing an audible buzz and a gentle vibration.

## Life-saving pager

Patients waiting for organ transplants can now be in constant touch with their hospitals through Life Page, a service offered free by BT Radiopaging. Many potential transplant patients are still active and mobile, not necessarily tied to their homes or beds. However if a transplant organ becomes available they need to be contacted very urgently so that the surgery can

be completed rapidly. Under the scheme, patients waiting for heart, kidney, liver or other organ transplants will be issued with a standard radiopager. The first recipient of a pager at the official launch of the service recently was Paul Stokes who is on the waiting list for heart surgery at Papworth Hospital. BT launched the service to celebrate their 250,000th subscription to Radiopaging.



# IBS

1 Montgomery Place  
Irvine, Ayrshire  
KA12 8PN  
Telex 777582  
(mark: attn IBS)

## THE ENGINEERS Z80 COMPUTER WITH IEEE 488

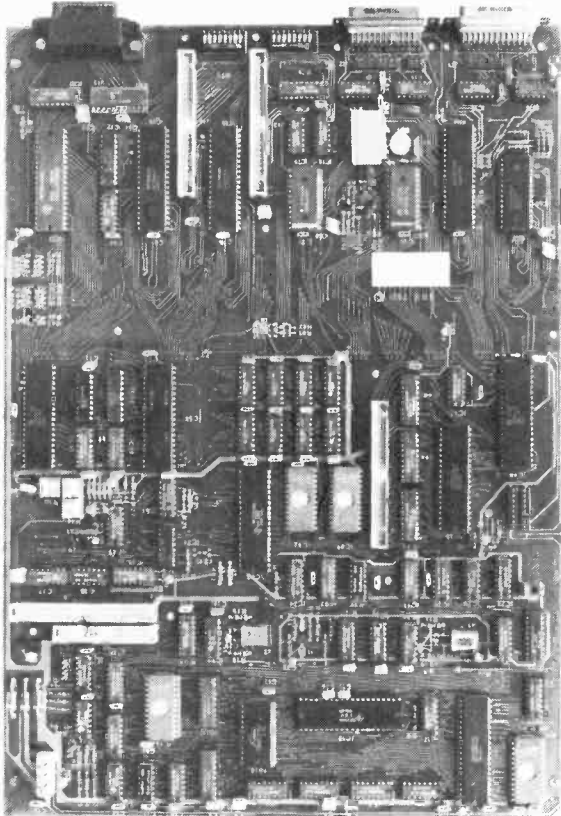

- \* 2 x Z80 CPU's (4MHz)
- \* 64K DYNAMIC RAM
- \* UP TO 32K EPROM
- \* FLOPPY DISK CONTROLLER FOR 3", 5" and 8" Disk Drives
- \* 2 x RS232 SERIAL I/O CHANNELS
- \* I/O MAPPED VIDEO GEN. 80 Cols. 24 Lines
- \* 4 x PARALLEL I/O CHANNELS
- \* PARALLEL KEYBOARD PORT (POWERED)
- \* IEEE 488 INTERFACE
- \* HARDWARE REAL TIME CLOCK
- \* 2 x 8 BIT SWITCHES (I/O MAPPED)
- \* MONITOR PROGRAM IN PROM
- \* PROM BASED SOFTWARE AVAILABLE such as ASSEMBLER/EDITOR, and XTAL BASIC WITH IEEE DRIVERS

The IBS 750 is an Industrial Quality Product designed for reliability and ease of use. It is normally supplied fully-built and tested but is also available in a number of partially-built options. The Monitor PROM contains 22 user commands which will assist in writing and de-bugging of the SBC's console and printer requirements by just opening or closing links on the PCB. The same configured version of CP/M 2.2 is available for various Disk sizes. A complete Development System and Desk Top Computer based on this board is available with a variety of Disk Drive sizes and case styles to suit users requirements and environment.

**Tel (0294) 75000/73333**

CIRCLE 85 FOR FURTHER DETAILS.

# MODEM FILTERS

LOWBAND HIGHBAND

550Hz NOTCH

R5635

V.22 bis, full-duplex filter

## NEW

- R5635** CCITT V.22 bis, full-duplex Switched-Capacitor Filter I.C. with MUXes.
- R5636** Bell 201/CCITT V.26 combo filter I.C.
- R5637** Bell 208/CCITT V.27 combo filter I.C.
- R5638** Bell 209/CCITT V.29 combo filter I.C.
- R5630** Bell 103, full-duplex filter I.C. with MUXes.
- R5631** CCITT V.21, full-duplex filter I.C. with MUXes.
- R5632** Industry Standard, Bell 212A/CCITT V.22 full-duplex combo filter I.C.
- R5633** Selectable filter array I.C. for 103, V.21, DTMF and Videotex applications.
- R5626** Mask programmable to your specification.

### Contact: EG & G RETICON

34/35 Market Place, Wokingham, Berks  
RG11 2PP. Telephone: 0734 788666.  
Telex: 847510 EGGUK.

 **EG&G RETICON**  
WHERE VISION AND TECHNOLOGY MEET

CIRCLE 70 FOR FURTHER DETAILS.

# COMPUTER WAREHOUSE

1000's OF BARGAINS FOR CALLERS

THE 'ALADDIN'S' CAVE OF COMPUTER AND ELECTRONIC EQUIPMENT

## RECHARGEABLE BATTERIES

Dry Fit Maintenance FREE by Sonnenschein.  
A300 07191315 12v 3 AH same as RS 591-770 NEW £13.95  
A300 07191202 6-0-5 1.8 AH same as RS 591-382 EX EQUIP £4.99  
Miniature PCB mount 3.6v 100 Mah as RS 591-477 NEW £11.00  
SAFT VR2C 1.2v "C" size NICADS in 18 cell ex equipment pack. Good condition - easily split to single cells £10.50 + pp £1.90

## EX-STOCK INTEGRATED CIRCUITS

2732 ex equip £3.25, 27128 - 250ns NEW £12.00.  
6116-200 £4.50, 6116-250 £3.95,  
6264LP-150 £22.00, 4164-200 £3.50, 4864-150 £4.00,  
4116-300, £1.20, 2114 £1.75, 6800 £2.50, 6821 £1.00,  
68A09 £8.00, 68B09 £10.00, 68B09E £14.50,  
D80B5AH-2 £12.00, D80B6 £20.00, Z80A £2.99.

## HOT LINE DATA BASE

# DISTEL ©

THE ORIGINAL FREE OF CHARGE dial up data base  
1000's of stock items and one off bargains.  
ON LINE NOW - 300 baud, full duplex CCITT tones, 8 bit word, no parity  
**01-679 1888**

## MAINS FILTERS

Cure those unnerving hang ups and data glitches caused by mains interference  
SD5A As recommended by ZX81 news letter, matchbox size up to 1000 watt load **£5.95**  
L2127 compact completely cased unit with 3 pin fitted socket Up to 750 watts **£9.99**

## Anderson Jacobson AJ510 VIDEO DISPLAY TERMINAL

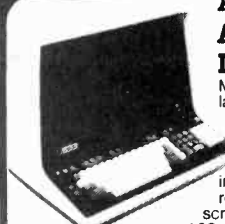

Made by one of the USA's largest peripheral manufacturers the AJ510 Professional VDU terminal has too many features to include in space available - just a few are: internal Z80 cpu control, very readable 15" non glare green screen, 24 lines by 80 characters, 128 ASCII character set with lower case and graphics, standard RS232 interface, Cursor addressing, numeric key pad etc. Supplied in good **TESTED** second hand condition with full manual **£225.00 + carr £10.00**. Data sheet on request.

## COOLING FANS

Keep your hot parts COOL and RELIABLE with our range of BRAND NEW professional cooling fans.  
ETRI 90KU01 Dim. 92 x 92 x 25 mm. Miniature 240 v equipment fan complete with finger guard. **£9.95**.  
GOULD JB-3AR Dim 3" x 3" x 2.5" compact very quiet running 240 v operation. **NEW £6.95**  
BUHLER 69.11.22. 8-16 v DC micro miniature reversible fan. Uses a brushless servo motor for extremely high air flow, almost silent running and guaranteed 10,000 hr life. Measures only 62 x 62 x 22 mm. Current cost **£32.00**. **OUR PRICE ONLY £12.95** complete with data.  
MUFFIN-CENTAUR standard 4" x 4" x 1.25" fan supplied tested EX EQUIPMENT 240 v at £6.25 or 110 v at £4.95 or BRAND NEW 240 v at £10.50 1000's of other fans EX Stock. Call for Details. Post & Packing on all fans £1.60

A Major company's over production problems, and a special BULK PURCHASE enable TWO outstanding offers.

# COLOUR MONITOR SPECIALS

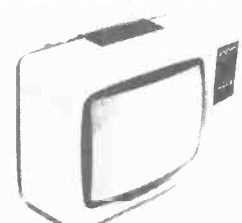

## 'SYSTEM ALPHA' 14" Multi Input Monitor.

Made in the UK by the famous REDIFFUSION Co. for their own professional computer system this monitor has all the features to suit your immediate and future monitor requirements. Two types of video input, RGB and PAL Composite Video, allow direct connection to most makes of micro computers and VCR's. An internal speaker and audio amplifier may be connected to your system's output or direct to a VCR machine, giving superior colour and sound quality. Many other features include PIL tube, Matching BBC case colour, Major controls on front panel, Separate Contrast and Brightness - even in RGB mode, Two types of audio input, Separate Colour and audio controls for Composite Video input, BNC plug for composite input, 15 way 'D' plug for RGB input, modular construction etc. etc.

This must be **ONE OF THE YEAR'S BEST BUYS!!!**

Supplied **BRAND NEW** and **BOXED**, complete with **DATA** and 90 day guarantee. **SUPPLIED BELOW ACTUAL COST - ONLY £149.00 + Carr.**

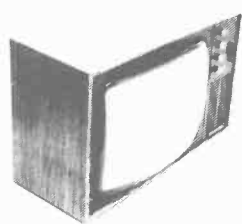

## DECCA RGB 80-100 Monitor.

Little or hardly used manufacturer's surplus enables us to offer this special converted DECCA RGB Colour Video TV Monitor at a super low price of only **£99.00**, a price for a colour monitor as yet unheard of!! Our own interface, safety modification and special 16" high definition PIL tube, combine with the tried and tested DECCA 80/100 series chassis to give 80 column definition and picture quality found only on monitors costing 3 TIMES OUR PRICE. In fact, **WE GUARANTEE** you will be delighted with this product, the quality for the price has to be seen to be believed. Supplied complete and ready to plug direct to a BBC MICRO computer or any other system with a TTL RGB output. Other features include internal audio amp and speaker, Modular construction, auto degaussing 34 H x 24 D, 90 day guarantee. Supplied in **EXCELLENT** condition, **ONLY £99.00 + Carr.** Also available **UN-MODIFIED** but complete with MOD DATA. Only **£75.00**. Carriage and Insurance on monitors **£10.00**

## BUDGET RANGE VIDEO MONITORS

At a price YOU can afford, our range of EX EQUIPMENT video monitors defy competition! All are for 240v working with standard composite video input. Units are pre tested and set for up to 80 col use on BBC micro. Even where MINOR screen burns MAY exist - normal data displays are unaffected.  
**1000's SOLD TO DATE**  
12" KGM 320-321, high bandwidth input will display up to 132 columns x 25 lines. Housed in attractive fully enclosed brushed alloy case. B/W only **£32.95**  
24" KGM large screen black & white monitor fully enclosed in light alloy case. Ideal schools, shops, clubs etc. **ONLY £55.00** Carriage **£10.00**

## DATA MODEMS

Join the communications revolution with our super range of DATA MODEMS with prices and types to suit all applications and budgets!! Most modems are EX BRITISH TELECOM and are made to the highest standard for continuous use and reliability. RS232 interfaces are standard to all our modems, so will connect to ANY micro etc. with an RS232 serial interface.

- DATTEL 2B** see SPECIAL OFFER centre of this ad.  
**MODEM 13A**, 300 baud. Compact unit only 2" high and same size as telephone base. Standard CCITT tones. CALL mode only. Tested with data. **ONLY £45.00 + PP £9.50**  
**MODEM 20-1**, 75-1200 baud. Compact unit for use as subscriber end to PRESTEL, MICRONET or TELECOM GOLD. Tested with data. **£39.95 + PP £6.50**  
**MODEM 20-2**, same as 20-1 but 1200-75 baud **£99.00**.  
**TRANSDATA 307A**, 300 baud acoustic coupler. Brand new with RS232 interface. **ONLY £49.95**  
**DACOM DSL2123** Multi Standard Modem. Switchable CCITT or USA BELL. 103 standard V21 300-300, V23 75-1200, V23 1200-75 or 1200-1200 half duplex.  
Auto answer via MODEM or CPU. CALL or ANSWER modes plus LED status indication. DIM 2.5" x 8.5" x 9". **BRAND NEW** fully guaranteed **ONLY £268.00 + PP £4.50**.  
**DATTEL 2412** Made by SE LABS for BT. This two part unit is for synchronous data links at 1200 or 2400 baud using 2780/3780 protocol. Many features include Auto answer, 2 or 4 wire working etc. etc. **COST OVER £800**, **OUR PRICE £185.00**.  
**DATTEL 4800**, RACAL MPS4800 high speed good condition **£285.00 CARR £10.00**

## SPECIAL 300 BAUD MODEM OFFER

Another GIGANTIC purchase of these EX BRITISH TELECOM, BRAND NEW or little used 2B data modems allows US to make the FINAL REDUCTION, and for YOU to join the exciting world of data communications at an UNHEARD OF PRICE OF ONLY **£29.95**. Made to the highest POST OFFICE APPROVED spec at a cost of hundreds of pounds each, the 2B has all the standard requirements for data base, business or hobby communications. All this and more!!

- 300 baud full duplex
- Full remote control
- CCITT tone standards
- Supplied with full data
- Modular construction
- Direct isolated connection
- CALL, ANSWER and AUTO modes
- Standard RS232 serial interface
- Built in test switching
- 240v Mains operation
- 1 year full guarantee
- Just 2 wires to comms. line

**NOW ONLY £29.95**

Order now - while stocks last. Carriage and Ins. **£10.00**

**SAVE £250**  
**SUPER PRINTER SCOOP**  
**BRAND NEW CENTRONICS 739-2**  
The "Do Everything Printer" at a price that will NEVER be repeated. Standard CENTRONICS parallel interface for direct connection to BBC, ORIC, DRAGON etc. Superb print quality with full pin addressable graphics and 4 type fonts plus HIGH DEFINITION internal PROPORTIONAL SPACED MODE for WORD PROCESSOR applications. 90-132 columns, single sheet, sprocket or roll paper handling plus much more. Available ONLY from DISPLAY ELECTRONICS at the ridiculous price of **ONLY £199.00 + VAT** Complete with full manual etc. Limited quantity - Hurry while stocks last.  
Options: Interface cable (specify for BBC, ORIC, DRAGON or CENTRONICS 36 way pig) **£12.50**. Spare ribbon **£3.50** each. BBC graphics screen dump utility program **£8.60**. Carriage and Ins **£10.00 + VAT**

**HUNDREDS OF PRINTERS EX STOCK FROM £49.00**. Call Sales Office for Details.

1 only large CALCOMP 1036 AO 3 pen drum plotter and offline 915 magtape controller. Good working order. **ADD VAT TO ALL PRICES £2500.00.**

## EX STOCK DEC CORNER

- PDP 1140 System** comprising of CPU, 124k memory + MMU, 16 line RS232 interface, RP02 40 MB hard disk drive, TU10 9 track 800 BPI Mag tape drive, dual rack system, VT52 VDU etc. etc. Tested and running **£3750.00**
- BA11-MB 3.5" Box, PSU, LTC** **£385.00**  
**DH11-AD 16 x RS232 DMA interface** **£2100.00**  
**DLV11-J 4 x EIA interface** **£310.00**  
**DLVII-E Serial, Modem support** **£200.00**  
**DUP11 Sych. Serial data i/o** **£650.00**  
**DQ200 Dialog - multi RK controller** **£495.00**  
**DZ11-B 8 line RS232 mux board** **£650.00**  
**KDF11-B M8189 PDP 1123+ A136 Decoder EIA or 20 ma loop** **£1100.00**  
**LAX34-AL LA34 tractor feed** **£85.00**  
**MS11-JP Unibus 32 kb Ram** **£80.00**  
**MS11-LB Unibus 128 kb Ram** **£450.00**  
**MS11-LD Unibus 256 kb Ram** **£850.00**  
**MSC4804 Obus (Equiv MSV11-L) 256 kb** **£499.00**  
**PDP11/05 Cpu, Ram, i/o, etc.** **£450.00**  
**PDP11/40 Cpu, 124k MMU** **£1850.00**  
**RT11 ver. 3B documentation kit** **£70.00**  
**RK05-J 2.5 Mb disk drives** **£650.00**  
**KLBJA PDP 8 Async i/o** **£175.00**  
**MIBR PDP 8 Bootstrp option** **£75.00**  
**VT50 VDU and Keyboard - current loop** **£175.00**  
**VT52 VDU with RS232 interface** **£250.00**

1000's of EX STOCK spares for DEC PDP8, PDP8A, PDP11 systems & peripherals. Call for details. All types of Computer equipment and spares wanted for PROMPT CASH PAYMENT.

# DISPLAY ELECTRONICS

All prices quoted are for U.K. Mainland, paid cash with order in Pounds Sterling PLUS VAT. Minimum order value **£2.00**. Minimum Credit Card order **£10.00**. Minimum BONA FIDE account orders from Government Depts., Schools, Universities and established companies **£20.00**. Where post and packing not indicated please add **£1.00 + VAT**. Warehouse open Mon-Fri 9.30-5.30. Sat 10.30-5.30. We reserve the right to change prices and specifications without notice. Trade, Bulk and Export

32 Biggin Way, Upper Norwood, London SE19 3XF  
Telephone 01-679 4414 Telex 894502 Data 01-679 1888



# ERS — PRINTERS — PRINTERS — PRINTERS PRINTERS — PRINTERS — PRINTERS — PRI

## SUPER DEAL? NO — SUPER STEAL!!

The FABULOUS 25CPS TEC Starwriter

**BRAND NEW AT ONLY £499 + VAT**

Made to the very highest spec the TEC Starwriter FP1500-25 features a heavy duty die cast chassis and DIABLO type print mechanism giving superb registration and print quality. Micro-processor electronics offer full DIABLO/QUEME command compatibility and full control via CPM Wordstar etc.

Many other features include bidirectional printing, switchable 10 or 12 pitch, full width 381 mm paper handling with upto 163 characters per line, friction feed rollers for single sheet or continuous paper, internal buffer, standard RS232 serial interface with handshake. Supplied absolutely BRAND NEW with 90 day guarantee and FREE daisy wheel and dust cover. Order NOW or contact sales office for more information. Optional extras: RS232 data cable £10.00. Tech manual £7.50. Tractor feed £14.00. Spare daisy wheel £3.00. Carriage & Ins. (UK Mainland) £10.00.



Save over £400  
a fraction of its original cost.

## PROFESSIONAL KEYBOARD OFFER

An advantageous purchase of brand new surplus allows a great QWERTY, full travel, chassis keyboard offer at fractions of their original costs.

ALPHAMERIC 7204/60 full ASCII 60 key, upper, lower + control key, parallel TTL output plus strobe. Dim 12" x 6 1/2" x 5 1/2" 12 DC. £29.90.  
DEC LA34 Unencoded keyboard with 67 quality, GOLD, normally open switches on standard X, Y matrix. Complete with 3 LED indicators & I/O cable - ideal micro conversions etc. pcb DIM 15" x 4.5" £24.95 Carriage on keyboards £3.00.

## 66% DISCOUNT

ELECTRONIC COMPONENTS EQUIPMENT

Due to our massive bulk purchasing programme which enables us to bring you the best possible bargains, we have thousands of I.C.'s, Transistors, Relays, Caps, P.C.B's, Sub-assemblies, Switches, etc. etc. surplus to our requirements. Because we don't have sufficient stocks of any one item to include in our ads, we are packing all these items into the 'BARGAIN PARCEL OF A LIFETIME'. Thousands of components at giveaway prices! Guaranteed to be worth at least 3 times what you pay. Unbeatable value!! Sold by weight.

2.5kls £4.25 + pp £1.25  
10kls £10.25 + pp £2.25

5kls £3.90 + £1.80  
20kls £17.50 + £4.75



## GE MODEL 30

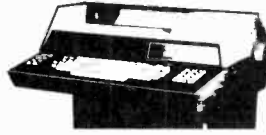

A large purchase of these stand alone terminal units offers an EXTREMELY LOW PRICE for a professional printer for direct connection to your micro. The printer has a standard RS232 serial interface with switchable rates of 110, 200 and 300 baud. Upper and lower case characters are printed by a matrix head with character widths up to 132 columns. Unit accepts standard fan fold sprocket fed paper from 4" to 9.5". Many other features such as numeric keypad, electronic keyboard, auto motor on/off and FREE floor stand. Supplied in good S/H working condition - complete with manual ONLY £95.00  
CARRIAGE & INS. £10.00

## GE TERMIPRINTER

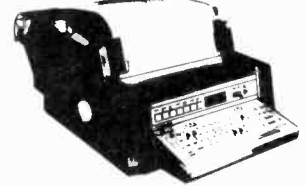

A massive purchase of these desk top printer-terminals enables us to offer you these quality 30 cps printers at a SUPER LOW PRICE against their original cost of over £1000. Unit comprises of full QWERTY, electronic keyboard and printer mesh with print face similar to correspondence quality typewriter. Variable forms tractor unit enables full width - up to 13.5" 120 column paper, upper - lower case, standard RS232 serial interface, internal vertical and horizontal tab settings, standard ribbon adjustable baud rates, quiet operation plus many other features. Supplied complete with manual. Guaranteed working £130.00 or untested £85.00 optional floor stand £12.50 Carr & Ins £10.00.

## EXTEL PRINTERS

EX NEWS SERVICE compact, quality built 50 column matrix printer, type AE11. Unit operates on 5 BIT BAUDOT code from current loop, RS232 or TTL serial interfaces. May be connected direct to micro, or comms receiver via simple filter network to enable printing of most world wide NEWS, TELEX and RTTY services. Supplied in tested second hand condition with 50 and 75 baud xtals, data sheet and large paper roll. ONLY £69.95.  
Dimensions 15" D x 5 1/2" H x 10 1/2" W  
CARR £6.00 Spare paper rolls £4.50 each

## TELETYPE ASR33 I/O TERMINALS



FROM £195 + CAR + VAT  
Fully fledged industry standard ASR33 data terminal. Many features including ASCII keyboard and printer for data I/O auto data detect circuitry, RS232 serial interface, 110 baud, 8 bit paper tape punch and reader for off line data preparation and ridiculously cheap and reliable data storage. Supplied in good condition and in working order.  
Options: Floor stand £12.50 + VAT  
KSR33 with 20ma loop interface £125.00 + Sound proof enclosure £25.00 + VAT

## 20,000 FEET OF ELECTRONIC AND COMPUTER GOODIES ENGLAND'S LARGEST SURPLUS STORE - SEEING IS BELIEVING!!

### D.C. POWER SUPPLY SPECIALS

Experimentors PSU Ex-GPO. All silicon electronics. Outputs give +5v @ 2 amps +12v @ 800 ma -12v @ 800 ma +24v @ 350 ma and 5v floating @ 50 ma. Dim 160 x 120 x 350 mm. All outputs are fully regulated and short circuit proof. Supplied in NEW or little used condition. Complete with circuit.

Only £15.50 + £2.50 pp  
FARNELL 5 Volt 40 amps. Type number G6-40A. This miniature switching PSU measures only 160mm wide 175mm deep and 90mm high, yet delivers a massive 40 amps!! Fully regulated and smoothed with over voltage protection etc. 120 or 240 volts AC input. Supplied BRAND NEW and boxed with circuit at a fraction of the current list price. Only £130.00 + £3.00 carr & ins.

LAMBDA LMCC 5V BRAND NEW 240v AC input with 5 volts DC at 8 to 10 amps fully regulated output. Completely enclosed unit measures only 9" x 4" x 5" £28.99

LAMBDA LMCC5V 110v AC input with 5 volts DC at 8 to 10 amps fully regulated output. Slightly smoke damaged, hence ONLY £10.95

PERIPHERAL SYSTEM SUPPLY. Runs almost any system. Fully cased unit supplied in a brand new or little used condition. Outputs give 5v @ 11 amps "+" 15-17v @ 8 amps "-" 15-17v @ 8 amps and "+" 24v @ 4 amps. All outputs are crowbar protected and the 5 volt output is fully regulated. Fan cooled. Supplied tested with circuit. £55.00 + £8.50 carr.

1000's of other POWER SUPPLIES EX STOCK - CALL SALES OFFICE FOR DETAILS

### DUAL DISK DRIVE/WINCHESTER CASES

Very smart, fully enclosed case unit custom made to accept two full height 5 1/4" floppy disk drives or two 5 1/4" winchesters such as the RHODIME RO200 or TANDEM series etc. An internal switching mode PSU supplies all the required voltages to enable you to plug in your drives and go!!

Other features include mains filter, internal cables with standard drive connectors, space for internal PCB, standard fan cut out and mounting, air filter. Overall dimensions 28 cm W x 30 cm D x 19 cm H  
ONLY £55.00 + £6.00 CARR.

### SEMICONDUCTOR 'GRAB BAGS'

Mixed Semis amazing value contents include transistors, digital, linear, I.C.'s triacs, diodes, bridge recs. etc etc All devices guaranteed brand new full spec, with manufacturer's markings, fully guaranteed.  
50+ £2.95 100+ £5.15  
TTL 74 Series A gigantic purchase of an "across the board" range of 74 TTL series I.C.'s enables us to offer 100+ mixed "mostly TTL" grab bags at a price which two or three chips in the bag would normally cost to buy. Fully guaranteed all I.C.'s full spec 100+ £6.90 200+ £12.30 300+ £19.50

### NORTH STAR HORIZON

Pro S100 system with dual 5 1/4" floppy drives, software, manuals etc.  
£850.00 Call sales office for details

### ULTRA COMPACT 300 BAUD ACOUSTIC MODEM — COUPLER

A Major manufacturer's over production and a bulk buy special enables us to offer this BRAND NEW TRANSDATA 307A ultra compact, BT APPROVED, 300 baud full duplex acoustic modem at a fraction of manufacturer's list price. The unit operates on the standard CCITT V21 frequencies with RS232 interface via 25 way 'D' skt.

Combine the adjustable cup system, which fits almost any phone with the benefit of "No jacks or phone cables" and a light weight of only 1.2 Kg and you have a truly portable modem!! Supplied complete with data, 90 day guarantee and ready to use.

ONLY £49.95 + £3.00 pp



### PROFESSIONAL 6 FOOT

19" RACK CABINETS  
LARGE 19" equipment cabinet. Totally enclosed with locking front and rear doors. An internal sub frame 63" high is pre drilled for standard 19" equipment etc. Other features include internal 12" cooling fan, two-tone blue and grey finish with alloy trims. Mounted on 4 heavy duty castors, mains panel etc. And at a current cost from IMHOFS of over £500 A snip at ONLY £125. Supplied in NEW or little used condition. Carriage £22.00. Ext. Dim 72.5" h x 23.5" w x 26" d

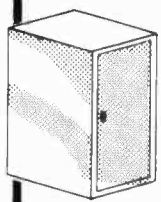

### LOGICAL KEYBOARD

Heavy duty unit in attractive satin alloy case. 55 full travel keys are laid out in a logical format of:



Making a very useful keyboard, ideal for persons unfamiliar with or confused by the standard QWERTY layout. All keys generate the equivalent ASCII outputs and various control codes shown in data. A 7 bit latched parallel TTL output with strobe enables direct connection to any similar micro port etc. Many other features such as internal 240v to 5v PSU, MAINS ON/OFF switch. Supplied in NEW or little used condition with data.  
ONLY £25.95 Post and packing £4.50

1000's of other EX STOCK items including POWER SUPPLIES, RACKS, RELAYS, TRANSFORMERS, TEST EQUIPMENT, CABLE, CONNECTORS, HARDWARE, MODEMS, TELEPHONES, VARIACS, VDU'S, PRINTERS, POWER SUPPLIES, OPTICS, KEYBOARDS etc. etc. Give us a call for your spare part requirements. Stock changes almost daily.

Don't forget, ALL TYPES and QUANTITIES of electronic surplus purchased for CASH

CIRCLE 63 FOR FURTHER DETAILS.



# LOW PRICES

# DIGITASH

BUSINESS SYSTEMS LTD  
56, MAPLE DRIVE, EAST GRINSTEAD, WEST SUSSEX, RH19 3UR

# SERVICE ADVICE



The PC-16 16-bit computer provides PERFECT COMPATIBILITY with the IBM PC/XT range. The motherboard can be supplied in two versions for stereoscopic convenience. The 'N' version has no memory on board and the 'B' version with space for 64 to 256K RAM. Addition of the Memory Expansion Card provides a further 64 to 512KB of RAM. BASIC FEATURES INCLUDE:

- \* 8088 CPU operating at 4.77 MHz
- \* Provision for 8087 co-processor
- \* Four DMA channels
- \* Three TIMER channels on board
- \* 8 EXPANSION SLOTS

- \* RUNS MS/PC-DOS & CP/M 86
- \* READS & WRITES IBM-PC format
- \* Accepts IBM-PC Peripherals
- \* Up to 256K RAM ON BOARD

**SYSTEM—5 PC16 (B/3) — PRICE £1599** — Main computer employing 'B' board with 128K on board (upgradeable to 256K on board) PLUS Colour/Graphics adaptor providing signal capable of running monochrome displays on RGB output for full colour. Multi I/O card, providing floppy drive controller for two drives, one parallel port, one serial port, one games port with battery backed clock alander. RAM extension card for 512K. Two DS/DD floppy drives. 83-key keyboard. All complete, built & tested in case with power supply together with Concurrent (multiuser, multitasking)CP/M, CCP/M manual, Basic manual and computer operations manual — ready to run!

MOTHERBOARD 'B', 8-slot, 128K ..... **£490**  
MOTHERBOARD 'N', 8-slot ..... **£395**  
MULTIFUNCTION card with 128K (expandable to 256K) one PLL-port, one SER-port (2nd option) Clock/Calendar with backup ..... **£195**  
MONOCHROME/Graphic adaptor with printer port ..... **£279**  
MULTI I/O CARD — one pll, one serial port, one games port, floppy drive controller, clock calendar with battery backup..... **£256**

Sanyo DMC 7650 IBM/Apricot colour monitor..... **£349**  
12in HI-RES GREEN MON ..... **£84**  
64K RAM EXTEND MODULE ..... **£18**  
TEAC 55B DS/DD Floppy drive..... **£172**  
WD 1002 SWX-2 Winchester controller ..... **£249**  
512K Expansion RAM card — comes with 128K RAM installed fully IBM compatible ..... **£119**  
PC Case ..... **£112**



MR521 10MB Hard drive ..... **£523**  
MR522 22MB Hard drive ..... **£735**  
IBM COMPATIBLE KEYBOARD (83 key) ..... **£139**  
KEYTRONIC 5150 K/BOARD..... **£175**  
KEYTRONIC 5151 K/BOARD..... **£210**  
130 watt Switching Power Supply..... **£160**  
Add on serial port kit..... **£23**  
FDD-100 drive controller for 4 drive..... **£96**

**DRIVES — MEGABYTES FOR MICROPOUNDS!**

5" Height 500KB 40/80.....	<b>£119</b>
5" Height 1MB 40/48.....	<b>£125</b>
5" Height 1.6MB 40/80.....	<b>£159</b>
5" Height 2MB 40/80.....	<b>£199</b>
5" Height 500KB.....	<b>£119</b>
3" Height 1MB.....	<b>£125</b>
8" Full Size 1.6MB.....	<b>£309</b>
8" Size 1.6MB.....	<b>£282</b>

All brand new, uncased, with full electronics — standard power requirements. Full documentation and technical details available.

Add 15% VAT to all prices given. Remember, VAT is also applicable on carriage at 15%. Terms CWO. DEALER ENQUIRES WELCOME. FOREIGN enquiries if possible by telex please. However, French & German speaking staff at your disposal. MONEY BACK GUARANTEE. SEND £100 for our latest catalogue of over 3000 items, computers, peripherals, consumables, robotics, etc etc

★ TEL: (0342) 313427 • 24631/2 ★   ★ TLX: 957547 ★

CIRCLE 86 FOR FURTHER DETAILS.

KITS	OPTO	LED CLIPS	LINEAR ICs
CT1000KB* Clock/Timer 17.40	3mm red 9 5mm red 9	555 21 ML926 1.80	556 40 ML927 1.80
CT6000* † Programmable Timer 39.00	3mm green 12 5mm green 12	741 22 ML928 1.80	748 30 ML929 1.80
KK114 Relay Kit for above 3.90	3mm yellow 12 5mm yellow 12	AD560 3.30 MM74C911 6.50	AY38910 3.90 MM74C915 96
KK101 Electronic Lock 11.50	Rectangular square arrow or (triangular flat face)	CA3080 65 MM74C922 3.90	CA3130 85 MM74C926 4.50
KK102* 3 Note Door Chime 5.50	Red 15 Green 18 Yellow 18	CA3140 40 NE561 1.25	ICL7107 9.00 MS666 2.20
KK104 Solid State Switch 2.40	Bicolour 65 Flashing Red 50	ICL7126 8.00 MS760 2.20	ICM7555 95 SA80529 3.50
KK112 Mains Wiring Remote Control 42.00	Tricolour Red Continuous 55	LM324 85 TB4800 70	LM3342 85 TB4810AS 90
KK113 MW Radio 5.50	Round 32 Continuous 55	LM3352 1.20 TDA1024 1.20	LM338 40 TDA1024 1.20
KK126 DVM/Thermometer 15.50	Rectangular 45	LM348 55 TDA4290 1.98	LM352 48 TL061 40
DL1000K 4 Ch Light Chaser 15.95	IL74TIL111 55 MOC3020 1.10	LM380 1.20 TL062 60	LM381 1.40 TL064 1.30
DL21000K 4 Ch Light Chaser 8.95	ILD74 1.70 MOC3040 1.50	LM382 1.10 TL071 45	LM386 88 TL072 70
DLA11 Opto Input for above 70	DRP12 75 MEL11 35	LM1035 3.95 TL074 1.30	LM1458 34 TL081 35
DL3000K 3 Ch sound to light 12.95	Seven Segment LED Displays	LM2917 1.90 TL082 48	LM3900 68 TL084 1.00
TD300K † 300W Touchdimmer 7.75	DL704 3 cc 75 4 Dig 18 cc	LM3909 80 TL170 50	LM3911 1.75 TL507C 1.20
TS300K † 300W Touchswitch 7.75	FND500.5 ca 85 DIRECT DRIVE	LM3914 2.40 TMS1121 8.50	LM3915 2.40 TMS1501 9.50
LD300K † 300W Lightdimmer 3.95	FND507.5 ca 85 Display 7.00	LM13600 1.10 UA2240 1.45	LS7210 4.75 ULN2003 75
TDR300K † IR Remote Controlled Lightdimmer 14.95	<b>400V TRIACS</b>	LS7220 2.75 ULN2004 75	LS7225 2.60 ZN414 80
MK6 † IR Transmitter for TDR300K & MK7 4.50	4A 49 8A 58	MF10C 2.97 ZN425 3.40	ML922 3.80 ZN427 5.70
TDEIK † Touchdimmer Ext. 2.50	12A 85	ML924 2.50 ZN428 4.50	ML925 2.10 ZN1034E 1.80
TSA300K † Time Delay Touch Switch (300W) 5.00	8A isolated 65 16A 95	NOW IN STOCK SP0256AL2 4.15	
MK1 Thermostat 4.60	25A 2.10		
MK2 Solid State Relay 2.60	8A sensitive 66 Dac 18		
MK4 Proportional Temperature Controller 6.50			
MK5 Mains Timer 4.50			
MK7 Single channel IR Receiver (240V) 10.50			
MK9 4 way Keyboard 1.90			
MK10 16 way Keyboard 5.40			
MK11 10 channel 1+3 analogue o/p IR Receiver 13.50			
MK12 16-channel IR Receiver 13.50			
MK13 11 way Keyboard 4.75			
MK14 AC Power Controller 5.20			
MK15 Dual Latched SS Relay 4.50			
MK16 Mains powered IR Transmitter 3.50			
MK17 Single channel IR Receiver (12V) 10.50			
MK18 Coded IR Transmitter 6.80			
MK19 DC Controlled Audio Amplifier 10.70			

\*Includes box †Includes frontpanel  
All kits include PCBs, components and assembly instructions  
For further details send S.A.E.

**SPECIAL OFFERS**

2716	3.10	Z80A PIO	1.99
2732	3.20	Z80A CPU	1.99
2764	4.20	6821	1.40
	27128	7.50!!	

**COMPONENT PACKS**

1 650 Resistors 47R 10M	4.00
10 per value	
2 40 15V Electrolytics 10 1000µF	3.25
5 per value	
3 50 Polyester Capacitors	5.55
0 01 1µF 250V 5 values	3.00
4 45 Presets 100R 1M	2.40
5 30 Low Profile IC Sockets	1.75
8 14 & 16 pin	
6 25 Red LEDs (5mm)	

We stock: VERO, VELLEMAN KITS, PANTEC KITS, ANTEK IRONS, BOXES FROM BABANI, T.I., AND ELEKTOR.

For FREE 28 page catalogue send 9x6 SAE today!  
Telephone Orders Access & Barclay Card  
**RING 01-567 8910 (24 Hrs)**  
Five Six Seven Eight Nine Ten

**ORDERING INFORMATION: ALL PRICES EX CLUDE VAT. FREE P&P on orders over £20 (UK only) otherwise add 75p VAT Overseas P&P: Europe £2.75 Elsewhere £6.50. Send cheque/PO/Barclaycard/ Access No. with order. Giro No. 529314002 LOCAL AUTHORITY AND EXPORT ORDERS WELCOME. GOODS BY RETURN SUBJECT TO AVAILABILITY.**

CIRCLE 9 FOR FURTHER DETAILS.

# CHUM ONE A Industrial Computer

**£258**

- ★ Control BASIC and Z80 Assembler Language
- ★ On Board EPROM Programmer
- ★ Detachable Hand-Held Keyboard and Display
- ★ 4K Bytes of Battery Backed Memory
- ★ Up to 64 Relay Outputs
- ★ Up to 64 Opto-Coupled Inputs
- ★ 4 Analogue Inputs
- ★ 1 Analogue Output
- ★ RS232 Interface
- ★ Cassette Back-Up Memory
- ★ Real Time Clock

The Chum One A offers the complete solution to all measurement and control problems. Programs can be written, tested and modified in RAM then at a touch of a switch blown into an EPROM.

**WARWICK DESIGN GROUP, 12 ST. GEORGE'S ROAD LEAMINGTON SPA CV31 3AY (0926) 34311**

CIRCLE 87 FOR FURTHER DETAILS.

ELECTRONICS & WIRELESS WORLD JUNE 1985

**TYPE 9051**

**TMOS WIDEBAND LINEAR POWER AMPLIFIERS.** 4W/10W/20 watts RF output. Without tuning. Power gain 10dB. 24V. + supply

TYPE 9046 100KHz - 100MHz, 4 watts	£84.50 + £3.50 p&p
TYPE 9051 15MHz - 200MHz, 4 watts	£84.50 + £3.50 p&p
TYPE 9171 15MHz - 200MHz, 10 watts	£140.00 + £8.00 p&p
TYPE 9172 As above with integral power supply unit	£200.00 + £15.00 p&p
TYPE 9174 15MHz - 200MHz, 20 watts	£180.00 + £8.00 p&p
TYPE 9175 As above with integral mains power supply unit	£240.00 + £15.00 p&p



**TYPE 9046**

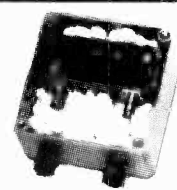

**TYPE 9010**

**TWO STAGE GASFET STRIPLINE PREAMPLIFIERS**  
Tuned to your specified channels in bands IV or V

TYPE 9002 Two stage Gasfet preamplifier. N.F. 0.7dB. Gain 25dB. High Q filter ... £85 + £2 p&p  
 TYPE 9004 UHF two stage Gasfet preamplifier. N.F. 0.6dB. Gain 25dB. Aligned to your specified frequency in the range 250-500MHz. High Q filter ... £85 + £2 p&p  
 TYPE 9012 Gasfet preamplifier mains power supply unit ... £24.50 + £3 p&p  
 TYPE 9010 Masthead weatherproof unit ... £9.50 + £2 p&p



**TYPE 9152**



**TYPE 9159**

**TELEVISION LINEAR POWER AMPLIFIERS.** Tuned to your specified channels in bands IV or V. (or 400-900MHz).

TYPE 9061 150mV. input, 10mW. output	£140 + £5 p&p
TYPE 9152 10mW. input, 500mW output	£180 + £5 p&p
TYPE 9159 500mW. input, 5 watts output	£210 + £5 p&p

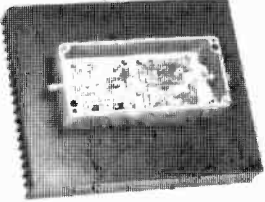

**TYPE 9157**



**TYPE 9155**

**TMOS RF LINEAR POWER AMPLIFIERS.** Tuned to your specified frequency in the range 10-250 MHz.

TYPE 9105 10 mW. input, 3 watts output	£160.00 + £10.00 p&p
TYPE 9155 3 watts input, 30 watts output	£240.00 + £10.00 p&p
TYPE 9156 As above with integral mains power supply unit	£320.00 + £15.00 p&p
TYPE 9106 100 mW. input, 10 watts output	£180.00 + £10.00 p&p
TYPE 9158 10 watts input, 80 watts output	£320.00 + £10.00 p&p
TYPE 9157 As above with integral mains power supply unit	£400.00 + £15.00 p&p

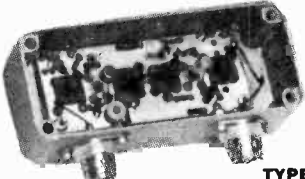

**TYPE 9006**

**GASFET RF PREAMPLIFIERS.** Aligned to your specified frequency in the range 30-250MHz. Masthead or local use.

TYPE 9006 N.F. 0.6dB. Gain 10-40dB variable	£65.00 + £2 p&p
TYPE 9006FM As above. Band II 88-108MHz	£65.00 + £2 p&p
TYPE 9035 Mains power supply unit for above types	£24.50 + £3 p&p



**TYPE 9035**

TYPE 8034 PHASE LOCKED SIGNAL SOURCE using low frequency reference crystal. Specify output in the range 1-600MHz. Output 10mW + 10dBm ... £84.50 + £2 p&p  
 TYPE 9190 80 WATT COLOUR TELEVISION TRANSMITTER. 40-250 MHz American, British or Continental system ... £1500.00  
 TYPE 9191 10 WATT COLOUR TELEVISION TRANSMITTER. UHF bands IV or V. American, British or Continental system ... £1500.00  
 TYPE 9086 FM TRANSMITTER 88-108MHz. 50 watts RF output. 24V + supply. Complete modular system ... £480 + £30 p&p  
 TYPE 9087 As above with integral mains power supply unit ... £540 + £40 p&p

**RESEARCH COMMUNICATIONS LTD.**

UNIT 3, DANE JOHN WORKS, GORDON ROAD, CANTERBURY, KENT CT1 3PP  
 TELEPHONE: CANTERBURY (0227) 456489

PLEASE ADD 15% V.A.T. ON TOTAL

CIRCLE 80 FOR FURTHER DETAILS.

**SAMSONS**

(ELECTRONICS) LTD.

9-1D Chapel Street, Marylebone London NW1 5DN  
 21-23 Bell Street, London, NW1 01-262 5125 & 01-723 7851

CREDIT CARDS ACCEPTED FOR TELEPHONE ORDERS



We are stockists of the complete range of "DOUGLAS" transformers. Please ring or send S.A.E. for details.

Precision made Swiss D.C. motor running on 6-9v dc these motors have a 70:1 gearbox and are extremely powerful! Size 26mm x 45mm 3mm output shaft normal cost over £20 our price £4.95 inc VAT & postage.

**AC 240V BLOWERS**

ex computer equipment In good condition housed in metal frame Size 11" X7" X7" air outlet 4" X3" motor spec 1300 rpm cont rated £5.95 postage £3.00

**MEMORE V.D.U.s 1377**

We do not as yet have full information on these very attractive units which features a 12" monitor mounted in an adjustable cradle, and a full Alpha Numeric Keyboard. But response to them has been such that we feel you should be told about them. Comes with diagrams for monitor offered to you at £85.00 inc VAT. Carriage £17.00. Ring for details.

**NEW TRANSFORMER BARGAINS**

By famous makers

No. 1. Pri 115-230V Sec 21V 3A + 40V 300mA	£5.25
No. 2. Pri 220-240V Sec 17.5V 1A 3 times	£5.75
No. 3. Pri 220-240V Sec 29-28-27-0-27-28-29V 0.3A	£4.00
No. 4. Pri 220-240V Sec 6.3V 5ACT 6.3V 2ACT	£5.00
No. 5. Pri 220-240V Sec 40V 3A	£6.25

All prices inc VAT and carriage

**15AMP ISOLATION TRANSFORMERS BY FAMOUS MAKERS**

These high grade transformers are as new and were manufactured for a top U.K. electronics company to extremely high standards. Each transformer has a large range of tappings for adjusting inputs and outputs.

**RECHARGEABLE BATTERIES**

We have on offer these fantastic long life batteries which have a large variety of uses. Completely unspillable using a special jelly electrolyte.

Type 1. Dryfit 12v 5.7AH. Size 3", X6X2"	Price £9.50 inc VAT & carr.
Type 2. Yuasa 12v2AH. Size 5x6"x6"	Price £24 inc VAT & carr.

**PAPER BLOCK CAPACITORS**

BMFD 2500V WKG DC	£6.50
10MFD 350V WKG DC	£15.00
8 MFD 400V WKG DC	£2.50
4 MFD 1000V WKG DC	£2.00
1 MFD 1000V WKG DC	£1.25

All prices inc. VAT and carriage

**FANS**

MUFFIN 4 1/2" 110V	£4.00
WOODS 6" and 8" 240V	£9.50

Tangential Blowers 240V approx 3"x15" vent. Very powerful. £11.  
 All prices inc. VAT and carriage

**AUTO STEPDOWN TRANSFORMERS FOR AMERICAN EQUIPMENT**

240/110 Volts. 80-2250 watts. Regular stock line. Types 80-1500 watts are fully shrouded. Fitted with American two or three pin socket outlets and 3 core 240V mains lead. Types 1750 and 2250 watts are steel cased with two American socket outlets. Neon indicator, three core mains lead and carrying handle. Send SAE for price list and further details. American sockets, plugs, adaptors also available.

**ASCO SOLENOID VALVES**

Fantastic value!! These valves are designed for air gas water L.T. Oil normally closed. Approx 2" bore ideal for central heating 240 ac our price £9.50 inc VAT & carr

**JOYSTICK CONTROL**

Joystick controls made for the video game industry with sturdy micro switch action. 2 way control £1.95 inc VAT & carr. 2 way heavy service type £2.95 inc VAT & carr.

**DIGITAL CLOCK MOVEMENTS**

A well made clock 'movement' fitted with timer mechanism and neon illumination. Size approx 110mmx50mmx50mm 240V a.c. operation. A Snip At £3.95 inc VAT & carriage

**9v 800m/a DC SUPPLIES**

As made for a famous micro computer firm these units have a mains lead and standard jack output £5.50 inc VAT & postage.

**HIGH GRADE LT TRANSFORMERS**

ALL PRIMARIES 240V  
 OPEN FRAME TOP PANEL CONNECTIONS

No. 1 tapped. 2-3-4-5-6-7-8-9-10-11-12-13-14-15V 8A £10.	No. 2 12v 8A £7.50.	No. 3 tapped 13-12-10-8v 8 1/2A £9.	No. 4 Sec 3.2V 2A 6.3V 2A 32-0-32V 280 m/a £4.75.	No. 5 Sec 3v 2A 1.5A, 15V 1/2A, 9v 50 m/a £3.95.	No. 6 Sec 14V 2A £3.95.	No. 7 Sec 7v 5-0-27.5v 1.2A and 7-0-7v 750 m/a £3.50.
--	---------------------	-------------------------------------	---	--	-------------------------	---

All prices include postage and VAT.

**PARMEKO LT TRANSFORMERS**

Open frame type top panel connections, prices include postage and VAT

No. 1 12-18-32V 2A (DC rating) and 12-18-32V 1/2A (DC) £9.	No. 2 12-18-32V 1A (DC) and 12-18-32V 1/4A £5.	No. 3 12-18-32V 1/2A (DC) and 12-18-32V 100 m/a £3.95.	No. 4 12-18-32V 1/4A (DC) and 12-18-32V 1/4A (DC) and 12-18-32V 50 m/a (DC) £2.50.	No. 5 32V 100 m/a (DC) and 32V 25 m/a DC £2.50.
--	--	--	--	---

**L.T. TRANSFORMERS**

Parmeko Atlantic Series potted type. Pri 220-240V. Sec tapped 2-6v 1.6A and 14-42v 1.6A. The following voltages can be obtained 2-6v 1.6A-12-14-28-36-40-42-44-48v @ 1.6A conservatively rated £7.50 inc VAT & carr.  
 Repanco. Pri 240V. Sec 25.3v 3A 10.5v 2A 10.5v 16A open frame type £6.75 inc VAT & postage.

**GARDENERS 'C' CORE TRANSFORMERS**

PRI+10V, 0V, 200V, 220V, 240V, (screen).  
 Main outputs separate windings 25V and 3V tapped at 1V will give 26V, 28V, 30V, 33V at 15amps. Size 150x133x170.  
 Price £18.00 inc VAT & Carriage.

**SPECIAL OFFER. CLAUDE LYONS VOLTAGE STABILISER.** Input 210 270V a.c. Output 240V a.c. ± 5%!!! Rated at 2.9kVA. Ideal for stabilising computer supplies  
 £195 inc. VAT. Carriage £12  
 Hurry - only a few left

**GOULD ADVANCE P.S.U.s.** 13.8V 30amp d.c. supplies. Great for linears!!! ONLY £65 inc. VAT. Carriage £3. Limited offer

**6000w CONSTANT VOLTAGE TRANSFORMER BY REGAVOLT**

This high grade piece of equipment has inputs of either 220 or 240V a.c. - 20% + 12% Output 220 or 240V + - 1% Please Note This C.V.T. Has Isolated Secondaries  
 Size 17.5"x11.5"x28" Weight 36w  
 Price £550 inc VAT Ring for carriage details  
 Note: this transformer is ideal for computer P.S.U.s

**GPO JACK FIELDS**  
 As new perfect condition 7 contact £6.50 inc VAT & postage

**E.H.T. TRANSFORMERS**  
 High-grade E.H.T. Tranny. PRI 240V, sec. 10,000V, 18 M.A. Probably used for boiler ignition but with 101 other uses!!!  
 £5 inc. carr. & VAT

**PARMEKO OP TRANSFORMERS**  
 Pri 6000 or 8000ft or CT Sec 3.75 or 15ft Ser/Par for EL84x2 12 5W £4.50. Pri 5000 for EL84 3W Sec £3.75 or 15ft Ser/Par £2.50. Pri 30-45-60-90 to 1 also 90TOI for push/pull Sec 3.75ft £2. All prices include postage and VAT

**AC WKG CAPACITORS**

MFD	AC wkg	Price	MFD	AC wkg	Price
0.25	1500v	£1.50	5	360v	£1.75
0.75	440v	£1.00	5	440v	£2.00
1	400v	£1.50	4	600v	£2.00
2.5	360v	£1.50	6	300v	£2.00
2.7	700v	£1.75	8.4	250v	£1.50

All prices include postage and VAT

**ELECTROLYTIC CAPACITORS**

All prices include VAT & post high ripple type.

20,000mfd 40v dc wkg £3.50
7100 mfd 40v dc wkg £2.50
4700 mfd 40v dc wkg £2.50
4500 mfd 54v dc wkg £2.50
6500 mfd 60v dc wkg £2.50

**PARMEKO HT CHOKES**

10H 250m/a	£5.95	20H 75m/a	£3.50
5H 250m/a	£5.50	10H 75m/a	£2.95
5H 180m/a	£4.75	7.5H 60m/a	£2.50
5H 500m/a	£5.95	15H 120m/a	£3.95
2.5H 250m/a	£5.50	50H 10m/a	£2.50
20H 120m/a	£4.75	25H 60m/a	£2.75

All prices include postage and VAT

**SPECIAL OFFER HIGH-GRADE ISOLATION TRANSFORMERS**

Open frame terminal block connections £29.50, carr. £4, VAT £5.02. Pri 240V, Sec 240V, 250 volts, open frame type tag connections, £10, P&P £2, VAT £1.80. Pri 100-110-200-210-220-230-240-250V, Sec 220-230-240V 600W, can be used in reversed open frame type terminal block connections, £15, carr. £2.80, VAT £2.67.

**PARMEKO NEON TRANSFORMERS**

PRI tapped 200-220-230-240-250V. Size 7000V 55 M.A. Totally enclosed in wall mounting steel case. Size 9 1/2x8 1/2x4 1/2in  
 £17.50 inc VAT and carriage  
 PRI tapped 200-220-230-240-250V. Size 5000V 20 M.A. Totally enclosed in wall mounting steel case. Size 7x6x5in.  
 £12.50 inc VAT and carriage

**HIGH GRADE L.T. TRANSFORMERS**

By famous makers fraction of list price all primaries 240v price includes postage & VAT. No. 1 45v 3A £6.90 No. 2 40v 3A £6.90. No. 3 21v 3A and 40v 300m/A £6.90. No. 4 27.5v-0-27.5v 1.2A and 7-0-7 370m/A £6.95. No. 5 10v/1A 10v/1A 10v/1A £6.95. No. 6 27v/1A 22v/1A 10v/1A 10v/1A £6.95. No. 7 60v/1.5A £4.95. No. 8 10-7-0-7-10v 500m/A 29-21-0-21-29v 370m/A £4.95. No. 9 28-27-0-27-28-350m/A £4.95. No. 10 24v/2A £4.50. No. 11 14v/3A £4.50. No. 12 6.3v/2A 6.3v/2A 32-0-32 280m/A £4.50. No. 13 13v/2A 15v/1A £4.95. No. 14 27.5v/1A(DC) £2.50. No. 15 4.5-0-4.5v 200m/A 2.2 v 600m/A £2.25. No. 16 13-0-13v/1A 1.2v 500m/A £3.95. No. 17 55v 2A 30-0-30v 100m/A 10v 300m/A £4.95. No. 18 55v/500m/A £3.95. No. 19 24.30 32v 2A £4.95

**STOP PRESS**

We have in stock a very limited number of Epson portable computers BRAND NEW never been used offered at fantastic low prices. Please ring for details!!

**PARMEKO HT TRANSFORMERS**

ALL PRIMARIES 220-240V POTTED TYPES

No 3 No 4 Sec 400-0-400V 150 m/a and 150-0-150V 20 m/a £6.50 inc postage and VAT. No 5 Sec 350-325-0-325-350V 120 m/a £6.50 inc postage and VAT. Gresham Pri 220-240V, Sec 250V 80 m/a 6.3V 4.5A 15V 1.2A £5.95 inc postage and VAT. Pri 230-250V, Sec tapped 190-210V 24 m/a 6V 1A £3.95 inc postage and VAT. Pri 220-240V Sec 300V 20 m/a 30V 100 m/a 6.3V 5A half shrouded, sub chassis mounting £6.50 inc postage and VAT. Pri 220-240V Sec 370-390-410V 6 m/a £2.75 inc postage and VAT. WWW-1

CIRCLE 68 FOR FURTHER DETAILS.

# B. BAMBER ELECTRONICS

## RADIOTELEPHONE EQUIPMENT

Pye Base Station Type F30 AM High Band & Low Band	£220
Pye Base Station Type F401 AM High Band	£350
Pye Base Station Type F4001 AM High Band	£550
Pye Reporter Type MF6 AM High Band & Low Band	£90
Pye Europa Type MF5FM High Band	£90
Pye Olympic Type M201 AM High Band	£65
Pye Motofone Type MF5AM High Band & Low Band	£45
Pye Westminster Type W15AM High Band & Low Band	£50
Pye M294 FM High Band	£200
Pye Base Station Type F9U UHF	£90
Pye Base Station Type F9AM High Band	£90
Pye Base Station Type F17FM High Band	£250
Pye Base Station Type F412 UHF	£200
ITT Base Station Type 30LRU43A UHF	£150
Pye Pocketfone Type PF2FM High Band & Low Band	£80
Pye Pocketfone Type PF2AM High Band & Low Band	£80
Pye Pocketfone Type PF2UB UHF	£80
Pye Pocketfone Type PF5 UHF	£40
Pye Pocketfone Type PF8 UHF	£80
Pye Pocketfone Type PF9 UHF	£80
Pye Mains Power Unit Type AC15	£25
Pye Mains Power Unit Type AC200	£120
Pye Power Amp. Type A200 High Band	£50
Pye Controllers Type PC1	£85
Pye Controllers Type M61	£195
Pye Westminster Type W30 AM High Band & Low Band	£25
Pye Westminster Type LW15 FM High Band	£40
Pye Base Station Type F30FM Mid Band	£200
Pye Europa Type MF5FM Mid Band	£60

PLEASE NOTE all sets are solid less crystals, mikes, speakers, power leads etc unless otherwise stated.  
CARRIAGE on RT equipment — Mobiles £2.00 each, Base Stations £15.00 each. Red Star available at cost.

Tektronix Storage Oscilloscope Type 568	£280
Tektronix Storage Oscilloscope Type 564	£250
Tektronix Oscilloscope Type 556 c/w 1A1 Plug-ins	£250
Tektronix Oscilloscope Type 567 c/w 3S76 & 3T77 Plug-ins	£450
Tektronix Oscilloscope Type 561 c/w 4S3 Plug-in	£180
Tektronix Oscilloscope Type 585 c/w Type 86 Plug-in	£120
Tektronix Oscilloscope Type 453 50MHz	£375
Tektronix Oscilloscope Type 454 150MHz	£675
Tektronix Oscilloscope Type 515A	£100
Dynaco Oscilloscope Type 07100	£290
Teleguipment Oscilloscope Type S51	£75
Teleguipment Oscilloscope Type S54	£150
Teleguipment Oscilloscope Type S34	£85
Solartron Oscilloscope Type C1436	£85
Cossor Oscilloscope Type CDU 110	£150
Telex 500 Series Plug-ins, D-E20, E-E15, G-E20, H-E20, W-E20, Z-E20, K-E15, L-E15, O-E20, 1A4-E100, 1A7-E50, 1S1-E50, Type 80-E15	£90
Tektronix Time Mark Generator Type 180A	£90
Tektronix Square Wave Generator Type 107	£40
Tektronix Pretrigger Pulse Generator Type 111	£40
Tektronix Trigger Countdown Unit Type 280	£20
Tektronix Low Level Preamp/ifier Type 122	£20
Marconi AM/FM Signal Generator Type TF 995A/5	£120
Marconi AM/FM Signal Generator Type TF 995B/5	£240
Marconi AM/FM Signal Generator Type TF 1064	£60
Marconi AM/FM Signal Generator Type TF 2008	£875
Marconi AM Signal Generator Type 801D 10MHz-485MHz	£90
Marconi Standard Signal Generator Type TF 144H/4S	£90
Marconi UHF Signal Generator Type TF 1060/2	£90
Marconi FM Signal Generator Type TF 1066B/1 10-470MHz	£300
Marconi RC Oscillator 20Hz-200kHz Type TF 1101	£65
Marconi Valve Voltmeter Type TE 1041B	£40
Marconi Power Meter Type TF 893A	£50
Marconi RF Attenuator Type TF 1073A	£25
Marconi RF Power Meter Type TE 1020A	£65
Marconi Universal Bridge Type TF 1313	£220
Marconi Universal Bridge Type TF 868B	£90
Marconi Universal Bridge Type TF 868A	£60

Marconi Delay Generator Type TF 1415	£60
Marconi White Noise Test Set Type OA 2090B	£220
Marconi Carrier Deviation Meter Type TF 791D	£120
Hewlett Packard SHF Signal Generator 7-11GHz Type 620A	£220
Hewlett Packard Power Supply 0-40v @ 30amp. Type 6268B	£330
Hewlett Packard Power Supply 5 volt @ 8 amp. Type 62005E	£30
Hewlett Packard Power Supply 5 volt @ 60 amp. Type 62605L	£85
Rohde & Schwarz Standard Signal Generator 0-300 mhz Type BN 41409	£150
Rohde & Schwarz Decade Signal Generator 0.3-500MHz Type BN41104	£850
Rohde & Schwarz Power Signal Generator 0.1-30MHz Type BN41001	£120
Avo Meters Model 7	£40
Avo Meters Model 8	£80
General Radio VHF Oscillator Type 1363 56-500MHz	£50
Wayne Kerr A. F. Signal Generator 10 Hz-120 kHz	£40
General Radio Audio Oscillator Type 1311A 50 Hz-10KHz	£50
Airmec Oscillator Type 858 30kHz-30MHz	£65
EH Pulse Generator Model 1391B	£45
Solartron Pulse Generator Model GO 1101	£25
Airmec Oscillator Type 304A 50 KHz-100MHz	£85
Airmec Modulation Meter Type 409	£90
Airmec Modulation Meter Type 210A	£40
Ad-Yu Precision Phase Meter Type 405H	£85
Bruel & Kjaer Microphone Amplifier Type 2604	£50
Dawe Phase Meter Type 632A	£40
Dawe Vibration Meter Type 1433A	£55
Ferroglyph Series 7 Mono Tape Recorders	£100
Avo Valve Characteristic Meter Type VCM 163 with data 60 amp. Alternator & Generator Noise Filters	£250
Tektronix Oscilloscope Probes	£10
Mullard Vari-cap Tuners Type ELC2003 Ex Brand New Equip	£3.50
Pye Cambridge/Vanguard 18 Way Control Leads	£4
BNC Plugs 75 ohm	50p
Circulators 590-720 Mhz "N" sockets	£25
Transformers Type 2N3055 Brand New	4 for £1
Transformers 30 volt @ 1 amp	£1
Transformers 36 volt @ 1.5 amp	£1
10.7 Mhz SSB Xtal Filters (2.4 KHz Bandwidth) Low imp. type Carrier and unwanted sideband rejection min -40db (needs 10 69835 & 10 70165 xtals for USB/LSB no supplied) Size approx 2in x 1in x 1in	£10

## LOGIC ANALYSERS

Fluke Model 3010A Programmable PCB Logic Tester	£1,500
Fluke Model 3020A Programmable PCB Logic Tester	£2,500

## DIODES

1N5406 & 1N5407 10p each, 100 of £5, 1000 of £30

## WANTED

Electronic Surplus, we also welcome the opportunity to quote for complete factory clearance.

### PYE POCKETPHONE PF1 UHF RECEIVER

440-470 MHz, Single Channel, int. speaker and aerial. Supplied complete with rechargeable battery and service manual, **£6 each plus £1 p.p. plus V.A.T.**

### BREAKING TEK 545A SCOPES FOR SPARES

CRT type T543 P2 **£18 each**, Mains Transformers T601 **£15**, High Voltage Transformer T801 with valves **£25**. Also Switches, Knobs, Fans, Capacitors and Metalwork.

### RADIOSONDE RS21 METEOROLOGICAL BALLOON TRANSMITTER

with Water Activated Battery, contains all-weather sensors, fully solid state, **£5 each plus £1 p.p. plus V.A.T.**

P. & P. or Carriage and V.A.T. at 15% on total must be added to all orders.

Callers very welcome, strictly between 9 a.m. and 1 p.m. and 2 and 5 p.m. Monday to Friday inc.

Barclaycard and Access taken  
Official orders welcome **ww27**



**5 STATION ROAD, LITTLEPORT, CAMBS CB6 1QE**  
**PHONE: ELY (0353) 860185**



CIRCLE 49 FOR FURTHER DETAILS.

# It's easy to complain about an advertisement. Once you know how.

One of the ways we keep a check on the advertising that appears in the press, on posters and in the cinema is by responding to consumers' complaints.

Any complaint sent to us is considered carefully and, if there's a case to answer, a full investigation is made.

If you think you've got good reason to complain about an advertisement, send off for a copy of our free leaflet.

It will tell you all you need to know to help us process your complaint as quickly as possible.

**The Advertising Standards Authority.** ✓  
**If an advertisement is wrong, we're here to put it right.**

ASA Ltd, Dept 1 Brook House, Torrington Place, London WC1E 7HN

This space is donated in the interests of high standards of advertising.



# Introducing...



**Serpent**  
under £2000!

## Serpent SCARA assembly robot

On show at Automan NEC 14-17th May  
and at

Training & Development NEC 9-11th July



AND To be featured as a  
constructional project in  
Practical Electronics  
September issue.

CIRCLE 38 FOR FURTHER DETAILS.

## 11 Ghz SATELLITE TV RECEPTION.

THE FOLLOWING TV TRANSPONDERS ARE AVAILABLE NOW FROM ECS/INTELSAT:-

Premiere (UK film channel). Screen Sport (UK Sports channel) TEN (UK film channel). Childrens Channel (UK). RAI (Italy). Teleclub (Switzerland). Olympus (Pan European TV) Film Net (Belgium, mainly American films). WPN (World Public News). PKS (Germany). TV5 (France). New World Channel (Norway — religious, multi language). SKY. Music Box (Stereo pop video channel). Norway (C-Mac system).

Additional channels late 85 — Cable News Network, Life Style channel, plus all TV transponders on ECS 3 due for August launch.

A typical system consists of our 1.6m dish in either fixed, AZ/EL or Polar mount. Scalar horn & feed in Aluminium, brass or phosphor bronze. Low noise block downconverter (2.2 — 3.0 dB noise figures) converting the 10.9 — 11.7Ghz signal to 950 — 1750Mhz IF feed to the indoor unit. Demodulator, gives audio & video output to feed a colour monitor or a VCR.

Package price for a complete system from £1550 plus VAT & carr.

Through our joint venture Company "Tele Aerials" of Harrogate, we can offer an installation service from a single point to a Major Hotel System, Housing Complex etc.

The Company has supplied systems to:- Foreign Embassies, British Government, Overseas Hotels, Universities, Research Organisations, TV retail Trade and the Public.

**TO DISCUSS YOUR REQUIREMENT,  
CONTACT:- D.J. STANDEN.**

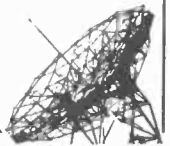

## North East Satellite Systems

Manufacturers of Microwave Dishes, Feed Horns and Specialised Electronics  
Suppliers of Satellite Systems and Closed Circuit T.V. Equipment

**CROPTON, PICKERING, NORTH YORKSHIRE YO18 8HL**

**TEL: LASTINGHAM (07515) 598 VAT No. 347 557132**

CIRCLE 74 FOR FURTHER DETAILS.

We are Cash Purchasers of large and small parcels of Surplus I/C, Transistors, Capacitors, Connectors and related electronic stock.

We also welcome the opportunity to quote for complete Factory Clearance incl. Production Machines & Tools.

We would appreciate a telephone call or a list available. We pay top prices and collect.

Enquiries also welcomed from Europe.

**LANCO LTD.**  
10 LABURNUM HOUSE  
LORDSHIP TERRACE, LONDON N16 0JB  
TELEPHONE: 01-249 5373

**Lynwood GD1 VDUs:** Intelligent Green micro controlled, RS232, printer port, 101 key k/b. Full Video enhancements. ONLY £149 + £15 P&P (S/H)

**Burroughs MT686/7/TD710:** Intelligent Green 12" VDU with 3 micros and 64K store. RS232. Programmable. Only £199 new or £149 S/H + £15 P&P

**Open Chassis Video Monitors** from above VDUs £40 + 7.00 p&p

**Multitrail Switching PSUs** from above 5v 4A 12v + 24v £25 + £1.50

**Data General 6012 VDU's** very attractive display working RS232 with integral 73 key k/b either dumb terminal mode or page buffered. Only £120.00 + £15.00 p&p

**Centronics 306 Line printers:** Professional fast (120 cps), superb quality 80 column printer. Parallel i/f. ONLY £99 + £15.00 P&P

**Osborne Executive Portable CP/M system** with oodles of software. Twin floppy drives £900 + £15 p&p

**Diablo 630 Daisywheel printer.** OEM i/f. NEW £599 + £15 P&P

**Calcomp 565 Drum Plotter,** 10thou steps. ONLY £450 + £10 P&P



### BECKENHAM PERIPHERALS LTD

Callers welcome  
by appointment

01-466 5582  
34 Rodway Road, Bromley  
Kent BR1 3JL

We also buy  
redundant peripherals

CIRCLE 61 FOR FURTHER DETAILS.

## ROBOTS For Education, Training and Industry

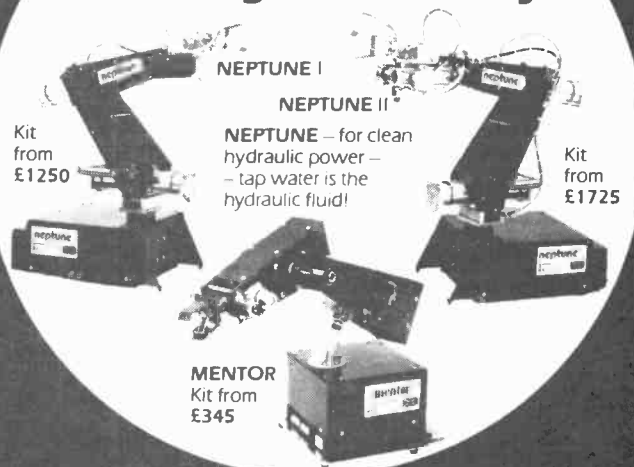

Kit  
from  
£1250

NEPTUNE I

NEPTUNE II

NEPTUNE — for clean  
hydraulic power —  
— tap water is the  
hydraulic fluid!

Kit  
from  
£1725

MENTOR  
Kit from  
£345

**NEPTUNE I** 6 axes. 8 bit control system. 2.5Kg capacity. 1120mm reach

**NEPTUNE II** 7 axes. 12 bit control system. 2.5Kg capacity. 1120mm reach

**MENTOR DC** servo desktop robot. 8 bit control system. 300gm capacity. 420mm reach

Robots programmed from keyboard or hand-held simulator (model robot)

Robots may also be taught by lead by the nose method

Extensive software is supplied free with each robot.

Leads available for connection to BBC, ZX Spectrum, Apple IIe, Commodore 64 and VIC 20

Most other micros are also easily usable with these robots

Robots also available ready built



Please phone for brochure: 0264 50093.

**West Portway Industrial Estate, Andover SP10 3WV.**

A private and independent company giving prompt, personal service.

CIRCLE 30 FOR FURTHER DETAILS.

# TURN YOUR BBC MICRO INTO A PROFESSIONAL MICROPROCESSOR DEVELOPMENT SYSTEM

## THE OPERATING SYSTEM

- FLEX—The Professional Operating System
- Versatile, Flexible & Powerful, the ideal operating system for industrial control
- Provides the power, sophistication and ease of development, previously only offered by larger, more expensive systems

## THE HARDWARE

- 6809 Advanced 16 Bit Processor
- Choice of Industrial Interfaces for Target Applications:
  - High Resolution Colour Graphics
  - Industrial input/output boards
  - IEEE communications
  - and many more

## THE TOOLS

- PL9—A fast, efficient control language
- CMS FORTH Interpreter & Compiler
- Cross Assemblers for most 8 bit & 16 bit micro's
- "C", BCPL, PASCAL

## THE SUPPORT

- Top rate after sales technical support
- Systems / Hardware Design

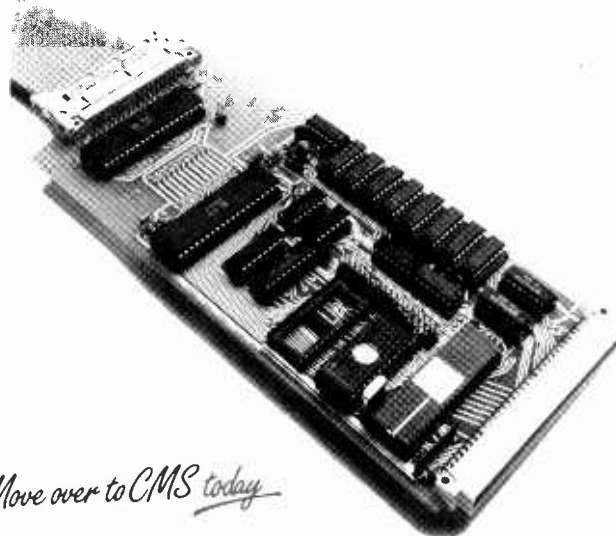

*Move over to CMS today*

<b>CMS</b>	44a Hobson Street Cambridge CB1 1NL (0223) 324141	Cambridge Microprocessor Systems Limited
------------	---	--

CIRCLE 66 FOR FURTHER DETAILS.

## EXTRACTOR FANS — MAINS OPERATED

Woods extractor.  
5" — £5.75, Post £1.25.  
6" — £6.95, Post £1.25.  
5" Plannair extractor  
£6.50, Post £1.25.  
4" x 4" Muffin 115v.  
£4.50, 230v.  
£5.75, Post 75p.  
All the above ex-computer,  
those below are unused.  
4" x 4" £8.50, Post 75p.  
9" American made £11.50, Post  
£2.00.  
Tangential Blower 10 x 3 air  
outlet, dual speed £4.60.  
Post £1.50.

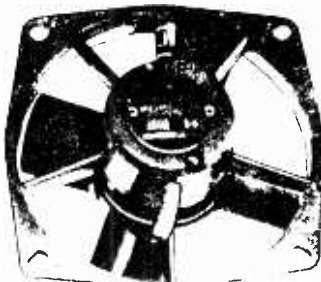

**MICRO SWITCHES** V3 type all 250V 10 amp SpST 15p  
1000 — £100 Spdt 20p 1000 — £150, very low torque Spdt  
30p 1000 for £200

**ROCKER SWITCHES** Standard size fit 11.5 x 28 mm cut out.  
Single pole on/off — 10p each 1000 for £75. Single pole changeover 20p  
each — 1000 for £100. Single pole changeover with centre off — 25p each —  
1000 for £125. Single pole on/off with neon — 36p — 1000 for £180.



**MINIATURE WAFER SWITCHES**  
2 pole, 2 way — 4 pole, 2 way — 3 pole, 3 way —  
4 pole, 3 way — 2 pole, 4 way — 3 pole, 4 way —  
2 pole, 6 way — 1 pole, 12 way.  
All at 25p each or 100 for £20.

**12 volt MOTOR BY SMITHS**  
Made for use in cars, etc. these are very  
powerful and easily reversible. Size 3 1/2"  
long by 3" dia. They have a good length of  
1/2" spindle —  
Price £3.45 or 100 for £250



■ **N.B. ELECTRONIC SUPPLIES** ■  
34 America Lane, Haywards Heath, Sussex RH16 3QU  
Phone 0444 454563 for Access or B.C.  
Please add £1 if order under £20.

CIRCLE 79 FOR FURTHER DETAILS.

## Toroidal Transformers

as manufacturers we are able to  
offer a range of quality Toroidal  
Transformers at highly competitive  
prices and fast delivery.

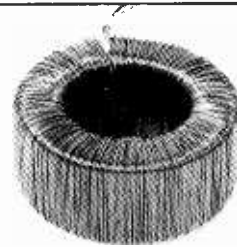

### Mail Order Price List

15VA 6.92 30VA 7.18. 50VA 8.86. 80VA 9.92. 120VA 10.59. 160VA 12.10. 225VA 13.69.  
300VA 14.77. 500VA 19.20. 625VA 22.09. 750VA 26.17. 1KVA 38.82. 1.2KVA 44.06  
price includes p+p & vat.  
Available from stock in the following voltages:—6-0-6,9-0-9,12-0-12,15-0-15,  
18-0-18,22-0-22,25-0-25,30-0-30,35-0-35,40-0-40,45-0-45,50-0-  
50,110,220,240(max.10 amp). Primary 240 volt.

**Quantity Prices and delivery on request**  
(we also manufacture conventional E1 type transformers)



**Airlink Transformers.**  
Unit 6, The Maltings, Station Road,  
Sawbridgeworth, Herts. Tel: 0279-724425.

CIRCLE 59 FOR FURTHER DETAILS.

## ELECTRONICS C.A.D. "ANALYSER"

PERFORMANCE ANALYSIS of LINEAR CIRCUITS using the BBC MODEL B AND  
SINCLAIR SPECTRUM 48K MICRO'S.

Simulates Resistors, Capacitors, Inductors, Transformers, Bipolar and Field effect Transistors, and  
Operational Amplifiers in any circuit configuration.

Performs FREQUENCY RESPONSE ANALYSIS on Circuits with up to 30 Nodes  
and 100 Components, for Phase and Gain/Loss, Input Impedance and Output  
Impedance

Ideal for the analysis of ACTIVE and PASSIVE FILTERS, AUDIO, WIDEBAND and R.F.  
AMPLIFIERS, LINEAR INTEGRATED CIRCUITS etc., etc.

"ANALYSER" can greatly reduce or even eliminate the need to breadboard new designs.

USED BY INDUSTRIAL AND UNIVERSITY R&D DEPARTMENTS WORLD WIDE  
VERY EASY TO USE. PRICES FROM £20 ACCESS OR AMERICAN EXPRESS  
WELCOME...

For further details write or phone NUMBER ONE SYSTEMS

DEPARTMENT WA/V  
9A CROWN STREET, ST IVES  
HUNTINGDON  
CAMBS. U.K. PE17 4EB  
TEL: 0480 61778 TELEX: 32339

CIRCLE 60 FOR FURTHER DETAILS.

ELECTRONICS & WIRELESS WORLD JUNE 1985

# Fast camera interface

by Safa S. Omran

Signals from standard video cameras are too fast to feed directly into a microcomputer. A solution is to take one picture element from each line in successive frames until a picture is built up. This design is faster, taking eight elements at each pass.

Video cameras scan a picture in a sequential series of horizontal lines. This scanning makes it possible for one video signal to include all the elements for an entire picture. Television frames conforming to the CCIR standard consist of two fields, each of 312.5 lines. A line is 64µs long and picture information is transmitted for about 40µs of this time.

A method of interfacing a video camera to a micro computer was described by P.

Howard in the February 1982 issue of *WW* on pages 30-36. The major problem with this type of interface is the high speed of the camera relative to the microprocessor.

Howard's method involves storing one picture element, or pixel, from each scan line in the field then storing the next picture element from each line of the next field, and so on for all the pixels across the picture. In this way, the microprocessor has 64µs in which to store each

pixel. An entire picture with a horizontal resolution of 256 pixels is stored in 5.12s.

Our method is to make the microprocessor store eight pixels from each scan line at each pass which reduces the time for storing a picture by a factor of eight. The time needed to store a picture with a horizontal resolution of 256 pixels is thus 256 divided by eight, multiplied by 20ms, which is 0.64s. The circuit designed uses this resolution with an eight-bit

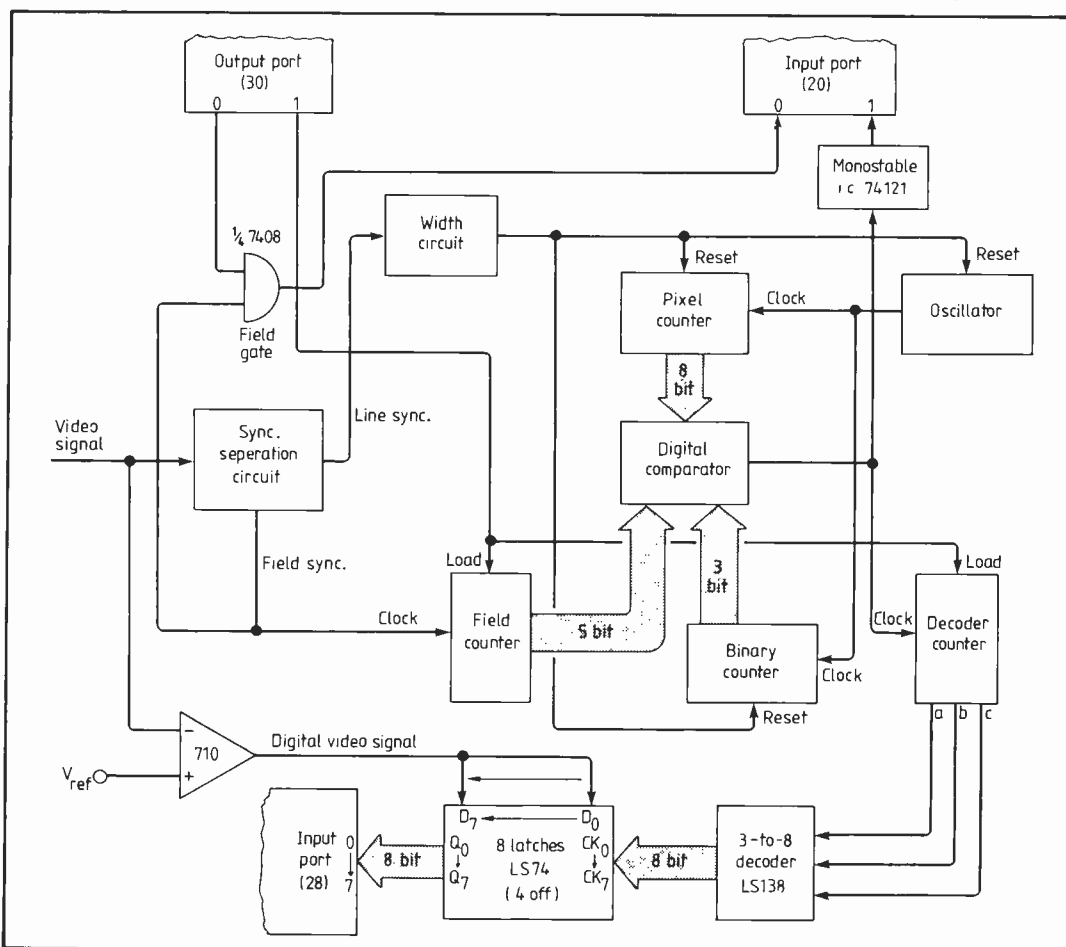

Fig. 1. Block diagram for the video camera interface timing circuit. By taking eight pixels from each line in successive frames, the interface allows a 256-pixel by 256-line picture to be stored in 0.64s.

Safa Omran is with the Institute of Technology in Baghdad.



Addr.	Content	Label	Instruction	Comment
6000	21 00 40		LXI H,4000	:Set HL register to start of picture store
6003	3E 00	STRT:	MVI A,00	
6005	77		MOV M,A	:Clear memory location
6006	23		INX H	:Go to next location
6007	76		MOV A,H	
6008	FE 60		CPI 60	:End of picture store?
600A	C2 03 60		JNZ STRT	:Go back if not
600D	21 00 40		LXI H,4000	:Set HL to start again
6010	11 20 00		LXI D,0020	
6013	0E 00		MVI C,00	:Reg.C contents=no. of lines
6015	3E 02		MVI A,02	
6017	D3 30		OUT 30	:Initialize video camera interface
6019	3E 03		MVI A,03	
601B	D3 30		OUT 30	
601D	3E 01		MVI A,01	:Open field gate
601F	D3 30		OUT 30	
6021	DB 20	FLD:	IN 20	:Wait for field pulse
6023	E6 01		ANI 01	
6025	FE 00		CPI 00	
6027	C2 21 60		JNZ FLD	
602A	DB 20	PLSE:	IN 20	:Wait for strobe pulse
602C	FE 02		CPI 02	
602E	DA 2A 60		JC PLSE	
6031	DB 28		IN 28	:Put data in A reg.
6033	77		MOV M,A	:Store it in memory
6034	19		DAD D	:Go to next video line
6035	0C		INR C	
6036	79		MOV A,C	:End of 256 lines?
6037	FE 00		CPI 00	
6039	C2 2A 60		JNZ PLSE	:If not, go back to store data from next line
603C	26 40		MVI H,40	
603E	2C		INR L	:Increment content of Reg L
603F	7D		MOV A,L	:End of 256 pixels? (32 x 8)
6040	FE 20		CPI 20	
6042	C2 21 60		JNZ FLD	:Go back if not
6045	76	END:	HLT	:Stop

**Assembly language program for reading the camera interface using the 8085 microprocessor.**

word 8085A microprocessor.

**Circuit description**

As shown in the block diagram, Fig. 1, the video signal feeds the synchronization separator which separates the line and field sync. pulses.

The video signal is +0.5V peak combined with synchronizing pulses of +0.2V. To separate sync. pulses, the video signal is first passed to a comparator with a reference of 0.1V, Fig. 2, which gives only sync. pulses at its output. This output is passed to an RC circuit with a time constant of about 50µs which integrates

field pulses only. Width of the field sync. pulses is about 2ms, while that of line pulses is about 2µs. From the RC circuit, the signal feeds a comparator with a positive reference of 2V, which gives only field pulses.

Line-sync. pulses are passed to a circuit which increases their width. This is required because data only exists for about 40µs of the scan line. A voltage-controlled oscillator, v.c.o., determines the number of picture elements wanted on a line. Output from the width circuit enables the v.c.o. and only allows it to oscillate for 40µs.

Output of the pixel counter is

compared with output from the field and binary counters by a digital comparator which generates a pulse when its two inputs are equal, Fig. 3. Assume that output from the field counter is one, i.e. 00001. When output from the pixel counter is zero, the binary counter output is also zero so the two digital comparator inputs are unequal, being zero and eight.

When output of the pixel counter increments by one, the binary counter output also increments by one, but the two inputs to the comparator are still not equal. They remain unequal until the output of the pixel counter becomes eight, in which case output of the binary counter is zero. Now the two inputs to the digital comparator are equal (00001000) so it generates a pulse.

In the next count, outputs of the pixel counter and field/binary counters are also equal (00001001) so another comparator pulse is generated. This is so for each count until output of the pixel counter becomes 16 (00010000), so eight pulses will be generated from the digital comparator in this scan line, Fig. 4.

After 64µs, another eight pulses will be generated for the next scan line, and the process will be repeated for all the scan lines of the field. This means that the comparator generates eight pulses corresponding to eight pixels (pixels 8-15) of each scan line.

In the next field, output of the field counter is two (00010) and the comparator inputs are equal when the output of the pixel counter is 16. In this case, output of the binary counter is zero. These inputs remain equal until the output of the pixel counter becomes 24

(00011000) which means that the digital comparator generates another eight pulses corresponding to the next eight pixels for each scan line. This process is then repeated so that eight pulses are generated by the comparator in each field.

These eight pulses enter the decoder counter, the output of which varies from 000<sub>2</sub> to 111<sub>2</sub> as shown in Fig. 4. This output is the input of the decoder, one output of which is active for each state of the decoder counter. The eight latches put eight consecutive pixels from

Fig. 2. Sync. separator circuit. The first 710 comparator takes composite line/field pulses from the video signal and the second one produces field pulses only with the aid of an RC integrator at its input.

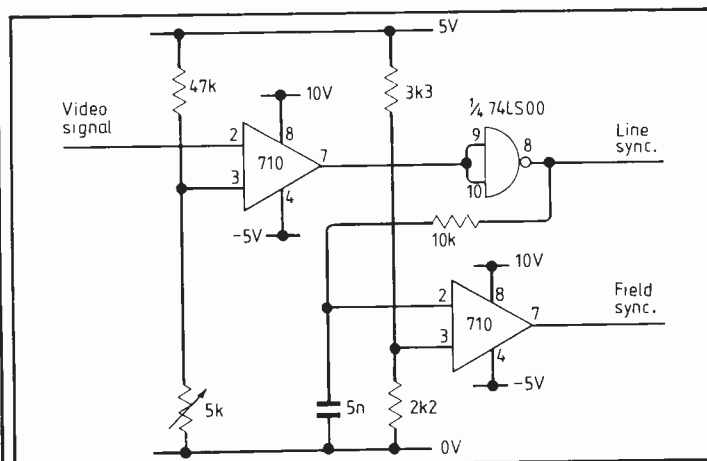

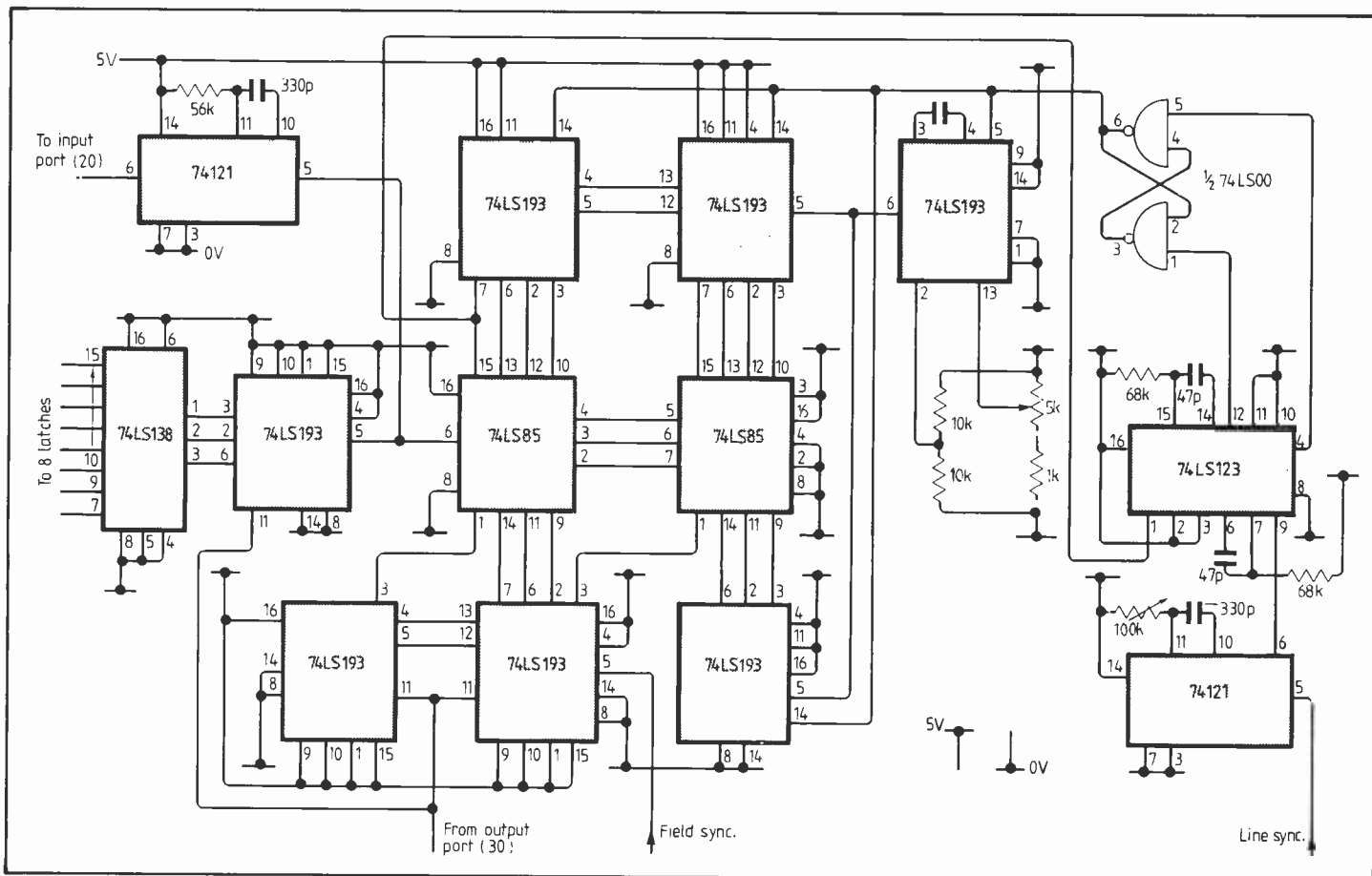

Fig. 3. Timing circuit for the video-camera interface. Data latches, video driver and i/o gating are shown in the block diagram.

the video signal on to the input port of the microprocessor, hence the microprocessor stores eight pixels at a time from each scan line.

e. repeats steps (a) to (d) 32 times, equal to the number of pixels in a line, i.e.  $32 \times 8 = 256$

f. ends

### Software

Movement of data from the camera to the microprocessor is controlled by software which stores 256 pixels per line for 256 lines in the field.

At the start, the field and decoder counters are loaded with their maximum counts by a pulse from the microprocessor. This ensures that the output of the field counter is zero after its first count and that output of the decoder is zero to ensure that the microprocessor stores the first pixel. Next the microprocessor opens the field gate and

For step (b), a monostable i.c. stretches the strobe pulse to about  $16\mu\text{s}$  to make it suitable for the microprocessor. An assembly-language program is shown for the 8085 microprocessor assuming 256 pixels by 256 lines. In this program, memory location  $4000_{16}$  is the start of the picture store and location  $5FFF_{16}$  is the end. Port 30 is used for output and ports 20 and 28 are used for input, see block diagram.

Figure 5 shows a circuit diagram which was digitized using the interface and displayed on a storage oscilloscope.

- waits for the field sync. pulse
- waits for a strobe pulse from the digital comparator
- stores the eight pixels from its input port in less than  $64\mu\text{s}$
- repeats steps (b) and (c) 256 times, equal to the number of lines required

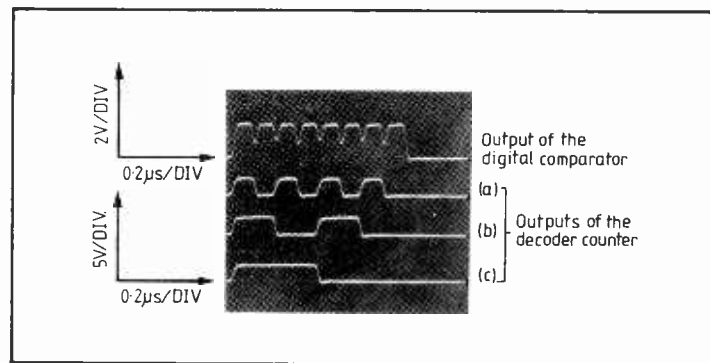
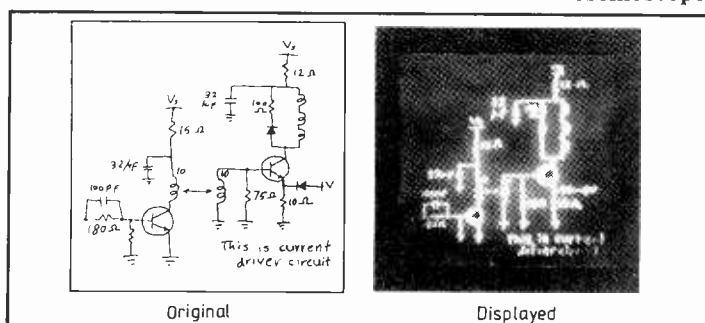

Fig. 4. Output of the digital comparator, top, consists of eight pulses which step the decoder counter. On each count, one pixel from the line is latched ready for reading by the microprocessor.

Fig. 5. An example of a circuit diagram digitized using the video camera interface and displayed on a storage oscilloscope.



**The Hacker's Handbook** by Hugo Cornwall: Century Communications, 149 pages, soft covers, £4.95. The Book They Tried To Ban. Fascinating guide to dial-up computer systems and the psychology of people who devise and use them. Gives few real secrets away, but could be worth having just for the technical reference material. Rather expensive.

**An Introduction to Z80 Machine Code** by R.A. and J.W. Penfold: Bernard Babani (Publishing), ref. BP152, 127 pages, soft covers, £2.25. Beginner's guide for the home computer user. Chapter 3, which describes the instruction set, takes up about half of the book. Addressing modes are covered rather sketchily in just four pages with no program examples. At the end are a few brief specimen listings for the ZX81, ZX Spectrum, Amstrad and Memotech micros.

**An Introduction to 6502 Machine Code** by R.A. and J.W. Penfold: Bernard Babani (Publishing), ref. BP147, 107 pages, soft covers, £1.95. Much the same treatment as in the Z80 version above. Demonstration listings at the end relate to the BBC Micro/Electron, Oric, VIC-20 and Commodore 64.

**Microprocessors: Hardware and Applications**, by Andrew Veronis: Prentice-Hall International, 928 pages, hard covers, £51.45, ISBN 0 8359 4382 8. Heavyweight guide to a wide selection of 8-bit and 16-bit types. Chapters cover chip architecture, programming, memory systems, i/o, interrupts, d-to-a and a-to-d conversion, disc and tape storage, single-chip microcomputers, arithmetic processors and trouble-shooting with logic analyzers. Data sheets for several of the chips are included among the ten appendices.

**An Introduction to Programming the Atari 600/800XL** by R.A. and J.W. Penfold: Bernard Babani (Publishing), ref. BP143, 108 pages, soft covers, £2.25. All about Atari Basic, with a few games listings thrown in.

**An Introduction to Programming the Sinclair QL** by R.A. and J.W. Penfold: Bernard Babani (Publishing), ref. BP150, 99 pages, soft covers, £1.95. Programming and interfacing with Superbasic. Listings look as if they have been printed by a bus-ticket machine — a pity.

**Learning Microsoft Basic for the Macintosh** by David A. Lien: Compusoft Publishing, 458 pages, soft covers, ISBN 0 932760 27 9. Chatty, persuasive introduction to Basic on the Apple Macintosh, with numerous examples, exercises and cartoons.

**Learning TRS-80 Model 4/4P Basic** by David A. Lien: Compusoft Publishing, 483 pages, soft covers, ISBN 0 932760 19 8. Ditto for the new TRS-80 models. Just shows what you can do with a word-processor!

**Micro Interfacing Circuits, book 1** by R.A. Penfold: Bernard Babani (Publishing), ref. BP130, 96 pages, soft covers, £2.25, ISBN 0 85934 105 4. Practical guide for the hobbyist. Chapters cover address decoding, serial and parallel i/o chips, driving relays, de-bouncing switches, d-to-a and a-to-d conversion.

**Pascal for Electronics Engineers** by J. Attikiouzel: van Nostrand Reinhold, 148 pages, soft covers, £5.75, ISBN 0 442 30597 4 pbk. Tutorial guide at first-year undergraduate level, with exercises and worked examples. Makes attractive use of marginal notes for hints and asides. Three case studies at the end illustrate the use of Pascal for writing circuit analysis programs.

**Practical Electronics Building Blocks, book 2**, by R.A. Penfold: Bernard Babani (Publishing), ref. BP118, 94 pages, soft covers, £1.95. Audio stages, filters and flip-flops for beginners.

**Questions and Answers on Radio Repair** by Les Lawry-Johns: Newnes Technical Books, 106 pages, soft covers, £2.65, ISBN 0 408 01509 8. Heaps of practical advice and good humour from an experienced practitioner.

**Radio and Television Servicing, 1983-84 models** edited by R.N. Wainwright: Macdonald, 863 pages, hard covers, £22.50, ISBN 0 356 10259 9. Diagrams and servicing information for a variety of models by Alba, Binatone, Fidelity, G.E.C., Hitachi, Luxor, Mitsubishi, National Panasonic, Network, Perdio, Philips, Pye, Roberts, Saba, Salora, Sharp, Sony, Tatung, Teleton, Thorn-EMI and Toshiba.

**Signal Processor Chips** edited by David J. Quarmby: Granada Publishing, 179 pages, hard covers, ISBN 0 246 12171 8. Not ordinary analogue chips, but digital programmable l.s.i. chips with widespread applications in filters, modems, speech processing, sonar and video. The editor contributes chapters on what they are and how

they work and then hands over to contributors from Intel (on the 2920), NEC (on the 7720) and Texas Instruments (on the TMS320) for the practical details.

**Single-chip Microcomputers** edited by Paul F. Lister: Granada Publishing, 231 pages, hard covers, ISBN 0 246 12106 8. An introduction to some commercial chips with design examples: the Motorola M6801 and M6805 (with a speedometer/tachometer/odometer); the Texas TMS1000 (with a speech synthesizer interface); the Zilog Z8 (with a data logger); the National Semiconductor COPS400 (with a digital tv tuning system) and the Mostek MK68200 (with a machine controller).

**Telecommunication Principles** by J.J. O'Reilly: van Nostrand Reinhold, 143 pages, soft covers, £5.75, ISBN 0 442 30592 3 pbk. Tutorial guide for first and second-year undergraduates covering communications theory, modulation methods, radio receiver principles and digital communications. Three case studies at the end describe techniques used in stereo f.m. broadcasting, U.K. colour tv and videotext.

**Transmitted Picture Assessment** by John Allnatt: John Wiley and Sons, 303 pages, hard covers, £19.50, ISBN 0 471 90113 X. A practical guide to assessing tv picture impairments in the laboratory and in the field. The author is head of the Visual Performance Standards Section at British Telecom's Martlesham laboratories.

**The Motorola MC68000 Microprocessor Family** by Thomas Harman and Barbara Lawson: Prentice-Hall International, 574 pages, hard covers, £37.90, ISBN 0 13 603960 X. Heavyweight guide to Motorola's 16-biters. Chapters cover the instruction set, program control, arithmetic operations, programming techniques, system operation, i/o handling and interfacing. Numerous exercises.

**Murphy's Law** and other reasons why things go wrong, by Arthur Bloch: Price/Stern/Sloan Inc., Los Angeles, 94 pages, soft covers, \$2.95 ISBN 0 8431 0428 7. Treasure chest of quips, axioms and aphorisms for engineers and others. Also **Murphy's Law Book Two**, 94 pages, \$2.95 ISBN 0 8431 0674 3. Sample rib-tickler: "A computer does what you tell it to do, not what you want it to do" (Greer's Third Law).

## Uosat data decoder p.c.b.

A new printed circuit board is available for the high-performance G3RUH Uosat data demodulator (*Wireless World*, May 1983).

The board includes the 1200 baud circuits, (limiter, phase-locked loop, integrate-and-dump and lock detector), regenerated and RS232C output interfaces. The input filter, 300 baud and c.c.d. line-sync detectors have been omitted. The p.c.b. is single sided and legended, measures 160×100mm and has space for an RS Components encapsulated 12V p.s.u., RS 591-281. A suitable case is RS 508-605. Connections to the p.c.b. are via a single 16-pin d.i.l. plug.

Prices: p.c.b., instructions and (air mail) postage — UK £10, Europe £11, overseas £12. Note that the *Wireless World* article is not included: a reprint is available at an extra £1 (abroad £1.40). Available now from the author (for address see table 3) or from Amsat-UK, London, E12 5EQ.

## Data Recording

*continued from page 64*

may need to be varied for different heads. It does not seem critical.

During reading, the write output is shorted to prevent noise interfering with the read signal. The read signal is applied to A<sub>3</sub>, a non-inverting amplifier with a gain of about 25. Because of the head's inductive reactance, this amplifier must have a high input impedance to preserve the signal at high frequencies. About 400mV (peak-to-peak) is available at the output of A<sub>3</sub>.

Coupling between A<sub>3</sub> and A<sub>4</sub> is via a small-value capacitor which differentiates the signal. The output to the BBC Micro is a 1.4V peak-to-peak square wave with very little jitter on the edges.

This design has proved to be very reliable over the past year. The cost of the components is about £3 plus a cheap cassette recorder (mine was £9.99 from Woolco).





*Your product?*

# One superb product deserves another.

You know your product is the best you can make but today's electronic products are crammed full of components any one of which could damage your reputation.

In the wound magnetics world, more and more electronics manufacturers are turning to Weyrad because they find the expertise, quality and reliability they need.

They also find the flexibility in manufacture, the pricing they want and the dedication they need to help them make a better product. And they find a company determined to keep its lead in the market.

Weyrad have been in the business of high technology wound mechanics for over 30 years and now with massive resources have a fully equipped factory and an experienced staff of designers and engineers capable of making the



*Our product*

smallest to the largest components; capable of making simple windings or the most complex; capable of designing and manufacturing custom assemblies including voltage generation and power modules.

Weyrad's products are found in TVs and audio equipment with household names. In aircraft, ships and fighting vehicles. In industrial and commercial machinery around the world. In telecommunications equipment and in the automotive industry.

Weyrad were Britain's first wound electronics company to win the coveted standard BSI BS 5750 for its quality control, which gives Weyrad customers unrivalled assurance of manufacturing standards. But then, when you make an outstanding product, it's important to make sure it stays the best, isn't it?

For more details of how Weyrad can help you improve your products contact our Marketing Department.



H I G H · T E C H · W O U N D M A G N E T I C S

Contact the Marketing Dept., Weyrad (Electronics) Ltd., Lynch Lane, Weymouth, Dorset. Telephone: (0305) 783801



CIRCLE 75 FOR FURTHER DETAILS.

# The Archer Z80 SBC

The **SDS ARCHER** — The Z80 based single board computer chosen by professionals and OEM users.

- ★ High quality double sided plated through PCB
- ★ 4 Byte-wide memory sockets — upto 64k
- ★ Power-fail and watchdog timer circuits
- ★ 2 Serial ports with full flow control
- ★ 4 Parallel ports with handshaking
- ★ Bus expansion connector
- ★ CMOS battery back-up
- ★ Counter-timer chip
- ★ 4 MHz. Z80A

## OPTIONS:

- ★ SDS BASIC with ROMable autostarting user code
- ★ The powerful 8k byte SDS DEBUG MONITOR
- ★ On board 120 / 240 volt MAINS POWER SUPPLY
- ★ Attractive INSTRUMENT CASE — see photo.
- ★ 64k / 128k byte DYNAMIC RAM card   ★ NEW ★
- ★ 4 socket RAM — ROM EXPANSION card ★ NEW ★
- ★ DISC INTERFACE card                   ★ NEW ★

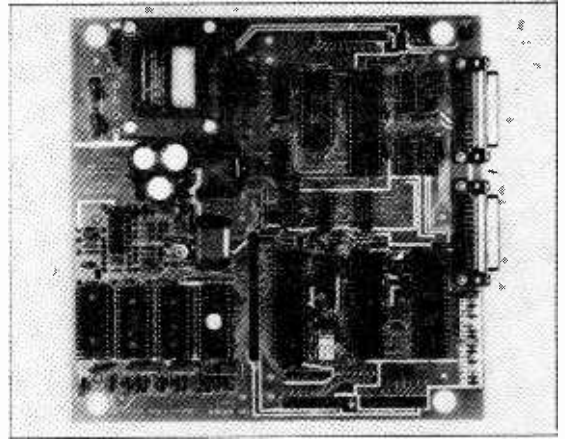

# Sherwood Data Systems Ltd

Sherwood House, The Avenue, Farnham Common, Slough SL2 3JX. Tel. 02814-5067

CIRCLE 56 FOR FURTHER DETAILS.

## PRECISION GOLD MULTI-METERS

A new range of superb quality professional multimeters at incredibly low prices. Model M5010 Features ■ 20Ω and 20μA AC/DC FSD ranges! ■ 10MΩ input impedance on all ranges (+ 100pF AC) ■ Reads up to 1,000V DC, 750V AC, 10A AC/DC, 20MΩ. ■ 31 ranges including continuity buzzer and diode test. ■ 3½ digit, ½ inch LCD display. ■ Safety probes, recessed sockets bench stand. ■ Overload protected to UL1244 ■ Battery, test leads and instruction booklet included. ■ Gold-plated P.C.B for long-term reliability and consistent high-precision (basic accuracy ±0.25% + 1 digit!)

**PRECISION AT A GOLDEN PRICE - ONLY £36.95 + VAT**  
 Order As YJ10L. Full technical spec. on request.  
**MAPLIN PROFESSIONAL SUPPLIES, P.O. Box 777, Rayleigh, Essex.**  
 Telephone: Southend (0702) 552961. Telex: 995695.

## MAPLIN GOLD

MPS is a division of Maplin Electronic Supplies Ltd., Oak Road South, Benfleet, Essex.

CIRCLE 10 FOR FURTHER DETAILS.

## RACKMOUNT CASES

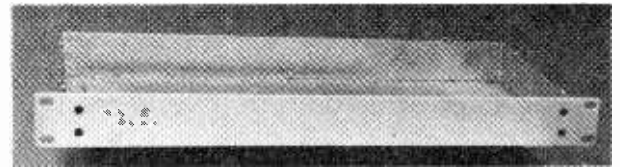

19" Self Assembly Rack Mounting Case with lift off Covers. Front Panel 10 gauge, Brushed Anodised Aluminium, Case 18 gauge, Plated Steel with Removeable Rear & Side Panels. In 1U & 2U Types, a Subplate Chassis is Mounted to Bottom Cover. In 3U Type the Subplate is located on two Rails Mounted Between The Side Plates.

- 1U (1½) height, 230m depth..... £27.00
- 2U (3½) height, 308m depth..... £32.00
- 3U (5½) height, 230m depth..... £39.00

Width Behind Front Panel 437m (All Types).

All Prices include Postage & V.A.T. Cheques, Postal Orders Payable to:-

**J. D. R. Sheetmetal, 131 Grenfell Road, Maidenhead, Berks. SL6 1EX. Maidenhead 29450.**

CIRCLE 16 FOR FURTHER DETAILS.

## BRAND NEW ELECTRONIC COMPONENTS

### QUALITY .25W CARBON FILM RESISTORS

Qty	1-9K	10-24K	25-49K	50-99K	100K+
Price	4-25	3-95	3-70	3-45	3-25

Price per 1000. Sold in multiples of 1000.

Small quantity prices available.

### LEAD-FORMING SERVICE AVAILABLE

Save assembly time and money with pre-formed leads. Size setting £2-00 plus £1-50 per 1000.

Write or Phone for full Details

### HARRISON ELECTRONICS

22 MILTON ROAD, WESTCLIFF-ON-SEA, ESSEX SS0 7JX Tel: (0702) 332338

CIRCLE 54 FOR FURTHER DETAILS.

ELECTRONICS & WIRELESS WORLD JUNE 1985

## Costly Def

Do the Services and tax-payers obtain value for money in their purchases of radio, electronic and related equipment for advanced weapons and communications system? In the case of some projects, such as the painful long-running £5000-million saga of British torpedo development, patently not. For all military equipment, price tags tend to be very high when judged by civilian equipment standards. But are these not justified by the high standards of reliability and environmental testing involved in the manufacture of equipment to the defence and MIL-spec standards demanded by the UK, NATO and USA services?

In general terms all semiconductor devices and components are required to work over the impressively large temperature range of  $-55$  to  $+125^{\circ}\text{C}$ . Semiconductors for aerospace applications have to be in hermetically sealed metal or ceramic packages. Batch testing of samples, normal practice for most electronic equipment, is ruled out. To permit traceability, all stages of manufacture and assembly have to be documented and monitored.

As one reader who is involved with making equipment to defence specifications puts it: "The standard 'commercial' device will rarely have received very much in the way of testing before despatch; normally the procedure is one of lot sample testing with the entire batch accepted or rejected on the results of the sample testing. MIL-spec devices, on the other hand, will have been 100 per cent tested and burned-in for 168 hours at  $125^{\circ}\text{C}$ ."

Traceability also adds quite a cost penalty. It is necessary to be able to check on a specific semiconductor device, for instance, right back to the materials used and to the diffusion process. This facility is essential when batch related problems are discovered so that suspect batches can be isolated very rapidly and appropriate action taken. . . drop-offs do occur even in the best regulated circles! The most worrying thing, from an equipment manufacturer's point of view, is that such problems often do not become evident for quite a long

time. So as soon as the problem is detected, it is necessary to establish very rapidly which equipments contain devices from the suspect batches — impossible to do without full traceability. . . The low cost of many consumer items is gained as the result of automated flow line production; once you disturb this process to add inspection and test stages, the production costs can increase very rapidly indeed."

These arguments seem very convincing, that is until you start to wonder how much all these extra precautions have really added to reliability in the field. When a few years ago I asked the technical director of a firm supplying military communications equipment what had been the effect of the DEF component specification he replied that it had greatly increased costs but had made very little difference to reliability. The Pentagon is currently complaining that it has to spend something approaching a quarter of its annual budget on maintenance and repair of equipment. Horror stories abound of the American services paying \$110 for electric plugs available in hardware stores for about 5c, \$7622 rather than less than \$100 for coffee makers fitted in cargo planes, \$170 for battery-operated torches. In the UK it is more difficult to discover just how much is paid for what — and with what results. Nobody likes the idea of people being sent into action with poorly made equipment, but it has been pointed out that video games in arcades are expected to withstand rough treatment without being made to MIL-spec standards!

## Vhf changes

As a result of decisions made at the 1984 ITU Regional Administrative Conference for the planning of the v.h.f. broadcast band between 87.5 and 108MHz, attended by 500 delegates from 77 countries, a considerable number of frequency changes are due to take effect before July 1987 to UK local radio (BBC and ILR) stations, including some later this year. Eventually all UK local stations will be in two sub-bands of 94.6 to 97.6MHz and 102.0 to 104.9MHz with the

possibility of "community radio" stations between 105 and 107.9MHz, a part of the spectrum now expected to be cleared of present communications services by about 1990 rather than the 1995 date originally written into the 1979 WARC.

The conference, the first part of which was held in 1982, produced a formal "Geneva Agreement 1984" covering Region 1 and part of Region 3. To this is annexed a "Geneva Plan 1984" covering frequency assignments for more than 53,000 sound broadcasting stations. The UK part of the plan foresees five national networks (four for BBC, one for Independent National Radio), the BBC and IBA local radio stations most of which will be grouped into separate sub-sub-bands, plus the proposed new tier of community radio.

## Radar up-date

The Fylingdale long-range radar, which forms part of the American ballistic missile early warning system (BMEWS) is soon to be up-graded and modernized. A radically different solid-state phased antenna array, similar to one currently being installed at Thule, Greenland, is likely to be installed. These have 2560 active elements in each 84-ft high antenna face, providing almost a megawatt of power. Unlike the present mechanically steered antennas, the phased-array is fixed with electronic beam steering under the control of CDC865 computers. Such arrays can simultaneously track a number of targets.

The Americans are also currently building a network of over-the-horizon h.f. radars with an operational range of about 5000 miles, almost twice that of the BMEWS installations. For the reception of o.t.h. signals, 4980ft long-wire Beverage antennas are used.

Much longer antennas are needed for transmission of extremely low frequency (e.l.f.) communication signals at frequencies below 100 hertz, and a 30-mile antenna is reportedly to be erected in Scotland though it is not clear whether this will be an American or British operated system for broadcasting messages to submerged

submarines at extremely low data rates. At e.l.f. even a 30-mile antenna is very short in terms of wavelength and efficiencies are extremely low. Signals can, however, be received at great range and at considerable depth on compact frame antennas.

The American customs service is planning to use six Orion long-range patrol aircraft equipped with airborne (AN/APG-63) radar capable of detecting and tracking small low-flying aircraft and surface vessels. This is part of the current American campaign to reduce the large-scale smuggling of drugs into the USA, although this campaign could be rendered ineffective by the increasing manufacture of synthetic hard drugs within the USA. Target information from the patrol craft will be passed to the US Coast Guard and other government agencies whose task it is to intercept and apprehend suspects.

## Cordless tv

One of the most thankless, yet vitally important, tasks of governments is to uphold, and if possible improve, the regulation of the radio spectrum. While in recent years in the UK public attention has been focussed primarily on "pirate" broadcasters and before that on 27MHz c.b., the general situation has been deteriorating alarmingly rapidly. Point-to-point services are tending to occupy and hold channels not registered with the International Frequency Registration Board; megawatt over-the-horizon radars, including Russian pulsers and American continuous-wave radars, are taking over chunks of h.f. not allocated for radar in ITU Radio Regulations; out-of-band high-power h.f. broadcasting is flourishing (the DTI has described this as "semi-regulated anarchy"); by no means all private mobile radio networks strictly adhere to their regulations; licensing authorities find it increasingly difficult to cope with all the administration and paperwork; the Merriman Committee noted the increasing need for the UK Radio Regulatory Department to devote "adequate resources" to "spectrum monitoring,



particularly of the mobile and fixed bands, as an aid to efficient spectrum management".

On one of the few occasions when the Radio Regulatory regime has been the subject of an adjournment debate in the House of Commons (March 26, 1985) it started at 8.43 a.m. after an all-night sitting and ended 17 minutes later at 9 a.m. when the motion duly lapsed "without Question put".

Barry Henderson, Conservative MP for north-east Fife, who has been described as "an unobtrusive New Technology man with old values" attacked the efficiency of RRD, drew attention to its draconian powers and provided a number examples to show how delays and errors were adversely effecting business and personal users of the radio spectrum. In reply, John Butcher, Under-secretary of State for Trade and Industry, simply filled in time by describing some of the many tasks of RRD without getting round to his promised outline of "Government's policy on the enforcement of wireless telegraphy legislation" before being saved by the bell.

While RRD has been successful in closing some but by no means all of the pirate broadcasters, a good example of the confused state of enforcement concerns the power given to RRD by the 1984 Telecommunications Act to specify "restricted"

transmitting equipment and so make manufacturing, selling, offering for sale or hire of it illegal. In the twelve months following the enactment of this legislation not a single restriction order has been formulated.

What is one to make, for example, of the low-power television transmitters recently announced by Waveview Holdings Ltd of South London? These range from outputs of 4 to 200mW for their "Multiview" series and 1 to 1000 watts for low-power television. The Multiview units are being offered for use in homes, hotels, etc. as local "cordless" distribution systems with outputs tuned to u.h.f. channel 36, one of the non-allocated channels between Bands IV and V and used by airport radars, etc. All such units, even the

lowest power Multiview unit with its built-in antenna, have one feature in common; the use of any would clearly contravene the Wireless Telegraphy Acts and could be seized if used — yet it is perfectly legal, despite last year's Act, for the company to make, advertise and sell these transmitting units!

## Amateur Radio

### Jas-1 in 1986

An amateur radio satellite, JAS-1, currently being built and tested jointly by JARL the Japanese national amateur-radio society and NASDA, Japan's national space agency, is due to be launched from the Tanegashima space centre in early 1986 on board a newly developed H-1 two-stage launcher, as part of a multi-payload. This will be the first multi-payload launch by NASDA and the agency will depend on the telemetry from JAS-1 in assessing results. Orbital height of the 50kg JAS-1 will be about 1500km, inclination about 50° and period about 120 minutes (roughly similar to Oscar 7). Ground stations will have about eight passes per day, with "windows" of about 20 minutes.

JAS-1 will carry two mode-J (145MHz up, 435MHz down) transponders with a design lifetime of three years. One will be a conventional linear transponder, the other a digital store-and-forward transponder for communication between stations in different time zones. The digital transponder will have four input channels in the 145MHz band using p.s.k./f.m. with a single 1200-baud downlink at 435.91MHz.

AMSAT-UK reports that two more Russian amateur satellites, RS-9 and RS-10, may be launched this year. RS-10 will carry Mode A (145.9MHz up, 29.5MHz down) and Mode K (21.2MHz up, 29.5MHz down) and possibly also a 21.2MHz up, 145.9MHz down transponders.

JARL has a special station at the large International Science and Technology Exposition 85 at Tsukuba (100km north of Tokyo) from March 17 to September 1, 1985. Visiting

amateurs, including those from overseas, will be able to operate the station provided that they produce their licence certificate.

### The Mark III

H.W. King's graphic account ("SOE" in *Feedback*, April 1965) of the travails of Veljke Dragičević, as SOE's first radio operator in Yugoslavia, in having to hump around a 80-100lb "Mark III" transmitter package, highlighted the problems of clandestine radio in occupied countries in the period 1941-42, though personally I doubt if his package included an HRO receiver in what became known as the "coffin" configuration. More likely is that the receiver was a "straight" r.f./regenerative detector/a.f. receiver similar to the Mark XV receiver. It once fell to my lot in less unfavourable circumstances to manoeuvre a "coffin" package up a steep narrow spiral staircase and can confirm it was no lightweight, miniaturized equipment!

However I must come to the defence of what Mr King terms "the notorious Mark III" — a two-stage transmitter built in various versions throughout World War II at Whaddon and Little Horwood, near Milton Keynes. Allegedly based on a 1938 design in one of the American amateur radio handbooks it usually comprised a wooden-boxed, crystal-controlled 6V6 oscillator and 807 power amplifier with a separate (heavy) mains power supply unit. It delivered about 25 watts r.f. output between about 3 to 16MHz with plug-in coils. It was a versatile and reliable transmitter although the power unit could occasionally catch fire, and it was all-too-easy to tune the p.a. to a harmonic.

Although not designed for field operation it was sometimes run from vehicle batteries with the aid of a rotary converter or alternatively from a 150 watt Onan petrol-electric generator, though these were far from "portable".

The original purpose of the Mark III was for the British Intelligence h.f. network organized from 1938 onwards by (Sir) Richard Gambier-Parry ("G.P." or "Pop") with most of

the transmitters located in Embassies or other diplomatic buildings in the days when British Intelligence operated under the transparent cover of Passport Control. A more powerful transmitter, the Mark X, had an 813 power amplifier and was sometimes used.

When early in 1940 the first results of Bletchley Park's cracking (with the aid of the Poles and French) of the German Enigma machine became available, Special Liaison Units were set up to distribute what became known as "Ultra" to overseas commands, and the Mark III became the mainstay of SLU communications. During late 1944, there were no less than about 45 SLU out-stations in contact with the "Windy Ridge" base station, handling large quantities of Ultra and Pearl traffic enciphered with one-time pads or Britain's successful answer to Enigma, the Type X cipher machine.

So while agreeing that the idea of mule-humping such equipment around the mountains of Yugoslavia must have been well calculated to fuel the often bitter rivalry between SOE and British Intelligence, it can be argued that the "notorious" Mark III successfully provided some of the most vital radio links of WWII, despite its bulk and lack of miniaturization!

### In brief

After a long interval, amateur radio licences are again being issued in Turkey, with the first going to Dr Unal Akbal who becomes TA1A. . . A number of special call signs with the prefix "GV" were issued for use in early May by special event stations marking the 40th anniversary of the end of World War 2 in Europe. . . British Standard BS6527:1984 provides a specification for "Limits and measurements of spurious signals generated by data processing and electronic office equipment" but does not appear specifically to cover home computers which can be the source of considerable problems to radio amateurs. . . The Tyne-Wear Repeater Group reports that both of their repeaters — GB3TW (R5) and GB3NT (RBo) — are now operational. Pat Hawker, G3VA.



Here is the complete range of ICOM marine radio-telephone equipment, from left to right: the M700 HF SSB transceiver offers long-range capability at a sensible price. The M5 VHF hand-portable, quick channel access with its push-button keyboard. M12 and M2 VHF hand-portables, 12 and 56 channels respectively using knobs or thumb-wheels. Finally the M80 VHF radio-telephone, a wide range of options are available for this and all other ICOM marine radios. ICOM radios are versatile, rugged, water-resistant and most important of all - reliable.

More detailed information is readily available from your local ICOM dealer or direct from Thanet Electronics Ltd.

## Thanet Electronics Ltd

Suppliers of Radio Communication Equipment to the Ministry of Defence.  
143 Reculver Road, Herne Bay, Kent, England. Tel: (0227) 363859/363850

CIRCLE 28 FOR FURTHER DETAILS.

# pantechnic

■ design manufacture and supply

**POWER AMPLIFIERS  
HIGH POWER ASSEMBLIES  
CONTROL CIRCUITRY**

■ for application in

**INDUSTRY  
PUBLIC ADDRESS  
HI-FI**

■ available

**OFF THE SHELF  
CUSTOMISED  
C A D DESIGNED**

tel. 01.361.8715 132 High Road  
telex 266 873 New Southgate  
PANTEC G LONDON N11 1PG.

CIRCLE 58 FOR FURTHER DETAILS.

VISIT OR  
PHONE  
OPEN 6 DAYS  
A WEEK  
ALL STOCKS  
ON DISPLAY

# HENRY'S AUDIO ELECTRONICS



Equipment • Communications • Computers • Components

## INSTRUMENTS STOCKED

SCOPES (UK C/P £6.50)	
*HAMEG	
HM203/5 Dual 20MHZ	£264.00
HM204 Dual 20MHZ	£365.00
HM605 Dual 60MHZ	£515.00
*CROTECH	
3030 15MHZ Portable	£188.00
3035 15MHZ Bench	£208.00
3132 Dual 20MHZ	£312.00
(*HAMEG/CROTECH INCLUDE COMPONENT TESTERS)	
HITACHI	
V212 Dual 20MHZ	£329.00
V222 Dual 20MHZ*	£395.00
V223 Dual 20MHZ*	£450.00
V423 Dual 40MHZ*	£650.00
V650 Dual 60MHZ*	£880.00
*with probes	
THANOR SC110A 10MHZ battery/mains	£175.00
SCOPE PROBES X1-X10	£10.00

GENERATORS (UK C/P £1.00)	
(F) Function (P) Pulse (A) Audio (R) RF	
500 0.1HZ-500KHZ (F)	£110.00
TG101 0.02HZ-200KHZ (F)	£110.00
TG102 0.2HZ-2MHZ (F)	£160.00
TG501 0.005HZ-5MHZ (F)	£295.00
TG105 5HZ-5MHZ (P)	£105.00
AG202A 20HZ-200KHZ (A)	£99.00
LAG27 10HZ-1MHZ (A)	£115.00
SG402 100HZ-30MHZ (R)	£79.00
LSG12 100HZ-150MHZ (R)	£115.00
AG203 10HZ-1MHZ (A)	£155.00

POWER SUPPLIES (UK C/P £2.00)	
*Twin meter • Single meter (switched) + Digital	
*241 0/30v 0/1AMP	£33.00
*242 0/30v 0/3AMP	£52.13
*154 5/15v 0/4AMP	£43.43
*2302 0/30v 0/2AMP + 5v 1A AND PULSE GEN	£230.00
+ PL320 0/30v 2AMP	£145.00

COUNTERS (UK C/P £1.00)	
+ LED • LCD AN 8 digit	
+ 100 100MHZ	£99.00
+ 600 600MHZ	£126.00
+ 1000 1000MHZ	£175.00
+ TF600 600MHZ	£132.50
+ TF040 40MHZ	£120.00
+ TF200 200MHZ	£175.00

TV EQUIPMENT (UK C/P £1.00)	
TC40 VHF/UHF F/S meter	£215.00
LTC910A Tube Tester	£199.00
MC321 PAL(UK) Colour gen.	£252.00
MC32B PAL(B) Colour gen.	£252.00
LHM80A 40Kv meter	£30.00

STOCK SELECTION (+UK C/P 65p *UK C/P £1.50)	
*LP1 10MHZ Logic Probe	£24.95
*DP70 30MHZ Logic Probe	£29.00
*DP71 50MHZ Logic Probe	£57.00
*ST300 AC Clamp Meter	£30.87
*VF501 Elec. Ins. Tester	£59.13
*DM6013 Digital Cap Meter	£60.43
*KM65 200MHZ TR DIP Meter	£48.70
*LCR740 LCR Bridge	£230.00
*OM358 Scope Multiplexer	£169.00
*HZ65 Scope Comp. Tester	£24.00
*TC1 Transistor Tester	£24.30
*CM200 Bench Dig. Cap. Tester	£89.00

HAND DMM'S 3 1/2 digit (UK C/P 65p)	
(R) Rotary (PB) Push-Button • With case	
*3500 10A AC/DC (R)	£41.48
*3510 Plus Hfe & Buzzer (R)	£47.78
ME540 10A AC/DC Auto/Man (R)	£41.50
DM73 Auto-range probe - buzzer	£39.75
*KD615 10A DC Hfe Tester (R)	£34.75
6010 10A AC/DC (PB)	£37.83
7030 10A AC/DC 0.1% (PB)	£46.91
*KD55C 10A AC/DC (R)	£38.70
*KD528T Miniature with Hfe test	£29.52
DM20 10A AC/DC Hfe • conductance (R)	£47.00
DM77 10A AC/DC Auto - buzzer (R)	£46.00
*3530 10A AC/DC Hfe • Cap. • buzzer (R)	£57.29

BENCH DMMs (UK C/P £1.00)	
TM355 3 1/2 digit LEO 0.25%	£85.00
TM356 3 1/2 digit LEO 0.25%	£95.00
TM351 3 1/2 digit LEO 0.1%	£115.00
5025 3 1/2 digit Auto-manual comparator	£210.00
5030 3 1/2 digit Auto-manual comparator	£137.00
1503A 4 1/2 digit LEO 0.05%	£169.00
1503MA 4 1/2 digit LEO 0.03%	£185.00
1504 4 1/2 digit LCD True RMS	£199.00

## SWITCH MODE AND LINEAR POWER SUPPLIES

Gould and ITT/STC (UK C/P & ins. £1.50 each)	
A. 12/15 V 500mA linear	£6.91
B. 12/15 V 1amp linear	£8.65
C. 5V 3 amp linear	£8.65
D. 5V 2 amp Eurocard linear	£7.78
E. 5V 10 amp SW mode	£15.61
F. 5V 20 amp SW mode	£19.96
G. • 5V 5A. • 23V 0.25A. • 12V 0.1A. • 12V 0.5A. SW mode	£17.35
H. • 5V 2A. • 30V 0.025A. • 12V 0.1A. • 12V 0.35A SW mode	£17.35
I. 24V DC input 12 volt 1.2A SW mode converter	£5.17

## SOFTWARE

(Please state format required and machine)	
GATEWAY/PATHWAY Relational database for all CP/m	
MOIS Intelligent Disassembler for all CP/m based	£100.00
IVC HI-RES Provides Pseudo high resolution graphics	£50.00
DISKPEN (VG3) Low cost word processor for multiboard based overlays for diskpen	£50.00
MAXIFILE SPOOLER	£20.00
MAXIFILE SPOOLER	£15.00
HENRY'S CP/m UTILITIES	
41 Programs	£15.00
ALL DISC Variable disc format for GEMINI/NASCOM CP/m's	£150.00
PRETEL 2 Interface Galaxy or Nascom to Modem for use with BT Prestel service	£26.04

## ASC11 KEYBOARDS

695 D5 Compact 64 key - 5 function keys. Hall effect keyboard with reprogrammable (2716) ASC11 output decoder EPROM. Steel key frame for good rigidity. Negative going strobe. Requires + 5 volt + 12 volt supplies. (UK C/P £1.00)		£21.70
---	---	--------

2070 COMPACT 58 KEY KEYBOARD	
Contactless capacitive high reliability keys. Full 128 ASC11 codes. Steel key frame for positive rigidity. 1mS strobe. Single + 5 volt supply. Repeat key, control and caps. lock. (UK C/P £1.00)	£28.26

COMPUTER POWER SUPPLY	
Switch mode. Stabilised. Self protecting S/C protected, etc. 220/240V AC • 5V 3.3A + 12V 2.4A. 40% cycle - 5V 0.5A - 12V 0.5A. Suitable Apple replacement (UK C/P £1.50)	£50.00

## ITT 2020 CABINET

Professional computer case with keyboard cutout. 18 x 15.5 x 4.5 (front slopes). Ideal for single board computers like the Nascom or Gemini Multi-board (3 cards, etc). Very heavy gauge (.25") plastic with metal base. Attractive silver grey finish. (UK C/P £1.78)		£19.95
--	---	--------

## COMPUTER FANS

(UK C/P 60p each. £1.00 per pair)	
4" 220/230V AC Brand new	£6.52
4" 220/240V AC Ex-units	£4.78
4" 110/115V AC Ex-units	£4.35

## CASSETTE MECHANISMS

Fitted counter. Motor. Stereo record and erase heads. Autostop, solenoid. Brand new available 6V DC or 12V DC (state which). (UK C/P 65p)		£5.17
ALSO miniature stereo cassette replay mechanism. 12v. 105 x 100 x 40mm. (UK C/P 65p)		£4.78

## TELETEXT BOARD

Mullard VM6101/5 board. Complete and brand new. £10.87 (UK C/P £1.00) (Thorn TX9)	
---	--

## TOROIDAL TRANSFORMER

250 watt isolating trans. Plus 22v 1A. 6.3v 1A 4 1/2 dia x 1 1/4". £4.50 (UK C/P 85p)	
---	---

ALSO IN STOCK Large range of analogue multimeters, breadboards.

SUPPLIERS OF ELECTRONICS FOR EVERY PURPOSE (Official Orders Welcome (subject to confirmation))

ORDER BY POST OR PHONE	301 Edgware Road, London W2 Test Equipment • Audio 01-724 3564	ASK HENRY'S FIRST ALL PRICES EXCLUDE VAT
Up to £1000 instant credit Available through Lombard Tricity Finance	404 Edgware Road, London W2 Computers 01-402 6822 Equipment 01-724 0323 Components 01-723 1008	

CIRCLE 37 FOR FURTHER DETAILS.

**BBC Micro Computer System**  
**BBC Computer & Econet Referral Centre**  
**BBC Computers:**

Model B: £299 (a) B+DFS: £346 (a)  
 Model B+Econet: £335 (a) B+Econet+DFS £399 (a)  
**ACORN 10 Mbyte Hard Disc £1300 (a)**  
**ACORN 2nd Processors: 6502: £175 (a) Z80: £352 (a)**  
**TORCH UNICORN: Z80 Card: £275 (a) Z80 Disc Pack: £599 (a)**  
**TORCH Graduate G800/2 £999(a)**  
**20 Mbyte Hard Disc+400K Floppy: £1950 (a)**

We stock the full range of ACORN hardware and firmware and a very wide range of other peripherals and firmware for the BBC. For detailed specifications and pricing please send for our leaflet.

**PRINTERS**

EPSON: RX80T £210 (a); RX80FT £220 (a); RX100 £345 (a);  
 FX80 £315 (a); FX100 £430 (a); JX80 Full Colour Printer £525 (a)  
 KAGA TAXAN: KP810 £255 (a); KP910 £359 (a)  
 BROTHER: HR15 £340 (a); JUKI 6100 £340 (a).  
 GRAPHICS PLOTTER WORKSTATION Complete £490 (a)  
 Basic Plotter £270 (a); HI-Plotter £399 (a)

**ACCESSORIES**

EPSON Serial Interface: 8143 £28 (b); 8148 with 2K buffer £57 (b).  
 EPSON Paper Roll Holder £17 (b); FX80 Tractor Attach £37 (b); RX/FX80 Dust Cover £4.50 (d)  
 BUFFALO 32K Buffer for Epson printers £99 (d). EPSON Ribbons: MX/RX/FX80 £5.00; MX/RX/FX100 £10 (d).  
 JUKI: Serial Interface £65 (c); Tractor Attach, £99 (a); Sheet Feeder £180 (a); Ribbon £2.50 (a)  
 BROTHER HR15: Sheet Feeder £199; Ribbons — Carbonor Nylon £4.50; Multistrike £5.50 (d);  
 2000 Sheets Fanfold with extra fine perf. 9.5in. — £13; 14.5in. £18.50 (b).  
 BBC Parallel Lead £8; Serial Lead £7 (d).

**BT Approved Modems**

**MIRACLE WS2000:**  
 The ultimate world standard BT approved modem covering all common BELL and CCITT standards up to 1200 Baud. Allows communication with virtually any computer system in the world. The optional AUTO DIAL and AUTO ANSWER boards enhance the considerable facilities already provided on the modem. Mains powered. £129 (c) Auto Dial Board/ Auto Answer Board £30 (d) each (awaiting BABT approval). Software lead £4.50  
**BUZZBOX:**  
 This pocket sized modem complies with V21 300/300 Baud and provides an ideal solution for communications between users, with main frame computers and bulletin boards at a very economic cost. Battery or mains operated. £62 (c) Mains Adaptor £8 (d) BBC to Modem data lead £7

**SOFTY II**

This low cost intelligent eeprom programmer can program 2716, 2516, 2532, 2732, and with an adaptor, 2564 and 2764. Displays 512 byte page on TV — has a serial and parallel I/O routines. Can be used as an emulator, cassette interface.  
 Softy II ..... £195.00(b)  
 Adaptor for 2764/2564 ..... £25.00

**ATTENTION**

All prices in this double page advertisement are subject to change without notice.

**ALL PRICES EXCLUDE VAT**  
 Please add carriage 50p unless indicated as follows:  
 (a) £8 (b) £2.50 (c) £1.50 (d) £1.00

**ACORN IEEE INTERFACE**

A full implementation of the IEEE-488 standard, providing computer control of compatible scientific & technical equipment, at a lower price than other systems. Typical applications are in experimental work in academic and industrial laboratories. The interface can support a network of up to 14 other compatible devices, and would typically link several items of test equipment allowing them to run with the optimum of efficiency. The IEEE Filing System ROM is supplied £282.

**INDUSTRIAL PROGRAMMER**

**EP8000.**  
 This CPU controlled Emulator Programmer is a powerful tool for both Eeprom programming and development work. EP8000 can emulate and program all eeproms up to 8Kx8 bytes, can be used as stand alone unit for editing and duplicating EPROMS, as a slave programmer or as an eeprom emulator £695(a)

**I.D. CONNECTORS**

No of ways	(Speedblock Type)		Edge Conn.
	Header	Recep.	
10	90p	85p	120p
20	145p	125p	195p
26	175p	150p	240p
34	200p	160p	320p
40	220p	190p	340p
50	235p	200p	390p

**D CONNECTORS**

MALE:	No of ways		
	9	15	25
Ang Pins	120	180	230
Solder	60	85	125
IDC	175	275	325
FEMALE:			
St Pin	100	140	210
Ang Pins	160	210	275
Solder	90	130	195
IDC	195	325	375
St Hood	90	95	100
Screw	130	150	175
Lock			

**TEXTTOOL ZIF**

SOCKETS	24-pin £7.50
	28-pin £9.00
	40-pin £12.00

**EDGE CONNECTORS**

2 x 6 way (Commodore)	0.1" 0.156"	300p
2 x 10 way	150p	—
2 x 12 way (VIC 20)	—	350p
2 x 18 way	—	140p
2 x 23 way (ZX81)	175p	—
2 x 25 way	225p	—
2 x 28 way (Spectrum)	200p	—
2 x 36 way	250p	—
1 x 43 way	260p	—
2 x 22 way	190p	—
2 x 43 way	395p	—
1 x 77 way	400p	500p
2 x 50 way (S100conn)	600p	—

**EURO CONNECTORS**

DIN 41612	Plug	Skt
2 X 32 way St Pin	230p	275p
3 X 32 way Ang Pin	275p	320p
3 X 32 way St Pin	260p	300p
3 X 32 way Ang Pin	375p	400p
IDC Skt A + B	400p	—
IDC Skt A + C	400p	—

For 2 X 32 way please specify spacing (A + B, A + C).

**AMPHENOL CONNECTORS**

36 way plug Centronics (solder) 500p (IDC) 475p
36 way skt Centronics (solder) 550p (IDC) 500p
24 way plug IEEE (solder) 475p (IDC) 475p
24 way skt IEEE (solder) 500p (IDC) 500p
PCB Mtg Skt Ang Pin
24 way 700p 36 way 750p

**GENOER CHANGERS**  
 25 way D type

Male to Male	£10
Male to Female	£10
Female to Female	£10

**RS 232 JUMPERS**  
 (25 way D)

24" Single end Male	£5.00
24" Single end Female	£5.25
24" Female Female	£10.00
24" Male Male	£9.50
24" Male Female	£9.50

**DIL SWITCHES**

4-way	90p	6-way	105p
8-way	120p	10-way	150p

**TELEPHONE CONNECTORS**

4-way plug	110p
6-way plug	180p
6-way rt ang skt	160p
Flexible cable	
4-way	50p/m
6-way	72p/m

**RIBBON CABLE**  
 (grey/metre)

10-way	40p	34-way	160p
16-way	60p	40-way	180p
20-way	85p	50-way	200p
26-way	120p	64-way	280p

**DIL HEADERS**

	Solder		IDC
	14 pin	40p	
16 pin	50p	110p	
18 pin	60p	—	
20 pin	75p	—	
24 pin	100p	150p	
28 pin	160p	200p	
40 pin	200p	225p	

**MISC CONNS**

21 pin Scart Connector	200p
8 pin Video Connector	200p

**DISC DRIVES**

TECHNOMATIC drives are fitted with high quality slimline Mitsubishi mechanisms and are available with or without integral mains power supply. The dual drive power supplies are switch mode type and are generously rated. All drives with integral power supply are fitted with a mains indicator.

All drives are supplied with all the necessary cables, manual and a formatting disc. All drives are capable of operating in single or double density modes.

**Single Drives:**  
 1x100K 40T SS: TS100 £85 (b); PS100 with psu £125 (b)  
 1x400K 80/40T DS: TS400 £125 (b); PS400 with psu £149 (b)

**Dual Drives**  
**Stacked Version:**  
 2x100K 40T SS: TD200 £175 (a); PD200 with psu £200 (a)  
 2x400K 80/40 DS: TD800 £250 (a); PD800 with psu £290 (a)

**Plinth Version:**  
 2x100K 40T SS: TD200P £195 (a); PD200P with psu £220 (a)  
 2x400K (80/40) DS: TD800P £265 (a); PD800P with psu £305 (a)

**Authorised Distributor**  
**Data Recording Products**



**3M FLOPPY DISCS**

Industry Standard floppy discs with a lifetime guarantee Discs in packs of 10  
 40 Track SS DD £13 (c) 40 Track DS DD £18 (c)  
 80 Track SS DD £22 (c) 80 Track DS DD £24 (c)

**FLOPPICLENE DRIVEHEAD CLEANING KIT**

FLOPPICLENE Disc Head Cleaning Kit with 28 disposable cleaning discs ensures continued optimum performance of the drives. £14.50 (b)

**DRIVE ACCESSORIES**

Single Disc Cable £6 (d) Dual Disc Cable £8.50 (d)  
 10 Disc Library Case £1.80 (d) 30 Disc Storage Box £6 (c)  
 30/40 Disc Lockable Box £14 (c) 100 Disc Lockable Box £19 (c)

**MONITORS**

**MICROVITEC 14in. & 20in RGB**

1431 Std Res £165 (a); 1431 Ap std Res PAL/Audio £205 (a);  
 1451 Med Res £240 (a); 1441 Hi Res £389 (a);  
 2030CS Std Res £380 (a); 2040CS Hi Res £685 (a)  
 Plinth for 14in. Monitors £8.50.  
 Microvitec Monitors with TTL/Linear Inputs also available.

**KAGA TAXAN 12in. RGB**

Vision II Hi Res £225 (a); Vision III Super Hi Res £325 (a)  
 Green Screens; KAGA 12G £99 (a); SANYO DM811 112CX £90 (a);  
 Swivel Stand for Kaga Green £21 (c)  
 BBC Leads: KAGA RGB £5 Microvitec £3.50; Monochrome £3.50 (d)  
 SANYO CD 3125 NB 14in. RGB Std Res £169 (a)

**UV ERASERS**

UV1T Eraser with built-in timer and mains indicator. Built-in safety interlock to avoid accidental exposure to the harmful UV rays. It can handle up to 5 eeproms at a time with an average erasing time of about 20 mins. £59 + £2 p&p.  
 UV1 as above but without the timer. £47 + £2 p&p.  
 For Industrial Users, we offer UV140 & UV141 erasers with handling capacity of 14 eeproms. UV141 has a built in timer. Both offer full built in safety features  
 UV140 £61, UV141 £79, p&p £2.50.

**PRINTER BUFFER**

This printer sharer/buffer provides a simple way to upgrade a multiple computer system by providing greater utilisation of available resources. The buffer offers a storage of 64K. Data from three computers can be loaded into the buffer which will continue accepting data until it is full. The buffer will automatically switch from one computer to next as soon as that computer has dumped all its data. The computer then is available for other uses. LED bargraph indicates memory usage. Simple push button control provides. REPEAT, PAUSE and RESET functions. Integral power supply. £205 (a).  
 Cable set £30

**CONNECTOR SYSTEMS**





# TEST INSTRUMENTS

A wide range of high performance instruments that put professional test capability on your bench.

**COUNTERS** — TF600 5Hz to 600MHz TF200 10Hz to 200MHz TF040 10Hz to 40MHz PFM200A 20Hz to 200MHz (hand-held model) TP600 prescales to 600MHz TP1000 prescales to 1000MHz

**MULTIMETERS** — TM351 0.1% 3 1/2 digit LCD TM356 0.25% 3 1/2 digit LCD TM355 0.25% 3 1/2 digit LED TM354 0.75% 3 1/2 digit LCD (hand-held model) TM451 0.03% 4 1/2 digit LCD with autoranging and sample hold TM452 0.05% 4 1/2 digit LCD with built-in frequency counter (hand-held model)

**OSCILLOSCOPE** — SC110A 10MHz 10mV sensitivity 40mm CRT with 6mm graticule divisions

**THERMOMETERS** TH301 -50°C to +750°C 1° resolution TH302 -40°C to +1100°C and -40°F to +2000°F 0.1° and 1° resolution Both accept any type K thermocouple

**GENERATORS** — TG101 0.02Hz to 200kHz Function Generator TG102 0.2Hz to 2MHz Function Generator TG105 5Hz to 5MHz Pulse Generator TG501 0.005Hz to 5MHz Function Generator TG502 0.005Hz to 5MHz Sweep Function Generator TG503 0.005Hz to 5MHz Pulse Function Generator

**LOGIC ANALYSERS** — TA2080 8 channel 20MHz TA2160 16 channel 20MHz

**ACCESSORIES** — Bench rack test leads carrying cases mains adaptors probes thermocouple probes microprocessor disassembly options

For further information contact:

Thandar Electronics Ltd London Road Stives Huntingdon Cambs PE17 4HJ  
Telephone (0480) 64646 Telex 32250

 **thandar**  
ELECTRONICS LIMITED  
CIRCLE 57 FOR FURTHER DETAILS.



FOR QUALITY COMPONENTS  
BY MAIL ORDER

**ELECTROVALUE**

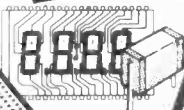
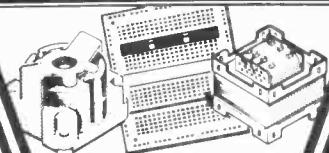

**FREE**  
44 PAGE  
PRICED AND  
ILLUSTRATED  
CATALOGUE  
ON REQUEST

**FREE POSTAGE**  
**GOOD DISCOUNTS**  
**GOOD SERVICE**  
**THOUSANDS OF**  
**STOCK ITEMS**  
**PHONE YOUR ORDER**  
**ACCESS OR**  
**BARCLAYCARD**

**ELECTROVALUE LTD** 28 St. Jude's Road, Englefield Green, Egham,  
Surrey TW20 0HB Phone Egham (0784) 33603. Telex 264475  
North Branch, 680 Burnage Lane, Manchester M19 1NA  
Phone 061 432 4945  
Please mention this publication when replying

CIRCLE 72 FOR FURTHER DETAILS.

NEW NEW NEW NEW NEW NEW NEW NEW

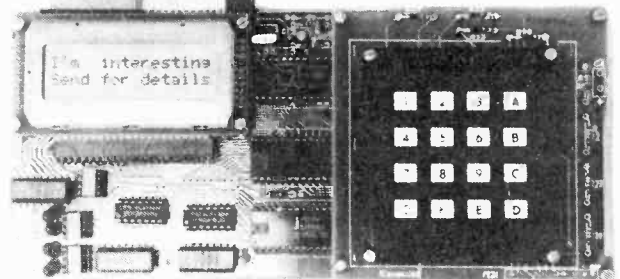

## 83000 SUB-ASSEMBLY

The 83000 is a single board micro-computer with an alphanumeric display and keyboard. It is based on an 8085 microprocessor and is ideal for control applications requiring up to 26 input/outputs. Opto-isolation of the inputs is provided and there is a 14 bit timer on board. Software utilities are available for operating the display and keyboard, initialising the system and performing self tests. Applications include:-

- ★ Remote Intelligent Display
- ★ Password Security Applications
- ★ Small System Process Control
- ★ Watchdog Monitoring
- ★ Printer Interface

**Automation  
and Control  
Technology**

**£199**

Cofton Road, March Barton, Exeter EX2 8QW. Tel: 37190.

NEW NEW NEW NEW NEW NEW NEW NEW

CIRCLE 51 FOR FURTHER DETAILS.

## Automatic inverter switch

Electrical appliances such as a blender or sewing machine require power intermittently and when run from an inverter, power consumption of the idling inverter can exceed consumption of the appliance. This circuit automatically switches on the inverter when a load is connected, and removes the need for remote switching when the power is to be distributed.

When a load is connected, it takes the lower contact of the second relay, and therefore the comparator inverting input via  $R_1$ , to ground. The first relay is energized by the comparator output being high and power is delivered to the inverter and the coil of the second relay.

With the second relay energized, the load is connected to the inverter-transformer output winding through the parallel-connected diodes. Voltage drop over these diodes keeps the left-most transistor switched on and therefore the comparator inverting input remains low.

When the load is

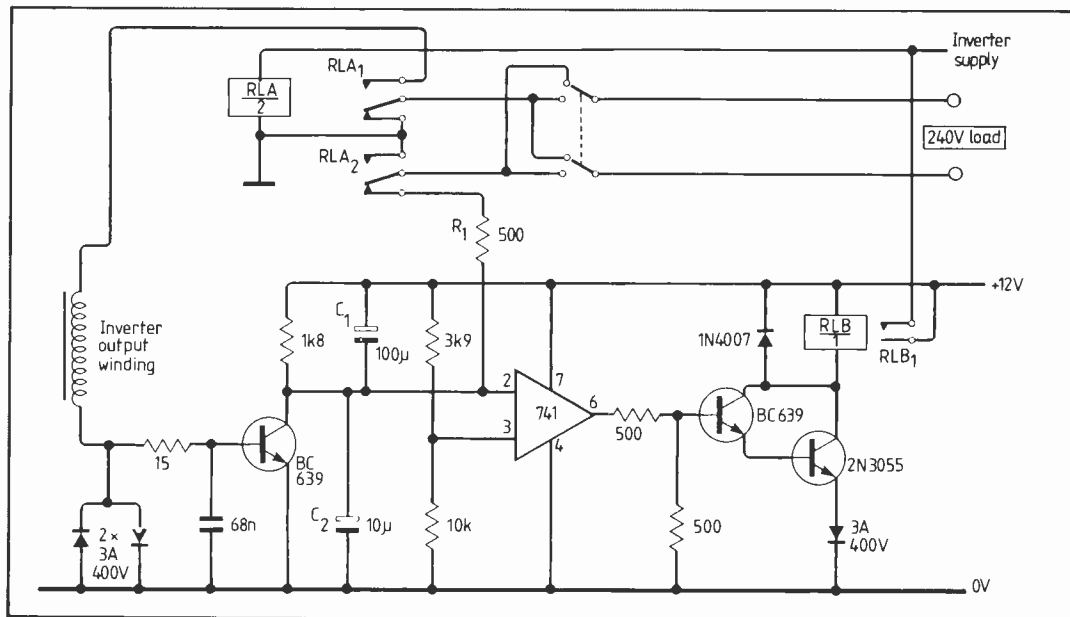

disconnected, the leftmost transistor turns off and allows the comparator inverting input to go high, removing power from the first relay coil and therefore disconnecting the inverter input. Standby current is around 12mA.

The power-transistor emitter diode ensures that the transistor switches off when the comparator output goes low. Capacitors  $C_{1,2}$  stop relay

chatter during switch on and off. The first relay only has to be large enough to switch the inverter in its idling state; the second relay connects the load at 230V and the first relay does not open until the load is disconnected.

A changeover switch is included to change the inverter output phase since some appliances place a diode in series with the load for half-

speed or half-power operation. If the anode of the appliance diode is connected to  $R_1$ , the load will not be sensed.

Heat sinking for the parallel diodes and power transistor should be isolated from earth and all connections to the inverter should be insulated for safety.

Nicholas Butt  
Glemsford  
Suffolk

## Lower-noise oscillator

Standard two-gate oscillators generate noise spikes around the zero-crossing point. This cheap circuit using a 4001/4011 type i.c. provides a much cleaner output which is also buffered. Further, the oscillator may be gated on and off using one of the inputs shown strapped together.

I have used more expensive 4093 i.c.s for similar applications but I found that they had a higher failure rate.

I.J. Eamus  
Ampro Enterprises  
Aylesbury  
Buckinghamshire

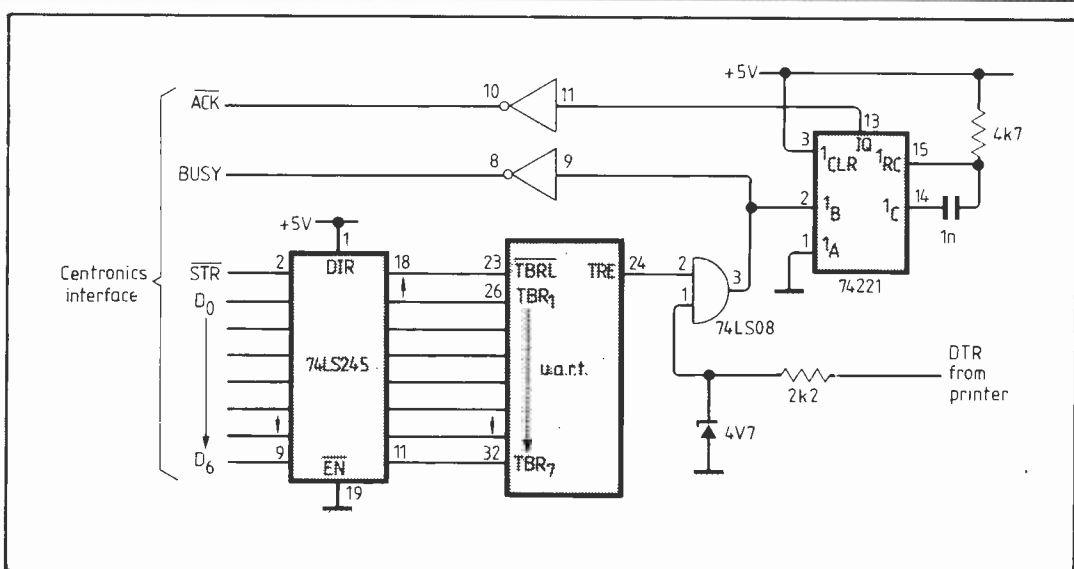
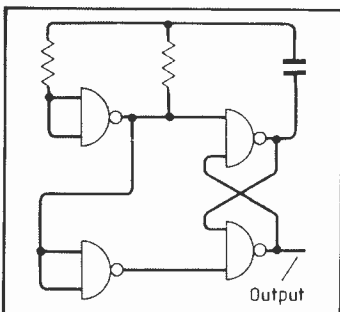

## Centronics-to-RS232 converter

We have made one or two modifications to Burd's excellent idea for producing serial output from a Centronics printer interface, described in the February issue.

As the u.a.r.t. is a cmos device,

we added a buffer to protect its inputs when power is on and the link is disconnected. The computer needs to stop sending data when a serial printer buffer is full so we added an And gate to combine the data-terminal ready signal from the printer with the uart TRE signal.

Finally, the Centronics standard specifies an

acknowledge pulse of approximately 5µs. The original monostable circuit gave a pulse of approximately 25ms so we replaced it with a t.t.l. monostable i.c.

John Wike and Dave Pinch  
South Wales Radio Therapy and  
Oncology Service  
Velindre Hospital  
Cardiff

## Fast converter for repetitive signals

Flash analogue-to-digital converters and sample-and-hold circuits are widely used for sampling analogue data, but when the input signal is repetitive, there is a good case for using a successive approximation technique — an effective sampling rate as good as for flash converters is possible at a fraction of the cost. Speed of this circuit is only limited by the comparator and acquisition time of the D-type bistable devices of IC<sub>1</sub>.

Commercial a-to-d converters are usually single-chip i.c.s and the time taken for each approximation is not externally controllable, so discrete components are used. This circuit is for four-bit conversion, but expansion to six or eight bits is relatively easy.

When the reset line is pulsed, outputs of the bistable elements and the two-bit counter are cleared. The one-of-four decoder Q<sub>0</sub> output becomes high. This signal is sent to the

d-to-a converter most-significant input through an Or gate; all other inputs are low.

To obtain a sample, the strobe line is pulsed. Its leading edge clocks bistable device IC<sub>1d</sub> through the And gate, and the comparator output state appears at the output of IC<sub>1d</sub>. The strobe signal trailing edge clocks the two-bit counter, making Q<sub>0</sub> and Q<sub>1</sub> outputs of the decoder low and high respectively. Thus if the input signal was greater than the most significant bit when the strobe leading edge occurred, output of IC<sub>1d</sub> will be high, otherwise it will be low.

Four strobe signals must be applied at the same point in successive signal repetitions, allowing enough time for the converter to settle between each one. When four strobe signals have been applied, data can be read at outputs A to D, the reset signal applied, and the sequence restarted at a different point in the signal cycle. Device types depend on the application and resolution required.

T. Hunter  
Doncaster  
South Yorkshire

## Two i.c. shortwave calibrator

Inexpensive portable shortwave receivers are often quite sensitive but have vague dial markings, making tuning difficult. Lack of a b.f.o. precludes use of a conventional crystal calibrator since its signals would be inaudible in

many cases.

This circuit uses two c-mos i.c.s to generate a modulated calibration signal at switch-selectable frequencies of 100kHz or 1MHz. The signal is audible as a distinctive tone when the receiver is tuned to

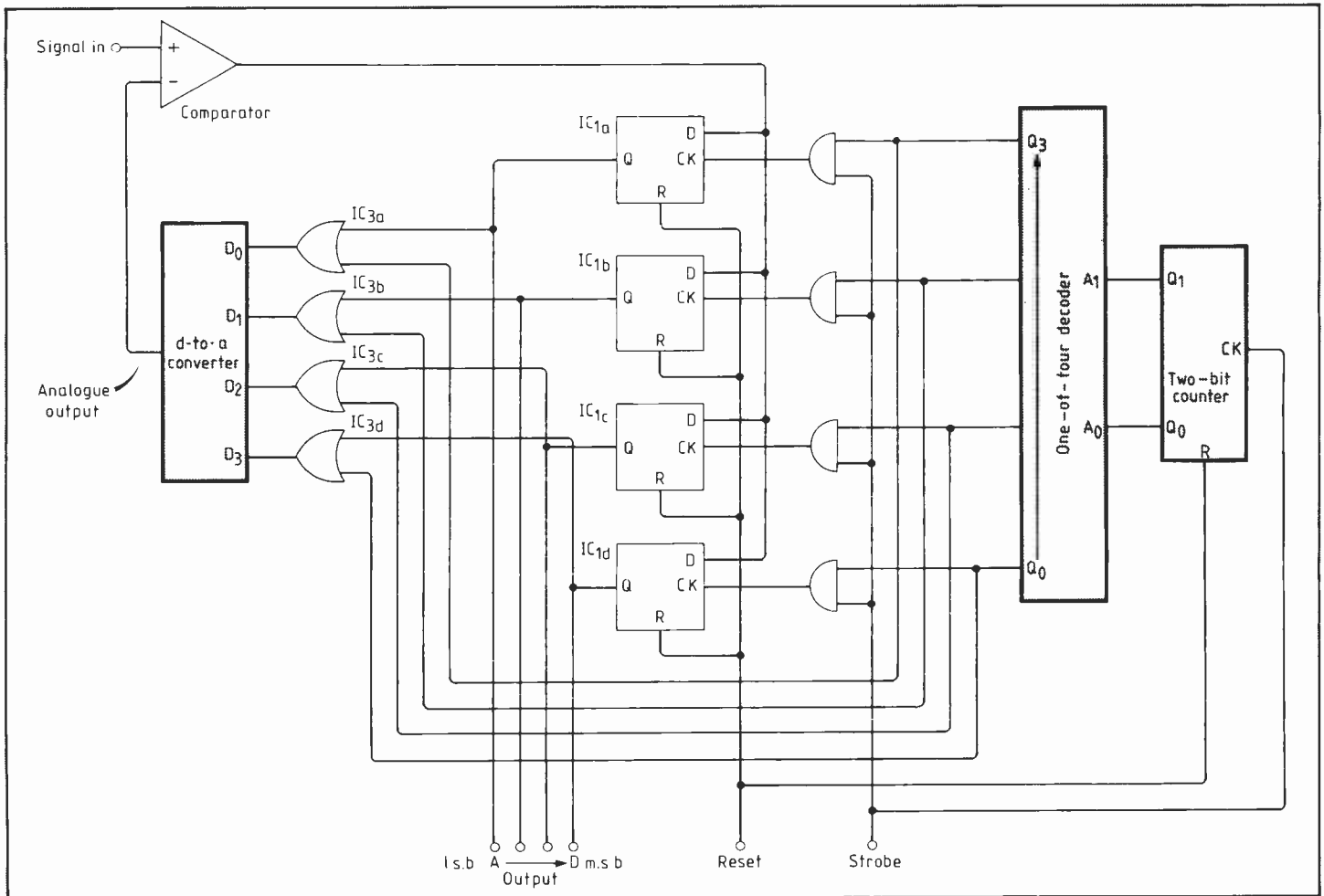
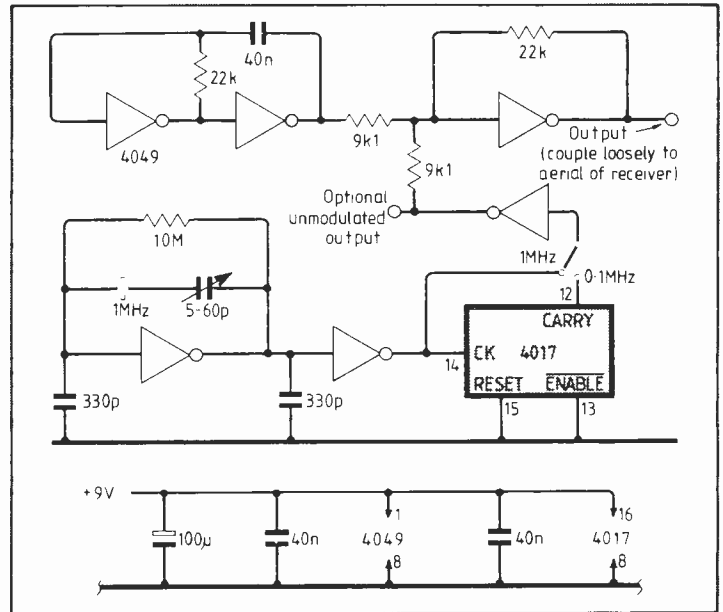

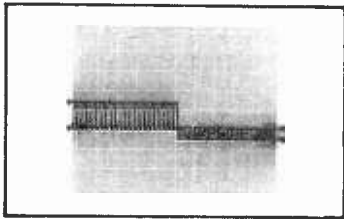
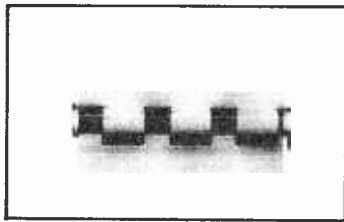

any multiple of the calibration frequency.

The last inverter stage — actually a linear operational amplifier fed by a summing network — functions as a modulator. The output waveform is somewhat odd-looking (see photograph) but definitely amplitude modulated. Modulation can be adjusted by varying one or both of the 9.1kΩ resistors.

M. Covington  
Athens  
Georgia  
USA

## Easy to read hex. display

Onlug's circuit for displaying hexadecimal numbers in decimal form (Dec. 1984) can be simplified. This circuit does the same job, but saves 14

## Trip for power switches

Overcurrent protection for switching power transistors is provided by this simple add-on circuit. Emitter current is monitored by  $R_2$  and the comparator. At the trip current, the p-n-p transistor turns on and shunts the base drive away through  $R_2$  to provide positive feedback. The stage remains disabled until the drive is removed, which is useful for p.w.m. systems.

The comparator is an open-collector one. Base-drive current multiplied by  $R_2$  should be around 250mV and base-emitter voltage of the output Darlington should be at least 900mV; if not add a resistor or diode. To ensure that the comparator circuit switches right over, the rise in voltage of

diodes. If only one display is needed it also saves two i.cs.

The 4011 detects inputs greater than nine and illuminates the second digit. The same signal causes six to be added to the 4008 adder input. The result always has an overflow of 16, with the effect that 10 is actually subtracted, leaving a number between zero and five which can still be decoded by the 4511 i.c.

John Cook  
Ipswich  
Suffolk

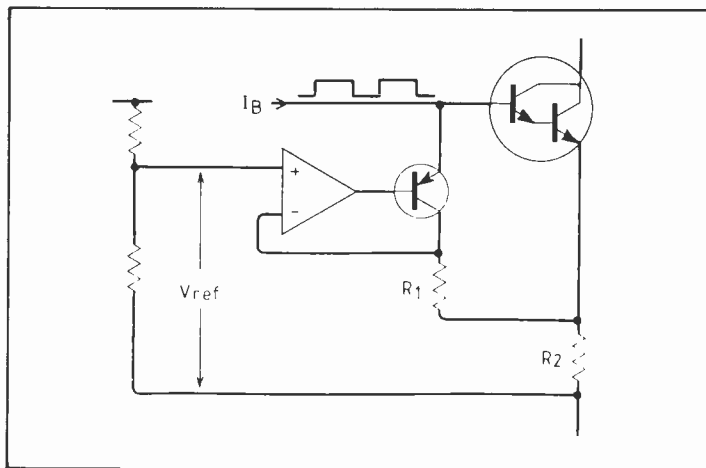

$R_1$  must exceed the fall over  $R_2$ . A safe rule is to let the normal excess drive, shunted through  $R_1$ , replace the drop across  $R_2$  before the transistor comes out of saturation at the trip current. Typically, this makes  $R_2$  quite small.

As an example using

MJ11030 transistors at 50A, 339 comparators and 2N3703 p-n-p transistors,  $V_{ref}$  was 100mV and was shared between several stages. Resistor  $R_1$  was about 2Ω and  $R_2$  only 2 mΩ.  
D.H. Potter  
Axminster  
Devon

## Adapting for double-sided drives

Microcomputers designed to select independent single-sided disc drives can be interfaced with double-sided drives using this small modification which makes the drive's second side appear as an independent drive to the computer. To do this, a drive-select signal forms the side-select signal.

The circuit, which may be installed in the microcomputer or in any of the drives, relies on drive and side-select signals being open-collector sourced; check this before installing. Using signals shown, DS0 selects the first side of the drive and DS1 the second side. Which drive-select signals are used will depend on the logical position required for the drive.

Decouple the 7417 close to the supply pins and connect all unused inputs to the positive rail through a common 1kΩ resistor. In many drives, supply, ground and signal lines will be available at di socket. Pin numbers shown are for a standard 5¼in drive interface (further details in the article Floppy discs on pages 44/45 of the January issue).

David March  
London

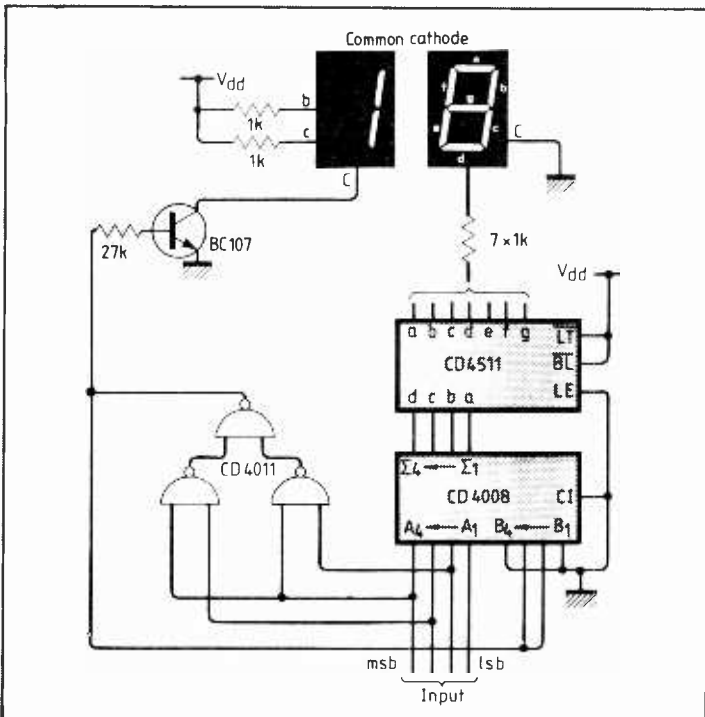
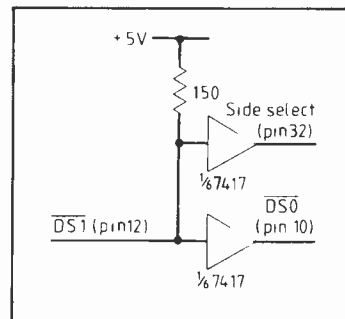





**PHONE**  
0474 813225  
3 LINES

# P. M. COMPONENTS LTD

**SELECTION HOUSE, WROTHAM ROAD**  
**MEOPHAM GREEN, MEOPHAM, KENT DA130QY**

**TELEX**  
966371  
**PM COMP**

## INTEGRATED CIRCUITS

AN124	2.50	MC1327	0.95
AN214Q	2.50	MC13270	0.95
AN240P	2.80	MC1349P	1.20
AN612	2.15	MC1351P	1.50
AN7140	3.50	MC1351P	1.50
AN7145	3.50	MC1358	1.58
AN7150	2.95	MC1357	2.35
BA521	3.35	MC1495	3.00
CA1352E	1.75	MC1496	1.25
CA3086	0.46	MC45106P7	95
CA3123E	1.50	MC1723	0.50
ET16016	2.50	MC3557	2.75
HA1377	3.50	ML231B	1.75
HA1156W	1.50	MN2972	2.50
HA1339A	2.95	MSM5807	6.75
HA1551	2.95	PLL02A	5.75
LA1230	1.15	SAA500A	3.50
LA4031P	1.95	SAA1125	7.25
LA4102	2.95	SA5010	6.35
LA4140	2.95	SAS5605	1.75
LA4400	4.15	SAS5705	1.75
LA4420	1.95	SAS580	2.85
LA4422	2.50	SL901B	4.85
LA4430	2.50	SL917B	6.85
LA4461	3.50	SL1210	1.80
LC7120	3.25	SL1327	1.10
LC7130	3.50	SL1327Q	1.10
LC7131	5.50	SN76030N	1.95
LC7137	5.50	SN76031N	1.95
LM324N	0.45	SN76023N	2.75
LM3808N	1.50	SN76019	3.50
LM3808A	1.75	SN76110N	0.89
LM383T	2.95	SN76115N	1.25
LM3900N	3.50	SN76131N	1.30
M5151L	2.30	SN76226N	2.95
M5152L	2.30	SN76227N	1.05
MB3712	2.00	SN76544N	2.65
MC1307P	1.00	SN76570N	1.00
MC1310P	1.50	SN76650N	1.15

## SEMICONDUCTORS

AA172	0.25	BC174	0.09
AC126	0.45	BC174A	0.09
AC127	0.45	BC177	0.15
AC128	0.28	BC178	0.15
AC128K	0.32	BC182	0.10
AC141	0.28	BC182LB	0.10
AC141K	0.34	BC183	0.10
AC142K	0.30	BC183L	0.09
AC176	0.22	BC184LB	0.09
AC176K	0.31	BC207B	0.10
AC187	0.25	BC207B	0.10
AC187K	0.28	BC208B	0.13
AC188	0.25	BC212	0.09
AC188K	0.37	BC212L	0.09
AD142	0.79	BC212LA	0.09
AD143	0.82	BC213	0.09
AD149	0.70	BC213L	0.09
AD161	0.39	BC214	0.09
AD162	0.39	BC214C	0.09
AD161/2	0.90	BC214L	0.09
AF106	0.50	BC238	0.09
AF114	0.95	BC238	0.09
AF121	0.60	BC239	0.12
AF124	0.65	BC251A	0.12
AF125	0.35	BC252A	0.15
AF126	0.32	BC252B	0.12
AF127	0.65	BC258A	0.39
AF139	0.40	BC284	0.30
AF150	0.60	BC300	0.30
AF178	1.95	BC301	0.30
AF239	0.47	BC303	0.26
AU106	4.50	BC307B	0.09
AU107	3.50	BC327	0.10
AU110	3.50	BC328	0.10
BC107A	0.11	BC337	0.10
BC107B	0.11	BC338	0.09
BC108	0.10	BC347A	0.10
BC108A	0.11	BC347B	0.11
BC108B	0.12	BC478	0.20
BC109	0.10	BC527	0.20
BC109B	0.12	BC547	0.10
BC109C	0.12	BC548	0.10
BC114	0.11	BC549A	0.10
BC115A	0.15	BC559	0.14
BC117	0.15	BC559B	0.08
BC119	0.24	BC557B	0.08
BC125	0.25	BC558	0.10
BC139	0.20	BCY33A	1.60
BC140	0.31	BD115	0.30
BC141	0.25	BD124P	0.59
BC142	0.21	BD131	0.42
BC143	0.24	BD132	0.42
BC147A	0.12	BD133	0.40
BC148A	0.09	BD136	0.30
BC148B	0.09	BD136	0.30
BC149	0.09	BD137	0.32
BC157	0.12	BD138	0.30
BC158	0.09	BD139	0.32
BC159	0.09	BD140	0.30
		BD144	1.10
		BD150C	0.29
		BD159	0.65
		BD160	1.50
		BD166	0.55
		BD179	0.72
		BD182	0.70
		BD201	0.63
		BD202	0.85
		BD203	0.78

## DIODES

AA119	0.08	BY206	0.14
BA115	0.13	BY208	0.80
BA145	0.16	BY210-800	0.33
BA148	0.17	BY223	0.90
BA154	0.06	BY298	0.22
BA156	0.15	BYX10	0.20
BA157	0.30	BYX36-1500	0.20
BAX13	0.04	BYX38-6000	0.60
BA165	0.10	BYX55-600	0.30
BB105B	0.30	BYX71-600	1.10
BT151	0.79	BZY95C30	0.35
BY126	0.10	CS48	0.45
BY127	0.11	CS10B	0.45
BY133	0.15	OA47	0.09
BY164	0.45	OA90	0.05
BY176	1.20	OA95	0.06
BY179	0.83	OA202	0.10
BT182	0.55	IN21DR	5.00
BY184	0.35	IN23B	5.00
BY199	0.40	IN23C	5.00
		IN23ER	5.00

## LINE OUTPUT TRANSFORMERS

DECCA 100	7.95	ITT CVC30	8.25
DECCA 1700 MONO	9.95	ITT CVC30	8.25
DECCA 1730	8.95	PHILIPS G8 550	6.96
DECCA 2230	8.25	RANK T20A	6.91
GEC 2040	8.95	THORN 3000/3500	7.57
GRUNDIG 1500	15.45	THORN 8500	8.00
GRUNDIG 5010-6010. 2222 5011-6011	13.45	THORN 9000	8.00
ITT CVC30	8.25	UNIVERSAL TRIPLER	5.45
PHILIPS G8	8.50		
PHILIPS G9	8.90		
PHILIPS G11	13.39		
PYE T25	12.40		
RBM T20A	12.40		
TANDBERGE 90'	11.15		
TELEFUNKEN 711A	11.15		
THORN 1500	9.50		
THORN 8000	2.25		
THORN 9000	9.95		
THORN 9800	22.40		
THORN MAIN TRANSFORMER	9.70		
3000/3500			

## ZENER DIODES

BZK61 Series	0.15
BZY88 Series	0.15

## REPLACEMENT ELECTROLYTIC CAPACITORS

DECCA 30 (400-400/350V)	2.85
DECCA 80/100 (400/350V)	2.99
DECCA 1700	7.95
DECCA 1730	9.95
DECCA 2230	8.25
GEC 2040	8.95
GRUNDIG 1500	15.45
GRUNDIG 5010-6010. 2222 5011-6011	13.45
ITT CVC30	8.25
PHILIPS G8	8.50
PHILIPS G9	8.90
PHILIPS G11	13.39
PYE T25	12.40
RBM T20A	12.40
TANDBERGE 90'	11.15
TELEFUNKEN 711A	11.15
THORN 1500	9.50
THORN 8000	2.25
THORN 9000	9.95
THORN 9800	22.40
THORN MAIN TRANSFORMER	9.70
3000/3500	

## REPLACEMENT ELECTROLYTIC CAPACITORS

ITT CVC20	6.35
ITT CVC30	6.35
PHILIPS G8 550	6.96
RANK T20A	6.91
THORN 3000/3500	7.57
THORN 8500	8.00
THORN 9000	8.00
UNIVERSAL TRIPLER	5.45

## REPLACEMENT ELECTROLYTIC CAPACITORS

DECCA 30 (400-400/350V)	2.85
DECCA 80/100 (400/350V)	2.99
DECCA 1700	7.95
DECCA 1730	9.95
DECCA 2230	8.25
GEC 2040	8.95
GRUNDIG 1500	15.45
GRUNDIG 5010-6010. 2222 5011-6011	13.45
ITT CVC30	8.25
PHILIPS G8	8.50
PHILIPS G9	8.90
PHILIPS G11	13.39
PYE T25	12.40
RBM T20A	12.40
TANDBERGE 90'	11.15
TELEFUNKEN 711A	11.15
THORN 1500	9.50
THORN 8000	2.25
THORN 9000	9.95
THORN 9800	22.40
THORN MAIN TRANSFORMER	9.70
3000/3500	

## REPLACEMENT ELECTROLYTIC CAPACITORS

ITT CVC20	6.35
ITT CVC30	6.35
PHILIPS G8 550	6.96
RANK T20A	6.91
THORN 3000/3500	7.57
THORN 8500	8.00
THORN 9000	8.00
UNIVERSAL TRIPLER	5.45

# NEW BRANDED CATHODE RAY TUBES

PLEASE ALLOW ADDITIONAL £3 PER TUBE FOR CARRIAGE.

A1865/20	85.00	F31-10GM	85.00	M50-120GV	85.00
AW3611	25.00	F31-10GR	85.00	M50-120LC	85.00
CM8222W	19.00	F31-10LC	85.00	M61-120LC	75.00
CME1428GH	25.00	F31-10LD	85.00	M61-120W	75.00
CME1428H	45.00	F31-12LC	85.00	SE4B	45.00
CME1523A	39.00	F31-13GR	85.00	SE4D/P7	45.00
CME1523W	39.00	F31-13LD	85.00	SE42BP31AL	55.00
CME1431GH	39.00	F31-13LG	85.00	SE42BP31L	55.00
CME1431W	39.00	F41-123LC	160.00	SE52AP31AL	55.00
CME202GH	45.00	F41-141LG	160.00	SE5FP31	85.00
CME2024W	45.00	F41-142LC	185.00	T93T	85.00
CME3235W	45.00	M17-120W	19.00	T948N	85.00
CME3126GH	45.00	M14-100GM	45.00	T948H	59.00
CME3128GH	45.00	M14-100KA	55.00	V1391	59.00
CME3128W	45.00	M14-100L	175.00	V4150LC	55.00
CME3132GH	45.00	M17-151GR	175.00	V4254E	65.00
CME3155W	45.00	M17-151R	175.00	V4274GH	59.00
CV429	25.00	M19-100GY	55.00	V4283W	65.00
CV1450	35.00	M19-100W	45.00	V5002LD	65.00
CV1526	19.00	M19-101GR	55.00	V5004GR	59.00
CV2185	15.00	M19-103V	55.00	V5004LD	59.00
CV2191	15.00	M23-110GH	55.00	V6001GH	85.00
CV2191	15.00	M23-111W	55.00	V6006GH	65.00
CV2191	15.00	M23-111GH	55.00	V6007DP31	59.00
CV5119	85.00	M23-111LD	55.00	V6007GW	59.00
CV5320	85.00	M23-112GM	55.00	V6008W	59.00
CVX389	55.00	M23-112GV	55.00	V6034WA	59.00
D9-110GH	39.50	M23-110GH	55.00	V6049CLA	59.00
D9-120	78.05	M23-112KA	55.00	V6048F	45.00
D10-210GH	45.00	M23-112LD	55.00	V6048J	65.00
D10-210GH68B	65.00	M23-112W	55.00	V6048L	49.00
D10-210GH72	65.00	M24-120GM	59.00	V6052GR	65.00
D10-230GH	35.00	M24-120GR	59.00	V6052GR	65.00
D10-230GV/90	55.00	M24-120LC	59.00	V6064BLA	65.00
D13-30GH	49.50	M24-120WAR	59.00	V6064BP31	55.00
D13-33GM	49.00	M24-121GH	59.00	V6069GH	55.00
D13-47GH/26	55.00	M24-121WA	59.00	V6070P31	49.00
D13-47GH/34	55.00	M28-12GH	55.00	V7016A	65.00
D13-51GL/26	85.00	M28-12LC	49.00	V7030	59.00
D13-51GL/34	85.00	M28-13LC	49.00	V7031GH	59.00
D13-51GL/36	85.00	M28-13LG	49.00	V7031/67A	59.00
D13-51GH/26	55.00	M28-13GR	49.00	V7035A	49.00
D13-550GH	65.00	M28-131GR	55.00	V7037GH	45.00
D13-600GM	59.00	M28-132GM	55.00	V8004GR	65.00
D13-610GH	59.00	M28-133GH	55.00	V8006GH	65.00
D13-610GH	59.00	M31-100GH	55.00	V8010A	65.00
D13-610GH	59.00	M31-100H	55.00	3BP1	9.00
D13-610GH	59.00	M31-182GR	53.00	3BP1	13.50
D13-630GH	59.00	M			

PHONE  
0474 813225  
3 LINES

# P. M. COMPONENTS LTD

## SELECTION HOUSE, WROTHAM ROAD MEOPHAM GREEN, MEOPHAM, KENT DA13QQY

TELEX  
966371  
PM COMP



### A SELECTION FROM OUR STOCK OF BRANDED VALVES

A1714 18.50	ELB22 12.95	M8223 4.50	Q51202 3.95	ULB4 0.85	3AT2 3.35	6BC8 1.00	6JUB 2.50	12SJT 0.60	833A 80.00
A1834 7.50	EM1 9.00	M8224 2.00	Q51203 4.15	UU5 3.50	3B2 3.00	6BD4 1.50	6JUS6 4.95	12SN7GT 1.85	866A 4.50
A1998 11.50	EM4 9.00	M8225 3.50	Q51205 3.95	UU7 8.00	3B4 7.00	6B06 2.50	6J7G 4.15	12SR7 2.50	872A 27.50
A2087 11.50	EM80 0.70	ME1401 29.50	Q51206 1.05	UU8 9.00	3B7 4.50	6BE6 0.72	6K7G 2.00	12SQ07GT 1.50	873 60.00
A2134 14.95	EM81 0.70	ME1402 26.50	Q51207 0.90	UY1 3.50	3B24 10.00	6BF5 1.80	6KBV/G 3.00	1303 3.20	884 5.50
A2293 6.50	EM84 1.85	ME1501 14.00	Q51208 0.90	UY4 0.70	3B26 24.00	6BG06 3.00	6K6 5.50	1307 3.20	930 19.95
A2599 37.50	EM85 3.95	MH4 4.50	Q51209 3.15	V235A/1K	3B28 12.00	6BH6 1.95	6KM8 2.50	1309 3.20	931A 13.95
A2792 27.50	EM87 2.50	MHLD6 4.00	Q51210 1.50	V250.00	3B28 12.00	6BH8 1.50	6L1 2.50	1317 3.20	954 1.00
A2900 11.50	EM88 0.70	ML4 4.50	Q51211 1.50	V238A/1K	3B26 1.50	6B16 1.20	6KT8 2.95	13DE7 2.95	955 1.00
A3042 24.00	EM89 1.50	MS4B 5.50	Q51212 3.20	V295.00	3C13 19.00	6BK4 4.00	6L15 3.15	13DR7 2.95	958A 1.00
A3283 24.00	EM92 4.50	MS48 2.50	Q51213 5.00	V240C/2K	3C45 24.00	6BK7A 1.95	6L19 3.95	13E7M 3.50	959 0.60
AC/HL/DD/AC/	EM94 1.85	MU14 1.50	Q51214 5.00	V225.00	3CB6 1.50	6BL8 1.15	6L6GC 2.95	1457 1.00	1019 2.00
AC/THI	EM95 3.95	MZI-100 125.00	Q51215 5.00	V241C/1K	3CB6 1.50	6BM8 0.58	6L6GC(GE) 3.95	170W4A 2.95	1026 0.50
ACT22 59.75	EM96 1.10	N37 12.50	Q51216 5.00	V2464A/2K	3C3A 1.00	6BN4 1.65	6L7E 1.50	17EWH8 0.95	2050W 4.50
AH271 39.00	EM97 0.75	N78 9.85	Q51217 5.00	V295.00	3C33 19.00	6BN6 1.85	6L8D 0.80	17ZJ8 4.50	2050 3.95
AH238 39.00	EM98 1.50	OA2 2.50	Q51218 5.00	V339 315.00	3C33 19.00	6BN8 4.50	6LJ8 2.50	1803 1.80	3545 4.00
AL60 6.00	EM99 1.75	OA2WA 1.50	Q51219 5.00	V453 12.00	3C35 2.50	6BN8 3.95	6LJ8 2.50	1803 1.80	404A 15.00
AN1 14.00	EC93 1.50	OB2 0.95	Q51220 3.95	V250045.00	3C35 2.50	6BQ5 0.75	6LJ8 2.50	1803 1.80	404A 15.00
ARP12 0.70	EC95 7.00	OB2WA 1.50	Q51221 3.95	V453 12.00	3C35 2.50	6BQ5 0.75	6LJ8 2.50	1803 1.80	404A 15.00
ARP34 1.25	EC97 1.10	OC2 2.50	Q51222 3.95	VL5631 10.95	3C35 2.50	6BQ5 0.75	6LJ8 2.50	1803 1.80	404A 15.00
ARP35 2.00	EC98 1.75	OC3 1.50	Q51223 3.95	VP48 4.50	3C35 2.50	6BQ5 0.75	6LJ8 2.50	1803 1.80	404A 15.00
ATP4 2.50	EC99 1.50	OC4 1.70	Q51224 3.95	VP133 2.00	3C35 2.50	6BQ5 0.75	6LJ8 2.50	1803 1.80	404A 15.00
AX50 5.50	EC99 1.50	OC4 1.70	Q51225 3.95	VR35/30 3.00	3C35 2.50	6BQ5 0.75	6LJ8 2.50	1803 1.80	404A 15.00
AZ11 4.50	EC99 1.50	OC4 1.70	Q51226 3.95	VR101 2.00	3C35 2.50	6BQ5 0.75	6LJ8 2.50	1803 1.80	404A 15.00
AZ31 2.50	EC99 1.50	OC4 1.70	Q51227 3.95	VR105/30 1.50	3C35 2.50	6BQ5 0.75	6LJ8 2.50	1803 1.80	404A 15.00
BL63 1.00	EC99 1.50	OC4 1.70	Q51228 3.95	VR150/30 1.15	3C35 2.50	6BQ5 0.75	6LJ8 2.50	1803 1.80	404A 15.00
BS450 67.00	EC99 1.50	OC4 1.70	Q51229 3.95	VT52 2.50	3C35 2.50	6BQ5 0.75	6LJ8 2.50	1803 1.80	404A 15.00
BS810 55.00	EC99 1.50	OC4 1.70	Q51230 3.95	VR19 4.50	3C35 2.50	6BQ5 0.75	6LJ8 2.50	1803 1.80	404A 15.00
BS814 55.00	EC99 1.50	OC4 1.70	Q51231 3.95	VR129 1.20	3C35 2.50	6BQ5 0.75	6LJ8 2.50	1803 1.80	404A 15.00
CIK 19.00	EC99 1.50	OC4 1.70	Q51232 3.95	VR129 1.20	3C35 2.50	6BQ5 0.75	6LJ8 2.50	1803 1.80	404A 15.00
CJ3A 21.00	EC99 1.50	OC4 1.70	Q51233 3.95	VR129 1.20	3C35 2.50	6BQ5 0.75	6LJ8 2.50	1803 1.80	404A 15.00
CEA 9.00	EC99 1.50	OC4 1.70	Q51234 3.95	VR129 1.20	3C35 2.50	6BQ5 0.75	6LJ8 2.50	1803 1.80	404A 15.00
C1108 54.95	EC99 1.50	OC4 1.70	Q51235 3.95	VR129 1.20	3C35 2.50	6BQ5 0.75	6LJ8 2.50	1803 1.80	404A 15.00
C112G 70.00	EC99 1.50	OC4 1.70	Q51236 3.95	VR129 1.20	3C35 2.50	6BQ5 0.75	6LJ8 2.50	1803 1.80	404A 15.00
C1134 32.00	EC99 1.50	OC4 1.70	Q51237 3.95	VR129 1.20	3C35 2.50	6BQ5 0.75	6LJ8 2.50	1803 1.80	404A 15.00
C1148A 115.00	EC99 1.50	OC4 1.70	Q51238 3.95	VR129 1.20	3C35 2.50	6BQ5 0.75	6LJ8 2.50	1803 1.80	404A 15.00
C1149/1 130.00	EC99 1.50	OC4 1.70	Q51239 3.95	VR129 1.20	3C35 2.50	6BQ5 0.75	6LJ8 2.50	1803 1.80	404A 15.00
C1150/1 135.00	EC99 1.50	OC4 1.70	Q51240 3.95	VR129 1.20	3C35 2.50	6BQ5 0.75	6LJ8 2.50	1803 1.80	404A 15.00
C1534 32.00	EC99 1.50	OC4 1.70	Q51241 3.95	VR129 1.20	3C35 2.50	6BQ5 0.75	6LJ8 2.50	1803 1.80	404A 15.00
CCA 2.60	EC99 1.50	OC4 1.70	Q51242 3.95	VR129 1.20	3C35 2.50	6BQ5 0.75	6LJ8 2.50	1803 1.80	404A 15.00
CC3L 0.90	EC99 1.50	OC4 1.70	Q51243 3.95	VR129 1.20	3C35 2.50	6BQ5 0.75	6LJ8 2.50	1803 1.80	404A 15.00
CL33 2.00	EC99 1.50	OC4 1.70	Q51244 3.95	VR129 1.20	3C35 2.50	6BQ5 0.75	6LJ8 2.50	1803 1.80	404A 15.00
CV Nos Prices on request	EC99 1.50	OC4 1.70	Q51245 3.95	VR129 1.20	3C35 2.50	6BQ5 0.75	6LJ8 2.50	1803 1.80	404A 15.00
D63 1.20	EC99 1.50	OC4 1.70	Q51246 3.95	VR129 1.20	3C35 2.50	6BQ5 0.75	6LJ8 2.50	1803 1.80	404A 15.00
DA41 22.50	EC99 1.50	OC4 1.70	Q51247 3.95	VR129 1.20	3C35 2.50	6BQ5 0.75	6LJ8 2.50	1803 1.80	404A 15.00
DA42 17.50	EC99 1.50	OC4 1.70	Q51248 3.95	VR129 1.20	3C35 2.50	6BQ5 0.75	6LJ8 2.50	1803 1.80	404A 15.00
DA50 4.50	EC99 1.50	OC4 1.70	Q51249 3.95	VR129 1.20	3C35 2.50	6BQ5 0.75	6LJ8 2.50	1803 1.80	404A 15.00
DA100 125.00	EC99 1.50	OC4 1.70	Q51250 3.95	VR129 1.20	3C35 2.50	6BQ5 0.75	6LJ8 2.50	1803 1.80	404A 15.00
DAF91 0.70	EC99 1.50	OC4 1.70	Q51251 3.95	VR129 1.20	3C35 2.50	6BQ5 0.75	6LJ8 2.50	1803 1.80	404A 15.00
DAF96 0.65	EC99 1.50	OC4 1.70	Q51252 3.95	VR129 1.20	3C35 2.50	6BQ5 0.75	6LJ8 2.50	1803 1.80	404A 15.00
DC70 1.75	EC99 1.50	OC4 1.70	Q51253 3.95	VR129 1.20	3C35 2.50	6BQ5 0.75	6LJ8 2.50	1803 1.80	404A 15.00
DC90 1.20	EC99 1.50	OC4 1.70	Q51254 3.95	VR129 1.20	3C35 2.50	6BQ5 0.75	6LJ8 2.50	1803 1.80	404A 15.00
DCX4-1000 12.00	EC99 1.50	OC4 1.70	Q51255 3.95	VR129 1.20	3C35 2.50	6BQ5 0.75	6LJ8 2.50	1803 1.80	404A 15.00
DCX4-5000 25.00	EC99 1.50	OC4 1.70	Q51256 3.95	VR129 1.20	3C35 2.50	6BQ5 0.75	6LJ8 2.50	1803 1.80	404A 15.00
DET16 28.50	EC99 1.50	OC4 1.70	Q51257 3.95	VR129 1.20	3C35 2.50	6BQ5 0.75	6LJ8 2.50	1803 1.80	404A 15.00
DET18 28.50	EC99 1.50	OC4 1.70	Q51258 3.95	VR129 1.20	3C35 2.50	6BQ5 0.75	6LJ8 2.50	1803 1.80	404A 15.00
DET23 35.00	EC99 1.50	OC4 1.70	Q51259 3.95	VR129 1.20	3C35 2.50	6BQ5 0.75	6LJ8 2.50	1803 1.80	404A 15.00
DET24 39.00	EC99 1.50	OC4 1.70	Q51260 3.95	VR129 1.20	3C35 2.50	6BQ5 0.75	6LJ8 2.50	1803 1.80	404A 15.00
DET25 22.00	EC99 1.50	OC4 1.70	Q51261 3.95	VR129 1.20	3C35 2.50	6BQ5 0.75	6LJ8 2.50	1803 1.80	404A 15.00
DET29 32.00	EC99 1.50	OC4 1.70	Q51262 3.95	VR129 1.20	3C35 2.50	6BQ5 0.75	6LJ8 2.50	1803 1.80	404A 15.00
DF91 0.70	EC99 1.50	OC4 1.70	Q51263 3.95	VR129 1.20	3C35 2.50	6BQ5 0.75	6LJ8 2.50	1803 1.80	404A 15.00
DF92 2.50	EC99 1.50	OC4 1.70	Q51264 3.95	VR129 1.20	3C35 2.50	6BQ5 0.75	6LJ8 2.50	1803 1.80	404A 15.00
DF96 0.65	EC99 1.50	OC4 1.70	Q51265 3.95	VR129 1.20	3C35 2.50	6BQ5 0.75	6LJ8 2.50	1803 1.80	404A 15.00
DF97 1.00	EC99 1.50	OC4 1.70	Q51266 3.95	VR129 1.20	3C35 2.50	6BQ5 0.75	6LJ8 2.50	1803 1.80	404A 15.00
DH63 1.20	EC99 1.50	OC4 1.70	Q51267 3.95	VR129 1.20	3C35 2.50	6BQ5 0.75	6LJ8 2.50	1803 1.80	404A 15.00
DH77 0.90	EC99 1.50	OC4 1.70	Q51268 3.95	VR129 1.20	3C35 2.50	6BQ5 0.75	6LJ8 2.50	1803 1.80	404A 15.00
DH78 0.50	EC99 1.50	OC4 1.70	Q51269 3.95	VR129 1.20	3C35 2.50	6BQ5 0.75	6LJ8 2.50	1803 1.80	404A 15.00
DH149 2.00	EC99 1.50	OC4 1.70	Q51270 3.95	VR129 1.20	3C35 2.50	6BQ5 0.75	6LJ8 2.50	1803 1.80	404A 15.00
DK91 0.90	EC99 1.50	OC4 1.70	Q51271 3.95	VR129 1.20	3C35 2.50	6BQ5 0.75	6LJ8 2.50	1803 1.80	404A 15.00
DK92 1.20	EC99 1.50	OC4 1.70	Q51272 3.95	VR129 1.20	3C35 2.50	6BQ5 0.75	6LJ8 2.50	1803 1.80	404A 15.00
DK96 2.50	EC99 1.50	OC4 1.70	Q51273 3.95	VR129 1.20	3C35 2.50	6BQ5 0.75	6LJ8 2.50	1803 1.80	404A 15.00
DL35 2.00	EC99 1.50	OC4 1.70	Q51274 3.95	VR129 1.20	3C35 2.50	6BQ5 0.75	6LJ8 2.50	1803 1.80	404A 15.00
DL63 1.00	EC99 1.50	OC4 1.70	Q51275 3.95	VR129 1.20	3C35 2.50	6BQ5 0.75	6LJ8 2.50	1803 1.80	404A 15.00
DL70 2.50	EC99 1.50	OC4 1.70	Q51276 3.95	VR129 1.20	3C35 2.50	6BQ5 0.75	6LJ8 2.50	1803 1.80	404A 15.00
DL73 2.50	EC99 1.50	OC4 1.70	Q51277 3.95	VR129 1.20	3C35 2.50	6BQ5 0.75	6LJ8 2.50	1803 1.80	404A 15.00
DL91 1.50	EC99 1.50	OC4 1.70	Q51278 3.95	VR129 1.20	3C35 2.50	6BQ5 0.75	6LJ8 2.50	1803 1.80	404A 15.00
DL92 0.95	EC99 1.50	OC4 1.70	Q51279 3.95	VR129 1.20	3C35 2.50	6BQ5 0.75	6LJ8 2.50	1803 1.80	404A 15.00
DL									

by D.M. Taub

# Sampled data servos — a new analysis

This fourth instalment considers the response of a servo system to a sinusoidal signal

If a single frequency  $\omega_0$  is applied to a conventional servo loop such as the one shown in Fig. 1, then provided that the system is linear, this is the only frequency that exists anywhere in the system. We can then define the 'open-loop gain' at this frequency as the ratio of the signal at Y to that at V. This ratio will of course be a function of  $\omega_0$ , and the nature of the function determines whether or not the system is stable and how it will respond to any input stimulus.

In the case of a sampled-data servo such as shown in Fig. 18, the situation is more complicated. The important point to notice here is that over part of the loop the signal exists in sampled-data form, and over the remainder including the hold circuit and the plant, it exists as a continuous signal. As indicated in the last part (May) compensation may take place in either part or it may be divided between the two. The last-mentioned is assumed, for generality.

When a single frequency  $\omega_0$  is applied to this system, the sampling action introduces new frequencies  $\omega_s - \omega_0, \omega_s + \omega_0, 2\omega_s - \omega_0, 2\omega_s + \omega_0$  and so on. Within the sampled-data portion there is a simple relationship between the gains at these various frequencies as discussed in April but this is not so in the continuous-signal portion. Here the gains at these fre-

quencies will be quite unrelated to one another and so one can no longer speak of an 'open-loop gain' in the same sense as in a continuous system.

There is a way out of the difficulty. For the purpose of analysis we can replace the single sampler following the subtractor (Fig. 18) by a sampler in each of its input lines (Fig. 19), the two operating in synchronism. Thus instead of doing a subtraction between two continuous signals and sampling the result, we sample the signals first, and carry out the subtraction on the sampled versions.

This is not something that would generally be possible in practice because it would entail measuring the input and output signals relative to some fixed reference, instead of merely measuring the difference between them. But if we could, it would give exactly the same error signal, and so there is no reason why we should not assume it in the interests of the analysis.

The signals at V and Y in Fig. 19 are now both of sampled-data form, and we can define the gain between them, the open-loop gain, as a function of frequency. This will be a periodic function of frequency (as explained in April's article) and the objective is to find it in terms of the gains of the sam-

pled-data and continuous-signal portions of the loop.

### Time delay in the sampled-data portion

In practice, there can be a time delay in the sampled-data portion of a loop; that is to say its output values can appear a fraction of a sampling interval later than the corresponding input values, as illustrated in Fig. 20. Part of this delay can occur in the sampler, for instance when sample values are converted from analogue to digital form. Another contributor can be the compensator. If this uses digital techniques it generally has to carry out at least one multiplication and one addition between receiving an input value and producing the corresponding output value, and this takes time.

These delays can be allowed-for as follows. For the purpose of the analysis, assume the samplers and sampled-data compensator to be delay-free, and follow the last-mentioned by a pure-delay element representing the total delay through the sampled-data section. This element will introduce the same delay whether its input is a continuous or a sampled-data signal, and so it makes no difference whether we include it in the continuous or the sampled-data portion of the loop. Mathematically, it is easier to do the first which gives the arrangement shown in Fig. 21. In terms of complex frequency the gain of the time-delay element is

$$H_{AB}(S) = e^{-s\Delta\tau}$$

where  $\Delta\tau$  is the delay introduced. In terms of  $\omega$  it is

$$H_{AB}(j\omega) = e^{-j\omega\Delta\tau} \quad \dots 4.1$$

In other words, the gain has a modulus of 1 at all values of  $\omega$ , and a phase of  $-\omega\Delta\tau$ .

### Gain characteristic of sampled-data portion

The output from a sampled-data network at any sampling instant  $n$  is generally expressed as a linear function of the input at that instant and the inputs and outputs at earlier sampling instants. Referring to Fig. 21, denote the sample values at V and X at instant  $n$  by  $v(n)$  and  $x(n)$  respect-

Fig. 18. Servo loop in which the error signal is sampled.

Fig. 19. Sampling the input and output signals is equivalent to the arrangement in Fig. 18.

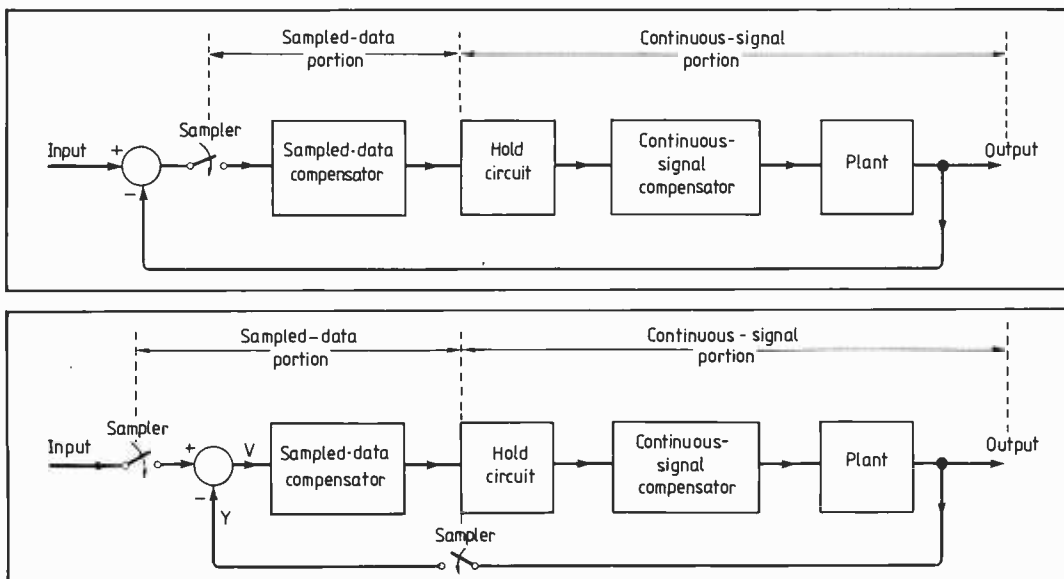

ively, the values one instant earlier by  $v(n-1)$  and  $x(n-1)$ , two instants earlier by  $v(n-2)$  and  $x(n-2)$ , and so on. The algorithm of the sampled-data compensator can then be expressed as

$$x(n) = \beta_m v(n) + \beta_{m-1} v(n-1) + \dots + \beta_0 v(n-m) - [\gamma_{m-1} x(n-1) + \dots + \gamma_0 x(n-m)]$$

where  $\beta_m, \beta_{m-1}$  etc and  $\gamma_{m-1}, \gamma_{m-2}$  etc are constants. Moving the 'x' terms to the left-hand side,

$$x(n) + \gamma_{m-1} x(n-1) + \dots + \gamma_0 x(n-m) = \beta_m v(n) + \beta_{m-1} v(n-1) + \dots + \beta_0 v(n-m)$$

From this expression, known as a 'recurrence formula', one can write down a corresponding expression relating the z-transforms of the signals at X and V,  $X(z)$  and  $V(z)$  respectively (see ref.5, sections 4.4 and 9.4). This expression is

$$X(z) [1 + \gamma_{m-1} z^{-1} + \dots + \gamma_0 z^{-m}] = V(z) [\beta_m + \beta_{m-1} z^{-1} + \dots + \beta_0 z^{-m}]$$

where  $z = e^{Ts}$ .

Both sides can now be multiplied by  $z^m$  and rearranged to give the gain as a function of z:

$$H_{VX}(z) = \frac{X(z)}{V(z)} = \frac{\beta_m z^m + \beta_{m-1} z^{m-1} + \dots + \beta_0}{z^m + \gamma_{m-1} z^{m-1} + \dots + \gamma_0}$$

To find the gain as a function of  $\omega$  set  $z = e^{j\omega T}$ , giving  $H_{VX}(j\omega) =$

$$\frac{\beta_m e^{jm\omega T} + \beta_{m-1} e^{j(m-1)\omega T} + \dots + \beta_0}{e^{jm\omega T} + \gamma_{m-1} e^{j(m-1)\omega T} + \dots + \gamma_0} \quad 4.2$$

All the exponential terms repeat their values whenever  $T\omega$  increases by  $2\pi$ , and so the function will be periodic as illustrated in the April issue.

#### Gain of continuous-signal portion followed by sampler

The gain of this section is found by assuming a sampled cosine wave at X (Fig. 21), calculating the spectrum of the signal this produces at Y, and taking the ratio between the spectral components of the two as in April's article. The mathematics can be kept simple by assuming the signal at X to be the sampled version of  $2 \cos \omega_0 t$ , so that from the equations for  $q(t)$  and  $v(t)$ , all its spectral components will have unit magnitude and zero phase angle. The spectral components at Y will then be a direct measure of the gain at the corresponding frequencies.

The spectrum of the signal at X is shown in Fig. 22(a), and as it passes from X to D each component is subjected to a different value of gain. The gain characteristics of the hold circuit,  $H_{XA}(j\omega)$  and of the time delay,  $H_{AB}(j\omega)$ , have already been given

(equations 3.2 and 4.1 respectively). The gain of any continuous signal compensation present is  $H_{BC}(j\omega)$  and that of the plant,  $H_{CD}(j\omega)$ .

Multiplying these gains together gives the gain characteristic  $H_{XD}(j\omega)$  covering the whole of the continuous-signal portion. A possible shape is sketched in Fig. 22(b). For the assumed signal at X, the signal at D will then be as represented by the line spectrum in Fig. 22(c).

The effect of sampling is to cause each component in this spectrum to be repeated indefinitely, at intervals of  $\omega_s$ . After the sampler, therefore, the total component at  $\omega_0$ , representing the gain  $H_{XY}(j\omega_0)$ , will be the sum of the following:

$H_{XD}(j\omega_0)$ , which was already present before sampling,  
 $H_{XD}[j(\omega_s + \omega_0)]$ , repeated from  $\omega_s + \omega_0$ ,  
 $H_{XD}[j(2\omega_s + \omega_0)]$ , repeated from  $2\omega_s + \omega_0$ ,  
 and so on for higher multiples of  $\omega_s$ ,  
 $H_{XD}[j(-\omega_s + \omega_0)]$ , repeated from  $-\omega_s + \omega_0$ ,  
 $H_{XD}[j(-2\omega_s + \omega_0)]$ , repeated from  $-2\omega_s + \omega_0$ ,

and so on for higher negative multiples of  $\omega_s$ .

This sum will also represent the gains at  $\omega_s + \omega_0, 2\omega_s + \omega_0$  etc and at  $-\omega_s + \omega_0, -2\omega_s + \omega_0$  etc, i.e. at all values of  $m\omega_s + \omega_0$ , because the same terms are being summed in each case. In other words the value of  $H_{XY}$  at every one of the frequencies  $m\omega_s + \omega_0$  is the sum of the values of  $H_{XD}$  at all of them. The corresponding relationship also exists for the frequencies  $m\omega_s - \omega_0$ .  $H_{XY}$ , the gain of the continuous-signal portion followed by the sampler is thus  $H_{XY}(j\omega_0) =$

$$\sum_{m=-\infty}^{\infty} H_{XD}[j(m\omega_s + \omega_0)] \quad \dots 4.3$$

The negative values of m in this expression can be eliminated by noting that the gains at equal positive and negative values of  $\omega$  are the complex conjugates of one another. This gives

$$H_{XY}(j\omega_0) = H_{XD}(j\omega_0) + \sum_{m=1}^{\infty} \{ H_{XD}[j(m\omega_s + \omega_0)] + \text{conj } H_{XD}[j(m\omega_s - \omega_0)] \}$$

In practice the characteristics of the plant generally cause  $H_{XD}$  to fall to a

**Fig. 21. Time delay (Fig. 20) can be allowed-for in the continuous-signal portion of the loop.**

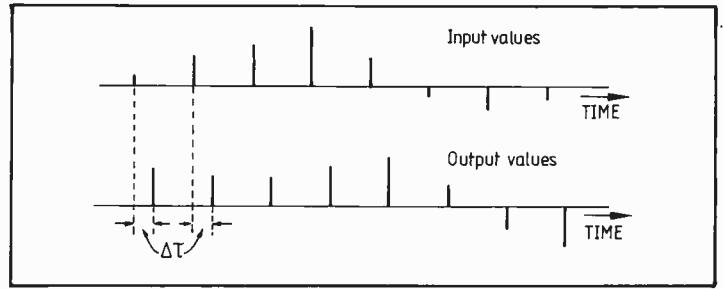

**Fig. 20. Sampled-data portion of the loop introduces a time delay caused by the analogue-to-digital conversion process and digital computation time.**

**Fig. 22. Derivation of the gain  $H_{XY}$  covering the continuous-signal portion of the loop on the output sampler.**

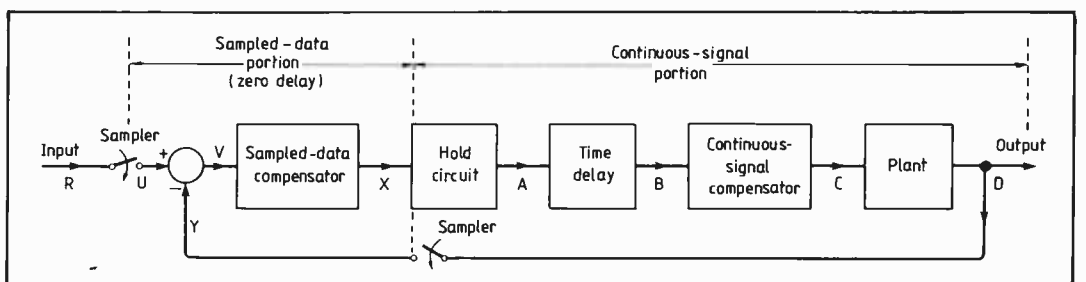
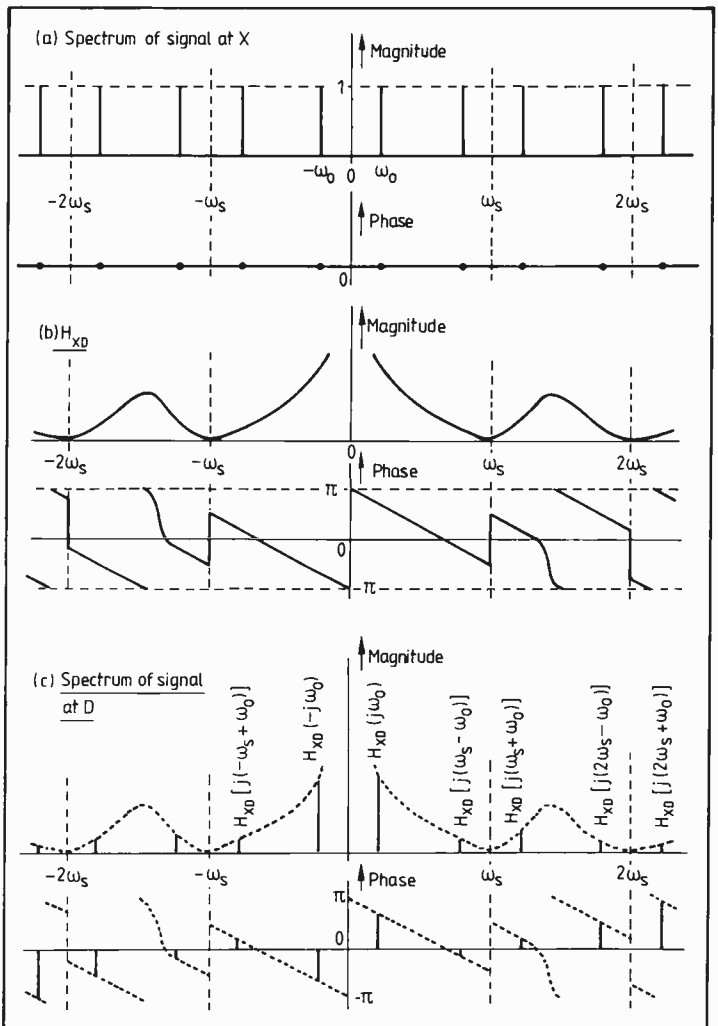



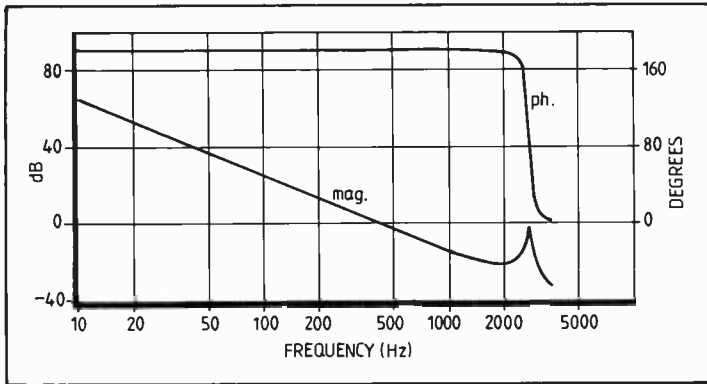

Fig. 23. Gain characteristic of the plant being controlled:  $H_{CD}$ . Notice the resonance at 2750Hz.

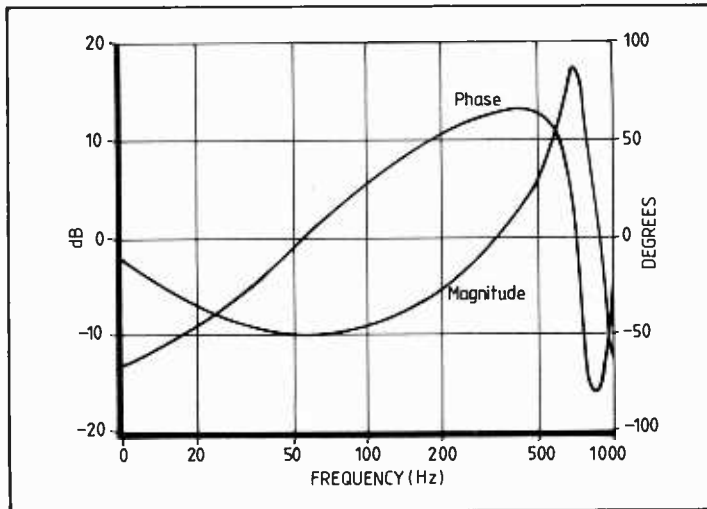

Fig. 24. Gain characteristic of the compensator,  $H_{VX}$ , up to half the sampling frequency.

negligible value beyond two or three times the sampling frequency. Therefore only the terms of the above summations corresponding to low values of  $m$  need to be taken into account.

### Open and closed-loop gain and error ratio

The total gain between V and Y in Fig. 21, i.e. the open-loop gain, is the product of the gains of the sampled-data and continuous-signal portions, i.e.

$$H_{VY}(j\omega) = H_{VX}(j\omega) \cdot H_{XY}(j\omega) \dots 4.4$$

where  $H_{VX}(j\omega)$  is given by equations 4.2 and  $H_{XY}(j\omega)$  by 4.3.

The input signal at U is the sum of the signals at V and Y, and so the gain between U and Y, the closed-loop gain, is

$$H_{UY}(j\omega) = \frac{H_{VY}(j\omega)}{1 + H_{VY}(j\omega)} \dots 4.5$$

The gain between U and V, i.e. the ratio of the error signal to the input, is

$$H_{UV}(j\omega) = \frac{1}{1 + H_{VY}(j\omega)}$$

### Example

The results obtained so far will now be used to compute the open and closed-loop response of a position-control servo. Details of the system are as follows.

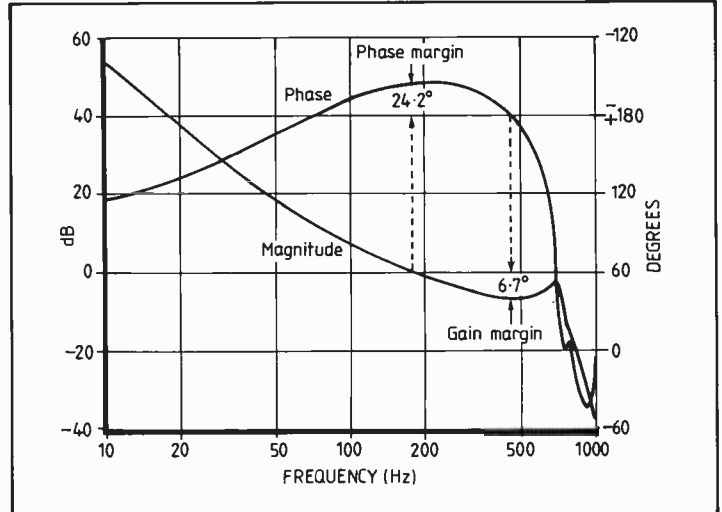

Fig. 25. Open-loop gain characteristic,  $H_{VY}$ . Peaks between 500 and 1000Hz are caused respectively by the peak in the compensator gain characteristic (Fig. 24) and by the effect of aliasing on the 2750Hz plant resonance.

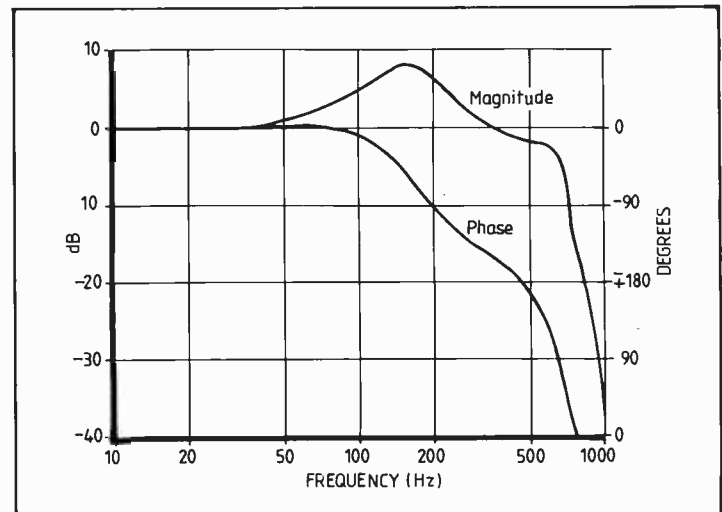

Fig. 26. Closed-loop gain characteristic,  $H_{UY}$ . Notice that around 170Hz the output is about 2.5 times the input.

**Plant:** Two stages of integration together with a 30db resonance at 2750Hz, as shown by the gain characteristic in Fig. 23. The gain is

$$H_{CD}(j\omega) = \frac{-2.137 \times 10^{15}}{\omega^2(j\omega + 273 - j17280)} \times \frac{1}{(j\omega + 273 + j17280)}$$

**Sampled-data compensator:** a digital compensator is used. Its gain is given by equation 4.2 the polynomials being of fifth order. The numerator coefficients  $\beta_5$  to  $\beta_0$  are respectively 1.258 0.03125 -1.711 -0.03516 0.5664 0. The denominator coefficients  $\gamma_5$  to  $\gamma_0$ , ( $\gamma_5$  being the coefficient of the  $z^5$  term, ie 1) are respectively 1 0.7344 -0.2891 -0.9688 -0.4609 -0.01172

**Time delay in sampled-data section:**

$$\Delta\tau = 117 \mu s$$

**Continuous-signal compensation:** none, but the gain multiplication constant within this section,  $K_{BC}$ , is adjusted to give an open-loop gain of unity at 180Hz. Its value is 0.3555.

**Sampling frequency:**  $f_s = 2000\text{Hz}$

**Hold circuit** (see May issue): Zero-order, i.e.  $\alpha = 0$

Figure 24 shows the characteristic of the compensator, computed from equation 4.2. Fig. 25 the open-loop gain computed from equations 4.3 and 4.4, and Fig. 26 the closed-loop gain, computed from the above equations and 4.5. Fig. 25 shows the stability margins to be as follows:

phase margin 24.2°  
gain margin 6.7dB.

These terms are explained in Ref.1, section 10.4. Details of the programs used in the computations are given in ref.9.

### Appendix

Gain of continuous-signal portion of loop followed by sampler:

$$H_{XY}(s) = \frac{1}{T} \sum_{m=-\infty}^{\infty} H_{XU}(s + jm\omega_s) \dots U4.3$$

### REFERENCES

- J.J. Distefano, A.R. Stubberud and I.J. Williams. 'Feedback and Control Systems' (Schaum's Outline Series, McGraw-Hill, New York, 1976).
- M. Healey. 'Principles of automatic control', (Hodder and Stoughton, London, 1975).
- M.K. Haynes. 'Magnetic recording techniques for buried servos'. *IEEE Transactions on Magnetics*, Vol. MAG 17, 1981 pp 2730-4.
- N.H. Hansen. 'Head-positioning system using buried servo', *ibid* pp 2735-8.
- P.A. Lynn. 'Introduction to the analysis and processing of signals' (Macmillan, London, 1973).
- B.C. Kuo. 'Analysis and synthesis of sampled-data control systems' (Prentice-Hall, Englewood Cliffs, NJ, 1963)
- A.M. Tropper. 'Matrix theory for electrical engineering students' (Harrap, London, 1962).
- S. Goldman. 'Transformation calculus and electrical transients', (Prentice-Hall, New York, 1949).
- D.M. Taub. 'Programs for computing sampled-data servo performance', IBM Technical Report no.12.199, (IBM United Kingdom Laboratories, Hursley, May 1982).

# Now! Tek quality and expert advice are just a free phone call away...

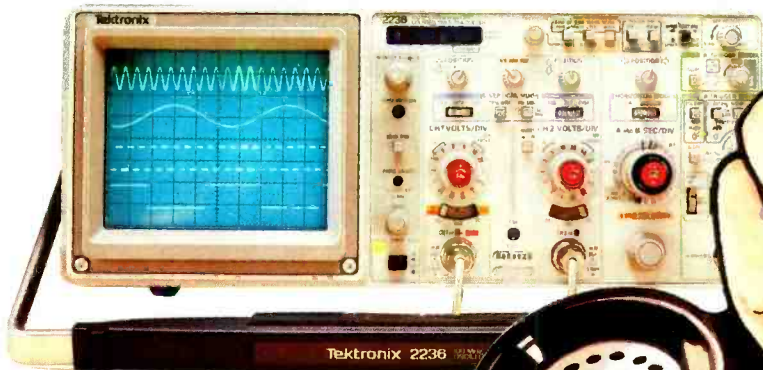

Our National Order Desk line gets you fast delivery of the industry's leading value/performance portables... and technical advice from experts!

The 60MHz 2213A, 2215A and the 100MHz 2235 and 2236 offer unprecedented reliability and affordability, plus the industry's first 3 year warranty on labour and parts, CRT included.

All 2200 series scopes have the bandwidth for digital circuits and sensitivity for low signal analogue measurement. The sweep speeds for fast logic families, and delayed sweep for fast, accurate timing measurement. The top of the range 2236 combines a counter/timer/DMM with the scope to provide fast, easy measurements for voltage, resistance and temperature.

These UK manufactured 'scopes are obtainable through the National Order Desk. Call us to order or obtain literature, or to talk to our expert on 'scope applications.

## ...talk to Pete

### Dial 100 and ask for Freefone Tek-scope

**Tektronix UK Ltd**  
Fourth Avenue, Globe Park,  
Marlow, Bucks SL7 1YD  
Tel: (06284) 6000  
Telex: 847277 & 847378

The Company reserves the right to modify designs, specifications and change prices without notice.

**Tektronix**  
COMMITTED TO EXCELLENCE

CIRCLE 48 FOR FURTHER DETAILS.



# CAD-8

## Low-cost Colour Multi-layer P.C.B. Design



CAD-8 is a low cost easy to operate system specifically designed for creating accurate two-dimensional multilayered P.C.B.'s using high-resolution colour graphics.

Artwork is prepared interactively on the screen using pre-defined function keys and trackball, providing single-key commands together with fast cursor positioning. Output can be delivered through a plotter, modem or colour printer. To facilitate the checking of artwork, a point-to-point wiring list can be sent to a standard printer.

The CAD-8 system is micro-processor based with considerable scope for enlargement, upgrading and networking.

CAD-8 provides a direct replacement for the traditional drawing-board and eliminates manual taping. It has been developed to provide the benefits of computer assistance without having to learn a new way of working.

Although CAD-8 is specifically orientated towards P.C.B. design, the package has considerable potential for use in the creation of circuit diagrams where a fast line-drawing aid with easy editing and alteration facilities to scale are required.

For further CAD-8 information contact Quantum at the address below.

Quantum  
Computer Systems



Quantum Computer Systems Ltd., 18 Woodside Road, Amersham, Bucks, England HP6 0BH. Tel: (02403) 28321. Telex: 837788.

CIRCLE 39 FOR FURTHER DETAILS.



# Managing research and development

by R.E. Young,  
B.Sc (Eng.), F.I.E.E.,  
M.R.Ae.S.

**Our series continues with a description of the working of a small integrated team's approach to R & D, in contrast with the hierarchical approach often found. Management of large projects is discussed.**

Examples of successful 'small-team' projects have been given in earlier articles, notably the 'video-on-telephone-cable' system developed by the BBC prior to World War II. This "——— model of engineering R & D" was outstanding in several respects, especially with regard to the way in which research and development were made, in effect, an integrated whole, and did not exist in watertight compartments. This is virtually impossible with 'family-tree' — separated level — style management which, by its very nature, almost invariably brings a comparatively large organisation with it. It should be pointed out that such extensive management organisations have to be set up for large-scale projects; where, as an extreme example, putting men on the moon demands the deployment of immense resources, both technical and human, and which all have to be managed and controlled.

Reverting, however, to the BBC case, the integration of research and development also included a user-component with all members of the team having in-the-field experience of the equipment, both in setting-up the complete video links and in their operation for actual programme service.

Thus, among the economic advantages which can be claimed for the small-team approach, (and which have been outlined in earlier articles), is the way in which the coordination and interchange possible with a closely-knit small team enables them to finalize the product as development proceeds. This means that, with suitable experi-

ence behind them (see Article 1), the group can cut expensive development time sufficiently to hold a project within acceptable cost limits. By the same token, interchange can prevent more than one being altered at a time. Violation of this ground rule of engineering R & D, i.e. for members of a team to make major technical changes in isolation, can be one of the biggest threats that a project has to face.

That this small-team approach is considered vital at the present time, in the context of advances development engineering, is shown quite specifically in an

interview given late in 1984 by car designer and innovator, Sir Alec Issigonis, on the occasion of the 25th 'birthday' of his world-famous 'Mini'. His success as the originator of the transverse-engine, front wheel drive layout — now "the norm for most small cars" — is seen, not only in the way the Mini continues (has not become out-dated, rather the reverse), but also in the fact that he is ---still doing research on small cars. His statement that "It is terribly important to have a small team, otherwise communication breaks down" takes on a special significance in the present

Fig. 1. An example of a 'supra-management' project — the Anglo-French Concorde.





connection.

The implications of this statement, together with the spread of Sir Alec's achievements, will be examined more closely in a later article, which is based to some extent on a current private venture R and D programme on a combined electronics system/automobile engineering approach to vehicle design and development. Its first part describes some aspects of early work carried out on telemetry (instrumentation) equipment for development testing of motor vehicles; and it is of interest that, with relevant documentation published in early 1961, this original work was carried out towards the end of the 1950s.

## Activity chart and project administration

In general, an engineering project taken to a successful conclusion has a certain well-defined 'shape'. This is shown in the activity chart of Fig. 1, with its build-up to a pronounced peak and associated distribution of effort. Drawn in this instance for a multi-team R & D project, it may be taken as applying equally to a single small-team programme or as an overall criterion for a major new technology venture at national level, or the equivalent. This aspect is covered in the next section — on Supra-Management — particularly in terms of the British ability to evolve a wide-ranging and yet flexible management approach, where much of the coordination and organization *appear* to develop almost automatically, but nevertheless where unobtrusive, but full, control is maintained.

It will be appreciated that, despite its apparent simplicity, the activity chart brings out clearly 'project-state' information crucial for R & D technical (progress) management and for control and direction of resources. These can be, of course, 'survival' issues; as for instance, where the extent of the peak in activity has not been realised, and the peak has become a crisis with the future of the project possibly in doubt from then on.

Obviously, drawing any form of activity diagram does not necessarily guarantee the elimination of all R & D problems; but,

although the experienced manager draws the equivalent of these diagrams mentally and revises them continuously, this is not a complete substitute for putting them on paper. Thus, one of the advantages of producing such diagrams is seen with the situation in which more and more effort is being brought to bear on a particularly intractable problem without any sign of its being cracked. The accumulation of resources can pass almost unnoticed in the absence of diagrammatic analysis when attention is focussed almost exclusively on the effective deployment of the additional effort. In addition to its 'real-time' reporting role, the rapidly rising activity diagram can often provide valuable early warning and enable anticipatory action to be taken.

Also among the facilities given by the generalized activity chart is the ability to keep a watch on the manning position, particularly with regard to peak loading. Two working rules may be quoted here. The immediate one is that peaks in manning on any single sub-project or the equivalent should be held to a ratio not greatly exceeding 2:1 on the initial level of staff allocation for that particular section of the work. This corresponds with the other guideline principle that if the chart shows a rise in activity continuing much beyond the half-way point in the programme time scale, serious reassessment of the whole situation is required.

From the background given in the introduction and from subsequent articles, it will be realised that a peak usually represents the appearance of the unknowns which are inseparable from R & D, and which because a new field is being entered, cannot be foreseen, at least not for the particular combination of circumstances being encountered. It is, in fact, the need to cope with the unexpected that singles out R & D [project] administration from all other forms of management.

In the attack on such a peak and its underlying causes, the project manager, as a team leader, must plan to 'stretch' his team, and the test of his leadership will be to do this with the full knowledge and cooperation of each individual in it. This will be recognized as one of the elements in the small team approach; and it will be realized that this approach has contributed to the technical flexibility

seen, for example, in the industrial 'clusters' of Great Britain.

These points have made in some detail to show how full 'family-tree' management control can be exercised over an R & D project being run in the much more open style as described, and without obtruding on it.

The name 'Farmer's Foot', adopted a number of years ago for this style of management, has proved its worth as a self-defining term with its allusion to the golden days of British agriculture when the watchword was 'the farmer's foot is the best fertilizer'. This allusion covers an individual approach to management just as applicable to modern technology as to those years of advance in agriculture. Thus, during that period, when enormous advances were made in the breeding of plants and animals, British farmers were in effect engaged in an international level-project indistinguishable in principle from a modern engineering R & D programme.

One aspect of R & D which should be introduced at this point is the way in which research and applications of it have been transferred from one branch of UK technology to another. A generalized illustration of this may be given in terms of biotechnology, announced publicly in 1980 as a potential foundation of a new industry; and which obviously involved a number of earlier technological developments. Also, the technical continuity maintained over the whole field of UK advanced engineering, with the accumulation of experience that goes with it, represent a national asset which should never be under-estimated; and which is particularly significant as being one of the main factors giving a flying start to any new work.

The advantage that can be taken of this flying start depends on the flexibility that can be shown during development, especially during the crucial early stages; and this, of course, is where 'shop-floor' management often makes its greatest contribution. In turn, the efficacy of this contribution will be determined to a great extent by the rapport (the Issigonis 'communication') that has been established between the manager and his team, and between the individuals in it.

In fact, as noted earlier, it is the need to deal with the unknowns that is one of the main justifica-

tions for adopting this style of management involvement. As already indicated, this approach can be reconciled with family-tree management principles; but it does place heavy demands on the manager's judgement, not least with regard to his allocation of time between his overall responsibility for the project itself and the direct contribution which his range of experience enables him to make to the actual work on it. The spread of this contribution may extend from giving guidance during the evolution of 'sub-inventions' to producing the solution to a problem which appears totally intractable. The latter, which may well be the key to the successful continuation of the project, is perhaps best illustrated by one of the achievements of Sir Robert Watson-Watt.

In his book on the development of radar<sup>2</sup>, A.P. Rowe recalls how a critical point had been reached in the original work at Orfordness where aircraft were being 'followed' by radar with "--- the range from the observers being continuously measured", but no method of finding bearing seemed in sight. In other words, it was not possible to bring even a primitive form of single-station radar system into operation until this key problem of obtaining bearing — direction finding — had been overcome. (Full operational use of these stations also demands determination of height; but the fundamental requirement is for range/bearing, and the original CHL stations did work on this 'plan-position' basis.)

The astonishing speed with which the problem was solved, and what may be called the 'project stream' restored, is best shown by quoting from Rowe. After being presented with an explicit statement of the situation seen operationally, "--- Watson-Watt was back with a solution -- *within a few days*"; and the future of radar [notably in interception was never again in doubt.

There is no need to stress the vital nature and importance of this high technology breakthrough. Even if not quite so spectacular, similar turning-point successes by individuals are on record<sup>3</sup> extending over the whole spectrum of British radar; while Sir Stanley Hooker's recently published autobiography<sup>4</sup> gives an up-to-date account of how one individual, admittedly

of unquestioned international standing, provided the crucial direction which "saved" a major high-technology development project - the RB 211 jet engine - from the disastrous failure which seemed inevitable at the time.

As with Sir Robert Watson-Watt the value of Sir Stanley's work is incalculable. Also, even before these outstanding achievements, both men had demonstrated their extraordinary capacity to move into any plane of development engineering, and, however new, to make a master contribution to it. Hooker had 'sorted-out' a number of aero-engines, beginning with the Merlin piston engine and culminating with the RB 211 (the names of fifteen are given in his Appendix 1); while the degree of Watson-Watt's participation is exemplified by his being named as sole or co-inventor for five British patents coming from the work alone done in the 1930s and associated with the Slough research station.

## Supra-management and R & D

The individual manager is concerned primarily with the 'management economics' aspect of running a comparatively small but carefully selected team; and, at the same time, maintaining his own technical interest in the project to give it the maximum benefit of his background and experience. Although basically for single-project administration and control, this general management style can be adapted for more than one team, provided the limitations of 'spread' are recognised.

'Supra-Management' — mentioned by name for the first time at the beginning of this article - has already been introduced indirectly in this series, notably in connection with the unparalleled evolution of British radar in World War II. In this general context, A.P. Rowe<sup>3</sup> has given insight into the workings of "that grand body" the Tizard Committee, with its "objectivity and driving power" which, in effect, set in train these "momentous events". Not only did this mark - as has already been noted - the commencement of the high-technology era in Great Britain, but it also represented the emergence of supra-management in the coordination and direction of the work of a number of independent

(Government-level) organisations achieved by the Tizard Committee. This achievement was perhaps seen at its height in the period of 'getting it going'. This colloquialism covers intensive effort directed over a range extending from gaining technical support at high level for what was little more than an unproved idea, to obtaining the necessary Cabinet authority for the unprecedented amount of finance required for carrying out the programme which was being put forward.

As noted in the first article, the magnitude of the technological strength that was eventually brought together on a national scale for this programme has not really been approached in the UK since those days. It was suggested at the same time, however, that the potential for undertaking such an extensive project still existed (was "--- not far below the surface"); and indeed this can be taken further with the recent publication of 'inside' information on the Concorde development programme. Though not of the same absolute size, the Anglo-French Concorde was strictly comparable - as a supra-management project - with the UK radar development; and thus it can be said that in implementing their share of the programme, the British demonstrated that the potential was there and could be activated.

The main source of information, on the Concorde programme, seen as an interlocking 'multi-project', is Sir Stanley Hooker's autobiography<sup>4</sup>. Already brought into this article, this book gives a penetrating view of the complexity and difficulty of maintaining project flow and cohesion in a co-operative undertaking of this size. This is done not only with regard to the propulsion side with Sir Stanley's involvement with the application of the Olympus engine to the Concorde; but also in terms of the remarkable overall management of the development of this unique airliner. Problems there were with this 'bi-national' venture, not the least being language (with technical interchange, this involves 'way of thinking' in addition to straight translation), but with this, as with the engineering problems, there was managerial anticipation and - evidently - almost inspired forward planning.

The immensity of the task that lay ahead cannot be over-empha-

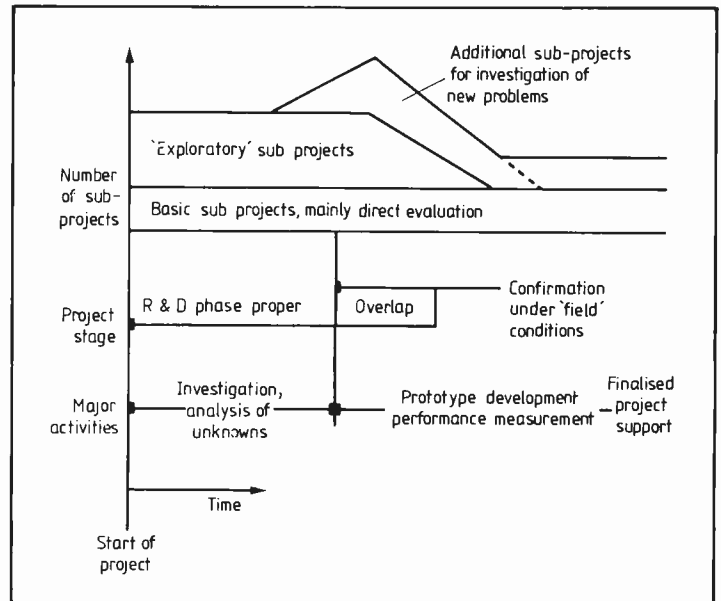

sized, with entrance into a number of technological worlds; but the success of the supra-management is seen in the project development times achieved despite the 'design interplay' which compounded all the problems as they were uncovered and then attacked.

These problems could fairly be called high-technology ones (almost invariably the techniques evolved to meet them were entirely new, and usually had an electronic content). Typical of this was the means which was developed to deal with the very large variations which take place in engine airflow with change in aircraft speed, varying from virtually zero at take-off to the supersonic cruise condition at Mach 2. In this instance, an engine inlet system was developed consisting of very large movable flaps, ramps and doors, the control of which is scheduled by an automatic electronic system.

From experience of comparable project work it will be apparent that, with the interaction with other areas of technology, such a development programme would call for a correspondingly large amount of time and effort to be expended on it.

Of even more significance in the present context is a paper by Hilton and Steed, published in *Aerospace* for March 1984<sup>5</sup>, which throws considerable light on the Concorde flying control system and its development.

More than one major aspect is brought in here, outstandingly that of the spin-off and exchange achieved as part of management economics. The key is in the title,

Fig. 2. Generalized activity chart for multi-team R&D projects

initially perhaps somewhat surprising in this instance — Fly-by-wire Actuation for *Combat Aircraft*. As stated in the paper "Many of the system characteristics of Concorde, such as pressures, temperatures and performance are typical of those required for actuation in the field of military aircraft".

This information flow had started with an experimental Tay-engined Viscount aircraft equipped with two electrical control systems and one mechanical standby system with the co-pilot in control of it. This general system philosophy, as developed, appears in the Concorde with two electrical lanes (channels) in an active/standby arrangement with self-monitoring of the operating lane. Control is automatically switched to the standby lane in the event of failure on the active system. As a further safeguard, there is a back-up mechanical monitoring system which comes into operation should a common fault or the equivalent develop on the electrical side.

It will be appreciated that there is a certain independent check element in such a main/standby multiple system; but that near-instantaneous decision-taking required in an emergency demands human intervention for changeover action. The question of human intervention — its degree and timing — is, of course, common to other complex control systems; and represents just one element in flight trials and analysis and assessment which

can rarely be carried out concurrently. With the multiple-programme character of the Concorde project in mind, it will be realised how remarkable was the

## The national 'mix' and the universities

During the earlier part of 1984, an advertisement appeared in the British Press for "real engineers" — all rounders with management-grade experience in more than one field of engineering. The pros and cons of bringing non-specialists into innovative work have already been discussed at several points in this series; and it does seem possible to state that provided the necessary flexibility and adaptability are there the more broadly based engineer can contribute to the practical development of an idea, which after all is specialized in itself.

Now it is one of the main submissions of the series that these qualities of flexibility and adaptability to the new and untried are found in Great Britain, almost as a national characteristic. It has also been made clear that of the many factors that have contributed to this result, education in its widest sense is of crucial importance; and it is in this connection that the invention of the cavity magnetron<sup>3</sup> can be used to illustrate how the 'British' approach works in practice and, at the same time, to show how this remarkable advance was made by a university.

The cavity magnetron of J.T. Randall and H.A.H. Boot, with its initial basic development in the physics laboratory at Birmingham University, "—on the second design, worked - and worked so well that it is literally true to say that for years no substantial variation from the original main lines was an improvement". Anyone who has been engaged in R & D at a comparable level will realise the full import of this quotation from 'Science at War', not least the soundness of the way of thinking it represents.

The account that follows of the work on the ten-centimetre front continues to show the same pattern of high-technology achievement, and specifically the transfer to manufacture by GEC with "—no inconsiderable part" played by B.T.H.

As found by all who write on

this era, it is only possible to include a fraction of the names of those who were responsible for advances in this area of British radar; but, in the present context, it is imperative to list the following, not necessarily in chronological order.

J. Sayers in Birmingham introduced strapping between cavity segments to obviate mode jumping on the generated radio frequency.

A team at Leeds under Prof. E.C. Stoner, working in collaboration with one at Manchester under Prof. D.R. Hartree, explained and determined a full physical picture of the complex path distribution of electrons inside the magnetron when oscillating.

A new technique to overcome the difficulty of making the reflex klystron (used as a local oscillator) was developed in the University of Bristol under R.W. Sutton, "with close contact ——— with the G.E.C., and in particular, with E.M.I."

In addition, a paragraph in 'Science at War' gives "Prof. J.D. Cockcroft, Prof. M.L.E. Oliphant, Lewis and others" as the team brought in from fundamental research in atomic physics to look into the need for very short waves. The contribution that was made by this team is stated to have been a most important factor in the success achieved in this national programme.

Professor J.D. Cockcroft, who became Sir John Cockcroft, O.M., F.R.S., represents another golden age in Britain. This is essentially associated with that great institution the Cavendish Laboratory at Cambridge and the nuclear research carried on there. Apart from his pre-eminence as a research physicist, Cockcroft was an outstanding development engineer possessing all the talents of the ideal 'participation' R & D manager. Also, as with Sir Stanley Hooker, he was a brilliant mathematician.

In rounding off this section, the word 'mix' has been chosen to cover two specific and interlinked issues in the conduct of technology in the UK. Both of these issues will be considered from the national point of view, and in the case of the first largely from that of the 'total' education of the individual. Thus, as an illustration, and by virtue of the documentation that exists on his

career, the mix of Cockcroft's deliberately acquired and immense technical experience, combined with his world-level research, may be said to represent, within the technological climate of Great Britain, the ultimate, and ideal, career training course for the engineering student.

Two examples will be taken from Egon Larson's book 'The Cavendish Laboratory'<sup>6</sup> to give some indication of Cockcroft's depth of penetration into most branches of engineering practice.

The first shows Cockcroft winding armatures, assembling switchgear, and testing electrical machines at Metropolitan-Vickers in Manchester. He had joined the firm as a college apprentice in 1920, following the interruption to his studies with his three year service in the Army in the 1914-18 War. Larson quotes Cockcroft's recalling that he found that his mathematics "—came back with surprising completeness" on his return to the (then) Manchester College of Technology.

The second example speaks for itself. During his construction of the first particle accelerator at the Cavendish (significantly in the period 1929-32), the workshop-trained Cockcroft built his machine, in effect, round two disused petrol-pump cylinders. He had to overcome formidable high-vacuum problems, while it is worthy of note that the machine worked at 300,000 volts.

The second of these two issues is firmly on the national scale. In the present context it concerns the mix within each university (including the apportioning of resources and effort generally), between the various universities and between them and the outside world, e.g. their Government-type sponsoring/directing authorities.

The structure and existence of this mix will have already been gathered from the accounts given earlier in this series and more particularly from this article. There is perhaps one aspect which might be elaborated — relations with the local industry-based cluster. This has already been mentioned with the reference to the Manchester University contribution to computers; and, in line with the preceding treatment it seems appropriate to couple the name Ferranti with the Manchester computer mix.

## References

1. Langley, J. Small Car with big Reputation, *The Daily Telegraph* 29th August 1984
2. Young R.E.: 'Vehicle Instrumentation and Development,' article (This series *Wireless World*. To be published)
3. Rowe E, A.P.: One story of Radar, The University Press, Cambridge 1948
4. Crowther, J.G. & Whiddington, P.: Science at War; His Majesty's Stationery Office, London, 1947
5. Hooker, S.G.: Not Much of an Engineer, Air Life Publishing Limited, Shrewsbury, England 1984
6. Hilton, R.G. and Steed, D.I. Fly - by - Wire Actuation for Combat Aircraft *Aerospace*, Vol. 11 No. 3 March 1985
7. Larsen, E.: The Cavendish Laboratory, Edmund Ward, London 1962.

## Articles in this series

- British invention, innovation and electronics (March)
- Radar and television — interchange and spin-off (April)
- The post war stride into aerospace (May)
- R & D management and economics
- Big system automation and telemetry
- Vehicle instrumentation
- Human communications
- The future

# Helical antennas for 435MHz

## An easy-to-construct design offering true circular polarization

This antenna design was produced for satellite working with Oscar-10, but it has also proved excellent for ordinary local and long-distance operation. It has eliminated at a stroke the frustration of accurately matching and phasing crossed Yagis to true circular polarization and obtaining an acceptable s.w.r. throughout the band.

Compared with other antennas it has a very wide bandwidth - a low Q - which makes it forgiving of dimensional inaccuracies. It is therefore easy to construct successfully.

This article describes 9 and 16-turn helices for the 430-440MHz amateur band. The nine-turn version simply has fewer turns and spacers, but it is short enough to permit end-mounting. Gain figures of the two versions are 12.8 and 15.2dB respectively. You can use more turns, but the mechanical penalties increase rapidly at this wavelength, whilst the extra gain per turn is marginal.

For many years Kraus<sup>1</sup> has been a central figure in promoting helix antennas, and a little detective work reveals dimensions identical to his figures in almost every design guide (for example the R.S.G.B. VHF/UHF Manual, ITT Reference Data for Radio Engineers etc.).

More recently, King and Wong in their brief summary paper<sup>2</sup> presented performance characteristics based on a large number of gain and pattern measurements of helices of 5 to 35 turns, with various pitch angles and other parameters. The paper augments and expands Kraus's theories.

The design of this antenna is based on that work. A pitch angle of 12.8° with a circumference of about 1.08 wavelengths are used. From King and Wong's curves this yields a maximum gain (allowing for mechanical tolerances) at 435MHz, for aerials

of reasonable size (Fig. 1). These gains are typically 3dB lower than Kraus gives, but seem to be representative of actual practice.

### Materials

In choosing materials I was guided by the need to make an antenna that could survive several years' weathering with only minor attention; and that for the most part used common material and needed simple workshop practice. I did not consider timber stable enough - but you could try it.

The reflector and boom are aluminium and the helix copper. The feed-strap is brass and the screws are zinc-plated. The spacers are of black Delrin. A waterproof N-type connector is used for the r.f. connection. For protection, the completed antenna should be varnished.

To ensure success, it is important to do things in the right order: for example, the length to which the spacers must be cut depends on the final diameter of the helix. Handling the helix itself calls for a boom through its middle and so it is easier to do drilling first. So:

- obtain all materials - see table 3;
- build up the reflector assembly;
- drill the boom;
- wind the helix and stretch along the boom;
- make and fit spacers;
- fix the copper spiral to spacers;
- fix reflector to boom;
- install feed strap;
- adjust s.w.r.

### Reflector

The reflector is a nominally 600mm square piece of expanded aluminium fret, obtainable as *Expamet* 351A, which is widely used as a grille material. The size

is not critical and 500mm square could be used if windage is a problem. Take especial care to cut the *Expamet* sheet without leaving jagged edges.

The mesh must be stiffened, or it will bend easily in a light breeze and may quickly break. In one prototype the support/stiffening was fabricated from a 100 x 100mm 16 s.w.g. (1.6mm) centre plate and some 10 x 10mm 18 s.w.g. (1.2mm) aluminium angle, and was quite satisfactorily strong and lightweight.

For the final version model I tried a simpler design, bent up entirely from 18 s.w.g. sheet metal (Fig. 2,3). The stiffening is bolted through the mesh with M3 x 10 screws and stiffnuts, using 16mm diameter washers on the front face, cut from waste metal. To keep the reflector all-aluminium, 3mm (1/8") pop rivets could be used instead of screws.

Once the stiffening is fixed, mesh can be snipped away to allow the boom and N-type connector through. The connector is a single-hole-fixing type and can be fitted either way round depending on whether the feed is to be from the rear or along the boom from the front.

Aluminium tube 19mm square and of 16 s.w.g. wall is obtainable from most ironmongers or non-

by James Miller  
B.Sc.  
G3RUH

Fig. 1. Gain versus number of turns for helical antennas having a pitch angle of 12.8° and circumference of 1.08λ (based on curves in reference 2). The 9 and 16-turn designs described here have gains of 12.8dB and 15.2dB respectively. At 435MHz, longer antennas would need a stronger boom.

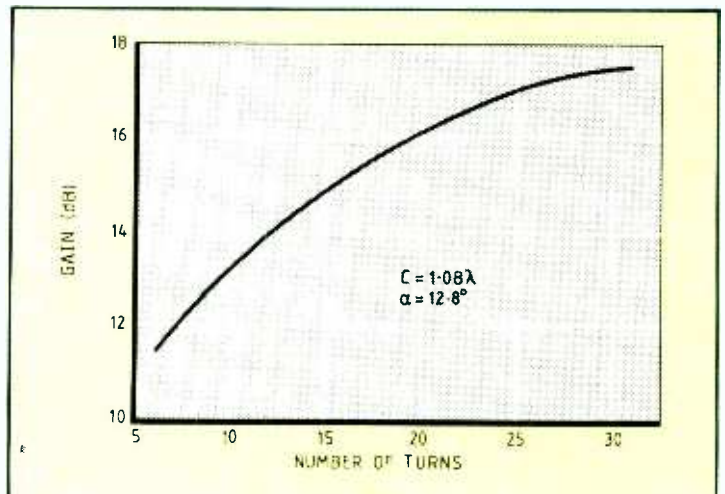



# HELICAL ANTENNAS

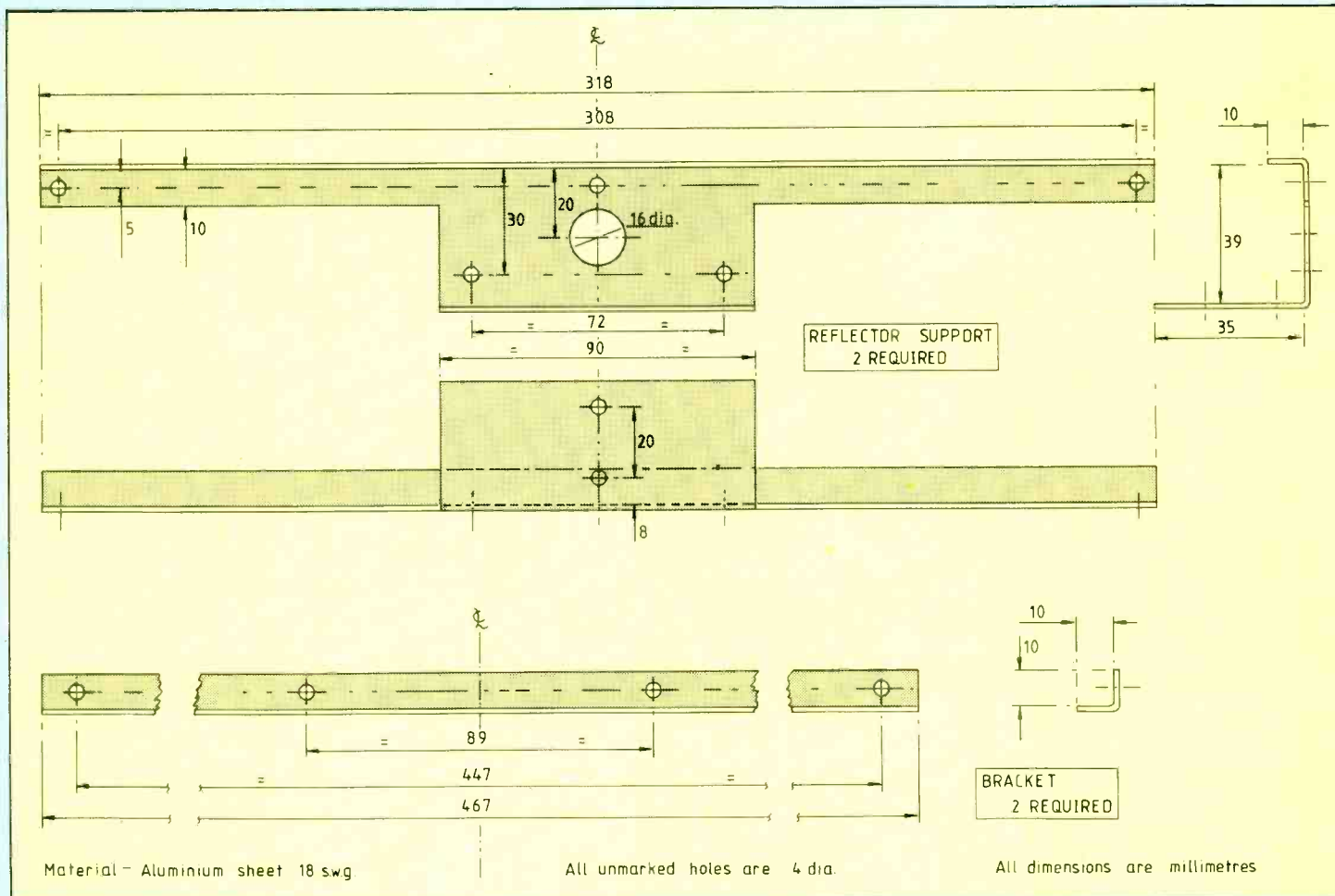

Fig.2. Reflector support is fabricated from 18 s.w.g. aluminium sheet; two of each part are needed. Assemble as shown in Fig.3. The parts are fixed through the reflector mesh with twelve 10mm M3 screws and stiff-nuts, backed with 16mm diameter washers cut from waste aluminium.

ferrous metal suppliers. You will need two or three metres, which will allow you a little surplus at each end to clamp the boom for support during construction.

Drill holes of 4.3mm diameter for the spacers and to secure the reflector (see Fig.4). Spacers are used every 1.75 turns; the holes must therefore be alternately vertical and horizontal on a 3.5 turn (595mm) pitch. The first

spacer is a quarter-turn into the helix; the last supports the end of the final turn.

First drill the spacer holes. Position the reflector mounting holes so as to locate the front face of the reflector 53mm from the first spacer hole. This will ensure an adjustment gap of about 5mm between the reflector and the start of the helix.

## Helix

The helix is made from 10mm diameter copper central-heating pipe, which is readily available, easy to bend by hand and quite cheap. It usually comes in 10 or 20m coils. Each turn takes 0.7m, so you can get up to 13 turns out of a 10m length; 20m will make two antennas, one of nine turns and one of 16. If you can obtain odd lengths from a plumber then the pieces can be soldered together. Do not uncoil the raw tubing before winding.

You will need a mandrel around which to wind the helix. It should have a diameter of 229mm and, for comfort, a length of at least 180mm. A search around your attic, scarpard or the shops may well produce a suitable object. I found a nine-inch cake tin exactly the right diameter though a little short, and I was able to wind the first prototype, somewhat unevenly, using two pairs of hands and a lot of patience. For subsequent models this experience prompted me to make up a proper drum of the correct size out of two plywood discs and some slats.

Particular thanks to Francis Pullen G4XXX for machining services during the development of this antenna, and to Cambridge Consultants Limited for the free use of facilities.

Fig.3. Rear view of the reflector showing assembly of support parts. Rear feed may be obtained by reversing the N-type connector and omitting the feedthrough insulator. Anti-static protection (not shown) can be effected with a small inductor from connector pip to a solder tag on the boom.

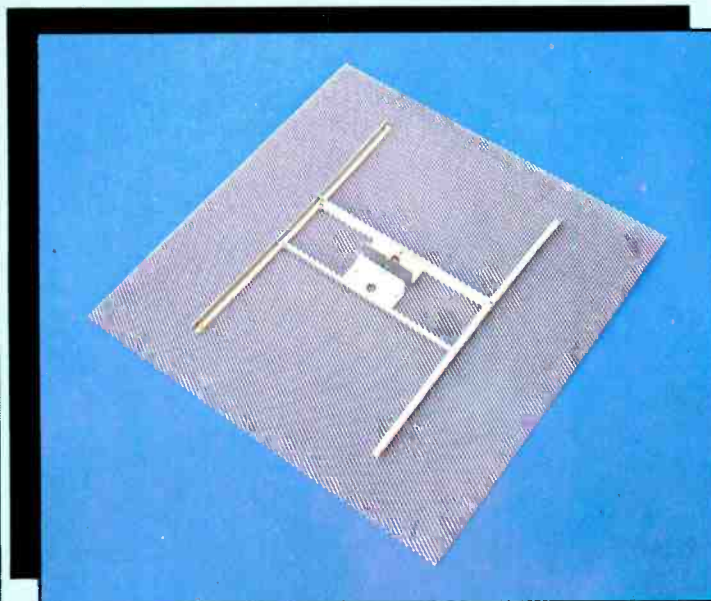

Table 1: measured performance data

Size	9	16 turns
Gain	12.8	15.2dB
3dB beamwidth	-	±11°
First nulls	-	±23°
Typ. sidelobe	-	-18dB
F/b ratio	-	14dB
S.w.r. (typ.)	less than	1.1:1
Overall length	1.59	2.78m
Weight incl. clamp	2.7	4.0kg

Table 2: electrical and mechanical design

Frequency	430-440MHz
Wavelength	$\lambda = 690\text{mm}$ nominal
Pitch angle	$p = 12.8^\circ$ , circumference $C = 1.08\lambda$

	symbol	wavelengths	size, mm
Circumference	C	1.08	745
Diameter	$D = C/\pi$	0.344	237
Turn length	$L_t = C/\cos(p)$	1.108	764
Turn spacing	$S = C \tan(p)$	0.245	170
Tube diameter	d	0.014	10
Reflector		0.87	600 x 600

Table 3: materials

Quantities for a 16-turn helix (figures in brackets are for nine turns):

**Reflector:**

- Expamet 351A expanded aluminium mesh, about 600 x 600mm
- Support/stiffeners fabricated from 500 x 250mm 18 s.w.g. aluminium sheet
- 12 M3 x 10 pan-head screws and stiffnuts, plated
- 12 16mm diameter washers drilled 3.3mm, cut from aluminium waste
- 2 M4 x 30 pan-head screws and stiffnuts
- 1 N-type socket e.g. Cirkit (formerly Ambit) part no. 10-01301
- 1 feedthrough insulator, 4mm dia. x 13.7mm e.g. Sealectro type FT310P51

**Boom:**

- 3 [1.8] metres aluminium tube, 19 x 19mm section, 16 s.w.g. wall thickness
- 2 19mm square plastic end plugs - e.g. Dexlon finishers
- 1 antenna clamp, double U-bolt type, e.g. Jaybeam type 9891 or similar

**Helix:**

- 13 [7] metres 10mm diameter copper micro-bore central heating tube
- 1 10mm end cap, e.g. Yorkshire type 61

**Spacers:**

- 1.2 [0.7] metres 16mm diameter black Delrin rod
- 10 [6] M4 x 30 screws, pan-head, plated

**Feed strap:**

- 100 x 7mm 16 s.w.g. brass strip

The following parts may be obtained from the author:

1. Pre-formed reflector support/stiffeners, screws, nuts, and washers: £15 per set.
2. Machined spacers with screw: £2.30 each.

Complete antennas and kits are also available to special order. Prices include carriage to U.K. addresses only. For more details, please send a stamped, self-addressed envelope to J.R. Miller, 3 Benny's Way, Coton, Cambridge, CB3 7PS.

There is no need to worry if the mandrel is not exactly 229mm in diameter, but be sure to err on the small side, since the design is already close to the maximum size for 440MHz. If your helix diameter ends up N mm less than nominal, then simply make the spacers (N/2)mm shorter.

Start winding about half a metre into coil. Holding the short end tight against the mandrel, pointing away from you, pull the long end down on to the mandrel into a curve. Slip the helix back an eighth of a turn and bend again. In this way a whole turn can be built up smoothly and will start gripping the mandrel as soon as tension is applied.

After winding the first turn,

stop and inspect your work. Make absolutely sure you are winding a right-hand or left-hand spiral as you really want. If in doubt, compare it with a normal woodscrew. Most people instinctively wind left-handed spirals.

Continue to close wind the copper until you have 9 or 16 tightly coiled turns. The helix will spring out naturally to the desired (coiled) diameter of about 253mm outside.

**Stretching**

First mark the top of each turn: stick black tape along the outside of the coil, slit the tape between turns and smooth each marker

down firmly

Support the boom at each end. Mark the location of the first and last turns on the boom (1.53 or 2.27m apart) boldly, with black tape.

Now slip the coiled helix over the boom. With an assistant holding one end, draw the other, gently stretching the coils apart, keeping the top markers vertical until the full extent is reached. Take care to avoid distorting the first and last turns through rough handling.

You should now have a fairly even helix with the correct average spacing of 170mm and nominal o.d. of 247mm.

Fig.4. Boom drilling. Material is 19x19mm aluminium tube. The reflector is secured via two vertical holes to prevent twisting; spacers are used every 1.75 turns.

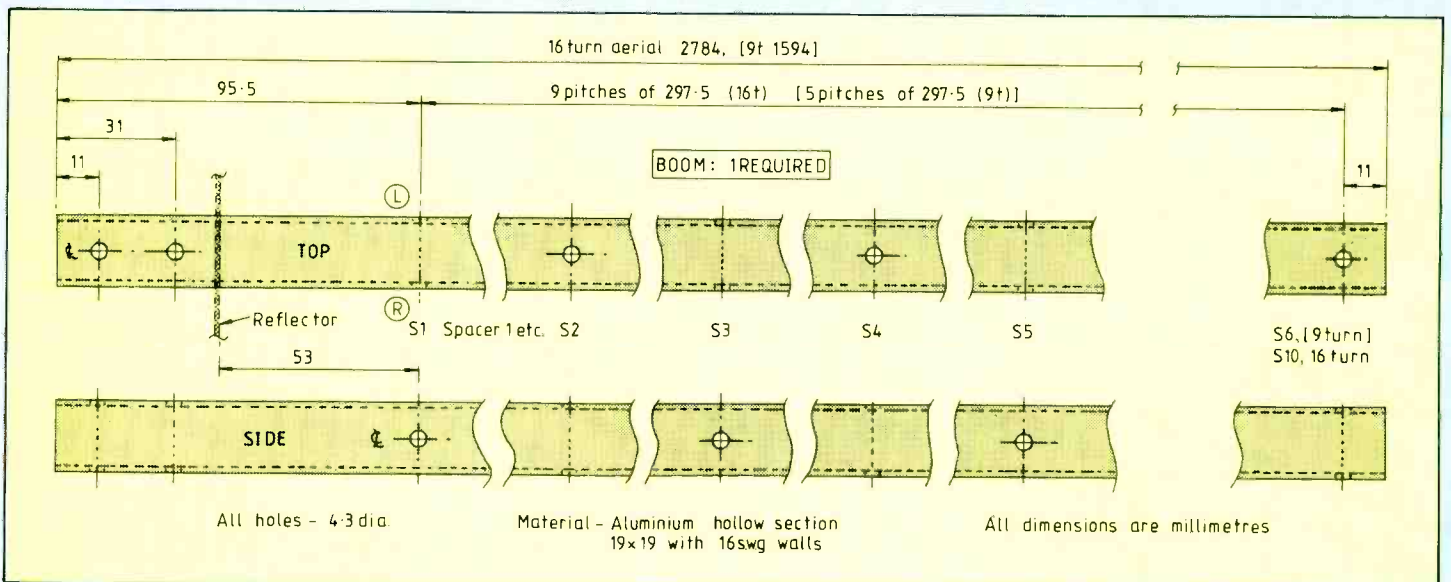



# HELICAL ANTENNAS

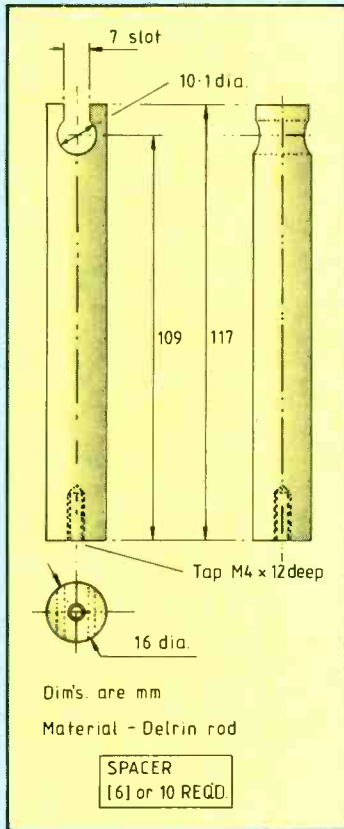

**Fig.5. Spacers are machined from 16mm black Delrin rod and are fitted at  $1\frac{3}{4}$  - turn intervals. The helix structure snaps into the slot. A vee-notch may be used as an alternative to the slot and hole illustrated here: the copper is then secured by wire passed through a small hole beneath the notch.**

**Fig.6. The feed strap: an accurate match is found by adjusting the spacing between strap and reflector. An s.w.r. of better than 1.1:1 can be obtained easily over 430-440MHz.**

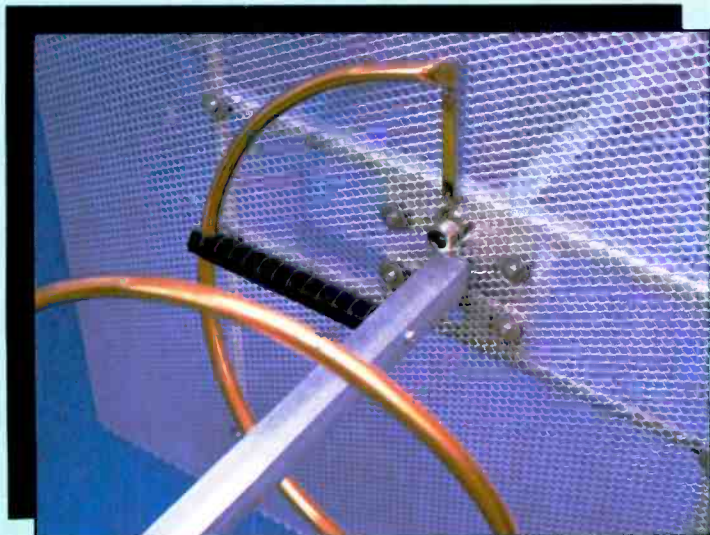

The spacers are made from 16mm extruded black Delrin rod, which can be obtained from plastics suppliers listed in the classified telephone directory; but any ultra-violet and weather-resistant loss-free material could be used instead. Cross sections of the spacers are shown in Fig.5. They can be made by hand using a saw and drill, though a lot of care will be needed; I used a lathe. You will need six or ten spacers.

The slot in the top is wide enough to allow the copper tube to be snapped into place. Other methods of mounting may be just as effective, though. One possibility is a V-notch, with the tube secured by a couple of turns of 18 s.w.g. copper wire (as used in mains power wiring) via a small hole drilled beneath the notch. Whichever method is used, the tube centre must be supported 109mm above the boom surface, allowing for any error in the dimensions of the spiral.

Fix the spacers loosely to the boom in such a way that the start turn will be uppermost. Lift the helix on to the top spacers at 2, 9 and 16 turns, guided by the markers, and secure it. Next, fix the spiral at the bottom, and then at the sides.

Fine adjustment of spacing may be needed to correct any distortion. Make up a 160mm-long gauge from a strip of metal: it should just slip between the turns.

Now bolt on the reflector assembly.

## Feed strap

This consists of a strip of 16 s.w.g. brass, 7mm wide and about 100mm long running from

the start of the helix down direct to the connector (for rear feed). For front feed, the strap is about 85mm long and runs to a feed-through insulator mounted on the reflector support. It is linked by an 18 s.w.g. insulated copper wire across to the connector pip.

Carefully squash flat about 10mm of the start of the helix so that the strap can be soldered flat, close and parallel to the reflector. The tube can be sealed up at the same time.

If a large soldering iron or blowtorch is available, a 10mm copper end-cap makes a neat finish for the front end of the helix; but while fitting it, temporarily remove the leading spacer from the heat.

## Tuning

First make sure that all screws are tight. Using an s.w.r. bridge, adjust the spacing between strap and reflector, gently bending the first quarter turn as needed. The gap should be about 3mm. Relieve any stress at the connector or feed-through by re-melting the solder.

Tuning can be done at ground level, with the antenna on a two-metre pole. In fact, after the initial adjustments indoors, little further tuning seems to be needed when the aerial is taken outside.

Use no more than 5W when experimenting, and remember the e.i.r.p. at the sharp end is high: avoid prolonged exposure. With care a virtually perfect match can be achieved from 430 to 440MHz.

## Installation

In a gale the force acting on the reflector is very high, and results in a considerable torque at the clamp. Therefore pay special attention to this fixing point. Use a double U-bolt design and install with care. If in doubt run an M8 bolt right through clamp and mast. There is just room.

Consider also the parking position when the aerial is not in use. Small rotators such as the Hirschmann 250 are not really suitable for the 16-turn antenna. Windage can be reduced by cutting the reflector to a  $500 \times 500$ mm square or to a circular pattern.

The centre of gravity of the 16-turn antenna is about 6.7 turns along the boom, and at this point the bending moment of 1.6kg.m results in a 20mm sag at each end, which is quite acceptable.

The nine-turn antenna can be fixed in the same way, or end-mounted with a counterbalance weight of moment 1.7kg.m referred to the clamp. (Front-end sag will be 20mm again).

Using a metal mast through the helix seems to produce no ill effect. Glass-fibre masts are becoming more common, but unfortunately are still expensive.

The antenna's finish can be preserved with a coat of yacht varnish. This will flake off if the metalwork is not first degreased using hot soapy water, blue Ajax or Inhibisol.

This type of antenna inevitably picks up a static charge which will damage pre-amplifiers or receivers that do not have a low input resistance to d.c. Check your system! A simple protector would be a 4.7k $\Omega$  1W resistor from connector pip to boom, which I have not tried, or small inductor in the same place, (say 300nH, a few turns), which I have. You are warned!

## Performance

I would have welcomed an opportunity to evaluate the antenna on a proper test range, but lacking both of these I had to devise another method. My local u.h.f. repeater is fortunately only 1km distant and it provides a strong, steady line-of-sight signal. I rotated the antenna in small increments and measured the response using a calibrated 1GHz variable attenuator.

With this test I was able to assess the nulls and sidelobes, and by graphically integrating the polar plot<sup>3</sup> I arrived at an estimate of the gain achieved (table 1).

In actual practice, performance has surpassed my expectation. Oscar-10 working has been transformed since my crossed Yagis were replaced. Terrestrial working is excellent, the circular polarization eliminating the need for dual feeds, changeover relays and the like. Of course there is a 3dB penalty for using circular instead of linear, but does anyone actually notice? The polarization from mobile signals constantly changes, and circular polarization should actually be better than vertical alone.

The prototype has been in use since December 1983, and apart from the redesigned reflector stiffening has needed no attention. Without doubt it has been one of the easiest antennas of all to design and build.

# LANGREX SUPPLIES LTD

**RST** Climax House, Fallsbrook Rd., Streatham, London SW16 6ED **RST**  
Tel: 01-677 2424 Telex: 946708

## SEMICONDUCTORS

AA119 0.10	AA120 0.10	AA121 0.10	AA122 0.10	AA123 0.10	AA124 0.10	AA125 0.10	AA126 0.10	AA127 0.10	AA128 0.10	AA129 0.10	AA130 0.10	AA131 0.10	AA132 0.10	AA133 0.10	AA134 0.10	AA135 0.10	AA136 0.10	AA137 0.10	AA138 0.10	AA139 0.10	AA140 0.10	AA141 0.10	AA142 0.10	AA143 0.10	AA144 0.10	AA145 0.10	AA146 0.10	AA147 0.10	AA148 0.10	AA149 0.10	AA150 0.10	AA151 0.10	AA152 0.10	AA153 0.10	AA154 0.10	AA155 0.10	AA156 0.10	AA157 0.10	AA158 0.10	AA159 0.10	AA160 0.10	AA161 0.10	AA162 0.10	AA163 0.10	AA164 0.10	AA165 0.10	AA166 0.10	AA167 0.10	AA168 0.10	AA169 0.10	AA170 0.10	AA171 0.10	AA172 0.10	AA173 0.10	AA174 0.10	AA175 0.10	AA176 0.10	AA177 0.10	AA178 0.10	AA179 0.10	AA180 0.10	AA181 0.10	AA182 0.10	AA183 0.10	AA184 0.10	AA185 0.10	AA186 0.10	AA187 0.10	AA188 0.10	AA189 0.10	AA190 0.10	AA191 0.10	AA192 0.10	AA193 0.10	AA194 0.10	AA195 0.10	AA196 0.10	AA197 0.10	AA198 0.10	AA199 0.10	AA200 0.10
------------	------------	------------	------------	------------	------------	------------	------------	------------	------------	------------	------------	------------	------------	------------	------------	------------	------------	------------	------------	------------	------------	------------	------------	------------	------------	------------	------------	------------	------------	------------	------------	------------	------------	------------	------------	------------	------------	------------	------------	------------	------------	------------	------------	------------	------------	------------	------------	------------	------------	------------	------------	------------	------------	------------	------------	------------	------------	------------	------------	------------	------------	------------	------------	------------	------------	------------	------------	------------	------------	------------	------------	------------	------------	------------	------------	------------	------------	------------	------------	------------	------------

## VALVES

A1834 9.00	A2087 13.50	A2134 17.50	A2293 16.00	A2426 27.50	A2521 25.00	A2900 15.00	A3434 45.00	AZ31 2.75	AZ41 1.40	BK448 114.90	BK484 155.35	BS90 58.00	BS100 60.00	B75 58.95	BT17 151.00	BT19 44.05	BT29 349.15	BT39 354.80	BT95 129.90	CB131 4.00	CL33 4.00	CY31 3.00	C1K 20.00	C3A 22.00	D41 25.00	DA42 18.70	DAF91 1.75	DAF96 1.75	DET22 35.00	DET24 49.00	DF91 1.75	DF96 1.75	DK91 1.75	DK92 2.00	DK96 1.75	DL12 2.00	DL19 1.75	DL96 1.75	DL10 1.75	DL15 1.75	DL16 1.75	DL19 1.75	DM70 2.00	DM71 2.00	DM160 4.75	DY87 1.50	DY802 1.50	ES51 45.00	E80CC 8.81	E80CF 11.27	E80L 14.19	E80F 13.73	E80K 8.00	E81L 13.27	E81L 35.48	E82CC 8.10	E83C 8.10	E83C 8.25	E83CC 8.42	E90CC 9.47	E90F 9.90	E91H 6.25	E92C 8.75	E99F 9.10	EF85 1.75	EF86 1.75	EF87 1.75	EF88 1.75	EF89 1.75	EF90 1.75	EF91 1.75	EF92 1.75	EF93 1.75	EF94 1.75	EF95 1.75	EF96 1.75	EF97 1.75	EF98 1.75	EF99 1.75	EF00 1.75	EF01 1.75	EF02 1.75	EF03 1.75	EF04 1.75	EF05 1.75	EF06 1.75	EF07 1.75	EF08 1.75	EF09 1.75	EF10 1.75	EF11 1.75	EF12 1.75	EF13 1.75	EF14 1.75	EF15 1.75	EF16 1.75	EF17 1.75	EF18 1.75	EF19 1.75	EF20 1.75	EF21 1.75	EF22 1.75	EF23 1.75	EF24 1.75	EF25 1.75	EF26 1.75	EF27 1.75	EF28 1.75	EF29 1.75	EF30 1.75	EF31 1.75	EF32 1.75	EF33 1.75	EF34 1.75	EF35 1.75	EF36 1.75	EF37 1.75	EF38 1.75	EF39 1.75	EF40 1.75	EF41 1.75	EF42 1.75	EF43 1.75	EF44 1.75	EF45 1.75	EF46 1.75	EF47 1.75	EF48 1.75	EF49 1.75	EF50 1.75	EF51 1.75	EF52 1.75	EF53 1.75	EF54 1.75	EF55 1.75	EF56 1.75	EF57 1.75	EF58 1.75	EF59 1.75	EF60 1.75	EF61 1.75	EF62 1.75	EF63 1.75	EF64 1.75	EF65 1.75	EF66 1.75	EF67 1.75	EF68 1.75	EF69 1.75	EF70 1.75	EF71 1.75	EF72 1.75	EF73 1.75	EF74 1.75	EF75 1.75	EF76 1.75	EF77 1.75	EF78 1.75	EF79 1.75	EF80 1.75	EF81 1.75	EF82 1.75	EF83 1.75	EF84 1.75	EF85 1.75	EF86 1.75	EF87 1.75	EF88 1.75	EF89 1.75	EF90 1.75	EF91 1.75	EF92 1.75	EF93 1.75	EF94 1.75	EF95 1.75	EF96 1.75	EF97 1.75	EF98 1.75	EF99 1.75	EF00 1.75
------------	-------------	-------------	-------------	-------------	-------------	-------------	-------------	-----------	-----------	--------------	--------------	------------	-------------	-----------	-------------	------------	-------------	-------------	-------------	------------	-----------	-----------	-----------	-----------	-----------	------------	------------	------------	-------------	-------------	-----------	-----------	-----------	-----------	-----------	-----------	-----------	-----------	-----------	-----------	-----------	-----------	-----------	-----------	------------	-----------	------------	------------	------------	-------------	------------	------------	-----------	------------	------------	------------	-----------	-----------	------------	------------	-----------	-----------	-----------	-----------	-----------	-----------	-----------	-----------	-----------	-----------	-----------	-----------	-----------	-----------	-----------	-----------	-----------	-----------	-----------	-----------	-----------	-----------	-----------	-----------	-----------	-----------	-----------	-----------	-----------	-----------	-----------	-----------	-----------	-----------	-----------	-----------	-----------	-----------	-----------	-----------	-----------	-----------	-----------	-----------	-----------	-----------	-----------	-----------	-----------	-----------	-----------	-----------	-----------	-----------	-----------	-----------	-----------	-----------	-----------	-----------	-----------	-----------	-----------	-----------	-----------	-----------	-----------	-----------	-----------	-----------	-----------	-----------	-----------	-----------	-----------	-----------	-----------	-----------	-----------	-----------	-----------	-----------	-----------	-----------	-----------	-----------	-----------	-----------	-----------	-----------	-----------	-----------	-----------	-----------	-----------	-----------	-----------	-----------	-----------	-----------	-----------	-----------	-----------	-----------	-----------	-----------	-----------	-----------	-----------	-----------	-----------	-----------	-----------	-----------	-----------	-----------	-----------	-----------	-----------	-----------

## BASES

B7G unskirted 0.25	B7G skirted 0.35	B9A unskirted 0.25	B9A skirted 0.35	Int A 0.35	Locat 0.55	Nuvistor base 2.00	Valve screening 3JP2 8.00	3JP2 8.00	3JP7 10.00	3KP1 15.00	3KP1 35.00	3WP1 20.00
--------------------	------------------	--------------------	------------------	------------	------------	--------------------	---------------------------	-----------	------------	------------	------------	------------

## CRTS

SADP1 55.00	SCP1A 10.00	SCP1A 40.00	STP15A 45.00	SUP7 25.00	DG7-5 63.32	DG7-3 58.07	DG7-32 58.07	DG7-31 63.32	DG7-11 113.12	VCR97 12.00	VCR138A 12.50	VCR139A 8.00
-------------	-------------	-------------	--------------	------------	-------------	-------------	--------------	--------------	---------------	-------------	---------------	--------------

## VCR517B 10.00

VCR517C 10.00	CRT sockets	Prices on application	L/C sockets	Texas	low profile	8 pin 10p	14 pin 10p	16 pin 10p
---------------	-------------	-----------------------	-------------	-------	-------------	-----------	------------	------------

## INTEGRATED CIRCUITS

7400 0.16	7401 0.16	7402 0.17	7403 0.17	7404 0.18	7405 0.18	7406 0.18	7407 0.18	7408 0.20	7409 0.20	7410 0.20	7411 0.20	7412 0.20	7413 0.20	7414 0.20	7415 0.20	7416 0.20	7417 0.20	7418 0.20	7419 0.20	7420 0.20	7421 0.20	7422 0.20	7423 0.33	7424 0.33	7425 0.33	7426 0.33	7427 0.33	7428 0.33	7429 0.33	7430 0.33	7431 0.33	7432 0.33	7433 0.33	7434 0.33	7435 0.33	7436 0.33	7437 0.33	7438 0.33	7439 0.33	7440 0.33	7441 0.33	7442 0.33	7443 0.33	7444 0.33	7445 0.33	7446 0.33	7447 0.33	7448 0.33	7449 0.33	7450 0.33	7451 0.33	7452 0.33	7453 0.33	7454 0.33	7455 0.33	7456 0.33	7457 0.33	7458 0.33	7459 0.33	7460 0.33	7461 0.33	7462 0.33	7463 0.33	7464 0.33	7465 0.33	7466 0.33	7467 0.33	7468 0.33	7469 0.33	7470 0.33	7471 0.33	7472 0.33	7473 0.33	7474 0.33	7475 0.33	7476 0.33	7477 0.33	7478 0.33	7479 0.33	7480 0.33	7481 0.33	7482 0.33	7483 0.33	7484 0.33	7485 0.33	7486 0.33	7487 0.33	7488 0.33	7489 0.33	7490 0.33	7491 0.33	7492 0.33	7493 0.33	7494 0.33	7495 0.33	7496 0.33	7497 0.33	7498 0.33	7499 0.33	7500 0.33
-----------	-----------	-----------	-----------	-----------	-----------	-----------	-----------	-----------	-----------	-----------	-----------	-----------	-----------	-----------	-----------	-----------	-----------	-----------	-----------	-----------	-----------	-----------	-----------	-----------	-----------	-----------	-----------	-----------	-----------	-----------	-----------	-----------	-----------	-----------	-----------	-----------	-----------	-----------	-----------	-----------	-----------	-----------	-----------	-----------	-----------	-----------	-----------	-----------	-----------	-----------	-----------	-----------	-----------	-----------	-----------	-----------	-----------	-----------	-----------	-----------	-----------	-----------	-----------	-----------	-----------	-----------	-----------	-----------	-----------	-----------	-----------	-----------	-----------	-----------	-----------	-----------	-----------	-----------	-----------	-----------	-----------	-----------	-----------	-----------	-----------	-----------	-----------	-----------	-----------	-----------	-----------	-----------	-----------	-----------	-----------	-----------	-----------	-----------	-----------	-----------

Terms of business: CWO. Postage and packing valves and semiconductors 50p per order. CRTs £1.50. Prices excluding VAT, add 15%.  
 Telephone 01-677 2424/7  
 Telex 946708  
 E. & O.E.  
 Open to callers Monday-Friday 9 a.m.-5 p.m.

Account facilities available to approved companies with minimum order charge £10. Carriage and packing £1.50 on credit orders.  
 Over 10,000 types of valves, tubes and semiconductors in stock. Quotations for any types not listed, S.A.E.

CIRCLE 47 FOR FURTHER DETAILS.



# Oryx

## connect with quality

The Oryx name means a range of soldering tools and accessories designed to meet any modern requirement. Our comprehensive range includes lightweight, cordless rechargeable soldering irons, the famous "Super" and "Viking" standard designs and lightweight and temperature - controlled models. All with a wide selection of tip designs and sizes. The unique Portasol butane gas soldering iron completes the range. Oryx also supply the largest range of SR desoldering tools, including the new anti-static pump, power supply units, safety stands and solder pots.



## Oryx - advanced design at an ordinary price

**GREENWOOD ELECTRONICS DISTRIBUTORS**  
 Toolrange 0734 22245 Reading, S.T.C. Electronic Services 0279 26777 Harlow, Verospeed 0703 641111 Eastleigh, Electroplan 0763 41171 Royston, Engineering and Electronic Supplies 0639 54162 Wales, Cobbies 01-699 2282 London, Buck & Hickman U.K. Anglio Components 0945 63281 Cambridge, E.I.C. Ltd. 0727 36311 St. Albans, Willowvale Electronics 0734 860158 Reading, Longs 09328 61241 Surrey.

Please telephone or write for further information to:  
**Greenwood Electronics** Portman Road, Reading, Berkshire, RG3 1NE  
 Tel: Reading 0734 595844. Telex: 848659

CIRCLE 19 FOR FURTHER DETAILS.

## FUNCTION GENERATOR 0.1Hz-500kHz

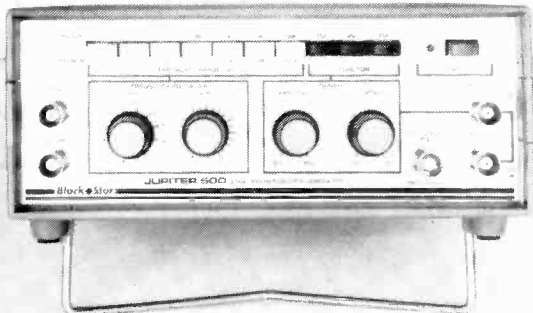

- \* Sine, Square, Triangle, TTL
- \* Accuracy typically 1% of output
- \* Typically 0.02Hz - 700kHz
- \* 7 switched ranges with coarse and fine frequency controls
- \*  $\pm 30V$  output capability
- \* Variable DC offset
- \* External A.M. facility
- \* External sweep facility
- \* Short circuit protection all outputs

**JUPITER 500 (inc. P & P and VAT) £128.80**

Colour leaflet with specifications and prices available from:

BLACK STAR LTD, (Dept. WW) 4 Stephenson Road, St. Ives, Huntingdon, Cambs. PE17 4WJ, England. Tel: (0480) 62440 Telex: 32339



Designed and manufactured in Britain

**Black★Star**

CIRCLE 11 FOR FURTHER DETAILS.

## PPM5

**PEAK PROGRAMME METER  
DRIVE CIRCUIT:  
20-PIN DUAL IN-LINE**

- Vcc 8.5V-35V at 3mA
- Only signal level and meter tolerance presets required
- Applications Note and full specifications on request
- +9dB IBA flasher with Mother Board 3

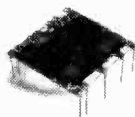

APRS  
STAND  
163

**SURREY ELECTRONICS LTD.**  
 The Forge, Lucks Green  
 Cranleigh, Surrey, GU6 7BG  
 Tel: 0483 275997

CIRCLE 4 FOR FURTHER DETAILS.

## LOGICAL EE/EPROM PROGRAMMERS & ERASERS

**PROMPRO 8 - £775**

Powerful commands, easy communications.

64/128/256k buffer.

Emulation, keypad option.

Programs all EPROMS & MPU's

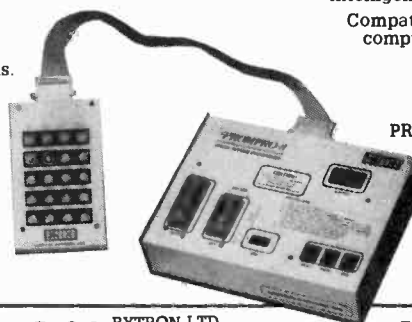

Choose from stand alone, intelligent RS232 units.

Compatible with any computer/terminal.

ERASERS  
FROM £88.00

EPROM PROGRAMMERS  
FROM

£395.00  
(ex VAT)

BIPOLAR & PAL  
- CALL!

**byTRON**

BYTRON LTD.,  
High Street, Kirmington,  
S. Humberside, DN39 6YZ

Tel. 0652 688626  
Telex 527339

CIRCLE 24 FOR FURTHER DETAILS.  
ELECTRONICS & WIRELESS WORLD JUNE 1985

# D.c. supplies from a.c. sources - 5

by K.L. Smith,  
Ph.D.\*

\* University of Kent at Canterbury

## Switched-mode supply design

The brief excursion into s.m.p.s. principles in Part 1 pointed to the tantalisingly high efficiencies in power conversion they promise. This means small sizes and mass in the equipment for a given throughput, but at the cost of a higher component count and r.f.i. problems. Control and drive circuit complications can be overcome to some extent by means of circuit integration, together with good filtering, screening and circuit layout to reduce harmonic interference.

### Circuit development

The three broad categories of s.m.p.s. circuits are often developed further than the simple outline I discussed before. You will find multiple windings on chokes and transformers, with the mains isolation these provide. Consider the flyback converter, which includes a limiting case, the ringing choke converter. Flybacks find the greatest use in low and medium level power supplies and work well for relatively high voltage outputs. Figure 1 offers a rough breakdown of the useful power and voltage ranges obtainable from the various types.

One advantage of the flyback circuit is the ease of obtaining multiple outputs (the rectification is simpler). Disadvantages include the high ripple component in the output and the larger choke required for a given throughput. This is because all the energy has to be stored by the magnetization current flowing in the winding round the core. Of interest is that in the ringing choke case, choke utilization is best.

The semiconductor switch and rectifier diodes have to withstand high peak voltages and currents. Because of these high switching levels, transients and interference tend to be larger in flyback designs.

In comparison, the forward converter delivers power to the output while the switch is 'on'.

The inductor acts as a true transformer and a high throughput can be obtained with a relatively small cross section of core. The circuit is suitable for medium and high powers at low output voltages. One disadvantage is the requirement for a second inductor to store the energy over the 'off' period — tending to put up the cost. But this is compensated by the resulting low ripple component in the output, which requires a less stringent filter. Another slight disadvantage is the need to recover the magnetization current (or rather, energy) in the transformer core during the 'off' period. Unlike in the flyback circuit, the magnetizing current does not form part of the output. In practice, a similar recovery circuit is also used in a flyback s.m.p.s. for safety, to limit spikes and return the magnetization energy if the load is removed.

The inductance of the main transformer in a forward converter is kept high to minimize the magnetizing current. A rule of thumb is to aim for  $I_m$  to be about 10% of the load current.

The third circuit technique uses push-pull or bridge connections in the switching stage. There is a number of versions of these, including half bridge or full bridge designs. The switch drive circuits are necessarily more complex to cope with all the transistors going on and off in the right sequence, but you can obtain high and very high throughput powers, (Fig. 1.) The transformers are magnetized in both directions, since the push-pull action reverses the current, which means that a maximum flux swing can be obtained for a given core.

### Flyback converter

Figure 2(a) is a two-winding choke version of the circuit. Figure 2(b) shows the waveforms when operating. You might think that L looks like a transformer, but in the flyback circuit it actu-

ally works as two 'chokes' because only one winding conducts at any given time. It operates on a 'bucket-brigade' principle: the primary choke stores the energy, some of which is extracted later by the secondary at a different pressure and quantity level, according to the turns ratio. The other quantity which adjusts the relative levels is the duty cycle  $\delta$ , of the switching waveform, the amount of energy stored during the 'on' time varying with  $\delta$ . The rest of the period is available to abstract this variable amount of stored energy.

The third winding on L with  $D_3$  is the one that returns any stored energy with nowhere else to go, back to the primary source. This limits the voltage peaks across the transistor.

A simple analysis of how the circuit operates clarifies the picture and yields design information. To start, there are a few assumptions to simplify things. One is that the inductance of the windings on L is large enough to prevent current falling to zero during the 'off' period. (It falls to zero in the ringing choke converter). Given L, you will find there is a certain minimum current,  $I_{o(min)}$  to satisfy this requirement. As we saw in article 2, designers write down a quantity called  $\eta$  for

Fig.1. Voltage and power output obtainable from the three main classes of switched-mode supply.

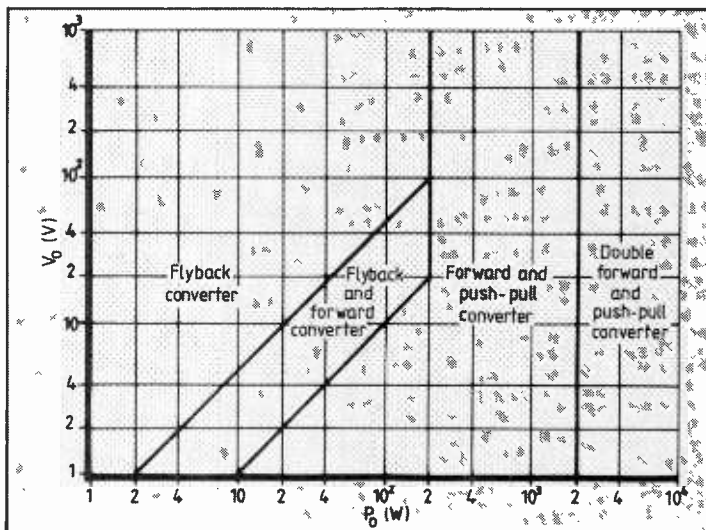

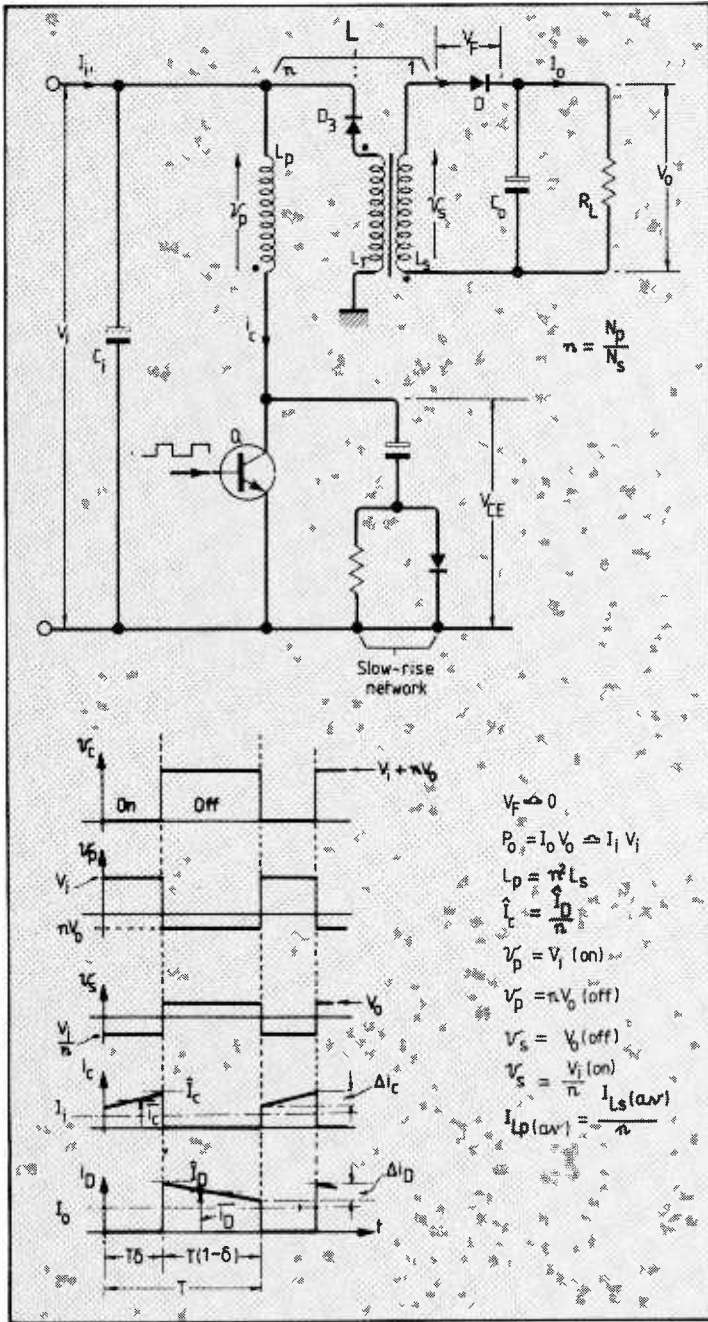

Fig. 2. Two-winding choke type of flyback converter at (a). Operating waveforms are shown at (b).

a choke or transformer, such that

$$\eta = \frac{I_{o(\min)}}{\text{MAXIMUM } I_o}$$

Another assumption made is linear growth and decay of currents in the windings on L. As you know, switching transistors take a finite time to operate, but assume they are very fast for the moment. More detailed investigation of the current commutation effects and to rise and fall times at the switching edges is a little complex and will stretch your reasoning. Designers have to consider these effects for peak and average switching loss calculations.

The voltage across any winding carrying a current  $i$  is

$$v = L \frac{di}{dt}$$

if L is its inductance. The linear current ramps in L's windings mean constant  $di/dt$ 's. I have defined all the quantities 'by implication' in Fig. 2. So from these we can write:-

$$\frac{di}{dt} = \frac{\Delta i_c}{T\delta} = \frac{\Delta i_D}{(1-\delta)T}$$

$$\therefore \Delta i_c = \frac{V_i T \delta}{L_p}$$

and

$$\Delta i_D = \frac{V_o(1-\delta)T}{L_s}$$

Referring everything to the input side by using  $\Delta i_D = \eta \Delta i_C$  and  $L_s = L_p/n^2$  enables us to eliminate T, the inductances and  $\Delta i_C$ ,  $\Delta i_D$  from the previous two equations. This yields,

$$V_o = \frac{V_i}{n} \cdot \frac{\delta}{1-\delta} \quad (1)$$

Equation 1. shows that the volt-seconds product in the choke sums to zero over one cycle. In particular, it also shows that  $V_o$  depends on the duty cycle parameter  $\delta$  as well as on the usual 'transformer' turns ratio  $n:1$ .

As you can see from  $v = L di/dt$ , to keep  $v$  constant over the 'off' period, L must be sufficiently large. This is to make  $di/dt$  slow enough to keep the diode current going throughout the period. As I mentioned, if  $i_D$  does fall to zero, we have the ringing choke condition.

Again working in terms of quantities from Fig. 2 reflected into the primary circuit, you can find  $L_{p(\min)}$  to avoid the ringing choke condition. By equating areas on the  $i_D$  graph,

$$i_D = I_o \frac{1}{1-\delta}$$

Now from this result, if the output current just reaches zero, then the peak value,  $\hat{I}_D$ , will just reach,

$$2 \frac{I_o}{1-\delta}$$

As an aside, this gives a useful result for the peak current in the rectifier diode. For example if  $\delta = 0.5$  the worst case  $\hat{I}_D = 4I_o$ . In other words, the repetitive peak forward current,  $I_{FRM}$  rating of the diode must be equal to or greater than  $4I_o$ .

$$2I_o/(1-\delta)$$

will also be the change  $\Delta i_D$  under the conditions of minimum inductance.

$$\therefore \Delta i_D = \frac{V_o(1-\delta)T}{L_{s(\min)}} = \frac{2I_o}{1-\delta}$$

(where  $I_o$  should strictly be written  $I_{o(\min)}$  here.) We know

$$\delta = \frac{n V_o}{V_i + n V_o}$$

from Equation 1.

$$\therefore 1-\delta = \frac{V_i}{V_i + n V_o}$$

Also,  $I_o = P_o/V_o$  where  $P_o$  is the output power. Together with this, of course,

$$I_{o(\min)} = \frac{P_{o(\min)}}{V_o}$$

Inserting these quantities and solving for  $L_{s(\min)}$  gives:

$$L_{s(\min)} = \frac{V_o^2(1-\delta)^2 T}{2 P_{o(\min)}} = V_o^2 \left( \frac{V_i}{V_i + n V_o} \right)^2 \frac{T}{2 P_{o(\min)}}$$

Or in terms of  $L_{p(\min)}$ :

$$L_{p(\min)} = \left( \frac{V_i \eta V_o}{V_i + \eta V_o} \right)^2 \frac{T}{2 P_{o(\min)}} \quad (2)$$

You can see that there is a definite  $I_{O(\min)}$  for constant  $V_o$  given  $L_{p(\min)}$ . Your semiconductor switches must withstand peak values  $\hat{I}_C$  and  $\hat{V}_{CE}$  in this application. Finding  $\hat{I}_C$  is fairly simple:

$$\hat{I}_C = I_{Lp(\text{ave})} + \frac{\Delta i_c}{2}$$

By reflecting through the  $n:1$  transformer ratio again, this can be written:

$$\hat{I}_C = \frac{I_{Ls(\text{AVE})}}{n} + \frac{\Delta i_D}{2n} = \frac{I_o}{n(1-\delta)} + \frac{V_o(1-\delta)nT}{2L_p} = P_o \frac{V_i + nV_o}{V_i n V_o} + \frac{T}{2L_p} \frac{V_i n V_o}{V_i + nV_o} \quad (3)$$

Finally, for the peak collector to emitter voltage:

$$\hat{V}_{CE} = V_i + n V_o \quad (4)$$

These equations express general, or average operation. It is the worst case conditions that would see off your devices.

The worst case will occur if  $P_{o(\min)}$  is being drawn when  $V_i$  is equal to  $V_{i(\max)}$ .

$$\hat{V}_{CE(\max)} = V_{i(\max)} + n V_{o(\max)}$$

and the constraint on  $L_p$  is:

$$L_{p(\min)} \geq \left( \frac{V_{i(\max)} n V_o}{V_{i(\max)} + n V_o} \right)^2 \frac{T}{2 P_{o(\min)}} \quad (2a)$$

On the other hand,  $\hat{I}_{C(\max)}$  will occur when  $P_o$  is running at the maximum demand, coincident with the lowest  $V_i$ .

$$\hat{I}_{C(\max)} = P_o \left( \frac{V_{i(\min)} + n V_o}{V_{i(\min)} n V_o} \right) + \frac{T}{2L_p} \left( \frac{V_{i(\min)} n V_o}{V_{i(\min)} + n V_o} \right) \quad (3a)$$

In order to keep  $V_o$  constant with varying  $V_i$ ,  $\delta$  will have to change.

$$\delta_{\min} = \frac{n V_o}{V_{i(\max)} + n V_o}$$

$$\delta_{\max} = \frac{n V_o}{V_{i(\min)} + n V_o}$$

The 'd.c.' value  $V_i$  will be at maximum when the mains supply is high and the peak of the 100Hz ripple from the primary full-wave rectification. Conversely,  $V_{i(\min)}$  will occur with a low mains input together with the trough of the 100Hz ripple. If the maximum mains r.m.s. voltage is 265 volts, the  $V_{i(\max)}$  might reach 375 volts d.c. If the ripple amplitude is, say, 25 volts peak to peak, then when the mains is low at 190 volts  $V_{i(\min)}$  will be about 244 volts.

### Forward converter

The circuit and waveforms given in Fig.3. enable you to understand the operation in a similar way to the flyback converter. I won't go through the analysis, as space hardly permits such a duplication, but to quote a cliché 'it is left as an exercise for the student'. A brief note of a few details about the circuit operation and a quotation of the results for comparison should help anyone to derive the formulae.

The magnetic component T, operates as a true transformer. With Tr 'on',  $D_1$  is on and energy is passed through from the input. Some is stored in L, some flows on to the output load. When T turns off, primary and secondary currents,  $i_c$  and  $i_{D1}$  cease. The voltage  $v_L$  across the choke reverses, diode  $D_1$  goes off and 'flywheel diode'  $D_2$  comes on. The current in choke L 'commutes' from  $D_1$  to  $D_2$ . The magnetizing current in the transformer would also stop flowing, since no path now exists for it in the primary or secondary circuits. An extremely high voltage inductive 'kick' would occur across T. Therefore the energy recovery winding with  $D_3$  is essential in this form of converter.  $D_3$  limits  $v_{CE}$  to  $2V_i$  by returning the stored magnetic energy to the source.

The designer must consider two limiting requirements. The transformer core should reach zero magnetization in less time than the 'off' period of the switching, so that the circuit starts the

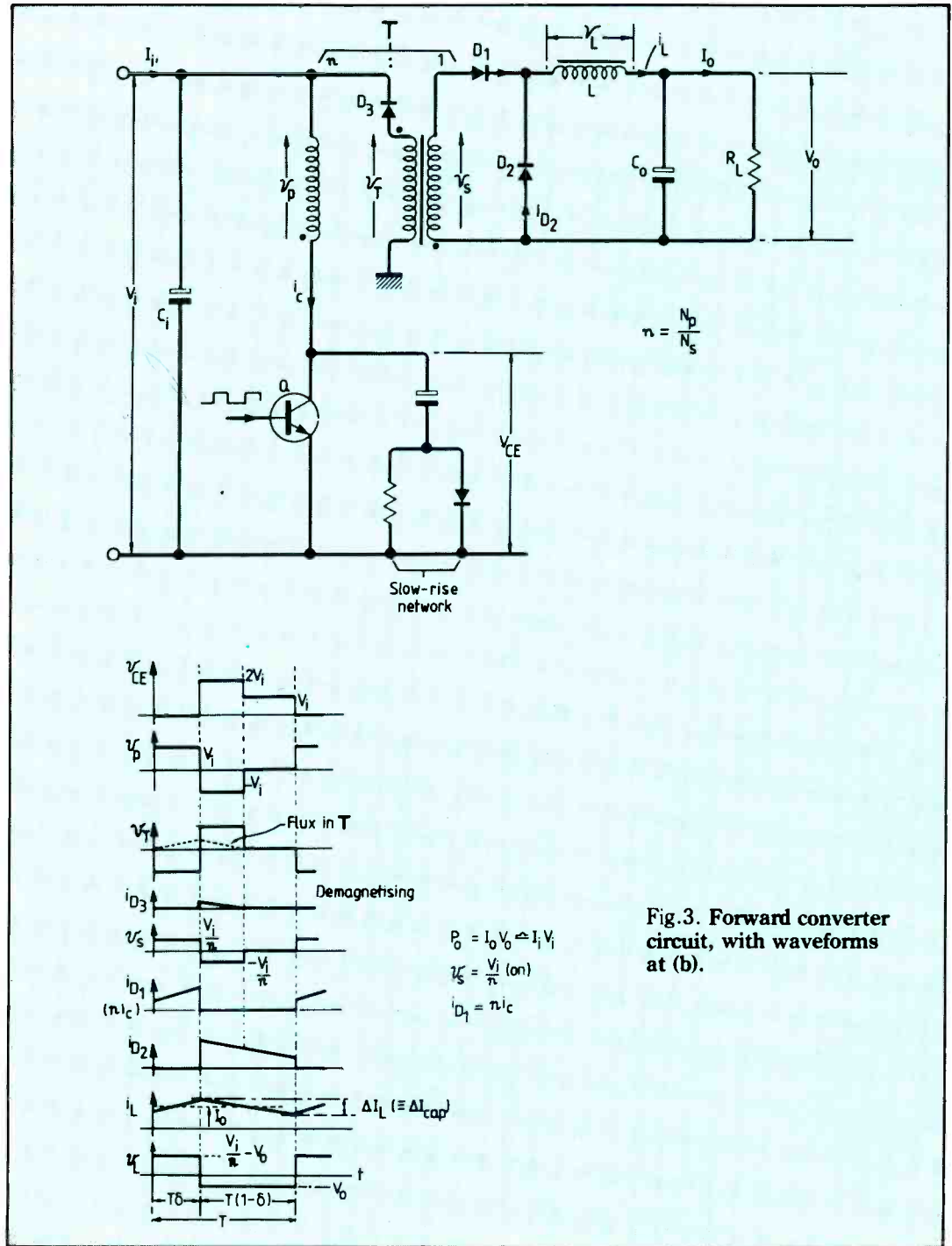

Fig.3. Forward converter circuit, with waveforms at (b).

next cycle with a clean slate, as it were. The choke L should be large enough to keep the current going during the 'off' period, for a similar reason to that given for the flyback converter. As you can see, current flows through a sufficiently large L all the time. In fact it ramps gently (and linearly...) up and down. This means the ripple duty for  $C_o$  is much less stringent than the corresponding filter component in the flyback circuit, where bursts of current arrive followed by nothing for a while.

In a similar argument for Equation 1. you can show  $V_o$  and  $V_i$  relate as:

$$V_o = \frac{\delta V_i}{n} \quad (5)$$

The criterion for the design of T is to make its winding inductance large enough to keep the magnetizing current small compared to the load currents. The energy storage inductor L has a certain minimum value  $L_{\min}$ , which will keep the current going, down to a stipulated minimum current out,  $I_{o(\min)}$ . With a similar approach to Equation 2. for the flyback circuit:

$$L_{\min} = \frac{V_o^2 T}{2 P_{o(\min)}} \left(1 - \frac{n V_o}{n_i}\right) \quad (6)$$

$\hat{I}_c$  is also found in a similar way:—

$$\hat{I}_c = \frac{V_o T}{2 L} \left(1 - \frac{n V_o}{n_i}\right) + \frac{P_o}{n V_o} \quad (7)$$

Finally  $D_3$  clamps  $\hat{V}_{CE}$  to  $2V_i$ ,

$$\hat{V}_{CE} = 2 V_i \quad (8)$$

Precisely similar arguments as before will give you the 'worst-case' magnitudes the devices would have to handle in practice.

### Will the transformer handle the power?

Always central to power supply design is the question of whether your transformer will burst into



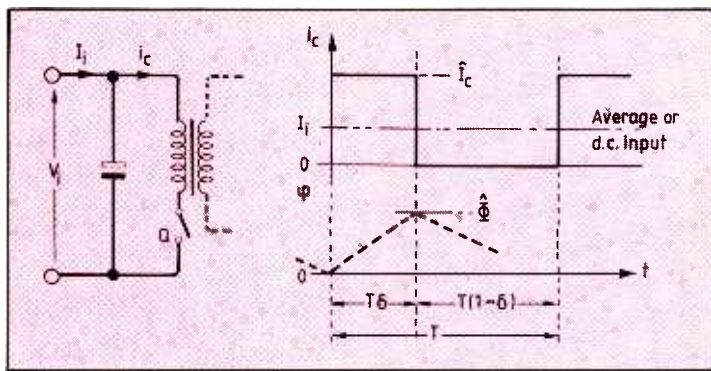

Fig. 4. D.C. pulse drive in a forward-converter transformer.

flames. The inductors in s.m.p.s. systems are no exception. We hope their power to weight ratio will be very good, but they must still handle the VA. Because forward converters and flyback circuits deal with the throughput in different ways, we must consider the inductors accordingly. Designing flyback chokes is quite involved and I have relegated the discussion of these to an appendix, (always assuming the Editor can find room for it...) (next article - Ed.)

The throughput performance of a forward converter transformer is reasonably simple to analyse; you can try your hand with the flyback choke later. However, we cannot get away with only the simple forward converter or push-pull transformer design. Both of these circuits require energy storage chokes in addition to the transformers. The choke design requires the full 'flyback-type' analysis — complete with the appropriate parameter,  $\eta$ .

### Forward converter transformer.

I will draw on the discussion we had in Part 2, especially details given in the appendix there. In particular, it all starts with:

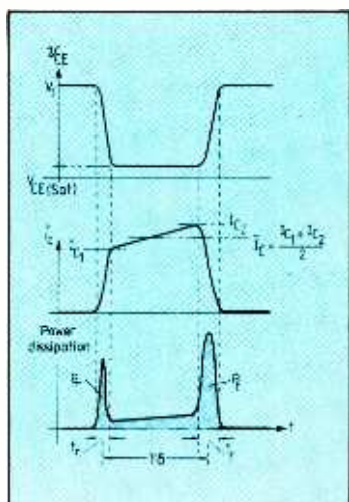
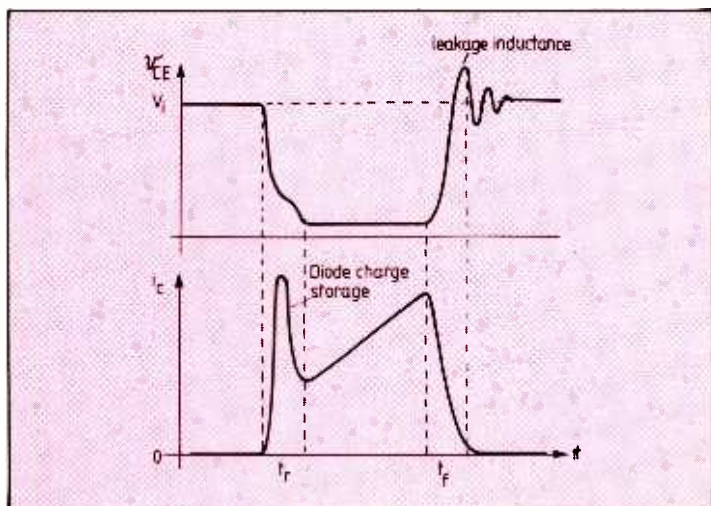

Fig. 5. Calculating losses due to finite switching times.

Fig. 6. Modified waveforms caused by reactances in a practical circuit.



VA = ampere-turns  $\times$  volts per turn

The true transformer action in the forward converter means that magnetizing currents can be ignored for the moment. They can be checked at a later stage in the design. The d.c. pulse drive is illustrated in Fig. 4, from which, the peak primary current is:

$$I_1 = \frac{I_c}{\delta} \quad (9)$$

R.m.s. current  $I_c$  is given by:

$$I_c = \left[ \frac{1}{T} \int_0^{T\delta} I_c^2 dt \right]^{1/2} = I_c \sqrt{\delta}$$

or in terms of  $I_1$ :

$$I_c = \frac{I_1}{\sqrt{\delta}} \quad (10)$$

The transformer efficiency is high (about 96%) which means:

$$VA_{(in)} = VA_{(out)}$$

Equations A5 in Part 2 give the resistance of the windings. Equations A6 built up a picture of current density in the copper and power dissipation. We can quote via Equation A6(a):

$$P_w = 2\rho_c m I_d^2 A_w F_p l_w \quad (11)$$

The rate of change of magnetic flux gives the volts per turn:

$$\frac{V_1}{N_p} = \frac{d\phi}{dt}$$

where the linear rate of change of flux  $d\phi/dt$  is simply  $\Phi/T\delta$  from Fig. 4.

$$\frac{V_1}{N_p} = \frac{\Phi f}{\delta} \quad (12)$$

And from Equations 10 and 12 we obtain:

$$VA = V_1 I_1 = \sqrt{\eta} I_d A_w F_p \times \frac{\Phi f}{\delta}$$

where  $I_c$  has been replaced by the current density  $I_d$  times the effective copper area,  $A_w F_w^{1/2}$  of the primary winding, the number of turns,  $N_p$ , cancelling. Now substitute for  $I_d$  from Equation 11:

$$VA = \left( \frac{P_w A_w F_w}{\rho_c m l_w} \right)^{1/2} \frac{\hat{B} A_{core} f}{2\sqrt{\delta}} \quad (13)$$

Or writing in terms of the cooling surface,  $A_c$ , and the heat transfer,  $P_h$  (see Part 2) Equation 13 becomes:

$$VA = \left( \frac{2F_w A_w A_c P_h}{3\rho_c m l_w} \right)^{1/2} \frac{\hat{B} A_{core} f}{2\sqrt{\delta}}$$

Looking at this result, you can see that the throughput VA is a minimum (or temperature rise is maximum for a given VA) when  $\delta$  is at its maximum value, 0.5 — together with minimum  $V_1$ ,  $V_{i(min)}$

minimizes  $\hat{B}$  and so we have the smallest numerator divided by the largest denominator in Equation 13. Hence the throughput conditions are explained.

**Design note.** In practice, you would calculate the windings from the minimum supply voltage and maximum  $\delta$  ( $=0.5$ ) conditions. The volts per turn for the three types of converter work out as:

forward converter  $\frac{V}{N} = 2f\Phi$

flyback converter  $\frac{V}{N} = \frac{4f\Phi\eta}{1+\eta}$

push-pull circuit  $\frac{V}{N} = 4f\Phi$

Some d.c. flux will occur in a forward converter transformer core — and might occur in an unbalanced push-pull circuit. A slight reduction in your chosen  $\Phi$  can be made to take this into account.

Chokes carrying d.c. such as those in the flyback converter and the smoothing chokes in forward converter and push-pull circuits, require some thought. The d.c. component biases the flux in one direction and the relatively small alternating swings go round and round a minor hysteresis loop. The incremental permeability might very well be much less than the amplitude permeability we have assumed to apply. The inductance is optimized by using an air gap in these cases, since a gap in the magnetic circuit can increase the incremental permeability. The best approach would be for you to use the appropriate Hanna curves for the chosen core.

### Switching to new endeavours

The efficiency of conversion will only remain high if you endeavour to keep down the dissipation in the switches as well as the transformers. The primary switch has been bipolar transistors, but power fets are challenging this position. We can look upon the steering and rectifier diodes as secondary switches. In all of them, time is required to turn on and off. Especially in the diodes, charge storage can cause trouble at turn-off.

While the current rises through the switches at turn-on, the previously high voltage across the devices has to fall rapidly. The power dissipation is high during the rise and fall times but, averaged over a whole period, the fractional energy lost can be quite small.

There is always an offset, or forward saturation voltage across semiconductor devices. The 'on' period dissipation arises through the product of this voltage with the saturation current. The time taken by the switching edges is so short that they are a tiny fraction of the steady periods of the cycle. The fraction of time a particular device is 'on' and dissipating steadily changes with  $\delta$ . You can see that operating at higher frequencies increases the switching edge average losses, as there are more of them per second, but the 'on' dissipation remains steady. If you consider a simplified set of switching waveforms, for example those shown in Figure 5, a loss estimate is straightforward. The 'on' dissipation is the average on current, multiplied by  $V_{CE(sat)}$  over period  $nT$ , averaged over the whole period  $T$ :

$$P_{on} = \delta \frac{I_{c1} + I_{c2}}{2} V_{CE(sat)} \quad (14)$$

The approximately linear rise and fall ramps on the switching edges makes for a simple integral of the following form. At switch on:

$$v_{CE} = -\frac{V_i}{t_r} t + V_i$$

and

$$i_c = \frac{I_{c1} t}{t_r}$$

The energy dissipated and averaged over the period  $T$  is:

$$P_r = \frac{1}{T} \int_0^{t_r} v_{CE} i_c dt = -\frac{1}{T} \int_0^{t_r} V_i I_{c1} \left(1 - \frac{t}{t_r}\right) \frac{t}{t_r} dt = \frac{V_i I_{c1} t_r}{6T} \quad (15)$$

Similarly at turn off:

$$P_f = \frac{V_i I_{c2} t_f}{6T} \quad (16)$$

The sum of these powers gives the total dissipation in the switch:

$$P = P_{on} + P_r + P_f = \delta \frac{I_{c1} + I_{c2}}{2} V_{CE(sat)} + \frac{V_i}{6} (I_{c1} t_r + I_{c2} t_f) f_s \quad (17)$$

where I have written  $f_s$ , the switching frequency, for  $1/T$ . You can see from this that the power lost is proportional to the frequency  $f_s$ . Fast rise and fall times are required in the devices

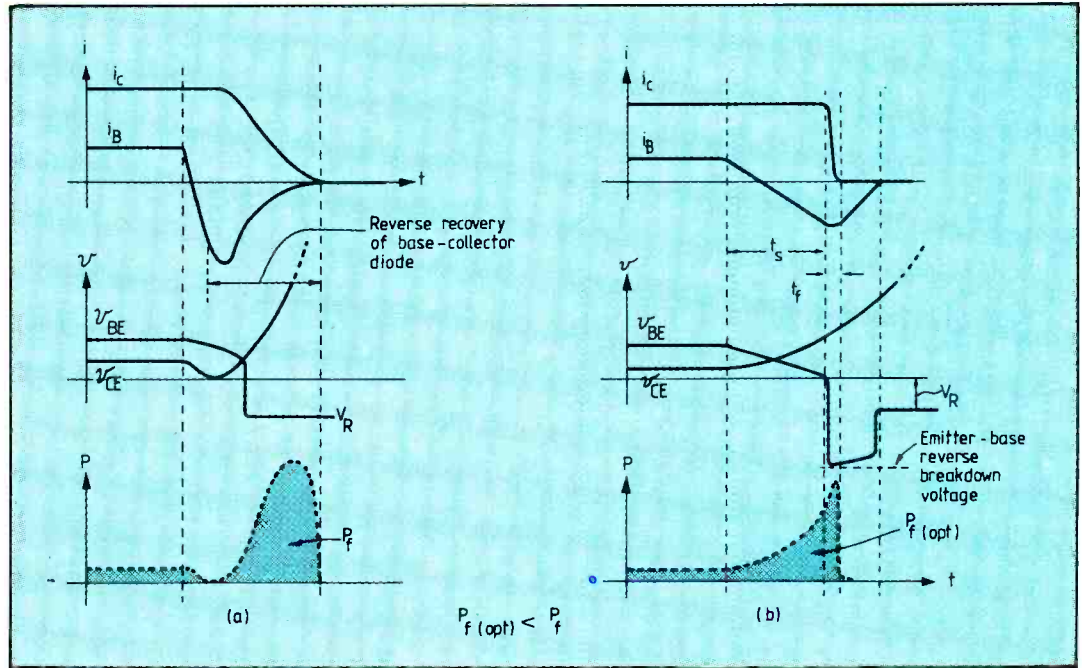

Fig. 7. Minimizing loss of power during transistor turn-off. Rapid turn-off of collector current at (b) produces optimum result.

to minimize  $t_r$  and  $t_f$ , and a low saturation voltage  $V_{CE(sat)}$ .

The estimate for  $P$  is optimistic and applies best to switching in resistive circuits. S.m.p.s. circuits are anything but resistive: there are additional effects from leakage inductance, charge storage in the diodes and capacitances charging and discharging. The transient losses are likely to be worse than the simple analysis shows. Typical waveforms in s.m.p.s. circuits are shown in Fig. 6.

#### Optimising $t_r$ and $t_f$

The problems of getting the switching transistor to turn off quickly include the need to prevent the emitter-base junction losing con-

trol. If this happens, the charge stored in the base-collector junction causes energy dissipation over a long time with high loss. The trajectory of the operating point at turn off must be arranged to avoid the dangerous second breakdown region of the devices. The slow rise network ensures this, see Fig. 3.

Stored charge must be taken out via the base-emitter circuit. The current  $i_c$  remains constant during the time this occurs in a correctly designed circuit, then snaps off quickly. The  $V_{CE}$  edge has begun to rise, but overall the power lost,  $P_f$ , is minimized. Figure 7 shows the two possibilities: the required base drive waveforms to achieve the desired result are shown. A series induc-

Fig. 8. Optimum turn-on waveforms at (b), while (a) shows result without extra  $i_b$  pulse.

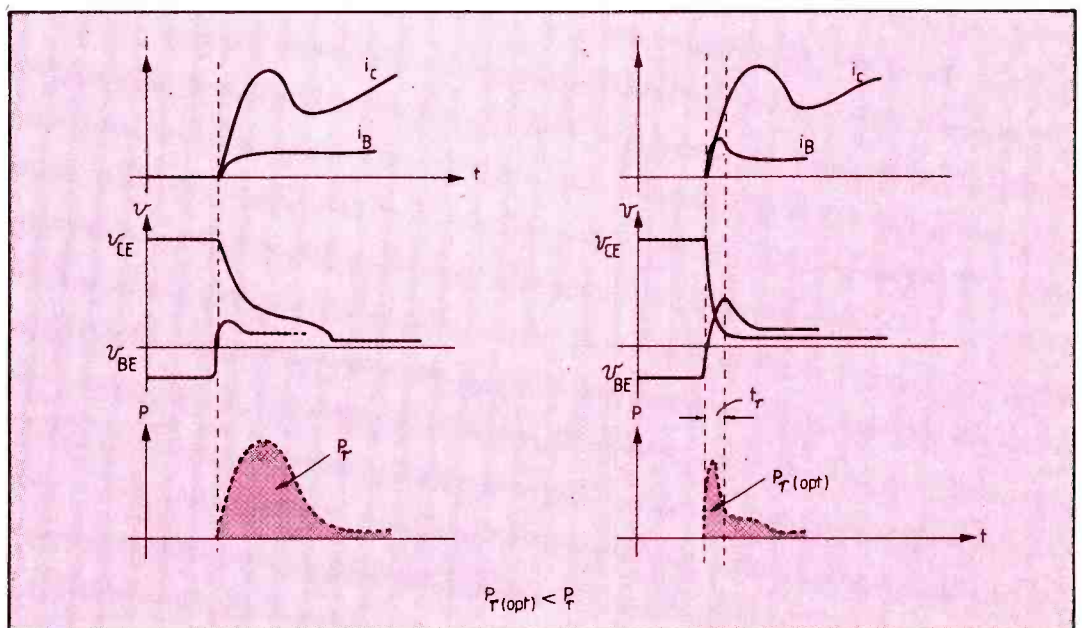



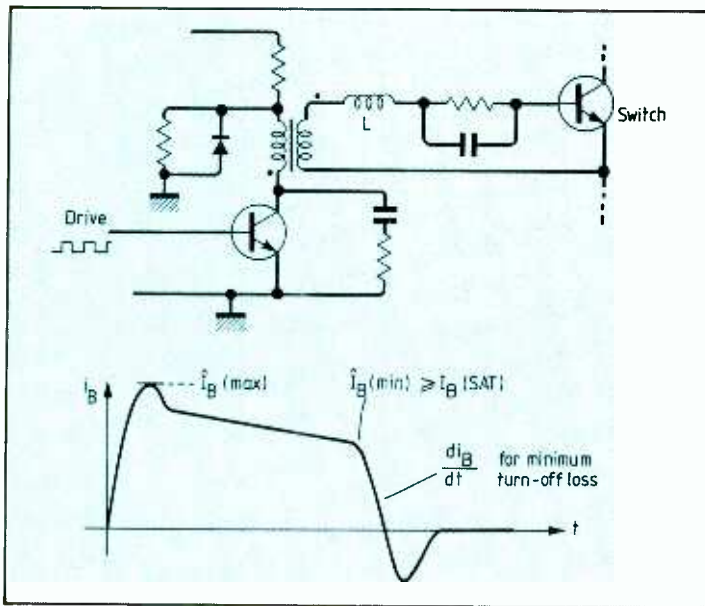

Fig. 9. One type of base drive to obtain optimum switching.

tor is used to store energy to form the waveshapes at switch off.

During switch on, the base current drive must rise above the  $I_{B(sat)}$  level in order to flood the base-collector region with injected charge. This produces a fast rise in  $i_c$  and minimizes  $t_r$ . The extra pulse of base current at turn on is usually obtained from a capacitor. Figure 8 shows the rising edge of current at switch on for two conditions. The kind of results that can be achieved in practice are impressive: for instance, special s.m.p.s. transistor type BUS13 switching directly rectified and smoothed 230 volt mains in a forward converter, can handle a maximum throughput of 1000 watts at 20kHz switching rate. The BUS13 has an  $I_{C(sat)}$  of 10 and a  $V_{CEO}$  of 400 V. Its makers state that test results gave  $< 1\mu s$  for the turn-on time and typically

40ns for  $t_r$ , with the 'off' storage time  $t_s$ , less than  $3\mu s$ , (Figs 7 and 8). You would have to exercise some caution because, as I have shown, the switching times can be very circuit dependent.

To achieve circuit optimization of the switching characteristics, you will come across base drive arrangements such as that shown in Fig. 9 which also illustrates the desired base current waveform it provides.

## Rectifiers

There was a hint earlier that unless you choose carefully, diodes can cause trouble in high-speed switching circuits. At turn-on, the depletion layer in a p-n junction has to be flooded with charge. This is called forward recovery and lifts the voltage drop (and therefore the power dissipation) slightly. Things are worse at turn-off: charge storage can cause a big increase in power loss and transients. Typical waveforms for an ordinary double-diffused diode are shown in Fig. 10. The diode cannot support any reverse voltage until the reverse current reaches its peak. Then reverse voltage increase rapidly while the remaining reverse current sweeps out the remnants of stored charge  $Q_s$ . This accounts for the pulse of energy dissipation shown in (b). The usual forward  $V_F$  times  $I_F$  dissipation is also occurring and by adding up the total over one cycle, you can calculate the heat sinking requirement for the diode, if any, to remove the waste watts in your particular application.

Fig. 10. Waveforms in the diodes. Power pulse at (b) is caused by stored charge remaining after peak of reverse voltage.

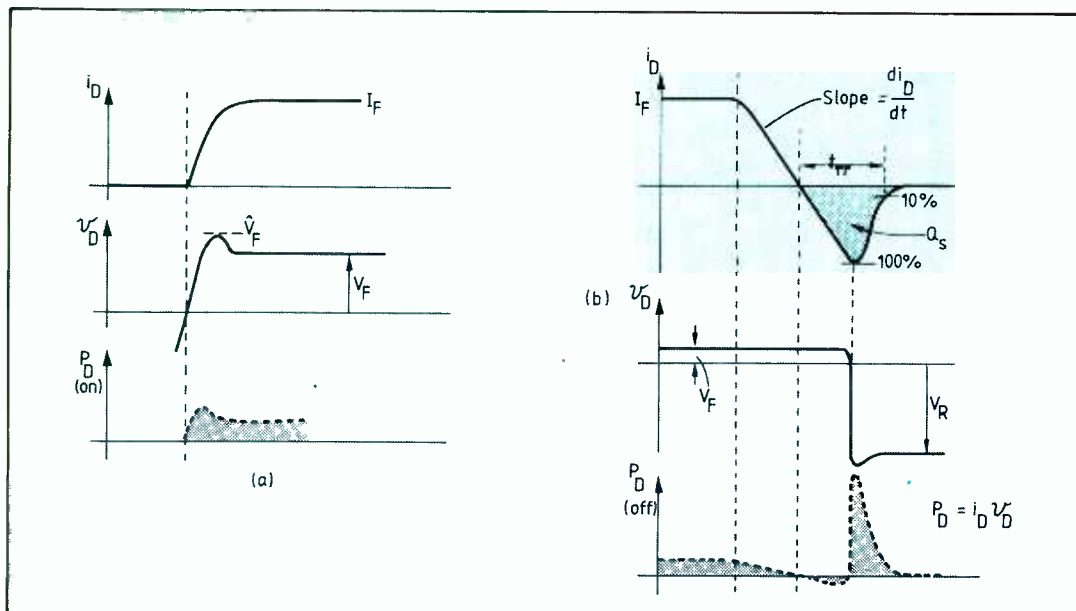

The reverse current pulse has ramifications elsewhere. The transformer winding is effectively short circuited by the diode in the first part of  $t_{rr}$ : the current pulse is reflected through to the main switch (see Fig. 6) and increases the dissipation there. All in all, very fast recovery epitaxial diodes should be chosen for this duty. For example, a BYW30 has a  $t_{rr}$  less than 35 ns and a stored charge,  $Q_s$ , less than 15nC. Figure 11 compares an ordinary diode with one from the BYW series. As a bonus, these diodes also tend to have a lower forward voltage drop,  $V_F$ .

## Output filtering: just a capacitor?

There is further trouble if we take the well known smoothing capacitor techniques from 50Hz linear supplies and apply them to s.m.p.s. systems without thought. Figure 12 illustrates a straightforward s.m.p.s. output circuit, with the real equivalent circuit of the filter capacitor. At 100Hz say, the e.s.l. has negligible effect, but consider 50kHz...? Also, very high peak currents can occur in an s.m.p.s. and the e.s.r. becomes significant. The upshot of all this is that it is difficult to get ripple components down in switching systems. The capacitors have to be carefully designed for this service. They tend to be expensive — and any old electrolytic won't do.

The forward converter shown in Fig. 12 supplies a sawtooth current wave whose mean value is  $I_o$ . The variable component flows through the capacitor and its parasitic series components. If we know the value of this ripple current, then the ripple voltage amplitude is easily calculated. Fig. 13 shows the current waveform  $i_{cap}$ , and the resultant peak to peak voltages across the e.s.r., e.s.l. and capacitor itself. These voltages are found as follows.

A glance at Fig. 3 with linear current ramps again, enables you to write down the peak to peak ripple current as:—

$$\Delta I_L = \Delta I_{cap} = \frac{(V_i - V_o) T \delta}{L}$$

But from Equation 5:

$$V_o = \delta \frac{V_i}{n}$$

$$\therefore \Delta I_{cap} = \frac{(V_i - n V_o)}{f L V_i} V_o$$

Continued on page 79

# DATAMAN ORIGINALS...

**GANG-OF-EIGHT** is our FAST EPROM PROGRAMMER which handles CMOS or NMOS EPROMS from 2716 to 27256 (25XX too) using FAST or NORMAL programming methods.

FAST programming 27128's takes 2 minutes, NORMAL programming takes 14. All possible levels of Vpp are covered including 25, 21 and 12.5 volts. G8 has an LCD which tells you what you're doing — or doing wrong. BLANK CHECK, VERIFY and CHECKSUM facilities are included. Good value. . . . . **£395**

**GANG-OF-EIGHT-PLUS** is now available. PLUS what? Well, PLUS an RS232 INTERFACE which lets you download in INTELHEX, MOTOROLA S, TEKHEX, ASCII, SIMPLE HEX etc. . . . . **£445**

Oh, yes, PLUS 50 quid too, but you might think it's worth it . . . . . **£445**

## EPROM PROGRAMMERS



## EMULATOR/EDITORS



**SOFTY 2**, our intelligent EPROM PROGRAMMER/EMULATOR, plugs into a TV, shows you memory and lets you TEXT-EDIT in HEX (INSERT, DELETE, SHIFT BLOCKS without overwriting or rewriting etc). It also calculates ADDRESS-OFFSETS in hex, UPLOADS and DOWNLOADS in SERIAL and PARALLEL, saves programs on TAPE, and PROGRAMS, COPIES and EMULATES EPROMS 2716, 2732 and 2532. Great DEVELOPMENT TOOL for PIGGY-BACK SINGLE-CHIPPERs and other small microsystems. TV lead, ROMULATOR-cable with 24 pin DIL Plug and power supply included, ready to plug-in and use . . . . . **£195**

**2764 and 27128 ADAPTOR** lets SOFTY 2 handle larger EPROMS for . . . . . **£25.00**

## Z80 DEVELOPMENT TOOLS

**MENTA** is a Z80 development system designed by DATAMAN for the SCHOOLS COUNCIL. MENTA has a built in ASSEMBLER and TV hex display: it lets you enter program in hex or mnemonics and execute them FULL SPEED or A STEP AT A TIME. All the REGISTERS and the STACK are displayed on-screen and you can SEE MEMORY CONTENTS CHANGING as instructions are executed. MENTA is a microsystem with 24 bits I/O — it can be used as a controller for ROBOTS and intelligent machines. MENTA appears in GCE syllabuses; a TEACHER'S GUIDE, PUPIL READER and WORKSHEETS are available — also CONTROL MODULES — UNIVERSAL I/O, A to D, D to A, MOTOR and VARIABLE SWITCHED INPUT for less than £20 each. A MENTA with TV flylead and power-supply costs . . . . . **£99**

**MICRODOCTOR** is for DIAGNOSIS, finding troubles in microsystems. You just plug into the micro-processor socket, READ and WRITE to the MEMORY and I/O. MD does CHECKSUMS, RAMTESTS on memory, checks for SHORTS on the bus, and prints memory in HEX or ASCII. You can also DISASSEMBLE and print the SOURCECODE in Z80, 6502, 6800 or 8085 mnemonics.

When your SCOPE or MULTIMETER can't find the problem — consult the MD. When you order say which processor or ask about multiprocessor MD . . . . . **£295**

## MICROSYSTEM TESTERS



## CONNECTIVITY TESTERS

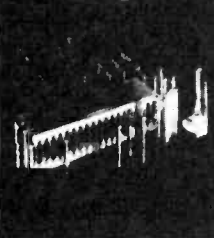

**I.C.T.** (Intelligent Connectivity Tester) is the project name for a 40 pin dual-in-line CUSTOM-CHIP developed by DATAMAN.

The chip is called the MT72017 and it will appear soon in BARE-BOARD TESTERS, IDC CABLE TESTERS and LOOM ASSEMBLY EQUIPMENT all over the world. An EVALUATION-SYSTEM/CONTROLLER for the MT72017 is available on a EUROCARD and you can BUILD YOUR OWN custom connection-pattern tester for . . . . . **£295**

The controller has full documentation, source-code, circuit diagram, parts-list and a description of operation. Each MT72017 tests 26 points and a single controller will handle hundreds of 'em — thousands of test-points.

MT72017 chip prices: **£12.50** (1 to 99) **£11.25** (100-999) **£10.25** (1000 up). We do not sell samples of the MT72017 without a controller.

**LOGIC ANALYSER TA2080** by THANDAR with SPECIAL MODS by DATAMAN which gives RS232 interface and prints TIMING and STATE diagrams — and DISASSEMBLES Z80, 6502, 6800 code on the screen or printer.

THANDAR TA2080 . . . . . **£1950** DATAMAN RETROFIT . . . . . **£295**

**EPSON AND NEC COMPUTERS** QX10, HX20 and PX8, PC8800. ALL COMPUTERS are sold with a free bundle of useful software written by DATAMAN.

**OLIVETTI TYPEWRITER INTERFACES** designed by DATAMAN for ET121 and 221 — cheaper than a DAISYWHEEL printer RS232, HPIB (IEEE) and PARALLEL including fitting. . . . . **£195**

**EPROM ERASERS** from. . . . . **£39.00**

## LOGIC ANALYSERS

## CP/M COMPUTERS

## OLIVETTI INTERFACES

If you need more data send for a FREE LIT-PACK and an ORDER FORM or, better still, JUST BUY THE PRODUCT AND EXAMINE IT — you may return any item within 14 days for A FULL REFUND (we deduct only postal charges). Add £2.50 for carriage to orders below £100. ADD VAT TO ALL UK ORDERS. Terms: cheque with order. Dealers who mean business welcome. Goods normally in stock — TODAY DESPATCH IS POSSIBLE — please phone us **DATAMAN DESIGNS, LOMBARD HOUSE, DORCHESTER, DORSET DT1 1RX. TELÉX: 418442. PHONE (0305) 68066.**

CIRCLE 22 FOR FURTHER DETAILS.



# TELESCOPIC MASTS

Pneumatically operated telescopic masts.  
25 Standard models. ranging from 5 metres  
to 30 metres.

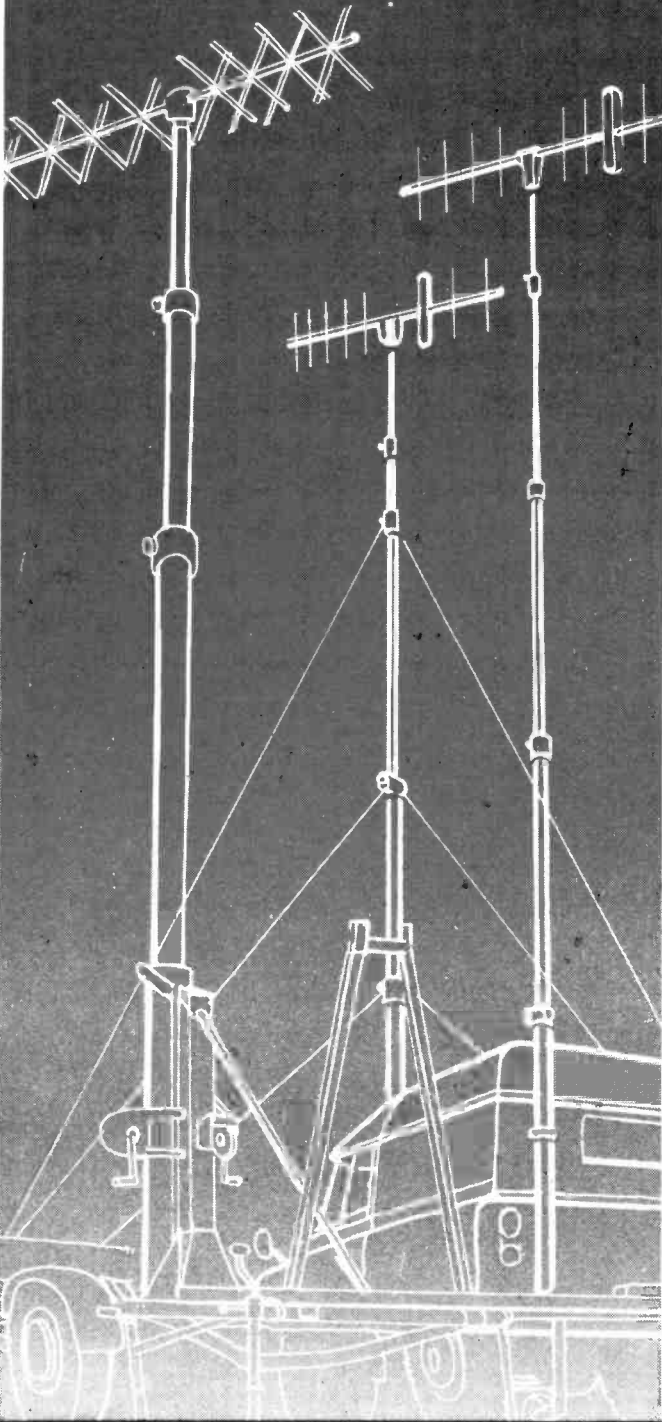

# Hilomast Ltd

THE STREET HEYBRIDGE — MALDON  
ESSEX CM9 7NB ENGLAND  
Tel. MALDON (0621) 56480  
Telex No. 995855

CIRCLE 41 FOR FURTHER DETAILS.

# VALVES

	Minimum Order £1	*SPECIAL QUALITY	VAT PAID PRICES MAY VARY
A1065	1.40	EF91	1.60
A2293	8.80	EF92	2.90
A2900	13.75	EF95	0.95
ARB	0.75	EF96	0.60
ARP	0.70	EF183	0.80
ATF4	0.80	EF184	1.00
B12H	3.90	EFB12	0.75
CY31	1.40	EFL200	1.85
DAF96	1.25	EH90	0.85
DET22	28.50	EL32	1.10
DF92	0.80	EL34	1.80
DF96	0.70	EL37	4.55*
DH75	0.75	EL37	5.20
DL92	0.60	EL82	0.70
DY86/87	0.65	EL84	0.80
DY802	0.70	EL86	0.95
E92C	2.80	EL90	1.00
E180CC	8.25	EL91	6.50
EA76	2.25	EL95	0.80
EABC80	0.80	EL504	2.70
EB91	0.60	EL509	5.85
EBC33	1.15	EL159	6.90
EBC90	0.90	EL821	8.20
EBF80	0.60	EL822	9.995
EBF83	0.60	ELL80(SE)	2.80
EBF89	0.80	Em80	0.85
EC52	0.65	EM87	2.50
EC91	4.40	EY51	0.95
EC92	0.85	EY81	0.65
ECC81	0.85	EY86/87	0.80
ECC82	0.60	EY88	0.55
ECC83	0.65	EZ80	0.70
ECC84	0.60	EZ81	0.70
ECC85	0.60	GM4	5.90
ECC88	0.80	GY501	1.30
ECC189	0.95	GZ32	1.05
ECC804	0.90	GZ33	4.20
ECF80	0.85	GZ34	2.75
ECF82	0.85	GZ37	3.95
ECF801	1.05	KT66	14.50
ECH34	2.25	KT81	7.00
ECH42	1.20	KT88	23.00
ECH81	0.70	ML4	2.80
ECH84	0.80	ML6	2.80
ECL80	0.70	N78	9.90
ECL82	0.75	OA2	0.70
ECL85	0.80	OB2	0.80
ECL86	0.90	PCL82	0.95
EF37A	2.15	PCL84	0.90
EF39	1.50	PCL86	0.75
EF80	0.65	PCL86	0.75
EF83	3.10	PCL805/85	0.95
EF85	0.60	PD500/510	4.30
EF86	1.25	PFL200	1.10
EF89	1.60	Z80*	2.80*
PL36	1.10	1A3	1.40
PL81	0.85	1L4	0.80
PL82	0.70	1R5	0.80
PL83	0.60	1S4	0.65
PL84	0.95	1S5	0.65
PL504	1.00	1T4	0.95
PL508	2.40	1U4	0.80
PL509	5.85	1X2B	1.40
PL519	5.85	2X2A	2.50
PL802(SE)	2.95	3A4	0.70
PY80	0.70	3AT2	3.40
PY81/800	0.85	3B2S	12.00
PL504	1.00	19.50*	19.50*
PY88	0.60	3D6	0.60
PY500A	2.10	3E29	19.00
QQV03/10	5.95	3S4	0.70
10.10*		4B32	18.25
QQV03-20A		5R4GY	2.20
SUAG	1.40	6F23	0.75
QQV03-25A	21.50	5V4G	0.75
5V4G	0.75	8F24	1.75
5Y3GT	0.95	8F33	10.50
QQV06/40A	36.50	5Z3	2.80*
5Z4G	1.25	6G8A	1.95
QQV03-12	4.20	5Z4GT	1.15
SP61	1.80	6/30L2	0.90
TT21	32.20	6J10	5.85
TT22	29.50	6J14	1.35
UAB80	0.75	6A6S	0.60
UAF42	1.40	6AH6	1.15
UBF80	0.70	6AK5	0.65
UBF89	0.70	6AK8	0.60
UCC84	0.85	6AL5	0.60
UCC85	0.70	6AL5W	0.85
UCF80	1.30	6AM5	4.20
UCH42	1.65	6AM6	1.50
UCH81	0.75	6AN8A	2.50
UCL82	0.95	6AQ4	4.40
UF41	1.35	6AS6	1.30
UF80	0.95	6AQ5W	2.20
UF85	0.95	6AS6	1.15
UL84	0.95	6AS7G	4.195
UM80	0.90	6AT6	0.90
UM84	0.70	6AU6	1.25
UY82	0.70	6AV6	0.35
UY85	0.85	6AX4GT	1.30
VR105/30	1.25	6AX5GT	1.30
VR150/30	1.35	6BA60	
X66	1.80	0.70/1.20*	
X61M	1.70	6B49	3.45
Z759	19.00	6BE6	6SN7GT
Z749	0.75	0.65/120*	6SQ7
Z800U	3.45	6BG6G	1.60
Z801U	3.75	6BJ6	1.30
Z803U	16.00	6BQ7A	0.85
Z900T	2.45	6BR7	4.80
6BWB	6.20	6BY6	6.20
6BW7	1.80	6C4	0.70
6C4	0.70	6C6	1.20
6C6	1.20	6CH6	8.20
6CH6	8.20	6CL6	2.75
6CL6	2.75	6CW4	8.50
6CW4	8.50	6CX8	3.80
6CX8	3.80	6CY5	1.15
6CY5	1.15	6D6	1.50
6D6	1.50	6E6	1.60
6E6	1.60	6F6	1.10
6F6	1.10	6F8G	0.85
6F8G	0.85	6F12	1.50
6F12	1.50	6F14	1.15
6F14	1.15	6F15	1.30
6F15	1.30	6F17	3.20
6F17	3.20	6F23	0.75
6F23	0.75	6F24	1.75
6F24	1.75	6F33	10.50
6F33	10.50	6FH8	17.80
6FH8	17.80	6G8A	1.95
6G8A	1.95	6GH8A	1.95
6GH8A	1.95	6H6	1.60
6H6	1.60	6J10	5.85
6J10	5.85	6J14	1.35
6J14	1.35	6J16	2.80
6J16	2.80	6J20	1.90
6J20	1.90	6J5	2.00
6J5	2.00	6J5GT	0.90
6J5GT	0.90	6K8	5.50
6K8	5.50	6K8B	4.80
6K8B	4.80	6L6	2.80
6L6	2.80	6L6GT	1.95
6L6GT	1.95	6L8	0.70
6L8	0.70	6L20	0.70
6L20	0.70	6M6	4.85
6M6	4.85	6N7G	1.60
6N7G	1.60	6P6	1.20
6P6	1.20	6Q7G	0.95
6Q7G	0.95	6R7	4.60
6R7	4.60	6S7	1.80
6S7	1.80	6S7GT	1.80
6S7GT	1.80	6SK7	1.40
6SK7	1.40	6SL7GT	0.85
6SL7GT	0.85	6SN7GT	1.60
6SN7GT	1.60	6SQ7	0.95
6SQ7	0.95	6SR7	4.60
6SR7	4.60	6S7	1.80
6S7	1.80	6V6G	1.50
6V6G	1.50	6V6GT	1.30
6V6GT	1.30	6X4	1.50
6X4	1.50	6X5GT	0.65
6X5GT	0.65		

**VALVES AND TRANSISTORS** NEW PYE EQUIPMENT & SPARES  
Telephone enquiries for valves, transistors, etc.:  
retail 749 3934, trade and export 743 0899  
FIELD TELEPHONE, CABLE TYPE D10  
FIELD TELEPHONES TYPE 'J'. Tropical in metal cases. HARNESS "A" & "B" CONTROL UNITS "A" "R" "J1" "J2" Microphones No 5, 6, 7 connectors, frames, carrier sets, etc.  
10-line MAGNETO SWITCH-BOARD. Can work with every type of magneto telephones.  
POSTAGE: £1-£3 50p; £3-£5 60p; £5-£10 80p; £10-£15 £1.00; £15-£20 £1.50

**COLOMOR (ELECTRONICS LTD.)** 170 Goldhawk Rd, London W12  
Tel. 01-743 0899 or 01-749 3934. Open Monday to Friday 9 a.m.-5.30 p.m.

CIRCLE 5 FOR FURTHER DETAILS.

# E.M.S. POWER SYSTEMS



Solve all your Power Problems by contacting E.M.S.

E.M.S. specialise in systems to eliminate your power problems.

Products range from 35VA switched square wave Power Packs to 1KVA fully uninterruptible sine wave systems.

E.M.S. also manufacture chargers which range up to 60 amps.

For further details please contact:

**E.M.S. Manufacturing Limited**  
Chairborough Road  
High Wycombe  
Bucks  
Tel: (0494) 448484

CIRCLE 26 FOR FURTHER DETAILS.

ELECTRONICS & WIRELESS WORLD JUNE 1985

# Reactivating Band III

## Trunked repeater networks and worsening interference problems were among the topics discussed by mobile radio users at their annual conference

These are exciting times for the mobile radio industry: in January, cellular radio opened for business on 900MHz while at the same time tv broadcasting ended in Band III leaving the way clear for a big expansion in private mobile radio. So there was no shortage of subjects for consideration when members of the Mobile Radio Users' Association met at Wadham College, Oxford in March.

Opening the conference, Lord Lloyd of Kilgerran said that the emergence of cellular radio would act as a prod to the entire mobile industry. He emphasized its value to the small businessman: for a large company, cellular could mean better service and improved efficiency, but to a self-employed plumber it could be the difference between profits and bankruptcy.

Speaking of his own role in Westminster, Lord Lloyd said that five years ago no-one in Parliament had been interested in information technology; but now things were different. And he called on the industry to give presentations to Pitcom, the Parliamentary Information Technology Committee, so that MPs could be better informed.

One of the more provocative speakers at the conference was Walter Stevenson of Air Call, a founder-member of the MRUA. He criticized the "unhelpful" regulatory attitude in Britain, which he said had fallen behind the United States in mobile radio. And he reminded his audience of the about-turns by the regulating

authority from which the industry had suffered.

For example, Band III had been given to the land mobile service in the early 1950s because the BBC did not require it for television; yet on the opening day of one of the largest mobile radio schemes outside the US, a 1000-unit radio-taxi network in London, the Government changed its mind and handed over the band to the new commercial tv service. The same had happened to Band II, where the presence of public service transmissions continued to restrict the expansion of broadcasting.

Smarting, perhaps, under this onslaught there came next Rod Stewart of the Radio Regulatory Department of the DTI, one of a strong contingent from that unit, whose involvement in the conference was warmly welcomed by several speakers.

### Allocating band III

Mr Stewart spoke about the technical problems of frequency assignment, especially those of Band III. This band is still in use by television broadcasters in continental Europe and in Ireland; and Britain, through bilateral agreements, has a duty to minimise interference caused there by mobile services.

The most serious source of difficulty for British users, he explained, would be the new French 625-line service Canal Plus. Strong signals from this service were often present over wide areas of Britain, their inter-

ference-causing potential being greatest around the vision carrier frequencies. For this reason, the new mobile band had been split into six sub-bands with intervening gaps centred on those frequencies. With this arrangement the Department hoped to be able to provide up to 1200 interference-free channel pairs, with scope for trunked systems where needed.

Answering questions afterwards, Mr Stewart said that there were no plans to use the gaps for mobile radio, although they might be assigned later to low-power services in the cities.

Another questioner raised the issue of delays by the department in granting allocations: he was told that the cause was a serious manpower shortage.

Also from the DTI came Les Barclay, who described his department's activities in monitoring interference and spectrum usage.

The Monitoring Section's main centre of activity is at Baldock in Hertfordshire, where it can monitor frequencies ranging from 10kHz to 12.75GHz. This station, recognised by the ITU, concentrates on the h.f. band, where it is mainly concerned with protecting British services against interference from abroad. Baldock now has two 12m satellite dishes, covering 4GHz and 12GHz.

For investigating mobile services, the department has a van newly equipped with automatic and manually-controlled equipment covering the spectrum up to

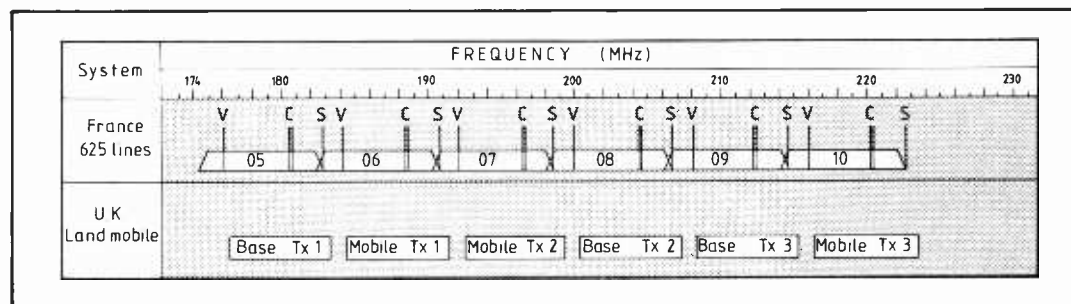

Fig. 1. Band plan for the new U.K. land mobile allocation in band III. The gaps are to avoid interference caused by strong signals around the vision carrier frequencies of the French Canal Plus network.

**Table 1: post-WARC '79 allocations to the mobile service in Britain (Walter Stevenson)**

Band	Name	MHz	Total r.f.
1	v.h.f. low band	30-88 (F,B)	57.9MHz
2	v.h.f. mid band	97-102 (B)	4.5MHz
		(until 1989)	
3	v.h.f. high band	104-108	4.0MHz
		(until 1995)	
4	v.h.f. high band	138-235 (F)	94.85MHz
5	v.h.f.-u.h.f.	235-399 (F)	168.1MHz
6	u.h.f. band	401-470 (F)	58.9MHz
7	u.h.f. band	862-960 (F)	98.0MHz
	total, all bands 30-960MHz,		486.25MHz

(F) - shared with fixed services  
(B) - shared with broadcasting

**Table 2: mobile radio users in Britain, 1985 (Walter Stevenson)**

400 000	despatch-type radio-telephone, including police, fire, prisons and civil defence
220 000	radio message and signalling pagers, including wide-area, national and on-site pagers
35 000	public mobile radio telephones, including message-handling and cellular
100 000	vehicle and portable telemetry and radio-control devices
30 000	amateur radio, mobile and portable
200 000	citizen's band radio including unlicensed users
100 000	cordless telephones

Fig. 2. Typical noise output of a high-band solid-state transmitter. Even at frequencies several megahertz away from the carrier, the noise is still strong enough to open the muting of other receivers on the same site. Ferrite isolators and careful filtering can provide a cure. (Gerald David)

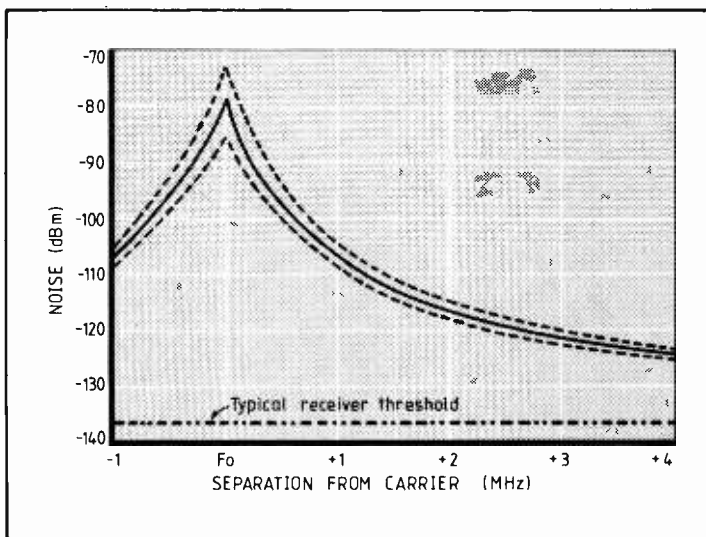

1300MHz. The automatic system scans 300 channels per second and measures the signal level on each. Data is stored on a Winchester disc and then transferred to magnetic tape for off-line computer analysis later on. Up to 10 hours of data can be held on a single tape.

With this information, operators can list channels in order of their traffic congestion. And they can study in detail any channels with anomalous traffic loadings. A second van is to go into service later this year.

## Spectrum pricing

The final DTI speaker was the head of the Licensing Branch, Ian Jones, who was introduced light-heartedly as the man delegates would most like to stick pins into.

Mr Jones discussed, among other matters, the issue of 'spectrum pricing', an approach to frequency allocation by which channels might be let to the highest bidders. His department had decided to investigate the feasibility of spectrum pricing, though he stressed that there was no commitment to implement it. The first study would take six months and would deal with fixed services; the second, covering private mobile radio, broadcasting, the amateur and emergency services and others, was unlikely to be completed before late 1986.

If adopted, spectrum pricing might enable R.R.D. to drop its existing spectrum-loading criteria in deciding whether to assign further channels: the user's willingness to pay would become the main factor. At present, he said, licensing costs were "quite incredibly low" in relation to the other costs of running a mobile system, and some operators made excessive demands for frequencies. Spectrum pricing might sharpen their appreciation of a valuable resource. "Why must the Government decide what is a frivolous use of radio?", he asked; "shouldn't the market decide?"

Mr Jones spoke also about the announcement in January by the industry minister, Geoffrey Pattie, of the Government's initial decision on the uses to which Bands I and III would be put. The minister was considering the possibility of one or more large national mobile radio networks; these would not however be allowed to interconnect with the public telephone system, except possibly on a very limited basis. Applications would probably be invited for up to five trunked radio systems in major conurbations, using the common signalling standard now being drawn up. The government also wanted to hear from companies interested in setting up two-way mobile data transmission systems.

Mr Jones promised further ministerial announcements by early summer.

A questioner asked why the 900MHz band had been given so cheaply to the cellular radio operators. Mr Jones said that the

charge was £1000 per national channel (for 160 channels) plus £8 per mobile user, which he felt was quite a good start to spectrum pricing.

## Trunked systems

The theme of trunked networks, or community repeater systems, was taken up by Norman Croft of Motorola, a company which has played a large part in introducing such systems in North America.

Trunked systems can provide a big increase in the efficiency of channel usage. Users, instead of having their own private frequencies, share between them a much smaller number of pooled channels. Each user has access to all of them, and on initiating a call is switched automatically (via a separate control channel) to a vacant communications path as soon as one is free. When the call is over, the channels are released for other users.

Such a system, according to Mr Croft, had many advantages. It was simple to use, offered privacy (though not secrecy), reliability (failure of an individual channel did not mean total loss of communication) and easy expansion to accommodate new users. Since costs were shared it was especially attractive to the small user. As a bonus, trunked repeater systems offered reliable mobile-to-mobile contact.

Even greater traffic densities could be achieved by grouping the mobiles under network controllers or 'dispatchers', such as were used by taxi firms.

Cellular radio was itself a trunked system, though the networks now envisaged would not permit hand-off from one base-station to another as the mobile roamed about. To cover adequately a large region such as the London area, trunked systems would probably have to transmit simultaneously from multiple sites and incorporate voting techniques on the receive side.

## Cellular radio

The first three months' experience with Cellnet, one of Britain's two new cellular radio systems was the subject of a presentation by Bernard Mallinder, formerly the consortium's technical director and now general manager. (No representatives of the rival Racal-Vodafone system were present at the conference.)

At the end of March, Cellnet had just over 4000 subscribers. Areas covered now include Birmingham, Manchester and Liverpool, and the system is expected to cover 80% of the population by the middle of next year.

The busiest times for callers are just before noon and just after. Four-fifths of all traffic occurs between 0800 and 2000; 70% of it is originated by mobiles and the average call duration is about 93s. Calls cost 25p per minute at peak times but fall to 8p per minute in the evenings and weekends.

Cellnet is now working on protocols to permit data communication with mobiles: at present there are difficulties because of the momentary interruptions as the mobile passes from one call to another.

## Tackling interference

With the rapid growth in mobile radio during the last few years, there has been a marked increase in the number of radio stations sharing a common site. Co-siting can result in severe mutual interference; and the mechanisms by which this occurs were described by Gerald David of Aerial Facilities Ltd.

One problem results from the fact that the transmit-receive frequency spacing is generally constant within a given band. An incoming signal from a mobile will mix at the base station's transmitter output to produce a difference frequency. Any other transmitter in that base station can now mix with that difference frequency to produce its own receive frequency, which will be treated as a valid input on that channel. With 1mV of received signal coming in, up to 50µV of the transmit-receive difference frequency could be floating about in the installation.

Interference problems at shared base stations could be very hard to solve. Mr David mentioned one case of intermodulation interference at a site equipped with 35 transmitters, where it had taken four hours of mainframe computer time to track the fifth-order intermodulation products. The signal being looked for turned out to be an 11th order product.

A further source of interference was the noise generated by modern solid-state transmitters. The spurious noise 2-3% away from the carrier in a typical 25W

unit is rarely better than 130dB below, which is much worse than with earlier thermionic designs. Thus, at a multi-channel transmitting site, the accumulated noise can be sufficient to open the muting of all the receivers.

The cure, said Mr David, was to add cavity and bandpass filters throughout and to insert ferrite isolators in each transmitter's output to prevent unwanted mixing.

## A switch to s.s.b.?

The prospect of novel modulation modes was looked at by Prof. J.D. Parsons of the University of Liverpool in a paper which was published at the conference, but which he was unable to present in person.

The Government, he wrote, was under pressure to allocate a substantial part of Band III to systems using amplitude-companded single-sideband transmission. This would greatly increase the traffic capacity of the band by making possible a reduction in channel spacing to 5kHz. But its cost in receiver complexity would be significant. However, some sort of pilot-tone would need to be added to the transmission to provide a.g.c. and a.f.c.

Further investigation of a.c.s.s.b. was needed to evaluate its susceptibility to interference, particularly on the signalling channel; however, in the meantime it looked as though the first systems to be licensed would employ conventional f.m.

## Improving coverage

A common source of complaint among mobile radio operators is failure to achieve adequate coverage of a system's service area. Brian Collins of C & S Antennas said that many of these problems could be avoided at the planning stage by a better choice of site for the base station and by better aerials.

A folded dipole mounted on the side of a steel mast was usually not good enough, since the mast created unwanted lobes which would confound the intentions of the planners. Attempting to deal with this by mounting a dipole on each side of the mast produced even worse results: a radiation pattern with deep nulls. A better approach was to use dipole or slot-fed panels on each face of the tower, driving them in phase: this would be more expensive, but the antenna would have a broadband characteristic and so could be shared by several services.

Typical aerials used by cellular systems consisted of ten-tier panels, which gave high gain in the horizontal direction, but could have sharp nulls at other angles. This could give rise to poor coverage in areas close to the base-station, especially where the station was at a high site above a town. In this case, Mr Collins said, mobile operators could borrow an idea from broadcasters, who phased the elements of such arrays so as to produce a slight downward tilt. A tilt of about 2.5° to 3° was common in tv practice: it directed the main beam more accurately at the boundary of the service area and filled in the nulls close to the station.

Another idea worth borrowing from broadcasters was to avoid hilltop sites where possible: it could help reduce co-channel interference.

Mr. Collins added that coverage with mobile systems was often restricted by multi-path reception: the use of polarization diversity at the receiving site could bring about worthwhile performance improvements.

Guest speaker at the conference dinner was Professor Brian Carsberg, director-general of OfTel since its inception last year. Prof. Carsberg outlined the functions of OfTel, which by next year will have a staff of up to 110, with powers to enforce the licence

conditions of telecommunications operators and to investigate complaints within the industry.

Speaking of Bands I and III, Prof. Carsberg said the Government had asked his advice on their allocation, and that he would be reporting shortly. The interests of the consumer would be paramount, he said. "We welcome the opportunity to have contacts with organisations on matters which are important. They should not wait to be invited."

Fig. 3. Polar diagram of a vertical high-band folded dipole stood off a 2m-square solid mast on a 1.5m boom (left): a common arrangement in mobile radio practise, but one which gives disappointing coverage. Adding dipoles on the other faces of the mast (right) makes matters even worse: eight deep nulls appear and the strong lobes between them frustrate the efforts of frequency planners. Much more even coverage (centre) results from phased array of dipole or slot-fed panels mounted around the mast. This arrangement costs more, but has broadband characteristics and can be shared between several users. (C&S Antennas)

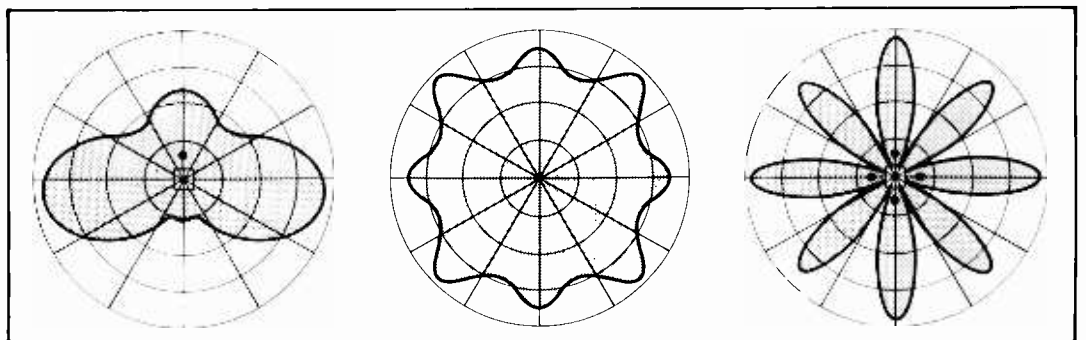



by Rod Cooper

# Avoiding failure of sealed NiCd cells

Nickel-cadmium cells are expensive to buy, yet are often thrown away for lack of a few drops of water! More attention is needed in their day-to-day use to achieve their full lifespan, argues Rod Cooper — the use of cheap chargers that do not do their job properly is a completely false economy.

Failure mode no.1 (May issue) dealt with the importance of water to cell operation, and how loss of even a small amount caused by reverse-charging could result in a drastic shortening of cell life. The article continues with loss of water as the theme.

## Failure mode 2: loss of electrolyte water due to incorrect charging

Oxygen is absorbed in a recombination process with cadmium during normal overcharge. The rate at which this reaction can proceed is determined by how much extra active material is provided by the manufacturer at the negative plate and by the ambient

temperature, all other factors being equal. For standard cells the designed rate is  $C/10$  where  $C$  is the capacity in amp-hours, the cell being able to tolerate this rate at  $20^{\circ}\text{C}$  without immediate problems (but see failure mode 3).

During normal overcharge (i.e.  $C/10$  at  $20^{\circ}\text{C}$ ) the internal pressure will rise slightly due to the presence of oxygen and the small increase in temperature. Neither of these effects present a problem until the  $C/10$  rate is exceeded, when the internal pressure will rise rapidly until the safety vent opens, due to an accumulation of unrecombined oxygen. This condition is often exacerbated by a rise in temperature if the charge current is uncontrolled because this lowers the internal resistance and increases the current further i.e. thermal runaway, Fig. 6. The end result of exceeding  $C/10$  is loss of capacity, and often an abused cell will show one or two other symptoms; a bulge in the bottom of the steel case as shown in Fig. 7 and splitting of the plastic sleeve, both due to the high internal pressures that are generated before the safety vent opens. Opening pressures in excess of 140 p.s.i. are quoted.

There is another way that electrolyte can be lost via the safety vent which is often overlooked. At low temperatures, like most chemical reactions, the oxygen recombination process becomes much slower. If charging is maintained at  $C/10$  the pressure will build up due to excess oxygen in just the same way as during overcharge with excessive current. Indeed a reasonably high temperature is needed for the oxygen

recombination process to place at so-called 'safe' rates. For standard cells a temperature of  $20^{\circ}$  to  $30^{\circ}$  is suitable. Even charging at  $10^{\circ}\text{C}$  can result in a doubling of the usual overcharge pressure, a point worth remembering if attempting to charge standard cells at fast rates at low temperatures, for example out of doors on a cold day.

A common practice is to recharge NiCd cells overnight, which usually means that the charger is unattended, so for safety's sake many people choose to do this in an outbuilding where a malfunction can do little damage. More often than not such an outbuilding is unheated, and in winter it is quite easy to damage cells at a supposedly safe rate of charging.

## Avoidance tactics

Both of the above effects are more likely to happen during fast-charging so for standard cells it is best to adhere to the recommended rate of  $C/10$  and ensure an ambient temperature of  $20^{\circ}\text{C}$ . Some fast-chargers have a temperature cut-out which operates when overcharge has been reached, so it might be thought that this neatly avoids such problems with standard cells. However, some excessive overcharging has already taken place by the time a temperature cut-out can operate, because of the time-lag between the rise in internal pressure and the rise in temperature which follows it.

If fast charging is required it is far better to adopt special fast-charge cells which have a greater oxygen recombination capacity.

Construction of typical sealed nickel-cadmium cell.

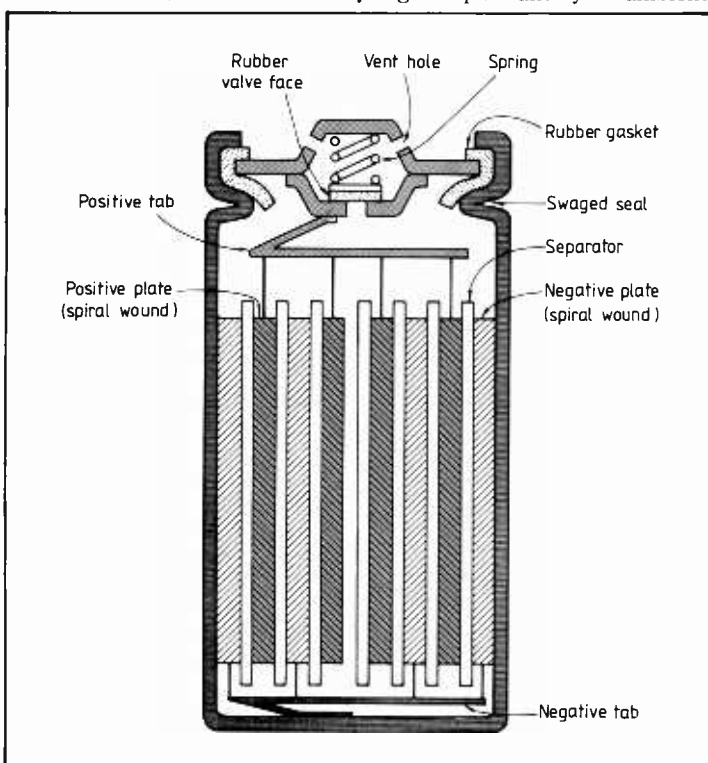

The penalty paid is a reduction in Ah capacity — generally about 10% — but such cells can withstand typically a charge of C/3 during overcharge at 20°C. An example of this type of cell is the Cadnica N-500 AAF. The capacity of this cell is 450mAh compared to 500mAh for the standard cell, but it can be recharged in 4 to 6 hours instead of the usual 14 to 16 hours. The size and weight are about the same and the price only slightly more.

### Experimental cure

Several D and C-size cells in my own collection of NiCd cells had been subjected to severe overcharge, reverse-charge and low-temperature abuse, due to accidents in faulty charging equipment and also deliberate experiment, and were known to have little or no capacity. Some of these cells were stripped of their steel casing (this was done precisely by machine-tool and so did not damage the contents — it is not recommended due to the highly hazardous nature of the KOH/LiOH electrolyte and the possibility of internal pressure) the electrodes removed and wound with nylon cord to prevent disintegration. Immersion in fresh electrolyte and subsequent recharging showed that much of the capacity had returned, indicating that the active materials of the plates were relatively undamaged.

Following this successful experiment, a small hole was drilled and then tapped in the nylon top of another 'dead' cell. A matching nylon screw and neoprene washer resealed the hole, Fig. 8. Small quantities of distilled water were gradually introduced via the hole with a hypodermic syringe during a succession of recharge/discharge cycles, until most (but not all) of the capacity had returned. This cell was eventually returned to service.

The only cells that refused to respond to this treatment were those that had been subjected to high temperatures, the inference being that high temperatures cause more damage of an irreversible nature than does excessive overcharging or reverse-charging.

It is easy to calculate the minimum theoretical amount of water needed in any particular type of cell from the basic reaction shown on page 61, May Issue.

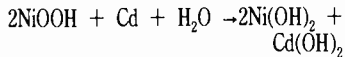

The electrochemical equivalent and atomic weight of cadmium can be looked up in any reference book on electrochemistry, and these are 2.097g/Ah and 112.4 respectively for cadmium.

A D-cell has 4Ah capacity and thus 8.388g of active cadmium. From the above equation, 112.4g of cadmium reacts with 18g of water. Thus 8.388g of cadmium will react with 1.342 g water.

Of course, this may not be the amount put into a cell but it shows the order of magnitude of the quantities used, which is very useful when refilling a dead cell.

### Failure mode 3: degradation of plates and separator

Due to the dangers of loss of electrolyte already detailed, it is tempting to think that a low rate of charge spread over a long period was the best solution. However, this would be a mistake because low rates of charge over extended periods appear to cause another type of failure. This is referred to obliquely in manufacturers data sheets as 'crystal deformation' of the plates, but what it means in practice is that the cell develops an internal short-circuit which renders it useless long before the expected life-span is reached.

The trouble is caused by the pronounced crystalline nature of cadmium, which is of the hexagonal-pyramid type, and also the very slight solubility of cadmium in the electrolyte. During the charging process, if conditions are right, cadmium can be deposited in the form of dendrites, which are miniature tree-like growths with spiky branches sprouting from a central trunk and standing clear of the electrode. There is also a sub-species of dendrite, the whisker; these are single filament or rod-like structures 1 — 2µm in diameter which stand out like stubble on an unshaven chin. Cadmium has the dubious distinction of being the first metal in which whiskers were observed. There are some good photomicrographs of dendritic growth in ref.2.

The dendrite can grow through the separator and eventually bridge the very small gap between the plates, providing an internal short-circuit. This often happens to an apparently healthy cell; during the charging process a dendrite will bridge the gap and divert further charging current

through itself so that the cell never becomes fully charged. When put into service, any charge already in the cell rapidly leaks away through the dendrite, perhaps in only a few hours. The short time needed for a healthy cell to become 'dud' must provide a source of surprise, puzzlement and possibly indignation to the user, who may well have followed instructions to the letter and who cannot see that he has done anything wrong to the cell to cause it to malfunction.

The charging conditions that favour dendritic growth, on the evidence available, appear to be low current over extended periods. The Cadnica handbook for example warns of 'continuous charge over a long period' and the article by K.C. Johnson on NiCd cells (WW Feb. 1977) suggests that 'gentle cycles of charging and discharging are likely to accelerate the process'. My own experience confirms this.

Apart from this problem, the plates of a NiCd cell are both physically and chemically robust and cause few problems. The same cannot be said of the separator, usually polypropylene or nylon in fibrous form. During normal over-charge the separator material is subjected to attack by the oxygen which must diffuse from positive to negative plate for recombination. This attack is made worse by the high pressures and temperatures encountered during excessive overcharge. A cell temperature of 50°C is often quoted as being the maximum permissible to avoid failure.

The more usual form of deterioration is a slow process and failure occurs due to accumulated effects over a long period. Manufacturers state in their data sheets that prolonged or repeated overcharge even at safe rates has a deleterious effect on cell life, yet it is still common procedure to leave cells on charge for hours after full charge has been reached. This is bad practice. Unfortunately there is an almost universal belief that an indefinite amount of overcharge at C/10 is perfectly alright.

To assure full life expectancy a NiCd cell should have its recharge period terminated shortly after the oxygen recombination process has set in, preferably by automatic means.

### Avoidance tactics

A cycle life of 500 times and up to

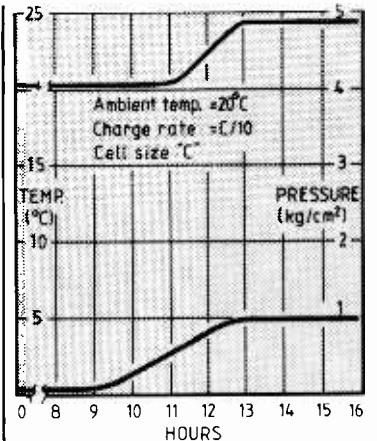

**Correlation between rise in pressure on reaching overcharge phase and rise in temperature that follows one or two hours after (from the Cadnica Engineering Handbook).**

## Do's and Don'ts

### Recharging

- Don't recharge cells connected in batteries if at all possible. Recharge cells singly instead.
- Avoid temperatures above 50 and below 5°C.
- Don't persistently overcharge cells — use an end-of-charge cut-out.
- Recharge standard cells at C/10 — invest in fast-charge cells if you want faster recharge.

### Discharging

- Where possible, don't use cells connected in batteries. Use a d.c./d.c. converter to step the voltage up whenever such a technique is suitable or redesign circuit around a working voltage of 1.25V.
- If batteries are essential to the application, make use of protection diodes or low voltage cut-out.

### General

- Avoid encapsulated batteries like PP9
- Don't replace dead cells in a battery with brand-new cells, and do not add partly-used cells onto a new battery.



Fig. 6. An overcharged cell, sectioned to show the collapsed base. This cell was overcharged due to a fault in the charger, but shows what can happen when any cell is charged for longer than is necessary at a rate which is too high. The contents of this cell were expelled when the cell became hot, and on cooling the case collapsed inward.



Fig. 7. An overcharged cell showing a bulge in the base caused by high internal pressure prior to the safety vent opening. A normal cell is shown for comparison. A condition like this is a sure sign of abuse, whether due to charging at too low a temperature, reverse charging or to charging in excess of C/10.



Fig. 11. Localised pin-hole corrosion caused in this instance by contact with sea water for a short time. This also could have been prevented by grease or paint.



Fig. 8. A cell which has "dried out", modified by putting a filler hole in the top so that water can be introduced in controlled quantities. The filler hole in this particular cell is sealed with a nickel-plated steel pan-head M2.5 screw, which does not interfere with normal use of the cell. A small neoprene washer completes the seal.



Fig. 9. The effects of electrolyte creepage on two types of cell. The deposit has started to corrode the cell on the left.



Fig. 10. Generalised corrosion caused by water being trapped between the plastic sleeve and the side of the cell. Plastic sleeves are best removed and replaced if necessary with full-width adhesive tape. Exposed parts can be coated with "Komoline" grease or painted with "Celvar" to prevent this type of corrosion.

2000 times has been claimed by the manufacturers at charge rates of C/10. It would seem from this that charging at this rate does not lead to dendrite problems, at least in laboratory tests. My own experience is that, in practice, charging at C/10 does lead to dendrite problems in some cells but not in others, although they may be in the same battery. There seems to be no hard and fast rules about predicting which cells are prone to form dendrites.

I have experimented with a promising technique for suppressing the initial formation of dendrites, and this will be described as a practical construction project in a later article.

To avoid material degradation it is safe to assume that a standard cell should be charged at C/10 provided that the overcharge period is detected and curtailed.

## Experimental cure

There is no cure for a damaged separator, but an interesting cure for dendrites was put forward in K.C. Johnson's article. Essentially this consists of a charge and discharge programme at controlled but very high rates, to melt the dendrites and reform the cadmium on the negative plate. A period of normal overcharge is recommended to oxidize remaining dendrite material, the theory being that the dendrites are in a relatively prone position for oxidation compared to the rest of the electrode. There must be a compromise between controlling dendrites and degradation of the separator with the oxygen of the overcharge mechanism.

Temperature must be carefully



controlled during the above treatment or more problems will be created than solved. I recommend looking at this article in detail. I have tried it and it works, but I have reservations about the separator failing, as nylon melts at around 220°C and polypropylene at 170°C so localized melting may occur in the areas around dendrites which will lead to premature failure anyway. Also, I have found that cells treated with this method rapidly reform their dendrites.

#### Failure mode 4: electrolyte creepage

Electrolyte creepage manifests itself as a furry white deposit, often confined to the top of the cell but sometimes spreading to sides and onto surrounding components such as circuit boards and wiring where it wreaks havoc due to corrosion, particularly of copper, zinc and tin parts. The cause of this phenomenon lies in the penetrating nature of the potassium hydroxide solution used as the electrolyte, which seems able to get past seals which on the face of it appear to be well designed. After creeping past the seal the hydroxide is converted to carbonate by reacting with CO<sub>2</sub> in the atmosphere. Potassium carbonate is less hazardous than the hydroxide (which can remove skin with rapidity) but still presents a corrosion problem for metal parts particularly in damp conditions.

Loss of electrolyte leads to loss of capacity but experience suggests that this is a lengthy process. In the battery of cells in the photograph (Fig. 9) the cells that showed the most efflorescence also showed the largest drop in capacity, as one would expect, but it took 12 months to get to the stage shown.

#### Avoidance tactics

Some manufacturers' products tend to suffer more than others from this defect. The only avoidance tactic one can practice is based on experience — simply avoid those manufacturers whose cells give creepage. I have tried four different makes of cell and only one — the nylon-topped variety made by Saft — has shown freedom from this trouble.

#### Experimental cures

I have tried re-sealing cells suffering from efflorescence with neoprene compounds, urethane

and nitrile rubbers, epoxy resin and also thermal sealing with various thermoplastics. All attempts failed, although sealing with urethane solution (used for making the seams in neoprene wet-suits) did last several months before the signs of creepage re-appeared. I concluded that there is no really satisfactory cure and that it is better to throw away a faulty cell than risk corrosion damage to surrounding equipment.

#### Failure mode 5:

The external case material is commonly thin-walled steel. Rusting is prevented by nickel-plating, which is adequate for most purposes but not entirely satisfactory. The case is usually covered by a plastics sleeve, and this can assist corrosion by trapping moisture between sleeve and case. Fig. 10 shows an example of such corrosion, which was completely hidden despite its advanced state until the sleeve was removed. The cause was moisture from a damp atmosphere assisted by slight electrolyte creepage.

Fig. 11 shows another cell which was exposed for a short time to a small amount of sea-spray, again trapped by the sleeve despite washing down in fresh water. This rapid corrosion resulted in a pin-hole and a ruined cell.

In another instance of corrosion, a zinc-plated screw was left on top of a NiCd cell and this caused a pin-hole with surprising rapidity, probably assisted again by slight electrolyte creepage.

#### Avoidance tactics

It is best to keep dissimilar metals like copper and zinc away from the steel case. Where a damp environment is likely, it is a good plan to strip off the plastic sleeve altogether — it is more trouble than it is worth, especially if the cell is subject to electrolyte creepage. If insulation is required then the cell can be wrapped in 50mm wide adhesive fabric-backed tape (RS Components 512-058). Exposed metal can be painted with Celvar cell paint or smeared with Komoline grease, both these products being made by Chloride-Alcad\* for nickel-cadmium cells. I have tried all three techniques and they are effective in avoiding corrosion.

\* Celvar is an alkali-resistant paint for steel cell containers, Komoline is a special mineral jelly for greasing steel cell tops, both available from J. Biles Engineering.

Unfortunately there is no effective cure for pinholes or remedy for advanced corrosion as shown Figs 10 and 11.

#### Multiple failure modes

Damaged cells are less amenable to diagnosis, and corrective action more difficult to implement, if more than one failure mode is present. For example, a cell may be suffering simultaneously from being over-charged and reverse-charged, or may be dendrited and have separator failure.

Recharging and discharging cells in series tends to promote the disparities between cells and increase the number of defects. This is explained as follows. Suppose a battery has seven cells; after a period in service perhaps four of these cells have full capacity, two slightly less capacity and one cell is in the early stages of dendrite formation. Cells are never exactly equal to start with and diverge in their performance in service even if they are of the same type and same manufacture, so this is a realistic assumption.

If this battery is recharged so that the four healthy cells are fully charged, then the two reduced-capacity cells will be over-charged. The dendrited cell may not reach full charge. When this battery is fully discharged, the two cells of reduced capacity and the dendrited cell will be reverse-charged. The two cells of reduced capacity will also eventually suffer from separator deterioration by being persistently over-charged. One cycle of the charge/discharge described may not make much difference but 20 or 50 cycles certainly will, and two failure modes will have been introduced simply by cycling the cells in series.

Even if the charging process is modified so that the two cells with reduced capacity are fully charged, leaving the healthy cells undercharged, the dendrited cells will in all probability still not be fully charged and will be reverse-charged when the battery is discharged. Further modifying charging so that this dendrited cell receives an extra charge leads to overcharging of the other six cells.

The correct way to charge cells is to charge them individually each according to their needs. This is not a difficult requirement if the battery is made up of cells like the AA, C, D and F types held

in a battery compartment, but is ruled out if the cells are spot-welded together or are encased in a container like the PP9 or PP3. These batteries are best avoided for this reason.

#### Conclusion

NiCd cells are expensive to buy, they use up the relatively scarce and finite resources of nickel and cadmium, and consume large amounts of energy and industrial capacity in their production, yet they are often thrown away for lack of a few drops of water!

More attention is needed in the practical day-to-day usage of NiCd cells so that the full lifespan of 500 to 2000 cycles can be achieved, present practice being more akin to that associated with a throw-away product.

In particular, because NiCd cells are expensive, the use of cheap charging equipment that does not do the job properly is a completely false economy. (These are the ones that charge cells in series, have no over-charge limiting device and no low-temperature control.)

Also, it would be useful if the makers provided some means of giving the electrolyte a partial service; a re-sealable valve similar to that already provided for venting excess pressure so that a measured quantity of water could be injected for example. This is not a suggestion that diverges too far from the sealed-cell concept. It would be expensive and could be made quite safe. The other item that manufacturers could assist with is the provision of more comprehensive information on fault-finding than in presently available.

An article dealing solely with failure modes naturally gives a false impression of the technical integrity of the subject under discussion. Given a proper system of management, it must be said that nickel-cadmium cells can give superb performance, paying back many times over the investment in recharging gear, the higher cost of the cells themselves over other types of cell, and the extra equipment needed to prevent accidental abuse in service.

#### Further reading

Alkaline storage batteries, by Falk & Salkind. Wiley, 1969.  
Cadmium, by D.M. Chizhikov. Pergamon, 1966.  
Nickel-Cadmium Battery, by Grant. General Electric, 1975.  
Nickel cadmium cells, by K.C. Johnson, *Wireless World*, February 1977, pp. 47, 48.



by David Stonebanks

# Cassette recording with the BBC micro

## Improved performance with conventional recorders and an alternative digital method

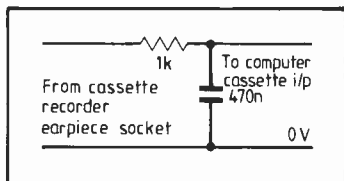

Fig. 1. This simple integrating network can help reduce uncertainty at data transitions.

The cassette port of the BBC Microcomputer encodes logic 0 as one cycle of 1200Hz tone and a logic 1 as two cycles of 2400Hz. These tones are synthesized sine waves, the frequency changes occurring at the zero-crossing point (trace 1).

When such a waveform is replayed from tape, the read head differentiates it, giving an output proportional to the rate of change of flux (trace 2).

After amplification and limiting, the waveform is as shown in trace 3. Continuous logic zeros correctly produce 1200Hz square waves (417 $\mu$ s for each half-cycle) and continuous logic ones produce 2400Hz square waves (208 $\mu$ s for each half-cycle). But where the logic value changes for consecutive bits, the result is a pulse of intermediate length (312 $\mu$ s), which is impossible to interpret correctly. No wonder cassettes are so unreliable!

Tape recorders do integrate

the read waveform somewhat to overcome this uncertainty, but not always enough. A simple integrating circuit (Fig.1) can often improve reliability. It causes some attenuation and reduces the amplitude of the 2400Hz waves to half that of the 1200Hz waves; but the BBC Micro includes a limiting amplifier and is quite tolerant of amplitude variations provided that the signal is correctly phased.

If the frequency change could be made at the peak of the recorded waveform (trace 4) the differentiated waveform would be as required (trace 5). When amplified and limited, this produces the easily-interpreted waveform of trace 6.

reversals on the tape;

- elimination of the need for a replay volume control (there is nothing to set incorrectly);
- reliability.

In the circuit of Fig.2, amplifier A<sub>1</sub> limits the writing (record) signal from the computer to square-off the waveform. The input capacitor is not really necessary, but I am happier with the input isolated.

Amplifier A<sub>2</sub> provides a  $\pm 6V$  square wave drive to the write head via a 4.7k $\Omega$  current-limiting resistor. If the power supply used is itself  $\pm 6V$  then the zener diodes are not required.

To ensure fast current reversals the head must be driven from a high impedance. Head current must be enough to saturate the tape fully, but not so great as to leave the head magnetized, erasing the signal instead of reading it. With the recorders I have modified, 4.7k $\Omega$  was suitable, but it

cont. on page 20

Fig. 2. Replacing the cassette recorder's electronics with this digital read-write chain gives high reliability at low cost.

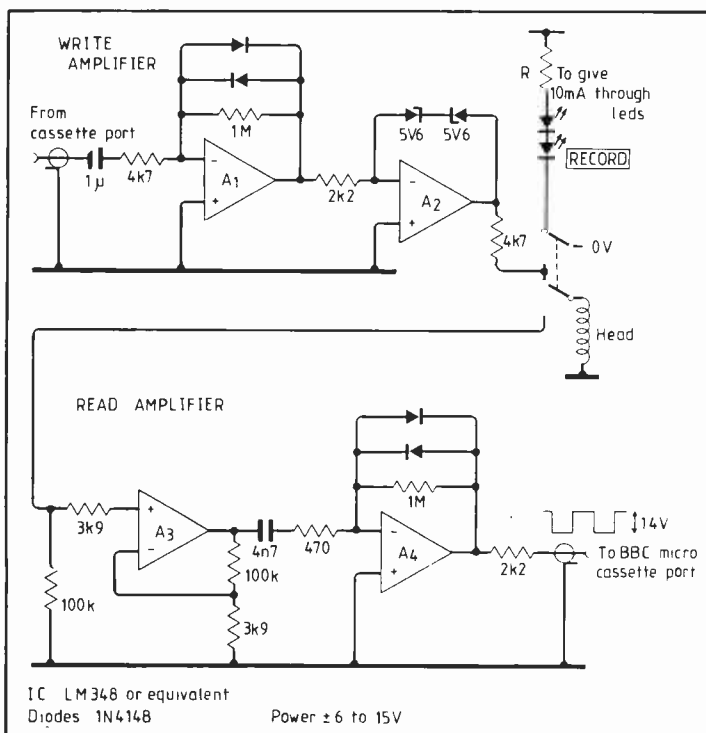
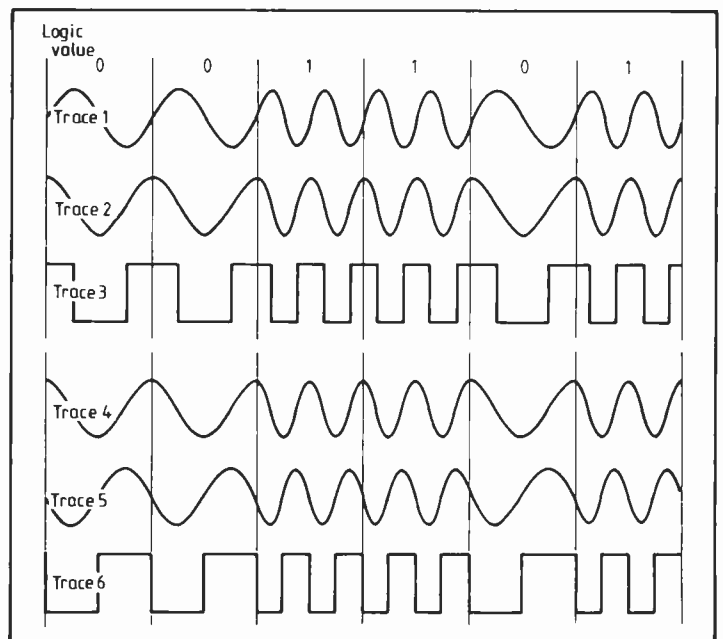

Fig. 3. Data recording on cassette: the problem and the solution (see text).



# TOROIDALS

The toroidal transformer is now accepted as the standard in industry, overtaking the obsolete laminated type. Industry has been quick to recognise the advantages toroidals offer in size, weight, lower radiated field and, thanks to I.L.P., PRICE.

Our large standard range is complemented by our **SPECIAL DESIGN** section which can offer a **prototype service within 14 DAYS** together with a short lead time on quantity orders which can be programmed to your requirements with no price penalty.

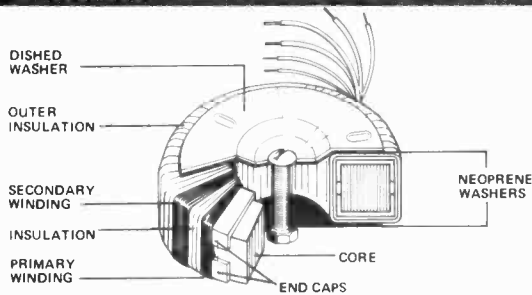

15 VA 62 x 34mm 0.35Kg Regulation 19%			50 VA 80 x 35mm 0.9Kg Regulation 13%			120 VA 90 x 40mm 1.2Kg Regulation 11%			225 VA 110 x 45mm 2.2Kg Regulation 7%			500 VA 140 x 60mm 4Kg Regulation 4%		
<b>SERIES</b>	<b>SECONDARY</b>	<b>RMS</b>	2x010	6+6	4.16	4x010	6+6	10.00	6x012	12+12	9.38	8x016	25+25	10.00
	<b>No</b>	<b>Current</b>	2x011	9+9	2.77	4x011	9+9	6.66	6x013	15+15	7.50	8x017	30+30	8.33
	<b>Volts</b>		2x012	12+12	2.08	4x012	12+12	5.00	6x014	18+18	6.25	8x018	35+35	7.14
0x010	6+6	1.25	2x013	15+15	1.66	4x013	15+15	4.00	6x015	22+22	5.11	8x026	40+40	6.25
0x011	9+9	0.83	2x014	18+18	1.38	4x014	18+18	3.33	6x016	25+25	4.50	8x025	45+45	5.55
0x012	12+12	0.63	2x015	22+22	1.13	4x015	22+22	2.72	6x017	30+30	3.75	8x033	50+50	5.00
0x013	15+15	0.50	2x016	25+25	1.00	4x016	25+25	2.40	6x018	35+35	3.21	8x042	55+55	4.54
0x014	18+18	0.42	2x017	30+30	0.83	4x017	30+30	2.00	6x026	40+40	2.81	8x028	110	4.54
0x015	22+22	0.34	2x028	110	0.45	4x018	35+35	1.71	6x025	45+45	2.50	8x029	220	2.27
0x016	25+25	0.30	2x029	220	0.22	4x028	110	1.09	6x033	50+50	2.25	8x030	240	2.08
0x017	30+30	0.25	2x030	240	0.20	4x029	220	0.54	6x028	110	2.04			
						4x030	240	0.50	6x029	220	1.02			
									6x030	240	0.93			
<b>(encased in ABS plastic)</b>			80 VA 90 x 30mm 1Kg Regulation 12%			160 VA 110 x 40mm 1.8Kg Regulation 8%			300 VA 110 x 50mm 2.6Kg Regulation 6%			625 VA 140 x 75mm 5Kg Regulation 4%		
	<b>30 VA</b>	<b>0.45Kg</b>	3x010	6+6	6.64	5x011	9+9	8.89	7x013	15+15	10.00	9x017	30+30	10.41
	<b>70 x 30mm</b>	<b>Regulation 18%</b>	3x011	9+9	4.44	5x012	12+12	6.66	7x014	18+18	8.33	9x018	35+35	8.92
1x010	6+6	2.50	3x012	12+12	3.33	5x013	15+15	5.33	7x015	22+22	6.82	9x026	40+40	7.81
1x011	9+9	1.66	3x013	15+15	2.66	5x014	18+18	4.44	7x016	25+25	6.00	9x025	45+45	6.94
1x012	12+12	1.25	3x014	18+18	2.22	5x015	22+22	3.63	7x017	30+30	5.00	9x033	50+50	6.25
1x013	15+15	1.00	3x015	22+22	1.81	5x016	25+25	3.20	7x018	35+35	4.28	9x042	55+55	5.68
1x014	18+18	0.83	3x016	25+25	1.60	5x017	30+30	2.66	7x019	40+40	3.75	9x028	110	5.68
1x015	22+22	0.65	3x017	30+30	1.33	5x018	35+35	2.28	7x025	45+45	3.33	9x029	220	2.84
1x016	25+25	0.60	3x028	110	0.72	5x026	40+40	2.00	7x033	50+50	3.00	9x030	240	2.60
1x017	30+30	0.50	3x029	220	0.36	5x028	110	1.45	7x028	110	2.72			
			3x030	240	0.33	5x029	220	0.72	7x029	220	1.36			
						5x030	240	0.66	7x030	240	1.25			

### Why a Toroid?

- \* Smaller size & weight to meet modern 'slimline' requirements.
- \* Low electrically induced noise demanded by compact equipment.
- \* High efficiency enabling conservative rating whilst maintaining size advantages.
- \* Lower operating temperature.

### Why ILP?

- \* Ex stock delivery for standard 240V range
- \* Fast prototype service available
- \* 3 weeks despatch for special orders
- \* 2 year no quibble guarantee
- \* No price penalty for call-off order

Prices including P & P and VAT

VA	Size	£	VA	Size	£
15	0	7.06	160	5	12.17
30	2	7.67	225	6	13.75
50	2	8.90	300	7	14.97
80	3	10.06	500	8	19.60
120	4	10.65	625	9	22.30

For 110V primary insert "O" in place of "X" in type number.  
For 220V primary (Europe) insert "1" in place of "X" in type number.  
For 240V primary (UK) insert "2" in place of "X" in type number.  
**IMPORTANT:** Regulator: All voltages quoted are FULL LOAD.  
Please add regulation figure to secondary voltage to obtain off load voltage.

**Mail Order** — Please make your crossed cheques or postal orders payable to ILP Electronics Ltd.

**Trade** — We will open your credit account immediately upon receipt of your first order.

**Post to:** ILP Electronics Ltd., Dept. 3  
Graham Bell House, Roper Close,  
Canterbury, Kent. CT2 7EP  
Tel: (0227) 454778 Telex: 965780



**ILP ELECTRONICS LTD.**

CIRCLE 23 FOR FURTHER DETAILS.

**HM 102 BZ**  
**£13.00**

## AFFORDABLE ACCURACY

### QUALITY MULTIMETERS FROM ARMON

**ANALOGUE**

**HM-102BZ**  
10ADC Range, 20kV/VDC, Buzzer, Battery Test Scale **£13.00**  
19 measuring ranges

**HM-102R**  
Low end voltage & current ranges. Jack for Audio o/p Voltages. **£11.00**  
20 measuring ranges.

**HM-1015**  
Rugged. Pocket sized meter. for general purpose use. **£7.50**  
16 measuring ranges  
Battery, Test Leads and Manual included with each model.

**HC 5010**  
**0.25% accuracy**  
**£36.50**

**HM 1015**  
**£7.50**

**FULL DETAILS ON APPLICATION FROM:-**

## ARMON ELECTRONICS LTD

DEPT A HERON HOUSE, 109 WEMBLEY HILL ROAD, WEMBLEY, MIDDLESEX HA9 8AQ  
TELEPHONE 01-902 4321 TELEX 923965  
PLEASE ADD 18% to your order for VAT. P&P Free of charge. Payment by cheque with order  
Offer applicable to mainland UK only. Please allow 28 days for delivery

**HC 7030**  
**0.1% accuracy**  
**£39.50**  
push button

CIRCLE 44 FOR FURTHER DETAILS.

IN VIEW OF THE EXTREMELY RAPID CHANGE TAKING PLACE IN THE ELECTRONICS INDUSTRY, LARGE QUANTITIES OF COMPONENTS BECOME REDUNDANT. WE ARE CASH PURCHASERS OF SUCH MATERIALS AND WOULD APPRECIATE A TELEPHONE CALL OR A LIST IF AVAILABLE. WE PAY TOP PRICES AND COLLECT.

## R. Henson Ltd.

21 Lodge Lane, N. Finchley, London, N.12. 5 mins. from Tally Ho corner

Telephone 01 445 2713/0749

CIRCLE 46 FOR FURTHER DETAILS.

## METER PROBLEMS?

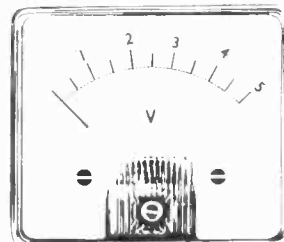

137 Standard Ranges in a variety of sizes and stylings available for 10-14 days' delivery. Other Ranges and special scales can be made to order.

Full Information from:

**HARRIS ELECTRONICS (London)**

138 GRAY'S INN ROAD, W.C.1

Phone: 01-837 7937

Telex: 892301

CIRCLE 14 FOR FURTHER DETAILS.

# It's a whole new board game.....with our 7000 Series

Many operations and tasks are now possible through BASIC which could previously only be accessed in ASSEMBLER.

Taking advantage of the new-generation software-on-silicon devices Cavendish Automation has already implemented a complete range of computer boards with full support specifically for industrial control applications. Our system enables very rapid interactive development of user software for super-easy deployment in the target system.

Static MOS RAM boards (to 128k), Power down control boards, Decoder boards providing further address line decoding, watchdog, Real-time clock/calendar, plus additional output flags and I/O. Mass storage devices. Backplanes, PSU and battery packs. Drive boards offering power output, pulse generation, or externally gated outputs. Multi-channel expandable ADC, Remote switch units for power, sound or V.I.S. of vision

For Industrial Control or Data Acquisition at board, sub-system or turn-key level we offer solutions and professional implementation.

## BASIC LANGUAGE CONTROLLER

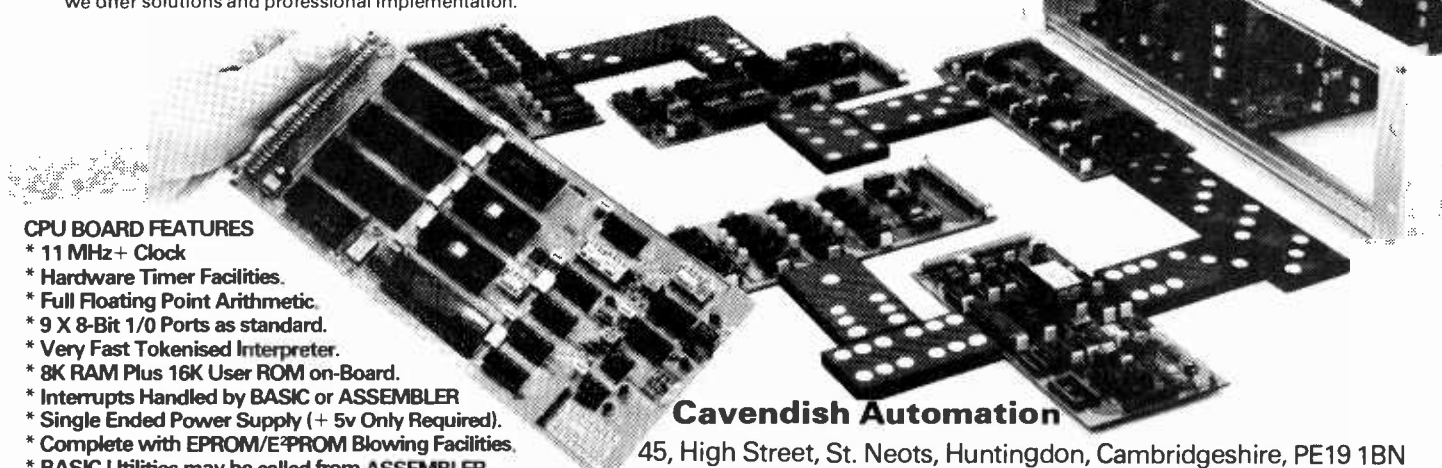

### CPU BOARD FEATURES

- \* 11 MHz+ Clock
- \* Hardware Timer Facilities.
- \* Full Floating Point Arithmetic.
- \* 9 X 8-Bit I/O Ports as standard.
- \* Very Fast Tokenised Interpreter.
- \* 8K RAM Plus 16K User ROM on-Board.
- \* Interrupts Handled by BASIC or ASSEMBLER
- \* Single Ended Power Supply (+ 5v Only Required).
- \* Complete with EPROM/E<sup>2</sup>PROM Blowing Facilities.
- \* BASIC Utilities may be called from ASSEMBLER.
- \* Serial Communications on Board (EIA, RS232) Plus printer Port.

### Cavendish Automation

45, High Street, St. Neots, Huntingdon, Cambridgeshire, PE19 1BN

Telephone: 0480 219457 Telex: 32681 CAVCOM G

CIRCLE 6 FOR FURTHER DETAILS.

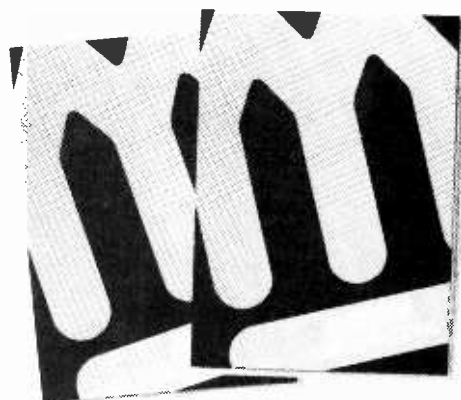

**IT WON'T COST YOU A PENNY.**

**BEING WITHOUT ONE COULD COST YOU DEARLY.**

The 1985 Midwich catalogue is now available, absolutely free.

It's the most comprehensive catalogue yet, containing many of the latest and very best computer components on the market, at highly competitive Midwich prices and a service that is second to none.

Which means it will provide your organisation with a vital source of information including numerous technical specifications and pin-out diagrams. Order your free copy by calling Diss (0379) 4131 today.

**MIDWICH**  
COMPUTER COMPANY LIMITED

Midwich Computer Company Limited, Gilray Road, Diss, Norfolk, IP22 3EU Tel: Diss (0379) 4131

CIRCLE 8 FOR FURTHER DETAILS.

## FIBRE-OPTICS EDUCATOR

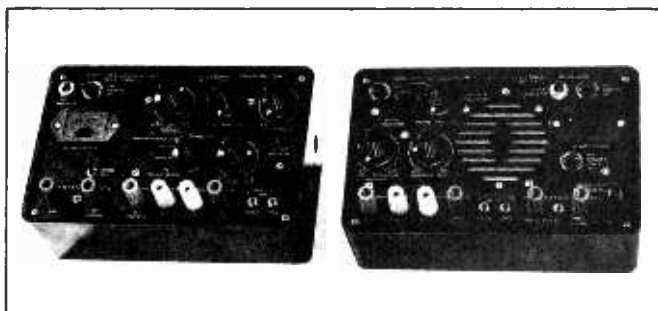

### A New Concept in Optical Equipment

The Fibre-Optics Educator is a **low-cost**, versatile instrument designed primarily for organisations involved in or about to enter the field of fibre-optics.

It can function as:

**TEST EQUIPMENT** e.g. for accurate fibre attenuation measurements to a range of 50dB, optical level measurements, and for testing out analogue and digital optical transmitters and receivers. Also, it may be set to give an audible indication of low level infra-red radiation using the analogue loudspeaker output or the digital buzzer output, with a length of optical cable acting as a probe.

**TRANSMISSION EQUIPMENT** for both **analogue** and **digital** data, over **free-space** as well as **optical fibres**. It is also ideal for:

**TRAINING** engineers, technicians and executives in the growing field of fibre-optics. Suitable for industry, colleges and technology training centres.

The Fibre-Optics Educator comprises fully portable optical transmitter and receiver units, optical cables, together with numerous accessories, a comprehensive manual, and carrying case.

*Designed and Manufactured in the U.K.*

For further details contact:  
ELLMAX Electronics Ltd.,  
Unit 29, Leyton Business Centre,  
Eloee Road, Leyton, London, E10 7BT.  
Tel: (01) 539 0136

**ELLMAX**  
**ELECTRONICS**

CIRCLE 13 FOR FURTHER DETAILS.

ELECTRONICS & WIRELESS WORLD JUNE 1985



# Right to the point

The point is accuracy, under all conditions. Something only a DMM with true RMS AC measurement can achieve. For £165\*, something only Philips new PM 2518 can offer.

Now only  
**£145**



Look at the table and you'll see how important true RMS can be. Look at the PM 2518 and see how much more you get – DC accuracy of 0.1%, plus wide-ranging standard and optional facilities (including "Backlite" display).

true RMS	5V	5V	5V	5V
reading on PM 2518	5V	5V	5V	5V
reading on average detecting meter	5V	5.55V	4.7V	3.2V

Like the idea of bench-top spec. with the convenience and price of a portable? Take a closer look at Philips PM 2518. You'll find the point is well made.

**Authorized distributors:**  
Electronic Brokers (01-267 7070)  
Philips Service (01-636 0505)  
Wessex Electronics Ltd (0272-571404)

**Philips Test and Measurement  
Pye Unicam Ltd**  
York Street Cambridge CB1 2PX  
Tel: (0223) 358866 Telex 817331

DM 12

\* Price excludes VAT and is correct at time of going to press.



**Test & Measurement**

# PHILIPS

CIRCLE 7 FOR FURTHER DETAILS.

# RADIOCODE CLOCKS LTD

SPECIALISTS IN ATOMIC TIME, FREQUENCY AND SYNCHRONISATION EQUIPMENT

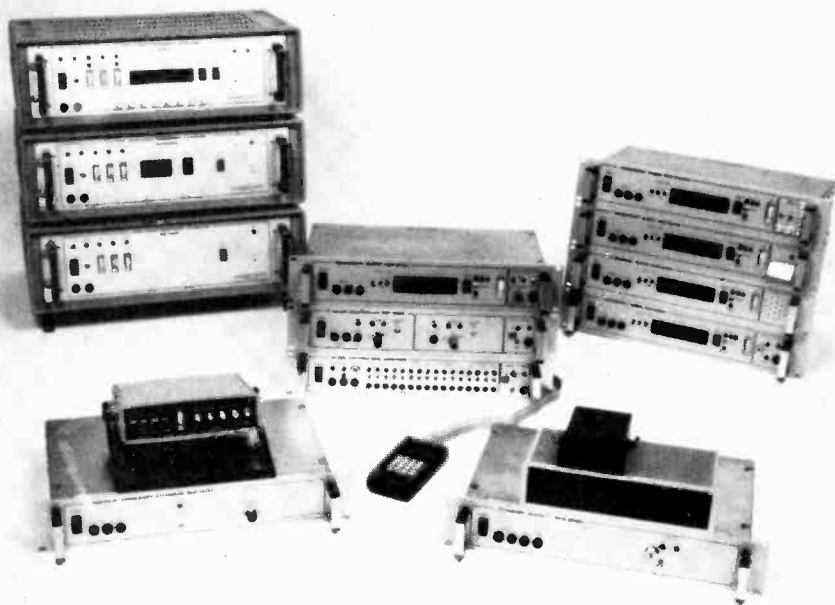

## NEW PRODUCTS

- **MINIATURE RUBIDIUM OSCILLATOR MODULE**  
Lower power, fast warm up, optional output frequencies, programmable frequency offsets.
- **RUBIDIUM FREQUENCY STANDARD**  
High performance, compact and rugged instrument. 2U rack or 1/4 ATR case options.
- **INTELLIGENT OFF-AIR FREQUENCY STANDARDS**  
Microcomputer controlled instruments, directly traceable to N.P.L., precision ovened local oscillator, comprehensive monitoring and status information, real time synchronisation.
- **LOW COST MSF FREQUENCY STANDARD**  
Instant operation, directly traceable to N.P.L., self-contained portable unit, no scheduled frequency changes, 24 hr transmission, real time synchronisation.

- Off-air frequency standards
- Intelligent time systems
- Caesium/Rubidium based clocks & oscillators
- Master/slave systems

- Time code generators/readers
- Record/replay systems
- Intelligent display systems
- Precision ovened oscillators
- Time/frequency distribution systems

## Radiocode Clocks Ltd\*

Unit 19, Parkengue, Kernick Road Industrial Estate, Penryn, Falmouth, Cornwall. Tel: Falmouth (0326) 76007

(\*A Circuit Services Associate Co.)

CIRCLE 27 FOR FURTHER DETAILS.

# CRICKLEWOOD ELECTRONICS LTD



## It's no secret...

that there is a real difference at Cricklewood Electronics. That's why you should never be without the FREE CRICKLEWOOD ELECTRONICS COMPONENTS CATALOGUE, for sheer variety, competitive prices and service from the U.K.'s number one 100% component shop. No gimmicks, no gadgets or computers, just components, millions of them, all easily available by mail order, calling or credit card telephone orders. Just pick up the phone (or a pen) to get your FREE copy now (no SAE required). You have nothing to lose.

### CRICKLEWOOD ELECTRONICS LIMITED

40 Cricklewood Broadway, London NW2 3ET

Tel: 01-450 0995/01-452 0161

Telex: 91 4977



EWV

CIRCLE 20 FOR FURTHER DETAILS.

# MICRO-TEL

## Universal Microtelemetry System

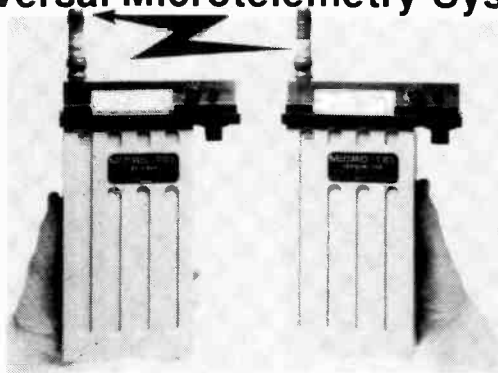

Micro-tel is a system of integrated UHF radio/modems ruggedly constructed and suitable for a wide range of 'line of sight' data communications applications.

### Features:

- UHF Home Office type approved radio (MPT 1309)
- 5 Radio Channels
- 1200 BAUD Modem/Demodem
- 12 Volts/250 m Amps Power
- RS232 Data Input/Output
- Small size 145 x 210 x 60 mm

### Micro-tel offers a simple and reliable solution for:

- Building to building computer comms
- Instrument to computer data links
- Industrial systems data links

Dealer and OEM enquiries welcome.

# MIDL

### MEASUREMENT DEVICES LIMITED

Silverburn Crescent, Bridge of Don Industrial Estate, Aberdeen, AB2 8EW Telephone: (0224) 824141 Telex: 739506 (MDLAB)

CIRCLE 45 FOR FURTHER DETAILS.

ELECTRONICS & WIRELESS WORLD JUNE 1985

## FUNDAMENTALS OF ENERGY TRANSFER

Mr Catt evidently assumes that the often-repeated statement that the field round a transmission line if TEM has been proved. But has it? If there is a proof that the electric field is everywhere strictly transverse then, please believe me. I would be really glad to see it.

The proof would have to deal with the following point. As a step wave passes down the line it sets in motion the electrons in the conductors. That is, the electrons are given (kinetic) energy by the field. Hence, somewhere, energy passes through the surface of each conductor, that is, somewhere there is a component of the Poynting vector into the conductor. So somewhere, there is a component of electric field along the conductor.

P.L. Taylor  
Marple  
Cheshire

I believe Mr Catt (Letters, February 1985) has made an error.

He seems to be saying that the principle of superposition should apply to the situation he describes — the case of the forces between conductors carrying overlapping pulses. It is, of course, wrong to try to apply superposition here, since the equations he has written down for his forces  $F_1$  and  $F_2$  are not linear (as superposition demands), but quadratic.

The equations

$$F_1 = iB \text{ and } F_2 = qE$$

appear at first sight to be linear, but since B is itself proportional to i, and E to q

$$F_1 = k_1 i^2 \text{ and } F_2 = k_2 q^2$$

Thus the forces are quadratic functions of the current and charge on the conductors and linear superposition is invalid. We should therefore not be surprised by the appearance of these 'strange' forces.

This is perhaps more clearly illustrated by the corresponding problem in electrostatics. The forces on a positively and

negatively charged sphere are shown in Fig 1.

The forces on the spheres in Fig. 2 are the same in magnitude and sign. However, in the situation of Fig. 3 where we have superposed the charges on the spheres from Figs 1 and 2, we find that the forces disappear.

If Mr Catt is searching for unification of electric and magnetic forces, he may be interested to consider the following.

In the double beam c.r.o. mentioned in Chris Parton's letter (December, 1984), the force per unit length on each beam of electrons can be written as the sum of the electrostatic repulsion and magnetic attraction

$$F = \frac{\mu_0 I^2}{2\pi a} - \frac{q^2}{2\pi \epsilon_0 a}$$

where a is the separation of the two beams.

But, if you transform to the rest frame of the electrons, travelling at speed v, the magnetic field disappears since the charges are now at rest. Now, if q is the charge per unit length in the beams in the laboratory frame, then the length part of q must be Lorentz transformed to q' giving

$$q' = q/\gamma$$

where  $\gamma = (1 - v^2/c^2)^{-1/2}$

Thus the electrostatic repulsive force can be rewritten

$$F = \frac{q'^2}{2\pi \epsilon_0 a} = \frac{q^2 v^2}{2\pi \epsilon_0 a c^2} - \frac{q^2}{2\pi \epsilon_0 a}$$

Finally, substituting

$$c^2 = \frac{1}{\mu_0 \epsilon_0}$$

where the current in the beams is  $I=q.v$ , we have

$$F = \frac{I^2 \mu_0}{2\pi a} - \frac{q^2}{2\pi \epsilon_0 a}$$

which is exactly the same force as we derived using magnetic theory.

This is a general result embodied in the relativistic invariance of Maxwell's equations and may be considered to be the unification of electromagnetic and electrostatic field theory.

N.C. Hawkes  
Abingdon  
Oxfordshire

## RELATIVITY

Recent articles and letters on relativity and the speed of light make me consider the greatest observable experiment, the "red shift" of distant astronomical objects. The faster the object recedes, the slower the peaks arrive so the redder they appear. Now suppose the object recedes at light speed: then no energy is arriving, no phase is changing, in fact nothing is happening, yet according to standard theory the light — at infinitesimal energy — is still arriving at c. In what sense can anything be said to be travelling past an observer's position if it is impossible even in principle to observe it? We cannot escape this by claiming that it is impossible for even astronomical objects to travel at light speed away from us, since there is no evidence of their behaving with any such limitation. The only sensible way to interpret it is that we cannot observe a velocity greater than c, which may well be true in most cases.

R.A. Rees  
Kirkland  
WA  
USA

May I draw your readers' attention to the implications of E. Eastwood's article 'Radio and the birth of the universe' (*Wireless World*, August 1981). H. Aspden has already

recognised the significance of the article's subject. (*Spec. Sci. Tech.* 5, pp. 421-431, 1982).

Eastwood's article deals with experiments (actual, not thought) performed to determine the peculiar or absolute velocity of our galaxy relative to the 3K cosmic microwave background radiation. As velocities are calculated relative to a point in space assumed to be at rest, the 3K microwave radiation is assumed to be at rest, i.e. standing waves caused by the constructive interference of crests and troughs of waves moving relative to Newton's absolute space at rest.

In the part of Eastwood's article headed 'Anisotropy of microwave background' Eastwood gives the true or absolute velocity of the earth relative to the 3K background assumed to be at rest as about 390 km/sec. This velocity vector is the Newtonian vector sum of three other velocity vectors assigned to empty space filled with 3K electromagnetic radiation by cranks and crackpots. ("...nor assign a velocity vector to a point in the empty space in which electromagnetic processes take place." — the introduction to Einstein's 1905 paper).

The other three velocity vectors are:-

- (1) The orbital velocity of the earth relative to the sun, assumed to be at rest — 30 km/sec.
- (2) The orbital velocity of the sun relative to our galaxy's centre of gravity assumed to be at rest — about 300 km/sec.
- (3) The absolute linear (?) velocity of our galaxy's centre of gravity relative to the 3K background assumed to be at rest — about 600km/sec.

The earth's absolute velocity vector of 390 km/sec. relative to the stationary 3K background is constantly directed from Aquarius to Leo but continuously variable in direction relative to a point on the earth's surface. In the northern hemisphere Aquarius is an autumn constellation and Leo a spring constellation.

Lorentz used the earth's orbital velocity vector of 30 km/sec. to calculate the earth's constant equatorial contraction of "about 6.5 cm." due to the constant pressure exerted by the ether wind. (*The Principle of Relativity*, Dover. p.6.) The

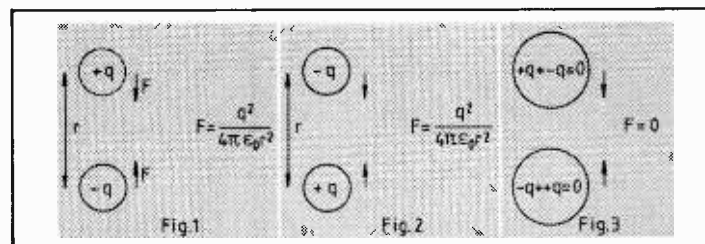



model of the relative motions of the heavenly bodies used by Lorentz in his calculations is one step removed from the flat earth theory and just as dangerous.

Michelson, Morley, Lorentz and Einstein assumed the velocity vector of Stoke's hypothetical ether wind was equal in magnitude but opposite in direction to the earth's orbital velocity vector relative to the sun, which they believed to be stationary at the centre of the universe. They believed the orbital directions of the vectors were absolute and constant relative to the supposedly stationary sun, and that both vectors were directed parallel to the plane of Michelson and Morley's apparatus.

They were unaware of the real experimental fact that the direction of the earth's absolute velocity vector is a continuous variable relative to the plane of Michelson and Morley's apparatus, and that Stokes's ether wind blows seasonally and daily at continuously varying angles through the ceiling of Michelson and Morley's laboratory.

Any theory based on a false model of the universe is false. The stationary sun and stars model is as false as the flat earth model in explaining the Doppler shift of receding galaxies. Hence Einstein's self-contradictory assumption that as his 'fixed stars' were stationary in Newton's stationary space, the magnitude of a star's red-shift is a function of the intensity of the star's gravitational field. Proved mathematically, of course.

M.G. Wellard  
Kenley  
Surrey

## RELATIVITY

In Dr W.A. Murrays' article on Relativity (*WW* May, 84) some assumptions were made that I feel were not quite as cut and dried as he made them seem.

Firstly, Time Dilation has been experimentally demonstrated with the aid of the atomic clocks on board the later Apollo space missions. These results agreed closely with those predicted by Special Relativity.

Secondly, relativistic principles have been shown to affect sub-atomic particles travelling at speeds in excess of

0.9c. It has thus been shown that the physical velocity limit of  $c$  is a reality when the  $E=Mc^2$  equation is used. If one assumes that mass is constant, as Dr Murray presumably does, then where does the exponential increase in energy input arise?

Thirdly, in his argument on the train experiment it would appear that a subtle change takes place between the disproving of Einstein assumptions and its paraphrasing on the following page.

In Einstein's argument the flash at A and B take place at the moment M and M' coincide, hence it is to the observers future positions that the light will arrive.

However, in Dr Murray's analysis he maintains that the light will travel the distance A-M and A-M' in the same time, hence reaching both observers simultaneously. In other words he has their future positions coinciding, not their present ones.

But in the paraphrasing of the above paragraph this has been changed back in order to refute the Einsteinian argument, which naturally will not agree with the author's assumptions.

I must point out that I neither agree or disagree with Einsteinian Relativity, but surely a principle that can be demonstrated to work would require a very strong argument to topple.

G.R. Moore  
Braintree  
Essex

I have been following the arguments about Einstein's train hypothesis with amazement and incredulity. There have been so many assertions and counterclaims that now we cannot see the wood for the trains.

In the February 1985 issue, Messrs Marquis and Scott Murray fall into opposite ends of the same trap, in describing apparently similar but actually different cases.

In Mr Marquis's case, M' and M perceive the flashes simultaneously, but will measure different distances. The error here is to transfer measurements from one world to the other. Scott Murray's observers would measure identical distances, but perceive

the flashes at different times; he begs the question by transferring Ms definition of simultaneity to the world of M'.

An incident recently brought to my attention is a good illustration of the problem. My friend Tom was sitting in his signal box, watching the up and down trains rattling past, when he noticed two flashes of lightning at different points of the track. His portable Lightning Detector informed him that the flashes had arrived at precisely the same instant. Dick on the up-train and Harry on the down-train happened to be opposite the signal box then, and got similar results from their instruments.

Tom subsequently discovered that the scorch marks on the track were precisely equidistant from his box. Dick and Harry found that the scorch marks on their respective trains were not equidistant from their seats; the differences were several thousand nanometres.

When the three of them compared notes that evening in the taproom of the Monkey's Nest, there was some initial disagreement, not only over the simultaneity of the flashes but also which came first. However, when Dick and Harry made allowance for the velocity of light and of their respective trains, all agreed that the flashes had been truly simultaneous in their present frame of reference. Old Lorentz in the corner muttered something about comparing the sums of the pairs of measurements, as well as the differences, but a game of dominoes was now in progress and this was not taken up.

Had Dick and Harry remained on their trains for ever, each would have been confident that the lightning strikes had NOT been simultaneous. Both would have been correct, even though the order of occurrence was not the same.

I trust that this incident adequately explains the situation, and will terminate this particular dispute.

R. Priestley  
Southsea  
Hants

Let there be a pyramid upon an ever-changing foundation of information, its four courses being (upwards) systems, scientific laws, abstract laws,

and Causation. Let Max Planck sit on top of it as an abstract quantum of energy positively glowing with absolutism. Let a special relation in the shape of a creative ape called Roy Hodges MIEE run down and up the pyramid, translating the abstraction of method into material means and vice versa, so demonstrating the creative and analytical process of visualisation so abhorred by digital theoreticians who use computers when they run out of fingers, so to get it as declinatory as the average monetarist.

One might now be deboggled as Mr A.H. Winterflood was when he grasped that energy is and mass becomes — between them lies a Constant Time Function, the fastest thing on wheels, which also has a reverse gear so allowing Mr Hodges to run up as well as down. (Wheels are frictional — when energy is in abstraction it has none, so it can go as fast as it is pushed).

Special Relativity applies when correcting the error of scale seen in our tiny Cyclopsian local frame after leaping from it either to a microcosm (an abstraction) or to the macrocosm (another abstraction). For those bogged down in the mud of our local frame the golden oldies are quite accurate enough for everyday use — may they rest in their wellies.

A pleasantly harmonic orchestration of an original theme, Mr Hodges! Let us rename it the Planck-Hodges Constant, whose dimensions are  $Md^2/t$ , or in this context  $Mdc$ , where  $d$  is the single directional dimension of linear movement of a quantum of energy towards a mass  $M$ : the change occurs at  $c$  (regardless of the speed of approach) and represents the change of state of mass from which we deduce the existence of energy, even in the case of human receptors (for those who possess them).

The photon leaving an atom is a little more tired than the one arriving, having wound it up a bit during its brief stay. It's that entropy thing.

Now, gentlefolk, what happens to the energy radiated by an atom which is moving at the speed of light? Seemingly it is caught in the act of being radiated, so what happens to



the atom? And what happens to an atom rushing at the speed of light towards a source of energy? It can only translate the energy (or whatever it does to it) at the speed of light: one likes to imagine that there is a limit for relativistic mass just as there is for everything else.

Might the four horsemen of quadrature have a little something to say upon the matter? Or the mass-energy dualism? Or are we coming to the monistic conclusion that there is no such thing as energy, that all mass is inherently static, all movement being imaginary and causation non-existent?

Thank you for your revelation, Mr Hodges: wellies rot eventually. But do tell us; in considering the photon, who are they that play pass-the-parcel? J.A. MacHarg  
Wooler  
Northumberland

In the February Letters Dr Scott Murray once again quotes Einstein with the provisos (as judged from the embankment) and (considered with reference to the embankment) faithfully included, and once again proceeds to argue as if he were blind to their presence in the text, as I previously pointed out in the December 84 letters, and A.J. Clayton in the January letters.

However the real crunch comes with the second half of his letter, and with his description of Figs 5 and 6 as Minkowski diagrams. A basic feature of a Minkowski diagram is that any event or encounter which is represented at all is represented by one point and one point only. Thus Dr Murray's figures and the discussion in which he talks about a single event being represented by two distinct points show not only that he doesn't understand Minkowski diagrams, but also that he doesn't even understand the physical interpretation of Lorentz transformations. In fact they relate the coordinations attributed to a given event relative to the two noncoincident sets of time and position axes which according to special relativity are used by any two observers such as M and M' who are at rest in two distinct inertial frames. No one worries about a point having

different coordinates with respect to two sets of spatial axes which are rotated with respect to one another; special relativity says that something rather similar occurs with mixed time and space axes.

If his Fig. 5 had really been a Minkowski diagram he would have shown the t-axis along the line labelled M, and the x-axis along the line between the points labelled (wrongly) A' and B'. With respect to those two sets of axes the lightning strike at A at time zero in the embankment frame would be represented by the point labelled A', which has the coordinates Dr Murray calculates with respect to these two sets of axes, the embankment axes being oblique. Similarly the strike at B would be represented by the point labelled B'. The sloping lines through the points labelled A' and B' would then represent the world lines of A and B, while vertical lines through those points would represent the world lines of the observers on the train who are present at the lightning strikes, A' and B'.

The points labelled (wrongly) A and B represent nothing in particular, but the cuts of the line through them with the world lines for A and B would represent the positions relative to the train of those observers at the train time of the encounter between M and M', represented by the intersection of the t' and x' axes. An important feature is that the lines labelled 'c', which represent light rays, bisect both the angle between the x' and t' axes, and the angle between the x and t axes, which means that both the train and the embankment observers interpret the light flashes as travelling at the speed 'c'. Almost any question one can ask about the interpretation of events by the train and embankment observers can be read off this diagram.

Dr Murray asserts that direct demonstrations of any correspondence between the predictions of special relativity and the workings of the world as it is are 'conspicuously non-existent'. The prediction of time dilatation was verified over fifteen years ago by measurements of the lifetime of pi mesons travelling with respect to the laboratory at a speed

very close to the speed of light, so that the time dilatation factor was not just marginally larger than one, but over 2.5. The measurements (see refs) agreed with the special relativity predictions to better than 0.5%. C.F. Coleman  
Wantage  
Oxon

#### References

Ayres, D.S, Cormack, A.M, Greenberg, A.J., Kenney, R.W, Caldwell, D.O, Elings, V.B, Hesse, W.P, and Morrison, R.J, *Phys Rev Lett* 21(1968)261.  
Greenberg, A.J, Ayres, D.S, Cormack, A.M, Kenney, R.W, Caldwell, D.O, Elings, V.B, Hesse, W.P, and Morrison, R.J, *Phys Rev Lett* 23(1969)1267.

## D.C. SUPPLIES

It may be helpful to Dr Smith to have two additional references brought to his attention. These are:

1. Walz, F.C. and Burkhard 'Analysis of Capacitive filtering of full wave rectification' *International J. Elect Engng* 1967 5 pp 563-572.
2. Ridler P.F. 'Analysis of single phase capacitor input rectifier circuits' *Proc. IEE* 17 12 December 1970 pp 2261 — 2266.

Schade's original work was extremely good for the full and half-wave rectifiers, but for the voltage doubler circuits was seriously in error due to a false assumption. Also his work was done at a time when the low values of load resistance imposed by solid-state circuits were unusual and it did not predict the instantaneous minimum voltage which is needed to ensure that regulators do not 'drop-out'.

The writer can supply, for non-commercial users, a listing of a Pascal program which will produce instantaneous minimum output voltage, peak-peak ripple voltage, peak rectifier current and r.m.s. rectifier current, given the values of  $\omega C R_L$  and  $r/R$  where C is the filter capacitance  $R_L$  — load resistance and r is the equivalent source resistance.

The calculations take about eight seconds using a 4MHz

Z80 machine and the 'Turbo Pascal' compiler. Professor P.F. Ridler  
University of Zimbabwe  
Harare

## ELECTRO-REDUCTIONISM

Thank you, *Wireless World*, for coining the useful term: electro-reductionism, to describe the fashionable variety of intellectual suicide. But anyone can disprove it; we do not need an irrational leap of faith.

The failure of rationalism to account for your own consciousness means that it is a rotten theory. So its failure to address values, human nature and ultimate questions is only to be expected.

We cannot answer whether a machine could have a conscious mind until we have a model that predicts the know fact of human awareness.

It is the reductionist who is forced to a leap of faith — that science will one-day be able to tackle consciousness. What is consciousness? What is colour? We divide colour into the objective wavelength and physiology model, and the sensation. We divide morality into behaviour, absolute moral imperatives, and subjective conscience. Science refuses to touch the absolutes or the subjectives. And consciousness is both indisputably factual, and subjective.

Which leaves a fact hanging. Which destroys the garbage. Which makes monkeys of them all, as, no doubt, they would agree.

D.H. Potter  
Axminster  
Devon

## RAILROADING RELATIVITY

Over the last year Dr Murray has used a lot of your column inches attacking Einstein and his theories. I have no particular objection to this as a sport, but in his case both of the main lines of his arguments are based on easily demonstrable fallacies.

With regard to Einstein's "rare but crucial conceptual error", Dr Murray asks us to believe that Einstein tells us

that when the train is moving, both the light flashes reach  $M'$  together. Since he twice quotes for us the passage where Einstein says precisely the opposite, it is hard to see the justification for such an allegation. Einstein says quite clearly that  $M'$  will see one flash before the other, and this is based on the argument that  $M$  sees them arrive together. Since at that moment  $M$  and  $M'$  do not coincide, it is a physical impossibility for the flashes to reach  $M'$  together, and we hardly need to invoke Minkowski to tell us this. Now what is a physical impossibility in one frame of reference is still a physical impossibility in any other, so the statement that  $M'$  sees one flash before the other is an absolute statement for this experiment. Of course, there is no denying that if the conditions for simultaneity had been met in the frame of reference of the train, those flashes much indeed arrive at  $M'$  together. The impossibility of this is proof that the events were not simultaneous in the train's frame of reference. Which is precisely what Einstein said.

The other argument concerns the constancy of the speed of light. Dr Murray is one of the very numerous band who tell us that Einstein's "second postulate" says that the velocity of light is the same for all observers despite their mutual relative motions. It doesn't. This is a paraphrase of the conclusions reached from the experiment of the two similar laboratories passing in space and the light at the centre of each flashing as they draw level. This makes it a little difficult to support the contention that this is an "irrational assumption", or that Einstein "accepted it without evidence". We need to go rather further back in the argument to find what the "second postulate" really does say.

When he set out to save Maxwellian theory, Einstein encountered therein the concept of the aether. The characteristics of this where that light would be propagated through it at constant speed, and that any motion of the source through the aether would not alter this speed. The analogy of sound through air is apt. Einstein adopted these

ideas in the form that in the absence of matter, light travels with a definite speed  $c$  that does not depend on the motion of its source. It is worth our while to take a further look at this assumption.

Suppose for a moment that we invert these characteristics, so that the light does not travel with constant speed, and that speed is dependent on the source's motion. In the first case, the speed would have to depend upon some function of time/distance. The alternative that it might be totally random belongs, I think; to the realm of science fiction, and it could hardly depend on the value of some local field, because there is no matter to anchor it to. The consequence of time/distance dependence is that any change in the position of the source would result in a change of the "local" value at every other point in space. No matter whether the observer's motion enters into the final equation or not, this change in value would be detected by that observer, who would thus be able to detect any motion of the source. The same thing happens if the value is altered by the source's motion. The "local" value will change, and though the observer would again be able to detect the source's motion. But to detect such motion is a violation of Newton's principle that no experiment exists that is capable of detecting absolute rest or uniform motion. This must be applied equally to the light and its source as it is to everything else. The conclusion is clear. The requirement that light travels at constant speed and that the speed is independent of the source's motion comes directly from Newton's principles, and in introducing his "second postulate" Einstein introduced no new information not already implicit in those principles. This puts the mathematical arguments into their correct perspective. As Dr Murray says, they are circular and do not constitute a proof of any assumption at all, only being a demonstration that the conclusions can be handled mathematically. I suggest that that is all they were ever intended to be.

In saving Maxwellian theory, Einstein found the way to save

Newtonian theory. By the end of the 19th century the cracks were beginning to show: by now the evidence against it is overwhelming. Fortunately Einstein realised that the basic inconsistency in Newtonian theory that was causing all the trouble was that the existence of absolute space and absolute time was not compatible with Newton's principles.

Fortunately for us, too, he produced in 1915 the necessary correction, otherwise the "baby with the bathwater" brigade would long ago have been screaming for us to abandon those principles, too. Of course it is a profound emotional shock to find that all those terrible consequences are only the logical outcome of Newton's principles, and I don't blame anyone for hoping they will go away if we pretend they are not there. It is interesting that many scientists are just as irrational as the rest of us.

Finally, Dr Murray is highly dogmatic about the non-existence of direct demonstrations of the correspondence between the "workings of the world as it is" and the predictions of the theory. I would refer him to the experiments of Hafele and Keating in 1971, who set out to see if the predictions of theory about clocks could be confirmed. They were.

(*SCIENCE* vol. 177, 1972, p.68ff).

Alan Watson  
Pollensa  
Mallorca

## NEXT MONTH

Among the features in the July issue is a Z80-based telephone call-charge indicator which, among other facilities, provides a running total cost. It is usable anywhere in the world.

John Linsley Hood describes a mains power controller intended mainly for use with a photographic enlarger to ensure stability of light output, but useful for other application as well. It uses triacs to control the amount of a mains cycle passed to the load.

Ken Smith writes of his work with young people and electronics. His views are provocative and may raise a few hackles amongst those of a more conservative disposition.

## Correction

Ivor Catt has asked me to point out an error in his letter on The Catt Anomaly in the May issue. On page 18, the penultimate line of the second paragraph should refer to the conductor, not the dielectric.

Amorphous metals, previously only possible to produce in strips on 0.05mm thick, have now been made 1mm thick using a technique known as rapid diffusion. The picture shows X-ray diffraction photographs of a nickel-zirconium sample. In A, typical X-ray reflexes of crystalline metals can be seen from an NiZr sample before annealing. After annealing, B, the sample is amorphous and causes diffusion.

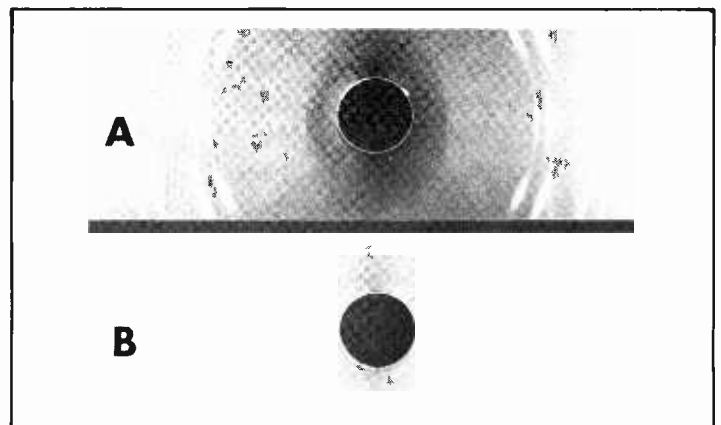

# Disc preamplifier

by Richard Brice

This valve design with no overall feedback uses passive equalization and a cascode input stage.

I designed this disc preamplifier working on three assumptions. The first is that good valve amplifiers sound better than good solid-state ones. Secondly, records sound better when passive equalization is used and lastly, amplifiers sound better when loop feedback is not used and linearity is an inherent part of the gain block.

The only problem with passive equalization is overloading of the first stage due to high-level treble signals. A valve with a high-voltage supply handles high-level signals and provides good linearity but the first stage must also have high gain to

reduce the effect of noise in the following RC network.

For a high-gain stage, the obvious choice of valve is a pentode but these valves generate more shot noise than triodes because the cathode current splits between the anode and screen. The amount of shot noise depends on valve construction. Good low-noise pentodes are expensive so I chose a cascode circuit.

The second valve,  $V_{1b}$  contributes little to noise; total stage noise is substantially that of  $V_{1a}$ . Gain obtainable is approximately the product of the anode  $V_{1b}$  and the working mutual

conductance of  $V_{1a}$ .

Equalization components are shown boxed. You may want to calculate values for the network more accurately than I have. At the expense of the convenience of using easily obtainable high accuracy capacitors, the network could operate at a lower overall impedance which would thus reduce the noise contribution of  $R_c$ .

Current consumption is low, at around 11mA for both channels, so a very smooth h.t. supply can be obtained using simple RC filtering. To keep hum to a minimum, a 6V d.c. supply feeds the heaters as shown in

the upper diagram. A complete valve is used for  $V_{1c}$ . Of the remaining three valves, one half is used for one channel, the other half for the other channel.

Total gain is around 40dB and distortion is calculated as well below 0.1% for 10mV r.m.s. input a 1kHz. Distortion is mainly produced by the triode directly following the equalizing network.

It's all too easy to jump to conclusions but I, together with interested friends and musicians, consider this circuit to be as good as or better than my previous design using a frequency-dependent shunt 5532 op-amp. In turn, this circuit had proved better than any series feedback equalization circuit and better than shunt-feedback circuits using simple transistor triples.

**A d.c. regulated supply feeds the valve heaters to reduce hum, top.**

**The cascode input circuit feeds a passive equalization network, tinted area, whose component values are a compromise, bottom.**

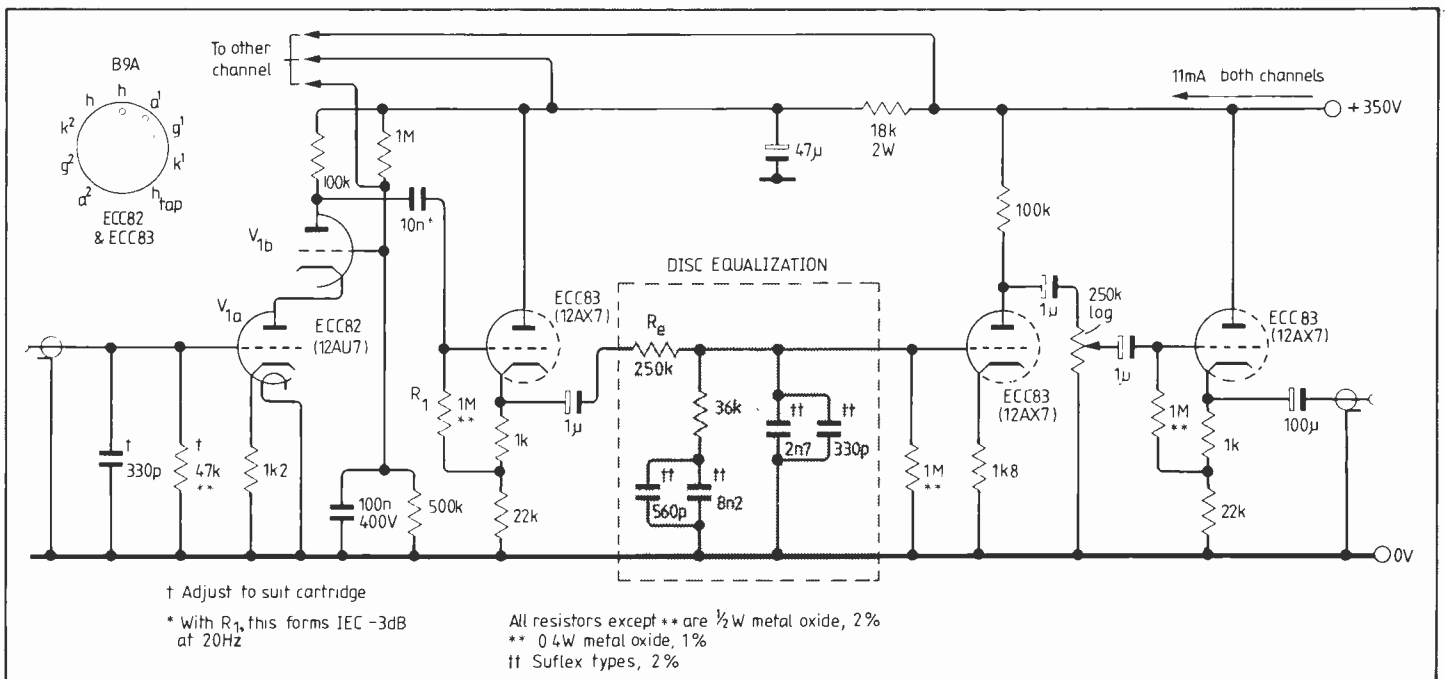
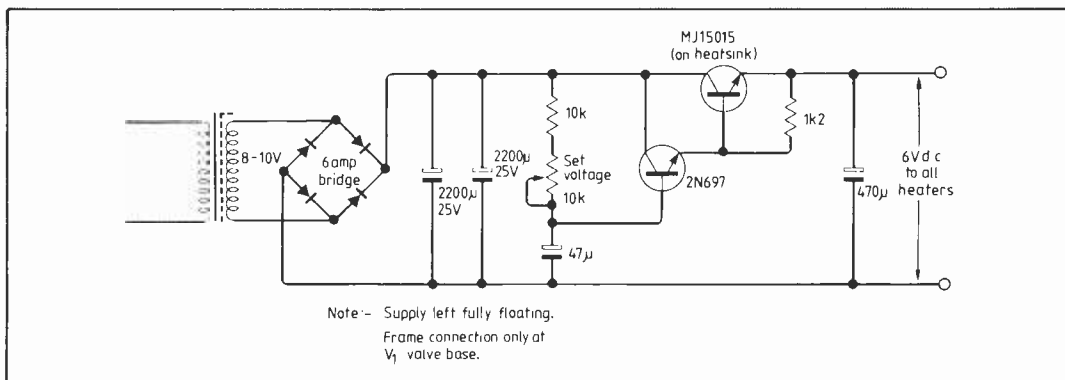

# SAREL'S CHASSIS SYSTEMS SET THE STANDARD

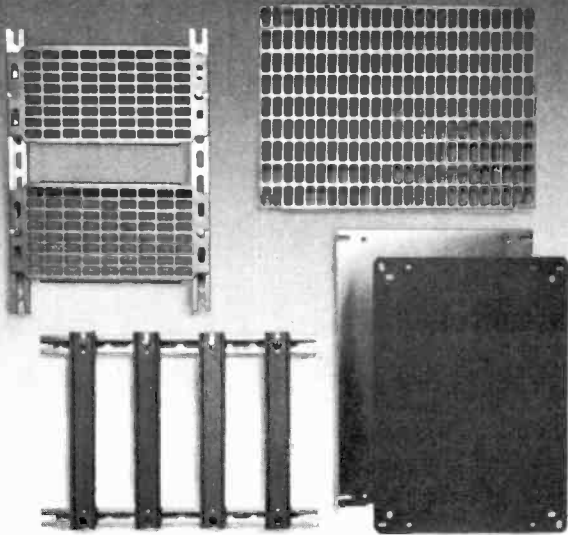

- Sarel Chassis are designed for use in their relevant size enclosures and are available ex-stock.
- **FLAT PLATE CHASSIS:** 3 types of sheet steel, coated in anti-rust lacquer or finished in zinc bichromate, plain or perforated according to type.
- **RAIL CHASSIS:** Using Symmetric or Asymmetric DIN section, each kit consisting of longitudinal members, transverse rails, nuts and screws.
- **PERFORATED PLATE CHASSIS:** Sarel nuts, adjustable vertically and horizontally, aid rapid assembly of control gear on this design offering great flexibility.
- **COMBINED CHASSIS:** A combination of transverse rails and perforated plates provides an infinite variety of chassis possibilities from a wide range of components.
- **TELEQUICK CHASSIS:** The basis of a complete wiring and installation system, simple to fit in the Sarel range of enclosures.

Please send me full details of how Sarel's Chassis Systems set the standard.

Name \_\_\_\_\_  
 Company \_\_\_\_\_  
 Position \_\_\_\_\_  
 Address \_\_\_\_\_  
 Telephone \_\_\_\_\_



**Sarel Limited**  
 Cosgrove Way, Luton, Beds.  
 Telephone: Luton 20121

*The infinite choice!*

CIRCLE 36 FOR FURTHER DETAILS.



## microview

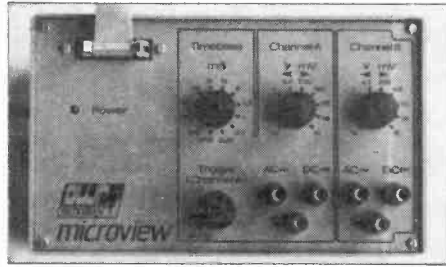

New from AWR Technology the MICROVIEW digital Oscilloscope/spectrum analyser.

ONLY **£140** incl. VAT and p & p

The MICROVIEW offers a wide range of features normally found on more expensive devices, including:

- ★ Simple connection to micro
- ★ Menu driven and user friendly software
- ★ Dual channels
- ★ Spectrum analysis of either channel
- ★ Large screen display
- ★ Magnification of selected areas of the display
- ★ Selectable Timebase
- ★ Save or load waveforms using a tape cassette
- ★ The ability to print selected waveforms

Compatible with ZX Spectrum and BBC B Computers

MICROVIEW (Complete) .....	£140
Demonstration Pack (Handbook and Tape) .....	£2
Scope probe kit .....	£12.85
BNC 4mm Adaptor .....	£4.40

All prices include VAT and p & p

AWR TECHNOLOGY

Simmonds Road, Wincheap, Canterbury, Kent  
 Telephone: (0227) 459000

CIRCLE 76 FOR FURTHER DETAILS.

## 4GHZ + 11GHZ SATELLITE TV RECEIVING EQUIPMENT

4GHz low noise amplifiers, receivers downconverters, feed horns. 11GHz blockconverters, demodulators. Antennas for both frequencies. Satellite reception feasibility report. A full report on reception feasibilities at a given location; price: £50-00. Please state longitude and latitude.

For further details contact

**HARRISON ELECTRONICS**

22 MILTON ROAD, WESTCLIFF-ON-SEA, ESSEX SS0 7JX Tel: (0702) 332338

CIRCLE 50 FOR FURTHER DETAILS.

## VIDEO TERMINAL BOARD

★ 80 characters × 24 lines ★

Requires ASCII encoded keyboard and monitor to make fully configurable intelligent terminal. Uses 6802 micro and 6845 controller. Program and character generator (7 × 9 matrix with descenders) in two 2716 EPROMs. Full scrolling at 9600 baud with 8 switch selectable rates. RS232 interface.

Bare board with 2 EPROMs and program listing — £48 plus VAT. Assembled and tested — £118 Send for details or CWO to:



**AM Electronics**  
 Wood Farm, Leiston, Suffolk IP16 4HT  
 Tel: 0728 831131

CIRCLE 25 FOR FURTHER DETAILS.

ELECTRONICS & WIRELESS WORLD JUNE 1985



# Power '85 Exhibitor List

Power '85 Exhibition and Conference, sponsored by the Power Supply Manufacturers Association at the Brighton Metropole Exhibition Centre from the 21st to the 23rd May 1985, is supported by the manufacturers listed below. The exhibition includes virtually everything connected with all types of power-handling equipment from batteries to automatic test gear and from components to systems.

A full conference and seminar programme will run concurrently. For free tickets apply to TCM Expositions Limited, Exchange House, 33 Station Road, Liphook, Hampshire GU30 7DN. Opening Times: 9 - 5 on Tuesday and Wednesday, 9 - 4.30 on Thursday.

## GREEN HALL

Allbatteries (Medicharge) Ltd.  
 AVX Limited  
 APLAB (UK) Ltd  
 R Baker (Electrical) Ltd  
 F W O Bauch Limited  
 Boschert Incorporated  
 Bowes Electronics Ltd  
 Bowthorpe EMP Ltd  
 Brandner U.K.  
 A F Bulgin & Co plc  
 Campbell Collins-Rifa Ltd  
 Cerberus Ltd  
 Cole Electronics Ltd  
 E D Transformers Ltd  
 Electronic Product News  
 Frako GmbH.  
 Hinchley Engineering Co Ltd  
 Hipotronics Inc.  
 Hi-Wire Ltd  
 Hollidyne Electronics Ltd  
 Huethig Publishing  
 Hunting Hivolt Ltd  
 Kingshill Electronic Products Ltd  
 M A Systems Ltd  
 MTL Microtesting Ltd  
 Merrimack Magnetics  
 Nedap N V  
 New Electronics  
 Papst Motors Ltd  
 Plessey Wound Products Ltd  
 Power Concepts Ltd  
 Power Conversion Ltd  
 Power Electronics  
 Powertron Ltd  
 R W Electronics Ltd  
  
 Renata AG.  
 Salicru SA.  
 Sharetree Ltd  
 Starkstrom (London) Ltd  
 Startronic Ltd  
 Systron-Donner Ltd  
 Techmation Ltd  
 Technitron Ltd  
 Tekelec Ltd  
 Venable Industries Inc.  
 Verospeed  
 Wavetek Electronics Ltd  
 Yuasa Battery Sales

## Stand No.

515  
618  
515  
419  
505  
508  
407  
425  
516  
404  
418  
617  
512  
667  
620  
518  
520  
609  
616  
409  
605  
412  
416  
509  
626  
621  
507  
422  
608  
612  
511  
519  
606  
526  
619  
  
406  
411  
522  
408  
414  
405/506  
613  
663  
611  
622  
415  
615  
521

## RED HALL

Abbott Transistor Labs.  
 Cetronic (P F) Ltd.  
 Ferranti Computer Systems Ltd  
 Gardners Transformers Ltd  
 Hanover Press Ltd  
 Kollmorgan (UK) Ltd  
 Micro Forecast  
 Transduktor Teoranta  
 Tungstone Batteries Ltd  
 Varta Limited  
 Watford Control

900  
1004  
906  
707  
1006  
1007  
705  
706  
704  
700  
1001

## BLUE HALL

Advance Power Supplies Ltd  
 Amplicon Electronics Ltd  
 The Belix Company Ltd  
 Brandenburg Limited  
 California Instruments  
 Canadian Instruments & Electronics Ltd.  
 Celab-Exem Limited  
 Chloride Power Electronics  
 Coutant Electronics Ltd  
 Electronic Product Review  
 F R Electronics  
 GEC Avionics Ltd  
 Gates Energy Products  
 Grenson Electronics Ltd  
 Gresham Lion Power Technology Ltd  
 Gresham Powerdyne Ltd  
 Harmer & Simmons Ltd  
 Hartley Measurements Ltd  
 ILP Electronics Ltd  
 Kenure Developments Ltd  
 Keysource Technology Ltd  
 Kingslo Limited  
 Power International Ltd  
 Power Supply Manufacturers Assoc.  
 Rel Industrial Ltd  
 Rhopoint Ltd  
 STC Components Ltd  
 Savage Power Ltd  
 VA Electronics Ltd  
 VMS Professional Power  
 Venture Technology Ltd

118  
119  
206  
251  
312  
303  
109/210  
113/214  
205/306  
220  
207  
305  
315  
213  
209/211  
112  
208  
310  
320  
311  
108  
313  
309  
102  
217  
308  
105  
104  
106  
314  
307

by R.N. Gorgui-Naguib, K.M. Henein and R.A. King

# 2-D digital filter design techniques

## A comparison of different techniques for designing two-dimensional digital filters.

R.N. Gorgui-Naguib and K.M. Henein obtained their M.Sc. with distinction in digital communications from the department of electrical engineering, Imperial College, University of London, in 1983. R.N. Gorgui-Naguib is currently a research student in that department. R.A. King, who obtained his Ph.D. from the University of London in 1978, is a reader in the digital communications section of the department of electrical engineering, Imperial College.

Two-dimensional digital signal processing is a relatively new field. Almost all of the work reported in this area has occurred during the last 15 years. In spite of its recent origin, significant progress has been made in the analysis, design and implementation of two-dimensional digital signal processors. This article focuses particularly on the design techniques of two-dimensional finite impulse response (f.i.r.) filters and infinite impulse response (i.i.r.) filters.

In the case of f.i.r. filters, most of the methods used for the design of one-dimensional (1-D) filters can be extended to the two-dimensional (2-D) case:

- frequency sampling technique
- window method
- optimal design methods.

Another, different, technique is used in the design of 2-D f.i.r. filters and is compared to the previous ones. This is

- frequency transformation.

In the design of 2-D i.i.r. filters, on the other hand, 1-D techniques are not carried directly to the two-dimensional case. This is due to the fact that in two dimensions the 2-D z-transforms cannot generally be factored into lower order systems. This leads to many design problems, such as the difficulty in determining the stability as well as in finding an efficient realization where the coefficients of the transfer function may be truncated to a reasonable number of bits. Because of these difficulties very little work has been done on designing 2-D i.i.r. filters.

Consequently, we concentrate more on the design techniques of 2-D f.i.r. filters and give a brief survey of some design principles for 2-D i.i.r. filters.

### Two-dimensional f.i.r. filter design

If  $h(n_1, n_2)$  is the impulse response of 2-D filter where  $n_1$  and  $n_2$  are finite and defined over the range

$$0 \leq n_1 \leq N_1 - 1$$

and

$$0 \leq n_2 \leq N_2 - 1$$

then the system function of a 2-D f.i.r. filter can be expressed as

$$H(z_1, z_2) = \sum_{n_1=0}^{N_1-1} \sum_{n_2=0}^{N_2-1} h(n_1, n_2) \cdot z_1^{-n_1} \cdot z_2^{-n_2}$$

where  $H(z_1, z_2)$  is the 2-D z-transform of the finite length sequence  $h(n_1, n_2)$ .

The convergence of the z-transform is guaranteed because the above equation has finite limits on all the summations and as  $h(n_1, n_2)$  is bounded, so is  $h(n_1, n_2) \cdot z_1^{-n_1} \cdot z_2^{-n_2}$  bounded for finite values of  $z_1$  and  $z_2$ . As the z-transform converges everywhere in the  $z_1$  and  $z_2$  planes for finite sequences, this guarantees that filters designed from finite sequences will be stable.

### Frequency sampling technique

This method is based on the principle that any 2-D finite duration sequence can be represented by its 2-D discrete Fourier transform  $F(k_1, k_2)$ . This is an approximation of the analogue frequency response at the appropriate samples, and so  $h(n_1, n_2)$  can be obtained via the inverse discrete Fourier transform given by  $h(n_1, n_2) =$

$$\frac{1}{N_1} \frac{1}{N_2} \sum_{k_1=0}^{N_1-1} \sum_{k_2=0}^{N_2-1} F(k_1, k_2) e^{j2\pi(a+b)}$$

where

$$a = \frac{k_1 n_1}{N_1} \quad b = \frac{k_2 n_2}{N_2}$$

And, since for the designed filter,

$$H(z_1, z_2) = \sum_{n_1=0}^{N_1-1} \sum_{n_2=0}^{N_2-1} h(n_1, n_2) \cdot z_1^{-n_1} \cdot z_2^{-n_2}$$

then the frequency response may be calculated by substituting the value of  $h(n_1, n_2)$ , obtained from the inverse discrete transform, in the z-transform equation given above and by putting  $z_1 = e^{j\omega_1}$  and  $z_2 = e^{j\omega_2}$ . This gives

$$H(e^{j\omega_1}, e^{j\omega_2}) =$$

$$\sum_{k_1=0}^{N_1-1} \sum_{k_2=0}^{N_2-1} F(k_1, k_2) \cdot I_{\omega_1, \omega_2, k_1, k_2}$$

where

$$I_{\omega_1, \omega_2, k_1, k_2} = \frac{1}{N_1 N_2} \cdot \exp(1) \cdot \exp(2)$$

$$\text{and} \quad \exp(i) = \frac{1 - e^{-j\omega_1 N_1}}{1 - e^{j(2\pi k_1/N_1 - \omega_1)}}$$

As in the 1-D case, the above relation is called the frequency interpolating function and it forms the basis for the design of 2-D f.i.r. digital filters using the frequency sampling technique. This function expresses the interpolated frequency response as a linear combination of its frequency samples, and Fig. 1 shows the frequency response of a low-pass filter designed through this method.

Again, as in 1-D case, the interpolation effect may be highly reflected in the oscillations that occur in the transition region since peak in-band and out-of-band ripples may develop at the edges of the passband and stopband respectively.

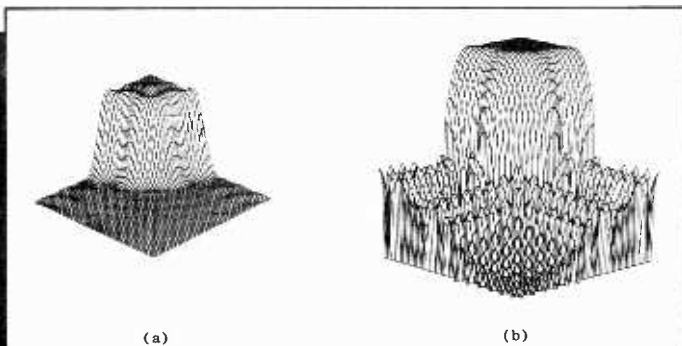

Fig. 1. (a) Linear and (b) log magnitude spatial frequency response of a 2-D frequency sampling digital low-pass filter for the case where  $N_1=N_2=25$  and for a specified set of frequency bands.

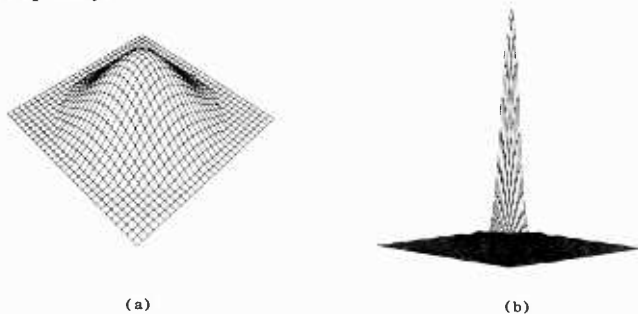

Fig. 2. Type and frequency responses of a 2-D Kaiser window defined as

$$w(n_1, n_2) = I_0 \alpha \sqrt{1 - \sqrt{1 - n_1^2 - n_2^2}} / 14 \quad / I_0(\alpha)$$

where  $\alpha=5.0$  and  $I_0(x)$  is the modified zero-order Bessel function. (a) is a perspective plot of the window and (b) the 2-D amplitude response.

## The Window method

The window method can be directly extended to 2-D f.i.r. filters where the 2-D impulse response sequence  $h(n_1, n_2)$  is multiplied by a 2-D window function,  $w(n_1, n_2)$ , defined equal to zero outside a certain region of interest.

This results in truncating the impulse response to obtain a finite matrix of finite dimensions and is expressed as follows:  $h'(n_1, n_2) =$

$$h(n_1, n_2) \cdot w(n_1, n_2) \begin{cases} 0 \leq n_1 \leq N_1 - 1 \\ 0 \leq n_2 \leq N_2 - 1 \\ = 0 \text{ otherwise.} \end{cases}$$

In this case, the frequency response is equal to the convolution of  $H(e^{j\omega_1}, e^{j\omega_2})$  and  $W(e^{j\omega_1}, e^{j\omega_2})$  where  $W(e^{j\omega_1}, e^{j\omega_2})$  is the Fourier transform of  $w(n_1, n_2)$ .

If a window sequence (corresponding to the rectangular window in the case of one dimensional design) is defined as

$$w(n_1, n_2) = 1 \begin{cases} 0 \leq n_1 \leq N_1 - 1 \\ 0 \leq n_2 \leq N_2 - 1 \\ = 0 \text{ otherwise.} \end{cases}$$

then some oscillations are bound to occur in the frequency transfer function of the filter and, consequently, the task for windowing is to choose an appropriate window function  $w(n_1, n_2)$  which will have the following transform properties

1.  $W(e^{j\omega_1}, e^{j\omega_2})$  should approximate a circularly symmetric function.
2. The volume under the main lobe of  $W(e^{j\omega_1}, e^{j\omega_2})$  should be large.
3. The volume under the side lobes should be small.

Huang showed that

$$w(n_1, n_2) = \hat{w}(\sqrt{n_1^2 + n_2^2})$$

is a good circularly symmetric 2-D window where  $\hat{w}$  is a good symmetrical 1-D window sampled at the appropriate values.

Accordingly, through the above equation, one can design approximations to circularly symmetric rectangular, Hamming, Blackman and Kaiser windows. As an example, Fig. 2 shows a 2-D Kaiser window.

## Optimal design methods

As in the case of 1-D filters, the problem of designing 2-D optimum f.i.r. filters in the Tchebycheff sense involves techniques where all the impulse response coefficients of the filter or, equivalently, all the discrete transform coefficients are allowed to vary and are solved by an optimization routine.

However, a direct multiple exchange algorithm such as the Remez exchange algorithm devised for 1-D f.i.r. filter design cannot be directly extended to the 2-D case. This is because of the alternation problem which is not directly generalizable in the 2-D case.

On the other hand, although theoretically the problem is in principle solvable by means of linear programming, practically it becomes

computationally intractable because of the extremely high number of variables involved in the computations and because of the number of constraints that have to be set to solve the problem.

## Frequency transformation method

This is an efficient technique developed by McClellan for the design of 2-D f.i.r. filters consisting of mapping an optimal 1-D f.i.r. filter into its 2-D counterpart.

To illustrate the technique, consider the frequency response of a linear phase 2-D filter with  $N_1$  and  $N_2$  odd where  $a(n_1, n_2) = R(h(n_1, n_2))$ :

$$H(e^{j\omega_1}, e^{j\omega_2}) = \sum_{n_1=0}^{(N_1-1)/2} \sum_{n_2=0}^{(N_2-1)/2} [a(n_1, n_2) \cos n_1 \omega_1 \cos n_2 \omega_2 \times e^{-j(\omega_1 n_1 + \omega_2 n_2)}]$$

Then multiplying both sides of the equation by  $e^{+j(\omega_1 n_1 + \omega_2 n_2)}$  a real function  $H_R(e^{j\omega_1}, e^{j\omega_2})$  may be defined as

$$H_R(e^{j\omega_1}, e^{j\omega_2}) = \sum_{n_1=0}^{(N_1-1)/2} \sum_{n_2=0}^{(N_2-1)/2} a(n_1, n_2) \cos n_1 \omega_1 \cos n_2 \omega_2$$

Now consider the frequency response of a 1-D filter with  $N$  also odd

$$H(e^{j\omega}) = \sum_{n=0}^{(N-1)/2} a(n) \cos n \omega$$

If we let  $x = \cos \omega$ , then

$$\cos n \omega = \cos [n \cos^{-1}(x)] = C_n(x)$$

where  $C_n(x)$  is a Tchebycheff polynomial of the  $n$ th order. However

$$\sum_{n=0}^{(N-1)/2} a(n) C_n(x) = \sum_{n=0}^{(N-1)/2} \tilde{a}(n) x^n$$

and therefore

$$H(e^{j\omega}) = \sum_{n=0}^{(N-1)/2} \tilde{a}(n) \cos^n(\omega)$$

Hence, by the transformation

$$\cos \omega = A \cos \omega_1 + B \cos \omega_2 + C \cos \omega_1 \cos \omega_2 + D$$

then  $H(e^{j\omega_1}, e^{j\omega_2}) =$

$$\sum_{n_1=0}^{(N_1-1)/2} \sum_{n_2=0}^{(N_2-1)/2} \tilde{a}(n_1, n_2) \cos n_1 \omega_1 \cos n_2 \omega_2$$

which can be put in the form

$$\sum_{n_1=0}^{(N_1-1)/2} \sum_{n_2=0}^{(N_2-1)/2} a(n_1, n_2) \cos n_1 \omega_1 \cos n_2 \omega_2$$

which corresponds with  $H_R(e^{j\omega_1}, e^{j\omega_2})$ .

An example of spatial frequency response of a digital filter designed by this technique is shown in Fig. 3.

This design method appears to be the most efficient and for many filters of practical interest the resulting 2-D approximation is nearly optimal in the Tchebycheff sense.

Moreover, higher order transformations may be developed to give a better approximation.

## Two-dimensional i.i.r. filter design

Although much research has recently been done on half-plane filters, almost all of the work reported in this area is concerned with the design of causal, quarter-plane stable filters from two different approaches: the frequency and the spatial domain approaches.

In the frequency domain case, most of the design efforts can be grouped into two categories: those involving spectral transformations and those involving computer-aided optimization techniques.

In the spectral transformation approach, a design technique proposed by Shanks consists of mapping analogue 1-D into 2-D filter with arbitrary directivity in a 2-D frequency plane. These analogue filters are called rotated filters because they are obtained by rotating the 1-D filters and then converting them into their digital two-dimensional equivalent via a 2-D bilinear transformation defined by the following two equations:

$$s_1 = \frac{1 - z_1}{1 + z_1} \quad s_2 = \frac{1 - z_2}{1 + z_2}$$

However, for angles of rotation above  $90^\circ$ , this technique does not guarantee the stability of the designed filter and the warping effects of the bilinear transformation affect the filter frequency response.

Costa and Venetsanopoulos improved this method by using a number of rotated filters whose angles of rotation are uniformly distributed over  $180^\circ$ . This results in a filter having a magnitude response which approximates a circularly symmetric cut-off boundary by a polygon.

Also, as a necessary but insufficient condition for the stability of the designed filter, the angle of rotation must be in the range of  $270^\circ$  to  $360^\circ$ .

Alternatively, in computer-aided optimization approaches, an iterative nonlinear optimization procedure is used to adjust the filter coefficients to minimize a specified error criterion. Again, the chief problem is to ensure the stability of the resultant 2-D digital transfer function.

In the spatial domain design problem, a filter transfer function is chosen to approximate a finite extent, 2-D, impulse response. A least-squares approach is developed with a spatial error criterion to reach a best approximation of the spatial error criterion to reach a best approximation of the spatial response. Unfortunately, as with other 2-D i.i.r. design techniques, this approach does not lead to stable filters. Furthermore, it may lead to a filter whose impulse response does not adequately meet the prescribed specifications.

However, a technique has been developed which relies on the fact that, by using an infinite sequence rather than of finite length, the least mean square solution would then necessarily lead to a stable filter. But the main disadvantage of using such a

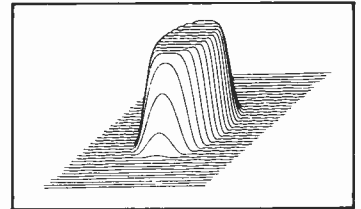

Fig. 3. Spatial frequency response of a digital filter designed by means of the McClellan transformation method for  $N_1 = N_2 = 27$ .

method lies in the very complicated computational effort involved in the analysis.

## Conclusions

Most of the techniques used for 1-D f.i.r. filter design can be extended to the 2-D case, amongst them, the window method proves to yield good 2-D non-recursive ideal low-pass filters.

The other two techniques discussed in this category, namely the frequency sampling technique and the optimal design methods have some problems associated with their implementation. In the frequency sampling technique, the interpolating function gives rise to oscillations and when using optimal methods, the design problem becomes extremely complicated by the number of variables and constraint equations that must be solved to obtain a reasonable solution.

The last design technique considered for f.i.r. filters involves designing a 1-D filter and then transforming it to a corresponding 2-D filter directly, according to a certain mapping criterion. This technique is very efficient and the resulting approximations are reasonable.

In the case of 2-D digital i.i.r. filters, problems associated with the stability of the resulting filters are very dominant and hence most of the design principles suffer from them and, although two design approaches were presented, no simple technique is readily available.

## References

1. B.M.G. Cheetham and P.M. Hughes: Digital filter design, *Wireless World*, May, June, August 1982.
2. R.N. Gorgui-Naguib and K.M. Henein: Digital filter design Techniques, *Wireless World*, November 1983.
3. K.M. Henein: Digital Filters (experimental report), Imperial College, December 1982.
4. R.A. King: Design of Multidimensional Digital Filters by Spectral Transformations, Ph.D. Thesis, Imperial College, University of London, 1978.
5. J.H. McClellan: Design of two dimensional digital filters by transformations. Proc. 7th Princeton Conference on Information Sciences and Systems, 1973, pp 247-51.
6. S.K. Mitra and M.P. Ekstrom (Editors): Two-Dimensional Signal Processing, Benchmark Papers in Electrical Engineering and Computer Science, vol. 20, 1978.
7. B. Nowrouzian: Space Domain Design and Stability of N-Dimensional Recursive Digital Filters, M.Sc. Thesis, Imperial College, University of London, 1976.
8. L.R. Rabiner and B. Gold: Theory and Applications of Digital Signal Processing, Prentice Hall, 1975.

THE ELECTRONICS MAGAZINE  
PROFESSIONALS CAN'T RESIST.

**Wireless** **ELECTRONICS & world**

June 1985

84 advanced  
microcomputer

Optical-fibre  
communication

Modem  
design

Electronics and Wireless World is the only electronics magazine to really tempt the professionals.

It's the only one they take the trouble to pick up for themselves.

That's because it's written for the engineer who sees electronics not only as a job, but also as a hobby.

It's written on a technical level that doesn't talk down to you.

It keeps you up to date with all the latest products and processes, applications and equipment.

And it covers every industry where electronics is involved.

Just one look at the new look magazine and you'll see why it gets professionals like you out of the office, and down to the newsagents.

**ELECTRONICS &**  
**Wireless world**

The leading magazine for electronics engineers.



so that the peak value of the current through the capacitor is given by:

$$i_{cap} = \frac{(V_i - n V_o)}{2 f L V_i} V_o \quad (18)$$

Because the ripple current has a triangular waveshape, the r.m.s. value is:

$$I_{cap} = \frac{i_{cap}}{\sqrt{3}} \quad (19)$$

Now using these results, we can proceed to get:

a) the ripple voltage across the e.s.r., which is simply:

$$\Delta V_{ESR} = \frac{(V_i - n V_o) V_o \times ESR}{f L V_i} \quad (20)$$

b) the peak to peak voltage across the e.s.l. by means of:

$$V_{ESL} = (ESL) \frac{di_{cap}}{dt}$$

which on the positive ramp gives:

$$\hat{V}_{ESL}^+ = (ESL) \frac{V_i}{n L} - V_o$$

and on the negative ramp:

$$\hat{V}_{ESL}^- = \frac{V_o}{L} (ESL)$$

The peak to peak voltage across the e.s.l. is the sum of these:—

$$\Delta V_{ESL} = \hat{V}_{ESL}^+ + \hat{V}_{ESL}^- = \frac{V_i}{n L} \times ESL \quad (21)$$

c) finally the ripple across the actual capacitor.

The charge going on and off the capacitor  $\Delta Q$ , is represented by the shaded area on Fig. 13.

$$\Delta Q = \text{AREA} = \frac{1}{2} \text{base} \times \text{height}$$

$$= \frac{1}{2} \frac{T}{2} \frac{di_{cap}}{dt} \frac{T\delta}{2}$$

and:

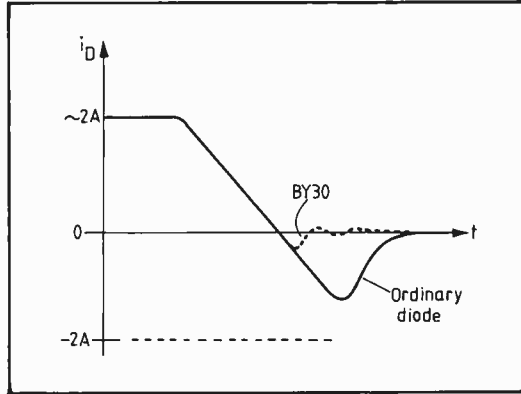

Fig. 11. Ordinary diode compared with fast-recovery type.

$$\Delta V_{cap} = \frac{\Delta Q}{C_o} = \frac{\delta}{8 f^2 C_o} \frac{di_{cap}}{dt} = \frac{\delta}{8 f^2 C_o} \left( \frac{V_i}{n} - V_o \right) \frac{1}{L}$$

again,

$$\delta = \frac{n V_o}{V_i}$$

from 5.

$$\therefore \Delta V_{cap} = \frac{(V_i - n V_o) V_o}{8 f^2 L C_o V_i}$$

Thus the output ripple is the sum of all these and it can be a complicated, noisy residue.

Commutation effects in the fly-back circuit impose considerably worse constraints on the performance of the filter. In particular, the flyback choke leakage inductance significantly affects the performance, particularly the effect of the e.s.l. The analysis is involved.

Fig. 13. Output ripple is sum of all these components.

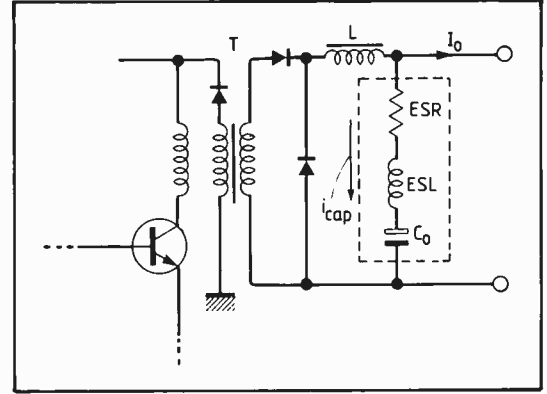
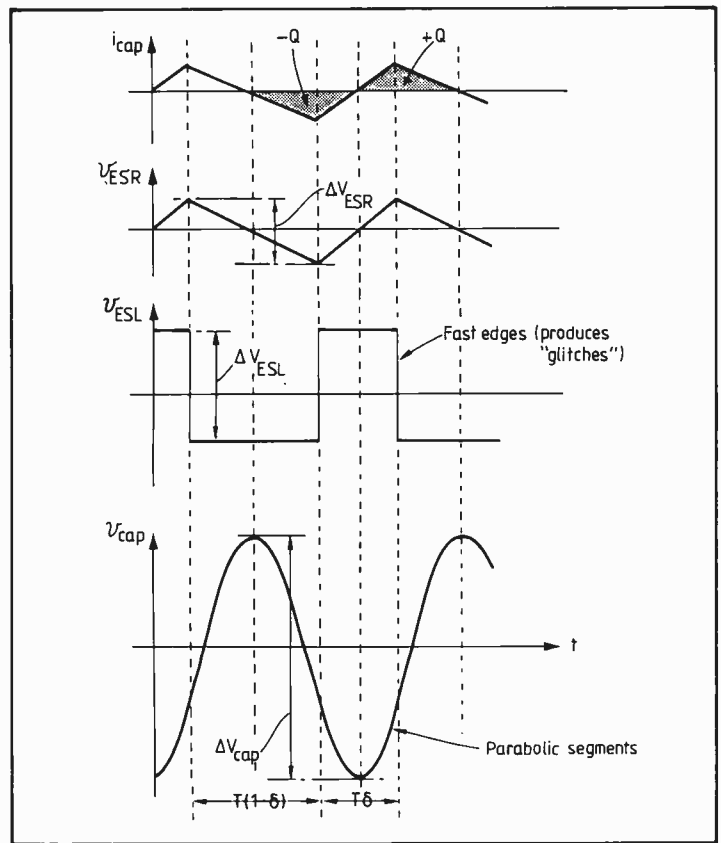

Fig. 12 S.m.p.s. output circuit, showing 'invisible' components of  $C_o$ .



## BOOKS

**Designing Microprocessor-based Instrumentation** by Joseph J. Carr: Prentice-Hall International, 323 pages, hard covers, ISBN 0 8359 1270 1. Practical guide to microprocessors (the Z80 in particular) and their support chips, and how to interface them to the outside world. Later chapters deal with basics of data conversion, transducers, sample-and-hold circuits and interfacing keyboards, switches and displays.

**Fault Tolerant Hardware Design** by Parag K. Lala: Prentice-Hall International, 263 pages, hard covers, £24.95, ISBN 0 13 308248 2. Chapters cover

basic concepts of reliability, types of faults in digital circuits and how to model them, test generation, fault-tolerant design of l.s.i. and v.l.s.i. chips, self-checking and fail-safe logic and design for testability.

**Going Online 1984**, ed. Jacky Deunette: Online Information Centre (Aslib, 26-27 Boswell Street, London WC1N 3JZ), 60 A4 pages, soft covers, £5. What services are available, how to use them and how much they cost. An extensive list of addresses covers UK user groups and system operators on both sides of the Atlantic; there is also a useful bibliography.

**International Electrotechnical Vocabulary**, chapter 521: Semiconductors and Integrated Circuits. International Electrotechnical Commission (3 rue de Varembé, Geneva), 90 pages, soft covers, Sw.Fr.103. How to render 'reverse recovery time' and several hundred other phrases into German, Spanish, Italian, Dutch, Polish and Danish. Translations and fuller explanations are given in French, English and Russian.

**Fundamentals of Electric Circuits** by David A. Bell (of Ontario, Canada): third edition, Prentice-Hall International, 847 pages, hard covers, £32.90, ISBN

0 8359 2125 5. A-level style textbook covering basic theory, units, resistive and reactive circuits, phasors and complex numbers, resonance, transformers, a.c. systems and non-sinusoidal waveforms. Rather expensive.

**Microprocessors: Hardware, Software and Design Applications**, by Wunnava V. Subbarao: Prentice-Hall International, 364 pages, hard covers, £30.85, ISBN 0 8359 4394 1. A self-teaching book for the engineer or student. Describes eight-bit processors in general and 8085, 6800, 6502, Z80 and 1802 in particular. Numerous design examples.

By J.R. Watkinson

# Channel code and disc format — 2

## How information is organized on the disc surface

The last article in this series discussed channel code and showed how binary data is adapted to a form which suits the characteristics of the medium. This part explains how information is organized on the disc surface.

Fig. 6 reveals the timing relationships of the CD format. The sampling rate of 44.1kHz with 16-bit words in left and right channels results in an audio data rate of 196.4kbyte/s ( $k = 1000$ ). There are 24 audio bytes in a data block, so the block rate will be

$$\frac{196.4}{24} \text{ kHz} = 7350\text{Hz}.$$

If this block rate is *divided* by 98, the subcode block rate of 75Hz results. This frequency will be divided down to provide running

time display in the player. If the block rate is *multiplied* by 588, the number of T periods in a block, the master clock rate of 4.3218MHz results. From this the maximum and minimum frequencies of e.f.m., 720kHz and 196kHz, can be obtained using the run-length limits.

Each data block contains 24 non-contiguous audio bytes. Their sequence and their relationship to the redundancy bytes is discussed next.

The error correction system has to deal with large burst errors resulting from surface contamination and the technique of interleaving reduces the amount of redundancy necessary<sup>5</sup>. The principle is that by storing data in a non-contiguous fashion,

several adjacent symbols destroyed by an error burst become single-symbol errors spread more widely.

There are a number of interleaves used in CD each with a specific purpose; the full structure is shown in Fig. 7(a). The first stage of interleave is to introduce a delay between odd and even samples. The effect is that uncorrectable errors cause odd and even samples to be destroyed at different times and interpolation can then be used to conceal the errors, with a reduction in audio bandwidth. The odd/even interleave is performed first in the encoder, as de-interleave in the player will be the reverse order, and interpolation is the last process. An odd/even delay of two blocks permits interpolation in the case where two uncor-

Fig. 7(a). CD interleave structure.

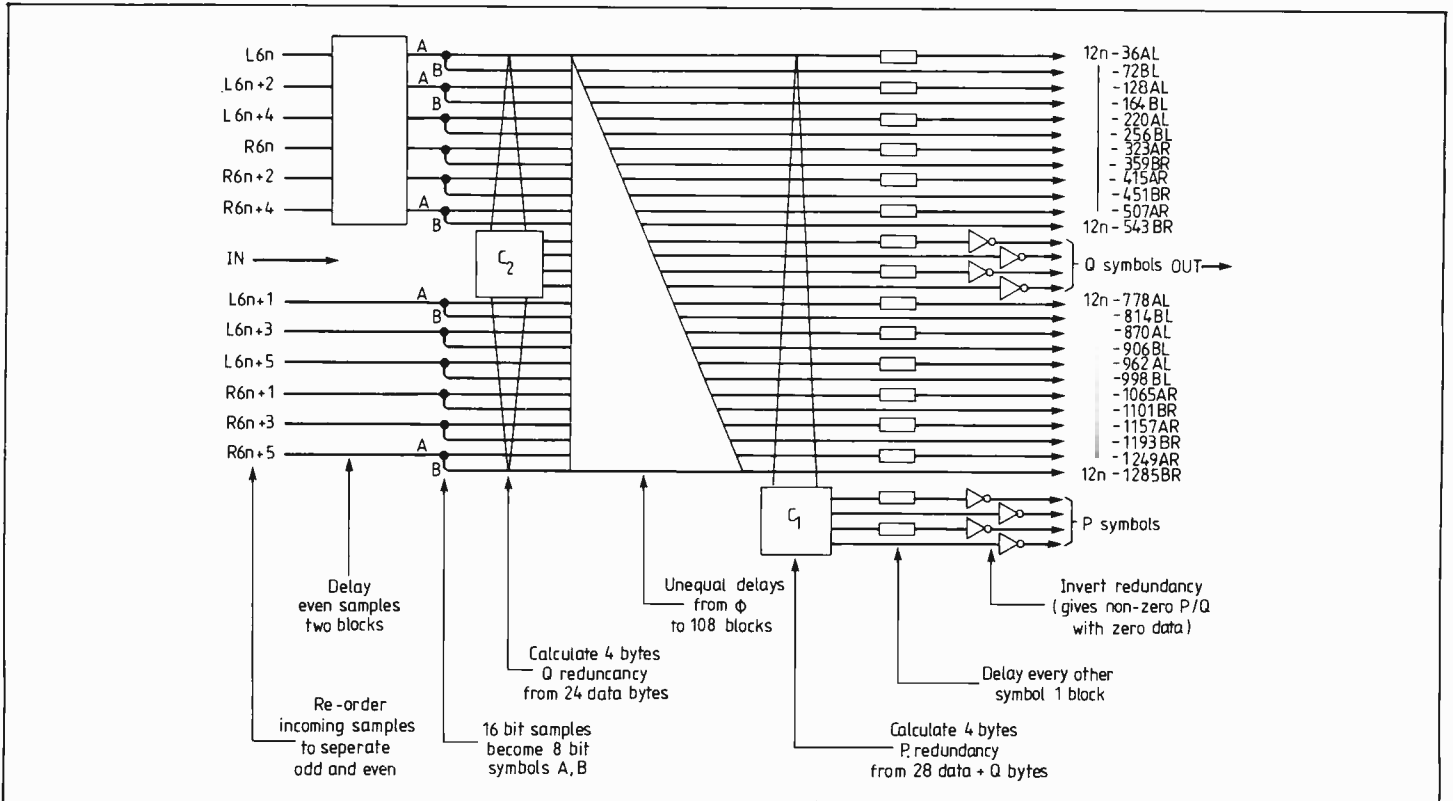

5. Error Correction Techniques in Digital Audio, John Watkinson. *Ibid.*

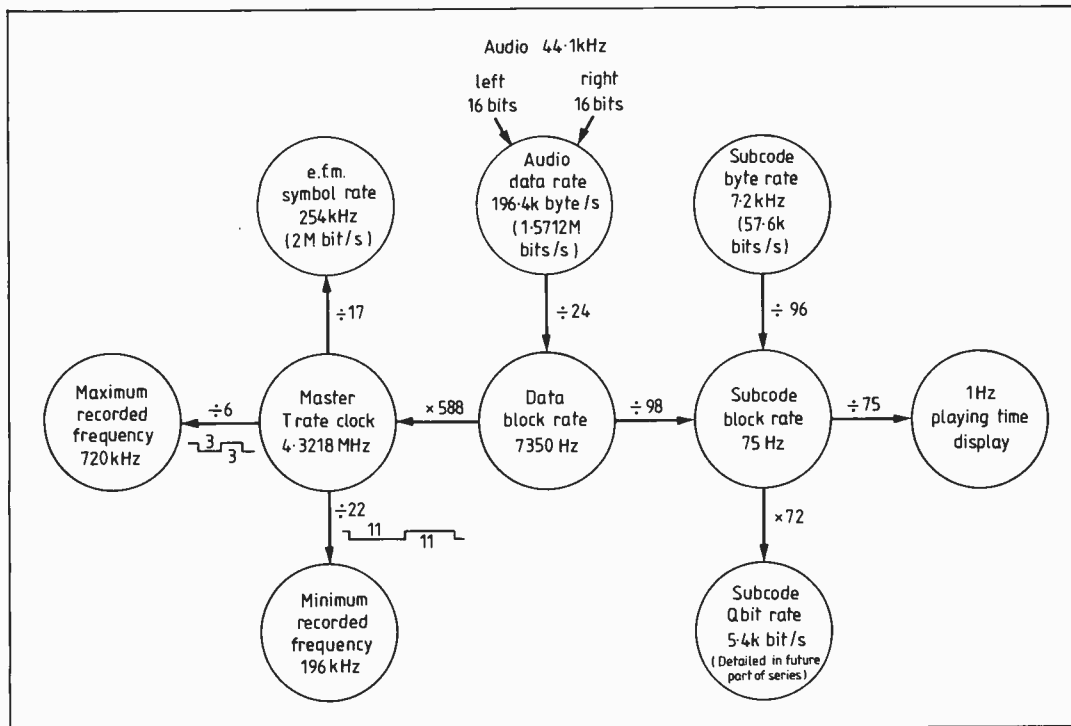

Fig. 6. The frequencies of the various events in compact disc timing are intimately connected — as the diagram shows — and the relationship cannot be broken. It should be self-evident that the drop frame time code should not be fed into a CD cutter.

rectable blocks leave the error correction system, Fig. 7(b).

Left and right samples at the same instant form a sample set. As the samples are of 16 bits, each sample set will be of four bytes, AL, BL, AR, BR. Six sample sets form a 24-byte parallel word, and the C2 encoder produces four bytes of redundancy Q. By placing the Q symbols in the centre of the block, the odd/even distance is increased, permitting interpolation over the largest possible error burst. The 28 bytes are now subject to differing delays, which are integer multiples of four blocks. This produces a convolutional interleave, where one C2 code word is stored in 28 different blocks, spread over a distance of 109 blocks.

At one instant, the C1 encoder will be presented with 28 bytes which have come from 28 different C2 code words. The C1 encoder produces a further four bytes of redundancy P. Thus the C1 and C2 code words are produced by crossing a data array in two directions ('cross interleaving').

The final interleave is an odd/even output symbol delay which causes P code words to be spread over two data blocks on the disc, as shown in Fig. 7(c). This mechanism prevents small random errors destroying more than one symbol in a P code word. The choice of eight-bit symbols in the e.f.m. channel code assists this strategy.

The expressions in Fig. 7(a) determine how the interleave is

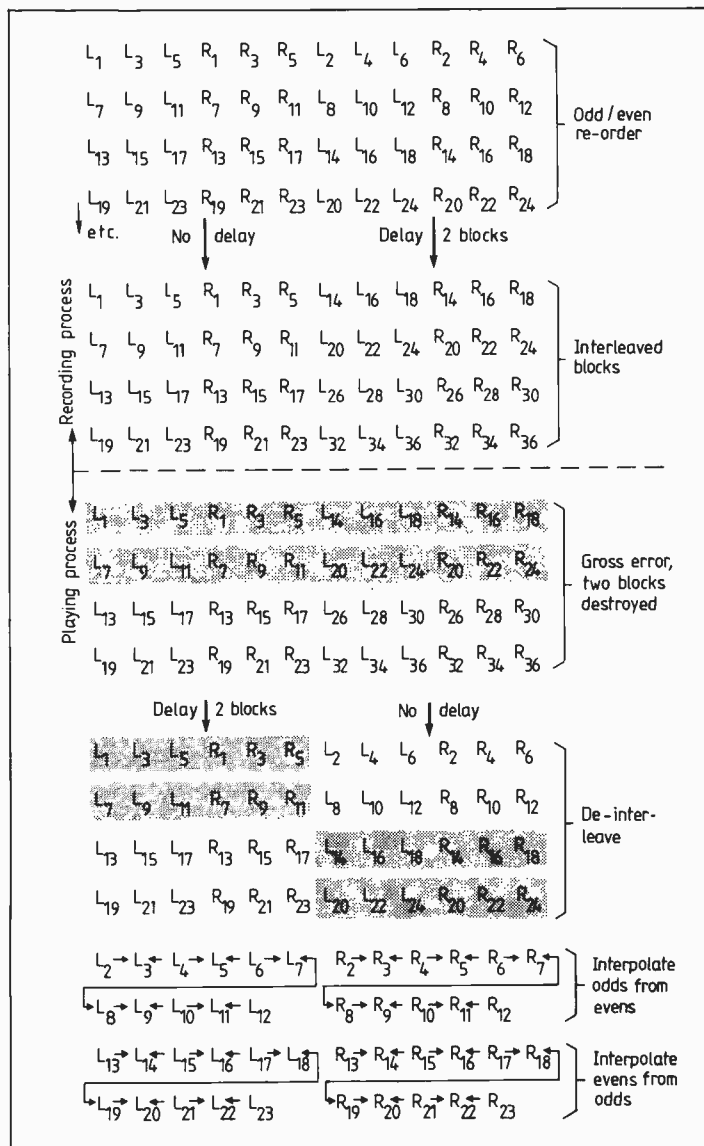

Fig. 7(b). Odd/even interleave permits the use of interpolation to conceal uncorrectable errors.



Following an M.Sc. course at Southampton's Institute of Sound and Vibration, John Watkinson worked in research before joining Digital Equipment Corporation, first as a field engineer, later as an instructor, specializing in mass storage devices. He joined Sony Broadcast in 1982 specialising in professional digital audio and timebase corrector training, and is currently training manager at Ampex International.

Fig. 7(c) The final interleave of the CD format spreads P code words over two blocks. Thus any small random error can only destroy one symbol in one code word, even if two adjacent symbols in one block are destroyed. Since the P code is optimized for single symbol error corrections, random errors will always be corrected by the CI process, maximizing the burst correcting power of the C2 process after deinterleave.

calculated. Fig. 7(d) shows an example of the use of these expressions to calculate the contents of a block and to demonstrate the cross interleave.

The calculation of the P and Q redundancy symbols is made using Reed-Solomon cyclic polynomial division. The P redundancy symbols are primarily for the purpose of detecting errors,

to provide error flags for the Q system. The P system can however correct single symbol errors. This mechanism will be described in greater detail in a later part.

Fig. 8 the encoder modulates the cutting laser. Audio and subcode data streams are supplied, and the cross interleaved block structure created. The e.f.m.

encoder produces a 14T pattern for every 8-bit symbol, and sync. patterns and merging patterns are multiplexed in.

The next article in the series assembles the disc, optics, servos and error correction system to form a CD player.

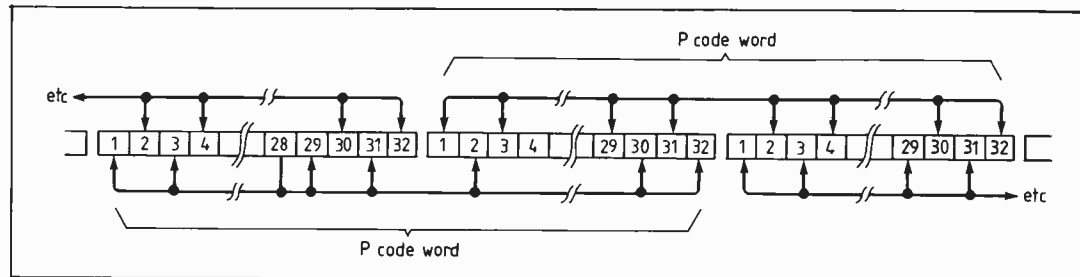

Fig. 7(d) Because of cross-interleave, the 28 symbols from the Q encode process (C2) are spread over 109 blocks. The final interleave of P code words, as in Fig. 7(c), is shown shaded. Result of the latter is that Q code word has 5,3,5,3 spacing rather than 4,4.

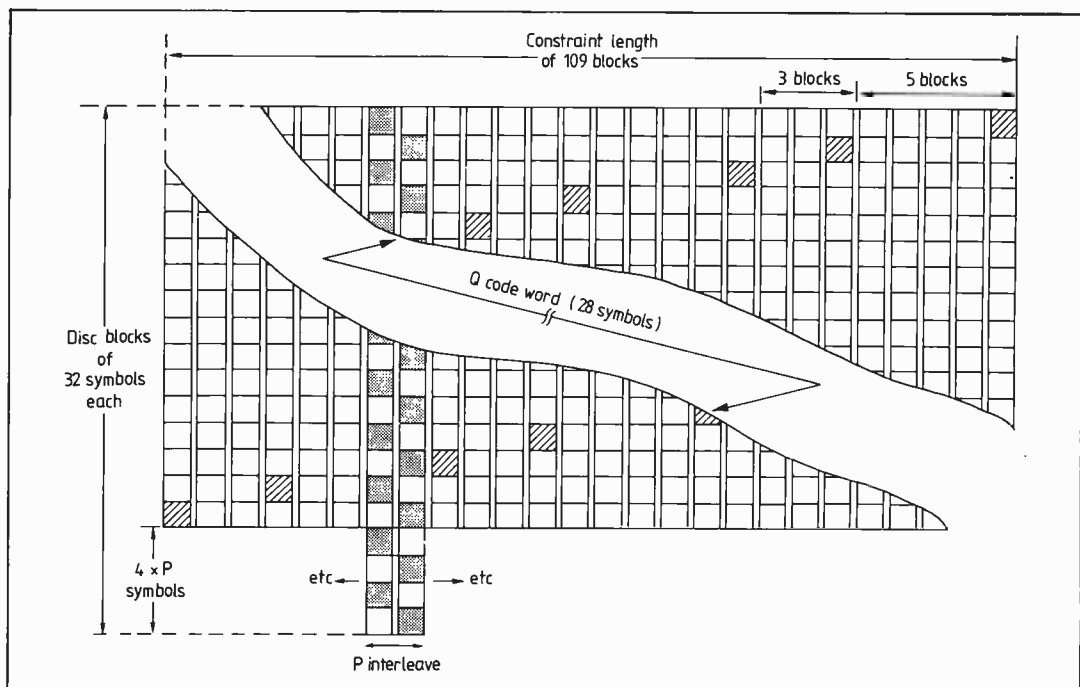
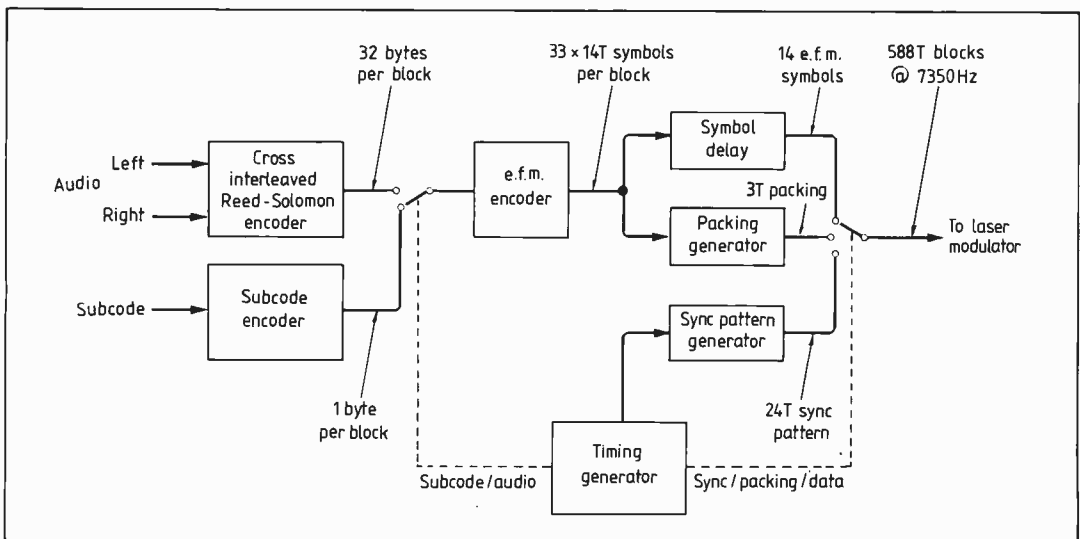
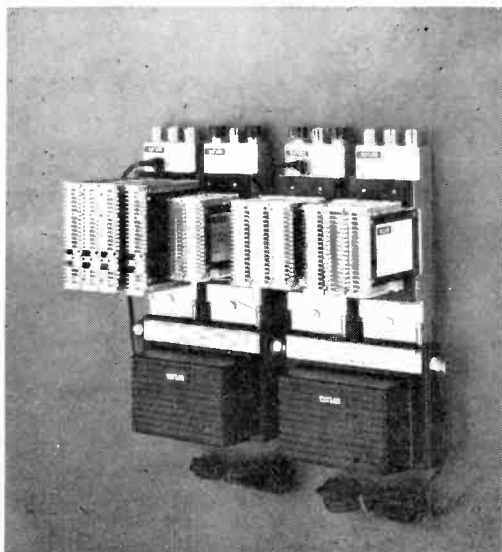

Fig. 8. CD encoder modulates cutting Laser. Audio samples are cross-interleaved and combined with subcode data. These 8-bit symbols are encoded into 14T e.f.m. symbols. The packing generator prevents run-length violations and provides d.c. content control via 3T packing symbols. The e.f.m. symbol delay allows the packing generator to look ahead. Two of the many functions of the timing generator are to switch in subcode bytes (left) and to assemble blocks by selecting sync patterns, data and packing (right).





# CABLE T.V. HEAD END AND REPEATER AMPLIFIERS



## CHANNEL CONVERTERS

TCUU UHF-UHF Single channel converter. Gain adjustable +2dB-16dB. Maximum output +26dBmV. Crystal controlled oscillator. Power requirement 14V 25mA. (Quote Channels required).  
 TCUV As TCUU except UHF to VHF converter. (Quote Channels required).  
 TCVU As TCUU except VHF to UHF converter. (Quote Channels required).

## SINGLE CHANNEL AUTOMATIC GAIN CONTROL AMPLIFIERS

TAG4863 Gain 48dB, maximum output 63dBmV. Regulator + or - 8dB. Power requirement 14V 210mA.  
 TAG4063 Gain 40dB, maximum output 64dBmV. Regulator + or - 16dB. Power requirement 14V 210mA.

## SINGLE CHANNEL AMPLIFIERS

TSS4663 Gain 28-46dB adjustable. Maximum output 63dBmV. Power requirement 14V 170mA.  
 TSS3062 Gain 12-30dB adjustable. Maximum output 62dBmV. Power requirement 14V 26mA.

## DRIVER AMPLIFIERS

TS1030FM FM driver amplifier. 10dB Gain. Maximum output 30dBmV. Power requirement 14V 10mA.  
 TS1030B3 Band III driver amplifier. 10dB gain. Maximum output 30dBmV. Power requirement 14V 10mA.  
 TS1030UHF UHF driver amplifier. 10dB gain. Maximum output 30dBmV. Power requirement 14V 10mA.  
 TS1040S Single channel UHF driver amplifier. 10dB gain. Maximum output 40dBmV. Power requirement 14V 10mA. (Quote channel required).

## DISTRIBUTION AMPLIFIERS

TE2042 Domestic distribution amplifier. 1 input, 1 output. Gain 20dB. Maximum output 42dBmV.  
 TE1638 Domestic distribution amplifier. 1 input, 2 outputs. Gain 16dB. Maximum output: 2 at 38dBmV.  
 TS2046 40-860MHz. Gain 20dB UHF, 18dB VHF. Maximum output 46dBmV.  
 TS2846 40-860MHz. Gain 28dB UHF, 22dB VHF. Maximum output 46dBmV.  
 TS2845 Separate UHF/UHF inputs. Gain 28dB UHF, 22dB VHF. Maximum output 46dBmV.  
 TS2054 40-860MHz. Gain 20dB UHF, 18dB VHF. Maximum output 54dBmV.  
 TS2060 40-860MHz. Gain 20dB UHF, 18dB VHF. Maximum output 60dBmV.  
 TS5565 Gain 55dB UHF, 55dB VHF, 42dB FM. Maximum output 65dBmV.

## REPEATER AMPLIFIERS

TSC3660 Repeater. Gain 16-36dB UHF, 10-30dB VHF. Maximum output 60dBmV.  
 TSC3665 Repeater. Gain 16-36dB UHF, 10-30dB VHF. Maximum output 65dBmV.  
 TSC3060 Repeater. Gain 10-30dB VHF. Maximum output 60dBmV.

## QUALITY AT LOW COST

## TAYLOR BROS (OLDHAM) LTD

LEE STREET, OLDHAM - TEL. 061-652 3221 - TELEX 669911

CIRCLE 18 FOR FURTHER DETAILS.

# Newrad

NEWRAD INSTRUMENT CASES LTD  
 Unit 19, Industrial Estate, Gore Road  
 New Milton, Hants BH25 6SJ  
 Tel: New Milton 0425 621195

WE HAVE INCREASED THE RANGE  
 OF OUR SUCCESSFUL NM40 ENCLOSURES

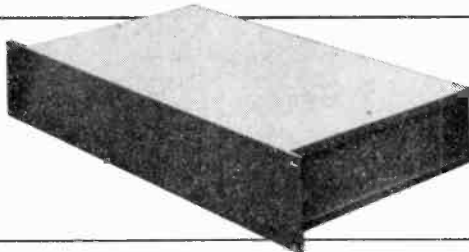

Beautifully made 19 inch Rack Mounting enclosures complete with heavy gauge chassis and top and bottom covers. Front, Side and Rear panels are aluminium and flat for easy machining. These panels are located with heavy duty aluminium extrusions. Front and Rear panels are satin anodised. Covers are finished in cream.

HEIGHT	DEPTH	PRICE
2U	150	£16.50
2U	250	18.60
2U	300	18.50
3U	150	18.00
3U	250	20.00
3U	300	22.00
4U	150	20.30
4U	250	24.50
4U	300	27.40
6U	150	25.00
6U	250	29.00
6U	300	35.00

PRICES ARE EXCLUSIVE OF VAT. P&P £3.00

CIRCLE 21 FOR FURTHER DETAILS.

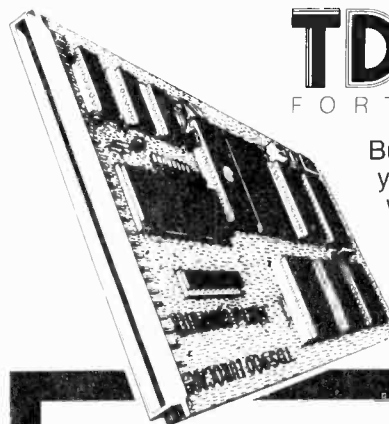

# TDS900

FORTH COMPUTER

Build the TDS 900 into your products, program it with a VDU and your forecasts become fact.

**NOW FROM  
 £99**

- ☆ Single board computer. 12k RAM and 8k ROM (expandable).
- ☆ All C-MOS for lower power. FORTH language. Compiled and fast. On-board screen-editor, compiler and debug facilities.
- ☆ Easy connection with serial and parallel channels, A/D, D/A converters, triacs, printers, keyboards and displays.



Triangle Digital Services Limited  
 100a Wood St. Walthamstow, London E17 England  
 Telephone 01-520 0442 Telex 262284 (Ref 775)

Agents in USA, France, Switzerland, Netherlands, S Africa, Australia

CIRCLE 29 FOR FURTHER DETAILS.

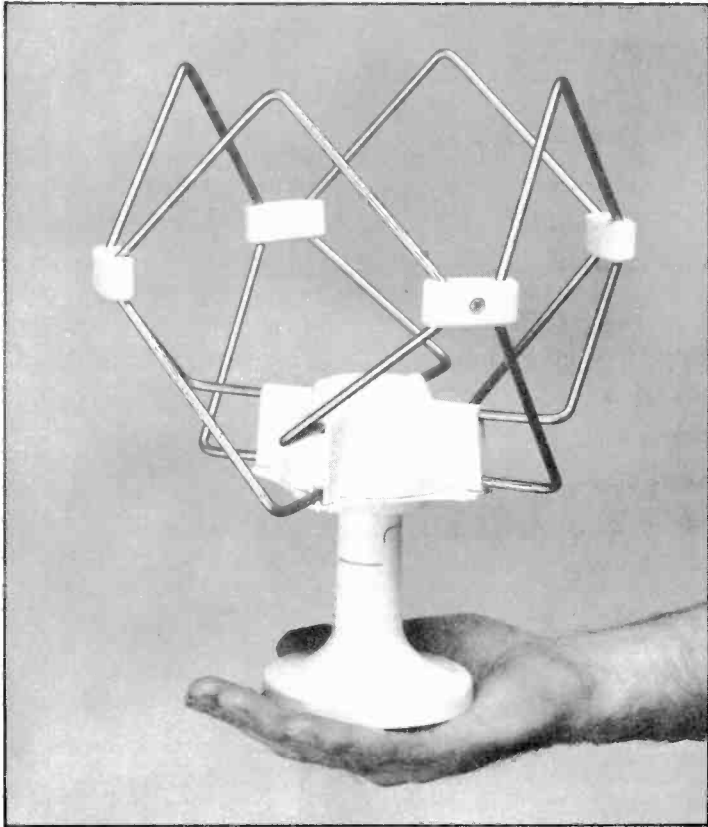

## Mobile tv aerial

Patents have been applied for the design of a u.h.f. tv receiving aerial for use on vehicles. It is an adaptation of the quad configuration. The objective behind the design was to evolve an aerial that would provide an omnidirectional field pattern where the direction of the wanted transmission station changes as the vehicle moves from one location to another. Of course it is possible to redirect a Yagi-type aerial but this requires physical movement of the aerial and the new design eliminates this. The success of the design can be judged by

looking at the polar field strength diagrams; it is not worth reproducing them as they are just circles! Suggested applications are for use in coaches, cars, caravans and on water craft. Because vehicles often operate in areas of low signal strength, the aerial is provided with a broadband amplifier giving a 22dB gain over the whole u.h.f. band. The UK price of the Omnimax Aerial, including the amplifier and 5m coaxial cable is £39.50 inclusive. Maxview Aerials Ltd. Setchey, King's Lynn, Norfolk. PE33 OAT. EWW213

## Transportable Unix

Trumpeted as the world's first transportable, fully integrated Unix-based computer the Hewlett-Packard Integral PC, incorporates multi-tasking, Multi-window facilities and combines processor, display, printer and disc drive all in one 11.2Kg (25lb) package. The Unix operating system is on a 256K rom, the computer is built around the Motorola 68000 processor, uses the fast H-P thinkjet printer and has a 3.3in double-sided, double-density disc drive.

The computer operates from a.c. mains supply. Display is provided by an amber electroluminescent screen with

a 9in diagonal. There is an HP-IB (=GPIB) interface, an input port for a mouse, and 512K of ram with expansion slots for more (up to 1.5MByte) and/or for a V23 modem. By using bus expanders, memory can be increased to 5.5MBytes. Eventually the computer will be able to address up to 8MB of user ram. An additional 32K ram is used for the screen memory. For software development, C and Technical Basic are available, as is a wide range of applications software. Stocked by Rapid Recall Ltd., Denmark Street, High Wycombe, Bucks. HP11 2ER EWW205



## Tiny trimmer

Another world's first is claimed for this device. The smallest ever precision trimmer capacitor. Designed to provide screwdriver adjustable tuning of high frequency circuits (up to 5GHz), The Voltronics CPA10 achieves its small size by eliminating the outer case and internal screw mechanism. Extreme precision is used to manufacture the parts and the Teflon dielectric is fused to the stainless steel moveable shuttle. Both the contact clamp and the shuttle clamp are gold-plated beryllium copper. Very

low contact resistance ensures low r.f. loss and high Q. The capacitor has been vibration tested to 40G with no variation in the set capacitance value. The use of the CP series of trimmers eliminates the cost of wirebonding small capacitance elements, allows the rough tuning of several stages before final tuning, eliminates the cost of matching and tuning integrated circuits and the r.f. loss is lower than for ceramic elements. Pascall Electronics Ltd, Hawke House, Green Street, Sunbury-on-Thames, Middlesex. TW16 6RA. EWW211

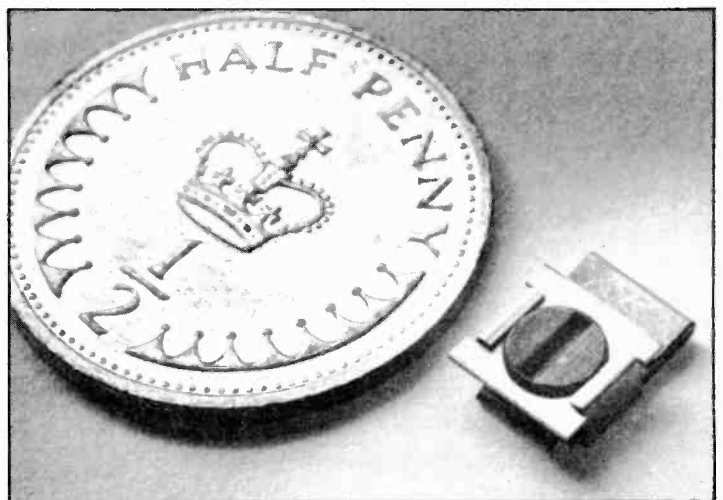

# AUDIO · VIDEO · DATA

A superb range of innovative loading  
and duplicating technology  
· Worldwide ·



## the leaders

Tape Automation Ltd, Unit 2, River Way, Harlow, Essex CM20 2DN.  
Telephone (0279) 442946, Telex 265871 MONREF G quoting Ref: 84:AUL001.

EUROPE · USA · JAPAN · UK · INDIA

CIRCLE 17 FOR FURTHER DETAILS.

### OSCILLOSCOPES

TEKTRONIX 465 Dual Trace 100MHZ Delay Sweep ..... **£1000**  
 GOULD OS4000 DIGITAL STORAGE. Dual Trace ..... **£650**  
 TELEQUIPMENT D75 Dual Trace 50MHZ Delay Sweep ..... **£350**  
 COSSOR CDU150 Dual Trace 35MHZ Delay Sweep ..... **£200**  
 S.E. LABS SM111 Dual Trace 18MHZ AC or external DC operation ..... **£175**  
 TELEQUIPMENT S54A. Single Trace 10MHZ Solid State ..... **£110**  
 TELEQUIPMENT D43. Dual Trace 25MHZ ..... **£110**  
 TELEQUIPMENT S43. Single Trace 25MHZ ..... **£75**

### SIGNAL GENERATORS

MARCONI TF995A/2 AM/FM 1.5 — 220MHZ. **£200**  
 MARCONI TF144H/4 10KHZ — 72MHZ ..... **£85**  
 ADVANCE type SG63E AM/FM 4 — 230MHZ. **£150**  
 ADVANCE type SG63A AM/FM 7.5 — 230MHZ. **£75**  
 ADVANCE type SG62B AM 150KHZ — 220MHZ. **£70**  
 ADVANCE type 62AM 150KHZ — 220MHZ ..... **£35**

### MULTIMETERS

UNBELIEVABLE — AVO 8 Mk V. Complete with batteries and leads for only ..... **£65**  
 PHILIPS DMM 2517. 4 digit. Auto ranging. Complete with Batteries. Leads (Un-used) P&P **£95**  
 AVO TEST SET No 1. (Similar to AVO 8X). Complete with Batteries, leads & carrying case. .... **£80**  
 AVO Model 73. Pocket Multimeter (Analogue) 30 ranges. Complete with batteries & leads ..... **£25**  
 AVO 72 — Similar to above but no AC Current range. with Batteries & Leads ..... **£18**

NOW ONLY **£12** p+p **£3**  
 AVO TRANSISTOR TESTER TT169  
 Handheld. GO/NO GO for In-situ Testing.  
 Complete with batteries, leads & instructions.

All above instruments in Working Order and Supplied with Manual

### NEW EQUIPMENT

HAMEG OSCILLOSCOPE 605. Dual Trace 60MHZ Delay Sweep. Component Tester ..... **£515**  
 HAMEG OSCILLOSCOPE 203.5. Dual Trace 20MHZ Component Tester ..... **£264**  
 BLACK STAR FREQUENCY COUNTERS. P&P **£4**  
 Meteor 100 — 100MHZ ..... **£99**  
 Meteor 600 — 600MHZ ..... **£126**  
 Meteor 1000 — 1GHZ ..... **£175**  
 BLACK STAR JUPITOR 500 FUNCTION GENERATOR Sine/Square/Triangle 0.1HZ — 500KHZ. P&P **£4** ..... **£110**

HUNG CHANG DMM 6010. 3½ digit. Hand held 28 ranges including 10 Amp AC/DC. Complete with batteries & leads. P&P **£4** ..... **£16**

OSCILLOSCOPES PROBES. Switched X1; X10. P&P **£2** ..... **£11**

### 5 1/4" FLOPPY DISK DRIVES

TANDON 1/2 Height. Brand New  
 Single Sided Double Density ..... **£70**  
 Double Sided Double Density ..... **£100**  
 SHUGART type SA460 Double Sided Double Density. 80 Track. Ex-eq **£75** P&P all drives **£5**.

### STEPPER MOTORS

Type 1. 200 Steps 4 Phase (5 wire) 12/24V 25oz inch. 2 1/2" dia ..... **£15**  
 Type 2. 6/12 Steps 3 Phase 12/24V. 1 1/2" dia. **£2** ea 5 for ..... **£7.50**  
 Type 3. 24 Steps 4 wire 5V 3.3A 0-250rpm 0-200PPs 2 1/2" dia ..... **£10** ea  
 Type 4. 200 Steps 120V (3 wire) 25oz inch. 2 1/2" dia ..... **£4**  
 P&P and VAT extra

**THIS IS A VERY SMALL SAMPLE OF STOCK, SAE Or Telephone for LISTS**  
 Please check availability before ordering.  
 Carriage all units **£12**  
 VAT to be added to Total of Goods & Carriage

### STEWART OF READING

110 WYKEHAM ROAD, READING, BERKS RG6 1PL

Telephone: 0734 68041

Callers welcome 9 a.m. to 5.30 p.m. Monday to Saturday inclusive

CIRCLE 84 FOR FURTHER DETAILS.

## Happy Memories

Part type	1 off	25-99	100 up
4116 200ns	1.25	1.15	1.10
4164 150ns Not Texas	2.10	1.90	1.80
2114 200ns Low Power	1.75	1.60	1.55
2016 150ns	2.75	2.50	2.30
6116 200ns Low power	7.75	Call	Call
6264 150ns Low power	9.80	8.75	8.40
2716 450ns 5 volt	3.85	3.45	3.30
2732 450ns Intel type	4.75	4.25	4.10
2732A 350ns	5.25	4.69	4.50
2532 450ns Texas type	3.85	3.45	3.30
2764 300ns Suit BBC	4.20	3.80	3.60
27128 300ns Suit BBC	5.60	5.00	4.80

Low profile IC sockets: Pins 8 14 16 18 20 24 28 40  
 Pence 12 13 14 16 18 24 27 38

Available now — The ROAM BOARD for the BBC Micro. Reads Roms via a Low Insertion Force Socket and saves their contents as files, then reloads a file into its sideways Ram as required. Full details on request.

74LS series TTL, wide stocks at low prices with DIY discounts starting at a mix of just 25 pieces. Write or 'phone for list.

Please add 50p post & packing to orders under £15 and VAT to total.  
 Access orders by 'phone or mail welcome.  
 Non-Military Government & Educational orders welcome., £15 minimum.

**HAPPY MEMORIES (WW),**  
 Newchurch, Kington,  
 Herefordshire HR5 3QR.  
 Tel: (054 422) 618

CIRCLE 81 FOR FURTHER DETAILS.

## Circuit diagrams on a micro

Using a light pen directly on the screen and a library of pre-programmed images it is possible to draw circuit diagrams, with a BBC Micro, very quickly and obtain a high-quality printout from a low-cost dot matrix printer. The Cirkwick kit consists of software on a disc and a lightpen which incorporates a switch. The graphics image of the circuit is displayed on the screen which acts as a window on a much larger 'virtual' screen; eight times the size of the screen in use. Although the system has been designed for electronic diagrams it may also be used for flow charts, power systems, pipework diagrams, fluid logic diagrams and many other engineering applications. A large number of electronic symbols are included in the

package and it is also easy to create further symbols with the light pen, on a magnified scale, even when drawing is in progress.

Printout is obtained from any dot matrix printer that can provide dual-density graphics. The printout is produced in one continuous action using a screen dump routine that manipulates the drawing file so that the correct portion of the diagram is on the screen while being printed. The drawing is stored in memory as a file of symbols and co-ordinates and may be manipulated by other programs if desired. The software costs £19.95 and the lightpen £25.00 (inclusive). Datapen Microtechnology Ltd., Kingsclere Road, Overton, Hants. RG25 3JB. EWW203

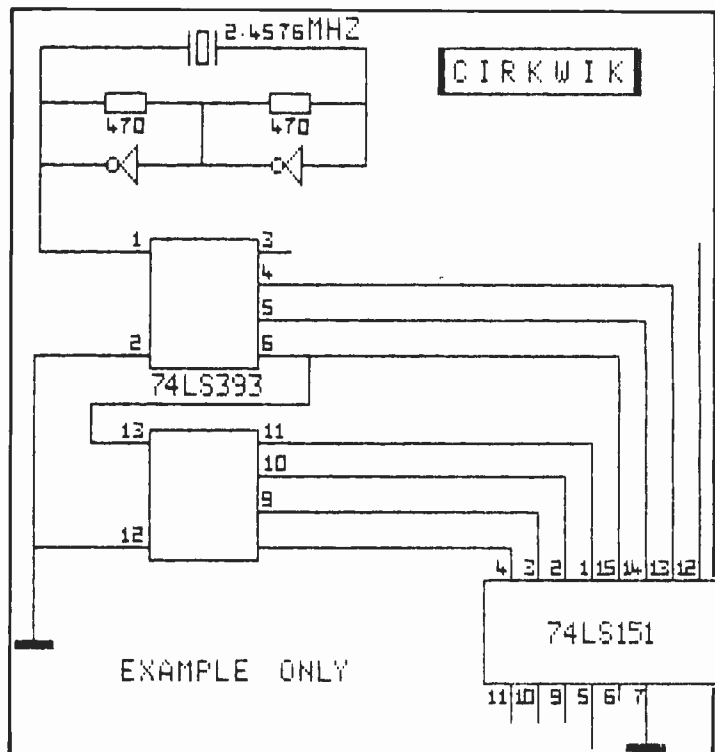

## Fast tape storage

A new wafer tape drive is available for the Commodore 64 computer which loads faster than cassette and is claimed to be more reliable and, because of the slow serial interface with Commodore discs, is even faster than disc. The medium is a continuous loop of 1.6mm magnetic tape in a tiny cartridge, somewhat similar, though a little larger and more robust, to the Sinclair Microdrive. The interface software for the Quick Data Drive includes an audio simulation which makes the Commodore think that it is communicating with a normal cassette and this routine takes up as much time as the actual transferring of the program. To

load the full 64K capacity of the computer takes 30s, compared with 2min for a Commodore discs drive and 23min for a Commodore tape. The drive complete with the operating system, one blank cartridge and one game cartridge costs just under £100. A wide range of software is already available on Wafadrive cartridges including many games, a word processor and a spreadsheet program. Other versions are planned for the BBC micro. The Rotronics Wafadrive for the Sinclair Spectrum uses the same mechanism. Dean Electronics Ltd, Glendale Park, Fernbank Road, Ascot, Berks. SL5 8JB EWW 201

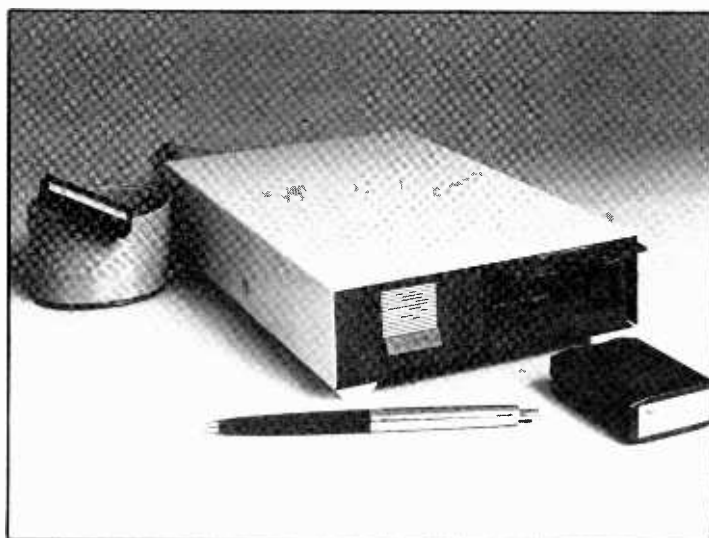
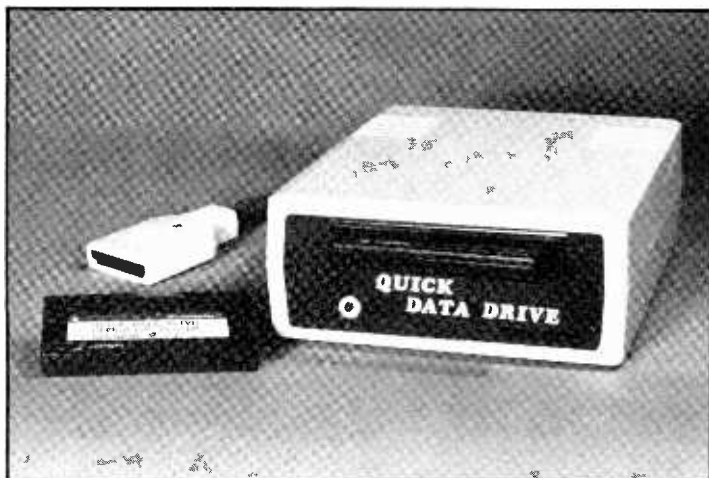

## Solid-state disc

Based around the Fujitsu 1Mbit bubble memory, the SSD1 has been designed to emulate a 5.25in floppy disc in applications where extra reliability and ruggedness are required. With no moving parts it has none of the potential mechanical problems of disc drives and offers a high immunity to the effects of temperature, humidity, dust, shock or vibration.

The unit can take two 1Mbit cassettes offering 125KBytes each, or the equivalent of two single-sided, single-density disc drives. The two cassettes can be combined to offer the equivalent of a single-sided

double density disc. Full emulation is included in the internal electronics so that the unit may be plugged into the disc drive port of most microcomputers. It operates from a single 5V supply. Track access time is about 150ms and data transfer rate is 125KByte/s. Bubble memory has an error rate of 1 in  $10^{16}$  and a calculated m.t.b.f. of 400 000h.

The units cost £960 including two cassettes and each additional cassette is £260. Tempatron Ltd., 6 Portman Road, Battle Farm Estate, Reading, Berks. RG3 1JQ. EWW216



## Pascal on the QL

The USCD p-system has been translated into a format usable on the Sinclair QL computer. This includes compilers for Pascal, Fortran-77 and USCD Basic, a screen editor, filer, utilities, print formatting and the Advanced Development Toolkit. USCD Pascal is widely used in as a teaching tool in universities and colleges and was chosen, for example, by the Open University for their course on structured programming in Pascal.

The P-system also provides a useful software development environment with its integrated editor and compilers. Programs so compiled are highly portable and may be used on a variety of

microcomputers. The system is very fast; 700 lines of Pascal can be compiled in a minute on the QL, twice as fast as a similar operation on the IBM PC. Standard benchmark tests show that the system takes the QL from its current position of 31st in the league table to 6th place, much faster than the IBM PC and close to the speed of the IBM AT. Pascal or Fortran-77, together with a full set of development utilities, is available for £99.95. The Advanced Development Toolkit costs £49.95. TDI Software Ltd, 29 Alma Vale Road, Bristol BS8 2HL EWW208

## Multitester

A miniature hand-held multimeter includes a socket for transistor testing. It is housed in a book-hinged box with a manual, battery, leads and a spare fuse. The instrument features a 12mm high 3½-digit l.c.d. It has an overload protection circuit and automatic polarity and zero adjustment.

The ranges and accuracies for each range are: alternating voltages, 0-200-500V (1.2%); direct voltages 0-20-200-1000V (0.8%); d.c. 0-2-20-mA (1.2%); Resistance 0-2-20-200kohms (1%). Transistors up to 1000<sub>HFE</sub> may be tested. Available through Semiconductor Supplies International Ltd, Dawson House, Carshalton Road, Sutton, Surrey. SM1 4RS. EWW219

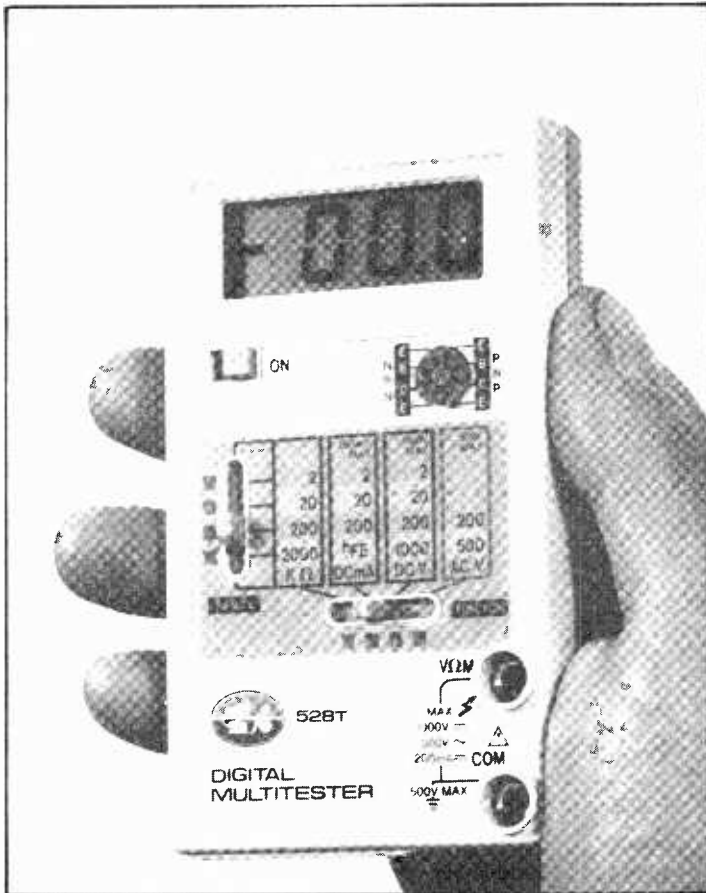

## STE-Bus to Micro interface

When an STE-bus system is connected to a BBC Micro using Arcom's Beebop interface board, both systems benefit. The BBC can have access to STE's data acquisition and control features, such as 1MByte addressing range and 4Kbyte of input/output space; and the STE system gains a fast and easy means of developing Basic programs, and the BBC's colour display facilities.

The interface is a single Eurocard which sits in an STE card frame and is connected to the BBC through the 1MHz bus port. A 'filing system' eeprom is installed in a BBC sideways rom socket and provides the computer with an additional set of STE-oriented commands to the Basic interpreter. These include dedicated facilities for a-to-d conversions, reading or writing to memory or i/o locations, and performing block

moves. The BBC can be used as the only processor in the system or as one processor in a multiprocessor system. It is possible to use an STE processor board for applications while the BBC provides colour graphics. STE, which is reaching the final stages of standardization by the IEEE in the USA, offers a variety of expansion boards including digital and analogue interfaces and real-time clocks. The interface includes two v.i.a. chips which send and receive data between the BBC and STE buses with the necessary logic to set up the required bus cycles and an arbiter circuit for use when the BBC is part of a multi-processor system. Beebop costs about £120. Arcom Control Systems Ltd., Unit 8, Clifton Road, Cambridge. CB1 4BW. EEW218



## Temperature controlled iron

Compact and light the miniature soldering iron from Oryx has a preset control adjusted by a screw which may be between 200 and 400°C. The operating temperature is reached within 45s from cold and is then maintained to within ±2%. This rapid heating and accurate heat control are made possible by

the use of a 50W element and a thermostat. The Oryx 50 iron is fitted with an iron coated, chrome plated screw-on tip there is a wide range of tips available. The bench stand is an optional extra. Greenwood Electronics Ltd., Portman Road, Reading, Berks. RG3 1NE. EWW204

# Now Thurlby makes logic analysis affordable! from the new Thurlby LA-160 £395 + vat



- 16 channels, expands to 32
- Clock rates up to 20MHz
- State and timing displays
- Selectable display formats
- 2K word acquisition memory
- Non-volatile reference memory
- Search and compare facilities
- Hard-copy data print-out

An oscilloscope and logic probe are not enough to unravel the complexities of today's electronic equipment. A logic analyser is as essential for observing digital signals as an oscilloscope is for observing analogue signals, and now Thurlby puts one within every engineer's reach. Contact us now and get the full technical data.



**Thurlby Electronics Ltd**  
New Road, St.Ives, Huntingdon,  
Cambs. PE17 4BG, England. Tel: (0480) 63570

CIRCLE 31 FOR FURTHER DETAILS.

# The world's most advanced low-cost bench multimeter!

## Thurlby 1905a £325 + VAT



### A complete high performance bench DMM

- 5½ digits; 0.015% acc; 1µV, 1mΩ, 1nA.
- Full ac and current functions as standard

### A sophisticated computing and logging DMM

- Linear scaling with offset; null/relative
- Percentage deviation; running average
- dBV, dBm general logarithmic calculations
- Limits comparison; min and max storage
- 100 reading timed data logging
- RS232 and IEEE-488 interface options

**Thurlby Electronics Ltd**  
New Road, St.Ives, Cambs. PE17 4BG  
Tel: (0480) 63570



CIRCLE 32 FOR FURTHER DETAILS.

# Add 8 channels to your 'scope

## New Thurlby OM358 multiplexer £169 +vat

The Thurlby OM358 gives any oscilloscope an 8 channel display. Observing many waveforms simultaneously can be essential when analysing sophisticated equipment. Application areas include microprocessor based products, data transmission systems, A to D converters, frequency synthesizers etc.

The OM358 is ideal for digital equipment (it can often solve problems that would otherwise need a fast logic analyser) but, unlike dedicated logic test instruments, it is equally suited to analogue waveforms.

The OM358 has a bandwidth of 35MHz and 3% calibration accuracy. Each input has an impedance of 1MΩ - 20pF and accepts signals up to ±6V. An 8 channel, 4 channel, or single channel display can be selected with triggering from any channel. *Colour data sheet with full specifications available.*



**Thurlby Electronics Ltd**  
New Road, St.Ives, Cambs.  
PE17 4BG Tel: (0480) 63570

OM358 with two BNC  
cables £197.80  
(inc P & P and VAT)

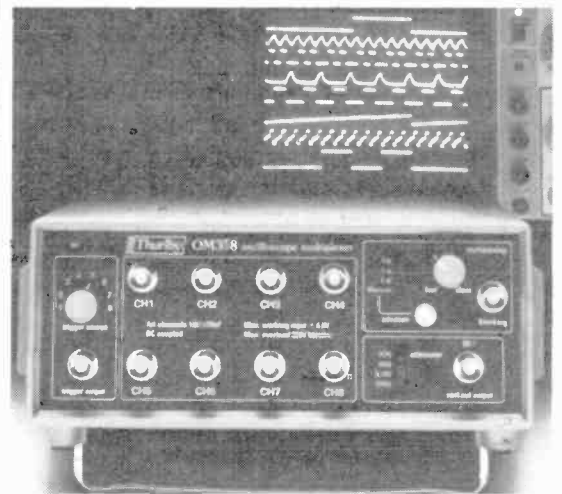

CIRCLE 33 FOR FURTHER DETAILS.

# Hitachi Oscilloscopes performance, reliability, value and immediate delivery!

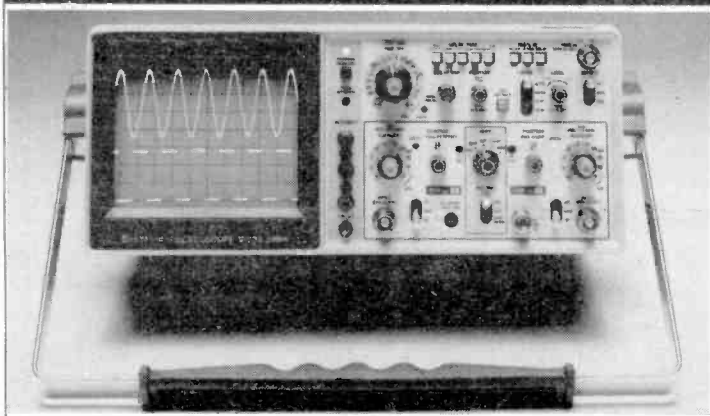

Hitachi Oscilloscopes provide the quality and performance that you'd expect from such a famous name, with a newly-extended 14 model range that represents the best value for money available anywhere.

V-212/222	20MHz Dual Trace	V-650	60MHz Dual Timebase
V-223	20MHz Sweep Delay (illustrated)	V-1050	100MHz Quad Trace
V-209	20MHz Mini-Portable	V-1070	100MHz Four Channel
V-422	40MHz Dual Trace	V-1100	100MHz DMM/Counter
V-423	40MHz Sweep Delay	V-134	10MHz Tube Storage
V-509	50MHz Mini-Portable	VC-6015	10MHz Digital Storage
		VC-6041	40MHz Digital Storage

Prices start at just over £300 plus vat and that includes a full 2 year warranty. We hold the range in stock for immediate delivery.

For colour brochure giving specifications and prices ring (0480) 63570  
Thurlby-Reltech, 46 High Street, Solihull, W. Midlands, B91 3TB.

CIRCLE 34 FOR FURTHER DETAILS.

# Call in at your 'local' for a CROTECH

## LONDON & HOME COUNTIES

Audio Electronics London W2 01-724 3564  
 Henry's London W2 01-724 0323  
 Carston Electronics Teddington 01-943 4477  
 Kentwood Electronics Reading 0734-698040  
 Aughton Instruments Stroud 0634-724751  
 The Instrument Centre Dunstable 0582-602739  
 Maplin Electronics Benfleet 0702-554155

## WALES & WEST

The Instrument Centre Newport 0633-280566  
 (Gwent)

## EAST ANGLIA

Electronic & Computer Workshop Chelmsford 0245-262149  
 Cirkit Broxbourne 0992-444111

## MIDLANDS & NORTH

Northern Instruments Leeds 0532-791054  
 The Instrument Centre Brierley Hill 0384-293898  
 Electronic Measurement Services Manchester 061-273 4653  
 Radio Telephone Service Derbyshire 0332-41235

## SCOTLAND

RMR Measurements Cumbernauld 02367-28170

## IRELAND

Electronic Instrument Brokers (IRL) Ltd. Dublin Dublin 857119

## Crotech Instruments Limited

2 Stephenson Road, St. Ives, Huntingdon, Cambs. PE17 4WJ  
 Telephone: (0480) 301818



CIRCLE 12 FOR FURTHER DETAILS.

## RF POWER

U.S. supplier of RF POWER DEVICES.  
 Prices LOWER than current domestic prices.  
 Query us for immediate needs.

A quality source for a complete range of RF POWER devices - From 2-30MHz, SSB 12.5V 7 28V transistors - 14-30 MHz CB/AMATEUR 27-50 MHz, low band FM - 66 - 88MHz, mid band FM - 66 - 88MHz, mid band FM - 156 - 162MHz VHF MARINE RADIO FM - 130 - 175MHz HI-BAND VHF FM - 108-152MHz VHF AIRCRAFT AM - 225 40MHz UHF 28V - 407 - 512 UHF CATV/MATV CLASS A linear transistors - A SMALL indication of types are listed below. SEND FOR OUR FREE BROCHURE AND/OR CONTACT FOR IMMEDIATE QUOTES.

MRF450 MRF453 MRF646 BLY88A BLY90 BLY93A  
 .2N3553 .2N4933 .2N5109 .2N3375 .2N5016 .2N5589  
 .2N4128 .2N5070 .2N5591 .2N6080 .2N4427 .2N5090  
 .2N5634 .2N6083 .2N4431 .2N5102 .2N5918 .2N6084

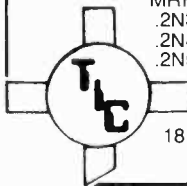

## TIC Semiconductor Inc.

18 WEST 21st STREET NEW YORK, N.Y. 10010 U.S.A.  
 TEL: (212) - 675 - 6722 TELEX: 968003 NYK

CIRCLE 88 FOR FURTHER DETAILS.

## CHIP SALE

4164 64K DRAM 150 NS  
**£1.99** each  
 (Upgrade IBM PC +  
 Compatibles)  
 42128 128K RAM 150 NS  
**£6.50** each  
 (Upgrade IBM PC/-AT)

41256 265K RAM 150 NS  
**£6.50** each  
 (Upgrade Olivetti M24,  
 Compaq deskpro etc.)  
 Any quantity up to 1,000  
 pieces. Bulk discounts  
 available.

# DIGITASH

BUSINESS SYSTEMS LTD  
 56, MAPLE DRIVE, EAST GRINSTEAD, WEST SUSSEX, RH19 3UR

Tel: 0342 313427 · 24631/2

CIRCLE 42 FOR FURTHER DETAILS.



## LINSLEY-HOOD 300 SERIES AMPLIFIERS



35 Watt Complete Kit, MosFet O/P ..... **£79.50**  
 45 Watt Complete Kit, MosFet O/P ..... **£83.50**  
 Reprints of Original Articles from 'Hi-Fi News' ..... **£1 no VAT.**

## LINSLEY-HOOD 100-WATT MOSFET POWER AMPLIFIER

The very latest amplifier design, published in 'Wireless World' by the renowned John Linsley-Hood. This may now be taken as the standard by which the rest are judged! Our kit, approved by the designer, has massive heat sinks and power supply and includes all components needed to build. Case size 412mm wide, 254mm deep and 145mm high. Automatic switched speaker protection is included as standard. Cost of all parts is over £120. Our complete stereo kit price **£105.50**.

## LINSLEY-HOOD CASSETTE RECORDER CIRCUITS

Complete record and replay circuits for very high quality low noise stereo cassette recorder. Circuits are optimised for our HS16 Super Quality Sendust Alloy Head. Switched bias and equalisation to cater for chrome and ferric tapes. Very easy to assemble on plug-in PCBs. Complete with full instructions. Complete Stereo Record/Play Kit ..... **£25.26**  
 VU Meters to suit ..... **£2.30 each**  
 Reprints of original Articles ..... **75p. No VAT.**

## STUART TAPE RECORDER CIRCUITS

Complete Studio quality record/Play electronics to bring that old valve machine back to life. Full details in our REPRINT ..... **£1.30 (No VAT).**

## PW WINTON STEREO AMP

Super HiFi Mosfet Amplifier Kit giving 50 Watts per channel at .014% distortion, housed in attractive wood veneered cabinet. Full Kit is normally **£109**. **SPECIAL OFFER, NOW ONLY £89.** Reprint of descriptive articles 85p (No VAT)

## DGS001 2-MOTOR, SOLENOID CONTROLLED CASSETTE DRIVE.

Fully solenoid controlled cassette mechanism suitable for Hi-Fi or digital use. With a logic control board the deck can be operated by lightweight touch controls or output from a micro. Ideal for applications under automatic control such as telephone answering machines, data loggers, automatic background music systems, remote control recorders and microcomputer program and data storage. Two motors and three solenoids control all functions including search in fast forward and rewind. Standard fittings include reed switch for auto off, 3 digit counter, stereo R/P and erase head. Overall size: 176mm x 130mm x 75mm. DGS001 Cassette Mechanism **£37.25** Quantity prices on request. INF140 Full technical specification and drawings **£1.**

## AM VARICAP DIODE BARGAIN SUPER wide range SMV2012 varicap diodes in matched sets to eliminate tracking errors!

Matched pair only **25p**. Matched 4 only **60p**. SET OF 4 COILS to use with above to make long, medium and short wave AM tuner. Normally 30p each. OUR PRICE FOR THE SET ONLY **55p**

INF10 Application circuit using coils and matched pair of SMV2012 varicaps. **35p**  
 168A IF Transformer ..... **30p**  
 CFU45F2 IF Filter ..... **50p**  
 Suitable PCB Board ..... **£1.50**  
 Push Button PC Mounting Wavechange Switch ..... **£1.60**

## COMPLETE STEREO TUNER MODULE

Three band LW/MW/FM Stereo Tuner fully assembled on PCB 165 x 85mm. Supplied with Ferrite rod aerial and band switch fully wired. Facility provided to drive tuning meter and stereo LED. Only needs 12v DC supply. FM sensitivity 2.5uV. Price only **£7.99 inc. Vat and Post.** Tuning Scale and accessories **£2.99**

Special Price for both items bought together **£9.70 inc Vat & Post.**

CLOCK/TIMER/FREQUENCY METER PARTS  
 Special offer of the fabulous MSM5524 clock, timer and frequency meter chip. MSL2318 prescaler chip and 6LT09 5-Digit fluorescent display. These are the 3 primary components for a complete timing and frequency display system covering the long, medium, short and FM wavebands. Total cost of these parts is normally over £25. OUR SPECIAL OFFER PRICE ONLY **£11.90**  
 INF230 Data on MSM5524 and MSL2318 ..... **70p**  
 INF260 Application Circuit ..... **20p**  
 Crystal 3276 8 KHz ..... **£1.90**

## VIDEO HEADS

Heads to suit all VHS, BETA and PHILIPS video cassette recorders. Do not take chances with 'near equivalents' there are nine different VHS heads and seven BETA MAX. Write or ring with the make and model number of your recorder for quotation. Prices start at **£47.25** for VHS and **£57.75** for Beta.

## HIGH QUALITY REPLACEMENT CASSETTE HEADS



Do your tapes lack treble? A worn head could be the problem. Fitting one of our replacement heads could restore performance to better than new! Standard mountings make fitting easy and our TC1 Test Cassette helps you set the azimuth spot-on. We are the actual importers which means you get the benefit of lower prices for prime parts. Compare us with other suppliers and see! The following is a list of our most popular heads, all are suitable for use on Dolby machines and are ex-stock.

HC20 Permalloy Stereo Head. This is the standard head fitted as original equipment on most decks ..... **£5.11**  
 HM90 High Beta Permalloy Head. A hard-wearing, higher performance head with metal capability ..... **£8.06**  
 HS16 Sendust Alloy Super Head, the best head we can find. Longer life than Permalloy, higher output than Ferrite, fantastic frequency response ..... **£9.91**  
 HQ551 4-Track Head for auto-reverse or quadrophonic use. Full specification record and playback head ..... **£9.73**  
 Please consult our list for technical data on these and other Special Purpose Heads.  
 MA481 Latest version Double Mono (2/2) Record/Play head. Replaces R484 ..... **£8.90**  
 SM166 Standard Mounting 2/2 Erase head. Compatible with above or HQ551 4 Track head ..... **£5.90**  
 H524 Standard Erase Head. Semi double gap, high efficiency ..... **£1.50**  
 H561 Metal Tape Erase Head. Full double gap ..... **£4.90**

## HART TRIPLE-PURPOSE TEST CASSETTE TC1

One inexpensive test cassette enables you to set up VU level, head azimuth and tape speed. Invaluable when fitting new heads. Only **£4.66** plus VAT and 50p postage.

Tape Head De-magnetiser. Handy size mains operated unit prevents build up of residual head magnetisation causing noise on playback ..... **£4.54**  
 Curved Pole Type for inaccessible heads ..... **£4.85**

Send for your free copy of our LISTS. Overseas please send 2 IRCs to cover surface Post or 5 IRCs for Airmail. Please add part cost of post, packing and insurance as follows:

INLAND Orders up to £10 - 50p  
 Orders £10 to £49 - £1  
 Orders over £50 - £1.50  
 OVERSEAS Please send sufficient to cover Surface or Air Post as required.



Personal callers are always very welcome but please note that we are closed all day Saturday

24hr SALES LINE  
 (0691) 652894

ALL PRICES EXCLUDE VAT UNLESS STATED

## Output power for mobile radio

For operation between 140 and 175MHz, the BLV45/12 power transistors are intended for use with v.h.f. mobile radio transmitters. They are designed for optimum performance under adverse conditions and can withstand a 20-to-1 v.s.w.r. under severe output mis-match conditions. They feature internal matching, diffused emitter balancing resistors and

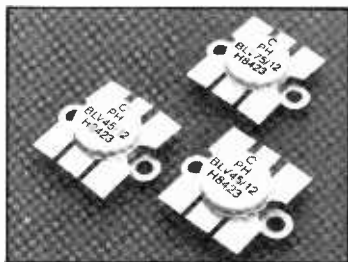

gold metallization. They can deliver 45 and 74W output power respectively in amplifiers powered from a 12V battery. They offer a gain of 6.5dB at 175MHz. Mullard Ltd., Torrington Place, London. WC1E 7DH. EWW220

## Alternative disc for Electron

Unlike the disc interface for the BBC micro, Acorn's Electron has a double density drive and would seem to provide all that may be required. Except that it exclusively uses a 3in drive. Cumana have come up with an alternative that may be used with 3.5 or 5.25in drives, double or single density, up to 89 file names and an interface that includes a battery-backed

real time clock so that file may be 'date stamped' when saved. Software included with the package includes the ability to copy to and from Acorn DFS discs that can be used with a BBC micro. It is also possible to format single-density discs for the Acorn DFS. Cumana Ltd, Pines Trading Estate, Broad Street, Guildford, Surrey. GU3 3BH EWW202

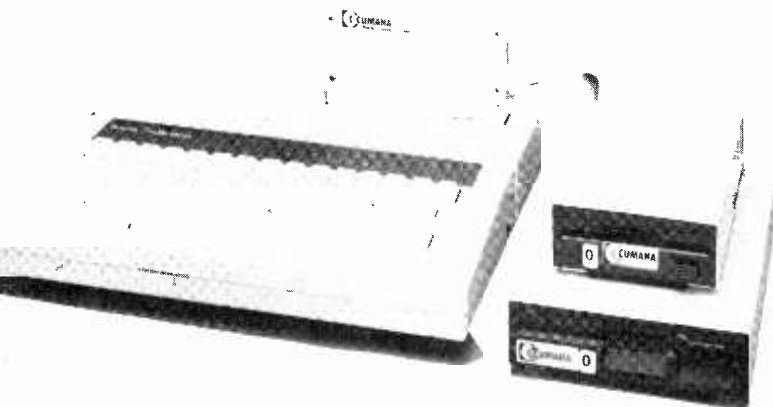

## Dry lubricant in a can

A special anti-stick and mould release agent is provided by Electrolube's Dry Film Lubricant. It is designed for use where mineral oils or silicones are not appropriate. Especially suitable for electronics applications, DFL assists in the insertion of p.c.b.s into edge connectors, stops squeaks in disc drives caused by friction between metal and plastics and improves the action of keys in keyboards. It may also be used for any plastic or plastic/metal connectors in such equipment

as video recorders, tape recorders, typewriters and printers.

The material is based on p.t.f.e. It is clean and non-oily, water repellent, fast drying, non-flammable and chemically inert. This enables it to be used on most materials, including leather, wood synthetic or natural fibres, glass, metals and most plastics. It is available in aerosol cans and in bulk containers. Electrolube Ltd, Blakes Road, Wargrave, Berks. RG10 8AW. EEW207

## Single-rail quad op-amp

High stability, fast slew rate and wide bandwidth are claimed for the Motorola MC3074 op.amp, comparable to those characteristic associated with bi.fet devices whilst offering single supply operation with input common mode range down to ground ( $V_{EE}$ ). In addition the NPN output stage provides a minimum output swing 36% greater than other standard op.amps and a

capacitive drive capability of 10000pF. Its high stability results in a settling time of 1.1us. Suitable for use in battery-operated equipment, automotive systems and in switch-mode power supplies, the op.amp can be operated from split supplies as well as single rail if required. Stocked by Celdis Ltd., 37 Loverock Road, Reading Berks. RG3 1ED. EWW221

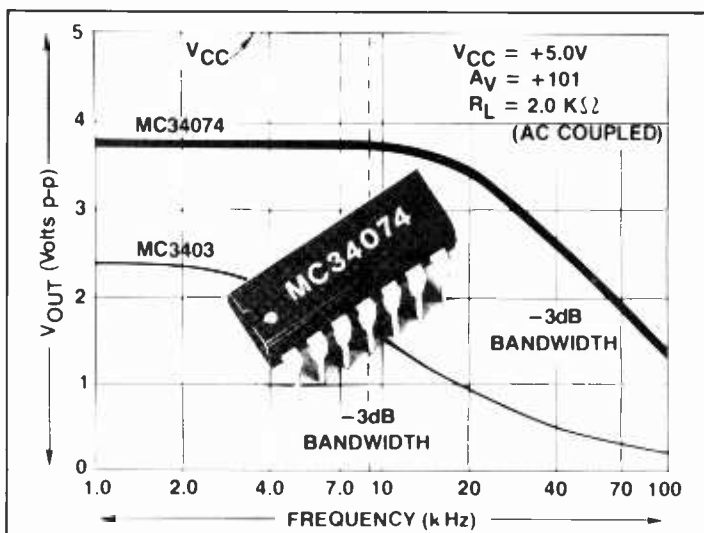

## Solid-state relays

Designed and manufactured in the UK by Allen-Bradley, relays are available in three formats, two for p.c.b. and on for chassis mounting. The p.c.b. relays differ in their shapes one being flat to allow rackmounting the other being mounted vertically for higher population density on each board. They are both rated at 3A r.m.s. at 240V a.c. load switching.

The chassis mounted versions have three current ratings 10, 25 and 45A r.m.s. for mains power switching. They all offer zero-crossing switching to reduce r.f.i. to negligible levels.

Applications include switching a.c. motors, burst fire regulation of electric heating elements and with capacitive input power supplies where the zero voltage

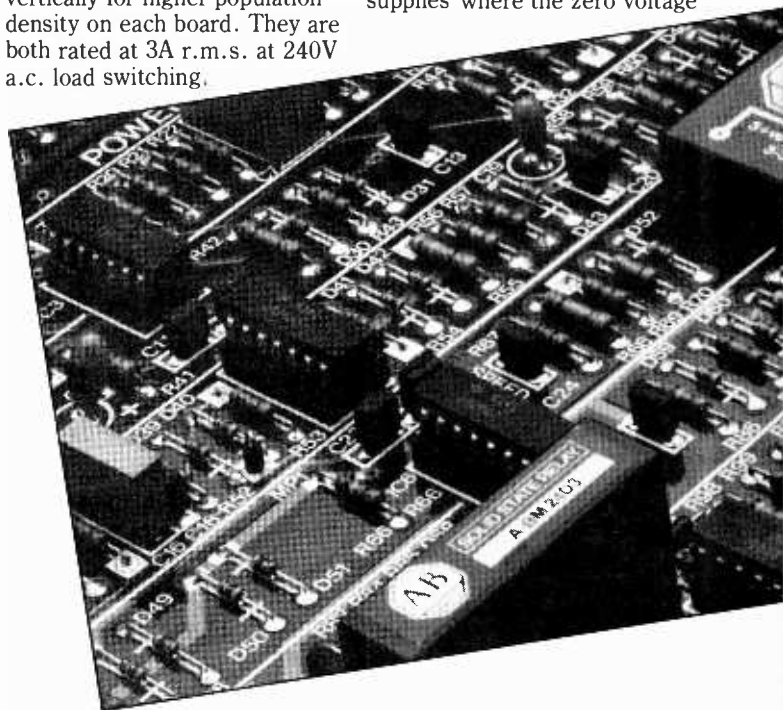



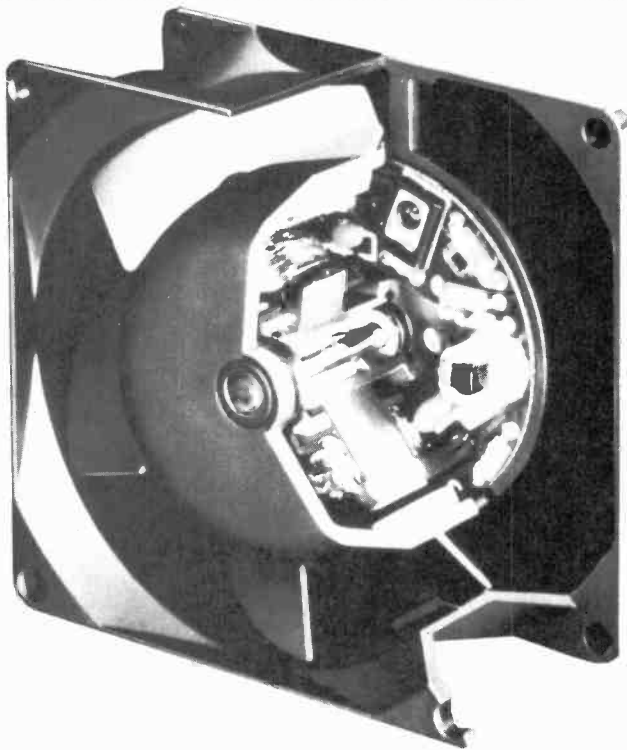

## D.C. fans

The shapes of the blades and the airflow venturi have been designed by computer in the latest range of 80 and 92mm fans from papst. The fans in this range have a depth of only 32mm but may move air up to 80<sup>3</sup>/h. The series III Multifan is

driven by a 4-pole brushless d.c. motor which features polarity protection and automatic restart. The use of a p.t.c. thermistor in the drive electronics allows the fan to start with a very slow ramp-up voltage. Papst Motors Ltd., East Portway, Andover, Hants. SP10 3RT. EWW210

switching limits inrush current. They may be used as transformer tap changers and for primary disconnect. The relays are suitable for driving by logic circuitry. Allen-Bradley Electronics, Ennia House, High Street, Edenbridge, Kent TN8 5LY. EWW217

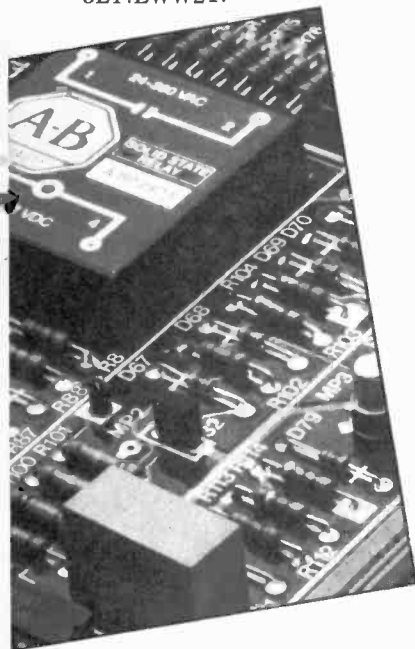

## Computer-video synchronizer

A device to allow the superimposition of computer text subtitles and graphics onto an incoming video signal has been developed by CCI Associates under licence from the BBC. Having been successfully prototyped the Super Genlock unit will be available very soon. It is capable of synchronising the RGB and video outputs of a BBC Micro to a stable reference

as offered by a tv camera, video disc or time-base corrected v.t.r. It can also synchronize with lower quality video recorders such as VHS or Betamax when it can cope with such errors as a line frequency difference of 2%, 7us line timing variation relative to a stable reference over one second, and it will correct a quarter line period timing error following head switching in about 15 lines.

## Motion sensor

A ultra-miniature precision linear motion potentiometer may be used in short-travel position sensing, in confined places and for linear movement voltage adjustment. The body is 31.75mm long with screwholes for mounting at 25.4mm centres. The shaft, 3.2mm thick has 16.6mm travel. A range of resistances from 1K to 10ohms are offered and independent linearity is specified as 1%. Spectrol Reliance Ltd., Drakes Way, Swindon, Wilts. SN3 3HY. EWW215

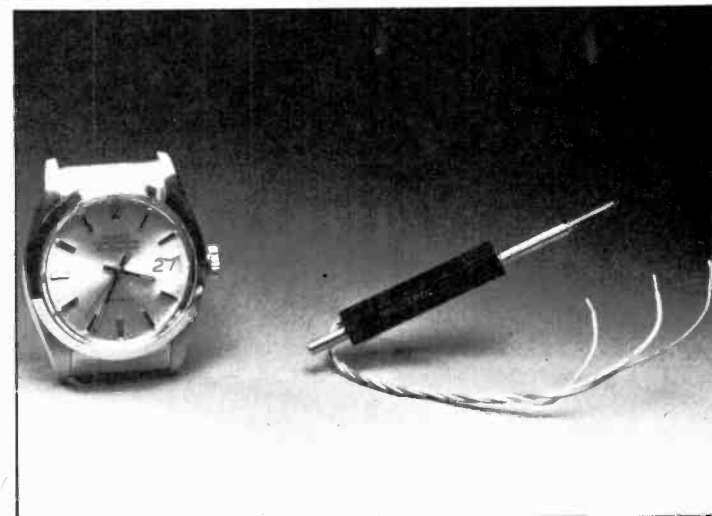

## 256K S.RAM

By combining memory chips onto a hybrid substrate, it is possible to make up larger memories. The C.mos 256-03 combines four ram chip and a decoder to give a 32Kbyte static ram, with an access time of 100ns, an operating current of 40mA and a standby current

of only 10uA. The hybrid is mounted in a standard 28-pin d.i.l. package and there are standard and military temperature tolerance versions available. Manufactured by Intergrated Circuits Inc. and available from Pascall Electronics, Hawke House, Green Street, Sunbury-on-thames, Middlesex. TW16 6RA EWW222

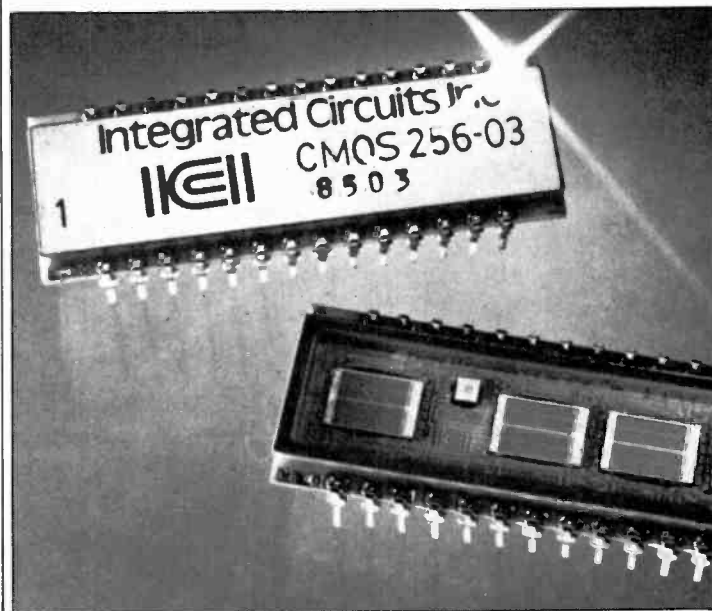

## Timing and signature analysis

Standard operating modes of this 40-channel instrument include the ability to save and recall blocks of data on disk, screen dumps of timing diagrams, signatures and the printing of data listings and disassembled code. Timing waveforms may be labelled automatically and software enables the user to create a label file or enter labels directly. The instrument has a 24-bit trigger and area trace with trigger and clock qualifiers operating up to 10MHz. Each of the 40 channels can have up to 1K memory allotted to it. Standard operations include the disassembly of 6502, Z80, 6800, 6809, 8080, 8085 and

other 8-bit processors.

Additional options include direct processor access for 6502 processors and cross-assemblers for 8088 and 68008 without the need to get expensive personality modules. Data may be transmitted to remote stations through a modem.

The system is based around a re-packaged BBC micro with a detachable keyboard. The housing includes two disc drives and space for such expansions as a hard disc drive, modem and a second processor. Lawrie T&M Ltd., Mercury House, Mercury Row, Otley, W Yorks LS21 3HE. EWW209



## Low-cost 8048 development system

Writing software for the popular 8048 family of single-chip microcomputers normally entails the use of an expensive microprocessor development system. But a low-cost alternative is now available in the form of the Saldep-48, development system based on the BBC microcomputer.

The unit, which is self-powered, plugs into the computer's 1MHz bus. The software, provided in eeprom, includes a text editor for entering programs, a symbolic two-pass 8048 assembler and interactive de-bugging tools. User programs can be stored on

disc or cassette. The unit can program, read and verify the 8748, 8748H and 8749H eeprom versions and it can act as an 8048 hardware emulator.

Saldep-48, which costs £925, was developed in co-operation with the Department of Electrical and Electronic Engineering at the University of Salford. Similar systems are in preparation for other single-chip microcomputers, such as the 8051 and 6800, and the IBM personal computer.

Volex Electronics Ltd., Volex House, Lissadel Street, Salford M6 6AP. EWW212

## 8088 educational system

The latest in the series of Microprofessor single-board computers is the MPF1/88 which is built around the 16-bit Intel 8088 processor. It is designed to teach the fundamentals of 8088-based hardware and may also, at £325, be used as a low cost development system. It allows designers to prototype control devices for robotics and other servo-systems and unlike many 'packaged' computers allows direct access to the processor.

Included in the standard software are instructions on writing and debugging programs, and introduction to assembly language and the fundamentals of i/o interfacing. Included on the board is 4K of ram (expandable to 24K) and a 16K rom which may be added to up to a total of 48K. There is

a two-line l.c. display which is actually a window onto a 20 column by 24 lines virtual screen. A full-sized qwerty keyboard is provided, together with a Centronics parallel interface and a 64-pin edge connector which allows any IBM-PC compatible expansion

cards to be used. This allows for memory expansion, RS232C communications, colour video output and many other facilities in common with the IBM PC.

Standard features include an on-board monitor with many interactive sub-routines to aid the assembly-language

programmer, routines to interface with any standard ASCII terminal, printer driver, and asynchronous communications routines. Also provided are a cassette interface, a power adaptor and a built in loudspeaker.

Documentation includes a User's manual, monitor source listing, and a software reference guide which introduces 8088 assembly-language instructions and explains the internal working of the monitor system software. Future options include a two-pass assembler with editor, a rom-based Basic interpreter and Forth. A low-cost 20-column thermal printer is available and an eeprom programmer. Flight Electronics Ltd., Quayside Road, Bitterne Manor, Southampton SO2 4AD. EWW206

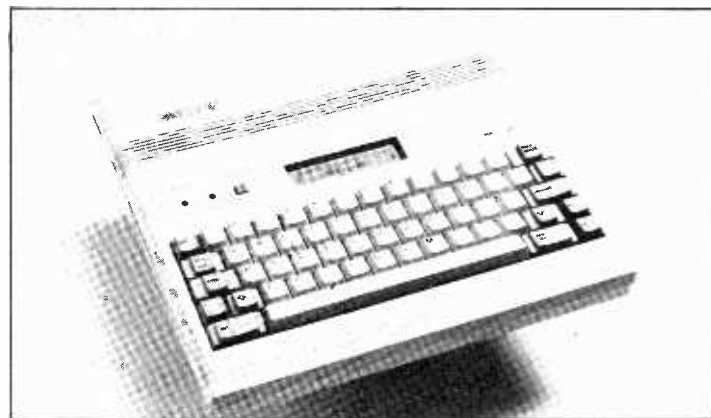

# JPR

**SEND NOW FOR OUR LATEST WHOLESALE CATALOGUE !!!**

capacitors, resistors, cables, connectors, switches, solder, indicators, buzzers, leds, plus many other ex-stock components.

**MANUFACTURERS & TRADE ENQUIRIES ONLY**

callers welcome. mon. - fri. 9am - 5pm.

## JPR ELECTRONICS

UNIT M  
KINGSWAY INDUSTRIAL ESTATE  
LUTON BEDS LU1 1LP

**TEL (0582) 410055**

**TELEX 925859 JPR**

CIRCLE 71 FOR FURTHER DETAILS.

BIRD THERMALINE Dummy loads 500 watt cont 50 ohm N connec DC to L Gz £85. X BAND W M 9170/9470 Mc/s with meter ind & var I/P atten cased. £23. PULSE GEN Services type CT500 mains 100c/s to 60Kc 3 ranges, delay, var O/P transis unit in neat case tested. £45. DOSE RATE METERS hand held as 4 ranges 4 to 4000 Mill/Rhnt meter indication, regs 4x HP2 to operate, sensor 4" approx ext size 10x7x8" Beta/Gamma response. Tested. £75. HEAT DETECTORS for ceiling mounting (not smoke) as N.O. contact protects approx area of 20ft sq, new Chloride with base. £12.50 new 24v Bells for these. £6.50. PARAMETRIC AMP UNITS by Mullard tunable S band self contained unit with N connec, mains operated, with I/P circulator power supply & small blower, in case 9x10x10", tuning by Micrometer head, complete but classed as faulty by M.O.D. £75. METER IND special purpose with meter 5-0-5 Ua 3" dia in neat case. £14.50. BENCH P. U. 240v I/P provides DC smoothed & semi reg O/P of 28v DC at 15 amps with volt meter, approx size 7x7x16" tested. £38. AVO TYPE CT446 Transis Anylizers provides wide range of tests uses int dry batteries in neat case £23. MAST ARMY telescopic manual approx 27ft open 5ft closed. £28 guy kit. £8. ELEC CONDOS HD type 2700uf at 250v size 5x3x3" insul case new. £3.50 ea. ADVANCE A.F. Osc gen purpose, mains, 15c/s to 50Kc 5 & 600 ohm O/P var tested £29. TERMINAL panel mt insul H.D. type in black, 2 for £2 or 4 for £3.50. SIG GENs Marconi type TF995, A3 CT420 1.5/220Mc/s AM/FM tested. £100. MOTOR with gearbox 24v DC 60RPM approx size 2x1x1", £4.50 V.H.F. AMP/SIG GEN R&S Model ASV 30/300Mc/s new with book. £95. The following items for callers. Collins R389/URR VLF Rx 15/1500Kc £175. Closed Circ TV system with Cam. lense, viewfinder £125. WWV HF Standards Rx all HF chan to 25Mc/s 115v £85. REDIFON G479 HF Station 100 watt CW/SSB mains 24v 2/12Mc/s decade tuned. £345. Amer G. E. 5 circ Nic Chargers 240v new. £29. L.T. Trans 230v to 20v at 170 amps cont. £55. Mil CT336 Trig Mon Scopes 3" £15 Varres 1 ohm 27 amps new £18 & .72 ohm 50 amps fixed new. £11.50. C.V.T. 230v out 150/250 watt £32. Above prices inc carr/VAT goods ex equipment unless stated new. List 36 available on request.

**A.H. Supplies. 122, Handsworth Rd, SHEFFIELD. S9 4AE  
Ph. 444278 (0742).**

# BIND IT... FIND IT!



Keep tabs on those valuable back issues the easy way with purpose-designed binders. They're sturdily made in a black finish with gold blocked title on spine. Each one holds six issues of Electronics and Wireless World.

£3.45 each (including postage) from Sundry Sales, Room 303, Quadrant House, The Quadrant, Sutton, Surrey SM2 5AS.

# low-cost control

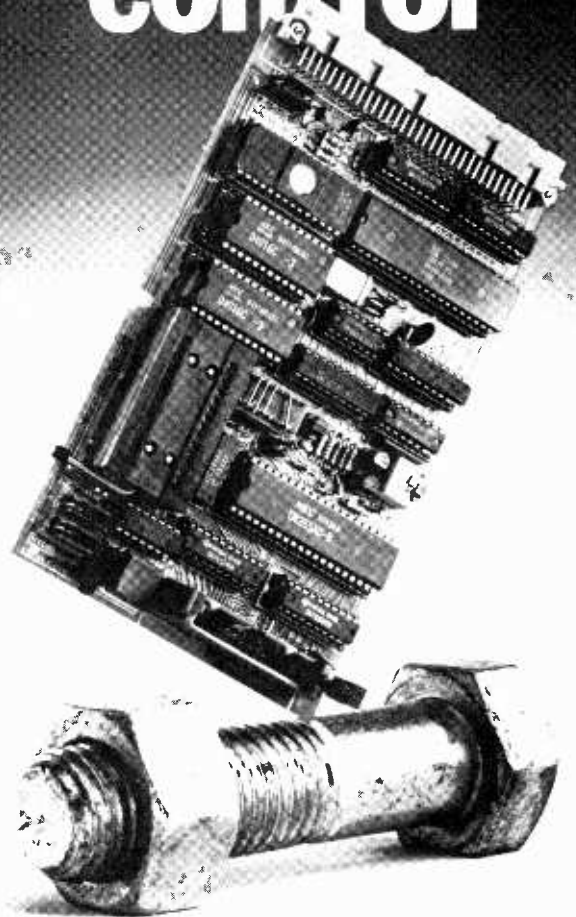

## We're not kidding.

This board offers all you need to implement a simple controller. And you can develop your application on it as well. All you need is access to a VDU since the board comes with its own BASIC interpreter and PROM programmer. On-board is a Z8, 4k of CMOS RAM (expandable to 16k), one ROM socket, 40 lines of parallel I/O and a serial interface. For £169! For this and our large range of I/O boards, give us a call.

# Arcom

**Arcom Control Systems**

Unit 8, Clifton Road, Cambridge CB1 4BW  
Telephone: (0223) 242224

Arcom products are distributed by  
**Crellon:** (06286) 4300, **Dago:** (0296) 33200,  
**Hi-Tek:** (0223) 213333

CIRCLE 65 FOR FURTHER DETAILS.

# Appointments

Advertisements accepted up to 12 noon June 5 for July issue

**DISPLAYED APPOINTMENTS VACANT:** £19 per single col. centimetre (min. 3cm).  
**LINE advertisements (run on):** £4.00 per line, minimum £25 (prepayable).  
**BOX NUMBERS:** £5 extra. (Replies should be addressed to the Box Number in the advertisement, c/o Quadrant House, The Quadrant, Sutton, Surrey SM2 4AS).  
**PHONE:** IAN FAUX, 01 661 3033 (DIRECT LINE)

15% VALUE ADDED TAX NOT INCLUDED

Cheques and Postal Orders payable to **BUSINESS PRESS INTERNATIONAL LTD.** and crossed.



**ECM**

## THE BEST APPROACH

£7,000-£30,000 + CAR

- ★ **Where does your interest lie:** Graphics; CAD; Robotics; Simulation; Image and Signal Processing; Medical; Automation; Avionics; Acoustics; Weapons; Comms; Radar; Opto and Laser?
- ★ **Experienced in:** VLSI; Microprocessor Hardware or Software; Digital and Analogue circuitry; RF and Microwave techniques?
- ★ **There are hundreds of opportunities in:** Design; Test; Sales and Service for Engineers and Managers
- ★ **For free professional guidance:** Call: 0638 742244 (till 8pm most evenings) or write (no stamp needed) to

**ELECTRONIC COMPUTER AND MANAGEMENT APPOINTMENTS LIMITED**  
FREEPOST, The Maltings, Burwell, Cambridge, CB5 0HB.

(1926)

*Don't Forget!*

for your classified adverts  
ring

**Ian Faux 01 661 3033**

**IMPERIAL COLLEGE**  
Department of Electrical Engineering  
**ELECTRONICS TECHNICIAN**  
(£7831 to £8934 inc. under review)

Required in the Microprocessor Teaching Unit. Duties will include the construction of digital and analogue circuits the repair and modification of electronic equipment and general technician support to the teaching and research programmes of the unit.

Applicants must hold an ONC or full C & G certificate, and it is essential that they have substantial experience of modern electronic circuits.

Applications giving details of education, training and experience should be sent to:- Departmental Superintendent, Department of Electrical Engineering, Imperial College, London SW7 2BT. Tel: 01-589 5111 Ext. 5105.

(2585)

UNIVERSITY OF ST ANDREWS  
**S.E.R.C. CASE STUDENTSHIP**  
Applications are invited for a CASE studentship in collaboration with the National Physical Laboratory.

The successful applicant will become involved in the design and development of detectors, interferometers, and other forms of quasi-optical instrumentation for use in the far-infrared (millimetre-wave) spectral region. The student would then become involved in using the new instrumentation at the NPL as part of a programme aimed at providing ways of gaining a better understanding of the behaviour of fusion research plasmas.

It is anticipated that the project would be best suited to a student with a practical outlook who has an interest in developing his or her skills in the areas of microwaves, optics and electronic engineering.

Applicants should possess (or expect to obtain) a good degree in science or engineering OR be able to offer a sound background of relevant equivalent experience.

The award is for a period of three years from October 1985 and the successful candidate will be expected to register for a higher degree.

Applications, which should include a CV and the names of two referees, should be sent to Dr J. Lesurf, Physics Department, University of St Andrews, Fife KY16 9SS, as soon as possible.

(2583)

Inner London Education Authority Learning Resources Branch,  
Television & Publishing Centre, Thackeray Road, London SW8.

### Television Engineer

Salary range £7836 to £9906 plus £1419 London Weighting Allowance and an irregular hours allowance of £228.

The Mobile Videorecording Section, which is equipped to broadcast standard, makes observational classroom recordings for teacher education. A Television Engineer is required to join a technical team of 8 for operational and maintenance work involving rigging and driving duties.

Further details, including full job description and application forms from EO/Estab 1B, Room 366, The County Hall, London SE1 7PB. (Please enclose S.A.E.). The closing date for completed application forms is 5th July 1985.

This post is suitable for Job-share.

**ILEA IS AN EQUAL OPPORTUNITIES EMPLOYER.**

(2586)



## Professional Career Opportunities

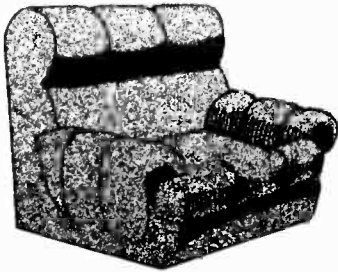

The Easy Way to look for your new job from the comfort of your own armchair. Our well qualified consultants will carefully match your requirements against appropriate vacancies.

We have many clients seeking Engineers and Technicians at all levels and we are particularly interested in hearing from you if you have experience in the following:-

- Signal Processing
- Radar Systems
- Technical Sales
- RF Development
- ATE Programming
- Real Time Software

Your next step is to complete and return the attached coupon or telephone **John Prodger** on 0442 47311 or one of our duty consultants on 0442 212650 during evenings or weekends.



### Executive Recruitment Services

THE INTERNATIONAL SPECIALISTS IN RECRUITMENT FOR THE ELECTRONICS, COMPUTING AND DEFENCE INDUSTRIES

25-33 Bridge Street, Hemel Hempstead, Herts., HP1 1EG.



NAME ..... (Mr/Miss/Mrs)

ADDRESS .....

POST CODE .....

TEL NO. ....

QUALIFICATIONS ..... AGE .....

NONE     CG/HNC     DEGREE     OTHER

SALARY .....

0-£6000     £6-10000     £10-15000     £15000+

JOB .....

(2584)

The Queen's University of Belfast  
The Computer Centre  
**HEAD OF HARDWARE SUPPORT  
AND COMMUNICATIONS DIVISION**  
**£14,136 – £17,706**  
(under review)

As part of the Senior Management team reporting to the Director of the Computer Centre, the successful applicant will lead a group of seven staff responsible for the Centre's data-communications, hardware development and equipment maintenance programme. The post offers an invigorating opportunity to take over a senior managerial, technical and motivational role in a very active and stimulating University environment.

Applicants, male or female, should preferably be university graduates or equivalent in electrical or electronic engineering; demonstrating a comprehensive, in-depth knowledge and practical experience of data-communications, state-of-the-art hardware, active managerial and technical expertise and a thorough knowledge of the general field of computing.

Salary scale (Universities Other Related Staff Grade III): **£14,137 – £17,706** (under review from 1.4.85), initial placing according to age, experience and qualifications. Assistance with relocation.

Applications, including a full curriculum vitae and the names and addresses of three referees should be sent to the Personnel Officer, The Queen's University of Belfast, Northern Ireland, BT7 1NN, from whom further particulars may be obtained.

(2536)

**If you are a 28 to 38 year old RF design engineer with a desire to learn the Scandinavian way of life — this ad might be the turning point of your professional career.**

FINDIT is a small electronics Hi-Tech company closely associated with one of Norway's most profitable electronics industries.

Located in the picturesque city of Trondheim, we are developing sophisticated RF based mobile systems for relocation of moving objects.

Trondheim, being the number one R & D centre of Norway, is the ideal place for electronics industries. We have a good network of suppliers and necessary services as well as excellent communications.

As a result of continued expansion of our development program we need to strengthen our design engineering team.

The candidate should be a graduate electronics engineer. 5 years with the industry is preferable and experience within VHF/UHF circuit design a must.

We can offer a starting salary of **£18,000-£24,000** according to qualifications and experience, good fringe benefits and a generous pension scheme. Fees for students at Trondheim British School will be paid by us.

You will find an open, young and creative environment where you can see your ideas progress from initial concepts through prototype construction, test and evaluation to the pre-production stage.

(2576)

**Still interested?  
Why hesitate? Call  
collect right away,  
today, now!**



**FOR MORE INFORMATION  
010.47.7.525872 ASK FOR NJAARD  
HESTNES OR EIGIL SOERLI. THEY ARE  
EAGER TO ANSWER YOUR QUESTIONS.**

**FINDIT P.O. BOX 2845  
N-7001 TRONDHEIM  
TEL (07) 525872 TLX 55086 FOUND**

# Appointments

## CUT THIS OUT!

Clip this advert and you can stop hunting for your next appointment. We have a wide selection of the best appointments in Digital, Analogue, RF, Microwave, Micro-processor, Computer, Data Comms and Medical Electronics and we're here to serve *your* interests.

Call us now for posts in Design, Test, Sales or Field Service, at all levels from £6,000 - £16,000.



11 Westbourne Grove, London W2. Tel: 01-229 9239.

(1935)



## THE START OF SOMETHING NEW

If you are leaving College and planning a career in modern communications or if your present job lacks interest and challenge ..... why not join us in GCHQ?

We are recruiting

## RADIO OFFICERS

who are after initial training will become members of an organisation that is in the forefront of communications technology. Government Communications Headquarters can offer you a satisfying and rewarding career in the wide field of communications. Training involves a 32 week course (38 weeks if you come straight from Nautical College) which will fit you for appointment to RADIO OFFICER.

Not only will you find the work as an R O extremely interesting but there are also good prospects for promotion opportunities for overseas travel and a good salary. Add to this the security of working for an important Government Department and you could really have the start of something new.

The basic requirement for the job is 2 years radio operating experience or hold a PMG, MPT or MRGC or be about to obtain a MRGC. Registered disabled people are welcome to apply.

Salaries start at £4,762 at age 19 to £5,755 at age 25 and over during training and then £6,399 at 19 to £8,510 at 25 and over as a Radio Officer. Increments then follow annually to £11,741 inclusive of shift and weekend working allowances.

For full details and application form phone 0242 32912/3 or write to:



The Recruitment Office A/1108  
Priors Road  
CHELTENHAM  
Glos GL52 5AJ

(2806)



## CAPITAL APPOINTMENTS LTD

### THE UK's No. 1 ELECTRONICS AGENCY

If you have HNC/TEC or higher qualifications and are looking for a job in design, test, customer service, technical sales or similar fields:

**Telephone now for our free jobs list  
We have vacancies in all areas of the UK  
Salaries to £15,000 pa**

**01 808 3050  
(24 hours)**

**CAPITAL APPOINTMENTS LTD  
76 WILLOUGHBY LANE, LONDON N17 0SF**

(291)

# Electronic Engineers - What you want, where you want!

TJB Electrotechnical Personnel Services is a specialised appointments service for electrical and electronic engineers. We have clients throughout the UK who urgently need technical staff at all levels from Junior Technician to Senior Management. Vacancies exist in all branches of electronics and allied disciplines - right through from design to marketing - at salary levels from around **£6,000 - £20,000**.

If you wish to make the most of your qualifications and experience and move another rung or two up the ladder we will be pleased to help you.

All applications are treated in strict confidence and there is no danger of your present employer (or other companies you specify) being made aware of your application.

TJB ELECTROTECHNICAL  
PERSONNEL SERVICES,  
12 Mount Ephraim,  
Tunbridge Wells,  
Kent. TN4 8AS.

Tel: 0892 39388  
(24 Hour Answering Service)



Please send me a TJB Appointments Registration form

Name .....

Address .....

(861)

## CLIVEDEN

### TEST ENGINEERS

For full systems test on  
datacommunications networks.  
**£8,000 + Wokingham**

### FIELD SERVICE ENGINEERS

USA training on ATE systems  
Suit experienced repair  
technician

**£10,000 + car Woking**

### TECHNICIAN ENGINEER

To maintain VAX PDP11 & flight  
simulation systems.  
**to £11,000 Middlesex.**

### TEST ENGINEER

Fault-find data-processing  
equipment to component level.  
Some systems involvement  
**c£10,500 Herts**

### SERVICE ENGINEER

Mobile radiocommunications  
equipment.  
**£8,000 + car Hants & Central  
London.**

### TEST/SERVICE ENGINEER

Repair & fault-find microprocessor  
based broadcast systems.  
**£9,000 + Reading**

Phone/write/call Roger Howard C. Eng  
MIEE, Cliveden Technical Recruitment  
Consultants, 92 The Broadway,  
Bracknell, Berks RG12 1AR. Tel:  
Bracknell (0355) 489489 (six lines)

(1640)

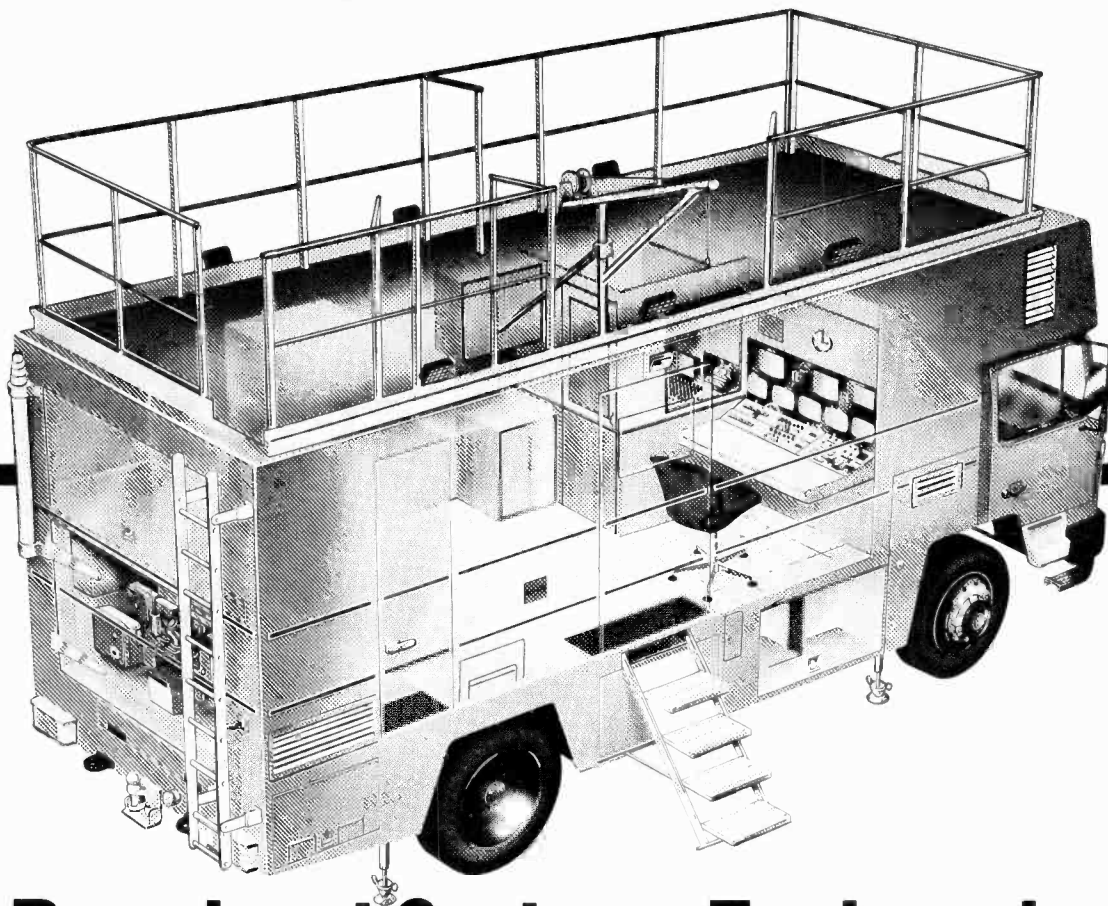

# Broadcast Systems Engineering

## Turning top products into total Systems.

Established in 1978, to specialise in the high technology field of professional broadcast television equipment, Sony Broadcast now has 10 overseas branches providing sales and other specialist engineering support to our customers, in a marketing area that covers Europe, the Middle East and Africa. We now employ 400 staff and enjoy a prominent position as a market leader with a wide range of state-of-the-art broadcast video and audio products.

The Systems Engineering Division plays a key role in the success of the Company, designing and equipping complete sound and vision broadcast and recording facilities. These facilities may comprise an entire television studio complex or a single mobile outside broadcast unit, often forming part of an existing, highly sophisticated national broadcast network, or representing a pioneering thrust into one of the world's remoter areas. Applications are now invited for the following challenging opportunities in the Systems Group:

### Project Engineer

You will be expected to make a significant contribution to a project team which will turn a design concept into reality. This will involve the in-depth design, building and commissioning of facilities that will satisfy our customers' diverse needs. To assist, you will be supported by a Systems Production Department comprising Materials Acquisition, Mechanical Engineering, Installation and Drawing Office skills. Project time-scales of 4-12 months will offer you a stimulating challenge, and the satisfaction of seeing your contributions in action fast.

Applicants should possess a formal electronics/electrical engineering qualification (a minimum of a Higher TEC) together with experience gained in the electronic manufacturing industry. A television broadcast background would be particularly relevant. The ability to interface confidently with technical customers is essential. Both positions will involve some overseas travel, and full product training will be provided.

First class conditions of employment are offered, and generous relocation assistance will be given where appropriate. Our salaries reflect the importance we place upon attracting the best highly skilled engineering staff and keeping them.

*Please apply in the first instance to David Parry,  
Personnel Officer with details of your career to date*

### Marketing Engineer

As a member of a Specialist Systems Marketing Team, you will be engaged in the conceptual design and costing of broadcast Systems. You must have an ability to analyse operational and technical requirements and turn them into practical solutions.

You can expect to meet a wide range of customers from Professional Broadcasters and Production Companies through to National Government Officials in order to discuss their project and offer expert advice. To assist in the preparation of detailed proposals you will have the use of modern computer based graphic design and information processing equipment.

**SONY**  
Broadcast



**Sony Broadcast Ltd.**

City Wall House  
Basing View, Basingstoke  
Hampshire RG21 2LA  
United Kingdom  
Telephone (0256) 59 5 83

(2590)

# Appointments

## More Hi-Tech Jobs

**£8000 - £20,000**

As a leading recruitment consultancy we have a wide selection of opportunities for high calibre Design, Development, Systems and supporting staff throughout the UK.

If you have experience in any of the following then you should be talking to us for your next career move

- ARTIFICIAL INTELLIGENCE • IMAGE PROCESSING
- MICRO HARDWARE & SOFTWARE • GUIDED WEAPONS
- OPERATIONAL RESEARCH • RF & MICROWAVE • OPTICS
- MATHEMATICAL MODELLING • SIMULATION • C<sup>3</sup>
- HIGH LEVEL PROGRAMMING • SYSTEMS ENGINEERING
- ACOUSTICS & SONAR • FLUID DYNAMICS • RADAR
- SATELLITES • AVIONICS • CONTROL • ANTENNA

Opportunities exist with National, International and consultancy companies offering excellent salaries and career advancement

For Free and Confidential career guidance call John Spencer or send a detailed C.V. Please quote reference WW/3



**Skyquip Technical Services**

85 High Street, Winchester, Hampshire. SO23 9AP  
Tel: Winchester (0962) 69478 (24 hours) (2579)

Specialist recruitment for Aerospace, Defence & Communications Industries

TVS, the ITV programme company serving the South and South-East of England, requires an

## Engineer - Vision Line Up

### Central Technical Area

A vacancy has arisen within the Engineering Division for a Vision Line Up Engineer to be based at the TVS Studio Centre in Maidstone.

Applications are invited from qualified engineers who have preferably worked in a Central Technical Area within a broadcast television company; however, candidates from related engineering backgrounds will be considered.

We will also consider the possibility of a trainee to fill this position. In this instance, applicants should have 'A' level qualifications in both mathematics and physics.

If you think that you fit the bill, please apply in writing giving full details of your qualifications and experience, and quoting ref no. 15/SE/85, to:

Personnel Manager



Vinters Park, Maidstone,  
Kent ME14 5NZ

*TVS is an equal opportunities employer.*

**ITV for the South & South - East**

(2581)

Philip Drake Electronics is a successful and growing company that has now established itself as the leading U.K. supplier of studio communications equipment and programme quality sound distribution modules to the Broadcasting industry.

An increasing workload has led to a requirement for the following personnel;

### PROJECT AND TEST ENGINEERS

Project and test engineers are required to work in the Systems Engineering Group which primarily deals with the custom design, manufacture and test of studio talkback and intercom systems.

**Project Engineers** should have a suitable engineering qualification and at least two years experience of system/project engineering with professional analogue equipment. The work includes detailed system design, liaison with customers, and technical support for production and test.

**Test Engineers** should have analogue experience but have the ability to adapt to digital technology. The job entails testing custom built equipment from prototype circuit boards to complete studio systems and providing after sales service and support. The post is one which provides excellent opportunities for advancement within the systems group.

### TECHNICIAN/JUNIOR ENGINEER

An opportunity exists for a Technician/Junior Engineer to join our product development team. The successful candidate will be involved in all aspects of design from concept to production. He/she will work primarily with analogue circuits although there will be involvement with digital circuits. An ability to work with minimum supervision is essential and it is expected that the successful candidate will be qualified to TEC or degree level although ability is more important. Experience of the professional audio industry would be an advantage.

### SOFTWARE ENGINEER

We are currently looking for two suitably qualified software engineers to strengthen our development team. The successful candidates would be required to write software in PASCAL and ASSEMBLER for the MC68000 family and must be able to work on their own initiative with minimal supervision. The ability to communicate ideas clearly is essential.

In addition to attractive salaries, the company offers a non-contributory pension scheme, BUPA membership and a pleasant working environment in newly constructed premises in Welwyn Garden City.

If any of the above positions appeal to you please apply in writing including your current CV or phone Jenni McCoy on Welwyn Garden City (0707) 333866 for an application form.

**Philip Drake Electronics Ltd.,**  
37 Broadwater Road,  
Welwyn Garden City,  
Herts AL7 3AX.

(2589)

## ELECTRONICS ENGINEER

Required by fast growing company. An electronics engineer, competent in digital and analogue systems. Must be capable of working without supervision in the production, testing and trouble shooting of our range of instruments. While a practical approach is essential, the successful candidate will be qualified to at least HNC standard. Salary level will not be a problem for the suitable candidate.

Write in the first instance detailing age, qualifications and salary expected to:

Mr. B.E. Stevens, Managing Director,  
Hounsfield Test Equipment, 37 Fulleton Road, Croydon, Surrey.  
CR0 6OR

(2575)



LEWISHAM AND NORTH SOUTHWARK HEALTH AUTHORITY

## GUY'S HOSPITAL

DEPARTMENT OF CLINICAL PHYSICS AND BIOENGINEERING

### ELECTRONICS TECHNICIAN — MEDICAL PHYSICS TECHNICIAN III

This active, well established and well equipped Department provides a physical sciences service for a number of clinical departments in the Hospital. We require a technician to join our electronics servicing group. This work includes the maintenance and servicing of a varied range of medical electronic equipment and covers all aspects of patient orientated equipment from fixed installations to small portable instruments.

Experience in this type of work would be an advantage, but candidates with HM Forces experience or having a good background of TV servicing are encouraged to apply.

An ONC/HNC or equivalent qualification, followed by at least three years technical experience, are required.

Day release is available for approved studies for higher qualifications.

Salary: £7,492 p.a. rising to £9,367 p.a. inc.

For further information contact Mr. F. Trowell

Tel: 01-407 7600 Ext: 2574

Application forms are available from the Personnel Department Guy's Hospital, St Thomas Street, London SW1 9RT. Tel: 01-407 7600 Ext: 3471 quoting Ref. No: P/153.

Closing date for completed applications: 31st May 1985.

(2588)

### UNIVERSITY OF LEICESTER DEPARTMENT OF COMPUTING STUDIES Post of Experimental Officer

Applications are invited for a post of Experimental Officer in the Department of Computing Studies, available from 1st July 1985.

Applicants will be expected to have some hardware design experience and it would be an advantage to have a suitable postgraduate or industrial background. The post will involve working with members of staff to develop both hardware and software for research and teaching, and will also involve some supervision of laboratory classes and student projects. The Department uses mostly 16-bit and 8-bit microcomputers and experience of this type of machine would be an advantage.

Initial salary will depend on qualifications and experience and will be on the scale £6,600 to £10,330.

Further particulars may be obtained from the Registrar, University of Leicester, University Road, Leicester LE1 7RH, to whom applications should be sent on the form provided by 31st May 1985.

(2577)

### CHARING CROSS HOSPITAL ELECTRONICS TECHNICIAN (MPT IV)

Technician required to work with a team engaged on the maintenance of a wide range of electro-medical equipment.

The successful applicant will largely be involved with repair, calibration and safety checking.

ONC or equivalent is essential and a mechanical aptitude would be an advantage.

Salary: £6488 p.a. — £8188 p.a. inclusive.

For further details please contact the Unit Personnel Department, Riverside Health Authority, Parsons House, Charing Cross Hospital, Fulham Palace Road, Hammersmith W6. Tel. 01-748 2040 extn 2992.

(2580)

## SOUND ENGINEER

Applications are invited for the newly-created post of TECHNICAL ASSISTANT to the studio's HEAD OF TECHNICAL SERVICES.

The successful candidate will work in the field of SOUND ENGINEERING for film post-production, and must have a thorough theoretical background in electronics and light electrical engineering. Ability in project management is a priority, involving audio and control systems, planning, specification and installation, with skills at the drawing board and development bench. A working understanding of remedial and routine maintenance is required, and experience with video systems would be an advantage.

The prospects for advancement would be best for an applicant having a good manner and appearance, an even temperament, and the ability to deal with clients, to handle administrative duties and to write clear English. The suggested age range is 28 to 40 years.

In conformity with studio practice, membership of ACTT (the Association of Cinematograph, Television and allied Technicians) would be expected, and due weight would be given to applications from present members. Non-members should be willing to apply for acceptance by this union.

Please forward a full c.v. (quoting ref: ACN/GFL/A) to:— Personnel Dept., Pinewood Studios, Pinewood Road, Iver, Bucks SLO 0NH.  
Tel: Iver (0753) 651700



(2535)

### RECORDING STUDIO MAINTENANCE MANAGER

Required for major North London Studio complex. Applicants should have a minimum of 3 years experience in this field. Knowledge of Studer tape machines, SSL desks an advantage.

Phone: Chris Dunn  
01-459 8899

(2595)

### YOU ARE UNDER STARTERS ORDERS

For the biggest Mobile Rally in the South Of England on July 14th 10 a.m. to 5 p.m. at the Brighton Race Ground. Huge "Bring & Buy Stall", 20,000 sq. ft under cover exhibition area, plus attractions for the XYL and children, restaurant facilities. The Rally which caters for the whole family. Talk In S22 and 3.5 Mhz. Admission £1 children free if accompanied by an adult. For further details ring 07918-5103.

(2593)

### College of Technology, Yarmouk University, Jordan.

Faculty and technical staff positions in EE Technology available Sep 85 and Feb 86. Relevant educational qualifications and demonstrated teaching/industrial abilities required. Areas of interest include, but are not restricted to Power & Machines, Communications, Electronics, Computers, Controls, Instrumentation, and Manufacturing. Responsibilities include teaching and advisory duties in a quality undergraduate EE Technology program, as well as assisting in the overall development of the College. Rank and Salary commensurate with qualifications and experience. An excellent benefits package. Positions open until filled. Letters of application, detailed resumes, copies of official transcripts, and at least three professional letters of reference should be sent to Faculty Affairs Division, Yarmouk University, Irbid, Jordan.

(2574)

### The Queen's University of Belfast The Computer Centre COMPUTER DEVELOPMENT ENGINEER £11,676 — £14,925 (under review)

The computer development Engineer will be a senior member of the Hardware Support and Communications Division, which is responsible for the Centre's data-communications, hardware development and equipment maintenance programme. The post offers an invigorating opportunity to take over a senior technical role in a very active and stimulating University environment.

Applicants, male or female, should preferably be university graduates or equivalent in electrical or electronic engineering; demonstrating an in-depth knowledge and practical experience of data-communications, state-of-the-art hardware and active technical expertise.

Salary scale (Universities Other Related Staff Grade II): £11,676 — £14,925 (under review from 1.4.85), initial placing according to age, experience and qualifications. Assistance with relocation.

Further particulars and an application form are available from the Personnel Officer, The Queen's University of Belfast, Northern Ireland, BT7 1NN.

(2578)

### ■ AUCTION NOTICE ELECTRONICS ■

Auctions Held Every Other Friday Lots Include:  
Electronic and Electrical Equipment, Components, Test Gear,  
Radiotelephones, Computers, Photographic and Video Equipment,  
also Manufacturers Plant and General Works Effect.  
Catalogues Available, Subscription £10 per year, Post Paid.

ANGLIA INDUSTRIAL AUCTIONS  
5 Station Road, Littleport, Cambs. CB6 1QE. Phone. 0353 860185.

(2573)

# LINK

## ELECTRONIC ENGINEERS

We are in the forefront of providing state-of-the-art broadcast tv equipment to the BBC and independent companies in this country and similar organisations throughout the world. Our new type 130 micro-processor based colour camera is in production in addition to which we have a world-wide market for outside broadcast and studio installations.

To help us broaden our product range and continue our success we urgently need to recruit well qualified electronic engineers (some at senior level) who are looking for the opportunity to develop their talents in a close knit team. Current requirements include:

**DESIGN AND DEVELOPMENT —  
HARDWARE/SOFTWARE  
ENGINEERS**

**SALES ENGINEERS  
TEST ENGINEERS**

Salaries offered will reflect the high standard of engineer we are looking for and are accompanied by 25 days holiday per year, free health and life assurance. A pension scheme and, where appropriate, generous assistance in relocating to this pleasant part of Hampshire.

Please phone Jean Smith on Andover (0264) 61345 for an application form or further details of the vacancies. Alternatively you might like to let us have a full cv with details of your background and experience.

(2597)

# LINK

## ELECTRONICS

Walworth Industrial Estate, Andover, Hampshire, England  
Telephone: Andover (0264) 61345

## MEDICAL RESEARCH COUNCIL INSTITUTE OF HEARING RESEARCH SOUTHAMPTON CLINICAL OUTSTATION RESEARCH OFFICER IN ELECTRONICS (RO/SRO)

A vacancy exists for a research officer with experience in electronics at IHR Southampton. The post will be based at the Institute of Sound and Vibration Research at the University, but will also relate to the other half of the team's activities, at the Royal South Hants Hospital.

The research is on clinically applicable aspects of hearing and deafness, advanced testing techniques, and the use of signal averaging equipment by computer for which a very high level of technical support is required. The appointee will be required, with minimal supervision to design and construct new equipment involving transducers and interfaces. There will also be a little general technical support for the research team including calibration, repair and servicing work. A general electronics background is needed and a knowledge of Z80 CP/M systems and of digital interface techniques would be advantageous. For further information about the post please contact Dr. A.R.D. Thornton (Tel: 0703 37946).

The appointment will be made on the Research Officer grade (£6483-8492) or Senior Research Officer grade (£8574-10,938). The MRC has a pension scheme and generous leave allowances.

(2566)

## CALIBRATION/ SERVICE ENGINEERS

c £8,250 + Overtime + July Review

Bradley Electronics is one of the leading organisations in the electronics industry. We provide a range of advanced electronic equipment and engineering services to MoD, Industry and the Health Care market.

Our Repair and Calibration laboratory, the largest of its type in the UK, provides a comprehensive service for commercial and military organisations, with its full facilities for maintaining and calibrating all types of electronic equipment.

Opportunities exist for Engineers to work with a wide variety of equipment, including Multimeters, Oscilloscopes, Navigation Systems and Electronic Counter Measure Systems. Ability to trace, diagnose and rectify faults in these complex equipments is essential. Education to a minimum of C&G/TEC or equivalent is required, together with considerable practical knowledge and experience in electronic testing, servicing of radar, and telecommunications equipment. Experience of this nature gained in the Services will be of particular value.

The Company is located close to the underground, bus routes and the North Circular Road/M1. The salary and conditions package available is consistent with the Company's membership of a large, successful Group with considerable resources.

For full details please call our Personnel Manager, Roger Loughney, on 01-450 7811. Or write to him at Bradley Electronics Limited, Electral House, Neasden Lane, London NW10 1RR.

## Bradley Electronics

(2560)

## Telecommunications Engineering Technicians

**Openings in Servicing and Maintenance Up to £8,873**

Our business is to install and maintain the communications equipment used by the Police and Fire Brigades in England and Wales - some of the latest you will find in operation anywhere.

We have a number of vacancies at our Service Centres in various parts of the country, for Telecommunications Engineering Technicians with practical skills in locating and diagnosing faults in a wide range of equipment from computer-based data transmission to FM and AM radio systems.

The work provides excellent opportunities for extending your technical expertise, with specialised courses and training to keep you up to date on developments and new equipment. There are also opportunities for day release to gain higher qualifications.

Applicants, male or female, must be qualified to at least City & Guilds Intermediate Telecommunications standard and possess a current driving licence. Some

travelling will normally be involved. Registered disabled persons can of course apply.

The Home Office is an equal opportunities employer.

Salary will be on a scale £6501 to £8873 a year with generous leave allowance and pension scheme.

Good prospects for promotion.

If you are interested in working with us, please write for further details and an application form, quoting reference WW/3 to: Miss M Andrews, Home Office, Directorate of Telecommunications, Horseferry House, Dean Ryle Street, London SW1P 2AW. (2557)



### Home Office

### Directorate of Telecommunications

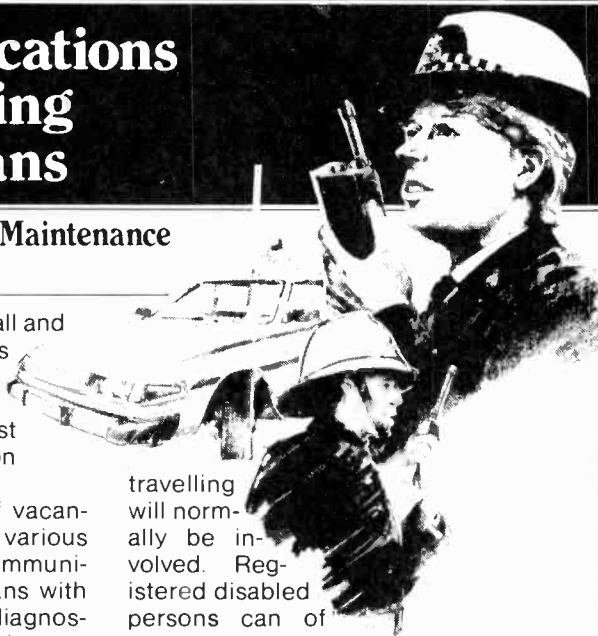

## BORED ?

**Then change your job!**

- 1) **TEST CALIBRATION ENGINEERS**  
To work on a variety of micro based instruments and A.T.E. Windsor £12,000+
- 2) **REMOTE CAMERA EQUIPMENT**  
Test engineers to work on high speed digital systems to £10,000. Surrey.
- 3) **TECHNICIAN ENGINEER**  
For maintenance of VAX pdp11 and flight simulation systems. Middx. To £11,000.
- 4) **DATA PROCESSING EQUIPMENT**  
Customer service engineer to work on PDP8 and PDP11's, printers and graphics displays. £12,000 + car. Berks/Bucks.
- 5) **MARINE SERVICE ENGINEER**  
To maintain a variety of marine communications and navigation systems. Surrey. To £10,000.
- 6) **DEVELOPMENT/TEST ENGINEER**  
To design and support a variety of medical systems. £10,000. Berks/Middx.

*Hundreds of other Electronic and Computer vacancies to £12,500*

Phone or write:  
**Roger Howard, C.Eng., M.I.E.E., M.I.E.R.E.**  
**CLIVEDEN CONSULTANTS**  
92 The Broadway, Bracknell, Berkshire  
Tel: 0344 489485 (1640)

## CLIVEDEN

## DESIGN AND DEVELOPMENT ENGINEER

Experienced engineer required to join small electronics company involved in design and manufacture of telecomms products for BT and other PeT authorities.

Applicants should have experience in line equalisation equipment, filters, SMPS and automatic testing using microprocessor techniques.

Qualifications to degree or HNC with suitable experience. Attractive salary + usual benefits to right person.

Application to include current c.v. to: **Kenton Research Ltd. Europe Trading Estate, Erith, Kent DA8 1QL.**  
Telephone: (032 24) 419 33

(2519)

## COMMUNICATIONS DESIGN FROM START...

At H.M. Government Communications Centre we're using the very latest ideas in electronics technology to design and develop sophisticated communications systems and installations for special Government needs at home and overseas.

With full technical support facilities on hand, it's an environment where you can see your ideas progress from initial concepts through prototype construction, test and evaluation, to the pre-production phase, with a chance to influence every stage. Working conditions are

pleasant, the surroundings are attractive, and the career prospects are excellent.

Ideally we're looking for men and women who have studied electronics or electronics related subjects to degree level or equivalent and have had some experience of design, whether obtained at work or through hobby activities. Appointments will be made as Higher Scientific Officer (£7,435-£10,039) or Scientific Officer (£5,909-£8,153) according to qualifications and experience.

For further details please write to the address given below. It would be particularly helpful if an outline of your personal interests and practical experience could be included.

The Recruitment Officer, HMGCC, Hanslope Park, Buckinghamshire MK19 7BH.

## ... TO FINISH

(2523)

**SMALL SELECTION ONLY LISTED  
RING US FOR YOUR  
REQUIREMENTS WHICH MAY BE  
IN STOCK**



Portable Battery or Mains Oscilloscope. SE Laboratories 111 Oscilloscope — Solid State — General purpose — Bandwidth DC to 18/20MC/S at 20MVICM — Dual Channel — Rise time 19NS — Calibrated Sweep — Calibrator — Display 10CMSx8CMS — Power AC — 95Volts to 100-190 Volts to 260 or 24 Volt DC Battery — Size. W.25.5CM — H.25.5CMS — 56CM Deep — WT.11.4KGS — Carrying handle — Tested in fair condition with operating instructions £120.00.

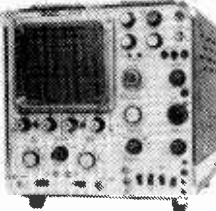

Latest Bulk Government Release — Cossor Oscilloscope COU150 (CT531/3) £150 only. Solid state general purpose bandwidth DC to 35MHz at 5MVICM — Dual Channel — High brightness display (8x10cm) Full delayed time base with gated mode — Rise time 10MS — Illuminated graticule — Beam limiter — Calibrator 1KHz squarewave — Power 100 — 120V.200V — 250 volts AC — Size W 26CM — 41CM deep — WT 12.5 K.G. carrying handle — colour blue — protection cover front containing polarized viewer and camera adaptor plate — probe (1) — Mains lead. Tested in Fair condition with operating instructions — £150.00.

Communication Receivers. Rascal 500KC/S to 30MC/S in 30 bands 1MC/SWIDE — RA17 MK11 £125. RA17L £150. RA17E £200. New Metal Louvered Cases for above £25. All receivers are air tested and calibrated in our workshop — supplied with dust cover — operation instructions — circuit — in fair used condition. Rascal Synthesizers (Decade frequency generators) MA350B Solid State for use with — MA79 — RA217 — RA1218 Etc £100 to £150. MA250 — 1.6MC/S to 31.6 MC/S £100. MA1350 for use with RA17 receiver £100. MA259G Precision frequency standard 5MC/S — 1MC/S — 100KHz £100 to £150. Panoramic Adaptor RA86 £150. RA137 and RA37 £40 to £75 LF converters 10 to 90KC/S. RA216 Independent SSB unit £50 RA98 SSB-15M Converter £50. RA121 SSB-15B converter £75. EC964/7K Solid state — single channel — SSB — mains or battery — 1.6 to 27.5 MC/S and 400 to 535KHz £100 with manual Plessey PR155G Solid State 60KC/S — 30MC/S £400. Creed 75 Teleprinters — Fitted tape punch and gearbox for 50 and 75 bauds — 110Volts AC supply — in original transport tray sealed in polythene — like new £15A. Redifon TT11 Audio Teleprinter converter receiver solid state — supply 110 or 240AC — Made for use with above teleprinter enabling print-out of messages received from audio input of communication receiver £15 with circuit tested. Redifon TT10 Converter as above but includes transmit facilities £20. Oscilloscopes — stocks always changing Tektronix 465 — 100MC/S £750. FM Recorder Sanghad Sabre 111 14 channels £350. Transtel Matrix printers — AF11R — 5 level Baudot Code — up to 300 Bauds — for print out on plain teleprinter paper £50 to £100. Transtel AH11R — As above but also 8 level ASC11 (CCITT No 2 and CCITT No. 5) Like new £100. Army field telephone sets. Type F — L and J — Large quantity in stock £5 to £15 depending on type and quantity P.O.R. Don 10 Telephone Cable — half mile canvas containers £20. Night viewing infra-red AFV periscopes. Twin Eyepiece — 24 volt dc supply £100ea. Original cost to government over £11,000ea. Static invertors — 12 or 24 volt input — 240 volt AC sine wave output — various wattages P.O.R. XY Plotters and pen recorders various — P.O.R. Ferrograph series 7 Tape recorders mono £100, stereo £150. Signal Generators various — TF995/A3 £60. TF801D/8s — 10MC/S to 485MC/S £90 TF144H/A4 £90. TF1060/2 £60. HP605A — £90 £140 HP608 £50 HP614A £100 HP618B £100 HP620A £100. Marconi TF1064B/5 £100 TF791 Deviation meter £100 TF893A Power meter £50 Aerial mast assembly 30ft high complete with 16ft whip aerial to mount on top — groups — insulators — Base and Spikes etc. in heavy duty carrying bag — new £30. Rascal frequency counter Type 836 £50 Tektronix plugs-ins — 1A1 £50. 1A2 £40. 1A4 £100 ME50. All items are bought direct from H.M. Government being surplus equipment. Price is Ex works. S.A.E. for enquiries. Phone for appointment for demonstration of any items. Also availability or price change. V.A.T. and carriage extra.

**EXPORT TRADE AND QUANTITY  
DISCOUNTS GIVEN  
JOHNS RADIO (0274) 684007  
WHITEHALL WORKS,  
84 WHITEHALL ROAD,  
EAST BIRKENSHAW, BRADFORD  
BD11 2ER**

WANTED: REDUNDANT TEST EQUIPMENT — RECEIVING AND TRANSMITTING EQUIPMENT — VALVES — PLUGS — SOCKETS SYNCHROS ETC. (2734)

## ARTICLES FOR SALE

**MORSE READING PROGS.** Work on clean signals without hardware interface. ZX81 1K UNEXPANDED MEMORY. Translated code with word and line spaces for easy reading Automatic scroll action. £7 incl. (2532)

**WAVEGUIDE**, Flanges and dishes. All standard sizes and alloys (new material only) from stock. Special sizes to order. Earth Stations, 01-228 7876, 22 Howie Street, London SW11 4AR. (2099)

## APPOINTMENTS

Do you regard yourself as an electronics whizz kid. Then I would like to hear from you. Formal qualifications may not be necessary; Age not important. Interested? Then telephone 01 941 2225 and ask for Mr Lawrence. 2596

## BUSINESS OPPORTUNITY

Due to very strong demand, ILP Electronics Limited — UK manufacturer of audio modules and related products — urgently seek Yugoslavian based representative/distributor to market their range. Reply to:

**ILP Electronics Limited  
Graham Bell House, Roper  
Close, Canterbury,  
Kent. Telephone: 0227-  
454778**

(2591)

**FREE P.T.H. PROTOTYPE** of the finest quality with EVERY P.C.B. artwork designed by us. Competitive hourly rates, and high standard of work. Halstead Designs Limited, 34, High St., Halstead, Essex. Tel. (0787) 477408/474554. (2126)

**SHEETMETAL FOLDERS** vice or bench model. 24" x 16G £45. Leaflet 01-890 7838 anytime (2558)

**QUARTZ CRYSTALS OSCILLATORS** AND **FILTERS** of all types. Large stocks of standard items. Specials supplied to order. Personal and export orders welcomed — SAE for lists please. OEM support thru: design advice; prototype quantities, production schedules. Golledge Electronics, Merriott, Somerset TA16 5NS. Tel: 0460 73718 (2472)

## T.I. DATA BOOKS

Opto Electronics £5.00  
Linear Circuits £9.00  
TTL (7th Ed.) Vol.1. £9.00  
TTL (7th Ed.) Vol.2. £8.00  
'Understanding' series £4.50

Post free CWO. SAE for full list

**MG Books, 24A Newgate,  
Barnard Castle, Co.  
Durham DL12 8NG.  
Tel: (0833) 31130**

(2540)

## SERVICES

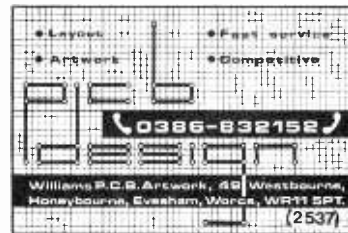

**SMALL BATCH PCBs**, produced from your artwork, also DIALS, PANELS, LABELS. Camera work undertaken. FAST TURNAROUND. Details: Winston Promotions, 9 Hatton Place, London EC1N 8RU. Tel. 01-405 4127/0960. (9794)

**DESIGN AND DEVELOPMENT SERVICE.** RF transmitters and receivers. Telemetry U.H.F. V.H.F. Analogue and digital circuits, control systems. Full manufacturing facilities. RCS Electronics, Wolsey Road, Ashford, Middx. Phone Dr. Eric Falkner on 53661. (2637)

**DESIGN AND MANUFACTURE.** ANALOGUE, DIGITAL, RF AND MICROWAVE CIRCUIT AND SYSTEM DESIGN. Also PCB design, mechanical design and prototype/small batch production. — Adenmore Limited, 27 Longshot Estate, Bracknell, Berks. Tel: Bracknell (0344) 52023. (656)

**The Publishers take all reasonable care to ensure that classified advertisements are genuine, but readers must satisfy themselves that they will be obtaining what they require before entering into transactions, particularly if they involve large sums of money.** (2519)

**DOLCH LOGIC ANALYZER LAM3250**, 50MHz, 48 channel; 32 data, 2 external clocks, 6 clock qualifiers and 3 trigger qualifiers. TTL & ECL thresholds. 5ns Glitch capture. Including 6ALP88 active logic pods. £2,500 Tel: Bordon (04203) 7194. (2582)

**QUANTUM & SHUGART** 8 inch wind drives & 8 inch floppy drives, 10.66 meg & 400K. QZ010, 801 available new. Full manual. Phone Steve 0462 711815. (2594)

## HALF PRICE ENCLOSURES

Manufacturers Brand New Surplus and Seconds at almost Half Price. 19" Rack Mounting and smaller Free Standing Enclosures. No damage and only blemishes on the finish at the very worst. Send S.A.E. for List. C. Phillips 'The Laurels' Tiptoe Road, Wootton, New Milton, Hants BH25 5SJ. Mail Order Only. (2592)

Apollo Scribmaster X-Y, micrometer calibrated, table £89. Metals Research Macrotope, diamond cutters, accessories etc., £275. Stanton Electronic Balance single pan £150. Advance Twin Stabilised Power Supplies £59. Wayne-Kerr Universal Bridge £98. Ignition Analyser Unit/Diagnostic manual £39. Low-voltage Electroplater for rust prevention/rectification £39. Microscope with micrometer table £89. Miscellaneous stabilised power supplies £18-£45. Avo In-Circuit transistor, diode, thyristor tester £25. Philips RM/AM/Sweep generator £89. Creed Teleprinter £75. High Intensity Fibre-Optic Light Supply, twin lamps, twin outputs each £35. Hughes Micro-Spot Welding Head £69, ditto-Sippicam £35. Chart Recorders, Audio Generator Audio Analyser, Wow/Flutter Meter, Digital Calibration Voltmeter, five digits. DC/AC plug-ins £85. Infra-Red Analyser Heads £30. Four-Phase Signal Generator £85. Pulse generators. Sweep Generators, etc. etc. (2016)

**040 376236**

## SERVISCOPE

**EAST STREET, FARNHAM, SURREY.**

**TEL: 0252 722666**

**CONTACT: G.P. SKINNER**

## A SELECTION OF TELEVISION AND ELECTRONIC COMPONENTS FOR DISPOSAL

68 PF Ceramic Cap  
470 PF Pulse Ceramic 12K  
PYE 731/728 — Mains Switch  
TEC — 8000/8500 Therm Cut Out  
GEC — 1040/Therm Cut Out  
IN4002  
BC308B  
BD137  
BC307  
BAX 13  
TAA661  
PHIL 210 — Brightness Knob  
PHIL 210 — Volume Knob  
TEC 1500 — Brill/on-off Knob

TEC 1500 Earth Strip UHG Tuner  
PHIL G8 Focus Control  
PHIL G8 UHG Tuner  
VRistor — E299/DC/p348  
TEC 1400 Mains Dropper  
PHIL 210 Frame Out Put Transformer  
PHIL G8 AFC Assembly  
PHIL G8 — Vision Selectivity Assembly  
PHIL G8 — Vision Gain Assembly  
PHIL G8 — Sound Selectivity Assembly  
PCF80  
PL36  
EF184

**CATHODE RAY TUBES COLOUR**  
A51 — 110X/A51 — 220X A67 — 120X A56 — 120X

**ALL AT KNOCK DOWN PRICES**

— FOR A DETAILED LIST PLEASE APPLY TO

**0252-722666**

(2533)

## TO MANUFACTURERS, WHOLESALERS BULK BUYERS. ETC.

## LARGE QUANTITIES OF RADIO, TV AND ELECTRONIC COMPONENTS FOR DISPOSAL

SEMICONDUCTORS, all types, INTEGRATED CIRCUITS, TRANSISTORS, DIODES, RECTIFIERS, THYRISTORS, etc. RESISTORS, C/F, M/F, W/W, etc. CAPACITORS, SILVER MICA, POLYSTYRENE, C280, C296, DISC CERAMICS, PLATE CERAMICS, etc.

ELECTROLYTIC CONDENSERS, SPEAKERS, CONNECTING WIRE, CABLES, SCREENED WIRE, SCREWS, NUTS, CHOKES, TRANSFORMERS, etc.

**ALL AT KNOCKOUT PRICES** — Come and pay us a visit ALADDIN'S CAVE

**TELEPHONE: 445 0749/445 2713**

R. HENSON LTD.

21 Lodge Lane, North Finchley, London, N.12

(5 minutes from Tally Ho Corner)

(1613)





# NEW INSTRUMENTS FROM STOCK - A BETTER CHOICE

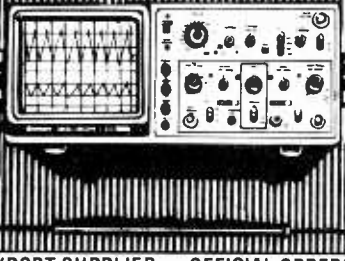

**'SCOPES**  
HITACHI • HAMEG  
CROTECH • SCOPEX

**GENERATORS**  
BLACK STAR • THANDAR  
LEADER • TRIO • SALDETA

**MULTIMETERS**  
METEX • SOAR • METRIX  
THURLBY • THANDAR  
PLUS LOW COST RANGE

**POWER SUPPLIES**  
THURLBY • PLUS LOW COST RANGE

**RANGE OF EQUIPMENT INCLUDES**  
TV TESTING: DIGITAL AND ANALOGUE MULTIMETERS:  
'SCOPES: CLAMP METERS: INSULATION TESTERS:  
WOW/FLUTTER METERS: DISTORTION METERS: FUNCTION,  
PULSE AND R-C GENERATORS: LCR BRIDGE: DIGITAL  
CAPACITANCE: MULTIPLEXERS: LOGIC ANALYSER: LOGIC  
PROBES: COUNTERS: POWER SUPPLIES: TRANSISTOR  
CHECKERS, ETC.

**PLUS COMPONENTS: TOOLS: COMPUTER SOFTWARE  
AND ACCESSORIES: SEMICONDUCTORS:**

**COUNTERS**  
THANDAR • BLACK STAR



LET US QUOTE FOR YOUR REQUIREMENTS

EXPORT SUPPLIED — OFFICIAL ORDERS (SUBJECT TO APPROVAL) WELCOMED EDUCATIONAL DISCOUNTS AVAILABLE

**HENRY'S** AUDIO ELECTRONICS

301 Edgware Road, London W2 01-724 3564  
404 Edgware Road, London W2 01-724 0323  
ACCOUNT AND EXPORT ENQUIRIES 01-258 1831

OPEN 6 DAYS A WEEK

CIRCLE 35 FOR FURTHER DETAILS.

# WIRELESS WORLD

## INDEX TO ADVERTISERS

Appointments Vacant Advertisements appear on pages 95 — 103

PAGE	PAGE	PAGE
AH Supplies.....93	Electrovalue.....28	Newrad Instrument Cases.....83
AM Electronics.....74	Electronics & Wireless World.....78	North East Satellite Systems.....15
AWR Technology.....74	Electronics & Wireless World Binders.....93	Number One Systems.....16
Advertising Standards Authority.....14	Ellmax Electronics.....66	
Air Link Trans.....16	Ervine Business Systems.....9	P.F. Ralfe.....4
Antex (Electrical)..... Outside back cover	European Electronic Systems..... Inside back cover	PM Components.....32/33
Arcom.....93	Field Electric.....4	Pantechnic.....25
Armon Products Ltd.....65	Gemini Microcomputer.....38	Pye Unicam.....67
Aspen Electronics.....2	Greenwood Electronics.....48	
Audio Electronics.....104	Happy Memorie.....85	R. Henson Ltd.....65
Automation & Control Technolog.....28	Harris Electronics.....65	Radford.....2
	Harrison Bros.....22, 74	Radio Code Clocks.....68
B Bamber Electronics.....14	Hart Electronic.....89	Research Communications.....13
Beckenham Peripherals.....15	Henry's Audio Electronics.....25	
Black Star Ltd.....48	Hilomast Ltd.....56	Samsons Electronics.....13
Bytron Ltd.....48	ILP Electronics.....65	Sarel Electric Ltd.....74
	Integrex.....3	Satellite Technology.....4
Cambridge Microprocessor.....16	J. Bull.....16	Sherwood Data Systems.....22
Cavendish Automation.....66	JDR Metal.....22	Stewart of Reading.....85
Colomar Electronics.....56	JPR.....93	Surrey Electronics.....48
Computer Appreciation.....2	L.J. Electronics.....5	
Conquin Software..... Inside front cover	Lanco Ltd.....15	TIC Semicond.....89
Crash Barrier.....2	Langrex Supplies.....47	TK Electronics.....12
Cricklewood Electronics.....68	Levell Electronics.....3	Tape Automation.....85
Crotech Instruments.....89	Maplin Electronic Supplies.....22	Taylor Bros.....83
Cybernetics Application.....15	Measurement Devices.....68	Technomatic.....26/27
	Micro Processing Engineering.....4	Tektronix Ltd.....37
Dataman Design.....55	Midwich Computer Co.....66	Thandar Electronics.....28
Digitask.....89		Thanet Electronics.....25
Digitask Business System.....12		Thurlby Electronics.....88
Display Electronics.....10/11		Triangle Digital Services.....83
E.A. Sowter.....5		
EG & G Reticon.....9		Warwick Design.....12
EMS Mfg.....56		Weyrad Instruments.....21

**OVERSEAS ADVERTISEMENT AGENTS**

**France and Belgium:** Pierre Mussard, 18 — 20 Place de la Madeleine, Paris 75008.

**Hungary:** Ms Edit, Bajusz, Hungexpo Advertising Agency, Budapest XIV, Varosliget.  
Telephone: 225 008 — Telex: Budapest 22-4525  
INFOIRE

**Italy:** Sig C. Epis, Etas-Kompass, S.p.a. — Servizio Estero, Via Mantegna 6, 20154 Milan.  
Telephone: 347051 — Telex: 37342 Kompass.

**Japan:** Mr Inatsuki, Trade Media — IBPA (Japan), B.212. Azabu Heights, 1-5-10 Roppongi, Minato-ku 106.  
Telephone: (03) 585 0581.

**United States of America:** Jay Feinnan, Business Press International Ltd, 205 East 42nd Street, New York, NY 10017 — Telephone (212) 867-2080 — Telex: 23827.  
Jack Farley Jr., The Farley Coi. Suite 1584, 35 East Walker Drive, Chicago, Illinois 60601 — Telephone (312) 63074.  
Victor A. Jauch, Elmalex International, P.O. Box 34607, Los Angeles, Calif. 90034, USA — Telephone (213) 821-8581 — Telex: 18-1059.

Jack Mantel, The Farley Co., Suite 650, Ranna Building, Cleveland, Ohio 4415 — Telephone (216) 621 1919.  
Ray Rickles, Ray Rickles & Co., P.O. Box 2028, Miami Beach, Florida 33140 — Telephone (305) 532 7301.  
Tim Parks, Ray Rickles & Co., 3116 Maple Drive N.E., Atlanta, Georgia 30305. Telephone (404) 237 7432.  
Mike Loughlin Business Press International, 15055, memorial Ste 119, Houston, Texas — Telephone (713) 783 8673.

**Canada:** Colin H. MacCulloch, International Advertising Consultants Ltd., 915 Carlton Tower, 2 Carlton Street, Toronto 2 — Telephone (416) 364 2269.  
\*Also subscription agents.

Printed in Great Britain by Index Printers Ltd., Oldhill, Dunstable, and typeset by Legendary Characters, South Street, Lancing, for the proprietors. Business Press International, Quadrant House, The Quadrant, Sutton, Surrey SM2 5AS. © Business Press International 1984. *Wireless World* can be obtained abroad from the following: AUSTRALIA and NEW ZEALAND: Gordon & Gotch Ltd. INDIA: A. H. Wheeler & Co. CANADA: The Wm. Dawson Subscription Service Ltd., Gordon & Gotch Ltd. SOUTH AFRICA: Central News Agency Ltd; Wilian Dawson & Sons (S.A.) Ltd. UNITED STATES: Eastern News Distribution Inc., 14th Floor, 111 Eighth Avenue, New York, N.Y. 10011.



# Spot On!

Time has been our business since 1974.  
Precision has been our aim.  
We have experience in display,  
code generation, off air time,  
off air frequency and  
frequency standards.  
Single units to the largest system.

Our time is at your disposal.



**European Electronic  
Systems Limited,**  
Woodham Mortimer Place,  
Maldon, Essex. CM9 6SW.  
Telephone: 024541-5911.  
Telex: 995917

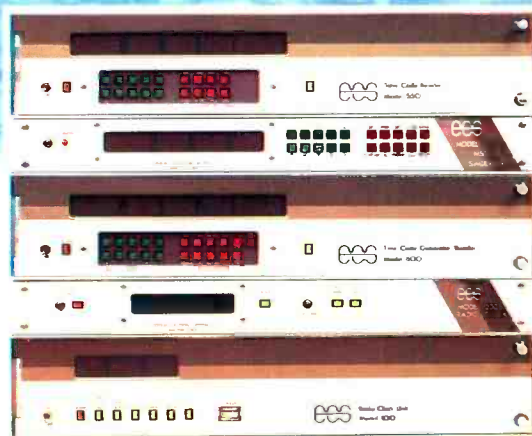

Time Code Reader.

MSF Rugby Simulator.

Tape Search System.

Radio Clock (5 mSec)

Radio Clock (500  $\mu$ Sec)

Made in England.

**CIRCLE 2 FOR FURTHER INFORMATION**



# ANTEX a world of soldering

## Tomorrows Soldering Technology Today.

ANTEX has a worldwide reputation for quality & service & for many years has been one of the best known & most popular names in soldering. Always at the forefront of technology, ANTEX is continually researching new and better ways of achieving more accurate, reliable, and cost effective soldering. On ANTEX Soldering Irons, the advanced design of the interface between the element & the bit allows more efficient heat transfer to the bit and improved stability of the temperature at the point of contact with the work. Indeed, experiments have shown that an XS25 watt iron can be used for tasks where a 40 watt iron would normally have been required.

ANTEX Soldering Irons exhibit exceptionally low leakage currents & hence are suitable for use on Static Sensitive Devices. Sophisticated temperature controlled soldering units have recently been added to the ANTEX range.

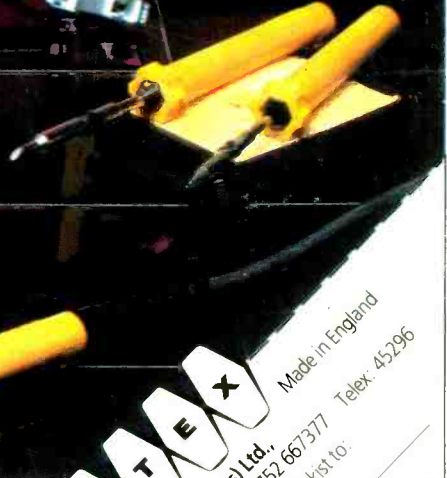

SK5 Soldering Kit

Model XS

Model CS

Model C

TCSU-D Temperature-Controlled Soldering Unit

TCSU1 Soldering Unit

ST4 Stand

**Model C**  
- 15 Watts. Available for 250, 220, 115, 100, 50 or 24 volts.

**Model XS**  
- 25 Watts. Available for 240, 220, 115, 100, 50, 24 or 12 volts.

**Model XS-BP**  
- 25 Watts. 240 volts, fitted with British Plug.

**ST4 Stand**  
- To suit all irons.

**SK5 Soldering Kit.** Contains model CS 240v Iron, an ST4 Stand and solder.

**SK6 Soldering Kit.** Contains model XS240v Iron, an ST4 Stand and solder.

**SK5-BP and SK6-BP** Soldering Kits as above with British Plug.

**Model CS**  
- 17 Watts. Available for 240, 220, 115, 100, 50, 24 or 12 volts.

**Model CS-BP**  
- 17 Watts. 240 volts, fitted with British Plug.

**TCSU1**  
- Very robust temperature controlled Soldering Unit, with a choice of 30 Watt (CSTC) or 40 Watt (XSTC) miniature irons. Range 65°C to 420°C. Accuracy 2%

**TCSU-D**  
Elegant Temperature Controlled Soldering Unit with 50 W Iron (XSD) and built around FERRANTI custom-made ULA. Range Ambient to 450°C. Accuracy  $\pm 5^\circ\text{C}$ . Zero crossing switching. Detachable sponge tray.

EWV/6/85

**ANTEX** Made in England  
**ANTEX (Electronics) Ltd.** Tel: 0752 667377 Telex: 45296  
 Mayflower House, Plymouth, Devon.  
 Please send literature, price list and my nearest stockist to:  
 Name \_\_\_\_\_  
 Address \_\_\_\_\_  
 Telephone \_\_\_\_\_

CIRCLE 3 FOR FURTHER INFORMATION