

# wireless world

JULY 1975 30p

**Digital wristwatch**  
**Active notch filters**



Australia \$1.00  
Belgium Fr. 61.50  
Canada \$1.25  
Denmark Kr. 11.00  
Finland J. mk 5.00  
Germany DM. 4.00  
Greece Dr. 40.00  
Holland Dfl. 4.50  
Italy L.900  
Malaysia MS\$ 3.25  
New Zealand \$1.00  
Nigeria 25k  
Norway Kr. 10.00 incl. 10 pins  
Portugal Esc. 35.00  
South Africa 98 Cents  
Spain Ptas 80.00  
Sweden Kr. 6.00 incl. 10 pins  
Switzerland Fr. 5.80  
U.S.A. \$1.50



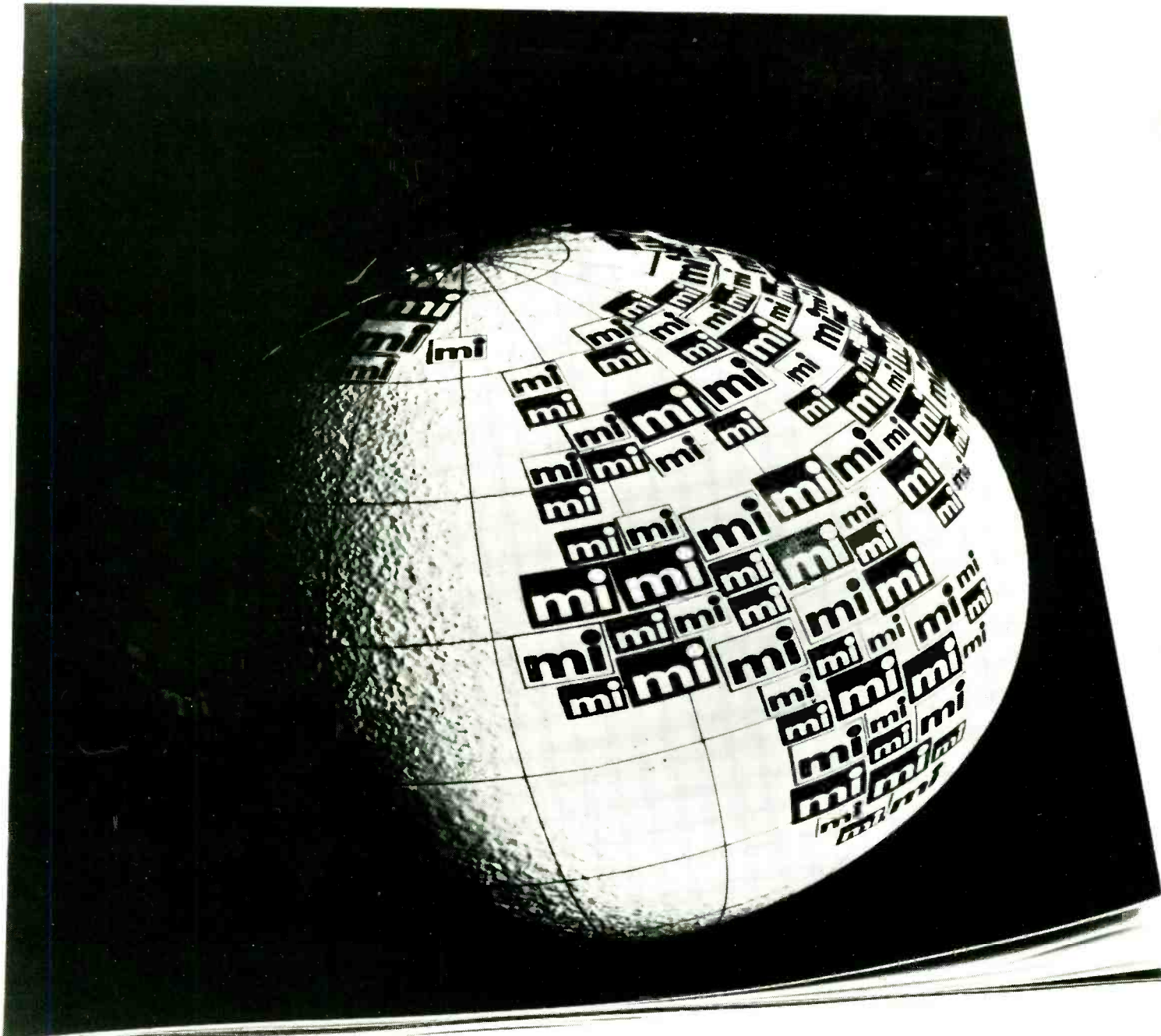

## Cover Story

Some Marconi Instruments are designed to be mobile. Others are not – but do a lot of travelling all the same. In fact, nearly three-quarters of **mi**'s total sales stem from export orders.

So there are plenty of people in Milwaukee or Mannheim or Melbourne or Montevideo who are just as discerning about Marconi Instruments as you are. And they're equally enthusiastic about **mi** service, too. We've service organisations in New Jersey, Munich, Paris and a whole lot of other

places to see to that.

There are **mi** distributors and representatives in more than 60 countries throughout the world and we have 14 associated companies in Africa, the Middle, Near and Far East, North and South America and Europe.

**mi**, then, doesn't only cover all the intricacies of planning and producing some of the world's finest electronic testing and measuring instruments . . . .

It covers the world, as well.

## **mi**: THE INTERNATIONALISTS

MARCONI INSTRUMENTS LIMITED

Longacres • St. Albans • Hertfordshire AL4 0JN • England • Telephone: St. Albans 59292 • Telex: 23350

A GEC-Marconi Electronics company.

# LOW COST TESTERS



## LEVELL

### PORTABLE INSTRUMENTS

#### INSULATION TESTER

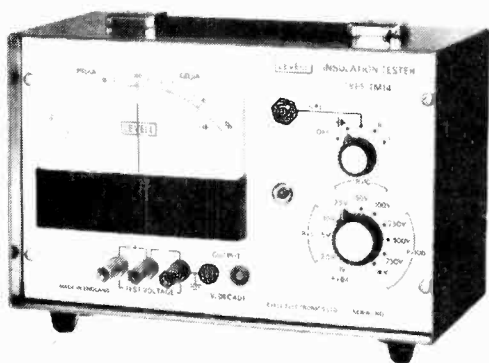

A logarithmic scale covering 6 decades is used to display either insulation resistance or leakage current at a fixed stabilised test voltage. The current available is limited to a maximum value of 3mA for safety and capacitors are automatically discharged when the instrument is switched off or to the CAL condition. The instrument operates from a 9V internal battery.

##### RESISTANCE RANGES

10M  $\Omega$  to 10T  $\Omega$  ( $10^{13}$   $\Omega$ ) at 250V, 500V, 750V and 1kV.

1M  $\Omega$  to 1T  $\Omega$  at 25V, 50V and 100V.

100k  $\Omega$  to 100G  $\Omega$  at 2.5V, 5V and 10V.

10k  $\Omega$  to 10G  $\Omega$  at 1V.

Accuracy  $\pm 15\%$  +800  $\Omega$  on 6 decade logarithmic scale.

Accuracy of test voltages  $\pm 3\%$   $\pm 50$ mV at scale centre.

Fall of test voltages  $< 2\%$  at 10 $\mu$ A and  $< 20\%$  at 100 $\mu$ A.

Short circuit current between 500 $\mu$ A and 3mA.

##### CURRENT RANGE

100pA to 100 $\mu$ A on 6 decade logarithmic scale.

Accuracy of current measurement  $\pm 15\%$  of indicated value.

Input voltage drop is approximately 20mV at 100pA, 200mV at 100nA and 400mV at 100 $\mu$ A.

Maximum safe continuous overload is 50mA.

##### MEASUREMENT TIME

$< 3$ s for resistance on all ranges relative to CAL position.

$< 10$ s for resistance of 10G  $\Omega$  across 1 $\mu$ F on 50V to 500V.

Discharge time to 1% is 0.1s per  $\mu$ F on CAL position.

##### RECORDER OUTPUT

1V per decade  $\pm 2\%$  with zero output at scale centre.

Maximum output  $\pm 3$ V. Output resistance 1k  $\Omega$ .

type  
TM14

**£88**

#### TRANSISTOR TESTER

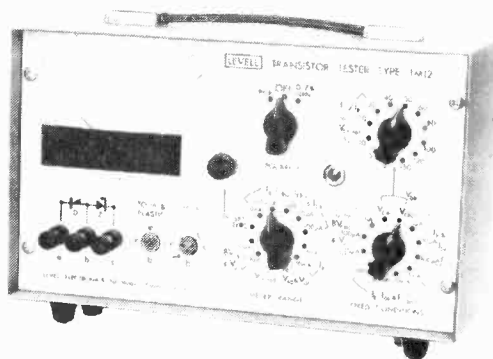

Tests bipolar transistors, diodes and zener diodes. Measures leakage down to 0.5 nA at 2V to 150V. Current gains are checked from 1 $\mu$ A to 100mA. Breakdown voltages up to 100V are measured at 10 $\mu$ A, 100 $\mu$ A and 1mA. Collector to emitter saturation voltage is measured at 1mA, 10mA, 30mA and 100mA for  $I_C/I_B$  ratios of 10, 20, 30. The instrument is powered by a 9V battery.

##### TRANSISTOR RANGES (PNP OR NPN)

$I_{CBO}$  &  $I_{EBO}$ : 10nA, 100nA, 1 $\mu$ A, 10 $\mu$ A and 100 $\mu$ A f.s.d. acc.  $\pm 2\%$  f.s.d.  $\pm 1\%$  at voltages of 2V, 5V, 10V, 20V, 30V, 40V, 50V, 60V, 80V, 100V, 120V, and 150V acc.  $\pm 3\%$   $\pm 100$ mV up to 10 $\mu$ A with fall at 100 $\mu$ A  $< 5\%$  +250mV.

$BV_{CBO}$ : 10V or 100V f.s.d. acc.  $\pm 2\%$  f.s.d.  $\pm 1\%$  at currents of 10 $\mu$ A, 100 $\mu$ A and 1mA  $\pm 20\%$ .

$I_B$ : 10nA, 100nA, 1 $\mu$ A ... 10mA f.s.d. acc.  $\pm 2\%$  f.s.d.  $\pm 1\%$  at fixed  $I_E$  of 1 $\mu$ A, 10 $\mu$ A, 100 $\mu$ A, 1mA, 10mA, 30mA, and 100mA acc.  $\pm 1\%$ .

$h_{FE}$ : 3 inverse scales of 2000 to 100, 400 to 30 and 100 to 10 convert  $I_B$  into  $h_{FE}$  readings.

$V_{BE}$ : 1V f.s.d. acc.  $\pm 20$ mV measured at conditions on  $h_{FE}$  test.

$V_{CE(sat)}$ : 1V f.s.d. acc.  $\pm 20$ mV at collector currents of 1mA, 10mA, 30mA and 100mA with  $I_C/I_B$  selected at 10, 20 or 30 acc.  $\pm 20\%$ .

##### DIODE & ZENER DIODE RANGES

$I_{DR}$ : As  $I_{EBO}$  transistor ranges.

$V_Z$ : Breakdown ranges as  $BV_{CBO}$  for transistors.

$V_{DF}$ : 1V f.s.d. acc.  $\pm 20$ mV at  $I_{DF}$  of 1 $\mu$ A, 10 $\mu$ A, 100 $\mu$ A, 1mA, 10mA, 30mA and 100mA.

type  
TM12

**£88**

### LEVELL ELECTRONICS LTD.

Moxon Street, High Barnet, Herts. EN5 5SD  
Tel: 01-449 5028/440 8686

Prices include batteries and U.K. delivery, V.A.T. extra. Optional extras are leather cases and mains power units. Send for data covering our range of portable instruments.

# SYSTEM 2000

# VORTEXION

A new range of sound equipment from **Vortexion, System 2000** has been designed by our engineers to combine the aesthetics of design in the domestic equipment field with the near flexibility of a modular system. Like all our equipment **Vortexion System 2000** is built to last.

No matter what your sound problem, whether hotel or local pop group, ask our Design Consultants how it can be solved with **System 2000**.

**CSI VORTEXION** Vortexion Ltd., 257-263 The Broadway, Wimbledon, SW19 1SF  
Telephone: 01-542 2814 and 01-542 6242/3/4  
Telegrams: "Vortexion London SW19"

WW-064 FOR FURTHER DETAILS



# The Dymar 1785 portable AM-FM modulation meter.

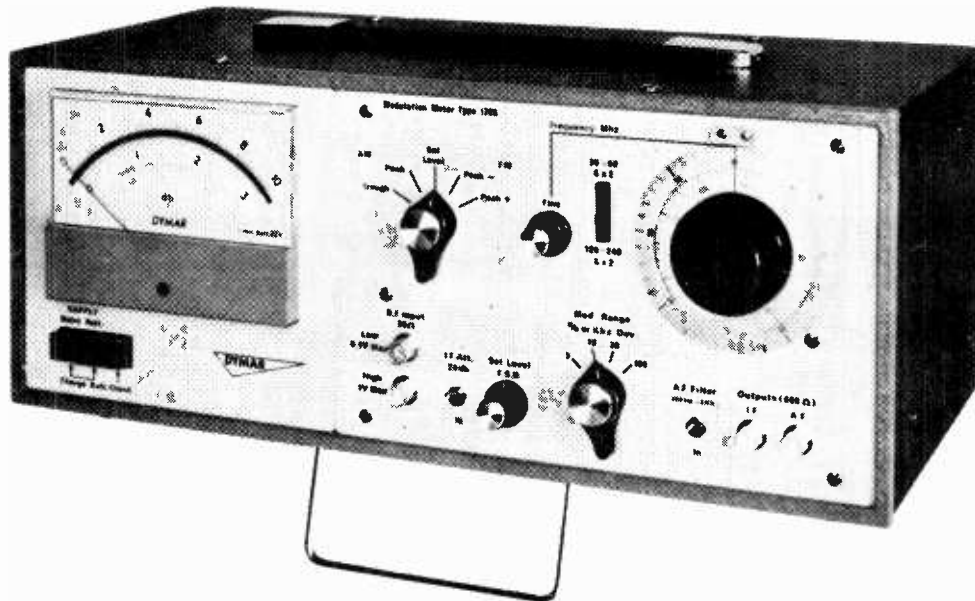

## No need to ask who's in control. It's you!

The Dymar Type 1785 is quickly and easily tuneable anywhere across the entire VHF band and into UHF to encompass the mobile 470MHz band.

Designed to measure the depth of modulation or frequency deviation of today's demanding mobile and portable transmitters, the 1785 offers four ranges of both peak or trough percentage modulation (3% fsd to 100%) and both positive and negative deviation (3kHz to 100kHz).

The sensitivity over the entire frequency range is better than 2.5mV into 50 ohms (-40dbm),

which permits loose coupling to the transmitter under test. And internal noise is typically 44db below 3kHz.

Then, like most Dymar instruments, the 1785 is equally at home working from mains supply or in action in the field operating on its own rechargeable NiCd batteries.

With such value-for-money performance, you'll want to drive the 1785 to the limit – and that's why we emphasise that the 1785 is fully tuneable.

Want to know more? Use the Reader Reply Service or contact Dymar direct.

## **DYMAR**

**the name in radiotelephones**

*The Dymar range of instruments – designed for the mobile land, marine and air communications industry.*

DYMAR ELECTRONICS LIMITED,  
Colonial Way, Radlett Road, Watford,  
Herts. WD2 4LA, Telephone Watford 37321.  
Telex: 923035. Cables: Dymar Watford.

# Again and again and again

Given the time, the patience, and the money, one can connect\* fifty 303 amplifiers nose to tail so that the programme goes through one after the other gradually deteriorating along the way.

Deteriorating? The fact is, that apart from a very slight background hiss - akin to a good tape recording - the programme will sound exactly

the same at the end as when it started.

\*Of course one must fit an attenuator to reduce the signal back to its original level between each amplifier.

Send postcard for illustrated leaflet to Dept. WW  
Acoustical Manufacturing Co. Ltd.,  
Huntingdon PE18 7DB. Telephone (0480) 52561.

## QUAD

Products of The Acoustical Manufacturing Co. Ltd.

for the closest approach to the original sound

*QUAD is a Registered Trade Mark*



W/W-049 FOR FURTHER DETAILS



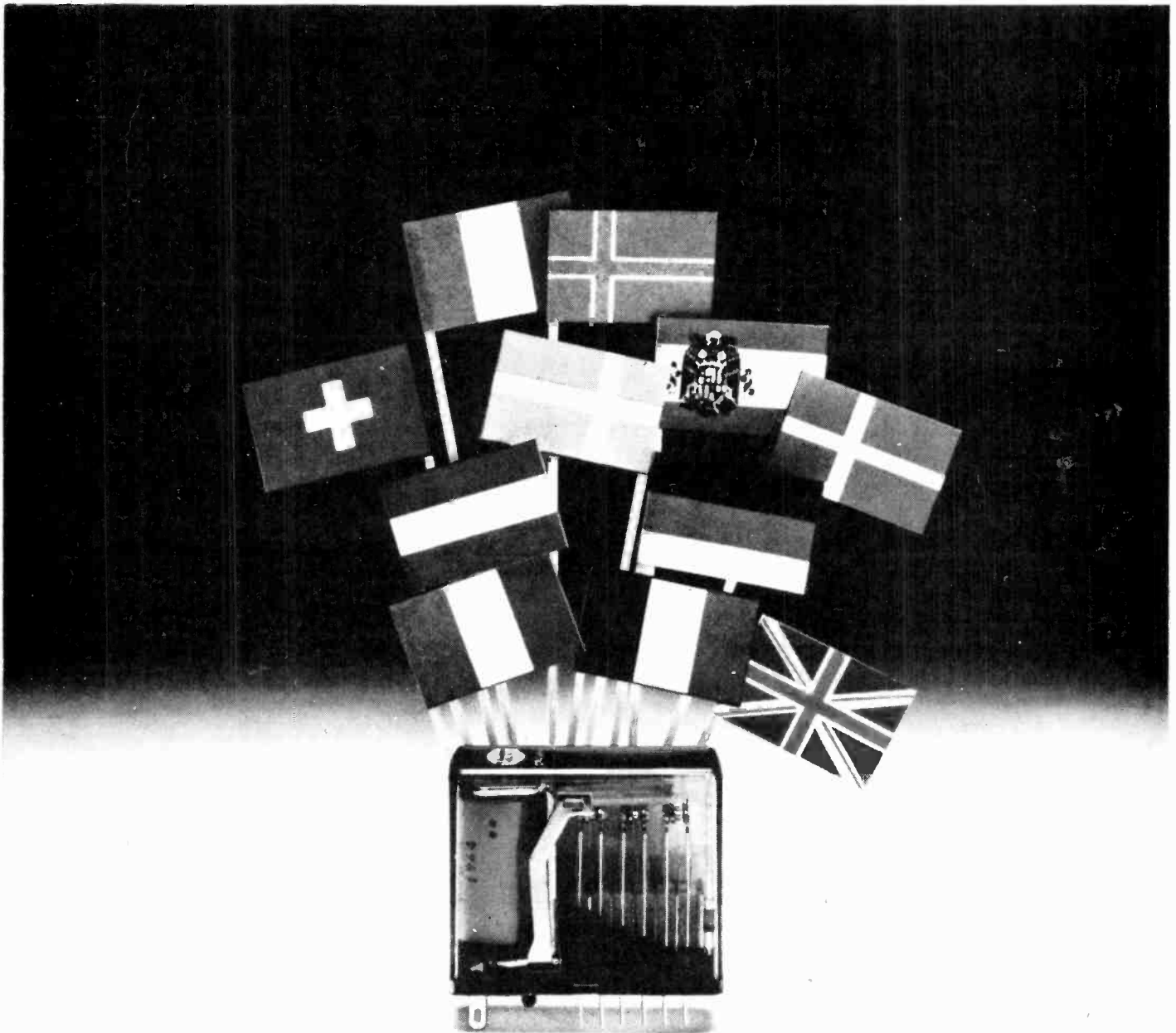

# Euro relay

**Varley is one of Europe's big names in miniature plug-in relays.**

The Miniaturised Bi-stable polarised relay type VPR and the P.O. approved relay type 23 are but two from a range used and approved throughout

the electronics world.

Each is built to uncompromising quality standards . . . with ultrasonic cleaning throughout coupled with exacting performance and timing checks.

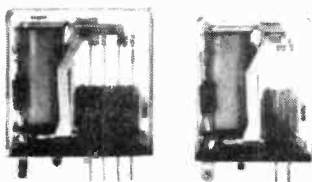

**The same goes for our new AC range.**

These miniature plug-in relays have the same physical dimensions as the DC range. Shown: 2 and 4-contact versions. For all the help you need, contact Varley Technicians now - or send for the catalogue.

Oliver Pell Control Ltd.,  
Cambridge Row, Burrage Rd., Woolwich London SE18.  
Tel: 01-854 1422 Telex: 897071

Name \_\_\_\_\_

Company \_\_\_\_\_

Address \_\_\_\_\_

WW775

## Stable companions

# Wide-range universal bridge **B602** 0.1-100MHz source/detector **SR268** from Wayne Kerr

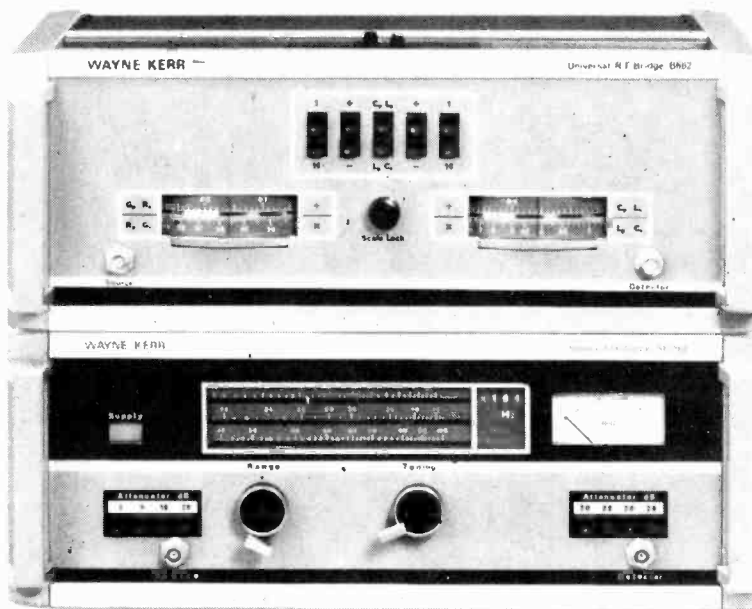

### SPECIFICATION

#### **B602**

Frequency range:	100kHz to 10MHz
Accuracy:	1% up to 3MHz, 1pF to 10nF 10Ω to 100kΩ 1μH to 10mH
Overall impedance range:	1fF to 1mF 100μΩ to 100MΩ (10nΩ to 10kΩ) 10pH to 10H

#### **SR268**

Frequency Range:	100kHz to 100MHz in 9 bands (SR268L 46.5kHz to 46.5MHz)
Frequency accuracy:	2-3% according to band used.
Short Term Frequency Stability:	0.01%
Output level:	0.5-2.0V according to band used.
Output attenuator:	3, 6, 10, 20 dB additive steps. 75Ω
Input sensitivity for 10% meter deflection:	1 to 30μV according to frequency setting
Input attenuator:	4 steps of 20 dB. 75Ω
Detector bandwidth:	2-3% according to band used

For more information, either phone Bognor Regis (02433) 25811 or write to the address below:

## **WAYNE KERR**

Durban Road, Bognor Regis, Sussex  
Telex: 86120. Cables: Waynkerr, Bognor

*A member of the Wilmot Breeden group*

The B602 transformer ratio arm bridge measures impedance in all four quadrants of the complex plane over the frequency range 100kHz to 10MHz. Because of novel features incorporated in the design, values from virtually a short circuit to an open circuit can be measured. This bridge has established a standard of performance and flexibility which is unobtainable from any other radio frequency bridge.

A standard inductor is included in the bridge network in addition to standards of capacitance and resistance enabling a periodic calibration of the scales which are correct at any frequency between 100kHz and 10MHz.

There are only two balance controls. One is direct reading in resistance and conductance, the other in capacitance and inductance and there is no interaction between them.

The stability realised allows a discrimination of 0.1% to be obtained for all types of measurement with a general accuracy of 1% over most of the impedance and frequency range.

The bridge is shown together with the SR268 Source and Detector which can also be used with other bridges in the Wayne Kerr range over the frequency band 100kHz to 100MHz. Nine frequency ranges are provided by this instrument and a single tuning control adjusts both source and detector to the exact frequency required.

Meticulous screening between the two sections provides freedom from bridge measurement errors due to leakage of the source signal into the detector. Common mode rejection transformers are incorporated in the input and output networks to reduce interference from unwanted signals, and push button attenuators are included to assist the logarithmic detector circuit to indicate approach of the bridge balance point.



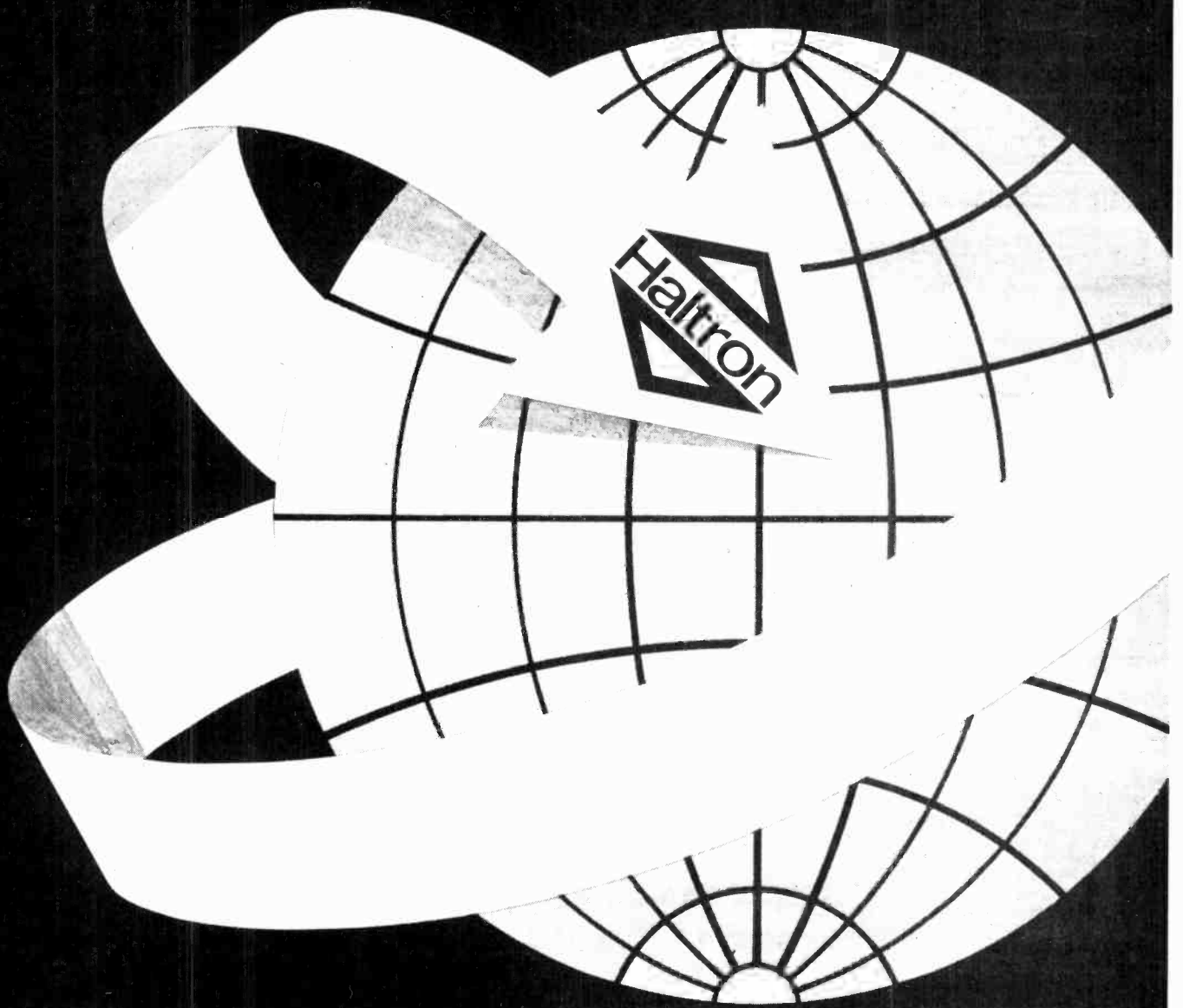

**The world over-  
You get the  
best service  
from Haltron**

For high quality electronic valves, semiconductors and integrated circuits – and the speediest service – specify Haltron. It's the first choice of Governments and many other users throughout the world. Haltron product quality and reliability are clearly confirmed. The product range is very, very wide. And Haltron export expertise will surely meet your requirements. Wherever you are, get the best service. From Haltron.



Hall Electric Limited,  
Electron House,  
Cray Avenue, St. Mary Cray,  
Orpington, Kent BR5 3QJ.  
Telephone : Orpington 27099  
Telex : 896141

WW-005 FOR FURTHER DETAILS

# IP I.L.P. (Electronics) Ltd

## SHEER SIMPLICITY!

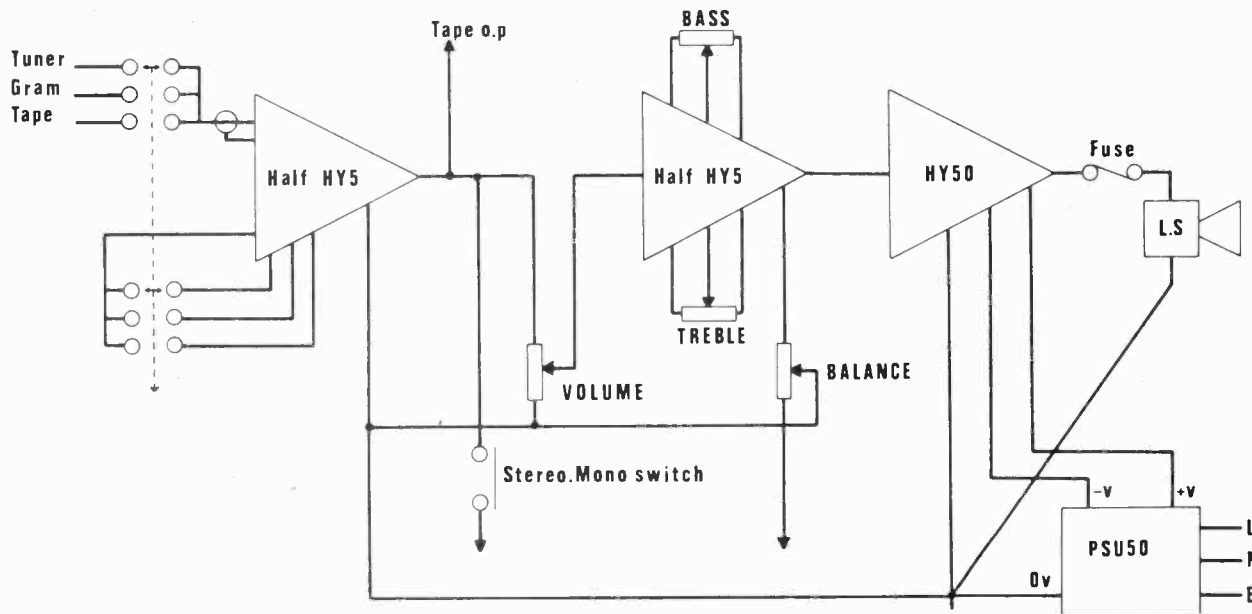

*Mono electrical circuit diagram with interconnections for stereo shown*

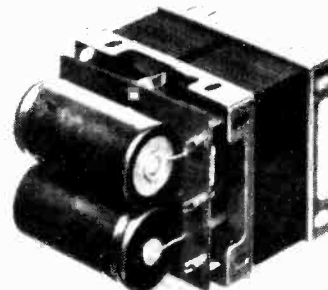
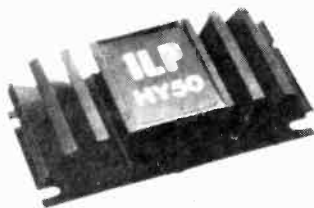
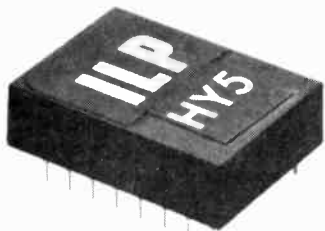

The HY5 is a complete mono hybrid preamplifier, ideally suited for both mono and stereo applications. Internally the device consists of two high quality amplifiers - the first contains frequency equalisation and gain correction, while the second caters for tone control and balance.

**TECHNICAL SPECIFICATION**

**Inputs**  
 Magnetic Pick-up 3mV, RIAA  
 Ceramic Pick-up 30mV  
 Microphone 10mV  
 Tuner 100mV  
 Auxiliary 3-100mV  
 Input impedance 47kΩ at 1kHz

**Outputs**  
 Tape 100mV  
 Main output 0db (0.775 volts RMS)

**Active Tone Control:**  
 Treble ±12db at 10kHz  
 Bass ±12db at 100Hz

**Distortion** 0.05% at 1kHz  
**Signal/Noise Ratio** 68db  
**Overload Capability** 40 db on most sensitive input

**Supply Voltage** 16-25 volts.  
 PRICE £4.75 + £1.19 V.A.T. P & P free.

The HY50 is a complete solid state hybrid Hi-Fi amplifier incorporating its own high conductivity heatsink hermetically sealed in black epoxy resin. Only five connections are provided: Input, output, power lines and earth.

**TECHNICAL SPECIFICATION**

**Output Power** 25 watts RMS into 8Ω  
**Load Impedance** 4-16Ω  
**Input Sensitivity** 0db (0.775 volts RMS)  
**Input Impedance** 47kΩ  
**Distortion** Less than 0.1% at 25 watts typically 0.05%  
**Signal/Noise Ratio** Better than 75db  
**Frequency Response** 10Hz - 50kHz ± 3db  
**Supply Voltage** 25 volts  
**Size** 105 x 50 x 25 mm.  
 PRICE £6.20 + £1.55 V.A.T. P & P free

The PSU50 incorporated a specially designed transformer and can be used for either mono or stereo systems.

**TECHNICAL SPECIFICATIONS**

**Output voltage** 50 volts (25-0-25)  
**Input voltage** 210-240 volts  
**Size** L.70. D.90. H.60 mm.  
 PRICE £6.25 + £1.56 V.A.T. P & P free

**TWO YEARS GUARANTEE ON ALL OUR PRODUCTS**

**I.L.P. Electronics Ltd,**  
**Crossland House,**  
**Nackington, Canterbury,**  
**Kent CT4 7AD**  
**Tel (0227) 63218**

Please Supply \_\_\_\_\_  
 Total Purchase Price \_\_\_\_\_  
 Enclose Cheque  Postal Orders  Money Order   
 Please debit my Access account  Barclay card account   
 Account number \_\_\_\_\_  
 Name & Address \_\_\_\_\_  
 Signature \_\_\_\_\_



# r.f. test equipment

**TM6 R.F. MILLIVOLTMETER**  
1mV to 300V f.s.d.  
50kHz to 1.5GHz  
Useful to 3GHz  
Near true r.m.s. readings on low ranges



**WW—039 FOR FURTHER DETAILS**

A range of general purpose r.f. signal generators, synthesizers and sweepers is offered covering 100kHz to 512MHz. Specialist instruments include a Marine Test Set covering 0.1 to 12MHz for use with receivers with narrow i.f. filters for S.S.B. reception and u.h.f./v.h.f. Test Sets suitable for work on alerters, pocket pagers and two-way personal radios. All the equipment is programmable and may therefore be used in A.T.E. systems or operated manually.

Complementary r.f. test equipment includes an r.f. millivoltmeter, a programmable attenuator and an x-y recorder.

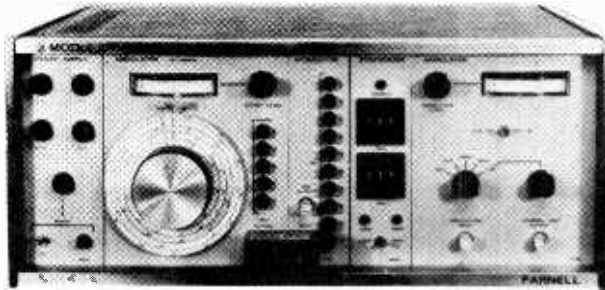

### MODULAR SIGNAL GENERATORS

100kHz to 12MHz M1A/ABM AM,FM Signal Generator	10MHz to 100MHz M2/ACM AM,FM Signal Generator
M1A/ADM Synthesised AM/FM Signal Generator	M2/ADM Synthesizer AM/FM Signal Generator
M1A/ACS Sweep Generator	M2/ACS Sweep Generator

10MHz to 512MHz M3A/ABM AM FM Signal Generator
M3A/ACM Synthesized Signal Generator
M3A/ACS Sweep Generator

**WW—040 FOR FURTHER DETAILS**



**T6003 TEST SET**  
Synthesized signal generator 0.1 to 12MHz  
Accuracy 5PPM. Resolution 100Hz  
3 to 50Hz narrowband sweep Five settable markers  
A.M./F.M. capability Built-in detector

**WW—041 FOR FURTHER DETAILS**

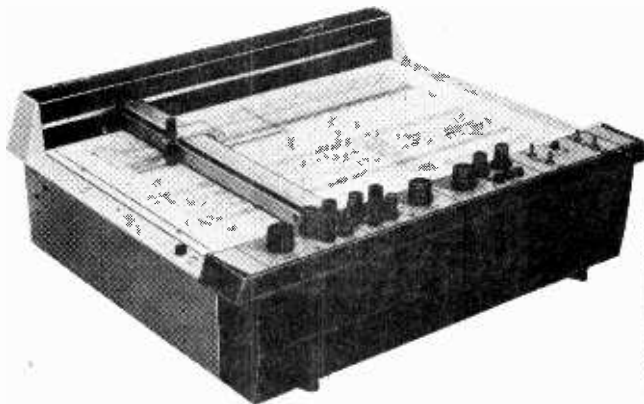

**X-Y RECORDER**  
A3 Size flatbed Ideal for use with sweepers  
Also available with timebase for general use  
Electrostatic paper hold Disposable pens

**WW—042 FOR FURTHER DETAILS**



**PA112 ATTENUATOR**  
Manual or programmable operation  
0-122dB in 1dB steps  
Uses thick film technology and reed relay switching  
Small size  
Built-in power supply

**WW—043 FOR FURTHER DETAILS**

... from  Farnell

# A clear view of the band

Eddystone EP961 MkII Panoramic Display Units provide visual monitoring of all signals in a selected band.

MkII-A is tunable from 50kHz to 800kHz, matching the IFs used in MF and HF communication receivers.

MkII-B covers 500kHz to 36.5MHz. It is ideal for use with VHF and UHF receivers for monitoring FM broadcasts and communication transmissions, and its usefulness extends into the laboratory field.

Both versions can be used with direct aerial input in many applications.

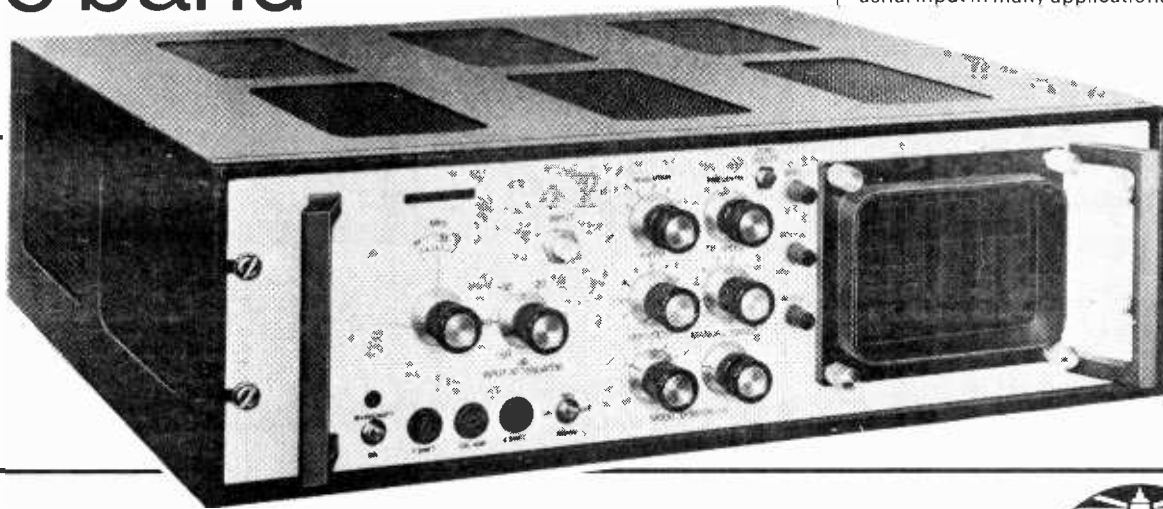

## Eddystone Radio Limited

Member of Marconi Communication Systems Limited

Alvechurch Road, Birmingham B31 3PP, England  
Telephone: 021-475 2231 Telex: 337081

A GEC-Marconi Electronics Company



WW-024 FOR FURTHER DETAILS

# RCA's new 3-inch scope... an entire servicing system



1. It's an 8MHz general purpose scope. Typical composite TV video signal.

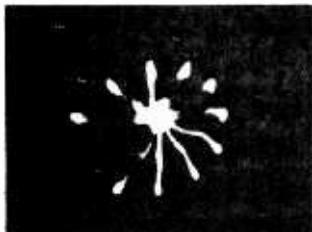

3. It's a Vectorscope for colour TV AFP C alignment. Colour bar generator used for test signal.

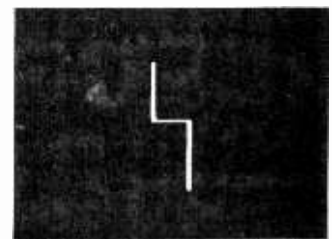

2. It's a "Quicktracer" Transistor/Diode and Component Tester. Typical junction wave form.

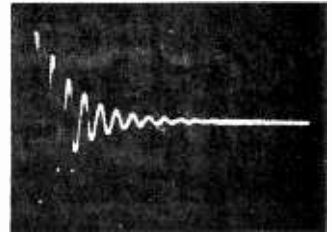

4. It's a "ringing" tester for coils, yokes, transformers. Typical ringing test pattern.

5. It includes the WG-400A Direct Low-Capacitance Switch Probe and Cable with BNC type connector, and a special "Quicktracer" probe.

For full information on the new WO-33B, contact **RCA Electronic Components** Sunbury-on-Thames, Middlesex Tel: Sunbury 85511 or an appointed RCA (EC) Distributor:

**ELECTRONIC COMPONENT SUPPLIES (WINDSOR) Ltd**  
Thames Avenue, Windsor, Berkshire Tel: Windsor 68101

**EDMUNSON ELECTRONIC COMPONENTS Ltd** 30-50 Ossory Road, London SE1 5AN Tel: 01-237 0404

**BLACK ARROW ELECTRONICS Ltd** Millbrook Road, Yate, Bristol BS17 5NX. Tel: Chipping Sodbury 315824

WW-033 FOR FURTHER DETAILS

**RCA** Electronic Components





# Now suitable for U.K., European and American voltages...

Minimod, the versatile British range of encapsulated power supplies first introduced in 1973, has now been extended to cover European and North American mains voltages (and is interchangeable with most American types). Normally available ex-stock, all units are fully stabilised with fold back current limiting – the 5V models have over voltage crowbar too!

### STANDARD MODELS

Type Number	Output Voltage	Output Current Amps	Short Circuit Current mA (Typical)	% Regulation Line and Load (Typical)
PU01	5 ± 0.1	0.5	370	0.3
PU02	5 ± 0.1	1.0	770	0.5
PU03	15 - 0 - 15 ± 0.2	0.10	37	0.1
PU04	15 - 0 - 15 ± 0.2	0.20	84	0.1
PU05	12 - 0 - 12 ± 0.2	0.12	45	0.1
PU06	12 - 0 - 12 ± 0.2	0.24	120	0.2
PU11	18 - 0 - 18 ± 0.2	.15	50	0.1
PU10	15 ± 0.2	.10	37	0.1
PU12	12 ± 0.2	.10	45	0.1
PU13	18 ± 0.2	.065	23	0.1

Input voltage ranges 103 - 126V, 200 - 240V, 210 - 250V. Frequency 50 - 400 Hz all types.

Comprehensive specification given in brochure GT 29b which is available on request.

### ★ SPECIAL DESIGN SERVICE

Custom built units for applications requiring different specifications are produced as part of our standard service. Try us first.



Specialists in Electronic Transformers & Power Supplies.

# GARDNERS

TRANSFORMERS LIMITED

Gardners Transformers Limited, Christchurch, Dorset, BH23 3PN.  
Tel. Christchurch 2284 (STD 0201 5 2284) Telex. 41276 GARDNERS XCH  
WW—038 FOR FURTHER DETAILS

# NEW!...the decon-dalo 33 PC Quick -Dri etch -resist marker



A unique drafting aid for the electronics engineer enabling him to prepare in minutes a perfect PCB.

A fine-tipped marking pen charged with free-flowing etch-resist ink – new formulation QUICK-DRI ink is ready for etching in just two minutes!

Simply draw the desired circuit onto copper laminated board – etch – clean.

The circuit is ready to use

## NO MESS – NO MASKING A perfect circuit every time!

Still only £1.00 for one-off, £4.00 for six, £8.00 for twelve VAT and post extra. Available now in every country in Europe.

Decon Laboratories Ltd., Ellen Street, Portslade, Brighton BN4 1EQ Phone: 0273 414371

Please send me further details on the 33 PC Quick-Dri

Name .....

Address .....

Post to: DECON LABORATORIES LTD.  
FREEPOST

PORTSLADE, BRIGHTON, ENGLAND  
(No Stamp Needed) Phone 0273 414371

WW—052 FOR FURTHER DETAILS

*"He's asking  
for a  
reed relay  
assembly  
with a 30kV  
isolated coil"*

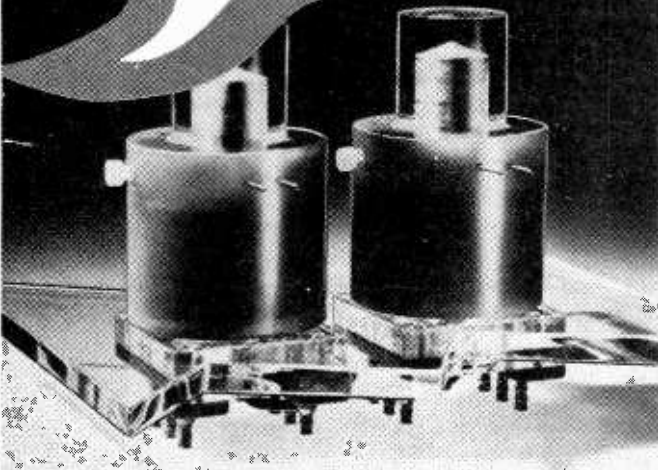

People often bring their need to us. They know the Whiteley speciality. Being helpful! And the item that started life as a customer request, joins the Whiteley product list, ready to help other designers over a problem. You, perhaps? Consider a neat relay assembly — one or two dry reed switches with a rating of 25W, housed in a mounting tube, with either 'normally open' or 'change-over' contacts. Around them, a coil operating from 8, 12, 24 or 50V supply, 30kV isolated from the contacts. The whole unit mounting on a 0.25" insulating plate with a couple of 3 way tag strips. If you're interested, ask for a data sheet. But more, keep Whiteley in mind as the people who make useful things.

*Surprising how often you'll find*

**Whiteley  
make it.**

Whiteley Electrical Radio Co. Ltd.

Mansfield, Notts NG18 5RW, England. Tel: 0623 24762.

WW—060 FOR FURTHER DETAILS

## METER PROBLEMS?

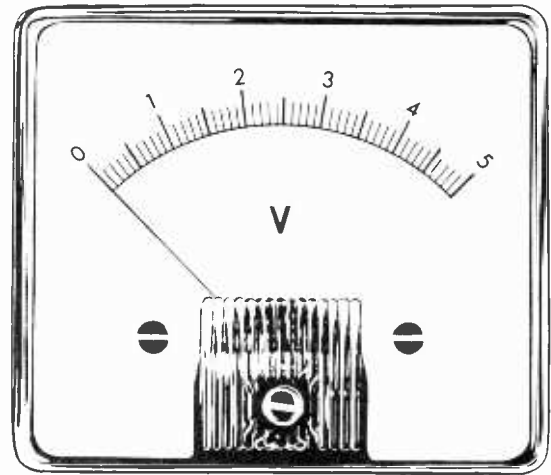

137 Standard Ranges in a variety of sizes and stylings available for 10-14 days delivery. Other Ranges and special scales can be made to order.

Full Information from:

**HARRIS ELECTRONICS (London)**

138 GRAYS INN ROAD, W.C.1 Phone: 01/837/7937

WW—021 FOR FURTHER DETAILS

**Valradio**

**TRANSVERTORS**

Valradio sinewave and square wave transvertors now incorporate SILICON transistors resulting in greater reliability and more stable performance at high ambient temperatures, including tropical climates.



### TYPE D12/400S

A wide selection of types are available to drive practically any equipment within the power rating

A random selection of types:

	Input	Output		Price
C12/30S	12v DC	115/230v	30watts Sine wave	£40.00
C24/60S	24v DC	115/230v	60watts Sine wave	£58.20
D12/400S	12v DC	115/230v	400watts Sine wave	£206.85
D12/500T	12v DC	115/230v	500watts Square wave	£110.55
D24/150T	24v DC	115/230v	150watts Square wave	£39.60
D12/250/24	12v DC	24v DC	8A	£83.10

Please send for literature WW675

**VALRADIO LIMITED**  
BROWELLS LANE, FELTHAM, MIDDLESEX, TW13 7EN  
Tel: 01-890 4242/4837

WW—053 FOR FURTHER DETAILS



# A WORLD FIRST\* FROM CAMBRIDGE AUDIO

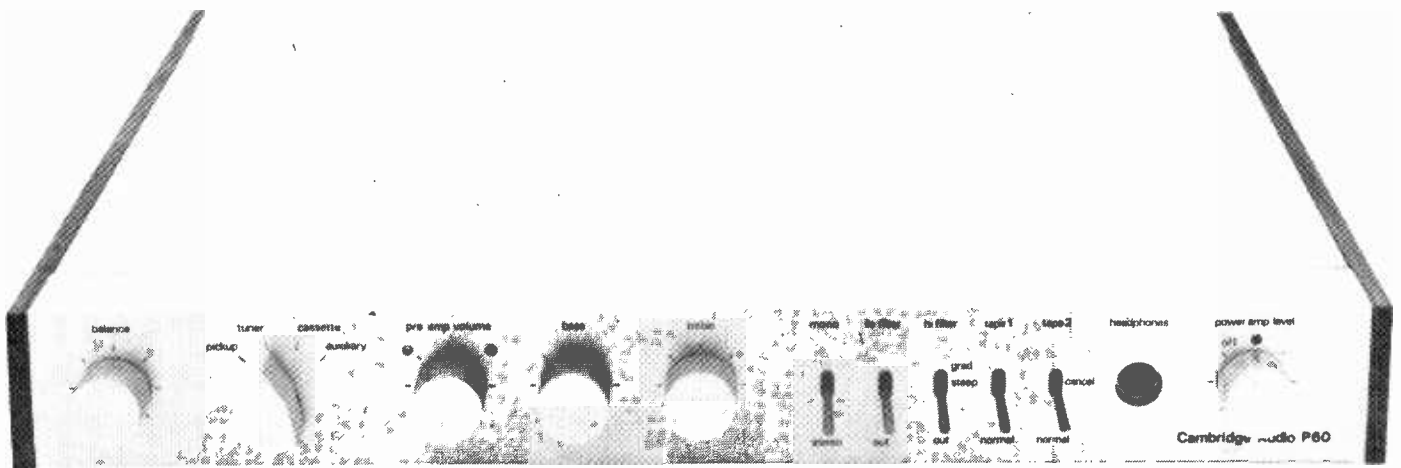

## THE NEW P60 INTEGRATED STEREO AMPLIFIER

Low profile design only 2" high.  
Recording with or without tone  
correction.

\*Peak level indicator for tape recording.  
Suitable for continual high power  
operation.

Dual independent tape operation.

\*Light Emitting Diodes for level monitoring  
in main and pre-amplifiers.  
Toroidal mains transformer.

Facilities for three tape recorders.  
\*Separate main and pre-amp gain  
controls.

Fully protected output stages.  
RIAA phono correction unaffected by  
cartridge inductance.

Ultra low distortion circuits.

\*New tape monitoring, A-B and A-B-C  
facilities.

International state-of-the-art circuitry  
from Cambridge Audio in Britain.

\*To the best of our knowledge these features have never been included in a comparable amplifier hitherto.



for people who listen to music

Cambridge Audio Limited  
The River Mill, St. Ives, Huntingdon PE17 4EP  
Telephone: St. Ives 62901

Please send me details of the revolutionary New  
Cambridge P60 Integrated Stereo Amplifier.

Name .....  
Address .....

WW 25

# DEMA ELECTRONICS INTERNATIONAL

ELECTRONIC COMPONENTS DISTRIBUTOR FOR INDUSTRY AND HOBBYIST

POSTAGE PAID SHIPMENT VIA AIR MAIL

MONTHLY SPECIALS - Free Data included on Calculator and Clock Chip

CT 5001	40 Pin 12 Digit Four Function	£ 1.49	3/3.95
LS1	Chain Operation - Fixed Decimal		
CT 5002	Same as 5001 only Battery Operated	£ 1.49	3/3.95
CT 5005	28 Pin 12 Digit 4 Function w/Memory	£ 2.25	3/5.95
CT 7001	28 Pin Clock Chip 4 or 6 Digit Alarm	£ 2.95	3/7.95
ICL 8038	Function Generator Voltage Controlled Oscillator. Sine, Square, Tri Output 14 Pin	£ 1.95	555 Timer £ 0.40 556 Dual Timer £ 0.70

**TTL 7400 SERIES**

7400	£ 0.11	7440	£ 0.11	7485	£ 0.85	74155	£ 0.59
7401	0.11	7441	0.60	7486	0.24	74156	0.59
7402	0.11	7442	0.55	7488	2.50	74157	0.70
7403	0.11	7443	0.75	7489	1.50	74158	0.70
7404	0.13	7444	0.75	7490	0.73	74160	0.85
7405	0.13	7445	0.70	7491	0.71	74162	0.85
7406	0.24	7446	0.85	7492	0.39	74163	0.85
7407	0.24	7447	0.75	7493	0.39	74164	0.25
7408	0.12	7448	0.69	7494	0.42	74165	1.25
7409	0.12	7450	0.11	7495	0.51	74166	1.15
7410	0.11	7451	0.12	7496	0.55	74170	1.65
7411	0.16	7453	0.12	74100	1.25	74175	0.85
7413	0.26	7454	0.12	74107	0.25	74180	0.85
7416	0.25	7460	0.11	74121	0.25	74181	2.95
7417	0.25	7470	0.25	74122	0.35	74182	0.85
7420	0.11	7472	0.21	74123	0.49	74192	0.90
7426	0.22	7473	0.26	74145	0.85	74193	0.90
7430	0.11	7474	0.26	74150	0.75	74194	0.95
7432	0.22	7475	0.37	74151	0.57	74195	0.80
7437	0.24	7476	0.26	74153	0.59	74198	1.70
7438	0.24	7483	0.65	74154	1.15	74199	1.70

**HIGH SPEED 74H00**

74H00	£ 0.16	74H20	£ 0.16	74H52	£ 0.16	74H72	£ 0.26
74H01	0.16	74H21	0.16	74H53	0.16	74H74	0.28
74H04	0.16	74H22	0.16	74H55	0.16	74H76	0.28
74H08	0.16	74H30	0.16	74H60	0.16		
74H10	0.16	74H40	0.16	74H61	0.16		
74H11	0.16	74H50	0.16	74H62	0.16		

**CMOS 4000 SERIES**

4000A	£ 0.21	4014	£ 1.10	4028	£ 0.95	4073	£ 0.29
4001	0.21	4015	1.10	4030	0.50	4075	0.29
4002	0.21	4016	0.55	4042	0.95	4078	0.29
4006	0.90	4019	1.10	4049	0.48	4081	0.29
4009	0.29	4020	1.15	4050	0.48	4082	0.29
4008	1.30	4021	1.10	4066	0.75	4528	0.85
4009	0.49	4023	0.21	4068	0.29	4585	1.25
4010	0.49	4024	0.85	4069	0.29		
4011	0.21	4025	0.21	4071	0.29		
4013	0.29	4027	0.75	4072	0.29		

**DTL**

930	£ 0.10	936	£ 0.10	944	£ 0.10	962	£ 0.10
932	0.10	937	0.10	946	0.10	963	0.10

**LINEARS**

LM300	TO99	£ 0.45	340U	TO92	£ 1.25	739	A DIP	£ 0.65
301	V DIP	0.25	380	A QIP	80	741	V DIP	0.22
302	TO99	0.45	546	V DIP	0.51	747	A DIP	0.44
304	TO100	0.50	550	A DIP	0.55	748	V DIP	0.25
305	TU99	0.60	555	V DIP	0.45	5556 (11456)	V DIP	0.65
307	V DIP	0.38	556	B DIP	0.75	5558 (11458)	V DIP	0.65
	TO99	0.45	560	B DIP	2.55	ULN 2111	A DIP	0.95
308	A DIP	0.65	561	B DIP	2.55	LM3900	A DIP	0.35
	TO99	0.90	562	B DIP	2.55	75450	V DIP	0.45
309K	703	1.45	565	A DIP	1.45	75451	V DIP	0.45
311	V DIP	0.90	566	V DIP	1.50	75452	V DIP	0.45
320K	TO 3 NEG		567	V DIP	1.60	75453	V DIP	0.45
	5.2, 12, 15	1.25	709	A DIP	0.22	75454	V DIP	0.45
324	A DIP	1.07	710	A DIP	0.25			
340K	TO3	2.10	711	A DIP	0.30			
	12V 1 AMP		723	A DIP	0.38			

V Mini Dip A 146 Dip B 166 Dip  
Data sheets supplied on request. Add 20 ea. excepted as noted.

**MEMORIES w/DATA**

1101	256 Bit Ram Mos	£ 1.95
1103	1024 Bit Ram Mos	2.70
7489	(8225) 64 Bit Ram TTL	1.50
8223	Programmable ROM	2.50
5260	1024 Bit Ram Low Power	1.95

**CALCULATORS & CLOCKS w/DATA**

5001	Cal Chip	£ 1.95
5002	Cal Chip	1.95
5005	Cal Chip	2.95
5311	Clock Chip	2.95
5312	Clock Chip	2.95
5313	Clock Chip	2.95
5316	Clock Chip	3.95
Data Only for any of above 0.50		

**LEDS**

MV 5020	Jumbo Red or Clear	£ 0.15
MAN 1	Red 7 Seg 270	1.30
MAN 5	Green 7 Seg 270	1.75
MAN 6	6 Solid Seg	2.50
9	Digit Array Fairchild 37 with clear magnifying lens	2.95

**TRANSISTORS**

2N 2219A	TO5	£ 0.37	2N 4124	TO92 0 10
2N 2222	TO18	0.15	2N 4126	TO92 0 10
2N 2369	TO18	0.10	2N 4401	TO92 0 10
2N 2905A	TO5	0.38	2N 5225	TO92 0 10
2N 3227	TO18	0.32	2N 5226	TO92 0 10

ALL ITEMS NEW BRANDED SUBJECT TO MANUFACTURER'S GUARANTEE.

**TERMS:** PRICES AS LISTED ARE IN BRITISH POUNDS & PENCE. SEND BANK CHEQUE OR PERSONAL CHEQUE WITH ORDER. SEND RECEIPT WITH ORDER IF INTER. POSTAGE MONEY ORDER IS USED. MASTERCARD, BANKAMERICARD ACCEPTED.

**DEMA Electronics International**  
P.O. Box 407A San Ramon, CA 94583 U.S.A.

**50W STEREO AMP. TEMPERATURE ALARM. LM380 INTERCOM AND RECORD PLAYER. RUMBLE FILTER. BATTERY CHARGER. TAPE/SLIDE SYNCHRONISER. METED 75p**

# ETI TOP PROJECTS

## No 2 electronics today international 75p



**...MULTI BEATER. ...MULTI FERRY. LINEAR IC TESTER. IGNITION TIMING LIGHT. SPRING LINE REVERBERATION UNIT. ADD-ON QUAD UNIT. NI-CAD BATTERY CHARGER. DIGITAL STOPWATCH. HI-POWER STROBE. TRAFFICATOR CANCELLOR. AUDIO WATTMETER. FET 4-INPUT MIXER. PRINTIMER. AUTOMATIC CAR THEFT ALARM. IC POWER SUPPLY. OVER-LED. AERIAL MATCHER. LOGIC PROBE. PLUS MANY MORE...**

**ON SALE NOW**

From your newsgagent or send 90p to Electronics Today International, 36 Ebury Street, London SW1W 0LW.

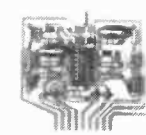

**SQ IS A TRADEMARK OF CBS INC.**

### SQ QUADRAPHONIC DECODERS

SQ the leading quadraphonic system, designed by CBS engineers, offers not only 4 channel ambiphony from the fast expanding range of SQ encoded discs but also immensely increased depth and fullness of sound from standard stereo recordings too.

Feed 2 channels (200-1000mV as obtainable from most pre-amplifiers) into your choice of any of our 3 decoders and take 4 channels out with no overall signal level reduction. On the logic enhanced decoders Volume, Front Back, LF-RF, LB-RB and Dimension controls can all be implemented by simple single gang potentiometers—no need for exotic 4-gang units!

These state-of-the-art circuits used under licence from CBS are offered in kit form comprising first grade components only—fibre glass circuit boards of professional quality designed for edge connector insertion; all resistors 2% metal oxide, all polystyrene and polycarbonate capacitors 5% or better; and in decoder L2 ultra low noise (MPS A18 0.5dB typ.) transistors used in each amplifying stage.

**M1** Basic matrix decoder with fixed 10-40° blend 10 Resistors, 14 Capacitors, 1 Integrated Circuit Printed Circuit Board **£19.90**

**L1** Full logic controlled decoder with wave matching and front-back logic for enhanced channel separation using three specially designed Integrated Circuits, 24 Resistors, 42 Capacitors, 3 Integrated Circuits, Printed Circuit Board **£19.90**

**L2** More advanced full logic decoder with variable blend extended frequency response, increased front-back separation 43 Resistors, 44 Capacitors, 3 Integrated Circuits, 9 Transistors, 6 Diodes, Printed Circuit Board, **£28.20**

All kits include IC sockets and construction notes. Prices include CBS licence fee.

Please write for further details in FREE LISTS

United Kingdom: Post Free. Please add 25% VAT Overseas: No VAT. Please add (per kit) £2.00 p & p AIR MAIL or £1.00 p & p SURFACE MAIL.

# AMBIENTACOUSTICS

PO BOX 3000  
ANDOVER, HANTS SP10 3EQ

WW—055 FOR FURTHER DETAILS

# At Home Soldering?

You should be -- with the LITESOLD CONQUEROR

A superbly handling lightweight iron, fully insulated and earthed for safety. Bits are interchangeable, non seize, and are available in 16 different shapes and sizes, from 1/16" up to 1/4", in copper and long-life types. (Standard fitting, 1/8" copper single chisel shape.) Covers a range of work often needing several different irons.

A special spring stand gives safe, easy location of the iron and spare bits. The heavy heat-resistant base is complete with non-slip pads and bit cleaning sponge.

Send cheque/PO direct, or ask for leaflet.



Conqueror Iron Only	£3.08
Iron & Spring Stand	£5.39
Iron, Stand & set of 4 spare copper bits	£6.90
(Prices include 8% VAT and p. & p.)	

## LIGHT SOLDERING DEVELOPMENTS LTD

97-99, Gloucester Road, Croydon, CRO 2DN. 01-689 0574

LS/M

WW035 FOR FURTHER DETAILS

# MINI BLOWTORCH with the maxi uses

A high quality tool designed for precision work; that puts the heat exactly where its wanted with its pencil point flame.

Invaluable for electricians, technicians, engineers, electronic engineers etc., in the manufacturing, servicing and repair industries.

- \*PIN POINT FLAME UP TO 3500°F.
- \*LIGHTWEIGHT \*EASY AND SAFE TO USE
- \*4-5 HOURS LIFE \*BUTANE GAS \*REFILLS READILY AVAILABLE
- \*ADJUSTABLE HEAT INTENSITY



1. SPECIAL COOLING FINS
2. BRASS NOZZLE
3. PIN POINT FLAME
4. DETACHABLE SOLDER PENCIL

TRADE TERMS AND QUANTITY DISCOUNTS ON REQUEST



**ONLY! £6.25**  
(incl. VAT P & P)

## Longs

Reg England 68496.  
Longs Ltd.,  
Hanworth Lane  
Trading Estate,  
Chertsey,  
Surrey KT16 9LZ  
Tel: Chertsey 61241  
Telex: 929811

Fill in this coupon now and send for your Mini Blow Torch. Money back guarantee if not satisfied. Please send me ..... Mini Blow Torch/es at £6.25 each I enclose cheque/postal order for £.....

NAME ..... POSITION .....  
COMPANY .....  
ADDRESS .....

SIGNED ..... WW



# THE TUNER YOU CAN TRUST

(W.W. APRIL/MAY 1974)

*This tuner has been designed for use with high quality audio equipment. It has therefore been designed so that only high quality audio signals may be heard. There are no interstation noises, distorted or mis-tuned stations, spurious tuning responses, or other unwanted effects. There are only clear stereo programmes set against a background of silence.*

*When the tuning lamp is out – silence; tuning lamp on – one of a multitude of receivable stations, in perfect tune, and held by powerful a.f.c.*

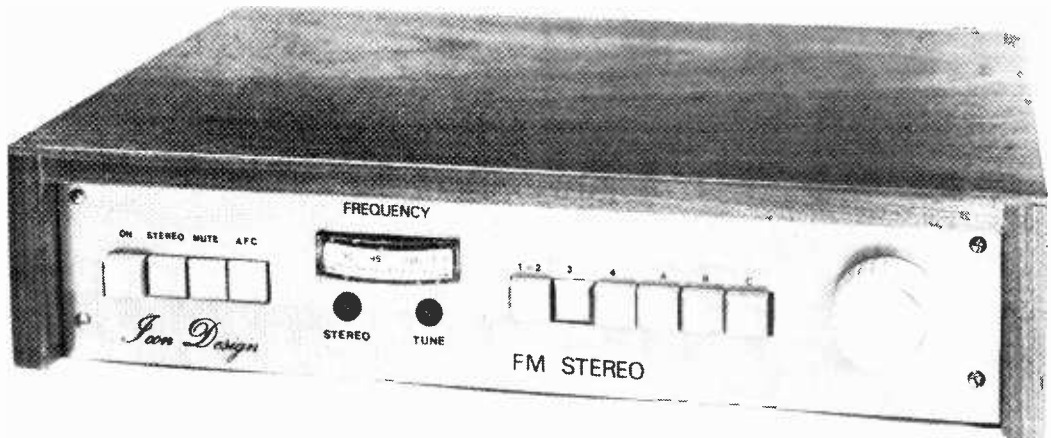

This tuner was designed by us and published in this magazine last year. Since then we have made some small circuit improvements, which have been included in these kits. We also include a guarantee of success, and personal after-sales attention and service. Our accent is on quality.

### NEW REVISED PRICES (EXC. VAT)

K1-4 Main receiver board	£24.55
K5-7 Stereo decode board	£7.05
K8 Function Switches	£4.95
K9a Pre-set station unit	£13.75
K10 Power supply unit	£5.59
K11 Cabinet and all else	£27.70
K12 Meter with drive components	£11.00
K1-12 package price	£85.00
	saving £9.59
Postage 30p per kit, free over £15	

### OTHER ITEMS

LP1186 front end	£4.53
MC1310P decoder	£3.15
SBA750B i.f. amp	£2.95
SL3046B trans. array	£1.70
SL301B dual trans.	£1.40
Filter SFG10.7MA	£2.95
Coil with wire	£0.50
Ten turn pot. 50K	£3.55
Postage per item	£0.10

S.A.E. please for details to:

*Icon Design*

33 RESTROP VIEW, PURTON, WILTS SN5 9DG

J. A. SKINGLEY & N. C. THOMPSON

# HEPWORTH ELECTRONICS

Hepworth House, Worcester Road, KIDDERMINSTER. Tel. 0562 2212 or 3

— for —

No Fuss — No Soldering — No Waste — Digital and Analog Design Aids

The all in one Component Holder with Bus Bars built in.  
For D.I.P. and T05 packages

### The SK10 Socket

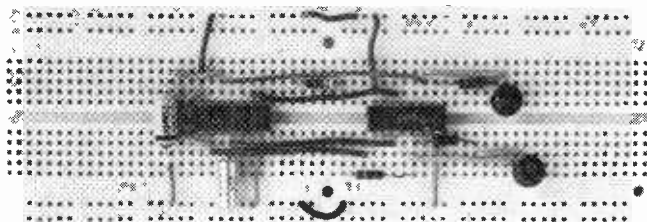

8—Bus Bars of 25 connectors  
128 set of contacts 5 in a row

### The SK20 Socket

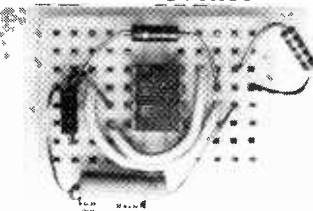

### The SK50 Socket

NEW NEW NEW  
Half the SK10 Socket  
at Half the price

Also Available from Stockists

**Quarndon Electronics (Semiconductors) Ltd.**  
Slack Lane Derby DE3 3ED  
Tel. 32651

Extensions of the SK10 socket give the simple and inexpensive Digi & Op Amp Designers

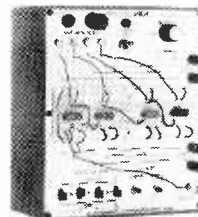

Digi Designer

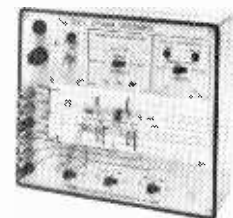

Op Amp Designer

also the more complex

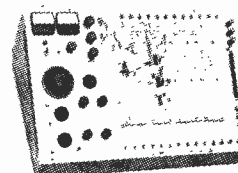

The 'Elite'— Series I, II & III

These Complete instruments in a Box are available only from **Hepworth Electronics**, for details and demonstration look out for our stand at LEEDS.

WW—031 FOR FURTHER DETAILS

# The 'HOT HAND' Tubing Shrinker

'Hot Hand' opens and closes like a thumb and forefinger to encircle tubing with instant, radiant heat.

The 'Hot Hand' shrinker is available with elements of 1", 2" and 3" diameter to take a wide range of tubing sizes. There is a hand model, suitable for intermittent use, and a table model for continuous operation (manual or automated).

'Hot Hand' gives unprecedented safety, long life, low operating expense and will not generate electronic interference. It is an efficient tool for many similar uses, including: sweating solder tubing, bending polyvinyl chloride pipe and tubing, etc. For operation on 120 and 220/240 Volts AC.



Another fine  
American Beauty tool  
available from:

**SPECIAL PRODUCTS  
DISTRIBUTORS LIMITED**

81 Piccadilly, London W1V 0HL  
Tel: 01-629 9556

WW-013 FOR FURTHER DETAILS



## Check in one direct move with Brandenburg's new HV meter

We thought it was about time somebody supplied *direct reading* meters for high voltage, so we've produced three—one for up to 5kV, one for 15kV and one for 30kV to complement our range of HV power supplies.

The meters are operated by two 9V internal batteries (800 hours life) linked with a built-in checking facility. Positive or negative ground is available, selected by a front panel switch. And, as with all Brandenburg products, there is a 12 months unconditional guarantee.

- Accuracy of 1% fsd over voltage range of 0-30kV d.c.
- Less than 1µA drawn at 30kV d.c.
- 4.5in (114 mm) scale mirror-backed meter.
- Temperature range 5-35°C.
- Dimensions only 7 x 8 x 5½in high (200 x 145 x 178mm).
- Recorder output.

Yet another Brandenburg piece in the  
high voltage game

# brandenburg

STABILISED HIGH VOLTAGE

Brandenburg Limited, 939 London Road, Thornton Heath, Surrey, CR4 6JE, England. Tel: 01-689 0441 Telex: 946149

Agents or distributors in most principal countries.

P6437

WW-061 FOR FURTHER DETAILS

Contractors to H.M. Govt. P.O.

## REPAIRS OF ELECTRICAL MEASURING INSTRUMENTS 7-14 DAYS SERVICE

◀ MODEL 8 MK.V

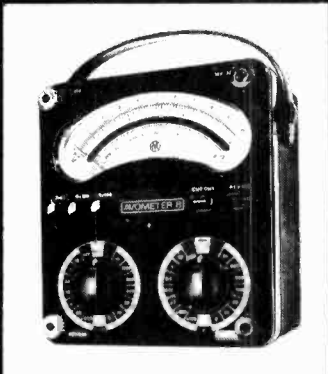

**STOCKISTS**  
ALSO SUPPLIERS OF GEC  
RISSO AND OTHER  
MULTI-RANGE TEST SETS

WE SPECIALISE IN ASSEMBLIES, AND IN THE  
REPAIR, CALIBRATION AND CONVERSION  
OF ALL TYPES OF INSTRUMENTS, INDUSTRIAL  
AND PRECISION GRADE

**LEDON INSTRUMENTS LTD.**

**GLADSTONE WORKS, GLADSTONE RD,  
FOLKESTONE, KENT.  
TEL: (STD) 0303 57555**

WW-020 FOR FURTHER DETAILS



# THE ULTIMATE IN TONE CONTROL

Teknik Dual 11S Graphic Equaliser

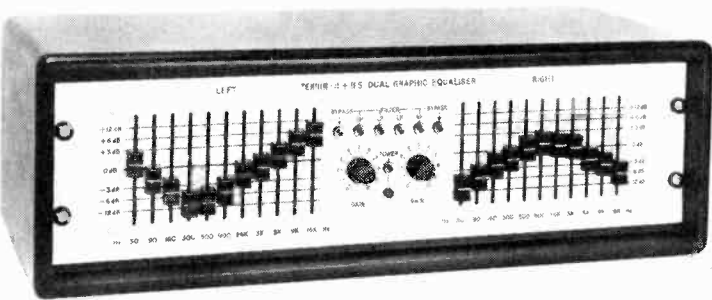

Klark Teknik Limited, Summerfield, Kidderminster DY11 7RE  
Telephone: Kidderminster 64027

WW—018 FOR FURTHER DETAILS

# THE WHO, WHAT AND WHERE OF HI-FI

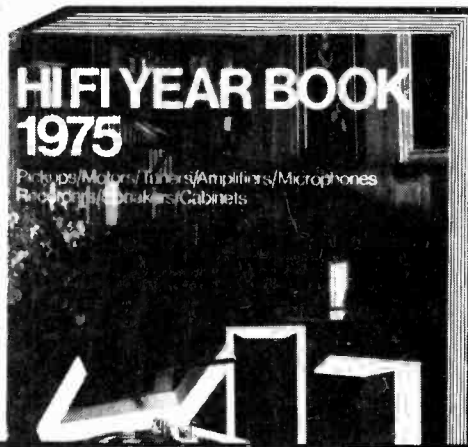

In the search for quality it helps to know where to look. Hi-Fi Year Book tells you everything you need to know, with separate illustrated sections for every major category, giving you prices and specifications of over 2,000 products. And it's got directories of dealers and manufacturers – plus a host of articles on the latest hi-fi developments and their application. So if you want information like you want hi-fi, order your copy today because it sells out pretty quickly! £2.00 inclusive from the publishers.

## HI-FI YEAR BOOK 1975

### ORDER FORM:

To: Room 11, IPC Electrical-Electronic Press Ltd., Dorset House, Stamford Street, London SE1 9LU.

Please send me ..... copy/copies of Hi-Fi Year Book 1975 at £2.00 per copy inclusive. I enclose remittance of £..... (cheque/P.O. payable to IPC Business Press Ltd).

NAME (please print)  
ADDRESS

Registered in England No. 677128  
Regd. Office Dorset House, Stamford Street, London SE1 9LU

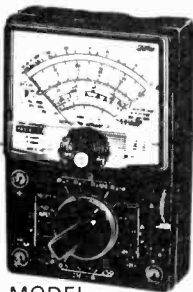

MODEL U-50DX

## sanwa MULTI TESTERS

USED THROUGHOUT THE WORLD, SANWA'S EXPERIENCE OF 30 YEARS ENSURES ACCURACY, RELIABILITY, VERSATILITY, UNSURPASSED TESTER PERFORMANCE COMES WITH EVERY SANWA.

6 Months Guarantee	£11.75	MODEL F80TR0	£26.40
MODEL P2B	£12.80	MODEL AT45	£23.15
MODEL BX 50S	£22.90	MODEL 380CE	£29.12
MODEL YX36DTR	£14.90	MODEL N1D1	£31.85
MODEL U500X	£16.10	MODEL 460ED	£35.13
MODEL A303TR0	£19.15	MODEL EM800	£74.50
MODEL K30 THD	£24.20	MODEL R1000CB	£75.27

THESE PRICES DO NOT INCLUDE VAT  
Cases extra available for most meters, but not sold separately

Please write for illustrated leaflet of these and other specialised Sanwa meters

### SOLE IMPORTERS IN U.K. QUALITY ELECTRONICS LTD.

47-49 HIGH STREET, KINGSTON-UPON-THAMES, SURREY. KT1 1LP  
Tel: 01-546 4585

WW—027 FOR FURTHER DETAILS

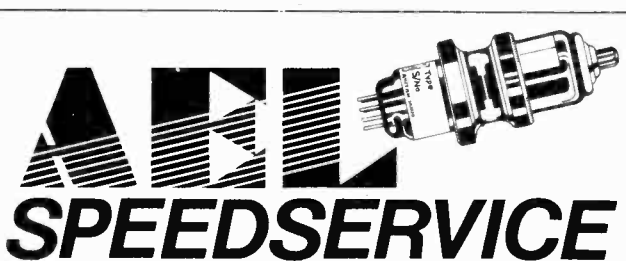

## SPEEDSERVICE

Hard-to-find tubes and semiconductors are normally included in our quotations. We try to give a complete answer.

AEL GATWICK HOUSE HORLEY SURREY RH6 9SU  
Telex 87116 Cables Aerocon Telex Horley Telephone Horley 5353

WW—047 FOR FURTHER DETAILS



# POWER AMPLIFIER

120 watts RMS into 4 ohms



For full details on our range of mixers, amplifiers and light control units, contact:

## ICELECTRICS LTD

15 ALBERT ROAD, ALDERSHOT  
HANTS. TEL: 0252 28514

WW-083 FOR FURTHER DETAILS

### LOW-COST INSTRUMENTS

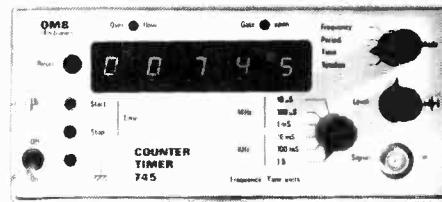

**NEW!**

**£82**  
+ £1.50 p.p.  
+ VAT

#### 745 COUNTER TIMER

Measures frequency, period, time and totalises  
32 MHz frequency range (DC coupled)  
5-digit .3" LED display  
6 Gate times/Time units, 10µs to 1 S in decades  
Sensitive, protected FET input



#### 744 COUNTER TIMER

£74 + £1.50 p.&p. + VAT

Measures frequency, period and time  
30MHz frequency range (DC coupled)  
5-digit, long-life incandescent display  
Sensitive, protected FET input



#### 643 FUNCTION GENERATOR

£86 + £1.50 p.&p. + VAT

Accurate, digital frequency setting  
0.1Hz-1MHz  
Wide range external control of frequency  
Triangle, Squarewave and Low Distortion  
Sinewave outputs  
50Ω + simultaneous outputs  
DC offset

*Delivery is normally ex-stock—telephone for confirmation  
Prices correct at time of going to press, subject to change without notice*

### OMB ELECTRONICS

Riverside, Eynsford, Kent DA4 0AE  
Tel. Farningham (0322) 863567

WW-006 FOR FURTHER DETAILS

# Stepper motors and drive systems



McLennan stock a wide range of stepper motors and ancillary equipment, such as:—  
Translator modules, Voltage control oscillators,  
Linear accelerators, Compensator networks,  
Pulse multipliers, Power supplies, Digital  
indexers, Co-ordinate generators,  
Gearboxes, linear actuators, etc.

These basic units, which are economically priced, even in smaller quantities, can be used to build systems to cater for a wide range of applications.

Moreover, we can advise on additional function units needed for more specialised applications.

We also offer a complete system design and production facility.



**McLennan**

McLennan Engineering Ltd Kings Road, Crowthorne, Berkshire. Tel: Crowthorne 5757/8

WW-011 FOR FURTHER DETAILS

# THINK SCOPEX

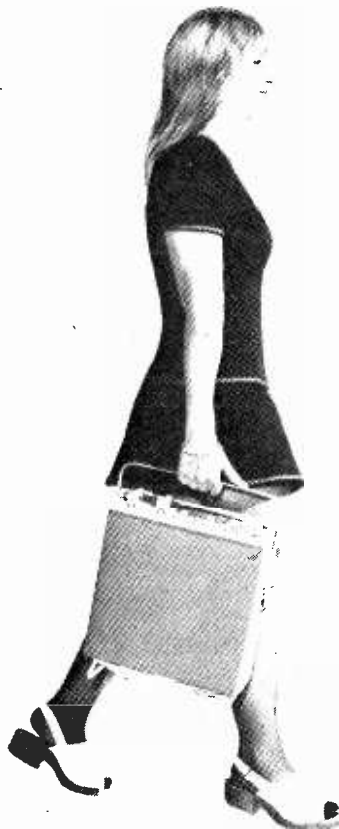

# THINK SCOPEX

... and life can become complicated. But think Scopex and you find practical, professional, dual-channel portables as easy-to-use as to carry. Sensible bandwidth, no-nonsense controls, trig level and polarity from one knob, and the ever-popular time-saving trace-locate feature. As an example, the Scopex 4D10 gives 10MHz over the full screen area, 5% accuracy, and all for £118\*. It makes sense to ...

\* Ex. VAT.



**SCOPEX**

Write or 'phone for details

**Scopex Instruments Ltd,**  
Pixmore Industrial Estate,  
Pixmore Avenue, Letchworth, Herts. SG6 1JJ  
Tel: Letchworth (04626) 72771

WW-044 FOR FURTHER DETAILS

## New LOGIC PROBE 340

Generates a single minus pulse of  $0.2 \pm 0.05$  millisecond. Built-in pulse generator

- RED & GREEN-LED APPLIED LOGIC LEVEL INDICATOR
- \* Wrong polarity & overload protectors provided
  - \* Detection of the peak value of input waveform
  - \* Open circuit or faulty IC can be detected
  - \* All logic levels are visible at a glance
  - \* Unique high/low level probe

For use in detecting TTL, DTL flip-flop and other pulse circuits.

Each **£14.00**  
including pp + VAT  
Discounts for quantity

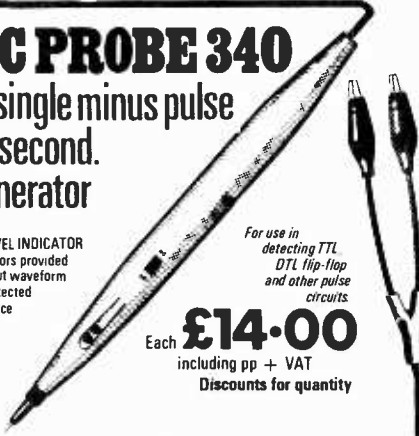

**JH**

**ASSOCIATES LIMITED**  
52 Silver Street, Stansted, Essex. Tel: (0279) 814929. Telex: 81675 Jaylamps.

WW-023 FOR FURTHER DETAILS

## 4 CHANNEL POTENTIOMETER

Four 10k potentiometers mounted at 90° to each other and mechanically interlinked through hoop system to Joystick. 85° travel of control covers complete resistance track. Ideal for use in Quadrophonic remote control, synthesiser etc. applications. Supplied with circuit details.



**Type 1** P.C. mounting. Size 55mm x 55mm x 22mm (less stick) = £6.00 + Postage & Packing 30p + VAT.

**Type 2** Tag wiring size 80mm x 80mm x 35mm. £6.60 + Postage & Packing 30p + VAT.

Allen & Heath Ltd.  
Pembroke House, Campsbourne Road  
Hornsey, London N8  
Telephone 01-340 3291

WW-098 FOR FURTHER DETAILS

## DIGITAL CLOCK KIT. FANTASTIC OFFER

on our Quality Units. Ready made — or the most comprehensive Kit and Instructions you have ever seen. Very quick to build. No knowledge of electronics required.

**£14.40** in Kit Form + £1.60 VAT p&p



**£18** Ready built Fully tested VAT p&p £1.90

KIT COMPRISES:- or separately at:-	£
1 MOS CLOCK CHIP 12-24 hr option	4.00
4 0.63" LED Displays (latest HI BRI Type)	5.00
1 Segment Driver Chip	0.30
1 Pack Resistors, Caps., Transistors, switch	1.20
1 Double Sided Glass Fibre P.C. Board	1.00
1 Double Wound Mains Transformer	1.00
1 Circuit/Assembly Manual	0.50
1 Futuristically styled Perspex case (state colour)	3.00
Yellow, Orange, Red, Black, White, Mauve, Green, Blue.	
Individual items also include P&P + VAT.	

C.W.O. to:  
**Pulse Electronics Ltd., Dept. W.W.1.**  
202 Shefford Road, Clifton, Beds. Tel. 0462 813453.

# New Course in Digital Design

Understand the latest developments in calculators, computers, watches, telephones, television, automotive instrumentation . . . .

Each of the 6 volumes of this self-instruction course measures 11¼" x 8¼" and contains 60 pages packed with information, diagrams and questions designed to lead you step-by-step through number systems and Boolean algebra, to memories, counters and simple arithmetic circuits, and on to a complete understanding of the design and operation of calculators and computers.

After completing this course you will have broadened your career prospects and considerably increased your fundamental understanding of the changing technological world around you.

**Design of Digital Systems**  
A Self-Instruction Course in 6 Volumes

- 1 Computer Arithmetic**
- 2 Boolean Logic**
- 3 Arithmetic Circuits**
- 4 Memories & Counters**
- 5 Calculator Design**
- 6 Computer Architecture**



**Digital Computer Logic and Electronics**  
A Self-Instruction Course  
Book 1  
**8's**

Also available — a more elementary course assuming no prior knowledge except simple arithmetic.

In 4 volumes:

1. Basic Computer Logic
2. Logical Circuit Elements
3. Designing Circuits to Carry Out Logical Functions
4. Flip flops and Registers

**£3.95** plus 50p p&p

Offer Order this together with Oesign of Digital Systems for the bargain price of £9.25, plus 50p p&p

Design of Digital Systems contains over twice as much information in each volume as the simpler course, Digital Computer Logic and Electronics. All the information in the simpler course is covered as part of the first volumes of Design of Digital Systems which, as you can see from its contents, also covers many more advanced topics.



# £5.95

plus 50p packing and surface post anywhere in the world.  
Payments may be made in foreign currencies.  
Quantity discounts available on request.  
Total packaged weight does not exceed 4lb. Please allow enough extra for air mail.  
VAT zero rated.

**Designer  
Manager  
Enthusiast  
Scientist  
Engineer  
Student**

These courses were written so that you could teach yourself the theory and application of digital logic. Learning by self-instruction has the advantages of being quicker and more thorough than classroom learning. You work at your own speed and must respond by answering questions on each new piece of information before proceeding to the next.

### Guarantee — no risk to you

If you are not entirely satisfied with Design of Digital Systems or Digital Computer Logic and Electronics, you may return them to us and your money will be refunded in full, no questions asked.

To: Cambridge Learning Enterprises  
FREEPOST, St. Ives, Huntingdon, Cambs PE17 4BR

\*Please send me . . . . set(s) of Design of Digital Systems at £6.45 each, p & p included  
\*or . . . . set(s) of Digital Computer Logic and Electronics at £4.45 each, p & p included  
\*or . . . . combined set(s) at £9.75 each, p & p included

Name . . . . .

Address . . . . .

. . . . .

\* delete as applicable  
No need to use a stamp — just print FREEPOST on the envelope.

WW7





**"I MADE IT MYSELF"**

*Imagine the thrill you'll feel! Imagine how impressed people will be when they're hearing a programme on a modern radio you made yourself.*

**Now! Learn the secrets of radio and electronics by building your own modern transistor radio!**

Practical lessons teach you sooner than you would dream possible.

What a wonderful way to learn—and pave the way to a new, better-paid career! No dreary ploughing through page after page of dull facts and figures. With this fascinating technatron course, you learn by building!

You build a modern transistor radio . . . a burglar alarm. You learn radio and electronics by doing actual projects you enjoy—making things with your own hands that you'll be proud to own! No wonder it's so fast and easy to learn this way. Because learning becomes a hobby! And what a profitable hobby. Because opportunities in the field of radio and electronics are growing faster than they can find people to fill the jobs!

**No soldering—yet you learn faster than you ever dreamed possible.**

Yes! Faster than you can imagine, you pick up the technical know-how you need. Specially prepared step-by-step lessons show you how to: read circuits—assemble components—build things—experiment. You enjoy every minute of it! You get everything you need, tools, components. Even a versatile multimeter that we teach you how to use. All included in the course AT NO EXTRA CHARGE! And this is a course anyone can afford. You can even pay for it by easy instalments.

**So fast, so easy, this personalised course will teach you even if you don't know a thing today!**

No matter how little you know now, no matter what your background or education, we'll teach you. Step by step, in simple easy-

to-understand language, you pick up the secrets of radio and electronics.

You become a man who makes things, not just another of the millions who don't understand. And you could pave the way to a great new career, to add to the thrill and pride you receive when you look at what you have achieved. Within weeks you could hold in your hand your own transistor radio. And after the course you can go on to acquire high-powered technical qualifications, because our famous courses go right up to City & Guilds levels.

**Send now for FREE 76-page book—see how easy it is—read what others say!**

Find out more now! This is the gateway to a thrilling new career, or a wonderful hobby you'll enjoy for years. Send the coupon now. There's no obligation.

**POST TODAY FOR FREE BOOK**

To: **BRITISH INSTITUTE OF ENGINEERING TECHNOLOGY**  
 Aldermaston College, Dept. CWW03, Reading RG7 4PF  
 Also at our London Advisory Office, 4 Fore Street, Moorgate, London EC2Y 5EJ. Tel. 01-628 2721

Yes, I'd like to know more about your course. Please send me free details—plus your big, 76-page book that tells about all your courses.

NAME \_\_\_\_\_

ADDRESS \_\_\_\_\_

POSTCODE \_\_\_\_\_

**BIET**

**HOME OF BRITISH INSTITUTE OF ENGINEERING TECHNOLOGY**

**Switching problems? Rely on Zettler.**

Producing 30 basic types of relay and 15,000 variants with regard to contact stacks, terminals, energizing current and contact material, Zettler is among the largest manufacturers of electro-mechanical components.

Our product range comprises:  
 Low profile (flatform) · Timing · Miniature · Low contact capacity · Hermetically sealed · Stepping · Mains switching · Latching · Contact stacks · Solenoids

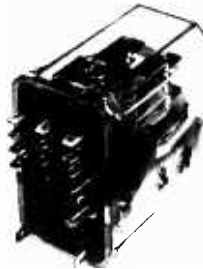

**Miniature Relays AZ 420 . . . 439**

International standard relay. 2, 4, or 6 change-overs. Plug-in type saves maintenance costs. Coil voltages: 1.2 to 180 Volts D.C. 6 to 240 Volts A.C. Life expectancy to 100 million operations. Balanced spring-held armature allows operation in any mounting position. Relay extends only ¼" from PC board when used with right-angle socket.

We resolve your switching problems rapidly and expertly. Please contact us for further details.



**ZETTLER** Zettler UK Division  
 Equitable House, Lyon Road  
 Harrow, Middx. HA1 2DU, Tel. (01) 8636329

A member of the worldwide ZETTLER electrical engineering group, est 1877

WW—010 FOR FURTHER DETAILS

**Great Sound . . .**



THE S3 PRESSURE UNIT has been designed to meet the growing demand for considerably increased power handling capacity without the sacrifice of either efficiency or frequency response. It features a powerful ceramic magnet and a strong but light diaphragm and voice coil assembly with many new features. It is a robust, reliable unit of exceptional quality. The S3 is one of the units of the Vitavox Power Range



**VITAVOX** Limited  
 Westmoreland Road  
 London NW9 9RJ  
 Telephone: 01-204 4234

Please send me further information on your product range

Name \_\_\_\_\_  
 Company \_\_\_\_\_  
 Address \_\_\_\_\_

V 186

★ ALL INCLUSIVE PRICES — NO HIDDEN EXTRAS! ★

A SMALL SELECTION FROM OUR RANGE

CD4000AE	27p	CD4017AE	£1.85	CD4030AE	77p	AC128	22p	MC1310P	£2.86
CD4001AE	27p	CD4018AE	£2.59	CD4035AE	£1.85	AC176	26p	NE555V	63p
CD4002AE	27p	CD4019AE	84p	CD4040AE	£2.11	AD161	51p	ORP12	56p
CD4007AE	27p	CD4020AE	£2.06	CD4042AE	£1.56	AD162	51p	TBA810S	£1.29
CD4009AE	85p	CD4022AE	£1.92	CD4043AE	£2.29	BC107	12p	TIL209	14p
CD4010AE	77p	CD4023AE	27p	CD4044AE	£2.29	BC108	12p	ZTX300	15p
CD4011AE	27p	CD4024AE	£1.32	CD4046AE	£2.29	BC109	12p	2N2926	12p
CD4012AE	27p	CD4025AE	27p	CD4049AE	27p	BC109C	21p	ZX500	15p
CD4013AE	71p	CD4026AE	£2.21	CD4050AE	71p	BC182	14p	2N3055	48p
CD4014AE	£1.83	CD4027AE	£1.03	CD4051AE	£2.92	BC212	17p	2N3702	15p
CD4015AE	£1.83	CD4028AE	£1.59	CD4056AE	£1.83	BFY51	26p	741/8DIL	33p
CD4016AE	71p	CD4029AE	£2.21	CD4069AE	27p	BZY88	11p	40673	68p

NO V.A.T. TO ADD

component specialists for the discerning amateur and professional

# ARROW ELECTRONICS LTD.



DEPT. WW9, 7 COPTFOLD ROAD, BRENTWOOD, ESSEX.

WW-008 FOR FURTHER DETAILS



sound equipment  
by **Grampian**

GRAMPIAN REPRODUCERS LTD. HANWORTH TRADING ESTATE FELTHAM, MIDDLESEX TELEPHONE 01-894 9141

X209

WW-065 FOR FURTHER DETAILS

## PETITE PRECISION!

A 12V DC POWER TOOL FOR THE DESIGN AND RESEARCH ENGINEER

AVAILABLE IN KIT FORM OR SEPARATES

On demonstration daily 1 p.m.-9.30 p.m. at Brighton and Hove Exhibition Ideal Homes Trades & Hobbies, New Hove Town Halls, 9th July-17th July. Come and try our equipment for yourselves.

Diameter 33mm  
Weight 160g  
Length 125mm  
Torque 105cmg  
RPM approx. 3000 at 12V DC  
Power 9/14V DC  
Batteries or AC/DC transformer



Drill. £6.65 P&P 25p

PRECISION EXAMPLE OF FRENCH ENGINEERING



Flexible drive.  
£4.80  
P&P 25p

Now in use by the following:  
GPO, BBC, Atomic Energy Authority, British Nuclear Fuels, Weekend TV, Ministry of Defence, Hospitals, Opticians, etc.



Stand £3.50.  
P&P 40p

UK DISTRIBUTOR  
**PRECISION PETITE LTD**  
(Les Applications Rationnelles Paris)  
119A HIGH STREET  
TEDDINGTON, MIDDX. UK  
TEL. 01-977 0878

SAE for leaflets, price list and order form

WW-017 FOR FURTHER DETAILS

# NOW IT'S THE AMCRON M600

## M600 POWER AMPLIFIER



# 1350 watts

## DC-Coupled

The M600 amplifier is a new high-power amplifier capable of providing 1,350 watts RMS over a bandwidth of DC to 20 kHz. 70 volts RMS at the output terminals, very low noise and distortion. AC/DC selector switch, plug-in front panel circuit board, built-in fan for cooling and the ability to connect two M600s together to double the power and output voltage, are just some of the features which place the Amcron M600 in the forefront when considering power amplifiers. Driving shakers and vibrators, motors, and difficult speaker systems, providing power for material or components testing or used as a large distribution amplifier, the M600 is equally at home.

Brief specifications:

RMS power out	750 watts into 8 ohms 1,350 watts into 4 ohms
DC output	20 amps (supply fuse limited)
Power bandwidth	DC to 20 kHz + 1 db - 0 db 600 W into 8Ω
Phase response	+ 0 db - 15 db DC - 20 kHz
Slew rate	16 V/μsecond
Damping factor (8Ω)	greater than 400 DC - 1 kHz
Hum & noise	120 db below 600 Watts
THD	less than 0.05% DC - 20 kHz, 600 W into 8Ω
Dimensions	19" std rack, 8¾" H, 16½" deep. Wt. 92 lb.

Coupling two M600s together through a socket provided at the back of each amplifier produces a 140 Volt balanced output. This configuration is called an M2000, and produces 2 kilowatts into an 8ohm load. A peak catching meter, and threshold lights provide convenient front panel output monitoring.



**MACINNES LABORATORIES LTD**

MACINNES HOUSE, CARLTON PARK INDUSTRIAL ESTATE,  
SAXMUNDHAM, SUFFOLK IP17 2NL  
TEL: (0728) 2262 2615

WW-050 FOR DETAILS

## FREQUENCY COUNTERS

HIGH PERFORMANCE REASONABLY PRICED ELECTRONIC INSTRUMENTS

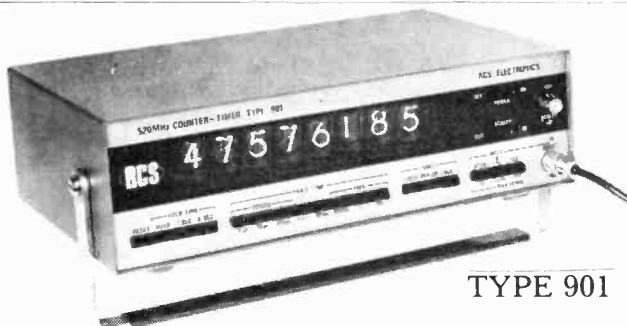

TYPE 901

CRYSTAL OVEN

TWO TONE BLUE CASE

£370 **520** MHz

Sensitivity 10mV. Stability 5 parts 10<sup>10</sup>

301M	32MHz 5 Digit £75	401	32MHz 6 Digit £118
501	32MHz 8 Digit £175	701	50MHz 8 Digit £185
701A	80MHz 8 Digit £195	801M	300MHz 8 Digit £285
901M	520MHz 8 Digit £370	Memory versions available if not suffixed M £25 extra	

Start/Stop versions plus £12

Type 101 1MHz 100KHz 10KHz Crystal Standard £80

Type 103 Off/Air Standard £78

SUPPLIERS TO: Ministry of Defence, G.P.O. Government Dept., Crystal Manufacturers and Electronic Laboratories world-wide.



**R.C.S. ELECTRONICS**  
NATIONAL WORKS, BATH ROAD  
HOUNSLOW, MIDDX. TW4 7EE  
Telephone: 01-572 0933/4

WW - 048 FOR FURTHER DETAILS

## ELECTRONIC INDUSTRIAL THERMOMETER

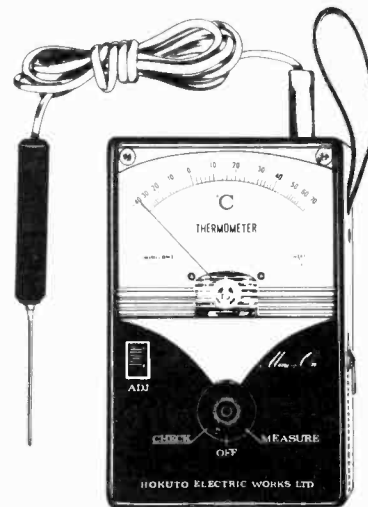

### THE MODERN WAY TO MEASURE TEMPERATURE

A Thermometer designed to operate as an Electronic Test Meter. Will measure temperature of Air, Metals, Liquids, Machinery, etc., etc. Just plug-in the Probe, and read the temperature on the large open scale meter. Supplied in zippered vinyl case with transparent front and carrying loop. Probe, and internal 1½ volt standard size battery. Model "Mini-On 1" measures from - 40°C to + 70°C, price £17.50 Model "Mini-On Hi" measures from + 100°C to + 500°C, price £20.00 (V.A.T. EXTRA)

Write for further details to

**HARRIS ELECTRONICS (LONDON),**  
138 GRAY'S INN ROAD, LONDON. WC1X 8AX  
(Phone 01-837 7937)

WW-038 FOR FURTHER DETAILS

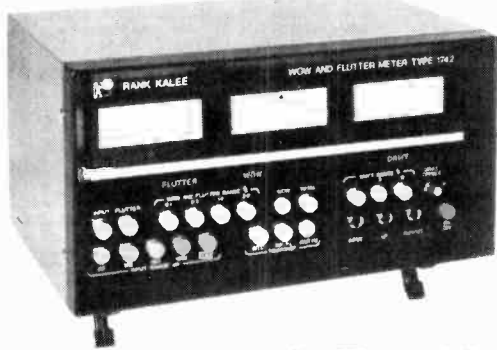

**\*  
The  
new  
Rank**

**WOW & FLUTTER Meter  
Type 1742**

Fully transistorised  
for high reliability

**Versatile**

Meets in every respect all current specifications for measurement of Wow, Flutter and Drift on Optical and Magnetic sound recording/reproduction equipment using film, tape or disc

**High accuracy**

with crystal controlled oscillator

**Simple to use**

accepts wide range of input signals with no manual tuning or adjustment

**Two models available:**

Type 1742 'A' BS-4847: 1972 DIN 45507  
CCIR 409-2 Specifications  
Type 1742 'B' BS 1988: 1953 Rank Kalee Specifications

For further information please address your enquiry to  
Mrs B. Nodwell

Rank Film Equipment, PO Box 70  
Great West Road, Brentford  
Middlesex TW8 9HR

Tel: 01-568 9222 Telex 24408 Cables Rankaudio Brentford



**RANK FILM  
EQUIPMENT**

**HAND  
MADE CABINETS**

**FOR HI-FI, RECORDS AND EQUIPMENT  
MADE TO SPECIAL ORDER OR FROM OUR  
STANDARD RANGE**

Model 48" DN4H

As shown . . . . . £143  
With Dropdoor . . . £118  
Sliding Glass Door . . . £130  
in teak, nat. oak, etc.



Model C420, £197  
Cabinet for 420 cassettes

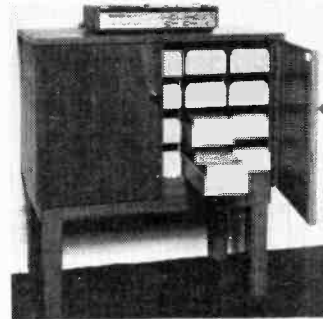

Equipment kindly loaned by:  
Darwen Hi-Fi Centre  
77 Duckworth Street  
Darwen, Lancs.

Photos: Spa Studios, Harrogate

Also available with open shelf above

For further information on our range of cabinets write for brochure to:



**ECC  
4 BRUNSWICK DRIVE  
HARROGATE, YORKSHIRE  
PHONE 60921**

Please quote 7W75 and enclose 11p in stamps

**WW-032 FOR FURTHER DETAILS**

**Bias oscillator blocks; AM/FM tunerheads.**

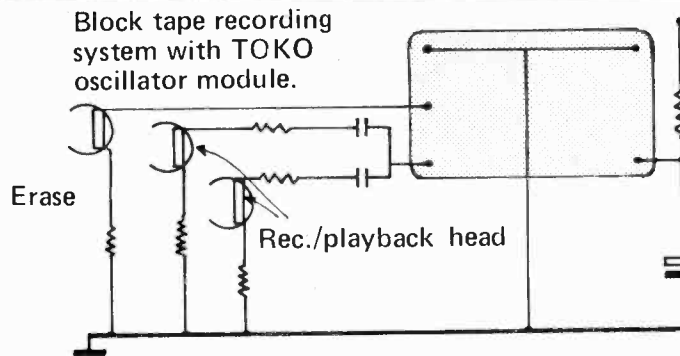
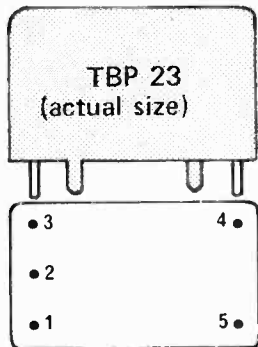

Supply +16v

TOKO now offer a series of prebuilt oscillator blocks, in fully screened PC mounting assemblies.

Various specifications are available to suit supplies of 6-20v, with impedances that will suit most standard heads.

Frequencies 35/100 kHz.  
Erase current up to 80mA.  
(into 300 ohm erase head.)



**EC3302 - Varicap FM.**  
The latest varactor tuned VHF head from TOKO. FET input with AFC, and very small size.  
100+.....£3.20 each.

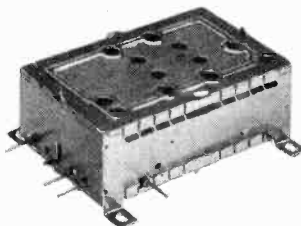

**EF5603 - varicap FM.**  
MOS input, 5 tracked tuned circuits. 100+ ..£5.85

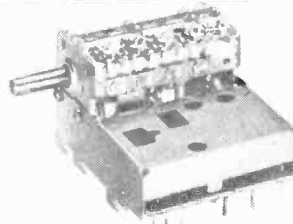

**MT3302 - FM+AM gang.**  
A new low cost tunerhead with two gang capacitor and reduction gearing. 100+ £3

**Varicap tuned MW AM.**  
A new concept in MW radio with 3 stage tracking, and IC RF/IF system with a ceramic IF filter. The 'All Electric Wireless', with the benefits of remote tuning and location of the entire AM/FM radio. The MC720 MW varicap tuner has been specially devised to let engineers and enthusiasts evaluate this new concept - Kit (PC+ all components) £8 Ready built £9.95.



TOKO (UK) Ltd., Shirley Lodge, 470 London Road, Slough, Berks. tel. (0753) 48444; tlx. 847185  
Distributor Ambit International, 37 High Street, Brentwood, Essex. tel. (0277) 216029; tlx. 995194



WW-058 FOR FURTHER DETAILS



# itam

## ITAM 805 (8TRACK) MASTER RECORDER

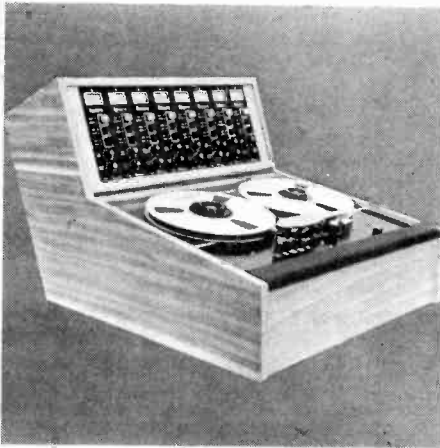

Fully modular electronics using plug-in PCB's through-out. Separate sync and replay amps give identical levels. Switchable VU's with slow decay. Individual oscillator for each channel. Dolby A switching facility. Comprehensive facilities include sync on all channels, servo controlled capstan, modular electronics, variable speed (optional), relay-solenoid operation. Compact presentation for easy portability.

**£1790 + VAT** Full console optional extra.

Compatible 8-output Mixer available  
**£1260 + VAT**

# OTARI

## OTARI DP-4050 CASSETTE COPIER



Ideal for one copy or ten thousand. Eight times copy speed. foolproof operation for non-skilled personnel. modular construction, servo-controlled direct capstan drive.

Immediate delivery

THESE ITEMS ARE INDUSTRIAL PRODUCTS AND SUBJECT TO 8% VAT

### Industrial Tape Applications



5 Pratt Street, London NW1 0AE  
Telephone: 01-485 6162. Telex: 21879

WW-063 FOR FURTHER DETAILS

### TRANSDUCER MEASUREMENT

#### Synchronous Mod/Demodulators

This is an AC energised system used for strain gauges, lvd, linear potentiometer, pressure transducers, etc. AC energisation and transformer coupling give immunity to outside interference, and operation at high gains is permissible without drift problems.

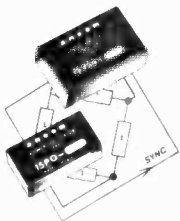

#### Bridge Measuring Unit TB-100 Series

A complete unit utilising the above modules, and offering quarter, half or full wave configuration from resistive capacitor or inductive types of transducer.

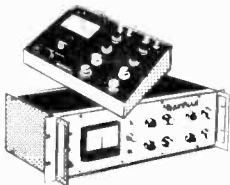

DEVONSHIRE STREET  
CHELTENHAM, ENGLAND  
☎ 0242 53861 or 24690

WW-066 FOR FURTHER DETAILS

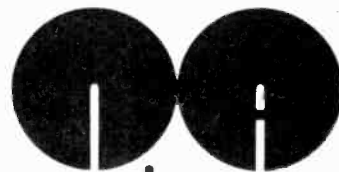

## naim audio the preamplifier

BE FAIR TO YOUR MUSIC

Reproduction of sound and its acceptability is dependent on a combination of physical parameters not yet fully explored. We believe that only a compatible combination of specifications will enable a system to reproduce music.

We have taken care that the NAC 12 and NAP 160 pre and power amplifier will do so faithfully, while accepting the output of any pick up cartridge and driving any loudspeaker.

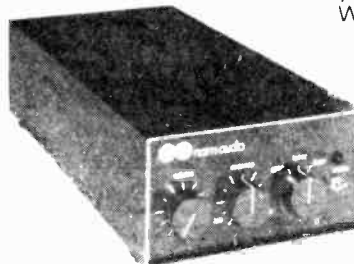

Naim Audio Ltd., 11 Salt Lane, Salisbury, Wilts. Tel: (0722) 3746

WW 025 FOR FURTHER DETAILS

# MULTI-PEN RECORDERS

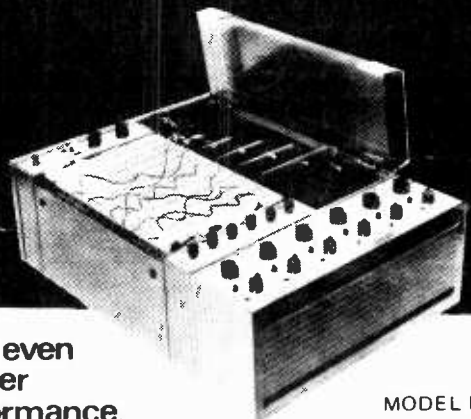

with even greater performance.

MODEL MC 641

100 uVf.s. 0.3 sec.f.s.

## MULTICORDER

- Multi-channel, 2-6 with full range zero set
- Multi-pen - fibre tip. 6 colours. ● 16 switched chart speeds.
- Choice of Z fold or roll chart. ● Five plug-in preamplifiers switched ranges 100 uv - 500 Vf.s. ● 250mm(10") chart width



**ENVIRONMENTAL EQUIPMENTS LTD.**  
Eastheath Avenue, Wokingham,  
Berks. RG11 2PP. Tel: Wokingham 784922

WW-080 FOR FURTHER DETAILS

# GROOVAC

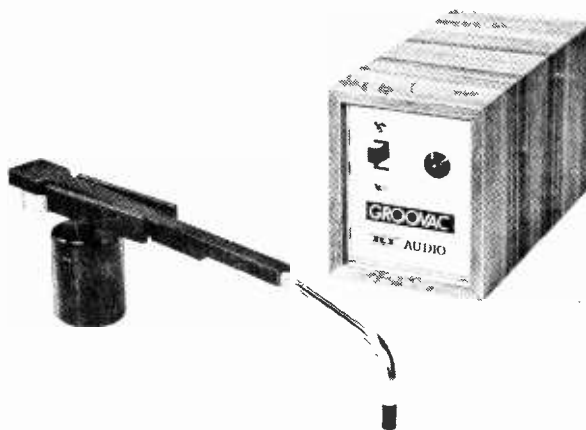

## vacuum record cleaner

Vacuum cleaning is the best way to remove dust, especially fine dust. Now with the Groovac, vacuum cleaning is available for extracting the particles from inside record grooves which are responsible for record and stylus wear - while your record is playing.

For full details please write to:-

**RI AUDIO** Kernick Rd, Penryn  
Cornwall, England

WW-012 FOR FURTHER DETAILS



## Audio Connectors

Broadcast pattern jackfields, jackcords, plugs and jacks.

Quick disconnect microphone connectors  
Amphenol (Tuchel) miniature connectors with coupling nut.

Hirschmann Banana plugs and test probes  
XLR compatible in-line attenuators and reversers.

Low cost slider faders by Ruf.



**Future Film Developments Ltd.**  
90 Wardour Street  
London W1V 3LE  
01-437 1892/3

WW-028 FOR FURTHER DETAILS

## CONSTRUCTIONAL KITS

In stock:

- Mullard CCTV Camera, P.E. CCTV Camera
- P.W. Tele-Tennis, Crofton UHF Modulator
- Crofton VHF Modulator
- Electronic Dic (Ready Assembled) in attractive case
- P.W. Electronic Organ Kit.

Further kits will be added to the range. Kits are complete, down to the last nut, including attractively finished ready drilled, painted and silk screened panels. A FREE get you going technical Back up service is available.

A P.C.B. service is available for any published design at competitive prices.

As well as holding large stocks of electronic components we are also importing a range of competitive products such as Stereo Headphones, Telephone Desk Amplifiers, Stereo 8-track Head Cleaner and Demagnetizers, Mini Drills, etc.

Full list send 12½p stamp on large envelope. Alternatively, call in for a demonstration of any kit

### CROFTON ELECTRONICS

124 Colne Road, Twickenham, Middlesex TW2 6QS  
Tele: 01-898 1569 Telex: 934642 Cadanac LDN



WW-067 FOR FURTHER DETAILS

ANADIX CF-700

## 1 GHz COUNTER FOR £475

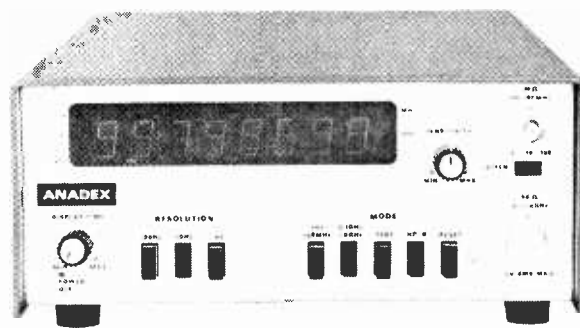

Features include:-

- ★ 1 GHz count rate with 1Hz resolution
- ★ 30mv sensitivity with high overload capability
- ★ 8 digit 'SPERRY' display

Also: Model CF-710 giving 0.001Hz resolution up to 10k Hz

**aspen electronics limited**

18a HIGH STREET, NORTHWOOD, MIDDX  
HA61BN  
TELEPHONE NORTHWOOD 27688

WW-034 FOR FURTHER DETAILS

# S-2020TA STEREO TUNER/AMPLIFIER KIT

## NEW PRODUCT

*A high-quality push-button FM Varicap Stereo Tuner combined with a 20W r.m.s. per channel Stereo Amplifier.*



**SOLID  
MAHOGANY  
CABINET**

**Brief Spec.** Amplifier: Low field Toroidal transformer, Mag. input, Tape In/Out facility (for noise reduction unit, etc), THD less than 0.1% at 20W into 8 ohms. All sockets, fuses, etc, are PC mounted for ease of assembly. Tuner section: uses Mullard LP1186 module requiring no RF alignment, ceramic IF, INTERSTATION MUTE, and phase-locked IC stereo decoder. LED tuning and stereo indicators. Tuning range 88–104MHz. 30dB mono S/N @ 1.8µV. THD typ. 0.4%.

**PRICE: £47.95 + 99p p&p + VAT.**



## NELSON-JONES STEREO FM TUNER

*A very high performance tuner with dual gate MOSFET RF and Mixer front end, triple gang varicap tuning, and dual ceramic filter/dual IC IF amp.*

**Brief Spec.** Tuning range 88–104MHz. 20dB mono quieting @ 0.75µV. Image rejection—70dB. IF rejection—85dB. THD typically 0.4%.

IC stabilized PSU and LED tuning indicators. Push-button tuning and AFC unit. Choice of either mono or stereo with a choice of stereo decoders.

**PRICE: Mono £25.46 + 85p p&p + VAT;**

**With Portus-Haywood Decoder £31.96 + 85p p&p + VAT;**

**With ICPL Decoder £29.73 + 85p p&p + VAT.**

## NEW PRODUCT

### S-2020A AMPLIFIER KIT

*Developed in our laboratories from the highly successful "TEXAN" design. PC mounting potentiometers, switches, sockets and fuses are used for ease of assembly and to minimize wiring.*

**Typ. Spec.** 20 + 20W r.m.s. into 8-ohm load at less than 0.1% THD. Mag. PU input S/N 60dB. Radio input S/N 72dB. Head-phone output. Tape In/Out facility (for noise reduction unit, etc). Toroidal mains transformer.

**PRICE: £29.95 + 99p p&p + VAT.**

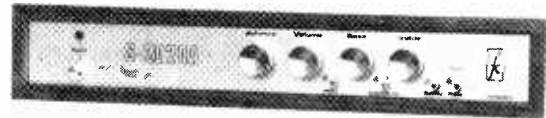

## STEREO MODULE TUNER

*A low-cost Stereo Tuner based on the Mullard LP1186 RF module requiring no alignment. The IF comprises a ceramic filter and high-performance IC. Variable INTERSTATION MUTE. PLL stereo decoder IC.*

**Typ. Spec.** Sens. 30dB S/N mono @ 1.8µV. Tuning range 88–104MHz. LED sig. strength indicator. LED Stereo indicator. THD typically 0.4%.

**PRICE: Stereo £26.32 + 85p p&p + VAT. Mono £22.40 + 85p p&p + VAT.**

**ALL THE ABOVE KITS ARE SUPPLIED COMPLETE WITH ALL METALWORK, SOCKETS, FUSES, NUTS AND BOLTS, KNOBS, FRONT PANELS, SOLID MAHOGANY CABINETS AND COMPREHENSIVE INSTRUCTIONS.**

## SUB ASSEMBLIES

### BASIC NELSON-JONES TUNER

Supplied as a printed circuit board with all components and screening box to build a varicap tuner module. Performance spec as above for complete N-J Tuner. For suitable stereo decoders see below. (Illustrated without screening box.)

**PRICE: £12.88 + 25p p&p + VAT.**



### BASIC MODULE TUNER

Supplied as a printed circuit board with all components and screened Mullard LP1186, to build a mono or stereo tuner module. Performance spec as above for Stereo Module Tuner complete kit.

**PRICE: Mono £11.11 + 25p p&p + VAT; Stereo £13.89 + 25p p&p + VAT.**



### PORTUS-HAYWOOD PHASE-LOCKED STEREO DECODER

Mk II version of this design (WW Sept. 1970). The lowest distortion phase-locked stereo decoder kit available (Typ. 0.05% @ N-J Tuner O/P level). Separation 40dB up to 15KHz. Complete kit comprises PCB and all components, inc. stereo LED.

**PRICE: £7.68 + 25p p&p + VAT.**



### PHASE-LOCKED IC DECODER

Integrated circuit phase-locked stereo decoder based on the MC1310. THD typically 0.3%. Separation 40dB @ 1KHz.

**PRICE: £4.27 + 20p p&p + VAT.**



### PUSH-BUTTON UNIT

The six-position push-button unit used in our tuners and tuner/amp. Each track has the required diode law for stability of tuning. There are approx. 40 turns on each button and there are six separate moving pointers. An AFC disable switch is incorporated with each button. The unit is finished in black with red pointers.

**PRICE: £3.00 + 20p p&p + VAT.**



*Please send SAE for complete lists and specifications.*

**INTEGREX LIMITED**, Portwood Industrial Estate, Church Gresley, Burton-on-Trent, Staffs, DE11 9PT.  
Tel. Swadlincote (0283 87) 5432. Telex 377106.

# INSIST ON VERSATOWER

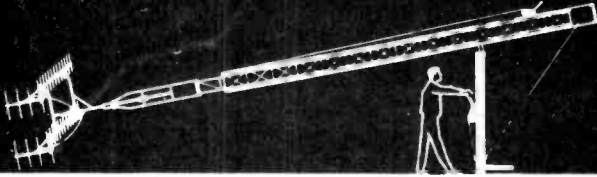

Acclaimed as the World's leading telescopic tilt-over tower in the field of radio communication  
Models from 25' to 120'



Look for the name  
**STRUMECH**

Strumech Engineering Co Ltd  
Coppice Side, Brownhills, Walsall, Staffs.

WW-026 FOR FURTHER DETAILS

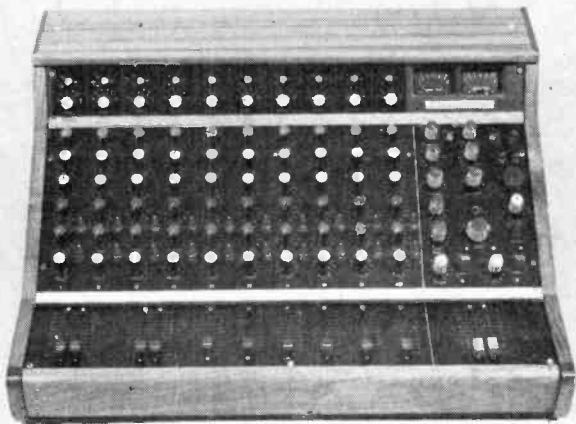

## IS CHILTON'S MIXER THE BEST FOR YOUR USE?

Magnetic Tapes Ltd make the 10/2 above as well as a 16/2 and a 12/4 with all the inherent flexibility and quality customarily found in big studio mixers. Most of our mixers are constructed to meet the varying demands of the customer, perhaps we can do one for you. Prices start at £350 for the basic 10/2.

**MAGNETIC TAPES LTD.**  
Chilton Works, Garden Road, Richmond  
Surrey TW9 4NS - 01-876 7957

# OLSON

# MINICASES

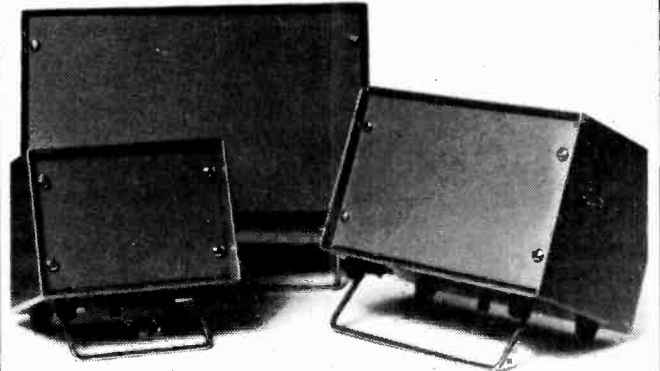

Standard minicases are made from 20g. mild steel sheets zinc-coated and finished in silver grey hammer-tone stove enamel. Front panels made from 18g. steel, finished in light grey high gloss enamel.

Type	Overall Dimension			Case no vents	Case with vents	Chrome leg
	Width	Height	Depth			
21	6 1/2"	4 1/2"	4 1/2"	—	<b>3.57</b>	<b>0.82</b>
22	8 1/2"	5 1/2"	5 1/2"	—	<b>4.01</b>	<b>0.82</b>
23	10 1/2"	6 1/2"	6 1/2"	—	<b>4.78</b>	<b>0.88</b>
24	12 1/2"	7 1/2"	7 1/2"	—	<b>5.22</b>	<b>0.88</b>
25A	6 1/2"	4 1/2"	4 1/2"	<b>3.46</b>	<b>3.90</b>	<b>0.82</b>
25B	6 1/2"	4 1/2"	6 1/4"	<b>3.63</b>	<b>4.07</b>	<b>0.82</b>
26A	8 3/4"	5 3/4"	6 1/4"	<b>4.89</b>	<b>5.33</b>	<b>0.88</b>
26B	8 3/4"	5 3/4"	8 1/4"	<b>5.11</b>	<b>5.55</b>	<b>0.88</b>
27A	12 1/4"	7 1/2"	5 1/2"	<b>5.33</b>	<b>5.88</b>	<b>0.88</b>
27B	12 1/4"	7 1/2"	8"	<b>5.77</b>	<b>6.32</b>	<b>0.88</b>
28A	14"	10 1/2"	6 1/2"	<b>6.32</b>	<b>6.87</b>	—
28B	14"	10 1/2"	8 1/2"	<b>6.87</b>	<b>7.42</b>	—
29A	10"	4"	6"	<b>4.40</b>	<b>4.84</b>	<b>0.88</b>
29B	10"	4"	8"	<b>4.67</b>	<b>5.11</b>	<b>0.88</b>
30A	12"	5"	6"	<b>4.78</b>	<b>5.33</b>	<b>0.88</b>
30B	12"	5"	8"	<b>5.06</b>	<b>5.61</b>	<b>0.88</b>
31A	14"	6"	6"	<b>5.22</b>	<b>5.77</b>	<b>0.88</b>
31B	14"	6"	8"	<b>5.50</b>	<b>6.05</b>	<b>0.88</b>
61	15 1/2"	7 1/2"	9 1/2"	—	<b>7.97</b>	—
62	17 1/2"	8 1/2"	9 1/2"	—	<b>9.24</b>	—
63	16 1/2"	9 1/2"	9 1/2"	—	<b>9.24</b>	—
64	15 1/2"	7 1/2"	12 1/2"	—	<b>9.24</b>	—
65	17 1/2"	8 1/2"	12 1/2"	—	<b>10.56</b>	—
66	16 1/2"	9 1/2"	12 1/2"	—	<b>10.56</b>	—

Types 21, 22, 23 and 24 are finished in olive green hammertone with front panels in light straw gloss enamel. Fitted with ventilated rear panels only. No louvres in the base.

## PORTABLE POWER DISTRIBUTION



COMPLETE WITH 6FT CABLE AND 13AMP PLUG

4 SOCKETS 13A.	£8.00
6 SOCKETS 13A.	£9.50
4 SOCKETS 13A. + SW.	£9.15
6 SOCKETS 13A. + SW.	£10.10

PLEASE ADD FOR POSTAGE & PACKING AND V.A.T.  
Trade Counter is open for personal callers from 9 a.m. to 5.00 p.m. Monday-Friday

**OLSON ELECTRONICS LTD.**, 5-7 LONG ST., LONDON, E.2.  
TEL: 01-739 2343

WW-068 FOR FURTHER DETAILS



## Telequipment's new dual trace 10 MHz battery operated oscilloscope



...and that's about the size of it

4 x 9 x 11 inches! Weight, less than 10lb!  
Price, only £275\*.

Small in all but specification, Telequipment pack into the tiny frame of the D32 features normally associated with instruments twice its size.

Easily carried on any assignment the D32 is probably the smallest and least expensive scope of its kind in the world.

Priced at £275\* (including re-chargeable batteries) this dual trace scope offers 10MHz bandwidth at 10mV/div sensitivity; automatic selection of chopped or alternate modes; automatic selection of TV line or frame displays; and the choice of battery or mains operation.

Size up the D32 for yourself and write or phone for a demonstration of this truly remarkable instrument now.

**Telequipment gives you more scope for your budget**

**TELEQUIPMENT**



**Tektronix U.K. Ltd.,  
Beaverton House, P.O. Box 69, Harpenden, Herts.  
Telephone: Harpenden 63141 Telex: 25559**

TQ14

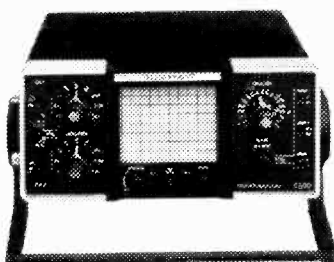

\*Exclusive  
of VAT

WW-037 FOR FURTHER DETAILS

# wireless world

**Electronics, Television, Radio, Audio**

JULY 1975 Vol 81 No 1475

- 297 **The analogue-to-digital conversion**
- 298 **Digital wristwatch—1** by *D. D. Clegg*
- 302 **HF predictions**
- 303 **News of the month**  
Josephson faster than transistors  
Antenna system for Aerosat  
VAT
- 307 **Active notch filters** by *Yishay Nezer*
- 311 **Books received**
- 312 **Letters to the editor**  
High quality f.m. tuner  
Computer power  
Instrument read-out in Braille?
- 314 **Wireless World Dolby noise reducer—3** by *Geoffrey Shorter*
- 319 **A 50MHz oscilloscope—3** by *C. M. J. Little*
- 322 **Hermetic plastics i.c.s**
- 323 **Electronic circuit calculations simplified—2** by *S. W. Amos*
- 326 **Noise — confusion in more ways than one—4** by *K. L. Smith*
- 331 **Resistance comparator** by *D. Griffiths*
- 334 **Realm of microwaves—10** by *M. W. Hosking*
- 339 **Sixty years ago**
- 340 **World of amateur radio**
- 341 **75 years of magnetic recording—5** by *Basil Lane*
- 343 **New products**
- a73 **APPOINTMENTS VACANT**
- a94 **INDEX TO ADVERTISERS**

Price 30p. (Back numbers 50p. from Room 11, Dorset House, Stamford Street, London SE1 9LU.)  
Editorial & Advertising offices: Dorset House, Stamford Street, London SE1 9LU.  
Telephones: Editorial 01-261 8620; Advertising 01-261 8339.  
Telegrams/Telex, Wiworld Bisnespres 25137 London. Cables, "Ethaworld, London SE1."  
Subscription rates: 1 year, £6 UK and overseas (\$15.60 USA and Canada); 3 years, £15.30 UK and overseas (\$39.80 USA and Canada). Student rates: 1 year, £3 UK and overseas (\$7.80 USA and Canada); 3 years, £7.70 UK and overseas (\$20.00 USA and Canada).  
Distribution: 40 Bowling Green Lane, London EC1R 0NE. Telephone 01-837 3636.  
Subscriptions: Oakfield House, Perrymount Rd, Haywards Heath, Sussex RH16 3DH. Telephone 0444 53281.  
Subscribers are requested to notify a change of address four weeks in advance and to return envelope bearing previous address.  
© I.P.C. Business Press Ltd. 1975



This month's front cover is a composite view of David Clegg's digital watch, a full description of which starts this month.

## IN OUR NEXT ISSUE

**Electronics and the railways**, a survey of past, present and future developments in communications from signalling to fail-safe systems in high-speed travel.

**Audio level meter.** Constructional design, using columns of l.e.d.s for logarithmic display, has characteristics similar to BBC peak programme meter.

**Solid-state wristwatch.** The second part of this unusual project gives the printed circuit board design and other constructional details.

SIXTY-FIFTH YEAR  
OF PUBLICATION



INTERNATIONAL BUSINESS  
PRESS ASSOCIATION

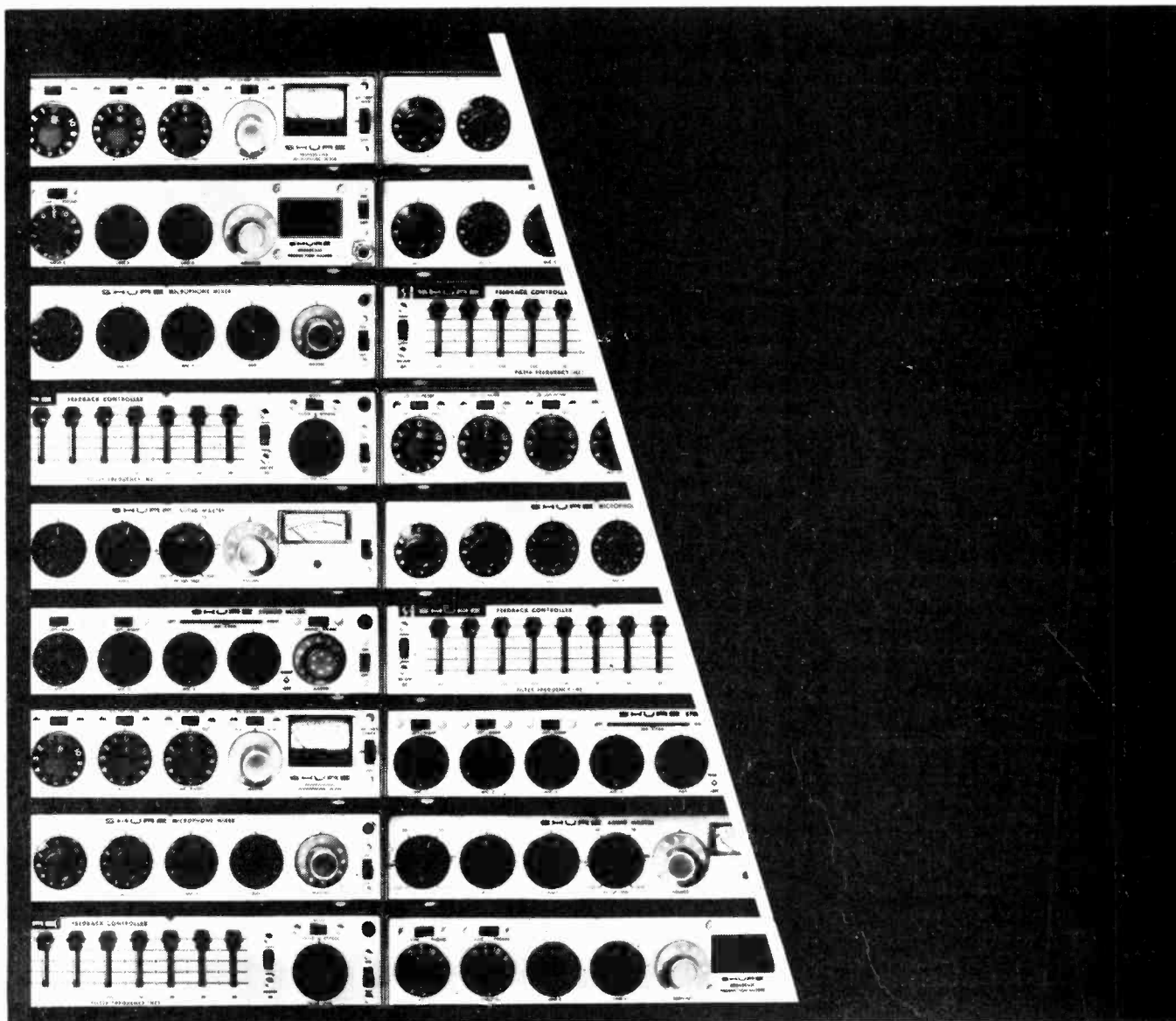

## It's a mod. mod. modular world.



Simplify, simplify! Instead of paying more for bigger, bulkier audio control components, pay less for compact Shure modular components that—singly or in combination—handle critical functions flawlessly. Cases in point: (1) the *M67 and M68 Microphone Mixers*, the original high-performance, low-cost mixers; (2) the *M610 Feedback Controller*, the compact component that permits dramatically increased gain before feedback; (3) the *M63 Audio Master*, that gives almost unlimited response-shaping characteristics; (4) the *M688 Stereo Mixer*, for stereo recording and multi-source audio-visual work; (5) the *M675 Broadcast Production Master*, that works with our M67 to create a complete production console (with cuing!) for a fraction of the cost of conventional consoles; and (6) the *SE30 Gated Compressor/Mixer*, (not shown above) with the memory circuit that eliminates “pumping.” For more on how to “go modular,” write for the Shure Microphone Circuitry Catalogue.

Shure Electronics Limited  
Eccleston Road, Maidstone ME15 6AU  
Telephone: Maidstone (0622) 59881



WW—016 FOR FURTHER DETAILS

# wireless world

## The analogue to digital conversion

**Editor:**

TOM IVALL, M.I.E.R.E.

**Deputy Editor:**

 PHILIP DARRINGTON  
 Phone 01-261 8429

**Technical Editor:**

 GEOFFREY SHORTER, B.Sc.  
 Phone 01-261 8443

**Assistant Editors:**

 BILL ANDERTON, B.Sc.  
 Phone 01-261 8620  
 BASIL LANE  
 Phone 01-261 8043  
 MIKE SAGIN  
 Phone 01-261 8429

**Drawing Office:**

LEONARD H. DARRAH

**Production:**

D. R. BRAY

**Advertisements:**

 G. BENTON ROWELL (*Manager*)

 KEVIN BURNAL  
 Phone 01-261 8515

 ROGER PORT  
 Phone 01-261 8037

 A. PETTÈRS (*Classified Advertisements*)  
 Phone 01-261 8508 or 01-928 4597

 JOHN GIBBON (*Make-up and copy*)  
 Phone 01-261 8353

 I.P.C. Electrical-Electronic Press Ltd  
 Managing Director: George Fowkes  
 Administration Director: George H. Mansell  
 Publisher: Gordon Henderson

Until about twenty years ago, the majority of measuring instruments displayed their results in an analogue manner, usually by means of a pointer meter. The accuracy of measuring electronics was such that the precision of this kind of indication was adequate. At this point, frequency measurement using flip-flops and logical gates came into large-scale use, and a numerical indication was the obvious way to display the reading. The numbers did not imply a spurious, mythical accuracy of measurement, because these instruments were capable of a high degree of accuracy.

Since then, measurement capabilities in many fields have improved and digital indication has been adopted to take advantage of this improvement. We have now reached the stage where an instrument is sometimes regarded as not quite "with it" unless a row of numbers appears on the front panel. Digital readout appears, in a sense, to have become a fashion and is sometimes used when the simpler pointer indication may have advantages. It ought to be remembered that the presentation of a measurement in numerical form does not mean that it is necessarily a more accurate measurement. It may give a more precise reading, but that is not to be confused with precision of measurement.

In some instances, a digital display can be a liability. Any slowly-varying quantity or a parameter which is only required to be known roughly is not a suitable case for the digital treatment. In the first instance the display may be a jumble of changing figures and in the second the display must be *read* rather than recognized. Clock faces, for instance, are very rarely read and are sometimes made without numerals: the position of the hands is taken in at a glance. Or again, a speedometer is usually an analogue indicator and one feels that any time spent reading numbers on a car dashboard would be better employed in looking where one is going, particularly while accelerating or decelerating, when the numerals on a digital indicator can be incomprehensible.

This is not, of course, a tirade against the superb digital instruments designed for precision voltage or frequency measurement — there is often no other way to present such readings. But a feeling persists that the humble moving-coil meter on the end of amplifying or impedance-changing electronics (or even displaying the results of measurements made by digital means, such as frequency) can still give a good account of itself.

Doubtless, many engineers who would consider themselves improperly dressed without an array of digital instruments in their equipment will disagree, pointing out that not only have we published a design for a digital speedo, but are now in the digital watch and clock business. We welcome their comments and, if they are sufficiently numerous and interesting to other readers, will publish a selection of them in a future issue.



# Solid-state digital wristwatch

C.m.o.s. circuitry and liquid-crystal display give long battery life 1 — Design

by D. D. Clegg

This article describes the design and construction of a wristwatch having a liquid crystal digital display and a quartz crystal time reference. The author was originally tempted to consider the design of a watch with a conventional display, i.e., one with hands driven by a sub-miniature stepping motor. This was later ruled out, however, because it involved a lot of conventional watchmaking expertise quite beyond the limited resources of the author.

## Design considerations

As a starting point, the following requirements were set down in order of importance:

- (1) The watch should be accurate; at least as accurate as a more conventional watch of equivalent price. The timing reference must, therefore, be a quartz crystal which will result in a stability of better than 1 second per day.
- (2) The finished watch should be a reasonably presentable piece of jewellery, i.e. it must not only look good, but also be a sensible size. The author had no intention of wearing a three-inch die-cast box on his wrist!
- (3) The display must be easy to read under all reasonable conditions of use.
- (4) The batteries must be easily obtainable and must last a sensible length of time. The absolute minimum acceptable battery life would be three months or, preferably, longer.

While compiling this list, the author was tempted to add a fifth requirement — that the watch should be easy to assemble — but later realised that this and requirement (2) are incompatible. It will become obvious during the course of this article that this design is very much a compromise because, in early 1974, there were very few suitable components available: all the major ones being imported from either the USA or Europe. For this reason the watch is quite difficult to construct and is, unfortunately, not suitable for economic manufacture in quantity. The watch described here can be built for around £50.

**Logic type.** Considerations of size and power consumption ruled out the use of

## SPECIFICATION

**Time reference:** 32.768kHz quartz crystal.

**Display:** field-effect liquid crystal.

**Power supply:** three RM312H mercury cells or WH1 watch cells. Typical life 1 year. (Minimum 9 months.)

**Stability:** better than 1s per day. typically 3 seconds per week.

**Size:** module diameter 31mm.

Depth of main part of module 7.3mm.

Depth of front part of module 1.75mm.

s.s.i. or m.s.i. bipolar logic for the watch: the only alternative was l.s.i./c.m.o.s. and at that time only one manufacturer's product was available in this country. This was the two-chip system designed for wristwatches with digital displays by Solid State Scientific Inc. One of the chips is a silicon gate c.m.o.s. oscillator and divider packaged in a ten-lead flat-pack — the SCL-5425-AF — and the other is an aluminium-gate watch circuit with outputs suitable for driving liquid-crystal displays, packaged in a 30-lead flat-pack — the SCL5424-F.

**Display.** After deciding on a digital display, the author's first intention had been to use an l.e.d. display and to provide a "Display" button to reduce power requirements, so that the display would draw power from the battery only when required. The SCL-5424-F watch chip will not drive an l.e.d. display directly and so it was decided to interface it with CD-4009 c.m.o.s. inverters. At that time, however, c.m.o.s. was in short supply, and c.m.o.s. in flat-packs (necessary because of the size) was almost completely unobtainable; delivery times in excess of six months being quoted in some cases.

The alternative was to use a liquid-crystal display which would require no interfacing, since the SCL-5424-F watch chip was designed to drive this type of display directly. Again, at this time there was considerable difficulty in



obtaining a liquid-crystal display suitable for a watch. There was quite a lot of literature from various manufacturers, but the only device which was actually obtainable was the LC-201135 from Brown, Boveri and Company. One important advantage gained from using this particular display was its ability to operate from a very low voltage (1.5V to 5V r.m.s.) and still provide a reasonable contrast ratio.

**Crystal.** The quartz crystal required by the SCL-5425-AF is a 32.768 kHz type. Motorola manufacture a suitable crystal in a sub-miniature vacuum envelope — the MTQ-32. They also make a sub-miniature ceramic trimmer capacitor for wristwatches; this is the MTT-02.

**Batteries.** It took the author approximately four months to obtain the main components for the watch, these being logic i.c.s, display, quartz crystal and trimmer capacitor. Batteries were now the only components outstanding on the shopping list and the author confidently expected this to be very easy since he had obtained the "Designers Guide to Battery Systems" from Mallory. This book describes a very comprehensive range of batteries including no less than six specifically designed for electronic watches.

At this time the author discovered that empty wristwatch cases were available from wholesale watchmakers, so rather than try to make one (the die-cast box effect) it was decided to buy a suitable case ready-made. Before this could be done, however, the type and size of battery or batteries would have to be decided upon.

After visiting a number of large jewellers in central London, it was discovered that watch batteries are not available for sale over the counter; electronic watches requiring new batteries are, apparently, returned to the manufacturers to have their batteries replaced.

To have gone ahead and designed a watch using a battery from the Mallory range, but which proved difficult to obtain in practice, would have broken design rule (4). The author spent some time, therefore, visiting chemists,

jewellers and photographic shops in central London to determine which small mercury batteries were easily obtainable. The result of this investigation showed that the best battery for the watch would be the RM-312H mercury battery designed primarily for hearing aids. This is obtainable from most chemists and with a capacity of 36mAh it would appear to fulfil design requirement (4). Three of these batteries are used in the watch and they will have a life in excess of nine months.

**Oscillator design**

The timing reference in this watch is a quartz crystal oscillating at 32.768kHz. This frequency is popular with i.c. manufacturers because it is an exact power of two, ( $2^{15} = 32768$ ) thus simplifying frequency divider design. It is also a compromise between power consumption in the oscillator and the physical size of the crystal; lowering the frequency increases the size of the crystal, making it too large for a wristwatch, while increasing the frequency causes an unacceptable increase in power consumption. Future trends in watch design, however, are tending towards much higher frequencies (as high as 4MHz) to increase stability, with the use of silicon-on-sapphire c.m.o.s. integrated circuits to maintain extremely low power consumption.

The equivalent circuit for the Motorola MTQ-32 quartz crystal is shown in Fig. 1 which gives some typical component values. A typical Q of 50,000 would be obtained. The MTQ-32 is an NT-cut crystal and is mounted in an evacuated sub-miniature envelope.

There are two resonance conditions that a quartz crystal can exhibit – parallel resonance and series resonance. If it is assumed, for simplicity, that  $R_s = 0$ , then the crystal impedance is given by:

$$Z = \frac{j(1 - \omega^2 LC_s)}{\omega^3 LC_s C_p - \omega(C_s + C_p)}$$

The series resonant frequency  $f_s$  is defined at the zero impedance point, where  $\omega^2 LC_s = 1$ , as:

$$f_s = \frac{1}{2\pi\sqrt{LC_s}}$$

The parallel resonant frequency  $f_p$  is defined as occurring at the infinite-impedance point; where  $\omega^3 LC_s C_p = \omega(C_s + C_p)$ , and is

$$f_p = \frac{1}{2\pi\sqrt{L\left\{\frac{1}{C_s} + \frac{1}{C_p}\right\}}}$$

Figs. 2(a) and 2(b) respectively show the variations of  $X_E$  and  $R_E$  with frequency for typical crystal. Unfortunately  $R_s \neq 0$  for practical crystals and the real condition frequencies are called resonance ( $f_r$ ) and antiresonance ( $f_a$ ). These two frequencies are defined as occurring when the crystal appears purely resistive, i.e. when  $X_E = 0$ . In

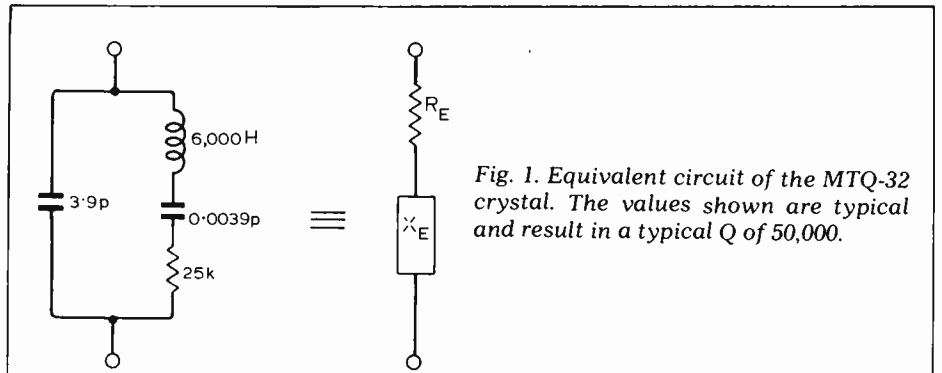

Fig. 1. Equivalent circuit of the MTQ-32 crystal. The values shown are typical and result in a typical Q of 50,000.

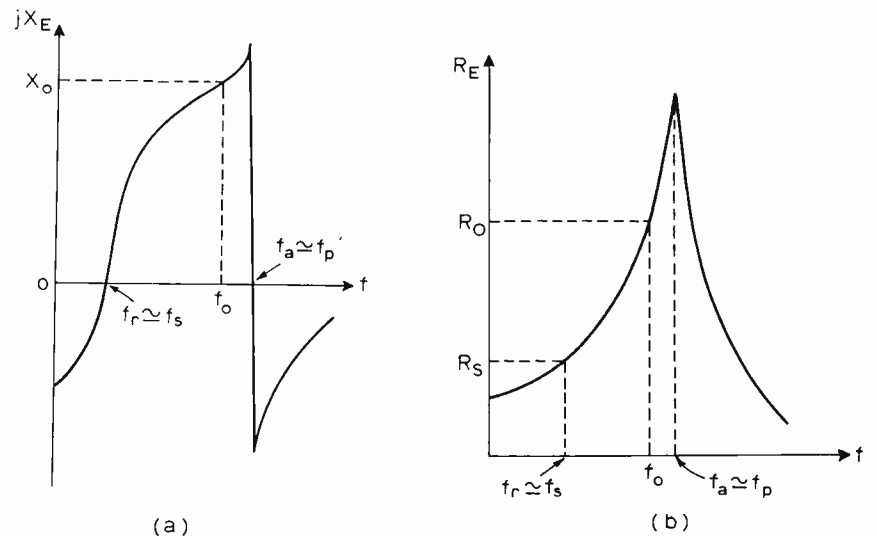
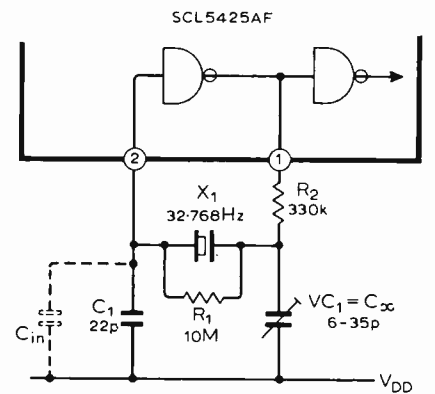

Fig. 2. The crystal reactance  $X_E$  plotted against frequency is shown at (a), while (b) is the resistance  $R_E$  against frequency.

Fig. 3. The practical crystal oscillator circuit, using a logical inverter as the maintaining amplifier. The trimmer is type MTT-02.



practice  $f_r$  is very close to  $f_s$  and  $f_a$  is very close to  $f_p$ . Fig. 3 shows the practical oscillator circuit used in the watch – in this circuit the resonant frequency  $f_0$  lies very close to, but below  $f_a$ . The MTQ-32 crystal is designed to resonate at the specified frequency of 32.768kHz only when it has an external capacitance  $C_L$  of 10-12pF in value in shunt with  $C_p$ .

$$C_L = \frac{(C_{in} + C_1)C_x}{C_{in} + C_1 + C_x}$$

where  $C_{in}$  is the input capacitance of the 5425 inverter, and is probably in the region of 5pF.

The inverter is biased into its linear mode by the series combination of ( $R_1 + R_2$ ) which should have a value of about ten times the crystal impedance

at resonance  $f_0$  (typically  $Z \gg 10^6$  ohms) but should be lower than the various d.c. leakage impedances – the inverter input impedance, for example. A value of between 10 and 100MΩ for  $R_1$  satisfies these requirements. Unfortunately, however, physically small high value resistors ( $>10M\Omega$ ) are very scarce; indeed, only a very few types of small resistor can be obtained in values above about 330kΩ. The Mullard CR25 range of carbon film resistors extends to 10MΩ and this is the value of  $R_1$ .

Resistor  $R_2$  controls the drive level to the crystal and contributes to the feedback network attenuation constant. Its value should be about ten times the crystal series resistance  $R_s$ , to give reduced dependence of frequency on the supply voltage.

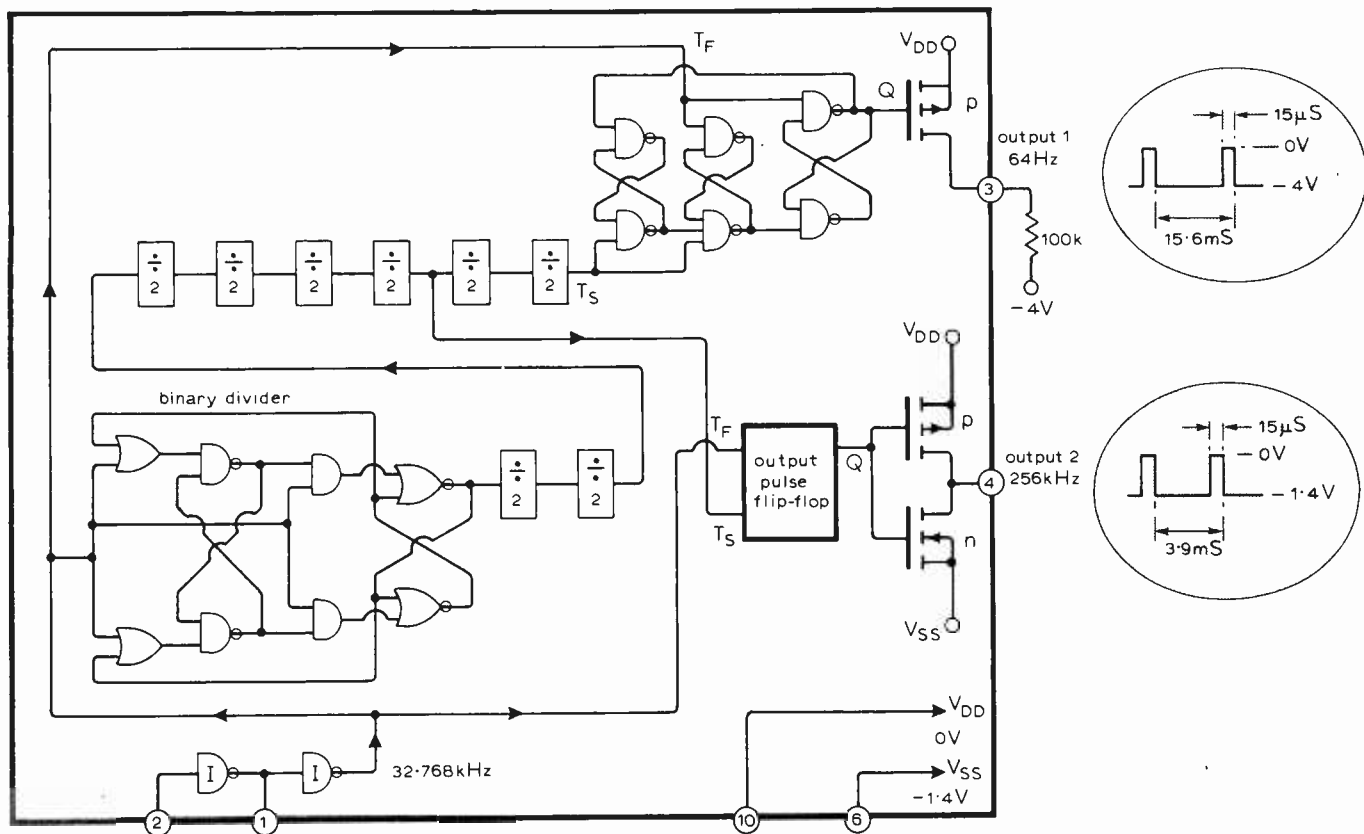

The trimmer capacitor  $VC_1$  is adjustable between 6 and 35pF, giving a frequency adjustment of about  $\pm 1$  Hz from the nominal 32.768kHz. This represents a timing adjustment of about  $\pm 2\frac{1}{2}$  seconds per day.  $VC_1$  is a sub-miniature ceramic trimmer, the MTT-02, manufactured by Motorola to complement the MTQ-32 crystal.

**Dividers**

The main watch integrated circuit (SCL-5424-F) requires an input of 64Hz and this is provided by the oscillator and divider integrated circuit, the SCL-5425-AF.

Fig. 4 is a logical block diagram of the SCL-5425-AF. It consists of an inverter between pins 1 and 2, to which are connected the frequency determining

Fig. 4. The logic diagram of the SCL-5425-AF.

components to form the oscillator, followed by nine binary dividers. There are two outputs, one at the input frequency divided by  $2^9$  (output 1) and the other at the input frequency divided by  $2^7$  (output 2). With an input of 32.768kHz, output 1 will be  $32768 \div 512 = 64$ Hz and output 2 will be  $32768 \div 128 = 256$ Hz.

The binary dividers used in the 5425 are master/slave toggle flip-flops whose output transitions occur on the rising edge (logic 0 to logic 1 transition) of the

Fig. 5. Generation of low output duty cycles.

input clock. The logical construction of these toggle flip-flops can be seen in Fig. 4. The output from these dividers has, of course, a 50% duty cycle (1:1 mark:space ratio). Resistive loads connected to the outputs would, under these conditions, dissipate an unacceptable amount of power, and the output pulse duty cycle is therefore reduced from 50% to 0.1% for output 1 and to 0.4% for output 2. These low duty cycles are generated by the output pulse flip-flops which are set by the first logic 0 to logic 1 transition of  $T_F$  when  $T_S$  is high and reset by the next logic 1 to logic 0 transition of  $T_F$  (Fig. 5). Further changes in  $T_F$  have no effect until  $T_S$  has gone low and then high again, when another output pulse is generated. The net result of this is that the output pulse flip-flop gates one 15μs pulse of the input frequency at the repetition rate of the output frequency.

Output 1 is an uncommitted p-channel transistor and requires an external drain load of 100kΩ. Output 2 is a conventional c.m.o.s. inverter with an output "on" resistance of 1kΩ at a current of 300μA. This output of 256Hz is primarily intended for driving voltage up-converters to produce the 10 to 15 volts required by many liquid-crystal displays, and it is not used in this design.

**Main logic and display**

A block diagram of the SCL-5424-F watch is shown in Fig. 6. It accepts an input of 64Hz from the oscillator and divider i.c. and directly drives the liquid crystal display. The 64Hz input (pin 23) has an n-channel transistor connected down to  $V_{SS}$  with its gate connected to  $V_{DD}$ . It is intended to provide a load for

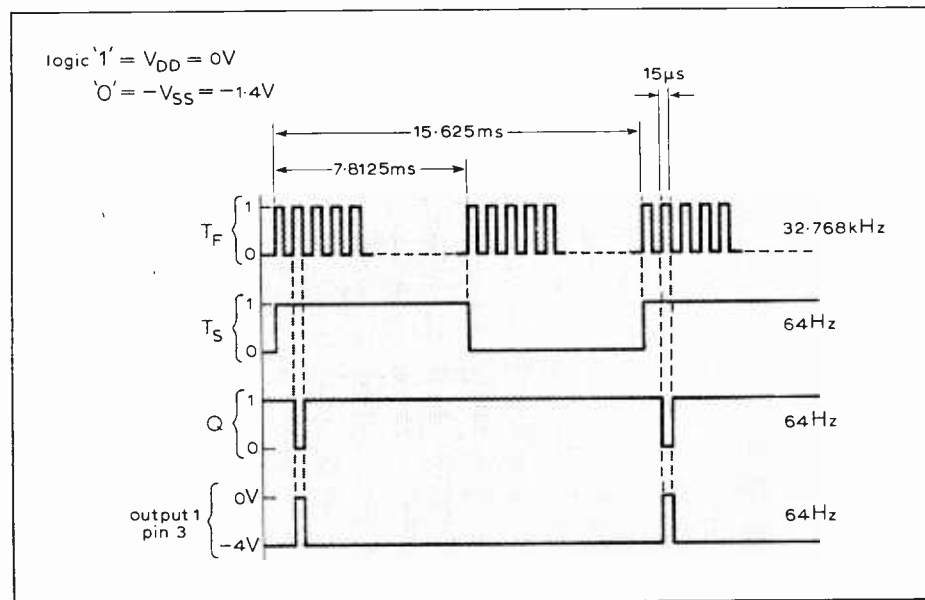

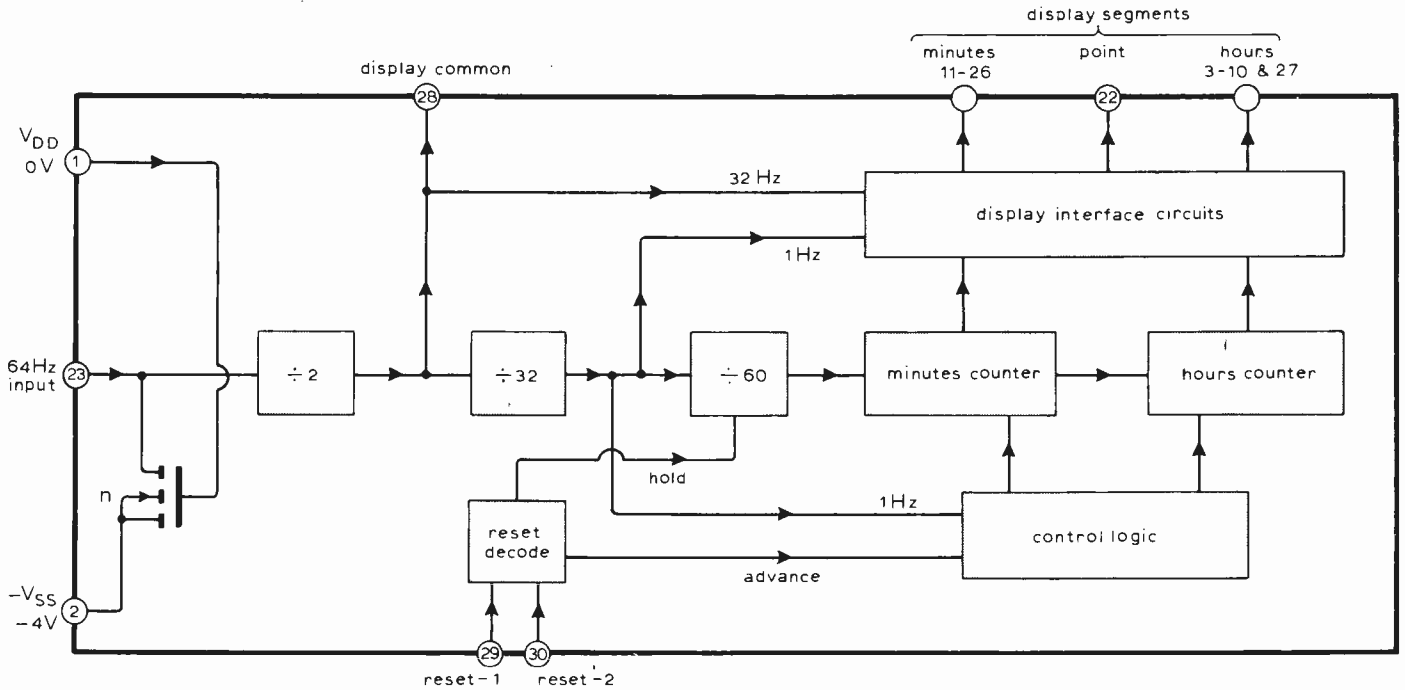

Fig. 6. Block diagram of the SCL-5424-F.

the p-channel current source transistor in the SCL-5425-AF. It is only effective, however, with a supply of 15 volts; with  $V_{ss} = -4$  volts an external resistor of  $100k\Omega$  is required, since at this voltage the transistor has a very high channel resistance. This value of load resistor might appear to be rather low as it results in a peak current of  $40\mu A$  ( $I = 4 \div 10^5 A$ ) but, since there is only one  $15\mu s$  pulse every 15ms (duty cycle 0.1%), the mean current is only  $40nA$ . If this resistor is made too large, then the 64Hz input pulse fall time will be too long and may cause incorrect operation of the divider stages following.

There are two "Reset" inputs (pins 29 and 30) which for normal operation are connected to  $V_{DD}$  (0V) through two  $1M\Omega$  resistors ( $R_4$  and  $R_5$ ). When reset 2 (pin 30) is taken to  $-V_{ss}$  (case potential) the hours increment at a 1Hz rate. Connecting both resets 1 and 2 to  $-V_{ss}$  causes the minutes to increment as for the hours. Connecting reset 1 to  $-V_{ss}$  by itself, stops the watch and resets the divide-by-60 stage preceding the minutes counters. This is to enable the watch to be synchronized to a reference time source, for example, the Greenwich Time Signal.

Liquid crystal displays require a symmetrical a.c. waveform for correct operation. There must be no d.c. component present in this waveform or electrolytic effects within the cell will seriously damage the display, thus shortening its life. The SCL-5424-F watch chip, therefore, contains interface circuitry which produces the required symmetrical square waveform from the output of the seven-segment decoders: Fig. 7 shows one of these circuits together with the associated waveforms. The interface circuit consists, essentially, of two c.m.o.s. transmission gates connected so that the segment output can be either in phase

with the display common output, or  $180^\circ$  out of phase with it.

When all inputs to the segment decoding gate are at logic 1, then its output (a) is logic 0; transmission gate  $S_1$  is on (conducting) and gate  $S_2$  is off. Under these conditions the 32Hz waveforms at pins 28 and 26 are, therefore, out of phase and the net result is that segment  $E_1$  "sees" a symmetrical square wave of 8 volts peak-to-peak, which turns it on. When this segment is

Fig. 7. Display interface circuits.

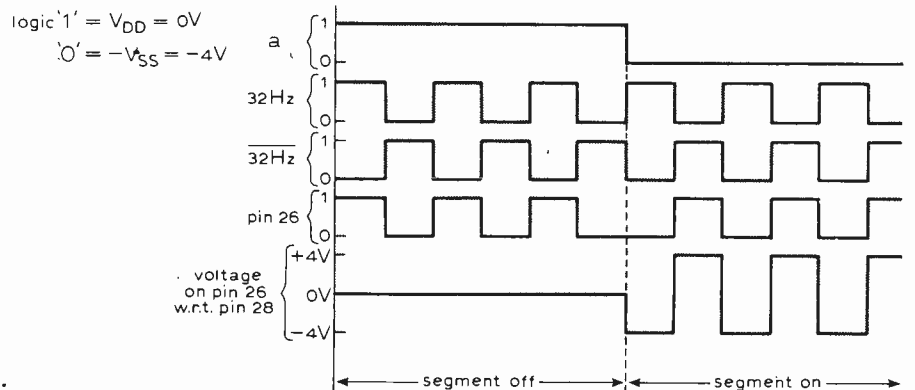
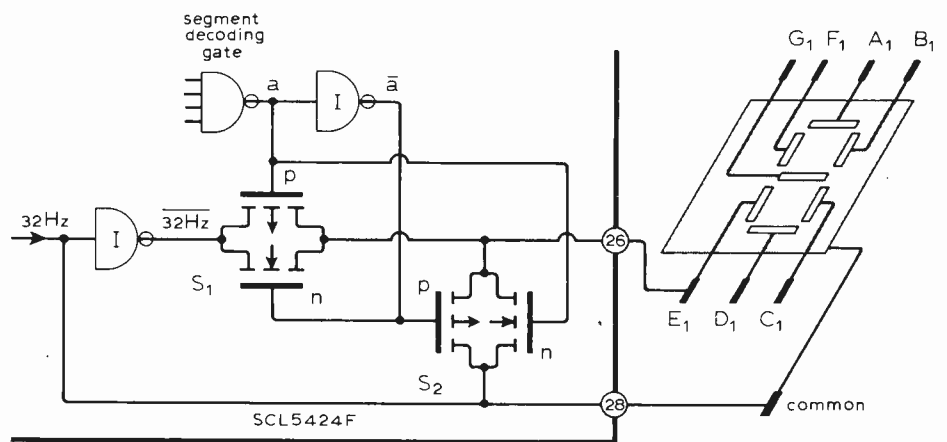



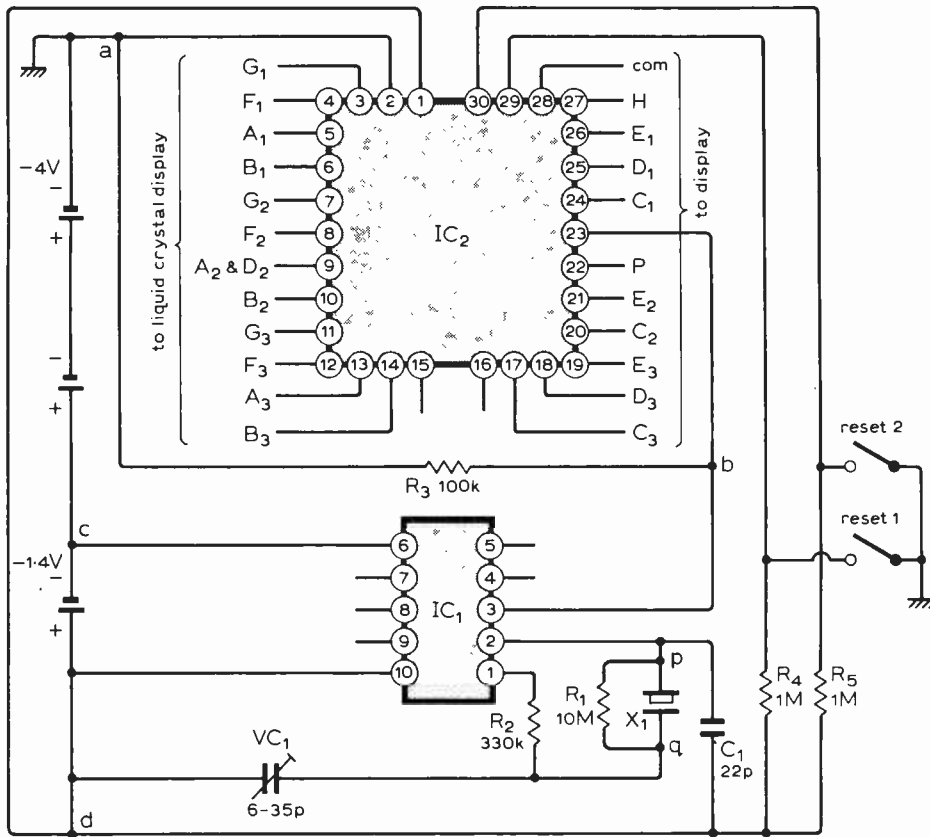

Fig. 8. Complete circuit diagram of the watch.

not required at least one of the inputs to the decoding NAND gate will be at logic 0, its output is logic 1 and transmission gate  $S_1$  will be off, while gate  $S_2$  will be on. There is now no voltage across the cell for this segment, and it is, therefore, off.

Many liquid-crystal displays for wristwatches have a colon between the hours and minutes; the Brown Boveri display used in this design, however, has only a single point. The P output of the watch chip (pin 22) is driven by a 1Hz waveform, through an interface circuit, which results in the display point flashing at a 1Hz rate. This serves two purposes; it gives the wearer confidence that the watch is, in fact, operating, and it can be used as a seconds timer if one is prepared to count the seconds.

**Power supply**

The SCL-5425-AF oscillator and divider i.c., being a silicon-gate device, will operate with a supply voltage between 1.2 and 10 volts: the main logic i.c. (SCL-5424-F), being an aluminium gate device, operates with a supply of between 3 and 15 volts, while the display requires a voltage of between 1.5 and 10 volts: Three 1.4 volt mercury cells, giving a supply of 4.2 volts, satisfy these requirements. The current consumed by the SCL-5425-AF is typically between 2 and  $5\mu A$  at 1.4 volts; above this the current rises quite rapidly, until at 4 volts it will be about  $15\mu A$ . This is far too high for prolonged battery life, so this i.c. is supplied by only one of the three cells. The main logic i.c. and display together consume a maximum current of  $300nA$  ( $0.3\mu A$ ) at 4 volts; the total current required by the complete

watch will, therefore, lie somewhere between  $2.3$  and  $5.3\mu A$ .

The capacity of the RM-312-H mercury cells used in this design is  $36mAH$  or, as it is more usefully quoted in this application,  $4\mu A$ years. These cells will therefore last between nine and about eighteen months. For those constructors who would like to try to obtain one of the range of Mallory watch batteries, the WH1 cell is dimensionally the same as the RM312H but it has a slightly higher capacity of  $45mAH$  ( $5\mu A$ years). (Although the capacity of the RM312H cell is given in the data as  $36mAH$ , this is for a drain of about 2 milliamps and it may in practice have a slightly higher capacity. The capacity of the WH1 is quoted for a current drain of about  $50\mu A$ .)

Fig. 8 shows the circuit diagram of the complete watch, omitting only the display for clarity. (Constructional and operational details will be presented in Part 2 of the article.)

**Vision cassette and cartridge recorders**

Thorn Electrical Industries have asked us to say that the price of the Radio Rentals Contracts Model 8200 V.C.R. is £335 plus v.a.t., or £132 plus v.a.t. per annum when rented. The firm's address is now APEX House, Twickenham Road, Feltham, Middlesex.

**HF predictions**

Magnetic activity is still reaching disturbance level on more than fifty per cent of days. This feature developed rapidly in February 1974 and has persisted to date. The same feature was present in 1973 and terminated abruptly in July of that year.

Smoothed sunspot number is now very low with rate of change near zero. It should start increasing in a few months' time.

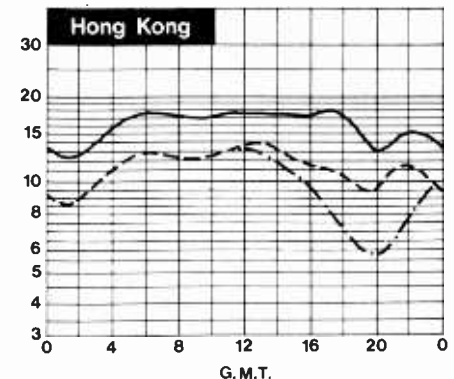
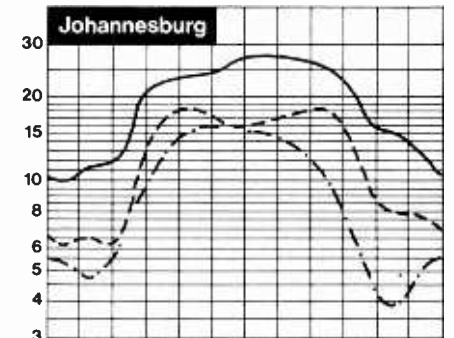
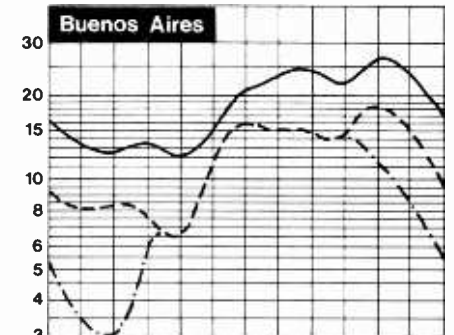
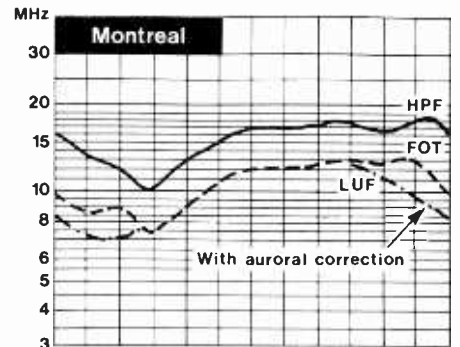

# News of the Month

## Josephson faster than transistors

A US patent covering the fabrication of a new type of electronic switch, whose performance far exceeds that of transistors, describes a technique used to grow a thin insulating layer — only 10 to 30 atom layers thick — that is the heart of a device called a Josephson tunnel diode. (The Josephson effect was described in an article by B. D. Josephson in *Wireless World*, October 1966, entitled "New superconducting devices").

It has been recognized for some time that the Josephson effect could provide an extremely fast logic switch that would require very little energy. However, a device based on these effects requires an insulating layer far thinner than has previously been used in electronic devices. The new process, accredited to James H. Greiner of the IBM Thomas J. Watson Research Centre, New York, uses a glow discharge somewhat like that in a fluorescent lamp. When a gas such as oxygen is present in the discharge, an insulating oxide is formed on the surface of the sample up to a certain thickness which is dependent on the oxygen pressure and other factors. As the oxide approaches this thickness, the discharge begins to remove oxide at almost the same rate as it is produced. Thus the oxide layer quickly approaches an equilibrium at the desired thickness.

The Josephson switch device is based on a phenomenon called electron tunnelling. Because electrons appear to behave as waves as well as particles, they can penetrate or "tunnel" through a barrier such as a thin layer of insulation which would be expected to stop them according to classical physics. The type of tunnelling exploited in the new device occurs only at very low temperatures, where some metals lose all resistance to current flow and become "superconductors." It was discovered in the early 1960s that two different types of tunnelling can occur through a thin insulator separating two

superconductors. In one type there is no voltage drop and the insulator acts like a weak superconductor itself. In the other type, there is a slight voltage drop across the insulator. The insulator can be switched from the no voltage drop state by a small magnetic field. (Discovery of these effects was recognised by the 1973 Nobel Prize in physics.)

## 1975 Spring trade shows

The annual trade shows for the radio and television industry took place in London during May amid an air of surprising confidence and optimism from both retailers and suppliers. Perhaps also, the fact that this was the last show to be held in the London Hotels before the move next year to the Birmingham exhibition centre was the reason for the unusually large number of exhibitors.

It was very evident, from the range of hi-fi equipment introduced, that many manufacturers believe that one way of ensuring buoyant trade prospects is to move up-market to the very expensive (and very large!) end of the scale. A typical example of this philosophy was to be found at the Cumberland Hotel, where Sony (UK) Ltd were introducing a range of esoteric audio equipment of phenomenally high price. Among these were some loudspeakers priced at about £1,500 a pair and a new reel-to-reel tape recorder priced at around £1,200!

In total contrast, AEG Telefunken were showing some brightly coloured pocket-sized portable radios that were of quite modest price. Significantly, no new developments appeared on show

*The Sony SS8150 loudspeaker is a typical example of a new technique announced during the show. The drive unit cones are loaded with carbon fibre filaments to give a very high stiffness.*

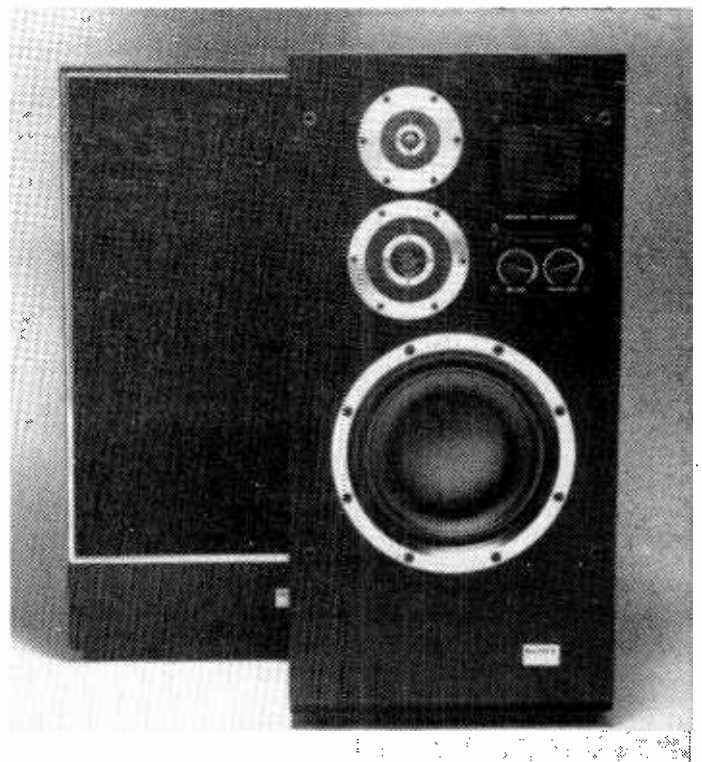

for television, with the exception of an increase in the incidence of slot-mask tubes and the new 20 inch screen size.

Philips were showing a rather battered prototype Teletext decoder incorporated in a large screen television and since it did not seem to be fully functional, little interest was shown by those dealers present at the time.

At the end of the five days, most exhibitors reported a steady trade with dealers buying products, but in many cases, in a cautious way. So much new technology was shown, that this will form the subject of a brief report in the next issue of this journal.

In conclusion, the overall impression gained was of a very high morale and a determination to fight back against the trends of the current decline in consumer sales.

## VAT muddle

The introduction of the 25% VAT rate on certain so-called luxury goods appears to have resulted in a good deal of confusion not only among component suppliers and kit companies but also among advertisers using magazines such as *Wireless World* which are aimed at a combined audience of professional engineers and enthusiasts.

As a result we have asked the Customs and Excise for clarification on a number of common questions. The question of VAT liability requires that a distinction be made between those who are VAT registered and those who are not.

For those who are registered, VAT is recoverable, so no change will result in accounting procedures. The changes affect the non-registered purchaser who

is either a business with a turn-over less than £5,000 per annum, or is a private purchaser. The types of goods and services subject to the high rate of VAT are defined in Notice 742 from Customs and Excise and are quite clear in all instances except where related to components and borderline products having a possible consumer application.

Taking components first; all those components forming parts of higher rated goods are subject to 25% VAT. Those that have been specifically excluded by the VAT Liability Office may be rated at the higher rate, if they are fitted as a spare part by an engineer performing a service classified at the higher rate. Examples of such components would be those that are rated to a higher specification than that normally used in, say, audio amplifiers. Hence a high power thyristor is excluded and rated at 8% unless it is used by a service engineer as a spare part in a domestic audio amplifier.

A telephone enquiry to the VAT Liability Office elicited the information that there are still many "grey" areas where final decisions on rating have yet to be made. They informed us that local VAT offices are issuing conflicting information and that enquiries concerning electronic and electrical goods not specifically mentioned in Notice 742 should be addressed via the appropriate trade association who will then negotiate with the London VAT Liability Office. It is only this office that is in the position of making final decisions on specific exclusions.

The VAT officer went on to say that in the intervening period of uncertainty, manufacturers are expected to make their own decisions regarding the rating of their components, in instances where Notice 742 has provided insufficient information.

Finally, two specific examples of liability in relation to advertising. Notice 742 states "Appliances . . . are generally regarded as being for domestic use if they are . . . advertised in those periodicals intended for the public." We are informed by the VAT Liability Office that this is only one of the criteria applied and that where the only advertising outlet for a professional product is through a publicly available journal than this would not result in the high rate being applied. For example, public address equipment is tentatively rated at 8% (subject to discussion with the trade associations resulting in a permanent decision). Advertising in a magazine such as *Wireless World* would not result in the high rate being applied. Similarly professional discotheque equipment may be advertised in the *Melody Maker* and yet be rated at 8%.

All this note serves to show is that in areas of doubt final clarification can only be obtained from the central VAT Liability Office, preferably through a trade association.

---

## Antenna system for AEROSAT

---

A complete L-band aircraft antenna system of a type suitable for airliners using the projected AEROSAT aircraft/satellite communication system has been developed under contract to the Ministry of Defence in close co-operation with the Royal Aircraft Establishment and completed in time to be installed in one of RAE's Comet 4 aircraft for the AEROSAT system trials. The trials, based on the Azores, are organised by the European Space Research Organisation and started at the end of February. NASA's ATS6 satellite is being used to assess performance of the L-band system, which is of particular significance since in this geographical area the access angle from the aircraft to the satellite is low, resulting in appreciable noise temperature and accentuating possible multipath problems.

The antenna system consists of two antenna groups with two switching and phasing units with their associated cabling. The antenna groups are virtually flush mounted on each side of the aircraft fuselage at about 40° from the zenith. The switch units are installed in a convenient location inside the fuselage.

An antenna group consists of six slot-dipole elements, three transmitting and three receiving which give the required beam coverage with good multipath signal rejection. The slot-

dipole element itself was developed by RAE's Radio and Navigation Department and was selected after detailed examination of a wide range of alternative elements. The L-band system is rated at 200 watts, 50% duty, and has been designed to transmit on 1640-1660MHz and receive on 1540-1560MHz with omni azimuth coverage for elevation angles of 10° and above. After two weeks and nearly 50 hours of flying time the antenna system was working well. There were several days of torrential rain when the Comet 4 remained on the tarmac, during which time the impedance of both the transmitter and receiver were measured several times and no change was observed.

---

## Brema on VAT

---

The following text of a telegram to Members of Parliament was issued by the British Radio Equipment Manufacturers' Association on 22nd April. "To all members of Parliament from Lord Thorneycroft. President of British Radio Equipment Manufacturers' Association. The recent budgetary proposals to increase VAT to 25 per cent will have the immediate effect of causing serious and permanent redundancies in this industry. At a special meeting of the Association today member companies estimate that permanent and unavoidable lay-offs of staff would exceed 6,000 at least 20 per cent of direct labour employed by the industry. These figures in addition to the 5,000 redundancies which occurred in the calendar year 1974, and exclude serious position which will undoubtedly occur in component and associated industries. Position is grossly aggravated by the retro-active effect of VAT proposals on rental side of industry. We wholeheartedly endorse representations already made by members of the National Television Rental Association. We emphasise that enforced reduction in production capacity now cannot fail to increase the cost of imports when the market next improves, with serious consequences on balance of payments position."

---

*"No madam, this is not Harrods." Pyc Telecommunication's specially adapted "Westminster" mobile radiotelephone in use at the Silverstone Racetrack during recent police trials. The police motorcyclist is using the hand-set for transmitting, and a loudspeaker, mounted on the motorcycle's fairing, for receiving.*



---

## Is circularly polarized TV coming?

---

The heading to this item was the title of a paper by M. S. Siukola presented in the *IEEE Transactions on Broadcasting*, Vol. BC-21, No. 1, March 1975. According to the paper, there is on the horizon a new approach to the way TV signals are radiated. The technique is circular polarization, and while this has been in use for several years in f.m. broadcasting, it is now being viewed for TV as an

effective antidote for ghosting, spotty coverage, multipath, poor reception on whips and rabbit ears, misoriented antennas, co-channel and adjacent-channel interference – all ills that have plagued broadcasters and viewers since TV's inception. The conclusions reached in the paper indicate that the principal deterrent would seem to be the cost to the broadcaster, but this may well be completely compensated by the more solid coverage, increased viewer enthusiasm for the enhanced reception and the additional viewer audience that circularly polarized TV is expected to provide within existing coverage areas. Present receiving antennas would not be made obsolescent, but viewers would certainly benefit most by acquiring circularly polarized types. The designs for receiving antennas as well as transmitting types are available and the antennas can be built now.

---

## Association of research contractors formed

---

The Association of Independent Contract Research Organizations has been formed to represent and promote the resources of seven constituent founder members. Contract research is becoming increasingly important in its scope for serving industrial, commercial, institutional and governmental clients as a world-wide business. The seven major independent organizations based in the UK serve home and overseas markets. Between them they employ 2,250 staff of whom 800 are of professional consultant status. The Association aims to communicate on behalf of its members with international and intergovernmental bodies, with central governments in the UK and overseas, with industry – representational bodies and industry groups – and with commercial organizations able to benefit from contract research services. Further information can be obtained from D. McA. Craig, 7 Catherine Place, London SW1E 6EB.

---

## Queen's awards to electronics

---

Worthy of note are the following companies who were included in those honoured by the Queen earlier this year for their contribution to Britain's technological development and exports: Beckman Instruments for export achievements during the last three years; Mullard for outstanding export success and development; Micro Consultants for outstanding work in the field of ultra high speed analogue-to-digital conversion; EMI Sound and Vision Equipment for export achievement of the brain diagnostic EMI-Scanner;

*For radio relay systems using the microwave range above 3GHz Siemens are now developing aluminium waveguides with rectangular cross sections which can be bent and twisted and which simplify the planning and installation of connecting lines between radio relay equipment and antennas.*

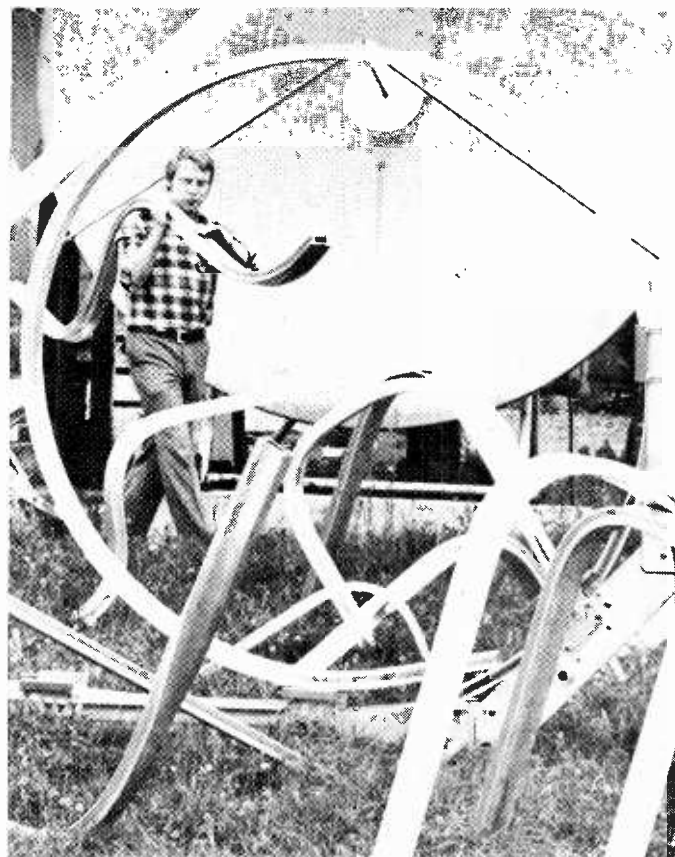

Marconi-Elliott Avionic Systems for technological innovations in the sophisticated navigation and weapon aiming system NAVWASS, supplied for Jaguar aircraft; KEF Electronics for export achievement of loudspeakers; Sinclair Radionics for outstanding export achievement and for technological innovation in electronic calculators; British Aircraft Corporation for export achievement and for technical innovation in high performance flight radomes by the Reinforced and Microwave Plastics Group. Our congratulations go to all concerned.

---

## Transistor assembly automated

---

A recently developed transistor assembly system that can assemble a variety of transistor types by means of pattern recognition techniques comprises a minicomputer and image processors and will ultimately have 50 wire-bonding machines with visual functions to determine chip positions of transistors fed into the machines. The system has been installed at Hitachi's Takasaki Works, in Japan.

To recognise the position of transistor chips, an artificial eye is needed to replace the human eye. For this purpose, a microscope and a TV camera are mounted on each wire-bonding machine, so that the image signal from the camera is analyzed by a combination of the image processor and the computer to give a high-speed position

recognition rate of 0.2 seconds per chip average. Position data is fed back from the computer to the appropriate wire-bonding machine, whose servomechanism can stretch the gold wire between emitter and base electrodes on the chip and the corresponding outer leads. It is claimed that the production rate has more than doubled since replacement of traditional methods.

---

## World markets decline

---

An extract from the 1975 first quarter and stockholders meeting report issued by Texas Instruments indicated that the decline in demand for their electronics products experienced in 1974 was generated by the longest, deepest recession since recovery from World War II. The major difference between this and past recessions is the almost concurrent decline of all major economies. In 1970, while the US economy was declining, Japan and Europe continued to grow. In contrast, late 1973 industrial production turned down simultaneously in Japan, Europe and the US.

In the US real growth has dropped for the past five quarters. High unemployment, inventory liquidation and sluggish capital spending suggest they (TI) will not reach the bottom before the third quarter of 1975, with at best a modest upturn this year and a slow recovery in 1976.

Japan appears close to the bottom of its recession, spring wage negotiations



influencing the rate of recovery. West Germany probably will have a moderate upturn in the second half of the year. France will have minimal real growth in 1975. In Italy, industrial production is falling still, but the trade balance is improving and inflation is down compared with 1974. The UK economy is expected to remain sluggish well into 1976.

---

## Direct-drive a.c. motor

---

Matsushita, who are represented in the UK by Symot, have announced a direct drive a.c. motor for use in record turntables. The unit, which is called the FF-2000 is basically a linear motor, which drives a light-weight aluminium platter, by eddy currents. Underneath the platter is a geared magnetic speed sensor which forms part of a feedback system for speed regulation. The motor is electronically controlled and requires an a.c. supply of 18V, 40mA. Performance of the FF-2000 is claimed to be equal to or better than the existing d.c. direct-drive motors used in the Technics range (also manufactured by Matsushita). We understand that these motors will cost around £12. in production quantities, and will be available at the end of this year.

---

## Ceefax, Oracle — now Tifax

---

Texas Instruments announced at a press conference given in May that they have now completed the design of a modular data processor which will decode the Teletext transmissions broadcast by the BBC and IBA. Although no product has yet appeared, samples of the first generation processor will become available later this year, followed by full production in 1976.

What makes the difference in the "Tifax" decoder, from those already designed by such companies as Decca and GEC, is that the Tifax unit is being offered as a p.c.b. module carrying a relatively small number of dedicated l.s.i. circuits.

The projected cost of the "Tifax" module is expected to be around £50, reducing to £10-£15 over a few years. Power consumption is said to be 5W drawn from a regulated +5V  $\pm$ 0.25V supply with a maximum ripple of 10mV pk-pk. Interface to the receiver is by direct connection to the R.G.B. video drive stage from 15V, 20mA current sink open collector outputs. The brightness display can be varied using three integral common base transistors. The video input requires a signal amplitude of 2-3V pk-pk, negative going sync, with an input impedance of typically 10k $\Omega$ .



*New microwave distance measuring equipment, the Tellurometer MRA5, indicates directly in metres and centimetres, operation being either fully automatic or manual at the choice of the operator. Measurement can be accomplished in less than 20 seconds.*

---

## Microwave Conference overwhelmed

---

The organizers of the fifth European Microwave Conference, which takes place September 1-4, 1975, at the Congress Centrum, Hamburg, have announced the list of papers that have been selected by their technical programme Committee and paper review board for this annual event. The response to the conference call for papers has been overwhelming. Over 350 papers from 30 countries were submitted and from those, a total of 112 will be presented at Hamburg. The papers will be grouped into 20 sessions and the morning sessions will be preceded by a total of nine specially invited state-of-the-art survey papers to be given by a number of the world's leading microwave experts. Papers will be presented in English and are limited to 15 minutes duration. A book of abstracts for the conference was published during May. Further information can be obtained from the organizers, Microwave Exhibitions and Publishers Ltd, Temple House, 34-36 High Street, Sevenoaks, Kent TN13 1JG.

---

## TV deliveries down again

---

Deliveries to UK distributors of UK-made and imported colour television receivers reached 139,000 in March, a 26% decrease over March 1974 (188,000), according to the latest statistics compiled by the British Radio Equip-

ment Manufacturers' Association. This brought the year's total to 475,000, a fall of 23% compared with the same period in 1974 (619,000). Total monochrome television deliveries for March were 63,000, a fall of 22% compared with March 1974. BREMA members delivered 65,000 audio stereo systems in the month, a fall of 10% compared with March 1974 (72,000). This brought the year's total to 192,000, comparable with 202,000 for the same period in 1974. Deliveries of radio receivers reached 351,000 for the month, bringing the year's total to 1,032,000, compared with 1,345,000 in 1974, a fall of 23%.

---

## Briefly

---

**IEA plus Electrex.** The International Instruments, Electronics and Automation Exhibition running at Olympia since 1957 and the International Electrical Exhibition (Electrex) organised at Earls Court since 1953 are to be held as a combined event, short title IEA-Electrex, in 1976, at the new National Exhibition Centre, Birmingham.

**VAT late extra.** An itemized list of components on which specific agreement has been reached between HM Customs & Excise and the Electronic Components Board is now available. It is recognized that there may be some individual products to which the application of these definitions is not entirely straightforward. In such cases, an individual ruling will be given by Customs & Excise, the facts being initially reported to the Electronic Components Board.

## Teletext

We plan to publish in the near future a short series of articles on the Teletext television information system, culminating in a design for a decoder for use with domestic receivers. Teletext is a unified version of the BBC's CEEFAX system (*Wireless World*, May 1973, p.222) and the ORACLE system developed by the IBA (July 1973 issue, p.314). Test transmissions were started by the BBC in September 1974 on BBC1, while a group of independent television companies (London Weekend, ITN and Thames) will be starting them in July 1975. The Teletext broadcasting standard was outlined in News of the Month, November 1974 issue.

# Active notch filters

## Design theory behind the development of discrete frequency rejection circuits

by Yishay Nezer, B.Sc.

**We often need to separate a wanted signal from periodic interference. This may happen, for example, when a whistle or a power-line hum is disturbing a radio programme. In simple cases a filter which has zero transmission at one discrete frequency and unity transmission at all other frequencies is sufficient. In contrast to a practical low-pass or high-pass filter, an almost ideal notch filter can be realized with only one section; moreover it can be voltage tuned or even automatically track the interference.**

The major class of notch filters, both passive and active, is of the second order and has the following transfer function:

$$G(s) = \frac{s^2 + \omega_0^2}{s^2 + \frac{\omega_0}{Q_0}s + \omega_0^2} \quad (1)$$

where  $\omega_0$  is the rejection frequency and  $Q_0$  is the figure of merit of the filter, which is given by  $Q_0 = \frac{\omega_0}{\Delta\omega}$  where  $\Delta\omega$  is the rejection bandwidth defined by the 3dB attenuation points. Some typical frequency response curves are plotted in Fig. 1 with  $Q_0$  as the fixed parameter.

Many passive notch networks are known. This article will deal mainly with RC networks, since the use of coils is inconvenient, particularly at low frequencies. The best-known RC notch network is the symmetric twin-tee illustrated in Fig. 2(a), for this network  $\omega_0 = 1/RC$  and  $Q_0 = 1/4$ . The function is, of course, realized only if the network is fed by a voltage source and subjected to an infinite load.

Another well-known notch network is the Wien bridge. This network is characterized by  $\omega_0 = 1/RC$  and  $Q_0 = 1/3$ . The left side of the bridge shown in Fig. 2(b) is composed of equal resistors and capacitors and, in order to obtain an infinite null, the other two resistors must satisfy the relationship  $r_1 = 2r_2$ . The notch response, however, can be achieved even if the corresponding components in the reactive side of the bridge are not equal. The rejection frequency will then be  $\omega_0 = 1/\sqrt{R_1R_2C_1C_2}$  but the ratio  $r_1/r_2$  will no longer equal two. An important special case occurs when  $R_1 = 2R_2$  and  $C_1 = C_2/2$ ; we then have  $r_1 = r_2$ .

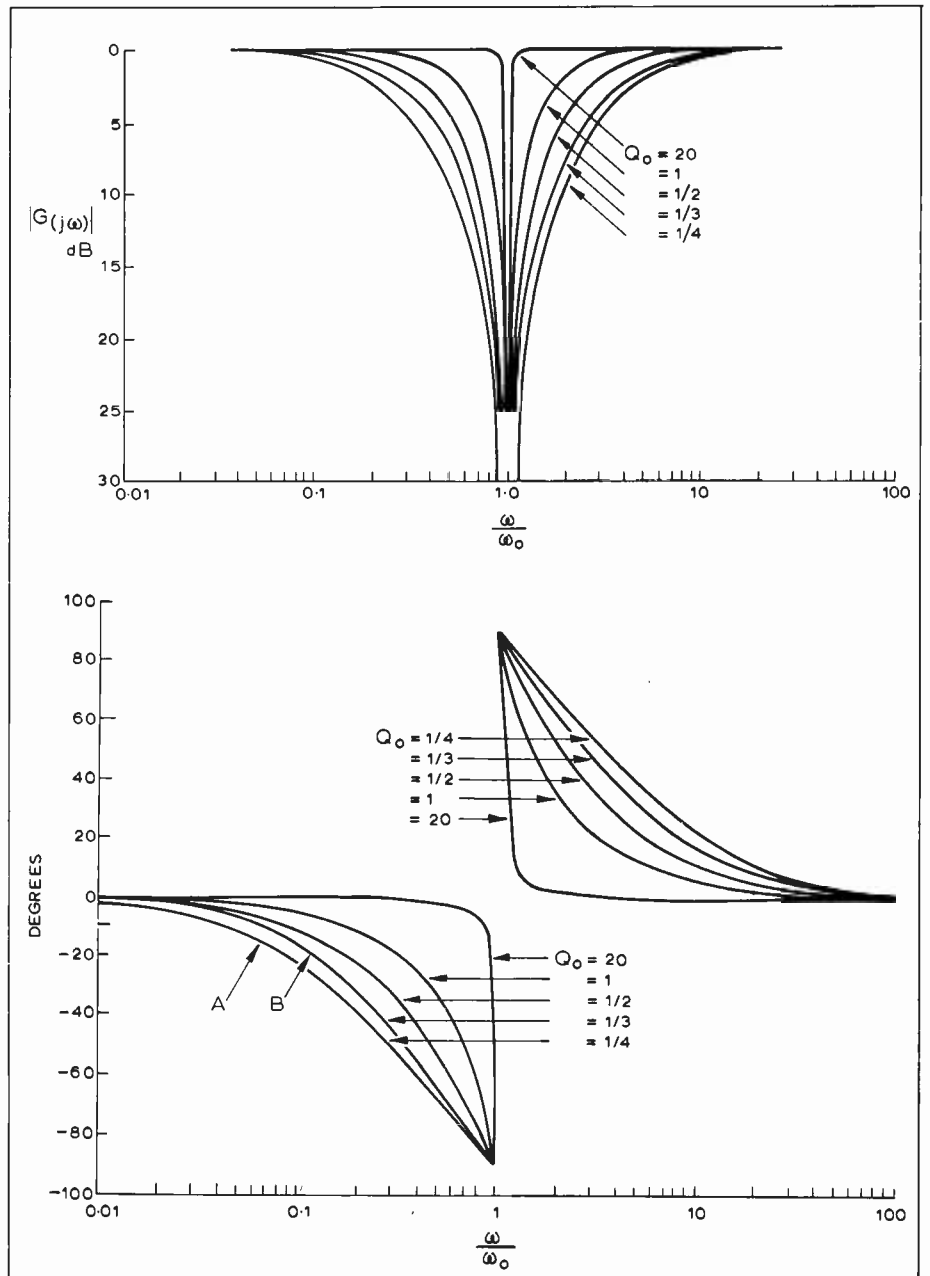

Fig. 1. Normalized phase and magnitude response curves of a notch filter for several values of  $Q_0$ .

A drawback of the above two networks is that in order to vary the centre frequency and still maintain the infinite null, two or three closely matching ganged variable components must be used. Several RC bridge networks are known in which a single component is sufficient to control the rejection frequency. However, their practical significance is limited because the frequency response becomes severely asymmetric as the rejection frequency is varied.

A more acceptable variable network was proposed by Hall<sup>1</sup>. It is shown in Fig. 2(c). This network can be tuned by means of a single potentiometer and the tuning law is  $\omega_0 = 1/RC\sqrt{\alpha(1-\alpha)}$  which in theory spans the whole frequency range. In practice the tuning range is quite limited due to the extreme non-linear dependence of  $\omega_0$  on  $\alpha$ . However, this network has unity gain on both sides of the null frequency, irrespective of the tuning.

However, unlike the twin-tee and the Wien bridge it is asymmetric on a logarithmic frequency scale. This follows from the fact that the transfer function of this network is not given by expression (1) but contains an additional real pole and real zero.

A similar potentiometer tuned null network based on the twin-tee was proposed by Andreyev<sup>2</sup>.

All the networks discussed so far are

characterized by low selectivity. In fact<sup>3</sup>, no passive RC notch network, however complex, is capable of achieving  $Q_0$  higher than 0.9. If the notch filter must be passive, a relatively high  $Q_0$  may be achieved by including an inductance as in the bridged-tee network shown in Fig. 3. In order to achieve a complete null this network must satisfy the two conditions:

$$\begin{aligned} \omega_0^2 &= C_1 + C_2/LC_1C_2 \text{ and} \\ \omega_0^2 &= 1/rRC_1C_2 \end{aligned} \quad (2)$$

The figure of merit will then be  $Q_0 = 2\omega_0L/r$ , i.e. proportional to the quality factor of the coil.

**Active notch filters**

As has been mentioned above, passive RC notch filters suffer from a low selectivity. A theoretically unlimited selectivity can be obtained by the use of active notch filters. These can be built by various active realizations of the transfer function given by expression (1). Simple active circuits are based on passive null networks in which the selectivity is raised by means of negative feedback.

One such scheme is shown in Fig. 4 and the effect of feedback can be explained as follows: When the feedback loop is open the network is simply a passive null network with a passband gain of  $A_0$  represented by curve (a) in Fig. 5. When the feedback loop is closed,

the network tends to maintain a voltage gain of  $A_0/(1 + A_0)$ . However, it fails to do so where the forward gain is low, i.e. in the vicinity of  $\omega_0$ . As a result, the response curve is compressed as shown in curve (b) and the rejection band is narrower. As an additional benefit, the active filter can now be cascaded without being subjected to loading.

The calculated transfer function of the active notch filter is:

$$G(s) = \frac{A_0}{1 + A_0} \cdot \frac{s^2 + \omega_0^2}{s^2 + \omega_0s/(1 + A_0)Q_0 + \omega_0^2} \quad (3)$$

A different realization is shown in Fig. 6 which relies on a single, less-than-unity gain amplifier. It can be seen that there are two feedback paths in the configuration, a positive unity-gain feedback which renders the effective gain of the amplifier equal to  $K/(1-K)$  instead of  $K$ , and a negative feedback which subtracts the output voltage from the input. If  $K/(1-K) = A_0$ , this method is equivalent to the former and the transfer function is:

$$G(s) = \frac{s^2 + \omega_0^2}{s^2 + \omega_0s(1-K)/Q_0 + \omega_0^2} \quad (4)$$

in which the selectivity is multiplied by  $1/(1-K)$ .

**Practical circuits**

The simplest amplifier for the above method is the emitter follower. How-

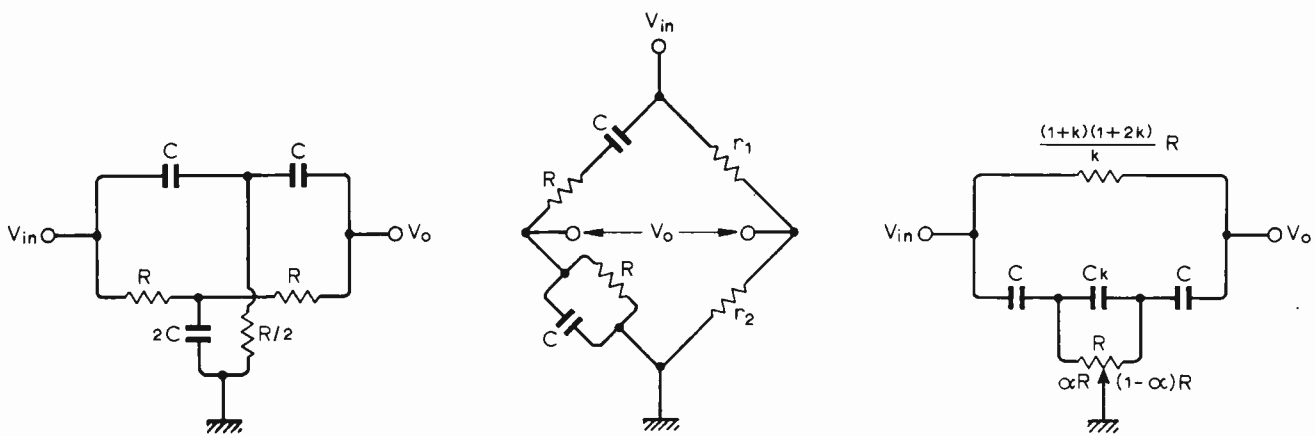

Fig. 2. Three RC null networks: (a) the symmetric twin-tee, (b) the Wien bridge, (c) a potentiometer-tuned network.

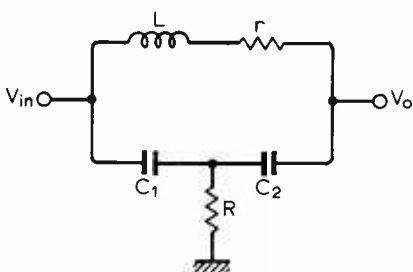

Fig. 3. Bridge-tee RCL null network, the selectivity of which depends on the Q factor of the coil.

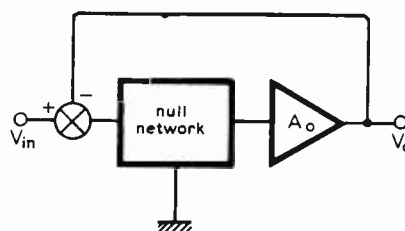

Fig. 4. Basic active configuration for enhancing the selectivity of passive notch filters.

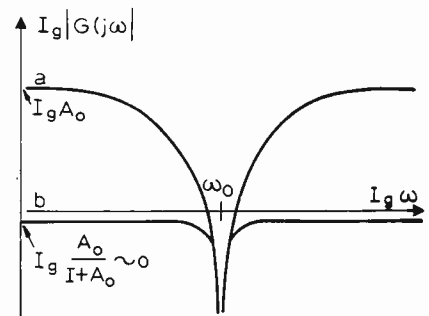

Fig. 5. Frequency characteristics of the network in Fig. 4 (a) open loop, (b) closed loop.

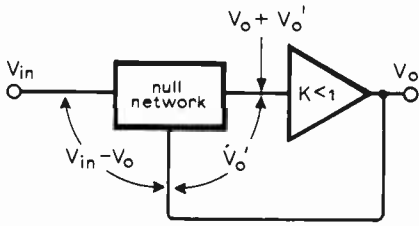

Fig. 6. Practical configuration for enhancing the selectivity of a passive notch network with a single voltage amplifier having a gain of less than unity.

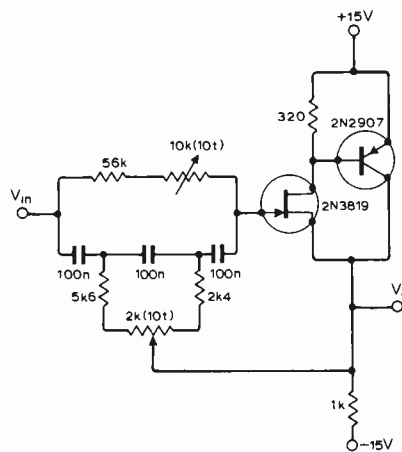
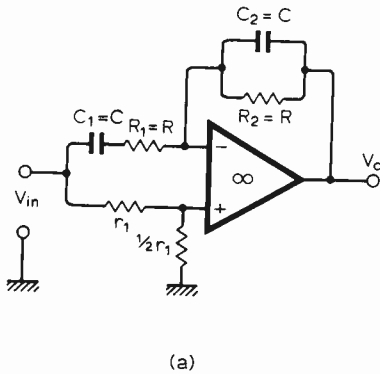
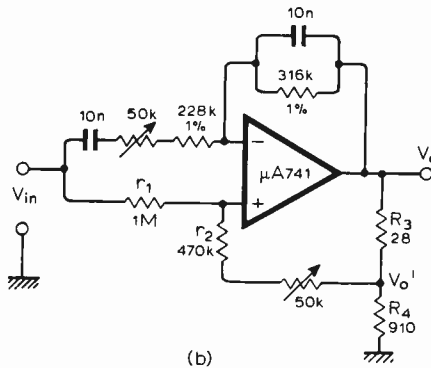

Fig. 7. Simple potentiometer-tuned active notch filter based on the network in Fig. 2(c). Tuning range  $200 \pm 10\text{Hz}$ ; rejection bandwidth  $10\text{Hz}$  (3dB).



(a)



(b)

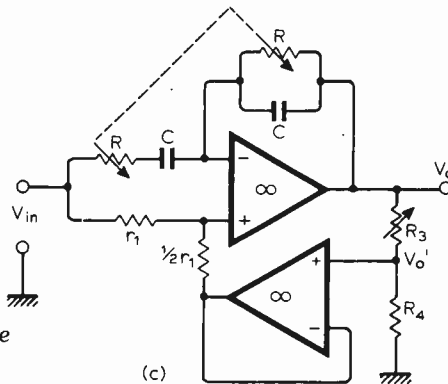

(c)

Fig. 8. (a) Wien bridge converted to a three-terminal network; (b) 50Hz active notch filter; (c) variable rejection frequency and bandwidth Wien-bridge active notch filter.

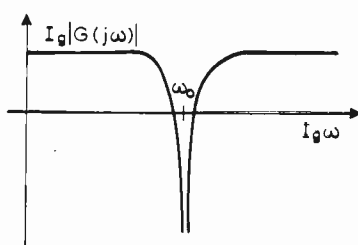

Fig. 9. Wider rejection bandwidth is attained by cascading two notch filters.

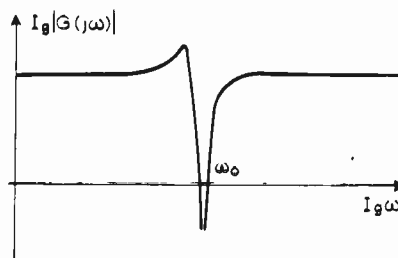

Fig. 10. Asymmetry in the frequency response curve of high Q notch filter as a result of excessive phase shift in the amplifier.

ever, it is not very suitable because in order to prevent the null network from being loaded by the relatively low-input impedance, the resistors must be relatively low and the capacitors must be correspondingly large.

It is obviously possible to replace the transistor by an f.e.t. and use smaller capacitors, but the increase in the selectivity would be limited due to the smaller gain usually associated with the f.e.t. The bootstrapped source follower benefits from high-input impedance and also a gain closer to unity and is shown in Fig. 7 together with the network of Fig. 2(c).

The networks discussed above have ideally an infinite attenuation at the notch frequency. Practically, the attenuation is limited by the tolerances of the components and is typically 40dB for 1% tolerance. This figure may be exceeded by trimming and is ultimately limited by stray capacitance.

The Wien bridge is attractive owing to its simplicity. However, it is not a three-terminal network, and cannot be activated directly.

The circuit in Fig. 8(a) is a Wien bridge built around an operational amplifier. In spite of being active, the factor of merit is only  $\frac{1}{2}$  instead of  $\frac{1}{3}$  in the passive bridge (it does not belong to either of the schemes shown in Figs. 4 and 6) yet, being a three-terminal network, its selectivity can be improved as shown in Fig. 6. Since the output impedance is already zero an additional buffer amplifier is unnecessary, so that we only have to decrease the gain to below unity by a voltage divider and close the feedback loop at  $r_2$ . The network Fig. 8(b) then contains an equivalent amplifier whose gain and output impedance are:

$K = R_4 / (R_3 + R_4)$  and  $R_3 \parallel R_4$  respectively. Accordingly, the latter value must be subtracted from  $r_2$  or must be much smaller. Alternatively the voltage divider can be buffered as in Fig. 8(c).

If we use  $V_o$  as the output of the filter instead of  $V_o'$ , an advantage results with respect to the network of Fig. 6, in that the passband gain is unity instead of  $K$ . However, as the internal amplifier's gain is  $K = R_4 / R_3 \times R_4$ , the factor of merit will be

$$Q = Q_0 / (1 - K) = (1 + R_4 / R_3) / 2 \quad (5)$$

and the rejection bandwidth can be varied by means of either  $R_3$  or  $R_4$ . The null frequency can be varied, for example, by  $R_1$  and the notch depth can then be adjusted by means of  $r_2$ .

If it is desired to vary the rejection frequency over a wide range, it is best to vary simultaneously resistors  $R_1$  and  $R_2$ . If the tracking is good, the null will be maintained throughout the tuning range without further adjustments.

### High Q notch filters

At a frequency  $\omega = \omega_0(1 \pm \epsilon)$  close to the resonant frequency, that is  $\epsilon \ll 1/2Q$ , the response of a notch filter can be approximated by two



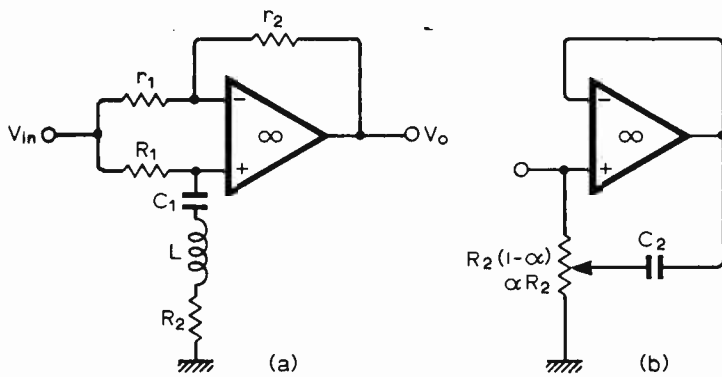
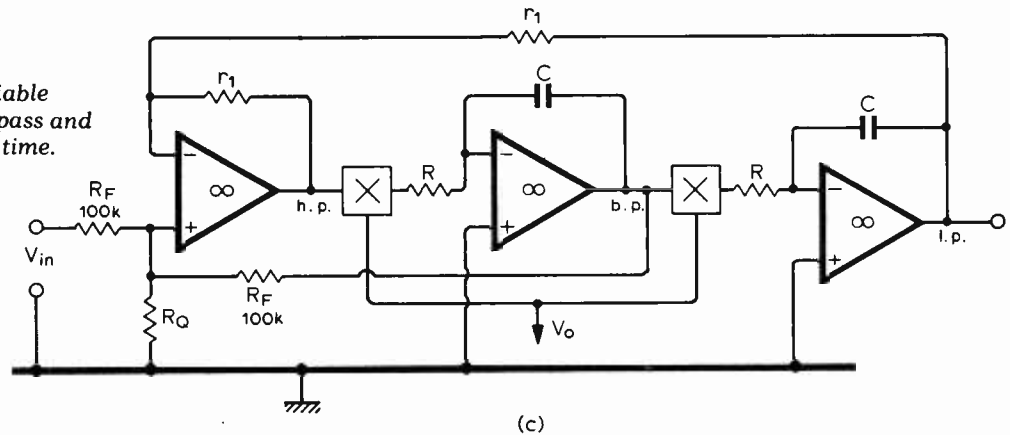

Fig. 11. (a) An active RCL notch filter; (b) a potentiometer-controlled simulated grounded coil.

Fig. 12. Programmed state variable filter provides low-pass, band-pass and high-pass outputs at the same time.



straight lines with slopes  $\pm 2Q$ , and the filter can be used as a frequency discriminator. If  $Q$  is large, very small frequency deviations can be observed. On the other hand, if a high  $Q$  notch filter is used to reject a power-line hum, for example, a slight deviation of the frequency from its nominal value will suffice to render the attenuation excessively low. In this case a filter with an infinite attenuation over a band of frequencies would be desirable. However, such a filter cannot be realized. It is then possible either to lower the  $Q$  of the filter or to stagger-tune two or more filters in cascade and obtain a frequency response as in Fig. 9. A more elaborate solution is to use an interference tracking notch filter as suggested in the last paragraph.

When dealing with high  $Q$  notch filters, the increasing sensitivity of the notch symmetry and depth to the tolerance of the passive components becomes a serious problem. A practical solution is to use stable capacitors and trim resistors for the required notch frequency and depth. It has been seen that the most suitable network from this standpoint is the Wien bridge, but for ultimate stability the state variable filter (see below) is required owing to its extreme stability.

Another problem in realizing high  $Q$  notch filters is the roll-off in the open loop gain of operational amplifiers at high frequencies. It is found that there is a limitation on the maximum possible  $Q$  which is inversely proportional to the rejection frequency. This limitation may cause asymmetric frequency

response (Fig. 10), even if the values of the passive components are accurate. With the increase in  $Q$ , the size of the "the hump" increases to the appearance of oscillations. If the notch frequency is preset this can be rectified by adding an RC phase leading section at the input of the amplifier of Fig. 6 and experimentally adjusting the time constant. If the notch frequency must be variable, the only remedy is to use a wide bandwidth amplifier. However, at fairly high frequencies high  $Q$  inductors are available, and a passive filter such as the one in Fig. 3 may be preferable.

**Simulated inductance**

The circuit of Fig. 11(a) is an active bridge similar to that shown in Fig. 8(a), but has a series resonant circuit in one of its arms. If  $R_1/R_2 = r_1/r_2$ , the circuit will behave as a notch filter whose rejection frequency and factor of merit are

$$\omega_0 = 1/\sqrt{LC_1} \text{ and } Q_0 = \omega_0 L/R_2 \quad (6)$$

In order to avoid using an inductance, the series connection of  $R_2$  and  $L$  can be replaced by the circuit of Fig. 11(b)<sup>4</sup> which is equivalent to a coil whose value is  $L = C_2 R_2 \alpha(1-\alpha)$  in series with a resistor  $R_2$ . The resulting notch filter has a rejection frequency and factor of merit given by:

$$\omega_0 = 1/\sqrt{C_1 C_2 R_2^2 \alpha(1-\alpha)} \text{ and } Q_0 = \alpha(1-\alpha) \sqrt{C_2/C_1} \quad (7)$$

respectively; the tuning law is thus exactly the same as that of Fig. 2(c).

This network can also be tuned by means of  $C_1$ , which may consist of a small trimming capacitor if the simulated inductance is made appropriately large.

**State variable filters**

A unique active notch filter may be realized by the so-called state variable method<sup>5</sup>. This method is based on a multiple feedback network containing integrators and adders. In spite of the rather large number of operational amplifiers, the number of capacitors needed for the realization of any arbitrary transfer function is minimal.

The basic building block shown in Fig. 12 simultaneously provides three transfer functions of the second order; these are high-pass, band-pass and low-pass function, given by:

$$V_H(s) = Ks^2/(s^2 + (\omega_0/Q_0)s + \omega_0^2) \quad (8)$$

$$V_B(s) = K \frac{-\frac{1}{\tau_1} s}{s^2 + \frac{\omega_0}{Q_0} s + \omega_0^2}$$

$$V_L(s) = K \frac{\omega_0^2}{s^2 + \frac{\omega_0}{Q_0} s + \omega_0^2}$$

The resonant frequency  $\omega_0$  is determined by the time constants  $\tau_1, \tau_2$  of the integrators, and is given by  $\omega_0 = 1/\sqrt{\tau_1 \tau_2}$ . The factor of merit is  $Q_0 = 1/K \sqrt{\tau_2/\tau_1}$  where  $K = 1/(1 + R_F/2R_Q)$ .

This configuration does not provide complex zeros and in order to obtain

the symmetric notch response given by expression (1) we must sum the high-pass and low-pass outputs. The filter obtained contains four operational amplifiers but has the following characteristics: if  $\tau_2$  varies, the rejection frequency is varied while the bandwidth  $\Delta\omega = \omega_0/Q_0$  remains unchanged; if  $\tau_1$  and  $\tau_2$  vary simultaneously, the rejection frequency varies linearly while the factor of merit  $Q_0$  remains unchanged; if  $K$  is varied with the aid of the resistor  $R_Q$ , the rejection frequency remains unchanged and the rejection bandwidth and gain alone will change; the network is quite insensitive both to the values of the passive components and to the gain of the amplifier. Its stability approaches that of passive filters.

The transfer function of a conventional integrator is:  $G(s) = 1/\tau s = 1/RCs$  and the variation of  $\tau$  can be obtained by varying  $R$  or  $C$ . If we connect an amplifier with a gain  $K$  in series with the integrator, the transfer function changes to  $G(s) = K/\tau s$ ; i.e.,  $\tau$  is decreased without altering  $R$  or  $C$ . If an analogue multiplier is substituted for the amplifier, an integrator is obtained, in which the time constant  $\tau$  is dependent on a control voltage. A notch filter with a constant  $Q$  and rejection frequency directly proportional to the control voltage can thus be built from two such integrators.

It has already been mentioned that the maximum  $Q$  factor which can be obtained in an active filter realization is limited – for a given resonant frequency – by the bandwidth of the operational amplifier. The state variable method is no exception to this rule. Design considerations resulting from these limitations were discussed by Thomas<sup>6</sup>.

**Bandpass filter synthesis**

A common disadvantage which is probably shared by all accepted active bandpass realizations is that the bandwidth is inversely proportional to the midband gain; in other words an increase of  $Q$  is accompanied by a proportional rise in gain, which is often undesirable.

A different realization of bandpass filter is given in Fig. 13(a) based on the equation:

$$A\left(1 - \frac{s^2 + \omega_0^2}{s^2 + \frac{\omega_0}{Q}s + \omega_0^2}\right) = A \frac{(s/Q)\omega_0}{s^2 + \frac{\omega_0}{Q}s + \omega_0^2} \tag{9}$$

which results in a bandpass transfer function whose midband gain is independent of  $Q$ . The configuration operates as follows: at frequencies which are remote from  $\bar{\omega}_0$  the notch filter transmission is unity, and the input to the differential amplifier is zero. At frequency  $\omega_0$  the notch filter transmission is zero and the input to the amplifier is unity. As equation (9) shows, the resulting bandpass filter has the same  $Q$  as the notch filter. Now it is easy to realize notch filters in which the

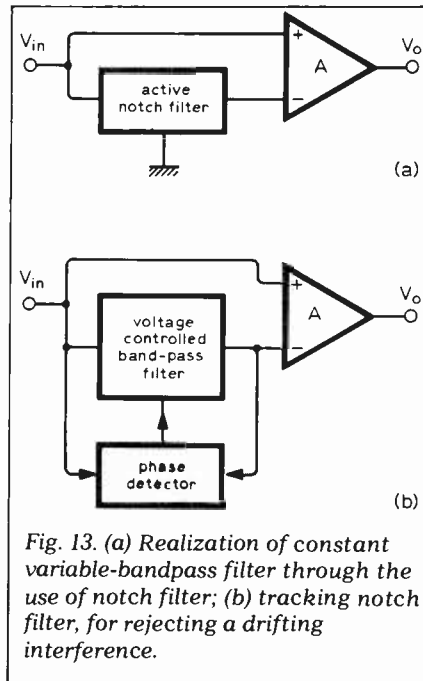

Fig. 13. (a) Realization of constant variable-bandpass filter through the use of notch filter; (b) tracking notch filter, for rejecting a drifting interference.

selectivity is controlled by a single resistor, such as the one shown in Fig. 8. If such a filter is incorporated, a constant-gain variable bandpass filter is obtained.

**Interference-tracking notch filter**

It has been previously mentioned that a sufficiently narrow-band notch filter may not be effective in rejecting interference which drifts in frequency. Such interference could in principle be tracked by a phase-locked loop, and the output of the loop, which is proportional to the frequency, then applied to a voltage-controlled notch filter. A drawback of such a method is that it is an open-loop system and any residual interference at the output due to imperfect tracking is not corrected for.

In contrast to the phase-locked loop, which is a signal-tracking oscillator, a signal-tracking band-pass filter can be easily built<sup>7</sup>. It is similar to the phase-locked loop and consists of a voltage-controlled band-pass filter, a phase detector and a low-pass filter. The closed loop then centres the band-pass filter on the signal by maintaining an (ideally) zero phase shift between the interference and the output of the filter. This bandpass filter can be converted to a signal-tracking notch filter as shown in Fig. 13(b), in which the filtered interference is subtracted from the original input. However, unlike conventional notch filters, the input to this filter must contain a minimum of interference for locking to occur.

**References**

1. Hall, Henry P., "RC networks with single-component frequency control," *IRE Transactions-Circuit Theory*, Vol. CT-2, No. 3, Sept. 1955, pp. 283-288.
2. Andreyev, *Telecommunications*, No. 2 (Pergamon Press Translations), 1960, p. 195.
3. Ramachandan, V., "High Selectivity Passive Resistance-Capacitance Null

- Networks." *Proc. IEEE*, July 1968, pp. 1237-1238.
4. Harris, R. J., "The Design of Operational Amplifier Notch Filters," *Proc. IEEE*, October 1968, pp. 1722-1723.
5. Kerwin, W. J., and others, "State Variable Synthesis for Insensitive Circuit Transfer Functions," *IEEE Journal of Solid State Circuits*, Vol. SC-2, September 1967, pp. 87-92.
6. Thomas, Lee C., "The Riquad: Part 1 – Some Practical Design Considerations," *IEEE Transactions – Circuit Theory*, Vol. CT-18, No. 3, May 1971, pp. 350-357.
7. Gordon, J. and others, "Automatically Tuned Filter uses IC Operational Amplifier," *Electronic Design News*, February 1972, pp. 38-41.

**Books Received**

**Dictionary of Data Processing** by Jeff Maynard is designed mainly as a source of reference for those interested in, or using computers and data processing equipment. Over 4000 terms are defined, as well as acronyms and abbreviations, in alphabetical order. The final section of the book lists British and American standards relating to data processing. Price £3.90. Pp.269. Butterworth & Co. Ltd, Borough Green, Sevenoaks, Kent TN15 8PH.

**Energy and Humanity** edited by M. W. Thring and R. J. Crookes, as a former US Secretary of Commerce has pointed out, a finite world with finite energy resources cannot support an exponential growth rate. This book presents the problem as it exists now, with a view to what might be the situation at the turn of the century. An attempt has been made to cover the existing sources of energy along with their associated problems and to assess what might become available in the future. Much of the material has been drawn from an international conference on energy and humanity, held by the SSRS in September 1972. Price £5.50. Pp.195. Peter Peregrinus Ltd, P.O. Box 8, Southgate House, Stevenage, Herts SG1 1HQ.

Recent, updated additions to the **D.A.T.A.** books range cover discontinued thyristors, m.s.i.-l.s.i. memories, diodes, linear i.c.s., microwave tubes, digital integrated circuits, and thyristors. As usual these books provide information on components from most of the producers in the world. Outline diagrams are provided together with pin configurations, and an index of manufacturers is also incorporated making these volumes an invaluable source of information. London Information Ltd, Index House, Ascot, Berks SL5 7EU.

**The International VHF-FM Guide** by Julian Baldwin and Kris Partridge. This booklet is a useful source of information for the radio amateur who wishes to operate through the VHF repeater networks both at home and abroad. Price 25p + 5p postage and packing. Pp. 38. J. E. C. Baldwin, 50 Aldbourne Road, Burnham, Slough, SL1 7NJ.

# Letters to the Editor

## "HIGH QUALITY F.M. TUNER"

I was most interested to see that the position of the ceramic filter in Mr J. B. Dance's f.m. tuner (March issue) was after the limiting amplifier. Surely if the filter is to aid tuner selectivity then it must be placed before those parts of the tuner which have non-linear transfer characteristics, i.e. before the limiting amplifier.

Assuming that the input signal level is sufficient to cause limiting (as it should be for any usable signal) then any spurious signal components emerging from the r.f. unit outside the desired i.f. bandwidth will be subjected to intermodulation by the limiting process. Any intermodulation products which appear within the i.f. bandwidth will not be removed by subsequent filtering, but will affect the audio output. Consider, for example the case where one is trying to receive a weak signal in the presence of strong signals in adjacent channels. The output of the r.f. section may contain levels of the adjacent channels of similar or greater amplitude than that of the required signal. In this design the limiter may act on these adjacent channel signals so that these subsequently affect the audio output. Placing the i.f. selectivity before limiting will reduce the levels of unwanted signals entering the limiter, and reduce audible effects due to them.

Intermodulation in the limiter may explain the poor performance observed by the author on an r.f. unit with a high level of local oscillator output.

Note that some filtering after the limiter may be necessary to avoid harmonics of the 10.7MHz i.f. signal affecting the operation of the second mixer.

J. E. Marshall,  
Bilborough,  
Nottingham.

*Mr Dance replies:*

I am grateful to Mr Marshall for raising an important point. The NE563 limiter has a bandwidth of 22MHz (typical) and a gain of 60dB. The filter placed between the limiter output and the mixer will

reject any noise which lies outside the required passband and will also attenuate any harmonics generated in the limiter.

If one wishes to have a tuner which provides optimum reception of weak signals in a crowded band, then additional filtering is required before the limiter. However, the front-end specified in my article contains a double tuned 10.7MHz circuit before the emitter follower output stage and I felt that the overall selectivity was adequate for normal domestic reception.

I did experiment with an additional FM-4 filter between the front-end and the limiter input. This involved the use of a matching resistor (270 ohm) between the front-end and the filter and a 330 ohm resistor on the output side of the filter. An active circuit is required between the filter output and the limiter, since the input impedance of the latter is quoted as 135 ohms. An active circuit providing gain will also improve the a.m. rejection. However, it seemed that the published circuit was satisfactory for domestic reception and I felt its simplicity would appeal to many readers.

With reference to Mr Marshall's penultimate paragraph, I did try an extra FM-4 filter with the front-end which gave unsatisfactory results, but I still did not obtain audio output of satisfactory quality.

Dr A. Tip of FOM-Instituut Voor Atoom-En Molecuulfysica, Amsterdam, has kindly sent me details of his unpublished work with a more complex system which he uses to receive many UK transmissions. Unfortunately only a few brief details can be mentioned here. Dr Tip employs a BFY90 amplifier by his aerial, and a Valvo FD1A front-end which feeds a 3028A variable gain cascode stage. Four ceramic filters are used, followed by a LM733 stage (set for a gain of 100); the latter feeds the NE563 limiter. The a.g.c. output from the NE563 is fed to a transistor amplifier which provides a.g.c. for the 3028A stage; the amplified a.g.c. also feeds a signal strength meter which is unaffected by the setting of the 563 muting circuit.

In conclusion, may I mention that the NE563 masks are being modified in California? The new NE563 devices will have a different oscillator impedance and should operate more reliably with the Taiyo CR-9.8 ceramic resonators mentioned in my article; the parallel 2.2kilohm resistor and 5pF capacitor should not be required with the new NE 563. In addition, Signetics expect the new device will produce an output with less distortion, but no figures are available at the time of writing. In their current data Signetics suggest a value of 5.1 kilohm for  $R_6$  of my Fig. 1; this will give a slightly improved signal-to-noise ratio and a reduced bandwidth, but the difference is not very noticeable.

J. B. Dance,  
Alcester, Warwickshire.

## SILENT STEREO SWITCH

Mr Moulana's article in the January 1975 issue, involving the use of f.e.t.s for audio switching, prompts me to raise a couple of points:

(1) Using a switching f.e.t at the virtual earth point of an inverting amplifier in series with the input arm (as shown in Fig. 1) ensures low voltage swings at the

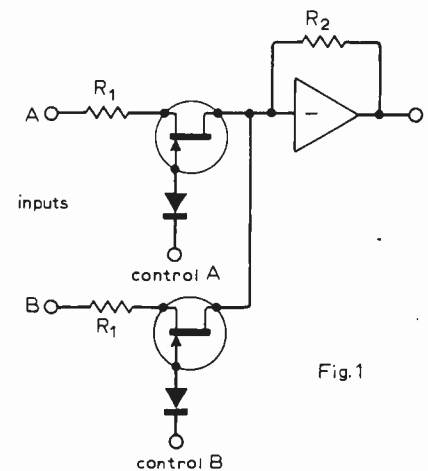

Fig. 1

f.e.t. and takes care of biasing. This configuration is often used in audio equipment.

(2) It seems reasonable that an f.e.t. with a low value of  $r_{ds(on)}$  should have a variation in this resistance with  $v_{ds}$  that is also of a low order (in absolute, if not proportional terms). Thus if an f.e.t. such as a TIS73L (Texas) is chosen, which has an  $r_{ds(on)}$  of 25 ohms maximum, we can see that the variation in  $r_{ds(on)}$  can be quite small.

Suppose that in the circuit of Fig. 1 we use the TIS73L, and make  $R_1 = R_2$  (for unity gain) = 10k $\Omega$ , then a variation in  $r_{ds(on)}$  of 20% (5 ohms) due to changing  $v_{ds}$  will give a rise to a distortion of approximately  $5/10^4$ , or 0.05%. Attenuation of the input signal by 20dB, and making  $R_2 = 100k\Omega$  will obviously improve the distortion performance while retaining unity gain. Pinch-off voltage for the TIS73L is a maximum of -11 volts, therefore control voltages in the off mode should be at least -12 volts. Choice of input arm resistance can

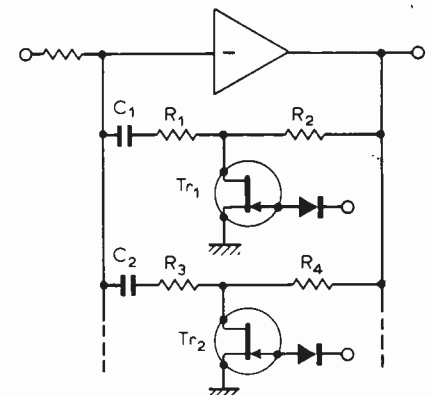

Fig. 2

optimize on/off ratio on the one hand, distortion and input impedance on the other.

As a postscript, a useful configuration when, for example, equalizations are to be switched, is shown in Fig. 2. In this circuit, using low impedance termination of the feedback networks at both ends, the required equalization time constant,  $(R_1 + R_2)C_1$  or  $(R_3 + R_4)C_2$  in Fig. 2, is selected by turning the f.e.t ( $Tr_1$  or  $Tr_2$  respectively) off, and all others on. Thus all feedback paths except that required are shunted to ground. If  $R_1, 2, 3, 4$  are of the order of  $100k\Omega$  and  $Tr_1$  and  $Tr_2$  are TIS73L, attenuation of the unwanted f.b. is  $(25 + 100k)/25$ , greater than 70dB. Distortion is low because the selected f.b. path uses an f.e.t. in the "off" mode, and contributions from f.e.t.s in the "on" mode are at very low level.

S. F. Bywaters,  
London, N.W.11.

## COMPUTER POWER

It is your privilege as editor to don the mantle of Cassandra from time to time; and we may have cause to be grateful to you for warning us (leader, May issue) of the latent threat of computer power.

Readers of your editorial may however care to join me as I hasten to bury my head in the sand. Or, as it might be, paper; since waste paper is the most obvious product of today's computers. What can be discovered in this mountain of paper is that a computer with remote terminal and interactive conversational language can take all the arithmetical grind out of hitherto laborious calculations in radio and electronics. And this generally involves only a minimal knowledge of computer programming - rather less, I suspect, than is currently mastered by schoolchildren. Indeed, readers who have no direct access to such computing facilities might well bribe sons and daughters to compute for them.

There is of course an additional bonus in speed and accuracy. For example, given the radio frequency range required together with the intermediate frequency, one can calculate component values for superheterodyne tracking to an accuracy much higher than the tolerances of actual components in less than five minutes. A similar time is required to plot the actual tracking error curve. If one then requires information on where the tracking curve moves to at the limits of specified component tolerances, another five minutes will suffice. Most of this total of fifteen minutes is spent by the system in organising itself and in printing - actual computing time may be only two or three minutes.

The story is very similar if one wishes to perform calculations on coupled tuned circuits - the complex arithmetic takes much less time than printing the

(unnecessarily accurate) results.

Any reader who has problems with tedious calculations of this kind is welcome to contact me.

D. P. C. Thackeray,  
Department of Chemical Physics  
University of Surrey,  
Guildford, Surrey.

## ELECTRODYNAMICALLY INDUCED E.M.F.

"Cathode Ray's" article and Mr Meade's letter (February issue) have prompted some questions concerning a well known problem in school-boy physics:

"If an aeroplane flies a level course through a known vertical component of the earth's magnetic field, then its wings act as a flux cutting conductor and an e.m.f. is induced in them. Can this e.m.f. be measured and, hence, the speed of the aircraft deduced?"

The answer is, of course, no, because as "Cathode Ray" stated, connecting a voltmeter to the ends of the conductor (in this case the wings) would form a closed loop embracing a constant magnetic flux.

Not being well versed in the theory of electromagnetic induction, we would like to ask the following questions:

"Can the induced e.m.f. be measured if the meter leads are screened with a high permeability material?" and, naturally, "If not, why not?"

D. C. E. Todd and  
N. G. S. Taylor,  
Brunel University,  
London.

## DIRECTORY OF AUDIO COURSES

The Audio Engineering Society is preparing a Directory of educational facilities and institutions in its field of interest, which embraces sound recording and reproduction, instrumentation, sound reinforcement etc. This information will appear in the *Journal* of the AES and be included in a career booklet eventually to be prepared by the Society.

As the UK representative of the AES Education Committee, I have been asked to act as a focal point for the collection of such information from schools, colleges and universities in the British Isles.

To simplify the listings, I can supply copies of a short questionnaire and I would urge all organisers of courses related to audio engineering to apply to me for copies as soon as possible.

John Borwick,  
Senior Lecturer,  
Recording Techniques  
University of Surrey,  
Guildford,  
Surrey.

## INSTRUMENT READ-OUT IN BRAILLE?

I have recently become interested in the problems of teaching science to blind pupils. Present techniques offer analogue derived information in tactile or audible form. For example in typical science experiments one might wish to indicate the height of a liquid column or the reading of a meter. The liquid level would be located by a light probe whose audio tone would alter on discovering the surface; the meter pointer would be located either by the light probe or feeling the pointer in an instrument made specially for the blind. The actual reading is then taken from an adjacent Braille scale.

Of necessity these procedures are slow, clumsy and very approximate. It occurs to me that in the case of meter readings digital techniques could be exploited with considerable advantage. Many readouts are available in digital form - voltmeters, ammeters, frequency meters, multimeters, balances, calculators - and in many cases the electronics involves binary processing of numbers which in b.c.d. form is decoded for a visual readout such as a seven-segment device. Could not the b.c.d. be decoded direct to Braille format and used to operate a tactile display? It should be possible to devise an electromechanical Braille readout as only four pins are required as shown in the diagram. My guess, based on no direct experience, is that blind pupils would find the reading of electrical quantities more direct and so more meaningful. In the case of balances the accuracy of the weighing would certainly help science teaching. If it proved possible to use this idea with electronic calculator chips, perhaps a new era in teaching maths to the blind might follow also.

Recent progress in artificial vision, reported in your April issue, raises an even more powerful possibility, namely direct excitation of the optic nerve with numerical data. Whether this should be b.c.d., seven-segment, Braille, or some other format is a matter for speculation. Braille has already been used successfully (WW, April p.157) for text by this means.

J. M. Osborne,  
London, SE5.

	b.c.d.	denoted by Braille letter	A B D C	a binary equivalent of Braille
0	0000	J		0111
1	0001	A		1000
2	0010	B		1001
3	0011	C		1100
4	0100	D		1110
5	0101	E		1010
6	0110	F		1101
7	0111	G		1111
8	1000	H		1011
9	1001	I		0101

Binary coded decimal compared with numbers in Braille.

# Wireless World Dolby noise reducer

## 3 — Kit alignment and calibration

by Geoffrey Shorter

**Intended mainly for hiss reduction in magnetic-tape recording machines, this noise reduction unit can be switched to decode commercially-available Dolby B-encoded cassette tapes, Dolby B-encoded f.m. radio transmissions (current in the USA), or to encode blank tapes from any source. As an alternative it can be used in trading some of the noise improvement for reduced distortion at peak recorded levels. Part 1 in the May issue gave background to the Dolby system and part 2 gave circuit and constructional details together with some suggestions for circuit options and alignment procedure. This part shows how to set-up the kit version design without using additional equipment and gives calibration procedure.**

Constructors who build a Dolby-B processor without using the full WW kit have the option of using the power supply included in the circuit of Fig. 12 or of using an alternative one, for instance one built into existing equipment. Component values for the circuit of Fig. 12 have been optimized to provide an overload margin of 16dB (equivalent to 1200nWb/m on open-reel) for a 15-volt supply, but voltages between 15 and 24 volts could be used provided component voltage ratings are chosen appropriately. The main requirement is that supply ripple be less than 200 $\mu$ V r.m.s. Current consumption at 15 volts is 20mA per processor; with IC<sub>1</sub> and IC<sub>2</sub> it is 30mA. The voltage regulator IC<sub>2</sub>, whose output is 15 volts  $\pm$  5%, is essential if the meter calibration oscillator of Fig. 14 is used. Input to the regulator should be not greater than 25V and not less than 18.25V.

### Kit setting-up procedure

The procedure for setting up the kit design is a little more elaborate than the basic alignment instructions because it is designed to eliminate necessity for additional equipment i.e. a.c. millivoltmeter and variable-frequency a.f. oscillator. It therefore includes a facility for generating a 5kHz circuit alignment tone, as well as a 400Hz calibration tone. Two meter amplifiers, and a 580mV source (1kHz oscillator) to calibrate the meters, are included to obviate the need for an a.c. millivoltmeter.

In using the in-built meter scale in setting up, it is better to use close-tolerance resistors in an attenuator so that all measurements can be made at one meter reading (0dB). Errors in meter reading are minimized by this tech-

nique, and errors due to an inaccurate scale eliminated.

### Right-channel meter calibration

The unit is aligned using part of IC<sub>1</sub> as a meter calibration oscillator. The amplifier section of IC<sub>1</sub> based on pins 10, 11 and 12 is first used as shown in Fig. 14. In this mode the amplifier is wired as an astable multivibrator switching between the 15V supply rail and 0V, with a mark-to-space ratio of about 1:1 and a frequency of around 1kHz. The real voltage swing is a little less due to saturation voltages, but is highly repeatable from one sample to another.

### Typical performance

Noise reduction: better than 9dB weighted

Clipping level: 16.5dB above Dolby level (measured at 1% third harmonic content)

Harmonic distortion: 0.1% at Dolby level (typically 0.05% over most of band, rising to a maximum of 0.12%)

Signal-to-noise ratio: 66dB (20Hz to 20kHz, signal at Dolby level)

Approximate voltage readings (AVO 8)

	collector	emitter
Tr <sub>1</sub>	9.0	0.6
Tr <sub>2</sub>	14.3	1.5
Tr <sub>3</sub>	7.6	rail
Tr <sub>5</sub>	rail	7.6
Tr <sub>6</sub>	—	8.8
Tr <sub>7</sub>	8.4	rail
Tr <sub>8</sub>	8.0	2.6
IC <sub>1</sub>	pin 4	6.8V
	pin 5	7.7V

—Connect resistor R<sub>59</sub> (3.9M $\Omega$ ) from the pin at R<sub>51</sub> to pin 2 or the L<sub>2</sub>' position.

—Wire R<sub>58</sub> (10k $\Omega$ ) in parallel with R<sub>47</sub> (1M $\Omega$ ) across the pins at R<sub>47</sub> position.

—Form an attenuator with R<sub>60</sub> (110k $\Omega$  2%) and R<sub>61</sub> (10k $\Omega$  2%) in series, Fig. 14, earthing the end of R<sub>61</sub> by connecting to pin 3 of L<sub>2</sub>' and connecting R<sub>60</sub> to pin 1.

—Solder one end each of R<sub>55</sub> (330k $\Omega$  2%) and R<sub>155</sub> (330k $\Omega$ ) to their pins. Take the other end of R<sub>55</sub> to the junction of R<sub>60</sub>, R<sub>61</sub> (R<sub>155</sub> remaining floating). Switch on.

—Adjust RV<sub>8</sub> (Fig. 15) until the r.h. meter reads 0dB. Switch off.

—Remove R<sub>55</sub>, R<sub>58</sub>, R<sub>59</sub>, R<sub>60</sub>, R<sub>61</sub> and do not alter the setting of RV<sub>8</sub>.

### Circuit alignment

The now-calibrated r.h. meter is used to set the gain and f.e.t. bias controls of both left and right processors with the help of a 5-kHz oscillator, Fig. 14, adapted from the 1-kHz oscillator circuit by using arrangement (b).

—Solder C<sub>30</sub> in position, removing and replacing the p.c.b.

—Solder L<sub>2</sub> on to pins 1 and 2 of the L<sub>2</sub>' position. Gently screw in the core.

### Right-channel circuit alignment.

—Connect R<sub>61</sub> (10k $\Omega$  2%) between the R<sub>55</sub> pin and test point 1 (TP1) on the sub-board.

—wire the oscillator pin, marked "osc." to the sub-board pin marked R' (input to processor).

—Set RV<sub>5</sub> (oscillator level) fully anticlockwise. Check that no plugs are connected into the sockets.



- Set  $RV_{2,102}$  fully anticlockwise. Switch on.
- Select the auxiliary position for  $Sw_2$ . Set the balance control  $RV_9$  to mid-position and the input level control  $RV_{10}$  fully clockwise.
- Ensure the calibration tone switch  $Sw_3$ , the noise reduce switch  $Sw_4$ , and the 19-kHz filter switch  $Sw_6$  are in the off position (out), and the check tape switch  $Sw_5$  is in the normal position (out).
- Check that the f.e.t. gates have previously been shorted to ground by two looped links.
- Turn the law control  $RV_1$  fully clockwise to pinch-off f.e.t.
- Switch  $Sw_1$  to record and adjust  $RV_5$  until the meter reads 0dB (equivalent to 17.5mV at TP1). Switch off.
- Transfer the end of  $R_{61}$  from TP1 on the sub-board to TP2 and switch on. Meter should read within  $\pm 1$ dB of the previous, 0-dB reading. Note actual reading \*. Switch off.
- Solder  $R_{62}$  (15k $\Omega$  2%) and  $R_{63}$  (6.8k $\Omega$ ) in series with  $R_{61}$  (i.e. between the  $R_{55}$  pin and TP2), decreasing meter sensitivity by 10dB. Switch on and check meter reading reduces by roughly two thirds.
- Switch on noise reduction,  $Sw_4$  and

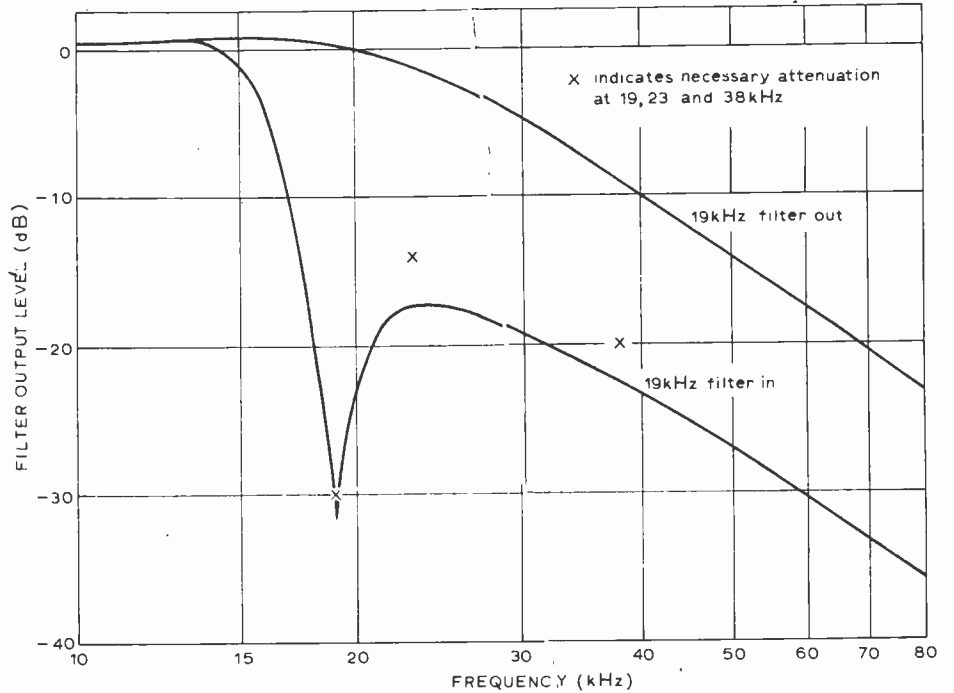

Amplitude response with and without 19kHz filter.

Fig. 18. First part in setting-up procedure for kit version (left) shows arrangement used in calibrating the right-channel meter. For aligning the noise reduction circuit the meter calibration oscillator is changed to a 5kHz oscillator, using  $L_2$  temporarily in the  $L_2'$  position (centre). Its output, via the "osc" pin, is taken to the processor input (R' for the right channel). To calibrate the 400Hz oscillator,  $L_2$  is put in its normal position, the i.c. oscillator disabled, and the oscillator output taken from TP1 or TP101 (right).

- adjust  $RV_2$  (gain) to bring back meter reading to that noted above at \*. Switch off.
- Cut the f.e.t. gate short for the right-hand channel with wire cutters and short-circuit  $R_{63}$  increasing meter sensitivity by 2dB. Switch on.
- Adjust  $RV_1$  (law) until meter reads as noted above, at \*. Switch off.
- Re-apply f.e.t. gate short and replace  $R_{63}$ . Switch on and check meter still reads as above, at \*. Switch off. Remove gate short.

**Encode/decode matching check.**

- Switch  $Sw_1$  to play and switch noise reduction off,  $Sw_4$ .
- Short-circuit  $R_{63}$ , leaving  $R_{61}$  and  $R_{62}$  connected. Set  $RV_{4,104}$  fully clockwise. Switch on.
- Adjust 5-kHz oscillator output level control  $RV_5$  until meter reads 0dB

- (equivalent to 44mV at TP2). Switch off.
- Switch noise reduction on,  $Sw_4$ . Short-circuit  $R_{62}$  and  $R_{63}$  so that only  $R_{61}$  is in circuit. Switch on. Meter should read 0dB to within  $\pm 1$ dB. Switch off.

**Left-channel circuit alignment.** Now repeat this process for the left channel, starting from the point of connecting  $R_{61}$  between the  $R_{55}$  pin, (not  $R_{155}$ ) and the test point — now to be TP101 — on the sub-board. Note that the right channel meter, being calibrated, is still used in setting up the left channel, and that TP101 is to be read for TP1, TP102 for TP2,  $RV_{101}$  for  $RV_1$ ,  $RV_{102}$  for  $RV_2$ , and that the left-channel f.e.t. gate-shorting loop is now implied. The "osc" pin is to be connected to the point L' on the sub-board at the appropriate time.

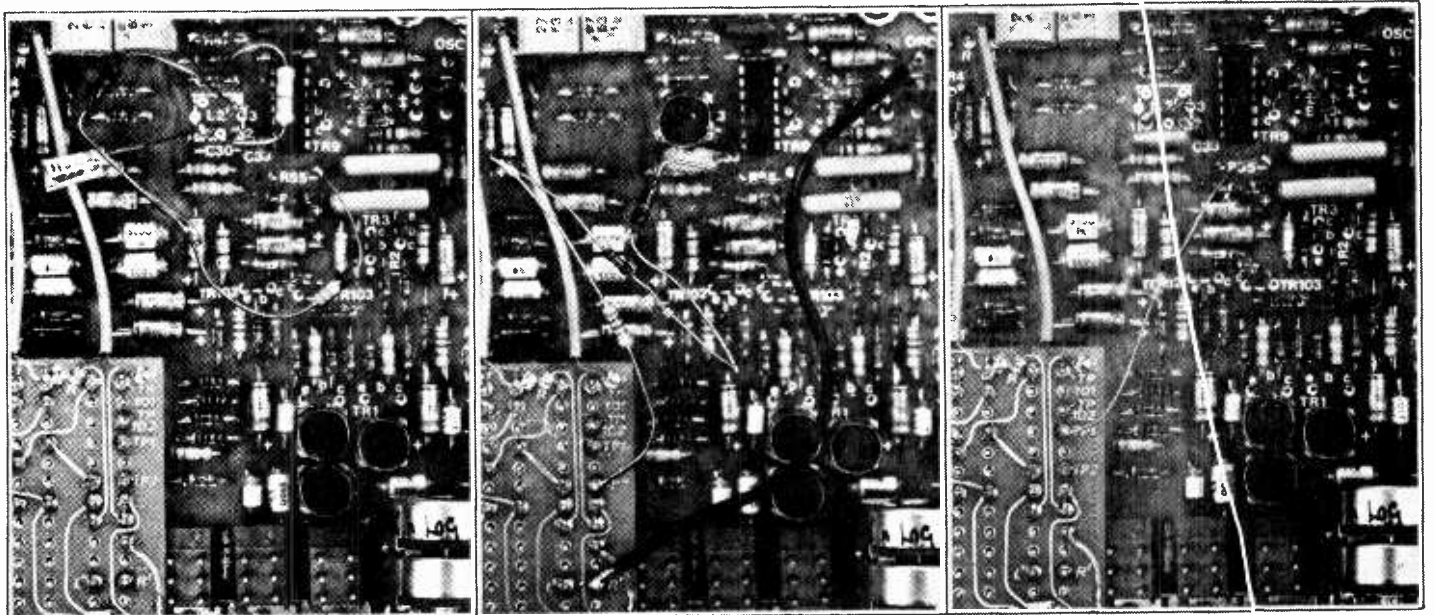

After repeating for the left channel, switch off. The gain and law adjustments are now complete.

- Remove the f.e.t. gate shorts,  $R_{61}$ ,  $R_{62}$  and  $L_2$ , inserting  $L_2$  into its normal (final) location.

#### 400Hz oscillator calibration

- Solder one end of  $R_{55}$  to its pin and connect the other end to TP1.
- Short pins 1 and 3† at the  $L_2'$  position, and remove the wire from osc pin to point L'. Switch on.
- Switch  $Sw_1$  to record, press the noise reduce switch  $Sw_4$  off and switch on the 400-Hz calibration tone oscillator,  $Sw_3$ .
- Adjust  $RV_3$  (oscillator level) until the right-channel meter reads 0dB. Switch off.
- Transfer the end of  $R_{55}$  from TP1 to TP101 and switch on. Adjust  $RV_{103}$  until the r.h. meter reads 0dB.
- Repeat this procedure because of a slight interaction between  $RV_3$  and  $RV_{103}$ . Switch off.

#### Left-channel meter calibration

- Disconnect  $R_{55}$  from TP101 and connect the free end of  $R_{155}$  to TP101 and switch on.
- Adjust  $RV_{108}$  to obtain 0dB at the left-channel meter, being careful not to disturb  $RV_8$ . Switch off the cal. tone oscillator. Switch off.

†Experience has shown that a better method of disabling the 5kHz oscillator is to remove  $R_{47}$ .

#### 19kHz filter adjustment

- Wire  $R_{155}$  permanently onto the main board, replace  $R_{55}$  with  $R_{61}$  and connect free end to TP1.
- Connect an f.m. stereo tuner to the auxiliary input and with the aux-tuner links wired in, switch on and tune to a BBC stereo test transmission.\*

Alternatively, if a high accuracy ( $\pm 50$ Hz) 19kHz oscillator is available, connect its output to point R' on the sub-board.

- With zero a.f. modulation,\* adjust the record level control  $RV_{10}$  to give a 0dB meter reading. Switch the 19kHz filter on,  $Sw_6$ .
- Adjust  $L_2$  for minimum reading on the right-channel meter. Do not adjust  $L_1$  or  $L_{101}$ . Increase record level for sharper null near tuning point.

Repeat for the left channel starting by transferring end of  $R_{61}$  from TP1 to TP101, and adjusting  $L_{102}$  for minimum reading. (In using a 19kHz oscillator, connect to point L' on the sub-board and transfer  $R_{61}$  lead from TP1 to TP101 before adjusting  $L_{102}$ .)

#### Calibration

To ensure interchangeability of all Dolby B-encoded tapes and of Dolby

\* Stereophonic test transmissions are broadcast about four minutes after the close of Radio 3 programmes on Mondays and Saturdays. The zero a.f. modulation part occurs about 11 minutes after the start and lasts for nearly two minutes.

B-equipped machines, the voltage levels in the processors must be related to flux levels on the tape. A certain amplitude level is used that bears a fixed relationship to the noise reduction parameters and to conditions between encoder and decoder. The level chosen corresponds with a flux on open-reel tapes and cartridges of 185nWb/m, with 200nWb/m for cassette tapes, with a deviation of 37.5kHz on f.m. transmissions, and with a voltage level at the processor output of 580mV r.m.s.

This level, often called Dolby level, should not be taken to imply an operating level. If the level-setting meters in the unit are to be used as modulation-depth meters, a mark may be made on the meter to indicate the reference level. Whilst setting this level equal to 0VU on meters can often lead to reasonable modulation depths, this is not always the case: for cassette recorders it is best set at +3VU.

The 400Hz oscillator and tapes recorded with a 400Hz tone to the above level are used in calibrating units, once the circuitry has been set up. When playing or recording the standard flux level, the 580mV level is set by adjusting the play calibration potentiometers during play, and the record calibration potentiometers during recording.

**Playback-only decks and units.** As the signal levels on encoded tape cassettes are to be related to those in the decoder during playback only, the 400Hz oscillator is not required and calibration is achieved with a calibration cassette, containing the reference flux.

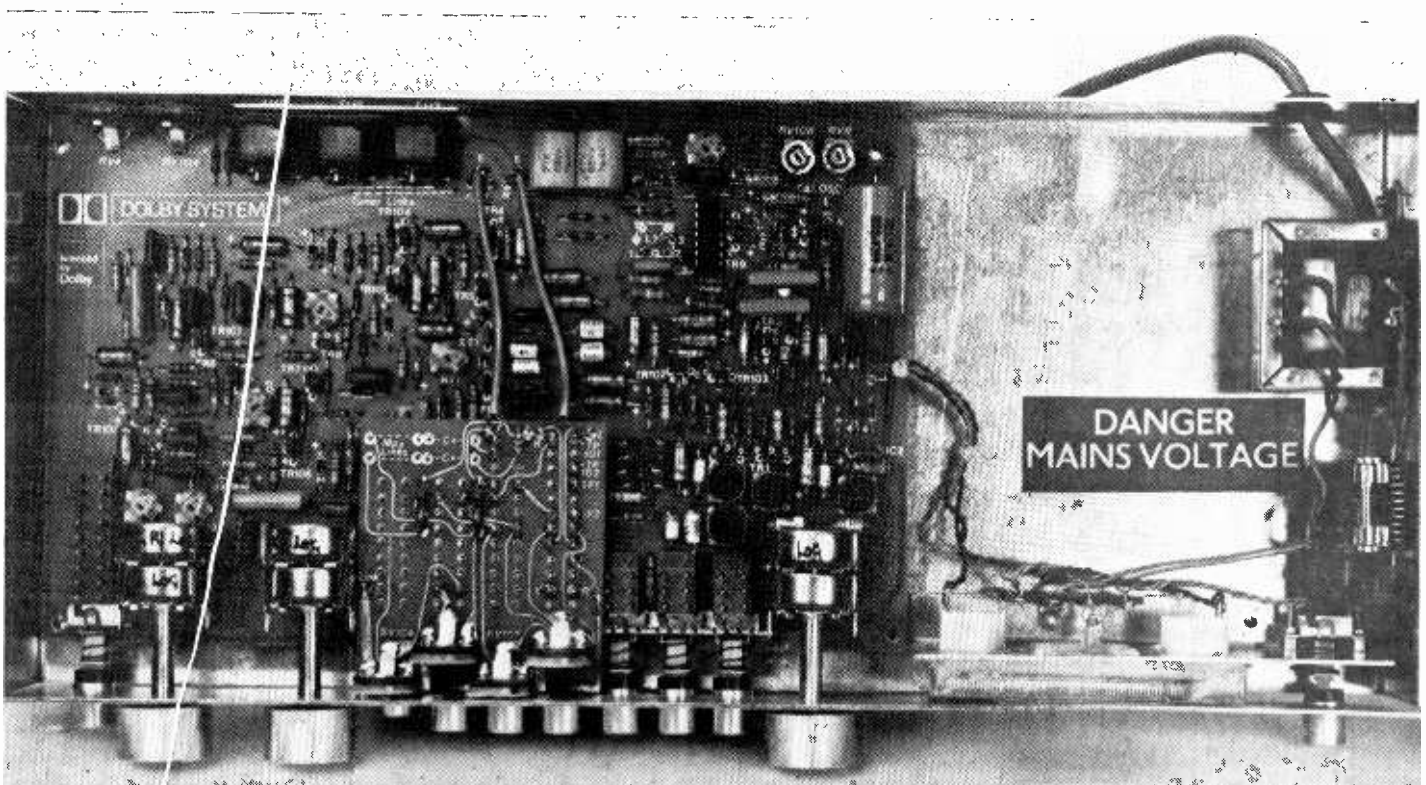

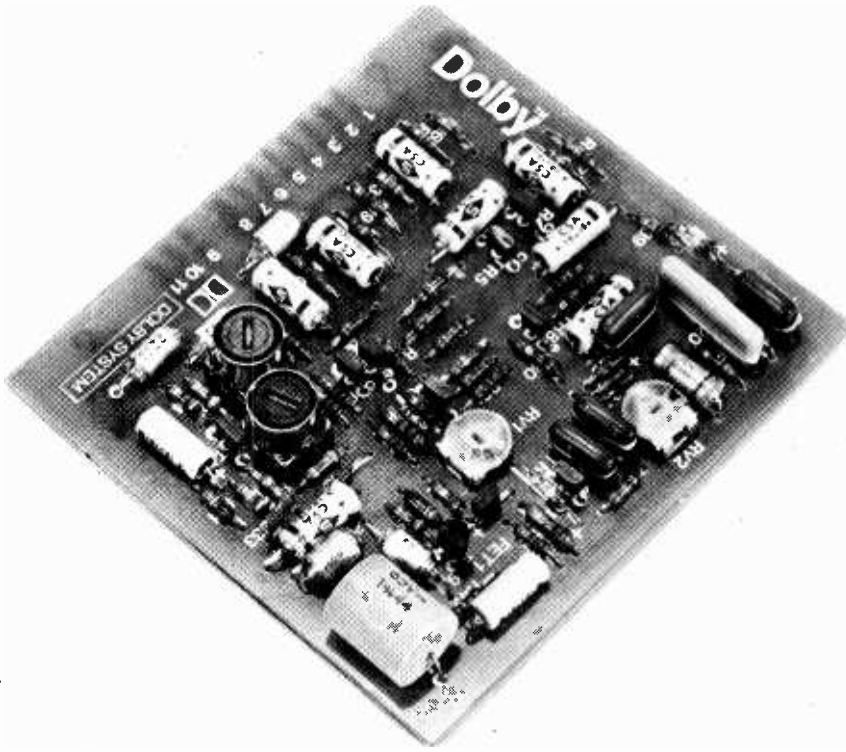

An alternative to the kit design is this single-channel processor, using the circuit of Fig. 12 but excluding power supply, alignment and calibration circuitry. (Track diagram will be given in a subsequent issue.)

- Switch noise reduction off.
- Play calibration tape. Set play gain control on tape deck to 0VU on deck meter, if possible, or to mid-position otherwise.
- Adjust play cal. control for 580mV on meter or Dolby level indication, depending on meter used.

Playback gain controls on the recorder in the signal path en route to the processor input should not now be disturbed.

#### Switchable encode/decode processors.

##### Playback calibration

- Switch to play and switch off noise reduction. Connect millivoltmeter to point G if meters not built-in.
- Play calibration tape. Set play gain control on tape deck if fitted to 0VU on deck meter, if possible, otherwise to mid-position.
- Adjust play cal. control for 580mV indication.

This completes playback calibration and the play gain controls on the tape deck should not be altered. Adjust listening level with the output level control following the decoder output (as in Fig.13).

##### Record calibration

Start by setting record gain control on tape deck to mid-position, if fitted. (If combined with playback gain, do not adjust.)

- Switch to record.
- Fit blank tape (as recommended by maker or for which bias is correctly adjusted) and feed in 400Hz at points from external or internal oscillator. (If unit has been built into cassette machine and 400Hz input is via line input socket, adjust record level control so that meter reads 580mV, or Dolby level.)
- Record on tape for a few seconds, rewind and playback, switching to play on the noise reduction circuit as well as on the deck. Note whether meter shows about or below 580mV, or Dolby level.
- Make small adjustment to record cal. controls in appropriate direction and record 400Hz tone again, observing meter reading on playback. Repeat this procedure as many times as necessary to obtain correct reading.

This completes record calibration for tapes. If the circuit of Fig.13 or similar has been adopted, recording level is adjusted with record balance and level controls on the noise reduction unit, the level being judged by the tape deck's normal meters.

When the noise reduction unit is connected to a three-head machine with a simultaneous monitoring facility the tape signal may be monitored in its encoded form by operating the check tape switch.

**Simultaneous encode/decode circuits.** Constructors with three-head machines having a simultaneous monitoring

facility can use single-processor boards permanently wired in the encode and decode modes. If provision for encoded f.m. transmissions is required switching must be arranged so that encoding does not take place during recording. A monitor switch can be provided at the input to the decoder, to switch from tape, via a play cal. potentiometer, to source i.e. a connection to the encoder output via a 580-30mV attenuator, Fig 19.

Playback calibration procedure is as above, but record calibration is simplified.

- Set record level controls on tape recorder to mid-position. Set monitor switch to tape.
- Record on blank tape, operating the calibration tone switch or injecting a 400Hz tone from an external oscillator.
- Adjust record cal. control so that meter reads 580mV, or Dolby level.

**FM calibration.** If you wish to set the controls for encoded f.m. transmissions, currently being transmitted by stations in the USA, an approximate calibration can be achieved by tuning to a local station, switching to f.m. or Dolby f.m. and setting the f.m. cal. control to give meter readings similar to those obtained when playing pre-recorded tapes. More accurate adjustment can be obtained if a station can be received which transmits the 400Hz calibration tone, identified by a characteristic warbling, or alternatively by using an f.m. generator. In this last-mentioned case, modulation frequency should be set to about 400Hz with a peak deviation of 37.5kHz (not including pilot tone).

#### Change of time-constant for encoded f.m. transmissions

There are two commonly used pre-emphasis time constants, 50 $\mu$ s and 75 $\mu$ s. Under certain conditions, these values can lead to reduced modulation at low and medium frequencies or severe amplitude distortion at high frequencies. In the USA the FCC has approved Dolby Laboratories' proposal of using 25 $\mu$ s for encoded transmissions, and to receive such broadcasts it is necessary to alter the de-emphasis time constant. In the circuit of Fig.13 this is achieved with components R<sub>x</sub> and C<sub>x</sub>, values being given in the components list on page 259 (June) for the change from 75 to 25 $\mu$ s and for a change from 50 to 25 $\mu$ s (not yet authorized in 50 $\mu$ s countries). When recording such broadcasts the encoding function of the noise reduction unit is clearly not required and the "Dolby f.m." switch position automatically switches off the encoding function. Application of the Dolby B system to f.m. broadcasting is discussed in two articles in the *Journal of the Audio Engineering Society*, June 1973, pp.351-62, and briefly in the July 1974 issue of *Wireless World*, page 237.

- Tune in to whichever of these signals is available.
- Switch to record, and to either f.m. or Dolby f.m.
- Adjust f.m. cal. control so that meter reads 580mV, or Dolby level.

### Using the unit

The calibration procedures described theoretically apply to the one tape speed used during calibration. Whether the calibration will hold for different tape speeds depends on the design of the deck, so check calibration when speed is changed. The calibration tape available can be used at 4.75 and 19cm/s, as well as 9.5cm/s. (For 38cm/s tape speed, where the noise spectrum is wideband, applying the B-type system may result in the remaining mid and low-frequency noise becoming more apparent). When the brand of tape is changed it is usually necessary to readjust the record cal. controls, the play cal. setting remaining unchanged. The characteristics of cassette tapes are more critical, and changing brand will normally require adjustment of bias (and equalization when using CrO<sub>2</sub> tapes).

When the unit is connected to the normal input and output points of a tape recorder, the recorder's own input and output controls from part of the calibrated system. The settings used during calibration should not be disturbed,

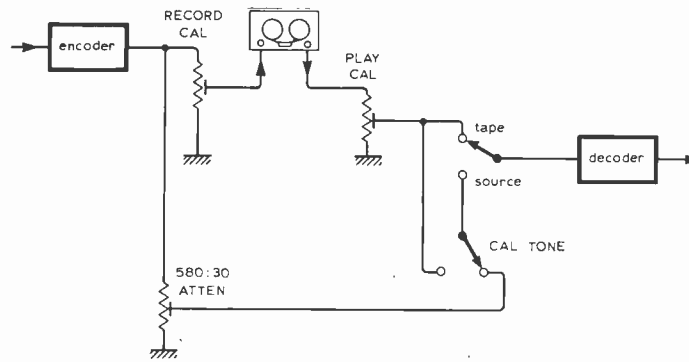

Fig. 19. Monitor switch arrangement for permanently-wired processors in three-head machines.

input and output level controls being provided on the noise reduction unit, and it is a good idea to mark the tape recorder control settings.

The amplitude response of the tape recorder must be flat and its gain unity, measured between point G of the processor in record and play, to ensure correct operation, so that the signal voltage in the decoder is the same as that at the encoder (to within 2dB). If there is a bandwidth restriction between encoder and decoder, e.g. if the response of the recorder does not extend up to at least 10kHz, a non-complementary situation arises, unless of course the encoder input bandwidth is similarly limited.

In using the unit don't forget that it will only reduce noise generated after

the encoder and before the decoder. If the input signal is noisy in itself or is made noisy by poor circuitry prior to encoding, this noise will be reproduced unaltered along with the signal. In some cassette decks, the line inputs are attenuated prior to amplification by a sometimes noisy microphone pre-amplifier.

As the sensitivity of the processor is of the order of 30mV, a line input amplifier is not required when the circuits are built into a tape recorder, and the input signal should be taken directly to the input gain control via a switch, or socket with switch, to disconnect the microphone pre-amplifier. It's a good idea too to make sure any automatic level limiter operates only in the microphone input and not in the line input.



Complete kits for the *Wireless World* Dolby B noise reducer are available through the address given below. The two-channel design features:

- a weighted noise reduction of 9dB
- switching for both encoding (low-level h.f. compression) and decoding
- a switchable f.m. stereo multiplex and bias filter
- provision for decoding Dolby f.m. radio transmissions (as in USA)
- no equipment needed for alignment
- suitability for both open-reel and cassette tape machines
- check tape switch for encoded monitoring in three-head machines

The kit includes:

- complete set of components for a stereo processor
  - regulated power supply components
  - board-mounted DIN sockets and push-button switches
  - fibreglass board designed for minimum wiring
  - solid mahogany cabinet, chassis, two meters, front panel, knobs, mounting screws and nuts.
- Price is £43 inclusive.

A single-channel printed-circuit board, with f.e.t. costs £2.50 and £8.63 with all components inclusive (excluding edge connector, £1.37 extra). Selected field-effect transis-

tors cost 68p each inclusive, £1.20 for two and £2.20 for four.

Calibration tapes are available, costing £1.94 inclusive for 9.5cm/s open-reel use and for cassette (specify which).

Send cash with order, making cheques payable to IPC Business Press Ltd, to:

Wireless World noise reducer  
General sales department  
Room 11, Dorset House,  
Stamford Street  
London SE1 9LU  
Allow three weeks for delivery.

# A 50 MHz oscilloscope

## 3 — E.h.t. oscillator, power supply and tube circuit

by C. M. J. Little, B.A.

Department of Electronics, Southampton University

The requirements of the c.r.t. are a negative supply of 1kV with a current capability of 2mA at maximum brilliance, and a positive supply of 3kV, at a current of 50 $\mu$ A. The e.h.t. supply must be stabilized in order to avoid changes in X and Y plate sensitivities with brilliance. Some oscilloscope designs use mains-derived e.h.t. and rely on the large current capability of the supply to avoid changes in voltage with loading. There are two major disadvantages of this system. First, the need for large-value smoothing capacitors, and second, the danger of lethal electric shock. This design uses the alternative, which is a transistor inverter operating at about 20kHz. Smoothing is easy at this frequency, and feedback stabilization can be used.

### E.h.t. generator

The circuit is shown in Fig. 11. Tr<sub>82</sub> and Tr<sub>83</sub> form a current-switched class D oscillator. This type of circuit produces

a sine wave, but has the high efficiency usually associated with square-wave inverters. The transistors act as switches with, ideally, zero voltage across the transistor for half the cycle. The waveforms are illustrated in Fig. 12. L<sub>7</sub> provides a constant current at the frequency of oscillation, and is uncritical as to exact value. The criterion is that its impedance at the working frequency should be large compared with the static resistance of the oscillator (supply voltage divided by supply current). The output voltage of this type of oscillator is very dependent on load.

The transformer T<sub>2</sub> resonates with its stray capacitance at about 18kHz. The secondary winding steps up the voltage to about 1.5kV peak, which is rectified to give -1kV d.c. and voltage trebled to give about +3kV d.c. The loading on the negative peaks is much greater than that on the positive so the trebler gives a higher voltage than one would expect. The feed to the stabilizer is taken from C<sub>128</sub> in order to avoid including the extra

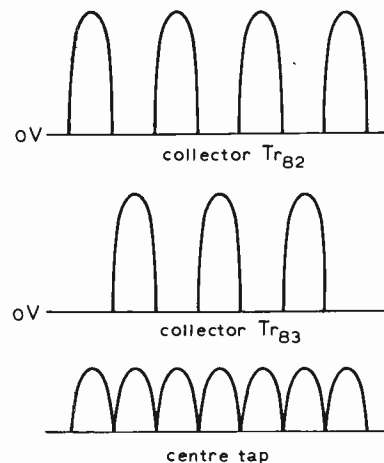
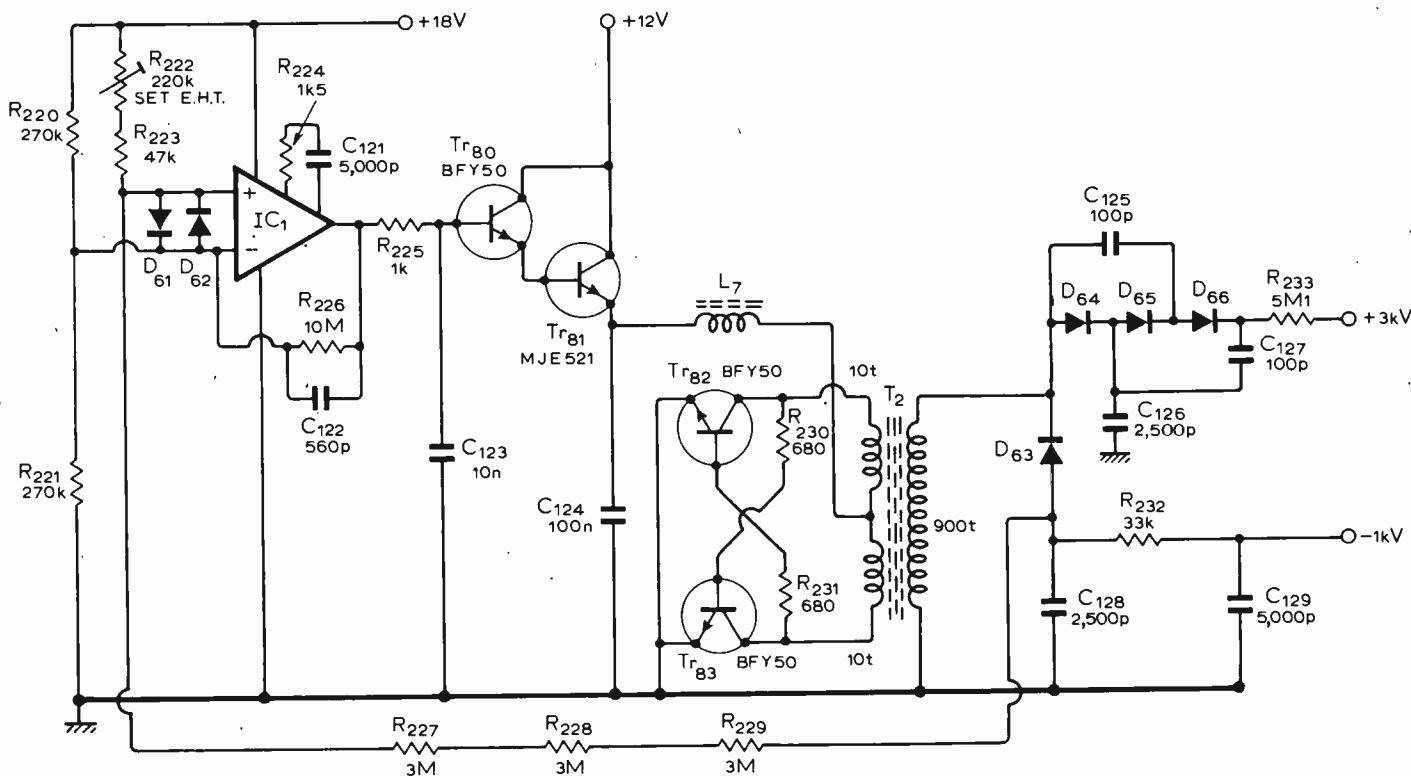

Fig. 12. Waveforms in the e.h.t. class D oscillator.

Fig. 11. The e.h.t. generator.





pole  $R_{232}$  and  $C_{129}$  in the feedback loop.

The error amplifier is an integrated operational amplifier with current multiplication provided by  $Tr_{80}$  and  $Tr_{81}$ . The amplifier is used in non-inverting mode and the negative e.h.t. is compared with the 18V rail.  $R_{226}$  and  $C_{122}$  provide a dominant pole at 30Hz. The gain at 50Hz is high enough to eliminate mains hum from the e.h.t. voltages. If a 741 type of amplifier is used instead of a 709,  $R_{224}$  and  $C_{121}$  may be left out.  $C_{124}$  is probably unnecessary and could be left out, as the effect of  $C_{123}$ ,  $Tr_{80}$  and  $Tr_{81}$  will be equivalent to a large capacitor at this point.

**C.r.t. and blanking**

The circuit associated with the cathode ray tube and the blanking amplifier are shown in Fig. 14. Before considering these, I would like to make some comments regarding the c.r.t. used in the instrument.

Of all the parts in an oscilloscope, the c.r.t. is the most critical, and the choice of tube will affect the performance that it is possible to obtain, and also the circuit techniques used. For these reasons I chose a currently available c.r.t. of modern design, instead of trying to find a surplus tube that might be satisfactory.

The c.r.t. specified has many modern features, such as a flat rectangular screen, built-in parallax-free graticule, spiral p.d.a. (post deflection acceleration) and high deflection sensitivities. It also has a second grid so that retrace blanking may be applied at earth potential. This greatly simplifies the blanking amplifier.

The penalty to be paid for this high performance, of course, is cost. The c.r.t., Mumetal shield, and base will cost about £40. For those readers who would otherwise hurriedly stop reading this article, I will now give some suggestions for possible use of surplus tubes.

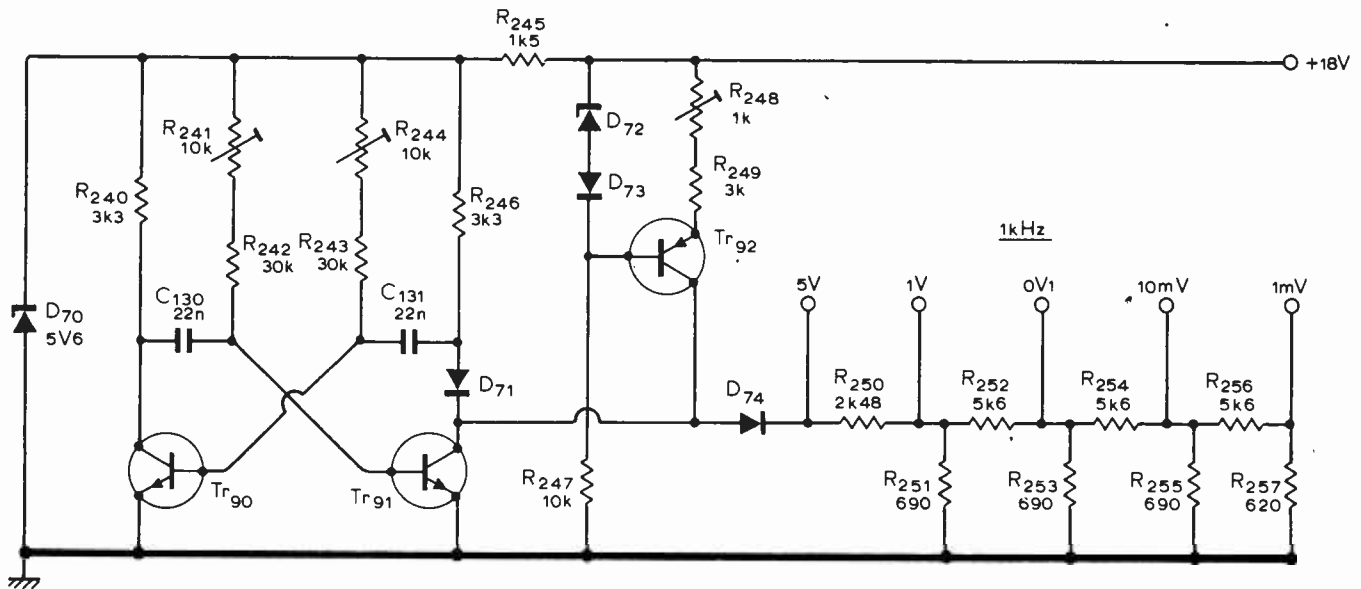
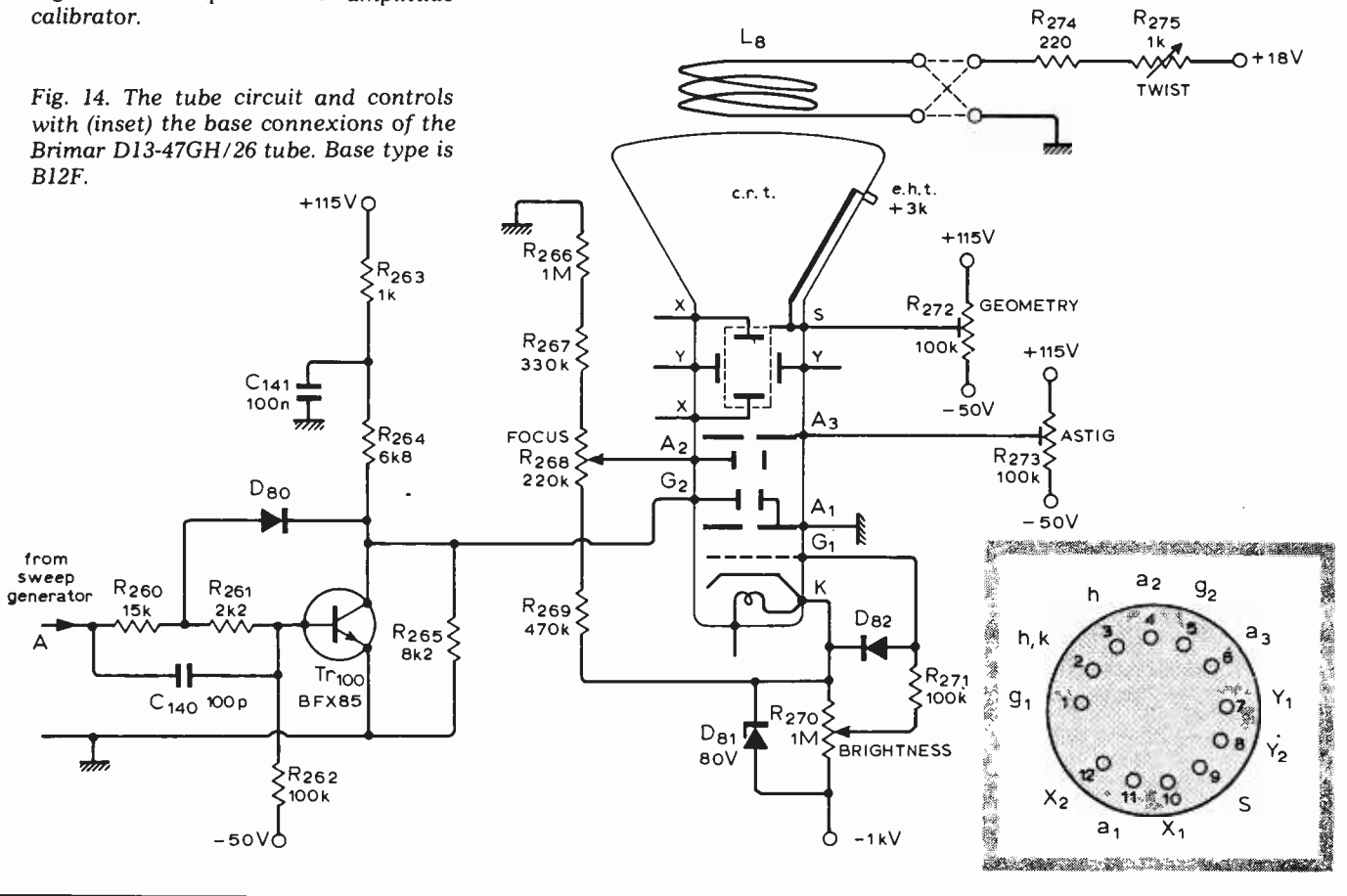

Fig. 13. The square-wave amplitude calibrator.

Fig. 14. The tube circuit and controls with (inset) the base connexions of the Brimar D13-47GH/26 tube. Base type is B12F.



Surplus p.d.a. tubes sometimes come on the market, and it is possible that a suitable one may be found. To aid bargain hunters, I have included, in Table 1, extracts from the manufacturers application data giving the main details of the c.r.t. The most important characteristics are the X and Y plate sensitivities, and it is necessary to use a tube with, at worst, sensitivities of 2/3 of these figures. If this is not adhered to, complete redesign of the amplifiers will be necessary. E.h.t. and other voltages are not usually so critical. If a tube is found that does not possess a second grid for blanking, but

is otherwise satisfactory, a circuit similar to Fig. 15 may be used.

An additional winding on the e.h.t. transformer is used to provide a floating supply of about 1.2kV. This is used to add a sufficient negative voltage to the output of the blanking amplifier to come within the required range of brilliance control voltages on the grid. The blanking amplifier needs an additional inverting stage to maintain correct polarities. Apart from these ideas I can provide no other information on other c.r.t.s, and any constructor who tries some other tube must make his own decisions.

To return to Fig. 14,  $D_{81}$  provides a negative voltage of 80V w.r.t. the cathode for the brilliance control.  $D_{82}$  is a safety diode to ensure that the grid cannot go positive with respect to the cathode.  $L_8$  provides an axial magnetic field for alignment of the horizontal trace with the internal graticule.  $R_{275}$  adjusts the current in this coil, and the connections are reversed if the correction is in the wrong direction.

$Tr_{100}$  is the blanking amplifier and is an unsaturated switch, with  $D_{80}$  preventing saturation. The beam is unblanked when  $Tr_{100}$  is on and grid 2 on the c.r.t. is at the same potential as anode 1, i.e. 0 volts. About 60 volts is necessary to fully blank the trace.

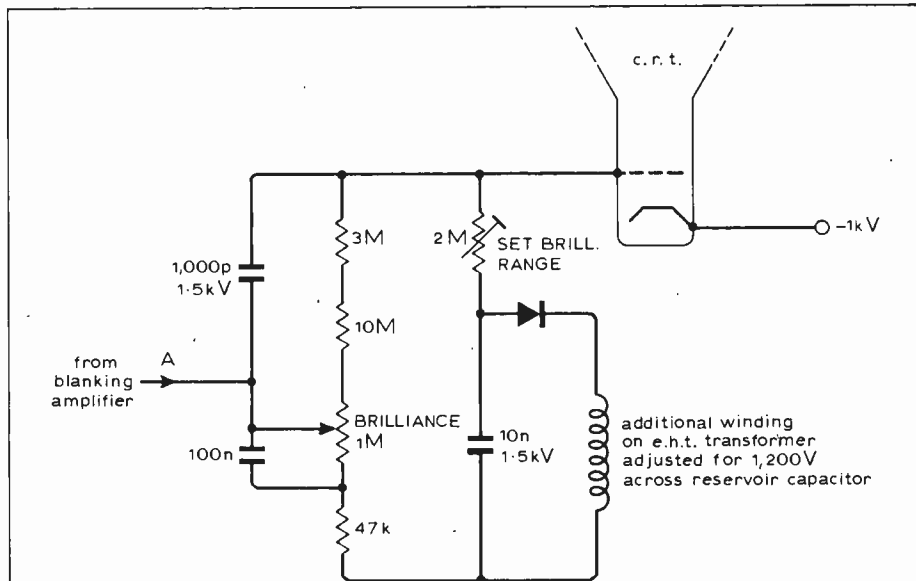

Fig. 15. Alternative grid drive when tube in use does not possess second grid.

**Calibrator**

The amplitude and time calibrator is shown in Fig. 13. It is a conventional multivibrator which switches a constant current to and from a ladder attenuator. This provides a square wave of good rise and fall times with an amplitude that is independent of supply voltage variations.  $R_{241}$  and  $R_{244}$  enable the frequency to be set to 1kHz, and the mark-space ratio to unity.  $D_{73}$  provides temperature compensation for  $Tr_{92}$ .

**Power supply**

The mains power supply (Fig. 16) has been kept as simple as possible, consistent with a reasonable degree of stabilization. The main points are the large

Fig. 16. Main power supply.

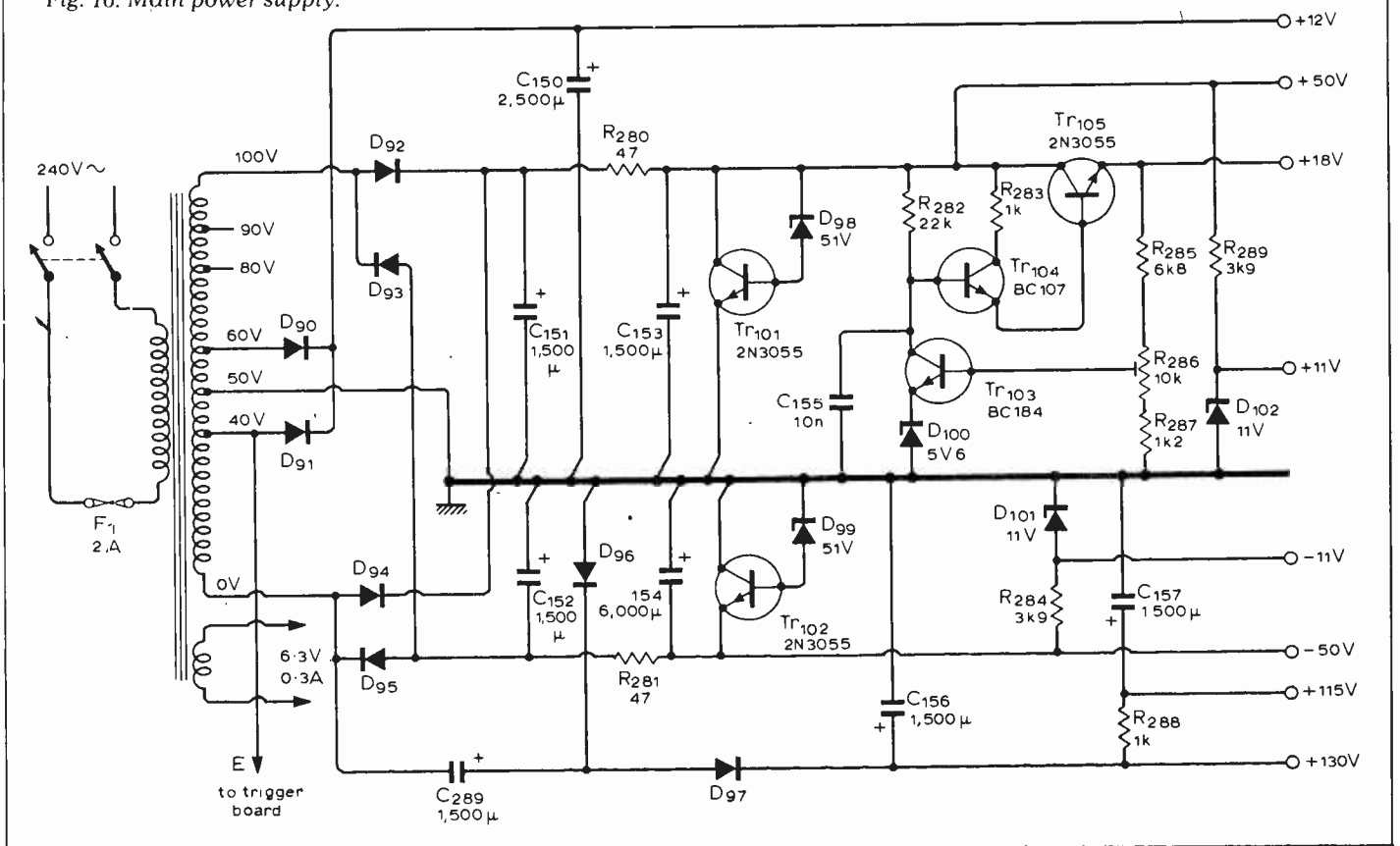

number of different rail voltages needed, and the provision of a 6.3V, 0.3A a.c. supply for the c.r.t. heater. This winding floats at 1kV from earth. The +50 volt and -50 volt rails are derived from full-wave-rectified 70 volt unstabilized supplies by simple shunt stabilizers, which give adequate regulation and smoothing. The +18V rail is fed from a conventional negative-feedback stabilizer which uses the +50V line as its input. A preset,  $R_{286}$ , is used to set the rail voltage.  $R_{283}$  provides short circuit protection by limiting the drive current to  $Tr_{105}$ .

The X amplifier and the blanking amplifier need a higher voltage than 50V, in fact around 130V. This is obtained from a voltage doubler operating from one side of the 50-0-50 secondary on the transformer. The 130 volt rail is unstabilized. There is a fairly large amount of a.c. ripple on this rail, measured as 700mV peak to peak, and a dropping resistor  $R_{288}$  gives a smoothed voltage of +115V which is used in some of the circuits.

An unstabilized 12 volt supply feeds the e.h.t. generator, and finally a highly stable +11V and -11V for the shift controls is obtained from  $D_{102}$  and  $D_{101}$ .

The mains transformer is available from Osmabet Ltd, and its modification will be described in the section on construction.

**Table 1**

Some extracts from the manufacturers data on the c.r.t. type D13-47GH  
All voltages with respect to anode 1

4th anode (p.d.a.) voltage	+3kV
3rd anode voltage	-50V to +50V (astig)
2nd anode voltage	-600V to -825V (focus)
Cathode voltage	-1000V
Grid 1 volts for cut off	-1065V (brilliance)
Grid 2 volts for blanked trace	65 Volts
X plate sensitivity	14.5 to 17.5 V/cm
Y plate sensitivity	6.7 to 8.3 V/cm
Screen area	10x6cm

**Capacitances**

$X_1$ to $X_2$	2pF
$X_1$ to all less $X_2$	6.8pF
$X_2$ to all less $X_1$	6.8pF
$Y_1$ to $Y_2$	1.5pF
$Y_1$ to all less $Y_2$	6.4pF
$Y_2$ to all less $Y_1$	6.4pF

## Reference circuits — Circards 23

Set 23 of Circards, covering reference circuits, is now available. (Because of space limitations the introductory article has been omitted from this issue.) Titles in the set are

Reference circuits  
Zener diode characteristics  
Williams ring-of-two reference  
Variable reference diodes  
Bipolar references  
Low temperature coefficient voltage reference  
Voltage & current calibrator  
Compensated reference circuits  
Simple current reference  
Monolithic reference

### New circuit book

"Circuit designs — 1, Collected Circards" brings together the first ten sets of Circards, introductory articles to each of the subjects, and ten pages of additional circuits. The hardback A4 book contains 168 pages, in which 120 cards are rearranged so that each is laid out on one page. A brief introduction precedes the articles, which were previously published in *Wireless World*, and each of the ten subjects is followed by an up-dating page. Corrections have been incorporated where appropriate. "Circuit designs" is obtainable through leading bookstalls at £10 per copy. In case of difficulty order direct by sending remittance for £10.40 (includes postage and packing) to the address given later, making cheques payable to IPC Business Press Ltd. Advertisement appears on page 27.

Circards are a new method of collating and presenting data about circuits in a compact and easily retrievable way. The sets of 203x127mm (8x5in) double-sided cards are designed for easy filing in standard boxes and for easy access at the desk or at the bench, where transparent plastic wallets keep the cards in good condition.

Each card normally describes operation of a selected circuit, gives measured performance data and graphs, component values and ranges, circuit limitations and modifications to alter performance. Suggestions for further reading are included together with cross references to related circuits. The Circard concept was outlined more fully in the October 1972 issue of *Wireless World*, pp.469/70.

### How to get Circards

Order a subscription by sending £13.50 for a series of ten sets to:

Circards  
IPC Electrical-Electronic Press Ltd  
General Sales Department, Room 11  
Dorset House  
Stamford Street  
London SE1 9LU  
Specify which set your order should

start with, if not the current one. One set costs £1.50, postage included (all countries). Make cheques payable to IPC Business Press Ltd.

Topics covered so far in Circards are:

- 1 active filters
- 2 switching circuits (comparator and Schmitt circuits)
- 3 waveform generators
- 4 a.c. measurement
- 5 audio circuits (equalizers, tone controls, filters)
- 6 constant-current circuits
- 7 power amplifiers (classes A, B, C & D)
- 8 astable multivibrator circuits
- 9 optoelectronics: devices and uses
- 10 micropower circuits
- 11 basic logic gates
- 12 wideband amplifiers
- 13 alarm circuits
- 14 digital counters
- 15 pulse modulators
- 16 current-differencing amplifiers — signal processing
- 17 c.d.as—signal generation
- 18 c.d.as—measurement and detection
- 19 monostable circuits
- 20 transistor pairs
- 21 voltage to frequency converters
- 22 amplitude modulators.
- 23 reference circuits

## Hermetic plastics i.cs.

A process introduced by RCA is claimed to have overcome the problems of obtaining a hermetic seal in a plastic-packaged integrated circuit at no increase in cost. A high degree of hermeticity has previously been obtainable only with relatively expensive ceramic or glass packages and seals, the package bearing the brunt of atmospheric attack. In the new "trime-tal" process, the chip itself is sealed.

At the equivalent of the final oxide step in ordinary i.cs, a silicon nitride layer seals the junctions, a mask being used to gain access to contacts. Platinum is then sputtered over the wafer and sintered locally to provide platinum silicide. Layers of titanium and platinum are now laid down, the platinum layer being etched to provide interconnections, which are then gold-plated. (Titanium is used to provide an easy bond between platinum and silicon nitride.) All this avoids the use of aluminium interconnecting runs, which are prone to attack by moisture. The new process is applied to six RCA linear i.cs, including the CA741G and 747G which take the name of "Gold Chip" devices.

# Electronic circuit calculations simplified

## 2 — Resistive circuits (continued)

by S. W. Amos, B.Sc., M.I.E.E.

**Two resistors in parallel.** Every experimenter knows that the effective value of a resistor is reduced by connecting another resistor in parallel with it. But by how much is it reduced? To find out we can, of course, use the following well-known expression for the resistance of two resistors ( $R_1$  and  $R_2$ ) connected in parallel:

$$\text{effective resistance } (R_{eff}) = \frac{R_1 R_2}{R_1 + R_2}$$

$$= \frac{\text{product of individual resistances}}{\text{sum of individual resistances}}$$

As an example a 33-kilohm resistor in parallel with a 47-kilohm resistor has an effective value given by:

$$R_{eff} = \frac{33k \times 47k}{33k + 47k} = 19.4 \text{ kilohms}$$

In practice, however, problems concerning resistors in parallel are usually presented differently. Often we need to know what value of resistor must be connected in parallel with a given resistor to obtain a desired lower value of resistance. It is tedious and unnecessary to repeat the above calculation several times in order to obtain the answer. Instead the above expression can be rearranged as shown below to give the required information directly:

$$\text{resistor to be added } (R_2) = \frac{R_1 R_{eff}}{R_1 - R_{eff}}$$

$$= \frac{\text{product of original and effective resistances}}{\text{difference of original and effective resistances}}$$

As an example, if it is desired to reduce a resistor of 27 kilohms effectively to 22 kilohms, the resistance which must be connected in parallel is given by:

$$R_2 = \frac{27k \times 22k}{27k - 22k} = 120 \text{ kilohms}$$

The above expressions show that the value of a resistor is effectively halved by connecting an equal-value resistor in parallel with it. If the added resistor has twice the value of the original resistor, the net resistance is two thirds that of

the original resistor. If the added resistor has three times the resistance of the original, the net resistance is three quarters that of the original. In general if a resistor with  $n$  times the resistance of the original resistor is connected across the original, the net resistance is  $n/(n + 1)$  that of the original resistor.

Another useful rule which can be deduced from the above expressions is that in order to reduce the effective value of a resistor by 10%, the parallel resistor must have a value 9 times that of the original. For a 5% reduction, the parallel resistance must have 19 times the resistance of the original and for a 1% reduction the parallel resistance must be 99 times the original resistance. These added resistances are respectively approximately 10 times, 20 times and 100 times the original resistance — in each case 100 times the reciprocal of the percentage reduction required. Thus to effect a 2.5% reduction, the added resistance should be  $100/2.5$  i.e. 40 times the original resistance. In general to

reduce the effective value of  $p\%$  the added resistance should have a value of  $(100 - p)/p$  times the original and if  $p$  is small compared with 100, it can be neglected in the numerator of the fraction so that the added resistance is approximately  $100/p$  as deduced from the numerical examples earlier.

**Current divider.** The current  $I$  which flows externally to a parallel combination of resistors divides between them in the inverse ratio of their resistances. Thus in Fig. 16 the current ( $I_1$ ) flowing in  $R_1$  is given by

$$I_1 = \frac{R_2}{R_1 + R_2} \cdot I$$

and  $I_2$ , the current in  $R_2$ , is given by

$$I_2 = \frac{R_1}{R_1 + R_2} \cdot I$$

It is useful to regard a parallel resistor combination as a current divider because such a combination is often used as the basic negative feedback circuit in a current amplifier, and this approach enables the resistor values needed to give a wanted value of current gain to be readily calculated. Alternatively it enables the current gain of an amplifier to be deduced from inspection of the resistor values used in the feedback circuit.

For example, in the simplified circuit diagram of Fig. 17,  $R_e$  and  $R_b$  are effectively in parallel, the current path through  $R_b$  being completed by the input resistance of  $Tr_1$  which is normally small compared with  $R_b$ . The emitter current of  $Tr_2$  splits at the junction of  $R_e$  and  $R_b$  and the fraction of it which is returned to  $Tr_1$  base as a negative feedback signal is, as shown by the above expressions, given by  $R_e/(R_e + R_b)$ . Normally  $R_b$  is large compared with  $R_e$  and the fraction is thus approximately  $R_e/R_b$ . The current gain of the amplifier is equal to the reciprocal of this fraction i.e.  $R_b/R_e$ . The values of  $R_e$  and  $R_b$  should thus be chosen to give the desired value of current gain. Now  $R_e$  is one of the components used for biasing  $Tr_2$  and this consideration imposes limitations on its value: a likely value

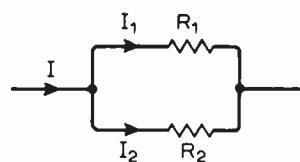

Fig. 16. Current division in a circuit composed of two resistors in parallel.

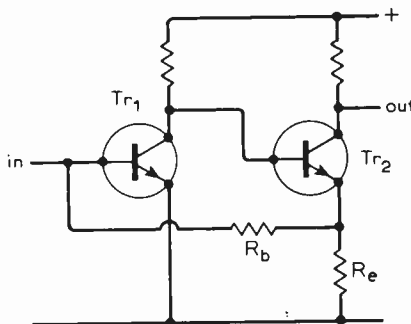

Fig. 17. Simplified diagram of a two-stage current amplifier in which gain is determined by the negative feedback circuit  $R_e R_b$ .

for  $R_e$  is 100 ohms.  $R_b$ , on the other hand, can be made almost any value and, to give a current gain of 100, should have a value of  $100 \times 100$  ohms i.e. 10 kilohms. Only the essential signal-frequency components are shown in Fig. 17: in a practical circuit additional components may be necessary, e.g. for stabilising the mean emitter currents of the transistors.

**Two resistors in series.** The effective value of two resistors  $R_1$  and  $R_2$  connected in series is the arithmetical sum of the two thus

$$R_{eff} = R_1 + R_2$$

Thus is a small resistor is connected in series with a large one, the effective resistance is slightly greater than the larger. (If the resistors are connected in parallel, of course, the effective resistance is slightly less than the smaller of the two.)

Two resistors connected in series are often regarded as a potential divider because the voltage  $V_{out}$  across  $R_2$  (Fig. 18) is a certain fraction of that ( $V_{in}$ ) applied to the combination: the fraction is determined by the resistor values according to the expression

$$V_{out} = \frac{R_2}{R_1 + R_2} \cdot V_{in}$$

which is similar to the expression for the current in  $R_1$  in a parallel resistor combination.

Potential dividers are often used for biasing transistors and Fig. 19 shows a typical circuit using an f.e.t. The potential divider  $R_1R_2$  impresses a particular value of voltage on the gate of the f.e.t. and the external source resistance  $R_s$  then determines the drain current of the transistor. This bias circuit is preferable to that in Fig. 3 (June) because it gives better d.c. stability i.e. it defines the mean drain current more accurately in spite of manufacturing spreads in transistor parameters and variations in parameters with temperature.

As mentioned earlier one of the features of f.e.t.s is that their input resistance is very high. Thus there is virtually no gate current and the resistors  $R_1$  and  $R_2$  are required solely to provide a particular voltage for the gate. The only current in  $R_1$  and  $R_2$  is therefore that which flows through them from the supply (the bleed current) and this can be made any desired value. Normally the bleed current is made very small because this enables the input resistance of the circuit to be kept high. To illustrate this let us assume that there is a 15-V supply and that the transistor is required to take 2mA mean drain (and therefore source) current. For such a current the transistor will be assumed to require a gate-source bias voltage of -1.5V. The gate voltage can be given any desired value up to 15V: 3V is a convenient

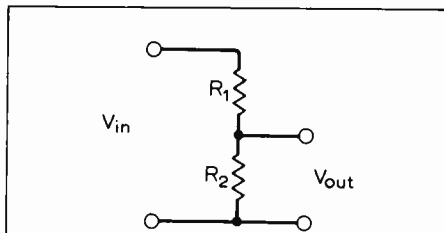

Fig. 18. Potential division in a circuit composed of two resistors in series.

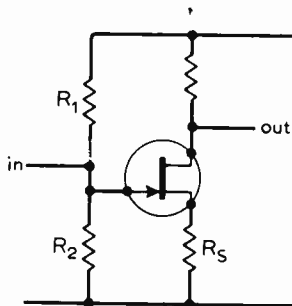

Fig. 19. Potential divider used to bias an f.e.t.

value. The mean source voltage must then be 4.5V to give the required gate-source bias. Thus the voltage across  $R_s$  is 4.5 and the current required in it is 2mA. Ohm's law gives the value of  $R_s$  as 2.2 kilohms.

The potential divider must give a gate voltage of 3 and the supply voltage is 15. Let us assume a very low value of bleed current, say  $10\mu A$ . This is then the current in  $R_2$  and the voltage across  $R_2$  is 3. Thus, from Ohm's law, the value of  $R_2$  is 300 kilohms. The current in  $R_1$  is also  $10\mu A$  and the voltage across it is 12 so that its value, also from Ohm's law, is 1.2 megohms.  $R_1$  is four times  $R_2$  and provided this ratio is maintained the gate voltage always has the same value of 3: the particular values chosen for  $R_1$  and  $R_2$  determine the bleed current.

In practice we are often concerned about the input resistance of the circuit. The input resistance of the f.e.t. itself is practically infinite but the input resistance of the circuit depends on  $R_1$  and  $R_2$ , which are effectively in parallel at signal frequencies. For the values of  $R_1$  and  $R_2$  calculated above the effective input resistance of the circuit is given by:

$$\text{input resistance} = \frac{\text{product of } R_1 \text{ and } R_2}{\text{sum of } R_1 \text{ and } R_2}$$

$$= \frac{1200k \times 300k}{1200k + 300k} = 240 \text{ kilohms}$$

With f.e.t.s it is possible to achieve much higher input resistances than this. For example, suppose we require an input resistance of 5 megohms: such a value might be required to terminate a capacitor or piezo-electric microphone or pickup cartridge. A useful way of calculating the values of  $R_1$  and  $R_2$  to give this value of input resistance as well as the required value of gate voltage is as follows. Let the ratio of the

gate voltage to supply voltage be  $a$ . This  $a$  is also therefore the step-down voltage ratio of the potential divider. Then the resistor values to use in the potential divider are given by:

$$R_1 = \frac{\text{input resistance}}{a}$$

and 
$$R_2 = \frac{\text{input resistance}}{1-a}$$

For the example in question  $a = 3/15 = 0.2$

$$\therefore R_1 = \frac{5}{0.2} = 25 \text{ megohms}$$

$$\therefore R_2 = \frac{5}{1-0.2} = 6.25 \text{ megohms.}$$

$R_1$  is four times  $R_2$  which ensures the required gate voltage. A calculation of the resistance  $R_1$  and  $R_2$  in parallel shows that this is 5 megohms as required.

The circuit of Fig.19 is also used to bias bipolar transistors but the design usually proceeds along entirely different lines from those described for f.e.t.s. This is primarily because the bipolar transistor has a significant input (base) current: as a result the input resistance is low and, because this shunts both resistors of the potential divider, there is no point in using high-resistance components for  $R_1$  and  $R_2$ . Indeed there is a good reason for using low-value resistors, namely that d.c. stability of the circuit is dependent on the value of these resistors, increasing as the resistor value is decreased. The resistors should therefore be made as low as possible subject to keeping the bleed current acceptable: in battery-operated equipment the potential divider should preferably not take as much current as the transistor itself.

A good starting point for the design is thus to decide on a value for the bleed current. Suppose the transistor is to take 1mA mean collector current. Then it is reasonable to let the potential divider take  $0.1mA$ . Let the required base voltage be 3V as before. Then a simple application of Ohm's law tells us that  $R_2 = 3/(0.1 \times 10^{-3}) = 30$  kilohms. Now  $R_1$  carries the base current of the transistor in addition to the bleed current of  $0.1mA$ . We can take the base current as  $1/\beta$  of the collector current. If  $\beta$  is 100 then the base current is  $0.01mA$  and the total current in  $R_1$  is  $0.11mA$ . If the supply voltage is 12 then there are 9V across  $R_1$  and the value of  $R_1$  is, from Ohm's law,  $9/(0.11 \times 10^{-3})$  i.e. 82 kilohms.

Finally we need to calculate the emitter resistor value. If the transistor is a germanium type the emitter potential is very nearly equal to the base potential and there is thus 3V across  $R_e$ . Since the current in  $R_e$  is 1mA, the value of  $R_e$  is given by  $3/(1 \times 10^{-3}) = 3$  kilohms. If, however, the transistor is a silicon type there is an offset voltage of approximately 0.7V between base and



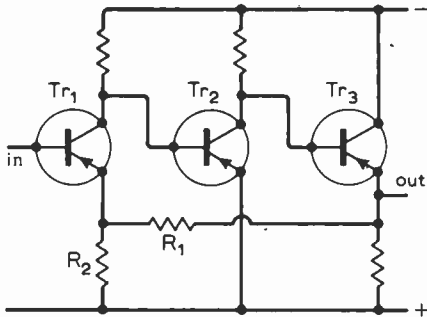

Fig. 20. Simplified diagram of a two-stage voltage amplifier with emitter follower output in which the gain is determined by the negative feedback circuit  $R_1 R_2$

emitter potentials and the voltage across the emitter resistor is only 2.3V, giving  $R_e$  as 2.3 kilohms.

If the base current had been ignored  $R_1$  would have been calculated as 90 kilohms instead of 81 kilohms. The difference is not great and to obtain approximate estimates of resistor values it is often permissible to neglect the base current.

A potential divider is often used as the basic element in the negative feedback circuit of a voltage amplifier and the values of the two resistors enable the gain of the amplifier to be set at a particular wanted value. Alternatively the gain of a voltage amplifier can be deduced from the values of the resistors in the negative feedback circuit. For example, in the simplified circuit diagram of Fig. 20  $Tr_1$  and  $Tr_2$  are common-emitter stages and  $Tr_3$  is an emitter-follower stage which provides the amplifier with a low output resistance.  $R_1$  and  $R_2$  constitute the potential divider which defines the voltage gain of the amplifier. The step-down voltage ratio of the potential divider is  $R_2/(R_1+R_2)$  but  $R_1$  is usually large compared with  $R_2$  and the step-down ratio is therefore approximately  $R_2/R_1$ . The voltage gain of the amplifier is equal to the reciprocal of this i.e.  $R_1/R_2$ . Thus if voltage gain of 200 is required  $R_1$  must equal  $200R_2$ .  $R_2$  is used to provide bias for  $Tr_1$  and its value is to a large extent determined by this consideration: a likely value for  $R_2$  is 100 ohms.  $R_1$ , on the other hand, can be given almost any value and, to give the desired value of voltage gain, should be  $200 \times 100$  i.e. 20 kilohms.

Only the essential signal-frequency components are shown in this circuit diagram: in a practical circuit additional components are necessary, e.g. for stabilising the mean collector currents of the transistors.

(Next article: capacitive circuits)

## Announcements

A one day conference in Cynenergetics is being organized at Chelsea College, University of London, by the Cybernetics Society on September 1st, 1975. Topics will include artificial intelligence, pattern recognition, cybernetic medicine, systems theory and other topics relating to cybernetics. Further details about the conference or offers of papers can be obtained from the conference organizers: E. Insam, c/o The Cybernetics Society, Chelsea College, University of London, Pulton Place, London S.W.6 or Dr. C. M. Elstob, Cybernetics Dept., Brunel University, Uxbridge, Middlesex. The Society also holds monthly meetings in London with speakers from various fields in cybernetics and other related topics, anyone interested in attending the meetings or becoming a member of the Society should contact Mr Kevin Clifton at the Cybernetics Society address or by telephone, 01-736 1244, ext 229.

**Norse Audio Systems Ltd** recently launched the Radionette range of audio and television equipment in the UK. The range, which is manufactured in Norway, includes colour television receivers, music centres, tuner-amplifiers, record decks, speakers, and transistor radios. Radionette (a subsidiary of the Tandberg organization) have said that the product range will be backed-up by a first-class after sales service.

Agreement has been reached to house the **Vintage Wireless Museum** of the Wireless Preservation Society in one of the Isle of Wight's "Stately Homes" — Arreton Manor, the home of Count and Countess Slade de Pomeroy. Arreton Manor already houses a Folk Museum, and a unique collection of dolls and dolls' houses.

**Dieter Assmann Electronics Ltd**, of Watford, manufacturers of a very wide range of components for printed circuit board assembly, have appointed Giltech Components of 22 Portman Road, Reading, as their first distributor in the U.K. Initially, Giltech will hold stocks of the major Assmann lines such as i.c. and transistor sockets, terminals, connectors and heat sinks.

**G. A. Stanley Palmer Ltd**, Elmbridge Works, Island Farm Avenue, West Molesey Trading Estate, Surrey KT8 0UR, have been appointed exclusive U.K. representatives for the National Wire and Cable Corporation of Los Angeles, California. Products manufactured include connecting wire both screened and unscreened, microminiature low voltage instrument control cable in single or pairs, under water cables, ultra flexible wires, multiple (single and pair) signal and control cables, and digital data transmission cables.

**Double R Electronics Ltd.**, Angus House, 13 Tilehouse Street, Hitchin, Herts SG5 2DU, have been appointed U.K. distributors for Ampower Semi-conductor Corporation in the United Kingdom.

## Vision network switcher

Logic-controlled network-switching equipment, recently installed at Yorkshire Television's Leeds studios, provides very simple routing of signals from 34 inputs (studios, telecine, v.t.r., etc) to three main external outputs and several internal monitoring and recording stations.

The photograph shows the control panel of the switcher, which contains the relevant buttons for two of the external outputs, the other being on another panel. The top two banks (of 68 buttons) each consist of 34 buttons to select signal source, coupled with "on air" lamps. When switching codes, set up in memory by the selector buttons, are activated by output "take" buttons, the "on air" lamps illuminate. Outputs

are to the Emley Moor YTV transmitter, the national network and the YTV Belmont transmitter, the selectors for this being on a separate panel. The bottom bank of buttons select inputs for previewing or prelistening and the left-hand set controls feeds to internal monitoring stations, etc.

In essence, the control panel sets up in memory the switching configuration required, resulting logic states being used to control single-f.e.t. cross-point switches (reeds, in the case of audio cross-points).

The equipment was supplied by Crow of Reading, the cross-points originating with Sandar Electronics — a Norwegian company.

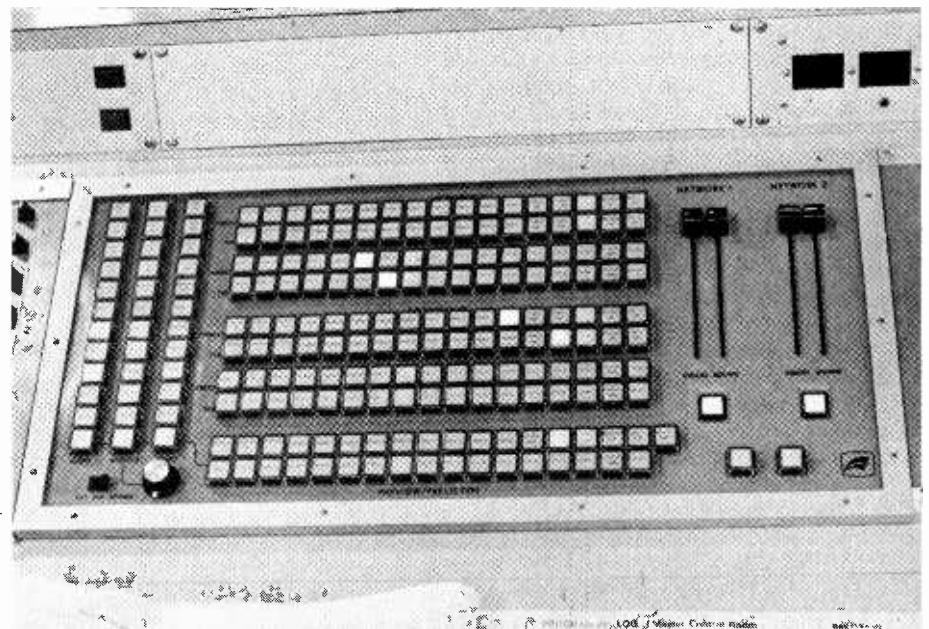

# Noise — confusion in more ways than one

## 4—Noise figure and the design of front-ends

by K. L. Smith  
University of Kent at Canterbury

**The quest for low equipment noise temperature has formed a large part of research and development effort in recent times. The maser, parametric amplifier and other aspects of low-noise technique are covered in this concluding article. Noise figure is still commonly used to characterise performance and this idea, together with the earlier discussion of noise temperature, is considered to show that basically they are saying the same thing.**

Getting noise levels down at the front end of modern equipment has been a success story. In this section I will present an outline of some of the strides that have been made, but will not attempt a detailed description of actual front-end hardware, or specific devices and techniques. If you have any special interest requiring a little more detail, I have mentioned a few references for you to follow up.

The basic mechanism of noise generation in active devices is the shot effect, found, of course, in semiconductors as well as in thermionic emission devices. A serious limitation in microwave receivers has been the crystal mixer. Until the advent of low-noise r.f. stages such as the ruby maser and parametric amplifier, the crystal mixer was the front-end component. The crystal has a direct current flowing when operating and therefore shot noise is produced. This makes it appear "hotter" than an equivalent resistor under the same conditions. It also has a conversion loss. If you glance at equation 9 (Part 3), with  $L$  now standing for the mixer conversion loss and  $T_L$  somewhat above room temperature and related to the crystal noise temperature, then you will see that crystal mixers do not enhance the requirement for low effective input noise temperatures or microwave receivers.

One awkward point arises because of a traditional definition. The crystal noise temperature,  $T_x$ , is defined as the effective temperature at the output of the mixer stage when the input is terminated with a matched source resistor at  $T_0$  (290K). So  $T_x$  includes the source contribution at  $T_0$ . From this, taking care to account for the source contribution, we can write down an analogous equation to (9) for the  $T_e$  of the superhet with a crystal mixer front end and an i.f. amplifier whose effective

input noise temperature is  $T_{i.f.}$

$$T_e = LT_x - T_0 + LT_{i.f.} \quad (11)$$

The first term is the crystal noise temperature referred to the front end or input terminals; the second term is the subtraction of the standard source temperature, assumed in the definition of  $T_x$ ; and the third term is the i.f. amplifier input temperature referred forward to the front-end terminals. For good noise performance, a low  $T_x$  and small  $L$  is required. A manufacturer's catalogue shows the following for the 1N23C point-contact X-band mixer diode:  $t_x (= T_x/290) = 2, L = 6\text{dB}$ , which is a loss of four times.

Putting these values into (11) gives

$$T_e = 4 \times 2 \times 290 - 290 + 4 \times 116 \approx 2500\text{K}.$$

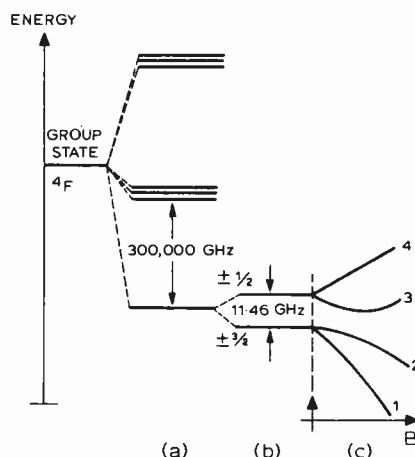

Fig. 16. Quantum mechanics explains the pattern of energy levels obtained in crystal lattice structures (among other things). Example shown is for chromium ions in ruby crystals. Altering value of the magnetic flux  $B$ , sets the levels 1, 2, 3 and 4 at convenient energy intervals for maser action.

I have assumed a low-noise i.f. amplifier, a temperature of  $T_{i.f.} = 116\text{K}$ . The noise temperature of 2500K is not a very good performance. From the same catalogue, a modern Schottky-barrier mixer diode type P1906F would give an effective input noise temperature of 740K if used in the same receiver.

Other hazards exist which I have ignored in the above discussion. An important one is the noise generated in the local oscillator. The noise sidebands from the oscillator mix to produce an appreciable output at the i.f. frequency. A balanced mixer should be used to reduce noise from this source. Another dodge is to lock the local oscillator to a low-noise stable frequency generator, such as a crystal oscillator and multiplier chain (which, incidentally, reduces the drift, frequency jumping and the f.m. noise of the local oscillator). The noise performance of the i.f. amplifier is critical with direct conversion receivers. The presence of the loss factor  $L$  makes this so, as you can see from (11).

The first stages of the amplifier require transistors specially selected for their good noise performance and the optimum matching conditions between mixer and i.f. input circuit is important. It is possible to obtain optimum performance empirically by switching on and off a gas-tube noise source coupled into the front end, attenuated if necessary, while adjusting the mixer, local oscillator, and i.f. couplings for minimum  $T_e$ , as monitored by observing the changes on a power meter at the output of the system. The calculation of the optimum conditions for any given case, including the effects of parasitic reactance, etc, is extremely difficult. If you wish to follow this up, E. G. Nielsen<sup>14</sup> wrote an interesting article on the topic.

You may recall the publicity, about a decade ago, in connection with the Goonhilly station system. The "signifi-

cant" results that the new maser amplifier was going to make possible were indeed achieved, after the usual teething troubles. We had visions of large Dewar flasks surrounded by liquid-nitrogen-produced vapour clouds and all the other complexities of the cryogenics. The cost and complexity of the maser hardware and cryogenics, and the relatively narrow bandwidth obtainable has meant a decline in their use, and the much more convenient parametric amplifier has taken over. In spite of this, the maser still offers the ultimate in low-noise performance, because not only are the "working bits-n-pieces" cooled to about 4K with liquid helium, you will sometimes see negative temperatures mentioned! Of course, the physical temperature is never below absolute zero, but in some ways the maser acts as if it were.

The action of the solid-state maser depends on materials with paramagnetic ions in a crystal lattice, such as the chromium<sup>3+</sup> ion in ruby. The spin and orbital motion in these atomic particles are quantized, which means that the only energies allowed them by the laws of quantum physics are very definite values. Any change in energy of particles means a jump from one energy level to another with the absorption or emission of radiation of characteristic frequency. This is pictured in a diagram such as that in Fig. 16; (a) shows some of the chromium ion levels in ruby. The lowest level is the only one of interest for maser work.

In this ion, there are three available electrons which contribute to the paramagnetic splitting. The three electrons give four possible energy levels and the fields of force in the crystal lattice split the levels into two pairs 11.46-GHz apart (the energy difference is measured in "frequency" - this being the frequency of the radiation involved in any jump between the levels), see Fig. 16 (b). A long time ago a fellow named Zeeman in 1896 found that applying an external magnetic field to atoms or molecules with levels which have the same energy (the jargon for this is that they are "degenerate", but this does not mean that they suffer from anything nasty!) separates them, or as we say lifts

the degeneracy by an amount depending on how strong the magnetic field is.

Sure enough, this happens with our chromium ions in ruby, see Fig. 16 (c). The low energy levels of the billions of particles in the crystal lattice are occupied according to the quantum laws, and the absolute temperature  $T$ . The lowest levels are crowded while higher levels are only sparsely filled. The whole point of maser action is to invert this population distribution - by pumping, so that when dropping back to a low energy level, the electrons involved give energy to the passing signal wave, boosting its amplitude. The waves passing through the crystal (we are discussing a travelling-wave maser) need time to interact with the excited atoms, so a careful design is made of a slow wave structure for this purpose.

The correct populations can only be produced at very low temperatures - hence the liquid helium involved. The magnetic field to split the energy levels to just the right value for the frequency of the signal and pump is often applied by the use of a "persistent current superconducting magnet" - a case of exploiting the very low temperature available and the resulting superconductivity in some materials. Fig. 17 (a) illustrates this and (b) shows diagrammatically the parts of the travelling-wave maser.

We can sum up all of this by noting that the signal wave in a maser extracts energy in phase from the excited ions in

the crystal. The presence of the signal stimulates the emission - hence the name of the device, Microwave Amplification by Stimulated Emission of Radiation, as you probably already know. The extremely low effective noise temperature of this amplifying mechanism arises from the requirement to use liquid helium temperature, together with a further reduction of this already low temperature according to  $T_{e(maser)} = T_{amb}/I$ , where  $T_{amb} \approx 4.2K$  (liquid helium) and  $I$  is the inversion ratio of the maser, usually about three and is the number of times the upper energy level is more densely populated than the lower, as a result of the pumping action.

Naturally, the signal has to be got into the amplifying part of the maser, and out again. Equation 9 shows that the effect of any attenuation in the feeder at the input, will very convincingly degrade the noise performance.

$$T_e = (L-1)T_L + \frac{LT_{amb}}{I} \quad (12)$$

If  $T_L$  is a mean temperature of around 100K and  $L$  is a loss of only 0.5dB (1.12 times), then  $T_e = (1.12 + 56)K$ . That is, the loss contributes about 11K and the maser itself about 1.5K. Herein lies a big difficulty with such amplifiers: how to get the signal down into the crystal in the Dewar, through the couplings and hardware of the front-end feeder system, without introducing prohibitive losses. Taking the signal out is all right, it has been amplified by the maser gain,

Fig. 17. Inconvenience of maser amplifiers is mainly because of the complex cryogenic system required. Also, getting the signal in and out and the pump power in to the crystal is troublesome. Shown here is a typical example of a maser with rutile for the slow-wave structure and in interacting element (a). Magnet could be a self-sustaining superconducting one. Velocity of the wave in rutile is very much less than the velocity in free space, because of the high dielectric constant. One method of feeding in the pump power that has been proposed is to use a side radiating horn, as shown at (b). (A. Fletcher).

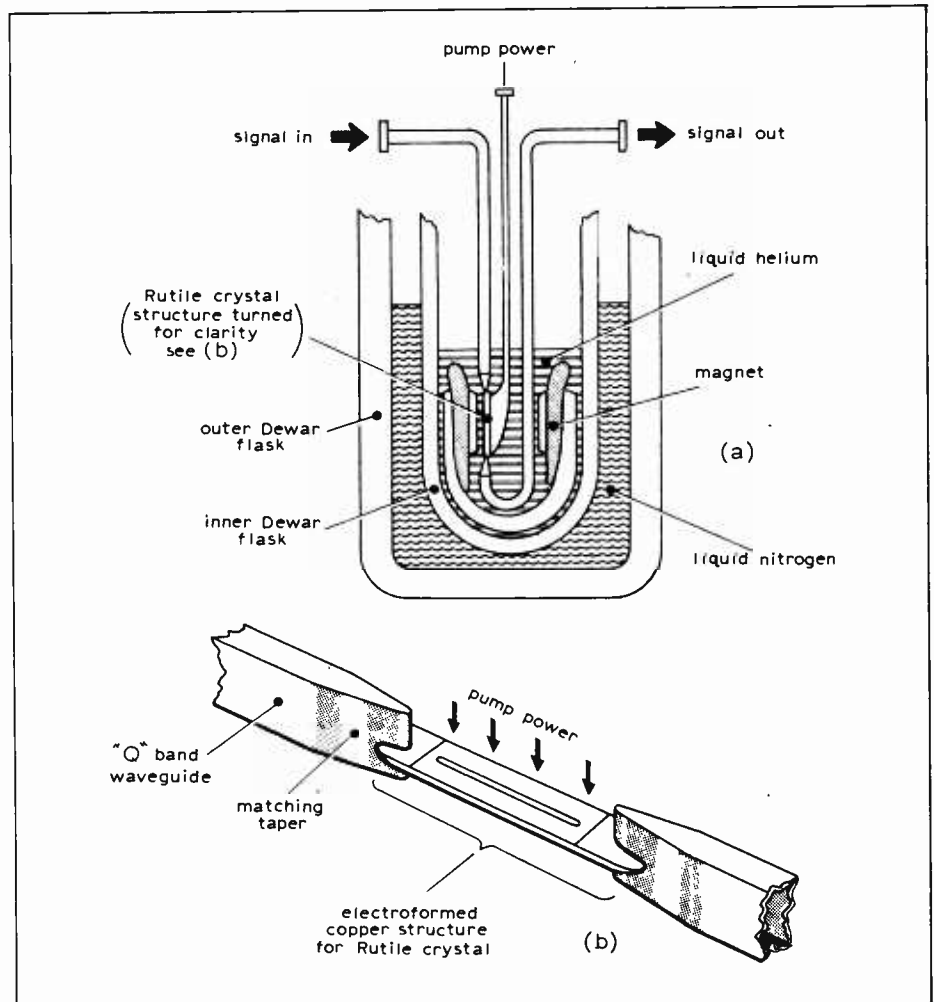

perhaps 45dB or so. A good article on masers was presented in *Philips Technical Review* in 1965 if you can get hold of a copy<sup>15</sup>. The practical description of the Goonhilly Down maser is discussed fully.

**Parametric amplifier**

The source of gain in the parametric amplifier is an entirely different physical mechanism to that in the maser system, although a pump oscillator is again employed. Most of the literature proudly states that Lord Rayleigh, and even Michael Faraday, spoke of the paramp principle way back in the last century. This is so, but the electronic realization of the principle for low-noise amplification is recent (the 1950s). Basically a reactive parameter, such as a capacitance, is varied and this feeds energy into a signal wave. Being a virtually noiseless parameter (reactance), the usual Johnson and current noise contributions are reduced. There is some loss in the active device, which is usually a varactor diode, and in the feeder hardware. Cooling will therefore lower the effective noise temperature. Noise contributions also arrive in the pump frequency oscillations and can degrade the performance.

Three frequencies are usually involved in a paramp; the signal frequency  $f_s$ , the pump  $f_p$  and the idler frequency  $f_i$ . The idler frequency is the mixing product of  $f_s$  and  $f_p$ , i.e.  $f_i = f_p - f_s$ . Much of the design work in parametric amplifier projects is involved with the correct design of the resonant structures for  $f_s$  and  $f_i$  and in ensuring the isolation between them. A circulator is required at the signal front end, because the varactor diode is a two-terminal device. (Tunnel diode amplifiers also have this drawback.) You are correct if you immediately assumed that isolators, circulators, switches or any other such lossy hardware in the input feeder are bad for low-noise performance, equation 9 or 12 operates again.

Fig. 18 gives some idea of the electrical arrangement of a pumped paramp of the "two-tank" variety. The input signal arriving at port 1 of the circulator is diverted out of port 2 into the signal-tuned circuit  $CL_s$  in the paramp. The pump is, varying the capacitance of the varactor and energy is fed into the signal oscillations by this action. The amplified signal is passed back to port 2 of the circulator. (You could look upon all this as a signal passing into the paramp on the input transmission line and there reflected with a reflection coefficient greater than unity back down the line.) The circulator passes the amplified signal out of port 3 to the load. The circuit  $CL_i$  resonates at the idler frequency and filters  $F_i$  and  $F_s$  reject the idler and signal frequencies respectively so keeping the various signals and oscillatory powers in their places.

There are various ways in which the realization of the scheme shown in Fig. 18 can be carried out. Fig. 19 shows just one possibility. The pump is much higher in frequency than the signal and is usually supplied via a waveguide, although microstrip techniques are increasingly being employed.

A theoretical analysis of Fig. 18 enables the gain, noise temperature and bandwidth of the amplifier to be derived. If you are interested in some of the theoretical argument, you will find a very good discussion in reference 16. One factor of great importance is  $\gamma$ , which is defined as

$$\frac{C_{max} - C_{min}}{2(C_{max} + C_{min})}$$

This is a kind of goodness factor for the varactor diode and indicates the amount of capacitance variation obtainable by pumping. Another diode parameter is the cut-off frequency,  $f_c = 1/2\pi CR_d$ , which must be way above the frequencies involved in the amplifier. Noise is contributed directly by the diode loss resistance  $R_d$  and also  $R_i$  in the idler circuit. It is in cooling these

that the improved performance at low frequencies is obtained. Quoting now the noise temperature expression (see reference 16)

$$T_e = T \left[ \frac{R_d}{R_g} + A \frac{f_s}{f_i} \left( 1 + \frac{R_d}{R_g} \right) \right]$$

where  $R_g/R_d$  is often called the over-coupling ratio and  $T$  is the physical temperature.  $A$  is dependent on the gain, but is normally close to unity, especially at high gain. This means that if we make  $R_g \gg R_d$ , then the effective noise temperature of the paramp is

$$T_e \approx T \frac{f_s}{f_i} \tag{13}$$

Under these conditions, we can see that if the pump frequency is high, so that  $f_s \ll f_i$  then the effective input noise temperature of the parametric amplifier can be made less than the physical temperature (i.e. by the fraction  $f_s/f_i$ ). Lest you think "Ah! let's push up the idler frequency to millions of gigahertz - and get noise temperatures around absolute zero", life is not so kind. Remember  $f_c$  for the diode, and other losses limit the possibility of an unlimited rise in the pump and therefore idler frequency. The noise temperature given by (13) is oversimplified and as the gain drops when  $f_p$  goes up the noise temperature will start to increase again. This would indicate that there is a minimum noise temperature for an optimized paramp with a given diode, packaging, and so on. It can be shown that

$$T_{e(min)} = \frac{2f_s}{\gamma f_c}$$

As would be expected, a large  $\gamma$  and high  $f_c$  for the diode is the best way to a low  $T_e$  at any given signal frequency  $f_s$ .

**Handling the idea of noise figures**

The noise figure,  $F$ , has already been mentioned and you may recall from part 1 that H. T. Friis and D. O. North were instrumental in getting the concept off the ground. All the equations to calculate  $F$ , are derived from the basic definitions in a similar way to the expressions for  $T_e$ . If we went through it all again, it would mean a duplication of effort. The main point now is to derive the relationship between  $F$  and  $T_e$  so that all the earlier equations can be written in terms of  $F$ , if required. Friis defined  $F$  as the signal-to-noise ratio at the input of a network when the source resistance is at 290°K; divided by the signal-to-noise ratio at the output of amplifiers, receivers and so on, are always smaller than those at the input, then  $F$  is always larger than one.

From the above verbal definition you will see that

$$F = \frac{S_i}{P_{Ni}} \bigg/ \frac{S_o}{P_{No}}, \text{ and this ties up to } \frac{S_i P_{No}}{P_{Ni} S_o}$$

If the network has a power gain of  $G_A$ ,

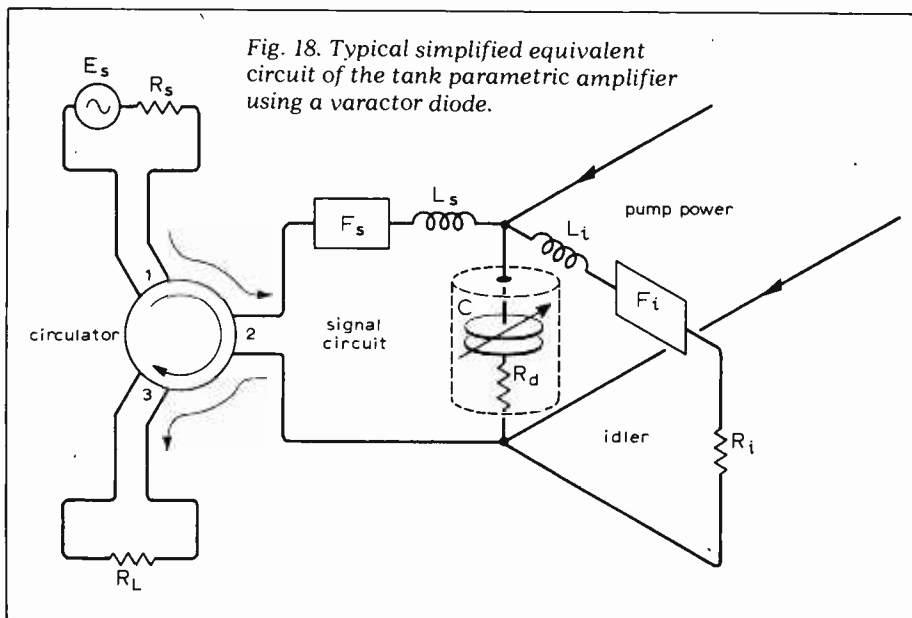

Fig. 18. Typical simplified equivalent circuit of the tank parametric amplifier using a varactor diode.

then  $S_o = G_A S_i$  and  $P_{No} = G_A P_{Ni} + P_{Na}$ , by precisely the same argument that was made in part 2 (first paragraph). This means that

$$F = \frac{S_i(G_A P_{Ni} + P_{Na})}{P_{Ni} G_A S_i} = 1 + \frac{P_{Na}}{G_A P_{Ni}} \quad (14)$$

Immediately from the equation  $P_{Na} = G_A k T_e B$ , (part 2) and  $P_{Ni} = k(290)B$ , so that from equation 14

$$F = 1 + \frac{T_e}{290} \quad (15)$$

This is the relationship connecting  $F$  and  $T_e$  we set out to find.

I indicated at the beginning of this series that D. O. North also defined a noise factor. His definition dispensed with signals right from the start. You may like to see that his definition is just the same as that just given in (15), although North originally suggested 300K for the standard temperature. North's definition went like this: "F is the ratio of the total noise power output from a system when its input termination is at 290K, to that part of the output which arises from the input termination only".

In symbols, this is

$$F = \frac{P_{No} \text{ (when } T_i \text{ is 290K)}}{G_A k(290)B}$$

but  $P_{No} = G_A k B(290 + T_e)$ , see part 2, p.169, and therefore

$$F = 1 + \frac{T_e}{290}, \text{ as before.}$$

Some early ideas connected with this topic was discussed in *Wireless World* by L. A. Moxon<sup>17</sup>.

We are now in a position to write down any noise expression in terms of  $F$  by using the fact that  $T_e = 290(F-1)$  by transposing (15). You can see this from the following examples.

Substituting for  $T_e$  in the equation on p.171 (part 2) gives

$$F = F_1 \frac{F_2 - 1}{G_i} + \frac{F_3 - 1}{G_1 G_2}$$

From equation 6

$$T_e = \frac{T_{hot} - A T_{cold}}{A - 1} \text{ or}$$

$$290(F - 1) = \frac{T_{hot} - A T_{cold}}{A - 1},$$

$$F = \frac{\frac{T_{hot}}{290} - A \frac{T_{cold}}{290}}{A - 1} + 1 \text{ which is}$$

$$F = \frac{\left(\frac{T_{hot}}{290} - 1\right) - A \left(\frac{T_{cold}}{290} - 1\right)}{A - 1}$$

The quantities in the brackets are excess noise ratios. Very often  $T_{cold} = 290K$ , so that

$$F = \frac{\frac{T_{hot}}{290} - 1}{A - 1}$$

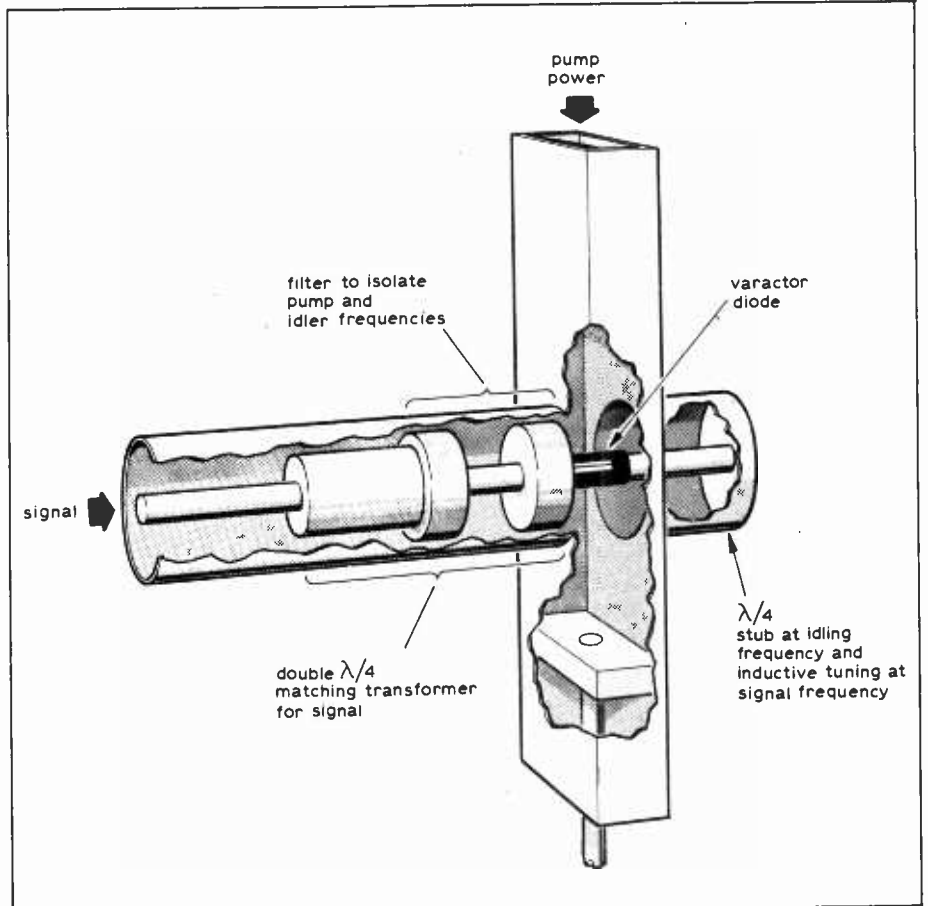
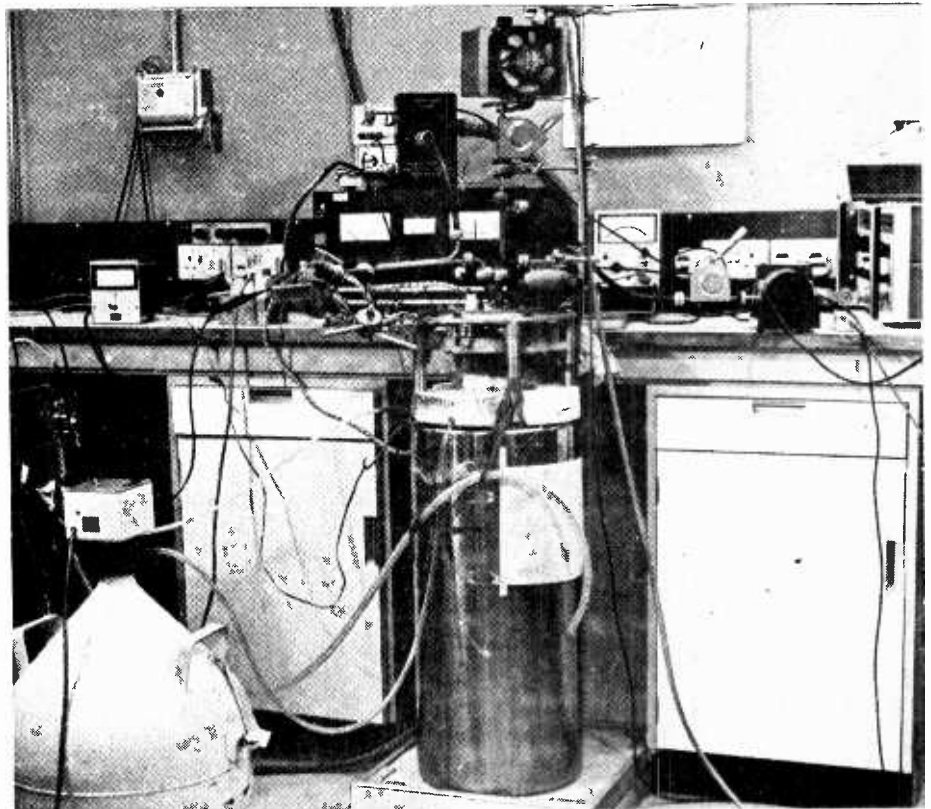

Fig. 19. Hardware of a parametric amplifier for the hundreds of megahertz to lower gigahertz region often consists of a mixture of coaxial and waveguide techniques. This illustration is based on a system described by Aitchison, Davies and Gibson of Mullard Research Labs.

View of Tony Fletcher's 35GHz maser at the University of Kent. Pump power is obtained from a klystron operation at 80GHz. The complexity of the cryogenics is obvious.





If  $A$  is made 2 by choosing the value of  $T_{hot}$  to make it so, then

$$F = \frac{T_{hot}}{290} - 1$$

The last equation in part 2 shows this to be equal to  $20I_a R$  for a noise diode, so that we have the interesting result  $F = 20I_a R$ , a well-known expression.

For the next example, we can look at (8), which when substituted gives

$$F = 1 + \frac{(L-1)T_L}{290}$$

Similarly from (9)

$$290(F-1) = (L-1)T_L + L(290[F_R-1])$$

$$F = 1 + (L-1)\frac{T_L}{290} + L(F_R-1)$$

Considering equation (11), we can now see why we had some argument about  $T_x$ , because the original derivations were in terms of  $F$ . We should expect to see a simplification when "going backwards" to  $F$ , to the well-known equation for crystal mixer performance. Now  $T_e = 290(F-1)$  and  $T_{if} = 290(F_{if}-1)$ , also  $T_0 = 290K$  all by definition, so that equation 11 gives

$$290(F-1) = LT_x - 290 + L290(F_{if}-1)$$

$$F = L(t_x + F_{if}-1)$$

where  $t_x = T_x/290$ . This is often seen quoted in discussions about crystal mixers.

And so we could go on. Notice that there is often a "1" for the first term on the right-hand side in noise figure

equations. This arises because of the contribution of the source at 290K. When the division by 290 is made to obtain the ratio that is  $F$ , the first term is "1". This means (by subtracting the "1" from both sides) that the expression  $F-1$  occurs frequently, hence the growth of the term excess noise figure for this. Because I am making a case for a decline in the use of  $F$  and an increase in thinking in terms of temperature, I will not labour the point any further.

If you would like to give more prominence to  $F$ , and convert all the formulae, for instance, then you can go ahead. But, in this series of articles, I have attempted to show that the mysteries of "temperature" are only imaginary and that so long as care is taken to realise that the term has been extended to mean more than physical hotness, then the idea is valuable in noise discussions.

I suggest that the noise figure is not so clear as temperature, and is tied to "290K", which is sometimes manipulated behind the scenes for the unwary, and this makes a mockery of "F".  $F$  has

*This is a typical low-noise (50K) commercially-made parametric amplifier. Example illustrated operates at a signal frequency of 1414MHz. Coaxial circulator is seen at the bottom right and the pump power is obtained from the solid state oscillator at the bottom left, which feeds power to the varactor via a ferrite isolator. Amplifier was supplied to Cambridge University for radio astronomical observations around the hydrogen-line frequency. (Courtesy of Ferranti Ltd.)*

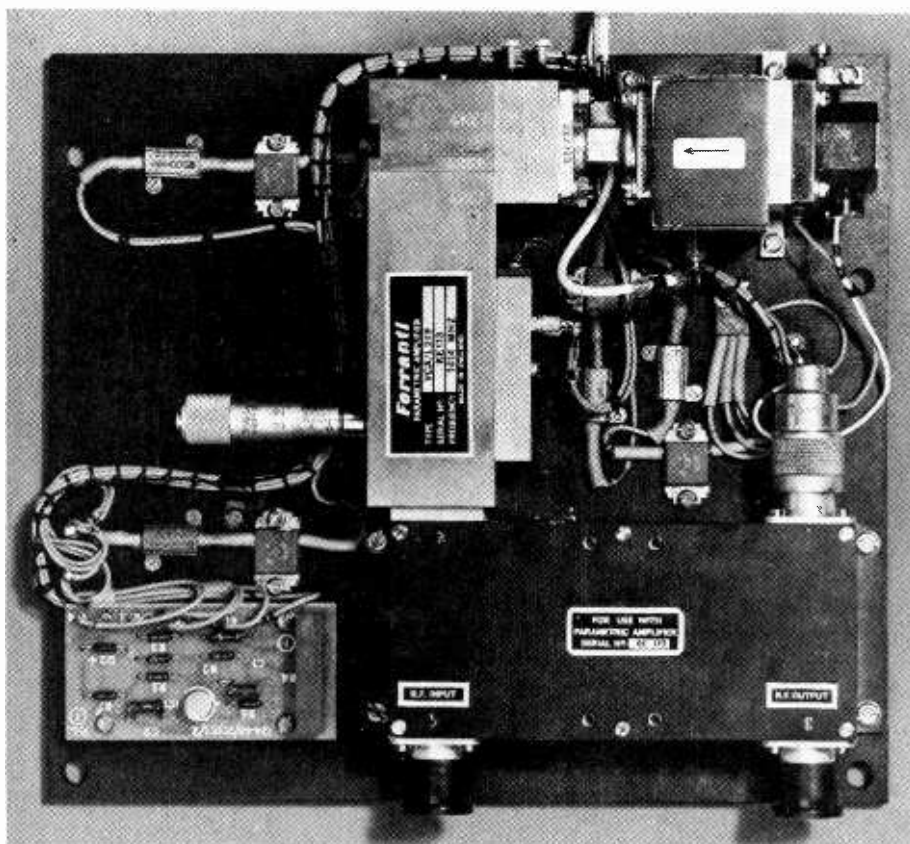

a habit of being what anyone wants it to be (see the satirical article The Art of Noisemanship by J. C. Green<sup>18</sup>, also The Noise Figure Muddle by Seymour B. Cohn<sup>19</sup>). As you might see, a lot of confusion can arise. If you have not yet embarked upon a course of advanced study in electronics, perhaps I have been able to give you an inkling of the interesting concepts concerning equipment limitations, meanings of temperature, etc, that you are likely to meet as part of your studies. If you are already doing some work in communications engineering, then a few of the points covered in these articles may show a little of what is "behind the scenes". Mastering the technique of handling  $T_e$ , and especially  $T_{op}$  or  $T_{sys}$  gives you a direct route to the overall signals-to-noise ratio - which when all is said and done, is the vital parameter in modern communications systems.

**References**

14. Nielsen, E.G. "Behaviour of noise figure in junction transistors", *Proc. IRE*, vol.45, 1957, p.957.
15. Walling, J. C., and Smith, F. W. "Solid-state masers and their use in satellite communication systems", *Philips Technical Review*, vol.25, 1964, p.289.
16. Van der Ziel, A "Solid State Electronics", Prentice-Hall.
17. Moxon, L. A. "Noise factor", *Wireless World*, vol.52, 1946, p.391; vol.53, 1947, p.11.
18. Green, J. C. "The art of noisemanship", *Proc. IRE*, vol.49, 1961, p.1223.
19. Cohn, S. B. "The noise figure muddle", *Microwave Journal*, vol.2, 1959, March, p.7.

**Correction to part 2 (April issue)**

An error occurred in the discussion of noise bandwidths in Appendix B, page 173. The two equations for  $G_A$  at the top of the page are correct, but  $L$  and  $C$  have subsequently become transposed. There is a symmetry about  $L$  and  $C$ , so the final result is correct, but the statement

$$R = \omega C \frac{1}{\omega L} \text{ should read } R = \omega L \frac{1}{\omega C}$$

and all  $L$ s and  $C$ s should be interchanged from then on. (The error is obvious if you look at the statement  $B_{3dB} = R/2\pi C$ , which cannot be true because it is dimensionally incorrect. Replace  $C$  with  $L$  and it is then alright.)

# See more. More to see.



M-OV E14-110C

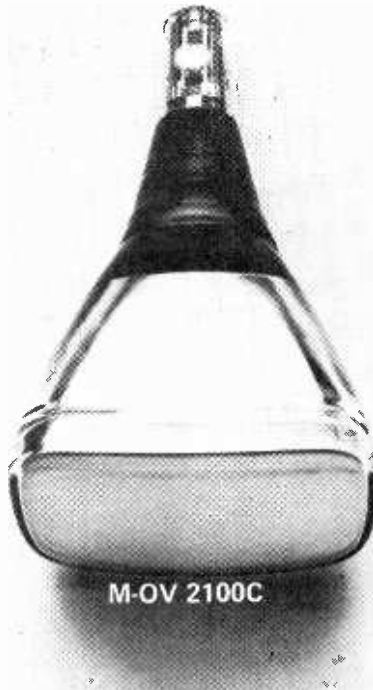

M-OV 2100C

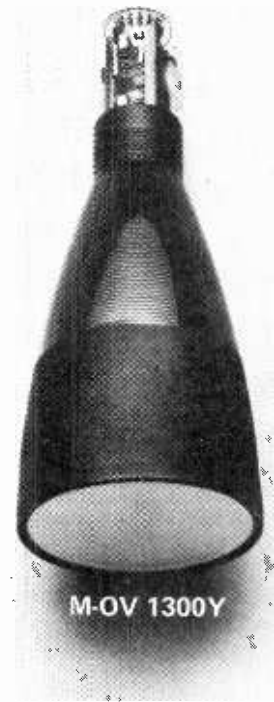

M-OV 1300Y

**See double** on M-OV's new true double gun instrument CRT. 14cm rectangular flat faceplate displays two sweep speeds simultaneously. M-OV E14-110GM.

**See rapid waveforms** on M-OV's large display 21cm rectangular instrument CRTs. Electrostatic deflection. Fast writing speed. M-OV 2100C.

**See clearly at low cost** on M-OV's less expensive CRTs like the 13cm medium bandwidth tube. M-OV 1300Y.

**For instrument CRTs**, the M-OV range has the versatility to meet

a wide variety of specific needs.

Round or rectangular screens. Sizes from 7-21cm. Complete range of phosphors. Selection of graticules. Fibre optic types, too.

Plus the design and engineering capability to deliver precisely the tube you need.

Write for our new catalogue and data sheets on CRTs for instrument, radar including multi-colour, avionic, data display and TV studio applications.

Or if you have a specific problem, phone us.

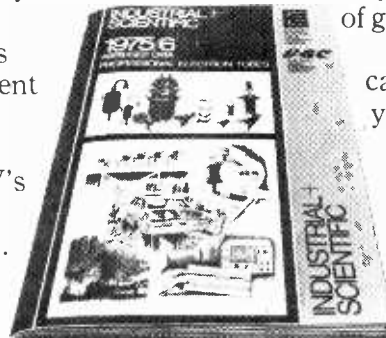

## EEV and M-OV know how.

THE M-O VALVE CO LTD. Hammersmith, London, England W6 7PE. Tel: 01-603 3431. Telex: 23435. Grams: Thermionic London.



WW-069 FOR FURTHER DETAILS

# The Sinclair DM2 Multimeter.

## Comprehensive. Accurate. Portable.

### And really rugged.

Yet only **£59.** (PLUS VAT)



State-of-the-art circuit design, incorporating high-quality components, has resulted in a professional,  $3\frac{1}{2}$  digit instrument of outstanding performance and reliability at a realistic price.

A custom-designed MOS LSI digital processing IC controls the auto-polarity dual-slope-integration A to D converter. The circuit built around this IC uses a MOSFET op-amp input buffer with 0.1% metal-film resistors. The result is excellent accuracy and stability with a very high basic input impedance.

The instrument reads to  $\pm 1999$  and has a basic accuracy on the 1 V DC range of  $0.3\% \pm 1$  digit. Four 8 mm LED displays provide excellent legibility and angle of view. Battery operation allows complete independence of mains supply.

The Sinclair DM2 has all the capability you need. Just take a look at its features and compare them with higher-priced multimeters. You'll find the DM2 is their equal in virtually everything – except price!

#### Features of the Sinclair DM2

**5 functions giving 22 ranges**  
 DC volts – 1 mV to 1000 V  
 AC volts – 1 mV to 500 V  
 DC current – 0.1  $\mu$ A to 1 A  
 AC current – 1  $\mu$ A to 1 A  
 Resistance – 1  $\Omega$  to 20 M  $\Omega$

#### Easy to use

Automatic polarity, bush-button selection for all ranges and modes from a single input terminal pair.

#### Easy to read

Big, bright 8 mm LED display gives a quick, clear reading.

#### $3\frac{1}{2}$ digit display

Display reads from 000 to 1999. Overload indicator.

#### Protected

Separate fuses for current and resistance circuits.

#### Accurate

Dual slope integration. High stability.

#### Rugged construction

Tough metal casing takes the roughest treatment – try standing on it!

#### Two power sources

Supplied with a 9 V battery, giving 60-hour typical life. Mains adaptor also available

#### Portable

Weighs only 2  $\frac{1}{2}$  lb approx, including battery. Measures only 2 in x 9 in x 6 in approx.

#### Optional extras

Mains adaptor – £3.19 inc VAT.  
 Carrying case – £5.40 inc VAT.  
**12-month no-quibble guarantee**

# The Sinclair DM2 Multimeter: full technical story

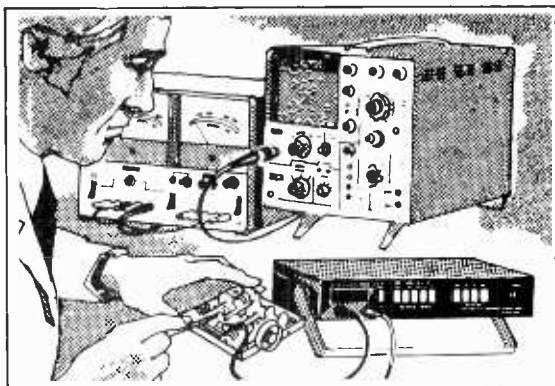

Use it in your laboratory. The DM2 sits rigidly on its combined carrying handle/stand.

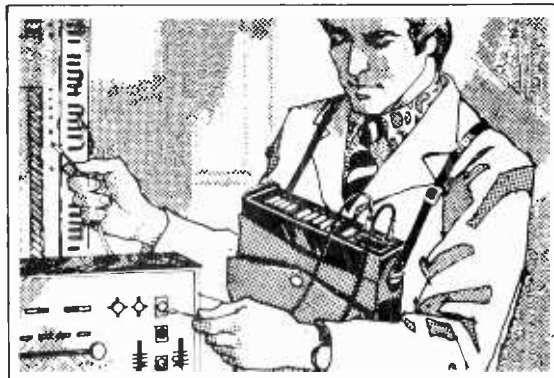

Use it on the move. Keep the DM2 in its carrying case - it's always ready for use.

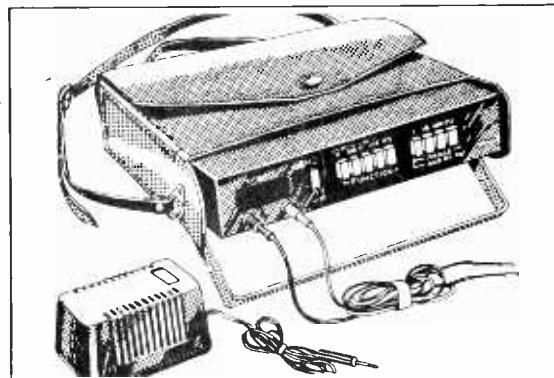

All you need to use the DM2... anywhere. Mains adaptor... carrying case... multimeter... you're ready for quick, efficient metering - whatever the situation.

DC Volts Range	Accuracy	Input Impedance	Resolution
1 V	0.3% ± 1 Digit	> 100 MΩ	1 mV
10 V	0.5% ± 1 "	10 MΩ	10 mV
100 V	0.5% ± 1 "	10 MΩ	100 mV
1000 V	0.5% ± 1 "	10 MΩ	1 V

Maximum overload - 350 V on 1 V range  
1000 V on all other ranges.

AC Volts Range	Accuracy	Input Impedance	Frequency Range
1 V	1.0% ± 2 Digits	10 MΩ/40 pF	20 Hz-3 KHz
10 V	1.0% ± 2 "	10 MΩ/40 pF	20 Hz-3 KHz
100 V	2.0% ± 2 "	10 MΩ/40 pF	20 Hz-3 KHz
1000 V	2.0% ± 2 "	10 MΩ/40 pF	20 Hz-1 KHz

Maximum overload - 300 V on 1 V range  
500 V on all other ranges.

DC Current Range	Accuracy	Input Impedance	Resolution
100 μA	2.0% ± 1 Digit	10 KΩ	100 nA
1 mA	0.8% ± 1 "	1 KΩ	1 μA
10 mA	0.8% ± 1 "	100 Ω	10 μA
100 mA	0.8% ± 1 "	10 Ω	100 μA
1000 mA	2.0% ± 1 "	1 Ω	1 mA

Maximum overload - 1 A (fused).

AC Current Range	Accuracy	Frequency Range
1 mA	1.5% ± 2 Digits	20 Hz-1 KHz
10 mA	1.5% ± 2 "	20 Hz-1 KHz
100 mA	1.5% ± 2 "	20 Hz-1 KHz
1000 mA	2.0% ± 2 "	20 Hz-1 KHz

Maximum overload - 1 A (fused).

Resistance Range	Accuracy	Measuring Current
1 KΩ	1.0% ± 1 Digit	1 mA
10 KΩ	1.0% ± 1 "	100 μA
100 KΩ	1.0% ± 1 "	10 μA
1000 KΩ	1.0% ± 1 "	1 μA
10 MΩ	2.0% ± 1 "	100 nA

Overload protection - 50 mA (fused).

## Take advantage of this money-back, no-risk offer today

Test the Sinclair DM2 for yourself. Simply send us a cheque, your Access/Barclaycard number, or an official company order, with the coupon below. And in the unlikely event you find it's not what you need, return it to us within 10 days and we'll refund your money in full.

Interested in a quantity discount?

Use the coupon to arrange a demonstration and get details of prices on 5 or more instruments.

**Sinclair Radionics Ltd,**  
London Road, St Ives, Huntingdon,  
Cambs., PE17 4HJ.

**Tel: St Ives (0480) 64646.**

VAT Registration No: 213 8170 88.

# SINCLAIR

To: Sinclair Radionics Ltd, FREEPOST, St Ives, Huntingdon, Cambs., PE17 4BR.

Please send me:

- ..... Multimeters " £63 72 inc VAT.
- ..... Mains adaptors " £3.19 inc VAT.
- ..... Carrying cases " £5 40 inc VAT.

\*I enclose a cheque for £

\*My Access/Barclaycard number:

I am interested in 5 or more multimeters

- ..... Please arrange a demonstration.
- ..... Please send details of quantity discounts.

\*I enclose an official company order - signed and dated.

\*Please complete or delete as applicable.

Name \_\_\_\_\_

Address \_\_\_\_\_

Please print

FREEPOST - no stamp needed with address above.

WW/7/75

# WATCH OUR Television

## NOW IT'S BIGGER & BETTER

More pages! Larger size! Extra features!

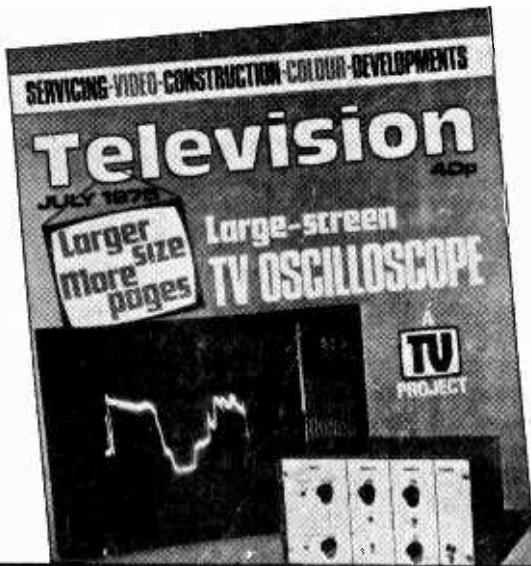

*Special Features this month:*

### **LARGE SCREEN TV OSCILLOSCOPE**

How a large-screen monochrome receiver can be converted for displaying television waveforms.

### **CEEFAX/ORACLE RECEPTION**

Start of a new series explaining the principles and the practical techniques used for teletext news displays.

### **LATEST COLOUR RECEIVER CIRCUITRY**

An account of the many novel circuit techniques used in the latest Rank colour chassis.

### **VIDEO SIGNAL EXTRACTION**

Many VCRs require a v.f. input. K. Cummins presents a suitable circuit for extracting the video signal from a domestic TV set.

### **COLOUR RECEIVER SERVICING**

Les Lawry-Johns deals with faults experienced on the Philips G6 colour chassis.

### **PLUS ALL THE REGULAR FEATURES**

JULY ISSUE OUT MONDAY 16th JUNE, PRICE 40p.

## transformers

mains, audio, microphone, ferrite core  
and other wound components

A wide range of transformers  
manufactured in production  
quantities to customers  
individual requirements

Prompt Prototype  
Service available



MICROPHONE  
TRANSFORMER IN  
MUMETAL CAN

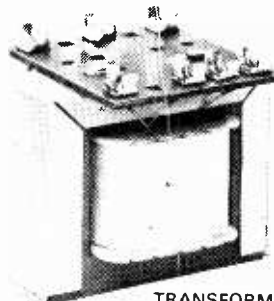

TRANSFORMER WITH  
TWO HOLE CLAMP AND  
SOLDER TAG CONNECTIONS

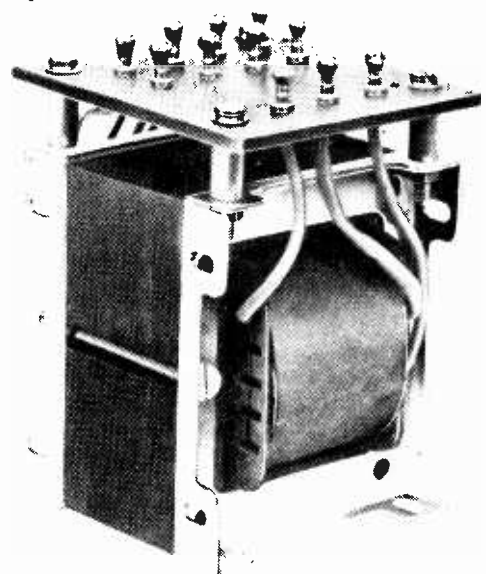

TRANSFORMER  
WITH UNIVERSAL  
END FRAMES AND  
TURRET LUG CONNECTIONS

## Drake Transformers Limited

Telephone:  
Billericay 51155

Kennel Lane,  
Billericay, Essex.

WW-029 FOR FURTHER DETAILS



# Resistance comparator

—with linear fractional off-balance indication

by D. Griffiths Ph.D.

Imperial College, London

## A simple d.c. op-amp design featuring linear reading of percentage unbalance for any arbitrary value of reference resistor without recalibration in the range 100Ω to 10kΩ.

It was not very clear what the design objectives were at the beginning of this effort; they never seem to be in my experience. It appeared that we needed either (a) to display the variation of the reciprocal of the unknown resistance  $R_x$  about some nominal value  $R_f$  with zero output when  $1/R_x = 1/R_f$  or (b) to give a strictly linear output proportional to the fractional deviation of  $R_x$  up to 100% above and below  $R_f$  with zero output when  $R_x = R_f$ . The further proposal that accurately-calibrated percentage deviations should be shown on plugging in any arbitrary value of reference resistor  $R_f$  without recalibration, did not seem to simplify matters.

In the event both requirements (a) and (b) were met in a single circuit design which also gave the proposed constant calibration of the fractional unbalance indication. An accuracy of order 0.1% is achieved with full scale indications of unbalance between 1% and 100% in the range 100Ω to 10kΩ.

The design may be useful on small production runs where resistors have to be hand-trimmed within certain readily-seen percentages of different awkward values; the components used in the original bread-board can then be the master references during trimming. The original application however was with temperature sensors which could be of widely different values although all had

similar temperature coefficients of resistance when expressed as a percentage change; this circuit then gave the same loop gain to a process controller when used with different sensors.

As is often the case it was difficult to get away from the first lines of attack that occur to one at the initial doodling stage; I felt that something in the ratio transformer or Wheatstone bridge line would be required. After all, item (a) involved  $1/R_x$ , i.e. a conductance, and invited a ratio arm transformer technique; but it was not evident how to maintain a calibrated fractional unbalance indication with arbitrary values of  $R_f$  at least with a reasonably simple circuit (watch forthcoming Letters' columns). On the other hand alternative (b), which involved direct display of resistance variations, ruled out a Wheatstone bridge scheme by the wide range of linearity said to be required.

The requirement (b) can be looked at thus: suppose we keep a constant and known voltage across  $R_f$ ; then if the current through  $R_f$  also flows through  $R_x$ , the difference in the voltage drops across  $R_f$  and  $R_x$  will only depend on the fractional relation of  $R_f$  and  $R_x$  and not on their actual values. It then starts to look like an exercise in op-amp techniques, as indicated in Fig. 1. (Requirements (b) can also be met by interchanging  $R_f$  and  $R_x$ .

In the prototype the voltage across  $R_f$  was set at 1 volt, a higher value bringing power dissipation problems in the test resistors. A proposed system accuracy of order 0.1% implied keeping drifts and computing errors to less than 1mV when referred to this 1-volt level. Past experience suggested that a d.c. technique with type 741 op-amps would just suffice to achieve this, especially in view of the comparatively low values of resistance to be compared. (The use of an a.c. carrier scheme would enable  $V_f$  and the power in the test resistors to be set many orders of magnitude smaller but the circuitry would then be a good deal more complex.)

It just remained to convert these ideas into hardware. The functions required are: (1) to hold the voltage  $V_f$  across  $R_f$  constant at 1 volt; (2) to use a differential amplifier to monitor  $V_x$ ; and (3) to subtract  $V_x$  and  $V_f$ , and scale the unbalance appropriately.

Consider first how to hold  $V_f$  constant. In an op-amp follower-with-gain circuit, drawn in the usual way in Fig. 2, the ideal action of the negative feedback is to maintain the inverting input terminal (-) at the same voltage as the non-inverting input (+). This will be so, irrespective of the value of  $R_2$ , provided  $R_1$  is not so large as to cause the output of the amplifier to saturate at either full positive or negative excursion. Calling

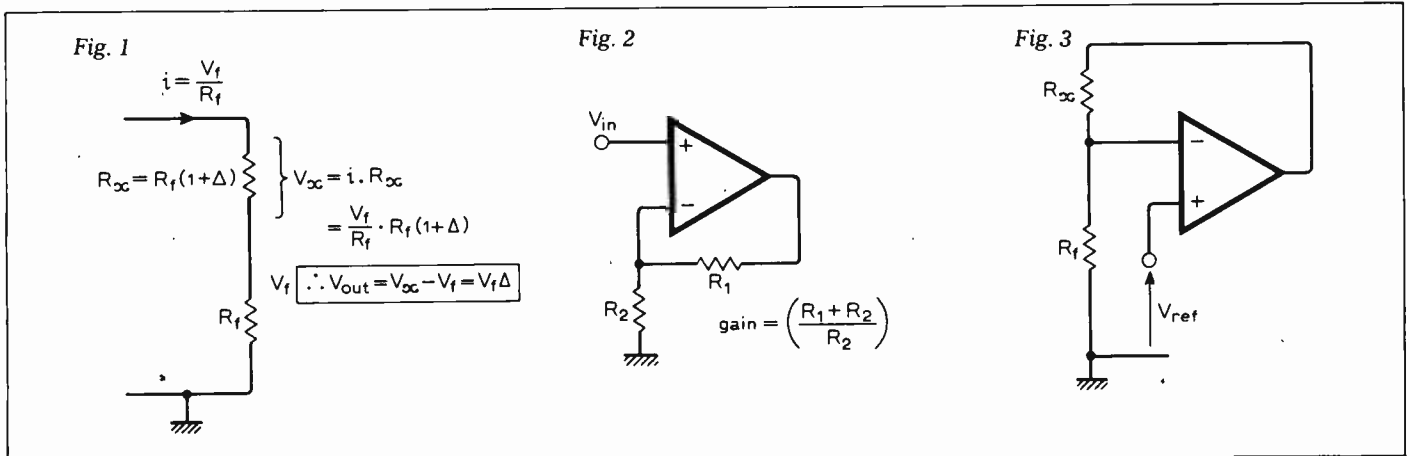

$R_1 = R_x$  and  $R_2 = R_f$ , we can redraw Fig. 2 as in Fig. 3, where the voltage across  $R_f$  will be held at  $V_{ref}$ , for an ideal amplifier. This is the first step in a realization of Fig. 1.

The second function to be achieved is that of causing the voltage across  $R_x$  to appear referenced to the common line, so it can be compared subsequently with the voltage appearing across  $R_f$ ; this is the function of a differential amplifier. Such an amplifier can have its input stage operating in the inverting mode, whereupon the common-mode rejection ratio (c.m.r.r.) of the amplifiers does not limit the achievable c.m.r.r. of the circuit. On the other hand, inverting stages usually have a much lower input resistance than follower stages, though in differential applications the latter are limited by the c.m.r.r. of the op-amps used. The choice is easily made here for  $R_f$  has a constant voltage across it which lessens the c.m.r.r. demands on the amplifier and we require a high input resistance to minimize the loading of  $R_x$ ; if  $R_x = 10k\Omega$ , an amplifier input resistance of  $10M\Omega$  will effectively lower this resistance by 0.1%.

Fig. 4(a) shows a high input resistance differential amplifier, while Fig. 4(b) is intended to show how the common-mode rejection occurs by

emphasizing the bridge action through drawing it in a more "Wheatstone" way. If  $R_a = R_b = R_c = R_d$ , and if in Fig. 4(b) both points A and B move up and down in voltage together (i.e.  $V_{AB} = 0$ ), then points C and D will experience equal voltage excursions of one half of this magnitude if E remains at ground potential. This absence of output from the op-amp is consistent with its zero input,  $V_{CD} = 0$  as required.

In Fig. 4(a) the gain to differential input signals is  $-1$  if all the bridge resistors are of equal value. This can perhaps be seen most easily by thinking of the differential input  $V_{AB}$  as riding on top of the common-mode signal  $V_{CM}$  and remembering that ideally  $V_{CM}$  does not affect the voltage at E. Thus one can consider  $V_{CM} = 0$  when thinking only of the differential signal and note that this makes point D at ground potential. Resistances  $R_a$  and  $R_c$  are then evidently seen as a unity-gain see-saw amplifier with phase inversion.

In the prototype circuit the maximum voltage across  $R_f$  had to be limited to 1 volt and to reduce the effects of voltage offset drifts the voltage across  $R_f$  and  $R_x$  was multiplied by three before passing it to the remaining op-amps. The differential amplifier of Fig. 4(a) can give gain by the addition of three resistors as shown in Fig. 5.

If  $R_3 = R_5$ , the voltage gain of the input stage is  $+(1 + 2R_3/R_4)$ . At first glance one might expect the factor of two to be outside the bracket but inspection of Fig. 5 shows that

$$\begin{aligned} V_{AB} &= V_1 + V_2 - V_{IN} \text{ (across } R_4) \\ &= V_{IN} \left( \frac{R_3 + R_4}{R_4} \right) + V_{IN} \left( \frac{R_4 + R_5}{R_4} \right) - V_{IN} \\ &= V_{IN} \left( 1 + \frac{2R_3}{R_4} \right), \text{ if } R_3 = R_5. \end{aligned}$$

Compared with many other difference amplifiers that of Fig. 5 has two outstanding advantages. First, the gain can be adjusted by varying a single resistor,  $R_4$ . Secondly, setting of the gain is quite independent of trimming for best c.m.r.r. It should be noted that if  $R_3$  does not equal  $R_5$  exactly, then this only affects the gain and does not reduce the common mode rejection of the circuit.

The addition of a standard virtual-earth summing amplifier to the circuits of Figs 3 and 5 finishes the design, the complete circuit of which is shown in Fig. 6. A saturated 741 o-amp with  $\pm 15V$  supplies will have an output of 13 to 14 volts and gives only a modest overload to the meter which requires  $\pm 10V$  at the output of  $A_6$  for full-scale deflection. The  $2.2-\mu F$  feedback capacitor reduces needle jitter below the visible limit with a 90-mm scale length meter.

One might imagine at first sight that a 1% change in  $V_{ref}$  (and hence  $V_d$ ) would cause a full-scale change in meter reading when the output stage is on the 1% f.s.d. setting. (If this were so it would place a stringent demand on the stability of  $V_{ref}$  and make the circuit rather unattractive.) This misconception can arise by visualizing a 1% change in the voltage across  $R_f$  and seeing this as giving rise to a 1% unbalance at the input of the summing amplifier. However, this overlooks the changed voltage across  $R_x$ .

It is evident that if  $R_x$  exactly equals  $R_f$  then the output meter will register zero ideally for any value of  $V_{ref}$ . Suppose next that  $R_x = (R_f + \frac{1}{2}\%)$  with  $V_{ref} = 1V$  and the output meter indicates  $+\frac{1}{2}\%$  (i.e. half scale on the 1% range). If now  $V_{ref}$  increases by 1% say, then it is the extra voltage drop across the extra  $\frac{1}{2}\%$  of  $R_x$  (compared with  $\bar{R}_f$ ) that is the unbalanced input to the summing amplifier and will come through to the output; the new output reading would be  $(0.5 \times 101/100)\% = 0.505\%$ . Thus it is the span of the final meter deflection which is affected in direct proportion to possible changes in  $V_{ref}$ .

Fig. 6 shows that  $V_{ref}$  is derived here from the integrated power regulator output; the prototype used MVR15 devices from RS Components. These sort of devices have impressive output stability and modest price. Under constant load and in normal laboratory conditions their voltage drift is not

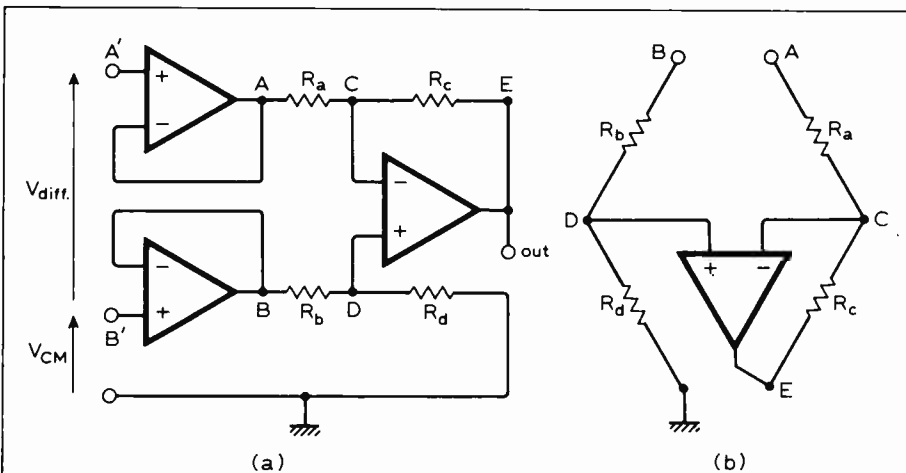

Fig. 4 (a) high input resistance differential amplifier, (b) diagram emphasizing bridge action of (a).

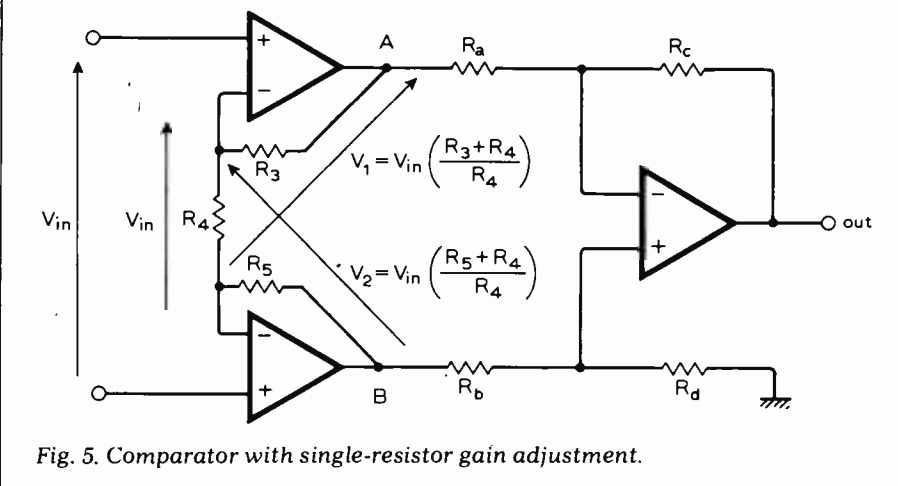
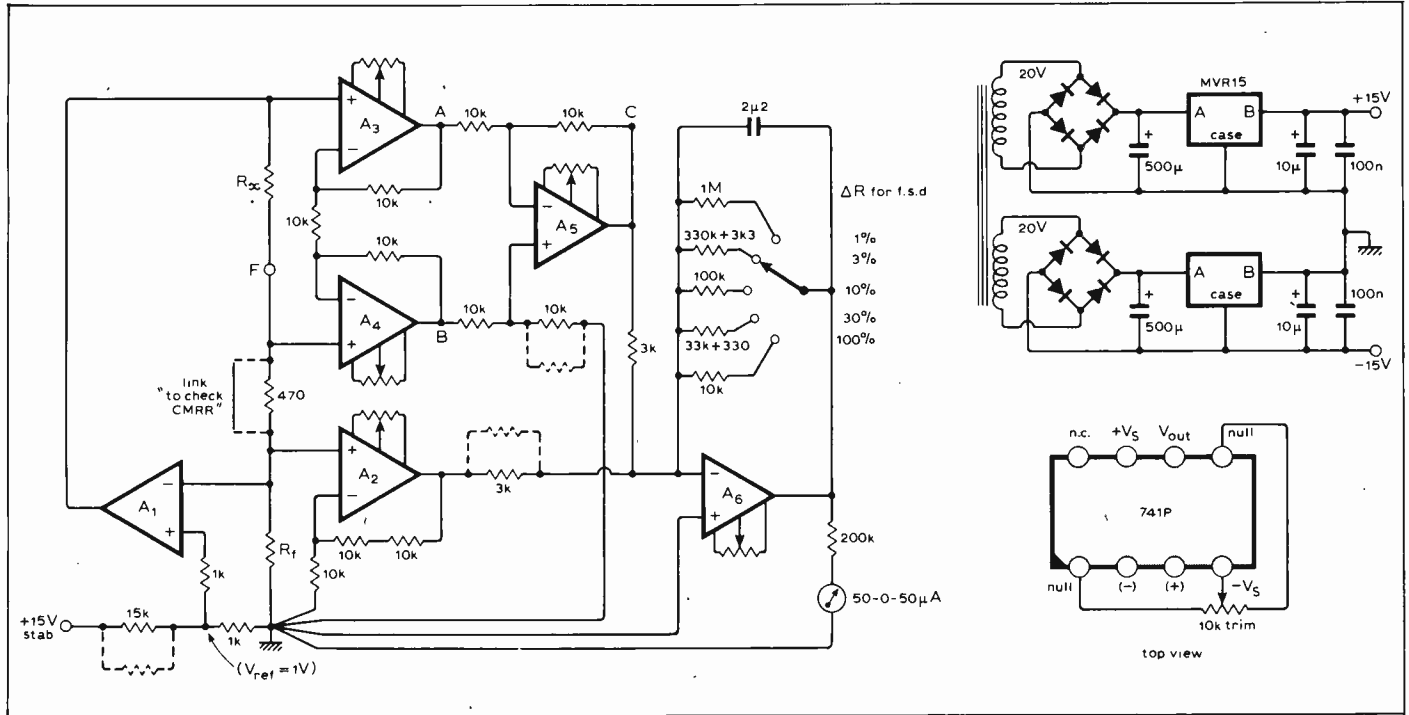

Fig. 5. Comparator with single-resistor gain adjustment.



visible on a 3½-digit multimeter on its 20-V range after a few minutes from switch-on, i.e. the output is steady to better than 10mV. In view of the insensitivity of this comparator circuit to changes in reference voltage, these regulators are more than adequate for supplying the reference voltage here.

Next we describe the procedure to trim the offsets of the op-amps, balance the differential amplifier and equalize the gains to the summing junction. It may sound a shade long-winded but it is quite straightforward and can be done in a few minutes, at least on the second time round.

Type 741 op-amps were used in all stages and the 10-kΩ offset controls were standard miniature carbon presets. The use of cermet-track elements may give a better temperature stability to the balance of the amplifiers but the extra cost is considerable. When trimming these offset voltages it is necessary to short various resistors; constructors are reminded that (a) the resistance of a "short" can sometimes be significant and (b) the short may be carrying more current than was at first thought. A current of only 10mA flowing through 6 inches (pardon, 15cm) of ordinary 2-amp connecting wire (7/0.2mm, 0.22mm<sup>2</sup>) produces a voltage drop of 0.1mV. The zero stability of even ordinary unselected 741 amplifiers is sufficiently good that it is worthwhile zeroing them to at least 0.1mV (referred to the input). As indicated in Fig. 6 a single point earthing scheme is a sensible precaution too. However,  $R_x$  can be quite distant from the rest of the circuit as the potential drop in the input leads to  $A_3$  and  $A_4$  is only that due to the 0.2μA bias currents of the 741 amplifiers.

A 3½-digit multimeter with least significant digit of 0.1mV was used in setting up the prototype; zeroes were adjusted until the + and - polarity

Fig. 6. Complete circuit where  $V_{ref}$  is derived from the integrated power regulator having an output stable within 10mV.

signals were flicking equally. If the 10kΩ preset used with a particular 741 has to be adjusted to more than say 2½kΩ from its mid-track position to balance the offset, it is perhaps prudent to select another 741 in this application.

The trimming procedure is as follows.  
 (1) Short  $R_x$ , trim the offset of  $A_3$  and  $A_4$  to give  $V_{AF} = V_{BF} = 0$ , checking  $V_{AB} = 0$ .  
 (2) Keeping  $R_x$  shorted also short  $R_f$ , measure  $V_{AB}$  (ideally zero) and trim  $A_5$  to give  $V_{CE} = -V_{AB}$ .  
 (3) With  $R_f$  and  $R_x$  still shorted, trim  $A_2$  for zero output, put  $A_6$  to the 10kΩ f.b. setting and trim  $A_6$  to give an output of  $-3.3 \times V_{CE}$  (found in step 2).  
 (4) With  $R_x$  shorted but restoring  $R_f$  to about 500Ω, adjust the balance of the differential 10kΩ bridge until  $V_{CE}$  remains constant when opening and closing the link across 470Ω (marked "to check c.m.r.r.").  
 (5) Select  $R_x$  and  $R_f$  to be exactly the same value (around 2KΩ) and adjust one of the 3kΩ summing resistors to  $A_6$  until the output meter reads zero on the 1% f.s.d. range.  
 (6) See three paragraphs below.

If two resistors of known equality are not available for use in step(5) the comparator can still be used to set up two resistors to the necessary degree of equality. One of the nominally equal pair is made trimmable and adjustment carried out until interchanging these two resistors in the positions  $R_f$  and  $R_x$  causes no change in the output meter reading; it is of no importance if the reading is non-zero at this point since step (5) has not yet been completed.

The prototype on the 1% range had a zero stability of about 0.005% during a normal day and a drift from cold switch-on of about 0.04%.

The linearity of output was checked

on the 100% and 10% ranges with a 3½-digit d.v.m. on the output of  $A_6$  and was found to be better than 0.1% ( $\pm 1$  digit) with  $R_f$  of 200Ω, 1kΩ and 5kΩ and full-scale unbalance on either side of equality. This good linearity makes scaling of the output ranges easy and the final item of the trimming procedure, step (6) is: With  $R_x = 0$  and the output stage on the 100% range, then for any value of  $R_f$  (100Ω to 10kΩ) the meter is made to read -100% by trimming the voltage divider giving the nominal 1 volt reference. Accuracy of the scale of the remaining ranges depends almost entirely on the accuracy of the f.h. resistors around  $A_6$  since the open-loop gain of a 741 at zero frequency is typically about  $10^5$ .

And what, you may ask is the fudge which is ill-concealed by the 1-kΩ resistor forlornly stuck between the + terminal of  $A_1$  and the point marked  $V_{ref}$  in Fig. 6? Well, it is tied up with the 100-Ω and 10-kΩ limits which were so casually mentioned earlier without explanation. The lower limit is set by  $A_1$  running out of the enthusiasm for supplying current much greater than 10mA, at least to the 0.1% accuracy required here. The prototype was satisfactory of  $R_f$  down to 70Ω and lower values could doubtless be accommodated by buffering the output of  $A_1$  with a power transistor. The upper limit arises from errors due to the bias currents in the increasing source resistance presented by  $A_1$  by  $R_f$  and  $R_x$  in parallel. Making the source resistance of  $V_{ref}$  about 2kΩ (as seen by  $A_1$ ) distributes this offset equally for  $R_f = 100Ω$  and 10kΩ: on the prototype this error amounted to  $\pm 0.07%$ , causing high values of  $R_x$  to read low by this amount. Substituting superbeta or f.e.t.-input op-amps for the 741 would enable the upper resistance limit to be pushed up.

# Realm of microwaves

## 10—Power and frequency measurements

by M. W. Hosking, M.Sc.

*British Aircraft Corporation, Filton*

At the low frequencies, where a cyclical change of current and voltage can be recorded and where the wavelengths are many orders of magnitude greater than the transverse dimensions of a conductor or component, it is possible to insert a current- or voltage-measuring instrument into the circuit to determine these quantities. The instrument itself has either a negligible or precisely known (internal resistance) effect on the circuit and one knows, say in the case of an ammeter, that it is indicating the total current flowing at that point.

Consider, however, the case of a hollow, metal waveguide: to d.c. this is a single conductor and one has difficulty with the concept of a "potential difference". Furthermore, as shown earlier in this series, the microwave current flows in circulating loops confined closely to the metal surfaces, and even were it possible to measure this current directly one could not say that this was the total current associated with an overall potential. It thus becomes conceptually inconvenient to think in terms of current and voltage as well as impracti-

cal to measure, and so these more fundamental quantities are lumped together and it is the total, time-average power which is measured.

Compared with the accuracy to which d.c. or low-frequency power can be measured, the absolute determination of microwave power is rather poor. Typical day-to-day accuracies using standard commercial power meters lie between 5% and 10% and even national standards are only in the region of 0.5% accurate. The fact that high-quality tracking and communication systems have evolved in spite of this limitation demonstrates that it is only on comparatively rare occasions that a highly accurate knowledge of power is necessary. Even then, it is usually required during the development of other

instruments. In the majority of cases the important factor is the power difference between one space or time and that in another space or time, i.e. relative power. Using standard laboratory test gear relative microwave power can be measured to within a small fraction of 1%.

As yet there is no practical, absolute method of microwave power measurement; that is, one which will indicate microwave power directly without calibration or transfer from some more primary effect. Although varied principles and techniques have been proposed and demonstrated over the years, the most practical way of determining microwave power has been by using some element to absorb the power and then observing the resulting heat dissipation. Devices used can conveniently be placed in one of two categories:

- in which the dissipated power produces a change in the electrical resistance of the absorbing element (called a bolometer), or a voltage difference (called a thermocouple);
- in which the rise in temperature of the dissipating element is measured and calibrated to read power (called a calorimeter).

These two groups are by no means exhaustive and there exist both variations and completely different methods of indicating microwave power. However, this series is essentially concerned with the real world of microwave electronics and, in this context, the above categories are the only ones of practical use.

### Bolometric devices

Bolometers are temperature-sensitive resistances taking the form of either a thin resistive wire or film, called barreters, or small-bead thermistors. Calibration of these elements is carried out by low-frequency substitution; that is, the change in resistance with microwave power is noted and identified with the d.c. power necessary to produce the same change. Here one starts off with the chain of accumulating errors in the microwave power-measuring system by asking: does the

*Fig. 1. Most common bolometric elements consist of either a very thin platinum wire having response curves shown in 1(a) or else a thermistor bead having the opposite type of response shown in 1(b).*

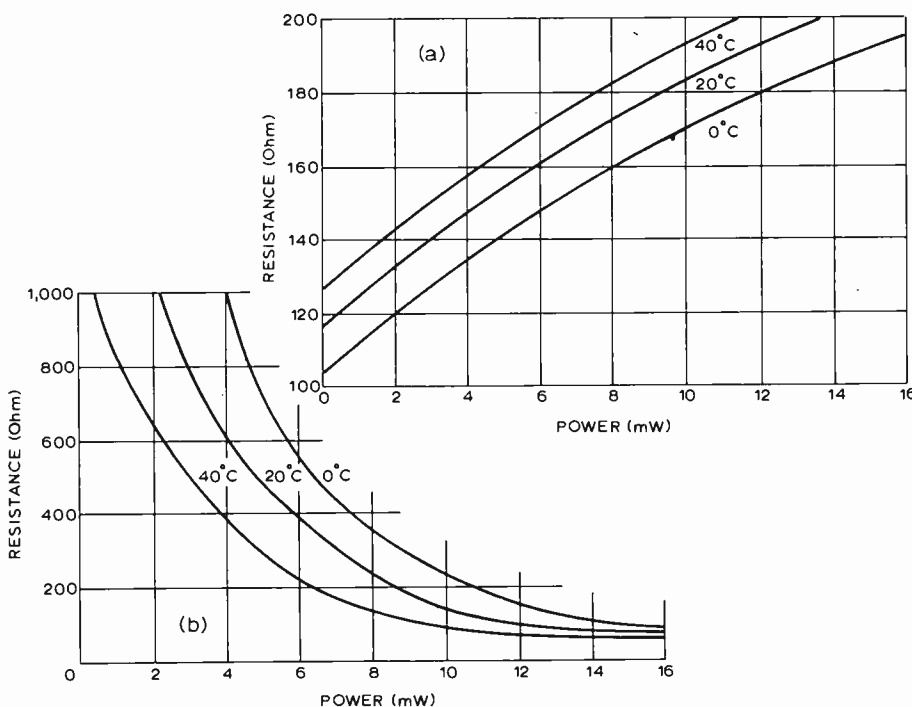

d.c. power represent the total incident microwave power? The answer is that it need not do so and several requirements have to be met before the answer can be changed to "yes" with confidence.

These requirements are that the cross-sectional dimensions of the wire or thermistor should be similar to the skin depth at the operating frequency, so that the d.c. and a.c. densities are similar; and that the physical length of the device should be as small as possible to minimize the very significant inductive reactance.

As a consequence, the barreter is usually constructed from a length of silver-plated platinum wire having a section perhaps 1mm long of the silver etched away, exposing the resistive platinum wire to the microwave field. This wire is very thin, typically 0.002mm in diameter, and is mounted inside a sealed cartridge or on a dielectric support of suitable dimensions for mounting in a waveguide or coaxial monitor. Barreters have a positive temperature coefficient of resistance, and a resistance/power sensitivity shown in Fig. 1(a). They have a very short thermal time constant of several hundred microseconds, useful for fluctuating signals, but this can produce errors when measuring the average power of a pulsed waveform because of the tendency to respond to the signal peaks.

Most popular of the general run of power-sensing elements is the bead thermistor. Composed of semiconducting, sintered metallic oxides, the bead is about 1/4mm diameter with two very fine wire contacts and has a negative coefficient of resistance. Its resistance/power sensitivity, shown in Fig. 1(b), is much greater than that of the barreter, operating temperature can be higher, it is more rugged and has a thermal time constant several times longer.

Whichever type of bolometer is used, most power-measuring instruments come in two units. One is the bolometer mount, consisting of the microwave input connection, either waveguide or coaxial, in which the wire or thermistor forms an absorptive termination, plus a relatively large thermal mass. The second is the meter with associated circuitry, connected to the mount by flexible cable carrying d.c. or low-frequency bias signals.

Within the meter the basic circuit is the balanced bridge with automatic feedback shown in Fig. 2 in which the bolometer element forms one arm. A suitable resistance, usually 100 to 200 ohms, is selected for the element to balance the bridge and is achieved by passing low-frequency current through the element. Audio frequency power is usually chosen for ease of measurement and amplification and, in the case of the thermistor, Fig. 1(b) shows that the current required for a single bead lies between 1 and 15mA.

At this stage, with no microwave power present, the bridge is balanced

and the meter reading will be zero. With microwave power present, however, the thermistor will be hotter, its resistance will decrease and, in order to maintain a balance, the audio power must decrease by an amount equal to the microwave power, which can then be identified and displayed. There are many refinements adopted to preserve accuracy and stability in commercial instruments, but the balanced bridge remains the heart of the circuit. The dynamic range of these instruments is generally 40dB with good sensitivity, switchable meter ranges lying between 10 microwatts full scale and 10 milliwatts full scale.

Within the bolometer mount itself lie the sensing elements, usually thermistors, a large thermal mass to help reduce fluctuating external temperatures and also a couple of other thermistors to sense changes in ambient temperature. These latter are not connected to the microwave circuit but form part of another bridge within the power meter and help to distinguish between

ambient temperature variations and changes in microwave power. With a large thermal mass, this may appear trivial but, when measuring a few microwatts of power, a 25% meter drift can easily occur with an uncompensated mount.

To be accurate the sensing elements in the microwave circuit must, ideally, form a perfectly matched termination to the transmission line. In the case of standard 50-ohm coaxial line, Fig. 3 shows a mount and method of thermistor attachment. Two beads are used and are mounted between the inner and outer conductors to give the type of electrical circuit shown in Fig. 4.  $C_1$  is a d.c. blocking capacitor to eliminate spurious effects from the source and of the circuit and, with a value of 1 to 2nF, has a very low reactance at the microwave input frequency.

For convenience in biasing and matching, two thermistors are used and are connected in series as far as the audio frequency substitution circuit is

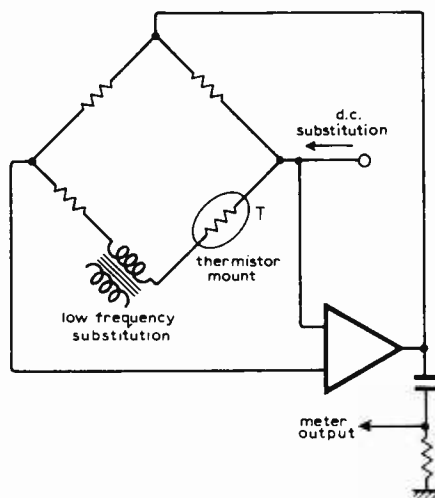
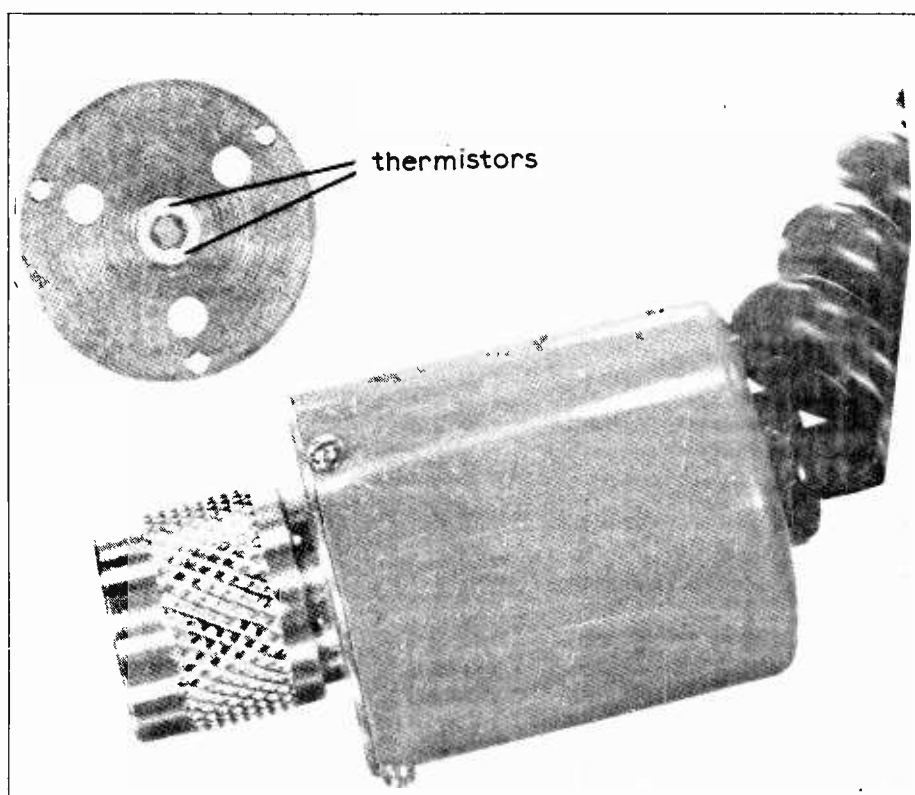

Fig. 2. Variations in bolometer resistance due to incident microwave power are detected by a resistive bridge. The substituted d.c. power to rebalance the bridge is an indication of the microwave power level.

Fig. 3. Coaxial thermistor head in which the thermistor beads terminate the transmission line in a good match and so absorb the microwave power. Head is electrically connected to the power meter bridge, amplifier and display unit.





concerned. They are biased to a value of 100 ohms each. Capacitor  $C_2$  is similar in value to  $C_1$  and thus also presents a low impedance to the input signal, the effect being to cause the thermistors to appear in parallel at r.f. Overall impedance presented to the 50-ohm transmission line is thus 50 ohms and helps towards achieving a good match. The compensating thermistors are electrically isolated from the microwave circuit but are in close enough thermal proximity to experience, identically with the detection thermistors, any variation in ambient temperature.

With a range of waveguide mounts also available, the thermistor power meter is a sufficiently accurate and reliable instrument and, for many years, has been the backbone of engineering power measurements.

### Thermocouple power meter

A strong challenge to the position of the thermistor is being made by the thin-film thermocouple and, with the improvements made in recent years, this device now offers several advantages such as very much greater temperature stability and higher burn-out levels. The coaxial mount construction is very similar to that of the thermistor except that, instead of fine wire supports, the favoured technology is that of thin film deposition on as thin as possible a substrate.

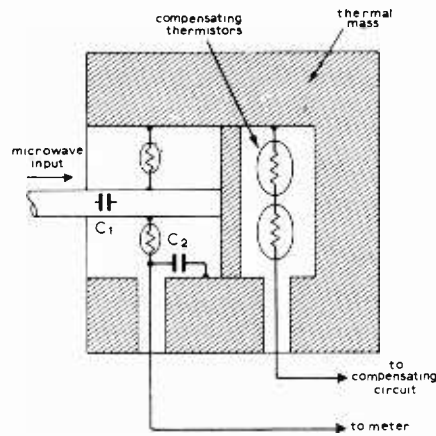

Fig. 4. Thermistors which terminate coaxial line appear in series to the d.c. substitution and bridge circuit but in parallel to the high-frequency microwaves. A large thermal mass together with twin compensating thermistors substantially eliminate ambient temperature fluctuations.

An example is shown in Fig. 5, the thermocouple being formed from evaporated bismuth and antimony with the hot junction lying in the gap between centre and outer conductors; the large semicircular contact pads are of gold.

Thermocouple resistance, and hence match, are controlled by the bismuth and antimony film thickness. Incident

microwave power absorbed at these hot junctions raises their temperature, giving rise to a thermoelectric voltage which is then amplified and displayed in terms of microwave power.

The voltage generated in this fashion can be as low as several hundred nanovolts and thus requires careful circuit design to avoid odd thermocouple effects creeping in from dissimilar metal junctions and other sources of noise. Amplification is carried out after first chopping the d.c. signal and the signal is then synchronously detected. Unlike the bolometric power element, instrument calibration is carried out by direct comparison with a national substandard and not by d.c. substitution.

Recently an improved form of thermocouple sensor has appeared on the market\* using a silicon p-n diffused region as one arm of the thermocouple with a gold contact to act as the cold junction and a resistive tantalum nitride contact as the hot junction. The complete element is less than 1mm square and 0.005mm thick and offers a better r.f. match because of lower reactance, a faster response time and greater long-term stability than the normal bismuth-antimony element.

### Calorimeters

In contrast to the devices so far mentioned, in which microwave power is measured by some calibrated change in an electrical property, the calorimeter relies upon dissipating the incident power within some absorbing medium and then measuring the associated rise in temperature. The microwave power can then either be calculated from a knowledge of the temperature rise versus time and the thermal mass, or a calibration can be made against known quantities of d.c. or low-frequency input power.

Commercially available calorimeters are bulky and expensive devices and have measurement rise times of several minutes. Consequently they are usually kept in the standards room of the user as a calibration reference for the more general-purpose bolometric instruments. Higher-order standards tend to be individually designed and vary from country to country and are always being improved. Thus, although the operating principles are the same, there are many different types of calorimeter. Instead of enumerating these, it will probably be of greater interest to describe briefly one of the instruments which has recently been developed at the National Physical Laboratory for use as a national standard.

### NPL calorimeter

This device is a twin calorimeter and operates in the system shown in Fig. 6 between d.c. and 6,000MHz and for input power levels of between 10mW

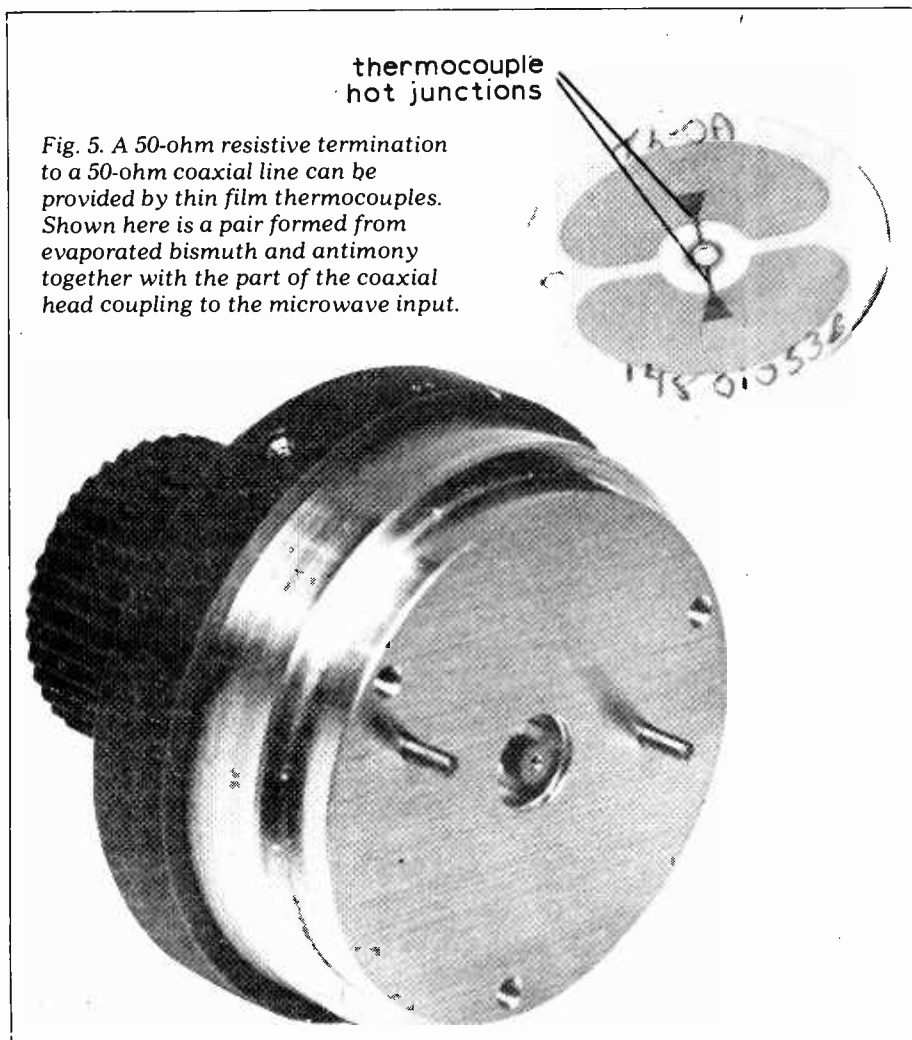

Fig. 5. A 50-ohm resistive termination to a 50-ohm coaxial line can be provided by thin film thermocouples. Shown here is a pair formed from evaporated bismuth and antimony together with the part of the coaxial head coupling to the microwave input.

\* Hewlett Packard Journal, Sept. 1974.

and 100mW. The instrument uses two coaxial transmission lines of 50-ohm characteristic impedance, each terminated in a matched, power-absorbing, resistive load. Microwave power is fed into one of the lines and the resulting rise in temperature difference between the two matched loads is measured by the thermopile. This unit consists of 800 junction pairs of copper-constantan. The loads and thermopile at the end of the calorimeter are shown in Fig. 7. After the heating effect is noted the microwave power level can be determined by measuring the amount of d.c. power which must be applied to the load to produce the same effect. The symmetry of the calorimeter, together with the double-packed thermal insulation, helps to eliminate the effects of room-temperature fluctuations.

An interesting technique used in the development of this NPL calorimeter and in building up a thermal equivalent circuit was the determination of thermal resistances by localized heating with a laser beam. Instead of supplying heat to the calorimeter and noting the temperature response in different areas with thermocouples, these areas were painted black and irradiated with a laser beam, so producing an output from the thermopile. By calculating the local thermal capacities from a knowledge of dimensions and using the laser technique to measure the local resistances, a very comprehensive equivalent was obtained.

In practice, to speed up the reading time the calorimeter is operated in a feedback loop wherein the output from the thermopile is fed via an amplifier and frequency-compensating network back to the second input of the calorimeter. The load at the end of this line is thus heated to the same temperature as that terminating the microwave input and the microwave power can be determined from the substituted d.c. input power necessary to produce the same power in the feedback loop.

With corrections made for losses in the input lines, power lost in heating the thermopile, load mismatch error and d.c. instrumentation errors, the absolute accuracy in measuring the microwave power lies between 0.2% and 0.5% with a measurement time of several minutes.

So, even for a national standard, the accuracy with which microwave power can be measured is not as good as that for d.c. or low-frequency power. The uncertainty of the d.c. calibration power in the calorimeter, for instance, was an order of magnitude loss. Even so the general purpose commercial instruments are many times worse than this in absolute accuracy and it is worthwhile noting the prime causes of error.

#### Power measurement errors

There are three main sources of error:

- instrumentation error,
- d.c. substitution error,
- mismatch error.

The first is not particular to microwave measurements as it is caused by such things as amplifier non-linearities, range switching and meter display, but might typically lie in the region of 1% of f.s.d. The substitution error has been mentioned previously and is due to the d.c. or low frequency power producing a slightly different heating effect than the microwave power. As such it is a function of the sensing element dimensions compared with the wavelength and is different for the barretter, thermistor and thermo-couple. Usually the error is quoted as an efficiency defined by

$$\frac{\text{d.c. substituted power}}{\text{dissipated microwave power}}$$

and can be quite significant, typically lying between 90% and 99% depending upon frequency. The way round this error is by the instrument manufacturer maintaining a standard microwave power reference source and calibrating each sensing element. An efficiency versus frequency plot is then supplied with each mount and a manual control allows for compensation. By this means the substitution error can be made smaller than the other two main sources.

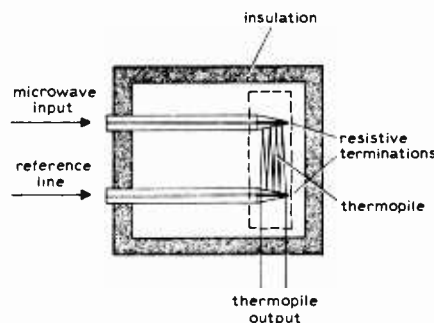
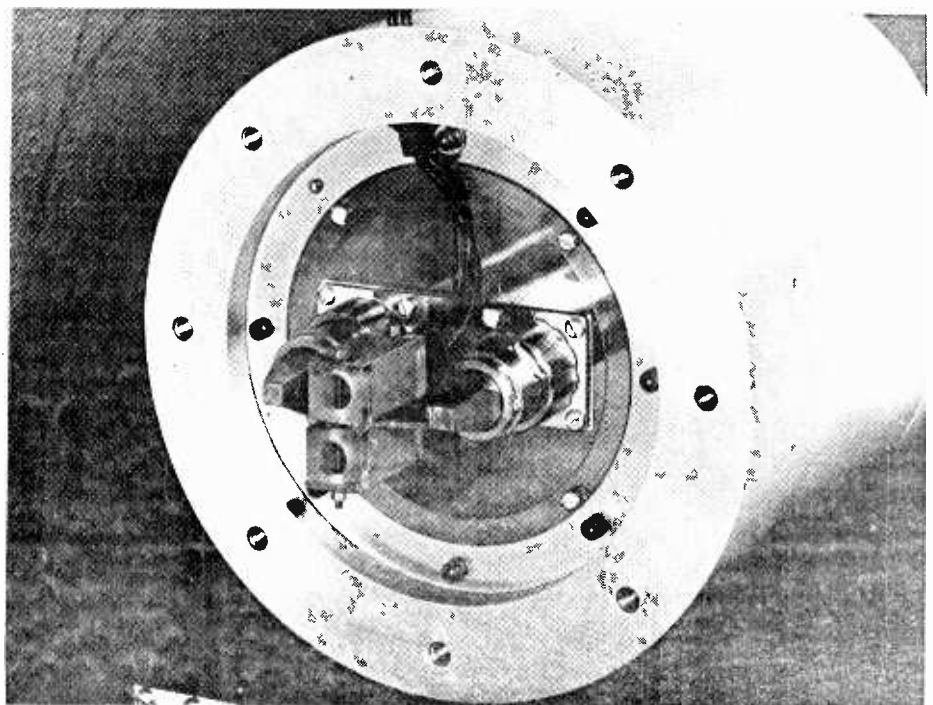

Fig. 6. Schematic of a twin calorimeter wherein the microwave power is absorbed in a resistive load and the resultant rise in temperature measured and calibrated.

Fig. 7. Rear view of the NPL calorimeter showing the resistive load terminations and thermopile coupling. (Courtesy National Physical Laboratory, Crown Copyright reserved.)



duced, the day-to-day practice is for manufacturers to design components to as low a v.s.w.r. as possible and for the user to accept the resultant error.

By way of illustration and to recap on previous subject matter: the ratio of the electric field magnitude reflected from a mismatch to that incident is termed the voltage reflection coefficient ( $\rho$ ) and this reflected signal gives rise to a transmission-line standing wave pattern as shown in Fig. 1 of Part 9. The ratio of the electric field maximum to minimum of this pattern, which can be directly measured, is termed the voltage standing wave ratio  $S$  (v.s.w.r.), and is universally used as an indication of the degree of mismatch of a component. A perfect match is when  $S = 1 + \rho / 1 - \rho$  remembering that, in general,  $\rho$  is the modulus of a more complete reflection coefficient containing phase information.

Now when two or more sources of mismatch are present the amount of power that is actually reflected from any one of them depends upon the way in which the reflected waves combine, that is, upon their relative phase, and this is the quantity usually unknown. It is, however, possible to define a worst case and a best case limit to the resultant mismatch from just a knowledge of the v.s.w.r.s involved. Take the case of a microwave generator having v.s.w.r.  $S_1$  and power monitor of v.s.w.r.  $S_2$  ( $S_2 > S_1$ ), then the worst combination would be if one had a v.s.w.r. of  $S_1$ ,  $S_2$  and the other unity, and the best case would be if one were  $S_2/S_1$  and the other unity.

Taking some practical values of  $S_1 = 1.30$  and  $S_2 = 1.50$ , which are typical for general test equipment up to J-band (12.4GHz), the worst and best cases result in values of 1.95 and 1.15 corre-

sponding to values of  $\rho$  of 0.32 and 0.07 respectively. The power reflected is proportional to  $\rho^2$  and so, in this case, the power meter error will lie between -10.2% and -0.5% depending upon the way in which the mismatches combine. A reduction of the power monitor v.s.w.r. to, say, 1.2 would have a significant effect on the error, reducing the uncertainty range to between -4.8% and 0.2%. The way in which other variations in match can effect the power measurement error is shown in Fig. 8 in which the above two cases are plotted as points A and B. It can readily be seen how easy it is to introduce quite large errors into microwave power measurement and how important it is to minimize the mismatch loss of microwave components.

A final point concerning Fig. 8: the percentage error introduced by combining the v.s.w.r.s on this basis is that compared to what would be delivered to a power monitor having an impedance equal to that of the transmission line.

**Measurement of frequency**

In general the direct measurement of frequency is basically a measurement of time but, because of the manageable size of wavelengths in this region of the spectrum, frequency can also be determined by a measurement of length. An example of this latter method is the slotted line used for v.s.w.r. measurements previously dis-

*Fig. 8. Effect of the mismatched source and load can be quite serious in terms of measurement error. This graph shows the limits of maximum and minimum loss set by two mismatches; the exact value cannot be determined without phase information, which is usually lacking.*

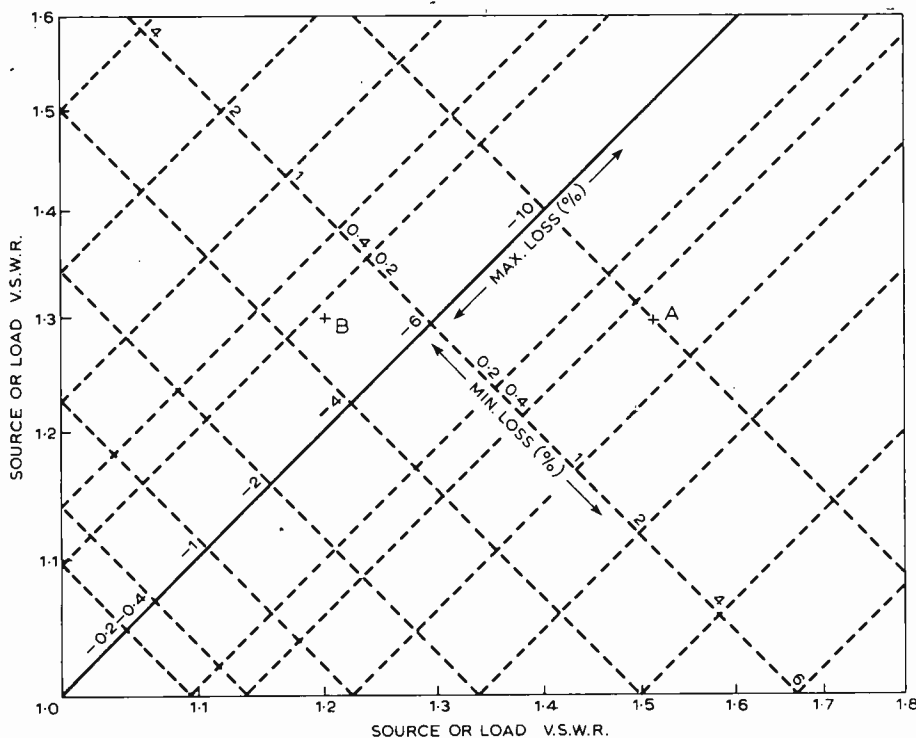

cussed in Part 9. By moving the sliding carriage, the attached probe samples the periodic standing wave pattern in the transmission line which repeats itself every half wavelength. The position of the carriage is indicated by a calibrated vernier scale like that used in vernier calipers or sometimes by a clock gauge. In either case position can be measured to about 0.1%, but this accuracy is somewhat degraded when applied to measuring wavelength because of the error in finding the identical probe positions on different cycles of the pattern. This method is comparatively laborious and is only used nowadays either as a teaching aid or in those cases of dire emergency when one's own frequency counting system has broken down and one can't borrow a replacement from someone else.

A second frequency-measuring instrument, and the most widely used of all, is the wavemeter. Many designs exist but all are based on noting the response of a three-dimensional microwave cavity at its point of resonance, this point being adjustable. A popular method is shown in Fig. 9, which illustrates a cylindrical cavity into which slides an adjustable spindle. The cavity is loosely coupled to the main transmission line so that a small amount of microwave power can enter.

With the spindle withdrawn completely from the cavity a waveguide mode can exist, and the cavity will appear as an electrically resonant circuit with a resonant frequency determined by its diameter. As the spindle is inserted the resonant frequency is reduced from this upper limit and becomes a function of the spindle length,  $L$ , and the cavity now supports a hybrid mode consisting of the original waveguide one and a TEM mode due to the coaxial section formed by the spindle.

Finally, as the spindle penetration becomes greater, the fringing capacitance between the end of the spindle and the base of the cavity starts to influence the resonant frequency, which starts to decrease quite rapidly. The Q factor of this type of microwave resonant circuit is a function of the ratio of cavity to spindle diameters and can be in the vicinity of 1,000.

A practical realization of the instrument is shown in Fig. 10, in this case for use with miniature coaxial connectors. The right-hand component is inserted in series with the coaxial line carrying the frequency to be measured so that the microwave power enters the left-hand connector, say, and leaves via the right-hand one, which might be terminated in either a crystal detector or a power meter. The hole by which a sample of the power can be coupled out can be clearly seen between the two connectors.

On the left of Fig. 10 is the other part of the wavemeter, which contains the cavity, spindle and frequency readout

Fig. 9. Popular version of the wavemeter cavity in which the resonant frequency is governed by the spindle penetration. Cavity is coupled electrically to the main transmission line and the frequency is indicated by the point at which the cavity absorbs power at resonance.

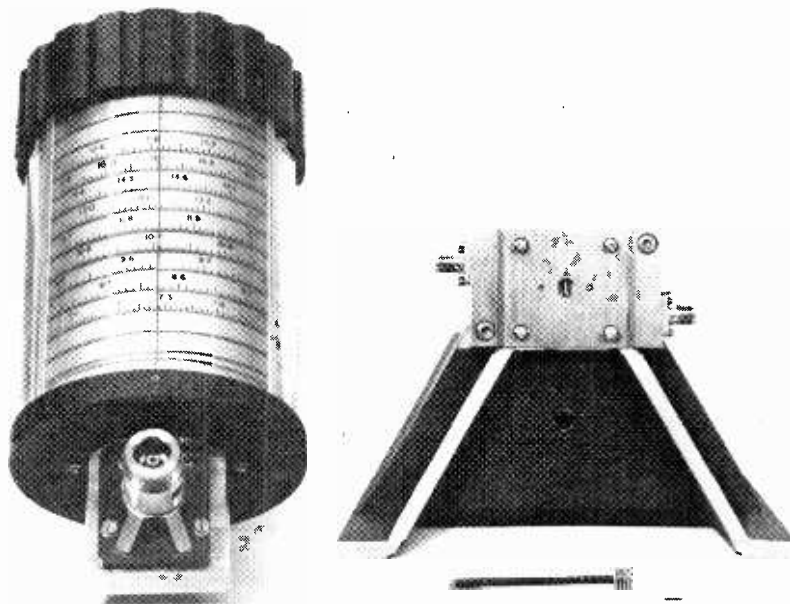
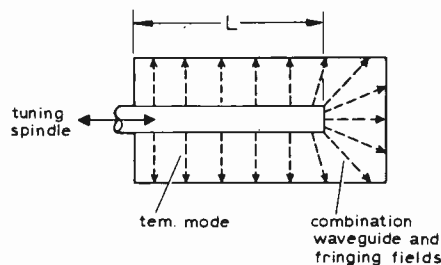

Fig. 10. Commercial wavemeter operating from about 5 to 18GHz, showing the series-mounted section and coupling hole on the right. Bolt-on unit on the left comprises the tunable cavity and frequency readout.

and which bolts onto the other component. Thus, when measuring an unknown frequency, the large drum carrying the scale is slowly rotated, thereby turning also a micrometer thread carrying the spindle and varying its penetration into the cavity. When the point is reached where the cavity is resonant at the transmission line frequency, it will absorb energy from the main line and a sharp dip in output will be observed from the detector or power meter.

The instrument is calibrated from a frequency standard and the advantage of this type of readout is that it enables a large, finely graduated scale to be used. In this case the unwound scale length is about 2m and the measurement accuracy is  $\pm 0.1\%$ . The larger type N connector in the photograph is an additional facility and enables the resonant condition to be identified by connecting a detector to monitor the power absorbed into the cavity.

Progressing in complexity (and cost), one comes to the frequency counter type of instrument which is a true

frequency meter in that it actually counts the cycles of a periodically varying waveform. For microwave frequencies the counter usually consists of two sections: a low-frequency part containing a crystal-controlled reference oscillator, digital counter and digital display and a high-frequency section containing a transfer oscillator, harmonic selector and r.f. input.

The transfer oscillator consists of a conventional low-frequency oscillator circuit operating at, say, 100MHz and it could either be a highly stabilized one or tunable by several tens of MHz either side of the fundamental, depending upon the approach adopted by the manufacturer. Whichever it is, the output from the oscillator is fed to an harmonic generation circuit producing usable outputs up to, say, the 100th harmonic.

Taking the tunable version as an example, the oscillator output plus harmonics would be fed to a tunable mixer along with the input signal to be measured. Harmonic selection circuitry then allows the harmonic nearest to the unknown frequency to be selected, to producing a low i.f. from the mixer which is displayed on an integral c.r.t. The fundamental oscillator can then be tuned to a frequency which gives a zero beat between the two mixer inputs, at which point the unknown frequency is now a known number of harmonics up

on the fundamental and is displayed on a digital readout. In arriving at this correct display it is necessary to know the fundamental oscillator frequency and this is counted directly by shift register in the low-frequency section. Here a reference oscillator accurately times the opening of a sample gate while the number of cycles passing is counted.

Accuracy of these counters is  $\pm$  one count in the low-frequency section, in this case at a nominal 100MHz plus crystal stability. This latter is typically 1 in  $10^7$  per week or 2 in  $10^{-9}$  per second with high stability options giving 1 in  $10^9$  per day. Most instruments also possess a switchable a.f.c. loop which eliminates zero beat error in this case and also enables f.m. signals to be counted.

At present, commercial instruments are available with transfer oscillator plug-ins which enable frequencies of up to 40,000-MHz to be directly measured. But, in principle, the technique can be applied to higher frequencies still.

**Acknowledgment** Many thanks to my old friends at the Sanders Division of Marconi Instruments Ltd for the photographs used in Figs. 3, 5 and 10 and also to Dr Alan Fanton at the NPL for details of the 6GHz calorimeter.

## Sixty Years Ago

ONE of the earliest methods of viewing response curves, now the province of cathode-ray and pen recorder instruments, was described in the issue of *Wireless World* for July 1915. Designed by Dr. J. A. Fleming (Sir Ambrose, of diode fame) the instrument was named the "Campograph" and was reminiscent of the Duddell oscillograph, in that it was "all done by mirrors".

A long, narrow mirror, mounted with its long axis horizontal, was connected by a cord to the spindle of a rotary potentiometer (a new device invented for this instrument) and was tilted as the pot. was turned. The wiper of the pot. derived a voltage which was applied to the device under examination (detector, valve, etc.). A mirror galvanometer, whose light spot was directed on the long mirror, was deflected by the dependent variable signal, such as anode current, the two together forming X and Y axes of the display, projected either onto a screen or photographic plate. Alternatively, the pot. could be replaced by a variable capacitor, when the instrument could be used to plot resonance curves.

Examples of photographs obtained in this way were shown in the article and included valve characteristics, hysteresis curves of iron wire and resonance curves. An instrument which uses a similar principle was described by H. J. N. Riddle in the issue for November, 1971.

# World of Amateur Radio

## Amateurs and emergencies

From time to time amateur radio finds itself firmly at the centre of the world stage — unfortunately most often in connection with major natural disasters that disrupt normal telecommunications leaving amateur stations as the only or first links with the stricken areas. Magazines from Australia and New Zealand reflect two such events: one last Christmas, the other in 1931.

*Electronics Australia* describes how when the cyclone struck Darwin on Christmas Day one of the first links to be established was from a mobile station in a car 13km outside Darwin operated by VK2BNN, his wife VK2BYL and VK8JT. They made contact with amateurs in Victoria more than 1,600 miles away, providing one of the few channels for police and emergency traffic. On Boxing Day an emergency s.s.b. net was established on 14.111 MHz with VK3AUP, Melbourne acting as control. VK8CW at Alice Springs acted as a relay station when required. By December 27 the net had become a nationwide system with participating amateurs in Cairns, Townsville, Rockhampton, Mackay, Mt Isa, Brisbane, Lismore, Armidal, Sydney, Canberra, Cooma, Melbourne, Adelaide, Perth and Alice Springs.

The New Zealand journal *Break-in* reports the death of James Mills, ZL2BE of Hastings who for many years was a leading figure of amateur radio in that country and whose activities attracted world interest in February 1931 when a major earthquake shattered the towns of Napier and Hastings. James Mills was one of the few amateurs having a rotary generator that could be run from car batteries and was able to make contact on 3.5 MHz, first with other amateur stations and then with the official New Zealand Government station ZLW at Wellington, handling a very large number of emergency messages. Later a relief expedition to Napier was accompanied by ZL2BO who set up a station there. The events generated enormous goodwill towards amateur radio and the country still maintains an Amateur,

Radio Emergency Corps which is frequently called upon to help; two recently reported cases involved a search for lost hikers who got into difficulties crossing the Roaring Meg River and a coastal rescue when a trawler went ashore off New Plymouth.

In the United Kingdom the "Raynet" or Radio Amateurs' Emergency Network of the RSGB maintains preparedness for emergency operations through local controllers and groups and by regular exercises in conjunction with the British Red Cross Society, the St John Ambulance Brigade and the police. They are ready and authorised to provide communications assistance on request from the user organisations in conditions where there is a real risk to human life, in the belief that Raynet is a way in which radio amateurs can use their knowledge as a service to the community. Fortunately, the occasions on which Raynet is called upon in earnest are relatively few: most "on air" activity is during simulated emergencies. Nevertheless it is a service that believes in being ready and willing.

## Hourly propagation forecasts from WWV

For amateurs and short-wave listeners a source of hourly propagation data is the American standard frequency transmissions from WWV (Colorado) and WWVH (Hawaii) on 2.5, 5, 10, 15, 20 and 25 MHz. These now include at 14 minutes past each hour an indication of solar flux (in the form 72 plus 0.6R) and geomagnetic activity (0 to 9 K scale).

In general for good h.f. conditions the higher the solar flux figure the better (for the next few years this is unlikely very often to exceed 100); conversely a low K figure (preferably 2 or under) is a good sign. High K ratings indicate a significant influx of solar particles, usually resulting in weaker signals, increased fading and noise: over 4 usually indicates a solar storm; 3-4 unstable or unsettled conditions. Unfortunately at the present time the standard frequency transmissions heard most strongly in the UK are seldom those from WWV or WWVH.

There is growing evidence to suggest we are now very close to the end of the present sunspot cycle, with its oddly distorted decay during 1972. Although it is unwise to make long term predictions about future sun-spot activity it looks increasingly as though the next cycle may have a relatively low maximum.

The ZB2VHF beacon station at Gibraltar is now in operation on 144.145 MHz beaming signals towards the UK.

## Look no batteries!

The energy crisis has made numbers of amateurs look quite seriously into the question of how radio communication could be maintained completely independently of mains supplies or primary batteries. Some recent experiments

have been based on solar batteries, wind generators and pedal- and hand-operated battery chargers. QST for example reports that a man on a jacked-up bicycle can generate 100 to 120 watts of power by driving a car generator at over 1,100 r.p.m. using the high gearing provided by a 27-inch wheel (generators for this purpose were dropped by the RAF to the French resistance during World War II).

But for sheer ingenuity a prize must surely go to a Dutch amateur J. M. H. Wagenmans, PA0HWE who claims to have built a milliwatt transmitter powered entirely by the action of the Morse key! He does this by linking the moving arm of a Morse key to the cone of a moving-coil loudspeaker so that the movement produces an electrical output which is rectified and stored in a 40,000 $\mu$ F capacitor to power a transistor crystal oscillator to a d.c. input of 1.5 mW. Brass pounding with a vengeance; although a nagging doubt remains, despite the photographs and circuit details in the April issue of the Dutch journal *Electron*: April issues of amateur journals are notorious for elaborate technical spoofs, though it is difficult to fault this idea!

## In brief

The RSGB has stated that it appears that the 25% VAT rating applies to all amateur radio equipment and components . . . The recent use of the callsign GB2IARU at Tonbridge School to mark the 50th anniversary of the formation of the IARU is believed to be the first time a four-letter callsign suffix has been authorised for amateur radio operation in the UK . . . During 1976, the bicentennial year of the constitution of the United States, American amateurs will be able to use callsigns beginning with an "A" instead of "W" or "K": all prefixes will have two letters before the district number, ranging from AA1 to AL7 and including AC4 which was formerly used by amateur stations in Tibet and thus one of the most eagerly sought after prefix of all time . . . American amateurs are concerned that a Dallas consulting firm has filed a proposal with the FCC for a new television channel that would result in the elimination of the 50MHz amateur band . . . A 10GHz beacon station at a temporary site on the Isle of Wight has been heard at distances up to 65km, the beacon uses an 80mW oscillator on 10,100  $\pm$  1MHz with an omnidirectional aerial with a gain of about 11dB. Callsign is GB3IOW . . . Among forthcoming mobile rallies are: Longleat near Warminster on June 29 by Bristol RSGB Group; Upton by Worcester society on July 6; Cornish RAC Rally, Camborne (provisional) on July 20 (details G3NKE); Polegate Steam Engine Rally on July 20 with exhibition station GB2SS.

PAT HAWKER, G3VA



# 75 Years of magnetic recording

## 5 — A diversity of applications

by Basil Lane

*Assistant Editor, Wireless World*

**Shortly after the end of World War II, events took an unexpected turn for magnetic recording. Up to that time, although other uses had been suggested for this versatile storage method, the technology had not developed to the stage where they could be practically realized. However, the war effort had resulted in new electronic techniques becoming available and at the same time magnetic recording itself came of age. From that date forward, the number of applications for magnetic recording were to multiply.**

Curiously, for the historian, the task of recording events in the recent past becomes more difficult the closer one approaches the present day. There could be many reasons for this, but in the case of magnetic recording it is because technology from 1945 advanced at such a rate that new developments followed one another at an incredible pace. This makes it difficult to say at times who was first in the field with a particular idea. One can only hope to describe from contemporary reports what happened.

A typical example is the computer. Where now we can hardly think of a computer without also thinking of the magnetic storage methods used, the earliest computers were without such an advantage. Suddenly, everyone seemed to be working on the idea of using magnetic tape as a storage medium. In an historical broadsheet put out by 3M a few years ago<sup>68</sup> it was suggested that flexible storage systems were one of the most significant steps taken by computer designers, and in the days just after the war a variety of memory devices were proposed including delay lines filled with gin!

Just about the earliest computer with a magnetic store was the ARC (Automatic Relay Calculator) made at Birkbeck College, London in 1947. Built for the British Rubber Research Association, it had a nickel plated drum store with a capacity for 256 numbers each of 21 binary digits. Shortly after, the experience gained in developing this computer was used to develop the SEC (Simple Electronic Computer), the first all-electronic computer with a drum store.

Also in 1947, Eckert and Mauchly built a machine called BINAC for the

Northrop Corporation, this computer using a mercury delay-line memory of 512 words and being the first to use a magnetic tape input and output.

Although magnetic drum and disc scored for short term storage with fast, random access, there was an increasing requirement for long term serial data stores of greater versatility than the punched paper tape and card type. Thus in the early 1950s several machines appeared with a tape storage system, one such machine being the IBM 701. This was the first of the IBM machines to use a combined drum and tape store, supplemented with Williams tubes to give a total memory capacity of 2048 words.

Most of the development from that time on, concentrated on the improvement of the magnetic media, not only to reduce the error rate due to drop-outs but also to increase the capacity of the media to record digital bits. Thus the capability rose from 100 bits per square inch in 1947 to 1500 in 1965<sup>69</sup> and as high as 6500 bits per square inch today — although there are at the moment few, if any, machines that are capable of recording such a bit density. Although

plated metal discs had been used from time to time, the real development of this form of recording medium did not start until Zaponi<sup>70</sup> developed a reliable plating technique in 1952. It is interesting to note that 46 years earlier, P. O. Pedersen had patented<sup>71</sup> a plated magnetic carrier though this was of course intended for audio recording.

In modern computers a variety of storage media is used, with magnetic methods still paramount. Disc is used for random access and usually is manufactured as a pack of discs in a standard format. The magnetic layer may be acicular Fe<sub>2</sub>O<sub>3</sub>, plated nickel-cobalt or other similar magnetic metals and the writing and reading are achieved by flying heads located in the appropriate position in the disc pack by high speed actuators. Magnetic tape is still strongly favoured for long term storage where access time is not so important and will be either ferric oxide, cobalt-doped ferric oxide or chromium dioxide, all of the latter having been developed from the early sixties.

The most popular material used in magnetic tapes is still the leader, this being gamma ferric oxide. Since the

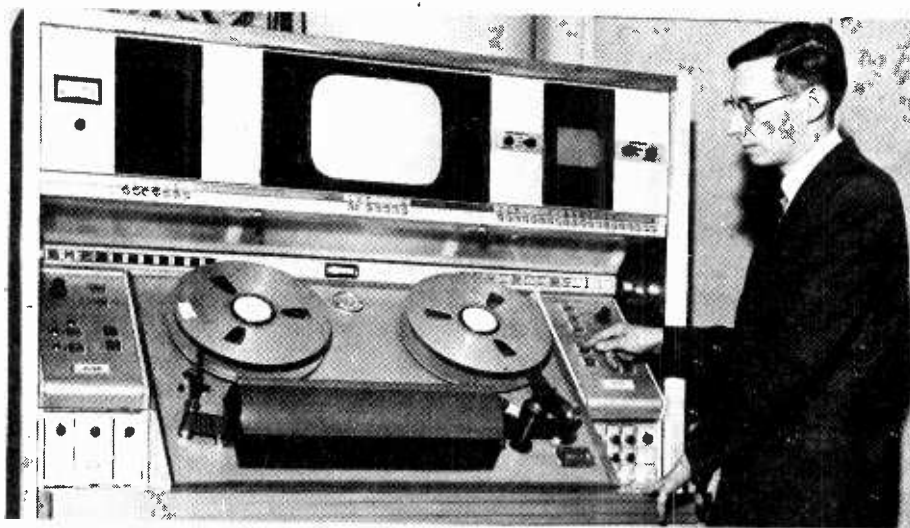

Fig. 2. The TR-22 video recorder by RCA, this was the first transistorized video recorder to enter service, May 7, 1961.

early days of its use as the basis for a coating formulation for magnetic tape, it has been improved and the coating formulation itself developed almost beyond recognition. However, it was inevitable that some challenge to the supremacy of ferric oxide should come from other materials and the demands placed on magnetic tape by the invention of the video recorder and the data recorders for computers provided the impetus for this to happen during the 1960s. From around 1956, cobalt doping of ferric oxide had been studied as a method of improving the short wavelength response of tape and by 1967 an experimental tape had been made. However, the problems associated with this type of magnetic material (e.g. pressure instability of magnetisation) prevented it from becoming as popular as more conventional coatings.

Another line of research had been undertaken by Swoboda<sup>72</sup> who had been concentrating on the problem of synthesizing chromium dioxide, a promising material for tape since it had a high remanence, which offered a very good short wavelength performance. In early 1961 this substance was produced successfully, though it was to be some time before it made its debut as a magnetic tape. As a matter of interest, it took ten years for CrO<sub>2</sub> to appear in a compact cassette, when Crolyn (the Du Pont name for CrO<sub>2</sub>) appeared under labels such as Advent and Memorex.

It is interesting to note that, due to a quirk of American Patent law which allows applications to be patented as well as processes, Du Pont held the master patent for the use of CrO<sub>2</sub> as a magnetic recording medium in America. Process patents are held in all the other countries of the world where applications are not patentable, and it was this situation that led to Agfa Gevaert trying to circumvent the Du Pont patent in 1972. They too had invented a process for the manufacture of CrO<sub>2</sub>, which differed from the Du Pont method, but were prevented from selling any tape in America because of the patent held by Du Pont. The ridiculous situation of being barred from one of their important markets eventually forced Agfa to take out a licence for the Du Pont process and pay for the privilege of selling CrO<sub>2</sub> tape in America.

Since the date of the appearance of CrO<sub>2</sub> as a magnetic medium for cassette tapes, other manufacturers and those who were licencees have been attempting to either equal the performance of this substance, using cheaper ferric oxide, or have been busy looking at other substances. One development that appeared to result from a parallel, but separate, development project was the dual layer coated tape. These had been proposed as early as 1953, when Kornei<sup>74</sup> suggested that short wavelength performance could be improved if a multi-layer tape was prepared with a high coercivity surface layer, followed

with successively deeper layers using oxide of a lower coercivity. Another quite novel idea proposed by Gabor and Bauer<sup>74</sup> was that a dual layer tape should be made with the top layer oriented in a vertical direction.

However, it was Sony and 3M that eventually produced a practical dual layer tape, with Sony marketing its product in Japan in January 1974 and, later that same year, 3M announcing its own product. Again, it would seem that the master patent is probably held in America by 3M,<sup>75</sup> so it is highly likely that Sony have had to come to some cross-licence agreement with 3M in order to sell their tape in the USA.

### Developments in heads

No history of magnetic recording would be complete (and this one is far from being so) without a mention of the development of ferrite heads. With the appearance of CrO<sub>2</sub> tape, which is a much more abrasive material, there was a particular requirement for a hard wearing head to be produced which would withstand many hours of use. This was very important in video recording where the head to tape speed is high and the track width is narrow.

Early heads had been made of laminated Mumetal and although experiments had been made with harder materials such as Alfenol, this proved, until recent years, too intractable to be used as a substitute. Permalloy and other harder grades of metal have been used with increasing success, but it was the ferrite head that made the big news when it was first developed. One of the first descriptions of a ferrite head appeared<sup>76</sup> in 1955, to be followed some years later by the classic paper by S. Duinker<sup>77</sup> of Philips, who described the method of using glass as a spacer and as a bonding material in the front gap of the head. This was a significant improvement that reduced the number of rejected heads that had suffered from chipping at the gap edges.

By 1968, Matsushita had developed the hot pressed ferrite head and about this same time Akai appeared with a glass-crystal ferrite head, made from a monocrystalline block of ferrite.

Other important head types used in specialist fields were the flux sensitive heads, either using a saturable limb in the magnetic circuit of the head, or the semiconductor Hall effect types described by Camras in the mid-1950s. It was Camras also that invented the cross-field head<sup>78</sup> for audio use, this being described January 1952.

In recent years there has been an increasing interest in the fabrication of very precisely defined narrow track heads and to this end experiments have been undertaken to produce sputtered film<sup>79</sup> cores in 1967 and later, in 1972, sputtered film heads using Sendust as the magnetic material.<sup>80</sup>

### Conclusion

In as brief a series as this has been it is difficult to be as thoroughgoing as perhaps one should be, and I am certain that some important inventions have been left out. Little has been said of the p.c.m. recorders developed by the BBC<sup>81</sup>, Nippon Columbia<sup>82</sup> and others<sup>83</sup>, nor has anything of note been mentioned of instrumentation recorders, including those used in the space effort. There are also the more exotic types of recorders such as the brilliant invention by Seimens<sup>84</sup> of the slow and stop motion video disc recorder. However, I feel that all of the significant stages in the development of magnetic recording on the broad front have been covered.

It still seems remarkable that only 75 years ago Poulsen and Pedersen could have been responsible for the whole chain of ideas and inventions that resulted in the magnetic recording process that so invades the everyday life of every one of us.

My apologies to Mrs Pedersen who was kind enough to write and point out an error in spelling P. O. Pedersen's name in earlier parts of this series.

### References

68. The birth of the computer, pub. 3M Company 1971.
69. Dudson, M. F. and Davies, A. V. Magnetic recording for computers. *Proc. I. E. E. Reviews*, Vol. 119, no. 8R, Aug. 1972, pp. 956-984.
70. U.S. Pat. 2,619,454. P. P. Zapponi, Nov. 25, 1952.
71. U.S. Pat. 836,339. P. O. Pedersen, Nov. 20, 1906.
72. Swoboda, T. J. et al. Synthesis and properties of ferromagnetic chromium dioxide. *Journal App. Phys.* Supplement to Vol. 32, No. 3, Mar. 1961, pp. 3745-3755.
73. U.S. Pat. 2,643,130. Kornei, June 1953.
74. U.S. Pat. 3,052,567. Gabor et al. Sept. 4, 1962.
75. U.S. Pat. 3,761,311. Perrington et al. Sept. 25, 1973.
76. Chynoweth, W. R. Ferrite heads for recording in the megacycle range. *Tele Tech* Aug. 1955, p. 85.
77. Duinker, S. Durable high resolution ferrite transducer heads employing bonding glass spacers. *Philips Res. Reports*, Vol. 15, 1960, pp. 342-367.
78. Camras, M. A new magnetic recording head. *Journal S.M.P.T.E.* Vol. 58, Jan. 1952, pp. 61-66.
79. Vodicka, V.W. Sputtering of ternary magnetic films and their use in the manufacture of magnetic recording heads. I.E.E. Conf. Publication (33) 1967, pp. 213-216.
80. Shibaya, Hiromichi. Fabrication of narrow-track video head with Sendust sputtered film. NHK Laboratory Note. Serial No. 154, July 1972.
81. Jones, A. H. and Bellis, F. A. Digital stereo sound recorder. *Wireless World*, Sept. 1972, pp. 432-435.
82. Iwamura, Hiroshi et al. Pulse code modulation recording system. *Journal A.E.S.* Vol. 21, No. 7, Sept. 1973, pp. 535-541.
83. Sato, N. PCM recorder. *Journal A.E.S.* Vol. 21, No. 7, Sept. 1973, pp. 542-548.
84. White, G. Video recording: record and replay systems. pub. Newnes Butterworth 1972.

# New Products

## Thick-film amplifier

A thick-film hybrid amplifier suitable for audio applications will deliver around 15W (average) into an 8Ω load. The class B quasi-complementary circuit has a frequency response from 0 to 80kHz, an input sensitivity of 350mV (typical), and a t.h.d. figure of 0.2%. The device is mounted on an integral heat sink measuring 30 x 30mm which allows full rated output at a temperature of 55°C. Tadiran, 193 Regent Street, London W1.

**WW 312 for further details**

## De-soldering instrument

Adcola Products have introduced an automatic de-soldering instrument for removing d.i.l. i.c.s from p.c. boards. The unit, which is called the Removic, consists of an operating gun powered from a control box which adjusts the temperature from 350 to 750°F. In

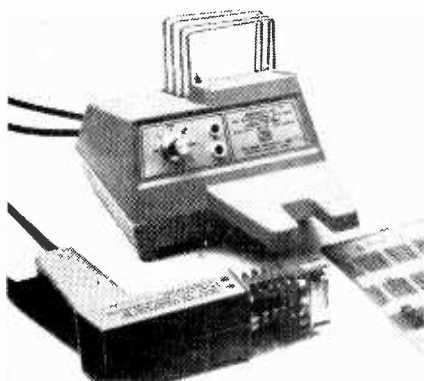

**WW308**

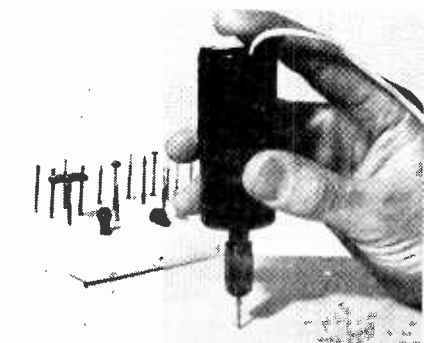

operation the gun is placed over an i.c., a handle is pressed which positions extractor claws and heater blocks on the i.c. When the solder melts the component is extracted by applying steady pressure on the handle. Adcola Products Ltd, Adcola House, Gauden Road, London SW4.

**WW308 for further details.**

## Mini drill

A small power drill manufactured by Expo operates from a 12V 1A supply and has a chuck speed of around 9000 r.p.m. The drill, which is supplied with a range of accessories which include twist drills, cutting, milling, reaming and grinding tools, is priced at £9.17 plus v.a.t. and is available from Electroplan Ltd, P.O. Box 19, Orchard Road, Royston, Herts SG8 5HH.

**WW310 for further details**

## Alarm unit

The Tellit is an audible alarm unit using a continuous loop of tape which may be recorded with any short message or warning specified by the user. Four basic types are available including an uncased playback mechanism for mounting into customers equipment. Highland Electronics Ltd, 33 Dallington Street, London EC1V 0DB.

**WW311 for further details**

## Counter

A 75-MHz counter/timer, model 5308A, measures frequency, frequency ratio, period, period average, and time inter-

val. The instrument also offers an auto-range facility which selects the range that will give the best resolution within a measuring time from 0.11 to 1.1s. Measurements are indicated by an eight-digit display housed in a 3½ x 6¼ x 9¾in case. Hewlett-Packard Ltd, King Street Lane, Winnersh, Wokingham, Berks RG11 5AR.

**WW303 for further details**

## Triacs

ITT Semiconductors have made their first step into the triac market by announcing the TC range of devices. These components, which have been designed and manufactured in the UK, are available with current ratings of 4, 6, 8, 10, 12 and 16A at voltages of 200, 400, 500 and 600V. The complete range uses a centre-gate construction for improved  $di/dt$  capability, and has glass passivated chips which improve high-voltage protection. All of the devices are housed in the TO-220AB plastic package and are priced between £0.416 and £1.88 each depending on type and quantity. ITT Semiconductors, Foots Cray, Sidcup, Kent.

**WW 335 for further details**

## Microwave coupler

Walmore are now supplying the Norsal 4834 microwave coupler. This device, which is claimed to be the first to cover the range 2 to 12.4GHz, has a v.s.w.r. of 1.4:1, amplitude imbalance of  $\pm 0.5$ dB, and a phase imbalance of  $\pm 7^\circ$ . The coupler is designed to handle input powers of 20W average with a 2kW

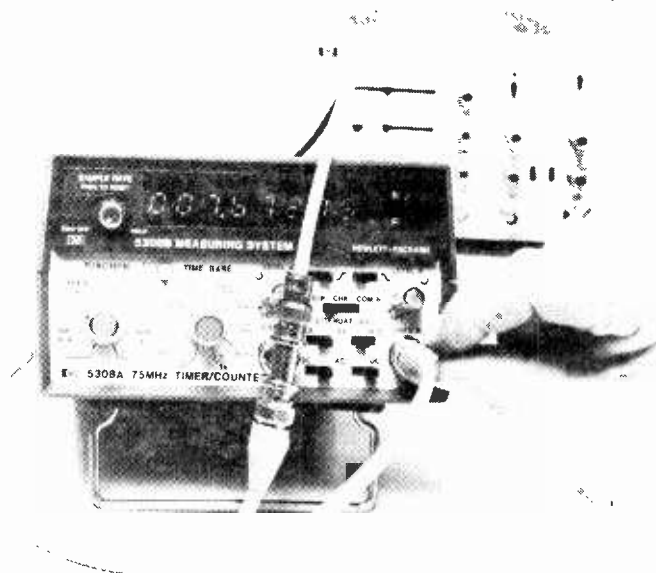

**WW303**

**WW310**



WW302



WW313



WW309

peak rating. Microwave Division, Walmore Electronics Ltd, 11 Betterton Street, London WC2H 9BS.

**WW307 for further details**

### Variable-filters

The EF3/03 and EF3/04 are recent additions to the Barr & Stroud range of variable filters. The units are high-pass and low-pass filters respectively which may be switched into several modes including band-pass and band-stop. The cut-off frequency is variable from 0.1Hz to 100kHz with a stop-band attenuation rate of 48dB/octave and a pass-band response from 0 to 700kHz. Barr & Stroud Ltd, Kinnaird House, 1 Pall Mall East, London SW1Y 5AU.

**WW302 for further details**

### Signal generator

The Fluke synthesized signal generator, model 6010A offers a keyboard entry with a manual fine control, and a built-in microprocessor which can store up to nine programmes. Each programme consists of a frequency, a frequency range, an amplitude, and a modulation (c.w., a.m., or f.m.). These programmes can be recalled at any point in a testing sequence. The instrument has a frequency range from 10Hz to 109kHz in 0.1Hz steps and 10Hz to 10MHz in 10Hz steps, an accuracy of  $\pm 3$  parts in  $10^6$  in the temperature range 0 to  $+50^\circ\text{C}$  and a variable output level from 0.25mV to 5V r.m.s. The selected frequency is indicated on a seven-digit l.e.d. display. Fluke (Nederland) B.V., Ledeborstraat 27, Tilburg, Netherlands.

**WW313 for further details**

### Testing system

The type 8309 test set connects directly to a computer terminal and will transmit to, or receive messages from the terminal for the purpose of checking and/or fault analysis. The 8309 can be operated at data rates between 110 and 9600 bits/sec in a synchronous or asynchronous mode. In the former mode it responds to either the EBCDIC or ASCII SYN character set, while in the latter case the number of stop bits sent by the transmitter may be selected as required. Data Recognition Ltd, Loverock Road, Battle Farm Estate, Reading, Berks.

**WW309 for further details**

### Bezel

A recent addition to the Roxburgh range of switches and accessories is a bezel incorporating a l.e.d. mounting facility. The bezel fits the J50, J60 and 800J switches and accepts a 0.2in l.e.d. Roxburgh Electronics Ltd, 22 Winchelsea Road, Rye, Sussex.

**WW301 for further details**

# Products seen at Hi-Fidelity 75

## Sansui tuner

The TU-7700 stereo tuner is one of a series of amplifiers and tuners which Sansui have added to their range. This model will receive f.m. broadcasts within the frequency range 88-108MHz and a.m. broadcasts in the range 535-1605kHz. Containing a high integrated-circuit count, the TU-7700 is to retail at a suggested price of £149.10 plus VAT. Vernitron Ltd, Thornhill, Southampton SO9 5QF.

## Four-channel tape deck

Well known on the Continent, but new to the UK, the Dokorder range of reel-to-reel recorders is being distributed by Acoustico Enterprises. The top of the domestic range is the model 7140 which is fully equipped to record and replay up to four tracks on 1/4in tape. The head block is interchangeable to offer two track stereo recording and a consequent improvement in signal-to-noise ratio.

A useful facility is offered by the so-called "Multi-Sync" which is a switching arrangement which connects one or more record head tracks to the replay amplifier to permit monitoring of previously recorded tracks, whilst adding in synchronism further recordings to remaining free tracks.

Other facilities include sound-on-sound, echo, bias and record equalisation for two types of tape and A-B monitoring. Acoustico Enterprises Ltd, Unit 7, Space Way, North Feltham Trading Estate, Feltham, Middx TW14 0TZ.

## Eagle range

Eagle International have added considerably to their range of products with the introduction of the 2000 series of equipment. This comprises the A2004 and A2006 amplifiers with a rated output of 20W per channel and having a rather more complex range of tone controls than usual. A matching tuner amplifier, the A2008, provides for reception of the a.m. and f.m. bands and

also there is a synchronous motor, belt drive turntable, the D2005. A second turntable, the D2006, is classified by Eagle as a servo-monitor type, though exactly what this means is not quite clear. Finally the 2000 series is completed by a choice of five loudspeakers and two headphones. Eagle International, Heather Park Drive, Wembley, Middx HA0 1SU.

## New belt drive turntables

The BDS80 and BDS90 are two turntables added to the series produced by BSR McDonald. Both models are semi-automatic in that when a record has finished playing the arm lifts up, returns to rest, locks and switches off. Both decks are also fitted with a click suppressor and muting switch which prevent an unwanted noise being fed to the amplifier while the automatic set-down and switch off are in operation. A special feature of the BDS90, according to the manufacturers is a new low-resonance tubular aluminium tone-arm, located in a concentric gimbal style mount which carries a calibrated stylus pressure control. The rumble figure for both units is stated to be 55dB. Standard units are available for either 100-125V 60Hz or 200-240V 50Hz. BSR Ltd, Monarch Works, Cradley Heath, Warley, Worcs.

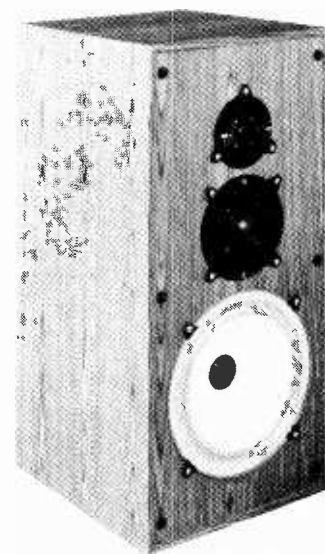

## Three new speakers

A new range of loudspeakers from Celestion are the UL6, UL8 and UL10 models. The two smaller models in the range are both two-unit systems, the bass driver being supplemented by a passive auxiliary bass radiator unit. The largest model is the UL10 (see photograph) which houses three in-line drive units. Cabinet dimensions are 673mm height, 317mm width, 380mm depth. Power handling is rated at 50W continuous or 100W peak music power. Sensitivity is sensibly rated using pink noise, an input of 12 volts r.m.s. being required to produce 96dB s.p.l. at 1 metre. Frequency response is stated to be 40Hz to 20kHz  $\pm$ 2dB. Drive units consist of the HF2000 super tweeter, the MD7000 pressure-dome mid range unit and a 254mm bass drive unit. Rola Celestion Ltd, Ditton Works, Foxhall Road, Ipswich, Suffolk IP3 8JP.

## New life for Wharfedale

Rank Radio introduced a new XP range of speakers carrying the well-known names of Denton, Linton and Glendale. All have greater power handling capability and are claimed to have improved performance over their predecessors. Taking the smallest in the range, the Denton 2XP, this is a two-way bookshelf enclosure of acoustic suspension



Sansui Tu-7700 stereo tuner



design. Main specifications are: power handling 25W (DIN), suitable for use with amplifiers rated from 3 to 30W continuous; frequency response 65-17kHz at -3dB points; crossover frequency 1.4kHz; sensitivity is 96dB at 1m for 6W input; impedance is 6Ω nominal; dimensions are 355 × 246 × 22mm. Finish is in teak or white. Rank Radio International Ltd, P.O. Box 596, Power Road, London W4 5PW.

## Amplifier with limiter circuit

The new Cambridge Classic One amplifier has several unusual features including l.e.d. monitoring of pre-amplifier signal level in 5dB steps. An l.e.d. indicator is used as a power supply indicator. This also flashes at a regular rate whenever a power amplifier limiter circuit is brought into operation. A circuit in conjunction with the input selector switch is provided to limit the effect of switch-on transients causing 'thumps' through the loudspeakers. Main specifications are: power output at 1kHz, 60W per channel into 8Ω; t.h.d. is less than 0.05% at all audio frequencies, typically 0.005%; signal-to-noise ratio is 65dB ref. 2mV (pickup input), 75dB ref. 250mV (line inputs); input sensitivities are pickup 2mV/47kΩ, tuner 250mV, cassette 100mV and auxiliary 100mV. The pickup input overload capability is rated at 45dB. Facility for the simultaneous use of three tape recorders is also provided. Cambridge Audio Ltd, Lamb House, Church Street, London W3 2PB.

## Solid State Devices

Names of suppliers of devices in this section are given in abbreviation after each entry and in full at the end of the section.

### Shift register

A 512-bit dynamic shift register with built-in recirculating and command logic has a maximum operating speed of 4MHz.

**WW350 for further details** G.E.

### Diodes

The 501PD series of diodes has an average current rating of 500A at an 84°C case temperature, and are available over the voltage range 2kV to 4kV with non-repetitive ratings up to 4.4kV.

**WW351 for further details** I.R.

### R.a.m.

The 1103-1 is a 1k dynamic r.a.m. offering a 340ns full-cycle time and a 150ns read access time. All address inputs are fully decoded and typical power dissipation is 0.4mW/bit.

**WW352 for further details** ITT

### Schottky register

A 4-bit register having three-state and standard t.t.l. outputs has been built using Schottky technology. The device is available in three packages and is priced from \$3.08 100 up.

**WW353 for further details** AMD

### Programmable op-amp

Parameters of the MC3476 op-amp are programmed by an external resistor to suit power supplies from ±6 to ±15V. The device does not require frequency compensation, has offset null capability and is protected against short circuits.

**WW354 for further details** Motorola

### Bridge rectifiers

A new range of bridge rectifiers has a built-in capacitor in parallel with each diode to absorb reverse voltage transients. The range has repetitive peak-reverse voltage ratings from 50 to 600V and an average direct current rating of 2A.

**WW355 for further details** ME

### Memory driver

An n-channel m.o.s. memory driver i.c., type MC3459, contains four identical driver circuits and is capable of maintaining a propagation delay of 20ns when driving a 360pF load.

**WW 356 for further details** Motorola

### A-to-d converter

The MC904 is claimed to be the first monolithic i.c. with all the functions necessary for a digital panel meter or multimeter. The device has a resolution of 100μV and an input impedance of 1000MΩ and is housed in a 28-pin d.i.l. package.

**WW358 for further details** Macro

### Image sensor

A new 1728-element charge-coupled linear image sensor, suitable for use in optical page scanning systems, has been introduced by Fairchild. The CCD121 is capable of reading a standard 8½ × 11-inch page in less than one second and up to 200 lines per inch can be resolved.

**WW 359 for further details** Fairchild

### Count/display i.c.

A t.t.l.-compatible universal count/display i.c., type ZN1040E, offers a count rate of over 5MHz. The device requires a 5V supply and is housed in a 28 pin d.i.l. package.

**WW360 for further details** Ferranti

### Low-voltage sensor

An i.c. intended for use with battery operated equipment, is internally set to trigger when a voltage drops to 2.4V ±2%. This value can be increased by adding a resistor.

**WW361 for further details** Bowmar

### Sample/hold amp

An adjustment-free sample/hold amplifier called the MN343 provides a droop rate of less than 0.3mV/ms and an acquisition time of better than 10μs.

**WW 362 for further details** Tranchant

### F.e.t. input amplifier

The 3670 is a f.e.t.-input i.c. instrumentation amplifier. Gain adjustment, from 1 to 1000V/V, is made with one resistor. Maximum bias current is 10pA, and the input impedance is 10<sup>13</sup> ohms.

**WW363 for further details** Burr Brown

**G.E. Electronics** (London) Ltd, 182/4 Campden Hill Road, Kensington, London W8 7AS.

**International Rectifier**, Hurst Green, Oxted, Surrey RH8 9BB.

**ITT Semiconductors**, Footscray, Sidcup, Kent.

**Advanced Micro Devices Inc.**, 901 Thompson Place, Sunnyvale, California 94086, U.S.A.

**Motorola Ltd**, Semiconductor Products Division, York House, Empire Way, Wembley, Middx.

**Micro Electronics Ltd**, York House, Empire Way, Wembley, Middx.

**Macro Marketing Ltd**, 396 Bath Road, Slough, Bucks.

**Fairchild Camera & Instrument Corporation**, Northway House, High Road, Whetstone, London N.20.

**Ferranti Ltd**, Electronic Components Division, Gem Mill, Chadderton, Oldham, OL9 8NP.

**Bowmar Arizona, Inc.**, 2355 West Williams Field Road, Chandler, Arizona 85224, U.S.A.

**Tranchant Electronics (UK) Ltd**, Tranchant House, 100a High Street, Hampton, Middx.

**Burr-Brown International**, 25a King Street, Watford, WD1 8BT.

# Industrial Action with the JAMES SCOTT INDUSTRIAL

## Microwave range of equipments

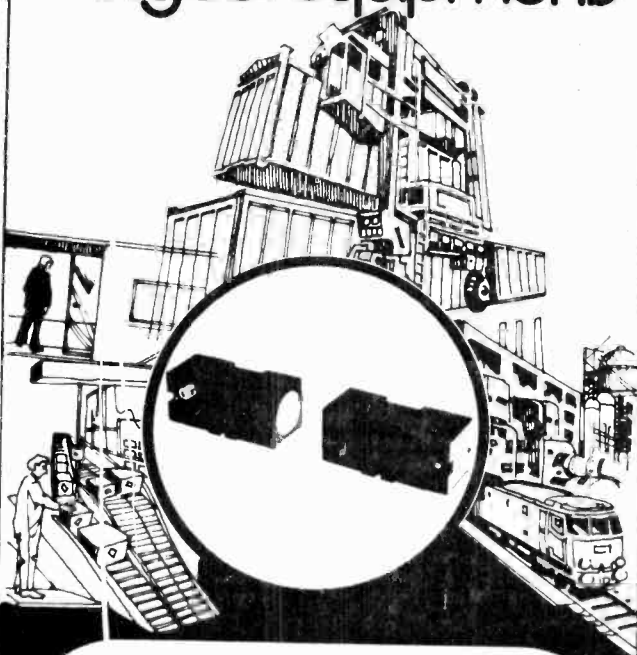

The James Scott range of Microwave equipment now offers industrial users a greater choice of alternative systems in robust, industrial, cast aluminium housings, for a wide variety of applications.

The range is made up of standard sub-assemblies which can be permuted to suit individual application requirements.

**Some Suggested Applications for these Units** Level controllers; Proximity alarms; Small object counters; Process control systems; Positioning systems; Door opening systems; Safety barriers; Presence/detectors; Train control systems; Vibration sensing systems; Intruder alarms; Road vehicle systems.

If any of the above are your problems or if you have a particular problem for which we could adapt a system please write or telephone for further information and technical literature to.



**JAMES SCOTT**  
(Electronic Engineering) Ltd

CARNTYNE INDUSTRIAL ESTATE  
GLASGOW G32 6AB  
Tel: 041-778 4206

WW-007 FOR FURTHER DETAILS

# Sinclair Project 80

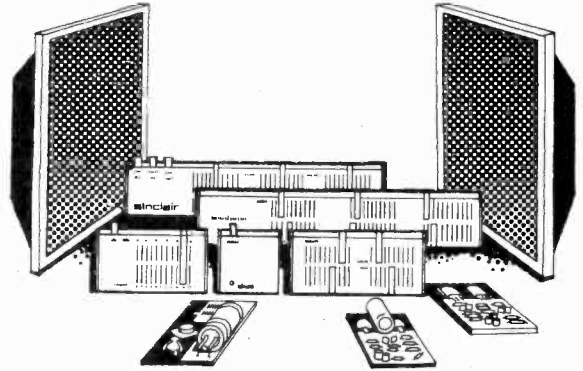

## The watts...

14 different hi-fi modules.

Between them they cater for every variety of hi-fi set-up, from a tuner amp to a full CBS SQ quadraphonic system.

The value for money's amazing. A genuine 25 W per channel quadraphonic amplifier for under £80...

a 12 W per channel stereo amp for around £30...

And the satisfaction's even greater! If you can handle a soldering iron, you can handle Project 80. And if you can't... use Project 805 - the same modules but with solderless clip connections.

## and the wherefores.

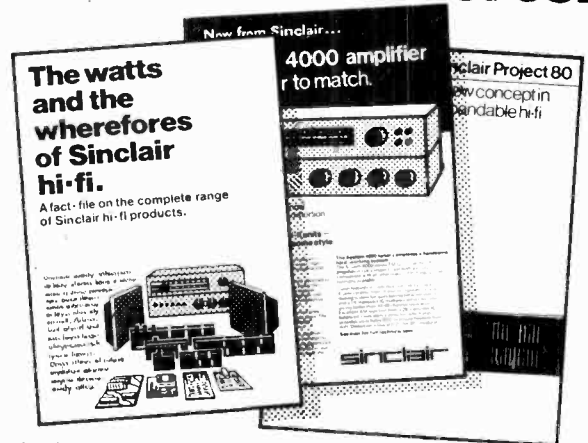

Take a look at some of the hi-fi systems you can build...

Get the full technical specifications...

See what impartial hi-fi journals thought of its performance...

And read up on the rest of the Sinclair hi-fi range...

It's all in the Sinclair hi-fi range fact-file.

**Send for Sinclair's fact-file - now!**

See if the answer's here - the information on the component you've been looking for.

Simply cut the coupon and send it to the no-stamp-needed FREEPOST address below.

We'll send you the Sinclair fact-file - giving you all you need to know about Project 80, and the rest of the Sinclair hi-fi range.

Plus information about a few extras you're sure to find rather interesting.

You've plenty to gain... so cut the coupon - now!

Sinclair Radionics Ltd,  
London Road, St Ives,  
Huntingdon, Cambs., PE17 4HJ  
St Ives (0480) 64646

Please send me the Sinclair range fact-file immediately

Name \_\_\_\_\_

Address \_\_\_\_\_

To: Sinclair Radionics Ltd,  
FREEPOST, St Ives,  
Huntingdon, Cambs., PE17 4BR WW

Please print

**sinclair**

# CONTIL SAMOS miniature cases

in easy-to-work blue and white PVC/steel. Assemble in the lower half complete before springing cover into place—four Pozidrivs, two to hinge it, two to fasten it. Carries four PC boards horizontally, or two vertically, four required for each case (for one vertical board, two each case) Prices correct May 1975

S1	100 x 50 x 50mm	1 off	1.41
S2	100 x 100 x 50mm		£1.26
S3	100 x 150 x 50mm		£1.41
S4	125 x 50 x 75mm		£1.58
S5	125 x 100 x 75mm		£1.81
S6	125 x 150 x 75mm		£2.12
S7	125 x 200 x 75mm		2.36

Much less for quantity. Prices include P & P 8% VAT, four feet and four plated screws. Special feet to carry Printed Circuit Boards sold separately. Price, incl. 8% VAT, 25p for four PC feet

# CONTIL MOD-3

Contil Mod-3 cases are in six sizes and offer the manufacturer of small instruments an attractive low cost case available ex-stock. Made in blue PVC-coated steel and complete with front and rear panels and chassis, they are light, strong and rigid. PCB and PSU mounting systems available

Mod 301	£4.90	Width	7"	Height	3"	Depth	1 1/4"
Mod 302	£5.21		7"		4 1/2"		5 1/4"
Mod 303	£6.04		7"		6"		5 1/4"
Mod 304	£6.04		11"		3"		5 1/4"
Mod 305	£7.04		11"		4 1/2"		5 1/4"
Mod 306	£8.07		11"		6"		5 1/4"

Less for quantities. Prices correct May 1975

# BOPLAST Polycarbonate housing

Blue-grey polycarbonate environmental housings in 28 sizes built to VDE Std IP65. Gaskets are recessed and oil, petrol, and water resistant. Mounting screws are in the wall of the enclosure. Cover retaining screws are captive. Pads internally for mounting chassis etc. Suitable for up to 140 C

28 SIZES AVAILABLE

Prices	1 off incl P&P and VAT	Outside dimensions		
		L	B	H
M205	£1.42	52mm	50mm	35mm
M221	£5.55	200	120	75
M228	£4.62	122	120	110
M241	£8.79	250	180	120
M255	£10.95	360	200	150

Much less for quantities. Boplast cases are available with clear covers. M210, 221, 223, 233, 244 (suffix G when ordering). Cable glands available. Prices correct May 1975

WEST HYDE NOW HAVE OVER 160 SIZES AND TYPES OF CASES, PLASTIC AND METAL.

# SWIFT Instrument cases

## Heat Sink and Case in One

The front and back heavy extrusions contain slots for mounting power transistors or transformers. Access is by means of the removable side plates which allow the black PVC top and bottom panels to be slid out so providing good access to the interior. With 3/16" thick side removed, the case is still mechanically stiff.

The good-looking Swift case is made of aluminium. Side plates black anodised, the front and rear extrusions satin anodised. Only 8 parts and 8 screws. The feet lock into the case below for stacking.

Full width rack 3 1/2" high	1 off incl P&P and VAT	Size
Half width rack 3 1/2" high	£14.12	17" x 10 3/4"
	£11.43	8 3/4" x 10 3/4"

Much less for quantities. "Swift Rack Brackets" 86p per pair incl VAT. No extra charge for Louvers. Add L to order.

Prices correct May 1975

# CONTIL MOD-2

The design of these cases permits the instrument to be built or serviced within their external panels. 48 shapes. Low cost. Blue PVC/steel with grey PVC-coated aluminium panels.

Width	Height	Depth	1 off	Width	Height	Depth	1 of
A 4 1/2"	3"	6 1/2"	£4.67	M 4 1/2"	7"	13"	£5.50
B 4 1/2"	7"	6 1/2"	£5.50	N 4 1/2"	7"	13"	£7.35
C 4 1/2"	10"	6 1/2"	£6.68	O 4 1/2"	10"	13"	£9.69
D 9"	6 1/2"	6 1/2"	£6.68	P 9"	3"	13"	£7.35
E 9"	7"	6 1/2"	£7.35	Q 9"	7"	13"	£9.69
F 9"	10"	6 1/2"	£8.67	R 9"	10"	13"	£11.92
G 13"	3"	6 1/2"	£7.35	S 13"	3"	13"	£9.69
H 13"	7"	6 1/2"	£8.67	T 13"	7"	13"	£11.92
I 13"	10"	6 1/2"	£9.69	U 13"	10"	13"	£15.78
J 18"	3"	6 1/2"	£8.67	V 18"	3"	13"	£11.92
K 18"	7"	6 1/2"	£11.92	W 18"	7"	13"	£15.78
L 18"	10"	6 1/2"	£15.78	X 18"	10"	13"	£17.37

Mod-2 in Woodgrain finish in sizes A, B, C, D, E, G, F, H, J, K & L

Prices as for one price up on Mod-2, e.g. Mod 2A Woodgrain is £5.50

Prices include screws, rubber feet, one or two chassis according to size. P&P and 8% VAT

Write or phone for our May catalogue

# WEST HYDE

WEST HYDE DEVELOPMENTS Ltd, Ryefield Cres., Northwood Hills, Northwood, Middx HA6 1NN.

Tel: Northwood 24941/26732

Telex: 923231

WW 036 FOR FURTHER DETAILS

# ROGERS AUDIO TEST EQUIPMENT



A comprehensive, versatile range of test equipment primarily designed for the measurement of high quality audio equipment but with additional applications in the electronics industry in general. The equipment is of particular interest to the professional audio engineer, recording studios, broadcasting authorities and educational establishments.

**DM344A Distortion Factor Meter.** Designed to make accurate and rapid measurements of total harmonic distortion generated within high quality audio amplifiers, recording and transmission equipment. **Selling Price: c/w Bench Case £175.00 + VAT.**

**S324 Low Distortion Oscillator.** Generates a pure sine wave and has been designed as a general purpose low distortion signal source. The primary application, used in conjunction with the DM344A, is the measurement of total harmonic distortion. **Selling Price: c/w Bench Case £80.00 + VAT.**

**AM324 AF Millivoltmeter.** Designed for voltage measurements in the audio and low RF ranges and principally for measuring low level signals in high impedance circuits. **Selling Price: c/w Bench Case £75.00 + VAT.**

**PS1A. Regulated Mains Power Supply.** **Selling Price: £18.50 + VAT.**

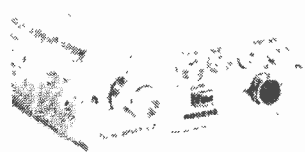

**Model 'A' Noise Generator.** A portable battery operated unit designed for carrying out listening tests on loudspeakers. 'Pink' or 'White' noise can be selected and output can be continuous or burst. Output is continuously variable. **Selling Price: £37.50 + VAT.**

Full Colour Literature describing the complete range may be had on request

## ROGERS DEVELOPMENTS (Electronics) LIMITED

4/14 Barmeston Road, London SE6 3BN, England  
Telephone: 01-698 7424/4340

WW-030 FOR FURTHER DETAILS

# HART ELECTRONICS Audio Kit Specialists since 1961



**BAILEY/BURROWS/QUILTER PRE AMP** This is the tone control section of the best pre-amp kit currently available. Consider the advantages—\*First quality fibreglass printed circuits with roller tinned finish and all component locations printed on reverse. \*Low noise carbon film and metal film resistors throughout. \*Finest quality low noise ganged controls with matched tracks and shafts cut to length. \*Well engineered layout for total stability. \*Special decoupling and earthing arrangements to eliminate hum loops. \*Controls, switches and input sockets mount directly on the boards to TOTALLY ELIMINATE wiring to these components. (We know of one pre amp kit which claims its controls mount directly on the board—and so they do, by their shaft bushes! You still have to wire them up!)

\*We incorporate the Quilter modification which is most important as it reduces distortion and increases the bass and treble control range.

As can be seen from the photograph the tone control unit is very slim (only 1 1/2" from front to back) and may therefore be used in many other applications than our Bailey metalwork which it is designed to fit.

**METALWORK AND WOODEN CASES** These have been under review for some time please send for latest information.

**F.M. TUNER** This latest addition to our range is designed to offer the best possible performance allied to the ease of operation given by push button varicap tuning. We have taken great care to look after the constructors point of view and there are no coils to wind, no RF circuits to wire and no alignment is required. In fact the whole unit and two ready built aligned modules comprising the active components. We have abandoned the concept of having a tuner as large as the amplifier as this new unit has a frontal size of only 1 1/2" x 4 in. It can be mounted on the side of our Bailey amplifier metalwork thus turning it into a tuner/amplifier whilst only increasing its width by 1 1/2 in. Cost of tuner chassis (no case) is £22 for mono. £25.45 for stereo. Metal case £35.50. An extended wooden case to fit tuner and amplifier will be offered shortly.

**STUART TAPE CIRCUITS** Our printed circuits and components offer the easy way to convert any suitable quality deck into a very high quality Stereo Tape unit. Input and output levels suit Bailey pre amp. Total cost varies but around £35. All you need. We can offer tape heads as well if you want new ones.

All above kits have fibreglass PCB's. Prices exclude VAT but P&P is included.

**FURTHER INFORMATION ON ALL KITS FREE if you send us a 9 in. x 4 in. S.A.E.**

REPRINTS Post free, no VAT

Bailey 30W 15p

STUART TAPE RECORDER All 3 articles under one cover 30p.

BAILEY/BURROWS/QUILTER Preamp circuits, layouts and assembly notes 15p.

All prices exclude VAT

# Penylan Mill, Oswestry, Salop

Personal callers are always welcome, but please note we are closed all day Saturday

# More than just a catalogue!

## PROJECTS FOR YOU TO BUILD

4-digit clock, 6-digit clock, 10W high quality power amp., High quality stereo pre-amp., Stereo Tuner, F.M. Stereo decoder, etc., etc.

CIRCUITS . . . Frequency Doublers, Oscillators, Timers, Voltmeters, Power Supplies, Amplifiers, Capacitance Multiplier, etc., etc. . . .

Full details and pictures of our wide range of components, e.g. capacitors, cases, knobs, veroboards, edge connectors, plugs and sockets, lamps and lampholders, audio leads, adaptor plugs, rotary and slide potentiometers, presets, relays, resistors (even 1% types!), switches, interlocking pushbutton switches, pot cores, transformers, cable and wire, panel meters, nuts and bolts, tools, organ components, keyboards, L.E.D.'s, 7-segment displays, heatsinks, transistors, diodes, integrated circuits, etc., etc. . . .

Really good value for money at just 40p.

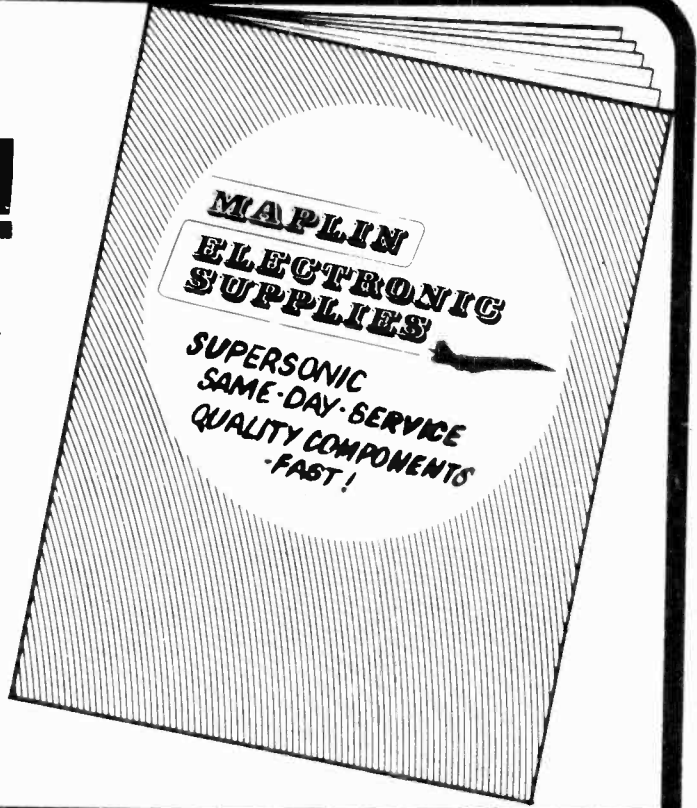

### The 3600 SYNTHESISER

The 3600 synthesiser includes the most popular features of the 4600 model, but is simpler. Faster to operate, it has a switch patching system rather than the matrix patchboard of the larger unit and is particularly suitable for live performance and portable use.

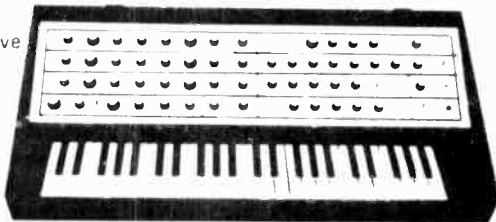

Please send S.A.E. for our price list.

### The 4600 SYNTHESISER

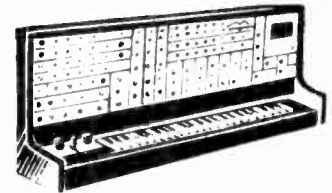

We stock all the parts for this brilliantly designed synthesiser, including all the PCB's, metalwork and a drilled and printed front panel, giving a superb professional finish. Opinions of authority agree the ETI International Synthesiser is technically superior to most of today's models. Complete construction details available shortly in our booklet price £1.50, or S.A.E. please for specification.

### GRAPHIC EQUALIZER

A really superior high quality stereo graphic equaliser as described in Jan. 1975 issue of ETI. We stock all parts (except woodwork) including all the metal work drilled and printed as required to suit our components and PCB's. S.A.E. for price list or complete reprint of article - price 15p.

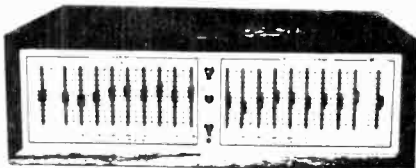

### ELECTRONIC ORGAN

Build yourself an exciting Electronic Organ. Our leaflet MES51, price 15p, deals with the basic theory of electronic organs and describes the construction of a simple 49-note instrument with a single keyboard and a limited number of stops. Leaflet MES52, price 15p, describes the extension of the organ to two keyboards each with five voices and the extension by an octave of the organ's range. Solid-state switching and new footages along with a pedal board and a further extension of the organ's range are shown in leaflet MES53, also priced at 15p.



### NO MORE DOUBTS ABOUT PRICES

Now our prices are GUARANTEED (changes in VAT excluded) for two month periods. We'll tell you about price changes in advance for just 30p a year (refunded on purchases). If you already have our catalogue send us an s.a.e. and we'll send you our latest list of GUARANTEED prices. Send us 30p and we'll put you on our mailing list - you'll receive immediately our latest price list then every two months from the starting date shown on that list you'll receive details of our prices for the next GUARANTEED period before the prices are implemented! - plus details of any new lines, special offers, interesting projects - and coupons to spend on components to repay your 30p

NOTE: The price list is based on the Order Codes shown in our catalogue so an investment in our super catalogue is an essential first step.

Call in at our shop, 284 London Road, Westcliff on Sea, Essex. Please address all mail to

**MAPLIN ELECTRONIC SUPPLIES**  
P.O. Box 3 Rayleigh Essex SS6 8LR

I enclose Cheque/P.O. value \_\_\_\_\_ ww  
For \_\_\_\_\_ copy/copies of your Catalogue  
Name \_\_\_\_\_  
Address \_\_\_\_\_

MAPLIN ELECTRONIC SUPPLIES P.O. Box 3 Rayleigh Essex SS6 8LR







TRANSMITTING, INDUSTRIAL AND SPECIAL VALVES

Table listing various valves with columns for part numbers, prices, and descriptions. Includes items like 2C39A, 2E26, 2K25, etc.

TAUT SUSPENSION MULTIMETERS Made in USSR



U4312: 41 ranges 0.3mA - 6A D.C., 1.5mA - 6A A.C., 0.3-900v A.C./D.C., 0.2-50kΩ; Mirror scale. Sensitivity 667Ω/v; Accuracy 1% D.C.; 1.5% A.C. £10.75.

U4313: 40 ranges 0.06mA - 1.5A D.C.; 0.6-1.5A A.C.; 1.5-600v A.C./D.C., 0.06-60kΩ; Mirror scale. Sensitivity 20kΩ/v D.C.; 2kΩ/v A.C. Accuracy 1.5% D.C., 2.5% A.C. £13.80.

U4315: 43 ranges 0.05mA-2.5A D.C.; 0.5mA-2.5A A.C.; 1-1000v D.C./A.C.; 0.3-500kΩ; Sensitivity 20kΩ/v D.C., 2kΩ/v A.C. Accuracy 2.5% D.C., 4% A.C. £10.00.

U4324: 33 ranges 0.06mA - 3A D.C., 0.3mA - 3A A.C., 0.6-1200v D.C., 3-900v A.C., 0.5-500kΩ; Sensitivity 20,000Ω/v D.C., 4000Ω/v A.C. Accuracy 2.5% D.C., 4% A.C. Re-chargeable cadmium cell operation. £9.85.

POSTAGE AND V.A.T.: PRICES QUOTED ARE EX-WAREHOUSE EXCLUSIVE OF V.A.T. Handling and postage is charged at £0.50 per multimeter and £0.20 in £ for other items. Please note that new rate of V.A.T. of 25% applies to all valves, semi-conductors and components. Test equipment, including multimeters, are subject to 8% V.A.T.

OUR NEW 1975 CATALOGUE OF VALVES, TUBES, SEMICONDUCTORS, TEST EQUIPMENT AND PASSIVE COMPONENTS IS AVAILABLE. PLEASE ENCLOSE £0.20 FOR YOUR COPY.

MINIMUM ACCOUNT ORDER CHARGE £10.00 PLUS VAT. OTHERWISE CASH WITH ORDER PLEASE

Our new Catalogue is ready. Please send £0.20 for your copy.

Z & I AERO SERVICES LTD

Tel. 727 5641

44A WESTBOURNE GROVE, LONDON W2 5JF

Telex 261306

ALL MAIL ORDER BY RETURN, C.O.D. SERVICE WELCOME

C. T. ELECTRONICS

We are open from 9.30 a.m.-6.00 p.m., Monday-Saturday

V.A.T. Unless otherwise stated all prices are exclusive of VAT. Please check whether the goods you are ordering are 25% or 8% Carriage orders under £5 please add 33p. Orders over £10 post free in U.K. only. This to be at our discretion.

All mail order and enquiries to 270 Acton Lane, Chiswick, London W4 5DG. Tel: 01-994 6275

SEMICONDUCTORS

Table listing semiconductor components with columns for part numbers, prices, and descriptions. Includes items like AC107, AC125, AC127, etc.

METAL BOXES 8% VAT

Table listing metal boxes with columns for part numbers, prices, and descriptions. Includes items like 2N2218, 2N2219, 2N2220, etc.

ALUMINIUM BOXES IDEAL FOR VEROBORD WITH B&P K. SCREWS

Table listing aluminium boxes with columns for part numbers, prices, and descriptions. Includes items like AB7, AB8, AB9, etc.

SPECIAL OFFERS

Table listing special offers with columns for product names, prices, and descriptions. Includes items like Miniature Mains Transformer, Mullard Pot Core Type, etc.

LINEAR I.C.s

Table listing linear integrated circuits with columns for part numbers, prices, and descriptions. Includes items like LM309K, LM723C, etc.

MULTI-CORE CABLE

20 way 14/0076 + Screen at 70p per yard + postage. Phone for details.

POTENTIOMETERS

Table listing potentiometers with columns for part numbers, prices, and descriptions. Includes items like Linear or Log, Rotary, etc.

DIGITAL INTEGRATED CIRCUITS

Table listing digital integrated circuits with columns for part numbers, prices, and descriptions. Includes items like SN7400, SN7401, etc.

# ELECTROVALUE

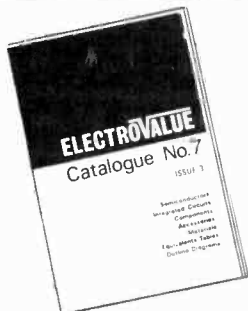

**Why hunt around when there's Catalogue 7 issue no 3?**

**UP-DATED PRODUCT & PRICE INFORMATION REFUND VOUCHER**

We have made it just about as comprehensive and up-to-the-minute as possible. Thousands of items from vast ranges of semi-conductors including I.C.s to components, tools, accessories, technical information and diagrams are included as well as a refund voucher worth 25p for spending on orders list value £5 or more. SEND NOW FOR YOUR COPY BY RETURN. It's an investment in practical money-saving and reliability!

**30p** post paid

**+ E.V. PRICE STABILIZATION POLICY**

PRICES shown in Catalogue No. 7 issue 3 have so far been maintained since the beginning of the year. E.V. prices continue to be reviewed at 3-month intervals. Instead of making day-to-day price changes next price review due July 1st.

**+ E.V. DISCOUNT PLAN**

Applies to all items except the few where prices are shown NETT. 5% on orders from £5 to £14.99; 10% on orders value £15 or more.

**+ FREE POST & PACKING**

In UK for pre-paid mail orders over £2 (except Baxandall cabinets). If under there is an additional handling charge of 10p.

**+ QUALITY GUARANTEE**

All goods are sold on the understanding that they conform to makers' specifications. No rejects, seconds or sub-standard merchandise.

## ELECTROVALUE LTD

All communications to Section 2/6  
**28 ST. JUDES ROAD, ENGLEFIELD GREEN, EGHAM, SURREY TW20 0HB**  
 Telephone Egham 3603, Telex 264475. Shop hours: 9-5.30 daily, 9-1 p.m. Sats  
**NORTHERN BRANCH: 680 Burnage Lane, Burnage, Manchester M19 1NA**  
 Telephone (061) 432 4945. Shop hours: Daily 9-5.30 p.m., 9-1 p.m. Sats  
**U.S.A. CUSTOMERS** are invited to contact ELECTROVALUE AMERICA, P.O. Box 27, Swarthmore PA 19081.

## RADFORD HD250

*High Definition Stereo Amplifier*

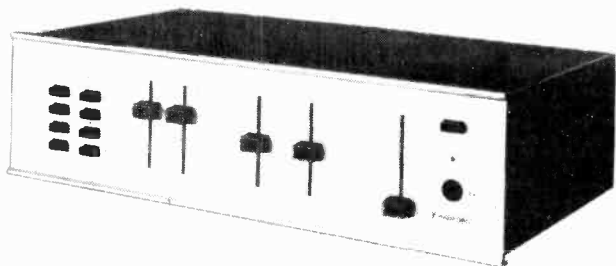

**A new standard for sound reproduction in the home! We believe that no other amplifier in the world can match the overall specification of the HD250.**

Rated power output: 50 watts av. continuous per channel into any impedance from 4 to 8 ohms, both channels driven.

Maximum power output: 90 watts av. per channel into 5 ohms.

Distortion, preamplifier: Virtually zero (cannot be identified or measured as it is below inherent circuit noise.)

Distortion, power amplifier: Typically 0.006% at 25 watts, less than 0.02% at rated output (Typically 0.01% at 1 KHz)

Hum and noise: Disc.—83dBV measured flat with noise band width 23 KHz (ref 5mV); —88dBV "A" weighted (ref. 5mV)

Line —85 dBV measured flat (ref 100v)  
 —88dBV "A" weighted (ref 100v)

Hear the HD250 at

## SWIFT OF WILMSLOW

Dept. WW

5 Swan Street, Wilmslow, Cheshire (Tel. 26213)  
 Mail Order and Personal Export enquiries: Wilmslow Audio, Swan Works, Bank Square, Wilmslow (Tel. 29599)

**ALL RADFORD SPEAKER DRIVE UNITS & CROSSOVERS IN STOCK**

WW—073 FOR FURTHER DETAILS

## Sinclair hi-fi

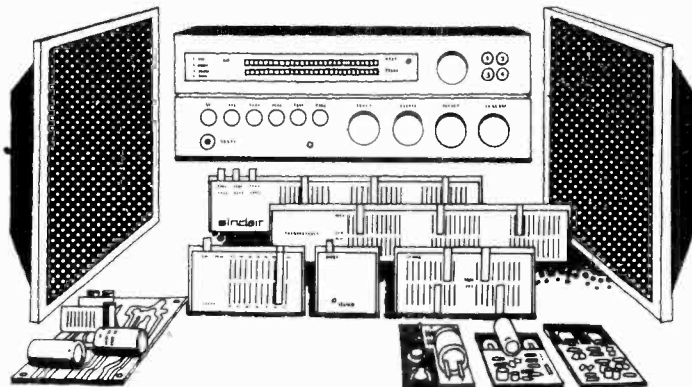

### The watts...

The Sinclair range of hi-fi products. Three different ways of achieving hi-fi excellence — whatever area of hi-fi you're interested in.

And the Sinclair range fact-file gives you the full run-down on all of them.

On Project 80 — the build-as-you-please hi-fi module system.

On IC20 — the revolutionary integrated circuit amplifier kit.

And System 4000 — the luxury hi-fi amplifier and matching tuner.

### and the wherefores.

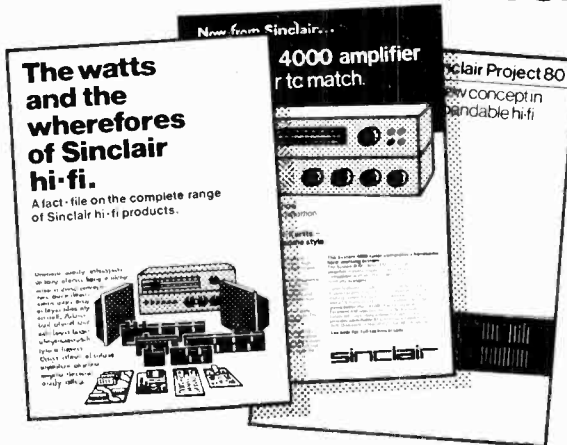

The Sinclair range fact-file shows you the whole story. Technical specifications... complete descriptions... big, clear pictures... and test reports by impartial hi-fi journals.

A real bundle of goodies.

**Send for Sinclair's range fact-file — now!**

See if the answer's here — the information on the component you've been looking for.

Simply cut the coupon and send it to the no-stamp-needed FREEPOST address below.

We'll send you the Sinclair fact-file — giving you all you need to know about Sinclair hi-fi. And information about a few extras you're sure to find rather interesting.

Sinclair Radionics Ltd,  
 London Road, St Ives,  
 Huntingdon, Cambs., PE17 4HJ  
 St Ives (0480) 64646

Please send me the Sinclair range fact-file immediately

Name \_\_\_\_\_

Address \_\_\_\_\_  
 \_\_\_\_\_  
 \_\_\_\_\_

To: Sinclair Radionics Ltd,  
 FREEPOST, St Ives,  
 Huntingdon, Cambs., PE17 4BR WW

Please print

**sinclair**



# TRAMPUS

## Electronics Ltd.

WINDSOR BERKS.  
58/60 GROVE RD;  
SEND C.M.G. ADD VAT TO ALL PRICES IN U.K. P&P 15p. EXPORTS 60p.

MONY BACK IF NOT SATISFIED.  
LARGE STOCKS. LOW PRICES.  
ALL BRANDS NEW TOP GRADE FULL  
SPEC DEVICES. CALLERS WELCOME.  
CATALOGUE/LIST FREE SEND SAE.  
BARCLAYCARD & ACCESS x POST.

---

### Digital Displays



SLA7 RED LED 0.3" DIGIT 0-9DP 89p ea  
GREEN/YELLOW £1.40  
JUMBO LED 0.6" 747 DISPLAY £2.25 ea.  
3015F 0-9DP £1 ea.  
ZENON FLASH TUBE £4. Data 15p.

### LEDS red 13p

LEDS 209 STYLE ONLY 13p ea  
TIL 209 WITH CLIP RED 15p ea  
TIL 211 & CLIP GREEN 29p ea  
LARGE 0.2" & CLIP RED 17p ea  
LARGE 0.2" CLIP GREEN 30p ea  
209 STYLE OR .2" ORANGE 29p ea  
INFRA RED LED £1.2N5777 33p.

### PHOTO IC 81p

TEC12 PHOTO AMP/SCMITT/RELAY DRIVER or LED TTL INTERFACE 81p



FLUORESCENT LIGHTS 12V MADE IN UK  
8 WATT 13" £3. 13W 22" £3.50

### DIGITAL CLOCK

IC AY51224 4 DIGIT CLOCK £3.75  
M55311/4 6 DIGIT CLOCK £7

### CASSETTE mechanics £13.75

NEW 8tk CARTRIDGE MECHANISM £8  
STEREO CASSETTE MECHANISM £13.75  
Suitable for 'PW ASCOT' recorder with heads etc. SEND 15p for DATA

### INTEGRATED CIRCUITS

709 DIL14 29p	LM377 2x2W £2.87
555 TIMER 54p	LM380 2W AF 89p
703 HF/IF 28p	LM381 2xPre £2
709 T099 23p	LM3900 4xOPA69p
709 DIL 14 28p	MC1303 £1.20
710 DIL 14 34p	MC1306 49p
723 Reg. 51p	MC1310&LED12.65
741 DIL 8 27p	MC1312 SQ £2.10
741 DIL 14 29p	MC1330 69p
741 T099 29p	MC1339 2xPre £1
747 2x741 70p	MC1350 55p
748 DIL 8 33p	NE536 fetOPA £2
7805 5V £1.40	NE540 Driver £1
7812 & 15 £1.40	NE550 2vRef 79p
76013 6W AF £1	NE555 Timer 55p
8038 SIG GEN £3	NE556 2x £1.20
CA302A £1	NE580 PLL £3.15
CA304A 15p	NE581 PLL £3.15
CA304B £2	NE582 PLL £3.19
CA3052 £1.50	NE585 PLL £2.69
CA3054 £1	SN72709 709 28p
LM300 2-20V £2	SN72741 741 26p
LM301 OPA 45p	SN72748 748 33p
LM304 0-40V £3	SN76660 IF £1
LM307 OPA 49p	SN76611 IF £1.25
LM308 H1Ro 95p	TAD110 & IF £2
LM309K 5V £1.48	TDA810 7WAF 95p
LM372 IF £1.80	ZN414 RX £1.09

### SPECIAL OFFERS

2N3055 FULL HIGH SPEC 115W 37p  
741C 8PIN DIL 27p. MFC4000B 33p  
NE555 TIMER 55p. ZN414 RX £1.09  
BC109 9p. 2N3819e 16p. BFY51 15p

### 747 TTL

7400 GATES 13p	7473/74/76 29p
7475 15p	
7404 INVERT 17p	7490 52p
7401/2/10etc 14p	7491/2/3/4 59p
7413 SCMITT 31p	74100 74175 £1
7440 BUFFER 14p	74121 32p
7447 DRIVER 89p	74123 59p
7470 & 7472 29p	74141 (& 7441) 73p

### TRANSISTORS & DIODES

Price each

AC127 & 128 16p	MATCHING 16p
AC187 & 188 19p	INS. BUSH SET 10p
AD149 43p	TIP 41 70p
AD161 & 162 33p	TIP 42 88p
BC107 & 108 9p	TIP 2955 90p
BC109 10p	TIP 3055 55p
BC147/8/9 10p	TIS43 see 2N2646
BC157/8/9 12p	ZTX109&301 13p
BC167/8/9 12p	1N4001 4p
BC177/8/9 18p	1N4004 & 7 7p
BC182/3/4 44£10p	1N4148 & 914 4p
BC212/3/4 44£11p	2N697 14p
BCY70/1/2 17p	2N7068 11p
BD131 & 132 39p	2N2646 UJT 32p
BRF51	2N2904 & 5 20p
BRF50/51 23p	2N2926 9p
BRF88 250V 29p	2N3053 17p
BFY50/1/2 15p	2N3055 115W 37p
	2N3563 & 64 16p
	2N3614 49p
BSX19/20/21 16p	2N3702 & 3 9p
MJE2955 90p	2N3704 & 5 10p
MJE3055 65p	2N3706 & 7 9p
MU131 PUT 49p	2N3708 & 9 8p
OA91 OA81 6p	2N3710 & 11 10p
OA81 & OA91 6p	2N3819E FET 16p
TIP 29 & 30 52p	2N3823E FET 17p
TIP 31 & 32 69p	2N3904/5/6 15p

FULL SELECTION IN OUR FREE LISTS.

### NEW TRAMPUS FULL SPEC PAKS

PAK A 10 RED LEDS our choice £1
PAK B 4 741 OP AMP " £1
PAK C 4 2N3055 £1. D 12 BC109 £1
PAK E 10 BC182 £1. F 11 2N3704 £1
PAK G 8 BFY51 £1. H 9 2N3819e £1
PAK J 9 2N3053 £1. K 40 1N914 £1

### Oil sockets

TEXAS GOLD ea  
LOW PROFILE ea  
8, 14, & 16 PIN 13p

SOLDERING STRIPS:  
100 PINS 50p. 1K £3.

WW—051 FOR FURTHER DETAILS

## AMATEUR RADIO BULK BUYING GROUP

Specialising in components and modules for the SWL, Radio Amateur and Hobbyist. (Trade also supplied of course!) Try our prices, try our service. All our prices include VAT.

### COMPONENTS FOR POCKET V.H.F. TRANSCEIVER

By D. A. Tong (July and August '74 W.W.)  
Many of the components required for this project are in stock as follows:

Filters: BFB-455A, 43p; CFR-455H, £16.20  
Integrated Circuits: SL612, £2.00; SL630, £1.87  
Transistors etc: 40673, 61p; ZTX500, 17p; 1N4148, 7p  
Also: FX1115, 1p; FX1886, 5p; 2 1/2 in. 25ohm L.S., £1.56

### CMOS I.C.'s at LOWEST PRICES

4000, 30p; 4001, 30p; 4002, 30p; 4009, 73p; 4010, 73p; 4011, 30p; 4021, 30p; 4013, 73p; 4017, £2.03; 4018, £2.27; 4020, £2.27; 4023, 30p; 4024, £1.41; 4025, 30p; 4026, £3.23; 4027, £1.09; 4028, £1.76; 4029, £2.44; 4030, 76p; 4033, £3.23; 4049, 67p; 4050, 67p; 4055, £1.35; 4056, £1.69; 4511, £2.63; 4518, £2.71; 4520, £2.71.

The above is a selection from our wide range, full details in our price list.

### PLESSEY SL600 ics at LOWEST PRICES

We carry the most comprehensive stocks of SL600 devices anywhere in the country—available for immediate delivery

SL610	£2.00	SL613	£4.30	SL622	£7.55	SL630	£1.87
SL611	£2.00	SL620	£3.00	SL623	£5.57	SL640	£3.65
SL612	£2.00	SL621	£3.00	SL624	£2.83	SL641	£3.65

Full data sheets on all SL600 devices are included in our Data Catalogue. 35 pages crammed with information for 25p plus large 9 1/2 p.s.a.e.



### UKW-BERICHTE VHF-COMMUNICATIONS MAGAZINE

Send for FREE index to past editions to see range of items covered (SAE please) SUBSCRIPTION: £3.20 for 1975 volume. Plastic Binders—£1.35. ALL POST PAID. Back issues as follows: 1970, 1971—£2.45 per year, 1972-1973, 1974—£2.85 per year. A limited number of back issues now held in stock at 85p each post paid.

We also stock a wide range of other products—diodes, transistors, Minitrans, Microwave Modules converters, etc. Jaybeam aerials, KVG filters, etc. Write for free price list (enclose sae please) or send 25p plus large 9 1/2 p.s.a.e. for our Data Catalogue.

All prices include VAT. Minimum post and packing charge 15p. Orders should be sent to our mail order address as follows:

**A.R.B.B.G., Dept. 506, 20 THORNTON CRESCENT  
OLD COULSDON, SURREY CR3 1LH**

We are now the official U.K. agents for this VHF equipment constructors' magazine.

WW — 046 FOR FURTHER DETAILS

# Transsonics



## THE 5 MILLION ORGANISATION

Five million solid-state devices in stock daily, that is! Covering over 2,000 different types, including all the current CMOS range.

To keep up with the dozens of additions to our range each week, we are continually issuing new up-dated stock-lists. And they are automatically sent out to all catalogue holders, as well as anyone else who wants them.

So ask for your new Transsonics catalogue today. And find out about our stocks of ICs, transistors and other solid-state devices by Mullard, ITT, Texas, RCA and other manufacturers. They're all part of the Transsonics 5,000,000 daily stock figure—a vital statistic in your business.

Call us now on 01-723 3646 for O.E.M. Sales and 01-723 6603 for Distributor Sales. Or use Freepost. Transsonics Ltd. Freepost London W2 6BR.

## Transsonics

303 EDGWARE ROAD, LONDON W2 6BR. TELEX: 28116.





# VALVE MAIL ORDER CO.

16a Wellfield Rd., London, SW16 2BS  
Tel: 01-677 2424 Telex: 946 708.

### VALVES

EAZ13	0.70	EAZ14	0.80	EAZ15	0.90	EAZ16	1.00	EAZ17	1.10	EAZ18	1.20	EAZ19	1.30	EAZ20	1.40	EAZ21	1.50	EAZ22	1.60	EAZ23	1.70	EAZ24	1.80	EAZ25	1.90	EAZ26	2.00	EAZ27	2.10	EAZ28	2.20	EAZ29	2.30	EAZ30	2.40	EAZ31	2.50	EAZ32	2.60	EAZ33	2.70	EAZ34	2.80	EAZ35	2.90	EAZ36	3.00	EAZ37	3.10	EAZ38	3.20	EAZ39	3.30	EAZ40	3.40	EAZ41	3.50	EAZ42	3.60	EAZ43	3.70	EAZ44	3.80	EAZ45	3.90	EAZ46	4.00	EAZ47	4.10	EAZ48	4.20	EAZ49	4.30	EAZ50	4.40	EAZ51	4.50	EAZ52	4.60	EAZ53	4.70	EAZ54	4.80	EAZ55	4.90	EAZ56	5.00	EAZ57	5.10	EAZ58	5.20	EAZ59	5.30	EAZ60	5.40	EAZ61	5.50	EAZ62	5.60	EAZ63	5.70	EAZ64	5.80	EAZ65	5.90	EAZ66	6.00	EAZ67	6.10	EAZ68	6.20	EAZ69	6.30	EAZ70	6.40	EAZ71	6.50	EAZ72	6.60	EAZ73	6.70	EAZ74	6.80	EAZ75	6.90	EAZ76	7.00	EAZ77	7.10	EAZ78	7.20	EAZ79	7.30	EAZ80	7.40	EAZ81	7.50	EAZ82	7.60	EAZ83	7.70	EAZ84	7.80	EAZ85	7.90	EAZ86	8.00	EAZ87	8.10	EAZ88	8.20	EAZ89	8.30	EAZ90	8.40	EAZ91	8.50	EAZ92	8.60	EAZ93	8.70	EAZ94	8.80	EAZ95	8.90	EAZ96	9.00	EAZ97	9.10	EAZ98	9.20	EAZ99	9.30	EAZ100	9.40	EAZ101	9.50	EAZ102	9.60	EAZ103	9.70	EAZ104	9.80	EAZ105	9.90	EAZ106	10.00	EAZ107	10.10	EAZ108	10.20	EAZ109	10.30	EAZ110	10.40	EAZ111	10.50	EAZ112	10.60	EAZ113	10.70	EAZ114	10.80	EAZ115	10.90	EAZ116	11.00	EAZ117	11.10	EAZ118	11.20	EAZ119	11.30	EAZ120	11.40	EAZ121	11.50	EAZ122	11.60	EAZ123	11.70	EAZ124	11.80	EAZ125	11.90	EAZ126	12.00	EAZ127	12.10	EAZ128	12.20	EAZ129	12.30	EAZ130	12.40	EAZ131	12.50	EAZ132	12.60	EAZ133	12.70	EAZ134	12.80	EAZ135	12.90	EAZ136	13.00	EAZ137	13.10	EAZ138	13.20	EAZ139	13.30	EAZ140	13.40	EAZ141	13.50	EAZ142	13.60	EAZ143	13.70	EAZ144	13.80	EAZ145	13.90	EAZ146	14.00	EAZ147	14.10	EAZ148	14.20	EAZ149	14.30	EAZ150	14.40	EAZ151	14.50	EAZ152	14.60	EAZ153	14.70	EAZ154	14.80	EAZ155	14.90	EAZ156	15.00	EAZ157	15.10	EAZ158	15.20	EAZ159	15.30	EAZ160	15.40	EAZ161	15.50	EAZ162	15.60	EAZ163	15.70	EAZ164	15.80	EAZ165	15.90	EAZ166	16.00	EAZ167	16.10	EAZ168	16.20	EAZ169	16.30	EAZ170	16.40	EAZ171	16.50	EAZ172	16.60	EAZ173	16.70	EAZ174	16.80	EAZ175	16.90	EAZ176	17.00	EAZ177	17.10	EAZ178	17.20	EAZ179	17.30	EAZ180	17.40	EAZ181	17.50	EAZ182	17.60	EAZ183	17.70	EAZ184	17.80	EAZ185	17.90	EAZ186	18.00	EAZ187	18.10	EAZ188	18.20	EAZ189	18.30	EAZ190	18.40	EAZ191	18.50	EAZ192	18.60	EAZ193	18.70	EAZ194	18.80	EAZ195	18.90	EAZ196	19.00	EAZ197	19.10	EAZ198	19.20	EAZ199	19.30	EAZ200	19.40	EAZ201	19.50	EAZ202	19.60	EAZ203	19.70	EAZ204	19.80	EAZ205	19.90	EAZ206	20.00	EAZ207	20.10	EAZ208	20.20	EAZ209	20.30	EAZ210	20.40	EAZ211	20.50	EAZ212	20.60	EAZ213	20.70	EAZ214	20.80	EAZ215	20.90	EAZ216	21.00	EAZ217	21.10	EAZ218	21.20	EAZ219	21.30	EAZ220	21.40	EAZ221	21.50	EAZ222	21.60	EAZ223	21.70	EAZ224	21.80	EAZ225	21.90	EAZ226	22.00	EAZ227	22.10	EAZ228	22.20	EAZ229	22.30	EAZ230	22.40	EAZ231	22.50	EAZ232	22.60	EAZ233	22.70	EAZ234	22.80	EAZ235	22.90	EAZ236	23.00	EAZ237	23.10	EAZ238	23.20	EAZ239	23.30	EAZ240	23.40	EAZ241	23.50	EAZ242	23.60	EAZ243	23.70	EAZ244	23.80	EAZ245	23.90	EAZ246	24.00	EAZ247	24.10	EAZ248	24.20	EAZ249	24.30	EAZ250	24.40	EAZ251	24.50	EAZ252	24.60	EAZ253	24.70	EAZ254	24.80	EAZ255	24.90	EAZ256	25.00	EAZ257	25.10	EAZ258	25.20	EAZ259	25.30	EAZ260	25.40	EAZ261	25.50	EAZ262	25.60	EAZ263	25.70	EAZ264	25.80	EAZ265	25.90	EAZ266	26.00	EAZ267	26.10	EAZ268	26.20	EAZ269	26.30	EAZ270	26.40	EAZ271	26.50	EAZ272	26.60	EAZ273	26.70	EAZ274	26.80	EAZ275	26.90	EAZ276	27.00	EAZ277	27.10	EAZ278	27.20	EAZ279	27.30	EAZ280	27.40	EAZ281	27.50	EAZ282	27.60	EAZ283	27.70	EAZ284	27.80	EAZ285	27.90	EAZ286	28.00	EAZ287	28.10	EAZ288	28.20	EAZ289	28.30	EAZ290	28.40	EAZ291	28.50	EAZ292	28.60	EAZ293	28.70	EAZ294	28.80	EAZ295	28.90	EAZ296	29.00	EAZ297	29.10	EAZ298	29.20	EAZ299	29.30	EAZ300	29.40	EAZ301	29.50	EAZ302	29.60	EAZ303	29.70	EAZ304	29.80	EAZ305	29.90	EAZ306	30.00	EAZ307	30.10	EAZ308	30.20	EAZ309	30.30	EAZ310	30.40	EAZ311	30.50	EAZ312	30.60	EAZ313	30.70	EAZ314	30.80	EAZ315	30.90	EAZ316	31.00	EAZ317	31.10	EAZ318	31.20	EAZ319	31.30	EAZ320	31.40	EAZ321	31.50	EAZ322	31.60	EAZ323	31.70	EAZ324	31.80	EAZ325	31.90	EAZ326	32.00	EAZ327	32.10	EAZ328	32.20	EAZ329	32.30	EAZ330	32.40	EAZ331	32.50	EAZ332	32.60	EAZ333	32.70	EAZ334	32.80	EAZ335	32.90	EAZ336	33.00	EAZ337	33.10	EAZ338	33.20	EAZ339	33.30	EAZ340	33.40	EAZ341	33.50	EAZ342	33.60	EAZ343	33.70	EAZ344	33.80	EAZ345	33.90	EAZ346	34.00	EAZ347	34.10	EAZ348	34.20	EAZ349	34.30	EAZ350	34.40	EAZ351	34.50	EAZ352	34.60	EAZ353	34.70	EAZ354	34.80	EAZ355	34.90	EAZ356	35.00	EAZ357	35.10	EAZ358	35.20	EAZ359	35.30	EAZ360	35.40	EAZ361	35.50	EAZ362	35.60	EAZ363	35.70	EAZ364	35.80	EAZ365	35.90	EAZ366	36.00	EAZ367	36.10	EAZ368	36.20	EAZ369	36.30	EAZ370	36.40	EAZ371	36.50	EAZ372	36.60	EAZ373	36.70	EAZ374	36.80	EAZ375	36.90	EAZ376	37.00	EAZ377	37.10	EAZ378	37.20	EAZ379	37.30	EAZ380	37.40	EAZ381	37.50	EAZ382	37.60	EAZ383	37.70	EAZ384	37.80	EAZ385	37.90	EAZ386	38.00	EAZ387	38.10	EAZ388	38.20	EAZ389	38.30	EAZ390	38.40	EAZ391	38.50	EAZ392	38.60	EAZ393	38.70	EAZ394	38.80	EAZ395	38.90	EAZ396	39.00	EAZ397	39.10	EAZ398	39.20	EAZ399	39.30	EAZ400	39.40	EAZ401	39.50	EAZ402	39.60	EAZ403	39.70	EAZ404	39.80	EAZ405	39.90	EAZ406	40.00	EAZ407	40.10	EAZ408	40.20	EAZ409	40.30	EAZ410	40.40	EAZ411	40.50	EAZ412	40.60	EAZ413	40.70	EAZ414	40.80	EAZ415	40.90	EAZ416	41.00	EAZ417	41.10	EAZ418	41.20	EAZ419	41.30	EAZ420	41.40	EAZ421	41.50	EAZ422	41.60	EAZ423	41.70	EAZ424	41.80	EAZ425	41.90	EAZ426	42.00	EAZ427	42.10	EAZ428	42.20	EAZ429	42.30	EAZ430	42.40	EAZ431	42.50	EAZ432	42.60	EAZ433	42.70	EAZ434	42.80	EAZ435	42.90	EAZ436	43.00	EAZ437	43.10	EAZ438	43.20	EAZ439	43.30	EAZ440	43.40	EAZ441	43.50	EAZ442	43.60	EAZ443	43.70	EAZ444	43.80	EAZ445	43.90	EAZ446	44.00	EAZ447	44.10	EAZ448	44.20	EAZ449	44.30	EAZ450	44.40	EAZ451	44.50	EAZ452	44.60	EAZ453	44.70	EAZ454	44.80	EAZ455	44.90	EAZ456	45.00	EAZ457	45.10	EAZ458	45.20	EAZ459	45.30	EAZ460	45.40	EAZ461	45.50	EAZ462	45.60	EAZ463	45.70	EAZ464	45.80	EAZ465	45.90	EAZ466	46.00	EAZ467	46.10	EAZ468	46.20	EAZ469	46.30	EAZ470	46.40	EAZ471	46.50	EAZ472	46.60	EAZ473	46.70	EAZ474	46.80	EAZ475	46.90	EAZ476	47.00	EAZ477	47.10	EAZ478	47.20	EAZ479	47.30	EAZ480	47.40	EAZ481	47.50	EAZ482	47.60	EAZ483	47.70	EAZ484	47.80	EAZ485	47.90	EAZ486	48.00	EAZ487	48.10	EAZ488	48.20	EAZ489	48.30	EAZ490	48.40	EAZ491	48.50	EAZ492	48.60	EAZ493	48.70	EAZ494	48.80	EAZ495	48.90	EAZ496	49.00	EAZ497	49.10	EAZ498	49.20	EAZ499	49.30	EAZ500	49.40	EAZ501	49.50	EAZ502	49.60	EAZ503	49.70	EAZ504	49.80	EAZ505	49.90	EAZ506	50.00	EAZ507	50.10	EAZ508	50.20	EAZ509	50.30	EAZ510	50.40	EAZ511	50.50	EAZ512	50.60	EAZ513	50.70	EAZ514	50.80	EAZ515	50.90	EAZ516	51.00	EAZ517	51.10	EAZ518	51.20	EAZ519	51.30	EAZ520	51.40	EAZ521	51.50	EAZ522	51.60	EAZ523	51.70	EAZ524	51.80	EAZ525	51.90	EAZ526	52.00	EAZ527	52.10	EAZ528	52.20	EAZ529	52.30	EAZ530	52.40	EAZ531	52.50	EAZ532	52.60	EAZ533	52.70	EAZ534	52.80	EAZ535	52.90	EAZ536	53.00	EAZ537	53.10	EAZ538	53.20	EAZ539	53.30	EAZ540	53.40	EAZ541	53.50	EAZ542	53.60	EAZ543	53.70	EAZ544	53.80	EAZ545	53.90	EAZ546	54.00	EAZ547	54.10	EAZ548	54.20	EAZ549	54.30	EAZ550	54.40	EAZ551	54.50	EAZ552	54.60	EAZ553	54.70	EAZ554	54.80	EAZ555	54.90	EAZ556	55.00	EAZ557	55.10	EAZ558	55.20	EAZ559	55.30	EAZ560	55.40	EAZ561	55.50	EAZ562	55.60	EAZ563	55.70	EAZ564	55.80	EAZ565	55.90	EAZ566	56.00	EAZ567	56.10	EAZ568	56.20	EAZ569	56.30	EAZ570	56.40	EAZ571	56.50	EAZ572	56.60	EAZ573	56.70	EAZ574	56.80	EAZ575	56.90	EAZ576	57.00	EAZ577	57.10	EAZ578	57.20	EAZ579	57.30	EAZ580	57.40	EAZ581	57.50	EAZ582	57.60	EAZ583	57.70	EAZ584	57.80	EAZ585	57.90	EAZ586	58.00	EAZ587	58.10	EAZ588	58.20	EAZ589	58.30	EAZ590	58.40	EAZ591	58.50	EAZ592	58.60	EAZ593	58.70	EAZ594	58.80	EAZ595	58.90	EAZ596	59.00	EAZ597	59.10	EAZ598	59.20	EAZ599	59.30	EAZ600	59.40	EAZ601	59.50	EAZ602	59.60	EAZ603	59.70	EAZ604	59.80	EAZ605	59.90	EAZ606	60.00	EAZ607	60.10	EAZ608	60.20	EAZ609	60.30	EAZ610	60.40	EAZ611	60.50	EAZ612	60.60	EAZ613	60.70	EAZ614	60.80	EAZ615	60.90	EAZ616	61.00	EAZ617	61.10	EAZ618	61.20	EAZ619	61.30	EAZ620	61.40	EAZ621	61.50	EAZ622	61.60	EAZ623	61.70	EAZ624	61.80	EAZ625	61.90	EAZ626	6
-------	------	-------	------	-------	------	-------	------	-------	------	-------	------	-------	------	-------	------	-------	------	-------	------	-------	------	-------	------	-------	------	-------	------	-------	------	-------	------	-------	------	-------	------	-------	------	-------	------	-------	------	-------	------	-------	------	-------	------	-------	------	-------	------	-------	------	-------	------	-------	------	-------	------	-------	------	-------	------	-------	------	-------	------	-------	------	-------	------	-------	------	-------	------	-------	------	-------	------	-------	------	-------	------	-------	------	-------	------	-------	------	-------	------	-------	------	-------	------	-------	------	-------	------	-------	------	-------	------	-------	------	-------	------	-------	------	-------	------	-------	------	-------	------	-------	------	-------	------	-------	------	-------	------	-------	------	-------	------	-------	------	-------	------	-------	------	-------	------	-------	------	-------	------	-------	------	-------	------	-------	------	-------	------	-------	------	-------	------	-------	------	-------	------	-------	------	-------	------	-------	------	-------	------	-------	------	-------	------	-------	------	-------	------	-------	------	--------	------	--------	------	--------	------	--------	------	--------	------	--------	------	--------	-------	--------	-------	--------	-------	--------	-------	--------	-------	--------	-------	--------	-------	--------	-------	--------	-------	--------	-------	--------	-------	--------	-------	--------	-------	--------	-------	--------	-------	--------	-------	--------	-------	--------	-------	--------	-------	--------	-------	--------	-------	--------	-------	--------	-------	--------	-------	--------	-------	--------	-------	--------	-------	--------	-------	--------	-------	--------	-------	--------	-------	--------	-------	--------	-------	--------	-------	--------	-------	--------	-------	--------	-------	--------	-------	--------	-------	--------	-------	--------	-------	--------	-------	--------	-------	--------	-------	--------	-------	--------	-------	--------	-------	--------	-------	--------	-------	--------	-------	--------	-------	--------	-------	--------	-------	--------	-------	--------	-------	--------	-------	--------	-------	--------	-------	--------	-------	--------	-------	--------	-------	--------	-------	--------	-------	--------	-------	--------	-------	--------	-------	--------	-------	--------	-------	--------	-------	--------	-------	--------	-------	--------	-------	--------	-------	--------	-------	--------	-------	--------	-------	--------	-------	--------	-------	--------	-------	--------	-------	--------	-------	--------	-------	--------	-------	--------	-------	--------	-------	--------	-------	--------	-------	--------	-------	--------	-------	--------	-------	--------	-------	--------	-------	--------	-------	--------	-------	--------	-------	--------	-------	--------	-------	--------	-------	--------	-------	--------	-------	--------	-------	--------	-------	--------	-------	--------	-------	--------	-------	--------	-------	--------	-------	--------	-------	--------	-------	--------	-------	--------	-------	--------	-------	--------	-------	--------	-------	--------	-------	--------	-------	--------	-------	--------	-------	--------	-------	--------	-------	--------	-------	--------	-------	--------	-------	--------	-------	--------	-------	--------	-------	--------	-------	--------	-------	--------	-------	--------	-------	--------	-------	--------	-------	--------	-------	--------	-------	--------	-------	--------	-------	--------	-------	--------	-------	--------	-------	--------	-------	--------	-------	--------	-------	--------	-------	--------	-------	--------	-------	--------	-------	--------	-------	--------	-------	--------	-------	--------	-------	--------	-------	--------	-------	--------	-------	--------	-------	--------	-------	--------	-------	--------	-------	--------	-------	--------	-------	--------	-------	--------	-------	--------	-------	--------	-------	--------	-------	--------	-------	--------	-------	--------	-------	--------	-------	--------	-------	--------	-------	--------	-------	--------	-------	--------	-------	--------	-------	--------	-------	--------	-------	--------	-------	--------	-------	--------	-------	--------	-------	--------	-------	--------	-------	--------	-------	--------	-------	--------	-------	--------	-------	--------	-------	--------	-------	--------	-------	--------	-------	--------	-------	--------	-------	--------	-------	--------	-------	--------	-------	--------	-------	--------	-------	--------	-------	--------	-------	--------	-------	--------	-------	--------	-------	--------	-------	--------	-------	--------	-------	--------	-------	--------	-------	--------	-------	--------	-------	--------	-------	--------	-------	--------	-------	--------	-------	--------	-------	--------	-------	--------	-------	--------	-------	--------	-------	--------	-------	--------	-------	--------	-------	--------	-------	--------	-------	--------	-------	--------	-------	--------	-------	--------	-------	--------	-------	--------	-------	--------	-------	--------	-------	--------	-------	--------	-------	--------	-------	--------	-------	--------	-------	--------	-------	--------	-------	--------	-------	--------	-------	--------	-------	--------	-------	--------	-------	--------	-------	--------	-------	--------	-------	--------	-------	--------	-------	--------	-------	--------	-------	--------	-------	--------	-------	--------	-------	--------	-------	--------	-------	--------	-------	--------	-------	--------	-------	--------	-------	--------	-------	--------	-------	--------	-------	--------	-------	--------	-------	--------	-------	--------	-------	--------	-------	--------	-------	--------	-------	--------	-------	--------	-------	--------	-------	--------	-------	--------	-------	--------	-------	--------	-------	--------	-------	--------	-------	--------	-------	--------	-------	--------	-------	--------	-------	--------	-------	--------	-------	--------	-------	--------	-------	--------	-------	--------	-------	--------	-------	--------	-------	--------	-------	--------	-------	--------	-------	--------	-------	--------	-------	--------	-------	--------	-------	--------	-------	--------	-------	--------	-------	--------	-------	--------	-------	--------	-------	--------	-------	--------	-------	--------	-------	--------	-------	--------	-------	--------	-------	--------	-------	--------	-------	--------	-------	--------	-------	--------	-------	--------	-------	--------	-------	--------	-------	--------	-------	--------	-------	--------	-------	--------	-------	--------	-------	--------	-------	--------	-------	--------	-------	--------	-------	--------	-------	--------	-------	--------	-------	--------	-------	--------	-------	--------	-------	--------	-------	--------	-------	--------	-------	--------	-------	--------	-------	--------	-------	--------	-------	--------	-------	--------	-------	--------	-------	--------	-------	--------	-------	--------	-------	--------	-------	--------	-------	--------	-------	--------	-------	--------	-------	--------	-------	--------	-------	--------	-------	--------	-------	--------	-------	--------	-------	--------	-------	--------	-------	--------	-------	--------	-------	--------	-------	--------	-------	--------	-------	--------	-------	--------	-------	--------	-------	--------	-------	--------	-------	--------	-------	--------	-------	--------	-------	--------	-------	--------	-------	--------	-------	--------	-------	--------	-------	--------	-------	--------	-------	--------	-------	--------	-------	--------	-------	--------	-------	--------	-------	--------	-------	--------	-------	--------	-------	--------	-------	--------	-------	--------	-------	--------	-------	--------	-------	--------	-------	--------	-------	--------	-------	--------	-------	--------	-------	--------	-------	--------	-------	--------	-------	--------	-------	--------	-------	--------	-------	--------	-------	--------	-------	--------	-------	--------	-------	--------	-------	--------	-------	--------	-------	--------	-------	--------	-------	--------	-------	--------	-------	--------	-------	--------	-------	--------	-------	--------	-------	--------	-------	--------	-------	--------	-------	--------	-------	--------	-------	--------	-------	--------	-------	--------	-------	--------	-------	--------	-------	--------	-------	--------	-------	--------	-------	--------	-------	--------	-------	--------	-------	--------	-------	--------	-------	--------	-------	--------	-------	--------	-------	--------	-------	--------	-------	--------	-------	--------	-------	--------	-------	--------	-------	--------	-------	--------	-------	--------	-------	--------	-------	--------	-------	--------	-------	--------	-------	--------	-------	--------	-------	--------	-------	--------	-------	--------	-------	--------	-------	--------	-------	--------	-------	--------	-------	--------	-------	--------	-------	--------	-------	--------	-------	--------	-------	--------	-------	--------	-------	--------	-------	--------	-------	--------	-------	--------	-------	--------	-------	--------	-------	--------	-------	--------	-------	--------	-------	--------	-------	--------	-------	--------	-------	--------	-------	--------	-------	--------	-------	--------	-------	--------	-------	--------	-------	--------	-------	--------	-------	--------	-------	--------	-------	--------	-------	--------	-------	--------	-------	--------	-------	--------	-------	--------	-------	--------	-------	--------	-------	--------	-------	--------	-------	--------	-------	--------	-------	--------	-------	--------	-------	--------	-------	--------	-------	--------	-------	--------	-------	--------	-------	--------	-------	--------	-------	--------	-------	--------	-------	--------	-------	--------	-------	--------	-------	--------	-------	--------	-------	--------	-------	--------	-------	--------	-------	--------	---





## MAKE BIG REDUCTIONS WITH JACKSON



CATALOGUE NO. 5870

The Jackson Friction Ball Drive Reduction Unit is unique. Simply because it's the only one of its type and size available in the United Kingdom. It has sealed lubrication, with a hardened steel shaft and bearings to give it extra long life. And it's low in price. The unit has a 10:1 reduction ratio, with an output torque of 8 oz. ins. minimum.

Our skilled personnel can produce custom made components to suit your individual needs. And with 45 years of experience your guarantee is our reliability.



B.S. 9000  
Approved.

Write for fully illustrated catalogue:

### JACKSON BROTHERS (LONDON) LIMITED

Kingsway, Waddon, Croydon CR9 4DG.  
Tel: 01-681 2754/7 Telex: 946849  
U.S. Office: M. Swedgal, 258 Broadway,  
New York, N.Y. 10007

WW-14 FOR FURTHER DETAILS

# Celestion Dittons for the perfectionist

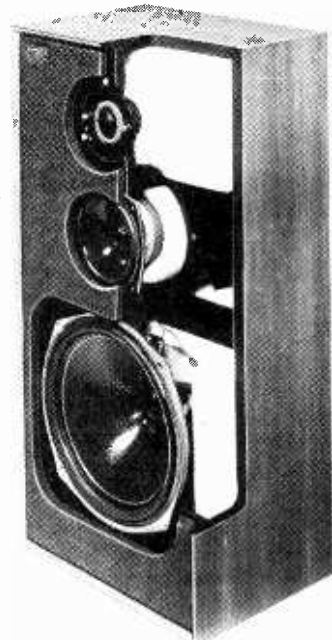

**DITTON 44 MONITOR** 30x14½x10in (76x37x25cm) 44w  
Cut-away illustration showing the Celestion transducers – seen at the top HF 2000 Tweeter, now accepted as the world's finest; at centre, a FC6 mid-range using special rubber suspension, 50,000 Maxwell magnet, and transmission line rear loading; at the base, a FC12, this rugged long coil low resonance unit being tuned to its 43.47 litre hermetically sealed enclosure. On test has accepted quite safely transient signals ten times greater than the rated maximum wattage. Now recognised as providing an exceptional standard of sound reproduction by independent reviewers in England, the USA and Europe. A thoroughbred monitor class loudspeaker for the discerning listener, priced absolutely realistically.



**HADLEIGH** 13¾x10x9½in 20w  
(34x25x24cm)

The Hadleigh loudspeaker, was specially created to meet a public demand for a high quality speaker of compact proportions. Not a difficult task for Celestion who produce the most popular bookshelf speaker ever (Ditton 15) – but we set out not only to produce an immaculate loudspeaker with a sparkling performance, but to do so at a budget price. For the enthusiast seeking a really excellent Hi-Fi system at reasonable outlay we recommend without hesitation the Hadleigh.

## Celestion



ROLA CELESTION LIMITED, DITTON WORKS,  
FOXHALL ROAD, IPSWICH, SUFFOLK IP3 8JP

WW-093 FOR FURTHER DETAILS.

# QUALITY AMPLIFIER KITS by POWERTRAN ELECTRONICS

## WIRELESS WORLD AMPLIFIER DESIGNS

Component packs for a choice of three outstanding amplifiers are stocked together with packs for a regulated power supply suitable for use with a pair of any of them. Also stocked are packs for a very well-established pre-amplifier—the Bailey-Burrows design which features six inputs, a scratch and rumble filter and wide range tone controls which may be either rotary or slider operating.

### 30W BAILEY

- Pk. 1 F/Glass PCB £0.80
- Pk. 2 Resistors, capacitors, pots £1.75
- Pk. 3 Semiconductor set £4.70

### 20W LINSLEY-HOOD

- Pk. 1 F/Glass PCB £0.85
- Pk. 2 Resistors, capacitors, pots £2.40
- Pk. 3 Semiconductor set £3.35

### 60V REGULATED POWER SUPPLY

- Pk. 1 F/Glass PCB £0.75
- Pk. 2 Resistors, capacitors, pots £1.40
- Pk. 3 Semiconductor set £3.10

### BAILEY-BURROWS PRE-AMP

- Pk. 1 F/Glass PCB £2.05
- Pk. 2 Resistors, capacitors, pre-sets, transistors £4.95

- Pk. 3R Rotary potentiometer set £1.60
- Pk. 3S Slider potentiometer set (with knobs) £2.70

### STUART TAPE RECORDER

A set of three printed-circuit boards has been prepared for the stereo integrated circuit version of this high-performance *Wireless World* published design.

- TRRP Pk. 1 Reply amplifier F/Glass PCB £0.90
- TRRC Pk. 1 Record amp./meter drive cct. F/Glass PCB £1.40
- TROS Pk. 1 Bias/erase/stabilizer cct. F/Glass PCB £1.00

For details of component packs for this design please write for free list.

## 20 WATTS/CHANNEL

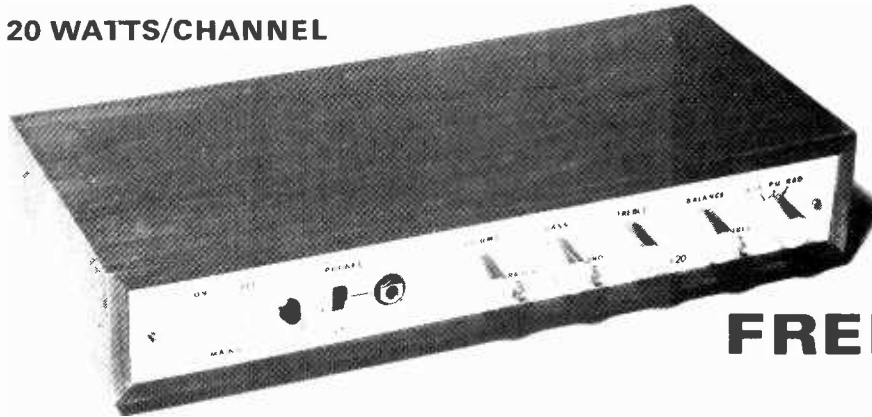

**FREE** TEAK CASE and HANDBOOK with full kits

KIT PRICE STILL ONLY **£28.25** post free (U.K.)

Pack	Price
1	Set of all low noise resistors £0.95
2	Set of all small capacitors £1.50
3	Set of 4 power supply capacitors £1.40
4	Set of miscellaneous parts including DIN sockets, fuses fuse holders, control knobs, etc. £1.90
5	Set of slide and push-button switches £1.20
6	Set of potentiometers and selector switch £2.00
7	Set of all semiconductors £7.25
8	Special Toroidal Transformer £4.95
9	Fibreglass PC Panel £2.50
10	Complete chassis work, hardware and brackets £4.20
11	Preformed cable/leads £0.40
12	Handbook £0.25
13	Teak Cabinet £2.75

### SEMICONDUCTORS AS USED IN OUR RANGE OF QUALITY AMPLIFIERS

2N699 £0.25	2N5459 £0.45	BC184L £0.11	MC1351 £1.05	SN72741P £0.40
2N1613 £0.20	2N5461 £0.50	BC212L £0.12	MFC4010 £0.95	SN72748P £0.40
2N1711 £0.25	2N5830 £0.30	BC214L £0.14	MJ481 £1.20	TIL209 £0.30
2N2926G £0.10	40361 £0.40	BCY72 £0.13	MJ491 £1.30	TIP29A £0.50
2N3055 £0.45	40362 £0.45	BD529 £0.85	MJE521 £0.60	TIP30A £0.60
2N3442 £1.20	BC107 £0.10	BD530 £0.85	MPSA05 £0.25	TIP29C £0.71
2N3704 £0.10	BC108 £0.10	BDY56 £1.60	MPSA12 £0.55	TIP30C £0.78
2N3707 £0.10	BC109 £0.10	BF257 £0.40	MPSA14 £0.35	TIP41A £0.74
2N3711 £0.09	BC109C £0.12	BF259 £0.47	MPSA55 £0.25	TIP42A £0.90
2N3904 £0.17	BC125 £0.15	BFR39 £0.25	MPSA65 £0.35	1N914 £0.07
2N3906 £0.20	BC126 £0.15	BFR79 £0.25	MPSA66 £0.40	1N916 £0.07
2N4062 £0.11	BC182 £0.10	BFV51 £0.20	MPSU05 £0.60	1S920 £0.10
2N4302 £0.60	BC212 £0.12	BFV52 £0.20	MPSU55 £0.70	5805 £1.20
2N5087 £0.42	BC182K £0.10	CA3046 £0.70	SBA750A £2.50	<b>FILTERS</b>
2N5210 £0.54	BC212K £0.12	LP1186 £5.50	SL301 £1.30	FM4 £0.80
2N5457 £0.45	RC182L £0.10	MC1310 £2.90	SL3045 £1.60	SFG10.7MA £2.80

### ACTIVE FILTER CROSSOVER

An essential and critical component in a high-quality speaker system is the crossover unit conventionally comprising of a series of passive networks which unfortunately, though introducing reactive impedances between the amplifier and the speakers, result in the loss of the advantage of high amplifier damping factor and renders the speakers prone to overshoots and resonances. An elegant solution to this problem, described by D. C. Read in *Wireless World*, involves the use of a series of active filters splitting the output of the pre-amplifier into three channels, of closely defined bandwidth, each of which is fed to the appropriate speaker by its own power amplifier. A design for a suitable 20-watt amplifier, based on a proven Texas circuit, was also described by Mr Read. The printed-circuit board for this has been designed such that three amplifiers may be stacked and mounted together on a common heat sink to achieve a conveniently compact module.

#### ACTIVE FILTER

- Pack 1 Fibreglass PCB (accommodates all filters for one channel) £1.05
  - 2 Set of pre-sets, solid tantalum capacitors, 2% metal oxide resistors, 2% polystyrene capacitors £4.20
  - 3 Set of semiconductors £2.65
- 2 off each pack required for stereo system

#### READ/TEXAS 20w amp.

- Pack 1 Fibreglass PCB £0.70
  - 2 Set of resistors, capacitors pre-sets (not including O/P coupling capacitors) £1.10
  - 3 Sets of semiconductors £2.40
  - 6 off each pack required for stereo system
  - 4 Special heat sink assembly for set of 3 amplifiers £0.85
  - 5 Set of 3 O/P coupling capacitors £1.00
- 2 off packs 4, 5 required for stereo system

#### POWER SUPPLY

- FOR 20W/CHANNEL STEREO SYSTEM
- Pack 1 Fibreglass PCB £0.50
- 2 Set of rectifiers, zener diode, capacitors, fuses, fuse holders £2.60
- 3 Toroidal transformer £4.95

SUITABLE ALSO FOR FEEDING ANY OF OUR HIGH-POWER DESIGNS

**MORE KITS ON PAGE 47!**

for further information please write for **FREE LIST NOW!**

## ★ SPECIAL OFFER ★

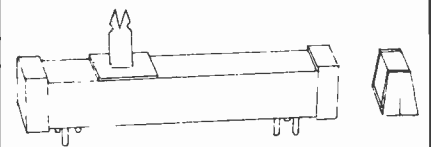

### SLIDER POTENTIOMETER SALE!

Most values 1K-1M lin/log available

	Normal price	Sale Price
Single	35p	25p
Dual	55p	35p
Knob	15p	10p

V.A.T. Please add 25%\* to all U.K. orders

(\*or at current rate if changed)

U.K. ORDERS—Post free (mail order only)

SECURICOR DELIVERY—for this optional service (Mainland only) add £2.00 + VAT per kit

OVERSEAS—Postage at cost + 50p special packing, handling

Dept. WW06

**POWERTRAN ELECTRONICS**

PORTWAY INDUSTRIAL ESTATE ANDOVER, HANTS SP10 3NN

# BI-PRE-PAK

**Bargains in Semi-Conductors, components, modules & equipment.**

## Bargains from our FREE Catalogue

20 large pages, filled with real bargains in transistors, I.C.s, components, equipment, etc. Send large S.A.E. with 7p stamp for your FREE copy of 6th Edition by return. Meanwhile, for prompt delivery why not order from this month's ad. NOW. Payment may be made by Access.

### TRANSISTOR PACKS ALL AT 50p EACH TESTED & GUARANTEED

<b>B79</b>	<b>4</b>	IN4007 Sil. Rec. diodes 1.000PIV 1 amp plastic	<b>H39</b>	<b>6</b>	Integrated circuits 4 gates BMC 962, 2 flip flops BMC945
<b>B81</b>	<b>10</b>	Reed Switches. 1" long 1/8" dia High-speed P.O. type	<b>H41</b>	<b>2</b>	BD131/BD132 Complementary Plastic Transistors 40361 Type NPN Sil Transistors TO-5 can comp. to H66
<b>H35</b>	<b>100</b>	Mixed Diodes. Germ. Gold bonded, etc. Marked and Unmarked.	<b>H65</b>	<b>4</b>	40362 Type PNP Sil Transistors TO-5 can comp. to H65
<b>H38</b>	<b>30</b>	Short lead. NPN Silicon Planar Ex Equipment.			

### UNMARKED & UNTESTED PACKS—50p EACH

<b>B1</b>	<b>50</b>	Germanium Transistors PNP, AF and RF	<b>B86</b>	<b>100</b>	Sil Diodes sub min. IN914 and IN916 types
<b>B66</b>	<b>150</b>	Germanium Diodes Min. Glass type	<b>H34</b>	<b>15</b>	Power Transistors PNP Germ. NPN Silicon TO-3 Can
<b>B84</b>	<b>100</b>	Silicon Diodes DO-7 Min glass equivalent to IN4148	<b>H67</b>	<b>10</b>	3B19N Channel FET's plastic case type

### PLASTIC POWER TRANSISTORS

40 WATT SILICON				
Type	Polarity	Gain	VCE	Price
40N1	NPN	15	15	20p
40N2	NPN	40	40	30p
40P1	PNP	15	15	20p
40P2	PNP	40	40	30p

90 WATT SILICON				
Type	Polarity	Gain	VCE	Price
90N1	NPN	15	15	25p
90N2	NPN	40	40	35p
90P1	PNP	15	15	25p
90P2	PNP	40	40	35p

**LM 380 AUDIO IC** (Marked 60745). Brand new and to spec. 3 watts R.M.S. out. With data **£1**

**PAK No. 1.** Short lead semiconductor and components on PCBs marked. Up to 170 Herz Date. **50p**

**TWO GOOD IC OFFERS.** Brand new, to spec. Two SN 7490 decade counters. **£1**

**THREE SN 7400 Quad 2 input Nan gate ICs** **50p**

### CAPACITOR DISCHARGE IGNITION KIT

Simple to assemble and fit. Improves car performance. saves on fuel. P/P 30p

**£7.50**

### Bi-Pre-Pak X-Hatch Generator Mk. 2

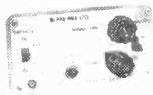

- Four-pattern selector switch 3"x5 1/4"x3"
- Ready-built and tested **£9.93\***
- In kit form **£7.93\***

Please add 30p for postage and packing

Is invaluable to industrial and home user alike. Improved circuitry assures reliability and still better accuracy. Very compact; self-contained. Robustly built. Widely used by TV rental and other engineers. With reinforced fibreglass case, instructions, but less batteries. (Three U2 type required.)

### TV SIGNAL STRENGTH METER

Complete kit as described in "Television" **£19.50** plus 40p for P&P

#### MAINS TRANSFORMERS

A. 18V 1 amp (suitable for SS 103)	<b>£1.50</b>
B. 25V 2 amp (suitable for SS 110)	<b>£2.00</b>
C. 30V 2 amp (suitable for SS 140)	<b>£4.50</b>

Add 35p for P&P per transformer

#### BRIDGE RECTIFIERS

Type A 45V/1A 27p B & C 100V/2A **36p**

**MAINS RELAYS** 230, 240V AC 3-pole change-over heavy duty contacts **60p**  
Ex-GPO Telephone Handsets, each **55p**

**TO CLEAR.** Hundreds of various portable transistor radio chassis with FM & AM tuning. Ideal for experimenters. All components in good electronic order, but no instructions or tuning drives per chassis. Each **£1.00**. 8 assorted relays **£1.00**. Rev. counter device (for cars) **£1.00**. U.H.F./TV Tuner Units 625 line, rotary control **£2.50**. Technical books of all kinds including Newnes & Butterworth, Bernards Press, etc.

## BI-PRE-PAK LTD

Co Reg No 820919

222 224 WEST ROAD, WESTCLIFF-ON-SEA, ESSEX SSO 9DF.

TELEPHONE: SOUTHEND (0702) 46344.

Made and sold direct by Bi-Pre-Pak



## Stirling Sound

Today's most challenging values!

### AMPLIFIER MODULES

<b>SS100</b>	Active tone control unit to provide Bass and Treble facilities (stereo).	<b>£1.60</b>
<b>SS101</b>	Pre-amp for stereo ceramic cartridges, radio and tape.	<b>£1.60</b>
<b>SS102</b>	Pre-amp for low-output stereo magnetic cartridges, radio and tape.	<b>£2.25</b>
<b>SS103</b>	Compact I.C. amp. 3 watts R.M.S. Single channel (mono). On P.C.B. size 3 1/2"x2". Needs 10-20V supply	<b>£1.75</b>
<b>SS103-3</b>	Stereo version of above. (Two I.C.s.)	<b>£3.25</b>
<b>SS105 Mk. 2</b>	Improved design and performance. A compact all-purpose power amp. Can be run from 12V car battery. Size 3 1/2" x 2". Useful 5w output (mono). Excellent value	<b>£2.25</b>
<b>SS110 Mk. 2</b>	Similar in size to SS105 Mk. 2 but will give 10w output (mono). Two in stereo give first-class results, suitable for many domestic applications.	<b>£2.75</b>
<b>SS140</b>	Beautifully designed. Will give up to 40w R.M.S. into 4Ω. Excellent S.N.R. and transient response. Fine for P.A., disco use, etc. Operates from 45V DC. Two in bridge formation will give 80w R.M.S. into 8Ω.	<b>£3.60</b>
<b>FM TUNER MODULES</b>		
<b>SS201</b>	Front End assembly. Ganged tuning with well engineered slow-motion geared drive in robust housing. A.F.C. facility. Requires 6-16V. Excellent sensitivity. Tuners from 88-108MHz	<b>£6.25</b>
<b>SS202</b>	I.F. Stage (with I.C.) Designed to use with SS201. Uses I.C. Carefully checked before despatch.	<b>£5.25</b>
<b>SS203</b>	Stereo Decoder. Designed essentially for use with SS201 and SS202, this excellent decoder can also make a stereo tuner of almost any single channel FM tuner. Supplied ready aligned. A LED can easily be fitted for stereo reception indication.	<b>£5.62</b>
<b>SS300</b>	<b>POWER SUPPLY STABILISER.</b> Add this to your unstabilised supply to obtain a steady working voltage from 16 to 60V for your audio system, workbench, etc. Money saving and very reliable	<b>£5.62</b>

### SPECIAL F.M. TUNER OFFER TO SAVE YOU £5

Buy Stirling Sound Units SS201, 202 and 203 together to make a first class stereo F.M. tuner, total advertised price £17.12 and it will cost you only giving a genuine saving of £5.

**£12.12**

### BI-PRE-PAK COMPONENT PACKS — ALL 50p EACH

<b>CP1</b>	<b>150</b>	Capacitors, mixed (Electrolytic Silver Mic. Quantity approx. sold by weight)	<b>CP4</b>	<b>12</b>	Pots, pre-sets, mixed W/wound carbons, dual with/without switches
<b>CP2</b>	<b>200</b>	Resistors, mixed values and wattage (Quantity approx. sold by weight)	<b>CP7</b>	<b>25</b>	Heat sinks assorted To fit SO2 (OC72) TO-1 (AC 128) etc
<b>CP3</b>	<b>40</b>	Wirewound resistors Mixed types and values	<b>CP10</b>	<b>3</b>	2.5mm plugs sub-miniature White bodies
			<b>CP11</b>	<b>6</b>	Screwdrivers 1 x mains neon tester. 5 grub types (8%)

**TERMS OF BUSINESS:** VAT at 25% must be added to total value of order including postage and packing charges. For prices marked \* or (8%) please add 8% for VAT. No VAT on overseas orders. **POST & PACKING** Add 20p for UK orders. Minimum mail order acceptable — £1. Overseas orders, add £1 for postage. Any difference will be credited or charged. **PRICES** Subject to alteration without notice. **AVAILABILITY** All items available at time of going to press when every effort is made to ensure correctness of information.

### To BI-PRE-PAK, 222-224 WEST ROAD WESTCLIFF-ON-SEA, ESSEX

Please send .....  
for which I enclose ..... inc. VAT  
NAME .....  
ADDRESS .....  
..... WW7

Pack	Price	Pack	Price
1 Fibreglass printed circuit board for front end, I.F. strip, demodulator, AFC and mute circuits	£2.15	9 Function switch, 10 turn tuning potentiometer, knobs	£5.30
2 Set of metal oxide resistors, thermistor, capacitors, cermet preset for mounting on pack 1	£4.80	10 Frequency meter, meter drive components, fibreglass printed circuit board	£8.60
3 Set of transistors, diodes, LED, integrated circuits for mounting on pack 1	£6.25	11 Toroidal transformer with electrostatic screen, Primary: 0-117V-234V	£4.45
4 Pre-aligned front end module, coil assembly, three-section ceramic filter	£8.80	12 Set of capacitors, rectifiers, voltage regulator for power supply	£2.95
5 Fibreglass printed circuit board for stereo decoder	£1.10	13 Set of miscellaneous parts, including sockets, fuse holder, fuses, inter-connecting wire, etc.	£1.50
6 Set of metal oxide resistors, capacitors, cermet preset for decoder	£2.60	14 Set of metal work parts including silk screen printed fascia panel, acrylic silk screen printed tuning indicator panel insert, internal screen, fixing parts, etc.	£6.50
7 Set of transistors LED integrated circuit for decoder	£3.45	16 Teak cabinet	£7.35
8 Set of components for channel selector switch module including fibreglass printed circuit board, push-button switches, knobs, LEDs preset adjusters, etc.	£8.30	One each of packs 1-16 inclusive are required for complete stereo FM tuner	£74.10
		Total cost of individually purchased packs	£74.10

**NOVEL STEREO FM TUNER**

In the April and May 1974 issues of *Wireless World* there was published by J. Skingley and N. C. Thompson a novel design for an f.m. tuner which combines consistent high performance with the elimination of the critical setting-up procedure required by too many earlier tuners. The front end is a ready built pre-aligned module which then feeds an amplifier driven screened three section ceramic filter leading to an integrated circuit five-stage limiting amplifier providing excellent a.m. rejection. This is followed by a single coil integrated balanced demodulator from which the audio output may be taken. Temperature compensated varicap tuning allows stations to be selected either by a ten-turn tuning potentiometer or by a choice of six preset push-button controls. Each of the preset controls can be adjusted on the front panel with the settings being indicated by six LED lamps behind an acrylic silk screen printed fascia panel insert. Additional circuitry includes temperature compensated AFC restricted to less than station spacing, inter-station muting, a single-lamp LED tuning indicator and a linear scale frequency meter. The stereo decoder, built on a separate board, is based on a well-proven integrated circuit phase-locked-loop to which has been added active filters to remove sub carrier harmonics and 'birdies'. The power supply, to ensure station holding stability, uses an integrated circuit voltage regulator which is powered via a low-hum field specially designed TOROIDAL TRANSFORMER.

**STYLED TO COMPLEMENT THE WORLD-WIDE ACCLAIMED LINSLEY-HOOD 75W AMPLIFIER**

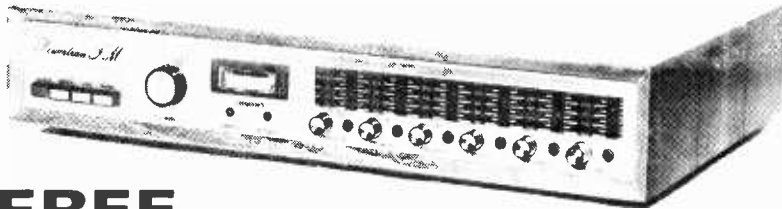

**FREE TEAK CASE WITH FULL KITS**

KIT PRICE only **£66.75** carriage free (U.K.)

**THE FM TUNER KIT YOU HAVE WAITED FOR!**

for further information please write for **FREE LIST**

\*\*\*\*\*

**NEW!**

FROM

**POWERTRAN ELECTRONICS**

MORE ON NEXT PAGE!

\*\*\*\*\*

**DESIGNER APPROVED KIT**

In *Hi-Fi News* there was published by Mr Linsley-Hood a series of four articles (November 1972-February 1973) and a subsequent follow-up article (April 1974) on a design for an amplifier of exceptional performance which has as its principal feature an ability to supply from a direct coupled fully protected output stage, power in excess of 75 watts whilst maintaining distortion at less than 0.01% even at very low power levels. The power amplifier is complemented by a pre-amplifier based on a discrete component operational amplifier referred to as the Liniac which is employed in the two most critical points of the system, namely the equalization stage and tone control stage, positions where most conventional designs run out of gain at the extremes of the frequency spectrum. Unusual features of the design are the variable transition frequencies, of the tone controls and the variable slope of the scratch filter. There is a choice of four inputs, two equalized and two linear, each having independently adjustable signal level. The attractive slimline unit pictured has been made practical by highly compact PCBs and a specially designed Toroidal transformer.

Hi-Fi News Linsley-Hood 75W/Channel Amplifier Mk III Version (modifications as per *Hi-Fi News* April 1974)

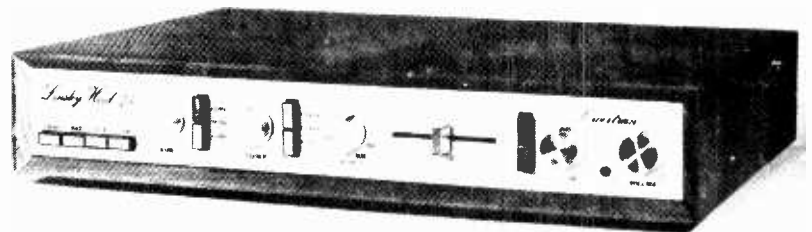

Full circuit description in handbook (pack 15—price 30p)

**FREE** TEAK CASE WITH FULL KITS  
KIT PRICE only **£62.40** carriage free (U.K.)

V A T Please add 25%\* to all U.K. orders -

(\* or at current rate if changed)

U K ORDERS—Post free (mail order only)

SECURICOR DELIVERY: For Securicor delivery to mainland—add £2 + VAT per kit.

OVERSEAS—Postage at cost + 50p special packing

Dept. WW06

**POWERTRAN ELECTRONICS**

PORTWAY INDUSTRIAL ESTATE

ANDOVER, HANTS SP10 3NN

Pack	Price	Pack	Price
1 Fibreglass printed circuit board for power amp	£0.85	11 Fibreglass printed-circuit board for power supply	£0.65
2 Set of resistors, capacitors, pre-sets for power amp.	£1.70	12 Set of resistors, capacitors, secondary fuses, semiconductor for power supply	£3.50
3 Set of semiconductors for power amp. (now using BDY56 BD529, BD530)	£6.50	13 Set of miscellaneous parts including DIN skts, mains input skt, fuse holder inter-connecting cable, control knobs	£4.25
4 Pair of 2 drilled, finned heat sinks	£0.80	14 Set of metalwork parts including silk screen printed fascia panel and all brackets, fixing parts etc.	£6.30
5 Fibreglass printed circuit board for pre-amp	£1.30	15 Handbook	£0.30
6 Set of low noise resistors, capacitors, pre-sets for pre-amp	£2.70	16 Teak cabinet	£7.35
7 Set of low noise, high gain semiconductors for pre-amp	£2.40	2 each of packs 1-7 inclusive are required for complete stereo system	£69.75
8 Set of potentiometers (including mains switch)	£2.05	Total cost of individually purchased packs	£69.75
9 Set of 4 push button switches, rotary mode switch	£3.70		
10 Toroidal transformer complete with magnetic screen/housing primary 0 117-234 V, secondaries: 33-0-33 V 25-0-25 V.	£9.15		

WW-074 FOR FURTHER DETAILS

### MAINS TRANSFORMERS

All standard to 230-250 volt primaries

1v	1 amp (special)	£ 1.75
2.4v	5 amp	85
6.3v	2 amp	1.00
6.3v	3 amp	1.50
9v	1 amp	.95
9v	3.5 amp	1.95
12v	2 amp	1.50
12v	1 amp	1.00
15v-0-6.5v	1 amp	1.35
18v	1 amp	1.25
20v	3 amp	1.50
20v	1 amp	1.50
24v	3 amp	3.50
24-0-12v	50mA	1.20
24-0-12v	50mA	1.20
6-0-6v	4 amp	1.25
8-0-8v	2 amp	3.50
18-0-18v	3 amp	1.95
25v	1 amp	1.50
50v 2 amp & 6.3v	1 amp	5.50
60v 5 amp & 5v	8 amp	7.50
27v	37 amp	4.50
30v	4 amp	22.00
80v tapped 75v & 70v	4 amp	5.50
230v-60mA & 6.3v	1.5 amp	1.75
275-0-275v at 90mA & 6.4v	3 amp	2.25
EHT Transformer 5kV at 23mA (intermittent)	1 amp	5.50

#### Charger Transformers

6v and 12v	2 amp	1.25
6v and 12v	3 amp	2.25
6v and 12v	5 amp	3.50

### HONEYWELL PROGRAMMER

This is a drum type timing device... Price from makers probably over £20 each. Special snip price **£8.50** plus 25p post and insurance. Don't miss this terrific bargain.

### SWITCH TRIGGER MATS

So thin is undetectable under carpet but will switch on with slightest pressure. For burglar alarms, shop doors, etc.

### MULLARD UNILEX STEREO SYSTEM

There is no doubt that it is a good system, we believe that for the money it is without comparison.

1 Unilex Amplifier	Ref. EP 9000	£1.75
1 Unilex Amplifier	Ref. EP 9000	£1.75
1 Unilex Pre-Amp	Ref. EP 9001	£2.00
1 Unilex Power Unit	Ref. EP 9002	£2.50

1 Control panel kit with spun aluminium-faced knobs **£3.80**

Pair of 15 ohm speakers made by Goodmans are also available if required, price **£3.30** the pair. No extra postage if ordered with the above, otherwise add 25p.

### INFRA RED BINOCULARS

Made for military purposes during and immediately after last war to enable snipers, vehicle drivers etc. to see in the dark... Price **£16.50** per set + £1 carriage.

### NEW ITEMS THIS MONTH

AC mains operated relay with single changeover 10 amp contacts open type single screw fixing through the base 50p each.

Battery condition testers. This is another item which has been out of stock temporarily but we are pleased to say, in stock again. Price now **£3.50**.

AM/FM tuning condenser as fitted to many Japanese and Hong Kong portables, has two main tuning sections and four trimmers. Approx size 1" x 1" x 1" 60p each.

Battery charger kit comprising 2 amp transformer, 2 amp full wave rectifier and 2 amp meter suitable for charging 6v or 12v. Special bargain price **£1.50** the kit + 30p post.

MacDonald record auto-changer with tuning arm and ceramic stereo cartridge. This is a very superior auto-changer and one we can thoroughly recommend. Limited quantity, special price **£7.35** + £1 post and insurance. Plinth and cover (the plinth has to be modified very slightly) available, price **£4.95** + £1 post or if you buy both together you can get a discount of £1.

Instrument case measures 18" x 12" x 12". This is a very well-made case built on an angled framework, has rounded corners and edges into this framework fit the 8 panels. All panels are hinged for ventilation, side panels are also fitted with handles, the bottom panel has 4 rubber feet. These instrument cases, would probably cost around **£15** each. We have approx 100, not new but in very good condition and offer them at **£3** each.

Mains transistor power pack. Designed to operate transistor sets and amplifiers. Adjustable output 0v-9v-12v for up to 500mA (class B working). Takes the place of any of the following batteries: PPI, PP3, PP4, PP6, PP7, PPS and others. Kit comprises: main transformer rectifier, smoothing and load resistor, condensers and instructions. Real snip at only **£1.50**.

Soil heating transformer, 4v, 5v or 6v output, very heavy duty secondary rated at 250 amps, price **£20** + carriage **£2** plus 100 miles then £1 per 100 miles extra.

7 watt stereo/mono amplifier with useful switching and controls, in attractive teak style case **£9**.

3 core lead, 7' 6" long, ribbed, virtually non-kinkable 23/36 conductors, so OK for 8 amps. Price 10p each.

0-1 mA meter 2 1/2" square, flush mounting, English make ex equipment but perfect **£1.75**.

0-100 microamp meters, as the above but **£2.25**.

Solenoid 4-6v, size approx 1" x 1" x 0.4" thick, twin coils give excellent pull. Mounted in frame but easily removable from this frame, fitted with lever giving approx 0.4" push or pull. Price 30p each.

Cold cathode tube Swiss made "Elasta" type No ER 12A. We have no technical information on this tube and if any reader has this we will be obliged for any information. Price of the tubes 30p each.

Push switch, double pole changeover contacts rated at 10 amps 250 volts made by the American Honeywell Co. A very reliable and robust switch with plenty of applications. Oblong plastic body, snap fitting into a hole size 1 1/2" x 1". Offered at only a fraction of its proper price, namely **20p** each.

Ditto but single pole changeover, fits into a hole size 1" x 1 1/2". Price **15p** each.

(Note: the two switches above do not require a knob as they have a polished and tapered plunger.)

Ditto but dished knob 10p extra with knob.

### NUMICATOR TUBES

For digital instruments, counters, timers, clocks, etc. Hi-vac XN.3 Price **99p** each, 10 for **£5**.

### OIL PUMP

Driven by Redmond Motor of approx 1/20th horse power, pump originally intended for oil-fired boilers etc. with normal inlet and outlet pipes and unions. **£1.15** plus 30p post and insurance.

### RELAY BARGAIN

Type 600 relay, 2 changeover one open and one closed contact twin 500 ohm coils make this suitable for closing off DC 6v DC 12v DC 24v or AC mains using resistor and rectifier. **33p** each.

### MULLARD THYRISTOR TRIGGER MODULE

This produces pulses for phase control triggering, it has two isolated outputs, so one thyristor or two thyristors (in separate arms of bridge) may be controlled by one module. The timing circuit is synchronised to the mains frequency and control is by an external variable resistor or from a voltage or current source. Provision is made for feedback where automatic control is required. Price **£5.95**.

### HORSTMANN 24-HOUR TIME SWITCH

With 6 position programmer. When fitted to hot water systems this could programme as follows:

Programme	Hot Water	Central Heating
0	Off	Off
1	Off	Off
2	Twice Daily	Off
3	All Day	Off
4	Twice Daily	Twice Daily
5	All Day	All Day
6	Continuously	Continuously

Suitable, of course, to programme other than central heating and hot water, for instance, programme upstairs and downstairs electric heating or heating and cooling or taped music and radio. In fact there is no limit to the versatility of this programmer. Mains operated. Size 3in x 3in x 2in deep. Price **£4.35** as illustrated but less case.

### TAPE DECK

In metal case with carrying handle, heavy fly wheel and capstan drive. Tape speed 3 1/2". Mains operated on metal platform with tape head and guide. Not new but in good order. Price **£1.95** plus £1 post and insurance.

### SPECIAL JULY OFFER - ALL PRICES INCLUDE VAT

TERMS. Send postage where quoted - other items, post free if order for these items is £6, otherwise add 30p.

## J. BULL (ELECTRICAL) LTD.

(Dept. W.W.)  
102/3, TAMWORTH ROAD, CROYDON, CR0 1XX

REDIFON TELEPRINTER RELAY UNIT No. 12: ZA-41196 and power supply 200-250V a.c. Polarised relay type 3SE1TR. 80-0V 25mA. Two stabilised valves CV 286. Centre Zero Meter 10-0-10. Size 8in. x 8in. x 8in. New condition. **£10**. Carr. **75p**.

SOLARTRON PULSE GENERATOR TYPE G1101-2: **£75.00** each. Carr. **£2.00**.

TELEPRINT<sup>®</sup> TYPE 7B: Pageprinter 24V d.c. power supply, speed 50 bauds per min. second hand cond. (excellent order) no parts broken. **£20** each. Carriage **£3**.

INSULATION TEST SET: 0-10 kV negative, earth with amplifier provision for checking ionisation. 110/230v a.c. input. S/hand, good cond. **£35** + £1 carr.

BRIDGE MEGGER: 250V. (Evershed Vignoles) series 2. **£30** each. Carr. **£1**.

BRIDGE MEGGER: 2,400V. series 1. **£30** each. Carr. **£1**.

CRYSTAL TEST SET TYPE 193: used for checking crystals in freq. range 3000-10,000KHz. Mains 230V 50Hz. Measures crystal current under oscillatory conditions and the equivalent resistance. Crystal freq. can be tested in conjunction with a freq. meter. **£25**. Carr. **£1.50**.

TYPE 174/1 FREQUENCY SHIFT ADAPTOR (Northern Radio Co.): Convert mark and space frequencies from the output of one or two Receivers into d.c. pulses. Suitable to operate Teleprinters or similar devices. 110/220V. Further details on request, s.a.e. **£55** each. Carr. **£1.50**.

TELEGRAPH TERMINAL UNIT (A.T.E.) TYPE TFS3: Converts signals from Receivers into d.c. pulses. Complete with monitor. **£75** each. Carr. **£2**.

FURZHILL SENSITIVE VALVE VOLTMETER V.200: Freq. 10Hz-6MHz (can be used beyond 6MHz). Probe in circuit — voltage range 1mV-1kV in 6 decade ranges; full scale deflection 10mV, 100mV-1kV. Without probe 100µV-100V in 6 decade ranges; full scale deflection 1mV, 10mV-100V. Accuracy ± 5%. **£30** each. Carr. **£1**.

NOISE FIGURE METER TYPE 113A (Magnetic AB, Sweden): **£125** each. Carr. **£1**.

PRECISION PHASE DETECTOR TYPE 205: Freq. 0.1-15MHz in 5 ranges. Variable time delay microseconds 0-0.1c, 115V input. **£55** each. Carr. **£1**.

RHODE & SCHWARZ HF MILLIVOLTMETER: 30Hz-30MHz TYPE UVH, 1mV-1V in 7 ranges. 220V. **£75** each. Carr. **£2**.

CT-38 ELECTRONIC MULTIMETER: A.C./D.C. volts 1-10,000 A.C./D.C. current 1µA-25 amps. **£30** each. Carr. **£1.00**.

PHILIPS VALVE VOLTMETER TYPE GM6014: 1-300mV in 6 ranges. 70-20dB. probe 1000Hz-30MHz. 300mV maximum. **£35** each. Carr. **£1**.

TF-1345/2 DIGITAL FREQUENCY COUNTER: Range 10KHz-100MHz with extension units. Details on request, s.a.e. **£100**. Carr. **£2**.

UHF MICROWAVE MILLIWATTMETER TYPE 14: Direct reading, can be used to measure power from 100MHz upwards. F.S.D. on 4in. scale meter 2.5mW. **£40** each. Carr. **£1**.

MARCONI HF SPECTRUM ANALYSER OA. 1094/3. Further details on request. **£250** each. Carr. **£5**.

Q METER: 30MHz-200MHz. **£55**. Carr. **£1**.

AVO TRANSISTOR ANALYSER CT.446: **£35**. Carr. **£1.50**.

ALL CARRIAGE QUOTES GIVEN ARE FOR 50-MILE RADIUS OF LONDON ONLY.

SIGNAL GENERATOR AIRMEC TYPE 701: 30KHz-30MHz. 7 ranges. **£65**. Carr. **£1**.

TF-1278/1 TRAVELLING TUBE WAVE AMPLIFIER: **£25**. Carr. **£2**.

BPL A.C. MILLIVOLTMETER TYPE VM.348-D Mk. 3: 2 millivolts-2 volts, 6 ranges. **£30**. Carr. **£1**.

WAYNE KERR WAVEFORM ANALYSER A.221: Low scale 0-1200 c/s. High scale 1-20 Kc/s. 600 ohms. Harmonic level is 0.55 dB in 12 steps. **£75**. Carr. **£1.50**.

SPECTRUM ANALYSER TYPE MW.69S (Decca): Further details on request. **£200**.

MARCONI DUAL TRACE UNIT TM-6456: **£30**. Post **60p**.

SIGNAL GENERATOR TS-403B/U (or URM-61A): (Hewlett Packard). A portable, self-contained, general-purpose test equipment designed for use with radio and radar receivers and for other applications requiring small amounts of RF power such as measuring standing-wave ratios, antenna and transmission line characteristics, conversion gain, etc. Both the output, freq. and power are indicated on direct-reading dials. 115V. AC. 50 c/s. Freq. — 1800-4000 Mc/s. CW. FM. Modulated Pulse — 40-400 pulses per sec. Pulse Width — 0.5-10 microseconds. Timing — Undelayed or delayed from 3-300 microseconds from external or internal pulse. Output — 1 milliwatt max., 0 to — 127 dB variable. Output Impedance — 500. Price: **£120** each + **£2** carr.

H.V. TRANSFORMER: 8000/8000. Output 300mA. rms. Size: 12in. x 12in. x 36in. 230V input. **£40**. Carr. **£4**.

FIREPROOF TELEPHONES: **£25.00** each. carr. **£1.50**.

POWER UNIT: 110/230 volts a.c. input. 28 volts d.c. at 40 amps output. **£30.00** each. carr. **£3.00**.

SMOOTHING UNIT (for the above): **£10.00** each. Carr. **£2.00**.

X-BAND MODULATOR CALIBRATOR TYPE MC-4420-X: Mfr. James Scott. **£125** each. Carr. **£1**.

HP-766D DUAL DIRECTIONAL COUPLER: 940-1975MHz. **£35** each. 75 post.

BACKWARD WAVE OSCILLATOR TYPE SE-125: 6.3 heater, 105V Anode. 7.9mA. Mfr. Watkins & Johnson. **£85** each. Carr. **£1**.

TEKTRONIX TIME MARK GENERATOR TYPE 180-S1: 5, 10, 50 MHz. **£65**. Carr. **£2**.

TRANSISTOR ANALYSER TA 1001 (K.&N. Electronics Ltd): **£95**. Carr. **£3**.

CHRONOTON MODEL 25E: 0.4-10 seconds in seven ranges. **£50**. Carr. **£1**.

MARCONI SIGNAL GENERATOR TYPE TF-144G: Freq. 85 Kc/s-25 Mc/s in 8 ranges. Incremental: ± 1% at 1 Mc/s. Output: continuously variable 1 microvolt to 1 volt. Output Impedance: 1 microvolt to 100 millivolts, 10 ohms 100mV-1 volt - 52.5 ohms. Internal Modulation: 400 c/s sine wave 75% depth. External Modulation: Direct or via internal amplifier. A.C. mains 200/250V. 40-100 c/s. Consumption approx. 40 watts. Measurements 29in. x 12 1/2in. x 10in. Secondhand condition. **£32.50** each. Carr. **£2.50**.

ROTARY INVERTERS: TYPE PE.218E — input 24-28V d.c., 80 Amps. 4,800 rpm. Output 115V a.c. 13 Amp 400 c/s. 1Ph. P.F.9. **£20.00** each. Carr. **£2.50**.

FREQUENCY METER BC-221: 125-20,000 Kc/s complete with original calibration charts. Checked out, working order **£20** + **£1.50** carr. (used as new condition complete with headset, spare valves, charts. **£35** + **£2.00** carr.

ALL U.K. ORDERS SUBJECT TO VALUE ADDED TAX. THIS MUST BE ADDED TO THE TOTAL PRICE (including post or carriage)

If wishing to call at stores, please telephone for appointment

## W. MILLS

3-B TRULOCK ROAD, LONDON, N17 0PG  
Phone. 01-808 9213 and Bedford 740605 (STD 0234)



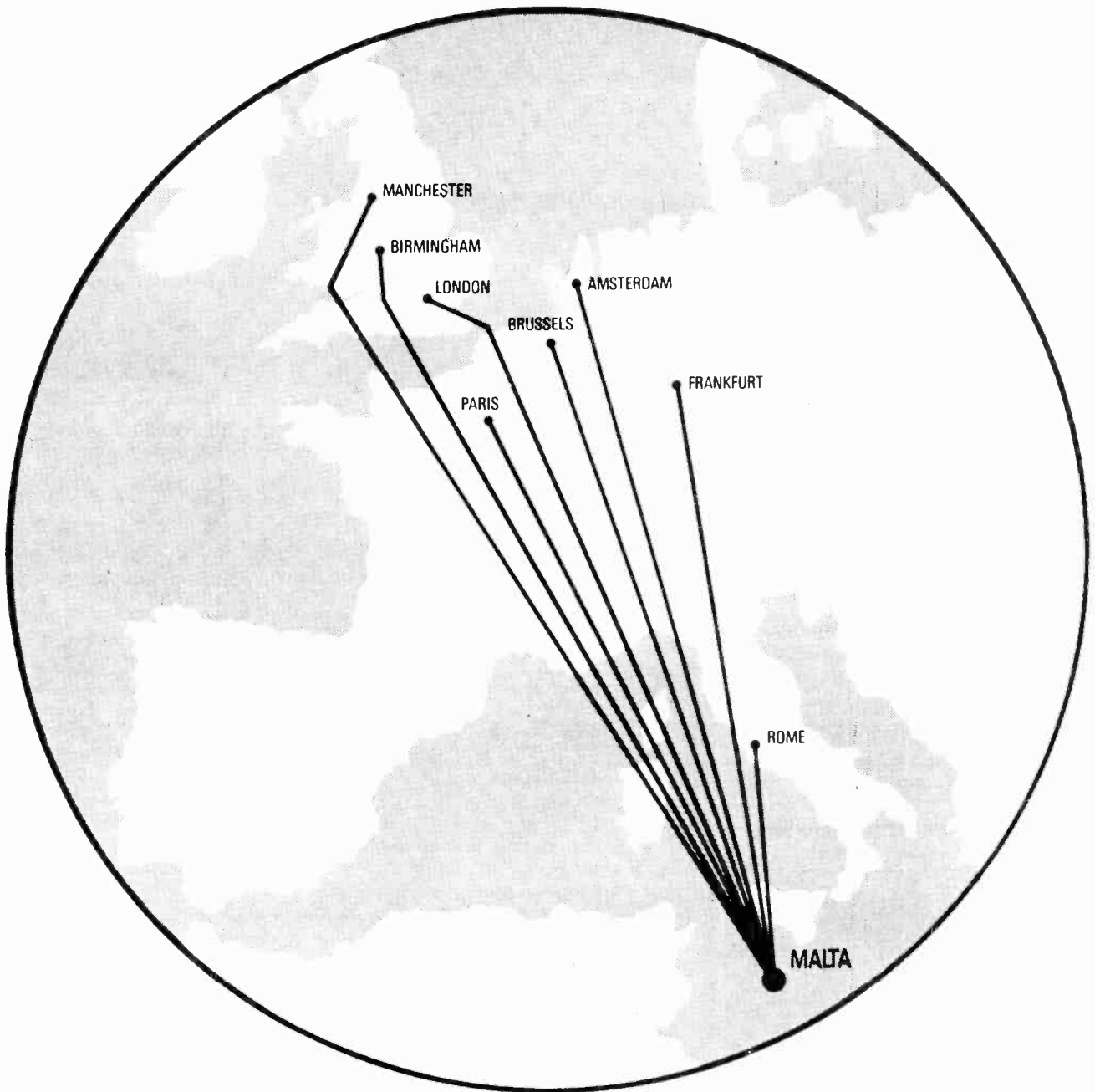

## Sub-Contract & Sub-Assembly Facilities in Malta

Teleng Malta Ltd., have capacity available for electronic sub-assembly work.

Now more than ever you need a low cost production area in order to remain competitive.

In Malta you have the benefit of some of the lowest labour rates in Western Europe plus the advantages of

- (i) Our skilled labour force backed by a fully qualified engineering team and administrative staff
- (ii) A modern factory which is only 3 hours from the major European business centres

(iii) Advantageous customs rates—Malta is an associate member of the E.E.C. and therefore benefits from a nil tariff rating on most electronic products

(iv) Teleng's hourly rate of 86 Maltese cents excluding freight and insurance (i.e. D.M. 5.6 or 0.99p sterling)\* subject to variations in Exchange Rates

(v) Free feasibility studies which will be carried out by our experienced staff.

# Teleng Malta Limited

**Contact:**

**UNITED KINGDOM:** G Stone Teleng Ltd, Arisdale Avenue, South Ockenden, Essex, England. Tel. South Ockenden 3477. Telex No. 896154

**MALTA:** J Toledo Teleng Ltd, Factory No. 30, Industrial Estate, Bulebel, Malta. Tel. Malta 78195. Telex No. Valletta Malta 270. Telegrams: TELENG MALTA.

WW—054 FOR FURTHER DETAILS

# The largest selection

## BIB HI-FI ACCESSORIES

**EX-COMPUTER STABILISED POWER MODULES**  
complete with circuit diagrams, etc.  
99p each 22p p & p.

**LOW COST CAPACITORS**  
01 µF 400V 3p each 3p each  
500 µF 50V Elect. 10p each

**DECON-DALO 33PC Marker**  
Etch resistant printed circuit marker pen  
89p each

**VEROBOARDS**  
Packs containing approx., 50sq. ins. various sizes, all 0.1 metric 55p

**REPANCO CHOKES & COILS**  
RF Chokes  
CH1. 2.5mH 29p CH2. 5.0mH 30p  
CH3. 7.5mH 31p CH4. 10mH 33p  
CH5. 1.5mH 28p

**COILS**  
DRX1 Crystal set 31p DRR2 Dual range 45p

**COIL FORMERS & CORES**  
NORMAN 1/2 Core & Formers 8p  
1/2 Cores & Formers 10p

**SWITCHES**  
DP/DT Toggle 38p SP/ST Toggle 30p

**FUSES**  
1 1/2 and 20mm, 100mA, 200mA, 250mA, 500mA, 1A, 1.5A, 2A QUICK-BLOW 5p ea.

**EARPHONES**  
Crystal 2.5mm plug 42p  
Crystal 3.5mm plug 42p  
8 ohms 2.5mm plug 22p  
8 ohms 3.5mm plug 22p

**DYNAMIC MICROPHONES**  
H1223 200 ohms plus on/off switch and 2.5mm and 3.5mm plugs £1.85

**3-WAY STEREO HEADPHONE JUNCTION BOX**  
H1012 £1.87

**2-WAY CROSSOVER NETWORK**  
K4007, 80 ohms Imp. Insertion loss 3dB £1.21

**TRANSISTOR EQUIVALENT BOOK**  
9th EDITION  
256 pages of cross references and equivalents for European, American and Japanese transistors. Approximately 9,000 types with more than 35,000 substitutes have been included. The tables were compiled with the utmost care from manufacturers own specification. The most comprehensive Equivalents Book on the market today!

ONLY £2.30

### INSTRUMENT CASES



(Black Vinyl covered)  
No. Length Width Height Price  
BV1 8" x 5 1/2" x 2" £1.35  
BV2 11" x 6" x 3" £1.75

**ALUMINIUM BOXES**  
BA1 5 1/2" x 2 1/2" x 1 1/2" 49p  
BA2 4" x 2 1/2" x 1 1/2" 49p  
BA3 4" x 2 1/2" x 1 1/2" 49p  
BA4 5 1/2" x 4" x 1 1/2" 59p  
BA5 4" x 2 1/2" x 1 1/2" 49p  
BA6 3" x 2" x 1" 42p  
BA7 7" x 5" x 2 1/2" 85p  
BA8 8" x 6" x 3" £1.10  
BA9 6" x 4" x 2" 70p

p & p 15p on each box

PLEASE NOTE: ALL OUR PRICES INCLUDE V.A.T. AMTRON KITS

Model No.	Description	Price
UK605	Simple transistor tester	£1.79
UK145	Amplifier 1.5W	£5.14
UK220	Signal Injector	£3.53
UK230	AM/FM Antenna Amplifier	£3.53
UK275	Mike Pre-amplifier	£7.38
UK300	4-channel Radio Control Transmitter	£7.80
UK310	Radio Control Receiver	£3.60
UK325	'GCX2' Channel splitting unit 1,000 & 2,000 Hz	£9.75
UK330	'GCX2' Channel splitting unit 1,500 & 2,500 Hz	£9.75
UK345	Superhetrodyne Radio Control Receiver	£7.25
UK525	VHF Tuner 120 to 160 MHz	£12.46
UK555	Radio Control Field Strength Meter	£7.25
UK705	Windscreen Wiper Timer	£7.33
UK710	4-Channel AF mixer	£11.85
UK780	Electronics Unit for Metal Detector	£12.89
UK835	Guitar pre-amplifier	£5.37
UK875	Capacitive Discharge Electronic Ignition for Internal Combustion Engines	£14.47

### VISIT OUR COMPONENT SHOP

18 BALDOCK ST., WARE, HERTS. (A10)  
Open Mon.-Sat. 9-5.30 p.m. Tel. 61593

### De Luxe Groov-Kleen

Model 42 £1.95  
Chrome Finish  
Model 60 £1.50



Ref. B. Stylus and Turntable Cleaning Kit 34p  
Ref. 36A. Record/Stylus Cleaning Kit 33p  
Ref. 43. Record Care Kit £2.42  
Ref. 31. Cassette Head Cleaner 58p  
Ref. 32. Tape editing Kit £1.68  
Model 9. Wire Stripper/Cutter 83p

Ref. P. Hi-Fi Cleaner 31p  
Ref. 32A. Stylus Balance £1.37  
Ref. J. Tape Head Cleaning Kit 62p  
Ref. 56. Hi-Fi Stereo Hints & Tips 42p

### ANTEX SOLDERING IRONS

X25. 25 watt £2.05  
CCN 240. 15 watt £2.48  
Model G. 18 watt £2.26  
SK2. Soldering Kit £3.25  
STANDS: ST1 £1  
SOLDER: 18SWG Multicores 7oz £1.81  
22SWG £1.16 18SWG 2oz 51p  
22SWG Tube 33p

### ANTEX BITS AND ELEMENTS

Bits No.  
102 For model CCN240 42p  
104 For model CCN240 42p  
1100 For model CCN240 42p  
1101 For model CCN240 42p  
1102 For model CCN240 42p  
1020 For model G240 42p  
1021 For model G240 42p  
1022 For model G240 42p  
50 For model X25 42p  
51 For model X25 48p  
52 For model X25 48p

ELEMENTS  
ECN 240 £1.30 ECCN 240 £1.32  
EG 240 £1.07 EX 25 £1.16

### ANTEX HEAT SINKS 10p

V. A. T. included in all prices. Please add 10p P. & P. (U.K. only). Overseas orders—please add extra for postage.

### NEW COMPONENT PAK BARGAINS

Pack No. Qty.	Description	Price
C1 200	Resistors mixed values approx. count by weight	0.54
C2 150	Capacitors mixed values approx. count by weight	0.54
C3 50	Precision Resistors mixed values 1-2%	0.54
C4 75	1/4W Resistors mixed preferred values	0.54
C5 5	Pieces assorted Ferrite Rods	0.54
C6 2	Tuning Gangs, MV/LV VHF/54	0.54
C7 1	Pack Wire 50 metres assorted colours	0.54
C8 10	Reed Switches	0.54
C9 3	Micro switches	0.54
C10 15	Assorted Pots & Pre-Sets	0.54
C11 5	Jack Sockets 3 x 3.5m 2 x Standard Switch Type	0.54
C12 30	Paper Condensers preferred types mixed valued	0.54
C13 20	Electrolytics Trans. types	0.54
C14 1	Pack assorted Hardware—Nuts/Bolts, Grommets, etc.	0.54
C15 5	Mains Slide Switches, 2 Amp	0.54
C16 20	Assorted Tag Strips & Panels	0.54
C17 10	Assorted Control Knobs	0.54
C18 4	Rotary Wave Change Switches	0.54
C19 2	Relays 6-24V Operating	0.54
C20	Sheets Copper Laminate to make approx 200 sq inches	0.54

Please add 20p post and packing on all component packs, plus a further 10p on pack Nos. C1, C2, C10 & C20

### PLUGS

PS 1 D.I.N. 2 Pin (Speaker) 0.11  
PS 2 D.I.N. 3 Pin 0.12  
PS 3 D.I.N. 4 Pin 0.15  
PS 4 D.I.N. 5 Pin 180° 0.16  
PS 5 D.I.N. 5 Pin 240° 0.16  
PS 6 D.I.N. 6 Pin 0.17  
PS 7 D.I.N. 7 Pin 0.18  
PS 8 Jack 2.5mm Screened 0.18  
PS 9 Jack 3.5mm Plastic 0.12  
PS 10 Jack 3.5mm Screened 0.18  
PS 11 Jack 1/2" Plastic 0.15  
PS 12 Jack 1/2" Screened 0.22  
PS 13 Jack Stereo Screened 0.38  
PS 14 Phono 0.10  
PS 15 Car Aerial 0.22  
PS 16 Co-Axial 0.15

### INLINE SOCKETS

PS 21 D.I.N. 2 Pin (Speaker) 0.14  
PS 22 D.I.N. 3 Pin 0.20  
PS 23 D.I.N. 5 Pin 180° 0.20  
PS 24 D.I.N. 5 Pin 240° 0.20  
PS 25 Jack 2.5mm Plastic 0.16  
PS 26 Jack 3.5mm Plastic 0.18  
PS 27 Jack 1/2" Plastic 0.30  
PS 28 Jack 1/2" Screened 0.35  
PS 29 Jack Stereo Plastic 0.30  
PS 30 Jack Stereo Screened 0.38  
PS 31 Phono Screened 0.18  
PS 32 Car Aerial 0.22  
PS 33 Co-Axial 0.22

### SOCKETS

PS 35 D.I.N. 2 Pin (Speaker) 0.08  
PS 36 D.I.N. 3 Pin 0.11  
PS 37 D.I.N. 5 Pin 180° 0.11  
PS 38 D.I.N. 5 Pin 240° 0.11  
PS 39 Jack 2.5mm Switched 0.12  
PS 40 Jack 3.5mm Switched 0.12  
PS 41 Jack 1/2" Switched 0.20  
PS 42 Jack Stereo Switched 0.30  
PS 43 Phono Single 0.18  
PS 44 Phono Double 0.10  
PS 46 Co-Axial Surface 0.10  
PS 47 Co-Axial Flush 0.20

### LEADS

LS 1 Speaker lead 2 pin D.I.N. plug to open ends approx. 3 metres long (code-1) 0.20

### CABLES

CP 1 Single Lapped Screen 0.07  
CP 2 Twin Common Screen 0.11  
CP 3 Stereo Screened 0.12  
CP 4 Four Core Common Screen 0.23  
CP 5 Four Core Individually Screened 0.30  
CP 6 Microphone Fully Braided Cable 0.10  
CP 7 Three Core Mains Cable 0.09  
CP 8 Twin Oval Mains Cable 0.07  
CP 9 Speaker Cable 0.05  
CP 10 Low Loss Co-Axial 0.15

### CARBON POTENTIOMETERS

Log and Lin  
4.7K, 10K, 22K, 47K, 100K, 220K, 470K, 1M, 2M  
VC 1 Single Less Switch 0.15  
VC 2 Single D.P. Switch 0.28  
VC 3 Tandem Less Switch 0.46  
VC 4 1K Lin Less Switch 0.15  
VC 5 100K Log anti-Log 0.46

### HORIZONTAL CARBON PRESETS

0.1 watt 0.08 each  
100, 220, 470, 1K, 2.2K, 4.7K, 10K, 22K, 47K, 100K, 220K, 470K, 1M, 2M, 4.7M

### SELENIUM BRIDGE RECTIFIERS

18V. 2A. Ideal for those building battery, chargers. 15p each. 10 for 55p

### REPANCO TRANSFORMERS

240V. Primary. Secondary voltages available from selected tappings 4V, 7V, 8V, 10V, 14V, 15V, 17V, 19V, 21V, 25V, 31V, 33V, 40V, 50V, and 25V-0-25V.  
Type Amps Price P \* P  
MT50/4 4 41.93 45p  
MT50/1 1 42.42 48p  
MT50/2 2 43.30 60p

## WORLD SCOOP!

### JUMBO SEMICONDUCTOR PACK

Transistors-Germ and Silicon  
Rectifiers-Diodes-Triacs-Thyristors  
I.C's and Zenners ALL NEW AND CODE  
APPROX 100 PIECES!

Offering the amateur a fantastic bargain Pak ar an enormous saving—identification and data sheet in every Pak  
ONLY £2 p & p 30p

## MAMMOTH I.C. PAK

APPROX. 200 PIECES  
Assorted fall-out integrated circuits including: Logic 74 Series, Linear, Audio and D.T.L. Many coded devices but some unmarked—you to identify.  
OUR SPECIAL PRICE  
£1.25 including V.A.T. & p. & p.

## SPECIAL PURCHASE by BI-PAK

2N3055. Silicon Power Transistors NF  
Famous manufacturers out-of-spec devices free from open and short defects—every one able! 115 watts TC Metal Case.  
OUR SPECIAL PRICE 8 for £1.

8-TRACK CART-CASES  
Holds 14 13" x 5" x 6" £1.95.  
Holds 24 13" x 8" x 5" £2.70.  
Both with lock and handle

CASSETTE CASES £1.30  
Holds 12 10" x 3 1/2" x 5". Lock & Handle

SOLVE THOSE STICKY PROBLEMS!  
with  
  
CYANOACRYLATE C2 ADHESIVE  
The wonder bond which works in seconds—bond plastic, rubber, transistors, components permanently, immediately!

OUR PRICE ONLY 54p for 2gm phial

BATTERY HOLDERS  
Takes 6 hp 7s complete with terminal clip and lead. 34p each

CARTRIDGES  
ACOS GP92-1SC 200mV at 1.2cm/sec £1.35  
ACOS GP93-1 280mV at 1cm/sec £1.85  
ACOS GP96-1 100mV at 1cm/sec £2.80  
TTC J-2005 Crystal/HI Output £1.05  
TTC J-2010C Crystal/HI Output Compatible £1.20  
TTC J-2006S Stereo/HI Output £1.75  
TTC J-2105 Ceramic/Med Output £1.95  
TTC J-2203 Magnetic 5mV, 5cm/sec. including stylus £4.85  
TTC J-2203S Replacement stylus for above £3.00  
TTC AT-55 Audio-technica magnetic cartridge 4mV/5cm/sec £3.30

CARBON FILM RESISTORS  
The E12 Range of Carbon Film Resistors. 1/2 watt available in PAKS of 50 pieces, assorted into the following groups:—  
R1 50 Mixed 100 ohms-820 ohms 50p  
R2 50 Mixed 1K ohms-8.2K ohms 50p  
R3 50 Mixed 10K ohms-82K ohms 50p  
R4 50 Mixed 100K ohms-1 Meg. ohms 50p  
THESE ARE UNBEATABLE PRICES—JUST 1p EACH INCL. V.A.T.

BI-PAK SUPERIOR QUALITY LOW-NOISE CASSETTES  
C90. 32p C90. 41p C120. 52p

SEE OUR COMPLETE RANGE IN PRACTICAL ELECTRONICS, PRACTICAL WIRELESS, RADIO CONSTRUCTOR, EVERYDAY ELECTRONICS, ELECTRONICS TODAY

INTERNATIONAL OR SEND 5p. FOR THE FULL LIST OF ALL BI-PAK PRODUCTS

### BOOK BARGAIN BUNDLE

- 8 Books comprising:  
2 Transistor Equivalent books  
1 Radio & Electronic colour code data chart  
1 Radio valve guide PLUS  
3 Other constructional books  
Receivers, FM Tuners, etc  
ALSO 1 General construction book  
VALUE £3. OUR PRICE £2 p & p 10p.
- BP1 Handbook of Transistors Equivalents & Substitutes
- BP2 Handbook of Radio, T.V., Industrial Tube & Valve Equiv.
- BP3 Handbook of Tested Transistor Circuits
- BP4 International Handbook of the World's Short Wave Radio Stations and FM/T Listings
- BP5 Handbook of Simple Transistor Circuits
- BP7 Radio and Electronics colour codes and Data Charts 1
- BP8 Sound and Loudspeakers Manual
- BP9 38 Practical Tested Diode Circuits for the Home constructor
- BP10 Modern Crystal and Triode Set Circuits 1 beginners
- BP11 Practical Transistor Novelty Circuits 4
- BP13 Electronic Novelties for the Motorist
- BP14 Second book of Transistor Equivalents
- BP15 Constructors Manual of Electronic Circuits for the home
- 129 Universal Grain Motor Speed Indicator
- 138 How to make FM and T.V. aerials Bands 1/2/3
- 141 Radio Servicing for Amateur
- 146 High Fidelity Loudspeaker enclosures
- 156 Transistor Circuits Manual No. 1
- 160 Coil Manual and Constructional
- 161 Radio T.V. and Electronic Data book
- 174 Transistor sub-miniatur receivers
- 175 Transistor Test Equipment Servicing Manual
- 176 Manual of Transistor Audio Amplifiers
- 178 A comprehensive Radio Valve Guide—Book 5
- 183 How to receive foreign T.V. programmes on your set by simple modifications
- 196 AF-HF Reactance-Frequency chart for Constructors
- 200 Handbook of Practical Electronic Musical Novelties 50p
- 201 Practical Transistor Novelty Circuits for Hi-Fi enthusiasts
- 351
- 202 Handbook of Integrated Circuits Equivalents and Substitutes
- RCC Resistor Colour Code Disc Calculator 10



**TRANSISTORS AND DIODES (25%)**

Type	Pc	VCBO	FT MHz	17p
BSY29 (SNPN)	300mw	15	20	65p
BD107 (SNPN)	11 5w	64	100	
2N711B/2G106 (SNPN)	150mw	18	120/150 Tot Sw Time 275 nS Tot Sw Time 115 nS	45p
2N885 (GPNP)	300mw	15	6	£1.00
2N1304 (GPNP)	150mw	30	15	17p
2N1309 (GPNP)	150mw	30	20	32p
2N1046 (GPNP)	50w	100	15	£2.60
2N1146A (GPNP)	90w	70	0 35	50p
2N1557 (G)	106w	40	0 2	55p
2N2080 (G)	170w	70	0 2	£1.20
2N2082 (G)	170w	40	120	£1.20
2N2405 (SNPN)	1w	120	1 2	57p
2N3054 (SNPN)	29w	90		45p
2N3055 (SNPN)	115w	100		47p
2N3375 (SNPN)	11 6w	65	500	£3.60
2N4427 (SNPN)	3 5w	40	700	55p
2N5322 (SNPN)	10w	65	325	55p

**ASZ18/OC26 25p, OC35 45p, OC42 45p, OC71 12p, CV7006/OC72 20p, OC75 25p, OC83 25p, GE1110/NKT303 25p, OC702 10p, OA10 25p, RAS508AF 25p, RAS310AF 25p, STC Wire End 400P1V1A 4 for 50p, IN3193 13p, IN3194 14p, IN3255 20p.**

**RECTIFIER STACKS (8%)**

GEX54181P2	£6.88	GEX541HP3F	£6.00
GEX54181P1	£3.50	SK751N181P1F	£6.00
GEX54181P1F	£6.00		

**WESTINGHOUSE (8%)**

Westinghouse 3ph bridge rectifier assy type U5028/10 input 35v rms output DC 47v 480 amps. naturally air cooled Inc carr £56.00  
Type G2 5066 input 38v rms output 47 5v DC 54 amps 30° C, naturally air cooled Inc carr £25.00

**SWITCHES (8%)**

Edward High Vacuum Speedvac model VSK1B range 25-760 torr contact ratings 250v 5a volume 4.2 cu cm max working pressure 15lb/sq in gauge net weight 17 ozs £6.50  
Belling Delay hand reset L415 £1.25  
Stappole min rocker 125v 10a 250v 5a 25p  
Tippalite Rocker 12v 65p

**CIRCUIT BREAKERS 250V AC each £1.35**

AMP	TRIP	TYPE	(8%)
20	N	Westing 550	
40	-	Securax 5000	
70	Inst	Westing 550	
70	4	Heinemann (60c) AM12	
80	Inst	Westing 550	
80	-	Securax 5000	
90	Inst	Westing 550	
100	-	Securax 5000	
200	-	ETA Magnetic	

**DIGITAL COUNTERS (8%)**

Veeder Root Mech Reset 4 dig 55p

**STABILIZED POWER SUPPLIES (8%)**

Gresham Lion GX60/10a-60v 10 amp set to 30v £65.00 incl carriage  
Lambda CC28v-inp 205-265v output 28v dc +/-5% 3.4 amp £38.50 incl p & p  
Power Elect Inp 240v outputs 20v 6.5a 10v 3.4 amp + 10v 300ma £38.50 inc carr

**RELAYS (8%)**

Varley ITT Min 7000 20v Magnetic Dev Type 596E 50p

**CONNECTORS (8%)**

McMurdo Red Range Plug RP24 56p  
McMurdo Red Range SKT RS32 90p  
Eng Elect Edge 36 way 0.2 inch pair £1.00  
Sylvania Edge 48 way 0.125 inch pair £4.50  
Amphenol MS3106B-36-10 40p  
Continental microminiature 28 1080IN26 £1.30

**RCA PHOTOMULTIPLIER (8%)**

C31005B Caesium and Anthony Cathode Spectral Response Designation RCA 107 or S-11 Incl P/P £38.00.

**INTEGRATED CIRCUITS (8%)**

MC353G Half Adder £2.20  
MC356G 3 inp OR/NOR GATE £1.60  
MC358AG AC coupled JK Flipflop £5.50  
MC365G Line Driver £5.50  
CA3020 Wideband Pow Amp £1.00  
CA3021 Low power video £1.30  
CA3028A RF 1F Amp £1.00  
CA3038A Operational Amp £2.30  
CA3055 Pos Volt Regulator £1.35  
CA3085 Pos Volt Regulator 90p  
CD4035AE 4-stage Serial Register £2.00  
CD4017AE Decade Counter Divider £4.00  
CD4047AO Monostable Astable Multivibrator £4.00

**THYRISTORS (8%)**

GE2N1774 200v 5a £1.20  
CR1021C 20v 1a 25p  
CR10101B 100v 10a £1.00  
CR10021 10a £1.00  
CR1040B 10a £1.00  
CR10051 10a £1.00  
CR10017 10a £1.00  
BTX 92 1200R 16a 1200v £2.85

**CAPACITORS (25%)**

Daly Electrolytic 9000 F 25v 60p p/p 15p 500uF 50v 35p p/p 10p TCC 16uF + 16uF + 8uF 450v 75p p/p 15p CCL 50uF + 50uF 275v 45p p/p 10p CCL Suppressor Unit Type SU103/1 comprising capacitor Diode and Resistor 45p p/p 10p Dupliser Metalised Paper type 426 100uF 15v 60p p/p 25p RIC 1 8 1/4 F 440v a c 40p p/p 10p

**FANS (25%), CENTRIFUGAL BLOWERS, VAC. PUMPS & MOTORS (8%)**

**Airmax** Type M1/Y3954 (3 blades) Cast Aluminium alloy impeller & casing (corresponds to current type 3965 7 1/2") 230v 1ph 50c 2900Rpm Class A insulation 425 cfm free air weight 9 1/2lbs incl p p £23.00

**Woods** Aerofoil short casing type S Ref HS895/4/66 Cap 2 5/8" Non-reverse 220/240v 1ph 50c 0.19a 2700rpm 6" cast alum impeller 4 blades w/dth casing 2 1/4" total 5 1/4" weight 5 1/2lbs incl p p £13.00. Aerofoil Code 7.5 280K 200/250v. 1 1/4" 1 ph 50c 2700rpm 550cfm free air 7 1/2" impeller 14 blades incl p p £16.00.

**Service Electric** Hi-Velocity Fans suitable for Gas combustion Systems Steam exhausting Pneumatic conveying Cooling Electronic equipment Air blast for Oil burners **Secomak** Model 365 (corresponds to 575) Airblast Fan 440v 3ph 50c 0.75hp 2850rpm continuous 160cfm 12 in w g net weight 44lb price incl carr £47.00. **Secomak** model 350 250v 1ph 50c 0.166hp 2800rpm continuous 50cfm 2 in w g net weight 34lbs price incl carr £33.00. (8%)

**Air Controls** type VBL4 200/250v 1ph 50c 110cfm free air weight 7 1/2lbs Price incl p p £16.50.

**Type VBL5** 200/250v 1ph 50c 172cfm free air Weight 10 1/2lbs price incl p p £19.50.

**William Allday** Alcosa rotary vane oil free Single Stage Vacuum Pump Model HSP08 HG Rpm 1420 E E 3 phase induction motor 1/3hp cont 220/250v 380, 440v Class E ins incl carr £29.00.

**Alcosa blower** FAD 3 8clm at 5psi Rpm 1420 Motor EE 3ph 50c 1/4hp 1400rpm incl carr £29.00.

**Gast MFG.** Vacuum pump 0522-P702-R26X Motor 110/120v a c 1ph 60c 1725rpm Class E 10cuft to 10in Mercury in 2 mins maintains vacuum 635mm Mercury Oras compressor 10psi cont or 15psi incl carr £29.00.

3 phase 2HP motor 60/50c 1800/1500 RPM, 208/220/440v £25 00 incl Carriage  
Cat 2026391 Potier Instruments flange mounting capacitor motor 0.2HP cont 110v DC 4 amp £27.50 inc carr

Where p p not advised add 10p per £ handling and post (in UK). Cash with order. Personal callers welcome. Open Mon, Wed 9.30-5.00 Fri Sat 9.30-5.00. Free Car Park adj. **PRICES SHOWN ARE EXCLUSIVE OF V.A.T. RATE SHOWN IN BRACKETS.**

**W. & B. MACFARLANE**  
126 UXBRIDGE ROAD, HANWELL, LONDON W7 3SL

WW-045 FOR FURTHER DETAILS

**P. F. RALFE**

10 CHAPEL ST. LONDON NW1.

Phone 01-723 8753

**SIGNAL GENERATORS**



**MARCONI TF801D/IS.** 10-480 mHz P.O.A.  
**MARCONI TF801B/2S.** 10-480 mHz £225.  
**MARCONI TF144H** 10kHz-72 mHz P.O.A.  
**ADVANCE SG63D.** AM/FM 7.5-230mHz £125.  
**HGN MS4U** AM/FM 9.6-240mHz. N.Dev.Fac.  
**ROHDE & SCHWARZ SMLR** 15-30mHz power generator. P.O.A.  
**RACAL/AIRMEC 201A.** 30kHz-30mHz. As new. P.O.A.  
**ADVANCE SG21** VHF Square-wave generator 9kHz-100mHz. £25.

**OSCILLOSCOPES**



**TEKTRONIX 661** Sampling scope with 4S1 & 5T1A plug-in units. 3GHz. £200.  
**TEKTRONIX 545A** with CA unit. DC-30mHz. Price only £295.00  
**TEKTRONIX 531** DC-15mHz with L type plug-in  
**TEKTRONIX 535** DC-15mHz with L type plug-in  
**TEKTRONIX 545B** DC-30mHz with 'CA' plug-in.  
**TEKTRONIX 585A.** DC-80mHz with type B2 plug-in  
**TEKTRONIX 654B.** Storage oscilloscope.  
**TEKTRONIX 502.** 200uV. Sens. X-Y.  
**TEKTRONIX C27** Polaroid Camera. Series 125 with 560 series adapter

**MISCELLANEOUS TEST EQUIPMENT**

**MARCONI TF1400S** double pulse generator with TM6600/S secondary pulse unit. £105.  
**MARCONI TF791D** deviation meter. 4-1024mHz 0-100kHz deviation  
**MARCONI 455E** Wave Analyser £120.  
**MARCONI TF2600** Valve Voltmeter 1mV-300V. Excellent £75.  
**ROHDE & SCHWARZ** USVD calibrated receiver 280-940mHz (4600mHz)  
**ROHDE & SCHWARZ** A.F. Wave Analyser type FTA 0-20kHz plus log/in AF meter incorporated. Excellent condition  
**ROHDE & SCHWARZ** URV milli-voltmeter BN10913 (late type) 1mV-10V. With 'T' type insertion unit, free probe and attenuator heads. 1kHz-1,600mHz £175.  
**COSSOR 1453** True RMS milli-voltmeter. Excellent. £75.  
**AIRMEC TYPE 210** modulation meter. Excellent condition.  
**ROHDE & SCHWARZ** "SCR" V.H.F. Signal Generator 1000-1900 mHz  
**ADVANCE** type SG68 low distortion A.F. oscillator. 1.5 Hz-150kHz Sine and square wave. Battery operated. £75.  
**MARCONI** type TF936 Impedance Bridge. £85.00.  
**GERTCH** Phase Angle V. Meters. Range 1mV-300V, in 12 ranges.  
**SOLARTRON** oscillator type CO 546. 25Hz-500kHz. £30.00.  
**GAMBRELL** Precision 4 Decade Resistance Box. 1-11, 110 ohms £24.50.

**BOXER INSTRUMENT DIMENSIONS**

Dimensions 4.5 x 4.5 x 1.5 ins. Very quiet running, precision fan specially designed for cooling electronic equipment, amplifiers etc. For 110V. AC operation—(practise is to run from split primary of mains transformer or use suitable mains dropper). CC only 11 Watts. List price over £10 each. Our price, in brand new condition is £4.50.

**POWER SUPPLIES**

**WEIR** Electronics modular unit Model OCAR Regulated & stabilised. 0-7V @ 2A. £9.50.  
**APT** Electronics. model TCV250. Dual-scaled metered supply. Current limiting Variable 0-50V @ 2A £70.00. 0-40V @ 3A. £75.00.

**MANY TYPES OF RF PLUGS AND SOCKETS IN STOCK:**

BNC plugs 50Ω. 30p. BNC sockets 50Ω. 25p. N. Type plugs 50Ω. 50p. Burndept plugs. 40p. Burndept sockets. 40p. Miniature PYE. 20p. Miniature sockets. 20p.  
All connectors are brand new. Immediate delivery. Please add appropriate postage.

**AEI miniature uniselectors.** Type 2200C. 3 banks 1 bridging. 2 non-bridging wipers 12 positions Coil resistance 50 ohms. Complete with bases. Brand new £4 50 each  
**20-way BPO Jack strips** to accept 316 type Jack plugs Also quantity of 316 plugs available. All good condition.

**AVO VALVE TESTERS**

Brief-case type 160. Full working condition throughout. £65.

**AERIAL CHANGE/OVER RELAYS**

of current manufacture designed especially for mobile equipments, coil voltage 12v., frequency up to 250 MHz at 50 Watts. Small size only. 2 in. x 1 in. Offered brand new, boxed. Price £1.50, inc. P.&P.

**RACAL/AIRMEC VHF/UHF Milli-voltmeter**

type 301A. Frequency range 50Hz-900mHz. Voltage range 300uV-3V in eight ranges. Co-axial input 50 and 75 ohms BNC connectors. DC Ranges 100uV-10V in ten ranges. Light-weight mains operated instrument in as new condition with handbooks. Other makes of voltmeter also available from stock.

**EDDYSTONE RECEIVER**

type 770R  
Continuous coverage from 27 165mHz AM/FM Also 770U, 150-500 mHz, and model 770S, 500-1000 mHz All in first class condition Prices upon application

**HEWLETT PACKARD/BOONTON TYPE 8900B**

Peak-power calibrator. Measures true peak power ±.6 db absolute. Frequency range 50-2000mHz. RF power range 200mW peak, full-scale. RF Impedance 50 ohms. P.O.A.

**MARCONI TF995A2/M AM/FM R.F. SIGNAL GENERATORS.**

1.5-220mHz. 0-100kHz Deviation. 1uV-100mV output. Sold in excellent condition. P.O.A.

**PLEASE ADD 8% V.A.T. TO THE TOTAL AMOUNT WHEN ORDERING. INCORRECT AMOUNTS WILL CAUSE DELAY IN DESPATCH. THANK YOU.**

# Sinclair Scientific kit

## Britain's most original calculator – now in kit form

The Sinclair Scientific is an amazing calculator.

It offers logs, trig, and true scientific notation over a 200-decade range – features normally found on calculators costing around £50 or more.

Yet even ready-built, it costs a mere £21.55 (including VAT).

And as a kit it costs under £15!

## Forget slide rules and four-figure tables

On the Scientific, you can handle *directly* all three trig functions, their inverses,  $\log_{10}$ ,  $\text{antilog}_{10}$ , giving quick access to  $x^y$  (including square and other roots),

plus, of course, the four arithmetic functions and any calculation based on them.

In fact, virtually all complex scientific or mathematical calculations can be handled with ease.

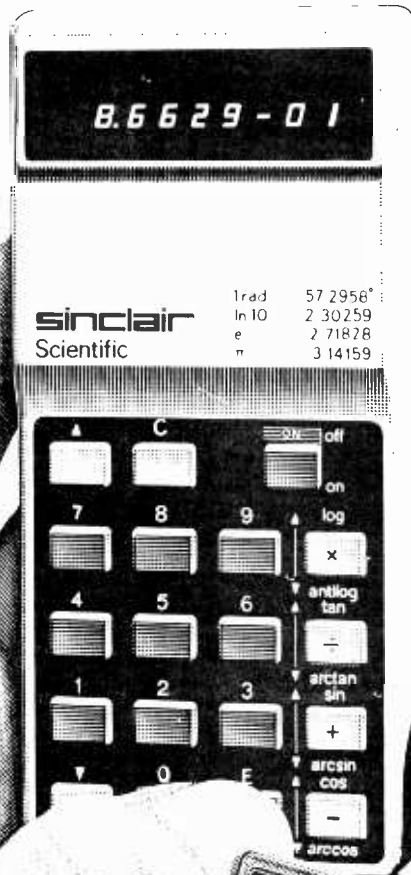

**Now only  
£14.95  
(inc. VAT)**

## So is the Scientific difficult to assemble?

No. Powerful though it is, the Sinclair Scientific is a model of tidy engineering.

All parts are supplied – all you need provide is a soldering iron and pair of cutters. Complete step-by-step instructions are provided, and our Service Department will back you throughout if you've any queries or problems.

Of course, we'll happily supply the Scientific or the Cambridge already built, if you prefer – they're still exceptional value. Use the order form.

## Features of the Scientific

- 12 functions on a simple keyboard
- Scientific notation
- 200-decade range
- Reverse Polish logic
- 25-hour battery life
- Genuinely pocketable

## Features of the Cambridge

- Only  $4\frac{1}{2}'' \times 2'' \times 1\frac{1}{8}''$ . Weight  $3\frac{1}{2}$  oz.
- Fully-floating decimal point.
- Algebraic logic.
- Constant on all four functions (+ - × ÷).
- Constant and algebraic logic combine to act as limited memory.
  - Clear, bright 8-digit display.
  - Operates for weeks on 4 AAA batteries.

**Now only  
£9.95  
(inc. VAT)**



# Sinclair Cambridge kit

At its new low price, the Sinclair Cambridge kit remains unbeatable value.

The Cambridge is now Britain's most popular pocket calculator. And it's not surprising. Check the features – then ask yourself what other calculator offers such a powerful package at such a reasonable price

## Take advantage of this money-back no-risk offer today

The Sinclair Cambridge and Scientific kits are fully guaranteed. Return either kit within 10 days, and we'll refund your money without question. All parts are tested and checked before despatch – and we guarantee any correctly-assembled calculator for a year. This guarantee also applies to calculators supplied in built form.

Simply fill in the preferential order form below and post it – today!

To: Sinclair Radionics Ltd, FREEPOST, St Ives, Huntingdon, Cambs., PE17 4BR.

Please send me

- Scientific kit – £14.95 inc. VAT
- Scientific built – £21.55 inc. VAT
- Cambridge kit – £9.55 inc. VAT
- Cambridge built – £13.99 inc. VAT

\*I enclose a cheque for ..... made out to Sinclair Radionics Ltd, crossed.  
\*Please debit my \*Access/Barclaycard account number:

\*Delete as required

Signed \_\_\_\_\_

Name \_\_\_\_\_

Address \_\_\_\_\_

Please print. FREEPOST – no stamp required.

ww 7/75

Sinclair Radionics Ltd,  
London Road, St Ives, Huntingdon, Cambs., PE17 4JH. Tel: St Ives (0480) 64646  
Reg. no: 699483 England. VAT Reg. no: 213 8170 83







# SERVICE TRADING CO

RELAYS				SIEMENS PLESSEY, etc. MINIATURE RELAYS			
1	2	3	4	1	2	3	4
52	4 8	2c/o	70p	700	16 24	4 M2B	60p
58	5-9	6c/o	80p	700	16-24	4c/o	80p
185	8-12	6 M	60p	1250	18 36	2c/o	60p
230	9-18	2c/o	70p	2500	36 45	6 M	60p
430	15-24	4c/o	80p	2500	31 43	2c/oHO	60p
700	12-24	2c/o	60p	3000	40 70	2c/o	60p
				15k	85 110	6 M	60p

(1) Coil ohms; (2) Working d.c. volts; (3) Contacts; (4) Price HD=Heavy Duty. All Post Paid. (\*Including Base)

## OPEN TYPE RELAYS

**6 VOLT D.C.** 1 make con. 35p Post 15p.

**9 VOLT D.C. RELAY**  
3 c/o 5 amp contacts 70 ohm coil 75p Post 15p

**12 VOLT D.C. RELAY**  
3 c/o 5 amp contacts 120 ohm coil 75p Post 15p

**24 VOLT D.C.** 3 c/o 600 ohm coil 75p Post 15p  
2 HD c/o 700 ohm coil 75p Post 15p  
4 c/o 300 ohm coil 85p Post 15p

## ENCLOSED TYPE RELAYS

**24V DC 3 c/o 75p.** Post 15p Base 15p

**24 VOLT A.C.** Mfg. IFT 3 h.d. c/o contacts 55p. Post 15p Base 15p extra.

**55 VOLT A.C.**

3 heavy duty c/o contacts Price 55p Post 15p Base 15p

**100 VOLT A.C.**

2 c/o sealed type octal base 75p Post 15p Base 15p

**240 VOLT A.C. RELAY**

240V A.C. heavy duty 3 c/o contacts  
Price 75p Post 15p Octal base 15p extra

**220/240 VOLT AC RELAY**

3 c/o 5 amp cont. Sealed Mfg. ISKRA. £1.25 Post 15p Base 15p extra

**ARROW 230/240V AC** 2 c/o 15 amp contacts  
Amp connectors £1.00 Post 15p

**110 VOLT A.C.** 2 c/o 20 amp £1.25 Post 15p

**CLARE-ELLIOT Type RP 7641 G8**  
Miniature relay. 675 ohm coil. 24 volt D.C. 2 c/o 70p P.P

MANY OTHERS FROM STOCK. PHONE FOR DETAILS

## VARIABLE VOLTAGE TRANSFORMERS

Carriage extra  
INPUT 230 v. A.C. 50/60  
OUTPUT VARIABLE 0/260 v. A.C.

BRAND NEW. All types.  
200W (1 Amp) ..... £10.00

0.5 KVA (Max. 2 1/2 Amp) ..... £11.50

1 KVA (Max. 5 Amp) ..... £16.50

2 KVA (Max. 10 Amp) ..... £30.00

3 KVA (Max. 15 Amp) ..... £33.00

4 KVA (Max. 20 Amp) ..... £60.00  
(max. 37.5 Amp) ..... £102.50

1 Amp OPEN TYPE  
(Panel Mounting) ..... £10.00

## 300 VA ISOLATING TRANSFORMER

115/230-230/230 volts Screened Primary two separate 0-115 volts for 115 or 230 volts output. Secondary two 115 volts at 150 VA each for 115 or 230 volts output. Can be used in series or parallel connections. Fully tropicalised. Length 13.5 cm Width 11 cm Height 13.5 cm. Weight 15 lb. SPECIAL OFFER PRICE Only

£5.00 Carr. 80p.

## LT TRANSFORMERS

0.6 12 volt n 10 amp ..... £5.60 Post 70p.

0.10 17 18 volt n 10 amp ..... £7.90 Post 70p.

0.6 12 volt n 20 amp ..... £9.00 Post 70p.

0.12 24 volt n 10 amp ..... £9.20 Post 70p.

0.4 6 24 32 volt n 12 amp ..... £9.90 Post 70p.

0.6 12 17 18 20 volt n 20 amp ..... £10.40 Post 70p.

Other types to order at short notice. Phone your enquiries

## AUTO TRANSFORMERS

Step up step down 0 115 200 220 240 volts.  
At 75 watt £2.64 Post 40p 150 watt £3.50 Post 50p 300 watt  
£6.20 Post 60p 500 watt £9.20 Post 75p 1000 watt £12.00 Post 90p

## 20 r.p.m. GEARED MOTOR

230 240 volt 20 r.p.m. motor. £1.00 Post 15p

## 9/12 VOLT DC GOVERNED REVERSIBLE MOTOR

Machine-cut gear train giving final speed of 2 r.p.m. with cam driving 3 sub miniature micro switches (removable). Spindle 12mm long 6mm dia. Built to PD spec in heavy metal hinged case £3.75 Post 40p

## BODINE TYPE N.C.I. GEARED MOTOR

(Type 1) 71 r.p.m. torque 10 lb. in. Reversible 1/70th h.p. cycle 38 amp  
(Type 2) 28 r.p.m. torque 20 lb. in. Reversible 1/80th h.p. cycle 28 amp. The above two precision made U.S.A. motors are offered in as new condition. Input voltage of motor 115v A.C. Supplied complete with transformer for 230/240v A.C. input. Price either type £6.25 Post 65p or less transformer £3.75 Post 50p.

These motors are ideal for rotating aerials, drawing curtains, display stands, vending machines, etc. etc

## BENDIX MAGNETIC CLUTCH

A superb example of Electro-mechanics! The main body is in two sections. The coil section is fixed and has a 1/8 in. sleeve. The drive section rotating on the outer perimeters. The uniting plate has 1/8 in. ID bearing concentric with main section and 18 tooth cog wheel. When energized transmission is extremely powerful. 24V d.c. at 240 MA OUR PRICE JUST £2.50. Post 30p

## NICKEL CADMIUM BATTERY

1.5 Volt 15 Amp Size 154mm high, 76mm wide, 29mm deep Price £1.50 post 50p

## POWER RHEOSTATS

New ceramic construction, vitreous enamel embedded winding, heavy duty brush assembly, continuously rated.

25 WATT 10 25 100 150 250 500 1k 1.5k 2.5k ohm  
£1.70 Post 15p 50 WATT 1 5 10 25 50 100 500 1k  
ohm £2.10 Post 20p 100 WATT 1 10 25 50 100 250  
500 1k 1.5k 2.5k/5k ohm £3.30 Post 25p

Black Silver Skirted knob calibrated in Nos. 1-9. 1 1/2 in. dia brass bush. Ideal for above Rheostats, 22p ea.

## TRIAC

Raytheon Tag symmetrical Triac. Type TAG 250/500V 10 amp 500 p.i.v. Glass passivated plastic triac. Swiss precision product for long term reliability. £1.00 Post 10p. Incl. data and application sheet. Suitable Diac 18p

## INSULATION TESTERS (NEW)

Test to I.E.E. Spec. Rugged metal construction, suitable for bench or field work, constant speed clutch. Size L. 8 in. W. 4 in. H. 6 in. weight 6 lb.  
500 VOLTS 500 megohms £30.00 Post 80p

## VAT

VAT AT THE APPROPRIATE RATE MUST BE ADDED TO ALL ORDERS FOR THE TOTAL VALUE OF GOODS INCLUDING POSTAGE.

# STROBE! STROBE! STROBE!

\* FOUR EASY TO BUILD KITS USING XENON WHITE \*  
\* LIGHT FLASH TUBES, SOLID STATE TIMING + \*  
\* TRIGGERING CIRCUITS, PROVISION FOR EX- \*  
\* TERNAL TRIGGERING. 230-250v. A.C. OPERATION. \*  
\* RANGE OF 4 STROBE KITS FROM STOCK. \*  
\* PRICES FROM £6.30-£22.00. SAE FOR \*  
\* DETAILS \*  
\* \*\*\*\*\* \*  
\* **BIG BLACK LIGHT** \*  
\* 400 Watt Mercury vapour ultra violet lamp \*  
\* Extremely compact and powerful source of u.v. \*  
\* Innumerable industrial applications also ideal for \*  
\* stage, display, discos etc. P.F. ballast is essential \*  
\* with these bulbs. Price of matched ballast and bulb \*  
\* £21.00. Post £1 Spare bulb £8.00. Post 40p \*  
\* \*\*\*\*\* \*  
\* **BLACK LIGHT FLUORESCENT U.V. TUBES** \*  
\* 4ft. 40 watt £5.50 (callers only) 2ft. 20 watt £4.25. Post 40p \*  
\* (For use in stan-by-pin fittings) MINI 12in. 8 watt £1.60. Post \*  
\* 25p 9in. 6 watt £1.30. Post 25p. Complete ballast unit and \*  
\* holders for either 9" or 12" tube £1.70. Post 25p (9in x 12in \*  
\* measures approx ) \*  
\* \*\*\*\*\* \*  
\* **METERS NEW** \*  
\* 90mm Diameter. \*  
\* Type 65C5 2A D.C. M/C 5A D.C. M/C 10A D.C. M/C \*  
\* 20A D.C. M/C 50A D.C. M/C \*  
\* Type 62T2 1A A.C. M/I 20A A.C. M/I 300V A.C. M/I ALL ABOVE \*  
\* £2.50 Post 20p \*  
\* Type 65L5 300V A.C. R/M/C £2.75. Post 20p \*  
\* 64mm x 56mm RECTANGULAR \*  
\* Type 85C1 5A D.C. M/C 20A D.C. M/C \*  
\* Type 85L1 5A A.C. R/M/C 10A A.C. R/M/C 300V A.C. R/M/C. All \*  
\* at £3.00. Post 20p \*  
\* **'CARTER 230 VOLT A.C. GEARED MOTOR** \*  
\* 230/240 volt A.C. smooth powerful continuously rated \*  
\* Two types 32 r.p.m. or 110 r.p.m. \*  
\* Either type £4.50 post 50p \*  
\* **'FRACMO' 240VOLT A.C. 50 cycle SINGLE PHASE GEARED MOTOR** \*  
\* 33 r.p.m. 30 lb ins Reversible fitted \*  
\* with mounting feet. Brand New \*  
\* £14.00 Post £1.00. (Total price incl. \*  
\* VAT £16.20) \*  
\* **REVERSIBLE MOTOR** \*  
\* A.E.I. 110th h.p. reversible motor 100 \*  
\* 120V A.C. 50/60 cycle. 1400.1680 r.p.m. \*  
\* Flange fixing Dia. 4 length 6 1/2 shaft \*  
\* 1/8 in. Price £2.50 Post 50p Brand \*  
\* new. Size 110/240V 150 watt Auto \*  
\* Transformer £3.50 Post 50p (Post for \*  
\* both items together 75p) \*  
\* **ROTARY VACUUM AIR COMPRESSOR AND PUMP** \*  
\* Carbon vane oil-less 100.115V A.C. 1/12 \*  
\* h.p. motor 50/60 cycle 2875 3450 r.p.m. \*  
\* 20" vacuum 1.25 c.f.m. 10 b.s.i. (approx \*  
\* figures) New unused surplus stock with elect \*  
\* connection data. Fraction of maker's price \*  
\* £12.00 Post 50p. Suitable transformer as \*  
\* above \*  
\* **240 V.A.C. SOLENOID OPERATED FLUID VALVE** \*  
\* Rated 1 p.s.i. will handle up to 7 p.s.i. Forged \*  
\* brass body stainless steel core and spring. In \*  
\* b.s.p. inlet outlet. Precision made. British mfg \*  
\* PRICE £2.00. Post 25p. NEW original packing \*  
\* **TIME SWITCH** \*  
\* Horstmann Type V Mk II Time Switch 200/250 volt \*  
\* A.C. Two on/two off every 24 hours, at any manually \*  
\* pre-set time. 30 amp contacts. 36-hour spring reserve \*  
\* in case of power failure. Day omitting device. Fitted in \*  
\* heavy high impact case with glass observation \*  
\* window. Built to highest Electricity Board spec \*  
\* individually tested. Price £7.75. Post 50p (Total inc \*  
\* VAT £8.91) \*  
\* **A.C. MAINS TIMER UNIT** \*  
\* Based on an electric clock with 25 amp \*  
\* single pole switch which can be preset for \*  
\* any period up to 12 hrs. ahead to switch on \*  
\* for any length of time from 10 mins. to 6 \*  
\* hrs. then switch off. An additional 60 min. audible timer is also \*  
\* incorporated. Ideal for Tape Recorders, Lights, Electric Blankets, \*  
\* etc. Attractive satin copper finish. Size 135 mm x 130 mm x \*  
\* 60 mm. Price £2.00 Post 40p (Total inc. VAT & Post £2.59) \*  
\* **PROGRAMME TIMERS** \*  
\* 230/240 Volt A.C. 15 RPM Motors \*  
\* Each cam operates a c/o micro \*  
\* switch. Ideal for lighting effects, \*  
\* animated displays etc. Ex equipment \*  
\* tested similar to illustration \*  
\* 2 cam model 15 r.p.m. £2.00 post 35p \*  
\* 2 cam model 15 r.p.m. £2.50 post 35p \*  
\* 8 cam model 20 r.p.m. £4.75 post 40p \*  
\* 8 cam model each cam fully adjustable 6 r.p.m. Mfg by \*  
\* Magnetic Devices. £7.50 Post 35p \*  
\* **UNISELECTOR SWITCHES - NEW** \*  
\* 4 BANK 25 WAY FULL WIPER 25 ohm coil, 24v. D.C. \*  
\* operation £6.90. Post 30p. \*  
\* 6 BANK 25 WAY FULL WIPER 25 ohm \*  
\* coil, 24 v. D.C. £7.90. Post 30p. \*  
\* 8 BANK 25 WAY FULL WIPER \*  
\* 24 v. D.C. operation £9.50. Post 40p. \*  
\* 

ALL MAIL ORDERS ALSO CALLERS AT:

57 BRIDGMAN ROAD, CHISWICK,  
LONDON, W4 5BB. Phone: 01-995 1560  
Closed Saturdays.

# SERVICE TRADING CO.

SHOWROOMS NOW OPEN  
AMPLE PARKING

PERSONAL CALLERS ONLY

9 LITTLE NEWPORT STREET,  
LONDON, WC2H 7JJ.  
Tel.: 01-437 0576

# BARGAINS NOW AVAILABLE . . .

Top class used instruments from such famous names as Tektronix, Hewlett-Packard, Solartron, Philips, STC, Racal, etc., etc.

## ALL IN SUPERB CONDITION AND AT REDUCED PRICES!

AUDIO EQUIPMENT	Sale Price Range	OSCILLOSCOPES	Sale Price Range	SPECTRUM ANALYSERS	Sale Price Range
<b>Crown*</b> Professional Stereo Deck with Record and Replay electronics	£100	<b>Cossor</b> CDU150 DC-35MHz 5mV-50V/DIV dual trace	£259	<b>Hewlett Packard</b> B551B/B51, 10MHz-12GHz (Extends to 40GHz with extra accessories)	£2,310
<b>BRIDGES, ETC.</b> <b>Wayne Kerr</b> 601Z. LCR Bridge. Wide Frequency range	£80	546. DC-50MHz. Main Frame with delayed sweep dual time base	£240-£350	<b>SWEET GENERATORS</b> <b>Hewlett Packard</b> 8693B. 3.7-7.8GHz plug-ins (For use with 8690 Main Frame)	£290-£498
SR26B. Source & Detector	£109	547. DC-50MHz. Main Frame with delayed sweep dual time base	£280-£390	<b>TELEPHONE TV AND MICROWAVE</b> <b>Hewlett Packard</b> 3701/02/03. Microwave Link Analyser	£2,420
B221/Q221. LCR Bridge	£159	1A1. Plug-in for 546 or 547 DC-50MHz 5mV-20V/Div. Dual Trace	£90-£290	<b>Marconi</b> OA 2090A. White Noise Test Set	£712
B224. LCR Bridge	£179	1A2. Plug-in for 546 or 547. DC-50MHz. 50mV-20V/Div Dual Trace	£70-£120	(Filters also available at extra charge)	
<b>COUNTERS &amp; TIMERS</b> <b>Hewlett Packard</b> 3734. 5 Digits 3 Hz-5MHz	£50	585. DC-80MHz. Main Frame with Delay Time Base	£240-£400	TF 2905/5. Sin 2 P & B. Gen. 525 lines 60Hz	£298
5221A. 6 Digits. 5 Hz-10MHz	£80	82. Plug-in for 585. DC-80MHz. 100mV-50V/Div. Dual Trace	£50-£90	TF 2909. Grey Scale Gen. 625 lines	£440-£750
5216. 7 Digits. 12MHz	£198	564. DC-10MHz/14GHz. Storage or Sampling Main Frame	£220-£350	<b>Philips</b> PM 5508B. Pattern Gen. 625 lines PAL	UK Systems £159-£280
5245. 8 Digits. DC-50MHz. 3 x 10 <sup>-1</sup> per day ageing rate	£90-£550	Necessary plug-ins supplied (Real time and Sampling)	£40-£400		
5246. 6 Digit Counters DC-50MHz	£198	<b>Solartron</b> CD1740. DC-50MHz. Main Frame			
5252A. Pre-Scaler plug-ins. 350MHz	£90-£115	CX1741. Plug-in. DC-50MHz 5mV-20V/cm Dual Trace			
5253B. Converter plug-ins. 512MHz	£46-£182	CX1744. Plug-in. Time Base 0.5µs-1s/cm (Complete)	£295-£390		
5254C. Converter plug-ins. 0.15-3GHz	£159-£300	<b>Tequipment</b> D53S with 2 x 'A' amps. Storage. Dual Trace	£220		
5255A. Converter plug-ins. 3-12.4GHz	£280-£490	A. DC-15MHz. Single Trace Amplifier plug-ins (Two Plug-ins per Main Frame)	£10-£20		
5260A. Automatic Divider Unit. DC-12.4GHz (use with 50MHz Counter)	£570-£980				
<b>Marconi</b> TF1417/A. 6 Digits 0-15MHz	£130				
<b>DEVIATION METERS AND POWER METERS</b> <b>Marconi</b> TF791D. 4-1024MHz	£132				
TF2502. Power Meter	£130				
TF934. Power Meter	£80-£120				
<b>DIGITAL VOLTMETERS</b> <b>Dana</b> 3800A. Digital Multimeter 0.1% Max RDG 1999	£98-£140				
5230. DVM. 0.02% 10µV Max RDG 119999	£349-£450				
5530. DVM. 0.02% 1µV. Max RDG 119999	£290-£610				
<b>Dynacore</b> DM2022. D40 DC. 0.02% 10µV resolution-2kV	£98-£340				
DM2140/A1/B1. Mean AC Converters	£98-£240				
DM2140/A1/B3. RMS AC. Converters	£61				
<b>Hewlett Packard</b> 3440 and Range of plug-ins (Complete)	£540				
3480 Main Frame 5 Digits	£198-£480				
Complete with 3482 DC plug-in					
3484 Multimeter Plug-in	£349				
<b>Solartron</b> LM1420. 2 0.05% 2.5µV resolution to 1kV DC	£96-£190				
LM1420BA. DC and RMS/Mean A C	£319-£400				
LM1219. A.C. Converter 30 mV-300V Mean Reading	£40-£190				
LM1480.3. Max. Rdg. 29999 5µV-2kV DC. Auto-ranging	£280				
LM1604. Max. Rdg. 19999. 1µV-1kV DC. Auto-ranging	£280-£420				
LM1867. Max. Rdg. 101999. 10µV-1kV DC	£259				
*Requires heads and recalibration.					
<b>POWER SUPPLIES</b> <b>Farnell</b> 30/10. 0-30V 10A Pre-set	£38-£50				
SSE. 0-15V 1A Pre-set	£22-£40				
<b>RECORDERS</b> <b>Bell &amp; Howell</b> 5-127 Ultra Violet Light Beam 12 Channels	£269				
(Galvos to 13kHz available at extra charge)					
<b>SIGNAL SOURCES</b> <b>General Radio</b> 1363. UHF Oscillator (needs power supply)	£80				
<b>Muirhead</b> D880A. 0.01Hz-11.2kHz. Decade. 2 Phase	£120-£198				
D890 1Hz-111.1kHz Decade 0-7V	£230				
<b>Marconi</b> TF144H/4 10kHz-72MHz. Xtal. check Int/Ext AM 50 ohms	£198-£320				
TF801D/1 10MHz-470MHz Int/Ext AM and Pulse modulation	£259				
<b>Wayne Kerr</b> O.22D. 10KHz-10MHz Video Oscillator	£98				
<b>Richmond Hill</b> TSP. TV Studio Precision Signal Generator Sin 2 P & B. Window. Starcase 525 lines. Requires all drives (Modification to 625 lines arranged at extra charge)	£290				
<b>Siemens</b> REL3K53. Contact Fault Locators. 1MHz Test Signal Variable levels. High sensitivity	£80				
<b>STC</b> 74166. Milliwatt Test Sets	£36-£45				
74184B. Selective Measuring Sets	£80				
74216. Noise Generators. 20Hz-4kHz	£80-£180				
74306B. Oscillators 10kHz-20MHz	£80-£110				
74600. R.F. Attenuators. 10 steps each unit total Att 0.9 9 0 90 Odb.	£15				
74B32B. Selective Level Measuring Set	£80-£100				
<b>Wandel &amp; Goltermann</b> TFPM43. 14MHz. Selective Meters	£210-£510				
VZM1. Differential Phase Meters (TV)					
VZMG1. Sampling Attachments (Complete)	£310				
<b>TRANSFER FUNCTION ANALYSER</b> JM1600/JX1639 0.00001Hz-159kHz. Phase resolution 10 minutes of arc	£1,800-£2,400				
<b>WAVE ANALYSERS</b> <b>Airmec/Racal</b> 248A. 5-300MHz. Harmonic Analysers	£132				
<b>ASSOCIATED EQUIPMENT</b> <b>Marconi</b> TF2606. Differential Voltmeter. 0-1000V	£120				
<b>Radiometer</b> RV24. D.C. Electronic Multimeter	£20*				
<b>Siemens</b> Multizet. R.F. Voltmeter. 0-100V	£5*				
<b>Racal</b> T3000 FM Tape Recorder. 4 channels 5kHz at Hispeed.	£550				
CAT 9883. Headset and Mic/Amplifier Complete	£550				
<b>MP</b> Surface Pyrometer 50-600°C (with Probe)	£19*				
*Uncalibrated					

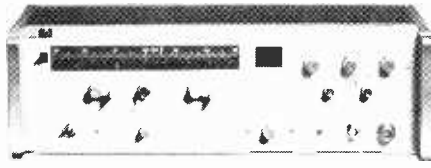
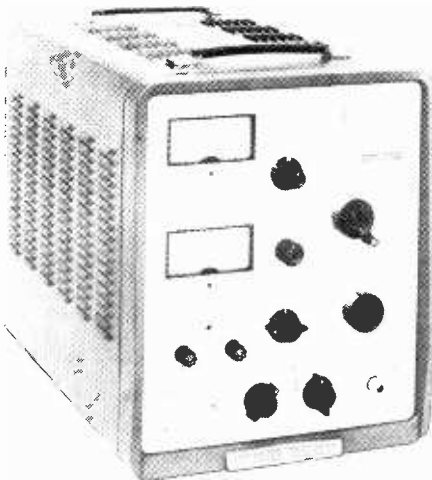
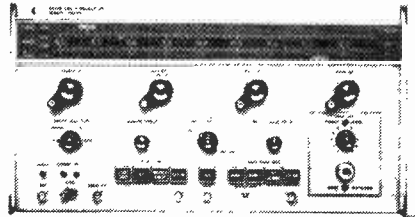

## Carston Electronics Limited

Shirley House, 27 Camden Road  
London, NW1. Tel: 01-267 4257

Call us now

WW-082 FOR FURTHER DETAILS

# HERE'S A 'LOGICAL' SHOPPING LIST YOU CAN'T AFFORD TO MISS!

# SOLID-STATE ACCURACY

### 7400 Series TTL

	1	25	100+
SN7400	0.14	0.13	0.12
SN7401	0.14	0.13	0.12
SN7402	0.14	0.13	0.12
SN7403	0.14	0.13	0.12
SN7404	0.15	0.14	0.13
SN7405	0.15	0.14	0.13
SN7406	0.30	0.29	0.28
SN7407	0.30	0.29	0.28
SN7408	0.15	0.13	0.12
SN7409	0.15	0.13	0.12
SN7410	0.14	0.13	0.12
SN7411	0.23	0.22	0.21
SN7412	0.19	0.18	0.17
SN7413	0.30	0.29	0.28
SN7414	0.71	0.70	0.69
SN7415	0.30	0.29	0.27
SN7416	0.28	0.27	0.26
SN7417	0.28	0.27	0.26
SN7420	0.14	0.13	0.12
SN7421	0.95	0.94	0.93
SN7422	0.25	0.24	0.23
SN7423	0.26	0.25	0.22
SN7425	0.26	0.25	0.22
SN7426	0.26	0.25	0.22
SN7427	0.26	0.25	0.22
SN7428	0.39	0.38	0.37
SN7430	0.14	0.13	0.12
SN7432	0.25	0.24	0.22
SN7433	0.36	0.35	0.34
SN7437	0.27	0.26	0.22
SN7438	0.27	0.26	0.22
SN7439	1.10	1.08	1.06
SN7440	0.14	0.13	0.12
SN7441	0.70	0.69	0.66
SN7442	0.63	0.60	0.53
SN7443	1.00	0.99	0.90
SN7444	1.08	1.07	1.05
SN7445	0.85	0.83	0.70
SN7446	1.03	1.00	0.85
SN7447	1.03	1.00	0.85
SN7448	0.85	0.83	0.70
SN7450	0.14	0.13	0.12
SN7451	0.14	0.13	0.12
SN7453	0.14	0.13	0.12
SN7454	0.14	0.13	0.12
SN7455	0.40	0.39	0.38
SN7460	0.14	0.13	0.12
SN7462	0.45	0.44	0.42
SN7464	0.45	0.44	0.42
SN7465	0.45	0.44	0.42
SN7470	0.30	0.27	0.25
SN7471	0.60	0.59	0.58
SN7472	0.25	0.24	0.21
SN7473	0.30	0.27	0.26
SN7474	0.31	0.29	0.26
SN7475	0.40	0.39	0.38
SN7476	0.31	0.29	0.26
SN7478	0.65	0.63	0.61
SN7480	0.43	0.41	0.36
SN7481	1.00	0.95	0.90
SN7482	0.75	0.70	0.62
SN7483	0.81	0.80	0.68
SN7484	0.90	0.86	0.85
SN7485	1.25	1.15	1.00
SN7486	0.31	0.28	0.25
SN7489	3.50	3.20	3.00
SN7490	0.45	0.42	0.35
SN7491	1.00	0.95	0.90
SN7492	0.45	0.42	0.35
SN7493	0.45	0.42	0.35
SN7494	0.48	0.45	0.40

	1	25	100+
SN7495	0.60	0.56	0.50
SN7496	0.70	0.67	0.60
SN7497	0.70	0.69	0.68
SN74100	1.35	1.30	1.25
SN74104	0.31	0.29	0.26
SN74105	0.31	0.29	0.26
SN74107	0.31	0.29	0.26
SN74109	1.00	0.97	0.95
SN74110	0.55	0.50	0.45
SN74111	0.81	0.80	0.76
SN74114	1.00	0.97	0.95
SN74115	1.00	0.97	0.95
SN74118	1.00	0.95	0.90
SN74121	0.31	0.29	0.25
SN74122	0.44	0.41	0.37
SN74123	0.62	0.58	0.50
SN74125	0.70	0.65	0.60
SN74126	0.75	0.70	0.65
SN74128	1.40	1.35	1.30
SN74132	2.10	2.05	2.00
SN74136	0.95	0.90	0.85
SN74140	2.50	2.45	2.40
SN74141	0.75	0.70	0.62
SN74145	1.15	1.10	1.05
SN74147	2.95	2.90	2.85
SN74148	2.30	2.25	2.20
SN74150	1.35	1.30	1.25
SN74151	0.68	0.62	0.55
SN74152	1.55	1.50	1.45
SN74153	0.68	0.62	0.55
SN74154	1.55	1.50	1.45
SN74155	0.68	0.62	0.55
SN74156	0.68	0.62	0.55
SN74157	0.90	0.85	0.80
SN74158	1.50	1.45	1.40
SN74160	0.95	0.90	0.80
SN74161	0.95	0.90	0.80
SN74162	0.95	0.90	0.80
SN74163	0.95	0.90	0.80
SN74164	1.60	1.55	1.50
SN74165	1.60	1.55	1.50
SN74166	1.40	1.30	1.15
SN74170	2.40	2.30	2.20
SN74173	1.65	1.60	1.55
SN74174	1.15	1.10	1.00
SN74175	0.97	0.90	0.80
SN74176	1.10	1.05	1.00
SN74177	1.10	1.05	1.00
SN74180	1.10	1.05	1.00
SN74181	3.50	3.45	3.35
SN74182	1.10	1.05	1.00
SN74184	1.60	1.55	1.50
SN74185	2.30	2.25	2.20
SN74188	4.90	4.85	4.80
SN74190	1.75	1.70	1.65
SN74191	1.70	1.65	1.60
SN74192	1.25	1.05	1.00
SN74193	1.25	1.05	1.00
SN74194	1.10	1.05	1.00
SN74195	0.90	0.85	0.80
SN74196	1.05	1.00	0.95
SN74197	1.05	1.00	0.95
SN74198	2.05	2.00	1.70
SN74199	2.05	2.00	1.70
SN74200	6.00	5.95	5.80
SN74221	1.80	1.75	1.70
SN74251	1.80	1.75	1.70
SN74278	3.00	2.90	2.80
SN74279	1.20	1.15	1.10
SN74293	1.00	0.95	0.90
SN74298	2.60	2.55	2.50

### C-MOS Types

	1	25	100+
4000AE	0.24	0.19	0.16
4001AE	0.24	0.19	0.16
4002AE	0.24	0.19	0.16
4004AE	4.90	4.80	4.70
4006AE	1.55	1.50	1.45
4007AE	0.24	0.19	0.16
4008AE	1.60	1.55	1.50
4009AE	0.35	0.34	0.30
4010AE	0.50	0.48	0.46
4011AE	0.24	0.19	0.16
4012AE	0.24	0.19	0.16
4013AE	0.59	0.47	0.39
4014AE	1.65	1.33	1.10
4015AE	1.65	1.33	1.10
4016AE	0.62	0.50	0.41
4017AE	1.62	1.31	1.08
4018AE	2.45	2.40	2.30
4019AE	0.62	0.50	0.41
4020AE	1.82	1.46	1.21
4021AE	1.65	1.33	1.10
4022AE	1.65	1.33	1.10
4023AE	0.24	0.19	0.16
4024AE	1.13	0.91	0.75
4025AE	0.24	0.19	0.16
4026AE	6.50	6.40	6.30
4027AE	0.42	0.41	0.40
4028AE	1.41	1.14	0.94
4029AE	1.95	1.57	1.30
4030AE	0.62	0.50	0.41
4033AE	2.80	2.70	2.60
4035AE	1.71	1.38	1.14
4040AE	1.82	1.46	1.21
4041AE	0.90	0.85	0.80
4042AE	1.00	0.90	0.80
4043AE	1.00	0.90	0.80
4044AE	1.00	0.90	0.80
4047AE	1.50	1.45	1.40
4048AE	1.30	1.25	1.20
4049AE	0.54	0.44	0.36
4050AE	0.54	0.44	0.36
4051AE	1.77	1.43	1.18
4052AE	2.00	1.90	1.80
4053AE	2.70	2.60	2.50
4055AE	2.60	2.50	2.40
4056AE	1.35	1.09	0.90
4060AE	2.25	1.82	1.50
4066AE	0.95	0.90	0.85
4069AE	0.38	0.30	0.25
4071AE	0.34	0.27	0.23
4076AE	1.45	1.40	1.35
4081AE	0.34	0.27	0.23
4510AE	1.75	1.70	1.65
4516AE	1.76	1.42	1.18
4518AE	2.17	1.75	1.45
4520AE	1.65	1.60	1.50
4901AE	0.37	0.35	0.33
4911AE	0.37	0.35	0.33

### D.I.L. SOCKETS

	1	100	500+
8-pin	0.11	0.09	0.08
14-pin	0.13	0.11	0.10
16-pin	0.14	0.12	0.10
18-pin	0.15	0.13	0.11

### 7-SEGMENT DISPLAYS

	1	25	100+
0.3" DIL	0.90	0.80	0.75
Comm. Anode. 14-pin DIL. Red LED			

## SOLAR POWERED 100-Year Calendar Watch



SP-1

This is the world's first solar-powered timepiece. Solar cells (similar to those used in the Skylab program) draw power from the sun (10 to 15 minutes per day) or from ambient light (slightly longer) to keep batteries fully charged. Batteries operate up to 10 years without replacement. A true calendar watch — LSI circuitry is programmed to provide a calendar to the year 2100, automatically adjusting for 30 and 31 day months, even leap years. Automatic brightness control adjusts LED for perfect viewing even in outdoors. Shows minutes and hours, counts out seconds or shows the date. Easily adjusts to reset hour or date without affecting calendar. Shock and water resistant. Accurate to 5 seconds per month. **£298.50.**

### PRECISION TIMEPIECE WITH

## Brilliant LED Display

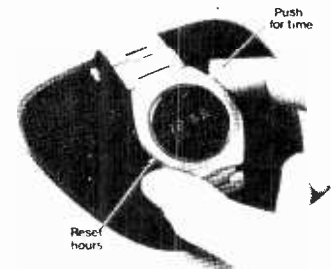

Reset hours

Push for time

TYPE LED-2

Press the button and the time is visible, brilliantly displayed in large easily read LED numerals. Pulsating colon marks the passage of each second. Quartz crystal assures highest possible accuracy. Stainless steel, water resistant case with comfortable band. **£74.00.**



Reset minutes

All goods brand new, to full manufacturer's spec. No standard parts sold. Visitors welcome, by appointment. Colleges, Govt. and Account orders welcomed.

TERMS: Non-Account Customers, Cash with Order. Standard P&P 40p. Please add VAT to overall total.



# RASTRA ELECTRONICS LTD.

275-281 King Street · Hammersmith · London W6 9NF · Tel. 01-748 3143/2960 · Telex 24443





# VALVES

A1065	1.25	EF184	0.35
ARR	0.55	EF1200	0.75
ATP4	0.50	EL133	2.50
B13H	3.00	EL34	0.70
CY31	0.50	EL36	0.60
DAF96	0.50	EL41	0.80
DF96	0.55	EL81	0.60
DK96	0.55	EL82	0.55
DL92	0.40	EL84	0.30
DL96	0.60	EL85	0.60
DF96/B7	0.40	EL86	0.45
DY802	0.45	EL90	0.45
EB8CC/01120	0.40	EL504	0.80
E180CC	0.70	EM31	0.60
E182CC	1.25	FM80	0.55
EA50	0.40	EM84	0.40
EABC80	0.40	EM87	1.00
EAF42	0.75	EY51	0.45
EB91	0.30	EY81	0.45
EB93C3	1.00	EY86	0.40
EB94	0.75	EY88	0.50
EBF80	0.40	EZ40	0.70
EBF83	0.50	EZ41	0.75
EBF89	0.40	SC1/400	3.00
ECC52	0.35	EZ81	0.30
ECC81	0.40	GY501	0.75
ECC82	0.35	GZ34	0.70
ECC83	0.35	GZ37	1.00
ECC84	0.35	K166	2.50
ECC85	0.40	K189	3.20
ECC86	0.90	MM4	0.75
ECC88	0.50	ML6	0.65
ECC89	0.70	OA2	0.45
ECCF80	0.40	OB2	0.45
ECCF82	0.40	PABC80	0.40
ECCF81	0.75	PC37	0.50
ECH42	0.80	PC90	0.40
ECH81	0.35	PC84	0.40
ECH83	0.45	PC85	0.40
ECH84	0.45	PC89	0.50
ECL80	0.55	PC189	0.60
ECL82	0.35	PCF80	0.40
ECL83	0.70	PCF82	0.80
ECL86	0.50	PCF84	0.80
EF36	0.65	PCF86	0.60
EF37A	1.20	PCF200	0.75
EF40	0.75	PCF201	0.75
EF41	0.65	PCF801	0.55
EF80	0.30	PCF802	0.50
EF83	1.25	PCF805	0.80
EF85	0.35	PCF806	0.75
EF86	0.35	PCF808	0.90
EF89	0.30	PCF200	0.80
EF91	0.45	PC181	0.55
EF92	0.50	PC182	0.40
EF95	0.40	PC183	0.65
EF183	0.35	PC184	0.45

PCL86	0.50	Z801U	2.70	6AK5	0.40	6CL6	0.75	6X5GT	0.50
PCL805	0.60	Z900T	1.20	6AK8	0.40	606	0.55	6Y6G	0.90
PFL200	0.70	1A3	0.55	6AL5	0.30	6E8A	0.85	6Z4	0.85
PL36	0.60	1L4	0.25	6AL5W	0.55	6F7	1.10	630L2	0.90
PL81	0.50	3A4	0.60	6AM6	0.45	6FR6	0.75	7B7	0.80
PL82	0.45	1R5	0.40	6AN8	0.45	6FZ3	0.90	7Y4	0.80
PL83	0.45	1S4	0.30	6AX5	0.75	6F32	0.75	9D6	0.40
PL84	0.45	1T4	0.30	6AQ5W	0.70	6F33	3.50	9D7	6.00
						6H6	0.35	12A6	0.55
						6J4WA	1.25	12A6	0.45
						6J5	0.65	12A7	0.40
						6J5GT	0.50	12A7	0.35
						6J6	0.60	12A6V	0.50
						6J7	0.60		
						6J7G	0.40		
						6K6GT	0.80		
						6K7	0.55		
						6K7G	0.30		
						6K8GT	0.50		
						6K25	1.00		
						6L6	1.90		
						6L6G	0.60		
						6L7G	0.40		
						65A7	0.50		
						65A7GT	0.40		
						65H7	0.90		
						12C8	0.55		
						12E1	3.50		
						12K5	1.10		
						12K7GT	0.50		
						12K8GT	0.70		
						12Q7GT	0.70		
						12S4GT	0.70		
						12S7	0.55		
						12S7J	0.55		
						12Y4	0.40		
						14S7	1.00		
						19A05	0.65		
						19G3	8.00		
						19G6	6.60		
						19H5	14.00		
						20P3	6.00		
						20P4	1.10		
						25L6GT	0.70		

Many of these valves are imported and prices vary for each delivery so we reserve the right to change prices for new stock when unavoidable

PL504	0.80	1X2A	0.60	6AS6	0.80	6X5GT	0.50
PL508	1.00	1X2B	0.75	6AT6	0.45	6Y6G	0.90
PL509	1.35	2D21	0.50	6AU6	0.40	6Z4	0.85
PL512	0.95	2K25	9.00	6AV6	0.45	630L2	0.90
PY80	0.40	3D6	0.40	6AX4GT	0.75	7B7	0.80
PY81	0.40	3S4	0.40	6AX5GT	1.00	7Y4	0.80
PY82	0.40	3V4	0.85	6B7	0.70	9D6	0.40
PY83	0.40	5B/254M	4.50	6BA6	0.35	9D7	6.00
PY84	0.40	5B25M	3.50	6BE6	0.40	12A6	0.55
PY85	1.00	5R4GY	0.90	6BG6G	0.90	12A7	0.40
PY86	0.40	5U4G	0.50	6B6J	0.65	12A6V	0.50

## VALVES AND TRANSISTORS

Telephone enquiries for valves, transistors etc. retail 749 3934; trade and export 743 0899

SV4G	0.55	6B07A	0.80	6SJ7GT	0.35	AC113	2.00
5Y3GT	0.55	6BR7	1.20	6SK7	0.55	AC126	2.00
5Z3	0.80	6BW6	1.00	6SL7GT	0.50	AC127	2.00
5Z4	0.80	6BW7	1.00	6SN7GT	0.50	AC128	2.00
5Z4TG	0.55	6C4	0.40	6S07	0.55	AC176	2.00
6A87	0.60	6C6	0.50	6V6GT	0.50	AC18	2.00
6AC7	0.60	6CB6	1.50	6X4	0.40	AC19	2.00
6AH6	0.70	6CH6	1.45	6X5G	0.40	AC20	2.00
						AC27	2.00
						AC28	2.00
						AC76	2.00
						AC18	2.00
						AC19	2.00
						AC20	2.00
						AC27	2.00
						AC28	2.00
						AC76	2.00
						AC18	2.00
						AC19	2.00
						AC20	2.00
						AC27	2.00
						AC28	2.00
						AC76	2.00
						AC18	2.00
						AC19	2.00
						AC20	2.00
						AC27	2.00
						AC28	2.00
						AC76	2.00
						AC18	2.00
						AC19	2.00
						AC20	2.00
						AC27	2.00
						AC28	2.00
						AC76	2.00
						AC18	2.00
						AC19	2.00
						AC20	2.00
						AC27	2.00
						AC28	2.00
						AC76	2.00
						AC18	2.00
						AC19	2.00
						AC20	2.00
						AC27	2.00
						AC28	2.00
						AC76	2.00
						AC18	2.00
						AC19	2.00
						AC20	2.00
						AC27	2.00
						AC28	2.00
						AC76	2.00
						AC18	2.00
						AC19	2.00
						AC20	2.00
						AC27	2.00
						AC28	2.00
						AC76	2.00
						AC18	2.00
						AC19	2.00
						AC20	2.00
						AC27	2.00
						AC28	2.00
						AC76	2.00
						AC18	2.00
						AC19	2.00
						AC20	2.00
						AC27	2.00
						AC28	2.00
						AC76	2.00
						AC18	2.00
						AC19	2.00
						AC20	2.00
						AC27	2.00
						AC28	2.00
						AC76	2.00
						AC18	2.00
						AC19	2.00
						AC20	2.00
						AC27	2.00
						AC28	2.00
						AC76	2.00
						AC18	2.00
						AC19	2.00
						AC20	2.00
						AC27	2.00
						AC28	2.00
						AC76	2.00
						AC18	2.00
						AC19	2.00
						AC20	2.00
						AC27	2.00
						AC28	2.00
						AC76	2.00
						AC18	2.00
						AC19	2.00
						AC20	2.00
						AC27	2.00
						AC28	2.00
						AC76	2.00
						AC18	2.00
						AC19	2.00
						AC20	2.00
						AC27	2.00
						AC28	2.00
						AC76	2.00
						AC18	2.00
						AC19	2.00
						AC20	2.00
						AC27	2.00
						AC28	2.00
						AC76	2.00
						AC18	2.00
						AC19	2.00
						AC20	2.00
						AC27	2.00
						AC28	2.00
						AC76	2.00
						AC18	2.00
						AC19	2.00
						AC20	2.00
						AC27	2.00
						AC28	2.00
						AC76	2.00
						AC18	2.00
						AC19	2.

# ELECTRONIC BROKERS

## SIGNAL SOURCES

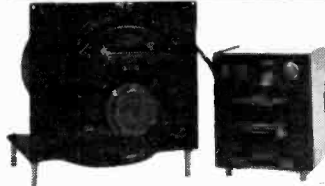

Unit Oscillator. General Radio Type 1209C. Freq. 250-920 MHz Accuracy 1% Drift 0.2%. Output into 50 ohms = 150 MW with PSU 1201 - CO18 as illustrated **£215**

**ADVANCE**  
Audio Signal Generator HIB 15Hz-50 KHz 200V-20V± 2dB Sine Wave & Square Wave **£65**  
Audio Signal Generator J18 15Hz-50KHz 0.2V-25V **£65**  
VHF Square Wave Generator SG 21 9KHz-100MHz Max 0/p 2V **£35**  
Signal Generator D1 **£39**  
**AIRMEC**  
Signal Generator 702 30Hz-30KHz in 3 bands **£60**  
Signal Generator 701 **£60**  
H.F. Signal Generator 201 30KHz-30MHz in 7 Bands Int.Xtal calibrator 0/p level variable 1µV-11V 75 ohms impedance Int. Mod. at 1KHz Ext. Mod 30Hz-10KHz **£75-£115**

**GENERAL RADIO**  
Unit Oscillator 1218-A P.O.A.  
**HEWLETT PACKARD**  
U.H.F. Signal Generator 614A 900-2100MHz 1% Accuracy Output 0.1µV-0.2V into 50 ohms Modulation CWInt or EXT FM & Pulse S.H.F. Signal Generator 618C 3.8-7.6GHz ± 1% 50 ohms **£550**  
Signal Generator 6088 10-400MHz 0.1µV-0.8V **£195**  
Signal Generator 612A 450MHz-1230MHz Internal & Ext. A.M. 50 ohms **£495**  
Audio Oscillator Type 201C 20 Hz-20 KHz 0.40 dB in 10 dB steps. Distortion less than 0.5%. Also 200 CD & 200B **£95**  
FM/AM Signal Generator 202H **£495**

**MARCONI INTS.**  
Oscillator TF1247 20-300MHz (Suitable for use with Marconi TF 1245 & 1245A O-Meters) **£135**  
FM/AM Signal Generator TF 995A/3S 1.5 Mhz-220 MHz. 2µ V-200mV Superb condition **£385**  
U.H.F. Signal Generator TF 1060/2 450-1200 MHz 0.1µV-447mV Sine and pulse mod. facilities **£420**  
U.H.F. & S.H.F. Signal Generator TF 1058 1600-4000 MHz 0.1µV-445mV **£295**  
Signal Generator TF 867. 15 KHz-30 MHz 0.4µ V-4V. Int and ext mod facilities **£135**  
Phase/AM Signal Generator TF 2003 0.4-12 MHz Bargain price - super condition **£150**

**WAYNE KERR**  
Video Oscillator 0.22D 10 KHz-10 MHz **£150**  
A.F. Oscillator S121 10 Hz-120 KHz **£45**  
**BRUEL & KJAER**  
Portable Sound Level and Vibration Meter 2203 and Octave Filter Set 1613 **£275**  
Level Recorder 2305 P.O.A. **£395**  
S.E.U.V. Recorder 3006

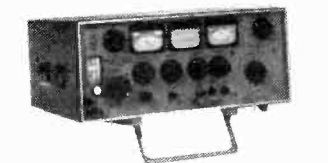

**HEWLETT PACKARD**  
Sweep Oscillator 692D 2-4GHz **£495**  
Sweep Oscillator 693B 4-8GHz **£495**  
**JERROLD**  
Sweep Signal Generator 900B Centre Freqs 500KHz-1200MHz Sweep widths narrow as 10KHz to 400MHz wide 50ohms

## SWEEP GENERATORS

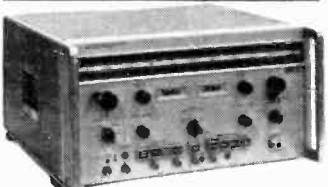

**HEWLETT PACKARD**  
Sweep Oscillator 692D 2-4GHz **£495**  
Sweep Oscillator 693B 4-8GHz **£495**  
**JERROLD**  
Sweep Signal Generator 900B Centre Freqs 500KHz-1200MHz Sweep widths narrow as 10KHz to 400MHz wide 50ohms

## PULSE GENERATORS

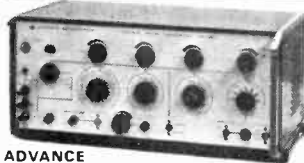

**ADVANCE**  
Double Pulse Generator PG 56 Pulse Amplitude 0.1V-10V Sq wave 0-10V Rise Time 10nsec (typically) **£87.50**  
Pulse Generator PG 55 P.O.A.  
Modular Pulse Generator Advance Type PG 52 System of 5 Signal generating & Processing units Repetition freqs up to 20MHz & Output pulses to 20V (50 ohms) Rise & Fall times 5nsec Its versatility enables the production of complex pulse & ramp waveforms not obtainable from conventional pulse generators **£250**

**MARCONI**  
Double Pulse Generator TF 1400 S. Min type CT 434 c/w TM 6600 Sec Pulse gen Plug In. 10Hz-100KHz 100nsec-100µsec Negative pulses up to 200V E.M.F. +VE pulses up to 60V E.M.F. & Simultaneous +VE & -VE pulses up to 20V E.M.F. P.O.A.  
**SOLARTRON**  
Precision Pulse Generator G.O 1377 100V single or double pulses 0.2 amp paraphase outputs Simultaneous +VE & -VE outputs. Square wave to 5MHz 10nsec Rise time Pulse repetition freq - 10Hz-1MHz Pulse duration 0.1µsec-100nsec **£125**  
Pulse Generator OPS 100C P.O.A.

## TELEPHONE TEST EQUIPMENT

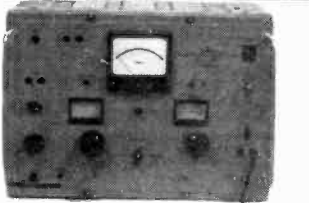

Siemens Level Meter 3D 335 10KHz-17MHz Complete system by Siemens comprising 3W 518 Level Oscillator 3D 335 Level Meter. 3W 933 Sweep Attachment. 3D 346 Screen Level Tracing Receiver P.O.A.  
Siemens Level Meter 3D 332 0.3-1200KHz Level Oscillator 3W 29 0.3-1200KHz P.O.A. S.T.C.

Octave Filter 74143A 37.5-12.800Hz For analysing noise and interference on comms systems, particularly useful with 74142 psophometer P.O.A.  
Selective level Measuring Set 74184B 60-1364KHz P.O.A.  
Measuring Set 74831A P.O.A.

**A.T.&E.**  
Telegraph Distortion Measuring Set Various types 5BV 5BV3 6BV 6A P.O.A.  
**MURPHY RADIO**  
Receiver VHF field strength RX 506 & interference measuring set c/w Power Unit P.O.A.

## OSCILLOSCOPE TEST EQUIPMENT



**TEKTRONIX**  
Pulse Generator Type III 0.5µsec risetime Amplitude ± 5V 30 to 250 nsec difference between trigger and output pulses **£60**  
Time Mark Generator 180A **£85**  
Pulse Generator 109 0.25 nsec Risetime 0-55V Calibrated variable amplitude Impedance 50 ohms **£35**  
Pre-Trigger Pulse Generator III **£60**

## RESISTANCE & DECADE BOXES



**MARCONI**  
Decade Potentiometer TF 221 **£40**  
Variable Air Condenser Muirhead Type 11-8 1250pF Max. P.O.A.  
AC-DC Converter Type AC-DC For use with Precision R Boxes **£90**

**NEGRETTI & ZAMBRA**  
Quick Reading Potentiometer **£55**  
Tinsley Vernier Potentiometer Type 3126B A precision equipment as used in laboratories and measurement standards areas **£125**

**DORAN**  
Whetstone Bridge Type 1401 **£45**  
Whetstone Bridge Type 3557 **£45**

## T.V. TEST EQUIPMENT

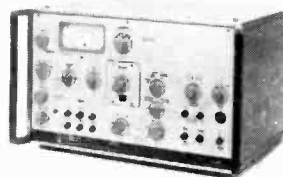

Wandel & Goltermann VZM 2 Distortion measuring set for phase & amplitude mod. For multichannel FM Radio Systems up to 12MHz Base bands **£400**

**MARCONI**  
Sine Squared Pulse & Bar Generator TF 2905/8 **£225**

**GRESHAM LION**  
Waveform Generator 625 lines Sine squared Pulse & Bar P.O.A.  
Waveform Generator 625 lines staircase P.O.A.

**MARCONI**  
Colour Gain & Delay Test Set TF 2904 **£275**  
**WANDEL & GOLTERMAN**  
Measuring Set VZM 1 **£495**  
Generator & Receiver VZM 83 **£275**

## COMPONENTS

Numeric Tube B 5853 0.9 Digit 1.4 height Brand New **£1.00**

Also Alpha Numeric Nixie Tube  
B.7971 Displays alphabet & 0-9 numerals **99p**

**ACCELEROMETERS**  
G.E.C. Type F **£2.50**  
Graseby Insts. Type 821 12G-0-12G **£25**  
Sperry Type 212502-0100 P.O.A. **£45**  
Sperry Type 214202-0100 P.O.A. **£25**  
Langham Thompson LA 2 Types up to 100G Choppers - **£4**  
Ericsson N 29834Hz **£4**  
Elliott Synchroverter G 1280 **£4**  
Elliott Synchroverter 95908 **£4**

**MODULATORS**  
S.E. Labs SE 441/2 **£45**  
S.E. Labs SE 501/2 **£45**  
Osc. amp. demod. SE Labs Type SE 62/12 4000 p.s.i. **£85**

**TRANSDUCERS**  
S.E. Labs SE 150T 2.5 p.s.i. **£35**  
S.E. Labs SE 153 A7481 15 p.s.i. **£35**  
S.E. Labs SE 250 A5962 1000 p.s.i. **£25**  
S.E. Labs SE 150B 50 p.s.i. **£35**  
S.E. Labs SE 105 1000 p.s.i. **£25**  
S.E. Labs SE 165 4000 p.s.i. **£25**

**TEMPERATURE INDICATORS**  
Made by Ether. Models with Temp Ranges 0-600 C 0-800 C & 0-1000 C **£25-£50**

**POTENTIOMETERS**  
3 turn and 5 turn available 10 turn 3600 Rotation

5 ohms	Beckman	Type A	£3 00
50 ohms	Bourns	35005-2-500	£1 00
100 ohms	Relcon	05 B10	£1 00
300 ohms	Beckman	7216	£2 50
500 ohms	Beckman	A	£2 50
500 ohms	Colvern	2501/264	£3 00
500 ohms	Colvern	2402/13	£3 00
500 ohms	Colvern	2501/9	£3 00
500 ohms	Relcon	07-10	£2 50
1K	Beckman	as 690	£3 00

## X-Y & U/V RECORDERS

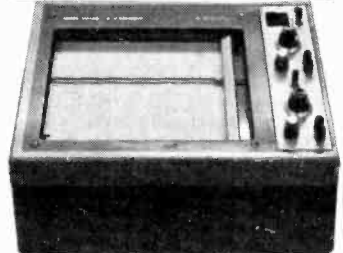

X-Y Recorder Advance Type HR 96 **£195**  
**ADVANCE**  
X-Y Recorder HR. 92/1 **£150**  
**BELL & HOWELL**  
U.V. Recorder 5/127, without Galvo s **£225**  
**BRYANS**  
X-Y Recorder 20021 **£195**  
**ELECTRONIC ASSOCIATES**  
Vari-Plotter **£145**

## INSULATION TESTERS

**EVERSHED & VIGNOLES**  
Circuit Tester Ohmmeter 0-3 ohms 0-39 ohms **£18**  
Circuit Tester Ohmmeter 0-1000 ohms 100-200 kohms **£18**  
Megger Series 4-II 250V **£12**  
Megger Series III Mk 3 250V **£20**  
Megger 250V **£20**  
Megger 500V **£37**  
Battery Megger 500V **£37**  
**PYE**  
Insulation Tester 108 500V **£25**

## MISCELLANEOUS

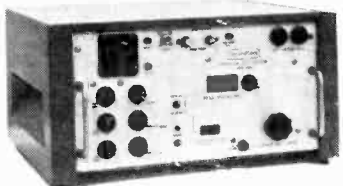

Transfer Oscillator Type 7580HBy Beckman DC 15GHz with counter 7.5MHz-15GHz without counter Sensitivity 100mV (R.M.S.) **£350**

**MARCONI**  
Distortion Factor Meter TF 142F Fundamental Freq. Range 100Hz-8KHz Dist measurement ranges 0-5% & 0-50% **£60**  
Precision Crystal Calibrator TF 1374 10KHz check points up to 10MHz 100KHz check points up to 500MHz 500KHz 2 & 10MHz **£40**

Portable Recener Tester TF 888/3 70KHz 70MHz Xtal check 500KHz & 5MHz 1KHz A.F. Oscillator. A.F. Power 10mW 100mW & 1W **£69**  
Carrier Deviation Meter TF 791C Carrier Freq. range 4-250MHz Freq. dev. ranges 0 to -5KHz 0 to +25KHz 0 to -75KHz & 0 to +125KHz Input impedance 50 ohms **£75**  
Wave Analyser TF 455E **£95**  
Noise Generator TF 1301 200-1700 MHz **£60**

**ADVANCE**  
Recorder Calibrator HC 20 **£20**  
Printer PR 1 Intended for use with almost any kind of counter. 7 digit display. 2" wide paper print-out **£55**

**B.P.L.**  
Megohmmeter RM 160 For insulation resistance up to 400 million M ohms **£35**  
Meter T1 **£75**

**AIRMEC**  
Modulation Meter 210 **£75**  
Modulation Meter 210A **£135**

**EDDYSTONE**  
Receiver 770R 1 **£285**

**HEWLETT PACKARD**  
Microwave Link Analyser 3701 02 03 **£2000**

**MUIRHEAD**  
Facsimile Transmitter Receiver Type 900 Easily convertible to receive weather pictures from satellite systems **£850**

**SAVAGE**  
Amplifier Mark II Star Model 1KM2Z 1 KW output Freq. 50-10 KHz Guo condition **£1650**

**WAYNE KERR**  
Video Noise Level Meter M 131 **£75**

# The test equipment people

Come and visit Europe's first Electronic Instrumentation Centre

**49-53 Pancras Road  
London NW1 2QB  
Tel: 01-837 7781**

**Next to KING'S CROSS  
ST. PANCRAS**

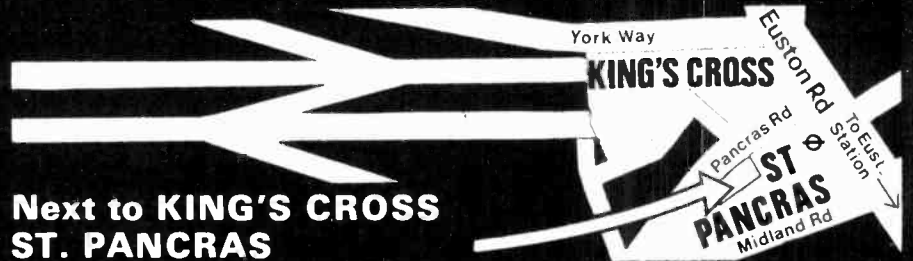

## OSCILLOSCOPES & PLUGS INS

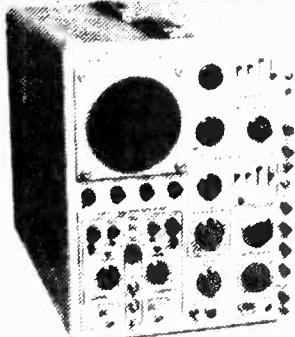

**TEKTRONIX**  
The most versatile oscilloscopes ever produced by Tektronix to accept Multi trace, Differential, Sampling, Spectrum Analysers, and special purpose Plug-ins, etc. A few examples offered below:

IA1 — DC 50 Meg. 5mV/cm Dual Trace **£125.00**  
IA2 — DC 50 Meg. 50mV/cm Dual Trace **£90.00**  
CA — DC 24 Meg. **£69.50**  
IA4 — Four trace amplifier 10mV/cm **£390.00**  
5458 DC to 33 Meg. calibrated sweep delay **£325.00**  
546 Dual time base/Delayed sweep DC 50 Meg. **£275.00**  
547 Dual time base/Delayed sweep/alternate display DC 50 Meg. **£325.00**



**HEWLETT PACKARD**  
Model 130C 200μV/cm Oscilloscope. This scope is a versatile all purpose instrument for laboratory production line industrial process measurements and medical applications. The outputs of rf detectors, strain gauges, transducers, and other low level devices may be viewed directly without preamplification. The Model 130C is easy to operate even by inexperienced personnel. Specification: Time Base Range — 1 μs/cm to 5 s/cm. 21 ranges in a 1.2.5 sequence, accuracy ± 3%. vernier provides continuous adjustment between steps and extends the 5 s/cm step to at least 12.5 s/cm. Automatic triggering (baseline displayed in the absence of an input signal). Vertical and horizontal amplifiers. Bandwidth, d.c. coupled, dc to 500 KHz; ac coupled (input), 2 Hz to 500 KHz; ac coupled (amplifier), 25 Hz to 500 KHz at 0.2 mV/cm deflection factor **£175**  
Scope 175A DC — 50 MHz Main trace. **£150**

Various plug-ins available for above **£25-£55 each**  
75 MHz Portable Transistorised Scope 1707A **£750**  
Sampling Scope 1858 DC:3.5 GHz **£395**  
**MARCONI**  
Scope TF 2200A/1 c/w TV Differential plug in TM 6457A. DC — 30 MHz 50 mV/cm **£190**  
**TELEQUIPMENT**  
Dual Beam Scope D31. DC — 6 MHz **£75**

## MULTIMETERS

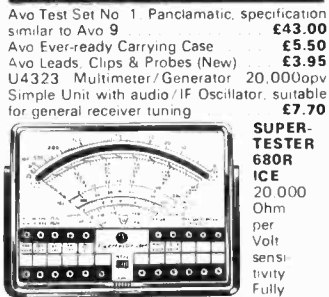

Avo Test Set No. 1 Panclomatic, specification similar to Avo 9 **£43.00**  
Avo Ever-ready Carrying Case **£5.50**  
Avo Leads, Clips & Probes (New) **£3.95**  
U4323 Multimeter/Generator 20,000opv Simple Unit with audio /IF Oscillator, suitable for general receiver tuning **£7.70**  
**SUPER-TESTER 680R ICE**  
20,000 Ohm per Volt sensitivity Fully screened against external magnetic fields. Scale width and small case dimensions (128 x 95 x 32mm). Accuracy and stability (1% in DC, 2% in AC) of indicated reading. Simplicity and ease of use and readability. Full ranges of accessories. 1000 times overload. Printed Circuit board is removable without desoldering. More ranges than any other meter. Ask for free catalogue. **£18.50**  
Accessories (extra) available to convert Microtest 80 & SuperTester 680R into following: SIGNAL INJECTOR GAUSS METER ELECTRONIC VOLTMETER AMPER-CLAMP TRANSISTOR TESTER TEMPERATURE PROBE, PHASE SEQUENCE INDICATOR — Send for details!

**MORE RANGES FOR LESS MONEY!**  
AC/DC Multi-meter type U4324 A-DC 0.06-3A — 6 Ranges A-AC 0.3A — 5 Ranges V-DC 0.6-1200V — 9 Ranges V-AC 3-900V — 8 Ranges Freq. In the range of 45 to 20kHz Resistance 500 ohm to 5 Mohm — 5 Ranges Decibel —10 to +12dB Accuracy ± 2.5%  
All above Multimeters (except AVO) are brand new.  
DC ±4% AC Dimensions: 167 x 98 x 63mm Only **£9.25**

## VOLTMETERS

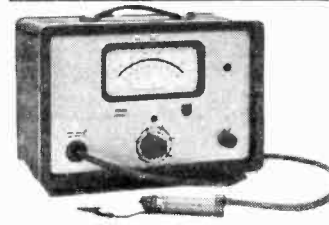

H.F. Multivoltmeter, Philips Type GM 6014 Ranges 1mV-300mV in 6 Ranges. Facility also for 100mV-30V. Meter equipped with dB scale. Accuracy at 30KHz less than 3% F.S.D. Amplitude characteristic flat within ± 5% **£55**  
**HEWLETT PACKARD**  
D.C. Vacuum Tube Voltmeter 412A 1mV-1000V 1% Accuracy. Can also be used as Ohmmeter & Ammeter **£75**  
**MARCONI**  
Sensitive Valve Voltmeter TF.1100 100μV-300V AC Freq. coverage 10Hz-10MHz. Meter has dB scale facility **£85**

## DIGITAL VOLTMETERS



DC Digital Voltmeter Solartron Type LM 1420.2.2 5μV-1 KV in 6 Ranges 0.05% DC Accuracy. 250KHz Counter Facility **£235**  
**DYNAMCO**  
DM 2022S 10μV-2kV. Max. reading 39999 Accuracy 0.02% **£245**  
D.V.M. DM2001 Mk. II **£125**  
D.V.M. DM2004 **£95**  
**SOLARTRON**  
Autoranging Digital Voltmeter LM 1480 Accuracy: 0.005% 10μV — 2kV DC. Resolution 1 part in 30,000. 20,000 M input resistance. 6 Operating modes. Long term accuracy stability. Suitable for the Standards Room, Laboratory or Industrial uses.

## RECORDERS

**RECORD ELECTRICAL**  
Single Pen Recorder 3" chart sensitivity 1 milliamp chart speed 1 and 6" per hr. Size 8" x 11" x 6" Offered complete with pen assembly. Listed at over £120 — this month's special price due to bulk purchase. 1mA version **£50**  
500μA version **£60**

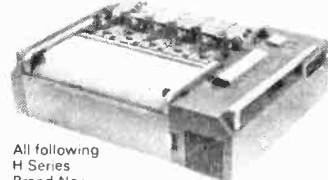

All following H Series Brand New  
**H3020** 8mA FSD 5Hz 80mm per channel. 0.1-25mm/sec chart drive inc. time and event marker **£80**, 3 pen **£130**  
**H320** 8mA FSD 100Hz transistorised amp. as above **£180**, 3 pen **£275**, 5 pen **£435**  
**H390** AC/DC recorder 5mA-5 amps. 5-volts-500V 20-5400mm/hr **£78**  
**H3100**, Miniature 1mA DC-80mm chart width 20-5400mm/hr **£44**

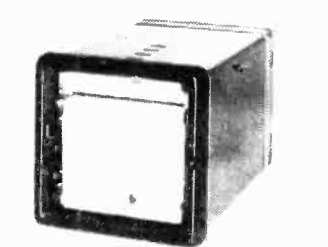

**H30**, Ten channel event recorder **£62**  
**RECORD** 500μA single channel 1 1/2" x 6" per hr. **£59**  
**RECORD** 1mA version **£49**  
**RUSTRACK** 88 1mA

## POWER SUPPLIES



Advance Power Module Type PM2. 15-30V at at 1 Amp **£19.50**  
**ADVANCE**  
Stabilised Power Supply (new) PP 1. 0-600V DC @ 300mA-200V DC Fixed 50mA 0-200V at 5mA 6.3V AC at 4A **£49.50**  
E.H.T. Power Supply PP12. Variable 0-5kV DC **£39.50**  
DC Supply Unit DC6. 24V 5A **£12.50**  
DC Supply Unit DC 22 AF. 24V 5A **£12.50**  
DC Supply Unit DC8 48V 4A **£15**  
Power Module PM 3. 30-50V 1Amp **£19.50**  
Power Module PM 2. 15-30V 1Amp **£19.50**  
Power Module PM 1. 4-15V 1Amp **£19.50**  
Power Module PM 18. 0-6V 5Amp **£30**  
Power Supply PM 4. 4-15V 3Amp **£26**  
Power Supply PM 5. 15-30V 3Amp **£26**  
D.C. Power Supply DC 6. 24V 5A **£75**  
D.C. Power Supply DC 8. 48V 4A **£15**  
Power Supply PP 13 **£50**  
Power Supply DC192A@1. 20V 16A **£30**  
Power Supply DC 192A/2. —10V @ 5.5A, —20V @ 2.5A +10V @ 13A **£30**  
Power Supply DCX 194. 6.3V (AC) @ 3.5A —40V @ 5A ± 24V @ 4A **£30**  
Power Supply DC 197 **£30**  
Power Supply DC 198 **£30**  
Power Supply DC 200 **£30**

**I.B.M.**  
Power Supplies Input 115V:  
3V 5A **£12** 12V 15A **£29**  
3V 8A **£15** 15V 2.5A **£15**  
6V 2A **£8** 20V 6A **£20**  
6V 6A **£12** 20V 15A **£25**  
6V 8A **£15** 30V 4A **£12**  
6V 12A **£18** 20V 7A **£20**  
6V 16A **£22** 36V 2A **£12**  
12V 5A **£22** 60V 6A **£49**

**A.P.T. ELECTRONICS**  
Power Supply SP 110. D16 D17 20V @ 4.5A +10V @ 300mA **£12**  
Power Supply SP 126 D 16 20V @ 4.5A, —10V @ 3A +10V @ 300mA **£12**  
Power Supply SP 126A D17 20V @ 4.5A, —10V @ 3A +10V @ 300mA **£14**  
Power Supply SP 135 D17 20V @ 9A, —10V @ 4A +10V @ 300mA **£18**

Shown on these pages are just a few samples of our huge stock. If the item you require is not shown please give us a ring.

**01-837 7781**

# ELECTRONIC BROKERS LIMITED

Carriage and packing charge extra on all items unless otherwise stated. Please note: All instruments offered are secondhand and tested and guaranteed 12 months unless otherwise stated. **ADD 8% VAT TO ALL PRICES**

WW—082 FOR FURTHER DETAILS

# BENTLEY ACOUSTIC CORPORATION LTD.

7A GLOUCESTER ROAD, LITTLEHAMPTON, SUSSEX. Tel. 6743  
ALL PRICES SHOWN INCLUDE V.A.T.

0B2	0.47	6BA6	0.41	6L6GC	0.68	12AV6	0.59	30P4MR	AL60	1.17	E8L21	2.34	EV31	0.52	UY41	0.53	AF121	0.39	BVZ13	0.33	OA211	0.86
0Z4	0.55	6BC8	0.70	6L7(M)	0.59	12AX7	0.39	30P12	AL70	0.70	E8L41	0.70	EV32	0.53	UY42	0.53	AF124	0.33	BVZ15	0.33	OC19	1.62
1A3	0.53	6BE6	0.41	6L8	0.64	12AY7	0.94	30P12	ATP4	0.59	EC53	1.17	EM81	0.87	UY85	0.22	AF125	0.22	CG12E	0.26	OC22	0.49
1ASGT	0.59	6BG6G	1.23	6L19	2.34	12BA6	0.53	30P19	AZ1	0.29	FC54	1.17	EM82	1.12	UY10	1.17	AF126	0.23	CG64H	0.26	OC23	0.49
1ATGT	0.76	6BH6	0.70	6L1D12	0.45	12BE6	0.59	30P4	AZ31	0.70	FC66	0.82	EM83	0.64	UY12	1.17	AF129	0.84	FSY11A	0.29	OC24	0.49
1B3GT	0.59	6BK6	0.64	6LD20	0.88	12BH7	0.59	30P11	BL1	0.29	FC88	0.82	EM84	0.76	UY16	1.17	AF138	0.84	FSY41A	0.29	OC25	0.49
1C2	0.82	6BK7A	0.70	6N7GT	0.70	12B7V	0.88	30P13	BL21	0.29	FC88	0.82	EM85	0.76	UY17	0.88	AF140	0.62	GD4	0.42	OC28	0.77
1G6	1.17	6BQ5	0.36	6PL12	0.40	12E1	3.51	30P14	CL33	1.87	FC32	1.76	EV31	0.47	UY20	1.17	AF156	0.71	GD5	0.36	OC29	0.81
1HSGT	0.70	6BQ7A	0.64	6P15	0.36	12S1GT	0.39	30P15	CV6	0.62	FC33	1.76	EV32	0.47	UY23	2.93	AF159	0.49	GD6	0.36	OC36	0.55
1L4	0.33	6BR7	1.17	6Q7G	0.59	12J7GT	0.70	35A3	CV63	0.88	FC33	1.76	EV33	0.47	UY24	0.88	AF160	0.62	GD4	0.42	OC38	0.77
1LD5	0.70	6BR8	1.76	6Q7GT	0.59	12K5	1.17	35C5	CV988	0.29	EC40	1.17	EV37	0.63	UY28	1.17	AF166	0.71	GD5	0.36	OC39	0.81
1LNS	0.70	6BS7	1.64	6Q7(M)	0.64	12K7GT	0.59	35D5	CY1C	1.17	EC81	0.40	EV38	0.47	UY30	1.17	AF179	0.49	GD6	0.36	OC38	0.55
1NSGT	0.76	6RW6	0.94	6R7G	0.70	12Q7GT	0.53	35L6GT	CY31	0.59	EC82	0.39	EV39	0.68	UY32	0.88	AF180	0.52	GD8	0.26	OC38	0.55
1RS	0.53	6BW7	0.82	6R7(M)	0.68	12Q7GT	0.53	35W4	D63	0.29	FC83	0.39	EV35	0.53	UY37	2.05	AF182	0.47	GD9	0.26	OC41	0.64
1S4	0.39	6BK6	0.29	6SA7	0.52	12S7	0.59	35Z3	DAC32	0.70	EC84	0.41	EZ40	0.59	UY38	0.76	AF183	0.20	GD11	0.26	OC42	0.81
1S5	0.35	6BY7	0.35	6SC7GT	0.39	12S7GT	0.47	35Z4GT	DAF96	0.59	EC85	0.47	EZ41	0.64	UY41	0.76	AF184	0.20	GD12	0.26	OC43	1.52
1U4	0.70	6BZ6	0.57	6SG7	0.52	12SH7	0.41	35Z5GT	DC90	0.70	EC86	1.00	EZ40	0.33	UY42	1.76	AF185	0.18	GD14	0.64	OC44	0.13
1U5	0.88	6C4	0.47	6SH7	0.52	12S17	0.52	42	DD4	1.17	EC88	0.52	EZ41	0.33	UY43	0.84	AF186	0.21	GD5	0.36	OC45	0.14
2D21	0.53	6CSG	0.59	6S4	0.64	12SK7	0.64	38B5	DF91	0.40	FC189	0.76	EZ40	0.47	UY44	1.17	AF187	0.18	GD6	0.36	OC46	0.20
2X2	0.64	6C6	0.47	6SK7GT	0.52	12SN7GT	0.70	50C5	DF96	0.59	EC804	0.70	F4	1.17	UY45	1.17	AF188	0.18	GD13	0.64	OC65	1.45
2GK5	0.70	6C9	1.17	6SQ7GT	0.53	0.70	50C6DG	1.46	DH63	0.59	EC807	0.70	FC4	1.17	UY47	0.70	AF189	0.20	GD16	0.26	OC46	0.20
3A4	0.59	6C86A	0.47	6U4GT	0.82	12SQ7GT	0.70	50F5H	DH76	0.53	EC80	0.53	FC4	1.17	UY49	0.76	AF190	0.20	GD17	0.26	OC67	1.14
3B7	0.53	6C12	0.39	6U7G	0.53	0.76	50L6GT	0.76	DH77	0.53	EC82	0.53	FC4	1.17	UY50	0.76	AF191	0.20	GD18	0.26	OC72	0.14
3D6	0.47	6C17	2.34	6V6G	0.20	12SR7	0.88	72	DH81	0.88	EC86	0.88	FC4	1.17	UY51	0.82	AF192	0.20	GD19	0.26	OC73	0.29
3Q4	0.70	6C24	0.70	6V6GT	0.53	14H7	0.64	77	DD32	0.76	EC87A	0.88	FC4	1.17	UY52	0.82	AF193	0.20	GD20	0.26	OC74	0.29
3QSGT	0.64	6C8GA	0.88	6X4	0.47	14S7	0.84	85A2	GZ0	0.30	EC88	0.52	GZ30	0.53	UY53	0.82	AF194	0.20	GD21	0.26	OC75	0.14
3S4	0.47	6C16	0.76	6X5GT	0.53	1.17	85A3	0.70	DK92	0.82	EC821	2.34	GZ32	0.59	UY54	0.82	AF195	0.20	GD22	0.26	OC76	0.20
3V4	0.82	6CL8A	0.94	6Y6G	0.94	19A05	0.59	90A9	DK96	0.70	EC835	1.46	GZ33	1.46	UY55	0.82	AF196	0.20	GD23	0.26	OC77	0.35
4CB6	0.64	6CM7	0.88	6Y7G	1.17	19B6G6	0.90	90C9	DL92	0.47	EC842	2.63	GZ34	0.70	UY56	0.82	AF197	0.20	GD24	0.26	OC78	0.20
5C68	0.64	6C05	0.88	7A7	1.17	1.17	90CV	2.81	DL94	0.82	EC848	0.82	GZ37	1.17	UY57	0.82	AF198	0.20	GD25	0.26	OC79	0.52
5R4GY	0.94	6CW4	1.17	7B6	0.88	19G6	7.02	90C1	DL96	0.64	EC848	0.82	GZ37	1.17	UY58	0.82	AF199	0.20	GD26	0.26	OC81	0.14
5TA	0.47	6D3	0.70	7B7	0.82	19H1	2.34	150B2	DM70	0.70	EC864	0.52	HAB80	0.70	UY59	0.82	AF200	0.20	GD27	0.26	OC82	0.29
5U4G	0.47	6D7	0.88	7F8	1.76	20D1	0.70	2155G	DM71	1.76	EC80	0.47	HL13C	0.59	UY60	0.82	AF201	0.20	GD28	0.26	OC83	0.29
5V4G	0.59	6DT6A	0.88	7H7	0.88	20D4	2.34	301	DM74	0.82	EC82	0.40	HL13D	0.70	UY61	0.82	AF202	0.20	GD29	0.26	OC84	0.14
5Y3GT	0.53	6EW6	0.88	7R7	0.82	20P2	0.88	302	DW4/350	1.17	EC83	0.82	HL23DD	0.70	UY62	0.82	AF203	0.20	GD30	0.26	OC85	0.14
5Z3	0.88	6E5	1.17	7V7	1.76	20L1	1.29	303	DY87/6	0.41	EC84	0.70	HL30	0.88	UY63	0.82	AF204	0.20	GD31	0.26	OC86	0.14
5Z4G	0.53	6F1	0.88	7Y4	0.88	20P1	0.64	305	DY802	0.41	EC85	0.70	HL41	1.17	UY64	0.82	AF205	0.20	GD32	0.26	OC87	0.14
5Z4GT	0.53	6F6G	0.59	7Z4	0.94	20P3	0.84	307	EM0CC	2.57	EC86	0.47	HL41D	1.17	UY65	0.82	AF206	0.20	GD33	0.26	OC88	0.14
6/30L2	0.70	6F12	0.43	9BW6	0.82	20P4	1.17	956	E80F	1.64	EC87	1.76	HL42	2.34	UY66	0.82	AF207	0.20	GD34	0.26	OC89	0.14
6A8G	1.46	6F13	0.82	9D7	0.76	20P5	1.52	1821	E83F	1.52	EC88	0.47	HL42DD	2.34	UY67	0.82	AF208	0.20	GD35	0.26	OC90	0.14
6A7C	0.57	6F14	0.88	10C2	0.76	25A6G	0.70	4033X	E88CC	0.88	EC89	0.47	HL43	2.34	UY68	0.82	AF209	0.20	GD36	0.26	OC91	0.14
6AG5	0.32	6F15	0.76	10D1	0.82	25L6G	0.70	5702	E92CC	0.70	EC90	0.47	HL44	2.34	UY69	0.82	AF210	0.20	GD37	0.26	OC92	0.14
6AH6	0.70	6F18	0.46	10E7	0.88	25V5	0.84	5763	F1R0CC	0.82	EC91	0.47	HL45	2.34	UY70	0.82	AF211	0.20	GD38	0.26	OC93	0.14
6A15	0.76	6F23	0.82	10F1	0.88	25V5G	0.82	6057	F1R0F	1.17	EC92	0.47	HL46	2.34	UY71	0.82	AF212	0.20	GD39	0.26	OC94	0.14
6A18	0.39	6F24	1.00	10F3	1.17	25Z4G	0.47	6080	F1R2C	1.46	EC93	0.47	HL47	2.34	UY72	0.82	AF213	0.20	GD40	0.26	OC95	0.14
6AK5	0.47	6F25	1.17	10F9	0.76	25Z5	0.94	6067	F1L14	0.82	EC94	0.47	HL48	2.34	UY73	0.82	AF214	0.20	GD41	0.26	OC96	0.14
6AK6	0.70	6F26	0.35	10F18	0.64	25Z6G	0.82	7193	EASO	0.32	EC95	0.47	HL49	2.34	UY74	0.82	AF215	0.20	GD42	0.26	OC97	0.14
6AK8	0.45	6F28	0.78	10L14	0.53	28D7	1.17	7475	EAB7E	1.17	EC96	0.47	HL50	2.34	UY75	0.82	AF216	0.20	GD43	0.26	OC98	0.14
6AL5	0.23	6F32	0.59	10LD11	0.82	30A5	0.76	9002	EAC80	0.88	EC97	0.47	HL51	2.34	UY76	0.82	AF217	0.20	GD44	0.26	OC99	0.14
6AM8A	0.64	6G6G	0.59	10LD12	20.47	30C1	0.47	9006	EC91	0.45	EC98	0.47	HL52	2.34	UY77	0.82	AF218	0.20	GD45	0.26	OC100	0.14
6AN8	0.82	6CH8A	0.88	10P12	0.45	30C5	0.82	A1834	EC92	1.17	EC99	0.47	HL53	2.34	UY78	0.82	AF219	0.20	GD46	0.26	OC101	0.14
6AQ5	0.53	6C15	0.76	10P13	0.88	30C7	0.84	A2134	FAF42	0.88	EC99	0.47	HL54	2.34	UY79	0.82	AF220	0.20	GD47	0.26	OC102	0.14
6AQ8	0.47	6G7U	0.88	10P14	2.34	30C8	0.82	A3042	FAE801	0.88	EC98	0.47	HL55	2.34	UY80	0.82	AF221	0.20	GD48	0.26	OC103	0.14
6AR5	0.70	6H6GT	0.29	10P18	0.49	30F5	0.88	AC2PEN	EB34	0.29	EC98	0.35	KTW62	1.17	UY81	0.82	AF222	0.20	GD49	0.26	OC104	0.14
6AR6	1.17	6J5GT	0.53	12A6	1.17	30F11	0.78	AC2PENDD	EB91	0.23	EC98	0.41	KTW62	1.17	UY82	0.82	AF223	0.20	GD50	0.26	OC105	0.14
6AS7	1.17	63C	0.35	12AC6	0.82	30FL2	0.78	AC2PENDD	FBC41	0.88	EC98	1.46	MH14	0.82	UY83	0.82	AF224	0.20	GD51	0.26	OC106	0.14
6AT6	0.53	617G	0.35	12D6	0.76	30FL12	1.05	AC6/PEN	FBC81	0.88	EC99	0.53	MH16	1.17	UY84	0.82	AF225	0.20	GD52	0.26	OC107	0.14
6AU6	0.53	617(M)	0.53	12A6E	0.76	30FL13	0.64	AC6/PEN	EB90	0.35	EC90	0.41	MKT4	1.17	UY85	0.82	AF226	0.20	GD53	0.26	OC108	0.14
6AV6	0.53	6J0A	0.88	12A76	0																	



TRANSISTORS						I.C.s 74 SERIES						JETS SUPER BARGAIN PACKS							
AC107	0.16	BC158	0.11	CV7464	0.10	2G106	0.21	SN7400	0.14	SN7413	0.30	SN7442	0.73	SN7497	0.75	No.	Ctry.	Contents	Price
AC126	0.16	BC159	0.13	CV7594	0.25	2G306	0.44	SN7401	0.14	SN7416	0.30	SN7450	0.15	SN7493	0.73	J1		1 Pre-amp component kit plus data	0.65
AC127	0.16	BC171	0.16	CV7648	0.30	2G345A	0.18	SN7402	0.14	SN7417	0.29	SN7460	0.15	SN7494	0.80	J2		3 Transistors AF115 new and marked	0.65
AC128	0.12	BC172	0.16	CV8762	0.40	2G402	0.25	SN7403	0.14	SN7423	0.40	SN7472	0.30	SN74121	0.49	J4		4 Transistors 2N726 new and marked	0.65
AC138	0.20	BC173	0.18	MOS33	0.30	2N526	0.16	SN7404	0.14	SN7425	0.39	SN7473	0.41	SN74122	0.70	J5		8 Zener diodes top hat type 7.5 volt	0.65
AC141	0.20	BC184	0.18	MJE4102	0.12	2N697	0.15	SN7405	0.15	SN7430	0.14	SN7474	0.40	SN74123	0.70	J7		50 Metres con/wire mixed colours	0.65
AC142	0.20	BC208	0.12	MJE2021	0.85	2N715	0.35	SN7406	0.39	SN7432	0.39	SN7476	0.42	SN74151	1.05	J8		25 Metres con/wire 4 Metres 60/40 solder	0.65
AC153	0.22	BC209	0.13	MJE2955	0.95	2N726	0.25	SN7407	0.37	SN7433	0.40	SN7480	0.16	SN74153	0.95	J9		100 Resistors HI/STAB 1/4w mixed values	0.65
AC154	0.22	BC212L	0.14	MJE3055	0.60	2N753	0.55	SN7408	0.26	SN7440	0.15	SN7486	0.34	SN74195	1.07	J10		100 Resistors HI/STAB 1/4w mixed values	0.65
AC167	0.21	BC213L	0.12	NKT1162	0.25	2N1303	0.16	SN7409	0.23	SN7441	0.70	SN7490	0.50	SN74196	1.20	J12		250 Resistors mixed values	0.65
AC168	0.27	BC214L	0.14	NKT1164	0.25	2N1304	0.19	<b>930 SERIES LOGIC I.C.s</b>						MC948	0.25	J14		100 Capacitors miniature mixed values	0.65
AC169	0.16	BC301	0.30	NKT1212	0.20	2N1305	0.19	MC930	0.15	MC933	0.15	MC945	0.30	MC962	0.15	J15		5 Terminal blocks brand new 12 way	0.65
AC176	0.15	BC337	0.15	NKT221	0.17	2N1309	0.25	MC932	0.15	MC944	0.16	MC946	0.14	MC9093	0.40	J18		12 Standard crocodile clips	0.65
AC176	MP	BC211	0.28	NKT224	0.15	2N1754	0.30	SN741	0.35	SN76115	1.20	TCA270B	3.00	MC1103L	1.50	J19		12 Screwdrivers 5 inches long	0.65
AC128	0.25	BD131	0.40	NKT270	0.15	2N2484	0.30	LM380N	0.95	LM1310	1.25	<b>TESTED S.C.R.s</b>				J20		1 Pack nuts & bolts self tappers, etc.	0.65
AC177	0.26	BD132	0.40	NKT278	0.15	2N2923	0.16	<b>TESTED S.C.R.s</b>				J22		20 Volume controls lin & log mixed values	0.65				
AC178	0.25	BD131	MP	OC22	0.50	2N2924	0.18	50 PIV 1AMP TO-5 CASE 0.26	50 PIV 3AMP TO-66 CASE 0.29	J23		75 Syn/rubber grommets mixed sizes	0.65						
ACV17	0.28	BD132	0.75	OC28	0.80	2N2925	0.15	100 PIV 1AMP TO-5 CASE 0.31	100 PIV 3AMP TO-66 CASE 0.29	J26		20 Screw on rubber feet 1/4inch dia approx	0.65						
ACV18	0.22	BD139	0.70	OC35	0.45	2N2926	0.14	200 PIV 1AMP TO-5 CASE 0.32	200 PIV 3AMP TO-66 CASE 0.35	J26		1 Pack marker sleeve mixed colours & sizes	0.65						
ACV19	0.22	BD140	0.70	OC36	0.55	2N2926Y	0.12	400 PIV 1AMP TO-5 CASE 0.37	400 PIV 3AMP TO-66 CASE 0.47	J27		5 lengths ferrite rod mixed flat & round	0.65						
ACV20	0.20	BD243	0.85	OC44	0.17	2N2926R	0.11	600 PIV 1AMP TO-5 CASE 0.49	600 PIV 3AMP TO-66 CASE 0.57	J28		20 Tag strips assorted lengths	0.65						
ACV21	0.18	BD244	0.85	OC45	0.14	2N2926O	0.11	800 PIV 1AMP TO-5 CASE 0.78	800 PIV 3AMP TO-66 CASE 0.70	J29		4 Micro switches brand new	0.65						
ACV27	0.20	BF167	0.24	OC70	0.11	2N2926B	0.11	<b>THYRISTOR BT109 CON/BRI</b>				J29		20 Preset pots lin & log mixed	0.65				
ACV28	0.22	BF181	0.33	OC71	0.11	2N3053	0.19	<b>BRIDGE RECTIFIERS</b>				J32		20 Capacitors can type mixed values	0.65				
AD140	0.53	BF182	0.40	OC72	0.15	2N3054	0.50	50 RMS PLASTIC CASE 0.40	<b>OPTOELECTRONICS</b>				J33		50 Ceramic plate capacitors mixed values	0.65			
AD142	0.53	BF183	0.40	OC81	0.17	2N3055	0.50	100 RMS PLASTIC CASE 0.45	ORP 12 BRAND NEW	0.58	J34		1 Pack copper clad paxolin board	0.65					
AD149	0.55	BF194	0.12	OC200	0.28	2N3702	0.12	200 RMS PLASTIC CASE 0.49	ORP 60 BRAND NEW	0.56	J35		20 Fuse holders mixed	0.65					
AD161	0.43	BF195	0.30	OC201	0.32	2N3703	0.12	400 RMS PLASTIC CASE 0.52	OCF 71 BRAND NEW	0.54	J36		8 Metres multi/core solder 60/40 22swg	0.65					
AD162	0.43	BF196	0.15	OC202	0.27	2N3704	0.14	<b>UJT 2N6027 BRAND NEW</b>				J37		10 3.5mm Jack sockets chrome	0.65				
AD161	MP	BF197	0.16	OC203	0.29	2N3705	0.13	<b>ELECTROLYTICS 0.02/250v 4 0/64v 4 7/16v 6 8/40v</b>				J38		8 Sockets 5 pin & 2 pin	0.65				
AD162	0.85	BF200	0.50	OC204	0.28	2N3707	0.14	10/35volt 33uF/35v 40uF/16v ALL ONE PRICE 0.7 each	<b>TRIAIC 6AMP 400v CASE 66</b>				J39		2 Relays 12 & 24 volt	0.65			
AF115	0.26	BF234	0.39	OC445K	0.20	2N3710	0.10	47uF/35v 100uF/10v 0.8 each 125uF/16v 220uF/40v 680	<b>0.85</b>				J40		1 Pack of component boards ICs Transistors etc	0.65			
AF116	0.26	BU105	2.00	SGS26920	1.15	2N3711	0.10	uF/16v 6.3v/1500uF 0.12 each 16.16uF/500V 32.32uF/275v	<b>0.25 each 32.32uF/450v 0.35 each BARGAIN PRICES.</b>				<b>J PACKS ONLY ADD 10% TO TOTAL ORDER PLEASE FOR POST &amp; PACK</b>						
AF124	0.33	BFX29	0.28	SGS26942	1.14	2N3713	1.20	<b>POLYCARBONATE. 0.01uF/250v 0.033uF/250v10uF/250v</b>				<b>PAPST TAPE MOTOR 220v 50HZ E.50 p&amp;p 25p</b>							
AF125	0.31	BFX84	0.33	SGS26949	1.15	2N3094	0.33	0.1uF/250v 0.22uF/250v all 0.5 each. 1uF/250v 0.12 each.	<b>0.03 each QUOTATION GIVEN FOR 1000 of</b>				<b>AMPLIFIER 9 volt 500 Mw 0.95 p&amp;p 10p</b>						
AF178	0.50	BFX85	0.33	SGS27022	1.18	2N3905	0.31	<b>POLYESTER 0.0015/400v 0.022/160v 0.22/250v 6 8/400v</b>				<b>TELEPHONE DIALS BRAND NEW £1.00 p&amp;p free</b>							
ASV51	0.26	BFY50	0.20	SU203	0.65	2N3905	0.30	<b>METALISED FILM CAPACITORS. 0.047uF/250v 0.15/250V</b>				<b>P.A.R. BISTABLE RELAY LATCHING 24v DC4 C/O CONTACTS</b>							
BC107	0.11	BFY52	0.16	TK100	0.75	2N3908	0.30	<b>0.04 each</b>				<b>0.55</b>							
BC108	0.11	BFY81	0.65	THS91M	0.33	2N4059	0.15	<b>CAPACITORS 0.0015/350v 0.0047/500v 0.047/400V</b>				<b>RELAY T.M.C. MINIATURE 3 300 ohms 2 pole 4 way 0.55</b>							
BC109	0.11	BSY38	0.20	TK217	0.30	2N4287	0.20	<b>1uF/180v 0.25uF/250v 125uF/10v all 0.05 each</b>				<b>RELAY T.M.C. MINIATURE 3 300 ohms 2 pole 4 way 0.55</b>							
BC142	0.30	BSY39	0.20	V405A	0.25	2N4289	0.20	<b>SPECIAL OFFER I.C.s</b>				<b>SWITCH 4 POLE 2 CHANGE/OVER 0.15.</b>							
BC143	0.30	BSY40	0.31	V10/50	0.40	2N4291	0.22	<b>BULK PURCHASE</b>				<b>OUR BONAZZA CAPACITORS PACK IS STILL AVAILABLE ONLY £1.50</b>							
BC147	0.10	BSY41	0.31	Z116	0.75	2N4293	0.19	<b>BRAND NEW 14 PIN</b>				<b>100 MIXED VALUES &amp; TYPES VALUED AT OVER £5 (LATEST TYPES)</b>							
BC148	0.10	C111	0.50	ZTX107	0.12	25322	0.48	<b>OECADE COUNTERS 2</b>				<b>TWIN V/U METERS PLASTIC APPROX 40mm BY 80mm BRAND</b>							
BC149	0.10	C111E	0.55	ZTX302	0.17	25712	0.46	<b>SN7290 FOR ONLY</b>				<b>NEW READS 20 TO 1 MINUS ZERO TO 3 PLUS. L/R BARGAIN ONLY</b>							
BC157	0.11	CV5441	0.20	ZTX502	0.17	25745	0.45	<b>£1.00.</b>				<b>£2.95.</b>							
<b>DIODES</b>						<b>SPECIAL OFFER RESISTORS</b>						<b>MINIATURE EDGE LEVEL METER LOTS OF USES ONLY 0.95</b>							
AA119	0.06	BY127	0.12	OA202	0.07	IN4003	0.05	<b>CARBON FILM CR 75 TYPE 1M2. 2M2.</b>				<b>FREE OFFER ONE J PACK OF YOUR OWN CHOICE WITH ALL ORDERS</b>							
2/AA119	0.09	BY164	0.38	IN34A	0.08	IN4004	0.06	<b>10% 10 120 470K etc 200 mixed for only</b>				<b>VALUED AT OVER £5</b>							
AA215	0.11	BYX38/300	IN202	0.09	IN4005	0.07	<b>£1.25.</b>				<b>PLEASE ADD 10p MIN. TO ALL ORDERS WHERE NOT STATED</b>								
BA30	0.10	BY2213	0.46	IN252	0.19	IN4006	0.08	<b>LOW LOSS CO/AX CABLE 17p A METRE TWIN SPEAKER CABLE 8p</b>				<b>VAT INCLUDED AT CURRENT RATE</b>							
BA111	0.18	BY2213	0.28	IN914	0.06	IN4007	0.09	<b>A METRE</b>				<b>OVERSEAS POST AT COST</b>							
BA112	0.18	BZY95	0.15	IN984B	0.10	IN4151	0.06					<b>MAIL ORDER DEPT. ONLY</b>							
BAX7B/1	0.10	OA10	0.12	IN1124	0.09	IN4148	0.04					<b>(Callers by appointment)</b>							
BAY31	0.14	OA47	0.10	IN3064	0.10	IN4244	0.07					<b>J.E.T. ELECTRONICS</b>							
BAY74	0.12	OA81	0.08	IN4001	0.05	IS3036A	0.15					<b>90A MAWNEY ROAD, ROMFORD, ESSEX RM7 7DA</b>							
<b>ZENER DIODES</b>						<b>SPECIAL OFFER</b>						<b>SPECIAL OFFER</b>							
<b>400 mW 2.33v ALL 0.9 each</b>						<b>10 2N6027 P U T</b>						<b>10 2N6027 P U T</b>							
<b>1Watt 1.5 &amp; 2.33v ALL 0.19 each</b>						<b>FOR ONLY £1.25.</b>						<b>FOR ONLY £1.25.</b>							

# 8 DECADE RESISTANCE BOX

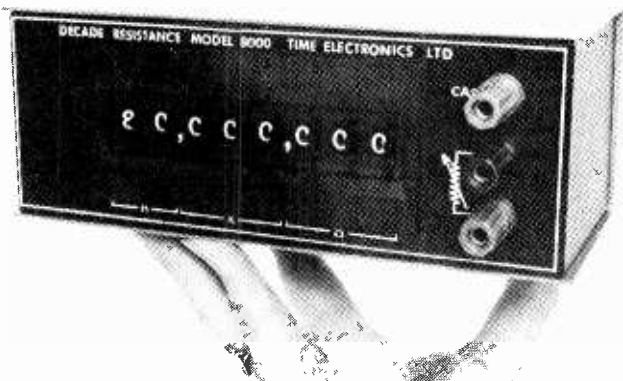

TIME ELECTRONICS LTD.  
Botany Industrial Estate  
Tonbridge Kent  
Tel. Tonbridge (07322) 5993, 3 lines

- ★ 1Ω -100MΩ
- ★ 0.1% Accuracy
- ★ Colour coded digits, Ω yellow, KΩ white, MΩ red.

WW—083 FOR FURTHER DETAILS

## INDUSTRIAL PRICES FOR THE HOBBYIST ALL 'BIG NAME' BRANDED GOODS SAME DAY SERVICE MONEY BACK GUARANTEE

LINEAR 1/C'S	DIODES	ZENER DIODES	
709C 0.24	IN4001 4	BZY88 400mW	
710C 0.24	IN4002 4	Voltagess 3.3v—30v	
741C (8P in Minidip) 0.20	IN4003 5	6p	
CA3046 0.50	IN4004 5	<b>AUDIO 1/C'S</b>	
LM309K 1.25	IN4005 6	IN4006 6	TAA661B 1.0
<b>COS/MOS</b>		IN4006 6	CA3089E 1.5
CD4001 0.24	IN914 2	OA47 4	CA3090Q 3.0
CD4009 0.40	OA47 4	OA200 6	CA3028 1.0
CD4011 0.20	OA200 6	IN4148 1.5	CA3048 2.0
CD4012 0.20	IN4148 1.5		
CD4018 1.80			
CD4029 1.50			
TRANSISTORS			
BC107 0.07	BFY50 0.14	2N696 0.15	
BC108 0.07	BFY51 0.12	2N697 0.20	
BC109 0.07	BFY52 0.15	2N706 0.10	
BCY70 0.09	BFY90 0.60	2N930 0.18	
BCY71 0.09	BSY95A 0.10	2N1302 0.16	
BCY72 0.09	C426 0.28	2N1303 0.12	
BFX29 0.16	40360 0.40	2N1304 0.20	
BFX84 0.16	40361 0.40	2N1305 0.20	
BFX85 0.16	40362 0.40	2N2160 0.50	
BFX86 0.16	40669 0.80	2N2646 0.40	
BFX87 0.16	40673 0.50	2N3053 0.15	
BFX88 0.16	40602 0.40	2N3054 0.40	
BC237 0.08		2N3055 0.40	

TERMS: CWO—10p POST & PACKING—ADD 25% VAT

### ROWNSGEM LTD.

Rosebank Parade, Plough Road, Yateley, Camberley, Surrey  
Phone No. 0252 871388

THE PROFESSIONAL ORGANISATION FOR THE 'HOBBYIST'



# Samson's

(ELECTRONICS) LTD.

9 & 10 CHAPEL ST., LONDON, N.W.1  
01-723 7851 01-262 5125

ADJACENT TO EDGWARE ROAD MET. LINE STATION

## CURRENT RANGE OF NEW L.T. TRANSFORMERS FULLY SHROUDED TERMINAL BLOCK CONNECTIONS ALL PRIMARIES 220/240V

Type	Sec Taps	Amperes	Price	Postage
1A	25:33-40-50v	15	<b>£15.50</b>	£1.00
1B	25:33-40-50v	10	<b>£13.25</b>	£1.00
1C	25:33-40-50v	6	<b>£9.50</b>	85p
1D	25:33-40-50v	3	<b>£8.25</b>	85p
2A	4:16-24-32v	12	<b>£11.25</b>	£1.00
2B	4:16-24-32v	8	<b>£8.75</b>	85p
2C	4:16-24-32v	4	<b>£5.25</b>	65p
2D	4:16-24-32v	2	<b>£3.85</b>	60p
3A	24-30-36v	10	<b>£10.00</b>	85p
3B	24-30-36v	5	<b>£8.25</b>	65p
3C	24-30-36v	2	<b>£3.85</b>	60p
4A	12-20-24v	20	<b>£13.25</b>	£1.00
4B	12-20-24v	10	<b>£8.25</b>	85p
4C	12-20-24v	5	<b>£5.25</b>	65p
4D	3-12-18v	20	<b>£11.25</b>	£1.00
5A	3-12-18v	10	<b>£7.75</b>	85p
5B	3-12-18v	5	<b>£4.95</b>	65p
5C	3-12-18v	2	<b>£4.95</b>	65p
6A	48-56-60v	1	<b>£13.25</b>	£1.00
6B	48-56-60v	2	<b>£8.50</b>	85p
7A	6-12v	20	<b>£12.50</b>	£1.00
7B	6-12v	10	<b>£5.25</b>	65p
7C	6-12v	5	<b>£3.85</b>	60p
8A	17-32v	8	<b>£8.50</b>	85p
9A	12-24v	1	<b>£2.70</b>	50p
10A	9-15v	2	<b>£2.70</b>	50p
11A	8-0-8v	2	<b>£2.70</b>	50p

## 9 INCH FLYING LEADS ALL PRIMARIES 240V

Type No	Sec. Volt	Tap	Amperes
1	24-30-36	20	20
2	12-20-24	30	30
3	3-12-18	30	30
4	6-12	50	50

## CENTRE TAPPED L.T. TRANSFORMERS

Fully shrouded Terminal block connections Pri 220-240V. Screen Tapped sec 30-25-0-25-30v 2 amps **£4.95**, carr 60p 36-25-0-25-36v 5 amps **£9.95**, carr 85p 28-0-28v 10a **£12.50**, carr £1

PLEASE ADD 8% V.A.T. TO ALL ORDERS INC. CARR

## STEP DOWN AUTO TRANSFORMERS

Open type Terminal block connections Tapped 0-25-35-45-55-65-75-85-95-240v 600 watts conservatively rated. Size 5½" x 4½" x 4½" **£4.75**. Carr 75p 300 watts **£3.00**. Carr 50p 200 watts **£2.00**. Carr 50p Gardners enclosed type auto transformers Tapped 0-110-115-210-230-250v conservatively rated 60 watts Totally enclosed **£2.00**. P.P 50p Partridge mains booster transformer Tapped 0-220-230-240-250v 500 watts open type terminal block connections **£3.00**. Carr 50p Drake isolation transformer PRI 200-220-240V. Sec 110v 50 watts. Open Type Terminal block connections **£2.75**. Carr 50p

Other Types Available: 80-1500 watts fully shrouded with American socket outlet and 6 ft mains lead. Let us know your requirements. Lists available

## GRESHAM MULTI-TAPPED L.T. TRANSFORMERS

C Core Types No 1 Pri 200-220-240v Sec 16.3v 1 amp Twice 10v 1 amp twice 22.5-25-26-28 8v 5 amps 26.5v 2.5A, 23.9v 1A, 6.3v 2A, 145-0-145v 200M/A All separate winds **£5.50**, carr £1.00 No 2 Pri 200-220-240v Sec 16.3v 1 amp twice 10-12-13-16-18-19-22-24-25v 6 amp twice 26-28-29-32-34-35 38-40-41v 2 amps 16-18-19-20-22-25v 200M/A twice 16-18-20-22v 200M/A 70-72-74v 200M/A Separate windings **£10.00**, carr £2.00 No 3 Pri 220-240v Scr Sec 18-0-18v 12.5 amps **£8.50**, carr £1.50

## PARMEKO L.T. TRANSFORMERS

Open types Pri 110-220-240V Sec 30v 5.5 amps and 12v 2.2 amps Table top connections **£4.95**, P.P 75p Pri 240v Sec 26v 10 amps and 12v 0.1 amps Table top connections **£5.50**, P.P 75p Potted types Pri 115-230v Sec 24-30-32v 2 amps **£2.75**, P.P 35p Pri 220-240V Sec 50v 0.4 amps **£1.50**, P.P 35p Pri 115-230v tapped 40-45 50v 5 amps **£8.50**, P.P 75p Pri 115-220-230v Sec 6v 6v twice and 5v 6A **£4.75**, Carr 75p Pri 110-220-240-250v Scr Sec 2-0-2v 24 amp 6.4v 0.5 amp High voltage insulation **£5.50**, carr £1.25

## CLAUDE LYONS REGULAC V/TRANSFORMERS 400Hz

Input 120v 400Hz, output 0-135v 6 amps Enclosed base mounting type with control knob. **£3.50**, carr 75p

## H.T. SMOOTHING CHOKES

Gresham Potted type 9H 500M/A 5kv working Size 9x8x8 inches **£8.50**, carr £2 C Core types 10H 350M/A **£3.50**, carr £1 20H 180M/A **£2.50**, carr 75p 5H 180M/A **£1.75**, P.P 50p Potted types 15H 180M/A **£2.00**, carr 75p 10H 250M/A **£2.00**, carr 75p 20H 40M/A 75p P.P 25p Parmeko Potted type 10H 180M/A **£2.00**, carr 50p Swinging type 5H 0.04A-4H 0.25A 2H 250M/A 1.4kv WKG **£1.00**, P.P 35p 50H 25M/A **£1.00**, P.P 25p 10H 75M/A **75p**, P.P 25p 40H 40M/A 4kv WKG **£1.00**, P.P 35p 50H 25M/A **£1.00**, P.P 25p 5H 450M/A **£2.00**, P.P 75p 100H 20M/A **£2.00**, P.P 35p

## OIL-FILLED BLOCK CAPACITORS

MFD	DCV WKG	PRICE
10	500V 60 C	75p
8	350V 70 C	50p
8	200V 71 C	35p
4	1250V 60 C	<b>£1.00</b>
4	1000V 71 C	65p
2	5000V 60 C	<b>£1.25</b>
2	2000V 60 C	65p
1	2500V 70 C	65p
1	2000V 60 C	60p
1	600V 70 C	25p
0.5	2500V 70 C	50p
0.1	3000V 85 C	50p

The above capacitors are either TCC or Dubilier. Please add postage 10p ea 1.4 MFD. 20p ea 8-10 MFD

Dubilier metalised caps block type 50 MFD 150V WKG 75p P.P 20p TCC Plastapack 0.5 MFD 350V DC WKG 30p P.P 15p Jensen 0.25 MFD 7000V WKG AC 50-60 HZ. **£2.00**, P.P 75p

## L.T. TRANSFORMERS BY FAMOUS MAKERS

No 1 GARDNERS Potted type Pri 220-240v Scr Sec 24v in one volt steps 4 amps **£4.95**, P.P 75p No 2 Pri 220-240v Scr Sec 24v 1 amp and 24v 0.75 amp **£3.00**, P.P 75p No 3 Pri 110-220-240v Scr Sec tapped 4-5-3.6-3v 10-12-22-24-26v 1 amp and 55v 1 amp **£3.25**, P.P 75p No 4 Pri 115-220-240v Scr Sec 4-5v 10 Amps Intermittent **£1.50**, P.P 35p No 5 OPEN TYPES Pri 110-220-240 Scr Sec 17-0-17v 1.2 amp and 36v 50M/A No 6 Pri 220-240v Scr Sec 55v 1/2 amp **£2.00**, P.P 50p C Core Table Top connections No 7 Pri 220-240v Sec 2.65-0.2 65v 42 amps **£4.50**, P.P 75p No 8 Pri 110-220v Sec 2.5v 10 amps and 2.5v 5 amps twice **£3.50**, P.P 75p No 9 Pri 220-240v Sec 24v 3 amps **£3.00**, P.P 50p No 10 Pri 220-240v Sec 25-0-25v 154M/A and 7v 1.35 amps **£1.75**, P.P 25p No 11 Pri 220-240v Sec 36v 350M/A **£1.00**, P.P 25p No 12 Pri 230v Sec 1 25-0-1 25v 10 amps **£2.00**, P.P 35p

## HILGER AND WATTS

200-210-220-230-240-250-270-320v Pri Sec 12v 16 74 amps open type Terminal connections **£6.95**, carr £1 Well known makes. Open type Terminal block connections No 1 Pri 110-205-220-235v Scr Sec 12v 2.2A and 12v 1A and 200v 35M/A **£2.00**, P.P 50p No 2 Pri 112-205-225-245v Scr Sec 17v 2A and 6.3v 0.5A **£1.75**, P.P 50p No 3 Pri 220-240v Scr Sec tapped 30-31v 3A **£2.50**, P.P 50p No 4 Pri 110-220-240v Scr Sec 33v 300M/A and 6.3v 4A and 160v 80M/A **£2.00**, P.P 50p

## POTTED H.T. TRANSFORMERS BY FAMOUS MAKERS

No 1 Pri 110-220-240v Scr Sec tapped 408-200-200-408v High taps 165M/A Low taps 500M/A **£5.50**, carr £1 No 2 Pri 115-220-240v Scr Sec 400-0-400v 400M/A **£5.75**, carr £1 No 3 Pri 115-220-240v Scr Sec 350-0-350v 200M/A 6.3v 6A, 5v 3A **£4.50**, carr £1 No 4 Pri 115-220-240v Scr Sec 330-0-330v 200M/A 6.3v 6A, 5v 3A **£4.00**, carr £1 No 5 Pri 220-240v Sec 250-0-250v 320M/A 6.3v 10A **£4.50**, carr £1 No 6 Pri 110-220-240v Scr Sec 1875v 60M/A and 500v 31M/A **£5.00**, carr £1 No 7 Pri 110-220-240v Scr Sec 230v 200M/A 6.3v 7A **£3.00**, carr 75p No 8 Pri 220-240v Scr Sec 250-0-250v 75M/A 6.3v 2A, 6.3v 1A, 6.3v 1A **£3.00**, carr 75p No 9 Pri 220-240v Scr Sec tapped 170-180-190 200-210-220-230-240v 175M/A 6.3v 3A, 6.3v 2A, 6.3v 2A **£3.75**, carr 75p No 10 Pri 220-240v Scr Sec 250-0-250v 100M/A 6.3v 3A, 6.3v 3A, 5v 2A **£3.00**, carr 75p No 11 Pri 220-240v Scr Sec 250-0-250v 70M/A 6.3v 2A, 6.3v 1A **£2.50**, carr 75p No 12 Pri 220-240v Scr Sec 250-0-250v 70M/A 6.3v 2A, 6.3v 1A **£2.50**, carr 75p No 13 Pri 115-220-240v Scr Sec 240-0-240v 60M/A 6.3v 1A, 6.3v 3A **£2.50**, carr 75p Open types No 1 Pri 220-240v Scr Sec 250-0-250v 50M/A, 6.3v 1A, 6.3v 0.7A 6.3v 0.6A C Core **£1.75**, P.P 50p No 2 Pri 230v Scr Sec 125-0-125v 125M/A **£1.50**, P.P 50p No 3 Pri 230v Scr Sec 350v 40M/A, 850v 15M/A, 6.3vct 4A, 6.3v 0.6A **£3.00**, P.P 75p No 4 Pri 110-220-240v Scr Sec 160v 80M/A, 33v 100M/A, 6.3v 4A, No 5 Pri 110-220-240v Scr Sec 250v 80M/A, 15v 2A, 6.3v 4A, No 6 Pri 230v Scr Sec tapped 890-710-0-710-890v 120M/A **£3.50**, carr 75p No 7 Pri 110-220-240v Scr Sec tapped 470-490v 350M/A **£4.50**, carr £1 No 8 Pri 220-240v Sec tapped 150-160v 3amp **£6.00**, carr £1.50 No 9 Pri 110-220v Sec 250-0-250v 60M/A 24v 3A 6.3v 3A, 5v 2A, 2.8-0.2 8v 28 amp C Core **£6.00**, carr £1 No 10 Pri 220-240v Scr C Core Sec tapped 370-390-410v 60M/A **75p**, P.P 25p Pri 200-220-240v Sec 400-230-0-230-400v 120M/A 6.3v 4A, 6.3v 3A, 6.3v 3A, 5v 3.5A Enclosed type **£4.00**, carr 75p

## H.T. TRANSFORMERS

Gresham Pri 240v Sec 2300v 10M/A 6.3v 5A, Table Top connections Size 5x3x3 inches **£3.00**, carr 50p Gardners Pri 110-220-240v Sec 1200v 7M/A DC 20M/A RMS 6.3v 1A, 6.3v 1A **£4.00**, carr 50p Potted type Pri 220-240v Sec tapped 300-330v 25M/A **£8.50**, carr £1 Pri 220-240v Sec 2000v 10M/A 6.3v 1.5A 2.4v 2A **£5.00**, carr 75p

# The SECOND-USER Computer Specialists

## Peripherals and Systems for Data Processing

### Systems, Equipment and Components

### COMPUTER SALES AND SERVICES

### Peripherals and Systems for Data Processing

## Mini-Computer Exchange

Our Mini Computer Exchange has systems for immediate delivery at greatly reduced prices. A few examples of our stock include

- PDP8L 8K Processor (pictured below)
- PDP11/15 4K Processor
- PDP11/20 24K Processor
- RF11/RS11 Discs
- DEC High Speed Reader PDP8L
- PDP8E Modules — Databreak, Bootstrap, Powerfail.
- PDP11/20 Processor housed in 6ft rack cabinet complete with console Teletype
- NOVA 800 Processor in Jumbo Chassis
- DEC 6ft Rack Cabinets.

Ring now for prices. Other models becoming available all the time — let us know your requirements.



TERMINALS ASR33 and 35 KSR33 IBM Model B and Selectric COSSOR and HAZELTINE VDUs p.o.a

## PAPER TAPE PUNCHES & READERS

**TELETYPE BRPE 110** c/s Synchronous Punch 5/7/8 channel. Self-contained mains-operated unit consisting of punch unit, base, motor and tape supply spool. Price **£145.00**. Sound-reducing cabinet available at **£25.00**.

**DATA DYNAMICS 1114 Rack Mounted** 110 c/s Punch as new Mounted in sound-reducing rack cabinet and complete with control and interface electronics and power supply unit with short circuit and overload protection. Asynchronous operation up to 110 c/s. Our special price **£550**. Control Module for PDP8E also available.

**FACIT 4060 Rack-Mounted** 150 c/s Punch Heavy duty punch suitable for all types of tape inc. Mylar UNUSED SURPLUS — A BARGAIN AT **£595**.

**FACIT 4001 High Speed Reader** rack-mounted version 5/6/7/8 channel dielectric reader speeds up to 600 c/s (or 1000 c/s using separate spooler) **£650.00**. Control Module for PDP8E also available.

**TALLY 424 Brush Reader** Reads all 5 to 8 channel tape asynchronously at speeds up to 60 c/s in either direction Rack mounted complete with spools **£125.00**.

**FERRANTI TR5 photoelectric transistorised reader.** 300 c/s. 5/6/7/8 channel tape. Mains-operated. Price **£90.00**.

**INVAC Photoelectric Reader.** Motorless, solenoid-operated solid state unit to read any 5/6/7/8 hole tape at speeds up to 20 c/s. Compact (10 9/16" x 10 1/2") Power Requirements Solenoids — 26VDC 2A Amplifier — 12VDC 500mA Price **£55.00**.

**FERRANTI TR2 Photoelectric Reader.** Mains operated up to 200 c/s. 5/7 channel tape Price **£35.00**.

**TALLY Model 420** rack-mounting paper tape punch Asynchronous operation up to 60 c/s Integral supply and take-up spools Bi-directional tape transport. Complete with Model 1588 transistorised Drive Package **£495.00**.

## Keyboards

### NEW REED-SWITCH KEYBOARDS BY CLARE-PENDAR WITH READ ONLY MEMORY ASCII-CODED OUTPUT



Ideal for communications equipment, VDUs, prototype designs, etc. 68-key positions plus 11 instruction keys. Positive logic. Input voltage — 12V DC + 5V.

**OUR INCREDIBLE PRICE (DUE TO SPECIAL PURCHASE) + £1.00 P&P £29.50**

**ELECTRO-MECHANICAL NUMERIC AND ALPHA-NUMERIC KEYBOARDS** originally designed for 80-column card punch and verifier machines. Numeric with 2 character keys and 8 instruction keys Alpha-numeric with 47 character keys and 8 instruction keys Price Numeric **£4.50** + £1.00 P&P Alpha-numeric **£15** + £3.00 P&P

**PAPER TAPE PUNCH/VERIFIER KEYBOARDS.** Full alphanumeric keyboard with 65 keys + 4 shift keys in 4-bank layout 150 coded. Operating speed up to 25 ch. sec. Mounted in attractive case with control panel. Price **£25** + £3.50 P&P

**REED-SWITCH 4-BANK ALPHA-NUMERIC KEYBOARD** mounted on printed circuit board with ASCII coded output. 43 character keys + 2 shift keys and 12 instructional keys. Ideal for data displays, computer programming, etc. (a) Ex-equipment, housed in metal case **£30.00** + £3.00 P&P (b) Brand new, mounted on PC board only **£30.00** + £1.00 P&P

**PHOTOELECTRIC ENCODED KEYBOARDS.** No metallic switches or contacts. Generates any eight-bit code to specification. Photoelectric keyboard combines Photoelectric encoder and power-rated solenoid actuators. 45 key alpha-numeric keyboard + space bar + key interlock. Output — Photocells 550k to 3 Meg, for Logic 1, 800 Ohms 2K Ohms for Logic 2 — 12V DC OV DC Logic 1 Voltage requirements — 25VDC mA — 12V 60mA + 8V5mA. Price **£45** + £4.50 P&P

Callers welcome — Monday to Friday 9 a.m. to 5 p.m.

## COMPUTER SALES & SERVICES (EQUIPMENT) LIMITED

49/53 Pancras Road, London NW1 2QB. Tel. 01-278 5571

WW — 077 FOR FURTHER DETAILS

www.americanradiohistory.com



# Mincom Memo!

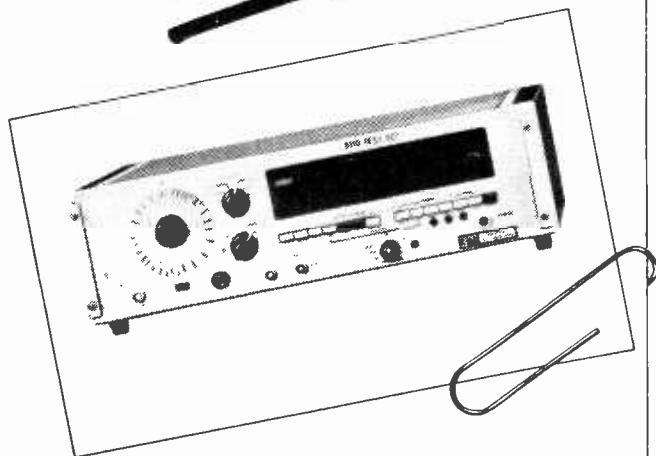

3M 6100 TEST SET

The single instrument approach to simplified testing of analogue networks.

Combines a sine and square wave oscillator, frequency counter, digital readout of volts/decibels/harmonic distortion percentages, and tunable wave analyser in one unit.

Provides automatic tracking, ranging and bandwidth selection, and indicates when an out-of-range condition exists.

Available for rack or bench mounting; weighs under 25 lbs (11.36 Kg.). Power requirement 115/230 volts  $\pm$  10%.

ALSO AVAILABLE

- 8100A-W Audio Flutter Meter/Wave Analyser
- 8300A-W IRIG Flutter Meter/Wave Analyser
- 610A Sweep Generator-400 Hz/2 MHz
- 6275 IRIG FM Test Set
- 120A Instrumentation Recorder Reproducer

3M United Kingdom Limited, Mincom Group, Witley Works, Witley Gardens, Southall, Middlesex.  
Telephone: 01-574 5929/01-574 6045

3M 2280

3M, Mincom and Wollensak are trademarks.



WW-072 FOR FURTHER DETAILS

# Semiconductor Data ?

THE SEMICON  
\* INTERNATIONAL TRANSISTOR INDEX  
1975/6 (6th Edition) NOW AVAILABLE

Easy reference alpha-numeric listings of about 24,000 transistors of international origin. Over 400 pages. Updating guarantee for 1 year.

EXTENSIVE SUBSTITUTION GUIDE  
CV & BS NUMBERED DEVICES  
TERMINATION OUTLINE DRAWINGS

ALTERNATIVE  
MANUFACTURERS  
AND AGENTS ADDRESSES

ORDER NOW £9.40 includes postage in UK.  
(outside UK add 80p postage by surface mail)

FROM  
SEMICON INDEXES LTD.  
2(WW) DENMARK ST, WOKINGHAM. Berks. RG11 2BB  
Tel: Wokingham (STD 0734) 786161

\* This is Vol.1 of the Semicon Index Series  
Vol.2 (Diodes & SCRs) and Vol.3 (ICs) available soon  
All same price. 10% discount if all 3 ordered together.

66 PAGES  
3000 ITEMS  
600 PICTURES

YOUR COMPLETE ELECTRONIC STORES MAIL ORDER AND SHOP

★ DISCOUNTS  
★ ALL NEW STOCK  
★ SATISFACTION GUARANTEE  
★ DEPENDABLE SERVICE

HAVE YOU GOT YOURS?  
CATALOGUE NO. 4 FULLY ILLUSTRATED

20p

**B H COMPONENT FACTORS LTD.**

LEIGHTON ELECTRONICS CENTRE, 59 NORTH ST.,  
LEIGHTON BUZZARD, BEDS. LU7 7EG. Tel. (05253) 2316.

NEW! AMERICAN STYLE CRADLE  
**TELEPHONE AMPLIFIER**

ONLY  
**£11.95**  
+ VAT 96p

Latest transistorised Telephone Amplifier is completely automatic with detachable plug-in speaker. Placing the receiver on to the cradle activates a switch for immediate two-way conversation without holding the hand-set. Many people can listen at a time. Increase efficiency in office, shop, workshop. Perfect for "conference" calls: leaves the user's hands free to make notes, consult files. No long waiting. On/Off switch, volume control. Model with tape-recording facility £12.95 + VAT £1.04 P & P 65p C W O 10-day price refund guarantee

**4-STATION INTERCOM**

**£16.15**

This NEW, versatile De Luxe 4-Station Transistorised Intercom (1 Master and 3 Subs) for desk or wall mounting can solve your communication problems instantly. Effective range 300ft. Call/talk/listen from Master to Subs and Subs to Master. With selector switch. Ideally suitable for office, shop, home or surgery. Adaptable for Mains. Complete with three 66ft. connecting wires and accessories. On/Off switch volume control. P. & P. 65p.

**WEST LONDON DIRECT SUPPLIES (W/W)**  
169 Kensington High Street, London W.8

## Ex-BEA CONTROL UNITS by UNIVAC

### A free-standing, modern style diecast case consisting of:

2-50way gold-plated plug and sockets; sub-assembly with 3-multiway switch assemblies; 4-decade push button assembly with electrical reset; 2-decade push button assembly with electrical reset; single-bank 8-push button assembly; 1-decade lamp assembly; 1-2-decade lamp assembly; 1-12 X 3-lamp assembly; 4-decade thumb wheel assembly; 16-bit inline card code assembly; 6-13way plus and sockets.

Limited stocks at **£12.50** ea plus £2 carriage

## ALSO MODERN STYLE TYPEWRITER KEYBOARD

with 21 separate function keys. Housed in slimline diecast case. Transistorised.

No information but a "buy" at **£15** ea plus £2 carriage

**MARCONI** TF801A/1 Signal Generator 10 to 310 MHz **£55** ea.  
**MARCONI** TF801B Signal Generator **£120** ea.  
**MARCONI** TF801C Signal Generator **£180**.  
**MARCONI** TF791B Carrier Deviation Meter **£30** ea.  
**MARCONI** TF934/2 FM Deviation Meter **£35**.  
**MARCONI** TF1020A RF Power Meter 150 and 300 Watts. As New **£75** ea.  
**MARCONI** TF1020A RF Power Meter 50 and 100 Watts. As New **£50** ea.  
**MARCONI** TF1094A/S HF Spectrum Analyser. Late model. Must go. **£160**.  
**MARCONI** TF1434/2 Counter Range extension unit 10-100MHz **£25** ea.  
**KELVIN & HUGHES** Single Channel Recorders with spare paper **£18** ea.  
**DAWE** Digital Printer type 3094A. As new **£27.50** ea.

**WESTON THERMOPROBE** -60 to +100 degrees Centigrade **£70**.  
**WANDEL & GOLTERMAN** TFEK41 Level Meter **£60**.  
**PROSSER SCIENTIFIC INSTRUMENTS** Model A100 Waveform Generator. Multi wave forms **£160**.  
**RHODE & SCHWARZ** Admittance Meter VLUK-BN3511. As new **£140**.  
**HEWLETT PACKARD** DB Oscilloscope type 175A. 3dB-50MHz twice. Large 6 X 10cm screen **£185**.  
**AIRMEC** 4 trace Oscilloscope. DC to 3MHz. Good condition **£50**.  
**PYE SCALAMP GALVANOMETER**. Hammer grey. Tested **£5** ea.  
**SOLARTRON** Multipurpose stab PU type 1094. Standard mains input. Outputs: +250V DC 200MA; +18V DC 2A; +6V DC 8A; -3.5V DC

100MA; -6V DC 8A; -18V DC 4A; 25V AC 150MA. All DC lines will withstand short-circuits to earth. With copy of manual **£20** ea.  
**DUAL TRACE PLUG-IN** units for CD1212 Scopes DC-24MHz **£35** ea.  
**TEKTRONIX** Colour Monitor type 654 **£550**.  
**TEKTRONIX** RM527 Waveform Monitor **£250**.  
**TELONIC** Sweep Generator SM2000/1. Main frame with 0-20kHz plug-in **£300**.  
**COLLINS RECEIVER** IP-10ULR. 90MHz to 10GHz in 8 bands. Panoramic. Analyser or DF modes. With power unit **£350** ea.  
**TEKTRONIX** Oscilloscope type 516 **£240**.  
**TEKTRONIX** Oscilloscope type 422 **£430**.

### AB POTENTIOMETERS

100K + 100K LIN DUAL GANG **25p** ea.  
 Discount for quantities. P. & P. extra

**EX-MINISTRY** CT436 Double Beam Oscilloscope DC-6 megs. Max Sensitivity 10mv/cm. Small compact. Size 10 X 10 X 16 in. Suitable for Colour TV servicing. Price **£85** each including copy of manual.

**HARTLEY** 13A Double Beam Oscilloscope TB 2c/s-750 kc/s. Bandwidth 5.5Mc/s. Sensitivity 33Mv/cm. Calibration markers 100kc/s and 1Mc/s. **£30** each.

## TELEPHONES

**MODERN STYLE 706** BLACK OR TWO-TONE GREY **£3.75** ea. P. & P. 45p. **STYLE 7006** TWO-TONE GREEN OR GREY **£3.75** ea. P. & P. 45p.  
**HANDSETS**—complete with 2 insets and lead **75p** ea. P. & P. 37p.  
**DIALS ONLY** **75p** ea. P. & P. 30p.  
**STILL AVAILABLE** MODERN STANDARD TELEPHONES IN GREY OR GREEN WITH A PLACE TO PUT YOUR FINGERS LIKE THE 746. **£3.00** ea. P. & P. 45p.

**CAPACITOR PACK** 50 Brand new components only **50p** P & P. 27p.

2 Twin 10/60 pf ceramic; 2 min strips with 4 preset 5/20 pf on each; 3 air spaced preset 30/100 pf on ceramic base. ALL BRAND NEW **25p** the LOT P & P. 15p.  
**PHOTOCELL** equivalent OCP71 **13p** ea  
**MULLARD OCP70** **10p** ea.  
**GRATICULES**. 12 cm. by 14 cm. in High Quality plastic. **15p** each. P & P. 8p

20: 50, 100 200, 500 ohms 1; 2: 2.5, 5, 10; 25K at **35p** ea ALL BRAND NEW

**HIGH VALUE PRINTED BOARD PACK**, no two boards the same—no short leaded computer boards **£1.75** post paid

**P.C. MOUNT SKELETON PRE-SETS**. Screwdriver adjust 10 5 and 2.5M  $\alpha$  2p ea. 1M 500 250 and 25K  $\alpha$  4p ea Finger adjust 10, 5 and 2.5M  $\alpha$  3p ea. 1M, 500, 250 and 25K  $\alpha$  5p ea. Min. P. & P. 15p.

Vast quantity of good quality components — NO PASSING TRADE—so we offer **3 LB. OF ELECTRONIC GOODIES** for £1.70 post paid

**RELIANCE P.C.B.** mounting 270: 470: 500ohms; 10K at **35p** ea ALL BRAND NEW.

**METER PACKS**—3 different meters for **£2**. P & P 55p.

**Beehive Trimmer 3/30 pf.**  
 Brand new. Qty 1-9 **13p** ea P & P 15p;  
 10-99 **10p** ea. P. & P. 25p; 100-999 **7p** ea. P. & P. free.

**HF** Crystal Drive Unit 19 in. rack mount. Standard 240V input with superb crystal oven by Labgear (no crystals) **£5** ea. Carr. £2.

**VENNER** Hour Meters—5 digit. wall mount —sealed case Standard mains. **£3.75** ea. P & P 55p

**RESETTABLE COUNTERS**—4 digit by Stonebridge/Sodeco. 1 000 ohm coil **£2** ea P. & P 35p

**DELIVERED TO YOUR DOOR** 1 cwt. of Electronic Scrap chassis, boards, etc. No Rubbish. **FOR ONLY £4**. N Ireland £2 extra  
**P.C.B. PACK** S & D. Quantity 2 sq. ft —no tiny pieces. **50p** plus P. & P. 25p  
**TRIMMER PACK**. 2 Twin 50/200 pf ceramic

**ROTARY SWITCH PACK**—6 Brand New switches (1 ceramic; 1-4 pole 2 way etc). **50p**. P & P 25p.  
**BOURNS TRIMPOT POTENTIOMETERS**.

**TRANSFORMERS**. All standard inputs. Gard/Param/Part. 450-400-0-400-450. 180 MA. 2 X 6 3v **£3** ea.

### FANTASTIC VALUE

Miniature Transformer. Standard 240V input +3V 1 amp output. Brand New. **65p** ea P & P. 20p. Discount for quantity

### E.H.T. CAPACITORS

1 mfd 7.5KV working 2 mfd 5KV working 8 mfd 2.5KV working 0.5 mfd 10KV working **£2** each

### RAPID DISCHARGE

1 mfd 5.6KV **£2.50** ea 0.9 mfd 15KV **£3.50** ea 0 15 mfd 120KV **£7** ea. Carriage extra.

**DON'T FORGET YOUR MANUALS S.A.E. WITH REQUIREMENTS**

## LOW FREQUENCY WOBBLATOR

For alignment of Receivers. Filters, etc. 250KHz to 5MHz. effective to 30MHz on harmonics. Three controls—RF level, sweep width and frequency. Order LX63. Price **£8.50** P. & P. 35p.  
 As above but can have extended cover range down to 20KHz by addition of external capacitors. Order LX63E. Price **£11.50** P. & P. 35p.  
 Both models can be used with any general-purpose oscilloscope. Requires 6.3V AC input. Supplied connected for automatic 50Hz sweeping. An external sweep voltage can be used instead. These units are encapsulated for additional reliability, with the exception of the controls (not cased, not calibrated).

## 20HZ to 200KHZ

### SINE AND SQUARE WAVE GENERATOR

In four ranges. Wien bridge oscillator thermistor stabilised. Separate independent sine and square wave amplitude controls. 3V max sine 6V max square outputs. Completely assembled P.C. Board, ready to use. 9 to 12V supply required. **£8.85** each. P. & P. 25p. Sine Wave only **£6.85** each. P. & P. 25p.

## WIDE RANGE WOBBLATOR

5 MHZ to 150 MHZ (Useful harmonics up to 1.5 GHZ) up to 15 MHz sweep width. Only 3 controls, preset RF level, sweep width and frequency. Ideal for 10-7 or TV IF alignment, filters, receivers. Can be used with any general purpose scope. Full instructions supplied. Connect 6-3V AC and use within minutes of receiving. All this for only **£6.75**. P. & P. 25p. (Not cased, not calibrated.)

## TRANSISTOR INVERTORS

<b>TYPE A</b> Input: 12V DC Output: 1.3kV AC 1.5MA Price <b>£3.45</b>	<b>TYPE B</b> Input: 12V DC Output: 1.3kV DC 1.5MA Price <b>£4.70</b>	<b>TYPE C</b> Input: 12V to 24V DC Output: 1.5kV to 4kV AC 0.5MA Price <b>£6.35</b> Postage & Packing <b>36p</b>	<b>TYPE D</b> Input: 12V to 24V DC Output: 14kV DC 100 micro amps at 24V. Progressively reducing for lower input voltages Price <b>£11</b>
--	--	--	--

## MAKE YOUR SINGLE BEAM SCOPE INTO A DOUBLE WITH OUR NEW LOW PRICED SOLID STATE SWITCH.

2 HZ to 8 MHz. Hook up a 9 volt battery and connect to your scope and have two traces for **ONLY £6.25**. P. & P. 25p.  
**STILL AVAILABLE** our 20 MHz version at **£9.75**. P. & P. 25p.

Unless stated — please add **£2.00** carriage to all units.

**VALUE ADDED TAX** not included in prices—please add **8%**

Official Orders Welcomed, Gov./Educational Depts., Authorities, etc., otherwise Cash with Order

Open 9 a.m. to 5.30 p.m. Mon. to Sat.



# CHILTMHEAD LTD



7/9 ARTHUR ROAD, READING, BERKS. (rear Tech. College, Kings Road) Tel.: Reading 582605/65916

# For all who want to know about electronic circuits

Here's a book of very special appeal to all concerned with designing, using or understanding electronic circuits. It comprises information previously included in the first ten sets of Wireless World's highly successful Circards – regularly published cards giving *selected* and *tested* circuits, descriptions of circuit operation, component values and ranges, circuit limitations, modifications, performance data and graphs. Each of the ten sets – including additional circuits – in this magazine size hard cover book has been updated where necessary, and is preceded by an explanatory introduction. Circuit designs (1) is the first collection of its kind.

Circuits covered are:

- Basic active filters**
- Switching circuits**
- Waveform generators**
- AC measurements**
- Audio circuits**
- Constant-current circuits**
- Power amplifiers**
- Astable circuits**
- Optoelectronics**
- Micropower circuits**

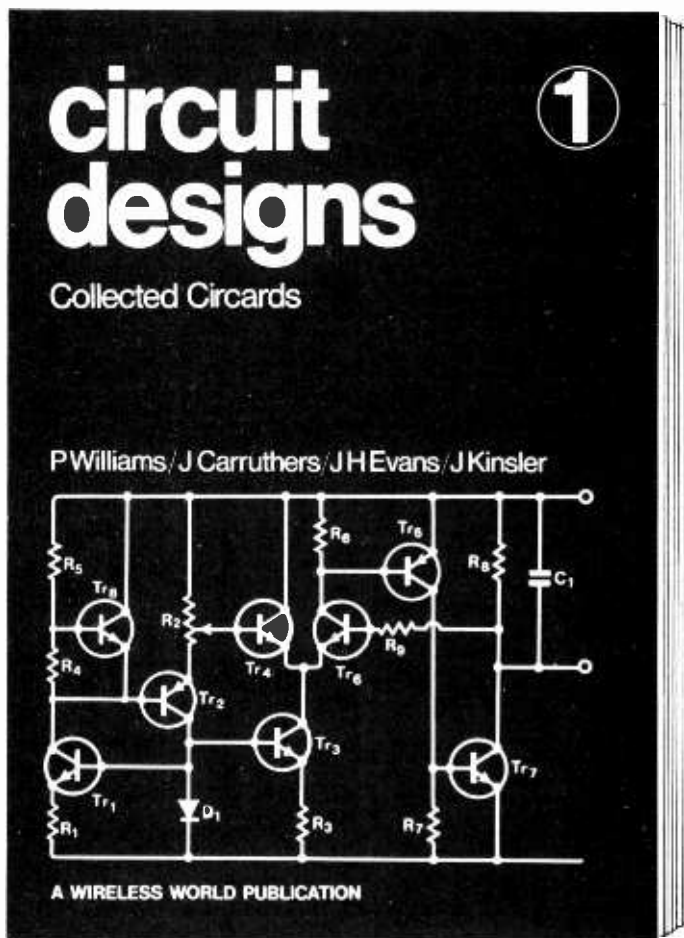

## A new book from Wireless World

### ORDER FORM

To: General Sales Department,  
IPC Business Press Limited,  
Room 11, Dorset House,  
Stamford Street, London SE1 9LU.

Please send me . . . . . copy/copies of  
Circuit Designs – Number 1 at £10.40  
each inclusive. I enclose remittance  
value £. . . . . (cheques payable to  
IPC Business Press Ltd.)

NAME (please print) . . . . .

ADDRESS . . . . .

Company registered in England and a subsidiary of Reed  
International Limited Registered No 677128 Regd. office  
Dorset House, Stamford Street, London SE1 9LU.



**G. F. MILWARD**

**ELECTRONIC COMPONENTS**

369 Alum Rock Road, Birmingham B8 3DR. Tel. 021-327 2339

**SCOOP  
PURCHASE!**

**6,000,000  
TRANSISTORS!**

**ALL POPULAR TYPES,  
NEW,**

**BOXED, BRANDED**

**VERY SPECIAL  
PRICES FOR  
BULK ORDERS!**

**SEND S.A.E. NOW FOR  
DETAILS OF TYPES  
AND QUANTITIES  
AVAILABLE**

If you haven't got it already there's only one place you're going to find it.

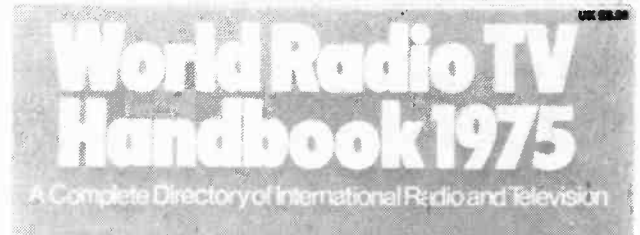

# RIGHT HERE!

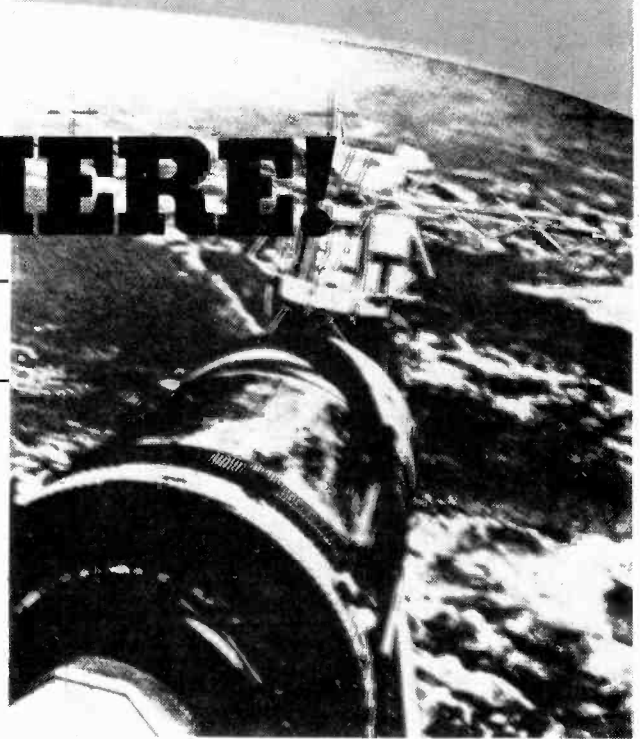

## World Radio TV Handbook 1975

The professional and enthusiast's fully comprehensive guide to the technical world of television and radio. Packed with valuable information including bands, DX programmes, time charts, short wave stations throughout the world and much, much more.

Available from your bookshop or direct from the distributors, Argus Books Limited, Station Road, Kings Langley, Hertfordshire, price £3.50.

Billboard Publications Ltd., 7 Carnaby Street, London W1V 1PG.

## Wireless World FULL COLOUR WALLCHART OF FREQUENCY ALLOCATIONS 80p

The wallchart shows the allocation of frequencies within the radio spectrum ranging from 3 kHz to 300 GHz and is scaled on eight logarithmic bands contriving 15 main categories of transmissions which are identified by colours. All the important spot frequencies and 'special interest' frequencies are marked. The information is taken from the ITU and has been condensed into easily read chart form. Measures 2' 11" x 1' 11".

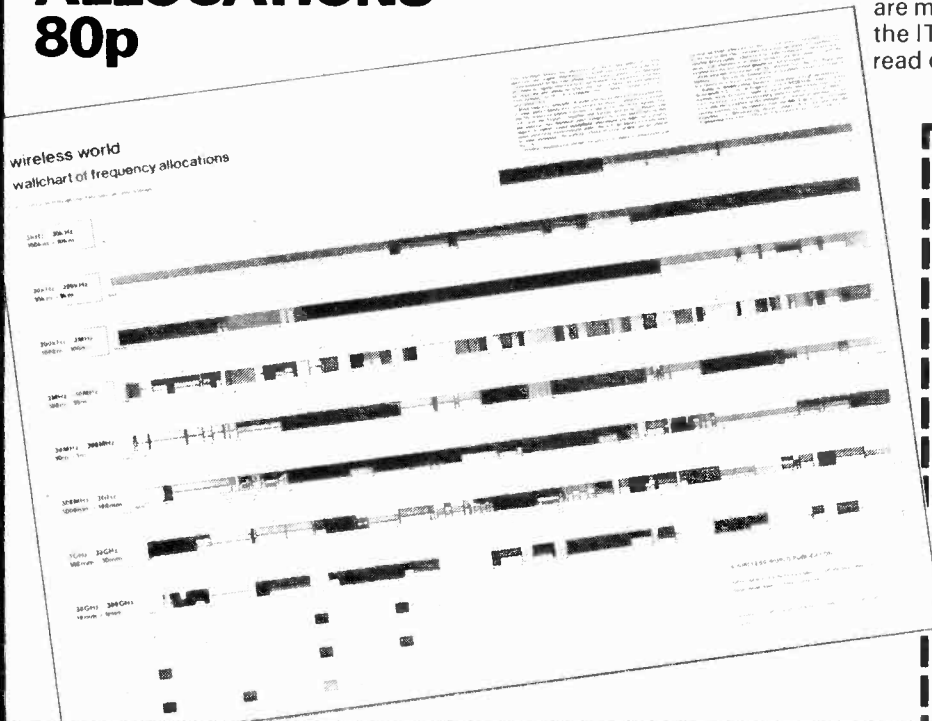

### ORDER FORM

To: IPC Electrical-Electronic Press Ltd.,  
General Sales Dept., Room 11,  
32 Stamford Street, London SE1 9LU

Please send me \_\_\_\_\_ copies of the  
Wireless World Wallchart of Frequency  
Allocations at 80p each inclusive.

I enclose remittance value £ \_\_\_\_\_  
(cheque/p.o. payable to IPC Business  
Press Ltd.)

Name \_\_\_\_\_  
(please print)  
Address \_\_\_\_\_

Registered in England No. 677128  
Regd. office: Dorset House, Stamford Street,  
London SE1 9LU

# APPOINTMENTS VACANT

**DISPLAYED APPOINTMENTS VACANT:** £6.08 per single col. centimetre (min. 3cm).  
**LINE advertisements (run on):** 86p per line (approx. 7 words), minimum three lines.  
**BOX NUMBERS:** 35p extra. (Replies should be addressed to the Box number in the advertisement, c/o Wireless World, Dorset House, Stamford Street, London SE1 9LU).  
**PHONE:** Allan Petters on 01-261 8508 or 01-261 8423  
 Classified Advertisement Rates are currently zero rated for the purpose of V.A.T.

Advertisements accepted up to 12 noon Wednesday, July 2nd, for the August issue subject to space being available.

## Advanced Electronics Technology your future – and ours

At Marconi Space and Defence Systems, Hillend Fife, we are constantly working at the frontiers of modern technology – designing, developing and manufacturing some of the world's most advanced computer controlled Simulators and Automatic Test Equipment.

As a result of our success in gaining several recent major contracts, we require highly motivated and enthusiastic staff to join us in the following areas –

### Electronics Design Engineers

To specialise in particular aspects of the design and development of Simulators and/or Automatic Test Equipment. At least one years experience in electronic design, both analogue and digital is essential and applicants should preferably hold a

relevant degree, although suitably experienced applicants with HNC or HND qualifications will also be considered.

### Test and Commissioning Engineers

To assist in the commissioning of prototype builds including systems testing, recording test results and diagnosing and correcting malfunctions of the equipment. Applicants should have at least two years experience in the test and commissioning of complex electronic equipment, and should be qualified to a minimum of ONC standard. Service within HM Forces will also be suitable.

Opportunities at senior level also exist in the above two categories. All posts offer a high level of professional involvement and excellent opportunities for advancement within our expanding organisation. Assistance will be given, where applicable, with relocation expenses to Fife – an attractive rural area offering relatively low-cost housing and outstanding sports and recreational facilities.

For full details and an Application Form, please return the coupon to Mr. D. D. Bennett, General Manager, Marconi Space & Defence Systems Limited, Hillend Industrial Estate, By Dunfermline, Fife.

Please send me details of career opportunities at Hillend.

Name \_\_\_\_\_

Address \_\_\_\_\_  
 \_\_\_\_\_  
 \_\_\_\_\_

Age \_\_\_\_\_

Qualifications \_\_\_\_\_

**Marconi  
Space & Defence  
Systems (Hillend Fife)**

A GEC, Marconi Electronic Company

(4732)

# OK

## A Great new opportunity for TV Technicians in South Africa £3750

Now that Television has started in South Africa, OK Bazaars is all set to capture the major share of the market. We're the largest retail organisation in Southern Africa and are building up the most extensive and professional TV operation in the Republic. Because of the size of the Company's activities in this exciting new development we are able to offer outstanding prospects to experienced personnel, and in order to ensure first-rate service for our customers, we now need to enlarge our already substantial staff by appointing TV Technicians in various centres throughout the Country.

The work will entail carrying out repairs in the field and in the workshops, keeping records of time and materials involved and feeding back information to management on recurrent faults and defects in apparatus.

Essential requirements are a recognised apprenticeship or training course on radio and TV servicing and at least three years' experience in colour TV. Applicants should also possess a City & Guilds Final Certificate with RTEB colour endorsement or an equivalent qualification.

Salary will be at least £3750 per annum with an extensive range of fringe benefits including company assisted pension and medical aid schemes, full air passage, initial hotel accommodation and relocation allowances.

Interviews will be held in the UK, so write now with details of age, qualifications, experience to Mrs. M. Dunn (TVT), Austin Knight Limited, London W1A 1DS, including a telephone number where you can be contacted.

**Live and work in the sun**

(4755)



# RADIO OFFICERS

Do you have PMG I, PMG II, MPT 2 years' operating experience?

Possession of one of these qualifies you for consideration for a Radio Officer post with composite signals organisation.

On satisfactory completion of a 7-month specialist training course, successful applicants are paid on a scale rising to £3,242 pa; commencing salary according to age — 25 years and over £2,383 pa. During training salary also by age, 25 and over £1,724 pa with free accommodation.

The future holds good opportunities for established status, service overseas and promotion.

Training courses commence at intervals throughout the year. Earliest possible application advised.

Applications only from British-born UK residents up to 35 years of age (40 years if exceptionally well qualified) will be considered.

Full details from:

**Recruitment Officer**  
**Government Communications Headquarters**  
**Room A/1105, Priors Road, Oakley**  
**Cheltenham, Glos GL52 5AJ**  
**Telephone Cheltenham 21491 Ext 2270**

92

## CHELSEA COLLEGE UNIVERSITY OF LONDON ELECTRONICS TECHNICIAN GRADE 3

required as soon as possible for the Department of Pharmacy.

The work is concerned mainly with servicing a variety of instruments used within the department and some design and construction work is called for.

Applicants should hold appropriate qualifications at Intermediate Level and possess three years' experience, including training. Enthusiasm and initiative are important.

Salary £2,013-£2,343 plus £410 per annum London Allowance.

Application forms from Manager of Technical Services, Department of Pharmacy, Chelsea College, Manresa Road, London, S.W.3.

4752

# “We aim to match the best ten companies in the rewards and conditions we offer”

Engineers! If you are interested in electronics, data transmission, digital systems, this could mean a lot more to you than you imagine – both now and in the future.

What are the tangible results of this declared policy by Neville Cooper, STC Director with responsibility for personnel policies? What does it mean in terms of salaries and benefits, working conditions, prospects of promotion and development within the company? What does it leave unsaid about STC's attitude to its people and their needs as individuals?

STC – one of the world's leading companies in telecommunications and a pioneer of the new British Telephone Switching System, TXE4 – is looking for professional and technical engineers at all levels of experience for Advanced Systems Development, Application Engineering, Systems Design and Integration, and Circuit and Logic Design.

## STC – on record!

To answer some of the questions you might be expected to ask about us, Ken Corfield, STC's Managing Director, and three of his colleagues – Neville Cooper, Jock Marsh and Geoff Samson – have chosen to make a record, each explaining the thinking behind the tasks and challenges of his own specific area of responsibility, and outlining the opportunities within STC. In this way, you can build up a positive picture of the company as a whole: its attitudes, approach to business, present and long-term views.

*You can have a free copy of this record now. Send for it. Play it. Listen to it. Consider whether you like the sound of us. It could mean a lot to you, your future – and ours!*



Neville Cooper, Standard Telephones and Cables Limited, 190 Strand, London WC2R 1DU  
Please send me a free copy of your record "Just for the record," and the illustrated brochure that goes with it.

Name

Address

Present job title  
WW206



**Standard Telephones and Cables Limited**

A British Company of **ITT** (4716)



# Opportunities in Electronics

## Train to be an Electronics Technician

If you are 16-18 years old and would like a career in Electronics, our special 3 year training scheme provides the opportunity you are looking for.

We are offering you the opportunity to become an Electronics Technician in a fast expanding industry with an ever increasing demand for those with the ability to

understand the practical workings of complex electronic equipment.

Our scheme includes well paid employment whilst training and day release to attend college to study for the City and Guilds Electronics Technician Certificate.

In addition to a practical interest in electronics you will require 'O' levels or CSE grades in

Maths, Physics and English.

Telephone or write to R. F. Honnor,

Personnel Manager,

**G & E BRADLEY LTD.,**

Electral House,

Neasden Lane, N.W.10.

Tel. 01-450 7811.



**A LUCAS COMPANY**

4738

**A Career with Marconi is a Qualification in itself ....**

If you are a skilled Electronic Technician and want to hear more about career prospects salaries etc contact :- J. Prodger

**mi** MARCONI INSTRUMENTS LTD.

Longacres, Hatfield Road, St Albans, Herts.  
Tel: St Albans 59292

A GEC Marconi Electronics Co.

4588

### COMPUTER ENGINEERS

All Systems Go  
Target to £4,500 p.a.  
+ Car or allowance  
Many locations

Eric Stack  
**MALESTAFF**  
01-388 1607  
362 Euston Road  
London, N.W.1



4678

### UNIVERSITY OF GLASGOW

## ELECTRONIC RESEARCH ASSISTANT

Applications are invited for an Electronic Research Assistant in the Department of Physiology to join team working on electrical properties of nerve muscle and heart cells. No previous biological experience required. Applicants of degree standard may register for a postgraduate degree on a part-time basis.

Salary according to qualifications and experience in electronics within national salary structure for research staff (Range 1B £1809-£2757 or Range 1A £2118-£3990).

Applications to: Professor O. F. Hutter, Department of Physiology, University of Glasgow, G12 8QQ, from whom further particulars may be obtained.

In reply please quote Ref. No. 3681 FH.

4756

# Her Majesty's Government Communications Centre

HANSLOPE PARK,  
MILTON KEYNES MK19 7BH

has vacancies in the following fields of R & D work:

- (a) VHF/UHF COMMUNICATIONS
- (b) COMMUNICATION FIELD TRIALS
- (c) ACOUSTICS
- (d) MICROWAVES
- (e) GENERAL CIRCUIT DESIGN — ANALOGUE, DIGITAL
- (f) STATISTICS/OPERATIONAL ANALYSIS/SYSTEMS

### ANALYSIS

Most posts will be at Hanslope Park but some, in particular (f), will be in London. Posts in London carry a London allowance of £410 per annum in addition to the salaries quoted below.

Candidates for post (f) should be experienced scientists/engineers who have specialised later in one of the required fields. An ability to deal with non-technical people is essential.

Appointments will be made within the grades of Higher Scientific Officer except for (d) and (f) where appointments may also be made within the Senior Scientific Officer grade. The appointments will be established within Government Service with a non-contributory pension scheme.

### Higher Scientific Officer

Applicants should be under 30 years of age but this requirement may be waived if special qualifications or experience can be offered. They should have one of the following qualifications:

- (a) A degree in a scientific or engineering subject.
- (b) Degree-standard membership of a Professional Institution.
- (c) A Higher National Certificate or Higher National Diploma in a scientific or engineering subject
- (d) A qualification equivalent to (c) above

In addition the following relevant experience is required.

- (a) Applicants with 1st or 2nd class honours degrees -- at least two years' post-graduate experience.
- (b) Applicants with other qualifications -- at least five years' post qualifications experience.

Salary Scale £3254 - £4454 with entry point dependent upon experience beyond the minimum required

### Senior Scientific Officer

Applicants should be at least 25 and under 32 years of age, although the upper age limit may be waived if experience of special value can be offered.

Applicants should have obtained a 1st or 2nd class honours degree and have had a minimum of four years' appropriate post-graduate experience.

Salary Scale £4185-£5778 Entry will normally be at the minimum of the scale but applicants with experience of special value may be entered above the minimum

Applications, stating the field of work and the grade required should be made to

**Administration Officer**  
**HM GOVERNMENT COMMUNICATIONS CENTRE**  
**Hanslope Park**  
**Hanslope**  
**MILTON KEYNES MK19 7BH**

4743

*Looking  
for  
a  
new  
job?*

## Perhaps we can help!

We have regular contact with hundreds of Electronics and Electrical companies needing qualified technicians and engineers and can therefore help you find an interesting and well paid job. All you need do is to return the coupon below or give us a ring. Our service is confidential and costs you nothing.

**TJB Technical Services Bureau,**  
**3A South Bar,**  
**Banbury, Oxfordshire.**  
**Banbury (0295) 53529**

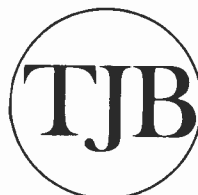

Technical Services Bureau is a division of Technical & Executive Personnel Ltd and is solely concerned with job placement in the Electronics and Electrical Industries

Please send me an "Application for Employment" form  
NAME .....  
ADDRESS .....  
.....  
.....4768

# Find your place in British Gas

Training in Engineering

## CONTROL AND INSTRUMENTATION

British Gas has vacancies from time to time for control and instrumentation engineers at graduate level, technician engineer level and technician level. The posts concerned demand good standards of ability and a high sense of responsibility. To help fill them, we are prepared to train small numbers of selected men of suitable educational and technical ability who have previously worked in a related technological field, such as light current electrical engineering, or electronic control engineering. The courses are designed to train suitable men quickly to a standard which will enable them to contribute effectively to the Industry's work at the earliest possible stage, following which expertise will be developed through more advanced training.

If you are thinking of a change of career and would like to be involved in an undertaking which gives scope for personal development, and at the same time contributes to the wellbeing of the country, write in confidence, giving full details of your age, educational and technical qualifications and experience, and indicating the area of the country in which you would prefer to work, to:-

Mr. T. A. Lucas,  
Communications and Instrumentation Dept. (WW),  
British Gas, National Westminster House,  
326 High Holborn, London WC1V 7PT.



**BRITISH GAS**

4729

## C.C.T.V. SYSTEMS

Teletape Video, U.K.'s most progressive video systems company, are seeking a top man to organise and run a new division formed to actively develop the C.C.T.V. security surveillance activities of the company. Existing international contracts run into six figures, and we hold distribution rights on all good agencies so the opportunities are unlimited.

We are looking for a man fully experienced in all aspects of this business with good product knowledge and capable of dealing at Government level on large contracts. He should be capable of working entirely on his own initiative and will report directly to the Managing Director.

We envisage a good basic salary plus a sensible incentive participation on sales, with a company vehicle, etc.

This is a unique opportunity.

Please apply in confidence to:

**Ian Crammond**  
Managing Director  
TELETAPE VIDEO  
76 Brewer Street, W1R 3PH  
Telephone 734 1319 or 434 1267

(4758)

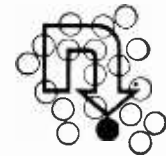

## Opportunities in the ELECTRONICS FIELD

Men with analogue or digital qualifications / experience seeking higher paid posts in: TEST - SERVICE - DESIGN SALES.

Phone: Mike Gernat, Ref. W.W.

**NEWMAN APPOINTMENTS**  
360 Oxford Street, W.1,  
01-629 0501

## LINK



## DEVELOPMENT ENGINEER

to work in our audio group on the development of studio talkback and communications equipment used in TV studio broadcasting systems.

You should be 21-25, have HNC or equivalent plus 1-2 years' experience in the use and/or design of audio products.

As an independent and well established Company we have kept a young and flexible outlook and attach great importance to people fitting in. Apart from an above average salary we also offer free life and health insurance, pension scheme of course and a subsidised canteen, as well as a congenial environment which we think is very important. We will help with relocation expenses where necessary. Andover is a growing town in an attractive part of rural Hampshire, close to Salisbury and Winchester and within easy reach of London and the south coast.

Either telephone Mic Comber at Andover 61345 (reverse charge if you wish) or write with brief details so that we can send you an application form.

4745

**LINK**  
ELECTRONICS

Walworth Industrial Estate,  
Andover, Hampshire, England Telephone: Andover (0264) 61345

## Applied Physicist

or

## Electronics Engineer

required by the Institute of Cancer Research at Sutton, Surrey, to join an active R and D programme on ultrasonic diagnosis of cancer. The work will be varied and responsible, in a joint hospital/research institute environment and will call for a range of practical abilities in the development and application of novel instrumentation. Previous experience in ultrasonics would be useful but is not essential.

Appointment will be on the MRC Technical Officer/JTO scale at a salary in the range £2,688 - £3,792 (TO) or £1,494 - £2,592 (JTO) plus Threshold award of £229 plus London allowance of £312 Scales under review

Applicants should normally hold an appropriate degree or equivalent qualification and preferably have some R & D or industrial experience. Exceptionally possession of two appropriate "A" levels can be accepted for appointment to a junior post.

Applications with curriculum vitae in duplicate and naming two referees to: The Secretary, Institute of Cancer Research, 34 Sumner Place, London SW7 3NU, quoting ref. 300/G/85.

4742



# How do you value your electronics testing ability?

All the benefits of the world's largest radio-telephone exporters, could soon be yours. If you value your expertise highly, this is where to get most mileage from it.

Career progression paths are long and wide—the Company's expansion rate has been unaffected by the present economic situation. Equally significant is the importance Pye Telecom rightly attaches to fault-finding and testing to exacting specifications their VHF/UHF advanced design communications equipment. Reasons are obvious – not only is reliability crucial in furthering the Company's progress, but frequently lives depend on the performance of the equipment, because fire, police and ambulance services use it extensively.

So if you have practical experience of this work, maybe in the armed forces, it will pay you handsomely to get full information about the conditions, the relocation assistance and other attractions. Work and live in the attractive university city of Cambridge; alternatively in the nearby expanding town of Haverhill where there are excellent possibilities for private and rented housing.

Phone or write today to

Mrs Audrey Darkin  
 Pye Telecommunications Ltd  
 Cambridge Works  
 Elizabeth Way, Cambridge CB4 1DW  
 Tel: Cambridge 58985

or

Mrs Cath Dawe  
 Pye Telecommunications Ltd  
 Colne Valley Road  
 Haverhill, Suffolk CB9 8DU  
 Tel: Haverhill 4422



**Pye Telecommunications Ltd**

(4717)

Kensington and Chelsea and Westminster  
 Area Health Authority  
 North East District

## MEDICAL PHYSICS TECHNICIAN

Applications are invited for the post of Medical Physics Technician Grade IV at the Middlesex Hospital. Salary according to Whitley Council B Scales. Duties will involve a wide variety of work in Physiological measurement including work in the Department of Cardiology. Day release facilities for study at approved Colleges can be arranged.

Applicants with full details of career to date and quoting two referees, should be sent to Establishment Officer, The Middlesex Hospital, London W1N 8AA. Closing date for applications 2nd June, 1975.

4650

# RADIO ENGINEER

Telerenters (London & Provincial) Limited have vacancy for Senior Engineer at Watford.

The Engineer should have detailed knowledge of RF and audio measurements and be familiar with European specifications to enable him to implement and manage a test laboratory for the type approval of domestic radio, audio and recording equipment. Factory experience essential.

Salary: £4,000-£5,000.

Write giving brief details to: The Director, Telerenters (London & Provincial) Limited, 155/159 Queen's Road, Watford, Herts WD1 2QH.

(4724)

## RADIO TECHNICIANS

Are you a Radio Technician with a City and Guilds Intermediate Telecommunications Certificate or equivalent, plus 1 year's practical work-shop experience? If so, then why not join the Home Office. We have a vacancy at Baldock, Hertfordshire to carry out installation, maintenance, modification and construction of complex specialised radio communications equipment and systems.

### Pay

£2010 at 17, £2230 at 19, rising to £3385 a year.

### A Secure Future

with a non-contributory pension scheme, good prospects of promotion and a generous leave allowance. 5-day week of 42 hours.

### Interested?

Then telephone or write for an application form to: Mr J J Willis, Directorate of Radio Technology, Room 514, Waterloo Bridge House, Waterloo Road, London, SE1 8UA. Telephone 01-275 3006.

4722



*Home Office*

## SERVICE ENGINEER

Required to service our range of scientific and laboratory instruments, which include Fraction Collectors, U.V. Monitoring, Ultramicrotomy equipment. The applicant should be resident in an area North of the Thames to Luton or prepared to move. A good working knowledge of modern electronics and a scientific background is desirable.

The Company offers excellent working conditions including pension scheme, profit sharing bonus scheme, BUPA membership and Company car.

Write or telephone for an application form.

**The Service Manager  
LKB Instruments Limited  
232 Addington Road  
Selsdon, South Croydon, Surrey  
01-657 8822**

**LKB LKB INSTRUMENTS LTD.**

## CATV - MATV ENGINEERS

AND

## PRODUCTION MANAGER

Canada's Leader in Cable Television requires personnel for research and production departments.

Openings for research in amplifier, passives, converter, aerial designing — your choice

Opening for **CHIEF ENGINEER** — should have CATV or related experience. Electronics person strong in leadership, Methods and Mechanical Acumen required for capacity of **PRODUCTION MANAGER**.

Good salaries, generous benefits. Please Airmail complete Personal History and references to:

**Mr. J. E. Thomas  
Lindsay Speciality Products Ltd.  
50 Mary Street  
Lindsey, Ontario  
Canada**

(4759)

### CHELSEA COLLEGE UNIVERSITY OF LONDON

## ELECTRONICS TECHNICIAN

### GRADE 5

required for interesting design and development work in an Electronics Workshop, catering for the prototype requirements for teaching and research in the Departments of Electronics and Physics.

Salary £2,849-£3,305 per annum, including London Allowance.

Five-day, 37½-hour week.

Generous holidays.

Application forms and further details from Mr. M. E. Cane (5EW), Chelsea College, Pulton Place, London SW6 5PR.

4753

### CHELSEA COLLEGE UNIVERSITY OF LONDON ELECTRONICS ENGINEER

required to take charge of Electronics Workshop for the design and production of prototype electronic equipment for electronics and physics research and teaching, and also for the servicing and maintenance of a wide range of commercial electronic equipment.

A wide practical experience and a sound theoretical knowledge of electronics is essential. Experience in microwave instrumentation would be an advantage, five-day, 37½-hour week. Salary (Technical Staff Grade 6) £3,254-£3,860 per annum, including London Allowance.

Further details and application form from Mr. M. E. Cane (EW7), Chelsea College (University of London), Departments of Electronics and Physics, Pulton Place, Fulham, London SW6 5PR.

4754



**ELECTROSONIC LTD SE LONDON****SENIOR DEVELOPMENT ENGINEER****AUDIO PRODUCTS c£4200 pa**

Electrosonic Ltd are seeking a professional engineer with at least five years experience of developing audio equipment. He will primarily be required to make significant technical contributions to the company's new products which will range from AV replay equipment to studio mixers.

It is also expected that through his commercial awareness of the audio field he will help to define the product range and expansion in this important area of the company's business.

**MANAGER —****ELECTRONIC TEST DEPARTMENT c£3,500 pa**

A candidate is required having wide experience in a production test shop. Technical ability in analogue and digital circuitry is essential together with experience of supervising the work of others.

Duties will include the organisation and day-to-day running of the test shop, providing technical oversight, training of junior engineers, the introduction and programming of automatic test equipment and supervision of quality control.

**TEST AND SERVICE ENGINEERS****£2,400-£2,800 pa**

Vacancies exist in both these departments for electronic engineers having a minimum of two years experience of control and/or audio systems. On the job training will be given and opportunities for advancement are available. Service engineers will be required to work both in the factory and on site and the holding of a current driving licence is desirable.

The company is leader in the rapidly expanding fields of lighting control, audio and audio visual systems and offers a wide range of interesting work in an attractive environment and excellent conditions of employment.

Apply: Personnel Director, Electrosonic Ltd, 815 Woolwich Road, Charlton SE7 8LT.  
Tel: 01-855 1101



## Colour CCTV Engineer

We are looking for a first-class electro-mechanical service engineer to maintain television, film, electronic and other equipment including Shibaden 1212 colour cameras, IVC colour VTRs, Sony U-matic recorders, etc. This equipment is sited in our theatre, studio, cinema and boardrooms in Shell Centre and at our Conference Centre at Teddington.

The job also involves production of programmes, organisation of staff, design and building of prototypes of mechanical, optical and electronic units in our busy AV Centre.

Starting salary would be negotiable, dependent upon qualification/experience. 5 day week, contributory Pension Fund, free 3-course lunches, 4 weeks annual holiday. Sports and social facilities in the building, including squash, badminton, swimming.

Telephone or write for an application form to: Shell International Petroleum Company Limited, LP 112, Shell Centre, London SE1 7NA. 01-034 2828.

4767

### GLASGOW COLLEGE OF TECHNOLOGY PART-TIME B.Sc. DEGREE (C.N.A.A.) IN ELECTRICAL ENGINEERING with choices in Power or Electronic subjects

Holders of a good HNC or HND in Electrical/Electronic Engineering or related disciplines may be eligible to enter the above course commencing 18th August, 1975. If you are interested in the above course, write or telephone now for application form and further details to:

The Academic Registrar, Glasgow College of Technology, North Hanover Place, Glasgow, G4 0BA. (Telephone: 041-332 7090).

(4765)

### BRITISH MEDICAL ASSOCIATION DEPARTMENT OF AUDIO/VISUAL COMMUNICATION

## Electronics Officer

Up to £3008 (increase is currently being negotiated) + £410 London Weighting

With lively interest in Audio/Visual aids for education.

Duties will include liaising with medical teachers and providing information and advice on a wide range of equipment; supervising a workshop for repair and maintenance of closed circuit television and audio equipment for research purposes; supervising the design and construction of prototype equipment and an audio cassette duplication service; undertaking sound and television recordings in a small studio.

Applicants should have at least 5 years' experience in the educational uses of audio/visual aids.

Starting salary according to qualifications and experience.

Applications, with a full curriculum vitae and the names of two referees, to the Director, BMA House, Tavistock Square, London WC1H 9JP, not later than 11th July.

(4719)

THE ROYAL NATIONAL THROAT,  
NOSE & EAR HOSPITAL  
Gray's Inn Road, London WC1X 8DA

### PHYSICIST (BASIC GRADE)

Applications are invited for a newly established post of Physicist (Basic Grade) for work in the field of hearing disorders and the applications of hearing aids. Suitable candidates will have a degree in Physics and should have experience in electronics and acoustics. He/she will be based in a new electronic-acoustics laboratory and in the Hearing Aid Centre.

Salary scale £2046-£2562+ £312 London Weighting + current Threshold payments.

Applications giving details and names of two referees to Senior Administrative Assistant.

### ELECTRONICS TECHNICIAN

Grade 5

required for the Chemistry Department. Duties include the servicing and repair of a wide range of optical and electronic instrumentation, the design, construction and modification of electronic units concerned with instruments. Minimum qualification O.N.C. or equivalent. Salary on scale £2849 p.a.-£3305 p.a. (including London weighting) according to experience. Apply in writing giving full details to the Head Clerk (WW), University of London King's College, Strand WC2R 2LS.

4749

### CITY OF LONDON POLYTECHNIC TV ENGINEER

(MAINTENANCE) REQUIRED to join a small team working on the installation and maintenance of a wide range of equipment from CCTV equipment to slide projectors.

Applicants must have a sound practical knowledge of electronics and mechanics; relevant qualifications an advantage.

Salary Technician Grade 3 scale: £2,424-£2,754 including London Weighting. Entry point according to qualifications and experience.

Application forms and further details from The Assistant Secretary, City of London Polytechnic, 117/119 Houndsditch, London EC3A 7BU.

(4737)

### ELECTRONICS TECHNICIAN

(Grade 5)

required in the Department of Physiology to be responsible for the servicing of a wide range of sophisticated electronic instruments for both research and teaching and the design and construction of prototype apparatus. Good electronic background and qualifications essential. Some experience in medical or biological field preferable. Salary on scale £2849 per annum-£3305 per annum (including London weighting) according to age and qualifications, four weeks' annual holiday. Contributory Pension Scheme. Apply in writing with full details to the Head Clerk (WW), King's College, London, Strand WC2R 2LS.

4740

## TEST ENGINEERS

S. LONDON  
UP TO £2,800 p.a.

Dolby Laboratories is a young, go-ahead company with a world wide reputation for their audio noise reduction system. Test Engineers with a good understanding of basic circuits are required to test and trouble shoot professional audio P.C.B.s and equipment. This is interesting and well paid work. We give over four weeks' holiday per annum.

Write or phone:

Mr. C. Keys  
Dolby Laboratories Inc.  
346 Clapham Road  
London, S.W.9  
Tel. 01-720 1111

(4764)

## VIDEO ENGINEER

Good all-rounder required by London's liveliest video dealers.

Due to continuing expansion in all departments we need another good engineer. Our team is small but very good so we are seeking someone with sound practical knowledge and wide product experience.

In return we are prepared to pay a more than generous wage with fringe benefits.

Please contact in confidence:

Peter Ellis, Technical Manager  
TELETAPE VIDEO  
76 Brewer Street  
London, W1R 3PH  
Telephone 743 1319 or 434 1267

(4757)

## UNIVERSITY OF SOUTHAMPTON

Research Fellow in  
Optical Communications

Applications are invited for a Research Fellow or Assistant to join an active group working on Optical Fibre Communications in the Department of Electronics. The work involves the use of fibres in multi-access communication systems including the development of couplers and junctions. The normal qualifications required are a PhD or equivalent research experience although applicants with other qualifications will be considered. Some knowledge of electronics, communications or opto-electronics is desirable. Salary will depend on experience and qualifications and will be within the range £1 809 to £3,813 (under review) plus Threshold payments.

Applications, including curriculum vitae and the names of two referees, should be sent to Mr. D. A. S. Copland, The University, Southampton SO9 5NH, quoting reference 383/R/WW.

(4744)

# Opportunities for Electronics Engineers

To change to wider fields of electronics  
— join the EMI Service Team at Hayes.

Vacancies exist on repair and calibration of a wide range of electronic test gear including oscilloscopes, DVMs, pulse generators, power supplies etc.

Also

Servicing and commissioning closed circuit television equipment including cameras, VTRs, Monitors etc.

Applicants should have at least 5 years practical experience.

These positions offer varied and interesting work. Attractive starting salaries, subsidised lunches, 4 weeks holiday and excellent sick pay and pension schemes.

For further details telephone or write to:- M. Ford, 01-573 3888, Ext. 2167, EMI Service, 254 Blyth Road, Hayes, Middlesex.



The international music, electronics and leisure Group.

4741

## Directorate of Radio Technology Telecommunications Officers

(£4,190-£4,620)

to be responsible for the study of radio propagation matters over the whole of the radio frequency spectrum (10kHz-275 GHz) and for the forward planning, management and regulation of frequency bands allocated to broadcasting, fixed, maritime and land mobile, and space services.

Duties also include: preparing specifications and type-approval of equipment for fixed and mobile services; application of computer techniques to frequency assignment problems; development of equipment for the location and suppression of radio interference; technical advice on all aspects of licensing of radio services and advice in connection with the international radio monitoring service.

Candidates (aged at least 25) must have ONC in Engineering (with a pass in Electrical Engineering 'A') or in Applied Physics or an equivalent qualification. In addition they must have had at least 7 years' experience of skilled work on radio, radar or other electronic work.

Salary, starting at £4,190, rises to £4,625. Good promotion prospects. Non-contributory pension scheme.

For further details and an application form (to be returned by 10 July, 1975) write to Civil Service Commission, Alencon Link, Basingstoke, Hants. RG21 1JB, or telephone Basingstoke (0256) 68551 (answering service operates outside office hours) or London 01-839 1992 (24 hour answering service). Please quote ref. T/9017.

HOME OFFICE, London

4720

## UNIVERSITY OF SURREY ELECTRONIC ENGINEER

Applications are invited for the above position in the Electronic Workshop of the Psychics Department. The person appointed will work, together with two other members of the technical staff, under the general direction of a Chief Technician.

Applicants should have a good electronics background, a sound theoretical knowledge and should have experience in the development and construction of computer interfacing and be familiar with nucleonic instrumentation. Qualification: HNC or equivalent. Salary scale: £2,844 - £3,450.

For further details and application forms please apply to the Staff Officer, University of Surrey, Guildford, Surrey GU2 5XH or Tel: Guildford 71281, Ext. 452.

(4654)

## NORTHAMPTON COLLEGE OF TECHNOLOGY

DEPARTMENT OF ENGINEERING

# Lecturer Grade I in Electrical Engineering

Applicants should have had previous experience of light current / electronic work and hold an H.N.C. or a final C.G.L.I. certificate with electronic subjects. Previous teaching is not essential, although desirable.

Duties will commence on 1st September 1975. Salary scale (under review) £1869-£3633 per annum plus threshold payment.

On 1st September 1975 the Northampton Colleges of Technology, Art and Education will amalgamate to form a new College of Higher Education (Nene College).

Further particulars and application forms can be obtained from the Chief Administrative Officer, Northampton College of Technology, St. George's Avenue, Northampton NN2 6JB. Telephone (0604) 713505.

4769

## PRODUCTION MANAGER

for small quartz crystal manufacturing plant

in

### NEW ZEALAND

An opportunity exists for a Production Manager familiar with all aspects of quartz crystal manufacturing for the communications market. Past experience should encompass grinding, vacuum plating and finishing to frequency. The company, Hatfield Crystals Ltd., has recently entered the field of quartz crystal filter manufacture thus, although not an essential, it would be useful if the applicant has knowledge of quartz crystal design, particularly monolithic crystal filters in the 10.7 MHz band.

The successful applicant must be prepared to reside permanently in New Zealand and will be sponsored through the Migration Department of the New Zealand High Commission. The company is located at Napier, North Island, in a temperate climate not unlike the South of France. An attractive salary together with the usual fringe benefits will be offered.

Applicants to write in the first instance to:

**The Managing Director  
HATFIELD INSTRUMENTS LTD.  
Burrington Way  
Plymouth, PL5 3LZ  
Devon**

4646

# TEST ENGINEERS

We have vacancies for Test Engineers to fault find and test a wide variety of quality control equipment, with experience of working on chemical, gas and oil analysis essential.

These positions would be ideal for ex-service personnel with relevant experience.

Good rates of pay, 4 weeks holiday, pension and sick pay schemes.

Ring Sylvia Borra 01-692 1271 Ext 393  
or write to her at  
The Personnel Department

**GEC-ELLIOTT PROCESS INSTRUMENTS**

Century Works, Connington Road,

Lewisham, London SE13 7LN

### SERVICE AND REPAIRS

**THOR-HOLE CONVENTIONAL P.C.B.'s** gold plating, roller tinning, prototypes, silk screening, drilling. All or part service. — **ELECTRO-CIRCUITS (P.C.) LTD.**, Delamare Road, Chesnut, Herts. Tel. Waltham Cross 38600 or 20344. (75)

### CAPACITY AVAILABLE

**DESIGN**, development, repair, test and small production of electronic equipment. Specialist in production of printed circuit assemblies. **YOUNG ELECTRONICS LTD.**, 184 Royal College Street, London NW1 9NN. 01-267 0201. (29)

### NEW GRAM AND SOUND EQUIPMENT

**GLASGOW**, Hi Fi, Cassette Decks, Tape Recorders, Video Equipment, always available we buy, sell and exchange for Hi Fi sets and photographic equipment. **VICTOR MORRIS** Audio Visual Ltd, 340 Argyle Street, Glasgow, G1, 8/10 Glassford Street, Glasgow, G2, 31 Sauchiehall Street, Tele: 041-221 8958. (11)

**RING  
YOUR  
CLASSIFIEDS  
TO  
ALLAN  
PETTERS  
ON  
01-261  
8508  
OR  
01-261  
8423**

#### SITUATIONS VACANT

**HI-FI AUDIO ENGINEERS.** We require experienced Junior and Seniors and will pay top rates to get them. Tell us about your abilities. 01-437 4607. (19)

**ELECTRONICS TECHNICIAN** required in Department of Psychology, University of Reading. Should have or be completing final C & G in Electronic Servicing or equivalent. Salary in scale £2439-£2895 p.a. (Grade 5). Apply with names of 2 referees and full details, quoting Ref. TZZ.23A to Assistant Bursar (Personnel), University of Reading, Whiteknights, Reading RG6 2AH. (4725)

#### ARTICLES FOR SALE

**MINIATURE ALUMINIUM ELECTROLYTIC CAPACITORS.** Axle and Radial Leads.

MFD	6.3v	10v	16v	25v	35v	50v
1	—	—	—	—	—	7p
10	—	6p	—	—	—	—
22	—	—	—	7p	—	7p
33	—	6p	—	7p	—	7p
47	—	6p	—	8p	8p	8p
100	—	—	7p	9p	11p	10p
220	—	7p	7p	9p	14p	—
330	—	—	11p	14p	17p	18p
470	7p	11p	15p	18p	—	18p
1000	15p	—	18p	18p	—	35p
2200	15p	18p	—	—	—	—
3300	15p	18p	—	—	—	—
4700	18p	—	—	—	—	—

C.W.O. Post & Packing 15p for orders below 10p. Please add 8% VAT to all orders. Min. order 1.

**SYSTEM TECHNIQUES (ELECTRONICS) LIMITED, 8 Manor House Gardens, Edenbridge, Kent, TN8 5EG, Edenbridge (073 271) 2610. (4750)**

#### TAPE RECORDING ETC.

##### RECORDS MADE TO ORDER

DEMO DISCS  
MASTERS FOR  
RECORD COMPANIES

VINYLITE  
PRESSINGS

Single discs. 1-20 Mono or Stereo. delivery 4 days from your tapes. Quantity runs 25 to 1,000 records. PRESSED IN VINYLITE IN OUR OWN PLANT. Delivery 3-4 weeks. Sleeves/Labels. Finest quality NEUMANN STEREO Mono Lathes. We cut for many studios UK/OVERSEAS. SAE list.

**DEROY RECORDS**

PO Box 3, Hawk Street, Carnforth, Lancs.  
Tel. 2273 (82)

## ELECTRONIC CRAFTSMEN

*Is your present job routine and uninteresting?*

We are a research establishment and our craftsmen are engaged on a wide variety of work in the fields of prototype and small batch wiring and assembly, test and inspection, maintenance fault finding and repair. Why not join us and enjoy working in first-class conditions in the country?

Earnings are good and our rates of pay are currently under review. We can offer good housing at low rental (for applicants who live outside the radius of our Assisted Travel Area) together with 3 weeks' paid holiday with holiday bonus, free pension and excellent sick benefit scheme.

Applicants who should have served a recognised apprenticeship or have had equivalent training together with experience in one of the fields detailed should phone Tadley 4111 (STD 073-56 4111) Ext. 5230, or write to:

**INDUSTRIAL RECRUITMENT OFFICER  
(PA/87/WW) PROCUREMENT EXECUTIVE  
MINISTRY OF DEFENCE  
AWRE ALDERMASTON  
READING, BERKS.  
RG7 4PR**

(4718)

# SONY®

## Trainee V.T.R. Service Engineer

Due to the continued growth in the sales of our products we have a vacancy for a qualified V.T.R. Engineer in our Central Service Division, Ascot Road, Bedfont, Middlesex. Ideally we require an engineer with previous experience of servicing Video products, but we are prepared to train engineers who have experience of televisions and tape-recorders.

The duties will involve the servicing of our wide range of Video products, including recorders, cameras and microphones.

We are offering an attractive salary which will be based on qualifications and experience and generous staff discounts on all of our products.

**Please apply to: The Personnel Officer, Sony (UK) Ltd., Pyrene House, Sunbury-on-Thames, Middlesex. Tel: Sunbury 87644.**

4739

#### MINISTRY OF DEFENCE (ARMY DEPARTMENT)

##### A vacancy exists for a CIVILIAN INSTRUCTIONAL OFFICER

Grade III (Telecommunications), TV Servicing at 2 Resettlement Centre, Aldershot.

The post is open to men and women fully skilled and experienced in Television Servicing.

Appropriate ONC, C & G Certificate or equivalent qualification desirable. Selection is by test and interview.

Starting salary £2825 to £3209 (at age 28 or over), rising to £3925.

Non-contributory pensionable employment.

Write for application forms to:

Commandant, 2 Resettlement Centre, Galloway Road  
Aldershot, Hants. GU11 2DG

Closing date: 16th July, 1975.



# Radio Operators. How to see more of your wife without losing sight of the sea.



Join the Post Office Maritime Service. We have openings for Radio Operators at several of our coastal stations. The work is just as interesting, just as rewarding as aboard ship, but you get home to see your wife and family more often. You need a United Kingdom General or First Class Certificate in Radiocommunications, or an equivalent certificate issued by a Commonwealth Administration or the Irish Republic.

Starting pay for a man of 25 or over is £2,270, plus cost of living allowance with further

annual increases after that. Though we're happy to take people from 19 up.

In addition to your basic salary, you'll get an average allowance of £450 a year for shift duties and there are opportunities for overtime.

Other benefits include a good pension scheme, sick pay and prospects of promotion to Senior Management.

For more information, write to: ETE Maritime Radio Services Division (R/B/6), ET 17.1.1.2., Room 643, Union House, St. Martins-le-Grand, London, EC1A 1AS.

**Post Office**  
Telecommunications



## AREA SALES MANAGER

(London Area, Kent, Surrey and Sussex)

Applications are invited for this important position from experienced representatives with the following qualities:

1. Good sales experience in the field of high quality radio and audio equipment.
2. Enthusiasm and a determination to expand the Company's activities in this highly competitive field.
3. Preferred age group 28-40. A pleasing personality, presentable appearance and an attitude of diligent dedication are considered to be essential.

In return we offer:

1. An excellent salary.
2. Quality Company car and all expenses.
3. First-class pension and life assurance scheme.
4. The opportunity to play a real part in the further expansion of this quality conscious company.

Applications in writing to:

**Mrs. J. Pollard**  
**Hacker Radio Ltd., Norreys Drive**  
**Cox Green, Maidenhead, Berks., SL6 4BP**

(4763)

### ARTICLES FOR SALE

## Economise on Semiconductors

All prices include new rate VAT

- ★ Low Price CMOS
- ★ Low price DIL sockets
- ★ Lower Price 741C
- ★ Plastic 3 terminal Regulators

	1+	10+	25+	TTL Mixed Prices	1+	10+	25+
709C Op Amp + data 8 pin DIL	37	35	33	7400	18	17	16
723C Regulator + data 14 pin DIL	70	68	64	7402	18	17	16
741C Op Amp + data 8 pin DIL	26	25	24	7403	18	17	16
748C Op Amp + data 8 pin DIL	43	41	39	7404	19	18	17
NE555 Timer + data 8 pin DIL	65	62	59	7405	19	18	17
CA3046 Array 14 pin DIL	84	81	77	7410	19	17	16
TDA1405 Reg. 5V 650mA	95	90	85	7413	36	34	33
TDA1412 Reg. 12V 500mA	95	90	85	7420	18	17	16
TDA1415 Reg. 15V 450mA	95	90	85	7430	18	17	16
8C107. 108. 109	11	10.5	10	7442	77	73	70
8C182. 184	12	11.5	11	7447	99	94	89
8C212. 214	13	12.5	12	7473	42	40	38
HP LED 1/4"	20	19	18	7474	38	36	34
HP LED 0.2"	21	20	19	7476	42	40	38
DIL Sockets	8 pin 12	11	10	7486	33	31	29
Low Profile	14 pin 13	12	11	7490	60	57	54
	16 pin 14	13	12	7493	60	57	54
				74121	48	46	44

				CMOS Mixed Prices			
9C108C	13	RZY88C		4000	24		22
8C177	21	3V3-15V	12	4001	24		22
8C178	21	2N3702	13	4002	24		22
8F244	27	2N3704	13	4007	24		22
8F244B	30	2N3708	11	4011	24		22
8F51	19	2N3055	55	4012	24		22
				4013	66		60
				4015	175		158
				4023	24		22
				4025	24		22
				4027	97		87
				4030	72		65

AY-5-1224 Digital Clock TC. 12 or 24 hr., 7 segment or BCD outputs. drives LED. Minitor displays. Simple interfacing. 16 pin DIL. IC + data + circuits £4.90.  
HP5082-7740 0.3" digits £2.00. IC + 4 0.3" digits £12.30. IC + 4 0.3" digits + transistors + transformer £14.30.  
TBAB10AS 7W Audio Amp with thermal protection + data + circuit £1.25  
TCAB40 10W Audio Amp with thermal protection + current limit + circuit £2.40  
TAD100 Radio IC + IF filter + circuit £1.80  
Carbob film resistors. high stability 1/4W 5%. E12 Values 10-2M 1p 2p ea.. 10 11p. 100 95p.  
By return service. Prices include 25% VAT. P&P 10p (UK). overseas at cost. All items new. TI, Motorola, Mullard, SGS, etc. SAE lists, enquiries, schools, colleges, etc. supplied

**SILICON SEMICONDUCTOR SERVICES**  
41 Dunstable Road, Caddington, Luton LU1 4AL

ARTICLES FOR SALE

The Shop Window for the Very Best...



COMBINED  
PRECISION  
COMPONENTS  
(PRESTON)LTD

194-200 North Rd,  
Preston PR1 1YP  
Tel: 55034  
Telex: 677122.

TOSHIBA VALVES

Type	Price (p)	Type	Price Each (p)	Type	Price Each (p)	Type	Price Each (p)
DY87	30.0	AD149	40	8D124	75	DIODES	
DY802	30.0	AD161	38	8D131	45	BA115	7
ECC82	28.0	AD162	38	8D132	39	BA145	14
EF80	29.5	AF114	24	8D160	£1.39	BA148	19
EF183	34.5	AF115	21	8D235	49	BA154/201	11
EF184	34.5	AF116	22	8D237	52	BY126	11
EH90	35.5	AF117	19	8DX32	£2.40	BY127	12
PC900	24.5	AF118	50	BF115	20	BY199	27
PCC89	40.0	AF139	35	BF160	15	BY206	21
PCC189	41.0	AF178	45	BF167	20	BY238	25
PCF80	31.5	AF180	45	BF173	20	OA90	6
PCF86	39.0	AF181	45	BF178	35	OA202	7.5
PCF801	42.0	AF239	40	BF179	40	IN60 OA91	5
PCF802	40.0	AF240	60	BF180	31	NEW TOSHIBA TUBES	
PCL82	39.0	BC107	11	BF181	32	19" A49/1E1X	£48.95
PCL84	39.0	BC108	10	BF184	25	20" 510DJ822	£50.75
PCL85	44.5	BC109	14	BF185	25	22" A56/12CX	£54.25
PCL86	41.0	BC109C	14	BF194	9	EHT MULTIPLIERS MONOCHROME (BRC)	
PFL200	59.5	BC113	13	BF195	8	2HD 950ME1.960	Price Each
PL36	55.5	BC116A	19	BF196	10	2TQ 950MK2.1400	£1.70
PL84	25.0	BC117	14	BF197	12	2DAK 1500 (17" & 19")	£1.85
PL504	64.5	BC125B	15	BF198	23	2TAK 1500 (23" & 24")	£2.00
PL508	67.0	BC132	25	BF200	25	EHT MULTIPLIERS - COLOUR	
PL519	£1.50	BC135	15	BF218	30	11TAQ ITT 2VC1.2 & 3	£4.50
PY88	35.5	BC137	19	BF224	23	ITN GEC Sobell	£4.50
PY800	33.0	BC138	26	BF258	34	11TAZ GEC 2110	£4.85
PY500A	85.0	BC142	23	BF336	28	11TAM Philips G8	£4.50
		BC143	25	BF337	35	11TBD Philips 550	£4.50
		BC147	11	BF355	54	3TCW Pye E31/653	£3.50
		BC147A	11	BF386	28	11H Decca 30 Series	£4.50
		BC148	10	BFY50	19	11TAQ Decca Bradford	£4.50
		BC149	10	BFY52	20	3TCU Thorn 3000/3500	£5.00
		BC153	15	BSY52	35	11HAA Thorn 8000	£1.90
		BC154	15	BT106	£1.20	11HAB Thorn 8500	£4.25
		BC157	14	BU105/02	£1.95		
		BC158	10	BU108	£2.10		
		BC159	11	BU208	£2.95		
		BC173	18	E1222	30		
		BC178B	20	MJE340	45		
		BC182L	12	OC71	15		
		BC183L	12	OC72	16		
		BC187	25	R2008B	£2.00		
		BC214L	15	R2010B	£2.00		
		BC328	28	RCA16334	80		
		BC337	19	RCA16335	80		

PRICES SUBJECT TO 25% V A T.  
All goods subject to settlement  
discount of 5% 7 days and 2%  
monthly.  
No postage charges or minimum  
order values.  
Write or phone for full details now.

...In Prices, Quality and Service.

PM ELECTRONIC SERVICES

CRYSTALS FOR PROFESSIONAL AND AMATEUR USE

We can supply crystals to most commercial specifications, with an express service for that urgent order. For the amateur we carry a large stock of the more popular frequencies, backed by a quick service for those "Specials"

Please send SAE for details or telephone between 4.30-7 p.m. and ask for Mr. Norcliffe

7A ARROWE PARK ROAD, WIRRAL  
MERSEYSIDE L49 0UB  
Tel. 051-677 8918 (until 7 p.m.)

(58)

MICRO ELECTRONIC TRANSMITTER

Receive on a VHF RADIO  
The smallest Transmitter available in the UK.

Only 2" x 1". Can pick up and transmit minute sounds and voices. Range 500 yards plus. Can be worn round the neck, held in the hand, or operated in a drawer. Works almost anywhere, uses PP3 battery (very long life). Completely self-contained, transistorised printed circuit. Used the world over. Fully guaranteed. Latest model now dispatched.

Transmitter ..... £15.50

If required, Pocket Radio for receiving transmissions ..... £14.30

P. & P. 45p. MAIL ORDER AND CDD Welcome.

Mulhall Electronics, (WW)  
Ardglass, Co. Down, UK. BT30 7SF.  
Tel: 039-684 461.



COLOUR, UHF and TV SPARES. Colour and UHF lists available on request. Signal strength meter kit £18.00, P/P 45p. 625 TV. If unit, suitable for Hi-Fi amp or tape recording, £6.75, P/P 35p. Television construction cross hatch kit, £3.60, P/P 15p. Bush CTV 25. New convergence panels plus yoke and blue lat., £3.85, P/P 40p. New Philips single standard convergence panels complete, incl. 16 controls, coils, P.B. switches, leads £3.75 P/P 50p. New Colour Scan Coils. Mullard or Plessey plus convergence yoke and blue lateral, £9.20, P/P 55p. Mullard AT1025/05 Convergence Yoke, £2.30, P/P 50p. Mullard or Plessey Blue Laterals, 75p P/P 20p. BRC 3000 type Scan Coils, £2.00 P/P 40p. Delay Lines DL20, £3.50, DL1E, DLL, £1.00, P/P 35p. Lum Delay Lines, 50p, P/P 15p. EHT Colour Quadrupler for Bush Murphy CTV 25 111/174 series, £7.50, P/P 35p. EHT Colour Tripler ITT TH25/1TH suitable most sets, £2.00 P/P 25p. GEC 2040 colour tripler £1.75 P/P 25p. Colour surplus/salvaged Philips G8 panels part complete, Decoder, £2.50, IF incl. 5 modules, £2.25. T. Base, £1.00, P/P 25p. CRT base, 75p, P/P 15p. GEC 2040 panels, for spares Decoder £3.50, Time Base £1.00, P/P 50p. B9D valve bases 10p, P/P 6p. VARICAP TUNERS: UHF ELC 1043 NEW, £4.20. ELC1043/05 £5.00. ELC1042 (VHF) £5.50. Salvaged VHF and UHF Varicap tuners, £1.40, P/P 25p. UHF TUNERS NEW. Transistorised. Incl. slow motion drive, £3.80. 4 position and 6 pos. push-button transistorised, £4.20. All tuners P/P 45p. MURPHY 600/700 series complete UHF Conversion Kits incl. tuner, drive assy., 625 IF amplifier 7 valves, accessories housed in cabinet plinth assembly, £5.50, P/P 65p. THORN 850 Dual standard time base panel, 50p, P/P 50p. PHILIPS 625 IF amplifier panel incl. ect., 50p P/P 45p. VHF turret tuners AT7650 incl. valves for K.B. Featherlight, Philips 19TG170, GEC 2010, etc., £2.50. PYE miniature incremental for 110 to 830. Pam and Invieta, £1.00, A.B. miniature with UHF injection suitable K.B. Baird, Ferguson, 75p. New fireball tuners Ferguson, HMV, Marconi, £1.80 P/P all tuners 50p. Mullard 110 mono scan coils, new suitable all standard Philips, Stella, Pye, Ekco, Ferranti, Invieta, £2.00, P/P 35p. Large selection LOPTS, FOPTS available for most popular makes. 200+200+100. Microfarad 350v Electrolytic, £1.00 P/P 20p. MANOR SUPPLIES, 172 WEST END LANE, LONDON, N.W.6. Shop premises, callers welcome. (No. 28, 59, 159 Buses or W. Hampstead Bakerloo and Brit. Rail). MAIL ORDER: 84 GOLDERS MANOR DRIVE LONDON, N.W.11. Tel. 01-794 8751. VAT PLEASE ADD 25% TO ALL PRICES.

Hair Transplant

For free brochure, clip this ad. and send to:  
Room 6  
HAIR TRANSPLANT INTERNATIONAL  
502 Eccleshall Road, Sheffield

(4224)

CARBON FILM RESISTORS—E12 SERIES. High Stab. 1/10W 5%, 1p, 75p/100, £5.50/1000 [22, 1M, 10M]. RESISTOR KITS 22: 1M—E12 SERIES. 10E12 KIT 10 of each value [Total of 510]. 1W, £3.65; 1/2W, £3.85; 25E12 KIT 25 of each value [Total of 1425]. 1W, £8.35; 1/2W, £8.45.  
EQUIPMENT SALE: Regulated power supply modules. New in original packing ATC 24/2A, E10, Fenlow 15V/1A, with F. Panel, E12 50, NGR Vacuum Meters PR10 [Used], E15, Marconi D.A. Converters TF2402, E20, Code Converter TF2403, E20, Lumbs Indicator TF2404, E20, NAAE Const Temp. Water Circulators type F Junior (-0.10) Used, E50, Transformers 50V/30A E20, 7.5KV/0.015A, E7, Honeywell Chart Recorders E50, Solartron VF252 Precision Millivoltmeter E35, Solartron CAS12 V.S.W.R. Indicators E25, 400V 250mA Bench Power Supplies E15, Hatfield Inc. PUM1/16 400 cycle Generators E30, Muirhead 2PH, Dec. Osc. E30. Many other items available. Please add £1 carriage and P. & VAT. METAL FILM KITS ALSO AVAILABLE. CATALOGUES No. 3 (Approx. 2000 Parts) 20p. C.W.D. P & P 10p on orders under £5 Overseas at cost. B. H. COMPONENT FACTORS LTD., Dept. WW, 61 Cheddington Road, PITSTONE, Nr. Leighton Buzzard, Beds., LU7 9AU, Cheddington (0296) 668446 [32]

Build a mixer to your own spec. using our easy to wire AUDIO MODULES  
For full details contact Richard Brown at Zero 88, 115 Hatfield Road, St Albans, Herts AL1 4JS Tel 63727

## ARTICLES FOR SALE

# B. BAMBER ELECTRONICS

5 STATION ROAD, LITTLEPORT, CAMBS, CB6 1QE  
TEL: ELY (0353) 860185 (TUESDAY-SATURDAY)

**TERMS OF BUSINESS: CASH WITH ORDER**  
ALL PRICES INCLUDE POST AND PACKING (UK ONLY)  
EXPORT ENQUIRIES WELCOME. CALLERS WELCOME TUES.-SAT.  
PLEASE ADD 25% VAT. MINIMUM ORDER £1  
PLEASE ENCLOSE STAMPED ADDRESSED ENVELOPE WITH ALL ENQUIRIES

4746

### HANDI-PACKS

**T.V. PLUGS** (metal type), 6 for 50p.  
**T.V. SOCKETS** (metal type), 5 for 50p.  
**T.V. LINE CONNECTORS** (back-to-back skt.), 5 for 50p.  
**TO3 TRANSISTOR INSULATOR SETS**, 10 for 50p.  
**MIXED ELECTROLYTICS**, large bag, £1.00.  
**PC BOARD WITHDRAWAL HANDLES**, mixed cols., 8 for 50p.  
**SOLDER**, 20SWG. 60/40 alloy, approx 9 yds 25p.  
**OA81 DIODES**, 15 for 25p.  
**OC200 TRANSISTORS**, 6 for 50p.  
**PERSPEX COIL FORMERS**, 1 1/4 in x 1/2 in dia., 5 for 25p.  
**TURRET TAGS**, 1/16th in dia., 25p pack.  
**ROTARY SWITCHES**, min. 4 pole 2 way, 2 for 50p.  
**TELEPHONE TYPE EARPIECE INSERT**, 50p.  
**REEDS** (for reed relays) Single-pole make, 5 for 30p.  
**MULLARD TUBULAR CERAMIC TRIMMERS**, 1-18pf, 6 for 50p. (as featured in Rad. Comm. Jan. p.25)  
**ICs**, some coded. 14DIL type, untested mixed, 20 for 25p.  
**IF CANS**, 1/2 in square, suitable for rewind, 6 for 30p.  
**SMALL NEONS**, 6 for 25p  
**24V MIN. REED RELAYS**, encapsulated single-pole make, 2 for 50p.  
**24V 2.8W LAMPS**, MES type, 6 for 20p.  
**CHASSIS TAGES**, 25p pack  
**CABLE CLIPS**, for nailing cable, 15p pack  
**MINIATURE SLIDER SWITCHES**, 2 pole, 2 way, 5 for 50p.  
**BSY95A TRANSISTORS**, 6 for 50p  
**6.3V 0.3A CAPLESS LAMPS**, 10 for 25p.  
**PNP AUDIO TYPE TOS TRANSISTORS**, 12 for 25p.  
**BLACK PLASTIC KNOBS**, 1/2 in dia 1/4 in spindle, 4 for 50p.  
**RINGS MAGNETS**, 7mm outside dia., 20 for 50p.  
**150B2 MULLARD 150V REG.** (Equiv OA2) (new, boxed) 40p.

**ROTARY SWITCHES** 9 way 4 pole (separate wafers, plastic), 1/4 in spindle, 40p each  
**FERRITE COILS** on 1/8 in dia ferrite rings, 3 for 50p.  
**HEATSINKS** (Approx 3 in x 4 in x 2 in, high), 12 fins (drilled for 1 x TO3 transistor) Brand new, 45p each  
**VHF RF CHOKES** (wound on 2 2K 1/2W Resistors), 5 for 35p.  
**SMALL CHROME HANDLES**, 1/4 in dia., 1 1/4 in between holes, 1 in clearance, tapped 4BA (with screws & washers), 2 pair for 40p.  
**RELAYS**, single pole, change over, 12 DC, approx 1/4 in x 1/2 in x 1 1/4 in, 35p each  
**AT LAST WE HAVE A STOCK OF THE TRIMMERS YOU'VE ALL BEEN ASKING FOR!**  
2-6pf, 10mm circular, ceramic trimmers (for VHF/UHF work), 3 pin mounting, 5 for 50p.  
**CERAMIC HIGH VOLTAGE PILLARS** (metal ends, tapped 4BA), approx 1 in long, 10 for 60p.  
**CURLY LEADS**, 4 core telephone-type, 18 in closed, approx 5ft extended, 2 for 20p.  
**STUD RECTIFIERS**, BYX42/300R, 300V at 10A, 30p each, or 4 for £1.00.  
**TRANSISTOR HEATSINKS**, to make 2 x TO18 transistors, screw in clamps, block size 1 in x 1/2 in x 1/4 in with 2 holes for mounting, 3 for 50p.  
**DUBILIER ELECTROLYTICS**, 50uF, 450V, 2 for 50p.  
**DUBILIER ELECTROLYTICS**, 100uF, 275V, 2 for 50p.  
**PLESSEY ELECTROLYTICS**, 470uF, 63V, 3 for 50p.  
**TCC ELECTROLYTICS**, 1000uF, 30V, 3 for 60p.  
**PLESSEY ELECTROLYTICS**, 1000uF, 180V, 40p each (3 for £1.00).  
**DUBILIER ELECTROLYTICS**, 5000mfd at 35V, 50p each  
**DUBILIER ELECTROLYTICS**, 5000uF, 50V, 60p each  
**DUBILIER ELECTROLYTICS**, 5000mfd at 70V, 65p each

**ITT ELECTROLYTICS**, 6800mfd at 25V, high grade, screw terminals, with mounting clip, 50p each  
**PLESSEY ELECTROLYTICS**, 10000mfd at 63V, 75p each  
**PLESSEY CATHODRAY CAPACITORS**, 0.04uF at 12.5KVDC, screw terminals, £1.50 each.

### PLUGS AND SOCKETS

**25-WAY ISEP PLUGS AND SOCKETS**, 40p set (1 plug + 1 skt) Plugs and sockets sold separately at 25p each  
**DIN SKTS**, 5 pin, 250 deg., 4 for 50p.  
**DIN SPEAKER SKTS**, 2-pin, 4 for 50p.  
**STANDARD JACK PLUGS**, 1/4 in., 4 for 50p.  
**ANDREWS 44AN FREE SKTS.** (N-type) for FH4/50B or FHJ4/50B cable, £1.00 each  
**BULGIN ROUND FREE SKTS**, 3 pin, for mains input on test equipment, etc., 25p each  
**SO239 BACK TO BACK SOCKETS**, £1.25 each  
**BNC INSULATED SOCKETS** (single hole type), 65p each  
**PL259 PLUGS (PTFE)**, Brand new, 50p each, or 5 for £2.25.  
Reducers for above 15p each  
**SO239 SOCKETS (PTFE)**, Brand new (4 hole fixing type), 50p each, or 5 for £2.25.  
**N-TYPE SKTS.** (4 hole chassis mounting, 50ohms, small coax lead type), 50p each  
**BNC PLUGS** (Amphenol, new, packed) 35p each (4 for £1.20).  
**BNC SOCKETS** (4 hole chassis mounting, lead type), 35p each (4 for £1.20).  
**GREENPAR (GE30015) CHASSIS LEAD TERMINATIONS** (These are the units which bolt on to the chassis: the lead is secured by screw cap, and the inner of the coax passes through the chassis) 30p each, 4 for £1.00.

### VALVES

**QQV03/10** (ex. equipment), 75p each  
**2C39A** (ex. equipment), £1.00 each  
**QQV02/6** (ex. equipment), £1.00 each  
**4CX250B** (ex. equipment), £2.10 each  
**4X250B** (ex. equipment), £1.50 each  
**DET22** (ex. equipment), 2 for £1.00.  
**FF80** (new), 25p. **EZ81** (new) 25p.

### MAINS TRANSFORMERS

All 240V input, voltages quoted approx RMS  
(Please quote Type No. only when ordering)  
**TYPE 10/2** 10-0-10V at 2A, £1.50.  
**TYPE 18/2** 18V at 2A, £1.65.  
**TYPE 16/6** 16V at 6A, 45V at 100mA, £4.00.  
**TYPE 28/4** 28V at 4A, 125V at 500mA, £4.00.  
**TYPE 129** 400V at 20mA, 200V at 10mA, 6.3V at 500mA, £1.25.  
**TYPE 72703** 400V at 10mA, 200V at 5mA, 6.3V at 400mA, £1.25.  
**TYPE 70462** 250-0-250V 50-0-50V 6.3V, £1.75.  
**TYPE 125BS**, approx. 125V at 30mA, 65p.

### MAINS ISOLATING TRANSFORMER

(ex. equip.), in metal cases, totally enclosed, tapped mains input, 110-240V etc. output 240V at 3A + 12V at 0.5A, £11.00.  
**AS ABOVE**, output 240V at 12A + 12V at 3A + 22V at 2.5A, £27.50.  
**RADIO SPARES 500WATT AUTO TRANSFORMER**, 100 / 110 / 150 / 200 / 220 / 240 / 250V tapped input and output step up or step down facility, ex. new equip., £6.00.

**HIGH QUALITY SPEAKERS**, 8 1/2 in x 6 in elliptical, 2 in. deep, 4ohms, inverse magnet, rated up to 10W, £1.50 each, or 2 for £2.75 (Quantity discount available)

**VARIABLE STABILISED PSU**, solid state, 240V AC input, output 0-24V DC at 500mA + 32V at 50mA (approx.) Size 7 1/2 in x 4 in x 2 1/2 in (voltage controlled by external 5k ohm pot) (less 5k ohm pot) £5.00 each  
5k ohm pots, 3 turn, for above, 75p each

**MANUFACTURERS** — SEND SAE FOR OUR LATEST BARGAIN CAPACITOR LIST

### PYE RADIO-TELEPHONE EQUIPMENT

Cambridge, Westminster, Motofone, Europa series Send s.a.e. for full details, stating requirements, frequency, channel spacing, etc.

### SERVICE AND REPAIRS

**PHOTO ETCH LIMITED**  
9 LOWER QUEEN STREET  
PENZANCE, CORNWALL, TR18 4DF  
Prototype or long run — we will supply your printed circuit requirements  
Also facilities for Design, Assembly and Test  
Prompt and efficient service assured  
contact David Webster  
PENZANCE (0738) 4472

**AUDIOMASTER BACKGROUND MUSIC**... service, sales. Tape programmes. P. J. Equipments, 3 Onslow Street, Guildford 4801. (12)

**TUBE POLISHING**, mono £5.63, colour £5.94. C.W.O. Return carriage and VAT paid. Phone: N.S. 300, Retube Limited, North Somercotes, Lough, Lincs. (27)

### RECEIVERS AND AMPLIFIERS — SURPLUS AND SECONDHAND

**HRO** Rx5s, etc., AR88, CR100, BRT400, G209, S640, etc., etc., in stock, R. T. & I. Electronics, Ltd., Ashville Old Hall, Ashville Rd., London, E11 Ley 4986. (65)

**SIGNAL** Generators, Oscilloscopes, Output Meters, Wave Voltmeters, Frequency Meters, Multi-range Meters, etc., etc., in stock, R. T. & I. Electronics, Ltd., Ashville Old Hall, Ashville Rd., London, E.11. Ley 4986. (64)

### COURSES

## The Polytechnic of North London

### INTERESTED IN ELECTRONICS?

'With 2 'A' levels, ONE, or equivalent, you could become a **CHARTERED ELECTRONIC AND RADIO ENGINEER**.  
Write for details of our 3-year full-time course in Electronic and Communication Engineering

'With 3 'O' levels, City and Guilds Part 1 or equivalent, you could become a **PROFESSIONAL TECHNICIAN ENGINEER (CEI)**.

Write for details of a 2-year full-time course in Electronics  
Department of Electronic and Communications Engineering  
Polytechnic of North London Holloway, N7 8DB 01 607 6767 (4723)

### COLOUR TV SERVICING

Learn the techniques of servicing Colour TV sets through new home study course provided by leading manufacturer. Covers principles, practice and alignment with numerous illustrations and diagrams. Other courses for radio and audio servicing

Full details from ICS School of Electronics, Dept. 327, Intertext House, London SW8 4UJ. Tel. 01-622 9911 (all hours). 4736

### TECHNICAL TRAINING

Get the training you need to move up into a higher paid job. Take the first step now — write or phone ICS for details of ICS specialist homestudy courses on Radio TV Audio Eng and Servicing, Electronics, Computers, also self-build radio kits

Full details from ICS School of Electronics, Dept. 326, Intertext House, London SW8 4UJ. Tel. 01-622 9911 (all hours). 4735

**RADIO** and Radar M.P.T. and C.G.L.I. Courses. Write: Principal, Nautical College, Fleetwood, FY7 8JZ. (25)

### VALVES WANTED

**WE BUY** new valves, transistors and clean new components, large or small quantities, all details, quotation by return. — Walton's, 55 Worcester St., Wolverhampton. (62)

### CITY & GUILDS EXAMS

Study for success with ICS. An ICS home study course will ensure that you pass your C & G exams. Special courses for Telecoms Technicians, Electrical Installations, Radio, TV & Electronics Technicians' Radio Amateurs

Full details from ICS School of Electronics, Dept. 325, Intertext House, London SW8 4UJ. Tel. 01-622 9911 (all hours). 4734

## ARTICLES FOR SALE

**SURPLUS BARGAINS****EASTER LINE ANGUS**

chart recorders, model A601R  
500-0-500u.a. f.s.d. 110v AC.  
as new, with manual. **£35.00**  
(carr. £1).



Kent Chart recorders single point **£20**,  
multipoint **£30** (£1.50).

A.E.I. 4-stage sequential transistorised  
electronic timer, many applications, inc  
3 channel auto-light flasher (750 watts  
240v). Circuits provided for fully inter-  
rupted and dim/bright flashing. Modification  
instructions and mains transformer. **£4.50**  
only (50p).

Printed circuit Kits. **£1.25** (30p).  
Instant Heat Soldering Irons, 240v 100 watt  
**£2.65** (30p).

Veedor root 4 digit resettable counters 115v  
AC **£1.25** (10p).  
AMPEX VIDIO Tape 2" x 1670'. New **£9**  
(50p).

Ferric Chloride **25p** lb (20p). 10 lbs for  
**£2.50** (45p).

TELEPRINTER PAPERS and TAPES. 8 1/2"  
wide, 3-ply carbon, buff manilla **60p** (35p),  
ditto 7-ply NCR, no carbon required **£1**  
(35p). TAPES, 7/8", white **£2** per 8 rolls (65p).  
1/8" buff **£2** per 10 rolls (65p). 1" tape suit  
Friden, etc. **£2** per 7 rolls (65p).

B & R VHF change over coaxial relays 50v  
DC operating coil 2 1/4" x 2 1/4" x 2 1/4" **£1.25**  
(15p).

35 watt Mains transformer outputs 2, 3, 6,  
20, 24, 27, 30. **£1.25** (25p).

All prices plus (p&p) total plus VAT 8%.

Large S.A.E. for list.

**CASEY BROS.**, 235 Boundary Rd, St Helens,  
Lancs. 86

**BUDGET MINI AUDIO MIXERS****With Professional Facilities**

Slider Faders ★ Tone Controls ★ Monitoring ★  
VU Meter

Mono or Stereo ★ Ready to use or kits

Details Ref. WW

**PARTRIDGE ELECTRONICS**

21-25 Hart Road, Benfleet, Essex

**CRYSTALS**

Fast delivery of prototypes and production runs

**INCLUDING:**

Stalek LF crystals in TO5 package  
Buckman LF, clock and mobile radio crystals  
Astro Filter crystals  
Jan General purpose crystals

**Interface Quartz Devices Limited**

29 Market Street, Crewkerne, Somerset  
Tel. (046031) 2578. Telex: 46283 (57)

**AARVAK SOUNDLIGHT CONVERTERS** **£9!**

Strobes £21! Sequencers £27! . . . etc., etc.  
Bumper Catalogue:— 98a(W) West Green  
Road, N15 5NS. 01-800 8656. (23)

**CHEAPEST EVER NATIONAL DIGITAL CLOCK**

CHIP. MM534 now available for only £3.78, 10  
for £32.40, 24 pin dill socket 85p. Suitable red  
L.E.D. Displays 0.3" high. Pin compatible  
with DL 707 etc. £1.08 each. 10 for £8.64. 14  
pin dill socket 18p. Limited quantities avail-  
able. 10p for catalogue. Postage free. All prices  
include VAT at current rates. Mail order only  
to G. Newman, 12 Francis Avenue, St.  
Albans AL3 6BK. (4747)

**INTEGREX** S-2020TA stereo tuner/amplifier.  
Carefully built, performs to specification, £69.50  
plus 95p post and packing. — I. G. Bowman,  
35 Park Hill Road, Torquay, S. Devon. (4733)

**16MM B & H 631** Sound projectors c/w speaker  
and transformers £135. — Hilton Cine, 9 West  
Hill, Dartford -T, 20009. (15)

**SCOPE TUBES** D14-121 GH with mumetal  
shield and base, £20 each. Suitable unassembled  
cases £9 each. — Tel 01-202 6282. (4728)

**TEKTRONIX** power supply/mainframe PS503/  
TH 501 + —20v + —400 MA SV supplies new  
£180. Tektronix triple mainframe TM503 for  
TM 500 modules new £100. — 359 0051. (4727)

**HUNDREDS** of Dual Standard Colour TV's for  
sale. Contact: S. H. C. Televisions Ltd., 024-  
026 (Radnage) 3321. (20)

**VACUUM** is our speciality, new and second-  
hand rotary pumps, diffusion outfits, accessori-  
es., coaters, etc. Silicone rubber or varnish  
outgassing equipment from £40. V. N. Barrett  
(Sales) Ltd., 1 Mayo Road, Croydon, 01-684  
9917. (24)

**ELECTRONIC KITS**

requires reliable firms well  
connected in own markets  
for handling exclusive sales  
in countries where no  
organisation yet exists.

Send enquiries to:

**AMTRON**  
Casella Postale 4160,  
Milano,  
Italy 22

60 KHz MSF Rugby and 75 KHz Neuchatel  
Radio Receivers Signal and audio outputs.  
Small, compact units. Two available versions.  
Toolex, Bristol Road, Sherborne (3211), Dorset.  
(21)

**CONSTRUCTION AIDS** — Screws, nuts, spacers,  
etc., in small quantities. Aluminium panels  
punched to spec. or plain sheet supplied. Fascia  
panels etched aluminium to individual re-  
quirements. Printed circuit boards — masters,  
negatives and board, one-off or small numbers.  
Send 9p for list. Ramar Constructor Services,  
29 Shelbourne Road, Stratford on Avon.  
Warks. Tel. Stratford on Avon (STD 0789) 4879.  
(22)

**LOW COST IC MOUNTING.** Use Soldercon IC  
socket pins for 8 to 40 pin DILs, 70p (plus  
5p VAT) for strip of 100 pins, **£1.50** (plus 12p  
VAT) for 3 strips of 100, **£4** (plus 32p VAT)  
for 1,000. Instructions supplied. Send for sam-  
ple. Sintel, 53c Aston Street, Oxford. Tel:  
0865 43203. (67)

**DIGITAL CLOCK CHIP, AY-5-1224**, with data  
and circuit diagram, **£3.66** plus VAT. 'Jumbo'  
LED digits (16mm high) type economy DL/747  
only £2.04 each plus VAT, post free. Greenbank  
Electronics, 94 New Chester Road, Wirral,  
Merseyside L62 5AG. (83)

**TRANSFORMERS**, Pri 200/240V & Sec. 12, 15, 20,  
24, 30V. 1A £2.10 p.p. 38p, 2A £3.10 p.p. 38p,  
3A £4 p.p. 42p, 4A £4.45 p.p. 52p, 5A £5.60  
p.p. 52p, 6A £6.30 p.p. 52p. Pri, 200/240. Sec.  
19, 25, 33, 40, 50V. 1A £2.85 p.p. 38p, 2A £4.35  
p.p. 42p, 3A £5 p.p. 52p, 4A £6.70 p.p. 52p,  
5A £10.80 p.p. 67p. Pri, 200/240V. Sec. 24, 30,  
48, 60V. 1A £2.75 p.p. 38p, 2A £4.45 p.p. 42p,  
3A £6.70 p.p. 52p, 4A £7.80 p.p. 67p, 5A £8.65  
p.p. 67p, 6A £10 p.p. 82p. Open type, table  
top connections. Quotations for sizes up to  
500 VA. Add 8% V.A.T. TRANKIT ELECTRICAL,  
192 SILVERTONHILL AVENUE, HAMILTON  
ML3 7PF. (4655)

**LADDERS** unvarnished 14ft lin, closed, 25ft  
4in extd. £21.40 delivered. Tel: Telford 586644.  
(16)

**INTEGREX NELSON-JONES TUNER** fitted with  
Mark 2 Portus and Haywood decoder, £51.50,  
plus 80p post and packing. — I. G. Bowman,  
35 Park Hill Road, Torquay, S. Devon. (4761)

**MULLARD** ferrite cores LA3 100 to 500 kHz  
50p, LA4 10 to 30 kHz, 75p; LA 2100 3 to 200  
kHz 50p. Toroids approx sizes O.D. 101, 6 M.M.  
1.D 50.8 M.M. Widely used in frequencies from  
500 kHz to 2 Mhz. 50p. Small toroids O.D.  
127 M.M. 1.D 6.35 min effective permeability  
700, 50 for £2.50. Enquiries invited for other  
ferrites, cores, beads, tubes, etc. Ceramic  
formers L23 M.M. diam. 13 M.M. Bore 1 end  
8 M.M. other end 4 M.M. 100 for £1.50. Very  
large quantities of all above components ex-  
stock Also available large quantities of poly-  
ester, Ceramic, Polystyrene and Electrolytic  
capacitors relays, key switches etc. Please add  
25% V.A.T. to all orders. Mail order only.  
Xeroza Radio, 1 East Street, Bishop's Tawton,  
Devon. (4760)

**ENAMELLED COPPER WIRE**

S.W.G.	1lb Reel	1/2lb Reel
10-14	£2.05	£1.15
15-19	£2.15	£1.20
20-24	£2.20	£1.25
25-29	£2.25	£1.30
30-34	£2.35	£1.38
35-40	£2.50	£1.45

All the above prices are inclusive in U.K.

**COPPER SUPPLIES**

102 Parrwood Road, Withington, Manchester 20  
Telephone 061-445 8753

**HEWLETT PACKETT** Oscilloscope 175A, Verical  
Amplifier 175B, Delayed Generator 1781B, Abso-  
lute mint condition with hand books, trolley  
and probes, £250, D43 Tequipment Oscillo-  
scope, mint condition £90. — Box WW4762.

**ARTICLES WANTED****WE SELL CONSTRUCTION PLANS**

Police-Radar-Detector, Open Channel, Electro  
Ball, Telephone Scrambler, Quarter Mike, Tail  
Transmitter, TV Camera, Infinity Transmitter,  
Voice Typewriter, each plan are U.S. \$7.50,  
Play TV Ping Pong \$11.50, Infra Red TV  
Camera \$11.00, Infra Red Mike \$13.50,  
Martini Olive Mike \$13.50. Catalogue \$0.75.

T. Strik, Postbox 618  
Rotterdam, HOLLAND (33)

**WE BUY** modern 16mm sound projectors. Bur-  
gess Lane & Co. Ltd., Thornton Works, Thorn-  
ton Avenue, Chiswick W.4 994 5752/5953. (4387)

**WANTED**, all types of communications receiv-  
ers and test equipment. Details to R. T. & I.  
Electronics, Ltd., Ashville Old Hall, Ashville  
Rd., London, E.11. Ley 4986. (63)

**SURPLUS COMPONENTS**, Equipment and Com-  
puter panels wanted for cash. Ring Southamp-  
ton 772501. (4748)

**WANTED** surplus capacitors, resistors and tran-  
sistors in bulk for cash. — Electronic Mail-  
order Ltd., Ramsbottom, Bury, Lancs. Tel (STD  
70682) 3036. (4751)

**CAPACITY AVAILABLE**

**PRINTED CIRCUIT BOARDS** — Quick  
deliveries, competitive prices, quotations on  
request, roller tinning, drilling, etc., speciality  
small batches, larger quantities available.  
Jamiesons Automatics Ltd, 1-5 Westgate, Brid-  
lington, N. Humberside, for the attention of  
Mr. J. Harrison. Tel: (0262) 4738/77877. (18)

**LABELS, NAMEPLATES, FASCIA**s on anodised  
aluminium or perspex. Any quantity, superb  
quality, fast delivery. G.S.M. Graphics Ltd.,  
1-5 Rectory Lane, Guisborough (Tel. 02873-  
4443), Yorks. (26)

**SMALL** Batch Production, wiring assembly, to  
sample or drawings. Specialist in printing cir-  
cuit assemblies. D. & D. Electronics, 42 Bis-  
hopsfield, Harlow, Essex. Tel: Harlow 33018.  
(17)

**CAPACITY** available for the Assembly of Elec-  
tronic or Electrical Components P.C.B.s, etc.  
Small or large batch production. Remploy  
Ltd., Jupiter Road, Norwich NR6 6SU. (31)

**CAPACITY** available for the Electronic Industry.  
Precision turned parts, engraving, milling and  
grinding both in metals and plastics. Limited  
capacity available on Mathey SP33 µg borer.  
Write for lists of full plant capacity to C.B.  
Industrial Engineering Ltd., 1 Mackintosh Lane,  
E9 6AB. Tel: 01-985 7057. (14)

**BATCH** Production Wiring and Assembly to  
sample or drawings. Deane Electricals, 19B  
Station Parade, Ealing Common, London, W.5.  
Tel: 01-992 8976. (20)

**AIRTRONICS LTD.**, for Coil Winding — large or  
small production runs. Also PC Boards Assem-  
blies. Suppliers to P.O., M.O.D., etc. Export en-  
quiries welcomed. 3a Walerand Road, London,  
SE13 7PE. Tel: 01-852 1706. (61)

# You've asked for it!

Time and again we are asked for reprints of Wireless World constructional projects: tape, disc, radio, amplifiers, speakers, headphones. Demand continues long after copies are out of print. To meet the situation we have collected fifteen of the most sought after designs and put them in one inexpensive book. And we've updated specifications where necessary to include new components which have become available. A complete range of instruments is presented, from the Stuart tape recorder and Nelson-Jones f.m. tuner, through the Bailey, Blomley and Linsley Hood amplifiers, to the Bailey and Baxandall loudspeakers - some of which have been accepted as standard in the industry.

## high fidelity designs

£1 from newsagents and bookshops or £1.35 (inclusive) by post from the publishers.

A book from

# Wireless World



To: General Sales Department, Room 11, Dorset House, Stamford Street, London, SE1 9LU

Please send me \_\_\_\_\_ copy copies of High Fidelity Designs at £1.35 inclusive. I enclose remittance value £ (cheques payable to IPC Business Press Ltd.).

NAME  
please print

ADDRESS

Company registered in England No. 077128  
Regd. office, Dorset House, Stamford Street, London SE1 9LU



# Guide to Broadcasting Stations

17th Edition

A title which has sold more than 250,000 copies. The bulk of the book is devoted to lists of stations broadcasting in the long, medium, short and v.h.f. bands in both frequency and geographical and alphabetical order. The book also contains useful information on radio receivers, aerials and earth, propagation, signal identification and reception reports.

1973 206 pp., illustrated  
0 592 00081 £1.00

# Illustrations in Applied Network Theory

F. E. Rogers

A hundred numerical and algebraic illustrations designed to exemplify practical circuit problems and introduce, in analysis, principles consistent with studies of synthesis that may be pursued later.

1973 240 pp., illustrated  
0 408 70425 X cased £5.75  
0 408 70426 8 limp £2.65  
Obtainable through any bookseller

**Newnes-Butterworths**

BOROUGH GREEN  
SEVENOAKS  
KENT TN15 8PH

TEL. 884567



## Quartz Crystal Units

ACCURATE  
RELIABLE

Private enquiries, send 10p in stamps for brochure

### THE QUARTZ CRYSTAL CO. LTD.

Q.C.C. WORKS, WELLINGTON CRESCENT,  
NEW MALDEN, SURREY. 01-942-0334 & 2988

## SINTEL

Data and circuits supplied with orders or available separately (send s.a.e.)

DISPLAYS		CLOCK KITS, IC, PCBs	
DL704E 3" CC	0.85	4 digit Alarm Clock Kit	14.75
DL707 3"	1.70	(complete less case, sws, LS, fmr)	
DL747 6" CA	2.45	6 digit Alarm Clock Kit	16.55
FND500 5" CC	2.20	MK50250N Alarm IC	5.60
MAN3M 12" CC	0.48	PCBs, skt. for above	2.45
SLT014 x 5" Phos D. C1	5.80	PCB for 6 x DL704	1.35
32.768 kHz Quartz Crystal	trimmable to ±0 ppm		3.60
32.768 kHz Xtal plus CMOS to provide 50 cps (with circuit)			5.84

**SOLDERCON Pins:** 100 for 50p, 400—£2, 1000—£4, 3000—£10.50  
CMOS from **RCA** and **MOTOROLA** (sae/phone for full stock list)

CD4001A	0.21	CD4016A	0.62	CD4046A	2.02
CD4002A	0.21	CD4017A	1.63	CD4049A	0.62
CD4007A	1.47	CD4020A	1.82	CD4060A	2.29
CD4009A	0.67	CD4023A	0.21	CD4069B	0.26
CD4011A	0.21	CD4024A	1.16	MC14511C	1.95
CD4013A	0.63	CD4030A	0.65	MC14518C	1.87
				MC14553C	4.07

RCA 1975 CMOS Databook containing pin-outs, data, circuits and applications (645 pages) £2.30 (No VAT) + 37p p&p

**ADD VAT at 8%** new 25% rate does not apply to any of these goods  
10p P&P on orders under £2 (Send s.a.e. for Price List 6)  
SINTEL 53c ASTON STREET, OXFORD. Tel. 0865 43203

## EXPRESS

PRINTED CIRCUITS - ROLLER TINNING  
GOLDPLATING - FLEXIBLE FILMS, ETC

**EURO-CIRCUITS LTD.**  
Highfield House, West Kingsdown  
Nr. Sevenoaks, Kent  
Tel: West Kingsdown 2344

## TAPE ★ TAPE ★ TAPE

EMI PROFESSIONAL LOW NOISE TAPE

7" LP 1800'	£2 30 (10 for £21 00)
10½" LP 3600' NAB	£5 60 (10 for £51 00)
Dynamic cassettes C90	64p (10 for £6 30)
X1000 cassettes C90	89p (10 for £8 70)

Please add 20p P&P and then 8% VAT to orders

**FRASER-MANNING LTD.**  
40 TUDENHAM ROAD, IPSWICH, IP4 2SL

## SOWTER TRANSFORMERS

FOR SOUND RECORDING AND REPRODUCING EQUIPMENT

We are suppliers to many well-known companies, studios and broadcasting authorities and were established in 1941  
Early deliveries. Competitive prices. Large or small quantities. Let us quote.

**E. A. SOWTER LTD.**  
Transformer Manufacturers and Designers  
12 Dedham Place, Waterworks Street  
Ipswich IP4 1J.P. Telephone 0473 52794

WW 081 FOR FURTHER DETAILS

**WE PURCHASE ALL FORMS OF ELECTRONIC EQUIPMENT AND COMPONENTS, ETC.**

**SPOT CASH**

**CHILTMead LTD.**  
7, 9, 11 Arthur Road, Reading, Berks.  
Tel: 582 605

## QUARTZ CRYSTALS

- Quality Units 2 — 105 MHz
- Competitive Prices
- Industrial and Mobile Radio Crystals a speciality
- Prompt Delivery (Appx 3 weeks)

For full details write or telephone

### C&C electronics

10 West Park, London SE9 4RQ  
Telephone 01-852 9397

WW—078 FOR FURTHER DETAILS

## EXCLUSIVE OFFERS

**WORLD-WIDE RANGE NEVER BEFORE OFFERED**

**COMPLETE TRANSPORTABLE H.F. COMMUNICATIONS CENTRE** housed in Air Conditioned TRAILER fitted two COLLINS KWT-6 500W S.S.B. Transmitter-Receiver and one COLLINS Receiver all fully tunable to 30 mc/s digital readout synthesised frequency control, with line amplifiers and inputs, operating position and remote control facilities and ancillary equipment. Power input 115V or 230V A.C. Full details on application.

**PHILCO HC-150 POINT-TO-POINT STRIP RADIO HF RECEIVERS** 2/30 m/cs. Ten fully tuneable channels to 0.5 mc/s with synthesisers. Single and diversity reception on ISB, DSB, SSB with 4 sub-bands to each channel. Full details and prices on application.

## HIGHEST QUALITY 19" RACK MOUNTING CABINETS & RACKS

Our Ref.	Height in inches	Width in inches	Depth in inches	Rack Panel Space in ins.	Price
CL	30	60	36	42	£12.50
CR	66	30	20	—	£24.00
DM	70	20	26	138	£21.00
FA	85	22	36	160	£22.00
FC	52	25	22	47	£17.00
FG	11	19	18	10	£11.00
FH	15	21	17	11	£12.00
FJ	15	21	15	12	£12.00
FN	70	24	20	68	£17.00
LL6	11	21	17	9	£15.00
LL7	16	20	12	14	£15.00
LL8	10	20	10	9	£15.00
LL9	17	21	17	14	£15.00
LL10	52	21	18	18	£18.00

Also Consoles, twin and multi-way Cabinets.

**OPEN RACKS**

Our Ref.	Height in inches	Channel	Rack Panel Space	Raise	Price
R5	35	3	7.9	15	£11.00
RG	57	2	5.1	14	£9.00

Full details of all above on request.

We have a large quantity of "bits and pieces" we cannot list—please send us your requirements we can probably help—all enquiries answered.

- All Racal Units are in unused condition.
- \* Racal RA63 S.S.B. Adaptors £70.00
  - \* Racal RA237 Long Wave Adaptors £70.00
  - \* Racal RA 17/17 Factory Test Rigs £125.00
  - \* Racal RA 298 I.S.B. Adaptors £100.00
  - \* Racal RA 70 Converters £30.00
  - \* Racal Front Panels RA.17, etc. £12.00
  - \* Racal MA 240 Modulators £70.00
  - \* Racal MA 141 Distortion Units £50.00
  - \* Racal MA 143 Oscillators £50.00
  - \* Apex Electro-stat Photo Copier Electrostatic £50.00
  - \* Apex Dial a Copy Photo Copier Electrostatic £75.00
  - \* Omal Electronat Photo Copier Electrostatic £25.00
  - \* Hewlett Packard 560A Digital Recorder P.U.R.
  - \* Hewlett Packard 524C Digital Counter P.U.R.
  - \* Tektronic 519 Oscilloscopes 1 GMC P.U.R.
  - \* Ferroglyph Model 808 Recorders £45.00
  - \* Airmec 701 Sig. Generators 30 kc/30 m/cs £30.00
  - \* Airmec 702 Sig. Generators 30 cyc/30 kc/ £23.00
  - \* CT 381 test Sets Freq. Response £140.00
  - \* Rustrack Chart Recorders 1.0-1 m/a (New) £30.00
  - \* DG7/5 CRT's 2½" and CV-2175 £3.00
  - \* Laboratory Radio Interference Filters £2.50
  - \* Aido 5/8 track Tape Punches £48.00
  - \* Tally 5/8 track Tape Readers 60 c.p.s. £48.00
  - \* Tally 5/8 track Tape Readers 120 c.p.s. £85.00
  - \* Auto Electric Carillon Chimes £250.00
  - \* Triangular Lattice Mast Sections, 15' sides £29.00
  - \* Ampex Audio Stereo Tape Machines £250.00
  - \* Astrodata 5190 Time Code Generators £60.00
  - \* Geotech 4983 Helio Amplifiers £16.00

We have a varied assortment of industrial and professional Cathode Ray Tubes available. List on request.

## INSTRUMENTATION-TAPE RECORDER-REPRODUCERS

### AMPEX

FR-600 1" and ½" 14 and 7 tracks 4 speeds Transistorised.  
Also ½" 2 track 6 speeds

### MINCOM

CMP-100  
¼" ½" 1" 7 tracks 6 speeds

### E.M.I.

BTR-1 R-301  
Several other smaller decks  
Full details on request

Prices of above are from £100 to £400

### COMPUTER HARDWARE

- ★ CARD READER 80 col. 600 c.p.m.
- ★ PRINTER, High speed 1000 lines p.m.
- ★ TAPE READER, High speed 5/8 track 800 c.p.m.

Prices on Application  
**PLEASE ADD V.A.T. AND CARRIAGE TO ABOVE AT APPROPRIATE RATE**

## P. HARRIS

**ORGANFORD-DORSET**  
BH16 6ER  
BOURNEMOUTH-765051

# Wilmslow Audio

## THE firm for speakers!

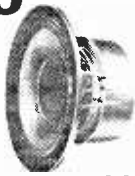

Baker Group 25, 3, 8, or 15 Ohm	£8.64
Baker Group 35, 3, 8 or 15 ohm	£10.25
Baker Deluxe, 8 or 15 ohm	£13.75
Baker Major, 3, 8 or 15 ohm	£11.87
Baker Regent, 8 or 15 ohm	£10.00
Baker Superb, 8 or 15 ohm	£18.12
Celestion HF1300 8 or 15 ohm	£7.75
Celestion MF 1000 horn, 8 or 15 ohm	£10.95
EMI 13 x 8, 150 d/c, 3, 8 or 15 ohm	£2.94
EMI 13 x 8, 8 ohm	£9.56
EMI 13 x 8, 20 watt bass	£7.69
EMI 2 1/4" tweeter 8 ohm	£0.77
EMI 8 x 5, 10 watt, d/c, roll/s 8 ohm	£3.44
Elac 59RM 109 15 ohm, 59RM 1148 ohm	£3.44
Elac 6 1/2" d/c roll/s 8 ohm	£4.06
Fane Pop 15 watt 12"	£5.25
Fane Pop 20T 10" 20 watt	£6.50
Fane Pop 25T 30 watt 12"	£7.50
Fane Pop 50 watt, 12"	£12.00
Fane Pop 55, 12" 60 watt	£2.95
Fane Pop 60 watt, 15"	£13.75
Fane Pop 100 watt, 18"	£29.95
Fane Crescendo 12A or B, 8 or 15 ohm	£34.50
Fane Crescendo 15, 8 or 15 ohm	£47.50
Fane Crescendo 18, 8 or 15 ohm	£62.95
Fane 807T 8" d/c, rolls/s, 8 or 15 ohm	£4.62
Fane 801T 8" d/c roll/s 8 ohm	£8.12
Goodmans 8P 8 or 15 ohm	£5.50
Goodmans 10P 8 or 15 ohm	£5.80
Goodmans 12P 8 or 15 ohm	£13.95
Goodmans 12P-D 8 or 15 ohms	£16.95
Goodmans 12P-G 8 or 15 ohms	£15.95
Goodmans Audiom 100 8 or 15 ohm	£13.90
Goodmans Audiom 200 8 ohm	£13.90
Goodmans Axent 100 8 ohm	£8.44
Goodmans Axiom 402 8 or 15 ohm	£20.00
Goodmans Twinaxiom 8" 8 or 15 ohm	£10.14
Goodmans Twinaxiom 10" 8 or 15 ohm	£10.75
Kef T27	£6.06
Kef T15	£6.94
Kef B110	£8.37
Kef B200	£9.50
Kef B139	£16.50
Peerless Kolo DT Tweeter	£8.06
Kef DN8	£2.31
Kef DN12	£5.75
Kef DN13	£3.87
Richard Allan CG8T 8" d/c roll/s	£7.37
STC 400 1 G super tweeter	£6.56
Baker Major Module, each	£13.44
Goodmans Mezzo Twinkit, pair	£47.19
Goodmans DIN 20, 4 ohm, each	£13.44
Helme XLK25, pair	£25.44
Helme XLK30, pair	£17.19
Helme XLK50, pair	£46.25
Kefkit 1, pair	£48.44
Kef kit III, each	£42.50
Richard Allan Twinkit, each	£10.37
Richard Allan Triple 8, each	£15.94
Richard Allan Triple, each	£23.12
Richard Allan Super Triple, each	£27.50
Richard Allan HP8B 8" 45 watt	£12.95
Wharfedale Linton 2 kit (pair)	£23.12
Wharfedale Glendale 3 kit, pair	£40.62
Wharfedale Dovedale 3 kit, pair	£63.12
Decca London and X over	£37.50
Decca DK30 and X over	£24.06

All Radford, Gauss, Castle, Jordan Watt, Eagle, Lowther, Tannoy units in stock.

**INCLUDING VAT AT 25% ON HI-FI, 8% ON PRO AND PA**

Cabinets for PA AND HiFi, wadding, Vynair, etc. Send stamp for free booklet "Choosing a Speaker"

**FREE with all orders over £7 — HiFi Loudspeaker Enclosures Book**

**All units are guaranteed new and perfect**

Prompt despatch

Carriage: Speakers 38p each, 12" and up 50p each, tweeters and cross-overs 25p each, kits 75p each (£1.50 pair)

## WILMSLOW AUDIO

Dept. WW

Loudspeakers & Export Dept: Swan Works, Bank Square, Wilmslow, Cheshire SK9 1HF.

Discount HiFi, PA etc: 10 Swan Street, Wilmslow. Radio, HiFi, TV: Swift of Wilmslow, 5 Swan Street, Wilmslow. Tel. (Loudspeakers) Wilmslow 29599, (HiFi, etc.) Wilmslow 26213

WW-070 FOR FURTHER DETAILS

# VIDEO HIRE

EQUIPMENT, EDITING, OPERATORS' STUDIO FACILITIES ETC.  
THE MOST EXPERIENCED VIDEO COMPANY IN THE BUSINESS

## R.E.W.

R.E.W. HOUSE,  
10, 12 HIGH STREET,  
COLLIERS WOOD,  
LONDON, SW19 2BE PHONE: 01-540 9684

## LONDON CENTRAL RADIO STORES

**TELEPHONE CABLE.** Plastic covered grey 4-core colour coded. 10p per yard

**ELECTRICITY SLOT METERS** (5p in slot) for A.C. mains. Fixed tariff to your requirements. Suitable for hotels, etc. 200/250c 15A **£8.38**. 20A **£9.30**. P.P. 75p. Other amperages available. Reconditioned as new. 2 years guarantee

**MODERN TYPE DESK PHONES,** red, green, blue or 2-tone grey or black, with internal bell and handset with 0-1 dial **£6.50**.

**5-WAY PRESS-BUTTON INTER-COM TELEPHONES** in Bakelite case with junction box handset. Thoroughly overhauled, guaranteed. Price **£5.25**. Send s a e

**10-WAY PRESS-BUTTON INTER-COM TELEPHONES** in Bakelite case with junction box handset. Thoroughly overhauled. Guaranteed **£6.75** per unit. Send s a e

**20-WAY PRESS-BUTTON INTER-COM TELEPHONES** in Bakelite case with junction box. Thoroughly overhauled. Guaranteed **£7.75** per unit. Send s a e

**QUARTERLY CHECK METERS** 15A **£3.90**. 20A **£4.22**. P & P 50p

*All prices subject to fluctuation*

Multi Relay Units, Group selectors, Final end selectors and Relays in stock. 20-way jack strips and tip ring and sleeve plugs. For callers only

**23 LISLE STREET, LONDON, W.C.2**  
437 2969  
Open all day Saturday

## EX-COMPUTER STABILISED POWER SUPPLIES

RECONDITIONED, TESTED AND GUARANTEED

Ripple <10mV. Over-voltage protection, 120-130v. 50 c/s. Stepdown transformer to suit about **£3**. **Γ & P £1.80**. 5/6v. 8A. **£12**. 5/6v. 12A. **£14**

**PAPST FANS** 4 1/2 x 4 1/2 x 2in. 100 cfm. 240v. 50/60 c/s. **£3.50 (35p)**.

**PAPST FANS** 6; dia x 2 1/2 deep, type 7576 **£5.00 (35p)**. 250w light dimmers **£2.70 (15p)**

**TRANSISTORS** p & p 10p  
BC107/8/9 BC147/8/9 BC157/8/9 all 9p  
BF180 25p. BF182/3 40p. BF184 17p. BFW10 55p.  
2N3819 20p. BF336 35p. 741 8 di 28p. 2N3771 **£1.10**. BD131 40p. NE555 55p.

**ELECTROLYTICS**  
2.800µ 100v 80p (20p). 2.240µ 100v 75p (20p).  
4.500µ 25v 60p (13p). 30.000µ 25v. 15.000µ 30v. 65p (35p). 5.000µ 35v 40p (15p). 2.000µ 50v with clip 35p (11p). 2.200µ 63v 35p (11p).

**EX COMPUTER PC PANELS** 2 x 4 in. 25 boards **£1 (35p)**.

**OPCOA** 7 seg led display SLA-7 7mm characters with dec. point. ea **£1.50 (10p)**  
QH bulbs 12v. 55w. 55p (8p)  
150 mixed HI STABS. 60p (11p)  
250 mixed resistors. 60p (15p)  
250 mixed capacitors. 60p (15p)  
20A, 100 pV Si RECS. 4 for **£1 (12p)**  
2N3055 Equip. 4 for **£1 (12p)**

**SMALL ELECTROLYTICS**  
2.2µ 10/16v. 10µ 35v. 50µ 40v. 100µ 40v.  
100µ 6v 150µ 10v. 64µ 10v. 300µ 10v  
12 for **45p (7p)**

**PIHER PRESETS** 100mW 220, 470, 4k7, 10k, 100k 12 for **50p (6p)**

Postage and packing shown in brackets

Please add 25% VAT to TOTAL

## KEYTRONICS

Mail Order only.

44 EARLS COURT ROAD, LONDON, W.8  
01-478 8499

**TRANSFORMER LAMINATIONS** enormous range in Radiometal, Mumetal and H.C.R. ALSO "C" & "E" cores. Case and Frame assemblies.

## MULTICORE CABLE IN STOCK CONNECTING WIRES

Large quantities of miniature potentiometers (trim pots) 20 ohm to 25K. Various makes. Wholesale and Export only

## J. Black

OFFICE: 44 GREEN LANE, HENDON, NW4 2AH

Tel: 01-203 1855. 01-203 3033

STORE: LESWIN ROAD, N.16

Tel: 01-249 2260

## BROADFIELDS & MAYCO DISPOSALS

21 Lodge Lane, N. Finchley  
London, N12 8JG

Telephone:

01-445 0749

01-445 2713

01-958 7624

MAY WE ASSIST YOU TO DISPOSE OF YOUR SURPLUS AND REDUNDANT STOCKS.

We will call anywhere in the British Isles, and pay **SPOT CASH** for Electronic Components and Equipment.

## QUARTZ CRYSTAL UNITS from

- 1.0-60.0 MHZ
- FAST DELIVERY
- HIGH STABILITY
- TO DEF 6271-A

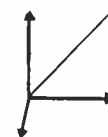

WRITE FOR LEAFLET AT 1

McKNIGHT

CRYSTAL Co.

HARDLEY INDUSTRIAL

ESTATE, HYTHE,

SOUTHAMPTON SO4 6ZY

TEL. HYTHE 848961  
STD CODE 0703

## J. LINSLEY HOOD HIGH QUALITY AMPLIFIERS AND TEST EQUIPMENT

available from

**TELERADIO HI FI**  
325 Fore Street, Edmonton  
London, N.9 (01-807 3719)

Examples:

75 Watt Amplifier P.A. Module	Kit £11.00	Made £14.95
Pre-amp Module	Kit £10.25	.. £14.50
P.S. Units from	Kit £13.70	.. £15.30
F.M. Tuner, Basic Kit	£30.00	p&p 70p
De Luxe Kit	£35.00	p&p 70p
Stereo Decoder, Made	£ 5.85	
Millivoltmeter Kit	£13.00	
Low Distortion Oscillator Kit	£ 8.95	
Tax extra. P&P extra (min. 25p)		

FOR DETAILED AND ILLUSTRATED LISTS SEND S.A.E.

## STEREO DISC AMP

FOR BROADCASTING AND DISC MONITORING  
Mains in. Balanced lines out. Excellent distortion and LF performance. **MEETS IBA SPECIFICATION £95.00.**

## 10-OUTLET DISTRIBUTION AMP

One balanced input—10 isolated balanced outputs  
GENERAL STUDIO WORK ★ FEEDING MULTIPLE SLAVE PA  
AMPLIFIERS ★ DRIVING FOLDBACK HEADPHONES  
Meets IBA signal path specification. Complete boxed unit **£94.00.**  
Set of parts less case and all XLR connectors **£55.00.**

## PEAK PROGRAM METERS TO BS4297

also 200KHz version for high speed copying.

Drive circuit 35 x 80mm for 1mA LH zero meter to BBC  
ED1477 Gold 8 way edge con supplied  
Complete kit **£12.00** Built and aligned **£17.00**  
ERNEST TURNER PPM meters scalings 1.7 OR 2.2 - 4 Type  
642 71 x 56mm **£12.60** 643 102 x 79mm **£15.00**  
Twin movement scale 86 x 54mm **£37.00**

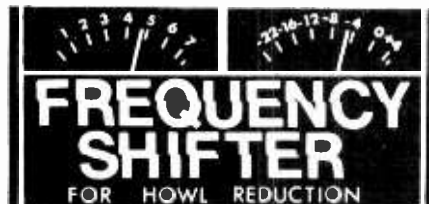

## FREQUENCY SHIFTER

FOR HOWL REDUCTION

## PUBLIC ADDRESS : SOUND REINFORCEMENT

In any public address system where the microphones and loudspeakers are in the same vicinity acoustic feedback (howl round) occurs if the amplification exceeds a critical value. By shifting the audio spectrum fed to the speakers by a few Hertz the tendency to howling at room resonance frequencies is destroyed and an increase in gain of 5-8dB is possible before the onset of feedback.

SHIFTERS IN BOXES with overload LED, shift bypass switch, BS4491 mains connector and housed in strong die-cast boxes finished in attractive durable blue acrylic. Jack or XLR audio connectors.

Type	A	B	C
Input impedance	200kohm	200kohm	10kohm BALANCED
Output impedance	2kohm	20 or 600 ohm	20 or 600 ohm BAL
PRICE	£58 00	£68 00	£84 00

SHIFTER CIRCUIT BOARDS FOR WW July 1973 inside

Complete kit and board **£24.00** Including PSU and DESIGNER  
Board built and aligned **£31.00** mains transformer APPROVED

SPECTRUM SHIFTER: variable shifts, 0.1-1000Hz, for weird special effects and phasing. Ring for leaflets

## SURREY ELECTRONICS

The Forge, Luicks Green, Cranleigh,  
Surrey GU6 7BG. (STD 04866) 5997  
CASH WITH ORDER. less 5% UK post free. add VAT

## PRECISION POLYCARBONATE CAPACITORS

All High Stability — Extremely Low Leakage

440V AC (±10%)		63V Range	±1%	±2%	±5%
0.1µF (1% "x" 1/4")	50p	0.47µF	56p	46p	36p
0.22µF (1% "x" 3/8")	59p	1.0µF	66p	56p	46p
0.25µF (1% "x" 3/8")	62p	2.2µF	80p	65p	55p
0.47µF (1% "x" 3/4")	71p	4.7µF	£1.30	£1.05	85p
0.5µF (1% "x" 3/4")	75p	6.8µF	£1.64	£1.29	£1.09
0.68µF (2% "x" 1")	80p	10.0µF	£2.00	£1.60	£1.40
1.0µF (2% "x" 1")	91p	15.0µF	£2.75	£2.15	£1.90
2.0µF (2% "x" 1")	£1.22	22.0µF	£3.50	£2.70	£2.55

TANTALUM BEAD CAPACITORS — Values available: 0.1, 0.22, 0.47, 1.0, 2.2, 4.7, 6.8µF at 15V/25V or 35V; 10µF at 16V/20V or 25V; 22.0µF at 6V or 16V; 33.0µF at 6V or 10V; 47.0µF at 3V or 6V; 100.0µF at 3V. ALL at 10p each, 10 for 95p, 50 for £1.

TRANSISTOR

AC128	14p	BC183/183L	11p	BFY50	20p
BC107/8/9	9p	BC184/184L	12p	BFY51	20p
BC114	12p	BC212/212L	14p	BFY52	20p
BC147/8/9	10p	BC547/558A	12p	AF178	30p
BC153/7/8	12p	BF194/195	12p	OC71	12p
BC182/182L	11p	BF196,197	13p	2N3055	50p

POPULAR DIODES—1N914 6p, 8 for 45p, 18 for 90p; 1N916 6p, 6 for 45p, 14 for 90p; 1S44 5p, 11 for 50p, 24 for £1.00; 1N4148 5p, 6 for 27p, 12 for 48p; 1N4001 5p, 002 6p, 003 6p, 004 7p, 006 8p; 007 8p.

LOW PRICE ZENER DIODES—400MW. Tol. ±5% at 5mA. Values available: 3V, 3.3V, 3.6V, 4.7V, 5.1V, 5.6V, 6.2V, 6.8V, 7.5V, 8.2V, 9.1V, 10V, 11V, 12V, 13V, 13.5V, 15V, 16V, 18V, 20V, 22V, 24V, 27V, 30V. All at 7p each, 6 for 39p, 14 for 84p. SPECIAL OFFER, 100 Zeners for £5.50.

RESISTORS—High stability, low noise carbon film 5%, 1/2W at 40°C, 1/4W at 70°C. E12 series only—from 2.2Ω to 2.2MΩ. ALL at 1p each, 8p for 10 of any one value, 70p for 100 of any one value. SPECIAL PACK: 10 of each value 2.2Ω to 2.2MΩ (730 resistors) 8p.

SILICON PLASTIC RECTIFIERS—15 amp, brand new wire ended D027, 100 P.I.V. 7p (4 for 26p), 400 P.I.V. 8p (4 for 30p)

BRIDGE RECTIFIERS—2 1/2 amp, 200V 40p, 350V 45p, 600V 55p.

SUBMINIATURE VERTICAL PRESETS—0.1W only ALL at 5p each, 50Ω, 100Ω, 220Ω, 470Ω, 680Ω, 1kΩ, 2.2kΩ, 4.7kΩ, 6.8kΩ, 10kΩ, 15kΩ, 22kΩ, 47kΩ, 68kΩ, 100Ω, 250kΩ, 680kΩ, 1MΩ, 2.5MΩ, 5MΩ.

PLEASE ADD 15p POST AND PACKING ON ALL ORDERS. BELOW £5. ALL EXPORT ORDERS ADD COST OF SEA/AIR MAIL.

PLEASE ADD 25% VAT TO ORDERS

Send S.A.E. for lists of additional ex-stock items. Wholesale price lists available to bona fide companies.

## MARCO TRADING

(Dept. D7)

The Old School, Edstaston, Nr. Wem  
Shropshire  
Tel. Whixall (Shropshire) (STD 094872)  
464/5  
(proprs - Mincost Trading Ltd.)

## INTERNATIONAL TRANSISTOR SELECTOR

Over 10,000 USA, EURO., JAP., BRITISH TRANSISTORS, ELECTRICAL, MECHANICAL SPECIFICATIONS, MANUFACTURERS AND AVAILABLE SUBSTITUTES  
by T. D. Towers, M.B.E. Price **£3.40\***

## 1975 EDITION THE RADIO AMATEUR'S HANDBOOK

by A.R.R.L. Price **£3.60**

VIDEOTAPE RECORDING THEORY AND PRACTICE  
by J. F. Robinson Price **£4.85**

OPERATIONAL AMPLIFIERS Design & Application  
by Barr Brown Price **£4.60**

DIGITAL ELECTRONIC CIRCUITS AND SYSTEMS  
by N. M. Morris Price **£2.55**

COLOUR TV with Particular Ref to PAL SYSTEM  
by G. N. Patchett Price **£5.25**  
★ PRICE INCLUDES POSTAGE ★

## THE MODERN BOOK CO.

BRITAIN'S LARGEST STOCKIST of British and American Technical Books

19-21 PRAED STREET, LONDON, W2 1NP

Phone 723 4185  
Closed Sat. 1 p.m.

## CLASSIFIED ADVERTISEMENTS

### Use this Form for your Sales and Wants

To "Wireless World" Classified Advertisement Dept., Dorset House, Stamford Street, London, SE1 9LU

PLEASE INSERT THE ADVERTISEMENT INDICATED ON FORM BELOW

- Rate: 86p PER LINE. Average seven words per line. Minimum THREE lines.
- Name and address to be included in charge if used in advertisement.
- Box No. Allow two words plus 35p.
- Cheques, etc., payable to "Wireless World" and crossed "& Co."

NAME.....

ADDRESS.....

.....

REMITTANCE VALUE..... ENCLOSED

PLEASE WRITE IN BLOCK LETTERS. CLASSIFICATION..... NUMBER OF INSERTIONS.....

## LOW FREQUENCY ANALYSER

50Hz-50kHz  
ASSEMBLY AND INSTRUCTION  
INFORMATION S.A.E.

PRICE £27 p&p 75p

Board, modules and all  
components (excluding  
P.U.).

## 12" CRT

Magnetic Deflection. Blue Trace  
Yellow Afterglow (P7). Informa-  
tion and recommended circuits  
with all purchases. Brand new,  
boxed, **£4 each**. Carriage £2.

V.A.T. at 8%

### CHILTMEAD LTD

7-9 ARTHUR ROAD, READING, BERKS. (rear Tech. College). Tel. Reading 582605

## 100MHz SCOPE TUBES

MULLARD D13-450GH-03. P31 PHOSPHOR.  
INTERNAL GRATICULE-6CM X 10CM  
RECTANGULAR. Y SENSITIVITY 3V PER  
CM X SENSITIVITY IIV PER CM. SINGLE  
GUN. DISTRIBUTED Y PLATES, TRACE  
ROTATE COILS.

BRAND NEW BOXED. **£30 each**. Carriage £2.

## INDEX TO ADVERTISERS

Appointments Vacant Advertisements appear on pages 73-90

PAGE	PAGE	PAGE
Acoustical MFG Co. Ltd. .... 4	Gardners Transformers Ltd. .... 11	Quality Electronics Ltd. .... 18
Aero Electronics Ltd. .... 18	Grampian Reproducers Ltd. .... 23	Quartz Crystal Co. Ltd. .... 91
Allen & Heath Ltd. .... 20	Hall Electrics Ltd. .... 7	Ralfe, P. .... 54
Ambientacoustics .... 14	Harris Electronics (London) Ltd. .... 12, 24	Rank Film Equipment .... 25
Ambit International .... 25	Harris P. .... 91	Rastra Electronics Ltd. .... 59
Ancom Ltd. .... 26	Hart Electronics. .... 38	R.C.A. Electronics Ltd. .... 10
Arrow Electronics Ltd. .... 23	Henry's Radio Ltd. .... 40	R.C.S. Electronics .... 24
A.R.B.B.G. .... 44	Hepworth, B. & Co. Ltd. .... 16	Research Instruments Ltd. .... 27
Aspen Electronic Ltd. .... 27	Hi-Fi-Year Book .... 18	R.E.W. Audio Visual Co. .... 92
A.S.P. Ltd. .... 60	Hi-Fidelity Designs .... 90	Rogers Developments (Electronics) Ltd. .... 38
Barrie Electronics Ltd. .... 41	I.L.P. (Electronics) Ltd. .... 8	Rola Celestion Ltd. .... 46
Bentley Acoustic Corp. Ltd. .... 64	Icelectrics Ltd. .... 18	Rownsgem Ltd. .... 65
B.H. Component Factors Ltd. .... 68	Icon Design .... 16	R.S.T. Valves Ltd. .... 45
Bi-Pak Semiconductors .... 52, 53	Industrial Tape Applications Ltd. .... 26	Samsons (Electronics) Ltd. .... 66
Bi-Pre Pak Ltd. .... 48	Integrex Ltd. .... 28	Scopex Instruments Ltd. .... 20
B.I.E.T. Technatron. .... 22	I.P.C. Magazines (Television). .... 36	Scott James (Electron Eng.) Ltd. .... 37
Billboard .... 72	Jackson Bros. (Ldn.) Ltd. .... 46	Semicon Indexes Ltd. .... 68
Black, J. .... 92	J.H. Associates Ltd. .... 20	Service Trading Co. .... 57
Brandenburg Ltd. .... 17	J.E.T. Electronics .... 65	Servo & Electronics Sales Ltd. .... 64
Broadfields & Mayco Disposals .... 92	Keytronics Ltd. .... 92	Shure Electronics Ltd. .... 32
Bull, J., Electrical Ltd. .... 50	Klark Teknik .... 18	Sinclair Radionics Ltd. .... 34, 35, 37, 43, 55
Cambridge Audio Ltd. .... 13	Ledon Instruments Ltd. .... 17	Sintel .... 91
Cambridge Learning .... 21	Leeds University .... 45	S.M.E. Ltd. .... cover iii
Carston Electronics .... 58	Levell Electronics Ltd. .... 1	Sowter, E. A., Ltd. .... 91
Catronics .... 44	Light Soldering Developments Ltd. .... 15	Special Product Distributors Ltd. .... 17
C&C Electronics .... 91	London Central Radio Stores .... 92	Strumech Eng. Ltd. .... 29
Chiltmead Ltd. .... 69, 91, 94	Longs Ltd. .... 15	Surrey Electronics .... 93
Chromasonic Electronics .... 67	Lynx (Electronics) London Ltd. .... 56	Swift of Wilmslow .... 43
Colomor (Electronics) Ltd. .... 61	Macinnies Labs Ltd. .... 24	3M UK Ltd. .... 68
Computer Sales & Services .... 66	Macfarlane, W. & B. .... 54	Technomatic Ltd. .... 56
Crofton Electronics .... 27	Maplin Electronic Supplies .... 39	Teleng Ltd. .... 51
C.T. Electronics Ltd. .... 42	Marco Trading Co. .... 93	Tequipment Products (Tektronix U.K.) Ltd. .... 30
Decon Labs. Ltd. .... 11	McLennan Eng. Ltd. .... 19	Teleradio Special Products .... 92
Dema Electronics International. .... 14	Marconi Instruments Ltd. .... cover ii	Time Electronics Ltd. .... 65
Direct Electronics Ltd. .... 61	Marshall, A., & Sons (London) Ltd. .... 41	Toko (U.K.) Ltd. .... 25
Drake Transformers Ltd. .... 36	Magnetic Tapes Ltd. .... 29	Trampus Electronics .... 44
Dymar Electronics Ltd. .... 3	McKnight Crystal Co. .... 92	Transonics .... 44
East Cornwall Components .... 40	Mills, W. .... 50	Valradio Ltd. .... 12
ECC .... 25	Milward, G. F. .... 71	Vitavox .... 22
Eddystone Radio Ltd. .... 10	Modern Book Co. .... 93	Vortexion Ltd. .... 2
Electronic Brokers Ltd. .... 62, 63	Multicore Solders Ltd. .... cover iv	Wayne, Kerr, The, Co. Ltd. .... 6
Electronics Today .... 14	Naim Audio .... 26	West Hyde Developments Ltd. .... 38
Electrovalue .... 43	Oliver Pell Controls Ltd. .... 5	West London Direct Supplies .... 68
English Electric Valve Co. Ltd. .... 33	Olson Electronics Ltd. .... 29	Whitley Electrical Radio Co. Ltd. .... 12
Environmental Equipment Ltd. .... 27	OMB Electronics .... 19	Wilmslow Audio .... 92
Euro-Circuits .... 91	Pattrick & Kinnie .... 60	Wilkinson, L. (Croydon) Ltd. .... 61
Farnell Instruments Ltd. .... 9	Powertran Electronics .... 47, 49	Wireless World Wall Chart .... 72
Fi-Comp Electronics .... 61	Precision Petite Ltd. .... 23	Wireless World Circuit Designs .... 70
Fraser-Manning Ltd. .... 91	Pulse Electronics Ltd. .... 20	Z. & I. Aero Services Ltd. .... 42
Future Film Developments Ltd. .... 27		Zettler GmbH .... 22

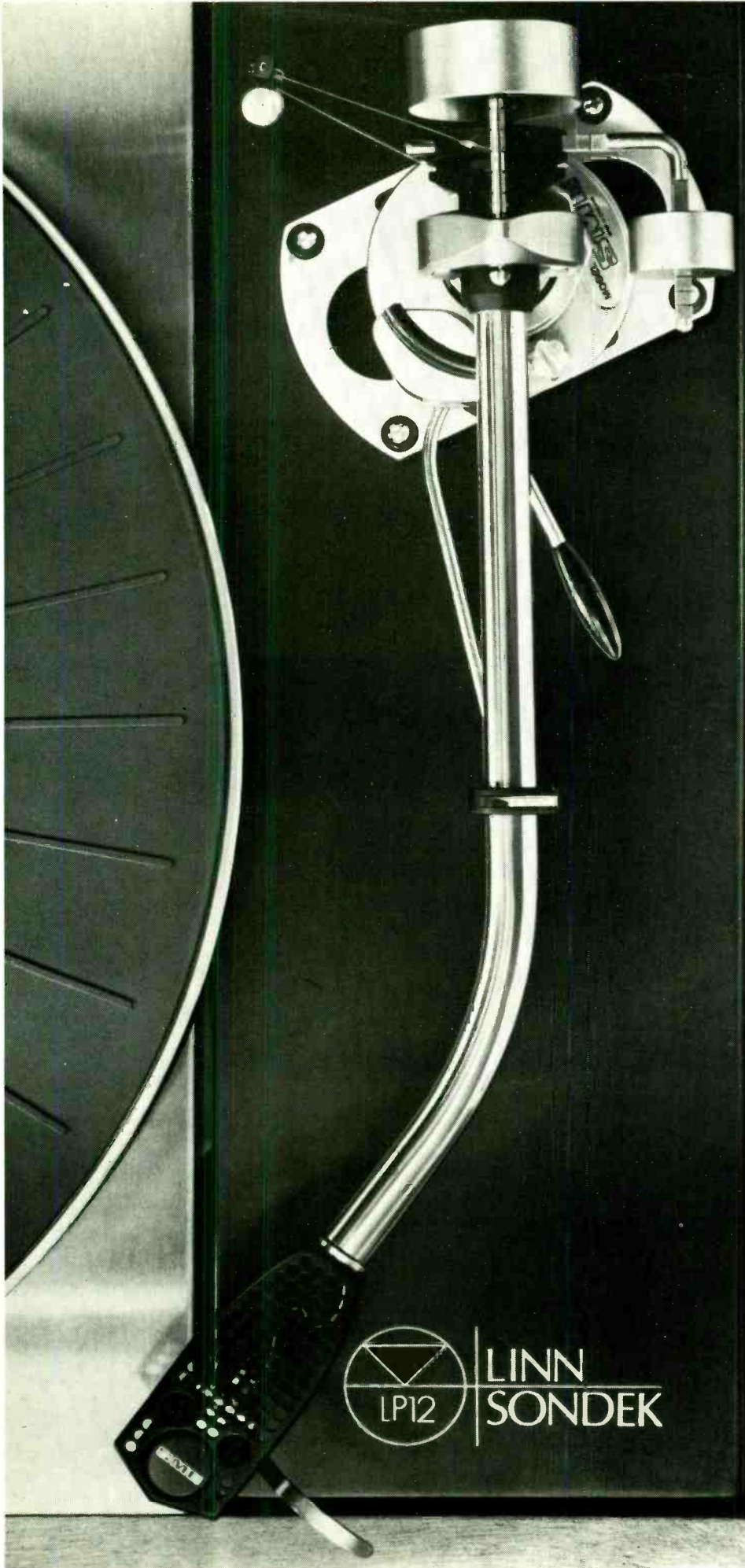

## 3009 + LP12

Information sheet No 3 details the use of our precision pick-up arms with this well-engineered British turntable.

We shall be pleased to send you a copy on request.

# SME

The best pick-up arm in the world

Write to SME Limited  
Steyning · Sussex · England  
Telephone: Steyning (0903) 814321

LTD/S32

WW-002 FOR FURTHER DETAILS

[www.americanradiohistory.com](http://www.americanradiohistory.com)



# Multicore Solder preforms, a little something for automatic processes.

## Multicore Preforms.

Multicore precision made solder preforms come in virtually any shape or size. Rings, washers, discs, pellets, and lengths of solder tape — in most soft solder alloys. Designed, with or without flux cores, to make the most of automatic soldering processes, a solder preform is simple and accurate to use. It's just positioned between the parts to be soldered and the temperature of the metal surfaces raised to about 50°C above the melting temperature of the solder. The solder preform does the rest. Heating techniques can include gas flame, hot plate, oven conveyor, induction coils, resistance/electrode soldering, hot gas and infra-red.

Multicore Solder Preforms just get on with the job. Automatically.



## Our Solder Creams, something else again...

New Multicore Solder Creams are designed for electronics assembly where quality is vital. Like manufacturing diodes, for instance, or making a tuner chassis, or soldering thick-film circuits.

A finely graded solder alloy powder in a thixotropic organic vehicle. It's often quicker, cheaper, easier and more reliable than other soldering techniques. It's different. It doesn't spit or need stirring. It can be applied by syringe, automatic dispenser or screen printing — giving instant soldering with good spread, strong joints with low contact angles. It can act as a temporary adhesive during assembly and the clear colour flux residue — without solder globules — simplifies inspection.

There are three types of Multicore Solder Cream — one of them may be just what you've been looking for.

Approved USA Federal Specification QQ-S-571E

Multicore Product Ref.	XM 27330	XM 27298	XM 27328
Alloy Composition	62/36/2 Sn/Pb/Ag	60/40 Sn/Pb	96/4 Sn/Ag
Melting Point or Liquidus °C	179	188	221
Recommended Flow Temperature °C	239	250	280
Typical Application	Low Melting Point Soldering of silver and gold-plated surfaces	General purpose joints requiring high quality solder cream	Higher temperature resistant joints. Lead free. Higher joint strength than Sn/Pb

*On Qualified Products List of U.S.A. Defense Supply Agency*

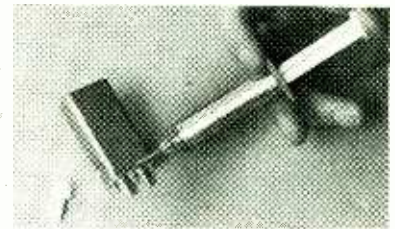

For full information on these or any other Multicore products, please write on your company's letterhead direct to: **Multicore Solders Limited**, Maylands Avenue, Hemel Hempstead, Hertfordshire HP2 7EP. Tel: Hemel Hempstead 3636. Telex: 82363.