

Wireless World

August 1969 Three Shillings

Lasers in electronics
Hyperbolic navigation systems

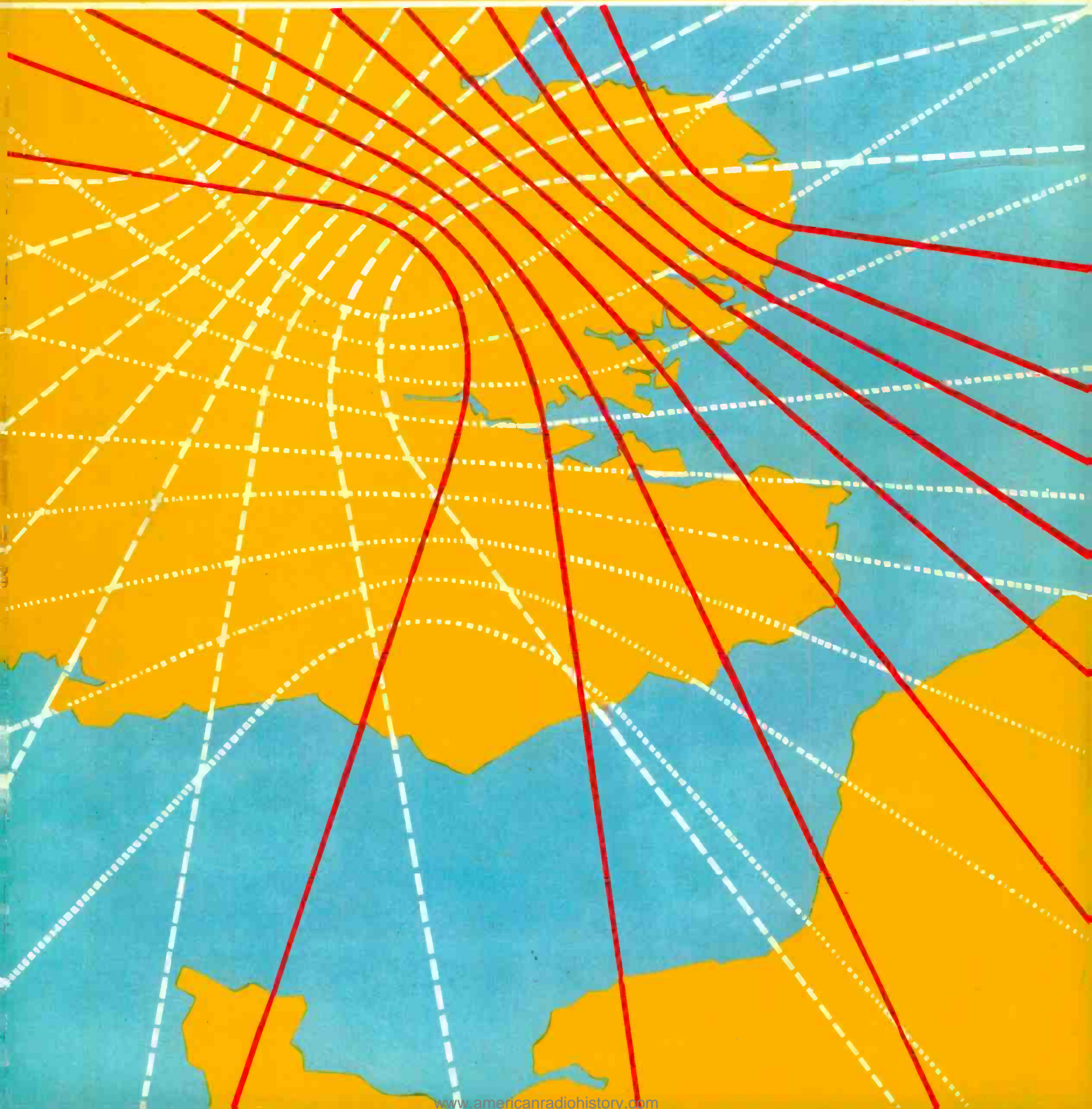

TEKTRONIX INSTRUMENTATION FOR TELEVISION

TYPE 528. MOD 188G. Waveform Monitor for use with camera outputs, video system output lines, transmitter video input lines, CCTV systems and educational TV systems. (Also available for use on NTSC standard.) £394 plus £64.4.0. duty

TYPE RM 529. MOD 188D. Multi-standard Waveform Monitor—can be used on any of the 4 systems without internal adjustment to carry out the majority of television waveform measurements required. £641 plus £104.10.0. duty.

TYPE 520. MOD 188M. Vectorscope with push-button controls for quick, accurate measurements. Chrominance Phase and Amplitude, Differential Phase and Differential Gain Measurements. Solid-state reliability. (Also available for use on NTSC standard.) £898 plus £146.8.0. duty.

TYPE R141. PAL. Television Test Signal Generator is an all solid-state source of high-quality television test signals for 625-line, 50-cycle field standard PAL colour TV Systems. £715 plus £153. 5.0. duty.

TYPE 453. MOD 127C. DC-to-50MHz. Portable Sweep-delay Oscilloscope with built-in TV Sync Separator, solid-state design for highly-accurate work in tough environmental conditions. £948.



TYPE RM 529 MOD 188D



TYPE R141

TYPE 528
MOD 188G

TYPE 520 MOD 188M

TYPE 453
MOD 127C

TEKTRONIX U.K. LTD.

Beaverton House · P.O. Box 69 · Harpenden · Herts.
Telephone: Harpenden 61251 · Telex: 25559.

WW—001 FOR FURTHER DETAILS

New pulse tetrode for low power radars added to EEV's range

The new C1179—a high vacuum beam tetrode designed primarily for the output stage of power amplifier pulse modulators in 5kW-10kW radars.



C1179



C1148



C1149/1



C1150/1

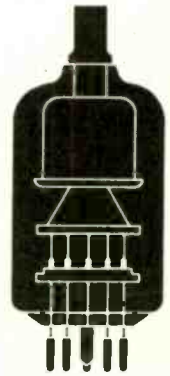

C1166

Type	Service type	Anode dissipation max. (W)	Pulse output power (kW)	Anode voltage max. D.C. (kV)	Pulse anode current max. (A)	Heater ratings		Base
						(V)	(A)	
C1148	—	40	130	14.0	12	6.3	5.0	B5F
C1149/1	CV6131	60	330	20.0	18	26.0	2.15	B4A
C1150/1	CV427	60	205	17.5	15	26.0	2.15	B4A
C1166	—	60	205	17.5	15	6.3	9.0	B5F
C1179	—	18	65	8.0	9.0	6.3	2.8	B7A

Send for full data on the EEV range of pulse amplifier tetrodes



English Electric Valve Co Ltd
 Chelmsford Essex England Telephone: 61777
 Telex : 99103 Grams : Enelectico Chelmsford



Please send me full details on your range of pulse tetrodes.
 I am particularly interested in using a pulse tetrode with the following parameters:

Pulse output power	Anode dissipation	Anode voltage	Pulse anode current
NAME		POSITION	
COMPANY			
ADDRESS			
TELEPHONE NUMBER		EXTENSION	

WW—006 FOR FURTHER DETAILS

Audix

SOUND SYSTEMS

**STANSTED
ESSEX**

**Stansted
3132
3437**

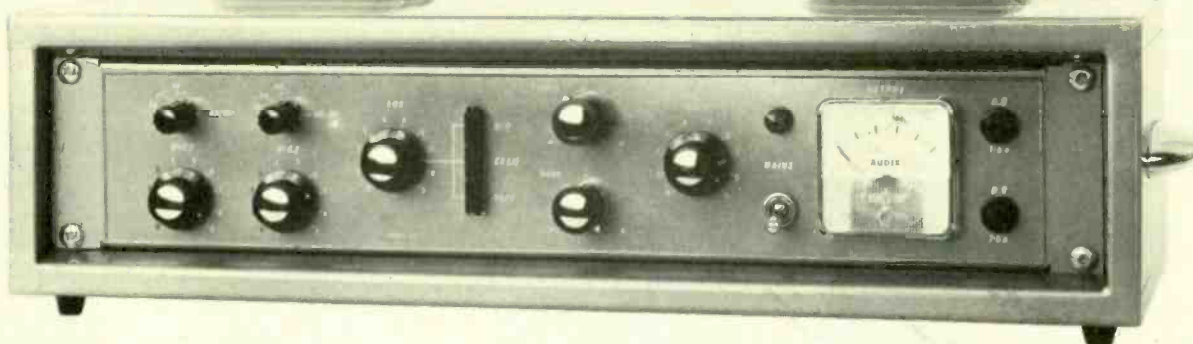

- **SOUND CONTROL CONSOLES**
- **INTEGRATED MIXER AMPLIFIERS**
- **COMPLETE SOUND SYSTEMS**

A25X AMPLIFIER

A recent development in the Audix range of integrated amplifiers, the A25X meets completely, the exacting requirements of professional broadcasting authorities for outside broadcasts.

Output: 100V line or 15 ohms.
Distortion: 0.8% 100Hz-10kHz.
Signal/Noise: Ratio -65db.
Frequency Response ± 1 db 40Hz-15kHz.
Stepped attenuation on microphone inputs. 20, 40 & 60db.
Metered output.
Full short and open circuit protection.
All connectors Cannon and GPO.

WW-007 FOR FURTHER DETAILS

"Astronic"

AUDIO RESPONSE CONTROL UNIT TYPE A1671

PROVIDES ABSOLUTE CONTROL OF FREQUENCY RESPONSE OVER THE AUDIO BAND

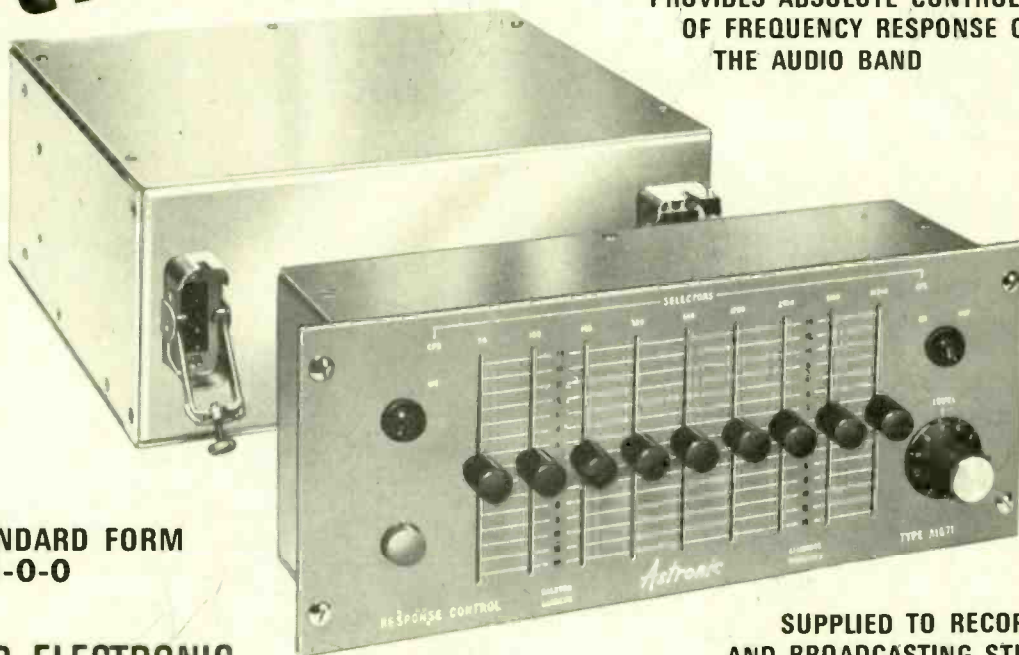

**PRICE IN STANDARD FORM
£145-0-0**

ASSOCIATED ELECTRONIC ENGINEERS LTD.

SUPPLIED TO RECORDING AND BROADCASTING STUDIOS THROUGHOUT THE WORLD

**DALSTON GARDENS · STANMORE · MIDDLESEX
TELEPHONE 01-907 4474/5/6**

WW-008 FOR FURTHER DETAILS

The secret is in the fixing of the Brewster window—the angled glass plate at each end of the tube. In many tubes the seal is made with an epoxy resin which eventually cracks and ruins efficiency by letting in air. EEV, on the other hand, use fusion sealed windows where the seal is as strong as any other part of the tube. Fusion sealing allows the tube to be heated to a very high temperature during manufacture, driving out all the gases in the tube surface which would otherwise contaminate the helium-neon filling. EEV tubes have been life tested up to 6000 hours which is two or three times the life generally expected from tubes employing epoxy sealing techniques. There is a standard range of EEV laser tubes available, full details of which can be obtained by filling in the coupon. If your laser design calls for a special tube give us brief details of what you need as we can probably meet your requirements.

Why EEV gas laser tubes

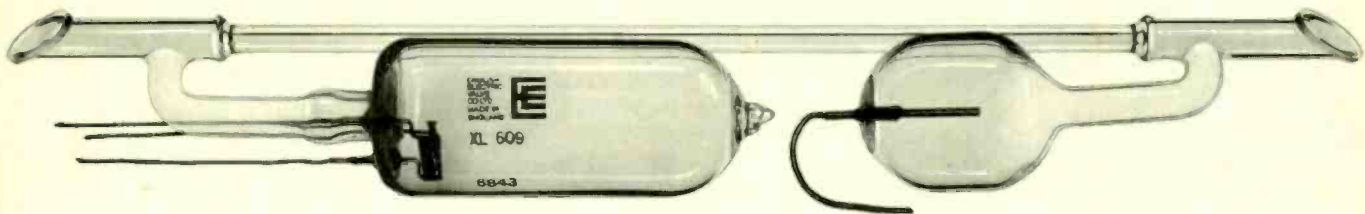

last longer

Type	Excitation	Output power at 632.8nm (mW)	Bore diameter (mm)	Active length (mm)
XL607	R.F. (27MHz)	3.0	7.0	483
XL609	D.C.	2.5	3.0	229
XL612	D.C.	6.0	7.0	457
XL614	D.C.	8.0	7.0	584

Send for full details of the complete range of EEV gas laser tubes.



English Electric Valve Co Ltd
 Chelmsford Essex England Telephone : 61777
 Telex : 99103 Grams : Enelectico Chelmsford



Please send me full data on your range of gas laser tubes. I am particularly interested in using a tube with the following parameters.

Wavelength (nm)	Power Output (mW)	Mode (Single or Multi?)
NAME	POSITION	
COMPANY		
ADDRESS		
TELEPHONE NUMBER	EXTENSION	

WW-009 FOR FURTHER DETAILS

ww 26
 AP357



Armstrong
the high fidelity sound

**A STEREO
TUNER-AMPLIFIER
for the
BUDGET SYSTEM**



127 STEREO TUNER-AMPLIFIER £43-13-9
OPTIONAL CASE As illustrated £3-17-0

If you want high fidelity in the highest class don't buy the 127 Tuner-Amplifier; it isn't meant for you. But if you want a good quality system that is a great deal better than the average radiogram, and your power requirements, as well as your budget, are of modest proportions, then this is meant for you.

The 10 watts power output, 5 from each channel, won't fill a hall, but it is more than adequate for most domestic purposes. The AM-FM Tuner incorporated is doubly attractive because, as well as covering the medium wave-band, it has a performance on FM which is good enough to give excellent results on stereo radio once you add the optional M5 stereo radio decoder.

There are of course the usual facilities; pickup and tape inputs, tape recording outputs, bass and treble tone controls.

As we said at the outset, if you are after top-class hi-fi you don't want the 127, what you want is the Armstrong series 400 or series 500 models.

For details and technical specifications of all models, plus list of stockists, post coupon or write, mentioning 8WW69.

ARMSTRONG AUDIO LTD., WARLTERS ROAD N.7
Telephone 01-607 3213

name

address

8WW69

WW-010 FOR FURTHER DETAILS

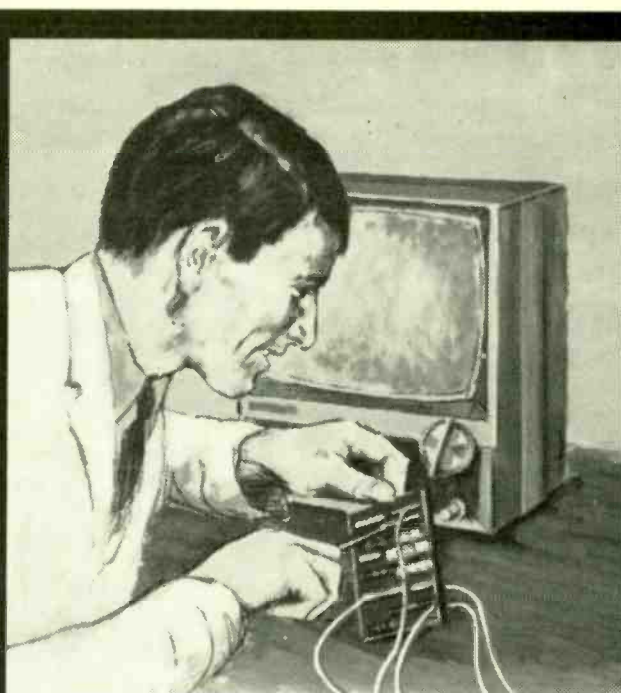

**Train for tomorrow's world
in Radio and Television
at The Pembridge College
of Electronics.**

The next full time 16 month College Diploma Course which gives a thorough fundamental training for radio and television engineers, starts on 3rd Sept. 1969.

The Course includes theoretical and practical instruction on Colour Television receivers and is recognised by the Radio Trades Examination Board for the Radio and Television Servicing Certificate examinations. College Diplomas are awarded to successful students.

The way to get ahead in this fast growing industry—an industry that gives you many far-reaching opportunities—is to enrol now with the world famous Pembridge College. Minimum entrance requirements: 'O' Level, Senior Cambridge or equivalent in Mathematics and English.

To: The Pembridge College of Electronics
(Dept. ww9), 34a Hereford Road, London, W.2
Please send, without obligation, details of the Full-time Course in Radio and Television.

NAME

ADDRESS

WW-011 FOR FURTHER DETAILS

Don't take our word for it—test EEV flash tubes against the equivalents you're now using and learn why other users think so highly of those made by EEV. Incorporating extra heavy duty electrodes, EEV flash tubes are renowned for their reliability, long life (up to 10⁶ flashes) and high conversion efficiency. EEV liquid-cooled and air-cooled xenon flash tubes for pumping laser rods offer a wide range of input energy levels and they are capable of operation at high repetition rates.

Full details of the range are available on request—but if your application calls for a flash tube that is not in the present range, tell us your requirement because we can probably make it for you.

Outstanding in quality, reliability and performance

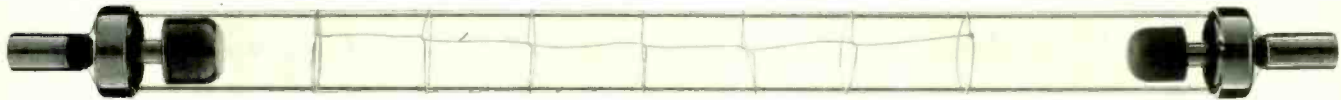

EEV flash tubes

Type	Energy input per flash max. (J)	Arc length (mm)	Bore diameter (mm)	Typical operating conditions			
				Voltage (kV)	Series inductance (μH)	Flash rate	Trigger voltage (kV)
XL615/7/3	600	76	7.0	2.5	400	1 per 15 sec.	12-16
XL615/9/4	1500	102	9.0	2.5	400	1 per 30 sec.	12-16
XL615/10/5.5	3500	140	10.0	2.5	400	1 per 30 sec.	16-20
XL615/10/6.5	5000	165	10.0	2.5	800	1 per 2 min.	20-25
XL615/13/6.5	10000	165	13.0	2.5	800	1 per 2 min.	25

Send for full details of the complete range of EEV flash tubes.



English Electric Valve Co Ltd
Chelmsford Essex England Telephone : 61777
Telex : 99103 Grams : Enelectico Chelmsford



I am interested in EEV flash tubes for (application).
Please send me data sheets on your full range.

NAME _____ POSITION _____

COMPANY _____

ADDRESS _____

TELEPHONE NUMBER _____ EXTENSION _____

WW—012 FOR FURTHER DETAILS

FIT AND FORGET

A.P.T. POWER UNITS

the power pack people

A.P.T. ELECTRONIC INDUSTRIES LIMITED

Chertsey Road, Byfleet, Surrey. Tel: Byfleet 41131-2-3-4

D.C. POWER UNIT MODEL TSU-0500

Stabilised output 0.5A at
preset voltage in range
6-30V.

Very small size 14.3 x
7.8 x 7.0 cm high
($5\frac{5}{8}$ " x $3\frac{1}{16}$ " x $2\frac{3}{4}$ ").

Price £19.0s.0d. net
ex-works, prompt delivery.

For further details send
for fully descriptive
leaflet.

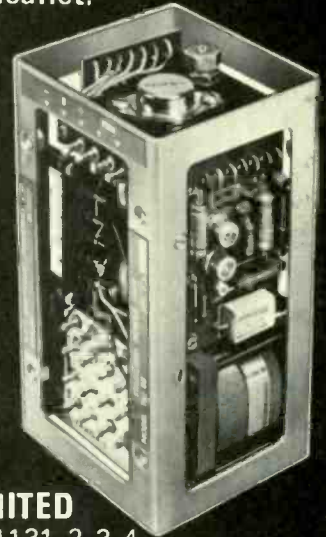

WW-013 FOR FURTHER DETAILS

COPENHAGEN

Bella-Centret 22nd to 31st August

ELECTRONICA

'69

Electronics
Radio · TV

Open daily 10 a.m. to
10 p.m.
From 10 a.m. to 2 p.m.
for trade only



WELCOME!

The electronics industry is one of the leading branches of industry in Denmark - with exports equal to that of our famous butter! You have an opportunity at ELECTRONICA '69 to see what these exports comprise, from the tiniest components to a wide range of colour TVs, stereo radios and professional electronic equipment of every type. And the Danish electronics industry is open-minded, too! We invite our foreign competitors to take part in the exhibition. ELECTRONICA '69 is thus very much an international electronics exhibition. ELECTRONICA '69 has been arranged jointly by the Danish Broadcasting Corporation and the Danish electronics industry. It is purely a display of electronics. Exhibition patron is H.R.H. Prince Henrik.

ELECTRONICA '69 consists of two sections: one for professional equipment and components, and the other for radio, TV, tape recording equipment, record players, Hi-Fi and stereo material, and with a working colour TV studio and stereo and Hi-Fi demonstrations.

ELECTRONICA '69 in its professional section will show such components and professional electronics as are on the market in Denmark, including:

- Automation equipment and instrumentation
- Audio and acoustic instruments
- Boiler controls and instrumentation
- Chemical measuring-equipment for laboratories and industry

- Communication receivers
- Computers, data processing and ancillary apparatus
- Digital read-out- and positioning systems
- Educational equipment, electronic and electrical measuring instruments
- Industrial measurement, pressure, level, flow, etc.
- Laboratory apparatus, equipment, furnishings
- Medical electronics
- Microwave and waveguide apparatus
- Nuclear reactor and nucleonic instrumentation
- Optical instruments, components and accessories
- Radar and navigational aids
- Radio test gear and equipment
- Spectrographic and allied equipment
- Telemetering and remote control
- Television engineering equipment
- Television equipment for closed circuits, black & white, and colour
- Telecommunications equipment
- Valves, electronic, cathode ray tubes etc.
- X-ray equipment, industrial and scientific

Secretariat and press office:
Graabrødre Torv 16
1154 Copenhagen K.

Write for brochure.

WW-014 FOR FURTHER DETAILS

EEV klystrons - a wide and flexible range for UHF TV

5 7 10 25 40 kW

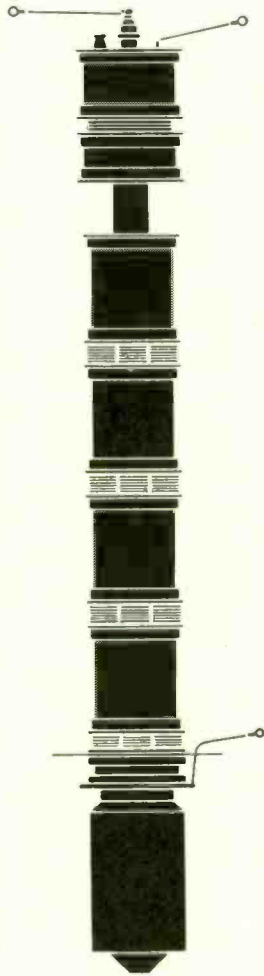
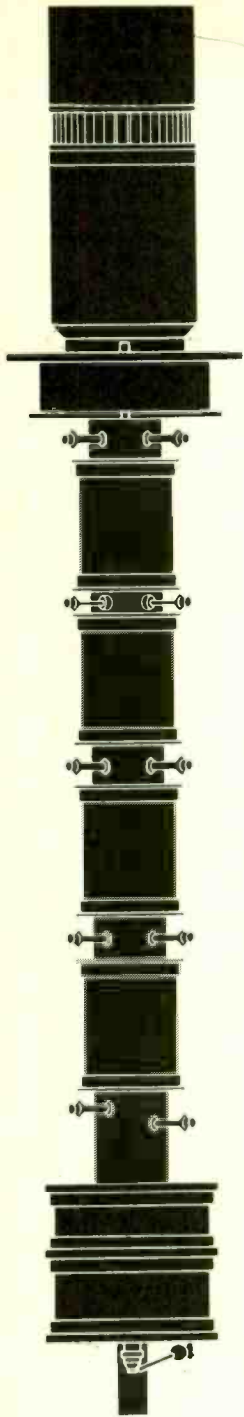

Send for full details of the complete range of EEV amplifier klystrons.



EEV make amplifier klystrons for UHF TV at power levels 5, 7, 10, 25 and 40kW into the aerial. Their reliability is established, their operating efficiency is good and their design provides a high degree of operational flexibility. A 40kW tube can, for example, be operated at the same efficiency at any power level between 20kW and 40kW. When operated at 40kW the tube needs only 135kW d.c. input.

English Electric Valve Co Ltd
Chelmsford Essex England Telephone: 61777
Telex: 99103 Grams: Enelectico Chelmsford



Please send me full details of your range of UHF TV amplifier klystrons.

I am interested in a klystron with the following parameters :

Frequency Range Bandwidth Power Level

NAME POSITION

COMPANY

ADDRESS

TELEPHONE NUMBER EXTENSION

WW25

AP 354

... made quiet by the power
Of harmony, and the deep power of joy,
We see into the life of things'

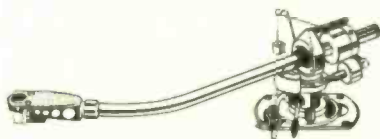
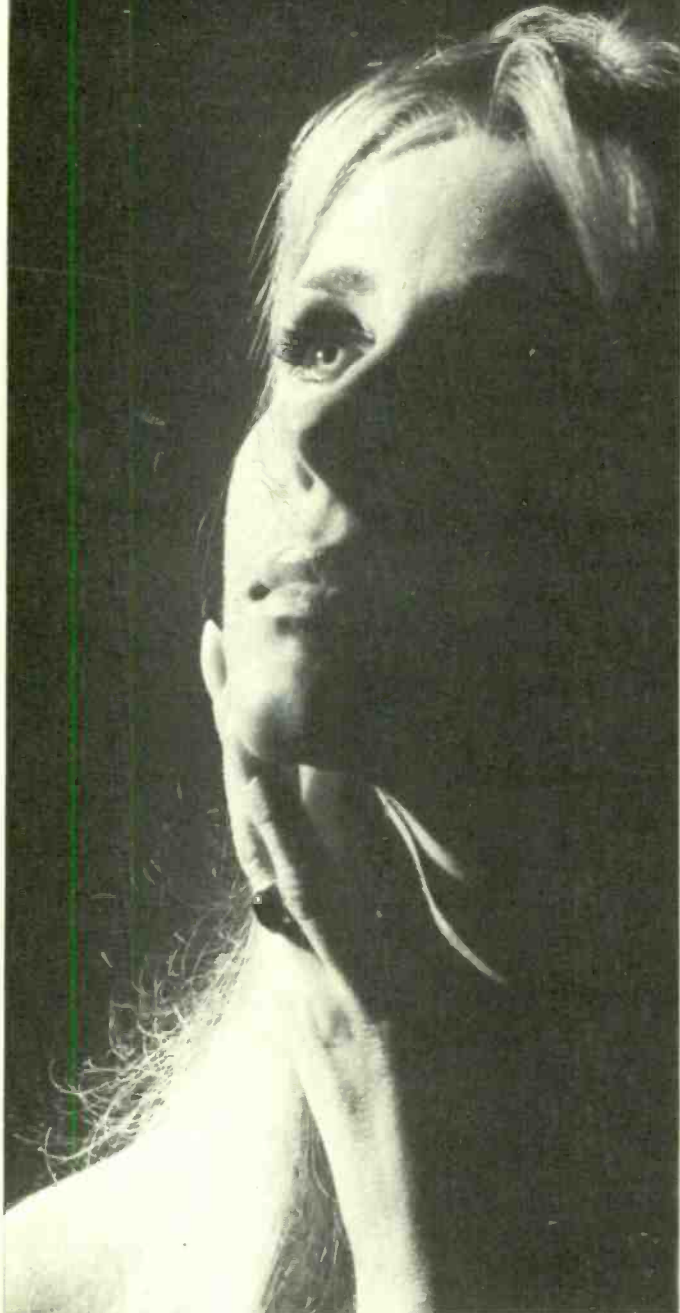

SME The best pick-up arm in the world

Write to SME Limited · Steyning · Sussex · England

WW—016 FOR FURTHER DETAILS

YOU WANT PARTS URGENTLY

—almost
immediately!

So what do you do?

You reach for the 'phone and dial ONO 239 8072, if it is anything made by the United-Carr Group. You will be surprised how soon you'll get what you want.

Your immediate needs are our business

We exist to supply the small user quickly with *standard* parts made by these Companies and carry large stocks of their fasteners and clips and a wide range of Radio, Electronic and Electrical components. We're geared to speedy handling and dispatch.

But you will need our latest catalogue

For quick and accurate ordering you should keep our comprehensive catalogue by you. This useful reference book gives full details of the wide range of parts we stock—nearly everything of the kind that you are likely to require. Even though not ordering anything immediately, you should write now for this useful publication and so be ready to handle rush jobs whenever they arise.

United-Carr Supplies Ltd.,
Frederick Road, Stapleford, Nottingham.
Sandiacre 8072 STD ONO 239 8072



WW—017 FOR FURTHER DETAILS

EMI-varian



A new power in microwave tube technology

EMI and Varian Associates of California have formed a new company, EMI-VARIAN LTD., which is a subsidiary of EMI ELECTRONICS LTD., Hayes, Middlesex. This new company is responsible for marketing and manufacture for the following product groups:

EMI ELECTRONICS LTD., Power Tube Division, and Microwave Section of the Valve Division.
PALO ALTO TUBE DIVISION OF VARIAN, Palo Alto, California.
EIMAC DIVISION, San Carlos, California.
BOMAC DIVISION, Beverly, Massachusetts.
S-F-D LABORATORIES, Inc., Union, New Jersey.
LEL DIVISION, Copiague L.I., New York.
SOLID STATE MICROWAVE DIVISION, Beverly, Massachusetts.
VARIAN OF CANADA.

EMI-VARIAN thus combines the research, technology and manufacturing resources of two companies with vast experience in microwave and power tubes and associated components.

EMI-VARIAN LTD Hayes Midcx. England Phone 01-573 3888 extn. 2740 Telex 22417 Cables EMIVAR LONDON

WW—018 FOR FURTHER DETAILS

E 100-UK

Expand your Universe of Electronic Instrumentation with Hewlett-Packard

... for better solutions
to your measuring problems

- 1 Frequency domain oscilloscope
- 2 200 MHz multichannel analyzer
- 3 Low-priced digital voltmeter
- 4 400 kHz-40 GHz sweep system
- 5 A new solid state digital display

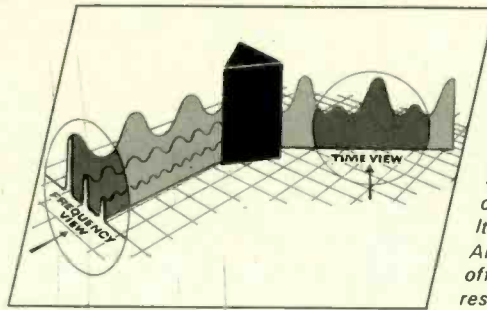

1 Adding absolute amplitude calibration to frequency domain measurements

The most meaningful and practical way of evaluating circuit systems performance is in the frequency domain. Doing it in the 1 kHz-1250 MHz range—fast and accurately—is the job of hp spectrum analyzers. They let you measure the absolute magnitude of each component of a simple or complex signal. The result is shown directly without distortion or spurious responses over a 70 dB range on the hp 140S display unit. For high-resolution measurements, use the hp 141S variable persistence unit.

Using the 8553L RF unit with the 8552A IF unit, you cover 1 kHz-110 MHz in a single, highly linear sweep. Resolution is a narrow 50 Hz. Flatness (± 0.5 dB) and sensitivity (-130 dBm) are equally outstanding.

Combining the 8554L RF unit with the 8552A, your range is 500 kHz-1250 MHz—in one sweep with excellent linearity and resolution (300 Hz) and sensitivity (-120 dBm) to match.

RF units. 8553L, £822
8554L, £1502
IF units. 8552A, £866
Display units. 140S, £339
141S, £704

WW—200 FOR FURTHER DETAILS

2 Fact or Fiction?

A 4096 channel analyzer with a 200 MHz clock rate? That would be just about the fastest ADC clock rate ever. And it would mean that you could count more than 30,000 impulses per second over all the channels.

It's a fact. It's the 5401A Multichannel Analyzer from hp. This precision instrument offers you a 12-bit ADC (with 4K resolution) and memory expandable from 1024 to 4096 or 8192 channels. Now you can get an extremely high digitizing rate in addition to outstanding linearity and stability specs, I/O flexibility, and multimode operation that hp has already contributed to nuclear and statistical analysis work.

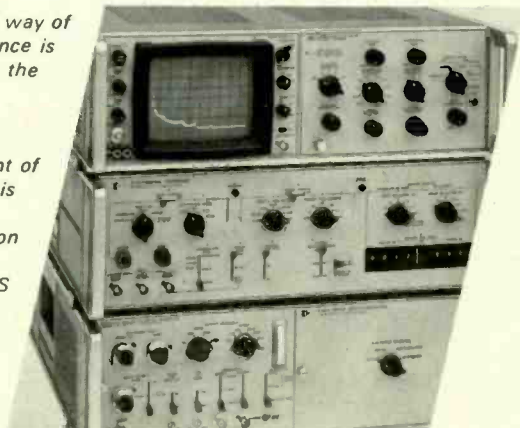

Linearity: integral, $\pm 0.1\%$, differential, $\pm 1\%$ over full range above trigger level.

Stability: baseline and gain are automatically stabilized 30 times per second.

I/O flexibility: easy, with hp quick-change interface cards.

Versatility: Multi-mode operation includes pulse height analysis, multichannel scaling and sample voltage analysis.

5401A systems are priced from £5459.

WW—201 FOR FURTHER DETAILS

E 100-UK

3 A digital voltmeter for the fair sex?

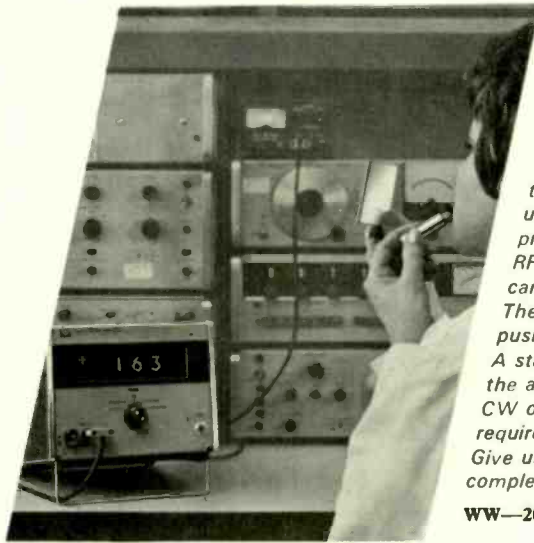

Why not? Isn't many a production line staffed by girls? And don't the ladies also contribute their share to quality control? Don't they rate a rugged, foolproof digital voltmeter of their own? Of course they do. That's why hp designed the 3430A, for use by inexperienced personnel. And this low-priced instrument is equally handy for repair and laboratory work.

The 3430A has a large, easy-to-read 3-digit display, with a 4th digit for 60% overranging. Polarity and decimal point are indicated automatically. Measurement range: ± 100 mV to ± 1000 V. The chance of circuit loading is reduced by the 10 megohm input resistance in all ranges. No need for frequent calibrations either. The 3430A maintains its $\pm 0.1\%$ of reading $\pm 0.1\%$ of range) accuracy for 90 days. May we send you the data sheet? The 3430A is priced at £ 259 and its made in Britain.

WW—202 FOR FURTHER DETAILS

once you consider its versatility. Over 20 standard RF plug-ins give the system an impressive frequency range from 400 kHz to 40 GHz. Included are two new all-solid-state plug-ins for the 400 kHz-4 GHz range.

For multiband sequential swept coverage, there is the 8706A pushbutton control unit. You'll find it a handy device in production testing. Used with up to three RF unit holders (8707A), the mainframe can drive up to nine plug-in oscillators. There's also a multiplexer (8705A) for push-button distribution of RF outputs. A stabilized sweep oscillator system is the answer if it's ultra-stable phase-locked CW or swept frequency outputs you require. Give us a call so that we can send you complete details.

WW—203 FOR FURTHER DETAILS

5 New light-emitting diode is bright idea behind all-solid-state numeric display

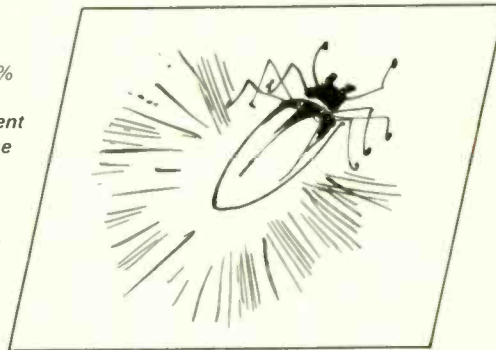

Like a gallium arsenide phosphide firefly, you might say.

Bright indeed. Our researchers were looking for a diode that would emit a significantly increased number of photons at energies compatible with the characteristics of the human eye. In this they succeeded. And thus made solid-state numeric displays a practical proposition.

Practical because high-intensity, variable light output is here accompanied by the frugal power consumption of solid-state circuits...

Twenty-eight tiny GaAsPs diode chips deliver bright red numerals. The BCD driven switching logic is a monolithic integrated circuit with over 250 active elements. And it's all housed in a compact, sealed package only 25 x 15 x 4 mm. The price, depending on quantity ordered, is about £ 26 per unit...

Which buys you all the advantages of solid-state displays, including long life, ruggedness, and freedom from catastrophic failure. So you'll want to remember our bright idea when space is at a premium and reliability is vital.

WW—204 FOR FURTHER DETAILS

4 Between 400 kHz and 40 GHz: a sweep system of great versatility



When it comes to accuracy, linearity and low residual FM, the hp 8690B sweep system has few peers. It has even fewer

HEWLETT  PACKARD

Hewlett-Packard Ltd.
224 Bath Road, Slough, Bucks, Great Britain
Tel. 33 341

European headquarters:
Hewlett-Packard S.A., rue du Bois-du-Lan 7
1217 Meyrin-Geneva, tel. (022) 41 54 00

the sensitive type—one in ten million!



PHILIPS

Every aspect of microphone manufacture is covered by the makers of ten million of them—Philips. Presentation and directivity are made to suit requirements. In fact, whatever your needs, there's one in ten million for you. Please ask for full information.



PYE TVT LIMITED

PHILIPS SOUND DIVISION
Addlestone Road, Weybridge
Tel: Weybridge 45511. Telex: London 262319

WW—019 FOR FURTHER DETAILS

TVT 23

"Q-MAX" sheet metal punches

FOR QUICK AND CLEAN HOLES

30 SIZES:

ROUND:
 $\frac{3}{8}$ " to 3"

SQUARE:
 $\frac{11}{16}$ " and 1"

RECTANGULAR:
 $\frac{21}{32}$ " x $\frac{15}{16}$ "

Full list on application



- Simple operation
- Quick, clean holes (up to 16 gauge mild steel)
- Saves time and energy
- Burr-free holes—no jagged edges
- Special heat treatment maintains keen cutting edge
- Anti-corrosive finish prevents rusting
- Used all over the world

Obtainable from Radio, Electrical and Tool Dealers, Wholesale and Export Enquiries to:—

"Q-MAX" (electronics) LTD. Napier House, High Holborn, London, W.C.1.

WW—020 FOR FURTHER DETAILS

Looking for one like this?

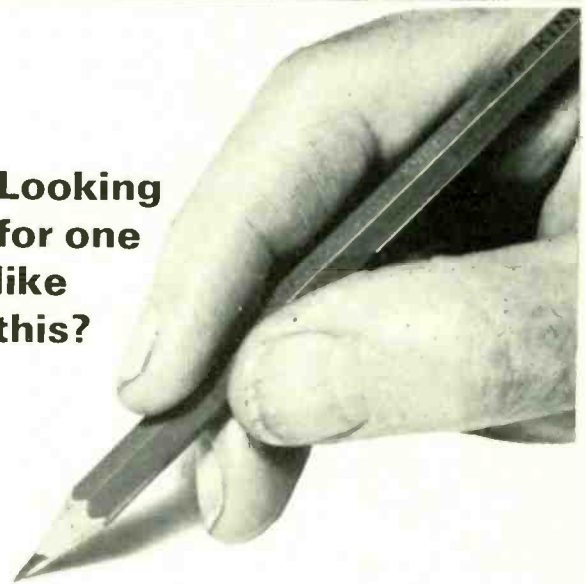

4 mm., tubular, wire ended, length 11.5 mm. Just one of the many Vitality Instrument and Indicator Lamps, made in an unusually large number of types, ratings and sizes. It may be just what you need for an existing or new project. If not, another from the hundreds of types and ratings detailed in Vitality Catalogue 69 may well be.

* Many a product owes its success to the intelligent addition of an indicator light

VITALITY BULBS

VITALITY BULBS LTD., MINIATURE AND SUB-MINIATURE LAMP SPECIALISTS
BEETONS WAY, RIBBY ST EDMUNDS, SUFFOLK TEL: 0284 2071.

Member of the General Instrument Group.

WW—021 FOR FURTHER DETAILS

VALUABLE NEW HANDBOOK FREE TO AMBITIOUS ENGINEERS

Have you had *your* copy of "Engineering Opportunities"?

The new edition of "ENGINEERING OPPORTUNITIES" is now available—without charge—to all who are anxious for a worthwhile post in Engineering. Frank, informative and completely up to date, the new "ENGINEERING OPPORTUNITIES" should be in the hands of every person engaged in any branch of the Engineering industry, irrespective of age, experience or training.

On 'SATISFACTION OR REFUND OF FEE' terms

This remarkable book gives details of examinations, and courses in every branch of Engineering, Building, etc., outlines the openings available and describes our Special Appointments Department.

WHICH OF THESE IS YOUR PET SUBJECT?

ELECTRONIC ENG.

Advanced Electronic Eng. — Gen. Electronic Eng. — Applied Electronics — Practical Electronics — Radar Tech. — Frequency Modulation — Transistors.

ELECTRICAL ENG.

Advanced Electrical Eng. — Gen. Electrical Eng. — Installations — Draughtsmanship — Illuminating Eng. — Refrigeration — Elem. Electrical Science — Electrical Science — Electrical Supply — Mining Electrical Eng.

CIVIL ENG.

Advanced Civil Eng. — Gen. Civil Eng. — Municipal Eng. — Structural Eng. — Sanitary Eng. — Road Eng. — Hydraulics — Mining — Water Supply — Petrol Tech.

WE HAVE A WIDE RANGE OF COURSES IN OTHER SUBJECTS INCLUDING CHEMICAL ENG., AERO ENG., MANAGEMENT, INSTRUMENT TECHNOLOGY, WORKS STUDY, MATHEMATICS, ETC.

Which qualification would increase your earning power?
A.M.I.E.R.E., B.Sc. (Eng.), A.M.S.E., R.T.E.B., A.M.I.P.E.,
A.M.I.M.I., A.R.I.B.A., A.I.O.B., P.M.G., A.R.I.C.S.,
M.R.S.H., A.M.I.E.D., A.M.I.Mun.E., C.ENG., CITY & GUILDS,
GEN. CERT. OF EDUCATION, ETC.

BRITISH INSTITUTE OF ENGINEERING TECHNOLOGY
446A ALDERMASTON COURT, ALDERMASTON, BERKSHIRE

THIS BOOK TELLS YOU

- ★ HOW to get a better paid, more interesting job.
- ★ HOW to qualify for rapid promotion.
- ★ HOW to put some letters after your name and become a key man . . . quickly and easily.
- ★ HOW to benefit from our free Advisory and Appointments Depts.
- ★ HOW you can take advantage of the chances you are now missing.
- ★ HOW, irrespective of your age, education or experience, YOU can succeed in any branch of Engineering.

164 PAGES OF EXPERT CAREER-GUIDANCE

PRACTICAL EQUIPMENT

Basic Practical and Theoretic Courses for beginners in Radio, T.V., Electronics, etc. A.M.I.E.R.E. City & Guilds Radio Amateurs' Exam., R.T.E.B. Certificate, P.M.G. Certificate, Practical Radio, Radio & Television Servicing, Practical Electronics, Electronics' Engineering, Automation.

INCLUDING TOOLS

The specialist Electronics Division of B.I.E.T. NOW offers you a real laboratory training at home with practical equipment. Ask for details.

B.I.E.T.

You are bound to benefit from reading "ENGINEERING OPPORTUNITIES." Send for your copy *now*—FREE and without obligation.



POST COUPON NOW!

TO B.I.E.T., 446A ALDERMASTON COURT, ALDERMASTON, BERKSHIRE.

Please send me a FREE copy of "ENGINEERING OPPORTUNITIES." I am interested in (state subject, exam., or career).

NAME

ADDRESS

WRITE IF YOU PREFER NOT TO CUT THIS PAGE

THE B.I.E.T. IS THE LEADING INSTITUTE OF ITS KIND IN THE WORLD

How do we intend to sell cynical old you our public address equipment?

By offering you the three things you really want.

- 1. Low Price (like column speakers from £17.6.4.)**
- 2. Durability (we back our muscles with a two-year guarantee.)**
- 3. Quality specifications (Check ours).**

The Radon Public Address Range is wide and growing. It consists of amplifiers, speakers and microphone equipment. We show the M50/6 six-channel amplifier. Specifications below.

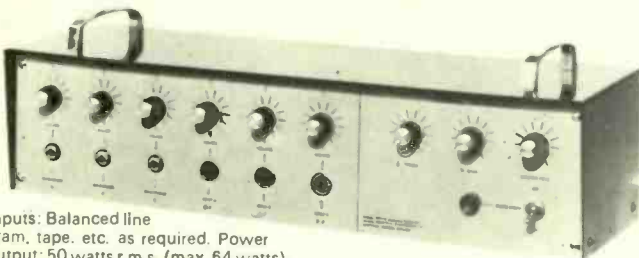

Inputs: Balanced line gram, tape, etc. as required. Power output: 50 watts r.m.s. (max. 64 watts). Output impedance and voltage: 15 ohms (other taps available), 156 ohms C.T. giving 50-0-50 volts or 100 volts. Harmonic distortion: Approx 1% at full power. Frequency response: plus or minus 2dB 20 c/s (Hz) to 35 Kc/s (KHz). Weight 38lb. Models available: M50/4, M50/6, M50/8 (suffix refers to channels)

In addition, the M/100, M/250, M/500 and M/1000 are built to order. The suffix number refers to the wattage and preamplifying facilities are available as required.

Radon / A growing name in amplifiers, wall speakers, sound columns, complete audio and hi-fi equipment, tuners & industrial electronics.

Our Public Address brochure gives the facts. It's a useful thing to have around.

TO: The Radon Industrial Electronics Co. Ltd.,
Brooklands Trading Estate, Warthing, Sussex. Tel: Warthing 1063
Please send me a brochure:

Name

Address

W W 4

WW-023 FOR FURTHER DETAILS

SEW PANEL METERS

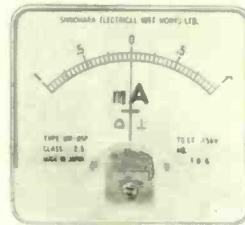

CLEAR PLASTIC METERS
Easy to read meters available in five basic sizes
Model MR.38P. 1 21/32" square
Model MR.45P. 2" square
Model MR.52P. 2 1/2" square
Model MR.65P. 3 1/2" X 3 1/2"
Model MR.85P. 4 1/2" X 4 1/2"

- **LOW COST**
- **IMMEDIATE DELIVERY**

Over 200 ranges available ex-stock—other ranges to order—special quantity discounts.

Send for leaflet and price list to Sole U.K. Distributors.



BAKELITE PANEL METERS
Model MR.65 3 1/2" square

BARNET FACTORS

LIMITED

4, LISLE STREET, LONDON, W.C.2.

Telephone: 01-437 2723

WW-024 FOR FURTHER DETAILS



P.O. TYPE 3000

HAVE YOU A RELAY PROBLEM?

Dependable can solve it! Price or delivery are better through Dependable. Dependable relays are produced to G.P.O. and Government specifications.

MICRO-SWITCH · TRANSISTORISED · HEAVY-DUTY · A/C LATCHING · 'SPECIALS' MADE TO YOUR OWN DRAWINGS

No order is too small or too large for Dependable; the only thing we worry about is you, the customer. Send for a free quotation now and compare our prices — our delivery. Prototypes within seven days.

DEPENDABLE RELAY (CONTROLS) LTD.
157 REGENTS PARK ROAD LONDON N.W.1. 01-722 8161

WW-025 FOR FURTHER DETAILS

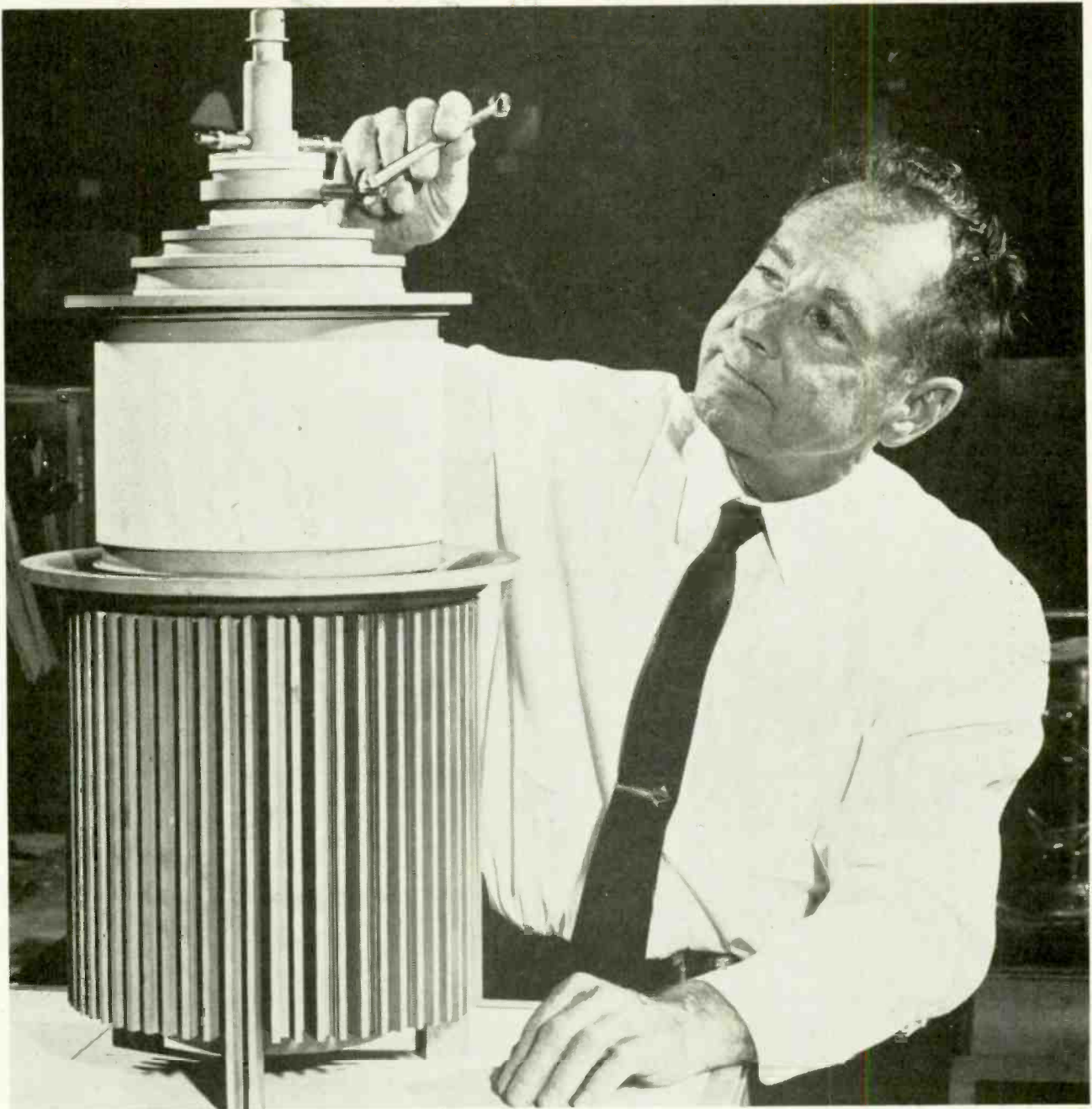

Eimac 250 kW Tetrode 4 CV 250.000 A now ready for Super-Power Transmitters.

The Eimac 4CV 250.000A is a ceramic-metal, vapour-cooled power tetrode intended for use at the 250 to 500 kilowatt output level.

It is recommended for use in class-C, class-AB linear or push-pull, and pulse operating modes.

The 4CV 250.000A can be used at full ratings for frequencies up to 30 MHz.

For more detailed information on this or other high power tetrodes in the Eimac range, including their new 100kW-50MHz and 50 kW-110MHz tubes, please contact:



Varian Associates Ltd.
Russell House / Molesey Road
Walton-on-Thames
Surrey / England
Tel.: Walton-on-Thames 28 766

WW—026 FOR FURTHER DETAILS

The Big Little Integrals That Can Make Or Break Your Product.

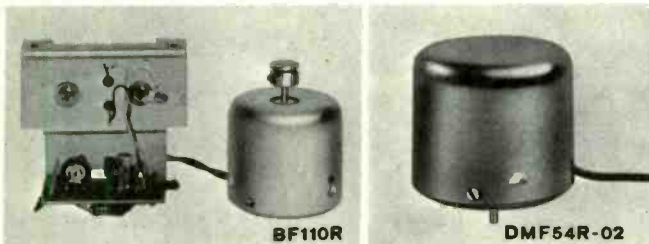
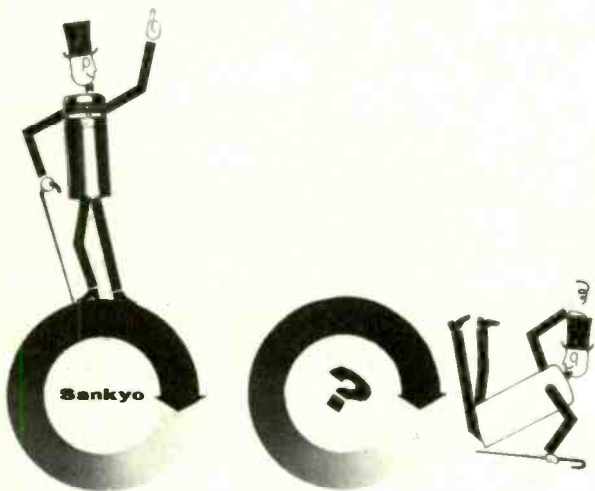

- SY173L** Single speed (2000 rpm) For record players.
- DMF54R-02** Single speed (2400 rpm) For tape recorders.
- RK201R** Single speed (2400 rpm) For car players.
- BF110R** Single speed (2000 rpm) With electrical governor motor. For tape recorders.
- BF200R** Single speed (2200 rpm) For car recorders & players.
- ZF200R** Variable speed (such as 1100, 2200 and 2800 rpm) With brushless & transistor motors. For de luxe record players & electronic calculators.
- VM250B** Single speed (3600 rpm) For auto tuners.

Specification for Sankyo micro motors

TYPE	Dimensions		Rated Voltage (V)	Range of Voltage (V)	Rated Torque (gr-cm)	Rated Speed (rpm)	Load Current (mA)	Starting Torque (gr-cm)	Life (Hr)	Direction of Revolution
	Ø (m/m)	Length (m/m)								
SY173L	40	32.4	6	4.5 - 6	3	2000	80	35	600	Left
DMF54R-02	38	34.8	6	4.5 - 6	9	2400	140	30	600	Right
RK201R	47.9	48	13.2	10 - 16	30	2400	210	100	1000	Right
BF110R	38	30	4.5	3.5 - 5.7	8	2000	160	30	1500	Right
BF200R	38	34.1	13.2	(5.5 - 19 - 16)	15	2200	180	30	1500	Right
ZF200	46	50	9	6 - 9	20	2200	300	45	3000	Left, Right
UP880R	20	44.5	4.5	4 - 6 4.5 - 6	14	3700 5000	160	60	30	Right
VM250B	25	36.5	7	6.5 - 7.5	0.4	3600	45	25	500	Left, Right



Sankyo (Europe) Export und Import G.m.b.H.: 4 Düsseldorf, Bahnstraße 45-47, W. Germany. Tel: 325652/3 Telex: 8587097
 Cables: SANKYORGEL DÜSSELDORF
 Sankyo Seiki Mfg. Co., Ltd.: 17-2, Shinbashi 1-chome, Minato-ku, Tokyo 105, Japan. Tel: Tokyo 591-8371
 Cables: SANYORGEL TOKYO
 American Sankyo Corp.: Rm. 801-3, 95 Madison Ave., New York, N.Y. 10016, U.S.A. Tel: LE-2-8020



WW-027 FOR FURTHER DETAILS

Made in England

ALL YOUR SOUND~ With the NEW LM 300 from London Microphone



Latest release in the range of LM Microphones is the most sophisticated design yet. The robust, metal construction with its good back-to-front discrimination is ideal for speech reinforcement systems and recordings. Recommended retail price from £12 including built-in cable and quick release stand adaptor, depending on impedances. For details of the LM300 and other superb microphones in the LM range, please ring or write to:

London Microphone Company Ltd
 182-4 Campden Hill Road, London W.8. Telephone: 01-727 0711
 (24 hour answering service) Telex 23894

WW-028 FOR FURTHER DETAILS

IT TAKES A SHORT TIME TO TELL A LONG STORY



CALAN TRACE SHIFTER C501D

- ★ A TRACE (9,600 MILLIMETRES LONG ON A 5 INCH TUBE!)
- ★ A THREE DIMENSIONAL DISPLAY!
- ★ VERTICAL COMPARISON OF SUCCESSIVE SCANS!

Add these facilities to your oscilloscope. They will help you to examine the functional waveforms of heart or combustion engine or for that matter any other long waveform phenomena.

Price £78 Export and Agency Enquiries Invited.

Calan Electronics Limited,

6 Croft Street, Dalkeith, Scotland
 Tel. 031-663-2344

WW-029 FOR FURTHER DETAILS

QUAD 50 is a single channel 50 Watt amplifier designed for Broadcast, Recording and other applications in the Audio industry, completely proof against misuse and giving the highest quality of reproduction.



INPUTS - 0.5 Vrms unbalanced with provision for an optional plug-in transformer for bridging 600 ohms lines.

OUTPUTS - isolated providing 50 watts into almost any impedance from 4 to 200 ohms.

DIMENSIONS - 12 $\frac{3}{4}$ " x 6 $\frac{1}{4}$ " x 4 $\frac{1}{2}$ "

Complete the coupon and post today.

QUAD
for the
closest approach
to the
original sound

Please send me full details of the QUAD 50 Amplifier

NAME

POSITION

COMPANY

ADDRESS

.....

(BLOCK CAPITALS)

ACOUSTICAL MANUFACTURING CO. LTD.,
HUNTINGDON. Telephone: Huntingdon (0480) 2561/2

ww

TECHNICAL TRAINING

in radio television and electronics

Whether you are a newcomer to radio and electronics, or are engaged in the industry and wish to prepare for a recognized examination, ICS can further your technical knowledge and provide the specialized training so essential to success. ICS have helped thousands of ambitious men to move up into higher paid jobs—they can help you too! Why not fill in the coupon below and find out how?

Many diploma and examination courses available, including expert coaching for:

- C. & G. Telecommunication Techns'. Certs.
- C. & G. Electronic Servicing
- R.T.E.B. Radio/T.V. Servicing Certificate
- Radio Amateurs' Examination
- P.M.G. Certs. in Radiotelegraphy
- General Certificate of Education, etc.

Examination Students coached until successful

NEW SELF-BUILD RADIO COURSES

Learn as you build. You can learn both the theory and practice of valve and transistor circuits, and servicing work while building your own 5-valve receiver, transistor portable, and high-grade test instruments, incl. professional-type valve volt meter—all under expert tuition. Transistor Portable available as separate course.

POST THIS COUPON TODAY

for full details of ICS courses in Radio, T.V. and Electronics.

INTERNATIONAL CORRESPONDENCE SCHOOLS

Dept. 222, Intertext House, Stewarts Road, London, S.W.11

Please send me the ICS prospectus—free and without obligation.

(state Subject or Exam.)

NAME

ADDRESS

8/69

INTERNATIONAL CORRESPONDENCE SCHOOLS

WW—031 FOR FURTHER DETAILS

audio tone burst generator



Frequency range 1 Hz to 20 kHz
 Signal starting and stopping phase can be varied $\pm 30^\circ$ approx.
 Pedestal output +5 Volts
 Synchronising pulse +5 Volts 10 μ secs.
 Counts On and Off 2, 4, 8, 16, 32, 64, 128 cycles
 Price £125.00



Kelly Acoustics
 Romagna,
 6, Bycullah Avenue,
 Enfield, Middlesex

Telephone 01-363 7890

WW—032 FOR FURTHER DETAILS

FRAHM vibrating reed FREQUENCY METERS

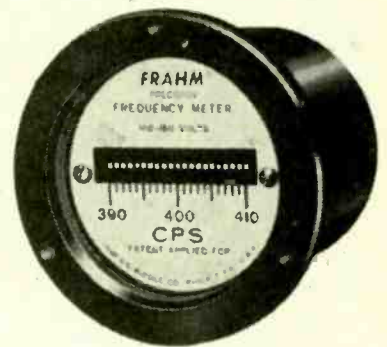

are widely used as standards in many industries because:—

- 1) They are accurate (to $\pm 0.3\%$ or $\pm 0.1\%$ as specified)
- 2) They are not voltage or temperature sensitive, within wide limits
- 3) They are unaffected by waveform errors, load, power factor or phase shift
- 4) They will operate on A.C., pulsating or interrupted D.C., and super-imposed circuits
- 5) They need only low input power
- 6) They are compact and self-contained
- 7) They are rugged and dependable

FRAHM Vibrating Reed Frequency Meters are available in miniature switchboard and portable forms, in ranges from 10 to 1700 cps. Descriptive literature on these meters, and on FRAHM Resonant Reed Tachometers, freely available from the sole U.K. distributors:—

ANDERS METER SERVICE

ANDERS ELECTRONICS LTD. 48/56 BAYHAM PLACE, BAYHAM STREET LONDON NW1 TEL: 01-387 9092.

WW—033 FOR FURTHER DETAILS

Not only beautiful, but...

- * Lightweight
- * Tropicalised
- * Practically unbreakable
- * High level phones
- * Carbon or Magnetic Javel
- * Extremely comfortable
- * Simple to service

The Astrolite headset is a unique design which brings together elegant appearance, high performance and reliability. Communications or high fidelity versions available.

For all the other desirable features write or telephone:-

AMPLIVOX
COMMUNICATIONS
LIMITED

BERESFORD AVENUE, WEMBLEY, MIDDLESEX
TELEPHONE 01-902 8991
GRAMS AND CABLES: AMPLIVOX, WEMBLEY

HIGH FIDELITY MOVING COIL STEREO HEADPHONES (TYPE LS43) Now available from DAYSTROM LTD. GLOUCESTER
WW—034 FOR FURTHER DETAILS

You could buy 5 bridges or one autobalance component bridge



The B421 will measure...



RESISTORS
from 0.01 ohm to 100 megohms, direct reading. Accuracy 0.25%.



CAPACITORS
from 0.01 pF to 10 microfarads. Accuracy 0.25%. Push-button for instant reading of loss (shunt) resistance.



INDUCTORS
from 1 microhenry to 100 henrys. Accuracy 2%. Push-button for measurement of series resistance.



ELECTROLYTICS
10 microfarads to 10 000 microfarads with d.c. applied. Also leakage from 1 micro-amp to 10 milliamps.



TOLERANCE
from -25% to +25%, for C and R.

... in seconds

THE WAYNE KERR COMPANY LIMITED

NEW MALDEN SURREY ENGLAND
TEL: 01-942 2202 TELEX 262333

WW-035 FOR FURTHER DETAILS

WELWYN TOOLS

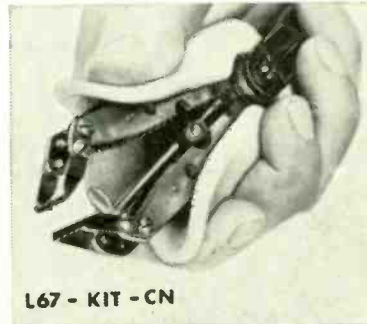
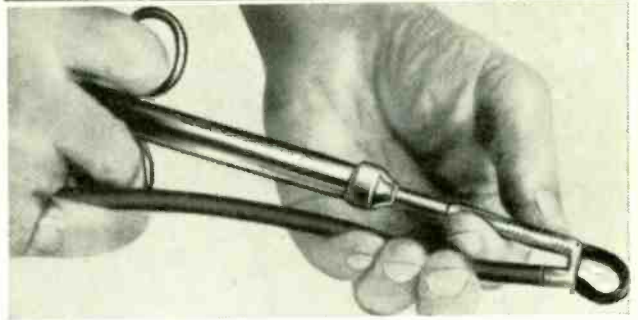

L67 - KIT - CN

For Inner Core Ejection and Heated Wirestripping Miniature Soldering and Electronic Instrument Work

USE W.T.C. Wire Ejectors, LUCO Electrically Heated Wire Strippers (see illustration), Finest Soldering Needles, Box Joint Miniature Cutters and Pliers including Tip Cutting Pliers, Printed Circuit Crimping and Cutting Pliers, Torque Wrenches and Piercing Punches. If you require quality tools ask for Catalogue WW/69.

Welwyn Tool Co. Ltd.



STONEHILLS HOUSE WELWYN GARDEN CITY
WELWYN GARDEN 25403

WW-036 FOR FURTHER DETAILS

SMOOTHED POWER UNITS WITH THE ACCUMULATOR PERFORMANCE.

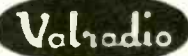

Smoothed power supplies having similar characteristics, regarding regulation and sustained current capacity to a lead acid accumulator. Unlike accumulators, these units require no maintenance and are always ready for instant use with consistent performance. A wide range of units is available for all purposes, where an accumulator is normally used.

APPLICATIONS

- ★ Production testing and servicing battery operated equipment.
- ★ Testing fuel pumps—DC motors—relays—windscreen wipers—car radios—and all types of battery operated equipment.
- ★ Radio telephone transmitter/receivers.

FEATURES

- ★ Output stabilised to accumulator performance.
- ★ Very low ripple.
- ★ Incorporates silicon rectifiers.
- ★ All models incorporate surge current limiting.
- ★ Output completely isolated from mains.

Typical random selection:

- Type 250RU/12/24. Output 12v. 24a. Adjustable 5 preset positions £58-16-0
- Type 250RU/24/5. Output 24v. 5a. Adjustable 5 preset positions £37-4-0
- Type 250VRU/30/20 Output 0-240v. 2.5a. continuously variable £131-5-0

Type 250 VRU/30/20

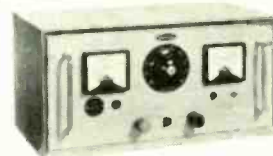

VALRADIO LTD.

Dept. WPU3, BOWELL'S LANE, FELTHAM, MIDDLESEX, ENGLAND
Telephone: 01-890 4837

WW-037 FOR FURTHER DETAILS

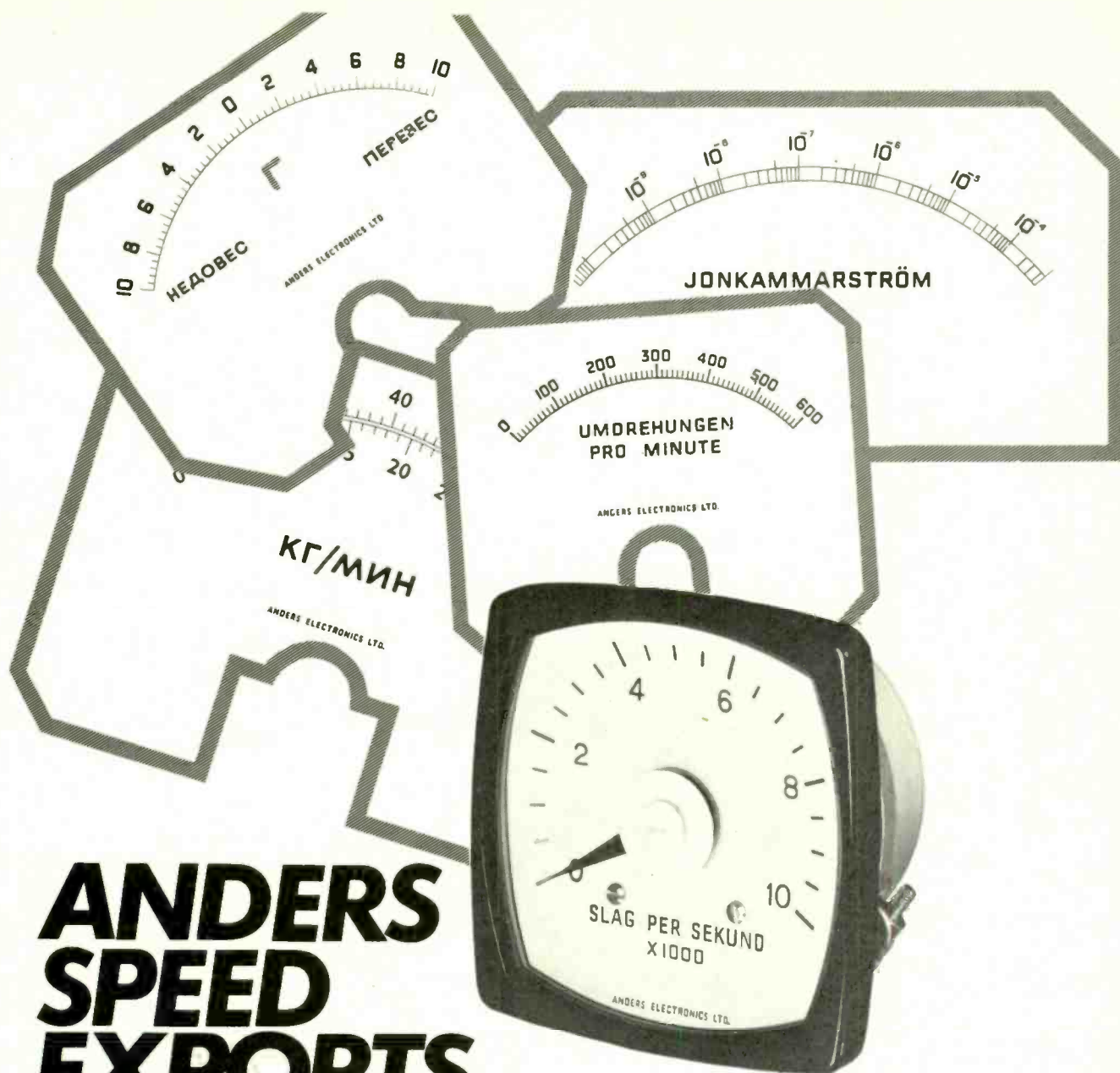

ANDERS SPEED EXPORTS

So you're doing your bit and making equipment for far-away places? And you're held up for meters? Like an 0-5mA calibrated in pulsfrekvens? Or a jonkamarström meter specially calibrated from 10^{-10} to 10^{-4} ? Or a straightforward (but impossible to locate) 100mA moving-coil job reading simply 0-35 КГ/МИН? Relax. No problem at all. Anders are legending most types of meters in all sorts of languages every day of the week—and as often as not calibrating them specially into the bargain. Hand lettering specialists are standing by for the one or two off. Fast, accurate techniques are here for the quantity orders. Ring us. You'll find we are as fast at this sort of thing as we are at supplying standard meters off the shelf . . . and, as you know (or should know), that's fast.

N.B. The variety of meters in our new catalogue is a revelation—and now we've got extensive new centralised premises for a better-than-ever service.

Manufacture and distribution of electrical measuring instruments and electronic equipment. The largest stocks in the U.K. for off-the-shelf delivery. Prompt supply of non-standard instruments and ancillaries. Sole U.K. distribution of FRAHM vibrating reed frequency meters and tachometers.

ANDERS METER SERVICE

Anders Electronics Ltd., 48-56 Bayham Place, Bayham Street, London, N.W.1. Telephone: 01-387 9092

WW—038 FOR FURTHER DETAILS

Hear Here!



Bad public address systems mean bad communication and that is bad public relations. Our business is communications. *Good* communications for industry and commerce. The Rediffusion service covers this field in all its aspects—from television and sound systems, including CCTV., public address, background music and intercom and telephone systems—to fire alarm and time control systems. In fact any area of electronics necessary to meet your custom-built requirements—from planning, equipping and installing, to maintaining.



see what we mean?

For further details contact:

REDIFFUSION 
INDUSTRIAL SERVICES LTD

Astronaut House, Hounslow Road, Feltham, Middx.
Tel: 01-890 6325

WW—039 FOR FURTHER DETAILS



Ballistics Computers by Westinghouse. Nine servo amplifiers with associated motors. Brand new in sealed containers. £95, delivered.

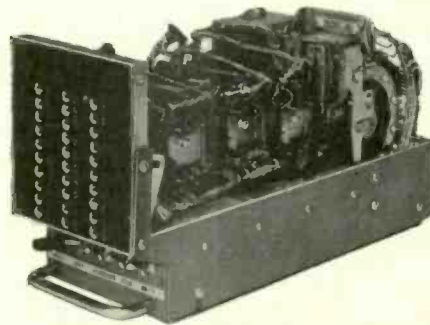

Automatic Numbering Machine by Western Union. Four Uniselectors and 30 neons. Ideal amateur computer. Application leaflet. £12.10s. post free.

PUNCHES, READERS, VERIFIERS AND TELEPRINTERS AT REALISTIC PRICES TO EDUCATIONISTS. MOBILE SHOWROOM CALLS ON REQUEST.

COMPUTER TRAINING PRODUCTS

2 Lordship Lane, LETCHWORTH, HERTS. Tel: 4536 0462/6

WW—040 FOR FURTHER DETAILS

Valradio

TRANSVERTORS

(transistorised D.C. Invertors/Convertors)



Type B12/250T

There is a VALRADIO transvertor for practically all applications, ranging from the operation of power tools, refrigerators, video tape recorders, instruments, ultra violet recorders, emergency lighting, navigational equipment, tv receivers, standby power systems, etc.

For use in boats, cars, coaches, trains, country house plants, caravans, etc. Available for all usual D.C. voltages from 12V upwards.

The range is covered by three basic groups, having distinct characteristics, broadly as follows:

- T series—Square wave, frequency tolerance ± 3 Hz.
- Q series—Square wave, frequency tolerance $\pm 1/2$ Hz
- S series—Sine wave, frequency tolerance $\pm 1/2$ Hz.

Typical, type B12/250T Maximum output 650W £34.13.0
Typical type B24/150Q Maximum output 200W £36.5.0
Typical type B12/30S Maximum output 30W £18.0.0

Input/output efficiency is over 80 per cent with most models.

These are just a random selection, for the full range send for our informative transvertor brochure WC2.

Remember—When you pay for VALRADIO products, the know-how and experience that goes with them is free; call on us to help solve your power problems.

VALRADIO LTD., Dept. W.C.3,
Browell's Lane, Feltham, Middx., England. Tel.: 01-890-4242.

WW—041 FOR FURTHER DETAILS

prepare now for tomorrow's world

Today there is a huge demand for technologists such as electronics, nuclear and computer systems engineers, radio and television engineers, etc. In the future, there will be even more such important positions requiring just the up-to-date, advanced technical education which C.R.E.I., the Home Study Division of McGraw-Hill Book Co. can provide.

C.R.E.I., Study Programmes are directly related to the problems of industry including the latest technological developments and advanced ideas. Students claim that the individual tuition given by the C.R.E.I. panel of experts in each specialised field is comparable in technological content with that of technical colleges.

Why C.R.E.I. Courses are best

No standard text books are used — these are often considerably out-of-date when printed. C.R.E.I. Lesson Material contains information not published elsewhere and is kept up-to-date continuously. (Over £50,000 is spent annually in revising text material.)

Step-by-step progress is assured by the concise, simply written and easily understood lessons. Each programme of study is based on the practical applications to, and specific needs of, Industry.

Take the first step to a better job now—enrol with C.R.E.I., the specialists in Technical Home Study Courses.

C.R.E.I. PROGRAMMES ARE AVAILABLE IN:

Electronic Engineering Technology * Industrial Electronics for Automation * Computer Systems Technology * Nuclear Engineering * Mathematics for Electronics Engineers * Television Engineering * Radar and Servo Engineering
City and Guilds of London Institute: Subject No. 49 and Advanced Studies No. 300.



Member of the
Association of British
Correspondence Colleges
C.R.E.I. (London), Walpole House,
173-176 Sloane Street, London S.W.1.
A subsidiary of McGraw-Hill Inc.

POST THIS COUPON TODAY FOR A BETTER FUTURE

To C.R.E.I. (London), Walpole House, 173-176 Sloane Street, London, S.W.1.
Please send me (for my information and entirely without obligation) full details of the Educational Programmes offered by your Institute.

My interest is City and Guilds please tick General

NAME _____

ADDRESS _____

EDUCATIONAL BACKGROUND _____

ELECTRONICS EXPERIENCE _____

WW121

WW-042 FOR FURTHER DETAILS

Celestion PA

Loudspeakers for all Public Address Systems



Re-entrant Horns

These Horns are capable of delivering a highly concentrated beam of sound over long distances. They are recommended for recreation centres, noisy factories and workshops and all indoor and outdoor locations where a high noise level has to be overcome.

Driver Units

Pressure type units are available with or without tapped 100V line transformers. The following 'built-in' features are on all models—High Sensitivity, Weatherproof, Phase Equalising Throat and Self-centring Diaphragm Assembly.



Re-entrant Loudspeakers

Rola Celestion re-entrant loudspeakers are designed for use wherever conditions demand compactness, toughness, high efficiency and unfailing service. They are rainproof and built to withstand prolonged exposure to vibration and adverse conditions.

Loudspeaker in Glass Fibre

The Celestion Glass Fibre Loudspeaker is a compact robust and watertight unit, precision built for use on open boat decks, docks, chemical plants, plating shops, etc. where protection from the weather or corrosive atmosphere is vital.



Rola Celestion Ltd.
THAMES DITTON, SURREY
TELEPHONE 01-398 3402 TELEX 266 135

WW-043 FOR FURTHER DETAILS

METER PROBLEMS?

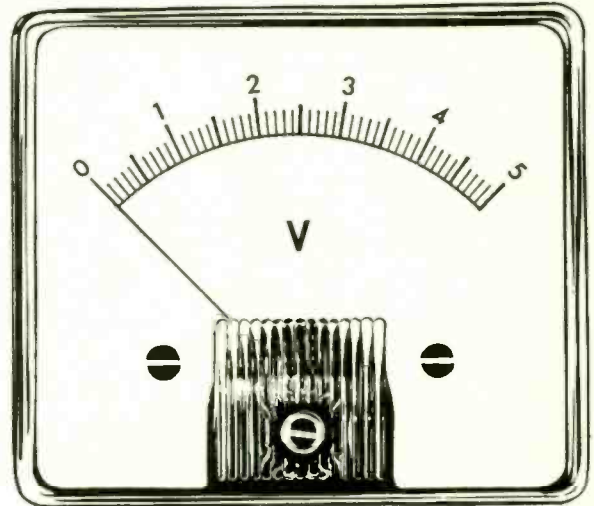

A very wide range of modern design instruments is available for 10/14 days' delivery.

Full Information from:

HARRIS ELECTRONICS (London)

138 GRAYS INN ROAD, W.C.1

Phone: 01/837/7937

WW-044 FOR FURTHER DETAILS

M. R. SUPPLIES, LTD., (Established 1935)

Universally recognised as suppliers of UP-TO-DATE MATERIAL, which does the job properly. Instant delivery. Satisfaction assured. Prices nett.

FAN FLOW EXTRACTOR FANS. Undoubtedly today's greatest bargain for domestic or industrial use. For 200/250 volts A.C. 7,500 cu. ft. per hour. Easily installed, fitted weatherproof louvres which open when motor is switched on and close when off. Only 6½ in. dia. Our nett price only £8/2/6 (despatch 7/6).

MINIATURE RUNNING TIME METERS (Sangamo). We have great demands for this remarkable unit and now can supply immediately from stock. 200/250 v. 50 c. synchronous. Counting up to 9,999 hours, with 1/10th indicator. Only 1½ in. square, with cyclometer dial depth 2 in. Many industrial and domestic applications to indicate the running time of any electrical apparatus, easy to install. 63/- (des. 1/6).

SYNCHRONOUS TIME SWITCHES. (Another one of our popular specialities) 200/240 v. 50c., for accurate pre-set switching operations. Sangamo 8.254, providing up to 3 on-off operations per 24 hours at any chosen times, with day-omitting device (use optional). Capacity 20-amps. Compactly housed 4 in. dia., 3½ in. deep, £8/4/6 (des. 4/6). Also same excellent make new domestic model, no wiring and easy setting and installation. Portable with lead and 13-amp plug, same duty as above (less day-omitting), £4/14/0 (des. 4/6). Full instructions with each.

ELECTRIC FANS (Papst), for extracting or blowing. The most exceptional offer we have yet made. 200/250 v. A.C. induction motor—silent running. 2,800 r.p.m. duty 100 C.F.M. Only 4½ in. square and 2½ in. deep. Ideal for domestic or industrial use. Easy mounting, £3/5/- (des. 3/6).

SMALL GEARED MOTORS. In addition to our well-known range (List GM.564), we offer small open type B.P. Units 200/250 v. A.C., 1, 6, 12, 24, 60 r.p.m., approx. 5½ in. long, with lift shaft projection each side and enclosed gearbox. Suitable for display work and many industrial uses. Only 60/6 (des. 3/-).

MINIATURE COOLING FANS. 200/250 v. A.C. With open type induction motor (no interference). Overall 4½ in. x 2½ in. x 2½ in. Fitted 6-bladed metal impeller. Ideal for projection lamp cooling, light duty extractors, etc., still only 28/6 (des. 4/6).

AIR BLOWERS. Highly efficient units fitted induction totally enclosed motor 230/260 v. 50 c. 1 ph. Model SD 26, 80 CFM (free air) to 11.5 CFM at 1.5 WG (size approx.) 6 x 6 x 7 in. Outlets 2½ in. square, £8/10/- (des. 5/-). Model SD 27, 120 CFM (free air) to 40 CFM at 1.2 WG, 8 x 7 x 9 in. outlet 2½ in. sq., £11/15/6 (des. 5/-). Model SD 28, 260 CFM (free air) to 127 CFM at 1.5 WG, 11 x 8 x 9 in. outlet 3 in. sq., £13/17/6 (des. U.K. 7/6).

SYNCHRONOUS ELECTRIC CLOCK MOVEMENTS (as mentioned and recommended in many national journals). 200/250 v. 50 c. Self-starting. Fitted spindles for hours, minutes and central hand. Any one 42/- (des. 2/-). Dia. 2½ in. Depth behind dial only 1½ in. With sweep second hands. Central one-hole fixing. Dia. 2½ in. Depth behind dial only 1½ in. With back dust cover, 39/6 (des. 2/-). Set of three brass hands in good plain style. For 6/7 in. dia. 2/6 For 6/10 in. dia. 3/6 act.

SYNCHRONOUS TIMER MOTORS (Sangamo). 200/250 v. 50 cfs. Self-starting 2½ in. dia. x 1½ in. deep. Choice of following speeds: 1 r.p.m., 12 r.p.m., 1 r.p.h., 1 rev. 12 hours, 1 rev. per day. Any one 42/- (des. 2/-). Also high-torque model (G.E.C.), 2½ in. x 2 in. x 1½ in. 6 r.p.m., 57/6 (des. 2/-).

SMALL BENCH GRINDERS. 200/250 v. A.C./D.C. With two 3 in. diameter wheels (coarse and fine surfaces). Bench mount, very useful household or industrial units. £7/17/6 (des. 6/-).

EXTRACTOR FANS. Ring mounted all metal construction. T/E induction motor, silent operation. 8 in. blade, 10 in. max. dia., 400 CFM, £8/2/6 (des. 5/-). Same model 10 in. blade, 12 in. max. dia., 500 CFM, £8/12/6 (des. 6/-).

IMMEDIATE DELIVERY of Stuart Centrifugal Pumps, including stainless steel (most models).

M. R. SUPPLIES, Ltd., 68 New Oxford Street, London, W.C.1
(Telephone: 01-636 2958)

WW-045 FOR FURTHER DETAILS

1's or

1000's

are all the same to us

OUR SMALLEST ORDER

last year was for a single radio valve, value 7/6d., urgently needed for ship-board replacement and rushed by us through the Rotherhithe tunnel to the London Docks so that they could sail with the tide. . . .

OUR LARGEST ORDER

last year was for 28,546 valves worth nearly £10,000, all specially selected within special parameters for an electronics manufacturer whose name is a by-word in Industry. . . .

Between these extremes we supplied a massive number of valves of one sort or another—used in everything from domestic television sets to porpoise-tracking equipment; from experimental laboratory hook-ups in Technical Colleges to nuclear magnetic resonance spectrometers;

The largest single valve independant

Pinnacle

**PINNACLE ELECTRONICS LIMITED, ACHILLES ST., NEW CROSS, LONDON SE14
TELEPHONE ALL DEPARTMENTS 01-692 7285 DIRECT ORDERS 01-692 7714**

WW—046 FOR FURTHER DETAILS

www.americanradiohistory.com

Microphones

for every purpose

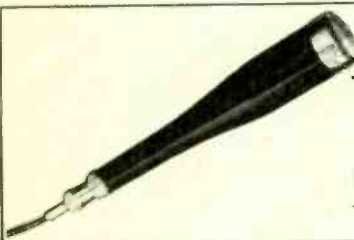

The DP4

Designed for general use
—P.A., tape recording etc.

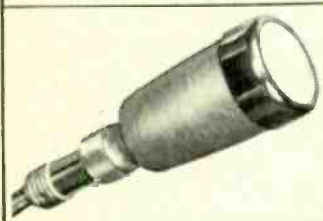

The DP6

Small in size, large in performance. As a lavalier type and for panel mounting on control units etc.

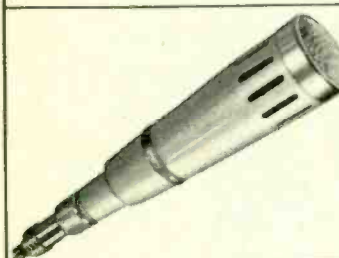

The GC/1 Cardioid

For stage and church work, P.A. use, lecture halls etc., where acoustic feedback is a serious problem.



The GR/1 and GR/2 Ribbon

Ideal for studio and similar uses, when a high standard of fidelity is essential. Easily replaceable ribbon assembly.

Other models and a full range of stands, reflectors, windshields and accessories available

All microphones are manufactured in a special section of our works, under strictly controlled conditions with stringent test and inspection at every stage. Each and every microphone is individually tested both aurally and on Bruel & Kjoer visual and graphic recording test equipment for conformity to a prescribed performance.

Grampian SOUND EQUIPMENT
Integrity that you hear

Send for leaflet giving full details

GRAMPIAN REPRODUCERS LTD.,
Hanworth Trading Estate, Feltham, Middlesex. 01-894-9141
WW—047 FOR FURTHER DETAILS



STOCKISTS



MULTIMINOR MK. IV

**REPAIR SERVICE
7-14 DAYS**

We specialise in repair, calibration and conversion of all types of instruments, industrial and precision grade to BSS.89.

Release notes and certificates of accuracy on request.

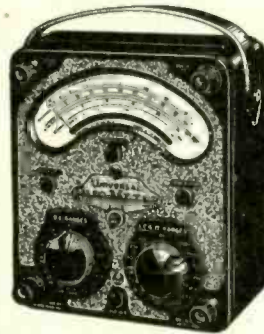

MODEL 8 MK. III

Suppliers of Elliott, Cambridge and Pye instruments

LEDON INSTRUMENTS LTD

76-78 DEPTFORD HIGH STREET, LONDON, S.E.8

Tel.: 01-692 2689

E.I.D. & G.P.O. APPROVED

CONTRACTOR TO H.M. GOVT.

WW—048 FOR FURTHER DETAILS

SPECIALIST SWITCHES

are again giving the fastest switch service in the world

**FROM THEIR NEW AND LARGER
PREMISES IN CHARD, SOMERSET**

Specialist Switches make Rotary and Lever switches, types H, DH, HC, and LO, to specification. There is one limitation (standard 2 in. long spindles), but this is not important when you are getting the fastest switch service in the world.

*Delivery of 1-20 switches: 24 hours.
Up to 50 or so: 72 hours.
If you want around 250 or so: 7-10 days.*

Please note our address:
SPECIALIST SWITCHES
P.O. Box 3,
CHARD, SOMERSET

Write for design charts and prices or
TELEPHONE—CHARD 3439

WW—049 FOR FURTHER DETAILS

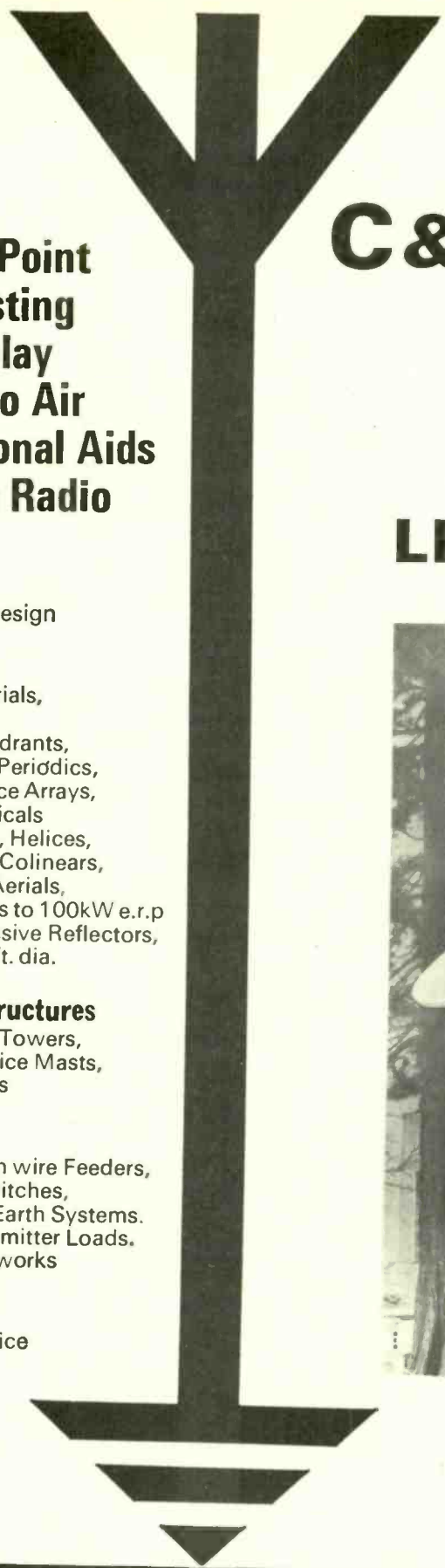

**Point to Point
Broadcasting
Radio Relay
Ground to Air
Navigational Aids
Business Radio**

Design

Site layouts
Aerial System Design

Aerials

LF 'T' and 'L' Aerials,
Mast Radiators,
HF Dipoles, Quadrants,
Rhombics, Log Periodics,
Vertical Incidence Arrays,
Conicals, Biconicals
VHF & UHF Yagis, Helices,
Ground Planes, Colinears,
Whips, Marine Aerials,
Television Arrays to 100kW e.r.p
MICROWAVE Passive Reflectors,
Dishes 3" to 60 ft. dia.

Supporting Structures

Self-supporting Towers,
Tubular and Lattice Masts,
Telescopic Masts

Accessories

Coaxial and open wire Feeders,
Filters, Aerial Switches,
Lead-in panels, Earth Systems.
Air-cooled Transmitter Loads.
Termination Networks

Installation

World Wide Service

C&S Antennas

provide
a complete
aerial service
LF to Microwave

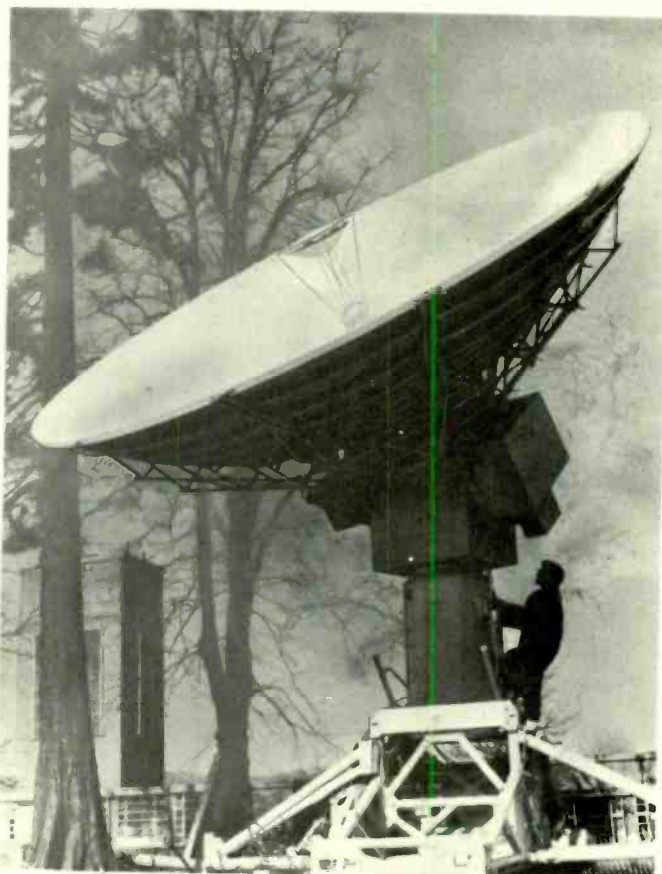

A 21 ft. diameter air-transportable dish reflector assembly, supplied to G.E.C.-A.E.I. (Electronics) Ltd., manufacturers of the earth terminal part of the satellite communications system "Skynet".



C&S Antennas Ltd

Wentworth House, Eastern Avenue, Ilford, Essex, England.
Telephone: 01-554-0102 Telex: 25850 Cables: Antennas Ilford (England)

WW-050 FOR FURTHER DETAILS

CS18

Adamin

MODEL 15

MICRO SOLDERING INSTRUMENT



● EXTREME VERSATILITY

Range of 8 interchangeable bits, from $\frac{3}{8}$ in. (.047in.) to $\frac{3}{16}$ in., including new non-wearing PERMATIPS.

● ULTRA-SMALL SIZE

Length $7\frac{1}{8}$ in. Weight $\frac{1}{2}$ oz.
Max. handle dia. $\frac{7}{16}$ in.

● EXTRA-HIGH PERFORMANCE

Heating time 90 secs. Max. bit temp. 390°C. Loading 15 watts—equals normal 30/40-watt iron.

● ALL VOLTAGES

The ADAMIN range includes five other models (5, 8, 12, 18 and 24 watts), Thermal Strippers (PVC and PTFE) and a De-Soldering Tool. Please ask for colour catalogue A/5.

LIGHT SOLDERING DEVELOPMENTS LTD

28 Sydenham Road, Croydon, CR9 2LL

Tel: 01-688 8589 & 4559

WW-051 FOR FURTHER DETAILS

It's colour TV that counts

during the German Radio and Television Show being held at the Killesberg Exhibition Park and Halls in Stuttgart from

August 29 to September 7 1969

Further information from the Sole Agents in the U.K.:

C.E.S. (Overseas) Ltd.

1-3 Astoria Parade, Streatham High Road
London, S.W.16 Tel: (01) 769 0950

WW-052 FOR FURTHER DETAILS

SOLDERING HANDBOOK

B. M. ALLEN,
Senior Works Chemist, Multicore Solders Ltd.

The latest and most comprehensive book on the subject, covering both practical and theoretical methods of soldering in the electronics and allied industries. All types of solder and solder chemicals are described for both hand-soldering and for the automatic soldering machines used for printed circuits. The book supplies some of the basic knowledge required for writing industrial training programmes. It is divided into three parts under the headings: Making a Joint—Choosing Methods and Materials—Reference Tables. For both the amateur and the industrial solderer.

128pp. 100 illustrations

45s. net case 47s. by post

21s. net student edition 23s. by post

Published in association with Multicore Solders Ltd.

ILIFFE BOOKS LTD

42 RUSSELL SQUARE, LONDON, W.C.1

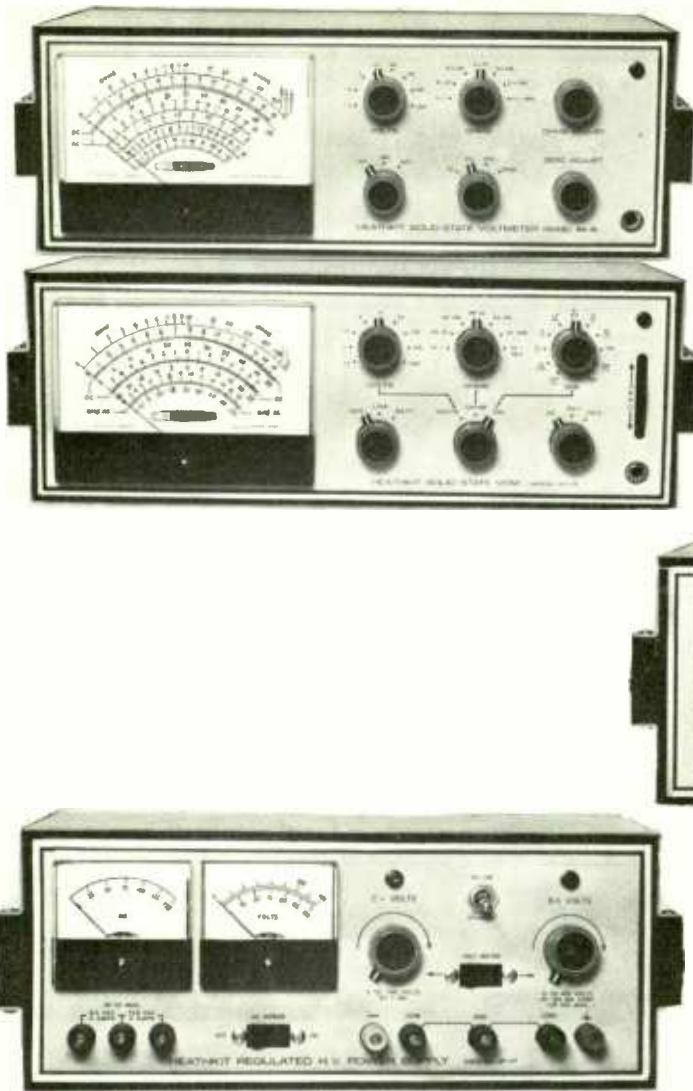

test match

HEATHKIT SCORE with their team of instruments

The opening pair, Heathkit DeLuxe Solid-State VVMs models IM-16 and IM-25, because of their excellent form and reliability, have quickly found a wide and appreciative audience. Their amazing versatility and style is always worth watching.

They are supported by the Heathkit HV and LV stabilised power supplies, models IP-17 and IP-27, which also are first class contestants in many fields throughout industry. These, backed by the excellent cover of the wide range of other Heathkit test instruments, make a team strong enough to challenge anyone.

Even when batting on a really sticky wicket, Heathkit instruments will give a good innings for your money.

Photographs, many in full colour, of all the Heathkit team of instruments as well as their performance records, can be found in our latest catalogue, which is available to all enquirers on request.

Send for your copy today.



DAYSTROM LTD., Gloucester GL2 6EE England
Tel.Glos.29451. Telex 43216.

WW—053 FOR FURTHER DETAILS

www.americanradiohistory.com

Please send me your fully-detailed catalogue immediately
Daystrom Limited, Gloucester GL2.6EE, England

NAME _____
ADDRESS _____

WW7

this new Ferranti edge connector

has G.P.O. approval..



and a lot more!

The new Ferranti EPP Edge Connector has been designed for electronic telephone exchange equipment, and has Post Office Approval to Specification D2343, TYPE 206D.

And a lot more.

EPP is a new generation of Edge Connectors — offering many new features designed to improve efficiency and reliability.

Such as the one-piece construction of the wrapping post and spring contact. This form of construction removes the possible source of unreliability in two part welded constructions.

Such as the brand new design which allows each wrapping post/contact unit to be removed from behind the equipment. This operation can be carried out in seconds using a simple extraction tool, without even disturbing the printed-circuit board.

Such as the remarkably low insertion force required — only 6oz maximum per pair of non-bridging contacts.

In addition to these new features, Ferranti EPP Edge Connectors retain many of the successful characteristics of earlier types — including the unique Ferranti 'rolling-leaf' spring contact with inherent stress-limiting properties, and the non-porous hard-gold plating 5 microns thick on the contact area.

12 and 18 pole single-sided 12 + 12 and 18 + 18 pole double-sided contacts are available.

Pole spacing 0.200 in (5.08mm).

The advanced design of Ferranti EPP Edge Connectors, together with many proved-in-service features, offers equipment manufacturers a connector which is versatile, easy to use and extremely reliable.

Full details available from

**Ferranti Ltd., Connector Sales Group,
Dunsinane Avenue, Dundee, DD2 3PN, Scotland.
Tel: 0382 89311 Telex: 76166**

FERRANTI

DS/T205

WW—054 FOR FURTHER DETAILS

TELEPRINTERS · PERFORATORS REPERFORATORS · TAPEREADERS DATA PROCESSING EQUIPMENT



Codes: Int. No. 2 Mercury/Pegasus, Elliot 803, Binary and special purpose Codes.



**2-5-6-7-8- TRACK AND
MULTIWIRE EQUIPMENT**

**TELEGRAPH AUTOMATION AND COMPUTER PERIPHERAL ACCESSORIES
DATEL MODEM TERMINALS, TELEPRINTER SWITCHBOARDS**

Picture Telegraph, Desk-Fax, Morse Equipment; Pen Recorders; Switchboards; Converters and Stabilised Rectifiers; Tape Holders, Pullers and Fast winders; Governed, Synchronous and Phonic Motors; Teleprinter Tables and Cabinets; Silence Covers; Distortion and Relay Testers; Send/Receive Low and High Pass filters; Teleprinter, Morse, Teleditos Paper, Tape and Ribbons; Polarised and specialised relays and Bases; Terminals V.F. and F.M. Equipment; Telephone Carriers and Repeaters; Diversity; Frequency Shift, Keying Equipment; Line Transformers and Noise Suppressors; Racks and Consoles; Plugs, Sockets, Key, Push, Miniature and other Switches; Cords, Wires, Cables and Switchboard Accessories; Teleprinter Tools; Stroboscopes and Electronic Forks; Cold Cathode Matrices; Test Equipment; Miscellaneous Accessories, Teleprinter and Teletype Spares.



W. BATEY & COMPANY

Galey Works, Akeman Street, Tring, Herts.
Tel.: Tring 3476 (3 lines) Cables: RAHNO TRING
STD: 0442 82 TELEX 82362

WW—055 FOR FURTHER DETAILS

TRANSFORMERS

DESIGNED TO CUSTOMER'S OWN SPECIFICATIONS FOR ALL APPLICATIONS UP TO 100 KVA. "C" CORE, PULSE, 3 PHASE, TOROIDS, HIGH TEMPERATURE, ETC.

Samples from our standard production ranges:—

* Mains	£	s.	d.
350-0-350V. 60mA., 6.3V. 2A.	2 2 0
500V. 300mA. 6.3V. 4A., 6.3V. 1A.	3 19 9
500-0-500V. 0.25A., 6.3V. 4 Act., 6.3V. 3 Act., 5V. 3A.	4 19 9
525-0-525V. 0.5A., 6.3V., 6 Act., 6.3V. 6 Act., 5V. 6A.	5 13 6

* Low Voltage	£	s.	d.
30-0-30V. 4A.	2 19 0
28V. 1A., 28V. 1A., 28V. 1A., 28V. 1A., 30V. 250mA.	4 15 0

*Primaries 10-0-200-220-240V.

20W Transistor Amplifier (W.W. Nov. 1966)			
Driver	1 4 6
Mains	1 16 6
L.P. Filter, Chassis Mounting	12 6
L.P. Filter, Printed Circuit Mounting	15 6

70V & 100V Line Matching			
Fitted with terminal panel, taps at 0.5, 2, 4 and 8W. into 15 ohms	9/- each in 100 Lots
Flying leads, taps at 1/2, 1, 2 and 4W. into 3 ohms	7/3 each in 100 Lots

Prices inclusive of postage and packing, each.
For small quantities, cash with order, please.

HOWELLS RADIO LIMITED
CARLTON ST., MANCHESTER, M14 4GT 061-226 3411

WW—056 FOR FURTHER DETAILS

Vortexion

STEREO MIXERS

These electronic Stereo Mixers range from 2+2 to 5+5 input channels, with left and right outputs at 500 millivolts into 20K ohms up to infinity.

Separate control knobs are provided for L & R signals on each stereo channel so that a Mono/Stereo changeover switch provided can give from four to ten channels for monaural operation, in which state the L & R outputs provide identical signals.

A single knob ganged Master Volume control is fitted, plus a pilot indicator.

The units are mains powered and have the same overall dimensions as monaural mixers.

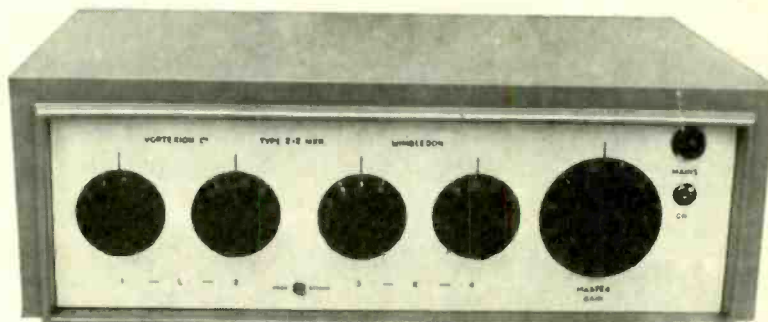

Also available Monaural Electronic Mixers:—

- | | |
|------------------------|-----------------------------------|
| 4 Way Monaural Mixers | 3 Way Monaural Mixers with P.P.M. |
| 6 Way Monaural Mixers | 4 Way Monaural Mixers with P.P.M. |
| 8 Way Monaural Mixers | 6 Way Monaural Mixers with P.P.M. |
| 10 Way Monaural Mixers | 8 Way Monaural Mixers with P.P.M. |

200 WATT AMPLIFIER. Can deliver its full audio power at any frequency in the range of 30 c/s—20 Kc/s \pm 1db. Less than 0.2% distortion at 1 Kc/s. Can be used to drive mechanical devices for which power is over 120 watt on continuous sine wave. Input 1 m W 600 ohms. Output 100-200 v or 200-400 v. Additional matching transformers for other impedances are available.

30/50 WATT AMPLIFIER. With 4 mixed inputs, and bass and treble tone controls. Can deliver 50 watts of speech and music or over 30 watts on continuous sine wave. Main amplifier has a response of 30 c/s—20 Kc/s \pm 1db. 0.15% distortion. Outputs 4, 7.5, 15 ohms and 100 volt line. Models are available with two, three or four mixed inputs for low impedance balanced line microphones, pick-up or guitar.

CP50 AMPLIFIER. An all silicon transistor 50 watt amplifier for mains and 12 volt battery operation, charging its own battery and automatically going to battery if mains fail. Protected inputs, and overload and short circuit protected outputs for 8 ohms—15 ohms and 100 volt line. Base and treble controls fitted. Models available with 1 gram and 2 low mic. inputs. 1 gram and 3 low mic. inputs or 4 low mic. inputs.

100 WATT ALL SILICON AMPLIFIER. A high quality amplifier with 8 ohms—15 ohms and 100 volt line output for A.C. Mains. Protection is given for short and open circuit output over driving and over temperature. Input 0.4 v on 100K ohms.

20/30 WATT MIXER AMPLIFIER. High fidelity all silicon model with F.E.T. input stages to reduce intermodulation distortion to a fraction of normal transistor input circuits. The response is level 20 to 20,000 cps within 2 db. and over 30 times damping factor. At 20 watts output there is less than 0.2% intermodulation even over the microphone stage at full gain with the treble and bass controls set level. Standard model 1-low mic. balanced input and Hi Z gram.

VORTEXION LIMITED, 257-263 The Broadway, Wimbledon, London, S.W.19

Telephone: 01-542 2814 & 01-542 6242/3/4

Telegrams: "Vortexion London S.W.19"

WW—057 FOR FURTHER DETAILS

Introducing the 1730 rotatable antenna from Granger Associates Ltd

Chosen for their reliability under the most rugged conditions, Granger Antennas have proved their worth from the Sahara to Alaska. Now we introduce our latest model — the Type 1730 Rotatable. This versatile antenna transmits or receives, is erected or dismantled easily, and rotates mechanically. Its revolutionary design eliminates rotating joints yet the new light-weight array withstands wind conditions of 160 m.p.h. Power and bandwidth are unequalled in its class.



Granger
Associates
Ltd.

GRANGER CORNER, 1, BROOKLANDS ROAD,
WEYBRIDGE, SURREY, ENGLAND.

Telephone: Byfleet 44261/4

- Aircraft communications accessories
- H.F. communication systems
- Ionosphere sounder
- Broadcast systems
- H.F. antennas

WW—058 FOR FURTHER DETAILS

www.americanradiohistory.com

VARIABLE VOLTAGE TRANSFORMERS

SLIDE-UP & SLIDE TRANS

- ★ Fully-rated current at all voltages
- ★ 0-260 volts output all models
- ★ All shrouded for safety (suitable for education authorities)
- ★ Bench or panel mounting
- ★ Smooth continuous adjustment 230v. A.C. input



10 amp. model.

PRICES START FROM

£5-10-0

1 Amp. £5 10 0	2.5 Amp. £6 15 0
5 Amp. £9 15 0	8 Amp. £14 10 0
10 Amp. £18 10 0	12 Amp. £21 0 0
20 Amp. £37 0 0	C. & P. Extra



20 AMP HEAVY DUTY L.T. SUPPLY UNIT

Output: 12 & 24v. D.C. adj. up to 20 AMPS CONTINUOUS. Fully Fused. Fitted ammeter and neon indicator. Input: 220/230/240v. A.C. 50 cycles. Size: 16" x 12" x 20" high. Weight: 50 lbs. Heavy gauge steel cabinet. Grey Hammer finish.

Supplied by us to UKAEA. Min. of Def. & G.P.O.
Current Manufacture

ONLY **£32-10-0**

40/- Packing and Carriage G.B. (INLAND)



(Dept. W.W.) 313 Edgware Road, London, W.2. Tel: 01-723 2231

TIMERS—MICRO SWITCHES

SYS MINI-TIMER

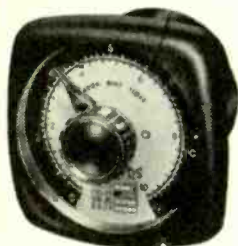

- ★ SYNCHRONOUS MOTOR & CLUTCH
- ★ 10 MILLION OPERATIONS
- ★ Instantaneous & Timed out 3 AMP contacts.
- ★ Repeat Accuracy $\pm \frac{1}{2}\%$. Dial ranges 0-10 secs up to 0-28 hrs. May also be used as impulse start and automatic reset.

£11.0.0 approx. dependent on quantity.

STP Sub-Mini Process Timer SYNCHRONOUS MOTOR & CLUTCH



- Matchbox size frontal area.
- Automatic re-set.
- ★ PLUG-IN OCTAL BASE
- ★ INSTANTANEOUS AND TIMED OUT 2 AMP CONTACTS
- ★ RANGES: 10 SECS. TO 36 MINS.

approx. £5.0.0 each.

VV-15-1A 10 AMP C/O (MICRO-SWITCH)



- ★ 15/10 AMPS. c/o
- ★ 100,000 ops. each per 1,000
- 2/- Single Throw 1/6 each

FLOATLESS LIQUID LEVEL CONTROL

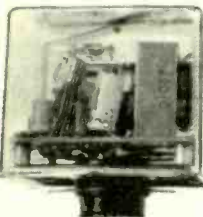

- ★ 5 amp. OUTPUT CONTROL CONTACTS
 - ★ Solid State
 - ★ Octal Base plug-in
- The most compact unit available, measures only $2\frac{1}{2} \times 2\frac{1}{2} \times 3$ ".

Approx. **£4.0.0.**
dependent on quantity.

SINGLE AND TREBLE STAINLESS ELECTRODES AVAILABLE.

CCR-5



Approx. 4/- each per 1000

Light force wire operated Micro-switch. Designed for even more economical coin operation mechanism.



VAQ

- ★ 10 amp. c/o PUSH BUTTON
- Panel mounting. Buttons in six colours.

4/4 each per 1,000.



S5G

- ★ 1 MILLION OPS. 5 amp. c/o Sub-miniature Micro-switch.
- 2/6 each per 1,000

ALL ITEMS ALWAYS IN STOCK

PROXIMITY SWITCH

YL2 GPA



- ★ For Batching, Conveyors, Machine Tool Control, Packaging, Sorting, etc.
- ★ Senses ferrous objects.
- ★ Needs no mechanical force or pressure to operate.
- ★ Solid state sensing head includes constant voltage circuit.
- ★ Mains operated.

approx. £12.10.0 dependent on quantity. OTHER INDUCTIVE AND CAPACITY TYPES AVAILABLE



- V-10-1B
- ★ 1 MILLION OPERATIONS.
- ★ 10 amp. c/o.
- ★ COMPARE OUR SPEC. & OUR PRICES WITH OTHER SIMILAR TYPES.

Screw Terms. 3/1 each per 1,000

OMRON PRECISION CONTROLS

DIVISION OF I.M.O. PRECISION CONTROLS LTD.

(Dept. W.W.9), 313 Edgware Road, London, W.2

Tel. 01-723 2231

WW-059 FOR FURTHER DETAILS

WEYRAD

COILS AND I.F. TRANSFORMERS IN LARGE-SCALE PRODUCTION FOR RECEIVER MANUFACTURERS

- P.9 SERIES** 10 mm.×10 mm.×14 mm. Ferrite cores 6 mm. 472 kc/s operation. Single-tuned I.F.s and Oscillator Coils.
- P.55 SERIES** 12 mm.×12 mm.×20 mm. Ferrite cores 4 mm. 472 kc/s operation. Single-tuned I.F.s and Oscillator Coils.
- T.41 SERIES** 25 mm.×12 mm.×20 mm. Ferrite cores 4 mm. 472 kc/s operation. Double-tuned 1st and 2nd I.F.s and Single-tuned 3rd I.F. complete with diode and by-pass capacitor.

These ranges are available to manufacturers in versions suitable for most of the popular types of Transistors. The Oscillator coils can be modified to enable specific tuning capacitors to be used provided that bulk quantities are required.

OUR WINDING CAPACITY NOW EXCEEDS 50,000 ITEMS PER WEEK

On the most up-to-date and efficient machines backed by a skilled assembly labour force for all types of coils and assemblies.

WEYRAD (ELECTRONICS) LIMITED, SCHOOL ST., WEYMOUTH, DORSET

WW—060 FOR FURTHER DETAILS

J E S AUDIO INSTRUMENTATION



Illustrated the Si452 Distortion Measuring Unit —low cost distortion measurement down to .01% **£25.0.0**

Si451 £30.0.0
Comprehensive Millivoltmeter
350 μ Volts 20 ranges

Si453 £35.0.0
Low distortion Oscillator
sine-square-RIAA

J. E. SUGDEN & CO., LTD. Tel. Cleckheaton (0WR62) 2501
BRADFORD ROAD, CLECKHEATON, YORKSHIRE.

WW—061 FOR FURTHER DETAILS

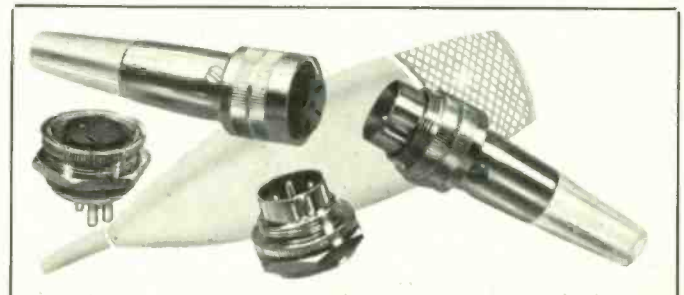

Sole Distributors

Super Electronics Ltd.

5 VIOLET HILL, LONDON N.W.8

TELEPHONE: MAIDA VALE 8281

WW—062 FOR FURTHER DETAILS

WHERE THE GOING IS TOUGH, THE NEED FOR QUALITY VITAL GOVERNMENTS AGREE ON TEONEX VALVES.

Governments all over the world have chosen TEONEX Valves for vital civil and military roles requiring compliance to E.V.S. or M.I.L. standards. In spite of rising demand for these valves from government departments the world over, increased production facilities have made it possible to offer the TEONEX range (incorporating the entire range of British-produced valves or their Continental equivalents) for use outside the U.K. only. Price list and technical specifications may be obtained from:

TEONEX LIMITED

2a Westbourne Grove Mews,
London, W.11, England

WW—063 FOR FURTHER DETAILS

Export Enquiries Only Please!

REGD. TRADE MARK



Before we sell you a Shure microphone we try to ruin it

just to make sure that you never will

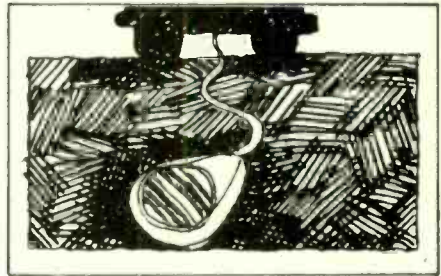
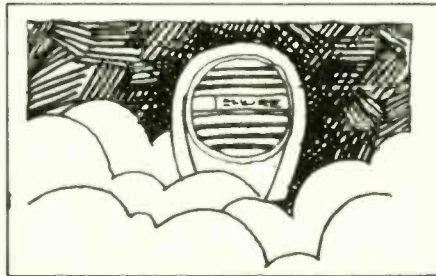
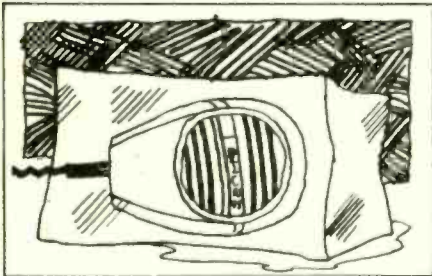
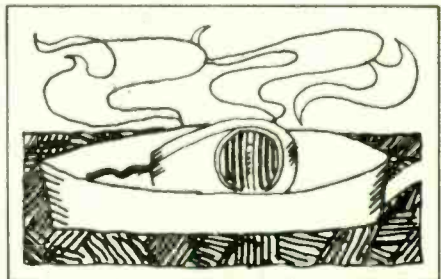
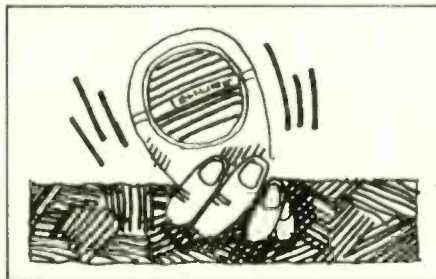
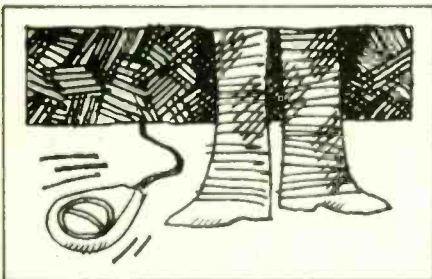

Microphones have to be rugged. Think of the punishment they take. That's why Shure Safety Communications Microphones get a tremendous going over before we dream of selling them.

We drop them. We vibrate them.
We fry them. We freeze them.
We steam them in Turkish baths.
We drag them behind fast moving cars.
We subject them to all kinds of torture.
Sand. Rain. Infra-red. Ultra-violet.
Acids. Alcohol. Salt spray. Wind.
Electrostatic fields. High altitude ...
and still they work

This savage testing, backed by stringent quality control, ensures that every Shure communications microphone will give you reliable performance. And will go on doing so even under conditions where other microphones would pack up. Always use Shure, the microphones that never fail to get the message through.

Communications

Controlled magnetic hand microphone providing a clear, crisp, highly intelligible voice response. Rugged and dependable, ideal for outdoor-indoor P.A., and communications. Frequency response 200 to 4,000 cps. High impedance. High output.

Model 414.



Amateur Radio

Provides optimum radio communications performance from single sideband transmitters as well as AM and FM units. Response cuts off sharply below 300 cps and above 3,000 cps, ensuring maximum speech intelligibility and audio punch to cut through noise and interference.

Model 444.



For full details of Shure microphones, SEND IN THIS COUPON TODAY

To: Shure Electronics Ltd., 84 Blackfriars Road, London SE1. Tel: 01-928 3424

I'd like to know more about Shure Microphones for
Communications Professional Recording
Amateur Radio Professional Entertainers

Please send me the facts:

NAME

ADDRESS

.....

.....



setting the world's standard in sound

ww4

WW-064 FOR FURTHER DETAILS

KEITH MONKS (AUDIO) LTD.*Proudly Present***MELODIUM MICROPHONES**

- ★ *Moving Coil Microphones*
- ★ *Large Range of Accessories*
- ★ *Factory Replacements available*
- ★ *Microphones built of Steel*
- ★ *Ribbon Microphones*
- ★ *Made in Paris*



Sole Distributor and Importer for the United Kingdom

KEITH MONKS (AUDIO) LTD.

54 ROUNTON ROAD,
CHURCH CROOKHAM,
NR. ALDERSHOT, HANTS.
Tel. FLEET (02514) 3566.

OTHER PRODUCTS IN OUR RANGE INCLUDE AUDIO AND DESIGN PRODUCTS, HYPERTONE LOUDSPEAKERS, FLOOR STANDS, BOOM ARMS and PICK-UP ARMS.

WW—065 FOR FURTHER DETAILS



—AVONCEL—
TM40 TROLLEY

EDITIONS FOR ALL MAKES AND
MODELS OF OSCILLOSCOPES

£25 EACH
PLUS £1
CARRIAGE

PRICE INCLUDES DRAWER; CARRYING-UNIT;
POWER-BOARD AND 2 BRAKED CASTORS.

AVON COMMUNICATIONS AND ELECTRONICS LTD.

318 BOURNEMOUTH (HURN) AIRPORT, CHRISTCHURCH, HAMPSHIRE
TEL. NORTHBOURNE 3774. TELEG. AVONCEL, CHRISTCHURCH

WW—066 FOR FURTHER DETAILS

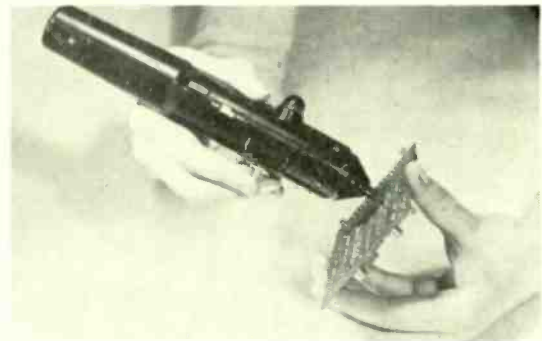
DIOTESTOR IN-CIRCUIT TRANSISTOR TESTER**BRITEC LIMITED, 17 Charing Cross Road, London, W.C.2**

Tel: 01-930-3070

WW—067 FOR FURTHER DETAILS

HATFIELD**CO-AXIAL SWITCHES**

**accurate
self
termination**

of all unused inputs
up to

1000 MHz



Hatfield Types RS and RST Coaxial Switches are designed for selected switching of RF signals without mismatch, with a high degree of isolation between individual ways, and functioning satisfactorily up to 1000 MHz. Standard models are available with 11 or 6 outputs or 2-way changeover and may be ganged to a common spindle. **Type RST is an extension of Type RS, with the addition of an automatic switching arrangement which provides accurate termination of unused inputs.** The switch is normally supplied without knob.

Also now available is a new miniature Coaxial Relay Type 779 operating from 24V. d.c. nominal and featuring single pole changeover switching for 50 and 75 ohm circuits in the frequency range d.c. to 500 MHz.

Write for full details and a copy of the latest edition of the HATFIELD SHORT FORM CATALOGUE.

HATFIELD INSTRUMENTS LTD., Dept. WW, Burrington Way, Plymouth, Devon.
Telephone: Plymouth (0752) 72773/5. Cables: Sigjen Plymouth.

TELEX/45592

HATFIELD BALUN

WW—068 FOR FURTHER DETAILS

THE MESSAGE IS PERFECTLY CLEAR:T-R-I-O



HS-4

9R-59DE

SP-5D

Model 9R-59DE BUILT IN MECHANICAL FILTER 8 TUBES COMMUNICATION RECEIVER

- Continuous coverage from 550 KHz to 30 MHz and direct reading dial on amateur bands.
- A mechanical filter enabling superb selectivity with ordinary IF transformers.
- Frequency Range: 550 KHz to 30 MHz (4 Bands)
- Sensitivity: 2 μ V for 10 dB S/N Ratio (at 10 MHz)
- Selectivity: \pm 5 KHz at -60dB (\pm 1.3 KHz at -6dB) When

using the Mechanical Filter.

- Dimensions: Width 15", Height 7", Depth 10".

Model SP-5D

- Communications Speaker which has been designed exclusively for use with the 9R-59DE.

Model HS-4

- Communications Head Phone

Model JR-500SE CRYSTAL CONTROL TYPE DOUBLE CONVERSION COMMUNICATION RECEIVER

- Superior stability performance is obtained by the use of a crystal controlled first local oscillator and also, a VFO type 2nd oscillator.
- Frequency Range: 3.5 MHz-29.7 MHz (7 Bands)
- Hi-Sensitivity: 1.5 μ V for 10 dB S/N Ratio (at 14 MHz)
- Hi-Selectivity: \pm 2 KHz at -6 dB \pm 6 KHz at -60 dB
- Dimensions: Width 13", Height 7", Depth 10".



JR-500SE



TO: B.H. Morris & Co. (Radio) Ltd. WW
Send me information on TRIO COMMUNICATION
RECEIVERS & name of nearest TRIO retailer.

NAME: _____ AGE: _____
ADDRESS: _____

TRIO KENWOOD ELECTRONICS S.A. 160 Ave., Brugmann, Bruxelles 6, Belgium

Sole Agent for the U.K. **B. H. MORRIS & CO., (RADIO) LTD.** 84/88, Nelson Street, Tower Hamlets, London E. 1, Phone: 01-790 4824.

WW-069 FOR FURTHER DETAILS

RADFORD

In an article in the Journal of the Audio Engineering Society for July 1967, Bart N. Locanthi, Vice-President, J. B. Lansing Sound Inc. describes the development of an ultra low distortion direct current audio amplifier. In it he says "... to get the highest accuracy possible, an English made RADFORD Low Distortion Oscillator was used which has less than 0.01% harmonic distortion at 20kHz."



LOW DISTORTION OSCILLATOR (Series 2)

An instrument of high stability providing very pure sine waves, and square waves, in the range of 5 Hz to 500 kHz. Hybrid design using valves and semiconductors.

- Specification**
- Frequency Range: 5 Hz-500 kHz (5 ranges).
 - Output Impedance: 600 Ohms.
 - Output Voltage: 10 Volts r.m.s. max.
 - Output Attenuation: 0-110 dB continuously variable.
 - Sine Wave Distortion: 0.005% from 200 Hz to 20 kHz increasing to 0.015% at 10 Hz and 100 kHz.
 - Square Wave Rise Time: Less than 0.1 microseconds.
 - Monitor Output Meter: Scaled 0-3, 0-10, and dBm.
 - Mains Input: 100 V.-250 V. 50/60 Hz.
 - Size: 17½ x 11 x 8in.
 - Weight: 25 lb.
 - Price: £150.



DISTORTION MEASURING SET (Series 2)

A sensitive instrument for the measurement of total harmonic distortion, designed for speedy and accurate use. Capable of measuring distortion products as low as 0.002%. Direct reading from calibrated meter scale.

- Specification**
- Frequency Range: 20 Hz-20 kHz (6 ranges).
 - Distortion Range: 0.01%-100% (s.d. (9 ranges).
 - Sensitivity: 100 mV.-100 V. (3 ranges).
 - Meter: Square law r.m.s. reading.
 - Input Resistance: 100 kOhms.
 - High Pass Filter: 3 dB down at 350 Hz. 30 dB down at 45 Hz.
 - Frequency Response: ±1 dB from second harmonic of rejection frequency to 250 kHz.
 - Power Requirements: Included battery.
 - Size: 17½ x 11 x 8in.
 - Weight: 15 lb.
 - Price: £120.
- Descriptive technical leaflets are available on request.

RADFORD LABORATORY INSTRUMENTS LTD.

ASHTON VALE ROAD, BRISTOL 3

Telephone: 662301/3

WW-070 FOR FURTHER DETAILS

DIFFERENTIAL DC AMPLIFIERS

for use with dc energised transducers



**03
150
160**
series
in
card
modular
cased
form

Extremely versatile high performance dc amplifiers with choice of output stage to drive a wide range of indicating, recording and control devices. Also Bridge Supplies and Bridge Balance Units.

FYLDE Electronic Laboratories Ltd.,
Oakham Court, PRESTON PR13XP
Telephone Preston 57560

WW-71 FOR FURTHER DETAILS

VOLTAGE-SELECTORS

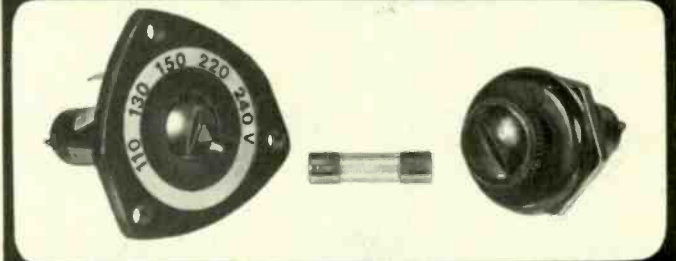

SOLE U.K. AGENTS

SUPER ELECTRONICS LIMITED

5 VIOLET HILL, LONDON, N.W.8.
TELEPHONE: MAIDA VALE 8281

WW-72 FOR FURTHER DETAILS



Make a reliable contact with Oxley P.T.F.E. insulated 'Barb' Plugs and Sockets. Subminiature and miniature versions for chassis or printed circuit mounting.

OXLEY DEVELOPMENTS COMPANY LTD.

Priory Park, Ulverston, North Lancs., England.
Tel: Ulverston 2821. Cables: Oxley Ulverston. Telex: 6541.



WW-73 FOR FURTHER DETAILS

No other electronic voltmeter packs this much performance for £90!

Marconi TF 2604 *Electronic Voltmeter*

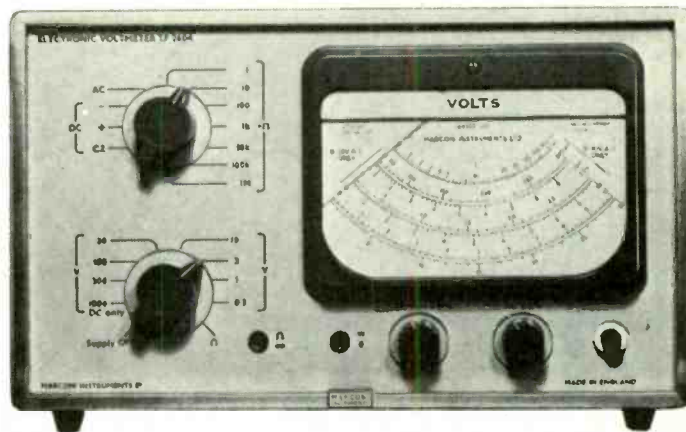

- Excellent zero stability:** less than 4 mV deflection at full scale on all ranges for changes in mains supply voltage of as much as 10%
- Seven a.c. ranges:** 300 mV to 300 V f.s. 20 Hz to 1.5 GHz
- Eight d.c. ranges:** 300 mV to 1000 V f.s.

- Seven resistance ranges:** 500 Ω to 500 M Ω
- Input resistance:** 100 M Ω
- Input capacitance:** 1.5 pF
- Multipliers available:** extend range to 2 kV a.c. and 30 kV d.c.

£90—U.K. f.o.b. Price. Full technical details on request.



MARCONI INSTRUMENTS LIMITED

A member of GEC—Marconi Electronics Limited
Longacres, St. Albans, Herts, England.

Tel: St. Albans 59292 Telex: 23350

WW—074 FOR FURTHER DETAILS

Crystal Controlled FET Converters

2 to 700 MHz.
for Satellite tracking
Space vehicle communications
Galactic noise measurement
Microwave I.F. amplifiers
Laboratory Standards
Wideband Television Translators
Radio Astronomy
Masthead preamplifiers
Radiotelephone
Aircraft & Marine
Meteorology

Employs the latest FETs and circuitry to provide noise figures of laboratory standard for utilising in practical working conditions.

FET Preamplifiers



2 to 300 MHz. Selected Texas TIS88A FETs neutralised cascode front-end. Pot core brass screened VHF coils. Link coupled bandpass filter ahead of mixer, RCA 3N141 dual gate MOSFET. Cathodeon HC/18 VHF crystal. Silicon planar injection stages. High Q break in mixer gate. Glass fibre printed circuit board using the latest sub-miniature VHF components.

Specification

Output Frequency:	2 to 100 MHz.
Bandwidth:	Up to 15% of signal frequency @ - 3dB.
Gain:	35 dB.
Noise Factor:	1.0 dB @ 150 MHz. 2.0 dB. @ 300 MHz.
Cross Modulation:	30 mV.
Blocking:	40 mV.
Impedance input & output:	52 or 75 ohms.
Size:	1½" x 2½" x 4½".
Weight:	10 oz.
Power:	12v. DC @ 12 ma.
Price:	£30 Preamplifier £20.

300 to 700 MHz. Union Carbide 2N4416A/Texas TIS88A neutralised cascode front-end. Cooper chassis and screening. RCA 3N141 dual gate MOSFET output.

Specification

Noise Factor:	2.5dB @ 450 MHz.
Weight:	12 oz.
Price:	£50. Preamplifier £30.
Other details as 2 to 300 MHz. unit.	

S.A.E. for further technical information (please state application) Telephone: Faversham 2064.

JXK CONVERTERS

PEEL HOUSE, PORTERS LANE, OSPRINGE, FAVERSHAM, KENT

WW—075 FOR FURTHER DETAILS

TINSLEY AUTOMATIC CURRENT CONTROLLERS

Suitable for all High Precision Potentiometers—Replaces messy lead-acid cells and enables Potentiometer to be used for the full working day.

If you use Measuring Potentiometers and have not yet seen the Automatic Current Controller demonstrated

Write for full details to:—

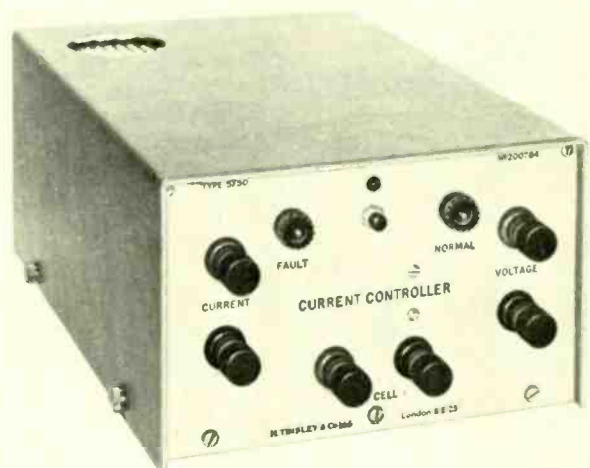

H. TINSLEY & CO LTD

WERNDÉE HALL, SOUTH NORWOOD,
LONDON, S.E.25. TEL 01-654 6046

WW—076 FOR FURTHER DETAILS

LEVELL VOLT METERS measure μV 's from 1Hz to 450MHz

TRANSISTOR A.C. MICROVOLTMETERS

Response from 1Hz to 3MHz with amplifier output available. Two versions differ only in meter size and bandwidth switch on type TM3B.

TYPE TM3A
£49

Complete with battery and input lead.

OPTIONAL EXTRAS
Leather case £4/10/-
A.C. Power Unit £7/10/-

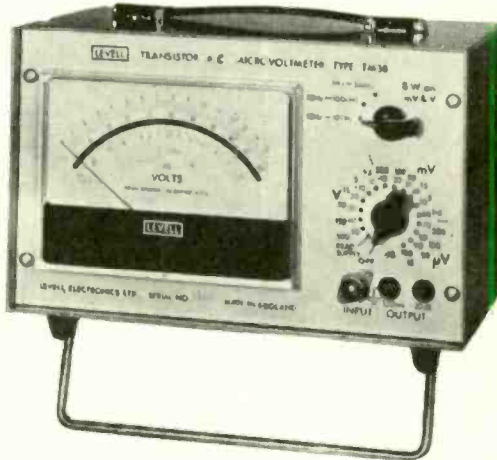

TYPE TM3B
£63

Complete with battery and input lead.

OPTIONAL EXTRAS
Leather Case £5.
A.C. Power Unit £7/10/-

VOLTMETER RANGES

15 μV , 50 μV , 150 μV 500V f.s.d.
Accuracy $\pm 1\% \pm 1\%$ f.s.d. $\pm 1\mu V$ at 1kHz.

dB RANGES

-100dB to +50dB in 10dB steps. Scale
-20dB to +6dB. 0dB = 1mW into 600 Ω .

FREQUENCY RESPONSE

Above 500 μV : ± 3 dB from 1Hz to 3MHz.
 ± 0.3 dB from 4Hz to 1MHz.
On 500 μV : ± 3 dB from 2Hz to 2MHz.
On 150 μV : ± 3 dB from 4Hz to 1MHz.
On 50 μV : ± 3 dB from 7Hz to 500kHz.
On 15 μV : ± 3 dB from 20Hz to 200kHz.

AMPLIFIER OUTPUT

150mV at f.s.d. on all ranges. Will drive a load of 200k Ω and 50pF without loss.

POWER SUPPLY

One type PP9 battery, life 1000 hours; or, A.C. mains when Power Unit is fitted.



BROADBAND VOLTMETERS

As A.C. Microvoltmeters plus H.F. probe to extend response to 450MHz. Two versions differ only in meter size and L.F. bandwidth switch on type TM6B.

TYPE TM6A
£85

Complete with battery and input lead.
OPTIONAL EXTRAS

Leather Case £4/10/-
A.C. Power Unit £7/10/-



TYPE TM6B
£99

Complete with battery and input lead.

OPTIONAL EXTRAS
Leather Case £5.
A.C. Power Unit £7/10/-

H.F. VOLTAGE RANGES

1mV, 3mV, 10mV 3V f.s.d. Square law scales. Accuracy $\pm 4\%$ of reading $\pm 1\%$ of f.s.d. at 30MHz.

H.F. dB RANGES

-50dB, -40dB, -30dB +20dB.
Scale -10dB to +3dB. 0dB = 1mV into 50 Ω .

H.F. RESPONSE

± 0.7 dB from 1MHz to 50MHz.
 ± 3 dB from 300kHz to 400MHz.
 ± 6 dB from 400MHz to 450MHz.

L.F. RANGES

As TM3A and TM3B except for the omission of 15 μV and 150 μV .

POWER SUPPLY

One type PP9 battery, life 1000 hours on L.F. ranges and 400 hours on H.F. ranges; or, A.C. mains when Levell Power Unit is fitted.

LEVELL

PORTABLE INSTRUMENTS

Fully detailed leaflets are available on our complete range of portable instruments

WW-077 FOR FURTHER DETAILS

LEVELL ELECTRONICS LTD., Park Road, High Barnet, Herts. Tel.: 01-449 5028

PYE SPANS THE WORLD

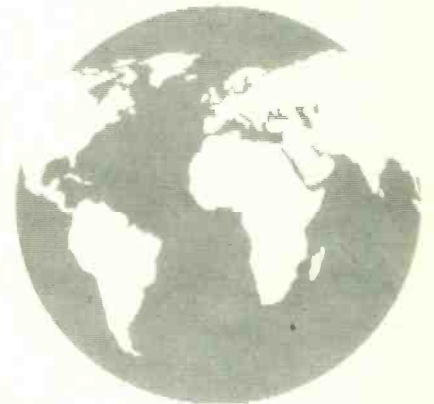

rely on

the vital contact

Pye Telecommunications is the world's largest exporter of radiotelephone equipment. Pye Radiotelephones are used all over the world to ensure *instant* contact. Pye research development and quality control really *do* keep in touch with tomorrow.



Pye 'Pocketfone' Personal Radiotelephone
 New battery economy circuit - Extremely light-weight and compact - Reception free from noise and interference - Minimum of controls - Transmit button automatically extends antenna - Hearing aid socket - Easily accessible batteries.



Pye 'Bantam' Portable VHF Radiotelephone
 Fully transistorised transmitter and receiver - Very high performance receiver - Crystal filter selectivity - 0.5W transmitter output - 250mW audio power - Long endurance with rechargeable or dry batteries - Can be used with external antenna to give greater range - Weatherproof.



Pye VHF Radiotelephone Fixed Station
 Solid-state receiver and transmitter - 10-15W R.F. output - Field-effect transistors used in receiver - Suitable for all climates - Electronic squelch - Designed to meet all relevant specifications.



Pye UHF Radiotelephone Fixed Station
 Solid state receiver and transmitter - 8-10W R.F. output - Very high R.F. selectivity using field-effect transistors - Very low noise factor - Electronic squelch - A. C. or 24V d.c. operation - Suitable for all climates - Designed to meet all relevant specifications.



Pye 'Westminster' Remote Mounted Radiotelephone
 Completely solid state - 5-8W R.F. output - 1-10 channels with solid state switching - Illuminated channel indicator - Suitable for all climates - Meets all relevant specifications.



Pye 'Westminster' Front Mounted Radiotelephone
 Completely solid state - 5-8W R.F. output - 1-10 channels with solid state switching - Suitable for all climates - Meets all relevant specifications.



Pye Single-Sideband Radiotelephone
 125W (d.e.p.) R.F. output - Fully transistorised receiver - C.W. facilities provided - Sideband selection by crystal filter - Carrier insertion for a.m. compatibility - Fixed or mobile application - Advanced transmitter design.



Pye 'Pioneer' Radiotelephone
 Fully transistorised - For use with automatic, CB manual, or magneto exchanges - Weatherproof cabinet - Unattended operation over long periods - Facility for fitting privacy equipment - Optional single antenna operation.



Pye 5-Circuit UHF Radiotelephone
 Compact 5-circuit radio terminal - Fully - transistorised channelling equipment - Frequency-shift signalling - Continuous unattended operation in all parts of the world - Twelve standard plans for terminals and repeaters.

PYE
 equipment gives you instant-contact with mobility

PYE TELECOMMUNICATIONS LTD. Cambridge England Telephone: Cambridge (0223) 61222 Telegrams: Pyetelecom Cambridge Telex: 81166



WW-078 FOR FURTHER DETAILS

Some notes on Bridge Measurement by WAYNE KERR

Number 1

The Transformer Ratio-Arm Bridge

This is the first of a series of notes describing a measurement technique which is becoming more generally accepted for its precision and reliability.

Like many sound scientific principles, the basic idea of this bridge goes back to the end of the 19th Century. However, at that time, technology had not evolved the high permeability nickel iron alloys and ferrites that we know today, and it is only comparatively recently that the full potentialities of this type of bridge network and its application to the science of measurement have been realised.

Figure 1 shows the simplest form of the transformer ratio-arm bridge.

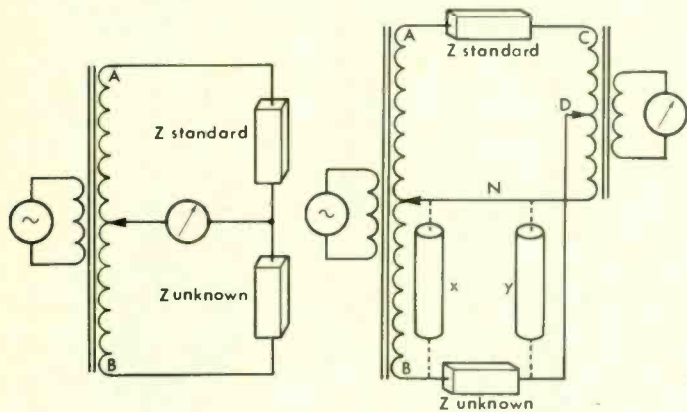

Fig. 1

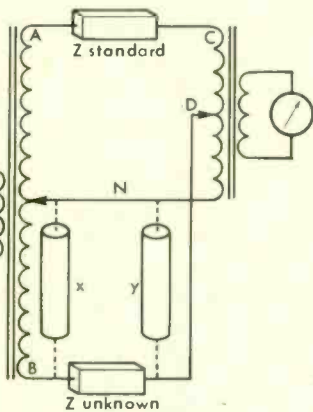

Fig. 2

The derivation of this network from the classical Wheatstone bridge can easily be seen, but the advantages are, perhaps, not quite so obvious. If the ratio arms A and B were resistors or capacitors, a large number would be necessary in order to make a wide range impedance bridge; but, by using a transformer, taps in the ratio 1, 10, 100 and 1000 can be readily achieved, and only one standard of reactance and one of resistance are required.

Furthermore, the accuracy of these ratios depends, in practical terms, only on the geometry of the windings and the difficulties of long term stability and component drift do not arise. With careful attention to the design of transformers, voltage ratios can be established to an accuracy of better than one part in a million, independent of normal changes in ambient temperature. This stability is to be compared with ratio arms made from resistors or capacitors in a conventional bridge.

Although the basic bridge circuit of Fig. 1 is still used in some instances, the incorporation of a second transformer, shown in figure 2, provides a bridge network of even wider range.

In addition to ratio arms A and B, the transformer on the detector side of the network can have variable ratios C and D, so that a further series of tappings from 1 to 1000 multiply with the original series to give an overall ratio of 10^6 to 1.

The operation of the bridge can now be explained quite simply. The voltage A produces a current when it is applied to the standard impedance. Likewise the voltage B, 180° out of phase with the voltage A, produces a current when it is applied to the unknown impedance. These two currents, making due allowance for the turns ratio of C and D, can now be balanced in the second transformer either by adjusting the voltage ratio or varying the value of the standard, or a combination of both.

Figure 2 also illustrates another extremely important feature of the bridge. If an impedance (x) is connected across the ratio arm B, that is to say between the voltage side of the unknown and N, the neutral connection of the bridge network, the accuracy of the measurement is virtually unaffected.

Although this impedance loads the transformer and causes a voltage drop, the tight coupling of the windings gives rise to an equivalent voltage drop on the standard side of the bridge, and for all practical purposes, the loading of the circuit does not affect the point at which the network balances. It is, perhaps, sufficient to point out that a similar situation arises in the event of an impedance (y) being connected across the second transformer winding.

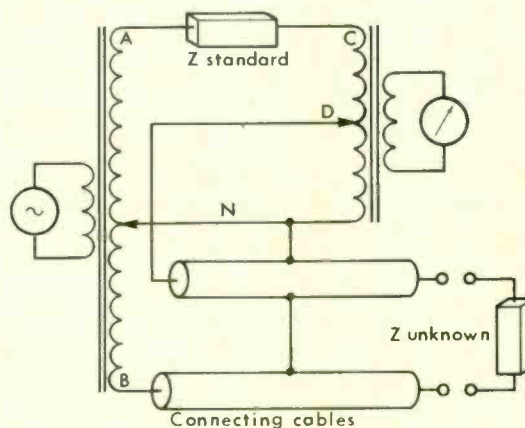

Fig. 3

If the basic circuit of Figure 2 is now re-drawn in the form of Figure 3, it will be seen that the capacitances of the two connecting cables replace the impedances (x) and (y). It now becomes clear that the use of relatively long cables to connect the unknown impedance to the bridge can be tolerated.

To give an example of the advantage of this facility, it is in practice possible to measure accurately a small fraction of one picofarad in the presence of cable capacitances of several hundred picofarads.

Further notes in this series will develop the principles which are explained in this issue, and also their application to a wide range of measurement problems.

THE WAYNE KERR COMPANY LIMITED
NEW MALDEN · SURREY · ENGLAND

Telephone 01-942 2202
Cables Waynkerr, Malden
Telex 262333

WW-079 FOR FURTHER DETAILS

WHITELEY

ELECTRICAL RADIO CO. LTD.

Stentorian HIGH FIDELITY UNITS

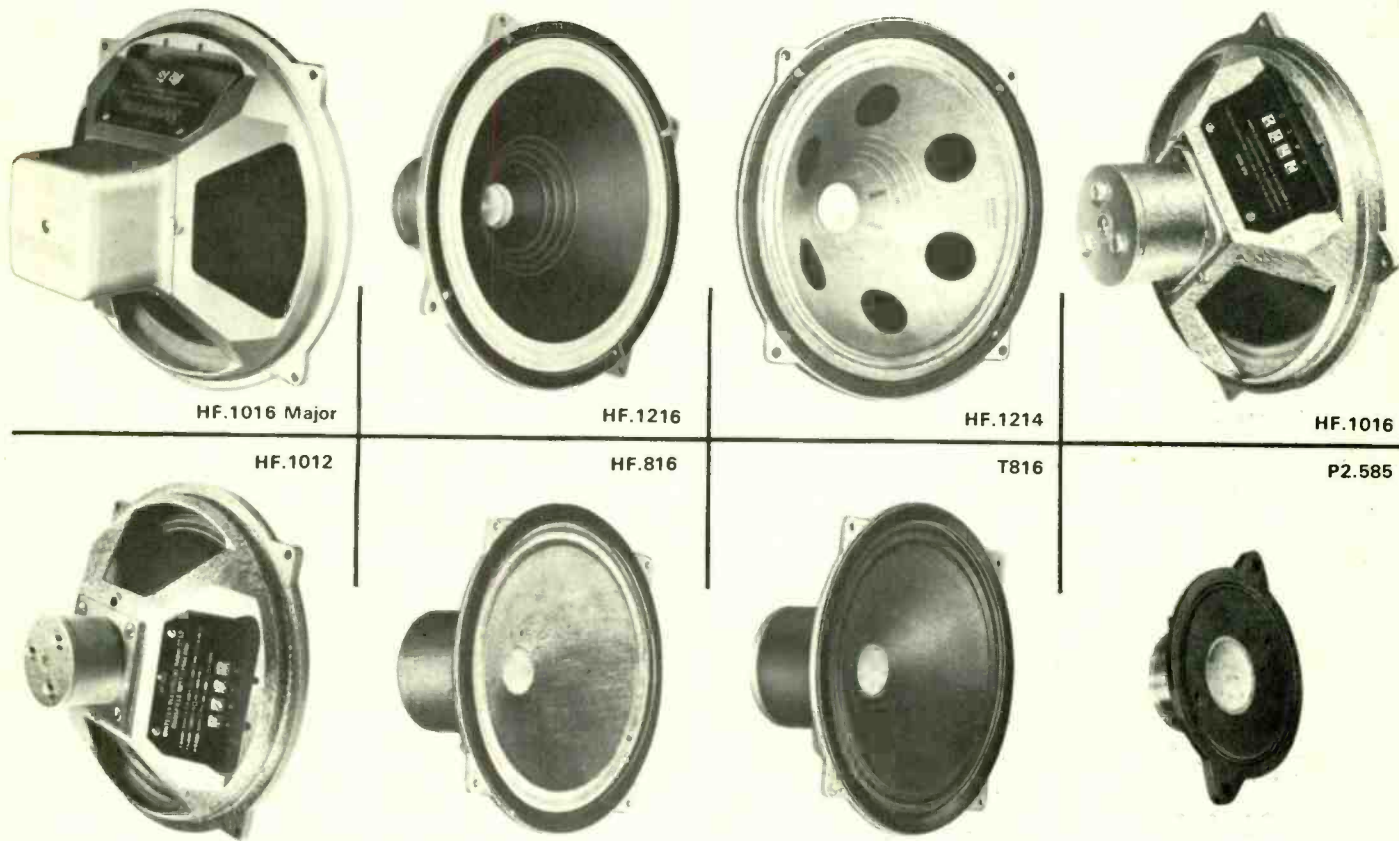

Type	Dimensions		Flux Density Gauss	Pole Dia. In.	Total Flux Maxwells	Imp. ohms	Handling Capacity Watts	Bass Res. c/s	Frequency Response c/s	Weight		Price*
	Depth	Dia.								lb.	oz.	
HF.816	4.218"	8"	16,000	1.0	63,000	U	6	63	50—15 K	4	8	£9.8.1
HF.1012	4 1/8"	10"	12,000	1.0	47,400	U	10	35	30—14 K	4	4	£6.17.6
HF.1016	4 1/4"	10"	16,000	1.0	63,000	U	10	35	30—15 K	5	13	£10.19.6
HF.1016 Major	5 1/4"	10"	16,000	1.0	63,000	15	10	39	30—16 K	6	0	£14.2.8
HF.1214	6 1/2"	12"	14,000	1.5	106,000	15	15	39	25—14 K	9	10	£15.1.8
HF.1216	7 1/2"	12"	16,000	1.5	121,140	15	15	37	20—16 K	13	0	£23.2.6
	4 1/4"	8"		1.0	63,000	15	15	—	1500—17 K	4	8	£8.18.3
P2.585	1 1/2"	2 1/2"	8,500	0.375	6,400	3	0.3	330	250—9 K	—	3	£1.12.9

* Includes 10% P.T. surcharge

Whiteley Stentorian Speakers incorporate 40 years of development in acoustic technology. Their frequency response is exceptionally wide, and their overall performance outstanding. Few speakers can equal, and none can excel the superb reproduction of the high fidelity speakers in the Whiteley Stentorian range.

WHITELEY ELECTRICAL RADIO CO. LTD.
MANSFIELD · NOTTS · ENGLAND

Telephone: Mansfield 24762
LONDON OFFICE: 109 KINGSWAY, W.C.2. Telephone: 01-405 3074

Listen-Look and Measure with
LOEWE-OPTA

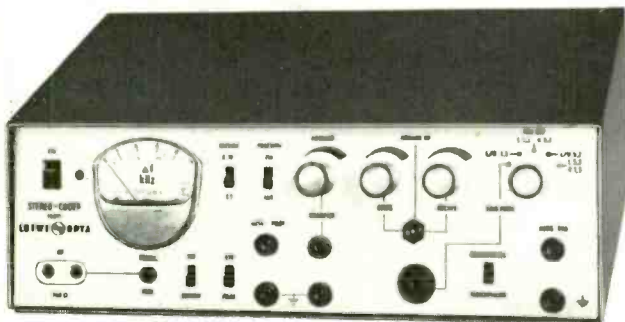

The En-Encoder you must have for

- Servicing purposes, checking of stereo-radio receivers and alignment of stereo-decoders.
- For demonstration of FM-stereo-receivers with, in accordance to the pilot-tone-system, standardized Multiplex-signal.
- All-transistor technique secures instantaneous readiness for operation.

Remarkably Low Trade Price: **£102.10.0**

Write for further details to:
HIGHGATE ACOUSTICS

184-188 Great Portland Street, London, W1
01-636 2901/4

WW—083 FOR FURTHER DETAILS

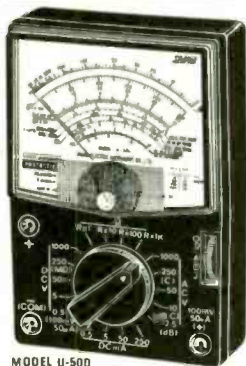

SANWA MULTI TESTERS

USED THROUGHOUT THE WORLD, SANWA'S EXPERIENCE OF 30 YEARS ENSURES ACCURACY, RELIABILITY, VERSATILITY. UNSURPASSED TESTER PERFORMANCE COMES WITH EVERY SANWA

6 Months' Guarantee - Excellent Repair Service

Model P-1B	£3 7 6
Model JP 5D	£5 10 0
Model U-50D	£7 5 0
Model 360-YTR	£7 17 6
Model AT-1	£11 7 6
Model 380-CD	£13 5 0
Model F-80TRD	£13 15 0
Model 430-ES	£19 0 0
Model EM-700	£51 0 0

PLEASE WRITE FOR ILLUSTRATED LEAFLETS OF THESE SANWA METERS

SOLE IMPORTERS IN U.K.;
QUALITY ELECTRONICS LTD.

47-49 HIGH STREET, KINGSTON-UPON-THAMES, SURREY. Tel: 01-546 4585

WW—084 FOR FURTHER DETAILS

A.C. SOLENOID TYPE SBM/T

Continuous Rating
3½ lb. at 1 in
Instantaneous
up to 16 lb.

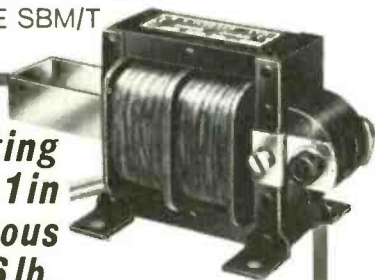

Fitted with stainless steel guides—6 times the life. Larger and smaller sizes available—also transformers to 8kVA 3-phase.

R.A. WEBBER LTD.

KNAPPS LANE, CLAY HILL, BRISTOL 5. TELEPHONE 65-7228/9

WW—085 FOR FURTHER DETAILS



WG

NEW IMPROVED
SOLDER
REMOVER

Model SR2

• Now with Safe Loading Mechanism which does not recoil on release.

• Adjustable Suction Control.

• Re-positioned Release Button for better handling of tool.

Instantly removes unwanted solder from printed circuits and all other solder joints without damage to unit or component. Saves valuable time resulting in increased production.

Available from

W.GREENWOOD
ELECTRONIC LTD

21 GERMAIN STREET,
CHESHAM, BUCKS

Chesham
4808/9

WW—086 FOR FURTHER DETAILS

Here are the features which make the S54 such good value for money.....

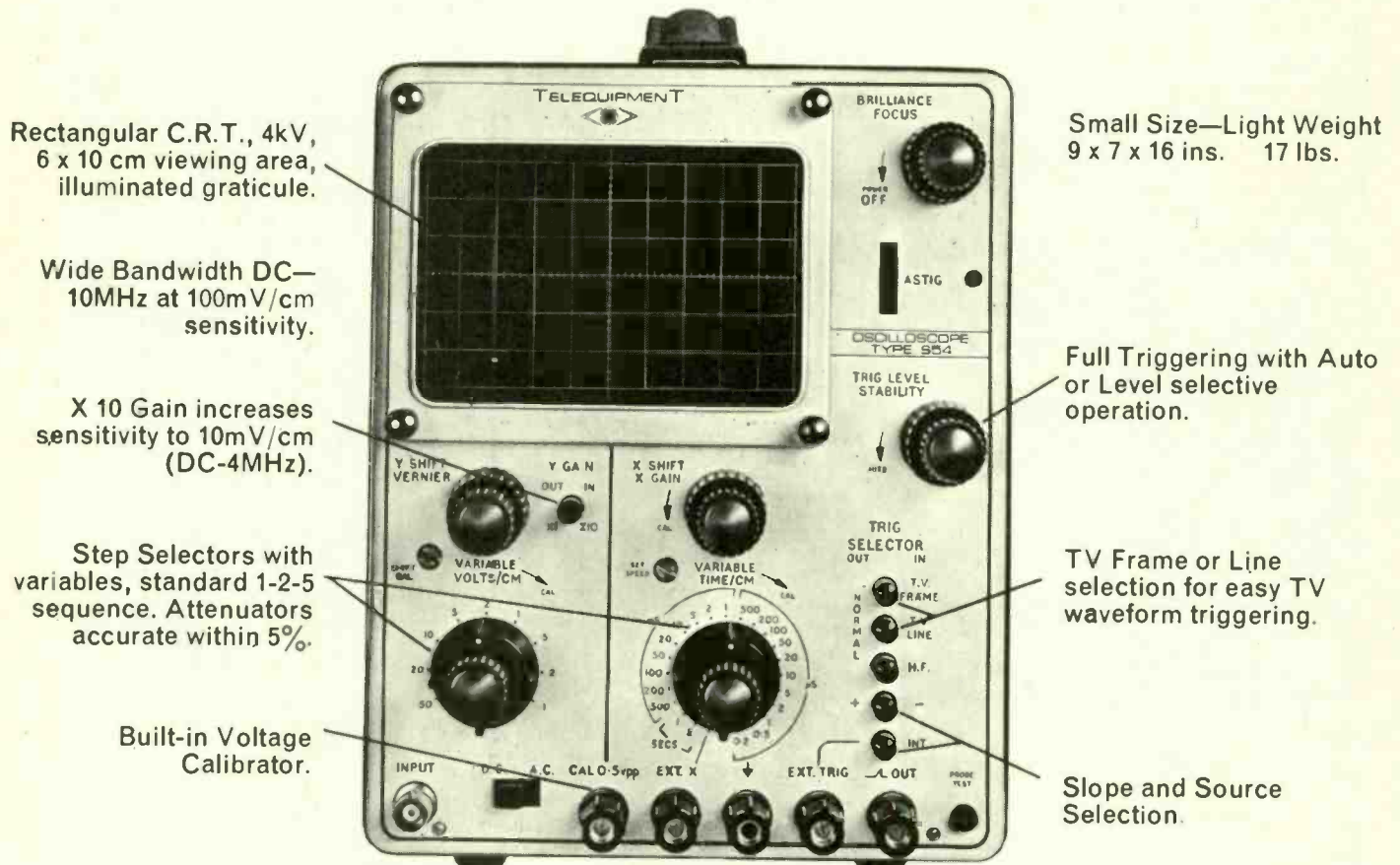

Rectangular C.R.T., 4kV, 6 x 10 cm viewing area, illuminated graticule.

Small Size—Light Weight
9 x 7 x 16 ins. 17 lbs.

Wide Bandwidth DC—10MHz at 100mV/cm sensitivity.

Full Triggering with Auto or Level selective operation.

X 10 Gain increases sensitivity to 10mV/cm (DC-4MHz).

TV Frame or Line selection for easy TV waveform triggering.

Step Selectors with variables, standard 1-2-5 sequence. Attenuators accurate within 5%.

Built-in Voltage Calibrator.

Slope and Source Selection.

SOLID STATE SINGLE-BEAM OSCILLOSCOPE

At £110 this oscilloscope must be seen to be believed—
Ask for a demonstration NOW!!!

TELEQUIPMENT LIMITED

313 Chase Road, Southgate, London N.14. Telephone: 01-882 1166



WW—087 FOR FURTHER DETAILS

www.americanradiohistory.com

Wireless World

Electronics, Television, Radio, Audio

Fifty-ninth year of publication

August 1969

Volume 75 Number 1406

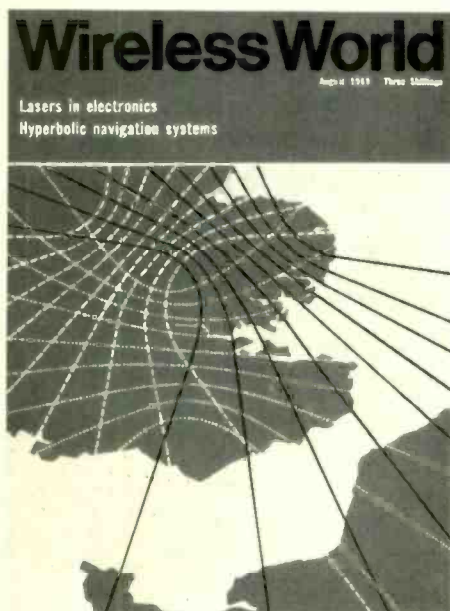

This month's cover. A Decca artist's interpretation of the hyperbolic patterns produced by the south-east England Decca Navigator Chain (see p. 353).

I.P.C. Electrical-Electronic Press Ltd
Managing Director: Kenneth Tett
Editorial Director: George H. Mansell
Advertisement Director: George Fowkes
Dorset House, Stamford Street, London, SE1

© I.P.C. Business Press Ltd, 1969
Permission in writing from the Editor must first be obtained before letterpress or illustrations are reproduced from this journal. Brief extracts or comments are allowed provided acknowledgement to the journal is given.

Contents

- 347 **Economics of Broadcasting Channels**
- 348 **Active Filters—1** by F. E. J. Girling & E. F. Good
- 352 **Liquid Encapsulation for Crystal Growing**
- 353 **Hyperbolic Radio Navigation Systems** by F. S. Stringer
- 358 **News of the Month**
 - Broadcasting in the seventies
 - New mast for Emley Moor
- 361 **Amateur Communications Receiver—2** by D. R. Bowman
- 367 **Laser Applications in Electronics** by W. A. Gambling & R. C. Smith
- 372 **Wireless World Logic Display Aid—4**
- 378 **Personalities**
- 379 **Circuit Ideas**
- 380 **Letters to the Editor**
- 383 **Conferences and Exhibitions**
- 384 **Operational Amplifiers—7** by G. B. Clayton
- 386 **Books Received**
- 386 **Announcements**
- 387 **Test Your Knowledge questions & answers** devised by L. Ibbotson
- 388 **Thyristor-stabilized Power Supplies** by A. R. Bailey
- 391 **New Products**
- 396 **World of Amateur Radio**
- 398 **Literature Received**
- 398 **H. F. Predictions**

PUBLISHED MONTHLY (3rd Monday of preceding month). Telephone: 01-928 3333 (70 lines). Telegrams/Telex: Wiworld Hiffepres 25137 London. Cables: "Ethaworld, London, S.E.1." Annual Subscriptions: Home; £2 15s 0d. Overseas; 1 year £2 15s 0d. Canada and U.S.A.; \$6.75; 3 years £7 0s 0d. Canada and U.S.A.; \$17.50 Second-Class mail privileges authorised at New York N.Y. Subscribers are requested to notify a change of address four weeks in advance and to return wrapper bearing previous address. BRANCH OFFICES: BIRMINGHAM: 201, Lynton House, Walsall Road, 22b. Telephone: 021-356 4838. BRISTOL: 20 Victoria Square, Clifton, 8. Telephone: 0272 33873. GLASGOW: 2-3 Clairmont Gardens, C.3. Telephone: 041-332 3792. MANCHESTER: 260, Deansgate, 3. Telephone: 061-834 4412. NEW YORK OFFICE U.S.A.: 300 East 42nd Street, New York 10017. Telephone: 867-3900.

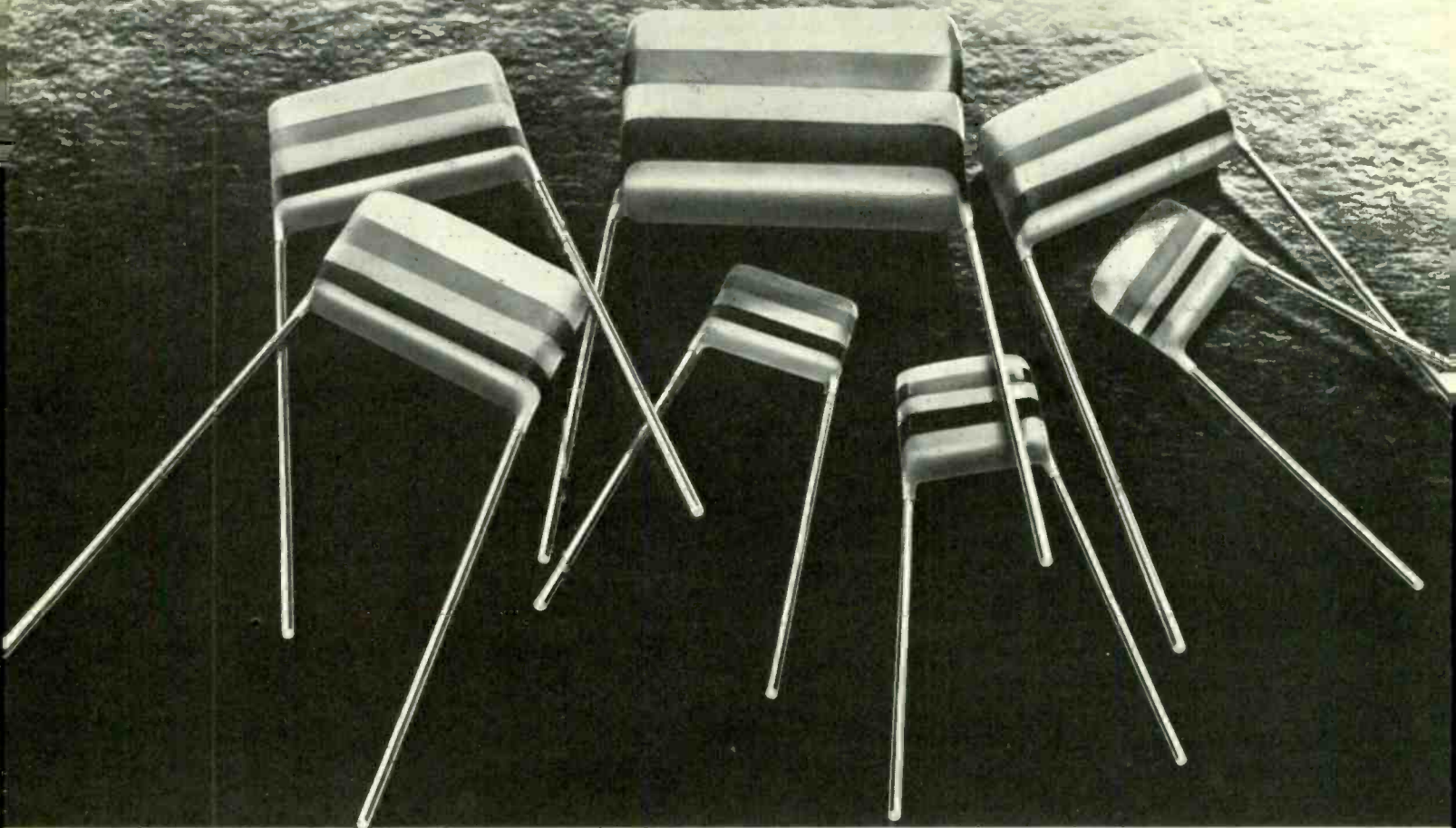

How we set the trend in plastic film capacitors

Ten years ago, Mullard introduced the C296 series of plastic film capacitors to replace the paper components then used exclusively in consumer applications in the UK. The film used is polyethylene-terephthalate generically known as polyester. This revolutionary film transformed the British capacitor market. It enabled Mullard to reduce component size by as much as 15% compared with paper types. Working voltages were up to 400V d.c. Insulation resistances greater than 50,000M Ω at 20°C were achieved for the first time in commercial quantities. The polyester film itself was non-hygroscopic and chemically inert. It was wound with aluminium using an extended foil technique to give minimal self-inductance. And the finished capacitors were encapsulated in hard, water repellent lacquer, which was unaffected by temperatures up to 150°C.

New techniques New manufacturing techniques were then introduced in plastic film capacitors, which allowed a metallised layer to be deposited on the film. This reduced our capacitor

sizes by up to a further 50%. About this time, the general acceptance of printed circuits created a strong demand for various components in different shapes, with particular dimensions to close tolerances. And because we at Mullard anticipated this trend we now produce the C280 miniature metallised film capacitors. These small devices have radial terminations in the standard I.E.C. 0.1 inch grid spacing, making them the economic answer to the problems of improving packing densities and reducing assembly production times. Due to their distinctive colour coding, small size and wide capacitance range the demand for these capacitors is far in advance of all others. The 400V units have a more recent polyester film (polycarbonate) which reduces losses at frequencies of 20kHz and above. This also applies to the C281 series with their axial leads and moulded encapsulation.

Development Work of course continues, and encouraging results are being achieved with capacitors for a.c. power handling, for example for interference suppression and power factor correction, using polypropylene films.

Higher demand The demand for discrete passive components has increased enormously during the last ten years. And today there is a

continual demand for polyester capacitors in the range 0.001 μ F to 10 μ F for most applications in the domestic field.

Worth it? Right from the beginning we've anticipated the changing requirements, tested new materials and techniques so that we can be sure the product will give consistent service. This also enables us to relate quality with the best possible price. Something which applies across our very wide capacitor range including electrolytic, variable and ceramic types. Mullard electronic components find applications as unexpected as astronomy and zoology, giving us experience in many technologies. Experience our customers now take for granted.

Mullard components for consumer electronics

Mullard Limited
Consumer Electronics Division
Mullard House Torrington Place
London WC1

Wireless World

Economics of broadcasting channels

Editor-in-chief:

W. T. COCKING, F.I.E.E.

Editor:

H. W. BARNARD

Technical Editor:

T. E. IVALL

Assistant Editors:

B. S. CRANK
J. H. WEADEN

Editorial Assistant

J. GREENBANK, B.A.

Drawing Office:

H. J. COOKE

Production:

D. R. BRAY

Advertisements:

G. BENTON ROWELL (*Manager*)
J. R. EYTON-JONES
R. PARSONS (*Classified Advertisement Manager*)
Telephone: 01-928 3333 Ext. 538

When the B.B.C. were deliberating on how to improve the distribution of sound radio transmissions (see "News", page 358) one wonders if anybody gave a passing thought to the more fundamental economics of broadcasting. Economics is not just management of cash, but good utilization of resources, whatever they happen to be. In the case of broadcasting one of the most important resources is channel capacity, a strictly limited commodity. Did anyone, in fact, consider whether our broadcasting channels are being utilized in the most economical way for the material they are required to carry? Probably not, first of all because it wasn't on the agenda and secondly because there is nobody with the right knowledge and authority to deal with such a problem—even if there is anybody who admits that it exists.

The trouble is we have the programme producer on the one hand and the engineer on the other. Each does his job independently of the other, though no doubt with understanding of the other's immediate problems. The overall organizers certainly have a synoptic view, but it cannot go very deep: they are essentially men of affairs. The programme producer is aware that there is only a limited number of channels and he distributes his material among them according to some formula. His idea of economics seems to be to fill up as many hours of broadcasting as possible—leave no silence, no raster unfilled. The engineer, also aware of channel limitation, international frequency allocations etc., sees a broadcasting channel as essentially a communications channel with a maximum information-carrying capacity, à la Shannon, determined by bandwidth and signal/noise ratio. He is apparently unperturbed that this view of information could mean complete absence of information to the programme producer—gibberish, noise, abstract patterns, could all produce high rates of "information" in bits per second. The engineer's idea of economics is largely a matter of saving bandwidth by techniques such as single- and vestigial-sideband working, frequency interleaving and pulse sound: he is not concerned with the economic use of what he has saved.

The utilization questions that seem to have nobody to investigate them are of this kind: If speech intelligence requires a bandwidth of only a few kilohertz, is it economic when an 8-MHz television channel or a 300kHz f.m. sound channel is used for news bulletins and the like? Does "sweet" background music for busy housewives, or pop foreground music for sated juveniles, require as much channel capacity as music with a subtle, complex approach to the emotions and intellect? (This is not a question of taste, but what are the required stimuli and responses in each case and the minimum information rates in bits per second needed to generate them. Some pop music may need higher rates than some classical music.) If the maximum rate at which a single television viewer can take in visual information at any given time corresponds to a 5-MHz video bandwidth, is it economic to operate a system that provides him with several times that information carrying capacity? (This point was raised recently by R. P. Gabriel, of Rediffusion International, as an argument in favour of his "dial back" cable television distribution system.) In short we are looking for an economic matching of communication channels to the human communication requirements at the inputs and outputs of the channels, an equation relating engineers' "information" to semantic information.

At present there are no obvious techniques for remedying any mis-matching that might be admitted to exist. But the continuing demand by society for more and more channels of communication (including broadcasting) might well provide a stimulus for work in this field in the future.

Active Filters

A practical approach on feedback amplifier theory

I. Survey of circuits

by F. E. J. Girling* and E. F. Good*

Many works on active filters are written so exclusively for a small circle of specialists that the ordinary circuit designer may easily feel that there is little hope of understanding the subject without first mastering a whole range of new concepts.

It is the aim of this series of articles to show that a comprehensive and practically useful theory of active-filter design can be built up from the theory of linear feedback amplifiers as laid down by Black, Nyquist, Blumlein, and others.

The present article is a survey of the expositions to be discussed. In subsequent articles we shall collect together some of the fundamentals of the theory of both passive and active networks; then later we shall look in detail at some of the more useful methods of realization.

Throughout we shall endeavour to base the exposition on the simplest and most widely known concepts, not only in order to be intelligible to the non-specialist reader, but also because we believe there is a real danger in taking too narrow a view: too close an inspection of a single tree can easily result in failure to appreciate the existence of the wood.

The dynamics of CR and LCR circuits

An LCR filter is a resonant structure, that is: at least one component of its natural motion or transient response is less than critically damped. This is necessary to obtain a sharp cutoff—as shown, for example, in the low-pass response of Fig. 1. In a passive CR circuit, no matter how complicated, dissipation in the resistances dominates and the natural motion is more than critically damped. Passive CR networks do not give sharp cutoffs.

(Many readers will be familiar with these facts in terms of the positions on the complex plane of the poles of the response functions.)

When, however, RC networks are used with gain and feedback (i.e. in an active system) the restriction on the type of natural motion is removed, and consequently on the type of frequency response obtain-

able. Indeed it has been common knowledge since the publication of the work of Bode and Nyquist that a feedback amplifier containing only CR coupling and feedback networks can show a peaky and resonant response and further can be unstable, i.e. oscillate. (Ref. 1). In amplifiers this is to be avoided: in active filters it is put to use.

Related fields

Two areas in which gain, feedback, and CR networks are used to obtain virtually any response that may be desired are analogue computers and servo simulators; and it was with some knowledge of these arts that the present authors began designing active filters (low-pass “scratch” filters for reducing surface hiss from 78 r.p.m. shellac discs).

The simplest electronic analogue of a 2nd-order servo system, i.e. one having two integrations in the forward path, is shown in Fig. 2(a). This uses three “operational” amplifiers, and so is rather cumbersome (or was so before silicon integrated amplifiers became available). An alternative circuit using a single amplifier is shown in Fig. 2(b). For both circuits the voltage transfer ratio in conventional transfer function form is (leaving out the minus sign, which is not of importance when discussing the frequency response)

$$\frac{V_{out}}{V_{in}} = \frac{1 + \alpha pT}{1 + \alpha pT + p^2 T^2} \quad (1)$$

where p is the Heaviside differential operator† (signifying the process d/dt), T is the reciprocal of the undamped natural frequency in radians/second (i.e. $T = 1/\omega_n$), and α is a measure of the damping (being equal to 2ζ , where ζ is the conventional damping factor‡). As will be seen later $\alpha = 1/q$, where q is the conventional Q-factor of a tuned circuit, and we shall take

† Some may prefer to write s , the complex-frequency variable. For our purposes it is immaterial which letter is used. The important thing is to understand that p (or s) represents differentiation and that $1/p$ (or $1/s$) represents integration.

‡ This is defined so that critical damping is given by $\zeta=1$. It should not be confused with the “damping factor” commonly used by audio engineers, which, although concerned with the same basic physical phenomenon—damping of a potentially oscillatory system—is given by loudspeaker impedance divided by amplifier output impedance.

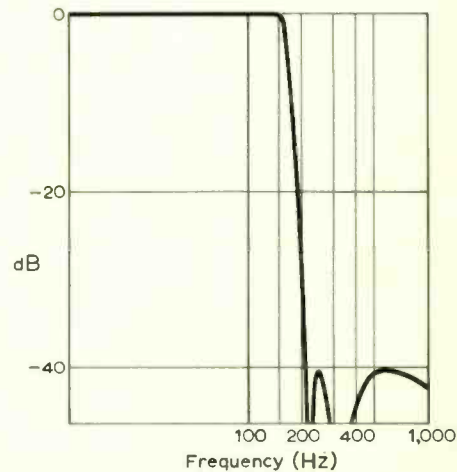

Fig. 1. Low-pass filter, 5th-order Darlington response. The ripples in the pass band do not show on the small scale used.

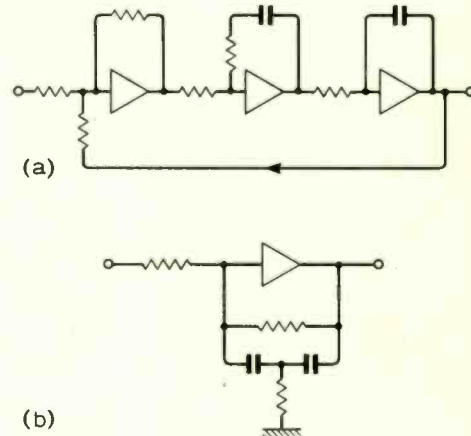

Fig. 2. Two analogues of a basic second-order servo system. All amplifiers are high-gain, sign-inverting.

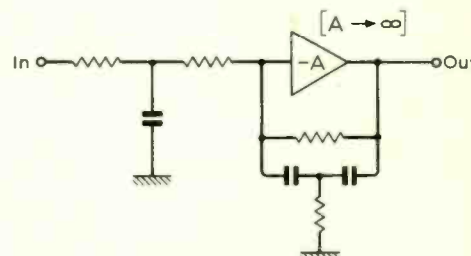

Fig. 3. Low-pass filter derived from an analogue of a second-order servo system.

* Royal Radar Establishment.

this relationship as the definition of the *Q*-factor of any 2nd-order system.

By writing $j\omega$ for p an expression for the frequency response is obtained,

$$\frac{V_{out}}{V_{in}} = \frac{1 + j\alpha \frac{\omega}{\omega_c}}{1 + j\alpha \frac{\omega}{\omega_c} - \left(\frac{\omega}{\omega_c}\right)^2} \quad (2)$$

When $\omega \gg \omega_c$

$$\left| \frac{V_{out}}{V_{in}} \right| \approx \frac{\alpha \frac{\omega}{\omega_c}}{\left(\frac{\omega}{\omega_c}\right)^2}$$

i.e.

$$\approx \frac{\alpha \omega_c}{\omega}$$

Thus in this region there is increasing attenuation as the frequency is raised, but the rate of cut off is not very great as the response is proportional to only $1/\omega$.

If we could remove the second term of the

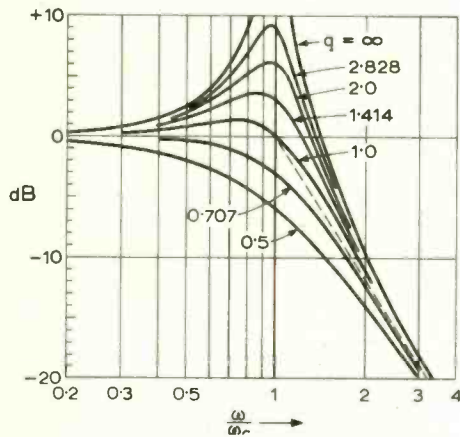

Fig. 4. Amplitude/frequency response of

$$\frac{1}{1 + \frac{1}{q} j \frac{\omega}{\omega_c} - \left(\frac{\omega}{\omega_c}\right)^2}$$

with q as parameter [$q = 1/\alpha$].

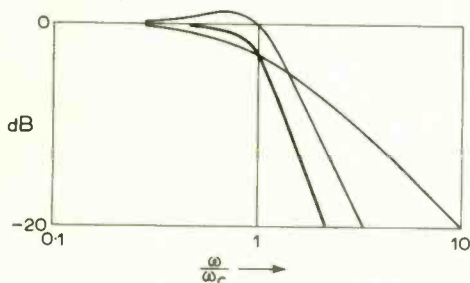

Fig. 5. Amplitude/frequency response of

$$\frac{1}{(1 + pT)(1 + pT + p^2T^2)}$$

and of the factors.

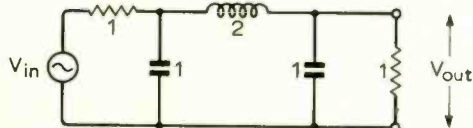

Fig. 6. Conventional 3rd-order low-pass filter.

numerator of the voltage transfer ratio we should have better filtering, as the response in the cutoff region would be proportional to $(\omega_c/\omega)^2$ approx. This can be done by multiplying by the factor $1/(1 + j\alpha\omega/\omega_c)$, which means that we must add a simple lag of time constant α/ω_c , i.e. αT . A convenient way of doing this is to split the input resistor into two and add a capacitor as shown in Fig. 3.

We now have a circuit which realises the equation

$$\frac{V_{out}}{V_{in}} = G(\omega) = \frac{1}{1 + j\alpha \frac{\omega}{\omega_c} - \left(\frac{\omega}{\omega_c}\right)^2} \quad (3)$$

The equation for the amplitude response is therefore

$$\begin{aligned} |G(\omega)| &= \frac{1}{\left\{ \left(1 - \frac{\omega^2}{\omega_c^2}\right)^2 + \left(\alpha \frac{\omega}{\omega_c}\right)^2 \right\}^{1/2}} \\ &= \frac{1}{\left\{ 1 + (\alpha^2 - 2)\left(\frac{\omega}{\omega_c}\right)^2 + \left(\frac{\omega}{\omega_c}\right)^4 \right\}^{1/2}} \quad (4) \end{aligned}$$

And from this, taking $\alpha (= 1/q)$ as parameter, we obtain the family of curves shown in Fig. 4.

If this rate of fall in the cutoff region is sufficient, $|G(\omega)| \propto (\omega_c/\omega)^2$, a curve which is likely to be selected is that for $\alpha = \sqrt{2}$. For this degree of damping (0.707 of critical) the middle term of the denominator of the expression for $|G(\omega)|$ vanishes, leaving

$$|G(\omega)| = \frac{1}{\left\{ 1 + \left(\frac{\omega}{\omega_c}\right)^4 \right\}^{1/2}} \quad (5)$$

This is the Butterworth or "maximally flat" response (Refs. 2, 3) for this set of curves, i.e. the response which shows the sharpest turn-over at the corner without crossing the low-frequency asymptote, $|G(\omega)| = 1$, or the high-frequency asymptote, $|G(\omega)| = (\omega_c/\omega)^2$.

If a sharper cut off is required we may select the slightly peaked response, $\alpha = 1$, and add somewhere in the signal path a simple lag of equal corner frequency so that we obtain an overall frequency response

$$\begin{aligned} |G(\omega)| &= \frac{1}{\sqrt{\left\{ 1 - \left(\frac{\omega}{\omega_c}\right)^2 + \left(\frac{\omega}{\omega_c}\right)^4 \right\} \left\{ 1 + \left(\frac{\omega}{\omega_c}\right)^2 \right\}}} \\ &= \frac{1}{\sqrt{\left\{ 1 + \left(\frac{\omega}{\omega_c}\right)^6 \right\}}} \quad (6) \end{aligned}$$

which is Butterworth response, 3rd-order. The shape of this response and of the two factors is shown in Fig. 5 (Ref. 4).

The next step is the appreciation that apart from the factor $\frac{1}{2}$ the above response is identically the same as the response of the conventional low-pass LC filter shown in

Fig. 6, for which the voltage transfer ratio is

$$\begin{aligned} &\frac{1}{2(1 + 2pT + 2p^2T^2 + p^3T^3)} \\ &\equiv \frac{1}{2(1 + pT)(1 + pT + p^2T^2)} \quad (8) \end{aligned}$$

This teaches us that we need not look for a new set of responses merely approximating to those of conventional LC filters, but can make RC active filters with responses identically the same as those of conventional LC filters. At one time it seemed that this would be of most use in helping us to understand from a study of their voltage transfer ratios how the responses of conventional LC filters are generated. Now, after the appearance of some important and most useful publications (Refs. 5, 6, 7) the lesson to be drawn is rather that design data prepared for passive filters can be used for active filters.

In the above we have seen in action in simple examples some of the basic notions of active-filter design:—

- The use of feedback techniques to obtain an accurately determined response.
- The value of the transfer-function form in defining the response of a system.
- The choice of a transfer function to give either a known frequency response, or to match that of a known passive filter.
- The realization of an active filter as a cascade of sections, each section realising a factor of the overall transfer function. It is, of course, in an active system easy to arrange the sections in cascade without unwanted interaction. Butterworth (Ref. 2) was the pioneer of this approach.

We may now pass on to the synthesis of active filters as an art in its own right.

Direct synthesis

To synthesize a circuit to realise 2nd-order low-pass response,

$$\frac{V_{out}}{V_{in}} = \frac{1}{1 + \alpha pT + p^2T^2} \quad (9)$$

we may compare this equation with Black's equation for a feedback system (Ref. 8),

$$\frac{V_{out}}{V_{in}} = \frac{\mu}{1 - \mu\beta} \quad (10)$$

in which μ = the forward gain, and β = the feedback factor. When $\beta = -1$, Black's equation reduces to

$$\frac{V_{out}}{V_{in}} = \frac{1}{1 + \frac{1}{\mu}} \quad (11)$$

The comparison then gives us

$$\begin{aligned} \mu &= \frac{1}{\alpha pT + p^2T^2} \\ &= \frac{1}{\alpha pT} \times \frac{1}{1 + p\frac{T}{\alpha}} \quad (12) \end{aligned}$$

which means that the forward path should consist of an integrator, voltage transfer ratio $1/pT_1$ (where the CR product $T_1 = \alpha T$), and a simple lag, voltage transfer

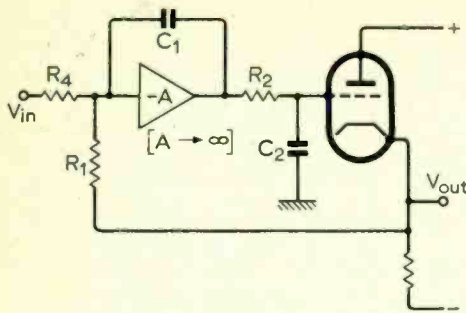

Fig. 7. Basic circuit for integrator-and-lag synthesis of 2nd-order low-pass filter. For $q = 1$, $R_1C_1 = R_2C_2$ (assuming $A = \infty$ and cathode-follower gain = 1).

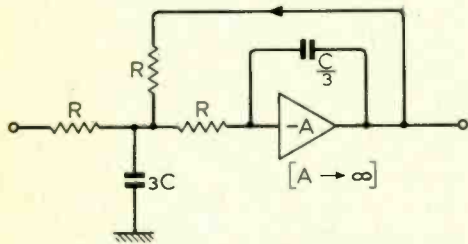

Fig. 8. Another circuit arrangement for a 2nd-order low-pass filter: values shown are for $q = 1$ (assuming $A = \infty$).

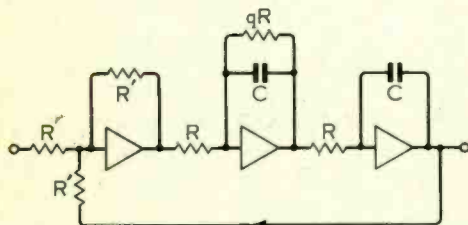

Fig. 9. Two-integrator loop for realizing 2nd-order low-pass response.

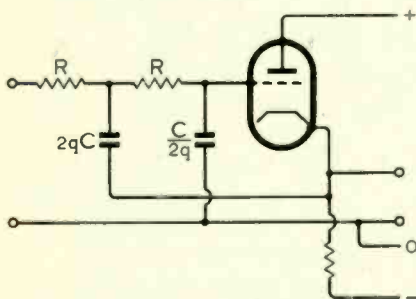

Fig. 10. Sallen and Key low-pass filter. Values shown assume cathode-follower voltage transfer ratio = 1.

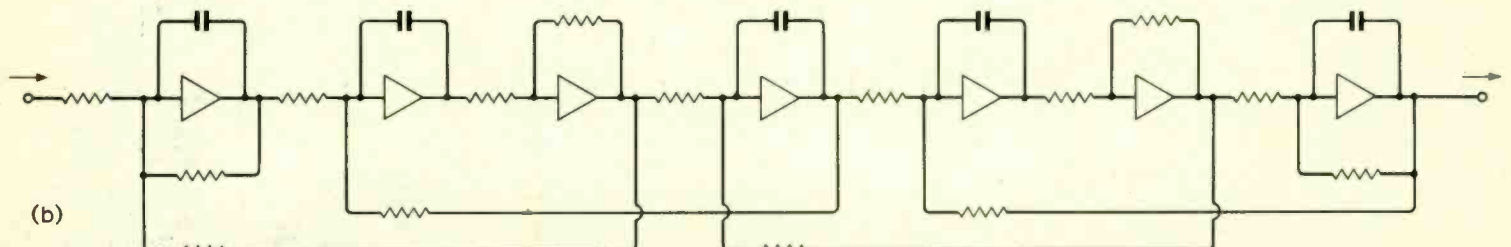
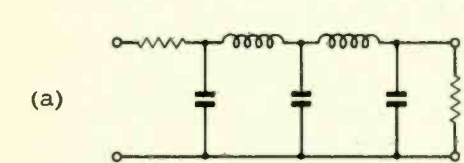

Fig. 11. The leapfrog feedback method of making an equivalent of a low-pass ladder filter.

ratio $1/(1 + pT_2)$ (where the time constant $T_2 = T/\alpha$), or some equivalent arrangement.

Three methods of realizing this synthesis are shown in Figs. 7, 8, and 9. Normally the design of the amplifiers presents little difficulty: often only one or two valves or transistors are needed per amplifier. [It should be understood that in Fig. 7 and elsewhere a valve is used as a simple and unambiguous symbol for an amplifier or active device, connected as a high-gain amplifier or (as here) as an approximately unity-gain amplifier. See Appendix.] In each circuit the output impedance is automatically low. The response is therefore virtually unaffected by any reasonable load, and any number of second-order sections may be cascaded if a higher-order filter is required.

The Sallen and Key type of circuit

In the well known Sallen and Key circuit, Fig. 10, (Ref. 9) an apparently completely different approach was made, using only a buffer amplifier having a voltage ratio of $\times 1$ (ideally) instead of a high-gain amplifier; and it was natural to compare the performance with what we had learned about a loop containing an integrator and a lag. We found, as we shall prove in a later part, that the circuits are essentially the same, the Sallen and Key circuit being also a loop containing an integrator and a lag, the overall feedback being effected by the cathode follower type of connection. The great apparent difference is due to the choice of a different earthing point.

Importance of high internal gain

We shall also show that in any 2nd-order loop the available gain limits the value of "q" that can be obtained, and that for "q" to be insensitive to changes in available gain there should be a surplus of available gain over the necessary minimum. This is, of course, an example of a general characteristic of feedback systems. Thus, because of the large total available gain, circuits based on three operational amplifiers (e.g. Fig. 9) are to be preferred for anything greater than a modest value of "q". The apparently prodigal use of amplifiers can also often be justified by the great versatility it gives, and by the fact that with the advent of silicon integrated circuits gain is small in size and will be low in cost.

The leapfrog or active-ladder method

From the methods mentioned so far the philosophy arises that the only necessary relationship between an active filter and its passive prototype, if any, is in having the same overall voltage transfer ratio (or, more generally, transfer function, since a

filter may have current input and voltage output, or vice versa). The internal workings of the active and passive filters may be expected to show no direct correspondence. If, on the other hand, we set up an analogue of the passive prototype in which the detailed workings of the prototype are reproduced, and in which there is a one-to-one correspondence between voltages or currents in the one and voltages or currents in the other, then there is no need to calculate the two overall transfer functions to see that they are alike, because automatically they will be.

Let us take the example of a ladder low-pass filter (Fig. 11a). A simple method of analysing such a network proceeds as follows. First assume an output voltage, V_{out} , and write down the currents in the load resistance and in the final capacitance. Then add these two currents to give the current through the adjoining inductance, and write down the voltage that the current will cause to appear across the inductance. And so we can go on until we obtain an expression for V_{in} . Each step is either a summation of quantities already found or a differential equation of the simplest kind,

$$i = C \frac{dv}{dt} \quad \text{i.e. } I = pCV \quad (12)$$

and

$$v = L \frac{di}{dt} \quad \text{i.e. } V = pLI \quad (13)$$

These operations may be "instrumented" very easily by a system of integrators and sign-changing stages with suitable forward and feedback connections, and the resulting active equivalent or analogue of the chosen example is shown in Fig. 11(b). The structure of the passive filter is no longer evident; but the new structure is a true analogue, since every process in the prototype is reproduced and in particular the voltage at the output of each amplifier represents some voltage or current in the prototype.

Of course the active filter has in addition properties which the prototype does not have. The voltages at the output of each amplifier are available with low source impedance, and so loads may be attached without disturbance. A corollary is that extra forward and feedback links may be connected to these voltages without affecting performance except in the way intended. Similarly the existence of the virtual earths at the input of each (high-gain) amplifier means that the currents flowing in the forward and feedback components are proportional simply to the voltages at the ends remote from the virtual earths. Consequently the scale factor for the voltage at

the output of any amplifier can be varied independently by multiplying all the impedances connected to it by a common factor. This property is especially useful in band-pass filters, where straightforward derivation from the passive prototype often produces a design in which the maximum voltage at the output of some amplifiers is considerably greater than at the output of others. Adjustment to approximately equalize the maximum voltages makes best use of the available gain and maximises dynamic range. The existence of the virtual earths also facilitates the provision of variable tuning, as will be shown.

The capacitor-loaded gyrator method

As a concept, the simplest method of applying the one-to-one correspondence principle is to accept the structure of the passive prototype and replace each inductor with a two-terminal "black box" for which $Z = V/I = pL$. If the black box is not to present an unwanted conductance between the terminals, it must sense the applied voltage with an amplifier or buffer of infinite input resistance. The current which must flow through the black box in response to the applied voltage is given by $I/V = 1/pL$. This shows that the current must be the integral of the voltage divided by the constant L . The input amplifier should therefore pass on the applied voltage to an integrator, which in turn applies its output to a current source, or voltage-to-current converter, the output of which is connected back to the input terminals. This current source should be ideal, i.e. have infinite output resistance, if it too is not to place unwanted conductance between the terminals.

The idea of simulating inductance with an RC active black box is not, of course, new. The most familiar example, probably, is the reactance-valve arrangement, Fig. 12, in which the valve is made to pass a current which is almost 90° lagging on the applied voltage. But this simple circuit is too far from ideal to be used in any precisely designed filter. Recently one particular type of realization of the idea has received much attention in the learned journals, and at least one RC active filter of remarkably fine performance constructed on these lines has been reported (Ref. 10). However, while we have no wish to get into an argument about the general concept of a gyrator, it does seem to us that when a gyrator is capacitor-loaded to form an inductance which is then tuned with another capacitor to form a resonant circuit, the resultant system can perfectly well be regarded as consisting of two integrators in a feedback loop, though the integrators are not of the usual operational-amplifier type. This was pointed out by a *Wireless World* reader (Ref. 11). Thus, while the gyrator-capacitor method offers another circuit option, which may be an appropriate practical choice in some applications, there is no need for the reader to learn a new theory just because he is confronted with a new name.

This preoccupation with finding common ground between apparently different circuits is a result of a desire to support the analysis

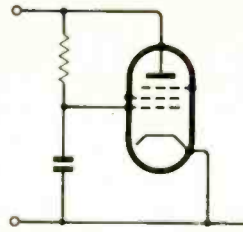

Fig. 12. Simple reactance-valve circuit simulating inductance.

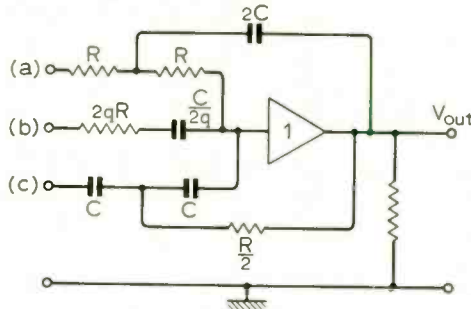

Fig. 13. Filter using parallel-tee to give general 2nd-order transfer function

$$\frac{V_{out}}{V_{in}} = \frac{A + \frac{B}{q} pT + Cp^2T^2}{1 + \frac{1}{q} pT + p^2T^2}, (T = CR)$$

The input voltages at (a), (b), (c) are, respectively, AV_{in} , BV_{in} , CV_{in} .

of as many different circuits as possible with the minimum number of basic theorems. This is important because when we come to consider the imperfections in practical circuits caused by (for example) finite amplifier gain, it would be unnecessarily laborious to analyse each circuit separately from first principles, when it can be shown that some of the analysis is repeating what has been done already. Assessment of the practicability of a number of circuits for meeting a particular specification is also made easier when it is known that the potentialities of each are bounded by a common set of theorems.

Negative-impedance converter circuits

We shall not discuss any applications of negative impedance converters, because we believe that nothing can be done with a n.i.c. that cannot be done better some other way. Nor shall we have anything to say about the use of the Wien bridge in a selective amplifier. Both are examples of lag-lead loops. In circuits of this type the method of increasing "q" is by the use of positive feedback acting in the same manner as in the reaction circuit in an old-fashioned t.r.f. receiver. This results in increased sensitivity to changes in loop gain, and it seems reasonable, therefore, to reject such circuits where accurate and stable performance is required. This conclusion must, however, be qualified for certain circuits in which the loop gain is stabilized by feedback, e.g. the Sallen and Key filter shown in Fig. 10.

Parallel-tee circuits

We shall, however, discuss circuits that make use of the selective properties of the well known parallel-T network. These

circuits are uneconomical in the number of capacitors they use, and need both Cs and Rs of close tolerance if their full potentiality is to be realized. But they can give much higher "q" for a given available gain than the circuits of Figs. 7, 8, and 9. A very useful circuit arrangement is shown in Fig. 13. It is particularly versatile in that it can give the general 2nd-order voltage transfer ratio

$$\frac{V_{out}}{V_{in}} = \frac{A + \frac{B}{q} pT + Cp^2T^2}{1 + \frac{1}{q} pT + p^2T^2} \quad (14)$$

in which the coefficients A, B, C, can be given the values 1 or 0 by connecting the corresponding input terminals, (a), (b), (c), either to the input voltage or to ground; and values intermediate between 1 and 0 by using attenuators (or potential dividers).

Appendix

A valve, or vacuum tube, is an example of a simple electronic amplifier. It is a three-terminal device. With grid and cathode as the input terminals, and anode and cathode as the output terminals, Fig. 14 (a), it is characterised to a first approximation by a voltage gain $-A_o$, where A_o is a positive number. It is thus a primitive example of an operation amplifier, and may be represented by the conventional symbol, Fig. 14(b). Very often the equivalent of the cathode lead, here shown dotted, is omitted—its existence being taken for granted.

If the input is applied between grid and anode, we have the cathode-follower or common-anode connection, Fig. 15(a). As is well known, this gives an approximation to a voltage gain of +1, and may therefore be represented by Fig. 15(b). The disadvantage of this symbol is that it does not reveal the close relationship with Fig. 14(b), and indeed seems often to be interpreted as representing a different breed of active device. Fig. 15(a), on the other hand, clearly shows that it uses the same type of device as

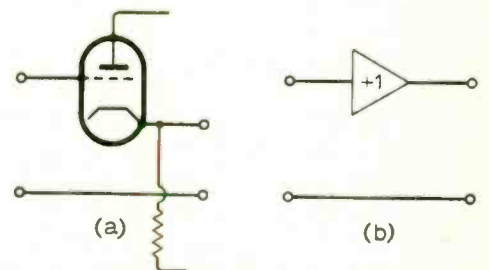
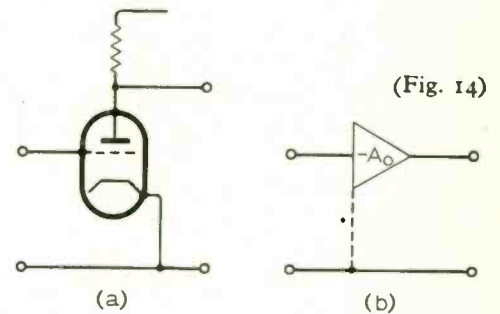

(Fig. 15)

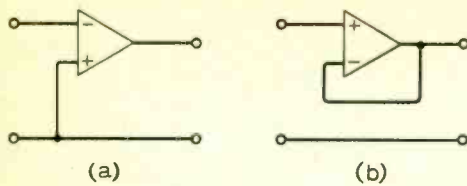

(Fig. 16)

Fig. 14(a), with the same intrinsic or internal properties, and that it is derived from it by connecting the output voltage in series with the input.

To look more up-to-date a bipolar transistor could be substituted for the valve. But then one would often have to imagine an astronomically large current gain, in order to make the input resistance negligibly high, as well as a voltage gain higher than can easily be obtained from a single stage. Very often a direct-coupled complementary pair of transistors is a suitable practical choice of amplifier; but to draw such a combination when discussing the basic theory of circuits might suggest an unintended particularisation. If the use of the valve symbol offends, we ask the reader mentally to substitute an alternative, e.g. Fig. 16(a) when the valve is shown in earthed- (common) cathode connection, and Fig. 16(b) when shown in cathode-follower (common-anode) connection.

REFERENCES

1. "Radio Engineers' Handbook" by F. E. Terman. McGraw-Hill, New York (1943), p. 402.
2. "On the Theory of Filter Amplifiers" by S. Butterworth. *Experimental Wireless and Wireless Engineer*, Oct. 1930, Vol. 7, No. 85 pp. 536-541.
3. "Cascade Amplifiers with Maximal Flatness" by V. D. Landon. *R.C.A. Review*, Jan. and April 1941, Vol. 5, No. 3, pp. 347-362, and Vol. 5, No. 4, pp. 481-497.
4. "Gramophone and Microphone Pre-Amplifier" by P. J. Baxandall. *Wireless World*, Jan. 1955, Vol. 61, No. 1, pp. 8-14.
5. "Design Data for Symmetrical Darlington Filters" by J. K. Skwirzynski and J. Zdunek. *Proc. I.E.E. Part C*, Sept. 1957, Vol. 104C, No. 6, pp. 366-380.
6. "Simplified Modern Filter Design" by P. R. Geffe. Iliffe, London, and Rider, New York, (1963).
7. "Design Theory and Data for Electrical Filters" by J. K. Skwirzynski. Van Nostrand, London (1965).
8. "Stabilized Feedback Amplifiers" by H. S. Black. *Bell System Tech. J.*, Jan. 1934, Vol. 13, No. 1, pp. 1-18.
9. "A Practical Method of Designing RC Active Filters" by R. P. Sallen and E. L. Key. *I.R.E. Transactions on Circuit Theory*, March 1955, Vol. 2, No. 1, pp. 74-85.
10. "Bandpass-Filter Realisation Using Gytrators" by D. F. Sheahan and H. J. Orchard. *Electronics Letters*, Jan. 1967, Vol. 3, No. 1, pp. 40-42.
11. "The Gytrator—Old Wine in a New Bottle?" Letter to the Editor by P. E. K. Donaldson. *Wireless World*, April 1967, Vol. 73, No. 4, p. 194.

Liquid Encapsulation for Crystal Growing

Crystal pulling from the melt by the Czochralski technique is one of the most important methods used for preparing bulk single crystals of semiconductor material for the electronics industry. The technique involves the crystallization of the material in an apparatus which provides a controllable thermal and gaseous environment. The temperature of the material is kept slightly above the melting point whilst a seed crystal, held in a chuck, is dipped into the surface of the melt. The seed crystal is then rotated and withdrawn at a controlled rate and, provided the temperature conditions are suitable, the material will crystallize on the seed and a large crystal will be pulled from the melt.

Difficulty is experienced with this process if the material is volatile, with gallium arsenide for instance. A technique called liquid encapsulation which overcomes the volatility problem was demonstrated at a recent "Open Day" at the Royal Radar Establishment. Liquid encapsulation as a concept in its own right can be applied to all crystal growing and has the added virtue of simplicity.

A large number of semiconductor compounds decompose at the melting point. Usually one of the components is volatile and distils from the melt. If the decomposition pressure is high the loss of volatile component is rapid. The transfer of the component is more marked if it can be removed from the gas atmosphere by condensing on cold parts of the equipment.

Liquid encapsulation provides a simple method of preventing the evaporation of volatile components from the melt. An inert liquid layer ("liquid seal or lid") which floats on the melt can suppress vapour loss provided an inert gas at a pressure in excess of the melt dissociation pressure is applied to the surface of the encapsulating liquid. The encapsulating liquid is usually boron trioxide which is a transparent low softening point glass. Crystals can be pulled by the usual method, the seed can be dipped through the encapsulating layer, visual observation can be maintained because boron trioxide is transparent. It has thus been possible to grow single crystals of compounds which generate pressure around 1 atmosphere, e.g. gallium arsenide and indium arsenide, without any modifications to the standard R.R.E. pulling equipment.

There are materials which generate pressures greatly in excess of 1 atmosphere when they decompose. Gallium phosphide (40 atmospheres at 1470°C) and indium phosphide (25 atmospheres at 1060°C) are typical examples. Liquid encapsulation is still a viable technique for growing these crystals, but a pressure vessel is required because of the high inert gas pressure necessary to suppress the decomposition pressure.

The design of a pressurized apparatus could have proved a formidable task but for one important feature of liquid encapsulation. The inert gas which is in contact with the walls of the pressure vessel contains negligible amounts of the volatile component and so the walls can be water cooled.

The R.R.E. designed and built pressure vessel can be pressurized to 200 atmospheres (3000 p.s.i.). It has been designed as an attachment to the standard crystal growth equipment. Both the puller and pressure attachment are now commercially available from two U.K. firms: Metals Research, Melbourn, Nr. Cambridge, and Electroheating Ltd., Lombard Works, Lombard Road, Merton, London, S.W.19.

CORRECTIONS

Book Review. It is regretted that a textural transposition made nonsense of the opening paragraph of P. J. Baxandall's review of Cherry & Hooper's book "Amplifying Devices and Low-Pass Amplifier Design" on page 334 of the July issue. The reviewer wrote "In the opinion of the present reviewer, this book is an outstandingly good one. It is intended primarily, but by no means exclusively, as a text for university electronic engineering students, who are expected to have the necessary theoretical background but who may be rather "green" as far as practical knowledge is concerned. This explains certain features..."

In the article "Distortion Factor Meter" in the July issue, the meter in Fig. 1 is shown as 100mA full-scale. It should be 100μA. Incidentally, the 3-gang potentiometer, RV_2 , RV_3 and RV_4 , is the Colvren type CLR5022/11 (sections A and B, 59,000 $\Omega \pm 2\%$; section C, 25,000 $\Omega \pm 2\%$).

"Modular Pre-amplifier Design". In the power supply, Fig. 10, the 500μF reservoir capacitor (on the diode side of the smoothing resistor) should have a working voltage of 35V not 25V as shown.

Hyperbolic Radio Navigation Systems

General principles, and a review of systems in use

by F. S. Stringer,* B.Sc., F.Inst. Nav.

Basically there are two main varieties of air and marine navigation technique; they are by dead reckoning or by means of reference to fixed positions on the earth's surface or to heavenly bodies. Dead reckoning demands an initial reference, some knowledge of wind or current and vehicle velocity which then permits the calculation of vehicle heading to make good a desired track. The exercise is completed with apparatus which is self-contained within the craft. A check upon the dead-reckoning system drift and other errors can be made by reference to an externally referenced system. Alternatively, the external system can be used continuously in a manner analogous to visual map reading. As a second alternative the external and the self-contained systems can be combined to form a hybrid.

Ground-based radio navigation aids provide a common frame of reference, hence, despite the advances in dead-reckoning technology, it is likely that radio will play a significant part in the future. The long-term developments may well produce a satellite navigation system which provides a viable fixing facility for civil marine and air navigation available to small as well as large craft. The present point-source systems such as non-directional beacons (NDB) for use with direction finders, visual omni-range beacons (VOR), distance-measuring systems (DME) and ground radar control give assistance to navigation in the form of one or two lines of position. The information is usually available at relatively short distances from the source of radiation because of the high, very-high or ultra-high frequencies employed. For instance, VOR and DME are usable to line of sight distances only.

Area coverage may be achieved either by calculation of a fix from two or more lines of position derived from point sources, or from a circular or hyperbolic lattice derived from a complex of ground transmitters. Such systems are generally designed for operation in the frequency bands 10-14kHz, 70-130kHz, 1-2MHz, and 30-40MHz. Those operating below 130kHz are of particular benefit to both marine and air craft used either independently or as sensors in a hybrid. Since the operational, technical and economic advantages to be gained from the use of circular or of hyperbolic lattice aids can be made available now or in the very near future, they are attractive solutions to the immediate navigation problems and they may provide sufficient facilities to affect the need for satellite systems which have yet to reach a state of development which is viable for general traffic.

Some general characteristics

The principle of the hyperbolic system is illustrated in Fig. 1. If two separated sources of radiation transmit synchronized signals then, assuming a homogenous transmission medium, a receiver positioned at any point along a perpendicular bisector of the baseline will detect no time or phase difference between

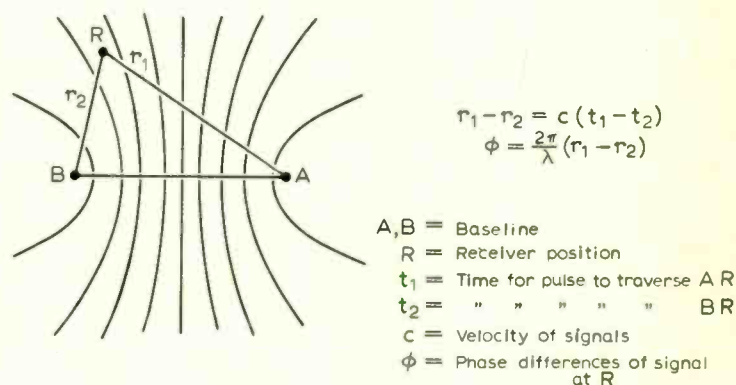

Fig. 1. Single hyperbolic pattern produced by two stations at A and B.

the signals. At a point to either side of this bisector a time difference or phase difference can be detected. The locus of all points with a constant difference is a hyperbola. Families of confocal hyperbolae can be generated with the sources of radiation as the foci. The difference in distance of the receiver from the two radiators is given by $r_1 - r_2 = c(t_1 - t_2)$ where the symbols are as defined in the figure.

Thus a single line of position can be generated by the two transmitters. A third transmitter can be synchronized with either of the other two to provide a second hyperbolic lattice as shown in Fig. 2. A further increase in transmitters will provide redundant data. If the signals radiated are in the form of pulses, and if the rise times of the pulses can be defined with adequate precision, the time of arrival of each pulse can be measured at the receiver and $t_1 - t_2$ will allow the identification of the appropriate line of position. It is assumed, of course, that the pulses can be identified from some code such as pulse width, or from a synchronized transmission with some selected delay time at the slave transmitters 2 and 3 after the radiation of a pulse from the master transmitter 1. The Gee and Loran systems operate on this time-difference principle.

Time-difference systems are inherently unambiguous except for the repetition of the lattice on either side of the baseline. An advantage is the higher order of accuracy achievable and they generally provide a maximum of two simultaneously presented lines of position per chain. A fundamental disadvantage of pulsed systems is the wide bandwidth required for the generation of a good pulse shape and the high peak powers required for adequate signal at the transmitter aerial to give a useful coverage.

Continuous-wave systems use the property of measured phase difference between pairs of signals at the receiver instead of the measurement of time difference directly. The signals are synchronous at the transmitters. Since identification of each transmission from the relevant transmitter in a chain must be established, identification is usually arranged by either the

* Royal Aircraft Establishment

radiation of a selected frequency associated with a particular transmitter, this is frequency multiplexing, or by radiation at a single frequency in bursts in an arranged order by time multiplexing. The former method requires some technique to provide for the phase comparison at the receiver by frequency multiplication or division to a common value.

Continuous-wave (c.w.) systems are inherently ambiguous. If a very stable oscillator, such as an atomic standard, is carried in a ship or aircraft and a synthesized signal is obtained from it at the frequency of a radiated signal from the ground, then a frequency comparison between the internally generated and the external signal will provide a line of position which is a circle. As the aircraft distance changes relative to the transmitter, so will there be a change of phase of the difference frequency or phase. After a change of distance of one wavelength λ an ambiguous repetition of the phase will occur. The circles which define these limits of ambiguity are termed lanes. In addition to the ambiguities presented by these distance-distance or "rho-rho" systems, the stability of the internal oscillator will limit the accuracy of the system in a time-dependent manner for long range navigation.

The hyperbolic c.w. systems are also ambiguous, but the lane width is $\lambda/2$ at the common comparison frequency. This can be seen readily if it is realized that as the receiver is moved towards one transmitter of a pair it moves away from the other. Thus twice the number of electrical phase degrees are traversed for an equivalent linear distance traversed by a rho-rho system. A highly stable oscillator is not required, however, and the long-term stability of the system is good although short-term performance will depend upon ambient noise and signal-to-noise ratio. The effect of noise can be limited significantly by a reduction of bandwidth, thus permitting long-distance transmission at acceptable radiated power and poor aerial radiation efficiency.

The accuracy of the fix will depend upon the geometrical angle of cut of the lines of position; two lines will produce a parallelogram or an ellipse of errors which becomes a circle with orthogonal hyperbolae. The hyperbolae will diverge as they recede from the baseline. As the baseline length increases so will the divergence of the lines decrease.

The radio frequencies of most medium- and long-range hyperbolic systems in use today or proposed for the near future are below 130kHz and the signals are affected to a greater or lesser degree by the ionosphere, particularly at night. At frequencies

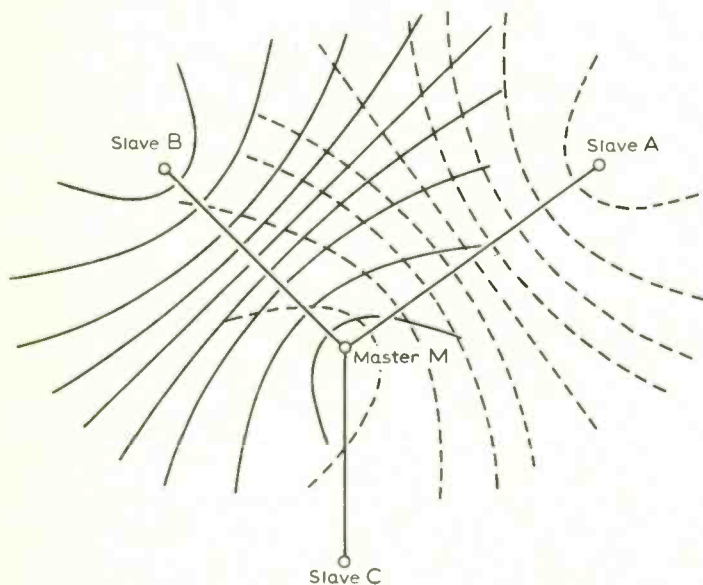

Fig. 2. Typical hyperbolic system chain of four stations. Only two overlapping hyperbolic patterns are shown, one produced by M and A and the other by M and B.

in the band 70-130kHz range is generally limited to that of the groundwave by day and by the interference effects of refracted skywaves by night. At frequencies in the 10-14kHz band ionospheric effects are sufficiently stable to permit the application of corrections to alleviate errors due to modal interference.

Decca

The Decca Navigator is fundamentally a frequency-multiplex continuous-wave hyperbolic lattice system operating in the frequency band 70-130kHz. The system is displayed in chains comprising a master and three slave transmitters positioned around it at distances of between 50 and 100 miles as shown in Fig. 2. The transmissions are radiated on selected frequencies which are harmonically related to a fundamental f . Each chain has a unique value of f of approximately 14kHz. The slaves are termed green, red and purple radiating $9f$, $8f$ and $5f$ respectively. The master radiates $6f$. The slaves are phase-locked to the master and each master slave pair produces a hyperbolic pattern of stable phase difference position lines over the coverage area. The hyperbolae are printed on charts as coloured position lines which are numbered. The colours correspond to the appropriate slave generating the hyperbolae.

The receivers contain a display comprising three integrating phasemeters known as Decometers which identify the appropriate position line so that a fix can be plotted on the chart manually. Alternatively, a pictorial display or Flight Log/Marine Automatic Plotter is available to provide a track history. Several types of computer are available to drive this variety of displays. A relatively simple unit is associated with displays using "diverse lattice" charts which contain inherent linear distortion, and a complex digital computer "Omnicrac" is available to drive a self-setting flight log which employs conformal charts. The Omnicrac can accept information from sensors other than Decca, can provide waypoint information, data-link encoding, dead-reckoning memory in the event of loss of signal and autopilot coupling.

For phase comparison of the pairs of master-slave signals two techniques are employed depending upon the mark of receiver equipment. Earlier versions multiply the signals to common frequencies of $18f$, $24f$ and $30f$ for green, red and purple respectively. Later versions are superheterodynes and the carrier signals are divided down F (16.2kHz). This is the intermediate frequency corresponding to f . One cycle of phase difference at F represents a "zone". A zone is about 6 miles wide on the baseline. It can be measured to one part in 1,024. The receivers which employ the multiplying technique experience a change of phase representing one "lane" for each phase-difference cycle. A lane is about $\frac{1}{4}$ -mile wide on the baseline and can be resolved to one part in 100. Decca is a cw frequency multiplex system and experiences ambiguities. There are 18, 24 and 30 phase ambiguities for each green, red and purple zone respectively. These correspond to lanes in multiplying receivers and the ambiguities are resolved by the integrating action of the Decometers and by independent lane-identification signals radiated from the ground transmitters three times per minute. A separate lane-identification meter assists the resolution. Automatic lane setting is provided in the dividing type of receiver. The phase ambiguities which result from the frequency division are resolved by the effective transmission of a frequency f which forms a phase datum. Frequency f is derived in some marks of receiver by generating a beat between two carriers. Other versions employ a pulse train generated from the summation of the four carriers $5f$, $6f$, $8f$ and $9f$ radiated as a "multipulse" transmission. Zone identification is available on the dividing receivers which use a beat between $8.2f$ and $8.0f$ transmitted from each station to indicate a correct zone within a group of five.

The receivers may select a required chain generally by a key. Although the selection available in transit is limited on earlier

models, the latest equipment permits selection of the full 63-chain capacity. The current deployment of Decca chains includes all of western Europe, Newfoundland, the eastern seaboard of the U.S.A., the Persian Gulf and other areas of the world. Accuracy diagrams are published to define the system performance and coverage during various seasons and conditions of daylight. The coverage lines indicate the area at sea level within which 95% of fixes are better than

- (a) 4 n.m. by night
- (b) 2 n.m. by day (winter season)
- (c) $\frac{1}{2}$ n.m. by day (spring to autumn).

Less accurate fixes may be obtained outside this area of coverage which is about 200 n.miles from the master by night. Fixing errors in full daylight within 100 n.miles of the master transmitter are generally less than $\frac{1}{4}$ n.mile (95%).

Decca

Decca is a hyperbolic long-range radio-navigation aid which operates in a time frequency multiplex mode at approximately 70kHz. The system has been developed by the Decca Navigator Company and in its latest form is made integral with a Decca receiver system, the Mark 17. Reference to Fig. 3 illustrates the basic principle of the system. Five transmitters are used, two pairs on short baselines of about 60 n.miles baseline length and a ranging station in Iceland. One pair is sited in the north west of the British Isles and the other pair is in Newfoundland. Both pairs are part of existing Decca chains.

Stations A and B in Newfoundland transmit frequency F_1 on a time-shared sequence to provide a tracking pattern of hyperbolic position lines. Similarly, stations C and D transmit on F_2 to provide a second tracking lattice. Ranging patterns are provided between stations A and C, also between E, A and C.

The tracking pattern is generated at a spot frequency F_1 near 70kHz as a continuous signal from one transmitter of a pair, except for a brief break every 10 seconds. During this break the other transmitter of the pair radiates F_1 . Slave B is phase locked to A. The lanes of the pattern diverge away from the baseline where the lane width is approximately 2,300yds.

The ranging pattern is generated by slave station C in the United Kingdom in conjunction with the master station A. The slave transmission C differs in frequency from A and time sharing is not needed. The difference frequency is roughly 150Hz which is the frequency of comparison in the receiver. The baseline lane width is approximately 2,320 yd wide.

$$\text{In practice } F_1 = nF_3 \\ F_2 = (n+1)F_3 \text{ and } n = 459$$

Similar ranging patterns are derived between A and E and C and E. The Decca receiver is operated with a flight log display and an Omnitrac computer. A fix is derived from the intersection of the ranging pattern lines of position. These lines are ambiguous and the integrating qualities of the flight log are used to provide a measure of resolution. If there is a conflict between the fix as defined by separate pairs of ranging pattern position lines reference will be made every 10 seconds to one or both of the tracking patterns which will provide an automatic correction. It will be seen that a substantial degree of dead reckoning is included in the Decca information. This has been proved essential to mitigate the effects of ionospheric interference, particularly at night.

Decca is an area coverage system particularly designed for route coverage over areas such as the north Atlantic Ocean.

Loran A

The first practical hyperbolic radio-navigation system was the British Gee system which was operational with the Royal Air Force from 1942 until recently. It was a time-difference system using pulses of radio frequency of 2-10 microseconds duration in synchronism from three or four ground transmitters separated

Fig. 3. Arrangement of Decca hyperbolic pattern.

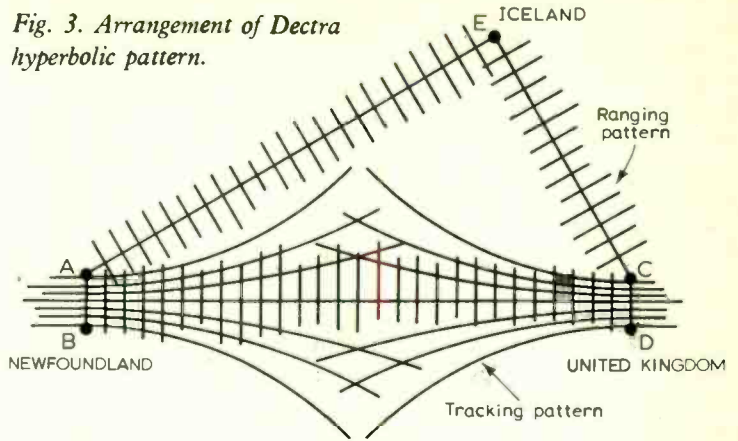

by about 75 miles. The differences in the times of arrival of the pulses at the receiver were measured on a cathode-ray tube indicator by a navigator to determine the position lines corresponding to the aircraft location within the coverage area. The radio frequency was in the band 20-85MHz giving a coverage area some 300 n.miles from the centre of the chain. The accuracy varied from a few hundred yards near the baselines to about 5 miles at maximum range.

The American Loran A system is similar in principle to Gee. It became operational in 1943 and is still available today. Loran A pulses are radiated synchronously in the frequency band 1750-2000kHz from pairs of transmitters spaced two to four hundred n.miles apart. The pulse from a slave transmitter B is delayed until the pulse from the master A has passed the slave location to prevent the A pulses from being mistaken for B pulses. To facilitate the identification of pulses, those from B are delayed by half the time between two pulses from A as received at B. The pulse recurrence rate of B is synchronized by A. The signals from a pair of ground stations are displayed on an oscilloscope with two horizontal traces synchronized with half the recurrence rate assigned to the transmitter. The leading edges of the pulses provide the datum for measurement of the time difference. Several transmitter pairs may have different pulse recurrent frequencies to allow a common radio frequency. The unwanted pulses drift across the traces and the stationary desired pulses without impairing the display.

The Loran A pulse width is 45 microseconds with a rise time of 10 microseconds. There are 96 available channels. The older receivers provided a microsecond scale on the trace to permit the operator to count the time differences between pulses. More modern equipment contains an electronic counter indicating the time difference directly in three decades. An inherent disadvantage of Loran A, common to all pulse systems, is the large frequency spectrum required. This is countered to some extent by the separation possible between groundwave and skywave at the receiver display although skill on the part of the operator is needed to ensure that the groundwave or skywave pulse is indeed being measured. The peak pulse power of the transmitters is about 100kW. The accuracy of Loran A is determined by the geometry of the hyperbolic lattice. The accuracy of measurement is some 1-5 microseconds time difference (standard deviation) between ground-wave components. Use of skywave introduces tolerances due to propagation variations which are dependent upon many factors. The 95% accuracy is generally quoted at 0.2-0.6 per cent of distance from the baseline centre.

The Loran A coverage of the groundwave depends upon the surface conductivity and the noise ambient. The maximum usable groundwave in tropical areas over seawater has been quoted as 400 n.miles whereas 800 n.miles is experienced in arctic regions. Ranges of 700-800 n.miles over sea and 200-500 n.miles over land have also been quoted for daytime operation with an average accuracy of 1.5 n.miles. Corresponding skywave

operation at night is recorded as providing a 5 n.mile accuracy to 1400 n.miles over both land and sea.

Position fix information is derived from Loran A charts which display the hyperbolic lattices of the operational chains which are operated by the U.S. Coast Guard. The chains provide groundwave cover over much of the north Atlantic Ocean, the U.S. eastern and western seaboard, part of the Pacific Ocean around the coast of South east Asia and Hawaii.

Loran C

Attempts were made to increase the coverage area of Loran A by employing radio frequencies in the 100-kHz band. The low efficiency of the transmitter aeriels, the long transient times of circuits and aeriels and the high noise levels in this band presented difficult technical problems. After prolonged experiment and development, however, a long-range Loran system known as Loran C was designed. This operates in the 90-110-kHz frequency band and employs transmitters spaced in pairs with baseline lengths of 600-1,000 n.miles long radiating pulses with peak powers of 60-200kW. The stations are arranged in triads, stars or squares.

Loran C has many similarities to Loran A. Pulses emitted from two transmitters are used for an approximate time difference measurement of equal time difference hyperbolae. A fine measurement is made possible by the phase difference measurement of the carrier frequencies. The 100-kHz carrier provides a 1 n.mile ambiguity along the baseline but this ambiguity is removed by the coarse time difference measurement. The positional accuracy is ten times better than that of Loran A because of the fine phase measurement.

By synchronization of the carriers which are contained within the pulse and by careful control of the pulse rise time it is possible, in addition to resolving the ambiguities, to obtain the fine fix independently of the skywave component of the received pulses. The fine measurement is usually made at the third cycle from the start of the relatively rounded pulse as shown in Fig. 4. The receivers can employ either a visual display such as a cathode-ray tube, similar to the advanced type of Loran A display, or it can be fully automatic providing continuous two-position line data for connection to an automatic chart recorder or a computer for integration with dead-reckoning sensors.

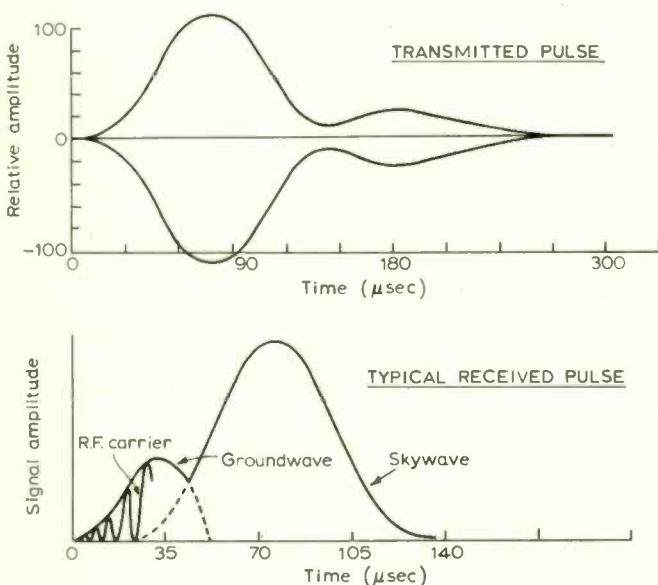

Fig. 4. Transmitted and received pulses of the Loran C system are shown here. A few cycles of the r.f. carrier within the pulse envelope are indicated in the received groundwave pulse.

Each transmitter radiates groups of eight pulses each spaced 1,000 microseconds apart. By storing them in the receiver it is possible to obtain an improved signal-to-noise ratio. Most Loran C repetition rates are compatible with Loran A and for these rates Loran A receivers can be modified to permit reception of the 100-kHz Loran C signals for envelope matching.

The phase of the carrier-frequency signals of individual pulses is kept constant or reversed in phase to a predetermined code for the master and slave transmitters. These coded-carrier oscillations may be compared with a locally generated reference in the receiver to remove a skywave component from the pulses. This is caused by pulse echoes which suffer considerable delay by multiple ionospheric reflection and are received at the time of arrival of the succeeding pulse. The coding also assists in station identification. The pulse rise time from zero to peak amplitude is approximately 75 microseconds. Skywave components of the received pulses are to be expected at less than 35 microseconds. Pulse shaping at the transmitter places the turning point of the rising leading edge at a 30 microsecond position. The pulse-recurrence frequencies are 10, 12½, 16⅓, 20, 25 and 33⅓ groups per second.

Loran C operates on one nominal radio frequency only, 100-kHz. The transmitters of a chain are identified by a known shift of the pulse transmissions with respect to time. By employing a variety of pulse groups and pulse-repetition rates and by the pulse-keying technique the relatively extravagant use of the radio-frequency spectrum is limited. 288 channels can be accommodated in this way but only 50 would be needed for world cover. It should be realised however that the cost of such a ground complex would be extremely high. The current coverage area extends over the north Atlantic Ocean, the Mediterranean and parts of the Pacific Ocean.

The overall system accuracy using the ground wave is claimed to be $\pm 0.25\mu\text{s}$ for 95 per cent of the time with a baseline of about 500 n.miles length. The limit of accuracy is determined by groundwave propagational errors. The accuracy is extremely high however being in the order of 300 yards (95%) within 650 n.miles from the baseline. The groundwave range over sea varies with season and time of day. Typical values observed are 1,250 n.miles on a summer night and 1,600 n.miles on a winter day.

Omega

It has been known for many years that very low radio frequencies in the band 10-14kHz have qualities attractive to very long range navigation systems. Research in the United Kingdom and the United States over the past decade has provided evidence of low attenuation with distance (approximately 5dB or less per 500 n.miles) and highly predictable propagational characteristics. Measurements have shown that the D layer of the ionosphere and the earth's surface affect the signals in a manner analogous to a spherical waveguide. First, second and higher modes are set up as illustrated in Fig. 5. By day the first mode predominates at distances greater than a few hundred miles from a transmitter. By night the D layer rises and the second mode is more in evidence. The diurnal variation is predictable, however, and changes of phase due to propagational variations can be estimated with much greater precision than is possible at frequencies above 50kHz.

A very low frequency system called Delrac was proposed by the Decca Navigator Company many years ago but it was not developed. The Omega system, proposed circa 1962 by the U.S. Navy, has attempted to employ the benefits of the very low frequency propagation to achieve world-wide cover and multiple-position line fixing information. Omega is a hyperbolic lattice time, frequency multiplex system. Eight transmitters should provide effective world cover. Four are transmitting at the present time providing a service of two

position lines over about a quarter of the earth's surface. Negotiations are proceeding for the implementation of the remaining four.

The principle of operation can be realised by reference to Fig. 6. A burst of continuous radiation at a frequency of 10.2kHz is radiated from station A in Norway for a period of about one second. A phase-locked synchronous burst of radiation is then transmitted for one second from transmitter B in Trinidad. This is followed by a similar burst from C in Hawaii and another from D at Forestport in New York State.

A remote receiver within the coverage area receives the four bursts of radiation and gates them into separate receiver channels. The gated signals are used to synchronize phase-locked loops which effectively provide continuous waves locked to the appropriate signals from each transmitter respectively. Phase comparison of pairs of signals in the receiver provides lines of position which are hyperbolic and characteristic of other systems. Due to the extremely long baselines, however, they have very little divergence relative to each other. The hyperbolae are ambiguous every 8 minutes along the baseline, this is of little significance to marine navigation but of importance to aircraft.

One method of resolving the ambiguities has been attempted by the radiation of two further carrier frequencies as shown in the illustrated format of Fig. 6. After each 10.2-kHz signal another is radiated at 13.6kHz. This is followed by a third at 11.33kHz. A second hyperbolic lattice derived from the 13.6kHz signals would be coincident with the 10.2-kHz lattice every 24 n.miles along the baseline. Thus an equivalent to a 3.4-kHz lattice can be derived. Similarly the 11.33-kHz signals are coincident with those of 10.2-kHz at 72 n.miles. Thus resolution to within 72 n.miles can be effected.

Experiment has shown that there may be propagational anomalies caused by second modal interference by night which could reduce the reliability of the beat-frequency ambiguity-resolving method. Alternatives have been investigated and it has been shown that since the aircraft or ship is likely to be within system coverage throughout its journey, only signal outage time, due to noise or interference for example, need cause concern. The application of data derived from the self-contained navigation aids or even air data over the period of the outage can be used to identify the appropriate 10.2-kHz lane upon resumption of reception. Redundancy can be applied to increase reliability by measuring the incremental lane change on all three carrier frequencies for selected periods, say 5 minutes. Reduction of the 13.6-kHz and 11.33-kHz increments to 10.2-kHz equivalent increments by the Omega or a general-purpose computer can provide a constant cross check upon lane slip or lane loss.

The long range of the Omega signals should be capable of providing a multiple position line fix. The 95% accuracy is expected to be about 5 n.miles. The application of correction tables, however, removes some of the propagation errors and improves the accuracy of the fix to better than 2 n.miles.

An attraction of Omega is the possible use of this long-range system over the medium-range distances near airfield terminal areas or harbours where navigation accuracy needs to be an order better than in the en route phase. By application of the Differential Omega or Corrected Omega techniques, experiment has shown that these requirements may be met. The improvement is gained by the removal of most of the short-term propagational errors by the use of monitor receivers positioned at known co-ordinates on the ground. Errors between the measured and datum co-ordinates are broadcast over a data link to airborne or marine users as corrections. Application of the corrections has been shown to give improvements over sixty miles from the monitor which would give a system performance to match the local navigation requirements. Experiments are continuing.

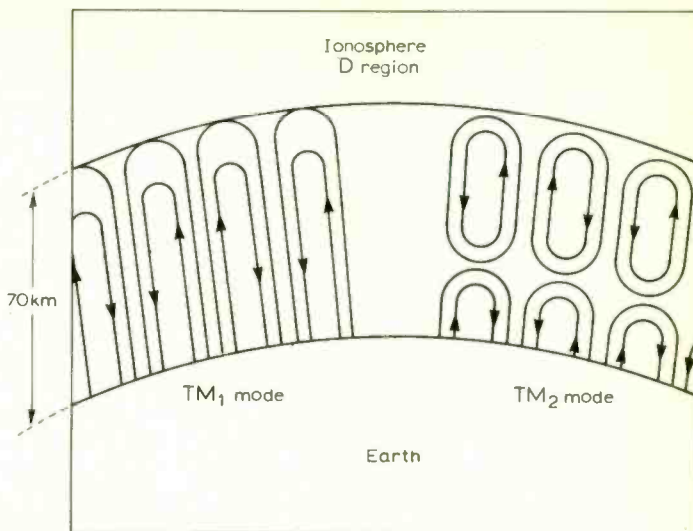

Fig. 5. In the Omega system transmission is at v.l.f. and in waveguide modes between the earth and the ionosphere. Two modes are shown here.

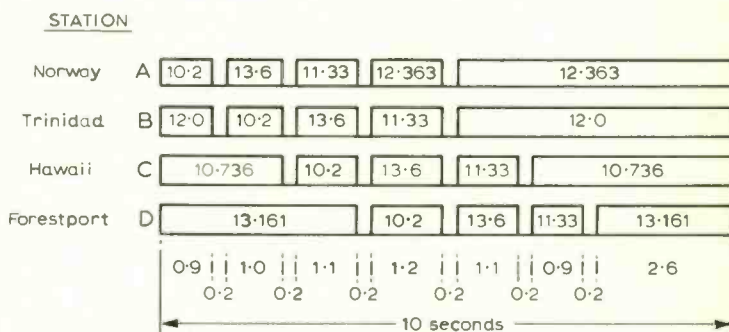

Fig. 6. This diagram indicates the format of the existing stations of the Omega system, together with frequencies involved in proposed methods of resolving ambiguities.

Future trends

Pulse systems are generally extravagant in their use of the radio-frequency spectrum, usually provide only one or two lines of position at a time, are limited in range and often require long signal acquisition times, particularly when automatic. Their inherent advantages are that the systems can be entered at any time since they are unambiguous and they are very accurate. For the price of whole cycle ambiguity, higher accuracy can be achieved by the use of continuous-wave techniques.

Continuous-wave systems are economical in spectrum and capable of operation in a high noise environment due to the narrow bandwidths employed. Lower frequencies may be used with consequent increase in available range. Although the transmitters and aerials may be expensive, they are relatively few and world cover would be cheaper overall. The c.w. systems can provide multiple position lines and therefore better reliability although with less accuracy at long range.

The problem of ambiguity resolution of c.w. systems has been a continual and only partially solved issue for many years. The advent of the v.l.f. navigation with world-wide cover could remove this difficulty since outage time would be the only cause for concern. The application of dead reckoning or of short-range radio-system information to resolve lanes at the termination of the outage should provide a powerful means of ensuring complete reliability. So far, hyperbolic systems have been designed to be completely independent, having their own computers, ambiguity-resolving systems and displays. The future may well see a trend towards the integration of the dead-reckoning and the externally generated systems with the accent upon sensor simplicity.

Crown copyright, reproduced with the permission of the Controller, H.M. Stationery Office.

News of the Month

Broadcasting in the seventies

The B.B.C.'s plans to rationalize and reshape the sound broadcasting services in the U.K. were announced on July 10th and outlined in a booklet entitled "Broadcasting in the Seventies" and have been submitted to the P.M.G. for approval. Basically there are planned four services to be provided by the national network: Radio 1 (pop music), medium wave only; Radio 2 (light music), long wave and v.h.f.; Radio 3 (classical music, plays, etc.), v.h.f. with possibly some m.w. support in daytime initially; and Radio 4 (largely speech and light entertainment), m.w. and v.h.f. In addition it is proposed that local radio will be extended on v.h.f. with some daytime medium-wave support.

To implement these proposals and to provide maximum coverage it will be necessary to redeploy the B.B.C. medium-wave and v.h.f. channels allocated under the Copenhagen and Stockholm Plans respectively and to build some additional transmitters.

As a high priority the B.B.C. plans to improve the medium-wave coverage of Radios 1 and 4. At present Radio 1 serves 86% of the population by day and 33% by night and Radio 4 serves 98% and 70%. The improvement can be achieved by using the medium-wave channels released by discontinuing regional and Radio 3 medium-wave transmissions. Radio 1 will have one more transmitter in the North (100kW), and the two frequencies used will be 908 and 1214kHz. Radio 4 will operate on three more frequencies, 647, 1052 and 1088kHz.

A proposal has been put to the P.M.G. for expanding the present experimental group of eight v.h.f. local broadcasting stations to about 40 to reach nearly 90% of the population of England. Additional Band II v.h.f. channels will be needed for this number of stations and the 95-97.6MHz part of the band at present occupied by non-broadcasting services is in the process of being cleared for broadcasting. The band 97.6-100MHz will be used for an educational network.

The increase of music programmes on Radio 3 in the evenings will encourage the extension of stereophonic transmissions in this network and this, together with the addition of stereo on local radio and possibly Radio 2, will be added attractions to the v.h.f. services.

It is to be hoped that set manufacturers will not drag their feet.

A model of the new Emley Moor mast

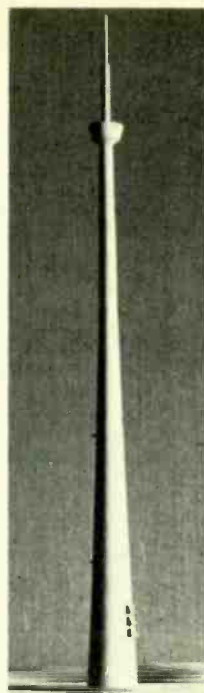

New mast for Emley Moor

The Independent Television Authority is to construct a new mast on the Emley Moor site to replace the one that collapsed. The new mast will be made of reinforced concrete and at 1080ft will probably be the third tallest structure of its type in the world. Similar, higher, structures exist in Moscow and in East Berlin.

It is hoped that the new mast, which will be used by both the I.T.A. and the B.B.C., will be in operation by the end of 1970. Work on the foundations is to start almost at once even though negotiations with the builders have not yet been finalized. Estimated cost for the project, including all aerials and associated equipment, is between £400,000 and £500,000. On completion of the concrete tower the 670ft Swedish mast, which was erected as an interim measure, will be dismantled.

The concrete tower, which will weigh a total of 14,000 tons, will be 80ft in diameter at the base tapering approximately exponentially to 20ft diameter at the 900ft level. A room built at this height will be equipped as a microwave link station for outside broadcast use. Above this a 100ft long, 12ft diameter glass fibre cylinder supported by a steel lattice structure will house the v.h.f. aerials. Above this another similarly supported glass fibre cylinder, 5ft diameter and 80ft long, will contain the u.h.f. aerials, bringing the total height to 1080ft.

German radio show

The biennial German radio show, to be held this year in Stuttgart from 29th August to 7th September, will be the last national show—the next is to be international and is planned for Berlin.

The show is given substantial support by the broadcasting organizations and the Bundespost who will provide a large display showing the wide variety of radio services it operates. Nearly 50% of all telephone calls

made in the Federal Republic are handled via radio links. The scheme to utilize the 12-GHz band for television broadcasting (mentioned in our report of the Montreux Television Symposium—July issue) will also be demonstrated. The 12-GHz signal from a transmitter at the exhibition will be received on standard television sets fitted with converters designed by the Bundespost. A 60-cm metalized plastic parabolic aerial is used.

Among the many other exhibits in the 15 halls occupied by the exhibition will be a demonstration by radio amateurs.

Licence evasion

In answer to a question in the House of Commons on July 3rd the Postmaster General announced that the Post Office was increasing its detector vans by 18 to 38. The estimated annual loss of revenue to the B.B.C. due to tax dodging by owners of television receivers is £7.5m. The widespread evasion of the payment of car radio licences is also causing concern. The P.M.G. stated "my estimate shows that there are about three million sets in use and that there are about two million evaders". He referred to the anomaly that a licence fee does not have to be paid for a battery operated set used in a car whereas a set installed in a car must have a licence. He said he was "examining the position". One M.P. suggested that motorists with car radios should display a disc indicating that an up-to-date radio licence has been obtained; but what good would that do?

Aid to big ship berthing

Following a series of trials and experiments at Milford Haven and on the Mersey, the Marconi International Marine Co. Ltd. is now in production with a new doppler Speed of Approach Measurement Indicator (SAMI) developed in conjunction with the Ministry of Technology's Royal Radar Establishment at Malvern to meet the requirements of the Marine Department of the Esso Petroleum Co. Ltd. Esso have now ordered an installation for their Milford Haven terminal jetty.

The velocity of first impact of a ship on a jetty is very critical. The momentum of a large loaded ship is immense, even at very slow speeds measured, not in knots, but in feet per minute. A final jetty approach at 30 feet per minute could result in substantial and costly impact damage to both ship and jetty.

Using the doppler effect, SAMI beams a microwave signal at an approaching vessel and, by measuring the change in frequency which is directly related to any movement of the vessel along the radar beam, shows the speed of such movement in feet per minute, or in knots. This is shown as on a meter reading and is simultaneously recorded in graph form on a chart from which any change in velocity, and the rate of any such change, is immediately apparent.

With SAMI installed ashore on the jetty, the operator or observer passes all velocity

information to the pilot of the incoming vessel by radiotelephone. It might, as an alternative, be installed on board the ship itself so that the pilot could read off the information for himself, although in very large vessels this might entail a dual installation to provide early warning of a bow or stern swing not immediately apparent to the pilot's eye.

The SAMI device is completely solid-state, including a Gunn diode microwave generator, and operates from low-voltage batteries or from a mains supply. Four speed ranges measure 0-50 feet/min, 0-100 feet/min, 0-5 knots, and 0-10 knots. The graph recorded during observation, besides displaying an absolute measurement of velocity, also shows whether the vessel is approaching or receding. When a dual installation is used, with one unit beamed on each end of the berthing vessel, any tendency to swing can be observed, advised to the pilot, and corrected.

Medical electronics technicians salaries too low?

Our hospitals will never be staffed with the best electronics and engineering technicians and development engineers while salaries remain so low—with the possible exception of those who regard their work as a calling and who are willing to put up with the low return.

An electronics engineer recently admitted to a large hospital with a suspected heart complaint came to the conclusion that the electronic equipment used by the staff to diagnose his complaint was sicker than he was! He was sorely tempted to jump out of bed and ask for a multimeter and soldering iron.

To illustrate the present state of affairs we print below an advertisement recently received by the journal "Hearing" and brought to our attention by the Royal National Institute for the Deaf

"Audiology technician, Grade I, required at H.M. Prison, Wormwood Scrubs, for up to two sessions per week. The fee for a three hour session is £1 8s 6d."

Laser to measure earth/moon distance

Shortly after the Apollo 11 astronauts land on the moon's surface, a "pancake" of laser light two and half miles across and ten feet thick will strike their landing area and bounce off a special reflector erected by them in a scientific experiment designed to measure the precise distance to the moon.

The "pancake" will represent a 10ns pulse of high-power laser light fired from a range-finder/telescope, built by the Hughes Aircraft Company of America, on an Arizona mountain top. The rangefinder, one of the most precise ever built, will be able to measure the relative earth-moon distance to within one and a half metres, a precision far greater than previously possible.

The light segment will remain its original length as it travels toward the moon but will gradually spread, just as a continuous

beam would, attaining a diameter of about two and a half miles on the moon.

A tiny portion of the light will strike a two square foot reflector and will be bounced back to the telescope. By measuring the precise travel time of the laser pulse, using a caesium beam timing system, (approximately 2.4 seconds) the distance between the reflector and telescope can be accurately computed.

International apprentice competition

Between the 6th and the 16th of July 23 young apprentices, all under 21 years old, from Britain were competing in the international apprentice competition which was held in Brussels. At the time of going to press the results were not known.

The competition—which covers the engineering, building, iron and steel, electrical, electronics, and radio and television industries—attracts entrants from West Germany, Japan, Italy, Switzerland, Holland and Belgium.

The British entrants in the categories that are of interest to *Wireless World* were as follows: in the industrial electronics section—Philip Robert Gutteridge (age 19) from Mintech and in the radio and television repair section—Roger Pheasant (age 20) who is at present working for Alex Owen Ltd., of Beeston, Notts. Next year the competition will be held in Japan.

Interplanetary billiards

After Mars and Venus come Jupiter, Saturn, Uranus, Neptune and Pluto in one of the most far-reaching space missions yet conceived by man.

Plans for two, three-planet grand tours in the late 1970s are being developed by the National Aeronautics and Space Administration's Jet Propulsion Laboratory, Pasadena,

Calif. One such mission would fly by Jupiter, Saturn and Pluto, the other would go to Jupiter, Uranus and Neptune.

The eight-to-eleven-year missions to the other planets are detailed by James E. Long of J.P.L.'s Advanced Studies Office in the June issue of *Astronautics and Aeronautics*. Mr. Long points out that, "The best outer planet alignment in 179 years, occurring in the 1976 to 1980 time period, opens the outer planets to exploration in an effective and timely manner." The infrequency of such favourable alignment is due to the slow movement of the outer planets about the Sun.

Mr. Long proposes the use of either conventional or solar-electric propelled spacecraft, with a nuclear isotope power source to operate spacecraft equipment. From Jupiter on, a grand tour spacecraft would employ the gravitational attraction of each planet to spin on to the next.

Television cameras and other scientific instruments aboard the unmanned spacecraft could study the planets, their atmosphere, magnetic fields and satellites, he suggests. Of special interest are Jupiter's red spot and radiation belts and Saturn's rings.

Long pinpoints 1977 through 1979 as the best years for launching grand tours. That period, he says, will afford "the best combination of the planets' closest approach altitude, flight time and launch energy requirements."

Computer course for £5

A computer appreciation course cheap enough to attract school-leavers, is to be run as an experiment by I.C.L., at its London training centre. The course—two evenings a week for five weeks began on July 1st—cost only £5.

The course, which was open to anyone, provided a comprehensive introduction to computers. It has been designed to give each trainee a general understanding of electronic data processing, its history and applications; and also to describe the job opportunities available in the field. The object of the course is to

The photograph shows the Quality Assurance Laboratory at the Erie Company's plant at Great Yarmouth, Norfolk. The laboratory has received approval under the BS9000 scheme (No. 1001/m).

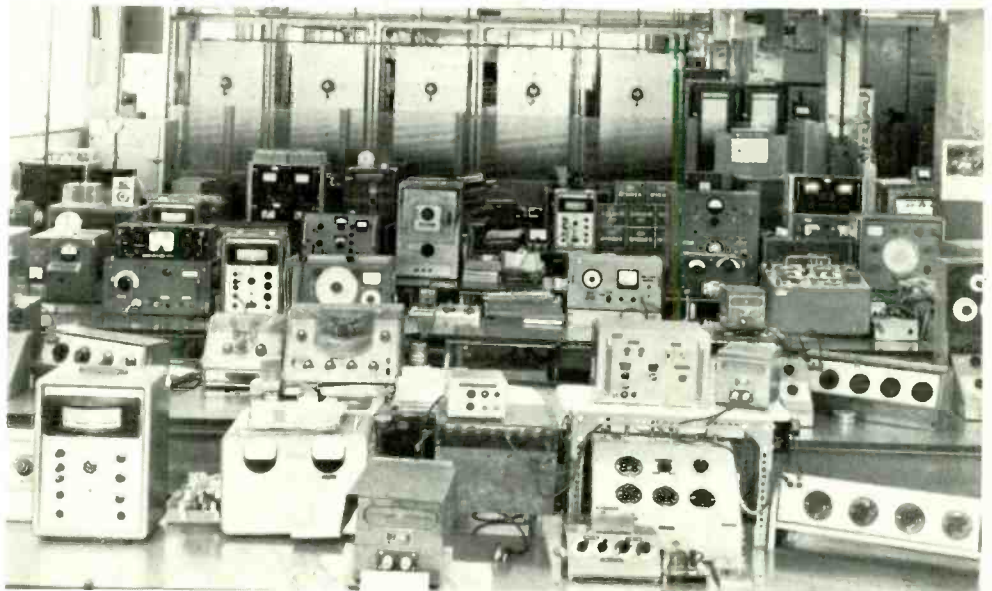

help overcome the shortage of staff that is apparent throughout the industry. Those interested in future courses should contact: I.C.L. Training Centre, South Ealing, London.

I.E.E.E. New York exhibition

The Electronic Engineering Association is again to sponsor participation by British companies in the Institute of Electrical and Electronics Engineers' international convention and exhibition to be held in New York from the 23rd to the 26th March, 1970.

U.K. companies exhibiting under E.E.A.'s sponsorship will qualify for financial assistance under the Board of Trade's Joint Venture Scheme. Already ten companies who took part this year have applied for space in the 1970 event.

Companies requiring further details should contact the E.E.A. Information Office, Berkeley Square House, Berkeley Square, London, W.1.

I.E.E.T.E. membership increases

The membership of the Institution of Electrical and Electronics Technician Engineers in the year ended 31st March, 1969, increased by 1,623 to 10,816.

The Institution was successful in its application for registration under the 1960 Charities Act and secured the licence of the Board of Trade to omit the word Limited from its title.

New resistor group

A Resistor Manufacturers Group has been formed recently within the Radio and Electronic Component Manufacturers Federation, and comprises all leading British firms producing fixed and variable resistors, and potentiometers. This follows the emergence

of other groups representing relay, capacitor and connector manufacturers.

The object is to provide not only a forum for promoting the interests of resistor manufacturers, but to serve the electronics industry in general, in particular by endeavouring to provide a better service for all resistor users.

At the inaugural meeting, J. Thomson (Morganite Resistors Ltd) was elected as the Group's chairman, and E.W. Embleton (Welwyn Electric Ltd) as vice-chairman. Enquiries should be made to the secretary, P. Costley, R.E.C.M.F., Mappin House, 4 Winsley Street, Oxford Street, London W1N 0DT.

Detecting overhead hiss

Many old style overhead telephone cables still in use employ paper insulated conductors which are pressurized with dry air to prevent damage should the protective sheath be punctured.

Such punctures generate ultrasonic noise as the air escapes and Bell Labs of America have built a simple device that enables such leaks to be detected from ground level. An ultrasonic detector is contained within a small Cassegrain type reflector (a 45mm hyperbolic reflector located at the focus of a 254mm paraboloid). The output of the detector is amplified and used to indicate the presence of a leak.

The reason for devoting so much space in news this month to what on the face of it may be considered to be an almost frivolous item is quite simple.

Many readers will work in plant or laboratories which employ gas and air lines where a leak would put a system out of action. The normal method of leak detection is to split the piping system into sections and to test each section individually by pressurizing the line and using some form of aneroid instrument to detect the presence of a leak. This method is expensive and

time consuming and does not give the exact position of the leak but only the section in which it lies. The writer knows this only too well after spending hour upon hour tracing leaks in aircraft pitot and static instrument air systems.

The Bell Labs equipment would appear to solve this problem once and for all and many firms will find that it would be worth the time and trouble involved in building a similar system.

Automatic measurement of airfield visual range

Five major British civil airports are to use an electronic system which will automatically provide air traffic control with a continuous report of a pilot's visual range along a runway as he lands his aircraft.

The I.V.R. system has been developed at the GEC-AEI's Leicester laboratories and is based upon photo-electric measurements of the atmospheric transmission of light at three points alongside the runway, one at each end, and one in the centre.

Measurements taken by instruments at these points are digitized and transmitted over telephone lines to the I.V.R. computer housed in the airfield's telecommunications equipment room.

The computer then performs the computation of runway visual range, assures the calibration and integrity checking, and controls the logging and formatting of data. The runway visual range is then displayed by digital readout on a six-inch square panel in the airport's operational control centre.

Landing system to be produced by Plessey

The responsibility for developing the correlation protected instrument landing system* originally conceived at the Royal Aircraft Establishment has been placed with Plessey Radar under a Mintech contract.

Unlike the traditional i.l.s. the new system is unaffected by interference or by changes in the strength of received signals. One of the main advantages of c.p.i.l.s. is that it is fully compatible with existing i.l.s., the only changes in the aircraft necessary being the addition of a smaller aerial and a minor modification to the i.l.s. receiver.

Scout tape recording contest becomes annual

Final judging took place at Baden Powell House on Whit Saturday of the first national Scout tape recording competition, sponsored by Philips Electrical Ltd. The panel of five judges made their selections before an invited audience of about 150, including a number of entrants.

Twenty of the winners will spend a 4-day holiday in Holland in August. Other prizes included cassette recorders and visits to recording studios.

*Wireless World, May 1967, p. 218.



At the invitation of the British Computer Society, Brian Crank, the designer, described the "Wireless World" Logic Display Aid at a meeting of the Logic Design Group on July 9th: a 19-inch oscilloscope made by Lan Electronics was used for the demonstration.

More and more the demand is for the consistent, high quality and reliability of Electrosil glass-tin-oxide resistors in instruments, telephone exchanges, computers, automation, missiles and, in fact, in every type of electronic equipment. Over and over again glass-tin-oxide proves its superiority. For example, recent independent tests by a major equipment manufacturer showed that Electrosil 100 p.p.m. C5 resistors gave a more consistent performance on load and temperature stability than metal film resistors by six competing suppliers.

Electrosil resistors owe their reliability to the unique glass-tin-oxide construction. Consistently high quality is assured by a most thorough programme of Quality

Control (regular, scheduled, customer's visiting our plant).

Inexpensive components initially, Electrosil oxide resistors work on for decades saving you maintenance and replacement costs. (Therein lies their irresistibility).

Electrosil Ltd., P.O. Box 37, Pallion, Sunderland, Co. Durham. Tel. Sunderland 71481. Telex 53273.



have the experience

The one that keeps on resisting is the one you can't resist

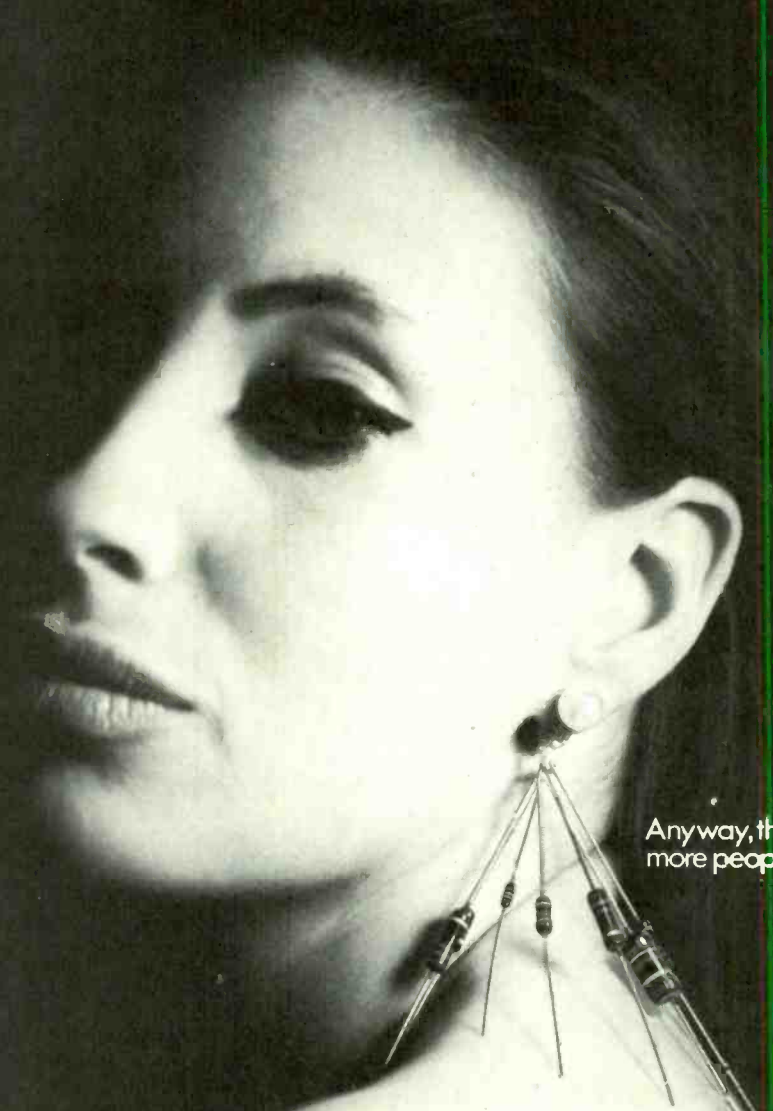

Anyway, that's what more and more people are telling us

Square?

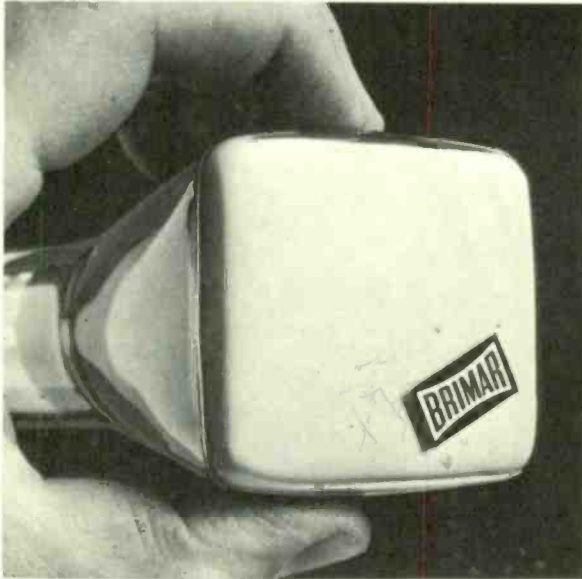

The price is special, too!

**Not quite, but the only
rectangular 3" tube
on the market...**

Another example of Thorn-AEI's renowned production engineering techniques – a top-quality oscilloscope tube at a minimum price.

The Brimar D7-200GH is the only rectangular tube available in the 3 inch size. The tube has a relatively flat screen and employs a mono-accelerator for reduced power requirements. With an overall length of only 18 cm, it provides a 5 cm x 4 cm display of waveforms or TV pictures.

Features include electrostatic deflection and focusing. Good geometry is ensured by specially developed production control techniques. Small spot size and focus uniformity over the entire screen give good resolution at all points of the useful screen area. High-deflection sensitivities permit the use of inexpensive transistor circuits.

Applications include:

alpha-numerical readout devices,
waveform monitors,
data processing equipment,
voltage and power output indicators,
educational equipment, etc.—

and of course, popularly-priced oscilloscopes.

$V_{a1+a3+a4}$	800	1200	V
V_{a2}	50 to 150	75 to 225	V
V_g (for cut-off)	-20 to -40	-30 to -60	V

For full technical data and prices, write or phone:

THORN Thorn-AEI Radio Valves & Tubes Limited
7 Soho Square, London, W1V 6DN Telephone 01-437 5233

Amateur Communications Receiver

2:i.f. amplifier, b.f.o., product detector and a.f. amplifier

by D. R. Bowman, A.M.Inst. E., G3LUB

This month sees the start of the description of the final design and construction of the receiver. Inevitably there will be quite a few loose ends that will be tidied-up later.

All the coil winding details are given although much of the circuitry does not appear in this issue.

Table one gives the complete frequency coverage and it will be noticed that this does not include the last section of 10 metres, however this can be added by incorporating an extra crystal if required.

TABLE ONE

Amateur bands		Rx. coverage
m	MHz	MHz
80m	3.5 — 3.8	3.5 — 4.0
40m	7.0 — 7.1	7.0 — 7.5
20m	14.0 — 14.35	14.0 — 14.5
15m	21.0 — 21.45	21.0 — 21.5
10m	28.0 — 29.7	28.0 — 28.5
		28.5 — 29.0
		29.0 — 29.5

Component considerations

Throughout the various components lists given in this article the values are as used by the author and it is strongly recommended that new components only be employed. The resistors, except where stated, are 0.25W carbon $\pm 5\%$ types, but $\pm 10\%$ types could equally well be used. In almost all cases where silver mica capacitors are specified they must be used. In the case of the larger values of disc ceramics, Mullard C280 miniature foil capacitors could be substituted. Again wherever Philips concentric air dielectric trimming capacitors are specified other types of trimmers could be substituted.

With two exceptions coils are wound on Radiospares core formers which can be obtained from Home Radio (Components) Ltd., Mitcham, Surrey, under catalogue number CR2. The iron dust cores can be obtained from the same address (catalogue number CR5).

Whilst on the subject of coil winding the author found the simplest method of anchoring the wire to the former was to wrap a number of turns of sewing cotton over the wire end and round

the former. The only exceptions are L_{10} and L_3 and L_{11} . L_{10} should be wound on a CR12 former with a screening can No. CR13. These are small $\frac{3}{4}$ in. \times $\frac{3}{4}$ in. i.f. transformer cans. L_3 and L_{11} are $\frac{1}{2}$ in dia. CR9 formers. The crystal filter used is the K.V.G. No. XF-9B which can be obtained from Lowe Electronics, 50/52 Wellington Street, Matlock, Derby. There are a number of alternative filters, but details are not included as this filter has by far the best performance and value for money. The various tuning capacitors can be supplied by Jackson Brothers (London) Ltd. C_{12} and C_{11} type are U102 6-75pF, 2 gang (front end tuning) and C_1 is type U101 6-75pF, single gang (v.f.o. tuning).

The dual ratio ball-drive type 4511/DRF can also be supplied by Jackson Bros. The odd r.f.c. is a standard valve type 2.5mH radio frequency choke.

Now we come to the transistor types. There are a number of devices which could be expected to perform equally well as an alternative to type 2N706. The following are a few 2N706A, 2N708, BSY38, BF115, C111, 2N2926. The BC107 can be

Fig. 10. Front view of the prototype showing the marking of the various controls.

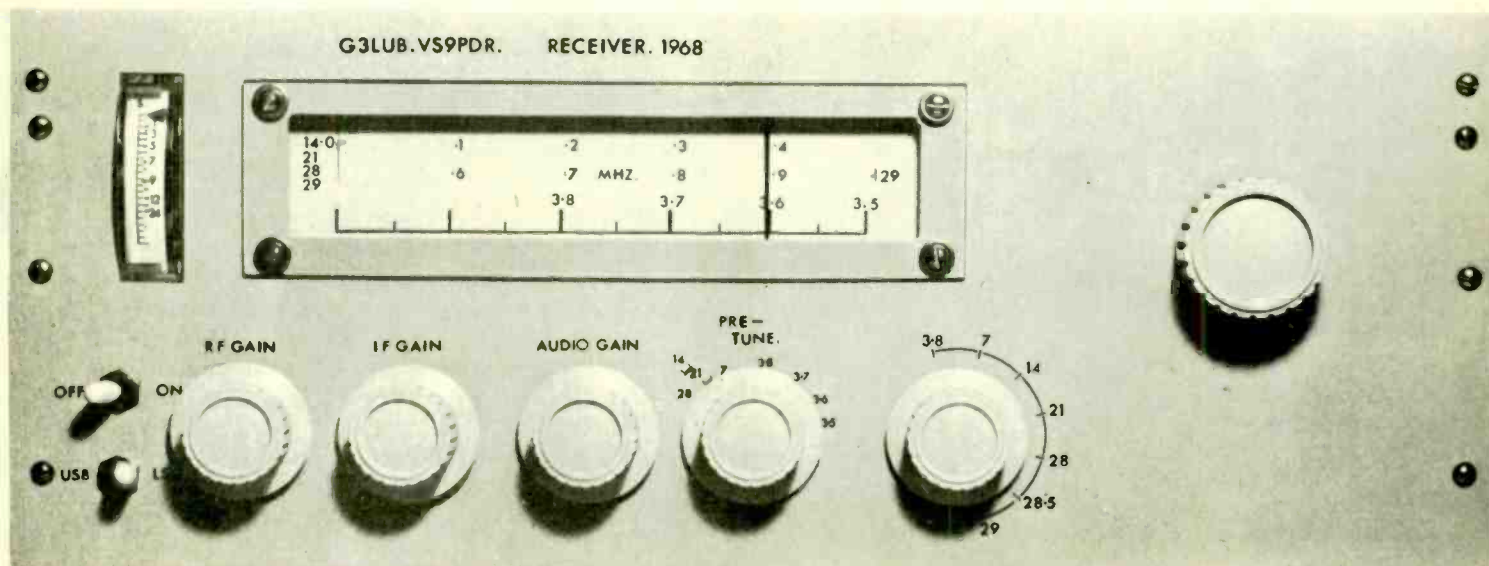

replaced by any silicon n-p-n high-gain transistor with an h_{fe} in excess of 150. The h.f. crystal oscillator uses a 2N918 for which any of the following devices could be used as an alternative 2N4292, BFY90, TIS48. The audio output pair ACY17 and a BFY50 are very cheap and unless a matched complementary pair are available the author would advise no change.

Since starting, a substitute for the 3N140 dual gate f.e.t. has come on the market which is strongly recommended since it incorporates built-in gate protection. The new device is the MEM564C and is available from: S.D.S. (Portsmouth) Ltd, Gunstone Road, Hilsea Industrial Estate, Portsmouth, Hants.

The diodes used in the power supply can be almost any types with at least a 50V p.i.v. rating. Zener diodes used can again be replaced by alternative types. (The 9 volt device has a power rating of 1 watt and the 5.6V zener a rating of 0.25 watt). All coils were wound using wire which can be obtained from Post Radio Supplies, 22 Bourne Gardens, London E.4. The h.f. oscillator crystals used were purchased from Cathodeon Ltd, who it should be noted have a minimum charge of £3. These crystals are for series, fundamental or third overtone mode operation, as noted in the crystal list. The particular types used in this receiver were of HC/6U construction.

Physical construction

Figs. 10, 11 and 12 show the layout of the original receiver built by the author. The dial drum used was home made, but an alternative would be Jackson Bros. Part No. 5035 3.5 in drum.

Fig. 11. A view of the upper side of the chassis.

The i.f. amplifier and particularly the b.f.o. and product detector must be completely screened, as must the h.f. crystal oscillator and synthesizer mixer (the screening covers were removed for photography). It is also advantageous to screen the i.f. break-through filter from the r.f. amplifier.

With the exception of the r.f. stage the various circuits can be laid out on individual printed circuit boards. As can be seen from the photographs the author used boards only for the following circuits: i.f. amplifier, a.f. amplifier, product detector, b.f.o. and the S meter. The other stages were built using conventional wiring techniques for convenience during circuit development.

The i.f. amplifier

The i.f. amplifier is constructed on a $5\frac{1}{8}$ in. \times 3 in. piece of copper clad printed circuit board. The layout drawing is shown in Fig. 13 and the circuit in Fig. 14. The holes should be drilled using a 0.03 in. drill. The components, with the exception of R_3 , R_{10} , and the transistors can be mounted as shown in the diagram and soldered into place. The small aluminium screens should be attached and the mounting screws firmly soldered to the copper earth mat to complete the construction of the board.

The constructor is advised to purchase twenty-five 2N706 transistors which should be graded according to gain, say, 20, 40, 60 and over 60, using the simple transistor tester shown in Fig. 15. Any meter with a 10mA range can be used in the circuit. With the range switch set to R_1 the meter will give a full scale deflection when the gain is 100 and 250 when set to R_2 . The switch S_2 has

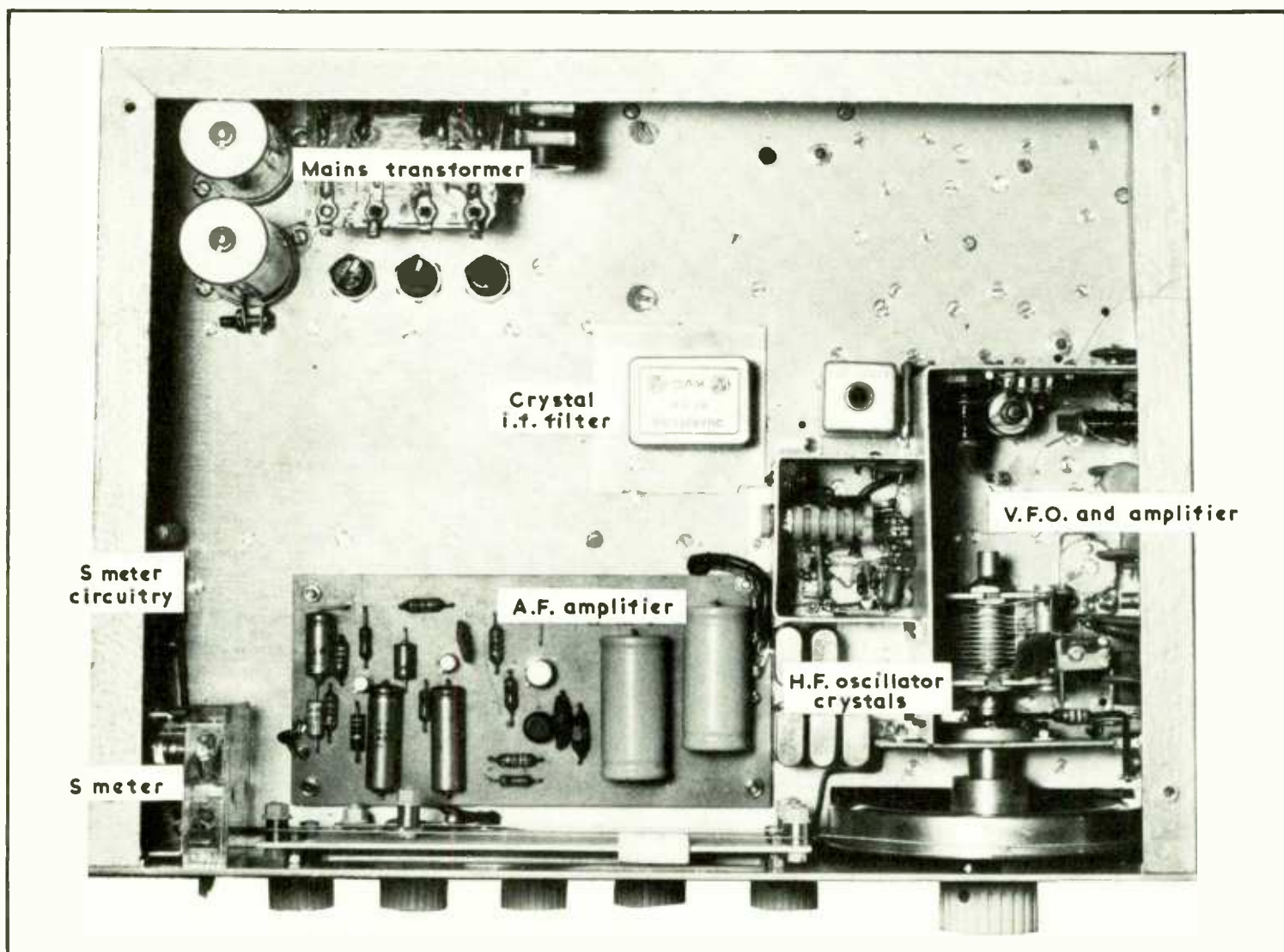

to be pressed to make these measurements. The two ranges may not quite agree, due to the transistor's gain dependency upon collector current, however, the discrepancy is unimportant. From the 25 transistors choose three pairs with similar gain figures. The author's devices were within the range 40 to 50. Solder these into the i.f. amplifier board, together with a transistor with a gain of 60 to 80 in the Tr_7 position. Temporarily connect two 120kΩ resistors into the board, at positions R_3 and R_{10} , connecting only the base ends at this stage. The other two ends are tied together and connected to the h.t. supply. After careful circuit checking connect the amplifier to a 9V supply and measure the potential at the collectors of Tr_2 and Tr_4 using either a valve voltmeter or a sensitive multimeter. This potential should be between 4 and 6V and can be varied by adjusting the value of the temporary h.t. to base resistors. Having found the appropriate resistance value the resistance of R_3 and R_{10} can be found as follows:

$$R_3 \text{ and } R_{10} = (R_{\text{h.t. to base}}/2) - R_{23}$$

For example the resistor from the h.t. supply to the base of Tr_1 was 120kΩ, then:

$$R_3 = [(120 \times 10^3)/2] - (33 \times 10^3) = 27k\Omega$$

Resistors of the calculated value should be soldered into circuit in the R_3 and R_{10} positions in place of the two temporary 120kΩ resistors. The next step is to reconnect the 9V supply, and a high value potentiometer of about 100kΩ between the point on the board marked X and the h.t. supply. Using a valve voltmeter the potential on terminal F should be monitored. It will be found that with potentiometer set to maximum resistance and no signal input, the potential should be between 5-6 volts.

A source of 9MHz r.f. voltage is injected into terminal D (from a grid dip oscillator, signal generator or simple test oscillator) and the i.f. transformer cores of T_1 , T_2 and T_3 are adjusted until the potential at F dips to a minimum. It will be necessary to progressively reduce the 9MHz drive, as this process continues. It is strongly advised that the amplifier be well screened during these tests and that all signal leads to and from the amplifier be made as short as possible. If the amplifier should show signs of instability, increasing the values of R_6 , R_9 and R_{19} should cure the trouble. R_4 , R_{11} , and R_{17} also can be increased if necessary. It will be found that the amplifier has more gain than is required and it will be unconditionally stable when incorporated as part of the receiver. A photograph of the i.f. amplifier is given in Fig. 16.

The b.f.o. and product detector

It is essential that these sections be constructed in a well screened aluminium box. The b.f.o. (Fig. 17) is required to generate either one of two frequencies, positioned on either side of the i.f. filter characteristic (Fig. 2). It is generally accepted that an audio frequency response covering the range 300Hz to 2.6kHz is the minimum for acceptable communication quality. This entails setting the b.f.o. frequencies about 20dB down either side of the filter characteristic. The particular filter used in this receiver is supplied with the appropriate b.f.o. crystals.

The author would advise any prospective constructor to purchase new crystals and not attempt to use war surplus which are now at least 25 years old. The b.f.o. uses a circuit configuration

Fig. 12. A view of the underside of the chassis. Certain screening covers have been removed for clarity.

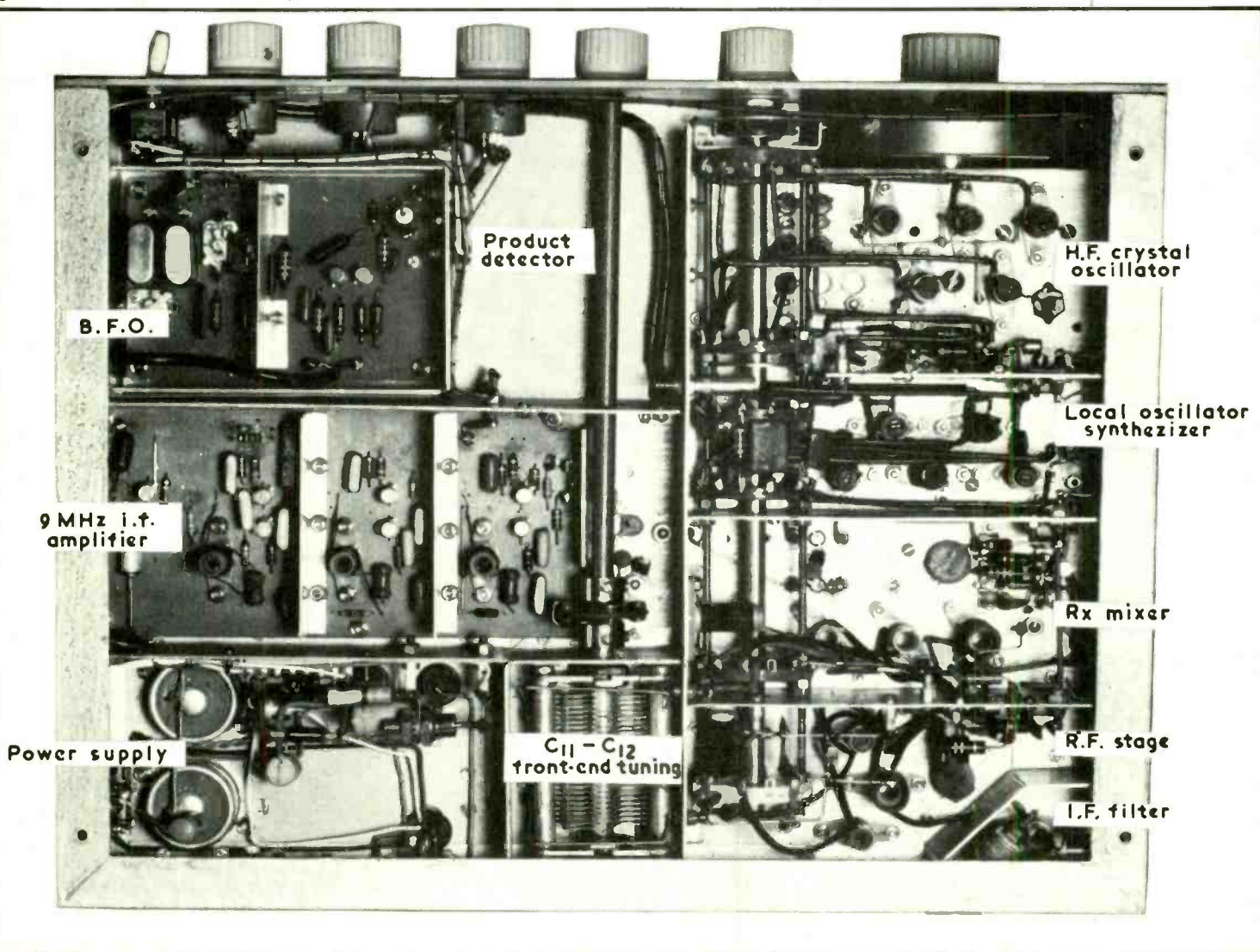

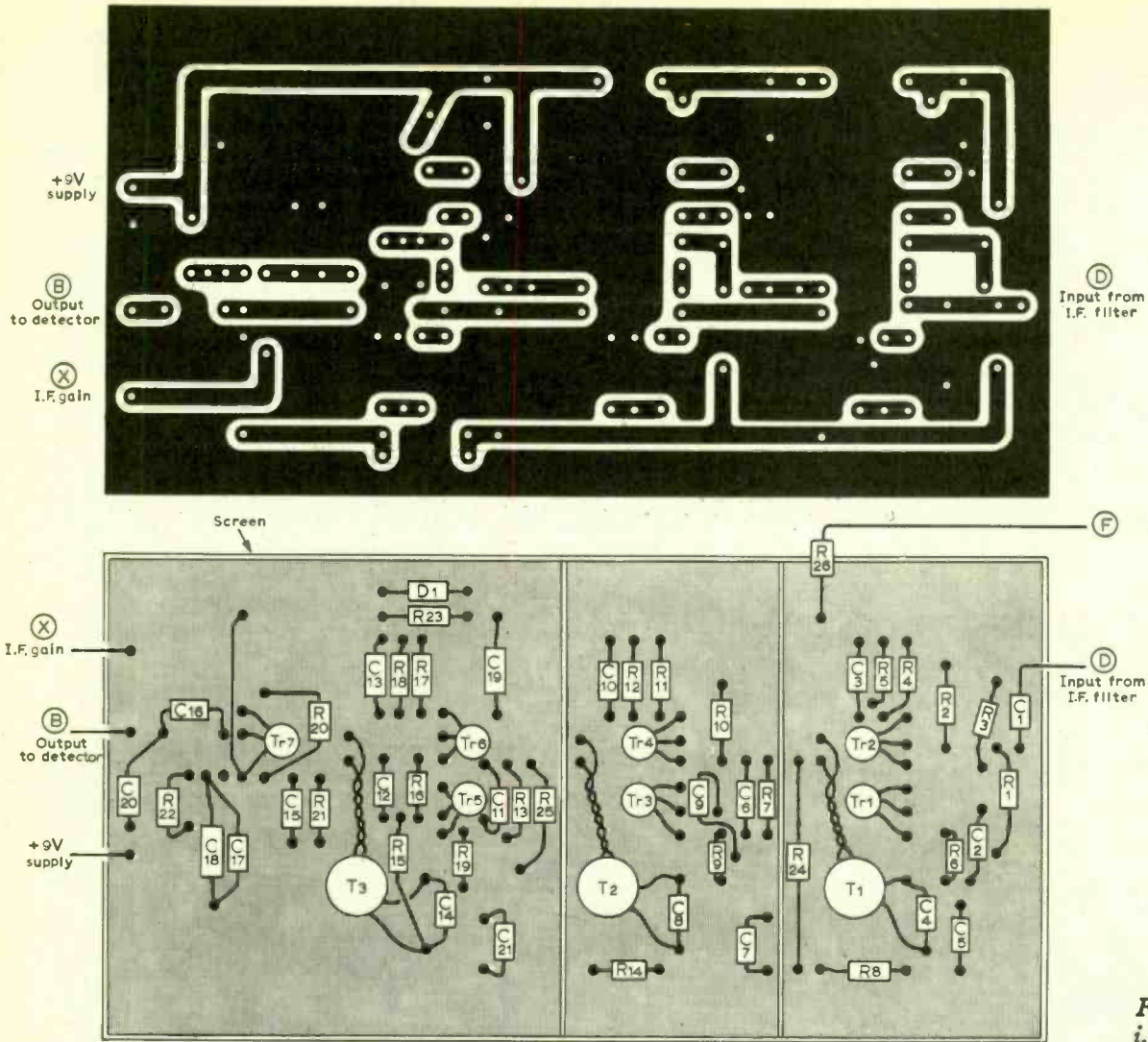

Fig. 13. Construction of the i.f. amplifier.

which should be familiar to many readers, as it is very similar to the valve Pierce oscillator. An interesting point is the method of changing the b.f.o. crystals. This uses diode switching which allows the sideband selection control to be positioned conveniently

on the front panel and remote from the oscillator box. This eases the problem of keeping stray b.f.o. voltages out of the i.f. amplifier as none of the leads external to the b.f.o. compartment carries r.f. The product detector requires the very low oscillator drive of

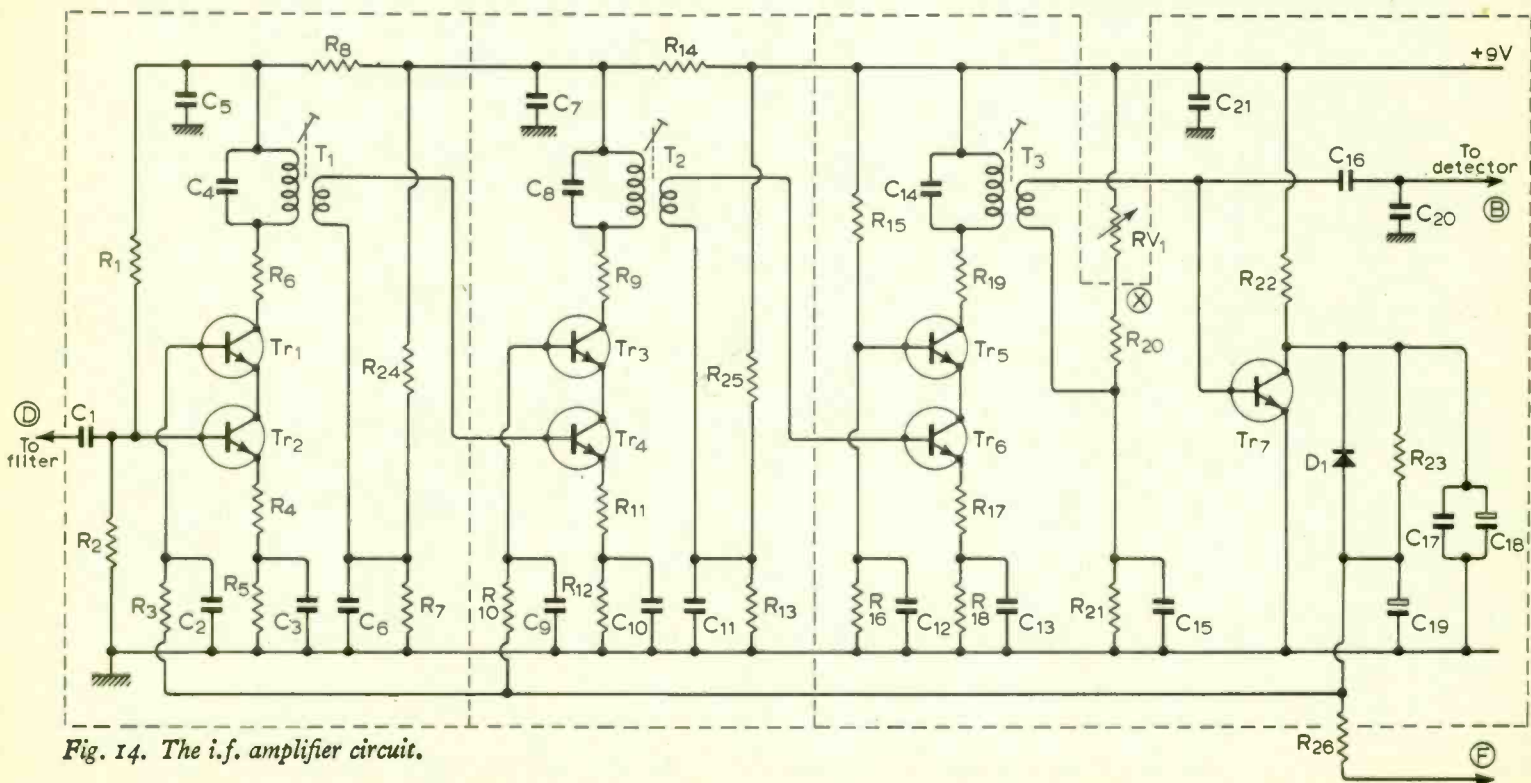

Fig. 14. The i.f. amplifier circuit.

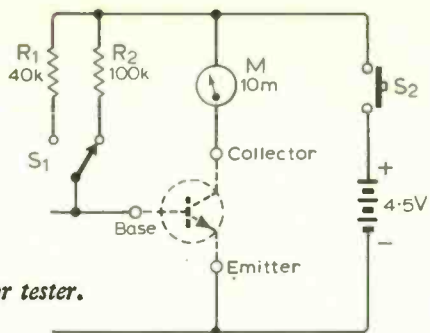

Fig. 15. A simple transistor tester.

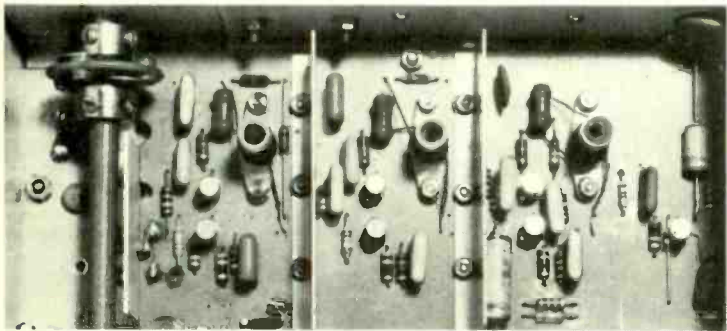

Fig. 16. The finished i.f. amplifier.

not more than 100mV which means a small value of coupling capacitance (5pF) between the oscillator and detector. The process of product detection is analogous to normal mixer action with the output being in the audio frequency spectrum. It is recommended that a pair of 2N706 transistors (Tr_2 & Tr_3 Fig. 17) with similar current gains should be used in the circuit. The signal requirement is modest at 10mV, and the capacitive potential divider (C_{16} & C_{20} Fig. 14) on the output of the i.f. amplifier serves the dual purpose of reducing the i.f. amplifier voltage to suit the detector and reducing the reverse transfer of stray b.f.o. voltage back into the i.f. amplifier.

The presence of unwanted b.f.o. signals in the final receiver can be checked by removing one b.f.o. crystal from the circuit and adjusting the receiver to a clear channel. The S meter reading should be identical when the sideband switch is operated. In other words the application of b.f.o. voltage to the detector should not affect the S meter zero reading. The r.f. filter in the detector collector circuit makes use of a $10\mu\text{H}$ r.f.c. which is easily constructed by close winding 30 turns of 34 s.w.g. enamel covered copper wire on a Radiospares coil former which is fitted with an iron dust core and adjusted to produce maximum inductance. This filter is used to eliminate the 9MHz component present in the audio signal at the output of the detector. The finished b.f.o. and product detector is shown in Fig. 18.

The a.f. amplifier

The audio amplifier is of conventional transformerless design (Fig. 19) consisting of two common emitter-connected stages driving a complementary output pair which drive the 3Ω loudspeaker. Considerable negative feedback is applied over the last two stages which tends to stabilize the d.c. operating point as well as reducing output non-linearity. It is essential that the following procedure is carried out to set-up bias levels otherwise the output stages transfer characteristic will include considerable cross-over distortion.

In the audio output circuit this bias voltage is determined by the values of the resistor chain R_7 and R_8 . First connect the audio amplifier to a 12V supply and a 3Ω loudspeaker to the output terminals. Connect an audio signal generator with an output of about 30mV to the amplifier input. A general multimeter or milliammeter set to 50mA full scale deflection should be connected in

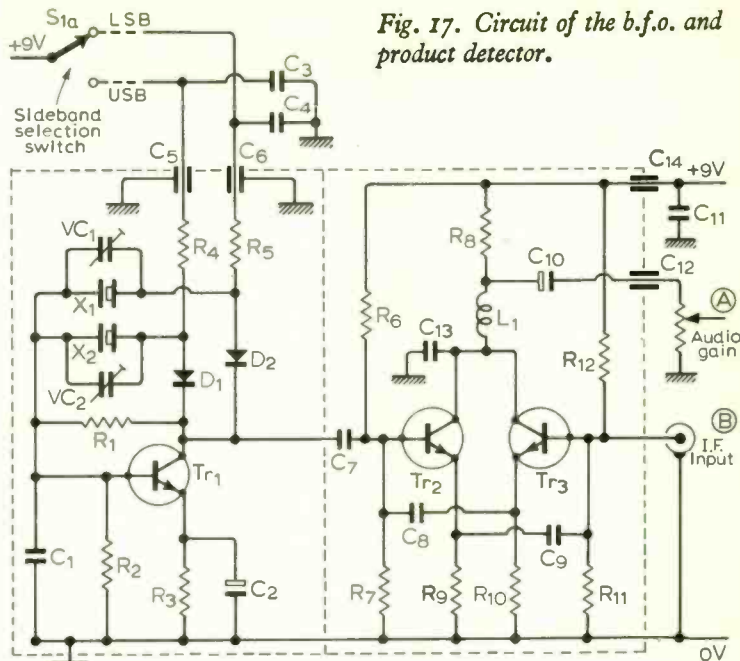

Fig. 17. Circuit of the b.f.o. and product detector.

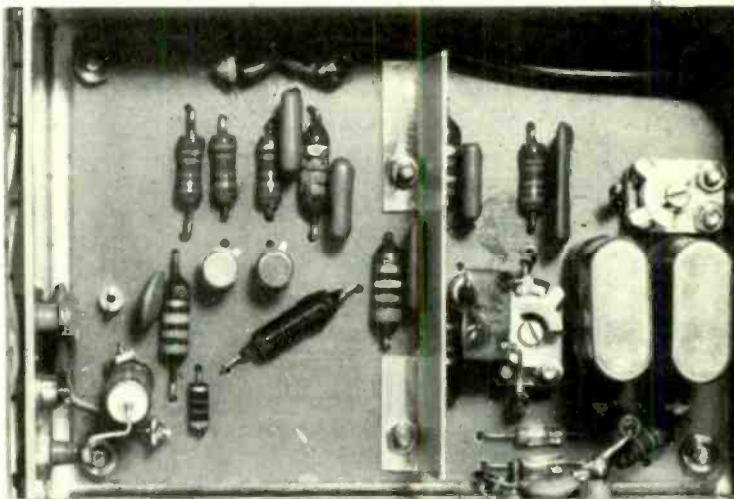

Fig. 18. Finished b.f.o. and product detector.

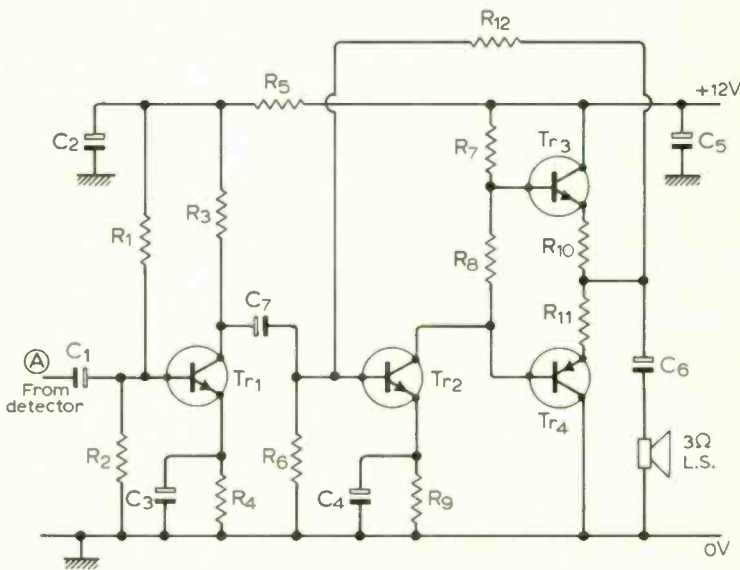

Fig. 19. The a.f. amplifier circuit.

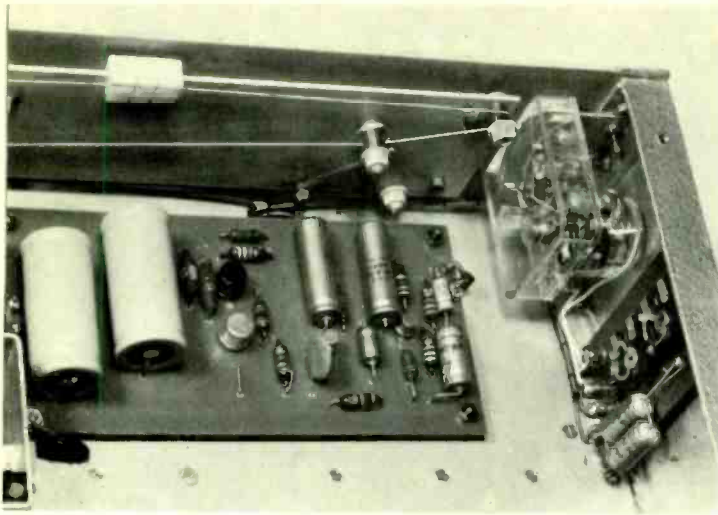

Fig. 20. On the left the a.f. amplifier and on the right the S meter and associated circuitry.

series with the 12V supply to the amplifier. With no input signal the current taken from the supply should be noted. The value of resistor R_8 should be progressively increased until the previously noted current begins to increase. The final value for R_8 will be that value which produces an increase in current from 1 to 3mA.

It is most important not to make the value of this resistor too large as this may cause thermal runaway in the output transistors. The complementary pair consist of one silicon n-p-n BFY50 and a germanium p-n-p ACY17 transistor. It is generally bad practice to mix silicon and germanium devices in a complementary circuit, but the continued high price and supply difficulties forced the author to consider their use. In practice it will be found that the performance of this amplifier is far better than is required for a communications receiver. By careful adjustment the cross-over distortion can be reduced to a very low level. The finished a.f. amplifier is shown in Fig. 20. In the photograph the not yet discussed S meter and associated circuitry can also be seen.

This description ends this month with components lists for the circuits described so far and all the data on coil winding for the complete receiver. Next month more design and constructional information will be given.

COMPONENTS LIST

i.f. amplifier

R_1 .. 33k Ω	R_9 .. 150 Ω	R_{18} .. 22k Ω	R_{23} .. 5.6k Ω
R_2 .. 10k Ω	R_8 .. 560 Ω	R_{19} .. 33k Ω	R_{22} .. 33k Ω
R_3 .. *	R_{10} .. *	R_{17} .. 33 Ω	R_{24} .. 3k Ω
R_4 .. 33 Ω	R_{11} .. 33 Ω	R_{16} .. 560 Ω	R_{21} .. 33k Ω
R_5 .. 560 Ω	R_{12} .. 560 Ω	R_{15} .. 560 Ω	R_{20} .. 1k Ω
R_6 .. 560 Ω	R_{13} .. 10k Ω	R_{14} .. 10k Ω	—
R_7 .. 10k Ω	R_{14} .. 100 Ω	R_{21} .. 3.6k Ω	—

* adjusted as described in the text.

C_1 .. 0.01 μ F†	C_9 .. 50pF*	C_{13} .. 0.1 μ F†
C_2 .. 0.1 μ F†	C_8 .. 0.1 μ F†	C_{18} .. 68pF†
C_3 .. 0.1 μ F†	C_{10} .. 0.1 μ F†	C_{17} .. 0.1 μ F†
C_4 .. 50pF*	C_{11} .. 0.1 μ F†	C_{19} .. 6.8 μ F§
C_5 .. 0.1 μ F†	C_{12} .. 0.1 μ F†	C_{20} .. †
C_6 .. 0.1 μ F†	C_{13} .. 0.1 μ F†	C_{21} .. 0.0001 μ F*
C_7 .. 0.1 μ F†	C_{14} .. 50pF*	C_{22} .. 0.1 μ F

† disc ceramic. * silver mica. § 10V working.
 † adjust to give a.g.c. time constant required.

All transistors type 2N706 selected as described in the text.
 D_1 .. germanium diode type CV448, OA91 or similar.
 RV_1 .. 25k Ω , i.f. gain.

a.f. amplifier

R_1 .. 33k Ω	R_4 .. 430 Ω	R_7 .. 620 Ω	R_{10} .. 1 Ω *
R_2 .. 6.8k Ω	R_5 .. 2.2k Ω	R_8 .. †	R_{11} .. 1 Ω *
R_3 .. 2.2k Ω	R_6 .. 1k Ω	R_9 .. 100 Ω	R_{12} .. 3.3k Ω

*† see text. * wire wound.

C_1 .. 2.5 μ F*	C_4 .. 125 μ F†	C_7 .. 25 μ F*
C_2 .. 50 μ F*	C_3 .. 1000 μ F†	—
C_5 .. 125 μ F†	C_6 .. 1000 μ F§	—

*20V working. † 6V working. § 15V working.

Tr_{1-3} .. 2N2706	Tr_2 .. BFY50	Tr_4 .. ACY17
3 Ω Loudspeaker.		

b.f.o. and detector

R_1 .. 47k Ω	R_4 .. 2.2k Ω	R_7 .. 2.2k Ω	R_{10} .. 1k Ω
R_2 .. 22k Ω	R_5 .. 2.2k Ω	R_8 .. 6.8k Ω	R_{11} .. 2.2k Ω
R_3 .. 220 Ω	R_6 .. 22k Ω	R_9 .. 1k Ω	R_{12} .. 22k Ω

C_1 .. 150pF*	C_6 .. 0.001 μ FΔ	C_{11} .. 0.01 μ F†
C_2 .. 0.01 μ F†	C_7 .. 5pF*	C_{12} .. 0.001 μ FΔ
C_3 .. 0.01 μ F†	C_8 .. 0.01 μ F†	C_{13} .. 0.001 μ F†
C_4 .. 0.01 μ F†	C_9 .. 0.01 μ F†	C_{14} .. 0.001 μ FΔ
C_5 .. 0.001 μ FΔ	C_{10} .. 25 μ F§	—

* silver mica. † disc ceramic. § 20V working. Δ feed-through.

All transistors type 2N706.

D_{1-3} .. germanium diodes type CV448 or OA91
VC_{1-3} .. 3 to 30 pF trimmers
X_{1-3} .. b.f.o. crystals supplied with crystal filter
L_1 .. 10 μ H r.f. choke
VR_1 .. 5k Ω logarithmic, a.f. gain

COIL WINDING DETAILS

function	frequency or band	winding details	coil no.
signal frequency gate 1	40m	Wound on 0.3in diameter former type CR9. 55 turns of 30 s.w.g. wire close wound. Primary winding four turns wound over the earthy end of the previous winding.	L_2
	20 m	33 turns of 34 s.w.g. wire close wound.	L_4
	15 m	20 turns of 30 s.w.g. wire close wound	L_5
	10 m	19 turns of 22 s.w.g. wire close wound	L_6
signal frequency drain	40 m	Wound on 0.3in diameter former type CR9. 55 turns of 30 s.w.g. wire tapped at 22 turns from the h.t. end	L_{11}
	20 m	33 turns of 34 s.w.g. wire close wound	L_7
	15 m	20 turns of 30 s.w.g. wire close wound	L_8
	10 m	19 turns of 22 s.w.g. wire close wound	L_9
9MHz i.f. transformer	9MHz	Wound on 0.25in screened former cat. No. CR12 can No. CR13. Primary 40 turns of 30 s.w.g. wire close wound. Secondary wound over earthy end of primary. 6 turns also of 30 s.w.g.	L_{10}
v.f.o. base coil	5 to 5.5MHz	30 turns of 30 s.w.g. wire close wound	L_1
v.f.o. amplifier	wideband coupler 5 to 5.5MHz	Two coils each wound with 50 turns of 34 s.w.g. wire close wound. In addition L_1 has a secondary consisting of 4 turns close wound over the primary	L_3
h.f. crystal oscillator	11MHz	30 turns of 34 s.w.g. wire close wound.	L_1
	25MHz	22 turns of 28 s.w.g. copper wire close wound	L_1
	32MHz	9 turns of 26 s.w.g. wire spread to a winding length of 0.5in.	L_2
	32.5MHz		L_4
	33MHz		L_5
oscillator mixer	5-25MHz	25 turns of 28 s.w.g. wire close wound and tuned by a parallel capacitor of 200pF	L_6
	16.25MHz	20 turns of 28 s.w.g. wire close wound and tuned with a parallel capacitance of 15pF	L_7
	30-25MHz	12 turns of 22 s.w.g. copper wire close wound and tuned with a parallel capacitance of 5pF	L_8
	37-25MHz	11 turns of 36 s.w.g. wire spread to a winding length of 0.5in tuned with a parallel capacitance of 5pF	L_9
	37-75MHz		L_{10}
	38-25MHz		L_{11}
9MHz i.f. amplifier	9MHz	Primary winding 35 turns of 30 s.w.g. wire close wound with the secondary consisting of 8 turns wound over the h.t. end of primary	
product detector	r.f.c. 10 μ H	30 turns of 34 s.w.g. wire close wound with an iron dust core	L_1
i.f. trap	9MHz	12 turns of 34 s.w.g. close wound	L_1
	9MHz	46 turns of 34 s.w.g. wire close wound	L_2

With the exceptions noted above, all coils are wound on Radiospares coil formers obtainable from Home Radio, Cat. No. CR2. Iron dust cores are used in all coils with the exception of the signal frequency and i.f. trap coil L_1 . See later for signal frequency coil tuning adjustment. Home Radio also supply iron dust cores under the catalogue number CR5. The author found that a satisfactory method of anchoring the wire ends to the former was to wind several turns of ordinary sewing cotton over the wire. To complete the job a small quantity of shellac can be applied to the cotton. Enamelled copper wire is used in all cases.

Laser Applications in Electronics

A review of the most significant fields of use of laser radiation

by W. A. Gambling* D.Sc., Ph.D., F.I.E.R.E., F.I.E.E.
and R. C. Smith*, B.Sc., Ph.D.

Electronic technology at the present time is based largely on semiconductor junction devices which, although developed to a high degree of sophistication, are continuing to improve with the evolution of new types and techniques. However, all components which involve interaction of charge carriers with electric fields at a junction become progressively more limited in their power-handling ability at high frequencies because of transit time and capacitance effects. Until recently therefore electronic techniques were limited to frequencies below 100GHz. Any significant improvement was clearly dependent on the development of a radically new technique, which, in all probability, would involve some kind of amplification process throughout the bulk of a material rather than at a junction. In fact this new technological revolution was hinted at by the invention of the maser in 1954 but really began to gather momentum in the early 1960s with the emergence, in rapid succession, of lasers¹, acousto-electric interaction in semiconductors² and the transferred electron or Gunn effect³, also in semiconductors. Each of these processes is of very great interest but this article is concerned only with the first of them. The basic properties of lasers are outlined in the Appendix, while typical present-day practical achievements are listed in Table 1.

The applications of lasers arise from the properties of coherent radiation at optical frequencies as compared with incoherent radiation, and the main ones are that it can be collimated and focused to a degree limited only by diffraction and it can give rise to interference and diffraction phenomena. A light beam of wavelength λ and diameter D can be focused to a spot or area of approximately λ^2 so that a laser output of as little as 1mW can produce a power density of about 10^5 W/cm². A beam of diameter D can be produced with a spreading half-angle of approximately λ/D so that a transmitting aperture of diameter 1m will give a patch of light on the moon of diameter only 600m.

Communications

Because of their high operating frequency lasers are potentially communications sources of enormous bandwidth, if suitable modulators and demodulators can be designed, but they are inherently more noisy than microwave and lower frequency sources. For example a power level of 1mW at a frequency of 10GHz corresponds to a flux of about 10^{10} photons per cycle whereas a similar power at optical frequencies corresponds to about 10 photons per cycle so that in the last-mentioned case the granular nature of the signal is much more evident. Thus even though thermal noise is negligible the best noise figure possible at visible light frequencies is no better than 10dB. This may be compared with the noise figure of a maser receiver of <1dB. This is the penalty to be paid for the increased bandwidth.

Unshielded systems. Because of turbulence and temperature gradients in the atmosphere point-to-point communication in

* University of Southampton. This article is a slightly modified version of a paper published in our associated journal *Optics Technology*, Vol. 1, No. 3.

Table 1 Properties of some typical lasers

Type	material	wavelength	power	operation
gas	helium-neon	0.63 μ m	1-100mW	continuous
	argon	0.49, 0.51 μ m	1-50mW	continuous
	carbon dioxide	10-6 μ m	100W-10kW	continuous
solid	neodymium: glass	1.06 μ m	10-100,000MW, 1-10,000J	10ns 10ms
	neodymium: YAG	1.06 μ m	1.1W	continuous
	plus SHG	0.54 μ m	1.1W	continuous
semiconductor	gallium arsenide	0.84-0.9 μ m	10W	100ns
parametric	lithium niobate	0.68-2.4 μ m	5kW	10ns

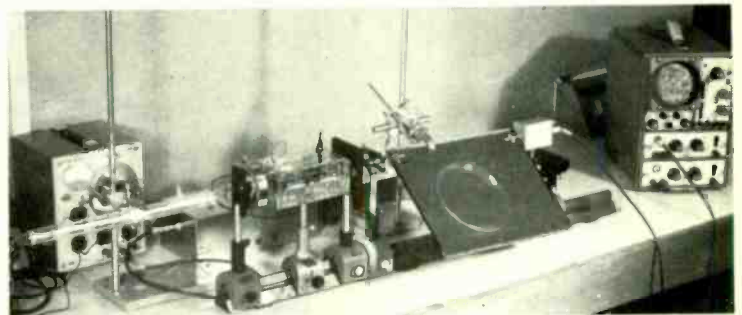

Experimental glass fibre communication link at Southampton University. A beam from a helium-neon laser (left) is modulated by the unit in the rectangular plastic box (left of centre) before it is passed through a coiled cladded glass fibre (on the rectangular flat plate, right of centre). The signal is shown on the c.r.o.

unshielded systems at optical frequencies is unlikely to be feasible over any appreciable distance even in clear weather. For example, large regions of different refractive index in a propagating beam can cause the beam to be deflected and small regions cause a breaking up of the beam. Since the atmosphere is seldom quiet the variations occur randomly and quite rapidly.

The magnitude of the problem can be judged from the fact that a collimated beam of 5cm diameter at visible wavelengths will be deflected by a transverse temperature gradient of only a few thousandths of a degree, over a distance of 1.5km, through a distance equal to its own diameter⁴. On the other hand for short distances and inconvenient locations such as building sites and rough country, and where high security is required, there are possible applications and hand-held sets using light-emitting diodes and semiconductor lasers operating at room temperature have already been produced.

Space communication. Outside the earth's atmosphere the situation is rather different because, with diffraction as the only limiting factor, the efficiency of transmission for given transmitting and receiving apertures increases as the square of the frequency. Above about 10^{13} Hz the photon noise level increases linearly with frequency so that the signal/noise ratio also increases linearly with

frequency. Thus in situations where size and weight are at a premium, such as on an artificial satellite, optical communications may eventually have an important application. The low operating efficiency of lasers may not be quite such a disadvantage since sunlight can be used as pumping radiation in certain optically-pumped lasers.

Calculations show that with a perfect 5m telescope and using existing lasers it should be possible to set up a communications link over a distance of 10 light years with a signal/noise ratio of 10^4 , although the delay in receiving any reply would tend to make the exercise one of only marginal interest. However, apart from the fact that a real need for transmitting over vast distances in space does not yet exist, there are still many problems to be overcome such as aiming with the required degree of accuracy, and improving the efficiency of modulators, detectors and, of course, lasers.

Guided systems. On the surface of the earth an optical beam can be protected from the weather by enclosing it in a pipe. Even with highly-reflecting coatings, reflection from the walls must be prevented to avoid high loss and dispersion, and the pipe must therefore be optically straight. Transverse thermal gradients must be avoided either by evacuating the pipe or by burying it underground. To keep the diameter within practicable limits the spreading of the beam due to diffraction can be counteracted by using a periodic sequence of weakly converging lenses^{4,5} as shown schematically in Fig. 1. The high loss due to reflection at each lens surface can be avoided by using anti-reflection coatings but these will not be entirely lossless.

Another possibility is to use a radial temperature gradient in a gas to produce a variation in refractive index and such thermal gas lenses are remarkably effective⁶. The transmission loss is negligible but obviously the rest of the system cannot be evacuated without introducing further surfaces and uncontrolled temperature gradients elsewhere can be every bit as troublesome as with an unshielded beam. There are many other difficulties such as the effect of skew or lateral displacement of the lenses. If these, and other, problems can be overcome a beam guiding system of enormous bandwidth may be possible but at best it will be very costly to install and maintain.

Yet another possibility is to use a transmission line structure of some kind. At optical frequencies metals are very lossy and only dielectric materials can be considered. For single-mode propagation, essential for broad-band communications, a surface-wave on a dielectric rod can be used. If the rod diameter is about equal to the wavelength of the carrier then only the HE_{11} mode can propagate but since at optical wavelengths λ is approximately $1\mu\text{m}$ the rod, or fibre, would be fragile and difficult to support without causing reflections of the electromagnetic field which is carried mainly in the space surrounding the fibre. The transmission loss would, of course, be very small.

By cladding the fibre with a material of lower dielectric constant a number of advantages are obtained⁷. Firstly the combined structure is mechanically more robust, and secondly, as long as the cladding is sufficiently thick (say about 50λ) that the surface wave

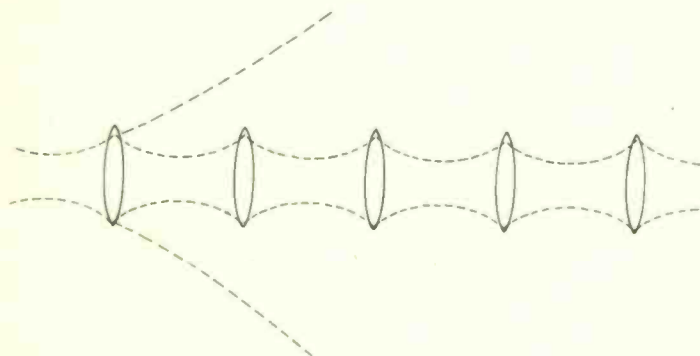

Fig. 1. Schematic diagram of correction of diffraction spread using a periodic system of converging lenses.

fields are extremely small at its outer surface, there is no difficulty in supporting the cladded fibre. Furthermore if the dielectric constant of the cladding ϵ_1 is only slightly less than that of the core ϵ_2 so that $(\epsilon_2 - \epsilon_1) \ll \epsilon_2$ then single mode operation can be achieved with a core diameter of perhaps four or five wavelengths, so that the manufacturing problem is eased somewhat. However the surface wave propagates largely in the cladding and it is essential that a low-loss material is used. Unfortunately the best glass available at the present time has a loss coefficient equivalent to several hundred dB/km and the success of the fibre-optic system depends on the development of a material with about an order of magnitude improvement.

Calculations show that if this can be achieved then a bandwidth of perhaps 1GHz can be obtained in a transmission system which is inherently very cheap and small. Even though the permissible bending radius is several thousand wavelengths, since λ is small the fibre is very flexible and is compatible with the existing cable duct telephone system. Each fibre would have a bandwidth of roughly ten times that of a coaxial cable and with an overall fibre diameter of $100\mu\text{m}$ several hundred could be combined in parallel in a cross-section of appreciably less than 1cm^2 , providing a much greater line bandwidth with a high degree of redundancy to compensate for breaks in individual fibres. The required reduction in glass attenuation by a factor of ten should be possible with present-day technology and already there are encouraging signs of an appreciable improvement.

This attempt at using lasers for communications is much less

Table 2 Comparison of optical guiding systems

Type of guide	attenuation in db/km	band-width per channel	diameter	flexibility	cost	remarks
Beam waveguide	very low	very large	2-100cm	zero	very high	sensitive to earth movement
Reflecting pipe (overmoded)	10-100 (or more depends on precision)	100MHz	5cm	low	high	performance very dependent on quality of surface
Cladded optical fibre (multi-mode)	20-100	10MHz	<1mm	excellent	low	low-loss glass required
Cladded optical fibre (single-mode)	20-100	more than 1GHz	<1mm	excellent	low	low-loss glass required

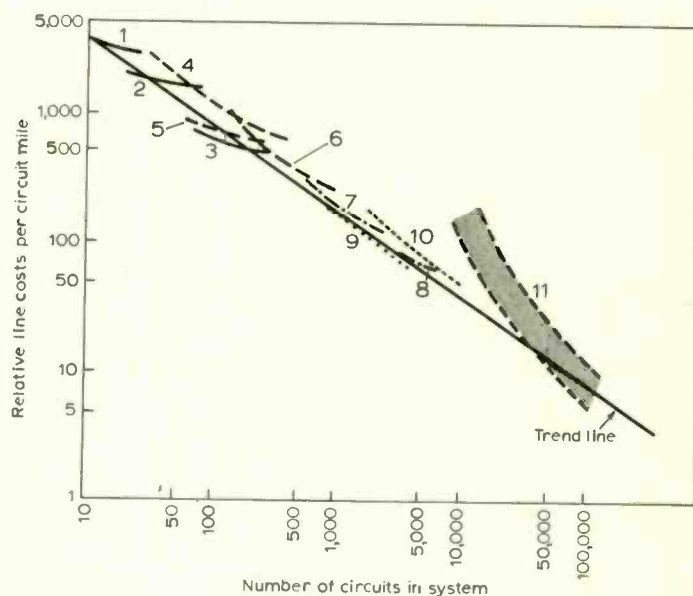

Fig. 2. Variation of relative line cost per circuit mile with the number of circuits in a system. Curves 1, 2, 3, types of open wire system; 4, 5, 6, cable systems; 7 and 8, coaxial cable systems; 9 and 10, microwave relay systems; and 11, circular waveguide. (Courtesy Professor A. E. Karbowiak.)

ambitious than the beam guiding system, which is being investigated by Bell Telephone Laboratories in the U.S.A., and there is a reasonable chance of achieving a practicable system by the mid-1970s. The cable system itself will be relatively cheap to produce and the installation costs using existing cable ducts will be relatively small. An obviously attractive type of source is a room-temperature injection laser but it seems unlikely that one can be developed to operate at the required pulse rate. A more reasonable possibility, or so it seems to the authors, would be to use the mode-locking technique (see Appendix) to produce a train of pulses from a laser⁸ which can then be deflection-modulated onto the core of the fibre to give a pulse-code-modulated signal. On the other hand it may be worthwhile trying to develop the three-terminal gallium arsenide device⁹ into a suitable modulator. Work on fibre-optic communications originated at Standard Telecommunication Laboratories and is being continued there and at the Post Office Research Station. The Signals Research & Development Establishment and the Department of Electronics, University of Southampton are collaborating in the development of a narrow-bandwidth glass fibre system for short distance links (see photo).

A comparison of various types of optical guiding structures is given in Table 2 while Fig. 2 shows how the cost per circuit mile has fallen with systems of increasing bandwidth. If this trend continues at optical frequencies then the prospect is a truly exciting one.

Holographic image recording

In conventional photography only information about the amplitude of light reflected from an object is recorded on a photographic plate and light from a point on the object is stored at a corresponding specific point on the recording plate. However by using the holographic technique in which both the object and the recording plate are illuminated with light from a coherent source such as a laser, and scattered light from the object is also allowed to fall on the plate, then an interference pattern is recorded which is characteristic of the object. Thus both amplitude and phase information is stored. A further consequence is that light from any point on the object is scattered and hence stored over the whole of the image plane, and therefore dust, blemishes or breakages do not render any of the stored information inaccessible. The original object or scene can be reproduced in true three dimensions by illuminating the recording plate with the same, or another, laser. The requirement on the laser radiation is that it must be coherent, which means in practice that the coherence length must be greater than (i) the depth of scene to be recorded and (ii) the path-length difference between laser-object-photographic plate and laser-photographic plate, i.e. between the object and reference beams.

There are several possible applications of this technique and one of the more interesting ones is in the optical storage of information. Accurately collimated light beams are now easy to produce and if they can be deflected with precision then one can envisage digital information stored on a photographic plate in the forms of ones and zeros represented by transparent and opaque areas, and a very high density of information storage is possible. High-speed deflection of a laser beam can be produced by the electro-optic or acousto-optic effects although it is to be hoped that development of improved materials will make the technique an easier one than it is at the present time. Nevertheless addressing rates of 10^6 per second can be achieved with existing technology. However a simple photographic store of this kind can be badly affected by dust and imperfections and an improved method¹⁰ is illustrated in Fig. 3.

Using a suitable deflector a laser beam is scanned to any one of an array of perhaps 100×100 small holograms in the storage plane. These are so oriented that each one produces a real image on an array of photodiodes which converts the optical signals into electrical ones. In the matrix each photodiode corresponds to one element of the image in which the presence or absence of light can correspond to a binary one or zero. An array of 100×100 diodes is

Fig. 3. Schematic diagram of a holographic memory system. (Courtesy American Telephone & Telegraph Co.).

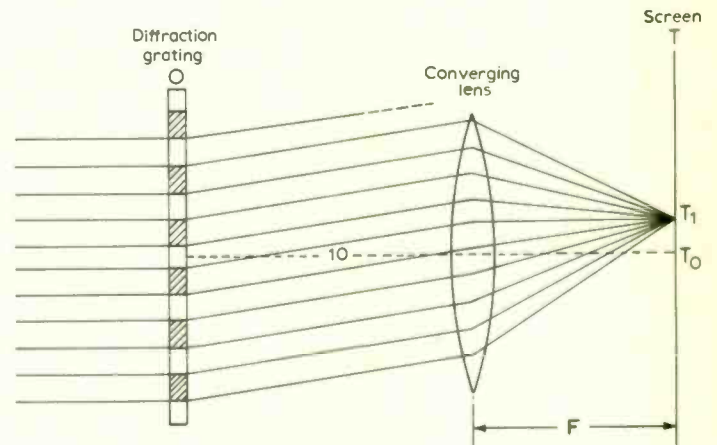
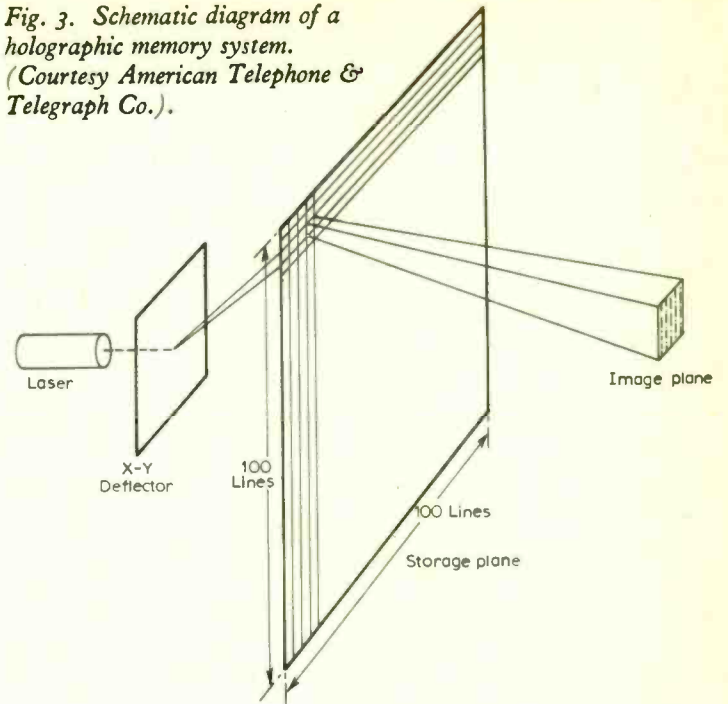

Fig. 4. Insertion of a diffraction grating in object plane O deflects the spot of light in plane T, which is at the focus of the lens, from T_0 to T_1 .

possible giving a store of 10^4 bits per hologram and a total capacity of 10^8 bits. With present-day technology an addressing rate in the storage plane of 10^6 hologram per second is probably just feasible but even with the easily achieved rate of $10^4 s^{-1}$ this method of 'page-storing' gives a net rate approaching 10^6 instructions per second.

Using the holographic technique the only effect of dust is to reduce the signal/noise ratio for all the bits in one hologram and the exact positioning of the holograms is not critical. The angular orientation of the hologram in the storage plane is important but the required precision of 0.1% is not difficult to achieve. The main difficulties lie in the preparation of holograms, although it appears possible to store 10^4 bits on each hologram and to contain the 10^4 holograms in a space $5\text{cm} \times 5\text{cm}$. Techniques for making photodiode arrays are being rapidly improved and a 100×100 array with associated read-out circuitry should soon be practicable. A semi-permanent memory of this kind, with high-speed random-access capability, could prove invaluable as a store for base programmes in the increasingly complex computers of the future.

Pattern recognition

Elementary optics shows that if a diffraction grating, which consists of an array of closely-spaced parallel slits, is illuminated by a

perpendicular coherent beam of light then the transmitted light is contained in a number of beams which are deflected through various angles. The angle of diffraction of the first-order beam is λ/s where λ is the wavelength of the light and s the spacing of the slits so that θ depends linearly on the reciprocal of the spacing or spatial frequency of the slits. If a converging lens, of focal length F , is placed in the deflected beam, as in Fig. 4, then a spot of light is focused on a screen at T_1 , distance F from the lens. With the diffraction grating removed the incident beam is brought to a focus at T_0 . In general with a grating of spatial frequency s_1^{-1} a spot of light is formed at T_1 which is at a distance $F\theta = (\lambda F/s_1)$ from T_0 . Thus the position of the spot T is a measure of the spatial frequency of the grating. Note that the position of the object transparency (the diffraction grating in the above example) is immaterial, the only requirement being that it must be perpendicular to the axis of the system. A similar argument applies in the transverse direction perpendicular to that of the paper and the result may be expressed mathematically by the theory of diffraction optics

$$E_2(x_2, y_2) = (i/\lambda F) \int E_1(x_1, y_1) \exp(2\pi i/\lambda F)(x_1 x_2 + y_1 y_2) dx dy$$

where $E(xy)$ is the two-dimensional, complex, electric field amplitude distribution in the transverse co-ordinates x, y and the suffixes 1 and 2 refer to the planes of the diffraction grating and screen respectively.

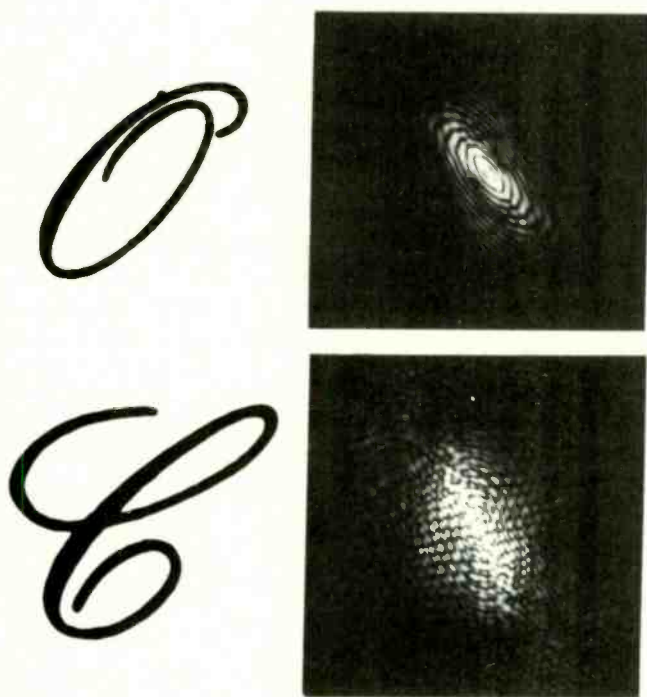

Fig. 5. Optical spatial transforms of two simple figures. (Courtesy A.W.R.E.)

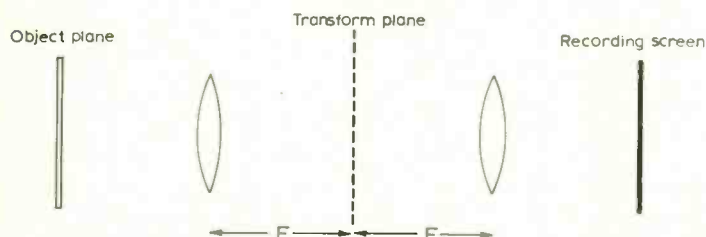

Fig. 6. The spatial Fourier transform of an object is produced in the plane shown by the central dotted line and the original object is reproduced from the Fourier components in the plane on the right. The transform plane is equidistant from two identical lenses of focal length F .

It can be seen that this equation is exactly analogous to that for the Fourier transform of a time-varying signal. Examples of the optical spatial transforms obtained with some simple shapes are shown in Fig. 5.

An optically spatially-varying signal (or pattern) can be synthesized from its spatial-frequency components simply by adding a second lens of focal length F at a distance F from the transform plane and by moving the recording screen to the position as shown in Fig. 6. The spatial Fourier transform of a transparency in the object plane is thus generated in the transform plane and the original object is reproduced in the recording plane. It is now possible to operate on the transform of the signal. For example if the object transparency lacks detail perhaps due to graininess (i.e. noise) an opaque disc placed on the longitudinal axis in the transform plane removes the low spatial frequency components and noise, thus accentuating the high-frequency components. Edge and lines in the reproduced image in the recording plane are thus made much clearer than in the original. The disc acts, in fact, as a high-pass filter. A low-pass filter consisting of an opaque sheet with a hole centred on the axis of the system removes high-frequency components and can be used, for instance, to remove wrinkles from the face of an aging actress. An opaque annular disc behaves as a band-pass filter.

The technique can be greatly extended¹¹ and it is possible to operate on data either in the transform or the image and object planes and effect multiplication, correlation, convolution, an improvement in signal/noise ratio, etc. Spatial processing has the great advantage over electrical methods of signal processing that large quantities of information can be processed in parallel. A typical application might be in the simultaneous processing of the signals from all the inputs of a multi-element aerial array.

If a transparency of a page of print is placed in the object plane then the spatial frequency distribution of each letter and word on the page is produced in the transform plane. Suppose now that a transform is made of the letter T and that a negative of the transform is placed in the transform plane. Then the only light passing through the transform negative, i.e. spatial filter, is that corresponding to the letter T. Thus the only images appearing in the recording plane will be those letters T in the page of print and thus we have a pattern recognition system. The method can be modified slightly to produce spots of light rather than specific letters and one example that has been demonstrated is filtering an integral sign from a page of mathematics. This is potentially a very useful tool in the field of pattern recognition, especially where complex patterns are involved, and one application which is being actively pursued is in the searching of fingerprint files which is at present a very tedious and time-consuming task.

Acknowledgements. The authors wish to make grateful acknowledgement to Professor A. E. Karbowiak of the University of New South Wales, Dr. F. M. Smits and Dr. L. E. Gallaher of the Bell Telephone Laboratories and Mr. C. D. Reid of the Atomic Weapons Research Establishment for permission to reproduce figures as indicated in the captions.

Appendix

Basic properties of lasers

In Fig. 7, a population inversion is maintained between two energy levels of the appropriate separation in a laser amplifying medium and the medium is placed in a resonant cavity consisting of two mirrors. If the cavity has a resonance at the frequency at which the active medium behaves as an amplifier, and if the round-trip gain exceeds the total loss, then an output may be obtained if one of the mirrors, M_2 in Fig. 7, partially transmits. Ideally the output is coherent, i.e. it consists of a single-frequency component having a phase front which is coherent in both space and time. The intensity variation across the wavefront is Gaussian and the spreading angle θ of the beam is limited only by diffraction to a value $\theta \approx \lambda/D$ where λ is the wavelength and D the spot diameter at

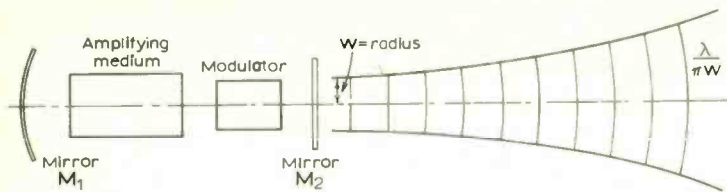

Fig. 7. Schematic diagram of laser with mirrors M_1 , M_2 between which are placed amplifying medium and modulator. Output beam is of radius W at M_2 and has beam spread angle of $\lambda/\pi W$.

the output mirror. In practice many factors operate to degrade the output.

Firstly the gain curve of the active material may embrace many cavity resonances so that if, as is usually the case, there is no coupling between the various frequency components of the fluorescence line then multi-mode operation occurs. Secondly the active material, particularly in solid-state and liquid lasers, may be spatially inhomogeneous, resulting in a distortion of the wavefront. Thirdly, in most optically-pumped lasers the rate of stimulated emission is greater than the rate at which energy can be supplied so that operation is intermittent and relaxation oscillations occur. In addition there may be imperfections in the mirrors and windows, non-uniform pumping and so on.

Nevertheless surprisingly good results may be obtained. For example the dominant transverse mode of the cavity can be selected by suitable resonator design or by using an aperture, and by replacing a single mirror with a two-mirror reflector all the available energy may be channelled into a single axial mode. Components can now be made to a high degree of excellence and by stabilising the frequency¹³ using solid mountings and perhaps servo-control of the resonator length, gas lasers can produce remarkably pure outputs. A line-width of only a few hertz has been measured and coherence lengths of hundreds of metres are typical. Beam spreads are close to the limit set by diffraction and the ideal coherent beam is approached quite closely.

In solid-state lasers using good quality material inhomogeneity is mainly due to heating because of the high pumping energies normally used but by carefully shaping the laser rod, and with a well-designed resonator, thermal effects can be effectively cancelled out¹⁴. The high rate at which stimulated emission occurs in solid-state, optically-pumped lasers, which usually prevents satisfactory continuous operation, can be used to produce short, high-power pulses by suitable internal modulation. In what is called Q-switching the cavity Q is made low during the pumping period by reducing the effective reflectivity of one of the mirrors. Then when a large population inversion has been produced the reflectivity is suddenly restored and a pulse lasting for about 20ns results at power levels up to 1GW¹⁵.

A second technique is that of mode locking¹⁶ and it may be applied to any kind of multi-mode laser. Briefly, the phases of the various resonator modes can be locked together so that the output consists of a continuous train of ultra-short pulses. The process is a kind of inverse Fourier analysis in which the various frequency components are generated and then locked in the appropriate phase to give a time-domain picture of a pulse train. For typical solid-state lasers the pulse width is approximately 10^{-12} s so that a new dimension of time scale has been introduced into electronics, and completely novel techniques must be used for measuring pulse lengths as short as this. Such a wave train contains only about 500 cycles of oscillation and occupies a length of only a few tenths of a millimetre. Power levels of 10^{12} W have been produced although the total energy is not large of course. By a combination of Q-switching and mode locking¹⁷, single pulses of this type, and of higher power and energy, can be obtained. Under the high coherent optical fields available from lasers many optical materials become non-linear in response¹⁸. Second (and higher)-harmonic generation of laser light is a well-established technique which can

be carried out at high efficiency and only recently (July 1968) the radiation of a neodymium laser at $10,600\text{\AA}$ has been doubled in frequency to $5,300\text{\AA}$ with 100% efficiency¹⁹. This is a remarkable result. Furthermore recent work on parametric interactions has produced optical amplifiers and oscillators which can be tuned²⁰ over ranges of an octave or more. At present the technique is not an easy one but further developments may be expected in the near future. Recent results with dye lasers have shown that they too can be tuned²¹, over a wavelength range of several hundred angstrom units, at quite high power levels.

REFERENCES

1. "The laser" by A. Yariv and J. P. Gordon. *Proc.IEEE*, vol. 51, 1963, p. 4.
2. "Electronic signal amplification in the u.h.f. range with the ultrasonic travelling wave amplifier" by John E. May. *Proc.IEEE*, vol. 53, 1965, p. 1465.
3. "Closing the frequency gap—some recent developments in submillimetre-wave generation" by W. A. Gambling. *Jnl.IEE*, vol. 13, 1967, p. 413.
4. "Optical transmission research", by S. E. Miller and L. C. Tillotson. *Proc.IEE*, vol. 54, 1966, p. 1300. "Optical communications systems—a survey" by J. Lytolis. *Optics Technology*, vol. 1, 1968, p. 1.
5. "Some aspects of beam waveguides for long-distance transmissions at optical frequencies" by G. Goubau and J. R. Christian. *IEEE Trans. Microwave Theory and Devices*, vol. MTT-12, 1964, p. 212.
6. "Gas mixture lens measurements" by A. C. Beck. *Bell System Technical Journal*, vol. 43, 1964, p. 1821.
7. "Dielectric-fibre surface waveguides for optical frequencies" by K. C. Kao and G. A. Hockham. *Proc.IEE*, vol. 113, 1966, p. 1151.
8. "Terminals for a high-speed optical pulse code modulation system" by R. T. Denton and T. S. Kinsel. *Proc.IEEE*, vol. 56, 1968, p. 140. Unpublished report by W. A. Gambling.
9. "Three-terminal GaAs light emitter-modulator device" by F. P. Califano and M. C. Steele. *Electronics Letters*, vol. 4, 1968, p. 411.
10. "Design considerations for a semipermanent optical memory" by F. M. Smits and L. E. Gallaher. *Bell System Technical Journal*, vol. 46, 1967, p. 1267.
11. "Optical and electro-optical processing of information" by J. T. Tippett et al. (Editors), 1965. "A review of optical data-processing techniques" by A. Vander Lugt. *Optica Acta*, vol. 15, 1968, p. 1.
12. "Optical processing of information" by D. K. Pollack et al. 1963.
13. "Frequency stabilization of gas lasers" by A. D. White. *IEEE Journal Quantum Electronics*, vol. QE-1, 1965, p. 349.
14. "Laser brightness gain and mode control by compensation for thermal distortion" by C. Martin Stickley. *IEEE Journal Quantum Electronics*, vol. QE-2, 1966, p. 511.
15. "Q modulation of lasers" by R. W. Hellwarth. *Advances in lasers*, vol. 1, 1966, p. 253.
16. "Ultrashort light pulses" by A. J. DeMaria, D. A. Stretser and W. H. Glenn. *Science*, 1967, p. 1557.
17. "Laser cavity dumping using time variable reflection" by W. R. Hook, R. H. Dishington and R. P. Hilberg. *Appl.Phys. Letters*, vol. 9, 1966, p. 125.
18. "Non-linear optics and problems of coherent radiation frequency conversion" by S. A. Akhmanov and R. V. Khokhlov. *Radio Engineering and Electronic Physics*, vol. 12, 1967, p. 1895.
19. "Continuous 0.532μ solid-state source using $\text{Ba}_2\text{NaNb}_5\text{O}_{15}$ " by J. E. Geusic, H. J. Levinstein, S. Singh, R. G. Smith and L. G. Van Uitert. *Appl.Phys.Letters*, vol. 9, 1968, p. 306.
20. "Continuous optical parametric oscillation in $\text{Ba}_2\text{NaNb}_5\text{O}_{15}$ " by R. G. Smith, J. E. Geusic, H. J. Levinstein, J. J. Rubin, S. Singh and L. G. Van Uitert. *Appl.Phys.Letters*, vol. 12, 1968, p. 308. "Optical parametric oscillation in the visible spectrum" by J. A. Giordmaine and R. C. Miller. *Appl.Phys.Letters*, vol. 9, 1966, p. 298.
21. "Continuously tunable narrow-band organic dye lasers" by B. H. Soffer and B. B. McFarland. *Appl.Phys.Letters*, vol. 10, 1967, p. 266.

Wireless World Logic Display Aid

4: Character positioning. Forming the output variables

designed by B. S. Crank*

Last month, amongst other things, we saw how the characters could be formed within the sub-matrices and it was mentioned that the character generators operated under the control of two signals, called W_0 and W_1 . It is worth while re-iterating at this point that during the course of construction the battery power supplies will have to be replaced with suitable bench power supplies as the amount of current taken from the 4.5V supply is considerable.

Forming the W_1 and W_0 signals

The W_0 and W_1 signals, as we have seen, control the character generators and determine when an 0 and when a 1 is to be written on the tube face. We can deduce, from what has gone before, that these signals are only used during the Karnaugh and Truth modes of operation.

For the Karnaugh map the derivation of the W_0 and W_1 signals is simplicity itself as they rely entirely on the mysterious variable Z introduced earlier. All that need be said is when Z is true a 1 is required on the map and when \bar{Z} is true an 0 is required. The Karnaugh mode is

*Assistant Editor, *Wireless World*.

T_{AB}	T_C	T_R	T_{AB}	T_C	T_R	T_{AB}	T_C	T_R
0	0	?	0	0	?	0	0	1
1	0	?	1	0	?	1	0	1
1	1	?	1	1	?	1	1	1
0	1	?	0	1	?	0	1	1

(a) (b) (c)

Fig. 49 Truth table presentation

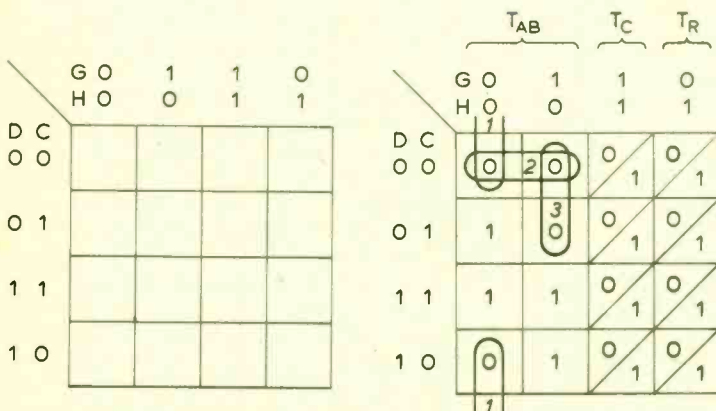

(left) Fig. 50 The sub-matrices form a Karnaugh map
(right) Fig. 51 Deriving the expression for W_0

represented in equations by the letter K. The W_0, W_1 , equations for the Karnaugh mode are therefore:

$$W_0 = K \bar{Z} \tag{7}$$

$$W_1 = K Z \tag{8}$$

The situation for Truth table presentation is rather more complex. A Truth table is divided into four separate columns. One column each for the variables A, B, C and one column for the result. In this article, for signal generation purposes, columns A and B are treated as a single entity and are represented by the symbol T_{AB} . In a similar way T_C represents the C variable column and T_R represents the result column.

The method of displaying a Truth table in this instrument is shown in Fig. 49. The first table (a) is for a two variable function only, (b) is for a three variable function where $C = 0$ and (c) is as (b) when $C = 1$. Some facts immediately come to light on examining these tables: T_{AB} never alters, T_C can either be nothing at all or all 0s or all 1s as dictated by the logic function being illustrated.

We now know what the requirements are, but how can signals be obtained to put all the characters in their proper places?

Examine Fig. 50 in conjunction with Fig. 42. Each square in Fig. 50 represents one of the sub-matrices and if looked at in terms of the variables C, D, H and G it can be seen that the whole thing forms yet another Karnaugh map. Clearly each sub-matrix can be individually addressed in terms of C, D, H and G so that these variables can be used to derive the W_0 and W_1 signals for Truth table display.

Firstly we will derive the expression for positioning the 0s in columns T_{AB} . The Karnaugh map for this is shown in Fig. 51. The 0s in T_{AB} have been ringed because it is the position of these that we require. Proceeding with the simplification in the normal way:

loop 1: $\bar{C} \bar{D} \bar{G} \bar{H}$
 $\bar{C} \bar{D} \bar{G} \bar{H} = \bar{C} \bar{G} \bar{H}$

loop 2: $\bar{C} \bar{D} G \bar{H}$
 $\bar{C} \bar{D} G \bar{H} = \bar{C} \bar{D} \bar{H}$

loop 3: $\bar{C} D G \bar{H}$
 $C \bar{D} G \bar{H} = \bar{D} G \bar{H}$

therefore:

$$W_0 (T_{AB}) = \bar{C} \bar{G} \bar{H} + \bar{C} \bar{D} \bar{H} + \bar{D} G \bar{H} \\ = \bar{H} (\bar{C} \bar{G} + \bar{C} \bar{D} + \bar{D} G) \tag{9}$$

What is displayed in column T_C depends on the position of a panel mounted switch. By inspection of Fig. 51 it can be seen that column T_C can be defined by $\overline{G H}$. For the time being it will be stated that when $\overline{G H}$ exists 1s have to be written in T_C and when $\overline{G H}$ exists 0s have to be written in T_C . For the record:

$$W_0 (T_C) = \overline{G H} \tag{10}$$

Turning to column T_R . The as yet unexplained variable Z decides whether a 1 or an 0 is to be displayed in any particular position in column T_R . T_R itself can be defined, by inspection of Fig. 51, as $\overline{Z G H}$. Therefore:

$$W_0 (T_R) = \overline{Z G H} \tag{11}$$

The complete W_0 equation can now be assembled from equations (7), (9), (10) and (11):

$$W_0 = T[\overline{H}(\overline{C D} + \overline{C G} + \overline{D G}) + \overline{G H} + \overline{Z G H}] + K \overline{Z} \tag{12}$$

Notice that the Truth table (T) control signal has been introduced into this equation.

It can be shown, using exactly the same methods as above, that the equations for W_1 are as follows (their derivation being left as an exercise for the reader):

$$W_1 (T_{AB}) = \overline{H} (C D + C \overline{G} + D G) \tag{13}$$

$$W_1 (T_C) = "G H" \tag{14}$$

$$W_1 (T_R) = Z \overline{G H} \tag{15}$$

therefore:

$$W_1 = T[\overline{H}(C D + C \overline{G} + D G) + "G H" + Z \overline{G H}] + K Z \tag{16}$$

The circuit that will produce the discussed W_0 and W_1 functions is shown in Fig. 52 and may now be constructed on board five. The following points regarding this circuit are brought to the reader's attention. The circuit does not produce either the Karnaugh or the T_C terms of the W_0 and W_1 equations. These are produced as another board and fed in on P17/B5 and P18/B5 (see Fig. 46).

The wiring on this board is a little tricky because of the large number of wires; however, as long as great care is taken, no real trouble should be experienced. Some of the board socket pins have been duplicated to avoid having many crossing wires confusing the drawing. As before the white letters in black circles refer to the equations above. After the board wiring has been completed the inter-socket wiring is carried out as indicated.

Testing the W_0 and W_1 generating circuits.

Temporarily connect P16/B5 to P17/B5 (coupling the W_0 signal to the 0 character generator) and P18/B5 to P19/B5 (coupling the W_1 signal to the 1 character generator). Also connect a length of wire to P15/B5; this could be terminated in a crocodile clip, the other end of which is attached to the 0V line (simulating \overline{Z}).

Switch everything on. Columns T_{AB} should display the pattern of 0s and 1s shown in Fig. 51. Column T_C should remain blank and column T_R should contain all 0s. Disconnect the lead to P15/B5 from earth (simulating Z). Column T_R should now contain all 1s. This test assumed that the probe had not been disconnected from P23/B5.

Again, in the event of trouble, use the probe to trace

back through the circuit. There is so much wiring to be done in this instrument that the constructor can really congratulate himself if he gets through it without a mistake; the writer didn't! A wiring mistake can give very peculiar results, or, of course, nothing at all. Leave all temporary connections as they stand as the same wiring will be required for tests after the next stage in the construction.

Adding the T_C signal

The circuit for providing the T_C part of the W_0 and W_1 equations is shown in Fig. 53 and is built on board six. A single-pole three-way test-switch is used to select all 0s, all 1s or nothing at all for column T_C . The reason for placing the $\overline{G H}$ and $\overline{G H}$ terms in earlier equations in inverted commas can now be seen as in reality they are not strictly correct. T_C functions are provided by switching $\overline{G H}$ between the 1 and 0 character generators.

After all necessary wiring has been done the circuit should be checked. This is done using the same test circuit as before and ensuring that the switch will produce all 1s, all 0s or nothing in column T_C .

Disconnect the temporary links between P16/B5 and P17/B5, and P18/B5 and P19/B5, leave the rest of the circuit as it is.

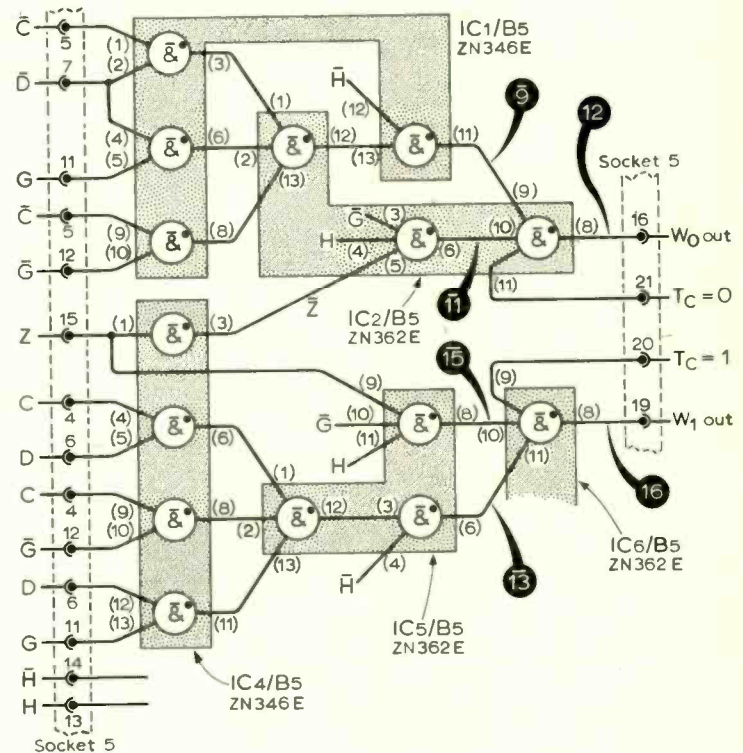

Fig. 52 The circuit for obtaining the Truth table part of the W_0 equation

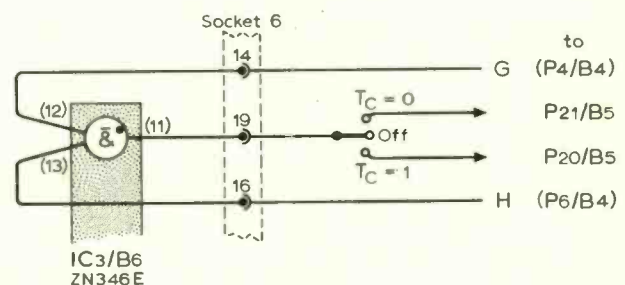

Fig. 53 The circuit for addressing column T_C

Adding control signals

The next stage is to add the missing Karnaugh term to the W_0 and W_1 equations and the Venn term to the video equation. At the same time the V, K and Z control signals are added.

The additional circuits are shown in Fig. 54. The W_0 out signal from board five is only the Truth table sec-

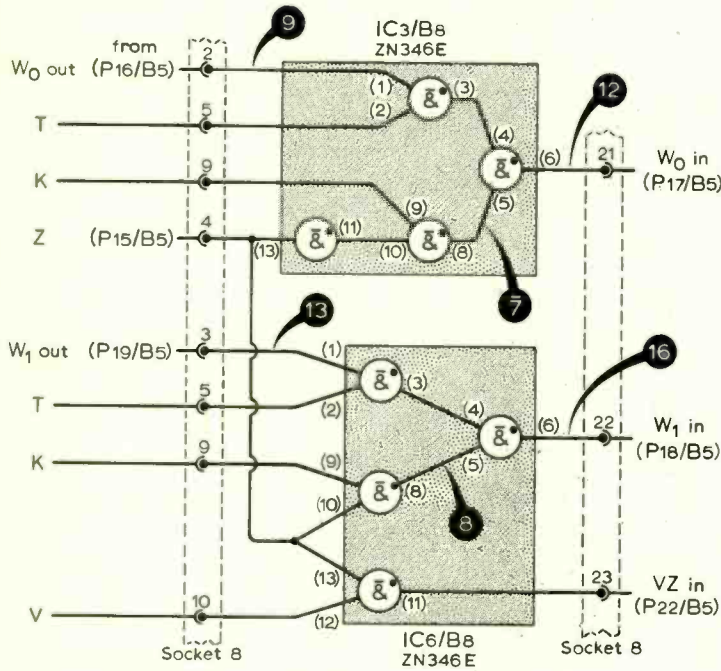
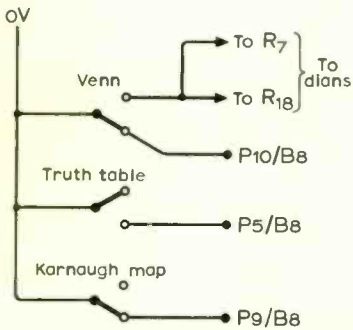
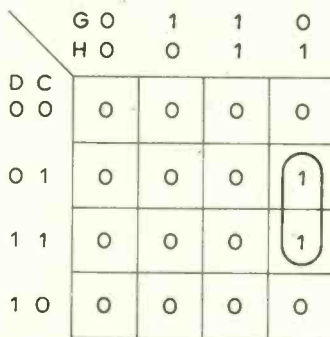

Fig. 54 Adding the control signals



(left) Fig. 55 Control signal switching



(right) Fig. 57 Deriving the expression for A_T

tion of the W_0 equation so this is gated with the Truth table control signal T. This is OR gated with $K \bar{Z}$ (equation (7)) to form the complete write 0 equation (W_0 in) at P21/B6. In the same way the Karnaugh term $K Z$ (equation (8)) and the Truth table and Karnaugh control signals are combined to form the composite W_1 signal available at P22/B6. The V Z term from the video equation is also produced in this circuit and is available at P23/B8.

To test this circuit three single-pole change-over switches are required to provide the control signals. One of these switches also performs the function of the Venn switch that has been used in the circuit so far. The switching circuit is shown in Fig. 55. With the switches in the positions shown the instrument would be operating in the Truth table mode because the K and V signals are at earth potential. Note that one switch controls the dians as well as producing the V control signal.

Complete the wiring shown and when interconnecting P15/B5 with P4/B8 (Z) provide a flying lead terminated in a crocodile clip to either of these pins. Connect the clip to 0V. Place the control switches in the positions shown in Fig. 55 and switch-on the various power supplies.

A Truth table should be displayed with the T_R column displaying all 0s. Disconnect the crocodile clip from earth; the T_R column should now contain all 1s; reconnect the clip to 0V. Check the operation of the switch controlling column T_C and ensure that this operates as before. Operate the Truth table control switch to connect T to earth and open the Karnaugh switch. A pattern of sixteen 0s should be displayed. Disconnect the crocodile clip from 0V and now the display should contain all 1s. At this stage there is no point in operating the Venn switch as the Venn circuits are still incomplete.

It can now be seen that the whole nature of the display hinges on the presence or absence of the as yet unexplained signal Z.

Most readers who have followed this series of articles carefully will have deduced where Z comes from. Fig. 56 tells the story. The signal Z is the output of the external logic to be displayed which can be any logic circuit or even a single gate. The inputs to the external logic circuit are the output variables of the display aid which are called A_0, B_0, C_0 and D_0 .

In the Karnaugh mode the Karnaugh variables, designated A_K, B_K, C_K and D_K , are decoded from the code converter outputs and become the output variables (A_0, B_0, C_0 and D_0) under the influence of the control signal K. In the same way the Truth table variables, A_T, B_T and C_T , and the Venn variables A_V, B_V and C_V are decoded from the code converter outputs and used as output variables under control of the T and V control signals.

With this knowledge we can write the equations for the output variables:

$$A_0 = KA_K + TA_T + VA_V \tag{17}$$

$$B_0 = KB_K + TB_T + VB_V \tag{18}$$

$$C_0 = KC_K + TC_T + VC_V \tag{19}$$

$$D_0 = D_K \tag{20}$$

Forming A_0

Referring to Fig. 10(a) it can be seen that the area occupied by A_K is a horizontal section across the centre of the map. Examining Fig. 42 will show that this area of the map can be addressed by C. C is true for this whole area and is not true for all other areas, therefore:

$$A_K = C \tag{21}$$

This can be demonstrated on the circuits that have been

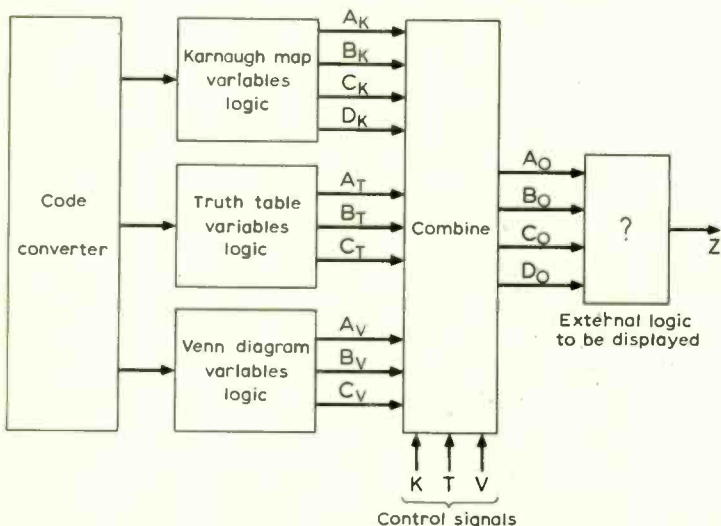

Fig. 56 Showing how the output variables are formed

constructed so far. With the instrument in the Karnaugh mode the flying lead that was connected last month to P15/B5 and P4/B8 can be connected to the code converter output C on P4/B3. Under these conditions the first horizontal row of the map should contain all 0s, the next two rows should contain all 1s and the last row should contain all 0s. The 1s show the area of the map where A_K is true. Disconnecting the flying lead from C and reconnecting it to \bar{C} on P3/B3 will reverse all 0s and 1s on the display showing the area where \bar{A}_K exists, because $\bar{C} = \bar{A}_K$.

No additional logic was required for form A_K , this applies to all the Karnaugh variables. This is to be expected as our matrix-raster is really Karnaugh map.

The next term in the A_O equation (17) is the Truth table variable A (A_T). It will be recalled, in fact it can be demonstrated on the circuits built so far by switching to the Truth table mode, that the display in the first three columns; T_A, T_B and T_C ; is fixed and that we only require the variable Z in the result or T_R column. Because of this it is only necessary to allocate areas for the variables in the T_R column. It should be remembered also that the T_R column was addressed by $\bar{G}H$, a fact that can be verified by examining Fig. 51. It would also be true to say that A_T exists in T_R in any position that corresponds to a 1 in T_A . A Karnaugh map for the solution of A_T is shown in Fig. 57. The 1s are placed in the same position in column T_R as the 1s appear in column T_A of the Truth table; compare Figs. 51 and 57 to see this.

As the two 1s fall in adjacent squares the terms can be combined to give:

$$A_T = C\bar{G}H \tag{22}$$

The most difficult variables to produce are those for the Venn diagram. The position of A_V on the matrix raster is shown in Fig. 58. Various areas of this circle have been looped so that the expressions can be derived in a similar manner to that of a Karnaugh map. Because the output of the code converter was only given a unit distance property over pairs of outputs, in Fig. 58, adjacent 1s will not necessarily combine.

Taking loop 1 first. In the Y axis it can be seen that this corresponds to CD and in the X axis to G. Therefore:

$$A_V(\text{loop 1}) = C\bar{D}G \tag{23}$$

Loop 2 is in two sections with a common X address but with separate Y addresses. In the X axis four terms are involved:

- $EFG\bar{H}$
- $\bar{E}FG\bar{H}$
- $\bar{E}\bar{F}GH$
- $E\bar{F}GH$

These four terms can be combined in pairs as each pair only differs by one variable, these are shown looped in Fig. 58. In the X direction then:

$$A_V(\text{loop 2. X}) = FG\bar{H} + \bar{F}GH$$

The Y terms, for loop 2, again there are four of them, can be combined in pairs in the same way to give:

$$A_V(\text{loop 2. Y}) = \bar{B}\bar{C}\bar{D} + \bar{B}CD$$

The composite equation for loop 2 can now be written as the AND of the X and Y terms in the normal way:

$$A_V(\text{loop 2}) = (\bar{B}\bar{C}\bar{D} + \bar{B}CD)(FG\bar{H} + \bar{F}GH) \tag{24}$$

Loop 3 encompasses four points in the matrix-raster which can be addressed by two Y terms and two X terms, no simplification is possible. Therefore:

$$A_V(\text{loop 3}) = (\bar{A}\bar{B}\bar{C}\bar{D} + \bar{A}\bar{B}CD)(E\bar{F}GH + EFGH) \tag{25}$$

The complete solution for A_V is the OR of the terms for the three loops, i.e. (23) + (24) + (25):

$$A_V = C\bar{D}G + (\bar{B}\bar{C}\bar{D} + \bar{B}CD)(FG\bar{H} + \bar{F}GH) + (\bar{A}\bar{B}\bar{C}\bar{D} + \bar{A}\bar{B}CD)(E\bar{F}GH + EFGH) \tag{26}$$

We now have enough information to form the complete equation for A_O . This is done by substituting equations (21), (22) and (26) into the A_O equation (17):

$$A_O = KC + TC\bar{G}H + V[C\bar{D}G + (\bar{B}\bar{C}\bar{D} + \bar{B}CD)(FG\bar{H} + \bar{F}GH) + (\bar{A}\bar{B}\bar{C}\bar{D} + \bar{A}\bar{B}CD)(E\bar{F}GH + EFGH)] \tag{27}$$

Forming B_O

The explanation for forming A_O applies equally to B_O only the equations are different. For the Karnaugh variable B_K compare Figs. 10(b) and 42. From this it can be seen that:

$$B_K = D \tag{28}$$

For the Truth table, B_T , the area covered in T_R corresponds to the positions of the 1s in T_B . Examination of Fig. 51 will show that:

$$B_T = DGH \tag{29}$$

The position of Venn circle B on the matrix raster is shown in Fig. 59. The whole section through the centre of

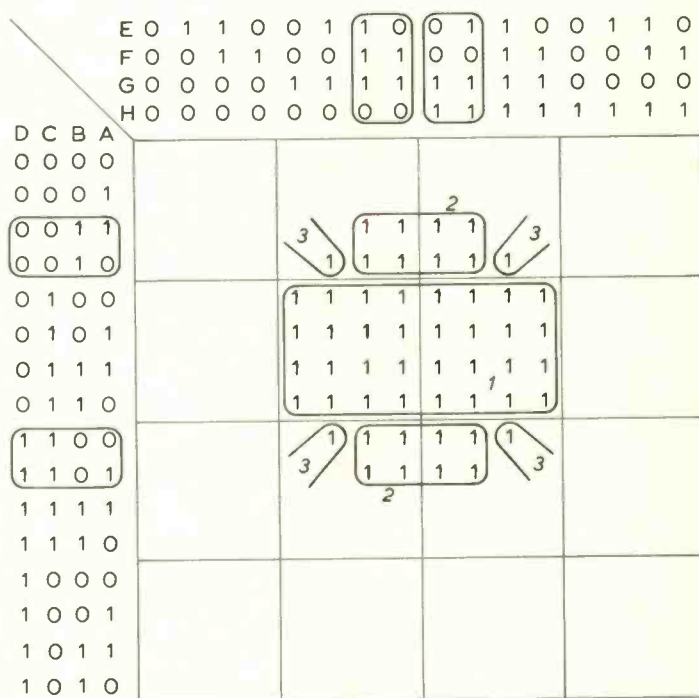

Fig. 58 Deriving the expression for A_V

this circle (loops 1 and 2) is covered by a single Y address. The X address of loops 1 and 2 can be combined into three terms as shown in Fig. 59:

$$B_V(\text{loops 1 and 2, Y}) = CD$$

and:

$$B_V(\text{loops 1 and 2, X}) = \overline{FGH} + \overline{GH} + \overline{FGH} \quad (30)$$

Loop 3, which has two parts, is covered by a single X address and a two Y addresses, as follows:

$$B_V(\text{loop 3}) = \overline{GH}(\overline{BCD} + \overline{BCD}) \quad (31)$$

The remaining loop, 4, requires two Y terms and two X terms:

$$B_V(\text{loop 4}) = (\overline{ABCD} + \overline{ABCD})(\overline{EFGH} + \overline{EFGH}) \quad (32)$$

The complete B_V equation is formed by the OR of the four loops:

$$B_V = CD(\overline{FGH} + \overline{FGH}) + \overline{GH}(\overline{BCD} + \overline{BCD} + CD) + (\overline{ABCD} + \overline{ABCD})(\overline{EFGH} + \overline{EFGH}) \quad (33)$$

The final equation for B_0 becomes:

$$B_0 = KD + TD\overline{GH} + V[CD(\overline{FGH} + \overline{FGH}) + \overline{GH}(\overline{BCD} + \overline{BCD} + CD) + (\overline{ABCD} + \overline{ABCD})(\overline{EFGH} + \overline{EFGH})] \quad (34)$$

Forming C_0 and D_0

The output variable C_0 is formed in exactly the same way and it can be shown that:

$$C_K = G \quad (35)$$

$$C_T = \overline{GH} \quad (36)$$

and that (referring to Fig. 60):

$$C_V(\text{loops 1 and 2}) = CD(\overline{FGH} + \overline{GH} + \overline{FGH}) \quad (37)$$

$$C_V(\text{loop 3}) = \overline{GH}(\overline{BCD} + \overline{BCD}) \quad (38)$$

$$C_V(\text{loop 4}) = (\overline{ABCD} + \overline{ABCD})(\overline{EFGH} + \overline{EFGH}) \quad (39)$$

therefore:

$$C_V = CD(\overline{FGH} + \overline{FGH}) + \overline{GH}(\overline{BCD} + \overline{BCD} + CD) + (\overline{ABCD} + \overline{ABCD})(\overline{EFGH} + \overline{EFGH}) \quad (40)$$

The final C_0 equation becomes:

$$C_0 = KG + T\overline{GH} + V[CD(\overline{FGH} + \overline{GH} + \overline{FGH}) + \overline{GH}(\overline{BCD} + \overline{BCD}) + (\overline{ABCD} + \overline{ABCD})(\overline{EFGH} + \overline{EFGH})] \quad (41)$$

It is important to note that the Y terms in the B_V equation are identical to those in the C_V equation—a fact that is made use of in the circuit design.

Finally by inspection of Figs. 10(d) and 42 it can be shown that:

$$D_0 = D_K = H \quad (42)$$

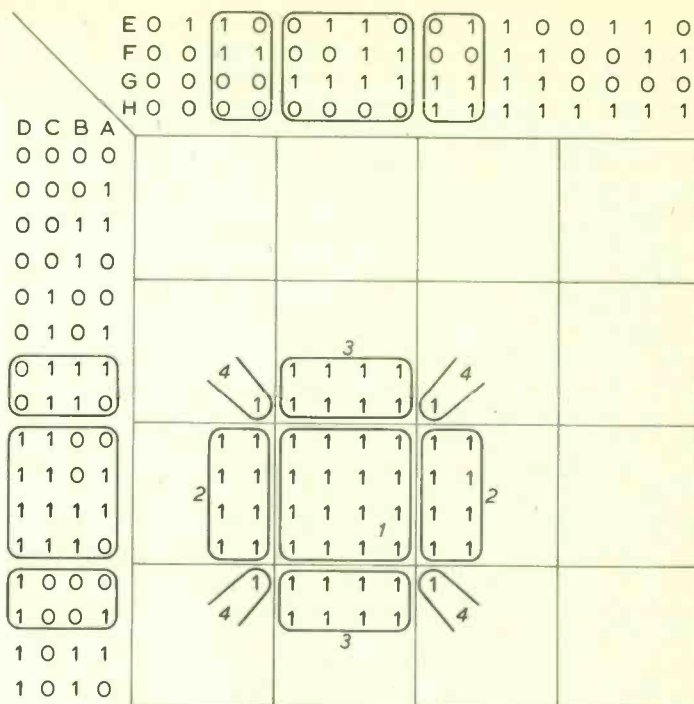

Fig. 59 Deriving the expression for B_V

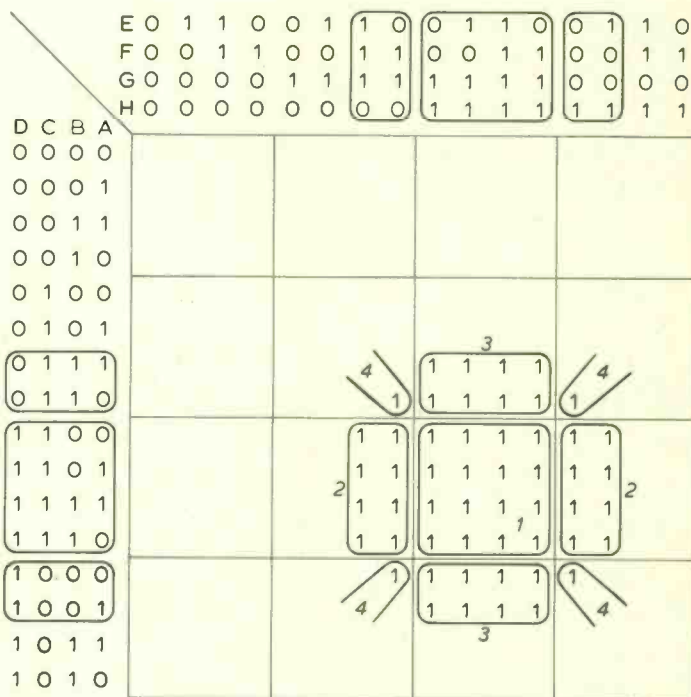

Fig. 60 Deriving the expression for C_V

Figs. 61, 62, 63 and 64 show the logic diagrams for forming the Truth table and Venn output variables which may now be built on the boards indicated and the appropriate inter-board wiring can be carried out. The Karnaugh variables are, of course, direct connections to the code and converter and are not made at this stage.

Next month: Testing the variable forming circuits; more control logic.

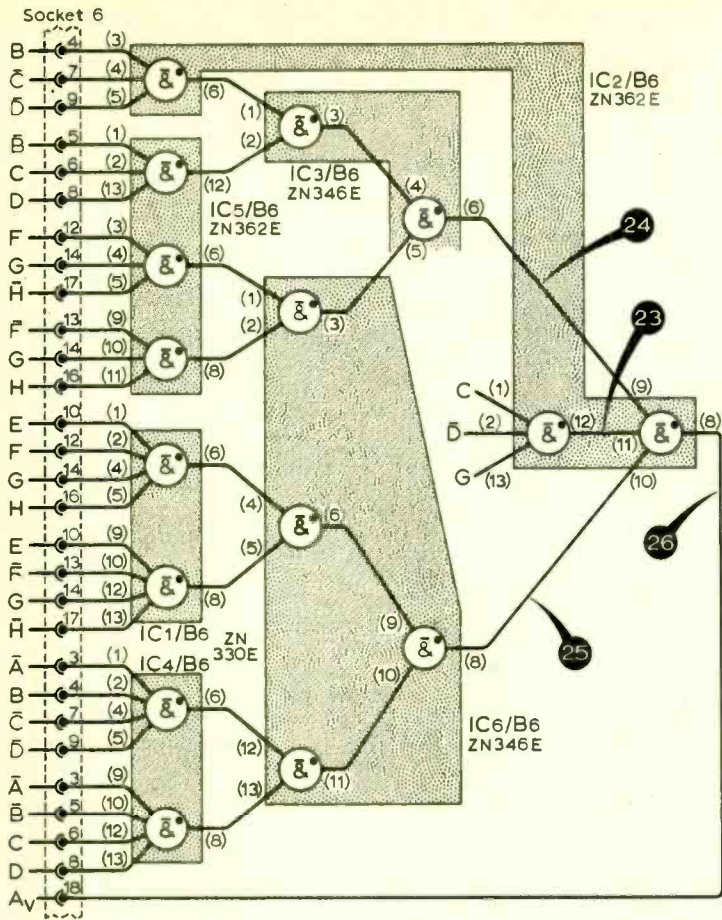

Fig. 61 The circuit to produce A_V

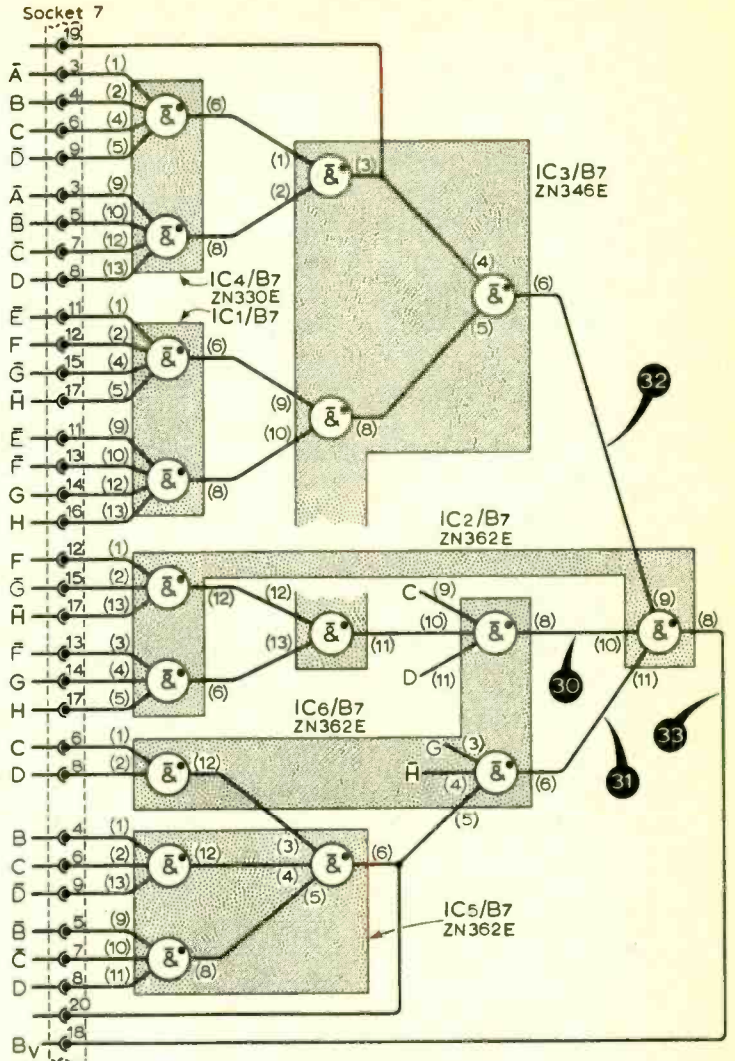

Fig. 62 The circuit which produces B_V

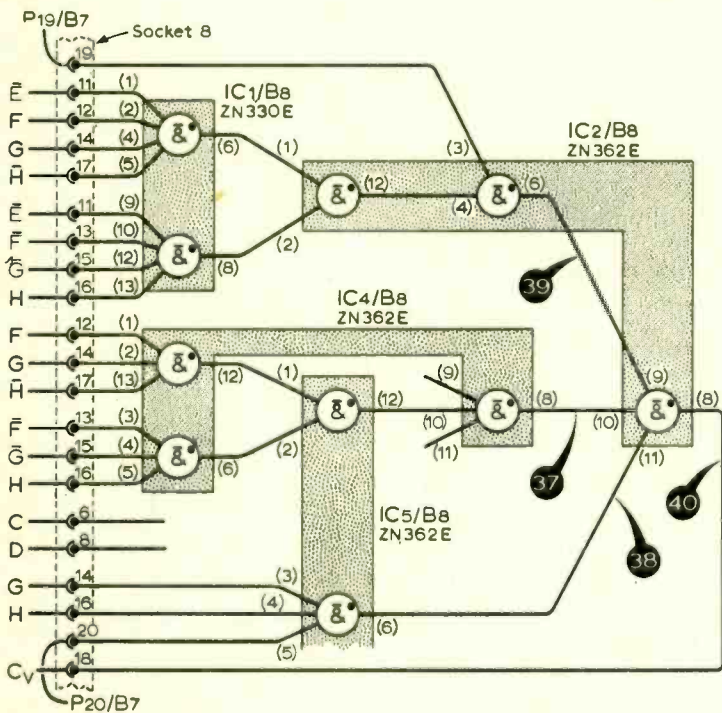

Fig. 63 The circuit which produces C_V

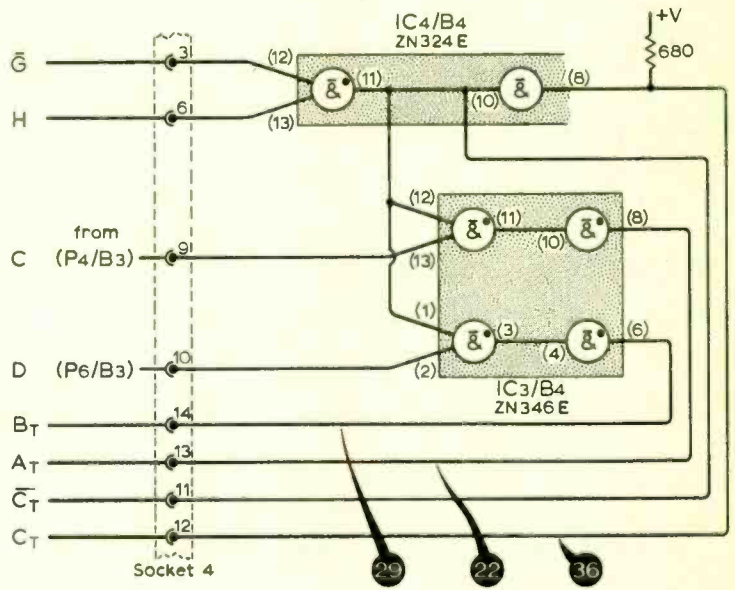

Fig. 64 The circuit necessary to form the Truth table variables

Personalities

Colin H. L. Goodman, M.A., B.Sc., F.Inst.P., has been appointed visiting professor in physics at Chelsea College of Science and Technology, University of London. Mr. Goodman, who is 42, has been with Standard Telecommunications Laboratories, Harlow, Essex, since 1960 and is head of the Materials



C. H. L. Goodman

Synthesis Department. He also acts as a general consultant to the laboratories on problems connected with electronic materials. The aim of the appointment, the first of its kind from S.T.L., is to bring industrial experience to university affairs in general. As well as lecturing in his specialist subject—the preparation and physical properties of materials used in electronics—Professor Goodman will also supervise some of the post-graduate work and act in an industrial advisory capacity.

Eric Willis-Jones, B.Sc. (Eng.), M.I.E.E., chairman of Thorn Automation Ltd, has been elected chairman of the B.E.A.M.A. Industrial Control and Electronics Board. Mr. Willis-Jones received his initial training with the Metropolitan-Vickers Electrical Company and, after various appointments with A.E.I., became managing director of G.E.C.-A.E.I. Control and Rectifiers. He joined the Thorn Group in August last year and is also deputy chairman and managing director of Avo Ltd., and Taylor Electrical Instruments Ltd., both of which are in the Thorn Group.

Robin Davies, M.A., of the B.B.C. Research Department, inventor of the field-store television standards converter, has been nominated to receive the S. G. Brown award and medal for 1969. The award is given annually by the Royal Society (jointly with the Institutions of Civil, Electrical and Mechanical Engineers). Mr. Davies, who is 34 and a graduate of Merton College, Oxford, has been with the B.B.C. since 1958 having previously spent two years with Decca Radar. He recently received the Pye travelling scholarship, worth 1000 guineas, plus a trophy "for the most significant technical contribution during the year to the development of colour television". He described the standards converter in our January 1969 issue.

R. A. Smith, C.B.E., F.R.S., principal and vice-chancellor of Heriot-Watt University, Edinburgh, has accepted an invitation to join the board of Hewlett-Packard Ltd as a part-time director. Dr. Smith graduated at Edinburgh University in 1930 with the degree of M.A. in mathematics and natural philosophy and obtained a B.A. degree at Cambridge University in 1932. Following three years research at the Cavendish Laboratory, Cambridge, he was awarded the degree of Ph.D. in 1936. Dr. Smith was Carnegie Research Fellow at St. Andrews University for two years. Then, after a short period as lecturer at Reading University, he joined, in August



Dr. R. A. Smith

1939, the Telecommunications Research Establishment (later the Royal Radar Establishment) for work on the development of radar, becoming head of the Physics Department there in 1945. He was appointed to the chair of physics at the University of Sheffield in 1961 and the following year was appointed to the chair of physics at the Massachusetts Institute of Technology and director of the Center for Materials and Science and Engineering at the Institute. He has been principal and vice-chancellor at Heriot-Watt University for the past year.

R. M. Glaister, B.Sc., Ph.D., A.Inst.P., recently joined ERG-A.C.I. Ltd., as general manager of their Maryport, Cumberland, electronic components manufacturing plant. The company, a manufacturing division within ERG Industrial



Dr. R. M. Glaister

Corporation and jointly owned with American Components Inc., is engaged primarily in the manufacture of precision metal film resistors. Dr. Glaister, lately chief engineer of the S.T.C. Microwave Transmission Group, graduated at Bristol University where he also carried out research on barrier layer dielectric capacitors to obtain his doctorate. Before joining S.T.C. he was in charge of electronic materials developed at G. V. Planer Ltd.

F. C. Thompson, Ph.D., B.Sc., F.I.E.E., assistant general manager of English Electric Valve Co. since 1962 has been appointed to the board. After graduating from Liverpool University, Dr. Thompson served with A.A. Command before becoming a senior scientific officer at the Telecommunications Research Establishment, Malvern, in 1942. He joined E.E.V. in 1945 as engineer in charge of microwave tube production, and was manager of the Radar Tube Division from 1956 to 1962. E.E.V. also announces the appointment of **R. H. Deighton** as a director and commercial manager. Mr. Deighton joined the Marconi Company in 1930, becoming chief of sales of the Aeronautical Division in 1945. He moved to the Central Division in 1951, becoming manager in 1954.

Two years later he became commercial manager of E.E.V. and was appointed to the board of E.E.V. (Canada) in 1962 of which he has been president for the past year.

Dennis Ward recently resigned his post as manager of E.M.I. Sound Products and has joined the board of B & W Electronics, of Worthing. Mr. Ward has for the past 15 years been almost exclusively concerned with the design and production of high-quality loudspeaker units at the E.M.I. Cae Mawr Factory, Treorchy.

BIRTHDAY HONOURS

Among those honoured by H.M. The Queen in her Birthday Honours list are:

Knight Bachelor

Raymond F. Brown, O.B.E., Comp.I.E.E.E., joint founder of Racal Ltd of which he was chairman until his appointment by the Government in 1966 as Head of Defence Sales.

C.B.

Professor J. H. H. Merriman, O.B.E., M.Sc., F.I.E.E., senior director of development at the Post Office, and recently appointed visiting professor in the Department of Electronic Science and Telecommunication at the University of Strathclyde, Glasgow.

C.B.E.

Brigadier J. L. Dobie, B.Sc., M.I.E.E., late Corps of R.E.M.E. **A. H. Reeves**, senior principal research engineer, Standard Telecommunication Laboratories, who invented pulse code modulation.

O.B.E.

Lieut.Col. F. D. Williams, B.Sc.(Eng.), M.I.E.E., Royal Corps of Signals.

H. Surtees, M.Sc., managing director, Elliott-Automation Space and Advanced Military Systems Ltd. **Miss Rosina Winslade**, an assistant secretary to the Council of Engineering Institutions, who receives the award for "services to the Women's Engineering Society" of which she was president from 1965-7.

M.B.E.

J. C. Gallagher, head of relays and links, Transmitter Planning and Installation Dept., B.B.C.

E. C. A. Haviland, chief development engineer, Marconi Instruments Ltd.

O. B. Kellett, F.I.E.E.E., regional wireless engineer, Home Office.

C. J. Macpherson, B.E.M., assistant executive engineer, G.P.O.

F. A. Messenger, radio officer, Eastern Region, British Railways Board.

I.S.O.

P. A. Hibberd, principal scientific officer, Royal Radar Establishment, Malvern.

B.E.M.

G. E. A. G. Barrett, senior scientific assistant, Radio and Space Research Station, Slough.

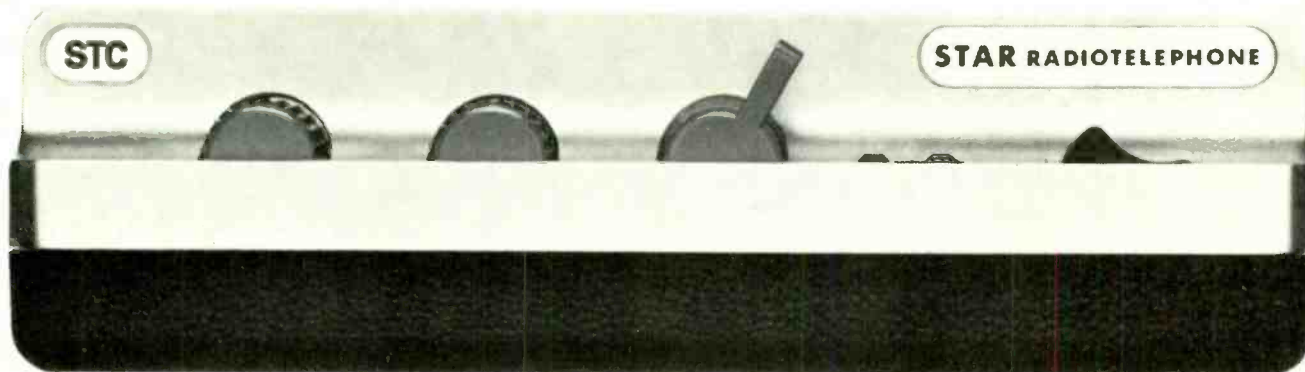

STAR performer

20 good reasons why
STAR UHF Mobile Radiotelephone
 is the best radiotelephone
 in the world

- ★ Elegantly styled.
- ★ Designed for safe use in vehicles.
- ★ Excellent range and penetration of built-up areas.
- ★ Crystal-clear speech quality.
- ★ Noise cancelling microphone.
- ★ No ignition noise.
- ★ Very low battery drain.
- ★ Simple installation and removal.
- ★ Anti-theft catch.
- ★ High reliability.
- ★ Meets world-wide specifications.
- ★ 25 kHz and 50 kHz channel spacing.
- ★ Printed UHF transmitter circuitry.
- ★ Transmission line coupling of power transistors.
- ★ Solid-state antenna change-over switching.
- ★ Helical tuning coils in receiver.
- ★ Quartz crystal filter.
- ★ Quartz crystal discriminator.
- ★ Integrated circuits.
- ★ Fully solid-state.

STC Mobile Radiotelephones Ltd., New Southgate, London N.11.
Telephone: 01-368 1200. Telex: 261912.

Attach your letterheading to this panel.
 Please send me full details of your
STAR MOBILE RADIOTELEPHONE

Name.....
 Position.....

ww 2

STC
 Mobile Radiotelephones



For programmes that emphasise performance

... MONOBLOC CERAMICONS BY ERIE ELECTRONICS

Monolithic Ceramic Capacitors that offer up to
100 times the capacitance-to-volume
ratio of conventional components.

Specified by performance-minded
engineers wherever space is at a premium ...
in Aerospace ... Computers ...
Communications ... Instrumentation.

- * Volumetric efficiencies up to 380 $\mu\text{F}/\text{cu. in.}$
- * Capacitance range, from 10 pF to over 1 μF
- * Tubular or rectangular types (axial or radial leads)
- * Phenolic coated, glass encased and moulded types
- * Unencapsulated chips for hybrid I.C.'s
- * Special printed circuit types
- * Up to 200 Vdc. working
- * Operating temperature -55°C up to 150°C
- * Erie manufacture Monoblocs in Great Britain



The technique: thin ceramic films and platinum electrodes
fused into a solid layered structure.



The result: an inherently stable dielectric,
resistant to the most severe environmental
conditions.

*Send today for the 12 page,
detailed brochure.*

ERIE ELECTRONICS LIMITED

Great Yarmouth, Norfolk.

Telephone : 0495 4911. Telex : 97421.

WW—091 FOR FURTHER DETAILS

Circuit Ideas

Pen-recorder amplifier

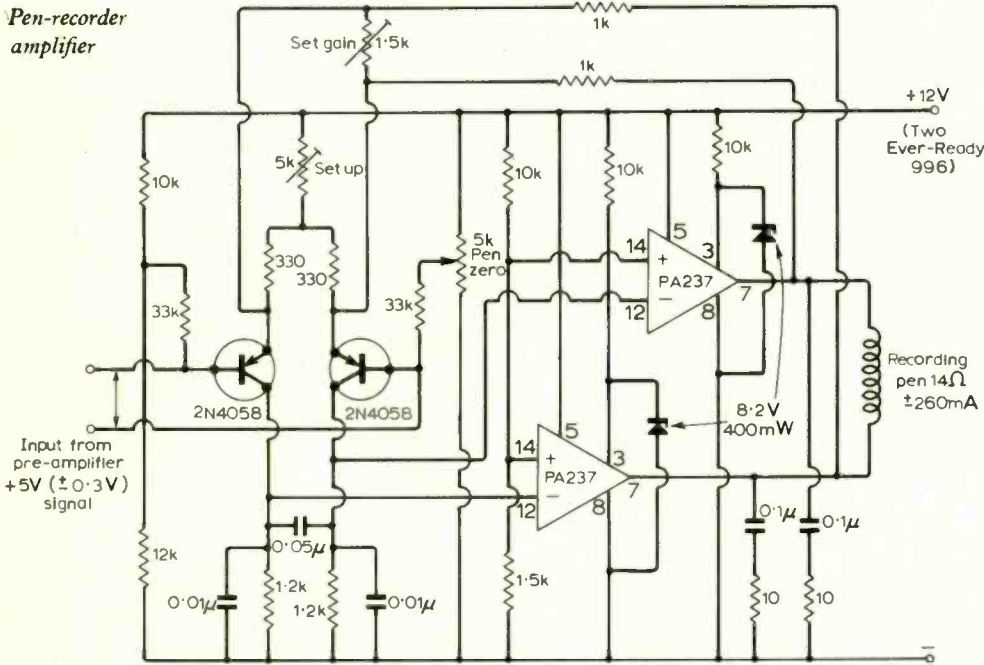

Driver amplifier for pen recorder

The construction of a direct-writing electrocardiograph called for a battery-powered amplifier to drive a moving-coil centre-zero pen recorder with a full-scale deflection of $\pm 260\text{mA}$ from d.c. to 100Hz. The General Electric PA237, with a peak current output of over 500mA (2 W into 15Ω), made design easy.

The balanced input from a d.c.-coupled pre-amplifier drives the long-tailed input pair, matched for h_{FE} at 1.2mA collector current, to provide a balanced drive to the inverting inputs of the pair of PA237s. The non-inverting inputs are set at 1.55 volts by a potential divider. The pen recorder is bridge-connected across the two i.c. outputs, the RC bypass on each being prescribed by the manufacturers to prevent oscillation. Further capacitors are required across the collector loads of the input pair for the same reason, and also to provide high-frequency roll-off. Balanced negative feedback to the emitters of the input transistors ensures linearity and sets gain.

Pin 3 on each i.c. is provided so that the external load resistor of the amplifying stage can be boot-strapped to the output for maximum positive voltage swing when used as an

audio amplifier, and this is not feasible in d.c. applications. However, a pair of zener diodes of suitable voltage rating here, limit the positive output voltage swing in each i.c.

The preset long-tailed pair emitter resistor sets the output voltage to a mean of 4.5V, allowing a positive swing to 6.5V, and a negative fall to 2.5V.

G. B. C. HARROP,
Leeds 16.

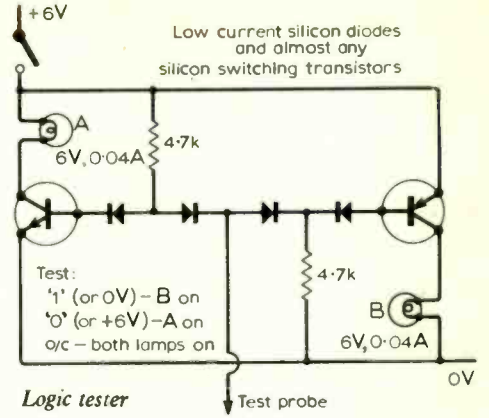

Simple logic tester

This logic-level tester indicates the presence of 1 or 0 in any logic system. It will also indicate the absence of either, i.e. an open circuit. Although primarily intended for static state testing it will indicate pulse waveforms of reasonable duration, say, 100ms or more—and, of course, repetitive waveforms such as the output of multi-vibrators. The circuit was developed for a +6V system using negative logic but can be adapted for any other system.

R. WILLIAMSON,
Norwich.

Motor control circuit with 200:1 speed range

In this circuit the motor driving voltage is made proportional to the difference between the control signal and the back e.m.f. of the motor. The latter are kept nearly equal and the small difference is amplified to drive the motor. The motor winding, of resistance R_W , is connected in one of the arms of a bridge (R_1, R_2, R_3, R_W). If $R_3 = R_W$ and $R_1 = R_2$ a voltage proportional to the back e.m.f. appears across the bridge¹. A speed range of at least 200:1 has been obtained using an Ether type 950A motor with an armature resistance of 40Ω and rated at 2.5V.

V. B. GERARD,
Dept. of Geodesy and Geophysics,
University of Cambridge.

1. Butterworth, H. M., "Speed control of d.c. model motors", *Wireless World*, Sept. 1967.

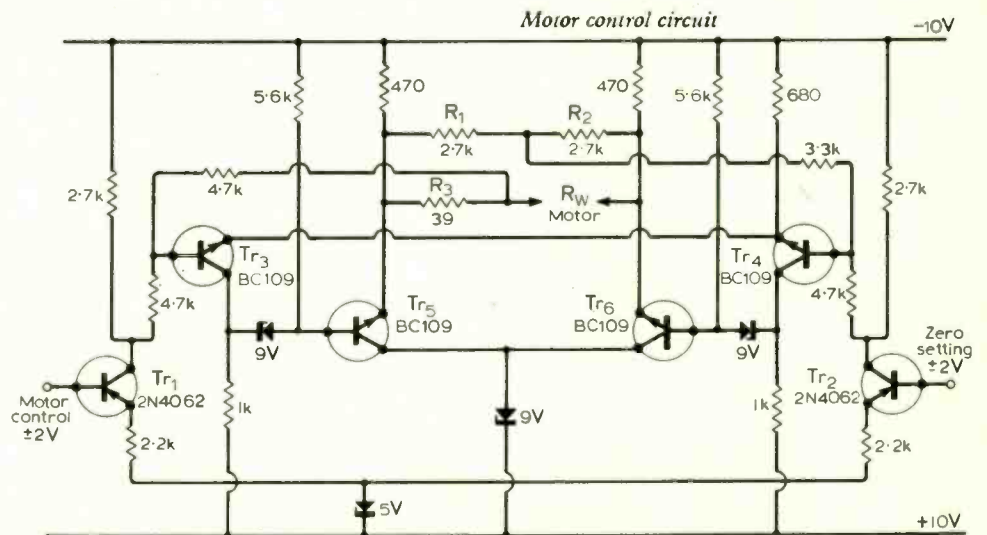

Letters to the Editor

The Editor does not necessarily endorse opinions expressed by his correspondents

Long-distance TV reception

On 30th May, I witnessed a phenomenon which I thought to be impossible. Reception of BBC-1, Channel 3, was badly distorted by foreign interference. By 19.20 G.M.T. the sound was swamped by a French station and the picture began to fade at intervals into a faint suggestion of another picture.

I tuned into other channels to check interference. On Channel 5, reception of French sound was perfect. On Channel 2, the impossible happened. A perfect picture was obtained of Tele Soir, the only abnormality being a double picture, side by side. The contrast at the peaks was better than normal BBC-1. We watched the French News for ten minutes (General de Gaulle's holiday being prominent) and then watched election speeches intermittently until 20.00. The sound was heard either by retuning Ch.2, or changing to Ch.5.

At 20.00 hrs, I went to fetch tools to realign Ch.2 to receive both vision and sound together. When I returned, the picture had disappeared because of swamping by Spanish sound!

First, we are 500 miles from the nearest point of France, and over 800 miles from Spain. Secondly, I understood that French TV uses negative modulation, but the technical editor of this journal informs me that the signal probably originated from one of several 20-kW "1st Programme" transmitters in the north of France. These transmit with positive modulation on 819 lines which is near enough double our 405 lines to lock the line timebase on a British receiver. This type of freak picture reception from France has been reported on several occasions in the past, but I have not heard of such great distances as were involved in this case.

For interest, the set is HMV 2614, and the aerial a Bands 1 + 3 modified Yagi aligned 228° true. I should be pleased to hear the comments of other readers, and their experiences of freak reception.

J. E. SCOTT,
Lochgilthead,
Argyll.

Who's to blame?

Mr. W. R. Seymour in his letter (July issue, p. 335) makes a valuable point by highlighting the paradox of the inexpensive bookshelf speaker calling for a costly amplifier to drive it satisfactorily.

The impedance/frequency curve of the speaker in question is by no means atypical as may be confirmed from any textbook on loudspeakers. Nevertheless, such speakers can be satisfactory in use since the increases in impedance are allied to increases in efficiency resulting in a smooth frequency response under constant voltage drive conditions.

At first glance it appears that a simple 10-W amplifier should suffice, the drop in delivered power at the frequencies in question being compensated by a corresponding increase in speaker efficiency. Unfortunately, many amplifiers rely on large quantities of feedback, both negative and positive (through the bootstrap circuit) to achieve low distortion, and such feedback is derived from a common point with the speaker. A rise in speaker impedance results in an abnormal amount of signal being injected into the feedback lines. This, together possibly with fluctuations caused in the h.t. rail, results in serious degradation of the sound.

The customary commercial answer is to drive bookshelf and other low-sensitivity speakers from amplifiers having considerably more power than the 10-W specified, since speaker load vagaries have little influence on an amplifier running at a fraction of its nominal rated power.

In the light of the above considerations we must apportion blame to any loudspeaker manufacturers who fail to make clear the loading imposed by their speakers and to amplifier manufacturers who fail to make clear the limits of acceptable load.

I. G. ABELSON,
Southgate,
London, N.14.

Classification by ability

Mr. Ibbotson's article "Are We Wasting Brain-power?" in the July issue was interesting and his suggested remedies to the existing system (or lack of system) would go a long way to clean up our "present system of labelling".

It is desirable that a system is not organized that favours students taking their degree on a full-time basis at a certain period of their lives, i.e. before entering employment. It is also important that the student has some control upon his rate of progress which ideally will be self-governed by his

innate ability. Both these criteria can be achieved by setting up a system which is a natural extension of the G.C.E. Courses could be put on by polytechnics, colleges of technology, etc., in specialized subjects at various levels and the student awarded a pass certificate in that subject at the end of the year if he has satisfied the examiners practically, orally and by examination. The work that has been carried out by the student and the examination would be assessed by a central body whose function is to maintain, as far as possible, the same level at the various colleges.

In order to obtain a degree in a certain field the student would be required to obtain a series of certificates, the subjects and levels of which would have been previously decided upon for the particular degree.

This system would have the advantage that pressures would, to a certain extent, be removed from the students at examinations since a fail in one subject would no longer mean the possibility of wasting several years' work. I cannot see any virtue in making it essential that the student reaches the final level in all subjects simultaneously. Full-time courses could be pursued as usual with all the well-known advantages offered by them. Organized evening courses for the more mature student, however, would not be difficult to arrange. The student would have control over the rate at which he amasses the necessary certificates depending upon his capabilities and time available.

It is surprising that such a system has not been developed through the C.N.A.A. as it would give equal opportunities to study for a degree, the main criterion being enthusiasm and drive.

In a technologically advanced country that depends so much upon its industry for survival it is essential that a degree-awarding system is set up that will make development of the existing brain-power attractive, enjoyable and available to all.

J. R. HIPWELL,
Chelmsford,
Essex.

Surely we all know that if observed over a large population, "intelligence" has a continuous "normal" distribution (Mr. Ibbotson's article, July p.302). But a university class is a smallish sample taken from the upper end of this distribution; and therefore although we may find any value of ability drawn from the continuous distribution we shall probably find gaps in any particular class. Nonetheless the division between "honours" and "pass" is a difficult one and for this reason is often left until *too late* in the course. So am I among those who are excessively eager to classify students? No, not to classify for its own sake, but I am anxious to recognize as soon as possible how to give each student the most appropriate education which is available. I maintain that a "pass" degree which really means "failed honours" does not indicate that the graduate has received a useful education: instead of struggling with mathematical and abstract concepts which in the end he failed to master, that student should have been following a more limited and practically biased curriculum

which he could have mastered and so obtained an honest "ordinary" (i.e. not honours) degree. Should such a curriculum be provided in universities? I think it should because the alternatives are unacceptable in the present climate of opinion: either one excludes from the universities all who might possibly fail to achieve honours (and so excludes many who would in fact succeed), or one throws out of the university all who fall below honours standard. Unless prepared to go to one of these extremes, one must have a "pass" course in the university as a safety net.

If the marks of two candidates differed by only 1%, one would be reluctant to give one of them a Class II(i) and the other a II(ii); but as long as classes are not so large as to make the distribution of marks statistically smooth, one stands a good chance of having gaps at about the right place to form boundaries of the different honours classes. But in spite of all that is said about lack of objectivity, one can in practice recognize outstanding ability and the corollary is that one should give no firsts if the candidates at the top of the lists are not good enough, just as it is generally accepted that prizes for literary or architectural competitions should be withheld if no entry of sufficient merit is submitted. Such judgments on a supposedly absolute scale are often distrusted; but university science degree classifications are based on the combination of quite a number of carefully monitored assessments of examination papers, course work, practical work, etc., and are by no means as subjective as is often suggested.

Finally there is the question of the attitude of the Engineering Institutions to the H.N.C. I used to be very sympathetic to the H.N.C. man (or woman, if there be such) but I am not so sure now. In addition to the old London External B.Sc. we now have the C.N.A.A. B.Sc. and are promised that there will be degrees from the Open University. With so much provision will there be any reason for the man or woman who has sufficient ability to gain a degree to go without one?

D. A. BELL,
Department of Electronic Engineering,
The University,
Hull.

Amplifier efficiency

Mr. Abelson's amplifier ("Letters", June p. 274) is essentially an active device in series with a 15Ω resistor R , and a capacitively coupled load R_L . The circuit essentials are shown in Fig. 1.

The active device has two limiting conditions (a) it can bottom (full on in Abelson's circuit) (b) it can cut off. If the bias point is V_{DC} , then the bias current is $I_{DC} = \frac{V_S - V_{DC}}{R}$

Thus if the transistor switches off, the capacitor (charged to V_{DC}) will oppose the supply voltage and the instantaneous output voltage will be $(V_S - V_{DC}) \frac{R_L}{R + R_L}$. This

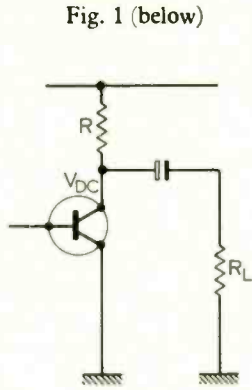

Fig. 1 (below)

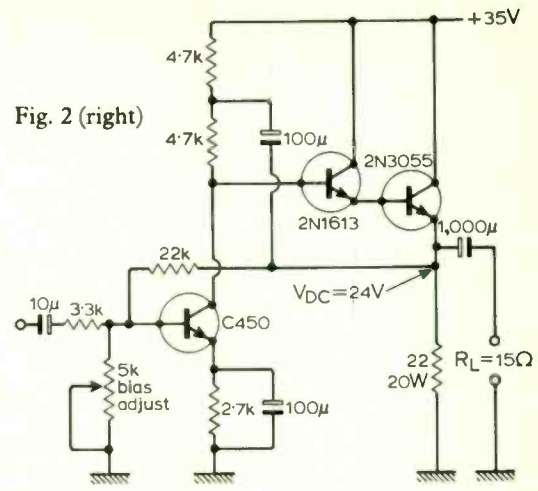

Fig. 2 (right)

represents the maximum positive output signal if the charge on the capacitor stays nearly fixed (as it is meant to). The maximum negative output voltage is $-V_{DC}$ if the transistor bottoms cleanly. One can see that the maximum voltage swing (and hence power output) is obtained when the two limits are of the same magnitude, or else clipping of the signal will occur prematurely.

Thus we have $V_{DC} = (V_S - V_{DC}) \frac{R_L}{R + R_L}$
 $= V_S \frac{R_L}{R + 2R_L}$. If the load has an arbitrary phase angle (such as a loudspeaker) the analysis can be suitably generalized to give $V_{DC} = V_S \frac{|Z|}{R + 2|Z|}$ where $|Z|$ represents the

magnitude of load impedance. The minimum load impedance of a speaker is usually close to its d.c. resistance and this value gives the most useful criterion for V_{DC} .

For maximum efficiency, we must calculate power developed to quiescent power dissipated. The dissipated power is $I_{DC} V_S = \frac{(V_S - V_{DC})}{R} V_S$

The power developed is $\frac{V_{out}^2}{2R_L} = \frac{V_{DC}^2}{2R_L}$. Letting $R = \gamma R_L$ we can show, using the earlier formula for the optimum bias point, that the efficiency is given by $\eta = \frac{\gamma}{2(\gamma + 2)(\gamma + 1)}$ and a little bit of calculus shows that $\gamma = \sqrt{2}$ gives a maximum efficiency. For Mr. Abelson's conditions the average power output is $\left[\frac{(16 - 15)}{15 + 15} \right]^2 \frac{64}{30}$ watts (~ 2 watts) but my

design gives about 3 watts with just slightly less total dissipation and considerably less heat sink need be used. The bias points to the driver may need alteration and a simple bootstrap to the bias chain would be required for the higher swing.

Several other features of Mr. Abelson's amplifier can be improved. The first stage has a large relative current variation and a small (47Ω) emitter resistor, which causes considerable distortion (see *W.W.* July 1968 p. 228). This distortion will of course disappear rapidly at lower levels, so that on

programme very little distortion is heard. Secondly, the BC119 may have some h_{FE} variation with current, which will lead to a rectification shift in the bias point at large signal level, because the bias resistors are high for the chosen bias current. Why not d.c. couple the driver to the output? A schematic of a circuit that I have built and tested is given in Fig. 2. The measured output voltage just before symmetrical clipping is 6.65 volts r.m.s. into a 15Ω resistive load (2.95 watts). The bias point for highest undistorted output power is 24 volts across the 22Ω resistor, in excellent agreement with the theory.

JOHN VANDERKOOY,
University of Cambridge

Amplifier input sensitivity

I have just realized what is an idiotic error in my article in the June "Amplifier Supplement", and one so elementary that readers may feel justified in questioning my sobriety at the time of writing it. I can only offer a feeble excuse, that of a rapidly approaching deadline, the imminence of which was no one's fault but my own.

The second paragraph under the heading "Input Sensitivity" was hastily conceived and is inaccurate. My arithmetic, for example, is quite wrong and any student will know that to attenuate the output of a power amplifier rated at 20 watts, down to 10 watts, the input signal voltage will be reduced by a factor of 0.7 not by half as implied. The remainder is thus reduced to muddled nonsense and I can only hope that readers with charity will overlook this aberration; I, in turn, have been duly rapped over the knuckles by my peers, and will remain in a corner until the next issue, clad in sack-cloth and with burnt ashes of the June supplement upon my head.

REG. WILLIAMSON,
Norwich,
Norfolk.

Cross-over distortion

I was very interested to read R. Williamson's survey in the June 1969 issue and can only agree with his comments on cross-over distortions at low output levels in quasi-complementary class B output stages. However, I was surprised to find from the "Audio Amplifier Data" which followed his

article that some manufacturers quote very low distortion figures at the 10mW output level apparently using the normal class B quasi-complementary output stage without modification. I would suspect that some of these manufacturers have not actually measured the distortion at this level due to the difficulties involved in measuring a 0.1% harmonic content in 10mW, and that they assume it must be at least as low as the full power level distortion. Can these claims be substantiated?

D. R. RAY,
Rochdale,
Lancs.

Aerial erection

We were interested to read the letter from P. J. A. Innes on page 235 of your May issue. We do, of course, supply our v.h.f./f.m. aerials through our appointed distributors to the retail trade and there should be no difficulty for members of the public to obtain their requirements from any local dealer.

A dealer who does not stock these aerials can, as a matter of course, always obtain any particular model for his customer through his wholesaler, but from Mr. Innes' letter it appears in Essex, at any rate, dealers are not very co-operative in this respect.

We are asking our Area Managers and representatives to report on the situation as it exists in each area and as a matter of policy we shall encourage local dealers to stock, and if any member of the public has any difficulty they should contact us direct so that we can advise them of a good local stockist.

R. STALLWORTHY,
Antiference Ltd.,
Aylesbury,
Bucks.

A balanced amplitude modulator

The "Simple Amplitude Modulator" (*Wireless World*, March 1969, Circuit Ideas) was used to obtain amplitude modulation with a carrier of 30 kHz and a modulating signal of 1kHz. The circuit was attractive, since the use of transformers and tuned circuits had been avoided. However, it was found

that, at the collector of Tr_1 , in the said reference, the output was a combination of the modulating signal and the amplitude modulated carrier. Since for the required purpose the presence of the modulating signal was undesirable, the following modification of the circuit has been tried and found useful. The circuit shown below has the additional advantage that by avoiding the use of the bypass capacitor C (of the circuit given in the reference) it presents no restriction regarding the relative choice of the modulating and carrier frequencies. It is however imperative that the difference (carrier) signal between the collectors be used to avoid the presence of the modulating signal.

P. E. SANKARANARAYANAN
and V. S. V. MANI,
Bangalore,
India

High-quality TV sound

Having read the letter from Mr. B. Pollard in the June issue, I am appalled at his suggestion of connecting the chassis of his television set and his hi-fi equipment to the neutral of the mains supply.

Consider what happens under fault conditions. Suppose the neutral wire in the television plug drops off or fractures. The neutral return to the television is now via the screening of the audio lead to the amplifier, a fact which may not come to light for some time. When the audio lead is pulled out of its socket on the amplifier, full mains potential will appear on the audio plug! It may be argued that, to avoid earth, or should it be neutral loops, the screening may be broken at the plug. Nevertheless, in this case if one of the neutral leads comes adrift, either the television chassis will become live or, worse still, the audio amplifier, pre-amp, pickup and turntable will do the same!

Which ever way you look at it, the situation is potentially lethal. The safest plan is an isolating transformer in the mains supply to the television set. At a cost of around £5, this cannot be said to be expensive compared to the safety it brings with it.

With regard to the quality of reception, I have found the main trouble to be vision on sound in the majority of sets I have used. This is generally of such low frequency as to be inaudible on the internal speaker of the set,

but somewhat disconcerting on the hi-fi system.

Nevertheless, I must agree with your previous correspondents that the improvement in quality is really worth the small amount of effort and expenditure needed.

The most interesting effect I have noticed is that the background music to documentaries, plays etc., which seems to bring forth the wrath of so many people, falls into its proper perspective when heard through good equipment, whereas it appears very strident and annoying on the built-in speaker. Perhaps some of your readers have noticed this effect as well?

J. WEBSTER,
Critchley Bros. Ltd.,
Stroud,
Glos.

Sampling adaptor

I was very interested in the letter from Mr. Bennée in the May *Wireless World* commenting on the need for a sampling adaptor for use with a 10 MHz oscilloscope.

Your readers may be interested to know that AIM Electronics are the first British company to design and manufacture a sampling adaptor for use with any low-frequency readout device, including oscilloscopes with direct coupled X-inputs (a.c. coupling causes some trace distortion). The instrument can be used to look at signals up to 1GHz.

M. J. HOLLAND,
AIM Electronics,
Cambridge.

Parameters and people

As one very much on the electronic fringe—less than a tyro in hi-fi but concerned with the provision of sound reinforcement without benefit of Union card; and after reading through hundreds of copies of *W.W.* over the years with diminishing comprehension—I was delighted to be able to read and understand "Vector" on organization in the May issue. He has however pointed in the wrong direction.

I have followed, mostly at a distance and sorrowfully, the fortunes of many of the "professional" or "quasi-professional" groups and have seen them one after another eventually reach similar conclusions to his on the desirability of organization—but of the wrong kind.

I have seen professional bodies sworn to eschew trade union organization by their constitutions, form parallel organizations with trade union constitutions and registered as such with virtually the same membership. And others clinging to their vocational respectability until pressures from below force them into action. The Nurses?

I am with Vector up to and (dare I say) including his statement that "... we were stupid".

Why does he boggle at trade union?

Some do because of the cloth cap connotation—snobbishness in fact!

Some think, like Vector it seems, that trade unions are synonymous with demarcation disputes; strikes; sending to Coventry; affiliation to the Labour Party and the like. The Union I serve (and have served)

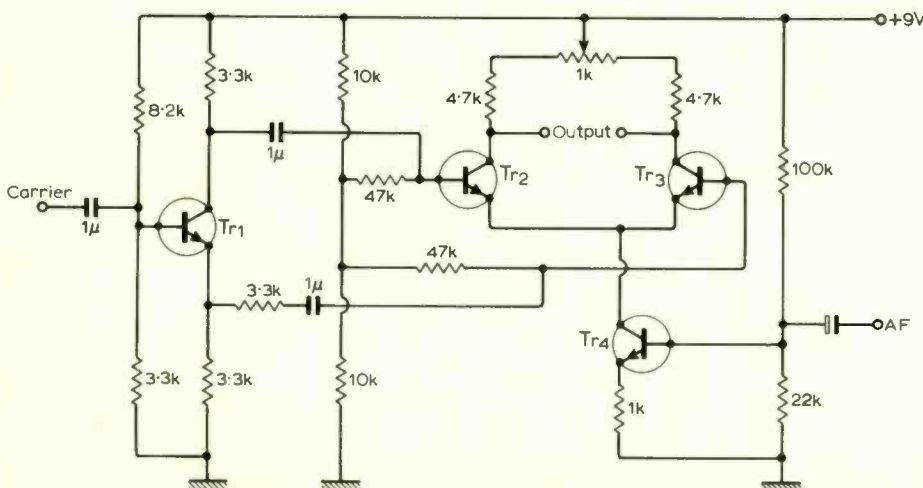

for over 20 years in both honorary and paid capacities) has suffered none of these and there are many the same. Yet have not *highly respectable* "trade unions" like the B.M.A. (Professor Bell and Vector's choice?) threatened to boycott the Health Service; bank employees and their managers taken militant action; and did not (a good comparison?) electrical engineers come close to abandoning their posts some years ago?

Vector dwells on the "latent power of the electronics engineer" the application of which would bring "complete chaos"; then shies away at the prospect, however remote, of a soldering dispute. He can't have it both ways nor need he. The main everyday "power" of the trade union ("Association" is still more acceptable to many) lies in *organization* and all that follows *not* in red-blooded militancy. Unfortunately the Press (particularly the "lay" section) blows up out of all proportion the "silly" disputes—these are, it seems, news and, regretfully, many of their readers *want* evidence that the trade unions are wicked and at the bottom of all our ills. Vector with me, recognizes there are other villains. Meantime the enormous amount of joint discussion and activity in industrial and human relations which keep the wheels turning (perhaps to an even greater effect than electronics) go virtually unreported and certainly *unsung*.

If Vector is right about the redundancy, bewilderment, humiliation and sense of grievance in the profession then there can be no doubt that organization is urgently needed. I have no doubt that for legal, technical and particularly practical reasons trade union organization is the only answer. The problems are not susceptible to the ministrations of learned societies. Professional standards; learned papers; libraries; research and all that these societies undertake so well do not fit them for the hurly-burly involved in, for example, negotiations or in bringing Parliamentary pressures to bear—militant or otherwise. Indeed their vocational pre-occupations may well, as hitherto, militate against the approach necessary to protect their members' bread-and-butter interests. There is a world of difference between dealing with parameters and dealing with people.

Of course the learned societies (at least the sensible ones) are not receptive nor would they be. They are not equipped to deal with the financial jugglers. They are more insular (or snobbish in the nicest sense) than individuals. If they did "bite" they would have to form separate sections to deal with the problems. Any new section would certainly represent "organization" (which I would strongly urge the enlightened to become) but it would be inhibited and could do but half a job.

I have found some antipathies between the "professionals" and the "technical" self-styled elite on the one hand and the "sales" and "admin" types on the other in some organizations and a learned society would probably have similar built-in shortcomings.

Politics have not, I think, been raised but all three political parties are on record as recommending membership of trade unions.

If therefore your professional and technical readers want to have *some* say in their

futures, bread-and-butter wise, I urge them to "get organized" and, in the absence of anything better, in a trade union.

My guess is that the up-the-ladder brigade; the shortsightedly ruthless (as is the financial juggler); the politically right; and the don't knows provide sufficient inertia to stop any movement before it starts. If so then, like Vector, may they have the grace in due course to admit it—"we were stupid".

ENIBAS.

Full cycle thyristor firing

In the review of the Physics Exhibition (May issue), we were particularly interested to read about the work done by Derby & District College of Technology using binary logic systems for triac control.

Your readers may like to know that we demonstrated a control system of this type at the E.D.A. Exhibition in Brighton last year, and our demonstration also included automatic protection against failure of the triac irrespective of whether the failure occurred whilst in use or out of use.

Patent applications were filed some time ago on binary and other more complex systems, bearing in mind the possibility of association with computer operation.

G. R. SHEPHERD,
Diamond H Controls Ltd,
Norwich,
Norfolk.

Sterile symbology

I was interested in the letter with the above heading in your July issue (page 335), and whilst in general I find myself in agreement with Mr. Green, I cannot agree with his interpretation of symbol 22.6.8. Having been trained as a power engineer, this to me means a broken and defunct three-phase alternator!

Perhaps other engineers have other interpretations.
M. G. FOSTER,
Croydon,
Surrey.

Components, complaints and complacency

Please accept our congratulations on your June Editorial. We are in agreement with all you say, but would like to enlarge on several points from a retailer's angle.

We have for the last eighteen years endeavoured to supply the amateur constructor with his needs, finding out what new components are coming along and having them in stock. The path we tread is a difficult one and we have often cast envious eyes on wholesalers and manufacturers, who can make immediate increases in prices, while it takes us six months to pass it on to *our* customers.

The basic trouble today is high labour costs—the larger the firm the higher the overheads—and in turn the higher the value of the minimum order they will deal with. At least two large firms asked us if we would deal with all their orders under £5. This is no reflection on their efficiency.

We started off supplying only the general

public, but inevitably we had to supply universities, schools, Government Departments and general industrial firms with their small orders. May we at this point mention your reader who was starting a small business and was asked for Trade and Banker's references for a catalogue? Our catalogue costs us £1 per copy and it is necessary that we get some of this amount back. We therefore charge everyone except schools and universities for our catalogue. Small firms are very bad risks, we have found to our cost. Many firms think that headed note paper entitles them to discount, however small their order—no doubt they learn in time that discount depends on quantity. Many large firms expect to run a credit account for an order of under 5s. One such firm, when we wrote and asked for cash, said it was impossible to obtain!!!

One of our almost insurmountable problems is making absolutely sure we have sufficient of any particular component for a design which you may bring out. Even if it were possible for you to tell us in advance what was required, it would not help because no one knows when a project is going to "catch on"—when it does, a situation arises where a component which sells at the rate of twelve in a year suddenly sells fifty in a week. The supplier as well as the retailer is sunk!

A. SPROXTON,
Home Radio (Components) Ltd.,
Mitcham,
Surrey.

Conferences and Exhibitions

Further details are obtainable from the addresses in parentheses

- MANCHESTER**
Aug. 25-29 The University
Datafair
(Brit. Computer Soc., 23 Dorset Sq., London N.W.1)
- OVERSEAS**
- Aug. 5-7 Boulder
Automatic Control Conference
(I.E.E.E., 345 E.47th St., New York, N.Y.10017)
- Aug. 19-22 San Francisco
Western Electronic Show & Convention
(Wescon, 3600 Wilshire Blvd., Los Angeles, Calif.90005)
- Aug. 22-31 Copenhagen
Electronica—Electronics, Radio & TV Show
(Electronica, Grabrodetorv 16, 1154 Copenhagen K)
- Aug. 26-28 Ithaca, N.Y.
Computerized Electronics
(I.E.E.E., 345 E. 47th St., New York, N.Y. 10017)
- Aug. 29-Sept. 7 Stuttgart
German Radio & Television Show
(Stuttgarter Ausstellungs-GmbH, 7 Stuttgart 1, Postfach 990)

Operational Amplifiers

7. Voltage comparators and multivibrators

by G. B. Clayton,* B.Sc., A.Inst.P.

A comparator is a device used to sense when a varying signal reaches some threshold value. Some operational amplifiers may be used open-loop to provide excellent comparator characteristics. Their very high open-loop gain means that only a very small differential input signal is needed to cause the amplifier output to make a transition between saturated states.

Comparator Using Differential Input.

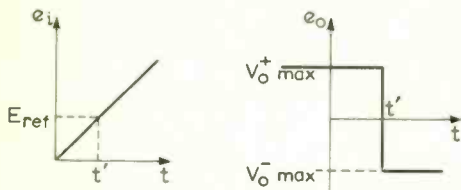
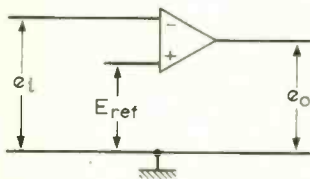

In this circuit the input threshold voltage is equal to E_{ref} . This E_{ref} must not exceed the maximum common-mode voltage (E_{cm}) for the particular amplifier in use. If required e_i and E_{ref} may be interchanged, so changing the polarity of the output transition.

Comparator Using Single Input.

Input threshold voltage

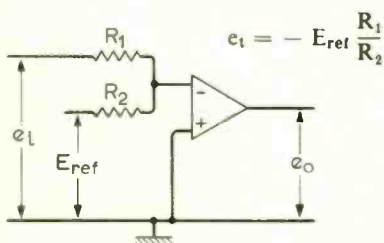

In this arrangement the reference and input voltages are applied to the same input terminal of the op. amp. through appropriate resistors. The other input terminal of the amplifier is earthed and consequently no common-mode limitations exist. E_{ref} may be any convenient voltage opposite in

polarity to the signal voltage. The threshold voltage is set by a choice of input resistors.

In both of these comparators the input voltage must swing past the threshold voltage by an amount

$$\frac{V_{omax}^+ - V_{omax}^-}{A_{VOL}}$$

for the full output transition to take place. In the case of rapidly changing input signals the output transition time is dependent on amplifier characteristics, but when the input voltage varies comparatively slowly this time is dependent on the rate of change of input voltage. In the latter case it is often advantageous to speed up the output transition time by using some form of regenerative comparator.

Regenerative Comparator.

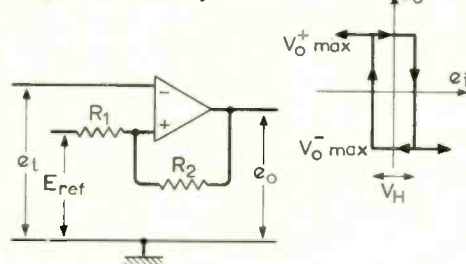

In this arrangement positive feedback is applied between output and input via resistors R_2 and R_1 and when e_i reaches the threshold voltage the amplifier switches regeneratively between saturated states, the output transition time being made virtually independent of the rate of change of input voltage. The circuit exhibits hysteresis, i.e. the transition takes place for different values of e_i dependent on whether e_i is increasing or decreasing to E_{ref} . The transfer curve for the comparator is illustrated for a value of E_{ref} equal to zero. The input threshold voltage at which the transition takes place has a value

$$\approx V_{omax} \frac{R_1}{R_1 + R_2}$$

and with V_{omax} having its positive and negative saturation values the amount of hysteresis is thus

$$V_H \approx (V_{omax}^+ - V_{omax}^-) \frac{R_1}{R_1 + R_2}$$

In all comparators outputs may be clamped to desired values rather than using saturation limiting, and it is emphasised again that care must be taken to ensure that reference and input voltages do not exceed allowable limits for common-mode and differential input signals.

Multivibrators

Multivibrators are circuits which provide two possible states. There are three types: astable multivibrators (free running), monostable multivibrators (one shot) and bistable multivibrators (flip-flop). In an astable multivibrator the two states of the circuit are momentarily stable and the circuit switches repetitively between these two states. The monostable multivibrator has only one stable state; it can be made to change to its other state by a suitable trigger, but it then returns to its stable state after a time interval determined by circuit values. The bistable multivibrator has two stable states in one of which it will remain indefinitely until appropriately triggered, when it will switch to the other state. Op. amps arranged with appropriate positive feedback can be made to operate well as multivibrators of all three types.

Astable Multivibrator.

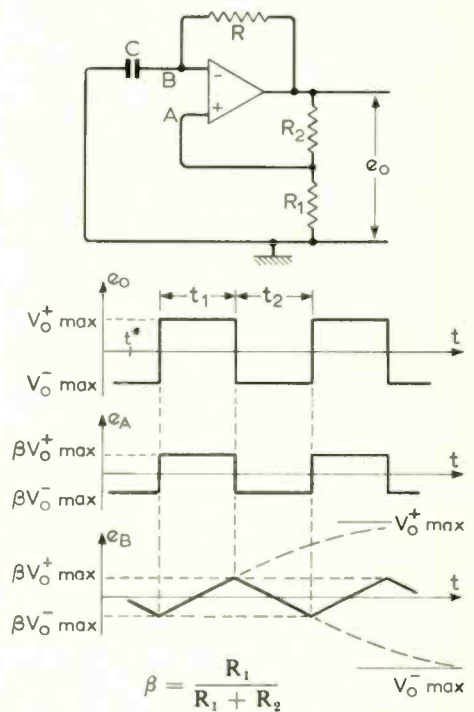

The two states of this circuit between which it switches are those in which the amplifier output is at positive and negative saturation. The output voltage is thus a square wave, its period is determined by the time constant CR and the feedback ratio established by the potential divider R_1, R_2 .

Starting at time t^* (above) when the amplifier is in negative saturation and the voltage at terminal A is βV_{omax}^-

$$\left(\beta = \frac{R_1}{R_1 + R_2} \right),$$

* Liverpool College of Technology.

terminal *B* is positive with respect to terminal *A* and its potential is decreasing as *C* charges down through *R*. When the potential difference between the two input terminals approaches zero the amplifier comes out of saturation and the positive feedback from the output to terminal *A* causes a regenerative switching, which drives the amplifier to positive saturation. The voltage across a capacitor in series with a resistor cannot change instantaneously and the potential of the terminal *B* therefore remains substantially constant during this rapid transition. *C* now charges up through *R*, the potential of the input terminal *B* rises exponentially and the amplifier makes the transition to negative saturation again when *B* reaches $\beta V_{o_{max}^+}$.

A capacitor *C* with an initial voltage V_t charged through a resistor *R* by a voltage V_f reaches a voltage V_b in a time

$$t = CR \log_e \frac{V_f - V_t}{V_f - V_b}$$

Then:

$$t_1 = CR \log_e \frac{V_{o_{max}^+} - \beta V_{o_{max}^-}}{V_{o_{max}^+} - \beta V_{o_{max}^+}} = CR \log_e \frac{V_{o_{max}^+} - \beta V_{o_{max}^-}}{V_{o_{max}^+} (1 - \beta)}$$

$$t_2 = CR \log_e \frac{V_{o_{max}^-} - \beta V_{o_{max}^+}}{V_{o_{max}^-} - \beta V_{o_{max}^+}} = CR \log_e \frac{V_{o_{max}^-} - \beta V_{o_{max}^+}}{V_{o_{max}^-} (1 - \beta)}$$

If the positive and negative values of the amplifier saturation voltage have the same magnitude, i.e. if $V_{o_{max}^+} = -V_{o_{max}^-}$, $t_1 = t_2$ and the expression for the period of oscillation becomes

$$t = t_1 + t_2 = 2 CR \log_e \frac{1 + \beta}{1 - \beta}$$

or

$$t = 2 CR \log_e \left(1 + 2 \frac{R_1}{R_2} \right)$$

Non Symmetrical Multivibrator.

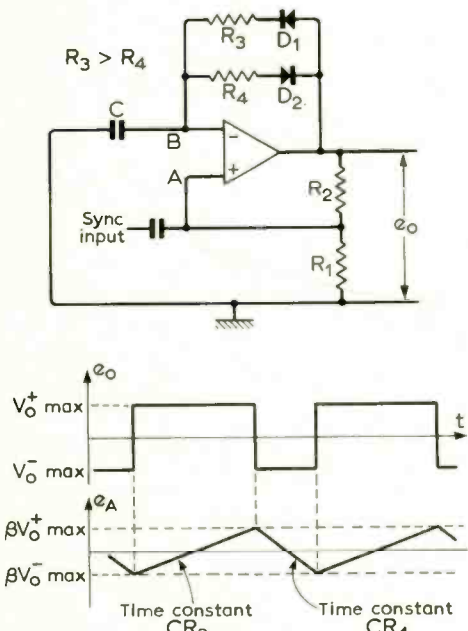

Non-symmetrical operation is obtained by the use of two separate timing resistors R_3 and R_4 as shown. In this circuit the appro-

prate timing resistor for each timing period is selected by the action of the two diodes D_1 and D_2 .

Astable multivibrators may be arranged so that the period is an exact multiple of the period of a synchronizing signal which may be injected into the circuit at the positive input terminal of the amplifier as indicated.

Monostable Multivibrator (1).

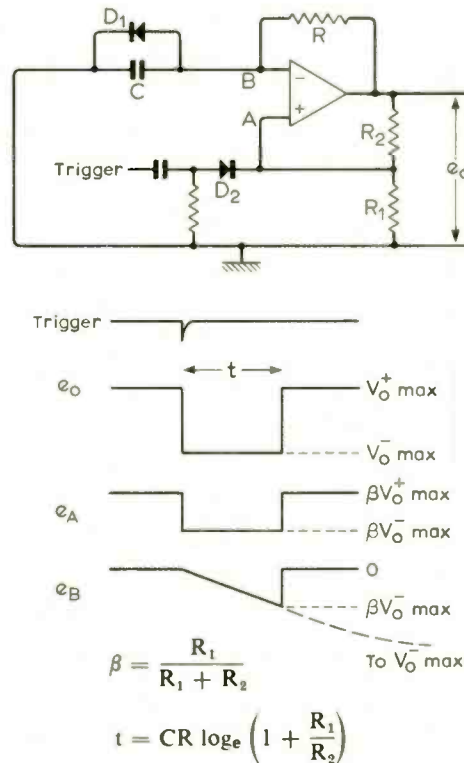

The connection of a diode D_1 in parallel with the timing capacitor in an astable circuit prevents the phase inverting input terminal (*B*) from going positive and results in a monostable circuit. In the permanently stable state of this circuit the amplifier output is at positive saturation, terminal *B* is clamped to earth by diode *D* and terminal *A* is positive with respect to earth by an amount $\beta V_{o_{max}^+}$. If the potential of *A* is brought down to earth by the application of a sufficiently large negative pulse the circuit switches regeneratively to its temporarily stable state in which the amplifier output is at negative saturation. Terminal *A* is then negative with respect to earth by an amount $\beta V_{o_{max}^-}$ and the potential of *B* falls exponentially as *C* charges down through *R*; diode D_1 is reverse biased. The circuit switches back to its permanently stable state when the potential of *B* reaches the value $\beta V_{o_{max}^-}$.

The expression for the timing period may be written by making use of the general expression for an exponential charging period, thus

$$t = CR \log_e \frac{V_{o_{max}^-} - 0}{V_{o_{max}^-} - \beta V_{o_{max}^-}} = CR \log_e \frac{1}{1 - \beta}$$

Substitution for β gives

$$t = CR \log_e \left(1 + \frac{R_1}{R_2} \right)$$

Monostable Multivibrator (2).

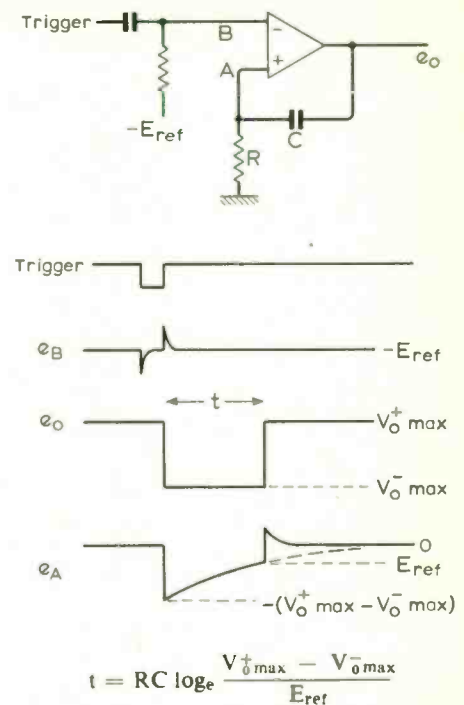

The circuit shows an alternative arrangement whereby the monostable timing period is controlled by the value of a negative reference voltage that is applied to the phase inverting input terminal (*B*) of the amplifier. The timing capacitor connected between amplifier output and the non-phase-inverting input terminal (*A*) provides the necessary positive feedback path. In the permanently stable state of the circuit the amplifier output is at positive saturation, the input terminal *A* is at earth potential and input terminal *B* is at the reference potential. A positive trigger of magnitude greater than E_{ref} applied to the terminal *B* brings the amplifier out of saturation and the circuit switches regeneratively to its temporarily stable state in which the amplifier output is at negative saturation. The negative voltage step at the output is communicated to *A* by the capacitor *C*, the potential of *A* then rises exponentially as *C* charges up through *R*. The circuit switches back to its permanently stable state when the potential at *A* reaches E_{ref} . In the expressions above for multivibrator timing periods the effects of amplifier offsets have been neglected.

Bistable Multivibrator.

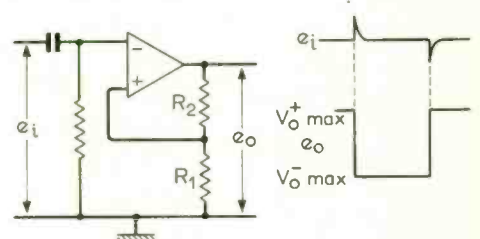

The two stable conditions for this circuit are with the amplifier output at positive or negative saturation. It is held in one or other of these states by the positive feedback applied via resistors R_1 and R_2 . A triggering pulse of suitable polarity applied to the phase-inverting input terminal causes the circuit to switch states regeneratively.

Staircase Generator.

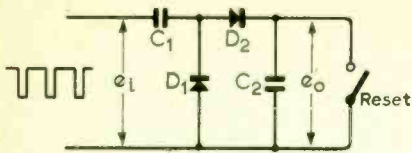

Simple diode pump (a)

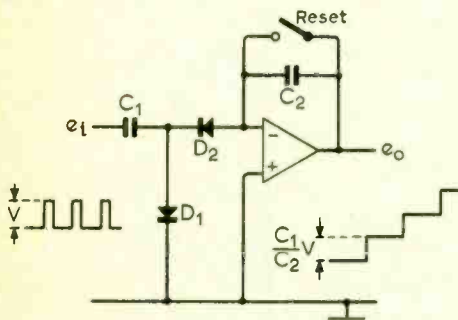
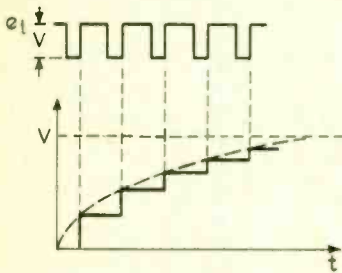

Linear staircase generator (b)

The output from a simple diode pump staircase generator (circuit (a)) is non-linear. If a sequence of input pulses of constant amplitude is applied the output steps become progressively smaller as the total output voltage approaches the magnitude of the input pulse amplitude. The action of the simple circuit is as follows: The capacitors are assumed to be initially uncharged; the first pulse charges C_1 through D_1 to a voltage equal to the pulse amplitude (V). The time-constant associated with C_1 and the source resistance must be shorter than the duration of the pulse. At the termination of the input pulse D_1 is reverse-biased and the charge on C_1 is transferred through D_2 to capacitor C_2 . If C_2 is much larger than C_1 practically all the charge on C_1 is transferred to C_2 . The process is repeated at each subsequent input pulse, but as the total voltage on C_2 increases the charge transferred through D_2 at the termination of each input pulse becomes less and less.

In circuit (b) the capacitor C_2 is connected between the output and the phase inverting input terminal of an op. amp. The feedback holds the phase inverting terminal at earth potential; equal increments of charge are "pumped" into C_2 at the termination of each input pulse and the steps at the amplifier output are thus of equal magnitude.

Both circuits must be provided with some means of resetting the voltage across C_2 to zero after some predetermined number of steps. In (b) amplifier bias current will cause output drift and a practical circuit would require some form of offset balancing (see section on integrator drift.)

Books Received

Semiconductors for Engineers, by P. F. Dunster, is a guide to the semiconductor devices used in modern electronics. It is intended to assist the understanding of the ideas behind the working of these devices, particular emphasis being placed on their function as circuit elements. The approach is mainly qualitative. All the ideas are developed from first principles, making it possible for an engineer with little or no academic background in semiconductor theory to understand the advanced concepts which are explained. Whenever possible, complications beyond the theme under discussion are ignored, and simplifying assumptions are made in order to develop a line of argument more clearly. At the same time, no simplification is taken beyond its usefulness, and at least the nature of the further problems involved is drawn to the reader's attention. (The author is principal lecturer in the Electrical Engineering Department of West Ham College of Technology, London.) Pp.278. Price £6. London Business Books Ltd., Mercury House, Waterloo Road, London S.E.1.

VHF-UHF Manual, by G. R. Jessop. The purpose of this specialized manual is to give a wide range of material for each of the amateur bands, so that the constructor has a selection of designs from which to choose and to suit his own individual need, together with some basic information on general matters. The first four short chapters discuss modulation, propagation, tuned circuits, and filters. Two long chapters cover a wide range of receiver and transmitter designs using both valves and transistors. The final chapters are on mobile systems, single-sideband transmission, aerials, and aerial test gear and accessories. There is a good index. Pp.244. Price 21s. Radio Society of Great Britain, 35 Doughty Street, London W.C.1.

Designing with Linear Integrated Circuits, edited by Jerry Eimbinder. This book is a collection of 18 contributions by 21 applications engineers drawn from a variety of American i.c. manufacturers. Detailed applications are suggested for the variety of i.c.s now available. Applications discussed include a.m. and a.m./f.m. receivers, d/a and a/d converters, logarithmic amplification, active filters, audio amplification, and voltage regulation. Pp.301. A good index is included. Price 105s. John Wiley & Sons Ltd., Baffins Lane, Chichester, Sussex.

Micropower Circuits, by James D. Meindl, is an introduction to the design of semiconductor circuits with quiescent power drain less than one milliwatt. Although written for practising engineers, the subject of each chapter is developed from a fundamental viewpoint. The treatment presumes that the reader is familiar with the basic principles of semiconductor devices and circuits, which

include the more prominent features of integrated circuits. It is emphasized that the minimum-power design criterion tends to produce a special-purpose rather than a general-purpose circuit. A wide range of amplifiers, oscillators and digital circuits using bipolar transistor and f.e.t.s is discussed. There is a concise index and an extensive list of symbols. Pp.257. Price 105s. John Wiley & Son Ltd., Baffins Lane, Chichester, Sussex.

Electrical & Electronic Trader Year Book 1969: Radio, Television and Electrical Appliances. 40th Edition. All sections in this new edition have been revised and brought up to date with details of new wage rates for service technicians, recent legislation, an enlarged service depots section, etc. The continuing aim of this reference book to the radio, television and domestic electrical industries is to assist traders to keep abreast of changes in the industries. Pp.500. Price 35s net (postage 2s 6d). I.P.C. Electrical-Electronic Press Ltd., Dorset House, Stamford Street, London S.E.1.

Announcements

A vacation school on **engineering aspects of microelectronics** will be held at the University of Essex, Colchester, from 15th to 19th September. Details are available from the Secretary, I.E.E., Savoy Place, London W.C.2.

Wolverhampton College of Technology has arranged a course of eight lectures on **high fidelity sound reproduction** to be held on Wednesday evenings from 15th October to 10th December. Fee £2.

A post-graduate evening course of fifteen lectures on **integrated circuit application theory** will be held at West Ham College of Technology, Romford Road, Stratford, London E.15, on Thursdays commencing 16th October. Fee £4.

Donald Blakey Ltd, Montauban Chambers, 339 Clifton Drive South, St. Annes-on-Sea, Lancs, have produced a **film on television servicing** and installation which will become available later this year for rental or purchase.

The Plessey Company Ltd and Illinois Tool Works Inc. of Chicago have formed a joint company in Britain for the manufacture and sale of **miniature electro-mechanical switches**. The new company, Licon Electronics Ltd, will for the present be located at the Plessey factory at Litchfield, Hants.

Celdis Ltd, of 43-45 Milford Road, Reading, Berks, are to act as distributors for **Transistor A.G.**'s range of thyristors, triacs, planar p-n-p transistors and rectifiers.

P.F. & A. R. Helme, Butcher Pasture, Summerbridge, Harrogate, Yorks, have been appointed sole U.K. distributors for **Peerless Fabrikkerne A/S**, of Copenhagen, Denmark, manufacturers of loudspeakers.

American Corporation, suppliers of **miniature coaxial connectors**, have appointed Microwave & Electronic Systems Ltd, of Newbridge, Midlothian, as their exclusive stockists and representatives in the U.K. and Eire.

Racal-BCC Ltd have received an order worth £250,000 from the Malaysian Ministry of Defence for 'Synca' and 'Squadcal' **military manpack radio-telephones**. 'Synca' is the new synthesized h.f. military radio manpack with 6,000 channels.

Racal and Airmec get together-

It's the Instrument event of the year!

Racal have made a big name in digital—and Airmec in analogue instruments. What better than to combine the efforts?

The brilliant new Airmec 422 VLF Digital Signal Generator is an outstanding example of the results achievable by combining analogue and digital know-how—

it will pay you to keep in touch with this get-together.

The highly successful Airmec range is now obtainable from the Airmec Division of Racal Instruments, with plus features of greatly improved service thinking and good solid Racal back-up.

It's going to be interesting.



RACAL INSTRUMENTS LTD · AIRMEC DIVISION · BENNET ROAD · READING · BERKS Tel: 35571 Telex: 84166.

RACAL

WW—296 FOR FURTHER DETAILS

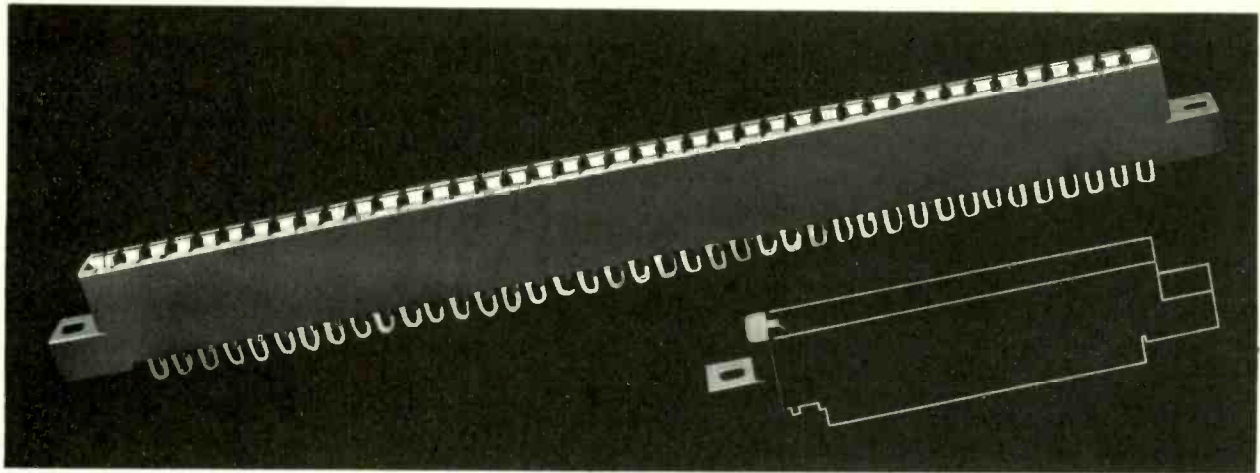

MP 1468 End Foot.

0.150" Edge Connector

"RL" SERIES

40 way single sided with solder tails	MP 1469
80 way double sided with solder tails	MP 1470
40 way single sided with printed wiring tails	MP 1471
80 way double sided with printed wiring tails	MP 1472
End foot	MP 1468
Polarising key	MP 1467

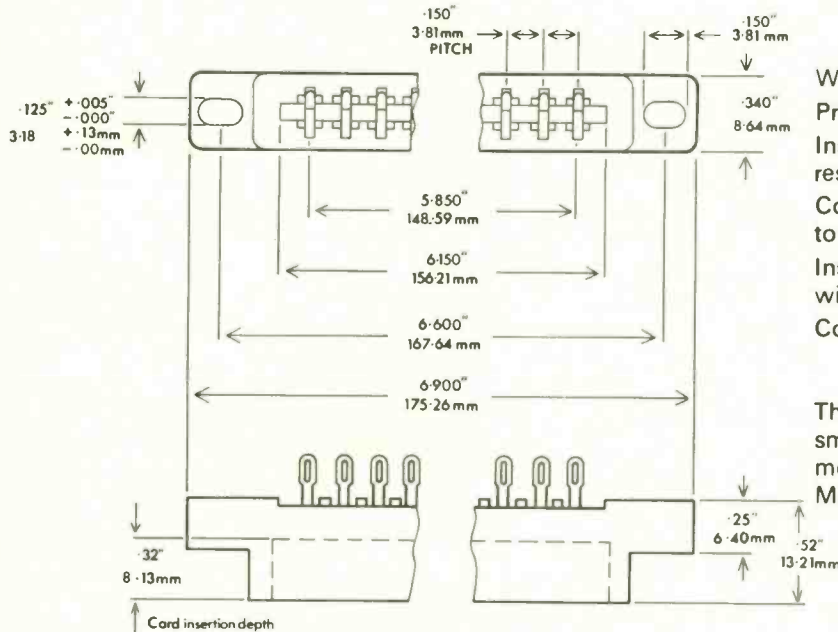

Working voltage	750V. D.C.
Proof voltage	2.5 KV
Insulation resistance (dry)	10^6 Megohms min.
Contact resistance to test gauge	10 Milli-ohms max.
Insertion and withdrawal forces	6 oz. per contact max.
Contact finish	Flow tin or hard gold (specify when ordering)

The connector can be reduced to a smaller number of poles by cutting the moulding and fitting a separate end foot, MP 1468.

mcMurdo
great facility for service

Member of the Louis Newmark Group, with access to the combined facilities of all other member companies.

Send for quotation

To: McMurdo Instrument Co. Ltd.,
Rodney Road, Portsmouth, Hampshire.
Telephone: Portsmouth 35361. Telex: 86112



Authorised Stockists:- Lugton & Co. Ltd., 209/210 Tottenham Court Road, London W.1. Tel: Museum 3261 Sasco, P.O. Box No.20, Gatwick Road, Crawley Sussex. Tel: Crawley 28700 (also Chipping Sodbury 2641, Cumbernauld 25601 and Hitchin 2242) and agents in principal overseas countries.

WW-092 FOR FURTHER DETAILS

Test Your Knowledge

Series devised by L. Ibbotson,* B.Sc., A.Inst.P., M.I.E.E., M.I.E.R.E.

5. Semiconductor diodes

1. Silicon junction diodes are being used increasingly for power rectification. The maximum power which can be handled by a single silicon diode (available at the present time) is of the order of:

- (a) tens of watts
- (b) hundreds of watts
- (c) thousands of watts
- (d) millions of watts.

2. Four normal p-n junction diodes of similar construction are made from the materials listed below. The diodes are connected in series across a direct voltage source so that all are forward biased. The diode across which the smallest voltage drop will occur will be that made of:

- (a) germanium
- (b) silicon
- (c) gallium arsenide
- (d) gallium phosphide.

3. Germanium point-contact diodes are used extensively in detection and demodulation circuits for radio and TV. Their advantage in this application, when compared to p-n junction diodes is:

- (a) low capacitance when reverse biased
- (b) low leakage current when reverse biased
- (c) high reverse-bias breakdown voltage
- (d) low forward-bias resistance.

4. A germanium photodiode has a load resistor connected across its terminals. When light of a frequency above the threshold value for electron-hole pair generation falls on the junction:

- (a) no current will flow in the load
- (b) current will flow in the load with a conventional direction out of the p side of the diode
- (c) current will flow in the load with a conventional direction out of the n side of the diode
- (d) the direction of current flow will depend on the value of load resistance.

5. A photodiode is required to feed an amplifier which has a high input impedance.

In order that the input signal to the amplifier shall be proportional to the intensity of illumination the photodiode must:

- (a) be unbiased
- (b) have a reverse-bias voltage applied
- (c) have a forward-bias voltage applied of a value less than the diffusion-potential of the junction
- (d) have a forward-bias voltage applied of a value greater than the diffusion-potential of the junction.

6. The essential feature of the construction of a tunnel diode is that it must:

- (a) be made of germanium
- (b) have a narrow junction region with very heavily doped material on each side
- (c) have a wide graded junction
- (d) have a wide layer of intrinsic semiconductor between the p and the n doped parts.

7. A germanium tunnel diode is to be used as a v.h.f. oscillator. For this purpose it requires:

- (a) zero bias
- (b) a reverse bias of about 0.2 volts
- (c) a forward bias of about 0.1 volts
- (d) a forward bias of about 0.3 volts.

8. In a backward diode the mechanism of current flow across the junction depletion layer in the low resistance direction is:

- (a) diffusion
- (b) drift
- (c) tunnelling
- (d) avalanching (impact ionization).

9. Voltage stabilizing and reference diodes all are used at a part of their characteristic where the current increases very rapidly with applied voltage. Of the mechanisms of current increase listed below one is not made use of for this purpose. It is:

- (a) thermal generation of carriers in the depletion layer
- (b) carrier tunnelling through the depletion layer
- (c) impact ionization in the depletion layer
- (d) a combination of Zener and avalanche breakdown.

10. The varactor diode, in addition to its use in parametric amplifiers, is used at microwave frequencies for all but one of the following applications. It is *not* normally used as:

- (a) a detector
- (b) a harmonic generator
- (c) a switch
- (d) a limiter

11. The most common use of a p-i-n diode is as a microwave

- (a) oscillator
- (b) switch
- (c) amplifier
- (d) detector

12. The important property of the Schottky-barrier (metal-semiconductor) diode is that:

- (a) it has a very low forward resistance
- (b) it has a very high reverse resistance
- (c) it has a very low diffusion capacitance
- (d) it has a very high depletion-layer capacitance.

13. A p-n junction diode, biased to a reverse voltage at which a significant amount of avalanching occurs in the depletion layer, can be used as a microwave

- (a) oscillator
- (b) switch
- (c) limiter
- (d) detector.

14. The essential feature of the construction of a Gunn diode is that:

- (a) it has two p-n junctions
- (b) it is made from a direct-energy-gap semiconductor
- (c) it has a graded junction
- (d) it has a wide layer of intrinsic semiconductor between the p and n doped parts.

15. The basic difference between a normal Gunn diode and a l.s.a. diode is that:

- (a) the l.s.a. diode has one extra p-n junction
- (b) the l.s.a. diode is used at much lower frequencies than the Gunn diode
- (c) in the l.s.a. diode dipole domains are not allowed to form
- (d) the l.s.a. diode must be made of an indirect-energy-gap semiconductor.

16. Step-recovery diodes find substantial use as harmonic generators to multiply up oscillations produced at v.h.f. into the microwave region. The property which makes the step-recovery diode suitable for this application is that it exhibits:

- (a) a sudden drop of current a short time after the applied voltage changes from forward to reverse
- (b) a negative-resistance region in its forward-bias characteristic
- (c) very low voltage Zener breakdown for both directions of applied voltage
- (d) a discontinuous increase in forward current at a particular applied voltage.

Answers and comments, page 397

*West Ham College of Technology, London, E.15

Thyristor-stabilized Power Supplies

Essential considerations in the development of d.c. power supplies using thyristor control

by Arthur R. Bailey*

The conventional method of stabilizing power supplies is to use linear devices as shunt or series regulators with an already smoothed d.c. power supply. For low powers shunt regulation with a zener diode is very common. For high powers a series transistor is normally used as the d.c. power loss is least with this circuit. It is also possible to control the output voltage of a d.c. supply by varying the angle of conduction of the main rectifier diodes.

The main advantage of using thyristors to stabilize d.c. supplies is that the power dissipated in the thyristor is far less than in a series transistor because the thyristor is either 'off' or hard 'on'.

The simplest regulation circuits are those where two of the diodes in a conventional full-wave rectifier circuit are replaced by thyristors (Figs. 1 and 2).

In Fig. 1 it will be seen that the two diodes in a conventional circuit have been replaced by two thyristors, the gates of these thyristors being returned to a fixed positive reference supply which can be obtained from a zener diode. The thyristors will conduct until their gate-cathode potential falls to below

about 0.5V when they will cease to 'fire' with forward-applied anode voltage. The output voltage is therefore theoretically held to within a fraction of a volt of the value fed to the gate supply. Unfortunately the circuit does not operate correctly when used in this form, the defect being particularly noticeable at low values of load current. The cause of the trouble is that conduction does not cease when the output voltage is correct, but only when the current falls to zero. At low load values, this has the effect of giving a large step in output voltage when one thyristor fires for its full period. As the load is low the output voltage may exceed the set value for many cycles, and the thyristors therefore conduct in single pulses separated by many cycles. This gives rise to large sub-mains-frequency ripples on the supply line.

To prevent this effect, which is shown in Fig. 3, it is necessary that the thyristors are given a superimposed quadrature alternating voltage on their gate circuits. This has the effect of starting conduction at the end of the possible 'on' period when the supply voltage is nearly correct and opening up the conduction angle as the output voltage falls. Unfortunately this reduces the regulation of the

system to some degree, but for stability it is a price that has to be paid. Nevertheless, it is possible to obtain a stability of better than 2% in a 60V supply.

The quadrature stabilizing voltage is readily obtained from the a.c. supply, either by cross-coupled capacitors with the centre-tapped transformer or with an integrating network for both systems. The connections necessary are shown in Figs. 4 and 5.

Either of the two systems mentioned is capable of driving into inductive or capacitive loads such as occur with choke input or capacitor input filters. Tests however indicate that with choke-input filters there is little problem of sub-harmonic generation as compared with capacitor input filters. Unfortunately capacitor input filters are the most common, and even with quadrature voltage fed to the thyristor gates, there is a serious possibility of uneven firing of the thyristors. As mentioned before, this occurs at low values of load currents, so the effect would be serious with a class B power amplifier supply but of no concern with the constant load of a class A amplifier.

The problem arises due to the low output impedance of normal power supply trans-

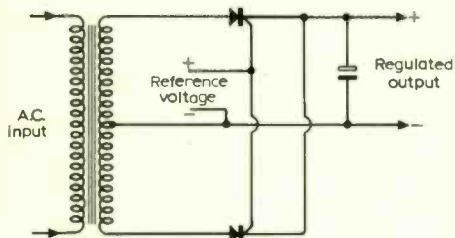

Fig. 1. Basic d.c. stabilizer using full-wave rectifying thyristors.

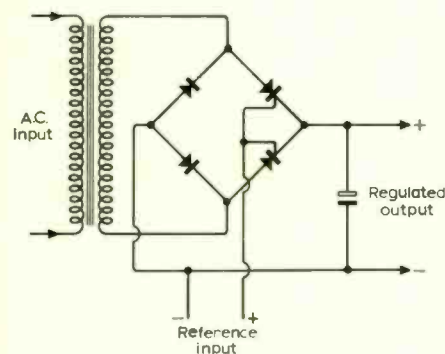

Fig. 2. D.c. stabilizer using thyristors as part of a conventional bridge rectifier.

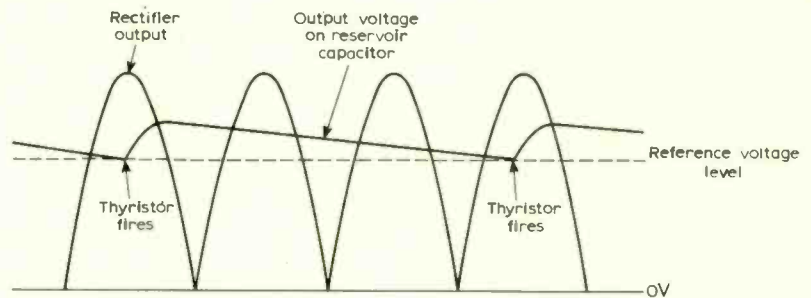

Fig. 3. Sub-harmonic generation caused by a thyristor.

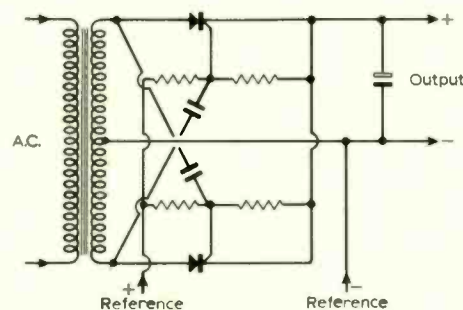

Fig. 4. Quadrature voltage supply obtained by differentiation.

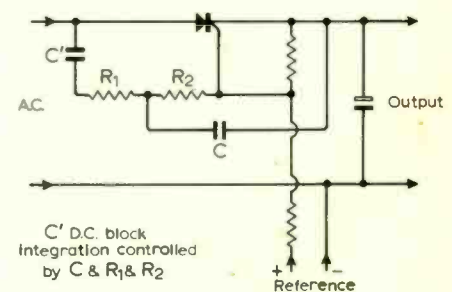

Fig. 5. Quadrature supply obtained by integration.

*University of Bradford.

formers. If the rate of rise of output voltage in the output smoothing capacitor can be held sufficiently low the trouble does not occur. It is therefore obvious that what is required is a transformer with a fairly large leakage reactance. As this reactance reduces the full-load output voltage of the transformer, this unfortunately necessitates a greater open-circuit voltage for adequate full-load stabilization. As large leakage reactances tend to cause bad stray hum fields from transformers it is preferable to use a separate choke for this purpose. This is not readily obtained using the centre-tapped transformer without involving a.c. in the windings, but it is readily applied in the bridge rectifier circuit. The full circuit then appears as shown in Fig. 11 discussed later.

Overload protection

For many purposes it is advisable that a power supply be protected against short-circuits. This is particularly important with thyristors, as they do not have good long-period overload characteristics. Provided that the overload can be restricted to say 20% greater than full load current then there is little likelihood of serious damage and the supply could be designed to cope with this current on a continuous basis if required. Using a very simple circuit it is possible to give overcurrent protection to the supply with little degradation in regulation. With a little more complexity the regulation need not be affected, and this circuit is shown in Fig. 6.

The basis of operation is that of shorting out the reference voltage supply by a transistor that is turned on when the designed load current is exceeded. The current-measuring resistor R is included in the supply side of the return current path so that its voltage drop does not affect the regulation of the output. As the current in this return lead has a large a.c. component it is necessary to smooth this out before feeding it to the base of the overload sensing transistor Tr_1 . When the voltage across this series resistor exceeds about 0.6V, the silicon transistor starts conducting and drops the reference voltage across the zener diode. If the overload is sufficiently severe the output voltage will fall to nearly zero.

For many purposes this overload performance will be quite adequate, but for some applications a more rapid onset of current limitation will be required. For these applications the circuit can be modified as shown in Fig. 7. Here a second transistor is used to amplify the output of the first one with consequent improvement in performance. If necessary, current lock-out can then be applied so that the circuit will trip out until the mains is switched off and then reapplied. This is done by the use of the two resistors shown dotted in Fig. 7. The presence of these resistors gives positive feedback around the two transistors which, if sufficient, will cause the circuit to act in a bistable manner.

An additional refinement that is frequently advisable in power supplies—particularly in audio-frequency amplifiers—is that the output voltage rises smoothly at switch-on. If the time-constant of the output-voltage rise is about a second or so, then unwanted surges in the amplifier can be greatly reduced. This is readily obtained in the circuit by splitting the feed resistor to the zener diode and using a

large value decoupling capacitor at the junction of the two resistors. This modification is seen in the 60 volt stabilized supply circuit of Fig. 11.

So far two thyristors have been assumed to be necessary. If a full-wave conventional system is used with a reservoir capacitor, then it is possible to use only one thyristor with a consequent saving in cost. The essential factor is that the reservoir capacitor must be sufficiently large to stop the main rectifiers conducting over part of each cycle. If this condition is fulfilled, then a thyristor can be used in series with a conventional transformer-rectifier configuration before the reservoir capacitor. This is shown in Fig. 8. Here it is seen that the quadrature voltage is obtained by integration of the anode voltage as before. In fact the anode voltage is non-sinusoidal and at double the mains frequency, but the action of integration improves the waveshape and gives perfectly adequate results. The doubled frequency also allows smaller smoothing capacitors to be used.

Practical circuits

Two examples of the application of these types of stabilizer now follow. The first is a case where a sub-harmonic generation is no particular disadvantage and is a controller for model railways. In fact the circuit is useful for low-impedance control of any d.c. motor, but has refinements that can be of particular value to model railways.

In large d.c. motors it is necessary to keep the supply as pure as possible or commutation can be seriously affected. In small motors without interpoles (such as typical 'universal' motors) this restriction does not apply. In the circuit shown in Fig. 9 the size of the smoothing capacitor is deliberately kept small so that the motor runs on only slightly smoothed rectified a.c. During the rectifier 'off' state, the resonant circuit formed by the motor inductance and resistance, and the small reservoir capacitor, resonates and destroys the stored energy. For small motors of low efficiency the circuit is heavily damped and the current falls to zero value before the next rectifier 'on' period. This means that the zener diode reference that determines the gating of the thyristor is therefore measuring the actual back e.m.f. of the machine. The circuit therefore is relatively insensitive to motor-

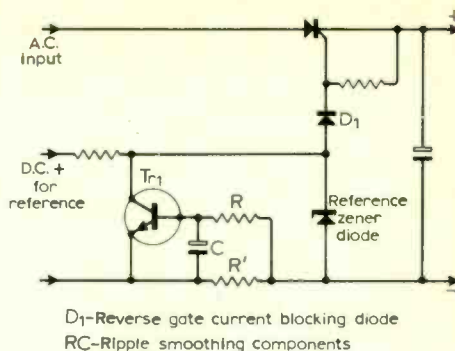

Fig. 6. Overload protection circuit.

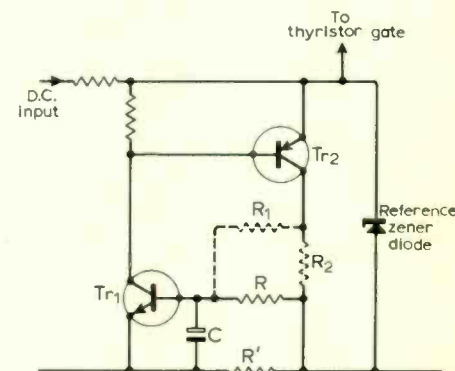

Fig. 7. Overload protection circuit giving more abrupt control than Fig. 6.

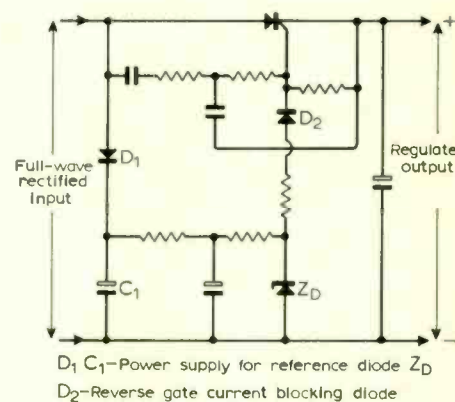

Fig. 8. Basic stabilizer circuit diagram for a single rectified input.

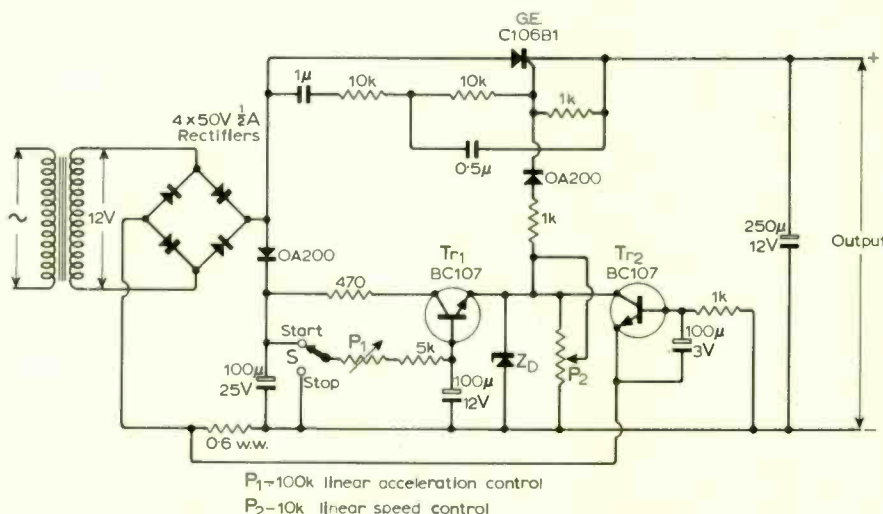

Fig. 9. Speed control system for small permanent-magnet or separately excited d.c. motor.

resistance drop and tends to run at constant speed irrespective of load. In practice the applied mean d.c. voltage to the motor rises as mechanical load is applied, the motor speed remaining approximately constant. When stalled nearly the full supply voltage appears across the motor. This performance is far better than that of a stabilized d.c. supply such as is obtained from a conventional smoothed regulator.

It is suspected that many of the thyristor electric drill controllers utilize this effect, relying on the residual magnetism in the field for the back e.m.f. generation.

As the thyristor is a rectifier in its own right, it is unnecessary to use a bridge rectifier if a transformer of twice the voltage is used for the supply. In this case the thyristor is gated at half the previous frequency and the amended values and parts of the circuit are shown in Fig. 10.

The overall performance of the circuit is extremely good and allows better 'constant-speed' characteristics to be obtained from small motors.

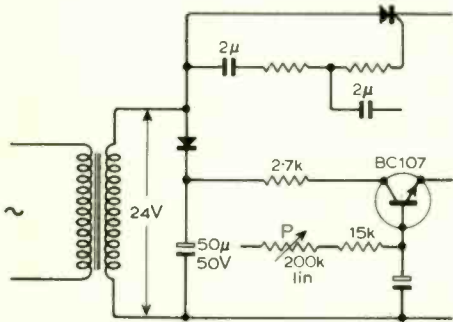

Fig. 10. A.c. drive modifications for Fig. 9.

In the circuits, the thyristor type given is specified on account of its high gate sensitivity. For the more common low sensitivity types where the gate current exceeds 1 mA (and may rise as high as 25 mA) a transistor is required to amplify the gate drive signal, the modifications being shown in Fig. 12.

The motor speed can be increased smoothly from zero to the set level by the 'start' switch S, Fig. 9. Equally, if this is switched off the speed will fall to zero gradually. The rate of acceleration and deceleration under these conditions is set by the potentiometer P₁. Overload protection is provided by the transistor Tr₂ which prevents damage to the thyristor. Practical tests on the completed circuit show that the wheel loading of a typical gauge 00 locomotive can be increased from zero to the value where the motor is 'full-on' with very little speed change. This performance is obtained even with the motor running at very low speed. The performance is certainly far better than that of conventional variable resistance controllers.

The second circuit, previously referred to, is shown in Fig. 11, and is of a 60V 1.6A stabilized supply suitable for a.f. amplifier applications. In fact the author developed this for the amplifier previously described in *Wireless World*¹ when used with the single h.t. rail modification.²

A choke is used in series with the transformer secondary to prevent uneven firing of the thyristor. This is not so much of a disadvantage as might be expected, as the longer thyristor conduction angles resulting give rise to better transformer utilization and consequently a smaller mains transformer. In addition the ripple on the h.t. line is reduced

by a factor of some 2.5 times by this increased period of conduction. Overload protection apart from fusing has not been applied as the system was designed for one application. If overload protection is required, and also a variable output voltage, then the modified circuit shown in Fig. 13 can be utilized.

The performance is quite adequate, regulation being about one volt change from no load to full load. Where sustained output is required from class B amplifiers such stability is necessary to prevent loss of power.

Where wide-range high-power stabilized supplies are required the thyristor regulated system has many advantages. For example a 60V, 5A fully variable supply would dissipate over 150 watts at half output voltage and full current, if a normal series transistor was used. In a thyristor supply the dissipation would only be some 6 to 8W. Nevertheless the low ripple and very good regulation of normal series regulators are often very attractive. In this case it is frequently the best solution to use a thyristor supply to stabilize some 5V above the wanted value and drop the remaining 5V in a conventional series regulator. Depending on the transistor type only two volts or so may be necessary with consequent power dissipation saving.

In conclusion, the author feels that there is a definite place for the thyristor regulated supply in applications where very low ripple voltages are not required. In high-power stabilized supplies the thyristor is advantageous as a pre-stabilizer to minimize the size and power dissipation of the series regulating transistors that are required.

REFERENCES

1. Bailey, A.R. 30-watt High-fidelity Amplifier, *Wireless World*, May 1968.
2. Bailey, A.R. 30-watt Amplifier Modification, *Wireless World*, November 1968.

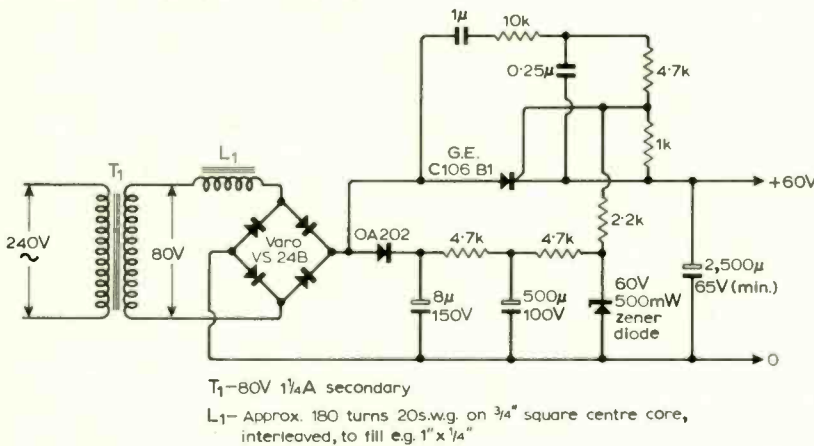

Fig. 11. Circuit for 60 volt 1.6 ampere stabilized d.c. supply.

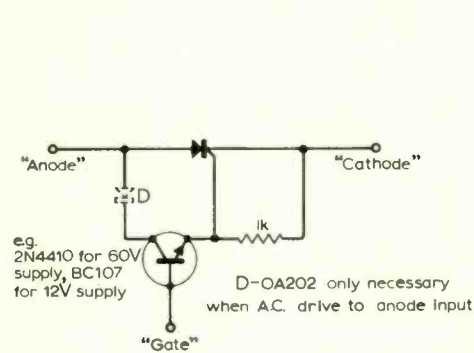

Fig. 12. Gate amplifying circuit for use when low sensitivity thyristors are used.

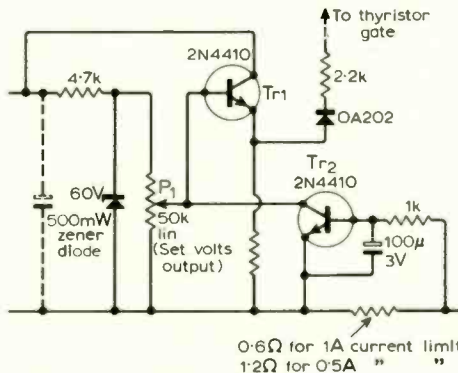

Fig. 13. Required modifications to Fig. 11 for variable output and current limiting.

THE SEPTEMBER ISSUE

A correspondent in this month's "Letters" mentions freak long-distance reception of television transmissions—a French station being received in Scotland. To facilitate the identification of Continental stations we plan to include in our next issue reproductions of a selection of test and identification cards used by some of the broadcasting services.

The issue will also include the second in the series of articles on active filters and, in addition to the continuation of the two constructional articles, contributions dealing with better stereophonic reproduction and acoustical holography.

New Products

Variable Waveform Generator

Model A100 variable phase waveform generator from Prosser Scientific Instruments, is a source of precisely shaped voltage waveforms. Both the frequency and the phase between outputs can be varied linearly over a large range. The amplitude of the waveshapes can be precisely selected and can be off-set and clipped. Simultaneously available are sine, square, triangle and ramp output waveforms in the frequency range 0.001Hz to 20kHz. The variable phase facility extends



the usefulness of the instrument into studies of phase and frequency modulation, and servo and circuit testing. The remote control of frequency and phase is intended for use on semi-automatic and automatic test gear. Voltage-to-phase conversion and voltage-to-frequency conversion relationships are linear. The output level is up to 10V. Prosser Scientific Instruments Ltd, 1 Northampton Street, Cambridge. WW312 for further details

Circuit Selector with P.C. Terminations

Sealectro's slide switch programming circuit selector is designed with printed-circuit output terminations which mate with standard edgemount p.c. card connectors. It is engineered for a minimum of 250,000 operations as a random-access unit which will switch from one given position to any



of eleven others without making contact with intermediate switch points. It has a modular, expandable construction which allows any practical number of units to be stacked side-by-side. Internal p.c. board construction permits special electrical codings to be supplied at minimum cost. Contacts will carry 3A d.c. and have a resistance of only 75 milliohms maximum. Sealectro Ltd, Walton Road, Farlington, Portsmouth, Hants. PO6 1TB. WW317 for further details

Low-Cost Decade Capacitor

Hewlett-Packard's model 4440B decade capacitor provides capacitances from 40pF to 1.2μF, accurate to within ±0.25% (+3pF). It has four easy-to-read in-line decade ranges for selecting capacitances in steps of 100pF. It also has an air capacitor vernier which allows continuous adjustment between the 100pF steps of the smallest decade. Resolution of the vernier is 1pF. Silvered-mica capacitors are used in all decade steps, in order to obtain high accuracy, low dissipation, and good stability with temperature. The capacitors in the HP 4440B are housed in a double shield and



can be operated in either a two-terminal or three-terminal connection. The accuracy specification of ±0.25% (+3pF) applies to the three-terminal connection. However, the increase in capacitance for the two-terminal connection is less than 1pF. Typical values for the resonant frequency of the HP 4440B are 450 kHz at 1μF, 4MHz at 0.01μF, and 40MHz at 100pF. The maximum voltage is 500V peak, and insulation resistance is greater than 5GΩ after 5 minutes at 500V d.c. The cost is £111. Hewlett Packard Ltd, 224 Bath Road, Slough, Bucks. WW313 for further details

Electronic Multimeter

The Comark portable electronic multimeter type 1231 is an accurate, high sensitivity instrument with high input impedance and wide bandwidth. It has more than 70 different measurement ranges, and readings are clearly indicated on a robust 130mm



meter. Overall accuracy of the 1231 is ±2% of full scale for d.c. measurements and ±3% of full scale for a.c. measurements over a bandwidth from 10Hz to 100kHz (3Hz to 250kHz for -3dB). Voltage sensitivity is from 1mV full scale to 300V in 12 ranges, with an input resistance of 1MΩ/V at d.c. The maximum current sensitivity is 1μA full scale with a meter volt drop of less than 12mV. Resistance is measured to an accuracy of ±5% of reading from 1Ω to 100MΩ and greater accuracy (±2%) may be achieved using the linear ohms ranges. Centre-zero operation may be selected on all d.c. ranges, for use as a galvanometer or differential voltmeter. Battery powered, the multimeter is protected on all ranges against overload greatly in excess of full scale of the selected range. The portable model is supplemented by alternative models suitable for laboratory and rack mounting; a leather carrying case is available for the portable version. U.K. list price £50. Comark Electronics Ltd, Brookside Avenue, Rustington, Sussex. WW318 for further details

Wide-range A.F. Power Meter

Accurate measurement of power and voltage is possible with the a.f. power meter TF2500 announced by Marconi Instruments. The instrument is accurate to ±2.5% full scale and measures power up to 20kHz from 100μW full scale to 25W full scale in seven ranges. Frequency response is 0.5dB over the a.f. range. Load impedance is 2.5Ω to 20kΩ in forty steps. A centre-tap terminal on the input transformer extends still further the impedance range. An outstanding feature of TF 2500 is that it also measures voltage up to 1MHz in nine ranges from 15mV to 150V full scale. Input impedance on the voltmeter is



1M Ω and the voltmeter may be used as an a.c./d.c. converter. The TF2500 is suitable for use with audio amplifiers, receivers and a wide variety of transmission systems including f.d.m. base-band networks. Its high sensitivity permits direct measurement of very low power levels, down to less than 10 μ V, so that it may be used for signal-to-noise ratio and noise factor measurements on low-noise equipment. This sensitivity is achieved by the use of an active measuring system based on what is essentially an amplifier-detector type voltmeter calibrated in terms of power, dBm, and voltage. Power measurement can be made with unbalanced, balanced or fully floating load. TF2500 has 50W overload capability on power and the meter is fully protected through the amplifier on all impedances. The instrument is battery operated and fully self-contained, with a built-in battery check facility. The price is £285. Marconi Instruments Ltd, St. Albans, Herts.

WW325 for further details

TO₃ Ceramic Heat-transfer Washers

The A26-2004 aluminium oxide ceramic washer from Jermyon exhibits very low thermal impedance and a breakdown voltage of 1,000 volts minimum. The low thermal resistance (0.15°C per watt) allows the full power capability of the semiconductor to be utilized with complete electrical insulation.



The thermal performance is approximately five times better than mica and is comparable with an equivalent hard anodized aluminium washer. It should be noted that aluminium oxide is non toxic. Samples are available upon request from Jermyon together with full information. Jermyon Industries, Vestry Estate, Sevenoaks, Kent.

WW301 for further details

Single-Reed Encoders and Decoders

Resonant reed encoders and decoders, types J-610A and J-510A, from Kynmore, cover the frequency range 67 to 1600Hz. They are designed for use where one or several frequencies need to be detected or generated in a single carrier system. Using these devices, it is possible to obtain as many as 100 frequencies in a single octave, with excellent separation. Typical applications include generating and sensing audio frequencies in telemetry, telecommunications,



signalling equipment, transponders, and controls. Claimed to be vibration-proof, they are well suited to railway signalling, alerting systems and telemetry systems operating in difficult environments. One of the reasons for their development was the need for a simple unit for use in squelch circuits in mobile communications equipment. Both encoder and decoder provide a tuning tolerance of $\pm 0.3\%$ or ± 1 Hz, whichever is less, for frequencies below 1kHz, and $\pm 0.1\%$ for frequencies above 1kHz. They will not generate external fields, and they are not influenced by such fields. They operate equally well in any position, irrespective of any mass to which they may be mounted. They are designed to operate over a temperature range from -40° to $+85^\circ$ C. They are enclosed in a nickel-plated drawn-copper can with a seven-pin hermetic seal header. The decoder has a sensitivity of 1.0V r.m.s. ± 0.5 V r.m.s., and a bandwidth of 5Hz ± 3 Hz at the 3.0V r.m.s. operating point. Kynmore Engineering Company Ltd, 19 Buckingham Street, London, W.C.2.

WW319 for further details

Oscilloscope Sampling Adaptor

A single-channel oscilloscope sampling adaptor from G. & E. Bradley allows waveforms at frequencies up to 1000MHz to be examined on any general purpose oscilloscope. It is capable of displaying signals with a rise time of 0.5ns. Sample density is continuously variable from 100 to 1,000 samples per sweep, and density is independent of sweep expansion, which is switchable from $\times 2$ to $\times 100$. Maximum sampling speed on a 100mm oscilloscope tube provides a display at just above flicker rate, simplifying waveform analysis. For permanent records, the instrument can be coupled directly to a chart recorder. The sampling technique used depends on the generation of a very fast pulse coincident with the incoming signal, which switches a sampling gate. Time separation is determined by comparing the pulse against a staircase generator. Automatic c.r.t. blanking is provided and manual sweep can be

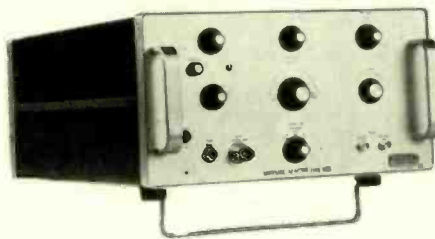

used when required. Drift of all calibrated parameters is less than 1% of full scale per 10°C change in ambient temperature, and noise is reduced to less than 2mV by a smoothing control. G. & E. Bradley Ltd, Electrical House, Neasden Lane, London N.W.10.

WW323 for further details

Universal Meter

Model TVM 1070 transistor universal meter from British Physical Laboratories replaces model TVM1063 and provides a total of 43 different a.c. and d.c. ranges. Particular attention has been paid to styling and presentation to provide ease of opera-



tion: all ranges are selected by a single control clearly marked with a colour-code scale. All ranges—both a.c. and d.c.—have linear scales, including a new 0/100mV a.c. range. The internal batteries, which can be changed with the minimum of inconvenience, can always be checked by selecting the 'battery check' position. The instrument is available at an ex-works price of £70. British Physical Laboratories, Radlet Herts.

WW302 for further details

Coaxial Stripline Couplers

A comprehensive range of stripline coaxial directional couplers is announced by Radiall. Within the frequency band 150MHz to 8000MHz they are offering 35 devices in families, each covering one frequency octave. 'N' and 'RIM' coaxial connector outlets are incorporated and couplings of 3, 6, 10, 20 and 30dB can be specified. The 8000MHz 3dB type has overall dimension of less than 39 \times 25 \times 8mm. They are designed for use under very severe environmental conditions which includes a temperature range from -55° C to $+100^\circ$ C. 3dB quadrature hybrids may be used as baluns, mixers, duplexers, power dividers, phase shifters and for other applications requiring equal division of power between two transmission lines. Radiall Microwave Components Ltd, Station Approach, Grov Park Road, Chiswick, London W.4.

WW305 for further details

Marine Radio Equipment from Redifon

A range of v.h.f. radiotelephones for fishing vessels and small merchant ships, and a radio selector unit which affords speedier and more efficient operation of ship stations, are announced by the Marine Division of Redifon. Three new all-transistor radiotelephones, types GR471, GR472 and GR473, are designed to comply with G.P.O. specifications TSC 53d, 55a, and 57a. Similar in size and appearance the three versions provide 12, 18 and 24 channel operation respectively, with a transmitter output power of 14 watts from the GR471 and 20 watts from the GR472 and GR473. Intended for bulkhead mounting, each set is constructed on a single hinged chassis which swings open to left or right to ensure full access, and is fitted into a waterproof diecast case. All three sets operate from a nominal 24 volt d.c. supply but will tolerate supply variations over the range 19 volts to 32 volts.

The RS11 radio selector unit is a compact control unit into which are concentrated facilities for switching the muting and signalling circuits for all m.f., i.f. and h.f. equipment in a ship's radio station. It serves as an aerial exchange for up to four receivers, and also provides a single termination panel for the supply and interconnection cables of the

We can mould your future -and even dye for you!

Plastic mouldings feature extensively in the millions of tiny fasteners and connectors that we make every week. Which in practice works out at hundreds of millions of mouldings per year.

We injection mould in glass filled polycarbonates, nylon, polypropylene, polythene, polystyrene and acetal resins for the electrical and electronics industries and compression mould to

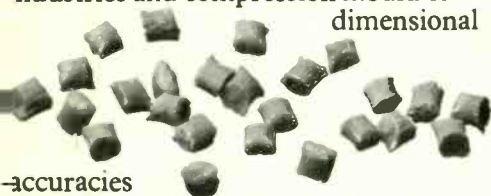

dimensional

accuracies of .001 in., with contact spacings as close as .050 in. And our research and development boys are constantly working to push these specifications to even finer limits.

We injection mould bits and pieces

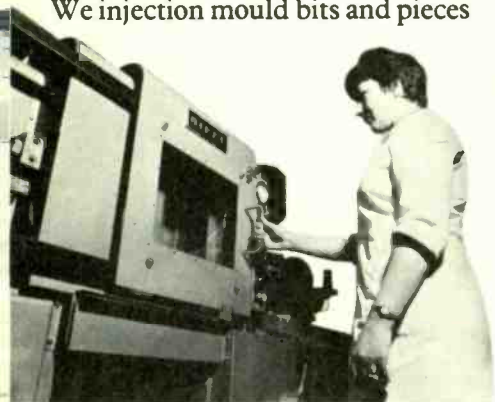

for practically every other industry you care to mention. And make the dies and moulds for these parts in our own toolroom. And if the raw material doesn't happen to come in the colours we require - and they often don't - we dye the mouldings in our own dye house.



From which you'll gather that we have *all* the facilities to shape and colour the thousands of very different mouldings that go into our vast product range, as well as the capacity to produce them in millions!

We don't leave off there either! By themselves plastic mouldings can only perform a certain number of functions. But marry them to metal and you can really start doing things. Make currents flow, or change. Make lights glow and valves hum. And so on and so

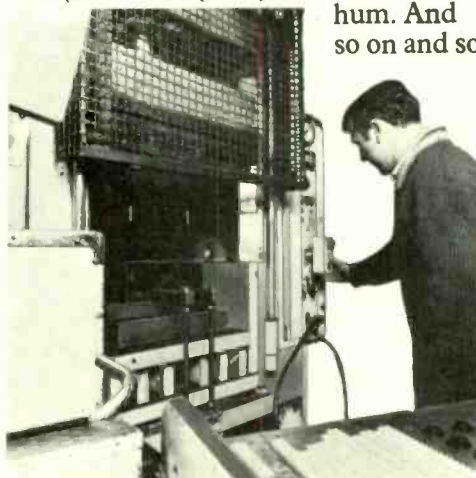

forth. Adding the metal bits can be difficult if you don't have the know-how. But we have it. Lots of it. And we'll even make the metal parts for you as well, if you like! In any metal, with any refinements such as plating, tempering, soldering, riveting etc, etc thrown in.

Carr Fastener Company Limited
Stapleford, Nottingham
Telephone: Sandiacre 2661 G8



WW-093 FOR FURTHER DETAILS

RANGE WIDE WITH COSSOR

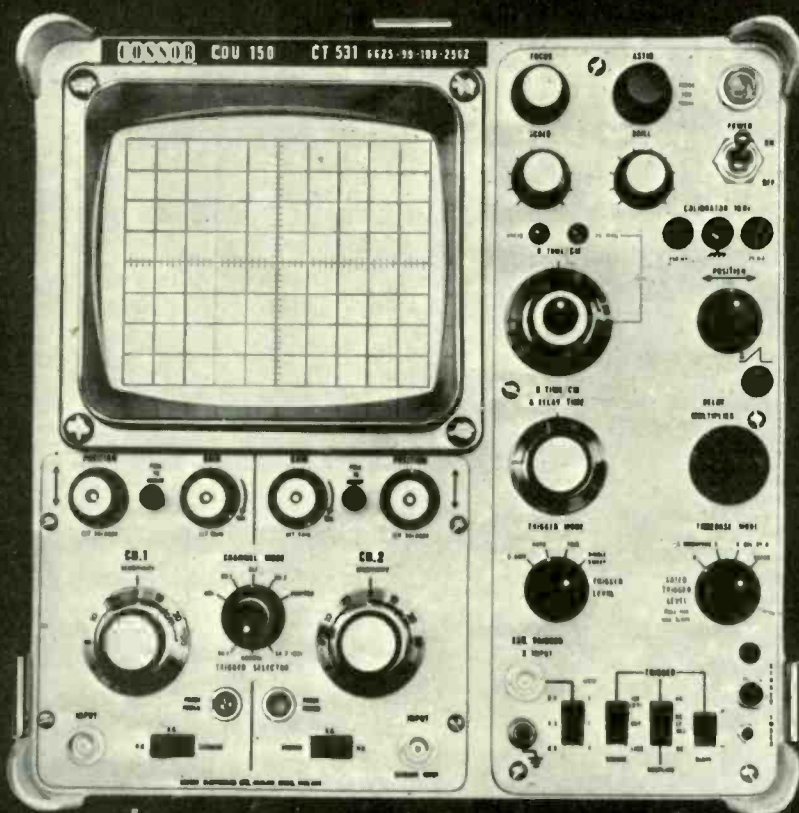

CDU 110

20 MHz Dual Channel
5 mV/cm Sweep Speeds
to 40 nS/cm Sweep Delay

CDU 120

50 MHz 5 mV/cm
25 MHz 1 mV/cm
Dual Channel. Sweep Delay

CDU 130

15 MHz 5 mV/div.
Mains/Internal Batteries
16.5 lbs. including battery

CDU 150

35 MHz Dual Channel
5 mV/cm Sweep Speeds to
20 nS/cm Sweep Delay

COSSOR

FIRST IN SCOPES

Please write or phone for further details:

Cossor Electronics Limited, Instruments Division.

The Pinnacles, Elizabeth Way, Harlow, Essex. Telephone: Harlow 26862

WW-094 FOR FURTHER DETAILS

ntire installation. It can be fitted into most any existing radio installation and is readily adaptable to individual systems for vessels where special facilities are to be provided. Redifon Ltd, Broomhill Rd., Wandsworth, S.W.18.

WW327 for further details

Stereo Tape Deck

The Tandberg 1600X has been designed to give mono or stereo recording and playback facilities of very high quality, but with simplicity of operation. It will be available in track, teak cabinet versions only. It is suitable for vertical or horizontal mounting, and employs the cross-field technique with combined heads, as used in the Series 200X. At the speeds 7 $\frac{1}{2}$, 3 $\frac{3}{4}$, and 1 $\frac{1}{2}$ i.p.s. frequency response is 40-18,000, 40-14,000, 0-8,000 Hz \pm 2dB; wow and flutter less than 0.1, 0.15, and 0.35; and signal to noise ratio better than -55dB, -53dB

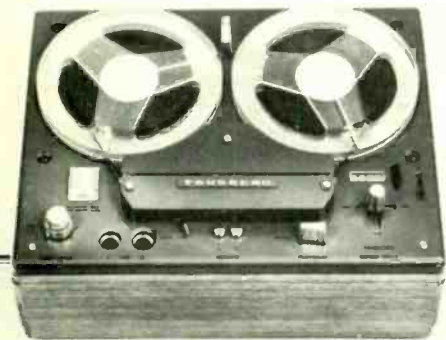

and -52dB. Cross talk is better than -60dB. The output is 0.9V each channel. There are two microphone inputs—impedance 200 Ω . The price is £89 10s 0d, which is a list price of £71 15s 6d, plus £17 14s 6d purchase tax. Elstone Electronics Ltd, Hereford House, Off Vicar Lane, Leeds

WV306 for further details

Electronic Thermometer

The Wayne Kerr electronic thermometer MB300 is available with a choice of 20 different sensors for a wide range of applications. Direct readings from -50°C to +150°C are obtained from solids, liquids or gases with the thermistor probe located at any distance up to 100 feet from the self-

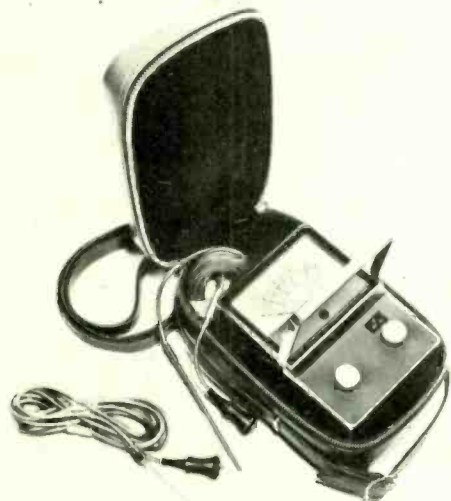

contained instrument. With a response time between 1 and 7 seconds, the thermometer is suited to many industrial, medical, and biological requirements. The thermometer with its probes is supplied in a leather carrying case with a shoulder strap. Accuracy is to within 1°C from 0° to 100°C, reducing to only 1.5°C from -50° to 0°C and from 100° to 150°C. Price in the U.K. is £70 including one probe, with alternative probes ranging in price from £7 to £54. Wayne Kerr Co. Ltd, New Malden, Surrey.

WW326 for further details

X-Y Recorder Plots Graphical Solutions

An X-Y recorder, designed by Hewlett-Packard for use with their Model 9100A computing calculator, makes permanent graphs of functions solved by the calculator and does so with greater precision and speed than hand plotting, and at a cost lower than that required to add a plotter to a digital computer. The calculator-recorder combination can be used to evaluate solutions for a wide variety of problems including statistical distribution analysis and curve fitting to data points, analysis of solutions of differential equations in fluid dynamics, heat transfer, mechanical resonance, and electrical network response, determinations of aerial patterns, orbital trajectories, and of shear force, bending moment and deflection in structures. Functions plotted by the calculator-recorder usually are iterative problems, in which the independent variable is incremented in small steps. The calculator computes the value of the dependent variable for each value of the independent variable, places the two values (appropri-

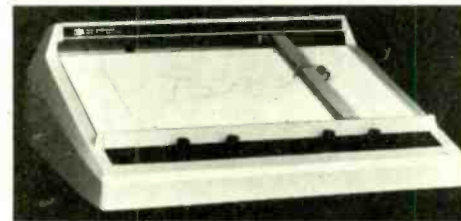

ately scaled) in its X and Y display registers, commands the recorder to move to the new coordinate point thus indicated, and plot it. It then increments the independent variable and computes the next point while the recorder is plotting the last. The calculator-recorder system takes only 0.9 second to plot each point. The recorder can plot the solution as a series of points, or it can draw line segments between adjacent points, tracing straight lines between points at any angle so that curves are smooth and do not have the "scalloping" that is characteristic of some incremental recorder plots. The plotting programme can be arranged so that the recorder draws dashed lines or dot-dash lines. Hewlett-Packard, 224 Bath Road, Slough, Bucks.

WW308 for further details

Printed Circuit Boards

CP series printed circuit boards from Circuit Integration are designed for the assembly of permanent or semi-permanent breadboards, or for small scale production of i.c. equipment. The standard range of 5 CP boards cater for 6, 12, 25, 30 and 42-14 or 16 pin circuits, respectively. The design of the CP series boards is such that a wide variety of actual board sizes may be achieved

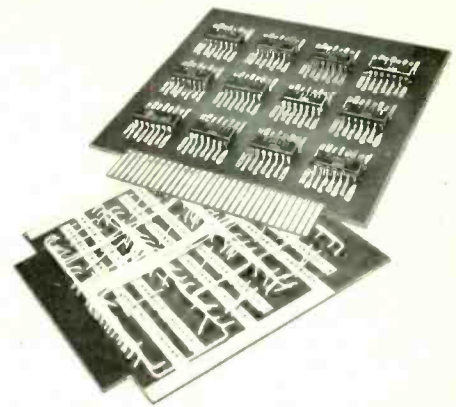

economically. Circuit Integration are prepared to carry out the manufacture of boards to customers' requirements: minimum order quantity 10 boards. Edge connectors may be gold plated or roller tinned coated. Circuit Integration Ltd, 99 Bancroft, Hitchin, Herts.

WW310 for further details

Metal Film Resistors

The RN5 is an addition to the resistor range available from G. A. Stanley Palmer. It is a low-value metal film resistor available between 0.1 and 68 ohms with a working voltage of 750V d.c. and a 1.5 watt rating at 70°C. It will operate over the temperature range -55°C to +170°C and has a temperature coefficient between +3,000 and +5,000 p.p.m. Dimensions are 23.0mm long by 6.5mm diameter. Resistors with tolerances of \pm 10% and \pm 20% are available, and prices range from 63s 6d to 207s per 100, depending upon quantity. G. A. Stanley Palmer Ltd, Island Farm Avenue, West Molesey Trading Estate, Surrey.

WW320 for further details

Rotary Transducers

Control and instrumentation engineers frequently need to convert rotary or angular movement into a train of electrical impulses. The electrical signal thus produced can be processed by appropriate electronic control or measuring equipment. Such devices, normally termed incremental shaft encoders, comprise an input shaft carrying a multi-aperture disc which modulates an optical light path, producing one impulse per aperture. Orbit Controls have introduced a new series of rotary transducers into their Orbit 70 series which is designed specifically for industrial applications. The transducers employ a solid state photo-optic system which eliminates the conventional lamp source, and uses, instead, infra-red light radiators in conjunction with silicone light sensors.

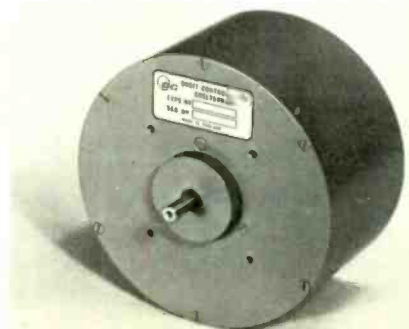

Each unit houses its own pre-amplifier system, and is thus able to transmit a high-level signal along its associated connecting cables. Standard single-line output transducers are available, giving either 60 or 100 impulses per revolution, thus providing a simple conversion to r.p.m. or to decimal measurement. Other disc configurations are available to cover a wide variety of application. A further refinement is provided in two quadrature-output versions, each containing two internal photo-optic systems so disposed that their outputs are phase displaced by 90° . Examination of the phase relationship of one output to the other enables the direction of rotation to be determined, thus making these transducers suitable for machine tool control. The transducers are housed in rugged aluminium cases and are fitted with robust low-torque bearings. Connections are brought to a terminal block at the rear of the unit. The transducers are capable of operating at speeds up to 4,000 r.p.m. Orbit Controls Ltd, P.O. Box 16, The Runnings, Cheltenham, Glos. GL51 9PL. **WW311 for further details**

Miniature Time-Delay Unit

A miniature time-delay unit designated T.D.10 provides a time delay adjustable up to 10 seconds. Operating voltages in the range 12 to 60V d.c. can be used. Its small size and printed circuit mounting make it a suitable component for operation with reed relays, solid state control schemes and

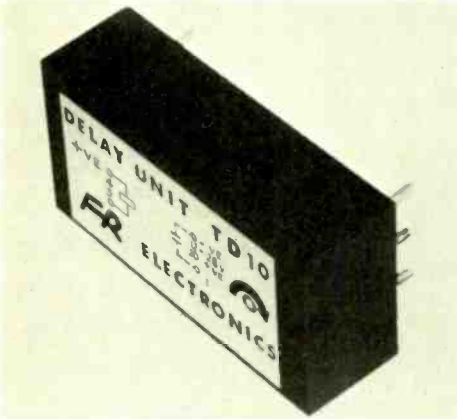

electro-mechanical devices. It is designed to operate over a wide temperature range, and is totally encapsulated. FR Electronics (a division of Flight Refuelling Ltd.), Wimborne, Dorset. **WW309 for further details**

General Purpose Linear I.C.s

Two new general-purpose linear integrated circuits operating from d.c. to 120MHz are now being offered by RCA. The CA3045 and CA3046 'building blocks' each contain five general purpose n-p-n transistors on a common monolithic substrate, two of the transistors being internally arranged to form a differentially-connected pair. The CA3045 is contained in a 14-lead dual in-line ceramic package (photo) and is rated for operation over the temperature range -55°C to $+125^\circ\text{C}$. The CA3046 is electrically identical to the CA3045, but is contained in a dual in-line plastic package for applications requiring a limited temperature range, between 0°C and $+85^\circ\text{C}$. Other features include a wide operating current range and a low noise figure,

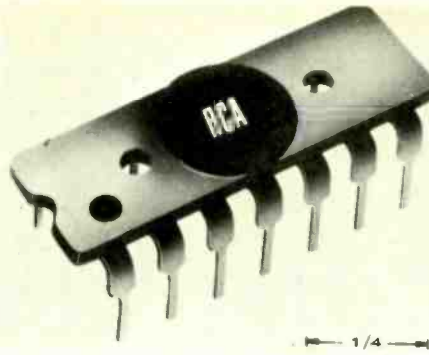

3.2dB being typical at 1kHz. The CA3046 is available at 13s 9d each for quantities of 100 and over from RCA's three distributors: Semicomps Northern Ltd, Robert Electronics Ltd, and Electronic Component Supplies (Slough) Ltd. RCA Ltd, Sunbury-on-Thames, Middlesex. **WW314 for further details**

High-power Moulded Capsule Thyristors

Westinghouse are now marketing nine moulded-capsule type converter-grade high power thyristors for single- or double-side cooling. Being generally symmetrical in shape, the capsule may be mounted either anode face or cathode face to heat sink. They are available either as devices or complete stacks. Current ratings are 75A to 370A single-side cooled and 110A to 550A double-side cooled. Semiconductor Division, Westinghouse Brake and Signal Co. Ltd, 82 York Way, Kings Cross, London N.1.

WW303 for further details

Slide-rule Component Bridge

An unusual feature of Wayne Kerr's Logarithmic LCR Bridge B500 is a slide-rule scale for balancing and reading. The bridge is balanced by sliding a cursor along a logarithmic scale to give a null indication on a meter. The final setting gives the L , C or R value, and a scale on the cursor itself indicates tolerance limits from -15% to $+15\%$ at all settings. The main scale of the slide-rule has a span of 1 to 16, which gives a good overlap from range to range (the ranges being selected by a rotary switch).

Overall coverage is: 10 nanohenrys to 16 kilohenrys; 10 femtofarads to 16 millifarads; and 100 micro-ohms to 160 megohms. Accuracy is claimed to be 1% on all ten ranges. There is also a calibrated control, operated when balancing, for measuring phase angle—range 0 to 45 degrees. The bridge is energized from 1kHz or 100 (or 120) Hz internal sources, selected by a switch. Detector sensitivity automatically rises as the balance point is



approached, but there is also a control for varying the sensitivity.

Four terminals are provided, catering for normal 2-wire components, in situ screened components, and precise measurements of very low impedances. A "subtract 1" button extends the effective range of the logarithmic scale from 1 to 0. Price is £12. The Wayne Kerr Company Ltd, New Malden, Surrey. **WW304 for further details**

Picosecond Pulse Diode

Microwave Associates have developed picosecond pulse switching diode, the first of a new series of charge control devices. The MA4-B200 diodes perform over wide temperature range and have a minimum breakdown voltage of 70 volts, and capacitance range of 3-5pF. Typical turn on and turn off times are 500ps and 75ps respectively. Typical circuit application are in pulse conversion circuits, variable pulse delays, impulse generation, an extremely wide band pulse counting discrimination. Microwave Associates Ltd, Cradock Road, Luton, Beds. **WW307 for further details**

Core-Driver Transistors

Motorola announces six multiple core driver transistors that are compatible with i.c.s in size and construction, and complete i.c.s by performing a task that present i.c.s cannot handle well. Their compact construction saves space and permits short leads, which are vital for fast high-current core driving. They can also be used as r.f. drivers at frequencies up to 200MHz. The new devices are multiple versions of the 2N3762 and 2N3467 fast, high-current p-n-p switches. Like the single transistors the new devices have high current handling ability, low saturation voltage, low capacitance (1pF, C_{cb}) and extremely fast switching time (22ns typical turn-on time, 46ns turn-off time, at rated current). The V_{ceo} is 40V. The MD3467 dual transistor in a TO5 type case, the MD3467F dual in a small 6-pin ceramic flat pack, and the MQ3467 quad in a standard 14-pin ceramic flat pack, are 0.5A transistors. The TO5 cases can dissipate a total of 600mW (500mW maximum per transistor) at a 25°C ambient temperature. The small flat pack duals are rated at 350mW total, 250mW per transistor, and the 14-pin flat packs containing four transistors 500mW total, 400mW per transistor. For popular complementary circuitry, the MD3725, MD3725F and MQ3725 dual and quad transistors are n-p-n complements in similar packages. Motorola Semiconductors Ltd, York House, Wembley, Middlesex. **WW321 for further details**

Collapsible Cabinets

A new range of instrument cabinets that will shortly be available will be delivered "packed flat". The component parts quickly slot together to produce the required cabinet. The main objects of this design are to ensure fast delivery by reducing handling problems and to reduce the storage space that needs to be set aside by users of the range. Bedco Ltd, Datum Division, Colne Way, Watford, WD2 4NE.

WW502 for further details.

Digital Picoammeter

There are two versions of this Keithley instrument, the model 445, which has fully automatic range changing, and the 440, which has manual range-change switch. The 445 has full scale range from 10^{-9} to 10^{-2} A with 10^{-12} A resolution. The 440 is one range more sensitive having a 10^{-13} resolution. Apart from these differences the two models are basically similar. On the most sensitive range accuracy is $\pm 0.5\% \pm 1$ digit and on the highest range $\pm 0.2\% \pm 1$ digit. Stability with temperature is better than 0.05% per °C and, at constant temperature, drift will not exceed one digit per day. A front-panel control is provided to compensate for any small drift.



The m.o.s.f.e.t. input stage is provided with overload protection that even a 1kV transient will not damage the instrument. To prevent inaccurate measurements being obtained the display is blanked during periods of overload. In no circumstances must the input current be allowed to exceed 125mA. Common mode rejection is such that 100V d.c. or 200V peak-to-peak at mains frequency will not affect the reading. When properly loaded the input voltage drop is less than 1mV for f.s.d. The display rate is adjustable from 20 readings per second to 1 reading every two seconds. Sockets on the rear of the instruments allow connection to a printer and external control circuits. Keithley Instruments, Reading.

WW501 for further details

Aerial Rotator

J. Beam Engineering Ltd, are British agents for Stolle automatic aerial rotators. Each rotator system is made up of a transistor control unit and an aerial drive unit. The control unit has a single selector knob set in a dial marked with compass points. When the aerial is still the whole system is switched off. Resetting the selector causes the aerial to rotate until it 'reaches' the dial position. The drive unit has a carrying capacity of 25kg and consumes approximately 65 watts (at 20V) during operation. Speed of rotation is one revolution in 50 seconds. A magnetic disc brake and self-restraining worm gear drive hold the aerial in its chosen position. Two models are available with different positioning accuracy. J. Beam Engineering Ltd, Rothershorpe Crescent, Northampton.

WW508 for further details

Cathode-ray Tubes

An inexpensive 3-inch flying-spot scanner tube (Brimar Q8-100AA) giving good resolution and a high light output has been introduced by Thorn Radio Valves & Tubes.

The deflection angle of 58° coupled with a carefully engineered gun construction, ensures that uniform focus of the 0.08mm spot can be maintained over the whole useful screen area of 53 x 38mm. The overall length of the tube is 245mm. Typical operating voltages are: final anode 20kV, first anode 1kV, and grid-to-cathode voltage for cut-off is -20 to -50V. Heater voltage is 6.3V at 0.3A. Thorn Radio Valves & Tubes Ltd, 7 Soho Square, London, W.1.

WW503 for further details

Transistor Coolers

Rastra Electronics Ltd, offers new types of Bentrion-coolers for TO5 and TO18 transistor cans in five different colours (blue, black, yellow, red and green). The coolers come in two pieces which are clamped to the transistor can very easily with a single spring. The different colours are useful for marking various stages in a circuit. Order numbers are BC 105A, BC 118A (normal 5.5mm) and BC 105B, BC 118B (high 10mm). Rastra Electronics Ltd, 275 King St., Hammersmith, London, W.6.

WW316 for further details

Sine-wave Inverters

Avel Products Ltd, introduce the Knud Lindberg range of sine-wave static inverters to the U.K. Available in three types for 24V, 110V or 220V d.c. input, these units provide a stabilized output at 220V, 50Hz, with a low-distortion sinusoidal waveform. The inverters use thyristors as the switching elements providing wide margins of safety under all conditions of input voltage and current. Output voltage stabilization is achieved by the use of

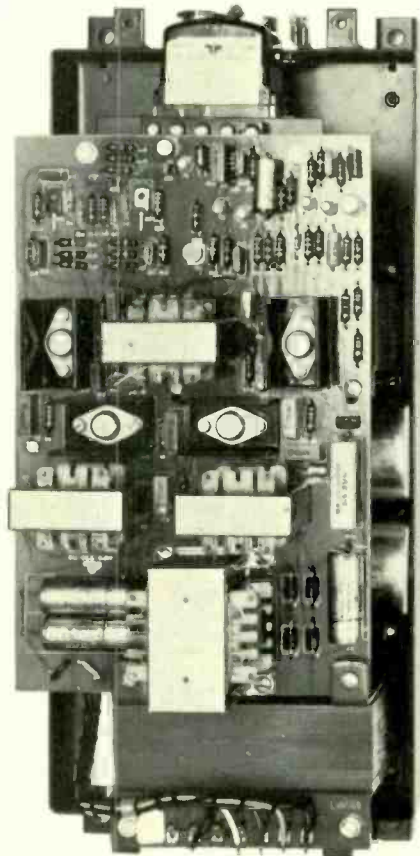

constant voltage transformers giving overall efficiency of 70% and output frequency is maintained at 50Hz ± 1%. Effective protection is provided against overload and also against over-voltage on the input to the inverter. Reliable operation is guaranteed under any load condition up to the maximum of 200VA. Priced between £75 and £80, these inverters are available from Avel Products Ltd, South Ockendon, Essex.

WW315 for further details

Adjustable High-Stability Inductors

High-stability inductors designed to provide smooth adjustment of inductance within very close limits have been released by Oxley Developments. A silver conductor coil is fixed at high temperature on to a low-expansion

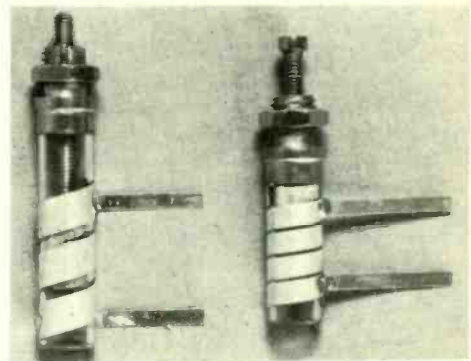

glass tube to give high mechanical adhesion, and inductance is adjustable ± 10% from nominal value by movement of a piston within the tube. Inductance values are from 0.03µH to 0.15µH and a typical Q for 0.04µH at 180MHz is 150. Oxley Developments Co. Ltd, Priory Park, Ulverston, North Lancs.

WW330 for further details

Flexible Coaxial Fittings

Coaxial fittings which allow movement in three dimensions in hook-ups using rigid coaxial lines are released by Hewlett-Packard. The electrical stability of rigid lines is maintained. Insertion loss is less than 0.5dB over

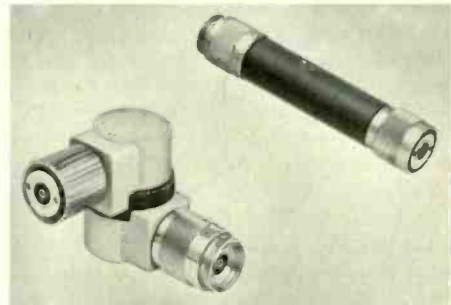

the frequency range d.c. to 12.4GHz and the effect of rotation during reflection measurements is more than 52dB below a full reflection. The coaxial rotary joint (model 11588A) costs £82 and the coaxial rotary air line (model 11606A) costs £53. Hewlett-Packard Ltd., 224 Bath Road, Slough, Bucks.

WW324 for further details

World of Amateur Radio

V.H.F. news

An Icelandic amateur, Finar Pálsson, TF3EA, has successfully received 70-MHz signals from the GB3GM beacon station at Thurso in the north of Scotland, and has also heard the Irish station, EI4RF. These are believed to be the first British Isles stations on 70 MHz to be logged in Iceland. The times of reception (about 23.55 to 00.55 G.M.T.) suggest that this may be due to an auroral E pattern opening. A few days later, on the morning of June 27th, the Icelandic amateur succeeded in making the first amateur two-way v.h.f. contacts from Iceland when he was in communication with Mike Walters, G3JVL, of Hayling Island, and Miss Constance Hall, G8LY, of Leon-Solent, on 70.25 MHz, probably the result of sporadic E. It is hoped that a 70-MHz beacon station (TF2VHF) will be established in Iceland. The Gibraltar beacon station (ZB2VHF) is now operating on 50.09, 70.31 and 145.13 MHz. During widespread sporadic E openings in June, the effects of which extended as high in frequency as the 144-MHz band, P. W. Haylett, G3IPV, of Norfolk, was in contact on two metres with HG5AIR near Budapest.

Amateurs' role in Arctic Trek

The recent successful completion of the 464-day, 3500-mile transarctic expedition led by Wally Herbert has underlined the valuable communications assistance provided by two British amateurs—Dennis Collins, G2FLB (Mintech) and Rowley Shears, G8KW (KW Electronics). These two amateurs, with occasional help from others, have taken over each weekend (for over 16 months) from Cove Radio (MPO) of the Royal Aircraft Establishment the task of maintaining radio contact with the expedition's base station (MPE) operated by S/Ldr Freddie Church. This base station, after some months at Point Barrow, Alaska, moved to the floating ice station T3 (85° N, 125° W). MPE was thus always within the Polar Cap absorption zone recognized as presenting many problems for h.f. point-to-point operation. This is believed to be first time that a British radio link to this zone has been maintained over such a long period, and has provided R.A.E. with valuable radio propagation information.

The two amateurs, using the callsign G7AE on 13999 kHz, passed over 160 official messages for the expedition as well

as handling many technical enquiries. They achieved a success rate approaching 95 per cent compared with the 96.2 per cent of Cove Radio with its large, sloping vee aerials and 3-kW linear amplifier. Almost all contacts were made on manual Morse, and both the amateurs and R.A.E. attribute the remarkable success of this difficult h.f. radio link to the use of this mode.

In the Arctic, S/Ldr Church used simple aerials and amateur-type equipment (Collins KWM2A transceiver, backed up with Plessey PR155 receiver) and kept in telephony contact with the sledge party who carried Redifon 15-watt s.s.b. GR345 packets. Both Rowley Shears and Dennis Collins used amateur equipment from the standard range of KW Electronics. By using a four-element Yagi, 60-ft high, the G7AE signals were often reported as exceptionally strong in the Arctic—the high-gain aerial gave an effective radiated power approaching 7.5 kW.

Contrary to expectations, the link was maintained throughout the period using the single twenty-metre channel. The results have shown clearly, that for weak but readable Morse signals, the path stays open far longer than might seem likely from the official propagation predictions.

New secretary for I.A.R.U. Region I

To fill the vacancy resulting from the death of John Clarricoats, G6CL, the British amateur Roy F. Stevens, G2BVN, has been elected secretary of the Region I (Europe and Africa) Division of the International Amateur Radio Union. Roy ("Steve") Stevens was the 1966 president of the R.S.G.B. and has been closely associated with national and international amateur radio activities for many years. He is an amateur enthusiast whose profession—surveyor for a major insurance group—has no connection with radio or electronics, although in 1939 as a young member of the old Civilian Wireless Reserve, he was one of the group of "Early Birds" rushed to France on the outbreak of war for wireless duties.

Long-delay echoes

Amateur assistance in the investigation of the 40-year-old mystery of long-delay h.f. echoes (of the order of 8 seconds delay or even more)—often called "cosmic echoes"—is being sought by a team at the Radio-science Laboratory of Stanford University, California. These strange echoes first attract-

ed attention in the late 1920s (Stormer a Van der Pol) and were followed up with experimental work in the early 1930s which appeared to verify that such echoes can occur on h.f. signals, if only rarely. However a year-long investigation at Cavendish Laboratory, Cambridge, just after World War II failed to find positive proof of any echoes. Little work has been done in this field for some time, despite occasional reports of amateurs hearing their own closing remarks (quite strongly and with relatively little distortion) when switching over to reception. Now the American team, which believes that new work in plasma physics could account for the existence of long-delay echoes, is appealing for exact details of any further amateur experience of this phenomenon.

Some August events

R.S.G.B. v.h.f. contests: 144 MHz s.s. August 4th; 432 MHz open contest August 10th; 70 MHz c.w. August 16th–17 (23.00 to 07.00 G.M.T.).

Mobile rallies include the R.S.G.B. national mobile rally at Woburn Abbey on August 10th; Derby and District (Ryknield School, Bedford Street) on August 17 (details Tom Darn, Sandham Lodge, Sandham Lane, Ripley DE5 3HE); August 24th Torbay and Swindon; August 31 Hartlebury Castle, near Kidderminster at Kimberley Barracks, Preston.

Contest results

The main, high-power section of the 32nd BERU Contest, held in March, was won by A. R. W. Cate 9H1BL, of Malta with a score of 6336 points from a record 819 contacts with Commonwealth stations. Over 100 stations submitted entries and some 1200 stations are believed to have participated. Leading British entrant was D. L. Courtie, Dutton, G3FPQ, with 6142 points from 34 contacts—he used a home-made receive 100-watt transmitter and two-element quad aerials on 14 MHz and above. During the 1969 R.S.G.B. low-power 3.5-MHz contest the winner, R. A. Wybrow (G3JVJ), made 50 contacts using 0.45-watt input. On entrant J. J. R. McDonnell (G3DOP), made almost 30 contacts using an all-f.e. transmitter with three small signal 2N381 devices and an input power of 176 milliwatt.

In Brief: A special-event amateur station using the call GB3SMG will be operating during the International Stoke Mandeville Games for the Paralysed (July 27th to August 2nd) . . . the International Amateur Radio Club is holding a convention in Geneva from September 12th–14th (detail I.A.R.C., P.O. Box 6, 1211 Geneva 20, Switzerland) . . . Lerwick Radio Club plan to run a special exhibition station during August to mark the 500th anniversary of the pledging of the Shetland Islands by the King of Denmark to the Scottish Crown. . . . The prefix C3A has been allotted for amateur operation in Andorra . . . Ray Folgate G3KDY, is using the call ZD9BE from Tristan da Cunha where he is now Master of Posts and Telegraphs. . . . It is hoped that the frequencies 3500–3510 and 3790–3800 kHz may be reserved for inter-continental amateur working.

PAT HAWKER, G3VA

Answers to "Test Your Knowledge"—15

Questions on page 387

1. (d)
2. (a) The "threshold" voltage for a diode is dependent on the energy gap of the material. Of the materials listed germanium has the smallest energy gap and thus the lowest threshold voltage.
3. (a) With respect to the other three factors p-n junction diodes are generally better than point-contact diodes. Point-contact diodes also have the advantage of cheapness.
4. (b) The light energy acts as a source of e.m.f. In the absence of light there is a balance in the diode between minority carriers from each side "drifting" through the depletion layer, and majority carriers from each side diffusing in the opposite direction. The optically-generated minority carriers increase the drift current, whereas the generated majority carriers have negligible effect. Thus a reverse current flows through the diode.
5. (b) If load-lines for a high resistance are drawn on a set of photodiode characteristics it will be seen that an output voltage proportional to light intensity requires the diode to be reverse-biased.
6. (b) The materials on each side of the junction must be degenerate, i.e. the Fermi level must lie in the conduction band on the n side and in the valence band on the p side. In addition, to allow the tunnelling to occur, the depletion layer must not be much wider than 100 Å.
7. (c) The diode must be biased to the point on its characteristic where it has the largest value of negative a.c. resistance. For germanium this is about 0.1 V forward bias.
8. (c) A backward diode is similar in construction to a tunnel diode; there is, however, little tunnelling for forward voltage, only for reverse voltages.
9. (a)
10. (a)
11. (b)
12. (c) For forward applied voltage the electrons enter the metal at a high energy. They rapidly come into thermodynamic equilibrium with the lattice, however, and are thus not able to return across the Schottky barrier when the applied voltage is reversed.
13. (a) A pulse of current generated by avalanching in the depletion layer takes a finite time to drift through the bulk material. An alternating voltage is induced which is in antiphase with the alternating component of the current so that the device acts as a negative resistance. Special structures, such as the IMPATT diode, are made for this purpose, but in principle any p-n junction diode can be used.
14. (b) The mechanisms of Gunn diode oscillations depend on properties of the structure of the conduction band which are only possessed by direct-energy-gap semiconductors (p-n junctions play no part).
15. (c) A diode operating in the Limited Spacecharge Accumulation mode is so arranged that for part of each r.f. cycle the voltage drops below the critical value so that any dipole domains which have started to form will disperse.
16. (a) The step-recovery diode has a doping profile which causes the current due to stored carriers to end abruptly a short time after the applied potential is changed from forward to reverse. In consequence when an alternating potential is applied the output is rich in harmonics.

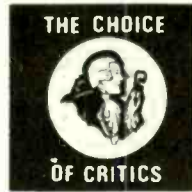

BULGIN INSTRUMENT KNOBS

NOW STANDARDISED BY WORLD FAMOUS MANUFACTURERS

Adequate stocks of standard knobs ensures quick delivery and specialised production enables us to give fast delivery to special knobs at competitive prices for quantity requirements.

		
List No. K.528	List No. K.492	List No. K.546/K.C.1
		
List No. K.551/BP.35	List No. K.526	List No. K.522 List No. K.523
		
List No. K.421	List No. K.531	List No. K.60
		
List No. K.464	List No. K.463	List No. K.462
		
List No. K.482	List No. K.442	List No. K.430

FOR DETAILS OF THE COMPLETE RANGE SEND FOR BROCHURE 1500/G

A. F. BULGIN & CO. LTD., BYE-PASS ROAD, BARKING, ESSEX
MANUFACTURERS OF PRECISION ELECTRONIC & ELECTRICAL COMPONENTS

TELEPHONE: 01-594 5588 (12 LINES) Private Branch Exchange

WW-095 FOR FURTHER DETAILS

Literature Received

CATALOGUES

The range of **semiconductors** manufactured by Newmarket Transistors Ltd (St. Andrews Rd., Cambridge CB4 1DP) is described in five broadsheets. (1) germanium devices, (2) silicon devices, (3) packaged circuits, (4) film attachment devices and (5) hybrid microcircuits. (1)—**WW 401**, (2)—**WW 402**, (3)—**WW 403**, (4)—**WW 404** and (5)—**WW 405** for further details.

Pergamon Press (Headington Hill Hall, Oxford OX3 0BW) have produced two catalogues which list the range of **technical books** they publish. (1) mathematics and (2) engineering science and technology. (1)—**WW 406** and (2)—**WW 407** for further details.

A six-page **f.e.t. selector guide** and cross reference chart (SG-15) is obtainable from Motorola (York House, Empire Way, Wembley, Middlesex). Equivalents lists are included. **WW 408** for further details.

Semiconductors, including e.c.l., and m.o.s. devices, from the Siemens range are described in a short-form catalogue available from Cole Electronics (Components Division, Lansdowne Rd., Croydon CR9 2HB). **WW 409** for further details.

Amendment No. 11 for the Hivac Ltd. (Stonefield Way, South Ruislip, Middlesex) **loose leaf catalogue** is available. **WW 411** for further details.

Additions to the catalogue of Erie Electronic Ltd. (South Denes, Great Yarmouth, Norfolk) are also available. **WW 412** for further details.

Brimar Industrial **Cathode Ray Tubes** catalogue 1969-70 lists more than 160 types (Thorn Radio Valves and Tubes Ltd., 7, Soho Square, London W.1). **WW 413** for further details.

APPLICATION NOTES

The Application of Linear Microcircuits (Vol. 1, 144 pages, price 30s.; Vol. 2, 36 pages, price 12s 6d) is the title of two soft cover books that are mines of information. Vol. 1 deals with the applications of the μA -702A, -709, -710, and -711 while Vol. 2 covers types L/ -103, -123, -127, -141, -T2. The booklets may be obtained from SGS (United Kingdom) Ltd, Planar House, Walton Street, Aylesbury, Bucks.

(1) **A.C. Voltage Regulators using Thyristors** (AN-3886) and (2) **U.H.F. Power Generation using r.f. Power Transistors** (AN-3755) are two new titles from R.C.A. Electronic Components, Harrison, New Jersey. (1)—**WW 414**, (2)—**WW 436** for further details.

The Dual Photocell is the title of a booklet which shows how analogue multipliers and low-noise choppers can be built with this component. Hewlett Packard, 224, Bath Rd., Slough, Bucks. **WW 415** for further details.

Power Module Users Handbook published by Advanced Industrial Electronics (Raynham Rd., Bishop's Stortford, Herts.) contains data, advice and circuits showing how the Advance range of modular power supplies can be used to best advantage. **WW 416** for further details.

The Advanced Products Department of the Corning Glass Company have produced a number of application notes concerned with **glass delay-lines** which are available from Electrosil Ltd., Pallion, Sunderland, Co. Durham. They are (1) Parallel operation of digital glass memories, (2) Glass memories bibliography, (3) Time multiplex operation of digital glass memories, (4) Sharpening TV pictures with glass memories, (5) Glass memories in low-cost computer driven displays, and (6) Digital memory modules in high-speed buffers. (1)—**WW 417**, (2)—**WW 418**, (3)—**WW 419**, (4)—**WW 420**, (5)—**WW 421** and (6)—**WW 422** for further details.

PRODUCT LITERATURE

Magnetic proximity switch, type MPS 16 is described in a leaflet from Herbert-BSA Electrics Ltd, Shaftmoor Lane, Birmingham 28. **WW 423** for further details.

Paper-tape reader series 119 manufactured by Oohr-tronics of America is described in literature available from Data Recognition Ltd., 7 Loverock Rd., Battle Farm Estate, Reading, Berks. **WW 424** for further details.

Aluminium electrolytic capacitors, turret terminal style, are described in an engineering bulletin 3430 from Sprague Electric Company, North Adams, Mass., U.S.A. **WW 432** for further details.

GENERAL INFORMATION

Adhesives Directory 1969 contains much valuable information such as manufacturers' addresses, trade names, glossary of terms and a "who's who". It is available from A. S. O'Connor & Co. Ltd., 30 Paradise Rd., Richmond, Surrey. Price 20s.

I.E.A. Purchasing Directory 1969, fifth edition, is prepared by the publishers of *Control & Instrumentation* and *Electronic Engineering*. It covers the instruments, electronics and automation industry and contains a comprehensive buyers' guide, manufacturers' addresses and lists many trade names. It can be obtained from Morgan-Grampian (publishers) Ltd, Summit House Globe Way, West Wickham, Kent. Price 100s.

Two new supplements (Nos. 2 and 3) have been produced by Motorola for the **Semiconductor Data Book**. Motorola Ltd, Empire House, York Way, Wembley, Middlesex. **WW 434** for further details.

The 1969-70 **prospectus** of full- and part-time courses is now available from Northern Polytechnic, Holloway, London N.7.

Government Surplus Wireless Handbook gives circuits and descriptions of a wide range of equipment on the surplus market. Giltext Ltd, 23, Stansfield Chambers, St. Georges St., Leeds 1. Price 45s.

H.F. Predictions—August

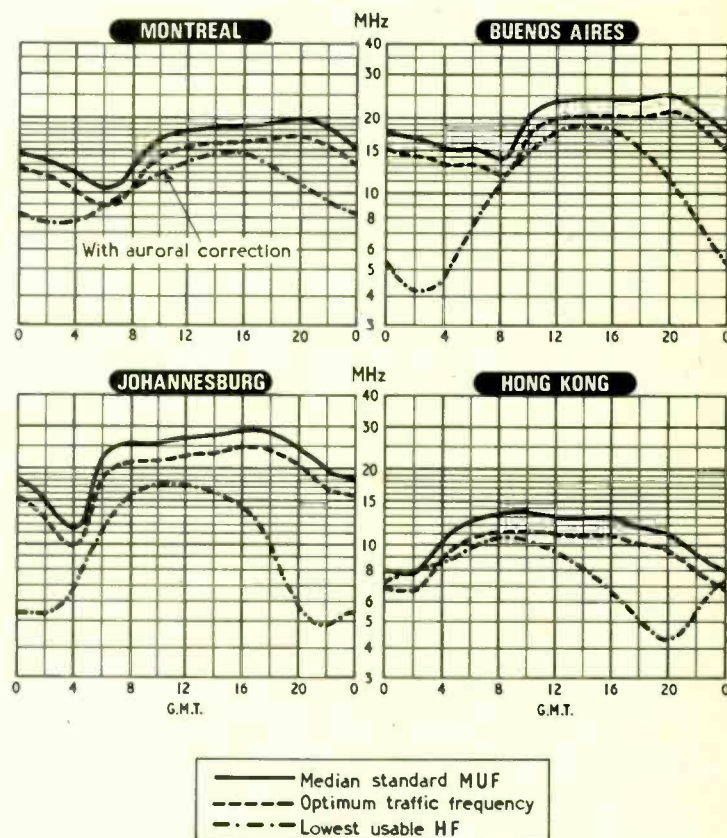

The upsurge of solar activity in March has been maintained to date. Current activity is on a par with that of twelve months ago, which was considered a maximum in the sunspot cycle.

Though not unexpected, such trends are masked in the predictions which are based on smoothed values of recent observed activity as well as comparison with corresponding periods of previous cycles. Seasonal trend, coupled with continued high solar activity, would produce median MUFs up to 10% higher than shown.

Frequency usage for the month will be the same as last year with magnetically disturbed days totalling about seven, but an increase in the number of fade-outs is expected; about six in the northern hemisphere.

Direct frequency counting to 120MHz...3.3GHz with plug-in units...and 90-second warm-up

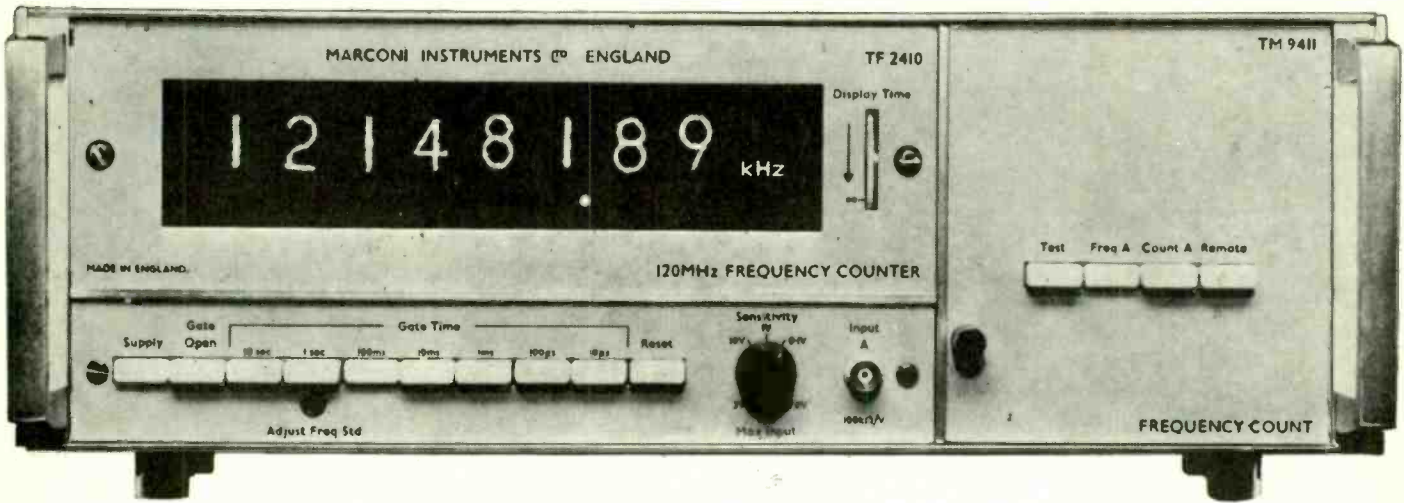

Why settle for less?

Direct reading from 10 Hz to 120 MHz, plug-in units to extend both sensitivity and frequency, and an extremely fast warm-up internal standard, characterize this outstanding frequency meter.

TF 2410, which makes extensive use of integrated circuits, incorporates a completely new type of reference standard which reaches within 4×10^{-7} of its final frequency in less than 90 seconds, overcoming the need to leave the instrument switched on or on 'standby'.

Other advantages: an 8-digit readout with genuine memory display and automatic decimal points and units indication; input level monitor; facilities for driving peripheral units; straightforward

operation and servicing – all at the highly competitive price of £830 f.o.b. U.K. including basic plug-in unit (illustrated).

Why settle for less?

Write for fully descriptive literature.

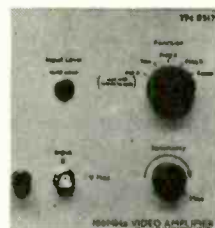

TM 8517 extends sensitivity to 1 mV r.m.s.



TM 8334 extends frequency to 600 MHz.



TM 8094 extends frequency to 3.3 GHz.



MARCONI INSTRUMENTS LIMITED

Member of GEC-Marconi Electronics Limited

Lqngacres · St. Albans · Hertfordshire · England · Telephone: St. Albans 59292 · Telex 23350

WW—096 FOR FURTHER DETAILS

TA 10038

Lasky's Radio

EXCLUSIVE THE IC-403 INTEGRATED CIRCUIT AMPLIFIER MODULE

AVAILABLE

NOW!

Originally developed for computer and space projects—these tiny modules—size only 25 x 10 x 5 millimetres—represent the most amazing breakthrough in circuit design since the introduction of the transistor. The IC-403 is an integrated power and pre-amplifier requiring only the addition of tone and volume controls, power source and speaker to form a complete audio amplifier of 3W output.

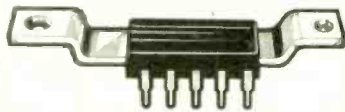

SPECIFICATION (ratings at 25°C): Output power typically 3W from 250mV input. Frequency response 20Hz to 80KHz +3dB. Max operating voltage 21V. Min operating load 7.5 ohms. Pre-amp. input imp. 2M/Ohms. Pre-amp. D.C. input current 50nA.

THE IC-403 IS AVAILABLE FROM STOCK EXCLUSIVELY FROM LASKY'S—COMPLETE WITH INSTRUCTION DATA AND SUGGESTED CIRCUIT APPLICATIONS FREE INSTRUCTION DATA LEAFLET ON REQUEST. JUST SEND S.A.E.

LASKY'S PRICE 52/6 POST FREE

DENSHI BOARD KITS EDUCATIONAL CIRCUIT SYSTEM

The DENSHI BOARD system enables the young experimenter and electronics hobbyist to produce a wide range of transistor circuits of increasing sophistication—without soldering or the use of any tools at all! Basically the system comprises a slotted circuit board into which plug-in components and bridge pieces are set to produce up to 30 different circuits. The components are encapsulated in transparent plastic blocks bearing the appropriate circuit symbol and value thus enabling even the complete novice to visually grasp the fundamentals of circuitry after only a few moments study. Each DENSHI

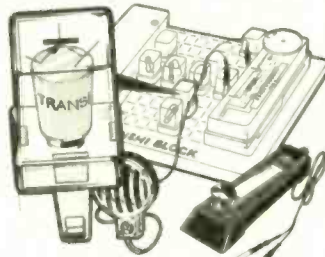

BOARD KIT comes complete with 80-page manual of circuits and data. THESE ARE JUST A FEW OF THE CIRCUITS YOU CAN BUILD IN MINUTES: VARIOUS RADIO RECEIVERS, AMPLIFIERS, MORSE CODE PRACTICE DEVICE, SIGNAL INJECTOR, SIGNAL TRACER, WIRELESS MICROPHONE, ETC. DENSHI BOARD KIT SR-1A comprises: Base board; tuner block; 4 resistors; choke coil transformer; 2SA transistor for RF; 2 diodes; 3 capacitors; battery block; morse key; antenna lead; crystal earphone; various bridge and connecting pieces and 80 page manual. **This kit permits the building of 16 basic circuits.**

LASKY'S PRICE £4.19.6 POST 3/6

DENSHI BOARD KIT SR-2A as SR-1A plus: 2SB transistor for AF; 2 resistors; 1 capacitor; crystal microphone; test probes; electrode; additional connecting pieces; 9V battery. **This kit permits the building of 30 circuits.**

LASKY'S PRICE £7.2.6 POST 3/6

NEW! THE AMAZING ASTRAD "ORION"

THE WORLD'S SMALLEST 6 TRANSISTOR TWO WAVEBAND RADIO RECEIVER

- ★ Made to highest Russian Space Age standards.
- ★ Super sensitive—fully tunable over Medium and Long Waves.
- ★ Built-in aerial—automatic volume adjustment.
- ★ Uses a miniature battery—available anywhere.
- ★ Ample volume from clear-tone personal earpiece.
- ★ Size only 1 11/16 x 1 3/16 x 5/16in.—weighs less than 1 oz.
- ★ Complete with earpiece, battery AND attractive presentation/pocket carrying case in black and ivory.



LASKY'S PRICE 39/6 POST 2/6 Extra batt. 3/6

GET YOUR LASKY'S AUDIO-TRONICS PICTORIAL FREE 16 colour pages in large 16" x 11in. format packed with 1,000's of items from our vast stocks. Hi-Fi Radio, Electronics, Test equipment, Components, etc.

Send 1/- for post only and inclusion on our regular mailing list (5/- overseas)

Branches

207 EDGWARE ROAD, LONDON, W.2 Tel.: 01-723 3271
33 TOTTENHAM CT. RD., LONDON, W.1 Tel.: 01-636 2605

Open all day, 9 a.m.—6 p.m. Monday to Saturday
152/3 FLEET STREET, LONDON, E.C.4 Tel.: 01-353 2833
Open all day Thursday, early closing 1 p.m. Saturday

High Fidelity Audio Centres

42-45 TOTTENHAM CT. RD., LONDON, W.1 Tel.: 01-580 2573
Open all day, 9 a.m.—6 p.m. Monday to Saturday

118 EDGWARE ROAD, LONDON, W.2 Tel.: 01-723 9789
Open all day Saturday, early closing 1 p.m. Thursday

ALL MAIL ORDERS AND CORRESPONDENCE TO:
3-15 CAVELL ST., LONDON, E.1 Tel.: 01-790 4821

WW—097 FOR FURTHER DETAILS

Kinver for Integrated Circuits

- Two Audio Power Amplifiers, each in dual-in-line package with heat transfer tab
G.E. type PA 234 1 Watt output 23/-
G.E. type PA 237 2 Watt output 34/-
 - D.C. coupled Wide-Band power amplifier in multilead TO-5 case
RCA type CA3020 1/2 Watt output 32/-
 - Ultra High Gain Amplifier in multilead TO-5 case
RCA type CA3035 typically 129 dB voltage gain at 40 kHz 30/-
 - Special Tape Recorder Record/playback pre-amplifier in multilead TO-5 case
Mullard type TAA310 32/-
 - Low cost General Purpose A. F. Amplifier in 4 lead TO-18 case
Mullard type TAA263 15/9
 - Low level, low noise pre-amplifier dual-in-line package
G.E. type PA230 21/-
 - MOS L.F. Pre-amplifier with 100 Gohm Gate-source resistance
Mullard type TAA320 13/5
 - Darlington Pair with $h_{FE}=7,000$ (min) and $f_T=60$ MHz (min) at $I_C=2$ mA
G.E. type 2N5306 11/6
 - Programmable Unijunction Transistor
G.E. type D13T1 10/8
- DATA SHEETS** are available for the above at 1/- each or, if purchased separately 1/6 each, post free.

TEXAS SELECT TRANSISTORS FOR LOWEST COST

NPN Types		PNP Types			
2N3704 Med. power	3/9	2N3702 Med. power	3/6	TIS44 NPN Fast switch	1/9
2N3705 Med. power	3/4	2N3703 Med. power	3/3	TIS49 NPN Fast switch	2/6
2N3707 Low level	4/-	2N4058 Low level	4/6	TIS50 PNP Fast switch	3/9
2N3708 Low level	2/5	2N4059 Low level	3/5	2N3819 N-Channel. FET	9/-
BC182L Low level	3/3	BC212L Low level	3/9	2N3820 P-Channel. FET	18/9
BC183L Low level	2/5	BC213L Low level	3/9		
BC184L Low level	3/2	BC214L Low level	4/-		

PROFESSIONAL COMPONENTS AT REALISTIC PRICES!
Send NOW for our new Components Catalogue, at only 2/- post free. This catalogue is packed with information on a host of up-to-the-minute components by leading manufacturers. Included are Integrated Circuits, Silicon and Germanium Transistors, Diodes, Rectifiers, Resistors, Capacitors, Plugs and Sockets, etc. Please note that all goods supplied by us are brand new and guaranteed to fully conform to the manufacturer's published specifications. **DISCOUNTS:** Order value over £5—10 per cent; Order value over £10—15 per cent. Cash with order please. Post and packing 1/6 per order. Overseas orders welcome. Carriage at Cost.



STONE LANE · KINVER
STOURBRIDGE · WORCS
Telephone: KINVER 2099

TRANSISTOR D.C. CONVERTORS

R GILFILLAN AND CO LTD
SOUTHDOWN VIEW ROAD
WORTHING SUSSEX
WORTHING 31587/8

WW—098 FOR FURTHER DETAILS

LONDON microphones

Quality sound—at low cost

The London Microphone range offers you quality microphones, good characteristics—and good looks, too, at remarkably little cost. Made in Britain.



NEW to the range: LM300 dynamic cardioid microphone incorporating top-quality moving-coil capsule. Gives maximum front-to-back ratio over a frequency range of 50-15,000 Hz. Elegant styling, robust metal case, natural anodised finish.

	Low imp.	Dual imp.
LM 300 (Cardioid)	£11 10 0	£12 10 0
LM 200S	£5 19 6	£6 15 0
LM 200	£4 19 6	£5 15 0
LM 100 (Omn)	£3 3 0	£3 18 6

Home or overseas trade enquiries welcome. Write or ring for details

LONDON MICROPHONE CO. LTD.
182/4 Campden Hill Road, London, W.8.

Tel: 01-727 0711. 24 Hr. Answering Service. Telex 23894

WW—099 FOR FURTHER DETAILS

THE SINCLAIR SYSTEM 2000 range is an original concept in which very advanced circuit and production techniques result in equipment comparable to far costlier types in quality and performance. The units form a complete stereophonic system or may be bought and used separately as required. Solid aluminium is used throughout in matching designs of outstanding elegance and the amplifier and tuner can be stacked or positioned side by side.

THE AMPLIFIER has a total output of 35 watts RMS music power (17.5 watts per channel). Total harmonic distortion is 0.5% at 1 kHz. Six push buttons serve for the selection of seven inputs—ceramic and low output magnetic pick-ups, radio, microphone, auxiliary, tape head outputs at 7½

and 3½ ips and mono/stereo. Frequency response extends from 15 Hz to 30 kHz ±1dB. Rotary controls are used for volume, bass, treble and balance. Outputs may be fed to loudspeakers of any impedance from 3 to 15 ohms. Case size—12 x 6 x 2 inches high (30 x 15 x 5 cm).

THE VHF/FM TUNER uses a pulse counting discriminator for the best possible audio quality. Important features include inter-station noise suppression, built-in AFC and electronic fine tuning, making the tuner a delight to handle. Tuning is from 86 to 108 MHz. A plug-in stereo decoder is available for adding to the mono version, or the tuner may be purchased complete in stereo form.

THE LOUDSPEAKER is an outstanding example of attractive contemporary design

in which very high standards of reproduction are incorporated. This remarkably compact unit handles up to 10 watts continuous loading and has an impedance of 4 ohms at 1 kHz. Size 9 inches diameter by 4 inches deep.

Ask your dealer to demonstrate the System 2000 and judge this imaginatively designed equipment for yourself, or write or phone for leaflet.

- System 2000 35 watt Integrated Stereo Amplifier 29 gns
 - System 2000 F.M. Tuner 25 gns
+9/6 P.T. surcharge 4 gns
 - Plug-in stereo decoder 4 gns
 - System 2000 4 ohm loudspeaker 12 gns
+4/7 P.T. surcharge
- Sinclair Radionics Limited, 22 Newmarket Road, Cambridge. Tel. Cambridge 52731

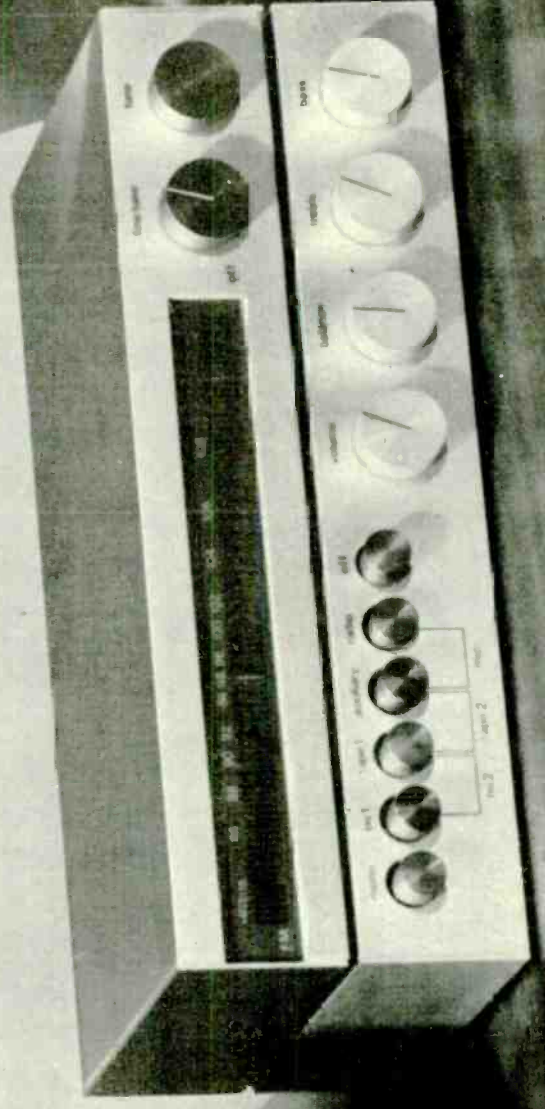
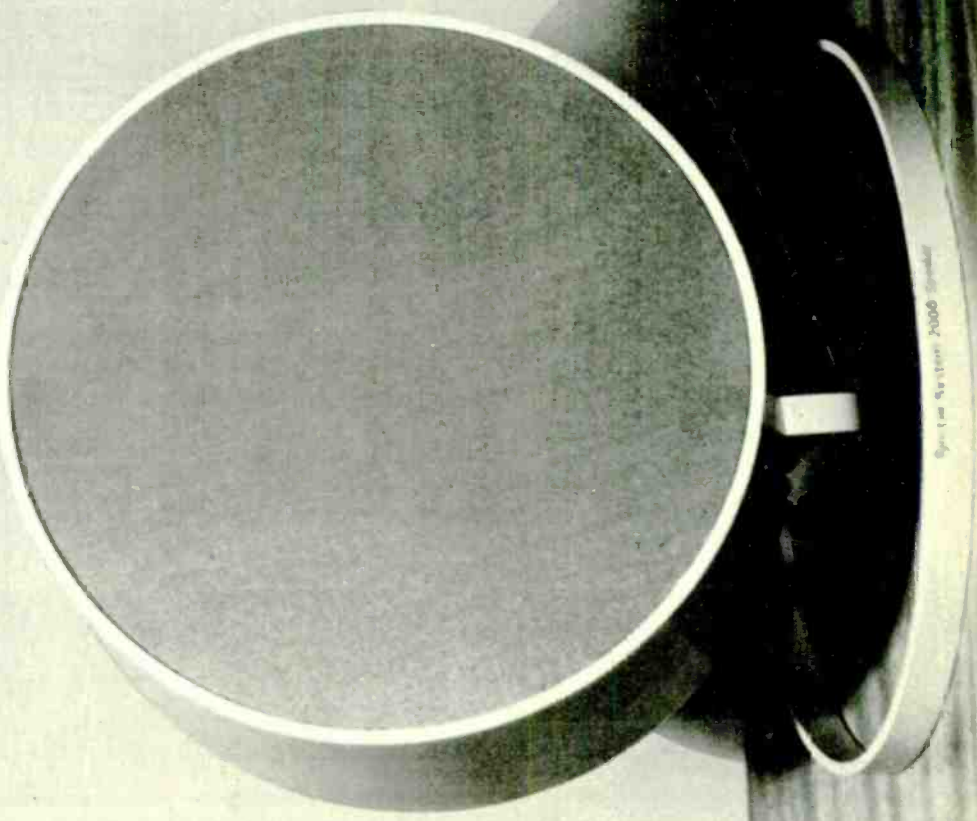

SINCLAIR

System 2000 Sinclair

WW-100 FOR FURTHER DETAILS

RACAL RA-17

First ministry release of these world famous communication receivers. Frequency range 500 Kc/s.-30 Mc/s. Available in excellent condition fully tested and guaranteed. £150 Carr. 40/-.

CLASS D. WAVEMETERS

A crystal controlled heterodyne frequency meter covering 1.7-8 Mc/s. Operation on 6 v. D.C. Ideal for amateur use. Available in good used condition £5.19.6 Carr. 7/6. Or brand new with accessories £7.19.6 Carr. 7/6.

CLASS D WAVEMETERS No. 2
Crystal controlled. 1.2-19 Mc/s. Mains or 12v. D.C. operation. Complete with calibration charts. Excellent condition £12.10/0. Carr. 30/-.

MARCONI CT44 TF956 AF ABSORPTION WATTMETER
1 w/watt to 6 watts. £20. Carr. 20/-.

LELAND MODEL 27 BEAT FREQUENCY OSCILLATORS
0-20 Kc/s. Output 5K or 500 ohms. 200/250 v. A.C. Offered in excellent condition. £12/10/- Carriage 10/-.

AVOMETERS
Supplied in excellent condition fully tested and checked. Complete with prods, leads and instructions.
Model 47A £9/19/8 P. & P. 7/6.

SOLARTRON CD. 1016. OSCILLOSCOPE
Double beam. D.C. To 5 Mc/s. Excellent condition. £55 each. Carr. 20/-.

AM/FM SIGNAL GENERATORS
Oscillator Test No. 2. A high quality precision instrument made for the Ministry by Alrmec. Frequency coverage 20-80 Mc/s. A31/CW/FM. Incorporates precision dial, level meter, precision attenuator 1µV-100mV. Operation from 12 volt D.C. or 0/110/200/250 v. A.C. Size 12 x 8 1/2 x 9 1/2. Supplied in brand new condition complete with all connectors, fully tested. £45. Carr. 20/-.

GEARED MAINS MOTORS
Paralux type 8D19 230/250 v. A.C. Reversible. 30 r.p.m. 40 lb. ins. Complete with capacitor. Excellent condition. 89/6. Carr. 10/-.

AMERICAN RECORDING TAPES

First grade quality	3in. 225ft. L.P. Acetate	3/6
American tapes.	3in. 600ft. T.P. Mylar.	10/6
	6in. 900ft. L.P. acetate.	8/6
Brand new and guaranteed.	5in. 1,200ft. D.P. Mylar	10/6
Discounts for quantities.	5 1/2in. 2,400ft. L.P. acetate	15/6
	5 1/2in. 1,200ft. D.P. Mylar	22/6
	5in. 2,400ft. T.P. Mylar	39/6
	7in. 1,200ft. Std. acetate	12/6
Postage 2/-.	7in. 1,800ft. L.P. acetate	15/6
Over £3 post paid.	7in. 1,800ft. L.P. Mylar	20/6
	7in. 2,400ft. D.P. Mylar	25/6
	7in. 3,600 ft. T.P. Mylar	45/6

SINCLAIR EQUIPMENT
Z12. 12 watt amplifier 89/8.
PZ4. Power supply Unit 89/8.
STEREO 25. Pre-amplifier 29/19/8.
Q.14 Speakers 27/19/8.
Micromatic Radio Kit 49/8. Built 59/8.
ALL POST PAID.
SPECIAL OFFER
2 Z12 amps. PZ4 Power Supply, Stereo 25, Pre-amplifier £22
or with two Q.14 Speakers £37
NEW SINCLAIR 2000 SYSTEM
35 watt Integrated Amplifier, £28. Carr. 5/-.
Self-powered FM Tuner, £25. Carr. 5/-.

ECHO HS-606 STEREO HEADPHONES
Wonderfully comfortable. Lightweight adjustable vinyl headband, 6ft. cable and stereo jack plug, 25-17,000 cps., 8Ω imp. 67/6. P. & P. 2/6.

NOW OPEN IN EDGWARE RD.
Our new walk around shop is now open at 311 Edgware Road, fully stocked with all Hi-Fi, Communication and Test Equipment. Call into your nearest shop - Edgware Rd. for all equipment - Little Street for all Equipment and Components.

UNR-30 4 BAND COMMUNICATION RECEIVER

Covering 550 Kc/s-30 Mc/s. Incorporates BFO. Built-in speaker and phone jack. Metal cabinet. Operation 220/240 v. A.C. Supplied brand new, guaranteed with instructions. 13gns. Carr. 7/6.



TRIO COMMUNICATION RECEIVER MODEL 9R-59DE

4 band receiver covering 500 Kc/s. to 30 Mc/s. continuous and electrical breadboard on 10, 40 and 80 metres. 8 valve plus 7 diode circuit. 4/8" output and phone jack. 88B-CW ● ANL ● Variable BFO ● 8 meter. ● Sep. Bandspread dial ● IF 45 Kc/s. ● audio output 1.5 w. ● Variable RF and AF gains controls. 115/250 v. A.C. mains. Beautifully designed. Size 7 x 16 x 10in. With instruction manual and service data. £42.10.0. Carriage paid. Trio Communication Type Headphones. Normally £5.19.8. Our price £3.15.0 if purchased with above receiver.



TRIO JR-500SE 10-80 Metre AMATEUR RECEIVER

Covers all the amateur bands in 7 separate ranges between 3.5 and 29.7 Mc/s. 7 valves, 2 transistors and 8 diodes plus 8 crystals: output 8 and 5,000 ohm phone jack. Crystal controlled oscillator. Variable BFO. VFO. AVC. ANL. 8 meter. 88B-CW. Stand-by switch. Special double gear dial drive with direct reading down to 1 kHz. Remote control socket for connection to a transmitter. Audio output 1 watt. 115/250 v. A.C. mains. Superb modern styling. Size 7 x 13 x 10in. with instruction manual and service data. £28.10.0. Carr. Paid.



SPECIAL BONUS OFFER! TRIO 8P2D Matching Speaker Mate and TRIO H84 Communication Headphones, Normal Value £10.7.0. FREE OF CHARGE with every JR.500SE purchased.

HAMMARLUND SP600JX COMMUNICATION RECEIVER

High quality professional dual conversion communication receivers available once again in this country at a reasonable price. Frequency range 540 Kc/s-54 Mc/s in 8 bands, variable tuning or 6 channel crystal controlled. 2.5 watt output into 600 ohms. Input 110/230 v. A.C. 20 valve circuit incorporating: Xtal filter, B.F.O., A.N.L., Xtal calibrator, 8 meter etc. Size 19 x 12 x 22 in. (List £220). Offered in excellent condition fully tested and checked. £100 each. Few only.

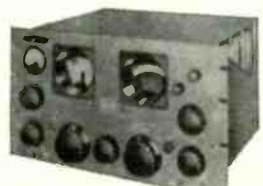

POWER RHEOSTATS

High quality ceramic construction. Windings embedded in vitreous enamel. Heavy duty brush wiper. Continuous rating. Wide range available ex-stock. Single hole fixing, 1/4 in. dia. shafts. Bulk quantities available.
25 WATT. 10/25/50/100/250/500/1000/1500/2500 or 5000 ohms. 14/6. P. & P. 1/6.
50 WATT. 10/25/50/100/250/500/1000/2500 or 5000 ohms. 21/- P. & P. 1/6.
100 WATT. 1/5/10/25/50/100/250/500/1000 or 2500 ohms. 27/6. P. & P. 1/6.



LAFAYETTE LA-224T TRANSISTOR STEREO AMPLIFIER



19 transistors, 8 diodes. THF music power 30 watts at 8 ohms. Res. 30-20,000 ± 3 dB at 1 w. Distortion 1% or less. Inputs 3 mV and 250 mV. Output 3.16 ohms. Separate L and R volume controls. Treble and bass controls. Stereo phone jack. Brushed aluminium, gold anodised extruded front panel with metal case. Size 10 1/2 in. x 8 1/2 in. x 7 1/2 in. Operation 115/230 volt A.C. £28. Carr. 7/6.

MULTIMETERS for EVERY purpose!



LAFAYETTE DE-LUXE 100 KO/VOLT "LAB TESTER" Giant 6 1/2 in. scale. Built in meter protection. 0.5/2.5/10/50/250/500/1,000 v. D.C. 0/3/10/50/250/500/1,000 v. A.C. 0/10/100µA/10/100/500 mA/2.5/10 Amp. 0/1K/10K/100K/1MΩ. 0/100KΩ. -10 to 49.4dB. £18/18/- P. & P. 8/-.



TE-900 20,000Ω/VOLT GIANT MULTIMETER Mirror scale and overload protection. 6 1/2 in. full view meter. 2 colour scale. 0/2.5/10/250/1,000/5,000 v. A.C. 0/25/12.5/10/50/250/1,000/5,000 v. D.C. 0/50µA/110/100/500mA/10 amp. D.C. 0/2K/200K/20 MEG. OHM. £15/- P. & P. 5/-.



LAFAYETTE 57 Range Super 60KΩ/V. Multimeter. D.C. volts 125mV-1000V. A.C. volts 1.5V-1000V. D.C. Current 25µA-10 Amp. Ohms 0-10 MegΩ. D.B.-20 to +81 db. Overload protection. £12/10/- P. & P. 3/6.



MODEL AS-100D. 100KΩ/Volt. 5in. mirror scale. Built-in meter protection 0/3/12/60/120/300/600/1,200 v. D.C. 0/6/30/120/300/600 v. A.C. 0/10µA/60/300mA/12 Amp. 0/2K/200K/2M/200M Ω. -20 to +17dB. £12/10/- P. & P. 3/6.



PROFESSIONAL 20,000 O.P.V. LAB TYPE MULTITESTER. Automatic overload protection. mirror scale. Range: 0/10/50/250/500/1,000 v. D.C. and A.C. 0-500µA, 10mA, 250mA, Current: 0/20K, 200K, 2megohm, Decibels:-20 to +22dB. £5/19/6. P. & P. 2/6.



MODEL TE-70. 30,000 O.P.V. Mirror scale overload protection. 0/3/15/60/300/600/1,200 v. D.C. 0/6/30/120/600/1,200 v. A.C. 0/30µA/3/30/300mA. 0/16K/160K/1.6M/16 MegΩ. £5.10/- P. & P. 3/6.

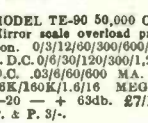

MODEL TE-90 50,000 O.P.V. Mirror scale overload protection. 0/3/12/60/300/600/1,200 v. D.C. 0/6/30/120/300/600 v. A.C. 0/30µA/60/600mA. D.C. 0/16K/160K/1.6M MEG Ω. -20 to +63dB. £7/10/0. P. & P. 3/6.



MODEL TE-12. 20,000 O.P.V. 0/0.6/30/120/600/1,200/3,000/6,000 v. D.C. 0/6/30/120/600/1,200 v. A.C. 0/60µA/60/600mA. 0/6K/60K/600K/6M/60 MEG Ω. 60 PF. 2 MFD £5/19/6. P. & P. 3/6.



MODEL TE-80. 20,000 O.P.V. 0/10/50/100/500/1,000 v. A.C. 0/15/25/50/250/500/1,000 v. D.C. 0-50µA. 5/50/500mA. 60K/10K/600K/6 MEG. £4/17/6. P. & P. 3/-.

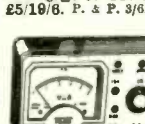

MODEL PT-34. 1,000 O.P.V. 0/10/50/100/250/500/1,000V. a.c. and d.c. 0/100/500 mA. d.c. 0/100 K Ω D 39/6. P. & P. 1/6.

TO-2 PORTABLE OSCILLOSCOPE

A general purpose low cost economy oscilloscope for every-day use. Y amp. Bandwidth 2 CPB-1 MHz. Input Imp. 2 meg Ω. 25 PF. Illuminated scale. 2" tube. 115 x 180 x 230 mm. Weight 8lbs. 220/240v. A.C. Supplied brand new with handbook. £22/10/- Carr. 10/-.



FIELD TELEPHONES TYPE L. Generator ringing, metal cases. Operate on 2 1.5 v. batteries (not supplied). Excellent condition. £4.10.0 per pair. Carr. 10/-.

T.E.40 HIGH SENSITIVITY A.C. VOLTMETER

10 meg. input 10 ranges: .01/.03/.1/.3/1.3/3/10/30/100/300 v. R.M.S. 4 cps.-12 Mc/s. Decibels -40 to +50 dB. Supplied brand new complete with leads and instructions. Operation 230 v. A.C. £17/10/- Carr. 5/-.



AUTO TRANSFORMERS

0/115/230v. Step up or step down. Fully shrouded. 150 W. 32/8. P. & P. 3/6
300 W. 47/8. P. & P. 4/6
500 W. 23/10/0. P. & P. 6/6
1,000 W. 25/10/0. P. & P. 7/6
1,500 W. 28/10/0. P. & P. 8/6
7,500 W. £15/10/0. P. & P. 20/-.

TE22 SINE SQUARE WAVE AUDIO GENERATORS

Sine: 20 cps to 200 kc/s. on 4 bands. Square 20 cps to 30 kc/s. Output impedance 5,000 ohms. 200/250 v. A.C. operation. Supplied brand new and guaranteed with instruction manual and leads. £18.10.0. Carr. 7/6.

RECORDING HEADS

Reuter 4-track. As fitted to Coliaro Mk. IV and Studio Decks. High Imp. record playback, low Imp. erase. Lower track only. Brand new 19/8 pair.
Cosmoord 4 track heads: Record/erase, High Imp. 65/-
Eraser, Low Imp. 20/-
Marriott 4 track heads: Record/Playback, high Imp. 65/-
Eraser, low Imp. 20/-
Post extra.

TE-65 VALVE VOLTMETER

High quality instrument with 28 ranges. D.C. volts 1.5-1,500 v. A.C. volts 1.5-1,500 v. Resistance up to 1,000 megohms. 220/240v. A.C. operation. Complete with probe and instructions £17/10.0. P. & P. 6/-.
Additional Probes available: B.F. 35/- H.V. 42/6.

TE11 DECADE RESISTANCE ATTENUATOR

Variable range 0-111 db. Connections: Unbalanced T and Bridge T. Impedance 600 ohms. Range (0.1 db x 10) + 10 + 20 + 30 + 40 db. Frequency: DC to 200 KHZ (-3db). Accuracy: 0.05 db. + indication db x 0.01. Maximum input less than 4 watts (50 volts). Built in 600 Ω load resistance with internal/external switch. Brand new £27/10/- P. & P. 5/-.



SOLARTRON CD.7115.2 OSCILLOSCOPES

Double Beam. D.C. to 9 Mc/s. Perfect order. £65. Carr. 50/-.

EDDYSTONE V.H.F. RECEIVERS

770R. 19-185 Mc/s. £150.
770U. 160-500 Mc/s. £100.
Both types in excellent condition.

CAR LIGHT FLASHERS

Heavy duty light flasher employs a condenser discharge principle operating on electro mechanical relay. (As inset.) Housed in strong plastic case. Flashing rate between 60-120 per minute. 12 volt D.C. operation. Maximum load 5 amps. Size 2 1/2 in. dia. by 4 in. Supplied brand new at a fraction of original cost. 6/6 each. P. & P. 2/6. (3 for 17/6. P. & P. 4/6.)

FULL RANGE OF Components ● Valves ● Semi-Conductors ● Test Equipment ● Receivers ● Hi-Fi AT DISCOUNT PRICES

G. W. SMITH & Co. (Radio) Ltd.
ALSO SEE OPPOSITE PAGE

NEW CATALOGUE

Nearly 200 pages giving full details of a comprehensive range of COMPONENTS, TEST EQUIPMENT, COMMUNICATION EQUIPMENT and HI-FI EQUIPMENT. Each section greatly enlarged and fully illustrated. Thousands of items, many at bargain prices. FREE DISCOUNT COUPONS VALUE 10/-.

SEND NOW—ONLY 7/6 PEP!

GARRARD

Full current range offered brand new and guaranteed at fantastic savings

*SRP22 Stereo	£5.19.8	*SP25 MKII	£11.19.8
*1023 Mono	£7.10.0	*RL55	£11.19.8
*1025 Stereo	£7.15.0	*A70 MKII	£12.10.0
*2025 Stereo	£7.19.8	*AT60 MKII	£13.5.0
*2025T/C Mono		*SL65	£14.14.8
Stereo	£8.17.8	AP75	£17.17.0
*3000 Stereo	£9.19.8	401	£28.7.8
		SL75	£28.10.0
		SL95	£38.0.0

Carriage/insurance 7/6 extra any model.
WB4 Bases £3/19/8. Perspex cover £3/10/0.
*Special offer base and cover available for these models at £4.15.0. Carr. 5/-.
Full range of Garrard accessories available

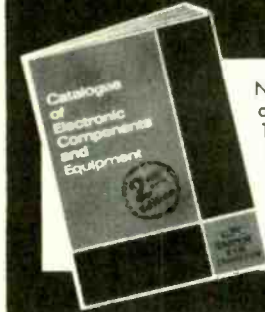
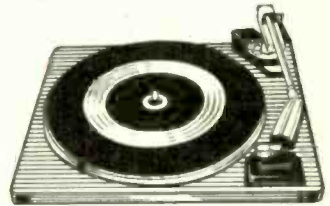

TYPE 13A DOUBLE BEAM OSCILLOSCOPES BARGAIN

An excellent general purpose D/B oscilloscope. T.B. 2 cps-750 Kc/s. Bandwidth 5.5 Mc/s. Sensitivity 33 Mv/cm. Operating voltage 0/110/200/250 v. A.C. Supplied in excellent working condition. £22/10/-. Or complete with all accessories, probe, leads, lid, etc. £25. Carriage 30/-.

ADMIRALTY B.40 RECEIVERS

High quality 10 valve receiver manufactured by Murphy. Coverage in 5 bands 650 Kc/s-30 Mc/s. I.F. 500Kc/s. Incorporates 2 R.F. and 3 I.F. stages, bandpass filter, noise limiter, crystal controlled B.F.O. calibrator I.F. output, etc. Built-in speaker, output for phones. Operation 150/230 volt A.C. Size 19 1/2 x 13 1/2 x 16in. Weight 114lb. Offered in good working condition. £22/10/0, carr. 30/-. With circuit diagrams. Also available B.41 L.F. version of above. 18 Kc/s-700 Kc/s. £17/10/-. Carr. 30/-.

R209 Mk. II COMMUNICATION RECEIVER

11 valve high grade communication receiver suitable for tropical use. 1-20 Mc/s. on 4 bands. A.M./C.W./P.M. operation. Incorporates precision vernier drive, B.F.O. Aerial trimmer, internal speaker and 12v. D.C. internal power supply. Supplied in excellent condition. Fully tested and checked. £15.0.0/20/-.

TRANSISTORISED L.C.R. A.C. MEASURING BRIDGE.

A new portable bridge offering excellent range and accuracy at low cost. Ranges: R. 1Ω to 11.1 MΩ ± 1%. L. 1μH-111 HEN. RES. 6 Ranges ± 2%. C. 10PF ± 1110MFD. 6 Ranges ± 2%. TURNS RATIO 1:1/1000-1:11000. 6 Ranges ± 1%. Bridge voltage at 1,000 CP/S. Operated from 9 volts, 100μA. Meter indication. Attractive 2 tone metal case. Size 7 1/2" x 5" x 2". £20. P. & P. 5/-.

ADVANCE TEST EQUIPMENT

Brand new and boxed in original sealed cartons.
VM.76. VALVE VOLTMETER. R.F. measurements in excess of 100 Mc/s and D.C. measurements up to 1000 v. with accuracy of ±2%. D.C. range 300 MV to 1 KV. A.C. range 300 MV to 300 V RMS. Resistance 0.02-500 M. Price £72.
VM.78. A.C. MILLIVOLT METER. Transistorised. 2 Mv-300V. Frequency 1 c/s to 1 Mc/s. Price £55.
VM.79. UHF MILLIVOLT METER. Transistorised. A.C. range 10 Mv-3V. D.C. current range 0.01A-0.3 Ma. Resistance 1 ohm-10 megohms. £125.
H1B. AUDIO SIGNAL GENERATOR. 15 c/s-50 Kc/s. sine or square wave. Price £30.
H1B. AUDIO SIGNAL GENERATOR. 15 c/s-50 Kc/s. Price £30.
J2B. AUDIO SIGNAL GENERATOR. As per H1B except fitted with output meter £35.
TT18. TRANSISTOR TESTER. £37/10/-. Carriage 10/- per item.

SOLARTRON MONITOR OSCILLOSCOPE TYPE 101

An extremely high quality oscilloscope with time base of 10 μs/sec. to 20 μs/sec. Internal Y amplifier. Separate main power supply, 200/250 V. Supplied in excellent condition with cables, probe, etc., as received from Ministry. £8/19/8. Carr. 30/-.



RCA COMMUNICATIONS RECEIVERS AR88D

Latest release by ministry BRAND NEW in original cases. 110-250v. A.C. operation. Frequency in 6 Bands. 535 Kc/s-32 Mc/s. continuous. Output impedance 2.5-600 ohms. Incorporating crystal filter, noise limiter, variable BFO. Variable selectivity, etc. Price £87.10.0. Carr. £2.



LAFAYETTE SOLID STATE HA600 RECEIVER

5 BAND AM/CW/SSB AMATEUR AND SHORT WAVE. 150 Kc/s-400 Kc/s AND 550 Kc/s-30 Mc/s. F.E.T. front end • 2 mechanical filters • Huge dial • Product detector • Variable BFO • Noise limiter • 8 Meter • 24in. Bandspread • 230 v. A.C./12 v. D.C. neg earth operation • RF gain control. Size 15in. x 9in. x 8 1/2in. Wt. 18 lbs. EXCEPTIONAL VALUE £45. CARR. 10/- S.A.E. FOR FULL DETAILS.

Variable Voltage TRANSFORMERS

Brand new, guaranteed and carriage paid. High quality construction. Input 230 v. 50-60 cycles. Output full variable from 0-260 volts. Bulk quantities available. 1 amp.—£5/10/-; 2.5 amp.—£8/15/-; 5 amp.—£9/15/-; 8 amp.—£14/10/-; 10 amp.—£18/10/-; 12 amp.—£21; 20 amp.—£37

SEW PANEL METERS

Send S.A.E. for full lists. Other ranges available. Please include postage. Special quotations for quantities.

5mA	37/8	300V. D.C.	37/8
10mA	37/8	15 V.A.C.	37/8
50mA	37/8	300V. A.C.	37/8
100mA	37/8	8 Meter 1mA	39/8
500mA	37/8	VU Meter	59/8
1 amp	37/8	1 amp. A.C.*	37/8
5 amp	37/8	5 amp. A.C.*	37/8
10V. D.C.	37/8	10 amp. A.C.*	37/8
20V. D.C.	37/8	20 amp. A.C.*	37/8
50V. D.C.	37/8	30 amp. A.C.*	37/8

Type MR.38P. 1 21/32in. square fronts.		Type M.R.85P. 4 1/2in. x 4 1/2in. fronts.	
50μA	37/8	50μA	69/8
50-0-50μA	35/-	50-0-50μA	59/8
100μA	35/-	100μA	59/8
100-0-100μA	32/8	100-0-100μA	59/8
200μA	32/8	200μA	55/-
500μA	27/8	500μA	52/8
500-0-500μA	25/-	500-0-500μA	49/8
1mA	25/-	1mA	49/8
1-0-1mA	25/-	1-0-1mA	49/8
2mA	25/-	5mA	49/8
5mA	25/-	10mA	49/8
10mA	25/-	50mA	49/8
20mA	25/-	100mA	49/8
50mA	25/-	1 amp	49/8
100mA	25/-	5 amp	49/8
150mA	25/-		
200mA	25/-		
300mA	25/-		
500mA	25/-		

Type MR.45P. 2in. square fronts.		Type MR.65F. 3 1/2in. x 3 1/2in. fronts.	
50μA	42/8	50μA	65/-
50-0-50μA	39/8	50-0-50μA	52/8
100μA	39/8	100μA	52/8
100-0-100μA	35/-	100-0-100μA	49/8
500μA	29/8	500μA	45/-
1mA	27/8	1mA	39/8
5mA	27/8	5mA	39/8
10mA	27/8	10mA	39/8
20mA	27/8	20mA	39/8
50mA	27/8	50mA	39/8
100mA	27/8	100mA	39/8
500mA	27/8	500mA	39/8
1 amp	27/8	1 amp	39/8
5 amp	27/8	5 amp	39/8
20 amp	27/8	20 amp	39/8
30 amp	27/8	30 amp	39/8

Type MR.52P. 2 1/2in. square fronts.		BAKELITE PANEL METERS		Type MR.85	
50μA	59/8	25μA	67/8	500mA	32/8
50-0-50μA	49/8	50μA	45/-	1 amp	32/8
100μA	49/8	50-0-50μA	42/8	5 amp	32/8
100-0-100μA	45/8	100μA	42/8	15 amp	32/8
500μA	39/8	500μA	39/8	30 amp	32/8
1mA	32/8	1mA	32/8	50 amp	32/8
5mA	32/8	5mA	32/8	5V. D.C.	32/8
10mA	32/8	10mA	32/8	10V. D.C.	32/8
20mA	32/8	20mA	32/8	20V. D.C.	32/8
50mA	32/8	50mA	32/8	50V. D.C.	32/8
100mA	32/8	100mA	32/8	150V. D.C.	32/8
				300V. D.C.	32/8

* Moving iron. all others moving coil

TRANSISTOR FM TUNER

6 TRANSISTOR HIGH QUALITY TUNER. SIZE ONLY 6in. x 4in. x 2 1/2in. 3 I.F. stages. Double tuned discriminator, ample output to feed most amplifiers. Operates on 9 volt battery. Coverage 88-108 Mc/s. Ready built ready for use. Fantastic value for money. £8/7/8. P. & P. 2/6. STEREO MULTIFLEX ADAPTONS, 99/8.

TRANSISTORISED TWO-WAY TELEPHONE INTERCOM

Operative over amazingly long distances. Separate call and press to talk buttons. 2-wire connection. 1000's of applications. Beautifully finished in ebony. Supplied complete with batteries and wall brackets. £8/19/8 Pair. P. & P. 5/6.

TE-16A TRANSISTORISED SIGNAL GENERATOR

5 Ranges 400 KHZ-30 MHZ. An inexpensive instrument for the handyman. Operates on 9v. battery. Wide easy to read scale. 800 KHZ modulation 5 1/2" x 5 1/2" x 3 1/2". Complete with instructions and leads. £7/19/8. P.P.P. 4/-.

MODEL ZQM TRANSISTOR CHECKER

It has the fullest capacity for checking on A, B and Ico. Equally adaptable for checking diodes, etc. Spec. A: 0.7-0.9967. B: 5-200. Ico: 0/50 microamps. 0.5 mA. Resistance for diode 200Ω + 1 MΩ. Supplied complete with instructions, battery and leads. £5/19/8. P. & P. 2/8.

TE-20RF SIGNAL GENERATOR

Accurate wide range signal generator covering 120 kc/s-260 Mc/s. on 6 bands. Directly calibrated. Variable R.F. attenuator. Operation 200/240 v. A.C. Brand new with instructions. £15. P. & P. 7/6. S.A.E. for details.

LAFAYETTE TE-46 RESISTANCE CAPACITY ANALYSER

2 pf-2,000 mid. 2 ohms-200 megohms. Also checks impedance turns ratio insulation. 200/250 v. A.C. Brand New, £17/10 Carr. 7/6.

ARF-100 COMBINED AF-RF SIGNAL GENERATOR

AF. SINE WAVE 20-200,000 cps. Square wave 20-30,000 cps. O/P 600Ω 3.3 v. P.P. R.F. 100 kc/s-300 Mc/s. Variable R.F. attenuation. Int./Ext. Modulation. Incorporates dual purpose meter to monitor AF output and % mod. on R.F. 220/240 v. A.C. £30. Carr. 7/6.

COSSOR 1049 DOUBLE BEAM OSCILLOSCOPES

D.C. coupled. Band width 1 Kc/s. Perfect order. £25. Carr. 30/-.

G.W. SMITH & CO (RADIO) LIMITED

3 and 34, LISLE STREET, LEICESTER SQ., LONDON, W.C.2 OI-437 8204
 311, EDGWARE RD., LONDON, W.2 OI-437 9155
 OI-262 0387

(ALL MAIL ORDERS TO:- 3, LISLE STREET, LEICESTER SQUARE, LONDON, W.C.2)

BENTLEY ACOUSTIC CORPORATION LTD.

38 CHALCOT ROAD, CHALK FARM, LONDON, N.W.1

THE VALVE SPECIALISTS Telephone 01-722-9090

GLOUCESTER ROAD, LITTLEHAMPTON, SUSSEX. Littlehampton 6743

Please forward all mail orders to Littlehampton

Save postal costs! Cash and carry by callers welcome.

0A2	5/9	6BR5	8/-	6K5GT	6/-	1487	15/-	150B2	14/6	DK91	5/8	ECP86	9/-	EY81	7/-	PC86	9/8	Q875/20	U25	13/-	2N3988	10/-	BCY33	4/5-	GET119	4/-	OC28	5/-			
0B3	6/-	6B87	16/6	6U4GT	12/-	18	12/6	150C2	5/9	DK92	7/8	ECP84	7/-	EY83	8/3	PC88	9/8	Q875/10	U26	11/9	2N3233	10/-	BCY34	4/6-	AA213	3/6	OC29	23/6			
0Z4	4/8	6BW6	12/9	6U7G	7/-	19	10/6	301	20/-	DK96	7/-			EY84	7/8	PC95	8/3	Q8150/15	U31	9/-	AA119	3/-	BCY38	5/-	GET573	7/8	OC30	5/-			
1A3	4/6	6BW7	11/-	6V6G	6/-	19AQ5	4/9	302	16/6	DL33	6/-	ECH21	12/6	EY86	8/-	PC87	9/8		U33	29/6	AA120	3/-	BCY39	4/6	GET589	8/8	OC35	5/-			
1A6	5/-	6C4	2/9	6V6GT	6/-	19H1	40/-	6U4GT	12/-	DL35	4/9	ECH35	5/9	EY88	7/6	PC84	8/-	R10	18/-	U37	34/1	AC107	3/-	BCZ11	3/6	GET872	10/-	OC38	7/8		
1A7GT	7/-	6C6	3/9	6X4	3/-	20D1	13/-	303	15/-	DL92	4/9	ECH42	10/-	EY91	3/-	PC85	8/6	R11	19/6	U45	15/6	AC113	6/-	BC108	3/6	GET874	4/-	OC41	10/-		
1C5	4/9	6C9	11/-	6X5GT	5/-	20D4	20/5	305	18/6	DL94	5/8	ECH81	5/9	EZ35	5/-	PC88	9/9	R16	34/11	U47	13/-	AC114	8/-	BC113	5/-		23/6	OC42	12/6		
1D6	6/9	6CDM6	19/6	6Y6G	8/-	20P9	14/-	306	13/-	DL96	7/-	ECH83	5/9	EZ40	7/8	PC89	9/6	R18	9/8	U50	5/8	AC154	6/-	BC115	3/-	GET882	10/-	OC43	29/6		
1FD1	6/-	6CL6	8/6	6Y7G	12/6	20L11	13/-	807	11/9	DM70	6/-	ECH84	7/-	EZ81	4/6	PCF82	9/6	R20	11/9	U78	4/9	AC155	6/6	BC118	4/6	GET889	8/8	OC44	PM 3/3		
1FD9	3/9	6CW4	12/-	7B7	7/-	20P3	18/1	1821	10/6	DW4/350	ECL82	6/-	HL13C	EZ90	3/6	PCF84	8/-	R52	7/8	U78	3/8	AC157	5/-	BD119	9/-	GET896	4/6	OC45	1/9		
1G6	6/-	6D3	7/6	7C8	6/-	20P4	18/6	5763	10/-		ECL83	9/-	HL22	10/6	PCF86	9/-	R53	7/8	U80	10/6	AC165	5/6	BFY50	4/6	GET897	4/6	OC46	3/6			
1H5GT	7/-	6D6	2/-	7E7	5/6	20P5	18/-	6090	5/6	DW4/500	ECL84	12/-	HL23	10/6	PCF87	7/-	R54	7/8	U81	12/6	AC166	5/6	BFY51	4/6	GET898	4/6	OC47	2/6			
1L4	2/6	6F1	9/6	7E7	12/-	20P6	18/6	7193	10/6		ECL85	12/-	HL24	10/6	PCF88	5/9	R55	7/8	U82	12/6	AC167	12/6	BFY52	4/6	GET899	4/6	OC48	2/6			
1LD5	5/-	6F6	12/6	7F7	5/-	25Y5G	8/6	AI834	20/-	DY86	8/8	ECL86	8/-	EY87	6/8	PC900	8/3	QV04/7	U35	16/8	AA129	3/-	BCZ11	3/6	GET872	10/-	OC38	7/8			
1LN5	3/-	6FG6	4/-	7V7	5/-	25Y5G	8/6	AI834	20/-	DY87	5/9	ECL87	8/-	EY88	7/6	PC84	8/-	R10	18/-	U37	34/1	AC107	3/-	BC108	3/6	GET874	4/-	OC41	10/-		
1N8GT	7/8	6F12	3/3	9B7	7/-	25Z4G	7/-	A2134	10/-	ES0F	84/-			EY91	3/-	PC85	8/6	R11	19/6	U45	15/6	AC113	6/-	BC108	3/6	GET874	4/-	OC41	10/-		
1R5	5/6	6F13	3/6	9D7	5/-	25Z5	7/-	A3042	15/-	ES3F	84/-	EP22	12/6	EZ35	5/-	PC88	9/9	R16	34/11	U47	13/-	AC114	8/-	BC113	5/-		23/6	OC42	12/6		
1B4	4/8	6F14	15/-	10C1	12/6	25Z6G	8/6	AC/PEN	12/6	EP36	3/6	HW3A	8/9	EZ40	7/8	PC89	9/6	R18	9/8	U50	5/8	AC154	6/-	BC115	3/-	GET882	10/-	OC43	29/6		
1B5	3/6	6F15	9/6	10C2	10/6	30C1	6/6	AC/PEN	19/6	EP37A	7/-	IW3	3/6	EZ81	4/6	PCF82	9/6	R20	11/9	U78	4/9	AC155	6/6	BC118	4/6	GET889	8/8	OC44	PM 3/3		
1U4	5/9	6F18	7/6	10D1	9/6	30C15	13/6	AC/PEN	19/6	EP39	5/6	ECL86	8/-	EZ90	3/6	PCF84	8/-	R52	7/8	U78	3/8	AC157	5/-	BD119	9/-	GET896	4/6	OC45	1/9		
1U5	6/9	6F23	13/3	10D2	14/7	30C17	12/6	DD	19/6	EP40	9/8	IW4/500	6/-	EZ90	3/6	PCF84	8/-	R52	7/8	U78	3/8	AC157	5/-	BD119	9/-	GET896	4/6	OC45	1/9		
2D21	5/6	6P23	11/9	10F1	15/-	30C18	9/6	AC/PEN	19/6	EP41	9/8	KBC32	20/5	EZ90	3/6	PCF84	8/-	R52	7/8	U78	3/8	AC157	5/-	BD119	9/-	GET896	4/6	OC45	1/9		
3A4	3/6	6P25	11/9	10F9	9/-	30P5	13/6	AC/PEN	19/6	EP42	3/6	KF35	12/6	EZ90	3/6	PCF84	8/-	R52	7/8	U78	3/8	AC157	5/-	BD119	9/-	GET896	4/6	OC45	1/9		
3A5	10/-	6P28	10/6	10F18	7/8	30P11	15/-	19/6	EP43	5/-	EP54	10/-	EK35	11/8	EZ90	3/6	PCF84	8/-	R52	7/8	U78	3/8	AC157	5/-	BD119	9/-	GET896	4/6	OC45	1/9	
3B7	6/-	6P32	9/6	10L12	11/0	30P12	15/-	AC/PEN	19/6	EP44	6/8	EK35	12/6	EZ90	3/6	PCF84	8/-	R52	7/8	U78	3/8	AC157	5/-	BD119	9/-	GET896	4/6	OC45	1/9		
3D6	3/6	6G6G	2/6	10L13	13/-	30P14	12/6	19/6	EP45	7/8	EK35	12/6	EZ90	3/6	PCF84	8/-	R52	7/8	U78	3/8	AC157	5/-	BD119	9/-	GET896	4/6	OC45	1/9			
3Q4	6/8	6HGT	1/9	10P13	13/-	30L1	6/-	AC/TH1	19/6	EP46	4/6	EP83	9/8	EZ90	3/6	PCF84	8/-	R52	7/8	U78	3/8	AC157	5/-	BD119	9/-	GET896	4/6	OC45	1/9		
3Q5GT	6/-	6J5G	3/9	10P14	12/6	30L13	13/9	10/-	EP47	2/3	EP85	5/3	KT39	5/6	EZ90	3/6	PCF84	8/-	R52	7/8	U78	3/8	AC157	5/-	BD119	9/-	GET896	4/6	OC45	1/9	
384	4/9	6J6	3/6	12A5	3/6	30L17	13/-	AC/TP	19/6	EP86	6/-	KT41	19/6	EZ90	3/6	PCF84	8/-	R52	7/8	U78	3/8	AC157	5/-	BD119	9/-	GET896	4/6	OC45	1/9		
3Y4	5/6	6J7G	4/9	12A6	6/-	30P4	12/6	AC/VP10/6	EP87	4/8	EP89	4/8	KT44	20/-	EZ90	3/6	PCF84	8/-	R52	7/8	U78	3/8	AC157	5/-	BD119	9/-	GET896	4/6	OC45	1/9	
FR4GT	4/9	6J7GT	4/9	12A7	7/6	30P4MR	12/6	18/8	EP88	5/9	EP91	4/8	KT2	5/-	EZ90	3/6	PCF84	8/-	R52	7/8	U78	3/8	AC157	5/-	BD119	9/-	GET896	4/6	OC45	1/9	
5U40	4/9	6K6G	6/-	12A8	7/6	30P4MR	12/6	ATP4	2/3	EP90	4/6	EP92	2/6	KT63	4/6	EZ90	3/6	PCF84	8/-	R52	7/8	U78	3/8	AC157	5/-	BD119	9/-	GET896	4/6	OC45	1/9
5V4G	7/8	6K7G	2/-	12A7E	4/6	30P12	13/-	AZ1	8/-	EP91	5/6	EP97	10/6	KT66	17/3	EZ90	3/6	PCF84	8/-	R52	7/8	U78	3/8	AC157	5/-	BD119	9/-	GET896	4/6	OC45	1/9
5Y3GT	5/6	6K7GT	4/6	12A7G	4/6	30P19	12/-	AZ31	8/9	EP98	10/6	KT74	12/6	PL802	15/-	U84	6/6	X66	7/8	U84	6/6	X66	7/8	U84	6/6	X66	7/8	U84	6/6	X66	7/8
5Z3	8/9	6K8GT	7/6	12A7H	4/6	30P11	15/-	AZ41	7/8	EP98	8/8	EP183	6/-	KT78	29/6	U84	6/6	X66	7/8	U84	6/6	X66	7/8	U84	6/6	X66	7/8	U84	6/6	X66	7/8
5Z4G	8/9	6K9GT	7/6	12A7T	4/6	30P13	15/-	BL63	10/6	EP98	8/8	EP184	6/-	KT78	29/6	U84	6/6	X66	7/8	U84	6/6	X66	7/8	U84	6/6	X66	7/8	U84	6/6	X66	7/8
6S0L2	12/6	6L1	12/6	12A7U	4/6	30P14	15/-	CH9	18/8	EP99	11/6	EP185	6/-	KT78	29/6	U84	6/6	X66	7/8	U84	6/6	X66	7/8	U84	6/6	X66	7/8	U84	6/6	X66	7/8
6A80	5/6	6L6GT	7/9	12A7V	4/6	30P15	15/-	CV6	10/6	EC53	12/6	EP186	6/-	KT78	29/6	U84	6/6	X66	7/8	U84	6/6	X66	7/8	U84	6/6	X66	7/8	U84	6/6	X66	7/8
6AC7	3/-	6L7GT	12/6	12A7W	4/6	30P16	15/-	CY10	10/6	EC54	6/-	EP187	6/-	KT78	29/6	U84	6/6	X66	7/8	U84	6/6	X66	7/8	U84	6/6	X66	7/8	U84	6/6	X66	7/8
6AG5	3/6	6L18	15/-	12B8E	6/9	35A5	15/-	CY31	7/8	EC70	4/9	EP188	6/-	KT78	29/6	U84	6/6	X66	7/8	U84	6/6	X66	7/8	U84	6/6	X66	7/8	U84	6/6	X66	7/8
6AK5	4/6	6L19	19/-	12B8F	6/9	35D5	19/8	D83	5/-	EC86	10/3	EP189	6/-	KT78	29/6	U84	6/6	X66	7/8	U84	6/6	X66	7/8	U84	6/6	X66	7/8	U84	6/6	X66	7/8
6AK6	6/-	6L20	8/6	12B8G	6/9	35L6GT	8/6	D77	2/3	EC92	6/6	EP190	6/-	KT78	29/6	U84	6/6	X66	7/8	U84	6/6	X66	7/8	U84	6/6	X66	7/8	U84	6/6	X66	7/8
6AL6	2/8	6N7GT	6/8	12E1	17/-	35W4	4/6	DAC3	7/8	EC93	15/6	EP191	6/-	KT78	29/6	U84	6/6	X66	7/8	U84	6/6	X66	7/8	U84	6/6	X66	7/8	U84	6/6	X66	7/8
6AM4	16/6	6P1	12/-	12J7GT	6/8	35Z3	10/-	DAP91	3/6	EC93	2/6	EP192	6/-	KT78	29/6	U84	6/6	X66	7/8	U84	6/6	X66	7/8	U84	6/6	X66	7/8	U84	6/6	X66	7/8
6AM6	3/3	6P28	12/-	12K5	10/-	35Z4GT	4/9	DAP96	6/-	EC93	29/1	EP193	6/-	KT78	29/6	U84	6/6	X66	7/8	U84	6/6	X66	7/8	U84	6/6	X66	7/8	U84	6/6	X66	7/8
6AQ5	4/9	6P25	12/-	12K7GT	6/9	35Z5GT	6/-	DCC90	10/-	EC93	29/1	EP194	6/-	KT78	29/6	U84	6/6	X66	7/8	U84	6/6	X66	7/8	U84	6/6	X66	7/8	U84	6/6	X66	7/8
6AR6	20/-	6P28	25/-	12K8GT	7/8	50A5	21/10	DD4	10/6	EC94	9/8	EP195	6/-	KT78	29/6	U84	6/6	X66	7/8	U84	6/6										

ENGLANDS LEADING COMPONENT & EQUIPMENT CENTRES

SOLID STATE-HIGH FIDELITY AUDIO EQUIPMENT

Mono or Stereo Audio, Equipment developed from Dinsdale Mk.II—each unit or system will compare favourably with other professional equipment selling at much higher prices.

COMPLETE SYSTEMS FROM £15.5.0

THE FINEST VALUE IN HIGH FIDELITY—CHOOSE A SYSTEM TO SUIT YOUR NEEDS AND SAVE POUNDS



All units available separately.

SEND FOR FREE BROCHURE (No. 21) TODAY!
DEMONSTRATIONS DAILY AT '303' EDGWARE ROAD



INTEGRATED TRANSISTOR AMPLIFIERS MA66 12 WATTS STEREO

We are pleased to offer two new designs with the choice of either mono or stereo systems. These BRITISH DESIGNED UNITS favour the user in so many ways—with fantastic power and quality with far greater adaptability, with freedom for battery or mains operation.

For complete listening satisfaction choose either the—

MA7 MONO
£8.10.0

OR THE STEREO
POST PACKING 5/-
EITHER MODEL

MA66
£16.10.0

OPTIONAL MAINS UNIT
PS20 62/6d. p.p. 4/-

Illustrated leaflets 12 and 14 FREE on request.

ELECTRONIC ORGANS KITS TO BUILD YOURSELF AND COMPLETE UNITS

Acclaimed by everyone

The MAYFAIR

A completely new development in portable electronic musical instruments and a new field for the home constructor. The 'MAYFAIR' produces a multitude of the most pleasing sounds with a wide range of tone colours suitable for classic or popular music. The organ is fully polyphonic, that is full chords can be played over the entire keyboard. Supplied as a kit of parts which includes 165 transistors, printed circuits panel, special fully sprung and depth of touch adjusted keyboard, attractive vinyl covered cabinet with carry handle. A complete detailed and illustrated construction manual is provided with circuits and full parts list. All items may be purchased separately. All parts supplied are fully guaranteed. Full after sales service.

Deferred terms available
COMPLETE KIT
Deposit £29.19.0
12 monthly payments of
£7. Total £113.19.0
BUILT AND TESTED
Deposit £38.8.0 and
12 monthly payments of
£9. Total £144.8.0



THE MAYFAIR 99 GNS
BROCHURE 9

The GROSVENOR

is designed for the more ambitious musician and has a much wider range than most commercial organs. It comprises two four-octave (49 note) keyboards and a thirteen-note Pedal board. It has four pitches (i.e. 8ft. 4ft. 2ft. 1ft.) on the upper or solo keyboard, three pitches (i.e. 16ft. 8ft. 4ft.) on the lower or accompaniment keyboard, two pitches (i.e. 16ft. 8ft.) on the pedal board. Variable sustain on the solo keyboard and variable vibrato on both keyboards. It has 15 voices in the solo tone-forming unit, 10 voices in accompaniment tone-forming unit and 4 voices in the pedal tone-forming unit. All components and kit sections are available separately including the Oak Console at £65.18.0.



THE GROSVENOR
KITS FROM £220 terms available
BROCHURE 9B

A complete detailed and illustrated construction manual is provided with circuits and full parts list. All items may be purchased separately. All parts supplied are fully guaranteed. Full after sales service and advice freely available. Once built the 'MAYFAIR' or 'GROSVENOR' will then provide years of enjoyable entertainment. Call in—See them for yourself.

PRACTICAL ELECTRONICS—ELECTRONIC ORGAN KIT

We are able to supply Parts as described in this series. Details on request.

ORGAN COMPONENTS: COMPLETE RANGE IN STOCK - 49 AND 61 NOTE KEYBOARDS - 2 TO 5 AMP GOLD CONTACTS COILS AND CHOKES - REVERBERATION SPRINGS AND UNITS - STOP TABS AND ASSEMBLIES - PEDAL BOARDS - RHODIUM AND GOLD CLAD WIRE. ALSO PRINTED CIRCUITS ETC. COMPLETE RANGES FOR TRANSISTORISED ORGANS. ASK FOR NEW PRICE LISTS WITH DETAILS. LEAFLET 9B ALL ENQUIRIES TO: ORGAN DEPT. - MR. ELVINS

PORTABLE GEIGER COUNTERS

FOR MEASUREMENT OF RADIO-ACTIVITY. Supplied complete with instructions, haversack, cables and probe. List price £70. **OUR PRICE, NEW, TESTED COMPLETE WITH BATTERIES £7.10.0** POST 10/- SPARE BATTERIES 15/- PAIR, POST 5/-

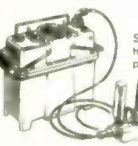

NEW MODELS NOMBREX TRANSISTORISED Test Equipment

MODEL	PRICE	Leaflet
28a RF. Gen.	21 0 0	35
29a Xtal RF Gen.	29 10 0	35
30 Audio Generator	18 10 0	24
31 R.F. Generator	12 10 0	26
32 C.R. Bridge	10 10 0	26
33 Inductance Bridge	20 0 0	29

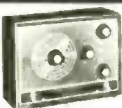

GRAVINER FIRE DETECTOR UNIT

The Detector Unit consists essentially of a highly sensitive 931A photo-electric cell combined with a firing circuit. Incorporates a single cold cathode electronic relay, capacitors and resistors designed to fall to safety if external wiring is open or short circuited. Encapsulated in a resin which fully insulates the unit electrically and provides a high degree of mechanical and thermal shockproofing. Original price £74. **OUR PRICE, BRAND NEW £6 each**, with data sheet



'SCOOP! STARR RECORD PLAYER

Deck. Plays 33, 45, 78 records. 9 volt operated. With mono cartridge Brand new. As illustrated. 59/6 post 3/6. **'MULLARD 1 WATT AMPLIFIER** 9 volt 5 transistor unit complete with volume control. Output to 3 ohms. Ideal for use with Starr Record Deck. 45/- post 3/- Send for leaflet 2



BUILD A QUALITY TAPE RECORDER

To get the best out of your MAGNAVOX DECK, you need a MARTIN RECORDAKIT. This comprises a special high quality 6 valve amplifier and pre-amplifier which comes to you assembled on its printed circuit board—in fact everything needed down to the last screw. FOR MAKING A SUPERB TAPE RECORDER, which, when built, will compare favourably with instruments costing twice as much, yet you need no experience or technical skill to bring this about. THE INSTRUCTIONS MANUAL MAKES BUILDING EASY AND SUCCESS ASSURED

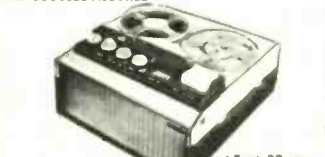

P.P. 22/6 either model
KIT comprises: Deck, Amplifier, Cabinet and speaker, with MICROPHONE 7 in 1,200 ft. tape, spare spool. ALL UNITS AVAILABLE SEPARATELY. ASK FOR BROCHURE 6. Today's Value £60.

VHF FM SUPERHET TUNER MKII

'5-MULLARD TRANSISTORS & 4 DIODES' 300 KC/S BANDWIDTH - PRINTED CIRCUIT CONSTRUCTION 'HIGH FIDELITY REPRODUCTION MONO AND STEREO' A Popular VHF FM Tuner now used throughout the country for quality reception of monophonic and, with the decoder stereophonic broadcasts. There is no doubt about it—VHF FM gives the real sound. Excellent stability economically priced. **PARTS TOTAL COST £6.19.6.** DECODER £5.19.6. (CABINET 20/- EXTRA) ASK FOR LEAFLET 3.



MANUFACTURERS—DISTRIBUTORS

We publish a QUANTITY, SEMI-CONDUCTOR BULLETIN listing over 500 different devices available FROM STOCK in medium to large quantities at KEEN PRICES coupled with PROMPT DELIVERIES. TO OBTAIN YOUR COPY, WRITE TO US (on Company Headed Notepaper please) requesting our SEMI-CONDUCTOR BULLETIN. For TELEPHONE QUOTATIONS, PHONE (01) 723 1008/9 Extn. 4 (01) 723 0401 Extn. 4. We purchase medium to large quantities of Transistors and Devices excess to Manufacturers and Distributors requirements. Write or phone 723-0401 extn. 4.

NEW—MALLORY LONG LIFE MERCURY BATTERIES

50% OFF LIST PRICES
*RM12 1.35 volts 3600 mAh size 2 1/2 dia. **OUR PRICE 5/- each**
*RM25 10.35 volts 350 mAh Pack of 8. Size 2 1/2 x 1 1/2. **OUR PRICE 10/- each**
Easily split into eight 1.35v cells. These cells are ideal for any application where SMALL SIZE HIGH CAPACITY and LONG LIFE are required. QUANTITIES AVAILABLE.

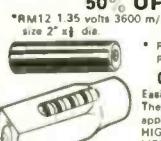

GARRARD RECORD DECKS

BRAND NEW All Below list price
2025 Mono/Stereo GKS 25 £ 8 8 0
3000 LM Mono/Stereo 9 TAHC 9 16 6
SP25 Mk II 11 19 6
AT60 Mk II 13 0 0
AP75 19 0 0
SL55 11 19 6
SL65 14 14 0
SL75 29 0 0
SL95 35 0 0
A70 Mk II 12 12 0
B.S.R. UA25 Mono 5 19 6
MA65 9 19 6
MA70 12 12 0
MA75 15 5 0
401 Garrard 28 10 0
Carriage/Packing 7/6d. all models. Complete range of accessories available. Send for New 8 page brochures 16, 17.



Hi-Fi equipment to suit EVERY POCKET

VISIT OUR NEW HI-FI CENTRE at 309 EDGWARE ROAD AND SAVE UP TO £25 ON SEPARATE UNITS OR THE SYSTEM OF YOUR CHOICE for all leading makes

- AMPLIFIERS
- TUNERS
- DECKS
- SPEAKERS
- MICROPHONES
- TEST EQUIPMENT
- HEADPHONES
- CARTRIDGES, etc.

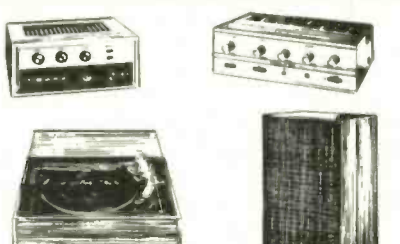

All with Terrific Savings It will PAY YOU to pay us a VISIT!
COMPLETE SYSTEMS from £46 - Saves £12.10.0
Send for new 8-page illustrated Hi-Fi list 16/17.

Fully Illustrated CATALOGUE

COMPLETELY NEW 9th EDITION (1969)
The most COMPREHENSIVE—CONCISE—CLEAR COMPONENTS CATALOGUE
Complete with 10/- worth discount vouchers
FREE WITH EVERY COPY
* 32 pages of transistors and semi-conductor devices, valves and crystals.
* 210 pages of components and equipment.
* 70 pages of microphones, decks and Hi-Fi equipment.
6,500 ITEMS
320 BIG PAGES
Send today 7'6 Post etc 2/-



HENRY'S RADIO LTD



OPEN MON.—SAT. 9 a.m.—6 p.m. THURS. 9 a.m.—1 p.m.

303 Edgware Road, London, W.2. Mail Order Dept. all types of Components, Organ Dept. (01) 723-1008/9 309 Edgware Road, London, W.2. High Fidelity Sales, P.A. and Test Equipment, Record Decks (01) 723-6963

ORGAN BUILDERS!

SILICON N.P.N. TRANSISTORS SUITABLE FOR FREQUENCY DIVIDER CIRCUITS 1/6d. each or £5 per 100.

Latest list of transistor stock. All brand-new and to manufacturers specifications.

NKT11	9/3	NKT401	18/-	BFX84	6/6	2N2219	10/9
NKT12	7/3	NKT402	19/3	BFX85	8/-	2N2219A	12/6
NKT72	5/-	NKT403	16/-	BFX86	6/6	2N2220	7/3
NKT73	5/-	NKT404	13/3	BFX87	8/-	2N2221	8/6
NKT124	8/6	NKT405	14/9	BFX88	7/3	2N2221A	10/-
NKT125	5/9	NKT406	13/3	BFY50	5/-	2N2222	10/9
NKT126	5/-	NKT420	40/-	BFY51	4/6	2N2222A	12/6
NKT135	5/-	NKT451	13/3	BFY52	5/-	2N2297	9/3
NKT137	6/6	NKT452	12/6	BFY53	4/6	2N2368	4/6
NKT210	5/9	NKT453	8/-	BFY90	29/6	2N2369	4/6
NKT211	5/-	NKT603F	6/6	BSX19	4/6	2N2369A	5/-
NKT212	5/-	NKT613F	7/3	BSX20	4/6	2N2483	8/6
NKT213	6/6	NKT674F	5/-	BSX60	16/6	2N2484	10/9
NKT214	4/6	NKT677F	4/6	BSX61	10/-	2N2220A	10/9
NKT215	5/-	NKT713	5/-	BSY95A	3/9	2N2904	10/9
NKT216	10/-	NKT717	8/-	2N696	5/-	2N2904A	12/-
NKT217	10/9	NKT734	5/-	2N697	5/-	2N2905	15/6
NKT219	5/-	NKT736	6/6	2N706	3/-	2N2905A	18/-
NKT223	5/9	NKT773	4/6	2N706A	3/-	2N2906	12/6
NKT224	4/6	NKT781	5/-	2N708	4/6	2N2906A	13/3
NKT225	4/6	NKT10419	5/-	2N709	11/6	2N2907	14/-
NKT229	5/-	NKT10519	5/9	2N914	5/-	2N2907A	20/9
NKT237	7/3	NKT10339	6/6	2N918	11/6	2N3053	5/9
NKT238	4/6	NKT10439	7/3	2N929	7/3	2N3055	20/9
NKT239	5/-	NKT12329	11/6	2N930	8/-	2G345	4/-
NKT240	4/6	NKT12429	14/-	2N1131	8/6	2G371	4/-
NKT241	5/-	NKT13329	5/-	2N1132	10/-	2G378	4/-
NKT242	3/-	NKT13429	5/-	2N1302	4/8	OC22	10/-
NKT243	14/-	NKT35219	22/3	2N1303	4/6	OC204	6/-
NKT244	3/-	NKT16229	11/6	2N1304	6/-	OC44	6/-
NKT245	3/9	NKT20329	12/6	2N1305	5/-	OC45	6/-
NKT261	3/9	NKT20339	8/6	2N1306	6/8	ASZ17	10/-
NKT262	3/9	BC107	4/6	2N1307	6/6		
NKT264	3/9	BC108	3/-	2N1308	8/6		
NKT271	3/9	BC109	4/6	2N1309	8/6		
NKT272	3/9	BCY55	70/-	2N1613	5/9		
NKT274	3/9	BCY70	5/-	2N1711	6/6	25/49	5%
NKT275	3/9	BCY71	9/3	2N1893	12/6	50/99	10%
NKT281	5/-	BCY72	4/6	2N2217	7/3	100/299	15%
NKT302	16/6	BDY20	22/3	2N2217A	15/6	300/999	20%
NKT304	13/3	BFX29	11/6	2N2218	8/6	1,000	25%
NKT351	11/6	BFX30	13/3	2N2218A	10/-		all one type.

Unmarked transistors (tested) similar to:
 2N753 1/6, BSY28 1/6, BSY65 1/6, OC44 1/6, OC71 1/-, OC72 1/-.
LIGHT SENSITIVE TRANSISTORS (similar to OCP71), 2/- each.
ORP12 CADMIUM SULPHIDE LIGHT-SENSITIVE RESISTORS
 9/- each.

GIANT-SIZE SELENIUM SOLAR CELLS—PRODUCE UP TO 6ma AT 0.6 VOLTS FROM DAYLIGHT!
 67mm. diameter 10/- each, 50mm. x 37mm. 2 for 10/-.

MULLARD POLYESTER CAPACITORS FAR BELOW COST PRICE!

0.001µF 400V	3d.	0.15µF 160V	6d.
0.0015µF 400V	3d.	0.22µF 160V	6d.
0.0018µF 400V	3d.	0.27µF 160V	6d.
0.0022µF 400V	3d.	1µF 125V	1/-
0.01µF 400V	3d.				

RECORD PLAYER CARTRIDGES. COMPLETE WITH NEEDLES.
 GP 67/2 Mono 15/-, GP 91/3 Compatible £1, GP 93/1 Crystal Stereo 25/-,
 GP 94/1 Ceramic 25/-.

TRANSISTORISED SIGNAL INJECTOR KIT 10/-, SIGNAL TRACER KIT 10/-, CAR REV. COUNTER KIT 10/-.

VEROBOARD

2½ in. x 1 in. 0.15 matrix	1/3	17 in. x 3½ in. 0.15 matrix	14/8
3½ in. x 2½ in. 0.15 matrix	3/3	3½ in. x 2½ in. 0.1 matrix	4/2
3½ in. x 3½ in. 0.15 matrix	3/11	3½ in. x 3½ in. 0.1 matrix	4/9
5 in. x 2½ in. 0.15 matrix	3/11	5 in. x 2½ in. 0.1 matrix	4/7
5 in. x 3½ in. 0.15 matrix	5/6	5 in. x 3½ in. 0.1 matrix	5/6
17 in. x 2½ in. 0.15 matrix	11/-		

Spot Face Cutter 7/6 Pin Insert Tool 9/6 Terminal Pins 3/6-36,
 Special Offer! Spot Face Cutter and 5 2½ in. x 1 in. boards, 9/9 only!

PAPER CONDENSERS. Mixed bags 0.001µF to 0.5µF, 12/6 per 100.
SILVER-MICA, Ceramic, Polystyrene Condensers. Well assorted. Mixed types and values, 10/- per 100.

RESISTORS. Mixed types and values, ¼ to 1 watt. 6/6 per 100, 55/- per 1,000. Wire-wound resistors. 1 watt to 10 watts. Mixed values. 20 for 10/-.
 Transistors. Mixed, unmarked, mainly O.K. 7/6 for 50.

12 VOLT TRANSISTORISED FLUORESCENT LIGHTS. HALF NORMAL PRICE! 8 watt 12 in. tube. Reflector type £2/19/6. 15 watt 18 in. Batten type £3/19/6.
IDEAL FOR CAMPING OR CARAVAN HOLIDAYS! A BRIGHT LIGHT FOR VERY LITTLE CURRENT!

ELECTROLYTIC CONDENSERS

0.25µF 3 volt	4µF 12 volt	25µF 6 volt	320µF 10 volt
1µF 6 volt	4µF 25 volt	25µF 12 volt	400µF 6.4 volt
1µF 20 volt	5µF 6 volt	25µF 25 volt	
1.25µF 16 volt	6µF 6 volt	30µF 6 volt	
2µF 3 volt	8µF 3 volt	30µF 10 volt	
2µF 350 volt	8µF 12 volt	50µF 6 volt	
2.5µF 16 volt	8µF 50 volt	64µF 2.5 volt	
3µF 25 volt	10µF 6 volt	64µF 9 volt	
3.2µF 64 volt	10µF 25 volt	100µF 9 volt	
4µF 4 volt	20µF 6 volt	320µF 4 volt	

All at 1/- each.
 20 assorted (our selection) 10/-

Orders by post to:
G. F. MILWARD
 DRAYTON BASSETT, NEAR TAMWORTH, STAFFS.

Please include suitable amount to cover post and packing. Minimum 2/-.
 Stamped addressed envelope must accompany any enquiries.
 For customers in Birmingham area goods may be obtained from Rock Exchanges, 231 Alum Rock Road, Birmingham 8.

Vari-Light LIQUID CRYSTAL KITS AND SOLUTIONS

for use in

- * Studying load temperature distributions on electronic circuits
- * Microwave energy determinations
- * Infra-red and visible light energy measurements
- * Laser output measurements
- * Thermal conductivity tests
- * On-off indicators for operating parts
- * Performance of insulating materials
- * Non-destructive testing of metals
- * Cutaneous Thermography

Kits supplied for versatile use or, solutions prepared to your requirements for use over specified temperature ranges.

All requests for price details and technical literature to:

PEBOC LIMITED

BELVUE ROAD, NORTHOLT, MIDDLESEX Tel. 01-845 3411

Sole U.K. Distributors for Vari-Light Liquid Crystal Products

TRANSFORMERS

COILS

LARGE OR SMALL QUANTITIES

CHOKES

TRADE ENQUIRIES WELCOMED

SPECIALISTS IN

FINE WIRE WINDINGS

MINIATURE TRANSFORMERS
 RELAY AND INSTRUMENT COILS, ETC.
 VACUUM IMPREGNATION TO APPROVED STANDARDS

ELECTRO-WINDS LTD.

CONTRACTORS TO G.P.O., A.W.R.E., L.E.B., B.B.C., ETC.

123 PARCHMORE ROAD, THORNTON HEATH, SURREY
 01-653 2261 CR4.8LZ EST. 1933

WW-103 FOR FURTHER DETAILS

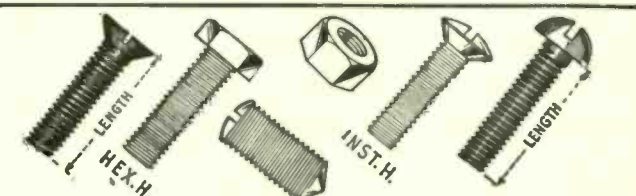

We supply B.A. Screws, etc. in brass, steel, stainless, phosphor bronze and nylon to laboratories throughout the Commonwealth.

We can also offer early delivery for many sizes of screws, etc. with Metric Threads

Please send for List W2/69 (WW)

WALKER-SPENCER COMPONENTS LTD.

5, High Street, Kings Heath, Birmingham, 14.

Telephone: 021-444 3155 (Sales) and 5278

WW-104 FOR FURTHER DETAILS

OPTOELECTRONICS from PROOPS

New Science Projects combine fascination of Optics with Electronics.

INFRA-RED TRANSMITTERS & RECEIVERS

Unique devices in a brand new electronic field that can be exploited in a wide range of applications. Miniaturized construction and solid state circuit design is combined with outstanding modulation and switching capabilities to provide infinite possibilities as short distance speech and data links, remote relay controls, safety devices, burglar alarms, batch counters, level detectors, etc., etc.

INFRA-RED PHOTO RECEIVER — MSP3

Ultra sensitive detector/amplifier for infra-red (Gallium Arsenide) or visible light optical links reception. Spectral response 9500 Å. Robust, cylindrical package is coaxial with incident light to facilitate optical alignment and heat sinking.

85/- post free



MAX RATINGS

Total dissipation (in free air, $T_{amb} = 25^{\circ}\text{C}.$).....100mW. Derating Factor.....2mW/ $^{\circ}\text{C}.$
Output Current Intensity.....100mA. Voltage.....25V. Operating Temperature.....from -30° to $+125^{\circ}\text{C}.$

Supplied complete with suitable lenses, full Technical Data and Application Sheets, including Line of Sight Speech Link.

Infra-red devices (except 31F2) are supplied complete with suitable lenses, technical data and typical application information.

GALLIUM ARSENIDE LIGHT SOURCE—MGA 100

Filamentless, infra-red emitter in a robust, sealed cylinder coaxial with beam to facilitate optical alignment and heat sinking.



35/- post free

MAX RATINGS

Forward current I_F max.* D.C.....400mA. Forward peak current I_F max.* (pk).....6A
Power dissipation*.....600mW. Derating factor for T_{amb} greater than $25^{\circ}\text{C}.$7.5mW/ $^{\circ}\text{C}.$
Reverse voltage V_R max 1-0V.

*When mounted on an aluminium heat sink 1 in. x 1/2 in. x 1/2 in.

Supplied complete with suitable lenses, full Technical Data and Application Sheets, including Line of Sight Speech Link.

MICRO-MINIATURE INFRA-RED DETECTOR — 31F2

Silicon NPN photo-diode of passivated planar construction, suitable for punched card readers, counters, film sound track, etc.



28/6 post free

PHOTOCONDUCTIVE CELLS

CADMIUM SULPHIDE CELLS (Cds)

Inexpensive light sensitive resistors which require only simple circuitry to work as light triggering units in a wide range of devices, such as: flashing or breakdown lights, exposure meters, brightness controls, automatic porch lights, etc. Not polarity conscious — use with A.C. or D.C. Spectral response covers whole visible light range.



MKY251

Epoxy sealed 1 1/2 in. diam. x 1/4 in. thick. Resistance at 100 Lux — 700 to 3,000 ohms. Maximum voltage 200 A.C. or D.C. Maximum current 500 mW. 12/6 post free



MKY101-C

Epoxy sealed, 1/2 in. diam. x 1/4 in. thick. Resistance at 100 Lux — 500 to 2,000 ohms. Maximum voltage 150 A.C. or D.C. Maximum current 150 mW. 10/6 post free

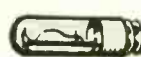

MKY71

Glass sealed with M.E.S. base. Glass envelope 1/2 in. diam. overall length 1 in. Resistance at 100 Lux — 50 Kohms to 150 Kohms. Maximum voltage 150 A.C. or D.C. Maximum current 75 mW. 8/6 post free

CADMIUM SELENIDE CELLS (Cdse)

These have a higher dark resistance in a given period than Cadmium Sulphide Cells, indicating much faster response. Suitable for all Cds applications plus applications in chopper, electronic musical instruments, computer and other sophisticated circuitry. Time response shown in megohms is dark resistance measured 10 secs. after 400 Lux light intensity is intercepted.



MKB5H

Hermetically metal sealed. 1/2 in. diam. x 1/4 in. thick. Time response 100 megohms. Resistance at 1,000 Lux — 1 Kohm to 10 Kohms. Resistance at 10 Lux — 50 Kohms to 1 megohm. Maximum voltage 50 A.C. or D.C. Maximum current 10 mW. Continuous current 5 mW. 16/6 post free



MKB12H

Hermetically metal sealed 1/2 in. diam. x 1/4 in. thick. Time response 100 megohms. Resistance at 1,000 Lux — 100 ohms to 1,000 ohms. Resistance at 10 Lux — 1 Kohm to 10 Kohms. Maximum voltage 50 A.C. or D.C. Maximum current 80 mW. Continuous 30 mW. 16/6 post free

PHOTOGENERATIVE CELLS

Selenium cells in which light energy is converted into electricity directly measurable on microammeter or used with amplifier as light trigger for alarm and counting devices. Luminous fluxmeters, exposure meters, colorimeters, etc.. Spectral response covers visible light range.

Type 1—1 1/2 x 1 1/4 in. Output 1 mA at 0.6 volts at 1,000 Lux 5/- post free

Type 2—28 x 18 mm. Output 500 μA at 0.6 volts at 1,000 Lux 3/6 post free

Type 3—100 x 50 mm. Output 4 mA at 0.6 volt at 1,000 Lux 22/6 post free

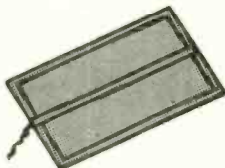

PROOPS

FIBRE OPTICS

Highly flexible light guides that transmit light to inaccessible places as easily as electricity is conducted by copper wires. Fibre optics make it possible to control, miniaturize, split, reflect or transfer light from one source to many places at once and to operate photo devices, logic circuits, or illuminate in ways never before possible. Proops offer both glass fibre optics or inexpensive Crofon plastic fibres for hundreds of experiments or serious applications in a fascinating new science.

RANK TAYLOR-HOBSON ENGINEERS KITS

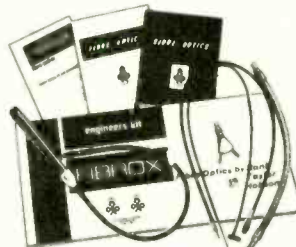

All the basic components needed to demonstrate new ways to use light in serious applications with glass fibre optics consisting of thousands of fibres tightly bundled in a flexible sheath with ferruled, optically polished ends. Kit includes 12, 18, and 24 inch standard light guides in 1.5, 3 and 6 mm widths, 24 inch twin exit guide with 2 x 1 mm. outputs. Non-random 'Y' guide with 2 x 3 mm. outputs, adaptors and battery operated light source. Supplied complete with card wallets containing technical data and illustrated applications.

£16 post free

LOW-COST CROFON FLEXIBLE LIGHT GUIDE

Newly developed plastic light transmitting media made by Du Pont and consisting of 64 special plastic fibres, each .010 in. diam. and bundled together in a tough, flexible sheath. Can be used for many serious projects and inexpensive prototype work. Ends can be ground flat, dyed or capped with epoxy resin. Temp. range -40° to $176^{\circ}\text{F}.$ No loss of light through bending. 12-page data and applications booklet supplied.

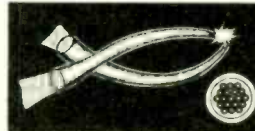

Minimum order—2 ft.

8/6 per foot post free

Other advanced Solid-State devices

RCA INTEGRATED CIRCUIT — CA3020

Complete Audio or Servo Amplifier in one tiny package! Preamp, phase inverter, driver and power output function in a single package only 1/2 in. diam. and 1/4 in. high. Operates from single D.C. supply of 3 to 9 volts; gives maximum output of more than 1/2 watt for 22 mA consumption. Low distortion, high gain is coupled with built-in temperature compensation (-55° to $123^{\circ}\text{C}.$) and wideband operation. Complete with data and circuit applications.

42/- post free



RCA TRIAC — CA40432

Suitable for light dimming and motor control circuits Gate-controlled, full-wave, A.C. silicon switch with integral trigger that blocks or conducts instantly by applying reverse polarity voltage. Suitable for A.C. operation up to 250 volts; controls currents up to 1440 watts. Size only 1/2 in. diam. x 1/4 in. high. Complete with heat sink, data and applications information.

45/- post free



Proops Bros. Ltd., 52 Tottenham Court Road, London W1P 0BA
Telephone: 01-580 0141

CURRENT RANGE OF BRAND NEW L.T. TRANSFORMERS. FULLY SHROUDED (*excepted) TERMINAL BLOCK CONNECTIONS. ALL PRIMARIES 220/240v.

No.	SEC. TAPS	AMPS	PRICE	CARR.
1A	25-33-40-50	15	£9 10 0	10/6
1B	25-33-40-50	10	£6 19 6	8/6
1C	25-33-40-50	6	£5 19 6	8/6
1D	25-33-40-50	3	£3 12 6	7/6
2A	4-16-24-32	12	£6 10 0	7/6
2B	4-16-24-32	8	£4 17 6	7/6
2C	4-16-24-32	4	£3 5 0	6/-
2D	4-16-24-32	2	£2 2 6	5/-
3A*	25-30-35	40	£14 17 6	15/-
3B*	25-30-35	20	£9 7 6	9/6
3C	25-30-35	10	£6 10 0	7/6
3D	25-30-35	5	£3 15 0	6/6
3E	25-30-35	2	£2 15 0	6/6
4A*	12-20-24	30	£11 15 0	10/-
4B	12-20-24	20	£7 10 0	8/6
4C	12-20-24	10	£4 15 0	7/6
4D	12-20-24	5	£3 5 0	6/6
5A	3-12-18	30	£8 15 0	7/6
5B	3-12-18	20	£6 10 0	7/6
5C	3-12-18	10	£3 17 6	6/6
5D	3-12-18	5	£2 12 6	6/6
6A	48-56-60	2	£3 5 0	5/6
6B	48-56-60	1	£2 7 6	5/6
7A*	6-12	50	£9 7 6	9/6
7B	6-12	20	£5 10 0	7/6
7C	6-12	10	£3 10 0	6/6
7D	6-12	5	£2 10 0	6/6
8A	12-24	1	£1 9 6	5/6
9A	17-32	8	£5 12 6	5/6
10A*	9-15	2	£1 5 0	5/6
11A	6-3	15	£2 5 0	5/6
12A	30-25-0-25-30	2	£3 5 0	5/6

Note: By using the intermediate taps many other voltages can be obtained.

Example: No. 1. 7-8-10-15-17-25-33-40-50v.
 .. 2. 4-8-12-16-20-24-32v.
 .. 5. 3-6-9-12-15-18v.

AUTO TRANSFORMERS

240v.-110v. or 100v. Completely Shrouded fitted with Two-pin American Sockets or terminal blocks. Please state which type required.

Type	Watts	Approx. Weight	Price	Carr.
1	80	2½ lb	£1 17 6	4 6
2	150	4 lb	£2 7 6	5 0
3	300	6½ lb	£3 7 6	6 0
4	500	8½ lb	£4 15 0	6 6
5	1000	15 lb	£6 12 6	7 6
6*	1750	25 lb	£13 10 0	10 6
7*	2250	30 lb	£16 10 0	12 6

*Completely enclosed in beautifully finished metal case fitted with two 2-pin American sockets, neon indicator, on/off switch, and carrying handle.

Samson's
(ELECTRONICS) LTD.

9 & 10 CHAPEL ST., LONDON, N.W.1
01-723-7851 01-262-5125

AMERICAN HIGHLY STABILISED POWER SUPPLY UNIT

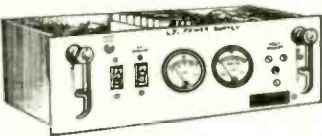

Regulation between 7-15 volts D.C. at 20 amps. Fitted 0-30 D.C. ammeter, 0-15 D.C. voltmeter and overload protection switch. Built to a very high specification. Bench or rack mounting. Size 19 x 8 x 17 ins. A.C. input 110v. 50 cycles. Ex equipment but guaranteed in perfect condition. Maker's price in excess of £200. Our price £25. Carr. 30/- 240/110 volt, 400 watts, Mains Transformer available if required. £3 extra.

SPECIAL OFFER OF L.T. TRANSFORMERS

Pri 110-120v.-200-240v. Sec. tapped 12, 18, 24, 30 v. 8a. Table top connections. Fully tropicalised. 75/- Carr. 7/6. As above 5 amp rating. 59/6. Carr. 6/-. Supplied brand new manufactured for the Phoenix Telephone Co.

Pri tapped 200-250v. Sec. 46v. Very conservatively rated at 29 amps. Size 11x7x7ins. Weight 75 lbs. approx. Manufactured by Partridge. £12.19.6. Carr. 15/-.

Pri tapped 110v. 220-250v. Sec. 55v. 24a., 14v. 10a., 60v. 2a. All windings very conservatively rated. Tropicallly finished. Terminal connections. Size 9x7½x7ins. Weight 65lbs. £10.19.6. Carr. 15/-.

SPECIAL OFFER OF A.E.R.E. TRANSFORMERS

Manufactured by famous makers. Offered at a fraction of List Prices. all Primaries tapped 200-240v. Table Top connects "C" core type. No. 1 sec. 600v. 220 m/a. 52/6 carr. 7/6. No. 2 Sec Tapped 630-650v. 150 m/a 52/6 carr. 7/6. No. 3 Sec 125v. 265 m/a Twice 35/-, P. & P. 5/-. No. 4 Sec Tapped 760-700, 40.20v. 50 m/a 27/6, P. & P. 4/6 No. 5 Sec Tapped 500-450-0-450-500v. 215 m/a 55/- P. & P. 8/6 No. 6 Sec 450-350-350-450v. 100 m/a 27/6, P. & P. 4/6 No. 7 Sec Tapped 370-390-410v. 6 m/a 12/6, P. & P. 3/6 No. 8 Sec Tapped 300-0-300v. 66 m/a. 6.3v. 4a. 17/6 P. & P. 5/- No. 9 Sec Tapped 27-0-27v. 0.3a Twice 6.3v. 1a. 6.3v. 0.3a. 6.3v. 0.6a. 29/6 P. & P. 4/6 No. 10 Sec 45v. 90 m/a. 6.3v. 1a. 6.3v. 0.5a. 17/6, P. & P. 3/6 No. 11 Sec 400v. 25 m/a. 25v. 25 m/a 15/-, P. & P. 3/6 No. 12 Sec 208v. 1.1a. 136v. 0.14a. 65/-, Carr. 10/-.

2,000 "C" Core, Potted Type HT Transformers and Chokes by famous manufacturers in stock, callers only. FRACTION OF MAKER'S PRICE.

ONE ONLY ZENITH L.T. TRANSFORMER Pri 230v. Sec 10 volts 170 amps Twice. Conservatively rated £35 Ex Warehouse.

DIGITAL HOUR METERS

6 figs inc. 1/10ths, 1/100ths 40v. A.C. but complete with transformer for 240v. A.C. operation. All in plastic case. Size 6½ x 6½ x 3in. Condition as new 45/-, P. & P. 5/-.

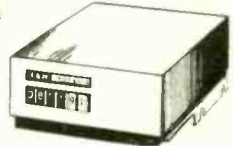

TRANSFORMERS, VARIABLE TRANSFORMERS, CHOKES, CAPACITORS, L.T. SUPPLY UNITS. Send 6d. stamp for latest 12-page Price List.

HIGH VOLTRONIC LTD. RAPID DISCHARGE CAPACITORS

40MFD. 3,000 v. D.C. Wkg. size. 12 x 8 x 6½ ins. £7.10.0. Carr. 20/-.

LONDEX PLUG-IN RELAYS

Sealed type, 28 v. D.C. Three heavy duty silver contacts. Size 2 x 2 x 1 in. Complete with base 8/6 P. & P. 2/-.

NO EXCUSES! NO DELAYS! FROM STOCK! VARIABLE VOLTAGE TRANSFORMERS

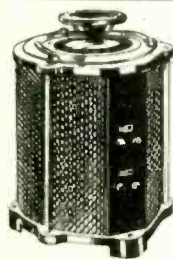

50 AMPS

INPUT 230 v. A.C. 50/60
BRAND NEW. Keenest prices in the country. All Types (and spares) from ½ to 50 amp. available from stock.

0-260 v. at 1 amp.	£5 10 0
0-260 v. at 2.5 amps. ...	£6 15 0
0-260 v. at 4 amps.	£9 0 0
0-260 v. at 5 amps.	£9 15 0
0-260 v. at 8 amps.	£14 10 0
0-260 v. at 10 amps. ...	£18 10 0
0-260 v. at 12 amps. ...	£21 0 0
0-260 v. at 15 amps. ...	£25 0 0
0-260 v. at 20 amps. ...	£37 0 0
0-260 v. at 37.5 amps. .	£72 0 0
0-260 v. at 50 amps. ...	£92 0 0

20 DIFFERENT TYPES AVAILABLE FOR IMMEDIATE DELIVERY.

Double Wound Variable Transformers

Fully isolated, low tension Secondary winding. Input 230 v. A.C. OUTPUT CONTINUOUSLY VARIABLE 0-36 v. A.C.

0-36 v. at 5 amp. £9.12.6— p. & p. 8/6
 0-36 v. at 20 amp. £21.0.0— 15/- p. & c.

These fully shrouded Transformers, designed to our specifications, are ideally suited for Educational, Industrial and Laboratory use.

SPEEDIVAC HIGH VOLTAGE HIGH FREQUENCY GENERATOR

Input 100/110 volts or 200/250 volts AC/DC. Output 19KV variable. Ideal for testing insulation, vacuum, leakage path, gas discharge lamps, neon etc. A useful ozone and HF supply. Manufactured by Edwards High Vacuum Ltd. Brand new in maker's polished wooden carrying case Offered at fraction of maker's price. £10.0.0 plus 7/6d. p. & p.

5Amp.AC/DC VARIABLE VOLTAGE OUTPUT UNIT

Input 230 v. A.C. Output 0-260 v. A.C. Output 0-240 v. D.C. Fitted large scale ammeter and voltmeter. Neon indicator, fully fused. Strong attractive metal case 15in. X 8½in. X 6in. Weight 24 lb. Infinitely variable, smooth stepless voltage variation over range. Similar in appearance to illustration below.

OPEN TYPES
 Designed for Panel Mounting.

Input 230 v. A.C. 50/60 Output variable. 0-260 v.
 ½ amp £3 10 0
 1 amp £5 10 0
 2½ amp £6 12 6
 P. & P. 7/6

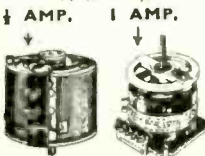

PORTABLE VARIABLE VOLTAGE TRANSFORMER

Input 230 v. A.C. Output variable 0-260 v. A.C. at 1.5 amp. Fitted in beautifully finished steel case. Complete with voltmeter, pilot lamp, fuse, switch, carrying handle. £9/5/-, P. & C. 10/-.

Also 2.5 amp. as above. £11/7/6. P. & C. 10/-.

CONSTANT VOLTAGE TRANSFORMER

Input 185-250 v. A.C. Output constant at 230 v. A.C. Capacity 250 watt. Attractive metal case. Fitted red signal lamp. Rubber feet. Weight 17lbs. Price £11/10/-, P. & P. 10/-.

LATEST TYPE SOLID STATE VARIABLE CONTROLLER

Ideal for lighting and heating circuits, compact panel mounting. Built in fuse protection. CONTINUOUSLY VARIABLE.
 Input 230v AC output 25-230v AC
 5 amp model £8. 7. 6
 10 amp model £13. 5. 0

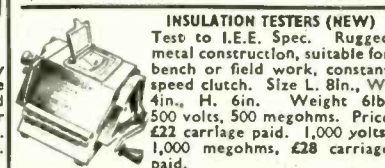

36 volt 30 amp. A.C. or D.C. Variable L.T. Supply Unit

INPUT 220/240 v. A.C. OUTPUT CONTINUOUSLY VARIABLE 0-36 v.

Fully isolated. Fitted in robust metal case with Voltmeter, Ammeter, Panel Indicator and chrome handles. Input and Output fully fused. Ideally suited for Lab. or Industrial use. £55 plus 40/- p. & c.

SERVICE TRADING COMPANY

SERVICE TRADING CO

Postage and Carriage shown below are inland only. For Overseas please ask for quotation. We do not issue a catalogue or list.

LIGHT SENSITIVE SWITCHES

Kit and parts including ORP.12 Cadmium Sulphide Photo-cell. Relay Transistor and Circuit. Now supplied with new Siemens High Speed Relay for 6 or 12 volt operations. Price 25/-, plus 2/6 P. & P. ORP 12 and Circuit 10/- post paid.



220/240 A.C. MAINS MODEL

incorporates mains transformer rectifier and special relay with 2 X 5 amp. mains c/o contacts. Price inc. circuit 47/6, plus 3/6 P. & P.

LIGHT SOURCE AND PHOTO CELL MOUNTING

Precision engineered light source with adjustable lens assembly and ventilated lamp housing to take MBC bulb. Separate photo cell mounting assembly for ORP.12 or similar cell with optic window. Both units are single hole fixing. Price per pair £21/5/0 plus 3/6 P. & P.



VAN DE GRAAF ELECTROSTATIC GENERATOR, fitted with motor drive for 230 v. A.C. giving a potential of approx. 50,000 volts. Supplied absolutely complete including accessories for carrying out a number of interesting experiments, and full instructions. This instrument is completely safe, and ideally suited for School demonstrations. Price £77/-, plus 4/- P. & P. L't. on req.

RADIO ALTIMETER

This precision instrument is based on a 24 v. D.C. LOW INERTIA (Integrating) Motor. The Motor drives two precision pots through close tolerance gear-trains, including slipping clutch. Offered at fraction of manufacturer's price: 32/6, plus 6/- P. & P.



LATEST TYPE SELENIUM BRIDGE RECTIFIERS 30 volt 3 amp., 11/-, plus 2/6 P. & P. 30 volt 5 amp., 16/-, plus 2/6 P. & P.

NICKEL CADMIUM BATTERY

Sintered Cadmium Type 1.2 v. 7AH. Size: height 3 1/2 in., width 2 1/2 in. x 1 1/2 in. Weight: approx. 13 ozs. Ex-R.A.F. Tested 12/6. P. & P. 2/6.

DRY REED SWITCHES

2 x lamp Dry Reeds (makes contacts) mounted in 870 ohm 9-18v coil. Size 3 in. x 3 1/2 in. x 1/2 in. New. Price 8/6 per pair. Post Paid. 6 of the above mentioned units (12 Reeds, 6 coils) fitted in metal box. Size 4 in. x 3 1/2 in. x 1 1/2 in. Mfg. by Elliott Bros. New 45/- each. Post Paid.

Telephone Dials (New) 14'6d. Post Paid.

230/250 v. A.C. SOLENOID

Heavy duty type. Approx. 3lb. pull. 17/6 plus 2/6 P. & P. 12/24 v. D.C. SOLENOID Approx. 8 oz. push, 8/6 plus 1/6 P. & P.



AUTO TRANSFORMERS. Step up, step down. 110-200-220-240 v. Fully shrouded. New. 300 watt type £3/10/- each, P. & P. 4/6. 500 watt type £4/12/6 each, P. & P. 6/6. 1,000 watt type £5/15/- each, P. & P. 7/6.

LEVER MICRO SWITCH

Brand new lever operated micro switch. 20 amp. A.C. Price 4/6 each plus 1/6 P. & P. 5 for £1 post paid.



COPPER LAMINATE PRINTED CIRCUIT BOARD, Large sheet 15 1/2 x 5 1/2 in. 3 for 10/- post paid. (3 minimum order).

SEMI-AUTOMATIC "BUG" SUPER SPEED MORSE KEY

7 adjustments, precision toolled, speed adjustable 10 w.p.m. to as high as desired. Weight 2 1/2 lb. £4/12/6 post paid.



NEW MODEL HIGH FREQUENCY TRANSISTORISED MORSE OSCILLATOR

Adjustable tone control. Fitted with moving coil speaker, also earpiece for personal monitoring. Complete with morse key. 45/- plus 3/6d. p. & p.

34R SILICON SOLAR CELL

4 x .5 volt unit series connected, output up to 2 v. at 20 mA. in sunlight, 30 times the efficiency of selenium. As used in power Earth Satellites, 45/- P. & P. 1/6d.

CONDENSERS

New at a fraction of maker's price. 2,500 mfd. 100 v... 12/6 4,000 mfd. 25 v... 10/ 10,000 mfd. 35 v... 15/- 4,000 mfd. 50 v... 15/

220/240v. A.C. COOLING UNIT

2,300 r.p.m. 6in. blade size. Smooth powerful motor. All metal construction. Continuously rated. Individually tested. Offered at fraction of maker's price, £21/5/- P. & P. 7/6.



POWER RHEOSTATS

(NEW) Ceramic construction, winding embedded in vitreous enamel, heavy duty brush assembly designed for continuous duty. AVAILABLE FROM STOCK IN THE FOLLOWING II VALUES: 100 WATT 1 ohm 10a., 5 ohm 4.7a., 10 ohm 3a., 25 ohm 2a., 50 ohm 1.4a., 100 ohm 1a., 250 ohm 7a., 500 ohm 45a., 1,000 ohm 280mA., 1,500 ohm 230mA., 2,500 ohm 2a. Diameter 3 1/2 in. Shaft length 3 1/2 in. dia. 3/16 in. 27/6. P. & P. 1/6. 50 WATT 1 1/2/10/25/50/100/250/500/1,000/1,500/2,500 ohm, 2 1/2 in. P. & P. 1/6. 25 WATT 10/25/50/100/250/500/1,000/1,500/2,500 ohm, 1 1/4 in. P. & P. 1/6. Black Silver Skirted knob calibrated in Nos. 1-9. 1 1/2 in. dia. brass bush. Ideal for above Rheostats. 3/6 each.

STROBE! STROBE! STROBE!

* THREE EASY TO BUILD KITS USING XENON WHITE LIGHT FLASH TUBES. SOLID STATE TIMING + TRIGGERING CIRCUITS. PROVISION FOR EXTERNAL TRIGGERING. 230-250v. A.C. OPERATION. * Strobe is one of the most useful and interesting instruments in the laboratory or workshop. It is invaluable for the study of movement and checking of speeds. Many uses can be found in the psychiatric and photographic fields, also in the entertainment business. It is used a great deal in the motor industry and is a real tool as well as an interesting scientific device. * EXPERIMENTERS "ECONOMY" KIT 1 to 36 Flash per sec. All electronic components including Veroboard S.C.R. Unijunction Xenon Tube + instructions £5.30 plus 5/- P. & P. * NEW INDUSTRIAL KIT Ideally suitable for schools, laboratories etc. Roller tin printed circuit. New trigger coil, plastic thyristor 1-80 f.p.s. Price 9 gns. 7/6 P. & P. * HY-LYGH T STROBE This strobe has been designed and produced in response to wide public demand, for use in large rooms, halls and the photographic field. It has 4 times the light output at 30 f.p.s. and utilizes a silica tube for longer life expectancy, printed circuit for easy assembly, also a special trigger coil and output capacitor. * Light output approx 4 joules. Price £10.17.6. P. & P. 7/6.

PARVALUX TYPE SD19 230/250 VOLT AC REVERSIBLE GEARED MOTORS

30 r.p.m. 40 lb. ins. Position of drive spindle adjustable to 3 different angles. Mounted on substantial cast aluminium base. Equipment. Tested and in first-class running order. A really powerful motor offered at a fraction of maker's price. 6 gns. P. & P. 10/-.

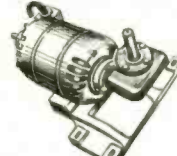

BODINE TYPE N.C.1 GEARED MOTOR

(Type 1) 71 r.p.m. torque 10 lb. in. Reversible 1/70th h.p. 50 cycle. 38 amp. (Type 2) 28 r.p.m. torque 20 lb. in. reversible 1/80th h.p. 50 cycle .28 amp. The above two precision made U.S.A. motors are offered in "as new" condition. Input voltage of motor 115v A.C. Supplied complete with transformer for 230/240v A.C. input Price, either type £2.17.6 plus 6/6 P. & P. or less transformer £2.2.6 plus 4/6d. P. & P. These motors are ideal for rotating aerials, drawing curtains, display stands, vending machines etc.

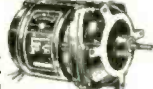

A.C. CONTACTOR

2 make and 2 break (or 2 c/o) 15 amp. contacts. 230/240 v. A.C. operation. Brand new. 22/6 plus 1/- P. & P.



CT82 NOISE GENERATOR

Ideal for alignment of all types of communication and VHF receivers. Self contained audio and output meter and mains power supply. 100kc/s to 160 Mc/s Frequency range. 43 ohm or 75 ohm impedance. Noise figure range to 20 db. In rugged alloy case with instructions for use. Offered untested but in excellent condition, less mains lead. £7.19.6. P. & P. 10/-.



Latest American. New. Plastic THYRISTOR 400 P.I.V. 8 amp. Data sheet. 19/6 post paid.

SEALED RELAY

230 volt AC Coil. Three c/o 5 amp. contacts. 17/6 Post Paid. Londex four c/o 3 amp contacts. 18/6. Post Paid. incl. base. Post Paid.



MINIATURE UNISELECTOR

3 banks of 11 positions, plus homing bank. 40 ohm coil. 24-36 v. D.C. operation. Carefully removed from equipment and tested. 22/6, plus 2/6 P. & P.



UNISELECTOR SWITCHES NEW 4 BANK 25 WAY FULL WIPER

25 ohm coil, 24 v. D.C. operation. £5/17/6, plus 2/6 P. & P.



8-BANK 25-WAY FULL WIPER

24 v. D.C. operation, £7/12/6, Plus 4/- P. & P.

RELAYS

BULK PURCHASE ENABLES US TO OFFER THE FOLLOWING NEW SIEMENS PLESSEY, etc. MINIATURE PLUG IN RELAYS COMPLETE WITH BASE, AT A HIGHLY COMPETITIVE PRICE

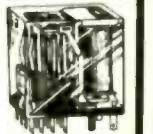

COIL	WORKING VOLTAGE	CONTACTS	PRICE
280	6-12	2 c/o	14/6
280	9-18	4 c/o	15/6
700	12-24	2 c/o	12/6
700	16-24	4 c/o	15/6
700	16-24	4M 2B	12/6
1250	20-40	2 c/o Heavy Duty	12/6
2500	30-50	2 c/o Heavy Duty	12/6
9000	40-70	2 c/o	10/-

POST PAID

INSULATED TERMINALS

Available in black, red, white, yellow, blue and green. New 17/- per doz. P. & P. 2/-.



SANGAMO WESTON

Dual range voltmeter. 0-5 and 0-100 v. D.C. FSD 1 mA. In carrying case with tests prods and leads. 32/6. P. & P. 3/6.



A.C. AMMETERS 0-1, 0-5, 0-10, 0-15, 0-20 amp. F.R. 2 1/2 in. dia. All at 21/- each.

A.C. VOLTMETERS 0-25 v., 0-50 v., 0-150 v. M.1 2 1/2 in. Flush round all at 21/- each. P. & P. extra. 0-300 v. A.C. Rect. M-Coil 2 1/2 in. 29/- 0-300 v. A.C. Rect. M-Coil 3 1/2 in. Type W23 55/-

PRECISION INTERVAL TIMER

From 0-30 seconds (repetitive). Jewelled balanced movement. Lever re-set. Operates 230 v. A.C. 5 amp. c/o micro-switch. Brand New 17/6 plus 2/6 P. & P.



'AVO' MODEL 47A

Ex-Admiralty in first class condition, complete with instructions, leads and case. £9/19/6. P. & P. 10/-.



'AVO' MODEL 48A

Ex-Admiralty in good condition with instructions, leads, plus D.C. Shunts for 120 Amp and 480 Amp. A.C. Transformer for 60 Amp. and 240 Amp. Multiplier for 3600 volt. Complete outfit in fitted case. £15/0/0. P. & P. 10/-.

DEMONSTRATION TRANSFORMER (STENZYL TYPE)

Two removable coils are tapped at 0, 110, 220 volts, and 6, 12, 36 volts respectively. A composite apparatus designed for class demonstration. Electro magnetic induction, jumping ring, Induction lamp, relationship between field intensity and ampere turns, induction melting, are just a few of the possible experiments. New modified model. £14/10/- P. & P. 10/-.

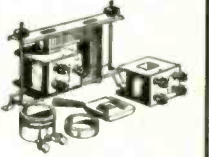

L.T. TRANSFORMERS

All primaries 220-240 volts.

Type No.	Sec. Taps	Price	Carr.
1	30, 32, 34, 36 v. at 5 amps.	£4 5 0	6/6
2	30, 40, 50 v. at 5 amps.	£6 5 0	4/6
3	10, 17, 18 v. at 10 amps.	£4 10 0	4/6
4	6, 12 v. at 20 amps.	£5 17 6	6/6
5	17, 18, 20 v. at 20 amps.	£6 12 6	6/6
6	6, 12, 20 v. at 20 amps.	£6 5 0	7/6
7	24 v. at 10 amps.	£4 15 0	5/6
8	4, 6, 24, 32 v. at 12 amps.	£6 10 0	6/6

ALL MAIL ORDERS. ALSO CALLERS AT:
57 BRIDGMAN ROAD,
LONDON, W.4. Phone: 995 1560
Closed Saturdays.

SERVICE TRADING CO.

SHOWROOMS NOW OPEN
AMPLE PARKING

PERSONAL CALLERS ONLY
9 LITTLE NEWPORT STREET,
LONDON, W.C.2.
Tel.: GER 0576

BI-PAK GUARANTEE SATISFACTION OR MONEY BACK

KING OF THE PAKS
SUPER PAKS
Unequalled Value and Quality
BI-PAK NEW—UNTESTED SEMICONDUCTORS

Satisfaction GUARANTEED in Every Pak, or money back.

PAK NO.	Description	Price
U1	120 Glass Sub-min. General Purpose Germanium Diodes	10/-
U2	60 Mixed Germanium Transistors AF/RF	10/-
U3	75 Germanium Gold Bonded Diodes sim. OA5, OA47	10/-
U4	40 Germanium Transistors like OC81, AC128	10/-
U5	60 200mA Submin. Sil. Diodes	10/-
U6	40 Silicon Planar Transistors NPN sim. BSY95A, 2N706	10/-
U7	16 Silicon Rectifiers Top-Hat 750mA up to 1000V	10/-
U8	50 Sil. Planar Diodes 250mA OA/200/202	10/-
U9	20 Mixed Volts 1 Watt Zener Diodes	10/-
U11	30 PNP Silicon Planar Transistors TO-5 sim. 2N1132	10/-
U12	12 Silicon Rectifiers EPOXY BY126/127	10/-
U13	30 PNP-NPN Sil. Transistors OC200 & 2S104	10/-
U14	150 Mixed Silicon and Germanium Diodes	10/-
U15	30 NPN Silicon Planar Transistors TO-5 sim. 2N897	10/-
U16	10 3-Amp Silicon Rectifiers Stud Type up to 1000 PIV	10/-
U17	30 Germanium PNP AF Transistors TO-5 like ACY 17-22	10/-
U18	8 6-Amp Silicon Rectifiers BYZ13 Type up to 600 PIV	10/-
U19	30 Silicon NPN Transistors like BC108	10/-
U20	12 1.5 Amp Silicon Rectifiers Top Hat up to 1000 PIV	10/-
U21	30 A.F. Germanium alloy Transistors 2G300 Series & OC71	10/-
U22	10 1-Amp Glass Min. Silicon Rectifiers, High Volts	10/-
U23	30 Madt's like MAT Series PNP Transistors	10/-
U24	20 Germanium 1-Amp Rectifiers GJM up to 300 PIV	10/-
U25	25 300 Mc/s NPN Silicon Transistors 2N708, BSY27	10/-
U26	30 Fast Switching Silicon Diodes like IN914 Micro-min	10/-
U28	Experimenters' Assortment of Integrated Circuits, untested. Gates, Flip-Flops, Registers, etc. 8 Assorted Pieces	20/-
U29	10 1 Amp SCR's TO-5 can up to 600 PIV CR51/25-600	20/-
U30	15 Plastic Silicon Planar trans. NPN 2N2924-2N2926	10/-
U31	20 Silicon Planar NPN trans. low noise 2N3707	10/-
U32	25 Zener diodes 400 mW DO-7 case mixed Vts. 3-18	10/-
U33	15 Plastic case 1 Amp silicon rectifiers W4000 series	10/-

Code Nos. mentioned above are given as a guide to the type of device in the Pak. The devices themselves are normally unmarked

QUALITY-TESTED PAKS

60 Matched Trans. OC44/45/81/81D	10/-
20 Red Spot AF Trans. PNP	10/-
16 White Spot RF Trans. PNP	10/-
8 Silicon Rects. 3 A 100-400 PIV	10/-
2 10 A Silicon Rects. 100 PIV	10/-
2 OC1 140 Trans. NPN Switching	10/-
1 12 A SCR 100 PIV	10/-
3 Sil. Trans. 28303 PNP	10/-
4 Zener Diodes 250W 5-12V	10/-
3 200 Mc/s Sil. Trans. NPN B8726/27	10/-
3 Zener Diodes 1W 33V 5% Tol.	10/-
4 High Current Trans. OC42 Evt.	10/-
2 Power Transistors 1 OC26 1 OC35	10/-
8 Silicon Rects. 400 PIV 250mA	10/-
4 OC76 Transistors	10/-
1 Power Trans. OC200 100V	10/-
10 OA202 Sil. Diodes Sub-min.	10/-
2 Low Noise Trans. NPN 2N929/30	10/-
1 Sil. Trans. NPN VCB 100 ZT88	10/-
8 OA81 Diodes	10/-
4 OC72 Transistors	10/-
4 OC77 Transistors	10/-
4 Sil. Rects. 400 PIV 500mA	10/-
6 GET884 Trans. Evt. OC44	10/-
6 GET888 Trans. Evt. OC45	10/-
2 2N708 Sil. Trans. 300 Mc/s. NPN	10/-
3 QT31 LF Low Noise Germ Trans. PNP	10/-
6 IN914 Sil. Diodes 75 PIV 750mA	10/-
8 OA95 Germ. Diodes Sub-min. IN69	10/-
3 NPN Germ. Trans. NKT773 Evt. AC130	10/-
2 OC22 Power Trans. Germ.	10/-
2 OC25 Power Trans. Germ.	10/-
4 AC128 Trans. PNP High Gain	10/-
4 AC127/128 Comp. pair PNP/NPN	10/-
3 2N1307 PNP Switching Trans.	10/-
7 CG28H Germ. Diodes Evt. OA71	10/-
3 AF116 Type Trans.	10/-
12 Assorted Germ. Diodes Marked	10/-
4 AC126 Germ. PNP Trans.	10/-
4 Silicon Rects. 100 PIV 750mA	10/-
3 AF117 Trans.	10/-
7 OC81 Type Trans.	10/-
3 OC171 Trans.	10/-
5 2N2926 Sil. Epoxy Trans.	10/-
7 OC71 Type Trans.	10/-
2 28701 Sil. Trans. Texas	10/-
3 12 Volt Zeners 400mW	10/-
2 10 A 600 PIV Sil. Rects. 1845R	10/-
3 BC108 Sil. NPN High Gain Trans.	10/-
1 2N910 NPN Sil. Trans. VCB100	10/-
2 1000 PIV Sil. Rect. 1.5 A R53810 AF	10/-
3 BSY95A Sil. Trans. NPN 200 Mc/s.	10/-
3 OC200 Sil. Trans.	10/-
2 Sil. Power Rects. BYZ13	15/-
1 Sil. Power Trans. NPN 100mc/s. TK201A	15/-
6 Zener Diodes 3-15V Sub-min.	15/-
1 2N1132 PNP Epitaxial Planar Sil.	15/-
1 2N697 Epitaxial Planar Trans. Sil.	15/-
4 Germ. Power Trans. Evt. OC18	15/-
1 Unijunction Trans. 2N2646	15/-
2 Sil. Trans. 200 Mc/s. 60Vcb ZT89/84	15/-
1 Tunnel Diode AEY11 1000 Mc/s.	15/-
2 2N2712 Sil. Epoxy Planar HFE225	15/-
8 BY 100 Type Sil. Rects.	20/-
26 Sil. and Germ. Trans. Mixed, all marked, New	30/-

FULL RANGE OF ZENER DIODES VOLTAGE RANGE 2-18V.

400mW (DO-7 Case) 2/6 each
1W (DO-7 Case) 3/6 each
10W (80-10 Stud) 5/- each
All fully tested 5% tol. and marked state voltage required.

TRANSISTOR EQVT. BOOK

52 pages of cross references for trans. and diodes. Types include British, European, American and Japanese. Specially imported by BI-PAK 10/- each

BRAND NEW TEXAS GERM. TRANSISTORS

Code and Guaranteed

Pak No.	EQVT	Price
T1	8 2G3710 OC71	10/-
T2	8 2G374	10/-
T3	8 2G3744A OC81D	10/-
T4	8 2G381A OC81	10/-
T5	8 2G382T OC82	10/-
T6	8 2G344A OC44	10/-
T7	8 2G345A OC45	10/-
T8	8 2G378 OC78	10/-
T9	8 2G399A 2N1302	10/-
T10	8 2G417 AF117	10/-

FREE

One 10/- Pak of your own choice free with orders valued £4 or over.

GERM. RECTIFIER SINGLE-PHASE BRIDGE. Mullard type. GEK541-B.P. Output Vts. 48V. Output I.C. 5A. List Price 58/- OUR PRICE 12/6 EACH

2N8940 NPN SIL. DUAL TRANS. CODE D1899 TEXAS. OUR PRICE 5/- each.

120 VCB NIXIE DRIVER TRANSISTOR Sim. B8X21 & C407. 2N1893 FULLY TESTED AND CODED N120. 1-24 3/6 each. TO-5 N.P.N. 25 up 3/- each.

PLEASE NOTE. To avoid any further increased Postal Charges to our Customers and enable us to keep our "By Return Postal service" which is second to none, we have re-organized and streamlined our Despatch Order Department and we now request you to send all your orders together with your remittance, direct to our Warehouse and Despatch Department, postal address: BI-PAK SEMICONDUCTORS, Despatch Dept., P.O. BOX 8, WARE, HERTS. Postage and packing still 1/- per order. Minimum order 10/-.

INTEGRATED CIRCUITS

BI-PAK MONOLITHIC DIGITAL CIRCUITS (10 lead TO-5)

BP305A, 6-Input AND gate, 9/8 each.
BP314A, 7-Input NOR gate, 9/8 each.
BP315A, Dual 3-Input NOR GATE, 9/8 each.
BP316A, Dual 2-Input NOR gate (expandable), 9/8 each.
BP320A, J-K-Binary element, 11/6 each.
BP332A, Dual 3-Input OR gate, 9/8 each.

BI-PAK MONOLITHIC AMPLIFIERS (TO-5 8 lead)

BP709C, Operational amplifier, 15/- each.
BP701C, Operational amplifier (with Zener output), 18/8 each.
BP702C, Operational amplifier (with direct output), 12/8 each.
BP601, Wide band amplifier, 18/8 each.
BP921, Logarithmic wide band amp, 14/- each.
BP210C, General purpose amplifier (TO-5 8 lead), (voltage or current amp), 12/8 each.

OTHER MONOLITHIC DEVICES

BP424, Zero voltage switch, 8/6 each.
This device is a monolithic I.C. that acts a combined threshold detector and trigger circuit for controlling a triac. It is designed to put the gate of a thyristor at the point of zero supply voltage, and therefore eliminate radio frequency interference when used with resistive loads.

D15D1 Silicon Unilateral switch 10/- each.

A Silicon Planar, monolithic integrated circuit having thyristor electrical characteristics, but with an anode gate and a built-in Zener diode between gate and cathode. Full data and application circuits available on request.

FAIRCHILD (U.S.A.) RTUL MICROLOGIC INTEGRATED CIRCUITS

Epoxy case T8-5 lead temp. range 10°C to 55°C. UL900, Buffer, 10/8 each. UL914, Dual two-input gate, 10/8 each. UL923, 1-k-clip-flop, 14/- each. Complete data and circuits for the Fairchild I.C.'s available in booklet form priced 1/8.

MULLARD I.C. AMPLIFIERS

TA4243, Operational amplifier, 70/- each.
TA4263, Linear AF amplifier, 18/6 each.
TA4293, General purpose amplifier, 21/- each.

CA3090 RCA (U.S.A.) LINEAR INTEGRATED CIRCUITS

Audio Power Amplifier, 30/- each.

Owing to the mass of I.C. printed matter often required by customers in connection with the I.C.'s themselves we ask you to help us in the cost of reproducing this literature by adding 2s. towards same. This is only necessary when a number of different sheets are required.

TESTED SCR'S

PIV 1A 7A 18A 30A	25	7/6	30/-
50	7/6	8/6	10/6 35/-
100	8/6	10/-	15/- 45/-
200	12/6	15/-	20/- 55/-
300	15/-	20/-	25/-
400	17/6	25/-	35/- 80/-
500	30/-	40/-	45/- 95/-
600	40/-	50/-	

SIL. RECTS TESTED

PIV 750mA 3A 10A 30A	50	1/-	2/9	4/3 9/8
100	1/3	3/3	4/6 15/-	
200	1/9	4/-	4/9 20/-	
300	2/3	4/6	6/6 22/-	
400	2/6	5/6	7/6 25/-	
500	3/-	6/-	8/6 30/-	
600	3/3	6/9	8/7-	
800	3/6	7/6	11/- 40/-	
1000	5/-	9/3	12/6 50/-	
1200	6/6	11/6	15/-	

Wilkinsons EST. 1921

for RELAYS P.O. TYPE 3000 AND 600
BUILT TO YOUR SPECIFICATION

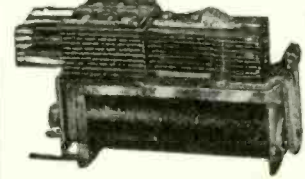

Contacts up to 8 changeover

- ★ QUICK DELIVERY
- ★ KEEN PRICES



KEY SWITCHES. 3 POSITION Type 212 2C lock/2C lock 12/6. Type 198 4C lock/4C lock 17/6. Type 290 2C non/lock 6C lock 17/-.
Type 295 4C non/lock 6C lock 20/-.
Many other types available. Knobs 8d.

ALL BRITISH METERS GUARANTEED. Complete list available.

VISCONOL CATHODRAY CONDENSERS. .001 mfd 10KV 5/- .002 mfd 15KV 9/- .02 mfd 10KV 10/- .025 2.5KV 5/- .05 mfd. 5KV 9/- .01 mfd 4KV 9/- .6KV 17/6. 0.5 mfd 2.5 KV 17/6. 1 mfd 2 KV 17/6.

LEDEX ROTARY SOLENOIDS AND CIRCUIT SELECTORS, size 5S. 4 pole 11 way and off 110/-, 24 pole 11 way and off 210/-, 54 pole On/Off 150/-.

FREQUENCY METERS. 45/55 c.p.s. 230 VAC 6" dia. flush round £10.10.0d.

SUB-MINIATURE LAMPS. Flying leads 0.75 volts 50/- per 100.

JACK PLUGS. 2 point screw on cover, 2/6, post 1/-, PO 201 3/- each, post 2/-.

ELCOM WINKLER SWITCHES. 12 pole 2 or 3 way types on 3 Banks 60/- each.

AIR BLOWERS. 200/250 volt A.C. cylindrical 7" x 7" suitable for intake or extraction, 1/50th h.p. £10. 1/15th h.p. £11. 1/10th h.p. £14.

HIGH SPEED COUNTERS. 3 1/2" x 1 1/2" 10 counts per second with 4 figures. The following D.C. voltages are available: 6v., 12v., 24v., 50v., or 100v. 35/- each.

VEEDER ROOT MAGNETIC COUNTERS with zero reset 800 counts per minute, counting to 999,999, 110 volts or 125 volts A.C. or 110 volts D.C., 65/- each, post 3/-.

PHOTOGRAPHIC LAMP HOUSES with pair of 6" lenses mounted in a square case. Ideal spotlight, 70/- each, post 10/-.

MINIATURE SILVER ZINC ACCUMULATOR. 1.5 volt 1.5 ampere size 2" x 1 1/2" x 0.63", only 1 1/2 oz. quantities available, 12/6 each, 120/- doz., post 1/6.

BRIDGE MEGGERS 1000 Volts 0/100 Megohms Resistance Box 0/9999 Ohms, £60.

P.O. STANDARD RACKS 6ft U channel sides drilled for 19" panels heavy angle base, 150/-, cge 20/-, Desk Units for Racks 30/-, cge 10/-.

CONNECTING WIRE 1/024, 7/0076 & 14/0048 PVC COVERED 100 & 200 YARD REELS 80/- PER 100 YARDS, POST 6/-.

L. WILKINSON (CROYDON) LTD.

LONGLEY HOUSE LONGLEY RD. CROYDON SURREY

Phone: THO 0236 Grams: WILCO CROYDON

SENSATIONAL STEREO OFFERS!

SAVE UP TO 33 1/3% OFF OUR STEREO SYSTEMS

As Britain's Largest Specialists our tremendous purchasing power enables us to offer you the famous makes—Garrard, Goldring, Rogers, Decca, Arena, Philips, Wharfedale, etc.—at unbelievably low prices. We offer over 30 Hi-Fi Stereo Systems utilising these famous makes and showing substantial savings off our normal list prices.

A Nusound Stereo System represents the finest value for money available today. Every system is complete with all leads, plugs, etc. Carrying full manufacturer's guarantee and backed by 100% Nusound after sales service.

Illustrated literature and technical data sent by return of post (Dept. WW/AT).

24 OXFORD ST., LONDON, W.1
Tel: 01-580 4638, 4639, 5755
50 yards from Tottenham Court Road
Tube—Open 6 days a week.

W.H.M. WOW AND FLUTTER METER (R.M.S) MODEL 111

SYDNEY HOUSE, 35 VILLIERS ROAD, WATFORD WDI-4AL

BI-PAK SEMICONDUCTORS
(DEPT. WW)

500 Chesham House
150 Regent Street
London, W.1

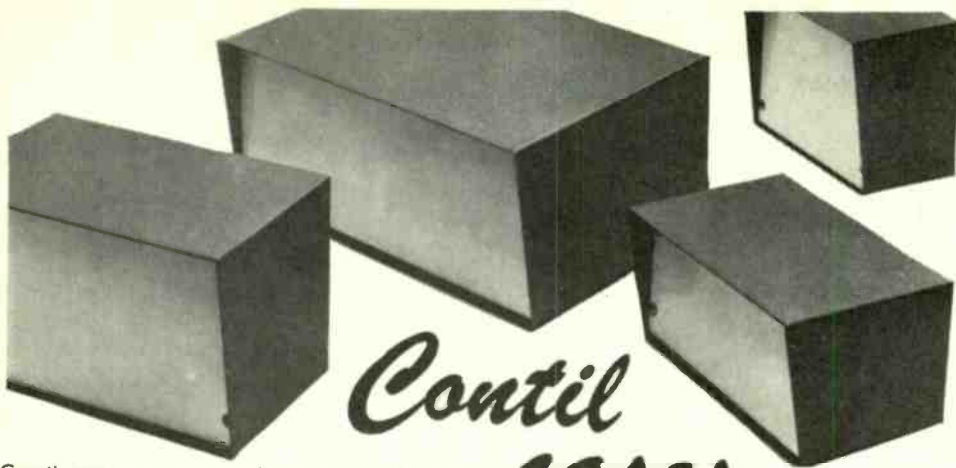

Contil cases

Contil cases are mass-produced to give lowest prices yet. In 21-gauge steel. Finished hammer blue, with 18-gauge front panel supplied with easy-to-strip protective covering for easy marking out. For ease of ordering Contil cases are described by their dimensions, i.e. 755 is 7 x 5 x 5. Individually packed, including feet and screws.

CONTIL LOW COST PRINTED CIRCUIT BOARDS

	1	10	50
Standard transistor board "A"	9/9	9/-	8/6
Half board "B"	7/6	7/-	6/6
Connectors 20-way "M"	9/6	9/-	8/-
Connectors 10-way "N"	6/-	5/6	5/-
"Q" Chassis	42/6	41/6	39/-
Printed chassis kit: including case, normally £14 8s. 6d. for only £11 19s. 6d.			

We also stock Veroboard as below	1	20	100
.2 Pitch, 18" x 4 1/2"	17/7	15/9	15/-
.15 Pitch, 17 1/2" x 3 1/2"	14/2	12/8	12/1
.1 Pitch, 17" x 3 1/2"	16/5	14/9	14/-

"A" board shown plugged into "M" 20-way connector with "S" board supports.
Note: Power supply rails at right angles to signal rails.



TRANSFORMERS

West Hyde have three transformers for transistorised equipment. TRA which provides low voltages at 2 Amps. and high voltages at 1 Amp. for driving neons or number tubes. TRB which provides 2 Amps. and TRC, a 1 Amp. transformer. The low voltages on TRA, TRB are 6, 10, 15, 18, 30 which can of course be connected to give 3, 4, 5, 6, 8, 9, 10, 12, 15, 18, 24 and 30 with 12-0-12 and 15-0-15.

The 1 Amp. transformer gives 6, 10, 18 voltage outputs. The TRA also gives 150-80-0-80-150. TRA at 57/6 each. TRB at 47/- each. TRC at 35/6 each.



PIDAM (Plug-in Digital and Analogue Modules) perform all the usual logic functions, but, unlike other units, can be plugged in, using their B9A bases and can be quickly connected to the required configuration. To help learning, the module covers are easily removable for circuit examination and sets of components are available. The 22 modules have an enormous range of use, from a single MONO for a tachometer, to over 300 units in a computer interface; nevertheless, their greatest asset is extreme simplicity. Design time is cut and elaborate breadboards superseded and any reader of "Wireless World" could with PIDAM, build up a low cost system for his own needs. 6 NEW modules—send for free information.

PIDAM PLUG-IN MODULES - PRICES

NEW

Prices range per module from 10/- to 28/- and all necessary accessories are supplied. A complete starting kit is only £21 19s. 0d. (normally £24 6s. 0d.).

PIDAM BROCHURE

Send for this complete explanatory booklet showing detailed examples and circuit diagrams of all modules. Examples and circuits given include voice-operated switch, alarms, flashers, tachometer, timers, batch counters, etc.

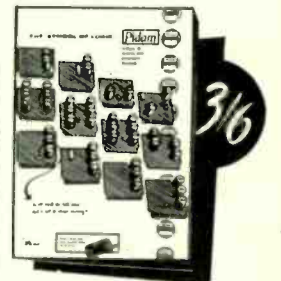

PLEASE NOTE

All products ex-stock for normal quantities. Return of post service. Minimum order £1. Fully detailed leaflets available.

Contil cases are also available with aluminum panels and Contilcote, which is applied after drilling and cutting.

CASE PRICES (All supplied with protective coated steel panels)

Nos. denote size in inches	1	5	10	25	50	100	200
755	43/6	41/6	40/6	39/6	38/6	36/-	35/-
867/975	45/6	44/-	43/6	41/6	40/6	38/6	37/-
1277 white or black panel	49/6	47/-	46/-	45/-	43/6	43/-	41/6
1277 unpainted	40/6	39/6	38/6	36/-	35/-	32/6	31/6
1277 nylon-coated	82/6	79/-	77/6	76/-	73/6	73/6	73/6
16127	96/6	94/6	92/6	91/6	89/6	88/-	86/-
16127S	129/-	127/-	125/-	124/-	122/-	119/-	116/-
191010	130/6	127/6	125/-	123/-	122/-	121/-	119/-
191010D	185/6	182/6	180/-	178/-	176/-	173/6	173/6

Postage and packing extra

Kit of five cases £11 19s. 0d. including postage and packing extra, normally £14 12s. 0d.

Your third hand

The ONTOS UNIVERSAL VICE is a new type of multi-purpose, multi-position light engineering vice and stand, fully adjustable for any angle and location in any desired plane. Applications are virtually limitless within its size capacity; i.e. holding P.C. boards for assembly or testing, building up modules, as a micrometer or gauge stand, as a light general purpose vice, in the chemical laboratory, or in fact for all those occasions when you could use a third hand! The ONTOS TWIN TWO-IN-ONE UNIVERSAL VICE is a unique two-in-one version of the Ontos vice, with two sets of jaws, each capable of rotation through 360 deg. of every plane independently of each other. Positive locking enables any such setting to be maintained for repetition work. Ideal for copying P.C. boards, assembly, soldering, bonding, welding, laboratory testing, etc.

ONTOS: 67/6 plus P&P 4/6.

ONTOS TWIN £5 18 0 plus P&P 4/6



'Brightlife' NEONS

25,000 hour average life. PC type 3/8" diameter, 6" leads with resistor inside. Nine different caps available, 160-260 V, 10 at 2/10 each, 100 at 2/6 each, 1,000 at 2/2 each, 10,000 at 2/- each. Also available with 30" leads; 110 volt resistor values. PP type 1/2" diameter also supplied with 30" leads and 110 volt variants. 10 at 2/10 each, 100 at 2/6 each, 1,000 at 2/2 each, 10,000 at 2/- each. Neon/resistor assemblies, 100 at 9d. each, 10,000 at 8d. each. Neons only, 100 at 9d. each, 10,000 at 6d. each. Neons driven by neon oscillator for 6 to 24 volt input down to 50 mW input. Neons driven by transistors with or without alphanumeric caps.

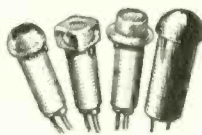

SUB-MINIATURE NEONS

The smallest yet, type "Q". Overall diameter 1/16", body .7", resistor mounted externally, medium intensity. Minimum quantity 10 at 3/10 each, 100 at 3/4 each, 500 at 3/2 each.



REED SWITCH

The West Hyde reed switch works up to 2,000 operations per second with a life of up to 50,000,000 operations when used in the recommended circuit. The hermetically sealed switch is protected in a brass tube and moulded into a polypropylene block giving accurate placing of the contents in relation to the mounting screws. 30" nominal leads fitted. Used for Rev. Counters, flowmeters, burglar alarms, under and over speed monitors, etc. 1 at 15/-, 10 at 12/6 each, 100 at 9/6 each.



ACCESSORIES

Flexible insulated test prods, colour red or black, at 13/- each with fine steel clips at the tip, opened by button on top. High speed resetting counter including bezel and socket with speed of over 40 operations per second 165/- Plug in octal relay, 24 volts, with two changeovers 17/6.



WEST HYDE DEVELOPMENTS LTD.

30 HIGH STREET NORTHWOOD MIDDXX.

Telephone: Northwood 24941

WW-105 FOR FURTHER DETAILS

R.S.C. SENSATIONAL HIGH FIDELITY STEREO PACKAGE OFFERS

Matching as recommended for optimum performance. Compare prices with equipment and cabinets purchased individually.

30 Watt Output

- ★ Goldring Transcription Turntable on Plinth.
- ★ Shure or Goldring Magnetic Pick-up Cartridge.
- ★ Super 30 Amplifier in veneered housing.
- ★ Pair of Stanton Loudspeaker Units.

Special total price. Four fully wired units ready to "plug-in". Really superb performance. Send S.A.E. for leaflet. Carr. 25/- **86 Gns.**

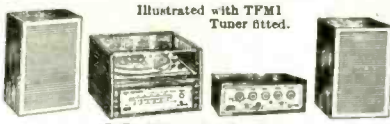

30 Watt Output

- ★ Garrard SP25 Mk. II Turntable on Plinth.
- ★ Goldring CS90 Ceramic P.U. Cartridge.
- ★ Super 30 Amplifier in veneered housing.
- ★ Pair of Stanton Loudspeaker Units.

Special total price. Four fully wired units ready to "plug-in".

76 Gns.

Carr. 25/- Extremely Extractive and Versatile Plinths finished in Teak or Afrormosia veneer. Tinted Transparent Plastic "roll over" cover with satin chrome handle.

13 Watt Output

- ★ Garrard SP25 Mk. II 4-speed Player Unit on plinth.
 - ★ Goldring CS90 Ceramic P.U. Cartridge.
 - ★ TA12 Amplifier in veneered housing.
 - ★ Pair of Dorchester Loudspeaker Units.
- Special total price. Transparent Plastic cover 3 gns extra. Or Dep. £10 and 9 monthly payments £5.11.0 **51 Gns.** (Total £59.19.0) Carr. 25/-

BLACKPOOL AGENT APPOINTED See addresses

AUDIOTRINE HIGH FIDELITY LOUSPEAKERS



Heavy construction. Latest high efficiency ceramic magnets. Treated cone surround giving low fundamental resonance. "D" indicates Tweeter Cone providing extended frequency range 40-15,000 c.p.s. Exceptional performance at low cost. Impedance 3 or 16 ohms.

Prices include carriage. PLEASE STATE IMPEDANCE

HF 810L 8" 10W	57/9	HF 138L 13" x 8" 10W	84/-
HF 801D 8" 8W	50/9	HF 120L 12" x 8" 15W	79/9
HF 811D 8" 10W	54/4	HF 120D 12" x 8" 15W	79/9
HF 102D 10" 10W	65/-	HF 128L 12" x 8" 15W	£51/5-
HF 100D 10" 15W	£5 15	HF 128D 12" x 8" 15W	£51/5-

HIGH FIDELITY LOUSPEAKER UNITS
Cabinets of latest styling Satin Teak or Afrormosia veneer. Acoustically lined or filled with woollen damping material. Ported where appropriate. Credit terms available.

DORCHESTER Size 16 x 11 x 9in. Appr. Range 45-15,000 c.p.s. Rating 8-10 watts. Fitted High flux 13 x 8in. **£8.19.9** Carr. 7/6

STANTON IIIIS Size 18 x 11 x 10in. Rating 10 watts. Incorporating Fane 803B speaker with roll rubber cone surround and 15,000 line magnet. High flux tweeter. Handsome Scandinavian design cabinet. Range 30-20,000 c.p.s. Impedance 15Ω. Gives smooth realistic sound output. Inc. carr. **16Gns.**

GLOUCESTER Size 25 x 16 x 10in. 12in. High flux 12,000 line speaker. Cross-over unit and Tweeter. Rating 10 watts. Frequency range 40-20,000 c.p.s. Impedance 15 ohms. **12 1/2 Gns.**

R.S.C. TA6 6 Watt HIGH FIDELITY SOLID STATE AMPLIFIER



200-250v. A.C. mains operated Frequency Response 30-20,000 c.p.s. —2dB. Harmonic Distortion 0.3% at 1,000 c.p.s. Separate bias and Mike, Gram and Tape. 3 input sockets for Output for 3-15 ohm speakers. Max. input sensitivity 0.5mV. Output rating I.E.P.M. in fully enclosed enamel case 91 x 2 1/2 x 5 1/2in. Attractive brushed silver finish fascia plate 10 1/2 x 3 1/2in. and matching knobs. Complete kit of parts with full wiring diagrams and instructions. Carr. 7/6. Or factory built with 12 months' guarantee. £8.19.9

Treble "lift" and "cut" controls. 3 input sockets for Mike, Gram and Tape. Input selector switch. Output for 3-15 ohm speakers. Max. input sensitivity 0.5mV. Output rating I.E.P.M. in fully enclosed enamel case 91 x 2 1/2 x 5 1/2in. Attractive brushed silver finish fascia plate 10 1/2 x 3 1/2in. and matching knobs. Complete kit of parts with full wiring diagrams and instructions. Carr. 7/6. Or factory built with 12 months' guarantee. £8.19.9

R.S.C. COLUMN SPEAKERS Covered in two-tone Bejme/Vynair. Ideal for vocalists and Public Address. 15 ohm matching. Type C57 15 watts in. five 7 x 4in. spkrs. £7/19/11. Type C48S, 30 watts. Fitted four 8in. high flux 8 watt speakers. Overall size approx. 42 x 10 x 5in. 16 Gns. Or deposit 67/- and 9 monthly pmts. £4/9 (Total £18/9/9) Carr. 10/-. Type C412S, 50 watts. Fitted four 8 x 12in. 15 watt speakers. Overall size 66 x 14 x 9in. approx. 28 Gns. Or deposit £5/17/6 and 9 monthly payments Carr. 15/- of 54/6 (Total £30/7/-).

R.S.C. TFM1 SOLID STATE VHF/FM RADIO TUNER



★ High-sensitivity 200-250v. A.C. Mains operation. ★ Sharp A.M. Selection. ★ Drift-free reception. ★ Output ample for any amplifier (approx. 500 m.v.). ★ Simple alignment instructions. ★ Output available for feeding tuning meter. ★ Output for feeding Stereo Multiplexer. ★ Tuner head using silicon Planar Transistors. ★ Designed for standard 80 ohm co-axial inputs. Visually matching our Super 15 and 30 amplifiers and of the same high standard of performance and reliability. The pre-wired tuning head facilitates speed and simplicity of construction. Printed circuitry. 11,000 components used. A quality product at considerably less than the cost of comparable units. Stereo version. All parts 20 Gns. Inc. Carr. Assembled £21 gns. Inc. Carr.

Total cost of parts with detailed wiring diagrams & instructions. Inc. Carr. **14 Gns.** Or factory built 16 1/2 gns. Or in Teak finished cabinet as illustrated 19 gns. Terms: Deposit £5 and 9 monthly payments £2. Total £23.

R.S.C. SUPER 15 HI-FI AMPLIFIER

FULLY TRANSISTORISED 200/250v. A.C. Mains. OUTPUT 10 WATTS R.M.S. continuous into 15 ohms. 15 WATTS R.M.S. continuous into 3-4 ohms. TRANSISTORS: 9 current types of high quality by leading manufacturers. 9 POSITION INPUT SELECTOR SWITCH EQUALISATION to Standard R.I.A.A. and C.C.I.R. Characteristics for Gram and Tape Heads. FULL TAPE MONITORING FACILITIES

SENSITIVITIES: Magnetic P.U. 4 mV. Crystal or Ceramic P.U. 400 mV. Microphone 4.5 mV. Tape Head 2.5 mV. Radio/Aux. or Ceramic P.U. 110 mV. FREQUENCY RESPONSE: ±2 dB 20-20,000 c.p.s. TREBLE CONTROL: +15dB to -14dB at 10 Kc/s. NEG. FEEDBACK: 52dB. BASS CONTROL: +17dB to -12dB at 80 c/s. HUM LEVEL: -70dB. HARMONIC DISTORTION at 10 watts 1,000 c.p.s. 0.2% Complete kit of parts with full constructional details and point to point wiring diagrams. Carr. 12/6. Supplied factory built 15 1/2 Gns. Carr. 12/6. Terms: Deposit 4 Gns. and 9 monthly payments 31/1 (Total £18/3/9). Or in Teak or Afrormosia veneer housing as ill. 19 Gns. COMPONENTS ETC. ARE OF A HIGH STANDARD AND SUPPLIED BY LEADING MANUFACTURERS.

SENSITIVITIES: Magnetic P.U. 4 mV. Crystal or Ceramic P.U. 400 mV. Microphone 4.5 mV. Tape Head 2.5 mV. Radio/Aux. or Ceramic P.U. 110 mV. FREQUENCY RESPONSE: ±2 dB 20-20,000 c.p.s. TREBLE CONTROL: +15dB to -14dB at 10 Kc/s. NEG. FEEDBACK: 52dB. BASS CONTROL: +17dB to -12dB at 80 c/s. HUM LEVEL: -70dB. HARMONIC DISTORTION at 10 watts 1,000 c.p.s. 0.2% Complete kit of parts with full constructional details and point to point wiring diagrams. Carr. 12/6. Supplied factory built 15 1/2 Gns. Carr. 12/6. Terms: Deposit 4 Gns. and 9 monthly payments 31/1 (Total £18/3/9). Or in Teak or Afrormosia veneer housing as ill. 19 Gns. COMPONENTS ETC. ARE OF A HIGH STANDARD AND SUPPLIED BY LEADING MANUFACTURERS.

- BRADFORD 10 North Parade (Half-day Wed.). Tel. 25349
- BLACKPOOL (Agent) O & C Electronics 227 Church St.
- BIRMINGHAM 30/31 Gt. Western Arcade, opp. Snow Hill Station 021-236 1279. Half-day Wed. Tel. 41361
- DARLINGTON 18 Priestgate (Half-day Wed.). Tel. 68043
- EDINBURGH 133 Leith St. (Half-day Wed.). Tel. Waverley 5766
- GLASGOW 326 Argyle St. (Half-day Tues.). Tel. CITY 4158
- 403 Sauchiehall St. (opp. Locarno) (Half-day Tues.). Tel. 332-1572
- HULL 91 Paragon Street (Half-day Thurs.). Tel. 20505

AUDIOTRINE HI-FI SPEAKER SYSTEMS

Consisting of matched 12in. 11,000 line 15 watt 15 ohm high quality speaker, cross-over unit and tweeter. Smooth response frequency range ensure surprisingly realistic reproduction.

Or Senior 15 watt line. HF 126 15,000 line speaker £8/15. Carr. 6/6. Carr. 5/9

HI-FI 'SPEAKER ENCLOSURES Teak or Afrormosia veneer finish. Modern design. Acoustically lined. Prices inc. carr. JER Size 16 x 11 x 9in. Pressurised. Gives pleasing results with any 8in. Hi-Fi speaker. **£4.10** SE8 For optimum performance with any 8in. Hi-Fi speaker. 22 x 15 x 9in. Ported SE10 For outstanding results with 10in. Hi-Fi speaker. 24 x 15 x 10in. Ported SE12 For high performance with 12in. Hi-Fi speaker and Tweeter. Size 25 x 16 x 10in. Pressurised. **£6.15**

THE 'YORK' HIGH FIDELITY 3'SPEAKER SYSTEM *Moderate size approx. 25 x 14 x 10in. *Range 30-20,000 Complete kit. c.p.s. Impedance 15 ohms. * Performance comparable with units costing considerably more. Consists of (1) 12 in. 15 watt Bass unit with cast chassis. Roll rubber cone surround for ultra low resonance, and ceramic magnet. (2) 3-way quarter section series cross-over system. (3) 8 x 5in. high flux middle range speaker (4) High efficiency tweeter. (5) Measured weight of woollen acoustic damping material. (6) Teak veneered cabinet. (7) Circuit and full instructions. HEAR IT AT ANY BRANCH. **20Gns.**

etc. Gram, Radio or Tape. Reserve L.T. and H.T. for Radio Tuner. Two inputs with associated volume controls so that two separate inputs such as Gram and "Mike" can be mixed. 200-250 v., 50 c/s. A.C. mains. For 3 and 15 ohm speakers. Complete Kit parts wiring diagrams, instructions. Twin-handled perforated cover 27/6. Or factory built with EL34 output valves and 12 months' guarantee for 17 gns. Tech. figs. apply to factory built units. Carr. 12/6. **14 Gns.** TERMS: Deposit £8 and 9 monthly payments of 38/- (Total £80/8/0) Send S.A.E. for leaflet.

R.S.C. A10 30 WATT ULTRA LINEAR HI-FI AMPLIFIER

Highly sensitive. Push-Pull high output, with Pre-amp/Tone Control Stages. Performance figures: Hum level—70dB. Frequency response ±3dB 30-20,000c/s. Sectionally wound output transformer. All high grade components. Valves EF86, EF86, ECC83, 807, 807, GZ34. Separate Bass and Treble Controls. Sensitivity 30 millivolts. Suitable for High Impedance mic. or pick-ups. Design for Ch. 12, 13, 14, 15, 16, 17, 18, 19, 20, 21, 22, 23, 24, 25, 26, 27, 28, 29, 30, 31, 32, 33, 34, 35, 36, 37, 38, 39, 40, 41, 42, 43, 44, 45, 46, 47, 48, 49, 50, 51, 52, 53, 54, 55, 56, 57, 58, 59, 60, 61, 62, 63, 64, 65, 66, 67, 68, 69, 70, 71, 72, 73, 74, 75, 76, 77, 78, 79, 80, 81, 82, 83, 84, 85, 86, 87, 88, 89, 90, 91, 92, 93, 94, 95, 96, 97, 98, 99, 100. Suitable for Mullard 510 Amplifier. Frequency response ±3dB 30-20,000 c/s. Hum level—60dB. SENSITIVITY 40 millivolts. For Crystal or Ceramic P.U.s. High impedance "mikes". For Musical Instruments such as String Bass, Electric Guitars, etc. Size approx. 12 x 9 x 7in. For A.C. mains 200-250v. 50 c.p.s. Output **9 Gns.** Full instructions and point-to-point wiring diagrams. Carr. 11/6 (or factory built 12 Gns.) Twin handled metal cover 27/6. Terms on assembled units. Deposit 9/6 and 9 monthly payments of 22/-. (Total £14/15/6) RSC A10T transistorised version of above complete kit 9 Gns. (Assembled 13 Gns.)

R.S.C. A11 HIGH FIDELITY 12-14 WATT AMPLIFIER

Push-pull ultra linear output "built-in" tone control pre-amp. Two input sockets with associated controls allowing mixing of "mike" and gram, etc. High sensitivity 5 millivolts. (2) 3-way sectionally wound output transformer. IND. BASS AND TREBLE CONTROLS. Frequency response ±3dB 30-20,000 c/s. Hum level—60dB. SENSITIVITY 40 millivolts. For Crystal or Ceramic P.U.s. High impedance "mikes". For Musical Instruments such as String Bass, Electric Guitars, etc. Size approx. 12 x 9 x 7in. For A.C. mains 200-250v. 50 c.p.s. Output **9 Gns.** Full instructions and point-to-point wiring diagrams. Carr. 11/6 (or factory built 12 Gns.) Twin handled metal cover 27/6. Terms on assembled units. Deposit 9/6 and 9 monthly payments of 22/-. (Total £14/15/6) RSC A11T transistorised version of above complete kit 9 Gns. (Assembled 13 Gns.)

INTEREST CHARGES REFUNDED

On Credit Sales settled in 3 months.

R.S.C. A11 HIGH FIDELITY 12-14 WATT AMPLIFIER

Push-pull ultra linear output "built-in" tone control pre-amp. Two input sockets with associated controls allowing mixing of "mike" and gram, etc. High sensitivity 5 millivolts. (2) 3-way sectionally wound output transformer. IND. BASS AND TREBLE CONTROLS. Frequency response ±3dB 30-20,000 c/s. Hum level—60dB. SENSITIVITY 40 millivolts. For Crystal or Ceramic P.U.s. High impedance "mikes". For Musical Instruments such as String Bass, Electric Guitars, etc. Size approx. 12 x 9 x 7in. For A.C. mains 200-250v. 50 c.p.s. Output **9 Gns.** Full instructions and point-to-point wiring diagrams. Carr. 11/6 (or factory built 12 Gns.) Twin handled metal cover 27/6. Terms on assembled units. Deposit 9/6 and 9 monthly payments of 22/-. (Total £14/15/6) RSC A11T transistorised version of above complete kit 9 Gns. (Assembled 13 Gns.)

High Quality LOUSPEAKERS

In Teak or Afrormosia veneered cabinets. £13 13s x 8" 10 Watt Model. Gauss 10,000 lines, 3 or 15 ohms. **£4/19/9** Carr. 7/6

£12 12s 20 Watt Model, 10 ohm, size 18 x 18 x 10in. Gauss 10,000 lines. Bejme, covered 10/- extra. Carr. 8/9 **£8/19/9**

TWO-WAY 'PHONE AMPLIFIER Listen and speak with both hands free. Handsome black case. Battery operated. **59/9**

R.S.C. SUPER 30 TEREAD AMPLIFIER

A DUAL CHANNEL VERSION OF THE SUPER 15. Employing Twin Printed Circuits. High quality Ganged Pots. Matched Components. CROSS TALK—52dB at 1,000 c.p.s. CONTROL: 5 position Input Selector. Bass Control. Treble Control. Volume Control. Balance Control. Stereo/Mono Switch. Tape Monitor Switch. Mains Switch. INPUT SOCKETS (Matched Pairs): (1) Magnetic P.U. (2) Ceramic or Crystal P.U. (3) Radio/Aux. (4) Tape Head/ Microphone. Operation of the Input Selector Switch assures appropriate equalisation. Rigid 18 s.w.g. Chassis. Size approx. 12in. wide, 3in. high and 8in. deep. Neon Panel Indicator. Attractive Facia Plate and 8pin Silver Matching Knobs. Above facilities, etc., except for Ganging and Balance control, apply also to Super 15.

These units are eminently suitable for use with any make of PICK-UP or MICROPHONE (Crystal, Ceramic, Magnetic, Moving Coil, Ribbon) CURRENTLY AVAILABLE. SUPERB SOUND OUTPUT QUALITY CAN BE OBTAINED BY USING WITH FIRST RATE ANCILLARY EQUIPMENT. All required parts, point to point wiring diagrams and detailed instructions. Carr. 15/- Unit factory built 28 Gns. or deposit 27/5/- and 9 monthly payments 56/3. (Total £32/13/3). Or in Teak or Afrormosia Veneered housing. 31 Gns. Carr. 15/- or Deposit 27/3/6 and 9 monthly payments. 64/- (Total £35/19/6) Send S.A.E. for leaflet

These units are eminently suitable for use with any make of PICK-UP or MICROPHONE (Crystal, Ceramic, Magnetic, Moving Coil, Ribbon) CURRENTLY AVAILABLE. SUPERB SOUND OUTPUT QUALITY CAN BE OBTAINED BY USING WITH FIRST RATE ANCILLARY EQUIPMENT. All required parts, point to point wiring diagrams and detailed instructions. Carr. 15/- Unit factory built 28 Gns. or deposit 27/5/- and 9 monthly payments 56/3. (Total £32/13/3). Or in Teak or Afrormosia Veneered housing. 31 Gns. Carr. 15/- or Deposit 27/3/6 and 9 monthly payments. 64/- (Total £35/19/6) Send S.A.E. for leaflet

- 32 High Street (Half-day Thurs.). Tel. 56420
- 5-7 County (Mecca) Arcade, Briggate (Half-day Wed.). Tel. 28252
- 73 Dale St. (Half-day Wed.). Tel. CENTral 3573
- 238 Edgware Road, W.2 (Half-day Thurs.). Tel. PAD 1629
- 60A Oldham Street (Half-day Wed.). Tel. CENTral 2778
- 106 Newport Rd. (Half-day Wed.). Tel. 47096
- 41 Blackett Street (opp. Fenwicks Store) (Half-day Wed.). Tel. 21469
- 13 Exchange Street (Castle Market Blds.) (Half-day Thurs.). Tel. 20716

R.S.C. TA12 13 WATT STEREO AMPLIFIER

FULLY TRANSISTORISED. SOLID STATE CONSTRUCTION HIGH FIDELITY OUTPUT OF 6.0 WATTS PER CHANNEL. Designed for optimum performance with any crystal or ceramic Gram P.U. cartridge. Radio tuner. Tape recorder. "Mike" etc. 3 separate switched input sockets on each channel. Separate Bass and Treble controls. 3 Slide Switch for mono use. Speaker Output 3-15 ohms. For 200-250 v. A.C. mains. Frequency Response 30-20,000 c.p.s. —2dB. Harmonic Distortion 0.3% at 1000 c.p.s. Hum and Noise —70dB. Sensitivities (1) 300 mV (2) 50 mV (3) 100 mV (4) 2 mV. Handsome brushed silver finish Facia and Knobs. Output rating I.E.P.M. Complete kit of parts with full wiring diagrams and instructions. 12 1/2 GNS. Carr. 7/6. Factory built with 12 mth. guarantee. 16 GNS. Or Dep. £52/6 and 9 monthly pmts. 31/6 (Total £19/6/0). Or in Teak or Afrormosia veneer housing 19 1/2 GNS. Or Dep. £51/0/6 and 9 mthly. pmts. 39/- (Total £23/1/6).

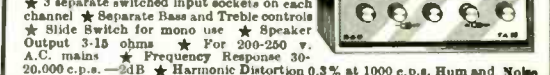

FULLY TRANSISTORISED. SOLID STATE CONSTRUCTION HIGH FIDELITY OUTPUT OF 6.0 WATTS PER CHANNEL. Designed for optimum performance with any crystal or ceramic Gram P.U. cartridge. Radio tuner. Tape recorder. "Mike" etc. 3 separate switched input sockets on each channel. Separate Bass and Treble controls. 3 Slide Switch for mono use. Speaker Output 3-15 ohms. For 200-250 v. A.C. mains. Frequency Response 30-20,000 c.p.s. —2dB. Harmonic Distortion 0.3% at 1000 c.p.s. Hum and Noise —70dB. Sensitivities (1) 300 mV (2) 50 mV (3) 100 mV (4) 2 mV. Handsome brushed silver finish Facia and Knobs. Output rating I.E.P.M. Complete kit of parts with full wiring diagrams and instructions. 12 1/2 GNS. Carr. 7/6. Factory built with 12 mth. guarantee. 16 GNS. Or Dep. £52/6 and 9 monthly pmts. 31/6 (Total £19/6/0). Or in Teak or Afrormosia veneer housing 19 1/2 GNS. Or Dep. £51/0/6 and 9 mthly. pmts. 39/- (Total £23/1/6).

R.S.C. BATTERY/MAINS CONVERSION UNITS

Type BM1. An all-dry battery eliminator. Size 6 1/2 x 4 1/2 x 2in. approx. Completely replaces batteries supplying 1.5 v. and 90 v. where A.C. mains 200/250 v. 50 c/s is available. Complete kit with diagrams. 49/11. Or Ready for use. 59/11

SELENIUM RECTIFIERS

F.W. Bridged 6/12v. D.C. O/P Input Max. 1.5A. A.C. In. 4/3 1 1/2 5/8; 2a. 6/11; 3a. 9/9; 4a. 12/9; 5a. 15/9

R.S.C. MAINS TRANSFORMERS

FULLY GUARANTEED. Interleaved and Impregnated. Primaries 200-250 v. 50 c/s. Screened MIDGET CLAMPED TYPE 2 1/2 x 2 1/2in. 250 v. 60 ma. 6.3 v. 2 a. 15/11 250-0-250v. 60mA. 6.3v. 2a. 16/11

250-0-250v. 70mA. 6.3v. 2a. 15/9 250-0-250v. 100mA. 6.3v. 3a. 21/9 250-0-250v. 100mA. 6.3v. 4a. 0.5-6.3v. 3a. 37/9 300-0-300v. 100mA. 6.3v. 4a. 0.5-6.3v. 3a. 37/9 300-0-300v. 130mA. 6.3v. 4a. c.t. 6.3v. 1a. 45/9

For Mullard 510 Amplifier 350-0-350v. 100mA. 6.3v. 4a. 0.5-6.3v. 3a. 37/9 350-0-350v. 150mA. 6.3v. 3a. 0.5-6.3v. 3a. 47/9 425-0-425v. 200mA. 6.3v. 4a. c.t. 5v. 3a. 69/9 425-0-425v. 200mA. 6.3v. 4a. c.t. 6.3v. 3a. 75/9 450-0-450v. 250mA. 6.3v. 4a. c.t. 5v. 3a. 87/9

TAPE SHROUDED DROP-THROUGH TYPE 250-0-250v. 70mA. 6.3v. 2a. 0.5-6.3v. 2a. 25/9 250-0-250v. 100mA. 6.3v. 3a. 26/9 250-0-250v. 100mA. 6.3v. 2a. 6.3v. 1a. 26/9 250-0-350v. 80mA. 6.3v. 2a. 0.5-6.3v. 2a. 27/9 250-0-250v. 100mA. 6.3v. 4a. 0.5-6.3v. 3a. 37/9 300-0-300v. 100mA. 6.3v. 4a. 0.5-6.3v. 3a. 37/9 300-0-300v. 130mA. 6.3v. 4a. 0.5-6.3v. 1a. 44/9

Suitable for Mullard 510 Amplifier 350-0-350v. 100mA. 6.3v. 4a. 0.5-6.3v. 3a. 37/9 350-0-350v. 150mA. 6.3v. 3a. 0.5-6.3v. 3a. 45/11 FILAMENT or TRANSFORMER POWER PACK TYPES 3.1v. 5a. 7/6; 6.3v. 2a. 8/9; 6.3v. 3a. 9/9; 6.3v. 4a. 11/9; 12v. 1a. 6/9; 12v. 2a. or 24v. 1.5a. 21/9; 0.9-18v. 1 1/2a. 17/9; 0.15-20-42v. 2a. 29/9

CHARGER TRANSFORMERS 9-15v. 11a. 14/11; 21a. 17/9; 3a. 19/11; 5a. 23/9; 6a. 27/9; 8a. 33/9 10a. 55/11

ATRO (Step Up/Step Down) TRANSFORMERS 0.110-120v. 200-230-250v. 50 c/s. 15/9 150 watts; 29/11; 250 watts 49/9; 500 watts 99/9

OUTPUT TRANSFORMERS Standard Pentode 5,000Ω or 7,000Ω to 3Ω 9/9 Push-Pull 8 watts EL84 to 3G or 16G 12/9 Push-Pull 10 watts 6V3 EL84 to 3, 5, 8 or 16G 21/9 Push-Pull EL84 to 3 or 15G 10-12 watts 21/9 Push-Pull Ultra Linear for Mullard 510, etc. 39/9 Push-Pull 15-18 watts, sectionally wound 6L6 KT66, etc., for 3 or 15G 35/9

Push-Pull 20 watt high quality sectionally wound EL34, 6L6, KT66, etc. to 3 or 15G 59/9 SMOOTHING CHOKES 150mA. 7-10H. 250Ω 12/9; 100mA. 10H. 200Ω 10/9; 80mA. 10H. 300Ω. 8/9; 60mA. 10H. 400Ω 4/11

Record Playing Units MONEY SAVING UNITS Ready to plug into Amplifier RP2 Consisting of Garrard RP20 Mk. II (with heavy turntable) fitted Goldring CS90 high compliance ceramic Stereo/Mono cartridge with diamond stylus. Mounted on plinth. Transparent plastic cover included. 22Gns. Inc. carr.

RP3 as above but with Goldring Lenco GL68 Transcription unit and CS90 Cartridge. Cover included. Inc. carr. 28Gns.

Various other types with Magnetic P.U. Cartridges and "Lift off" or "Roll over" transparent covers at lowest prices.

R.S.C. PLINTHS

for Record Playing Units. Teak finish cut for Garrard RP20 Mk. II. 59/9 1000. 2000.

3000, AT6, AT60, SP25 etc. etc. Available with Transparent plastic cover. Inc. carr. 6 Gns.

1 Watt Transistor Amplifiers. Min. size operated. For 3-5G loudspeakers. Brand new boxed. 37/9

COMPUTER MULTI-CORE CABLE

12, 14/0076 copper cores, each one insulated by coloured P.V.C. then separately screened, the 12 metal braided cores laid together and P.V.C. covered overall making a cable just under 1/2 in. dia. but quite pliable. Price 7/6 per ft. Any length cut.

FLEX BARGAINS

Screened 3 Core Flex. Each core 14/0076 Copper P.V.C. insulated and coloured, the 3 cores laid together and metal braided overall. Price £3.15 per 100 yds. coil.
 15 Amp 3 Core Non-kink Flex. 70/7076 insulated coloured cores, protected by tough rubber sheath, then black cotton braided with white tracer. A normal domestic flex as fitted to 3 Kw fuses. Regular price 3/6 per yd. 50 yd. coil £4.10, or cut to your length 2/6 per yd.
 10 Amp 3 Core Non-kink Flex. As above but cores are 20/0076 Copper. Normal price 2/6 per yd, 100 yd. coil £7.10, or cut to your length 1/9 per yd.
 6 Amp 2 Core Flex. As above, but 2 cores each 23/0076 as used for Vacuum Cleaners, Electric Blankets, etc., 33/6 100 yd. coil.

15A FOOT SWITCH



Suitable for Sewing Machine Motor, Drilling Machine or in fact to switch any job where both hands are to be left free. Rated at 13 amps, 250 volts. Price 22/6.

3 DIGIT COUNTER



For Tape Recorder or other application, re-settable by depressing button. Price 8/6.

TRANSDUCER



Made by Aco, reference No. 1.D.1001. For measuring vibration, etc., to be used in conjunction with "Q" Meter. Regular price £5. Our price 4/6. Brand new and unused.

ISOLATION SWITCH

20 Amp D.P. 250 Volts. Ideal to control Water Heater or any other appliance. Neon indicator shows when current is on, 4/6 48/- per dozen.



LIGHT CELL



Almost zero resistant in sunlight increases to 10 K. Ohms in dark or dull light, epoxy resin sealed. Size approx. 1in. dia. by 1/2 in. thick. Rated at 500 MW. wire ended. 8/6 with circuit.

INSTRUMENT BUZZER

6-12 volts, adjustable tone, a very neat metal case U.S.A. made unit approx. 1 1/2 in. x 1 in. x 1 in. thick. 6/6 each.



12 VOLT SOLENOID

For energizing Reed Switches, etc., size approx. 1 1/2 in. long by 1/2 in. diameter. Hole through Solenoid approx. 1/2 in. 8/6 each.

COMBINATION DIAL SWITCH



3 separate settings of the dial are necessary before this can be switched on or off. Combination can be changed as required. A useful Switch for security or novelty. Contacts rated at 1 Amp. 35/- each.

Electric clock with 20 amp switch

Made by Smith's these units are as fitted to many top quality cookers to control the oven. The clock is mains driven and frequency controlled so it is extremely accurate. The two small dials enable switch on and off times to be accurately set—also on the left is another time or alarm—this may be set in minutes up to 1 hour. At the end of the period a bell will sound. Offered at only a fraction of the regular price—45/-, less than the value of the clock alone—post and ins. 2/9.



NICAD RECHARGEABLE BATTERIES



3-6V 500mA size 1 1/2 x 1 1/2 in. dia. really powerful will deliver 1 amp for 1/2 hour. Regular price 32/6 our price 17/6 each. New and guaranteed. Other voltages available, single cell 1.2V 6/6. 5 cell 6V 29/6. 10 cell 12 volt 65/-

THIS MONTH'S SNIP

Horstmann 'Time & Set' Switch



(A 15 Amp Switch). Just the thing if you want to come home to a warm house without it costing you a fortune. You can delay the switch on time of your electric fires, etc., up to 14 hours from setting time or you can use the switch to give a boost on period of up to 3 hours. Equally suitable to control processing. Regular price probably around £3. Special snip price 28/6 post and ins. 4/6.

MOTORISED CAM SWITCH



Made by the famous meter company Chamberlain and Hookham, these have a normal mains 200-240v motor which drives a ratchet mechanism so geared to give one ratchet action per minute on a wheel with 60 teeth thus a complete revolution of the cam takes place in one hour. The cam operates 8 switches (6 changeover and 2 on/off thus 480 circuit changes per hour are possible). Contacts, rated at 15 amps have been set for certain switch combinations but can, no doubt, be altered to suit a special job. Also other switch wafers or devices can be attached to the shaft which extends approximately one inch. 47/6 p. & ins. 4/6.

DISTRIBUTION PANELS

Just what you need for work bench or lab. 4 x 13 amp sockets in metal box to take standard 13 amp fused plugs. Supplied complete with 6 feet of heavy cable and 13 amp plug. Similar panels advertised at £5. Our price 39/6, plus 3/6 post and insurance.



G.E.C. 13A SOCKETS



Opportunity to re-equip your house or workshop, or if a contractor, to stock up for future jobs. We offer bakelite 13A sockets for flush or surface mounting made by the famous G.E.C. company, and listed from 3/6 each. YOU CAN HAVE A BOX OF 12 flush type 24/-, surface type 29/6, post and ins. 4/6. (Gross or more carr. free.)

MINIATURE WAFER SWITCHES



2 pole, 2 way—4 pole, 2 way—3 pole, 3 way—4 pole, 3 way—2 pole, 4 way—3 pole, 4 way—2 pole, 6 way—1 pole, 12 way. All at 3/6 each, 36/- dozen, your assortment.

WATERPROOF HEATING ELEMENT

26 inches length 70W. Self-regulating temperature control. 10/- post free.

AC FAN

Small but very powerful mains motor with 6 1/2 in. blades. Ideal for cooling equipment or as extractor. Silent but very efficient. 17/6, post 4/6. Mounts from back or front with 4BA screws.

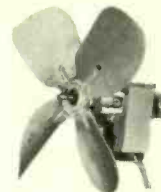

DRILL CONTROLLER

Electronically changes speed from approximately 10 revs. to maximum. Full power at all speeds by finger-tip control. Kit includes all parts, case, everything and full instructions 19/6, plus 2/6 post and insurance. Or available made up 29/6. Plus 2/6 post.

MAINS MOTOR



Precision made—as used in record decks and tape recorders—ideal also for extractor fans, blower, heater, etc. New and perfect. Snip at 9/6. Postage 3/- for first one then 1/- for each one ordered. 12 and over post free.

QUICK CUPPA

Mini Immersion Heater, 350w. 200/240v. Boils full cup in about two minutes. Use any socket or lamp holder. Have at bedside for tea, baby's food, etc. 19/6, post and insurance 1/6. 12v. car model also available.



You never need buy another battery for your transistor radio. Stupendous offer this month—a 6.9V Nickel Cadmium battery stack together with a mains operated charger which you mount on the back of your set. The mains flex unplugs so the set remains completely portable. Offered for less than the cost of the batteries alone. ONLY 28/6 plus 3/6 post.

ELECTRONICS (CROYDON) LTD

Dept. WW, 266 London Road, Croydon CRO-2TH
 Also 102/3 Tamworth Road, Croydon

LATEST RELEASE OF RCA COMMUNICATION RECEIVERS AR88

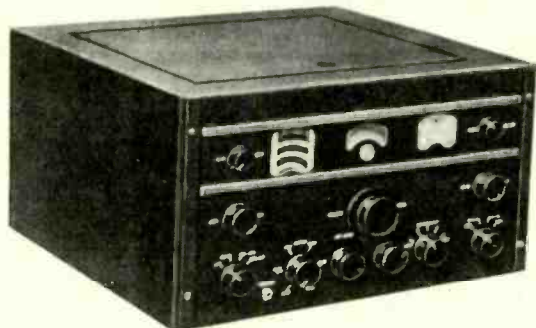

BRAND NEW and in original cases—A.C. mains input. 110V or 250V. Freq. in 6 bands 535 Kc/s-32 Mc/s. Output impedance 2.5-600 ohms. Complete with crystal filter, noise limiter, B.F.O., H.F. tone control, R.F. & A.F. variable controls. Price £87/10/- each, carr. £2.

Same model as above in secondhand cond. (guaranteed working order), from £45 to £60, carr. £2.

*SET OF VALVES: new, £3/10/- a set, post 7/6; SPEAKERS: new, £3 each, post 10/-; *HEADPHONES: new, £1/5/- a pair, 600 ohms impedance. Post 5/-.

AR88 SPARES. Antenna Coils L5 and 6 and L7 and 8. Oscillator coil L55. Price 10/- each, post 2/6. RF Coils 13 & 14; 17 & 18; 23 & 24; and 27 and 28. Price 12/6 each. 2/6 post. By-pass Capacitor K.98034-1, 3 x 0.05 mfd. and M.980344, 3 x 0.01 mfd., 3 for 10/-, post 2/6. Trimmers 95534-502, 2-20 p.f. Box of 3, 10/-, post 2/6. Block Condenser, 3 x 4 mfd., 600 v., £2 each, 4/- post. Output transformers 901666-501 27/6 each, 4/- post.

* Available with Receiver only.

S.A.E. for all enquiries. If wishing to call at Stores, please telephone for appointment.

W. MILLS

3-B TRULOCK ROAD, TOTTENHAM, N.17
 Phone: Tottenham 9213

MARCONI SIGNAL GENERATORS

TYPE TF-144G

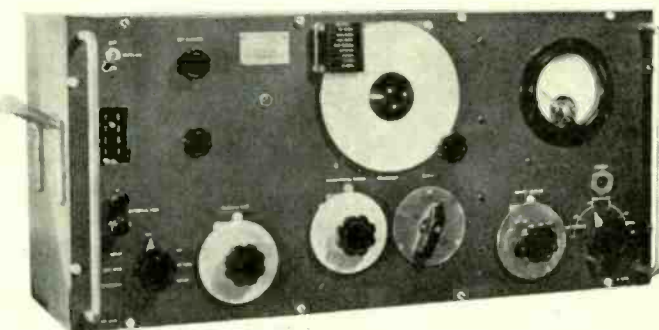

Freq. 85Kc/s-25Mc/s in 8 ranges. Incremental: +/- 1% at 1Mc/s. Output: continuously variable 1 microvolt to 1 volt. Output Impedance: 1 microvolt to 100 millivolts, 10 ohms 100mV-1 volt-52.5 ohms. Internal Modulation: 400 c/s sinewave 75% depth. External Modulation: Direct or via internal amplifier. A.C. mains 200/250V, 40-100 c/s. Consumption approx. 40 watts. Measurements: 19 1/2 x 12 1/2 x 10 in. The above come complete with Mains Leads, Dummy Aerial with screened lead, and plugs. As New, in Manufacturer's cases, £40 each. Carr. 30/-. DISCOUNT OF 10% FOR SCHOOLS, TECHNICAL COLLEGES, etc.

HRO RECEIVER. Model 5T. This is a famous American High Frequency superhet, suitable for CW, and MCW, reception crystal filter, with phasing control. AVC and signal strength meter. Freq. range 50 kc/s. to 30 Mc/s., with set of nine coils. Complete HRO 5T SET (Receiver, Coils and Power Unit) for £30, plus 30/- carr.

COMMAND RECEIVERS; Model 6-9 Mc/s., as new, price £5/10/- each, post 5/-.

COMMAND TRANSMITTERS, BC-458: 5.3-7 Mc/s., approx. 25W output, directly calibrated. Valves 2 x 1625 PA; 1 x 1626 osc.; 1 x 1629 Tuning Indicator; Crystal 6,200 Kc/s. New condition—£3/10/- each, 10/- post.

(Conversion as per "Surplus Radio Conversion Manual, Vol. No. 2," by R. C. Evenson and O. R. Beach.)

AIRCRAFT RECEIVER ARR. 2: Valve line-up 7 x 9001; 3 x 6AK5; and 1 x 12A6. Switch tuned 234-258 Mc/s. Rec. only £3 each, 7/6 post; or Rec. with 24 v. power unit and mounting tray £3/10/- each, 10/- post.

RECEIVERS: Type BC-348, operates from 24 v D.C., freq. range 200-500 Kc/s. 1.5-18 Mc/s. (New) £35.0.0 each; (second hand) £20.0.0 each, good condition, carr. 15/- both types.

MARCONI RECEIVER 1475 type 88: 1.5-20 Mc/s, second-hand condition £10.0.0 each. New condition £25.0.0 each, carr. 15/-.

RACAL EQUIPMENT: RA. 17 Outer Metal case for receiver available, as new, £10 each, carr. £1. Frequency Meter type SA20: £35 each, carr. £1. Frequency Counter type SA21: £65 each, carr. 30/-. Diversity Switching Unit type MA. 168: £35 each, post 10/-. Receiver Converter SA.80: 25 Mc/s-160 Mc/s, £40 each, carr. £1.

ROTARY CONVERTERS: Type 8a, 24 v D.C., 115 v A.C. @ 1.8 amps, 400 c/s 3 phase, £8/10/- each, 8/- post. 24 v D.C. input, 175 v D.C. @ 40mA output, 25/- each, post 2/-.

CONDENSERS: 150 mfd, 300 v A.C., £7/10/- each, carr. 15/-. 40 mfd, 440 v A.C. wkg., £5 each, 10/- post. 30 mfd, 600 v wkg. D.C., £3/10/- each, post 10/-. 15 mfd, 330 v A.C. wkg., 15/- each, post 5/-. 10 mfd, 1000 v, 12/6 each, post 2/6. 10 mfd, 600 v, 8/6 each, post 5/-. 8 mfd, 1200 v, 12/6 each, post 3/-. 8 mfd, 600 v, 8/6 each, post 2/6. 4 mfd, 3000 v wkg., £3 each, post 7/6. 2 mfd, 3000 v wkg., £2 each, post 7/6. 0.25 mfd, 32,000 v, £7/10/- each, carr. 15/-. 0.25 mfd, 2Kv, 4/- each, 1/6 post. 0.01 mfd. MICA 2.5 Kv. Price £1 for 5. Post 2/6. Capacitor: 0.125 mfd, 27,000v wkg. £3.15.0 each, 10/- post.

AVO MULTIRANGE No. 1 ELECTRONIC TEST SET: £25 each, carr. £1.

OSCILLOSCOPE Type 13A, 100/250 v. A.C. Time base 2 c/s.-750 Kc/s. Bandwidth up to 5 Mc/s. Calibration markers 100 Kc/s. and 1 Mc/s. Double Beam tube. Reliable general purpose scope, £22/10/- each, 30/- carr.

COSSAR 1035 OSCILLOSCOPE, £30 each, 30/- carr.

COSSAR 1049 Mk. 111, £45 each, 30/- carr.

RELAYS: GPO Type 600, 10 relays @ 300 ohms with 2M and 10 relays @ 50 ohms with 1M., £2 each, 6/- post.

12 Small American Relays, mixed types £2, post 4/-.

Many types of American Relays available, i.e., Sigma; Allied Controls; Leach; etc. Prices and further details on request 6d.

CALIBRATION TACHOMETER Mk. II: Maxwell Bridge Type 6C/869, £25 each, £2 carr.

ROTAX VARIAC & METER UNIT: Type 5G.3281. Reading 0-40 v., 0-40 mA and 0.5 amps., all on 275 deg. scales, £30 each, £2 carr.

HEWLETT PACKARD TYPE 400C: 115 v./230 v. input 50/60 c/s. Freq. range 20 c/s-2 Mc/s. Voltage range: 1mV-300 v. in 12 ranges. Input impedance 10 megohms. Designed for rack mounting, £30 each, carr. 15/-.

TCS MODULATION TRANSFORMERS, 20 watts, pr. 6,000 C.T., sec. 6,000 ohms. Price 25/-, post 5/-.

AUTOMATIC PILOT UNIT Mk. 2. This complex unit of diodes and valves, relays, magnetic clutches, motors and plug-in amplifiers, with many other items, price £7/10/-, £1 carriage.

FOR EXPORT ONLY: B.44 Transceiver Mk. III. Crystal control, 60-95 Mc/s. AMERICAN EQUIPMENT: BC-640 Transmitter, 100-156 Mc/s., 50 watt output. For 110 or 230 v. operation. ARC 27 transceivers, 28 v. D.C. input. Also have associated equipment. BC-375 Transmitter; BC-778 Dinghy transmitter. SCR-522 transceiver. Power supply, PP893; GRC 32A; Filter D.C. Power Supply F-170/GRC 32A; Cabinet Electrical CY 1288/GRC 32A; Antenna Box Base and Cables CY 728/GRC; Mast Erection Kits, 1186/GRC; Directional Antenna CRD.6; Comparator Unit CM.23; Directional Control CRD.6, 567/CRD and 568/CRD; Azimuth Control Units, 260/CRD. Test Set URM.44, complete with Signal Generator TS.622/U.

VARIABLE POWER UNIT: complete with Zenith variac 0-230 v., 9 amps.; 2 1/2 in. scale meter reading 0-250 v. Unit is mounted in 19in. rack, £16/10/- each, 30/- carr.

SOLENOID UNIT: 230 v. A.C. input, 2 pole, 15 amp contacts, £2/10/- each post 6/-.

CONTROL PANEL: 230 v. A.C., 24 v. D.C. @ 2 amps., £2/10/- each, carr. 12/6.

AUTO TRANSFORMER: 230-115 v.; 1,000 w. £5 each, carr. 12/6. 230-115 v.; 300VA, £3 each, carr. 10/-.

OHMITE VARIABLE RESISTOR: 5 ohms, 5 1/2 amps; or 2.6 ohms at 4 amps. Price (either type) £2 each, 4/6 post each.

POWER SUPPLY UNIT PN-12B: 230 v. A.C. input, 395-0-395 v. output @ 300 mA. Complete with two x 9H chokes and 10 mfd. oil filled capacitors. Mounted in 19in. panel, £6/10/- each, £1 carr.

TX DRIVER UNIT: Freq. 100-156 Mc/s. Valves 3 x 3C24's; complete with filament transformer 230 v. A.C. Mounted in 19in. panel, £4/10/- each, 15/- carr.

ALL GOODS OFFERED WHILST STOCKS LAST IN "AS IS" CONDITION UNLESS OTHERWISE STATED

CALLERS BY TELEPHONE
APPOINTMENT ONLY

W. MILLS

3-B TRULOCK ROAD, TOTTENHAM, N.17

Phone: Tottenham 9213

POWER UNIT: 110 v. or 230 v. input switched; 28 v. @ 45 amps. D.C. output. Wt. approx. 100 lbs., £17/10/- each, 30/- carr. SMOOTHING UNITS suitable for above £7/10/- each, 15/- carr.

DE-ICER CONTROLLER MK. III: Contains 10 relays D.P. changeover heavy duty contacts, 1 relay 4P, C/O. (235 ohms coil). Stud switch 30-way relay operated, one five-way ditto, D.C. timing motor with Chronometric governor 20-30 v., 12 r.p.m.; geared to two 30-way stud switches and two Ledex solenoids, 1 delay relay etc., sealed in steel case (4 x 5 x 7 ins.) £3 each, post 7/6.

MODULATOR UNIT: 50 watt, part of BC-640, complete with 2 x 811 valves, microphone and modulator transformers etc. £7/10/- each, 15/- carr.

ADVANCE TEST EQUIPMENT: VM78 A.C. Millivoltmeter (transistorised) £55 each; TT1S Transistor Tester (CT472) £37/10 each. Carr. 10/-, extra per item.

NIFE BATTERIES: 4 v. 160 amps, new, in cases, £20 each, £1 10/- carr.

FUEL INDICATOR Type 113R: 24 v. complete with 2 magnetic counters 0-9999, with locking and reset controls mounted in a 3in. diameter case. Price 30/- each, post 5/-.

UNISELECTORS (ex equipment): 5 Bank, 50 Way, 75 ohm Coil, alternate wipe, £2/5/- each, post 4/-.

FREQUENCY METERS: BC-221, meter only £30 each, BC-221 complete with stabilised power supply £35 each, carr. 15/-. LM13, 125-20,000 Kc/s., £25 each, carr. 15/-. TS.175/U, £75 each, carr. £1. TS323/UR, 20-450 Mc/s., £75 each, carr. 15/-. FR-67/U: This instrument is direct reading and the results are presented directly in digital form. Counting rate: 20-100,000 events per sec. Time Base Crystal Freq.: 100 Kc/s. per sec. Power supply: 115 v., 50/60 c/s., £100 each, carr. £1.

CT.49 ABSORPTION AUDIO FREQUENCY METER: freq. range 450 c/s-22 Kc/s., directly calibrated. Power supply 1.5 v.-22 v. D.C. £12/10/- each, carr. 15/-.

CATHODE RAY TUBE UNIT: With 3in. tube, colour green, medium persistence complete with nu-metal screen, £3/10/- each, post 7/6.

APNI ALTIMETER TRANS./REC., suitable for conversion 420 Mc/s., complete with all valves 28 v. D.C. 3 relays, 11 valves, price £3 each, carr. 10/-.

GEARED MOTORS: 24 v. D.C., current 150 mA, output 1 r.p.m., 30/- each, 4/- post. Assembly unit with Letcherbar Tuning Mechanism and potentiometer, 3 r.p.m., £2 each, 5/- post.

Actuator Type SR-43: 28 v. D.C. 2,000 r.p.m., output 26 watts, 5 inch screw thrust, reversible, torque approx. 25 lbs., rating intermittent, price £3 each, post 5/-.

SYNCHROS: and other special purpose motors available. British and American ex stock. List available 6d.

MARCONI NOISE GENERATOR TF-987/1: Used to determine noise factor of a.m. and f.m. receivers. Designed for 230 v. a.c. operation. In used condition, £20 each, carr. £1.

MARCONI TF-956 (CT.44) AUDIO FREQUENCY ABSORPTION WATTMETER; Large clear 6in. scale. 1 microW. to 6W. £25 each. Carr. 15/-.

MARCONI DIVERSITY RECEIVERS; Consisting of 2 x CR.150's and associated equipment. £175 each. Carr. £5.

MARCONI DEVIATION TEST SET TF-934: Freq. 2.5-100Mc/s. Can be extended to 500Mc/s. Deviation range 0-5, 0-25 and 0-65 Kc/s. £35 each, carr. £1

CANADIAN C52 TRANS./REC.: Freq. 1.75-16 Mc/s on 3 bands. R.T., M.C.W. and C.W. Crystal calibrator etc., power input 12V. D.C., new cond., complete set £50. Used condition working order £25. Carr. on both types £2/10/-. Transmitter only £7/10/- (few only) Carr. 15/-. Power Unit for Rec., new £3/5/-. Used power units in working order £2/5/-. Carr 10/-.

AVOMETERS: Model 47A, £10 each, 10/- post. Excellent secondhand cond. (meters only).

DECADE RESISTOR SWITCH: 0.1 ohm per step. 10 positions. 3 Gang, each 0.9 ohms. Tolerance $\pm 1\%$ £3 each, 5/- post. 90 ohms per step. 10 positions, total value 900 ohms. 3 Gang. Tolerance $\pm 1\%$ £3/10/- each, 5/- post.

TELESCOPIC ANTENNA: In 4 sections, adjustable to any height up to 20 ft. Closed measures 6 ft. Diameter 2 in. tapering to 1 in. £5 each + 10/- carr. Or £9 for two + £1 carr. (brand new condition).

COAXIAL TEST EQUIPMENT: COAXSWITCH—Mnfrs. Bird Electronic Corp. Model 72RS; two-circuit reversing switch, 75 ohms, type "N" female connectors fitted to receive UG-21/U series plugs. New in ctns, £6/10/- each, post 7/6. CO-AXIAL SWITCH—Mnfrs. Transco Products Inc., Type M1460-22, 2 pole, 2 throw. (New) £6/10/- each, 4/6 post. 1 pole, 4 throw, Type M1460-4. (New) £6/10/- each, 4/6 post.

TERMALINE RESISTOR UNITS: type 82A/U 500W, 5000W, freq. 0-3.3 KMC Max VSWR 1.2 Type "N" female connectors, etc. Brand new, £30 each, carr. 15/-.

PRD Electronic Inc. Equipment: FREQUENCY METER: Type 587-A, 0.250-1.0 KMC/SEC. (New) £75 each, post 12/6. FIXED ATTENUATOR: Type 130c, 2.0-10.0 KMC/SEC. (New) £5 each, post 4/-. FIXED ATTENUATOR: Type 1157S-1, (new) £6 each, post 5/-.

SEMICONDUCTORS

BRAND NEW FULLY GUARANTEED

DIODES & RECTIFIERS TRANSISTORS

IN461 1/6	2G371 3/1	Orange 2/6	40253 8/6	BF180 7/6	NKT216 7/6
IN491 1/6	2G374 5/6	2N3011 5/1	40254 10/6	BF181 6/6	NKT217 6/6
IN491 1/6	2G381 4/6	2N3053 6/6	40360 12/6	BF182 7/6	NKT261 4/6
IN491 1/6	2N696 5/1	2N3054 12/6	40361 12/6	BF184 7/6	NKT262 4/6
IN4007 4/6	2N697 5/1	2N3055 15/1	40362 14/6	BF194 6/6	NKT264 4/6
IS101 3/1	2N706 2/6	2N3133 6/1	40370 8/6	BFX12 5/6	NKT272 4/6
IS102 4/1	2N706A 2/6	2N3134 10/6	40467 16/6	BFX13 5/6	NKT274 4/6
IS102 5/1	2N708 4/1	2N3135 6/1	40468 16/6	BFX29 12/6	NKT281 5/6
IS113 3/1	2N753 5/6	2N3136 6/1	AC107 6/1	BFX30 9/1	NKT403 15/1
IS120 2/6	2N714 3/6	2N3390 10/6	AC126 4/1	BFX43 8/6	NKT404 12/6
IS131 2/6	2N916 3/6	2N3391 7/6	AC127 3/1	BFX44 8/6	NKT405 15/1
IS130 2/6	2N929 5/6	2N3391A 6/1	AC176 5/6	BFX84 8/3	NKT603 6/6
IS132 2/6	2N930 6/6	2N3392 6/6	AC187 12/1	BFX85 10/1	NKT613 6/6
IS131 3/1	2N987 10/6	2N3393 6/6	AC188 12/1	BFX86 8/1	NKT674F 5/1
AA119 2/1	2N1131 8/6	2N3394 5/6	ACV17 5/1	BFX87 10/1	NKT677F 5/1
AA213 2/1	2N1132 8/6	2N3402 8/6	ACV18 5/1	BFX88 10/1	NKT713 5/6
AA215 2/1	2N1302 4/6	2N3403 9/1	ACV19 5/1	BFY17 4/6	NKT736 6/6
AA217 2/6	2N1303 4/6	2N3404 12/6	ACV20 5/1	BFY18 4/6	NKT781 6/1
BA100 2/1	2N1304 5/6	2N3405 12/6	ACV21 5/1	BFY19 4/6	NKT10419 6/1
BA102 4/1	2N1305 5/6	2N3414 6/6	ACV222 4/1	BFY20 12/6	6/1
BA115 1/6	2N1306 6/6	2N3415 7/6	ACV28 4/1	BFY21 8/6	NKT10439 8/1
BA113 2/6	2N1307 6/6	2N3416 7/6	ACV40 4/1	BFY24 9/1	6/1
BA116 2/6	2N1308 8/6	2N3417 9/6	AD140 8/1	BFY25 5/1	NKT10519 6/1
BA18 1/6	2N1309 8/6	2N3570 12/6	AD149 8/1	BFY26 4/1	6/1
BA18 1/6	2N1420 7/6	2N3572 12/6	AD161 7/6	BFY29 10/1	NKT20329 10/1
BA18 1/6	2N1507 7/6	2N3605 5/6	AD162 7/6	BFY30 10/1	8/6
BY100 4/6	2N1527 7/6	2N3606 5/6	AF114 5/1	BFY36 4/1	NKT20339 8/6
BY103 4/6	2N1605 9/6	2N3607 4/6	AF116 5/1	BFY37 5/1	10/6
BY122 7/6	2N1613 6/6	2N3662 11/6	AF117 5/1	BFY41 10/1	NKT8011 15/6
BY124 3/1	2N1718 6/6	2N3663 12/6	AF149 8/6	BFY43 13/6	NKT8011 12/6
BYX10 5/6	2N1889 8/1	2N3702 4/6	AF124 5/1	BFY50 4/6	19/6
BYZ10 9/1	2N1893 8/1	2N3703 4/6	AF125 5/1	BFY51 4/6	NKT80113 4/6
BYZ11 7/6	2N2147 17/6	2N3704 5/6	AF126 5/1	BFY52 4/6	22/6
BYZ12 6/6	2N2148 12/6	2N3705 4/6	AF127 5/1	BFY53 5/6	NKT80211 4/6
BYZ13 5/1	2N2160 14/6	2N3706 4/6	AF181 8/6	BFY56A 11/1	18/6
FS134 4/6	2N2220 5/6	2N3707 4/6	AF186 11/1	BFY75 6/6	NKT80212 6/6
FS138 6/6	2N2193A 5/6	2N3708 4/6	AF239 7/6	BFY76 6/6	18/6
OA5 2/6	2N2194A 4/6	2N3709 4/6	AFZ11 5/6	BFY77 11/6	NKT80213 12/6
OA9 2/1	2N2217 6/1	2N3710 4/6	AFZ12 6/6	BFY90 12/6	18/6
OA47 2/1	2N2218 6/1	2N3711 4/6	AS26 5/6	BSX19 5/6	NKT80214 18/6
OA70 1/6	2N2219 6/1	2N3721 4/6	AS27 8/6	BSX20 5/6	18/6
OA73 2/1	2N2220 5/6	2N3819 9/6	AS28 8/6	BSX21 8/6	NKT80215 18/6
OA79 1/9	2N2221 5/1	2N3820 2/6	AS29 4/6	BSX76 4/6	18/6
OA81 1/6	2N2222 5/1	2N3823 2/6	AS220 7/6	BSX77 6/6	NKT80216 6/6
OA85 1/6	2N2287 21/6	2N3900 10/6	ASZ21 4/6	BSX78 6/6	18/6
OA90 1/6	2N2297 6/1	2N3900A 11/6	AU170 20/1	BSY26 4/6	6/6
OA91 1/6	2N2302 12/6	2N3901 19/6	BC107 3/6	BSY27 4/6	8/6
OA95 1/6	2N2303 13/6	2N3901 19/6	BC108 3/6	BSY28 4/6	8/6
OA182 2/1	2N2368 8/6	2N3903 8/6	BC109 3/6	BSY29 4/6	OC35 6/6
OA200 2/1	2N2369 7/6	2N3904 8/6	BC113 6/6	BSY38 4/6	OC36 6/6
OA202 2/1	2N2369A 5/1	2N3905 8/6	BC118 6/6	BSY39 4/6	OC41 4/1
	2N2411 6/6	2N3906 8/6	BC125 13/6	BSY40 5/6	OC44 4/1
	2N2412 6/6	2N4058 16/6	BC126 13/6	BSY41 5/6	OC45 2/6
	2N2483 5/6	2N4059 5/6	BC145 13/6	BSY52 6/1	OC71 2/6
	2N2484 5/6	2N4060 5/6	BC147 5/1	BSY95A 3/6	OC72 4/6
	2N2539 4/6	2N4061 5/6	BC148 4/6	D16P1 12/1	OC75 4/6
	2N2540 4/6	2N4062 5/6	BC149 5/6	D16P2 12/6	OC81 4/1
	2N2613 7/6	2N4244 8/6	BC169 3/6	D16P3 13/1	OC81D 3/1
	2N2618 7/6	2N4245 8/6	BC212L 12/6	D16P4 13/6	OC81DM 3/1
	2N2645 6/1	2N4285 3/6	BCY30 7/6	GET113 4/1	OC83 4/6
	2N2646 11/6	2N4286 3/6	BCY32 4/6	GET114 4/1	OC139 6/6
	2N2696 6/6	2N4287 3/6	BCY32 7/6	GET873 3/1	OC140 6/6
	2N2711 8/6	2N4291 3/6	BCY33 5/6	GET880 6/1	OC170 6/1
	2N2712 8/6	2N4292 3/6	BCY34 5/6	GET881 4/6	OC171 6/1
	2N2720 8/6	2N4333 6/6	BCY38 6/6	MAT100 6/1	OC200 5/6
	2N2714 9/1	2N4434 6/6	BCY39 6/6	MAT101 6/1	OC201 5/6
	2N2904 8/1	2N5305 10/6	BCY40 7/6	MAT120 6/1	OC202 8/6
	2N2904A 8/1	2N5306 11/6	BCY42 5/1	MAT121 6/1	OCPT7 8/6
	2N2905 8/1	25102 6/6	BCY43 5/6	MJ480 20/6	ORP12 8/6
	2N2905A 8/1	25103 6/6	BCY54 6/6	MJ481 27/6	ORP60 10/1
	2N2906 8/1	25104 6/6	BCY70 5/6	MJ490 22/6	ORP61 10/1
	2N2906A 8/1	3N120 18/6	BCY71 9/6	MJ491 29/6	P346A 5/6
	2N2907 8/1	3N148 21/6	BCY72 5/1	MPF102 8/6	TS34A 17/6
	2N2923 4/1	3N141 19/6	BD121 19/6	MPF103 7/6	TS43 8/6
	2N2924 4/6	3N142 19/6	BD124 12/1	MPF104 7/6	TS44 8/6
	2N2925 5/1	3N143 19/6	BF113 5/6	MPF105 8/1	ZTX300 2/6
	2N2926 4/1	40152 24/1	BF117 10/6	MPS3638 6/6	ZTX301 4/1
	Green 3/1	40250 16/6	BF167 6/6	NKT0013 8/6	ZTX302 5/1
	Yellow 2/9	40251 17/6	BF173 7/6	NKT212 5/6	ZTX303 5/1

INTEGRATED CIRCUITS

RCA	CA3005 30/1	CA3028B 30/1	FAIRCHILD I.C.'s	L900 11/1	Buffer
	CA3011 20/1	CA3035 35/1		L914 13/1	Dual Gate
	CA3012 25/1	CA3036 20/1		L923 14/1	JK Flip Flop
	CA3013 30/1	CA3039 25/1	GENERAL ELECTRIC I.C.'s		
	CA3014 30/1	CA3041 32/6		PA230	Low Level Amplifier 27/6
	CA3018 25/1	CA3042 32/6		PA234	Audio Amplifier 26/6
	CA3019 25/1	CA3043 35/1		PA237	2 Watt Audio Amplifier 45/1
	CA3020 27/6	CA3044 32/6			DATA SHEETS 6d. EACH TYPE
	CA3021 42/6	CA3045 32/6	MULLARD I.C.'s		
	CA3022 35/1	CA3046 25/1		TAA263 18/6	Linear AF Amplifier
	CA3023 32/6	CA3051 25/1		TAA293 25/6	General purpose Amplifier
	CA3026 27/6			TAA241 72/6	
	CA3028A 25/1			TAA320 15/6	M.O.S. Pre Amplifier

DATA AND APPLICATION SHEETS FOR RCA DEVICES 2/- PER TYPE

THYRISTORS	P1V	50	100	200	300	400
	1A	5/1	5/6	7/6	8/1	9/6
	3A	—	7/6	8/1	9/1	10/6
	5A	—	8/1	9/1	—	12/6
	7A	—	11/1	13/1	14/1	19/6
	25A	—	27/6	30/1	33/1	37/6
			Also 12 Amp 100 Piv 15/-	600 Piv 35/6		

PANEL METERS

38 Series—FACE SIZE 42 x 42 mm.		
All prices for 1-9 micromp		
50	Microamp	37/6
100	"	35/1
200	"	32/6
500	"	27/6
50-0-50	"	32/6
100-0-100	"	25/1
500-0-500	"	25/1
	Milliamp	25/1
5	"	25/1
10	"	25/1
50	"	25/1
100	"	25/1
500	"	25/1
	Amp	25/1
5	"	25/1
10	"	25/1
50	"	25/1
100	"	25/1
500	"	25/1
	Volts	25/1
10	"	25/1
50	"	25/1
300	"	25/1
500	"	25/1

CAPACITORS

A large range available.

Electrolytic, Polyester, Silvered Micas, Polystyrene, Ceramic, disc (see cat. for full list).	
Examples:	
1000 mfd 50V	7/6
2000 mfd 25V	8/6
2500 mfd 25V	9/6
5000 mfd 25V	12/6

VEROBORD

All sizes stocked. Available .1 or .15 matrix and also without copper strips. 17" x 31" .15 17/- 17" x 21" .15 Blanks 13/-

A LARGE RANGE OF PRESETS POTENTIOMETERS, THERMISTORS, SPEAKERS, ETC. AVAILABLE. SEND 6d. STAMP FOR CATALOGUE.

All overseas enquiries & orders please address to:
COLOMOR (ELECTRONICS) LTD.
 170 Goldhawk Rd., London, W.12. Tel. 01-743 0899

BRUEL & KJAER

The following two instruments are supplied with all leads, accessories, spares and comprehensive instruction and maintenance manuals.

B & K LEVEL RECORDER TYPE 2304. A high speed recording instrument designed for the measurement of reverberation time, noise level and the frequency response of microphone and loudspeakers. £265.

B. & K. B.F.O. Type 1013. Frequency 200-200,000 Hz. Accuracy 15, Matching 6;60;600;6,000 ohm. Output 2.2W at 6,000 ohm and 1.5W at 6 ohm. Output Antennator 0.4mV to 12.5v in 10 ranges, continuously variable in each range of Potentiometer. Other features: Mirror type voltmeter, incremental frequency scale, Frequency scanning, Automatic output regulator, F.M. £155. Carriage paid.

TELEMETRY STATION

We are able to offer, one only, Telemetry Station of very recent American manufacture. Comprising Helical Antenna, oscilloscope receiver and associated units, Ampex tape recorder and power supply for the entire installation. Interested clients with a knowledge of this type of equipment are invited to phone or write for further particulars.

HEWLETT-PACKARD MODEL 524B ELECTRONIC COUNTER.

Without plug in unit this instrument will measure frequencies from 10 c/s to 10⁻¹ mc/s and periods of from 0.10 kc/s. Frequencies are read in kc/s with the decimal point automatically positioned, and time is read in seconds, milliseconds or microseconds again with the decimal point automatically positioned. Registration is in eight places, first six on neon lamp decades, last two on meters. Self check facility from Internal 100 kc/s and 10 mc/s frequency standards. Full details and price on request. Plug in unit for extra range, 100/220 mc/s, is an optional extra. £22/10/-. Carriage 15/-

COSSOR OSCILLOSCOPE TYPE 1049.

Fuller descriptions of the following 3 instruments upon request.

SOLATRON STORAGE OSCILLOSCOPE TYPE QD 910.

MICROWAVE SPECTRUM ANALYZER TYPE SA 18 MANUFACTURED BY RACAL.

DAWE STORAGE OSCILLOSCOPE TOGETHER WITH TRACE SHIFTER.

"S" BAND SIGNAL GENERATOR No. 16 MADE BY SPERRY.

7.9-11 cma (2727-3797 mc/s.). Power output .001 micro watts—1 mW. at 72 ohms. Modulation: A unmodulated CW, B square wave modulated by internal free running modulator with PRF variable from 400c to 4kc. C Square wave modulated by internal modulator triggered by external source either sine or square, 20-100v. sine or 20-100v. p. to p. £85. P. & P. 30/-.

BOONTON "Q" METER TYPE 160A.

Frequency range 50 kc/s to 50 mc/s. "Q" range 0-250 with multiplier of 2.5. Main tuning capacitor 30-500pF with separate ± 3pF interpolating capacitor. Power supply 220/250VAC, £75. Carriage 30/-.

AVO VALVE TESTER MODEL 3.

Measurement of mutual conductance 0-100mA/V in four ranges. Screen 0-300v., panelled 0-400v., grid 0-100v., Filament 0/126v. Insulation 0/10m ohms. Rectifying valves and signal diodes can be tested under load conditions, short circuiting of electrodes and cathode. Insulation can also be measured. Complete with data book £45. Carriage 30/-.

RANK STUDIO WOW AND FLUTTER METER TYPE 1740.

£105. Carriage 7/6.

MARCONI VIDEO OSCILLATOR TF 885A.

Sine wave output 25 c/s to 5 Mc/s in 2

VALVES

AR8	5/-	EC92	5/8
AR3	3/-	EC93	5/8
ARP12	3/6	EC94	6/-
ARTP1	6/-	EC95	5/6
ATP4	2/3	EC96	8/-
BD78	4/8	EC97	7/-
BL63	10/-	EC189	9/8
BT35	15/-	ECF80	6/8
BT45	15/0	ECF82	6/8
BT83	35/-	ECF85	11/-
CV102	3/-	ECF86	10/-
CV103	4/-	ECF87	7/6
CV315	6/-	ECF88	7/6
(matched pairs) 120/-		ECF89	8/6
CV315	6/-	ECF90	7/6
(single) 60/-		ECF91	3/6
CY31	7/6	ECF92	10/9
D41	3/3	ECF93	10/9
D77	3/3	ECF94	10/9
DAF90	5/8	ECF95	13/6
DAF96	7/8	ECF96	13/6
DD41	4/-	ECF97	13/6
DET20	2/-	ECF98	13/6
DET25	10/-	ECF99	13/6
DF91	3/-	ECF100	13/6
DF92	2/6	ECF101	13/6
DF96	7/8	ECF102	13/6
DK92	7/8	ECF103	13/6
DL63	8/-	ECF104	13/6
DL92	4/8	ECF105	13/6
DL93	4/8	ECF106	13/6
DL94	6/8	ECF107	13/6
DL96	6/8	ECF108	13/6
DL810	12/-	ECF109	13/6
LY88	6/8	ECF110	13/6
DY87	6/8	ECF111	13/6
EB0F	18/-	ECF112	13/6
EB0K	18/-	ECF113	13/6
EB0O	8/8	ECF114	13/6
EB11	7/8	ECF115	13/6
EB20C	7/8	ECF116	13/6
EB20E	7/8	ECF117	13/6
EB20F	7/8	ECF118	13/6
EB20G	7/8	ECF119	13/6
EB20H	7/8	ECF120	13/6
EB20I	7/8	ECF121	13/6
EB20J	7/8	ECF122	13/6
EB20K	7/8	ECF123	13/6
EB20L	7/8	ECF124	13/6
EB20M	7/8	ECF125	13/6
EB20N	7/8	ECF126	13/6
EB20O	7/8	ECF127	13/6
EB20P	7/8	ECF128	13/6
EB20Q	7/8	ECF129	13/6
EB20R	7/8	ECF130	13/6
EB20S	7/8	ECF131	13/6
EB20T	7/8	ECF132	13/6
EB20U	7/8	ECF133	13/6
EB20V	7/8	ECF134	13/6
EB20W	7/8	ECF135	13/6
EB20X	7/8	ECF136	13/6
EB20Y	7/8	ECF137	13/6
EB20Z	7/8	ECF138	13/6
EB20A	7/8	ECF139	13/6
EB20B	7/8	ECF140	13/6
EB20C	7/8	ECF141	13/6
EB20D	7/8	ECF142	13/6
EB20E	7/8	ECF143	13/6
EB20F	7/8	ECF144	13/6
EB20G	7/8	ECF145	13/6
EB20H	7/8	ECF146	13/6
EB20I	7/8	ECF147	13/6
EB20J	7/8	ECF148	13/6
EB20K	7/8	ECF149	13/6
EB20L	7/8	ECF150	13/6
EB20M	7/8	ECF151	13/6
EB20N	7/8	ECF152	13/6
EB20O	7/8	ECF153	13/6
EB20P	7/8	ECF154	13/6
EB20Q	7/8	ECF155	13/6
EB20R	7/8	ECF156	13/6
EB20S	7/8	ECF157	13/6
EB20T	7/8	ECF158	13/6
EB20U	7/8	ECF159	13/6
EB20V	7/8	ECF160	13/6
EB20W	7/8	ECF161	13/6
EB20X	7/8	ECF162	13/6
EB20Y	7/8	ECF163	13/6
EB20Z	7/8	ECF164	13/6
EB20A	7/8	ECF165	13/6
EB20B	7/8	ECF166	13/6
EB20C	7/8	ECF167	13/6
EB20D	7/8	ECF168	13/6
EB20E	7/8	ECF169	13/6
EB20F	7/8	ECF170	13/6
EB20G	7/8	ECF171	13/6
EB20H	7/8	ECF172	13/6
EB20I	7/8	ECF173	13/6
EB20J	7/8	ECF174	13/6
EB20K	7/8	ECF175	13/6
EB20L	7/8	ECF176	13/6
EB20M	7/8	ECF177	13/6
EB20N	7/8	ECF178	13/6
EB20O	7/8	ECF179	13/6
EB20P	7/8	ECF180	13/6
EB20Q	7/8	ECF181	13/6
EB20R	7/8	ECF182	13/6
EB20S	7/8	ECF183	13/6
EB20T	7/8	ECF184	13/6
EB20U	7/8	ECF185	13/6
EB20V	7/8	ECF186	13/6
EB20W	7/8	ECF187	13/6
EB20X	7/8	ECF188	13/6
EB20Y	7/8	ECF189	13/6
EB20Z	7/8	ECF190	13/6
EB20A	7/8	ECF191	13/6
EB20B	7/8	ECF192	13/6
EB20C	7/8	ECF193	13/6
EB20D	7/8	ECF194	13/6
EB20E	7/8	ECF195	13/6
EB20F	7/8	ECF196	13/6
EB20G	7/8	ECF197	13/6
EB20H	7/8	ECF198	13/6
EB20I	7/8	ECF199	13/6
EB20J	7/8	ECF200	13/6

GI/370K	20/-
G50/24	20/-
G120/1B	25/-
GM4	45/-
GU50	28/-
GZ32	9/8
CZ24	11/8
H30	3/6
HL23DD	
HL41	4/-
HVR2	9/-
KT93	32/8
KT63	4/-
KT66	21/-
KT67	45/-
KT71	7/6
KT76	7/-
KT88	29/-
KT263	7/-
L63	3/6
MH4	5/-
MH41	8/-
WHLD6	7/6
ML6	6/-
N34	8/-
N73	25/-
OA2	6/-
OB2	6/-
OB3	9/-
OC3	6/8
OD3	6/8
OZAA	5/-
PACB80	7/6
PC86	10/3
PC97	9/-
PC900	9/8
PC984	6/8
PC989	6/8
PC990	6/8
PC991	6/8
PC992	6/8
PC993	6/8
PC994	6/8
PC995	6/8
PC996	6/8
PC997	6/8
PC998	6/8
PC999	6/8
PC1000	6/8
PC1001	6/8
PC1002	6/8
PC1003	6/8
PC1004	6/8
PC1005	6/8
PC1006	6/8
PC1007	6/8
PC1008	6/8
PC1009	6/8
PC1010	6/8
PC1011	6/8
PC1012	6/8
PC1013	6/8
PC1014	6/8
PC1015	6/8
PC1016	6/8
PC1017	6/8
PC1018	6/8
PC1019	6/8
PC1020	6/8
PC1021	6/8
PC1022	6/8
PC1023	6/8
PC1024	6/8
PC1025	6/8
PC1026	6/8
PC1027	6/8
PC1028	6/8
PC1029	6/8
PC1030	6/8
PC1031	6/8
PC1032	6/8
PC1033	6/8
PC1034	6/8
PC1035	6/8
PC1036	6/8
PC1037	6/8
PC1038	6/8
PC1039	6/8
PC1040	6/8
PC1041	6/8
PC1042	6/8
PC1043	6/8
PC1044	6/8
PC1045	6/8
PC1046	6/8
PC1047	6/8
PC1048	6/8
PC1049	6/8
PC1050	6/8

U26	14/6
U27	8/-
U28	4/6
U29	8/-
U30	8/-
U31	14/-
U32	8/-
U33	8/-
U34	8/-
U35	8/-
U36	8/-
U37	8/-
U38	8/-
U39	8/-
U40	8/-
U41	8/-
U42	8/-
U43	8/-
U44	8/-
U45	8/-
U46	8/-
U47	8/-
U48	8/-
U49	8/-
U50	8/-
U51	8/-
U52	8/-
U53	8/-
U54	8/-
U55	8/-
U56	8/-
U57	8/-
U58	8/-
U59	8/-
U60	8/-
U61	8/-
U62	8/-
U63	8/-
U64	8/-
U65	8/-
U66	8/-
U67	8/-
U68	8/-
U69	8/-
U70	8/-
U71	8/-
U72	8/-
U73	8/-
U74	8/-
U75	8/-
U76	8/-
U77	8/-
U78	8/-
U79	8/-
U80	8/-
U81	8/-
U82	8/-
U83	8/-
U84	8/-
U85	8/-
U86	8/-
U87	8/-
U88	8/-
U89	8/-
U90	8/-
U91	8/-
U92	8/-
U93	8/-
U94	8/-
U95	8/-
U96	8/-
U97	8/-
U98	8/-
U99	8/-
U100	8/-

3Q4	7/8
3Q4GT	6/-
3Q4GT	5/9
3V4	8/-
4D1	4/-
5A173G	5/-
5A174G	5/-
5B251M40	4/-
5B252M35	4/-
5B254M36	4/-
5B255M36	4/-
5B256M36	4/-
5B257M36	4/-
5B258M36	4/-
5B259M36	4/-
5B260M36	4/-
5B261M36	4/-
5B262M36	4/-
5B263M36	4/-
5B264M36	4/-
5B265M36	4/-
5B266M36	4/-
5B267M36	4/-
5B268M36	4/-
5B269M36	4/-
5B270M36	4/-
5B271M36	4/-
5B272M36	4/-
5B273M36	4/-
5B274M36	4/-
5B275M36	4/-
5B276M36	4/-
5B277M36	4/-
5B278M36	4/-
5B279M36	4/-
5B280M36	4/-
5B281M36	4/-
5B282M36	4/-
5B283M36	4/-
5B284M36	4/-
5B285M36	4/-
5B286M36	4/-
5B287M36	4/-
5B288M36	4/-
5B289M36	4/-
5B290M36	4/-
5B291M36	4/-
5B292M36	4/-
5B293M36	4/-
5B294M36	4/-
5B295M36	4/-
5B296M36	4/-
5B297M36	4/-
5B298M36	4/-
5B299M36	4/-
5B300M36	4/-



THE VALVE WITH A GUARANTEE

28D7	6/-	957	5/-
30C15	15/-	988A	4/-
30C17	16/-	991	6/-
30C18	15/-	1622	17/-
30P5	18/-	1625	6/-
30FL1	15/-	1629	4/8
30FL2	19/-	2051	5/-
30FL3	9/3	2729	25/-
30FL4	15/8	4043C	35/-
30FL5	17/-	4313C	20/-
30FL6	17/-	5878	10/-
30FL7	16/-	5878	10/-
30FL8	14/-	5896	6/-
30FL9	14/-	5704	9/-
30FL10	14/-	5726	7/-
30FL11	18/8	5833	22/6
33A/101K	8/-	6057	10/-
6064	7/6	6066	7/6
35V4	5/-	6065	9/-
35Z4	10/-	6080	27/8
35Z4GT	8/-	6146	28/-
35Z4GT	8/-	8013A	35/-
35Z4GT	8/-	8020	30/-
35Z4GT	8/-	9001	3/-
35Z4GT	8/-	9002	4/6
35Z4GT	8/-	9003	5/8
35Z4GT	8/-	9004	2/6
35Z4GT	8/-	9006	2/6
35Z4GT	8/-	9007	2/6
35Z4GT	8/-	9008	2/6
35Z4GT	8/-	9009	2/6
35Z4GT	8/-	9010	2/6
35Z4GT	8/-	9011	2/6
35Z4GT	8/-	9012	2/6
35Z4GT	8/-	9013	2/6
35Z4GT	8/-	9014	2/6
35Z4GT	8/-	9015	2/6
35Z4GT	8/-	9016	2/6
35Z4GT	8/-	9017	2/6
35Z4GT	8/-	9018	2/6
35Z4GT	8/-	9019	2/6
35Z4GT	8/-	9020	2/6
35Z4GT	8/-	9021	2/6
35Z4GT	8/-	9022	2/6
35Z4GT	8/-	9023	2/6
35Z4GT	8/-	9024	2/6
35Z4GT	8/-	9025	2/6
35Z4GT	8/-	9026	2/6
35Z4GT	8/-	9027	2/6

1. ULTRASONIC CLEANERS



(Burndept B.E.352) 60 watt model. Supplied Brand New complete with stainless steel tank 9½ x 6½ x 4½ in. £60. Carr. 20/-.

2. **FAST NEUTRON MONITORS** (Burndept 1407C) for measuring neutrons in the energy range 0.15-15 meV. £100.

3. **Radiation Monitors** (Burndept BN 110 MK. V) 0-5/50/500/5k. c.p.s. Brand new. £100. Alpha and Beta Gamma probes available at extra cost.

4. **PORTABLE RAOIATION MONITORS** (Burndept BN 132) 0-5/50/500/5k c.p.s. With built-in Gamma probe. Brand new. £50 complete with carrying harness.

S.A.E. for literature. 10% discount for Educational Authorities.

HIGH SPEED MAGNETIC COUNTERS



(4 x 1 x 1 in.) 4 digit. 6/12v. 24/48v. (state which), 6/6 ea. P.P. 1/-.

COPPER LAMINATE PRINTED CIRCUIT BOARD

(8½ x 5½ x 1/16 in.), 2/6 sheet, 5 for 10/-.
Also 11 x 9 in., 4/- ea., 3 for 10/-.

BULK COMPONENT OFFERS

100 Capacitors (latest types) 50pF to .5µF.
250 Resistors ½ and ¼ watt.
250 Resistors ½ and 1 watt.
150 Hi-Stab Resistors, ½, ¼ and 1 watt.
25 Vitreous W/W Resistors, 5%.
12 Precision Resistors .1% (several standards included).
12 Precision Capacitors 1 and 2% (several standards included).
12 Electrolytics (miniature and standard sizes).
ANY ITEM 12/6. ANY 5 ITEMS 50/-.

LARGE CAPACITY ELECTROLYTICS.

2,000 µF. 30v.; 2,500 µF. 25v.; 2,500 µF. 50v.; 4,000 µF. 90v.; 5,000 µF. 25v.; 7/6 ea. 5,000 µF. 50v.; 10,000 µF. 30v.; 16,000 µF. 10v. 10/- ea. p.p. 1/-

SPEAKER BARGAINS. E.M.I. 13 x 8 in. with double Tweeters 15 ohm, 65/-, P.P. 5/-; 4. As above less tweeters 3 or 15 ohm, 45/- ea., P.P. 5/-.

FANE 12 in. 20 watt (Dual Cone), £8. P.P. 5/-.

CAR RADIO SPEAKER 7 x 4 in. 3/5 ohm. 15/- ea. P.P. 2/6

PYE OHMMETER TYPE 10B.

500v. test. .3 meg. ohm—20 k. meg. ohm. 200/250v. A.C. Brand new Instrument £30. P.P. 30/-.

POT CORES TYPE LA 3. 10/- ea.

71 WAY PLUG & SOCKET (Painton Series 159). Gold plated contacts with hood & retaining clips. 30/- pair.

50 WAY PLUG & SOCKET (U.C.L. miniature). Gold plated contacts 20/- pair. 34 way version 15/- pair.

VALVE MILLIVOLTMETER (Marconi TF899) 0-2v. complete with R.F. probe £8/10/- p.p. 10/-.

LOGIC BOARDS with 31 ACY40s—38 diodes etc. 20/- ea. P.P. 2/6.

CO-AX RELAYS (magnetic devices) 1 change-over 12 v.w. 20/- ea.

SOLARTRON PULSE GENERATORS (OPS 100C) 50c/s-1m/c. £60 each. Carriage 50/-

WOBBULATORS TYPE 210 (Matrix) 0-220 M/c. Sweep width 1/2/5/10/20 m/c. £40. Carriage 30/-.

TELEPHONE DIALS (New) 20/- ea.



Amplified TELEPHONE HANSET (706) 27/6. P.P. 2/6.

EXTENSION TELEPHONE (Type 706) Black or 2 tone Grey. 65/-, P.P. 5/-.

UNISELECTORS (Brand new) 25-way 75 ohm. 8 bank ½ wipe 65/-. 10 bank ½ wipe 75/-.

REED RELAYS 4 make 9/12v. (1,000 ohm.) 12/6 ea. 2 make 7/6 ea. 1 make 5/- ea. Reed Switches (1½ in.) 2/- ea. £1 per doz.

EXTRACTOR/BLOWER FANS (Papst)



100 c.f.m. 4½ x 4½ x 2 in.
2800 r.p.m. Wonderful buy at 50/- ea. 240v. A.C.

TRANSFORMERS

H.T. TRANSFORMER (Parmeko 'Neptune') Prim. 200/250v. Sec. 350-0-350v. 150 m.a. 6.3v. @ 1/2/6 amp. 35/-, P.P. 5/-, Matching Choke 10h 180 m.a. 12/6.

E.H.T. TRANSFORMER (Parmeko 'Neptune') 3,000v 280 m.a. £12/10/0. P.P. 50/-.

L.T. TRANSFORMERS Prim. 200/250v. Sec. 0-1/0-3/0-9/0-27v. 30 amp. £7.10. 15 amp. £5. P.P. 15/-.

L.T. TRANSFORMER Prim. 200/250v. Sec. 0/25/35v 30 amp. £7.10. P.P. 20/-.

STEP-DOWN TRANSFORMERS Prim. 200/250v. Sec. 115v. 1.25 amps, 25/- ea. P.P. 5/-.

L.T. TRANSFORMERS Prim. 240v. Sec. 8/12/20/25v. 3.5 amp models 20/-; 5 amp model 25/-, P.P. 5/6.

L.T. TRANSFORMERS Prim. 240v. Sec. 14v. 1 amp 10/- ea. P.P. 2/6.

ELECTRIC SLOTMETERS (1/-) 25 amp. L.R. 240v. A.C. 85/- ea. P.P. 5/-.

QUARTERLY ELECTRIC CHECK METERS, 40 amp 240v. A.C., 20/- ea. P.P. 5/-.

CONTINUOUS LEVEL MONITORS (Burndept BE307) complete with Sensing Probe. £25.

Transistorised PROXIMITY SWITCHES (Burndept BE315) sensing speed 120 per min. £16.

LEVEL CONTROLLER (Burndept BE305). £8.

LIGHT SWITCH. COUNTER. (Burndept BE290) 750 Interruption per min., comprises: Light Source, Sensing Head, Control Unit. £15.
S.A.E. Literature.

PATRICK & KINNIE

81 PARK LANE · ROMFORD · ESSEX
ROMFORD 44473

NEW PRICES ON NEW COMPONENTS

RESISTORS

High stability, carbon film, low noise. Capless construction, molecular termination bonding.
Dimensions (mm.): Body: ¼W: 8 x 2.8
¼W: 10 x 4.3
Leads: 35

10% ranges: 10 Ohms to 10 Megohms (E12 Renard Series).
5% ranges: 4.7 Ohms to 1 Megohm (E24 Renard Series).
Prices—per Ohmic value.

¼W	10%	each	10 off	25 off	100 off
¼W	5%	2d.	1/6	3/3	10/4
¼W	5%	2½d.	1/9	3/8	11/8
¼W	10%	2½d.	1/9	3/8	11/7
¼W	5%	3d.	2/-	4/-	12/10

CAPACITORS

Subminiature Polyester film. Modular for P.C. mounting. Hard epoxy resin encapsulation. Radial leads.
±10% tolerance. 100 Volt working.
Prices—per Capacitance value (µF)

0-001, 0-002, 0-005, 0-01, 0-02 ..	each	10 off	25 off	100 off
0-05	6d.	4/3	8/4	30/-
0-1	8d.	6/-	12/6	41/8
0-2	10d.	7/1	15/6	51/-
0-2	1/2	10/-	20/10	68/6

Polystyrene film. Tubular. Axial leads. Unencapsulated ±5% or ±1pf tolerance.
160 Volt Working.
Prices—per Capacitance value (µF)

10, 12, 15, 18, 22, 27, 33, 39, 47, each	10 off	25 off	100 off	
56, 68, 82, 100, 120, 180, 220, 270, 330, 390	5d.	3/7	7/9	24/-
470, 560, 680, 820, 1,000, 1,500 6d.	4/-	8/8	26/8	
2,200, 3,300, 4,700, 5,600	7d.	5/-	10/10	
6,800, 8,200, 10,000, 15,000	8d.	6/-	13/-	
22,000	9d.	6/9	18/-	

POTENTIOMETERS (Carbon)

Superior grade enclosed controls. Low rotational noise. Body dia., 1in. Spindle, 2in. x ¼in. Tolerance, 20%.
Linear: 1K to 2M. (¼W at 40°C).
Logarithmic: 5K to 2M. (¼W at 40°C).
Prices per ohmic value

each	10 off	25 off	100 off
2/-	18/4	41/8	150/-

GANGED STEREO POTENTIOMETERS (Carbon)

¼W at 70°C. Long Spindle.
Logarithmic and Linear: 5k + 5k to 1M + 1M.
Prices per ohmic value

each	10 off	25 off	100 off
8/-	70/-	162/6	575/-

SKELETON PRE-SET POTENTIOMETERS (Carbon)

High quality pre-sets suitable for printed circuit boards of 0.1in. P.C.M. 100 ohms to 5 Megohms (Linear only). Miniature: 0-3W at 70°C, ±20% below ¼M, ±30% above ¼M. Horizontal (0-7in + 0.4in. P.C.M.) or Vertical (0-4in. x 0.2in. P.C.M.). Subminiature: 0-1W at 70°C, ±20% below 2-5M, ±30% above.

Prices—per ohmic value

each	10 off	25 off	100 off
1/-	8/9	18/9	66/8
10d.	7/1	14/7	46/8

ELECTROLYTIC CAPACITORS (Mullard)

—10% to +50%.
Subminiature (all values in µF)

4V	8	32	64	125	250	400
6-4V	6-4	25	50	100	200	320
10V	4	16	32	64	125	200
16V	2-5	10	20	40	80	125
25V	1-6	6-4	12-5	25	50	80
40V	1	4	8	16	32	50
64V	0-84	2-5	5	10	20	32
Price	1/4	1/3	1/2	1/-	1/1	1/2

POLYESTER CAPACITORS (Mullard)

Tubular 10%, 160V: 0-01, 0-015, 0-022µF, 7d. 0-033, 0-047 µF, 8d. 0-068, 0-1 µF, 9d. 0-15 µF, 11d. 0-22 µF, 1/-, 0-33 µF, 1/3. 0-47 µF, 1/6. 0-68 µF, 2/3. 1 µF, 2/8. 400V: 1,000, 1,500, 2,200, 3,300, 4,700pF, 6d. 6,800pF, 0-01, 0-015, 0-022 µF, 7d. 0-033 µF, 8d. 0-047 µF, 9d. 0-068, 0-1 µF, 11d. 0-15 µF, 1/2. 0-22 µF, 1/6. 0-33 µF, 2/3. 0-47 µF, 2/8.

SEMICONDUCTORS:

0A5, 0A81, 1/9, 0C44, 0C45, 0C71, 0C81, 0C81D, 0C82D, 2/-, 0C70, 0C72, 2/3. AC107, 0C170, 0C171, 2/6. AF115, AF116, AF117, ACY19, ACY21, 3/3. OC140, 4/3. OC200, 5/-, OC139, 5/3. OC25, 7/-, OC35, 8/-, OC23, OC28, 8/3.

SILICON RECTIFIERS (0-5A):

170 P.I.V., 2/9. 400 P.I.V., 3/-, 800 P.I.V., 3/3. 1,250 P.I.V., 3/9. 1,500 P.I.V., 4/-, (6A): 200 P.I.V., 3/-, 400 P.I.V., 4/-, 600 P.I.V., 5/-, 800 P.I.V., 6/-.

PRINTED CIRCUIT BOARD (Vero).

0-15in. Matrix: 3½in. x 2½in., 3/3. 5½in. x 2½in., 3/11. 3½in. x 3½in., 3/11. 5in. x 3½in., 5/6. 0-1 Matrix: 3½in. x 2½in., 4/-, 5in. x 2½in., 4/6. 3½in. x 3½in., 4/6. 5in. x 3½in., 5/3.

SEND S.A.E. FOR 1969 CATALOGUE

DUXFORD ELECTRONICS

97/97A MILL ROAD, CAMBRIDGE

Telephone: CAMBRIDGE (0223) 63687
(Visit us at our new Mail Order, Wholesale and Retail Premises)
MINIMUM ORDER VALUE 5/- C.W.O. Post and Packing 1/6

a complete stereo system for 28 gns



The new Duo general-purpose 2-way speaker system is beautifully finished in polished teak veneer, with matching wynaïr grille. It is ideal for wall or shelf mounting either upright or horizontally.

Type 1 SPECIFICATION:—
 Impedance 10 ohms. It incorporates Goodmans high flux 6" x 4" speaker and 2 1/4" tweeter. Teak finish 12" x 6 1/2" x 5 1/2", 4 guineas each. 7/6d. p. & p. Type 2 as type 1, size 17 1/2" x 10 1/2" x 6 1/2". Incorporating Elac 10 1/4" x 6 1/2" 10,000 lines and 2 1/4" tweeter. 3 ohms Impedance 5 1/2 gns + 7/6 p. & p.
 Garrard Changers from £7.19.6d. p. & p. 7/6d. Cover and Teak finish Plinth £4.15.0d. 7/6d. p. & p.

The Duo Integrated Transistor Stereo Amplifier **9 GNS.** - 7/6 p. & p.
 The Duo is a good quality amplifier, attractively styled and finished. It gives superb reproduction previously associated with amplifiers costing far more.

SPECIFICATION:—
 R.M.S. power output: 3 watts per channel into 10 ohms speakers.
INPUT SENSITIVITY: Suitable for medium or high output crystal cartridges and tuners. Cross-talk better than 30dB at 1Kc/s.
CONTROLS: 4-position selector switch (2 pos. mono & 2 pos. stereo) dual ganged volume control.
TONE CONTROL: Treble lift and cut. Separate on/off switch. A preset balance control.



The Classic Teak finished case **8 1/2 GNS.** plus 7/6 p. & p.

SPECIFICATION:— Sensitivities for 10 watt output at 1 KHz. Tape Head: 3mV (at 3 1/2 i.p.s.) Mag. P.U.: 2 mV. Cer.P.U.: 80 mV. Radio: 100mV. Aux. 100 mV. Tape/Rec. Output: 100 mV. Equalisation for each input is correct to within +2dB (R.I.A.A.) from 20 Hz to 20KHz. Tone Control Range: Bass +13 dB at 60 Hz. Treble +14 dB at 15 KHz. Total Distortion: (for 10 watt output) <1.5%. Signal Noise: <-60dB. AC Mains 200-250v. Size 12 1/2" long, 4 1/2" deep, 2 1/2" high. Built and tested.



The Viscount Integrated High Fidelity Transistor Stereo Amplifier **13 1/2 GNS.** + 7/6 p. & p.

SPECIFICATION:—
OUTPUT: 10 watts per channel into 3 to 4 ohms speakers (20 watts) monoral.
INPUT: 6-position rotary selector switch (3 pos. mono and 3 pos. stereo). P.U. Tuner. Tape and Tape Rec. out. Sensitivities: All inputs 100mV into 1.8M ohm.
FREQUENCY RESPONSE: 40Hz-20KHz ±2dB.
TONE CONTROLS: Separate bass and treble controls. TREBLE 13dB lift and out [at 15KHz] BASS 15dB lift and 25dB cut [at 60Hz].
VOLUME CONTROLS: Separate for each channel.
AC MAINS INPUT: 200-240v. 50-60Hz.
SIZE: 12 1/2" x 6" x 2 1/2" In teak-finished case. Built and tested. p & p 7/6d.
 Viscount Mark II for use with magnetic pick ups specification as above. Fully equalised for magnetic pick ups. Suitable for cartridges with minimum output of 4mV/cm/sec. at 1kc. Input Impedance 47k. **15 gns** plus 7/6 p&p.

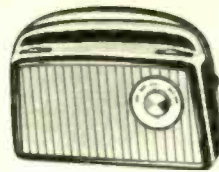

THE DORSET (600mW Output)

7-transistor fully tunable M.W.-L.W. superhet portable—with baby alarm facility. Set of parts. The latest modularized and pre-alignment techniques makes this simple to build. Sizes: 12" x 8" x 3".

MAINS POWER PACK KIT: 9/6 extra.

Price **£5.5.0** plus 7/6 p. & p. Circuit 2/6. FREE WITH PARTS

The ELEGANT SEVEN MK. III (350mW Output)

7-transistor fully tunable M.W.-L.W. portable. Set of parts. Complete with all components, including ready etched and drilled printed circuit board—back printed for foolproof construction.

MAINS POWER PACK KIT: 9/6 extra.

Price **£4.9.6** plus 7/6 p. & p. Circuit 2/6. FREE WITH PARTS

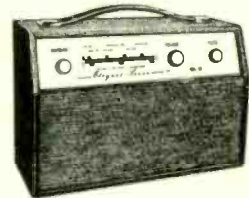

X101 10w. SOLID-STATE HI-FI AMP WITH INTEGRAL PRE-AMP.

Specifications: Power Output (into 3 ohms speaker) 10 watts. Sensitivity (for rated output): 1mV into 3K ohms (0.33 microamp) Total Distortion (at 1 KHz): At 5 watts 0.35%. At rated output 1.5%. Frequency Response: Minus 3 dB points 20 Hz and 40 KHz. Speaker: 3-4 ohms. (3-15 ohms may be used). Supply voltage: 24v D.C. at 800 mA. (6-24V. may be used).

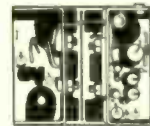

Price **69/6** plus 2/6 p. & p.

CONTROL ASSEMBLY: (Including resistors and capacitors). 1. Volume: Price 5/-. 2. Treble: Price 5/-. 3. Comprehensive bass and treble: Price 10/-. The above 3 items can be purchased for use with the X101. **POWER SUPPLIES FOR X101:** P101 M (mono) 35/- p. & p. 4/6. P101 (stereo) 42/6 p. & p. 4/6.



50 WATT AMPLIFIER AC MAINS 200-250V

An extremely reliable general purpose valve Amplifier—with six electronically mixed inputs. Suitable for use with: mics, guitars, gram, tuner, organ, etc. Separate bass and treble controls. Output Impedance 3, 8 and 15 ohms.

Price **27 gns.** plus 20/- p. & p.



THE RELIANT

Solid State General Purpose Amplifier

SPECIFICATION:—
OUTPUT: 10 watts into a 3 ohms speaker.
INPUTS: (1) for mike (10 m.v.). Input (2) for gram, radio (250 m.v.) individual bass and treble control.
TRANSISTORS: 4 silicone and three germanium.
MAINS INPUT: 220/250 volts.
SIZE: 10 1/2" x 4 1/2" x 2 1/2".
MIKE TO SUIT (CRYSTAL): 12/6d. + 1.0d p. & p.
 8" x 5" speaker 14/6d. + 3/- p. & p.
 Mk.I 5 1/2 gns + 7/6 p. & p. Less teak-finished case.
 Mk.II **6 1/2 gns** + 7/6 p. & p. In teak-finished case.

CYLDON 2 TRANSISTOR U.H.F. TUNER

Brand new. Complete with circuit diagram. **£2.10** +1/- p. & p.

CAR TRANSISTOR IGNITION SYSTEM

(by famous manufacturer)
 For 6 volt or 12 volt positive earth systems. Comprising: special high voltage working hermetically sealed silicon transistor mounted in finned heat-sink, high output ignition coil, ballast resistor and hardware (screws, washers, etc.)
 Price **£4.19.6** p. & p. 5/- extra.



MOTEK

3 Speed 2 track Tape Deck complete with heads, takes 7in. spool. Incorporating 3 motors. A.C. mains, 240 volts. listed at £21.0.0.

Our Price **£9.19.6** plus 10/- p. & p.

Goods not despatched outside U.K. Terms C.W.O. All enquiries stamped addressed envelope.

RADIO & TV COMPONENTS (ACTON) LIMITED
 21a High Street, Acton, London, W.3. and also at 323 Edgware Road, London, W.2.

PYE CAR-RADIO PUSH BUTTON TUNING HEART

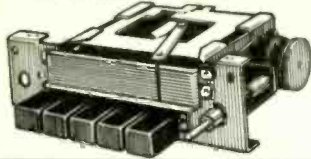

25/- + 3/- p. & p. This PRESTOLOCK 5 station Push-Button Tuner Heart with Manual Over-ride is an ideal basis for a quality AM car radio. Size $6\frac{1}{2}'' \times 4'' \times 2''$.

GARRARD TAPE MOTORS

39/6 per pair + 7/6 p. & p.

Fast forward and fast re-wind motors, as used by famous manufacturer. Size $3'' \times 2\frac{1}{2}'' \times 2\frac{3}{4}''$. Spindle $\frac{3}{8}''$ AC Mains 250v.

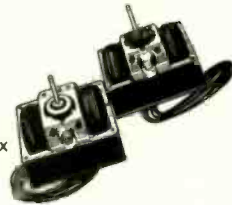

ADVANCE CONSTANT VOLTAGE TRANSFORMER

Price **22/6** p. & p. 7/6. Output 7.5 volts at 1 amp and 30v. at 100 MA. Mains input 125 volts (2 can be used in series for 250 volts).

LIVINGSTONE LAB

50 watt RMS Base Transistor Amplifier

27 Gns. plus 20/- p. & p. This amplifier is designed and manufactured by L.L. using the best quality components, thus making it an extremely reliable and almost indestructible. Size (Power supply) $16'' \times 9\frac{1}{2}'' \times 6\frac{1}{2}''$ (Amplifier) $14\frac{1}{2}'' \times 9'' \times 4''$ sensitivity for rated output 1 volt.

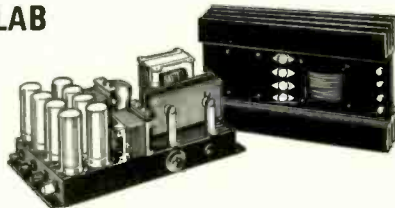

QUALITY MAINS TRANSFORMER

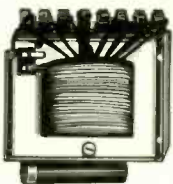

35/- p. & p. 7/6. Input 250 volts. OUTPUT (All RMS values) 4 windings of 11.5 volts connected in series total 46 volts at 4.5 amps (conservatively rated). The following combinations may be used.

1. 23—0—23 volts
2. 46 volts

Both of these above voltages are commonly used in medium to high powered transistor amplifiers, power supplies, etc.

SPECIAL OFFER!

Complete stereo systems comprising BALFOUR 4 speed auto player with stereo head 2 duo speaker systems size $12 \times 6\frac{3}{4} \times 5\frac{3}{4}$, Plinthe (less cover) and the DUETTO stereo amplifier. All above items 19 GNS. plus 20/-.

Goods not despatched outside U.K. Terms C.W.O. All enquiries SAE.

RADIO & TV COMPONENTS (ACTON) LIMITED

21A High Street, Acton, London, W.3

Orders by post to our Acton address please.

Also at 323 Edgware Road, London, W2.

WAREHOUSE CLEARANCE SALE — EVERYTHING MUST GO

MINIATURISED TRANSISTORISED B.F.O. UNITS. This small fully transistorised tunable BFO enables any set to receive CW or SSB reception. Compact single hole fixing. Full fitting details. Only **39/6** p.p. 2/6.

TRANSFORMER SALE. Type A. Mains 200/250 50 c/s Input. Output 5, 8, and 24v. at 3 amp. Price 7/6 p.p. 2/6. Two for 15/- post free. Four for 25/- post free. Six for 30/- post free. Type B. Mains input. Output 300v. at 100m.a. Also 300v. at 80 m.a. Plus 12.0.12 volts at 4 amps. Type C. Mains input. Output 300v. at 100 m.a. plus 12-0-12 volts at 4 amps. Type B. 39/6 post free. Type C 32/6 post free.

RHEOSTAT DIMMER UNITS. Will control up to 50v. at 3 amps. Compact metal case. Ideal for lab. work. Only 15/- p.p. 2/6. Two for 30/- post free.

HIGH QUALITY TANNOY MIKES (HEAVY DUTY). Ideal for P.A. work, combined with moving coil headset. Only 19/11 post free. Two sets 35/- post free.

IFT TRANSFORMER SETS. Comprising double tuned 1st and 2nd. 3rd IF single tuned. Only 12/6 per set of three post free.

PRINTED CIRCUIT SUPERHET CHASSIS. With circuit diagram. Ideal for TOP BAND uses standard components. Price 17/6 post free.

PRECISION PANEL METERS. Brand new and boxed and fully guaranteed. With fixing nuts and bolts. Size 3" square. TYPE A. 0-500v. FSD. price 32/6 each. Two for 55/- post free. TYPE B. 0-150 ma. Price 30/- each. Two for 50/- post free.

TANK AERIALS. Fully interlocking copper plated rods. One foot sections. Ideal for car or scooter aerials. Make excellent di-poles. Six sections 4/6. p.p. 1/6. 12 sections 10/- post free.

MATCHING MAINS P.S.U. for R1132 and 1392 receivers. Only **£2. 10s.** each, carr. 10/-. Absolutely brand new in makers' cartons.

TELEPHONE SPARES. 600 TYPE RELAYS. Only 3/6 each p.p. 1/-. Ten for £1 post free. EYEBALL INDICATORS. 6/- each. Four for £1 post free. TELEPHONE DIALS 4/6 each, p.p. 1/6. Four for £1 post free. STANDARD DESK TELEPHONES WITH DIAL. Not new but working. Only 17/6 each, p.p. 5/-. Two for 39/6 post free. Four for 75/- post free.

STABILISED POWER SUPPLY UNITS. Brand new units. Famous manufacture. Input 200/250v. 50 c/s AC. Output stabilised at 6, 7.5, and 9 volts DC. Also 250-300 volts DC at 100 m.a. plus 6 and 12 volts DC at 4 amps. Sturdy standard rack mounting cabinet. Price only **£8. 19s. 6d.** Carr. and insur. 10/6.

19 SET CONTROL BOXES. Brand new and boxed. 10/- p.p. 2/6. Two for £1 post free.

2 1/2" MOVING COIL SPEAKERS 3 ohms. Brand new. Only 4/11 p.p. 1/1. Two for 10/- post free. 30 mfd. 250v. **WIRE ENDED TUB ELECTROLYTIC CAPS.** £1 per doz. post free. 10 mfd 15v. working tag ended electrolytics. 1/6 each. 10/- per doz. post free.

GOVT. SURPLUS WIRELESS EQUIPMENT HANDBOOK. Gives Circuit details and information on most British and American Wireless equipment. Price 35/- post free.

HEAVY DUTY PETROL GENERATOR CHARGING SETS. Charges 6, 12, 24, 36v. battery arrangements at 35 amps. Four stroke engine. Nearly new. Cost Govt. £275 each. Our price **£25 10s.** carr. and insur. 90/-.

Dept. W.W.

GLOBE SCIENTIFIC LTD

38 Bridge End,
Meadow Lane, Leeds 1

USED ELECTRONIC INSTRUMENTS

M.I.T. KLYSTRON DRIVEN DIELECTRIC TEST SET (Brownly Labs, U.S.A.). Comprising: Square Wave generator. Type 8. RF Valve Voltmeter/Power Meter. Klystron power supply. Klystron and wave guide bench with verniers. Frequency 2.380MHz to 3,000MHz. Used as a dielectric test bench by N.P.L. Current new price around £3,000. Open to offer.

MARCONI E.H.F. SIGNAL GENERATOR SUPPLY UNIT XT71. Mounted in a 6" cabinet. Comprising: XTA 71 Pound Stabiliser (with power unit). XTA 73 3KV Stabilised power unit. XTA 72 700 Power Unit and Sweep Generator. XTA 74 250V Stabilised 400V Stabilised and 3KV Power Unit. XTA 75 AC Stabiliser. Instruction Manual. Open to offers. (Part of OA 1000 E.H.F. Signal Generator 9 to 8 mins.) 33.3 to 37.9 Mc/s

SOLARTON PULSE GENERATOR O.P.S. 100 C. Bench Model, modern style in very good order. Variable pulse amplitude 1-100V. Variable pulse width 1-250 micro sec. Rise Time 0.1 micro sec. P.R.F. 50Hz to 10KHz. Pulse delay behind trigger 2-4,000 micro sec. Instruction manual.

PULSE GENERATOR 1013D (EX MINISTRY). + on — output 1-50K. Rise Time 0 to 1,000 micro sec. Delay time 0 to 1,000 micro sec. Frequency 1Hz to 1KHz.

BARR & STROUD TUNED THERMOCOUPLE AMPLIFIER EL7921 with P.S.U. (EL7909 and cables, with tuned circuits 10Hz to 1,600Hz in 9 steps. Other frequencies can be easily made. Maximum gain 10*. Band width 9% of carrier frequency to 3db points. Output is a meter reading. Input will operate photocell as alternative to thermocouple. Instruction manual. £250.

AIRMEC MILLIVOLTMETER 784. Measures RF Millivolts or power in db to 1mV in 75 ohms, tested up to 30 Mc/s.

SUNVIC THERMOCOUPLE AMPLIFIERS. 3 off at £100 each.

LARGE HV POWER PACK (Manf. 1962). Stewart Transformer 10KV 600mA with 6 rectifier valves 10H at 650mA choke, 10H at 1A choke. Dubilier pulse forming network DN 371 50 ohm 20KV, peak pulse 2, 2, 6 micro secs. ditto unit 10 micro secs. £400.

BUTLER RADIO MULTI CHANNEL ANALYSER. 6 ft. cabinet with 10 sections each with 20 dekatrons CV 2271, 10 counters 48V50DECO, 10 valves ECC81. Also scaling unit, display unit, power unit, pulse height analyser, coding unit. Offers.

STRATOSPHERE CABINET. Kelvinator + 100 to -70°C. Vacuum to 80". Cabinet approx. 24" cube. Current price around £8,000. One only £1,000.

EDWARDS/A.E.I. ELECTRON BEAM FURNACE. £2,500 or £1,950 as seen. 9" Edwards pumping system for chamber. All power supplies and accessories. Beam current 1 amp max. Voltage 20KV max.

V. N. BARRETT & CO. LTD.

1 MAYO ROAD, CROYDON, SURREY.

CRO 2QP
FREE CATALOGUE

TELEPHONE: 01-684 9917-8-9

L.S.T. ELECTRONIC COMPONENTS LTD.

SEMI-CONDUCTORS, BRAND NEW AND FULLY GUARANTEED

1N914	2/-	2N4255	8/4	BC211	10/4	OC19	5/4	
1S113	3/-	2S018	8/4	BD121	19/4	OC20	33/-	
1S120	2/4	2S024	25/-	BD123	23/4	OC22	13/-	
1S130	2/4	2S034	15/-	BD124	17/-	OC23	15/-	
1S131	2/4	AC107	14/6	BF152	13/4	OC24	10/-	
1S132	2/6	AC126	6/6	BF154	8/-	OC25	6/8	
2G301	4/-	AC127	6/-	BF159	18/-	OC26	12/-	
2G302	3/0	AC128	4/-	BF163	9/-	OC28	12/-	
2G339A	5/-	AC176	7/6	BF167	6/8	OC29	15/-	
2G374	5/-	AC187	12/-	BF173	7/6	OC30	7/-	
2G381	5/-	AC188	12/-	BF181	7/-	OC35	9/6	
2G371	3/-	AC17	5/8	BF184	7/4	OC36	13/-	
2N385A	15/-	AC18	3/4	BFW57	7/4	OC41	3/6	
2N388A	15/-	AC19	4/4	BFW58	7/4	OC42	4/-	
2N494	6/-	AC20	3/8	BFW59	6/4	OC44	3/-	
2N497	4/-	AC21	2/4	BFW60	6/4	OC45	3/-	
2N498	4/4	AC22	2/4	BFK13	4/8	OC71	3/-	
2N706	3/-	AD140	15/-	BFK29	8/5	OC72	4/6	
2N706A	6/6	AD149	11/8	BFY50	6/-	OC73	3/-	
2N708	4/-	AD161	4/-	BFY51	6/-	OC75	5/-	
2N711	7/4	AD162	6/-	BFY52	6/-	OC76	2/6	
2N711A	7/4	ADT140	12/6	BFY53	4/-	OC77	8/8	
2N929	5/4	AF102	18/-	B5X20	3/3	OC810	3/-	
2N930	6/6	AF114	4/4	B5Y21	8/-	OC82	4/4	
2N1131	7/4	AF115	4/4	B5Y27	4/-	OC82D	3/-	
2N1132	7/4	AF116	4/4	BTX39	600	120/-	OC83	4/-
2N1302	4/4	AF117	4/4	BUY11	15/-	OC84	4/-	
2N1303	4/4	AF118	16/4	B5Y55A	3/4	OC123	7/4	
2N1304	5/4	AF124	6/-	BY100	6/-	OC139	8/-	
2N1305	5/4	AF127	4/-	BYX10	4/9	OC140	12/-	
2N1306	6/4	AF139	15/-	BYZ10	9/9	OC169	6/-	
2N1307	6/4	AF186	11/-	BYZ12	6/-	OC170	4/-	
2N1308	1/4	AF219	12/-	BYZ13	5/4	OC171	6/4	
2N1309	8/-	AFZ12	11/9	GET102	6/-	OC200	6/-	
2N1613	6/4	ASV26	5/8	GET103	4/6	OC201	10/-	
2N2147	17/-	ASV27	5/8	GET113	5/-	OC202	16/6	
2N2148	12/4	ASV28	4/4	GET573	7/4	OC203	8/-	
2N2149	14/4	ASV29	4/4	GMO378B	6/-	OC204	8/-	
2N2168	6/6	ASZ21	11/-	MPP102	9/9	OC205	9/9	
2N2169	5/6	AU110	39/6	MPP103	9/9	OC206	10/6	
2N2169A	7/4	BA115	2/8	MPP104	9/9	OC207	7/4	
2N2446	10/4	BA130	10/4	NKT201	9/9	ORF40	8/-	
2N2494	6/6	BA331	2/4	NKT216	10/5	ORP61	8/-	
2N2924	5/4	BA338	2/4	NKT217	10/5	ORP63	9/9	
2N2925	5/4	BC107	2/9	NKT261	4/3	SX631	7/4	
2N2926	5/4	BC108	2/9	NKT262	4/3	SX636	10/8	
Green	2/-	BC109	2/9	NKT264	4/3	SX638	12/-	
Yellow	2/-	BC113	5/-	NKT271	4/3	SZ20C	15/-	
Orange	2/-	BC114	18/-	NKT272	4/3	SCC1	17/4	
Red	2/-	BC115	12/4	NKT274	4/3	SC26	8/3	
2N3053	8/-	BC118	5/-	NKT275	3/4	P346A	6/4	
2N3054	15/-	BC125	14/-	NKT276	2/4	V405A	9/3	
2N3055	15/-	BC126	14/-	NKT281	5/6	EC401	5/-	
2N3702	4/4	BC134	4/4	NKT403	15/-	EC402	4/8	
2N3703	4/4	BC147	4/4	NKT405	15/-	C111E	18/-	
2N3704	4/4	BC148	4/4	NKT713	5/4	C400	9/-	
2N3705	4/4	BC149	4/4	NKT773	5/4	2C111	45/9	
2N3706	3/4	BC154	12/-	NKT774	5/4	2C425	3/4	
2N3707	4/4	BC156	4/4	OAS	3/8	EA403	3/4	
2N3708	3/4	BCY31	9/-	OA47	1/6	EB383	3/6	
2N3709	3/4	BCY32	16/-	OA70	1/6	M491	30/3	
2N3710	4/4	BCY33	4/8	OA73	1/6	M461	27/3	
2N3711	4/4	BCY34	6/4	OA79	1/6	40361	12/3	
2N3819	8/-	BCY38	8/-	OA81	1/6	40362	16/3	
2N3820	23/6	BCY39	27/4	OA85	1/6	OA2241	3/6	
2N4058	7/4	BCY40	13/4	OA90	1/6	OA2242	3/6	
2N4059	6/4	BCY54	15/4	OA91	1/6	OA2269	3/6	
2N4060	6/4	BCY70	4/4	OA95	1/6	OA2270	3/6	
2N4061	6/4	BCY71	8/8	OA200	2/-	OCP71	18/3	
2N4062	6/4	BCY72	6/4	OA202	2/-	ST140	3/-	
2N4254	9/6	BCY87	86/9	OA210	6/4	ST141	5/-	

CHEAPEST EVER SOLID-STATE SALE

BEST VALUE IN BRITAIN

- 40 Silicon Planar Transistors. TO-18 case. NPN & PNP mixed. Similar V405A, P346A, etc. Not tested or coded. Guaranteed minimum 50% good. 10/-
- 10 BFY50/1/2 type NPN T05. Planar tested, not coded. 10/-
- 10 PNP Silicon Planars. Similar B5X40/2N2904/A. 3 Watts. 100 Mc/s. Fully tested. Uncoded. 10/-
- 30 Silicon Planar Transistors. TO-18 case. NPN type similar BC107/8/9 range. Not tested or coded. Guaranteed minimum 50% good. 10/-
- 3 Silicon Power Transistors similar to BUY11. TO-3 case. Not tested or coded. Gold plated cases. 10/-
- 20 Germanium Transistors 2G371B. Case 50-2. Fully tested to makers' specifications PNP. Equal to OC71 range. Not coded. 10/-
- 25 Silicon NPN VHF Transistors. TO-18 case. Similar to B5Y27. etc. Not tested or coded. 10/-
- 20 Silicon Planar Transistors. Plastic type. NPN. Similar to 2N3705/7 range. Not tested or coded. Guaranteed minimum 50% good. 10/-
- 20 Silicon Planar Transistors. Plastic type. PNP. Similar to 2N3702. Not tested or coded. Guaranteed minimum 50% good. 10/-
- 16 Silicon Rectifiers. Top-Hat case. 750mA @ 100 - 1000 pvt. Guaranteed minimum 80% good. 10/-
- 12 Silicon Avalanche Rectifiers. Top-Hat case. 1 Amp @ up to 1200 pvt. Guaranteed minimum 80% good. 10/-
- 15 Silicon Epitaxial Planar Diodes—Sub-miniature. Type SD19 Plessey. Exact substitute for 1N914, etc. 100% perfect. Not coded. 10/-
- 30 Part made Top-Hat Rectifiers (top connection broken, but plenty room to solder) 750mA up to 800 pvt. Guaranteed minimum 80% good. 10/-

2G371B and SD19 are Manufacturers' tested devices. Other un-coded stock are given type numbers as a guide only. Money refunded if not satisfied. All above packs post free in UK.

EXPORT SPECIAL: 10% of above SALE goods are reserved for export until August 1969.

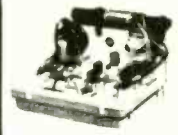

DeC's Single "DeC" with accessories and project manual ... 29/6
 "2-DeC" kit contains two "DeC's" component tray, accessories, instruction book, all packed in attractive plastic box ... 49/6
 "4-DeC" kit contains four "DeC's", accessories, manual, etc. ... 117/6

BOOKS FROM STOCK
 General Electric Transistor Manual. 660 pages of data & circuits 29/6
 RCA Transistor Manual. 554 pages, includes SCR circuits ... 28/-
 Designers' Guide to British Transistors. Excellent data book lists over 1,000 common types plus Computer-selected substitution chart 25/-
 (ADD 2/6 POST & PACKING FOR ALL BOOKS)

NEONS
 Signal neons for many types of circuit. type "N" Price 1/6 each or 16/- dozen.

HEATSINKS. Suitable for 2 x OC35, etc. As used in commercial equipment. Type 10D ... 6/-

ALUMINIUM CHASSIS
 6 x 4 x 2 1/2" with reinforced corners 6/9 each (P & P 1/6). Ally panel to fit 1/6. Paxolin panel to fit 2/-. Many other sizes in stock up to 12 x 8 x 2 1/2" (see catalogue).

X-LINE

MODULES YOU CAN OPEN!

- X-161 2 Watt Amplifier 35/-
- X481 Silen 35/-
- X-471 Burglar Alarm 35/-
- X681 Metronome 30/-
- X-761 Morse Oscillator 20/-
- X-891 Lamp Flasher (Double) 30/-



Generous discounts to retailers given on all "X-Line" products. Send for details now.

SILICON RECTIFIERS

PIV	200mA	750mA	2Amp	10Amp
50	6d	1/-	2/3	—
100	9d	1/6	2/3	4/6
200	1/3	2/-	2/9	5/-
400	—	2/6	4/-	8/-
600	—	3/-	4/6	9/6
800	—	3/9	5/-	11/3
1000	—	6/-	6/6	14/-

THYRISTORS - SCRS

PIV	1A	3A	10A	30A	100A
50	7/6	9/-	7/8	25/-	20/-
100	—	10/-	10/-	30/-	22/-
200	8/6	—	12/6	42/-	35/-
300	—	11/-	—	51/-	—
400	9/6	12/6	15/-	60/-	45/-
600	—	—	20/-	84/-	120/-
800	—	—	—	—	—

ZENER DIODES

1 Watt 10% Tolerance— Voltages:

3.0	4.7	7.5	12	ALL
3.3	5.1	8.2	13	ONE
3.6	5.6	9.1	15	PRICE:
3.9	6.2	10	16	3/6
4.3	6.8	11	—	each

See IR Panel for 1 Watt types. Full range 5 Watt also in stock.

BC107/8/9 NPN 2/9

LOGIC

- 2N3819 TEXAS FET 8/-
- 2N2646 UNI-JUNCTION 10/-

1-6 7-11 12+
 uL900 11/- 9/6 8/4
 uL914 11/- 9/6 8/4
 uL923 14/- 12/6 11/9
 Five Page Data and Circuits article 2/6
 Larger quantity prices (100+ and 1,000+) on application.

2N4871 MOTOROLA UNIJUNCTION SIMILAR 2N2646 T1S43 BEN 3000, ETC. 6/9

LINEAR AMP. IC'S

- CRS3/40AF 400V 3A SCR 12/6
- TD716 TUNNEL DIODE 12/-
- SC41D TRAC 8AMP EL 400PV 37/-

CA3020 1/2 Watt output 9 volt supply 30/6 (Price includes free circuit for Guitar/PA Amplifier !!)
 TAA263 Tiny Mullard linear only 17/6 - data on request.
 CA3012 Wide band with built-in regulation 27/6
 CA3014 3 stage amp. with Darlington output 32/6
 SL701 Plessey lin. amp. for PE circuits 18/-

2N3055 115 WATT POWER SILICON NPN 25 + 13/- 100 + 11/- 15/-

ULTRASONIC TRANSDUCERS

- 2N2926 POPULAR PLANAR NPN 2/-
- BF180 MULLARD UHF AMPLIFIER 6/-

Operate at 40kc/s. Can be used for remote control systems without cables or electronic links. Type 1404 transducers can transmit and receive.
 FREE: With each pair our complete transmitter and receiver circuit.
 PRICE £5.18.0 Pair (Sold only in pairs)

IOR

SOLAR CELLS
 B2M 0-2-0.4 volts @ 2mA Selenium type 12/6
 B3M 0-2-0.4 volts @ 11-24mA Selenium type 15/-
 SIM 0-3-0.4 volts @ 10-16mA Silicon 19/-
 S4M 0-3-0.4 volts @ 25-40mA Silicon 33/6

SOLAR DRIVE MOTOR
 EPS0A Runs from sunlight activity on S4M cells (above) 39/6

PHOTOCONDUCTIVE CELL
 CS120 20v 0.4 Watts Dark Res 110k ohms Min. R @ 10FC = 7.2k R @ 100 FC = 800 ohms 19/8

SOLAR CELL KITS
 DD190 Contains 4 Selenium photocells and free 24-page handbook 9/11
 K-421 Super assortment of 7 cells. 3 Selenium. 2 Silicon and 2 Sulphide. plus 24-page manual 58/6

TRANSISTOR KITS
 DD180 Contains 2 Audio and 1 RF Transistor plus free manual 11/4
 DD184 Contains Audio, RF, and Power transistors. Silicon solar cell and germanium diode. With FREE manual 33/6

SILICON RECTIFIER KITS
 DD175 Contains 4 100 pvt 1/2 amp diodes 9/11
 DD176 Contains 2 200 pvt 1/2 amp diodes 5/11
 DD177 Contains 2 400 pvt 1/2 amp diodes 9/11
 ALL INCLUDE FREE 24 PAGE MANUAL

ZENER DIODES
 Available in the following voltages with a dissipation of 1 watt and tolerance on 10%. All supplied with free manual describing many interesting projects
 3-9v, 4-7v, 5-6v, 6-8v, 8-2v, 10v, 12v, 15v, 18v, 22v, 27v
 ALL ONE PRICE 7/11

ZENER KIT
 DD170 Bargain pack—contains 5 popular 1 Watt diodes plus free project manual 19/6

TRANSISTOR SUBSTITUTION
 Our TR01-C to TR10-C range are universal replacements for over 700 JEDEC (2N—) types. Prices in our FREE Catalogue.

FULL SEMICONDUCTOR CENTRE LISTINGS.
 DOZENS OF INTERESTING DEVICES IN OUR CATALOGUE.

COMPONENTS

RESISTORS 1/2 or 1 Watt 5% LOW NOISE CARBON FILM 10, 12, 15, 18, 22, 27, 33, 39, 47, 56, 68, 82 ohms and decades (x10, x100, x1,000, x10,000) 1 Meg etc. to 8.2 Megohms (10% tolerance). PRICES: £1-25 4d, 26-99 3d, 100+ 2d (your selection) and/or 1/2 Watt mixed.

SKELETON PRESET POTS 20% Tol. Linear. Low noise. Available in sub-miniature or standard size, horizontal or vertical. 100, 250, 500, 1k, 2.5k, 5k, 10k, 25k, 50k, 100k, 250k, 500k, 1 Meg, 2.5 Meg, 5 Meg. NEW PRICE: 1/- each or any selection of 12 pieces 10/- (1/2 Watt mixed).

ELECTROLYTIC CAPACITORS (Mullard) -10% to +50% tol. Subminiature (all values in µF)

4V	9	32	64	125	250	400
6.4V	4	25	50	100	200	320
10V	4	16	32	64	125	200
16V	2.5	10	20	40	80	125
25V	1.6	6.4	12.5	25	50	80
40V	1	4	8	16	32	50
64V	0.64	2.5	5	10	20	32

Price 1/6 1/3 1/2 1/- 1/1 1/2

MIN. POLYESTER CAPACITORS. Printed circuit type 250 Vdc working. 0.01, 0.015, 0.022, 7d each; 0.033, 0.047, 8d each; 0.068, 0.10, 9d each.

VEROBOARD 0.15" Matrix FLUX COATED 2 1/2 x 3 1/2, 3 1/2 x 5, 3 1/2 x 3 1/2, 3 1/2 x 5, 5/6 x 3 1/2 x 18", 18/-, BARGAIN PACK of 36 square inches all good size pieces only 10/- pack.

VEROBOARD 0.1" Matrix. 3 1/2 x 2 1/2, 3/9.
VEROPINS for 0.15". 36 pieces 3/-.
VERO-CLUTTER. 9/- each plus FREE SAMPLE PIECES.

LST. BRENTWOOD ESSEX
 Telephone BRENTWOOD 224470/1
 Prices quoted are current at time of going to press and may be subject to variation. Semiconductors offered bear Manufacturers' original markings and are subject to our full replacement guarantee if not to published specifications. We DO NOT offer "re-marked" semiconductors. Catalogue (1969) shortly available free on request. Post and Packing (First class) 1/- per order. Retail and Trade supplied. Export enquiries particularly welcome.
GIRO No. 388-3159.

TRANSISTOR COMPONENTS PRICE SENSATION!



BIG BUYER DISCOUNTS

ORDERS EXCEEDING:—

- £50 or over 5% off
- £100 or over 10% off
- £250 or over 20% off
- £500 or over 33½% off
- £1000 or over 40% off

PHONO SOCKETS

Twin mounted on Angle Bracket. EACH **2/3**

CAPACITORS CERAMIC

180 p.f. 50 volt. 1½d. each MIN. ORDER **12/6** 100 for

EX. MANUFACTURER END OF PRODUCTION

NEW RESISTORS

MORGANITE ERIE TYPE "S" AND P.C. TYPE

(½ Watt. 10%—150 Ohm. 390 ohm. 390 ohm. 1 K, 1.5K, 10K, 15K, 18K, 22K, 25K, 27K, 33K, 47K, 82K, 100K, 120K, 220K, 330K, 470K, 1.2 MEG., 2 MEG., 2.2 MEG., 3 MEG.)

RESISTORS

MINIMUM ORDER 100 9/- ONLY

SIMILAR DISCOUNTS FOR OTHER ORDERS.

ONLY 1p each

TRY OUR POLI PACKS-FANTASTIC VALUE

A host of various components:— Resistors, Transistors, Capacitors, Mini-transformers. 1 FTS Oscillator coils, etc., etc. At least 30 items per pack 10/- per pack.

SPECIAL: LIMITED STOCK POWER TRANSISTORS

TED 941 **1/11** EACH
MIN. ORDER 6

NOTE: These are new unmarked, untested transistors.

FANTASTIC OFFER

TRANSISTOR RADIOS EACH **17/6**

These sets are m.v. only and are sold non working; but are complete, and require some attention. Ideal for experiments.

CASH WITH ORDER

Personal callers most welcome
REGRET NO C.O.D.
Closed Tuesday
FOR ORDERS UNDER £10 5/- for P. & P.
OVER £10 P. & P. FREE

BRITANNIC TRANSISTOR COMPONENTS SUPPLIES

100 SUMMERHILL RD., SPRINGHILL, BIRMINGHAM Tel. 021 CEN 7271

DIOTRAN

SALES
P.O. BOX 5
WARE, HERTS
TEL. WARE 3442

EX-COMPUTER PANELS I.B.M. Size 2in. x 4in. with TRANSISTORS, DIODES, RESISTORS, CAPACITORS, etc. Over ½ million already Sold out to the Trade. 70,000 only left at our Ridiculous Price of £3 per 100 panels or £28 per 1,000 panels. Plus carriage 6/-.

We will also buy your surplus stock—Send us your lists.

OVER 3 MILLION SILICON ALLOY & GERM. TRANSISTORS AVAILABLE FOR IMMEDIATE DELIVERY.

MANUFACTURERS END OF PRODUCTION SURPLUS.

TRANSISTORS

Type and Construction	Qty.	Qty.	Qty.	Qty.
	Price	Price	Price	Price
A 1 Germ. A.F. PNP T0-1	100	500	1,000	10,000
A 2 Germ. A.F. PNP T0-5	£3.10	£15	£25	£200
A 3 Germ. A.F. PNP T0-1	£1	£3	£5	£40
A 4 Germ. R.F. PNP T0-1	£1.10	£4.10	£7.10	£60
A 5 Germ. R.F. PNP T0-5	£1.10	£4.10	£7.10	£60
A 6 Germ. V.H.F. PNP T0-1	£3.10	£15	£25	£200
A 7 Assorted Germ. A.F.-R.F. PNP mixed cans, general purpose	15/-	£2.10	£4	£32
A 8 Germ. A.F. SO-2 PNP	£2	£7.10	£12.10	£100
A 9 Sil. Alloy PNP T0-5	£2	£7.10	£12.10	£100
A 10 Sil. Alloy PNP SO-2	£2	£7.10	£12.10	£100

A1 to A7 Guaranteed 80% Good usable Transistors ideal for low cost production work and experimental use.

A8 to A10 are all perfect devices, factory tested, no open or short circuit Transistors in these lots.

1/- TESTED TRANSISTORS 1/- EACH

ONE PRICE ONLY PNP, NPN, SILICON PLANAR 1/- EACH	ONE PRICE ONLY PNP, NPN, SILICON PLANAR 1/- EACH
BC108 2N696 2N1132 2N2220 25733	2N3391
BC109 2N697 2N1613 2N3707	2N3391
BFY50 2N706 2N1711 2N3711 T1544	
BFY51 2N708 2N2904 25102 2N2906	
BFX84 2N929 2N2905 25103 2N2907	
BFX86 2N930 2N2924 25104 2N2696	
BFX88 2N1131 2N2926 25732 2N3702	
From Manufacturers' Over-runs—Unmarked	2N3703

GERM. PNP AND NPN TRANSISTORS TESTED, UNMARKED SIM. TO:—1/6 EACH

AC125 ACY22 ACY36 NKT677 OC81	2G301
AC126 ACY27 NKT141 NKT713 OC82	2G302
AC127 ACY28 NKT142 NKT773	2G303
AC128 ACY29 NKT112 OC44	2G303
AC130 ACY30 NKT213 OC45	2G308
ACY19 ACY31 NKT214 OC71	2G371
ACY20 ACY34 NKT215 OC72	2G371
ACY21 ACY35 NKT271 OC75	2G374

TRANSISTOR EQVT. BOOK

2,500 cross references of transistors—British, European, American and Japanese. A must for every transistor user. Exclusively distributed by DIOTRAN SALES. 15/- EACH.

Post and Packing costs are continually rising. Please add 1/- towards same. CASH WITH ORDER PLEASE. QUANTITY QUOTATIONS FOR ANY DEVICE LISTED BY RETURN.

TO-5 METAL CAN SILICON PLANAR TRANSISTORS. VERY HIGH QUALITY 99% good type. 2N697, BFY51, 2N1893, £8 per 500 pieces. £13/0/0 for 1,000 pieces.

HIGH QUALITY SILICON PLANAR DIODES. SUB-MINIATURE DO-7 Glass Type, suitable replacements for OA200, OA202, BAY38, IS130, IS940, 200,000 to clear at £4 per 1,000 pieces. GUARANTEED 80% GOOD.

FULLY TESTED DEVICES AND QUALITY GUARANTEED—SURPLUS TO REQUIREMENTS

QA202 Silicon Diode. Fully Coded.
150 PIV 250mA Qty. Price £30 per 1,000 pieces.
ORP12 Cadmium Sulphide Cell.
1-24 9/- each; 25-99 7/- each; 100-999 6/- each; 1,000 up 5/6 each. Made in Holland.
BY100 SIL. RECT'S 800 PIV 550 mA.
1-49 2/6 each; 50-99 2/3 each; 100-999 2/- each; 1,000 up 1/10 each. Fully Coded. 1st Qty.

THYRISTORS (S.C.R.'s) TESTED, BRAND NEW AND CODED: TO-5 CASE

Type No.	PIV Amp	Each
2N1595	50 1	7/6
2N1596	100 1	8/-
2N1597	200 1	10/6
2N1598	300 1	14/-
2N1599	400 1	15/-
BTX30-500	500 1	22/6
BTX30-600	600 1	25/-

TO-48 CASE (STUD)

Type No.	PIV Amp	Each
2N682	50 16	13/-
2N683	100 16	15/-
2N685	200 16	19/6
2N687	300 16	25/6
2N688	400 16	32/6
2N689	500 16	47/6
2N690	600 16	50/-
2N691	700 16	56/-
2N692	800 16	62/-

TO-46 CASE (STUD)

Type No.	PIV Amp	Each
2N1771	50 47	9/-
2N1772	100 47	9/6
2N1774	200 47	12/6
2N1776	300 47	16/6
2N1777	400 47	19/-
2N1778	500 47	25/6
2N219	600 47	30/-
BTY79-150	150 47	12/-
BTY79-250	250 47	14/-
BTY79-400	400 47	20/-

TEXAS 2G371 A/B Eqvt. OC71 Germ. Gen. Purpose Trans.

Qty.	Each
1-99	1/6
100-499	1/3
500-999	1/3
1000 up	9d.

All Brand New and Coded.

Vast mixed lot of subminiature glass diodes. Comprising of Silicon, Germ. Point Contact and Gold Bonded types plus some Zeners. 500,000 available at Lowest of Low Price.
1,000 pieces £3.0.0. 5,000 pieces £13.10.0. 10,000 pieces £23.

OVERSEAS QUOTATIONS BY RETURN SHIPMENTS TO ANYWHERE IN THE WORLD AT COST

110 SEMICONDUCTOR PROJECTS FOR THE HOME CONSTRUCTOR

by R. M. Marston

25/- Postage 1/-

TRANSISTOR ELECTRONIC ORGANS FOR THE AMATEUR by Alna Douglas. 20/- Postage 1/-.

THE APPLICATION OF LINEAR MICROCIRCUITS VOL. I by S.G.S. 30/- Postage 1/6.

VHF-UHF MANUAL by G. R. Jessop. 21/- Postage 1/6.

COLOUR TELEVISION PAL SYSTEM by G. N. Patchett. 40/- Postage 1/-.

PRINCIPLES OF TRANSISTOR CIRCUITS by S. W. Amos. 25/- Postage 1/-.

PULSE, DIGITAL AND SWITCHING WAVEFORMS by Jacob Millman. 86/- Postage 4/-.

SOLUTION OF PROBLEMS IN ELECTRONICS AND TELECOMMUNICATIONS by C. S. Henson. 38/- Postage 2/-.

SCR MANUAL by General Electric Company. 25/- Postage 2/-.

THE INTEGRATED CIRCUIT DATA BOOK by Motorola 50/- Postage 4/6.

CATALOGUE 2/-

THE MODERN BOOK CO.

BRITAIN'S LARGEST STOCKIST of British and American Technical Books
19-21 PRAED STREET, LONDON, W.2

Phone PADddington 4185
Closed Sat. 1 p.m.

WW-107 FOR FURTHER DETAILS

ELECTRONIC BROKERS

MAGNETIC TAPE STORAGE DECK

Half-inch tape, 7-bit read-write heads. 567-bit words per inch. Ex. equipment, but new condition. Would make ideal tape transport. Few only. £72.10.0, including vacuum blower assembly.

MODEL 72 MAGNETIC TAPE UNIT

This unit consists of 8 channel read-write head. One track contains sprocket pulse, one contains parity (Check-bits) pulse, and the remaining six contain data any six bit code can be used to record on and be read from the tape. Data can be read in either a backward or forward direction. The unit contains circuits for receiving and storing instruction signals. Recording density 250 characters per inch. Tape speed 100 in. per second. £205. Excellent condition.

EVERSHED & VIGNOLE

3 Channel Mk I Pen Recorder with Amplifier

F.S.D. $\pm 10V$, with sensitivity control set to maximum. F.S.D. $\pm 51V$. Accuracy: Response such as to provide a record of a 3-5 c/s signal with not more than 30% loss of amplitude as compared with a d.c. signal of value equal to the peak a.c. amplitude. Power required: 230 volts and any of the following polarised voltages: 50V—50 c/s 115V—60 c/s 120V—400 c/s 58V—60 c/s 200V—60 c/s 20V—1,100 c/s 50V/1,100 c/s

Performance: Using Teledeton paper enabling three separate channels to be recorded simultaneously. Chart speed 12in./min., chart width 12in., 3in. per channel. Wt. 67 lb. Size: 22 x 21 x 11in. £59/10/0.

FOUR CHANNEL HIGH SPEED PEN RECORDER



By Kelvin Hughes, with four channel amplifier, giving a frequency range of 0-100 c/s.

The Recorder consists basically of a magnet carrying in its poles four stiffly suspended moving coil units, each with a stylus arm attached. The stiffness of the coil unit suspension enables the instrument to withstand the effects of vibration and acceleration. Sensitivity $\pm 3V$ input for full scale deflection of ± 7.5 mm. Mains operated. 6 chart speeds: 0.5; 1; 2; 4; 8; and 16 cm/sec. Excellent condition. £149/10/0.

N.B. Two channel version available, giving ± 16.5 m.m. deflection.

POTENTIOMETRIC 6 POINT STRIP CHART RECORDER

BRAND NEW

For use with thermocouples, pyrometers and other a.m.f. sources. 6 point. Range (-100)—0—(+100) mV; 6 1/2 in. chart width; pen speed 8 sec. Accuracy $\pm 0.5\%$; 10 chart speeds 20-720 mm/hr. Tropicalised. Including tools and spares. Listed at over £200. Our price £79.10.0. Thermo couplers available.



MEMORY PLANES

Ferrite core memory planes with wired Ferrite cores. Used for building your own computer or as an interesting exhibit in the demonstration of a computer. Mounted on plastic material, frame 5 x 8 in. Consisting of matrices 40 x 20 x 4 cores each one individually addressable and divided into 2 halves with independent sense and inhibit wires. £8.10.0.

Computer complete with 126 line printer, 80 col. card sorter, punch, central processor, drum store, six tape storage units and tape synchroniser. £3,000.

LINEAR THYRISTER CONTROLLED LIGHT DIMMER

600w. module. Ideally suitable for photohood or speed controller, etc. Will mount into standard socket boxes. Our price 49/6 + p. & p. 3/.

HIGH PRECISION FULLY STABILISED TRANSISTORISED LOW VOLTAGE POWER SUPPLIES

Incorporating:

- * B.C.R. Panel for overload protection.
- * OVERLOAD & CIRCUIT BREAKER WITH MANUAL RESET button.
- * RIPPLE better, better than 3000 : 1.
- * CHOKK OF CAPACITOR transistorised 120/130 volt A.C. INPUT.

Available in the following types:

6 Volt 9 Amp.....	£12.10.0	20 Volt 16 Amp.....	£25. 0.0
6 Volt 12 Amp.....	£17.10.0	24 Volt 4 Amp.....	£22.10.0
6 Volt 16 Amp.....	£22.10.0	30 Volt 8 Amp.....	£18.10.0
12 Volt 8 Amp.....	£22.10.0	56 Volt 7 Amp.....	£25. 0.0
12 Volt 16 Amp.....	£25. 0.0	Ex. equipment but fully tested in	
12 Volt 22 Amp.....	£25. 0.0	our laboratory. Carr. 30/-.	

SURFACE PROFILE MONITOR

TYPE SPM 10 by G. V. Planer. For the measurement of film thickness and surface quality this unit will measure thicknesses of thin films within the range 0—50,000 Å. The equipment is particularly suited for the thickness measurement of vacuum deposited layers as well as for the monitoring of the surface quality of materials such as Metal, Ceramics, Glass, etc. This equipment cost £800 and has never been used. Offers please.

PREVIOUS MONTH'S ADVERTISEMENT REPRINTS AVAILABLE ON REQUEST



MAINS Keynector

A REVOLUTIONARY NEW PRODUCT

cuts out plugs!

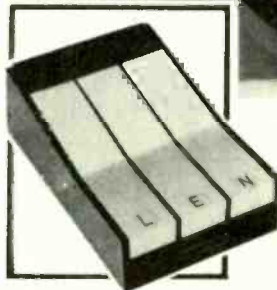
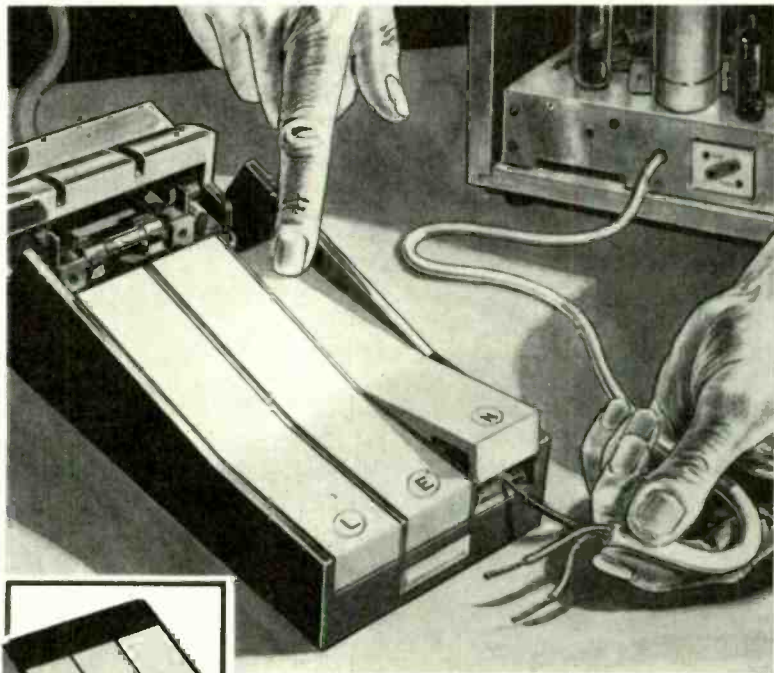

IT'S THE NEWEST • SAFEST AND QUICKEST WAY TO CONNECT ELECTRICAL EQUIPMENT TO THE MAINS

For the handyman or do-it-yourself enthusiast, for shop demonstration or bench testing, the revolutionary Keynector now offers a very much SAFER and QUICKER way of connecting electrical equipment to the mains. No plugs—no sockets—no risk of bare wires. To connect anything electrical, from an oscilloscope to an electric drill, simply open the fuse housing, depress the keys, insert the wires and close the housing. A neon light on the front of the Keynector glows to indicate proper connection. Multi-parallel connections can be made

up to 13 amps. Keys are colour coded and lettered LEN for quick identification. Note the safety features:

- * Opening fuse housing breaks circuit.
 - * Keys cannot be depressed until the fuse housing is open.
 - * Circuit is protected by 13 amp replaceable fuse.
 - * No live metal parts protrude to cause accidental shock.
- The Keynector casing is in two-tone plastic and measures 5in. x 3in. x 1 1/2 in. It can be fixed to wall or bench.

ONLY 39/6 plus 5/- pkg. & post

ALL GOODS GUARANTEED

CONVERTOR/BATTERY CHARGER. Input 240v 50 c/s. output 12v 5 amp DC. Input 12v DC, output 240v AC. 170 watt max. With fuse and indicator lamps. Size 9 1/2 x 10 x 4 1/2 in. Weight 19lb. An extremely compact unit that will give many years' reliable service. Supplied with plug and lead. Only £4/10/- P. & P. 15/- extra. As above—fully serviceable—perfect interior but soiled exterior cases. £3. P. & P. 15/- extra.

Synchronous chopper AEI type CK4. As new 22/6 ea. Top connector 2/6 ea. **CARPENTERS** polarised relays. Single pole c/o 20 ohm and 65 ohm coils. As new, complete with base, 14/- ea. **AMPHENOL.** Blue 12-way ribboned plug and socket, gold plated. Ex. eq. but mint, 22/6 a pr. Miniature Belling Co-ax double plug and socket ex. eq. as new, 7/-; 3-pair plug and socket holder, 3/- ea. T.M.C. Precision Capacitors. Plastic. 1 mfd 250v DC working 0.1% at 45°C. As new £3.

G.M. TUBES. Brand new. G24/G38/G60 at 27/6 ea. G53/1, brass cased, £6 ea.

PHOTOMULTIPLIERS. 5" Mullard 54AVP & EMI 6099 at £4/10/- ea. 2" EMI 6097X at £8/10/- ea.

SOLARTRON stab. P.U. type AS516 300v 50mA. £3/10/-; AS517 300v 100mA. £6. P. & P. 10/- extra.

TRANSISTOR OSCILLATOR. Variable frequency 40 c/s to 5 kc/s. 5 volt square wave o/p. for 6 to 12v DC input. Size 1 1/2 x 1 1/2 x 1 1/2 in. Not encapsulated. Brand new. Boxed. 11/6 ea.

TIMER UNIT, consisting standard mains input transformer 200/240v 50 c/s; output 18v 4 amp (conservative); GEC bridge rectifier; detachable accurate 1 sec timer subchassis with transistor BTC type TS2. 2 x 12AU7; one 500 ohm relay heavy duty contacts 2 make; lamps, fuse, switch, etc. In case. Size 10 x 10 x 5 in. Ideal battery charger, one second timer, transistor power supply, etc. Tested and guaranteed working. £2/15/- ea. P. & P. 15/-.

OSCILLOSCOPES
Cosmor DB 1035. £20; 1035 Mk. 2. £25; 1035 Mk. 3. £32/10/-; 1049. £22/10/-; 1049 Mk. 3. £30; CT52. £15; HARTLEY 13A. Now only £17/10/-.
All scopes carefully serviced and in excellent condition. Carriage 30/- extra.

AMPLIFIERS. Compact unit by Parmeko—rated 17 watts, capable of double. 2-KT66/2B254M; ECC81; 2-EF86; 5U4, matching to 15 ohms. High impedance or transformer input. Size 1 1/2 x 8 1/2 x 8 1/2 in. high. Standard mains input. Fully tested. £8/10/-, including carriage.

RELAYS
Omron/Schrack octal based plug-in relays. 2 pole c/o 5A, 230v and 6v. State which. Brand new. Boxed. 12/6 ea.
G.E.C. 4 pole c/o 6/12v operation 180 ohms. Platinum contacts. Brand new. Boxed. 14/6 ea.
3,000 series. 500 ohms 2 pole c/o and 2 make. As new condition, 4/6.
4 pole c/o and 1 make 1 break
3 break 1 make and 3 make heavy duty
2 make 2 break, 4 make heavy duty.
All at 4/6 ea. As new condition.

S.T.C. sealed 2 pole c/o 48v only. Complete with base, 4/6 ea.
Standard pots. Brand new. 250K; 500K: 1 meg; 2.5 meg. All at 1/9 ea.

INSTRUMENT POTENTIOMETERS. 3" Colverns. 5, 10, 25, 50, 100, 500 ohms; 1, 2.5, 10, 25, 100K. All at 7/- each.

HIGH RESOLUTION Potentiometer. 100K 80 turns. Complete with knob. 6/6 ea.

ALMA precision resistors. 100K and 400K 0.1%. 5/6 ea.

EL84 VALVES. Ex. eq. Tested. 7/- pair.

PANEL SWITCHES. All high quality. SP. 1/- ea.; DP. 2/- ea.; DP 2w. 3/6 ea.

COURTENAY TIMER unit. Accurate 1 sec timer. Variable mark space ratio. Input 12v AC or DC. Heavy duty relay contacts to switch external equipment, eg., flashing lights. Chassis mounting. Size 6 x 3 1/2 x 3 1/2 in. Tested with circuit diagram. 22/6 ea.

CRT. Modern replacement for the VCR138A. Blue trace with PDA available. 27/6 ea. Base, 3/6 ea. Geared Motors. 240v 50c/s synchronous. Geared down to 60 r.p.m. Brand new. 50/- ea. P. & P. 7/6 ea. Pair Mullard OC29's on fanned heat sink. 11/6 ea. Photocells, equivalent OCP 71, 2/6 ea. E.H.T. Condensers. 7.5kV working. 0.1 mfd. 5/6 ea.; 0.25 mfd. 8/6 ea. Brand new. 5kV working. 2 mfd. 22/6 ea.; 0.25 mfd. 10/6 ea.

VISCONOL E.H.T. Condensers. Brand new. 0.002 15kV, 8/6 ea.; 0.0005 25kV, 16/- ea.

PLESSEY plugs and sockets. Cleaned, ex. eq. Mark 4's plug or socket, 4/6 ea. 18- and 24-way, 8/- ea.

TRANSISTOR Stabilised Power Unit. 48v, 4 amp. Manufactured by E.M.I. Open chassis. Brand new. Highest quality. Size 10 1/2 x 5 1/2 x 6 1/2 in. high. £6 ea.

AMERICAN TX tuning units. TU7B 4.5-6.2 Mc/s. TU8B 6.2-7.7 Mc/s. £3 ea. Carriage 7/6 extra.

Cash with order. Post paid over 10/-
FOR CALLERS. Always a large quantity of components, transformers, chokes, valves, capacitors, odd units, etc., at 'Chiltmead' prices. Callers welcome 9 a.m. to 10 p.m. any day.

CHILTM EAD LTD.

22 SUN STREET • READING • BERKS,
Off Cumberland Road (Cemetery Junction) Tel. No. Reading 65916 (9 a.m. to 10 p.m.)

VALVE VOLTMETERS. Marconi TF899. £7/10/- carriage 10/-; TF428B. £3/15/-, carriage 10/-; Airtec 784. £8, carriage 15/-.

WESTREX 100 watt Amplifier in Imohof cabinet. 4 x 807; high and low level inputs; multi imp o/p. 15 ohms. 100v line, etc. In as new condition, £55.

ATTENUATORS. STC push-button 0/100 Dbs in 1 Db steps. DC 50 Mc/s, 75 ohm imp., £12 ea. **MUIR-HEAD** 0-50 Dbs in 1/2 Db steps, 75 ohm imp., £2/10/-.

19in. Rack Mounting CABINETS. 6ft. high, 2ft. deep. Side and rear doors. Fully tapped; complete with base and wheels. Excellent condition. £18 ea. Carriage at cost.

METERS

ELLIOTT 25-0-25 micro amp. Scale size 4 1/2 x 2 1/2 in. Scaled 100-0-100. £3/10/- ea.

TAYLOR 100-0-100 micro amp. Scale size 4 x 2 in. Internal lamp scaled -6 -0 -6+. £2/10/- ea.

GRIFFEN & GEORGE. 3in. round. In sloped open-ended case with terms. AC 50 c/s. 3 types available: 0/20; 0/100; and 0/250v. 25/- ea.

TRANSFORMERS

All standard inputs.
18v 6 amp and 12v 1 amp. Sep. windings. 18/6 ea.
18v 12 amps at £3 ea.
3kV 4.5mA, 4v 0.5 amp x 2, 4v 1-1 amp. Brand new. £5 ea. ex. eq. £3/10/- ea. 350-0-350 75mA, 5v 2amps x 2. 21/- ea. 350-0-350 at 2 amps. £3 10/- ea.

Gardners 6-3v 2A; 6-3v 1.5A; 6-3v 0.1A. Size 3 1/2 x 4 1/2 in. As new. 14/- ea.

Gardners 4v 30 amps. Brand new. £2/5/- ea. inc. postage.
Gardners Potter. Multi 6.3's combine to give 48v at 4 amps or 6.3 at 45A. With 350-0-350 at 50mA. As new. £2/10/- ea.

Parmeko/Gardners Potted. 475-60-0-60-475 at 160 mA; separate winding 215-0215 at 45mA; 6-3v 5A; 6-3v 0.75A; 6v 3A. As new. £3 ea.

Gardners 'C' Core. 350-300-250-200-150-100-0-100, etc., etc., at 140mA, 6-3v 2A; 6-3v 3A x 4. As new. £3/10/- ea.

Parmeko 6-3v at 2 amp x 4. New. 22/6 ea.
Parmeko 65v 1 amp. Separate 0-18-24v at 0.5 amp. 30/- ea.

CHOKES. 5H; 10H; 15H; up to 120mA, 8/6 ea. Large quantity LT, HT, EHT transformers. Your requirements, please.

ONE ONLY. CLAUDE LYONS Automatic Voltage Stabiliser. Type TS 2/R8619. 198/258v in 47/65 c/s; OP, 240 +/- 0-25% [at 12 amps. In brand new condition. £40.

MARCONI S band Spectrum Analyser. Type 984/2. Good condition. £25.

SPECIAL OFFER

E.M.I. Oscilloscope. Type WM2. 5in. tube. DC to 13 Mc/s. 0.03 Micro/s rise time; TB 150 m/s to 0.15 micro/s. £20. Carriage 30/-. Plug in pre-amp. £5.

LABORATORY OSCILLOSCOPE. Solartron CD 643. 5in. tube. DC. 12Mc/s. Rise time 30 M Micro/s. TG 100 M sec/cm to 0.1 Micro/s/cm with no expansion; with expansion 20 M Micro/s/cm. £90 only.

SOLARTRON EQUIPMENT

D.B. Oscilloscope. Type CD 7118.2. £55.
S.B. Oscilloscope. Type CD 513. £35.
Pulse generator. Type OPS 100C. 50 c/s to 1 Mc/s. £25.
Stabilised P.U. Type SR3 151. £15.

PULSE AMPLIFIER. Type 1430A. Head amp etc. 20 c/s to 3 Mc/s. £25. Carriage 30/-.

MAINS REGULATION UNITS. BPT REGA-VOLT. Mains in ex. 230v +/- 10%; 230v out 10 amps +/- 1%. In fine condition. £20 ea. Carriage 30/-.
As above but 2 amps out. £7/10/- ea. Carriage 25/-.

BRANDENBURG E.H.T. Power Supply. Adjustable 1kV-2.5kV 10 mA. Stabilised. 19in. rack mounting. Fine condition. £25. Carriage 30/-.

DAWE 'Q' Meter. Type 623A. 25 to 200 Mc/s. Good condition. £25. Carriage 25/-.

WATCH REPAIRING? British watch timer, for precision adjustment. Prints out error between watch and internal crystal standard. Supplied complete with watch holder, paper roll, etc. Standard mains input. £35.

E.H.T. POWER SUPPLY. 0/3kV 500mA. Variac controlled. Metered voltage and current. Potted choke and transformer, paper condensers, valve bridge rectifiers. In superb condition. 19in. rack mounting. £40. Carriage at cost.

E.M.I. Oscilloscope. Type 3794. (As used by BBC.) Single beam DC to 5 Mc/s. TB 10 c/s to 1 mc/s; metered, 'Y' shift; calibrated TB; will measure rise time, etc. to 0.1 micro second. 'X' expansion. £15 including carriage. Oscilloscope DELAY LINE, COAXIAL. Can be fitted in most scopes to improve trig., etc., in 1 yard lengths. Full instructions for fitting supplied. 15/- a yard.

OSMABET LTD.

WE MAKE TRANSFORMERS AMONGST OTHER THINGS
AUTO TRANSFORMERS. 0-110-200-220-240 v. a.c. up or down, fully shrouded fitted terminal blocks. 50 w. 31/-; 75 w. 37/-; 100 w. 45/-; 150 w. 57/6; 200 w. 71/6; 300 w. 90/-; 400 w. 112/6; 500 w. 127/6; 600 w. 135/-; 750 w. 172/6; 1,000 w. 210/-; 1,500 w. 345/-; 2,000 w. 400/-; 3,000 w. 560/-; 4,000 w. 750/-.

MAINS ISOLATION TRANSFORMERS. Input 200-240 v. a.c., 1:1 ratio. 50 w. 60/-; 100 w. 90/-; 200 w. 150/-; 300 w. 300/-.

MAINS TRANSFORMERS. Prim 200-240 v. a.c.; TX1 425-0-425 v. 250 Ma, 6.3 v. 4a. ct, 6.3 v. 4a. ct. 0.5-6.3 v. 3a. 135/-; TX2 250-0-250 v. 150 Ma, 6.3 v. 4a. ct. 0.5-6.3 v. 3a. 87/6; TX3 250-0-250 v. 100 Ma, 6.3 v. ct, 6.3 v. 1a. 56/6; TX4 300-0-300 v. 60 Ma, 6.3 v. 2a. ct, 6.3 v. 1a., 56/6; TX5 300-0-300 v. 120 Ma, 6.3 v. 1a., 6.3 v. 2a. ct, 6.3 v. 2a., 67/6; TX6 250-0-250 v. 65 Ma, 6.3 v. 1.5 a.; 32/8; MT1 200 v. 25 Ma, 6.3 v. 1.5 a., 17/8; MT2 230 v. 45 Ma, 6.3 v. 1.5 a., 25/-.

INSTRUMENT TRANSFORMERS. Prim 200/250 v. a.c. OMT/1 tapped sec. 5-20-30-40-60 v. giving 5-10-15-20-25-30-35-40-55-60, 10-0-10, 20-0-20, 30-0-30 v. a.c. 1 amp 36/-; 2 amp OMT/2 60/-; OMT/3 tapped sec. 40-50-60-80-100-110 v. giving, 10-20-30-40-50-60-70-80-90-100-110 v., 10-0-10 v., 20-0-20-30-0-30 v., 40-0-40, 50-0-50 v. a.c. 1 amp 60/-.

HEATER TRANSFORMERS. Prim 200/250 v. a.c. 6.3 v. 1.5 a. 11/6; 3 a. 18/6; 6 a. ct. 30/-; 12 v. 1.5 a. 18/8; 3 a. 30/-; 6 a. 56/-; 24 v. 1.5 a. 27/6; 3 a. 58/-; 5 a. 75/-; 8 a. 108/6; 12 a. 150/-.

MIDGET MAINS TRANSFORMERS. PW rectification, size 2 x 1 1/2 x 1 1/2 in. Prim 200/250 v. a.c. output 20-0-20 v. 0.15 a.; 12-0-12 v. 0.25 a.; 9-0-9 v. 0.3 a., at 19/6 each.

COLOUR TELEVISION W.V. as specified, choke L1 60/-; transformer T1 57/6; field output transformer 60/-.

OUTPUT TRANSFORMERS. Mullard 5/10. UL. 67/6; 7 watt stereo UL, 56/8; 3 watt PF3, 30/-; PF 11K. £21/-; 30 watt (KT 65, etc.), 3-15 ohms, 75/-; Multi ratio 7/10 watt, 30/-; auto matching transformer, 3, 7.5, 15 ohms up or down to 10 watt. 11/6. 50 watt P.P. Tran. PA/KT68, 3-7.5-15 ohms 135/-.

CHOKES. Inductance 10 H 65 Ma, 12/-; 85 Ma, 15/-; 150 Ma, 21/-; flying leads, clamp construction.

Carriage extra all transformers from 3/6 minimum. S.A.E. for transformer lists.

BATTERY ELIMINATORS. PP9 200/250 v. a.c., 9 v. d.c. 150 Ma, 45/-; PP3 ditto 15 Ma, 17/6. P. & P. 2/6.

FLUORESCENT LIGHTING LT, Input, 6, 12, 24 v. d.c. range, fittings, inverters, S.A.E. lists.

BULK TAPE ERASER. 200/250 v. a.c. Immediate and complete erasure of any size spool, suitable for tape head demagnetization. 42/6. P. & P. 3/- S.A.E. Leaflet.

LOUDSPEAKERS. Complete range, famous make, 35 watt, 27; 25 watt, 25; 15 watt, 25 etc. etc. P. & P. 6/- each. S.A.E. List.

LOUDSPEAKERS. Ex equipment, perfect, Elac, Goodman, Plessey, etc. 3 ohms only, 5 ins, 7/6; 6 ins, 10/-; 8 ins, 15/-; 8 x 5 ins., 15/-; 10 x 6 ins., 17/6. P. & P. 3/6 each.

Carriage extra on all orders. S.A.E. ALL ENQUIRIES PLEASE. MAIL ORDER ONLY. 46 KENILWORTH ROAD, EDGWARE, MIDDLESEX Tel: 01-958 9314

Thanks to a bulk purchase we can offer

BRAND NEW

P.V.C. POLYESTER & MYLAR RECORDING TAPES

Manufactured by the world-famous reputable British tape firm, our tapes are boxed in polythene and have fitted leaders, etc. Their quality is as good as any other on the market, in no way are the tapes faulty and are not to be confused with imported, used or sub-standard tapes. 24-hour despatch service.

Should goods not meet with full approval, purchase price and postage will be refunded.

S.P.	{ 3in. 160ft. 2/-	5in. 600ft. 6/-
	{ 5 1/2in. 900ft. 8/-	7in. 1,200ft. 9/-
L.P.	{ 3in. 225ft. 2/6	5in. 500ft. 8/6
	{ 5 1/2in. 1,200ft. 10/-	7in. 1,800ft. 13/-
D.P.	{ 3in. 350ft. 4/6	5in. 1,200ft. 12/-
	{ 5 1/2in. 1,800ft. 16/-	7in. 2,400ft. 20/-

Postage on all orders 1/6

COMPACT TAPE CASSETTES AT HALF PRICE

60, 90, and 120 minutes playing time, in original plastic library boxes. MC 60 9/- each. MC 90 12/6 each. MC 120 18/3 each.

STARMAN TAPES

28 LINKSCROFT AVENUE
ASHFORD, MIDDIX.
Ashford 53020

Z AND AERO SERVICES LTD

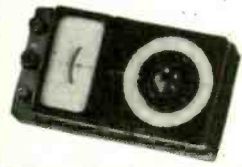

SLIDEWIRE WHEATSTONE BRIDGE

£15.150

Battery Powered Portable Resistance Bridge. Range 0.5 to 50 ohms with multiplier settings of 0.1-100-1000, providing a measuring range of 0.05 to 50,000 ohms. Accuracy in the middle 3 ranges—0.5% approx. PRICE £15 15 0

TRIACS TYPE 40432

Gated bi-directional Silicon Thyristors with integral trigger. The triac will control up to 1440 watts at 240V mains frequency. Supplied complete with heat sink, data sheet and application sheets for motor control and dimmer circuits 37/6 each.

UNIUNION TRANSISTORS 2N2646

Power dissipation 300mW R.M.S. Base-to-Base voltage 35V max. Peak emitter current 2.0A. Suitable for triggering of thyristors. 12/8.

SEMICONDUCTORS

The following leaflets are available free of charge: TRANSISTORS AND INTEGRATED CIRCUITS with full specifications and prices of over 200 types POWER RECTIFIERS AND ZENER DIODES

MULTIMETERS TYPE 108-IT

24-range precision portable meter. 5,000 o.p.v. D.C. Volts 2.5-10-50-250-500-2500V. A.C. Volt: 10-50-100-250-500-2500 V. D.C. current 0.5-5-50-500 mA. Resistance: 2,000-20,000 ohms-20 megohms. Power output calibration for 600 ohms line, £6/5-. P.P. 7/6. Dimensions: 7 1/4 in. x 6 in. x 3 1/4 in. Weight 3 1/2 lb.

TYPE MF16

D.C. Voltage range 0-0.5-10-50-250-500V. A.C. Voltage range 0-10-50-250-500V. D.C. current ranges: 500µA-10-100mA. Resistance ranges: 100MΩ-1MΩ. The meter is also calibrated for capacity and output level measurements. Sensitivity 2000µV. Accuracy ±2.5% for D.C. and ±4% for A.C. measurements. Dimensions: 4 1/4 in. x 3 1/4 in. x 1 1/4 in. Price £4/5-.

WHEN ORDERING BY POST PLEASE ADD 2/6 IN £ FOR HANDLING AND POSTAGE.

NO C.O.D. ORDERS ACCEPTED ALL MAIL ORDERS MUST BE SENT TO HEAD OFFICE AND NOT TO RETAIL SHOP.

TWO NEW OSCILLOSCOPES FROM RUSSIA



CI-5 SINGLE BEAM OSCILLOSCOPE

10 mc/s passband, triggered sweep from 1 µ sec. to 3 millisecc. Free running time base from 20 c/s to 200 kc/s. Built-in time marker and amplitude calibrator, 3-in. cathode ray tube with telescopic viewing hood £49/10/0

CI-16 DOUBLE BEAM OSCILLOSCOPE

5 mc/s passband separate Y1 and Y2 amplifiers rectangular 5 in. x 4 in. cathode ray tube. Callibrated triggered sweep from 0.2 µ sec. to 100 millisecc. per cm. Free running time base 50 c/s to 100 mc/s. Built-in time base calibrator and amplitude calibrator £87/10/0 Full details on request.



0A2	8/	6AK6	11/6	6F4	35/-	
0A3	8/8	6AL5	3/-	6F50	8/-	
0B2	6/-	6AM5	5/-	6P60B	6/8	
0B3	9/-	6AM6	4/-	6F7	9/-	
0C2	15/-	6AN8	8/-	6F11	6/8	
0C3	6/8	6AN8	10/-	6F13	6/8	
0D3	6/-	6AN8	10/-	6F13	6/8	
1A5GT	5/-	6AQ5	6/-	6P14	12/-	
1A7GT	7/6	6AQ6	10/-	6P15	11/-	
1A4	15/-	6A5	8/-	6P17	9/-	
1B5GT	7/-	6A85	6/-	6P18	7/6	
1C5GT	5/-	6A85	6/6	6P23	15/-	
1L4	3/-	6A86	7/-	6P24	13/-	
1N5GT	8/-	6A87G	15/-	6P25	14/-	
1R4	6/-	6A76	4/6	6P28	13/-	
1R5	6/-	6AU4GTA	6/6H8	11/10P13	10/-	
1B2	6/-	6AK6	12/-	10P14	16/-	
1B2A	6/8	6AU5GT	6/6W6	11/-	10Y 17/6	
1B4	5/-	22/6	6A4	9/-	11B3 7/-	
1B5	4/6	6A76	5/-	6J50T	5/6	
1T4	4/-	6AU8	10/-	6J6	3/6	
1U4	6/-	6AV6	5/8	6J7	8/-	
1V2	9/-	6AW8A11-	6K6GT	9/-	12AB5 9/-	
1XB2	6/-	6AX4GTB	6K7	8/-	12AC6 7/-	
1Z2	25/-	6AX6T	8/-	6K8G	4/-	
2A3	6/-	6AX6GT	6K23	9/-	12AE6 7/6	
2A40	35/-	12/6	6K25	15/-	12AL5 7/6	
2C26A	8/-	6AX7	10/-	6L80T	8/6	
2C34	10/-	6B40	15/-	6L7	6/-	
2C39A140-	6/8	6B7	7/6	6L18	6/-	
2C50	40/-	6B8G	2/6	6L19	20/-	
2C51	40/-	6BA6	4/-	6L20	5/6	
2C52	12/-	6BA7	15/-	6N7GT	6/6	
2C53	70/-	6B56	4/6	6P11	11/-	
2C54	12/-	6B57	15/-	6P25	13/-	
2C5W4	10/-	6B66G	11/-	6P28	12/6	
2D21	6/-	6B66	8/-	6Q7	7/-	
2E22	35/-	6B74	16/-	6R7	7/-	
2E26	27/6	6B8	8/-	6R7	7/-	
2X2	3/-	6B84	20/-	6R7	7/-	
2X3	11/-	6BK7A	9/-	6R7	7/-	
2A4	4/-	6BL7GTA	6B87	6/-	6R7	7/-
2A6	7/-	6B87	4/6	6R7	7/-	
2A7	6/-	6B87	7/6	6R7	7/-	
2A8	6/-	6B87	7/6	6R7	7/-	
2A9	6/-	6B87	7/6	6R7	7/-	
2B0	6/-	6B87	7/6	6R7	7/-	
2B1	6/-	6B87	7/6	6R7	7/-	
2B2	6/-	6B87	7/6	6R7	7/-	
2B3	6/-	6B87	7/6	6R7	7/-	
2B4	6/-	6B87	7/6	6R7	7/-	
2B5	6/-	6B87	7/6	6R7	7/-	
2B6	6/-	6B87	7/6	6R7	7/-	
2B7	6/-	6B87	7/6	6R7	7/-	
2B8	6/-	6B87	7/6	6R7	7/-	
2B9	6/-	6B87	7/6	6R7	7/-	
2C0	6/-	6B87	7/6	6R7	7/-	
2C1	6/-	6B87	7/6	6R7	7/-	
2C2	6/-	6B87	7/6	6R7	7/-	
2C3	6/-	6B87	7/6	6R7	7/-	
2C4	6/-	6B87	7/6	6R7	7/-	
2C5	6/-	6B87	7/6	6R7	7/-	
2C6	6/-	6B87	7/6	6R7	7/-	
2C7	6/-	6B87	7/6	6R7	7/-	
2C8	6/-	6B87	7/6	6R7	7/-	
2C9	6/-	6B87	7/6	6R7	7/-	
2D0	6/-	6B87	7/6	6R7	7/-	
2D1	6/-	6B87	7/6	6R7	7/-	
2D2	6/-	6B87	7/6	6R7	7/-	
2D3	6/-	6B87	7/6	6R7	7/-	
2D4	6/-	6B87	7/6	6R7	7/-	
2D5	6/-	6B87	7/6	6R7	7/-	
2D6	6/-	6B87	7/6	6R7	7/-	
2D7	6/-	6B87	7/6	6R7	7/-	
2D8	6/-	6B87	7/6	6R7	7/-	
2D9	6/-	6B87	7/6	6R7	7/-	
2E0	6/-	6B87	7/6	6R7	7/-	
2E1	6/-	6B87	7/6	6R7	7/-	
2E2	6/-	6B87	7/6	6R7	7/-	
2E3	6/-	6B87	7/6	6R7	7/-	
2E4	6/-	6B87	7/6	6R7	7/-	
2E5	6/-	6B87	7/6	6R7	7/-	
2E6	6/-	6B87	7/6	6R7	7/-	
2E7	6/-	6B87	7/6	6R7	7/-	
2E8	6/-	6B87	7/6	6R7	7/-	
2E9	6/-	6B87	7/6	6R7	7/-	
2F0	6/-	6B87	7/6	6R7	7/-	
2F1	6/-	6B87	7/6	6R7	7/-	
2F2	6/-	6B87	7/6	6R7	7/-	
2F3	6/-	6B87	7/6	6R7	7/-	
2F4	6/-	6B87	7/6	6R7	7/-	
2F5	6/-	6B87	7/6	6R7	7/-	
2F6	6/-	6B87	7/6	6R7	7/-	
2F7	6/-	6B87	7/6	6R7	7/-	
2F8	6/-	6B87	7/6	6R7	7/-	
2F9	6/-	6B87	7/6	6R7	7/-	
2G0	6/-	6B87	7/6	6R7	7/-	
2G1	6/-	6B87	7/6	6R7	7/-	
2G2	6/-	6B87	7/6	6R7	7/-	
2G3	6/-	6B87	7/6	6R7	7/-	
2G4	6/-	6B87	7/6	6R7	7/-	
2G5	6/-	6B87	7/6	6R7	7/-	
2G6	6/-	6B87	7/6	6R7	7/-	
2G7	6/-	6B87	7/6	6R7	7/-	
2G8	6/-	6B87	7/6	6R7	7/-	
2G9	6/-	6B87	7/6	6R7	7/-	
2H0	6/-	6B87	7/6	6R7	7/-	
2H1	6/-	6B87	7/6	6R7	7/-	
2H2	6/-	6B87	7/6	6R7	7/-	
2H3	6/-	6B87	7/6	6R7	7/-	
2H4	6/-	6B87	7/6	6R7	7/-	
2H5	6/-	6B87	7/6	6R7	7/-	
2H6	6/-	6B87	7/6	6R7	7/-	
2H7	6/-	6B87	7/6	6R7	7/-	
2H8	6/-	6B87	7/6	6R7	7/-	
2H9	6/-	6B87	7/6	6R7	7/-	
2I0	6/-	6B87	7/6	6R7	7/-	
2I1	6/-	6B87	7/6	6R7	7/-	
2I2	6/-	6B87	7/6	6R7	7/-	
2I3	6/-	6B87	7/6	6R7	7/-	
2I4	6/-	6B87	7/6	6R7	7/-	
2I5	6/-	6B87	7/6	6R7	7/-	
2I6	6/-	6B87	7/6	6R7	7/-	
2I7	6/-	6B87	7/6	6R7	7/-	
2I8	6/-	6B87	7/6	6R7	7/-	
2I9	6/-	6B87	7/6	6R7	7/-	
2J0	6/-	6B87	7/6	6R7	7/-	
2J1	6/-	6B87	7/6	6R7	7/-	
2J2	6/-	6B87	7/6	6R7	7/-	
2J3	6/-	6B87	7/6	6R7	7/-	
2J4	6/-	6B87	7/6	6R7	7/-	
2J5	6/-	6B87	7/6	6R7	7/-	
2J6	6/-	6B87	7/6	6R7	7/-	
2J7	6/-	6B87	7/6	6R7	7/-	
2J8	6/-	6B87	7/6	6R7	7/-	
2J9	6/-	6B87	7/6	6R7	7/-	
2K0	6/-	6B87	7/6	6R7	7/-	
2K1	6/-	6B87	7/6	6R7	7/-	
2K2	6/-	6B87	7/6	6R7	7/-	
2K3	6/-	6B87	7/6	6R7	7/-	
2K4	6/-	6B87	7/6	6R7	7/-	
2K5	6/-	6B87	7/6	6R7	7/-	
2K6	6/-	6B87	7/6	6R7	7/-	
2K7	6/-	6B87	7/6	6R7	7/-	
2K8	6/-	6B87	7/6	6R7	7/-	
2K9	6/-	6B87	7/6	6R7	7/-	
2L0	6/-	6B87	7/6	6R7	7/-	
2L1	6/-	6B87	7/6	6R7	7/-	
2L2	6/-	6B87	7/6	6R7	7/-	
2L3	6/-	6B87	7/6	6R7	7/-	
2L4	6/-	6B87	7/6	6R7	7/-	
2L5	6/-	6B87	7/6	6R7	7/-	
2L6	6/-	6B87	7/6	6R7	7/-	
2L7	6/-	6B87	7/6	6R7	7/-	
2L8	6/-	6B87	7/6	6R7	7/-	
2L9	6/-	6B87	7/6	6R7	7/-	
2M0	6/-	6B87	7/6	6R7	7/-	
2M1	6/-	6B87	7/6	6R7	7/-	
2M2	6/-	6B87	7/6	6R7	7/-	
2M3	6/-	6B87	7/6	6R7	7/-	
2M4	6/-	6B87	7/6	6R7	7/-	
2M5	6/-	6B87	7/6	6R7	7/-	
2M6	6/-	6B87	7/6	6R7	7/-	
2M7	6/-	6B87	7/6	6R7	7/-	
2M8	6/-	6B87	7/6	6R7	7/-	
2M9	6/-	6B87	7/6	6R7	7/-	
2N0	6/-	6B87	7/6	6R7	7/-	
2N1	6/-	6B87	7/6	6R7	7/-	
2N2	6/-	6B87	7/6	6R7	7/-	
2N3	6/-	6B87	7/6	6R7	7/-	
2N4	6/-	6B87	7/6	6R7	7/-	
2N5	6/-	6B87	7/6	6R7	7/-	
2N6	6/-	6B87	7/6	6R7	7/-	
2N7	6/-	6B87	7/6	6R7	7/-	
2N8	6/-	6B87	7/6	6R7	7/-	
2N9	6/-	6B87	7/6	6R7	7/-	
2O0	6/-	6B87	7/6	6R7	7/-	
2O1	6/-	6B87	7/6	6R7	7/-	
2O2	6/-	6B87	7/6	6R7	7/-	
2O3	6/-	6B87	7/6	6R7	7/-	
2O4	6/-	6B87	7/6	6R7	7/-	
2O5	6/-	6B87	7/6	6R7	7/-	
2O6	6/-	6B87	7/6	6R7	7/-	
2O7	6/-	6B87	7/6	6R7	7/-	
2O8	6/-	6B87	7/6	6R7	7/-	
2O9	6/-	6B87	7/6	6R7	7/-	
2P0	6/-	6B87	7/6	6R7	7/-	
2P1	6/-	6B87	7/6	6R7	7/-	
2P2	6/-	6B87	7/6	6R7	7/-	
2P3	6/-	6B87	7/6	6R7	7/-	
2P4	6/-	6B87	7/6	6R7	7/-	
2P5	6/-	6B87	7/6	6R7	7/-	
2P6	6/-	6B87	7/6	6R7	7/-	
2P7	6/-	6B87	7/6	6R7	7/-	
2P8	6/-	6B87	7/6	6R7	7/-	
2P9	6/-	6B87	7/6	6R7	7/-	
2Q0	6/-	6B87	7/6	6R7	7/-	
2Q1	6/-	6B87	7/6	6R7	7/-	
2Q2	6/-	6B87	7/6	6R7	7/-	
2Q3	6/-	6B87				

BI-PRE-PAK LIMITED

FULLY TESTED AND MARKED

AC107	3/-	OC170	3/-
AC126	2/6	OC171	4/-
AC127	2/6	OC200	3/6
AC128	2/6	OC201	7/-
AC176	5/-	2G301	2/6
ACY17	3/-	2G303	2/6
AF114	4/-	2N711	10/-
AF115	3/6	2N1302-3	4/-
AF116	3/6	2N1304-5	5/-
AF117	3/6	2N1306-7	6/-
AF239	12/6	2N1308-9	8/-
AF186	10/-	2N3844A	5/-
AF139	10/-	Power	
BFY50	4/-	Transistors	
BSY25	7/6	OC20	10/-
BSY28	2/6	OC23	10/-
BSY27	3/-	OC25	8/-
BSY28	3/-	OC26	5/-
BSY29	3/-	OC28	7/6
BSY95A	3/-	OC35	5/-
OC41	2/6	OC36	7/6
OC44	2/6	AD149	10/-
OC45	2/6	2N2287	20/-
OC71	2/6	2N3055	15/-
OC72	2/6	Diodes	
OC73	3/6	AA42	2/-
OC81	2/6	OA95	2/-
OC81D	2/6	OA70	1/9
OC83	4/-	OA79	1/9
OC139	2/6	OA81	1/9
OC140	3/6	IN914	1/6

TRY OUR X PACKS FOR UNEQUALLED VALUE

XA PAK

Germanium PNP type transistors, equivalents to a large part of the OC range, i.e. 44, 45, 71, 72, 81, etc.

PRICE £5 PER 1000

POST & PACKING 4/6 U.K.

XB PAK

Silicon TO-18 CAN type transistors NPN/PNP mixed lots, with equivalents to OC200-1, 2N706a, BSY27/29, BSY95A.

PRICE £4-5 PER 500

PRICE £8 PER 1000

POST & PACKING 2/6 U.K.

XC PAK

Silicon diodes miniature glass types, finished black with polarity marked, equivalents to OA200, OA202, BAY31-39 and DK10, etc.

PRICE £4-10 PER 1000

POST & PACKING 2/6 U.K.

ALL THE ABOVE UNTESTED PACKS HAVE AN AVERAGE OF 75% OR MORE GOOD SEMI-CONDUCTORS. FREE PACKS SUSPENDED WITH THESE ORDERS. ORDERS MUST NOT BE LESS THAN THE MINIMUM AMOUNTS QUOTED PER PACK.

NEW TESTED & GUARANTEED PAKS

B2	4	PHOTO CELLS. SUN BATTERIES. INC. BOOK OF INSTRUCTIONS	10/-
B77	2	AD161—AD162 NPN/PNP TRANS. COMP. OUTPUT PAIR	10/-
B79	4	IN4007 SIL. REC. DIODES 1000 PIV 1 AMP. MINIATURE	10/-
B81	10	REED SWITCHES MIXED TYPES LARGE & SMALL	10/-
B89	2	5 SP5 LIGHT SENSITIVE CELLS LIGHT RES. 400 Ω DARK 1 M Ω	10/-
B91	8	NKT163/164 PNP GERM. TO -5 EQUIVALENT TO OC44, OC45	10/-
B92	4	NPN SIL. TRANS. AO6=BSX20. 2N2369. 500MHz. 360mW	10/-
B93	5	GET113 TRANS. EQUIV. TO ACY17-21 PNP GERM.	10/-
B94	6	NPN SIL. PLANAR EPITAXIAL TRANS. CS4 SIMILAR TO BSY38 OR BC108	10/-
B96	5	2N3136 PNP SIL. TRANS. TO-18 HPE100-300 IC. 600mA. 200MHz	10/-
B98	10	XB112 & XB102 EQUIV. TO AC126 AC156, OC81/2, OC71/2, NKT271, ETC.	10/-
H2	2	2N2067 MATCHED PAIR PNP. GERM. 12 WATTS	10/-

FREE!

PACKS OF YOUR OWN CHOICE UP TO THE VALUE OF 10/- WITH ORDERS OVER £4

HUGE CLEARANCE OF UHF/VHF TUNER UNIT REJECTS

STOCKS ALMOST EXHAUSTED! PLACE YOUR ORDERS NOW!!!

FANTASTIC TRANSISTOR VALUE

TU.2. CONTAINING 2 AF186's & 2 AF178's PRICE 10/- EACH UNIT

TU.3. CONTAINING 2 AF186's & 2 AF178's PLUS WAVEBAND SLIDER SWITCH PRICE 12/6 EACH UNIT P & P 2/6d. EACH UNIT.

All the Units have many other components e.g. Capacitors, Resistors, Coils and Tuning Condensers etc.

ALL TUNER UNITS ARE SUPPLIED WITH CONNECTION DATA

SPECIAL OFFER
GERMANIUM BRIDGE RECTIFIERS, MULLARD TYPE GEX 541-BP. 48 VOLTS 5 AMPS.
List Price 58/-
OUR PRICE 10/-

NEW UNMARKED UNTESTED PAKS

B78	12	INTEGRATED CIRCUITS, DATA & CIRCUITS OF TYPES, SUPPLIED WITH ORDERS	10/-
B80	8	DUAL TRANS. MATCHED O/P PAIRS NPL-SIL INTO-5 CAN	10/-
B82	10	OC45, OC81D & OC81 TRANS MULLARD GLASS TYPE	10/-
B83	200		10/-
B84	100	SILICON DIODES DO-7 GLASS EQUIV. TO OA200, OA202	10/-
B86	150	HIGH QUALITY GERM. DIODES MIN. GLASS TYPE	10/-
B86	50	SIL. DIODES SUB. MIN. IN914 & IN916 TYPES	10/-
B87	100	GERM. PNP TRANS. EQUIV. TO OC44, OC45, OC81, ETC.	10/-
B88	50	SIL TRANS. NPN, PNP, EQUIV. TO OC200/1, 2N706A, BSY95A, ETC.	10/-
B80	10	7 WATT ZENER DIODES. MIXED VOLTAGES	10/-

PRE-PAK. N.605 POWER TRANSISTOR EQUIVALENT TO NKT301-2-3-4 **5/- each**

COMPLIMENTARY SET NPN/PNP GERM. TRANS. **2/6 pair**

Return of the unbeatable P.1 Pak.

Now greater value than ever

Full of Short Lead Semiconductors & Electronic Components, approx. 170. We guarantee at least 30 really high quality factory marked Transistors PNP & NPN, and a host of Diodes & Rectifiers mounted on Printed Circuit Panels. Identification Chart supplied to give some information on the Transistors.

Please ask for Pak **P.1**. Only **10/-** 2/- P & P on this Pak.

Make a Rev. Counter for your Car. The 'TACHO BLOCK'. This encapsulated block will turn any 0-1mA meter into a perfectly linear and accurate rev. **20/- each**

FREE CATALOGUE AND LISTS for:-

**ZENER DIODES
TRANSISTORS, RECTIFIERS
FULL PRE-PAK LISTS
& SUBSTITUTION CHART**

MINIMUM ORDER 10/- CASH WITH ORDER PLEASE. Add 1/- post and packing per order. OVERSEAS ADD EXTRA FOR AIRMAIL.

**THERE IS ONLY ONE
BI-PRE-PAK LTD
BEWARE OF IMITATIONS**

FREE! A WRITTEN GUARANTEE WITH ALL OUR TESTED SEMICONDUCTORS

BI-PRE-PAK LTD

DEPT. B, 222-224 WEST ROAD, WESTCLIFF-ON-SEA, ESSEX
TELEPHONE: SOUTHEND (0702) 46344

APPOINTMENTS VACANT

DISPLAYED SITUATIONS VACANT AND WANTED: £6 per single col. inch.

LINE advertisements (run-on): 7/- per line (approx. 7 words), minimum two lines.

Where an advertisement includes a box number (count as 2 words) there is an additional charge of 1/-.

SERIES DISCOUNT: 15% is allowed on orders for twelve monthly insertions provided a contract is placed in advance.

BOX NUMBERS: Replies should be addressed to the Box number in the advertisement, c/o Wireless World, Dorset House, Stamford Street, London, S.E.1.

No responsibility accepted for errors.

Advertisements accepted up to AUGUST 8 for the SEPTEMBER issue, subject to space being available.

THE UNIVERSITY OF ASTON IN BIRMINGHAM ELECTRICAL ENGINEERING DEPARTMENT

M.Sc. COURSES

October 1969 to September 1970

Graduate courses, of one year duration, leading to a Master's Degree are offered in Electrical Engineering and in Precision Measurement and Instrumentation.

M.Sc. in Electrical Engineering (ref. M.Sc. 8)

One third of the lecture work will cover mathematics and electrical engineering materials. The remaining time will be devoted to one specialist option selected from the following:

- (a) Communication Systems.
- (b) Control Systems.
- (c) Design of Pulse and Digital Circuits and Systems.
- (d) Electrical Machines.
- (e) Power Systems.

The Science Research Council has accepted this course as suitable for tenure of its advanced course studentships.

M.Sc. in Precision Measurement and Instrumentation (ref. M.Sc. 27)

This course is run by an interdepartmental group comprising Electrical Engineering, Mathematics, Mechanical Engineering, Physics and Production Engineering departments.

Both courses are open to applicants who have graduated in science or engineering or who hold equivalent professional qualifications.

Suitably qualified persons who wish to attend for part of either course (without examination) may do so by arrangement.

Application forms and further particulars (quoting ref. no.) may be obtained from:

THE HEAD OF THE DEPARTMENT OF ELECTRICAL ENGINEERING, THE UNIVERSITY OF ASTON IN BIRMINGHAM, GOSTA GREEN, BIRMINGHAM 4. 2315

UNIVERSITY OF CAMBRIDGE ENGINEERING DEPARTMENT

ELECTRONICS TECHNICIANS

Applications are invited for vacancies in the Electronics workshop of the department covering the manufacture and maintenance of a wide range of instrumentation and experimental equipment. Ability to service both proprietary and specialised equipment essential, HNC, ONC and City & Guilds level attainment highly desirable. Ample scope for design and development projects. Posts are available in the Technical Assistant grade, rising to £1,200 p.a. and High Technical Assistant grade, maximum £1,467 p.a. 5-day working week with 5½ weeks holiday per year.

Further particulars and application form from:

Superintendent of Workshops
Cambridge University Engineering Dept.
Trumpington Street
Cambridge, CB2 1PZ 2306

GEC-Marconi Electronics

Test Engineers

AT MARCONI WEMBLEY

Due to a further expansion of the Test Department, applications are invited from ELECTRONICS and TELECOMMUNICATIONS ENGINEERS to fill positions at the Company's Wembley establishment.

Applicants are expected to have a knowledge of Circuitry and be able to undertake testing and fault finding of a wide range of Communications Transmitters and Receivers, Data Handling Equipment, Radar, and a variety of Electronic Aids. Domestic Radio/TV service engineering experience is unsuitable.

We are looking for Engineers with several years' production test experience in these fields or for ex-Regular Service Technicians with appropriate Forces' training and experience.

A 37-hour, five-day week is worked (8.30 am-4.24 pm) with occasional paid overtime. We are well served by frequent rail and road transport services from most areas. Holiday commitments honoured.

Marconi



Please apply by letter giving age, education, experience and present salary, quoting reference WW/WW/1 to: The Personnel Officer, The Marconi Company Limited, Wembley Works, Lancelot Road, Wembley, Middlesex. Tel: 01-902 9421.

Member of GEC-Marconi Electronics Limited

REDIFFUSION

COLOUR TELEVISION FAULTFINDERS & TESTERS

We have a number of vacancies in our Production Test Departments for experienced faultfinders and testers.

Knowledge of transistor circuitry and experience with Colour Receivers together with R.T.E.B. Final Certificate or equivalent qualifications required.

These will be staff appointments with all the expected benefits.

Applications to:

Works Manager,
Rediffusion Vision Service Ltd.,
Fullers Way South,
Chessington, Surrey (near Ace of Spades).
Phone: 01-397 5411

**RADIO SYSTEMS DIVISION
AUTOMATED DYNAMIC TESTING**

Senior Development Engineers

are required by our Test Gear Department for work on fully automated systems, for carrying out dynamic tests on electronic equipments of advanced design. The project includes:

**Punch Tape Control
Programmable Stimuli
and Response
Logic Functions**

Engineers will work on individual facets of the project, as part of a team, and will be required to embrace conventional measuring methods and advanced digital techniques in new approaches to measurement problems. This is a new and sophisticated technique of production testing calling for SENIOR ENGINEERS capable of exploring new

**Micro Miniaturisation
D.C.—400 MHz
Dynamic Testing
Print Outs**

fields and carrying through to a practical conclusion. Further vacancies exist for TEST PROGRAMMERS and MAINTENANCE STAFF. Salaries will be negotiated individually and there are generous staff benefits. To apply please send a brief career history, quoting Ref. ILF/855/E to: The Technical Staff Manager, The Plessey Company Limited, Ilford, Essex.

PLESSEY ELECTRONICS



ANTARCTIC EXPEDITION

REQUIRES

**WIRELESS OPERATORS/
MECHANICS**

1st or 2nd Class PMG Certificate with current morse speed of 20 WPM. Servicing experience essential and knowledge of teleprinters desirable. Salary from £938 according to qualifications and experience with all living and messing free.

For further details apply to:

**BRITISH ANTARCTIC SURVEY
30 GILLINGHAM STREET, LONDON, S.W.1**

2299

Test Engineer required

For Digital and Analogue Equipment

As one of the leading companies in the field of Geophysical exploration, we carry out surveys for gas, oil and mineral companies using techniques that we have pioneered and developed ourselves. These involve the use of up-to-date digital and analogue equipment and we now require a senior TEST ENGINEER to prepare and test this equipment at our Kent headquarters.

Applicants should be suitably qualified, H.N.C., or similar standard preferred but not essential, and must have practical experience of digital data acquisition systems.

Salary is negotiable and will reflect the skill and experience offered. The post is permanent and we operate Pension and Life Assurance schemes. Please give relevant career details and address your application to:

Personnel Manager

SEISMOGRAPH SERVICE LIMITED
Holwood, Keston, Kent · Farnborough 53355

2313



R/F TEST ENGINEERS

Engineers are required for final test of Solid State R/F prototype and pre-production equipment operating at U.H.F. and microwave frequencies.

These positions would be ideally suitable to ex service radio/radar personnel or test engineers with experience in the use of R/F/Microwave test equipment and a knowledge of transistorised circuitry.

The Company offers first class holiday, sick payments and welfare facilities including an excellent group pension and insurance scheme.

Please apply in writing to:

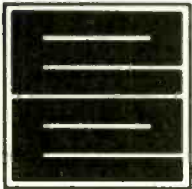

Personnel Officer,

Ether Engineering Ltd

Park Avenue, Bushey, Herts. Phone: Watford 28566.

THE LARGEST EXPORTERS  OF VHF/
UHF RADIOTELEPHONE EQUIPMENT
IN THE WORLD REQUIRE:

ELECTRONICS ENGINEERS

This expanding, dynamic company invites you to join our teams working on the design and development of fixed, mobile and portable UHF/VHF transmitters and receivers. The work involves an all-round approach to design and development including every stage between the drawing board and the production line.

Ideal Applicants will have experience in economic design for quantity production in our—or similar—fields of activity. An appropriate degree or diploma (or proven experience on a similar level) is essential.

Age should preferably be between 20 and 30
Contributory pension scheme
Re-location assistance



Pye Telecommunications Ltd

Newmarket Road, Cambridge Tel: 0223 61222

BBC

offers

OPPORTUNITIES IN ELECTRONICS

Ambitious, energetic and resourceful technicians are required to check and align new electronic systems which are being made by the BBC for its Colour Television and Radio Services.

Vacancies exist for Laboratory Technicians (grade maximum £1,560 p.a.) and for Senior Laboratory Technicians (grade maximum £1,775 p.a.).

Applicants lacking suitable qualifications or experience may be placed initially in a training grade which has a maximum salary of £1,345 p.a. Qualified Senior Laboratory Technicians are eligible after three years service for consideration for promotion to Engineering Technician, a grade which has a maximum salary of £2,060 p.a. Paid day release facilities are available for technicians to obtain approved technical qualifications.

The posts, which are permanent and pensionable, are based at Chiswick, London, W.4.

Request for application form to

Engineering Recruitment Officer,
BBC, Broadcasting House,
London W.1A 1AA,

quoting reference 69.E 2152 W.W.



Opportunities in Tektronix

**this is one of the world's
most advanced oscilloscopes**

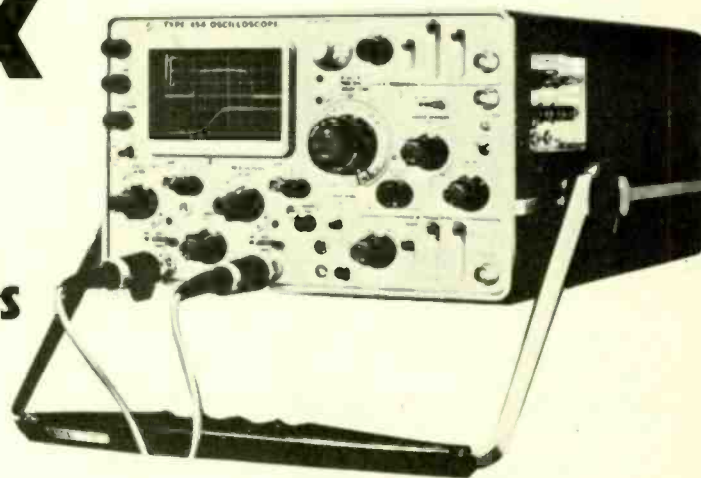

We need more top-grade Field-Sales Engineers to promote this and our ever-increasing range of Oscilloscopes and ancillary instruments in the southern half of England. Minimum technical requirement is HNC standard, preferably with experience of high-grade oscilloscopes.

Remuneration includes:
Profit-sharing, Non-Contributory Life-Assurance & Pension schemes, and progressive salaries commensurate with the importance we attach to these posts. If you think you have the necessary attributes, write to:-



BOB GARRETT
Field Engineering Manager,
Tektronix U.K. Ltd.,
Beaverton House, Station Approach,
Harpenden, Herts.

2346

SERVICE ENGINEERS

Our Group of Companies is currently extending its servicing function in its two principal fields of

COMMUNICATIONS AND INSTRUMENTATION

Both Senior and Intermediate vacancies exist in Reading and Bracknell in Company workshops furnished with modern test and fault finding equipment.

Previous servicing experience is desirable but our main requirement is for an enthusiastic sound technical approach to the servicing problems of our complete range of products.

Applications in writing please to:-

RACAL
THE RACAL GROUP

Mr. L. A. Jemmett,
Personnel Manager,
Racal-BCC Limited,
Western Road,
Bracknell, Berks.

SOUTH AFRICAN BROADCASTING CORP. MAINTENANCE TECHNICIANS and SENIOR TECHNICIANS

SALARY SCALE : £1,100 to £2,300 per annum

The South African Broadcasting Corporation Johannesburg, Republic of South Africa, has the following vacancies in its Engineering Department.

MAINTENANCE TECHNICIANS and SENIOR TECHNICIANS Sound Broadcasting Studios

To assist with the maintenance of broadcasting equipment in a large studio complex including sound mixers, programme routing equipment, automated programme equipment, tape and disc recording and playback units. Some shift work will be required.

The Corporation offers annual increments and bonus on merit and has a pension fund, medical aid scheme and group life assurance scheme of which membership is compulsory. Attractive commencing salaries, salary scales and a settling allowance are offered. Travelling expenses to the Republic of South Africa will be borne by the S.A.B.C.

Applications should be addressed to Mr. G. L. A. Jensen, Administrative Supervisor, S.A.B.C., C/o Agence France Presse, 43, Shoe Lane, London E.C.4, to reach him not later than 15th August 1969. Interviews will be conducted in London.

2303

Government of MALAWI

REQUIRES

Radio Engineer

[Police Department]

to serve on contract for one tour of 24—36 months in the first instance. Salary according to experience in scale £574—1223 a year (basic) plus Overseas Addition £401—612 a year. A further allowance of £196—244 a year is paid directly to the officer's bank in the U.K. Gratuity (free of Malawi tax) 25% of basic salary plus Overseas Addition provided minimum tour of 30 months is served. Liberal paid leave. Outfit and education allowances. Furnished accommodation. Free passages. Contributory pension scheme available in certain circumstances.

Candidates, up to 45 years, should have at least 5 years

practical experience in radio, preferably in a Police Force or the Armed Forces. Preference will be given to candidates possessing the City and Guilds Intermediate Telecommunications Certificate or equivalent. A good knowledge of transistor circuitry, multi-channel carrier telephone equipment and/or diesel plant and petrol/electric alternators would be an advantage.

Apply to CROWN AGENTS, 'M' Division, 4 Millbank, London, S.W.1., for application form and further particulars stating name, age, brief details of qualifications and experience and quoting reference number M2K/64949/WF

2349

Work as a RADIO TECHNICIAN attached to Scotland Yard

You'd be based at the Metropolitan Police Wireless Station, Thornton Heath. Your job would be to maintain the portable VHF 2-way radios, tape recorders, radio transmitters and other electronic equipment, which the Metropolitan Police must use to do their work efficiently.

We require a technical qualification such as the City & Guilds Intermediate (telecommunications) or equivalent.

Salary scale: £1,032 (age 21), rising by increases to £1,379. Promotion to Telecommunication Technical Officer will bring you more.

For full details of this worthwhile and unusual job, write to: Metropolitan Police, Room 733 (RT), New Scotland Yard, Broadway, London, S.W.1.

2350

Planning Engineer DATA TRANSMISSION SYSTEMS

THE POST is in the Systems Planning Department of our Head Office at Southall, and will involve the planning of national and international data transmission systems. These can either be self-contained networks or systems allied to computers.

THE MAN to fill this post must be an engineer with a broad knowledge of communication systems and practical experience of the problems associated with the transmission of data at low, medium and high speeds. He should possess specialised knowledge in two or more of the following fields.

- Data modem and international standards for modulation and interface parameters.
- Commissioning, equalising and subsequent quantity control of long distance circuits handling data.
- Distribution of high speed data from computers to video display terminals.
- Low speed data switching systems handling telegraph signals including polling systems.
- The use of G.P.O. datel services and the problems of demarcation between G.P.O. and lessee's equipment.
- Operation of long distance leased circuits carrying data with particular reference to reliability of different sections of route.

It is unlikely that the successful applicant will be less than 30 years old. He should preferably have membership of a professional institution or qualification leading to such membership.

OUR OFFER will carry a starting salary to be negotiated in the range of £1,800-£2,100, membership of an excellent Contributory Pension and Life Insurance Scheme and benefits also include substantial concessions on holiday air fares to most parts of the world after 1 year's service. The post offers very good career prospects.

Please apply stating briefly details of age and qualifications to date, to:

Personnel Officer (R),
International Aeradio Limited,
Aeradio House, Hayes Road, Southall, Middlesex.



INTERNATIONAL AERADIO LIMITED

AERADIO HOUSE · HAYES ROAD · SOUTHALL · MIDDLESEX

2359



The Stock Exchange require two

Television Service Engineers

Later this year, as the Stock Exchange continues its programme of modernisation, a closed circuit television system is being installed for the display of market prices.

To maintain this system, two experienced Television Service Engineers are required. Appropriate Television and Radio servicing certificates are essential, and applicants must be able to prove their ability as competent Service Engineers by suitable trade test.

Attractive salaries are offered in the region of £1,500-£1,600 p.a. with these positions and fringe benefits include a non-contributory pension scheme.

Applications giving brief details of qualifications and experience should be sent to: The Personnel Officer, Council of the Stock Exchange, 61 Threadneedle Street, EC2.

V.H.F. TELEVISION RELAY & COMMUNAL AERIAL SYSTEMS

We are planning a considerable expansion of our activities and have the following vacancies:

I. A SENIOR ENGINEER

to have control of all aspects of systems design, planning, estimating, installation and commissioning.

II. ENGINEERS

capable of undertaking either:

- (a) System planning and estimating.
- (b) control of installation work.

or (c) test and commissioning duties.

Candidates for these appointments must have a good background of practical experience in this field of work, and an up-to-date knowledge of techniques and equipment.

Applications, which will be treated in strict confidence, should be sent to:

BRITISH RELAY

The General Manager,
Special Services Division,
British Relay House,
41, Streatham High Road, S.W.16

2342

THE HANNAH DAIRY RESEARCH INSTITUTE

An ASSISTANT EXPERIMENTAL OFFICER

required to assist in operation and further development of calorimeter for studying heat losses from animals. A man interested in using physical and engineering techniques for biological measurements would be particularly suitable. Previous experience in animal calorimetry not essential. Minimum qualifications ordinary B.Sc. or a Higher National Certificate or its equivalent in general science or electrical engineering. Salary on the A.E.O. grade with entry according to age (£770 at age 20; £1,150 at age 26 or over; rising to maximum £1,385). Superannuation. Applications, with the names of two referees, to the Secretary, The Hannah Dairy Research Institute, Ayr, by 14th July, 1969.

2311

EXPERIMENTAL OFFICER

required to assist in the setting up and running of a technologically biased laboratory in electronic tubes. The laboratory forms part of postgraduate training scheme for electrical engineers in the tube manufacturing industry. Qualifications should be HNC, HND, degree or equivalent in electrical engineering. Experience in vacuum technology, electronic tubes, microwave systems or gas-filled tubes will be an advantage. Appointment in the first instance is for three years after a suitable probationary period. Salary—£1455 to £1865 per annum. Superannuation. Application to Departmental Superintendent, Electrical Engineering Department, Imperial College, South Kensington, S.W.7.

2296

Government of ZAMBIA

Requires

RADIO ENGINEER

for the Government Flight Department, Ministry of Power, Transport and Works, on contract for one tour of 36 months in the first instance. Total gross emoluments in scale up to £2,945, commencing point in scale according to experience. These emoluments comprise basic salary in scale Kwacha 1896 (Stg.£1106) rising to Kwacha 3516 (Stg. £2051) a year, plus an Inducement Allowance of £Stg.399-£Stg.603 a year. Gratuity 25% of total salary drawn. A direct payment of £Stg.233-£Stg.291 is also payable direct to an officer's home bank account. Both gratuity and supplement are normally TAX FREE. Free passages. Quarters at low rental. Children's education allowances. Liberal leave on full salary or terminal payment in lieu.

Candidates, preferably under 50 years of age, must have the minimum qualification of Radio 'A' Licence. Preference will be given to candidates holding electrical 'X' group 9.1, with experience on American V.H.F., VOR H/F, and possessing a Radio 'B' Licence.

The officer will be required to work on Piper Aztec type aircraft and to carry out the maintenance of the radios of the Government Communication Flight Aircrafts.

Apply to CROWN AGENTS, 'M' Division, 4 Millbank, London, S.W.1., for application form and further particulars stating name, age, brief details of qualifications and experience and quoting reference number MzZ/680906/WF.

BBC

DESIGNS DEPARTMENT LABORATORY TECHNICIANS

BBC offers permanent, pensionable appointments in its Engineering Designs Department, London, W.1. Duties involve assisting Engineers in the construction and development of units of sound and television broadcasting equipment and in carrying out performance tests on them. Candidates should have O.N.C. or equivalent C. & G. Telecommunications Technician Certificates. They must also have had at least two years' relevant practical experience and have sound knowledge of electronics theory. Possession of H.N.C. or equivalent an advantage. Depending on qualifications and experience on appointment, salary scale will be either (a) starting between £1215 p.a. and £1353 p.a. rising by £69 a year to maximum £1560 p.a., or (b) starting between £1400 p.a. and £1550 p.a. rising by £75 a year to maximum £1775 p.a. Junior applicants may be appointed at a training grade on a commencing salary of £1050 p.a. Opportunities exist for candidates appointed at lower scales to progress to the higher scales.

TELEVISION RECORDINGS LTD.

require:

ENGINEERS (Grade D)

ASSISTANT ENGINEERS (Grade E)

TECHNICAL ASSISTANTS (Grade H)

Experience in the operation and maintenance of either Broadcast VTR, telecine and associated equipment or Vision Control Studios and O.B's.

An incremental scheme plus colour and incentive payment operate. Basic salaries are in accordance with the A.C.T.T. rates.

Please apply in writing to:

**The Technical Controller,
Television Recordings Ltd.
9/11 Windmill Street, London, W.1**



Request for application form to Engineering Recruitment Officer, BBC, Broadcasting House, London, W1A 1AA, quoting reference 69.E.2168.W.W.

2312

2338



Digital is maintaining its position as the leading manufacturer of small, medium and large scientific computers and continuing expansion during 1969 has created further opportunities.

We offer:—

- A challenging career
- Excellent promotion prospects
- Opportunity to exercise initiative and imagination.
- Responsibility.

We require the following:—

Experienced

Electronics Engineer

Qualifications B.Sc., H.N.D. H.N.C. or equivalent. Preferably with 2 to 5 years of experience in the repair and maintenance of Electronic Equipment, Instruments, Circuits etc. down to component level. Further experience in Test Equipment design would be an advantage.

Responsibility to be the upgrading of a Module Repair Department by (a) Organising fault data collection and analysis; (b) Improving the test methods; (c) Development test equipment to increase the range of modules repaired.

Module Repair Technician

To assist the above Engineer. Qualifications are O.N.C. or equivalent with at least one year's relevant experience with Integrated Circuits and transistorised circuits.

Please write or telephone Personnel Department Ref. WW103
DIGITAL EQUIPMENT CO. LIMITED,
ARKWRIGHT ROAD, READING, BERKS. TEL: ORE 4-85131

EW 104

ELECTRONIC SERVICE ENGINEERS

required to work in this country and overseas, to maintain airborne navigational equipment. Ex-service Radar or Television and Radio Engineering experience an advantage.

Apply:

THE DECCA NAVIGATOR COMPANY LIMITED
SPUR ROAD, FELTHAM, MIDDX.
 Telephone: 01-890 4898

2301

UNIVERSITY OF SURREY EXPERIMENTAL OFFICER

Experimental Officer required, qualified and experienced in modern electronics to support the research groups in the Department of Electrical and Control Engineering.

The three major research groups are working in the fields of:

- Ion implantation into semiconductor materials.
- The applications of lasers and telecommunications.
- Control and computers.

The work includes design of special equipment and apparatus and assistance with experimental work. The contract of employment would be for three years in the first instance.

Salary in the range of £1,338 to £1,766 per annum. Applications should be sent to the Staff Officer, University of Surrey, Guildford, Surrey. 2327

NORWICH CITY COLLEGE DEPARTMENT OF ELECTRICAL ENGINEERING

Applications are invited for the position of

ELECTRONIC WORKSHOP TECHNICIAN

Applicants should have appreciable practical experience in electrical workshop practice and especially in the electronics field. Opportunities exist for study in order to obtain recognised qualifications.

Salary: Technical scale 2/3 (£765—£1,055 per annum). Additional payments for recognised qualifications.

Application forms may be obtained from the Registrar, Norwich City College, Ipswich Road, Norwich, Norfolk. NOR 67D. 2305

ELECTRONICS TECHNICIAN

Required to work in well equipped Electronics Department. Experience with Medical or Industrial Electronics or Nucleonic Equipment an advantage.

Salary according to age and experience

Applications to:

THE DIRECTOR,
NEUROPSYCHIATRIC RESEARCH UNIT,
MEDICAL RESEARCH COUNCIL LABORATORIES,
WOODMANSTERNE ROAD, CARSHALTON, SURREY

2326

Computer Engineering

NCR requires additional ELECTRONIC, ELECTRO-MECHANICAL ENGINEERS and TECHNICIANS to maintain medium to large scale digital computing systems in London and provincial towns.

Training courses will be arranged for successful applicants, 21 years of age and over, who have a good technical background to ONC/HNC level, City and Guilds or radio/radar experience in the Forces.

Starting salary will be in the range of £900/£1150 per annum, plus bonus. Shift allowances are payable, after training, where applicable. Opportunities also exist for Trainees, not less than 19 years of age, with a good standard of education, an aptitude towards and an interest in, mechanics, electronics and computers.

Excellent holiday, pension and sick pay arrangements. Please write for Application Form to Assistant Personnel Officer NCR, 1,000 North Circular Road, London, N.W.2, quoting publication and month of issue.

Plan your future with



Government of ZAMBIA

ZAMBIA BROADCASTING SERVICES

Requires

TECHNICAL OFFICER

[STUDIOS AND TRANSMITTERS]

on contract for one tour of 36 months in the first instance. Commencing salary according to experience in Scale Kwacha 1644 (£Stg.959) rising to Kwacha 3216 (£Stg. 1876) a year, plus an Inducement Allowance of £Stg.237-£Stg.615. Gratuity 25% of total salary drawn. A direct payment of £Stg.233-£Stg.291 is also payable direct to an officer's home bank account. Both gratuity and supplement are normally TAX FREE. Free passages. Quarters at low rental. Children's education allowances. Liberal leave on full salary or terminal payment in lieu.

Candidates preferably between 23 and 45 years of age, must possess the City and Guilds Intermediate Certificate in Telecommunications, or the equivalent and have at least

four years experience in a recognised Broadcasting Organisation on maintenance duties in:

- (a) Sound Transmission and recording studios, or
- (b) Television studios, or
- (c) Transmitting stations.

The officer will be required to undertake routine operational shift duties and to assist with the maintenance and installation of equipment.

Apply to CROWN AGENTS, 'M' Division, 4 Millbank, London, S.W.1., for application form and further particulars stating name, age, brief details of qualifications and experience and quoting reference number M2Z/680905/WF.

2352

MID-HERTS COLLEGE OF FURTHER EDUCATION
THE CAMPUS, WELWYN GARDEN CITY, HERTS.

DEPARTMENT OF ELECTRICAL ENGINEERING

LECTURER, before January 1970 if possible to teach on Electrical and Telecommunication Technician courses up to Pt. II level. Specialist in G.P.O. work subjects particularly suitable.

Minimum qualifications—H.N.C. Elec. with practical telecomm. industrial experience, Teacher training or experience an advantage, but training course available on day-release in the County.

Salary £1,035-£1,835 dependent on qualifications and experience in industry. For a candidate able to organise all telecomm. courses an extra £175 allowance may be paid. Assistance with housing and removal in certain cases.

Forms and further details from Principal at the College. Closing date 25th July.

2316

Electronics Technician or Junior Technical Officer

required to develop and build solid state equipment for the cyclotron control system embodying current computer techniques. Some relevant experience essential. Opportunities for day release study. Age under 25. Starting salary up to £1169 according to qualifications and experience. Write with full details to:

THE DIRECTOR,

Medical Research Council Cyclotron Unit,
HAMMERSMITH HOSPITAL,
DUCANE ROAD, LONDON, W.12.

2317

GEC-Marconi Electronics

ELECTRONIC TECHNICIANS

Marconi can offer you

Attractive salary. Annual salary reviews
Good working conditions. 37-hour working week
Non-tied housing in a new town
in certain circumstances

At Basildon we have a number of vacancies for technical test staff to work on advanced aeronautical electronic systems, maintenance and building of test equipment and other major projects. These positions will be of particular interest to men with experience of transmitters, receivers, aerials, closed circuit T.V. or digital systems.

Marconi



Please telephone or write for an application form to: Mr. R. McLachlan, Personnel Officer, The Personnel Dept, The Marconi Company Limited, Christopher Martin Road, Basildon, Essex. Phone: Basildon 22822.

Member of GEC-Marconi Electronics Limited

2345

communications technicians

Air Force Department

The Air Force Department now has two levels of entry for men as Telecommunication Technical Officers. Both involve work on the installation, calibration, repair, maintenance and inspection of airborne and ground radio and radar equipments at R.A.F. stations in the United Kingdom. Opportunities for overseas service.

Age: At least 25 for Grade II.
At least 21 for Grade III.

Starting salary: (National) Grade II £1,601 which rises with yearly increases to £1,853 (£1,975 after 1.1.70.)
Grade III. According to age, e.g. £1,086 at 21, £1,178 at 23, £1,418 at 28 or over. Rises to £1,601 (£1,735 after 1.1.70.)
Promotion can take you to posts carrying at least £2,825.

Working conditions: 5 day working week. Over 3 weeks annual holiday from the start. This rises to 6 weeks. Non-contributory pension.

Qualifications: City & Guilds Technical Intermediate (No. 49) plus Certificates in Mathematics B, Telecommunications Principles B and Radar and Line Transmission B, or O.N.C. or equivalent in appropriate subjects. *Grade II candidates must also have had experience of supervising staff engaged on radio, radar, or other electronic work.*

*Fuller details of acceptable qualifications supplied on request.
Write to: Civil Service Commission, Savile Row, London W1X 2AA; or telephone 01-734 6010, Ext. 229 (after 5.30 p.m. 01-734 6464 "Ansafone" service) for application form, quoting S/7225/A. Closing date 9th Sept. 1969.

ELECTRONICS ENGINEER

to design solid state circuits of high reliability in control, power supply and computer type applications. Pass degree or H.N.C. required. Some experience essential. Technical Officer category. Starting salary up to £1,518 p.a. Apply with career particulars to **THE DIRECTOR, MEDICAL RESEARCH COUNCIL CYCLOTRON UNIT, HAMMER-SMITH HOSPITAL, LONDON, W.12**

2337

FOR HIRE OR SALE

CLOSED CIRCUIT TELEVISION EQUIPMENT

23in. PYE Monitors and single channel 625 lines polished teak cabinets. PYE Lynx Cameras, working tubes lin. lenses: suitable for surveillance, education and general applications.

For details and prices contact Television Applications Limited, 9/11 Windmill Street, London, W.1. 01-636 3521. 2334

ELECTRONIC ENGINEER

required for development of apparatus for medical research purposes. The applicant should have a general knowledge of electronic instruments such as amplifiers, cathode ray tube displays and pressure measuring apparatus. Some workshop experience would be an advantage. The Salary is in the range £1,120-£1,455 as a Medical Physics Technician III according to age, qualifications and experience.

Applications, giving these details, and the names of two referees to: Geoffrey A. Robinson, Secretary to the Board of Governors, The National Hospital, Queen Square, London, W.C.1.

2298

TELEVISION ENGINEER

One-inch helical scan VTR and CCTV experience. Prospects of working in colour television.

Must be willing to travel occasionally through U.K. and Europe.

Salary approx. £1,500 per annum.

Telephone Mr. PANNAMAN 01 580 2283

2304

ROYAL FREE HOSPITAL

167 GRAYS INN ROAD, LONDON, W.C.1

MEDICAL ELECTRONICS DEPARTMENT

Technician required to assist in the development, construction and maintenance of medical research equipment. Previous experience in this field would be an advantage. Whitley Council rates. Please write, or telephone Mr. J. Green, Tel. No. 01-837 6411, Ext. No. 158, for further information.

[2331

THE COLLEGE OF AERONAUTICS

The following appointments are to be made in the High Frequency Section of the DEPARTMENT OF ELECTRICAL AND CONTROL ENGINEERING and are open to candidates who have experience in waveguide techniques.

TECHNICAL OFFICER TECHNICIAN

The vacancies are in the high frequency and radar laboratories which are concerned with postgraduate teaching and research in radar, radio and microwaves. Experience in the aviation field is not an essential requirement.

The TECHNICAL OFFICER will supervise the day-to-day activities in the laboratories and be responsible for the construction of specialised experimental equipment. Candidates should have passed the graduateship examination of the I.E.E., I.E.R.E., or possess a H.N.C. or equivalent qualification. Salary in scale rising to £1,517 p.a. (under review).

The TECHNICIAN, who will have received relevant training and experience, will be remunerated in a scale rising to £1,077 with a supplementary allowance of £50 p.a. for possession of a H.N.C. or equivalent qualification.

37 hour week of five days, generous holidays, staff superannuation and sick pay schemes.

Application form from Staff Records Officer, The College of Aeronautics, Cranfield, Bedford.

2309

Government of ZAMBIA

General Post Office

Professional Engineers

required for telecommunications on contract for one tour of 36 months in the first instance. Commencing salary according to experience in scale. Kwacha 2784 rising to Kwacha 4464 a year (£Stg.1624-£Stg.2605) plus inducement allowance of £Stg.348-£Stg.429 a year. Gratuity 25% of total salary drawn. A direct payment of Stg.£233-£Stg.350 is also payable direct to an officer's home bank account. Both gratuity and supplement are normally TAX FREE. Free Passages. Quarters at low rental. Children's education allowances. Liberal leave on full salary or terminal payment in lieu. Candidates should have a recognised degree in telecommunications or electrical engineering or equivalent qualification.

This should be followed by several years of experience with a telecommunications organisation. The duties of the posts are varied. They include planning of trunk and telegraph multiplex systems and radio systems, also the technical and economic evaluation of local and trunk line development policy in the field of underground cables and open wire lines.

Apply to CROWN AGENTS, 'M' Division, 4 Millbank, London, S.W.1., for application form and further particulars stating name, age, brief details of qualifications and experience and quoting reference number MzZ/61610/WF.

2353

TECHNICAL OFFICER

HOME OFFICE POLICE RESEARCH AND DEVELOPMENT BRANCH

Unestablished vacancy for a Technical Officer Grade III with knowledge and experience of workshop practice and electronic equipment. The successful candidate will work in the equipment group, which is concerned with assessment, trials and development of a wide range of equipment for police use, and will carry out construction, modification and test work in co-operation with police officers.

Qualifications: Ordinary National Certificate or evidence of an equivalent standard of technical education, together with a five year apprenticeship and at least three years' practical experience.

Salary: £1,114 (age 21)—£1,395 (age 28 or over on appointment)—£1,543.

Applications should be made to the Principal Establishment Officer, Room 327, Home Office, Whitehall, London, S.W.1, by 4th August, 1969.

2330

UNIVERSITY OF SURREY INSTITUTE FOR EDUCATIONAL TECHNOLOGY

A TECHNICIAN is required in the Institute of Electronic Technology to service a range of electronic equipment including audio visual aids. This will be a three-year appointment concerned with work for the Leverhulme Research Fellowship. Good holidays and conditions. Salary on a scale £773 to £1,077 p.a.

Applications should be forwarded to the Staff Officer, University of Surrey, Guildford.

2297

ATV NETWORK LIMITED

has vacancies in Birmingham for

4 ASSISTANT ENGINEERS

in their Telecine Section

required for operation and maintenance duties in this section of their Central Technical Department. This will involve working with modern 35 mm. and 16 mm. telecine projection equipment, caption and slide scanners and associated electronic equipment.

We would like to hear from applicants possessing a good knowledge of television electronics and who are interested in working in this particular field.

PLEASE QUOTE VACANCY No. 68.

SOUND ASSISTANT "A" or "B"

APPLICANTS should have wide experience of television sound techniques including boom operation and the use of disc and tape recording and reproducing equipment.

PLEASE QUOTE VACANCY No. 49.

APPLY fully in writing stating age, knowledge and experience, to

Head of Staff Relations Television

ATV NETWORK LIMITED

150 Edmund Street, Birmingham, 3

(quoting the appropriate vacancy No.)

circuit design engineers

for COLOUR TELEVISION

RANK BUSH MURPHY already occupy a leading position in the field of domestic radio and television. The brand names Bush and Murphy are synonymous with technical excellence and high reliability, and the current products continue to set the pace in technical design, aesthetic appeal and quality of reproduction.

The growth of the market in colour television creates further outstanding opportunities for electronics design and development engineers to join in this success and enjoy a future career with rewards matched to abilities and successful contribution to the business.

Our present need is for development engineers who have previous *successful experience of circuit design* in this or related fields such as communication systems or data processing.

The successful applicants will join our Advanced Development group at Chiswick and be concerned with examining the relevance and suitability of the latest techniques in electronics for inclusion in the design of our products. They should be around 27-30, qualified by degree and/or membership of I.E.E./or I.E.R.E., and earning a salary at present of around £1,800 per annum. Additional benefits on joining the Company include free life assurance, pension scheme and assistance with removals and relocation expenses in appropriate cases.

Applications should be addressed to:



Divisional Personnel Manager,
Rank Bush Murphy Ltd.,
Power Road, London, W.4.

The Rank Organisation

Holders of The Queen's Award to Industry for 3 successive years.



AIR FORCE DEPARTMENT

Vacancies at — RAF Sealand, near Chester — RAF Henlow, Bedfordshire and RAF Carlisle, Cumberland.

Interesting and vital work on RAF Radar and radio equipment for

RADIO TECHNICIANS

Minimum qualification, 3 years training and practical experience in radio engineering.

Starting pay according to age, up to £1130 p.a. (at age 25) rising to £1304 p.a. with prospects of promotion.

5-day week — good holidays — help with further studies — opportunities for pensionable employment.

Write for further details to:

Ministry of Defence CE3h (Air)
Sentinel House
Southampton Row
London, WC1

Applicants must be U.K. residents.

2307



RADIO & TELEVISION SERVICING RADAR THEORY & MAINTENANCE

This private College provides efficient theoretical and practical training in the above subjects. One-year day courses are available for beginners and shortened courses for men who have had previous training.

Write for details to: The Secretary, London Electronics College, 20 Penywern Road, Earls Court, London, S.W.5. Tel.: 01-373 8721.

84

ELECTRONICS TECHNICIAN

required, to be responsible to the Group Engineer for the maintenance, calibration and installation of a wide range of electronic equipment used in the medical and engineering field of hospital work. Qualifications required are to the level of H.N.C. with wide experience in the maintenance and calibration of electronic equipment. Salary range £1,030 to £1,365 p.a. Good applicants with reasonable prospects of acquiring the stated qualification will be considered. This post offers an ideal opportunity for a man to join a vital and growing service with prospects for advancement. Application forms from

**GROUP ENGINEER,
READING & DISTRICT HOSPITAL
MANAGEMENT COMMITTEE,
3 CRAVEN ROAD, READING**

2325

FIELD SERVICE ENGINEER

For public address and audio amplification equipment.

Based from our Glasgow office.
Experience essential.

Company vehicle or vehicle allowance provided.

Write: Service Manager, Magneta (B.V.C.) Ltd.,
Parson's Green Lane, London, S.W.6.

2300

BRAND NEW

Cossor pocket vhf transmitter/receivers, CC2/8, Mark 2. Two sets for 156.4mc (Chan 8, intership), also two sets 157.85 (Marinas and Yacht Clubs). All complete, reduced price of £100 each, or all four for £390. Hudson R/t a.m. base station, 50 watt tx, 25 kc rx, excellent condition, £200. Marconi TF 995/A5 Sig. Gen., as new, £275 "Telecomm" all-transistor Sig. Gen., 70/95mc, as new, £70. Carriage and packing extra on all above. Box. W.W. 2318, Wireless World.

2318

ENTHUSIASTS

have you considered a career in Technical Authorship? If you have sound experience in electronics or communications and ability to write clear concise English we would train you. The vacancies are in the Home Counties and the Midlands and salaries range from £1,600 to £1,900 p.a. depending on experience. Box W.W. 5056

2332

ATV NETWORK LIMITED

require an

ENGINEER

for their Technical Services Department (OB Vision Engineers Section). Applicants should have a thorough knowledge of Colour Television principles and practice, together with experience of modern 3 or 4 tube plumbicon television cameras.

Duties will include setting up, maintaining and controlling modern colour cameras and associated equipment on Outside Broadcast units, using advanced test equipment. Deputising for Vision Control Supervisor when necessary.

Salary £1900+.

Applications giving full details of age and experience should be sent to:

**Head of Staff Relations,
150 Edmund Street, Birmingham 3.**

Please mark on the envelope VACANCY 63 (E).
2324

Telecommunications Superintendent

Required by the GOVERNMENT OF THE GAMBIA to serve on contract for one tour of 18-24 months in the first instance. Salary according to experience in scale £G.1026-1266 a year plus Inducement Pay normally tax free, of £816-900 a year paid direct into officer's bank in U.K. Gratuity 25% of total emoluments. Generous paid leave. Furnished accommodation. Education and Outfit Allowances. Free passages. Contributory pension scheme available in certain circumstances.

Candidates, up to age 50, must possess a City and Guilds Intermediate Telecomms. Certificate (Radio) or equivalent plus 10 years' experience in telecommunications engineering, 5 of which should preferably have been in Africa. Experience of automatic telephone exchanges would be an advantage.

The officer selected will be responsible for:

- (A) the operation and maintenance of a V.H.F. multi-channel radio telephone and telegraph system throughout the Gambia.
- (B) the maintenance of Police V.H.F. and H.F. fixed and mobile system and signals vehicle.
- (C) general workshop practice including the repair and maintenance of miscellaneous equipment, i.e. tape recorders, public address equipment, etc.

He should be prepared to travel extensively in the Provinces.

Apply to CROWN AGENTS, "M" Division, 4 Millbank, London, S.W.1, for application form and further particulars, stating name, age, brief details of qualifications and experience and quoting reference number M2K/690526/WF.

2295

NORTHERN POLYTECHNIC

Holloway Road, London, N.7.

Principal:

J. Leicester, M.Sc., M.Sc. Tech., Ph.D., F.R.I.C.

Department of Electronic and Communications Engineering

Head of Department:

J. C. G. Gilbert, C.Eng., F.I.E.R.E., F.T.S., F.B.K.S.

Full-time 3-year course in preparation for the Northern Polytechnic Diploma in Electronics and Telecommunications. This course is recognised by the Institution of Electronic and Radio Engineers and gives full exemption from the Graduateship examination.

Part-time day release and evening courses for Section B of the Graduateship examination of the Institution of Electronic and Radio Engineers covering:-

Applied Electronics
Computer Engineering
Television Engineering
Advanced Telecommunication Principles

Advanced Short Courses on:-
Colour Television Engineering
Modern Network Theory
Pulse Techniques
Basic Microwave Techniques
Transistor Engineering
Medical Electronics
Audio Engineering Measurements.

Full-time, 3-year course leading to exemption from Part 1 of the Council of Engineering Institutions (C.E.I.) examination, and the Higher National Diploma (H.N.D.) in electronic engineering.

Full-time, 2-year course for Radio, Television and Electronic Technicians in preparation for the City & Guilds of London Institute and the Radio Trades Examination Board's Certificates. Part-time day release and evening classes for Electronic Technicians for the Electronic Servicing Certificate of the City & Guilds of London Institute (Subject 47).

All the above courses include practical laboratory and workshop experience (where applicable). London fees: £40 per year, plus £5 10s. registration fee, for all full-time courses. (No fee for students under 18 years of age.)

Evening class fees range from 50/- to 110/- per session.

Enrolment for day classes by appointment.

Enrolment for part-time day release and evening classes: 23rd & 24th September 1969 between 5.30 and 7.30 p.m.

New session commences 29th September 1969. Prospectus free on application to Secretary.

2310



and work at the nerve centres of civil aviation

The National Air Traffic Control Service, a Department of the Board of Trade, needs Radio Technicians to install and maintain the very latest electronic aids at Civil Airports such as Heathrow, Gatwick and Stansted, Air Traffic Control Centres, Radar Stations and specialist establishments.

This is responsible demanding work (for which you will get familiarisation training) involving communications, computers, radar and data extraction, automatic landing systems and closed-circuit television and it offers excellent prospects with ample opportunities to study for higher qualifications in this fast-expanding field.

If you are 19 or over, with practical experience in at least one of the main branches of telecommunications, fill in the coupon now.

Starting salary varies from £869 (at 19) to £1,130 (at 25 or over); scale maximum £1,304 (higher rates at Heathrow), and some posts attract shift-duty payments. The annual leave allowance is good and there is a non-contributory pension scheme for established staff.

Complete this coupon for full details and application form:
To: Mr. A. J. Edwards, C. Eng., M.I.E.E., M.I.E.R.E., Room 705, The Adelphi, John Adam Street, London WC2, marking your envelope 'Recruitment'.

Name

Address

WW/81

Not applicable to residents outside the United Kingdom.

NATCS National Air Traffic Control Service

GEC-Marconi Electronics

ELECTRONIC TECHNICIANS

are required to work on calibration, fault-finding and testing of telecommunications measuring instruments. The work is varied and will enable technicians with experience of r.f. circuits to broaden their knowledge of the latest techniques employed in the electronics and telecommunications industries by bringing them into contact with a wide range of the most advanced measuring instruments embracing all frequencies up to u.h.f.

Entrants may be graded as Testers, Test Technicians or Senior Test Technicians according to experience and qualifications. Our expanding production programme geared to our recognised export achievement provides security of employment combined with good prospects of advancement, not only within these grades, but into other technical and supervisory posts within the Company.

Salaries are attractive and conditions excellent. A Pension Scheme includes substantial life assurance cover provided by the Company. Assistance with removal may also be given in appropriate cases. Please apply in writing, giving brief details including age, experience and salary to:

The Recruitment Manager,
Marconi Instruments Ltd.
Longacres, St. Albans, Herts.



Member of GEC-Marconi Electronics Limited



2343

ELECTRONIC ENGINEERS

Service Engineers required for Offices, throughout the United Kingdom, of well-known Company manufacturing Electronic Desk Calculating Machines. Applicants should possess a sound knowledge of basic Electronics with experience in Electronics, Radar, Radio and TV or similar field. Position is permanent and pensionable. Comprehensive training on full pay will be given to successful applicants. Please send full details of experience to the Service Manager, Sumlock Comptometer Ltd., 102/108 Clerkenwell Road, London, E.C.1.

82

CAMBRIDGESHIRE AND ISLE OF ELY EDUCATION COMMITTEE
Cambridgeshire College of Arts and Technology
Collier Road Cambridge
Department of Engineering

HND IN ELECTRICAL AND ELECTRONIC ENGINEERING

A three-year sandwich course in which places are available for both College and Industry-based students.

LEADING TO CEI PART II COURSE

A sandwich course for CEI Part II in Electrical and Electronic Engineering starts on 5th January, 1970. Candidates must have passed CEI Part I or hold an exempting qualification, such as HND.

Further details of both courses may be obtained from the Head of the Department of Engineering

2302

SITUATIONS VACANT

AIRCRAFT RADIO ENGINEERS and Mechanics with specific workshop experience in one of the following: VHF/HF, ILS/VOR, ADF or WEATHER RADAR. Pension Scheme. 3 weeks holiday per year. Apply: **MANAGING DIRECTOR**, Air Transport (Charter) (C.I.) Ltd., Willow Road, Colnbrook, Bucks. Tel.: Colnbrook 2654. [2291]

A FULL-TIME technical experienced salesman required for retail sales; write giving details of age, previous experience, salary required to—**The Manager**, Henry's Radio, Ltd., 303 Edgware Rd., London, W.2. [67]

AN ENGINEER is required for an interesting post in medical research. Applicants should possess a sound knowledge of electronics and sufficient mechanical ability to produce a finished product. Previous experience in medical research would be an advantage. The appointment would be as **Chief Laboratory Technician I** with salary in the range £1,400 to £1,600. Applications in writing with the names of two referees should be sent to **The Secretary**, Institute of Neurology, Queen Square, London, W.C.1. [2360]

ATV NETWORK LIMITED, ELSTREE. Salaries up to £1,650 in Commercial Television. ATV has vacancies for **Assistant Engineers** based at their Elstree Production Centre to maintain and operate a wide range of modern Colour Television equipment including Video Tape Recorders, Telecine Machines and the latest Colour Cameras. Preferably applicants should have some experience in television broadcasting but persons with electronic experience of other kinds would be considered. Evidence of some academic training in electronics would be desirable. Applications giving full details of age, knowledge and experience should be sent to **Head of Staff Relations** Television, 150 Edmund Street, Birmingham 3—please mark on the envelope **VACANCY 57(E)**. [2367]

ENTHUSIASTIC Young Man required to assist Sales Manager in **CHISWICK** office selling Coaxial Components to Industry. **ONC/HNC** preferred with some knowledge of French. Responsibilities will include support work for **Field Engineers**, order processing and much more. Full training given, excellent salary and prospects for the right man. Tel.: Mr. S. W. Marsh 01-994 6667. [2361]

FULLY QUALIFIED Maintenance Engineer required full time for **Sound Studios South West London**. Telephone for appointment 01-748 7961.

PERSONAL ASSISTANT to Technical Director required, knowledge of Mathematics, Physics and Radio needed. Ability to give technical talks after training an asset. A wide field of interest with some travelling. Full details of qualifications, career and salary required to: **Technical Director**, J. Beam Engineering Limited, Rothersthorpe Crescent, Northampton. [2362]

RADIO MECHANIC wanted. Interesting opportunity undertaking overhaul and maintenance work on wide variety equipment providing support small airline southern England. Write giving experience, qualifications to **Box WW2363 Wireless World**.

RMS Wray Castle, Assistant Lecturer to instruct **Cadet Officers** for the P.M.G. General certificate and **B.O.T. Radar Maintenance** certificate. Candidates should possess first class P.M.G. certificate, B.O.T. Radar Maintenance certificate and have suitable sea experience. Previous teaching experience an advantage. Applications to **Senior Lecturer**, R.M.S. Wray Castle, Ambleside, Westmorland.

TAPE RECORDER engineer required, experience most makes. **Telesonic Ltd.**, 92 Tottenham Court Road, W.1. 01-636 8177. [2364]

TRAINEE Maintenance Engineer required for **Sound Studios South West London**. Day release if required. Telephone for appointment 01-748 7961. [2333]

WE HAVE VACANCIES for Four Experienced Test Engineers in our Production Test Department. Applicants are preferred who have Experience of Fault Finding and Testing of Mobile VHF and UHF Mobile Equipment. Excellent Opportunities for promotion due to Expansion Programme. Please apply to **Personnel Manager**, **Pye Telecommunications Ltd.**, Cambridge Works, Haig Road, Cambridge. Tel. Cambridge 51351, Extn. 327. [77]

ARTICLES FOR SALE

AIRMEC TELEVIEW, Type 259, unused, £38. **Newnes' Radio-TV Servicing Books**, Vols. 1 to 1964, £7 10s. Box W.W.2320.

AMP METERS. 6 in. Dial Flush Type. A.C. or D.C. 15, 30 or 50 amp. New & Boxed. Ex-Gov. 45/- ea. Post-Paid. **H. W. ENGLISH**, 469 **RAYLEIGH RD.**, **HUTTON, BRENTWOOD, ESSEX**. [86]

BBC2 KITS and **T.V. SERVICE SPARES**. Suitable for Colour: **Leading British Makers** dual 405/625 six position push button transistorised tuners £5 5s. 0d., 405/625 transistorised sound & vision IF panels £2 15s. 0d. incl. circuits and data. P/P 4/6. Basic dual purpose 405/625 transistorised tuners incl. circuit £2 10s. 0d., P/P 4/6. UHF list available on request. UHF tuners. **PYE/EKCO** incl. valves 55/-, P/P 4/6. **EKCO/FERRANTI** 4 position push button type, incl. valves, leads, knobs £5 10s. 0d., P/P 4/6. **SOBELL/GEC** UHF tuner kit incl. valves, right angle slow motion drive Assy, leads, fittings, knobs, instructions £5 18s. 6d., P/P 4/6. **FERGUSON** 4 position push button transistorised UHF tuners incl. leads & knobs £5 15s. 0d., P/P 4/6. **SOBELL/GEC** 405/625 IF & output chassis incl. circuit 4/2, P/P 4/6. Ultra 625 IF amplifier plus 405/625 switch Assy incl. circuit 25/-, P/P 4/6. New VHF tuners, **Cyldon C 20/-**, **Ekco 283/330** range 25/-, **Pye CTM 13 ch. incremental 25/-**, P/P 4/6. Many others available incl. large selection channel coils. **Fireball** tuners, used good cond. 30/-. Push button tuners **RGD 612/619** type use good cond. 30/-. P/P 4/6. **LOPTs**, Scan coils, Frame output transformers, Mains droppers etc., available for most popular makes. **TV signal boosters** transistorised **PYE/Labgear B1/B3**, or **UHF battery operated 75/-**. **UHF** mains operated 97/6, **UHF masthead 85/-**, post free. Enquiries invited, **COD** despatch available. **MANOR SUPPLIES**, 64 **GOLDERS MANOR DRIVE, LONDON, N.W.11. CALLERS 589B, HIGH ROAD, N. FINCHLEY, N.12 (near GRANVILLE RD.)**. Tel. 01-445 9118. [60]

BRAND NEW MINIATURE ELECTROLYTICS with long wires, 15/16 Volt, 0.5, 1, 2, 5, 10, 15, 20, 30, 40, 50, 100, 200 mfd. 8/- per dozen, postage 1/-. The C.R. Supply Co., 127 Chesterfield Road, Sheffield 8. [394]

BUILD IT in a DEWBOX quality plastics cabinet. 2 in. X 2 1/2 in. X any length. D.E.W. Ltd. (W), Ringwood Rd., FERNDOWN, Dorset. S.A.E. for leaflet. Write now—Right now. [76]

CCTV CAMERA, 3 Turretred, fitted with 2 lenses, associated time base generator and video amplifier, also local transmitter, all in 19in rack unit, not working. £100. Tel. 01-435 0999 office hours. [2321]

Eight Rectifiers K8/30 5/-, K3/50 7/6, K3/100 12/6: Oluf 6KV 4/6. Power Rheostat L25W 5ohms 10/-, OC28 8/6. Wafer switch 1P10W 2/6. Vib pack V7. 6V-220V o/p. 30/-, P.P. 1/6. SAE for list Bourdon Camps, 41 Higher Compton Rd., Plymouth, Devon. Tel. Plymouth 77974. [390]

HOW to Use Ex-Govt. Lenses and prisms. Booklets. Nos. 1 & 2, at 2/6 ea. List Free for S.A.E. H. W. ENGLISH, 469 RAYLEIGH RD., HUTTON, BRENTWOOD, ESSEX. [87]

NUT DRIVERS in 22 sizes B.A. A/F & N.M. Send S.A.E. FOR LISTS to Bargain Spot, 268 London Rd., Croydon. [368]

SOLARTRON CD.711S/2 oscilloscopes, dual beam, in excellent working order. £90 each. Carriage extra. —GOODWOOD TERRENA LTD., Goodwood Aerodrome, nr. Chichester. [2289]

SOUND LEVEL INDICATOR by Dawe, perfect working order and complete with leather carrying case, £18. 01-435 0999 office hours. [2322]

TAYLOR ELECTRONIC TEST METER. Model 171A. Hardly used; bargain for £20. 01-435 0999 office hours. [2323]

THE IDEAL PANEL Mounting Meter Movement for any Sensitive Test Meter, etc. 200 Micro Amp F.S.D. 4 1/2" X 4 1/2" in clear plastic case. Our special price only 39/6. P. & P. Free. Limited number only. Walton's Wireless Stores, 55A Worcester Street, Wolverhampton, Staffs. [71]

TRANSFORMERS. Outputs up to 1 KVA. Quotations by return. SOLENOIDS. AC and DC up to 40 lb". Available ex Stock. LEDEX ROTARY SOLENOIDS. 12V DC. 50 Available. UNIMAX MICRO SWITCHES. Prices on application. MAGNATROL (Farnborough) LIMITED, 28 Alexandra Road, Farnborough, Hants. Tel. 42590. [391]

TV PICTURE TUBES. New or re-runned. 2-year full replacement guarantee. RADIO & TV VALVES. 6 months guarantee. Price lists on application. SOLAR TUBES (Farnborough) LTD., 28 Alexandra Road, Farnborough, Hants. Tel. 42590. [392]

UFO DETECTOR CIRCUITS, data, 10s. (refundable). Paraphysical Laboratory (UFO Observatory), Downton, Wilts. [369]

BUSINESS OPPORTUNITIES

YOUNG qualified electronic engineer has well equipped workshop in Croydon Area with facilities for development work and small scale production. seeks another engineer to join in building an electronic business. Ideas, enthusiasm and determination vital. Box. [2341]

TEST EQUIPMENT — SURPLUS AND SECONDHAND

SIGNAL generators, oscilloscopes, output meters, wave voltmeters, frequency meters, multi-range meters, etc., etc., in stock.—R. T. & I. Electronics, Ltd., Ashville Old Hall, Ashville Rd., London, E.11. Ley. 4986. [64]

RECEIVERS AND AMPLIFIERS — SURPLUS AND SECONDHAND

HERO Rx5s, etc., AR88, CR100, BRT400, G209, S640, etc., etc., in stock.—R. T. & I. Electronics, Ltd., Ashville Old Hall, Ashville Rd., London, E.11. Ley. 4986. [65]

RCA AR88D excellent condition but requires new smoothing condenser pack. With speaker. Buyer collects. £45 or nearest. Taylor, 60 Headley Park Avenue, Bristol BS13 7NP. [388]

NEW GRAM AND SOUND EQUIPMENT

CONSULT first our 70-page illustrated equipment catalogue on HI-FI (5/6). Advisory service, generous terms to members. Membership 7/6 p.a.—Audio Supply Association, 18 Blenheim Road, London, W.4, 01-995 1661. [27]

GLASGOW—Recorders bought, sold, exchanged; cameras, etc., exchanged for recorders or vice-versa.—Victor Morris, 343 Argyle St., Glasgow, C.2. [11]

TAPE RECORDING ETC.

E.M.I. TR52 Stereo Professional Tape Recorder new, surplus to requirements, £175. No offers. C.B.C. Hawley Studios, Nr. Liss, Hants. Telephone Blackmoor 351.

F quality, durability matter, consult Britain's oldest transfer service. Quality records from your suitable tapes. (Excellent tax-free fund raisers for schools, churches.) Modern studio facilities with Steinway Grand.—Sound News, 18 Blenheim Road, London, W.4, 01-995 1661. [28]

TAPE to disc transfer, using latest feedback disc cutters; EPs from 22/-; s.a.e. leaflet.—Deroy, High Bank, Hawk St., Carnforth, Lancs. [70]

VALVES

VALVE cartons by return at keen prices; send 1/- for all samples and list.—J. & A. Boxmakers, 75a Godwin St., Bradford, 1. [10]

MISCELLANEOUS

SIX-YEAR-OLD detached 3-bedroom BUNGALOW. Garage, two toilets, central heating, in first-class north Leeds residential area. Very large garden, Ministry approved mast and cubical quad site. Vg good co-operative neighbours. For further details contact Box No. WW2366 Wireless World.

Junior Electronics Development Engineers

Junior Logic Designer

Men with 2nd class Degree or with H.N.C. and at least 2 years digital or systems experience in a development laboratory, are required to work on Data processing equipment.

Successful applicants, desirably with good grounding in telecommunications will work as members of a team but with individual responsibilities, including field work in the U.K. and abroad.

Apply stating age, experience and present salary to:



The Senior Personnel Officer
(Ref. NAV/48)
The Decca Navigator
Company Limited,
247 Burlington Road,
New Malden, Surrey
Telephone 942 7711

project engineer

A vacancy exists for a keen, enthusiastic Engineer to join a progressive section engaged on Professional Television Studio equipment.

Experience required — Television Design

Qualifications required — H.N.C. or equivalent

Location — Initially at Welwyn Garden City moving to new factory at Ware, Herts, later this year.

The successful applicant will receive an excellent salary together with the fringe benefits available to all Rank Organisation employees.

Applications will be treated in the strictest confidence. Please apply either in writing or by telephone:



Personnel Manager, Rank Precision Industries Ltd.,
Bessemer Road, Welwyn Garden City, Herts.
Telephone: Welwyn Garden 23434, ext. 314



Holders of The Queen's Award to Industry for 3 successive years.

Project Management- Electronic Kits

Applications are invited from suitably qualified, commercially oriented electronics engineers under 30 years of age, to assume responsibility for project control of the well-established 'Knight' range of educational, industrial and consumer kits. Reporting to the General Manager, service businesses and new ventures, the man appointed will be responsible for growth in terms of volume and product range. His resources will include field sales force, sales desk, computer controlled transaction system, customer service, engineering laboratory and production unit. Some of the resources are within, and controlled by, other units of the service businesses, but are

available to serve the project manager, Kits. The company also handles the Hallicrafter range of communications equipment and the appointment includes duties in connection with these high-quality American products. Kit project management will appeal to an engineer with proved business ability. This appointment will carry a competitive starting salary. For certain applicants rented accommodation is available in Harlow New Town, and generous assistance will be given with removal expenses. Please write, or preferably telephone Harlow 26811 ext. 223 in the first instance, for an application form, to:

**G. S. Hunt, Personnel Officer,
ITT Services Business,
EFTA Division, Components Group,
Standard Telephones & Cables Ltd.,
Edinburgh Way, Harlow, Essex.**

COMPONENTS **ITT**

ARE YOU QUALIFIED TO MOVE.

If you are a Design Engineer or in systems test, technical sales, production engineering, field service or technical writing, let **ELECTRONICS APPOINTMENTS** help you. They are in consultation with almost 800 companies on all aspects of electronic engineering.

Among our current vacancies are the following:—
Senior Sales Engineer, H.N.C. standard, with extensive selling experience in computer or computer peripheral field.
Salary £3,000, London based.

Senior Design Engineer, H.N.D. or equivalent, as Assistant to Chief Engineer. Experience in modern digital control electronics and high speed counting.
£1,800, South Herts based.

This placement service is entirely free and confidential.
Phone (any time day or night) or write:

ELECTRONICS APPOINTMENTS LTD.

NORMAN HOUSE · 105/109 STRAND · LONDON · W.C.2
TEL · 01-836 5557

NEWCASTLE UPON TYNE POLYTECHNIC (Designate)

RUTHERFORD COLLEGE OF TECHNOLOGY

B.Sc. ELECTRICAL AND ELECTRONIC ENGINEERING (Honours and Ordinary)

B.Sc. PHYSICAL ELECTRONICS (Honours and Ordinary)

M.Sc. ADVANCED EXPERIMENTAL PHYSICS

Further details of these and other courses and of residential accommodation available, may be obtained from **Administrative Officer, Rutherford College of Technology, Ellison Place, Newcastle upon Tyne, NE1 8ST** quoting **WW695**.

2314

FOR HIRE

FOR hire CCTV equipment including cameras, monitors, video tape recorders and tape—any period.—Details from Zoom Television, Amersham 5001. [2335]

KEEP IN TOUCH on that difficult job. Weekly Hire Service of VHF also UHF Radio Telephones. Radio Communications Co., 16 Abbey Street, Crewkerne, Somerset. Phone: Crewkerne 2662. [2294]

ARTICLES WANTED

WANTED, all types of communications receivers and test equipment.—Details to R. T. & I. Electronics, Ltd., Ashville Old Hall, Ashville Rd., London, E.11. Ley 4986. [63]

WANTED Cossor Oscilloscope Trolley for model 1035 Mark 2.—Box WW387 Wireless World.

WANTED televisions, tape recorders, radiograms, new valves, transistors, etc.—Stan Willetts, 37 High St., West Bromwich, Staffs. Tel. Wes. 0186. [72]

VALVES WANTED

WE buy new valves, transistors and clean new components, large or small quantities, all details, quotation by return.—Walton's Wireless Stores, 55 Worcester St., Wolverhampton. [62]

CAPACITY AVAILABLE

AIRTRONICS, Ltd., for coil winding, assembly and wiring of electronic equipment, transistorised sub-unit sheet metal work.—3a Waterland Rd., London, S.E.13. Tel. 01-852 1706. [61]

ASSEMBLY and wiring of electrical and electronic equipment. Prototypes, long or short runs. Reselec, 33 Snowdrop Way, Widmer End, Nr. High Wycombe, Bucks. [389]

COMPANY engaged in Sound Reproductions would like Company or Individual to undertake repairs of English and American manufactured magnetic cartridges. Please apply for details to Box W.W.2319.

ELECTRONIC and Electrical Manufacture and Assembly. Prototypes and short production runs. East Midlands Instrument Co. Ltd., Summergangs Lane, Gainsborough, Lincs. Tel. 3260. [88]

METALWORK, all types cabinets, chassis, racks, etc., to your own specification, capacity available for small milling and capstan work up to 1in bar.—**PHILPOT'S METALWORKS, Ltd.**, Chapman St., Loughborough. [17]

TECHNICAL TRAINING

BECOME "Technically Qualified" in your spare time, guaranteed diploma and exam. home-study courses in radio, TV, servicing and maintenance. R.T.E.B., City & Guilds, etc., highly informative 120-page Guide—free.—Chambers College (Dept. 837K), 148 Holborn, London, E.C.1. [16]

CITY & GUILDS (Electrical, etc.), on "Satisfaction or Refund of Fee" terms. Thousands of passes. For details of modern courses in all branches of electrical engineering, electronics, radio, T.V., automation, etc.; send for 132-page handbook—free.—**B.I.E.T.** (Dept. 152K), Aldermaston Court, Aldermaston, Berks. [13]

P.M.G. Certificates, and City & Guilds Examinations. Also many non-examination courses in Radio, TV and Electronics. Study at home with world famous ICS. Write for free prospectus to ICS, Dept. 443, Intertext House, Stewarts Road, London, S.W.8. [25]

RADIO officers see the world. Sea-going and shore appointments. Trainee vacancies in Sept. and Jan. Grants available. Day and boarding students. Stamp for prospectus. Wireless College, Colwyn Bay. [80]

TV and radio A.M.I.E.R.E., City & Guilds, R.T.E.B.; certs., etc., on satisfaction or refund of fee terms; thousands of passes; for full details of exams and home training courses (including practical equipment) in all branches of radio, TV, electronics, etc., write for 132-page handbook—free; please state subject.—**British Institute of Engineering Technology** (Dept. 150K), Aldermaston Court, Aldermaston, Berks. [15]

TUITION

ENGINEERS.—A Technical Certificate or qualification will bring you security and much better pay. Elem. and adv. Private postal courses for C.Eng., A.M.I.E.R.E., A.M.S.E. (Mech. & Elec.), City & Guilds, A.M.I.M.I., A.I.O.B., and G.C.E. Exams. Diploma courses in all branches of Engineering—Mech., Elec., Auto, Electronics, Radio, Computers, Draughts, Building, etc.—For full details write for **FREE** 132-page guide: **British Institute of Engineering Technology** (Dept. 151K), Aldermaston Court, Aldermaston, Berks. [14]

KINGSTON-UPON-HULL Education Committee. College of Technology. Principal: E. Jones, M.Sc., F.R.I.C.

FULL-TIME courses for P.M.G. certificates and the Radar Maintenance certificate.—Information from College of Technology, Queen's Gardens, Kingston-upon-Hull. [18]

TECHNICAL TRAINING in Radio, TV and Electronics through world-famous ICS. For details of proven home-study courses write: ICS, Dept. 443, Intertext House, Stewarts Road, London, S.W.8. [24]

BOOKS, INSTRUCTIONS, ETC.

MANUALS, circuits of all British ex-W.D. 1939-45 wireless equipment and instruments from original R.E.M.E. instructions; s.a.e. for list, over 70 types.—W. H. Bulley, 167a Moffat Road, Thornton Heath, Surrey, CR4-8PZ. [66]

REQUIRED Radio Amateur Handbook, 1936 or earlier. Litherland, 11 Birch Grove, Chippenham. [393]

COUNTY BOROUGH OF BRIGHTON EDUCATION COMMITTEE

TENDERS

are invited for the supply of closed circuit television equipment for the Brighton College of Catering. Forms of Tender are available from the Director of Education, 54 Old Steine, Brighton, BN1 1E.Q

W. O. DODD
Town Clerk.

2339



Communications Dept.

The discovery of North Sea Gas and the introduction of high pressure pipelines for the supply and transmission of natural gas necessitates the use of sophisticated control and communications systems.

Applications are invited for the following posts in the maintenance section of the expanding Communications Department who are, at present, installing a large computer controlled system involving the use of VHF/UHF/SHF radio, multiplex, telemetry and electronic instrumentation.

Assistant Engineer (Communications)

To plan routine maintenance schedules and control a staff of approximately 12 technicians engaged in the commissioning and maintenance of the above equipment. The ideal applicant should have experience in at least two of the following:

- (a) Electronic Instrumentation
- (b) Telemetry
- (c) VHF/UHF fixed and mobile radio
- (d) SHF radio and multiplex

Senior Technician (Radio)

The duties of the successful applicant will be to carry out specialised maintenance and rectification of the more difficult faults on VHF/UHF/SHF radio and multiplex

equipment. Applicants should have appropriate experience with either a manufacturer or communications user.

Technicians (Communications)

Two technicians are required to join an existing team engaged in the installation, commissioning and subsequent maintenance of the Board's Communications and Telemetry schemes. Applicants should ideally have some experience in servicing and maintenance of either communication or instrumentation equipment.

All the above posts will be based just north of London although successful candidates will be expected to travel throughout the Board's Area and a current driving licence will be necessary.

The salary's for the above posts will be as follows:

- Assistant Engineer £1,395 - £1,780 p.a.
- Senior Technician £1,305 - £1,670 p.a.
- Technician £1,120 - £1,460 p.a.

with initial placing dependant on experience and qualifications.

Please apply
Appointments Officer, Eastern Gas,
49 Clarendon Road, Watford, Herts.

Eastern GAS

PLEASE FILL IN THE COUPON FOR ★ FREE FLOG LIST No. 4

- ★ A FEW EXAMPLES!
- ★ QUANTITY DISCOUNTS!
- ★ GUARANTEED NEW GOODS!

TRANSISTOR RADIOS. Large 11 waveband AM/FM Radios many refinements, limited number. Recommended list price over £60 **39 GNS.**
Many Others Listed from only 49/-!

AMPLIFIERS. 10 watt high quality. Type AC106 Transistorised. Base and Treble Controls. Complete with built in Mains Power Pack. **9½ GNS.**
Many Others Listed from only 49/-!

AM/FM STEREO TUNER AMPLIFIERS with Stereo Multiplex. Famous make. 10 watts output. Full length S.M. scale. "Rosewood" case. Recommended list price over £40. Absolutely complete in sealed makers. **25 GNS.**

LOUDSPEAKERS. Bookshelf size in Heavy Veneered "Rosewood" Teak or Mahogany. Infinite Baffle Cases with most attractive Tygan Fronts. Size 12"×8"×6". High compliance "Piston" wide frequency. 8 ohms Drive Unit (8 watts USA). Most excellent reproduction for the price. Ideally matched for the above Tuner Amplifier. **6 GNS.**

- AND 100's MORE!!!**
- ★ Power Packs
 - ★ Cartridges
 - ★ Record Player Decks
 - ★ Tape Recorders
 - ★ Stereo Headsets
 - ★ Valves
 - ★ Tools
 - ★ Microphones
 - ★ Test Equipment
 - ★ Tuners
 - ★ Amplifiers
 - ★ Transformers
 - ★ Transistors
 - ★ Potentiometers
 - ★ Cabinets
 - ★ Aerials
 - ★ Speakers
 - ★ Etc., Etc.

POST NOW FOR FREE "FLOG LIST"
 To TECHNICAL TRADING CO., PARK CRESCENT PLACE, BRIGHTON
 Please send free "Flog List", without obligation, to

NAME.....
 BLOCK CAPITALS PLEASE

ADDRESS.....

WW 9.69



★ LONDON—10 Tottenham Court Road Tel: MUS 2639
 ★ PORTSMOUTH—350-352 Fratton Road Tel: 22034
 ★ BRIGHTON—Devonian Court, Park Crescent Place

**ANNUAL STOCKTAKING
 SUMMER SALES**

INCLUDING
 "FLOG LIST" ITEMS

**NOW ON
 AT ALL
 BRANCHES**

CALLERS—ENQUIRIES
 WELCOMED WITHOUT OBLIGATION

★ SOUTHAMPTON—72 East Street Tel: 25851
 ★ BRIGHTON—6 Queens Road Tel: 23975

All Mail Orders to Devonian Court (Orders Recorded 24 hours—Brighton 680722)



★ TAPES ★

We offer you fully tensilised polyester/mylar and P.V.C. tapes of identical quality hi-fi, wide range recording characteristics as top grade tapes. Quality control manufacture. They are truly worth a few more coppers than acetate, sub-standard, jointed or cheap imports. TRY ONE AND PROVE IT YOURSELF.

Standard		Long	
3in. 150ft.	2/3	3in. 225ft.	2/9
4in. 300ft.	4/6	4in. 450ft.	5/6
5in. 600ft.	7/6	5in. 900ft.	10/6
5½in. 900ft.	10/6	5½in. 1,200ft.	13/-
7in. 1,200ft.	12/6	7in. 1,800ft.	18/6
Double		Triple	
3in. 300ft.	4/-	4in. 900ft.	13/-
4in. 600ft.	8/-	5in. 1,800ft.	25/-
5in. 1,200ft.	15/-	5½in. 2,400ft.	34/-
5½in. 1,800ft.	19/-	7in. 3,600ft.	44/-
7in. 2,400ft.	27/-	Quadruple	
Postage 1/- reel.		3in. 600ft.	8/6

Post free less 5% on three reels.
Quality and Trade enquiries invited.
NOTE. Large tape stocks at all branches.

TECHNICAL TRAINING by I C S IN RADIO, TELEVISION AND ELECTRONIC ENGINEERING

First-class opportunities in Radio and Electronics await the I C S trained man. Let I C S train YOU for a well-paid post in this expanding field.

I C S courses offer the keen, ambitious man the opportunity to acquire, quickly and easily, the specialized training, so essential to success. Diploma courses in Radio/TV Engineering and Servicing, Electronics, Computers, etc. Expert coaching for:

- ★ C. & G. TELECOMMUNICATION TECHNICIANS' CERTS.
- ★ C. & G. ELECTRONIC SERVICING.
- ★ R.T.E.B. RADIO AND TV SERVICING CERTIFICATE.
- ★ RADIO AMATEURS' EXAMINATION.
- ★ P.M.G. CERTIFICATES IN RADIOTELEGRAPHY.

Examination Students Coached until Successful.

NEW SELF-BUILD RADIO AND ELECTRONIC COURSES

Build your own 5-valve receiver, transistor portable, signal generator, multi-meter and valve volt meter— all under expert guidance.

POST THIS COUPON TODAY and find out how I C S can help YOU in your career. Full details of I C S courses in Radio, Television and Electronics will be sent to you by return mail.

MEMBER OF THE ASSOCIATION OF BRITISH CORRESPONDENCE COLLEGES

**INTERNATIONAL
CORRESPONDENCE
SCHOOLS**

**A WHOLE WORLD
OF KNOWLEDGE
AWAITS YOU!**

International Correspondence Schools
(Dept. 173), Intertext House, Stewarts Road,
London, S.W. 8.

NAME

Block Capitals Please

ADDRESS

8/69

WW—110 FOR FURTHER DETAILS

AMATRONIX LTD (WW)

TRANSISTORS—MINT, NO SECONDS, NO RE-MARKS. GUARANTEED TO SPEC.

AD161/162	15/-	BFY51	4/-	2N3055	16/8
AF239	10/-	1B44	1/4	2N3707	4/3
B-5000Q	11/3	1B557	3/-	2N3794	2/10
BD121	18/-	MC140	4/-	2N3983	5/8
BC107B	2/8	SF115	2/10	2N4058	4/7
BC168B	2/-	T1B18	7/-	2N4285	2/10
BC168C	2/-	T1B60M	4/8	2N4289	2/10
BF167	5/3	T1B61M	4/11	2N4291	2/10
BF178	9/-	2N706	2/7	2N4292	2/10
BF225	4/-	2N2926Q	2/8	2SB187	2/-

NOTES. Our AD161/2 are comp. matched prs. with hFE=80 min. at IC=500mA. SF115 is epoxy BF115; 2N3794=mini 3704; 2N4291=mini 3702; 2N4289 is hi-gain Si pnp; 2N4285 is hi-reverse VEB Si pnp substitute for Ge types; 1B557 is 800 p.i.v. 500mA TV rect.; MC140 is 3W npn Si with insulated collector for easy heat sinking.

MOSFETS . . . hi-slope, low cross mod., N-channel, depletion, 40468A, improved 40468, 7.5mA/V typ. at 100MHz, 7/8. MEM554C, ruggedised 3N140 dual-gate; 12mA/V typ., NF 3.5dB typ. at 200MHz. Sim. Mullard BFS28. Only 15/-

INTEGRATED CIRCUITS—PA234, new dual-in-line 1W audio amp, with data, 24/-; CA3020, TO-5 push-pull amp., usable to 6MHz, 28/-; TAA320, MOST-input impedance converter, 15/-; TAB101, transistor quad for ring modulator, 21/-; TAA263, 3-stage low level a.f. amp., 16/8.

AMPLIFIER PACKAGES—Component kits for efficient transformerless class B power amps. Low standby current, reversible polarity, simple circuitry, no adjustments.
AX2 9V, 300mW in 10-20 ohms, other loads usable, 12/8; **AX3** 9V, 800mW in 8 ohms, 20mV in 20K input, 22/8; **AX4** 24V, 5W in 8 ohms, 4W in 15 ohms, input 100mV in 40K. Operable 18V with 12mA standby current and 2-3W output. Uses AD161/2 output pair with silicon low-level stages. Still only 30/-.

MINI MAINS TRANSFORMERS—1"×1"×1 1/2"
Osborn **MT9**, 0-0-9V 80mA, 12/8. Eagle **MT6**, 6-0-6V, 100mA, 13/8; **MT12**, 12-0-12V, 50mA, 13/8. A comprehensive data sheet giving regulation curves for all these transformers with push-pull bridge, and v.d. recta and covering outputs of 5-80V supplied free with orders. Tiny 8c bridge, suits all these, 3/8.
Mail order only. Cash with order. List 6d., free with orders. U.K. post free on orders over 10/-.
396 Selsdon Road, South Croydon, Surrey, CR2 0DE

DEIMOS LTD

TAPE RECORDERS FOR RESEARCH, INDUSTRY AND PROFESSIONAL AUDIO
single and multichannel
8 CORWELL LANE, HILLINGDON, MDX.
HAYes 3561

AMERICAN

TEST AND COMMUNICATIONS EQUIPMENT
★ GENERAL CATALOGUE AN/103 1/- ★
Manuals offered for most U.S. equipments
SUTTON ELECTRONICS
Salthouse, Nr. Holt, Norfolk. Cley 289
WW—111 FOR FURTHER DETAILS

SURPLUS HANDBOOKS

19 set Circuit and Notes	8/8 p/p 6d.
1165 set Circuit and Notes	6/8 p/p 6d.
H.R.O. Technical Instructions	5/8 p/p 6d.
38 set Technical Instructions	5/8 p/p 6d.
46 set Working Instructions	5/8 p/p 6d.
85 set Technical Instructions	7/- p/p 6d.
BC.221 Circuit and Notes	5/8 p/p 6d.
Wavemeter Class D Tech. Inst.	5/8 p/p 6d.
18 set Circuit and Notes	5/8 p/p 6d.
BC. 1060 (31 set) Circuit and Notes	5/8 p/p 6d.
CR. 100/B.28 Circuit and Notes	10/- p/p 6d.
R.107 Circuit and Notes	7/- p/p 6d.
AR.88D Instruction Manual	18/- p/p 6d.
62 set Circuit and Notes	6/8 p/p 6d.

Circuit Diagram 5/- each post free. R.1116/A, R.1294/A, R.1355, R.F. 24, 25 and 26, A.1134, T.1154, CE.300, BC.312, BC.342, BC.348J, BC.348 (E.M.F.), BC.624, 22 set.
92 set Sender and Receiver circuits 7/8 post free.
Resistor Colour Code Indicator 2/6, p/p 6d.
S.A.E. with all enquiries please.
Postage rates apply to U.K. only.
Mail order only to:
INSTRUCTIONAL HANDBOOK SUPPLIES
Dept. W.W. Talbot House, 28 Talbot Gardens, LEEDS 8
WW—112 FOR FURTHER DETAILS

GODLEYS

SHUDEHILL, MANCHESTER 4
Telephone: BLAckfriars 9432

Agents for Ampex, Akai, Ferrograph, Tandberg, Bryan, Brenell, B. & O, Vortexion, Truvox, Sony, Leak, Quad, Armstrong, Clarke & Smith, Lowther, Fisher, Goodmans, Wharfedale, Garrard, Goldring, Dual, Decca, Record Housing, Fibrobe, G.K.D., etc.
Any combination of leading amplifiers and speakers demonstrated without the slightest obligation

WANTED—

Redundant or Surplus stocks of Transformer materials (Laminations, C. cores, Copper wire, etc.), Electronic Components (Transistors, Diodes, etc.), P.V.C. Wires and Cables, Bakelite sheet, etc., etc.
Good prices paid
J. BLACK
44 Green Lane, Hendon, N.W.4
Tel. 01-203 1855 and 3033

WE BUY

any type of radio, television, and electronic equipment, components, meters, plugs and sockets, valves and transistors, cables, electrical appliances, copper wire, screws, nuts, etc. The larger the quantity the better. We pay Prompt Cash.

Broadfields & Mayco Disposals,
21 Lodge Lane, London, N.12

RING 445 2713
445 0749
958 7624

BAILEY 30W AMPLIFIER

All parts are now available for the 60-volt single supply rail version of this unit. We have also designed a new Printed Circuit intended for edge connector mounting. This has the component locations marked and is roller tinned for ease of assembly. Size is also smaller at 4 1/2 in. by 2 1/2 in. Price in SRBP material 11/6d. In Fibreglass 14/6d. Original Radford design. SRBP 12/-, Fibreglass 16/-. This does not have component locations marked.

BAILEY 20W AMPLIFIER

All parts in stock for this Amplifier including specially designed Printed Circuit Boards for pre-amp and power amp. Mains Transformer for mono or stereo with bifilar wound secondary and special 218V primary for use with CZ6 Thermistor, 35/6d., post 5/-.
Trifilar wound Driver Transformer, 22/6d., post 1/-.
Miniature Choke for treble filter, 10/6d., post 6d.
P.C. Board Pre-Amp 15/-, post 9d. Power Amp. 12/6d., post 9d.
Reprint of "Wireless World" articles, 5/6d. post free.

DINSDALE 10W AMPLIFIER

All parts still available for this design including our new power amp. P.C. Board with power transistors and heat sinks mounted directly to P.C. All parts for stereo cost approximately £24.
Reprint of articles 5/6d., post free.

LINSLEY HOOD CLASS A AMPLIFIER

Parts now available for this unit including special matt black anodised Metalwork and all power supply components.
PLEASE SEND S.A.E. FOR ALL LISTS.

HART ELECTRONICS,

321 Great Western St., Manchester 14
The firm for "quality".

Personal callers welcome, but please note we are closed all day Saturday.

NEW! HSL.700 Mono Transistor Amplifier

A really high fidelity monaural amplifier with performance characteristics to suit the most discriminating listener. 6 transistor circuit with integrated preamplifier assembled on special printed sub panel. AD-161-AD162 operating in symmetrical complementary pair. Output transformer coupled to 3 ohm and 15 ohm speaker sockets. Standard phono input sockets. Full wave bridge rectifier power supply for A.C. mains 200-240 v. Controls: Bass, Treble, Volume/on/off. Function selector for PUI, PU2, Tape, Radio. The HSL.700 is strongly constructed on rigid steel chassis, bronze hammer enamel finish, size 9 1/4 in. x 5 in. x 4 1/2 in. high. Performance figures:

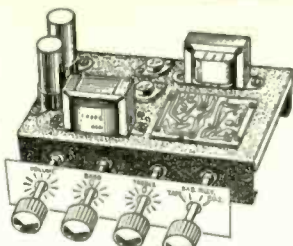

Sensitivity—PUI-50 m/v, 56K input impedance. PU2-110 m/v, 1 meg. input impedance. Tape—110 m/v, 1 meg. input impedance. Radio—110 m/v, 1 meg. input impedance. Output power measured at 1 Kc-2 watts RMS into 3 ohms, 5.8 watts RMS into 15 ohm. Overall frequency response 30 c/s-18 Kc/s: Continuously variable tone controls; Bass, + 8db to 12 db at 100 c/s. Treble, + 10 db to -10 db at 10 Kc/s. The HSL.700 has been designed for true high fidelity reproduction from Radio Tuner, Gramophone deck and Tape Recorder pre amp but is also capable of being used in conjunction with a guitar by connecting to PUI socket and the peak output power will then be in the region of 15 watts. Supplied ready built and tested, complete with knobs, attractive anodized aluminium front escutcheon panel, long spindles (can be cut to suit your housing requirements), full circuit diagram and operating instructions. **OUR SPECIAL PRICE £7/10/6. P. & P. 7/6.**

4-SPEED RECORD PLAYER BARGAINS
Mains models. All brand new in maker's original packing. B.S.E. UA25 with latest mono compatible cart. £6 19 6 All plus Carriage and Packing 6/6.

LATEST GARRARD MODELS.
All types available 1025, 2025, SP25, 3000, AT60 etc. Send S.A.E. for latest Prices.

Transistor Stereo 8+8 Mk. II

Now using Silicon Transistors in first five stages on each channel resulting in even lower noise level with improved sensitivity. A really first-class HI-FI Stereo Amplifier Kit. Uses 14 transistors giving 8 watts push pull output per channel (16W. mono), integrated pre-amp, with Bass, Treble and Volume controls. Suitable for use with Ceramic or Crystal cartridges. Output stage for any speakers from 3 to 15 ohms. Compact design, all parts supplied including drilled metal work. Clr-Kit board, attractive front panel knobs, wire, solder, nuts, bolts—no extras to buy. Simple step by step instructions enable any constructor to build an amplifier to be proud of. Brief Specification: Freq. response ±3dB, 20-20,000 c/s. Bass boost approx. to +12dB. Treble cut approx. to -16dB. Negative feedback 18dB. over main amp. Power requirements 25V. at 6 amps.

PRICES: Amplifier Kit £10/10/0; Power Pack Kit £3/0/0; Cabinet £3/0/0. ALL POST FREE.
Circuit diagram, construction details and parts list (free with kit) 1/6 (S.A.E.).

Official Stockists of all **PEAK SOUND HI-FI EQUIPMENT** including the P.W. DOUBLE 12 STEREO AMPLIFIER as featured in Practical Wireless April, May and June issues.

QUALITY RECORD PLAYER AMPLIFIER MK. II
A top-quality record player amplifier employing heavy duty double wound mains transformer. ECC83, EL84, E280 valves. Separate bass, treble and volume controls. Complete with output transformer matched for 3 ohm speaker. Size 7 1/2 in. w. x 3 1/2 in. d. x 6 in. h. Ready built and tested. PRICE 75/-. P. & P. 6/-. ALSO AVAILABLE in kit form with output transformer and speaker ready to fit into cabinet below. PRICE 97/6. P. & P. 7/6.

DE LUXE QUALITY PORTABLE R-PLAYER CABINET MK. 2
Uncut motor board size 14 1/2 x 12 in., clearance 2 in. below, 6 1/2 in. above. Will take amplifier above and any B.S.R. or GARRARD Autochanger or single Player Unit (except AT60 or SP25). Size 18 x 15 x 6 in. PRICE 79/6. Carr. 9/6.

3-VALVE AUDIO AMPLIFIER MODEL HA34 MK. II

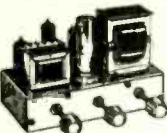

Designed for HI-FI reproduction of records. A.C. mains operation. Ready built on plated heavy gauge metal chassis, size 7 1/2 in. w. x 4 1/2 in. d. x 4 1/2 in. h. Incorporates ECC83, EL84, E280 valves. Heavy duty, double wound mains transformer and output transformer matched for 3 ohm speaker. Separate volume control and now with improved wide

range tone controls giving bass and treble lift and cut. Negative feedback line. Output 4 1/2 watts. Front panel can be detached and leads extended for remote mounting of controls. The HA34 has been specially designed for us and our quantity order enables us to offer them complete with knobs, valves, etc., wired and tested for only £4/15/-. P. & P. 6/-.

10/14 WATT HI-FI AMPLIFIER KIT

A stylishly finished monaural amplifier with an output of 14 watts from 2 EL84s in push-pull. Super reproduction of both music and speech, with negligible hum. Separate inputs for mike and gram allow records and announcements to follow each other. Fully shrouded section wound output transformer to match 3-15Ω speaker and 2 independent volume controls, and separate bass and treble controls are provided giving good lift and cut. Valve line-up: 2 EL84s, ECC83, EF86, and E280 rectifier. Simple instruction booklet 1/6 (Free with parts). All parts sold separately. ONLY £7/9/6. P. & P. 8/6. Also available ready built and tested complete with standard input sockets. £9/5/-. P. & P. 8/6.



HAVERSON SURPLUS CO. LTD.
170 HIGH STREET, MERTON, LONDON, S.W.19
Telephone: 01-540 3985
S.A.E. all enquiries.

Open all day Saturday (Wednesday 1 p.m.)
PLEASE NOTE: P. & P. CHARGES QUOTED APPLY TO U.K. ONLY. P. & P. ON OVERSEAS ORDERS CHARGED EXTRA.

Quartz Crystal Units



**ECONOMICAL!
ACCURATE!
RELIABLE!**



Write for illustrated Brochure & Price List

THE QUARTZ CRYSTAL CO. LTD.

Q.C.C. Works, Wellington Crescent, New Malden, Surrey (01-942 0334 & 2988)

WW—113 FOR FURTHER DETAILS

BEST PRICES • BEST PRICES

CONNECTORS

MOST MANUFACTURERS' SURPLUS STOCKS ARE SOLD TO

UNITED ELECTRONICS

We pay the highest prices

Contact

Mr. Astor or Mr. Kahn

UNITED ELECTRONICS LTD

12/14 Whitfield St., London, W.1

Tel: 01-580 4532, 01-580 1116.

01-636 5151. Telex: 27931

BEST PRICES • BEST PRICES

TRANSISTOR ELECTRONIC ORGANS

FOR THE AMATEUR

NEWED. by DOUGLAS 20/- P.&P. 1/6

Radio Communication Handbook by R.S.G.B. 63/- P. & P. 4/6.

F.E.T. Principles, Experiments, and Projects by Noll. 40/- P. & P. 2/-.

110, Semiconductor Projects for the Home Constructor, by Marston. 18/- P. & P. 1/3.

VHF-UHF Manual, by Jessop, R.S.G.B. 21/- P. & P. 1/9.

Amateur Radio Techniques, by R.S.G.B. 12/6. P. & P. 1/6.

Principles of Transistor Circuits, new edition by AMOS 25/- P. & P. 1/6.

Beginners Guide to Transistors, by Reddihough. 15/- P. & P. 1/3.

Industrial Transistor Circuits, by Lytel. 24/- P. & P. 1/6.

TV Fault Finding, by Data. 8/6. P. & P. 1/-.

UNIVERSAL BOOK CO.

12 LITTLE NEWPORT ST., LONDON, W.C.2

(Leicester Square Tube Station)

WW—114 FOR FURTHER DETAILS

EXCLUSIVE OFFER

AMPEX

MODEL FR-100 A

DATA TAPE

RECORDER-REPRODUCERS

COMPLETELY FITTED IN 6 ft. TOTALLY ENCLOSED CABINETS with recording and reproducing Amplifiers, electronic frequency control and all Power Supplies.

★SIX SPEEDS 1 1/2", 3 1/2", 7 1/2", 30" and 60" per second.

★INTERCHANGEABLE HEADS.

★1" TAPE, 5 TRACKS.

★UP TO 14" REEL CAPACITY.

★DC-FM-PCM-NEZ SYSTEMS.

★DC to 30,000 cycles.

★UP TO 10,000 Pulse Rate.

★DRIFT FREE WITHIN 1%.

★SERVO CONTROL to 0.75 μs.

★TRACK TIMING 5 μs/s.

★ACCURACY 10⁻⁵ per week.

★ELECTRONICS IN MODULES FRONT ACCESS TO ALL PARTS.

★POWER INPUT 105/125v 48 to 500 a/c.

★Made in U.S.A. these fine units cost the American Government \$9,000 each before devaluation.

Full details on application.

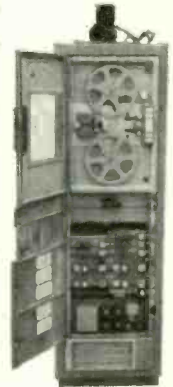

40-page list of over 1,000 different items in stock available—keep one by you.

- ★10 feet high triangular Lattice Mast Sections, galv. 6 inch sides with mating lugs for joining £8 0
- ★Universal Demultiplexers £125 0
- ★I.G. Testers with plug boards £95 0
- ★R.C.A. OP-8 Broadcast Amplifiers £8 10
- ★McElroy Tape Pullers £4 10
- ★Tinsley Phase-splitting Potentiometers £75 0
- ★E.M.I. WM-3 Measuring Oscilloscopes £32 10
- ★Marconi TF-1055 Noise Measuring Sets £150 0
- ★54 inch dia. Meteorological Balloons £2 0
- ★Micrometer Wavemeters General Electric 800/1530 and 1530/4900 m/cs. each £22 0
- ★455 kcs Precision Band Pass Filters £3 10
- ★7 track 1" tape head assemblies with rollers £30 0
- ★1" New Magnetic Recording Tape made by E.M.I. (USA) 3600 ft on N.A.B. Spools £25 10
- ★1" Used ditto "Scotch" Brand 4800 ft £4 0
- ★M.E. 11 R.F. Wattmeters up to 500 m/cs. £42 10
- ★T.D.M.S. Sets send/receive in cabinets £80 0
- ★Collins 600 w. Radio Telephone Transmitters Antotune 2 to 18 m/cs £20v. input new P. U. R.
- ★8 Track Data High Speed Tape Readers £40 0
- ★Mason Illuminated Drawing Tables 50" x 36" £17 10
- ★Amphenol Connector Assembling Machines £8 10
- ★Stelmis Telegraph Distortion Monitors £35 0
- ★5ft. Motorola enclosed Cabinets 19" £17 10
- ★Teletype Model 14 Tape Punches £29 10
- ★TS-497/URB Signal Generators 2/400 m/cs £35 0
- ★Jet Aircraft Joystick Handles with 5 Switches £1 10
- ★Sarah Trans/Receivers and Aerials £3 0
- ★Sigma 12000 ohm. DPDT Sealed Relays £1 0
- ★Freiz Airport "Weather Man" Masts £25 0
- ★76 foot high Lattice Triangular Wind up Masts £285 0
- ★Uniselectors 10 bank 25 way ex. new £1 15
- ★Precision Mains Filter Units new £1 10
- ★Marconi HR.22 5SB Receivers 2/32 m/cs £75 0
- ★Avo Geiger Counters new £7 10
- ★Telegraph Code-Decode Machines £17 10

Carriage extra at cost on all above.
All goods are ex-Government stores.

We have a large quantity of "bits and pieces" we cannot list—please send us your requirements we can probably help—all enquiries answered.

P. HARRIS
ORGANFORD — DORSET

BH16 6ER
WESTBOURNE 85051

BEST PRICES • BEST PRICES • BEST PRICES • BEST PRICES

SELL YOUR ELECTRONIC EQUIPMENT AND COMPONENTS FOR CASH

THE LARGEST AND BEST BUYERS IN THE COUNTRY
UNITED ELECTRONICS LTD

* Best Prices * Prompt Settlement
 * Immediate Spot Offers * Fast Collection

We buy
PLUGS AND SOCKETS - MOTORS - TRANSISTORS - VALVES - RESISTORS - CAPACITORS
POTENTIOMETERS - METERS - RELAYS - TRANSFORMERS - TEST EQUIPMENT - ETC.
 Any quantities considered. Send lists of goods available.
DON'T DELAY—contact Mr. Astor or Mr. Kahn—

UNITED ELECTRONICS LTD
 12-14 WHITFIELD ST., LONDON, W.1. Tel: 01-580 4532, 01-580 1116, 01-636 5151. Telex: 27931

BEST PRICES • BEST PRICES • BEST PRICES • BEST PRICES

TELEPHONE: LEEDS 622131

HENRY ELECTRIC LEEDS



EDDYSTONE EC10 battery (or mains) operated. 550 kc/s to 30 Mc/s for CW, SSB or AM. Mobile or fixed communications. Rugged, compact and light. £59.10.0. Carriage paid.



TRIO 9R-59DE. General coverage 550 Kc/s to 30 Mc/s. Amateur frequencies bandspread on separate calibrated dial. Elegant. Great value, outstanding performer. £42.10.0. Carriage paid. Both these receivers and full range Eddystone and Trio equipment immediate delivery.

LEARNING MORSE? Transistor code oscillators incorporates speaker and earphone. Key terminals and pitch control. Very smart. £49.0. inc. P & P.

DURAL MASTS 28ft. 2in. diameter, bright finish. Steel strength, feather lght. In two sections including jointing sleeve, base plate and guy clamps. Only £12.15.0. Carriage paid.

EVERYTHING FOR AMATEUR AND COMMERCIAL COMMUNICATIONS.
 S.A.E. WITH ENQUIRIES.

HENRY ELECTRIC LTD.,
 60 HARROGATE ROAD, LEEDS, LS7 4LA

ADJUSTABLE HOLE & WASHER CUTTERS

The right tool for trepanning holes 1"-12 1/2" in diameter

Adjustable hole and washer cutters 18% Tungsten High Speed Tool bits

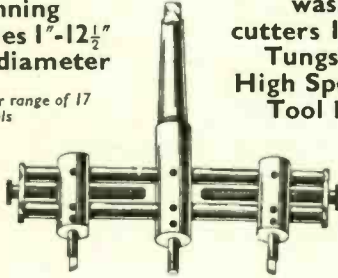

In our range of 17 Models

Write for illustrated brochure of our full range with straight or Morse taper 1-4 or Bitstock shank.
 All models available from stock
AKURATE ENGINEERING CO. LTD.
 Cross Lane, Hornsey, London, N.8
 TEL. 01-348 2670

WW-115 FOR FURTHER DETAILS

BAILEY 30 WATT AMPLIFIER

10 Transistors as specified & 1 Pcb	£6.10.0
20 Transistors as specified & 2 Pcb	£12.10.0
R1-R27 & Pot 12/6	C1-C6 (Mullard) 8/6
Mullard C431 2500mFd/64vw and clip	13/-
Finned solid Ali Heatsinks 4x4 1/2 in., each	12/6
International Bridge Rects. 200 p.i.v./1.8A	23/-
Transformer 230/40/50, E.S., 45v @ 2A	47/6
Photostats of May & Nov. '68 articles	7/6
FREE voltage/current chart with all orders.	

LINSLEY HOOD CLASS A AMP

Set of Resistors 6/-	Set of Capacitors 22/6
Matched pair MJ480 (Hi gain) for 8 ohm	42/6
Matched pair MJ481 (Hi gain) for 15 ohm	52/6
2N3906 7/-	2N697/2N1613 6/6
	MPP103 8/6
Pair of Heatsinks as specified for mono	22/6
Lektrokrit Pinboard 4x4 1/2 in. with pins	5/6
Hunts KA1 I2BT capacitors 2500mFd/50vw	12/6
Hunts 250mFd/50vw 3/-	Hunts 500mFd/50vw 5/9
Mullard I250mFd/40vw 9/-	Low gain MJ480 16/6

Postage 1/- below £1. Delivery by Return Post.
 A.I. FACTORS. 72 BLAKE ROAD, STAPLEFORD, NOTTS.

K&B PRINTED CIRCUITS

and ELECTRONIC EQUIPMENT MANUFACTURERS

Large and small quantities. Full design and Prototype Service. Assemblies at Reasonable Prices. G.P.O. Approved

Let us solve your problems

K. J. BENTLEY & PARTNERS
 18 GREENACRES ROAD. OLDHAM
 Tel: 061-624 0939

WW-116 FOR FURTHER DETAILS

LAWSON BRAND NEW TELEVISION TUBES

Complete fitting instructions are supplied with every tube.

The continually increasing demand for tubes of the very highest performance and reliability is now being met by the new Lawson "Century 99" range of C.R.T.s.

"Century 99" are absolutely brand new tubes throughout manufactured by Britain's largest C.R.T. manufacturers. They are guaranteed to give absolutely superb performance with needle sharp definition screens of the very latest type giving maximum Contrast and Light output; together with high reliability and very long life.

"Century 99" are a complete range of tubes in all sizes for all British sets manufactured 1947-1968.

2 YEARS FULL REPLACEMENT GUARANTEE
 WW-117 FOR FURTHER DETAILS



LAWSON TUBES
 18 CHURCHDOWN ROAD
 MALVERN, WORCS.
 Tel. MAL 2100

YUKAN SELF-SPRAY 50 PROFESSIONAL THE YUKAN AEROSOL WAY

Get these NOW! air drying **GREY HAMMER** OR **BLACK WRINKLE (CRACKLE)** finishes

Yukan Aerosol spraykit contains 16 ozs. fine quality durable easy instant spray. No stove baking required. Hammers available in grey, blue, gold, bronze. Modern Eggshell Black Winkles (Crackles) all at 15/11 at our counter or 16/11 carriage paid, per push-button self-spray can. Also Durable, heat and water resistant Black Matt Finish (12 ozs. self-spray cans only) 13/11 carriage paid.

SPECIAL OFFER: 1 can plus optional transferable snap-on trigger handle (value 5/-) for 18/11 carriage paid. Choice of 13 self-spray paint colours and primer (Motor car quality) also available. Please enclose cheque or crossed P.O. for total amount direct to:

Dept: 07 YUKAN, LONDON, W.2.
 307A, EDGWARE ROAD,
 We supply many Government Departments, Municipal Authorities, Institutes and Leading Industrial Organizations - we can supply you too.
 Open all day Saturday. Closed Thursday afternoons.

WW-118 FOR FURTHER DETAILS









symbol of quality
trade only

for electronic components - by return

WW-119 FOR FURTHER DETAILS

www.americanradiohistory.com



THE ONLY COMPREHENSIVE RANGE OF RECORD MAINTENANCE EQUIPMENT IN THE WORLD!

Send P.O. 2/6 for 48 page booklet providing all necessary information on Record Care.

Cecil E. Watts Limited
Darby House
Sunbury-on-Thames, Middx.

FOR YOUR ...

SYNCHRO & SERVO REQUIREMENTS!

SERVO & ELECTRONIC SALES LTD.
43 HIGH ST., ORPINGTON, KENT. Tel: 31066, 33976
Also at CROYDON. Tel: 01-688 1512 and LYDD, KENT. Tel: LYDD 252

WW-120 FOR FURTHER DETAILS

AGENCIES SOUGHT

Small company of electrical engineers situate Nottm. manufacturing and selling electronic counting equipment etc. seek agencies for industrial equipment and components.

Box No. WW 2308

TRANSFORMER LAMINATIONS enormous range in Radiometal, Mumetal and H.C.R., also "C" & "E" cores. Case and Frame assemblies.

MULTICORE CABLES screened and unscreened from 2 way to 25 way.

Large selection of stranded single p.v.c. covered Wire 7/0048, 7/0076, 14/0076 etc. P.T.F.E. covered Wire, and Silicon rubber covered wire, etc.

J. Black
44 GREEN LANE, HENDON, N.W.4
Tel: 01-203 1855. 01-203 3033

WE PURCHASE

COMPUTERS TAPE READERS AND ANY SCIENTIFIC TEST EQUIPMENT. PLUGS AND SOCKETS, MOTORS, TRANSISTORS, RESISTORS, CAPACITORS, POTENTIOMETERS, RELAYS TRANSFORMERS, ETC.

ELECTRONIC BROKERS LTD.
49 Pancras Road, London, N.W.1. 01-837 7781

DAMAGED METER?
Have it repaired by Glaser

Reduce overheads by having your damaged Electrical Measuring Instruments repaired by L. Glaser & Co. Ltd. We specialise in the repair of all types and makes of

INSTRUMENT REPAIRS

Voltmeters, Ammeters, Microammeters, Multirange Test Meters, Electrical Thermometers, Recording Instruments, Leak Detectors, Temp. Controllers, all types Bridges & Insulation Testers, etc.

As contractors to various Government Departments we are the leading Electrical Instrument Repairers in the Industry. For prompt estimate and speedy delivery send defective instruments by registered post, or write to Dept. W.W.:-

GLASER INSTRUMENTS
1-3 Berry Street, London, E.C.1
Tel.: 01-253 5481-2

BAKER "SUPERB" 20 WATT 12in. LOUDSPEAKER
BRITISH MADE THROUGHOUT

Suitable for all Hi-Fi Systems. Provides rich clear sound recreating the musical spectrum virtually flat $\pm 5dB$, 20-17,000 cps. Latest double cone with massive "Ferropa" ceramic magnet. Flux density 16,500 gauss. Bass resonance 22-26cps. Plastic Cone Surround. Coils available 8 or 15 ohms.

Price £15 Post Free



EMI TAPE MOTORS
(200-240v. A.C.)

Heavy duty 4 pole 100mA. Spindle $1\frac{1}{2} \times \frac{1}{8}$ in. diameter. Size $3\frac{1}{2} \times 2\frac{1}{2} \times 2\frac{1}{2}$ in.

BARGAIN PRICE **17/6** Post 2/6



TRANSISTOR AMPLIFIER WITH LOUDSPEAKER

A self-contained portable mini p.a. system. Many uses—Parties, Baby Alarm, Intercom, Telephone or Record Player Amplifier. Attractive rexine covered cabinet size 12x9x4 in., with powerful 7 x 4 in. speaker and four transistor one watt power amplifier. Uses PP9 battery. Brand new in Maker's carton with full maker's guarantee.

GRANADA 4

All for only **75/-** Post 4/6



THE INSTANT BULK TAPE ERASER AND RECORDING HEAD DEMAGNETISER

200/250 A.C. **42/6** Post 2/6
Leaflet S.A.E.



EXTENSION SPEAKER

Smart plastic cabinet speaker with 20ft. lead transistor radio, intercom, mains radio, tape recorder, etc. **30/-** Post 2/6
Size: 7 1/2 in. x 5 1/2 in. x 3 in.

RETURN OF POST DESPATCH - CALLERS WELCOME
HI-FI STOCKISTS - SALES - SERVICE - SPARES

RADIO COMPONENT SPECIALISTS
337 WHITEHORSE ROAD, CROYDON. Tel: 01-684 1665



BARGAIN BASEMENT

BABY ALARM/INTERPHONE

Fully transistorised Master & sub interphone Only 5" x 3" x 1". Crystal clear 2-way conversation. Works over 2 mile hours to house etc.)
G'reed 7-day trial offer. Long connecting lead & Batt. Suppl. **39/11** Post 3/6

FANTASTIC SPEAKER BARGAIN

Famous English. 12" high flux, heavy cone. 10 watts speaker with built-in tweeter. 3 or 15 ohms. **35/-** P. & I. 4/9
2 for 66/- (P. & I. 6/9) 12-month g'reed

HI-FI HORN

10 watts. Add this 16 ohms unit to your existing speaker system & create real live sound! **ONLY 25/6** P. & I. 3/6
Variable cross-over unit (for Horn) (P. & I. 2/6) 2/1/-



HI-FI PICK-UP

Your reproduction is only as good as your pick-up. Our diamond turnover unit assures quality repro. Mono 16/-; Stereo 26/- (Post 1/9). Send S.A.E. for catalogue

NEW RELEASE

HI-FI COLUMN SPEAKER CABINET

Beautifully made. Suitable for 7-12" speakers Rosewood finish. Screwed and glued. Attractive grey cloth front measures 24" x 13" x 10" with tweeter. Can hole above. **69/6** 10/-
With 12" speaker as advertised above 98/- (cart 10/-)

MULTIMETER

Measures AC/DC 0-1,000v.. AC/DC 1,000 ohms/v. DC current 150 mA. Resistance 100 k/ohms. Ideal for checking faults in household and car electronics. **39/6** P. & I. 3/6
G'reed.

ELECTRAMA
1 GEORGE STREET · HAILSHAM · SUSSEX





SELECTION OF SURPLUS TEST AND STUDIO EQUIPMENT

MONITORS
(Marconi & Peto Scot)

STABILIZING AMPLIFIER
— test signal

GENERATOR
— racks, etc.

For information
Telephone 01-248 3280 Ext. 32

VACUUM

OVENS, PUMPS, PLANT, GAUGES, FURNACES, ETC., GENERAL SCIENTIFIC EQUIPMENT EX-STOCK, RECORDERS, PYROMETERS, OVENS, R. F. HEATERS. FREE CATALOGUE.

V. N. BARRETT & CO. LTD.
1 MAYO ROAD, CROYDON,
CRO 2QP. 01-684 9917

Ex. GOVT. EQUIPMENT NEW & RECONDITIONED

Crystals 1m/c HC 6v. 10/- each. P & P 1/-.
Crystals 4.3m/c HC 6v. 7/6 each. P & P 1/-.
V.H.F. Receivers Clarke & Smith 98m/c, complete with Crystal. £7.10s. P & P 20/-.
High Speed Bridge Type 12 D.T. £5. P & P £1.
Racal Frequency Counters SA20. £45. P & P 20/-.
Marconi Signal Generators CT218 85k/c to 30m/c.
SPECIAL CLEARING LINE. 600 only.
Henley Solon Lightweight Soldering Irons. 3/4 in. blt. 110v.-120v. 65w. 17/6 each, with 240v. element 25/- P & P 2/6.
These Irons are brand new and boxed.
Send for Stock Lists 2/6 and let us know your requirements. We have unrivalled stocks of all Test Equipment Receivers, etc.
Teleprinter and Telegraph Equipment.

THE TRADING POST
Castle Street, Hastings. Phone: 2875

GOVT. SURPLUS WIRELESS EQUIPMENT HANDBOOK

This useful handbook gives detailed information and circuit diagrams for British and American Government surplus Receivers, Transmitters and Test equipment. etc., also contained are some suggested modification details and Improvements for the equipment. Incorporated in this revised edition is a surplus/commercial cross reference valve and transistor guide. This book is invaluable to Radio Clubs, Universities and Laboratories. Latest edition priced at 45/- per volume plus 5/- p & p. Only obtainable from us. Individual circuits and information available on request and S.A.E.

GILTEXT LTD.,
24, Stansfield Chambers, St. George Street,
LEDS 1.

PRINTED CIRCUITS

Small quantities are not expensive, we have full artwork and assembly facilities.

Let us quote you for any quantity.

OFRECT ELECTRONIC SYSTEMS LTD.
Hookstone Park, Harrogate
Harrogate 86258
Telex 57962

SCOOP PURCHASE

HEAVY DUTY CHARGING SETS

The famous PÉTTER 1260 WATT petrol charging set. Charges any 6v/12v/24v/36v battery arrangement at 36 amps. Four separate charging circuits are incorporated by means of which batteries may be charged independently at correct rates. Air cooled. Quiet running. Latest release of the world's most powerful charging set. Cost Govt. £275 each. Available from us at £25.10.0 carr. & Insur. 90/-
Dept. W.W., Globe Scientific Ltd., 38 Bridge End, Leeds 1.





CLEARWAY to lower production costs with ADCOLA Precision Tools

For increased efficiency find out more about our extensive range of ADCOLA Soldering Equipment—and we provide:

★ THREE DAY REPAIR SERVICE ★ INTER-CHANGEABLE BITS—STOCK ITEMS ★ SPECIAL TEMPERATURES AVAILABLE AT NO EXTRA COST.

ADCOLA TOOLS have been designed in co-operation with industry and developed to serve a wide range of applications. There is an ADCOLA Tool to meet your specific requirement. Find out more about our extensive range of efficient, robust soldering equipment.

◀ No. 107. GENERAL ASSEMBLY TYPE

Fill in the coupon to get your copy of our latest brochure:

ADCOLA PRODUCTS LTD

Adcola House · Gauden Road · London · SW4
Tel. 01-622 0291/3 Grams: Soljoint, London SW4



Please rush me a copy of your latest brochure:

NAME

COMPANY

ADDRESS

.....

WW

WW-002 FOR FURTHER DETAILS



SAVBIT

THIS EXCLUSIVE ERSIN MULTICORE ALLOY IS SATURATED WITH COPPER AND WILL NOT DISSOLVE COPPER FROM COPPER WIRES, CIRCUIT BOARDS AND SOLDERING IRON BITS.

Melting Point 215°C Recommended Bit Temperature 275°C

	Before Soldering	During Soldering	After Soldering
In soldering with straight tin/lead alloys...	Tin/Lead Solder + Copper Tip Solder contacted by copper tip...	Molten Tin/Lead/Copper + Copper Tip absorbs tip metal to saturation...	Tin/Lead/Copper Joint + Copper Tip and wears out tip rapidly!
Whereas... In soldering with SAVBIT ALLOY...	Tin/Lead/Copper Solder + Copper Tip Copper-saturated SAVBIT solder...	Molten Tin/Lead/Copper + Copper Tip cannot borrow copper from the iron...	Tin/Lead/Copper Joint + Copper Tip which receives hardly any wear.

THIS EXPLAINS HOW SAVBIT ALLOY STOPS THE WEARING OUT OF COPPER TIPS

Ersin Multicore Savbit Solder is used throughout the world by leading electronic manufacturers to overcome the rapid pitting and wear of copper soldering iron bits. Savbit is a soldering alloy to which copper has been added, thus preventing the copper of the soldering iron bit being absorbed into the solder alloy.

By the use of Savbit Alloy, the bit life is prolonged by up to ten times, eliminating the need for frequent

resurfacing of the copper bit, and, by keeping the copper bits in good condition the soldering speed and efficiency are increased. Also by using Savbit Alloy the diameter and strength of soldered copper wire will not be reduced.

Laboratory investigation and full-scale tests carried out by many manufacturers on their own production lines have proved the claims made for Savbit Alloy.

FOR FACTORY USE

7 lb. REELS

Available in standard wire gauges from 10-22 swg., on strong plastic reels.



1 lb. REELS

Available in all standard wire gauges from 10-34 swg., on unbreakable plastic reels. (From 24-34 swg. only 1/2 lb. is wound on one reel.)



FOR MAINTENANCE AND SERVICE ENGINEERS

SIZE 1 CARTONS

In 14, 16 and 18 swg. Packed in a coil, so it can be drawn out through the top of the carton.



SIZE 5

Contains 10 ft. of 18 swg., packed in a unique handy dispenser.



SIZE 12

90 ft. of 18 swg. on a plastic reel, packed individually in a carton.



USED THROUGHOUT THE WORLD

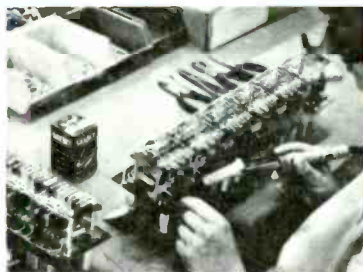

HOLLAND

Ersin Multicore Savbit Alloy is used by Bull Nederland of Amsterdam, Holland for the assembly of administration and statistics machines.

NEW ZEALAND

Ersin Multicore Savbit Alloy is seen being used at the factory of Bell Radio Television Corp. Ltd., Auckland, New Zealand.



For further details, please apply on your Company's notepaper to:
MULTICORE SOLDERS LTD., HEMEL HEMPSTEAD, HERTS. Telephone: HEMEL HEMPSTEAD 3636

