

Making a Skeleton Synchro-Electric Clock

NEWNES

1'

PRACTICAL MECHANICS

EDITOR: F.J. CAMM
FEBRUARY 1956



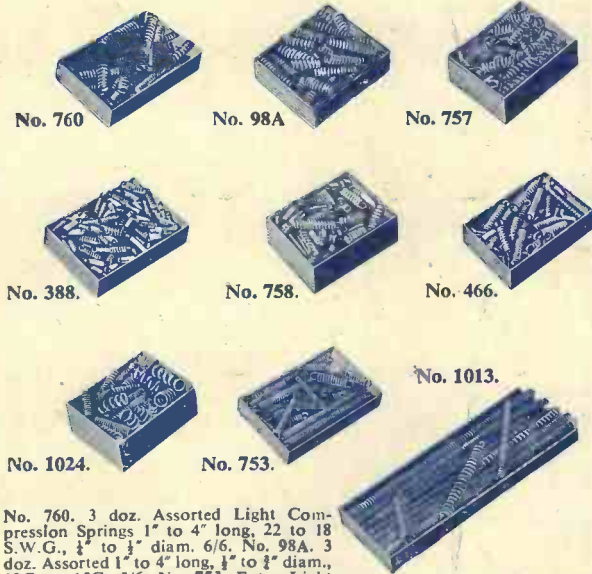

No. 760. 3 doz. Assorted Light Compression Springs, 1" to 4" long, 22 to 18 S.W.G., $\frac{1}{8}$ " to $\frac{1}{2}$ " diam. 6/6. No. 98A. 3 doz. Assorted 1" to 4" long, $\frac{1}{8}$ " to $\frac{1}{2}$ " diam., 19G to 15G. 5/6. No. 757. Extra Light Compression, 1 gross Assorted, $\frac{1}{8}$ " to $\frac{1}{2}$ ", $\frac{1}{8}$ " to 2" long, 27 to 20 S.W.G. 15/-.

No. 388. $\frac{1}{2}$ gross Assorted Small Expansion Springs, $\frac{1}{8}$ " to $\frac{1}{2}$ ", 18G to 21G. 9/6. No. 758. Fine Expansion Springs. 1 gross Assorted $\frac{1}{8}$ " to $\frac{1}{2}$ ", $\frac{1}{8}$ " to 2" long, 27 to 20 S.W.G. 15/-.

No. 466. $\frac{1}{2}$ gross Assorted Small Expansion Springs $\frac{1}{8}$ " to $\frac{1}{2}$ " long, $\frac{3}{32}$ " to $\frac{3}{16}$ " diam., 21G to 24G. 6/6. No. 1024. 20 Compression Springs 12" long, $\frac{1}{4}$ " to $\frac{1}{2}$ " diam., 24G to 18G, suitable for cutting into shorter lengths; and 30 Expansions $1\frac{1}{2}$ " to 12" long, $\frac{5}{32}$ " to $\frac{1}{2}$ " diam., 22G to 16G. 24/-.

No. 753. 3 doz. Assorted Light Expansion $\frac{1}{8}$ " to $\frac{1}{2}$ " diam., 2" to 6" long, 22 to 18 S.W.G. 10/6. No. 1013. 1 gross Small Coil Compression Springs, $\frac{1}{8}$ " to $1\frac{1}{2}$ " long, $\frac{3}{32}$ " to $\frac{7}{16}$ " diam., 24G to 19G 6/-.

How are you off for Springs?

TERRY'S BOXES OF ASSORTED SPRINGS are just the job for your experimental department — a wonderful assortment of Compression and Expansion Springs... all sorts of lengths, gauges, diameters. The nine boxes we show are just a few from our range. Why not let us send you a full list — free?

TERRY'S ASSORTED SPRINGS

The prices quoted are subject to the usual trade discount.

HERBERT TERRY & SONS LTD.
REDDITCH, WORCS.
SPRING MAKERS FOR 100 YEARS

These Boxes of Springs can also be obtained at:
LONDON
27 Holborn Viaduct
MANCHESTER
279 Deansgate
BIRMINGHAM
210 Corporation Street



"Baker's"

Regd

SOLDERING FLUID



QUICK · CLEAN · CERTAIN · ECONOMICAL

PRODUCT OF SIR Wm. BURNETT & CO. (Chemicals) LTD.
GREAT WEST ROAD · ISLEWORTH · MIDDLESEX · ENGLAND

LAY YOUR OWN FLOORS

Oak and Beech Flooring Blocks Free of Purchase Tax



Hardwood floors are not difficult to lay on concrete or wooden sub-floors. We supply kiln dried flooring blocks manufactured in Sweden from Prime quality Scandinavian Oak and Beech ready for laying with full instructions. At a modest cost you can transform concrete or softwood floors into beautiful polished Parquet floors that will last a lifetime, and add to the value of your property.

Beech 16/6
Per Sq. Yard

Oak 19/6
Per Sq. Yard

FULL DETAILS, SAMPLE AND LAYING INSTRUCTIONS ON APPLICATION.

THE SURREYBOARD COMPANY, LIMITED

Dept. PM.) · 72 HIGH STREET · CROYDON · SURREY

THE AMAZING EMCO-UNIMAT

Complete portable power workshop!

The Emco-Unimat, a miniature ball-bearing machine tool is the perfect equipment for model makers and amateur craftsmen. The standard motorised lathe, as illustrated, can be used as a pillar drill, milling machine, grinding machine, or hand-drill—and no extras are needed—though much additional equipment is available for its more extended use. We emphasise the fact that the Emco-Unimat is a precision tool, capable of a variety of machine shop operations on a miniature scale.

1. TURNING
2. DRILLING
3. MILLING
4. GRINDING
5. WOOD TURNING
6. POLISHING

precision tool, capable of a variety of machine shop operations on a miniature scale.

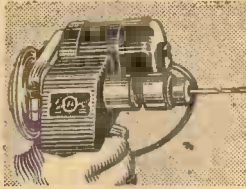
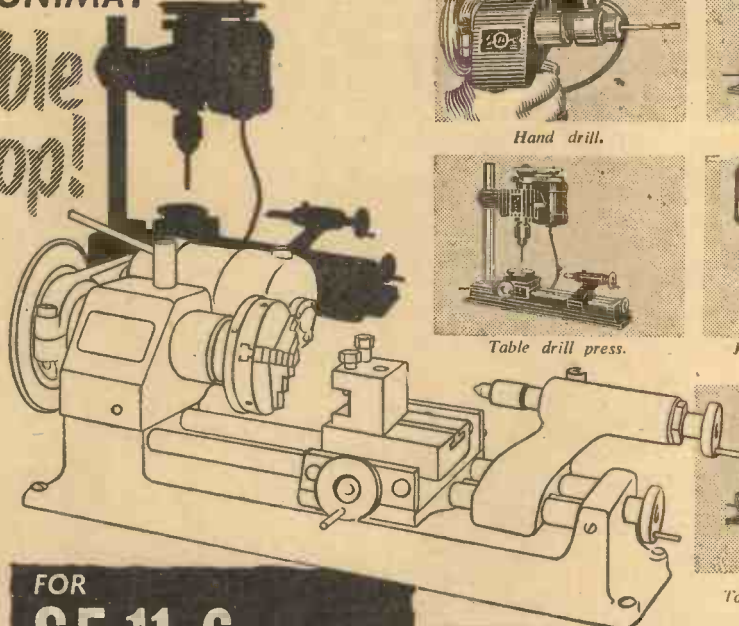

Hand drill.

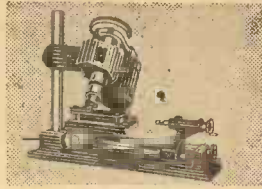

Milling machine.

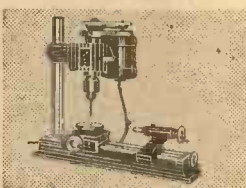
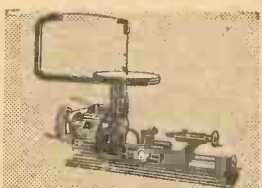
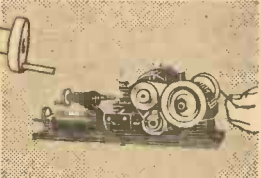

Table drill press.



Jig sawing machine (extra).



Tool grinding machine.

FOR
£5-11-6 and 40/11 p.m.
DEPOSIT for 12 months
 CASH PRICE **£27 17 6**

WRITE FOR DETAILS TO SOLE CONCESSIONAIRES:

J. & H. SMITH LTD., Dept. P.M.11, 16 Harrison Street, Leeds, 1

SPECIFICATION	ADDITIONAL EQUIPMENT
Centre height 1 3/8 in. Takes between centres 6 1/2 in. Hollow Spindle admits 1/2 in. Drill Chuck Cap. 1/2 in. Chuck to drill table, max. 4 3/8 in.	Jig saw, SC Lathe Chuck, circular saw, drilling vice, milling table, and clamps. Flexible shaft.



RADIO CONTROLS

The system of Tuned Reed, pioneered by E.D. has, after long and exhaustive tests, proved its reliability and ease. For realistic and finger-tip control there is nothing to compete with them.

E.D. Mk. IV RADIO CONTROL UNIT TUNED REED 3 CHANNELS

Comprising Transmitter, Control Box and Receiver. The last word for the control of models which demand progressive, personal and accurate following of multiple orders.



These 3 models will adequately meet the demands of all Radio Control enthusiasts.

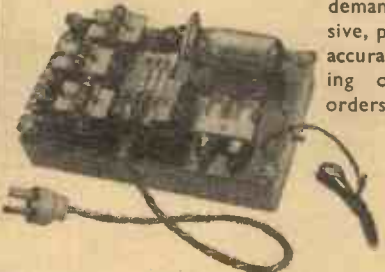

2 models available, Senior or Junior.

THE E.D. BOOMERANG

A Radio Control Unit completely wired and ready for use in your model plane or boat. Simplicity itself to install and most economical in use.

E.D. Mk. II MINIATURE 3 VALVE RADIO CONTROL UNIT

Comprises Transmitter and Receiver. A standard battery pack will give over 3 hours' continuous operation with a receiver and batteries weight of only 10 1/2 ozs.

Write for illustrated list giving full details of E.D. Radio Controls, Engines, Accessories, and Spare Parts, etc.

Order from your Model Shop.

E.D. ELECTRONIC DEVELOPMENTS (SURREY) LTD
DEVELOPMENT ENGINEERS
 KINGSTON 4411-2 18, VILLIERS ROAD, KINGSTON-ON-THAMES, SURREY, ENGLAND.

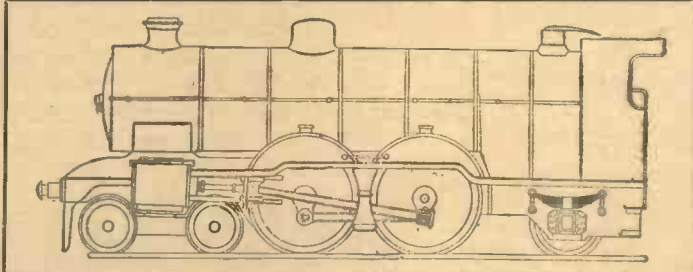

"MAISIE" G.N. ATLANTIC 4-4-2

Locomotive with outside cylinders. Stephenson's valve gear. In 3 1/2 in. Gauge. A great favourite with locomotive enthusiasts; designed by "L.B.S.C." the world renowned designer of small steam locomotives.

BOOK OF INSTRUCTIONS AVAILABLE

"MAISIE"—Words and "Music" by "L.B.S.C.", price 12/6, post paid. BLUEPRINTS, 24/6, per set. Post Paid.

LIST OF CASTINGS FREE ON APPLICATION

Build a really worthwhile loco. designed to do a job of work.

"THE CHOICE OF EXPERIENCE"

A. J. REEVES & CO. (BIRMINGHAM) LTD.
 416, MOSELEY ROAD, BIRMINGHAM 12
 Phone: CALthorpe 2554



We save **POUNDS** WITH THE **Wolf Cub**

Only 30/- down
(for Kits value £8.10.0 upwards)

You, too, can beat the high cost of home repairs with the Wolf Cub drill and become your own expert mechanic and carpenter. A wide range of low-priced attachments converts the drill for many practical uses as described, offering a much wider range of power operations, at a lower cost, than any other "do-it-yourself" equipment, and there's more to follow. It's impossible to tell you all the good things about Wolf Cub Power Equipment in this announcement, so please send for the special brochure prepared for readers of this paper.

Wolf Cub
POWER EQUIPMENT
'The Family Favourite'

Most Power Operations Drilling ($\frac{1}{4}$ " capacity in metal and $\frac{1}{2}$ " in wood), portable sanding, polishing, and buffing, also bench wood-turning, sawing, planing, sanding and fretsawing. And now—intricate engraving, carving, drilling, etc., with the new flexible shaft set. Obtainable from all tool merchants, the Cub drill is fully guaranteed and T.V. Suppressed.

Some of the Kits in the Wolf Cub Range



Lathe Kit



Saw Kit



Fretwork Kit



Sanding and Polishing Kit

Price of Cub drill now only **£5 · 9 · 6**

FREE! To all "Practical Mechanics" Readers

Dept. 102, Wolf Electric Tools Ltd., Hanger Lane, London, W.5

Please send descriptive Brochure of Wolf Cub Equipment and details of Easy Payments Plan.

Name:

Address:

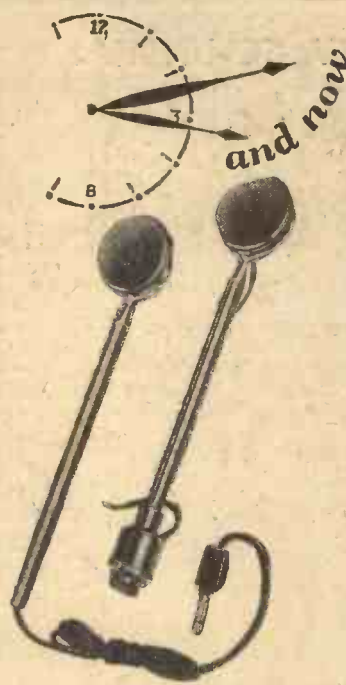

S.G. Brown
AUDIO AIDS

Handphones with individual volume control. Ideal for use with church and cinema deaf aid installations or for individuals with impaired hearing. They provide the essential clarity of reception when listening to Radio and T.V.

Send for Brochure 'P' of all types available. If desired, advice is given on selection of type most suited to individual needs.

S. G. Brown provide Headphones and associated equipment for all known purposes.

S.G. Brown, Ltd.

SHAKESPEARE STREET, WATFORD, HERTS.

Telephone: Watford 7241.

Clamp Hydraulically
and Slash Fabrication Costs!

Simple Units
Inexpensive
Equal Pressure
at all Points
No Distortion
Instant Clamp
Release



For **MILLING**
GRINDING
WELDING
GLUEING

and every other clamping problem

A NEWTON PRODUCT

Please send for Publication No. B1/243



POWER JACKS
LIMITED

VALETTA RD. · ACTON LONDON · W.3

Telephone: Shepherds Bush 3443/6

Telegrams: Newsorber, Ealux, London



GIVE YOURS A NEW LEASE OF LIFE

These silent running "Sealed Systems" will completely modernise that Pre-war Refrigerator. They are ready to install, no technical knowledge required. Fit it yourself, SILENT. EFFICIENT. CHEAP. 5 YEARS' FREE REPLACEMENT WRITTEN GUARANTEE WITH EACH UNIT. NO MORE SERVICING EXPENSES.

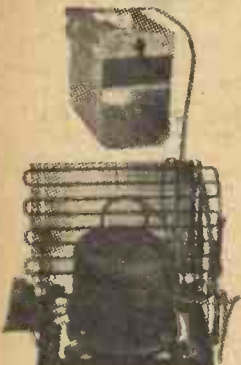

8 MODELS AVAILABLE, RANGING IN SIZE FROM 3 cu. ft. to 15 cu. ft.

Prices from £26/15/0 to £36/15/0.

Free Delivery in British Isles.

Send stamped, addressed envelope for

"SEALED SYSTEMS." Free Reduced Price Leaflet.

Latest complete general catalogue with many 'Hints & Tips,' price 1/- post free (Refunded on first order).

BRAID BROS.

for Home Refrigerator Construction.

50, Birchwood Ave., Hackbridge, Surrey. Tel.: Wallington 9309.

We do not wish to be associated with Scrapped Second-hand Ice-cream Components

I.C.S. TRAINED MEN are in Greater Demand than ever—Maximum production depends on high technical skill, such as that acquired by the I.C.S. Students

TENS OF THOUSANDS MORE TRAINED MEN ARE URGENTLY NEEDED NOW —BUT THERE IS NO WORTH-WHILE PLACE FOR THE UNTRAINED

Ambitious men everywhere have succeeded through I.C.S. Home-Study Courses. So also can you.

The man with an I.C.S. Training in any one of the subjects listed below knows it thoroughly, completely, practically. And he knows how to apply it in his everyday work.

- | | | |
|-------------------------|--|-----------------------------------|
| Accountancy | Electric Power, Lighting, Transmission | Motor Vehicle Elec. |
| Air Conditioning | Traction | Municipal Engineering |
| Architecture | Electronics | Plumbing |
| Architectural Drawing | Eng. Shop Practice | Production Engineering |
| Boiler Engineering | Fire Engineering | Quantity Surveying |
| Book-keeping | Fuel Technology | Radio Engineering |
| Building Construction | Heating and Ventilation | Radio Service Eng. |
| Building Specifications | Hydraulic Engineering | Refrigeration |
| Business Training | Illumination Eng. | Salesmanship |
| Business Management | Industrial Management | Sanitary and Domestic Engineering |
| Carpentry & Joinery | Machine Designing | Sheet-Metal Work |
| Chemistry, I. & O. | Machine-Tool Work | Short-Story Writing |
| Civil Engineering | Maintenance Eng. | Steam Engineering |
| Clerk of Works | Marine Engineering | Structural Steelwork |
| Coal Mining | Mechanical Drawing | Surveying |
| Concrete Engineering | Mechanical Engineering | Television Technology |
| Diesel Engines | Mining Engineering | Welding, Gas and Elec. |
| Draughtsmanship | Motor Engineering | Woodwork Drawing |
| Drawing Office Practice | Motor Mechanics | Works Engineering |
| Electrical Engineering | | |

Students intending to sit for examinations in Mech. Eng., Architecture, Quantities, Civil Eng., and others, should enrol NOW for preparatory Courses. Using a specially prepared Study Programme, the student studies in his spare time at his own pace and, with time for revision, sits with full confidence of success.

Courses are also available for General Certificate of Education and most other Technical, Professional, Commercial and Civil Service Exams.

(I.C.S. Examination Students are coached until successful)

Moderate fees include ALL Books required. REDUCED TERMS TO H.M. FORCES.

If you need technical training, our advice concerning your work and your career is yours for the asking—without obligation. Let us send our special free booklet on the subject in which you are specially interested.

The successful man DOES to-day what the failure INTENDS doing to-morrow. Write to us TO-DAY Dept. 169A, I.C.S., 71, KINGSWAY, W.C.2.

CUT HERE

INTERNATIONAL CORRESPONDENCE SCHOOLS

Dept. 169A, International Buildings, Kingsway, London, W.C.2.

Please send me free booklet on.....

Name..... Age.....
(USE BLOCK LETTERS)

Address

Addresses for Overseas Readers

Australia: 140, Elizabeth Street, Sydney. Egypt: 40, Sharia Abdel Kkalek Sarwat Pasha, Cairo. Eire: 3, North Earl Street, Dublin. India: Lakshmi Bldg., Sir Pherozsha Mehta Rd., Fort, Bombay. New Zealand: 182, Wakefield Street, Wellington. N. Ireland: 26, Howard Street, Belfast. South Africa: Dept. L., 45, Shortmarket Street, Cape Town.

"ZYTO" MACHINES FOR WOOD AND METAL WORK

"ZYTO" TEN INCH PRECISION SAW BENCH TAKES SAWS UP TO 10" DIAMETER—GIVING 3" DEPTH OF CUT



A strong, robust precision saw bench that will give years of hard and accurate work. The extra heavy cast and machined table has parallel rise and fall table canting to 45 deg. and measures 19in. x 15in. Spindle runs in ball bearings. Graduated mitre slide runs in left or right channels. Long rip and cross cut fence has special fine adjustment.

PRICE COMPLETE WITH SAW BLADE £22/13/3

"ZYTO" 10" PRECISION SAWBENCH MOTORIZED ON PEDESTAL STAND, ADJUSTABLE VEE BELT DRIVE I.H.P. MOTOR PRICE £44/10/0 3 PHASE ALSO SUPPLIED SINGLE PHASE & D.C. CURRENT

Screwcutting and turning, 12" between centres with many modern refinements. Back gear, tumbler reverse, hollow mandrel, No. 1 M.T. gap bed tailstock ribbed, full compound slidestock, rack feed, hollow tailstock mandrel No. 2 M.T. set over tailstock, extra heavy casting, well ribbed and machined.

"ZYTO" B.G.S.C. LATHE



Illustrated leaflet of these machines sent post free on request. All machines can be supplied on H.P. terms. Please ask for details.

PRICE COMPLETE WITH FULL SET OF CHANGE WHEELS £28/12/0

S. TYZACK & SON LTD. SHORREDTCH 8301 ten lines 341-345 OLD STREET, LONDON, E.C.1

TELEPHONES:

Where will it turn up next?

The Flamemaster torch turns up in the most unlikely places and among a surprising number of trades. Our books show that glass blowers, laboratory technicians, jewellers, dental mechanics and all kinds of metal workers were among the first to welcome this new precision heating tool, and that recently we've had orders from model engineers, electrical engineers, lead-burners and garage mechanics.

Why do they all find the Flamemaster so handy?

- Because: Installation is extremely simple.
- Flame control is easy and reliable.
- Waste is eliminated by our trigger grip economiser.
- Leaks are impossible.

FLAMEMASTER MARK II

If you'd like to deal with your heating problem in the up-to-date way, write for full details to:—

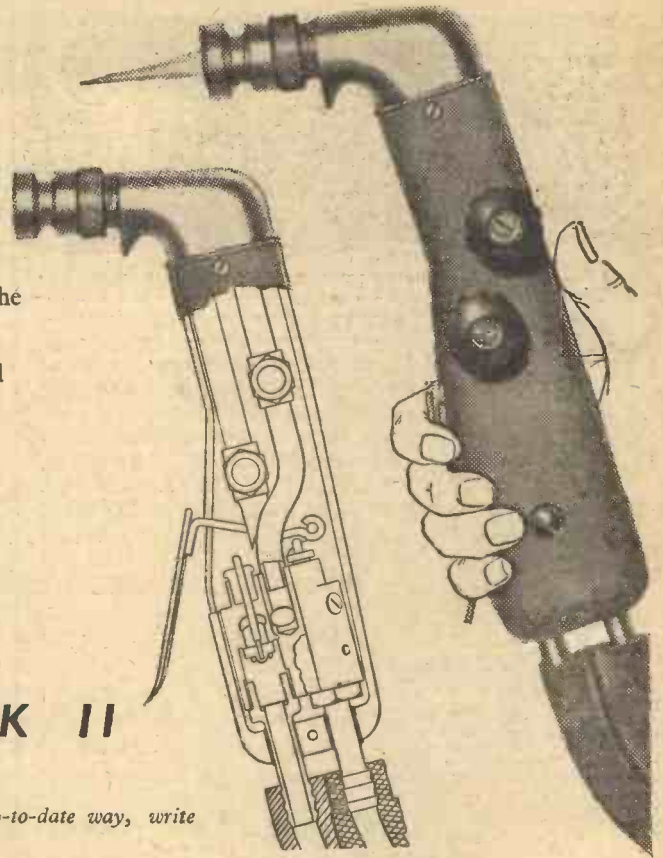

STONE-CHANCE LIMITED, DEPT. F20, 28 ST. JAMES'S SQUARE, S.W.I. TEL: TRAFALGAR 1954.

The BURGESS vibro-tool

the ideal engraving tool for the handyman!

YOU will be really amazed by the Vibro-Tool—the power hand-tool that is as easy to handle as a pencil. With it you can write on steel, engrave jewellery, glass and plastics, tool leather, carve wood and cut stencils—and a host of other handicraft and workshop jobs . . . with speed and facility you never dreamed possible.

The V.250 Vibro-Tool complete with standard engraving point.

The Vibro-Tool, which operates on the vibratory principle, is designed for working off 50-cycle A.C. supplies only. Just connect to any electric light socket or plug point. When ordering, please specify voltage.



52/6

Vibro-Tool De Luxe Kit

97/6



Write for Brochure V.T.1 to: BURGESS PRODUCTS CO. LTD. (Vibro-Tool Dept.), HINCKLEY, LEICESTERSHIRE.

MIDLAND INSTRUMENT CO. OFFER:—

INFRA-RED RECEIVERS TYPE 50/3157. A hand-held instrument for direct viewing of otherwise invisible sources of infra red, consists of the focusing optical system, infra-red filter, image inverter cell, eyepiece magnifier, with length of screened H.T. cable, requires 2 kV. to 4 kV. taking infinitesimal current to operate, size 6in. long, 2 1/2 in. dia., weight approx. 1 lb., new, unused, fraction of original cost, 30/-, post 1/6. **HAND GENERATORS,** fitted enclosed gearbox, also auxiliary open gearbox, detachable folding handle, generates 28 v., .175 amp. L.T. and 300 v., .040 amp. H.T., complete with data to convert to an efficient 200/250 v. A.C./D.C. motor, with final drives of approx. 60, 12 and 1 1/2 r.p.m., new, unused, an exceptional bargain, 17/6, post and packing 2/6. **HOOVER ROTARY TRANSFORMERS,** midget type, input 12 v., output 365, 310 v. at 30 mA, size 4 1/2 in. long, 2 1/2 in. dia., weight 20 oz., brand new, boxed, 15/-, post 1/-. **PARMEKO MAINS TRANSFORMERS,** tapped 200/250 v. A.C. input, output 250-0-250 v. 80 mA, 6.3 v. 2 amps., 6.3 v. 4 amps, screen, using the two 6 v. in series, makes an ideal 12 v. transformer, unused, worth 35/-, our price, 7/6, post and packing, 2/6. **BUZZERS,** 3-6 v. high note, platinum contacts, variable note control, very superior type, easily worth 30/-, our price brand new, 5/6, post 1/-. **G.E.C. RECTIFIERS,** selenium full-wave bridge, output 12 v. 1 1/2 amp. brand new stock, 10/-, post 9d., ditto 12 v. 4 amp. 15/-, post 1/-. mains transformers to suit both these rectifiers, 200/250 v. input, at 15/-, post 1/6 and 20/-, post 2/-, respectively. **ROSS ACHROMAT LENSES,** unmounted, all 40 mm. (1 1/2 in. plus) dia., 5 different types, f.1.7, f.2, f.2.3, f.2.7, f.3, focal lengths are approx. 2 1/2 in., 3in., 3 1/2 in., 4in. and 4 1/2 in. respectively, new, unused and perfect, ideal for projectors, enlargers, epidiascopes, telescopes, etc., 10/- each, post 6d., 50/- the 5, post paid. **SELSYN TRANSMITTERS (Magslips)** 3in. type, pure synchro x-y-1-2-3, suitable as master or slave, 50 v. 50-cycle single phase A.C. operated. When two or more of these are wired up, the rotation by hand (or other means) of one will result in a 100 per cent. follow in the other(s), both clockwise or anti-clockwise, supplied brand new with test report, in tropicalised, sealed cartons, value £9 each, our price 25/-, post 2/-; 2 for 50/-, post paid with wiring diagram. **TELEPHONE SETS,** consists of 2 combined receivers and microphones, connected by 20ft. twin flexible, provides perfect 2-way communication (up to 1 mile with extra flex), self-energised, no battery required, complete, ready for use, new, boxed, 12/6, post 1/-. **"K" TYPE CYLINDER LOCKS,** deadlocking and theftproof, has 7 concentric tumblers instead of the usual 5 in line, interchangeable with ordinary cylinder locks for right- or left-hand doors, complete with 2 keys and all fittings, instruction booklet, list price 18/9, our price, new, boxed, 5/-, post 1/1; 2 for 10/-, post paid. **HIGH-LOW IMMERSION HEATERS,** 230/250 v. 2,000 watts, removable link for 3-heat control, plated copper stem 18in. long from fixing screw, removable brass top termination cover with insulated cable bush, new, unused and guaranteed, 45/-, post paid. **RATCHET SPANNERS,** 10in. lever, reversible to screw or unscrew, fin. Whit. socket, superior make, value 25/-, our price, brand new, boxed, 4/6, post 1/-. Also hundreds of other interesting items. Send 3d. with s.a.e. for current lists.

MIDLAND INSTRUMENT CO.

MOORPOOL CIRCLE, BIRMINGHAM, 17.

Tel. HAR. 1308



BROCHURE ON THE LATEST METHODS OF HOME TRAINING

CAREERS—HOBBIES—NEW INTERESTS

PRIVATE AND INDIVIDUAL TUITION IN YOUR OWN HOME

Over 150 Courses including :—

- | | | | |
|--------------------------|--------------------------|------------------------------|-----------------------------------|
| Accountancy | Customs & Excise Officer | M.C.A. Licences | Salesmanship |
| Advertising | Draughtsmanship | Mechanical Eng. | Sanitation |
| Aeronautical Engineering | Economics | Musical Appreciation | Secretaryship |
| Automobile Engineering | Electrical Engineering | Motor Engineering | Sheet Metal Work |
| Banking | Electronics | Photography | Shorthand & Typing |
| Book-keeping | Fashion Drawing | P.M.G. Licences | Short Story Writing |
| Building | Heating & Ventilation | Police | Sound Recording |
| Business Management | Industrial Engineering | Production | Structural Engineering |
| Carpentry | Administration | Public Speaking | Telecommunications |
| Chemistry | Journalism | Radar | Television |
| Civil Engineering | Languages | Radio & Television Servicing | Time & Motion Study |
| Commercial Subjects | Marine Engineering | Radio Engineering | Tracing |
| Commercial Art & Drawing | Mathematics | Refrigeration | Welding |
| | | Retail Shop Management | Workshop Practice |
| | | | Works Management and many others. |

THE ADVANTAGES OF E.M.I. TRAINING

- ★ The teaching methods are planned to meet modern industrial requirements.
- ★ We offer training in all subjects which provide lucrative jobs or interesting hobbies.
- ★ The student is taken carefully and thoroughly through his chosen subject.
- ★ A tutor is personally allotted by name to ensure private and individual tuition.
- ★ Free advice covering all aspects of training is given to students before and after enrolment with us.

Also courses for University Degrees, General Certificate of Education, B.A., B.Sc.Eng. A.M.I.Mech. E., L.I.O.B., A.C.C.A., A.C.I.S., A.M.Brit.I.R.E., A.M.I.I.A., City & Guilds Examinations, R.S.A. Certificates, etc.



LEARN THE PRACTICAL WAY HOME COURSES—WITH KITS

Whether you are a student for an examination, starting a new hobby, intent upon a career in industry or running your own business — these Practical Courses are intended for YOU.

With these outfits, which you receive upon enrolment, you are given instructions that teach you the basic principles in the subject concerned.

COURSES WITH PRACTICAL EQUIPMENT INCLUDE: RADIO (Elementary and Advanced) · TELEVISION · MECHANICS · ELECTRICITY · CHEMISTRY · PHOTOGRAPHY · CARPENTRY. Also Draughtsmanship · Commercial Art · Amateur S.W. Radio · Languages, Etc.



Courses from 15/- per month

EMI INSTITUTES

An Educational Organisation associated with the E.M.I. group of Companies including 'HIS MASTER'S VOICE', COLUMBIA, etc.

POST THIS COUPON TODAY

Send without obligation your FREE book.
E.M.I. INSTITUTES, Dept. 144, 43 Grove Park Road, London, W.4.

NAME

ADDRESS

SUBJECT(S) OF INTEREST

Feb. (We shall not worry you with personal visits) I.C.26

THE TECHNICAL SERVICES Co.

SHRUBLANDS WORKS • BANSTEAD • SURREY

THE 'MAGSTAT'

This is a precision bi-metal thermostat for the control of alternating currents of up to ½ amp at 240 volts. The temperature range lies between minus 50° F. and plus 250° F. An ingenious magnetic snap action is incorporated which gives freedom from radio interference. The operating temperature is altered by rotation of the adjustment screw, clockwise for increase, and anti-clockwise for decrease. Dimensions: 2in. x ½in. x ¾in.

PRICE: 5/6 each. Post 3d.

★ NEW CATALOGUE ★

SEND 4d. IN STAMPS
NOW FOR
YOUR COPY

* SUPPRESSIT *

(TELEVISION SUPPRESSOR KIT)

For the suppression of Domestic Motor Driven Appliances. Comprises two chokes and two condensers mounted on a card with wiring instructions. Ideal for Vacuum Cleaners, Hairdriers, Sewing Motors, etc., up to 1 Amp. Price 3/6. Post Free.

WE HAVE A REPUTATION FOR HIGH QUALITY THERMOSTATS AND LIST SOME OF OUR STOCK ITEMS HERE:

THERMOSTAT. CS. Convector Thermostat for Space Heaters and Low temperature Ovens. 15 amps., 250 volts A.C. 40/80 deg. F. 25/-, post 6d.

THERMOSTAT. MB. For control of Electric Immersion Heaters up to 3 KW. 60/100 deg. F. 15 amps., 250 volts A.C. £2/0/0, post 9d.

THERMOSTATS. PF. Room Thermostat, 15 amps., 250 volts A.C. 5in. x 1½in. x 2in. A beautiful instrument. Temp. ranges 30/90, 40/100, 40/80, 60/100 deg. F. as required. £2/0/0, post 6d.

REPLACEMENT ELEMENTS

FOR DOMESTIC ELECTRICAL APPLIANCES

We stock over 200 types of element replacements for Fires, Irons, Kettles, Hairdriers, Toasters and Boiling Rings.

THERMOSTAT. BW/1. 3 amps. 250 volts A.C. For control of hot-plates, vulcanisers, etc. 50-550 deg. F. 15/8, post 4d. We are only too glad to send illustrated leaflets on any of these Thermostats if you will send a S.A.E. stating which model interests you.

IMMERSION HEATERS

We can offer a wide range from 2 to 4kW. and in stem lengths 1½in. to 42in. Please send for our catalogue.

GREENHOUSE THERMOSTAT

Type ML. Constructed specially for the amateur gardener. The scale plate is calibrated "High-Medium-Low" and has a temperature range of 40-90 deg. F. Current-carrying capacity is 10 amps. 250 v. A.C. Differential, 4 to 6 deg. F. Dimensions: 4½in. x 2in. x 1½in. Price 35/-. Post 6d.

Model Pj. Miniature Thermostat for control of domestic Electric Irons and special purpose machines where space is limited. Capacity: 5 amps. 250 v. A.C. ½in. x ½in. x 1½in. Single screw fixing. Price 9/3. Post 3d.

FIRE BARS

- No. 41. Bowed. 3in. x 9½in. 7/6 ea.
- No. 42. Bowed. 3in. x 7½in. 7/4 ea.
- No. 43. Bowed. 3½in. x 8½in. 7/6 ea.
- No. 44. Bowed. 3½in. x 8½in. 7/6 ea.
- No. 45. Flat. 3in. x 9½in. 7/6 ea.
- No. 46. Flat. 2½in. x 7in. 7/4 ea.
- No. 47. Bowed. 3in. x 9½in. 9/- ea.
- No. 41. Suitable for Sunbeam, Revo, Belling, Dudley, Swan.
- No. 42. Suitable for Small Revo and various types.
- No. 46. Suits Belling, Brightglow.
- No. 47. Suitable for Creda.

SPIRALS

- No. 70. Spiral, 1,500 w. 2/9 ea.
- No. 70a. Spiral, 1,000 w. 2/2 ea.
- No. 70b. Spiral, 750 w. 1/10 ea.
- No. 70c. Spiral, 600 w. 1/5 ea.
- No. 70d. Spiral, 500 w. 1/4 ea.
- No. 70e. Spiral, 200 w. 1/2 ea.
- No. 70f. Spiral, 100 w. 1/1 ea.

CAR HEATER ELEMENT

No. 87. 6in. x 1½in. 6/3 ea.
200/250 v. 100 w. ...



POPULAR RANGE OF PERMANENT MAGNETS

wide range of types and sizes always in stock

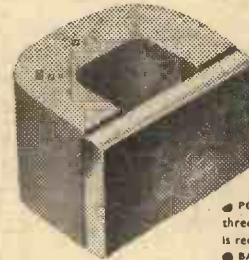

POWER MAGNET

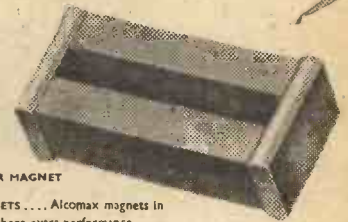

BAR MAGNET



POT MAGNET



MINOR MAGNET



BUTTON MAGNET



POCKET MAGNET

- **POWER MAGNETS**... Alcomax magnets in three sizes. Use where extra performance is required.
- **BAR MAGNETS**... In pairs. For general purposes. 2" and 3" sizes available.
- **POCKET MAGNETS**... Useful to every engineer for hundreds of uses in workshop or home.
- **MINOR MAGNETS**... Ideal for the model engineer. Compact yet powerful.
- **POT MAGNETS**... In three sizes. Powerful Alcomax assemblies for holding and lifting. Mild steel pot can be machined.
- **BUTTON MAGNETS**... For magnetic indicators, doorcatches and as magnetic collectors. In three sizes.

Made by James Neill & Company (Sheffield) Limited and obtainable from your usual tool distributor

EM57

OMARO SLIDE RULES

MODEL L.1. Calculation of weights of steel sections



Multiple scales giving simultaneously

- (a) Area of cross section.
- (b) Weight per foot.
- (c) Weight per length in feet (1-10,000 feet).
- (d) Lengths per cwt.(s) and ton(s).

according to width and thickness.

These scales can also be used for any other section if weight/foot or area are known. See our model P.1. 7/- post free.

MODEL W.2. Electrical Arc Welding

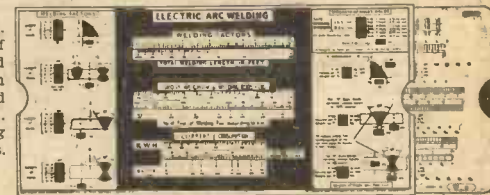

Side 1, as illustrated. Scales giving quantities of welding rods used and current consumption according to size, type and total length of welds. Side 2: Particulars relating to fillet and butt-welds. 7/- post free.

MODEL L.2.

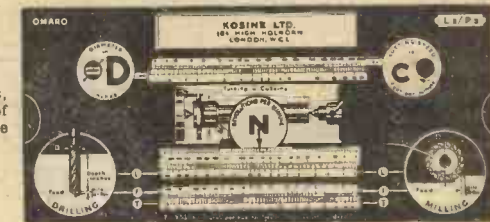

Ratios of Cutting Speeds, Diameters, Number of Revolutions, Feeds, Time for Machining, etc. 7/- post free.

List of other Models on application.
Kosine Ltd., 104, High Holborn, London, W.C.1

Telephone: HOLborn 1301

SPECIAL!
"MINIATURE"
AUTOLOCK

A REDUCED
 NOSE GIVING
 'AUTOLOCK'

PLUS
 VISION
 AND
 ACCESS

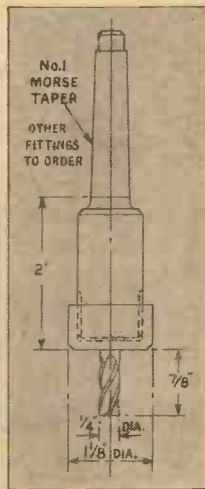

1/4" AUTOLOCK CAPACITY ONLY

THIS MEANS A RANGE OF 36 CUTTERS AND INCLUDES :-

- END MILLS AND SLOT DRILLS 1/16" to 1/4" in 1/32" s.
- LONG SERIES END MILLS AND SLOT DRILLS 1/8" to 1/4" in 1/32" s.
- BALL NOSE, COUNTERBORES AND A No. 3 WOODRUFF—1/2" x 1/8"

Clarkson
 (ENGINEERS) LIMITED

KING EDWARD ROAD,
 NUNEATON, WARWICKS.

5001



**WOODWORKERS
 TOOLS**

ACCEPTED BY DISCRIMINATING

Craftsmen

WHO DEMAND THE BEST

CRAMPS



Steel Sash cramp No. 104, also steel "T" Bar cramps.

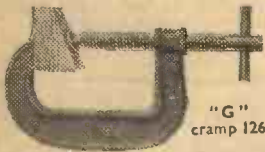

"G" cramp 126

also Veneering cramps and Flooring cramps.

VICES



Woodworkers Vice No. 189

and many other types of Engineers and Fitters vices, Pipe vices and Vice Stands.

PLANES

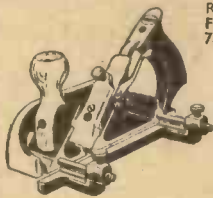

Rabbit and Fillister No. 78.



Jack Plane W5

and smooth planes, Jointer planes and Woodworkers Metal Bench planes.

WE INVITE YOU TO WRITE

Please send 52-page catalogue of Woden Tools.

Name

Address

County..... P.M.1

STEEL NUT & JOSEPH HAMPTON LTD
 WODEN WORKS WEDNESBURY STAFFS.

HERE IT IS!

THE NEW 1956 EDITION

NEWNES

Radio and Television Servicing

CLAIM YOURS NOW
7 DAYS' FREE EXAMINATION

THIS is the most complete collection of models ever assembled—over 1,550 including the latest Radio Show sets. Here at your elbow you have the circuit diagrams, component layouts, and all the data you need to service the hundreds of different models in use. The work covers Multi-channel T.V. receivers, Band III converters, Radios, Radiograms, VHF/FM receivers and adaptors, Portables, Car radios—they are all here to make servicing speedy and profitable. This great work can pay for itself within a week of receiving it—never has there been such an opportunity for you to make money. Prove this by claiming Free Examination. Post coupon now and see for yourself. But do this to-day—the demand will be terrific.

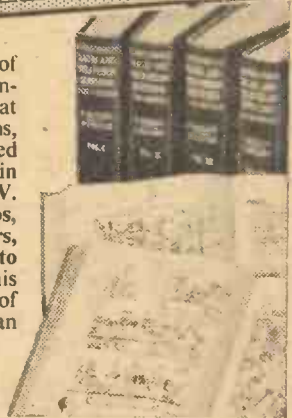

1,550 POPULAR MODELS including
LATEST RADIO SHOW MODELS

TELEVISION

RADIO

SERVICING DATA

for
 Acc, Alba, Ambassador, Argosy, Baird, Banner, Beethoven, Bush, Champion, Cossor, Decca, Defiant, Ekcovision, E.M.I., English Electric, Ferguson, Ferranti, G.E.C., H.M.V., Invicta, K-B., McCarthy, McMichael, Marconi-phonograph, Masteradio, Mullard, Murphy, Pam, Peto Scott, Philco, Philips, Pilot, Portadyne, Pye, Rainbow, Raymond, Regentone, R.G.D., Sobell, Stella, Ultra, Valradio, Vidor.

SERVICING DATA

for
 Ace, Ambassador, Banner, Beethoven, Bush, Champion, Cossor, Decca, Denco, Defiant, Eddystone, Ekco, Etronic, Ever Ready, Ferguson, Ferranti, G.E.C., Grundig, Invicta, K-B., McCarthy, McMichael, Marconi-phonograph, Masteradio, Mullard, Murphy, Pam, Peto Scott, Philco, Philips, Pilot, Pye, Rainbow, Raymond, Regentone, R.G.D., Roberts Radio, Sobell, Strad, Ultra, Vidor.

Owners said the last edition was worth a fortune! This up-to-the-minute New Edition is even more valuable. Prove it yourself by sending for Free Examination—there is no cost or obligation on your part. But please hurry!

YOURS FOR 7 DAYS' FREE EXAMINATION

- 6 volumes strongly bound in maroon cloth.
- 3,150 pages of up-to-the-minute data, and practical information written by skilled Radio & T.V. engineers.
- 1,550 models and more—the wanted data you must have for profitable servicing work.
- 3,000 circuit, component and chassis layout diagrams. Also photographs and explanatory illustrations.
- WITH QUICK - REFERENCE INDEXES TO ALL MODELS AND MAKERS
- FREE 2 Years' Technical Advisory Service on any of the many subjects in the work.

DON'T MISS THIS GREAT OPPORTUNITY

GEORGE NEWNES LTD., 66/69, Great Queen St., London, W.C.2.

Please send me Newnes RADIO AND TELEVISION SERVICING without obligation to purchase. I will either return the work within eight days or I will send the first payment of 9s. 0d. eight days after delivery, and 10s. 0d. monthly thereafter, until the sum of £9 9s. 0d. has been paid. Cash price within eight days is £9.

Name

Address.....

Occupation

Your Signature

(Or your Parent's Signature if under 21) RTV106

Place X where it applies

HouseOWNER	<input type="checkbox"/>
Householder	<input type="checkbox"/>
Living with Parents	<input type="checkbox"/>
Lodging Address	<input type="checkbox"/>

DORMER Drill Sets

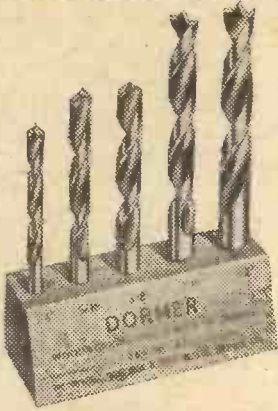

No. 33

WOODWORKING DRILLS

With 3/4 in. dia. Shanks
 Sizes : 3/8 in. to 1/2 in. by 16ths.



No. 52 - No. 53

HIGH SPEED STEEL • **CARBON STEEL**
STRAIGHT SHANK DRILLS
 Sizes : 1/16in. to 9/32in. by 32nds.

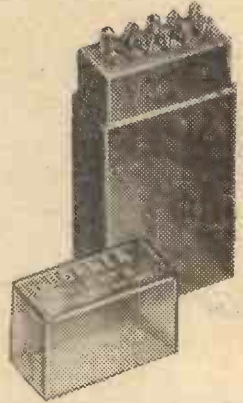

No. 9 - No. 10

CARBON STEEL • **HIGH SPEED STEEL**
STRAIGHT SHANK DRILLS
 Sizes : 1/16in. to 3/16in. by 64ths and 7/32in. to 1/4in.



OTHER POPULAR SETS ARE ALSO AVAILABLE

THE SHEFFIELD TWIST DRILL AND STEEL COMPANY LIMITED
 SHEFFIELD ENGLAND

DORMER DRILL SETS ARE OBTAINABLE FROM YOUR USUAL ENGINEERS' MERCHANTS



Wolf Cub

HOME CONSTRUCTOR ELECTRIC DRILL

Fitted with G.P.O. Approved T.V. Suppressor.

For as little as 5/- deposit you can obtain a beautifully efficient power unit for all home constructors, model makers and handymen. Takes all drudgery out of household repairs and construction jobs. With this as a basis you can soon build up a complete WOLF CUB Home Workshop. The Wolf Cub Drill drives all Wolf Cub Kits for Buffing, Vertical Bench Drilling, Fretsawing, Woodturning, Polishing, Drilling, Sawing, Wire-brushing, Sanding, Bench Planing, Grinding and Bench Sanding.

YOURS FOR ONLY 5/- DEPOSIT
 plus 2/- p. & p. and 6 monthly pms. of 19/6. CASH £5.96



BENCH SANDER

- | | | | | |
|--|----------|------|--------|-----|
| No. 11 FLEXIBLE SHAFT SET ... | £6.10.0 | 6/- | 23/- | 2/6 |
| FRETSAW SET ... | £3.15.0 | 3/- | 13/4 | 2/6 |
| SANDING AND POLISHING KIT ... | £6.10.6 | 6/- | 23/- | 3/- |
| (complete with drill, discs, lambswool bonnet, etc.) | | | | |
| LATHE KIT ... | £10.10.6 | 9/- | 37/- | 4/- |
| (complete with drill and tools) | | | | |
| WOLF HOME WORKSHOP OUTFIT ... | £16.17.6 | 12/6 | £3.0.0 | 6/- |
| (comprising drill, saw, lathe, sanding and polishing kits) | | | | |
| No. 5 SAW SET ... | £3.1.6 | 5/- | 10/6 | 2/6 |
| DRILL STAND ... | £3.8.0 | 6/- | 11/6 | 3/- |
| BENCH PLANNER SET | £3.13.6 | 5/- | 12/6 | 2/- |

Send for illustrated Brochure of the complete WOLF Cub range of tools and see how you can build up your own sets. When ordering please send Cash Price or Deposit and state Mains Voltage.

STANLEY TOOLS

TRIMMING KNIFE 5/6 Post 6d.
 Supplied with 5 double-ended, razor-sharp spare blades in handle. Ideal for lino, cardboard, sheet material. Heavy duty and hooked blades also available.

"YANKEE" HANDYMAN PUSH DRILL 19/3 Post 1/-

For small holes—all you have to do is push! Complete with 4 spare bits in magazine type handle. Please send P.O. with order.

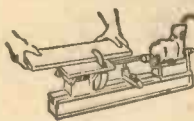

FRETSAW

All

Black & Decker
 UTILITY

obtainable on our very low deposit terms. Write NOW for free leaflet from—



THE HORVELL ELECTRIC PAINT STRIPPER

Removes any number of coats of paint. Can easily manage corners and window frames with specially shaped blade. 3/- deposit plus 1/- P. & P. and 6 monthly payments of 5/- Cash 30/-. Extra flex 1/- yard. Spare element 5/6. AC/DC. State voltage when ordering.

The "I & G" UNIVERSAL SAW
 No vibration, robust, light. Will fit any electric hand drill. Complete with attachment and two extra saw blades. Will jig saw, cross cut, rip saw, hack saw, etc. Cash 49/6.
 5/- deposit plus 2/- P. & P. and 6 monthly payments of 8/3.

BURGESS VIBRO PAINT SPRAYER

FOR ONLY 3/- DEPOSIT plus 2/- p. & pkg. & 6 mthly. pymts. of 13/4. CASH £3.15.0

All-electric. Sprays paint, varnish, lacquer, light oils and insecticides! No tedious hand brushing. Just plug in and spray. State voltage when ordering. ORDER NOW.

REID-EE 6in. CIRCULAR SAW BENCH

FOR ONLY 9/6 DEPOSIT

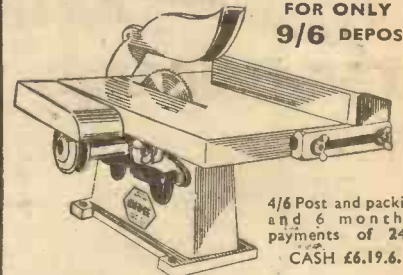

4/6 Post and packing and 6 monthly payments of 24/- CASH £6.19.6.

Send now for this CIRCULAR SAW BENCH for accurate and effortless sawings. Table, 12in. by 9 1/2in. Fully machined, with adjustable fence covering full table; 6in. Blade giving depth of cut 1 1/2in.; Bronze Bearings; Rise and Fall Saw Arbor; Adjustable Saw Guard; Cast Iron throughout; Weight, 28lb. (approx.).

LEWIN UNIVERSAL PLANE

YOURS FOR 10/6 DEPOSIT

plus 1/6 post and packing and 6 monthly payments of 23/-.

CASH PRICE £6.15.0

For all craftsmen in wood, tonguing and grooving, rabbeting, cutting dados, etc. Finished in wooden storage box with 19 cutter blades.

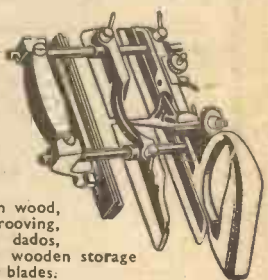

LAFCO COMPOUNDS LIMITED (Dept. PR5)
 3, Corbetts Passage, Rotherhithe New Road, London, S.E.16



This simple-to-use Mole wrench really grips firm and leaves both hands free to work on the many repair and maintenance jobs that arise in the home and workshop. It serves as pliers, clamp, vice, and so on—a most useful tool for handymen and engineers alike—your “third hand” in fact!
7in., 12/6 ; 10in., 15/-.

From Ironmongers, Motor or Motor Cycle Accessory Dealers.



M. MOLE & SON LTD., CHARLOTTE STREET, BIRMINGHAM, 3

THE RAGE OF AMERICA!!!

NOW AVAILABLE FOR THE FIRST TIME IN GREAT BRITAIN

VINYL **“Redi-FLO”** VINYL

THE WONDERFUL VINYL ‘POUR-ON’ FLOORING THAT ANYONE—EVEN A CHILD CAN DO



YOU
SIMPLY
POUR
IT
ON

YOU
SIMPLY
POUR
IT
ON

AND THEN BRUSH IT OUT!!

No longer is there any need to put up with those cold, dusty, unsightly, unhealthy stone, cement or tiled floors.

‘REDIFLO’ is a Vinyl Plastic Flooring which comes in many colours—will scrub and polish beautifully.

SAVE MANY POUNDS ON EXPENSIVE CARPETS

Ideal for wooden floors too, surrounds, etc.

Ideal for Factory, Workshops, Garages, Restaurants, Kitchens—everywhere there is a floor in trouble.

YOU DO IT YOURSELF

Write to ‘REDIFLO’ Division, Laymatt Flooring Company
40, Seabourne Rd., Bournemouth Telephone: Southbourne 44241

THE FAMOUS BENNETT COLLEGE can train your mind to SUCCESS

THROUGH PERSONAL POSTAL TUITION
A FREE book vital to your career!

Read how the famous Bennett College can help you to success! Send now for this recently published FREE book, “Train your mind to SUCCESS,” which tells you about The Bennett College proven success in postal tuition . . . and how it can help you to success in your career.

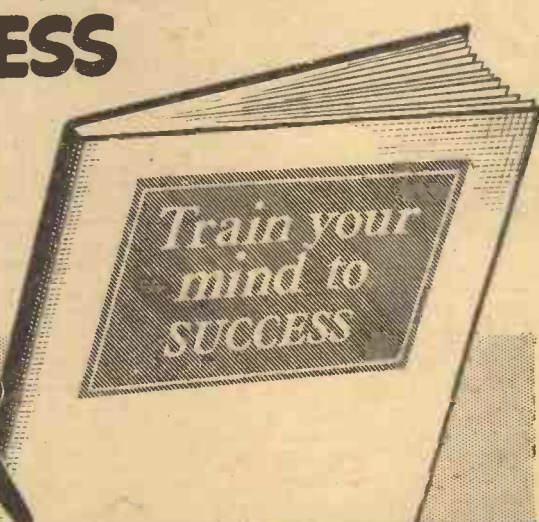

WHAT CAREER DO YOU WANT?

- | | | |
|------------------------|------------------------|--------------------|
| Agriculture | Forestry | Sanitary Science |
| Architecture | Locomotive Engineering | Steam Engineering |
| Aircraft Maintenance | Machine Design | Surveyor's Exams. |
| Building | Mechanical Engineering | Surveying |
| Carpentry | Motor Engineering | Telecommunications |
| Chemistry | Plumbing | Television |
| Commercial Art | Power Station Eng. | Textiles |
| Diesel Engines | Quantity Surveying | |
| Draughtsmanship | Radio Engineering | |
| Electrical Engineering | Road Making | |
| Electric Wiring | | |
| Accountancy Exams | Languages | |
| Auctioneer's Exams | Mathematics | |
| Auditing | Modern Business | |
| Book-keeping | Methods | |
| Civil Service | Police Subjects | |
| Commercial Arith | Salesmanship | |
| Costing | Secretarial Exams | |
| English | Shorthand | |
| General Education | Short Story Writing | |
| Geography | and many others | |
| Journalism | | |

GENERAL CERT. OF EDUCATION. R.S.A. EXAMS

TO THE BENNETT COLLEGE (DEPT. B.76N), SHEFFIELD

Please send me, without obligation, a free copy of “Train your mind to SUCCESS” and the College Prospectus on :

SUBJECT

NAME

ADDRESS

AGE (if under 21).....Please write in Block Letters

**THIS COUPON
COULD BE YOUR
PERSONAL PASSPORT
TO SUCCESS.
Send it NOW!**

1956 T.R.F.

For the benefit of those who already have a loud-speaker and odds and ends, the "1956 TRF" is available in basic form. This contains all the essential items, i.e. prepared metal chassis, 3 valves, mains transformer, gang condenser, coil, volume control, valve holders, smoothing condenser, bias condenser, 6 paper and metal condensers, 7 resistors and data. The total list value of all the items is 52/6, but as a Special Offer to publicise the set, we offer all for 32/6, plus 2/6 post and insurance.



THE TWIN

Complete fluorescent fitting. Has built-in ballast and starters—stove-enamelled white and ready to work.

Ideal unit for the kitchen, over the work-bench, uses two 20-watt lamps. Price complete, less tubes, 29/8, or with two tubes, 39/6. Post and insurance 5/-. Extra 20-watt tubes 7/6 each plus 2/6 P.P.

MULTI-METER KIT

Parts suitable for making a multi-meter to measure volts, milliamperes and ohms. Kit containing all the essential items including moving-coil meter, resistors, range selector, calibrated scale, etc., etc., is only 15/-, plus 1/- post and packing.



INDUSTRIAL OVERHEAD HEATER



Garages, large workshops and other places difficult or impossible to heat by normal means can now have "warm spots" at relatively low cost (1d. per hour where electricity costs 1d. per unit). The Infray Major gives light as well as heat and has controls giving four variations, consumption at full power is 1 kW. Price complete with chains, ready to work, £7.10.0, carriage and insurance 5/-.

INSTANTUS HEATER

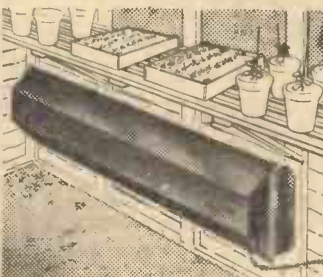

Practical convective heater, of 1kW. rating 4ft. long, made from heavy gauge sheet steel (galvanised). Can be used for any size house, up to three heaters can be controlled by one thermostat. Price, £2.10.0 or with thermostat £4.5.0, carriage 5/-.

WATER PUMPS, 32/6, Carr. Free

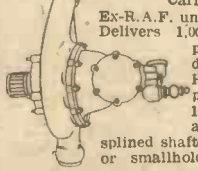

Ex-R.A.F. unused but soiled. Delivers 1,000-1,500 gallons per hour when driven by 1-hp. Motor or petrol engine. 1 1/2 in. bore inlet and outlet, splined shaft. Ideal for farm or smallholding.

12in. T.V. CABINET, 15/-

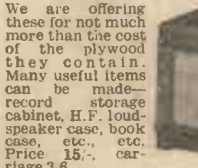

We are offering these for not much more than the cost of the plywood they contain. Many useful items can be made—record storage cabinet, H.F. loud-speaker case, book case, etc., etc. Price 15/-, carriage 3/6.

CLOCK CASE



Also suitable for barometer or other instrument. Nicely polished. Price 4/8, post and packing 1/6. Clock numerals to suit these cases etched on metal, 2/6.

SPECIAL OFFER—OFFICE INTERCOM

This is a 2-station "master" unit comprising an A.C. mains operated push-pull amplifier with built-in P.M. speaker which acts as microphone or loudspeaker depending on whether switch is set to "talk" or "listen." Complete in polished cabinet ready to work. Price only £4/19/6, plus 3/6 carriage and insurance.

THIS MONTH'S SNIP

The **"STRONIC"** Band III Converter

To-day's best value in Band III Converters suitable for your T.V. or money refunded. Complete, ready to operate, 59/6 non mains; or 85/- mains. Post and insurance 3/6.

ELECTRONIC PRECISION EQUIPMENT LTD.

Post orders should be addressed to Dept. 1, 123, Terminus Road, Eastbourne. Personal shoppers, however, please call at: 42-46, Windmill Hill, 152-3, Fleet Street, Ruislip, Middx. E.C.4. Phone: RUIRALIP 5780 Half day, Wednesday. Phone: FLEET 2833 Half day, Saturday. 29, Stroud Green Rd., Finsbury Park, N.4. Phone: ARCHWAY 1049 Half day, Thursday. 249, High Rd., Kilburn Phone: MAIDA VALE 4921 Half day, Thursday.

"SUNDIAL" PRECISION WOODWORKING MACHINES



Drill bit 1/4in. cap. Tool Power Electric Drill. This drill is motorised AC/DC, also suppressed for television and radio, complete with 6ft. cable. Cash Price, £7/19/6. Delivery ex stock. Postage Paid.



The "Sundial" 4in. Precision Planing Machine, fitted with circular cutterblock with 2 steel blades, adjustable fence fitted. Overall length of machine 15 1/2 in. Cash Price, £5/2/6. Delivery ex stock. Carriage and Packing 5/-.

The New "Sundial" 7in. Throat motorised Bandsaw Machine. Complete on rigid base and motorised 1/2 h.p. 230/250 volts electric motor. This machine has a tilting table, will cut wood up to approx. 2in. Also fitted with 3 speeds, ideal for cutting wood, metal, plastics and alloys, etc. Height of machine 21in., weight 56 lbs. Supplied on First Payment of £3/17/6, balance payable in 12 payments of £1/6/8. Cash Price, £16/17/6. Delivery ex stock. Carriage and Packing, 12/6.



The New "Sundial" Precision Saw Bench. Table size 14in. x 13in., fitted with rise and fall spindle, table will tilt 45 degrees. Machine complete with rip fence and mitre fence. Supplied on first payment of £3/5/6, balance in 12 monthly payments of £1/1/-, Cash Price, £12/5/6. Delivery ex stock. Carriage and Packing, 9/-.

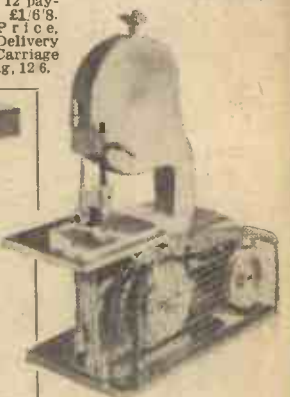

PARRY & SON (TOOLS) LTD., 329-333, OLD ST., LONDON, E.C.1. Tel. Shoreditch 3859, 3918, 3976.

EX-GOV. SURPLUS BARGAINS

INFRA RED MONOCULARS. (Tabby Equip Mk. 1.) A self-contained receiver in case size 8in. x 5in. x 2 1/2in. Weight 3 lbs. Incorporating image converter cell and self generating Zamboni pile E.H.T. unit, focusing eyepiece and object glass with infra red filter. Push-button switch. Complete with solid leather case with shoulder straps. Condition near new and working order, 37/6. Ditto good condition, but not working, 21/- ea.

SPARE PARTS FOR ABOVE UNITS. All checked O.K. and working.

IMAGE CONVERTER CELLS in mount complete with eyepiece, 25/-.

ZAMBONI PILES. (3 bank.) Checked O.K., 12/6 ea.

FOCUSING EYEPIECES. 8/6.

OBJECT GLASS with I.F. filter. In brass sleeve. 6/6.

LEATHER CASES. With straps. As new, 6/6 ea.

BENDIX HAND GENERATORS. Small type. 28 v. .175 a. and 300 v. 40 ma. Complete with enclosed duralium gear case and ratchet handle. Can be used as low geared motors on 24 v. A.C.-D.C. or 240 v. A.C.-D.C. Can also be converted to food mixers, etc. Brand New. 21/- ea.

RELAYS. Advance miniature type. 1,000 ohms. SPDT, weight 1 1/2 ozs. Size 1in. x 1in. x 1 1/2in. Brand new. 7/6 ea.

GEAR TRAINS. 10 different gears with 3 take offs with speed governor and cam-operated switches. New. 7/6 ea.

A.A. IDENTIFICATION TELESCOPES. COST £185 ea. A few more available in good condition at £12-10-0 ea.

BOOKLETS. "HOW TO USE EX-GOVERNMENT LENSES & PRISMS." Nos. 1 and 2. Price 2/6 ea.

Most types of surplus optical equipment in stock. Lists free for S.A.E.

H. W. ENGLISH
RAYLEIGH ROAD, HUTTON, BRENTWOOD, ESSEX

Finest Soldering? Always specify MULTICORE to be precise

ERSIN MULTICORE

Contains 5 cores of extra-active, non-corrosive Ersin Flux. Prevents oxidation and cleans surface oxides.

SIZE ONE CARTON
4 specifications for radio enthusiasts. Handyman's carton. Sufficient for 200 average joints.



BIB WIRE STRIPPER AND CUTTER
The 3 in 1 tool. For stripping insulation without nicking wire, cutting without leaving rough edges and splitting 3/6 ting extruded flex.



HOME CONSTRUCTORS' 2/6 PACK contains 19 ft. of 18 swg 60/40 high tin content alloy Ersin Multicore Solder wound on a reel.

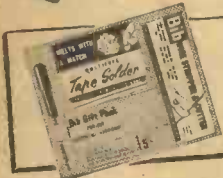

Bib GIFT PACK

The ideal present for any electrician or handyman—a Bib Stripper, Tape Solder and Insulated Screwdriver on a presentation card—all for 5/-

MULTICORE SOLDERS LTD.

MULTICORE WORKS, HEMEL HEMPSTEAD, HERTS (BOXMOOR 3636)

Wherever precision soldering is essential, manufacturers, engineers and handymen rely on MULTICORE. There's a MULTICORE SOLDER just made for the job you have in hand. Here are some of them.

ARAX MULTICORE

FOR METAL FABRICATION

(Not wire to tag joints)
Contains 2 cores of Arax Flux—a flux so fast that even blued spring steel can be soldered without pre-cleaning. Flux residue is easily removed with water.



SIZE 8 CARTON
5/-

MANUFACTURERS ARE INVITED TO WRITE FOR DETAILS OF BULK PACKS AT BULK PRICES

INTERESTING BARGAINS

SATISFACTION OR REFUND

ASTRO COMPASS MK II



An amazing instrument capable of many adaptations: we give full instructions for conversion to Dumpy Level, suitable for Camera Pan and tilt head and, of course, for Astro Navigation and Star identification. Good condition in sturdy transit box, must have cost many pounds to make. **23/-**
P. & P. 2/-

Full instructions for Astro Navigation and Star Identification sold separately price 2/6.

STAINLESS STEEL CONTAINERS



Ex M.O.S. 20 Gauge 18/8 stainless steel. Complete with outer lid as illus, plus inner anti-splash lid, both lids locked secure by depressing handle. Size 16in. x 11in. x 11in. Cap. 6 gal., 57/6. Size 8in. x 11in. x 11in. Cap. 3 gal., 50/-, carr. paid.

BUBBLE SEXTANTS MK IX



A precision instrument of enormous interest to the student of astro navigation and the amateur astronomer. Provided with illumination of bubble and scales for night observations. In handsome carrying case complete with illustrated instructions, 35/-, post free.

MORSE KEYS

Beautifully made, make useful foot switches for machines, car pass lights, etc., 2/6. P. & P. 4d. 4 1/2 v. buzzers, 3/- Visual Morse Signalling Units, 2 for 5/- P. & P. 1/3.



ALTIMETERS



The Mark XVIII complete with detailed instructions reprinted from P.M. for the conversion of this precision instrument into a first class BAROMETER. Brand New, 7/6, post free.

REV COUNTERS

Brand new, call brated 1,000/5,000 r.p.m. 3in. dial, operates 4:1 ratio, complete with 18in. flex drive 20/- post free. With 30" flex drive 30/- post free.



ELECTRIC GYROSCOPIC SPHERE

3" diameter, 24 v. A.C. weight 2lb. **27/6**
P. & P. 1/6.



The top half of this beautifully balanced piece of mechanism revolves at an incredibly fast speed. Supplied with gimbals at 35/-. This gyro unit is the heart of the Master Compass as used in aircraft, we sell the master units complete and in full working order at £10 each, or with platinum points removed but still containing voltage converter slava motor and a host of useful rears and parts 50/-. Must have cost hundreds of pounds to make. A useful addition to any physics lab.

GOVERNOR UNITS



Precision made mechanism, designed for Aircraft, with many other mechanical adaptations, 4in. overall, brand new, 3/8 post free.

PRESSURE GAUGES

Boost ... 0-24 p.s.i.
Air ... 0-80 p.s.i.
Hydraulic 0-1,000 p.s.i.
Air ... 0-2,000 p.s.i.
6/- each post free.



TERRY CLIPS



Sizes 1in, 1 1/4in, 1 1/2in, 2in, 2 1/2in, 3in, 3 1/2in, 4in, 4 1/2in, 5in, 5 1/2in, 6in, 6 1/2in, 7in, 7 1/2in, 8in, 8 1/2in, 9in, 9 1/2in, 10in, 10 1/2in, 11in, 11 1/2in, 12in, 12 1/2in, 13in, 13 1/2in, 14in, 14 1/2in, 15in, 15 1/2in, 16in, 16 1/2in, 17in, 17 1/2in, 18in, 18 1/2in, 19in, 19 1/2in, 20in, 20 1/2in, 21in, 21 1/2in, 22in, 22 1/2in, 23in, 23 1/2in, 24in, 24 1/2in, 25in, 25 1/2in, 26in, 26 1/2in, 27in, 27 1/2in, 28in, 28 1/2in, 29in, 29 1/2in, 30in, 30 1/2in, 31in, 31 1/2in, 32in, 32 1/2in, 33in, 33 1/2in, 34in, 34 1/2in, 35in, 35 1/2in, 36in, 36 1/2in, 37in, 37 1/2in, 38in, 38 1/2in, 39in, 39 1/2in, 40in, 40 1/2in, 41in, 41 1/2in, 42in, 42 1/2in, 43in, 43 1/2in, 44in, 44 1/2in, 45in, 45 1/2in, 46in, 46 1/2in, 47in, 47 1/2in, 48in, 48 1/2in, 49in, 49 1/2in, 50in, 50 1/2in, 51in, 51 1/2in, 52in, 52 1/2in, 53in, 53 1/2in, 54in, 54 1/2in, 55in, 55 1/2in, 56in, 56 1/2in, 57in, 57 1/2in, 58in, 58 1/2in, 59in, 59 1/2in, 60in, 60 1/2in, 61in, 61 1/2in, 62in, 62 1/2in, 63in, 63 1/2in, 64in, 64 1/2in, 65in, 65 1/2in, 66in, 66 1/2in, 67in, 67 1/2in, 68in, 68 1/2in, 69in, 69 1/2in, 70in, 70 1/2in, 71in, 71 1/2in, 72in, 72 1/2in, 73in, 73 1/2in, 74in, 74 1/2in, 75in, 75 1/2in, 76in, 76 1/2in, 77in, 77 1/2in, 78in, 78 1/2in, 79in, 79 1/2in, 80in, 80 1/2in, 81in, 81 1/2in, 82in, 82 1/2in, 83in, 83 1/2in, 84in, 84 1/2in, 85in, 85 1/2in, 86in, 86 1/2in, 87in, 87 1/2in, 88in, 88 1/2in, 89in, 89 1/2in, 90in, 90 1/2in, 91in, 91 1/2in, 92in, 92 1/2in, 93in, 93 1/2in, 94in, 94 1/2in, 95in, 95 1/2in, 96in, 96 1/2in, 97in, 97 1/2in, 98in, 98 1/2in, 99in, 99 1/2in, 100in, 100 1/2in, 101in, 101 1/2in, 102in, 102 1/2in, 103in, 103 1/2in, 104in, 104 1/2in, 105in, 105 1/2in, 106in, 106 1/2in, 107in, 107 1/2in, 108in, 108 1/2in, 109in, 109 1/2in, 110in, 110 1/2in, 111in, 111 1/2in, 112in, 112 1/2in, 113in, 113 1/2in, 114in, 114 1/2in, 115in, 115 1/2in, 116in, 116 1/2in, 117in, 117 1/2in, 118in, 118 1/2in, 119in, 119 1/2in, 120in, 120 1/2in, 121in, 121 1/2in, 122in, 122 1/2in, 123in, 123 1/2in, 124in, 124 1/2in, 125in, 125 1/2in, 126in, 126 1/2in, 127in, 127 1/2in, 128in, 128 1/2in, 129in, 129 1/2in, 130in, 130 1/2in, 131in, 131 1/2in, 132in, 132 1/2in, 133in, 133 1/2in, 134in, 134 1/2in, 135in, 135 1/2in, 136in, 136 1/2in, 137in, 137 1/2in, 138in, 138 1/2in, 139in, 139 1/2in, 140in, 140 1/2in, 141in, 141 1/2in, 142in, 142 1/2in, 143in, 143 1/2in, 144in, 144 1/2in, 145in, 145 1/2in, 146in, 146 1/2in, 147in, 147 1/2in, 148in, 148 1/2in, 149in, 149 1/2in, 150in, 150 1/2in, 151in, 151 1/2in, 152in, 152 1/2in, 153in, 153 1/2in, 154in, 154 1/2in, 155in, 155 1/2in, 156in, 156 1/2in, 157in, 157 1/2in, 158in, 158 1/2in, 159in, 159 1/2in, 160in, 160 1/2in, 161in, 161 1/2in, 162in, 162 1/2in, 163in, 163 1/2in, 164in, 164 1/2in, 165in, 165 1/2in, 166in, 166 1/2in, 167in, 167 1/2in, 168in, 168 1/2in, 169in, 169 1/2in, 170in, 170 1/2in, 171in, 171 1/2in, 172in, 172 1/2in, 173in, 173 1/2in, 174in, 174 1/2in, 175in, 175 1/2in, 176in, 176 1/2in, 177in, 177 1/2in, 178in, 178 1/2in, 179in, 179 1/2in, 180in, 180 1/2in, 181in, 181 1/2in, 182in, 182 1/2in, 183in, 183 1/2in, 184in, 184 1/2in, 185in, 185 1/2in, 186in, 186 1/2in, 187in, 187 1/2in, 188in, 188 1/2in, 189in, 189 1/2in, 190in, 190 1/2in, 191in, 191 1/2in, 192in, 192 1/2in, 193in, 193 1/2in, 194in, 194 1/2in, 195in, 195 1/2in, 196in, 196 1/2in, 197in, 197 1/2in, 198in, 198 1/2in, 199in, 199 1/2in, 200in, 200 1/2in, 201in, 201 1/2in, 202in, 202 1/2in, 203in, 203 1/2in, 204in, 204 1/2in, 205in, 205 1/2in, 206in, 206 1/2in, 207in, 207 1/2in, 208in, 208 1/2in, 209in, 209 1/2in, 210in, 210 1/2in, 211in, 211 1/2in, 212in, 212 1/2in, 213in, 213 1/2in, 214in, 214 1/2in, 215in, 215 1/2in, 216in, 216 1/2in, 217in, 217 1/2in, 218in, 218 1/2in, 219in, 219 1/2in, 220in, 220 1/2in, 221in, 221 1/2in, 222in, 222 1/2in, 223in, 223 1/2in, 224in, 224 1/2in, 225in, 225 1/2in, 226in, 226 1/2in, 227in, 227 1/2in, 228in, 228 1/2in, 229in, 229 1/2in, 230in, 230 1/2in, 231in, 231 1/2in, 232in, 232 1/2in, 233in, 233 1/2in, 234in, 234 1/2in, 235in, 235 1/2in, 236in, 236 1/2in, 237in, 237 1/2in, 238in, 238 1/2in, 239in, 239 1/2in, 240in, 240 1/2in, 241in, 241 1/2in, 242in, 242 1/2in, 243in, 243 1/2in, 244in, 244 1/2in, 245in, 245 1/2in, 246in, 246 1/2in, 247in, 247 1/2in, 248in, 248 1/2in, 249in, 249 1/2in, 250in, 250 1/2in, 251in, 251 1/2in, 252in, 252 1/2in, 253in, 253 1/2in, 254in, 254 1/2in, 255in, 255 1/2in, 256in, 256 1/2in, 257in, 257 1/2in, 258in, 258 1/2in, 259in, 259 1/2in, 260in, 260 1/2in, 261in, 261 1/2in, 262in, 262 1/2in, 263in, 263 1/2in, 264in, 264 1/2in, 265in, 265 1/2in, 266in, 266 1/2in, 267in, 267 1/2in, 268in, 268 1/2in, 269in, 269 1/2in, 270in, 270 1/2in, 271in, 271 1/2in, 272in, 272 1/2in, 273in, 273 1/2in, 274in, 274 1/2in, 275in, 275 1/2in, 276in, 276 1/2in, 277in, 277 1/2in, 278in, 278 1/2in, 279in, 279 1/2in, 280in, 280 1/2in, 281in, 281 1/2in, 282in, 282 1/2in, 283in, 283 1/2in, 284in, 284 1/2in, 285in, 285 1/2in, 286in, 286 1/2in, 287in, 287 1/2in, 288in, 288 1/2in, 289in, 289 1/2in, 290in, 290 1/2in, 291in, 291 1/2in, 292in, 292 1/2in, 293in, 293 1/2in, 294in, 294 1/2in, 295in, 295 1/2in, 296in, 296 1/2in, 297in, 297 1/2in, 298in, 298 1/2in, 299in, 299 1/2in, 300in, 300 1/2in, 301in, 301 1/2in, 302in, 302 1/2in, 303in, 303 1/2in, 304in, 304 1/2in, 305in, 305 1/2in, 306in, 306 1/2in, 307in, 307 1/2in, 308in, 308 1/2in, 309in, 309 1/2in, 310in, 310 1/2in, 311in, 311 1/2in, 312in, 312 1/2in, 313in, 313 1/2in, 314in, 314 1/2in, 315in, 315 1/2in, 316in, 316 1/2in, 317in, 317 1/2in, 318in, 318 1/2in, 319in, 319 1/2in, 320in, 320 1/2in, 321in, 321 1/2in, 322in, 322 1/2in, 323in, 323 1/2in, 324in, 324 1/2in, 325in, 325 1/2in, 326in, 326 1/2in, 327in, 327 1/2in, 328in, 328 1/2in, 329in, 329 1/2in, 330in, 330 1/2in, 331in, 331 1/2in, 332in, 332 1/2in, 333in, 333 1/2in, 334in, 334 1/2in, 335in, 335 1/2in, 336in, 336 1/2in, 337in, 337 1/2in, 338in, 338 1/2in, 339in, 339 1/2in, 340in, 340 1/2in, 341in, 341 1/2in, 342in, 342 1/2in, 343in, 343 1/2in, 344in, 344 1/2in, 345in, 345 1/2in, 346in, 346 1/2in, 347in, 347 1/2in, 348in, 348 1/2in, 349in, 349 1/2in, 350in, 350 1/2in, 351in, 351 1/2in, 352in, 352 1/2in, 353in, 353 1/2in, 354in, 354 1/2in, 355in, 355 1/2in, 356in, 356 1/2in, 357in, 357 1/2in, 358in, 358 1/2in, 359in, 359 1/2in, 360in, 360 1/2in, 361in, 361 1/2in, 362in, 362 1/2in, 363in, 363 1/2in, 364in, 364 1/2in, 365in, 365 1/2in, 366in, 366 1/2in, 367in, 367 1/2in, 368in, 368 1/2in, 369in, 369 1/2in, 370in, 370 1/2in, 371in, 371 1/2in, 372in, 372 1/2in, 373in, 373 1/2in, 374in, 374 1/2in, 375in, 375 1/2in, 376in, 376 1/2in, 377in, 377 1/2in, 378in, 378 1/2in, 379in, 379 1/2in, 380in, 380 1/2in, 381in, 381 1/2in, 382in, 382 1/2in, 383in, 383 1/2in, 384in, 384 1/2in, 385in, 385 1/2in, 386in, 386 1/2in, 387in, 387 1/2in, 388in, 388 1/2in, 389in, 389 1/2in, 390in, 390 1/2in, 391in, 391 1/2in, 392in, 392 1/2in, 393in, 393 1/2in, 394in, 394 1/2in, 395in, 395 1/2in, 396in, 396 1/2in, 397in, 397 1/2in, 398in, 398 1/2in, 399in, 399 1/2in, 400in, 400 1/2in, 401in, 401 1/2in, 402in, 402 1/2in, 403in, 403 1/2in, 404in, 404 1/2in, 405in, 405 1/2in, 406in, 406 1/2in, 407in, 407 1/2in, 408in, 408 1/2in, 409in, 409 1/2in, 410in, 410 1/2in, 411in, 411 1/2in, 412in, 412 1/2in, 413in, 413 1/2in, 414in, 414 1/2in, 415in, 415 1/2in, 416in, 416 1/2in, 417in, 417 1/2in, 418in, 418 1/2in, 419in, 419 1/2in, 420in, 420 1/2in, 421in, 421 1/2in, 422in, 422 1/2in, 423in, 423 1/2in, 424in, 424 1/2in, 425in, 425 1/2in, 426in, 426 1/2in, 427in, 427 1/2in, 428in, 428 1/2in, 429in, 429 1/2in, 430in, 430 1/2in, 431in, 431 1/2in, 432in, 432 1/2in, 433in, 433 1/2in, 434in, 434 1/2in, 435in, 435 1/2in, 436in, 436 1/2in, 437in, 437 1/2in, 438in, 438 1/2in, 439in, 439 1/2in, 440in, 440 1/2in, 441in, 441 1/2in, 442in, 442 1/2in, 443in, 443 1/2in, 444in, 444 1/2in, 445in, 445 1/2in, 446in, 446 1/2in, 447in, 447 1/2in, 448in, 448 1/2in, 449in, 449 1/2in, 450in, 450 1/2in, 451in, 451 1/2in, 452in, 452 1/2in, 453in, 453 1/2in, 454in, 454 1/2in, 455in, 455 1/2in, 456in, 456 1/2in, 457in, 457 1/2in, 458in, 458 1/2in, 459in, 459 1/2in, 460in, 460 1/2in, 461in, 461 1/2in, 462in, 462 1/2in, 463in, 463 1/2in, 464in, 464 1/2in, 465in, 465 1/2in, 466in, 466 1/2in, 467in, 467 1/2in, 468in, 468 1/2in, 469in, 469 1/2in, 470in, 470 1/2in, 471in, 471 1/2in, 472in, 472 1/2in, 473in, 473 1/2in, 474in, 474 1/2in, 475in, 475 1/2in, 476in, 476 1/2in, 477in, 477 1/2in, 478in, 478 1/2in, 479in, 479 1/2in, 480in, 480 1/2in, 481in, 481 1/2in, 482in, 482 1/2in, 483in, 483 1/2in, 484in, 484 1/2in, 485in, 485 1/2in, 486in, 486 1/2in, 487in, 487 1/2in, 488in, 488 1/2in, 489in, 489 1/2in, 490in, 490 1/2in, 491in, 491 1/2in, 492in, 492 1/2in, 493in, 493 1/2in, 494in, 494 1/2in, 495in, 495 1/2in, 496in, 496 1/2in, 497in, 497 1/2in, 498in, 498 1/2in, 499in, 499 1/2in, 500in, 500 1/2in, 501in, 501 1/2in, 502in, 502 1/2in, 503in, 503 1/2in, 504in, 504 1/2in, 505in, 505 1/2in, 506in, 506 1/2in, 507in, 507 1/2in, 508in, 508 1/2in, 509in, 509 1/2in, 510in, 510 1/2in, 511in, 511 1/2in, 512in, 512 1/2in, 513in, 513 1/2in, 514in, 514 1/2in, 515in, 515 1/2in, 516in, 516 1/2in, 517in, 517 1/2in, 518in, 518 1/2in, 519in, 519 1/2in, 520in, 520 1/2in, 521in, 521 1/2in, 522in, 522 1/2in, 523in, 523 1/2in, 524in, 524 1/2in, 525in, 525 1/2in, 526in, 526 1/2in, 527in, 527 1/2in, 528in, 528 1/2in, 529in, 529 1/2in, 530in, 530 1/2in, 531in, 531 1/2in, 532in, 532 1/2in, 533in, 533 1/2in, 534in, 534 1/2in, 535in, 535 1/2in, 536in, 536 1/2in, 537in, 537 1/2in, 538in, 538 1/2in, 539in, 539 1/2in, 540in, 540 1/2in, 541in, 541 1/2in, 542in, 542 1/2in, 543in, 543 1/2in, 544in, 544 1/2in, 545in, 545 1/2in, 546in, 546 1/2in, 547in, 547 1/2in, 548in, 548 1/2in, 549in, 549 1/2in, 550in, 550 1/2in, 551in, 551 1/2in, 552in, 552 1/2in, 553in, 553 1/2in, 554in, 554 1/2in, 555in, 555 1/2in, 556in, 556 1/2in, 557in, 557 1/2in, 558in, 558 1/2in, 559in, 559 1/2in, 560in, 560 1/2in, 561in, 561 1/2in, 562in, 562 1/2in, 563in, 563 1/2in, 564in, 564 1/2in, 565in, 565 1/2in, 566in, 566 1/2in, 567in, 567 1/2in, 568in, 568 1/2in, 569in, 569 1/2in, 570in, 570 1/2in, 571in, 571 1/2in, 572in, 572 1/2in, 573in, 573 1/2in, 574in, 574 1/2in, 575in, 575 1/2in, 576in, 576 1/2in, 577in, 577 1/2in, 578in, 578

VALUABLE NEW HANDBOOK FREE TO AMBITIOUS ENGINEERS

Have you had your copy of "Engineering Opportunities"?

The new edition of "ENGINEERING OPPORTUNITIES" is now available—without charge—to all who are anxious for a worthwhile post in Engineering. Frank, informative and completely up to date, the new "ENGINEERING OPPORTUNITIES" should be in the hands of every person engaged in any branch of the Engineering industry, irrespective of age, experience or training.

**We definitely Guarantee
"NO PASS—NO FEE"**

This remarkable book gives details of examinations and courses in every branch of Engineering, Building, etc., outlines the openings available and the essential requirements to quick promotion and describes the advantages of our Special Appointments Department.

WHICH OF THESE IS YOUR PET SUBJECT?

MECHANICAL ENGINEERING

Gen. Mech. Eng.—Maintenance — Draughtsmanship—Heavy Diesel—Die & Press Tool Work—Welding—Production Eng.—Jig & Tool Design—Sheet Metal Work—Works Management — Mining — Refrigeration—Metallurgy.

AUTOMOBILE ENGINEERING

Gen. Automobile Eng.—Motor Maintenance & Repairs — High Speed Diesel—Garage Mngment.

ELECTRICAL ENGINEERING

Gen. Elec. Eng.—Elementary & Advanced Elec. Technology — Installations Draughtsmanship—Supply —Maintenance — Design —Electrical Traction — Mining Electrical Eng.—Power Station Equipment, etc.

CIVIL ENGINEERING

Gen. Civil Eng.—Sanitary Eng.—Structural Eng.—Road Eng.—Reinforced Concrete—Geology.

RADIO ENGINEERING

Gen. Radio Eng.—Radio Servicing, Maintenance & Repairs—Sound Film Projection — Telegraphy — Telephony — Television — C. & G. Telecommunications.

BUILDING

Gen. Building—Heating & Ventilation—Architectural Draughtsmanship — Surveying — Clerk of Works — Carpentry and Joinery —Quantities — Valuations

WE HAVE A WIDE RANGE OF AERONAUTICAL COURSES AND COURSES IN FORESTRY, TIMBER TECHNOLOGY, PLASTICS, G.P.O. ENG., TEXTILE TECHNOLOGY, ETC., ETC.

One of these qualifications would increase your earning power

WHICH ONE?

A.M.I.Mech.E., A.M.I.C.E., A.M.I.P.E., B.Sc., A.M.Brit.I.R.E., A.F.R.Ae.S., A.M.I.M.I., L.I.O.B., A.R.I.B.A., A.M.I.H. & V.E., M.R.San.I., F.R.I.C.S., A.M.I.E.D., CITY & GUILDS, COMMON PRELIM., GEN. CERT. OF EDUCATION, ETC.

THE BRITISH INSTITUTE OF ENGINEERING TECHNOLOGY



410A, COLLEGE HOUSE,
29-31, WRIGHT'S LANE,
KENSINGTON, W.8.

Phone : WESTern 9861

WHAT THIS BOOK TELLS YOU

- ★ HOW to get a better paid, more interesting job.
- ★ HOW to qualify for rapid promotion.
- ★ HOW to put some valuable letters after your name and become a "key-man" . . . quickly and easily.
- ★ HOW to benefit from our free Advisory and Appointments Depts.
- ★ WHERE today's real opportunities are . . . and HOW you can take advantage of the chances you are now missing.
- ★ HOW, irrespective of your age, education or experience, YOU can succeed in any branch of Engineering that appeals to you.

**144 PAGES OF EXPERT
CAREER-GUIDANCE**

You are bound to benefit from reading "ENGINEERING OPPORTUNITIES," and if you are earning less than £15 a week you should send for your copy of this enlightening book now—FREE and without obligation.

POST NOW!

TO : B.I.E.T. 410A, COLLEGE
HOUSE, 29-31, WRIGHT'S LANE,
KENSINGTON, W.8.

Please send me FREE and without obligation, a copy of "ENGINEERING OPPORTUNITIES." I am interested in (state subject, exam, or career).....

NAME

ADDRESS.....

WRITE IF YOU PREFER NOT TO CUT THIS PAGE



Only 1d. stamp is needed if posted in an unsealed envelope.

THE B.I.E.T. IS THE LEADING INSTITUTE OF ITS KIND IN THE WORLD

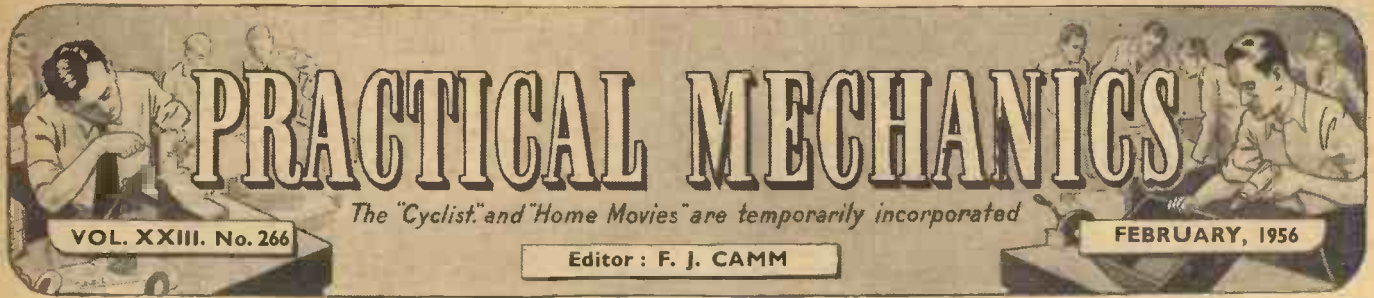

Woolly Views About Space Travel

I MUST gently chide the new Astronomer Royal, Prof. Richard vander Riet Woolley, for his recently expressed views on interplanetary travel. Prof. Woolley was chief assistant to the retiring Sir Harold Spencer Jones and he has been director of the Commonwealth Observatory at Mount Stromlo, Canberra. Prof. Woolley described himself as a straightforward scientist and as such he should not make the mistake of so many scientists before him of being dogmatic about the future. It is only possible to be dogmatic about the past. Only a quarter of a century ago those who forecast that we should be able to sit in our homes and watch a play taking place in a studio miles away were considered mental cases. Less than 60 years ago those who thought that we should fly in the air were considered mad. The medical profession thought that the motor car was impossible because, as they said, the heart could not withstand a speed of 60 miles an hour. Prof. Woolley referred to as "utter bilge" (most unscientific language) talk about the future of interplanetary travel. In support, he said that he did not think that "anybody would ever put up money to do such a thing. It would be enormously expensive. But if the next war could be won by the first chap getting to the moon and by that alone, some nation might put up the enormous amount required. I cannot give any idea how much it would cost, but it would be a very large sum indeed. It is all rather rot."

This is all rather "woolly" talk, and I am astonished that a scientific man should express such views, especially when those views are against the weight of scientific fact. He does not say that space travel is impossible, but merely that it will not take place because no country will put up the money! Quite apart from the general sloppiness of his phraseology, which is hardly that of one scientifically trained, he has no right whatever to presume that some country will not put up the money. The sum involved, in fact, for Prof. Woolley's information, would be considerably less than we are spending on the atomic bomb. Prof. Woolley, if he lives the normal span, will live to eat his words, and they will be quoted against him.

FAIR COMMENT

By

The Editor

Like Lord Dowding, who incidentally has not accepted my challenge to an open debate on the subject of flying saucers, Prof. Woolley indulges in generalities and personal opinions, unbacked by any scientific evidence, and he rejects all of the scientific evidence in favour of interplanetary travel. The phrase "utter bilge" more appropriately applies to his own remarks, and as in the case of Lord Dowding, I also issue a challenge to him to an open debate on the subject.

I can, however, support his views about flying saucers, with the slight distinction that where he does not believe in them, my view is that I do not believe in them in so far as they are advanced as visitors from other planets. Any aircraft manufacturer could make a flying saucer. Prof. Woolley just does not believe in them, anyhow, and he supports this statement with a story. "I was wakened up about 3 a.m. by the R.A.F., who asked about an object at 3,000ft. due west. I hopped out of bed and had a look, and then I missed my chance. I should have said 'Take off, boys. It's the Russians.' Instead, I had to tell them it was the planet Mars."

The Astronomer Royal, no matter who he may be, is not in the best position to express views such as these. Is Prof. Woolley suggesting that the launching of artificial satellites during the International Geophysical year is utter bilge, and that this country is wasting

its money on such a project? It is noted that Prof. Woolley's views are contrary to those of the man he succeeded, Sir Harold Spencer Jones, who has said that reaching the moon would be "well worth while." It seems a great pity that in taking over his new office Prof. Woolley should have made such absurd remarks which are quite contrary to the weight of scientific evidence.

Who Invented the Wheel?

THE great controversy which has ranged round the authorship of Shakespeare's plays has become a national hobby. Did Bacon write them, or Marlowe, or Jonson? The opening of the tomb of Sir Thomas Walsingham, who was the patron of Marlowe, may yield, although I doubt it, some information on the subject. Whilst the country, however, has always been concerned with literary mysteries of this sort (even Boswell's papers were found after a search) no one has bothered to trace the origin of some really fundamental scientific discoveries, and I would put the wheel at the top of the list. Who first invented the wheel? Who first discovered that by mounting a slice off a tree-trunk, roughly rounded, large loads could be transported by human beings as well as animals? Who first discovered that by cutting notches round the circumference positive gear ratios could be obtained? It was Archimedes who first discovered the principle of the lever. "Give me a lever and I'll lift the world!" he said. Who first discovered the method of casting? There are hundreds of examples of cast articles made in copper, silver and gold, dating to centuries before the Christian era, as the opening of Tut-ank-amen's tomb revealed. Should we not be more concerned with these things than with who wrote the Shakespeare plays? My personal opinion is that Shakespeare did not write any of them. He was the Cochran of his period. He bought plays at a time when it was a scandal to be associated with "rogues and vagabonds," as actors were then considered. Who first taught the art of recording thought by means of writing, and reproducing them by means of the diptych? These are problems just as interesting as the authorship of the Shakespeare plays.—F. J. C.

SUBSCRIPTION RATES

including postage for one year

Inland - - - - 14s. per annum.
Abroad - - - - 14s. per annum.

Editorial and Advertisement Office: "Practical Mechanics," George Newnes, Ltd., Tower House, Southampton Street, Strand, W.C.2
Phone: Temple Bar 4363
Telegrams: Newnes, Rand, London.

Copyright in all drawings, photographs and articles published in "Practical Mechanics" is specially reserved throughout the countries signatory to the Berne Convention and the U.S.A. Reproductions or imitations of any of these are therefore expressly forbidden.

A skeleton SYNCHRO-ELECTRIC Clock

By F. G. RAYER

An Easily-constructed Low Voltage Electric Timepiece

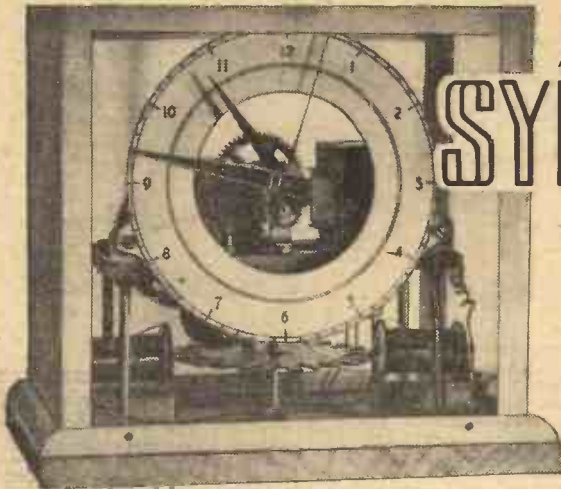

Fig. 1.—The author's completed clock.

THIS clock may readily be constructed with the aid of simple hand-tools alone, and the original was built in this way. An exposed, "skeleton" type of mechanism is used, and this further simplifies

day-to-day error, if any, being that present in the mains supply only.

If the necessary component parts are prepared first, the actual assembly of the clock will be quite straightforward. The various axles, gears, etc., can readily be purchased from suppliers of model-maker's parts and constructional toys. Or a broken clock, if to hand, would furnish all gears required except for the initial two-stage reduction drive to the shaft which rotates once per minute.

up from strips from an old transformer core, $1\frac{1}{2}$ in. long and $\frac{3}{16}$ in. wide. Four such strips are used for each core. If wider strips are to hand they may be used provided the end of the core near the synchronous wheel is filed down so that it is not wider than the teeth of the wheel.

Paxolin discs are pushed tightly upon the core, and the space between covered with insulating tape. The bobbins are then wound almost full with 26 s.w.g. enamelled wire, the ends being brought out through small holes in the cheeks. The finished magnet is mounted by an 8BA bolt passed through

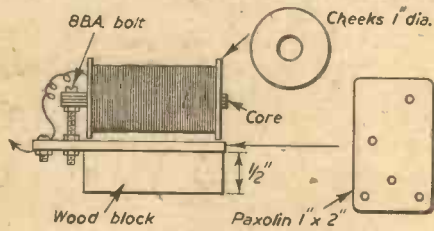

Fig. 2.—Construction of magnets.

building, while allowing all parts to be seen in movement. To exclude dust the finished clock may be placed in a domed glass of the type used to house 365-day skeleton clocks, etc., or a case may be built up from ordinary sheet glass. The completed clock is shown in Fig. 1.

Synchronous clocks usually employ energising magnets wound for the full mains voltage, which makes necessary some thousands of turns of very fine wire. In the present model, however, the magnets are wound for low-voltage only, thus greatly simplifying this part of the work. The clock will run with $\frac{1}{4}$ amp. at $2\frac{1}{2}$ volts. This is a consumption equal to over fifteen-hundred hours running from one unit of electricity, but in practice it will generally be observed that the house meter does not turn at all, if other equipment is switched off. The required current is provided by a small transformer mounted on the clock frame.

As with all synchronous clocks, the model is a very excellent time-keeper, the

The Magnets

Two of these are required, of the simple type shown in Fig. 2. The core is made

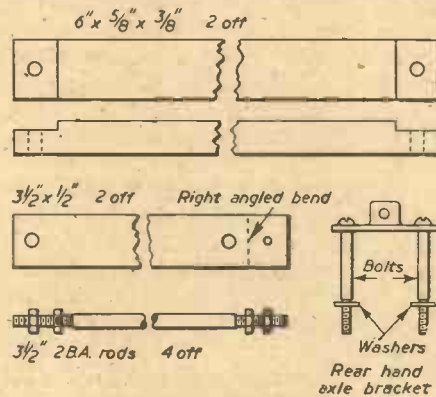

Fig. 4.—Pieces for supporting frame, etc.

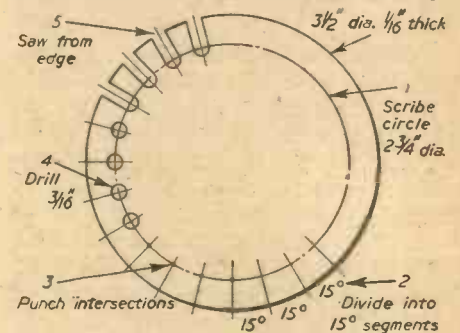

Fig. 6.—The synchronous wheel.

a hole drilled in the one end of the core, which secures the whole to the small paxolin base. A wooden block is screwed under this, to lift the cores to a position level with the synchronous wheel. Both magnets are the same, their cores being at the same height.

Holes are drilled up through the clock baseboard so that the magnets can be held in place by slender woodscrews driven up from below. They may be seen in position in Figs. 5 and 9.

Parts for Frame

The most important of these are shown in Fig. 4, consisting of two long members of smooth, hard wood, and two strips of stout aluminium or brass, with a right-angle bend to allow the clock dial to be bolted in position. The pieces are held together by means of four 2BA threaded

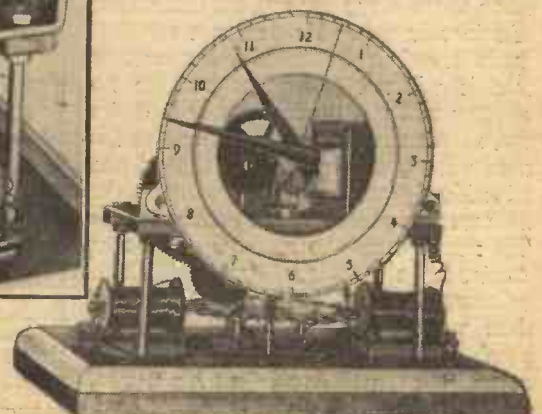
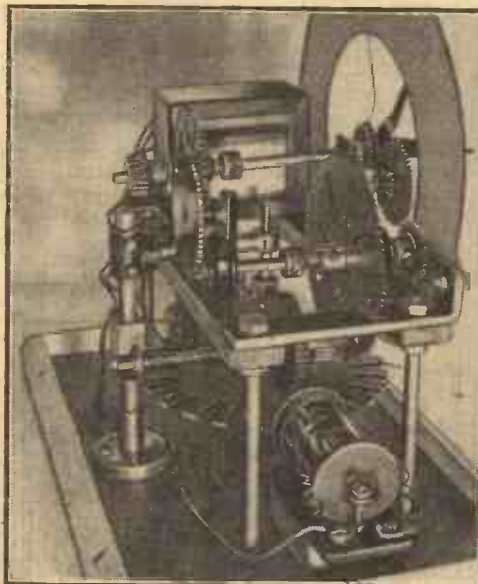
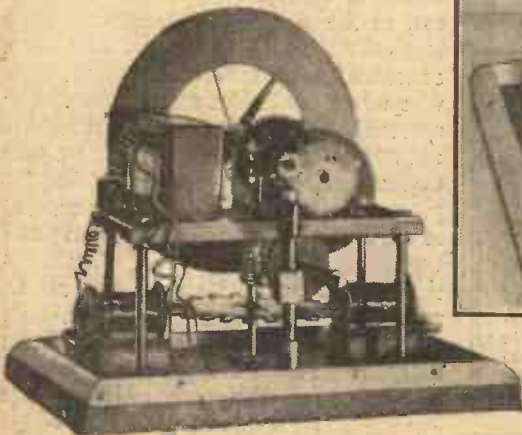

Fig. 3 (Left).—A rear view.
Fig. 5 (Above).—A view clearly showing the construction.
Fig. 7 (Right).—A frontal view of the completed clock.

rods, which pass down through holes in the baseboard, which needs to be about 4 1/2 in. by 7 in. All these parts may be clearly seen in Figs. 5 and 13.

The front end of the hand axle is run through a simple bracket-shaped bearing. The rear end requires the bearing in Fig. 4, however, since the support for the synchronous wheel axle passes under the hand axle here. The rear bracket is bent up from brass, supported on long bolts with spacing sleeves, as shown.

When the 2BA nuts are tightened, the whole frame should be square and rigid. Wear and stress upon the gears and bearing will be negligible, as there is no continuous pressure, as with a spring-driven clock.

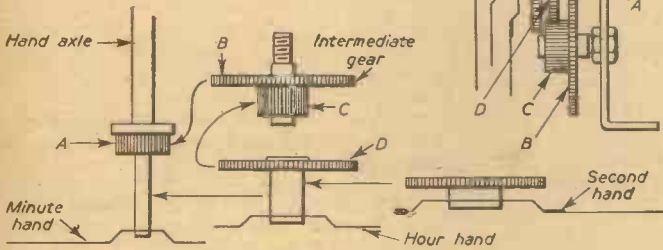

Fig. 8.—The hands.

Synchronous Wheel

This is cut from 1/16 in. sheet-iron, and working will be eased if the iron is soft, or left at red heat in a dying fire for some hours. The disc is cut by sawing away adjacent sections with a metal saw, and then filing up to the scribed line. A push-fit hole should then be drilled in the centre and the disc tested for any eccentricity. If present, this should be corrected by filing until the perimeter of the disc runs true, when the axle is turned.

A 2 1/2 in. dia. circle is then clearly scribed on the disc, and intersected at 15 degree intervals. The intersections are punched so that the drill will start in the correct position, and 24 holes are made, as in Fig. 6. The disc is then held vertically in a vice and sawn as shown, to form teeth and spaces of about equal width. When all are finished, the wheel is tested for balance. If heavy one side, the teeth are filed a little to restore balance.

The centre of the wheel should be cleaned and tinned. The axle is filed to a point at one end, and also cleaned and tinned. The wheel is then pushed on to the axle, and positioned so that it does not wobble when

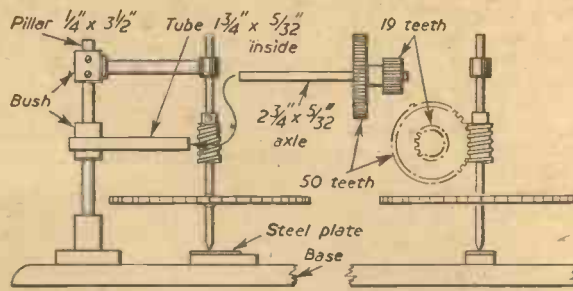

Fig. 10.—Synchronous wheel and drive.

the axle is turned. When correct, the solder is melted to fuse the joint, and additional solder added each side.

Hands and Gearing

As the clock has a sweep second hand the arrangement shown in Fig. 8 is required. The main axle has the small gear A soldered to it, which meshes with gear B. Gear C

meshes with D, producing an overall reduction ratio of 12:1. With most clock gears this will be arrived at by ratios of 3:1 x 4:1, but 6:1 x 2:1 is found in some clocks, and occasionally 12:1 x 1:1. Gear D slips on the hand axle. Gears B and C are integral, and run upon a small stub axle fixed to the bracket.

The second hand gear runs freely on the sleeve of gear D. A 1:1 ratio is required between second hand and the 1 r.p.m. axle of the clock, and this will be obtained with any two gears with the same number of teeth, the number of teeth on the idling gear between them being unimportant.

When the gears are in position the second

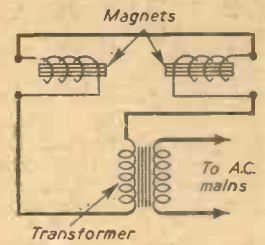

Fig. 11.—Electrical connections.

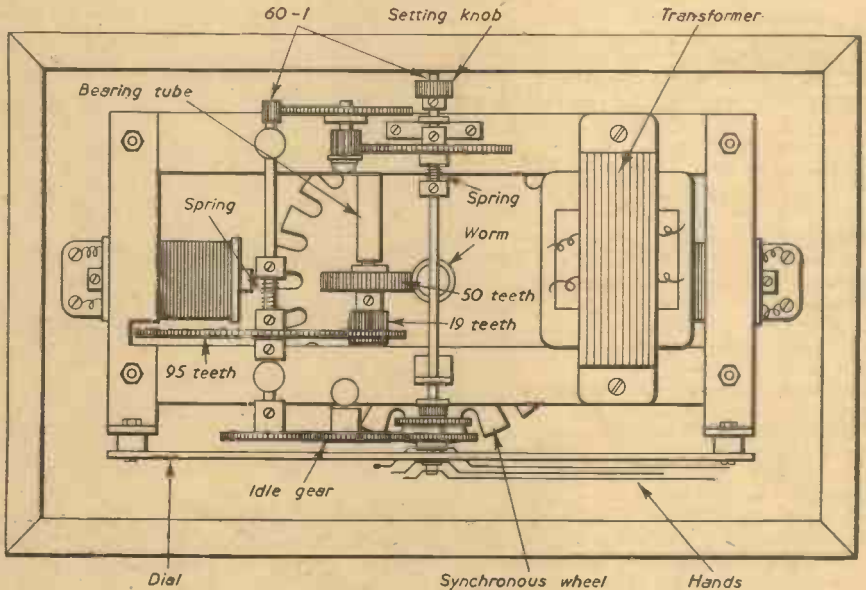

Fig. 12.—Plan view of clock.

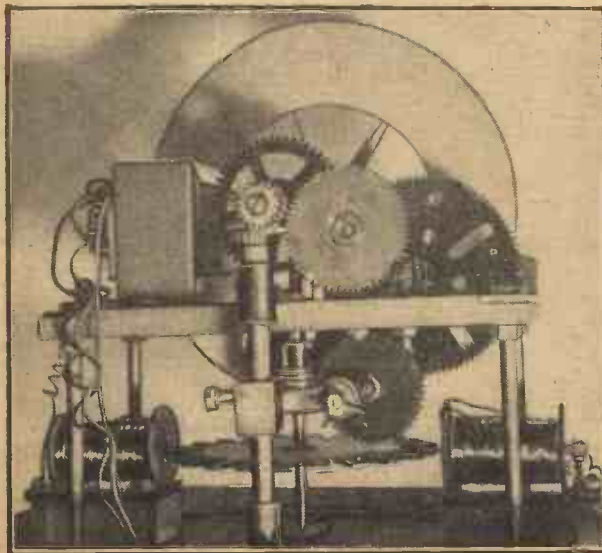

Fig. 9 (Left).—A rear view of the mechanism showing wheel mounting rod, etc.

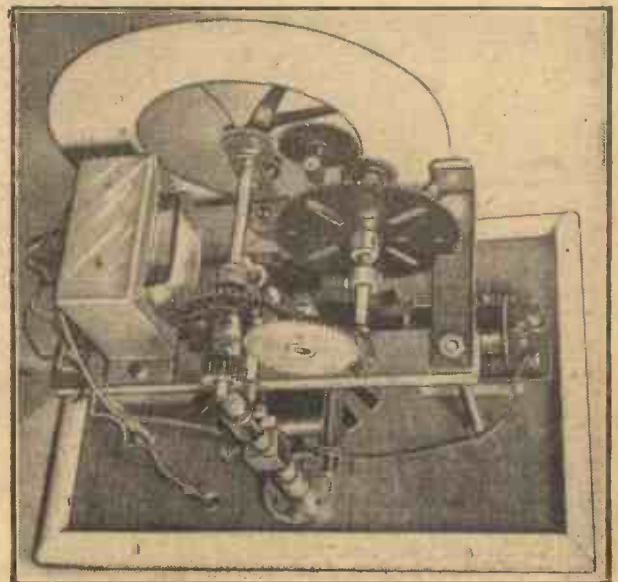

Fig. 13 (Right).—A top view of the clock.

hand is fitted first. It is 2½ in. long, consisting of a centre piece of 20 s.w.g. wire, to which is soldered a straight piece of 26 s.w.g. enamelled wire. The hour hand is fitted next, being 2½ in. long, and cut from a strip of metal ¾ in. wide. The minute hand is fitted last, being ¾ in. wide at the middle, and 2½ in. long. The hands are a push-fit, being secured with solder, and are cranked as shown, to provide increased clearance.

Wheel Mounting and Drive

A length of ¼ in. dia. brass rod is fixed vertically at the rear of the baseboard, and two bushes are secured to it with setscrews. A projecting rod is soldered to the top bush, and a collar, for bearing, is soldered to the end of this, as shown in Fig. 10. The wheel axle, with worm, rests upon a steel piece with a small indentation, thereby turning very freely. This assembly is seen in Figs. 3, 5 and 13.

The second bush has a small spacing piece and bearing tube soldered in place. The axle carrying 19- and 50-teeth gears slips into this tube, and by adjusting the position of the bush on the vertical pillar the 50-teeth gear may be brought into proper relationship to the worm. The 19-teeth gear rotates 5 times per minute, so that the 1 r.p.m. speed is obtained by meshing a 95-teeth gear with it. The axle of the latter gear is run in bearings bolted to the strip frame.

The parts in Fig. 10 may be regarded as the motor section of the clock, and should run freely. At the 1 r.p.m. spindle the power will be ample so that the clock will

not stop even if this spindle is held tightly with the fingers.

To obtain silent running the 50-teeth gear was subsequently cut from ¼ in. Bakelite, the pattern being taken from the original brass 50-teeth gear. Bakelite and gear were clamped together, and the Bakelite carefully filed to match. This eliminated a very slight scraping sound which was found to originate between worm and gear when the latter was of metal.

Connections for the magnets are shown in Fig. 11. It is best to connect so that the poles adjacent to the wheel are of opposite magnetic polarity. The poles should be diametrically opposite, or so arranged that teeth are presented to them simultaneously when the wheel is turned. Very close spacing is not necessary—a strip of postcard may be placed between poles and wheel teeth, to gauge this.

The transformer can be of any small type such as used for small bulb or heater circuits. A high output is by no means required, and may cause humming. If a 6.3v. heater type transformer is used, a resistor may be wired in one primary lead to reduce the output voltage. As the primary current is small, a 10,000 ohm to 15,000 ohm 1-watt resistor will generally be suitable. When current is applied, the nearest teeth of the wheel will be drawn to the magnet poles, the clock not being self-starting.

Completing Construction

A plan view of the completed clock is

shown in Fig. 12. The motor section (Fig. 10) with magnets, is best assembled first, and tested. To start, the projecting top of the wheel axle is turned between the fingers at synchronous speed, or 250 r.p.m. The mistake of spinning the axle too fast should be avoided. When the clock is completed, the correct speed may more readily be found, by noting the movement of the second hand over the dial. When the wheel has been set in motion at the correct speed it will continue to run as long as current is supplied.

The 95-teeth gear is loose upon its axle, the drive being taken by a spring friction arrangement. This was done to permit of setting the second hand by rotating the axle. A similar friction drive is used on the main hand axle, to allow the clock to be set to time by the small gear, or setting knob, at the back.

Two gears of the same size, with intermediate idler, transfer movement to the second hand. At the back, a 60 : 1 drive is used between the 95-teeth gear spindle and the main hand axle. This was made up from a 10 : 1 ratio followed by a 6 : 1 ratio, but 12 : 1 followed by 5 : 1, or any overall ratio of 60 : 1, is suitable. This gear, in common with the front idler, is mounted on a short stub axle.

The dial can be made from any suitable material, and is fixed in place with two bolts as shown in Fig. 7. A little thin oil should be applied to the various gears, bearings, etc.

A Useful Spindle Moulder

Details and Dimensions of a Jig and Flycutter for Use With an Electric Drill

By E. FREEMAN



Fig. 1.—The author's flycutter.

THIS spindle moulder was designed and used for machining a quantity of 6in. by 2in. by ¾ in.-thick mahogany block flooring with a gluing key. The construction of the wooden jig should be self evident from the drawing, Fig. 2. Wood ¾ in. thick was used and it was designed to fit the author's Wolf Cub electric drill. The top may be easily taken off by removing four screws, one from each of the four fixing cleats. The sizes given may be modified to suit individual requirements.

The flycutter was made to the dimensions given in Fig. 2, and Fig. 1 is a photograph of the author's original tool. The body and spindle could be turned in the lathe from a

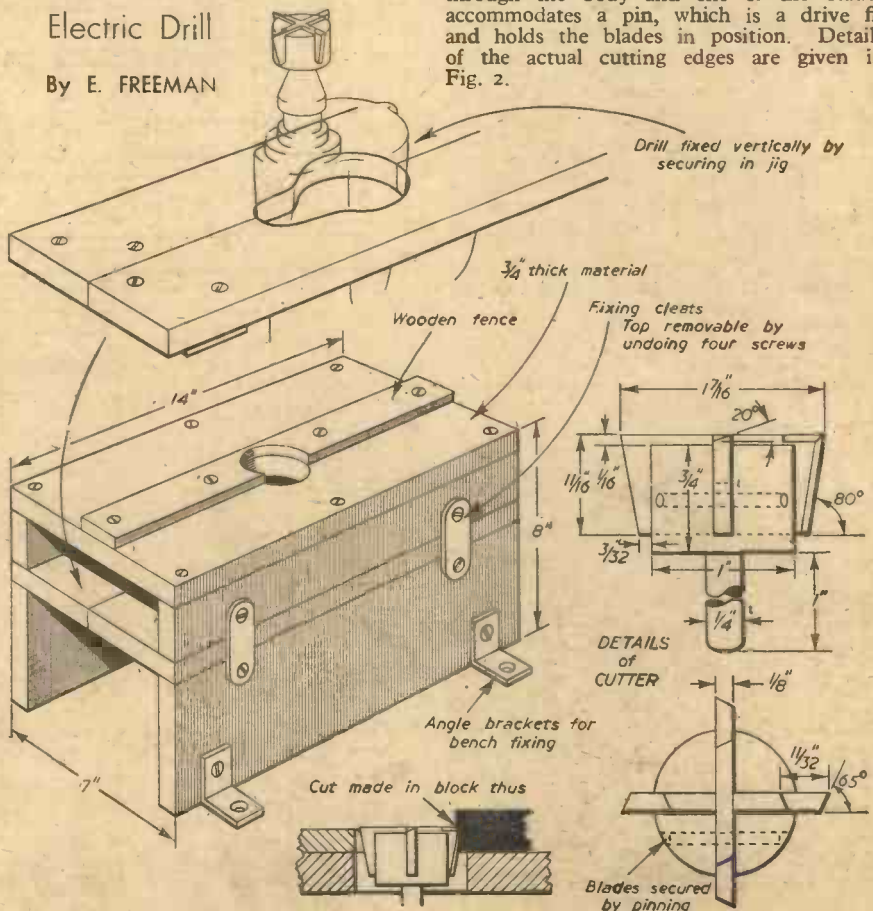

Fig. 2.—Details and dimensions of the wooden jig and flycutter.

single piece of M.S. bar. The cutter blades, made from silver steel and suitably tempered, may be half-jointed in the form of a cross and made a drive fit in slots in the body of the cutter. A ¼ in. hole drilled through the body and one of the blades accommodates a pin, which is a drive fit and holds the blades in position. Details of the actual cutting edges are given in Fig. 2.



Our artist's impression of a race in progress.

An Electrically-operated RACE GAME

THE principle of operation is very simple and a race in progress is shown in the heading picture and one just completed in Fig. 1. The horses are drawn along a smooth surface by cords connected to a motor-driven shaft set up at right angles to the course. The manner in which the cords pile up on the shaft when the latter is rotated decides the speed and progress of the various horses. The fastest horse will probably have its pile of cord in the form of a pyramid on the shaft. Then, being only one cord on the apex of the pile, and the next turn by necessity being directly on the shaft, the horse's speed will slow from one of the fastest to the slowest. Alternatively, an irregular pile of cord on the shaft may collapse, leaving many loose turns; then while the slack is being pulled taut the horse will remain motionless. The fortunes of all the runners are likely to change many times in the course of the race.

Principal Features

The author's unit contains the following features: six horses are used; the race is started manually and the operation is electrical; a white lamp lights when the race is in progress; the winning horse stops the race, extinguishes the white lamp and lights its own coloured lamp; the speed of the race, which is over a course 9ft. long, can be varied.

Details for Making and
Operating an Exciting Horse-
racing Game Which Can be
Played by All the Family

By T. S. SKEET

The Operating Equipment

As shown in Fig. 2, this consists of a transformer "stepping down" from 230 volts to 10 volts and feeding a full-wave selenium rectifier, producing 8 volts D.C. to drive a tiny ball-bearing dynamo, used as a motor. The motor has considerable torque

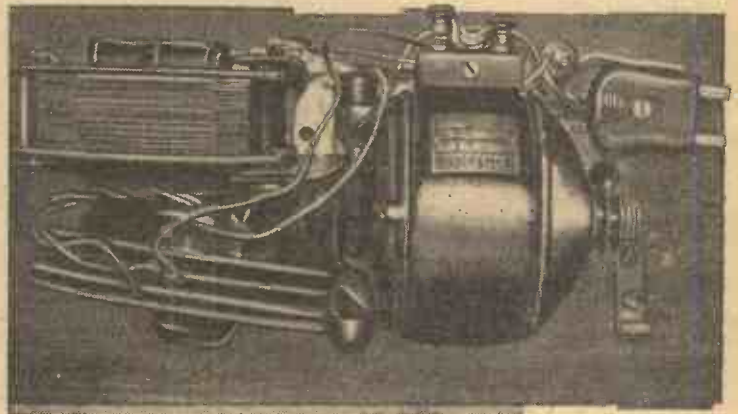

Fig. 2.—A rear view of the power plant.

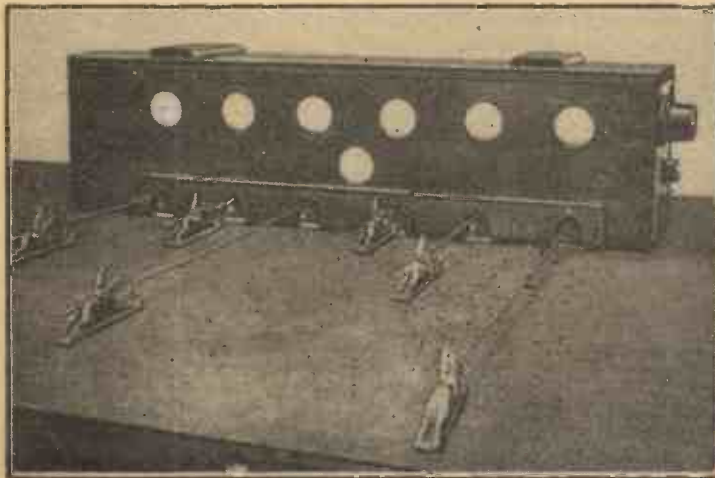

Fig. 1.—The game with a race just completed.

at a very low speed and is thus very suitable for the job in question. The rectifier discs are only half discs and the full-wave rectifier was constructed and partly melted discs from a scrap yard.

The motor drives with a step-up ratio of about 5:1 on to the minute-hand spindle of a small clock

movement; the hour-hand spindle carries a short length of channel-shaped brass, with the channel "facing" the end of the main shaft which it drives. This main shaft carries the strings attached to the horses, and on the end facing the gearing has a cross-piece which engages with the channel on the gearing. The long shaft is arranged to slide in its bearings in order that it may be disengaged from the gearing when it is desired to take the horses to the starting point. A spring-loaded fork, operating on a collet fixed to the shaft, tends to push the shaft out of gear, but this pressure is neutralised by a spring-loaded plunger operating on the free end of the shaft, which permits the latter to be locked in gear while a race is in progress. The general arrangement may be seen in Fig. 3.

The horses must all be taken to the starting point at the same time, otherwise the strings will become badly tangled and the "stop" switches may be damaged. It is important that the first horse home shall operate the stop switch immediately, otherwise the switch springs, which are very thin, may become distorted. To ensure satisfactory operation even with the lightest of pressures, the moving springs are made of 1½mm. hard brass sheet, with a triangular piece of thin sheet silver soldered at right angles to the face of the spring.

The sharp point of the triangle makes contact with the surface of a piece of silver sheet on the fixed contact.

Operation

Fig. 4 shows the circuit arrangements. The relay is a "dynamo cut-out" from an old car. The start lamp has a resistance included in its circuit to reduce the voltage applied to it. The operation of the "start switch" closes the 230 volt A.C. mains circuit; this applies, via the transformer and rectifier, 8 volts D.C. to the field coil of the motor and to the operating coil of the relay via the 10Ω resistor. The relay operates to complete the circuits for the motor armature and the start lamp; and when the first horse gets home, the appropriate stop lamp (then cold and of low resistance) is shunted across the relay coil and due to the presence of the 10Ω series resistance the voltage across the relay drops sufficiently to

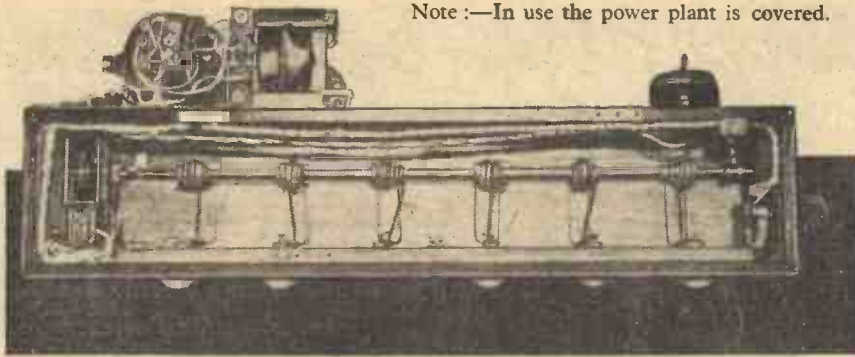

Fig. 3.—A view of the shaft and the associated mechanism.

permit the relay to release, this stopping the motor. The resistance of the stop lamp rises at once, but not to a value which will allow re-operation of the relay.

The Coloured Lamps

The seven white objects on the front of the long-box in Fig. 1 are sections of table tennis balls varnished. The sections are glued into a $\frac{1}{8}$ in. deep recess cut in the face of the box with a carpenter's centre bit, the hole being then continued right through the wood by another and smaller centre bit to leave a $\frac{1}{8}$ in. wide rebate. The single "globe" is the start lamp, which is white; the other six lamps are covered with tissue paper, silk, cellophane or any other coloured material which will transmit light and the jockeys have their shirts enamelled to match.

The Horses

A difficult and unavoidable job was the soldering of the horses, or their hooves, to the bases on which they travel. The bases are of brass sheet with the front end bent up at an angle of 40 deg. The tapered tip of the bent-up part is carefully rounded, as it is this part which operates the stop switch.

The strings are attached to loops in the tops of tiny eyebolts, made of copper wire, which are soldered to the tops of the running bases in which the horses are mounted. The length of these eyebolts is such that the "eyes" coincide exactly with the outside ends of six short brass tubes which pass through the front of the long box. The tubes, which are tilted at an angle "aimed at" the shaft, are for the purpose of providing smooth, easy running of the strings, which is essential to satisfactory operation.

Note:—In use the power plant is covered.

provided by a sheet of plywood arranged to "join up" with the table. The joint between table and extension may be bridged with a "jump" which should have a gradual rise and a short, steep downward slope to permit the horses to slide down faster than the towing speed. This arrangement affects the overall results of a race and provides some variety.

The horses are drawn by strings, but ordinary string or twine, as used for securing parcels, is not very satisfactory; its soft nature or rough surface does not permit the slipping which is so desirable. A smooth, glossy surfaced string is much more effective. The lamps used in this race game are ordinary "flash lamp" bulbs and in the case of the "start" lamp a series resistance is included

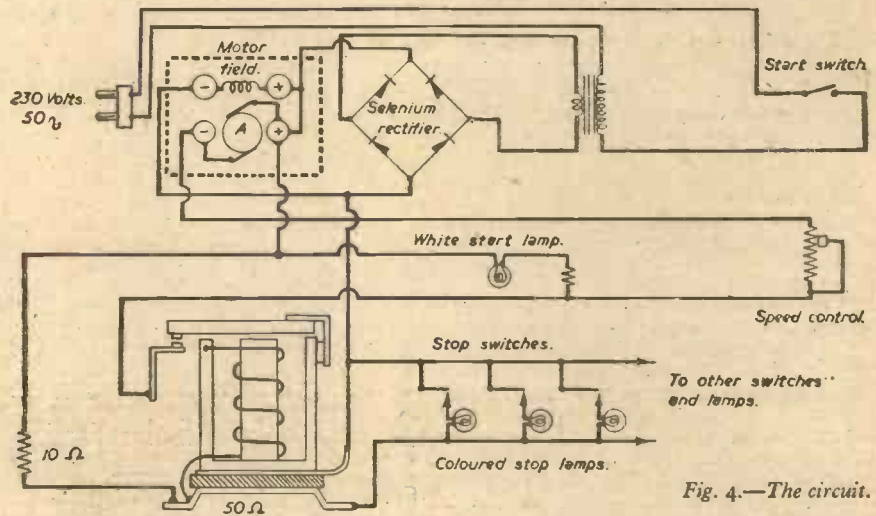

Fig. 4.—The circuit.

The difficulty of fixing the cast lead horses to the brass bases arose out of the fact that the horses were made of lead, which has, it is thought, a lower melting point than the solder.

The Course

As the game is used on a dining-table, plus extension, the undersides of the brass bases are covered in felt cut from a hat. The length of run available on a normal domestic table is insufficient to permit the accidental variations of speed which make the race interesting. A length of three yards is necessary and the additional length is readily

to reduce the voltage to a value safe for its operation.

The six thick copper wire "U"-shaped objects seen inside the long box in Fig. 3 are the bases of six vertical narrow loops, through which pass the six towing strings. The bases of the loops, i.e., the portions seen in the photograph, can slide in slots cut in the underside of the long hardwood strip which carries the long shaft. The position of the narrow vertical loops controls the piling of the strings and permits some adjustment of the running of any horse which may show a tendency to lose or win persistently.



Britain to Use French Air Device

A BRITISH aeroplane company has secured the rights for the French SNECMA jet deflector and reverser device for application to its range of gas turbines. The device is a practical solution to the problem of reducing the landing run of jet aircraft.

Nuclear Detection of Fire

THE scientific application of nuclear physics to the problem of fire prevention has drastically cut the time necessary for bringing fire-fighting services into action. A device, which is now being produced and installed in buildings housing valuables, is continually on watch, consuming no power whilst on guard but springing instantly to life and giving the alarm the moment smoke approaches any of its radio-active detector

heads. The device is produced by the Minerva Co., Ltd., Richmond, Surrey.

Electronic Painting in Hungary

ELECTRONIC painting, in which the paint flies on to the object without use of brush or high-pressure spray, is being developed in Hungary's Red Star Tractor Factory.

Parts to be painted are placed on a revolving stand surrounded by a copper-wire grid connected to the negative side of a 100,000 volts direct current. Electrons flow towards the object to be painted—which is an earthed positive pole—creating an electrostatic space around it. Into this space is injected atomised paint from a low-pressure gun. The paint articles pick up the negative charge and fly to their "positive" target like filings attracted to a magnet.

The Cinema of the Future?

A FRENCH inventor, M. Ruffin, has invented a cinema where, whatever the hour, the spectator will always be in time for the beginning of the big film.

His idea is a circular cinema divided into three parts in each of which on a separate screen, the big film will be shown in succeed-

ing sections of the hall at intervals of ten minutes. The projectors will be in the centre of the circular building and the film will run automatically from one projector to the other "in chain."

Improved Aircraft-Seat

SHORT BROTHERS AND HARLAND, LTD., aircraft manufacturers of Belfast, have designed a new aircraft passenger seat. The seat complies with the latest Air Registration Board requirements to withstand a force of 9G when facing forward or aft and, in the event of an emergency landing, the back of the seat, which is padded, will fold forward when struck from behind when forward facing. The seats are to be fitted to B.E.A. Viscounts and can be arranged for many other types of aircraft.

The Advance of Plastics

AT a recent congress of the "professional engineers of France" a paper on the subject of plastic motor-car bodies made particular mention of the employment of stratified polyester which, it is thought, could replace aluminium. It was also revealed that a synthetic resin had been produced which could stand a temperature of 1,000 deg. C.

RADIO CONTROLLED MODELS



By Members of I.R.C.M.S.

8.—A Detailed Design for a Radio-controlled Boat Using a Glow Plug Engine and an Electric Motor in the Power Unit

READERS of these articles will probably have different outlooks on the subject of the radio control of boats. Some will be chiefly interested in making the model and its fittings and will be probably quite satisfied with a minimum of control, i.e., merely steering their models by radio. Others will be mainly concerned with the techniques and circuitry involved and will see the boat merely as a floating test bed. The types of model which will be made by such people will vary considerably and generalisations on boat design are, therefore, difficult. However, a few main points stand out.

Type of Propulsion

With electric motors the good points are that they are clean, have easy control of speed and direction and are not temperamental. The bad points are poor power/weight ratio, need for heavy batteries, top speed usually not more than about 4 m.p.h.

Diesel, glow plug or petrol engines have two principal good points—high power-to-weight ratio, high speeds possible depending merely on how big an engine is fitted. The disadvantages are that they make a lot of dirt and can be awkward to start. Speed control is difficult, especially with smaller sizes, simple reversing is not practicable and there is excessive noise.

The authors have no experience of the steam power unit, but as far as we can see the method has most of the snags without many of the advantages.

The Control System

This series has now dealt with systems from the simplest rudder control to a system with four channels giving rudder and speed control. The choice here rests largely with the builder concerned and his particular inclinations. It

should be borne in mind, however, that rudder control only is suitable for boats down to 24in. to 30in. long with 1.5 c.c. to 2.5 c.c. engines or suitable motors, whereas the comprehensive systems normally call for a

detail a boat which has been constructed with some of these points in mind. Many of the circuits used are similar to, and have developed from, those already described, whilst others have been designed to meet

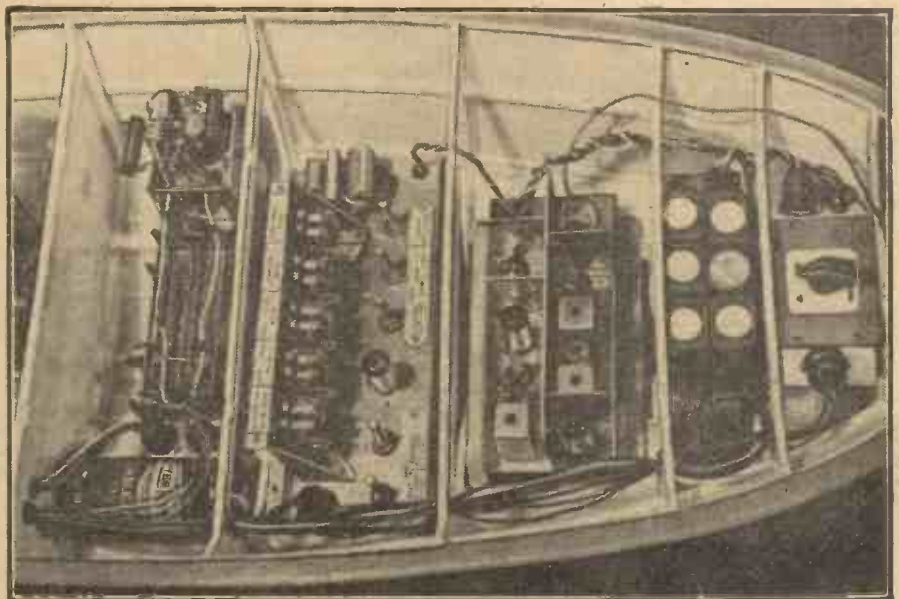

Fig. 2.—Contents of compartment, left to right : Engine speed control gear ; pulse decoder gear ; superhet receiver ; radio batteries ; master on/off switch.

boat 40in. or more long with more powerful propulsion machinery.

The Boat Design

It is now intended to describe in some

specific problems.

The Power Unit

When considering the design it was decided that an attempt would be made to obtain some of the performance of the IC-engined boats together with the control and manoeuvrability of the electrically-powered types. To do this the power unit in Fig. 1 was evolved. This consists of an ETA 29-5 c.c. glow-plug engine coupled via a centrifugal clutch to one end of an electric motor which has a shaft at each end. The engine is fitted with forced air cooling by means of a ducted fan and has throttle controls fitted to the carburettor. These throttle controls allow the engine to tick over at about 4,000 r.p.m. The centrifugal clutch is so adjusted that it begins to engage at approximately 6,000 r.p.m. Thus, with the engine on "tick over," the clutch disengages but when the throttle opens the engine revs. increase and the clutch takes up the drive.

On full throttle the engine settles down at about 16,000 r.p.m. Under full throttle conditions the drive is taken through the motor shaft and to the twin screws via 3-to-1 reduction gearing. The speed control unit seen at the right of Fig. 1 is arranged so that normally the engine runs on "tick over"

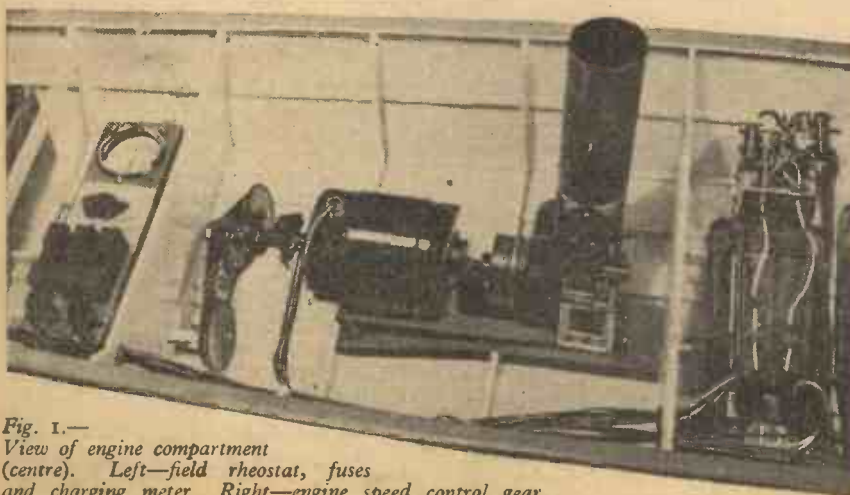

Fig. 1.—View of engine compartment (centre). Left—field rheostat, fuses and charging meter. Right—engine speed control gear.

when two astern speeds, stop and two ahead speeds are provided by the electric motor in the usual way, drawing power from a battery. With the motor at maximum power this spins the propeller at about 1,300 r.p.m. When full speed is required, however, the engine throttles are opened by a solenoid and the propeller speed rises to about 5,300 r.p.m. At full throttle the motor can be disconnected but in this case the motor is used as a dynamo to charge the main batteries and supply power for servo motors, etc. The amount of power absorbed in this way can be adjusted by a rheostat in the field circuit. This can be seen just below the motor at the left of Fig. 1.

The curious stack-like attachment on the engine is the exhaust stack and oil collector to avoid fouling the lake with oil. The stack mates up with one of two stacks mounted side by side on deck similar to the latest gas turbine boats.

Twin screws were adopted to cut out the tendency of a single-screw boat to slew when put into astern whist travelling ahead.

The Radio Apparatus.

As part of a programme of tests to endeavour to control several boats simultaneously this boat is fitted with a superhet receiver employing seven valves, which are seen in Figs. 9 and 10. The signals transmitted are "mark," "80/20," "50/50," "20/80" and "space," so quite a conventional set could be used if single boat operation only were being considered. Fig. 2 shows the receiver installed in the third compartment from the bow. The second compartment houses the main H.T. batteries for the receiver and pulse decoder, which is described later.

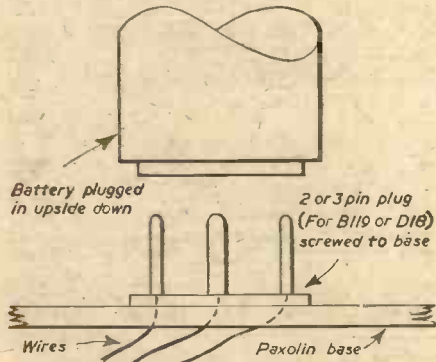

Fig. 3.—Method of mounting plugs.

If a little weight can be spared, the use of B119 30-volt H.T. batteries and D18 1.5-volt L.T. batteries can be strongly recommended for the receiver. Lighter batteries than these are obtainable but the fact that the types mentioned have plug connections makes battery changing very simple. On this boat the plugs are mounted as shown in Fig. 3. Here it can be seen that the 2- or 3-pin plugs used for these batteries are fixed to a paxolin base board located in the boat. All wiring, etc., is carried out underneath this base and the batteries are simply plugged into the base board at the appropriate point. This makes a very neat job and a spare set of batteries can be installed in a few seconds.

The bow compartment houses a multi-way wafer-type switch which in the off position; cuts out all circuits in the boat. With a complex system it is very easy to leave some part of the gear switched on if separate switches are used, and a main switch like this can save flat batteries.

The Control Signals

The control signals for this boat are similar to those described in last month's article, although the means of decoding is different. The following signals are required:

- Mark — Increase speed.
- 80/20 — Port rudder.

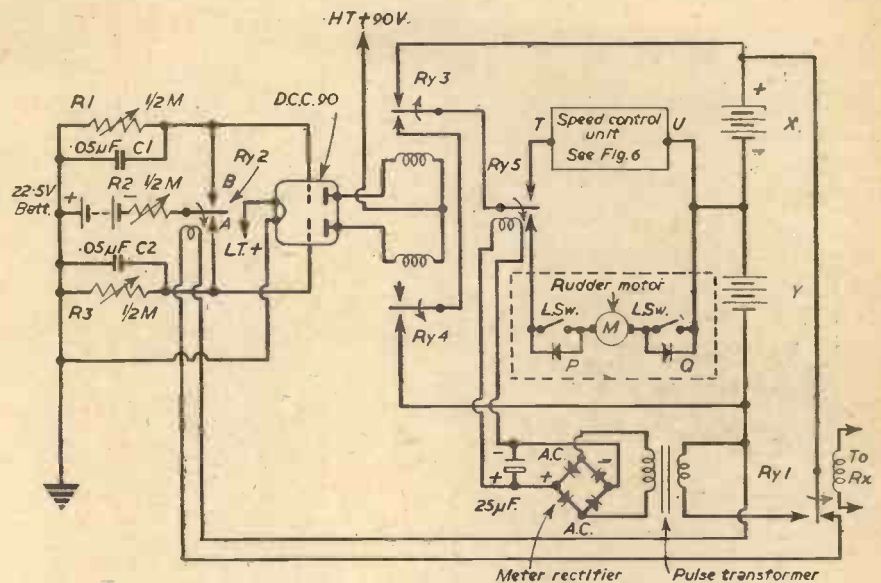

Fig. 4.—Circuit of pulse decoder.

- 50/50 — Neutral.
- 20/80 — Starboard rudder.
- Space — Decrease speed.

The signals are produced by keying the transmitter by a multivibrator control box similar to that shown in the last article. These are picked up by the receiver which passes the rectified and amplified signal to the pulse decoder. The function of this unit is to discriminate between the various types of signal which can arrive and to cause the correct function to take place on receipt of a particular signal. The circuit of this unit is given in Fig. 4 and Fig. 5 shows the general arrangement.

The receiver relay Ry1 is at the right in Fig. 4 and this is fed in the usual manner in the anode circuit of the last valve in the receiver and therefore it follows exactly the action of the relay in the control box keying the transmitter. Ry1 is a Siemens' high-speed relay as are all the others in Fig. 4. The front contact of Ry1 is used to drive Ry2 as a slave using power from the main battery, whilst the back contact feeds power from the same battery through one winding of a modified 1S4 output transformer. This was fully described in the last article and readers will recall that with this arrangement, as long as a rapidly interrupted D.C. current flows through this winding, an induced voltage will appear in the other winding. This is rectified by a 10 mA. bridge-type meter rectifier, smoothed by a 25 µF. 25-volt working electrolytic condenser and fed to Ry5. Thus when 80/20, 50/50 or 20/80 signal is being sent this action

will take place and Ry5 will pull in, whilst on mark and space Ry5 will drop out. Ry5 is termed the "Pulse/No Pulse" relay.

Ry2, being driven by Ry1 as a slave, also follows exactly the transmitted signal. The contacts of this relay are connected in a balancing circuit using a twin triode valve (DCC90 or 3A5). Examination of the circuit will show that when the reed of this relay is on contact (a) condenser C2 will be charged from the 22½ volt battery, the charging rate being adjusted by R2. When the reed moves on to contact (b) C1 will be charged in the same way. While the reed is on contact (b) C2 is discharging through R3. This process is continuous and with 50/50 being sent out the reed will dwell for equal periods on contacts (a) and (b) and if R1 and R3 are adjusted identically the mean voltage across C1 and C2 will be the same. The current is adjusted so that this voltage, which is applied to the grids of the triodes, will just cut them off in order that no anode current flows. If an 80/20 signal is now sent the reed of Ry2 will dwell on contact (a) for 80 per cent. of the cycle. Thus the voltage of C2 will more nearly approach the battery voltage and cut off one-half of the valve even more. C1, however, will have more chance to discharge and less chance to charge, and the negative voltage at the grid of the other half of the valve will be reduced and the circuit can easily be adjusted to allow anode current to flow through this half and so to close Ry3. Substantially the same effect will be caused by sending a mark, in that C2 will charge



Fig. 5.—Pulse decoder unit.

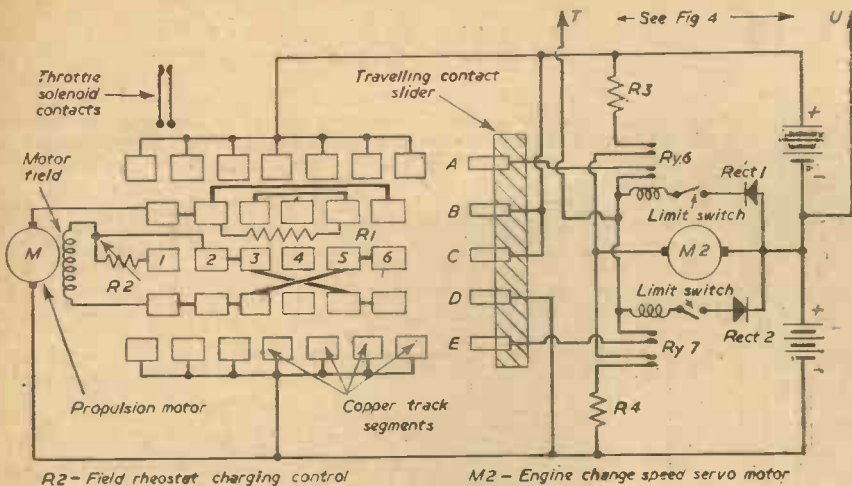

Fig. 6.—Speed control unit.

right up to battery voltage and C1 will discharge completely causing anode current to close Ry3.

The operation can be summarised as follows with reference to Fig. 4:—

(1) *Mark received.* Ry3 closes as described above and due to lack of transformer action Ry5 drops out. Thus power is fed to the speed control unit from battery X causing it to increase the speed of the propulsor unit.

(2) *Space received.* This time Ry4 closes due to C2 discharging completely. Ry5 will drop out due to lack of transformer action and power will again go to the speed control unit, but this time from main battery Y. The fact of the circuit now flowing in the opposite direction makes the speed control unit decrease the speed of the propulsor unit.

(3) *80/20 received.* As described above this will allow C1 to nearly discharge and Ry3 will again close. This time, however, Ry5 will be holding in due to the voltage induced in the transformer by the interrupted D.C. current flowing in its other winding. Power will now go to the rudder motor from battery X, giving port rudder.

(4) *20/80 received.* This is just as item 3 except that Ry4 closes instead of Ry3. Power again goes to the rudder motor but this time in the opposite direction from battery Y, giving starboard rudder.

(5) *50/50 received.* When Ry2 dwells for equal periods on both its contacts both halves of the valve are cut off. Thus both rudder motor and speed control unit are neutral (i.e., stay as they were last left).

It should be noted that the reed of Ry4 is connected via the back contact of Ry3. It

could be connected directly to the reed of Ry3 but if for any reason such as the failure of the 22½-volt bias battery both Ry3 and Ry4 came in together they would then impose a monumental short across the main battery. The connection given makes this impossible.

Readers may also be curious about the rectifiers shown across the limit switches for the rudder motor.

It was mentioned previously that slipping drives can be used and that, in those cases, limit switches are not needed. Some people may not wish to use this method however, and, if positive drive is used, limit switches are essential. Location of the switches in the circuit shown is very difficult since each switch must only stop the rudder motor from going in one direction, leaving it free to travel the other way. This is usually done by putting one limit switch in each battery circuit, but with this circuit this cannot be done as, when one of the steering limit switches opened, it would cut out the speed control unit and vice versa. The problem is overcome by putting both limit switches in series as shown and connecting rectifiers across them. Thus, if the rudder is going to port, it will eventually open, say, switch P, and the rectifier across this switch will not pass current in the direction to give more port rudder. When starboard is called for, however, the current is reversed and can by-pass the open contacts of switch P via the rectifier allowing the rudder to go to starboard. The same action applies in reverse when the starboard limit Q opens. Quite small rectifiers can be used and they can be grossly overloaded since they are only

in circuit for half a second or so until the switch they are shunting re-closes, shorting them out.

Fig. 2 shows the pulse decoder installed in the fourth compartment from the bow. The adjustments mentioned above are easily seen. These, of course, once set up can be left. The rS4 transformers can just be seen in Fig. 5 behind the black bridge rectifier with the smoothing condenser mounted on top of it.

The Speed Control Unit

The fifth compartment houses the speed



Fig. 8.—Overall view of Mr. A. Bailey's radio-controlled M.T.B.

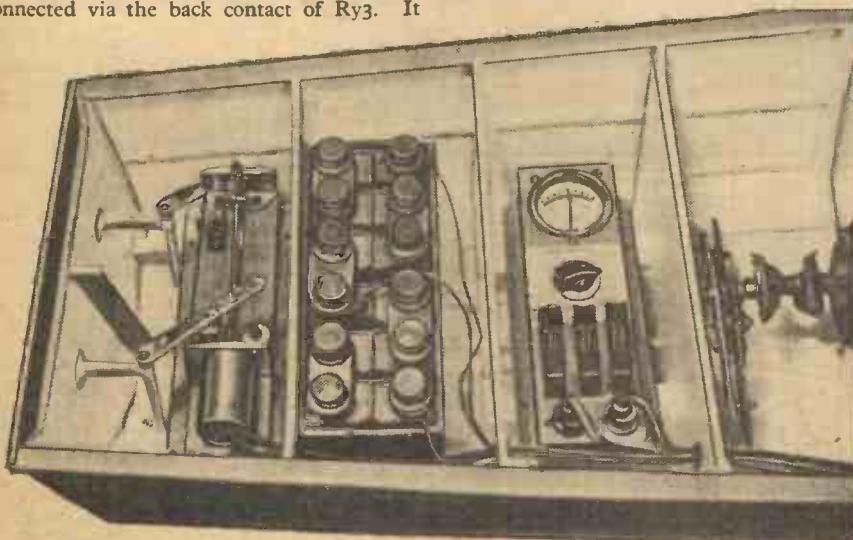

Fig. 7.—Left to right: Steering gear; driving motor and servo batteries; field rheostat, fuses and charging meter.

control unit. This is a reversible sequence unit and is arranged for the following speeds:

- (1) Half astern. Electric drive.
- (2) Slow astern. " "
- (3) Stop. " "
- (4) Slow ahead. " "
- (5) Half ahead. " "
- (6) Full ahead. Glow plug drive.

This type of equipment enables the operator to move either way through the sequence, e.g., if the boat is at slow ahead a mark will move it to half ahead and if the mark is maintained to full ahead. A space would give stop and then slow and half astern. It will be seen that this is very similar to that described in the last article. The unit consists of five segmented copper tracks on an insulated backing. A contact slider moves over this, propelled by a nut on a screwed rod driven by the servo motor. Reference to Fig. 6 shows that the three centre tracks B, C and D control the electric propulsor motor. With the slider on position 6 the armature and field will be straight across the main battery. This is half

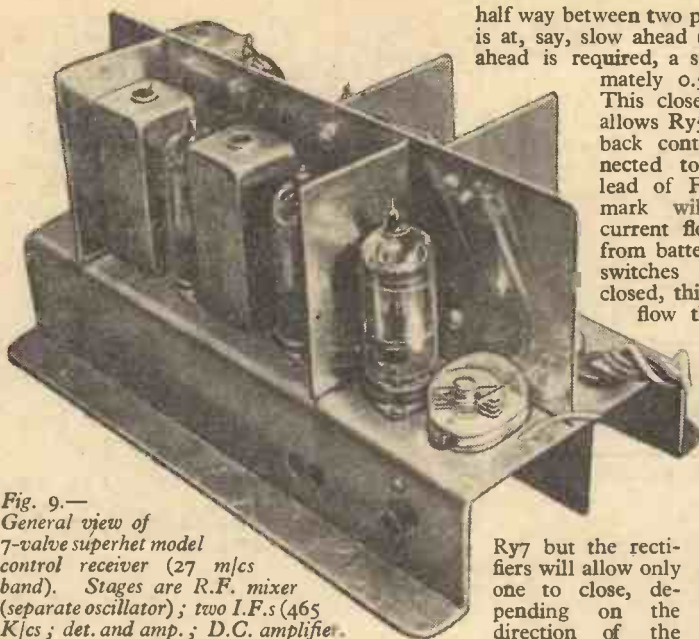

Fig. 9.—
General view of
7-valve superhet model
control receiver (27 m/cs
band). Stages are R.F. mixer
(separate oscillator); two I.F.s (465
K/cs; det. and amp.; D.C. amplifier.

half way between two positions. If the unit is at, say, slow ahead (position 3) and half ahead is required, a short mark (approximately 0.5 sec.) is sent out. This closes Ry3 (Fig. 4) and allows Ry5 to drop out. The back contact of Ry5 is connected to the control input lead of Fig. 6. This short mark will, therefore, start current flowing into the unit from battery X. If both limit switches on the unit are closed, this current will try to flow through both Ry6 and

ahead position. In practice this takes place quite rapidly (approximately one second to change from one speed to the next) and short marks or spaces ensure that the control unit travels smartly to the right position and stops correctly. A maintained mark or space will cause the slider to move to full ahead or full astern when the limit switches will stop the servo motor.

Resistances R3 and R4 in Fig. 6 are current limiting resistances in case Ry6 and Ry7 come in together. This can happen if a mark is sent closing Ry6 and while the maintaining action is still in progress a space is received. In this event Ry7 comes in and Ry6 drops out

Ry7 but the rectifiers will allow only one to close, depending on the direction of the current flow. Once

one of these relays (say, Ry6) has closed it starts the servo motor in the correct direction for increasing the speed to half ahead, by means of one of its sets of contact. Tracks A or E now come into the picture.

With the slider at rest on, say, position 3, the contacts on tracks A and E will be on the insulated portion between two segments. As soon as the servo motor starts, however, the slider begins to move towards the half ahead position and in doing so contact A will come on to one of the segments on track A. Once this has taken place the mark which initiated the process can be cut off and the flow of current to maintain Ry6 closed will come through track A. This will keep the servo motor running until contact A comes on to the next insulated portion, Ry6 will drop out stopping the servo motor when the main contacts (B, C and D) will be on the half

astern (there is no full astern). Position 5 inserts the resistance R1 in the armature lead and gives slow astern. Position 4 is stop. Position 3 is as position 5 except that the field connections are reversed giving slow ahead. The armature resistance comes out in position 2 giving half ahead. In position 1 the slider closes a pair of leaf contacts mounted at the side of the contact track. These contacts energise a solenoid which opens the throttle of the engine which is otherwise ticking over. When the engine speeds up the centrifugal clutch engages and the motor which normally spins at about 4,000 r.p.m. is taken up to 16,000 r.p.m. Under these conditions it generates power which is fed into the main battery. In this position R2 is inserted in the field circuit to control the amount of power fed back in this way.

A Servo Motor Refinement

The circuit associated with the servo motor at the right of Fig. 6 is a refinement to ensure that the contact slide does not come to rest

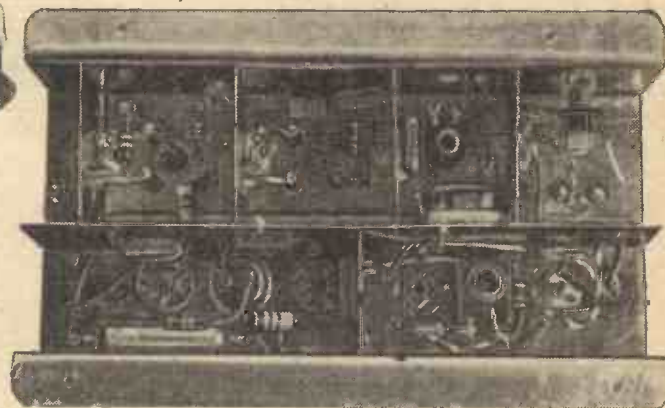

Fig. 10.—Under-chassis view of 7-valve superhet receiver.

immediately. For a split second, however, the battery is shorted through R3 and R4 but by adjusting these to limit the current to about one amp. welding of the relay contacts is avoided.

Astern of the control unit is the engine compartment seen in Fig. 1. Fig. 7 shows the remaining gear in the stern. The fuse unit and generator control can be seen and in the next compartment the main battery which is really in two sections. Finally, the stern compartment houses the rudder motor (permanent-magnet type) with its associated limit switches, rectifiers, etc.

The boat in which this gear is installed is 54in. long and its general layout can be seen from Fig. 8.

An Electric Drill Stand Modification

By A. J. SLATTER

READERS who possess a Black and Decker Sander Polisher Unit may find it difficult and inconvenient to use when fitted to a bench stand for use as a drill. The long handle projects straight in front of the operator, obscuring the vision and at the same time making the changing or fitting of a drill in the chuck difficult. If the stand and drill are packed up on the bench to a convenient level, one is apt to receive a poke in the eye or a jab on the head by the long handle.

This difficulty can be overcome by turning the polisher through 90 deg. to the left and it is much more satisfactory.

The locating prongs on the stand are cut off

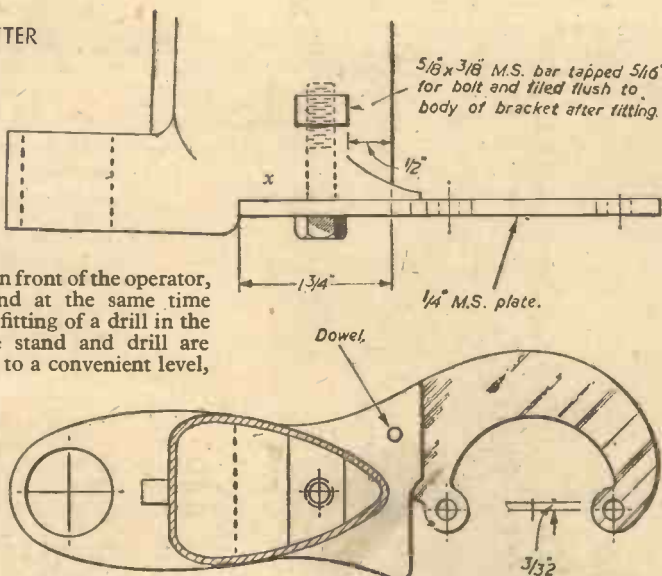

A side elevation and plan view of the drill stand modification.

and a steel plate fitted to the base of the bracket with the locating prongs for the polisher, also at 90 deg. The plate is held in position by a hex. head bolt which screws into a cross bar inserted into the body of the bracket. It was found the centre of the drill is 3/32in. off the centre line of the two screws in the polisher which act as locating pegs in the prongs of the bracket. The shape and size of the prongs were obtained by drawing carefully round the bracket on a sheet of paper or tin before cutting off, and this was then used as a template.

The drawing on the left will give most of the details required and it is advisable only to cut the prongs in the plate before fitting so that the exact position may be ascertained to give a perpendicular setting for the drill. This was found by bolting the plate in position and assembling polisher and bracket on the pillar, with a drill in the chuck and using a square to check off the base plate of the stand. For the same reason the tapped cross bar in the bracket was left long and when the correct position for the prongs was obtained both the plate and cross bar were shaped off.

The bracket was filed flat at x in the upper drawing to receive the plate.

Decorating with Stencils



Cutting a Stencil : Types of Design :
Stencilling : Oil Paint : The Effect of Stain : "Splash and Splatter"

By "HANDYMAN"

THE craft of stencilling is not entirely modern ; it was practised in foreign countries in the early eighteenth century, but modern demands, however, have brought great improvements.

When duplication of a design or letters is required, stencilling can be profitable and useful. The work may be described as the transference of a pattern to another surface by

cartridge paper, Manila paper, or Japanese Vellum. Thick lead foil, thin vellum, or metal foil is also suitable. Before attempting to cut stencils, it is a good idea to give the paper one or two coats of shellac varnish ; this stiffens it up and gives resistance to paint or distemper. A specially treated waterproof

letters and figures which can be produced. Special note should be made to see that the letters are correctly spaced, as shown in Fig. 4, otherwise you will obtain a design as shown in Fig. 5, which does not look very artistic.

Types of Design

Many effective designs can be obtained with stencilling, as will be seen from the butterfly design in Fig. 6. An animal arrangement looks well on children's furniture as shown in Fig. 7. Bird designs such as those shown in Fig. 8 can be used for lamp shades, etc. Fig. 9 shows silhouette stencils which are suitable for nursery friezes.

Type of Knife

It is only fair to say that the art of cutting stencils needs practice. A "clicker's" knife



Fig. 1.—Stencil alphabet.

brushing paint through perforations. It is said that stencilling is not appreciated as it should be because it is often considered as a cheap mechanical substitute for handwork.

paper for stencil cutting is Willesden paper, which does not require a coating of shellac.

The design can be outlined with a pencil on a suitable piece of thin paper and then be



Fig. 2.—Stencil numerals.

The stencil to-day has many possibilities as its scope is greater than many people realise. For instance, high-class wallpapers, fabrics, various goods, types of signs and many other things are stencilled. It is an inexpensive way

transferred to the stencil paper by tracing. The outline of the design or letters can also be traced through the lining paper to stencil paper with a sharp instrument after being roughed out. Figs. 1 to 3 show the type of

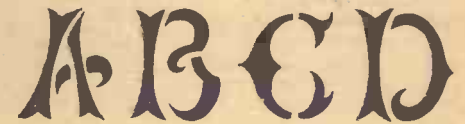

Fig. 3.—Fancy letters.

(shoemaker's knife) is handy for the job and two or three sizes of the knife are useful. Some readers may prefer an ordinary penknife sharpened to a point ; as a good deal of pressure is required in the cutting, it is essential that the handle of the knife should suit the hand to give easy working. A stencilling knife is shown in the heading above.

Fig. 6.—Butterfly design.



Fig. 4.—Showing letters correctly spaced.



Fig. 5.—Letters wrongly spaced.

of reproducing designs, when mass production is required.

The ease with which stencil plates can be prepared makes a popular appeal to the public. There are two classes of stencils, those in which the various parts are held together by "ties," and those without ties, where several plates are employed.

The best type of stencil for the handyman to consider are the stencils with ties, the latter being made as part of the design. After the stencilling is completed, the ties may be filled in, although this is not necessary when good stencils are employed.

Cutting a Stencil

The best paper to use for stencil cutting is

Fig. 7.—An animal arrangement looks well on children's furniture.



that it is on a perfectly flat surface; if in doubt fix a few sheets of old newspapers under the glass to bed it in, or prevent cracking. A piece of glasspaper fixed on a strip of wood will be found handy for sharpening the knife during cutting. By using a firm pressure the knife should cut through at one stroke with a clean edge. Cut across all projecting points and away from corners. Various shaped punches may be used to assist the cutting knife,

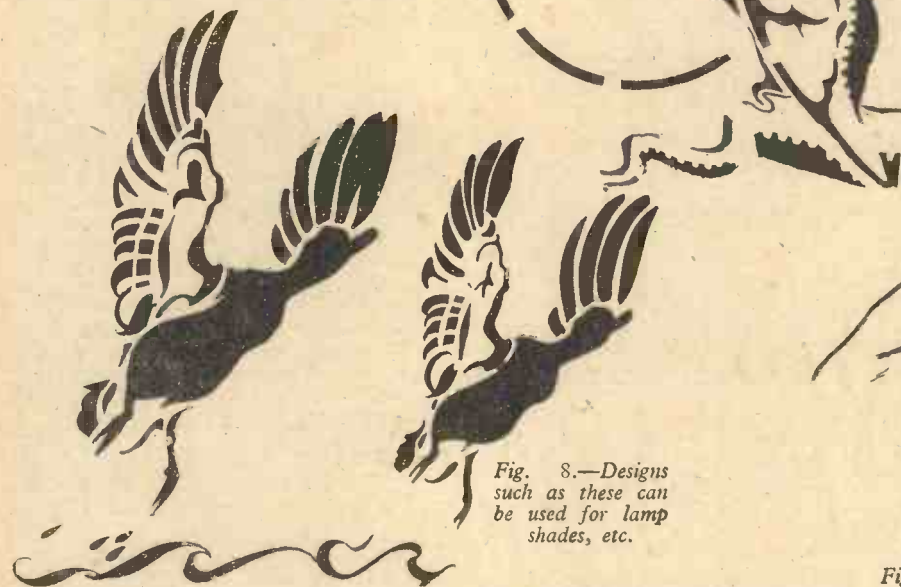

Fig. 8.—Designs such as these can be used for lamp shades, etc.

but the cutting, however, should be done before the punching to ensure holding together of the ties.

Stencilling

Having cut the stencil plate, fix it upon the surface to be stencilled. If the surface is paper or cardboard the plate may be held in position with drawing pins; on other surfaces, however, hold the plate firmly in position with hands. It is essential to keep the stencil pressed quite flat while working. Use a proper stencil brush for the job, as shown in Fig. 10, and use the paint as thick as possible. After having lightly charged the brush, rub it along a strip of clean cardboard to remove surplus paint, then apply to stencil in quick sharp dabs till all perforations are filled in. Be careful not to smudge the work when removing stencil.

Avoid using paint too thin, as it seeps beneath the edges of the stencil and spoils the design. Do not drag the brush sideways when applying paint, but apply in quick dabs straight down, and lift the brush straight up. Remember it is the ends of the bristles of the brush which apply the paint, and not the sides.

Two colours may often be applied to produce good effects, and in this case two stencil

depends upon the nature of the ground work, while stain can be used on wood, and ink on paper. The ground colour to be stencilled upon needs some consideration; it is a matter of suiting the stencil colour. While some grounds may require oil paint, others will be suited to water paint.

Oil Paint

It is always easier to stencil a dark colour on a light ground; dark colour obscures much better, and there is always less chance of the light colour showing through. The ground colour for stencilling upon should always be allowed ample time to dry, otherwise it will creep or crack up when stencilled upon with a quick, hard drying colour. The stencil colour should be thicker than for ground coating. A

good idea when stencilling in oil colour is to place a little colour on the pallet, from time to time, then work the brush into it, to get rid of surplus paint and to distribute the latter evenly. On old ground work a little goldsize added to the stencil colour will speed up the drying out.

Oil colours in tubes make suitable stencilling colours; they need only to be lightly thinned with turpentine, while varnish added to the colour, will give a glossy finish.

Distemper and Water Paints

The best stencil colour for this groundwork is made of dry colour, ground in turpentine, with the addition of a little goldsize. Oil colour placed on distemper is not very suitable as it spreads and gives ragged edges; flat paint is more satisfactory. As regards washable dis-

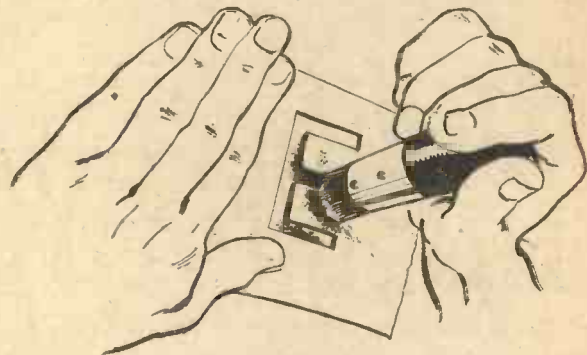

Fig. 10.—Stencilling letters with a stencil brush.

tempers, they should be left for a week or two before stencilling upon, when the material becomes petrified, through action of light and air.

The Effect of Stain

Good stencilling effects can be obtained on new wood by stains and dyes; they penetrate the wood, and bring out the grain. Care must be exercised not to lay the stain on too thick. By preparing the wood with a coat of weak size before stencilling the stain will be prevented from running; transparent colours are also suitable for the job.

Splash and Splatter

This is an effective way of getting colour on to a surface by stencil. Dip the ends of a stiff brush into colour, hold over the work and spray on colour by scraping the bristles of the brush with a knife. Adjoining surfaces should be protected by masking with old newspaper.

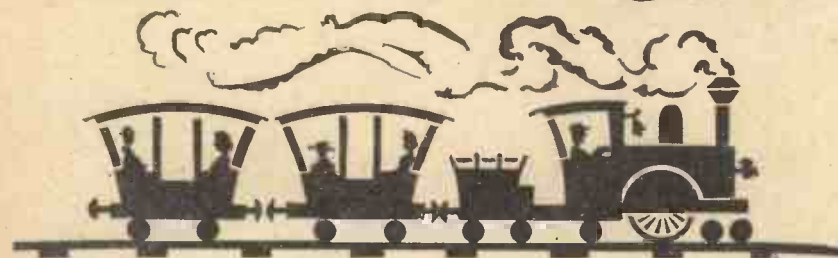

Fig. 9.—Silhouette stencils suitable for nursery friezes.

brushes will be necessary, the aim being to graduate tints and merge them into each other. It is also possible to produce two-coloured work by masking various parts of the stencil with paper while colouring the other parts.

Flat oil paint will be found best for stencilling oil-painted surfaces, glossy oil paint or distemper, water paint or plastic paint can be employed. The choice of paint, however,



This method is best employed with water-paints, especially on a landscape design to get a graded effect of horizon, sea and sky.

Although a little practice will bring results this method should not be overdone. Avoid making splashes too strong. For this job an ordinary scent spray bottle will be found handy. To prevent the colour from settling, shake or mix it up occasionally. As the colour for this method will be on the thin side, be careful not to apply too much to cause runs.



USING THE Simplified Orrery

Some Suggestions for Employing the July and August Issues

Model Solar System Described in—
By FRANK W. COUSINS, A.M.I.E.E., A.C.I.P.A., F.R.A.S.

Direct and Retrograde Motion of the Planets

FIRSTLY, what do we mean by direct and retrograde motion? Spin the enlarged Earth bead on its axis anti-clockwise viewed from above. Let objects on the wall of the room represent the fixed stars. The direction in which the objects would appear to

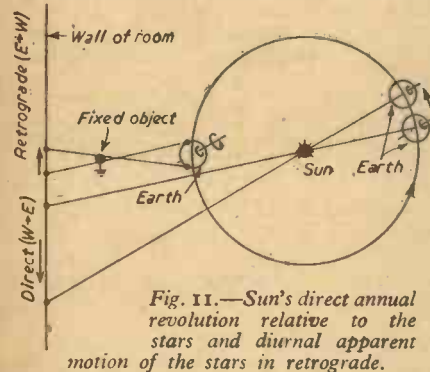

Fig. 11.—Sun's direct annual revolution relative to the stars and diurnal apparent motion of the stars in retrograde.

move for an observer on the Earth bead will be as shown in Fig. 11. This motion represents the apparent motion of the stars from east to west and is called retrograde; it is the rising and setting motion we see in the night sky. The apparent retrograde diurnal motion is accounted for by the direct rotation of the earth about its polar axis.

The real revolution of the main bodies in the solar system is direct, that is from west to east. This may be seen in the model by moving the Earth orbit rod anti-clockwise, then the Sun appears to move against fixed objects in the room opposite to that described above as retrograde motion (see Fig. 11).

Motion in the sky east to west is retrograde, motion west to east is direct. The planets move anti-clockwise in their orbits on the simplified orrery viewed from above. If the Earth bead is held stationary and the other planet orbit rods revolved, then all the planets would be seen in the sky moving from west to east i.e. direct. But the Earth, in fact, is never stationary in its orbit. The relative motions of the Earth and the planets cause them to have direct and retrograde motions. This is clearly seen in Figs. 12 and 13.

Setting of Model for any Date in 1955 to Agree with the Actual Heliocentric Positions of the Planets

Fig. 14 shows the heliocentric positions for 1955 of the planets. This diagram has been taken from "Anuario del Observatorio Astronomico de Madrid," page 126.

An alternative method presents itself in the use of Whitaker's Almanack for 1955 (or any other year). Each month of the year, in Whitaker's, shows the right ascension for Mercury, Venus, Mars, Jupiter, Saturn, Uranus and Neptune. Hence, use the right ascension circle provided on the orrery (see Fig. 2).

Eclipse Phenomena of Jupiter's Satellites and the Philosophical Implications

The simplified orrery provides a ready explanation of the great discovery of the Danish astronomer Roemer in 1675. I mention this for its importance is of such a far-reaching nature in the philosophy of science.

In the orrery it will be seen that Jupiter has five satellites which revolve in the plane of the planet's orbit. Jupiter casts (as do all the other planets) a cone of shadow away from the Sun (Fig. 15). Consequently, a satellite passes through the shadow cone once in nearly every revolution and is then eclipsed. Since the orbits and periods of the satellites have been accurately observed it is possible to predict the recurrence of the eclipses with precision. Roemer observed a remarkable discrepancy between the predicted and the observed times of the eclipses. When Jupiter was in opposition the eclipse times

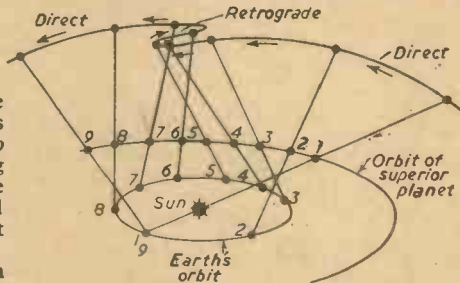

Fig. 12.—Combined motion of Earth and superior planet.

were correct but as Jupiter approached conjunction the times of the eclipses got later and later. After conjunction the discrepancy in the times decreased correspondingly until near opposition the eclipses again occurred on time.

Set the orrery as shown in Fig. 15. Let E_1, J_1 represent the Earth bead and Jupiter bead at a specific time. Let E_2, J_2 represent

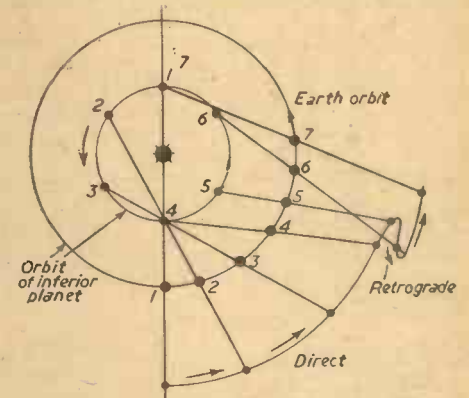

Fig. 13.—Combined motion of Earth and inferior planet.

them six months later. The distance E_2, J_2 is almost equal to $E_1, J_1 + E_1, E_2$. Hence a signal such as a satellite eclipse would reach E_2 later than at E_1 . Roemer put forward in 1675 what was then a most imaginative explanation of this phenomena. Instead of light appearing simultaneously everywhere, he said, it had a SPEED and from the lateness of the eclipse phenomena he calculated its speed.

Eclipses at conjunction were retarded relative to those at opposition by 16 min. 40 sec. Light took 16 min. 40 sec. to get from E_1 to E_2 . Thus the retardation is twice the time taken by the light to travel from the Sun to the Earth.

Light takes 8 min. 20 sec. to travel from the Sun to the Earth, this interval is called the equation of light. If we know the Sun's distance from the Earth then a figure for the velocity of light may be obtained, the method is not of high accuracy, however, and is of historic interest.

Note that 16 min. 40 sec. is 1,000 seconds and the distance of the Earth from the Sun 93,000,000 miles. The Earth's orbit is 2(93,000,000) miles across, i.e. 186,000,000 miles. If light takes 1,000 seconds for the journey the velocity of light is $\frac{186,000,000}{1,000}$ miles per second, i.e. 186,000 miles per second—the usually quoted approx. figure.

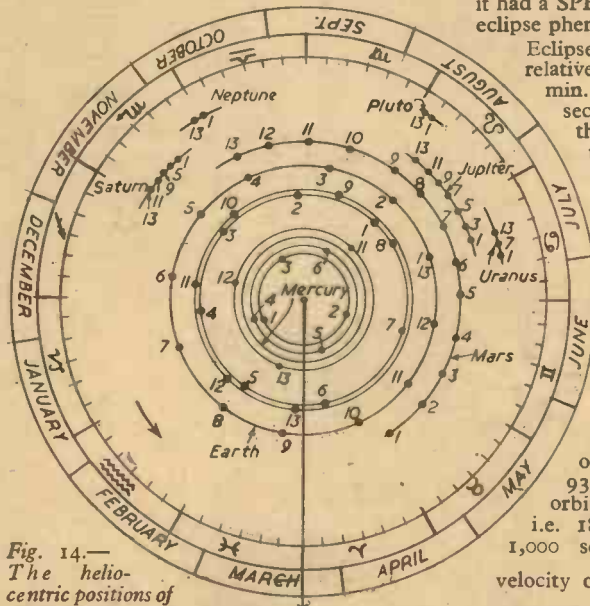

Fig. 14.—The heliocentric positions of the planets for 1955. Figures are months: January—1, December—12, etc.

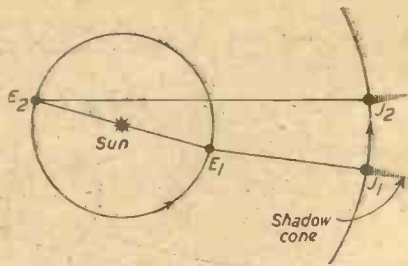

Fig. 15.—Eclipse phenomena of Jupiter's satellites.

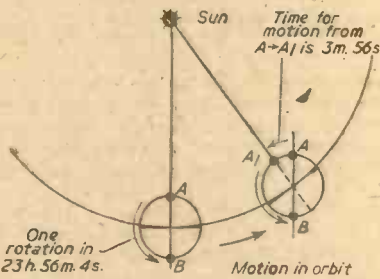

Fig. 16.—Using the orrery to study the Solar and Sidereal day.

Solar and Sidereal Day

Spin the enlarged Earth bead once on its axis of rotation. This takes 23 hours 56 min.

4 sec. in reality and is a Sidereal day, the true period of the Earth's rotation. But the Earth's orbit rod must be moved anticlockwise since the Earth is never stationary in orbit. The Solar day is from one Noon to the next Noon, hence the Sun must be on the meridian. In the model arrange the enlarged Earth bead as shown in Fig. 16 owing to the motion in orbit the time of Noon is longer than that for a sidereal day (23 hours 56 min. 4 sec.) by approx. 3 min. 56 sec. making Noon to Noon, 24 hours.

Moon Rides High in Winter, Low in Summer in Latitude of London
Set the model as shown (Fig. 17).

Moon's Libration

Revolve the Moon wire utilising the tilt of 7 deg. to the perpendicular to its orbit. In consequence during the Moon's revolution the Moon's North Pole and South Pole are alternately turned a little toward the Earth and a little away from the Earth. The libration in latitude enables us to see more of the Moon's surface than we would otherwise.

Much more may be demonstrated with the orrery but space will not permit of discussion.

Remember that the planets move in ellipses not circles and that this vital feature is not shown in the model.

References for Study

"Elementary Mathematical Astronomy."

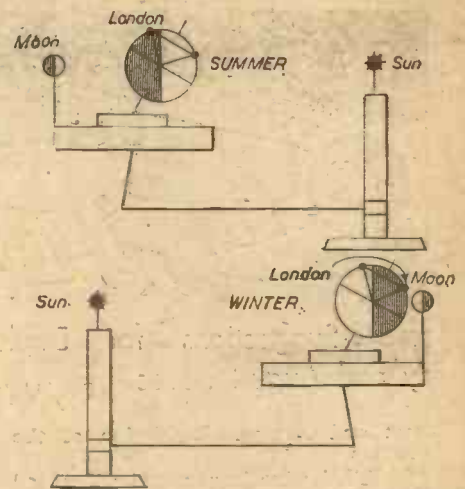

Fig. 17.—Why the moon above London rides high in winter and low in summer.

Barlow & Bryan. University Tutorial Press. 1946. (13s. 6d.).

"Handbook British Astronomical Association." 303, Bath Rd., Hounslow, Middx. Issued each year. (5s.).

"The Origin of the Earth." Prof. W. M. Smart. Pelican Book. 1955. (2s. 6d.).

"The Size of the Universe." F. J. Harveaves. Pelican Book. (1s. 6d.).

Adapting the Woodturning Lathe for Long Hole Boring

By P. WILDON

THOSE people who have lathes with a tailstock similar to mine (see Fig. 1) will find that the handwheel is secured with a nut at (a). Unscrew this nut and the hand-wheel will itself screw off. This enables the barrel of the tailstock to be unscrewed in the opposite direction, leaving the hollow tailstock casting.

Secure a piece of hollow tubing the same diameter as the tailstock barrel and about the same length. Turn the one end down to form a lip as shown in Fig. 2, and thread the other half so that it will screw into the tailstock

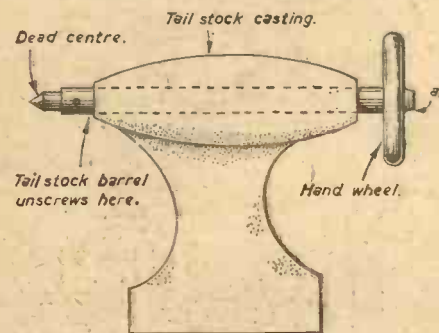

Fig. 1.—The author's lathe tailstock.

casting in place of the barrel. Now drill a hole about 1/4 in. diam. across the tube, about 1/2 in. away from the lip. This is to take a tommy bar.

Before screwing the tube into place, find the centre of the wood to be used and lightly tap with a mallet to give a guide for position. Screw the tube into the tailstock casting, lift the wood between the driving centre and the end of the tube and with the tommy bar screw the tube into its already marked position in the wood. The wood will now

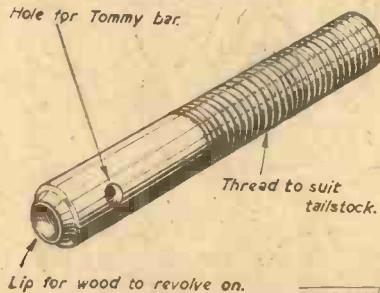
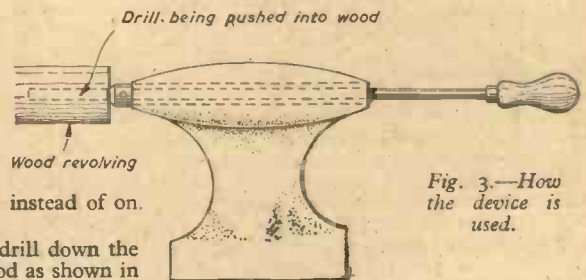

Fig. 2.—The screwed tube showing hole for tommy bar and lip.

turn on the "lip" of the tube instead of on the normal dead centre.

The user can now push his drill down the tube and into the revolving wood as shown in Fig. 3.

The best type of drill to use is a spoon bit. This has no point, but is quite flat at the end with the cutting edge on the face, the rest of the blade being semicircular in shape to hold the shavings. If one of these drills cannot be obtained from the local tool merchants, readers are advised to write to the Coronet Tool Co., Mansfield Rd., Derby, who stock sizes up to 2ft. in length, costing just over £1.



THE PRACTICAL HOUSEHOLDER

EDITED BY F. J. CAMM

February Issue Now On Sale

1/- Every Month

Place an Order with your Newsagent Now!

Principal Contents:

- Renovating that Favourite Chair; A Flex Holder for a Domestic Iron;
- Notes on Flooring; Damp-proofing Walls; Front Garden Gates; Making a Ladies' Work Cabinet; How to Remove Stains; A Fireplace Fitment; Making Concrete Posts for Fences and Gates; A Modern Brick Fireplace; A Record Rack; Chromium Plating at Home; Stair Carpet Binding; Constructing a Cutlery Cabinet; An Attractive Three-candle Chandelier; A Loft-access Ladder; Pelmets; A Kitchen Table Fitment; Making a Standard Lamp; Building Your Own Bungalow and many other interesting articles.

Pen & Ink Sketches

from Photographs



A Simple Method of Producing Artistic Sketches
Without Training

By E. W. M. HEDDLE, M.A., B.Sc.



Fig. 1.—The photograph selected as a basis for the pen and ink sketch.

DRAWING comes as a natural aptitude to some people or it may be acquired by training, but to others with a pencil or pen in their hands there is extreme difficulty in putting on paper anything that resembles a house or a tree or a landscape. The "bleach out" process is their solution.

In short, the process is to start with a photographic print (Fig. 1 is the example chosen), ink in the outlines of the picture with a waterproof ink and then to remove the photograph by bleaching out.

The best type of print to use is one which has had a full exposure but is only partially developed as it is better not to have very dense shadows; see Fig. 2.

For the next stage the main requisite is some waterproof ink of a reputable make such as is used by architects and draughtsmen. It is essential that the inks be *waterproof*. They are obtainable in a great variety of colours, but a start can be made with a black ink for use on white paper or a brown ink for cream base paper.

An ordinary writing pen may be used but for special effects and what might be called the quality of the drawing, artists' drawing pens should be obtained.

Fig. 2 shows the result of inking in the outline of the picture with a few touches here and there to produce some texture. Only two pens were used, an ordinary pen and the other a fine mapping pen. The general treatment should be to work over the heavier shadow portions of the picture with fairly broad lines and also to have the lines close together. The lighter parts of the picture are in the main visualised by lighter lines placed a little further apart. Finally, fine detail can be added with just a touch of ink from a very fine nib.

There is great opportunity for the personal touch. This means not only the character of the line generally but also the overall amount of ink in the final stage. It is often better not to overdo the inking but to leave



Fig. 2.—The under-developed print with the minimum amount of inking.

script. A single line in the right place can be so expressive. A badly drawn line can mar an exquisite scene.

In order to collect ideas it is a good plan to pass a little time over a set of etchings or to study some pen and ink sketches of an artist. It may help to get the artist's viewpoint as distinct from that of the camera, which is too all-embracing. The Gordon Randall sketches which appear in THE CYCLIST Supplement are good examples.

Next comes the removal of the photographic base. This can be done with the use of a bleaching bath containing iodine. Iodine is not very soluble in water, but if mixed with potassium iodide, can be readily dissolved. For the bleaching solution one gram of iodine flakes and three grams of potassium iodide are mixed together and

something to the imagination and individual interpretation.

The character of the line follows from the quick, easy movement of the pen. Slow manipulation of the pen results in kinks and awkward angular pieces of

dissolved in a small amount of water and finally the solution is made up to 150 c.c.s. and bottled.

The print is placed in a dish and covered with some of the solution in which it turns dark, both sides of the paper being affected. The print can remain for about two minutes or until it appears quite opaque when viewed against the light. The solution can be returned to the bottle and re-used until its useful life is at an end.

The print is now placed in a bath of plain hypo (20 per cent. solution) until the dark colour has disappeared and the usual washing of the photographic print will clear it of the chemicals used. Care must be taken, of course, at this stage not to smear the ink as it is in a soft condition.

After drying, further work can be carried out on the print.

Fig. 3 shows a print on which the minimum of inking has been done on the original stage while Fig. 4 illustrates how much more is possible. It is, of course, easier to ink in as much as possible while the photographic base is still available as a guide. What may be done so easily is to thicken some lines and add a few here and there to build up any special section of the picture. It may happen that too much ink has been built up in some portion—but there is a remedy. It is to apply some white ink with a fine sable brush.



Fig. 3.—The bleached-out print and the line work which is left.

Fig. 4 (Right).—The completed sketch.

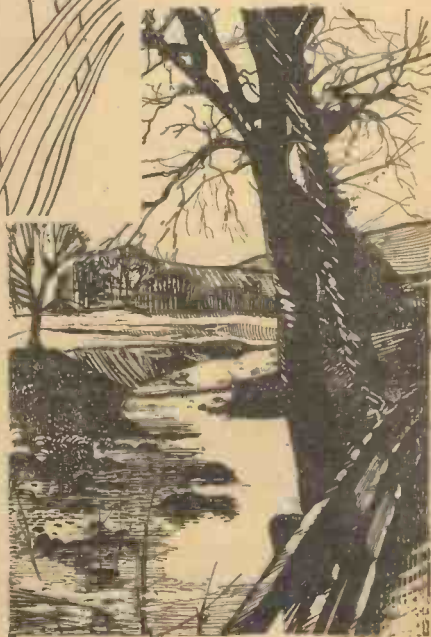

A 35MM-1¼SQ Enlarger

A Design for the Miniature Camera Enthusiast

By C. MONDAY



THE enlarger described in this article and illustrated in Fig. 1 is designed for simplicity and ease of construction and is intended to accept 35mm. negatives, or negatives approximately 1¼ in. square obtained from cameras taking 16 pictures on 127 roll film, and it employs a lens having a barrel focusing device.

If a camera such as the Leica or Fed is used the lens can be removed and fitted to the enlarger. This is an ideal arrangement as these lenses have a retractable lens barrel which can be used for coarse focusing for different sizes of enlargement, and also a multi-start thread giving fine focusing for picture sharpness.

The enlarger consists of four main parts: (1) The baseboard and column. (2) Condenser housing and support with negative carriers. (3) Detachable lamp-house. (4) Lens



Fig. 1.—A general view of the completed enlarger.

panel. With a retractable lens mount no bellows are needed.

Base and Column

The baseboard is made of ¾ in. or 1 in. plywood or blockboard, the size being about 22 in. × 15 in. For the column a piece of steel, brass, or dural tubing about 1¼ in. dia. × 30 in. long is required, with a collar of some similar material screwed or riveted to one end. Care must be taken to keep the face of the collar square with the tube, or else the face can be turned square subsequently in a lathe. The collar is drilled and firmly screwed or through bolted to the rear of the baseboard, the assembly being shown in Fig. 2.

The condenser support bracket, shown in Figs. 2 and 3, consists of an arm made from brass tube, soldered or brazed to a short piece of similar tube, the diameter of which allows

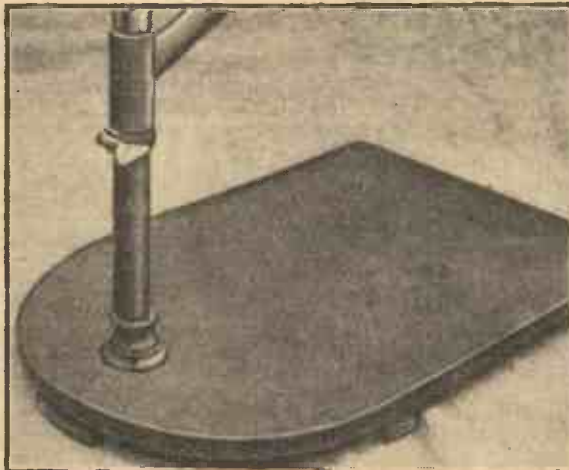

Fig. 2.—Support bracket, column and base.

it to be slid easily over the column. The lower 1 in. of the tube is split vertically, a jubilee clip is brazed to the tube and a small plate is brazed to the screwhead to form a wing screw.

The bracket can be slid up or down the column and operation of the wing screw clamps it in place.

A flattened vertical end is provided on the projecting arm carrying two holes, one for the clamp screw of the condenser housing and one for a locating dowel. The vertical face should be about 7 in. from the centre line of the

Condenser Housing

In order to illuminate the negative evenly the light from the lamp passes through a condenser which consists of a simple lens, or two lenses mounted in a holder. The focal length of the lens, or combination, should be approximately equal to that of the enlarging lens, in this case about 2 in. It is not critical, however, and any condenser having a focal length between 2 in. to 3½ in. would be suitable.

The condenser housing is made up as shown in Fig. 4 from brass or steel sheet bent to form a cylinder of about 4½ in. dia. × 2½ in. long, and brazed or soldered at the joint. As an alternative a length of thin-walled tube of a suitable diameter could be used. The housing is made larger than the diameter of the condenser to assist cooling.

The base is formed by two pieces of brass sheet ½ in. thick leaving a slot 3 in. wide at the centre, the sides of which are to be smooth and parallel to accept the negative carrier.

Location of the condenser is performed easily by setting it into a hole cut in a disc of sheet aluminium or plywood set in the bottom of the housing. No fixing is required as it is desirable for the condenser to be removable for cleaning.

A piece of bent sheet is brazed or riveted to the rear of the housing and carries a fixed stud for the clamp nut, and a hole to mate with the locating dowel on the support bracket. A second hole at right-angles to the first allowing the head to be tilted through 90 deg. and located for projecting on to a vertical surface is a useful addition. Four studs screwed 2 B.A. are tapped into the bottom of the housing to take the lens panel.

Lamphouse

Fig. 5 shows the lamphouse, which can be made from sheet metal or a suitably sized stout canister may be employed as a foundation. It is 4½ in. dia. × 7 in. long. A ring of sheet

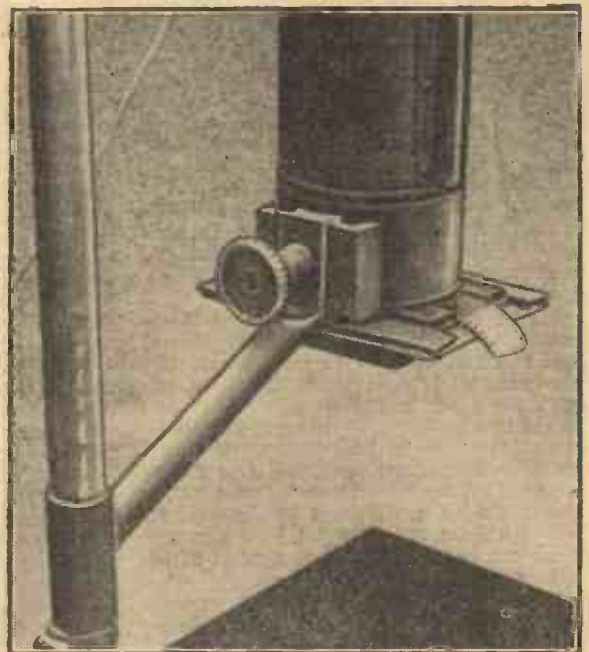

Fig. 3.—Condenser housing with negative carrier and lamp-house in position.

metal projecting about 1 in. is soldered to the inside at the bottom. This is a slide fit inside the condenser housing and allows the lamp-house to be readily detached for access to the condenser.

A hollow brass cap is soldered to the top and drilled to take a brass tube. The lower end of this is equipped with a lampholder, the connecting wires being led through the centre. A three-pin plug should be used, the earth connection being made on to any suitable metal part of the enlarger.

Holes are drilled in the top of the lamphouse within the cap and the latter is drilled in its sides to allow circulation of air and to form a light trap. Further holes are drilled in the sides of the house and formed cover channels are riveted or screwed over them as shown for the same purpose.

The lamp should be a 75 or 100 watt double sprayed enlarger lamp as the ordinary household type may cause uneven illumination due to the light from the filament being insufficiently diffused. Vertical adjustment for the lamp is performed by sliding the tube, a clamp screw being provided to lock it in position.

Negative Carrier

A smooth finish is essential for the negative carrier which is in two parts and is shown in Fig. 6. Aluminium or brass sheet can be used or 1/4 in. thick reinforced plastic sheet such as Tufnol or Paxolin. The guides are notched to locate the top member and are riveted or cemented to the base. It is necessary to remove all sharp edges and roughness as otherwise the negatives may be irreparably damaged.

A different carrier is required for 35mm. film to that used for 127 roll film with 1 1/2 in. square negatives. The outside edges of the carrier must be parallel to fit between the sides of the slot in the base of the condenser housing.

Lens Panel

The lens panel is visible in Fig. 3 and is shown in section in Fig. 7. It consists of a 1/4 in. plywood backing piece carrying guides 1/4 in. thick on the top to mate with the condenser housing and negative carrier, and a machine-planed hardwood block on the lower face to take the lens adaptor flange.

To establish the thickness of the block it is necessary to know the focal length of the lens, the range of movement of the retractable

mount, and the maximum and minimum degrees of enlargement that will be required.

Fig. 8 shows the path of the limiting light rays from the negative being projected through a point representing the lens on to the base-board. A.B. is the length of the image and C.D. is the length of the corresponding line enlarged. The degree of enlargement is represented by $\frac{C.D.}{A.B.}$ or $\frac{v}{u}$

If a minimum magnification of 2 and a

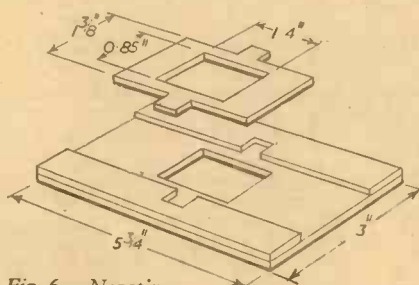

Fig. 6.—Negative carrier.

maximum of 10 is assumed then the formulae $V = \left(\frac{1+1}{m} \right)$, and $u = f(1+m)$ can be used, where f = focal length and m = degree of magnification.

For a magnification of 2 with a lens of 50 mm. or 1.968 in. focal length, $v = 1.968 \left(\frac{1+1}{2} \right) = 2.952$ in. while for a magnification of 10,

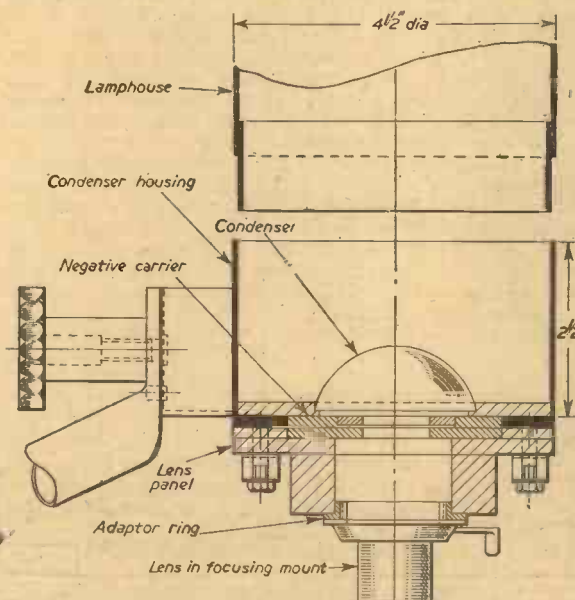

Fig. 7.—Section through condenser housing, negative carrier, lens panel and lens.

$v = 1.968 \left(\frac{1+1}{10} \right) = 2.165$ in. The movement of the lens retractable mount must, therefore, be equal to the difference between 2.952 and 2.165 or 0.787 in.

The thickness of the hardwood block should be such that with the lens mount fully extended the distance from the negative to the rear node of the lens is 2.952 in. Unfortunately the position of the nodal point is not usually known relative to the flange mounting although the manufacturer would be able to supply the information.

If a Leica camera lens is being used, the distance from the negative to the face of the flange is 1.134 in. As this represents the limiting infinity setting of the focusing mechanism it is the minimum distance that

could be required. The focal length is 50 mm. or 1.968 in., consequently the distance of the rear node in front of the fixing flange is 1.968 - 1.134 or 0.834 in. From the calculations above a dimension of 2.952 in. is required for the maximum degree of magnification, therefore from the negative to the lens flange using a Leica lens a distance of 2.952 - 0.834 or 2.118 in. is required.

The thickness of the hardwood block can then be obtained by subtracting the thickness of the adaptor ring, backing piece, and that portion of the negative carrier between the negative and backing piece from this figure.

It is not necessary to work to thousandths of an inch, if the nearest 1/32 in. is aimed at the focusing movement of the lens will be adequate to allow for minor errors.

When the node position is not known it is always possible to find the distance from the fixing flange to the negative by the following method.

Point the lens at the sun and use it as a "burning glass" to focus a spot of light on to a piece of wood held normal to the sun's rays. A measurement from the wood to the fixing flange will then establish this dimension with sufficient accuracy. Since the focal length is almost invariably marked on the lens mount the distance from fixing flange to rear node can be found by subtraction or addition.

If a lens without a retractable mount is to be used then a bellows or similar adjustment must be provided for focusing. For lenses of short focal length adjustable screwed mounts are obtainable.

The lens panel is drilled with four holes to accept the studs projecting from the body of the condenser housing. It is slipped over them and four nuts located against two flat springs as shown serve to clamp it in place. The pressure exerted by the springs against the negative carrier sandwiched between the condenser housing and lens panel is transmitted to the negative and holds it flat while the exposure is made.

When it is desired to slide the negative strip along or to remove the negative carrier a

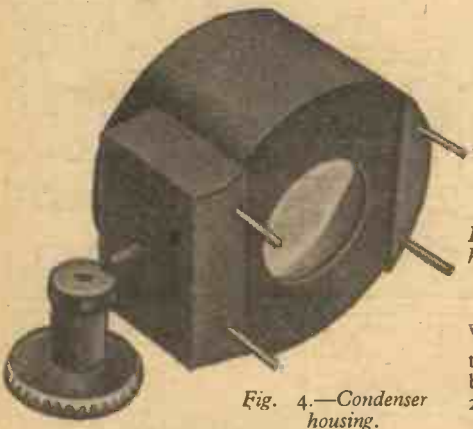

Fig. 4.—Condenser housing.



Fig. 5.—Lamphouse.

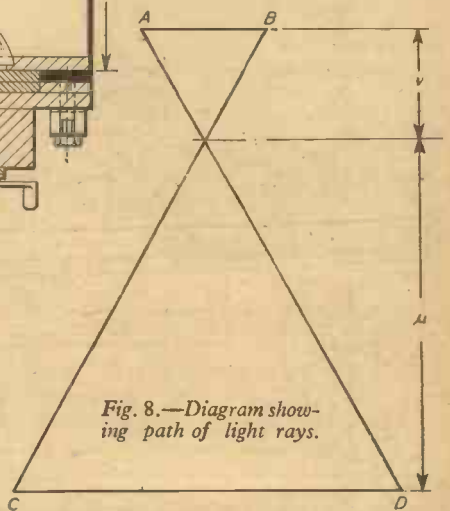

Fig. 8.—Diagram showing path of light rays.

slight downward thrust on the panel will release the pressure sufficiently to allow this to be done. A simple stop is fitted on top of the lens panel to locate the negative carrier in its correct position.

To finish off the enlarger, the baseboard, inside of condenser housing, all faces of the lens panel and negative carrier should be painted with a matt black paint. The inside of the lamphouse is painted white.

Of all the steam-powered vessels which, day after day and year after year, perform their humble and yet most useful tasks the tugboat, its master and his crew are, I think, most to be admired. When the tugboats are brightly painted and are kept in first-class condition they become worthy of being modelled.

If one is intending to make a model of a ship it is a great advantage to choose a small prototype and model it to a large scale, then all the parts are made big enough to handle without any minute detail, besides which there are fewer parts to make.

With this in view, I have designed and prepared drawings of a tug which is intended to be to a scale of $\frac{1}{4}$ in. to 1 ft., with an overall length of 28 in. This represents 112 ft. long and the model is a close copy of a tug which is working at Avonmouth and is named *John Payne*. It would be as well, however, to avoid giving the model this name, because no measurements of the prototype are available; even as regards the overall length and dimensions of other parts the model departs from scale, although the appearance and details above the waterline are very much the same.

Fig. 1 shows a complete sheer plan and a deck plan. From this it will be seen that the model above the waterline follows, except at the after end, the usual lines of tugs. But below the waterline the portion of the hull which is submerged is different and this is because the whole of the lower hull, i.e., the sides, the bottom and the stern, is made of tinned plate, which will be bent or curved in one direction only, and that all the parts will be vertical except the bottom and one piece of plate which will be horizontal, parallel with and just below the waterline. This vessel is correctly streamlined and is very easy to construct.

As will be seen, the propeller is completely submerged, as is also the rudder. The only beating of the plates to be called for will be the turning up of a slight flange around the edge of the shaped bottom plate; this is required in order to obtain a broader joint for soldering. It is not absolutely necessary, but will add strength. The joint can be formed with an angle made from copper foil, or thin brass, soldered around on the inside, or it can be made with a copper wire soldered in the angle. In fact in any way which will compel enough solder to lie in the angle and make a sufficiently strong joint which will remain watertight.

The Motor

That the model is to be electrically driven is obvious from Fig. 1. As a source of power I have chosen one of the marine motors of

Modelling a

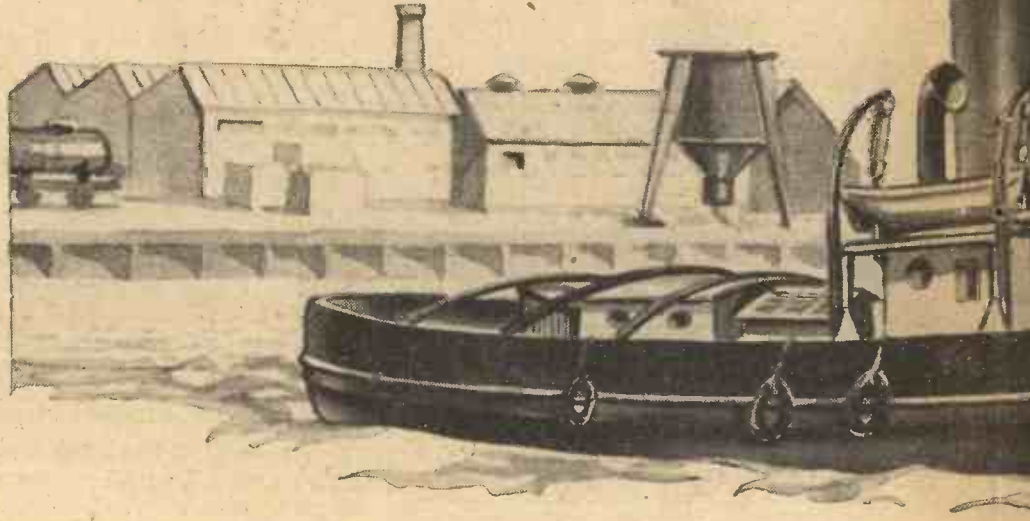

Constructional Details and Dimensions for Making

Bassett-Lowke, Ltd. It is the first one listed on page 28 of their catalogue. This motor drives a Bassett-Lowke propeller which, when purchased, will be $1\frac{1}{2}$ in. diameter, but it must be reduced by cutting one-eighth off each blade tip and neatly rounding off. The motor works off a supply of six volts, which may be given by an accumulator (which will weigh 2 lb. 12 oz.) or by two three-cell dry batteries connected in series. Batteries are indicated in the drawing, but the weight of an accumulator can be carried. No switches are shown, but obviously for switching on and off the current, for starting and stopping, a simple switch will be required. If it is necessary to run astern at any time a reversing switch will be needed in order to reverse the motor and propeller. As there is no field winding the motor is of the permanent magnet type, and to reverse the direction of rotation merely requires that the polarity of the battery current be changed over in the armature. A diagram of the circuit will be found in Fig. 5.

The Deck and Fittings

The deck is made of four pieces of plywood and each is secured by metal-threaded,

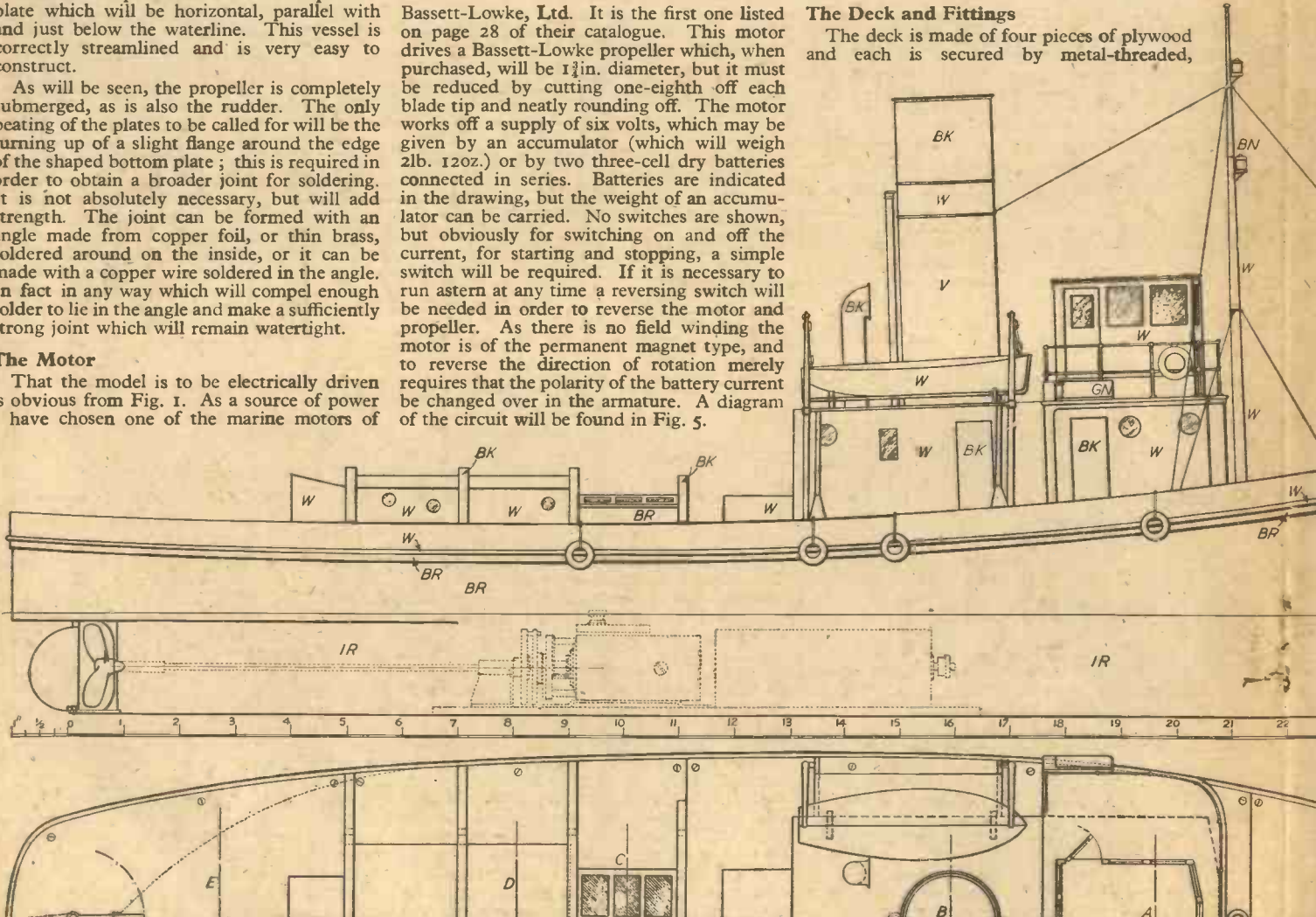
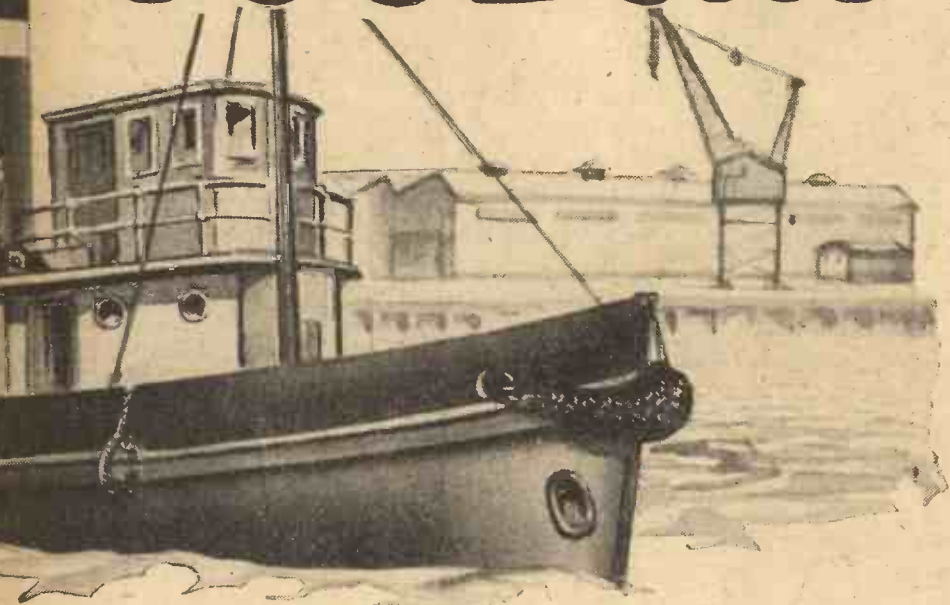

Fig. 1.—Sheer plan of the hull and deck plan.

TUGBOAT



a Scale, Electrically-driven Model of a Tug

By E. W. TWAINING

countersunk screws of No. 6 or No. 7 B.A. These will pass through the deck and screw into tapped holes in little angle brackets soldered to the inside of the hull. Then on the portions of the deck must be built the deck-houses as shown. These are all of aircraft quality plywood of about 2mm. thick. In any case

reinforced with angle pieces are shown put these pieces in at the same time as the joint is made.

The windows in the wheelhouse, the side-lights and the engine hatch can be cut from thin celluloid sheet, or from Perspex, and cemented with Durofix. A funnel could be made from brass tubing of 1 1/2 in. diameter, but it is preferable to make it of a paper or card-

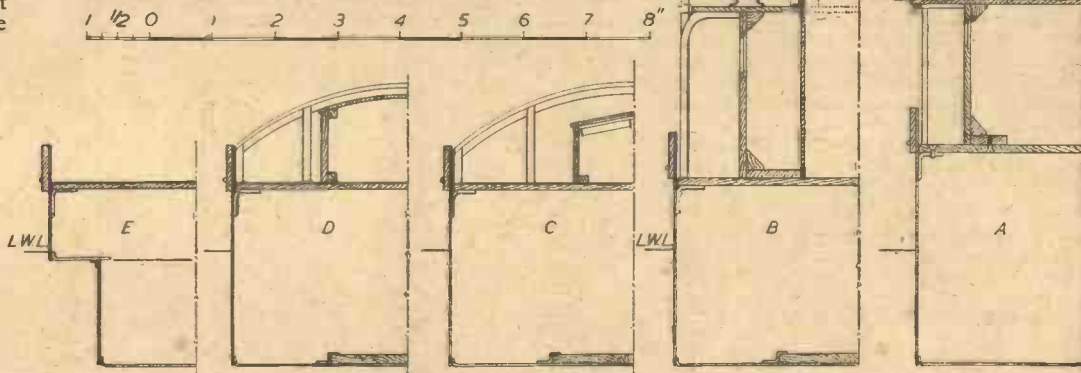

Fig. 2.—Five cross-sections at points where marked by letters on the sheer plan (Fig. 1).

it must not be more than 3mm. All the joints should be made with Durofix or some similar jointing adhesive made from celluloid, since it will yield an extremely strong and water-proof joint. A means will have to be provided for holding the plywood pieces in position whilst the cement dries. Stick only two pieces or at the most three pieces together at a time and see that they are set quite square with each other. Where joints

board tube of this or a little less diameter. Some rolls of toilet paper contain tubes of a very hard and durable nature, and if two of them are taken and wrapped around with two thicknesses of good quality cartridge paper the paper will join the tubes and make one which can be cut to the length of the funnel, which is 8 1/2 in. The paper had better be damped before glueing around the tubes, then when it dries it will shrink and pull tightly. To finish, coat all over, when dry, with celluloid lacquer, and when this is dry add the rings, cementing them with Durofix if funnel is of paper; if of metal solder them on, using fine tinned ironwire in either case.

The davits can be made of bits of dowel wood tapered off by planing and glasspapering and then steamed and bent to the required curvature. Boats can be carved from pieces of yellow pine or some similar softwood. They will not be hollowed out; the prototypes are covered by canvas.

Fig. 2 shows five cross-sections through the hull. The points at which the sections are taken are correspondingly lettered A, B, C, D and E in the deck plan, Fig. 1. The only point about these sections which calls for remark is in connection with C and D, where the curved ropeguards are shown.

These guards can be made of cardboard, each piece soaked in celluloid solution (celluloid dissolved in amylacetate), together with the wooden uprights, then all cemented together with Durofix. The whole of each guard will then be cemented down to the deck and also to the deckhouse. They ought to be made of metal throughout, soldered together; but unless some economy of weight can be effected in other places they may be too heavy. They can, of course, be left to see how the weight comes when the model is nearly finished. If it is decided to run with batteries instead of accumulators there will be a safe margin and the ropeguards can be made of strip brass.

The Displacement

The water to be displaced will be 217 1/2 cu. in. and the weight of this will be 7.86lb. or nearly 7lb. 14oz. The whole vessel will weigh the same amount to bring it to the

correct waterline and the amount will be made up approximately as per table at the foot of the page.

If dry cell batteries are used and metal rope-guards are fitted there may be a saving

Motor	11 1/2oz.
Accumulator	2lb. 12oz.
Hull, tinplate	1lb. 14oz.
Propeller shaft, rudder, etc.	7 1/2oz.
Brass angles and screws	3oz.
Woodwork, deck, etc.	1lb. 5oz.
Funnel	3oz.
Paint	3oz.
			7lb. 11oz.

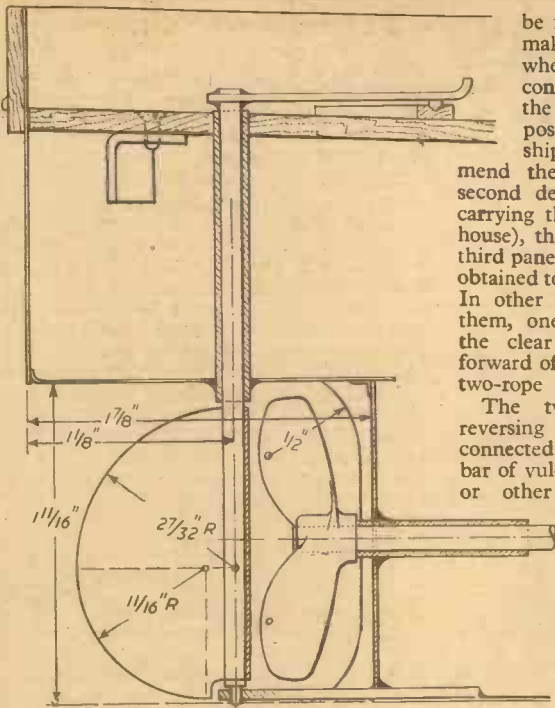

Fig. 4.—Details of propeller bearing and rudder.

enable the reader to get the trim of the tug exactly true and level.

Fig. 3 gives details of measurements both vertical and horizontal at every 3 in. from the bows throughout the length of the vessel. The figures can be taken off the drawing and marked on scribed lines on the tinplate, then all marked points connected up by means of curves or splines.

Fig. 4 is a longitudinal section showing the rudder, the rudder post and its bearing tube and the setting sector. It also shows the propeller and its shape and bearing. It will, when the driving gear is finally fixed, be necessary to pack a few windings of greased cotton wick inside the propeller shaft bearing to lubricate the bearing and to make a watertight joint around the shaft.

In order to fit up the inside of the hull all portions of the deck had better be removed. But they can be just placed in position when trying the trim on water, with the motor,

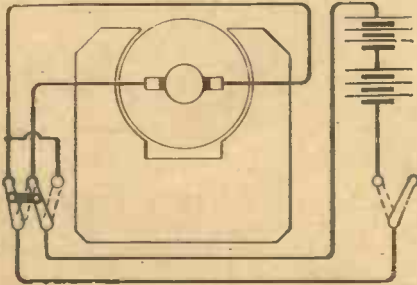

Fig. 5.—Diagram of electrical circuit.

batteries and ballast weights in place. Do this in the bath about one-half full. Then when the tug comes to the correct load waterline and is in perfect trim fix everything in its place with screws or soldered clips or in any other convenient way.

The Switches

The starting and reversing switches will have to be fixed to the deck and will have screwed pins passing through the same to the underneath side. These pins must be fitted with nuts and washers and under the washers the wires must be brought with an eye or a loop. Now just where the two switches shall

be fixed can be settled by the model-maker's taste, but they should be placed where one can get to their undersides conveniently for connecting up and at the same time be in an easily accessible position for working the ship. I should recommend

the after edge of the second deck panel (the panel carrying the funnel and deck-house), then by removing the third panel access can readily be obtained to the switch terminals. In other words, I would fix them, one on each side, in the clear deck spaces, just forward of the foremost curved two-rope guard.

The two leaves of the reversing switch should be connected mechanically by a bar of vulcanised fibre, ebonite or other insulating material so that they operate together. This coupling bar is shown in Fig. 5. The motor fills the centre with the two brushes and armature. The batteries, two three-cell type, at the top right-hand side with the main starting switch below. This switch is shown open. The reversing switch is on the left-hand of the motor. With the main switch closed and the reversing switch as shown the current will flow from right to left through the armature and brushes. Now visualise the reversing switch as having been thrown over to the right; the current will still flow in the same direction as far as the leaves of this switch, but beyond it will pass in the opposite direction, i.e., from left to right and back to the battery; therefore by reversing the direction of the current we reverse the polarity of the armature and obtain reversal of rotational direction.

Painting

For the list of colours in which the model is to be painted see Fig. 1, where are given the initial letters of the colours on all the parts; thus the funnel has a black top, Bk; below that a white band, W; and the rest is vermilion, lettered V. Bk is black in all cases and W is white. Br or Bn is brown. The particular shade is Artist's "Raw Umber." This appears mainly on the hull above the waterline. Below the waterline the colour is "Indian Red." The hull should be given three or four coats of paint, the first being of lead colour, Flake White with a little lamp-black added to it. The colour should be squeezed from the tubes on to a palette or a piece of glass and thinned with turpentine and Japan gold size, equal parts of each. The woodwork will need only three coats and for all the upper works the paint should be squeezed from the tubes on to art paper to extract some of the oil from it. It should be left for a little time, say, 20 minutes, then scraped up again on to the palette and thinned with only one part of Japan gold size to three of turpentine. The side-light boards or cases are in Fig. 1 shown Gn. But these letters, of course, refer to the starboard side only. The port or left-hand side-light will be painted vermilion as will also the insides of the ventilator cowls.

The wheelhouse should contain a compass, a wheel and an engine-room telegraph and these should be fitted

before closing in the house. The wheel on its standard and the engine telegraph will be found in Bassett-Lowke's catalogue, but the modelmaker will have to make the compass if one is to be fitted.

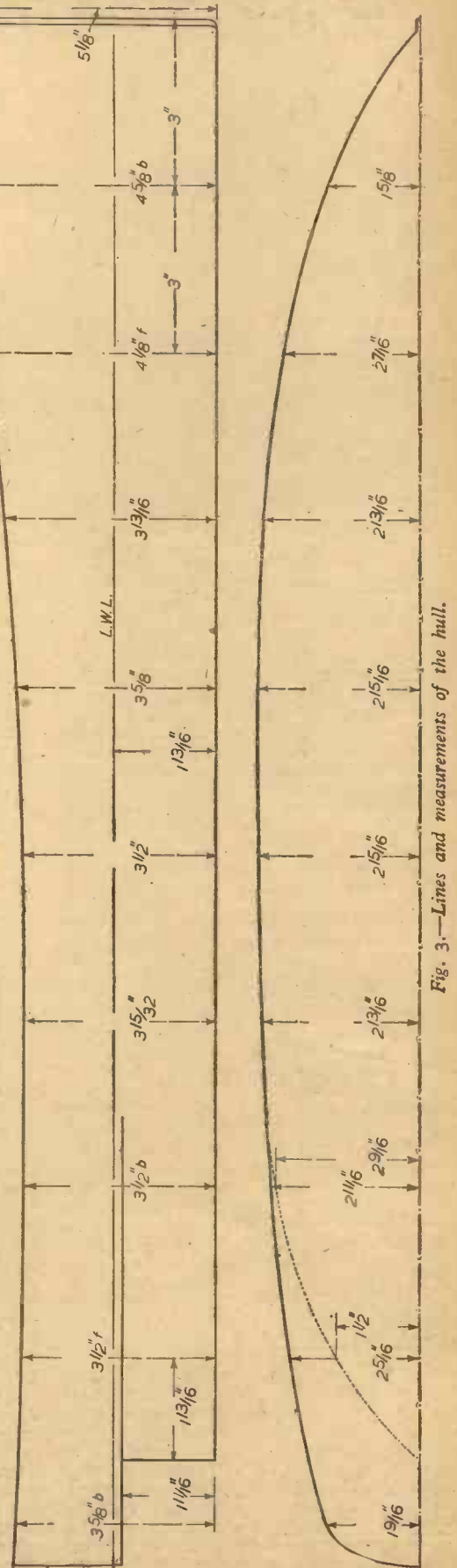

Fig. 3.—Lines and measurements of the hull.

CONDUIT WIRING FOR THE HOME WORKSHOP

Step-by-step Instructions for Carrying Out this Work in a Safe and Workmanlike Manner
By W. J. STANNAGE

ELECTRIC wiring in the home workshop is often not all it should be because the average person is at a loss to know exactly how to go about the job. Consequently lights are often strung up on flex and motors run off circuits designed for lights alone. Such installations are unsightly and in many cases dangerous. The safest and most workmanlike job is conduit wiring and for the handyman who wishes to rewire his workshop the following notes will be of interest.

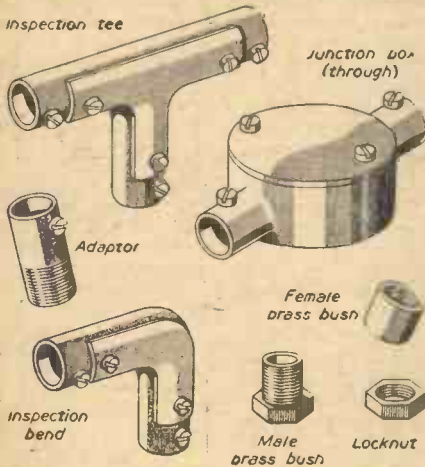

Fig. 1.—A selection of conduit fittings.

Conduit and Fittings

To avoid the use of expensive dies for threading, and a pipe vice necessary for screwed conduit, the "slip joint" type of enamelled conduit is recommended for home use. As the name implies, the conduit is not threaded but slips inside the bends, tees, etc., and is held in place by a grip screw.

For wiring a home workshop the following fittings will be found to be most useful:—

Channel Inspection Tees.—These are used where a run of conduit is taken from the main run such as down to a plug.

Junction Boxes.—These are made in a variety of shapes and the most common ones are used in the layout shown in Fig. 2. They are made with fixing lugs drilled and tapped at zin. centres to allow ceiling roses to be fitted, or if a light is not required at a particular point a cover.

Adaptors (screwed to grip).—These are very important items, as they allow conduit to be fitted to the "grip" end and standard screwed items such as locknuts and female brass bushes to be used on the screwed end. They are very useful where the conduit is entering a switch-fuse or fuseboard.

Multiple Switch Boxes.—These are metal switch boxes made to accommodate any number of switches from one to six and in some cases more. Fig. 1 shows a selection of these items.

Service

Before wiring commences find out from the area office if a service (a pair of cables from the mains and a meter) can be obtained for the workshop alone. In some cases this may be possible, but not always. If you are fortunate

enough to get a service erect a board large enough to accommodate the meter, the main fuse and link and all the control gear for your lights, motors and plugs.

If you do not get a service you will have to bring a pair of overheads from the meter board in the dwelling-house, together with an earth wire; so erect your board at a point convenient to the house. We will deal with these overheads later.

Erecting the Conduit

Fig. 2 shows a typical layout for six lights and is "tubed" as follows. Start at the meter board and erect a 10-amp. single pole and neutral (SPN) switch-fuse of the type drilled for conduit entry. It is best to use 3/4 in. conduit as this will leave enough space for additional cables should further lights be required at a future date. Screw a locknut on to an adaptor, fit the adaptor through the hole in the top of the switch-fuse, screw a female brass bush on from the inside and tighten down the locknut. Cut a piece of conduit and fit a bend at roof level. Clamp this conduit into the adaptor and from the bend continue the run to the first lighting point, marked No. 1 in Fig. 2. The junction box which forms this point is known as an intersection box. From

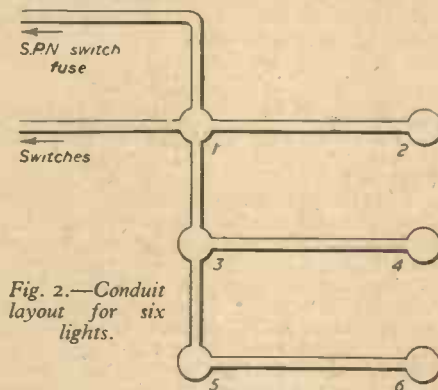

Fig. 2.—Conduit layout for six lights.

this continue to point No. 2, which is a terminal box, as are Nos. 4 and 6. Point No. 3 can now be erected, which is a tee box, and from there the run can be taken to point No. 5, an angle box. Points Nos. 4 and 6 can be fitted as was point No. 2. From the remaining spout in the intersection box a run is taken down into a suitable switch box.

It should be noted that when conduit is cut the inside of the tube must be reamed to remove any sharp edge that might injure the insulation of the cables. All conduit must be firmly attached to the walls or roof timbers by saddles spaced about 4ft. apart.

Wiring

Cable required for wiring is 3/029 V.I.R. and the circuit must be wired in colour: that is, red cable for the phase or "live" side and black for the neutral.

A convenient starting point for wiring a layout as shown is the first point, the intersection box. Step by step instructions are as follows:

1. From box No. 1 push in a red and black cable to reach box No. 2. When the cables appear at No. 2 pull through enough

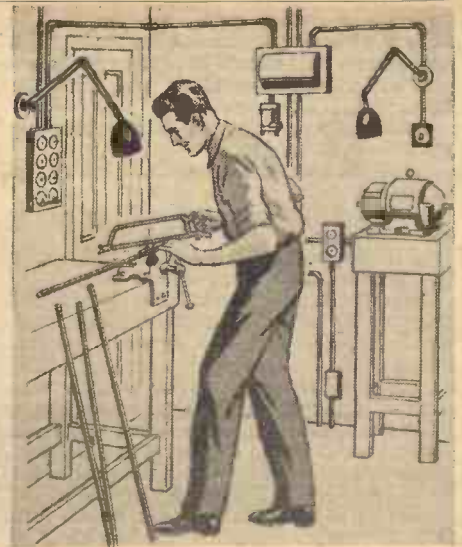

of each to leave two 6in. tails hanging from that point. Back at box No. 1 cut off the black leaving a 6in. tail. Measure off enough red cable to reach the switch box and cut. This is the switch-wire for the first two lights so put one mark on it at the end by gripping it between the blades of the wire cutters.

2. From box No. 1 push two cables, a red and a black, along to box No. 3. When they appear at No. 3 pull through enough to reach box No. 4 and feed them along to this point, pushing through enough to leave the usual two 6in. tails. At box No. 3 pull through enough to leave two 6in. loops. At box No. 1 cut off the black, leaving the usual tail, and cut the red, leaving enough to reach the switches. Put two marks on this cable.

3. Again starting at box No. 1 push through a red cable only to box No. 3. When this point is reached pull through enough to reach Nos. 5 and 6. Feed this red cable together with a black from the coil from No. 3 to No. 5 and from there to No. 6. At No. 6 leave the usual tails, at No. 5 pull through enough for two 6in. loops and at No. 3 cut off the black, leaving a tail. Back at No. 1 cut the red long enough to reach the switches and put three marks on this cable.

4. From box No. 1 feed a red and a black through to the switch-fuse. Cut the black

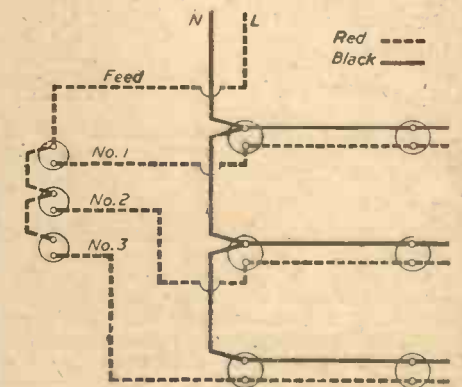

Fig. 3.—Wiring diagram for lights.

to leave the usual tail at No. 1 and the red to reach the switches.

5. The four long red cables at box No. 1 can now be fed along to the switches. Pull them in all the way with the exception of the one bearing the single mark. This one is pulled in far enough to leave a 6in. loop at box No. 1.

Connecting Up

Decide the height of the lights and make up the required number of "drops" or

"pendants," using 40/76 two-core T.R.S. flex and recessed porcelain ceiling roses. The lampholders used should be of the type incorporating a rubber grommet and must be fitted with H.O. skirts.

Connecting up is simple if the following points are observed:

1. Where there are loops these are cut to form tails.

2. All red tails are connected together in the same terminal of the ceiling rose.

3. All black tails are connected together in the other terminal of the ceiling rose.

Trim the tails to a convenient length and strip off the braiding for about 1½ in. Strip off the rubber sheath and expose about ½ in. of the wire. As previously mentioned, twist all cables of the same colour together and connect to the terminals of the ceiling roses.

To connect the switches select the cable with no marking and connect it to a terminal of the first switch, loop it to a terminal of the second switch and finish at a terminal of the third switch. This cable is the switch feed from the main switch-fuse and looping it as described makes one terminal of each switch "live." The three marked cables are connected as follows:

Marked 1.—To empty terminal of first switch.

Marked 2.—To empty terminal of second switch.

Marked 3.—To empty terminal of third switch.

At the switch-fuse the red cable is connected to the top terminal of the fuse and the black to the terminal of the neutral link. A pair of 7/029 tails are brought from the bottom terminals of the switch-fuse, the red being connected to the fused side and the black to the neutral link side. The hole through which these two cables pass must be bushed and this can be done by using a pair of bushes, a male and a female. It may be necessary to reduce the length of the male bush to allow the pair, when tightened up firmly to grip the metal

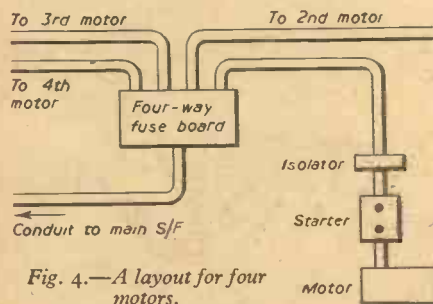

Fig. 4.—A layout for four motors.

of the switch-fuse. An alternative to this is to fit the male bush, clamp it in place with a locknut and then fit the female.

Motors

Motors in the home workshop rarely, if ever, exceed ½ h.p. and the wiring of these is a simple matter. For four motors it will be necessary to erect a four-way 5-amp. S.P.N. fuseboard in a central position. The best position is where only short runs of conduit will be required to reach the motors. In some cases it may be possible to carry two motor circuits in one run of conduit, using a tee to drop down to the first motor and continuing the run to the second.

Conduit is erected in much the same way as for the lights. Connect the conduit to the top of the fuseboard, using an adaptor and take the run to the first motor. Each motor must be fitted with a double-pole isolating switch and be controlled by an on-line starter fitted with start and stop buttons. The conduit will enter the top of the isolator and from the bottom of the isolator continue to the starter. It is usual to fit the starter to the left-hand side of the machine. From the

starter the run is taken to the motor and, if the motor is on slide rails, flexible conduit will be required. Adaptor nipples are available for this conduit and it should be noted that the nipples at each end of the flex must be connected with a length of 7/029 earth wire as the flexible conduit does not give perfect continuity for earthing. The nipples

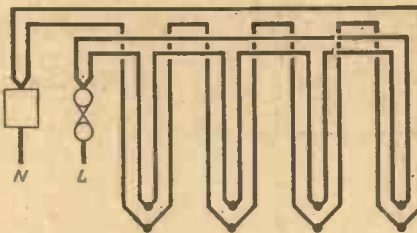

Fig. 5.—Wiring diagram for the plugs.

are provided with lugs for this purpose and the earth wire can be bound to the flexible conduit. Where the motors are not on slide rails ordinary conduit may be used.

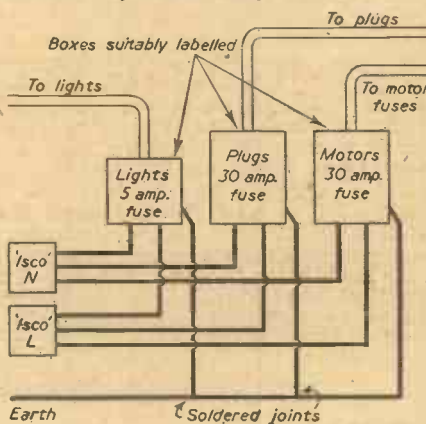

Fig. 6.—A typical fusebox layout.

Wiring is done with 3/029 V.I.R. cable, red and black being used as for the lights. The red cables are connected to the fuses and the black to the neutral link.

The fuseboard is fed from a 30 amp. S.P.N. switch-fuse which is erected on the main board. From the top of this switch a pair of 7/044 cables go to the fuseboard through a run of conduit. The hole at the bottom of the switch is bushed and a pair of 7/044 tails (T.R.S.) fitted as with the lighting circuit. Fig. 4 shows a layout for four motors. Should the workshop contain only three motors the extra "way" in the fuseboard can be left as a spare and may possibly be of use at a future date. A 30-amp. fuse is fitted to the carrier of the main switch, 5-amp. fuses to the carriers of the fuseboard and the overloads of the starters set at 25 per cent. above the amperage stated on the nameplate of the motor.

Plugs

In most cases four plugs or socket outlets will be enough, and the cheapest way to install these is on the ring main system. Erect a 30-amp. S.P.N. switch-fuse on the main board and from the top hole start the conduit run, fitting a tee for each point, with the exception of the last one, where a bend is used.

When wiring a pair of 7/029 cables are brought from the switch-fuse to the first plug, looped from the first to feed the second, looped from the second to feed the third, looped from the third to feed the fourth and from the fourth looped back to the switch-fuse. Fig. 5 shows this in detail.

This circuit is suitable only for A.C. For D.C. a four-way 15-amp. S.P.N. should be used and each plug wired individually.

As the last point is looped back to the switch-fuse there are four cables to be connected. Both reds are twisted together and connected to the top terminal of the fuse and both blacks connected to the neutral link. From the bottom terminals two 7/044 T.R.S. tails are fitted.

The tails coming from the main switches are bunched together into two 60-amp. Isco connectors, the reds into one and the blacks into the other. Fig. 6 shows a typical layout. If a service is available for the workshop a pair of 7/052 or 7/064 T.R.S. tails must be provided for connecting into the meter.

Overheads

If no service is available overheads will have to be erected. These will be 7/044 or 7/052 P.B.J. cable and are strung between one-piece insulators. These are securely screwed into the wall, the cables looped through and bound with copper binding wire as shown in Fig. 7. H.S.O.S. cable is connected to the tails with line taps, neatly clipped along the wall with cable clips suitable for outside work and taken through the wall via a suitable porcelain wall bush to the Isco connectors. At the meter in the dwelling-house a 60-amp. S.P.N. switch-fuse is erected and the overheads connected to this. From the bottom connections of this switch a pair of tails are provided for connecting to the supply.

Earthing

All metal parts must be earthed and this is best done by connecting them to the water main. A 7/044 earth wire will do and it will be connected to each main switch-fuse on the board by soldered earth lugs connected to the switches by the screw provided. The earth wire is best connected to the rising water main, below the stop-cock, by an Elmo earth clamp. In some cases it may be necessary so erect an overhead for the earthing in order to reach the water pipe or the earth wire at the meter. All joints in the earth wire must be soldered.

It may be necessary to give the conduit a slight offset in order that it may easily enter the various switches, etc. This may be done by using a stout wood block about 3ft. long, with a suitable hole in the centre. Place the end of the block on the ground, slip the conduit through the hole and "set" by pushing down with the right hand while the other steadies the block.

Supply of Conduit

It has been the writer's experience that many small shops selling electrical fittings do not stock conduit of any sort, and contractors stock only heavy gauge conduit suitable for use with screwed fittings. However, Jaylow Supplies, Ltd., 93, Fairholt Road, London, N.16, normally stock suitable conduit, fittings and all other items required.

S.P.N. switchgear is recommended for A.C. current only, and if the reader's supply is D.C. he should use double-pole switchgear. Also when ordering such items as switches and socket outlets he should specify them for use on D.C.

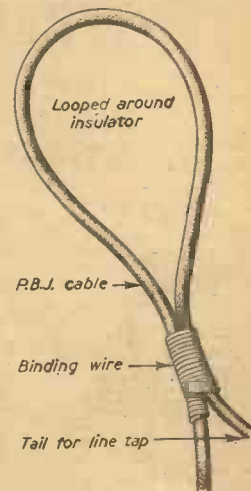

Fig. 7.—How the cable is looped around an insulator.

Can you stick it?

YES,
when
you use



Pliobond

IT STICKS ANYTHING TO ANYTHING!

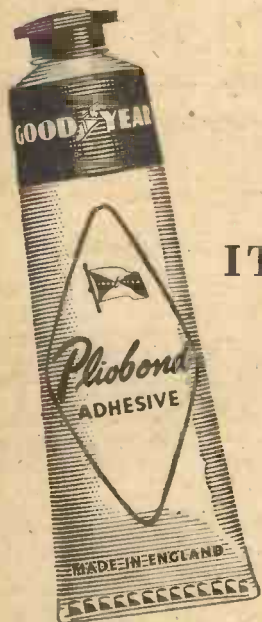

Pliobond not only sticks anything to anything, it sticks it quickly and permanently. Moreover, Pliobond is easy to apply and is versatile in its uses.

No matter what the material is, this 'quick-setting' adhesive will fix it. Pliobond has one thousand and one uses around the home, especially for hobby work. And there's no waste—Pliobond, sold in tubes, bottles and tins, keeps well in storage,

Try using Pliobond for repairing broken articles in the home and for repairs to the body and upholstery of your car.

You'll find Pliobond dries rapidly to give exceptionally strong, permanent bonds that effectively resist water, oils, greases and chemicals.

Make Pliobond a 'permanent fixture' in your home!

Pliobond IS A PRODUCT OF



THE MODERN MOTOR ENGINEER

A "must" for the mechanic and invaluable in any garage. Complete maintenance and overhaul of all motor components is covered.

SOME OF THE CONTENTS

Full coverage is given to:—Carburettor; Complete Electrical Systems; Clutch (including Hydraulic), Gear Box and Transmission; Hypoid Drive; Vacuum, Hydraulic and Servo Braking Systems; Independent Suspension; Steering; Diesel Engines (includes Servicing Methods and Fault-Finding Chart); Body and Frame Repairs; Sheet-Metal Work; Tyre Repairs and Vulcanisers; Fault Finding; Battery Maintenance and Charging; Welding, Brazing and Soldering. These are only a few of the subjects covered in this work which require attention in the course of automobile repairs and maintenance. The book is an excellent stand-by in the household garage.

ILLUSTRATIONS

"The Modern Motor Engineer" has almost 50 full-page plates in half-tone, one in colour, besides close on 2,000 diagrams and illustrations. All these have been chosen for their practical value, and are an immense help when studied in conjunction with the text.

FREE SERVICE

TWO YEARS' SERVICE to keep you up-to-date. Three times a year, data sheets and wiring diagrams will be sent to you, covering new vehicles and modifications to existing ones. This service constantly adds to the important loose-leaf volume, containing data sheets and wiring diagrams for nearly every vehicle on the road to-day, which forms part of "The Modern Motor Engineer".

OPINION

G. J. B. writes:—"The help I have received from 'The Modern Motor Engineer' makes me say quite truthfully that I consider your work to be almost as invaluable as his tool kit to any mechanic."

POST THIS COUPON TODAY

To THE CAXTON PUBLISHING CO., LTD.,
119, Morley Hall, St. George Street,
Hanover Square, London, W.1.

Please send me, without cost or obligation, fully illustrated brochure of "The Modern Motor Engineer".

Name

Address

ME I 119

(Please send this form in unsealed envelope, 1½d. stamp.)

MONEY BACK GUARANTEE **DUKE & CO** Tel: GRA 6677 CWO OF COD
621 ROMFORD RD. LONDON, E.12.

T.V. TUBES. £5. 6 months' guarantee. 12in. As supplied for the last 4 years. 15/6 ins. carr. Cash with order.

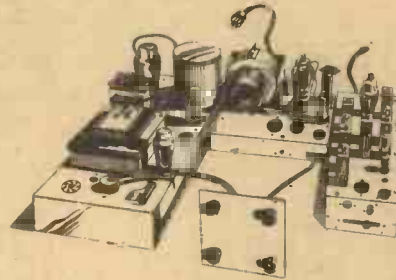

T.V. 12in. CHASSIS. 97/6. Complete chassis by famous manufacturer. R.F. E.H.T. Unit included. Drawing FREE. Easily fitted to Table or Console model, owing to this chassis being in three separate units (Power, Sound and Vision. Timebase) inter-connected. THIS CHASSIS IS LESS VALVES AND TUBE, but see our catalogue for cheap valves. Our £5 Tube fits this Chassis. List of valves by request. Carr. 5/- London. 10/- Provinces.

SPEAKER SALE, 10/9 each to clear. 8in. P.M. std. 3-5 ohms. or with matching O.P. trans. 12/9. Post 1/9.

V.H.F. 1124 RECEIVER. 17/6. With 6 valves, ex-W.D., new condition; 6-channel switching. Receives T.V. sound, police, fire and amateurs; 30/5 mc/s to 40 mc/s. I.F. 7 mc/s. Post 2/6. Drawings and conversion data free with each set.

V.H.F. 1125 SET. 7/9. New and boxed. This little set is a V.H.F. receiver, requires modification to put it into service. Complete with valves. Post 2/3.

R.F. 24 UNIT. 10/6. New and packed. Tuning 20-30 mc/s. Including 3 valves. Post 2/-.

RADIOGRAM CHASSIS. 29/9. Including 8in. speaker. 5 VALVES/HET. 3 w/band. A.C. mains, complete but less valves. All used, tested, and guaranteed. Carr. 4/6. Drawings 2/6 or free with order. Knobs 1/6 a set extra. Complete with valves, 97/6.

T.V. CHASSIS TO CLEAR. (Famous manufacturer). POWER PACK. 29/9. 5 K.V. E.H.T. 325 v., 250 m.a. Smoothed-H.T. heaters. 6 v. 5 amp., 4 v. 5 amp., 4 v. 5 amp. Carr. 4/6.

TIME BASES. 10/6. Containing scanning coil, focus unit, line trans., 10 controls, etc. Drawing free with unit. Carr. 2/6.

SOUND & VISION STRIP. 27/6. Superhet, 10 valve holders. A.C. Post-1/6.

MAINS TRANSFORMER. 5/9. 350-0-350 v. 2 heaters, 6 v. and 5 v. Post 2/-.

MAINS TRANSFORMER. 5/9. 350-0-350 v. 12 v. 4 v. heaters. Primary 100-250 v. Make ideal auto trans. Post 2/-.

MAINS TRANSFORMERS. 3/9. 350-0-350 v. 4 v., 4 v., heaters. Primary 200-250 v. Post 2/-.

O.P. TRANS. 1/9. Standard 3-5 ohms. Guaranteed. Post 9d. Stamp only for catalogue.

TAKE UP PELMANISM

For All Times and Circumstances



PELMANISM has stood the test of time. During the last half century, in peace and war, in times of prosperity and

A True Philosophy

Pelmanism is a true philosophy of living for ordinary sensible people who wish to make the best of themselves at all times and under all circumstances.

The general effect of the training is to induce an attitude of mind and a personal efficiency favourable to the happy management of life.

Reduced fees for members of Her Majesty's Forces. (Apply for Services Enrolment Form)

depression, it has helped and encouraged men and women in all the affairs of life. Now in these times of strenuous endeavour two facts stand out against a background of evidence—the increasing number of men and women, who want to make a success of life, enrolling for the Pelman Course; the continued support of serving and ex-Service members of H.M. Forces.

This increasing demand proves the creative and re-creative value of Pelmanism. Minds under stress and strain are sorely in need of restful recreation and soothing stimulus. Pelmanism gives all this and more. It is the way to clear thinking and calm but determined action under all circumstances. You cannot be harassed by anxieties, fears and worries, or feel helpless, mute and fearful in times of sudden emergency when imbued and buoyed up by the friendly personal guidance of Pelmanism. Take the Course to-day and possess those self-reliant attributes permanently enjoyed by over a million grateful Pelmanists.

The Pelman Course is simple and interesting, and takes up very little time; you can enrol on the most convenient terms. The Course is fully described in a book entitled "The Science of Success," which will be sent you, gratis and post free, on application to:—

PELMAN INSTITUTE,
130, Norfolk Mansions,
Wigmore Street, London, W.1.
POST THIS FREE COUPON TO-DAY

Pelman Institute,
130, Norfolk Mansions, Wigmore Street, London, W.1.

"The Science of Success," please.

Name

Address

Established over 60 years. WELbeck 1411/2

THE EVOLUTION OF GUIDED MISSILES



Rocket Motor

THE rocket motor is also simple in the sense that in the solid-propellant version there are no

moving parts at all and in the liquid-fuel version the only moving parts are associated, as in the ram jet, with fuel-supply and control. Aerodynamic problems associated with air swallowing are absent and motors can be tested up to full thrust on the ground with less extravagant facilities. In addition, because of its independence of the surround-

No. 3.—Rocket Motor : Performance Figures for Various Engines : Turbo-jet Engine : Choice of Propulsion Method : Aerodynamic Form, Flight Performance and Control : Mounting of Control Surface

By G. W. H. GARDNER, C.B.E., B.Sc.

(Director-General of Technical Development (Air), Ministry of Supply)

tures commonly used are about 2,500 deg. K. and the employment of even higher temperatures would introduce more severe engineering problems arising from heat transfer from the gases to the structure.

The other main avenue for improvement is the use of propellants which produce gases of low molecular weight. In this

the aircraft turbo-jet engine is only 600 hours by comparison with a year (equivalent to about 7,200 hours' operation) for the geared steam turbine (marine) engine (which again might explain their relative specific powers), but further examination reveals that whereas the aircraft engine might easily have covered 240,000 nautical miles the ship engine

installed in, say, a fast cargo boat would perhaps only have covered half this distance.

TABLE I.—SOME PERFORMANCE FIGURES FOR VARIOUS ENGINES

Engine	Thrust horsepower	Specific power, thrust h.p. per lb. weight of engine	Overhaul period	Distance travelled, nautical miles
V.2 liquid-fuel rocket ...	627,000 (at $M=5.2$)	281	60 seconds	13
Aircraft turbojet: Future ...	35,000 (at $M=1.5$)	9.5	600 hours	500,000
Present ...	8,700 (at $M=0.9$)	3.5	600 hours	240,000
Aircraft piston ...	1,080	0.54	600 hours	180,000
4-6-2 steam locomotive ...	1,800	0.009	18 months	130,000
Modern geared steam turbine (marine) ...	9,100	0.008	1 year	122,500
Geared steam turbine (R.M.S. Queen Mary) ...	104,000	0.0035	1 year	202,000

Turbo-jet Engine

In the past 10 years the thrust per unit area of British turbo-jet engines has

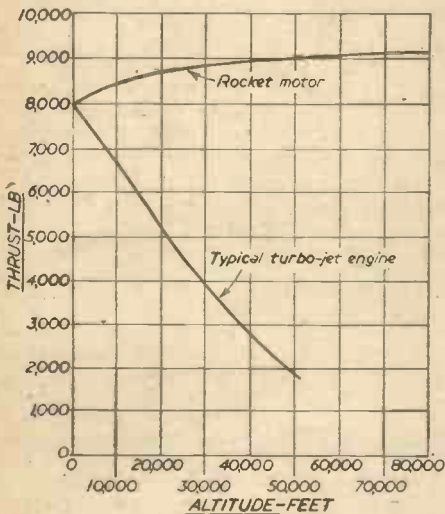

Fig. 22.—Variation of maximum thrust with altitude of a rocket motor and a turbo-jet engine.

ing atmosphere, thrust at altitude is maintained; in fact, it increases somewhat as the atmospheric pressure falls. Fig. 22 shows the variation of thrust of a rocket and turbo-jet engine with altitude. The chemical problems associated with rocket propulsion are, however, more acute and because the specific fuel consumption of rockets is many times greater than that of air-swallowing engines great endeavour is made to employ higher flame temperatures to reduce this deficiency. Flame tempera-

instance the performance is inversely proportional to the square root of the molecular weight. Fuels now available can be pressed, extruded or cast in the solid form. Liquid-hydrocarbon fuels, in association with highly concentrated hydrogen peroxide, liquid oxygen or nitric acid, are also used. Work on rocket motors has led to some most interesting mechanical developments. The development of the high-speed fuel pump and its associated bearings and seals due to Barske is worthy of note. Another notable development is the successful welding and heat treatment of thin high-tensile steel sheets in cylindrical form to provide casting for solid-propellant motors. Cylinders of 70-ton steel 0.063in. thick have been made in this way to withstand a pressure of 1,500lb. per sq. in.

Table I indicates, by comparison with examples of engines of other types, the enormous thrust horsepower achievable with the rocket motor for an extremely low weight. The V.2 liquid-fuel motor was remarkable in giving a thrust of 69,000lb. for a dry weight of only 2,235lb. complete. The speed reached by the missile after about 60 seconds, when the motor had completed its task, was approximately 5,000ft. per sec. ($M=5.2$). The engines are listed in Table I in order of specific power and, while it is of course, unfair, in view of the diverse duties and operating speeds of the vehicles which these engines propel, to compare performances from this aspect only, some interesting, if incidental, arguments can nevertheless be developed. For example, the very high specific power of the rocket is consistent with its very short designed life. On the other hand, the overhaul period of

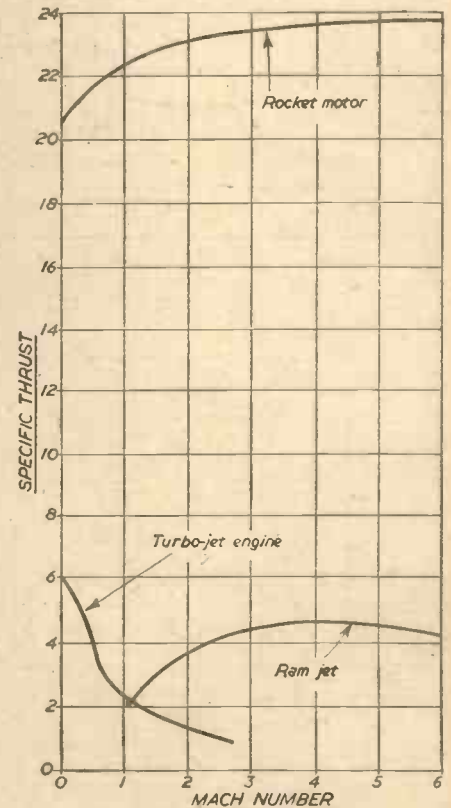

Fig. 23.—Specific thrust and rocket motor, turbo-jet engine and ram-jet at cruising altitude. Specific thrust=(net thrust at cruising altitude)/(engine dry weight).

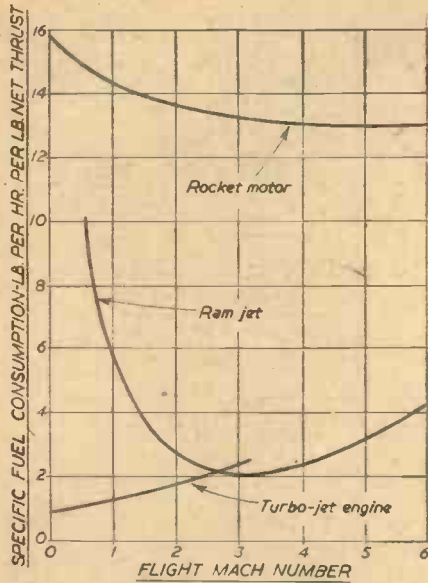

Fig. 24.—Specific fuel consumption of rocket motor, ram-jet and turbo-jet engine.

been increased six times, their specific weight has been halved and their specific fuel consumption reduced by 20 per cent. Nevertheless the turbo-jet does not yet compete with the rocket or ram jet as a means of propelling relatively short-range defensive missiles. We shall see better where it fits by examination of Figs. 23, 24 and 25.

Choice of Propulsion Method

Fig. 23 shows the outstanding merit of the rocket motor in terms of thrust divided by weight at all speeds by comparison with the turbo-jet engine and ram jet.

Fig. 24 shows the penalty in terms of fuel consumption of using a rocket motor and shows the superiority of the ram jet at speeds greater than $M=2.5$.

Fig. 25 shows the range superiority of the turbo-jet engine at moderate speeds and of the ram jet at the highest speeds.

In calculating the points on the curves just described an arbitrary relation between speed and height has been adopted. $M=2$ is assumed to occur at 60,000ft. and $M=4$ at 80,000ft.

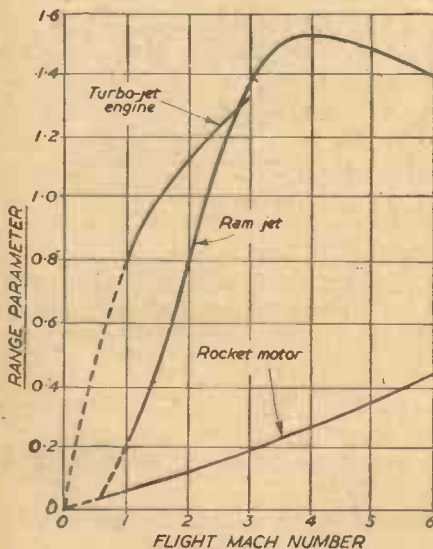

Fig. 25.—For a given ratio of initial to final weight and of lift to drag, range is proportional to the range parameter. At subsonic speeds lift-drag ratios are about three times those at supersonic speeds. The graph shows the range parameter plotted against speed.

It is clear that the rocket motor is most suitable for use as the boost to give an acceleration of, say, 25g, for, say, 2 seconds, and to achieve a speed of about one and a half times the speed of sound.

It is efficient to discard the boost motor carcase after the fuel is burnt, thereby reducing the weight and drag of the missile, and a solid fuel system fits this requirement most

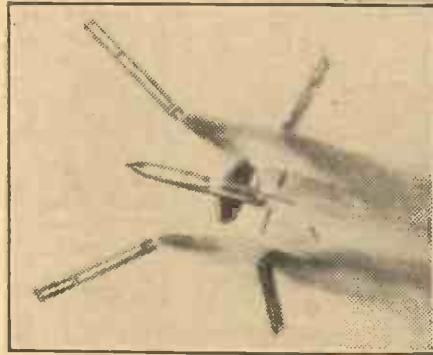

Fig. 26.—Separation of boost motors in flight.

conveniently. Fig. 26 shows a cluster of boost motors after separation in flight.

It is found that the weight of the boost motors is of the same order as that of the missile, and since it is important to keep this weight as low as possible great attention must be paid to the choice of propellant on the one hand and, on the other, to the reduction of deadweight consisting of the metal container, the nozzle, stabilising fins and other fittings. Work on methods of manufacture of very thin-walled tubes must

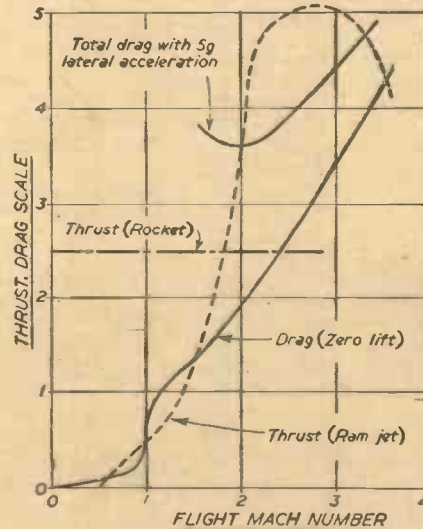

Fig. 27.—Thrust and drag curves for ram-jet and rocket missiles.

be continued, including the possible use of plastics for this and for the nozzle.

There is little doubt that the rocket motor provides the best main propulsive unit for very short short-range missiles or for those required to operate at very great heights. As missile range increases above about 20 miles the ram jet becomes more suitable, and at ranges greater than 100 miles the turbo-jet engine may have a place within limited height and speed boundaries.

Aerodynamic Form, Flight Performance and Control

To establish the aerodynamic form a vast amount of basic aerodynamic data are

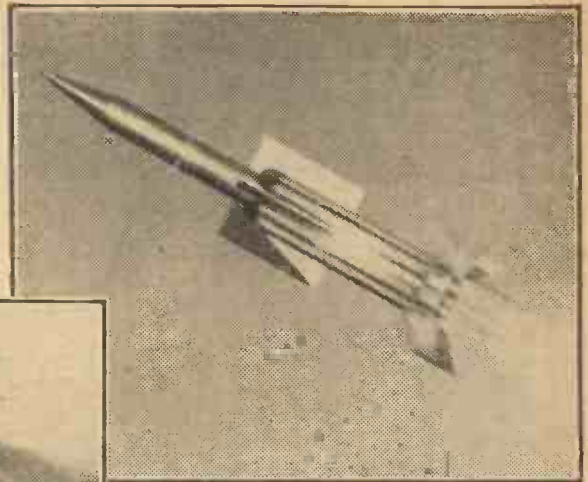

Fig. 28.—Cruciform wing configuration.

required on air forces exerted on aerofoils and bodies of different shapes and sizes over the whole speed, height and manoeuvrability range of the missile. One must deduce from these data, and check in wind tunnels or by full-flight experiment the forces and moments generated on combinations of those components. A typical deduced curve is shown in Fig. 27, which shows the total drag force on a missile plotted against speed. The sharp rise in the curve in the region of the speed of sound is due to the rise in the value of the drag coefficient in this region. Thrust curves for ram-jet and rocket motors can then be superimposed, chosen to ensure the required acceleration in straight flight and the excess thrust available to counter the additional drag induced in manoeuvres.

Finality can be reached only after the closest consideration of the control problems. An example is the choice between a four-wing or cruciform configuration and a two-wing system as used on aircraft (Fig. 28). The cruciform system enables wing incidence to be applied simultaneously in two directions at right angles to each other and a turn can thereby be induced in any required direction with a lag depending only on the time required to apply wing incidence. The other scheme, commonly known as "twist-and-steer," first requires the missile to be banked

(Continued on page 265.)

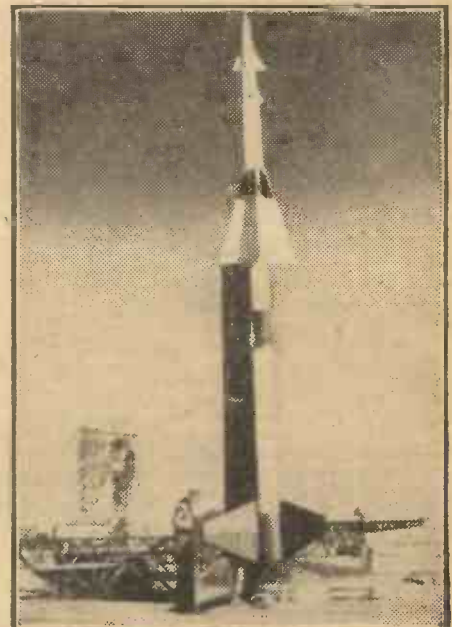

Fig. 29.—United States Army Ordnance missile, "Nike."

GAMAGES

LONDON'S BIGGEST TOOL SHOP

Thousands of Tools, both Hand and Machine, displayed for easy inspection and selection. Department adjoins the famous Motor Accessory showroom on ground floor. Come and look round—you'll enjoy it.



FLEX-I-PICK

Picks Up
Inaccessible Objects

Always useful to the mechanic, etc., engaged on assembly work. Extremely flexible steel cable $\frac{1}{16}$ in. diameter. Overall length 15 in. Will pick up objects up to $\frac{1}{16}$ in. diam. Just press the handle to operate shaft and release to close. Robust construction throughout. **12/6**
Post & Pkg. 9d.



ADJUSTABLE STEEL SHELVEING

Makes ideal racking for Greenhouse, Garage, Office, Warehouse, Factory, Shop, etc. Load up to 150 lb. per shelf. Perfect rigidity; adjustable every 2 in. Six shelf unit, 6 ft. high x 33 x 12 in. deep. Green finish. **COMPLETE 87/6**
Extra Shelves, 8/- each Carr. 2/3. Carr. & Pkg. 7/- outside Van Area.

RIGHT ANGLE DRIVE

WILL FIT MOST OF THE POPULAR ELECTRIC DRILLS
Reaches places otherwise difficult of access. Remove the chuck from the Electric Drill and fit the right angle drive. Supplied with adapter threaded $\frac{1}{4}$ in. x 24 T.P.I. Length 4 in. Depth 3 in. Weighs approx. 1 lb. Will drill extremely well metal up to $\frac{3}{16}$ in. thick. **21/-**



Post & Pkg. 1/3.

'WHANDA' Electrician's CABLE AND WIRE STRIPPER

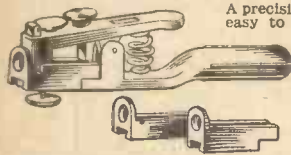

A precision tool which is extremely easy to use. Takes cable up to $\frac{3}{16}$ in. thick, fully adjustable. Will not damage the conductor wires. Also suitable for cutting wire. Usually 15/-.
GAMAGES PRICE 5/6
Post & Pkg. 9d.

TOOLS & MOTOR CAR ACCESSORIES LIST FREE.

GAMAGES, HOLBORN, E.C.1. HOLborn 8484. Open Thursdays 7 p.m.

NEW- for you!

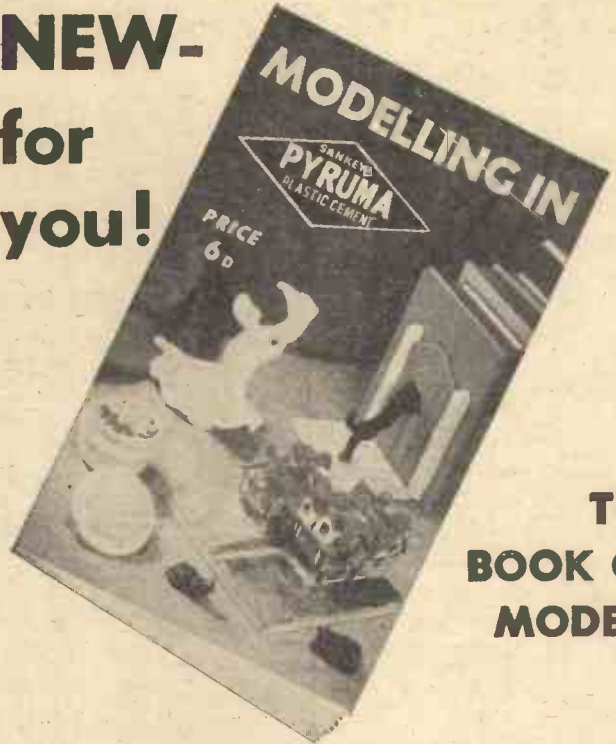

This BOOK OF MODELS

MODELS of every kind from one plastic ready-to-use material—PYRUMA! This book with new methods—new ideas—shows you how to acquire simple skill in making many types of permanent models listed below. And pages in full colour show how your models of animals, buildings, figures, etc., can be painted in natural tints.



Pyruma is supplied, plastic and ready for immediate use, in air-tight tins, obtainable from your local ironmonger, Hobbies shop or Art material dealer, from 1s. 6d. upwards. Finished Pyruma Models can be baked or air dried to stone hardness ready for colouring after simple treatment. Send 6d. P.O. (not stamps) with the coupon below for the book which shows how to make

MODEL RAILWAY STATIONS, SIGNAL CABINS, FARM COTTAGES, SHIPS, FIGURES, ANIMALS, ASH-TRAYS, BOOK-ENDS, MODEL FURNITURE, PLAQUES, RELIEF MAPS, ETC.

COUPON

TO: **J.H. SANKEY & SON, L^{TD}** DEPT. P.M., ILFORD, ESSEX.
Est. 1857.

Enclosed 6d. P.O. (not stamps) for PYRUMA MODELLING INSTRUCTION BOOK addressed to:

NAME (Block Letters).....

ADDRESS.....

Let this exciting FREE BOOK show you how to save pounds

AMAZING FURNI-KIT

SELF-BUILD LUXURY FURNITURE

Things you've always wanted for your home—at a fraction of shop prices! Truly beautiful furniture you can easily and quickly assemble yourself... SOLID Oak, Walnut, or Mahogany. All the parts satin-smooth... every joint made for you—even the screw-holes! POSITIVELY NO SKILL NEEDED. Furni-Kit, fully guaranteed by Andrew Merryfield Ltd., of Kensington, clicks together with fascinating ease. You'll love making this so-much-better furniture and you'll save pounds! You really must see the exciting Furni-Kit Book!

CLICK! and it's in... so easy a child could make it!

OAK, WALNUT OR MAHOGANY
Needlework Cabinets
Table Tea Trolley
Nest of Tables
T/V Tables
Unit Bookcases (with sliding glass doors and other styles)
Bedside Cabinets
Record Cabinets
Kitchen Cabinets
Rocking Horses
Many other Kits — all at amazing prices and on easy terms

POST THIS NOW!
COUPON
FREE!

THE SENSATIONAL NEW FURNI-KIT SELF-BUILD FURNITURE BOOK
TO: FURNI-KIT, Dept. PM/13
29 WRIGHT'S LANE, LONDON, W.8.
Send me FREE Furni-Kit Book & Rug Guide.
NAME _____
ADDRESS _____

... and now make a Big Rug in only Eight Evenings! Outdates all other methods of Home Rug-Making! Rich 100% Pure Wool 3" deep, backed with luxurious Foam Latex! And you make it in 8 evenings! No machine or frame to buy... many lovely designs and colours.

Sensational New Easy Method

NO SKILL — NO SPECIAL TOOLS NEEDED

FURNI-KIT SELF-BUILD FURNITURE

ELECTRO MAGNETIC COUNTERS



Post Office type 11A, counting to 9,999, 2 to 6 volts D.C., 3 ohm coil, 12/6 each, post 1/- Many other types in stock.

MECHANICAL COUNTERS to 99,999 only 7/6 each. Post 6d.

CONNECTOR BLOCKS.—2-way fully protected No. 5C 430, ideal for many purposes, 6d. ea., 4/- doz., or box of 50 for 15/- Post 1/-

ROTARY CONVERTERS.—From 24 volt D.C. to 230 volt A.C. 100 watts, 92/6 ea. Cge. 7/6. Also available in metal case with switch, 105/-, or in wood case with 0/300 A.C. voltmeter, variable resistance, 135/- Cge. 7/6.

THERMOSTAT.—For frost protection, on at 34 deg. F., off at 49 deg. 14 amps, at 250 volts adjustable, 4/6, post 6d.

TELEPHONE SETS, MODERN DESK TYPE.—£8/17/6 per pair complete.

WALL TYPE also available. 2 complete units £5. Batteries 5/6. Twin Wire 5d. per yd.

RELAYS, HIGH SPEED SIEMENS 1,700 +1,700 ohms, just the job for radio-controlled models, 17/6 each. Post 1/-

CHARGING RECTIFIERS.—Full Wave Bridge 12 volts 2 amps, 13/6, 4 amps, 22/6, 2 amp Transformers 24/-, 4 amp, 27/3, post 2/-

VENTAXIA FANS, brand new, complete with cowl, 12 v. D.C., 6in. diam. blades, silent running. £4 10/- each. Post 2/6. Will operate from 230 v. A.C. If used with the above 2 amp rectifier and transformer.

GENALEX EXTRACTION FANS.—230 250 volt 50 cy Induction motor, 1,350 r.p.m., 85 watts, 9 in. blades, silent running, 26/15/-, Cge. 7/6.

A.C. MOTORS, 1/2 h.p. 1,425 r.p.m., 1/2 shaft, Ball Bearings, Standard foot mounting 220/230 volts Single Phase made by Crompton Parkinson, Continuous rating, Brand New. £6 10/0.

A.C. MOTORS, Capacitor start and run, 230 volts 1/10 h.p., 1,425 r.p.m., foot mounting, 7in. x 6in. x 5in. overall, £3/10/0. Cge. 5/-, 12/24 VOLT D.C. MOTORS with double ended shaft 2in. x 3in., 8/6, postage 1/-

KLAXON GEARED MOTORS.—230 volt A.C. Induction type, No. 1K55B3-W7, Torque 15 lbs./in. 175 r.p.m. £10.

HEADPHONES, HIGH RESISTANCE.—4,000 ohms. New, 12/6 pr., post 1/6.

VERNIER DRIVES.—Mudhead, scaled 0-180 deg., 3/8 to 1, diam. 3 inch, 10/6. Post 1/-

ACFIL PUMPS.—These pumps enable you to fill all accumulators on the bench with the carboy at floor level. Brand new. Only 30/-, post 2/-

LOW VOLTAGE CIRCUIT TESTER.—A self-contained unit for making a complete and rapid check of the generator-battery circuit of a vehicle. Battery voltage, regulator and cut-out settings and generator performance can all be easily determined. American made. Complete with instruction book, £5/10/- Cge. 5/-

BALL RACES.—No. EE2, 1in. x 1in., 3/-, 30/- doz., post free.

THRUST RACES.—13/16in. x 1in., also 1in. x 1in., 1/6, 15/- doz. Post free.

SWITCHES.—A row of 5 in a flush mounting bakelite moulding 6in. x 1 1/2in. x 2in. Ideal for model railways, etc., 5/6, post 3d.

VACUUM PUMPS or Rotary Blowers.—Ex R.A.F. Brand New, 7 cu. ft. per min. 10 lbs. per sq. inch at 1,200 r.p.m. Ideal for a brazing torch, etc. Size 6in. x 4in. x 4in., 2x 1in. shaft, 22/6 each, post 2/-

PORTABLE ELECTRIC BLOWER.—This unit is a powerful 230 watts electric motor, operating on 230-230 volts. Enclosed type with handle, 8ft. of metallic flexible hose and nozzle is included, also 7 yds. C.T.S. flex for connection to the mains, 130/- complete. Carriage 7/6.

INSPECTION LAMP.—with Battery case. Fits on forehead. Leaves hands free, 7/6, post 1/- Ever Ready Battery, No. 1215 2/9, post 6d.

VOLTMETERS.—0-20 M.C. 2in. Flush, 10/6 each, post 1/-

INSTRUMENT RECTIFIERS.—Full wave Bridge 1 mA., 3/6; 5 mA., 7/6; 50mA., 5/- ea. **CELL TESTING VOLTMETERS**.—3-6 ea. In leather case with prod. 25/-, post 2/-

MICROAMMETERS.—250 F.S.D. 3in. Specially scaled for test meters. Guaranteed 55/- 2in. Flush Square, 0 500, 18/6. Post 1/-

VOLTMETERS for A.C. Mains 50 cy. reading 0 to 300 volt with clear 6in. dial only 50/- 0-15 volts A.C./D.C. 2in. Flush, 15/6.

VOLTMETERS.—0-300 D.C. 2in. Flush Square, 10/6; post 1/- Easily converted to read A.C. by using a 5 Millamp meter rectifier at 7/6. Post 6d.

AMMETERS.—2in. Flush Moving Coil D.C. 0.5, 12/6; 0.30, 10/6; 0.50, 12/6 ea. Post 1/-

LOUD SPEAKERS.—P.M. 12in. Plessey, 3ohms, special price 32/6, post 1/6. Also 10in. in Portable Wood Case 17in. x 17in. x 6 1/2in., complete with flex and plug in special compartment, only 50/-, carriage 5/-

LISTS AVAILABLE.—Motors, Meters, Telephone, Rectifiers, Relays, Potentiometers, Resistances. Send large S.A.E.

WILCO ELECTRONICS
Dept. P.M.
304, LOWER ADDISCOMBE ROAD,
CROYDON.

THE "FLUXITE QUINS" AT WORK

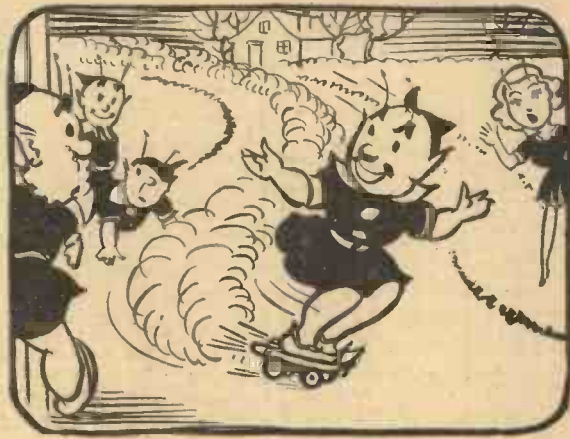

"You can scrap all your cars! They're just crates! Thousand miles to the pint is here, mates. Thanks to FLUID FLUXITE We've won fame in a night Behold! The first jet-propelled skates!"

FLUXITE

SOLDERING FLUID

and its famous equal

THE SOLDERING PASTE

Simplify all Soldering!

The standard sizes of FLUXITE FLUID are:—

4 fluid ozs. 8 fluid ozs.

20 fluid ozs. 1/2 & 1 gallon cans.

FLUXITE LTD BERMONDSEY ST LONDON S-E 1

TELEPHONE: HOP 2632

EXPORT ENQUIRIES INVITED

HIGHSTONE UTILITIES



Soldering Irons.—Our new stream lined iron is fitted with a Penold Bit. 200/250 v. 50 watts, 11/6, post 6d. Standard Iron with adjustable bit, 200 250 v. 60 watts, 13/6, post 6d. Heavy Duty Iron, 150 watts, 16/3, post 6d. All parts replaceable and fully guaranteed. Small Soldering Irons, for use on gas, 1/4 post 4d. Resin-cored solder for easy soldering, 6d. packets or large reels 5/-, post 9d.

Ex-R.A.F. 2-valve (2-volt) Microphone Amplifiers as used in plane intercom. In self-contained metal case; can be used to make up a deaf-aid outfit, intercommunication system, or with crystal set; complete with valves and fitting instructions, 20/-, post 2/6. Useful wooden box with partitions to hold amplifier, 2/- extra. Ditto, less valves, 10/-

Sparking Plug Neon Testers, with vest-pocket clip, 3/3, and with gauge, 3/6, post 3d. **S.H.C. Neon Indicator Lamps**, for use on mains showing "live" side of switches, etc., 2/6, post 4d. **Neon Indicator**, complete with condenser (pencil type), with vest-pocket clip, indispensable for electricians, etc., 7/6, post 5d.



Bell Transformers.—These guaranteed transformers work from any A.C. Mains, giving 3, 5, or 8 volts output at 1 amp., operate bulb, buzzer or bell. Will supply light in bedroom or larder, etc. PRICE 9/-, post 8d. **Similar Transformer** but with output of 4, 8 or 12 volts, 12/6, post 10d. **Transformer** with similar output but with fused secondary and earth terminal, 18/-, post 1/-.

BELLS for use with either the above or batteries, 6/6, post 6d. **"Big Ben" Chimes**. Housed in Cream Plastic Case. Easily connected to give Two-Note Chime from Front Door, and Single Note from Rear. Operated from 6-9 volt Batteries or Transformer (shown above), 22/6, post 1/3.

Crystal Sets. Our latest Model is a real radio receiver, which is fitted with a permanent crystal detector. Why not have a set in your own room? 12/6, post 5d. Spare Permanent Detectors, 2/- each. When ordered separately, 2/6. With clips and screws, 2/10, post 3d. Headphones, brand new, S. G. Brown, G.E.C., etc., 23/-, and super-sensitive, 30/- a pair, post 1/-

Headphones in Good Order, 6/-. Better quality, 7/6 and 10/-. Balanced armature type (very sensitive), 13/6. All post 1/- **New Single Earpieces**, 3/6. Balanced armature type, 4/6 (two of these will make an intercom. set). **Ex-R.A.F. earpiece**, 2/6, all post 4d. **Headphones** with moving coil mike, 15/- Similar phones with throat mike, 19/6, post 1/- **Headphone Cords**, 1/3 a pair, post 3d. **Replacement Bands**, 1/3, post 4d. **Wire Bands**, 6d. (All Headphones listed are suitable for use with our Crystal Sets.)

Hand Microphones, with switch in handle and lead, 5/6. **Tannoy**, 7/- Similar instrument, moving coil, 8/6. All post 1/- **Mike type** with switch, 3/6, post 4d. **Mike Buttons** (carbon), 2/- **Moving Coil**, 4/6; **Transformers**, 5/- All post 4d. each.

Black & Decker 1in. Drill (as illustrated). **Universal A.C. or D.C. motor** fully supported against interference, £5.19.6, post 2/6. **B. & D. 5in. Sander Polisher**, as above, but the addition of side handles makes it an ideal tool for waxing and polishing cars, furniture and floors, sanding to remove paint or rust, etc., £27.6, post 2/6, or complete with sander and polishing kit, which includes 1in. chuck for drilling, lamswool bonnet and pads, polishing and sanding discs, £9.17.8, post 2/6. **B. & D. Lathe** for use with either of the above, £5.5.0, post 2/6. **B. & D. Bench Stand**, for use with either drill or sander, £3.7.6, post 2/6.

More Keys.—Standard size keys wired to work Buzzer or Lamp, 3/-, post 6d. Slightly smaller keys, 2/6, post 4d. **BUZZERS**, 3/9, or heavy duty, 4/6, post 5d. **Terminals**, brass 2BA, mounted on strip, 6d. pair. **.0005 Airspaced Variable Condensers**, 2/6, post 4d. **.0003 twin gang** with trimmers, 2/6, post 4d. **24 volt, 15 mm. M.F.S. Buzzer** for model railways, etc., 1/6 each, 10/- doz., post 4d. **Wander Plug**, Brass 1/6 doz., post 4d. **Fuses**.—1 amp., 1 1/2in. packet of 10, 2/6, post 3d. Also 150 mA. and 250 mA., same price. **Ex-G.P.O. Telephone Twin Bells**, with box, 5/-, post 1/- **Single Telephone Bell**, 3/6, post 6d.

Barcaire Panels, of really useful equipment, containing, Meters, Condensers, Resistances, Phones, etc., 10/- or double assortment, 17/6; treble 25/- All carriage 2/3. This country only.

Meters, 20 amp. 2 1/2in. m.v. 12/6; 150 v., 2in., m.c., 10/-; 3.5 amp. 2in., T.C., 6/-; 4 amp. 2 1/2in. T.C., in case with switch, 9/6; 100 mA. 2in., m.c., 7/6; **Meter Units** containing 2-300 microamp. movements, 9/-, post 1/3.

Money refunded if not completely satisfied.

HIGHSTONE UTILITIES

58, New Wanstead, London, E.11

Letters only. New Illustrated List sent on request with 11d. stamp and S.A.E.

until its wings lie in a plane at right angles to the required direction of turn and then requires the application of incidence in that direction, the whole process thereby involving more time lag.

Control reversal can result from this effect. This can be minimised by ensuring that the fixed surface is adequately stiff in torsion, or avoided by using all-moving control surfaces separate from any other fixed surface. This effect is termed "aero-elasticity" and the effect increases in severity as flight speeds rise. Another most troublesome aero-elastic effect emerges in the form of body flexure. Modes of oscillation can be generated which are, unfortunately, detected by accelerometers and gyroscopes in the control system, and which can thereby induce unwanted missile movement.

A Complex Servo-loop

It is becoming apparent that the guided missile is a complex servo-loop in which the

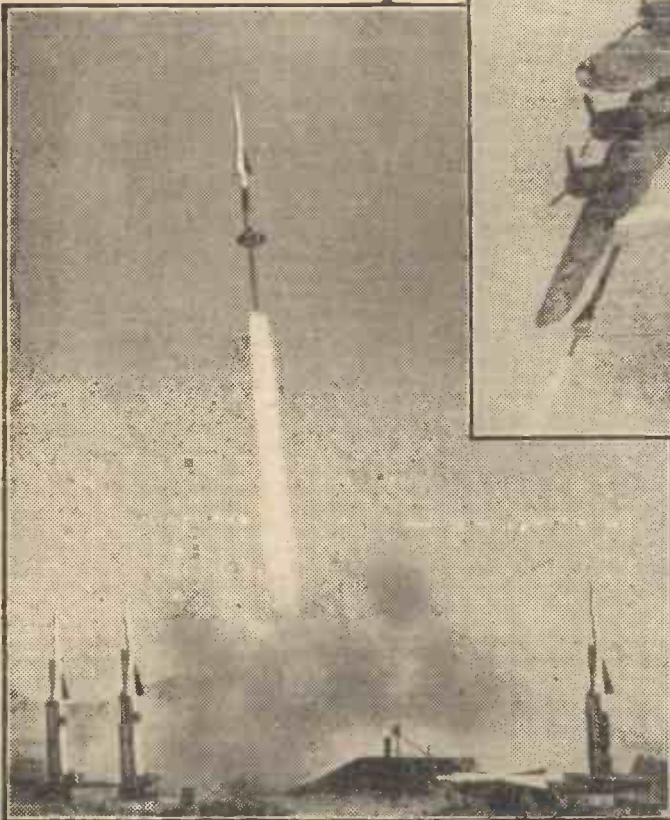

Fig. 30.—Launching of "Nike."

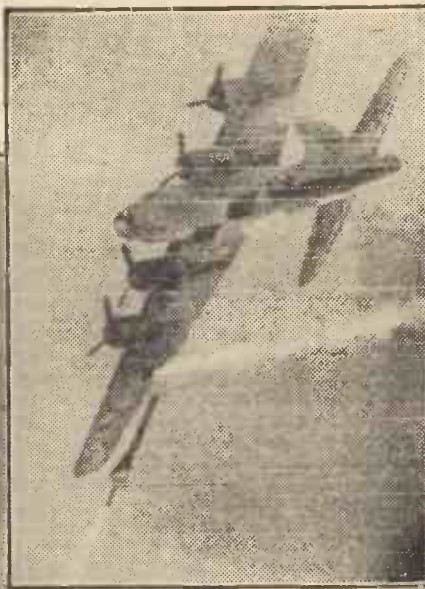

Fig. 32.—"Nike" engages the target.



Fig. 31.—"Nike" approaches target aircraft.

which is generated on 1 sq. ft. of lifting surface in a free airstream at $M=2$ and at 10 deg. incidence is 2,400lb. at sea level and unfortunately the centre of pressure changes with speed. It is necessary, therefore, to select the hinge line carefully so as to minimise the servo-power required to move a control of this kind very quickly. Even with care the peak requirements of a twist-and-steer control system for a missile of this kind can amount to 10 or 20 h.p.

Mounting of Control Surface

Another effect arises if the control surface is mounted, as in most aeroplane controls, as a flap behind a fixed surface. When the control is deflected the moment due to the lift force reacts on the fixed surface and causes it to twist and apply a moment on the missile in opposition to the control moment.



Fig. 34.—Target aircraft afire.



Fig. 33.—"Nike" explodes.



Fig. 35.—Aircraft disintegrates.

Alternative Systems

Clearly, these alternative systems present the automatic-control designer with very different problems, not the least of which is the avoidance of the situation where an underdamped twist-and-steer system, trying to steer steadily towards its target, would necessitate frequent excursions of just less than 180 deg. bank.

Possibly the most difficult aerodynamic problem is to provide satisfactory aerodynamic controls and to minimise the forces required to operate them. The lift force

reaction of the function of every component is felt through the loop and into which much spurious and disturbing information is injected, for example, by aero-elastic effects, radar "noise" and movement of the target. It remains for the automatic-control designer to close this complex loop.

The objective of the development of a ground-to-air missile is shown in Figs. 29-35. These depict the United States Army Ordnance missile "Nike" engaging a four-engined unmanned bomber target.

(To be continued)

Letters to the Editor

The Editor Does not Necessarily Agree with the Views of his Correspondents

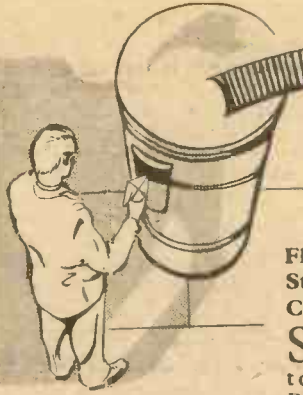
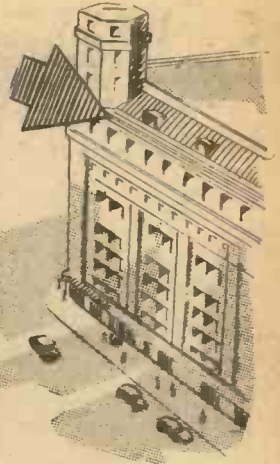

Fluorescent Stage Costumes

SIR,—With reference to Mr. L. Boucher's

query regarding fluorescent stage work in the December issue of PRACTICAL MECHANICS, the following notes may be of assistance.

The lamp is what is sometimes called a black light lamp, emitting ultra-violet rays which, when projected upon a background painted with fluorescent material, light up only the portion which has so been treated. The lamps are rather expensive and each one has to be fitted with its own choke. In fixing such lamps, care should be taken that the beam from the lamp does not shine upon the eyes of persons watching, as this causes confusion of vision due to the eyeball itself fluorescing under the influence of the light.

Fluorescent material can be obtained from May & Baker, Ltd., Dagenham, Essex; J. Frank Brockliss, Ltd., 167-169, Wardour Street, London, W.1; Burt Bros. (Bow), Ltd., Stoneleigh Works, Stanfield Road, Bow, London, E.3 (for fireproof and fluorescent flowers).

Ultra-violet lamps are obtained from Strand Electric, 29, King Street, London, W.C.2; G.E.C., Magnet House, Kingsway, London, W.C.2. These two firms also supply fluorescent material.—E. NEALE (Chichester).

SIR,—With regard to Mr. Boucher's query about fluorescent stage costumes, the following notes may be of assistance to him.

Certain substances have the property of glowing visibly when illuminated by "near ultra-violet light," and this is the system used in the stage. Under no circumstances should "true ultra-violet light," such as is emitted by medical lamps, be used, as the radiations can be harmful to skin and eyes.

Special lamps are constructed on the basis of a mercury discharge lamp in a black glass envelope, and these are rather expensive; a flood, complete with 125-watt lamp and choke for use on A.C. mains, would cost about £12 10s., but may be hired for approximately 15s. per week complete with 30ft. leads.

Fluorescent paints may be obtained in a variety of colours and may be painted or sprayed on to most materials (using a special undercoat if the material is not white). Some colours appear normal or white under ordinary light, whilst others are invisible. These again are rather expensive at 12s. 6d. per ¼lb. tin, but for the convenience of the small user sheets of cartridge paper 25in. by 20in. already treated may be obtained so that designs can be cut out and applied to scenery or costumes. These cost 3s. per sheet. All the above equipment may be obtained from the Strand Electric & Engineering Co., Ltd.

In addition, specially dyed satins may be obtained from Hall and Dixon, Ltd., 19, Garrick Street, London, W.C.2, and made up into costumes in the usual way.

For further information Mr. Boucher should write to Strand Electric, who will be only too pleased to assist him in any way they can.—R. PEDLINGHAM (Wallasey).

Cementing a Broken Ebonite Clarinet

SIR,—I read with interest the reply to the query on "Cementing a Broken Ebonite

Clarinet," in the October issue, and should like to comment.

Perhaps as one who has 40 years of experience in repairing, etc., all woodwind instruments, I could give you what is considered the best method of carrying out such a repair.

First of all, no cement that is known to me will hold this fracture for any length of time. The method we use is to chuck the broken sections in a lathe, and with a cutter bore out sufficient (about ¼in. in each section) to bush with a piece of tube—nickel silver for preference, or brass would do—the bore to be the same as the clarinet. This applies if the fracture is where the bore is parallel.

If at lower end where the bore flares out, then the bush may have to be bored and turned out of very thick tube or solid rod. This bush is made a good push-in fit and cemented with a rubber base cement (we use PC49), and then pinned with about three screwed nickel silver wire pins of 1/16in. diameter in each portion of the broken pieces.—W. MOORE (Western Australia).

A Tracing Box

SIR,—A useful gadget for tracing graphs, etc., may be made in the form of a "light box" similar to that used by tool-makers, but open along the back so that clips

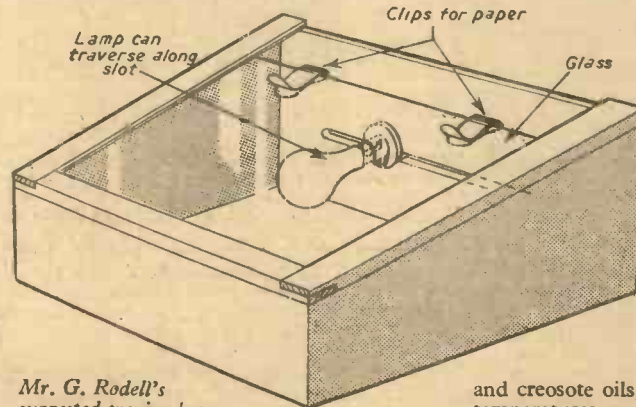

Mr. G. Rodell's suggested tracing box.

can be used for holding graph and the paper on which a copy is to be made. The lamp is also on a bracket which may be traversed.

With the light shining through, tracing becomes a simple matter.—G. RODELL (Herts).

Eliminating Taper on Long Shaft Turning

SIR,—Often I am faced with the problem of turning long shafts dead parallel between centres by normal methods. I always obtain a small taper (i.e., .0005in. in 12in.) and such errors are not permissible.

The ordinary method of correcting this would be to offset the tailstock, which I find is tiresome and impracticable for correcting very slight tapers, especially on lathes which have had considerable wear.

To overcome small amounts of taper I made an eccentric tailstock centre. The amount I made the centre eccentric was .004in. for a No. 3 Morse taper centre. I did this on a universal grinder by placing a piece of paper down the whole length of the taper and putting the centre in the Morse taper of the universal driving head on the machine. A piece of ordinary writing paper doubled gave me the .004in. thr—aw.

After the centre had been ground out of true, I removed it from the spindle and took away the paper and replaced the centre back in the spindle, and by using a dial gauge, found the zero point and marked it. It must also be noted that the eccentricity of the centre will also higher and lower the work being turned above and below centre but this I find does not make any inaccuracy in the finished article.

The operating of the centre is quite simple and only requires the minimum of thought. The centre is .004in. eccentric this will therefore give +.001in. offset for 90 deg. rotation of the centre in the tailstock barrel, +.002in. for 180 deg., +.003in. for 270 deg. and minus the same, if rotated in the opposite direction.—M. GROOME (Wellingborough).

Tar Oils for Boiler Firing

SIR,—I am most interested in the experiments of W. Renouf (Guernsey), in the use of tar oils for boiler firing; unfortunately, the details given at this stage are not sufficient for more than a generalisation of a scheme. A great deal more information would be required before much help could be given regarding this problem.

The tar oils referred to are, no doubt, the crude oils originating from the distillation of crude coal tar to road tar specification or tar base. They consist of naphtha, light, middle, and creosote oils, fractionating off the still at temperatures up to nearly 300 deg. C. Of relatively low free carbon content as compared with crude tar, they are not by any means pure enough to be used in any form of direct vaporising burner. Querist states that "the container always fills up with carbon" which reference is not quite clear—it may be a case of mistaken identity where naphthalene salts are crystallising out due to cold conditions, and choking the flow from the tank. A slight degree of warmth and lagging of pipes is the only way of avoiding the formation of crystals.

The size and type of boiler will naturally determine the best way of applying oil firing, and perhaps in the case of a hot water boiler requiring not more than ½ to ¾ gallons per hour, drip feed into the firebox might suffice; or a combination of low pressure air to effect some degree of atomisation or dispersal.

It is not known whether or not a solid fuel fire is to be retained, or if liquid fuel is ultimately required to carry the full load.

The maintenance of a small flow of oil is an uncertain business when attempted without the aid of mechanical dispensing gear, the simplest application of which may be seen on

(Continued on page 269)

GALPIN'S

ELECTRICAL STORES

408, HIGH STREET, LEWISHAM, S.E.13.

Tel.: Lee Green 0309. Nr. Lewisham Hospital.

TERMS: CASH WITH ORDER. (No C.O.D.)

All Goods sent on 7 days approval against cash

Notice: Owing to increases in Freight and Copper Wire prices we have no alternative but to increase our prices accordingly; all prices quoted are carriage paid unless otherwise stated.

MAINS TRANSFORMERS. Input 200/230 Volts OUTPUT 0/9/18 Volts at 3/4 amps., 25/- each; another output 12½/0/12½ volts 2 amps., 25/- each; another suitable for soil heating, garage lighting, etc., 0/14/17½ volts, 20/25 amps., 52/6 each; another 4 volts 20 amps. twice, 35/- each. Only 500 WATT TRANSMITTER complete with Valves, Crystals, etc., 13 meters 3/2kW Variacs Range 6.25 to 12.5 M/cys. 12.5 to 25 M/cys. In very good condition, all fitted into rack approx. weight 5/6 cwt. £100 to clear, buyer collects.

EX-GOVT. ROTARY CONVERTORS 24 volts D.C. Input 50 volts 50 cycles, 1 phase at 450 Watts. OUTPUT (complete with Step Up Transformer) from 50 volts to 230 volts, £13/10/- each or CONVERTOR only £9/10/- each.

EX-NAVAL ROTARY CONVERTORS 110 volts D.C. Input. Output 230 volts 50 cycle 1 phase 250 watts capable of 50 per cent. overload, in good condition, guaranteed weight approx. 110 lb. £13/10/- each.

MAINS TRANSFORMERS all 200/250 volts primaries (New) Heavy duty Output combination of 0/6/12/18/24/30/36 volts 4/5 amps., 38/6 each. Ditto 6/8 amps., 51/6 each. Ditto 15 amps. Output 75/- each. Another with combination of 0/6/12/18/24 volts 6/8 amps., 51/6 each. Ditto 10/12 amps., 58/6 each. Ditto 25/30 amps. Output 85/- each.

MEDIUM SPOT WELDER TRANSFORMERS. Input 200/250 volts, OUTPUT combination of 0/2/4/6/8/10/12 volts at 50/70 amps., £7/7/6 each. Ditto 120/150 amps. Output, £7/10/- each.

PRE-PAYMENT 1/- SLOT METERS 200/250 volts A.C. 10 amp. size only, 100 per cent. overload set at 2d. per unit (guaranteed 12 months), £3/17/6 each. Ditto credit type 10 amps. only, 25/- each. **RECTIFIERS FOR CHARGERS** 6 or 12 volts Output 2 amps, 9/6 each, 4 amps., 22/6 each, 6 amps., 36/- each. **MAINS TRANSFORMERS** 200/250 volts, 10 amp. and 46/6 each. **EX-C** **TE**



SOCKET & ATTACHMENT SET No. 488

In finest grade chrome-Vanadium steel, heat-treated and heavily plated. Complete in sprayed metal box. 2 1/2 in. x 5 1/2 in. x 1 1/2 in. overall. Weight 12½ lbs. With 6 Whitworth and 10 American sockets, Screwdriver, Bit/Draglink, Adjuster, Ratchet Handle, 1 1/2 in. Square Driver, 5 in. Extension Piece, 10 in. Extension Piece, Universal Joint, 12 in. Tommy Bar, Sliding "T" piece, Speed Brace. Deposit 25/- and 6 monthly payments of 23/6, or for Cash £7.12.3. Sent on payment of deposit.

THE MOST VERSATILE TOOL EVER PICADOR PUP

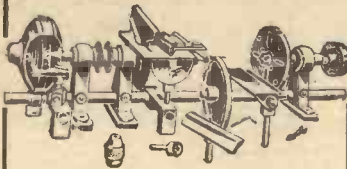

Save ground space with the PICADOR PUP. It comprises a wood turning lathe, a rise and fall, fully tilting circular saw, a hooded grindstone with drill sharpening attachment, together with sanding and drilling attachments. It GRINDS, including Twist Drill Grinding, TURNS, SAWS wood, plastics, etc. Only £6.15.0 cash or 25/- deposit and 6 monthly payments of £1.3in. four-jaw Chuck suitable for the above -£3 cash or 16/- deposit and three monthly payments of 16/6.

Send 4d. for illustrated Brochure.

BARGAIN DISTRIBUTORS (DEPT. 16), 5 SILVER STREET, LUTON

SAVE ON HOME REPAIRS WITH GLASS FIBRE

Leaks in water pipes, gutters, etc.; repairs to furniture, china and toys.

Kit I—15/- Kit II—25/- Kit III—30/-
stage 2/-

Wide range of... all

Wolf Cub ELECTRIC DRILL AT ONLY

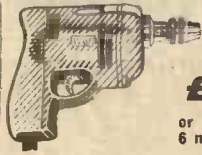

£5-9-6

or 6/- deposit and 6 monthly payments of 19/6.

This Electric Drill is the power unit for ALL Cub equipment. Drilling capacity: Mild Steel 1/2 in., Hard wood 1/2 in., with 210 watts input on full load. Complete with 1 1/2 in. three-jaw chuck, Allen key, 5ft. cable, TV suppressed, State voltage. ALSO Home Workshop Outfit (Drill, Saw, Lathe, Sanding and Polishing Kits) £16.17.6 or 40/- deposit and 8 monthly payments of 41/6. Send for Illus. Brochure of the complete WOLF Cub range of tools.

ELECTRIC PAINT SPRAYER



For 4/- deposit

Cash 75/- Or 4/- deposit and 6 monthly payments of 13/6.

Paint easily, evenly, and twice as fast with the Burgess Electric Paint Sprayer. For paint, varnish, light oils, etc. A.C. mains—state your actual voltage. Cash 75/- or 4/- deposit and 6 monthly payments of 13/6. Fully guaranteed. ALSO Horvell Electric Paint Striper, 30/- or 4/- deposit and 3 payments of 10/-.

Leaflets on request.

Telephone: MUSEUM 9594

H. FRANKS

58-60, NEW OXFORD ST., LONDON, W.C.1.

VARIABLE SPEED (Friction Drive) GEARBOX UNITS from 11 to 10 to 1 ratio, transmitting 1 10 h.p., approximate size 6 x 5 x 5 in. Totally enclosed unit. £4 each.

SENSITIVE TYPE ALTIMETERS. reads to 45,000ft. By means of 3 pointers, can be used as a Barometer at any height. 27/6 each.

TELEPHONES TYPES TELE-F, No. 2, table-type field telephone in bakelite moulded case, with bell magnet ringing generator, operated from internal 3 to 4½ volt battery (not supplied), suitable for 2-way communication up to a mile distance, when used in Pairs, overall dimensions 9 1/2 in. x 6 1/2 in. x 5 1/2 in. £3.19.6 each, carriage paid.

STEP-DOWN TRANSFORMERS, input 200-250v. A.C., 50 cycles, output 24v. 1 amp. 15/-

DYNAMOTORS, 12v. D.C. input 250-285 V.D.C., 75 mA. output. Ideal for car radios, electric shavers, etc. 28/6 each

SELECTOR UNIT. 12v. Ratchet operated. One pulse on-and-off. Fitted in die cast case. Ideal for remote control, etc. 10/6 each.

STEP-DOWN TRANSFORMERS, input 180/230v. A.C., 50 cycles, output 2 windings 4.2. 4.2v. 10 amps., ideal for soil heating, spot welding, etc. 22/6.

SIEMEN'S HIGH-SPEED RELAYS. 2,000 ohm coil. Single contact change-over, suitable for radio control. 13/6 each.

PRESSURE PUMP UNITS. Operated by 24 volt A.C./D.C. motor, develops 10 lbs. pressure, or vacuum. Complete with 10ft. length of pressure hose, cables and connectors, etc. Compact unit fitted in metal case, 6 x 4 x 4 in. Made in U.S.A. Ideal for laboratory use, etc. New in maker's cartons. £4 each.

8in. DIAM. VENT-AXIA EXTRACTOR FANS. 24v. D.C. or 96v. A.C. Fitted suppressor units. Ideal for caravans, yachts, etc. Unused, complete in transit case. £4.7.6 each.

NEW EX-W.D. ANASTIGMAT LENSES. 1 1/2" focus, F/2.9 aperture, fitted in flange mount, 1 1/2" diam., oxydised finish, no iris diaphragm. 37/6 each.

"ALDIS" ANASTIGMAT LENSES, F/2 aperture, 1 1/2" focus, 1 1/2" long, 1 1/2" diam., no iris diaphragm. 52/6 each.

EX-NAVAL RIGHT ANGLE TELESCOPE, C. R. F. Mk. 1, made by Cooke, Troughton & Sons, Ltd., fitted filters, 10 x magnification, overall length 13 1/2", weight approx. 14lb. £4.17.6 each.

SELF-PRIMING IMMERSION PUMP (Electric) Ex-Air Ministry. Fitted 24v. D.C. motor, will work on 24v. A.C. Overall length 20 2/4", delivers approx. 150 g.p.h. Ideal for use in caravans, boats, laboratories, etc. 37/6 each.

NEW "HEYWOOD" Ex-R.A.F. COMPRESSORS, pressure 45 lbs. per sq. inch, internal spline 1" diam., ideal for paint spraying, lab. use, etc. 47/6 each.

CAPILLARY RADIATOR THERMOMETERS, with 20ft. length of capillary tube, ref. 6A/1313 scaled 40/140 deg. C. 27/6.

MAGNETIC CONTROL UNITS. 12.24 V.D.C. operating rotating cam, selecting 5 sets of contacts in sequence. Ideal for radio control. Fitted in die cast case. 16/-

RHEOSTATS, graduated 100 ohms, 45 ohms, ideal for control etc. Ref. etc.

WATSON'S SPECIAL OFFERS



29/6
Post 2/6

MAGSLIPS These are extremely useful for all kinds of remote control by using two units 3in. diam. Designed for operating on 50 v. A.C. ALSO AVAILABLE, 2in. Magclip Indicator Units suitable for light indicating purposes, 9/6 each. Post 1/6.

"A.C." OIL BATH AIR CLEANERS.—These are beautifully made units 9in. diam. with 2 1/2in. or 2 1/4in. fitting. Also 6in. diam. with 1 1/2in. fitting. These are easily adaptable for any smaller fitting if required. New and boxed. Price 14/6. Post 2/4.

BOOST GAUGES.—2 1/2in. 0-24 Pressure. 0-6 Vacuum. Price 6/6. Post 1/-.

COIL SPRING BELTS.—1in. x 12in. long, extends to 15in. Any number can be joined together. 20 for 4/6. Post 9d.

LENS UNITS.—Consisting of two 1/2in. lens in 2in. brass focusing mount with adjustment 2in. overall. 14/6. Post 1/-.

BATTERY CHARGERS.—Metal Rectifier type. Output 24 v. Charges two 12 v. batteries. Built to a high service specification. £12-10-0. Carr. 15/-.

CLOCKWORK MOTORS.—Exceptionally well made heavy duty double spring motors taken from gun predictors, 37/6. Post 2/6.

HIGH PRESSURE FLEXIBLE TUBING.—To 300 lb. tin. bore, 22in. long, 1/2in. B.S.P. unions. Price 6/9. Post 1/3.

CO-AXIAL CABLE.—Impedance 50 ohms. 1/- yard. Plus carriage.

EX R.A.F. TOOL BOXES. size 14in. x 9in. x 8in. Dometalled and metal bound, 9/6 each. Carr. 2/6. LARGER SIZE 24in. x 12in. x 10in. Price 13/6. Carr. 3/6.

V-ROPE 2 1/2in. x 7/16in. 52in. overall. 3/6 each. 5 for 16/6. Post 1/6.

Hundreds of other Bargains available. Send 4d. Stamp for MONSTER ILLUSTRATED LIST.

EASTERN MOTORS
ALDEBURGH, SUFFOLK
Phone 51

GREATEST INVENTION SINCE THE ALPHABET
Gives the RIGHT word at a glance! Easy-Quick-Sure

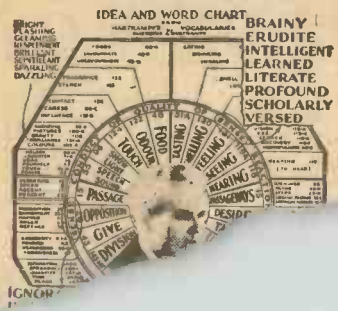

RUSTED FITTINGS?



Free them quickly with

Shell Easing Oil

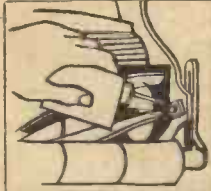

Shell Easing Oil comes in a handy 8 oz. tin with special pourer spout to eliminate waste.

Here's the way to free those rusted fittings! Free them quickly, too. Shell Easing Oil is sure and swift, penetrates deeply to loosen and free.

From nuts and bolts to taps and pipe joints, from bicycle frames to window catches, Shell Easing Oil is the answer to your rusted parts problem.

SHELL EASING OIL is very handy in the house. Buy some to-day—good ironmongers stock Shell Easing Oil.



NEW CABLES & FITTINGS

TOUGH RUBBER CABLES

Table listing various cable and fitting specifications including Twin, 3-core, T. & E., and Lead cables with prices per yard and per 100 yards.

LONDON WHOLESALE WAREHOUSE

165 (PM), QUEENS ROAD PECKHAM, S.E.15

Tel. : New Cross 7143 or 0890.

BEST VALUE YET

1,000 H.S. Inserted Blades Expanding Reamers, 21/32"-23/32", 16/-; 11/16"-1", 17/6; 1"-27/32", 17/6; 27/32"-15/16", 18/6; 1"-31/32", 18/6; 15/16"-11/16", 20/-; 31/32"-1", 22/6; 1 1/16"-1 3/16", 27/6; 1 3/16"-1 11/32", 32/6 each.

modern installations of crude coal tar fired horizontal gas retort settings.

About the only way to control a flow of oil without mechanical means is to use a system of more or less fixed flow jets under a relatively low head of from 6in. to 12in. so that jets and filter perforations are not unduly small and liable to frequent choking. Careful continuous filtration is essential, and where viscosity is variable, constant head tanks must be heated.

Assuming that experiments are to be continued in the simplest possible way the apparatus might be as follows:—

The T.O. is stored in a main tank from which it gravitates to a constant head tank of 2 to 3 gallon capacity fitted with a suitable automatic inlet float valve. The outlet from the tank is taken through a filter to a variable height fixed jet so that flow may be varied by head alterations.

The oil discharging from the jet into a cup gravitates to the burner where it is atomised by pressure air or steam according to the conditions.

Thermally air is more efficient, and indeed desirable for small throughputs of oil.

If no solid fuel is to be used it is very necessary to seal off all entry of air beneath the grate. If sufficient depth is available, the bars may be retained, covered with scrap sheet asbestos, and at least 9in. of broken firebrick (fines to 1in.) to form a refractory flame bed, otherwise the bars should be removed and the ash pit filled up with firebrick rubble.

Good insulation of flame bed is most desirable, as heat retained here does much to stabilise and safeguard combustion.

Secondary air is admitted round the injector.

Now, a few words of warning. Tar oils have a relatively high flash point, but are, nevertheless, highly inflammable, and therefore, make sure that all open containers such as constant head tanks have efficient overflows. Non-ferrous metals are subject to attack by tar oils, and, therefore, so-called ball valves should have the float replaced by one of light timber or steel. All valve seatings should be metallic.

When starting injection at any time, always have a piece of burning waste in the combustion chamber to start combustion at once, as finely atomised air mixtures of oil can be explosive in boiler flues.—J. W. YOUNG, M. Inst. Gas E.

Interplanetary Travel

SIR,—I have been re-reading the letters to Editor appearing in PRACTICAL MECHANICS of March, 1954, about Interplanetary Travel, in particular the one from Messrs. Allward and Behennah (of the British Interplanetary Society). They say, "the velocity of escape of the sun at its

surface is some 1,400,000 m.p.h. . . ."

Would not the presence of sunlight have some effect on a spaceship approaching the sun just as it has on the tail of a comet; or does such pressure act only on infinitesimal particles having little gravitational pull towards the sun?—J. ROSS (Aberdeenshire).

Gears for Remote-controlled Model Car

SIR,—After reading your article on "A Remote Controlled Model Car" in the December issue of PRACTICAL MECHANICS I would like to suggest that by making a simple gear switch the car could be made

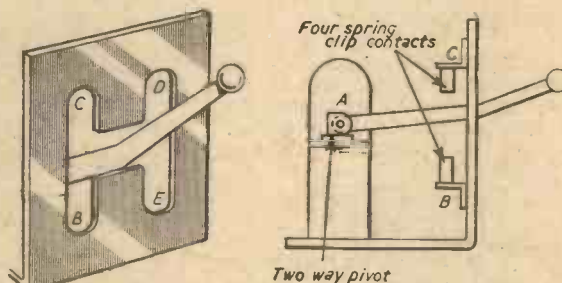

Fig. 1.—Two views showing the gear lever construction.

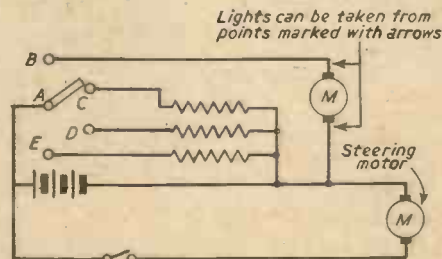

Fig. 2.—The circuit.

more realistic. Figs. 1 and 2 show the general principle of my design and I hope that it will be useful to some of your readers.—J. WOODHOUSE (E.5).

The Invisible Man

SIR,—Re "The Invisible Man" mentioned in "Letters to the Editor" January PRACTICAL MECHANICS, this was an illusion based on Pepper's Ghost. There have been several descriptions of this in PRACTICAL MECHANICS. But there are very many more.

There are no mirrors, but there are sheets of plate-glass. A light thrown on the front of the plate renders it opaque. The light thrown on the back renders it transparent. Raising and dimming these lights cause things to appear or disappear.

"The head on a plate" is an illusion of

this kind. In this the body is invisible but the head can be seen.

The lights can be so arranged that a person's body can be (apparently) seen through in sections. The outstretched arms the only parts visible, or the reverse.

"La Morte" was a very well known illusion on fairgrounds; this was where a lady's flesh fades and the skeleton left, then the skeleton fades and the design of the background is seen.

Most illusionists use some form of Pepper's Ghost in their acts.—C. V. THOMPSON (London, W.14).

Replies to Information Sought

SIR,—The following replies may be of help to the querists whose letters have been published recently in "Information Sought."—W. J. STANNAGE (Co. Down).

Infra-red Drier (Mr. L. Callumbell).—I doubt if it would be worth while attempting to make an infra-red heating unit, as these can be purchased at a very reasonable price. The heater I have in mind is used for rearing

livestock, and is available from most electrical dealers in country districts. Any dealer who does not stock them would take an order. One of the manufacturers of these heaters is Philips Electrical, Ltd., and the price of a 1,000-watt spare heater is about £1. It is possible to obtain smaller heaters of 150, 250, 300, 500 and 600 watts.

I think it should be possible to use one or more of these units to dry glue and paint.

Small Electric Kiln (J. Taylor).—In the May, 1950, issue of PRACTICAL MECHANICS there appeared an article on the making of a small electric oven. I feel that this design would be suitable for a small kiln, provided a larger element is used.

Imitation Cotswold Stone: Dyes for Cement Paths (W. D. Pagon).—I have seen these imitation stone blocks made, and the method is very simple. They are concrete blocks, faced with a mixture of coloured cement.

The method is to fill the mould about two-thirds with ordinary concrete mixture and the remaining one-third with the coloured cement/sand. A plate with a cut-out design representing the stone face is placed on top of the mixture and then compressed in the ordinary way.

For home making of such blocks, I suggest that a mould or casting frame be made as described in the article in the March, 1955, issue of PRACTICAL MECHANICS. This could be filled with the two mixtures, as described, and the design worked on the surface when damp with a piece of timber.

When using pigments to colour concrete it should be noted that the weight of the pigment used should not exceed 10 per cent. of the weight of cement, otherwise the strength of the concrete may be reduced. It is advisable to mix the pigment and cement together first and then add them to the aggregate.

The following table gives details of colour work: Yellow, yellow ochre; brown, brown oxide of iron; green, green oxide of chromium; red, red oxide of iron; black, manganese black.

Checking Rifle Sights (I. Clarkson).—

Rifle sights can be checked by firing five shots at the centre of the target. The sights are trained on the bull, but the slugs may group themselves away from the bull if the sights are not accurate. Observe where the group is and then correct the sights as follows: Group to left of bull, move sight to left; group to right of bull, move sight to right; group above bull, move sight down; group below bull, move sight up.

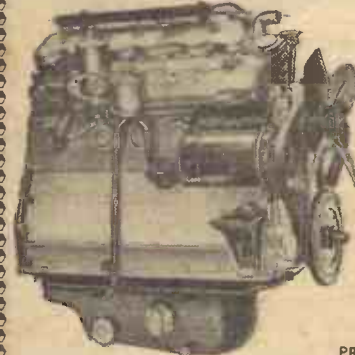

PRACTICAL MOTORIST AND MOTOR CYCLIST

Edited by F. J. CAMM

February Issue Now On Sale

1/- Every Month.

Place an Order with your Newsagent Now!

PRINCIPAL CONTENTS:

Disc Brake Progress; Slipping Gears; Front Wheel Looseness; Improving Vacuum-operated Windscreen Wipers; Lengthening the Life of your Battery; Reglazing Sidescreens; Accessories for Morris-8 Drivers; Magneto to Coil Ignition; Renovating a Pre-war Riley 9; Motor Vehicle Mechanics; A Radiator Muff for your Ford Popular; The Tracing and Rectification of Ignition Troubles; Overhauling Motor-cycle Crankshaft Assemblies; Morris-10 Series M; Garage Mechanic's Diary; Our Experts advise and many other valuable articles.

www.americanradiohistory.com

Trade Notes

Thor Soft-faced Hammers

THE Thor Hammer Company, Salop Street, Birmingham, 12, produces a wide range of soft-faced hammers and mallets in a variety of materials, including rawhide, copper, plastics, lignum, rubber, lead, etc. All the hammer faces are replaceable when worn out and each type of hammer is available in a range of useful sizes. In the larger sizes the handles are made of hickory and the small ones of ash.

It is common knowledge to the skilled mechanic that there are a vast number of operations that cannot be carried out with steel-faced hammers, but the amateur who



(Above.)—The new Thor rubber-faced hammer.
(Below.)—A rawhide and copper hammer.

does not know this may, in consequence, ruin hours of careful work with one careless blow with a hammer that is too hard for the job. Thor produce a soft hammer for almost every purpose and any requests for further information, etc., should be sent to the above address.

The Armstrong Universal Scriber

THE Armstrong Cork Co., Ltd., of Bush House, Aldwych, W.C.2, has just brought out a new tool which combines precision marking and the actual cutting of linoleum and similar materials. This comprehensive tool, called Armstrong's Universal Scriber, consists of 15 separate parts which can be assembled into tools adapted to all the processes of marking or cutting on flat, curved or angled surfaces.

It will scribe and cut all required shapes, including circles from 1in. to 7ft. in diameter, straight or circular linostrips from ¼in. to 6in. wide.

The scribing of recesses sometimes appears difficult to the operator of average ability. Two outstanding features of the Universal Scriber of particular importance in

recess scribing are: (1) the fine line scribed by the point of the instrument; and (2) the ease with which the pin can be raised and lowered by simply turning the top of the pin holder. It is possible for the operator to scribe at a distance of anywhere from 2in. to 3ft. 6in. from a wall or baseboard.

For cutting, the edges of the blades are bevelled to fit the bevelled grooves of the blade holders, and all the steel parts of the kit are precision-built and cadmium plated. The price is £6 10s.

Johnson Flash Competition

A NEW Johnson photographic competition for photographs taken by flashlight has been announced with £100 offered in 36 cash prizes. Any type of flash may be used and the closing date for entries is April 30th, 1956. A leaflet containing details and rules is available from most photographic stores.

New Heavy Soldering Iron

FROM the Acru Electric Tool Mfg. Co., Ltd., comes news of the new extra heavy duty soldering iron, manufactured under the trade name of "Pyrobit." It has been produced to cope with the soldering of heavier gauges of sheet metal, wire, etc., and it has been found that with the use of special Acru Ar solder even aluminium can be soldered. Robust construction, large heating areas, the size of copper bit and element are features designed to give long life even with continuous working. Power consumption is 450 watts and maximum heat is reached within approximately 5 minutes. Three types of bit are available, as shown in the photograph.

Also shown in the photograph is the "Pyrobit" branding iron which has been



The complete kit of the Armstrong Universal Scriber in case.

designed to provide a clean, quick method of branding timber, leather, etc. The main construction features are similar to the soldering iron. Letters or numerals are easily interchangeable into a printing surface of approximately 5in. x 1in.

The price of the extra heavy duty soldering iron is £5/10/- and the branding iron costs £7/10/-. Spares are available for both these appliances. Enquiries should be addressed to The Acru Electric Tool Mfg. Co., Ltd., Chapel Street, Stockport Road, Levenshulme, Manchester, 19.

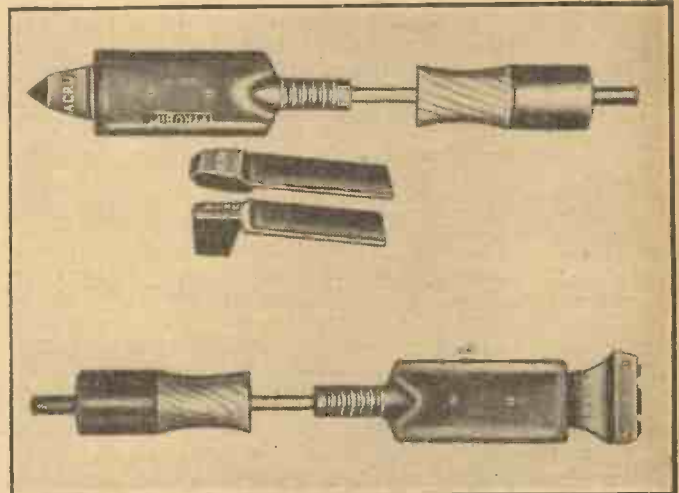

(Top.)—The "Pyrobit" soldering iron. (Below.)—"Pyrobit" branding iron.

The Arbe Aquarium

A COMPLETE departure from the conventional aquarium, this product is made of Perspex. It has a bow front with coloured bands running along the top and bottom which contrast with the pastel-coloured sides and back. These provide a frame to the clear Perspex front and hide the compost at the bottom and the waterline and strip light at the top. By installing the electrical arrangements at the rear and fitting an aluminium flush-fitting lid the makers have maintained clean external lines.

The circuit includes a built-in externally adjustable thermostat, a neon indicator light, a terminal block for connecting the immersion heater which is housed inside the aquarium behind the camouflaging panel, a press button light switch to the strip light, arranged towards the front of the aquarium to provide top front illumination, a three-way terminal block to connect the circuit to the power input cable. The press button light switch, neon indicator light, thermostat adjusting screw and power input cable are neatly located one beneath the other at the side of the aquarium.

Two sizes are available—18in. x 12in. x 11in. and 24in. x 12in. x 12in. All joints are rebated and chemically welded and are capable of withstanding a tensile stress of two tons per sq. in.

The special thermostat depends for its operation on the expansion and contraction of the tank itself as its temperature varies. This actuates a snap action micro-switch which bears against the other element of the thermostat—a rigid glass rod which for all practical purposes is unaffected by temperature change.

The makers are Messrs. Arbe Products, 2/3, Longwood Parade, Ilford, Essex, and further details and prices may be obtained from them.

WIRE AND WIRE GAUGES

3/6, or 3/9 by post

From George Newnes Ltd., Tower House, Southampton Street, Strand, London, W.C.2

AN ESSENTIAL ITEM FOR EVERYONE'S TOOL KIT THE "DERMIC" OILER



5/- Post Free

As supplied to Official Departments and Undertakings, Engineering, Aviation and Electrical firms, etc. Use a "DERMIC" Oiler for clean and accurate lubrication of models, clocks, watches, sewing machines, typewriters, movie cameras and projectors and any delicate instruments or mechanism. Can also be used for the clean and efficient application of soldering fluid. Packed in box with full instructions. Get one from your local Model or Tool Dealer or send direct to the actual manufacturers.

S. & B. PRODUCTIONS, Orton Buildings, Portland Road, South Norwood, London, S.E.25. Phone : LIV 4943

4/9 plus 6d. postage

CARPENTERS' APRONS

Made from extra strong twill with bib tops and pockets. Fitted with strong neck and waist tapes. Full size.

FOUR FOR 17s. 6d.

4/9 plus 6d. postage

CLAUDE H. VERRINDER ST. THOMAS'S WORKS, WANDSWORTH PLAIN, LONDON, S.W.18.



THE FINEST CLIP IN THE WORLD THERE'S NEVER A DROPPING THROUGH A Jubilee CLIP

L. ROBINSON & CO. (GILLINGHAM) LIMITED London Chambers, GILLINGHAM KENT Phone 5212

FREE

CORRESPONDENCE COURSES IN STEAM

TWO COURSES : (1) A simplified Course for the practical man in need of basic information about steam and steam applications ; (2) An Advanced Course for those with a background of technical training. There is no charge or obligation. Details on request to :

SPIRAX-SARCO LTD.

(TECHNICAL DEPT.), Cheltenham, Glos.

GOVERNMENT SURPLUS BARGAINS

ASTRO COMPASSES.—Mk. II. As described for Theodolite "P.M." Sept. '54 and Camera Pan & Tilt head Mar. '55. Each 17/6, post 2/-. (A few less slight not required for pan & tilt head) at 12/6, post 2/-. A

LANDING LAMP MOTORS.—12/24v. D.C. 20/30v. A.C. 2 amps in. shaft. Each 12/6, post 1/6. Similar type motor with gear and quadrant as described for SELF-OPENING GARAGE DOORS "Prac. Motorist" Aug. '54 (copy of article with motor if desired), 25/-, post 1/6.

TRANSFORMERS.—Input 200/250v. A.C. Output tapped for 3, 4, 5, 6, 8, 9, 10, 12, 15, 18, 20, 24, 30v. A.C. Max. 2 amps. Excellent for above motors, 21/-, post 1/-.

RECTIFIERS.—Full wave. Max. D.C. output 30v. 2 amps., 21/-, post 1/-.

MOTORS.—200/250v. A.C./D.C. FHP approx 80 watts. High speed. 4in. shaft (converted R.A.F. motor/generator, power about equal to sewing machine motor). Useful addition to workshop. Each 30/-, post 1/6.

GEARBOXES.—Give reduction of approx. 180/1. Drive recessed to take 1/2in. shaft, low speed shaft 3/16in. dia. Dimensions 4in. x 3 1/2in. x 2 1/2in. Each 10/-, post 6d. Send 3d. stamp for list of Motors, Telephones, Transformers, Pumps, Lamps, etc., etc. Hundreds of Bargains. MILLIGANS 24, Harford Street, Liverpool, 3. Money Back Guarantee.

EDITION

1956

Manual on Home Decoration, Repairs, Hints, Tips and Recipes, incl. Colour Harmony Chart, in comprehensive Book with every

ELECTRIC PAINT SPRAYER FREE

New model for up & downward Spraying for all Painting Jobs in & outdoors.

4/- down & 8 m'thly of 10/-



Just plug in and spray OR 75/- Cash or G.O.D. Easier than a brush—certain as foot.

Also Electric PAINT STRIPPER

outdates Blow-lamp. Cost 1d. per hour. 5/- down & 8 m'thly of 5/- or 39/6. 1 year guarantee. New Leaflet free.

John Bull (PM2) 246, High St., Harlesden, N.W.10

Broadcast in Your Own Home



The New Highly Sensitive Micro-phone incorporating a specially wound transformer designed to match any Radio or Radiogram, mains or battery. Hours of amusement at a party, good fun for all the family. Suitable for baby alarms and many other purposes. Not a toy but a guaranteed working instrument at a party, good fun for all the family. Full instructions enclosed. Made to sell at 21/-, OUR PRICE 15/- FREE. Trade supplied.

E. CLAPSHAW

369 Alexandra Rd., London, N.10.

ROGERS 31' NELSON ST., SOUTHPORT

- Compressors. Ex W.D. 3 cu. ft. 55/6 Steel Cabinets, 5 drawers ... 11/6 Abrasive Discs. 5in. Ass'd. doz. 3/6 Terminal Blocks. 12 way ... 1/3 Generators. D.C. 6 v. 12 v., 250 v. 12/6 Aloxit Abrasive. 13in. x 9in., doz. 4/9 Thread Gauges. 28 arms ... 4/9 Whitworth Screws. 144 Ass'd. 5/9 H.S. Drills. 12 Assorted. to 48 ... 4/- Pressure Tanks. 14in. x 1,000 lb. 16/6 Fibre Washers. 144 Assorted ... 3/6 Meter Rectifiers. A.C. to D.C. ... 3/9 Grinders. A.C. Mains Twin Ended 49/6 Self Tap Screws. 100 Assorted ... 3/- Copper Rivets. 12 doz. Assorted 1/3 Saw Bench Tops, with ball race spindle, pulley, etc., 18in. x 10in. 52/6 Rectifiers. 6/12 v. at 1 amp. ... 7/6 Oxygen Masks, with mike ... 3/9 Meters. 0-15 v. or 0-25 MfO ... 10/8 Races, Belts, Valves, Pulleys, Pumps, etc.

May we send our free list of hundreds of interesting items.

THE FAMOUS HARRIS ELECTRIC WELDER and Complete Kit

For Welding, Soldering, Brazing and metal construction & repairs in the home, on the car or cycle. Instant heat 6,000°F. Works from 6v. or 12v. car battery or transformer from A.C. mains. Complete kit of Welding Tools, 3 ft. cable, clip, carbons, cleaning fluid, flux, filler rods, goggles, instructions, hints. Thousands in daily use. As supplied to Depts. of H.M. Government, I.C.I., Standard Telephones, etc. Welds all Metals. Up to one-eighth inch. C.O.D. IF REQUIRED. Post Free. HARRIS ENGINEERING CO. (Dept. P.M.2) 269 Kingsland Road, London, E.2

57/6



RATCHET & REVOLUTION COUNTERS



PLEASE ASK FOR CATALOGUE Instrument Division B. & F. CARTER & Co., Ltd., Bolton 5

ELECTRIC WELDING PLANT

Arc Welding Sets by leading Makers. Unused. Surplus and Second Hand. Examples: Gen. Elec. and Others 200 amps. max. output, £42. 160 amps. max. output, £36. 100 amps. max. output, £28 10s. 85 amp. max. output, £24. All with infinitely variable current control.

Catalogue of Arc, Spot and Butt Welders for stamp. HARMSWORTH, TOWNLEY & CO., Brook Road, Manchester, 14.

BATTERY CHARGERS

Reliable, easily installed, economical Selector switch for 2, 6 and 12 volts 1 amp. In Black Crackle Steel Case with Ammeter, Mains-switch, fuses, etc. 200-250 volt A.C. Guaranteed. 55/- 2 amp. model, 70/-. Post 2/6, from manufacturers.

THAMES VALLEY PRODUCTS (P) "Orari," Eleanor Rd., Chalfont St. Peter, Bucks.

VIBRO-ARC

Electric Metal Engraving Tool

Engraves, etches, marks, writes... on Brass, Copper, Silver, Nickel, Aluminium, Chromium, Hardened Steel.

Only 10/- Post free complete with instructions for use. Additional 12 engraving points 2/6, post free. Operates from 4 or 6-volt Accumulator or Mains Transformer.

Suitable for Name Plates, Dog Collars, Cutlery, Tools, etc.

TEEBEE MANUFACTURING Co. Ltd. Dept. V57, 205, Hook Road, Chessington, Surrey

PORTASS LATHES

DIRECT PERSONAL SERVICE. LARGE DISCOUNT FOR CASH. NO INTEREST CHARGED for easy terms.

CAN ANYONE DO BETTER? 6d. for Lists, please. Dept. P.M. BUTTERMERE WKS., Sheffield, 8

CHEMISTRY APPARATUS

Send 2jd. stamp for COMPLETE PRICE LIST



BECK (Scientific Dept. A) 60 HIGH STREET, Stoke Newington, London, N.16

POTTERY

Potter's wheels from 16 gns. 3 k.w. electric kilns from £22 to £50. Also a wide range of pottery materials. Write for illustrated catalogue. MILLS & HUBBALL, Ltd. (Dept. P.M.), 244, Borough High St., London, S.E.1.

BATTERY CHARGERS

Good quality—direct from Makers. 2-6 and 12 v. with meter. 1 amp. £4 10s. Cash or C.O.D. 2 amp. £5 10s. Post & Packing free. 4 amp. £7 10s. Also transformers and chokes (standard and special); Coil testers, etc. Dept. P.M., THE BANNER ELECTRIC CO., LTD., Hoddesdon, Herts.

ACCURATE HARDHITTING Webley AIR PISTOLS

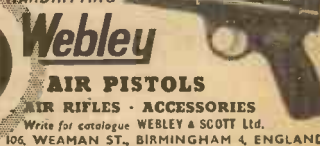

THE SOCIETY OF MODEL & EXPERIMENTAL ENGINEERS

Founded 1878 Headquarters, Workshops and Library at—28, Wanless Road, S.E.24 Meetings held in Westminster Particulars obtainable from the Secretary.

NON-FERROUS METALS

- BRASS COPPER PHOS. BRONZE ALUMINIUM DURALUMIN NICKEL-SILVER TIN-PLATE ZINC-SHEETS GUN METAL

- TEE RODS TUBES STRIPS SHEETS BLANKS ANGLES RIVETS CHANNEL

CITY METAL WORKS ESTABLISHED 1800

FLE 5769 STANTON BROS. (METALS) LTD.

73, SHOE LANE, LONDON, E.C.4

THE MOST COMPREHENSIVE STOCK AVAILABLE

WHOLESALE AND RETAIL

Your Queries Answered



RULES

A stamped, addressed envelope, a sixpenny, crossed postal order, and the query coupon from the current issue, which appears on the inside of back cover, must be enclosed with every letter containing a query. Every query and drawing which is sent must bear the name and address of the reader. Send your queries to the Editor, PRACTICAL MECHANICS, Geo. Newnes, Ltd., Tower House, Southampton Street, Strand, London, W.C.2.

Wood for Engraving

I WISH to make some engravings on wood and believe the wood is of special quality and type with very close graining. I understand, too, that the upper and under sides of the wood are prepared to a smooth surface by the suppliers.

Please inform me of the suppliers of the wood blocks and also inform me of the name of the wood.—Sidney H. Cane (Hackney, E.9).

THE blocks which are used for making wood engravings comprise nowadays quite a number of woods, many of which are of foreign origin. There are one or two types of African hardwoods used in the trade, together with a few Australian woods. Nevertheless, the traditional wood which has been used for many years for the preparation of wood-engraving blocks is boxwood, chunks of which are still procurable.

The commercial blocks are surfaced so as to have a pronounced end-grain. They are also highly polished on the surface which is intended to carry the incised lines.

Boxwood blocks with good end-grain and polished surface can be obtained retail from Dryad, Ltd., St. Nicholas Street, Leicester. They are fairly expensive, a block measuring 3in. x 2in. costing nearly 4s. Other firms which will probably be able to supply similar material are the following: Messrs. T. N. Lawrence and Son, Ltd., 7, Red Lion Court, Fleet Street, London, E.C.4; Messrs. J. Bryce Smith, Ltd., 117, Hampstead Road, London, N.W.1; Messrs. C. Roberson and Co., Ltd., 71, Parkway, London, N.W.1.

Treating Rotted Wooden Posts

COULD you recommend treatment for a pair of fairly substantial wooden gateposts which have partly rotted? The effect is that the decay has started from the ground and now extends some way up inside the posts, having reached the surface in one or two places.

The posts still appear to be strong enough for their purpose, and I am hoping that some process such as filling them with concrete would arrest the trouble and avoid the necessity for replacing the posts.

They are of 6in. x 6in. material and are set in concrete.—S. Milverton (Lancs).

THE injury to your wooden posts appears to be rather extensive and to have been due to the continual presence of uprising moisture over a number of years. Concrete would certainly act as a filling material for the posts, but in the long run it would make matters worse for the woodwork because concrete nearly always tends to absorb moisture out of damp situations. Hence, a concrete-filled wooden post would tend continually to have dampness in its interior.

The simplest treatment which you can give to this rather serious case of wood deterioration is to fill up the existing wood cavities with hot creosote. The gateposts need not be disturbed from their existing positions, but they should be creosote filled two or three times. The creosote will, of course, slowly drain away and, being a very powerful preservative, it will stop the progress of the wood-rotting micro-organisms which cause the progress of the wood deterioration. After (but not before) the wood posts have been creosote filled in this manner two or three times they should be filled with a hard asphalt mastic or a hard pitch, either of which will be preservative against further rotting and against dampness. Since the wood itself will now be creosote impregnated it will be necessary to fill the posts with the asphalt or the pitch at the lowest possible temperature at which the filling material can be poured. This merely means that care must be taken not to overheat the

pitch or asphalt in order to make it easily pourable. The pitch or asphalt fillings will give rigidity and strength to the wooden posts, will effectively damp-proof them and will oppose their further deterioration by wood-rotting organisms, thereby, on the whole, prolonging their life for years. If, as you say, the posts are set in concrete an endeavour should be made to get the pitch or asphalt under the concrete or, at any rate, between the contact of the posts and the concrete, for if this is not done the wood-concrete area of contact will always be damp—with very bad resultant effects on the wood.

Feathers for a Sleeping Bag

NOTING the high prices of good down sleeping bags, and even the comparatively high prices of "kapok" filled ones, I wondered if it would be practicable to collect the feathers and make my own. If so, could you give me details of the purifying process and any other relevant information.—J. Richards (Exeter).

EVEN the finest and the best quality farmyard poultry feathers are not the same as the orthodox "down", but, if you are prepared to put up with the comparative coarseness of the farmyard feathers, there is no reason why you should not successfully collect them and utilise them for yourself. You would, of course, have to obtain some of the special "feather-proof" cotton material, which is available at the large retail stores, or else, you would have to feather-proof your own material by rubbing it thoroughly inside with a bar of hard white soap and in this manner filling the meshes of the fibre with soap.

As regards to insulative material available for your use, you could use fibreglass sheeting or wadding which is available from Fibreglass Ltd., Ravenhead, St. Helens. Alternatively you could employ a medium-coarse asbestos fibre. This can be obtained from one or other of the following firms: Messrs. Turner Bros. Asbestos Co., Ltd., Rochdale, Lancs.; Messrs. Jas. Milne Cooper & Co., Ltd., Kobar Works, Bradford, Yorks.; Bell's Asbestos & Engineering Ltd., Bestobell Works, Slough, Bucks.

You would, of course, require the best quality and the lightest of these asbestos materials, but you would not find much difference between their prices and the retail prices of the present-day kapok fibre material. One advantage of asbestos and glass-wool material is that it is absolutely non-inflammable and incombustible, besides being light in weight and efficient as a heat insulator.

If, however, you determine to go on with the collecting of poultry feathers, it is advisable to note that such materials can be notorious harbourers of insects and mites which can have a very irritative effect on the skin. To get rid of any traces of these organisms, it is most important that the feather material should be thoroughly sterilised before it is used. Sterilisation can be effected quite reliably by subjecting the material to the temperature of boiling water for an hour or two, say by packing the material into a portable oven placed over, or in, a hot water bath. It is a good plan, also, to spray the feather material with a little formalin before commencing the heating process, so that, during the heating, the formalin may be vaporised and permeate thoroughly and effectively throughout the feathers. The admixture of a little D.D.T. with the feathers after sterilisation is also a good safeguard.

THE P.M. BLUE-PRINT SERVICE

12FT. ALL-WOOD CANOE. New Series. No. 1, 3s. 6d.*

10-WATT MOTOR. New Series. No. 2, 3s. 6d.*

COMPRESSED-AIR MODEL AERO ENGINE. New Series. No. 3, 5s.*

AIR RESERVOIR FOR COMPRESSED-AIR AERO ENGINE. New Series. No. 3a, 1s.

"SPORTS" PEDAL CAR. New Series. No. 4, 5s.*

F. J. CAMM'S FLASH STEAM PLANT. New Series. No. 5, 5s.*

SYNCHRONOUS ELECTRIC CLOCK. New Series. No. 6, 5s.*

ELECTRIC DOOR-CHIME. No. 7, 3s. 6d.*

ASTRONOMICAL TELESCOPE. New Series. Refractor. Object glass 3in. diam. Magnification x80. No. 8 (2 sheets), 7s.*

CANVAS CANOE. New Series. No. 9, 3s. 6d.*

DIASCOPE. New Series. No. 10, 3s. 6d.*

EPISCOPE. New Series. No. 11, 3s. 6d.*

PANTOGRAPH. New Series. No. 12, 1s. 6d.*

COMPRESSED-AIR PAINT SPRAYING PLANT. New Series. No. 13, 7s. 6d.*

MASTER BATTERY CLOCK.* Blue-prints (2 sheets), 3s. 6d. Art board dial for above clock, 1s.

OUTBOARD SPEEDBOAT. 10s. 6d. per set of three sheets.

LIGHTWEIGHT MODEL MONOPLANE. Full-size blue-print, 3s. 6d.

P.M. TRAILER CARAVAN. Complete set, 10s. 6d.*

P.M. BATTERY SLAVE CLOCK, 2s.

"PRACTICAL TELEVISION" RECEIVER (3 sheets), 10s. 6d.

P.M. CABIN HIGHWING MONOPLANE. 1s.*

P.M. TAPE RECORDER.* (2 sheets), 5s.

The above blue-prints are obtainable, post free, from Messrs. George Newnes, Ltd., Tower House, Southampton Street, Strand, W.C.2.

An * denotes constructional details are available free with the blue-prints.

Cementing New Knife Handle

I HAVE the blade of a Gurkha knife of "kukri" pattern, to which I wish to fix a new handle of the same style as the original, which has broken off. The tang is only 1½ in. long, and the old handle is no more than 3 in. long, and appears to be made of close-grained hardwood. Could you please let me know some method of attaching a haft, and also the materials which may be used.—J. C. Wright (St. Helens).

MIX three parts of powdered rosin, one part of caustic soda (sodium hydroxide) and five parts of water, with approximately half their weight of plaster of Paris. Pack this material immediately into the haft and then push the tang home into the required position.

An alternative and, perhaps, better recipe is as follows: Mix four parts of powdered rosin, one part of beeswax and one part of plaster of Paris. Pour the resulting powder into the hole in the shaft, heat the tang and then press it home into the shaft. The heat of the tang will melt the powder and secure the metal firmly in position.

Making Electromagnets

PLEASE give me construction details of solenoid units of the type shown in Fig. 1. I wish to construct four such solenoids, one having a 1 lb. and another having a 2 lb. pull, and operated from a 6-volt car battery; also two suitable for operation from a 12-volt battery (i.e. one of 1 lb. and the other of 2 lbs. pull).

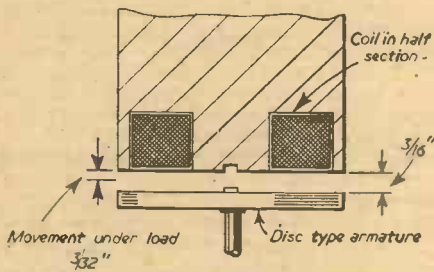

Fig. 1.—Mr. J. C. Kirby's solenoid.

Could you tell me the required number of turns and gauge of wire, with the coil and core dimensions for the four separate solenoids? Can I alter this layout to lessen the amount of heating up which would occur if the solenoid

were in operation for four or five minutes?—J. C. Kirby (Northampton).

WE suggest that you build all the electromagnets to the dimensions given below. For 2 lb. pull on 6 volts the coil could have 1,200 turns of 25 s.w.g. S.S.C. enamelled wire, and for the same pull on 12 volts the coil could have 2,400 turns of 29 s.w.g. For 1 lb. pull a 6-volt coil could have 1,200 turns of

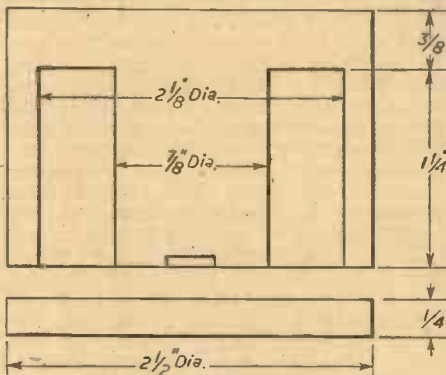

Fig. 2.—Shape and dimensions suggested for electromagnet.

29 s.w.g., whilst a 12-volt coil could have 2,400 turns of 32 s.w.g. We do not anticipate that the electromagnets would overheat to any serious degree in four or five minutes. However the heating could be reduced by connecting a resistance in series with the coil after the armature has made contact with the electromagnet.

Papier mâché

I AM building a small car and wish to construct the body of papier mâché. I will use a framework (mostly removed when finished) covered with wire-netting as a base for my contours. Can you give me the right formula, method of building up, thickness, etc., for this process? Also whether I should pulp the paper or leave it in sizable sheets for the greatest strength?—R. E. Baine (Birmingham, 24).

THERE are many ways of making and modelling papier mâché. The orthodox method is to boil old newspapers (torn into small pieces) with water until they are quite soft and pulpy. The pulp is then mixed with thin glue solution and stirred into a thin cream with plaster of Paris and the whole

beaten well together. If the material seems too dry, add more glue; if too sticky add more plaster. When rubbed on the hands this preparation should leave a thin, whitish coating.

In your case we should advise you to use a combination of methods. In the first place, dissolve about 15 parts of glue in about 85 parts of water and add sufficient carbolic acid or Lysol to this mixture to make it smell strongly. Then stir into the liquid sufficient zinc oxide to give it a pronounced milky appearance, like thin white paint. Take a sheet of strong white paper and pull it through the hot liquid prepared as above. Immediately withdraw the paper from the liquid, allow it to drain and press it down firmly on the base support. Then over this paper base apply the papier-mâché mixture prepared as above. If you do not wish to work this method apply full-sized sheets of paper (newspaper will do) previously treated by being drawn through the sizing solution in the manner described. Continue this until you build up a composite layer of the sheets of sufficient thickness for your requirements.

To get the best results we advise a mixture of the two processes using the flat sheet process for the large, flat areas and the "pulpy" process for the corners; but really, when employed separately, there is little difference in the effective strength of the two processes. It is important to have a substantial amount of zinc oxide, Lysol or other disinfectant material present because glue, being an organic compound, tends to mould and decompose in the presence of dampness, and such a decomposition would entirely ruin the papier mâché. It is usually an advantage to saturate the papier mâché after drying out with an oil varnish in order to increase its resistance to damp. A mere paint coating is hardly sufficient for this purpose. The thickness of the papier mâché coating need hardly be more than a quarter to a third of an inch. If you wish for extra strength in the papier-mâché material you should mix in with it a quantity of fibrous material such as asbestos wool, string, kapok or horsehair. Such material reinforces the papier mâché and strongly opposes all tendencies to cracking, splitting and flaking.

When building up the papier-mâché coating, do not try to do the job too quickly. Apply the material in layers and allow the one layer to dry out thoroughly before putting on the next. Failure to observe this precaution is a common cause of cracking and splitting.

Information Sought

Readers are invited to supply the required information to answer the following queries

A Small Furnace

I WORK in a school metal-work shop and wish to build a small furnace for forge-work. As there is no ventilation we cannot use coke. I want to avoid using a blower on account of noise, and oxy-acetylene cannot be used with younger children. This leaves some sort of bunsen flame. Do you know of a design which has actually been tried out that I could build up with confidence?—R. H. Lamb (London, E.11).

Paint for Carpet

PLEASE tell me what paint can be used for a worn carpet or matting. I have actually seen this! I have tried a carpet dye, without success.—M. ROBINS (Henley-on-Thames).

Building a Pottery Kiln

CAN you please give me details for making a gas, sump oil, or electrically-fired pottery kiln?—C. F. FRICKE (Australia).

A Bird Scarer

MY kitchen garden is plagued by a large number of hungry birds, and all the deterrents tried so far have been ineffective. I wish now to try something which would make a noise at irregular intervals, i.e., a device employing a number of electric buzzers placed around the garden. Can you help?—S. A. G. (Oxford).

Leather Dye

CAN you tell me how a baby's leather shoe may be dyed from its original colour to bright blue? Is it an expensive process?—W. I. JONES (Glam).

Barometer Filling

PLEASE tell me how to fill my Dutch barometer.—R. T. MCGAW (Godalming).

Electric Fire Construction

I WISH to construct an electric fire of my own design to imitate burning coal or logs. Can you tell me how this effect is obtained and the materials used?—J. WRIGHT (Hounslow).

Wood Pulping

PLEASE advise me on the method or methods of wood pulping and the materials used.—C. CRABTREE (Carlisle).

Making a Trampoline

CAN you kindly supply me with details for making a "home-size" Trampoline, with a list of suppliers of parts or a supplier of the finished article?—E. J. ROBJOHNS (Devon).

An Enlarger Focus Finder

CAN you please give me the details for making a "Focus Finder" for use in obtaining accurate focus on an enlarger baseboard? I should like it, if possible, to incorporate some degree of magnification of the projected image.—R. WEST (N.11).

SPECIAL OFFER

G.E.C. & B.T.H. GERMANIUM CRYSTAL DIODES

1/- each. Postage 2½d.

Diagrams and three Crystal Set Circuits Free with each Diode.

A large purchase of these fully GUARANTEED diodes from the manufacturers enables us to make this attractive offer.

COPPER INSTRUMENT WIRE ENAMELLED, TINNED, LITZ, COTTON AND SILK COVERED.
All gauges available.

B.A. SCREWS, NUTS, WASHERS, soldering tags, eyelets and rivets.

EBONITE AND BAKELITE PANELS, TUFNOL ROD, PAXOLIN TYPE COIL FORMERS AND TUBES.
ALL DIAMETERS.

Latest Radio Publications.
SEND STAMP FOR LISTS

CRYSTAL SET
INCORPORATING THE SILICON CRYSTAL VALVE
Adjustable Iron Cored Coil.

RECEPTION GUARANTEED
Polished wood cabinet, 15/-, post 1/-.
A REAL CRYSTAL SET NOT A TOY
POST RADIO SUPPLIES
33 Bourne Gardens, London, E.4.

MAKE A RADIO

NO SOLDERING—only a screwdriver and pliers needed. FULL-SIZE plans and easy-to-follow building instructions for 8 sets, 2/6 post free.

CRYSTAL RADIO KITS at 10/6, 17/6 and two at 21/- post free.

EXPERIMENTAL KIT NO. 1, builds 4 different crystal sets, 27/6 post free.

"BASIC", a very simple 1-valve set, 35/- post free with valve and batteries.

"NEW ECONOMY 1", 52/6 post free.

"NEW ECONOMY 2", 82/6 post free.

"PERFECT ONE", £3 post free.

Send S.A.E. for list—or send 2/6 P.O. for building instructions for all 8 sets.

BLANCHARD'S, DEPT. RM,
13, Gainford Gardens, Manchester, 10

UNUSED NIFE BATTERIES

In crates of 9 or 10 Cells 45AH.
10 Cells equal 12 volts. Size 12V. crate 27½in. x 9in. x 5½in.
Offered at the ridiculous price of 10/- per cell plus 1/- carr.

HUNT & CO.
STEPCOTE HILL, EXETER
'Phone 56687.

GENERAL CERT. OF EDUCATION

THE KEY TO SUCCESS & SECURITY
Essential to success in any walk of life! Whatever your age, you can now prepare at home for the important new General Cert. of Education Exam, on "NO PASS—NO FEE" terms. You choose your own subjects—Educational, Commercial or Technical. Recently announced big extension of subjects gives everyone chance to get this valuable Certificate.

SEND FOR FREE 136 PAGE BOOK
Full details of how you can obtain the General Cert. are given in our 136-page Guide—Free and without obligation. Personal advice on request. Write today. Dept. 186, S.O.C., 29-31, Wright's Lane, London, W.8.
"NO PASS — NO FEE"

PLEASURE AND PROFIT

SILK SCREEN PRINTER
with ALL SUPPLIES & FREE COURSE!

PRINTS IN SIX COLOURS This is the great new printing and colouring process for amateurs or professionals alike and all hobbyists. Its versatility is enormous. It will print a few copies, or hundreds, to a professional standard, in solid colours, or intricate designs, on cloth, paper, wood, glass, metal, etc. Print greeting cards, toys, models, drawings, paintings in full colour, photographs, type-script. Fluorescent colours, suede flock and novelty finishes, transfer papers for printing your own transfers also available. Can also be used as first-rate duplicator with any typewriter. Nowhere else is such a large and comprehensive outfit offered for so little money. As supplied to H.M. Government, Educational Authorities, Printers and private users throughout the world. Thousands testify to the quality and amazing value. Do not miss this opportunity.

—ON PAPER, WOOD, CLOTH, PLASTICS, etc.
AMERICAN PUBLISHERS SERVICE
(Graphic Arts Div.),
DOCKING ROAD, SEDGEFORD, NORFOLK

This IS the BARGAIN OF THE YEAR
COMPARE THE VALUE SEE WHAT YOU GET!
Large 16in. x 12in. PRINTING FRAME. Stout Laminated WOODEN BASE.
Patented ADJUSTABLE HINGES (for printing on material up to ¼in. thick).
FINE QUALITY SQUEEGEE.
SIX CONTAINERS COLOURS—Red, Blue, Yellow, Green, Black, White.
STENCIL FILM (design traced and applied with hot iron).
STENCIL CUTTERS and HOLDER. Register Guides, Masking Tape, etc., etc.
And FREE 10/- COURSE giving step by step procedure for every application of process, including PHOTO STENCILS, DAYGLO, FLOCK finishes, etc.

for 47/6 post paid
REFUND GUARANTEED IF NOT APPROVED WITHIN 7 DAYS.

BETTER CABINET MAKING

Eliminate the hard work in hand planing and give your work that professional look with the P.R.11 4½in. Bench Planer.



It Planes!
It Rebates!
It Bevells!

You can do a precision job on this sturdy machine, which will make your task so much easier, and bring greater pleasure to your Furniture making.

SEND FOR FULL DETAILS TO (DEPT. BP/43)

MYFORD BEESTON NOTTINGHAM

It's easy to come to terms with MONDEX

FOR PROMPT AND PERSONAL SERVICE

<p>● POWER TOOLS BY B & D U.1 ½" Drill (TV sup-pressed) The basis of tools for countless jobs. Cash £5.19.6 or 12/- dep. and 6 mthly. pmts. of 19/9. 12/-</p> <p>U.1004 ½" Electric Drill Kit with U.1 Drill Unit, Drills, Sanding and Polishing equipment, etc. Cash £12.9.8 or 25/- dep. and 6 mthly. pmts. of 41/2. 25/-</p> <p>U.50 B. 5" SANDER-POLISHER/1" DRILL KIT with faster and more powerful ½" drill unit, sanding discs, polishing bonnet, rubber pad, etc. Cash £8/10/0 or 17/- dep. and 6 mthly. pmts. of 28/1. 17/-</p> <p>B.7638 CRAFTSMAN'S LATHE for use with U.1 or U.50B Drill. Cash £5.15.6 or 12/- deposit and 6 mthly. pmts. of 19/-. 12/-</p>	<p>● POWER TOOLS BY WOLF CUB ½" DRILL (TV sup-pressed) Cash £5.9.6 or for 10/- dep. and 6 mthly. pmts. of 18/3. 10/-</p> <p>● SAW KIT. Including Cub Drill. Cash £9.17.0 or 20/- dep. and 6 mthly. pmts. of 32/6. 20/-</p> <p>● HOME WORKSHOP OUT-FIT. Including Cub Drill, Sanding and Polishing, drilling, turning and sawing equipment, etc. Cash £18.17.6 or 34/- dep. and 6 mthly. pmts. of 55/8. 34/-</p> <p>● POWER TOOLS BY BRIDGES No. 1 COMPLETE WORKSHOP. With DR.2T Drill and complete assembly. Cash £23.12.0 or 30/- dep. and 6 mthly. pmts. of 75/1. 60/-</p> <p>KIT D. Bench Lathe, with DR.2T drill and accessories. Cash £14.8.9 or 35/- dep. and 6 mthly. pmts. of 46/7. 35/-</p>
--	--

Wonderful Value in Fluorescent Lighting

More light for less cost! MONDEX FITTINGS are T.V./Radio suppressed ready to switch on. COMPLETE WITH BRILLIANT DAYLIGHT TUBES. OUTSTANDING VALUE.

M.22 2 ft. 40 w. twin tube fitting with 2 tubes. 75/- for 20/- dep. and 3 mthly. pmts. of 21/- (Regd. P. & P. 4/-).	M.21 2 ft. 20 w. single tube fitting with tube. 52/6 or 12/6 dep. and 3 mthly. pmts. of 15/- (Regd. P. & P. 3/6).
---	---

YOURS FOR 20/- **YOURS FOR 12/6**

ALL TOOLS BY BRIDGES, WOLF, B & D, I & G, BURGESS, ETC., ON MONDEX SPECIAL TERMS — SEND FOR LISTS

MONDEX

PRODUCTS LTD., Dept. PME.25,
5, Goswell Road, London, E.C.1.

KLIPPA ALL-PURPOSE LAMP. Hangs, clips, stands anywhere. Perfect for workshop, sewing, modelling, etc. With 40 w. lamp, switch and flex complete. Cash. 22/6

SHORT WAVES!

Introducing a New feature to the already noted World-wide service given to radio constructors by Sparks' Data Sheets.

CRAFTSMAN BUILT!

From the Workshops of L. Ormond Sparks comes the first of a new series of CRAFTSMAN BUILT AND TESTED Radio Receivers and Amplifiers in completed chassis/panel form ready for use.

THE "KESTREL" SHORT WAVE 3

A highly efficient compact receiver for all-dry battery operation. The circuit consists of H.F. stage, Pentode detector followed by a Pentode output. Latest B.V.A. Low-consumption valves. Electron-coupled Regeneration giving the most perfect form of control. Plug-in Coils. Band-spread Tuning. Slow-motion drive plus 9in. Scale length. Steel Panel stove finished in fine Smoke Grey crackle. Range from 9.5 metres upwards.

INDIVIDUALLY HAND BUILT AND TESTED

Only a very limited number of orders will be accepted in any one month, therefore, if you are interested in securing a high-grade piece of S.W. equipment, send S.A.E. or Stamp for Complete Details and Price.

L. ORMOND SPARKS (M),
8, COURT ROAD, SWANAGE, DORSET.

FLUORESCENT LIGHTING BARGAINS

COMPLETE KIT OF SUPERIOR QUALITY CONTROL GEAR TO OPERATE 6in. 80 WATT TUBE FOR ONLY 25/- (plus 2/6 p. & p.). C.W.O. or C.O.D.
Kit includes ballast unit, starter switch and holder, lampholders, tube clips, mains connector and simple wiring diagram of 5 connections.

ABOVE KIT WITH INSTANT START TRANSFORMER, 35/- (plus 2.6 p. & p.). 40 WATT KIT, 22/6 (plus 2/- p. & p.).
Send for detailed list of fluorescent kits.

E. BRILL
125A NORTHCOTE RD.
GLAPHAM JUNCTION, LONDON S.W.11 BAT 8960

FRENCH—SPANISH GERMAN—ITALIAN

Learned in Six Months by Pelman Method I have derived great benefit from Part I, in fact I believe that with no other system would so much progress have been made, as the time at my disposal has been both limited and irregular. Thanking you for the care with which your Institute has corrected my work sheets, and for a very enjoyable course. (G.P.643)

THIS letter is typical of thousands received from readers who are learning languages by the Pelman method, which has revolutionised language teaching.

This wonderful method enables you to learn French in French, Spanish in Spanish, German in German, and Italian in Italian, without using a word of English. The system is so simple that even a child can understand it. Grammatical complexities are eliminated and the whole of the instruction is given through the post.

Reduced fees for Her Majesty's Forces.

The Pelman method is explained in four little books, one for each language: French, Spanish, German, Italian (Also Courses in Afrikaans and Urdu)

State which book you want and it will be sent to you by return, together with a specimen lesson, gratis and post free.

.....POST THIS FREE COUPON TO-DAY.....

Pelman Languages Institute, Wigmore St., 130, Norfolk Mansions, Wigmore St., London, W.1.

Please send details of Pelman method of learning:
French, German, Spanish, Italian
(Cross out three of these)

Name

Address



A Steam Engine and Boiler

Constructional Details of a Simple High-speed Unit

IT will be noticed on reference to Figs. 1 and 2 that the model is very compact and only occupies a comparatively small amount of space. The engine, of the single-acting oscillating type is mounted on top of the boiler, and this is supported by a firebox which acts as a flame-guard for the spirit lamp. No lathe is required as the turned parts can be purchased at any model maker's supply stores.

Materials Required

- (a) A 6 in. length of 2 in. o.d. brass tubing, No. 20 gauge (for the boiler barrel).
- (b) Piece of sheet brass, $5\frac{1}{2}$ in. \times 2 in. \times $\frac{3}{32}$ in. thick (for boiler ends crank-webs and bearing plates).
- (c) A 4 in. length of No. 19 gauge strip brass, $\frac{3}{8}$ in. wide (for saddle bracket).
- (d) One single-acting oscillating cylinder, $\frac{3}{8}$ in. or $\frac{7}{8}$ in. bore \times $\frac{1}{2}$ in. stroke, two test cocks, and a small spring safety valve.
- (e) 2 in. of light brass tubing $\frac{7}{8}$ in. dia. for the lamp supply pipe and steam pipe.
- (f) One flywheel, 2 in. or 3 in. dia., and about $\frac{1}{8}$ in. across the rim; a small pulley wheel $\frac{1}{2}$ in. dia.
- (g) A $6\frac{1}{2}$ in. length of $\frac{1}{4}$ in. dia. brass rod (for the boiler stay).
- (h) Piece of tinfoil 15 in. long and $3\frac{1}{2}$ in. wide (for firebox).
- (i) 5 in. length of $\frac{3}{8}$ in. dia. thin brass tubing (for chimney).

The remaining two or three small pieces of metal required can, no doubt, be requisitioned from the scrap-box.

Boiler Construction

The ends of the piece of tube for the boiler barrel will probably require truing up and, if no lathe is available, filing will have to be resorted to. Scribe a line as near one end of the tube as possible; a thin, stiff piece of cardboard with a straight edge, wrapped round the tube, will act as a guide for the scriber, and will enable the line to be marked round accurately. After marking one line, measure off a distance of 6 in. and scribe another line. The two ends of the tube have now to be filed down to these lines. To test the squareness of the ends, apply a steel square at different positions round the tube while the filing is in progress.

After the boiler barrel is satisfactorily trued up, mark the position and drill the hole to take the safety valve bush, which can then be soldered in place. Now take the piece of $\frac{3}{32}$ in. sheet brass, and with a pair of dividers scribe on it two circles (for the boiler ends) of a diameter equal to that of the inside of the boiler. The two bearings and crank-webs can also be marked out on the same piece of brass plate.

At least $\frac{1}{8}$ in. should be allowed between

the marked-out parts, as the metal has to be sawn through with a hacksaw to separate them. The two centre holes for the stay may be drilled $\frac{1}{8}$ in. dia., and the two holes in one end for the test cocks should be drilled and tapped out to suit the screwed ends of the latter. Now separate the two pieces as above mentioned, and with a hammer and cold chisel chip away the superfluous metal, taking care to keep on the outside of the scribed circular line. Now hold one disc in the vice and carefully file the periphery down to the line, leaving the edge as square as possible, so that the end is a tight fit in the boiler tube. Treat the other end in the same way, and

adjusted so that they are quite square with the boiler barrel, the soldering can be done and the joint well sweated. Having treated both ends satisfactorily in this way, the projecting edges of the boiler barrel can be carefully filed down flush with the face of the ends as shown in Fig. 3.

Fixing the Stay Rod

This is the rod which runs through the centre of the boiler. Take the piece of $\frac{1}{4}$ in. dia. brass rod and after cutting a thread on each end for a distance of $\frac{1}{2}$ in., push the rod through the centre holes in the boiler ends and screw on two brass nuts so that they clamp the ends fairly tightly. The nuts can now be soldered to the boiler ends so as to make steam-tight joints. After removing any superfluous solder, file down the ends of the stays until they are nearly level with the face of the nuts.

The Firebox

Take a piece of tinfoil and carefully mark it out to the dimensions given in Fig. 4. Drill the ventilation holes and cut away the other parts with a small cold chisel and hammer.

Finish the edges down to the scribed lines with a file and then drill $\frac{1}{8}$ in. rivet holes along each end, where indicated. In each bottom lug drill a $\frac{1}{8}$ in. hole. Bend the firebox to shape on the dotted lines and then rivet the overlapping edges

together with copper wire rivets. The four fixing lugs at the bottom can be bent outwards and the two lugs at the top, where the boiler rests, are to be bent inwards. For the chimney support cut out a blank from a piece of tinfoil to the shape and sizes given in Fig. 5 and drill $\frac{1}{8}$ in. rivet holes at the points indicated. Bend to shape on the dotted lines and rivet together with short pieces of copper wire. Push the

(Continued on page 279.)

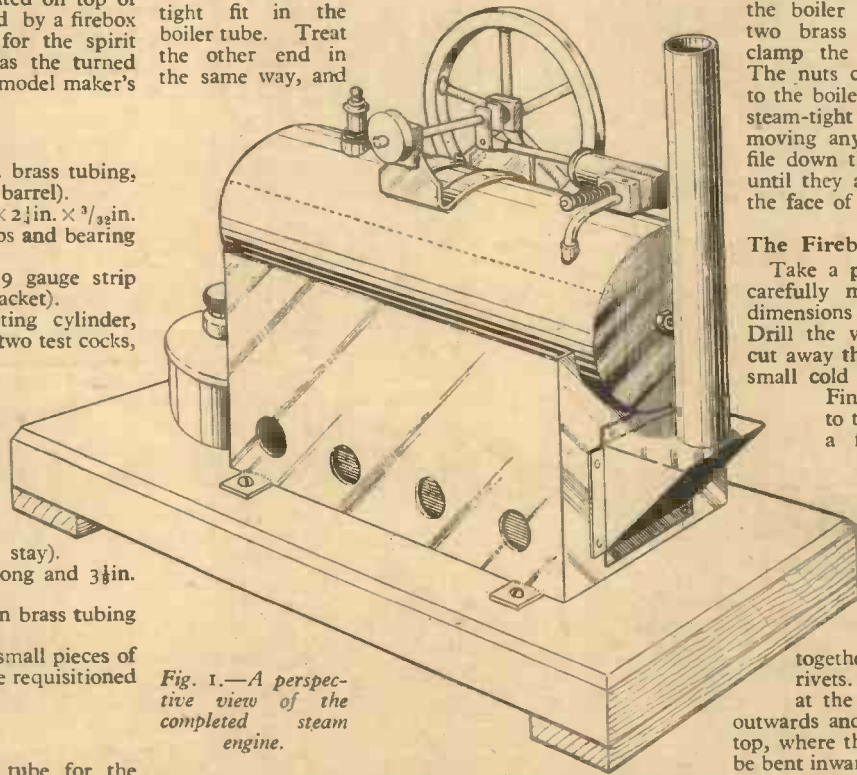

Fig. 1.—A perspective view of the completed steam engine.

then with a piece of fine emery-cloth clean thoroughly the inside of the boiler tube at both ends and press the discs in place (see Fig. 3). About $\frac{1}{32}$ in. of the boiler tube should be left projecting so as to assist the solder to flow round the joint. When the ends are

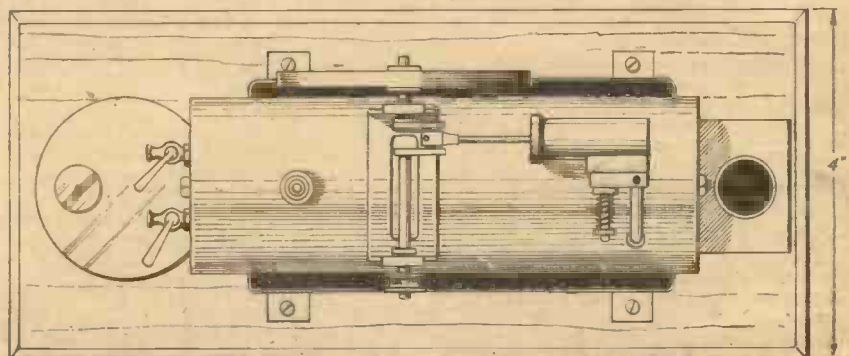

Fig. 2.—A top view of the engine.

The guide to endless pleasure

Here's the fullest guide yet to greater pleasure and interest for the Model Railway enthusiast. . . . In the systems offered in this New Gauge "O" and "OO" Catalogue, prepared train sets are now available in a variety of types: electric, steam or clockwork, passenger or goods. All the most popular classes of models may now be obtained in a wider range of types and prices than ever before.

Do you know what exciting prospects there are for owners of the Gauge "O" and other Model Railways? If you possibly can, pay a visit to Bassett-Lowke's London Display Showrooms where all the latest models and layouts are freely demonstrated for you.

SIGNALS

Signals, single and double arm, complete with ladders and red and green spectacles. Prices from: Bracket signal, 17/6. Single arm, 8/-. Two-arm signal, 11/6.

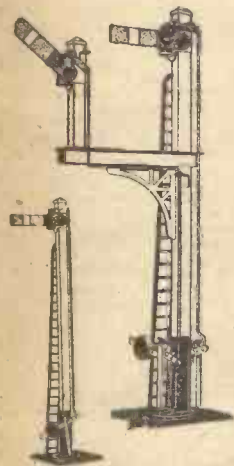

THE B.R. (L.M.R.) 4-4-0 COMPOUND



This is the model chosen by the B.B.C. for their television programme. Clockwork No. 3302/0, £7.17.6. Electric No. 5302/0, £8.18.0.

BASSETT-LOWKE LTD.

Head Office and Works : **NORTHAMPTON**

London Showrooms : 112, High Holborn, W.C.2. Manchester Showrooms : 28, Corporation St., 4

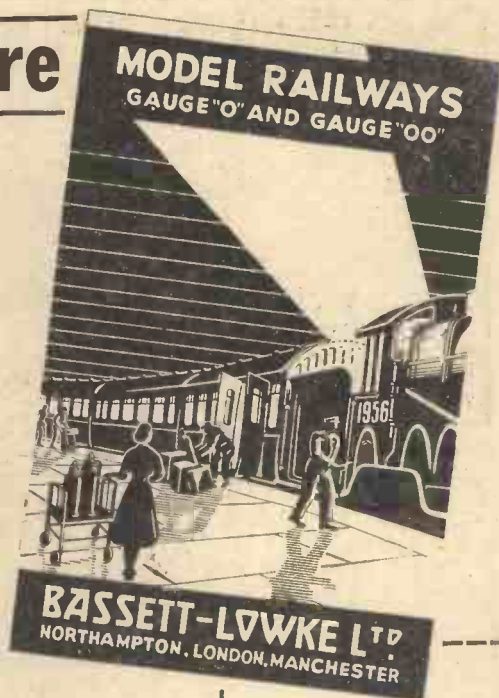

WRITE TODAY

Write now to Dept. MR/12 for this 100-page fully illustrated Catalogue. Price 2/-. The most comprehensive ever issued by BASSETT-LOWKE. Its exciting suggestions include details of Gauge "O" and "OO" Railways.



IT'S FAR QUICKER WITH RAWLPLUGS!



FASTEST EVER MASONRY DRILLING

Even when you've tried a Durium-tipped Masonry Drill you'll find it hard to believe that brick, stone and tile can be drilled with such speed and ease! You can use Durium-tipped Drills in a hand brace or electric drill. Sizes from 5/32" to 1" diameter.

There is nothing just as good; look for the name DURIUM on the shank.



RAWLPLUG

DURIUM-tipped DRILLS FROM YOUR IRONMONGER OR HARDWARE DEALER

WHEN YOU'RE FIXING SCREWS in brick, tiles, stone, etc., the world famous Rawlplug is still far and away the quickest way. Quickest and the easiest, and the safest way too! Get a Rawlplug Outfit for your toolkit. It contains all you need—Rawlplugs, Rawltool, screws and 16-page 'Hints on Fixing'.

Popular Outfit 2/6d: larger sizes 6/- and 9/6d.

THE ULTRA LENS AIDS PRODUCTION

This unequalled electric magnifier is of the most modern design and has proved its extreme and sustained usefulness to countless industrial firms engaged on minute examination of every conceivable object.

The ULTRA LENS is used extensively in collieries, foundries, electricity works, tool shops, forges, motor works, and practically every branch of the engineering trade. TELEVISION engineers need it to examine INTERLACING of picture.



Whether you are manufacturing, buying or selling, there are occasions when you have to submit some objects to a very close scrutiny. At these times the ULTRA LENS becomes indispensable.

Triple lenses ensure distortion-free, magnification and eliminate the necessity for adjustment of focus. The focus is always perfect.

The ULTRA LENS achieves a six-fold magnification in a brilliantly-lit field which is shadowless.

Write today for full particulars and price list to

THE ULTRA LENS COMPANY

Tel.: TRAFalgar 2055
17c, Oxendon Street, London, S.W.1.

NEW! EXPERIMENT DATA SHEETS

We have pleasure in presenting our latest range of "EXPERIMENT DATA SHEETS." Each Sheet gives complete instructions for a series of experiments, suitable for students and beginners.

E.D.S./1. The Home Laboratory	(3 Sheets)	PRICE 6d.
E.D.S./2. Home Made Apparatus	(2 Sheets)	PRICE 5d.
E.D.S./3. Carbon Dioxide	(1 Sheet)	PRICE 4d.
E.D.S./4. Oxygen & Oxides	(2 Sheets)	PRICE 5d.
E.D.S./5. Elements, etc.	(2 Sheets)	PRICE 5d.
E.D.S./6. Ammonia, etc.	(2 Sheets)	PRICE 5d.
Complete Set of all Six Sheets		PRICE 2/3d.

All post free.

ALSO OUR LATEST ILLUSTRATED CATALOGUE OF SCIENTIFIC APPARATUS AND CHEMICALS SUITABLE FOR ALL EXPERIMENTERS. SEND 2½d. STAMP TO:

A.D.P. CHEMICALS & APPARATUS
50 (D/PM) SUFFOLK ROAD, BARKING, ESSEX



SCIENTIFIC STUDENTS, KEEN PHOTOGRAPHERS &

anyone needing a good reliable Balance at a really

REASONABLE PRICE

should secure a "COURIER" Precision Balance Outfit (Pat. App. for) with which to build for themselves this Balance from genuine commercial balance parts, including real AGATE bearings, steel knives, brass pans and fittings.

Capacity: 100 grm. Sensitivity: 10 mgrm.

These outfits are designed and produced by Balance specialists. Complete, with full instructions and blueprint. From your usual supplier or direct.

WILLIAM A. WEBB LTD. (DEPT. C)

1-9, Perrymans Farm Road, ILFORD, ESSEX, ENG.

Price **47/6**

(UK postage 1/-)

90,000 PIANISTS

have learned to play the piano beautifully with the aid of my POSTAL lessons. Everything is so clearly explained that, even if you do not know a note, you will, with only half an hour's practice each day, become a proficient pianist in 9-12 months. Ordinary music: no freakish methods. My class is seldom less than 2,000 pupils. I have taught over 89,935 and I CAN TEACH YOU. Free Book and advice. Say if Beginner, Mod. or Adv.

Mr. H. BECKER,
158, The Hall,
Centurion Road,
Brighton, Sussex.

AUTOMATIC (TIME) SWITCHES

New and reconditioned 15 day clock-work and electric switches

from **35/-**

Send S.A.E. for illustrated details to:-

DONOHUE (TIMERS)
GEORGE STREET, NORTH SHIELDS,
NORTHUMBERLAND

MAKE MONEY — making casts with VINAMOLD

A grand spare-time occupation

WITHOUT any previous experience you can mass-produce any object, from a chessman to a candlestick, statuette or model ship, in plaster, resin, concrete, etc., with "VINAMOLD" the flexible mould that gives the BEST results. Easy to work, can be used over and over again. Needs NO special equipment, provides a profitable and enjoyable spare-time occupation with minimum outlay.

Write for full details and instructions. Also available: Illustrated booklet describing "VINAMOLD," methods of heating and melting, preparation of models and moulds, etc. Price 1/6 post free, from:-

VINATEX LTD. (Dept. P.M.3), CARSHALTON, SURREY



INSTRUMENT TRANSFORMERS

A selection of General Purpose and Radio Transformers, of high-class manufacture, vacuum impregnated and conservatively rated. Available from radio and electrical component stockists, or in cases of difficulty direct.

Please quote reference Numbers. each

M.1.—250 0 250 80 m a 6.3 v. 3 a. 5 v. 2 a.	23/6
M.2.—350 0 350 80 m a 6.3 v. 3 a. 5 v. 2 a.	25/-
M.3.—Model Makers 0-30 v. 2 a. Practically any intermediate voltages obtainable	22/6
M.3.A.—As M.3 but 4 amp. output	45/-
M.4.—Auto-wound voltage changing type 110-200-230-250 v. 150 watts...	22/6
M.5.—Battery Charger type 4 amps output	22/6
M.5.A.—As M.5 but 1.75 amps output	15/-
M.5.B.—As M.5 but 2.5 amps output	18/6
M.6.—As M.1 but 100 m/a	29/6
M.7.—As M.2 but 100 m/a	32/6
M.8.—As M.7 but 120 m/a	38/6

All above types open mounting, but available half-shrouded and totally enclosed.

Mullard-Osram Amplifier mains transformer, totally enclosed ... 45/-

DOUGLAS ELECTRONIC IND., LTD.,
BRINKLOW, RUGBY.

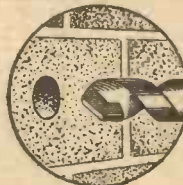

TUNGSTEN CARBIDE TIPPED TOOLS

PLUGGING DRILLS
For clean round holes in brick, concrete, tiles, marble, etc., for all fixing jobs with Maso Plugs.

GLAZEMASTER
For drilling windows, mirrors, glasses, bottles, plate glass, shelves, etc.

Write for Booklet P.M. Obtainable from your Tool Stockist and Ironmonger.

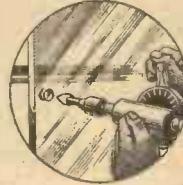

MASON MASTER

The Tradesman's Choice

Manufactured by

JOHN M. PERKINS & SMITH, LTD., BRAUNSTON, NR. RUGBY

GENUINE THREE QUARTER LENGTH DESPATCH RIDERS JACKETS 13/11
POST ETC 1/9

EX-GOVERNMENT, NEW 'TEDDY BEAR' ANTI-BLIZZARD WOVEN 39/11
POST ETC 2/11



Brand New Genuine Government Service Stocks 5,000 only, Don R 100% Water and Wind proof ¾ length Jackets. How well thousands of motor cyclists and ex-service men know this garment. A Hard Wearing double textured proofed woven material. The Real Thing. Price 36 to 40 only 13/11, post 1/9. 42 to 44 5/- extra. LISTS, CLOTHING, ETC. TERMS.

ALL WOOL TO FABRIC BASE SLIP OVER COATS
Full Length. Worn as over-garment. A special offer of these fine Garments, popular light fawn shade. The perfect insulation against the Bitterest Blizzard as experienced during the Arctic convoys to Russia when, below zero, frostbite had to be avoided at all costs. Warm as toast to a sleepy comfortable degree. Long sleeves. Never again will you feel the cold. Suitable for Men or Women. Give Chest or Bust Measurement. Only 39 11, post etc. 2.1. Lists. Clothing Terms

HEADQUARTER and GENERAL SUPPLIES LTD.

(DEPT. PMC/5) 196/200, COLDHARBOUR LANE, LOUGHBOROUGH JUNCTION, LONDON, S.E.5. Open all Saturday. 1 p.m. Wednesday.

DOUBLE "M" BEATS THEM ALL

AMAZINGLY POWERFUL ELECTRIC MOTORS

"MiniMo" 3 to 6	— D.C. VOLTS —	"MaxMo" 3 to 9
1 to 3	— AMPS —	15 to 75
4/5000	— SPEED —	4/5000
1 1/2" x 1 1/2"	— SIZE —	1 1/2" x 1 1/2"
1 1/2 oz.	— WEIGHT —	1 1/2 oz.

Boat Propeller 1" dia. } DRIVES { Boat Propeller 1 1/2" dia.
Aeroplane Propeller 5" } } DRIVES { Aeroplane Propeller 8"

PRICE 9/- MAIL ORDER Post Paid 13/-
6d. Spare Brushes 1/6, plus post per pair (Silver Tipped)

ETNA PRODUCTS LTD., Dept. P.M.
"Highland," Alvington Green, Middleton, Manchester

MONEY FOR YOUR WASTE

Mercury, Scrap gold, silver, aircraft plugs and all precious metals. Highest prices paid. Prompt payment. Details free.

WILTON TRADING CO.

(Dept. P.M.)
9 Melling Road, Southport.
Phone: Southport 3123.

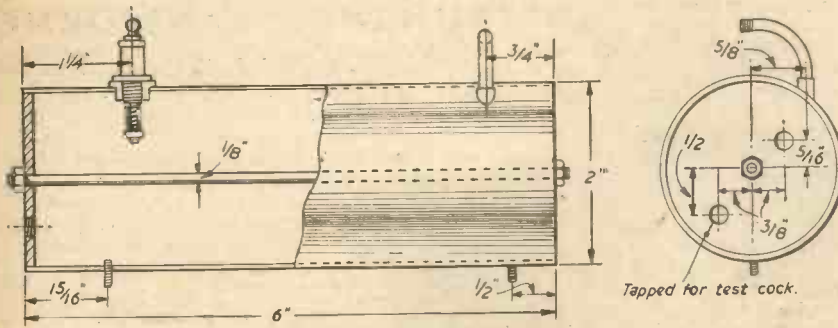

Fig. 3.—How the boiler is made.

chimney support (Fig. 6) in place from inside the firebox, mark the position of the eight rivet holes in the firebox front and rivet in position. The base of the chimney can be neatly soldered in the hole in the chimney support.

parts to shape with a half-round file and then drill and file out the rectangular hole in the middle. Now bend the bracket to shape so that it fits on the boiler shell nicely and the turned-up ends are quite parallel with each

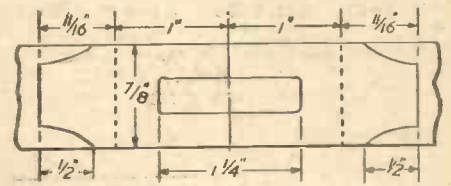

Fig. 7.—The bearing bracket marked out and bent to shape.

other. The bracket can now be soldered in position on top of the boiler after making sure that the turned-up ends are quite vertical when the boiler is placed in position on the firebox.

(To be concluded)

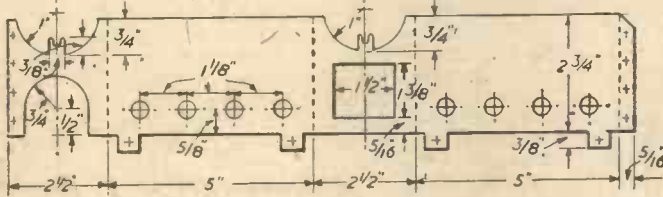

Fig. 4 (Left).—How to mark out the firebox.

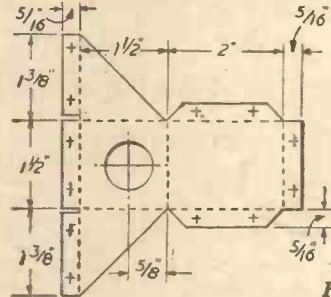

Fig. 5 (Right).—Details of the chimney supports.

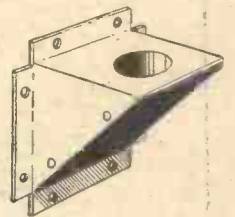
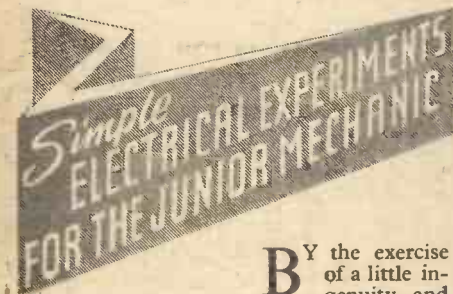

Fig. 6.—Chimney support assembly.

Bearing Bracket

This can be marked out on the piece of 7/16 in. wide strip brass to the dimensions given in Fig. 7. After chipping away the four corners with a hammer and chisel, file the curved



Apparatus from Electric Bells

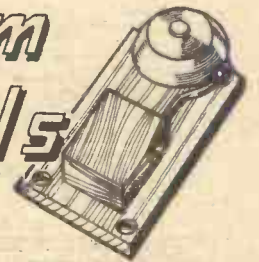

BY the exercise of a little ingenuity and patience a variety of interesting pieces of electrical apparatus may be constructed from old electric bells. The following are readily made, and represent but a few of the uses to which old bells and parts of bells may be put.

unscrewing it at its point of attachment to the bracket of the frame, and with a hacksaw cut off the hammer as shown in Fig. 1. Replace the armature in position, connect up with a battery, and adjust the contact screw until a pleasant note is obtained.

into a buzzer by the method already described. A waxed paper and tinfoil condenser is now to be constructed. The capacity is not critical. Select a few sheets of thin quality paper free from pinholes (a thin typewriter paper serves quite well), and out of it cut twenty strips 2 1/2 in. by 1 1/4 in. Soak these strips in hot, melted

The removal of the hammer lightens the armature and enables it to vibrate at a higher frequency, with the consequent production of a pleasing tone.

A Shocking Coil

As all students of electricity are aware, on breaking a circuit containing an electromagnet the voltage surge due to self induction is high enough to cause a spark. In the case of an electric bell the spark takes place between the contact screw and the armature, causing a loss in efficiency on account of indefinite make-and-break. It is this high voltage surge which is employed in order to obtain electrical shocks.

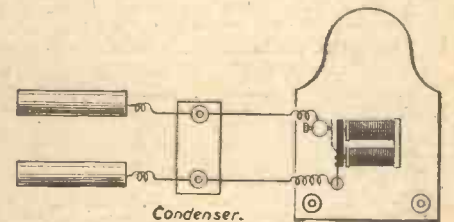

Fig. 3.—Layout of the shocking coil.

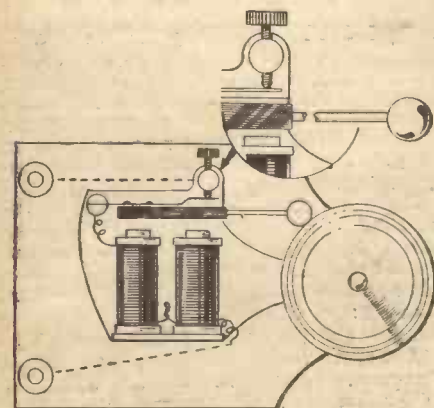

Fig. 1.—Converting an electric bell into a buzzer.

A Buzzer

The buzzer is a convenient substitute for the electric bell in cases where the large amount of noise produced by the latter would be objectionable.

To convert an old electric bell into a buzzer is a simple matter. Remove the armature by

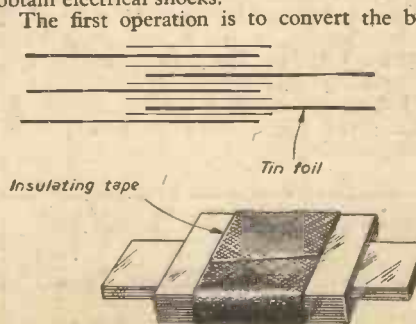

Fig. 2.—Details of the condenser.

paraffin wax for a few minutes, then remove and allow to drain and cool. Cut out of tinfoil nineteen strips 2 1/2 in. by 1 in. and by alternately laying tinfoil and paper build up the condenser, as shown in Fig. 2, so that nine strips of tinfoil project on one side and ten on the other, the length of the projecting portion in each case being 3/4 in. Now apply a hot flatiron to the pile, thus melting the wax on the paper and causing the sheets to adhere closely. Allow to cool under a weight, after which the condenser should hang together and stand fairly rough handling. As an additional precaution it is advisable to bind it with adhesive tape after which the projecting

strips of tinfoil may be soldered together and to a wire, using an iron just hot enough to melt the solder. The strips on the opposite side are treated similarly. A resin flux is suitable. The condenser may be used as it stands, but it is preferable to protect it from harm by placing it in a small box fitted with

and contact screw, the handles being in parallel.

If the bell is now operated by a battery quite powerful shocks may be felt on holding a handle in each hand. The strength of the shock may be controlled to some extent by adjustment of the contact screw.

work of a few minutes. Remove the hammer as in making a buzzer and break the wire connecting one terminal of the bell with the contact pillar. Connect this terminal with the armature pillar, and remove the contact adjusting screw. On connecting the "bell" now to a battery the armature will be drawn to the magnets with a "click," springing away again when the circuit is broken. If a morse key is introduced into the circuit the familiar dots and dashes will be reproduced by the sounder when the key is operated.

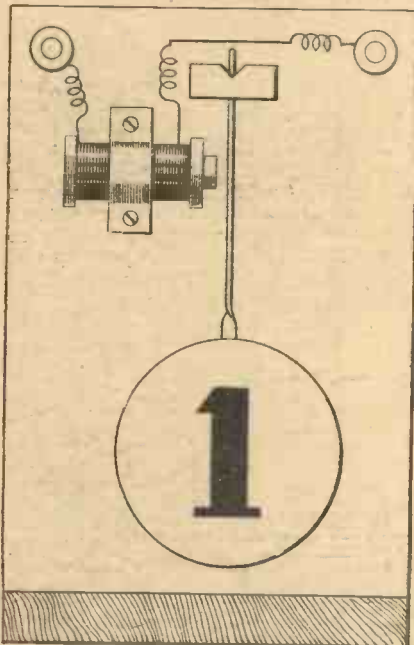

Fig. 4.—An electric indicator easily made from an old bell.

two terminals to which are attached the leads from the tinfoil strips.

Bend two thin sheets of tinfoil around a broom handle and solder the joints, and also solder a length of "flex" to each. These two cylinders constitute the shocking-coil handles. Connect the framework of the bell or armature pillar to one terminal of the condenser and to a coil handle. The remaining handle is connected to the other terminal of the condenser and the bracket supporting the contact screw of the bell. The layout is shown in Fig. 3. The condenser is across the armature

An Electric Indicator

To make an electric indicator an old bell is completely dismantled, the solenoids only being of use, and as one is needed for an indicator two indicators may be made from one bell. The diagram (Fig. 4) is self explanatory, and it is evident that there are numerous modifications possible in the method of construction. The action of the instrument is quite simple. Passage of current through the coil causes the tinplate armature carrying the flag to be attracted towards the magnet. On the circuit again being broken the indicator continues to swing for some little time until it comes to rest under the influence of gravity. Several indicators are generally used with as many push switches and an electric bell. Each switch operates the bell and a certain indicator, thus the source of the ring is shown by the movement of the flag. The indicator consists of a baseboard with a wooden upright which carries the solenoid and working part. The solenoid is screwed to an upright on the bracket in a horizontal position. The armature is a T-shaped piece of tinplate tapered to its lower extremity which carries a cardboard flag in order to reduce weight. The two arms of the T rest in V-shaped notches cut in a bent brass strip screwed to the wooden upright (see Fig. 5). The diagram (Fig. 6) shows the circuit employed when the two indicators are in use along with two bell pushes and one bell. On similar lines a whole battery of indicators may be wired up, each being operated from a different push.



An Electric Telegraph

The conversion of an electric bell into a morse sounder is the

Fig. 5 (Left).—How the armature is made.

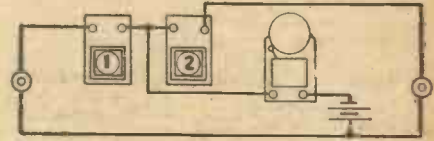

Fig. 6.—The circuit employed when two indicators are in use.

A simple type of key is shown in Fig. 7. It consists of a wooden base, to which is screwed a 4in. by 3/8in. strip of springy brass bent as shown. The free end of the brass is fitted with a knob, which when pressed down causes the strip to make contact with a stud in the baseboard. Two terminals are fitted to the key;

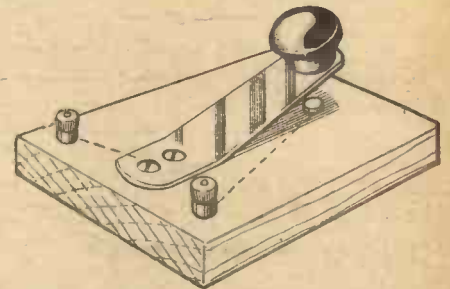

Fig. 7.—A simple type of morse key.

one is connected to the stud, the other to the brass strip. Much amusement is to be obtained by having the sounder and the key in different rooms and transmitting messages from one to the other.

With practice the beginner will acquire proficiency in the sending and deciphering of morse messages.

Making a Hectograph Pad and Ink

Do Your Own Duplicating Without Expensive Apparatus

THE formulae and instructions below are given in response to the many requests for them which we receive from our younger readers.

The Pad

Water	12	ozs.
Dextrin	1 1/2	"
Sugar	2	"
Glycerine	15	"
Gelatine	15	"
Zinc Oxide	1 1/2	"

The Ink

Methyl violet	10	parts.
Nigrosin	20	"
Glycerine	30	"
Gum Arabic	5	"
Alcohol	60	"

Make a "pad" mixture and pour this into a flat-bottomed metal tray, such as a biscuit tin lid. It will set on cooling, giving a perfectly flat, smooth surface.

Now take a piece of paper, write the matter to be duplicated on this, using for the purpose the special ink. When the ink is dry invert

the paper and press downwards on the hectograph surface and then strip off. The ink impression will be left on the gelatine surface. Finally, take a clean sheet of paper, press it down on the hectograph surface and then remove it. It will have duplicated on it the original written matter. Up to fifty copies can be obtained in this manner.

An alternative formula for the pad, which may be tried, is as follows:

Glue	...	100	parts (by weight).
Glycerine	...	500	" " "
China clay or whitening	...	25	" " "
Water	...	375	" " "

Soak the glue in the water overnight, during which period it will swell up. Then

add the gelatine and heat the liquid gently until the glue has dissolved. Add the China clay. Stir well and squeeze through fine-mesh cloth into shallow trays in which the mass will set and then be ready for duplicating.

The mixture of China clay or whiting is not absolutely essential, but it is advisable, since it gives capacity and additional firmness to the hectograph composition.

For an alternative hectograph ink, mix the following:

Methyl violet	...	2	parts (by weight).
Methylated spirit	...	2	" " "
Sugar	...	1	" " "
Glycerine	...	4	" " "
Water	...	20	" " "

Any other dye can be substituted for methyl violet.

The hectograph and ink formulae given above are not the only possible ones. There are many others which may be used and some further alternatives will no doubt be found in any good standard volume of recipes and formulae. The local reference library usually keeps at least one book of this type.

WATCHES ADJUSTMENT AND REPAIR

By F. J. CAMM

6th Edition

6/- or 6/6 by post

NEW! THE PRACTICAL WAY of learning RADIO • TELEVISION • ELECTRONICS

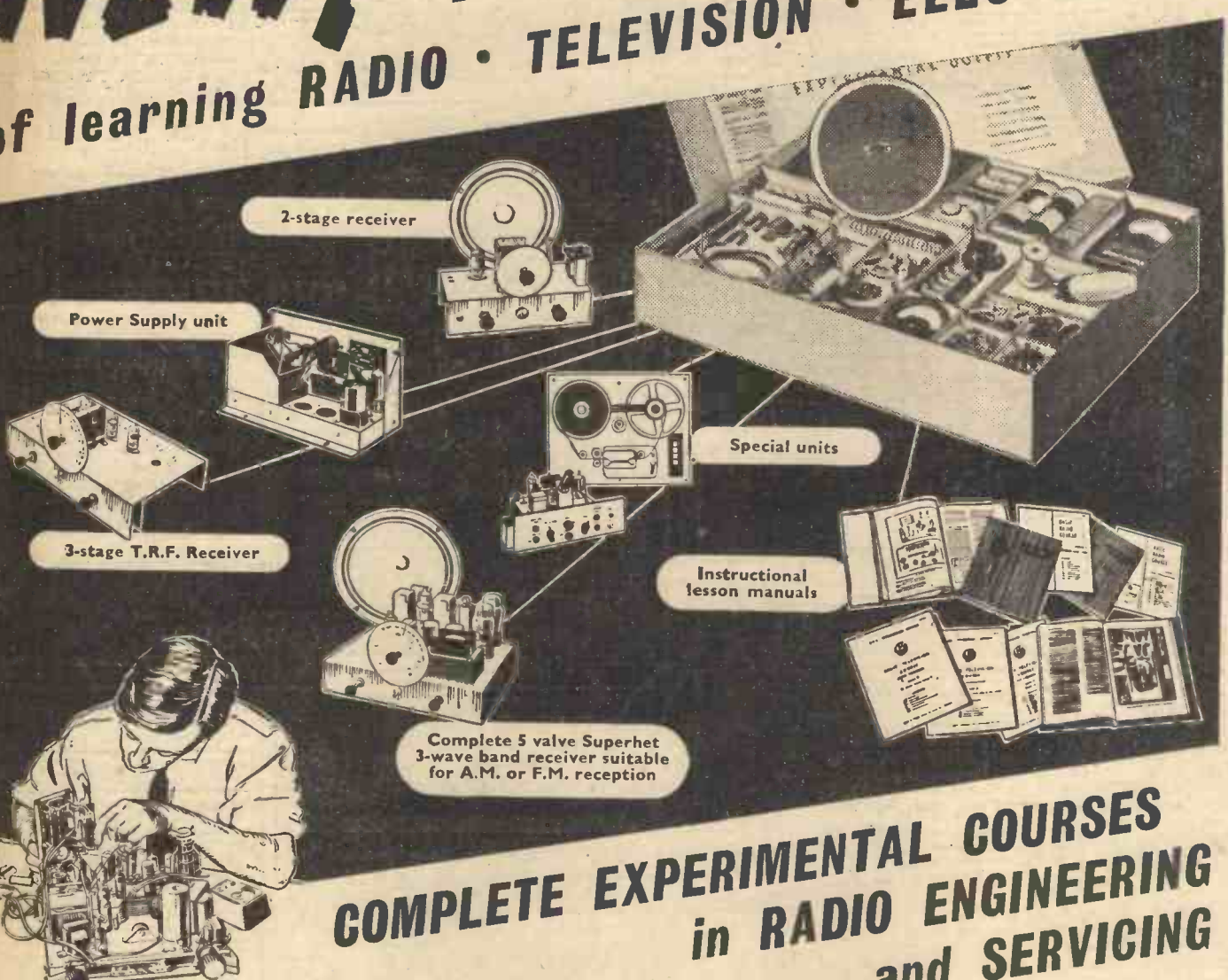

COMPLETE EXPERIMENTAL COURSES in RADIO ENGINEERING and SERVICING

An entirely new series of courses designed to teach Radio, Television and Electronics more quickly and thoroughly than any other method. Specially prepared sets of radio parts are supplied and with these we teach you, in your own home, the working of fundamental electronic circuits and bring you easily to the point when you can construct and service radio receivers, etc.

Whether you are a student for an examination; starting a new hobby; intent upon a career in industry; or running your own business — these Practical Courses are ideal and may be yours at very moderate cost.

With these outfits, which you receive upon enrolment and which remain your property, you are instructed how to build basic Electronic Circuits (Amplifiers, Oscillators, Power Units, etc.) leading to design, testing and servicing of complete Radio and Television Receivers.

NEW TELEVISION COURSE including a complete set of equipment dealing with the design, construction and servicing of a high quality television receiver.

Courses (with equipment) also available in many other engineering subjects.

COURSES FROM 15/- PER MONTH

EMI INSTITUTES

An educational organisation serving the E.M.I. Group of Companies which include "HIS MASTER'S VOICE," MARCONIPHONE, COLUMBIA, ETC.

FILL IN COUPON FOR **FREE** PROSPECTUS



To E.M.I. INSTITUTES
 Dept. 144X, Grove Park Road, London, W.4.
 Please send me your FREE book on Practical Courses.
 Subject(s) of Interest
 NAME
 ADDRESS
 FEBRUARY/56 IC.68A

HALFORDS

BOX SPANNERS



Double-ended Renshaw set. Sizes $\frac{3}{8}$ " x 5/16", 3/16" x $\frac{1}{4}$ ", $\frac{1}{2}$ " hexagon x 9/32", square, per set ... 3/6
Apollo box spanner set with combined screwdriver, bit and tommy bar. Sizes as above, per set ... 4/10

ENGINEERS' SPANNERS



Double ended. Drop forged, standard finish. Polished and hardened jaws. $\frac{1}{2}$ " x 3/16", 1/6. 3/16" x $\frac{1}{4}$ ", 1/8. $\frac{1}{2}$ " x 5/16", 1/10. 5/16" x $\frac{1}{4}$ ", 2/2. $\frac{1}{2}$ " x 7/16", 2/8. 7/16" x $\frac{1}{4}$ ", 3/-.

RING SPANNERS

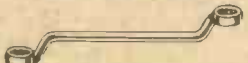

Eagle Brand. Double ended. Chrome vanadium. $\frac{1}{2}$ " x 3/16", 5/3. 3/16" x $\frac{1}{4}$ ", 5/10. $\frac{1}{2}$ " x 5/16", 6/6. 5/16" x $\frac{1}{4}$ ", 7/8. $\frac{1}{2}$ " x 7/16", 9/- . 7/16" x $\frac{1}{4}$ ", 10/3. Others from 6/2. Sets from 23/-.

TURN SCREWS



Cabinet Pattern: $\frac{1}{8}$ ", 1/7. 3", 1/11. 4", 2/1. 6", 2/8. 8", 3/5.

FILES



Bastard Cut: 6" Round, 2/- . 6" Flat, 2/- . 6" Half-round, 2/3. 6" Three Square, 2/5. Smooth Cut: 6" Round, 2/5. 6" Flat, 2/5. 6" Half Round, 2/8. Three Square, 3/1. 8" from 2/11.

SOCKET SPANNERS



Set of 7 sizes, 0-6 B.A. ... 4/3
Set of 7 sizes, $\frac{1}{8}$ " to $\frac{1}{2}$ " and 4 B.A. ... 5/3
Popular sets of 6 sizes, 3/10" x $\frac{1}{8}$ ", in case ... 6/9

PLIERS



Combination Pliers, 6", 6/3. 7", 6/6.
Combination Pliers, insulated handles, 6", 8/3. 7", 8/9.
Snipe Nose Pliers, 5 $\frac{1}{2}$ " ... 5/3
Radio Pattern, 5 $\frac{1}{2}$ " with side cutter ... 6/-
As above, but insulated 7/3

ADJUSTABLE SPANNERS



Billings type, 7", 4/5. 11", 8/3. K.D. Pattern, 6", 7/6.

DOUBLE-ENDED SPANNER SETS



"Super Slim." All black finish. Set of 6 sizes, $\frac{1}{8}$ " x 3/16" to 7/16" x $\frac{1}{2}$ " Whitworth, 13/9. Others from 13/2 to 36/6.

FITS THIS PATTERN SCREWHEAD



For Phillips Headed Screws: Plastic Handle, 3" x 3/16" Blade, 3/- . Or 4 $\frac{1}{2}$ " x $\frac{1}{8}$ " Blade, 4/9.

CALIPER GAUGES

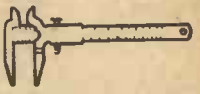

Ezered inside and outside, calibrated 1/32, 1/16 and $\frac{1}{8}$ " and millimetres, 3/9. Duplex pincer pattern, not calibrated, for inside and outside measurements, M.5651, 3/9.

DRILLS



Clipper Hand Drill, for sizes up to $\frac{1}{2}$ ", 12/6.

STILLSON TYPE



Stillson type, Blackbird, 8", 10/6. 10", 13/2. 14", 17/3.

The shop for TOOLS

228 BRANCHES THROUGHOUT ENGLAND, SCOTLAND AND WALES

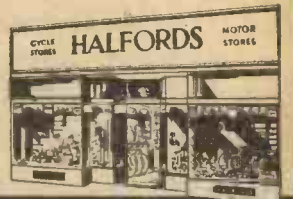

THE LESDIX LATEST CRYSTAL SET



Black or brown Bakelite case fitted with tapped aerial coil fitted wound, for long or short aerial, germanium diode variable condenser, transformer, plugs and sockets for aerial and earth connections, double headphones with headband cord and plug. All aerial tested, 30/-, post 2/6 write for leaflet.

TERRY ANGLEPOISE LAMPS for drawing boards or workshop; wall or machine fixing, stay in any position, S.B.C. lampholder and shade, resistance and 2-pin plug and cord. 35/-, post 2/6.

SEWING MACHINE MOTORS. 230 volts A.C. Radio and television suppressed. With fixing bracket, foot switch and needle-rite, suitable for any ordinary domestic sewing machine. Brand new and guaranteed. £7.5, post 3/6.

D.C. MOTORS. 50 volts shunt 6 H.P. by Small Electric Motors 1,500 r.p.m. brand new surplus, cost £79 ea. Offered at £50 carr. extra. Exide Traction Batteries, brand new. Write for full particulars.

SLOTTED ANGLE 14 gauge mild steel, 4in. wide in 10ft. lengths formed to 90 degree angle 3in. x 1 $\frac{1}{2}$ in. double slotting on 3in. side gives instant boltability. 1/5 per foot for 10ft. lengths, 1/7 per foot cut to shorter lengths. Carriage extra. Write for leaflet.



SMALL MOTORS for Models, etc. 3 $\frac{1}{2}$ in. x 2 $\frac{1}{2}$ in. x 2in. laminated fields, work on 6-12-24 volts D.C. or 12-24 volts A.C. through Transformer. 21/-, post 1/-.

ELECTRADIX RADIOS

Dept. H,
214, Queenstown Road, London, S.W.8
Telephone: MACaulay 2159

THE NEW

PATHFINDER



- Increased Output
- Push-Push Switch
- Hinged Front
- Pre-focus Bulb
- Meets All Regulations

Silver Finish 39/6
Chromium Plated 45/-

LUCAS "King of the Road"

CYCLE DYNAMO SETS

JOSEPH LUCAS (CYCLE ACCESSORIES) LTD • CHESTER STREET • BIRMINGHAM 6

100 yds. Fine Braided Copper Wire wound on fishing rod type reel 3 $\frac{1}{2}$ in. x 1 $\frac{1}{2}$ in. 6/6.

New Frequency Crystals, 10/6, List sent on request. 2.3-19.8 Mcs.

For Model Control—12 v. D.C. Geared Motor. With 4-Relays operating independent Clutches and Speeds. Takes 75 mA current. Overall size 4in. x 3 $\frac{1}{2}$ in. x 3in. Weight 28 ozs. 17/6.

Meter Kit, 2 $\frac{1}{2}$ in. M/c calibrated meter. Volts 0-3-30-150-300-600 D.C. 0-60 m/a. and 0-5,000 ohms with ebonite case 4in. x 6in. x 1 $\frac{1}{2}$ in., 27/6.

Transformers, Input 200/240 v. Sec. tapped 3-4-5-6-8-9-10-12-15-18-20-24-30 volts at 2 amps., 22/- . 17-11-5 volts at 5 amps., 22/9. 17-11-5 volts at 1 $\frac{1}{2}$ amps., 16/9. 6.3 volts, 2 amps., 8/6. 12 months' guarantee.

Selenium Rectifiers F.W. 12-6 volt, 300 mA 4/- . 1 A., 8/6. 3 A., 14/9. 4 A., 23/6. 6 A., 30/- . 16 A., 52/9. 24v. 3A. 43/- . 250 v. 100 mA H. W., 9/- . 250 mA., 17/6.

Miniature 12 or 6 v. Relays, 10 amp. Silver Contacts. SM, DM or SM and B, SCO, 8/6.

M/c Microphones with matched transformer, 15/9.

Small Motors. 12 v. A.C. D.C., 2in. x 1 $\frac{1}{2}$ in., 10/-.

Carbon Twist Drills. Sets of 9— $\frac{1}{8}$ in. to $\frac{1}{4}$ in. or 7— $\frac{1}{8}$ in. to $\frac{1}{4}$ in., 3/6.

12 v. D.C. Relays. S.P. D.C. 25 amp., 8/6.

Rheostats, 12 v. 1 A., 2/6. 12 v. 5 A., 10/6.

New 6 v. Oak Vibrators. 4 Pin, 8/9.

Fishing Rod Aerials. Sets of 3, 7/6. Sets of 2, 5/-, plus 1/6 Rail Charge.

All Carriage Paid in U.K.

THE RADIO & ELECTRICAL MART
309, Harrow Rd., Wembley, Middx.
Nr. The Triangle.
Telephone: WEMbley 6655



VOL. XXIV

FEBRUARY, 1956

No. 405

All letters should be addressed to the Editor, "THE CYCLIST," George Newnes, Ltd., Tower House, Southampton Street, Strand, London, W.C.2

Phone: Temple Bar 4363
Telegrams: Newnes, Rand, London

WHAT I THINK

By F. J. C.

Unnecessary Prosecutions

I MUST say that I was considerably surprised to find amongst the press cuttings dealing with cycling prosecutions a report of a cyclist who was convicted for riding a pedal cycle recklessly and causing it to collide with a pedestrian, both cyclist and pedestrian sustaining injuries. It is perhaps significant that the very first pedal cyclist, Kirkpatrick Macmillan, was fined 5s. in 1842 at Gorbals, on his first long-distance ride. It was at five-thirty in the evening, and according to records it was not Macmillan's fault. Information had travelled ahead of him that a "devil on wheels" was arriving, and a dense throng awaited him. In order to avoid them, he veered his mount round to ride along the pavement, when a five-year-old girl ran out from the crowd and Macmillan slightly grazed her leg. A number of constables arrived to catch the criminal, who was seized by these minions of the law, and took his machine into custody whilst he was led off to the nearest police station, where he was charged with obstruction of the Queen's Highway. His machine was placed under lock and key, whilst he was left in a cell. The police would not listen to his entreaties, and it was some hours later before he was bailed out. The following morning he was charged that, on June 7th, 1842, he rode along the pavement on a velocipede in the Barony of Gorbals to the obstruction of the passage and with having, by so doing, thrown over a child.

The magistrate found it difficult to believe that he had travelled from Old Cumnock, a distance of 40 miles, in five hours.

Said the magistrate: "I can't believe it. Eight miles an hour, and you say that he actually rode the machine under his own power! This modern craving for speed is something to be deplored, I must say. A man riding a machine of two wheels and making progress without having to touch the ground, I just can't believe it." He inspected the machine and then said to Macmillan: "But, my good man, you must know as well as I do that we can't have things like this going on. Eight miles an hour! Why, that's simply not done. It's indecent." Almost prophetically, he went on to say that "justice must be done, and that "we cannot have speedsters of this kind on the roads of Britain, you know. The highways of the country will soon not be safe to travel on. I fine you the sum of 5s., and don't let it happen again!"

The case to which I referred in my opening paragraph was also held in Scotland, where they have laws all unto themselves, and take trifling matters with supercilious seriousness. As in England, so in Scotland. There are those police who think that the donning of a blue uniform endows them with a mantle of great forensic knowledge. The fact is that a policeman is not a lawyer—indeed, few of them know anything about the law. They recite paragraphs from the Acts, and seem delightfully unaware, as indeed are many magistrates, of High Court decisions relating to those paragraphs. In courts of summary jurisdiction, magistrates as well as the police rely upon the ignorance of the public in securing wrongful convictions.

The cyclist in question appealed against his



The Manifold Valley, Staffs. A lovely view from the rocks on Wetton hill looking out over the valley towards Thor's Cave. The impressive entrance to this unique chasm is 30ft. high and nearly 20 ft. wide.

conviction and succeeded because, in the words of Lord Clyde who heard the appeal, "As the law stands, the complaint would only be relevant if it libelled that degree of recklessness which constituted as crime at common law; that is to say, a recklessness so high as to involve an indifference to the consequences for the public generally. The degree of recklessness charged does not constitute a crime." And he rejected the argument advanced by the Crown. He went on to say that recklessness by a pedal cyclist followed by an injury to a pedestrian does not constitute a crime in Scotland, any more than recklessness in driving followed by death would constitute culpable homicide. Perhaps there are some cyclists who could wish that Scottish law applied also in England.

The Late Sir Arthur Du Cros

I REGRET to record the passing of my old friend, Sir Arthur Du Cros, the last surviving member of the famous family of athletes who founded the original Pneumatic Tyre Co., which later became the Dunlop Rubber Co. In was in 1889 that Sir Arthur, who was one of the six sons of William Harvey Du Cros, president of Irish Cyclists' Association, on a solid-tyre Humber, won the Irish five-mile championship. Later that year he won the very first races on pneumatic tyres at the Queen's College Court, Belfast. He wrote

(Concluded on page 14)



Kenneth Horne uses a characteristic gag in a happy moment at the Publisher's Publicity Circle Lunch in London on Monday, December 12th. He was there to present the Newnes silver trophy designed and made by Mr. F. J. Camm, to the first winning publisher. Others in the picture include, left to right, John Burt, editor "Smith's Trade Circular"; P. Hocking Baker, director G. Newnes Ltd.; C. Ramsay, Sales and Publicity Manager, G. Newnes, Ltd., and, almost concealed behind Mrs. Beatrice Ward, publicity manager of the Monotype Association, our editor, Mr. Camm himself. Next to Mrs. Ward, Mr. Van Thal, of Arthur Barker, Ltd. and on Mr. K. Horne's left, James Gordon, chairman of the Pub. Pub. Circle and Major Charles Cousland of W. S. Crawford, Ltd., famous advertising agents.

A Simple *but* Efficient Cycle Stand

A Firm Support for Cleaning, etc.

By H. A. ROBINSON

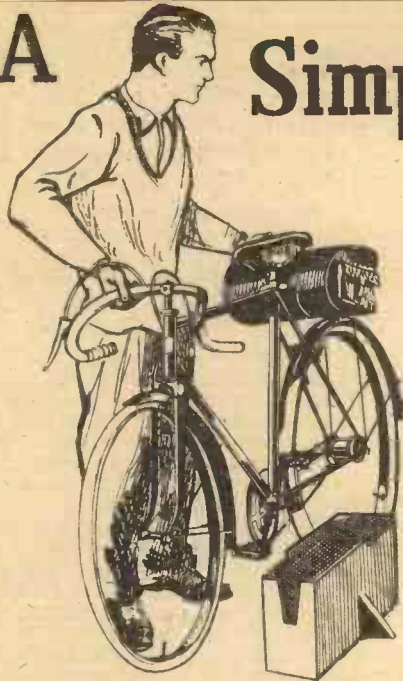

THE appearance of the device and how it supports the cycle may be seen in Figs. 1 and 4.

To make, first cut two ends and two sides to the dimensions shown in Fig. 2. The one end is just a rectangle 9in. x 11½in., the other is cut out as the lower diagram. Both sides are as the upper diagram and the base which will be required is a rectangle 16in. x 9in. To be sturdy, ½in. material is used for all these parts.

The opening (A) in the one end-piece is to take the back wheel. The lower edge of this opening will be about 8in. from the ground, but it will be as well to make a test with your own cycle. The main thing is that with the pedals in the slots the cycle should be quite horizontal.

The lower edge of the opening should be about 2½in. wide and bevelled towards the outside as shown to help in an easy fitting on of the wheel. A little way up on the chain side

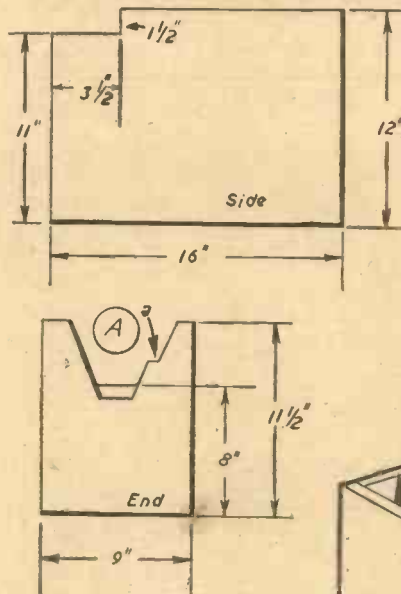

Fig. 2.—Details of the sides and ends.

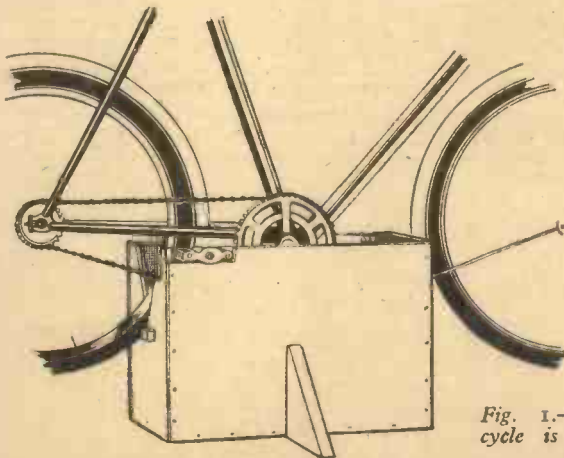

Fig. 1.—How the cycle is supported.

the wood is cut to form the step (a), this to give room for the chain.

Below the opening on the outside of the holder is the crosspiece (D in Fig. 3). This is 7in. x 2in. x 1in. and is held by four 1½in. wood screws. Its purpose is to strengthen the end and give a better bearing for the tyre.

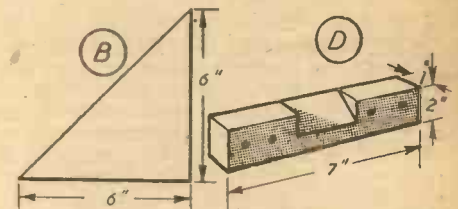

Fig. 3.—The triangular supports and crosspiece.

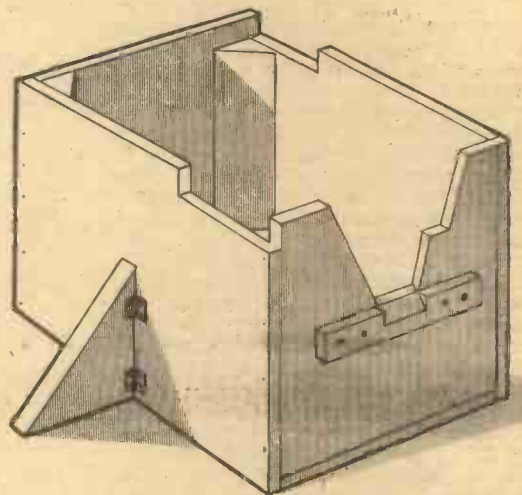

Fig. 4.—The completed stand.

Assembly

The base overlaps the ends and the sides overlap the ends and base. To make things more rigid still the holder is fitted with triangular corner strips (see Fig. 4).

To prevent any danger of the holder falling over with the cycle, two triangular supports (B in Fig. 3) are hinged to the sides. These are 6in. x 6in. and turn away when the holder is not in use.

WHAT I THINK

(Concluded from page 13.)

a fascinating volume, "The Romance of Wheels," the copyright in which I now own, together with all the blocks and illustrations. During the last 10 years of his life I collaborated with him very closely in a preparation of a monograph on the history of the Du Cros family.

He was convinced that Dunlop had not any prior knowledge of the Thomson tyre which had been marketed many decades before. When Dunlop was in Scotland he lived quite close to the inventor of the original tyre, who had actually marketed the tyre for the wheels of horse-drawn carriages. Announcements and advertisements of the tyre appeared in many journals. I have always held the view that it is practically impossible to believe that Dunlop did not have this in mind when he produced his first pneumatic tyre, not with the idea of inventing an epoch-making device

which was to benefit the whole of the world, but merely because his son Johnny found his solid-tyre tricycle harmful to his spine when he rode it over the stone setts of Dublin. Dunlop himself wrote a history of the pneumatic tyre, and in forming any opinion it must be read in conjunction with Du Cros's book, a copy of which was sent to every library in the world in the interests, as he said, of historical accuracy. He told me that it did not accept Dunlop's record of the early days, and personally I prefer to accept Sir Arthur Du Cros's record as representing the facts.

Motor-assisted Bicycles and Scooters

THE diehards are still of the opinion that the motorised bicycle will die and in its place will come a miniature motor-cycle. In other words, it will not be a pedal-assisted motor, for the pedals will vanish. Anyone capable of technical analysis of the exhibits at the recent Cycle and Motor Cycle Show cannot reach such a conclusion. The clip-on

in our view, is gaining in popularity and is here to stay—in spite of the wishful thinking of those with a C.T.C. outlook, who would like to see these nimble little machines die a natural death. It must be a source of great annoyance to the Cyclist Touring Club which, through its secretary, disowned them when they first came into use in any quantity just after the war. He described them as neither fish nor flesh, perhaps because he held the mistaken view that the C.T.C. could not take in as members riders of such machines. It would be the easiest possible matter for the C.T.C. to do so if it wished. No doubt, to-day, it wishes it had done so. It is too late now, however, for the movement has its own growing association. The statement was all the more surprising since the C.T.C. boasts of its legal department. Perhaps the C.T.C. would like to have second thoughts on the matter. If so, we should be glad to explain to its legal department how its memorandum and articles of association can be amended.

Johnson BATTERY PRINTER

With this new all-plastic Contact Printer you are independent of mains electricity supply. Two bulbs under an opal diffusing screen give even light for exposing, and a third bulb, controlled by a separate switch, is housed in the front compartment of the printer. This shines through the translucent body to provide a safelight for developing. The switches have luminous buttons. A heavy-duty battery housed within the body of the printer can be used to make hundreds of prints before becoming exhausted. Battery Printer, complete with three bulbs and set of three printing masks, **28/6.**



Battery (Ever Ready 126 or similar) extra 2/6.

SEE IT AT
YOUR DEALER'S

STOP!!

Pull up in time
by fitting



Fibrax

BRAKE BLOCKS

You brake gently, but firmly with FIBRAX brakes. The great thing is they are SURE in emergency. And they spell S-A-F-E-T-Y on the steepest gradients. For Steel rims, Fibrax Black Blocks; for alloy rims, Soft Red Blocks.

**FOR SAFETY'S SAKE
- FIT A SET NOW**

FIBRAX LIMITED

2, Tudor Street, London, E.C.4

THORNTON

stands for
QUALITY & VALUE
throughout the world
in the manufacture of
DRAWING INSTRUMENTS
ADJUSTABLE SET SQUARES
P.I.C. SLIDE RULES
PARALLEL RULES
and other drawing office equipment

Write for
illustrated leaflets
and address
of your
nearest stockist to:

A.G. THORNTON LTD.
P.O. BOX 3, WYTHENSHAW, MANCHESTER

INSIST ON THORNTON PRODUCTS ALL
OF WHICH ARE FULLY GUARANTEED

Send Now

for New Brochure detailing all points and interesting features; answered questions you would ask, showing machines in use and articles such as toys, patterns and turnery made on these machines. Ask also for details of fittings to the "Coronet" range and other makes. Is long hole drilling a problem to you? Send now for details of BORING ATTACHMENT and long drills, to suit any lathes.

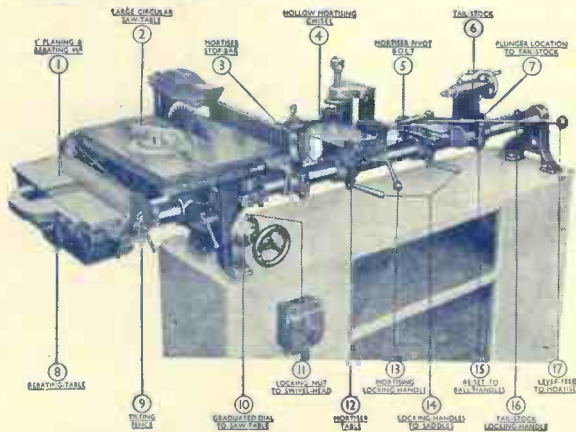

FITTINGS AND ACCESSORIES FOR ALL LATHES:

- CUP CENTRE No. 1 Morse Taper Shank.
- 4 Prong DRIVING CENTRE (Positive Drive for large or small work).
- GRINDING WHEEL ARBOR No. 1 Morse Taper—suit any machine with No. 1 Morse Taper.
- REVOLVING CENTRE
- 5" WOBBLER SAW—Ploughs— $\frac{1}{8}$ " to $\frac{1}{2}$ ". Index for quick setting and fine adjustment.
- TURNING TOOLS, set of six 18" overall, beautifully handled.
- WOODSCREW CHUCK to suit any machine No. 1 or 2 Morse
- 3 Jaw CHUCK and Self Centering 4 Jaw Independent Chuck.
- COMPOUND SLIDEREST—for wood and metal turning.
- ELECTRIC MOTORS, Brook $\frac{1}{2}$ and $\frac{1}{4}$ h.p.
- GRINDING WHEELS, SLIPSTONES, etc.

Write: Dept. P.M., enclosing stamp, for Catalogues showing photographs and price, etc.

CORONET TOOL CO. 8, MANSFIELD ROAD, DERBY.
Also at CITY ROAD MILLS, DERBY.

Free Guide — SUCCESS IN ENGINEERING

One of the following Courses taken quietly at home in your spare time can be the means of securing substantial well-paid promotion in your present calling, or entry into a more congenial career with better prospects.

ENGINEERING, RADIO, AERO, ETC.

Aero. Draughtsmanship	Elec. Draughtsmanship
Jig & Tool Design	Machine " "
Press Tool & Die Design	Automobile " "
Sheet Metalwork	Structural " "
Automobile Repairs	R/F Concrete " "
Garage Management	Structural Engineering
Works M'gmt. & Admin	Mathematics (all stages)
Practical Foremanship	Radio Technology
Ratefixing & Estimating	Telecommunications
Time & Motion Study	Wiring & Installation
Engineering Inspection	Television
Metallurgy	Radio Servicing
Refrigeration	Gen. Elec. Engineering
Welding (all branches)	Generators & Motors
Maintenance Engineering	Generation & Supply
Steam Engine Technology	Aircraft Mainten. Licences
I.C. Engine Technology	Aerodynamics
Diesel Engine Technology	Electrical Design
Ordnance Survey Dr'ship.	

BUILDING AND STRUCTURAL

L.L.O.B.	A.I.A.S.	A.R.S.H.	M.R.S.H.
A.M.I.P.H.E.	A.A.L.P.A.	L.A.B.S.S.	A.R.I.C.S.
Building Construction	Builders' Quantities		
Costs & Accounts	Carpentry & Joinery		
Surveying & Levelling	Building Inspector		
Clerk of Works	Building Draughtsmanship		
Quantity Surveying	Heating and Ventilating		

GENERAL, LOCAL GOVERNMENT, ETC.

Gen. Cert. of Education	Common. Prelim. Exam.
Book-keeping (all stages)	A.C.I.S., A.C.C.S.
College of Preceptors	A.C.W.A. (Costing)
Woodwork Teacher	School Attendance Officer
Metalwork Teacher	Sanitary Inspector
Housing Manager (A.I.Hsg.)	Civil Service Exams.

BECOME A DRAUGHTSMAN—LEARN AT HOME AND EARN BIG MONEY

Men and Youths urgently wanted for well paid positions as Draughtsmen, Inspectors, etc., in Aero, Jig and Tool, Press Tool, Electrical, Mechanical and other Branches of Engineering. Practical experience is unnecessary for those who are willing to learn—our Guaranteed "Home Study" courses will get you in. Those already engaged in the General Drawing Office should study some specialised Branch such as Jig and Tool or Press Tool Work and so considerably increase their scope and earning capacity.



★ OVER SEVENTY YEARS OF CONTINUOUS SUCCESS ★

NATIONAL INSTITUTE OF ENGINEERING

(Dept. 29)

148, HOLBORN, LONDON, E.C.1

SOUTH AFRICA: E.C.S.A., P.O. BOX NO. 8417, JOHANNESBURG

FOUNDED 1885 - FOREMOST TODAY

132-PAGE BOOK FREE!
SEND FOR YOUR COPY

This remarkable **FREE GUIDE** explains:

- ★ Openings, prospects, salaries, etc., in Draughtsmanship and in all other branches of Engineering and Building.
- ★ How to obtain money-making technical qualifications through special **RAPID FULLY-GUARANTEED COURSES**.

MANY INTERESTING COURSES TO SELECT FROM!

A.M.I.Mech.E., A.M.I.M.I.,
A.M.Brit.I.R.E., A.M.I.P.E.,
A.M.I.C.E., A.M.I.Struct.E.,
A.M.I.Mun.E., M.R.S.H.,
A.M.I.E.D., A.F.R.Ae.S.,
London B.Sc., Degrees.

Fully guaranteed postal courses for all the above and many other examinations and careers. Fully described in the *New Free Guide*.



THE ACID TEST OF TUTORIAL EFFICIENCY

SUCCESS—OR NO FEE

We definitely guarantee that if you fail to pass the examination for which you are preparing under our guidance, or if you are not satisfied in every way with our tutorial service—then your Tuition Fee will be returned in full and without question. This is surely the acid test of tutorial efficiency.

If you have ambition you must investigate the Tutorial and Employment services we offer. Founded in 1885, our success record is unapproachable.

ALL TEXTBOOKS ARE SUPPLIED FREE
PROMPT TUTORIAL SERVICE GUARANTEED
NO AGENTS OR TRAVELLERS EMPLOYED



Free Coupon

To: NATIONAL INSTITUTE OF ENGINEERING
(Dept. 29), 148-150, Holborn, London, E.C.1.

Please Forward your Free Guide to

NAME

ADDRESS

My general interest is in: (1) ENGINEERING
(2) AERO (3) RADIO (4) BUILDING
(5) MUNICIPAL WORK

SEND OFF THIS COUPON NOW AND BE ALL SET FOR SUCCESS

(Place a cross against the branches in which you are interested.)

The subject of examination in which I am especially interested is

To be filled in where you already have a special preference.
(1½d. stamp only required if unsealed envelope used.)