

PRACTICAL

Australia \$1.50 Malaysia \$4.95 IR £1.23 (inc. VAT)

# ELECTRONICS

JUNE 1983

85p



## PERCUSSION MICROSYNTH

## Computing: PROGRAM CONDITIONER

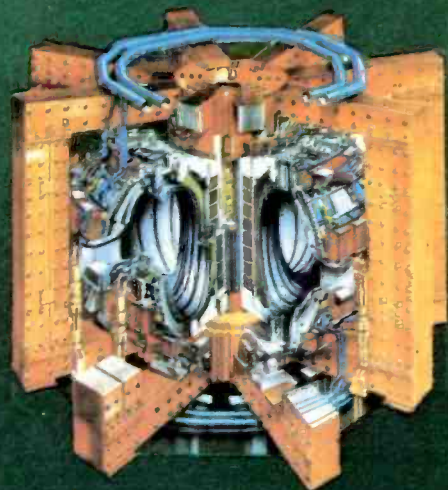

## FUSION: Towards Reality

Spacewatch • Equipment Bargains

# EXTRA EDITORIAL PAGES!



# SAVE ON THE PRICE OF YOUR COLOUR PRINTS!

NOW ONLY 12p EACH

## with the Practical Electronics Colour Print Service

While prices go up elsewhere, Practical Electronics makes a bargain offer in its Colour Print Service. Now you can have as many films printed as you like, including Giant Superprints, at only 12p a print. There is no developing charge and just 25p towards postage and packing.

At this new price, the magazine Colour Print Service, already used by hundreds of thousands of readers, is as fast and efficient as ever. Here's all you have to do to enjoy its advantages.

Send any make of colour print film, including disc film, inside the envelope enclosed with this issue. Or fill in the coupon below and send with your colour print film in a strong envelope to:

**Practical Electronics Colour Print Service, FREEPOST, READING RG1 1BR. No stamp is required.**

### SEND NO MONEY

We are so confident in the reliability of our service and the quality of our prints (each one date-stamped with the month and year of developing) that you don't pay until you've seen them.

### LUXURY COLOUR PRINTS

You will be amazed at the beautiful colours and sheen finish of these prints. They have elegant rounded corners and are borderless to give you maximum picture area. And with the Giant Superprints, you get 30 per cent more picture area than the standard enprints *at no extra cost!*

*Offer excludes Black & White, transparency, sub-miniature, C22 & Argva CNS film. Superprints can only be produced from Kodacolor II, C41 cassette, cartridge and disc film not half frame. Prices correct at time of going to press.*

### UNBEATABLE VALUE

All you pay for the Colour Print Service is 12p for each good print received plus 25p towards postage and packing. The most you would pay us for processing and printing a 24-exposure film for example is £3.13. Compare that with the price you would pay in the shops.

### FREE ALBUM PAGES

With each film we process, you receive an album page voucher. Collect and return three vouchers, and you receive a set of FREE album pages to fit into our specially designed album for any size of print up to 4in. by 6in.

### HOW YOU BENEFIT

You benefit in three ways. Firstly, you pay nothing for the actual processing—only for prints and postage and packing. Secondly, you enjoy a personal service with every care taken over each individual order. And thirdly, you pay only for what you get—with no credit vouchers as with many other companies. An invoice comes with your prints, so it is a straight business transaction.

### 48 HOURS IN-LAB SERVICE

Your films will be processed within 48 hours\* of receipt, but please allow for postal delays.

The price of this offer is limited to the U.K.

\*C41 Process cassette and cartridge film only.



### FILMS AT REDUCED PRICES

Always keep your camera action-ready. Order replacement films at our specially reduced prices: 110/24, 126/24 or 35/24 at £1.20 a roll, or three for £3; disc/15, £1.30 each (no quantity discount).

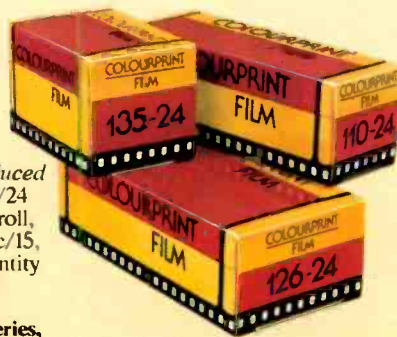

If you have any queries, contact our Customer Service on Reading (0734) 597332.

Use this label if you have no envelope, or pass it to a friend. It is used to pack your prints.

To: Practical Electronics Colour Print Service  
FREEPOST, READING RG1 1BR

- Please print my film Superprint size
- Standard Enprint size

If film is being ordered ● Please send me \_\_\_\_\_  
of 110/24  of 126/24  of 35/24  of disc/15

- Tick box(es) as required.

From: Practical Electronics Colour Print Service  
FREEPOST, READING RG1 1BR

Mr/Ms \_\_\_\_\_

Address \_\_\_\_\_

\_\_\_\_\_

Postcode \_\_\_\_\_

# PRACTICAL ELECTRONICS

VOLUME 19

No. 6

JUNE 1983

## CONSTRUCTIONAL PROJECTS

<b>PROGRAM CONDITIONER</b> by Ian Hickman	20
Obviates problems when copying computer programs	
<b>ROCKTONE</b> by D. Head BSc(Hons) and P. D'Lemos BSc	26
A versatile frequency generator for setting up sound systems	
<b>ZEAKER Part 2</b> by David Buckley	36
Construction and programming	
<b>PERCUSSION MICROSYNTH Part 1</b> by A. R. Bradford	50
A broad voiced drum kit	
<b>AUTOMOBILE TEST SET Part 2</b> by M. Tooley BA and D. Whitfield MA MSc	60
Construction and use	
<b>ULTIMUM Part 8</b> by William Edwards	68
Port Card	

## GENERAL FEATURES

<b>FUSION: TOWARDS REALITY</b> by Mike Abbott	30
Europe's Tokamak experiment	
<b>SEMICONDUCTOR CIRCUITS</b> by Tom Gaskell BA(Hons)	44
High quality audio preamplifier (HA 12017)	
<b>VERNON TRENT AT LARGE</b>	49
<b>MICROPROMPT</b>	57
Hardware and software ideas for PE computer projects	
<b>INGENUITY UNLIMITED</b>	65
Car intruder alarm—PWM motor controller with centre off	

## NEWS AND COMMENT

<b>EDITORIAL</b>	15
<b>NEWS AND MARKET PLACE</b>	16
Including Countdown	
<b>PATENTS REVIEW</b>	25
Theft detector	
<b>SPECIAL OFFER—CASSETTES</b>	34
<b>SPACEWATCH</b> by Frank W. Hyde	42
Extra-terrestrial activities chronicled	
<b>INDUSTRY NOTEBOOK</b> by Nexus	43
News and views on the electronics industry	
<b>BAZAAR</b>	46, 63
Free readers' advertisements	
<b>READOUT</b>	56

## SPECIAL SUPPLEMENT

<b>MICRO-FILE</b> by R. W. Coles	between pages 42 and 43
Filesheet 7 9900	

OUR JULY ISSUE WILL BE ON SALE FRIDAY, JUNE 3rd, 1983  
(for details of contents see page 41)

© IPC Magazines Limited 1983. Copyright in all drawings, photographs and articles published in PRACTICAL ELECTRONICS is fully protected, and reproduction or imitations in whole or part are expressly forbidden. All reasonable precautions are taken by PRACTICAL ELECTRONICS to ensure that the advice and data given to readers are reliable. We cannot, however, guarantee it, and we cannot accept legal responsibility for it. Prices quoted are those current as we go to press.

# WATFORD ELECTRONICS

33, CARDIFF ROAD, WATFORD, HERTS WD1 8ED, ENGLAND  
Tel. Watford (0923) 40588. Telex: 8956095 WAELEC

ALL DEVICES BRAND NEW. FULL SPEC. AND FULLY GUARANTEED. ORDERS DESPATCHED BY RETURN OF POST.  
GOVERNMENT AND EDUCATIONAL INSTITUTIONS OFFICIAL ORDERS ACCEPTED (ACCESS ORDERS BY TEL. PHONE 0923-50234). TRADE AND EXPORT INQUIRY WELCOME. P & P ADD 50p TO ALL CASH ORDERS. OVERSEAS POSTAGE AT COST.

**VAT** Export orders no VAT. U.K. customers please add 15% VAT to total cost incl. p&p. We stock thousands more items. It pays to visit us. We are situated behind Watford Football Ground. Open Monday to Saturday, 9.00am to 6.00pm. Ample FREE Car parking.

**POLYESTER CAPACITORS: (Axial Lead)** 400V: 1nF, 1.5n, 2n2, 3n3, 4n7, 6n8 11p; 100V: 15n, 18n, 22n 12p; 33n, 47n, 68n 16p; 100n, 150n 20p; 220n 30p; 330n 42p; 470n 52p; 680n 60p; 1µF: 68µ, 2µ, 4µ, 7.5µ. 1000V: 1nF 17p; 10nF 30p; 15n 40p; 22n 36p; 33n 42p; 47n, 100n 50p.

**POLYESTER RADIAL LEAD CAPACITORS:** 250V: 10n, 20n, 15n, 22n, 27n 6p; 33n, 47n, 68n, 100n 7p; 150n, 220n 10p; 330n, 470n 13p; 680n 19p; 1µ: 23µ, 15µ, 40µ; 2µ, 4µ, 7.5µ.

**ELECTROLYTIC CAPACITORS (Values in µF):** 500V: 10µF 52p; 47 78p; 63V: 0.47, 1.0, 1.5, 2.2, 3.3, 8p; 4.7 9p; 10 10p; 15 12p; 22 13p; 47 12p; 68 16p; 100 19p; 220 20p; 1000 70p; 2200 90p; 50V: 50µ 20p; 100 20p; 240V: 40V: 6.8, 10µ, 22µ, 33µ, 47µ, 68µ, 100µ 46p; 220V: 30µ, 33µ, 47µ, 68µ, 100µ 46p; 25V: 50µ, 30µ, 33µ, 47µ, 68µ, 100µ 46p; 10V: 2.2, 4.0, 8p; 100 9p; 15 10p; 22 11p; 33 12p; 47 12p; 68 13p; 100 13p; 220 13p; 330 16p; 470 16p; 1500 17p; 2200 19p.

**TANTALUM BEAD CAPACITORS:** 35V: 0.1µ, 0.22, 0.33 15p; 0.47, 0.68, 1.0, 1.5 16p; 2.2, 3.3 18p; 4.7 20p; 6.8 22p; 10 22p; 15 22p; 22 22p; 33 22p; 47 22p; 68 22p; 100 22p; 150 22p; 220 22p; 330 22p; 470 22p; 680 22p; 1000 22p; 1500 22p; 2200 22p; 3300 22p; 4700 22p; 6800 22p; 10000 22p.

**SILVER MICA (pf)** 2, 3, 3.3, 4.7, 6.8, 8.2, 10, 12, 18, 22, 27, 33, 39, 47, 50, 56, 68, 75, 82, 85, 100, 120, 150, 180 18p each. 120, 250, 270, 330, 360, 390, 470, 600, 800 & 820pf 21p each. 1000, 1200, 1800 30p each. 3300, 4700 60p each.

**SIEMENS** multilayer miniature capacitors. 250V: 1nF, 1.5n, 2n2, 3n3, 4n7, 6n8, 8n2, 10n, 15n, 22n 7p; 18n, 27n, 33n, 39n, 47n 8p; 39n, 56n, 68n 9p. 100V: 100n, 120n, 150n; 150n 11p; 220n 13p; 330n 18p; 470n 23p; 680n 30p; 1µF: 3µ, 4µ, 7.5µ.

**CERAMIC CAPACITORS: 50V** Range 1pF to 6800pF 4p; 10nF, 15n, 33n, 47n 6p; 100n/30p; 1500n/10p.

**POLYSTYRENE Caps:** 10pF to 1nF 8p; 1n5 to 12nF 10p.

**RESISTORS S.I.L. Package:** 7 Commoned, 100k, 680k, 1k, 2k, 4k, 7k, 10k, 47k, 100k 24p. 8 Commoned: (9 pins) 150k, 180k, 270k, 330k, 1k, 2k, 4k, 7k, 10k, 22k, 47k, 100k 26p.

**LINEAR IC's**  
555 CMOS 80 LM311 55  
702 78 LM319 195  
709C 8 pin 45 LM324 90  
710 48 LM335 128  
714 14 LM339 47  
747C 14 pin 68 LM348 64  
748C 8 pin 36 LM349 118  
753 8 pin 185 LM358 60  
810 15 SN7677 17  
850 75 LM392 48  
9400CJ 350 LM390 80  
AY-1-1320 225 LM381N 145  
AY-1-5050 99 LM384 118  
AY-1-5691 160 LM384 160  
AY-1-8720 20 LM386 90  
AY-3-1270 675 LM387 120  
AY-3-8910 420 LM389 95  
AY-3-8912 450 LM392 45  
AY-5-1230 450 LM393 45  
AY-5-1317A 630 LM394CH 290  
CA3011 120 LM257CN 325  
CA3012 175 MT33 70  
CA3014 275 LM2917 195  
CA3018 86 LM3302 75  
CA3019 80 LM3900 50  
CA3020 210 LM3929 88  
CA3023 210 LM3911 125  
CA3028A 205 LM3914 125  
CA3035 285 LM3915 200  
CA3036 270 LM3916 110  
CA3043 275 LM13600 280  
CA3045 365 LS7220 280  
CA3046 70 M15153L 230  
CA3048 295 M1515L 190  
CA3059 285 M70681 125  
CA3075 213 MB3712 220  
CA3080E 70 MB3756 440  
CA3081 190 MC1303 98  
CA3086 48 MC1304P 260  
CA3089E 280 MC1319 195  
CA3090A 375 MC1445 250  
CA3123 168 MC1455 50  
CA3130 90 MC1458 35  
CA3140 40 MC1469 300  
CA3160 95 MC1494 694  
CA3161E 180 MC1495 350  
CA3162E 180 MC1496 350  
CA3189 200 MC1596 225  
CA3240 110 MC1648 290  
HA1366 175 MC1709G 90  
HA1388 255 MC3302 90  
ICL7106 890 MC3340P 120  
ICL7107 978 MC3360P 120  
ICL7204 650 MC3401 65  
ICL7611 99 MC3403 75  
ICL7660 248 MC3405 150  
ICL803BCC 300 MC3423P 80  
ICL8211 350 MF10 380  
ICM7204 1150 MFC60390 630  
ICM7205 1150 MFC6240 630  
ICM7207 475 ML924 275  
ICM7215 1050 MSM5626 280  
ICM7216A 222 NE515 170  
ICM7217A 750 NE529 225  
ICM7224 785 NE531 140  
ICM7240 390 NE543 210  
ICM7555 80 NE544 210  
ICM7556 150 NE555 160  
LA3350 220 NE560 140  
LA4031P 240 NE568 140  
LA4032 295 NE560 325  
LA4400 295 NE571 395  
LA4422 275 NE562B 410  
LC7130 340 NE564 420  
LC7137 395 NE566 155  
LF347 150 NE567 140  
LF351 48 NE570 410  
LF352 48 NE571 410  
LF355 85 NE5532 145  
LF356 95 NE5534 105  
LF357 110 OM335 760  
LF398 475 RC1436D 60  
LM10 328 RC1458 60  
LM100A 24 S5668 225  
LM1001 48 SAB3209 425  
LM308 45 SAB3210 328

**COMPUTER IC's**  
74S00 24  
74S01 24  
74S02 24  
74S03 24  
74S04 30  
74S05 60  
74S06 60  
74S10 30  
74S11 60  
74S12 60  
74S13 60  
74S14 60  
74S15 60  
74S16 60  
74S17 60  
74S18 60  
74S19 60  
74S20 60  
74S21 60  
74S22 60  
74S23 60  
74S24 60  
74S25 60  
74S26 60  
74S27 60  
74S28 60  
74S29 60  
74S30 60  
74S31 60  
74S32 60  
74S33 60  
74S34 60  
74S35 60  
74S36 60  
74S37 60  
74S38 60  
74S39 60  
74S40 60  
74S41 60  
74S42 60  
74S43 60  
74S44 60  
74S45 60  
74S46 60  
74S47 60  
74S48 60  
74S49 60  
74S50 60  
74S51 60  
74S52 60  
74S53 60  
74S54 60  
74S55 60  
74S56 60  
74S57 60  
74S58 60  
74S59 60  
74S60 60  
74S61 60  
74S62 60  
74S63 60  
74S64 60  
74S65 60  
74S66 60  
74S67 60  
74S68 60  
74S69 60  
74S70 60  
74S71 60  
74S72 60  
74S73 60  
74S74 60  
74S75 60  
74S76 60  
74S77 60  
74S78 60  
74S79 60  
74S80 60  
74S81 60  
74S82 60  
74S83 60  
74S84 60  
74S85 60  
74S86 60  
74S87 60  
74S88 60  
74S89 60  
74S90 60  
74S91 60  
74S92 60  
74S93 60  
74S94 60  
74S95 60  
74S96 60  
74S97 60  
74S98 60  
74S99 60  
74S00 60

**RESISTORS** Range 1pF to 100k. 5% Carbon. Hi-stab, Miniature, 5% Carbon. 0.25W 202-4 M7 E24 3p 1p; 0.5W 202-4 M7 E12 3p 1p; 1W 202-10M E12 6p 4p; 1% Metal Film 511-1M 8p 8p.

## TRANSISTORS

AC125/6	35	BC307B	14	BFY64	35	TIP34C	88	2N1613	30	2SC1061	250
AC127/8	35	BC308B	16	BFY81	120	TIP35A	110	2N1617B	160	2SC1096	85
AC141/2	30	BC327/8	15	BFY90	80	TIP35C	128	2N1621B	295	2SC1162	30
AC176	28	BC337/8	15	BR939	40	TIP36A	130	2N2219A/20A	140	2SC1172	125
AC187/8	32	BC441	34	BSX20	25	TIP41A	50	2N2369A	18	2SC1306	100
AD145	41	BC442	34	BU105	170	TIP41B	52	2N2646	45	2SC1307	150
AD149	79	BC477/8	40	BU205	190	TIP42A	55	2N2846	80	2SC1449	85
AD161/2	42	BC516/7	40	BU206	200	TIP42B	58	2N3004A/05A	25	2SC1679	140
AF118	95	BC547/8	12	BU208	200	TIP210	70	06A/07A	28	2SC1678	190
AF139	40	BC549C	14	BU300	250	TIP212	70	2N2928G	10	2SC1923	50
AF239	55	BC556/7	15	BU308	250	TIP214	100	TIP141	100	2N2945	225
BC107/8	10	BC558/9	15	BU309	250	TIP217	105	2N3054	58	2SC1953	90
BC107B	12	BC569	15	BU310	250	TIP219	120	2N3055	48	2SC1957	90
BC108	12	BC570	10	BU311	250	TIP225	60	2N3442	140	2SC1969	140
BC108C	12	BCV71/2	20	BU312	250	TIP3055	60	2N3614	199	2SC2028	200
BC109	12	BD124	115	BU313	250	TIP3056	32	2N3615	199	2SC2029	200
BC109B	12	BD131/2	48	BU314	250	TIP3057	32	2N3616	199	2SC2030	200
BC109C	12	BD135	45	BU315	250	TIP3058	32	2N3617	199	2SC2031	200
BC117/8	20	BD136/7	45	BU316	250	TIP3059	32	2N3618	199	2SC2032	200
BC147/8	30	BD138/9	45	BU317	250	TIP3060	32	2N3619	199	2SC2033	200
BC147B	10	BD140	40	BU318	250	TIP3061	32	2N3620	199	2SC2034	200
BC148C	10	BD142	40	BU319	250	TIP3062	32	2N3621	199	2SC2035	200
BC149	10	BD144	40	BU320	250	TIP3063	32	2N3622	199	2SC2036	200
BC149C	12	BD146	40	BU321	250	TIP3064	32	2N3623	199	2SC2037	200
BC153/4	12	BD148	40	BU322	250	TIP3065	32	2N3624	199	2SC2038	200
BC157/8	10	BD150	40	BU323	250	TIP3066	32	2N3625	199	2SC2039	200
BC159	11	BD152	40	BU324	250	TIP3067	32	2N3626	199	2SC2040	200
BC167A	10	BD154	40	BU325	250	TIP3068	32	2N3627	199	2SC2041	200
BC168C	10	BD156	40	BU326	250	TIP3069	32	2N3628	199	2SC2042	200
BC169C	10	BD158	40	BU327	250	TIP3070	32	2N3629	199	2SC2043	200
BC170	15	BD160	40	BU328	250	TIP3071	32	2N3630	199	2SC2044	200
BC171/2	11	BD162	40	BU329	250	TIP3072	32	2N3631	199	2SC2045	200
BC173	11	BD164	40	BU330	250	TIP3073	32	2N3632	199	2SC2046	200
BC177/8	16	BD166	40	BU331	250	TIP3074	32	2N3633	199	2SC2047	200
BC179/81	20	BD168	40	BU332	250	TIP3075	32	2N3634	199	2SC2048	200
BC182/3	10	BD170	40	BU333	250	TIP3076	32	2N3635	199	2SC2049	200
BC184	10	BD172	40	BU334	250	TIP3077	32	2N3636	199	2SC2050	200
BC184L	10	BD174	40	BU335	250	TIP3078	32	2N3637	199	2SC2051	200
BC186/7	26	BD176	40	BU336	250	TIP3079	32	2N3638	199	2SC2052	200
BC212/3L	10	BD178	40	BU337	250	TIP3080	32	2N3639	199	2SC2053	200
BC214L	10	BD180	40	BU338	250	TIP3081	32	2N3640	199	2SC2054	200
BC214L	10	BD182	40	BU339	250	TIP3082	32	2N3641	199	2SC2055	200
BC237/8	14	BD184	40	BU340	250	TIP3083	32	2N3642	199	2SC2056	200

**74S Series**  
74S00 24  
74S01 24  
74S02 24  
74S03 24  
74S04 30  
74S05 60  
74S06 60  
74S10 30  
74S11 60  
74S12 60  
74S13 60  
74S14 60  
74S15 60  
74S16 60  
74S17 60  
74S18 60  
74S19 60  
74S20 60  
74S21 60  
74S22 60  
74S23 60  
74S24 60  
74S25 60  
74S26 60  
74S27 60  
74S28 60  
74S29 60  
74S30 60  
74S31 60  
74S32 60  
74S33 60  
74S34 60  
74S35 60  
74S36 60  
74S37 60  
74S38 60  
74S39 60  
74S40 60  
74S41 60  
74S42 60  
74S43 60  
74S44 60  
74S45 60  
74S46 60  
74S47 60  
74S48 60  
74S49 60  
74S50 60  
74S51 60  
74S52 60  
74S53 60  
74S54 60  
74S55 60  
74S56 60  
74S57 60  
74S58 60  
74S59 60  
74S60 60  
74S61 60  
74S62 60  
74S63 60  
74S64 60  
74S65 60  
74S66 60  
74S67 60  
74S68 60  
74S69 60  
74S70 60  
74S71 60  
74S72 60  
74S73 60  
74S74 60  
74S75 60  
74S76 60  
74S77 60  
74S78 60  
74S79 60  
74S80 60  
74S81 60  
74S82 60  
74S83 60  
74S84 60  
74S85 60  
74S86 60  
74S87 60  
74S88 60  
74S89 60  
74S90 60  
74S91 60  
74S92 60  
74S93 60  
74S94 60  
74S95 60  
74S96 60  
74S97 60  
74S98 60  
74S99 60  
74S00 60

**74LS Series**  
74LS00 24  
74LS01 24  
74LS02 24  
74LS03 24  
74LS04 30  
74LS05 60  
74LS06 60  
74LS10 30  
74LS11 60  
74LS12 60  
74LS13 60  
74LS14 60  
74LS15 60  
74LS16 60  
74LS17 60  
74LS18 60  
74LS19 60  
74LS20 60  
74LS21 60  
74LS22 60  
74LS23 60  
74LS24 60  
74LS25 60  
74LS26 60  
74LS27 60  
74LS28 60  
74LS29 60  
74LS30 60  
74LS31 60  
74LS32 60  
74LS33 60  
74LS34 60  
74LS35 60  
74LS36 60  
74LS37 60  
74LS38 60  
74LS39 60  
74LS40 60  
74LS41 60  
74LS42 60  
74LS43 60  
74LS44 60  
74LS45 60  
74LS46 60  
74LS47 60  
74LS48 60  
74LS49 60  
74LS50 60  
74LS51 60  
74LS52 60  
74LS53 60  
74LS54 60  
74LS55 60  
74LS56 60  
74LS57 60  
74LS58 60  
74LS59 60  
74LS60 60  
74LS61 60  
74LS62 60  
74LS63 60  
74LS64 60  
74LS65 60  
74LS66 60  
74LS67 60  
74LS68 60  
74LS69 60  
74LS70 60  
74LS71 60  
74LS72 60  
74LS73 60  
74LS74 60  
74LS75 60  
74LS76 60  
74LS77 60  
74LS78 60  
74LS79 60  
74LS80 60  
74LS81 60  
74LS82 60  
74LS83 60  
74LS84 60  
74LS85 60  
74LS86 60  
74LS87 60  
74LS88 60  
74LS89 60  
74LS90 60  
74LS91 60  
74LS92 60  
74LS93 60  
74LS94 60  
74LS95 60  
74LS96 60  
74LS97 60  
74LS98 60  
74LS99 60  
74LS00 60

**74ALS Series**  
74ALS00 24  
74ALS01 24  
74ALS02 24  
74ALS03 24  
74





# GET BIG POWER

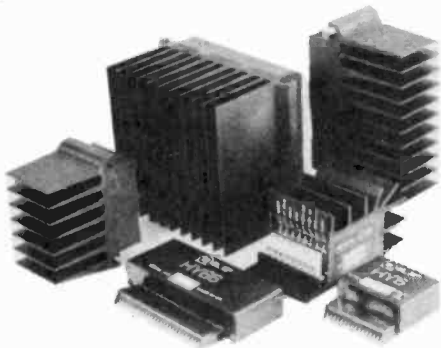

## Modular Amplifiers the third generation

Due to continuous improvements in components and design ILP now launch the largest and most advanced generation of modules ever.

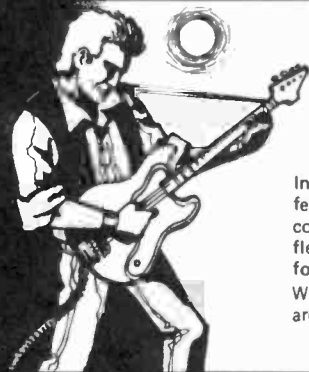

## WE'RE INSTRUMENTAL IN MAKING A LOT OF POWER

In keeping with ILP's tradition of entirely self-contained modules featuring, integral heatsinks, no external components and only 5 connections required, the range has been optimized for efficiency, flexibility, reliability, easy usage, outstanding performance, value for money.

With over 10 years experience in audio amplifier technology ILP are recognised as world leaders.



### BIPOLAR MODULES

Module Number	Output Power W rms	Load Impedance $\Omega$	DISTORTION T.H.D. Typ at 1KHz	I.M.D. 90Hz/7KHz 4:1	Supply Voltage Typ	Size mm	WT gms	Price inc. VAT
HY30	15	4.8	0.015%	<0.006%	$\pm 18$	76 x 68 x 40	240	£8.40
HY61	30	4.8	0.015%	<0.006%	$\pm 25$	76 x 68 x 40	240	£9.55
HY68/69	30 x 30	4.8	0.015%	<0.006%	$\pm 25$	120 x 78 x 40	420	£18.69
HY124	60	4	0.01%	<0.006%	$\pm 26$	120 x 78 x 40	410	£20.75
HY128	60	4	0.01%	<0.006%	$\pm 35$	120 x 78 x 40	410	£20.75
HY244	120	4	0.01%	<0.006%	$\pm 35$	120 x 78 x 50	520	£25.47
HY248	120	4	0.01%	<0.006%	$\pm 50$	120 x 78 x 50	520	£25.47
HY364	180	4	0.01%	<0.006%	$\pm 45$	120 x 78 x 100	1030	£38.41
HY368	180	4	0.01%	<0.006%	$\pm 45$	120 x 78 x 100	1030	£38.41

Protection: Full load line, Slew Rate: 15v/ $\mu$ s. Rise time: 5 $\mu$ s. S/N ratio: 100db. Frequency response (-3dB) 15Hz - 50KHz. Input sensitivity: 500mV rms. Input Impedance: 100K  $\Omega$ . Damping factor: 100Hz >400.

### MOSFET MODULES

Module Number	Output Power W rms	Load Impedance $\Omega$	DISTORTION T.H.D. Typ at 1KHz	I.M.D. 90Hz/7KHz 4:1	Supply Voltage Typ	Size mm	WT gms	Price inc. VAT
MOS128	60	4.8	<0.005%	<0.006%	$\pm 45$	120 x 78 x 40	420	£30.44
MOS248	120	4.8	<0.005%	<0.006%	$\pm 55$	120 x 78 x 80	850	£38.88
MOS364	180	4	<0.005%	<0.006%	$\pm 55$	120 x 78 x 100	1025	£45.54

Protection: Able to cope with complex loads without the need for very special protection circuitry (fuses will suffice). Slew rate: 20v/ $\mu$ s. Rise time: 3 $\mu$ s. S/N ratio: 100db. Frequency response (-3dB) 15Hz - 100KHz. Input sensitivity: 500mV rms. Input Impedance: 100K  $\Omega$ . Damping factor: 100Hz >400.

### PRE-AMP SYSTEMS

Module Number	Module	Functions	Current Required	Price inc. VAT
HY6	Mono pre-amp	Mic/Mag. Cartridge/Tuner/Tape/Aux + Voi/Bass/Treble	10mA	£7.60
HY66	Stereo pre-amp	Mic/Mag. Cartridge/Tuner/Tape/Aux + Voi/Bass/Treble/Balance	20mA	£14.32
HY73	Guitar pre-amp	Two Guitar (Bass Lead) and Mic + separate Volume/Bass/Treble + Mix	20mA	£15.36
HY78	Stereo pre-amp	As HY66 plus tone controls	20mA	£14.20

Most pre-amp modules can be driven by the PSU driving the main power amp. A separate PSU 30 is available purely for pre-amp modules if required for £5.47 (inc. VAT). Pre-amp and mixing modules in 18 different variations. Please send for details.

### Mounting Boards

For ease of construction we recommend the B6 for modules HY6-HY13 £1.05 (inc. VAT) and the B66 for modules HY66-HY78 £1.29 (inc. VAT).

### POWER SUPPLY UNITS (Incorporating our own toroidal transformers)

Model Number	For Use With	Price inc. VAT
PSU 21X	1 or 2 HY30	£11.93
PSU 41X	1 or 2 HY60, 1 x HY6060, 1 x HY124	£13.83
PSU 42X	1 x HY128	£15.90
PSU 43X	1 x MOS128	£16.70
PSU 51X	2 x HY128, 1 x HY244	£17.07

Model Number	For Use With	Price inc. VAT
PSU 52X	2 x HY124	£17.07
PSU 53X	2 x MOS128	£17.86
PSU 54X	1 x HY248	£17.86
PSU 55X	1 x MOS248	£19.52
PSU 71X	2 x HY244	£21.75

Model Number	For Use With	Price inc. VAT
PSU 72X	2 x HY248	£22.54
PSU 73X	1 x HY364	£22.54
PSU 74X	1 x HY368	£24.20
PSU 75X	2 x MOS248, 1 x MOS368	£24.20

Please note: X in part no. indicates primary voltage. Please insert "0" in place of X for 110V, "1" in place of X for 220V, and "2" in place of X for 240V.

# WITH A LOT OF HELP FROM



## PROFESSIONAL HI-FI THAT EVERY ENTHUSIAST CAN HANDLE...

### Unicase

Over the years ILP has been aware of the need for a complete packaging system for its products, it has now developed a unique system which meets all the requirements for ease of assembly, adaptability, ruggedness, modern styling and above all price.

Each Unicase kit contains all the hardware required down to the last nut and bolt to build a complete unit without the need for any special tools.

Because of ILP's modular approach, "open plan" construction is used and final assembly of the unit parts forms a compact aesthetic unit. By this method construction can be achieved in under two hours with little experience of electronic wiring and mechanical assembly.

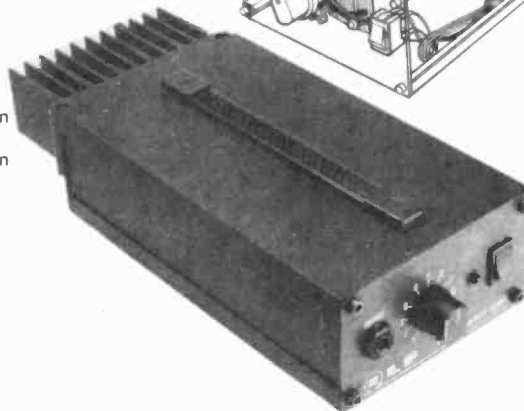
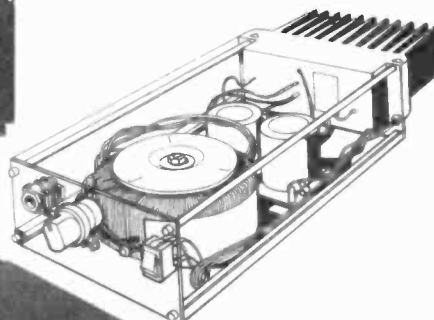

### Hi Fi Separates

**UC1 PRE AMP UNIT:** Incorporates the HY78 to provide a "no frills", low distortion, (< 0.01%), stereo control unit, providing inputs for magnetic cartridge, tuner, and tape/monitor facilities. This unit provides the heart of the hi fi system and can be used in conjunction with any of the UP Unicase series of power amps. For ultimate hum rejection the UC1 draws its power from the power amp unit.

**POWER AMPS:** The UP series feature a clean line front panel incorporating on/off switch and concealed indicator. They are designed to compliment the style of the UC1 pre-amp. Performance for each unit which includes the appropriate power supply, is as specified on the facing page.



### Power Slaves

Our power slaves, which have numerous uses i.e. instrument, discotheque, sound reinforcement, feature in addition to the hi fi series, front panel input jack, level control, and a carrying handle. Providing the smallest, lowest cost, slave on the market in this format.

#### UNICASES

HiFi Separates						Price Inc. VAT
UC1	Preamp					£29.95
UP1X	30 + 30W/4-8Ω	Bipolar	Stereo	HiFi		£54.95
UP2X	60W/4Ω	Bipolar	Mono	HiFi		£54.95
UP3X	60W/8Ω	Bipolar	Mono	HiFi		£54.95
UP4X	120W/4Ω	Bipolar	Mono	HiFi		£74.95
UP5X	120W/8Ω	Bipolar	Mono	HiFi		£74.95
UP6X	60W/4-8Ω	MOS	Mono	HiFi		£64.95
UP7X	120W/4-8Ω	MOS	Mono	HiFi		£84.95
Power Slaves						
US1X	60W/4 Ω	Bipolar	Power	Slave		£59.95
US2X	120W/4 Ω	Bipolar	Power	Slave		£79.95
US3X	60W/4-8Ω	MOS	Power	Slave		£69.95
US4X	120W/4-8Ω	MOS	Power	Slave		£89.95

Please note X in part number denotes mains voltage. Please insert '0' in place of X for 110V, '1' in place of X for 220V (Europe), and '2' in place of X for 240V (U.K.). All units except UC1 incorporate our own toroidal transformers.

#### TO ORDER USING OUR FREEPOST FACILITY

Fill in the coupon as shown, or write details on a separate sheet of paper, quoting the name and date of this journal. By sending your order to our address as shown at the bottom of the page opposite, with FREEPOST clearly shown on the envelope, you need not stamp it. We pay postage for you. Cheques and money orders must be crossed and made payable to I.L.P. Electronics Ltd. If sending cash, it must be by registered post. To pay C.O.D. please add £1 to TOTAL value of order.

**PAYMENT MAY BE MADE BY ACCESS OR BARCLAYCARD IF REQUIRED. Allow 28 days for delivery.**



Post to: ILP Electronics Ltd, Freepost 2, Graham Bell House, Roper Close, Canterbury, CT2 7EP, Kent, England. Telephone: (0227) 54778. Technical: (0227) 64723. Telex: 965780.

Please send me the following \_\_\_\_\_

Total purchase price \_\_\_\_\_

I enclose Cheque  Postal Orders  Int. Money Order

Please debit my Access/Barclaycard No. \_\_\_\_\_

Name \_\_\_\_\_

Address \_\_\_\_\_

Signature \_\_\_\_\_

# BI-PAK

# CATALOGUE

BI-PAK'S NEW 1983 CATALOGUE IS OUT!

## "IRRISISTABLE RESISTOR BARGAINS"

Pak No.	Qty.*	Description	Price
SX10	400	Mixed "All Type" Resistors	£1
SX11	400	Pre-formed 1/4-1/2 watt Carbon Resistors	£1
SX12	200	1/4 watt Carbon Resistors	£1
SX13	200	1/4 watt Carbon Resistors	£1
SX14	150	1/4 watt Resistors 22 ohm-2m2 Mixed	£1
SX15	100	1 and 2 watt Resistors 22 ohm-2m2 Mixed	£1

Paks SX12-15 contain a range of Carbon Film Resistors of assorted values from 22 ohms to 2.2 meg. Save pounds on these resistor paks and have a full range to cover your projects.

\*Quantities approximate, count by weight.

## "CAPABLE CAPACITOR PAKS"

Pak No.	Qty.*	Description	Price
SX16	250	Capacitors Mixed Types	£1
SX17	200	Ceramic Capacitors Miniature Mixed	£1
SX18	100	Mixed Ceramics 1pl-56pF	£1
SX19	100	Mixed Ceramics 680p-0.5mF	£1
SX20	100	Assorted Polyester/Polystyrene Capacitors	£1
SX21	60	Mixed C280 type capacitors metal foil	£1
SX22	100	Electrolytics, all sorts	£1
SX23	50	Quality Electrolytics 50-1000mF	£1
SX24	20	Tantalum Beads, mixed	£1

\*Quantities approximate, count by weight.



**SX52** 6 Black Heatsink will fit TO-3 and TO-220. Ready drilled. Half price value. £1

**SX53** 1 Power finned Heatsink. This heatsink gives the greatest possible heat dissipation in the smallest space owing to its unique staggered fin design, pre drilled.

TO-3 Size 45mm square x 20mm high 40p

**SX54** TO-66 size: 35mm x 30mm x 12mm. 35p

**SX55** 1 Heat Efficiency Lower Finned Heatsink. 90mm x 80mm x 15mm High. Drilled to take up to 4 x TO-3 devices £1.50 each

## BARGAINS

SX42	20 small, 125 Red LED's	£1
SX43	10 Rectangular Green LED's 2	£1
SX46	30 Assorted Zener Diodes 250mw-2 watt mixed voltages, all coded. New	£1
SX47	4 Black Instrument Knobs—winged with pointer 1/4" Standard screw. Fit size 29 x 20mm.	50p
SX49	20 Assorted Slider Knobs. Black/Chrome, etc.	£1
SX80	12 Neons and Filament Lamps. Low voltage and mains — various types and colours — some panel mounting	£1

## SEMICONDUCTORS FROM AROUND THE WORLD

100

A Collection of Transistors, Diodes, Rectifiers, Bridges, SCR's, Triacs, IC's both Logic and Linear plus Opto's all of which are current everyday usable devices.

100

Guaranteed Value over £10 at Normal Retail Price

yours for only **£4.00** Data etc. in every pak. Order No. SX56

## BI-PAK'S OPTO BARGAIN OF THE YEAR!



Valued at over £10—Normal Retail—we offer you a pack of 25 Opto devices to include LED's Large and Small in Red, Green, Yellow and Clear, 7 Segment Displays both Common Cathode and Common Anode PLUS bubble type displays—like DL-33. Photo Transistors—similar to OCP71 Photo Detectors—like MEL11-12. This whole pack of 25 devices will cost you just

**25 £4.00** 25

AND we guarantee your money back if you are not completely satisfied. FULL data etc included. Order No. SX57.

## TECASBOTY

The Electronic Components and Semiconductor Bargain of the Year. A host of Electronic components including potentiometers—rotary and slider, presets—horizontal and vertical Resistors of mixed values 22ohms to 2M2—1/8 to 2 Watt. A comprehensive range of capacitors including electrolytic and polyester types plus disc ceramics etcetera. Audio plugs and sockets of various types plus switches, fuses, heatsinks, wire, nuts/bolts, gromets, cable clips and ties, knobs and P.C. Board. Then add to that 100 Semiconductors to include transistors, diodes, SCR's opto's, all of which are current everyday usable devices. In all a Fantastic Parcel. No rubbish all identifiable and valued in current catalogues at well over £25.00. Our Fight Against Inflation

— Beat the Budget — Down with Depression **JUST £6.50.** Order No. SX85

Send your orders to Dept PE6, BI-PAK PO BOX 6, WARE, HERTS. SHOP AT 3 BALDOCK ST, WARE, HERTS.



Use your credit card. Ring us on Ware 3182 NOW and get your order even faster. Goods normally sent 2nd Class Mail.

Remember you must add VAT at 15% to your order. Total. Postage add 75p per total order.

Presented with a Professional Approach and Appeal to ALL who require Quality Electronic Components, Semiconductors and other Accessories ALL at realistic prices.

There are no wasted pages of useless information so often included in Catalogues published nowadays. Just solid facts i.e. price, description and individual features of what we have available. But remember, BI-PAK's policy has always been to sell quality components at competitive prices and THAT WE STILL DO.

We hold vast Stocks "in stock" for fast immediate delivery, all items in our Catalogue are available ex stock.

The Catalogue is designed for use with our 24 hours "ansaphone" service and the Visa/Access credit cards, which we accept over the telephone.

To receive your NEW 1983 BI-PAK Catalogue, send 75p PLUS 25p p&p to:-



**BI-PAK** Catalogues PO Box 6 WARE, Herts. SG12 9AD

Access & VISA accepted

Ring 0920 3182 for immediate despatch

## SOUND with SINCLAIR

MAKE AMAZING SOUND EFFECTS WITH YOUR ZX 81, TIMEX Sinclair 1000 or SPECTRUM

**THE ZON X 81**  
**£25.95**  
incl p&p & VAT



- The ZON SOUND UNIT is completely self-contained and especially designed for use with the ZX 81, TIMEX Sinclair 1000 and Spectrum Computers. It just plugs in — no dismantling or soldering.
- No power pack, batteries, leads or other extras.\*
- Manual Volume Control on panel — ample volume from built-in loud-speaker.
- Standard Sinclair — 16K Rampack or printer can be plugged into ZON X Sound Unit without affecting normal computer operation.
- Huge range of possible sounds for Games, Music, Helicopters, Sci-Fi, Space Invaders, Explosions, Gun-shots, Drums, Planes, Lasers, Organs, Bells, Tunes, Chords, etc., or whatever you devise!
- 8 full octaves. Uses 3-Channel sound chip giving programme control of pitch, volume of tones and noise all with envelope control.
- Easily added to existing games or programmes using a few simple "BASIC" lines or machine code.
- No memory addresses used — 10 mapped.

FULL instructions with many examples of how to obtain effects and the programmes, supplied. Fully guaranteed. British Made.

\*Except with Spectrum, you need the Spectrum Extension Board Order No. SE1 — PRICE £6.80 inc. VAT.

Payment may be made by Cheque, P.O. Giro No. 388 7006, Postal Order or Credit Card.

Export orders:- Bank Cheque, International Money Order, U.S. \$ or £ Sterling.

**BI-PAK**

Dept PE6, P.O. Box 6 63A, High Street, Ware, Herts.



Access & VISA accepted Ring 0920 3182 for immediate despatch



Step-by-step fully illustrated assembly and fitting instructions are included together with circuit descriptions. Highest quality components are used throughout.

# Sparkrite

BRANDLEADING ELECTRONICS  
NOW AVAILABLE IN KIT FORM

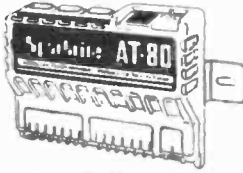

## AT-80 Electronic Car Security System

- Arms doors, boot, bonnet and has security loop to protect fog/spot lamps, radio/tape, CB equipment
- Programmable personal code entry system
- Armed and disarmed from outside vehicle using a special magnetic key fob against a windscreen sensor pad adhered to the inside of the screen
- Fits all 12V neg earth vehicles
- Over 250 components to assemble

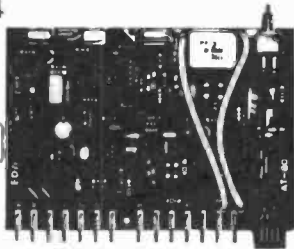

## VOYAGER Car Drive Computer

- A most sophisticated accessory
- Utilises a single chip mask programmed microprocessor incorporating a unique programme designed by EDA Sparkrite Ltd
- Affords 12 functions centred on Fuel, Speed, Distance and Time
- Visual and Audible alarms warning of Excess Speed, Frost/Ice, Lights-left-on
- Facility to operate LOG and TRIP functions independently or synchronously
- Large 10mm high 400ft-L fluorescent display with auto intensity
- Unique speed and fuel transducers giving a programmed accuracy of + or - 1%
- Large LOG & TRIP memories 2,000 miles, 180 gallons, 100 hours
- Full Imperial and Metric calibrations
- Over 300 components to assemble
- A real challenge for the electronics enthusiast!



## SX1000 Electronic Ignition

- Inductive Discharge
- Extended coil energy storage circuit
- Contact breaker driven
- Three position changeover switch
- Over 65 components to assemble
- Patented clip-to-coil fitting
- Fits all 12v neg. earth vehicles

## TX1002 Electronic Ignition

- Contactless or contact triggered
- Extended coil energy storage circuit
- Inductive Discharge
- Three position changeover switch
- Distributor triggerhead adaptors included
- Die cast weatherproof case
- Clip-to-coil or remote mounting facility
- Fits majority of 4 & 6 cyl. 12V. neg. earth vehicles
- Over 145 components to assemble.

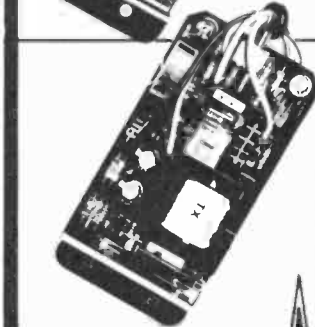

## SX2000 Electronic Ignition

- The brandleading system on the market today
- Unique Reactive Discharge
- Combined Inductive and Capacitive Discharge
- Contact breaker driven
- Three position changeover switch
- Over 130 components to assemble
- Patented clip-to-coil fitting
- Fits all 12v neg. earth vehicles

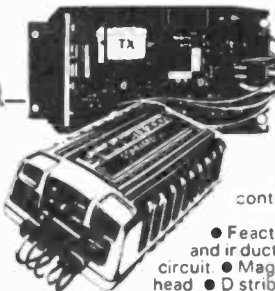

## TX2002 Electronic Ignition

- The ultimate system
- Switchable contactless
- Three position switch with Auxiliary back-up inductive circuit
- Feactive Discharge
- Combined capacitive and inductive
- Extended coil energy storage circuit
- Magnetic contactless distributor triggerhead
- Distributor triggerhead adaptors included
- Can also be triggered by existing contact breakers
- Die cast waterproof case with clip-to-coil fitting
- Fits majority of 4 and 6 cylinder 12v. neg. earth vehicles
- Over 150 components to assemble

All SPARKRITE products and designs are fully covered by one or more World Patents

**SPECIAL OFFER**  
"FREE" MAGIDICE KIT WITH ALL ORDERS OVER £45.00

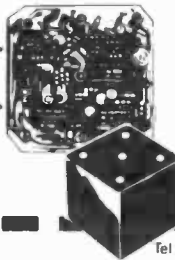

## MAGIDICE Electronic Dice

- Not an auto item but great fun for the family
- Total random selection
- Triggered by waving of hand over dice
- Bleeps and flashes during a 4 second tumble sequence
- Throw displayed for 10 seconds
- Auto display of last throw 1 second in 5
- Muting and Off switch on base
- Hours of continuous use from PP7 battery
- Over 100 components to assemble

SPARKRITE, 82 Bath St., Walsall, W. Midlands WS1 3DE.

SPARKRITE 82 Bath Street, Walsall, West Midlands, WS1 3DE England.

Tel (0922) 614791 Allow 28 days for delivery

	SELF ASSEMBLY KIT
SX 1000	£12.95
SX 2000	£19.95
TX 1002	£22.95
TX 2002	£32.95
AT 80	£32.95
VOYAGER	£64.95
MAGIDICE	£9.95

PRICES INC VAT, POSTAGE & PACKING

NAME \_\_\_\_\_ PE.6.83

ADDRESS \_\_\_\_\_

I ENCLOSE CHEQUE(S)/POSTAL ORDERS FOR

£ \_\_\_\_\_ KIT REF \_\_\_\_\_

CHEQUE NO \_\_\_\_\_

PHONE YOUR ORDER WITH   
SEND ONLY SAE IF BROCHURE IS REQUIRED

BRANDLEADING BRITISH ELECTRONICS  
CUT OUT THE COUPON NOW!

# Sinclair ZX Spect

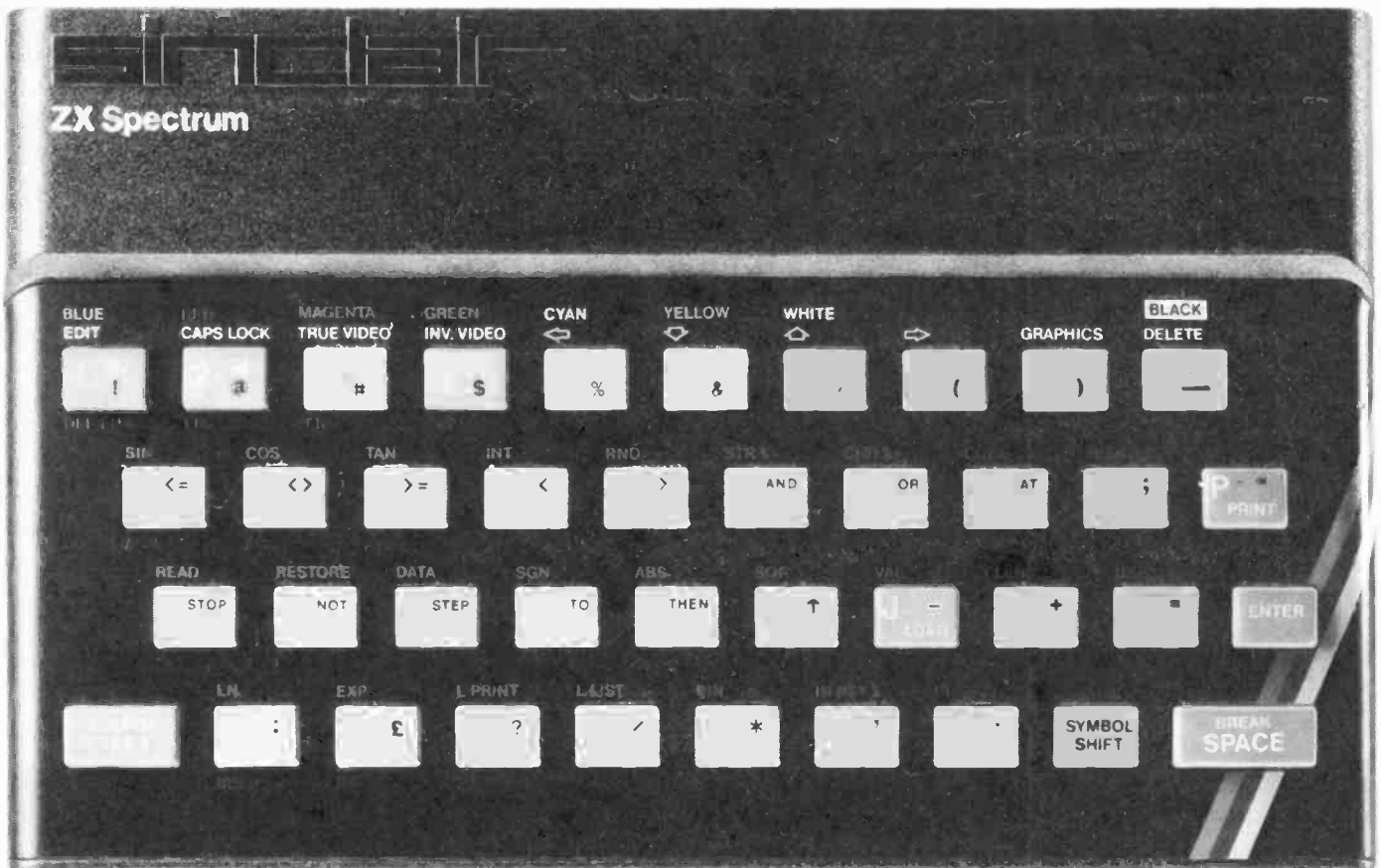

## The growing range of Spectrum Software



You'll know already that the Spectrum has generated an enormous range of bolt-ons and independent software. Our own range is growing very fast. You'll see some cassettes here. The rest are detailed in the Sinclair Software Catalogue - free with every ZX Spectrum.

# rum - news!

**16K now  
£99.95**

*Previously £125.*

**48K now  
£129.95**

*Previously £175.*

At last, a 16K colour computer with graphics for under £100!

Why have we done it?

Partly because the sheer volume of Spectrums sold (over 300,000 so far) has brought down unit production costs.

And partly, of course, because we hope you'll buy a Sinclair computer - and not some competitor's promise! We've all heard rumours that other colour computers will break the £100 barrier. Here's the computer that's done it - in a big way. A colour computer with advanced graphics that's fully supported, and fully available.

Right now, you can order a Sinclair Spectrum at these prices direct from Sinclair on the order form below. And to make it even easier to handle high-level computing at the

lowest possible price, we've cut the cost of the printer, too. At £39.95, it's almost unbelievable!

At prices like these, there's really no reason to wait.

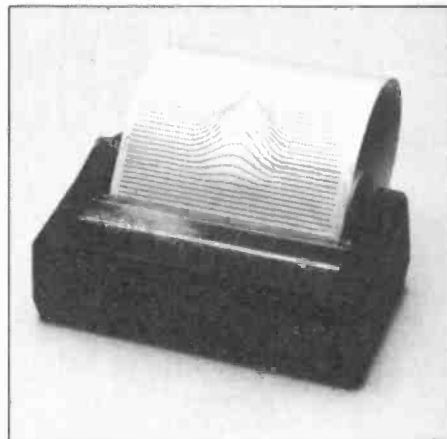

**ZX Printer now  
£39.95**

*Previously £59.95*

**How to order your ZX Spectrum**  
Access, Barclaycard or Trustcard holders - call 01-200 0200 24 hours a day, every day. By FREEPOST - use the coupon below. Please allow up to 28 days for delivery. 14-day money-back option.

**sinclair  
ZX Spectrum**

Sinclair Research Ltd., Stanhope Road,  
Camberley, Surrey, GU15 3PS.  
Tel: 0276 685311. Reg. no: 1135105.

Qty	Item	Code	Item Price £	Total £
	Sinclair ZX Spectrum - 16K RAM version	100	99.95	
	Sinclair ZX Spectrum - 48K RAM version	101	129.95	
	Sinclair ZX Printer	27	39.95	
	Printer paper (pack of 5 rolls)	16	11.95	
	Postage and packing: orders under £90	28	2.95	
	orders over £90	29	4.95	
				Total £ _____

To: Sinclair Research, FREEPOST, Camberley, Surrey, GU15 3BR. PRE 906 Order

Please tick if you require a VAT receipt

\* I enclose a cheque/postal order payable to Sinclair Research Ltd for £ \_\_\_\_\_

\* Please charge to my Access/Barclaycard/Trustcard account no. \_\_\_\_\_

\* Please delete/complete as applicable. \_\_\_\_\_

Signature \_\_\_\_\_ PLEASE PRINT

Name: Mr/Mrs/Miss \_\_\_\_\_

Address \_\_\_\_\_

\_\_\_\_\_

\_\_\_\_\_

FREEPOST - no stamp needed. Prices apply to UK only. Export prices on application.





# THE COMPLETE PACKAGE! MICROPROFESSOR PLUS THE STUDENT WORK BOOK



**A low cost tool for learning, teaching and prototyping.**

Micro-professor is a low-cost Z80 based micro computer which provides you with an interesting and inexpensive way to understand the world of microprocessors.

Micro-Professor is a complete hardware and software system and is a superb learning tool for students, hobbyists and microprocessor enthusiasts, as well as an excellent teaching aid for instructors of electrical engineering and computer science courses.

Micro-Professor **£99.50**  
(+£4.00 p&p)

Now with the Student Work Book available Flight offer you the complete package. An easy to follow manual that will help further your understanding of microprocessors.

Student Work Book **£16.00**

## FLIGHT Electronics Ltd.

Micro-Professor is a trade mark of Multitech Industrial Corporation. Z80 is a trade mark of Zilog Inc.

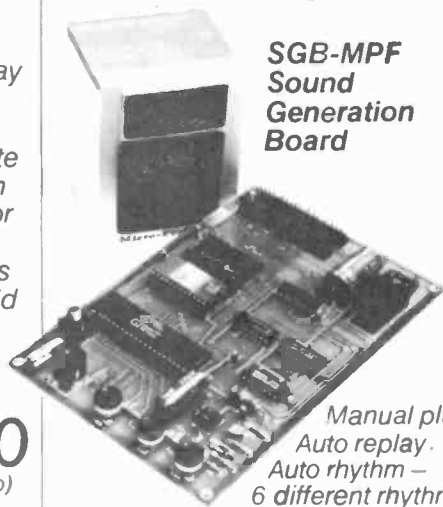

**SGB-MPF  
Sound  
Generation  
Board**

Manual play,  
Auto replay.  
Auto rhythm –  
6 different rhythms,  
Sound Synthesizer  
and Hi-fi speaker.

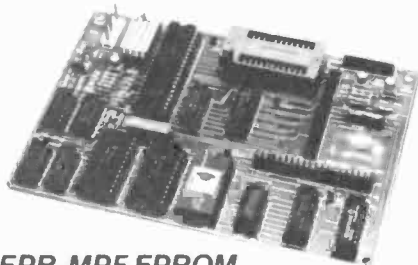

**EPB-MPF EPROM  
Programming Board**

For all +5V 1KB/2KB/4KB EPROMS  
Read/Copy/List/Verify Capability.

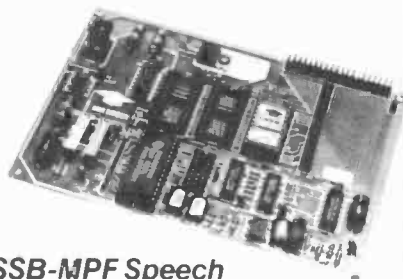

**SSB-MPF Speech  
Synthesizer Board**

A vocabulary of up to 400 words based on the TMS 5200 chip.

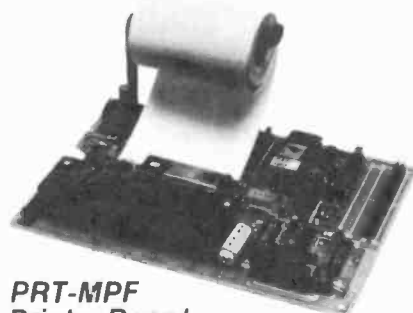

**PRT-MPF  
Printer Board**

Memory dump utility. BASIC program listing. Z80 disassembler.

**FLIGHT ELECTRONICS LTD.**  
Quayside Rd. Southampton,  
Hants SO24AD. Telex.477793.  
Tel.(0703)34003/27721.

Please send me	Qty
Micro-Professor	£99.50
	(+£4.00 p&p)
Student Work Book	£16.00
SGB-MPF board	£79.50
EPB-MPF board	£99.50
SSB-MPF board	£99.50
PRT-MPF board	£86.25

I enclose cheque/P.O. for £.....

Name .....

Address .....

Mail Order only  
Prices include VAT. Please  
allow 28 days for delivery.  By phone or post

### XK113 MW RADIO KIT

Based on ZN414 IC, kit includes PCB, wound aerial and crystal earpiece and all components to make a sensitive miniature radio. Size: 5.5 x 2.7 x 2cms. Requires PP3 9V battery. IDEAL FOR BEGINNERS. **£5.00**

### HOME LIGHTING KITS

These kits contain all necessary components and full instructions & are designed to replace a standard wall switch and control up to 300w of lighting.

TD300K Remote Control Dimmer **£14.30**

MK6 Transmitter for above **£ 4.20**

TD300K Touchdimmer **£ 7.00**

TDE/K Extension kit for 2-way switching for TD300K **£ 2.00**

LD300K Rotary Controlled Dimmer **£ 3.50**



### DVM/ULTRA SENSITIVE THERMOMETER KIT

This new design is based on the ICL7128 (a lower power version of the ICL7106 chip) and a 3 1/2 digit liquid crystal display. This kit will form the basis of a digital multimeter (only a few additional resistors and switches are required—details supplied), or a sensitive digital thermometer (-50°C to +150°C) reading to 0.1°C. The basic kit has a sensitivity of 200mV for a full scale reading, automatic polarity indication and an ultra low power requirement—giving a 2 year typical battery life from a standard 9V PP3 when used 8 hours a day, 7 days a week.

Price **£15.50**



# THE JUPITER ACE MICROCOMPUTER

uses FORTH which executes about 10 times faster and requires less program memory than a comparable program using basic. Features 8K ROM, 3K RAM, built in speaker, 40 key keyboard and a 32 x 24 line-flicker free display on TV. Comes supplied complete with leads, mains adaptor, a comprehensive easy-to-follow manual on Forth programming + FREE cassette containing 5 sample programs.

**ONLY £75.00** (+ £2.00 carriage + VAT)

JUPITER ACE SOFTWARE **J5 DOT MAN £3.90**  
**J3 SPACE INVADERS £3.90** **J7 ZAP 'EM (ASTEROIDS) DUCK £3.90**  
**J4 SWAMP MONSTERS £3.90** **SHOOT & MINEFIELD (3 programs) £5.20**

### COMPONENT PACKS

- PACK 1 650 Resistors 47 ohm to 10 Mohm — 10 per value **£4.00**
- PACK 2 40 x 16V Electrolytic Capacitors 10µF to 1000µF — 5 per value **£3.25**
- PACK 3 60 Polyester Capacitors 0.01 to 1µF/250V — 5 per value **£5.55**
- PACK 4 45 Sub-miniature Presets 100 ohm to 1 Mohm — 5 per value **£2.90**
- PACK 5 30 Low Profile IC Sockets 8, 14 and 16 — pin — 10 of each **£2.40**
- PACK 6 25 Red LEDs (5mm dia.) **£1.25**

### 3-NOTE DOOR CHIME

Based on the SAB0600 IC the kit is supplied with all components, including loudspeaker, printed circuit board, a pre-drilled box (95 x 71 x 35mm) and full instructions. Requires only a PP3 9V battery and push-switch to complete. AN IDEAL PROJECT FOR BEGINNERS. Order as XK102 **£5.00**

### LCD 3 1/2 DIGIT MULTIMETER

16 ranges including DC voltage (200 mv-1000 v) and AC voltage, DC current (200 mA-10 A) and resistance (0.2 MΩ - 999 MΩ) & PNP transistor gain and diode check. Input impedance 10MΩ. Size 155x86x31 mm. Requires PP3 9V battery. Test leads included **ONLY £29.00**

### ELECTRONIC LOCK KIT XK101

This KIT contains a purpose designed lock IC, 10-way keyboard, PCBs and all components to construct a Digital Lock, requiring a 4-key sequence to open and providing over 5000 different combinations. The open sequence may be easily changed by means of a pre-wired plug. Size: 7 x 6 x 3 cms. Supply: 5V to 15V d.c. at 40uA. Output: 750mA max. Hundreds of uses for doors and garages, car anti-theft device, electronic equipment, etc. Will drive most relays direct. Full instructions supplied.

**ONLY £10.50**

Electric lock mechanisms for use with latch locks and above kit **£13.50**

### DISCO LIGHTING KITS

DL 1000K

This value-for-money kit features a bi-directional sequence, speed of sequence and frequency of direction change, being variable by means of potentiometers and incorporates a master dimming control. **£14.60**

DL2100K

A lower cost version of the above, featuring unidirectional channel sequence with speed variable by means of a pre-set pot. Outputs switched only at mains zero crossing points to reduce radio interference to a minimum. **Only £8.00**

Optional opto input DLA1  
 Allowing audio ("beat")  
 —light response. **60p**

DL3000K

This 3 channel sound to light kit features zero voltage switching, automatic level control & built in mic. No connections to speaker or amp required. No knobs to adjust — simply connect to mains supply & lamps. (1Kw/Channel) **Only £11.95**

Have you got our FREE ORANGE CATALOGUE yet?  
 NO!! Send S.A.E. 6" x 9" TODAY!!

It's packed with details of all our KITS plus large range of SEMICONDUCTORS including CMOS, LS TTL, linear, microprocessors and memories; full range of LEDs, capacitors, resistors, hardware, relays, switches etc. We also stock VERO and Antex products as well as books from Texas Instruments, Babani and Elektor.

ALL AT VERY COMPETITIVE PRICES.

ORDERING IS EVEN EASIER — JUST RING THE NUMBER YOU CAN'T FORGET FOR PRICES YOU CAN'T RESIST.

**5-6-7 8-9-10**

and give us your Access or Barclaycard No. or write enclosing cheque or postal order. Official orders accepted from schools, etc.

Answering service evngs & weekends

## FAST SERVICE · TOP QUALITY · LOW LOW PRICES

No circuit is complete without a call to —

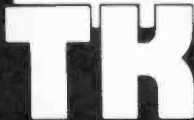

# ELECTRONICS

11 Boston Road  
 London W7 3SJ

Add 65p postage & packing + 15% VAT to total  
 Overseas Customers:  
 Add £2.50 (Europe), £8.00 (elsewhere) for p&p  
 Send S.A.E. for further STOCK DETAILS  
 Goods by return subject to availability.

**OPEN**

9am to 5pm (Mon to Fri)  
 10am to 4pm (Sat)

**ALL PRICES EXCLUDE VAT**

PE

# CLEF ELECTRONIC MUSIC

VISIT OUR SHOWROOM

## ELECTRONIC PIANOS

**SPECIALISTS SINCE 1972**  
 Clef Pianos adopt the most advanced form of Touch Sensitive action which simulates piano Key inertia using a patented electronic technique.

**7 1/2 OCTAVE DOMESTIC MODEL COMPONENT KIT £266**  
**COMPLETE KIT £442**

MANUFACTURED £895

Two Domestic Models are available including the 88-note full-size version. Four intermixable Voice Controls may be used to obtain a wide variation of Piano tone, including Harpsichord.

Both Soft and Sustain Pedals are incorporated in the Design and internal Effects are provided in the form of Tremolo, Honky-Chorus, and Phase/Flanger.

A power amplifier integrates into the Piano top which may be removed from the Base for easy transportation.

**SIX OCTAVE DOMESTIC MODEL COMPONENT KIT £234**  
**COMPLETE KIT £398 MAN. £620**

Component Kits include Keyboard, Key-switch hardware, and all electronic components and may be purchased in four stages at no extra cost.

Complete Kits further contain Cabinets, wiring harness, Pedals and in the case of Domestic Models both Power Amplifier and Speaker.

**SIX OCTAVE STAGE MODEL COMPONENT KIT £234**  
 MANUFACTURED £580

Please allow 3-14 days for normal despatch

## MICROSYNTH THE COMPACT MUSIC SYNTHESIZER

Design — Allan Bradford  
 Published in P.E.



**COMPLETE KIT £129** \* SWITCH ROUTING \* 2 1/2 OCTAVES  
**MANF £215** \* THUMBWHEEL \* 2 OSCILLATORS  
 \* 2 SUB-OCTAVES

**STRING ENSEMBLE**

(As Published in conjunction with 'Practical Electronics')

A very popular Keyboard Synthesizer Kit, for Group or Home use, with a four octave compass and split Keyboard facility.

**COMPONENT KIT £197.50**

**ROTOR-CHORUS**

Comprehensive two speed organ rotor simulator plus a three phase chorus generator.

**COMPONENT KIT £98.00**

**KEYBOARDS**

Our Square Front Keyboards  
**88 NOTE (A-C) £60**  
**73 NOTE (F-F) £50**  
**FIVE OCTAVE £39**  
**FOUR OCTAVE £29**

Since 1972 Clef Products have consistently produced leading designs in the field of Electronic Musical Instruments, many of which have been published in technical magazines. With musical quality of paramount importance, new techniques have been evolved and the latest musically valid technology has been incorporated into projects which have been successfully completed by constructors over a wide range of technical capability. Back up TELEPHONE advice is available to all our customers. All instruments are on show.

**PRICES INCLUDE VAT, UK CARRIAGE & INSURANCE (CARRIAGE EXTRA ON MPD PLANS).** Please send S.A.E. for our complete lists, or use our telephone VISA/ACCESS service. Competitive quotations can be given for EXPORT orders — in Australia please contact JAYCAR in Sydney. Please allow 7 days for normal despatch. Visit our Showroom.

**CLEF PRODUCTS (ELECTRONICS) LIMITED**

(Dept. P.E.) 44A Bramhall Lane South, Bramhall, Stockport, Cheshire SK7 1AH 061 439-3297

## "THE COMPUTER BAND-BOX"

(As Published in conjunction with "Practical Electronics")

**COMPLETE KIT £235**

**£327 MANFD.**



MASTER RHYTHM ALSO REQUIRED

**PROGRAMMABLE BACKING BAND FOR THE SOLOIST NOW INCLUDES PROGRAMMABLE BASS EXTENDABLE TO 9,500 LINES**

The BAND-BOX provides an Electronic Backing Trio consisting of Drums, Bass, and a Chord Instrument (one of 16 Waveform/Envelope combinations), with the capacity to store over 3,000 User Programmable Chord Changes on more than 120 different Chords. Using advanced Microprocessor technology, Playback of 50 100 Scores can be executed in any Key and at chosen Tempo. Complete Music Pad is electronically indexed and stored on secondary battery back-up. Facility exists for composition of Intro, Repeat Chorus, and Coda sections including Multiple Score Sequences. Sockets are provided for Volume Pedal and Footswitch plus separate and mixed instrument Outputs. Total size 19" x 11" x 4 1/2" incorporating Master Rhythm.

## THE Programmable DRUM MACHINE

(As Published in conjunction with 'Practical Electronics')

**EIGHT TRACK PROGRAMMING / TWENTY-FOUR PATTERNS / TWELVE INSTRUMENTS SEQUENCE OPERATION**

**COMPLETE KIT £79 MANFD. £122**



The Clef Master Rhythm is capable of storing 24 selectable rhythmic drum patterns, invented, modified, and entered by the Operator on to Eight Instrumentation tracks. A three position Instrumentation control expands the number of instruments available to twelve, grouped into sounds typical of playing with Drumsticks, Brushes, or Latin American Bongos and Claves.

Sequence operation allows two rhythm sections to be coupled with the second (B) section appearing at four eighth or quarter repetition. All drums can be adjusted for level and resonance on internal controls to suit individual taste, thus producing good musical sounds in a battery driven unit 8 1/2" x 5" x 2 1/2".



# MIDWICH COMPUTER COMPANY LIMITED

FAST EX-STOCK DELIVERY OF MICROCOMPUTER COMPONENTS AT UNBEATABLE PRICES

## Official BBC Dealer

### BBC COMPUTERS

Model B	346.95
Model B + Disc Interface (carriage 6.50 by Secunior)	441.95

### BBC MICRO DISC DRIVES

BBC 31 Single 100K Drive Expandable to 2x100K	229.00
BBC 32 Dual 100K Drives	340.00
BBC 33 100K Upgrade for BBC 31	122.00
BBC 34 Dual 400K Drives	649.00

All Disk Drives (except BBC 33) are complete with Manual Utilities Disc, and Connecting Cables

### BBC MICRO UPGRADE KITS

BBCA2B Complete A to B Upgrade	44.75
BBC 1 16K Memory	18.00
BBC 2 Printer/IO Kit	7.50
BBC 3 Disc Interface Kit	95.00
BBC 4 Analogue Input Kit	6.70
BBC 5 Serial I/O & RGB Kit	7.30
BBC 6 BUS Expansion Kit	6.45

All Kits are supplied with full fitting instructions

### BBC CONNECTORS

BBC 21 Printer Cable and Amphenol Plug (not assembled)	13.00
BBC 22 User Port Connector and Cable 36"	2.46
BBC 23 Cassette Lead	3.50
BBC 24 7 Pin DIN Plug	0.80
BBC 25 6 Pin DIN Plug	0.80
BBC 26 5 Pin DIN Plug	0.80
BBC 35 Disc I/O Cable 34W IDC to 2x34 way card edge	12.00
BBC 36 Disc Power Cable	2.25
BBC 44 Analogue Input Plug and Cover	2.25
BBC 66 IM Bus Connector + 36" Cable	3.50

### BBC ACCESSORIES

BBC 45 Joysticks (per pair)	11.30
BBC 67 Eeprom Programmer (assembled)	57.95
BBC 71 Teletext Receiver	225.00
BBC 72 Second Processor (6502)	170.00
BBC 73 Second Processor (280)	170.00

### ACORN SOFTWARE FOR THE BBC

SBE03 Business Games	8.85
SBE04 Tree of Knowledge	8.85
SBE02 Peeko Computer inc Manual	8.85
SBE01 Algebraic Manipulation Pk	8.85
SBX01 Creative Graphics Cassette	8.85
SBX02 Graphics and Charts Cassette	8.85
SBX01 Desk Diary inc Manual	8.85
SBL02 USP Cassette	14.85
SBL01 FORTH Cassette	14.85
SBG01 Philosophers Quest	8.85
SBG07 Sphinx Adventure	8.85
SBG03 Monsters	8.85
SBG04 Snapper	8.85
SBG15 Planetoid	8.85
SBG06 Arcade Action	10.35
SBG05 Rocket Raid	8.85
SBG13 Meteors	8.85
SBG14 Arcadians	8.85
SBG10 Chess	8.85

### ACORN SOFTWARE BOOKS FOR THE BBC MICRO

SBD01 Creative Graphics	7.50
SBD02 Graphs and Charts	7.50
SBD04 USP	7.50
SBD03 FORTH	7.50

Please ring for current delivery on Acornsoft Products before ordering.

### BBC MICRO COMPONENTS

4516 100ns	2.25	8271	38.00
6522	3.19	20 Way Header	1.46
74LS244	0.59	26 Way Header	1.78
74LS245	0.89	34 Way Header	2.06
74LS163	0.34	40 Way Header	2.32
DS3891N	4.50	15 Way D Skt	2.15
DS88LS120N	4.50	6 Way DIN Skt	0.80
UPD7002	4.50	5 Way DIN Skt	0.90

### BBC SOFTWARE IN EPROM

Wordprocessor "View"	52.00
12 MDS	10.00

## SPECIAL OFFER

Spectrum 32K Upgrade Kit  
**24.95**

DATA SHEETS are available on items marked D. Prices are as follows

D1	0.75
D2	1.00
D3	1.25
D4	2.00
D5	2.50
D6	3.00
D7	4.00

### MEMORIES

2114L 200ns D1	0.80
2708 450ns D2	2.95
2716 450ns D1	2.25
2716 350ns D1	4.95
2732 450ns D1	3.45
2732 350ns D1	5.45
2764 300ns D1	5.99
4116 150ns D2	0.85
4116 200ns D2	0.80
4118 150ns D1	3.25
5516 200ns D2	9.45
6116 150ns D1	3.30
6116 Low Power 150ns D2	4.95
4164 150ns D1	3.45
4164 200ns D1	3.95
4164 150ns D3	3.95
Mostek D3	4.45
4516/4816 100ns D2	2.25
4532 200ns D2	2.95

### 8800 FAMILY

6800 D7	2.25
6802 D5	2.50
6809 D6	6.30
6810 D1	1.15
6821 D3	1.00
6840 D4	3.75
6845 D5	0.50
6850 D2	1.10
68488 D2	7.30
68800 D7	5.25
68809 D6	12.00
68810 D1	2.26
68821 D3	2.20
68840 D4	6.00
68850 D2	2.20

### Z80 FAMILY

Z80 ACPU D2	2.99
Z80 BCPU D2	9.00
Z80 ACTC D1	2.00
Z80 BCTC D1	9.00
Z80 ADART D1	5.50
Z80 ADMA D2	0.95
Z80 AP10 D1	2.75
Z80 BP10 D1	9.00
Z80 AS10 D4	9.00

### 8080 FAMILY

8085A D4	3.50
8212	1.10
8216	1.00
8224	2.10
8228	3.27
8251A D5	2.50
8253	4.00
8255A D5	2.25
6502 FAMILY D3	3.25
6502A D3	5.00
6520 D1	2.50
6520A D1	3.16
6522 D5	3.19
6522A D5	5.50
6532 D2	5.50

### FLOPPY DISC CONTROLLERS

8271	38.00
F01771 D5	15.00
F01791 D6	22.00
F01793 D6	23.00
F01795 D6	29.00
F01797 D6	28.00
WD1691 D2	12.00
WD2143-01 D2	6.99

### INTERFACE DEVICES

6402	3.80
75107	0.47
75110	0.56
75150	0.64
75154	0.77
75160	2.56
75161	2.80
75162	3.95
75172	1.85
75173	1.44
75174	1.95
75175	1.44
75182	0.50
75183	0.50
75188	0.37
75189	0.37

### 75451

75451	0.22
75452	0.22
75453	0.22
75454	0.22
75468	0.88
75491	0.31
75492	0.42
AY31015 D2	3.00
AY31270	6.47
AY38910 D6	4.40
AY3600 D2	6.70
DP3004 D1	2.50
MC1488 D1	0.37
MC1489 D1	0.37
MC3242A	6.30
MC3446 D1	2.50
MC3448A D1	3.75
MC3480 D5	7.30
MC3487 D1	2.00
MC14411 D1	7.85
MC14412	9.45
RD32513L D1	6.50
RD32513U D1	6.50

### UMF MODULATORS

UM1111 6MHz D1	2.60
UM1233 8MHz D1	3.90

### BUFFERS

81LS95	0.80
81LS96	0.80
81LS97	0.80
81LS98	0.80
8126A	0.90
8128A	0.90
8195	0.90
8197A	0.90
8198	0.90

### LINEARS

L203	0.85
LF398N	4.75
LM301AN	0.24
LM309N	0.18
LM311P	0.50
LM319N	1.99
LM324N	0.30
LM348N	0.60
NE555P	0.16
NE556CP	0.45
TL010	0.39
TL011	0.32
TL012	0.34
TL014	0.34
TL021	0.34
TL061	0.29
TL062	0.49
TL064	0.98
TL066	0.29
TL068	0.32
TL071	0.29
TL072	0.47
TL074	1.00
TL081	0.28
TL082	0.46
TL084	1.58
TL091	0.40
TL092	0.58
TL094	1.34
TL487	0.82
TL489	0.82
TL494	1.63
TL496	0.80
TL507	1.33
725	1.60
741	0.14
747	0.48
748	0.27

### REGULATORS

78L05	0.30
78L12	0.30
78L15	0.30
7805	0.40
7812	0.40
7815	0.40
7905	0.45
7912	0.45
7915	0.45
LM309K	1.20
LM317K	2.40
LM323K	4.50
LM338K	6.25

### DATA CONVERTERS

AD7702 D1	4.26
ZN425 D1	3.45
ZN426 D1	3.00
ZN427 D1	5.99
ZN428 D1	4.75

### ZN429 D1

ZN429 D1	2.10
ZN432 D1	13.00
ZN449 D1	2.55

### OIL SOCKETS (TEXAS)

PINS TIN GOLD WW	
8 7 16 25	4555
14 10 26 35	4556
16 10 29 40	4557
18 13 33 50	4558
20 15 37 60	4559
22 17 38 65	7415
24 21 48 70	01
28 24 55 80	02
40 30 76 99	03

### ZIF SOCKETS (TEXTOL)

24 pin	5.75
28 pin	8.20
40 pin	9.75

### CMOS 4000

4000	0.10
4001	0.10
4002	0.12
4006	0.42
4007	0.14
4008	0.32
4009	0.24
4010	0.24
4011	0.10
4012	0.18
4013	0.20
4014	0.40
4015	0.36
4016	0.20
4017	0.32
4018	0.36
4019	0.36
4020	0.36
4021	0.40
4022	0.40
4023	0.13
4024	0.32
4025	0.13
4026	0.74
4027	0.20
4028	0.32
4031	0.94
4033	1.80
4034	0.94
4035	0.90
4040	0.39
4041	0.39
4042	0.40
4043	0.36
4044	0.38
4045	1.35
4046	0.42
4047	0.70
4048	0.38
4049	0.23
4051	0.39
4052	0.14
4053	0.44
4054	0.85
4055	0.85
4060	0.39
4063	0.85
4066	0.24
4068	0.14
4069	0.14
4070	0.13
4071	0.13
4072	0.13
4073	0.14
4075	0.13
4076	0.43
4077	0.13
4078	0.15
4081	0.13
4082	0.13
4085	0.50
4086	0.44
4093	0.20
4502	0.46
4507	0.32
4508	0.96

### 4510

4510	0.40
4511	0.41
4512	0.40
4514	0.86
4515	0.96

# No Compromise



**£295**  
+VAT

## Microdoctor

is an alternative to AUTOMATIC TEST EQUIPMENT which can be very expensive. MICRODOCTOR is perfectly adequate for diagnosing faults in microprocessor boards or computers in the REPAIR SHOP or on the PRODUCTION LINE. Reports are PRINTED on the integral thermal printer. Tests supported are CHECKSUM, RAMTEST, WAIT, READ, WRITE, I/O READ, I/O WRITE, DUMP IN HEX, DUMP IN ASCII, TEST DATA LINES (for shorts between data, address and rails), SEARCH (for two specified bytes), MAP (print a memory map of ROM, RAM, I/O and EMPTY SPACE). Supports both multiplexed and non-multiplexed address/data. Standard software will also DISASSEMBLE in Z80 mnemonics — other disassemblers cost extra. Programs for board-testing can be written in MINUTES — and retained for MONTHS even if the power is switched off (CMOS RAM is backed-up with rechargeable battery). Capacity is 15 different programs of 12 tests each, included are two PROBE CONFIGURATION CARDS (One Z80, other uncommitted) PROBE with 24 inch cable and 40-pin DIL plug — and POWER SUPPLY.

- OPTIONAL EXTRAS**
- 6502 Disassembler Card ..... £35.00
  - 6800 Disassembler Card ..... £35.00
  - 8055 Disassembler Card ..... £35.00
  - Clip-over probe (only needed if soldered-in) ..... £35.00
  - Thermal paper (10 Rolls) ..... £9.00
  - Spare configuration cards ..... £6.50
  - Extras available are 6502 disassembler retrofit ..... £35, 6800 disassembler retrofit ..... £35, Thermal paper £9.00 box of 10 Clip-over PROBE (only needed if uP is soldered-in) ..... £35, Spare cards ..... £6.50

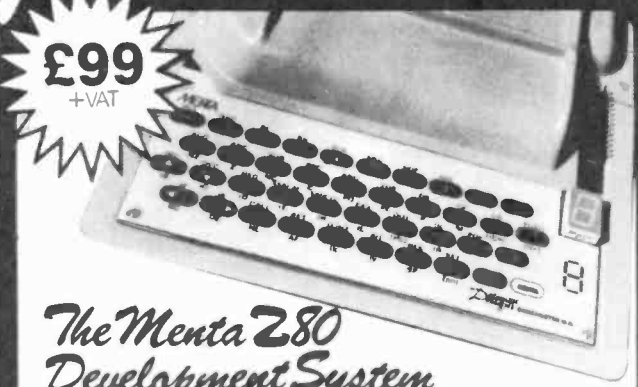

**£99**  
+VAT

## The Menta 280 Development System

uses the MOST POWERFUL LANGUAGE OF ALL — direct ASSEMBLER MNEMONICS. MENTA has VISUAL AID to program development which the big systems lack: a TV display of PROGRAM, REGISTERS and STACK; single-step operation (watch the cursor move from instruction to instruction, see the register-contents change, observe stack operations, etc.); BUGS can be fixed immediately without reassembling. Full-speed operation is supported too — with or without BREAKPOINTS. Designed originally for the Schools' Council to teach microprocessing, MENTA is a complex CONTROLLER in its own right, like any other Z80 system, with practical, commercial applications in ROBOTICS. Features include CASSETTE INTERFACE, ASSEMBLY EDITOR, serial DISASSEMBLER.

- MODULES AVAILABLE**
- Universal Input/Output Device ..... £21.00
  - Analogue to Digital Converter ..... £18.00
  - Digital to Analogue Converter ..... £14.00
  - Switching Input Module Analogue/Digital ..... £10.00
  - D.C. Motor and Current Buffer ..... £12.00
  - Teacher's Guide ..... £2.50
  - Pupil Reader ..... £3.00
  - 24 bits of I/O — also TV FLYLEAD, POWER SUPPLY and COMPREHENSIVE MANUAL with SOURCE-CODE LISTING



**£1950**  
+VAT

## Thandar T.A. 2080 20MHz Logic Analyser

**DATAMAN DESIGNS** Retrofit for T.A. 2080, gives R.S. 232 output feasibility for printed state and timing diagrams. Also disassembles in Z 80, 6502 or 6800 mnemonics on-screen or to printer **£295.00**

### Olivetti Typewriter Interfaces

for ET121 and ET221 machines which permit the typewriter to be used as a DAISY WHEEL PRINTER for computers implementing the RS232, IEEE 488 (PPI) or CENTRONICS PARALLEL buses; almost all computers in fact. Great for word processing and letter-writing! Same price, fitting free if requested (you pay carriage on typewriter if we fit). **£195.00**

**Ultra-Violet Eprom Erasers from** **£33.00**

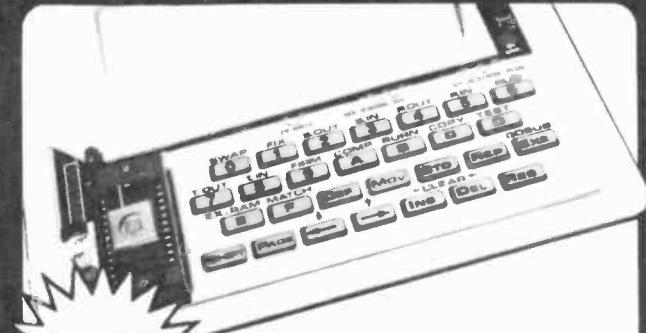

**£169**  
+VAT

## Softy Eprom Programmer/Emulator

SOFTY has functions equal, at least, to equipment which sells for over £500. SOFTY EMULATES AND PROGRAMS 2716, 2516, 2732, 2532 EPROMS. (The type is selected by a personality switch. SOFTY will copy any of these EPROMS to any other). SOFTY has a HEX KEYPAD, a fast CASSETTE INTERFACE, a MEMORY MAP TV DISPLAY with powerful editing — such as INSERT, DELETE, SHIFT-BLOCK and many other facilities — too many to list here. RS232 SERIAL and CENTRONICS PARALLEL routines for INPUT and OUTPUT are standard. The price includes TV FLY-LEAD, POWER SUPPLY and ROM EMULATOR CABLE WITH 24 PIN DIL PLUG. SOFTY is used as a DEVELOPMENT SYSTEM for new products or just as a STAND-ALONE EPROM PROGRAMMER.

*Adequate performance at sensible prices*

# Dataman Designs

**LOMBARD HOUSE, CORNWALL ROAD, DORCHESTER, DORSET DT1 1RX. Telephone: Dorchester (0305) 68066 Telex 418442 DATAMAN**

Prepaid orders normally shipped by return. Prices include first-class recorded post in UK. Securicor, Red Star, etc. at extra cost. VAT should be added at current rates.

Carriage Free on Orders in excess of £50.00. Add £2.50 if less.

## FEATURE

THIS issue of PE carries the first of a regular line of feature articles on various aspects of electronics and its applications. The first article could not get further from the hobbyist concept of PE. It describes a piece of equipment costing some £500 million to build, requiring 700 megawatts of power just to start it up and being quite simply gigantic in size.

No doubt some readers will be aware of the JET Tokamak, of the fact that its trials will be starting within the next month and that it has been built in the heart of Oxfordshire. But how many will know what it is designed to find out, the problems involved in generating and containing a plasma at 100 million degrees Centigrade and what impact it could have on our future energy supply? We must say that until recently we were not conscious of its existence and this article would not have appeared if our Technical Editor had not read a small piece in a newspaper he was standing on whilst decorating!

It is our intention on PE to bring you a wide range of feature articles, some

relating directly to our hobby and some, like *Fusion*, giving a glimpse into the future and showing how the application of complex electronics can change our world. Next month our feature will investigate the *Fairlight Music Computer*, an instrument that has changed the world of music. Ray Hammond, author of the recently released book *The Musician And The Micro*, takes an in-depth look at what the Fairlight is, what it can do and just how it does it. The feature will make fascinating reading to anyone with any interest in electronics, computing or music.

After that we are planning to look at such things as robot vision, satellite TV, fibre optics, radio astronomy and one or two other exciting and possibly "unknown" areas. We will reveal more at a later date.

Most of the articles will be written by experts at the sharp end of the developments or researched and written by experienced technical authors. They will be revealing, factual and authoritative. In fact just what you have come to expect from PE.

## CARTE BLANCHE

This issue also sees a new page from our very own "V.T.", Vernon Trent. We have given Vernon *carte blanche* to write what he likes about anything he likes, when he likes — provided it's linked to electronics and he does it every month (writes that is). Only his name has been changed to protect him from the wrath of anyone he takes to task!

*Vernon Trent at Large* should make entertaining reading, it will sometimes have a message or moral behind it. It might be instructive or informative, it could even be funny and it may well add to our post bag when all you "worthy sextons" start writing in. As we have said V.T. speaks for himself and not necessarily PE (or anyone else). Perhaps this is something you didn't expect from PE!

We hope these new features add to your enjoyment of the magazine.



**EDITOR** Mike Kenward  
**Gordon Godbold** ASSISTANT EDITOR  
**David Shortland** ASSISTANT  
EDITOR/PRODUCTION  
**Mike Abbott** TECHNICAL EDITOR  
**Brian Butler** TECHNICAL SUB EDITOR

**Jack Pountney** ART EDITOR  
**Keith Woodruff** ASSISTANT ART EDITOR  
**John Pickering** SEN. TECH. ILLUSTRATOR  
**Isabelle Greenaway** TECH. ILLUSTRATOR  
**Jenny Tremaine** SECRETARY

**ADVERTISEMENT MANAGER** **D. W. B. Tilleard** } **01-261 6676**  
**SECRETARY** **Christine Pocknell** }  
**AD. SALES EXEC.** **Alfred Tonge** **01-261 6819**  
**CLASSIFIED SUPERVISOR** **Barbara Blake** **01-261 5897**  
**AD. MAKE-UP/COPY** **Brian Lamb** **01-261 6601**

*Technical and Editorial queries and letters (see note below) to:*  
Practical Electronics Editorial,  
Westover House,  
West Quay Road, Poole,  
Dorset BH15 1JG  
**Phone: Editorial Poole 671191**

**We regret that lengthy technical enquiries cannot be answered over the telephone**

*Queries and letters concerning advertisements to:*  
Practical Electronics Advertisements,  
King's Reach Tower,  
King's Reach, Stamford Street, SE1 9LS  
Telex: 915748 MAGDIV-G

## Letters and Queries

We are unable to offer any advice on the use or purchase of commercial equipment or the incorporation or modification of designs published in PE. All letters requiring a reply should be accompanied by a stamped, self addressed envelope, or addressed envelope and international reply coupons, and each letter should relate to one published project only.

Components and p.c.b.s are usually available from advertisers; where we anticipate difficulties a source will be suggested.

## Back Numbers

Copies of most of our recent issues are available from: Post Sales Department (Practical Electronics), IPC Magazines Ltd., Lavington House, 25 Lavington Street, London SE1 0PF, at £1 each including Inland/Overseas p&p. Please state month and year of issue required.

## Binders

Binders for PE are available from the same address as back numbers at £5.50 each

to UK or overseas addresses, including postage and packing, and VAT where appropriate. Orders should state the year and volume required.

## Subscriptions

Copies of PE are available by post, inland or overseas, for £13.00 per 12 issues, from: Practical Electronics, Subscription Department, Oakfield House, Perrymount Road, Haywards Heath, West Sussex RH16 3DH. Cheques and postal orders should be made payable to IPC Magazines Limited.



Items mentioned are available through normal retail outlets, unless otherwise specified. Prices correct at time of going to press.

## Y's and Wherefores

**Why QWERTY? Do we stop at Y because it sounds friendly? Full name, then: QWERTYUIOP! But this is the lesser mystery surrounding the conventional typewriter keyboard. Why are the letters so arranged to start with. Conflicting reports have been published as to the historical explanation of this configuration, but in PE we now present the truth (of course).**

Over a century ago Frederick Sholes, E. P. Curry and G. W. Carr described the forerunner of today's typewriter in British patent 2418 of 1879. This is a fact stated in the UK PIN (Patents Information Network) Bulletin, and it is also a fact that the early keyboard was designed so that frequently adjacent characters in use are not adjacent mechanically. The letters E and F are an example of this, and by keeping them apart they will not jam together when the word "efficient" is typed rapidly. Sholes's typewriter comprised a circle of hammers, with T and H on opposite sides of the basket. It is a myth that the designer's intention was to avoid key jamming by deliberately slowing down the typist through the use of a *quirky* keyboard.

Why do we couple the high technology keyboard of today's word processor, for example, to a key layout philosophy governed by archaic mechanics? Answer: Commerce thrives on providing for people's needs, and people need what their fingers are familiar with . . . when it comes to typing.



Attempts to shatter the mould do exist. The first photograph shows PCD Maltron's ergonomically designed keyboard. Although this looks like a fire damaged item, it is shaped to accommodate the contours, and finger positions and lengths, of the human hand. The character positions are scientifically placed so that the most frequently used keys are the most convenient to press. Typing speed improvements of up to 40% have been achieved, and tests have shown that re-training the QWERTYite is surprisingly quick, leaving her confidently bidextrous. Humans, after all, are curvey, so this keyboard might be a guide to future architecture. Why should machines which we human beings have to work with be rigid, and squared off with sharp corners? Machines should *bend* to suit people, not vice versa.

Another key approach is the Microwriter, which completely abandons the concept of having a button to represent each alphanumeric character. Combinational use of only six keys enables one-handed operation. Imaginary linking of the shape of the required character, to the shape formed by the buttons to be pressed, allows the Microwriter to be mastered in as little as 20 minutes. A single-line display shows what has been keyed into this portable unit, and an integral word processor allows subsequent editing. Later the writer can be linked

to a host computer to download the day's work. The reclined executive, typing on the Microwriter, takes on the appearance of



someone impatiently tapping his fingers on the desk. Pen and paper are endangered species!

## ROBOTIC SHEEP SHEARING

*Robotic sheep shearing is here (in Australia, at least Bruce), according to a report in Electronics Times. In it, John Mathews, of the National Institute of Agricultural Engineering is said to believe that robotic sheep shearing, and even robotic artificial insemination is a workable idea. The Australian Wool Board has issued contracts to researchers to look into these possibilities. Melbourne and Perth, it is claimed, already have robotic shearers.*

*Not for animal lovers, the Perth system*

*takes a computerised picture of the sheep's contours as it moves along a conveyor belt. The computer then controls the shearing arm in accordance with this information, stored in its memory. In a demonstration, the sheep was held still whilst being shorn, using an electric current passed via an electrode in its mouth. This apparently freezes the animal's muscles, keeping nicks to a similar level to that of manual shearing. Mathews predicts that farmers will be using robotic sheep shearers by 1990.*



"THATS A PRETTY VOLATILE RAM BRUCE . . . YER'LL NEED A BYTE CHECK ON YER BUFFER WHEN HE'S DONE WITH YER!!"

# MARKET PLACE

## Pollution Monitor

A personal pollution monitor in use by the Environmental Protection Agency in the USA has been designed to be worn by people as they go about their daily business in urban areas, the unit weighs only 2 lb and continuously sucks in air to measure the level of carbon monoxide. It stores and displays hourly averages of the pollution that its wearer has inhaled, and can later chart a graph. The system is far more indicative of pollution dangers than the conventional fixed point sampling method, and Federal officials say that the study could lead to changes in carbon monoxide regulations in 90 US cities.

## DBS News

On March 7th, 1983, Bryce McCrerrick, BBC Director of Engineering, and Alan Jefferis, Managing Director of United Satellites Limited (Unisat), signed Heads of Agreement for provision by Unisat of two direct broadcasting by satellite television channels for the BBC DBS services due to start in 1986.

Unisat, jointly owned by British Telecom, British Aerospace and the General Electric Company, will be responsible for building and launching two satellites in 1986, the first to be operational and the second as a flying spare. A third spacecraft will be available on the ground as an additional safeguard. Launch will be by the European Ariane rocket or by the American Space Shuttle, the final choice to be made nearer the time. The satellites will be in geostationary orbit 36,000km above the equator and will provide signals of sufficient power for high-quality reception by individual households, with suitable receivers and small dish antennas less than 1 metre in diameter, within a 'footprint' covering the United Kingdom and parts of Western Europe. The agreement covers a period of operation of the satellite service of at least seven years.

The satellite will carry transponders for two BBC DBS services; DBS 1 will be a Subscription Channel carrying feature films and other attractions; and DBS 2 will have an international flavour. There will also be a number of digital sound channels affording stereo sound with television and some high-quality radio channels.

The signing of the Heads of Agreement represents a notable landmark in the development of British broadcasting. It will be followed later by completion of a full Agreement covering the finer details.

*PE will be publishing an article on the proposed new system in a few months' time*

## SOLID STATE MICRO

Lamentably, Solid State Micro Technology (for Music Inc.) has no current UK outlet. Although the SSM2040 Voltage Controlled Filter (used in the Audio Sweep Oscillator of PE Oct. '82) is available from Digisound (14 Queen St., Blackpool), this is a residual stock, since that company is no longer an outlet for Solid State Micro.

However, we are informed by Solid State Micro that they will take overseas orders from hobbyists, for their popular range of i.c.s. They require prepayment in the form of a money order in US dollars, allowing \$2 for p&p for small packets. Prices (1-24) are indicated:

SSM-2000, 2010, 2020, 2030, 2040, 2024, 2050 ...	\$7.50
SSM-2011, 2022, 2031, 2044, 2056 .....	\$5.75
SSM-2015, 2033, 2038 .....	\$10
SSM-2012/2012A .....	\$9.50
SSM-2100 .....	\$10

Solid State Micro are on the lookout for a non-OEM outlet in the UK, but

for the meantime, here is their US address: Solid State Micro Technology for Music Inc., 2076B Walsh Ave., Santa Clara, CA95050, USA.

## Static Bike

One day, when the final tree has fallen, the last lawn has gone nylon, and the world is artificially oxygenated, people may wonder what it must have been like to go for a leisurely bicycle ride down a country lane. The technology to simulate this experience will be old hat by then, but today it's the very latest thing, if only for Americans with sufficient disposable income to accommodate the dismissal of \$20,000.

The static exercise bike is connected to a laser video disc system which projects the way ahead onto a 45 inch screen. As the rider imbibes the fresh office air, the bike is electromechanically punched up and down to simulate bumps in the road. That's not all; a choice of directions accompanies each fork in the lane, selectable by push button. The video disc has the capacity to store many parallel route options from which the laser head can be instructed to select by computer.

## Silicon News Corner

Bulletins announcing new semiconductor devices arrive at PE daily, so it is possible only to describe them briefly. Details of how to obtain further information are included, however.

**National Semiconductor** ♦ CMOS UART with near-NMOS speed. The NSC858 interfaces to NSC800, 8085 and 1802  $\mu$ Ps. Has internal diagnostics and Baud generator, and consumes 50mW.

♦ The NMC9306/COP494 is a low cost 256-bit serial Electrically Erasable Programmable Memory. Needing only 5V to operate, this TTL compatible, non-volatile 16 x 16 serial read/write memory has Microwire™ I/O. It employs floating gate technology and is compatible with COP400 processors

♦ Combined 4-digit alphanumeric display and CMOS driver i.c. is called the NSM 1416. It features a 4mm, 16 segment font, and an on-board memory to store four 7-bit ASCII words (the four display chars), and an ASCII-to 16 seg. alphanumeric ROM decoder plus multiplexing. Other features: Cascade ability,  $\mu$ P bus compatibility with 300ns access time.

♦ New 4MHz version of NSC800  $\mu$ P speed compatible with all Z80 4MHz 8-bit micros. The NSC800D-4 has 60% speed improvement over NSC800. Set of 158 instructions; consumes 16mA typical. Also houses internal DRAM refresh circuitry. National Semiconductor, 301 Harpur Centre, Horne Lane, Bedford.

**Synertek (Honeywell)** ♦ Low cost SY68045 CRT Controller. 5V device pin compatible with industry standard 6845. Although flexible, primarily for interface with 6500/6800/68000  $\mu$ Ps. Adds to Synertek's CRT device family, of which the SY6545R is addressable up to 16K of video RAM, incorporating light pen interface. Synertek, 3001 Stender Way MS-34, Santa Clara, CA 95054.

**Mitel** ♦ Complete monolithic DTMF receiver (18 pin) incorporating bandsplit filter and digital decoder functions. Called the MT8870, this ISO-CMOS device also includes differential amp, clock osc., and latched tristate bus interface. Power is 15mW at 5V. Pronto Electronic Systems Ltd., 466-478 Cranbrook Road, Gants Hill, Ilford, Essex.

**Precision Monolithics** ♦ 1983 Product Selection Guide. Bourns Electronics Ltd., Hodford House, 17/27 High Street, Hounslow, Middx.

**Intersil** ♦ Two-stage, differential output, wide-band video amp, the NE/SE592 offers fixed gains of 100 and 400 using no external components, or variable gain. Bandpass capability makes this ideal for pulse amplification in floppy disc units. Pin-for-pin replacement for  $\mu$ A733.

♦ ICL7415 is a 16-bit,  $\mu$ P compatible multiplying D/A converter. Has 16-bit resolution, linearity of 0.003% FSR, output current settling time of 3 $\mu$ s, and four quadrant multiplication. Intersil Datel (UK) Ltd, Snamprogetti House, Basing View, Basingstoke.

## IBM's COOL CHIPS

Researchers at IBM's East Fishkill laboratories have found an ingenious way to remove heat from the silicon devices used in today's generation of fast computers. Their solution comes in the shape of a Thermal Conduction Module (TCM) which comprises up to 118 LSI chips mounted on a 30 layer ceramic substrate. The considerable heat generated in a densely packed TCM, typically containing over 25,000 logic circuits and 65,000 array bits of storage, is removed through a matrix of aluminium pistons, each spring-loaded against a chip. Backed up by water circulation, a TCM has a cooling capacity of up to 300 W.

The ceramic layers carry interwiring between the chips, with power distribution dominating the lower levels, and signal routes occupying the upper levels. A key feature is the routing of all signal connections from each chip via an array of surface pads, which in turn are connected to internal wiring layers. In the event of modifications, connections to buried layers may be removed and substitute wires ultrasonically bonded to the gold-plated pads.

The same function of one typical TCM would, using the technology of the IBM 3033 processor, require 1,880 single-chip logic modules, 80 array modules with associated terminating devices, 52 multi-layer printed circuit cards and four large

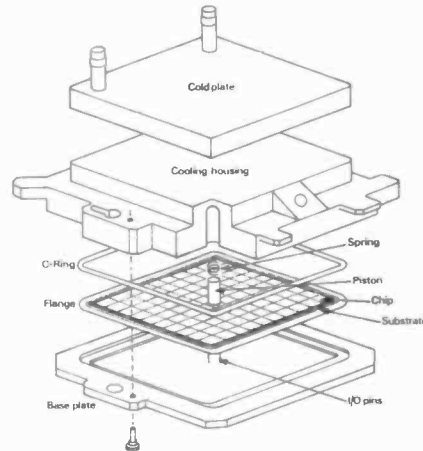

Exploded view of a TCM. Measures 15 x 15 x 6cm.

multilayer p.c.b.s with associated interconnecting cables. The reduction in hardware using TCM's results in greater reliability and cost saving. A reduction factor of 7:1 in interwiring length increases execution

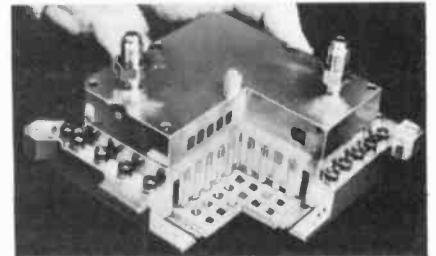

Cut-away view of a TCM, revealing the pistons that bear down on each LSI chip. The TCM is used in IBM's new 3081 series processor.

speed by reducing what is called "time-of-flight" circuit delay. This also limits the drive circuit power requirements.

The Japanese are said to be working on water-cooled computers, but it is believed that IBM has a clear lead at this stage.

## Robot Trainer

The robot arm shown in the photograph is called Armatron. It is manufactured by Tomy Corp, and has surprising flexibility due to the number of controllable axes. Armatron stands about 250mm high, being made out of blue/grey plastic, and comes with a set of important looking components for manipulation practice. This robot arm is intended to teach the geometrics of robot manipulation to youngsters, for it cannot be programmed and will not interface to a computer, but is operated entirely by way of two joysticks. It nevertheless is a fascinating and instructive gadget with which to experiment; any combination of axes can be simultaneously activated.

The robot's console has an integral timer switch that shuts off power from the battery (two D-cells) after a preset time period. One's progress can be monitored, or competitions held using this timer, during tasks using the "industrial components" supplied. The timer's lapsing "energy level" as it is called, can be seen through a row of windows on the robot's console, where orange squares disappear one by one.

Armatron is entirely mechanical, being powered from a single d.c. motor. Revolving drive shafts carry power through the arm to each axis, a system involving numerous differential gears. The joysticks

operate into a drum of centrifugal gears which distributes power from a single drive shaft. The mechanics alone of Armatron are intriguing enough, but by the same token a disappointment to the micro/robotics buff. There's no rational way to interface Armatron to a micro (our original reason for examining the robot). In any case, the machine lacks the necessary precision for simple operation from a program of instructions, and would therefore require positional feedback, making the modifications still more disproportionate.

By the time this item is in print, Armatron (called Robo I outside the UK) should be available through high street shops at around £35.

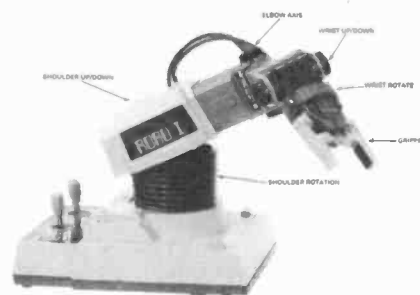

## GSC Launch

Global Specialties have just launched three new test instruments: an autoranging capacitance meter, a frequency counter and a handheld frequency counter-timer.

The autoranging capacitance meter, model 3002, incorporates a 3½ digit l.c.d. and measures 193 x 95 x 44mm. The unit provides direct readings of capacitance from 1pF to 19990µF over eight automatically selected ranges with an accuracy within 0.2% (± one count) from 1pF to 199µF and 1.0% (± one count) between





# MARKET PLACE

200µF and 19990µF. The 3002 is priced at £165.50 including VAT.

The frequency counter, model 6000, can measure from 50Hz to 650MHz and has an 8-digit l.e.d. display, simple push-button controls with l.e.d. indicators for selecting the input, gate time and low pass filter.

Two BNC inputs are provided: one covering the range 5Hz to 100MHz with a 1MΩ input impedance and the other for signals between 40MHz and 650MHz with a 50Ω impedance. Gate times of 0.1, 1.0 and 10 seconds are available. The instrument which measures 76 x 254 x 178mm is priced at £315.39 including VAT.

The last unit in the range is the model 5000 handheld counter-timer which is battery operated and includes pulse-width measurement facilities in addition to frequency and period.

The unit has an 8-digit l.c.d. and covers the frequency range from 0.1Hz to 50MHz incorporating a wide range of signal-conditioning facilities including attenuation, slope selection, a.c. or d.c. coupling and a variable trigger level.

The model 5000 is priced at £274.85 including VAT.

For complete details of these and the rest of the GSC range of instruments send a self-addressed envelope to GSC, Shire Hill Industrial Estate, Saffron Walden, Essex CB11 3AQ.

## Fair News

Those readers who came to the first Electronics Hobbies Fair last November will not want to miss the second one, so make a note of the dates now: October 27th to the 30th 1983. The event will take place in the same excellent venue (Alexandra Pavilion) and it will have all the best attractions of "number one" with plenty of new ones. Something for everyone with any interest in electronics.

The foremost consumer electronics exhibition goes forward so make sure you are there.

## Briefly...

A team of scientists from Lockheed's Palo Alto Research Laboratory and Stanford University have achieved a breakthrough in understanding how radio waves interact with the Earth's magnetosphere and ionosphere. The SEEP (Stimulated Emission of Energetic Particles)

study, sponsored by the Office of Naval Research, is said to have confirmed a long believed theory that man-made Very Low Frequency (v.l.f.) radio waves traverse earth's magnetic field lines to great altitudes and dislodge electrons. In a process identical to that caused by sunspot activity these electrons are dumped into the ionosphere, causing a miniature aurora borealis, and the release of X-rays. Remarkable improvements in radio communications could result from this discovery. It may be possible to use magnetic field lines to capture and amplify v.l.f. radio waves.



*A new component, developed by Ferranti at Dalkeith, is believed to be the most accurate and first of its kind in the world. It is an encoder, Type 35HA, and is used to measure the rotation of a shaft down to 1/3000th of a degree. According to Ferranti News, if you were to plot a triangle between the outer edges of a house brick and an observation point 24 miles away, this would be the angle formed at the observer's point!*

*Encoders are used for radio telescope tracking, laser pointing systems and robotics. The computerised 35HA can work accurately up to 1000 r.p.m.*

## Countdown ...

Please check dates before setting out, as we cannot *guarantee* the accuracy of the information presented below. Note: some exhibitions may be trade only. If you are organising any electrical/electronics, radio or scientific event, big or small, we shall be glad to include it here. Address details to Mike Abbott.

**Compec Scotland** May 17-19. Kelvin Hall, Glasgow. **Z1**  
**Welsh Amateur Radio, TV & Electronics Rally** May 22. Barry Memorial Hall, S. Glam. **C**  
**Computers In The City** (conf. & ex.) May 24-26. Barbican. **O**  
**Business Telecom** May 24-26. Barbican. **O**  
**International Word Processing** May 24-27. Wembley Conf. Cntr. **Z**  
**Motradex** May 25-27. Sandown Exhibition Centre, Surrey. **Z1**  
**East Suffolk Wireless Revival** May 29. Ipswich Civil Service Sportsground. **V1**  
**Russian Holography** June-Sept. Inc. Light Fantastic Gallery. **A8**  
**Apple Exhibition** June 3-5. Fulcrum Cntr., Slough. **J1**  
**Semlab** June. Olympia. **I**  
**IBM Productivity** (conf. & small ex.) June 14-16. Tara Hotel, London. **O**  
**The Computer Fair** June 16-19. Earls Court. **Z1**  
**Compec North** June 21-23. Belle Vue, Manchester. **Z1**  
**Transducer/Tempcon** June 28-30. Wembley Conf. Cntr. **T**  
**Leeds Electronics Show** July 5-7. University. **E**  
**Satellite TV & Cable TV** July 5-7. Alex. Palace, London. **G4**  
**IBM User Show** July 12-14. Wembley. **O**  
**BAEC Amateur Electronics** July 16-24. Shelter, Esplanade, Penarth, S. Glamorgan. **B9**

**Laboratory Edinburgh** July 18-20. University. **E**  
**Acorn Exhibition** Aug. 25-28. Cunard Int. Hotel, Hammersmith, London. **J3**  
**BARTAG Rally** (radio teleprinter) Aug. 29. Sandown Park, Esher, Surrey. **E2**  
**Weldex** Sept. 12-16. NEC B/ham. **I**  
**Testmex** Sept. 13-15. Grosvenor House, Park Lane, London. **E**  
**Personal Computer World Show** Sept. 28-Oct. 2. Barbican, London. **M**  
**Laboratory London** Oct. 12-14. Barbican Centre. **E**  
**Drives/Motors/Controls** Oct. 12-14. Leeds University. **E**  
**Computer Graphics** Oct. 18-20. Wembley. **O**  
**PARC** (computers in architecture, conf.) Oct. 18-20. Wembley. **O**  
**International Business Show** Oct. 18-26. NEC. **T**  
**Business Efficiency Exhibition** Oct. 22-26. Earls Court, London. **Z**  
**Electronics Hobbies Fair** Oct. 27-30. Alex Pavilion, London. **Z1**  
**Compec** Nov. 15-18. Olympia, London.  
**Northern Computer Fair** Nov. 24-26. Belle Vue, Manchester. **Z1**  
**A8** Holographic Exhibitions ☎ 01-826 6423  
**B9** Cyril Bogod, British Am. Elect. Club ☎ 0222 707813  
**C** Reg. Rowles ☎ Cardiff 565656  
**E** Evan Steadman ☎ 0799 22612  
**E2** BARTG 89 Linden Gdns., Enfield, Middx.  
**G4** Intech Exhibitions, 55 London Rd., St. Albans  
**I** Industrial Trade Fairs ☎ 021 705 6707  
**J1** Database Publications, Stockport, Cheshire  
**J3** Computer Marketplace. ☎ 01-930 1612  
**M** Montbuild ☎ 01-486 1951  
**O** Online ☎ 09274 28211  
**T** Trident ☎ 0822 4671  
**V1** Jack Tootill, 76 Fircroft Rd., Ipswich IP1 6PX  
**Z** BETA Exhibitions ☎ 01-405 6233  
**Z1** IPC Exhibitions ☎ 01-643 8040

# PROGRAM CONDITIONER

IAN HICKMAN

THE usual way to copy a personal computer program stored on cassette is to load the program into the computer and record it onto another cassette. This method has both advantages and disadvantages. On the plus side, only one cassette recorder is required, and the program listing can be checked for errors on the visual display unit screen—usually a TV set—as it loads. Further, when it is recorded, the new recording is retimed by the computer so that any timing imperfections on the original due to flutter or other cassette deck limitations are not compounded.

On the debit side, the computer is tied up whilst loading and recording are in progress. Also, it is sometimes found that the program won't load correctly in the first place, due to inadequacies in the original recording or in the cassette machine used for playback, or due to the combination of the two—there are fairly startling differences in performance between different models.

The circuit forming the subject of this article can often circumvent this problem and is thus useful as a signal conditioner to rescue poor recordings and enable them to be successfully loaded into a computer. Also, if two recorders are available, it permits programs to be copied directly without tying up a computer. The latter method is particularly useful for the enthusiast who is still saving up for a computer system but who wants to be able to collect programs from friends in the meantime.

The circuit consists of four sections—a selectable high-pass filter, an adjustable all-pass filter, an output stage providing clipping and shaping, and an audio stage driving a monitor loudspeaker. To understand the purpose of the various stages—particularly the all-pass filter (also known as a phase equaliser)—one needs to know a little of how tape recording works.

## RECORDING ON TAPE

Magnetic recording tape consists of thin plastic, coated with finely divided iron oxide or other suitable magnetic powder. You may have noticed that once pins have been picked up with a magnet, they will tend to stick together even in the absence of a magnet. This effect is called remanence and is the basis of tape recording. Fig. 1 shows how a recording head records the signal onto the tape.

The relation between the record current and the remanent magnetism is nonlinear, so a high frequency (50 to 100kHz) bias current is added to spread the recording to the linear parts of the characteristic. On cassette recorders the same head is usually used for playback, so that monitoring from

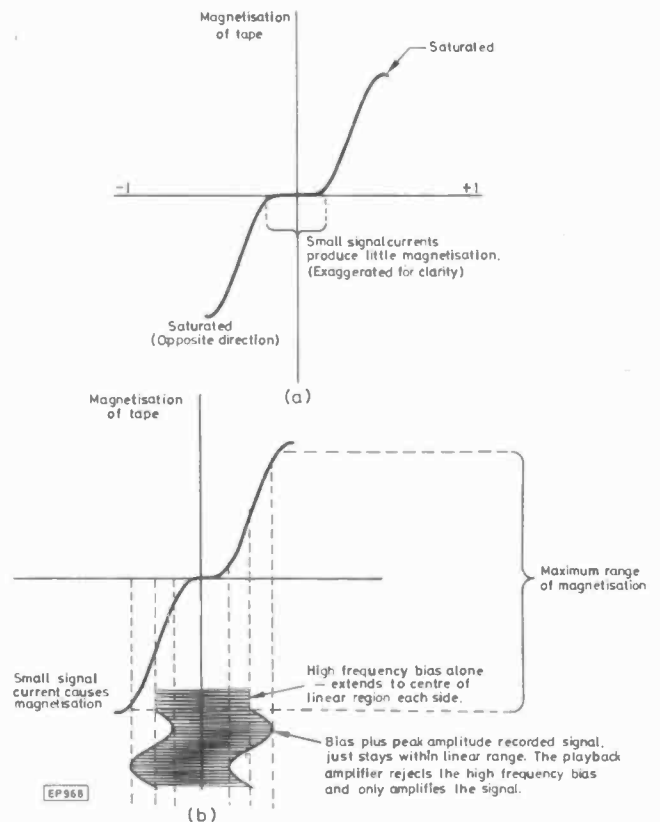

Fig. 1. Magnetic tape recording with (a) no bias and (b) the effect of bias

the tape is not possible. Another head uses the a.c. bias current at a much higher power to erase previous recordings. Quarter track heads are used in stereo cassette recorders, providing two tracks in either direction. Mono recorders use half track heads in the same way as older half track reel to reel recorders. With stereo cassette machines, the two tracks of the stereo signal are on the same side of the tape, and both are erased at the same time by the erase head. As with reel to reel recorders, the erase head is energised during recording and the tape passes over it first, before reaching the record head. Thus four track mono use is not available, but mono cassette recordings can be played on

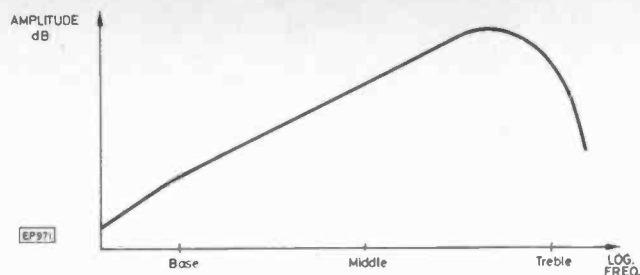

Fig. 2. Typical tape playback curve for constant peak recorded flux density

stereo cassette decks and vice versa. Of course the result is always mono except in the case of a cassette recorded on a stereo machine being replayed on a stereo machine.

There is nothing to prevent one using an older reel to reel recorder for storing personal computer programs on tape, though cassette machines are almost invariably used because of their greater convenience.

Also, the greater demands made on the tape by the very low tape speed ( $1\frac{1}{8}$  in per second) and narrow track of the heads used in cassette machines has resulted in the development of much better tape, suffering less from drop outs (random areas of low sensitivity along the tape) than older reel to reel tapes. However, whatever type of tape is used, one still has to cope with the basic frequency response of magnetic recording tape, as shown in Fig. 2. The 6dB per octave roll-off in the middle and lower frequency region is a result of the law of induction, the induced voltage on playback (for constant peak recorded flux level) is directly proportional to the rate of change of flux density, and hence to the frequency.

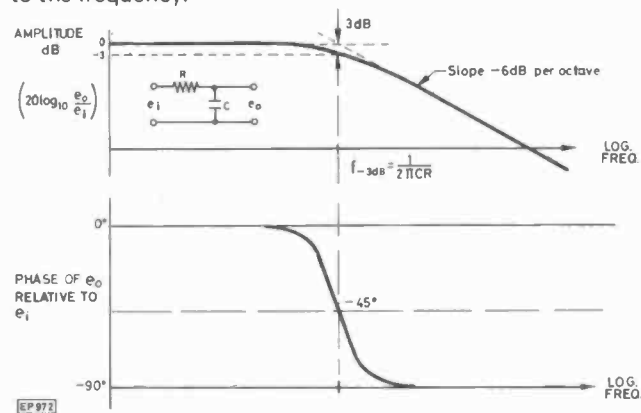

Fig. 3. Bode plot of phase and amplitude against frequency for a top-cut circuit

At higher frequencies, another effect takes over. The shorter and fatter a magnet, the greater the tendency to self-demagnetisation—which explains why, before the invention of modern improved magnetic materials, magnets were always long and thin. The same effect is observed in tape recording where the shorter recorded wavelength along the tape results in a falling high frequency response. The effect is compounded by the bias waveform, which unfortunately acts increasingly as an erase signal as the recorded frequency rises. The signal applied to the erase head is simply the bias waveform, but at a very much higher level.

To obtain a level overall response independent of frequency, on playback the middle and bass are boosted by 6dB per octave and the high frequencies, above the frequency of maximum response are also boosted. The rate of fall-off of the high frequency response is in fact faster than 6dB per octave, so boost is also applied during recording.

## EFFECT OF PHASE

It is usually claimed that the phase response of audio equipment is unimportant as the ear is not sensitive to phase, and this is certainly largely true as otherwise tape recordings would all sound awful. The fact is that audio tape recorders of all types do dreadful things to the relative phase of the harmonics of, for example, a squarewave. To see why we must now digress a moment and look at phase and amplitude responses versus frequency for various circuits and processes, usually called bode plots.

Fig. 3 shows a top cut or high frequency roll-off circuit, together with its Bode plots. It can be seen that at low frequencies, where the response is level, there is little if any phase shift; whilst at high frequencies, where the response is falling off at 6dB per octave, the phase shift approaches 90° lagging. At the point where the 6dB/octave asymptote crosses the level asymptote, the amplitude response is -3dB, and the phase shift is -45° (45° lagging). Bode's relations show that generally a lagging or negative phase shift is associated with an amplitude response which is falling with increase of frequency, and a leading or positive phase shift with a rising amplitude response. The change in amplitude of response in dBs (decibels) between two frequencies  $f_1$  and  $f_2$  is proportional to the integral of the phase shift between limits  $f_1$  and  $f_2$ , and the phase shift at any frequency is proportional to the rate of change of amplitude response. The going rate of exchange is 90° (lead or lag) for a 6dB/octave rate of change of amplitude (rising or falling with frequency respectively).

Does this apply universally? Well, almost; that is it applies to all "minimum phase" circuits and processes and this includes most tone control networks and filters. There are, however, "non minimum phase" networks. This can occur for example where there are two parallel paths through a network. In such cases Bode's relationships do not apply—a well known example is the twin tee network. There are a number of non minimum phase processes and two other examples are all-pass filters and tape recorders.

In tape recording, it has been explained that the high frequency roll off is due to self- and bias-demagnetisation, and in fact there is no associated phase shift involved—a non minimum phase process. The treble boost applied on both record and playback to maintain a level response is a minimum phase process and thus, overall, the amplitude response is level, but the phase advanced.

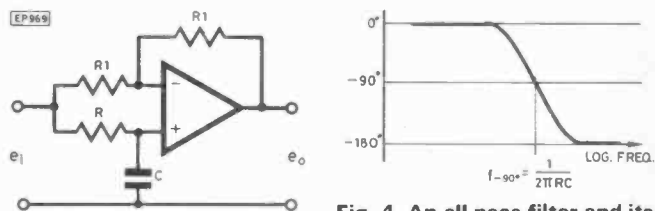

Fig. 4. An all pass filter and its phase response. Here gain is unity at all frequencies

The all pass filter in Fig. 4 has an amplitude response independent of frequency, but provides a phase response which varies with frequency. At very low frequencies, it is a non inverting amplifier with unity gain, i.e. 0° phase shift. At a frequency  $f_{90} = 1/(2\pi CR)$  it has a 90° phase lag and at high frequencies the phase shift becomes 180° lagging, all the while with a flat amplitude response. Fig. 5 shows the effect on a square wave of changing the product CR. When  $1/(2\pi CR)$  is very much lower than the fundamental frequency of the square wave,  $f_t$ , all the frequency components of the square wave are shifted by -180°, so the waveform is unaffected. If  $f_{90}$  rises—say by reducing the value of R—the

effect on the squarewave at first is not unlike the slope or tilt produced by an inadequate coupling capacitor—Fig. 5(a). As  $f_{90}$  approaches  $f_f$ , the effect is more marked, but as the fundamental is now shifted in phase relative to the harmonics without its amplitude being reduced, we see the waveform of Fig. 5(b), and as  $f_{90}$  becomes higher and then much higher than  $f_f$  we see waveforms like Figs. 5(c) and (d).

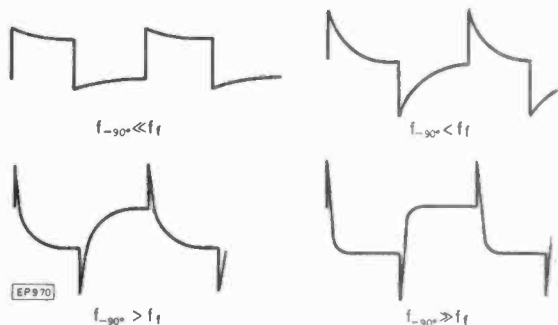

Fig. 5. Effect of the all pass filter on an ideal square wave of frequency  $f_f$

### RECORDING PROGRAMS

Returning now to the topic of recording programs on cassettes, the usual format is CUTS (computer users' tape system), also known as the Kansas City interface. This is an FSK (frequency shift keying) system where a frequency of 1200Hz represents a zero and 2400Hz a 1. As the signalling rate is 300 bauds (300 signal elements per second) one signal element consists of either 4 cycles of 1200Hz tone (a zero) or 8 cycles of 2400Hz tone (a 1). The format is a 1 as a start bit, eight data bits (1s or 0s according to the byte to be transmitted) and two stop bits. On replay, the computer looks for a 0 (start bit) following a long string of 1s, and thereafter for succeeding start bits following the two stop bits. Signal conditioning circuitry in the computer's CUTS input turns the two tones into 0 or 1 levels as appropriate.

Thus the system is asynchronous, and provided the difference in speed between the recorder used to make the recording and that used to reproduce it (allowing also for the effects of flutter and noise) is not more than a few percent then no problems should arise. Nevertheless, the phase distortion already noted is bound to occur in the cassette recording/playback process, so compensation for the phase advance of the harmonics is applied by a phase retard (top cut) circuit in the computer's CUTS output—Fig. 6(b). Allowing for the limited frequency response of most cassette recorders, this would ideally appear on playback as in Fig. 6(c).

Several deviations from the ideal playback waveform are commonly observed. The waveform often has superimposed hum at 50Hz (poor layout, induced hum from the recorder's mains transformer), at 100Hz (inadequate smoothing of full wave rectifier output), and at 150Hz (a third harmonic component of the mains transformer's magnetising current due to using the core laminations at a peak flux density approaching saturation). The smallish internal speaker used in many machines is relatively insensitive at 150Hz and completely dead at 50Hz, so the manufacturer has little incentive to worry over much about these hum components in the playback signal. To cope with this problem, the circuit described later has an active 2 pole high pass filter which can be switched into circuit if required.

Another problem one encounters is excessive phase distortion, due to a variety of causes. One commercially produced program appeared to have been recorded without sufficient phase retard, or maybe excessive peaking in the record circuitry. The result was that playback on the author's

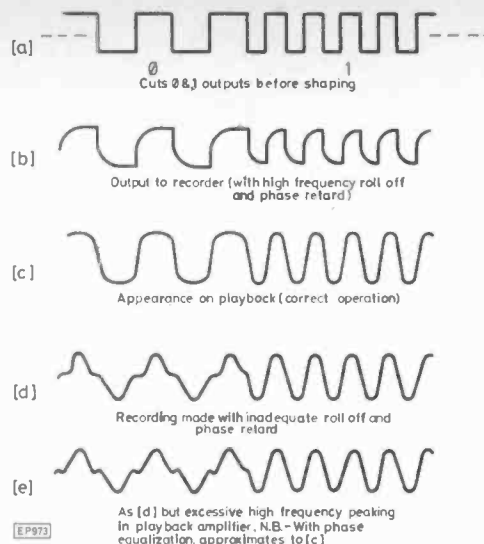

Fig. 6. Waveforms associated with cassette program recording

Trophy CR100 cassette recorder resulted in the 1200Hz tone appearing as in Fig. 6(d). The program loaded o.k., but on a colleague's cassette deck (which was evidently equipped with extra enthusiastic treble peaking in the playback equalisation section) the waveform appeared as in Fig. 6(e). The additional zero crossings got sliced in the computer's CUTS input circuit, turning occasional 0s into 1s and corrupting the program. The extraneous wiggles could be reduced with the aid of the tone control (which, like the volume control, controlled the output at the recorder's 5 pin DIN auxiliary socket) but that also had the undesirable effect of attenuating the 2400Hz 1 tone. The all pass filter in the signal conditioner described in this article permits the harmonics to be properly relocated in phase relative to the fundamental, resulting in the 1200Hz tone again resembling a squarewave, without attenuating the 2400Hz tone at all. So, having prepared the ground, let's look at the full circuit of the Program Conditioner, Fig. 7.

### THE SIGNAL CONDITIONER

This uses a TLO84 quad op-amp and the whole instrument fits in a small sloping panel plastic case, powered from an internal PP7 battery. Two input sockets are provided, the first (JK1) being a 3.5mm jack socket. This accepts a jack to jack lead from a cassette recorder's earphone socket, a suitable level being set with the recorder's volume control. The second input socket (SK2) accepts an input from the recorder's auxiliary socket. The latter is usually a 5 pin 180° DIN socket and to prevent the DIN plug to DIN plug lead from being connected the wrong way round, a 5 pin 270° DIN socket is used on the Program Conditioner. On the 180° DIN plug, the two signal output pins (usually pins 3 and 5) are connected in parallel so that a stereo cassette deck is used in the mono mode. Most recorders provide the AUX output signal at a fixed standard level, unaffected by the volume control or tone control (if any), but on some machines the AUX level is affected by these controls—in which case a medium volume setting (and no top cut) should be selected.

The input signal is applied to IC1b which acts as a non inverting buffer amplifier when S1 is closed, and as a high pass filter when S1 is open. In this mode, it provides, nominally, a 300Hz corner frequency with 12dB attenuation at 150Hz and 30dB at 50Hz, with little effect at 1200Hz—the lower of the two tones used in recording programs.



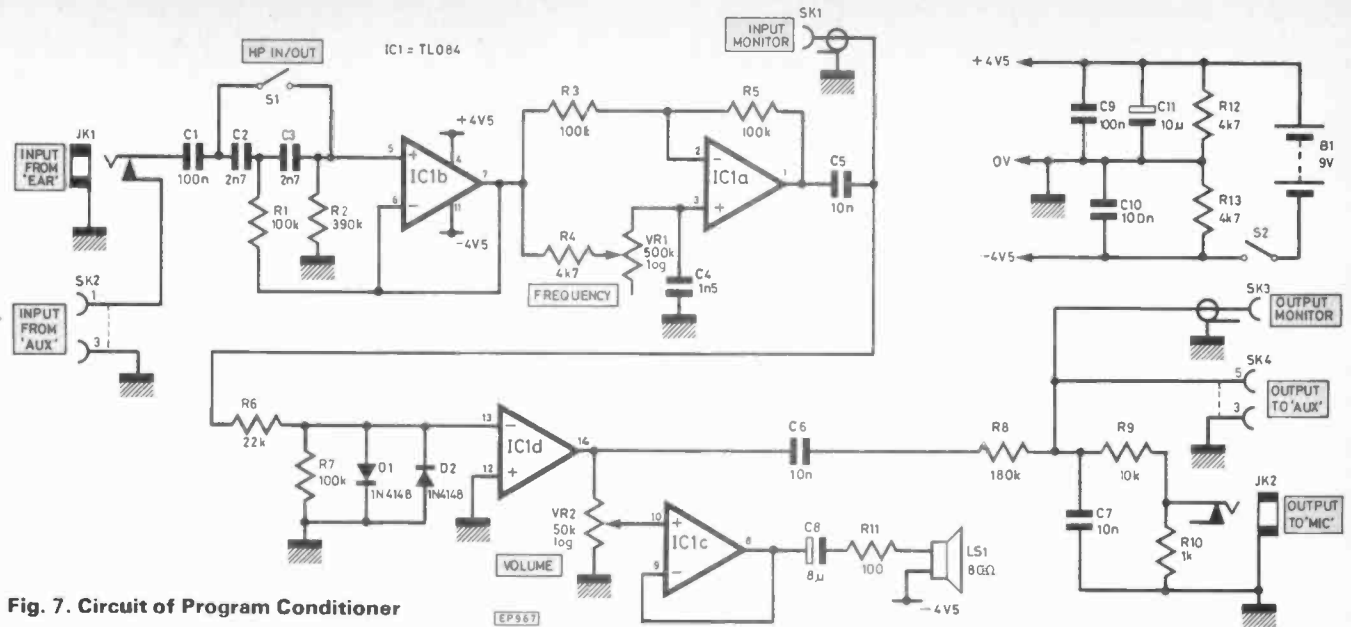

Fig. 7. Circuit of Program Conditioner

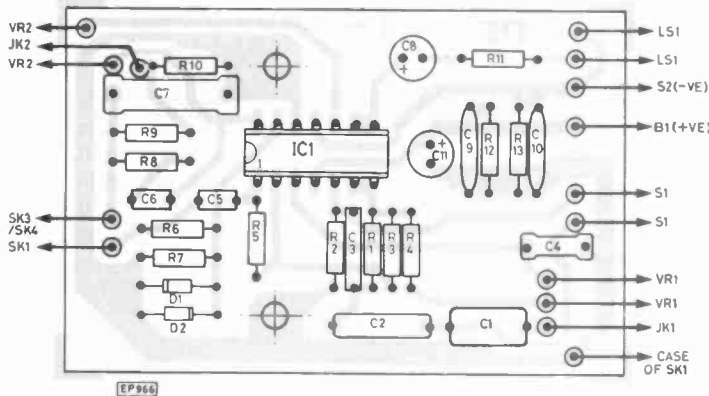
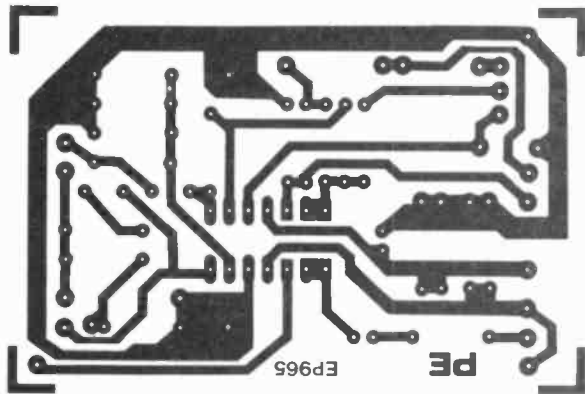

Fig. 8. Printed circuit detail and component overlay

The output of the high pass filter stage is applied to the all pass filter, IC1a. The turnover frequency of this stage (at which the phase shift is 90°) is adjustable by VR1 from about 200Hz to 20kHz. At the latter setting (VR1 fully anticlockwise) the all pass filter is effectively out of circuit since the vast majority of cassette recorders cannot reproduce frequencies this high. Thus, with VR1 set anticlockwise and S1 closed (high pass filter bypassed) the playback signal from the recorder can be observed by connecting an oscilloscope to SK1, the "Input Monitor" socket. Any hum or phase distortion can thus be observed, as can the corrective effect of the two filters. The filtered, phase corrected signal is fed to

Resistors		Integrated Circuit	
R1	100k	IC1	TL084
R2	390k	<b>Potentiometer</b>	
R3	100k	VR1	500k log
R4	4.7k	VR2	50k log
R5	100k	<b>Switches</b>	
R6	22k	S1	S.p.s.t.
R7	100k		miniature toggle
R8	180k	S2	S.p.s.t.
R9	10k		miniature toggle
R10	1k	<b>Battery</b>	
R11	100	B1	PP7
R12-R13	4.7k (2 off)	<b>Loudspeaker</b>	
All resistors ¼W 5%		LS1	80 ohm 2in
Capacitors		Sockets	
C1	0.1µ	JK1, JK2	miniature sockets
C2-C3	2.7n (2 off)	SK1, SK3	BNC connectors
C4	1.5n	SK2, SK4	5 way 240° chassis mounting sockets
C5-C7	10n (3 off)		
C8	8µ 16V		
C9-C10	0.1µ (2 off)		
C11	10µ 16V		

IC1d where it is sliced to produce a near ideal squarewave, as this op-amp is run open loop a.c. coupled as a comparator. IC1c, controlled by volume control VR2, provides a drive to the miniature loudspeaker, permitting audible monitoring. This is useful when using the EAR output of the cassette deck, as this cuts out the recorder's internal loudspeaker. R8, 9, 10 and C7 provide shaping, phase retard and level adjustment for the two outputs and the monitor output. The latter (SK3) is provided to permit viewing of the output waveform on a 'scope, whilst the output to a computer's cuts input (or to a second cassette machine for direct copying) is taken from SK4, or from JK2 if the cassette's microphone input is used instead of AUX.

**CONSTRUCTION**

With a quad op-amp and modern miniature components the circuit board takes up very little space and weighs very little. The p.c.b. assembly is stood off from the front panel as shown in Fig. 9 and the latter includes all circuit components

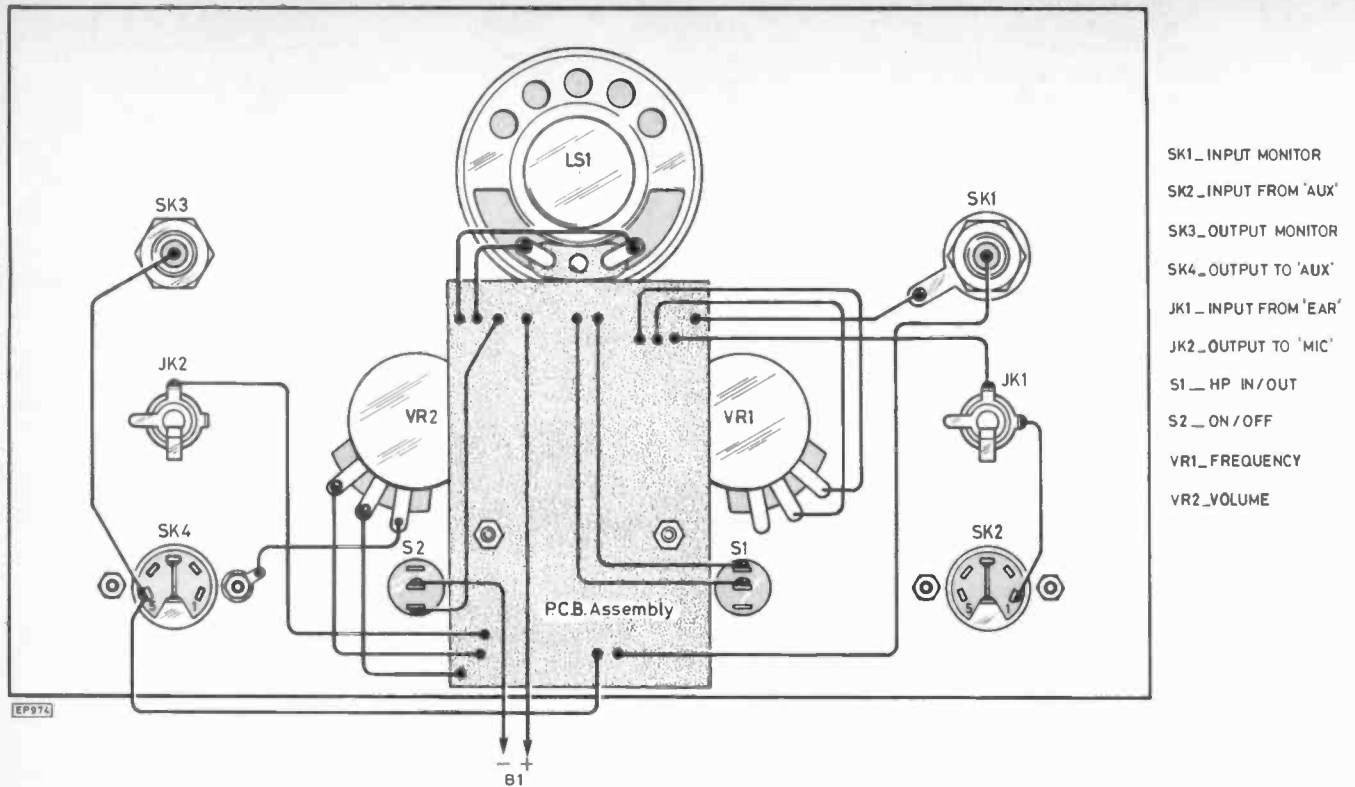

Fig. 9. Placement of case mounted components with board interwiring

except the battery. This combines for neatness and easy access if servicing is required.

Etching details for the printed circuit and the component overlay are shown in Fig. 8. Other layouts, such as on Veroboard, can be used but watch out for op-amp outputs running close to inputs—this could cause instability. The component assembly is built into a plastic box with a sloping front panel 12.5 by 21cm. This provides space for an uncluttered panel layout and just sufficient depth to accommodate a PP7 layer type battery. As the whole instrument draws only about 8 milliamps with intermittent use battery life should be almost indefinite. A photograph of the front panel is shown with appropriate legends.

## USE

To obtain the best from the Program Conditioner one really needs to observe the signal at the input monitor socket on a 'scope. The simplest of these suffices, e.g. a single trace instrument with a bandwidth covering the audio band is quite adequate, though good triggering is, as always, important. One can soon tell from the appearance of the trace and the sound from the monitor speaker whether the playback signal is of good quality. If the trace is fuzzy in the vertical direction, this usually indicates hum, as can be verified by switching to a slow timebase setting—switching in the high pass filter should cure this. Fuzziness of the trace in the horizontal direction usually indicates speed variations (wow and flutter), either due to the machine which recorded the program in the first place, or due to the cassette deck being used for playback. The ear becomes quite good at detecting this with practice. There is little that can be done about this (other than using a better cassette deck if the flutter is due to playback) but it does make correct equalisation more important. If the 1200Hz tone looks a bit peaky and triangular, advance the phase equaliser control VR1 from the fully

anticlockwise position. You should see the 1200Hz tone become squarer, with faster rise and fall times as it passes through the mean value, when the fundamental is correctly phased with respect to the harmonics.

This is the correct condition, over compensation will result in a return to the peaky, triangular waveform. There will be comparatively little effect on the 2400Hz tone on most small cassette machines as they will already be falling off considerably in frequency response at the odd harmonics of this frequency.

Use of this Program Conditioner can enable a program to be successfully loaded which otherwise might be difficult or impossible; it should then of course be recorded from the computer to avoid further problems. Alternatively, the Program Conditioner can be used to clean up and optimise a program on cassette for rerecording on another machine without tying up a computer at all. Providing the original recording loads, the rerecorded copies should likewise do so.

★



# Patents Review

Copies of Patents can be obtained from:  
 the Patents Office Sales, St. Mary Cray, Orpington, Kent. Price £1.60 each.

## THEFT DETECTOR

The Knogo Corporation of Hicksville USA (yes, there really is a Hicksville, USA!) has filed a British application, 2 101 454, on an elaborate approach to theft detection in shops. In Fig. 1 transmitter aerial 10 and receiver aerial 12 are arranged on opposite sides of a shop check-out point. All the goods in the shop carry targets 16 which are thin strips of magnetic material which is easily saturated in a strong field. The transmitter aerial 10 produces an alternating magnetic field of fixed frequency, around 2.5kHz, which is strong enough to cause a target strip in the check-out zone to become magnetically saturated and unsaturated in cycles synchronised to the alternating magnetic field. This makes the target emit its own alternating fields, which are at harmonics of the basic field frequency. A receiver, connected to aerial 12, responds to a selected harmonic e.g. the sixth at 15kHz, to set off an alarm when it senses a cyclically varying signal.

In practice the transmitter aerial 10 is a single one turn loop and the receiver aerial 12 is a pair of single turn loops. Mains power is fed through a zero crossing detector 24, which produces a pulse each time the voltage passes through zero. These pulses are applied through logic circuit 26 to an oscillator 28 which produces high frequency signal bursts. The oscillator output is divided down and converted into four separate 15kHz signals, each of different phase. The signals are fed to 2.5kHz generator 30 which divides them down again to produce square waves at 2.5kHz during the time periods when the oscillator 28 is on. The square wave outputs from the 2.5kHz generator 30 are filtered at 32 to produce a sine wave, which is applied to a series resonance circuit, made up from capacitor 36 and transformer primary 38.

Large currents, of over 100 amps r.m.s., are fed to the aerial 10. The receiver aerial 12 is in the form of two parallel loops, so a changing magnetic field applied uniformly to both loops induces bucking currents which cancel each other out. In this way the effect of direct transmission between the aerial 10 and 12 is eliminated. When a target strip 16 passes by the aerials it will always be closer to one of the two receiver aerial loops than the other. So its harmonic magnetic field gives a detectable current in receiver transformer coil 46. The signal is filtered to separate any sixth harmonic content. This is then pulsed and stored. When a

pre-determined number of pulses, for instance two, have accumulated during successive transmitter signal intervals alarm 82 is tripped. The storage feature prevents

false alarms through spurious harmonics getting into the system. The patent gives full details of the circuit, including component types and values.

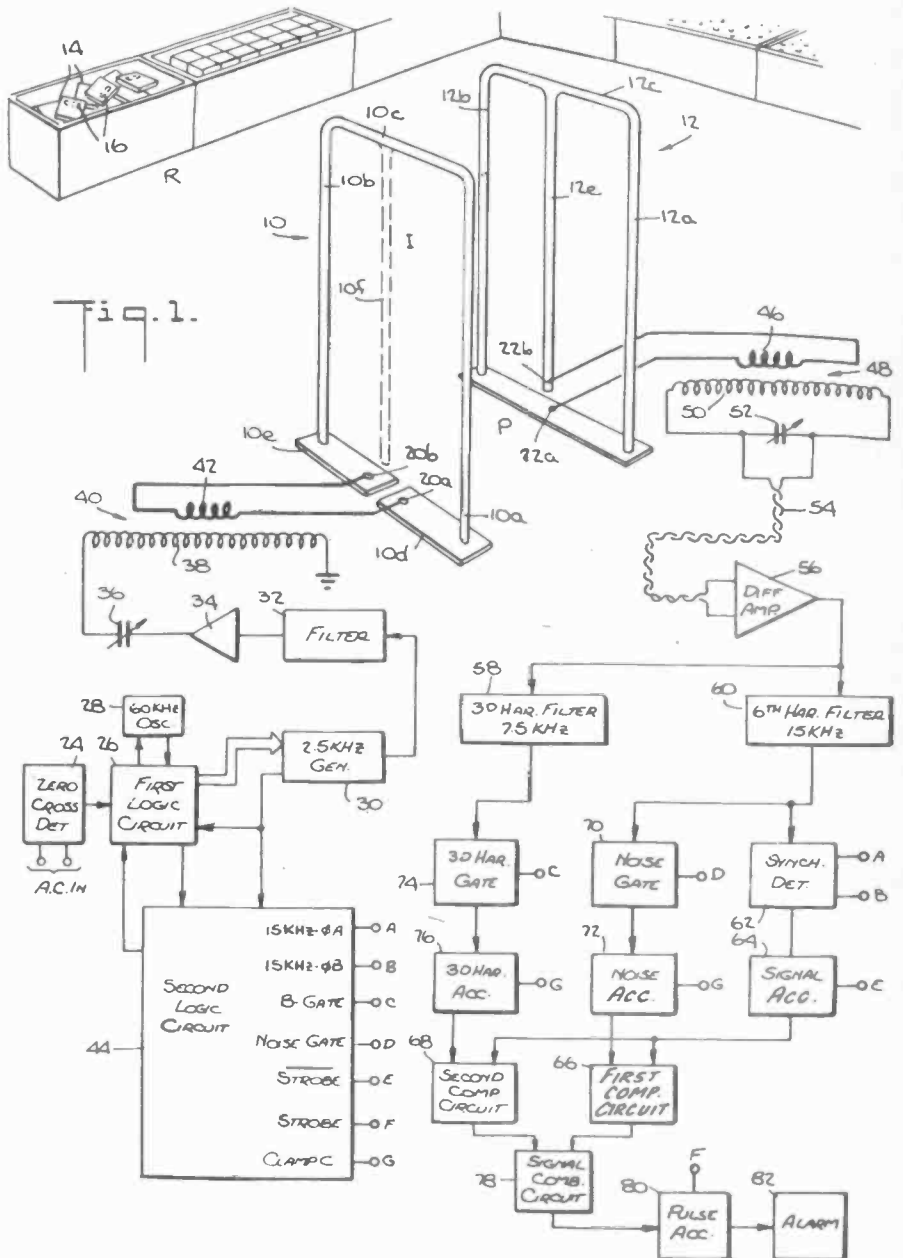



# ROCKTONE

THE ROCKTONE is intended as a versatile aid for technicians working within the music industry, such as soundcrew, DJs and engineers, and provides a compact and robust unit which allows accurate adjustment of tone controls, graphic equalisers and crossover units of a PA system or disco amplifier. It allows correct tonal balance to be obtained by pinpointing irregularities in frequency response thus achieving a true-to-life sound system.

A sinewave is injected into the input of the amplifier/mixer of the sound system to be tested or adjusted. This signal automatically sweeps through the audio band (20Hz–20kHz), and by adjusting parameters such as the graphics, speaker combinations, position and direction, tape or phono de-emphasis etc, a superior sound may be obtained. This method, unlike expensive real-time bandwidth analysers, which need a display and precision microphone and pre-amp set-up, requires only a trained ear to set up a complete PA system in minutes, free of any spurious resonances and dropouts that may occur.

## GENERAL

The Rocktone is based on two i.c.s—the XR2206 and the LM324 quad op-amp. The XR2206 is a high-quality waveform generator which can produce sinewave frequencies ranging from a fraction of a Hz to several hundred kHz, and which may be swept over a large range using an external current source or variable resistance.

The swept frequency output is buffered/amplified and inverted by two of the op-amps to produce a balanced line output of 0dB. The other two op-amps form a comparator and monostable which produce a reset mechanism enabling the circuitry to automatically sweep and resweep through the audio band at an adjustable rate.

## OPERATION

The output frequency of the generator is proportional to the current drawn from pin 7 of IC1, given a fixed value of C3. This variable current is generated by TR1, the base current of this device being supplied by the charge stored on C4 via a limiting resistor, R2. The discharge time of C4 is determined by the setting of VR1. D2, D3 and R5, D4 in this path produce a rate of discharge that allows even time spacing between octaves, as the frequency sweeps across the audio band. The voltage on C4 is monitored by IC2a which compares this to a preset value, determined by D6 and the variable potential divider, R7 and VR4. When the voltage on C4 falls to about 0.7 volts, i.e. the base-emitter threshold of TR1, the output of IC2a goes high which triggers IC2b, the monostable. The current through TR1 is now at a minimum and thus the output frequency also falls to a minimum value.

The monostable time period (approx 10ms) is determined by R15, C6 and the hysteresis produced by R13 and R14. D8 clamps the inverting input of IC2b pin 6, to a diode drop below

0 volts. When the monostable is triggered IC2b is switched on, charging up C4 via R3, and D1 to D5 producing a constant charging voltage. D1 is introduced to prevent C4 from discharging via the charging path. TR1 consequently conducts and the output frequency rapidly increases to its upper limit, determined by R1. The frequency then sweeps down as described earlier.

The automatic sweep may be disabled, and the frequency set manually by VR2. S2a disables the comparator, while S2b discharges C4 and switches in VR2. Note that VR2 is connected in the 'anti-log' configuration.

IC2c acts as a buffer/amplifier, the gain set at  $-1/3$  by R16, 17. IC2d acts as an inverter and together with the complementary output of IC2c produces a balanced output at 'line' level, about 2.2V pk-pk.

## CONSTRUCTION

Assemble the p.c.b. in the usual order, i.e. resistors first, then capacitors and diodes followed by semiconductors and i.c.s using the component layout in Fig. 3 as a guide. Check the polarity and orientation of the i.c.s, diodes and capacitors before soldering. On the prototype unit C5 was mounted on the track side of the p.c.b., care must be taken to ensure that the compo-



**D. HEAD B.Sc.(Hons) P.D'LEMOS B.Sc.**  
(OF MAZTEK ELECTRONIC SYSTEMS AND INSTRUMENTS)

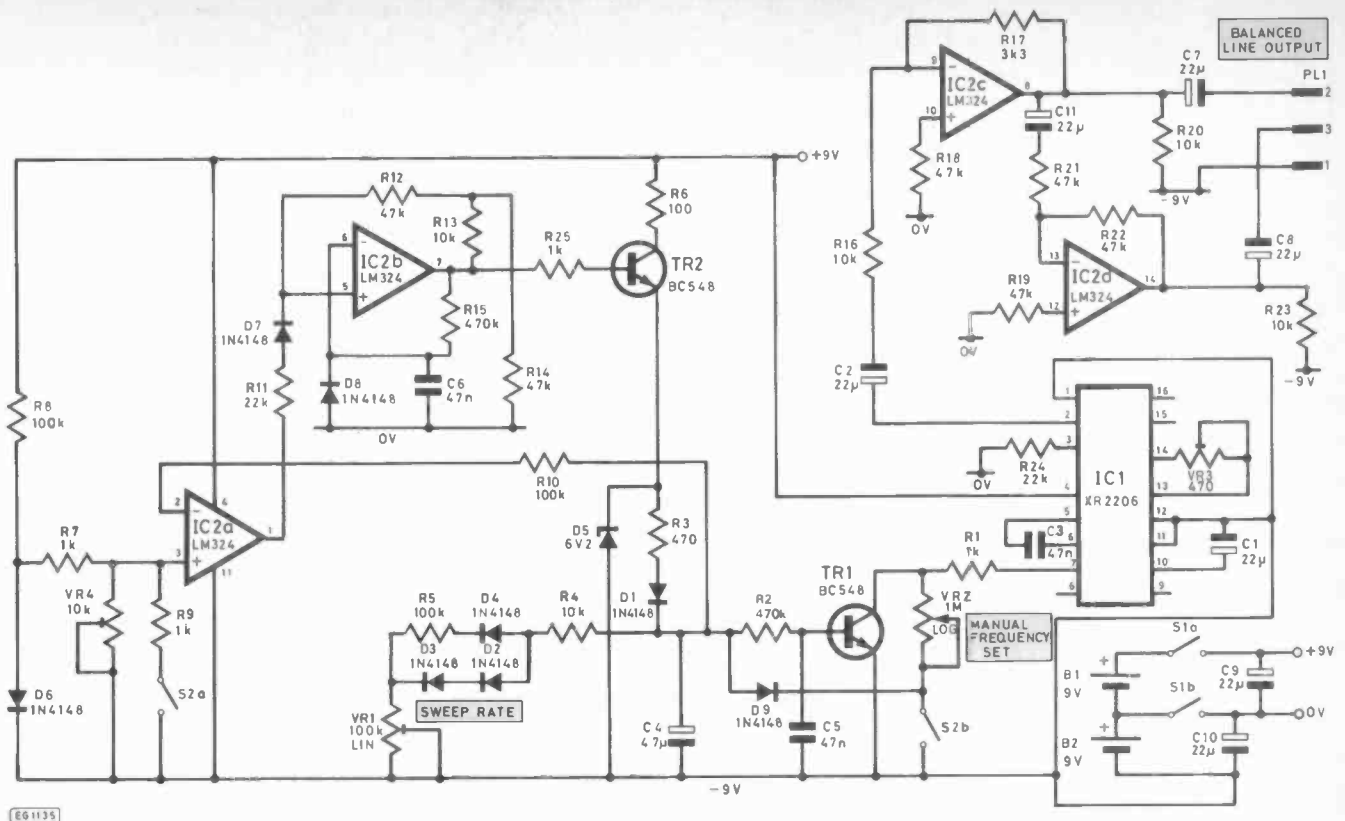

EG1135

Fig. 1. Circuit diagram

ment body remains clear of the tracks. Once the p.c.b. has been assembled, solder in the connecting wires, battery clips and potentiometers, taking care to wire up VR2 in the 'anti-log' configuration, i.e. maximum resistance between the potentiometer connections in the 'off' position.

### TESTING AND ALIGNMENT

Connect up the batteries and switch the unit on with the manual override control (VR2) set to 3/4 maximum. Monitor the output of IC1 (pin 2) with the aid of an oscilloscope and

check that a 3V pk-pk 1kHz signal is present. If no signal is present, check IC1 and associated components.

Adjust VR3 for best sinewave purity, i.e. with least 'triangle ramping' distortion. Monitor the outputs of IC2c-d (pins 8 & 14), and check that there is just over 1V pk-pk of signal with respect to 0V and approximately 2.2V between outputs. If there is any variation check R16 and R17, and IC2d associated components. Adjusting VR2 should give a range of frequencies between 20Hz and 20kHz. Switch over to automatic sweep and monitor the falling frequency waveform with VR1 set maximum

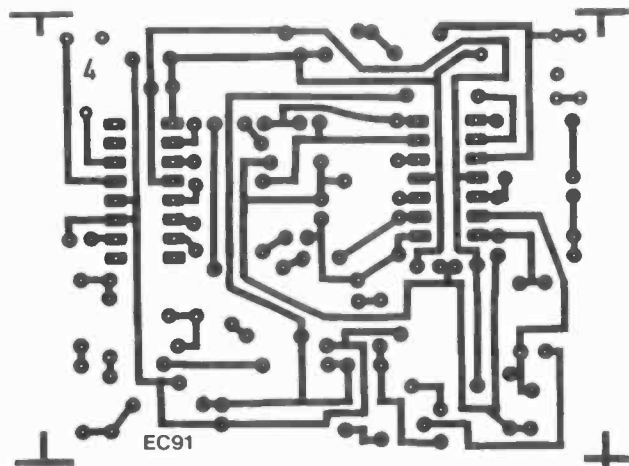
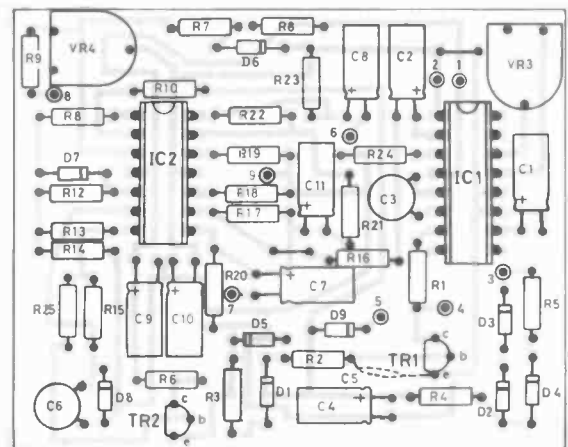

Fig. 2. P.c.b. design



EG1136

Fig. 3. Component layout

anticlockwise, i.e. slowest sweep rate. Adjust VR4 anticlockwise to decrease the lowest frequency output, which should be set at 20Hz. The sweep rate should be adjustable between about 5 and 20 seconds via VR1 and produce an even time span between octaves. If this is incorrect then check C4, TR1, VR1 and associated components.

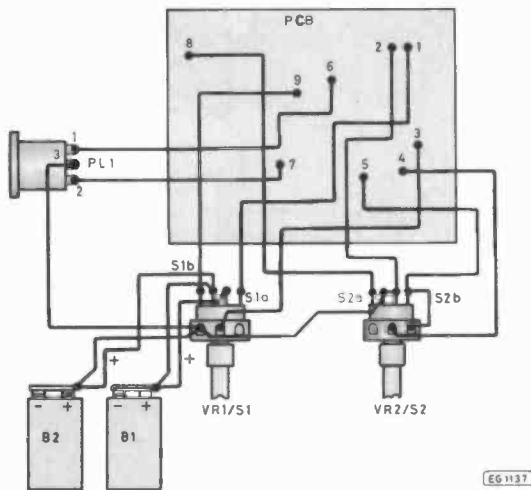
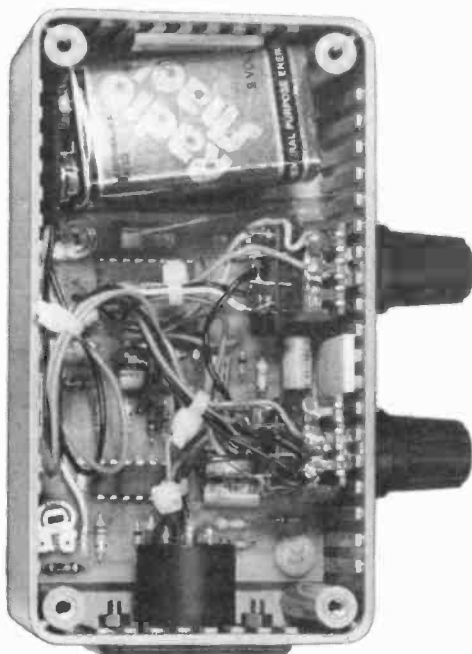

Fig. 4. Wiring details

**USAGE**

The PA should first be set up approximately using a vocal microphone or tape, the input equalisation being bypassed or set flat. Consideration should be given to the type of sound that is to be reproduced, thus providing a reasonable starting point for frequency analysis. The Rocktone can then replace the input to provide an accurate signal reference.

Using the Rocktone in its sweep mode and set to a long sweep time, the output of the speakers as affected by the acoustics of their environment can be heard. Careful attention to the volume



Final assembly showing p.c.b. in position

**COMPONENTS ...**

**Resistors**

- R1, R7, R9, R25 1k (4 off)
- R2, R15 470k (2 off)
- R3 470
- R4, R13, R16, R20, R23 10k (5 off)
- R5, R8, R10 100k (3 off)
- R6 100
- R11, R24 22k (2 off)
- R12, R14, R18, R19, R21, R22 47k (6 off)
- R17 3k3
- All resistors 1/4W 10%

**Capacitors**

- C1, C2, C6 to C10 22µ 16V electrolytic (7 off)
- C3, C5 47n ceramic (2 off)
- C4 47µ 16V electrolytic

**Semiconductors**

- D1 to D4, D6 to D9 1N4148 (8 off)
- D5 6V2 Zener, 400mW
- TR1, TR2 BC548 (2 off)
- IC1 XR2206
- IC2 LM324

**Potentiometers**

- VR1 100k Lin (miniature) plus dpst switch
- VR2 1M Log (miniature) plus dpst switch
- VR3 470 preset
- VR4 10k preset

**Miscellaneous**

- P.c.b. (see Constructor's note)
- Case, about 40 x 65 x 180mm
- PL11, XLR Series Connector, 3-pin plug
- 9V PP3 battery (2 off)
- Battery clips (2 off)
- Knobs (2 off)

**Constructor's note**

A complete kit of parts for this project is available from **Watford Electronics, 33 Cardiff Road, Watford, Herts (0923 40588)**. The kit is priced at £19.95 including VAT and p&p.

present in the room as each frequency sweeps through will reveal resonances of loud peaks and weaknesses where response is poor or absorption is high. Output equalisation should now be readjusted to provide a smoother response. As the response becomes increasingly flat with adjustment, smaller variations will become audibly apparent. It is common with most sound systems to have frequency bands of particularly high irregularity, often at 100-300Hz, 1-2.5kHz, and at 5-6kHz as cross-over points, cabinets, drivers, filters and amplifiers peak. These points will produce a warbling sound during incorrect adjustment when swept.

Use should also be made of the manual frequency control facility to pinpoint the frequencies concerned, rolling the frequency back and forth over the band required. With some practice and attention to detail a smooth response will be obtained. As a final check, the whole band should be covered at a fast sweep rate. Professional use of this unit at major European and UK concerts has revealed several additional uses for the Rocktone. It has proved invaluable for testing speakers, filters, signal cables, channel and effects patching and in the workshop as a general purpose frequency generator. ★

# Get moving with these new developments in UK Robotics

— advanced electrohydraulic designs for education, industry and now available to the home constructor.

Hebot II is a turtle-type robot which takes programming out of the two dimensional world of the VDU into the real three dimensional world. Given a DC supply of 9-15V it can perform a bewildering number of moves under computer control — forwards backwards, left and right — with each wheel independently controlled. It has blinking eyes, bleeps with a choice of two tones and has a solenoid operated pen to chart its progress. Touch sensors coupled to its shell return data about its environment to the computer for it to calculate evasive or exploratory action. Hebot II connects directly to an I/O port or alternatively with the universal interface board to the expansion bus of a ZX81 or other computer.

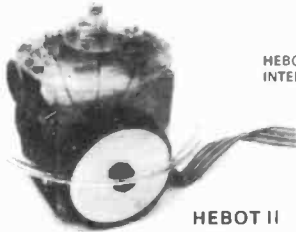

HEBOT II

Up to the nano-second hard, firm and software developments embodied in a complete system. 12 Mega Hertz 16 bit CPU; 64K upwardly compatible DRAM; separate 16K video DRAM and 24K TI Power Basic with overwrite. Supports up to four Disc drives of mixed type with 16 serial I/O ports. Programmable Baud rate and comprehensive E Bus interface designed to support real world applications.

Very high resolution graphics gives 3D simulation in 16 colours on 36 prioritised planes of user definable characters. Software FORTH coming includes this trendy language along with NOS C/PM.

Hardware components available separately with details in Nov. Dec. and Jan issues of ETI. Software features include: Real time clock, full renumber command, buffered I/O to free machine whilst

Robotic experience is becoming as essential a subject as computing. MICROGRASP provides the lowest cost means of acquiring that experience but despite its ultra low price the robot has considerable versatility. There are 5 axes each using a servo motor and there is feedback from each of the arm movements. Control is by any computer with an expansion bus — the ZX81 being particularly suitable. Servoing is achieved with hardware on the interface board to keep programming simple and the robot is operated under BASIC commands with no computer specific software required. The interface board is memory mapped using only 64 bytes at any of 1024 switch selectable locations.

MICROGRASP robot kit with power supply £145.00  
 Universal computer interface board kit £48.50  
 23 way edge connector £2.50  
 ZX81 peripheral RAM Pack splitter board £3.00



MICROGRASP, INTERFACE BOARD AND ZX81

HEBOT KIT £85.00  
 INTERFACE BOARD KIT £10.00

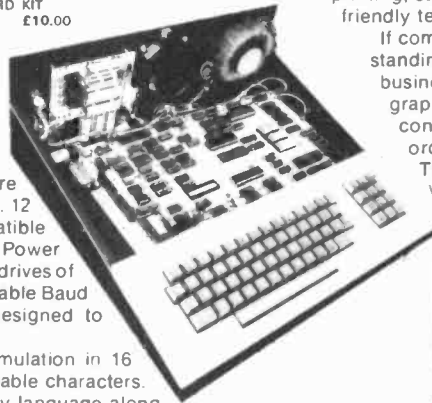

printing, call to machine code routines, hexadecimal support and user-friendly textual error trapping messages.

If computers interest you then the Cortex will expand your understanding infinitely more than off the shelf machines. Use it in business, education, research or just play with the incredible graphics capability. At Powertran we are using these machines in conventional roles, in product control and R & D. We shall co-ordinate the Cortex user group and distribute software for the TMS 9995 CPU. Complete 16 bit 64K computer kit £295.00 + VAT. Complete 16 bit 64K computer ready built £395.00 + VAT.



Top of the range is the Genesis P102 which has dual speed control, continuous servo operation and double acting cylinders for increased torque on the wrist and arm rotation joints. The microprocessor based control system has additional memory, position interrogation via the RS232C interface increasing the versatility of computer control and inputs are provided for machine tool interfacing.

6 axis system READY BUILT

£1950.00

#### Example prices and specifications

**Genesis S101**  
 Base: 19.5" x 11" x 7.5"  
 Lifting capacity: 1500gm  
 Arm lift: 6.6"  
 Weight: 29Kg  
 4 axis model in kit form £425  
 5 axis model in kit form £475

**Genesis P101**  
 Base: 19.5" x 11" x 7.5"  
 Lifting capacity: 2000gm  
 Arm lengths between axes: 14.0"  
 Weight: 34Kg  
 6 axis model in kit form £675

Complete Systems as shown in Photograph on right

**Genesis S101**  
 4 axis system in kit form £681.50  
 5 axis system in kit form £737.50  
 5 axis system Ready Built £1450

**Genesis P101**  
 6 axis system in kit form £945.00  
 6 axis system Ready Built £1650

All prices exclusive of VAT

With prices starting below £1,000 the Genesis range of general purpose robots provide a first rate introduction to robotics for both education and industry. Each has a self-contained hydraulic power source which enables loads of several pounds to be smoothly handled. The system operated from a single phase 240 or 120V AC supply or a 12V DC supply. The machine can be supplied with up to 6 axes each of which is fully independent but capable of simultaneous operation. Position control is achieved by means of a closed-loop feedback system based around a dedicated microprocessor. Movement sequences can be entered, stored and replayed by use of a hand held controller. Alternatively the systems can also be interfaced to an external computer via a standard RS 232C link.



GENESIS P102 PROCESSOR BOX AND HAND HELD CONTROLLER

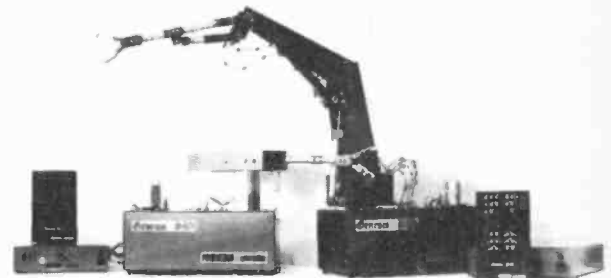

GENESIS S101 AND GENESIS P101 WITH PROCESSOR BOXES AND HAND-HELD CONTROLLERS



WORLD LEADERS IN ELECTRONIC KIT DESIGN AND SUPPLY

(CYBERNETIC DIVISION)  
 PORTWAY INDUSTRIAL ESTATE  
 ANDOVER HANTS SP10 3WN  
 Phone Enquiries (0264) 64455

Export enquiries to:-  
 Powertran International, Hollom Down Farm,  
 Lopcombe, Salisbury, Wilts. SP3 1BP.  
 Tel: 0264 781545 Telex: 477407 ZENMON



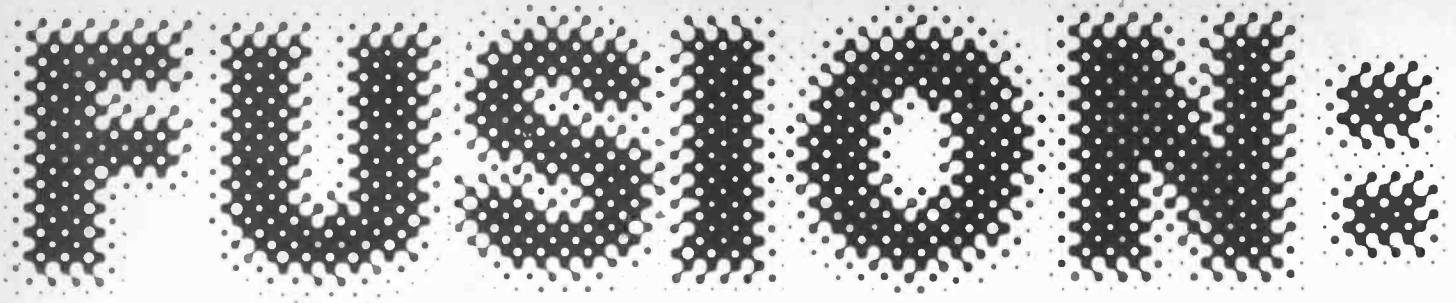

**T**HE DREAM a few decades ago, of abundant cheap energy, began as a nightmare. The power of the atom first flashed its awesome might across two Japanese cities. Yet as the horror subsided into that dream of peacetime nuclear power, mankind's fleeting phantasm of a clean, cheap energy culture threatened to revert to a nightmare again. Many feel that the unstable dream, in its original form at least, now lies at the bottom of the sea in a cannister marked "Radio Active Waste". Some argue that it has been stamped "Unmanageable", and laid to rest on Three Mile Island. Whatever the case, in the 1980s energy is neither cheap, nor abundant. The great illusionist is *fission*—the process of splitting atoms to generate heat, to generate steam, to generate electricity. Fission produces high energy radiation, and creates spent fuel that is a menace for generations.

#### INCREDIBLE OBJECTIVE

Matter to energy! Is the alchemy not safely possible? Collectively, Europe intends to find out. Whilst the Sizewell debate radiates through the media, a far more portentous project which *really could* change our lives, is quietly forcing back the frontier of nuclear engineering. The project, based at Culham in Oxfordshire, is known as the Joint European Torus (JET). The complex houses the most ambitious *fusion* venture of the European Atomic Energy Community (Eurotom). As far as the fusion alternative is concerned, only one mechanism has the potential to produce enough heat to generate commercially viable electric power. This toroidal machine is called a Tokamak, and at Culham they have constructed a leviathan.

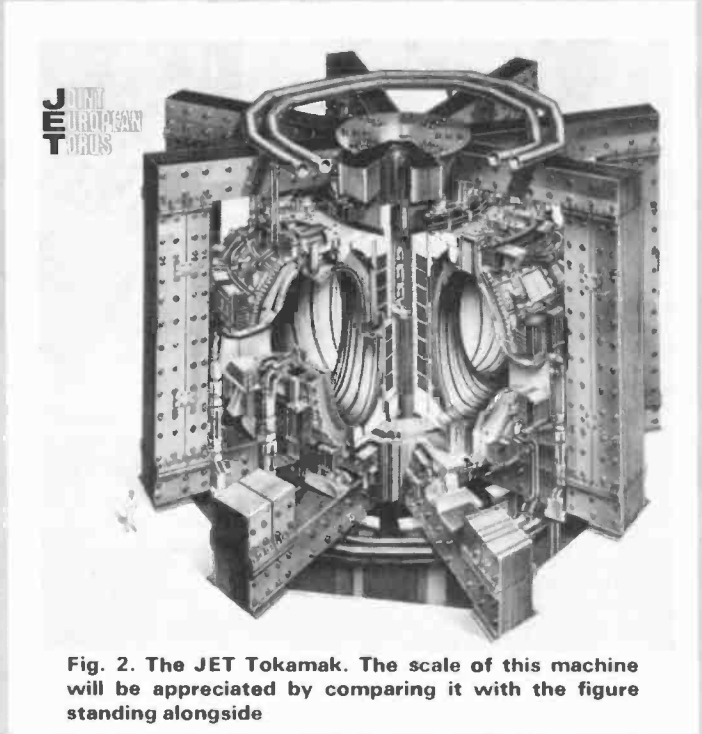

Fig. 2. The JET Tokamak. The scale of this machine will be appreciated by comparing it with the figure standing alongside



Fig. 1. Aerial view of the JET laboratories at Culham, in Oxfordshire

Fission's only attribute is the bare fact that it can generate electricity, but because of its deadly pollution it lacks widespread approbation. Fusion, on the other hand, could fulfil the promise of a renewable energy source *without* the need to handle and dump toxic wastes. An elegant, but demanding alternative, as you will see.

The objective of the JET project is to create a plasma with a size, density and temperature comparable to that required by a power producing reactor. This plasma will need to reach a temperature of 100 million degrees centigrade. The plasma column will be about two metres in diameter, and have a density 100 million million atoms per cubic centimetre. Although many other difficulties lie in the path towards an economic fusion power station, achieving these parameters on the JET will be a quantum leap forward.

Plasmas, and their physics are complicated, and not yet fully understood by scientists. There is no guarantee that the JET apparatus, designed in 1974, will be able to achieve the specified parameters. The *Joint European Torus* is nevertheless thought to be the most advanced Tokamak of its type in the world. In it incredible electric power is required to heat up the plasma. Even the 4.8 million amperes heating current is totally inadequate to generate the plasma temperatures necessary for nuclear fusion.

# Towards

# REALITY

**MIKE  
ABBOTT**

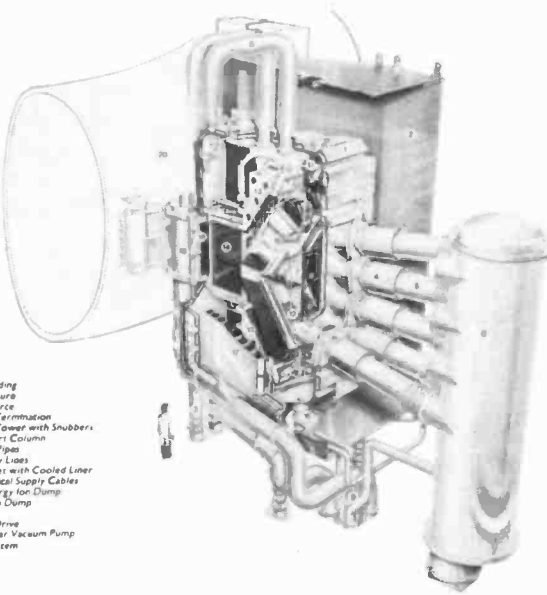

- 1 Vacuum Tank
- 2 Magnetic Shielding
- 3 Support Structure
- 4 PINI Beam Source
- 5 High Voltage Termination
- 6 High Voltage Tower with Snubbers
- 7 Central Support Column
- 8 Main Cooling Pipes
- 9 Coolant Supply Lines
- 10 Bending Magnet with Cooled Liner
- 11 Magnet Electrical Supply Cables
- 12 Fractional Energy Ion Dump
- 13 Full Energy Ion Dump
- 14 Calorimeter
- 15 Calorimeter Drive
- 16 Turbomolecular Vacuum Pump
- 17 Cropping System
- 18 Fast Shutter
- 19 Rotary Valve
- 20 JET Torus

**Fig. 3. The neutral injection system. This beams energetic neutral hydrogen atoms into the plasma. The power supply for this system is regulated and switched by large tetrode valves**

Further heating must be introduced by squirting in highly energetic neutral atoms, a process called Neutral Injection heating (Fig. 3). Still more energy has to be found by way of high energy Radio Frequency heating (Fig. 4).

Over a period of some four years, starting in 1983, the plasma power capability of the Tokamak will be increased in stages until it reaches 25 megawatts. At full power, temperatures averaging 50 million degrees are anticipated; at which stage the thermonuclear reactions brought about by the introduction of deuterium-tritium plasmas, will push the temperature up to the required 100 million degrees centigrade. If ignition is achieved, the powerful external heating systems can be turned off, leaving the plasma temperature to rise by itself until the end of the pulse. The less fortunate outcome would be that the plasma simply does not reach a high enough temperature to justify the use of tritium.

## WHAT IS FUSION?

At the centre of every atom is a nucleus comprising positively charged protons, and uncharged neutrons. Orbiting this cluster, as if in a microscopic solar system, are negatively charged electrons. The strength of the invisible force which holds together

the cluster of protons and neutrons varies from element to element, but it is possible to create a nuclear reshuffle in which a surplus quantity of that binding energy is released. Fusion is such a reshuffle, for it is the *fusing* together of two or more elements into one or more heavier elements, during which there is a yield of surplus binding energy. In the case of deuterium (D) and tritium (T), helium, and a neutron are also released upon fusing.

Deuterium and tritium (the two heavy isotopes of hydrogen) are favoured because they have a high reaction rate whilst imposing the least stringent conditions. Deuterium could not be more plentiful on this planet, as it is obtained from ordinary water. Tritium, however, is rare, but can be manufactured from the fusion process itself. By bombarding a blanket containing lithium (which is plentiful) with those expelled neutrons, both tritium and helium are produced.

## THE NEED FOR HEATING

Because the deuterium and tritium nuclei each have a positive electric charge they strongly repel each other. They simply will not come close enough together for a fusion reaction to occur. The way to overcome this obstacle is to impart sufficient energy to their nuclei to overcome the mutual electrostatic repulsion. Heating the gaseous fuels to a very high temperature will do just that, by ionising them—stripping the electrons away from their parent nuclei. The result is a mixture of positively and negatively charged particles. A gas in this disrupted condition is called a

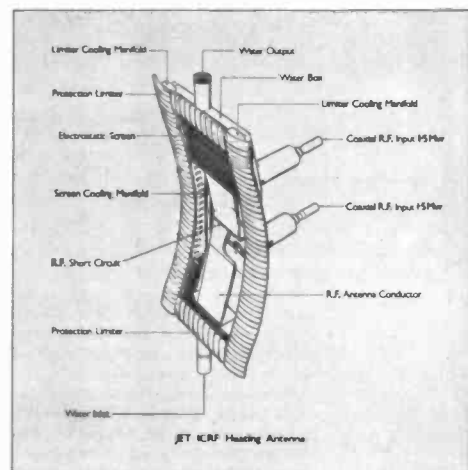

**Fig. 4. Radio frequency heating antenna. Operates at the ion cyclotron frequency (25–55MHz on the JET)**

plasma. See Fig. 5. At 100 million degrees centigrade, abundant fusion reactions occur in a deuterium-tritium plasma, releasing large amounts of energy.

### WHAT IS A TOKAMAK?

There is no known material out of which a vessel could be made, to contain a one hundred million degree inferno without itself vapourising. Yet containment is essential if the amount of energy produced by fusion is to exceed the amount of power required to run the system. The latter requirement is an obvious precondition, and is expressed as the product of fuel density and confinement time (known as Lawson's Criterion).

Since a plasma is a mixture of charged particles it can be influenced by a magnetic field, and for over thirty years investigations into how to achieve the magnetic suspension of a fusion reaction have led to a machine called the Tokamak. In this configuration, even though high temperature plasmas have a natural tendency to expand, they remain in a compressed column, held there by a magnetic force for periods in excess of one second. The plasma's charges whirl around randomly, unable to escape. See Fig. 6. Because of this, heat is not lost, nor are impurities released through contact with any physical object—in theory at least. But even the Tokamak is only partially efficient in these aims.

### THE JET TOKAMAK

A complex array of magnetic circuits are required to activate the JET Tokamak. The main component of the system is the set of toroidal field windings which are used to suspend the plasma. In shaping the plasma column, these toroidal coils, shown in Fig. 7, are assisted by poloidal coils. However, the most interesting field action is that of the transformer which induces the plasma heating current. Whilst the primary of this is also a poloidal winding, its secondary is the plasma itself. The toroidal circuit of plasma acts as a single-turn secondary winding.

The JET will use hydrogen plasmas during its early life, before moving on, if successful, to deuterium-tritium plasmas to obtain a fusion ignition.

### ENGINEERING STATISTICS

The accompanying photographs show the standard of engineering required to build the 100 tonne vacuum vessel and its peripherals. The 32 toroidal field coils alone add up to 384 tonnes (12 tonnes a piece), and these are each 24 turns of heavy

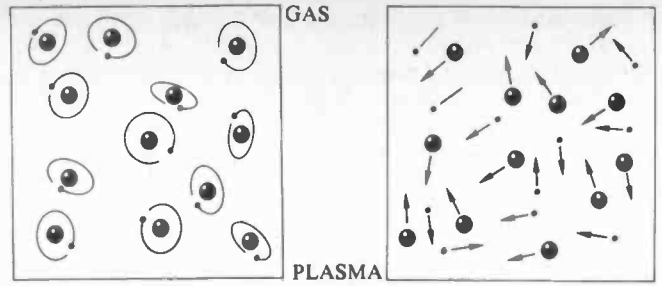

Fig. 5. Heat turns gas into plasma by dislodging the electrons from their orbits

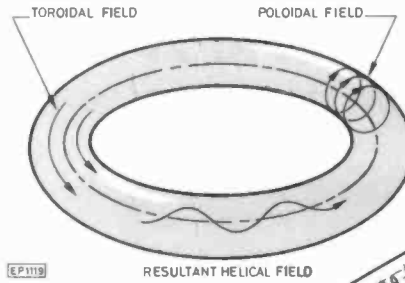
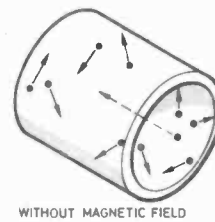
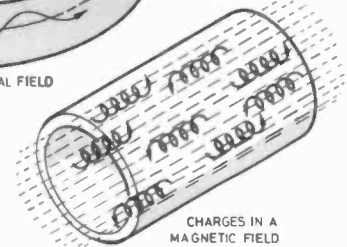

Fig. 6. The Tokamak is a toroidal vacuum container in which plasma is suspended away from the inside surface by a magnetic field set up by external coils



WITHOUT MAGNETIC FIELD



CHARGES IN A MAGNETIC FIELD

Fig. 7. The JET inductive system simplified. The plasma itself acts as a winding, to heat and shape the plasma

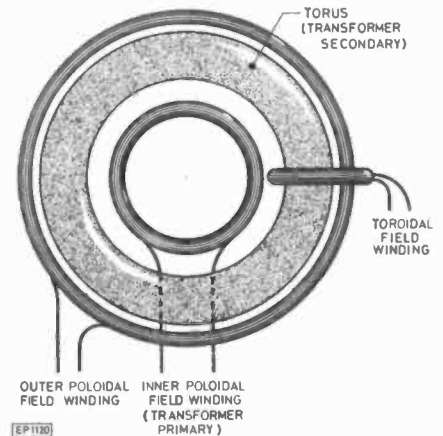
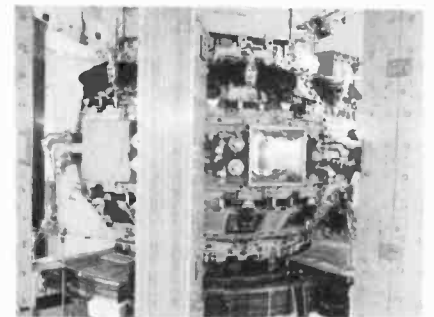
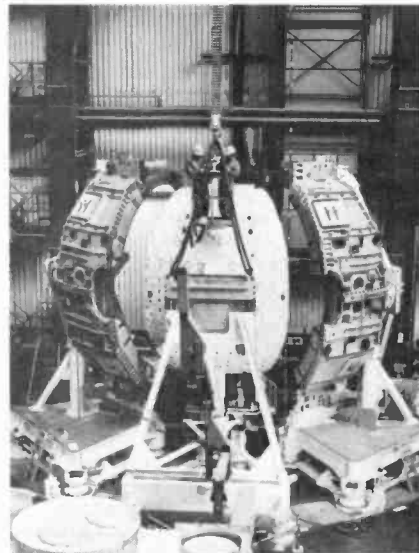
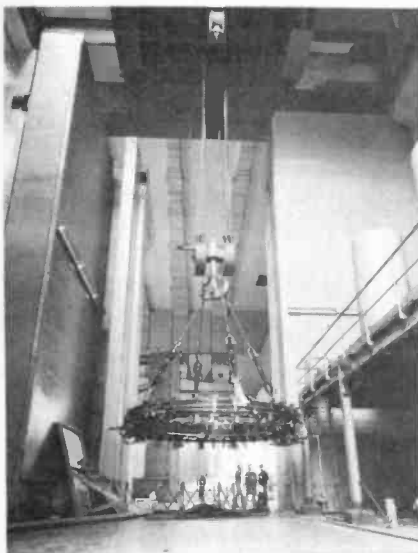

Fig. 8 (leftmost). A poloidal field coil suspended during construction

Fig. 9. An octant is seen being lowered into position

Fig. 10. Complexity of the JET hardware is apparent during construction



copper bar capable of conducting 66,000 amperes. It takes 700 litres of water per second to cool these coils. In the fully completed design, the total magnetic field at the plasma centre will be 3.4 Teslas. The coils are "D" shaped because this is the shape they would deform to, if flexible, under the 2000 tonnes of mechanical force developed by their own magnetic field. This geometry, therefore, gives rise to minimum stress. Magnetic effects produce an enormous twisting moment throughout the entire structure, which is designed to withstand up to 20,000 tonnes metre.

The torus hall is built around a pit housing the ring manifolds which supply water, the vacuum and hot carbon dioxide to the machine. The massive limbs of the magnetic circuit (Fig. 12), the bulkiest components of all, support the toroidal structure. This toroidal vacuum vessel is fabricated from eight welded sections, called octants. The vessel has to support a very high vacuum, and so before each run is baked at 500°C for several hours to "descale" its surfaces of potential gas forming particles, otherwise outgassing would offset the pressure. This is the purpose of the hot carbon dioxide supply. Welding between octants is so superb that it would take 3000 years for one litre of air to penetrate the system.

In use, conventional heating elements attached to the vessel help to achieve the base pressure of  $10^{-10}$  torr. required to minimise the level of impurities in the plasma.

Materials and engineering parts for the JET have been manufactured by industry throughout Europe, and the project has cost around £500 million.

#### FLYWHEEL GENERATOR

It would be unfair to dim the lights of Oxfordshire every time the JET is pulsed. With its 700 megawatt thirst for power, a substantial part of the supply has to come from two flywheel generators, each accelerated by a 8.8 megawatt pony motor. Flywheels weighing 775 tonnes rotate at 225 rev/min to make 2600 megajoules available to the Tokamak (Fig. 14). Four rectifier stacks convert the first rotor's output to d.c. for the toroidal coils. In the case of the poloidal field, specially designed fast air-blast circuit breakers initially interrupt 80 kiloamperes to generate a back e.m.f. capable of ionising the gas. This system also allows reversal of the poloidal coil connections to obtain maximum flux change in the heating current transformer.

Fig. 11. Octants awaiting assembly. A toroidal field winding assembly is in the foreground

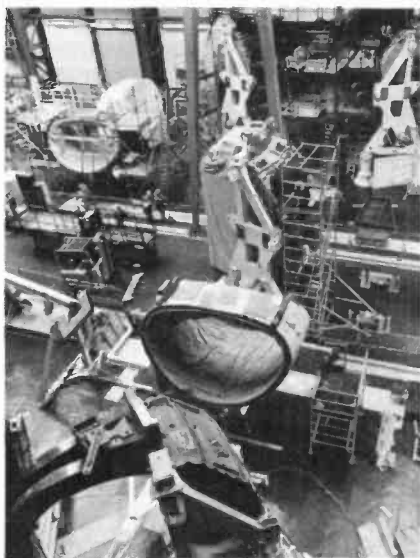
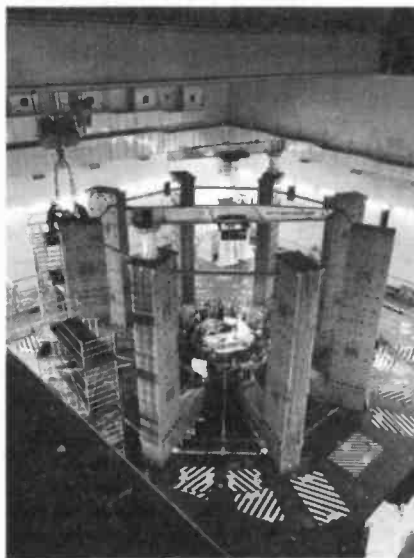
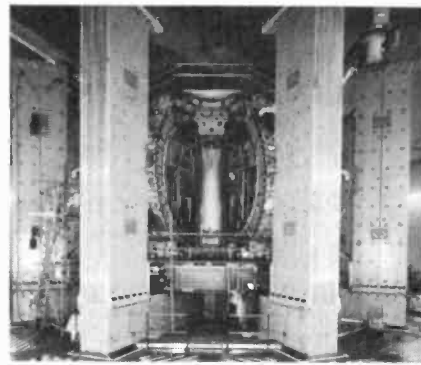

Fig. 12. Apparatus under construction, showing the massive transformer limbs



All photographs courtesy of the JET Joint Undertaking

Fig. 13. Octants in position between the transformer limbs



#### COMPUTER CONTROL

The JET is a learning tool, and because of this its computers have a dual task; the first being to control the operating parameters, the second being data acquisition and storage. A network of 25 Norsk Data ND-100 and ND-500 minicomputers is used in a hierarchical structure, in which each processor monitors its own part of the machine. Information is transmitted along fibre-optic loops at a rate of 5 million bits per second, and each pulse of the JET results in the collection of over one million datum entries.

The Control Room's ND-560 computer files the data for use by the experimentalists, before transferring it to Culham Laboratory's large computers for further analysis, and archiving.

#### DIAGNOSTICS

Gathering information about the behaviour of high temperature plasmas obviously cannot employ sensors requiring physical contact with it. Passive, and active particle beams, light, and electromagnetic radiations are used. Fig. 15 shows the complexity of the diagnostic equipment.

*Plasma position* within the vessel is detected using inductive coils integrated into the vacuum vessel wall.

Interferometers detect the delay, measured against a microwave or infra-red reference beam, caused by electrons in the plasma. This allows measurement of *electron density*.

The *type, density and temperature* of energetic atoms within the plasma determines the wavelength and intensity of emitted light. Spectrometers are used to detect this light emission.

*Local values of electron density and temperature* are discovered by a technique called Thomson Scattering. In this, the degree of scattering of high intensity, pulsed laser light is observed.

*Plasma ion temperature* is ascertained by observing the neutral particles escaping from the plasma. These particles have thermal equilibrium, and escape through the magnetic barrier because of their neutrality.

A bolometer measures the broad spectrum of *radiated energy loss*. A temperature-sensitive resistor mounted on a foil absorber acts as the detector.

Measurement of the plasma's X-ray emission yields information on *density, temperature and impurity content*.



**Fig. 14. One of the 400MW flywheel generators under construction. Two of these generators supply power to the Tokamak, which, when surge loaded, drop to half speed. The rotors weigh 775 tonnes each!**

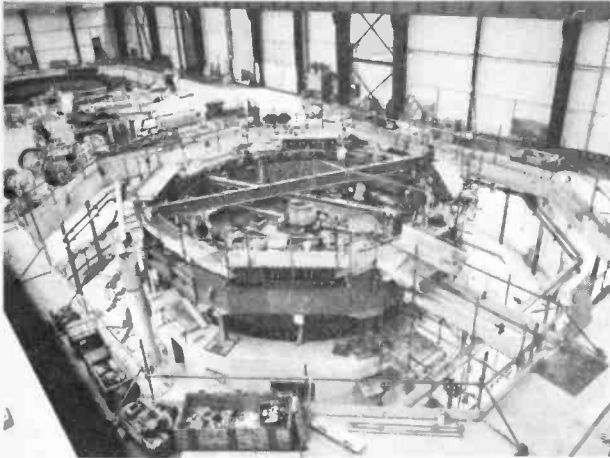

In the latter phase of the JET's life, measurement of the neutron emission during fusion will reveal the *reaction rate*.

Once deuterium-tritium fusion has occurred, this high energy neutron radiation will have activated the machinery, seriously restricting access by personnel. For this reason, all sensory transmitting and receiving equipment has been mounted outside the biological shield, despite the alignment exactitudes this imposed.

#### SERVOMANIPULATORS

Once irradiated, it will be unsafe for human beings to inspect the torus walls, or service the machine's auxiliary equipment. However, the unpredictable nature of the handling places this work outside the realm of programmable robots. It was decided to employ remote handling manipulators which operators control by viewing through closed circuit television links. The slave unit, at work in the radio active area, is designed to reflect back to the operator the forces exerted by its manipulator. This gives a "feel" to the operator as he remotely uses power tools, spanners and welding torches, etc.

#### LEAGUE OF FOUR

Only four large Tokamaks exist, either completed or under construction. Apart from the European torus, there is the

**Fig. 15. JET diagnostic system**

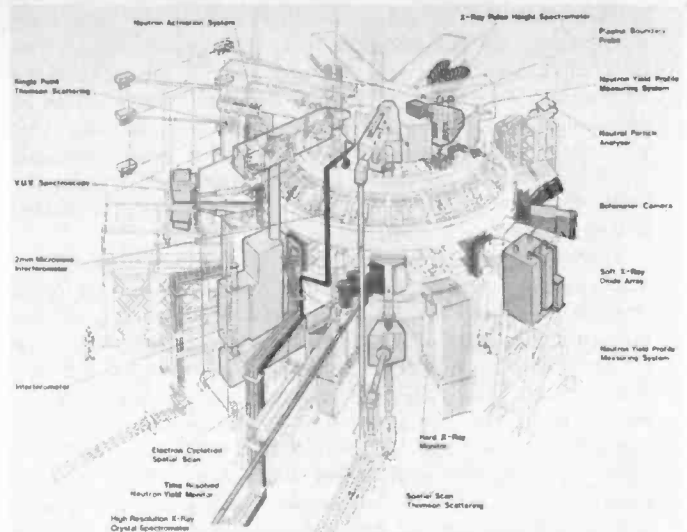

USSR's T15, the USA's TFTR, and Japan's JT-60.

The release of energetic neutrons from this type of machine could be used to heat up a surrounding blanket, in order to raise steam for a conventional steam-turbine generator. No such provision to generate electricity has been made on the JET, as this will be the subject of study for the next generation of fusion experiments.

At the time of going to press, it was thought that the JET would be powered up for the first time in June 1983.

The Sun is a typical star, producing  $3.3 \times 10^{26}$  joules per second by fusion, and is consequently reducing in mass at a rate of  $4.2 \times 10^9$  kg/s (one millionth of its total mass every ten million years).

The thermonuclear reactions which make our sun shine will not be casually mastered; notwithstanding Culham's wrestling ground, the commonplace fusion power station is reckoned to be sixty years away. In the meantime, therefore, fission, with all its imperfections, will continue to serve in an era of its own. ★

#### ACKNOWLEDGEMENTS

The technical data in this article is based entirely on material supplied by the JET Joint Undertaking. All photographs and diagrams shown are courtesy of same.

## PE SPECIAL CASSETTES OFFER

### CHROME C60 & C90

### FERRIC C90 AUDIO

Videotone Ltd., 98 Crofton Park Road, Crofton Park, London SE4.

Please send me ..... CRO2 C60 Audio cassettes at ..... p each (90p for 5 to 24, 80p for 25 or more; including VAT and postage).

Please send me ..... CRO2 C90 Audio cassettes at ..... p each (115p for 5 to 24, 105p for 25 or more; including VAT and postage).

Please send me ..... C90LH Audio tapes at ..... p each. (56p for 5 to 24, 53p for 25 or more; including VAT & postage.)

I enclose cheque/PO for £ ..... No. ....

Name .....

Address .....

BLOCK CAPITALS PLEASE

Coupon valid for posting before 3 June '83  
(or one month later for overseas readers).

## EVERYDAY ELECTRONICS and computer PROJECTS

THE JUNE ISSUE IS BURSTING WITH IDEAS

★ **COMPUTER USERS** ★

**EPROM PROGRAMMER—TRS80 & VIDEO GENIE**

★ **CARAVANNERS & CAMPERS** ★

**CARAVAN POWER SUPPLY  
CARAVAN FRIDGE ALARM**

★ **MUSICIAN** ★

**ENVELOPE SHAPER FOR BASS GUITAR**

★ **FOR THE HOME** ★

**PUSH BUTTON COMBINATION LOCK**

PLUS ALL THE REGULAR FEATURES

**JUNE ISSUE ON SALE  
MAY 20**

Place a regular order with your  
**NEWSAGENT—Now!**

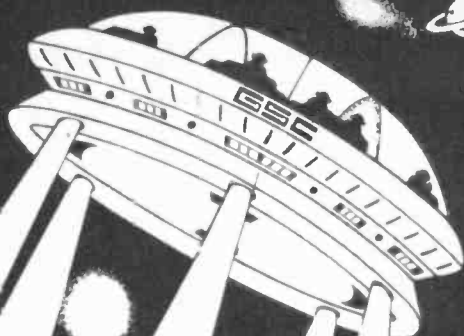
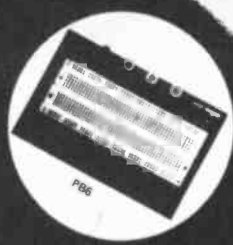

# NEW & FREE FROM GSC

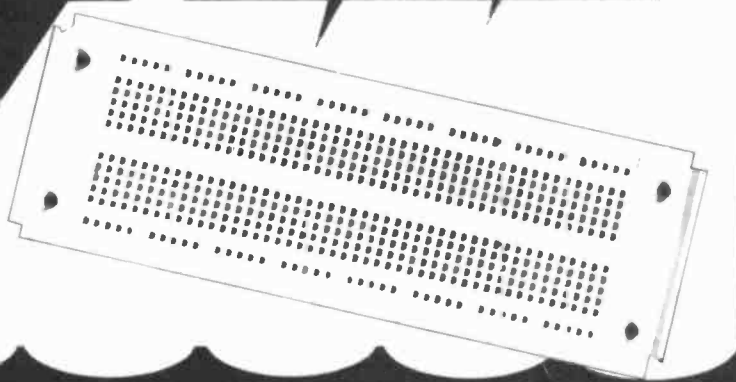

## NEW AND FREE FROM G.S.C.

**NEW** an exciting range of projects to build on the EXP300 breadboards. NOW anybody can build electronic projects using "Electronics-by-numbers", its as "Easy as A, B, C with G.S.C!"

**FREE** project **MUSICAL DOORBELL OF THE 3RD KIND** You've seen the film, now haunt your visitors with the tune! Each time the doorbell is pushed the eerie tune plays out, then switches off to conserve battery power.

**HOW DO YOU MAKE IT.** Our **FREE** project gives you clear "step-by-step" instructions. For example "take Resistor No.1 and plug it into hole numbers B45 and B47". "Take IC No.1 and plug it into hole numbers E35 to E42 and F35 to F42, (pin 1 on the IC goes into F35)". "Take... Well! why not "clip-the-coupon" and get your **FREE** step-by-step instruction sheet and your **FREE** 12 projects with each EXP300 bought and your **FREE** catalogue and.....

## EXPERIMENTOR BREADBOARDS

The largest range of breadboards from GSC. Each hole is identified by a letter-number system. EACH NICKEL SILVER CONTACT CARRIES A LIFE TIME GUARANTEE.

All modular construction means that any Experimentor breadboard can be "snap-locked" together to build breadboards of any size.



**EXP325**  
The "one chip" breadboard. Takes 8, 14, 16 and up to 22 pin IC's. Has 130 contact points including 2 bus bars.



**EXP350**  
The "beginners-breadboard". For limited period you can have **FREE** 12 "Electronics by Numbers" PROJECTS.

**EXP300**



The most "widely bought" breadboard. Don't miss out on our "NEW AND FREE" projects. They can be built on the EXP300.

**EXP600**  
The "Mobydick microprocessor" board  
**EXP650**  
The "one chip microprocessor" board  
**EXP48**  
"Snaps on" four extra bus bars

**PB6**  
The ultimate breadboard kit  
**PB100**  
The most kit for the least money

## NEW AND FREE FROM G.S.C. 24 HOUR SERVICE.

Tel (0799) 21682 with your Access, American Express, Barclaycard number and your order will be put in the post immediately.

TO ORDER JUST CLIP THE COUPON.

Experimentor Breadboards	Unit Price Inc. P & P + 15% VAT	Quantity Required
Exp 325	£3.16	
Exp 350	£4.83	
Exp 300	£8.05	
Exp 600	£9.48	
Exp 650	£5.75	
Exp 48	£3.73	
PB-6	£13.80	
PB-100	£17.53	

NAME

ADDRESS

I enclose cheque/PO for £

Debit my credit card No

Expiry date

Please send free catalogue Tick  Dept 5P

GLOBAL SPECIALTIES CORPORATION

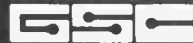

GSC Unit 1, Shire Mill Ind. Estate  
Saffron Walden, Essex, CB11 3AQ.  
Telephone (0799) 21682  
Telex 817477. Dept. 5P

# ZEAKER

## MICRO-ROBOT

PART 2

DAVID BUCKLEY

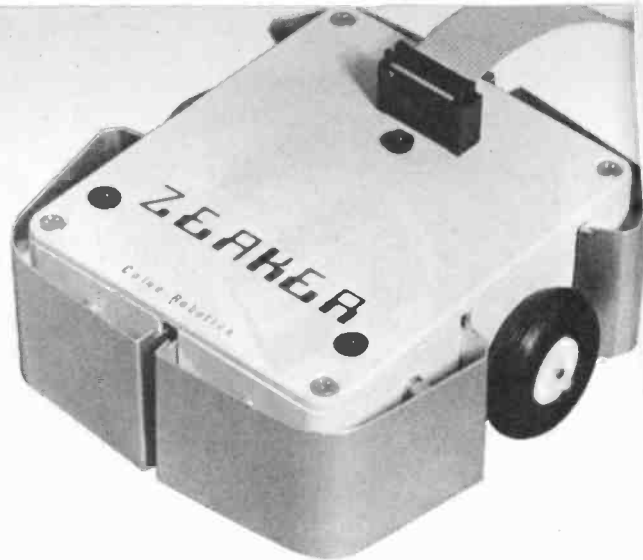

In the Control Station the holder for the four C-cell Nicads is bolted to the bottom of the box (actually the lid, but the box is used upside down), offset towards one side to allow room for the power/charge lamp. The Nicad supply on/off switch and indicator l.e.d. are fitted to the front of the box. The 3.5mm jack socket for the ZX81 power supply and 2½ foot link to the ZX81 are fitted to the rear.

The three 16 way ribbon cables (two to the computer interface board and the umbilical to Zeaker) leave the box through cut outs in what is now the lid, these should be of a size such that the ribbon cable is just clamped when the box is closed.

### CONTROL STATION CIRCUIT DESCRIPTION

The circuit (Fig. 1) can be divided into two distinct parts: the computer READ port and the computer WRITE port. In the prototype both these ports are memory mapped at address 35000 decimal.

Dealing first with the READ port. Data lines D0 to D7 are normally held high by resistor pack IC3. Lines D6 and D7 terminate on pads inside Zeaker and are not used hence D6 and D7 are always high. The remaining lines D0 to D5 terminate at the insulated pillars set into the sides of Zeaker and indicate the state of the tactile sensor switches, a low data line implying that Zeaker is touching something (see table of sensor codes). All the fenders are connected to 0V and on impact with an obstacle a fender will move in and make contact with one or more pillars, hence shorting the respective data lines to 0V.

Turning now to the WRITE port. D0, D1 control the port drive motor; D1, D2 control the starboard drive motor; D4 the pen; D5 the lights; and D6 and D7 the horn.

One end of the port drive motor goes to the centre tag of the battery and the other to the junction of TR3 and TR4. Turning on TR3 will cause the motor to run forwards and turning on TR4 will cause it to run in reverse.

D0 high is port motor forwards and D1 high is port motor reverse. IC1a and IC1b are wired as a set reset latch which ignores the condition D0 high and D1 high, so preventing destruction of TR3 and TR4.

When D0 goes high the output of IC1a goes low, so turning on TR2 which turns on TR3, when D0 is low TR2 is held off by R2 and R3. TR1 is normally held on by R1 and R4 and so shorts TR4 base to earth but when D1 goes high the output of IC1b goes low and turns off TR1, TR4 is now able to turn on by base current through R5.

The operation of the starboard motor is similar except that forward and reverse are switched around so TR8 on gives starboard motor forwards. This evens out battery drain when going forwards or backwards.

Data line D4 high turns on TR9 which turns on TR10, switching on the solenoid which lowers the pen. The l.e.d. D3 provides indication that the solenoid is activated. Diode D4 is to short out the inductive high reverse voltage when current through the solenoid is halted by TR10 turning off.

Data line D5 high turns on TR11 which turns on TR12, lighting D1 and D2, the red and green l.e.d.s.

Data lines D6 and D7 control the horn, via the reset lines of IC2 which is wired as two astables. The frequency components R20, R21, C2 and R22, R23, C5 were chosen by experiment so that the tones sounded right when both are on together. C3 and C4 are the usual blocking capacitors.

### CONTROL STATION PCB

The p.c.b. for the control station is shown in Fig. 2 with the component layout shown in Fig. 3. The resistors by the 556 are mounted on end but the others are mounted flat. There are a number of wire links to be soldered in place and these are best done with insulated wire. None of the transistors need heatsinks and are all mounted vertically. The three 16 way flying leads can be soldered directly into the p.c.b. but it is easier to use headers on the leads and plug them into the p.c.b.

### CONTROL STATION CHECKOUT

The easiest way is to plug the read and write cables into the interface board, plug the ZX81 power supply into the back of the control station and plug the flying power lead

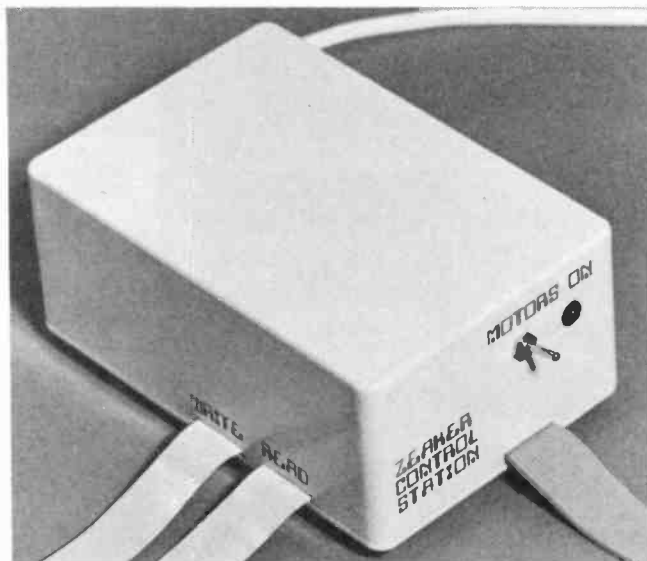





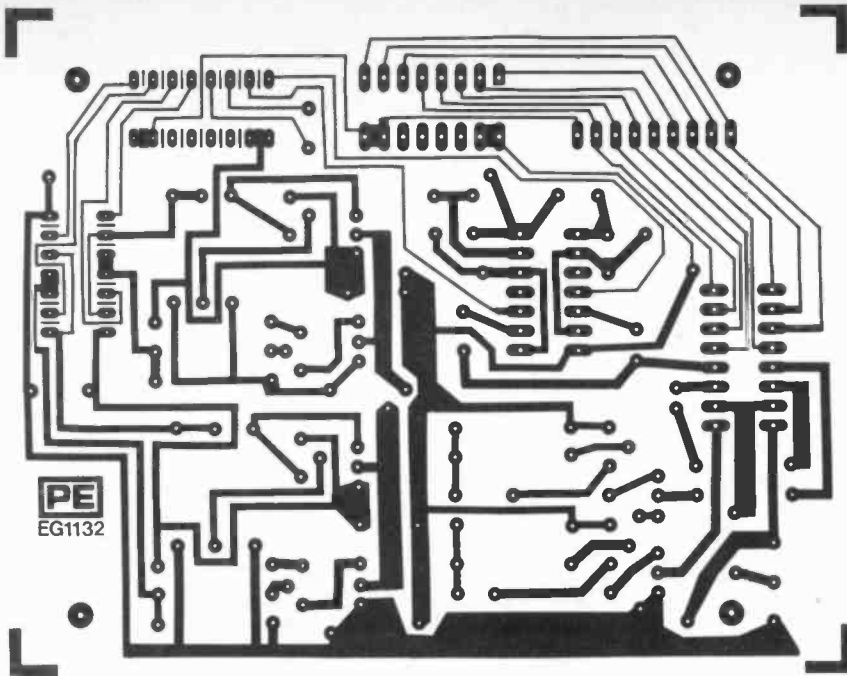

Fig. 2. P.c.b. design

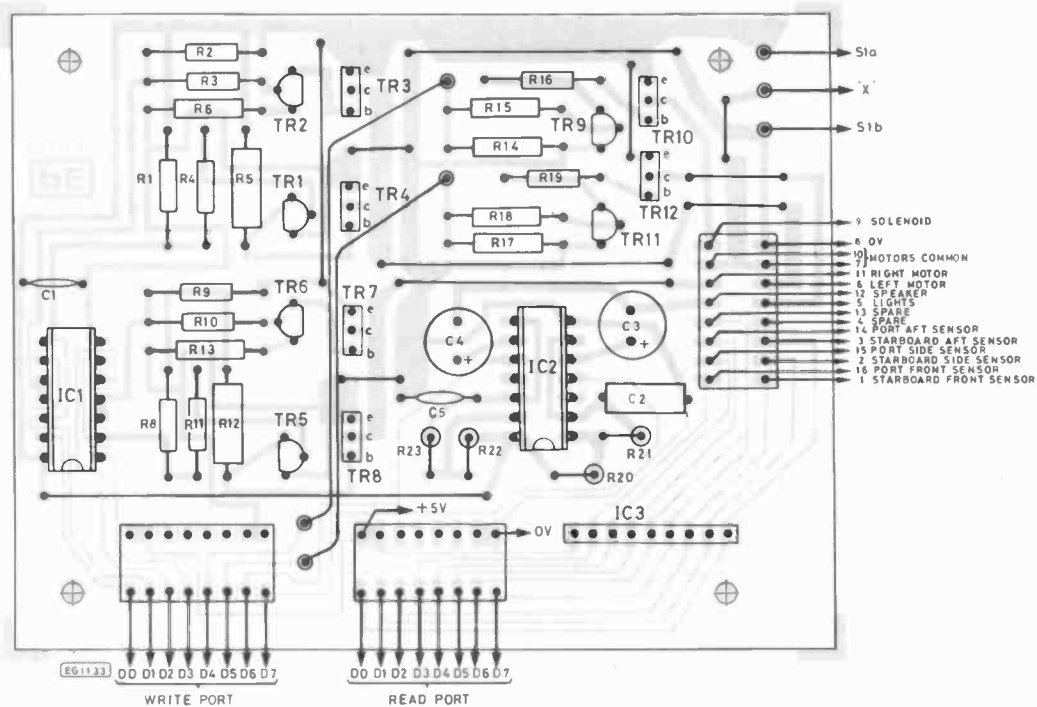

Fig. 3. Component layout

bits (6 for the unexpanded Zeaker). The particular way that these are available will depend upon the microcomputer and interface used. The signal allocation for the output and input connector leads are shown in Fig. 5.

Writing (POKEing for a memory mapped port) a word to the port sets the respective bits of the output latch. Reading (PEEKing) the port will return the status of the bump sensors.

A list of the control codes and their effect is given in Table 1. Any combination of control codes can be written to the port and Zeaker will be controlled by their combined effect e.g. writing a 1 will set the port motor to forwards and writing a 4 will set the starboard motor to forwards, hence writing 5 (=4+1) will set both motors on forwards. Writing 37 (=5+32) will set both motors on forwards and also switch on the lights.

# COMPONENTS . . .

## CONTROL STATION

### Resistors

R1,R2,R3,R4,R8,R9,R11, R19,R20,R22	10k (10 off)
R5,R12 $\frac{1}{2}$ W 10% carbon	820 (2 off)
R6,R13 $\frac{1}{2}$ W 5%	470 (2 off)
R7	100
R14,R17 $\frac{1}{2}$ W 2%	1M (2 off)
R15,R18 $\frac{1}{2}$ W 5%	4k7 (2 off)
R16,R19 $\frac{1}{2}$ W 2%	220 (2 off)
R21 $\frac{1}{2}$ W 5%	220k
R23 $\frac{1}{2}$ W 5%	56k
All resistors $\frac{1}{4}$ W 5% carbon except where otherwise stated	

### Capacitors

C1	100n ceramic disc
C2	10n ceramic disc
C3,C4	47 $\mu$ 16V elect (2 off)
C5	22n ceramic disc

### Semiconductors

D1	red l.e.d.
TR1,TR5,TR9,TR11	BC238 (4 off)
TR2,TR6	BC308 (2 off)
TR3,TR7,TR10,TR12	BD132 (4 off)
TR4,TR8	BD131 (2 off)
IC1	74LS00
IC2	556
IC3	pack of 8 commoned resistors RS type 140 271

### Miscellaneous

- ABS plastic box 150 x 100 x 60mm
- Battery holder for 4 C-cells
- Nicad C-cells (4 off)
- MES lampholder
- MES 12V 280mA bulb
- Double pole on/off switch
- 3.5mm jack plug and socket
- 16 pin d.i.l. IDC header (5 off)
- 16 pin d.i.l. sockets (3 off)
- 14 pin d.i.l. sockets (2 off)
- 3 metres of 16 way grey ribbon cable
- Molex 16 pin JD connector to mate with the 5332 series connector on Zeaker

### Constructor's Note

The toe cover cap is available from most hardware stores and the wheels and motor gearboxes assemblies are obtainable from hobby shops.

A complete kit of parts for the vehicle (including machined, cut and ready-bent items) and control station with a manual and software is available from Colne Robotics Ltd., Beaufort Road, off Richmond Road, Twickenham TW1 2PH (01-892 8197/8241). Price £59.95 inc. VAT.

Colne Robotics are also able to supply the separate parts, please write or phone for details.

The two longer programs mentioned in the text are available from Colne either on cassette or as a print-out. Please state the type of computer being used with Zeaker when ordering programs.

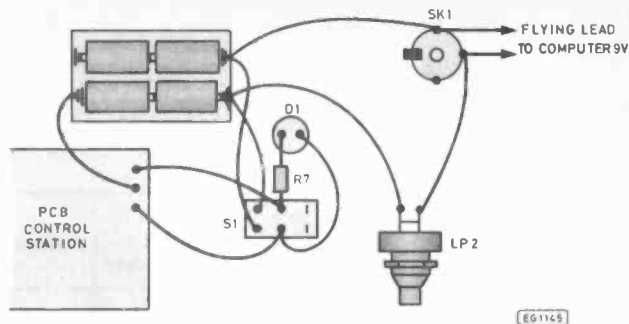
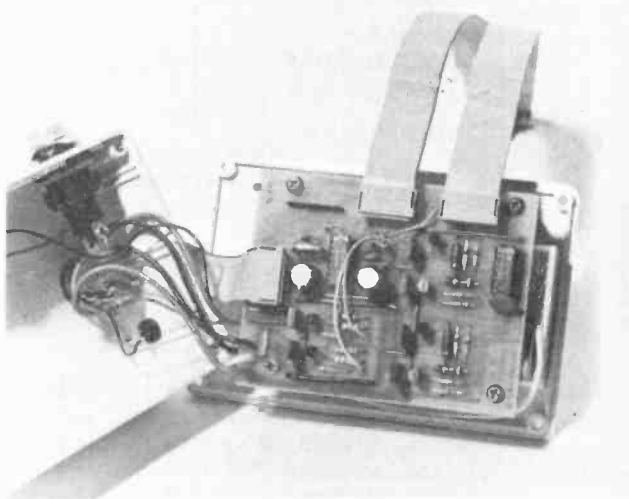
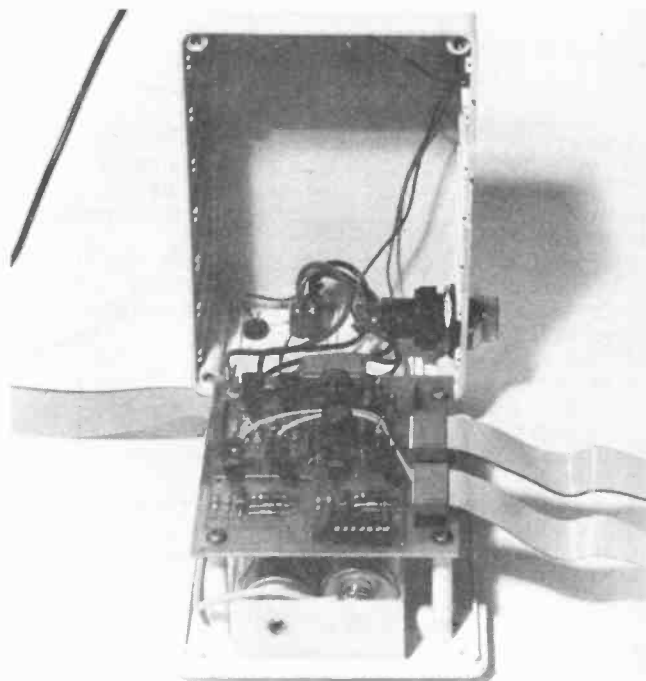

Fig. 4. Wiring diagram



Interior views of the Control Station showing the battery housing and the p.c.b. mounting details

FROM COMPUTER WRITE PORT

								Pin 1
D7	D6	D5	D4	D3	D2	D1	D0	
0V	0V					5V	5V	

TO COMPUTER READ PORT

								Pin 1
D7	D6	D5	D4	D3	D2	D1	D0	
0V	0V					5V	5V	

UMBILICAL CORD

0V	Motor Common 2.5V	Motor Starboard	Lights	Spare	Sensor Starboard Rear	Sensor Starboard Side	Sensor Starboard Front
Solenoid	Motor Common 2.5V	Motor	Speakers	Spare	Sensor Port Rear	Sensor Port Side	Sensor Port Front

Fig. 5. PSU DIL headers Signal Allocations

KEYBOARD TEACH PROGRAM  
1K ZX81

```

(1 REM TEACH/DOIT)
5 FAST
10 LET A=35000 _____ 35000 IS A PORT ADDRESS
20 POKE A,0 _____ SWITCH OFF VEHICLE
30 DIM M$(10,2)
40 LET K1=.6 _____ STRAIGHT RUN CONSTANT
50 LET K2=.61 _____ TURN CONSTANT
60 FOR S=1 TO 10
65 CLS
70 PRINT "TEACH", "STEP";S, "MOVE AND DIST/ANGLE/TIME"
80 INPUT C$
90 INPUT D
100 IF C$="F" THEN LET M$(S,1)=CHR$(5)
110 IF C$="B" THEN LET M$(S,1)=CHR$(10)
120 IF C$="L" THEN LET M$(S,1)=CHR$(6)
130 IF C$="R" THEN LET M$(S,1)=CHR$(9)
140 IF C$="S" THEN LET M$(S,1)=CHR$(0)
150 LET M$(S,2)=CHR$(D)
160 IF C$="F" OR C$="B" THEN LET M$(S,2)=CHR$(D*K1)
170 IF C$="R" OR C$="L" THEN LET M$(S,2)=CHR$(D*K2)
210 NEXT S
220 PRINT "TO DOIT PRESS D"
230 PAUSE 50000 _____ WAIT UNTIL ANY KEY PRESSED
240 FOR S=1 TO 10
250 POKE A,CODE M$(S,1)
260 PAUSE CODE M$(S,2)
270 NEXT S
280 POKE A,0
290 GOTO 230
    
```

RANDOM MOVE PROGRAM  
1K ZX81

```

1 REM RANDOM MOVE
10 LET A=35000 _____ 35000 IS PORT ADDRESS
20 POKE A,0 _____ SWITCH OFF VEHICLE
30 PRINT "PRESS S TO STOP"
40 IF INKEY$="S" THEN GOTO 200
50 PAUSE 5
60 POKE A,32+5 _____ SWITCH ON LIGHTS AND FORWARD
70 PAUSE 5
80 POKE A,5
90 LET B=PEEK A
100 IF B=255 THEN GOTO 40
110 POKE A,64+10 _____ LOW HORN AND BACKWARDS
120 PAUSE 30
130 IF B>250 THEN GOTO 170
140 POKE A,128+6 _____ HIGH HORN AND LEFT
150 PAUSE 50*RND _____ RANDOM TURN TIME
160 GOTO 40
170 POKE A,128+9 _____ HIGH HORN AND RIGHT
180 PAUSE 50*RND _____ RANDOM TURN TIME
190 GOTO 40
200 POKE A,0 _____ SWITCH OFF VEHICLE
    
```

CONTROL CODES

- 1 Port forward
- 2 Port back
- 4 Starboard forward
- 8 Starboard back
- 16 Solenoid on
- 32 Lights on
- 64 Horn 1
- 128 Horn 2
- 192 Horn 1 plus Horn 2

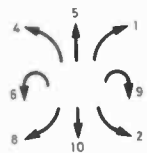

Table 1

SENSOR CODES

- D0 Starboard sensor Aft closed
- D1 Starboard sensor Side closed
- D2 Starboard sensor Front closed
- D3 Port sensor Front closed
- D4 Port sensor Side closed
- D5 Port sensor Aft closed
- D6 Spare
- D7 Spare

Table 2

When a port is read the resulting number will depend on which if any of the six sensor switches are closed. If none are closed i.e. if Zeaker is not touching anything then all 8 bits will be high and a read will return 255. If say the starboard front sensor is pressed then from Table 3, D3 will be low and hence a read will return 247. If both front sensors are pressed in then both D2 and D3 will be low and hence a read will return 243.

It is reasonably easy to determine which sensors are closed by subtracting the return value from 255 and transforming the result into binary. For the previous example of both front sensors closed this returns 243. Now  $255 - 243 = 12 = 8 + 4 = 2^3 + 2^2$  hence data lines 3 and 2 are at 0V which from Table 2 means that both front sensors are closed.

Although this may seem a complicated procedure to go through each time, remember a computer controls Zeaker and it will do all the tiresome calculations.

The initial software consists of two short programs, one which allows you to build a simple pattern and repeat it and the other lets Zeaker find its own way around obstacles, and two longer programs, which are available from Colne, one of which allows several patterns to be built up and joined together and the other allowing Zeaker to memorise its environment and to avoid obstacles sensibly.

For the initial ZX81 version of Zeaker the two short programs will each fit into 1K of memory and so can be run on an unexpanded ZX81. Writing a 1K program to control Zeaker from BASIC does not allow the full range of Zeaker's capabilities to be used. However, the two ZX81 1K programs here should give an idea of the ease with which Zeaker may be controlled from BASIC.

#### PROGRAM NOTES

Encoding the move code and time of move into the character array M\$ saves 80 bytes over using the numerical array. Against this must be set the 18 bytes for the CODE, CHR \$ and \$ used in the listing, resulting in 62 bytes saved. The program just fits in 1K and can be edited and run. Report code 4 (out of memory) comes up most of the time but should be ignored. The program can store up to 10 moves and prompts for the move.

F=Forward	and	Distance millimetres
B=Backward		Distance millimetres
R=Rotate Right		Angle degrees
L=Rotate Left		Angle degrees
S=Stop		Time in 50th second

To escape from the program press break.

The constants K1 and K2 should be fine tuned to the particular vehicle. The maximum value of any entry in M\$ is 255 and hence entering numbers greater than this in response to the prompt will cause the program to halt with an error code.

#### FURTHER DEVELOPMENTS

Although all 8 data read lines are connected to Zeaker only 6 of them are actually used, the remaining two terminate at pads by the Molex connector on the p.c.b. in the lid of Zeaker.

It is intended that these spare lines should be used to interface to add-on circuitry which will enable Zeaker to follow a white line, induction loop cable or simply seek or avoid light or heat.

Also instead of sending just the horn tones down the umbilical cord to the speaker it is possible to connect the output of a complex sound generator or a computer speech board to a pad by the umbilical cord connection on the p.s.u. board and Zeaker will be able to chuff along like a steam train or emit some more appropriate sound. It could also give a running commentary on its progress e.g. "Forward", "Right", "Left", "Ouch"! "Hit something at Left Front" etc.

Whilst Zeaker is relatively simple it is capable of quite complex interactions with its environment and in many respects it is only limited by the ingenuity of the controlling software. ★

all in your

# JULY

issue!



# ULTRALIGHT

An ultrasonic unit which provides automatic lighting and a burglar alarm. Invaluable in any home.

## TIMER PROJECTS

Based on an Intersil chip these four timer projects cover a wide range. They are: Hand Held Two Digit Down Counter; Hand Held Four Digit LCD Up Counter; Four Digit LCD Down Counter/Controller; and Four Digit LED Down Counter/Controller.

## FAIRLIGHT MUSIC COMPUTER

The computer that has changed the world of music. We take an in-depth look at this digital ear on the world of sound. A computer that listens, stores and reproduces the sound as music.

PRACTICAL  
**ELECTRONICS**

JULY ISSUE ON SALE FRIDAY, JUNE 3





## Space Watch...

### THE IRAS SATELLITE SUCCESS

If the International Infrared Astronomical Satellite continues as it has begun it will have added much to offset some of the other disappointing news in other directions. First then the good news.

Another pass of the satellite was witnessed by the Parliamentary Under Secretary of State for the Department of Education and Science, Mr. William Shelton MP. Certain initiating commands made from Chilton, Oxon, the control station for the satellite, were performed by Mr. Shelton. This second event to which the press were invited was also a great success. Already a large amount of data had been collected. It is clear that there may be quite a long gap between the cessation of operations and publication of all the data.

It was expected that the useful life of the satellite would be in the order of 200 days, but as the boiling off of the coolant (superfluid Helium) is slower than was expected it may be possible to extend the time to 300 days. Altogether this has been a most satisfactory scientific satellite. The actual planned survey was scheduled to be complete in 200 days and the principal scan may well be so completed. This will enable the bonus time to be used for extra scans by the Dutch special additional experiment (DAX). This was a special 'close-up' facility which means that if something unusual is seen it will be possible to look at it in greater detail. Already such a situation has arisen in that during the scan of the Greater Magellanic Cloud it was noticed that there was intense emission round the Tarantula Nebula. Also just one minute of time spent on surveying the Galaxy away from the Earth's atmosphere has yielded more than all previous surveys.

The wide range of the telescope enables it to assess the cool clouds and the hot new clouds. It has thus been possible to say that the cool clouds are large and extensive and that as they get hotter clouds or cloudlets formed are consistent with the present theories of the evolution of new stars. That is that the large and diffuse clouds at wavelengths of 100 micrometres are beginning to condense under gravitational pressure. As the clouds become smaller and are under the influence of the increased internal pressure giving rise to nuclear reactions they shine as stars in their own right. The telescope therefore can give extremely adequate proof of the theories of stellar evolution. It is no exaggeration to say that this 'eye' is another of those vital milestones that

precede not only acceptance of recent thinking but provide the impetus for the thinking of the immediate future.

A footnote here might be appropriate. During a private conversation with Mr. Shelton and in answer to some of his questions about the publication of scientific progress the author took the opportunity to emphasise that the change of name from SRC to SERC (Science and Engineering Research Council) had already been reflected in a more useful spread of information which enabled the very efficient publicity section to spread its wings.

### PROJECT UNIVERSE

This venture which involves the Orbital Test Satellite (OTS) was again a task for Mr. William Shelton to play the role of initiator of this new joint effort. In the early development of microelectronics there seemed to be much misapplication as well as a great deal of incompatibility and no doubt this was the partial cause of high prices. The new techniques and especially proper attention to the importance of compatibility has brought some order out of chaos, with the fall of prices and the increasing sophistication of both hardware and software, giving impetus to the number of users in business and at home, which now opens the way for real improvement and standardisation. In this regard the most exciting development has been the setting up of Local Area Networks. These set up communication links between computers and their peripherals whose performance in terms of speed and reliability is comparable to that of the computers themselves. Local Area Networks (LANs) can provide electronic mail, the sharing within an office of costly printers etc., and scope for integrating computer aided design and manufacture.

A single LAN can link scores of computers, work stations and peripherals. Like *LEGO* it can go on and on. All this means that computer technology is pushed to its limits. This is as it should be. There is in operation a ring LAN known as the Cambridge Ring. This was developed by the Cambridge University Computer Laboratory and can offer a capacity of 4.2 Megabits. In the literature this is the equivalent of 50 pages of the Concise Oxford Dictionary every second. Even so the Ring with all its facilities can only cope over short distances. To extend such a facility nationally or internationally requires another facility. This really is what Project Universe is all about. The name of that facility is provided by the consortium involved: The Universities Expanded Ring Experiment. The consortium comprises the Department of Industry, The Rutherford and Appleton Laboratory of the Science and Engineering Research Council, British Telecom, Cambridge University, GEC, Logica, Loughborough University of Technology and University College, London.

The operational set-up is as follows—the LANs at Rutherford, Loughborough, Cambridge, Martlesham (Telecom Research Laboratory), Chelmsford (GEC/Marconi Research Centre), and London (University College and Logica) with (a terrestrial link between them) are all linked via the Orbital Test Satellite, which provides the high bandwidth capacity required for fast transmission of data. To take data from a network and transmit it to a satellite requires a Satellite Bridge.

### THE LINK DRIVING COMPUTER

This is a major element of the Satellite Bridge. In the Project Universe sites this is provided by the GEC 4065 mini-computer with 64K bytes of semiconductor memory, a four-channel synchronous communications controller and cartridge discs. The LDC applies the necessary procedures, holds enormous amounts of data in buffer stores to await transmission and keeps account of the amount of traffic the Ring wants to send. It of course provides complementary functions for incoming data.

For the outward path the next step involves the Computer Interface Module which is responsible for controlling access to the satellite. There is a master Earth station which establishes a time frame by broadcasting every 130 milliseconds a reference burst which lasts for 100 to 200 microseconds, available to lock all the stations. Full assurance of confidentiality is achieved. The data is transmitted via a 3 metre dish at a frequency of 14GHz transmitting and 11GHz receiving. The real time for the out and return time is approaching 0.25 seconds.

### THE ORBITING SATELLITE

The European Space Agency satellite (Orbital Test Satellite), is a three axis stabilised geosynchronous satellite launched in 1978. It is in orbit 36,000km above equatorial Gabon. One of the purposes of the satellite was to prepare for the European Communications Satellite system with services such as British Telecom SatStream. It has a polar power transponder to re-broadcast up to 7,200 simultaneous telephone conversations. This project heralds the future in which the electronic office becomes truly international.

### SPACE POWER EFFORT

Three Energy Agencies, the Defence Department, the Energy Department and the Aeronautics and Space Research Projects Agency have agreed to proceed with the high power project which will be known as SP-100 (solar power 100kW) for future deployment in space. The organisation controlling the project will be the Defence Advanced Research Projects Agency. This decision marks the end of a ten year delay in coming to agreement among the parties. The escalation, promoted by defence authorities for military considerations and fear that America has of a space war, has overcome the profitability point of view.

Because the new agency, DARPA, is responsible for the space-borne laser technology, particle beam technology and space-borne radar techniques, it is in a position to assess the needs of such activities; and more closely when they will be needed DARPA will have disposition control. The scheme has far reaching consequences because some of the thinking is in terms of nuclear units of hundreds of kilowatts, and further to tens of megawatts into the 21st century. It is envisaged that this work could result in 100 kilowatt units using a combination of systems; reactors could be available in the second half of this decade.

## Frank W. Hyde

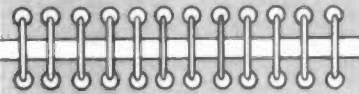

# INDUSTRY NOTEBOOK

By Nexus



## China Trade

Since writing a couple of months ago of prospects in China, more heartening news has emerged. At least two Racal Group companies are active in the market. Racal-Dana Instruments has concluded a deal with the Government of the People's Republic which involves assembly of the '99 series' frequency counters in Shanghai.

Kits will be shipped to Shanghai from the company's Windsor base, and although all details have not been revealed it is more than probable that the agreement includes provision of production aids including jigs, automated assembly and automatic test equipment. In fact a literal Chinese 'copy' of the UK production facility.

A couple of weeks after the instrument assembly deal Racal Recorders was able to announce that the Chinese Civil Aviation Authority had chosen the Racal International Communications Recorder as 'standard fit' at major airports. The ICR is a multi-channel (typically 20) long-play tape recorder which records all ground-air communications. Together with the aircraft-fitted 'black box' it provides major evidence in disaster enquiries. Thus, quality and reliability are all-important and it seems the Racal product was chosen after competitive trials with other makes.

At present such orders are marginal, a trickle rather than a flood of trade, and they need a lot of hard work and considerable investment in time and travel to obtain. Racal-Dana, for example, has been building bridges with 40 Import/Export Corporation branches in Shanghai, Beijing, Guanzhou and Harbin. Patience and dedication now could be richly rewarded by future business.

Cable & Wireless runs the hub of international telecommunications traffic in the Far East from its Hong Kong base. C & W's chairman and chief executive, Eric Sharp, asserts that the Far East is the region with fastest economic growth and that 'our involvement with the Chinese Telecommunications Authority is a major development of our established business there'. The extent of the involvement is not

revealed but is probably already considerable and increasing if only because C & W have a highly trained and Chinese speaking staff on the spot. Again, growth potential is clearly enormous, the number of telephones in the world 30 years ago was 70 million—today it is over 500 million; and China must be near the bottom of the world league in telephone sales penetration.

## Lesson

The recent water strike provided some much needed education. Few people outside the industry itself had the faintest idea of what is involved in gathering, purifying and distributing the precious liquid to our houses, offices and factories. Almost daily exposure on TV gave us a glimpse of the technology involved.

But the most potent lesson was in what didn't happen. City streets were not awash with sewage after a few days. Nor after a few weeks. Public health did not break down. Stand-by troops were never used.

Much of the credit for the maintenance of supply must go to automation, water supply may be the oldest of the distributive industries, preceding gas and electricity. Some of our town sewers are still 19th century but elsewhere the industry is far from old-fashioned, and new equipment and systems are going in all the while.

An example is a Marconi contract for radio monitoring and alarm for a network of 35 unattended sewage pumping stations in South Northamptonshire. The system is microprocessor-based and each pumping station is fitted with an 'intelligent' alarm to alert the control centre of any malfunction. A visual display and hard-copy printout of system status is at the control centre. Standard practice so far, except that the base control centre itself is open only in normal office hours.

To cover all contingencies Marconi is supplying two transportable control stations so that a duty controller can be in touch with system status from anywhere in the area and at any time.

We shall never know how long it would have been before public health became endangered. And we were lucky with the weather (fewer burst mains than expected) and with some essential maintenance carried out by management personnel. There was inconvenience to the public but no disaster. Which leaves us wondering whether the water industry might, perhaps, be a little overmanned.

## Recession?

What recession? Where? The electronics industry is clearly a special case but here, for the record, are a few success stories.

Marconi Avionics has signed a contract worth £30 million for the supply of 'head-up' displays for use in General Dynamics F-16 combat aircraft. This however, is for initial development and production, signifying follow-on orders.

Applied Computer Techniques (ACT) is investing £10 million in a new plant at Glenrothes, Fife, said to be one of the

world's biggest start-ups in microcomputers. Two hundred jobs this year, 400 by 1984.

Hewlett-Packard Ltd in the UK has enjoyed a 42 per cent increase in turnover. Exports were up 34 per cent and sales per employee have rocketed from £63,000 to £83,000 per year. Amazing!

IBM United Kingdom—Turnover up by 24 per cent to £1.24 billion. Pre-tax profits up 40 per cent to £225 million.

Standard Telephones and Cables—Turnover up 11 per cent, pre-tax profits up by 27 per cent. Exports at £143 million, 14 per cent up.

Plessey—Pre-tax profits up 29 per cent in the first nine months of the financial year.

Digital Equipment is spending £7 million setting up an office systems software development facility at Reading. Jobs for 250-300 in addition to the existing 120 in the present DEC software group.

Of course it's not all sweetness and light for every company but if these are hard times what's it going to be like in a boom?

## Jobs and Pay

The Institution of Electrical Engineers 1983 Salary Survey is full of interest. The sample totalled 7616 Fellows, Members and Associates in the UK and Republic of Ireland. The dominant field of occupation remains 'Electronic or telecommunications equipment development or manufacture'.

Compared with the 1982 Survey, unemployment is down from 1.2 per cent to 0.7 per cent, reflecting continued and indeed increasing demand for qualified engineers. But there is a small shift in employment from the public sector to the private sector of industry, up 2.1 per cent at 56.1 per cent. In 1976 only 45.8 per cent were in the private sector.

Salaries, however, are still higher in the public than in the private sector although the gap is narrowing. Taking all members in all grades and types of job, the salary range is from £6,000 for a young Associate up to £25,000 p.a. for a Member or Fellow in a senior position.

It's good to see salaries rising. But better still the low unemployment in the profession. Less than 1 per cent leads us to ask again, what recession?

## Shifting Pattern

The personal micro boom is shifting the pattern of trade. Many electronic hobbyists are spending on factory produced micros money they would otherwise be spending on components or kits. But perhaps only a temporary diversion of funds. The hard core of home constructors get as much if not more satisfaction from the making of a project and the understanding of how it works as from its end-use.

My own view is, that out of the thousands of purchasers of personal micros, quite a proportion will feel encouraged to take an interest in home construction where no interest had hitherto been shown. In fact a wider general enthusiasm for electronics could add to the ranks of the d.i.y. hobbyist.

**NEW SERIES**

# SEMICONDUCTOR CIRCUITS

**TOM GASKELL B.A. (Hons)**

## HIGH QUALITY AUDIO PREAMPLIFIER (HA 12017)

HI-FI preamplifier designs of recent years have tended to use one of two basic circuits for the 'disc' input amplifier; either a conventional high performance opamp, or a discrete transistor based design. Opamps are simple, cheap, and easy to use, but in the highest quality systems they can sometimes create problems of noise or distortion. Furthermore, their maximum supply voltage is normally limited to around  $\pm 15$  volts, thus limiting their dynamic range and overload handling capability. Discrete transistor preamps, on the other hand, can be very complex to design and build. They are usually rather bulky, requiring large areas of Veroboard or p.c.b., and are often difficult to modify and experiment with. The performance, however, can be made very good indeed. The Hitachi HA 12017 is an i.c. which is specifically designed as a low noise, very low distortion audio preamplifier, and is able to offer the high performance of complex discrete designs with all the advantages and simplicity of integrated circuit technology. The i.c. has been developed from a similar device produced by Hitachi a few years ago, which has become somewhat of a standard in Japanese hi-fi equipment.

Although the i.c. can be used in a flat configuration (i.e. with no audible frequency dependent response characteristics), it is primarily designed and optimised for use as an R.I.A.A. equalised magnetic pick up preamplifier, for use with audio discs. (R.I.A.A. is the response characteristic standardised for use in record reproduction; it is the exact converse of the filtration which is applied to the cutting head when the master disc of the record in question is first made. By using such an arrangement of filtration, the modulation level recorded onto the disc can be made relatively high, improving the signal-to-noise ratio substantially.)

The pin configuration is shown in Fig. 1, and probably the most notable point to make about this is that the device comes in a single-in-line package; there is only one row of pins which stick straight out of the side so that

when mounted on its circuit board, the package stands vertically off the board. For experimental purposes, you could plug the two i.c.s (for stereo) into one ordinary 16 pin i.c. socket, but for a permanent installation this is not recommended, since at very low signal levels the quality of the connection could be a little suspect.

The specifications for the HA 12017 are

Characteristic	Notes	Min. value	Typically	Max. value	Unit
Supply Voltage	All specs below are measured at $\pm 24V$	$\pm 6$	$\pm 24$	$\pm 26.5$	V
Quiescent current	No input signal		4.0	6.0	mA
Temp. range		-30		+75	$^{\circ}C$
Dissipation				500	mW
Total harmonic distortion	20Hz-20kHz output 10V r.m.s.		0.002	0.01	%
Output voltage	Freq. 1kHz, THD-0.1%	13.5	14.7		Vrms
Open loop gain	Freq. 1kHz	95	105		dB
Max. input level	Freq. 1kHz, THD -0.1%		235		mVrms
Output noise A	Source resistance -43 $\Omega$ Weighting curve used		11.5	15.6	$\mu V$
Output noise B	Source resistance -3k3 Wide band (20Hz-20kHz)		53	90	$\mu V$
Supply rejection ratios	+ve supply } @ 100Hz -ve supply } ripple		56 45		dB dB

shown in Fig. 1, and they make interesting reading for all those interested in high quality performance! All the figures are based on the use of the i.c. in a complete R.I.A.A. equalised circuit, as shown in Fig. 2, so they are realistic indicators of the performance of the whole disc preamplifier stage.

### SUPPLY AND OUTPUT VOLTAGES

Although the supply voltage can be as low as  $\pm 6V$ , the recommended rails are  $\pm 24V$ . This is intended to allow a very high output level to be obtained from the device before clipping occurs; typically 14.7V r.m.s., or 41.6V pk/pk. The R.I.A.A. equalised circuit of Fig. 2 has a gain of 35.9dB at 1kHz (a voltage gain of 62 times), so the maximum input level is defined as 1/62 of the maximum

**Fig. 1 (right) HA12017 pin-out and (below) its specification. Note that this refers to the R.I.A.A. equalised circuit of Fig. 2**

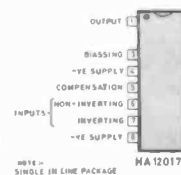

output voltage; this works out as an input of 235mV r.m.s. Most magnetic pick up cartridges only produce a typical signal level of a few millivolts, so this may seem to be an unnecessarily large input signal handling capability. However, some audio sounds and effects, especially those of a percussive or synthesised nature, can include much higher voltage short duration spikes or transients, which generate cartridge outputs much higher in level than the nominal few millivolts. By allowing up to 235mV (664mV pk/pk) before clipping occurs, the i.c. allows plenty of headroom before these transients are distorted in any way. (Typically in the order of 30 to 40dB, depending on the cartridge used.) As a result, the audible quality is excellent, and the sound is very clean. Many low supply rail designs are somewhat lacking in this

respect, so don't reduce the supply rails below  $\pm 24V$  unless it's absolutely necessary!

### DISTORTION

A large signal overload handling capability is of very little use to us if the device produces unacceptable amounts of distortion. In fact, the distortion specification is one of the HA 12017's most impressive features; typically 0.002% (1kHz at 10V r.m.s. out). The actual graph of third harmonic distortion versus output signal level is shown in Fig. 5, and it can be seen that clipping (i.e. the sudden onset of large amounts of distortion) occurs at around 15V r.m.s. (as we have already established), and distortion slowly starts to rise at below 1 to 2V r.m.s., which is not unreasonable. The distortion of this i.c. is so low that it could well be used in audio test equipment; as a front end amplifier in a distortion measuring set, or even

**Fig. 3. Feedback components for R.I.A.A. equalisation; extremely high accuracy system**

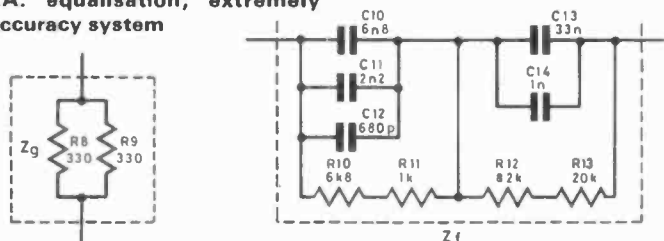

EG112C

as the central building block of a low distortion oscillator, for example. In this type of application, its own distortion is so low that it will have virtually no effect on the measurements of most audio system performance.

### NOISE

Noise is one of the most important and fundamental specifications in any audio system. Arguments may rage over the audibility of phase changes or certain types of distortion, but the undesirable and intrusive nature of noise in audio reproduction is not under dispute.

As the front end amplifier in the audio signal path, the disc preamplifier is required to add the most gain to the signal, and hence also adds the most noise, defining the overall noise level generated by the complete system. As with the other operational parameters of this device, the noise specifications are very good;

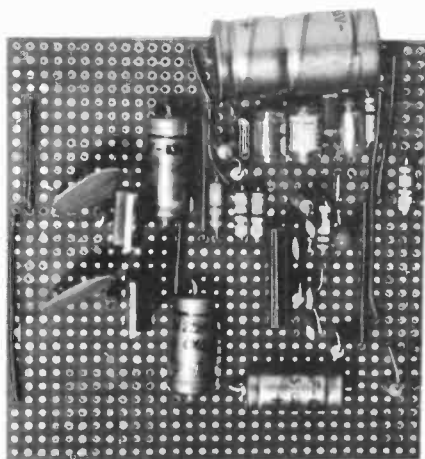

**Fig. 2. Audio preamplifier circuit**

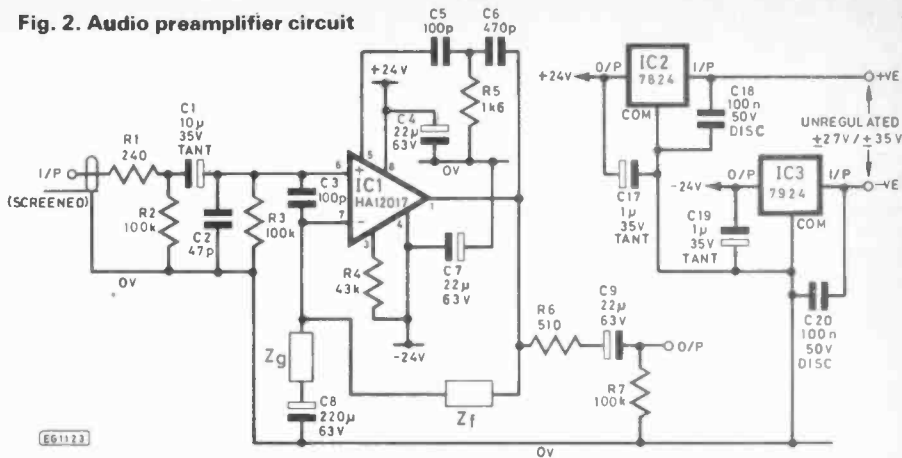

EG1123

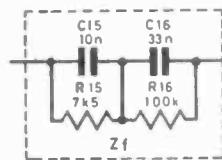

**Fig. 4. Feedback components for R.I.A.A. equalisation; non-critical accuracy**

EG1125

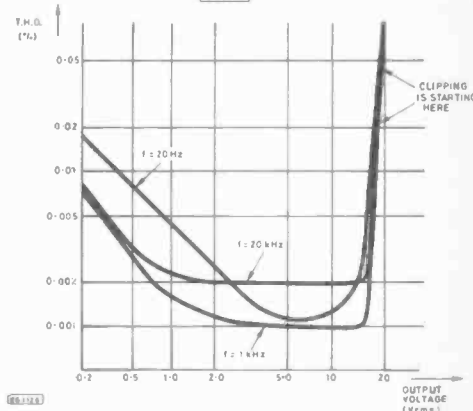

EG1124

**Fig. 5. Graph of distortion against output voltage for main circuit**

with a source resistance of 3k3, and a 20Hz to 20kHz bandwidth, the output noise voltage is typically 53 $\mu$ V, or -83dBu. This gives a dynamic range of 109dB (i.e. the difference between the maximum output signal level and the output noise), and a signal-to-noise ratio for a typical magnetic cartridge, producing 5mV r.m.s. signal, of 75dB (assuming a cartridge impedance of 3k3). In practice, the prototype circuit gave an output noise, including residual hum, of -84dBu (49 $\mu$ V) with a 3k3 resistor across its input, and -90dBu (25 $\mu$ V) with the input short circuited; both these figures were measured for the range 20Hz to 20kHz. The equivalent input noise, as derived from the specifications, is 0.85 $\mu$ V, or -119dBu.

**Fig. 6. Board assembly**

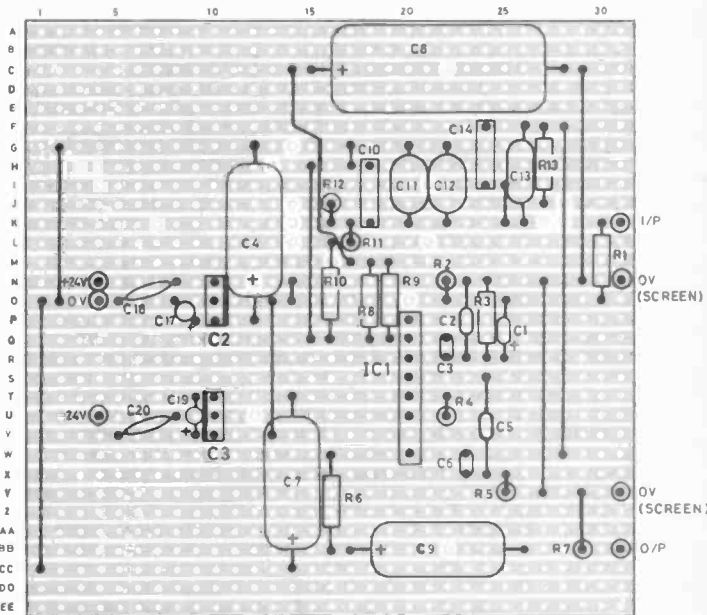

EG1127A



## CONSTRUCTION

Fig. 6 shows the Veroboard layout for a complete mono disc preamplifier. 24V power supply regulators have been added to allow any d.c. unregulated supply of +/- 27V to +/- 35V to be used. The regulated supplies can be used to feed a second preamplifier, of course, as in the case of a stereo system. The layout has been arranged to use the circuitry of Fig. 3, i.e. the high accuracy equalisation components, but the non-critical components of Fig. 4 could easily be fitted if preferred. For optimum performance, all resistors should be metal film types, and the capacitors should be as follows:

C2, C3, C5, C6 ceramic plate  
C1, C17, C19 tantalum bead, 35V rating or more

C10, C13 (or C15, C16) polycarbonate  
C11, C12, C14 polystyrene  
C4, C7, C8, C9 electrolytic, 63V rating (50V will also do)  
C18, C20 disc ceramic, 50V rating or more

All the normal rules and conventions of audio practice should be adhered to; plenty of supply decoupling, mains transformer far away from the preamplifier inputs, short signal leads, very thick earth wires, taken down to just one central common earth point, good quality connectors, etc. Some of the interconnections and layout of components in Fig. 6 may seem a little strange at first sight. Do beware of changing the layout arbitrarily, however, because some of the layout and linking is critical for achieving low hum and good stability from the system. Designing your own

p.c.b. for the circuit, in that respect, offers the chance of achieving even better performance than the Veroboard layout, but be prepared for some experimentation! The input impedance of the circuit is approximately 47k, to match the most popular magnetic pick-up cartridges (change C2 to suit the loading requirements of the cartridge in question). No volume or tone controlling is shown, of course, since our primary concern is the preamplifier i.e. We'll look at devices to do these other audio functions at a later date! However, we do now have a very high quality, very low distortion, low cost disc preamplifier design based on the HA 12017. The only problem now is the designing of the power amplifier to fully do the preamp justice!

The HA 12017 is readily available from **Ambit International**.

## FREE! READERS' ADVERTISEMENT SERVICE

# PE BAZAAR

**RULES** Maximum of 16 words plus address and/or phone no. Private advertisers only (trade or business ads. can be placed in our classified columns). Items related to electronics only. No computer software. PE cannot accept responsibility for the accuracy of ads. or for any transaction arising between readers as a result of a free ad. We reserve the right to refuse advertisements. Each ad. must be accompanied by a **cut-out valid "date corner"**. Ads. will not appear (or be returned) if these rules are broken.

**ROLAND** company THM. CR-78, 11 percussion, 34 preset rhythm patterns 4 channel programmer plus lots more £200. C. Stocken, 5 Dormie Cl, St. Albans, Herts. Tel: St. Albans 33304.

**CASIO** 202, JHS amp 3 watts. Ibarex FL301DX, £4 Talking pedal. Almost original showroom condition. Pete Tel: Eastbourne 31320.

**ACORN** Atom 12+12K, power supply, colour board, program software, 6522 VIA, LS244 buffer, excellent condition £179. Michael Payne, 8 Gossamer Lane, Bognor Regis, West Sussex. Phone: (Pagham) 5101.

**5 1/4"** floppy disc drives. Industry standard Tandem TM100-1. SSDD—300K byte per diskette. New ex-equipment £85 ea. Philip Kane, 29 Cobourg Rd, Camberwell, London SE5 OHT. Tel: 01-701 6665.

**ZX81**, TV, cassette recorder, 3 tapes, book and all leads, very good condition. £60 buyer collects. Simon Jones, 3 Carrington Ave, Borehamwood, Herts WD6 2EZ. 953 5713.

**WIRELESS** World 1950 to 1953 and 1956 to 1958. Offers. Collect or pay postage. Tel: (0865) 779855. G. Dean, 66 Fern Hill Rd, Oxford.

**EXCHANGE** Textet photocopier, used once, smart portable in its own briefcase. Swap for ZX81 and RAM. A. Jones, 52 Evenwood, Tranhouse 4, Skelmersdale, Lancashire.

**WANTED** supplier of electronic components for Practical Electronics projects. Payment in local currency. James K. Duah, Protection & Control Section, Kpong Generating Station, V.R.A., Akuse Ghana.

**HARVARD** 40 channel hand-held CB plus rechargeable batteries and charger £40. Tel: 0343 820217 evenings. John Smith, 50 High St., Fochabers, Moray IV32 7DU.

**SWAP** cased 125 watt stereo Crimson slave amp for Tangerine motherboard plus Tanram or graphics BASIC offers. Mr. Malcolm Dixon, 4 Oxleys Square, Mount Outlane, Huddersfield, West Yorks HD3 3XL.

**WANTED** Lafayette HA-63 communication receiver. Send details to J. Heraty, 1 New Hall House, New Hall Street, Walsall, West Mids. WS1 3DY.

**VIDEO** Genie Computer 16K RAM, 12K ROM extended Microsoft BASIC, manuals, 10 C12 blank cassettes £150 o.n.o. A. Lyons, 4 Hunsdon House, Cotts, Hunsdon, Nr. Ware, Herts SG12 8PP. Tel: Ware 870102.

**PE NOV 68** Rhythm Generator complete faulted £10. p and p. £4 Full instruction. L.T. Hill, 14 Rothesay Terr., Bedlington, Northumberland.

**TELETYPE** service manuals for type 32/33 models. 7 volumes £15 plus postage. Tel: Oxford (0865) 779855. G. Dean, 66 Fern Hill Rd, Oxford OX4 2JP.

**STARCHESS** video game + adaptor and plug nearly new only £15. Phone Empingham 671. S. Taylor, 35 Willoughby Dr., Empingham, Oakham, Rutland.

**MONO** DX TV for sale isolated chassis, pro. conversion audio video in/out all band tuner £25 o.n.o. Mr. A. Bouskill, 129 Lyminster Rd, Sheffield, S. Yorkshire S6 1HY. Tel: 0742 311191 after 4.30p.m.

**PCW** Sep. 80, Feb 83, 35 issues £10. PE Apr. 81 Feb 83, 24 issues £8. Kings Lynn O553 86 618. Mr. S.V. Windebank, 36 Springvale, Gayton, Kings Lynn, Norfolk PE32 1QZ.

**WANTED** circuit diagram and/or service manual for Telegquipment type D31 servicescope can return. Mr. A.C. Wheatley, c/o 17 Fairfield Rd, Chesterfield, Derbyshire.

**TR2300** 2M transceiver with Nicads, mag mount, rubber duck, etc. Good condition £135. Tel: 0202 886021. P. Higgins, 57 Countess Close, Wimborne, Dorset.

**STARCHESS** video game + adaptor and plug. Only £18. Phone Empingham 671 evenings. Stephen Taylor, 35 Willoughby Drive, Empingham, Nr. Oakham, Rutland.

**MANCHESTER.** Swap Hitachi Dolby front loader plus Grundig TK124 reel to reel. VGC. For 2-metre rig. Martin Black, 11 Moorland Av, Crumpsall, Manchester 8. Tel: 061-795 5025.

**APPLE II** Europlus 48K and software including Sargon chess, Lunar Lander etc. £500. Mr. R. Whitton, Berry Brow, The Knoll, Cranham, Gloucestershire. Tel: (0452) 812417.

**SINCLAIR** SC110 'scope X1 probe, hardly used. Slight scratch on cabinet. £100. Buyer collect. Mr. A. Parekh, 34 St. Margarets Rd, Great Barr, Birmingham B43 6LD. Tel: 021 358 6299.

**UK101** 16K cased CEGMONX SEK (20 screen formats) BASIC 5. 300/600 Baud 1-2MHz 5 amp p.s.u. RS232 interface £130 o.n.o. M.E. Wride, 84 Wentworth Dr, Nuneaton. Tel: Nuneaton 381177.

Please publish the following small ad. FREE in the next available issue. I am not a dealer in electronics or associated equipment. I have read the rules. I enclose a **cut-out valid date corner**.

Signature ..... Date .....

Please read the **RULES** then write your advertisement here— one word to each box. Add your name, address and/or phone no.

**COUPON VALID FOR POSTING BEFORE 3 JUNE 1983**

(One month later for overseas readers.)

**SEND TO: PE BAZAAR, PRACTICAL ELECTRONICS, WESTOVER HOUSE, WEST QUAY ROAD, POOLE, DORSET BH15 1JG.**

BLOCK CAPITALS PLEASE

Name & Address:			

For readers who don't want to damage the issue send a photostat or a copy of the coupon (filled in of course) with a **cut-out valid "date corner"**

PE BAZAAR  
JUNE '83

All devices guaranteed Brand New and to full spec. Items ex stock despatched same day. Prices are EXCLUSIVE of VAT. Please add 60p to order to cover P&P BEFORE calculating VAT. Payment by cheque, Postal Order, Bankers Draft or Cash (PLEASE register) with order. Official orders from Govt. Depts and Educational Institutions Welcome. Trade Accounts opened subject to satisfactory status - send for details. We are pleased to receive overseas orders (please allow adequate postage - surplus refunded) which unless accompanied by Bankers Draft in UK Currency may be subject to Bankers Commission and slight delay in despatch. Overseas trade enquiries welcome - send for full details. VAT not applicable to export orders. Price List detailing full range of components available - 30p refundable with first order. Please send SAE.

# COMM QUIP Ltd.

HAMILTON HOUSE, 11 WALKER ROAD,  
STEVENAGE, HERTS. SG1 3QQ.

Telephone (0438) 729771 Telex 825378 G

LINEAR		CMOS		LOGIC ICs		COMPUTER ICs		MEMORIES		74LS		TANTALUM BEADS		ZENER DIODES		BRIDGE RECTIFIERS		REGULATORS		63V MINI MONOLITHIC CERAMIC		DIODES		RESISTORS	
555CMOS	80	LM3900	45	ZN428E	395	4518	39	LS04	12	LS157	25	1N5406	17	1N5406	17	1A/100V	20	78L05	30	10nF	10	0A47	10	Carbon Film	
556CMOS	140	LM3909	70	ZN459	285	4520	48	LS05	12	LS158	27	1N5408	19	1N5408	19	1A/200V	23	78L12	30	22nF	10	1N4001	4	High Stab 5%	
709	25	LM3914	120	ZN1034E	200	4521	90	LS08	12	LS159	105					1A/400V	25	78L15	30	33nF	10	1N4002	5	1W 10 - 1M	2
741	14	LM3915	195			4522	105	LS09	12	LS160	30					1A/800V	38	78L24	30	47nF	10	1N4003	5	1W 10 - 1M	2
748	35	LM13600	105	AY5-2375	590	4523	55	LS10	12	LS161	35					2A/100V	36	78L24	30	68nF	10	1N4004	6	1W 10 - 1M	2
9400CJ	345	MC1496	68	MC1488	55	4528	55	LS12	12	LS162	35					2A/200V	40	78L24	30	100nF	14	1N4007	7	1W 10 - 1M	2
AY-3-1270	710	MC3340	120	MC1489	55	4531	65	LS14	22	LS163	35					2A/400V	40	78L24	30			1N4148	2	Metal Oxide/Film	
AY-3-8910	370	MC10CN	350	MM5303	625	4532	60	LS15	12	LS164	40					25/100V	52	78L24	36			1N5401	12	2% Met. Film E24	5
AY-3-8912	540	ML924	195	MM5307	1250	4538	60	LS20	12	LS165	50					25/200V	225	78L24	36			1N5404	14	1% Met. Film E24	8
CA3046	60	NE529	225	MM58174	700	4539	80	LS21	12	LS168	80					25/400V	270	78L24	36						
CA3080	65	NE531	135	TMS6011	365	4543	20	LS22	12	LS170	70					25/600V	325	78L24	36						
CA3089	190	NE544	180	ULN2003	75	4555	35	LS27	12	LS174	36							79L05	60						
CA3090A/D	370	NE555	16	8726	99	4556	35	LS28	14	LS175	36							79L12	60						
CA3130E	85	NE556	45	8728	120	4561	39	LS30	10	LS181	87							79L15	60						
CA3140E	36	NE565	110	8795	90	4583	80	LS32	13	LS183	105							79L15	60						
CA3161E	100	NE566	140	8797	90	4584	80	LS33	14	LS190	35							79L15	60						
CA3189	200	NE567	100	81LS95	80	4584	40	LS37	14	LS191	35							79L15	60						
CA3240E	110	NE570	370	81LS96	80	4585	50	LS37	14	LS192	35							79L15	60						
ICL7106	680	NE571	370	81LS97	80	4027	20	LS38	14	LS193	36							79L15	60						
ICL7511	95	RC4136	55	81LS98	85	4028	37	LS40	12	LS194	32							79L15	60						
ICL7621	180	RC4568	45	6522	310	4029	43	LS42	28	LS195	40							79L15	60						
ICL7622	180	SL490	250	6532	675	4035	45	LS47	35	LS196	43							79L15	60						
ICL8038	290	SL76477	380	6821	110	4040	40	LS48	40	LS197	45							79L15	60						
ICL8211A	150	SP8629	250	6845	650	4042	38	LS49	50	LS198	43							79L15	60						
ICM7224	775	TBA120S	70	6847	650	4043	40	LS51	14	LS199	43							79L15	60						
ICM7555	80	TBA800	75	6850	110	4044	40	LS54	14	LS200	50							79L15	60						
LF353	85	TBA810	95	6852	250	4049	21	LS55	14	LS201	50							79L15	60						
LF356	90	TBA820	70	6875	485	4050	22	LS54	14	LS202	50							79L15	60						
LM10	325	TBA950	220	8155	350	4051	42	LS74	16	LS203	50							79L15	60						
LM301A	74	TOA1008	310	8212	110	4052	48	LS75	16	LS204	55							79L15	60						
LM311	70	TOA1022	480	8216	100	4053	48	LS76	16	LS205	55							79L15	60						
LM318	120	TOA1024	115	8224	110	4066	22	LS77	17	LS206	55							79L15	60						
LM324	30	TL061	40	8225	250	4068	14	LS78	17	LS207	55							79L15	60						
LM334Z	90	TL062	60	8228	220	4069	13	LS83	33	LS208	29							79L15	60						
LM335Z	120	TL064	95	8243	270	4071	13	LS85	39	LS258	32							79L15	60						
LM339	45	TL071	25	8250	865	4072	13	LS86	15	LS259	53							79L15	60						
LM348	60	TL072	45	8251	250	4073	13	LS90	22	LS266	18							79L15	60						
LM358	55	TL074	95	8253	400	4075	13	LS93	26	LS267	18							79L15	60						
LM377	165	TL081	24	8255	225	4076	44	LS95	32	LS273	53							79L15	60						
LM380	65	TL082	45	8257	400	4078	13	LS99	36	LS279	53							79L15	60						
LM381	120	TL084	90	8259	395	4081	12	LS109	21	LS280	40							79L15	60						
LM382	110	TL170	49	8279	385	4082	12	LS112	20	LS283	38							79L15	60						
LM384	130	UA2240	115	8832	250	4093	23	LS113	20	LS289	40							79L15	60						
LM386	65	ULN2003	75	9602	220	4099	70	LS114	21	LS290	40							79L15	60						
LM387	120	ULN2004	75	Z80ACTC	260	4502	50	LS114	21	LS293	40							79L15	60						
LM393	95	XR2206	285	Z80ADART	775	4508	110	LS125	34	LS365	27							79L15	60						
LM711	60	ZN414	78	Z80ADMA	975	4510	45	LS126	25	LS366	27							79L15	60						
LM725	325	ZN423	130	Z80API0	270	4511	45	LS132	29	LS367	27							79L15	60						
LM733	60	ZN424	130	ZN425EB	320	4512	42	LS136	23	LS368	27							79L15	60						
LM747	60	ZN425E	340	ZN426EB	320	4514	110	LS138	27									79L15	60						
LM1458	40	ZN426E	290	ZN427EB	575	4515	110	LS139	27									79L15	60						
LM2917	185	ZN427E	575	ZN428EB	395	4516	50	LS01	11									79L15	60						

## Wersi - the Range of Organs You Build Yourself!

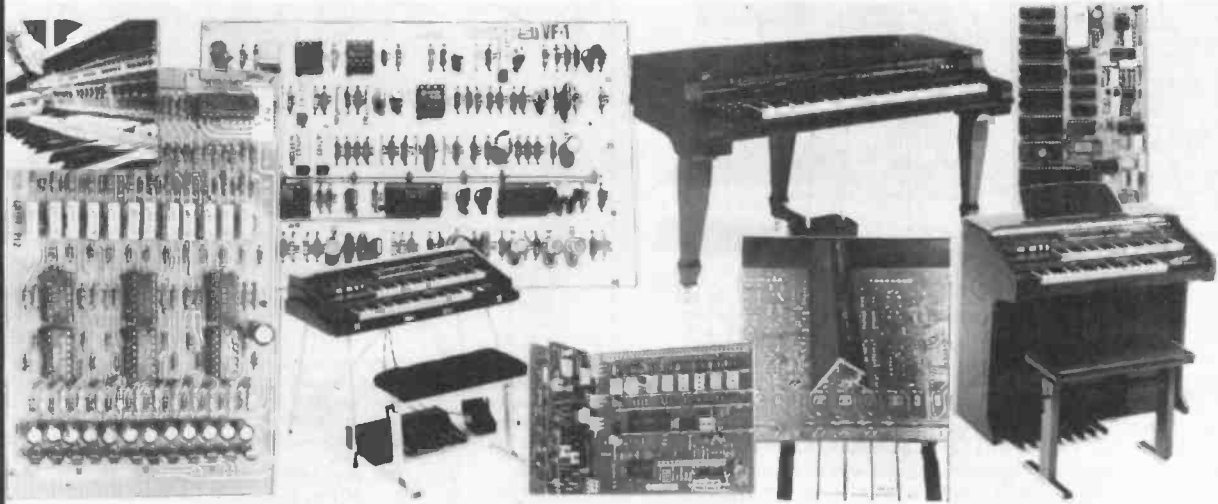

With the aid of revolutionary electronics, easy-to-follow instructions and our superb technical back-up service... anyone can build a WERSI organ from a kit — and save half the recommended retail price. Want to know more? Just fill in the coupon and we'll send you FREE details of the superb WERSI range — you'll get the facts — inside and out!



WERSI ORGANS & PIANOS LTD  
14-15 Royal Oak Centre, Brighton Road,  
Purley, Surrey. Tel: 01-668 9733.

PLEASE SEND ME FURTHER DETAILS OF THE WERSI RANGE  
UK & Northern Ireland only.

NAME \_\_\_\_\_

ADDRESS \_\_\_\_\_

PE 6/83

Send to WERSI ORGANS & PIANOS LTD.,  
14-15 Royal Oak Centre, Brighton Road, Purley, Surrey.

# T.V. SOUND TUNER

## BUILT AND TESTED

In the cut-throat world of consumer electronics, one of the questions designers apparently ponder over is "Will anyone notice if we save money by chopping this out?" In the domestic TV set, one of the first casualties seems to be the sound quality. Small speakers and no tone controls are common and all this is really quite sad, as the TV companies do their best to transmit the highest quality sound. Given this background a compact and independent TV tuner that connects direct to your Hi-Fi is a must for quality reproduction. The unit is mains-operated.

This TV SOUND TUNER offers full UHF coverage with 5 pre-selected tuning controls. It can also be used in conjunction with your video recorder. Dimensions: 11 1/2" x 8 3/4" x 3 1/4" E.T.I. kit version of above without chassis, case and hardware. £12.95 plus £1.50 p&p.



£24.95 + £2.00p&p.

## PRACTICAL ELECTRONICS STEREO CASSETTE RECORDER KIT COMPLETE WITH CASE

SPECIAL OFFER!

ONLY £31.00 plus £2.75 p&p.

• NOISE REDUCTION SYSTEM. • AUTO STOP. • TAPE COUNTER. • SWITCHABLE E.Q. • INDEPENDENT LEVEL CONTROLS. • TWIN V.U. METER. • WOW & FLUTTER 0.1%. • RECORD/PLAYBACK I.C. WITH ELECTRONIC SWITCHING. • FULLY VARIABLE RECORDING BIAS FOR ACCURATE MATCHING OF ALL TYPES.

Kit includes tape transport mechanism, ready punched and back printed quality circuit board and all electronic parts, i.e. semiconductors, resistors, capacitors, hardware, top cover, printed scale and mains transformer. You only supply solder & hook-up wire. Featured In April P.E. reprint 50p. Free with kit.



## STEREO TUNER KIT

This easy to build 3 band stereo AM/FM tuner kit is designed in conjunction with P.E. (July '81). For ease of construction and alignment it incorporates three Mullard modules and an I.C. IF System. FEATURES: VHF, MW, LW Bands, Interstation muting and AFC on VHF. Tuning meter. Two back printed PCB's. Ready made chassis and scale. Aerial: AM-ferrite rod, FM-75 or 300 ohms. Stabilised power supply with 'C' core mains transformer. All components supplied are to P.E. strict specification. Front scale size 10 1/2" x 2 1/4" approx. Complete with diagram and instructions.

SPECIAL OFFER! £13.95 + £2.50 p&p. Self assembly simulated wood cabinet sleeve to suit tuner only. Finish size: 11 1/2" x 8 3/4" x 3 1/4". £3.50 Plus £1.50 p&p.



## STEREO CASSETTE DECK

Stereo cassette tape deck transport with electronics. Manufacturer's surplus — brand new and operational — sold without warranty.

£11.95 plus £2.50 p&p.

Just requires mains transformer and input/output sockets and a volume control to complete. Supplied with full connection details.



## 125W HIGH POWER AMP MODULES

The power amp kit is a module for high power applications - disco units, guitar amplifiers, public address systems and even high power domestic systems. The unit is protected against short circuiting of the load and is safe in an open circuit condition. A large safety margin exists by use of generously rated components, result, a high powered rugged unit. The PC board is back printed, etched and ready to drill for ease of construction and the aluminium chassis is preformed and ready to use. Supplied with all parts, circuit diagrams and instructions.

ACCESSORIES: Stereo/mono mains power supply kit with transformer: £10.50 plus £2.00 p&p.



SPECIFICATIONS: Max. output power (RMS): 125 W. Operating voltage (DC): 50 - 80 max. Loads: 4 - 16 ohm. Frequency response measured @ 100 watts: 25Hz - 20KHz. Sensitivity for 100w: 400mV @ 47k. Typical T.H.D. @ 50 watts, 4 ohms: 0.1%. Dimensions: 205x90 and 190x36mm.

KIT £10.50 + £1.15 p&p. BUILT £14.25 + £1.15 p&p.

## BSR RECORD DECK

Manual single play record deck with auto return and cueing lever. Fitted with stereo ceramic cartridge 2 speeds with 45rpm spindle adaptor ideally suited for home or disco.

£12.95 + £1.75 p&p.



13" x 11" app.

SPECIAL OFFER! Replacement Stereo cassette tape heads — £1.80 each. Mono: £1.50 each. Erase: £0.70 each. Add 50p p&p to order.

## SPEAKER BARGAINS

### 2 WAY 10 WATT SPEAKER KIT

8" bass/mid range and 3 1/2" tweeter. Complete with screws, wire, crossover components and cabinet. All wood pre-cut — no cutting required. Finish - chipboard covered wood simulate, size 14 1/2" x 8 3/4" x 4". PAIR for ONLY £12.50 plus £1.75 p&p.



All mail to: 21B HIGH STREET, ACTON, W3 6NG.

Note: Goods despatched to U.K. postal addresses only. All items subject to availability. Prices correct at 31/5/83 and subject to change without notice. Please allow 14 working days from receipt of order for despatch, RTVC Limited reserve the right to update their products without notice. All enquiries send S.A.E. Telephone or mail orders by ACCESS welcome.

ALL CALLERS TO: 323 EDGWARE ROAD, LONDON W2. Telephone: 01-723 8432. (5 minutes walk from Edgware Road Tube Station) Now open 6 days a week 9 - 6. Prices include VAT.



TWO FABULOUS OFFERS FROM

# ALCON

## SUPER 20 20kΩ/V a.c. & d.c.

### A SUPER PROTECTED UNIVERSAL MULTIMETER

Undestructible, with automatic protection on all ranges but 10A.

ONLY £33.50

inc. VAT, P&P, complete with carrying case, leads and instructions.

This special offers is a wonderful opportunity to acquire an essential piece of test gear with a saving of nearly £20.00.

Accuracy: d.c. ranges and Ω 2% a.c. 3% (of f.s.d.)  
39 ranges: d.c. V 100mV, 1.0V, 3.0V, 10V, 30V, 100V, 300V, 1000V.  
d.c. I 50μA, 100μA, 300μA, 1.0mA, 3mA, 10mA, 30mA, 100mA, 1A, 10A  
a.c. V 10V, 30V, 100V, 300V, 1000V.  
a.c. I 3mA, 10mA, 30mA, 100mA, 1.0A, 10A.  
Ω 0-5.0kΩ, 0-50kΩ, 0-500kΩ, 5MΩ, 50MΩ.  
dB from -10 to +61 in 5 ranges.

Dimensions: 105 x 130 x 40mm.



## TESTER 50 39 ranges

50kΩ V a.c. and d.c. With protective diodes and quick-acting 1-25A fuse.

THE PROFESSIONAL SOLUTION TO GENERAL MEASUREMENT PROBLEMS

ONLY £36.30

incl. VAT, P&P, complete with carrying case, leads and instructions. Goods normally by return of post.

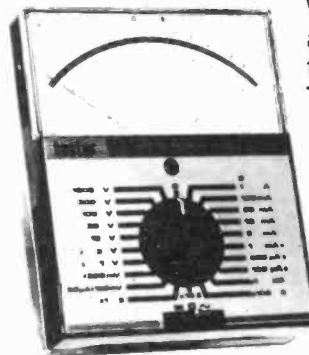

The best instrument for the workshop, school, toolbox, TV shop and anywhere accurate measurement is needed quickly and simply.

Accuracy: d.c. ranges and Ω 2% a.c. 3% (off.s.d.)  
39 ranges: d.c. V 150mV, 1V, 3V, 10V, 30V, 100V, 300V, 1000V;  
d.c. I 20μA, 100μA, 300μA, 1.0mA, 3mA, 10mA, 30mA, 100mA, 1A, 3A.  
a.c. V 10V, 30V, 100V, 300V, 1000V;  
a.c. I 3mA, 10mA, 30mA, 100mA, 1A, 3A.  
Ohms 5kΩ, 50kΩ, 500kΩ, 5MΩ, 50MΩ.  
dB from -10 to +61 in 5 ranges.

Dimensions: 105 x 130 x 40mm.

For details of these and the many other instruments in the Alcon range, including multimeters, components measuring, automotive and electronic instruments, please write or telephone:

ALCON Instruments Ltd.

19 MULBERRY WALK · LONDON SW3 6DZ · TEL: 01-352 1897 · TELEX: 918867

# VERNON TRENT *at Large!*

THE other night I had to go to one of those ghastly industry dinners. But for once it didn't turn out too badly. My table-mate chanced to be something of a high-flyer in the Patent Office and his witty conversation helped the steamed cod and mash down a treat. Over the brandy, which was extra (I could only afford one—he had three), he told me that his office cellars are full and running over with clever inventions which for some strange reasons never made it to the retail counters.

There was this harness for long-distance rail travellers. The idea was for the user to clamber into it and fix the free end to the luggage rack. Then whenever the train lurched he could go on snoozing without being shot into the lap of his unfortunate neighbour. I wonder why this excellent aid to passenger-comfort never rocked the marketplace? Maybe it was blacked by ASLEF.

Another innovation was a pair of plastic sleeves for melon-eaters. It was to stop the succulent juice oozing down to their armpits. It's believed that this one failed because the inventor didn't bother to find out that your genuine melon-lover looks upon the juice-flow as part of the ecstasy.

Happily such piffling restraints have not, in the main, held up the acceptance of that particle which all of us in the business prefer, the electron. Yet though it has wormed its way into most walks of life, there are still one or two areas where it has tended to be given the big elbow.

An outstanding example is the Church. Now, let's face it. Apart from fringe elements who scorn the dog-collar in favour of the T-shirt with the rude inscription ("Good grief man. I'm one of the lads, just like you") and who back the twang of the guitar against the swell of the organ, there is no body more resistant to change.

That could be good for the soul. After all, there's much to be said for stability in a world where standards and values change with the speed of a mannequin.

For all that, it's time the Church stopped standing still and for those at the pinnacle to have another think. So let's have a quick word with the Archbishop of Canterbury, Cardinal Hume, the chaps on the Nonconformist front and, naturally, the chief Rabbi. We have a duty to make them aware of the ways in which modern technology can do nothing but good for their missions.

Every day you can read about the sad financial plight of churches all over the country. There's hardly a parish which hasn't its crumbling tower (almost always Norman), on-the-blink heating, a cracked font or a bronchitic organ.

What about a set of microprocessor-

controlled doors which will not open until after the collection has been taken up? We all know the mean skivers who slip through the offertory net by pretending they've a bus to catch or feign an urgent need for the loo. This would stop them creeping out the minute the churchwarden picked up the plate.

A more sophisticated system would be one that linked the door-control to a collection-calculator, with a read-out in the vestry. Then all present would remain virtual prisoners until a previously-determined cash target had been reached.

One of the deadliest things that can happen to a clergyman—apart from dropping the first-born of the patron of the living in the font—is to watch horrified as members of his congregation nod off during what he thought was a pretty rivetting sermon. It's the sort of thing that's likely to happen at Sunday evening. Dieticians reckon it's the lunchtime meat and two veg followed by spotted dick and custard that does it.

A low-voltage electric shock, controlled from the pulpit and applied via the pew seat, would jolly soon remind these laggards that if they want to get to the pearly gates they'd better pay more attention to the directions. This shock therapy could also be made to work the other way. A high-intensity infrared beam—governed by a simple timer—would gently heat up the seat of the preacher's trousers if he droned on for longer than was decently acceptable.

Of course, you'd have to reckon with the wily old prelate—probably a reader of PE—who knew the drill and had equipped himself with a pair of pants insensitive to infra-red. One way to put him in his place would be to install an ejector apparatus under the pulpit floor instead. However, for reasons of sheer Christian charity it shouldn't be used on any incumbent over the age of 80.

You may think, if you have a business background, that a squad of robot choirboys is something of an extravagant capital investment yielding a small return. This is not so. Those clergymen who have been bold enough to take such a step are over the moon—which for them is a step in the right direction anyway.

One of them, a diocesan bishop no less, told me: "Ah, the blessed relief of witnessing the end of the placing of rude-sounding cushions on minor canons' stalls and the demise of bubble gum popping during the Venite." But, he admitted to me privately with a sigh, he did sometimes miss the pleasure of cuffing the little perishers round the lughole.

Baptisms have a special hazard for men of the cloth. They never know what to expect. All too often they are called upon to handle

infants who are either equipped with Tannoy-type voiceboxes or who have forgotten to go before they came out. Frequently both.

Apart from stuffing his stole down the baby's throat, there's not much a parson can do about the former. But if he's technically-minded enough to insert moisture-detectors in his cassock sleeves, he has a sporting chance of whipping junior back into mum's arms before any damage arises out of the latter. Electronics saves pounds on cleaning bills.

Most clerics are like actors. They must have the smell of the crowd and simply cannot do their stuff well in the hollowness of half-empty churches. They become about as helpful to the propagation of the Word as a pork butcher is to a vegetarian. Their confidence can be speedily restored by the use of holographic laser techniques to project images of large congregations.

There are three standard features of church weddings: The nudge-nudge innuendo of the groom's mates; snivelling matrons; and an appeal by the old knot-tier about scattering confetti in the churchyard. ("Not only does it spoil the beauty of the church's environment, but we have to pay our worthy sexton overtime to clear it up. And that grasping swine doesn't come cheap.")

The solution is as simple to me as the theory of relativity was to our Albert. You get yourself an electrostatically-charged cat and chase it round until not a scrap of confetti remains.

Satellite TV is something else that could also come in handy on the Church's march. Who knows? The way things move nowadays, it may eventually become possible to establish two-way communication (using triphonic techniques, of course, during Trinity) with Paradise. Such a facility would have to be used with dignity and care, being restricted in the first instance to ordained ministers only. We couldn't have laymen trying to get in by the back door.

I'm not daft enough to expect an early and positive response to my case, well-founded as it is. Down the centuries the Church has always moved in a pedestrian way its wonders to perform. There are, for example, still places with hand-pumped organs, reserved pews for the squire and his brood and venerable vergers who double-up as gravediggers and pull at their forelocks whenever the vicar comes within 50 yards. It takes a powerful electronic device to get through barriers like that.

But a seed has been sown. Let us trust that it has not fallen upon stony ground but will become fruitful and multiply.

*V.T.'s views and opinions are entirely his own and not necessarily those of PE or anyone else.*



# PERCUSSION MICROSYNTH

Effectively two complete synthesisers in one package, together with a variable angle LFO to modulate the VCOs or filters, and a voltage controlled phaser to phase either or both synthesiser outputs

## A.R. BRADFORD M.Sc.

THE Percussion Microsynth is provided with internal trigger pads of variable sensitivity so that it may be played with hands or drum sticks. Thus it may be used either to augment an existing drum kit (whether mechanical or electronic) or as a self contained free standing unit in the manner of a pair of electronic "bongos". While the unit is quite capable of imitating conventional drums, cymbals, etc, this is hardly the purpose for which it was conceived — it would for example be simpler and cheaper to use a real pair of bongos if this was all that was required. The strength of an instrument like this is that it is capable of creating a vast range of different sounds from bells to explosions, triangles to "Big Ben", gongs and metallic "dustbin lid" sounds, to rockets, marching feet, steam trains, wind and surf effects, as well as a vast array of abstract sounds. In this respect it should not be confused with the range of low cost "percussion synthesisers" currently on the market, which tend to be of extremely limited capability.

The Percussion Microsynth may also be triggered from an external microphone so as to respond to a particular part of a drum kit, as well as to voices, etc. It may also be triggered electronically from one output of a drum machine such as the *PE Master Rhythm*, as well as from the gate outputs of a sequencer. In relation to this, the 1V per octave control inputs to the VCOs enable the Percussion Microsynth to be used as a dual "slave" synthesiser in conjunction with a sequencer or a polyphonic keyboard controller.

In addition a dynamic sensitivity function is provided. That is, the harder you hit the drum pads, the greater the effect produced, be it loudness or sweep of pitch, etc.

In spite of the tremendous range of sounds available — greater than most commercial units — simple low cost circuitry has been employed throughout. The entire unit is built on one 16in x 5½in printed circuit board.

### PRINCIPLES OF OPERATION

The general scheme of the unit is shown in Fig. 1. The signal from the transducer is used both to trigger the envelope shaper and to provide the control voltage which is the basis of the touch sensitivity. The latter part of the circuitry comprises an envelope follower and a sample and hold which samples the rectified voltage from the transducer instantaneously, each time a new signal is received from the transducer. The output voltage from the envelope shaper is then multiplied by the output voltage from the sample and hold, so as to achieve envelopes of amplitude proportional to the size of the signal received from the transducer. With the "Touch" switch off, the envelope is multiplied by a constant factor of 1. Although no provision has been made for it as such, the astute synthesist will spot here a facility for external voltage control of the envelope size, and a possible modification for implementing this will be mentioned later.

The envelope is hard-wired to the VCA to effect volume contours, and may also be switched in to the VCO or VCF to produce sweeps in pitch or harmonic content. The envelope shaper itself is of the Attack/Release type, the provision of

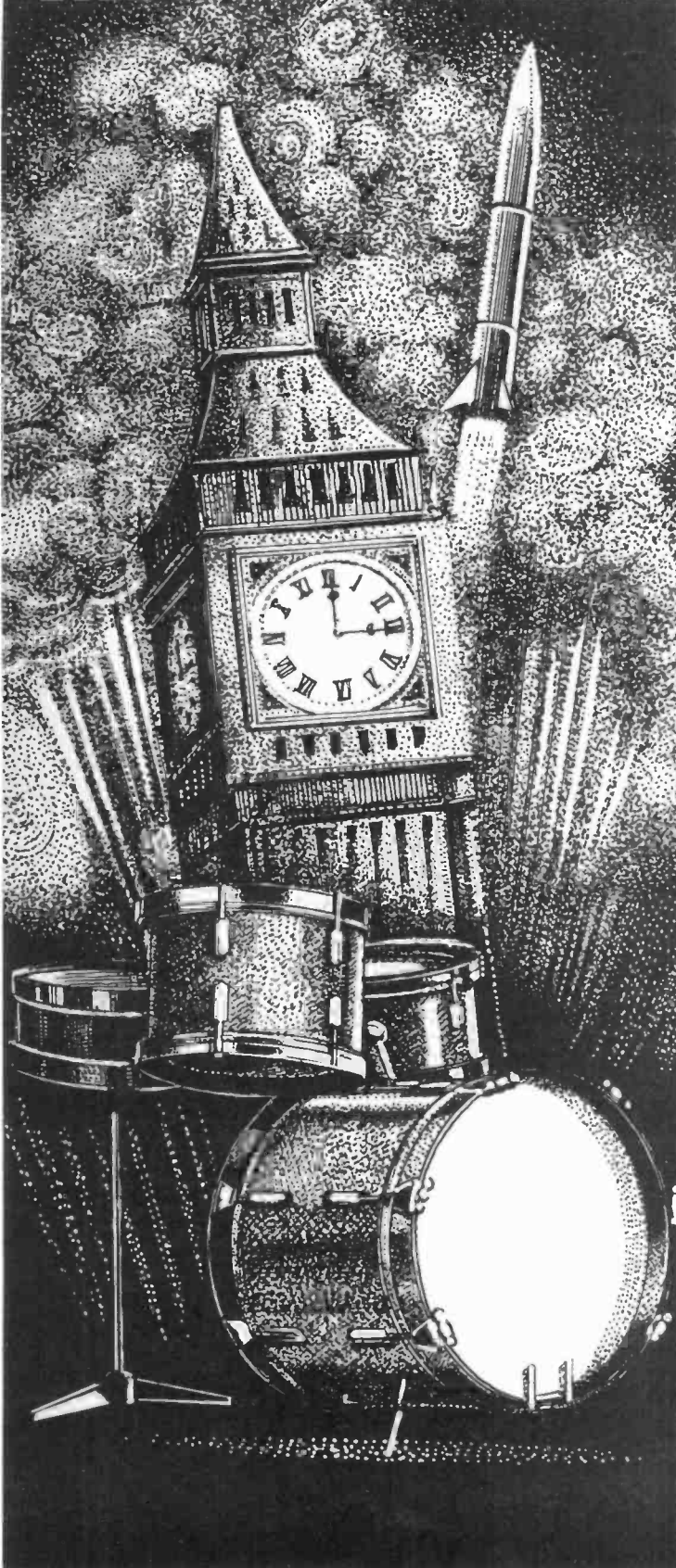

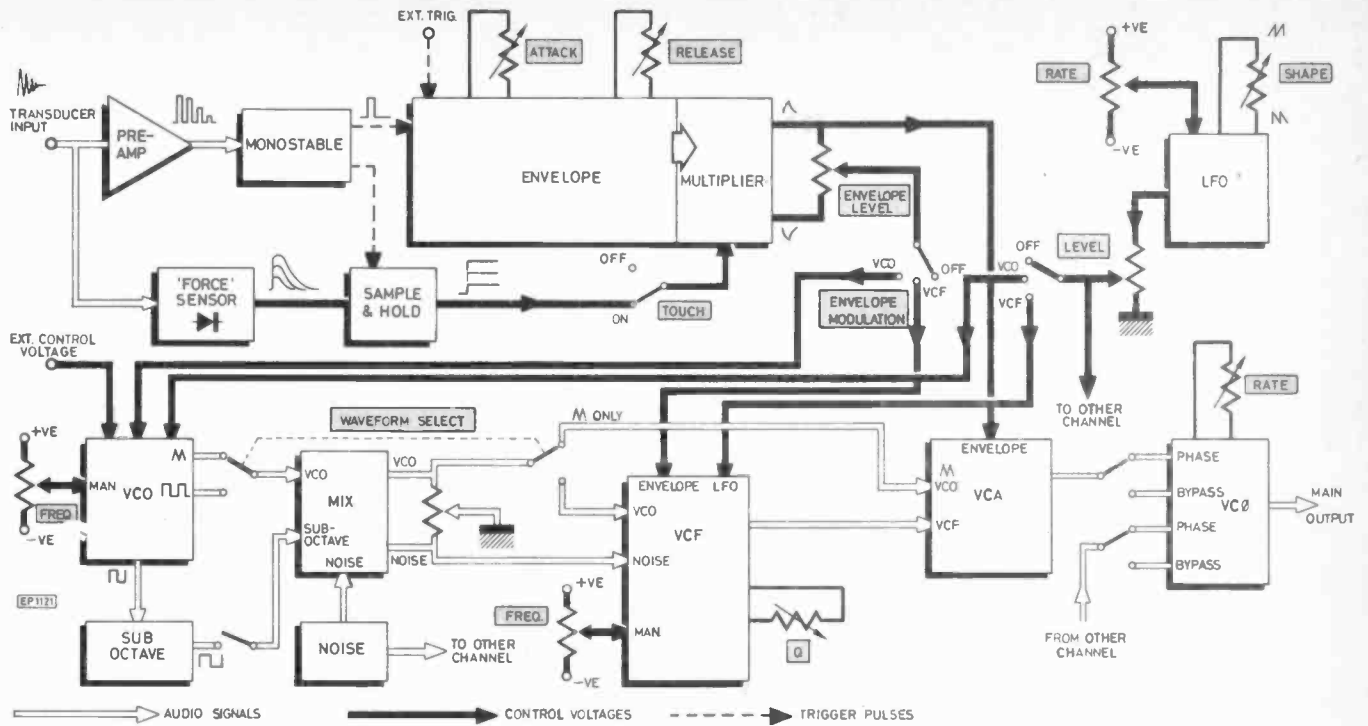

Fig. 1. Block diagram of one channel of the drum synth, plus phaser and LFO

an attack control greatly extending the range of sounds available (that is, they need not be percussive at all! They could for example be reversed starting slowly and finishing abruptly, or be of a gentle, singing quality).

The VCO produces either smooth sounding triangular, or harsh square waveforms, with provision for external voltage control of the pitch. A simple circuit provides a sub-octave. The triangle waveform goes straight to the VCA, while the square wave and/or sub-octave go to the VCF. In this way the instrument can produce warm sounds in which the VCF filters out the higher harmonics in the sub-octave waveform without affecting the triangular waveform an octave higher. The mix control cross-fades continuously from white noise (which is fed into the VCF) to oscillator output, including the sub-octave when it is switched in.

The VCF is a low-pass type with variable resonance, which has been modified so that it will also oscillate when the resonance control is turned fully clockwise. Thus the VCF can be used as an auxiliary sound source in conjunction with the triangle from the VCO, in order to produce bell-like sounds.

Each channel of the instrument may be switched through the phaser (VCØ), in which the phasing rate is manually controlled.

The LFO (low frequency oscillator) can be used to modulate either the VCO or VCFs, from 0.2Hz to 30Hz to any degree set by the "Depth" control. The LFO is of a novel design in which the "Shape" control varies the shape of the LFO waveform continuously from rising ramp, through triangular, to falling ramp, and many interesting effects can be obtained in the manipulation of this one control.

### CIRCUIT DESCRIPTION

The complete circuit of one channel of the synthesiser is shown in Fig. 2. IC1 pins 5, 6, and 7 (IC101 pins 1, 2 and 3) is a microphone preamplifier with a sensitivity of about -50dB, catering for the low impedance microphones found in stage or studio environments, although high impedance microphones will work just as well. C1 to C3 (C101 to

C103) form a band-pass network so that the unit responds neither to low frequency noises transmitted through the floor (vital on stage), nor to radio signals. The resultant signal is mixed with the output from the internal transducer which is of a high impedance crystal type. From here the signal takes two separate paths. IC1 pins 12, 13 and 14 (IC101 pins 8, 9 and 10) is a hard limiting amplifier and triggers the CMOS monostable (half of IC3, IC103), producing a 10 msec pulse, which in turn triggers the envelope shaper. VR1 (VR101) is the sensitivity control, while C4 (C104) removes radio pickup and local decoupling of the trigger circuitry also helps to eliminate spurious triggering.

The pulse from the monostable sets the set-reset flip-flop (the other half of IC3, IC103) which turns on the CMOS switch connecting the "Attack" pot to C11 (C111). This capacitor therefore charges down from +8.5V towards -8.5V. The voltage on C11 (C111) is inverted by IC7 (IC107) to give a positive going envelope, and this is fed back via divider R20, R21 (R120, R121) to the reset input of the flip-flop. Thus the flip-flop is reset when the output of IC7 (IC107) reaches about +6V. The "Attack" pot is then disconnected from C11 (C111) and connected instead by the other CMOS switch to the "Release" pot. Thus C11 (C111) discharges back up to +8.5V at a rate set by VR4 (VR104). The positive going envelope from IC7 (IC107) pins 1, 2 and 3 is reinverted by the other half of IC7 (IC107), pins 5, 6 and 7, and the "Level" control VR5 (VR105) cross fades between positive and negative going envelopes, with the back-to-back diodes creating a dead band around the centre (zero) position. The output is used via S4 (S104) to modulate the VCO or VCF.

The voltage from the microphone input or transducer is also amplified to a lesser extent by IC1 pins 1, 2 and 3 (IC101 pins 5, 6 and 7). D1, R12 and C8 (D101, R112 and C108) produce a d.c. envelope of the shape indicated and of amplitude proportional to the size of the signal coming from the microphone or transducer. This envelope, added to a d.c. offset from VR2 (VR102), is amplified and inverted by IC4 (IC104).

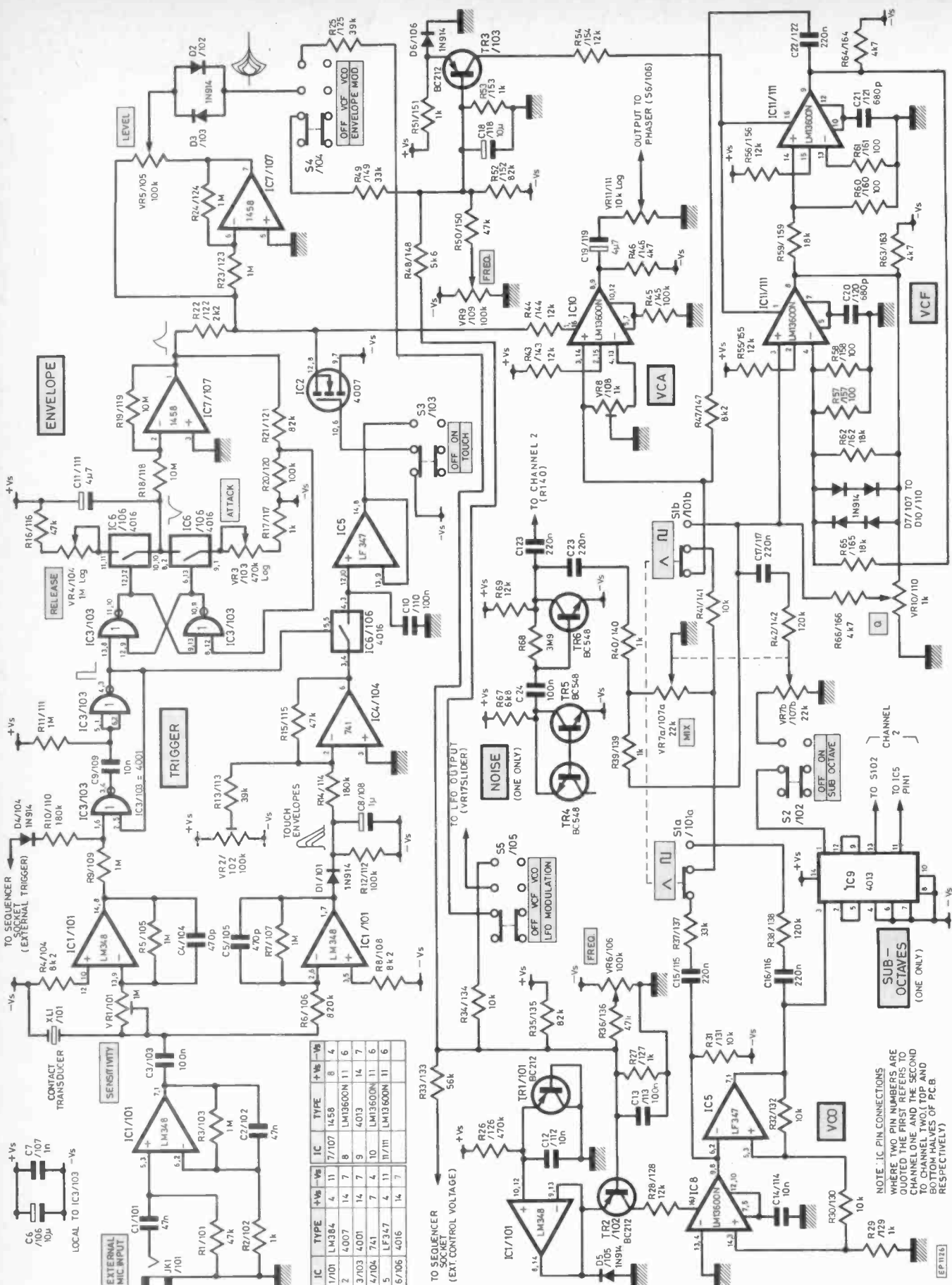

Fig. 2. Circuit of one channel of the synthesiser

CMOS switch IC6 pins 3, 4 and 5 (IC106 pins 3, 4 and 5) together with C10 (C110) and IC5 pins 12, 13 and 14 (IC105 pins 8, 9 and 10) form a sample and hold circuit, sampling the "touch" envelope each time the CMOS switch IC6 pins 3, 4, and 5 receives a pulse from the monostable. The output of IC7 (IC107) pin 1 passes through a divider formed by R22 (R122) and a CMOS FET IC2 pins 9, 10 and 12 (pins 6, 7 and 8). With the "Touch" switch S3 (S103) in the off position the gate of this FET is connected to the negative rail so that the FET is biased off and the envelope shaper output is unattenuated. With S3 (S103) on, the resistance of the FET, and therefore the size of the envelope, is determined by the touch circuitry.

It has been mentioned that there is potential for externally controlling the size of the envelopes. This could be achieved by feeding a control voltage into pin 2 of IC4 (IC104) — say 0 to 10V positive via a 180k resistor. Alternatively the connection between S3 (S103) and the negative rail could be broken, and a control voltage fed in directly to the gate of the FET. In doing this the gate of the FET should be connected to the negative rail via a 1M resistor.

## SOUND SOURCES

The VCO is a simple triangle/square oscillator. IC8 is a dual operational transconductance amplifier (OTA) configured as an integrator which ramps positive at a rate proportional to the current flowing into its control input, until the threshold of the Schmitt trigger IC5 pins 5, 6 and 7 (pins 1, 2 and 3) is exceeded. IC5 then changes state and the OTA output ramps downwards, and so on. The control current for the OTA is sourced by TR2 (TR102), temperature compensated by TR1 (TR101). The exponential law provided by the use of a transistor is not entirely necessary, but is preferred in this application as it renders the pitch of the VCO more controllable at low frequencies. Also it allows the control voltage inputs to be referenced to 0V instead of 1V above the negative rail, as is the case of OTA control input pins. In addition this arrangement allows the Percussion Microsynth to play musical scales when slaved to a standard 1V per octave sequencer or polyphonic keyboard controller. The external control voltage is applied via R33 (R133). (In connection with this usage, the sequencer or controller could also be made to determine the note length were it to provide the reset pulse, to the envelope flip-flop, instead of the resistive divider.) Such applications are however left entirely to constructors' ingenuity.

TR4, TR5 and TR6 form a white noise generator feeding both channels of the instrument, and VR7 (VR107) cross fades between noise and oscillator outputs.

IC9 contains two divide-by-two gates, each driven by the Schmitt output of its respective VCO in order to provide a square wave one octave below the VCO pitch. Each sub-octave may be switched into its respective filter, regardless of whether a triangular or square wave output is selected from the VCO.

## FILTERS

Each VCF is a standard state-variable design built round a dual OTA chip IC11 (IC111). This provides a low pass output into the VCA, with the degree of resonance controlled by VR10 (VR110). Although basically the same as used in the Microsynth, here the VCF has been modified so that with VR10 (VR110) at maximum, the circuit will oscillate in the range of a few hundred hertz to 10kHz, depending on the setting of VR9 (VR109) as well as any other modulating voltages selected from the envelope and/or the LFO. This is achieved by increasing the feedback, that is decreasing the value of R66 (R166); at the same time the diode network

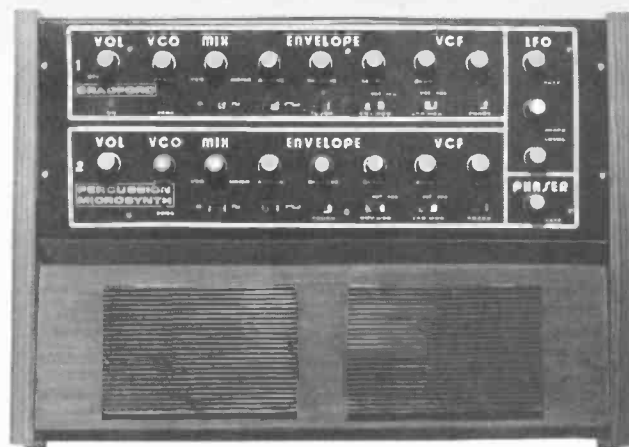

Showing control panel and trigger pads

around R62 (R162) limits the output excursions of IC11 (IC111) pin 8. The overall gain of the filter is fixed so that the output waveform is a reasonable facsimile of a sine wave.

The control current for the VCF is sourced by TR3 (TR103), temperature stabilised by D6 (D106). This arrangement is not accurate enough to drive a VCO for musical purposes, but is quite adequate for the filter in this application.

## VCA

IC10 pins 1 to 8 (pins 9 to 16) is another OTA without the time constants in the form of R-C networks that would otherwise make it a filter. Thus it behaves as a current controlled amplifier, with the gain determined by the current supplied by the envelope shaper.

## PHASER AND OUTPUT

The output from each VCA may be switched via S6 (S106) so that part of the output signal passes through the four stages of phase shift (IC12). The overall degree of phase shift is controlled by four CMOS FETs (IC15, IC2). Dual op-amp IC13 forms an oscillator providing a slow triangle waveform to sweep the phase shift at a rate set by VR15, while VR13 biases the FETs to the centre of their useful ranges. In order to actually create the phasing effect, the phase shifted signals are mixed back together with the original signals in TR7 (Fig. 3).

Three outputs are provided from the Percussion Microsynth: a line level output for feeding to a mixing desk or external amplifier, and two low impedance outputs, one for a speaker and the other for headphones. The line level is trimmed by VR12, and the amplified outputs by VR14, each of which is accessible by a screwdriver through holes in the front panel. IC14 is a monolithic power amplifier which can deliver 2 watts into 8 ohms. R101 and R102 attenuate this output to suit standard headphones.

## LOW FREQUENCY OSCILLATOR

The standard integrator/Schmitt oscillator of Fig. 4 is fed alternately with positive and negative going control voltages, selected by the CMOS switches which are driven in antiphase by the Schmitt output. The "Shape" control VR18 varies the relative rates at which the integrator ramps up and down but the overall time period remains constant, being determined only by the input control voltage from the "Rate" control VR16.

The LFO oscillates over the range 0.2Hz to 30Hz, and is used to modulate the VCOs or VCFs as selected by S5 (S105), to a degree set by the "Level" control VR17.



# COMPONENTS

## Resistors

R1,101	47k	R70	2k2
R2,102	1k	R71	2k2
R3,103	1M	R72	68k
R4,104	8k2	R73	68k
R5,105	1M	R74	1k
R6,106	820k	R75 to R87	100k (13 off)
R7,107	1M	R88	2M2
R8,108	8k2	R89	1k
R9,109	1M	R90	4k7
R10,110	180k	R91	10k
R11,111	1M	R92	2M2
R12,112	100k	R93	1M
R13,113	39k	R94	15k
R14,114	180k	R95	47k
R15,115	47k	R96	100k
R16,116	47k	R97	1M
R17,117	1k	R98	½ watt 10R
R18,118	10M	R99	2R7
R19,119	10M	R100	100R
R20,120	100k	R167	220R
R21,121	82k	R168	220R
R22,122	2k2	R169	10k
R23,123	1M	R170 to R174	1M (5 off)
R24,124	1M	R175	10k
R25,125	39k	R176	1k
R26,126	470k	R177	820R
R27,127	1k	R178	270R
R28,128	12k	R179	820R
R29,129	1k	R180	270R
R30,130	10k	R181	820R
R31,131	10k	R182	4k7

## Semiconductors

IC1,101	LM348
IC2	4007
IC3,103	4001
IC4,104	741
IC5	LF347
IC6,106	4016
IC7,107	1458
IC8	LM13600N
IC9	4013
IC10	LM13600N
IC11,111	LM13600N
IC12	LM348
IC13	1458
IC14	LM380N
IC15	4007
IC16	LM348
IC17	4016
IC18, IC19	LM317U
D1,101 to D10,110	1N914 (20 off)
D11 to D18	1N4001 (8 off)
TR1,101 to TR3,103	BC212L (3 off)
TR4 to TR7	BC548C (4 off)
D19	red l.e.d.

## Potentiometers

VR1,101	preset 1M
VR2,102	preset 100k
VR3,103	pot log 470k
VR4,104	pot log 1M
VR5,105	pot lin 100k
VR6,106	pot lin 100k
VR7,107	dual pot lin 22k /
VR8,108	preset 1k
VR9,109	pot lin 100k
VR10,110	pot lin 1k

VR11	SW pot log 10k	VR16	pot log 100k
VR111	pot log 10k	VR17	pot log 10k
VR12	preset 22k	VR18	pot lin 100k
VR13	preset 100k	VR19	preset 1k
VR14	preset 22k	VR20	preset 1k
VR15	pot log 1M		

## Capacitors

C1,101	polyester 47n
C2,102	polyester 47n
C3,103	polyester 100n
C4,104	polystyrene 470p
C5,105	polystyrene 470p
C6,106	p.c. elec 25V 10µ
C7,107	polystyrene 1n
C8,108	p.c. elec 25V 1µ
C9,109	polyester 10n
C10,110	polyester 100n
C11,111	p.c. elec 16V 4µ7
C12,112	polyester 10n
C13,113	polyester 100n
C14,114	polyester 10n
C15,115	polycarbonate 220n
C16,116	polycarbonate 220n
C17,117	polycarbonate 220n
C18,118	p.c. elec 10V 10µ
C19,119	p.c. elec 16V 4µ7
C20,120	polystyrene 680p
C21,121	polystyrene 680p
C22,122	polycarbonate 220n
C23,123	polycarbonate 220n
C24	polyester 100n
C25	polyester 10n
C26	polyester 100n
C27	polystyrene 1n
C28 to C30	polyester 10n (3 off)
C31 to C35	p.c. elec 10V 4µ7 (5 off)
C36	polystyrene 100p
C37	tantalum 4µ7
C38	p.c. elec 25V 4µ7
C39	polyester 100n
C40	p.c. elec 25V 470µ
C41	polycarbonate 470n
C42, C43	polyester 100n
C44, C45	p.c. elec 25V 2,200µ
C46, C47	p.c. elec 16V 10µ
C48, C49	p.c. elec 16V 1,000µ
C50, C51	polyester 47n

## Switches

S1,101 to S3,103, and S6,106 are 2-pole, 2-position p.c.b. mounting slide switches (8 off). S4,104 and S5,105 are 2-pole, 3-position p.c.b. mounting slide switches (4 off).

## Miscellaneous

T1—Transformer 0-12V, 0-12V 500mA, solder tag, panel fuseholder 20mm, FS1—20mm fuse 500mA, mono jack sockets (4 off), stereo jack socket (1 off), Dinlatch 5-pin A socket (1 off), miniature mains cable and grommet (¾ in. dia) to suit, 0.5m 4-way ribbon cable, 1m miniature screened cable, p.c.b., front panel, Microsynth cabinet, Percussion Microsynth dual trigger pad assembly, push-on knobs plus colour coded caps to taste, R.S. type (20 off), 6BA ½ in spacers (6 off), 6BA ¾ in bolts (10 off), 6BA nuts (20 off), domed-head ½ in self-tap screws (6 off), stick-on feet (4 off), crystal microphone inserts (2 off), M5 bolts ½ in. (4 off).

Parts and complete kits available from:—**Clef Products Ltd., 44A, Bramhall Lane South, Bramhall, Stockport, Cheshire SK7 1AH.**

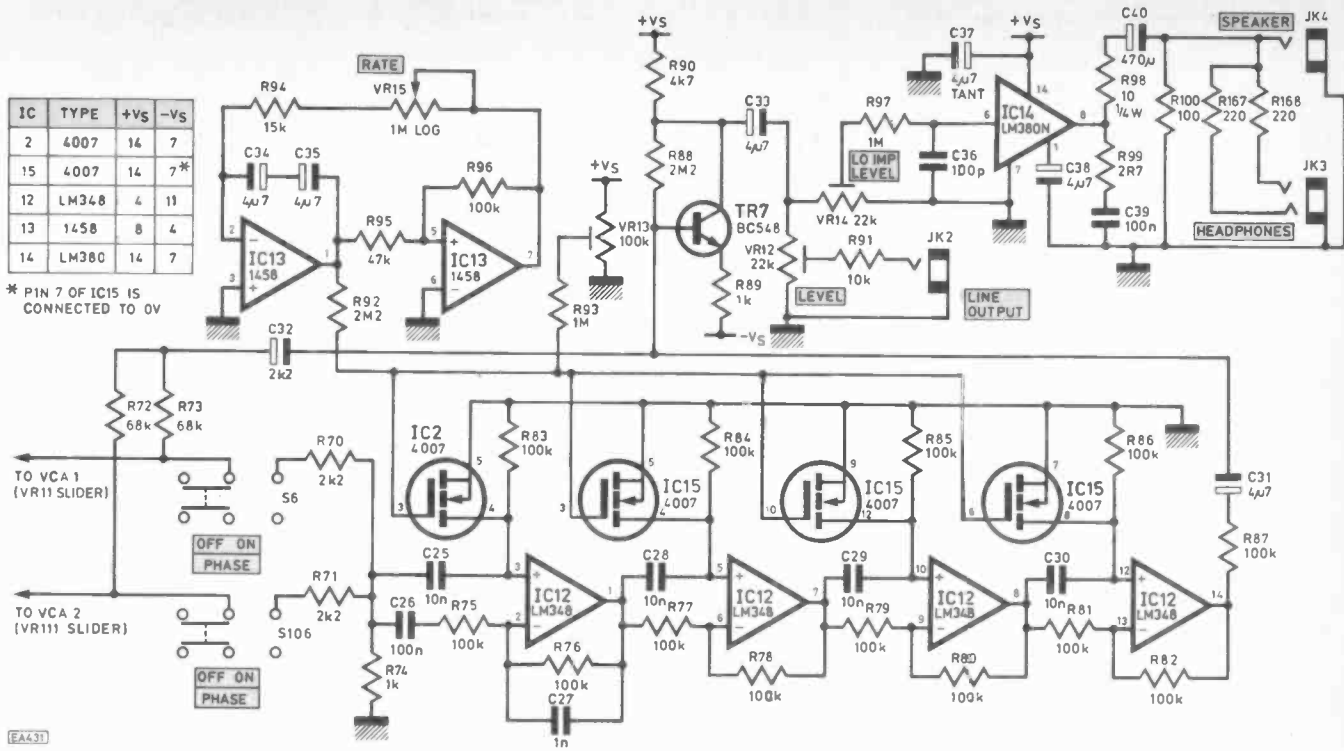

Fig. 3. Phaser and output

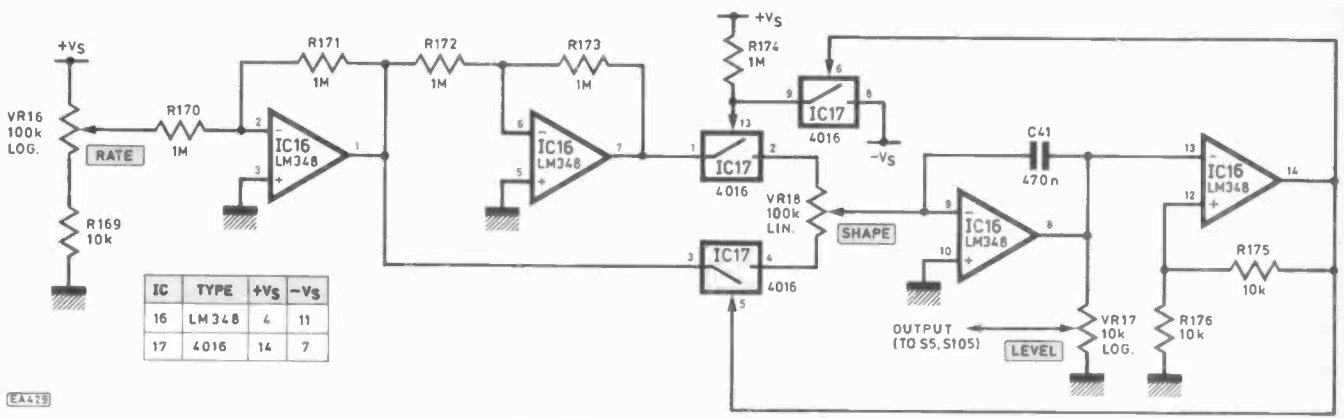

Fig. 4. Low frequency oscillator

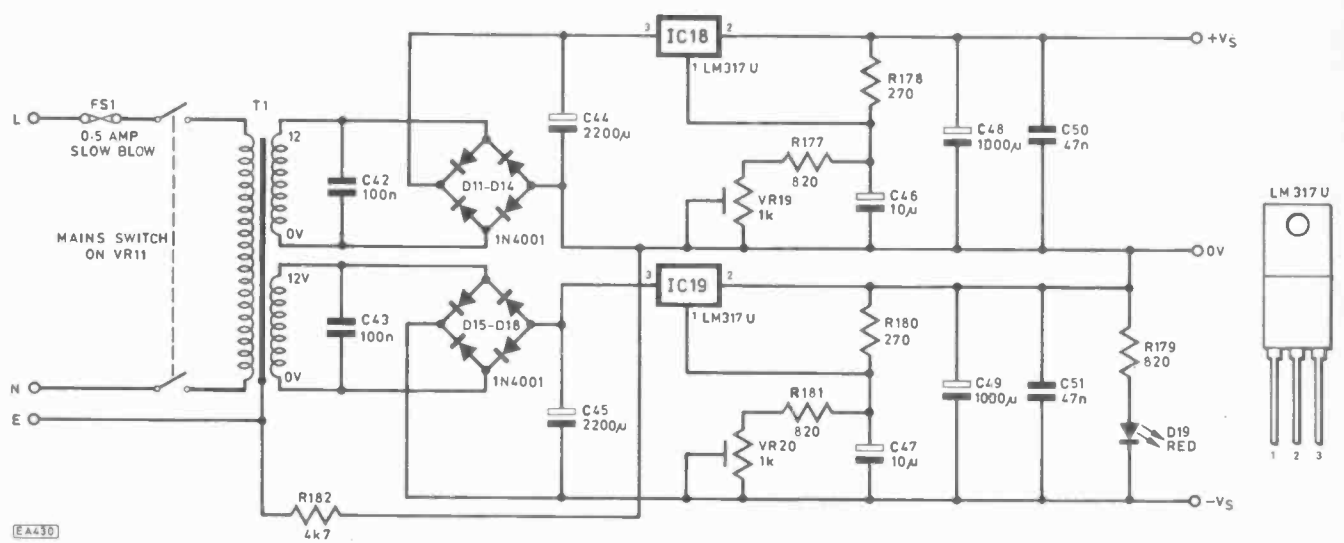
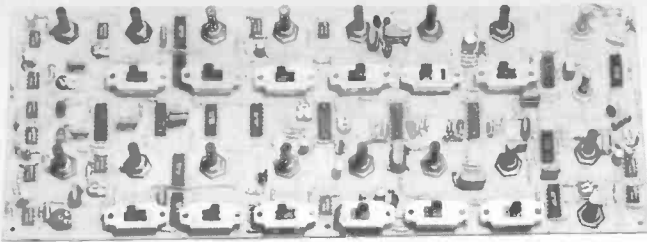

Fig. 5. Power supply unit



Board assembly

## POWER SUPPLY

This is a highly stable, monolithic regulator type providing  $\pm 8.5V$ , trimmed by VR18 and VR19. *Since the CMOS i.c.s are run directly across the positive and negative supply rails for economy of design, on no account must these voltages be exceeded, and the power supply voltages must be set before connecting power to the main part of the circuit board.* Wire links are provided on the p.c.b. for this reason and these should not be inserted until the supply rails are set.

**Next Month: Construction, setting-up and test programs.**

# Readout...

## Help Sought

I wonder if any of your readers can come up with a design to overcome a problem in AV (Audio-Visual) presentation. In this, a minimum of two slide projectors are used with a fade unit to dissolve from one picture to another throughout a continuous sequence of colour transparencies, usually shown on a large screen to an audience. Rather than cine's frames-per-second, the AV viewer has so many seconds-per-frame to take in the picture, this being controlled by a programme stored on tape via an electronic fade unit.

The problem is that the lamp fade system has eclipsed the old iris diaphragm mechanism used to regulate the projector's light source. Basic though the iris mechanism is, it can be exploited to obtain a wide range of effects that the lamp fade system cannot. Unfortunately, as things stand at present, use of the iris method necessitates manual operation of the AV performance, for there is no way by which this mechanism can be automatically controlled from tape.

Although PE has never published an automatic iris controller, I wondered if any of its readers have cracked this problem, or would be interested in having a go at it. I have been told that radio control type feedback servos might do the trick, but to maximise the special effects capability of the iris, timing and positional instructions would need to be able to go into the taped programme.

Tony Hadfield  
Wimborne, Dorset.

*If anyone would like to contact Mr. Hadfield, would they please write to him c/o PE.*

## Greed

I noticed in your Nexus column (issue April 1983), the glee or should I say greed, at the sale of Cable & Wireless, and the proposed sale of British Telecom.

Do you not feel there are greater issues at stake than the prospect of lining ones own pockets?

To de-nationalise British Telecom means that the profit will instead be shared by the few lucky enough to be able to buy sufficient shares. Therefore, the British public will be robbed of the money.

Services such as call boxes, emergency services and telephones for the disabled will be threatened.

Despite these services which are loss makers, British Telecom is a profitable and efficient service. In the past ten years telephones have doubled while staff has increased by only six per cent. What private firm can boast this productivity?

British Telecom belongs to the people. Help to keep it that way.

R.G.A. Dewhurst,  
Hoddesdon.

*Nexus comments:—*

*The Littlechild Report on BT privatisation makes provision for safeguarding emergency and rural call box services. The objective is to inject private capital to provide a more efficient service with lower costs. Far from robbing the public, lower costs will benefit private as well as business subscribers. Cable & Wireless was not sold outright. The Government, representing the people, retained a majority shareholding. C & W's 57 percent profit rise in its first year of privatisation yielded extra tax revenue. Profit and social responsibility are not incompatible. Without generating profit from trade and industry there would be no funds for education, health and other social services.*

## Sexist

I have just ordered a back issue of PE: and noticed your preview of the Electronics Hobby Fair at Alexandra Pavilion.

In your description of the event, you mention that "For wives/girl friends there is the added attraction of the nearby Wood Green Shopping City . . . although we are sure they will find plenty to interest them in the special exhibits at the Fair".

Reaction such as "sexist!" and "promu patriarchy!" are probably a bit strong, but I feel that your comment might have caused offence to the many competent women electrical engineers who read PE.

At a time when the number of women entering the field is disappointingly low (and a quote from the IEE is appropriate: Extract from IEE booklet "Training Requirements",

published 1979. "The Council of Engineering is concerned that few women take up electrical engineering as a profession, and is most anxious to see an increase in the number of women Members of the Institution") I feel that what you said was not encouraging.

I realise that at the moment, the majority of electronic enthusiasts are male, and that PE is targeted at this population, but I believe that such discrimination is to the disadvantage of expanding interest in the field.

Brian Carse,  
Coventry.

*No offence intended—Ed.*

## Slow Industry

With reference to the January edition of Practical Electronics concerning the slow approach to electronics of the motor industry. Isn't it the wrong way round? Isn't the electronic industry slow in taking in millions of pounds by designing and producing an all electric car (with one or two electric motors) with both speed and range (200 miles approx. before recharging). Are not the hybrid cars a sort of half way house?

I am quite confident that sooner or later an efficient electric car will arrive and the internal combustion engine will be an interested relic of the past.

Edwin R. Caruth,  
Leeds.

*This may well start to happen when Clive Sinclair launches his long awaited electric vehicle—Ed.*

## Excellent!

The recent issues of PE prompt me to send my congratulations to you and your staff on the excellent articles on microprocessors which have appeared.

Following the early articles on the UK101 to the *Ultimum* and *Microfile*, all have proved very useful. The *Ultimum* motherboard will give my UK101 some more years of interesting work.

The *Microfile* series, giving the characteristics and applications of i.c.s, is most welcome—an essential addition to tense manufacturers' data sheets.

As well as a "hobby interest" in the subject I lecture at a college of technology, and PE is an essential ingredient in keeping up with the subject.

With best wishes for the future.

George Small,  
Chesham, Bucks.

*Thank you.*

# MICRO PROMPT

The hardware and software exchange point for PE computer projects

## ULTIMUM UPDATE

We have now moved to Issue 2 of the Motherboard, to correct as many original errors as possible. As always, some anomalies have crept in.

The known errata for Issue 1 are as follows:

Link 11—Z80 position should be GND, not open (available near IC8, connects to IC8 pin 7).

Link 12—does not exist.

Link 13—located next to IC4 pin 11, should be open for Z80 systems and made for 65/68 systems.

There is insufficient provision for I/O mapping and external buffering close to the host.

The relevant part of the circuit in Issue 2 is as shown in Fig. 1, below.

Note that LK13 has been renamed LK14. LK12 now allows more reliable production of BRD, BWR in exclusively memory-mapped Z80 systems: 'B' should be connected to 'A' for Z80 and to 'C' for 65/68 systems. If I/O mapping is required then the LK13 default 'M' connections should be cut and the 'I/O' connections made. Pins 10 and 11 of the 40-way host connector (SK1, 2, 3) have been assigned and connected to, respectively, data buffer gate and +5V to simplify buffering at the host end of a cable. R/W or WR should be used for the data buffer direction on such buffering.

Yes, we will produce a complete manual but it will be available only after the series is completed. We are very keen to see an Ultimum user group. At present due to lack of space at 33, Cardiff Road, Watford we can't start the ball rolling, but in the latter part of 1983 we shall certainly make sure

## ROMDOS TO VORTEX

Sir—This short machine code routine should be of interest to any UK101 super-board owners who have upgraded their systems to 5¼" floppy disks.

The routine allows users of the new Vortex Disk system to read program files from the ROMDOS Disk system.

The need for the program arises because:

- 1) the directory is on a different track on both systems, and
- 2) the BASIC work space is different on both systems.

The routine is instant compared to the alternatives i.e. saving the program to tape, then booting up vortex and reloading the tape or indirect files, which limits the size of program to be moved to less than half the size of the free BASIC workspace (about 10K in A32K system). This routine only requires 70–80 Bytes of memory anywhere in RAM and is totally relocatable.

The routine works by loading a ROMDOS program into Vortex workspace then updating all the pointers and line links, allowing you to run or reSAVE the program on a Vortex Disk.

### To use the program

- 1) Make a note of the starting tracks of BASIC programs to be transferred.
- 2) Boot up Vortex Disk.

one is organised (we have already spoken to West London and North London computer users' groups and they are both keen to help us).

William Edwards,  
Watford Electronics.

- 3) Type in the routine and save on disk (the code is totally relocatable) i.e. it will run from anywhere in memory without modification.
- 4) Load the program required by using the !LO (Track No.) Command.
- 5) Execute code Reset M \$7000G or BASIC 5 and GO\$7000.
- 6) You should now be in immediate mode and can SAVE/LIST/RUN the program.

B. Brownhill,  
Midlothian.

```

7000 A97F LDA #87F
7002 B5FE STA $FE
7004 A927 LDA #827
7006 B5FF STA $FF
7008 A000 LDY #800
700A B1FE LDA ($FE), Y
700C AA TAX
700D 20F9FE JSR $FEF9
7010 B1FE LDA ($FE), Y
7012 F00E BEQ $7022
7014 18 CLC
7015 6915 ADC #815
7017 91FE STA ($FE), Y
7019 85FF STA $FF
    
```

```

701B 8A TXA
701C 85FE STA $FE
701E A900 LDA #800
7020 F0E8 BEQ $700A
7022 20F9FE JSR $FEF9
7025 A5FE LDA $FE
7027 857B STA $7B
7029 857D STA $7D
702B A5FF LDA $FF
702D 857C STA $7C
702F 857E STA $7E
7031 A927 LDA #827
7033 857A STA $7A
7035 A97F LDA #87F
    
```

```

7037 8579 STA $79
7039 60 RTS
    
```

## ULTIMUM CRUNCHER

Sir—I have been reading your Ultimum series and I am very impressed with the system.

However, for the benefit of myself and many others, could you please publish details of how to generate a signal similar to RFSH from an 8080/8085 system to allow the WE of the Dynamic RAM board.

I would also like to see a "number cruncher" board. Although chips such as the AM9511 and AM9512 are quite expensive, I feel that such a board would be worthwhile.

S. C. Winsor,  
Kenilworth.

On the point of the Number Cruncher, Watford Electronics replies: At present the cost of available number cruncher i.c.s is prohibitive, in that a number cruncher board for the Ultimum based on one of these chips would be of a disproportionately high price. However, it is the view of W.E. that at some time in the near future these chips will come down in price to a more suitable level, at which point a number cruncher for Ultimum will certainly become a reality.

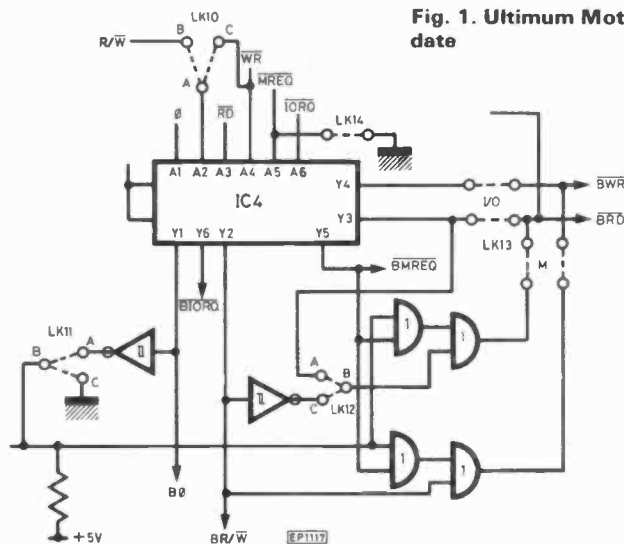

Fig. 1. Ultimum Motherboard update



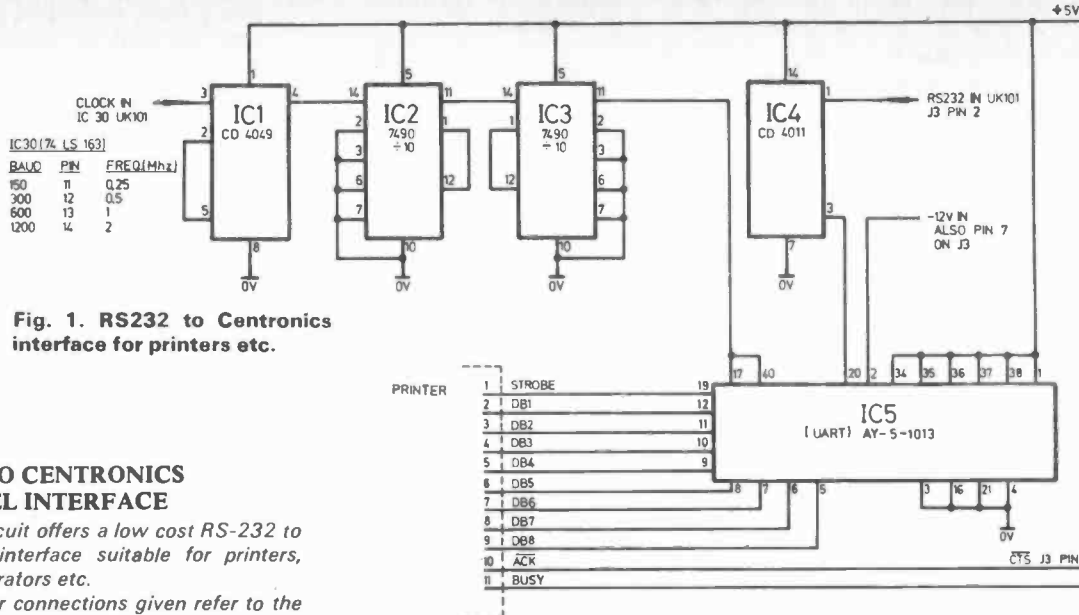

Fig. 1. RS232 to Centronics interface for printers etc.

### SERIAL TO CENTRONICS PARALLEL INTERFACE

Sir—This circuit offers a low cost RS-232 to centronics interface suitable for printers, sound generators etc.

Computer connections given refer to the UK-101 and Ohio CIP series, as subtle clock chain differences may be noted the approximate baud/frequency relationship is shown on the circuit diagram.

The circuit is based on a low cost AY-5-1013 UART configured for even parity, two stop and eight data bits. A clock signal equal to sixteen times the baud rate is required at pins 17 and 40 (i.e. 300 baud  $\times$  16 = 4 800hz). It is recommended that a data sheet be obtained with the chip. This will allow the constructor to configure the circuit for any computer.

IC1 provides a C-MOS buffer to the heavily loaded clock chain, whilst ICs 2 and 3 are divide-by-10 counters to feed the UART clock. The UART is frequency tolerant and a TTL clock could be constructed separately.

The RS-232 input is fed to the UART via an inverting gate IC4, this helps re-establish signal levels after the ribbon cable. The circuit is not critical and may be constructed on perforated board.

A -12 volt level is essential to proper UART operation. This can be provided with a small 12 volt transformer, bridge rectifier and 470 $\mu$ F/25 volt capacitor. A simple 12 volt Zener diode will ensure the recommended stability.

Ohio users must locate and cut the track connecting pin 7 of J3 to 0 volts. For those opposed to track cutting, the -12 volts may alternatively be fed to the collector of transistor (PNP) Q1 through a 1k 5% resistor.

The link between pin 9 of J3 (CTS) and 0 volts must also be removed, connecting a 1k 5% resistor between pin 9 and 0 volts will ensure computer operation with the peripheral disconnected.

Connections are best made with ribbon cable using the centronic recommendation, i.e. (1) 0 volts, (2) strobe, (3) 0 volts, (4) BDI, (5) 0 volts etc., this will minimise cross talk.

For cable lengths exceeding a metre, ICs 1-3 should be at the computer and ICs 4 and 5 at the peripheral.

Ohio/UK-101 users can turn on the inter-

face with POKE 517,1 (or SAVE) and turn off with POKE 517,0. OS-65D users should use POKE 8994,1 to turn on and POKE 8994,2 to disable.

Owners of Series Two dual display format boards and OS-65D version 3.3 will note that the Baud rate doubles from 300 to 600 when the 48 character mode is selected.

A word of caution; semiconductor junctions take exception to negative voltage inputs so be careful where you connect the -12 volts. If in doubt consult your local users' group which will have a number of members willing and competent to help you.

Experimentation with Busy and ACK will show which is best for connection to CTS.

It has been found in some instances both may be connected to CTS each via a 120 ohms series resistor. POKE 13,40 for ROM BASIC or 21,40 with disc will allow running without the CTS handshake,

P. Whittaker,  
Transvaal,  
S. Africa

### UK101 as clock

Sir—I have written a short program which displays a digital clock on the screen. Time is kept by the delay in line 190, which might have to be changed to suit other UK101's. The delay lasts approximately 1 second. At the beginning of the program you enter the current time, using the 24 hour clock, and then press return.

David C. Howarth,  
Bathgate.

```

10 PRINTCHR$(12);:K=48
20 PRINT:PRINT:PRINTTAB(12)"DIGITAL CLOCK"
30 PRINT:INPUT"TENS OF HOURS . . . .";H2:H2=H2+K
40 INPUT"UNITS OF HOURS . . .";H1:H1=H1+K
50 INPUT"TENS OF MINUTES . . .";M2:M2=M2+K
60 INPUT"UNITS OF MINUTES . . .";M1:M1=M1+K
70 INPUT"TENS OF SECONDS . . .";S2:S2=S2+K
80 INPUT"UNITS OF SECONDS . . .";S1:S1=S1+K
90 PRINTCHR$(12):POKE53325,32:PRINTTAB(12)"DIGITAL CLOCK"
100 POKE53732,58:POKE53727,58
110 POKE53735,S1:POKE53734,S2:POKE53730,M1:POKE53729,M2
120 POKE53725,H1:POKE53724,H2
130 S1=S1+1:IF S1=58 THEN S2=S2+1:S1=K
140 IF S2=54 AND S1=K THEN M1=M1+1:S2=K
150 IF M1=58 THEN M2=M2+1:M1=K
160 IF M2=54 AND M1=K THEN H1=H1+1:M2=K
170 IF H1=58 THEN H2=H2+1:H1=K
180 IF H2=50 AND H1=52 AND M2=K AND M1=K AND S2=K AND S1=K THEN GOTO SUB200
190 FOR I=1 TO 1042:NEXT:GOTO 110
200 M1=K:M2=K:S2=K:S1=K:H1=K:H2=K:RETURN
OK

```

## MICROCONTROLLER KEYBOARD

Sir—I have found the keyboard of the Microcontroller awkward to use owing to the unusual layout of the hex keys. The method used to decode which key is pressed makes it a relatively simple process to alter the keyboard layout with software modifications, without affecting the rest of the controller, its routines, or any programs already being used.

The keycode converter starting at F877 uses a table of key addresses at F89C—F8BB to determine which key is pressed, the value from this table is then converted to the key code with the aid of a subroutine at F86D.

All that is necessary to modify the keyboard layout to suit your personal taste is to re-arrange the order of the key address table. Table 1 shows the present order of the key address table in the monitor. Table 2 shows the order necessary to give a keyboard layout as shown adjacent.

W.T. Baillie  
Milton Keynes

**TABLE 1. DISBUG KEY ADDRESS TABLE**

ADDRESS	CONTENTS
F89C	00 01 11 12 20 21 22 30
F8A4	31 32 42 43 44 64 63 41
F8AC	33 23 13 03 35 17 27 37
F8B4	25 01 06 07 05 16 40 54

**TABLE 2. MODIFIED TABLE FOR LAYOUT AS SHOWN BELOW**

ADDRESS	CONTENTS
F89C	42 00 02 01 43 10 11 12
F8A4	44 20 21 22 64 30 31 32
F8AC	25 33 23 13 63 17 27 37
F8B4	41 03 06 07 05 16 40 54

PF1	C	D	E	F	BREAKPOINT	REGISTER	.	GO
PF2	8	9	A	B	PRESET			1/2
SHIFT	4	5	6	7	MEMORY	CANCEL	*	RESTART
#	∅	1	2	3	ENTER			NEXT

## M/C PROGRAM SEARCH

Sir—As this is my first attempt to write a program in machine code, it may be a little crude. But it works well and achieves the intended results.

The program is for UK101 owners, who like myself save several programs on one tape. It enables you to leave the searching for the start of the program to the computer. The first line of each program should be the name or code for that program, e.g. 1REM \* A123. In this case the code word is 4 digits long. But by changing the contents of 02AB it can be made to the length you require.

To operate the program you just type LOAD as usual. Then you give the code number. The computer then searches for, and loads, the required program. At the end it displays the message "Program Loaded" and disables the load flag so the next program is not loaded.

The program works by altering the load vectors at 021E 021F to cause a jump to the search routine. This is done by poking 542, 75 and 543, 2. When the code is found, the program jumps back to the load routine (FF8B). Within the program, the addresses 0004 and 0005 are altered to contain the address 0222. This causes a jump at the end of loading to this address, instead of the usual syntax error signal, followed by OK. The message "Program Loaded" is displayed, and the load flag is set to 0.

Although this routine takes up pretty well all the unused RAM, I think it is very useful. And no doubt the more skilful programmers will be able to shorten it.

```

0222 A9 C3 LD#SC3
0224 85 04 STAS0004
0226 A9 A8 LDA#$A8
0228 85 05 STAS0005
022A A9 00 LDA#$00
022C 8D 03 02 STAS0203
02F 20 5F 02 JSR$Z025F
    
```

```

0232 A2 00 LDX#$00
0234 20 B8 02 JSR$02B8
0237 A2 0A LDX#$0A
0239 20 B8 02 JSR$0238
023C A2 1F LDX#$1F
023E 20 B8 02 JSR$02B8
0241 60 RTS
0242 A9 22 LDA#$22
0244 85 04 STAS0004
0246 A9 02 LDA#$02
0248 85 05 STAS0005
024A 60 RTS
024B 48 PHA
024C 8A TXA
024D 48 PHA
024E A9 42 LDA#$42
0250 85 04 STAS0004
0252 A9 02 LDA#$02
0254 85 05 STAS0005
0256 20 73 02 JSR$0273
0259 68 PLA
025A AA TAX
025B 68 PLA
025C 4C 8B FF JMP$FF8B
025F A0 00 LDY#$00
0261 A9 20 LDA#$20
0263 99 00 D3 STASD300, Y
0266 99 00 D2 STASD200, Y
0269 99 00 D1 STASD100, Y
026C 99 00 D0 STASD000, Y
026F C8 1NY
0270 D0 F1 BNE$0261
0272 60 RTS
0273 20 5F 02 JSR$025F
0276 A2 00 LDX#$00
0278 20 B8 02 JSR$02B4
027B A2 11 LDX#$11
0270 20 B8 02 JSR$0238
0280 A2 00 LDX#$00
0282 20 00 FD JSR$FD00
0285 C9 1C CMP#$1C
0287 F0 EA BEQ$0273
0289 20 2D BF JSR$BF2D
028C C9 0D CMP#$0D
028E F0 07 BEQ$0297
0290 9D F0 00 STAS00F0, X
0293 E8 INX
0294 4C 82 02 JMP$0282
    
```

```

0297 20 SF 02 JSR$025F
029A A2 29 LDX#$29
029C 20 B8 02 JSR$02B8
029F A2 00 LDX#$00
02A1 20 80 FE JSR$FE80
02A4 DD F0 00 CMP$00F0, X
02A7 D0 06 BNE$02AF
02A9 E8 INX
02AA E0 04 CPX#$04
02AC D0 F3 BNE$02A1
02AE 60 RTS
02AF E0 00 CPX#$00
02B1 F0 EE BEQ$029F
02B3 A2 00 LDX#$00
02B5 4C A4 02 JMP$02A4
02B8 BD CA 02 LDA$02CA, X
02BB C9 00 CMP#$00
02BD F0 07 BEQ$02C6
02BF 20 2D BF JSR$BF2D
02C2 E8 INX
02C3 4C B8 02 JMP$02B8
02C6 60 RTS
02CA 0D 50 52 4F 47 52 41 4D
02D2 20 00
02D4 4C 4F 41 44 45 44 00
02DB 4E 55 4D 42 45 52 00
02E2 00 41 47 49 4E 00
02E9 0A 0A 0A 0A 0A 0A 00
02F0 53 45 41 52 43 48 49
02F7 4E 47 00
    
```

It should be emphasised that material presented in Prompt has not necessarily been proved by us. Neither can compatibility with all generations of the computer equipment to which it relates be guaranteed.

Software and hardware designs submitted should be accompanied by a declaration to the effect that it is the original work of the undersigned, and that it has not been accepted for publication elsewhere.

W. H. Ashworth,  
Preston.

# AUTOMOBILE TEST SET

MICHAEL TOOLEY B.A.

DAVID WHITFIELD M.A. M.Sc.

## PART TWO

In the first part of this article the principles of operation of the various functions of the Auto Test Set were described in detail, together with their usefulness to the troubleshooting and performance-conscious motorist. This article carries on from the detailed circuit description by covering the construction of the complete instrument, and concludes with a detailed series of tests and calibration steps, together with some fault-finding hints and suggestions.

### CONSTRUCTION

A diecast box is used in the construction of the Auto Test Set to ensure that the final unit is rugged enough to withstand hard use. The majority of the small components are mounted inside the box on a single-sided printed circuit board. The copper foil pattern for the board is shown in Fig. 7, with the corresponding component layout in Fig. 8. The interconnection wiring points have been labelled for later identification. No special handling procedures need to be observed in mounting the components on the p.c.b., but constructors may wish to use 14-pin d.i.l. sockets for mounting IC1 and IC2. Care should be taken to ensure the correct orientation of all of the polarised components (semiconductors and electrolytic capacitors) before soldering them in place. The use of terminal pins is recommended for ease of installation of the interconnection wiring.

When all of the components have been mounted on the p.c.b., a careful visual inspection of the track side of the board should be made before proceeding. Particular attention should be paid to soldered joints, and all dry joints and solder bridges should be rectified at this stage. After a final check on the orientation of polarised components, the p.c.b. may be mounted in the base of the diecast box using four short pillars. When positioning the board, adequate clearance should be left for the d.c. supply sockets, SK3 and SK4, which should be mounted on the side of the box and adjacent to pins A and B. Short lengths of insulated wire should then be used to connect SK3 (red) to pin B, and SK4 (black) to pin A; the wire links used should be long enough to allow the p.c.b. to be easily removed from the box for troubleshooting.

The remaining components are mounted on the lid of the diecast box, as shown in Fig. 9. The assembly sequence is simplified if all of the necessary holes are cut before any of the components are mounted. Marking out of the holes is simplified if the lid is first covered with masking tape, and the hole positions marked on the tape before being centrepunched. The cutout for the meter is most easily made by

drilling a series of holes around the circumference to remove the majority of the metal, and then cleaning up the hole with a file until the meter is an easy fit. When the meter, switches, terminals and l.e.d.s have been mounted, the next step is to fit the remaining components to the switch and meter terminals as shown in Fig. 9. It should be noted that, when making up the necessary values for R28 to R31, it may be easier to use a number of standard values in series/parallel, e.g. R28 may be made up from two 100 kilohm resistors in parallel.

The final assembly step is to install the interconnection wiring between the p.c.b. and the components mounted on the lid of the box. Ribbon cable provides one of the most convenient methods of installing the wiring, and it is suggested that one piece be used for each of the four groups of terminal pins. The cable lengths should be adequate to allow the lid to be laid flat alongside the box during calibration. The wire from S2 to one end of R33 should be connected as shown by the solid line, and R33 should temporarily be fitted as a short length of wire. A final check of the wiring should show that pins J and K on the p.c.b. are the only ones left unconnected; these may be used if an alternative buzzer is to be used off the board, but otherwise they may remain unconnected.

### TESTS AND ADJUSTMENTS

The initial tests and adjustments require the use of a power supply or battery capable of delivering 12 volts at up to approximately 120mA. Ideally, the supply should have an electronic over-current trip, but if this is not available, an appropriately rated line fuse will suffice to protect against catastrophic failures or errors. Before connecting the supply, the controls on the Auto Test Set should be set to the following: S1 to the 'Carry' position; S2 to the '4 cyl' position; S3 to 'Off'. The power supply should be connected to SK3/SK4 via a multimeter set to the d.c. current range rated at a minimum of 100mA.

Switching on the supply to the Auto Test Set should cause the 'NOGO' and the 'Power' l.e.d.s to be illuminated; no other l.e.d.s should be illuminated. The supply current indicated should be approximately 40mA, but only significant variations from this value should be considered as significant. Should neither of the l.e.d.s be illuminated and no supply current be drawn, the polarity of D12 and the power supply wiring should be carefully checked. Moving the instrument sharply should show that the meter movement is significantly damped; if not, the wiring to S1 and ME1

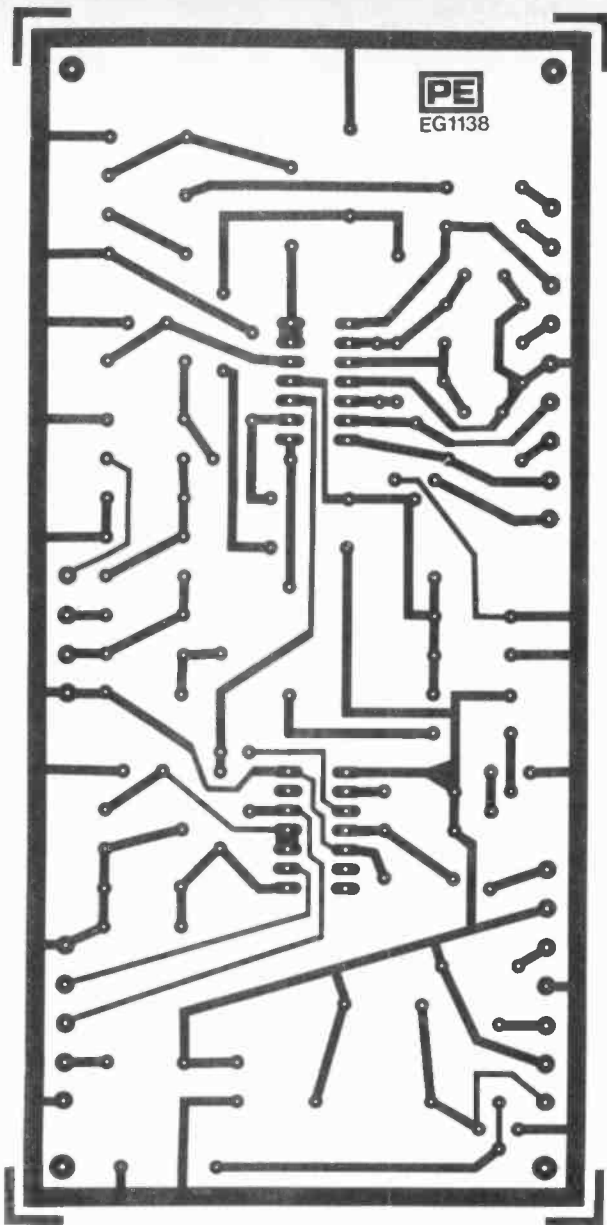

Fig. 7. Foil pattern for board underside

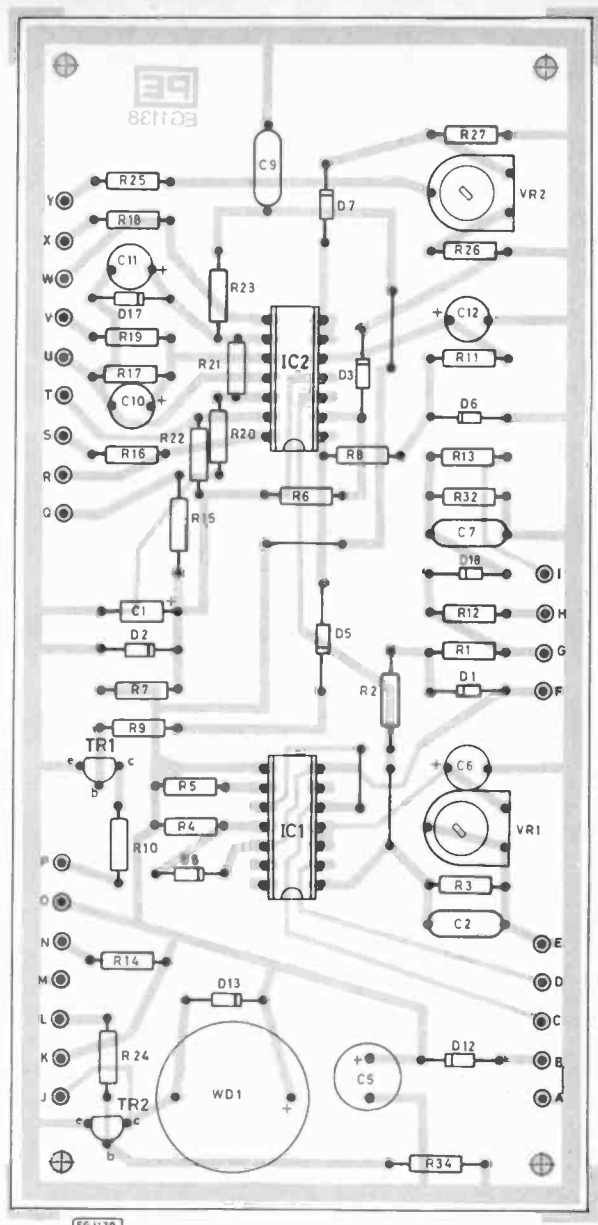

Fig. 8. Component layout. Note that in Fig. 2 pins 3/2 of IC2a should be reversed

should be re-examined. If the supply current is significantly lower than expected, and everything appears as normal except that no i.e.d.s are illuminated, then it is possible that the polarity of the i.e.d.s is incorrect. When these initial tests are satisfactory, the functions may be tested.

The function switch should now be moved to the '0 to 15V' position, and the circuit shown in Fig. 10 set up to allow testing of the two voltmeter ranges. As the potentiometer is varied from minimum to maximum setting, the meter indication should move over the full scale. Significant scale errors should lead to investigation of the wiring to ME1, S1, and the value of R12. As the setting of the potentiometer is increased from minimum, D4 should become illuminated at a potential of approximately 1V. Should the i.e.d. fail to illuminate, the polarity of D3, D4, D5 and TR1, and the power supply to IC2 should be checked to determine the source of the problem.

The offset zero voltage range is checked using the same arrangement as shown in Fig. 10, but with the function switch now set to '10 to 15V'. Varying the voltage applied to

SK1/SK2 over the range 10 to 15V by means of the potentiometer, and comparing the measured voltage with that indicated by the test set should produce a response of the type shown in Fig. 11. Any significant movement of the curve up or down the axis, representing consistently high or low indications, should initially lead to a check on the value of R13. The most likely cause, however, is that the nominal Zener voltage of D18 is at one end (high or low) of the tolerance band, and this may be cured by either replacing the diode with an alternative, or by padding the diode.

Calibration of the dwell range involves selecting the 'Dwell' position on the function switch, and disconnecting all inputs from SK1/SK2. In this condition the meter should indicate very close to zero, and D4 should be extinguished. Possible problems in the i.e.d. circuitry should already have been eliminated, so any significant meter indication would suggest a fault around IC2b. Calibration of the range involves the correct adjustment of VR2, and this is done most easily by connecting a lead between SK1 and SK3. VR2 is then adjusted to produce a full-scale meter indication,



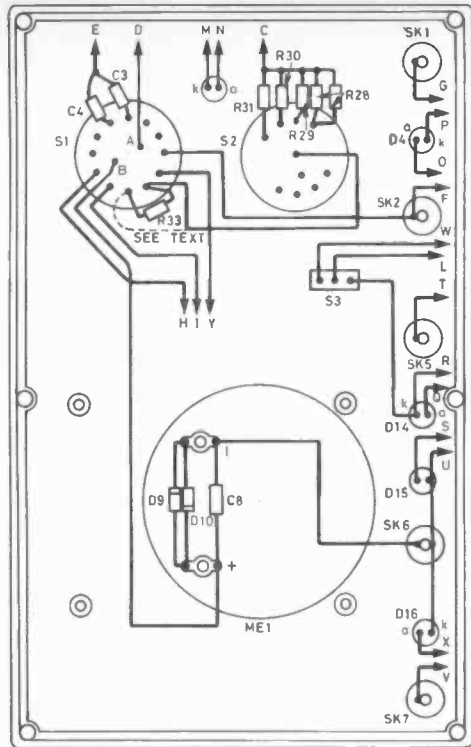

EG1140 Fig. 9. Interconnection wiring

equivalent to 100% duty cycle. With the component values and types specified, it is possible that the maximum indication which may be achieved by adjusting VR2 will be just below full-scale on the meter. In such cases D6 may be replaced by a diode rated at 6.2 volts, or a silicon diode (e.g. 1N4148) may be wired forward-biased in series with the existing diode. The calibration of the dwell meter scale is independent of the setting of S2, and depends only on the number of engine cylinders; Table 1 shows the way in which the meter markings correspond to the dwell angle. As a final stage in the calibration the scale may optionally be checked at mid-scale by applying a square wave signal, amplitude between 5 and 12V pk-pk and frequency between 10 and 300Hz, and verifying that a half-scale indication is obtained.

The tachometer ranges are calibrated by adjusting the setting of VR1, and determining the value and position of R33. The setting up procedure starts by selecting the '1500 RPM' position on S1, and ensuring that S2 is still set to '4 cyl'. A signal generator producing a signal at 50Hz (corresponding to a 4 cylinder engine at 1500 RPM) and an amplitude of 5 to 12V pk-pk should be applied to SK1/SK2. The circuit shown in Fig. 12 may be used in place of a signal generator if none is available. The setting of VR1 should now be increased from minimum until a full-scale indication is achieved. If such an adjustment is not possible, then the values of C3, VR1 and R28 should be checked, followed by a check to the wiring of IC1 and S1/S2 if this does not reveal

Table 1. Showing meter indication of dwell angle

Meter Indication ( $\mu\text{A}$ )	Equivalent Dwell Angle ( $^\circ$ )			
	4 cyl	5 cyl	6 cyl	8 cyl
0	90	72	60	45
10	72	57.6	48	36
20	54	43.2	36	27
30	36	28.8	24	18
40	18	14.4	12	9
50	0	0	0	0

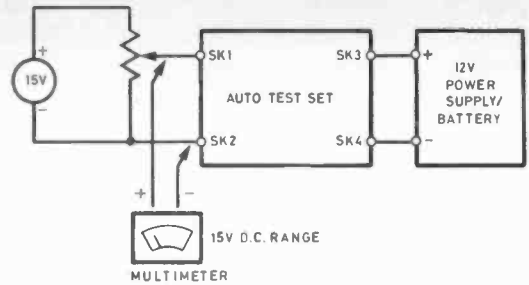
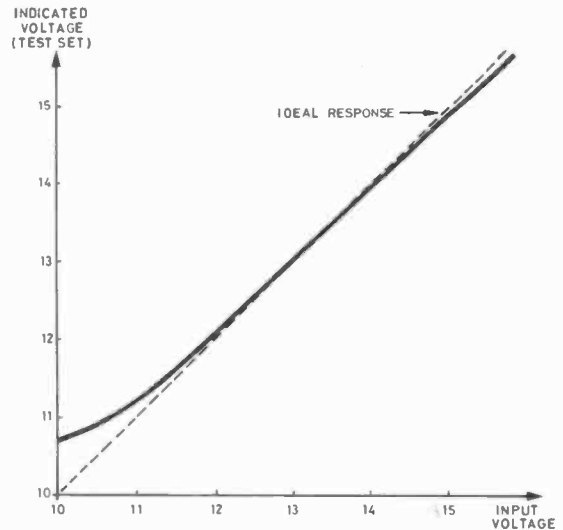

Fig. 10. Test configuration for the voltmeter ranges

the fault. When a full-scale indication has been obtained, S2 should be moved from the 4 cylinder position through the other positions. The meter indications should change from 1500 RPM (4 cylinders) through 1200 RPM, 1000 RPM to 750 RPM (8 cylinders) as the switch is rotated. Any errors would indicate that the values of R28 to R31 should be re-checked. The calibration of the basic range is now complete, but now the two ranges must be made to track correctly, and this involves R33. S2 should be set to the '4 cyl' position again.



EG1142

Fig. 11. Typical response for the offset zero voltmeter range

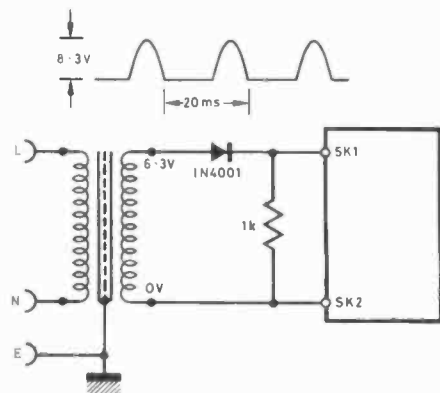

EG1143

Fig. 12. A tachometer calibration signal source

If moving S1 from '1500 RPM' to '5000 RPM' still produces an indication of 1500 RPM, then R33 is unnecessary, and the wire link should be retained in its place. The more likely result, however, is that the value indicated will be either too high or too low, by up to approximately 10%. If the new indication is too high, the temporary wire

link should be replaced by a suitable fixed resistor (typically in the range 1 to 4.7 kilohms) to restore the correct reading. If the new reading is too low, the wire from S1 to S2 should be reconnected in the position shown by the dotted line, i.e. at the other end of where R33 will be. VR1 should now be re-adjusted to produce an indication of 1500 RPM. S1 should then be moved back to the '1500 RPM', where the reading will now be too high. R33 is now selected to return the reading to 1500 RPM, and a value in the same 1 to 4.7 kilohms range is to be expected. It should be noted that the use of a single tracking correction resistor is a compromise to simplify the interconnection wiring; ideally a different value should be used for each of the ranges selected by S2. However, the error introduced will be small enough to be ignored in most cases, but the unused half of S2 may be used if necessary to allow individual calibration of the four ranges.

Verifying the correct operation of the lamp/fuse testing facility requires two fixed resistors, having values of 100 and 270ohms, respectively. S2 should be set to the 'Z' position, and with nothing connected to SK5, D14 should be illuminated, D15 should be extinguished and the buzzer should be silent. With the 270ohm resistor connected be-

tween SK5 and SK6 there should be no change in this situation. Replacing the 270ohm resistor by the 100ohm resistor, however, should cause the buzzer to sound and D15 to become illuminated. It is quite normal for D14 not to be totally extinguished. Any deviation from this behaviour should lead to investigation of IC2d and its associated components. Moving S3 to the 'Off' or 'V' position while the 100ohm resistor is connected should silence the buzzer but have no other effect. If the buzzer remains on, a check of the wiring of S3, the value of R34 and the polarity of TR2 should be made.

The circuit tracer facility is the only remaining part of the Auto Test Set to be tested. The configuration of Fig. 10 may be re-used for this purpose, but with SK7 and SK6 substituted for SK1 and SK2, respectively. S3 should be switched to the 'V' position. As the input voltage is increased from zero, D16 should become illuminated and the buzzer should sound at a level of approximately 9 to 10 volts. Moving S3 to 'Off' should silence the buzzer. Any error in the operation of the circuit tracer should lead to an investigation of the circuitry associated with IC2c.

This completes the testing and calibration of the Auto Test Set, which is now ready for use.

## BAZAAR

**IIP** audio modules Mullard f.m. modules i.c.'s cases switches many small components. All very cheap s.a.e. G.A. Noble, 50 Croft Hill Road, Slough, Berks SL2 1HF.

**CALSCOPE** Super 10 dual trace. Function gen. DMM. Exchange four track, 15 i.p.s. reel/reel tape recorder. P. Cooper, 27 Leeswood, Ashurst, Skelmersdale, Lancs WN8 6TH.

**ZX81** wanted must be in reasonable condition, have power supply and be in working order. 22 Primrose Drive, Haltons, Leeds 15. Tel: 641 505.

**RARE** collector's item: 1938 "Cossor" television set, walnut cabinet £150. F. Ashworth, 76 Hampton Road, London E7. Tel: 01-519 2286.

**WEMON** monitor for Superboard II series II £6. Old BASICS Mon, 1, 3, 4 ROMS. Any offers? J. Ellis, 44 Copthorne Road, Rickmansworth, Herts. Tel: Rickmansworth 772139.

**WANTED** video/audio/television test equipment in good condition and also service manuals. M. Patel, 46 Lockerbie Avenue, Rushyhead, Leicester. Tel: (0533) 65009.

**BINATONE** 5-star 40 channel 4 watt FM-CB mobile transceiver. Full controls. New. £35. Call Chang 041-332 7695 after 8p.m.

**PRACTICAL** Electronics 1964 to 1982. Everyday Electronics 1971 to 1982 buyer collects. Offers to 01-274 5495.

**WANTED** XBug plus manual for Microtan 65 system. C.W. Murray, 21 Canterbury Rd, Ash, Aldershot, Hants GU12 6SP. Tel: Ald 310661 after 6p.m.

**UK101** BK Cegmon 32/16 x 48 new BASICS 1,3,4, 300/600B cased part built P.E. interface boards £80 o.n.o. Somerton (SOM) 72663 evenings.

**CRYSTAL** radios wanted from the 1920's and 1930's and other wireless and radio sets and material. J.L. Troe, 111 Skyline Drive, Morristown, New Jersey 07960 U.S.A.

**OSCILLOSCOPE.** Tequipment mod S43, good condition £40.00. Tel: Thatcham 64617 evenings and weekends. A. Napier, 1 Elmgrove, Thatcham, Berks.

**GOLDRING** turntable with Shure cartridge plus Amstrad amp., both need repair £25 o.n.o. both. Buyer to collect. G. Wheaton—Tel (Bolton) 591449.

**AC 240V** power unit—900V/.5A 213V/60mA 24V/4.5A 15V/750mA 25V/2.5A in sturdy metal case. S.a.e. for details £50. J.B. Carlile, 10 Cedric Ave, Romford, Essex. Tel: Pomford 67627.

**ATOM** 12K, Acorn built, utility EPROM, leads. Manuals, magic book, 3A p.s.u., 2MHz option, software. Offers. G. Gray, 64 Lindisfarne Rd, Bessemer Park, Spennymoor, Co. Durham.

**NEWBRAIN** £199. Accessories available. Used for short time on systems communications and software tests. HX20 needed. Anthony Hode, 15 St Johns Court, Wakefield WF1 2RY.

**ATARI** Video computer 22 programs (Approx £400). Three sets controls £200 o.n.o. Tel: Derby 556294. G.H. Scott, 58 Buttermere Dr, Allestree, Derby.

**SEVEN** Digisound 80 modules for sale including keyboard controller, power amplifier, p.s.u. Offers. Will separate. Adam Rae, 34 Newtendale, Sutton Park, North Humberside.

**ZX81** Sinclair computer, brand new including power supply. Only £32 inc. postage. Mr. C.E. Nicholas, "Sunrays", 37 Phernyssick Rd, St. Austell, Cornwall. Tel: 0726 63938.

**EPSON** TX80 friction feed dot matrix printer, connector and paper mint condition. £200. Tel: 021 350 8271. Mr. A. Webster, 30 Blounts Rd, Erdington, Birmingham.

**PAIR** Ditton 161 speakers £60. Wharfedale Denton speakers £25, Neal 4-channel resolver £10. w.h.y. Mr. Mel Saunders, 7 Drumcliff Rd, Thurnby Lodge, Leicester LE5 2LH.

**PERTEC** 6840-9-25 tape transport £40. Memorex 651 disc drive £40. Both with manuals, buyer collects. N.R. Horder, 24 Kinsbourne Ave, Ensbury Park, Bournemouth BH10 4HE. Tel: 0202 512062.

**UK101** 8K cased, programmable sound board, many programs; invaders, supertrek £100. Sean Carey, 82 Firs Rd, Winterslow, Salisbury, Wilts SP5 1SW. Tel: Winterslow 862 348.

**BRAND** new full size moving key QUERTY keyboard, 60 keys £8.00. Phone 061 330 1309. B. Curry, 21 Cranbourne Rd, Ashton under Lyne, Gr. Manchester.

**WATFORD** Phaser £16, fuzz boxes also other projects and components. Space needed. S.a.e. for list. Martin, 6 Downland Gdns, Tattenham Corner, Epsom, Surrey.

**TRANSCENDENT** DPX must be sold now. £270. Please ring soon with an offer. J. Bedward, 21 Hartshill Rd, Olton, Birmingham B27 6PB. Tel: 021 706 9465.

**SHUGART** eight inch floppy drive with manual and diagrams for experienced constructor £75 o.n.o. J. McCarthy, 13 Gipsy Lane, Wokingham, Berks. Tel: Wokingham (0734) 789529.

**FOR** CompuKit RAM/EPROM board £20, Sound Board £5, Toolkit £5 BASIC 5 £5 Mother £5. Mr. N. Odell, 31 Humphrey Rd, Greenhill, Sheffield S8 7SE. Phone (0742) 745027.

**TE 20D** signal generator £25. 680R Multimeter £12. Kamoden transistor tester £20. Goodmans Audiom 100/Axent 100 speakers £40. P.A. Joiner, Speyside Cottage, Old Distillery Rd, Kingussie, Invernesshire. Tel: 05402 677.

**CHALLENGER** 1P, 8K, Cegmon, 48x32, Four speed cassette save, software, lots of info. Bargain £140 o.n.o. John, Leics. Tel: Thistleton (057283) 332.

**PE** years 1966 to 1973 £5 p&p £4. Tel: St. Albans (0727) 39171 Ask for Martin.

**SINCLAIR** stereo-60 units. Preamp, active filter, 2x230 power amps, power supply £20 o.n.o. Tel: Wivenhoe (020622) 5671. C. Hellen, Vine Cott, Main Rd, Alresford, Colchester, Essex CO7 8DD.

**PE/CLEF** Bandbox music programmes Q/step, Waltz, S/fox, beat etc. Specials written also unlimited memory mod. Enquiries F.P. Jones, 20 Blunham Rd, Mogerhanger, Bedford MK44 3RA. Phone: 0767 40220.

**SELMAR** 50 watt valve guitar amp with 4 x 12 speaker cab £65. Ronn Ferguson, 11 Avondale High, Croydon Road, Caterham, Surrey CR3 6QJ. Tel: Caterham 46376.

**GOOD** prices paid for very old junction and point contact transistors and diodes. Write for details. Mr. Andrew Wylie, 18 Rue De Lausanne, 1201 Geneva, Switzerland.

**TRS 80** PC-2 8K RAM pack. Brand new, unused, present. Normal price £79.95; selling for £51.00 including p&p. Zakariya Ahad, 92 Princes Park Ave., Golders Green, London NW11 0JX. Tel: 01 455 2800 (After 8p.m.).

**DAMAGED** Casio FX-602P required for spare parts reasonable price paid. M. Brown, 19 The Baulk, Worksop, Notts S81 0HU. Tel: 0909 485738.

**RS** signal injector £5, 30kV probe £10. Plenty strip board, prototype board £4. Phone Reading 694445. M. Harris, 32 Wilmington Cl, Woodley, Reading RG5 4LR.

**RS** Logic Pulser, RS CMOS Logic Probe, RS TTL Logic Probe £15 each. Phone Reading 694445. M. Harris, 32 Wilmington Cl, Woodley, Reading RG5 4LR.

# The Big Event for '83

Sponsored by Practical Electronics, Practical Wireless and Everyday Electronics

The first Electronic Hobbies Fair in 1982 immediately established itself as the foremost consumer electronics exhibition-the biggest attendance and the largest number of exhibitors.

The 1983 Fair will build on the success and the experience of the first year. It will be 1983's largest and most influential

shop window for the whole range of electronic equipment and components for the electronics hobby enthusiast-constructural projects, home computers, amateur radio, video games, musical instruments and peripheral equipment-whether for the beginner, the specialist or the all-round enthusiast.



## ELECTRONIC HOBBIES FAIR

Alexandra Palace, London - October 27-30, 1983

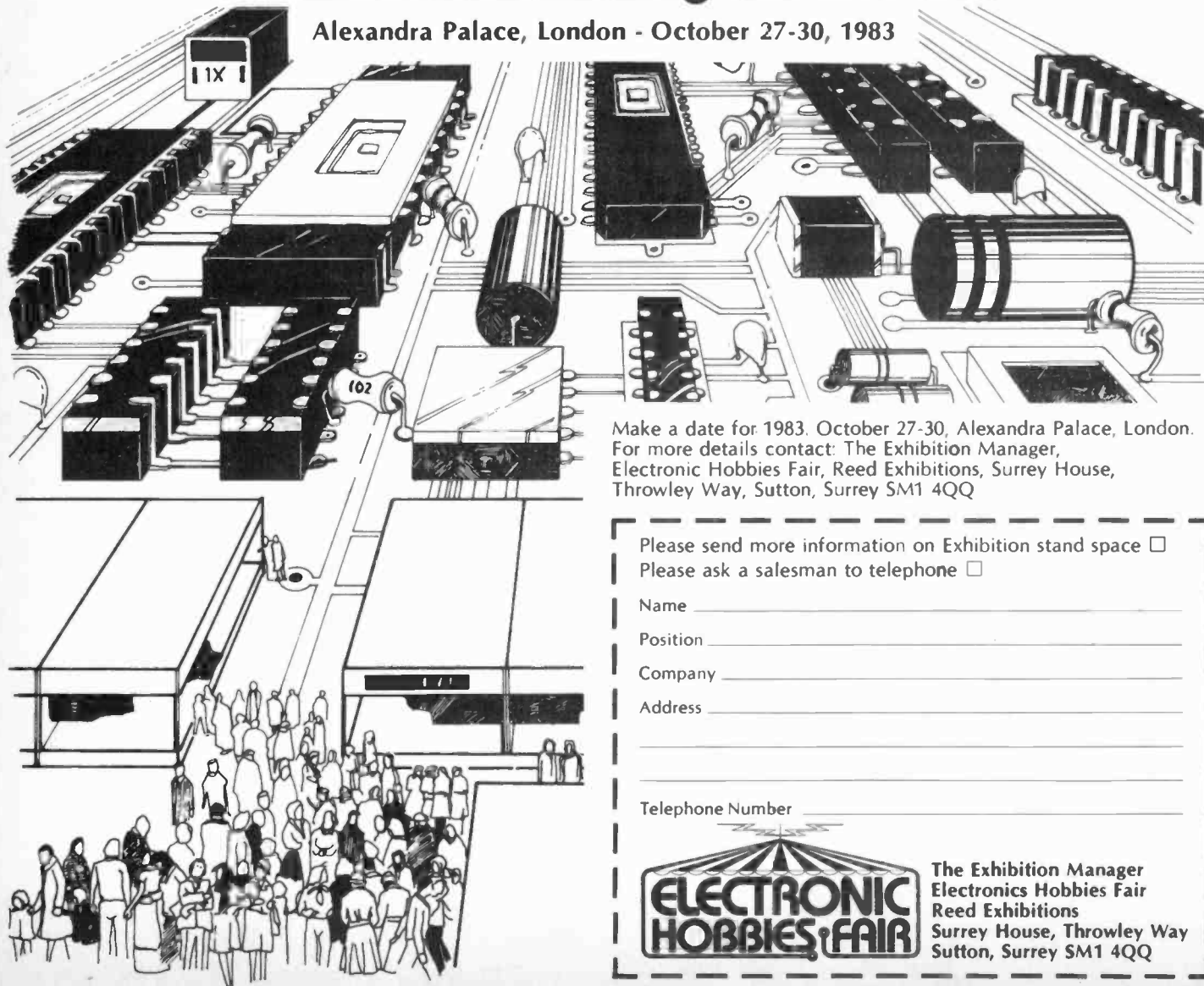

Make a date for 1983. October 27-30, Alexandra Palace, London. For more details contact: The Exhibition Manager, Electronic Hobbies Fair, Reed Exhibitions, Surrey House, Throwley Way, Sutton, Surrey SM1 4QQ

Please send more information on Exhibition stand space   
Please ask a salesman to telephone

Name \_\_\_\_\_

Position \_\_\_\_\_

Company \_\_\_\_\_

Address \_\_\_\_\_  
\_\_\_\_\_  
\_\_\_\_\_

Telephone Number \_\_\_\_\_



ELECTRONIC HOBBIES FAIR

The Exhibition Manager  
Electronics Hobbies Fair  
Reed Exhibitions  
Surrey House, Throwley Way  
Sutton, Surrey SM1 4QQ

# Ingenuity Unlimited

A selection of readers' original circuit ideas. Why not submit your idea? Any idea published will be awarded payment according to its merits.

Each idea submitted must be accompanied by a declaration to the effect that it has been tried and tested, is the original work of the undersigned, and that it has not been offered or accepted for publication elsewhere. It should be emphasised that these designs have not been proven by us. They will at any rate stimulate further thought.

Articles submitted for publication should conform to the usual practices of this journal, e.g. with regard to abbreviations and circuit symbols. Diagrams should be on separate sheets, not in the text.

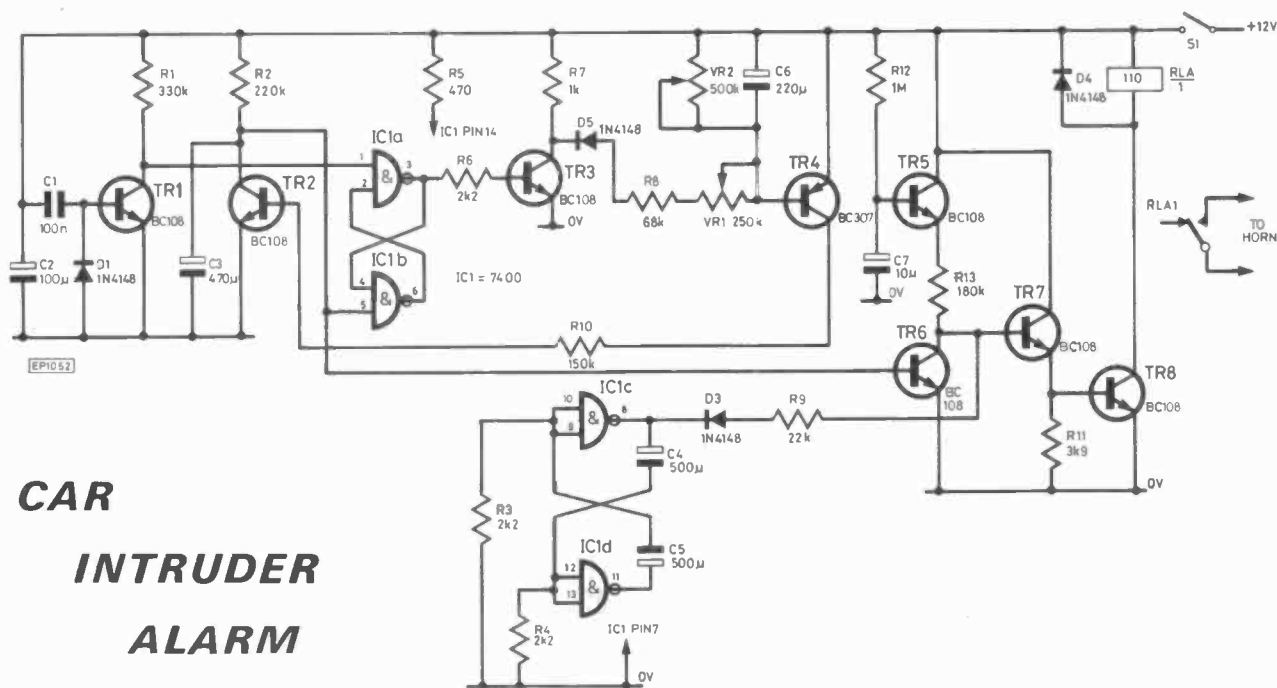

## CAR INTRUDER ALARM

THE design requirements for this were as follows.

Able to be triggered by any electrical equipment in the car being operated, i.e. courtesy light, ignition, lights etc., but not the horn when being used to provide the alarm. To provide a delay of about 15 seconds to allow the car owner time to leave the vehicle after switching on the internal arming switch and a delay of about 8–10 seconds before the alarm operates to allow time for the owner to disarm on re-entry to the vehicle.

It must have a pulsating alarm which ceases after 30 seconds, but re-arms the circuit after 10–15 seconds.

On closure of S1 it takes approximately 10 to 15 seconds for C3 to become positively charged via R2. This puts a positive potential on pin 5 of IC1a and the

base of TR6 which in turn makes the base of TR7 negative, which means that RLA1 is de-energised. R12 and C7 are included to stop TR6 collector going positive before its base goes positive.

On opening the car door the courtesy light operates, which causes a negative pulse at TR1 collector and pin 1 of IC1a. This causes the bistable to operate which turns on TR3 allowing C6 to charge, putting a negative potential on the base of TR4. The time for C6 to charge is determined by R8 and VR1. Discharge time is determined by VR2. The base of TR2 is now positive, causing the collector to go negative. This causes two functions.

The base of TR6 is made negative turning it off, which puts the base of TR7 positive, this is modulated by IC1b which is oscillating at about 1 hertz, thereby

switching TR8 on and off allowing alternate operation of the relay.

The second function causes pin 5 of IC1a to be held negative thus preventing operation of the bistable whilst the relay is operating.

When C6 has discharged the relay ceases to operate and the bistable returns to an operational state.

The relay in the prototype was used to pulsate the horn but it could also be used to pulsate the headlights or operate a siren. The relay contacts must be capable of carrying the current demanded by the warning devices being used. VR1 is used to adjust the re-entry time delay and VR2 to adjust the relay operation time.

W. Fairhurst,  
Anderton,  
Chorley,  
Lancs.





# MODULES FOR SECURITY & DETECTION

AS FEATURED IN  
**PRACTICAL ELECTRONICS**

## INTRUDER ALARM CONTROL UNIT CA 1250

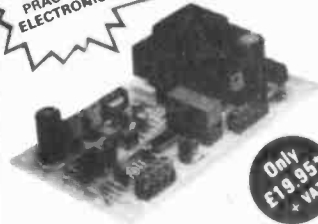

Only  
**£19.95+**  
+ VAT

This exciting new module offers all the possible features likely to be required when building an intruder alarm system. Whether used with only 1 or 2 magnetic switches or in conjunction with several ultrasonic alarm modules or infra-red units, a really effective system can be constructed at a fraction of the cost of comparable ready-made units. Supplied with a fully explanatory Data Sheet that makes installation straight forward, the module is fully tested and guaranteed.

\*available in kit form £16.95 plus VAT.

- Built-in electronic siren drives 2 loud speakers
- Provides exit and entrance delays together with fixed alarm time
- Battery back-up with trickle charging facility
- Operates with magnetic switches, u/sonic or I.R. units
- Anti-tamper and panic facility
- Stabilised output voltage
- 2 operating modes - full alarm/anti-tamper and panic facility
- Screw connections for ease of installation
- Separate relay contacts for switching external loads
- Test loop facility

## ULTRASONIC ALARM MODULE US 4012

Fully built & tested

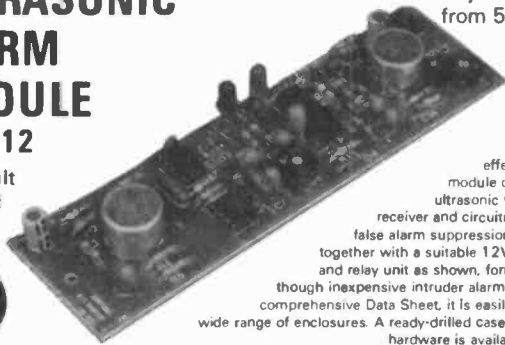

Adjustable range from 5ft. to 25ft.

A really effective fully built module containing both ultrasonic transmitter and receiver and circuitry for providing false alarm suppression. This module, together with a suitable 12V power supply and relay unit as shown, forms an effective though inexpensive intruder alarm. Supplied with comprehensive Data Sheet, it is easily mounted in a wide range of enclosures. A ready-drilled case and necessary hardware is available (see right).

only  
**£10.95**  
+ VAT

DIGITAL VOLTMETER MODULE DVM 314  
3 digit. Fully built & tested



only  
**£11.95**  
+ VAT

## INFRA-RED SYSTEM IR 1470

only  
**£25.51**  
+ VAT

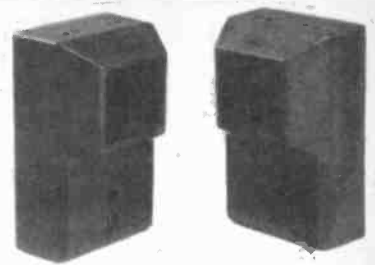

Fully built & tested

- Range up to 50'
- 12V operation
- Supplied with full instruction
- Easily installed

Now available, a really effective infra-red system built to the high standards demanded by the security industry, and yet offered at this low price. The system consists of a transmitter and receiver which provide an invisible beam over distances from 1-50ft or more. When the beam is interrupted, a relay is energised in the receiver unit. The use of a modulated beam combined with the infra-red filters, prevent interference from artificial or sunlight, whilst LED indicators ensure easy alignment of the beam. Both units are housed in attractive black moulded enclosures which are easily mounted. Supplied with full instructions, the unit is ideal for use in conjunction with the Control Unit CA 1250 or as an independent unit.

Power Supply & Relay Units PS 4012    £4.25 + VAT

Provides a stabilised 12V output and relay with 3A contacts. The unit is designed to operate one or two of the ultrasonic units. Fully built and tested.

Siren Module SL 157    £2.95 + VAT

Produces a loud and penetrating sliding tone operating from 9-15V. Capable of driving 2 off 8 ohm speakers to SPL of 110db at 2M. Contains an inhibit facility for use with shop lifting loops or other break to activate circuits.

Hardware Kit HW 4012    £4.25 + VAT

A suitable ready-drilled case with the various mounting pillars, mains switch socket and nuts and bolts. Designed to house the ultrasonic alarm module together with its power supply. Size: 153mm x 120mm x 45mm.

### ★ ACCESSORIES ★

- 3-position Key Switch for use with CA 1250, supplied with 2 keys    £3.43
- Magnetic switch (with magnet)    £1.17
- 5" Horn speaker for use with CA1250 and SL157    £4.95

Add VAT & 50p post and packing to all orders

Shop hours 9.00 - 5.30 p.m.  
(Wed. 9.00 - 1.00 p.m.)

Units on demonstration - callers welcome. S.A.E. with all enquiries.



Telephone orders welcome

## RISCOMP LIMITED

Dept. PE6  
21 Duke Street,  
Princes Risborough, Bucks.

Princes Risborough (084 44) 6326

Please allow 7 days for delivery

# MASTER ELECTRONICS NOW! The PRACTICAL way!

This new style course will enable anyone to have a real understanding of electronics by a modern, practical and visual method. No previous knowledge is required, no maths, and an absolute minimum of theory.

You learn the practical way in easy steps mastering all the essentials of your hobby or to start or further a career in electronics or as a self-employed servicing engineer.

All the training can be carried out in the comfort of your own home and at your own pace. A tutor is available to whom you can write personally at any time, for advice or help during your work. A Certificate is given at the end of every course.

You will do the following:

- Build a modern oscilloscope
- Recognise and handle current electronic components
- Read, draw and understand circuit diagrams
- Carry out 40 experiments on basic electronic circuits used in modern equipment
- Build and use digital electronic circuits and current solid state 'chips'
- Learn how to test and service every type of electronic device used in industry and commerce today. Servicing of radio, T.V., Hi-Fi and microprocessor/computer equipment.

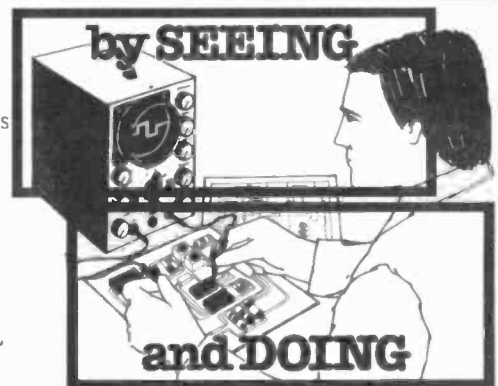

## New Job? New Career? New Hobby? Get into **Electronics** Now!

**FREE!**  
COLOUR BROCHURE

Please send your brochure without any obligation to

NAME \_\_\_\_\_

ADDRESS \_\_\_\_\_

I am interested in:

- COURSE IN ELECTRONICS as described above
- RADIO AMATEUR LICENCE
- MICROPROCESSORS
- LOGIC COURSE

OTHER SUBJECTS \_\_\_\_\_

POST NOW TO:

BLOCK CAPS PLEASE

PE/6/821

**British National Radio & Electronics School Reading, Berks. RG1 1BR**

# Ultimum Computer Interface

## Part 8

WILLIAM EDWARDS    WATFORD ELECTRONICS

THE PORT card for the Ultimum system provides all the facilities one is ever likely to need for running printers, terminals and so on, plus a few extra goodies. A real-time clock with battery backup is included, allowing your system to always know the correct date and time. Both this, and all of the ports provided by the card have interrupt facilities, to allow any or all of them to be run in an interrupt-driven mode with all its attendant advantages of software efficiency. All handshakes on the two parallel ports are performed by hardware, again reducing the software load. The serial port provides and accepts both full V24 level and TTL level RS232 signals in full-duplex mode with complete modem handshaking provision.

### HARDWARE

The circuit divides very neatly into four parts, as may be seen from the diagram (Fig. 8.1). The decoding section is fairly standard; ICs 7 & 8 compare the top eight address bits with those set up on link 1. IC6 decodes further using four more address bits to give sixteen outputs covering sixteen locations each, any of which is available (on link 2) for the master selects MS1 and MS2.

The 58174 real-time clock (IC2) consumes only ten microamps in standby mode and operates down to 2.2 volts. Since the trickle charge current for the battery is 1mA, rather odd but simple circuitry may be used in the backup supply. R9 charges the battery in normal operation and, when power is removed from the card, has very little effect on the 3.6 volts from the battery. The open collector output of IC5 combined with R10 ensures that the clock remains deselected under power-down conditions. Link 4 allows connection of the internal timer to the system interrupt line.

The serial port is handled by IC1, a 6551 asynchronous communications interface adaptor. This handles conversion between serial and parallel formats including some error checking features. Buffering and level conversion on the output side is provided by IC11. The CCITT recommendation V24 specifies a minimum  $\pm 3V$  signal and a typical  $\pm 12V$ . The EIA standard RS-232C is similar, and specifies in addition a maximum output slew rate of  $30V/\mu s$ , data rate of 20kb/s and cable length of 50 feet. The purpose of the slew rate specification is to control emission (which causes crosstalk) and reflection problems. The capacitors C1-3 perform this function, the outputs of the line drivers being current limited. Input buffering and level conversion is provided by IC10. Resistors R14-17, which are not normally fitted, allow correct termination of electrically long transmis-

sion lines. The transition points of the line receivers are about 1.3 volts. This has two useful effects. First, an open or shorted input will be seen as continuous "mark" (as if no characters were being output by the remote transmitter) rather than noise, and secondly, a TTL specification input ( $<0.8V = "0"$ ,  $>2.4V = "1"$ ) can be correctly read. IC10 also provides for filtering (C4-7) and about 500mV of hysteresis to eliminate noise on the input. The value of capacitor given causes the receiver to reject a 3V noise pulse less than 400ns wide. If noise problems are experienced they may be increased, paying careful attention to the Baud rate in use.

The values of C1-3 may be similarly modified if necessary. The supply-line diodes around IC10 protect it from damage when a signal is received with the power supply off.

Both the parallel ports are handled by (surprise, surprise!) an 8255, IC3. The circuitry is designed to take best advantage of the 8255 using port B in mode 1, output, for the Centronics parallel port and port A in mode 2, bidirectional, for the auxiliary port. ICs 4 and 5 provide increased current driving capability for the Centronics output. Link 3 may be used to select BUSY for the handshaking if  $\overline{ACK}$  is not available. In mode 1 the 8255 handles the required handshaking for the Centronics protocol on port B using lines 1 and 2 of port C. An interrupt request is available out of port C line zero; if interrupts will never be required for the Centronics port R5 may be omitted. Port A requires four handshake lines to run in full bidirectional mode; these are provided by port C lines 4-7 and consist of:

- a) Output Buffer Full and Acknowledge (output operations)
- b) Strobe and Input Buffer Full (input operations)

An interrupt request is available for the port on C3; R4 may be omitted if it will never be used. If no interrupts from the 8255 will ever be required then TR1 and R6 may also be omitted. It should be noted that the drive capability of port A is limited to 200 $\mu A$  (source), 1.7mA (sink) and buffering may be required for any particular application. The port may of course be used as a purely unidirectional one without modifying the 8255 mode (two parallel printers?).

### CONSTRUCTION

The usual order of construction applies: Sockets first followed by discrete components. Then fit the i.c.s and finally solder the battery in, being careful at all times not to short it out. Try not to subject the crystals to excessive brutality; they don't appreciate it. Finally choose and fit your

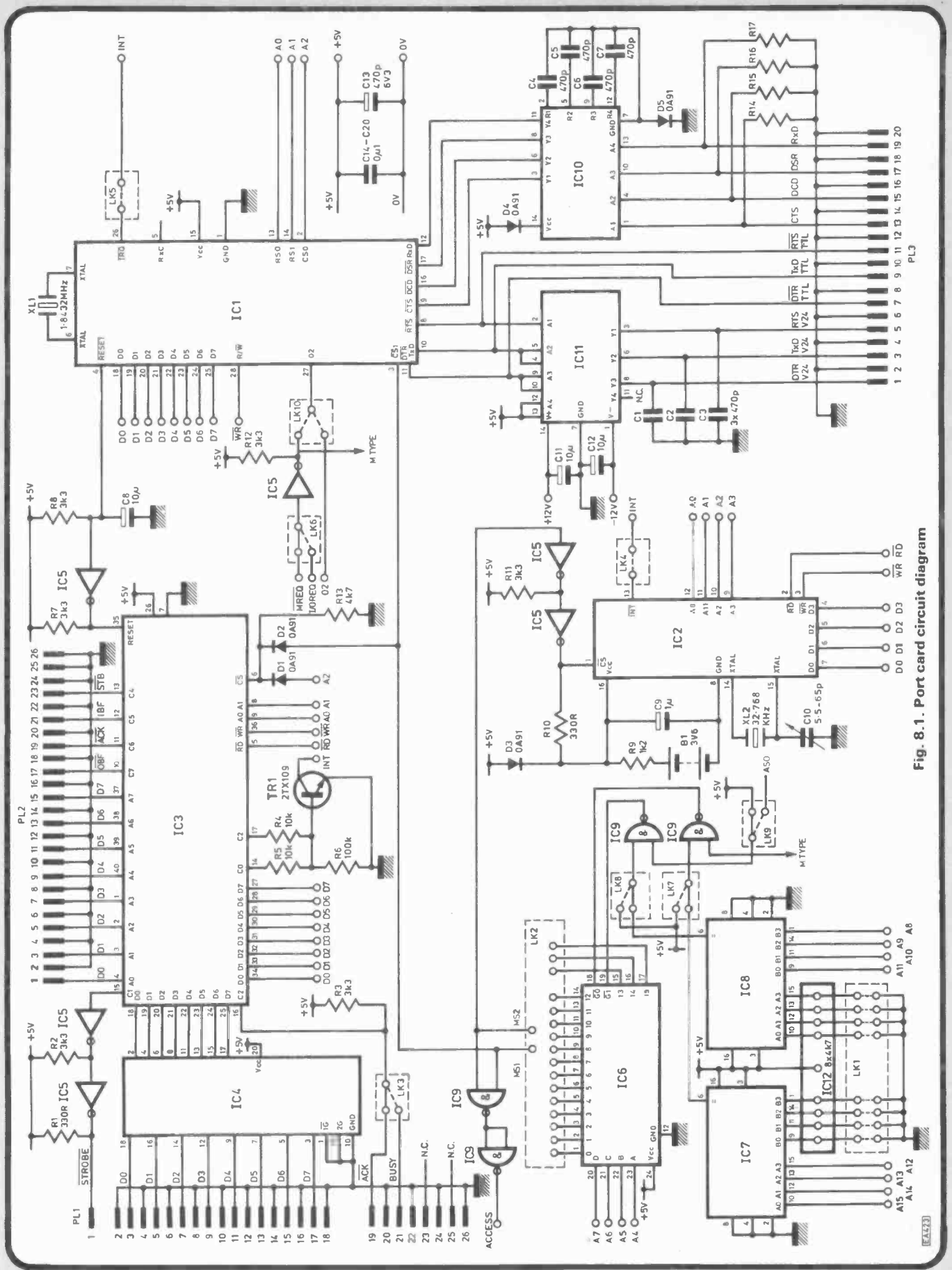

Fig. 8.1. Port card circuit diagram



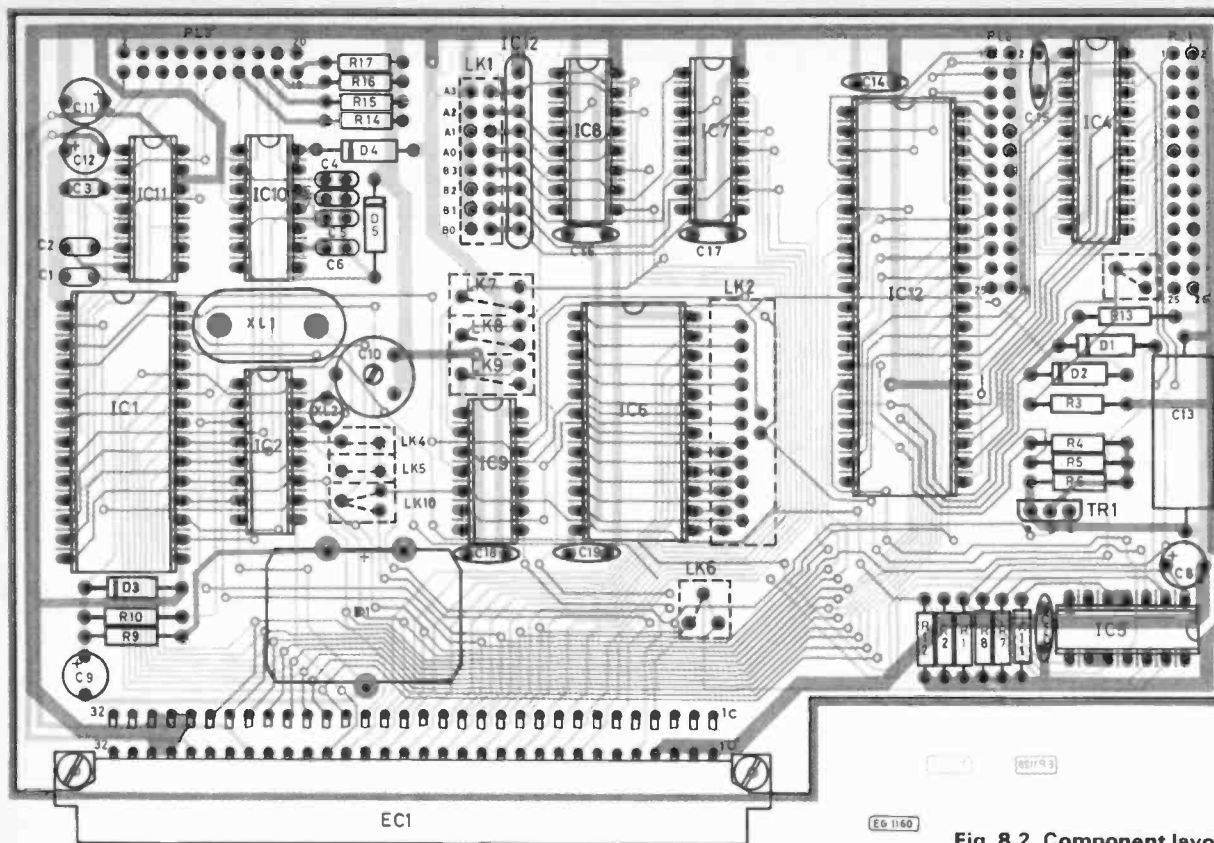

Fig. 8.2. Component layout (actual size)

## COMPONENTS ...

### Resistors

R1,R10	330 (2 off)
R2,R3,R7,R8,R11,R12	3k3 (6 off)
R4,R5	10k (2 off)
R6	100k
R9	1k2
R13	4k7
R14-17	not supplied in kit

### Capacitors

C1-7	470p ceramic (7 off)
C8,C11, C12	10 $\mu$ /16V tant. (3 off)
C9	1 $\mu$ /16V tant.
C10	5-65p trimmer
C13	470 $\mu$ /6V3
C14-20	100n ceramic (7 off)

### Semiconductors

D1-5	0A90 (5 off)
TR1	ZTX109
IC1	6551 ACIA
IC2	58174 RTC
IC3	8255 PPI
IC4	74LS244
IC5	74LS05

IC6	74LS154
IC7,IC8	74LS85 (2 off)
IC9	74LS00
IC10	1489 Quad line receiver
IC11	1488 Quad line driver
IC12	8 x 4k7 resistor s.i.l.

### Miscellaneous

X1	1.8432MHz crystal
X2	32.768kHz crystal
B1	3V6 p.c.b. mounting Ni-Cad
EC1	2 x 32 A+C right-angled male DIN
PL1, PL2	2 x 13 male IDC pins
PL3	2 x 10 male IDC pins
sockets ...	
14 pin	4 off
16 pin	3 off
20 pin	1 off
24 pin	1 off
28 pin	1 off
40 pin	1 off
Printed circuit board WE05PRT	

### Constructors' Note

Kits for all parts of the Ultimium will be available from **Watford Electronics**, 33 Cardiff Rd., Watford, Herts, WD1 8ED. Send SAE for price list of boards now available.

**Table 8.1. Link options**

1. Addressing: Top eight bits. Mode='0'. Marked end is least significant.
2. Addressing: Page subdivisions. Marked end is lowest address.
3. Centronics handshake: Default is  $\overline{ACK}$ . Alternative is BUSY.
4. Timer interrupt.
5. ACIA interrupt.
6. Address space: Default is memory-mapped. Alternative is I/O mapped.
7. Address space size: Make for 8-bit space and remove ICs 7 & 8.
8. Mapping: Default is 'permanent'. Alternative is 'mappable'.
9. Z80/65 or 68: No default.

**Table 8.3. Year status codes for register 13 of 58174**

Address 13 Write Mode

	DB3	DB2	DB1	DB0
Leap year	1	0	0	0
Leap year +1	0	1	0	0
Leap year +2	0	0	1	0
Leap year +3	0	0	0	1

Selected counter	Address bits				Mode
	AD3	AD2	AD1	AD0	
0 Test only	0	0	0	0	Write only
1 Tenths of sec.	0	0	0	1	Read only
2 Units of secs.	0	0	1	0	Read only
3 Tens of secs.	0	0	1	1	Read only
4 Units of mins.	0	1	0	0	Read or Write
5 Tens of mins.	0	1	0	1	Read or Write
6 Units of hours	0	1	1	0	Read or Write
7 Tens of hours	0	1	1	1	Read or Write
8 Units of days	1	0	0	0	Read or Write
9 Tens of days	1	0	0	1	Read or Write
10 Day of week	1	0	1	0	Read or Write
11 Units of months	1	0	1	1	Read or Write
12 Tens of months	1	1	0	0	Read or Write
13 Years	1	1	0	1	Write only
14 Stop/Start	1	1	1	0	Write only
15 Interrupt and status	1	1	1	1	Read or Write

**Table 8.2. Address decoding for clock registers of 58174**

**Table 8.4. Register 15 of 58174. Interrupt selection data**

Address 15 Write Mode

Function	DB3	DB2	DB1	DB0
No Interrupt	X	0	0	0
Interrupt at 60 sec. intervals*	0/1	1	0	0
Interrupt at 5.0 sec. intervals*	0/1	0	1	0
Interrupt at 0.5 sec. intervals*	0/1	0	0	1

\*±16.6 mS

DB3 = 0, single interrupt    DB3 = 1, repeated interrupt

**Fig. 8.3. Example clock program**

```

10 MS2=address of clock
20 R=9:GOSUB 1000
30 R=8:GOSUB 1000
40 PRINT " ";
50 R=12:GOSUB 1000
60 R=11:GOSUB 1000
70 PRINT " ";
80 R=7:GOSUB 1000
90 R=6:GOSUB 1000
100 PRINT ":";
110 R=5:GOSUB 1000
120 R=4:GOSUB 1000
130 PRINT ":";
140 R=3:GOSUB 1000
150 R=2:GOSUB 1000
160 PRINT
170 GOTO 20
1000 A=PEEK (MS2+R)
1010 IF A=15 THEN 1000
1020 PRINT A;
1030 RETURN
    
```

**Table 8.5. Internal registers of 6551**

RS <sub>1</sub>	RS <sub>0</sub>	Write	Read
0	0	Transmit Data Register	Receiver Data Register
0	1	Programmed Reset (Data is "Don't Care")	Status Register
1	0		Command Register
1	1		Control Register

required link options. The card occupies two sixteen-location chunks of address space which must be in the same 256-location page. Link 1 sets (in binary, made="0") the page number and link 2 selects two of sixteen subdivisions of the page. In hexadecimal terms, link 1 defines the first two digits and link 2 the third of the four required to describe a 64K address space. If the I/O option is being used in a machine with only one page of I/O space, ICs 7 & 8 should be omitted.

**SOFTWARE**

The 58174 maintains sixteen internal registers (Table 8.2) and as such uses the entire address space selected by MS2. The counter registers (1 to 12) hold the date-time in BCD format. If a counter is being updated at the time it is read, the value 15 will be returned which is an illegal BCD code and thus may be detected. The most significant four data bits will be ignored on a write and are undefined on a read and should be masked out by software. Register zero is used during manufacture and should not be accessed apart from writing a zero to it at system initialisation time. The value zero when written into register 14 will stop the clock; the

value one will re-start it. This allows time data to be loaded and the clock then to be started precisely. Register 13 may be used to set the year status according to Table 8.3. Register 15 is the interrupt status register. It may be set in accordance with Table 8.4 to request single or repeated interrupts in one of three time periods. Once set, the interrupt request will be cleared by a read of the status register. Fig. 8.3 is an example program which reads the date and time.

The 6551 has six internal locations mapped onto four addresses (Table 8.5). On the card these appear at MS1 + 4 to MS1 + 7. Figs. 4 to 7 give information on their function. The conditions reflected by bits 3 to 6 of the status register can cause an interrupt if enabled by bits 0 to 3 of the command register. The interrupt from status register bits 5 and 6 occurs on a change of state.

Note that CTS must be input to the 6551 for the transmit side to operate. If no suitable signal is available from the remote terminal then connect it to DTR/V24 at PL3. Fig. 8.8 gives an example program which uses the 6551 for output without using interrupts, and a suggested sequence of checks when interrupts are being used.

### CONTROL REGISTER

The Control Register is used to select the desired mode for the SY6551. The word length, number of stop bits, and clock controls are all determined by the Control Register, which is depicted in Figure 6.

#### STOP BITS

- 0 = 1 Stop Bit
- 1 = 2 Stop Bits
- 1 Stop Bit if Word Length = 8 Bits and Parity\*
- 1½ Stop Bits if Word Length = 5 Bits and No Parity

#### WORD LENGTH

BIT 6	BIT 5	DATA WORD LENGTH
0	0	8
0	1	7
1	0	6
1	1	5

#### RECEIVER CLOCK SOURCE

- 0 = External Receiver Clock
- 1 = Baud Rate Generator

\*This allows for 9-bit transmission (8 data bits plus parity).



				BAUD RATE GENERATOR
0	0	0	0	16x EXTERNAL CLOCK
0	0	0	1	50 BAUD
0	0	1	0	75
0	0	1	1	109.92
0	1	0	0	134.58
0	1	0	1	150
0	1	1	0	300
0	1	1	1	600
1	0	0	0	1200
1	0	0	1	1800
1	0	1	0	2400
1	0	1	1	3600
1	1	0	0	4800
1	1	0	1	7200
1	1	1	0	9600
1	1	1	1	19,200

HARDWARE RESET  
PROGRAM RESET

7	6	5	4	3	2	1	0
0	0	0	0	0	0	0	0
-	-	-	-	-	-	-	-

Fig. 8.4. Control register format

### COMMAND REGISTER

The Command Register is used to control Specific Transmit/Receive functions and is shown in Figure 7.

#### PARITY CHECK CONTROLS

BIT 7	BIT 6	BIT 5	OPERATION
-	-	0	Parity Disabled - No Parity Bit Generated - No Parity Bit Received
0	0	1	Odd Parity Receiver and Transmitter
0	1	1	Even Parity Receiver and Transmitter
1	0	1	Mark Parity Bit Transmitted, Parity Check Disabled
1	1	1	Space Parity Bit Transmitted, Parity Check Disabled

#### NORMAL/ECHO MODE FOR RECEIVER

- 0 = Normal
- 1 = Echo (Bits 2 and 3 must be "0")



#### DATA TERMINAL READY

- 0 = Disable Receiver and All Interrupts (DTR high)
- 1 = Enable Receiver and All Interrupts (DTR low)

#### RECEIVER INTERRUPT ENABLE

- 0 = IRQ Interrupt Enabled from Bit 3 of Status Register
- 1 = IRQ Interrupt Disabled

#### TRANSMITTER CONTROLS

BIT 3	BIT 2	TRANSMIT INTERRUPT	RTS LEVEL	TRANSMITTER
0	0	Disabled	High	Off
0	1	Enabled	Low	On
1	0	Disabled	Low	On
1	1	Disabled	Low	Transmit BRK

HARDWARE RESET  
PROGRAM RESET

7	6	5	4	3	2	1	0
0	0	0	0	0	0	0	0
-	-	-	0	0	0	0	0

Fig. 8.5. Command register format

## STATUS REGISTER

The Status Register is used to indicate to the processor the status of various SY6551 functions and is outlined in Figure 8.

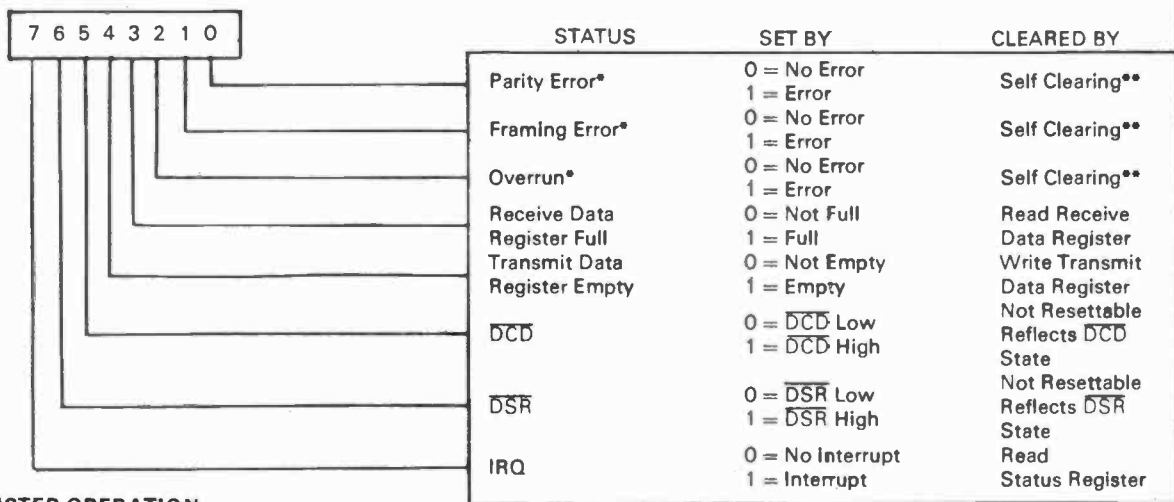

## STATUS REGISTER OPERATION

Because of the special functions of the various status bits, there is a suggested sequence for checking them. When an interrupt occurs, the R6551 should be interrogated, as follows:

1. Read Status Register  
This operation automatically clears Bit 7 (IRQ). Subsequent transitions on DSR and DCD will cause another interrupt.
2. Check IRQ Bit.  
If not set, Interrupt source is not the R6551.
3. Check DCD and DSR.  
These must be compared to their previous levels, which must have been saved by the processor. If they are both "0" (modem "on-line") and they are unchanged then the remaining bits must be checked.
4. Check RDRF (Bit 3).  
Check for Receiver Data Register Full.
5. Check Parity, Overrun, and Framing Error (Bits 0-2).  
Only if Receiver Data Register is full.
6. Check TDRE (Bit 4).  
Check for Transmitter Data Register Empty.
7. If none of the above, then CTS must have gone to the FALSE (high) state.

\*NO INTERRUPT GENERATED FOR THESE CONDITIONS.  
\*\*CLEARED AUTOMATICALLY AFTER A READ OF RDR AND THE NEXT ERROR FREE RECEIPT OF DATA.

	7	6	5	4	3	2	1	0
HARDWARE RESET	0	-	-	1	0	0	0	0
PROGRAM RESET	-	-	-	-	-	0	-	-

Fig. 8.6. Status register format

```

10 MS1=address
20 TDR=MS1 + 4:STR=MS1+5
30 CMR=MS1+6:CTR=MS1+7
40 POKE STR, 0 ; Reset
50 POKE CTR, 184 ; 2 stop bits, 7 data bits, 1200 baud
60 POKE CMR, 42 ; odd parity, transmit on, no
; interrupts
70 A$=characters to be output
80 L=LEN(A$)
90 FOR X=1 TO L
100 IF (PEEK(STR) AND 16) = 0 THEN 100;
; Wait for TDR empty
110 POKE TDR, ASC(MID$(A$,X,1))
120 NEXT X
    
```

Fig. 8.8. Example serial output program

These registers are used as temporary data storage for the 6551 Transmit and Receive circuits. The Transmit Data Register is characterized as follows:

- Bit 0 is the leading bit to be transmitted.
- Unused data bits are high-order bits and are "don't care" for transmission.

The Receive Data Register is characterized in a similar fashion:

- Bit 0 is the leading bit received.
- Unused data bits are the high-order bits and are "0" for the receiver.
- Parity bits are not contained in the Receive Data Register, but are stripped-off after being used for external parity checking. Parity and all unused high-order bits are "0".

Figure 9 illustrates a single transmitted or received data word, for the example of 8 data bits, parity, and 1 stop bit.

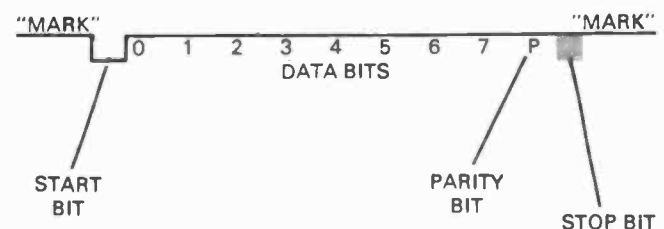

Fig. 8.7. Transmit and Receive data registers

# Micro Controller Expansion

A range of hardware and software backing up PE's 6800 System, adding power and flexibility to the micro. Only available from SAT ELECTRONICS.

- **EXPANSION SOCKET** A unique design which only requires 5 soldered connections and the rest just plug in. Gives full access to all busses and control lines. Installed in less than 5 minutes. Full kit of parts £11.91, order code CT100
- **VOU INTERFACE** 4 selectable pages of 512 characters on any TV or monitor. A set of 128 characters can be displayed normally in inverse video or flashing. The card has 2k of Ram and can be used as memory expansion on full battery back up.  
\* Note - expansion socket supplied free with this card \*  
Supplied ready built and tested £42.20 Order as CT101
- **SPEECH SYNTHESISER** This board is capable of speech of the highest order. Uses extended allophones as a key to the dictionary. UNLIMITED VOCABULARY, any word or sentence can be spoken. Has its own built-in amplifier. Easily programmed with worked examples. Supplied ready built and tested £27.65 Order as CT102/B Complete kit of parts £22.00 Order as CT102/A
- **8k RAM EXTENDER** This card contains a total of 8k of RAM on full battery back-up. Ideal for those larger programmes. 2 or more cards can be used with the mother board, to gain ever bigger memory space. Full kit of parts £19.59 Order as CT103/A Supplied, built and tested £23.70 Order as CT103/B
- **ANALOGUE INPUT/OUTPUT** Up to 16 analogue inputs and 2 analogue outputs can be added using this card. Plugs directly into expansion socket. The board is supplied with 8 inputs and 1 output extra I/O available. Measuring pressure, voltage, amps, light etc. is detailed in manual. Full kit of parts £24.64 Order as CT104/A Supplied ready built and tested £29.76 Order as CT104/B
- **REAL TIME CARD** Gives the controller an input of time and calendar down to 1/10 of a sec. Crystal controlled for accuracy with battery to maintain time keeping. Full kit of parts £21.89 Order as CT105/A. Supplied ready built and tested £26.44 Order as CT105/B
- **MOTHER BOARD** This unit plugs into the expansion socket to allow up to 6 expansion boards to be used simultaneously. Contains all logic required when using more than one board. Complete kit of parts £16.90 Order as CT106/A Supplied ready built and tested £19.83 Order as CT106/B

Available shortly will be software and literature for use with micro-controller. All the boards are supplied with full construction details and a comprehensive manual containing many programme examples. Please add £1 P & P PER BOARD and 15% VAT to TOTAL ORDER. Cheques and postal orders made payable to SAT ELECTRONICS

SAT ELECTRONICS, THE DESIGN CONSULTANTS, 235 CROSS ST SALE, CHESHIRE, M33 1JR Technical enquiry line 061 973 7882

D <sub>7</sub>	D <sub>6</sub>	D <sub>5</sub>	D <sub>4</sub>	D <sub>3</sub>	D <sub>2</sub>	D <sub>1</sub>	D <sub>0</sub>
OBF	INTE	IBF	INTE	INTR	INTE	OBF	INTR
A	AO	A	AI	A	B	B	B

INTE=Interrupt Enable  
INTR=Interrupt Request

Fig. 8.9. 8255 status word, mode 2 + 1

Fig. 8.10. Bit Set/Reset format

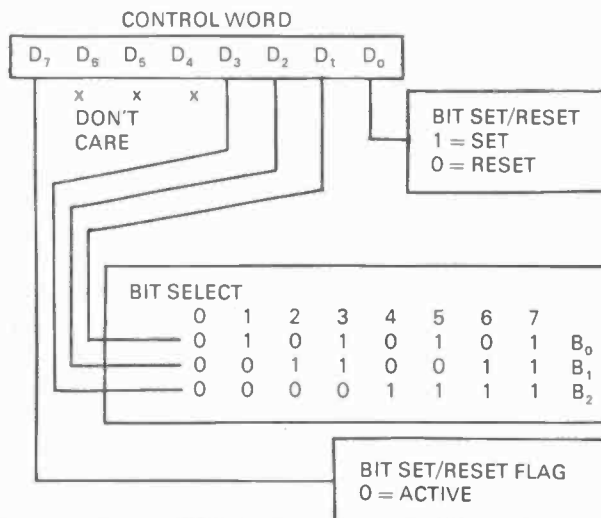

The 8255 has the usual four registers, located in the address space at MS1 to MS1 + 3. Having defined ports A and B to be working in modes requiring handshaking, port C is dedicated to these control functions and attempting to use it normally does not make much sense. Bits in it however do have specific uses as is shown in Fig. 8.9. It will often be most appropriate to manipulate them using the individual bit set/reset capability which the 8255 provides for port C. The required format is given in Fig. 8.10.

**NEXT MONTH:** The analogue I/O card.

## EXPANSION SYSTEM

Motherboard  
Dynamic 16/64K RAM card  
ROM & Battery Back-up card  
Universal PROM Programmer  
ROMulator card  
Speech card  
Sound Generator card (3-chip)  
Port & Real-time Clock  
Analogue card  
Disk Controller (intelligent)  
Display card (intelligent)  
Processor card  
Breadboarding card

**ULTIMUM** interfaces to: Acorn Atom, Apple II, Atari, BBC Micro, Commodore PET, Dragon 32, Jupiter ACE, Oric 1, RML 380Z, Spectrum, Superboard, Superbrain, S100 bus machines, UK101, Video Genie, ZX81.

Now  
is  
more!

*More value, more useful,  
more informative, more up  
to date, more interesting,  
more rewarding, more  
fun, more colourful, more  
exciting, more striking!*

**The price stays the same.**

PRACTICAL  
**ELECTRONICS**

JULY ISSUE ON SALE FRIDAY, JUNE 3



# VIDEOTONE

## Quality plus value ~ always

"The legendary  
"MINIMAX"  
— the small  
speaker produc-  
ing "Large  
speaker" sounds.  
Peak handling  
100 watts.

ONLY £74.95  
A PAIR!!!

NEW IMPROVED

# MINIMAX 2

VIDEOTONE — For full range of loudspeakers, in-car, C.B.,  
Video, audio & video cassettes, etc. Write for full details.

**VIDEOTONE** 98 CROFTON PARK ROAD,  
LONDON SE4.  
Tel: 01-690 8511. ext. 32.  
Send for our free brochure and  
details of outlets in the U.K.

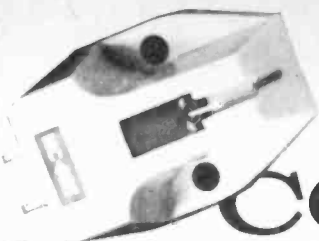

## the MC88E from CORAL

Moving Coil Cartridge — The MC88E is a high output cartridge  
— so you do not need to use a head amp. EXCEPTIONAL  
VALUE AT ONLY £29.95

Seoum Hi-Fi rep-  
resents EXCELLENT  
QUALITY AT A  
REALISTIC PRICE!  
The range offers a  
choice of amplifiers,  
tuner/amplifier, tuner,  
and the excellent  
SC4200 stereo cas-  
sette recorder.



THE SCIENCE OF AUDIO

# seoum

Post to: Videotone, Crofton Park Road, London SE4.

NAME \_\_\_\_\_

ADDRESS \_\_\_\_\_

PE

## A Micro-Mobile you CAN afford!

Colne Robotics brings you the ZEAKEE MICRO-MOBILE (as featured in this month's construction project), a low-cost mobile robot for use with microcomputers. It's compact (5x5x2") and rugged, with two separately-driven DC motors powering its wheels. Eight touch sensors indicate collision with obstacles to the computer, which can then instruct ZEAKEE to take evasive action. Touching an obstacle triggers a two-tone alarm horn which changes in pitch according to direction of travel. A retractable pen, controlled by the computer, is provided to enable ZEAKEE to trace its path and, if provided with appropriate software, produce logo graphics. LEDs indicate direction of motion and pen status, and with its two metres of umbilical ribbon cable ZEAKEE can roam over any flat surface. Drive ZEAKEE with any microcomputer fitted with an 8-bit bi-directional port (ZX81/SPECTRUM users note — we can supply a special interface).

Complete with power supply, operation manual and basic software, ZEAKEE is available at the special introductory price of only £59.95 (kit) or £79.95 (assembled) including VAT.

# ZEAKEE

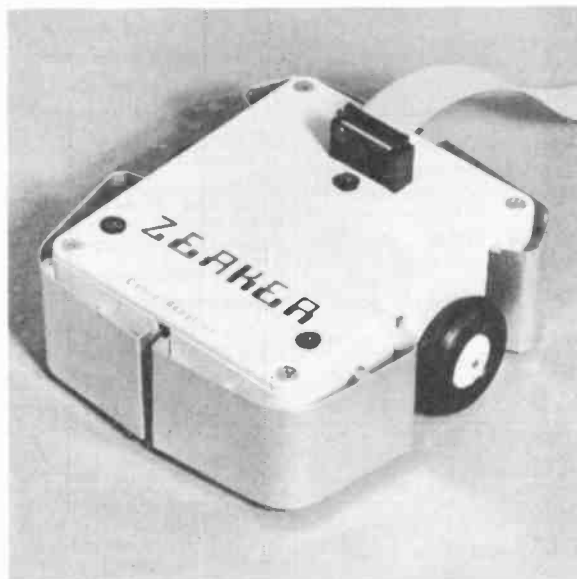

PLEASE SEND ME FURTHER DETAILS OF:

ZEAKEE

OTHER LOW-COST  
ROBOTIC PRODUCTS

NAME \_\_\_\_\_

ADDRESS \_\_\_\_\_

**COLNE ROBOTICS Co. Ltd.**  
BEAUFORT RD., OFF RICHMOND RD., EAST TWICKENHAM TW1 2PH

CALL IN AND SEE FOR YOURSELF

# AUDIO ELECTRONICS

ALL PRICES INCLUDE VAT

TEST EQUIPMENT CENTRES ALL MODELS ON DISPLAY OPEN SIX DAYS A WEEK

RETAIL • MAIL ORDER • EXPORT • INDUSTRIAL • EDUCATIONAL

## DIGITAL MULTIMETERS (UK C/P Free)

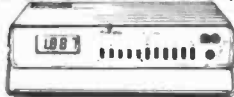

ALL MODELS 3 1/2 DIGIT UNLESS STATED

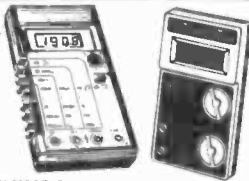

- HAND HELD** (With free carry case)
- K025C=13 range 0.2A DC 2 meg ohm £24.95
  - K030S=16 range 10A DC 2 meg ohm £29.95
  - K030C=26 range 1A AC/DC 20 meg ohm £34.95
  - K055C=28 range 10A AC/DC 20 meg ohm £39.95
  - 6010=22 range 10A AC/DC 20 meg ohm £34.40
  - 7030=As 6010 but 0.1% basic £41.30
  - K0615=18 range 10A DC 2 meg plus Hfe tester £39.95
  - 189M 30 range 10A AC/DC 20 meg plus Hfe tester £69.95
- HAND HELD AUTO RANGE**
- OM2350=21 range 10A AC/DC 20 meg ohm (Miniature) £49.95
  - H030 16 range 0.2A AC/DC 2 meg ohm £41.95
  - H030/B As above plus cont. buzzer £44.50
  - H031 22 range 10A AC/DC 2 meg ohms plus cont. buzzer £58.95
- +Optional carry case £2.95

## BENCH MODELS

- TM353=27 range LCD 2A AC/DC £86.25
  - TM355=29 range LED 10A AC/DC £86.25
  - TM351=28 range LCD 10A AC/DC £113.85
  - 2001 28 range LCD 10A AC/DC plus 5 range Cap. Meter with case £108.00
  - TM451 4 1/2 digit LCD every facility (0.02%) £171.00
  - 1503a 4 1/2 digit LCD every facility (0.05%) £171.00
  - 1503Ha 0.03% basic version of above £189.00
- \*Optional carry case £6.84

ALWAYS BARGAINS IN EQUIPMENT FOR CALLERS

## FREQUENCY COUNTERS



- PFM200A** 200 MHz hand held pocket 8 digit LED £67.50
- 8110A 8 digit LED bench 2 ranges 100 MHz £77.00
  - 8610B 9 digit LED bench 2 ranges 600 MHz £113.85
  - 8000B 9 digit LED 3 ranges 1 GHz £178.00
  - TF040 = 8 digit LCD 40 MHz £126.50
  - TF200 = 8 digit LCD 200 MHz £166.75
- Prescalers - Extended range of most counters
- TP600 600 MHz £43.00
  - TP1000 1 GHz £74.00

## SIGNAL GENERATORS (220/240v AC)



- FUNCTION** - All sine/square/triangle/TTL etc
- TG100 1 Hz - 100 KHz £90.00
  - TG102 0.2 Hz - 2 MHz £166.75
- PULSE**
- TG105 Various facilities 5 Hz - 5 MHz £97.75
- AUDIO** - Multiband Sine/Square
- LAG27 10 Hz to 1 MHz £90.85
  - AG202A 20 Hz to 200 KHz (List £94.50) £83.50
- RF**
- SG402 100 KHz to 30 MHz (Last few) £59.95
  - LSG17 100 KHz to 150 MHz £79.35

## ELECTRONIC INSULATION TESTER

YF 501 500 V/0-100m with carry case £63.00

## MULTIMETERS (UK C/P 65p)

- C7081 50K/V 21 ranges. Range doubler 10A DC. SPECIAL PRICE £15.95
- ETC5000/5001 21 ranges. 50K/V. Range doubler. 10A DC. £16.50
- TMK500 23 ranges 30K/V. 12A DC plus cont. buzzer. £23.95
- NH56R 20K/V. 22 range pocket £10.95
- u1102 14 range 2K/V pocket £5.95
- 830A 26 range 30K/V. 10A AC/DC overload protection. etc. £23.95
- 360TR 23 range 100K/V. Large scale 10A AC/DC plus Hfe £36.95
- AT1020 18 range 20K/V. Deluxe plus Hfe tester £17.50
- ST303TR 21 range 20K/V plus Hfe tester £16.95
- YM 360TR 19 range 20K/V plus Hfe tester £13.95



## AUDIO • RF • FUNCTION • PULSE OSCILLOSCOPES

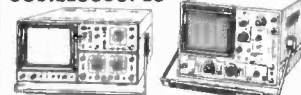

- Full specification any model on request. SAE by post
- HM Series NAMEG: SC THANOAR: CS Series TRIO: 3 Series CROTECH**
- SINGLE TRACE**
- 3030 15 MHz 5mv. 95mm tube plus component tester C/P £3.00 £177.10
  - SC110A = Miniature 10 MHz battery portable Post free £171.00
  - HM103 15 MHz 2mv. 6 x 7 display plus component tester C/P £3.00 £181.70
- = Optional carry case £6.84 AC adaptor £6.69
- Nicads £12.50
- DUAL TRACE (UK C/P £4.00)**
- HM203/4 Dual 20 MHz plus component tester £303.60
  - CS1562A Dual 10 MHz (List £321.00) £269.50
  - 3131 Dual 15 MHz + component tester £276.00
  - CS1566A Dual 20 MHz. All facilities (List £401.35) £349.50
  - HM204 Dual 20 MHz plus component tester sweep delay. £419.75
  - CS1820 Dual 20 MHz with extra facilities (List £508.30) £485.00
- OPTIONAL PROBE KITS**
- X1 £7.95
  - X10 £9.45
  - X1 - X10 £10.50
  - X100 £16.95

## VARIABLE POWER SUPPLIES (UK C/P £1.00)

- PP241 0/12/24V. 0/1A £35.00
- PP243 3 amp version £59.95
- PS 1307S 8/15V 7 amp t/w/meter £24.95



## DIGITAL THERMOMETER

TM301 LCD -50°C to +750°C with thermocouple £68.43

## AC CLAMP METER

ST300 0/300A: 0/600 VAC. 0/1 Kohm 9 ranges With carry case (UK C/P 65p) £28.50



## LOGIC PROBES

LP10 10 MHz £28.50  
LP076 50 MHz with carry case and accessories £71.30



## HIGH VOLTAGE METER

Direct reading 0/40 KV. 20K/VoIL (UK C/P 65p) £23.00

## DIGITAL CAPACITANCE METER

0.1 pF to 2000 mfd LCD 8 ranges OM6013 £52.75 (Carry case £2.95)

## TRANSISTOR TESTER

Direct reading PNP: NPN, etc. TC1 (UK C/P 65p) £21.95



FREE CATALOGUE SEND LARGE SAE (UK 20p)

ALL PRICES INCLUDE VAT

## AUDIO ELECTRONICS

301 EDGWARE ROAD, LONDON W2 1BN. TEL: 01-724 3564  
ALSO AT HENRY'S RADIO.  
404/406 EDGWARE ROAD, LONDON W2. TEL: 01-723 1008

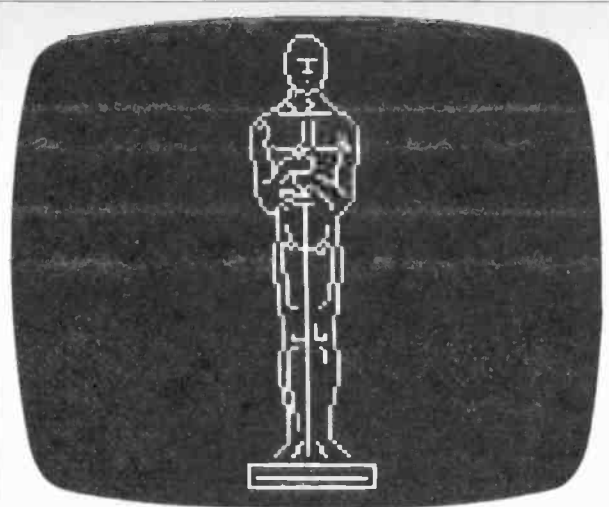

# BEST PICTURE OF 1983.

Ring 01-891 1923 for details of Crofton Monitors. They take all the prizes.

## CROFTON ELECTRONICS

Crofton Electronics Ltd., 35 Grosvenor Road, Twickenham, Middx. TW1 4AD. Tel: 01-891 1923/1513.

# ALARMS

## FREE CATALOGUE!

OUR GREAT NEW ILLUSTRATED CATALOGUE IS PACKED WITH INFORMATION ON SUPERB QUALITY, PROFESSIONAL BURGLAR ALARM EQUIPMENT

AT UNBEATABLE PRICES!

SEND SAE OR PHONE NOW FOR YOUR COPY

A.D. ELECTRONICS  
DEPT. PE  
217 WARBECK MOOR  
AINTREE LIVERPOOL  
L9 0HU/051 523 8440

THIEFCHECK BURGLAR ALARM D-I-Y SYSTEM  
MAIN DISTRIBUTOR

## TIME WRONG?

**MSF CLOCK** is ALWAYS CORRECT - never gains or loses, SELF SETTING at switch-on, 8 digits show Date, Hours, Minutes and Seconds, auto GMT/BST and leap year, can expand to Years, Months and Milliseconds, parallel BCD (including Weekday) output for alarm etc and audio to record and show time on playback, receives Rugby 60KHz atomic time signals, built-in antenna, 1000km range, GET the TIME RIGHT, £69.60.

**60KHZ RUGBY RECEIVER**, as in MSF Clock, serial data output, decoding details, Basic listings, £22.20.

FREE ZX81-games programs with May/June orders, each fun-to-build kit includes all parts, printed circuit, case etc, by-return postage, money back assurance, GET yours NOW.

**CAMBRIDGE KITS**  
45 (FT) Old School Lane, Milton, Cambridge.

# BIG NEWS

from

# EMOS

**VAST STOCKS OF COMPONENTS  
AT RIDICULOUSLY LOW PRICES**

### MAIL ORDER

we offer the best component prices in the business, and no order is too small to receive our first class attention.

### COMPONENT WAREHOUSE

we have a huge warehouse full of components, test equipment — in fact virtually everything you will ever need. Come and have a browse around. Open Mon. to Sat. — 9am to 4pm. You will easily find us opposite the John O'Gaunt Hotel on the A45.

**SEND A LARGE S.A.E. FOR OUR FREE  
COMPREHENSIVE CATALOGUE**

**EMOS** DEPT 1F  
HIGH MARCH,  
DAVENTRY

### TOYO MINI DRILLS, MD-1 and MD-1H — IDEAL FOR ELECTRONICS WORK

**MINI DRILL MD-1 — Basic Machine Price (inc. Drill Chuck) ..... £124.75**

#### SPECIFICATION

Drilling Capacity 6.5mm  
Maximum height of drill chuck above table — 178mm  
Table size — 170 x 170mm  
Motor input — 110w  
Motor — 220/240v — 50Hz A.C.  
Main spindle speeds (unloaded) — 850, 1150, 1550, 1700, 2300, 3100 rpm  
Overall dimensions — 170w x 350d x 430h (mm)

**MINI DRILL (HIGH SPEED) MD-1H — Basic Machine Drill (inc. Drill Chuck) ..... £129.75**

#### SPECIFICATION

As for MD-1 except as follows —  
Maximum speed of main spindle — 25mm  
Main spindle speeds — 8000 & 12000 rpm  
Overall dimensions — 170w x 315d x 395h (mm)

#### Accessory

Mini drill vice (45mm jaws) 50mm max opening ..... £14.00  
(Prices include p&p and VAT)

### MILLHILL SUPPLIES

Access/B Barclaycard welcome or cheque/PO to: 66 THE STREET, CROWMARSH, WALLINGFORD OXON, OX10 8ES. Tel: 0491 38653  
Delivery within 7 days.

## TALK TO THE WHOLE WORLD

Study now for the

### RADIO AMATEUR'S EXAMINATION

We have had 40 years successful experience in training men and women for the G.P.O. Transmitting licence.



FREE R.A.E. brochure without obligation from:—

**British National Radio & Electronics School  
READING, BERKS. RG1 1BR**

Name .....

Address .....

PE/6/817

BLOCK CAPS PLEASE

# SUPER KITS!

**SETS INCL. PCBS, ELECTRONIC PARTS, INSTRUCTIONS. MOST ALSO INCL. KNOBS, SKTS, WIRE, SOLDER, BOX. BATTERIES NOT INCL. BUT MOST WILL RUN FROM 9V TO 15V DC SUPPLIES. ALSO SEE BELOW.**

AUTOWAH: Guitar-triggered wah-wah	SET 58	£14.01
BASS BOOST: Increases volume of lower octaves	SET 138-B	£8.87
CALL SIGN: Programmable 8-note musical call sign	SET 121-LS	£14.23
CHORUS GENERATOR: Makes a solo voice or instrument sound like more	SET162	£31.59
COMPARATOR: LED level indicator or 2 channels	SET 129-LS	£16.70
COMPRESSOR: Limits & levels maximum signal strength	SET 133-LS	£12.37
FREQUENCY DOUBLER: Raises guitar frequency by 1 octave	SET 98	£11.75
FREQUENCY-GENERATOR: Multiple waveform test osc. variable 5Hz to 470KHz	SET 128	£18.44
FUNKY-WOBULO: Novelty voice modulator for funny effects	SET 149	£11.79
FLANGER: Fascinating delayed-feed-back effects plus phasing	SET 153	£22.49
FUZZ: Smooth distortion whilst keeping natural attack & decay	SET 91	£11.68
GUITAR EFFECTS: Multiple variation of level & filter modulation	SET 42	£15.92
GUITAR OVERDRIVE: Fuzz plus variable filter quality	SET 56	£21.17
GUITAR SUSTAIN: Extends effective note duration	SET 75	£11.77
HARMONOLA: 3-Octave organ with variable voicing attack, sustain vibrato	SET 124-T	£162.15
4-Octave version	SET 124-F	£184.71
HUM CUT: Tunable filter for reducing low frequency noise	SET 141	£11.43
JABBERVOX: Voice disguiser with clever use of reverb & tremolo	SET 150	£23.46
MAD-ROJ: Variable sirens, incl. police, galaxy machine-guns etc	SET 146	£9.99
METRONOME: With audible & visual beat & down-beat marking	SET 143	£13.52
MICROPHONE PRE-AMP: with switchable bass & treble response	SET 144	£8.92
MINISONIC (PE) MK2: 3-octave very versatile music synthesiser	SET 38	£181.56
MIXERS: Several — details in catalogue (see below)		
NOISE LIMITER: reduces tape & system hiss	SET 145	£9.99
PHASER: with automatic & manual rate & depth controls	SET 164	£21.20
POWER SUPPLIES (300mA): 9v	SET 130-N	£13.50
or preset 12 to 15v	SET 130-T	£13.85
REVERB: Analogue unit with variable delay & depth controls	SET 122-LS	£20.39
RHYTHM GENERATOR: 15 switchable rhythms controlling 10 instruments	SET 103F	£61.71
RING MODULATOR: for intermodulating 2 separate sine frequencies	SET 87	£13.62
ROBO BOX: Versatile Robot type voice modifier	SET 165	£21.89
ROGER 2-GONG: 2 gongs sounded at end of transmission	SET 126-LS	£12.31
ROGER BLEEP: Single bleep sounded at end of transmission	SET 127-LS	£10.07
SCRAMBLER: Codes & decodes transmission, authorised channels	SET 117-LS	£21.81
SEQUENCERS: 128-note keyboard controlled (keyboard incl.)	SET 76	£120.45
16-note (up to 64-bit pattern) panel controlled	SET 86	£64.63
SPEECH PROCESSOR: for clearer transmission & better level control	SET 110-LS	£11.77
STORM EFFECTS: Automatic & manual wind, rain & surf generator	SET 154	£16.72
SYNTHESISER INTERFACE: allows instrument to trigger synth functions	SET 81	£9.49
TREMOLO: Deep tremolo with depth & rate controls	SET 136	£10.71
TREBLE BOOST: Increases volume of upper octaves	SET 138-T	£8.46
tone CONTROL: bass & treble cut gain & range (6 controls)	SET 139	£13.62
VIBRATO: variable rate & depth plus additional phasing	SET 137	£23.99
VOCODER-BOX: Modular Vocoder	SET 152	£68.96
VODALEK: Robot type voice modulator with depth & rate controls	SET-155-LS	£12.40
VOICE FILTER: Tunable for selected freq bandwidth & gain	SET 142	£9.69
VOICE-OP-FADER: for reduction of music level during talk-over	SET 30	£9.85
VOICE-OP-SWITCH: with variable sensitivity & delay, 1A 2PC0 relay	SET 123-LS	£13.80
WAH-WAH: with auto-trigger, manual & oscillator control	SET 140	£17.31
WHEEBY-JEEBY: 2 intercoupled oscillators produce variable sirens	SET 151	£13.78
WIND & RAIN: manual control of these two effects	SET 28	£11.39
WOBBLE-WAH: Oscillator controlled wah-wah for fascinating effects	SET 161	£13.40

KIMBER ALLEN KEYBOARDS (surely the best?): 3-Oct £32.43, 4-Oct £40.68, 5-Oct £48.52  
KEYBOARD CONTACTS GJ (SPCC): 3-Oct £20.29, 4-Oct £26.50, 5-Oct £32.71  
KEYBOARD CONTACTS GB (OPST): 3-Oct £23.27, 4-Oct £30.45, 5-Oct £37.62

# PHONOSONICS

PHONOSONICS MAIL ORDER, DEPT PE3 6 22 HIGH STREET, SIDCUP, KENT DA14 6EH,  
01302 6184

Please use full address. Payment CWO, CHQ, PD, ACCESS, BARCLAY, or pre-arranged collection. Prices incl. UK P&P & 15% VAT. E&OE. Despatch usually 7 days on most items. Details of parts in above kits are stated in our comprehensive catalogue. Send S.A.E. (9x4 or bigger) for Catalogue (if you live overseas please send £1.00 or equiv.). MORE KITS ARE IN CATALOGUE.

# ELECTROVALUE

## FIRST FOR NASCOM 3



Highly recommended for its versatility and reliability, this latest Nascom microprocessor can be the foundation of a superb professionally styled system of excitingly useful applications and development... and of course, Electrovalue are accredited Nascom suppliers, ready to deliver your Nascom 3 (and ancillaries) NOW!

<b>Nascom 3 Microprocessor</b> (to drive monitor or TV set)	£549 + V.A.T.
<b>Monitor for above</b>	£120 + V.A.T.
<b>Nascom Dual Disc Drive SS/DD</b> (Takes standard 5 $\frac{1}{4}$ "	£685 + V.A.T.
<b>Nascom High Capacity Dual Drive</b>	£949 + V.A.T.
<b>Nascom 2 in kit form inc. keyboard but less power supply and RAM</b> Always available.	£225 + V.A.T.

DID YOU KNOW that for almost 20 years Electrovalue have been foremost suppliers of components etc. costing from pennies to hundreds of pounds? So send for our latest price list and see why it pays to buy from us.

**ELECTROVALUE LTD** Head office, Mail Order Dept and Shop 28C St Judes Road, Englefield Green, Egham, Surrey TW200HB, Egham (STD 0784: London 87) 33603: Telex 264475. North - personal shoppers only. 680 Burnage Lane, Burnage, Manchester M19 1NA (061 4324945)

EV Computing Shop 700 Burnage Lane, Manchester (061 431 4866)

# KITS & PCB's FOR P.E. PROJECTS

Full Kits including PCB's, Hardware and Cases (unless listed separately), I.C. Sockets, Veropins, Wire, Nuts & Bolts all included.

Switched Capacitance Phaser April 82 .....	£20.48
Battery Tester April 83 .....	£12.55
Wiper Delay April 83 (Less Relay) .....	£7.44
Ice Warning & Lights Reminder March 83 .....	£6.19
Car Audio Booster (Stereo) Jan 83 (Less Case) .....	£18.98
Diecast Case extra .....	£4.75
Frost/Overheating Warning Jan 83 .....	£6.20

## PCB's

Top quality printed Circuit Boards made from P.E. masters glass fibre board, roller tinned & drilled.

Mains Watchdog May 83 .....	£2.07	Audio Debug Probe Sept. 82 .....	£1.58
Personal Stereo Amp May 83 .....	£4.54	Waveform Digitiser Sept. 82 .....	£12.60
Battery Tester April 83 .....	£1.95	Combo Amp (Main) Aug. 82 .....	£3.45
Wiper Delay April 83 .....	£2.08	Combo Amp (Preamp) Aug. 82 .....	£3.62
Switched Capacitor Phaser April 83 .....	£2.26	Audio Test Set July 82 .....	£6.38
Ice Warning & Lights Reminder March 83 .....	£1.58	Instrument Tuner July 82 .....	£2.01
Digital Frequency Meter .....	£3.73	Versatile Car Alarm July 82 (2) .....	£3.65
Car Accessory P.S.U. March 83 .....	£1.53	Burglar Deterrent July 82 .....	£2.74
Car Radio Booster Feb. 83 .....	£1.74	Auto Flash Slave June 82 .....	£1.34
Digital Tacho Jan. 83 (3) .....	£4.80	Prescaler + Freq. Meter May 82 (3) .....	£2.80
Car Audio Booster Jan. 83 .....	£3.25	Prog. Timer/Controller May 82 (3) .....	£9.08
Stylochord Dec. 82 (3) .....	£7.49	Battery Backup June 82 .....	£2.34
Digital Stopwatch Oct. 82 .....	£2.23	Function Generator May 82 .....	£3.58
Audio Sweep Osc. Oct. 82 .....	£5.52	Mini Scorpio Ignition Feb. 82 .....	£1.56
Mini Chorus Unit Oct. 82 .....	£2.85		

## MAGENTA ELECTRONICS LTD

PA10, 135 HUNTER ST., BURTON-ON-TRENT, STAFFS DE14 2ST 0283 65435. MON-FRI 9-5. MAIL ORDER ONLY

ADD 45p P&P TO ALL ORDERS ACCESS and BARCLAYCARD (VISA) ORDERS ACCEPTED BY PHONE OR POST. SAE ALL ENQUIRIES

Prices inc. VAT OFFICIAL ORDERS WELCOME OVERSEAS Payment must be in sterling. IRISH REPUBLIC and BFPO - UK PRICES. EUROPE - UK PRICES + 10% ELSEWHERE - Write for Quote.

## ADVANCED TELECOMMUNICATIONS

### Careers with extensive scope at Cheltenham

Join the Government Communications Headquarters, one of the world's foremost centres for R & D and production in voice/data communications ranging from HF to satellite - and their security. Some of GCHQ's facilities are unique and there is substantial emphasis on creative solutions for solving complex communications problems using state-of-the-art techniques including computer/microprocessor applications. Current opportunities are for:

#### Telecommunication Technical Officers

Two levels of entry providing two salary scales: £5,980 - £8,180 & £8,065 - £9,085 Minimum qualifications are TEC/SCOTEC in Electronics/Telecommunications or a similar discipline or C & G Part II Telecommunications Technicians Certificate or Part I plus Maths B, Telecommunications Principles B and either Radio Line Transmission B or Computers B or equivalent: ONC in Electrical, Electronics or Telecommunications Engineering or a CIE part I Pass, or formal approved Service Technical training. Additionally, at least 4 years' (lower level) or seven years' (higher level) appropriate experience is essential in either radio communications or radar, data, computer or similar electronic systems.

At the lower entry level first line technical/supervisory control of technicians involves "hands-on" participation and may involve individual work of a highly technical nature. The higher level involves application of technical knowledge and experience to work planning including implementation of medium to large scale projects.

#### Radio Technicians - £5,232 - £7,450

To provide all aspects of technical support. Promotion prospects are good and linked with active encouragement to acquire further skills and experience. Minimum qualifications are a TEC Certificate in Telecommunications or equivalent plus 2 or more years' practical experience.

Cheltenham, a handsome Regency town, is finely-endowed with cultural, sports and other facilities which are equally available in nearby Gloucester. Close to some of Britain's most magnificent countryside, the area also offers reasonably-priced housing. Relocation assistance may be available.

For further information and your application form, please write to:

Recruitment Office, GCHQ Oakley, Priors Road, Cheltenham, Gloucestershire GL52 5AJ or phone 0242 21491 ext 2269.



## THE RADIO AMATEUR'S HANDBOOK

1983 ed. A.R.R.L. Price: £10.00

WORLD RADIO T.V. HANDBOOK 1983 by J. M. Frost Price: £12.00

THE ART OF ELECTRONICS by Horowitz/Hill Price: £16.00

ASSEMBLY LANGUAGE PROGRAMMING FOR THE BBC MICROCOMPUTER by I. Birnbaum Price: £9.50

PRACTICAL DESIGN OF DIGITAL CIRCUITS by I. Kempel Price: £11.00

OPTOELECTRONICS: AN INTRODUCTION by J. Wilson Price: £13.00

TESTING METHODS & RELIABILITY ELECTRONICS by A. Simpson Price: £5.50

THE COMPLETE H/B OF MAGNETIC RECORDING by F. Jorgensen Price: £9.20

ESSENTIAL ELECTRONICS AN A TO Z GUIDE by G. Loveday Price: £6.50

BASIC PROGRAMMING ON THE BBC MICROCOMPUTER by N. Cryer Price: £6.50

★ ALL PRICES INCLUDE POSTAGE ★

## THE MODERN BOOK CO.

BRITAIN'S LARGEST STOCKIST of British and American Technical Books

19-21 PRAED STREET LONDON W2 1NP

Phone 01-402 9176 Closed Saturday 1 p.m. Please allow 14 days for reply or delivery.

# TOROIDALS

The toroidal transformer is now accepted as the standard in industry, overtaking the obsolete laminated type. Industry has been quick to recognise the advantages toroidals offer in size, weight, lower radiated field and, thanks to I.L.P., PRICE.

Our large standard range is complemented by our **SPECIAL DESIGN** section which can offer a prototype service within 7 DAYS together with a short lead time on quantity orders which can be programmed to your requirements with no price penalty.

\*Gold service available.  
21 days manufacture for urgent deliveries.

\*Orders despatched within 7 days of receipt for single or small quantity orders.

\*5 year no quibble guarantee.

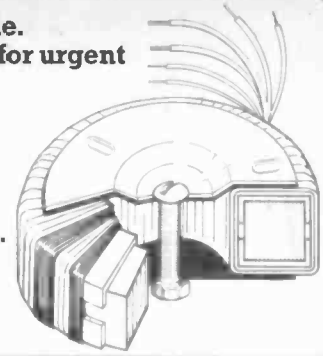

TYPE	SERIES No	SECONDARY Volts	RMS Current	PRICE	TYPE	SERIES No	SECONDARY Volts	RMS Current	PRICE	TYPE	SERIES No	SECONDARY Volts	RMS Current	PRICE																																								
<p><b>NEW! NEW! NEW!</b></p> <p><b>15 VA</b> 0x010 6+6 1.25            62 x 34mm 0x011 9+9 0.83            0.35Kg 0x012 12+12 0.63            Regulation 0x013 15+15 0.50            19% 0x014 18+18 0.42            0x015 22+22 0.34            0x016 25+25 0.30            0x017 30+30 0.25</p> <p><b>£5.12</b>            + p &amp; p £0.78            + VAT £0.89            TOTAL £6.79</p> <p>(encased in ABS plastic)</p>					<p><b>120 VA</b> 4x010 6+6 10.00            90 x 40mm 4x011 9+9 6.66            1.2Kg 4x012 12+12 5.00            Regulation 4x013 15+15 4.00            11% 4x014 18+18 3.33            4x015 22+22 2.72            4x016 25+25 2.40            4x017 30+30 2.00            4x018 35+35 1.71            4x028 110 1.09            4x029 220 0.54            4x030 240 0.50</p> <p><b>£7.42</b>            + p &amp; p £1.72            + VAT £1.37            TOTAL £10.51</p>					<p><b>300 VA</b> 7x013 15+15 10.00            110 x 50mm 7x014 18+18 8.33            2.6Kg 7x015 22+22 6.82            Regulation 7x016 25+25 6.00            6% 7x017 30+30 5.00            7x018 35+35 4.28            7x026 40+40 3.75            7x025 45+45 3.33            7x033 50+50 3.00            7x028 110 2.72            7x029 220 1.36            7x030 240 1.25</p> <p><b>£10.88</b>            + p &amp; p £2.05            + VAT £1.94            TOTAL £14.87</p>					<p><b>30 VA</b> 1x010 6+6 2.50            70 x 30mm 1x011 9+9 1.66            0.45Kg 1x012 12+12 1.25            Regulation 1x013 15+15 1.00            18% 1x014 18+18 0.83            1x015 22+22 0.68            1x016 25+25 0.60            1x017 30+30 0.50</p> <p><b>£5.49</b>            + p &amp; p £1.10            + VAT £0.99            TOTAL £7.58</p>					<p><b>160 VA</b> 5x011 9+9 8.89            110 x 40mm 5x012 12+12 6.66            1.8Kg 5x013 15+15 5.33            Regulation 5x014 18+18 4.44            8% 5x015 22+22 3.63            5x016 25+25 3.20            5x017 30+30 2.66            5x018 35+35 2.28            5x026 40+40 2.00            5x028 110 1.45            5x029 220 0.72            5x030 240 0.66</p> <p><b>£8.43</b>            + p &amp; p £1.72            + VAT £1.52            TOTAL £11.67</p>					<p><b>500 VA</b> 4x016 25+25 10.00            140 x 60mm 4x017 30+30 8.33            4Kg 4x018 35+35 7.14            Regulation 4x026 40+40 6.25            4% 4x025 45+45 5.55            4x033 50+50 5.00            4x042 55+55 4.54            4x028 110 4.54            4x029 220 2.27            4x030 240 2.08</p> <p><b>£14.38</b>            + p &amp; p £2.40            + VAT £1.94            TOTAL £19.30</p>					<p><b>50 VA</b> 2x010 6+6 4.16            80 x 35mm 2x011 9+9 2.77            0.9Kg 2x012 12+12 2.08            Regulation 2x013 15+15 1.66            13% 2x014 18+18 1.38            2x015 22+22 1.13            2x016 25+25 1.00            2x017 30+30 0.83            2x028 110 0.45            2x029 220 0.22            2x030 240 0.20</p> <p><b>£6.13</b>            + p &amp; p £1.35            + VAT £1.12            TOTAL £8.60</p>					<p><b>225 VA</b> 6x012 12+12 9.38            110 x 45mm 6x013 15+15 7.50            2.2Kg 6x014 18+18 6.25            Regulation 6x015 22+22 5.11            7% 6x016 25+25 4.50            6x017 30+30 3.75            6x018 35+35 3.21            6x026 40+40 2.81            6x025 45+45 2.50            6x033 50+50 2.25            6x028 110 2.04            6x029 220 1.02            6x030 240 0.93</p> <p><b>£9.81</b>            + p &amp; p £2.05            + VAT £1.78            TOTAL £13.64</p>					<p><b>625 VA</b> 9x017 30+30 10.41            140 x 75mm 9x018 35+35 8.92            5Kg 9x026 40+40 7.81            Regulation 9x025 45+45 6.94            4% 9x033 50+50 6.25            9x042 55+55 5.68            9x028 110 5.68            9x029 220 2.84            9x030 240 2.60</p> <p><b>£17.12</b>            + p &amp; p £2.55            + VAT £2.62            TOTAL £22.62</p>					<p><b>80 VA</b> 3x010 6+6 6.64            90 x 30mm 3x011 9+9 4.44            1Kg 3x012 12+12 3.33            Regulation 3x013 15+15 2.66            12% 3x014 18+18 2.22            3x015 22+22 1.81            3x016 25+25 1.60            3x017 30+30 1.33            3x028 110 0.72            3x029 220 0.36            3x030 240 0.33</p> <p><b>£6.66</b>            + p &amp; p £1.72            + VAT £1.26            TOTAL £9.64</p>					<p><b>ALSO AVAILABLE</b>            Sizes up to and including 5KVA are manufactured to order.</p>				
<p><b>30 VA</b> 1x010 6+6 2.50            70 x 30mm 1x011 9+9 1.66            0.45Kg 1x012 12+12 1.25            Regulation 1x013 15+15 1.00            18% 1x014 18+18 0.83            1x015 22+22 0.68            1x016 25+25 0.60            1x017 30+30 0.50</p> <p><b>£5.49</b>            + p &amp; p £1.10            + VAT £0.99            TOTAL £7.58</p>					<p><b>160 VA</b> 5x011 9+9 8.89            110 x 40mm 5x012 12+12 6.66            1.8Kg 5x013 15+15 5.33            Regulation 5x014 18+18 4.44            8% 5x015 22+22 3.63            5x016 25+25 3.20            5x017 30+30 2.66            5x018 35+35 2.28            5x026 40+40 2.00            5x028 110 1.45            5x029 220 0.72            5x030 240 0.66</p> <p><b>£8.43</b>            + p &amp; p £1.72            + VAT £1.52            TOTAL £11.67</p>					<p><b>500 VA</b> 4x016 25+25 10.00            140 x 60mm 4x017 30+30 8.33            4Kg 4x018 35+35 7.14            Regulation 4x026 40+40 6.25            4% 4x025 45+45 5.55            4x033 50+50 5.00            4x042 55+55 4.54            4x028 110 4.54            4x029 220 2.27            4x030 240 2.08</p> <p><b>£14.38</b>            + p &amp; p £2.40            + VAT £1.94            TOTAL £19.30</p>					<p><b>50 VA</b> 2x010 6+6 4.16            80 x 35mm 2x011 9+9 2.77            0.9Kg 2x012 12+12 2.08            Regulation 2x013 15+15 1.66            13% 2x014 18+18 1.38            2x015 22+22 1.13            2x016 25+25 1.00            2x017 30+30 0.83            2x028 110 0.45            2x029 220 0.22            2x030 240 0.20</p> <p><b>£6.13</b>            + p &amp; p £1.35            + VAT £1.12            TOTAL £8.60</p>					<p><b>225 VA</b> 6x012 12+12 9.38            110 x 45mm 6x013 15+15 7.50            2.2Kg 6x014 18+18 6.25            Regulation 6x015 22+22 5.11            7% 6x016 25+25 4.50            6x017 30+30 3.75            6x018 35+35 3.21            6x026 40+40 2.81            6x025 45+45 2.50            6x033 50+50 2.25            6x028 110 2.04            6x029 220 1.02            6x030 240 0.93</p> <p><b>£9.81</b>            + p &amp; p £2.05            + VAT £1.78            TOTAL £13.64</p>					<p><b>625 VA</b> 9x017 30+30 10.41            140 x 75mm 9x018 35+35 8.92            5Kg 9x026 40+40 7.81            Regulation 9x025 45+45 6.94            4% 9x033 50+50 6.25            9x042 55+55 5.68            9x028 110 5.68            9x029 220 2.84            9x030 240 2.60</p> <p><b>£17.12</b>            + p &amp; p £2.55            + VAT £2.62            TOTAL £22.62</p>					<p><b>80 VA</b> 3x010 6+6 6.64            90 x 30mm 3x011 9+9 4.44            1Kg 3x012 12+12 3.33            Regulation 3x013 15+15 2.66            12% 3x014 18+18 2.22            3x015 22+22 1.81            3x016 25+25 1.60            3x017 30+30 1.33            3x028 110 0.72            3x029 220 0.36            3x030 240 0.33</p> <p><b>£6.66</b>            + p &amp; p £1.72            + VAT £1.26            TOTAL £9.64</p>					<p><b>ALSO AVAILABLE</b>            Sizes up to and including 5KVA are manufactured to order.</p>																			
<p><b>50 VA</b> 2x010 6+6 4.16            80 x 35mm 2x011 9+9 2.77            0.9Kg 2x012 12+12 2.08            Regulation 2x013 15+15 1.66            13% 2x014 18+18 1.38            2x015 22+22 1.13            2x016 25+25 1.00            2x017 30+30 0.83            2x028 110 0.45            2x029 220 0.22            2x030 240 0.20</p> <p><b>£6.13</b>            + p &amp; p £1.35            + VAT £1.12            TOTAL £8.60</p>					<p><b>225 VA</b> 6x012 12+12 9.38            110 x 45mm 6x013 15+15 7.50            2.2Kg 6x014 18+18 6.25            Regulation 6x015 22+22 5.11            7% 6x016 25+25 4.50            6x017 30+30 3.75            6x018 35+35 3.21            6x026 40+40 2.81            6x025 45+45 2.50            6x033 50+50 2.25            6x028 110 2.04            6x029 220 1.02            6x030 240 0.93</p> <p><b>£9.81</b>            + p &amp; p £2.05            + VAT £1.78            TOTAL £13.64</p>					<p><b>625 VA</b> 9x017 30+30 10.41            140 x 75mm 9x018 35+35 8.92            5Kg 9x026 40+40 7.81            Regulation 9x025 45+45 6.94            4% 9x033 50+50 6.25            9x042 55+55 5.68            9x028 110 5.68            9x029 220 2.84            9x030 240 2.60</p> <p><b>£17.12</b>            + p &amp; p £2.55            + VAT £2.62            TOTAL £22.62</p>					<p><b>80 VA</b> 3x010 6+6 6.64            90 x 30mm 3x011 9+9 4.44            1Kg 3x012 12+12 3.33            Regulation 3x013 15+15 2.66            12% 3x014 18+18 2.22            3x015 22+22 1.81            3x016 25+25 1.60            3x017 30+30 1.33            3x028 110 0.72            3x029 220 0.36            3x030 240 0.33</p> <p><b>£6.66</b>            + p &amp; p £1.72            + VAT £1.26            TOTAL £9.64</p>					<p><b>ALSO AVAILABLE</b>            Sizes up to and including 5KVA are manufactured to order.</p>																																		
<p><b>80 VA</b> 3x010 6+6 6.64            90 x 30mm 3x011 9+9 4.44            1Kg 3x012 12+12 3.33            Regulation 3x013 15+15 2.66            12% 3x014 18+18 2.22            3x015 22+22 1.81            3x016 25+25 1.60            3x017 30+30 1.33            3x028 110 0.72            3x029 220 0.36            3x030 240 0.33</p> <p><b>£6.66</b>            + p &amp; p £1.72            + VAT £1.26            TOTAL £9.64</p>					<p><b>ALSO AVAILABLE</b>            Sizes up to and including 5KVA are manufactured to order.</p>																																																	

### The benefits of ILP toroidal transformers

ILP toroidal transformers are only half the weight and height of their laminated equivalents, and are available with 110V, 220V or 240V primaries coded as follows:

**IMPORTANT:** Regulation — All voltages quoted are FULL LOAD. Please add regulation figure to secondary voltage to obtain full load voltage.

For 110V primary insert "0" in place of "X" in type number

For 220V primary (Europe) insert "1" in place of "X" in type number

For 240V primary (UK) insert "2" in place of "X" in type number

Also available at Electrovalue, Maplin, Technomatic and Barrie Electronics.

For mail order please make your crossed cheques or postal orders payable to ILP Electronics Ltd, Barclaycard/Access welcome. Trade orders standard terms.

Post to: ILP Electronics Ltd, Graham Bell House, Roper Close, Canterbury CT2 7EP, Kent, England  
 Telephone (0227) 54778 Telex 965780



**ILP**  
 TRANSFORMERS  
 (a division of ILP Electronics Ltd)

## LOW COST PROFESSIONAL TEST INSTRUMENTS

**sabtronics**  
**FREQUENCY METERS**  
 100MHz, 600MHz, and 1GHz Models  
 from £67

**Belemic**  
 Hand Held  
 Analogue and  
 Digital  
 Multimeters  
 16 Models  
 from £18.75

**Belemic**

- ★ FREQUENCY METERS
- ★ ANALOGUE MULTIMETERS
- ★ DIGITAL MULTIMETERS
- ★ FUNCTION GENERATOR
- ★ OSCILLOSCOPES
- ★ POWER SUPPLIES
- ★ LOGIC PROBE
- ★ SCOPE PROBES

Write or phone for illustrated test instrument catalogue and price list

**Black Star Ltd.**  
 9A, Crown Street  
 St. Ives, Huntingdon  
 Cambs. PE17 4EB  
 Tel: (0480) 62440 Telex 32339





When replying to Classified Advertisements please ensure:

- (A) That you have clearly stated your requirements.
- (B) That you have enclosed the right remittance.
- (C) That your name and address is written in block capitals, and
- (D) That your letter is correctly addressed to the advertiser.

This will assist advertisers in processing and despatching orders with the minimum of delay.

### RECEIVERS AND COMPONENTS

**BOURNEMOUTH/BOSCOMBE.** Electronic components specialists for 33 years. Forresters (National Radio Supplies), Lane Holdenhurst Road, Now at 36, Ashley Road, Boscombe, Tel. 302204. Closed Weds.

**TURN YOUR SURPLUS** capacitors, transistors, etc. into cash. Contact COLEMAN HARDING & CO. 103 SOUTH BRINK, WISBECH, CAMBS. TEL: 0945 584188. Immediate settlement.

Ex-Govt. Transceiver type A40 complete station in used condition £17. Telephonist Headset & Mic (sound powered) new in box £4. Basic Oscilloscope unit 240V AC, contains X & Y amps, all solid state, size 14" x 7" x 5", tube dia 5" most units have tube burn marks £15. Aircraft mounted 35mm Camera contains precision mirror, lens, small 24V motor etc. £10. 24V Ni-Cad Battery contains 20 x 0.4 A/H cells (new) £7. CCTV Cameras sold for spares £20. Reel to Reel VTRs for spares £30. 24V Ni-Cad Battery contains 20 D type cells, used condition £10. All goods are surplus Ex-Ministry.

**A.C. ELECTRONICS**  
Tel: 0532 496048 after 6.30 pm

### FANTASTIC ELECTRONIC BARGAINS

#### VERSATILE BENCH POWER SUPPLY UNITS

Contains high quality transformer made to exacting specifications giving one 20v output and one 20-0-20v. output. All outputs 3amps. D.C. Input 110/250v. 50 c/s. Bridge Rectification. Contained on metal chassis with robust compact case size 7" x 5" x 4", easily modified to give 40v. or 60v output. Makes an ideal variable power supply. Normally cost around £60.00. OUR PRICE AS NEW with circuits £8.50. Carr. £3. 2 units for £20 carr. free.

**AMPLIYOX ULTRA LIGHTWEIGHT TRANSDUCER EARPHONES.** Impedance 300 ohms. Made to fit inside protective and crash helmets or can be used as pillow earphones. As new £6 per pair. P & P £1.00. 2 pairs £8 post free. 4 pairs £15 post free.

New release of **MODERN DYNAMIC MOVING COIL MICROPHONES.** 200 ohms impedance. Switch incorporated. Most with lead and DIN plug. Used but nice condition. 3 designs of case housing. Price one mike our choice £2 plus 50p p.p. Bargain offer all 3 mikes £4.50 p.p. £1.

**FOOT SWITCH.** (Mains operation). Contains two micro switches and lead. Metal case. Good condition. £3.50 each. Postage 50p. 2 for £7.50 post free.

**HAVE YOU SEEN THE GREEN CAT.** 1000+ of new components, radio, electronic, audio at unbelievably low prices. Send 50p for catalogue (refundable on purchase).

Try a **JUMBO PACK.** Contains transistors, resistors, caps, pots, switches, radio and electronic devices. **OVER £50 worth for £11.00.** Carriage and packing £2.50.

**MINI JUMBO PACK (£20 worth)** for £5. P & P £1.50. Please add 15% VAT to all orders including carriage and P.P.

*Myers Electronic Devices*

Dept PE3, 12/14 Harper Street, Leeds LS2 7EA. Leeds 452045. New retail premises at above address (opposite Corals). Callers welcome 9 to 5 Mon. to Sat. Sunday 10 to 1 by appointment. **GOVT. SURPLUS ITEMS ALWAYS IN STOCK.**

## SMALL ADS

The prepaid rate for classified advertisements is 34 pence per word (minimum 12 words), box number 60p extra. Semi-display setting £11.20 per single column centimetre (minimum 2.5 cms). All cheques, postal orders etc., to be made payable to Practical Electronics and crossed "Lloyds Banks Ltd". Treasury notes should always be sent registered post. Advertisements, together with remittance, should be sent to the Classified Advertisement Dept., Practical Electronics, Room 2612, IPC Magazines Limited, King's Reach Tower, Stamford St., London, SE1 9LS. (Telephone 01-261 5846).

### BRAND NEW COMPONENTS BY RETURN

**Electrolytic Capacitors 16V, 25, 50V**  
0.47 1.0 2.2 4.7 10 Mlds. 5p.  
22 47 100 7p. (50V 8p). 220 8p.  
150V 100p. 470 11p. (40V 16p). 1000 15V 15p.  
1000/25V 25p. 1000/40V 35p.

**Subminiature bead Tantulum electrolytics.**  
0.1 0.22 0.47 1.0 35V 4.7 6.3V 14p.  
2.2 35V 4.7 25V 15p. 10 25V 15 16V 20p.  
22 16V 33 10V 47 6V 68 3V & 100 3V 30p.  
15 25V 22 25V 47 10V 35p. 47 16V 80p.

**Subminiature Ceramic Caps. E12 Series 100V.**  
2% 10 pf. to 47 pf. 3p. 56 pf. to 330 pf. 4p.  
10% 390 pf. to 4700 pf. 4p.

**Vertical Mounting Ceramic Plate Caps. 50V.**  
E12 22 pf. to 1000 pf. E6 1500 pf. to 47000 pf. 2p.

**Polystyrene E12 Series 83V. Horizontal Mntg.**  
10 pf. to 820 pf. 3p. 1000 pf. to 10,000 pf. 4p.

**Miniature Polyester 250V Vert. Mtg. E6 Series.**  
0.1 to 0.68 4p. 1 5p. 15 22 6p. 33 2 47 10p.  
68 12p. 1 0 15p. 15 22 6p. 33 2 47 10p.

**Mylar (Polyester) Film 100V. Vertical Mounting.**  
0.01 0.022 0.047 3p. 0.1 0.22 4p. 0.4 0.5 0.1 5p.

**High Stability Miniature Film Resistors 5%.**  
1W E24 Series 0.51R - 10MΩ (Except 7MΩ) 1p.  
1/2W E12 Series 1R0 to 10MΩ 1p.  
1/4W E12 Series 10R to 10MΩ 1p.  
1/4W metal film E12 Series 10R 1MΩ 5% 2p. 1 2p.  
1N4148 - 2p. 1N4002 - 4p. 1N4008 - 6p. 1N4007 - 7p.  
BC107 B 9 12p. BC147 B 9. BC157 B 9. BF195 & 7 10p.  
8 Pin i.c.s 741 Op. amp. - 18p. 555 Timer - 24p.  
Dil Holders B pin - 9p. 14 pin - 12p. 16 pin - 14p.  
LED's 3 & 5mm. Red - 10p. Green & Yellow - 14p.  
Grommets for Junit 1 1/2p. Grommets for 5mm 2p.  
20mm. Q.B. Fusus 15 25 5 1 2 3 & 5A 5p.  
20mm. Anti Surge 100mA to 5 0A 8p.  
20mm. Fusoholders P.C. or Classis Mtg 8p.  
Battery Straps (leads) PP3 5p. PP9 12p.  
400mW Zener diodes E24 series 2V7 to 33V 8p.  
Prices VAT inclusive Post 15p. (Free over £5.00).

**THE C. R. SUPPLY CO.**  
127, Chesterfield Rd., Sheffield S8 0RN.

**ELECTRONIC COMPONENTS, MERSEYSIDE.** Mike Electronics, 2 Victoria Place, Seacombe Ferry, Wallasey, L34 6NR, Mer. Order, send 50p. For price list, refundable off first order. Tel. 051-638-8647.

**PRACTICAL ELECTRONICS PCB'S.** EA 400 £2.10; EA 1000 £0.54; EG 1000 £2.25; EG 1074 £0.85; EG 1076 £0.80; EG 84 £0.95; EA 398 £0.99 P&P inc. C.W.O. Delivery 2-3 days. Bradley Printed Circuits (G. D. Cowan), 9 Hancock Terrace, Headington, Oxford, OX3 7QJ.

### AERIALS

**AERIAL BOOSTERS** Trebles incoming signal. Price £7.00. SAE leaflets. **ELECTRONIC MAIL ORDER LTD.** Ramsbottom, Lancashire BL9 9AG.

### SOFTWARE

**UK 101 SOFTWARE - 8K -** Manoeuvr lost in the jungle, can you make it back to camp without being eaten, extremely addictive. CLEGMON 48 £32 £4.25. Cheques/P.O.s to: M. Scorer, 41, Weardale Ave., Forest Hill, Newcastle Upon Tyne.

**FANTASTIC 16K ZX81** Adventure, £3.00. Fight monsters, and collect as many treasures as possible. Only from Softbus (M. Beard), 6, Aston Mead, Salisbury, Wilts.

**CONVERT ZX81** to Epm programmer with ZP 4000 unit. SAE: details, Enterprise Technology Ltd., P.O. Box 140, Wigan WN3 6LE, Lancs.

### COURSES

**CONQUER THE CHIP**... Master modern electronics the PRACTICAL way by SEEING and DOING in your own home. Write for your free colour brochure now to British National Radio & Electronics School, Dept. C2, Reading, Berks. RG1 1BR.

**DIGITAL LOGIC COURSE**, unique home study. Pay by lesson. SAE: for details, Freeman Enterprises, 19, Graysmead, Sibbe Heddingham, Essex CO9 3PA.

## NOTICE TO READERS

*Whilst prices of goods shown in classified advertisements are correct at the time of closing for press, readers are advised to check with the advertiser to check both prices and availability of goods before ordering from non-current issues of the magazine.*

## BOOKS AND PUBLICATIONS

**ANY PUBLISHED**, full-size service sheet by return £2 + P&A. CTV/Music Centres £3. Repair data with all circuits, layouts etc. Your named TV or video £8.50. Free 50p mag. all orders queries. TIS (PE), 76 Churches, Larkhall, Lanarkshire.

## EDUCATIONAL

**CAREERS IN MARINE ELECTRONICS.** Courses commencing September and January. Further details. The Nautical College, Fleetwood FY7 8JZ. Tel: 03017 79123.

## SERVICE SHEETS

**BELL'S TELEVISION SERVICES** for Service Sheets on Radio, TV, etc £1.25 plus S.A.E. Colour TV Service Manuals on request. S.A.E. with enquiries to B.E.S. 190 Kings Road, Thirgrave, N. Yorkshire. Tel. (0423) 55885.

## FOR SALE

**SHEETMETAL FOLDERS.** 18" x 18G steel. 16G Aluminium Bench or Vice Held. £38. Carriage £4. Leaflet. 01-890 7838.

**PRACTICAL ELECTRONICS P.C.B.'s** 1.5mm fibre-glass, drilled and solder resist coated. **SAVE MONEY** - Boards PRINTED ONLY ready for own etching and drilling send S.A.E. for price list. ELECTROPRINT, 17 Showell Road, Babbury, Wolverhampton, West Midlands. Tel. 0902 721805.

**KSR TELETYPE** in good working order with paper punch reader. Only £75. Phone Davis (Surbiton) 01-399 5487.

## MISCELLANEOUS

**BUILD A TAPE DECK?** We supply Papst precision tape drive/rewind motors, 120/220 VAC, 12000 rpm, 14w only £4.90 new (£16.80 elsewhere). Matching capacitor 60p P&P £1.50. Stepping Motors. Ideal for Robotics, any precision control, six-wire S.S.v. 1.5A DC, torque 45ozin. £4.90 used P&P £1.50. Greenroo Robotics (PM-B), 5, Southernhay, Cavendish Road, Weybridge, Surrey KT13 0JN.

**PARAPHYSICAL JOURNAL** (Russian translations). Psychotronics, Kirilimography, heliophonic music, telekinetics. Computer software. SAE 4\*9\* - Parahel, Downton, Wilts.

**BURGLAR ALARM EQUIPMENT.** Ring Bradford (0274) 308920 for our catalogue or call at our large showrooms opposite Odsal Stadium.

**IONIZER.** Feel alert, invigorated and healthier with the amazing ZEPHYRON negative ion generator. Kit - £21.50. Built - £29.80 or SAE brings leaflets. Dataplus Developments, 81 Cholmeley Road, Reading, Berks RG1 3LY. 0734 67027.

## CENTURION ALARMS

We manufacture, you save £££'s  
Send s.a.e. or phone for our Free list of professional D.I.Y. Burglar Alarm Equipment and accessories.  
Discount up to 20% off list prices, e.g. Control Equipment for £15.98. Decoy Bell Boxes from £5.95 inc.

TRADE ENQUIRIES WELCOME

0484-21000

or 0484 35527 (24 hr. ans.)

CENTURION ALARMS (PE)

265 Wakefield Road, Huddersfield

HD5 9BE, W. Yorkshire

Access & Visa Orders Welcomed





# FREE CAREER BOOKLET

**Train for success in Electronics Engineering, T.V. Servicing, Electrical Engineering—or running your own business!**

ICS have helped thousands of ambitious people to move up into higher paid, more secure jobs in the fields of electronics, T.V., electrical engineering—now it can be your turn. Whether you are a newcomer to the field or already working in these industries, ICS can provide you with the specialised training so essential to success.

## Personal Tuition and 80 Years of Success

The expert and personal guidance by fully qualified tutors, backed by the long ICS record of success, is the key to our outstanding performance in the technical field. You study at the time and pace that suits you best and in your own home.

You study the subjects you enjoy, receive a formal Diploma, and you're ready for that better job, better pay.

**TICK THE FREE BOOKLET YOU WANT AND POST TODAY**

### ELECTRONICS ENGINEERING

A Diploma Course, recognised by the Institute of Engineers & Technicians as meeting all academic standards for application as an Associate.



### T.V. & AUDIO SERVICING

A Diploma Course, training you in all aspects of installing, maintaining and repairing T.V. and Audio equipment, domestic and industrial.



### ELECTRICAL ENGINEERING

A further Diploma Course recognised by the Institute of Engineers & Technicians, also covering business aspects of electrical contracting.



### RUNNING YOUR OWN BUSINESS

If running your own electronics, T.V. servicing or electrical business appeals, then this Diploma Course trains you in the vital business knowledge and techniques you'll need.



Name .....

Address .....

**ICS** ICS  
Dept H627  
160 Stewarts Road,  
London SW8 4UJ



01 622 9911  
(all hours)

### SINCLAIR AND ORIC COMPUTERS



UK prices are shown first. The bracketed prices are European export prices which include insured air-mail postage to all the countries of Europe including Norway, Sweden, Finland, Denmark, Spain and Italy. For overseas customers outside Europe an extra £5 postage per item is charged.

At last our new luxury versions of the 48K Sinclair Spectrum are here with full sized typewriter keyboards enclosed in a tough larger plastic case which also houses the power supply and the computer pcb. Full-travel, gold-plated switch contacts with a life of 10<sup>6</sup> operations are fitted. Believe it or not these cost only a tiny bit more than the standard model. Spectrum ZXK £161 (£181). Spectrum ZXKS (As above but also fitted with a space bar and double sized shift and enter keys) £169 (£189). Standard ZX Spectrum 16K £108.70 (£129). Standard ZX Spectrum 48K £152 (£172). 32K memory upgrade for 16K spectrum (Issue 2 only) £44 (£45). Fuller master unit for the Spectrum including speech synthesizer, sound synthesizer, amplifier and joystick ports £47.78 (£56). ZX microdrive n/a (n/a). ZX RS232 n/a (n/a). ZX printer £52.13 (£61). 5 printer rolls £10.43 (£16). ZX81 £43.43 (£52). ZX81 ram packs 16K £26.04 (£28). 64K £49 (£51). Oric 1 48K Computer £147 (£158). Keyboards for ZX81 and ZX Spectrum—without spacebar £28 (£33), with spacebar £36 (£41).

### DRAGON 32 £173

### COMMODORE COMPUTERS

Commodore 64 £299. Vic 20 £130. Kit to allow the use of an ordinary mono cassette recorder with the Vic 20 and the Commodore 64 £6. Commodore cassette recorder for these computers £36.50. Super expander high resolution cartridge £27.95. We stock most accessories.

### SWANLEY ELECTRONICS

Dept PE, 32 Goldsel Rd.,  
Swanley, Kent BR8 8EZ.  
Tel. Swanley (0322) 64851  
Please allow 7 days for delivery.

### GENIE COMPUTERS

New colour Genie £179. Cassette Recorder £25. 16K Ram Card £33. Light Pen £15. Accessories for Genie 1 and Genie 2—EG3014 32K £189. Disc drives single £199, dual £369. Double Density Converter £72. High Resolution Graphics £82. Printer Interface £36.

### UK101 AND SUPERBOARD

32x48 Display Expansion Kits UK101 £9. Series 1 Superboard £14. 32K Memory Expansion Board £40. Cegron £22.50. Word Processor Prog. £10. Centronics Interface Kit £10. Cased Disc Drives with DOS single £275, double £415. Stand alone floppy disc controller £85.

### PRINTERS

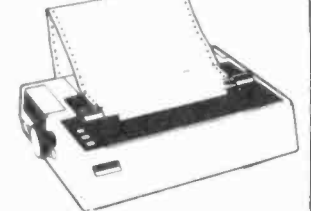

Low cost Daisy Wheels—Smith-Corona TPI £418. Brother HRI £520. Olivetti Praxis 30 Bytewriter—the latest miracle, a combined Daisy Wheel Printer and Electric Typewriter for only £418. Epson FX80 £387. Epson MX100/3 £425. Oki Microline 80 £199. Oki Microline 82A £343. Oki Microline 83A £467. Oki Microline 84 £684. Oki Microline 92 £437. Oki Microline 93 £599.

### 5V POWER KITS

Fully stabilized 5V Computer and TTL Power Kits 1.5A £7.83, 3A £12.17, 6A £20.87.

### SHARP COMPUTERS

We can supply Epson printers to run direct from the MZ80A, MZ80K (i/o box not needed) for £72 plus printer price. We also specialize in interfacing printers to the MZ80K, MZ80A and MZ80B both with and without the i/o box.

Postage £1 on Sinclair products (UK), £3.50 on other computers, £4.50 on printers and 50p on other orders. Please add VAT to all prices. Official credit and overseas orders welcome.



**Revolution in circuit board maker kits from leading manufacturer**

The Electrolube CM100 Circuit Maker provides everything necessary to produce positive photographic film masters from same-size published circuit layouts and to make either single or double-sided boards from these or other positive film masters.

### Features

- Economic and simple to use.
- No expensive equipment required e.g. darkroom, cameras etc.
- Photographic experience not needed.
- Simple etching process.
- Universal exposure and assembly frame custom-designed, professional quality.
- Ergonomically designed storage pack which includes free-standing shelf for chemicals.
- Step-by-step instruction manual, workbench and trouble-shooting charts provided.
- Special clearing process ensures excellent clear positive film masters.
- Photoresist available in non-aerosol form to eliminate 'spotting' when applied to the board.

Mercia Electronics, Coronet House, Upper Well St., Coventry CV1 4AF.

Send for full illustrated brochure and price details, post to:

Name .....

Address .....

Signature .....

**mercia**

**ELECTRONICS**

Coronet House,  
Upper Well Street  
Coventry CV1 4AF  
Tel: (0203) 58541

# SWITCH ON TO

JUNE 1983

NOW ON SALE 90p

# TELEVISION

SERVICING-VIDEO-CONSTRUCTION-DEVELOPMENTS

If you have trouble understanding chopper circuits and protection arrangements, want to know about flywheel line sync, are deeply interested in all things from pattern generators to satellite TV receiving techniques—well, have we got the magazine for you!

What would you say to a unique specialist magazine which offers guidance to enthusiasts as well as electronics technicians on all aspects of TV and Video, including servicing, news and developments?...it's well worth a closer look...

\*June project: In situ transistor SCR and diode tester—simple and inexpensive—uses l.e.d.s to indicate polarity and device condition.

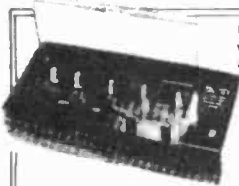

Universal NI-CAD, battery charger. All plastic case with lift up lid. Charge/Test switch. LED indicators at each of the five charging points.

Charges:- PP3 (9V), U12 (1.5V penlite), U11 (1.5V "C"), U2 (1.5V "D"). Power:- 220-240V AC. Dims:- 210 x 100 x 50mm. Knock down price only while stocks last.

Only **£6.00**  
Order No. MW 398

#### Multimeter & Transistor Tester

DC volts 0-1v-5v-2.5v-10v-50v-250v-1000v ±3%

AC volts 0-10v-50v-250v-1000v ±3%

DC current 0-50uA-2.5mA-25mA-0.25A ±3%

#### Resistance:

Minimum 0-2-2-200-200k ohms

Midscale 20-200-20k-200k ohms

Maximum 2k-20k-2m-20m ohms

As a transistor tester

Leakage current 0-150uA at Z1k range

0-15mA at X10 range

0-150mA at X1 range

PLEASE ADD 15% VAT & £1 P&P

Only **£11.95**  
Order No. HT 320

±3%  
±5% Please allow 10 days for delivery.



**ENFIELD ELECTRONICS**

208 BAKER ST., ENFIELD, MIDDX. Tel: 01-366 1873



## PARNDON ELECTRONICS LTD.

Dept. No. 21 44 Paddock Mead, Harlow, Essex. CM18 7RR. Tel: 0279 32700

**RESISTORS:** 1/4 Watt Carbon Film E24 range ± 5% tolerance. High quality resistors made under strictly controlled conditions by automatic machines. Banded and colour coded.

£1.00 per hundred mixed. (Min 10 per value)

£8.50 per thousand mixed. (Min 50 per value)

Special stock pack, 60 values, 10 off each **£5.50**



**DIODES:** IN4148 3p each. Min order quantity - 15 items  
£1.60 per hundred

**DIL SOCKETS:** High quality, low profile sockets.

8 pin - 10p. 14 pin - 11p. 16 pin - 12p. 18 pin - 19p. 20 pin - 21p.  
22 pin - 23p. 24 pin - 25p. 28 pin - 27p. 40 pin - 42p.

**CAPACITORS, REGULATORS, SWITCHES, IC, TRANSISTORS, DIODES, ETC. ETC.**  
Full List Available - Send SAE

ALL PRICES INCLUDE V.A.T. & POST & PACKING — NO EXTRAS  
MIN. ORDER — U.K. £1.00. OVERSEAS £5 CASH WITH ORDER PLEASE  
Same Day Despatch



When you need to update yourself with all that is available in the "Do-it-yourself" market, then you need the Hobby Herald.

Packed with product information essential to the electronics enthusiast, this new electronics catalogue lists over 60 exciting products ranging from All Purpose Cutters to Verobloc, the solderless breadboard. All products are available throughout the U.K. from over 200 stockists.

# HOBBY HERALD

Alternatively ordering products through the Herald is simplicity itself, and you can pay by either cheque, Barclaycard or Access. So make sure you get your copy of Hobby Herald by ringing

**(04215) 62829.**



BICC-Vero Electronics Ltd., Industrial Estate, Chandlers Ford, Hampshire, SO5 3ZR.



# INDEX TO ADVERTISERS

AC Electronics .....	80
A. D. Electronics .....	76
Alcon .....	48
Audio Electronics .....	76
Aura Sounds (Wersi) .....	47
Bicc Vero .....	83
Bi-Pak .....	6
Blackstar Limited .....	79
British National Radio & Electronics School .....	67 & 77
Cambridge Kits .....	76
Centurion Alarms .....	80
Clef Products .....	12
Colne Robotics .....	75
Commquip .....	47
Cricklewood Electronics .....	10
Crofton .....	76
The C.R. Supply Co. ....	80
Dataman Design .....	14
Electrovalue .....	78
Enfield Electronics .....	83
Flight Electronics .....	11
G.C.H.Q. ....	78
Grenson (EMOS) .....	77
G.S.C. ....	35
Adam Hall Supplies Ltd .....	81
ICS Intertext .....	82
I.L.P. Electronics .....	4 & 5, 79
Magenta .....	78
Maplin Electronics .....	Cover IV
Marconi Space & Defence Systems .....	81
Mercia .....	82
Midwich .....	13
Millhill Supplies .....	77
Modern Book Co. ....	78
Myers Electronics .....	80
Parndon Electronics .....	83
Phonosonics .....	77
P.K.G. Electronics .....	81
Powertran .....	29
Proto Design .....	81
Radio & T.V. Components .....	48
Riscomp Ltd. ....	67
S.A.T. ....	74
Scientific Wire Co. ....	81
Sinclair .....	8 & 9
Sparkrite .....	7
Swanley .....	82
Technomatic Ltd .....	84 & Cover III
T.K. Electronics .....	12
Videotone .....	75
Watford Electronics .....	2 & 3

# TECHNOMATIC LTD

01-452 1500 01-450 6597

## CONNECTOR SYSTEMS

I.D. CONNECTORS (Speedblock Type)				D-CONNECTORS 9 way 15 way 25 way 37 way				DIL HEADER PLUGS RS 232 Connectors Available from Stock		RIBBON CABLE (Grey)	
No. of ways	Header Plug	Recep. Tackle	Edge Conn.	Solder Angled	95p 160p	135p 230p	180p 265p	250p 425p	RS 232 Connectors Available from Stock	10 way	50p
10	90p	85p	200p							14 way	60p
20	145p	125p	240p							16 way	70p
26	175p	150p	300p							20 way	80p
34	200p	160p	380p							25 way	120p
40	220p	190p	550p							34 way	180p
50	235p	200p	600p							40 way	210p
										50 way	330p
										64 way	370p

JUMPER LEADS				EURO CONNECTORS (Indirect Edge Conn.)				EDGE CONNECTORS			
24" Ribbon Cable with headers				DIN STD				0.1" 0.156"			
1 end	145p	85p	240p	41617	21 way	180p	180p	2x18 way	140p		
2 ends	210p	230p	345p	41617	31 way	200p	200p	2x22 way	200p		
24" Ribbon Cable with sockets				41612				2x25 way		225p	
1 end	185p	210p	270p	41612	2x32 way	290p	330p	1x43 way	260p		
2 ends	290p	385p	490p	41612	3x32 way	325p	400p	2x43 way	395p		
24" Ribbon Cable with D Conn.				41612				2x50 way		—	
25 way Male 500p Female 550p.				Angled 3x32 way				—		400p	
				2x32 way IDC a+c				525p		1x77 way	700p
				(for 2x32 way specify a+b or a+c)				—		400p	
								\$100 Conn		—	600p

### ★ SPECIAL OFFER ★

2114L-450	80p	25-99	75p	2732	375p	1-24	25-99
4164-2	450p	430p	4116-200	80p	75p		
2716(+5V)	250p	225p	6116-150	375p	350p		
2532	350p	335p	6522	310p	300p		

### OFFICIAL BBC DEALER

BBC Model B £399 including VAT. (Carr. £8)

Model A to B upgrade kit £49.50

Installation charge £15

Individual upgrades and all mating connectors available.

### BBC DISC DRIVES

Disc Interface Kit £95 Installation £20  
BBC Single Drive 100K £235. BBC Dual Drive £799

### BBC COMPATIBLE DRIVES

Single 100K	£190	200K	£255	400K	£345
Dual 200K	£360	400K	£480	800K	£610

Cable for Single Drive £8. Dual Drive £12.

(Carr. Single Drive £6, Dual Drive £8)

Diskettes: 40 track SS £15, 80 track SS £24, 80 track DS £32.

(Price for 10 carr. £2)

VIEW 16K WORD PROCESSOR ROM £52

TELETEXT RECEIVER £195.65 + £2 p&p

PRESTEL RECEIVER £90.00 + £2 p&p

2ND PROCESSOR + 64K RAM £195 + £2

p&p

Please phone to confirm delivery details.

**NEW FOR BBC**

### PRINTERS

#### NEC PC 8023 BE

80 col 100 cps dot matrix printer. Bi-directional. Logic seeking, 2K buffer, Forward and Reverse line feed. Hi Res & Block Graphics, Proportional Spacing, International and Greek character sets, Auto underline, Friction/tractor selectable. £345 + £8 carr.

#### EPSON RX80 and EPSON FX80

RX80 100CPS 80 col Tractor Feed. FX80 160CPS 80 col F & T Feed. Logic seeking, Bi-directional, Bit Image Printing, 9 x 9 Matrix, Auto Underline. RX80 £298. FX80 £438 (Carr. £8/Unit)

#### SEIKOSHA GP100A

80 col. 30 cps dot matrix printer. High Res Graphics - Std & double with characters. £180 + £6 carr.

#### OLIVETTI SPARK-JET PRINTER

50 Lines/min or 83 cps, 1K buffer, full graphics, 96ASCII Characters, 7 x 7 dot matrix. £365 + £8 carr.

As recommended by ACORN.

ACORN ATOMS ALSO AVAILABLE IN STOCK.  
SEND FOR OUR BBC/ATOM LIST.



# COMPUTER COMPONENTS

7400	11p	74285	160p	74LS323	160p	74C10	20p	4053	50p	14495	300p	LM3915	200p	1800CE	650p	EP9385	£48	INTERFAC.	CRYSTALS
7401	11p	74290	75p	74LS324	150p	74C14	80p	4054	90p	14599	200p	LM3916	225p	2650A	£12	EP9386	£48	DS585CJ	775p
7402	11p	74293	75p	74LS348	80p	74C20	60p	4055	90p	LINEAR IC	200p	LM3917	110p	6502	350p	MC6845	£6	AD5861J	1250p
7403	12p	74298	100p	74LS352	80p	74C22	60p	4056	90p	AN103	200p	M51513L	230p	6502A	500p	MC6847	650p	AM25510	350p
7404	12p	74365A	30p	74LS353	60p	74C23	50p	4057	450p	AV1 0212	600p	M51516L	200p	6800	225p	SFF9364	£2	AM25L2521	£2
7405	15p	74368A	30p	74LS356	250p	74C24	45p	4058	55p	AV1 1320	225p	MB3712	200p	6809	650p	TMS1601	£12	AM26LS321	125p
7406	18p	74376	100p	74LS363	140p	74C25	50p	4059	406p	AV1 5010	99p	MC1310P	150p	6809E	£12	TMS9918	£36	AM26LS32	125p
7407	18p	74393	90p	74LS364	140p	74C26	45p	4060	55p	AV1 5910	380p	MC1458	36p	6809E	£12	TMS9927	£18	AM26LS32	125p
7408	14p	74430	95p	74LS374	140p	74C27	50p	4061	225p	AV3 8912	625p	MC1458	36p	6809E	£12	TMS9928	£20	DM8131	275p
7409	14p	74430	95p	74LS374	140p	74C28	45p	4062	175p	AV5 4007D	600p	MC1496	70p	6809E	£12	TMS9929	£20	DM8131	275p
7410	16p	74LS00	11p	74LS374	140p	74C29	45p	4063	90p	CA3028A	120p	MC3340P	150p	8035	350p	8039	£1	DP8304	250p
7411	16p	74LS01	11p	74LS374	140p	74C30	45p	4064	27p	CA3019	80p	MC3401	100p	8039	£1	8085A	250p	DS3691	300p
7412	14p	74LS01	11p	74LS374	140p	74C31	45p	4065	27p	CA3046	70p	MC3403	65p	8085A	250p	8085A	450p	DS8830	140p
7413	16p	74LS02	11p	74LS374	140p	74C32	45p	4066	27p	CA3048	220p	MF100N	250p	8748	£16	8748	£16	DS8831	140p
7414	18p	74LS03	12p	74LS374	140p	74C33	45p	4067	225p	CA3059	285p	MC50398	635p	8748	£16	INS8060	£11	DS8832	250p
7415	18p	74LS03	12p	74LS374	140p	74C34	45p	4068	14p	CA3086	48p	NE531	140p	8748	£16	INS9890	£20	DS8833	225p
7416	18p	74LS05	12p	74LS374	140p	74C35	45p	4069	14p	CA3089E	200p	NE555	16p	8748	£16	NE555	16p	DS8836	150p
7417	18p	74LS08	12p	74LS374	140p	74C36	45p	4070	14p	CA3090AQ	375p	NE555	45p	8748	£16	NE555	45p	DS8838	225p
7418	18p	74LS08	12p	74LS374	140p	74C37	45p	4071	14p	CA3100	90p	NE555	45p	8748	£16	NE555	45p	MC1488	55p
7419	18p	74LS08	12p	74LS374	140p	74C38	45p	4072	14p	CA3106	90p	NE555	45p	8748	£16	NE555	45p	MC1489	55p
7420	14p	74LS10	12p	74LS374	140p	74C39	45p	4073	14p	CA3140E	90p	NE555	45p	8748	£16	NE555	45p	MC3446	500p
7421	20p	74LS10	12p	74LS374	140p	74C40	45p	4074	14p	CA3160E	100p	NE555	45p	8748	£16	NE555	45p	MC3480	850p
7422	18p	74LS12	13p	74LS374	140p	74C41	45p	4075	14p	CA3161E	150p	NE555	45p	8748	£16	NE555	45p	MC3486	500p
7423	18p	74LS12	13p	74LS374	140p	74C42	45p	4076	14p	CA3161E	150p	NE555	45p	8748	£16	NE555	45p	MC3487	500p
7424	18p	74LS13	13p	74LS374	140p	74C43	45p	4077	14p	CA3161E	150p	NE555	45p	8748	£16	NE555	45p	MC3487	500p
7425	18p	74LS13	13p	74LS374	140p	74C44	45p	4078	14p	CA3161E	150p	NE555	45p	8748	£16	NE555	45p	MC3487	500p
7426	18p	74LS13	13p	74LS374	140p	74C45	45p	4079	14p	CA3161E	150p	NE555	45p	8748	£16	NE555	45p	MC3487	500p
7427	18p	74LS15	25p	74LS374	140p	74C46	45p	4080	14p	CA3161E	150p	NE555	45p	8748	£16	NE555	45p	MC3487	500p
7428	18p	74LS15	25p	74LS374	140p	74C47	45p	4081	14p	CA3161E	150p	NE555	45p	8748	£16	NE555	45p	MC3487	500p
7429	18p	74LS20	12p	74LS374	140p	74C48	45p	4082	14p	CA3161E	150p	NE555	45p	8748	£16	NE555	45p	MC3487	500p
7430	14p	74LS20	12p	74LS374	140p	74C49	45p	4083	14p	CA3161E	150p	NE555	45p	8748	£16	NE555	45p	MC3487	500p
7431	14p	74LS20	12p	74LS374	140p	74C50	45p	4084	14p	CA3161E	150p	NE555	45p	8748	£16	NE555	45p	MC3487	500p
7432	18p	74LS22	13p	74LS374	140p	74C51	45p	4085	14p	CA3161E	150p	NE555	45p	8748	£16	NE555	45p	MC3487	500p
7433	22p	74LS26	14p	74LS374	140p	74C52	45p	4086	14p	CA3161E	150p	NE555	45p	8748	£16	NE555	45p	MC3487	500p
7434	22p	74LS26	14p	74LS374	140p	74C53	45p	4087	14p	CA3161E	150p	NE555	45p	8748	£16	NE555	45p	MC3487	500p
7435	22p	74LS26	14p	74LS374	140p	74C54	45p	4088	14p	CA3161E	150p	NE555	45p	8748	£16	NE555	45p	MC3487	500p
7436	22p	74LS26	14p	74LS374	140p	74C55	45p	4089	14p	CA3161E	150p	NE555	45p	8748	£16	NE555	45p	MC3487	500p
7437	22p	74LS26	14p	74LS374	140p	74C56	45p	4090	14p	CA3161E	150p	NE555	45p	8748	£16	NE555	45p	MC3487	500p
7438	22p	74LS26	14p	74LS374	140p	74C57	45p	4091	14p	CA3161E	150p	NE555	45p	8748	£16	NE555	45p	MC3487	500p
7440	15p	74LS28	14p	74LS374	140p	74C58	45p	4092	14p	CA3161E	150p	NE555	45p	8748	£16	NE555	45p	MC3487	500p
7441	55p	74LS30	13p	74LS374	140p	74C59	45p	4093	14p	CA3161E	150p	NE555	45p	8748	£16	NE555	45p	MC3487	500p
7442A	30p	74LS32	13p	74LS374	140p	74C60	45p	4094	14p	CA3161E	150p	NE555	45p	8748	£16	NE555	45p	MC3487	500p
7443	30p	74LS32	13p	74LS374	140p	74C61	45p	4095	14p	CA3161E	150p	NE555	45p	8748	£16	NE555	45p	MC3487	500p
7444A	50p	74LS33	14p	74LS374	140p	74C62	45p	4096	14p	CA3161E	150p	NE555	45p	8748	£16	NE555	45p	MC3487	500p
7445A	50p	74LS33	14p	74LS374	140p	74C63	45p	4097	14p	CA3161E	150p	NE555	45p	8748	£16	NE555	45p	MC3487	500p
7446A	35p	74LS38	14p	74LS374	140p	74C64	45p	4098	14p	CA3161E	150p	NE555	45p	8748	£16	NE555	45p	MC3487	500p
7447A	35p	74LS38	14p	74LS374	140p	74C65	45p	4099	14p	CA3161E	150p	NE555	45p	8748	£16	NE555	45p	MC3487	500p
7448	45p	74LS42	14p	74LS374	140p	74C66	45p	4100	14p	CA3161E	150p	NE555	45p	8748	£16	NE555	45p	MC3487	500p
7449	45p	74LS42	14p	74LS374	140p	74C67	45p	4101	14p	CA3161E	150p	NE555	45p	8748	£16	NE555	45p	MC3487	500p
7450	15p	74LS47	36p	74LS374	140p	74C68	45p	4102	14p	CA3161E	150p	NE555	45p	8748	£16	NE555	45p	MC3487	500p
7451	15p	74LS47	36p	74LS374	140p	74C69	45p	4103	14p	CA3161E	150p	NE555	45p	8748	£16	NE555	45p	MC3487	500p
7452	15p	74LS47	36p	74LS374	140p	74C70	45p	4104	14p	CA3161E	150p	NE555	45p	8748	£16	NE555	45p	MC3487	500p
7453	15p	74LS47	36p	74LS374	140p	74C71	45p	4105	14p	CA3161E	150p	NE555	45p	8748	£16	NE555	45p	MC3487	500p
7454	15p	74LS55	14p	74LS374	140p	74C72	45p	4106	14p	CA3161E	150p	NE555	45p	8748	£16	NE555	45p	MC3487	500p
7455	15p	74LS55	14p	74LS374	140p	74C73	45p	4107	14p	CA3161E	150p	NE555	45p	8748	£16	NE555	45p	MC3487	500p
7456	15p	74LS55	14p	74LS374	140p	74C74	45p	4108	14p	CA3161E	150p	NE555	45p	8748	£16	NE555	45p	MC3487	500p
7457	15p	74LS55	14p	74LS374	140p	74C75	45p	4109	14p	CA3161E	150p	NE555	45p	8748	£16	NE555	45p	MC3487	500p
7458	15p	74LS55	14p	74LS374	140p	74C76	45p	4110	14p	CA3161E	150p	NE555	45p	8748	£16	NE555	45p	MC3487	500p
7459	15p	74LS55	14p	74LS374	140p	74C77	45p	4111	14p	CA3161E	150p	NE555	45p	8748	£16	NE555	45p	MC3487	500p
7460	15p	74LS55	14p	74LS374	140p	74C78	45p	4112	14p	CA3161E	150p	NE555	45p	8748	£16	NE555	45p	MC3487	500p
7461	15p	74LS55	14p	74LS374	140p	74C79	45p	4113	14p	CA3161E	150p	NE555	45p	8748	£16	NE555	45p	MC3487	500p
7462	15p	74LS55	14p	74LS374	140p	74C80	45p	4114	14p	CA3161E	150p	NE555	45p	8748	£16	NE555	45p	MC3487	500p
7463	15p	74LS55	14p	74LS374	140p	74C81	45p	4115	14p	CA3161E	150p	NE555	45p	8748	£16	NE555	45p	MC3487	500p
7464	15p	74LS55	14p	74LS374	140p	74C82	45p	4116	14p	CA3161E	150p	NE555	45p	8748	£16	NE555	45p	MC3487	500p
7465	15p	74LS55	14p	74LS374	140p	74C83	45p	4117	14p	CA3161E	150p	NE555	45p	8748	£16	NE555	45p	MC3487	500p
7466	15p	74LS55	14p	74LS374	140p	74C84	45p	4118	14p	CA3161E	150p	NE555	45p	8748	£16	NE555			

# Maplin News

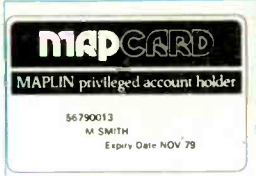

Send now for an application form — then buy it with MAPCARD.

MAPCARD gives you real spending power — up to 24 times your monthly payments — instantly!

## Sole UK Agents for Heathkit

NOW THE world-famous Heathkit range of superb electronic kits is available from Maplin — the newly appointed exclusive UK distributor. Kits range from a simple clock for beginners to a unique Robot (see pic) with which you can learn about robotics.

There is a range of training courses covering electronics and computing topics, many containing constructional projects. For full details, pick up a copy of the latest Maplin magazine or write for a free copy of our Heathkit catalogue. Order As XH62S.



### GREAT PROJECTS FROM E&MM



OUR NEW book "Best of E&MM Projects Vol. 1" brings together 21 fascinating and novel projects from E&MM's first year.

Projects include Harmony Generator, Guitar Tuner, Hexadrum, Syntom, Auto Swell, Partylite, Car Aerial Booster, MOS-FET Amp and other musical, hi-fi and car projects. ORDER AS XH161R. PRICE £1.

## Computer Shopping Arrives

AS FROM June 1st you can place orders directly with our computer from your personal computer. The computer shopping revolution has arrived! To communicate, you'll need a modem (our RS232 compatible modem kit is LW99H price £39.95) and an interface (our ZX81 interface LK08J price £24.95 is available already with many more for most popular micros coming soon).

Just dial us up on 0702 552941 and you'll be able to interrogate our stock file then place your order, type in your credit card number and a few minutes after you hang up your order will print out in our warehouse ready for packing. And all without saying a word.

Try out the future way of shopping now! You'll see immediately what stock we've got available and you'll discover how easy it is to ensure your order is exactly right. And you'll see precisely what the current price is for each item and what total amount will be charged to your credit card. It all helps to make buying easier. So give us a ring now!

## Maplin's Fantastic Projects

FULL DETAILS in our project books. Price 70p each.

**In Book 1 (XA01B)** 120W rms MOSFET Combo-Amplifier • Universal Timer with 18 program times and 4 outputs • Temperature Gauge • Six Vero Projects.

**In Book 2 (XA02C)** Home Security System • Train Controller for 14 trains on one circuit • Stopwatch with multiple modes • Miles-per-Gallon Meter.

**In Book 3 (XA03D)** ZX81 Keyboard with electronics • Stereo 25W MOSFET Amplifier • Doppler Radar Intruder Detector • Remote Control for Train Controller.

**In Book 4 (XA04E)** Telephone Exchange for 16 extensions • Frequency Counter 10Hz to



600MHz • Ultrasonic Intruder Detector • I/O Port for ZX81 • Car Burglar Alarm • Remote Control for 25W Stereo Amp.

**In Book 5 (XA05F)** Modem to European standard • 100W 240V AC Inverter • Sounds Generator for ZX81 • Central Heating Controller • Panic Button for Home Security System • Model Train Projects • Timer for External Sounder.

**In Book 6 (XA06G)** Speech Synthesiser for ZX81 & VIC 20 •

Module to Bridge two of our MOSFET Amps to make a 350W Amp • ZX81 Sound on your TV • Scratch Filter • Damp Meter • Four Simple Projects.

**In Book 7 (XA07H)** • Modem Interface for ZX81/VIC20 • Digital Enlarger Timer/Controller • DXers Audio Processor • Sweep Oscillator • Minilab Power Supply • Electronic Lock • and others.

\*Projects for Book 7 were in an advanced state at the time of writing, but contents may change prior to publication (due 14th May 1983).

### 25W Stereo MOSFET Amplifier



- Over 26W/channel into 8Ω at 1kHz both channels driven.
- Frequency response 20Hz to 40kHz ± 1dB.
- Low distortion, low noise and high reliability power MOSFET output stage.
- Extremely easy to build. Almost everything fits on main pcb, cutting interwiring to just 7

wires (plus toroidal transformer and mains lead terminations). • Complete kit contains everything you need including pre-drilled and printed chassis and wooden cabinet.

Full details in Projects Book 3. Price 70p (XA03D). Complete kit only £55.20 incl. VAT and carriage (LW71N).

### MATINEE ORGAN

EASY-TO-BUILD, superb specification. Comparable with organs selling for up to £1000.

Full construction details in our book (XH55K). Price £2.50. Complete kits available. Electronics (XY91Y) £299.95\*. Cabinet (XY93B) £99.50\*. Demo cassette (XX43W) £1.99. \*Carriage extra



### Maplin's New 1983 Catalogue

Over 390 pages packed with data and pictures and all completely revised and including over 1000 new items.

On sale in all branches of WH SMITH. Price £1.25.



MAPLIN ELECTRONIC SUPPLIES LIMITED, P.O. Box 3, Rayleigh, Essex SS6 8LR. Telephone: Sales (0702) 552911 General (0702) 554155.

Shops at: 159 King St., Hammersmith, London W6. Tel: 01-748 0926. 284 London Rd., Westcliff-on-Sea, Essex. Tel: (0702) 554000. Lynton Square, Perry Barr, Birmingham. Tel: (021) 356 7292.

Shops closed Mondays.

All prices include VAT & carriage. Please add 50p handling charge to orders under £5 total value.

#### POST THIS COUPON NOW!

Please send me a copy of your 1983 catalogue. I enclose £1.50 (inc. P&P). If I am not completely satisfied I may return the catalogue to you and have my money refunded. If you live outside the UK send £1.90 or 10 International Reply Coupons.

Name .....

Address .....

Post Code .....

PE 683

809