

*Kenneth*

**PRACTICAL**

# **ELECTRONICS**

MAY 1967

PRICE 2/6

**LIGHT-OPERATED  
STOPWATCH**



**SPECIAL  
IN THIS ISSUE!**

**SCOOTER ALARM SYSTEM  
BASS GUITAR**

FIRST OF A NEW SERIES...

**ELECTRONIC COMPUTERS**

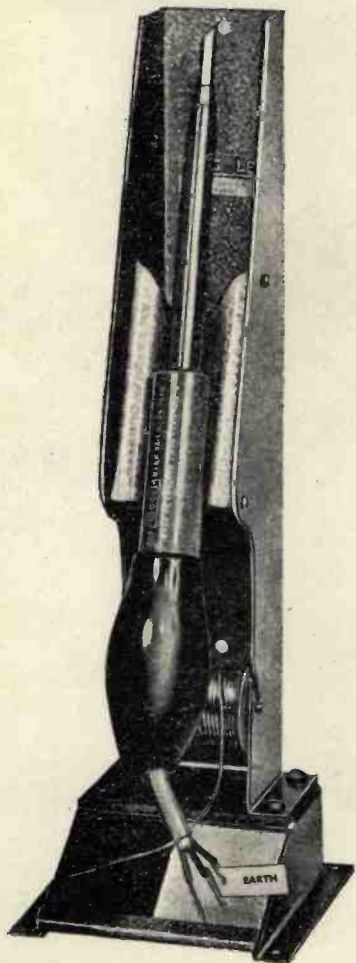
# ADCOLA

PRODUCTS LIMITED  
(Regd. Trade Mark)

SOLDERING EQUIPMENT

*for the*

DISCRIMINATING  
ENTHUSIAST



ILLUSTRATED:  
L64  $\frac{3}{8}$ " BIT INSTRUMENT IN  
L700 PROTECTIVE SHIELD

APPLY DIRECT TO:  
SALES & SERVICE DEPT.  
ADCOLA PRODUCTS LTD.  
ADCOLA HOUSE  
GAUDEN ROAD  
LONDON, S.W.4  
TELEPHONE: MACAULAY 0291/3

## ELECTROLYTIC CONDENSERS

0.25uf. .3V.	4uf. .4V.	16uf. .150V.	64uf. .40V.
1uf. .10V.	4uf. .12V.	20uf. .3V.	100uf. .3V.
1uf. .15V.	4uf. .25V.	20uf. .6V.	100uf. .6V.
1uf. .40V.	4uf. .100V.	20uf. .9V.	100uf. .10V.
1uf. .50V.	5uf. .6V.	20uf. .15V.	100uf. .12V.
1uf. .350V.	5uf. .25V.	25uf. .6V.	100uf. .15V.
1.25uf. .16V.	5uf. .50V.	25uf. .12V.	150uf. .12V.
2uf. .3V.	5uf. .70V.	25uf. .25V.	150uf. .15V.
2uf. .9V.	6uf. .12V.	25uf. .30V.	200uf. .3V.
2uf. .10V.	6uf. .15V.	30uf. .6V.	200uf. .4V.
2uf. .15V.	6.4uf. .40V.	30uf. .10V.	200uf. .16V.
2uf. .70V.	8uf. .3V.	30uf. .15V.	250uf. .2.5V.
2uf. .150V.	8uf. .6V.	32uf. .1.5V.	250uf. .9V.
2.5uf. .16V.	8uf. .50V.	32uf. .25V.	250uf. .15V.
2.5uf. .25V.	10uf. .6V.	40uf. .3V.	320uf. .2.5V.
3uf. .3V.	10uf. .10V.	40uf. .6.4V.	500uf. .4V.
3uf. .12V.	10uf. .12V.	50uf. .6V.	500uf. .25V.
3uf. .25V.	10uf. .25V.	50uf. .9V.	640uf. .2.5V.
3.2uf. .8V.	12.5uf. .4V.	64uf. .2.5V.	750uf. .18V.
3.2uf. .6.4V.	12.5uf. .40V.	64uf. .9V.	1000uf. .6V.
3.2uf. .40V.	16uf. .16V.	64uf. .10V.	
3.2uf. .64V.	16uf. .30V.	64uf. .16V.	

All at 1/- each, 9/- per dozen. Mixed packet (our selection) 20 for 10/-, 200/100uf., 275V.; 200/200uf., 275V.; 125/300/50uf., 275V.; 5/- each or 3 for 10/-.

## PAPER CONDENSERS

0.001uf. .500V.	0.005uf. .750V.	0.1uf. .350V.	0.5uf. .150V.
0.001uf. .1000V.	0.02uf. .600A.C.	0.1uf. .750V.	0.5uf. .350V.
0.002uf. .500V.	0.02uf. .350V.	0.25uf. .350V.	0.5uf. .500V.

All at 15/- per 100, or mixed packet (our selection) 50 for 10/-.

## VERY SPECIAL VALUE! SILVER MICA, POLYSTYRENE, CERAMIC CONDENSERS

Very well assorted. Mixed types and values. 10/- per 100.

## RESISTORS

Very small  $\frac{1}{4}$  watt, 5% long leads, ideal for transistor work, 10/- for 50.  $\frac{1}{2}$  watt assorted values including printed circuit types, 10/- for 100, 55/- per 1,000.  $\frac{1}{2}$  watt to 3 watt mixed values and types, 10/- for 100, 55/- per 1,000. TO CLEAR: 10 Meg. 1/6th watt resistors, £1 per 1,000.

## TRANSISTORS

AFZ12, Screened V.H.F. oscillator transistors, 5/- each. OC44, OC45, R.F. Transistors, 4/- each. OC81D, 4/- each. OC71 equivalent, 1/- each, £3 per 100. Switching Transistors ASY2 (npn) or L.B.M. (pnp), 6 for 10/-. Car radio type Output Transistors type NKT405, 10/- each.

## TELEVISION VALVES. BRAND NEW AND BOXED

PCF80, 7/6; PL81, 7/6; PCL82, 7/6; PCL85, 7/6; PCL84, 7/6; PCC84, 6/6; PY81, 6/6; ECC82, 6/6; PL36, 9/-; EY86, 6/6; PCL83, 9/-; PY33, 9/-; ECL80, 6/6; PCC89, 9/-.

Computer diodes. Make excellent detectors. Also suitable for keying electronic organs. 1/- each or 20 for 10/-.

BY100 TYPE TELEVISION H.T. RECTIFIERS, SPECIAL PRICE 5/- each, 30/- dozen.

ORP12 light sensitive resistors, 9/- each.

TRANSISTOR BATTERY ELIMINATORS—same size as PP9, 30/-; PP6, 20/-.

BATTERY CHARGERS, with meter and fuse, 4 amp. 6/12V., 55/- each.

SOLOON MODEL 615 Slim Pencil-bit Soldering Irons, 25/- each.

WELDER DUAL-HEAT SOLDERING GUN, 57/6.

NUTS, SCREWS and WASHERS, very useful assorted packs, 6/- each.

WALKIE-TALKIES (not for use in U.K.), £7/10/- pair.

## MAGNETIC RECORDING TAPE, BRITISH MADE, FULLY GUARANTEED

Standard Play, 3in., 150ft., 3/6; 5in., 600ft., 10/6; 5 $\frac{1}{2}$ in., 900ft., 13/6; 7in., 1,200ft., 16/3.

Long Play: 3in., 225ft., 4/-; 5in., 900ft., 12/9; 5 $\frac{1}{2}$ in., 1,200ft., 15/9; 7in., 1,800ft., 21/6.

Double Play: 3in., 400ft., 6/6; 5in., 1,200 ft., 20/-; 5 $\frac{1}{2}$ in., 1,800ft., 28/-; 7in., 2,400 ft., 34/-; 2 $\frac{1}{2}$ in., 300ft., 6/9.

Triple Play Polyester: 3in., 600ft., 12/6; 4in., 900ft., 16/6.

SIGNAL INJECTOR, parts and circuit to make, 10/- only.

SIGNAL TRACER, parts and circuit to make, 10/- only.

MOTOR CAR REV. COUNTER (loss 1mA meter), parts and circuit to make, 10/- only.

TRANSISTORS, COMPONENTS and CIRCUIT to convert 1mA meter to 0 to 10 Meg. ohm meter, 10/-.

TRANSISTORISED RUMBLE and SCRATCH FILTER (for improving reproduction of old records), all components and circuit, 30/-.

SINCLAIR. All products in stock including latest version of MICRO-6—World's smallest radio—and only 59/6!

NEEDLES FOR RECORD PLAYERS. HALF PRICE!

All types below at 3/6 each!

TC8LP; GC2LP; GC8LP; BF40LP; GP67LP; GP37; GP59; TC8 Stereo LP; Studio O LP.

CARTRIDGES

SONOTONE MONO, 10/-; ACOS, 15/-; ACOS STEREO SAPPHIRE 12/6;

DIAMOND, 17/6. All complete with needles!

LAPEL MICROPHONES, Magnetic or Crystal, 10/- each.

TAPE RECORDER MICROPHONES, Fantastic value at 12/- each.

ACOS MIC. 45, 30/- Many others, both crystal and dynamic in stock.

THIN CONNECTING WIRE. 10yd., 1/-; 100yd., 7/6; 500yd., 25/-; 1,000yd., 40/-.

LOUDSPEAKERS. 12in. Richard Allen, 37/6d. 12in. Bakers Guitar, 45/5/-; 3in., 4in., 5in. and 5in x 3in., all at 10/- each; 8in. x 2 $\frac{1}{2}$ in., 12/6; 2in. 80 ohm, 7/6.

EARPIECES. Magnetic or Crystal, 5/- each.

VEROBOARD

2 $\frac{1}{2}$ in. x 5in., 3/11; 2 $\frac{1}{2}$ in. x 3 $\frac{1}{2}$ in., 3/3; 3 $\frac{1}{2}$ in. x 5in., 5/6; 3 $\frac{1}{2}$ in. x 3 $\frac{1}{2}$ in., 3/11.

Terminal Pins, 50 for 3/-; Spot Face Cutter, 7/3; Pin Insert Tool, 9/6.

Special Offer—Cutter and 5 boards, 2 $\frac{1}{2}$ in. x 1in., 9/9.

ELECTRONIQUES DEALER. 600 PAGE CATALOGUE—10s. 6d.

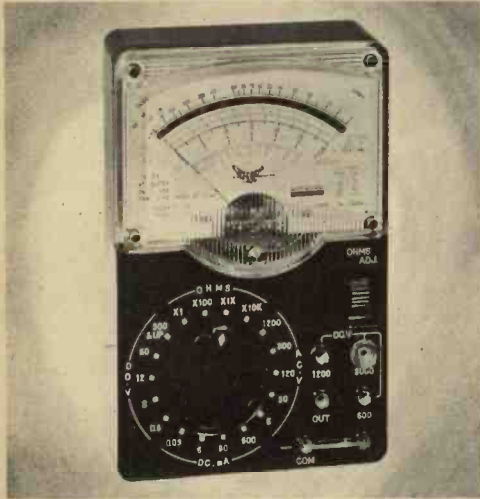
ORDERS BY POST—TO G. F. MILWARD, 17 PEEL CLOSE, DRAYTON BASSETT, STAFFS.

PLEASE INCLUDE POSTAGE COSTS

For customers in the Birmingham area, goods may be obtained from: ROCK EXCHANGES, 231 ALUM ROCK ROAD, BIRMINGHAM 8

have  
you  
seen...

SA.80N—8 watt  
Integrated Stereo Amplifier



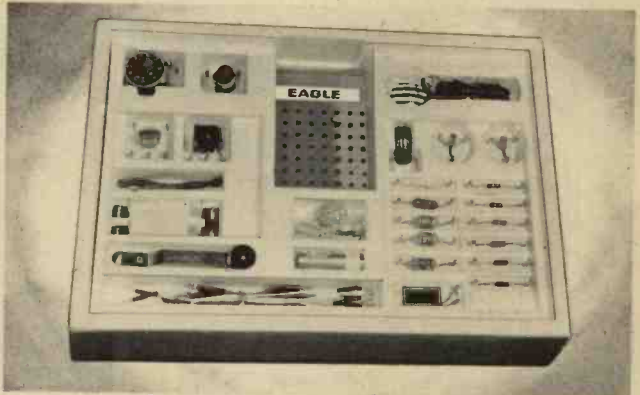
EP-30KN—30,000 o.p.v.  
Multimeter

the  
complete  
range of



EEK-28—28 Project  
Constructional Kit

**EAGLE**  
products



The "Eagle" Brand was launched 10 years ago and it was impossible to foresee that in such a short time the range would grow to cover over 500 items, all carrying the "Eagle" name. Whether you are interested in Hi-Fi, Amateur Radio, Do-it-Yourself projects or any field of Electronics, "Eagle" offer you the widest choice of sensibly priced products and by the end of the year we plan to increase our range to cover the formidable total of 700 items.

If you would like to study our entire range in the leisure of your home we will be delighted to send you our catalogue free of charge or why not ask your local dealer (there are over 6,000 "Eagle" stockists) to show you the latest "Eagle" Products today!

To: **EAGLE PRODUCTS, Dept. P.E.5,**  
Coptic Street, London, W.C.1.

Please send me catalogue of the entire "Eagle" range.

Name .....

Address .....



### 10 TRANSISTOR TWO-WAY RADIOS

Ultra sensitive superhet receiver with RF amplifier. 100mW output. Complete with telescopic aerials, leather carrying cases and batteries. A bargain at **£21.19.6** (These cannot be operated in U.K.).

### 4 CHANNEL MICROPHONE MIXER



Fully transistorised. Enables mixing of four separate signals—micro, radio, records, etc. Complete with battery at the amazing low price of **42/6**



**EEK 28.28 PROJECT CONSTRUCTIONAL KIT**  
This advanced educational kit is excellent for beginners as well as the more advanced experimenter. Not even a soldering iron is needed. Complete with 60 page booklet giving full details of suggested circuits. **£6.10.0**



### 10 WATT HORN TWEETER

Brings true hi-fi reproduction to your system. Frequency response 1,500 to 18,000 cps. Crossover 3,000 cps. Sensitivity 104 db/W. Impedance 16 ohm. Buy now while stocks last. **22/6**

Crossover Networks. CN.23—3 ohm, 2-way, 14/6; CN.216—16 ohm, 2-way, 14/6.

# RELDA RADIO LTD

(Dept. P.E. 16) 87 Tottenham Court Road, London, W.1

### FOR THE MOTORIST AND HOME HANDYMAN



Versatile home/automobile tester for all electrical circuits in home and car. Measures A.C. Voltage 0-150, 0-300 v. Resistance 0-1000 ohm. High resistance and leakage 1000 ohm, 2 megohm. Current and power 0-16 amps, 0-3 kW. Car battery 0-75, 0-15 v. A must for only **£5.2.6**

### MICROPHONE BARGAINS!

Gooseneck Dynamic Microphone. Dual impedance 600 ohm low/50 K high. Output—88 db. Response: 60-11,000 cps. With dual impedance on/off switch. Offered at well below regular price. **80/-**

PENCIL TYPE. 50 K impedance. Output—53 db. Response: 40-13,000 cps. On/off switch. Only **59/6**

### SEVEN IN ONE TESTER



Ideal for quick checks in the home or service dept. Supplied with batteries, test leads and instructions. Featuring Resistance substitution

In 5 ranges, Capacitance substitution in 5 ranges. R.F. Signal Generator 455 Kc/s, A. F. Signal Generator 400 c/s. D.C. and A.C. Voltmeter. 4 ranges; R.F. Field Indicator; 1-140 Mc/s. Unrepeatable at only **£5.10.0**

### TT.144 DYNAMIC TRANSISTOR TESTER



Tests in-circuit or out of circuit. Identifies PNP and NPN types. Indicates electrode open circuits, short circuits and current drain. Complete with instructions. **£4.10.0**

## ALL ITEMS SENT POST FREE

FOR FULL DETAILS OF THESE AND MANY OTHER ITEMS SEND FOR FREE COMPREHENSIVE CATALOGUE, EAGLE NEWS AND ORDER FORM. ALL ITEMS AVAILABLE POST FREE AND COVERED BY 12 MONTHS' GUARANTEE.

CALLERS WELCOME AT OUR HI-FI SHOWROOM

### 72" SHIELDED CABLES

Fitted variety of plugs, sockets, etc. for a variety of uses.

CA.1—Right Angle Jack plug/phone plug, 5/-. CA.2—Right Angle Jack plug/alligator clips, 5/-. CA.3—Right Angle Jack plug/Right Angle Jack plug, 7/6. CA.4—Right Angle Jack plug/Spade Terminals, 5/-. CA.5—Chrome phone plug/chrome phone socket, 5/-. CA.6—Phonoplug/Alligator clips, 5/-.



### SUB-MINIATURE TRANSISTORISED PUSH PULL AUDIO AMPLIFIERS

Ready built on printed circuit with full instructions. Ideal for building your own tuner, intercom, baby alarm, etc. 250 mW output, 32/6; 1 watt output, 42/6; 3 watt output, 49/6.



### MCK.2. MORSE CODE KIT

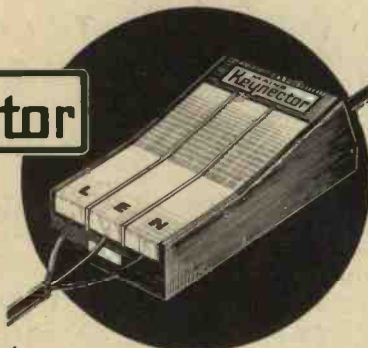
Two station morse code kit supplied with instructions, 50ft. of connection wire and morse code charts. Only **27/6**

## The safest, quick and handy connector for electrical appliances

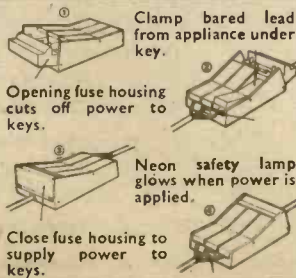
### MAINS Keynector

Measuring only 5in. x 3in. x 1 1/2in. the MAINS KEYNECTOR is made of non-combustible urea-formaldehyde. Designed in modern style and manufactured in attractive two-tone colour. The unit eliminates the need of terminating the mains input lead of any electrical instrument or appliance with a plug. It also enables more than one instrument or appliance to be connected in parallel and used simultaneously. In the workshop, the MAINS KEYNECTOR will prove invaluable to the experimenter and handyman.

Colour: Duo-Green **32/6**  
Rating: 13 amp. inc. p. & p.



British and Foreign Patents applied for



**CYBERNAUT CONTROLS LTD. (Ref. P.E.3)**  
28-30 Rivington St., London, E.C.2. Tel.: 01-739 2763



## GOODMANS HIGH FIDELITY MANUAL

A Guide to full listening enjoyment

The Manual is much more than a catalogue of Goodmans High Fidelity Loudspeakers—it contains informative articles, including advice on stereo, special beginners page, and full cabinet drawings. You'll find it interesting as well as informative.

### NEW MAXAMP 30 HIGH FIDELITY AMPLIFIER

**MAXAMP 30** is a fully transistorised stereophonic High Fidelity Amplifier using Silicon Transistors throughout. It is precision engineered and fullest use is made of printed circuits. It will deliver continuously up to 15 watts of power on each channel and it looks as good as it is. 10 1/2" x 5 1/2" x 7 1/4" **£49.10s.0d.**

Full specification of the Maxamp 30 is given in the High Fidelity Manual - send the coupon for your FREE copy - or pay an early visit to your Goodmans dealer.

### FREE

Please send Hi-Fi Manual together with name and address of my nearest Goodmans dealer.

Name .....

Address .....

PE 5/67

## GOODMANS INDUSTRIES

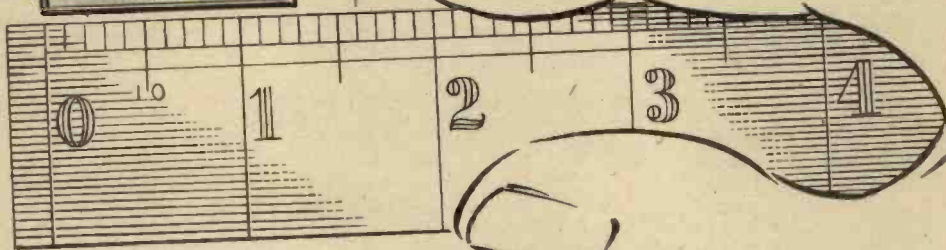
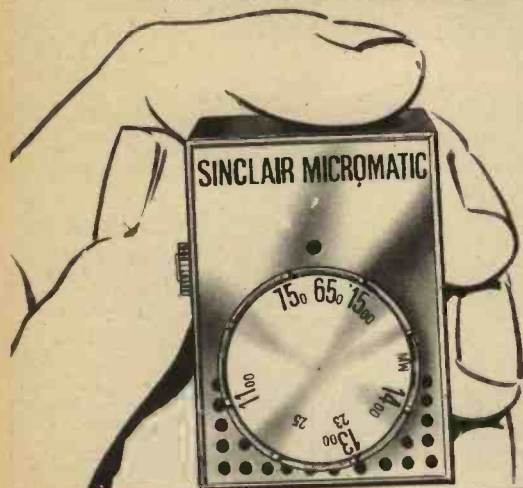
AXIOM WORKS · WEMBLEY · MIDDLESEX · Tel: WEM 1200  
A Division of Radio Rentaset Products Ltd

# THE WORLD'S SMALLEST RADIO

MEASURES ONLY  $1\frac{4}{5}$ " x  $1\frac{3}{10}$ " x  $\frac{1}{2}$ "

*Check it for yourself!*

AND CHECK THE PERFORMANCE TOO!



## SINCLAIR

# MICROMATIC

SIX STAGE  
TRANSISTOR  
RECEIVER

★  $1\frac{4}{5}$ " x  $1\frac{3}{10}$ " x  $\frac{1}{2}$ "

★ CALIBRATED  
DIAL

★ NEW CIRCUITRY

★ BANDSPREAD

★ AMAZING POWER  
AND RANGE

★ GUARANTEED  
5 YEARS

These are the facts — the Sinclair Micromatic is so small that its design brings it into the realm of real micro-electronics. Its performance and reliability are so good that it assures superb reception virtually anywhere. Its elegant styling inside and out make this a truly professional receiver, yet building the Micromatic is so simple that anyone can tackle it with complete confidence. Check these facts for yourself, and when you use your Micromatic, you will find it giving you the radio thrill of a lifetime.

### TECHNICAL DESCRIPTION

The Sinclair Micromatic is housed in an elegant plastic case with attractive aluminium front panel and aluminium tuning dial to match, calibrated in Kc/s and metres. It has a six stage circuit of exceptional power and sensitivity. Two R.F. stages are followed by a double diode detector from which the signal passes to a high gain three stage audio amplifier. A.G.C. counteracts fading from distant stations. The set is powered by two Mallory Mercury cells Type ZM.312 which are readily obtainable from radio shops, Boots Chemists, Stores, etc. for 1/7 each.

ORDER FORM AND MORE SINCLAIR DESIGNS ON PAGES FOLLOWING



IN THE UNIQUE "SEE FOR  
YOURSELF" KIT PACK

Complete kit in pack  
including ear piece  
and instructions

**59/6**

Ready built and tested

79/6

**sinclair**

SINCLAIR RADIONICS LTD., 22 Newmarket Rd., CAMBRIDGE

Telephone 52996 (STD Code OCA3)



# SINCLAIR STEREO 25 DE-LUXE PRE-AMP CONTROL UNIT

THE SINCLAIR STEREO 25 has been designed specially to ensure the highest possible standards of reproduction when used with two Z.12s or any other first class stereo power amplifier. Best possible components are used in the construction of this superb unit, whilst its appearance reflects the professional elegance characteristic of all Sinclair designs in hi-fi, radio and TV. The front panel of the Stereo 25 is in solid brushed and polished aluminium with beautifully styled solid aluminium control knobs. Mounting the unit is simple, and power is conveniently obtainable from the Sinclair PZ.3 which can also be used to supply two Z.12s to make a complete stereo assembly. Hi-fi enthusiasts seeking the ultimate in domestic listening will find all they want from this combination of Sinclair units. With a Micro FM for tuner, they will have an installation to compare favourably with anything costing from four to five times as much.

FOR USE WITH ANY GOOD STEREO SYSTEM

## TECHNICAL SPECIFICATIONS

Performance figures obtained using Stereo 25, two Z.12s and a PZ.3.

- **SENSITIVITY** for 10 watts into 1.5 ohms load per channel. Mic.—2 mV into 50K ohms. Pick-up—3 mV into 50K ohms. Radio—20 mV into 4.7K ohms.
- **FREQUENCY RESPONSE** (Mic. and Radio)—25 c/s to 30 kc/s  $\pm$  1dB extending to 100 kc/s  $\pm$  3dB.
- **EQUALISATION** — Correct to within  $\pm$  1dB on RIAA curve from 50 c/s to 20 kc/s.

## TONE CONTROLS

- **Treble** +12dB to -10dB at 10 kc/s. **Bass** +15dB to -12dB at 100 c/s.
- **SIZE**—6 $\frac{1}{2}$ in.x2 $\frac{1}{2}$ in.x2 $\frac{1}{2}$ in. overall, plus knobs.
- **FINISH**—Front panel sectioned in brushed and polished solid aluminium with solid aluminium knobs. Black figuring on front panel.

BUILT, TESTED AND GUARANTEED

£9.19.6

"Although a complete novice to radio I was able to assemble it (Micro-FM) without undue difficulty thanks to your clear and lucid instructions. I receive all B.B.C. programmes, etc. very strongly."  
H.T., Warrington, Lancs.

"Far more sensitive (Micro-FM) than many commercial models."  
M.M., New Romney, Kent


## GUARANTEE

If you are not completely satisfied when you receive your purchase from us, your money will be refunded at once in full and without question.

SINCLAIR MICROMATIC  
See previous page

## SINCLAIR MICRO-FM

### COMBINED FM TUNER AND POCKET FM RECEIVER



7 TRANSISTORS

●

NO ALIGNING

●

PULSE COUNTING DISCRIMINATOR

●

A.F.C.

●

TUNES 88-108 Mc/s

●

SIZE—less than 3" x 1 $\frac{3}{4}$ " x  $\frac{3}{4}$ "

This unique, superbly engineered FM superhet is the only set in the world which can be used both as an FM tuner and an independent FM pocket receiver just whenever you wish. Problems of alignment have been completely eliminated making the Micro-FM ready for use the moment you have built it. The pulse counting discriminator ensures best possible audio quality; sensitivity is such that the telescopic aerial included with the kit assures good reception in all but the very poorest reception areas. The Sinclair Micro-FM will give you all you want in FM reception and the satisfaction of building a unique design that will save you pounds.

ANYONE CAN BUILD IT

Complete kit, including transistors, case, aerial, earpiece, etc.

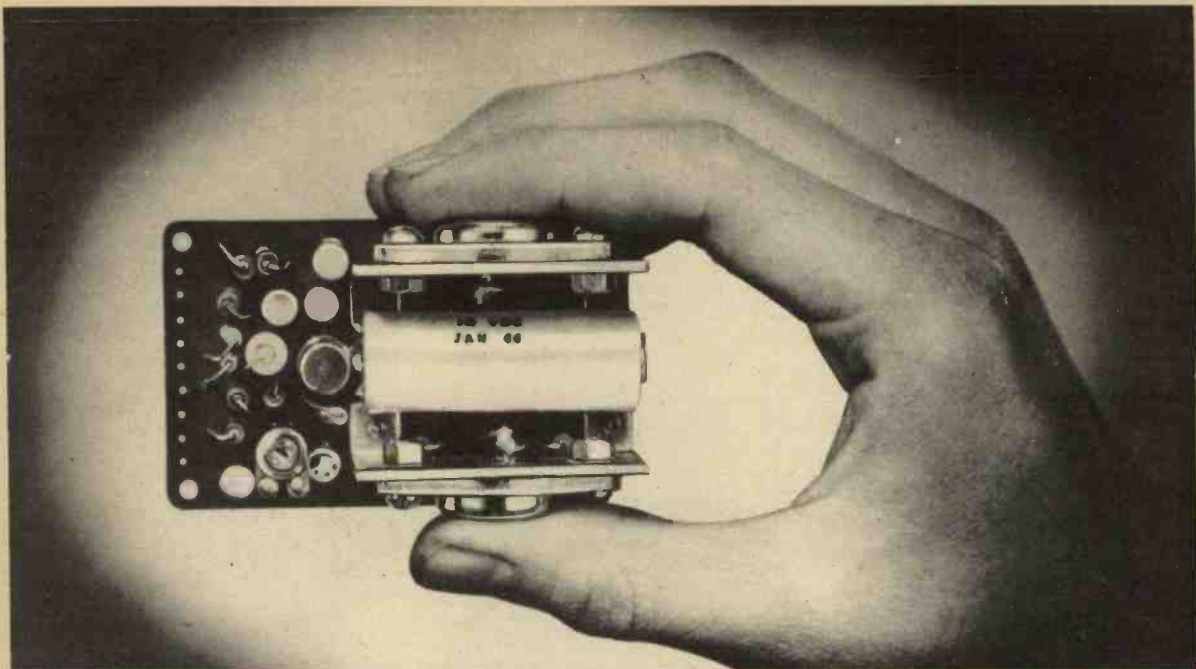
## £5.19.6

FULL SERVICE FACILITIES AVAILABLE TO ALL SINCLAIR CUSTOMERS

# sinclair

SINCLAIR RADIONICS LTD., 22 Newmarket Rd., CAMBRIDGE

Telephone 52996 (STD Code OCA3)



# SINCLAIR Z.12

COMBINED 12 WATT HIGH-FIDELITY  
AMPLIFIER AND PRE-AMP

**12 WATTS R.M.S. OUTPUT**  
CONTINUOUS SINE WAVE (24W. PEAK)

**8 TRANSISTOR CIRCUIT WITH  
CLASS B ULTRALINEAR OUTPUT**

IDEAL FOR HI-FI (STEREO OR MONO)  
CAR RADIO, ELECTRIC GUITAR, P.A.,  
INTERCOM, ETC.

## TECHNICAL SPECIFICATIONS

- Size 3 in. × 1½ in. × 1½ in.
- Class "B" ultralinear output
- **RESPONSE** 15-50,000 c/s ± 1 dB.
- Suitable for 3, 7.5 or 15Ω speakers. Two 3Ω speakers may be used in parallel
- **INPUT**—2mV into 2kΩ
- **OUTPUT**—12 watts R.M.S. continuous sine wave (24 w. peak); 15 watts music power (30 w. peak)
- Signal to noise ratio better than 60dB.
- Quiescent current consumption—15mA.

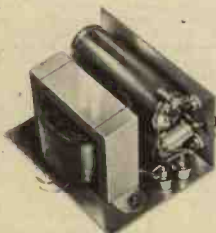
The amazing adaptability and rugged construction of this very powerful and exceptionally compact amplifier make it possible to use just one type of unit with outstanding success in an unusually wide variety of applications. The Z.12 accepts radio, microphone and pick-up inputs. Detailed instructions for connecting these in mono and stereo are given in the manual

supplied with every unit. The Z.12 will operate efficiently from any supply between 6 and 20 V. d.c. The PZ.3 is recommended as a main power supply source. Those wishing to have a ready made pre-amp control unit can feed inputs via the Stereo 25, which, with two Z.12s will provide the finest stereophonic hi-fi possible.

**89/6** Built, tested and guaranteed. Ready for immediate use. With Z.12 manual.

## PZ.3 MAINS POWER SUPPLY UNIT

This special power supply unit uses advanced transistorised circuitry to achieve exceptionally good smoothing. Ripple is a barely measurable 0.05 v. The PZ.3 will power two Z.12s and a Stereo 25 with ease.



**79/6**

## WHAT USERS SAY OF THIS VERSATILE UNIT

"I have recently bought a Z.12 and have been amazed at the power output from such a small unit. I use it for an electric guitar system and find that for small halls it is quite powerful enough."

*J.R.F., Londonderry*

"I have for some time been running my Z.12 with a PZ.3 power supply and may I say that I am thoroughly delighted with the performance which in my opinion is better than that given out by... costing many times as much as my unit."

*R.S.C., London, N.20*

"The whole assembly (two Z.12s, tone control circuits) works like a charm and is the envy of all who have listened to it."

*P.C., Durban, S.A.*

"I am the proud owner of a pair of those remarkable amplifiers, Z.12. I was more than surprised to hear the splendid tone and volume. The thing that staggered me most of all is the small size of the Z.12. May I express my thanks."

*C.R.R., St. Vincent, West Indies*

"It is wonderful to be able to hear my records properly (with the Z.12)."

*J.S.H.S., London, W.2*

"I have now had an opportunity of trying out the tuner with the Z.12 amplifier and my Quad speaker and am very pleased with the results."

*H.A., London, N.6*

If you prefer not to cut this page, please mention PE.567 when writing your order

To: SINCLAIR RADIONICS LTD., 22 NEWMARKET ROAD, CAMBRIDGE

Please send items detailed below:

NAME.....

ADDRESS.....

.....

.....

.....

For which I enclose cash/cheque/money order

PE.567

**sinclair**  
SINCLAIR RADIONICS LTD.  
22 Newmarket Road, Cambridge 52996





# LASKY'S RADIO

# For the Finest Value and Service to HOME CONSTRUCTORS & ELECTRONICS ENTHUSIASTS

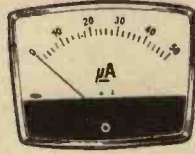
We consider our construction parcels to be the finest value on the home constructor market. If on receipt you feel not competent to build the set, you may return it as received within 7 days, when the sum paid will be refunded less postage.

## SPECIAL INTEREST ITEMS!

### NEW! LASKY'S CLEAR PLASTIC PANEL METERS

Precision made in Japan by HIOKI. Each meter boxed and fully guaranteed with all fixing nuts and washers. Sizes are of front panel. Add 1/6 Post on each.

Type KR-52 3" x 2 1/2 in. (illustrated)  
 1 mA DC ..... 32/6 ..... 300 V DC ..... 32/6  
 5 mA DC ..... 32/6 ..... 500 μA ..... 37/6  
 1 mA 8 Meter ..... 39/6



Type MK-35A 2 1/2 in. square  
 1 mA DC ..... 22/6 ..... 1 mA DC ..... 38/-  
 5 mA DC ..... 22/6 ..... 5 mA DC ..... 35/-  
 300 V DC ..... 22/6 ..... 300 V DC ..... 35/-  
 500 μA ..... 27/6 ..... 500 μA ..... 42/6  
 1 mA 8 Meter ..... 29/6 ..... 1 mA 8 Meter ..... 39/6

Type MK-65A 3 1/2 x 3 1/2 in.  
 1 mA DC ..... 38/- ..... 1 mA DC ..... 38/-  
 5 mA DC ..... 35/- ..... 5 mA DC ..... 35/-  
 300 V DC ..... 35/- ..... 300 V DC ..... 35/-  
 500 μA ..... 39/6 ..... 500 μA ..... 39/6  
 1 mA 8 Meter ..... 37/6 ..... 1 mA 8 Meter ..... 37/6

### VEROBOARD — High grade laminated board with copper strips bonded to it and pierced with holes.

Boards	Accessories
42/1503 2 1/2 x 5 in. .... 3/11	Terminal pins — pkt. of 50 ..... 3/-
43/1504 2 1/2 x 3 1/2 in. .... 3/3	Spot face cutter tool ..... 7/3
45/1507 3 1/2 x 5 in. .... 5/6	Pin inserting tool ..... 9/6
46/1508 3 1/2 x 3 1/2 in. .... 3/11	Post 6d. per item extra.
44/1505 3 1/2 x 17 in. .... 15/6	Orders of 10/- and over post free.

### SPECIAL PURCHASE—UHF/VHF T.V. TUNERS

Well known British makers' surplus stocks. Now available for the first time to the Home Constructor. Add 2/6 Post and Packing on each.

**VALVE UHF MODEL (illustrated)**  
 In metal case size 4 x 6 x 1 1/2 in. Fully tunable—complete with PCC86 and PCC88 valves. LASKY'S PRICE 29/6. Without valves 12/6

**TRANSISTORISED UHF MODEL**  
 Metal case size 3 1/2 (plus spindle) x 2 1/2 x 1 1/2 in. Fully tunable with slow motion drive. Comp. with two AF186 transistors and leads. LASKY'S PRICE 25/6

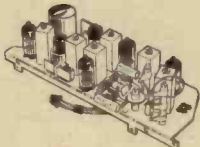
**TRANSISTORISED VHF TUNER**  
 Sub-miniature turret fitted with 12 sets of coils and 3 Mullard AF102 transistors. In metal case size 3 x 1 1/2 x 2 1/2 in. LASKY'S PRICE 37/6

Add 2/6 Post and Packing on each.

### TELEVISION IF AMPLIFIERS

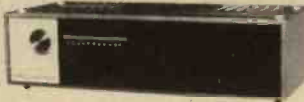
38 Mels. Contains a large number of components, 1F transformers, resistors, capacitors, etc., and the following valves: 2xPCF80, 1xEB91, EF80, EF183 and EF184. Overall size 1 1/2" x 3 1/2" x 4" deep. Ideal for servicemen and experimenters. This 1F amp. when used with the Valve model UHF Tuner (above) provides a suitable conversion for B.B.C.2. Circuit supplied.

LASKY'S PRICE 29/6 Post 2/6



### SPECIAL PACKAGE OFFER

Free standing table cabinet, size 17 1/2 x 9 x 6 1/2 in., finished in medium Mahogany. Scale marked 21 to 68 (UHF band). Designed to accept the above 1F Amplifier with space for a Valve UHF Tuner. Cabinet only 27/6 Post 3/6



Special Package Offer IF Amplifier, UHF Tuner with valves and Table Cabinet. **PACKAGE PRICE 59/6** Post 6/6

### WATER TEMPERATURE THERMOSTATS

British made—orig. for use in high quality washing machine. range adjustable between 114°F and 230°F. Rating 200/250 V.A.C., 20 amps (also D.C. up to 125 V.A.). Size 2 1/2 x 1 1/2 x 1 1/2 with 18 in. capillary tube and 6 in. bulb. Single hole fixing—3/16 in. spindle.

LASKY'S PRICE 15/- Post 2/6

207 EDGWARE ROAD, LONDON, W.2 Tel: PAD 3271  
 118 EDGWARE ROAD, LONDON, W.2 Tel: PAD 9789  
 33 TOTTENHAM CT. ROAD, LONDON, W.1 Tel: MUS 2605

The above branches open all day Saturday. Early closing Thursday.

Please address all Mail Orders and Correspondence to 3-15 Cavell Street, Tower Hamlets, London, E.1.

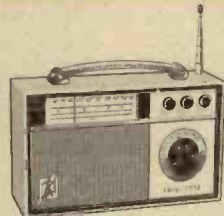
Tel.: STE 4821/2

## CONSTRUCTORS BARGAINS

### THE SKYROVER

#### De Luxe

7 transistor plus 2 diode superhet. 6 waveband portable receiver covering the full Medium Waveband and Short Waveband 31-94M and also 4 separate switched bandspread ranges, 13M., 16M., 19M. and 25M., with Band Spread Tuning for accurate Station Selection. The coil pack and tuning heart is factory assembled, and tested. Uses 4 U2 batteries. 3 in. Ceramic Magnet P.M. Speaker. Telescopic and Ferrite Rod Aerial. Tone Circuit, wood cabinet, size 11 1/2 x 6 1/2 x 3 in. covered with washable material, plastic trim and handle. Car aerial socket fitted.



Can be built for £8.19.6 Post H.P. Terms: 60/- deposit and 11 monthly payments of 12/6. Total H.P.P. £10.0.3. Data 2/6 extra: refunded if you purchase parcel. All parts avail. sep. Four U2 batt. 3/4 A simple additional circuit provides cover of the 1100/1980M Long Waveband. All components with construction data. Only 10/- extra Post Free.

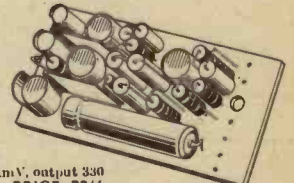
### NEW KIT — PEAK SOUND SA-88 TRANSISTORISED STEREO AMPLIFIER AND PRE-AMPLIFIER

A high quality 17 watt, 14 transistor High Fidelity Integrated Amplifier which anyone can easily build using the revolutionary Peak Sound "Cir-Kit" wiring system. Size assembled only 10 x 2 1/2 x 3 in. Complete kit with detailed construction data. LASKY'S PRICE £12.19.6 Post FREE.

POWER SUPPLY KIT for the SA-88 £3.10.0 Post FREE.

### LASKY'S MINIATURE TRANSISTOR AMPLIFIER MODULES

Incorporating the very latest circuitry to provide high sensitivity and good quality in conjunction with extreme small size and compactness. High quality Newmarket transistors used throughout. All designed to operate on 9v. miniature battery. Add 1/- on each for post & packing



- TYPE LRPC 1. 3 transistor. Input sens. 50 mV, output 150 mW, output imp. 40 Ω, size 2 x 1 x 1 1/2 in. PRICE 27/6
- TYPE LRPC 2. 5 transistor. Input sens. 1mV, output 330 mW, output imp. 15 Ω, size 2 1/2 x 1 1/2 x 2 in. PRICE 22/6
- TYPE LRPC 4. 5 transistor. Input sens. 150 mV, output 330 mW, output imp. 15 Ω, size 2 1/2 x 1 1/2 x 2 in. PRICE 22/6
- TYPE LRPC 5. 6 transistor. Input sens. 8mV, output 3W, output imp. 3 Ω, size 5 1/2 x 1 1/2 x 1 in. PRICE 59/6
- TYPE LRPC 6. Tape record/play back amp. (for use with self oscillating erase head) Output 750mW, output imp. 8 Ω. Size 4 1/2 x 2 x 1 in. LASKY'S PRICE 37/6

### FULLY ENCAPSULATED MODULES

- Special function modules — all one size 1 1/2 x 1 x 1 1/2 in. Complete with detailed function and installation instructions. Read S.A.E. for data.
- TYPE PA-1. Public address amp. for use with carbon, crystal or Dynamic microphones. 3 Ω output imp. PRICE 30/-
- TYPE GE-1. Gramophone amplifier — provides sufficient power to fill average room. 3 Ω output imp. PRICE 30/-
- TYPE CO-1. Morse code practice oscillator — for use with morse key and 3 Ω speaker. PRICE 20/-
- TYPE MT-1. Metronome module — provides audible and visual beat from 30 to 240 beats per minute (for use with 3 Ω speaker or loud lamp). PRICE 22/6

### SINCLAIR SUPER MINIATURE KITS

- We stock the complete range. Write for details of package deals.
- THE MICRO-6 miniature radio only 1 1/2 x 1 1/2 x 1 1/2 in. £2 19 6
- THE MICRO-FM, (tuner/receiver) £5 19 6
- THE MICROMATIC mini-radio Kit £2.19.6. Fully built £3 19 6
- STEREO 25 pre-amp control unit fully built. £9 19 6
- THE Z-12 12 watt amplifier and pre-amplifier. Fully built and tested £4 9 6
- PZ-3 power pack for Z-12 £3 19 6

**TRANSISTORS ALL BRAND NEW AND GUARANTEED**  
 GET 81, GET 85, GET 86 2/6; 873A, 874P 3/6; OC48, OC71, OC81D 4/6; OC 44, OC 70, OC 76, OC 81 5/6; pair (10/8); AF 117, OC 200 8/6; OC 42, OC 43, OC 73, OG 82D 7/6; OC 201, OC 204 15/-; OC 203, OC 206 18/6; OC 208 24/6; OC 78 8/-.

**TRANSFILTERS BY BRUSH CRYSTAL CO. Available from stock.**  
 TO-01B 465 kc/s. ± 2 kc/s. TO-02D 470 kc/s. ± 1 kc/s. 9/6 EACH  
 TO-01D 470 kc/s. ± 2 kc/s. TP-01B 465 kc/s. ± 2 kc/s.  
 TO-02B 465 kc/s. ± 1 kc/s. TP-01D 470 kc/s. ± 2 kc/s. Post 6d.

42 TOTTENHAM CT. ROAD, LONDON, W.1 Tel: 01-580 2573  
 152/3 FLEET STREET, LONDON, E.C.4 Tel: FLE 2833

Both open all day Thursday. Early closing Saturday.

# LASKY'S FOR SPEEDY MAIL ORDER SERVICE

# HI-FI AMPLIFIERS — TUNERS — RECORD PLAYERS



**FM TUNERS**  
FM-4U



TFM-IS

**HI-FI FM TUNER. Model FM-4U.** Available in two units. R.F. tuning unit (£2.15.0 incl. P.T.) with I.F. output of 10.7 Mc/s and I.F. amplifier unit, with power supply and valves (£13.13.0).  
Total Price Kit £16.8.0

**HI-FI AM/FM TUNER. Model AFM-1.** Available in two units which, for your convenience, are sold separately. Tuning heart (AFM-T1—£4.13.6 incl. P.T.) and I.F. amplifier (AFM-A1—£22.11.6). Printed circuit board, 8 valves. Covers L.W., M.W., S.W., and F.M. Built-in power supply. Total Price Kit £27.5.0  
STEREO DECODER available, please see below.

Hear the BBC stereo FM programmes on the **TRANSISTOR STEREO FM TUNER**. Elegantly designed to match the stereo Amplifier, AA-22U. Available in two units, sold separately, can be built for a Total Price:

Kit (STEREO) £24.18.0 incl. P.T.  
Kit (MONO) £20.19.0 incl. P.T.

**10W POWER AMP.**  
MA-12



**9 + 9W STEREO AMP.**  
S-99



**HI-FI MONO AMPLIFIER. Model MA-12.** 10W output, wide frequency range, low distortion. Use with control unit.  
Kit £12.18.0 Assembled £16.18.0

**3 + 3W STEREO AMPLIFIER. Model S-33.** An easy-to-build, low cost unit. While stocks last.  
Kit £13.7.6 Assembled £18.18.0

**DE LUXE STEREO AMPLIFIER. Model S-33H.** De luxe version of the S-33 with two-tone grey perspex panel, and high sensitivity necessary to accept the Decca Derampick-up. Kit £15.17.6 Assembled £21.7.6

**HI-FI STEREO AMPLIFIER. Model S-99.** 9+9W output. Ganged controls. Stereo/Mono gram, radio and tape inputs. Push-button selection. Printed circuit construction. Kit £28.9.6 Assembled £38.9.6

**TRANSISTOR MIXER. Model TM-1.** A must for the tape enthusiast. Four channels. Battery operated. Similar styling to Model AA-22U Amplifier. Kit £11.16.6 Assembled £16.17.6



## Enjoy Yourself While You Save

Here's the **STEREO DECODER** you have been looking for

Add Stereo RADIO to your listening pleasure at low cost. **FM DECODER SD-1.** This model will convert Heathkit valve (Mono) FM and AM/FM tuners to stereo. It can also be used with most other makes of FM tuner having facilities for multiplex output. Own built-in power supply. Compact, 3 1/4" x 3 1/4" x 9" deep. Kit £8.10.0. Assembled £12.5.0. Send for full specification details.



### TRANSISTOR RECEIVERS



Oxford

**"OXFORD" LUXURY PORTABLE Model UXR-2.** Specially designed for use as a domestic or personal portable receiver. Many features, including solid leather case. Kit £14.18.0 incl. P.T.



UXR-1

**TRANSISTOR PORTABLE. Model UXR-1.** Pre-aligned I.F. transformers, printed circuit. Covers L.W. and M.W. Has 7" x 4" loudspeaker. Real hide case. Kit £12.11.0 incl. P.T.



GC-1U

**JUNIOR EXPERIMENTAL WORKSHOP. Model EW-1.** More than a toy! Will make over 20 exciting electronic devices, incl.: Radios, Burglar Alarms, etc. 72 page Manual. The ideal present! Kit £7.13.6 incl. P.T.

**"MOHICAN" GENERAL COV. RECEIVER for Amateur or Short Wave listening.** Send for leaflet.  
Kit £37.17.6 Assembled £45.17.6

Prices quoted are Mail Order, retail prices 5% extra

**WELCOME TO OUR LONDON HEATHKIT CENTRE**  
233 Tottenham Court Road, W.1

We open **MONDAY-FRIDAY** 9 a.m.-5.30 p.m.  
**SATURDAY** ... 9 a.m.-1.0 p.m.

Telephone No.: 01-636 7349

WHEN YOU ARE IN TOWN, WE HOPE YOU WILL VISIT US THERE

### TEST INSTRUMENTS

Our wide range includes:

**3" LOW-PRICED SERVICE OSCILLOSCOPE. Model OS-2.** Compact size 5" x 7 1/2" x 12" deep. Wt. only 9 1/2 lb. "Y" bandwidth 2 c/s-3 Mc/s ± 3dB. Sensitivity 100mV/cm T/B 20 c/s-200 kc/s in four ranges, fitted mu-metal CRT Shield. Modern functional styling.  
Kit £23.18.0 Assembled £31.18.0

**5" GEN.-PURPOSE OSCILLOSCOPE. Model 10-12U.** An outstanding model with professional specification and styling. "Y" bandwidth 3 c/s-4.5 Mc/s ± 3dB. T/B 10 c/s-500 kc/s. Kit £35.17.6 Assembled £45.15.0

**DE LUXE LARGE-SCALE VALVE VOLTMETER. Model IM-13U.** Circuit and specification based on the well-known model V-7A but with many worth-while refinements. 6" Ernest Turner meter. Unique gimbal bracket allows operation of instrument in many positions. Modern styling.  
Kit £18.18.0 Assembled £26.18.0

**AUDIO SIGNAL GENERATOR. Model AG-9U.** 10 c/s to 100 kc/s, switch selected. Distortion less than 0.1%. 10V sine wave output metered in volts and dB's.  
Kit £23.15.0 Assembled £31.15.0

**VALVE VOLTMETER. Model V-7A.** 7 voltage ranges d.c. volts to 1,500. A.C. to 1,500 r.m.s. and 4,000 peak to peak. Resistance 0.1n to 1,000MΩ with internal battery. D.C. input resistance 11MΩ. dB measurement, has centre-zero scale. Complete with test prods, leads and standardising battery.  
Kit £13.18.6 Assembled £19.18.6

**MULTIMETER. Model MM-1U.** Ranges 0-1.5V to 1,500V a.c. and d.c.; 150μA to 15A d.c.; 0.2n to 20MΩ 4 1/2" 50μA meter. Kit £12.18.0 Assembled £18.11.6

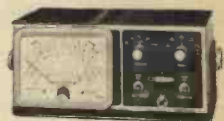
**R.F. SIGNAL GENERATOR. Model RF-1U.** Up to 100 Mc/s fundamental and 200 Mc/s on harmonics. Up to 100mV output.  
Kit £13.18.0 Assembled £20.8.0

**SINE/SQUARE GENERATOR. Model IG-82U.** Freq. range 20 c/s-1 Mc/s in 5 bands less than 0.5% sine wave dist. less than 0.15μ sec. sq. wave rise time.  
Kit £25.15.0 Assembled £37.15.0

**TRANSISTOR POWER SUPPLY. Model IP-20U.** Up to 50V, 1.5A output. Ideal for Laboratory use. Compact size.  
Kit £35.8.0 Assembled £47.8.0



OS-2



VVM, IM-13U



V-7A



RF-1U



IG-82U

Prices and specifications subject to change without notice

# TAPE AMPLIFIERS — TAPE DECKS — CONTROL UNITS

20 + 20W  
STEREO  
AMP.  
AA-22U



GARRARD  
PLAYER  
AT-60



20 + 20W TRANSISTOR STEREO AMPLIFIER. Model AA-22U. Outstanding performance and appearance. Kit £39.10.0 (less cabinet). Attractive walnut veneered cabinet £25.0 extra. Assembled incl. cabinet, £59.15.0

GARRARD AUTO/RECORD PLAYER. Model AT-60, less cartridge £14.12.10. With Decca Deram pick-up £19.7.4 incl. P.T.

Many other Garrard models available, ask for Lists.

HI-FI MONO AMPLIFIER. Model MA-5. A general purpose 5W Amplifier, with inputs for Gram., Radio. Modern functional appearance. Kit £11.9.6 Assembled £15.15.0

WIDE RANGE OF HI-FI CABINETS, send for details.

For example:

MALVERN Kit £18.1.0 incl. P.T.



TRUVOX  
DECK



AM/FM  
TUNER

TRUVOX D-106 and 108 TAPE DECKS. High quality stereo/mono tape decks. D106, 1 track, £39.15.0 D108, 1 track, £39.15.0

TRANSISTOR INTERCOM. Models XI-1U and XIR-1U. A time-saving device for office, shop or for the home. Master unit XI-1U will operate up to 5 remote stations. Master, XI-1U Kit £11.9.6 Assembled £17.9.6. Remote, XIR-1U Kit £4.9.6 Assembled £5.18.0. Send for full specification leaflet.

MONO CONTROL UNIT. Model UMC-1. Designed to work with the MA-12 or similar amplifier requiring 0.25V or less for full output. 5 inputs. Baxandall type controls. Kit £9.2.6 Assembled £14.2.6

STEREO CONTROL UNIT. Model USC-1. Push-button selection, accurately matched ganged controls to ±1dB. Rumble and variable low pass filters. Printed circuit boards. Kit £19.19.0 Assembled £27.5.0

## Build Your Own Electronics



### SPEAKER SYSTEMS



SSU-1

HI-FI SPEAKER SYSTEM. Model SSU-1. Ducted-port bass reflex cabinet "in the white". Two speakers. Vertical horizontal models with legs, Kit £12.12.0, without legs, Kit £11.17.6 incl. P.T.

The BERKELEY SLIM-LINE SPEAKER SYSTEM, fully finished walnut veneered cabinet for faster construction. Special 12" bass unit and 4" mid/high frequency unit. Range 30-17,000 c/s. Size 26" x 17" only 7 1/4" deep. Modern attractive styling. Excellent value. Kit £19.10.0 Assembled £24.0.0

COTSWOLD SPEAKER SYSTEMS. Outstanding performance for price. MFS: Size 36" x 16 1/2" x 14" deep. Kit £25.12.0 Assembled £33.17.0

STANDARD: Size 26" x 23" x 14 1/2" deep. Kit £25.12.0 Assembled £33.17.0.



Berkeley

Complete your motoring pleasure with this outstanding car radio. Model CR-1.



Kit (excl. L.S.) £12.17.0 incl. P.T. Hi-Fi Loudspeaker £1.16.1 extra. Send for full details.

Will give you superb LW and MW entertainment wherever you drive. Tastefully styled to harmonise with any car colour scheme. Available for your convenience in two parts. Can be built for a total price

### "AMATEUR" EQUIPMENT

80-10m TRANSMITTER. Model DX-40U. Power inputs 75W. C.W., 60W peak CC phone. Output 40W to aerial. Provision for VFO. Kit £29.19.0 Assembled £41.8.0

AMATEUR BANDS RECEIVER. Model RA-1. To cover all the Amateur Bands from 160-10 metres. Many special features, including: half-lattice crystal filter; 8 valves; signal strength "S" meter; tuned R.F. Amp. stage. Kit £39.6.6 Assembled £52.10.0

160-10M TRANSMITTER. Model DX-100U. Careful design has achieved high performance and stability. Completely self-contained. Kit £81.10.0 Assembled £106.15.0



DX-40U



RA-1

### NEW MODELS !

AVON HI-FI PERFORMANCE 'MINI' SPEAKER KIT. A compact, bookshelf size, 7 1/2" wide x 19 1/4" high x 8 1/2" deep speaker with beautiful walnut veneered fully-finished cabinet, wide frequency response, special 6" bass, 3" HF units and crossover network. Cabinet Kit £8.18.0. Speaker Kit £4.18.0. Total Price £13.16.0 incl. P.T.



LOW-COST TRANSISTOR STEREO AMPLIFIER KIT TS-23.

A really low priced unit yet incorporates all essential features for good reproduction from gramophone, radio and other sources, 3 watts for channel output (15 ohms). Kit £17.15.0. Beautiful walnut veneered cabinet £2.0.0 extra.



FREE !  
32 page Catalogue.  
SEND FOR YOUR  
COPY  
NOW !

Over 150 models shown,  
many in Full Colour

To DAYSTROM LTD., Dept. P.E.5, Gloucester

Without obligation please send me

FREE BRITISH HEATHKIT CATALOGUE.....  (Tick here)

FULL DETAILS OF MODEL(S).....

(Please write in BLOCK CAPITALS)

NAME .....

ADDRESS .....

Please send FREE catalogue to my friend.

NAME .....

ADDRESS .....

..... P.E.5

# STEREO AMPS.

FROM TRS — MULLARD 10-10

- 10 + 10 watts output
- For 3 and 15 ohm speakers
- Complete with valves

**£17.10.0**

(Carr. & pkg. 10/-)

Ready wired and tested, 50/- extra. (Ready built version only available at present)

This newest design from Mullard comprises integrated stereo pre-amp and amplifier with 10 watts output per channel. This is a very fine circuit, kitted by TRS to exact specification with top quality components. Features include ultralinear class B output on each channel with transformers tapped for 3 and 15 ohm speakers; bass, treble, volume and balance controls; switching for mono/stereo and speaker phasing; input switching; input sensitivity—210mV per section; H.T. and L.T. outlet for tuner. Pre-amp section metal shrouded. With eucetheon panel, pilot light indicator, knobs, plugs, etc. Size 1 1/2 in. x 1 1/4 in x 4 1/2 in. Ideal for use with Garrard Units offered below.

## SINCLAIR Z.12

Very good stereo is obtainable by using two of these famous integrated transistor amplifiers which can be used for 3, 8, 8 or 15 ohm speakers. Instructions included with the Z.12 enable you to use matched control circuits with all types of inputs for which we supply the necessary parts. Z.12 Amplifier as advertised in this journal.

**89/6**  
each

## SINCLAIR STEREO 25

De-luxe pre-amp readily built and ideal for two Z.12s **£9.19.6**

PZ.3

Mains Power Unit **79/6**

## PEAK SOUND SA.8-8

14 transistor integrated stereo pre-amp and amplifier giving 17 watts output into two 5 ohm speakers. A fascinating kit to build, crammed with original features including "Shadow Template" and supply of Cir-kit. Complete down to wire and solder. With front panel, transistors and instructions. **£12.19.6**  
Mains power supply unit for SA.8-8

## TRS FM STEREO DECODER

This outstanding kit is based on the highly successful Mullard design and uses 6 Transistors on a printed circuit size 5 1/2 in. x 2 1/2 in. A 2-stage transistor Stereo Beacon indicator is incorporated. Requires a 12v. supply.

Basic Kit is suitable for use with Transistor equipment. With simple mods (data supplied with Kit) easily adapted for use with Valve Tuners and Amplifiers.

Kit and assembly instructions complete with Mullard specified inductors Type WF2949 and WF2951.

**£4.19.6** with coils **£5.0.0**  
pre-aligned

Packing and postage either model 2/6.

## MULLARD FM DECODER COILS

Designed and made by Mullard, these inductors are as used in T.R.S. Decoder above. Type WF2949 and WF2951, each 25/- Per pair 49/6. Post free.

## GARRARD UNITS & PLINTHS

LM.3000 Record Player with 9 T.P. Stereo Cartridge. Limited number available. Brand new as from factory **8 gns.**

AT.60 De-luxe Auto-changer. 12in. turntable. Superbly engineered. Less cartridge **9 1/2 gns.**

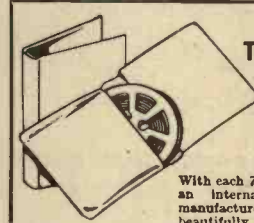
SP.25 De-luxe single record player, less cartridge **9 1/2 gns.**

Packing and carriage on any one of above, **7/6 extra.**

Garrard Plinth. The ideal modern mounting for the Garrard Units offered here. Will readily suit any hi-fi set-up. Beautifully finished in Teak. Complete with contemporary drop-on plastic cover. Packing and carriage **5/-**

Garrard Mono Cartridges from **15/-**; Stereo from **25/-**

Sinclair Micro-F.M. Kit **£5.19.6**  
Sinclair Micromatic Kit **89/6**  
Micromatic



## UNIQUE TAPE OFFER

Professional Tape in Unique Library Wallets only from TRS

With each 7in. reel of tape by an internationally famous manufacturer we give you a beautifully made wallet strongly made in simulated leather with stiff spring and space for a reel of tape each side. This is professional quality mylar tape with foil start and stop leads. These library wallets solve once and for all the problems of storing tapes efficiently and tidily.

7in. reel, **15/-**  
1,200 ft. with wallet

7in. reel, **22/6**  
1,800 ft. with wallet  
(p/p 1/6 per reel)

## HOW TO ORDER

Send cash, cheque or money order with order or pay C.O.D. Please mention "Practical Wireless". Packing and Carriage, unless stated add: 1lb. 1/-; 1 lb. 1/9; 2 lb. 3/6; 6 lb. 5/-; 10 lb. 6/6.



# RADIO COMPONENT SPECIALISTS

Est. 1946

70 BRIGSTOCK ROAD, THORNTON HEATH, SURREY

Daily 9.0 a.m. to 6.0 p.m.  
Wednesdays 1.0 p.m.

A few doors from Thornton Heath Stn. S.R. from Victoria

THO. 2188

## ELECTRONIC ORGAN KITS

NOW ALSO AVAILABLE IN PARTLY BUILT FORM **£105**

So easy to build, so delightful to play  
Suited to all types of music

The Solette. Precision made, pre-tuned units come to you ready to assemble in only 20 hours. Self-contained amplifier and speakers; perfect tone and generous volume, full 5-octave organ keyboard. Five pitches plus solo and melodic bass. Transistorised, portable. Price £118 complete (terms if needed).

Details from:

**Harmonics\***  
(Bromley) Ltd

DEPT. P.E.2, GLARION WORKS, NAPIER ROAD,  
BROMLEY, KENT. RAVensbourne 2122

★ Also two-manual and pedal organ kits up to £395.



## BUILD YOUR CIRCUITS ON VEROBOARD

—the Universal Wiring Board—  
obtainable from your local Retailer

Retail enquiries to:

**NORMAN ROSE (ELECTRICAL) LTD.**  
8 St. Chad's Place, Gray's Inn Road, London, W.C.1

Technical enquiries to:

**VERO ELECTRONICS LTD.**  
Industrial Estate, Chandler's Ford, Hants

## THE CORRECT SPEED AT FULL POWER

REVOLUTIONARY Electronic Speed Control

Fits simply into mains lead of any drill or power tool. Fingertip control gives speed variation from below 10 r.p.m. to maximum.

Uses famous Mullard semiconductors.

Satisfaction guaranteed. With instructions.

**59/6**

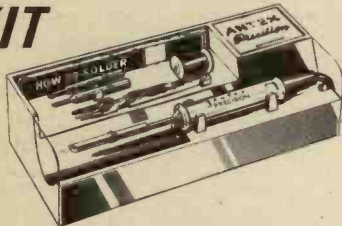
P&P 2/6

## SOUND & SCIENCE LTD.

Mail Order to, Dept. ED 3-5 EDEN GROVE, LONDON, N7. Personal shoppers: 18 & 52 TOTTENHAM CT. RD., London, W1.

# —AN IRON FOR EVERY PRECISION NEED!

## NEW—Complete Precision Soldering KIT



This kit—in a rigid plastic "tool-box"—contains everything you need for precision soldering.

- Model CN 15 watts miniature iron, fitted  $\frac{3}{16}$ " bit.
- Interchangeable spare bit,  $\frac{5}{32}$ "
- Interchangeable spare bit,  $\frac{3}{32}$ "
- Reel of resin-cored solder
- Felt cleaning pad
- Stand for soldering iron
- Space for stowage of lead and plug

PLUS 36-page booklet on "How-to-Solder"—a mine of information for amateur and professional.

**49/6d**

From Electrical and Radio Shops, or if unobtainable locally apply direct to ANTEX LTD.

# ANTEX

Grosvenor House,  
Croydon, CR9 1QE  
Telephone 01-686 2774



**CN** 15 watts. Ideal for miniature and micro miniature soldering. Interchangeable spare bits available from .040" (1 mm) up to  $\frac{3}{16}$ " For 240, 220, 110, 50 or 24 volts. **32/6**



**G** 18 watts. Ideal for miniature work on production lines. Interchangeable spare bits,  $\frac{3}{32}$ ",  $\frac{1}{8}$ ",  $\frac{3}{16}$ " and  $\frac{1}{4}$ " For 240, 220 or 110 volts. **32/6**



**E** 20 watts. Fitted with  $\frac{1}{4}$ " bit. Interchangeable spare bits  $\frac{3}{32}$ ",  $\frac{1}{8}$ ",  $\frac{3}{16}$ ". For 240, 220, 110 or 24 volts. **35/-**



**ES** 25 watts. Fitted with  $\frac{1}{8}$ " bit. Interchangeable bits  $\frac{3}{32}$ ",  $\frac{3}{16}$ " and  $\frac{1}{4}$ ". Ideal for high speed production lines. For 240, 220, 110, 24 or 12 volts. **35/-**



**F** 40 watts. Fitted  $\frac{5}{16}$ " bit. Interchangeable bits  $\frac{1}{4}$ ",  $\frac{3}{16}$ ",  $\frac{1}{8}$ ",  $\frac{3}{32}$ ". Very high temperature iron. Available for 240, 220, 110, 24 or 20 volts. **42/6**

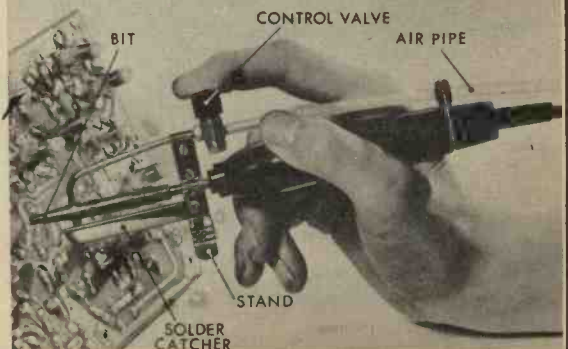
Spare bits and elements for all models and voltages immediately available from stock.

Send for the 16-page ANTEX main catalogue


## THE ANTEX DE-SOLDERING TOOL




Soldered joints can now be easily, speedily and neatly unsoldered. A self-cleaning nozzle, exclusive to the ANTEX De-Soldering Irons, sucks up molten solder into stainless steel catcher. Operates by compressed air from airline or standard foot-pump. Type ESS (25W) for 240, 220, 110 or 24 volts. Type GSS (18W) for 240, 220 or 110 volts. Price £4. 4. 0d. De-Soldering Tool complete with foot-pump, as illustrated £4.19.6d.



**NEW MODEL 500.** 80,000 o.p.v. With overload protection, 0/5/1/2.5/10/25/100/250/500/1,000v. D.C. 0/2.5/10/25/100/250 600/1,000v. A.C. 0/50µA/5/50/500mA. 12 amp. D.C. 0/60K/6 Meg./60. Meg. Ω. £8/17/6 Post Paid.



**PROFESSIONAL 20,000 o.p.v. LAB. TYPE MULTITESTER**




With automatic overload protection, mirror scale. Ranges: 1/10/50/250/500/1,000 volts, D.C. and A.C. 0-500 µA, 10 mA, 250 mA. Current: 0/20 K, 200 K, 2 megohm. Decibels -20 to +22db. £5/10/. P. & P. 2/6.


**TE-900** 20,000Ω/VOLT GIANT MULTITESTER 6in. full view meter. 2 colour scale. 0/2.5/10/250/1,000/5,000 v. A.C. 0/25/12.5/10/50/250/1,000/5,000 v. D.C. 0/50µA/110/100/500 mA/10 amp. D.C. 0.2K/200K/20 Megohm. £12/19/6. P. & P. 8/-.



**MODEL ZQM TRANSISTOR CHECKER** It has the fullest capacity for checking on A, B and Ico. Equally adaptable for checking diodes, etc. Spec.: A: 0-7; 0-9987; B: 5-200; Ico: 0-50 microamps, 0-5 mA. Resistance for diode 200 Ω. 1 Meg. Supplied complete with instructions, battery and leads. £8/19/6. P. & P. 2/6.



**★ TRANSISTORISED FM TUNER ★** 6 TRANSISTOR HIGH QUALITY TUNER. SIZE ONLY 6in. x 4in. x 2 1/2in. 3 I.F. stages. Double tuned discriminator. Ample output to feed most amplifiers. Operates on 9 volt battery. Coverage 88-108 Mc/s. Ready built ready for use. Fantastic value for money. £6/19/6. P. & P. 2/6.



**NOMBREX TRANSISTORISED EQUIPMENT** ALL Post Paid With Battery



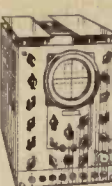
Transistorised Audio Generator 10-100,000 c/s. Sine or square wave. £18/15/-. Transistorised Signal Generator 150 kc/s. 230 Mc/s. £10/10/-. Transistorised resistance capacity bridge 1Ω. 100 Meg. Ω 1 p/100µF. £9. Transistorised Induction bridge 1µH-100H. £18. Mains operated Transistor power supply unit, output 1-15 v. up to 100 mA. £8/10/-.

**SILICON RECTIFIERS**

200 v. P.I.V. 200mA.	2/6
400 v. P.I.V. 8 amp.	5/6
400 v. P.I.V. 3 amp.	7/6
1,000 v. P.I.V. 850 mA.	6/8
800 v. P.I.V. 500mA.	5/8
800 v. P.I.V. 5 amp.	7/6
400 v. P.I.V. 600mA.	3/6
70 v. P.I.V. 1 amp.	3/6
150 v. P.I.V. 165mA.	1/-
150 v. P.I.V. 25 amp.	18/6
700 v. P.I.V. 100 amp.	4/6
400 v. P.I.V. 3 amp. (S.C.R.)	10/-
100 v. P.I.V. 5 amp. (S.C.R.)	13/6
200 v. P.I.V. 5 amp. (S.C.R.)	15/6
400 v. P.I.V. 5 amp. (S.C.R.)	17/6

Discounts for quantities. Post extra.


**TYPE 13A DOUBLE BEAM OSCILLOSCOPE BARGAIN!** A high quality instrument, offered at a fraction of original cost. Timebase 2 c/s-750 kc/s. Separate Y1 and Y2 amplifiers up to 5.5 Mc/s. Built-in calibrators at 100 kc/s. and 1 Mc. Operation for 115/250 v. A.C. Available in excellent condition, fully tested and checked. £22/10/-. Carr. 30/-.



**TE-20RF SIGNAL GENERATOR** Accurate wide range signal generator covering 120 kc/s-250 Mc/s on 6 bands. Directly calibrated. Variable R.F. attenuator. Operation 200/240 v. A.C. Brand new with instructions £12/10/-. P. & P. 7/6. S.A.E. for details.




**LAFAYETTE TE-46 RESISTANCE CAPACITY ANALYSER** 2 P.F. - 2,000 MFD. 2 ohms - 200 megohms. Also checks impedance turns ratio, insulation, 200/250 v. A.C. Brand New £15. Carr. 7/6.



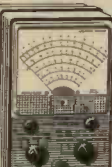
**TE22 SINE SQUARE WAVE AUDIO GENERATOR** Sine: 20 cps to 200 kc/s on 4 bands. Square: 20 cps to 30 kc/s. Output impedance 8,000 ohms, 200/250 v. A.C. Supplied brand new and guaranteed with instruction manual and leads, £15. Carr. 7/6.



**ARF-100 COMBINED AF-RF SIGNAL GENERATOR** AF. SINE WAVE 20 - 200,000 cps. Square wave 20,30,000 cps. O/P. HIGH IMP. 21 v. P/P 600 Ω 3-8 v. P/P. TF. 100 kc/s-300 Mc/s. Variable R.F. attenuation. Int/Ext. Modulation Incorporates dual purpose meter to monitor AF output and % mod. on R.F. 220/240 v. A.C. £27/10/-. Carr. 7/6.



**TE-65 VALVE VOLTMETER** High quality instrument with 25 ranges. D.C. volts 1.5-1,500 v. A.C. volts 1.5-1,500 v. Resistance up to 1,000 megohms. 220/249 v. A.C. operation. Complete with probe and instructions, £15. P.P. 6/-. Additional Probes available: R.F. 35/-; H.V. 42/6.



**F.M. WIRELESS MICROPHONE** 94-104 Mc/s. Transistorised. Operates from 9 v. battery. Complete with additional secret tie-clip microphone. List £12.10.0. ONLY £7.10.0. P. & P. 2/6. These cannot be operated in U.K.



**R.107 RECEIVERS** 1-7-7.5 Mc/s. Mains or 12 volt D.C. operation. Perfect condition. £15. Carr. 30/-.

**SP.600JX RECEIVERS** Few only of these outstanding receivers 540 Kc/s-54 Mc/s. Cost over £500. Available in excellent condition. £100.

Catalogue of Electronic Components and Equipment



Send today 5/- P&P 1/-

**CATALOGUE**

- ★ ELECTRONIC COMPONENTS
- ★ TEST EQUIPMENT
- ★ COMMUNICATION EQUIPMENT
- ★ HI-FI EQUIPMENT

We are proud to introduce our first comprehensive catalogue of Electronic Components and equipment. Over 150 pages, fully illustrated, listing thousands of items many at bargain prices. Free discount coupons with every catalogue. Everyone in electronics should have a copy.

**CLEAR PLASTIC PANEL METERS** First grade quality. Moving Coil panel meters, available ex-stock. S.A.E. for illustrated leaflet. Discounts for quantity. Available as follows: Type MR. 35P. 1 21/32in. square fronts.


100-0-100µA	27/8	200mA	22/8	100V D.C.	22/8
500-0-500A	22/8	300mA	22/8	150V D.C.	22/8
1-0-1mA	22/8	500mA	22/8	300V D.C.	22/8
1mA	22/8	750mA	22/8	500V D.C.	22/8
2mA	22/8	1A D.C.	22/8	750V D.C.	22/8
5mA	22/8	2A D.C.	22/8	15V A.C.	22/8
10mA	22/8	5A D.C.	22/8	50V A.C.	22/8
20mA	22/8	3V D.C.	22/8	150V A.C.	22/8
50mA	22/8	10V D.C.	22/8	300V A.C.	22/8
100mA	22/8	20V D.C.	22/8	500V A.C.	22/8
500µA	25/-	150mA	22/8	50V D.C.	22/8
50-0-50µA	29/6				

POST EXTRA. Larger sizes available—send for lists.

**R209 MK. II COMMUNICATION RECEIVER** 11 valve high grade communication receiver suitable for tropical use. 1-20 Mc/s on 4 bands. AM/CW/FM operation. Incorporates precision vernier driver, B.F.O. Aerial trimmer, internal speaker and 12 v. D.C. internal power supply. Supplied in excellent condition, fully tested and checked. £15. Carr. 20/-.



**HA-63A COMMUNICATION RECEIVER OUTSTANDING VALUE** High class receiver covering 850 kc/s-31 mc/s on 4 bands. Incorporates 7 valves plus rectifier, RF stage, illuminated 'S' meter, 1.5µV sensitivity, electrical bandspread on the 80/40/20/15 and 10 metre bands, slide rule dial, aerial trimmer, B.F.O., noise limiter, Output for phones or speaker. Operates on 115/220/240 v. A.C. Supplied brand new and guaranteed with manual. 24 gns. Carr. 10/-.




**LAFAYETTE KT-340 COMMUNICATION RECEIVER SEMI-KIT** Build this wonderful receiver and save Pounds! Supplied semi-completed, main components ready mounted, R.F. Section already wired and aligned. Full and precise instructions supplied. Specification: 8 valves + rectifier, 4 bands covering 550 Kc/s-30 Mc/s. Incorporates 1 R.F. and 2 I.F. stages, "Q" multiplier, B.F.O., A.N.L. "S" meter, bandspread, aerial trimmer, etc. Operation 115/230v. A.C. Price 25 GNS. Carr. 10/-.



**HAM-I. 4 BAND COMMUNICATION RECEIVER** 4 wavebands covering 535 kc/s-30 Mc/s 5-valve superhet circuit. Incorporates 8 meter, B.F.O., BANDSPREAD TUNING, BUILT-IN 4in. SPEAKER, FERRITE AERIAL AND EXTERNAL TELESCOPIC AERIAL. Operation 220/240v. A.C. Supplied brand new with handbook. £18/16/0. Carr. 10/-.



**NEWLAFAYETTE MODEL HA-700 AM/CW/SSB AMATEUR COMMUNICATION RECEIVER** 8 valves, 8 bands incorporating 2 MECHANICAL FILTERS for exceptional selectivity and sensitivity. Frequency coverage on 5 bands 150-400 kc/s, 850-1,600 kc/s, 1.8-4.0 Mc/s, 48-14.5 Mc/s, 10-5-30 Mc/s. Circuit incorporates R.F. stage, aerial trimmer, noise limiter, B.F.O., product detector, electrical bandspread, 8 meter, slide rule dial. Output for phones, low to 2K Ω or speaker 4 or 8 ohms. Operation 220/240 volt A.C. Size 7 1/2in. x 15in. x 10in. Supplied brand new and guaranteed with handbook 36 GNS. carr. 10/- S.A.E. for leaflet.



**CALLERS WELCOME!** Open 9 a.m. to 6 p.m. every day Monday to Saturday. Trade supplied.

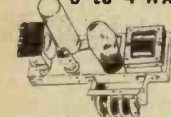
**G.W. SMITH & CO. (RADIO) LIMITED**  
Phone: GERRARD 8204/9155  
Cables: SMITHEX LESQUARE  
3-34 LISLE STREET, LONDON, W.C.2



### POCKET MULTI-METER

Size 3 1/2 x 2 1/4 x 1 1/4 in. Meter size 2 1/4 x 1 1/4 in. Sensitivity 1000, 0 P.V. on both A.C. and D.C. volts. 0-15, 0-150, 0-1000. D.C. current 0-150mA. Resistance 0-100k Ohm. Complete with test leads, battery and full instructions, 42/6. P. & P. 3/6. **FREE GIFT** for limited period only. 30 watt Electric Soldering Iron value 15/- to every purchaser of the Pocket Multi-Meter

### 3 to 4 WATT AMPLIFIER



3-4 watt Amplifier built and tested. Chassis size 7 x 3 1/4 x 1 in. Separate bass, treble and volume control. Double wound mains transformer, metal rectifier and output transformer for 3 ohms speaker. Valves ECC81 and 6V6. £2.5.0 plus 5/6 P. & P. The above in Kit Form, £1.14.6 plus 5/6 P. & P.

### CYLDON U.H.F. TUNER

complete with PC.88 and PC.86 Valves. Full variable tuning. New and unused. Size 4 1/2 x 5 1/2 x 1 1/2". Complete with circuit diagram. 35/- plus 3/6 P. & P.



### NEW Transistorised SIGNAL GENERATOR

Size 5 1/2 x 3 1/2 x 1 1/2". For IF and RF alignment and AF output, 700 c/s frequency coverage 460 Kc/s to 2 Mc/s in switched frequencies. Ideal for alignment to our Elegant Seven and Musette. Built and tested. 39/6. P. & P. 3/6.



### TRANSISTOR INVERTOR

50v. D.C. Input. Output 240 v. A.C. 40 watts incorporating transformers, choke, condensers and 2 Mullard OC28 in solid 16 gauge Aluminium Case. Size 15" x 6" x 2 1/2" by famous manufacturers. 19/6 plus 7/- P. & P.

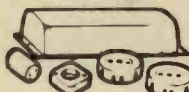


### 40W FLUORESCENT LIGHT KIT

Incorporating GEC Choke size 8 1/4 x 1 3/4 x 1 1/2", 2 bi-pin holders, starter and starter-holder. 11/6. P. & P. 5/6.

Similar to above: 80 W. Fluorescent Light Kit incorporating GEC Choke size 11 1/2 x 1 3/4 x 1 1/2", 2 bi-pin holders, starter and starter holder 17/6. P. & P. 6/6.

Twin 40 W Choke instant start for 2 x 2 ft. tubes 17/6. P. & P. 5/6.

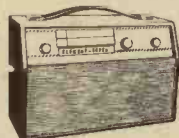


## Special offer ELEGANT SEVEN mk IIa

**SPECIAL OFFER.** 7" x 4" P.M. Speaker at no extra charge. Power supply kit to purchasers of 'Elegant Seven' parts, incorporating mains transformer, rectifier and smoothing condenser, A.C. mains 200/250 volts. Output 9v. 100 mA. 7/6 extra.

Buy yourself an easy to build 7 transistor radio and save at least £10.0.0. Now you can build this superb 7 transistor superhet radio for under £4.10.0. No one else can offer such a fantastic radio with so many de luxe star features.

★ De luxe grey wooden cabinet size 12 1/2 x 8 1/4 x 3 1/4". ★ Horizontal easy to read tuning scale printed grey with black letters, size 11 1/2 x 2". ★ High 'Q' ferrite rod aerial. ★ I.F. neutralisation on each separate stage. ★ D.C. coupled push pull output stage with separate A.C. negative feedback. ★ Room filling output 350mW. ★ Ready etched and drilled printed circuit board back printed for foolproof construction. ★ Fully comprehensive instructions and point to point wiring diagrams. ★ Car aerial socket. ★ Fully tunable over medium and long wave, 168-535 metres and 1250-2000 metres. ★ All components, ferrite rod and tuning assembly mount on printed board. ★ Parts list and circuit diagram 2/6, free with parts.



ONLY £4.4.0

plus 7/6 Post & Packing

### BSR Tape deck

AC 200/250 v., tape speed 3 1/2 twin track.

**Special price £5.19.6**

Post and packing 7/6

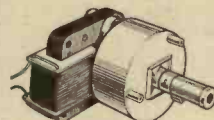


## 8-VALVE STEREO RADIOGRAM CHASSIS

### 3-4 WATTS PER CHANNEL

By Famous Manufacturer

Superb new 8-valve chassis covering long, medium and short waves on AM, also VHF transmissions on FM. AM circuit's high sensitivity permits internal aerial for most stations. Well-known Gortler tuning heart in separate FM input. Tone and volume controls. Extra large illuminated dial. External AM and FM aerial inputs. Gram. pick-up socket. Standard 3 ohm speaker. 200/250 volts A.C. **£14. 14. 0** P. & P. £1



### Type E MOTOR

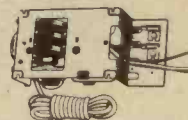
Small A.C. mains motor 230/250 volts complete with gearbox, 6 r.p.m. Price 15/- plus 4/- P. & P. Similar to above motor but without gearbox. Price 9/6 plus 3/- P. & P.

### SILICON RECTIFIERS

250 v. P.I.V. 750 milliamps. Six for 7/6, Post paid.

### TRANSISTORISED 1 1/2 WATT AMPLIFIER

comprising 2AC 128, 20C 75 and 2 AA129 separate bass and treble volume controls. Complete with Power Supply AC mains 240 v. Size 7 1/2 x 3 1/2 x 2". Price 50/- plus 2/6 P. & P.



### POWER SUPPLY KIT

A.C. MAINS 200-250 V Incorporating "C" core type mains transformer, full wave metal rectification and smoothing condenser. Smooth output 250 v. 250 mA and 6-3v. 4 amp. for Heaters. 25/- P. & P. 9/6.



### FIRST QUALITY P.V.C. TAPE

5 1/2" Std. 850ft. ... 9/-	5" L.P. 850ft. ... 10/6
7" Std. 1200ft. ... 11/6	3" T.P. 600ft. ... 10/6
3" L.P. 240ft. ... 4/-	5" T.P. 1800ft. ... 25/6
5 1/2" L.P. 1200ft. ... 11/6	5 1/2" T.P. 2400ft. ... 32/6
7" L.P. 1800ft. ... 18/6	7" T.P. 3600ft. ... 42/6
5 1/2" D.P. 1800ft. ... 18/6	4" T.P. 900ft. ... 15/-

P. & P. on each 1/6, 4 or more post free



### EXTRACTOR FAN

AC Mains 230/250v complete with pull switch. Size 6" x 6" x 4". Price 27/6 plus 5/- P. & P.

### GEC DOORBELL

Complete with mains transformer 240v AC and illuminated bell push. Price 12/6 plus 5/6 P. & P.



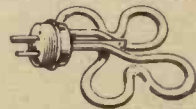
### 8-WATT 4-VALVE PUSH-PULL AMPLIFIER & Metal RECTIFIER



Size 9" x 6" x 1 1/4". A.C. Mains, 200-250 v. 4 valves. For use with Std. or L.P. records, musical instruments. All makes of pick-ups and mikes. Output 8 watts at 5 per cent of total distortion. Separate bass and treble lift control. Two inputs, with controls for gram. and mike. Output transformer tapped for 3 and 15 ohm speech coils. Built and tested. £4.4.0. P. & P. 11/- 8" x 5" Speaker to suit. Price 14/6 plus 1/6 P. & P. Crystal Mike to suit 12/6 plus 1/6 P. & P.

### GEC KETTLE ELEMENT

3,000W WITH AUTOMATIC EJECTION 200/240 v. size of hole required 1 1/8". List Price 32/- Our PRICE 15/- P. & P. 1/6.



## RADIO AND T.V. COMPONENTS (ACTON) LTD.

21D HIGH STREET, ACTON, LONDON, W.3

Shop hours 9 a.m. to 6 p.m. Early closing Wednesday. Goods not despatched outside U.K.

All enquiries stamped addressed envelope. Terms C.W.O.

Also at 323 EDGWARE ROAD, LONDON, W.2  
Early closing Thursday  
PERSONAL SHOPPERS ONLY  
All orders by post must be sent to our Acton Address

# G

## GET A GOLDRING HI-FI TURNTABLE UNIT FOR YOUR AMPLIFIER



### GOLDRING-LENCO G.99

Incorporates the unique Goldring-Lenco continuously variable speed control and vertical drive features. Machined 8 lb. non-magnetic turntable. Push-button switching. Neon-lit stroboscope. Speed constant within 1% for up to 13% mains voltage change. £21.19.5d.

### GOLDRING-LENCO GL 68

Continuously variable speed control with adjustable click-in positions for standard speeds. Arm takes interchangeable head-slides, and is raised and lowered by on/off switch. Wired for mono and stereo. £19.10.7d.



There's a Goldring, or Goldring-Lenco unit to match *any* amplifier—whether you build it or buy it. At the modest end of the scale there's the G.66 integrated hi-fi unit that comes complete with pick-up arm and cartridge for as little as 11 gns. Then there's the highly popular GL 68 (see left) and, for the man who wants the best he can get there's the GL 70 transcription unit with integrated transcription arm at a little under £30, or the sophisticated G 99 without arm, at around £22. Goldring hi-fi equipment includes transcription arms from 7 gns. upwards and a wide choice of cartridges. The coupon will bring you full descriptive leaflets.

### GOLDRING HI-FI EQUIPMENT



To: **GOLDRING MANUFACTURING CO. (G.B.) LTD.**, 486-488 High Road, Leytonstone, London, E.11.

Please send me descriptive leaflets on

- TURNTABLE UNITS     TRANSCRIPTION ARMS  
 MONO & STEREO CARTRIDGES     HI-FI ACCESSORIES

Name \_\_\_\_\_

Address \_\_\_\_\_

To: Goldring Manufacturing Co. (G.B.) Ltd., 486 High Road, Leytonstone, London, E.11. Telephone: Leytonstone 8343



## THREE SCORE AND TEN

**S**EVENTY years ago there occurred a momentous scientific discovery that was destined to set in motion the greatest technological revolution yet known. The ultimate extent of this revolution and its full consequences no one even today can envisage. Imagination cannot keep pace with events as developments in the field of electronics continue at a phenomenal rate.

Yet a mere three score years and ten separate us from the "pre-electron" era.

In May 1897 there appeared in the magazine the *Electrician* the first account to be published by J. J. Thomson of his epoch making investigations into cathode rays. These experiments definitely established that cathode rays are composed of discrete particles of matter, and that each of these particles has a negative electrical charge.

J. J. Thomson called these particles "corpuscles" and believed them to be a universal constituent of all matter. This was subsequently found to be true. The name electron was shortly afterwards given to these corpuscles.

It is of interest to note that the electrical industry played a significant part (if unwittingly) in this experimental work. Improved vacuum techniques developed for the manufacture of electric lamps greatly aided Thomson's investigations into the nature of the mysterious cathode rays.

Thus technology of the electrical industry contributed in this way to the outstanding scientific discovery of modern times: and from this discovery was to grow the most exciting and prolific technology of all. Once the electron had been identified many of the perplexing problems of atomic physics were soon resolved. Knowledge of the nature of the cathode rays lead to their utilisation under controlled conditions in vacuum tubes specially designed for particular applications. The production of X-rays, and of visible images on fluorescent screens; the control and amplification of electric currents; the use of the electron beam for microscopy—these were some of the major developments.

Born in the physicist's laboratory, subsequently developed and matured in industry, electronic technology has already completed the full circle by returning to the place of its birth in the form of elegant and powerful tools to aid the research workers probing at today's frontiers of science.

Three score years and ten may be the "normal" life span of man, but no worries of longevity need bother that spritely fellow the electron, for *his* active life as an agent of man has hardly yet begun!

## THIS MONTH

### CONSTRUCTIONAL PROJECTS

SCOOTER ALARM SYSTEM	340
DOOR SLAVE	355
BASS GUITAR	359
LIGHT OPERATED STOPWATCH	370

### SPECIAL SERIES

COMPUTER EVOLUTION—I	336
THE ELECTRONIC ORGAN—6	349

### GENERAL FEATURES

FIELD EFFECT TRANSISTORS	378
--------------------------	-----

### NEWS AND COMMENT

EDITORIAL	335
ELECTRONORAMA	366
AUDIO TRENDS	368
MARKET PLACE	386
DETACHED PARTICLES	389
READOUT	390

Our June issue will be published on  
Friday, May 12



Replica of Pascal's Calculating Machine . (Crown Copyright. Science Museum, London)

# COMPUTER

## PART ONE

## HISTORY OF CALCULATION

To the man in the street the subject of computers conjures up mysterious misconceptions of complex "robots" with minds of their own, or perhaps a threat to the working man's livelihood.

A computer cannot think for itself; it relies on operators to feed it with information. The process of converting this information (software) to arrive at a mathematical solution or to control the functions of some other machine is the task of the computer.

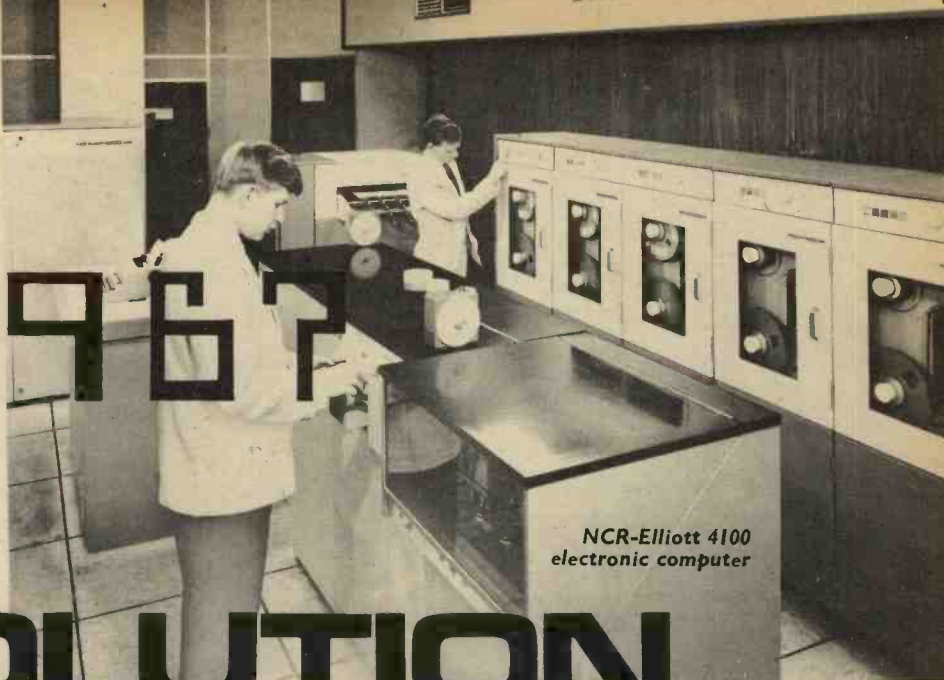
This series of articles sets out to show how the computer is, in fact, a slave of man and not the converse. The first part looks back over centuries of crude developments, of mechanical devices, the forerunners of modern electronic computers.

Later parts will be divided into two broad sections—analogue and digital.

**By S. A. HODSON B.Sc.**

# 335

# 1967



NCR-Elliott 4100  
electronic computer

# EVOLUTION

WHEN man first began to recognise discrete quantities, it is easy to guess that he turned first of all to his fingers as a measure of what he was counting. In fact the whole decimal system has been built up from these first gropings. The fact that we work to a base of 10 is due, no more no less, to the fact that man has eight fingers and two thumbs. As we shall see later in the series, any basic block of numbers can be used as a counting system; and we use this fact to great advantage in the field of digital computers.

Coming back now to man and his fingers, he has a very easy way of remembering any number up to and including 10. Simply by raising the appropriate digits he can represent any one of 11 numbers (remembering that zero is a number). The important thing to note is that he can only count in jumps of one; nothing smaller. Fractions have not entered the story as yet.

Having got to 10, what does he do next? Let us say he picks up a stone when he reaches his count of 10, and puts it on one side to remind him that he has reached 10 once. Then when he reaches 10 again he picks up another stone and puts it with the first. That takes him up to 20 with unlimited possibilities for further counting. Our man has invented the first computing system.

This system of counting spread until about 5,000 years ago in the Tigris-Euphrates valley when someone thought of cutting grooves in a block of stone or wood, and letting the pebbles run in these grooves.

When this reached the ears of the Chinese, who were at that time highly civilised, they had to go one better. They drilled holes in the pebbles and threaded them on to rods; this machine they called an Abacus. (The Japanese reached the same answer at about the same time but they called theirs a Soroban.) Both these peoples became, and still are highly proficient in the use of these machines. Even now a Japanese who is practised in the use of an abacus can perform calculations on it faster than a Westerner with a mechanical calculating machine.

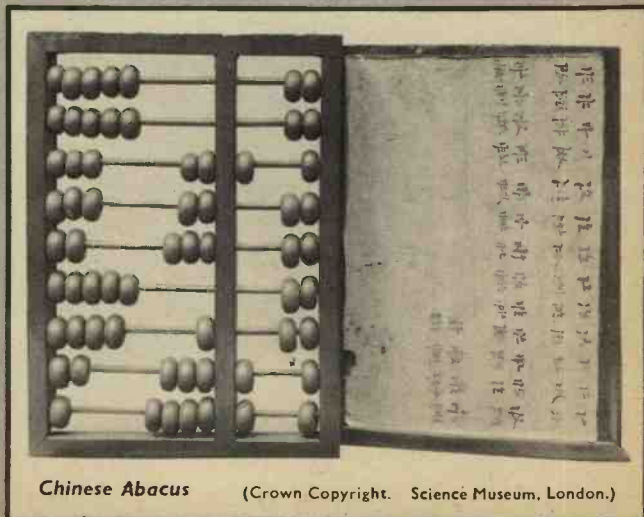
## 17th CENTURY MATHS

Having reached this stage of development, counting machines progressed little more until the early part of the 17th century.

Before going on to describe the development of calculating machines in the renaissance period, it should be pointed out that the machines discussed so far have been able only to add up discrete numbers. They cannot count anything smaller than one stone, pebble or bead; whichever is being used. This point will be of significance later in this article.

At the beginning of the 17th century the great mathematicians and philosophers like Leibniz, Descartes, Napier, Pascal, and others were pushing the frontiers of knowledge outwards at a great pace; not least in the field of mathematics. It is from their advances in this subject that the modern computing machine was developed.

These men worked in the realm of the mathematical equation or "function", and by means of these functions they explained many observable phenomena. What is

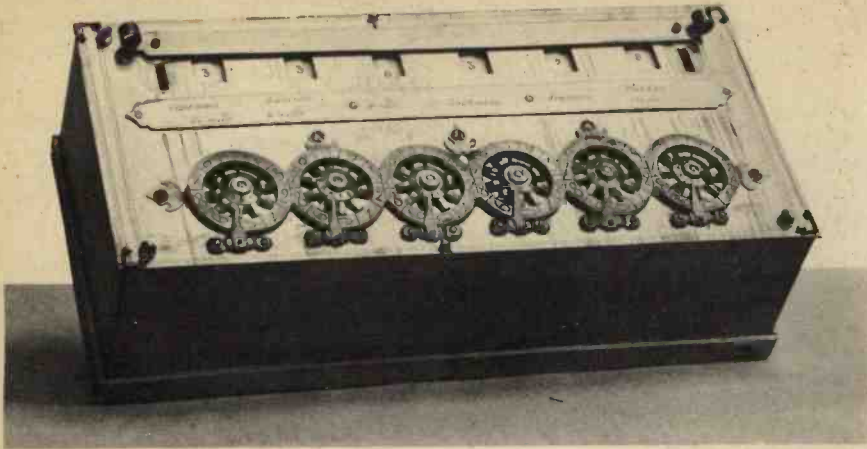


Chinese Abacus

(Crown Copyright. Science Museum, London.)

**Replica of Pascal's calculating machine**

(Crown Copyright. Science Museum, London)



perhaps more important is that they showed that any physical occurrence, be it observable or not, could be represented by some mathematical function. This is another of the axioms that is used to great effect in modern computers.

The first step in this period that was taken to make calculating easier was not a machine at all but a table of figures. In 1614 John Napier invented his Napierian Logarithms. In the following year Henry Briggs converted them to what mathematicians call "base 10", and gave us the familiar "log table" that we use today.

Directly derived from the log table is the slide rule, which is the most common form of analogue computing device in use today.

**INTEGRATION**

Mathematical development went on for 200 years after Napier without the aid of any new calculating machines until, in 1814, J. A. Hermann invented a device for measuring the area under a curve. This was the first true "integrator", and was the ancestor of the modern planimeter. The planimeter, which measures the area under any part of a curve, may be said to perform the function of integration; and as such is an analogue computing device.

The meaning of the term analogue should be explained at this point. It has been stated that the abacus and its contemporary machines have only been able to count in discrete jumps. Now history has

reached a point where a device for integrating has been invented. Integration is essentially a smooth process, and this is sufficient to define it as an analogue process. The question "is the process smooth or jerky?" is a good guide to the classification of a device. If the answer is smooth then the device falls under the heading "analogue". If the answer is jerky then the device can be classified as "digital".

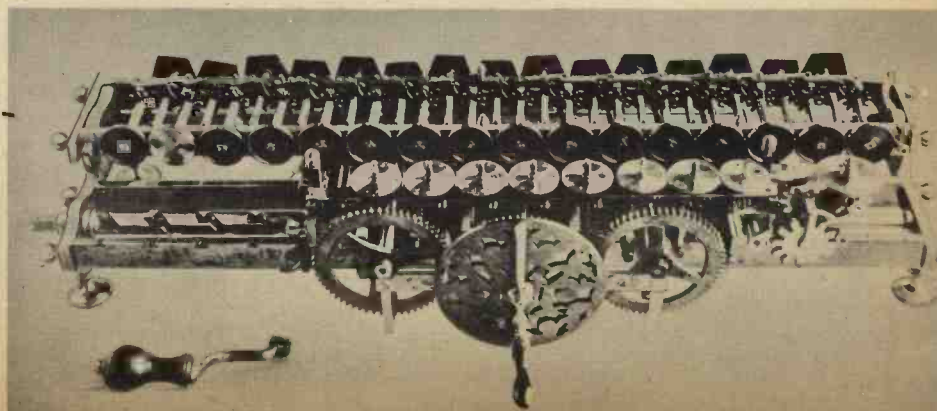
Broadly speaking, the term analogue can be interpreted as "model". An analogue device is a model of the system upon which it is performing calculations. For instance, the slide rule uses distance as a model of any unit that is being used in a calculation, be it feet per second, tons, or just a plain number.

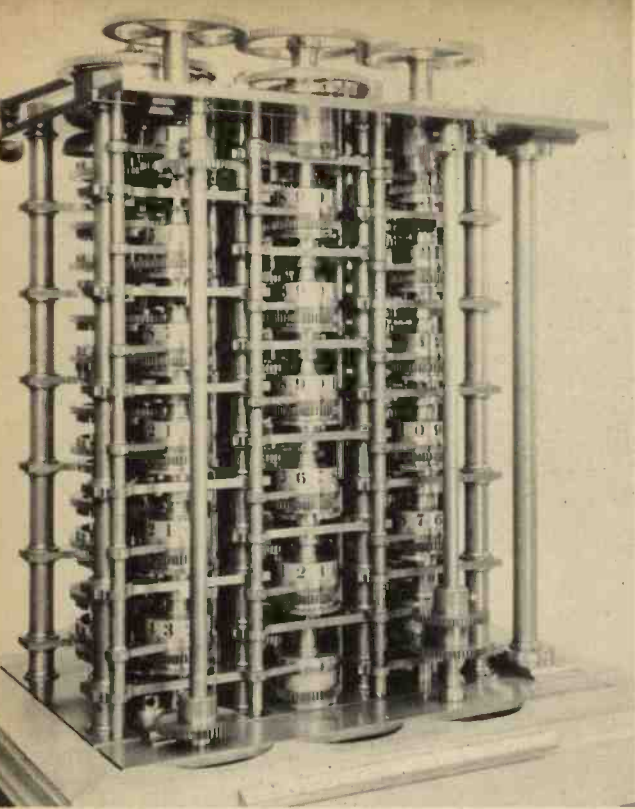
Soon after Hermann's invention of the integrator, James Thompson (the brother of Lord Kelvin) invented the ball-and-disc integrator which is still in use today. However, in this case credit must go to Lord Kelvin himself for connecting a series of his brother's integrators together in order to solve differential equations.

This spotlights one of the most important concepts to emerge from the renaissance period: a physical occurrence of any sort can be described in terms of a differential equation. This discovery is so general that it is sufficient, when designing an analogue computer, to make it able to solve differential equations. Once it can do this it can solve any physical problem whatsoever.

Thus Lord Kelvin's chain of integrators can claim to be the first step on the road to a modern analogue computer.

*Leibnitz calculating machine. The outer case has been removed*





**Babbage's difference engine** (Crown Copyright. Science Museum, London)

This has brought the development of analogue devices up to a point where they bear a recognisable relationship to modern machines, and it is convenient to leave their further progress until later in the series, and turn to that of the digital counting machine, which, at the present stage in this discussion has reached the stage of the abacus.

The nineteenth century was not devoted entirely to the development of the analogue computing device. Contemporary to the events described above were a

whole string of counting machines that used digital principles. The use of the term "counting machines" rather than "computing machines" is deliberate in that they had not progressed beyond the stage of being merely an aid to the memory.

Just after Napier had invented logarithms, Blaise Pascal introduced, in 1632, what must be one of the most significant developments in the history of digital machines. He designed a calculator using toothed wheels instead of beads. Pascal's machine could perform additions and subtractions, and, to a limited extent, multiplications and divisions.

Another advantage of this machine, and this marks a new and very important difference between analogue and digital machines, was that its range, and hence its accuracy, could be increased simply by adding further identical toothed wheels. For instance, with three wheels, numbers of up to 999 can be represented. This range can be increased by a factor of 10 simply by adding one more wheel. The addition of this wheel represents an increase in the actual hardware of the machine of one third.

Compare this now with a similar situation on an analogue machine. Suppose that one linear foot of a scale represents 1ft/sec in a calculation. If 10ft/sec should need to be represented, the scale will have to increase in length to 10ft, an increase in hardware of ten times for the same increase in range. This kind of example shows that physical limitations of a representative scale for large values become obvious. However, as will be seen later in the series, they also have advantages that, in certain fields, make them superior to digital machines.

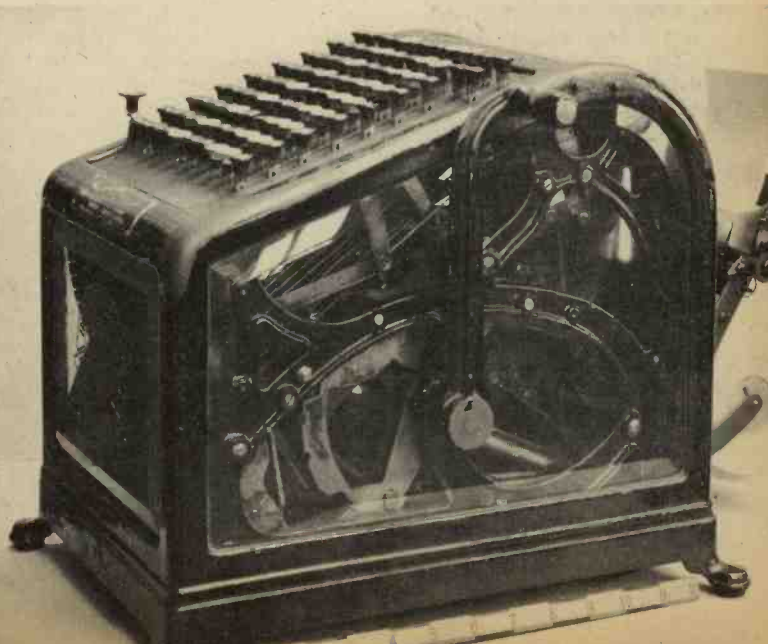
## CALCULATORS

Returning now to Pascal's calculator, the manner in which it performs additions and subtractions need hardly be described; but the way in which it can be made to perform multiplications and divisions is both instructive and useful, since it is still in use in some machines today.

Suppose that, on a digital machine, it is desired to multiply 8 by 8. This can be done in eight steps by starting with 8, and adding 8 to it seven times, thus giving "eight eights".

## An early Burroughs adding machine

(Lent to Science Museum, London, by the Burroughs Adding Machine Company)



In a similar manner, to divide 64 by 8, it is necessary only to keep subtracting 8 from 64, keeping a running total of both the result and the number of times the process has been repeated. This last figure then gives the answer when a zero running total is obtained. Should the answer not be exact, then the remainder is left in the running total.

These methods are known as: "multiplication by repeated addition" and "division by repeated subtraction". The important thing to note is that the results obtained by these methods are exact. The multiplication will always give the exact answer, and the division will give an exact answer with an exact remainder. If the same calculations are performed on a slide rule, it will be seen that the answers are only as accurate as the scale, and can only be given, at best, to four figures and sometimes only to three.

The next machine of any importance to be built after Pascal's, was designed by Baron von Leibniz, a very famous mathematician, who, unfortunately, was not as good at engineering as he was at mathematics. His first machine, finished in 1694, while being correct theoretically, was mechanically temperamental.

The important design feature of this machine was that it could perform multiplication and division by repeated addition and subtraction automatically. This set up a precedent, and from then on man has aimed for more and more automation in his calculating machines.

## AUTOMATIC COMPUTER

Development of digital machines followed the path that Leibniz had started, and made no further major advance until 1812 when Charles Babbage, an English mathematician, set out to make an automatic computer. This was no small task that Babbage was setting himself, since there was at that time no successful calculating machine available, let alone a computer.

Unfortunately for Babbage, the technology of the time was not sufficiently advanced, and he had to abandon his project in 1842. However, before he abandoned it, he had laid down a basic layout for his machine that has survived into present day computer engineering in very much its original form.

Babbage envisaged a machine that could perform one addition every second. This was very fast for his day, and was certainly much faster than any human operator could enter figures into the machine. He decided to divide his machine into three parts, which he called the "store", the "mill", and the "control".

The store was filled with all the data necessary for the calculation; this information was held in the shape of holes punched in pieces of card—another of Babbage's innovations that has survived into the present time. The mill was the unit full of toothed wheels that actually performed the operations of addition, multiplication, and so on, and the control unit told the mill what and when to do, and where to find the means to do it.

Babbage's machine was over a century ahead of its time and it suffered the fate of many other machines whose only faults were that they were ahead of their time.

It should be possible to see now that the field of digital machines is subdividing itself naturally into calculators or counting machines, and the true computers. Leibniz's machine was the ancestor of the modern comptometer or desk calculator, and Babbage's idea was developed to become the modern digital computer. It is the operation and construction of this last mentioned device that is of interest in this series.

Next month: The analogue computer, its components and layouts, and the uses to which it can be put.

**M**OTOR scooters are vulnerable to theft both in their entirety and in their accessories. This article is the result of some experience in combating would-be thieves. Even the steering lock is only a modest deterrent and is no match to violence.

What is really needed is a system that would detect pilfering or tampering with accessories, tool box, or even the battery. One system tried by the author failed to prevent excessive battery drain and required manual resetting to switch off the alarm circuit.

A later model was successful in that it automatically reset itself after a pre-determined time interval had lapsed. Its current drain in a quiescent condition was negligible and the detector control circuit was small enough to be hidden out of sight.

## D.C. AMPLIFIER

The circuit consists of a d.c. amplifier using two high gain transistors (about 70 to 110). In the configuration shown both transistors must be conducting before the alarm relay RLA can operate (see Fig. 1).

If the connection between the base of TR1 and chassis is broken (for example, if one of the micro-switches is operated) the base voltage rises to about -350mV and a current of  $9\mu\text{A}$  flows through the base, but TR1, and hence TR2, do not switch on until capacitor C2 has charged up, although this is only a very short time.



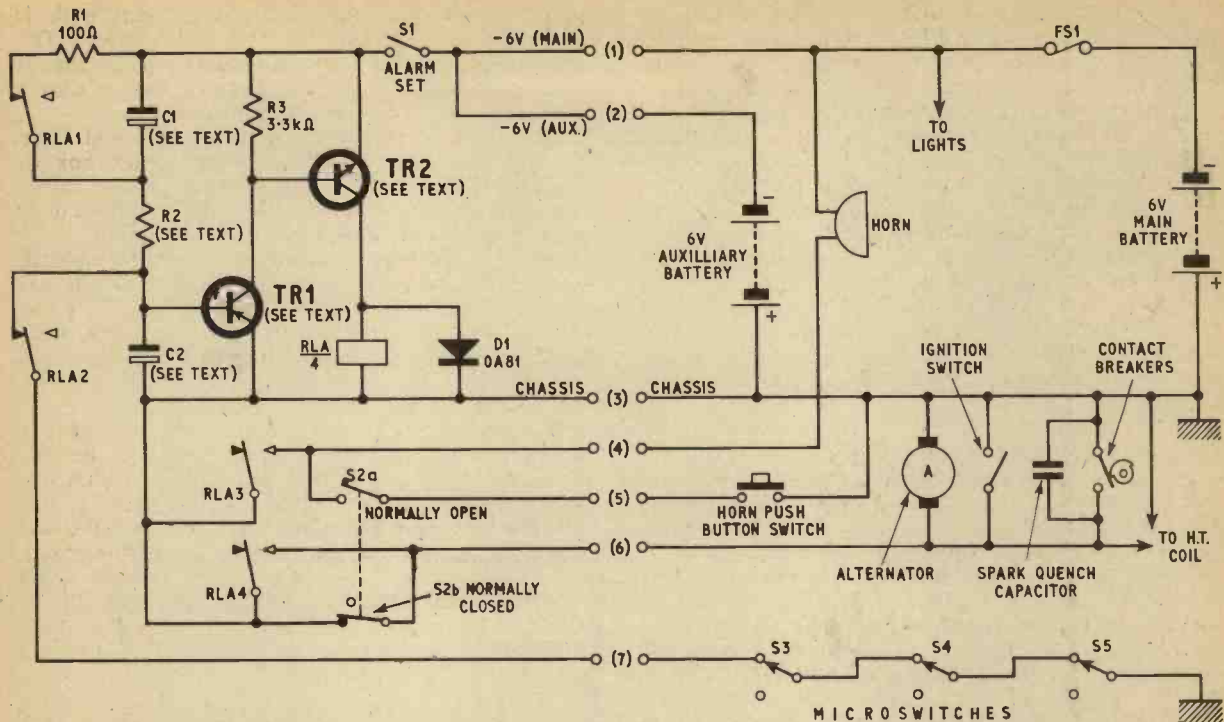


Fig. 1. Circuit diagram of the alarm system with associated scooter components and connections shown on the right. This diagram is for positive earth 6V systems

The four sets of contacts change over: RLA1 brings capacitor C1 into circuit to prepare for the time delay cut-off of the alarm; RLA2 maintains the break between TR1 base and chassis so that the microswitches are then made ineffective; RLA3 connects the horn direct to chassis, by-passing the horn push button and sounding the horn; RLA4 shorts the contact breaker points and prevents the sparking plug firing.

As the capacitor C1 charges up, the base current in TR1 falls until TR2 cannot supply enough current to operate the relay. When the relay switches off, capacitor C1 discharges via RLA1. The base connection of TR1 to earth via RLA2 is completed if none of the microswitches are open circuit. If any of the microswitches are open circuit then the alarm will be actuated again until the open circuit is closed. The horn and contact breaker circuits are broken by RLA3 and RLA4 changing back to their original state.

The value of R1 is found by placing a 1 megohm potentiometer in the base circuit of TR1 and adjusting

until the current in the relay is 60mA. Capacitor C1 is removed for this operation; the working value may be adjusted and found by experiment. The base current of  $9\mu\text{A}$  fell to  $4.5\mu\text{A}$  when the relay switched off.

The diode D1 connected across the relay coil protects TR2 from the transient back e.m.f. generated when the magnetic field collapses.

The microswitches are the key components in this system in that they allow C2 to become effective if any one of them is operated by the would-be thief. Any number of microswitches can be installed and wired in series between RLA2 and chassis. Fig. 1 shows, as an example, three microswitches in circuit. The installation of these microswitches is given later.

As can be seen from the circuit, two batteries are used; one was fused to prevent a short circuit from neutralising the alarm. The second (auxiliary) battery was mounted in the tool compartment. If the thief breaks into the rear tool box and disconnects the main battery, the alarm would continue to sound as the auxiliary battery is still in circuit. If he then shorted

# ALARM SYSTEM

By A. P. KEOGH





the negative line to chassis the fuse would blow, leaving the alarm and horn still being powered by the auxiliary battery.

### UNIT CONSTRUCTION

The printed circuit board is then made. The board measures 2.25in x 1in and is secured by two bolts as shown in Fig. 2. Normal etching processes can be used for this and it is suggested that the constructor refers to the special feature on printed circuits in the March 1966 issue of PRACTICAL ELECTRONICS.

When the printed circuit is ready to accept components, it is easier if they are mounted and soldered to the board in this order: C1, R2, C2, R3, TR1, D1, R1, and then TR2. Care should be taken to ensure that the transistors are not overheated when soldering in place, a pair of pliers should be used as a heat shunt by gripping each wire as it is being soldered. Both C1 and R2 should stand about 1/4in above the board, in order that they can be moved aside so that the bolts which secure the board to the chassis can be tightened. The board and the relay bases can now be secured to the chassis and a rubber mat is placed under the copper side of the board to prevent any short circuits.

The whole unit was mounted on a small chassis which was insulated from the main aluminium chassis by a rubber pad and insulated bolts.

The chassis and case are shown in Fig. 3; the chassis is insulated from the case because the base of TR2 is connected to its case and the heat sink on this transistor is connected to the chassis. All the holes are simple drillings except for the relay apertures. If a punch is not available, then the holes could be drilled and then filed to shape. The hank bushes are used to assist assembly of the case, as holding 6 B.A. nuts with a pair of long-nosed pliers is awkward.

The wires from the switches and the board are passed through the holes in the chassis and connected as shown in the circuit diagram (Fig. 1).

A 7-way plug could be used for connecting the board to other components but snap connectors (as frequently found in scooter wiring) can be used.

### INSTALLATION

When the case is assembled, the alarm is mounted in the scooter. In the Vespa scooter the alarm can be fitted in the front tool compartment and secured to an aluminium bracket by three 6 B.A. nuts and bolts.

Switch S2 is incorporated for use in the event of a "flat" battery or when the ignition key is not available. S2a connects the horn to the horn push button and S2b removes the short across the contact breaker points. This can be fitted either in the box containing the alarm unit or anywhere convenient for wiring to the horn and ignition systems.

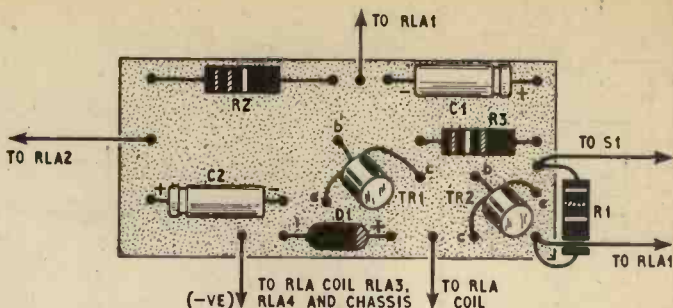


Fig. 2a. Component board layout for 6V positive earth systems

## COMPONENTS . . .

### 6 VOLT POSITIVE EARTH SYSTEM

#### Resistors

- R1 100Ω R3 3.9kΩ  
R2 Selected by experiment using a 1MΩ potentiometer (see text)

#### Capacitors

- C1 16μF tantalum foil elect. 25V (T.C.C. type TAI4CZ)  
C2 16μF tantalum foil elect. 25V

#### Transistors and Diode

- TR1 2N1303 or GET882  
TR2 2N1302  
D1 OA81

#### Relay

- RLA 90Ω 6V 4-pole changeover Omron type MH4 (Keyswitch Relays Ltd., 120-132 Cricklewood Lane, London, N.W.2)

#### Switches

- S1 Single pole on/off toggle switch  
S2 Double pole changeover toggle switch  
S3-5 Microswitches with operating lever (3 off)

#### Miscellaneous

- Small piece printed circuit board  
Heavy duty motor-cycle cable  
Box, nuts, bolts, rubber, etc. (see text)

### 6 VOLT NEGATIVE EARTH SYSTEM

- Reverse Polarity of C1, C2, and D1  
Reverse supply leads to control unit

#### Transistors

- TR1 2N1302  
TR2 2N1303

#### Resistor

- R2 (see text)

### 12 VOLT SYSTEMS

- Components as in relevant 6V systems except:

#### Relay

- RLA 430Ω 12V 4-pole changeover, Omron type MH4



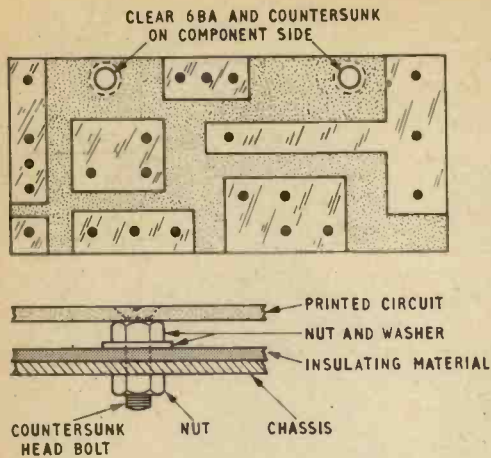


Fig. 2b. Printed circuit board (full size) and mounting detail

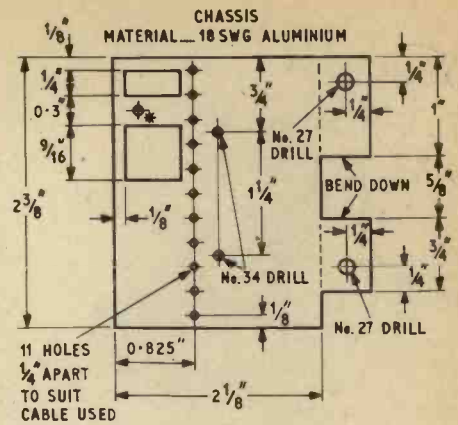


Fig. 3a. Chassis construction. The fixing hole for the relay base should be marked with the base in position

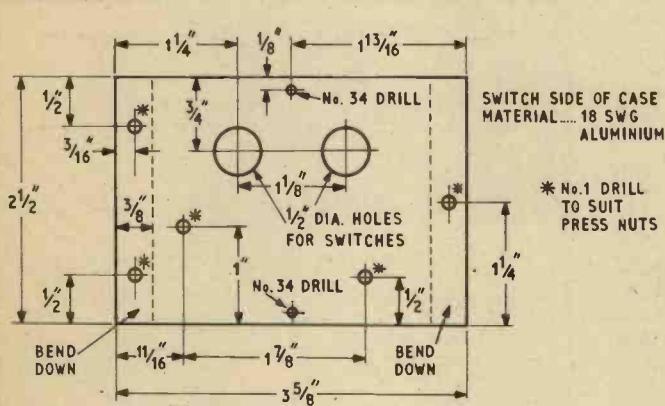
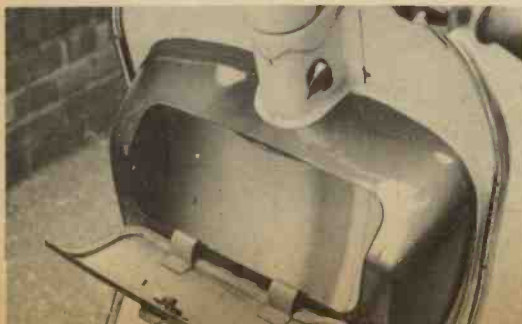
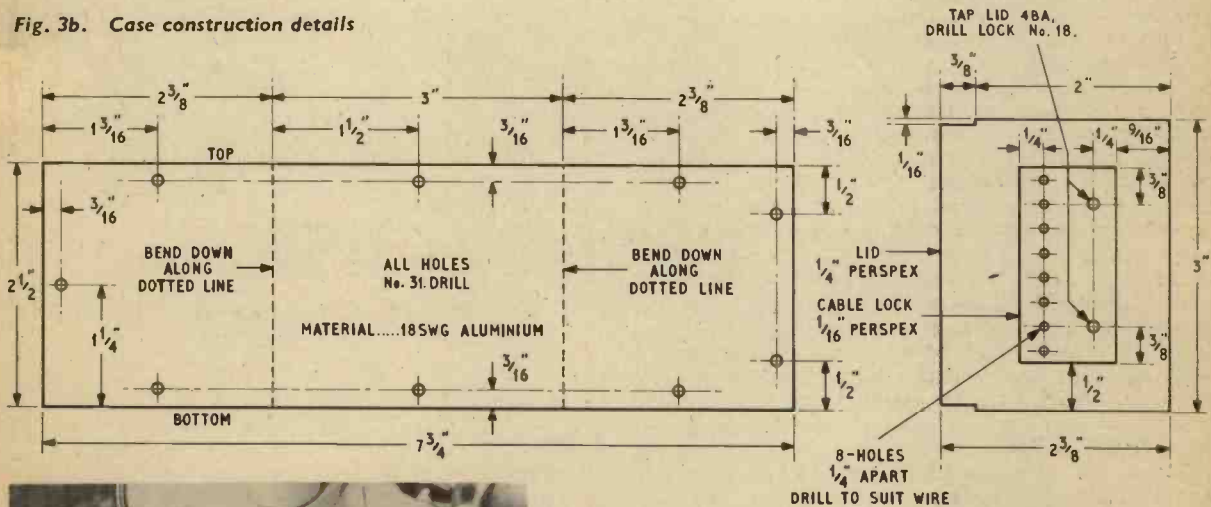
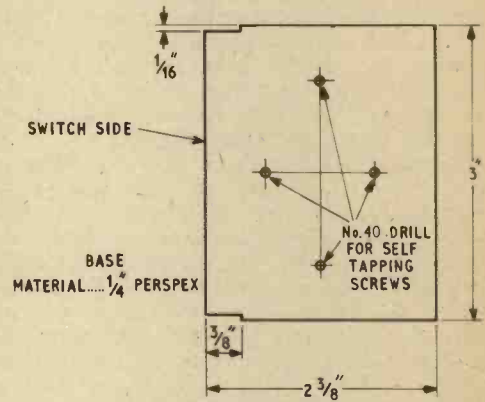
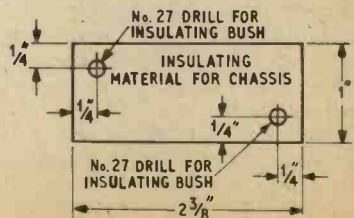


Fig. 3b. Case construction details



The unit is fitted in the front tool box



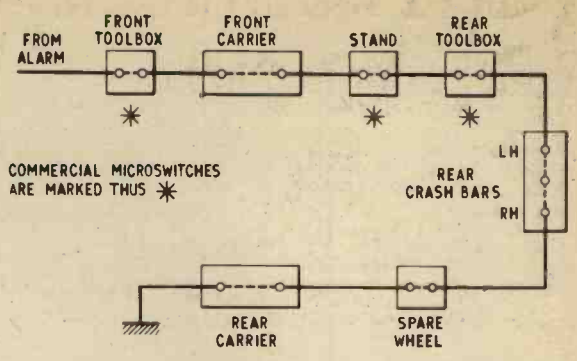


Fig. 4. Block diagram of accessory wiring

Unfortunately, the lids on tool compartments on most scooters are flexible and easily forced open when locked. To overcome this difficulty, fit braces (Fig. 5) to the lids making the lids more rigid to prevent forcing. The braces are tapped 4 B.A. and each bolt is held by two lock nuts to protect the bolts from removal from the outside. The braces were made from 1/4 in Perspex sheet; those shown are for the Vespa Sportique and G.S. tool compartments.

**ACCESSORY PROTECTION**

Although seven points are protected by the alarm system, only one relay and three microswitches need be used. Accessories are protected by insulation from earth and connecting a wire to one side and taking a wire discreetly from the other side. If the accessory is removed, then TR1 base circuit to earth is broken.

The front carrier is secured to the scooter at four points, two of which are lugs which hook over the top of the legshield. Both these lugs have rubber sheaths which insulate them from the chassis (Fig. 6). Two bolts secure the bottom of the carrier to the chassis and hold it firmly. Both these bolts are insulated from the chassis and they are used as contacts for a "home-made" microswitch.



Front carrier

Fig. 6. (below). Front carrier insulation

In Fig. 7 a sketch of the crashbar insulation is shown. The rear brackets are insulated by a piece of rubber and the wires connected to these brackets. The front bracket is insulated by rubber washers with nylon sleeves on the securing bolt.

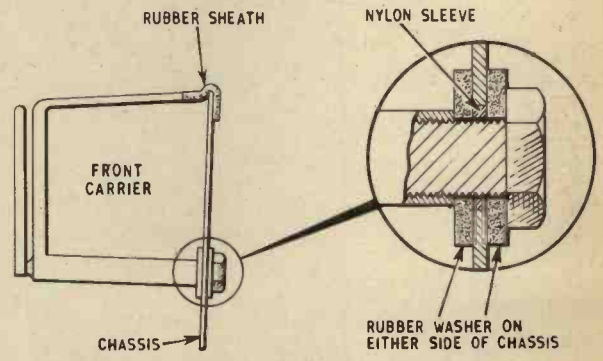
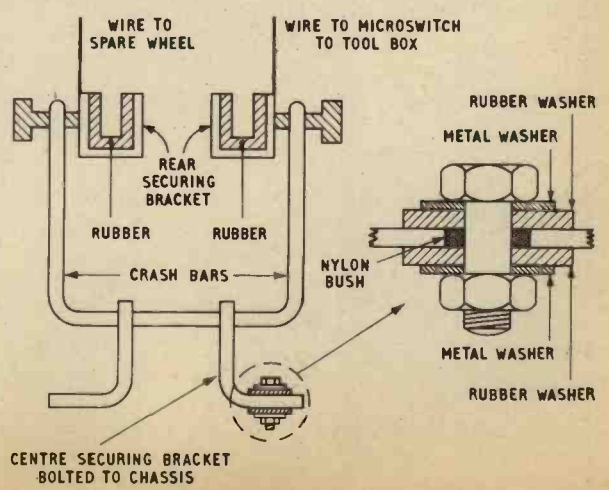


Fig. 7. (below). Crash bar insulation

The crashbars can be removed by unscrewing the nuts (shown hatched in Fig. 7) and can then be removed from the securing bracket by pulling. The wire will be broken near the securing bracket. If the wires from the tool box microswitch and the wire to the spare wheel are connected to the rear securing brackets, then immediately the nut securing the crashbar is loosened, the alarm will sound before the thief has a chance to pull it away from the securing bracket.



When either of the crashbars is removed, the circuit is broken. A similar method was used for the horn, front carrier, rear carrier, spare wheel and wheel disc. This insulation overcomes the problem of hiding microswitches, and hence avoided some expense.

The microswitch wire from the alarm unit is first connected to the microswitch in the front tool compartment (Fig. 8). From here it is attached to the front carrier.

If any of these bolts is disconnected from the front carrier (for example, by sawing the front carrier off) the connection between these two bolts is broken and the alarm sounds.

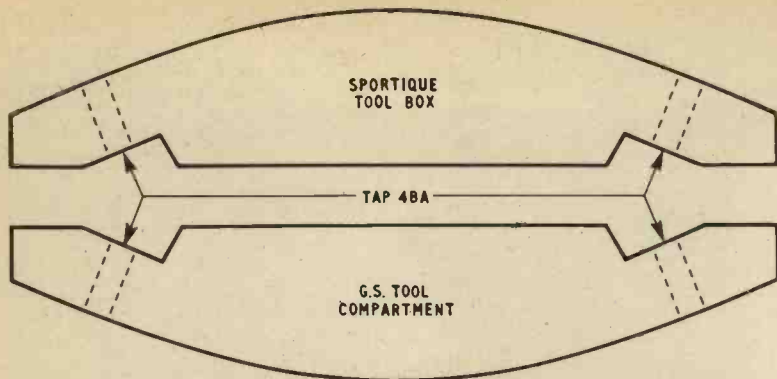


Fig. 5. Strengthening braces for Sportique and G. S. tool boxes

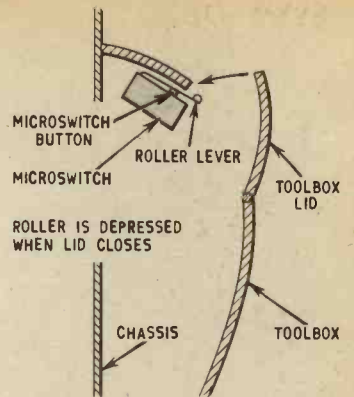


Fig. 8. Front toolbox with microswitch

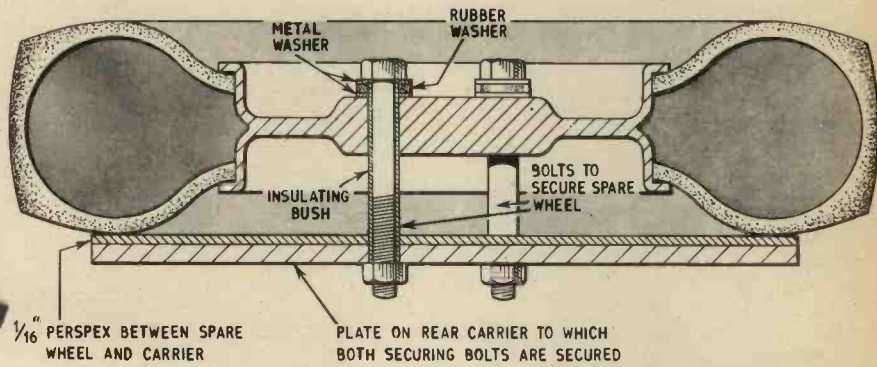


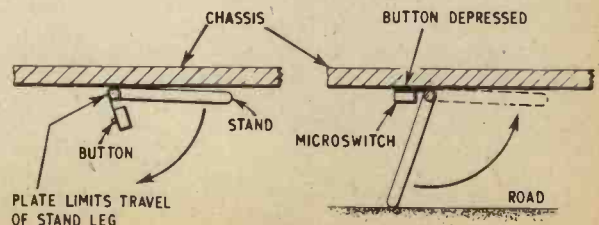
Fig. 9. Insulated spare wheel fitted to rear carrier

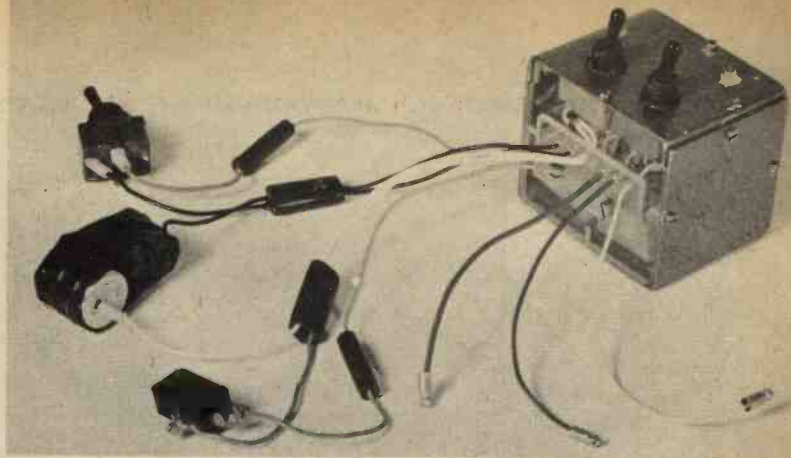


Spare wheel and battery compartment on the Sportique model



Fig. 10. Microswitch fitted to the stand





From the front carrier the microswitch wire now travels to the microswitch on the stand under the foot boards and then onto the microswitch on the rear tool box.

The footboards microswitch was bolted to the flat plate, on the stand, which limits the travel of the stand leg. When the stand is down, the microswitch button is depressed but there is no load on the microswitch itself (see Fig. 10).

The second spare wheel bolt has no insulation on it and gives an electrical contact between the spare wheel and the rear carrier. The carrier is then connected to earth. If either of the bolts securing the spare wheel

To determine the value of R2 for 12V systems, a 2 megohm potentiometer (or a 1 megohm potentiometer with 1 megohm resistor in series) should be used and adjusted until a current of 25mA flows through the relay.

The alarm is mounted in the front tool compartment and there is a push switch mounted on the tool box above the alarm. When the alarm is set, it may sound because the microswitch on the tool box may not be closed. To rectify this, a push-switch was

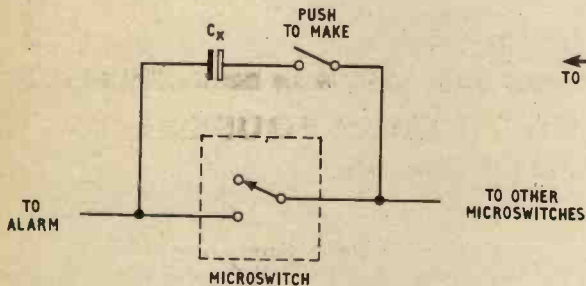


Fig. 11. By-pass capacitor for each microswitch

is removed, then the circuit to earth is broken since the wheel is insulated from the carrier. If the rear carrier is removed the connection to earth will once again be broken (see Fig. 9).

The electrical contact in the front carrier is from one bolt, through the metal carrier to the second securing bolt. The electrical contact in the rear crashbars is from one rear securing bracket through the left-hand crashbar, centre securing bracket, right-hand crashbar and the other rear securing bracket. Contact in the spare wheel is from the washer on the insulated bolt through the centre of the spare wheel through the carrier, via the second securing bolt and from the carrier to earth.

### ALTERNATIVE SYSTEMS

The component values for 6 or 12 volt operation with either positive or negative earth systems are shown in the components list. It should be pointed out to those who do not like the idea of an alarm which draws current, that the leakage from a metal rectifier is many times more than that of this alarm circuit. The battery drain in this system is a mere 18μA compared with the metal rectifier's leakage of about 760μA.

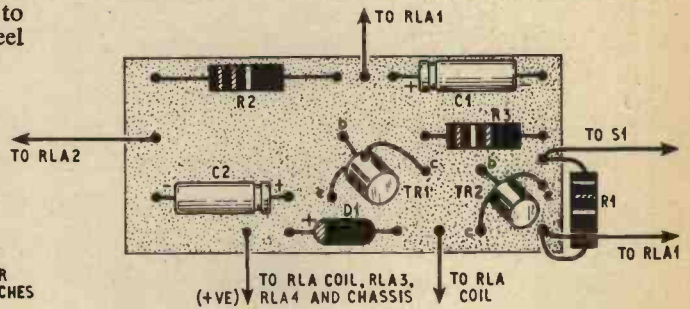
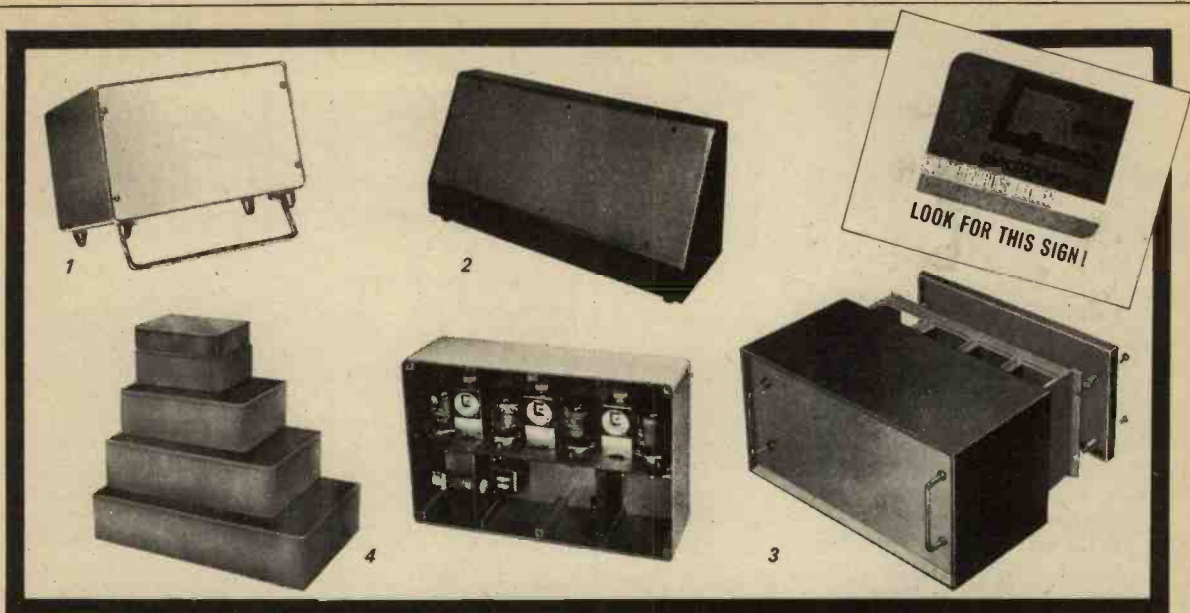


Fig. 12. Component layout for negative earth systems

fitted to bypass the microswitch. A 50μF capacitor was included in the line, so that it bypassed the microswitch for approximately 4 seconds. This is C<sub>x</sub> in Fig. 11.

The circuit which has been described here is for positive earth machines and must not be fitted to machines with negative earths. The printed circuit shown in Fig. 12 can be used for negative earth systems; the component arrangement is amended as shown. The other connections are as before. ★





I should like a copy of the *Electroniques Hobbies Manual*. Enclosed is a cheque/P.O. for 10/6.

NAME \_\_\_\_\_

ADDRESS \_\_\_\_\_

P.E.4

## OBTAIN A PROFESSIONAL FINISH TO YOUR EQUIPMENT!

### Choose housings and equipment practice from the **Electroniques catalogue.**

With the new 600 page Hobbies Manual, you can obtain these—and over 11,350 other items—direct from Electroniques or through your Local Electroniques dealer! The service is fast; the choice is the most comprehensive ever offered. And the components, which are supplied by 85 leading manufacturers, meet every kind of need—whether the project is advanced or elementary!

#### 1 For Small Electronic Assemblies

These attractive DATUM Dinkcases are available in four sizes ranging from 4" x 6" x 4" to 7" x 12" x 7". Grey hammer finish front and rear; panels front and rear grey/gloss enamel. A retractable leg can be supplied if required (as illustrated).

#### 2 Sloping Panel Cases

These DATUM cases, by using the feet provided in alternative positions, can provide a narrow base (upright) case or a wide based case. Four sizes provide eight alternatives. Dark grey hammer finish cases; top panels grey gloss enamel. Dimensions from 12½ to 24½ inches width overall.

#### 3 Modular Equipment Practice and Equipment Cases

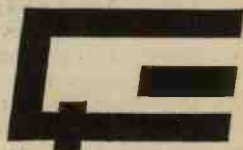
Professional quality 19 inch equipment cases available for the amateur at competitive prices.

Symmetrical design allows panels fitted front and rear. Ideally suited for MCS 19 in. modular dossier system. A complete range of panels, sub-racks and system accessories is available. Stocked in seven sizes. Finish matches Dinkcases.

#### 4 Diecast Boxes with unique slot guide system

These versatile diecast boxes are stocked in 5 sizes, to be used as screened sub-assemblies for complete equipments, test sets, and junction boxes, and they can be used as plug-in assemblies on the MCS board system. A special range of VEROBOARD is designed to fit the slot guides in the boxes, which will also fit DATUM Dinkcases. As used in our modular communication assemblies.

Send now for your Manual, on the coupon above, to this address: Electroniques (Prop. STC Ltd.) Edinburgh Way, Harlow, Essex. Telephone: Harlow 26777.



High-grade components for amateur communications

**electroniques**

# the WyndSOR Vanguard . . . the most versatile recorder at its price\* offering so many outstanding features . . .

- 4 track-3 speeds —7 in. spools
- Separate Record and replay amplifiers
- Double play
- Sound-on-Sound
- Detachable lid fitted 8" speaker
- Tape Monitoring facility



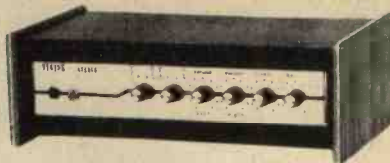
- Push button controls
- Recording meter and Playback indicator
- Straight through amplifier facility
- Bass, treble, volume and record gain controls
- Many other features

\* All British and full value for money at only 59 gns. inc. 1800 ft. LP tape and Tape manual. (less mike).

Before you buy an ordinary tape recorder write for full details of the Vanguard and other models.

**WYNDSOR RECORDING CO. LTD. (Dept. PE4)**  
WyndSOR Works, Bellevue Road, Friern Barnet, London, N.11. ENT. 2226

## VIKING STEREO 4 + 4 DE-LUXE HIGH QUALITY AMPLIFIER



### PRICE £13-17-0 COMPLETE

A high quality stereo amplifier, built to meet the requirements of budget Hi-Fi. Elegant styled cabinet in black rexine and woodgrained ends. Brushed aluminium panel, black and silver knobs. Quality components throughout. Ganged Bass and Treble controls, separate volume controls for each channel. Valves (Standard Model) 2 x ECL86 (De-Luxe Model) 1 x ECC83 (2) x ECL86. Output 3-ohms matching, suitable A.C. mains 230-240 volt. Cabinet size 16 1/2 in. wide, 8 1/2 in. high, 8 1/2 in. depth. Full instructions and guarantee. Send for leaflet. S.A.E.

**VIKING 10-12.** A twelve watt amplifier for use on 230-240 volt A.C. mains. Inputs suitable Microphone, Record Player, Tuner, Tape Recorder, etc. Printed circuitry. Five Mullard valves, reliable components. Front panel contains 2 Input Jacks, 2 Volume Controls, 1 Tone, Neon and On/Off switch. Designed to fit into same type and size cabinet as Stereo. Fully guaranteed. Send S.A.E. for leaflet.

PRICE Complete with case £8-19-6 PLUS 12/6 P.P.

**VIKING X.P.15 (Bass Model).** A frustrated order offered at a fraction of cost (original price 39 gns.). 15 watts output. Suitable for 210-240 Volt A.C. mains. Attractive Black chassis with slotted Chromed steel top cover, size 15 x 7 1/2 x 7 in. 4 Input Jacks, 2 volume controls, 2 tone, 5 Mullard valves. Fully guaranteed. Send S.A.E. for leaflet.

Price Complete £12-19-6 plus 12/6 P. & P. and Ins.

### L.P. TAPE BARGAIN

5 1/2 in. reels each containing 1,200ft. of top quality polyester recording tape (Limited quantity).

Price 3 reels for 35/- P.P. free.

Terms: C.W.O., C.O.D. Money back guarantee.

**VIKING (ELECTRONICS) LTD.** 37 HILLSIDE  
STONEBRIDGE  
LONDON, N.W.10  
Telephone: ELG 3644  
(MAIL ORDER ONLY)

## HOME RADIO LTD., Dept. PE, 187 London Rd., Mitcham, Surrey CR4 2YQ Phone: MIT 3282



NOTE:  
In Johnson's day  
a man was not drunk if he could lie on the ground  
without holding on!

*"I have not come here to sell a mere parcel of vats, but a potentiality of wealth beyond the dreams of avarice."*

Thus spoke the great Dr. Johnson when he was busy flogging off someone's Brewery. It must be wonderful to have such a command of English! Just think how I could bring to your notice the potentiality of the Home Radio Components Catalogue! However, belonging as I do to the Z stream, I must be content with such prosaic remarks as 218 pages, 6,000 items listed and over 1,000 illustrations, leaving the superlatives to our customers! Please let me add that the catalogue costs 7/6 plus 1/6 p. & p. and each copy contains 5 vouchers each worth a shilling if used as directed. While it is almost a gift, its true value to the constructor is "beyond the dreams of avarice."

Please write your Name and Address in block capitals

Name .....

Address .....

Home Radio Ltd., Dept. PE, 187 London Road, Mitcham, Surrey  
CR4 2YQ

# THE ELECTRONIC ORGAN



By ALAN DOUGLAS, Sen. Mem. I.E.E.E.

## PART SIX

# SOUND PROPOGATION AND SPECIAL EFFECTS

**T**HE propagation of sound from an organ requires a little thought. Consider first the reproduction of music from records: due either to the intimate nature of the music, or the degree of compression exercised during the making of the recordings, the whole of the sound spectrum is presented in such a way that the balance can be made correct from a listening point of view when reproduced by either monaural or stereophonic means.

But in the case of the electronic organ, we are feeding the various sound sources into loudspeakers in any way required, not being limited by groove spacing or over-modulation problems. We are in fact *producing* and not *reproducing* music.

Then again, in normal programme music it is rare to find sustained notes of any power; harmonics convey the sense of power and these are the main content of orchestral music. When we come to an organ, however, we have a power/frequency spectrum which is quite different from that of an orchestra, see Fig. 6.1. Further, we encounter an appreciable amount of sine wave drive, which is very tough on amplifiers and loudspeakers.

### LOUDSPEAKERS FOR ORGANS

Much is written about intermodulation distortion in reproducing systems, but this problem becomes so acute with organ sound that it is essential to separate the bass out into its own speaker. Then we have another problem peculiar to the organ: if we enter a building where a pipe organ is being played, it will be

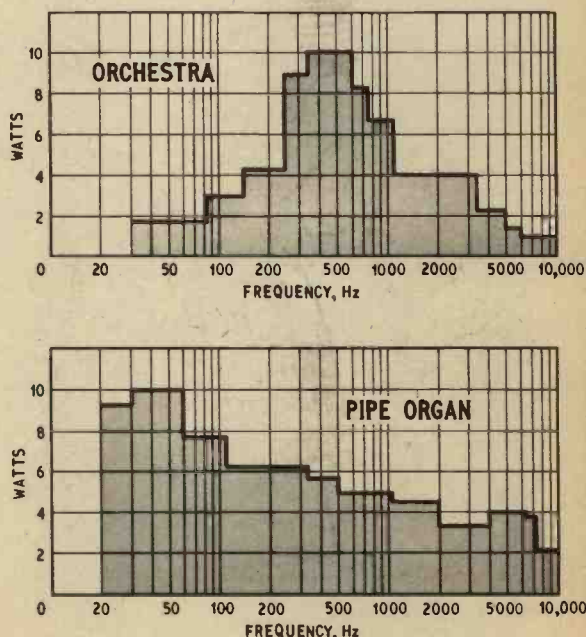


Fig. 6.1. Distribution of average power from an orchestra and an organ

quite easy to follow the sounds from the manual pipes; but one cannot pin-point the bass; it seems to come from everywhere. This is because of the distance needed to reflect long wavelengths

$$\left( \frac{\text{wavelength in feet} = \frac{\text{speed of sound in air, in feet per second}}{\text{frequency, cycles per second (or hertz)}} \right)$$

which may reach 80ft, and also, because the vibrating sides of the pipe contact a large volume of air, thus imparting a great amount of energy.

This does not necessarily mean that the sound is loud, indeed it is most noticeable on soft, breathing tones. For example, taking a small scale pedal bourdon pipe of  $CCC = 16\text{ft} = 32\text{Hz}$  approximately, then as it is stopped it will be 8ft in length and the two vibrating sides (two do not vibrate in a rectangular wood pipe) might be 9in wide. Thus we have  $8\text{ft} \times 9\text{in}$  twice, which is 12 square feet. Consider how many 18in cones would be required to produce the same effect!

Obviously this is quite impossible, but the largest available radiating area should be chosen. An economical way of doing this is to use 9 or 10 quite cheap 10in units mounted close together on a baffle, as in the Hammond H40 cabinet. This is much cheaper than one 18in unit. In passing, 27in units have been made by Altec-Lancing in the U.S.A., but the author has played organs with these pedal loudspeakers and was not greatly impressed.

Of course, we know that space is at a premium with domestic applications, but to obtain a free, natural, and unforced bass we will have to allow about 12 cubic feet for the bass cabinet. The dimensions of the H40 cabinet are given in Fig. 6.2.

Turning now to the manual range of frequencies, that is, from 65–8,000Hz, for most purposes this range can be handled by one unit. Small traces of hum,

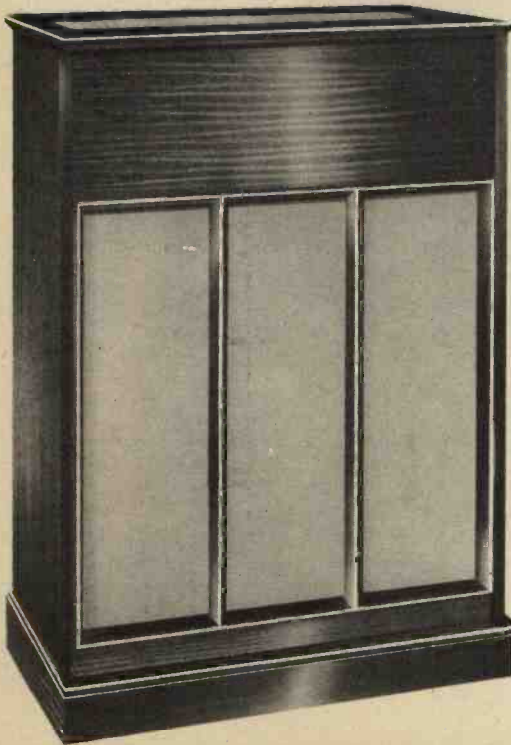


Fig. 6.2. The Hammond H40 loudspeaker enclosure. Dimensions: 33in wide, 48in high and 17in deep



Fig. 6.3. The Wharfedale Super 8/RS/DD speaker unit. This may be mounted in a 1 cubic foot enclosure, on a 3 feet square baffle, or in a concrete column

transients, mains interference, etc. are greatly reduced if the loudspeaker cone faces upwards. An excellent unit is the Wharfedale (Fig. 6.3), but owing to its exceptional high-frequency response, some top cut will have to be introduced into the amplifiers.

It is a mistake to think that great powers are called for in the home: 12–20 watts for the bass speaker, 7–10 watts for the treble will be more than ample in an average room. This does depend on the efficiency of the loudspeaker enclosures, which if properly designed can approach 10 per cent. Many small commercial organs have quite powerful amplifiers built in since their ultimate use is not known by the makers and this sometimes leads to a certain amount of dissatisfaction in the home as the balance may be difficult. No greater mistake could be made than to imagine that a large amplifier makes a large organ; one might as well amplify up a string quartet and expect it to sound like the complete string section of an orchestra. There is an optimum loudness for every kind of musical sound.

### RHYTHMIC EFFECTS

Many experimenters are interested in effects such as rhythmic aids which are not really part of an organ though they may be found on theatre organs. These are quite entertaining devices and of course are also useful in their own right, for they do not have to be associated with an organ or built into one.

The classic example of a rhythm generator is the Wurlitzer "Side Man", but this uses valves. It is probably best to give as an illustration a semiconductor circuit which, if not quite so comprehensive, does enable a performer to have additional effects under his control.

The rhythm sound most in demand is the cymbal. Accordingly we show a circuit (Fig. 6.4) which permits both a single stroke and a wire brush effect. Analysis of a conventional brass cymbal shows that all the energy resides in the band 8–12Hz. The obvious way to obtain this is to use a noise generator and filter off what is not required. At one time gas tubes were much in demand as white noise generators and are



still used in Germany; but one can also generate noise from a semiconductor.

It is a good idea to make the lighter "brush" effect available on the manuals, since it fits in better with most rhythm patterns and can be sustained at will. The single stroke is then put on the pedals, but it could go on a toe piston so as to be quite independent of any other sound.

### CYMBAL EFFECT CIRCUIT

Fig. 6.4 shows a simple arrangement for this scheme.

Taking the pedal circuit first, when a key is depressed a voltage is applied through VR3 to one plate of C11. This voltage passes through D4 so charging C12 and applying the keying voltage to the base of TR5, thus making it conduct and amplify the white noise from TR3. This noise is transferred to the base of TR5 through C6. The output level of this effect is set by VR3, which varies the amount of keying voltage.

In the collector circuit of TR5 is a broadly tuned circuit L2, C13 which is resonant at about 8Hz; from this shaping network the signal is amplified by TR4 and is then ready to be applied to the main amplifying system. The comparatively low frequency of 8Hz imparts a more solid sound to the cymbal, the pedal effect being in any case usually set to be much louder than the manual "brush". Note that the rate of decay of the tone is fixed by C12 and R15, whilst C11 and R13 control the shaping and keying. One cymbal stroke occurs every time a pedal key is operated.

The brush effect can be routed to either manual, but we only show one in the circuit. Of course, 61 of the 200 kilohm keying resistors are required. The circuitry is very similar to that just described. On actuating the cymbal stop switch, a small change in d.c. voltage appears at the base of TR1 when a key is used. This change is amplified by TR1 and appears in magnified form at one plate of C3. This voltage now passes through D2 and charges C4, reaching the base of TR2, which conducts and amplifies the noise from TR3. In the collector of TR2 is a circuit L1, C7 resonating at 11Hz. The pitch is thus higher than that of the pedal cymbal. The output of TR2 joins the common pre-amplifier TR4 and so meets the common line out. VR1 adjusts the "brush" output level whilst the decay time is set by C4 and R8.

There are in fact many circuits in use today to provide a cymbal-like sound; this one has been chosen because it is extremely simple.

### REVERBERATION

Everyone knows that the effect of any music is greatly enhanced if it is performed in a large hall or building. This is because of reverberation, which broadly speaking means that some of the sound waves which do not travel directly to the listener are reflected from the walls, floor, and roof, and reach the ears of the listener at varying times all slightly later than the original sound.

In an ordinary living room, the carpets, curtains,

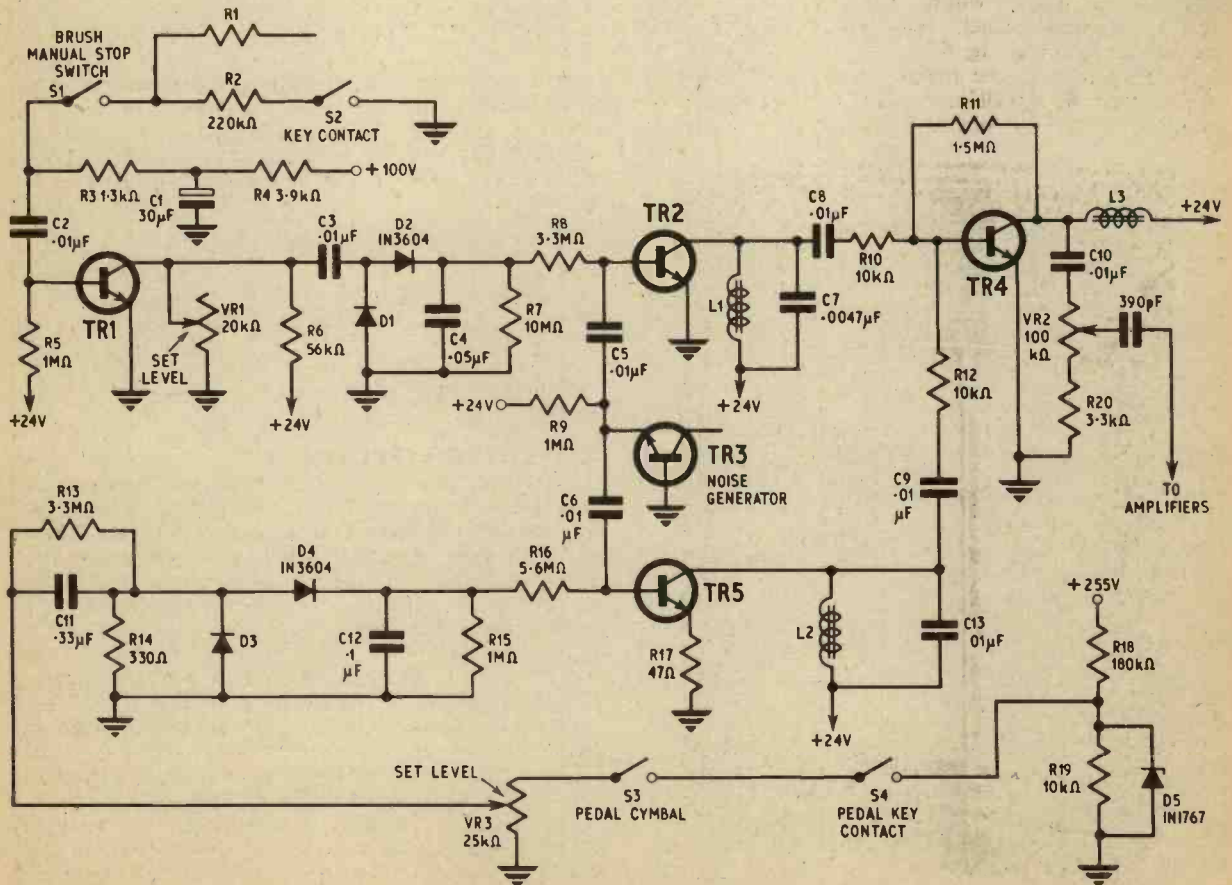


Fig. 6.4. Cymbal effect circuit

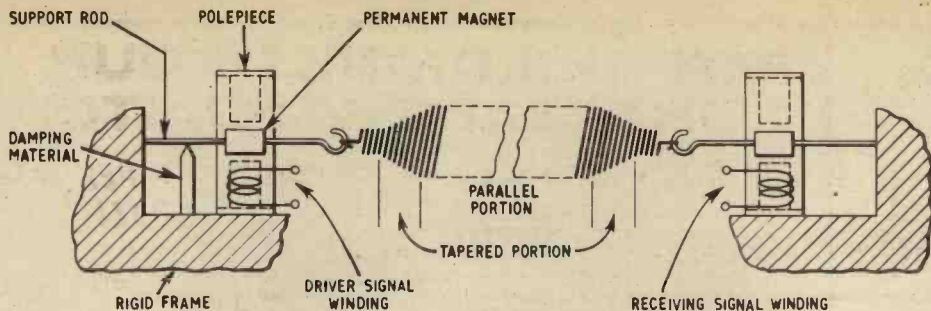


Fig. 6.5. Tapered spring reverberation delay line

and upholstery absorb all of the sound not coming directly to one's ears, and in any case the room is generally too small to contribute to reverberation. None would be evident in a room less than 30ft long or of about 4,000 cubic feet capacity.

Unfortunately the one instrument which benefits above all others from reverberation up to about 5 seconds is the organ. The sound tends to be clipped and lifeless without it, except at very low levels. However, we can produce some simulation of reverberation by causing part of the signal to traverse a delay line. It is then mixed with the instantaneous signal.

The most common method is to change the electrical signal energy into mechanical vibrations and then apply these to one end of a helical spring, in which (if properly proportioned) the rate of travel will be slowed down. The vibrations are then converted back at the end of the spring into an electrical signal by a transducer and coupled into the main amplifier circuit.

It has been customary to use one or more helical springs with adjacent coils not touching each other (or anything else); such springs, either horizontal or vertical, being driven at one end by a crystal or magnetic motor, translation of the mechanical vibrations at the other end being by the same means.

Now in a helix of constant diameter, no matter what this is, the rate of propagation is the same for all frequencies. Moreover, the signal must be held to a very low level to avoid over-driving the spring with consequent distortion and "flutter", and the lowest frequency transmitted must be well above the resonant frequency of the spring. Accordingly, some systems have used a plurality of springs, each favouring some particular frequency band. This is an attempt to imitate the actual time characteristics of the hall, where the unequal reflection lengths of the many pencils of sound cause the reverberant sound to arrive at different times at the ear of the listener.

With an organ the effect is further broadened by the fact that the treble pipes speak instantly, the bass pipes not so; this adds to the reverberant nature of the sound, but we will not notice this feature with an electronic instrument where the rate of speech is the same for all notes (in this kind of organ, at any rate; some instruments do have delays corresponding to the pitch).

### TAPERED SPRING DELAY LINE

An ingenious way to overcome the frequency-insensitive properties of a helical spring is shown in Fig. 6.5. Here we have a spring which is partly tapered, partly of uniform diameter. Neglecting the narrow neck, which is common to many springs

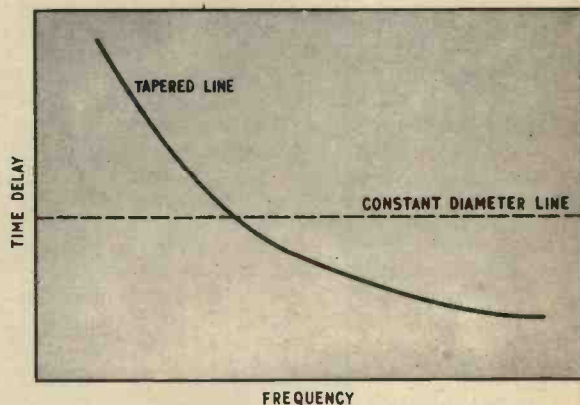


Fig. 6.6. Comparison of tapered and constant diameter delay lines

because of the means of attachment to the transducers, the spring is then gradually increased in radius for a distance. Since the mean turn length now alters, the rate of propagation for different frequencies will also vary; in other words, this part of the spring is frequency-sensitive, the helix radius differing for each component of the complex wave.

The energy is now transmitted along the constant diameter section of the helix until it reaches the far end taper, where the vibrations undergo a transition to the torsional mode and are converted back to an electrical signal by the receiving motor. These transducers may be crystals or electromagnetic, the latter being preferred as imposing less restraint on the delay line. Apart from the initial transport of the vibrations, as there is an impedance mismatch at the receiving end of the spring, some of the energy is reflected back again to the input end and in fact there may be a number of such reflections to and fro, the impulses gradually losing energy; in this way, the effect is like that of the concert hall.

A plot of the frequency response versus time for this delay unit is given in Fig. 6.6 with the response from a constant diameter spring shown dotted for comparison.

If used horizontally, it is permissible to support the spring in the centre by a thin nylon cord. Perhaps "spring" is not a very happy term in this application, since the coils will not touch if unloaded. The wire, 8 to 15 thou diameter, is wound like a spring but pulled apart so that adjacent turns cannot touch each other. Hard wire such as beryllium copper or music wire is preferred for the helix.

The next article will deal with the different methods of introducing vibrato into electronic organ circuits.

# Why

## NOT BUILD ONE OF OUR PORTABLE TRANSISTOR RADIOS...

**FIRST FOR PERFORMANCE, QUALITY & PRICE!**

**BACKED BY OUR SUPER AFTER SALES SERVICE**

"A wonderful range of transistor radios using first grade components guaranteed results."

### NEW ROAMER SEVEN Mk IV

7 WAVEBAND PORTABLE OR CAR RADIO

Amazing performance and specification

★ Now with PHILCO MICRO-ALLOY R.F. TRANSISTORS

FULLY TUNABLE ON ALL WAVEBANDS

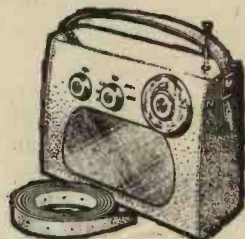
● 9 stages—7 transistors and 2 diodes

Covers Medium and Long Waves, Trawler Band and three Short Waves to approx. 15 metres. Push-pull output for room filling volume from rich toned 7" x 4" speaker. Air spaced ganged tuning condenser. Ferrite rod aerial for M & L Waves and telescopic aerial for S Waves. Real leather-look case with gilt trim and shoulder and hand straps. Size 9" x 7" x 4" approx.

The perfect portable and the ideal car radio. (Uses PP7 batteries, available anywhere.)

★ EXTRA BAND FOR EASIER TUNING OF LUXEMBOURG, etc.

Total cost of parts now only **£5.19.6** P. & P. 5/6



Parts Price List and easy build plans 3/- (Free with kit)

### NEW MELODY MAKER SIX



This amazing receiver may be built for only

**£3.9.6**

P. & P. 3/6

Parts Price List and easy build plans 2/- (Free with kit)

● 8 stages—6 transistors and 2 diodes  
Covers Medium and Long Waves and Extra Band for EASIER tuning of LUXEMBOURG, etc. Top grade 3in. Loudspeaker for quality output. Two R.F. stages for extra boost. High 'Q' 6in. Ferrite Rod Aerial. Approx. 350 Milliwatts push pull output. Handsome pocket size case with gilt fittings. Size 6½ x 3½ x 1½in. (Uses long-life PP6 battery).



**QUICK CHECK TRANSISTOR TESTER.** Checks gain of R.F. and Audio Transistors. Also checks for noise level and duds. All parts ready to be assembled in attractive grey case with red grille, complete with Dial, Knobs, and Dynamic Speaker. Simple assembly instructions free with set of parts. 19/6. P. & P. 2/6.



**FAULT TRACER.** A versatile signal injector. Something no constructor should be without. This ingenious device generates an audible signal through the Audio and R.F. ranges. With variable output. Telescopic Probe. Pocket size slim line case measures 4½ x 3½ x ½in. Complete set of parts with full instructions. 19/6. P. & P. 2/-.

NOW WITH 3IN. SPEAKER!

### NEW TRANSONA FIVE

"Home, Light, A.F.N. Lux. all at good volume"  
G.P., Durham

● 7 stages—5 transistors and 2 diodes

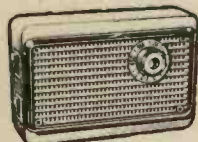
Fully tunable over Medium and Long Waves and Trawler Band. Incorporates Ferrite rod aerial, tuning condenser, volume control, new type fine tone super dynamic 3 in. speaker, etc. Attractive case. Size 6½ x 4½ x 1½in. with red speaker grille. (Uses 1289 battery available anywhere.)

Total cost of all parts now only

**42/6**

P. & P. 3/6

Parts Price List and easy build plans 2/- (Free with kit)



### POCKET FIVE NOW WITH 3in. SPEAKER!

● 7 stages—5 transistors and 2 diodes.

Covers Medium and Long Waves and Trawler Band, a feature usually found in only the most expensive radios. On test Home, Light, Luxembourg and many Continental stations were received loud and clear. Designed round supersensitive Ferrite Rod Aerial and fine tone 3 in. moving coil speaker, built into attractive black and gold case. Size 5½ x 1½ x 3½in. (Uses 1289 battery, available anywhere.)

Total cost of all parts now only

**42/6**

P. & P. 3/6

Parts Price List and easy build plans 1/6 (FREE with Kit)



STOP PRESS!

Pocket 5 Med and Long wave version with miniature speaker

**29/6**

P. & P. 3/-

### NEW ROAMER SIX

NOW WITH PHILCO MICRO-ALLOY R.F. TRANSISTORS

● 6 WAVEBAND !!

● 8 stages—6 transistors and 2 diodes

Listen to stations half a world away with this 6 waveband portable. Tunable on Medium and Long Waves, Trawler Band and two Short Waves. Sensitive Ferrite rod aerial and telescopic aerial for short waves. Top grade transistors. 3-inch speaker, handsome case with gilt fittings. Size 7½ x 5½ x 1½in. (Carrying Strap 1/6 extra.)

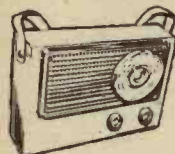
★ EXTRA BAND FOR EASIER TUNING OF LUX, ETC.

Total cost of all parts now only

**£3.19.6**

P. & P. 3/6

Parts Price List and easy build plans 2/- (Free with kit)



### TRANSONA SIX

● 8 stages—6 transistors and 2 diodes

This is a top performance receiver covering full Medium and Long Waves and Trawler Band. High-grade 3in. speaker makes listening a pleasure. Push-pull output. Ferrite rod aerial. Many stations listed in one evening including Luxembourg loud and clear. Attractive case in grey with red grille. Size 6½ x 4½ x 1½in. (Uses PP4 battery available anywhere.) Carrying Strap 1/- extra.

Total cost of all parts now only

**59/6**

P. & P. 3/6

Parts Price List and easy build plans 1/6 (Free with kit)



### MELODY SIX

● 8 stages—6 transistors and 2 diodes

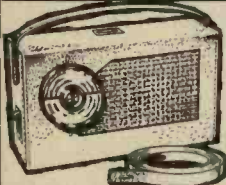
Our latest completely portable transistor radio covering Medium and Long Waves. Incorporates pre-tagged circuit board, 3in. heavy duty speaker, top grade transistors, volume control, tuning condenser, wave change slide switch, sensitive 6in. Ferrite rod aerial. Push-pull output. Wonderful reception of B.B.C. Home and Light, 208 and many Continental stations. Handsome leather-look pocket size case, only 6½ x 3½ x 1½in. approx. with gilt speaker grille and supplied with hand and shoulder straps.

Total cost of all parts now only

**£3.9.6**

P. & P. 3/6

Parts Price List and easy build plans 2/- (Free with kit)



### SUPER SEVEN

● 9 stages—7 transistors and 2 diodes

Covers Medium and Long Waves and Trawler Band. The ideal radio for home, car, or can be fitted with carrying strap for outdoor use. Completely portable—has built-in Ferrite rod aerial for wonderful reception. Special circuit incorporating 2 RF Stages, push-pull output, 3in. speaker (will drive large speaker). Size 7½ x 5½ x 1½in. (Uses 9v battery, available anywhere.)

Total cost of all parts now only

**£3.19.6**

P. & P. 3/6

Parts Price List and easy build plans 2/- (Free with kit)

Callers side entrance  
Barratts Shoe Shop.

## RADIO EXCHANGE Ltd

Open 9—5 p.m.  
Saturdays 9—12.30 p.m.

61a HIGH STREET, BEDFORD. Phone: 52367

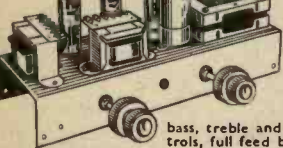
**HIGH GAIN 4 TRANSISTOR PRINTED CIRCUIT AMPLIFIER KIT Type TA1**

● Peak output 1n excess of 1½ watts.  
 ● All standard British components.  
 ● Built on printed circuit panel, size 6 x 3in.  
 ● Generous size Driver and Output Transformers.  
 ● Output transformer tapped for 3 ohm and 15 ohm speakers. ● Transistors (GET 114 or S1 Mullard OC81D and matched pair of OC81 o/p).  
 ● 9 volt operation. ● Everything supplied, wire, battery clips, solder, etc. ● Comprehensive easy to follow instructions and circuit diagram 1/6 (Free with Kit). All parts sold separately.  
**SPECIAL PRICE 45/- P. & P. 3/-.** Also ready built and tested, 52/6. P. & P. 3/-. A pair of TAs are ideal for stereo.



**STEREO AMPLIFIER**

Incorporating 2 ECL86s and 1 E280, heavy duty double wound mains transformer. Output 4 watts per channel into 3 ohm speakers. Full tone and volume controls. Absolutely complete.



**ONLY £4.19.6**  
 P. & P. 8/-

Super Deluxe version with ECL86 valves, sep. bass, treble and balance controls, full feedback. 4 watts per channel into 3 ohm speakers. 8 gns. P. & P. 8/-.

**SPECIAL OFFER!**

**GENUINE HIGH QUALITY TYGAN FABRIC.** 48in wide. Our price 10/- per foot run. P. & P. 1/6. 30/- per yard run. P. & P. 2/6.

**NEON A.C. MAINS INDICATOR.** For panel mounting, cut out size 1½ x ¾ x ¾ in. deep inc. terminal. White case with lens giving brighter light. For mains 200/250v. 2/6 each. P. & P. 6d. (6 or more post free).

**SPECIAL PURCHASE! TURRET TUNERS**  
 By famous maker. Brand new and unused. Complete with PCC84 and PCF80 valves 34-38 Mc/s I.F. Biscuits for Channel 1 to 5 and 8 and 9. Circuit diagram supplied. **ONLY 25/- each.** P. & P. 3/9.

**GÖRLER F.M. TUNER HEAD**

88-100 Mc/s 10.7 Mc/s I.F., 15/-, plus 2/- P. & P. (ECC85 valve, 8/6 extra).

**TAPE DECKS**

**B.S.R. MONARDECK** (Single speed) 3½in. per sec., simple control, uses 5½in. spools, £6/15/-.  
**LATEST COLLARO MAGNAVOX 363 TAPE DECK DE LUXE.** Three speeds, 2 track, takes up to 7 in. spools. 10 gns. Plus 7/6 carr. and ins. on each. (Tapes extra on both.)

**QUALITY PORTABLE TAPE RECORDER CASE.** Brand new. Beautifully made. Few only at 49/6. P. & P. 8/6.

**ACOS CRYSTAL MIKES.** High imp. For desk or hand use. High sensitivity, 18/6. P. & P. 1/6.

**ACOS HIGH IMPEDANCE CRYSTAL STICK MIKES.** Listed at 42/- Our price, 21/- P. & P. 1/6.

**TWIN TELESCOPIC AERIAL.** Two 3-section heavily chromed rods. Closed 12-in. each extending to 32 in. Completely adjustable. Universal mounting bracket, coax lead and plug. Ideal for F.M. or T.V. 12/6. P. & P. 2/6.

**'QUALITY RECORD PLAYER AMPLIFIER Mk II**

A top-quality record player amplifier employing heavy duty double wound mains transformer, ECC83, EL84, E280 valves. Separate Bass, Treble and Volume controls. Complete with output transformer matched for 3 ohm speaker. Size 7in. w. x 3in. d. x 6in. h. Ready built and tested. **PRICE 69/6. P. & P. 6/-.**

**ALSO AVAILABLE** mounted on board with output transformer and speaker ready to fit into cabinet below. **PRICE 89/6. P. & P. 7/6.**

**DE LUXE QUALITY PORTABLE R/P CABINET**

Uncut motor board size 14½in. x 12in. clearance 2in. below, 5½in. above. Will take above amplifier and any B.S.R. or GARRARD Autochanger or Single Player Unit (except AT60 and SP25). Size 18in. x 15in. x 8in. **PRICE £39/6. P. & P. 9/6.**

**4-SPEED PLAYER UNIT BARGAINS**

All brand new in maker's original packing.  
**SINGLE PLAYERS**  
 B.S.R. TU/12 ..... £39/6. Carr. 5/6.  
 GARRARD SP25 De Luxe... £12/0/0. Carr. 5/6.  
 B.S.R. GU7 with unit mounted pickup arm. £4/18/8. Carr. 5/6.

**AUTO. CHANGERS**

Latest B.S.R. UA25 Super slim ..... £6 2 6  
 GARRARD 1000 with special Hi-Fi cart. £6 19 6  
 GARRARD 2000 ..... £7 10 0  
 GARRARD 3000 ..... £8 15 0  
 GARRARD AT60 £10.10.0. Carr. 6/6 on each.  
 All the above units are complete with 7½ mono head and sapphire styl or can be supplied with compatible stereo head for 12/6 extra.

**BRAND NEW CARTRIDGE BARGAIN!**

**ACOS GP67-1.** Mono complete. List price 21/-. Our price 13/6. P. & P. 1/-.

**BRAND NEW.** 12" 15w. H/D Speakers, 3 or 15 ohm. Current production by well-known British maker. Offered below list price at 89/6. P. & P. 5/-.  
 Guitar models: 25w. £5.5.0; 35w. £8.8.0.

**BRAND NEW 3 OHM LOUD SPEAKERS**  
 5 in., 12/6; 6 in., 15/-; 8 in., 22/6; 10 in., 27/6; 7 in. x 4 in., 16/-; 10 in. x 6 in., 27/6.  
 E.M.I. 8 in. x 5 in. with high flux magnet 21/-.  
 E.M.I. 13½ x 8 in. with high flux ceramic magnet, 42/- (15 ohm, 45/-). P. & P. 4" x 5" 2/-, 6" x 8" 2/6, 10" x 12" 3/6 per speaker.  
**E.M.I. PLASTIC CONED TWEETER.**  
 2½" x 3 ohm. Limited number: 12/6 each, P. & P. 1/6.

**SPECIAL OFFER!**

Limited number of 12 in. 10 watt "R.A." Speakers: 3-ohm 25/-; 15 ohm, 27/6. P. & P. 3/6.

**VYNAIR AND REXINE SPEAKER AND CABINET FABRICS** app. 54 in. wide. Usually 35/- yd., our price 13/6 per yd. length (min. 1yd.) P. & P. 2/6. S.A.E. for samples.

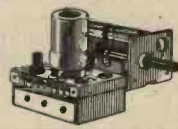
**7-10 watt output TRANSFORMERS** to match pair of ECL 86's in push-pull to 3 ohm output. **ONLY 11/- P. & P. 2/6.**

**MAINS TRANSFORMER** for transistor power supplies. Tapped at 200-250v. Sec. 40-0-40 at 1 amp (with electrostatic screen) and 6-3v. at 5 amp for dial lamps etc. Drop thro mounting. Stack size 1½" x 3½" x 3½" 27/6. P. & P. 4/6.

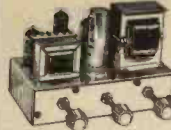
**MATCHED PAIR OF 2½ WATT TRANSISTOR DRIVER AND OUTPUT TRANSFORMERS.** Stack size 1½" x 1½" x 1 in. Output trans. tapped for 3 ohm and 15 ohm output. 10/- pair plus 2/- P. & P.

**'SPECIAL OFFER! FM/AM TUNER HEAD**

Beautifully designed and precision engineered by Dornier and Wadsworth Ltd. Supplied ready fitted with twin .0005 tuning condenser for AM connection. Preamplified FM section covers 86-102 Mc/s. I.F. output 10.7 Mc/s. Complete with ECC85 (6L12) valve and full circuit diagram of tuner head. Another special bulk purchase enables us to offer these at 27/6 each. P. & P. 3/-. Order quickly!  
 Limited number also available with precision geared 3:1 reduction drive. 30/- P. & P. 3/-.



**3-VALVE AUDIO AMPLIFIER MODEL HA34**



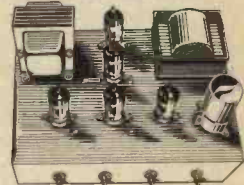
Designed for Hi-Fi reproduction of records. A.C. Mains operation. Ready built on plated heavy gauge metal chassis, size 7½in. w. x 4in. d. x 4½in. h. Incorporates ECC83, EL84, E280 valves. Heavy duty double wound mains transformer matched for 3 ohm speaker, separate Bass, Treble and volume controls. Negative feedback line. Output 4½ watts. Front panel can be detached and leads extended for remote mounting of controls.  
 The HA34 has been specially designed for us and our quantity order enables us to offer them complete with knobs, valves, etc., wired and tested for only **£4.5.0** P. & P. 6/-.

**HSL 'FOUR' AMPLIFIER KIT**

A.C. Mains 200/250v., 4 watt, using ECC83, EL84, E280 valves  
 ★ Heavy duty double-wound mains transformer with electrostatic screen.  
 ★ Separate Bass, Treble and volume controls giving fully variable boost and cut with minimum insertion loss.  
 ★ Heavy negative feedback loop over 2 stages ensures high output at excellent quality with very low distortion factor.  
 ★ Suitable for use with guitar, microphone or record player. ★ Provision for remote mounting of controls or direct on chassis. ★ Chassis size only 7½ in. wide x 4 in. deep. Overall height 4½ in. ★ All components and valves are brand new. ★ Very clear and concise instructions enable even the inexperienced amateur to construct with 100% success. ★ Supplied complete with valves, output transformer (3 ohms only), screened lead, wire, nuts, bolts, solder, etc. (No extras to buy.) **PRICE 79/6. P. & P. 6/-.**  
 Comprehensive circuit diagram, practical layout and parts lists 2/6 (free with kit).  
 This kit, although similar in appearance to HA34 employs entirely different and advanced circuitry.



**10/14 WATT HI-FI AMPLIFIER KIT**  
 A stylishly finished monaural amplifier with an output of 4 watts from 2 EL84s in push-pull. Super reproduction of both music and speech, with negligible hum. Separate inputs for mike and gram allow records and announcements to follow each other. Fully shrouded section wound output transformer to match 3.15Ω speaker and 2 independent volume controls, and separate bass and treble controls are provided giving good lift and cut. Valve line-up 2 EL84s, ECC83, EF86, and E280 rectifier. Simple instruction booklet 1/6. (Free with parts.) All parts sold separately. **ONLY £7/9/6. P. & P. 8/6.** Also available ready built and tested complete with rec. input sockets, £9/5/- P. & P. 8/6. Carrying Case for above 28/6. P. & P. 7/6.



**MATCHED PAIR AM/FM I.F.'s.** Comprising 1st I.F. and 2nd I.F. discriminator. (465 Kc/s/10.7 Mc/s). Size 1" x 1½" x 2½" H. Will match FM/AM Tuner head on left. 11½ pair. P. & P. 2/-.

**HARVERSON SURPLUS CO. LTD.**  
 170 HIGH ST., MERTON, S.W.19 CHerrywood 3985  
 Open all day Saturday Early closing Wed., 1 p.m.  
 A few minutes from South Wimbledon Tube Station. (Please write clearly)  
**OVERSEAS P. & P. CHARGED EXTRA. S.A.E. with all enquiries**

**CURRENTLY FITTED TO OVER 100 MODELS BY MAJOR MANUFACTURERS**  
 BRING YOUR RECORD PLAYER UP TO DATE WITH  
**Sonotone TEL**  
 HIGH FIDELITY STEREO-PHONIC CERAMIC CARTRIDGES  
 Sonotone 9TA SERIES. Superior quality ceramics offering extremely high compliance for a cartridge with dual styli. Tracking weights as low as 1-3 gm. allow reproduction from heavy modulated records without distortion on most changers. Standard ½" fixing centres. Prices: Sapphire £2.18.10. Tax paid. Diamond £3.16.7. Tax paid. Other types available. send for leaflet.

**metrosound** metrosound manufacturing co. Ltd. bridge works, wallace road, london, n.1. can 8641/2/3



# DOOR SLAVE

## PART TWO

By S.T. ANDREWS

LAST month's article described the Door Slave in theory. This concluding article deals with the practical aspect. Complete wiring diagrams for all units are included here, and also instructions for setting up the completed system.

Finally, a suggested method for obtaining "coded knocking" is outlined.

### CONSTRUCTIONAL DETAILS

The basic unit, which contains nearly all the electronics, is best kept near the door so that the lead from it to the microphone can be as short as possible. It can be built into any convenient box and a suitable component layout is given in Fig. 6.

The components are mounted on a wooden base-board measuring 6in  $\times$  7in.

Two 20-way group boards are used for the smaller components. The sockets SK1 and SK2 are actually B9A valveholders and these are fitted to a small bracket secured to one corner of the base board.

A metal box 4in deep fits over the base board, thus providing complete enclosure for the basic unit. The rear side of this box, or cover, carries the two jack sockets JK1, JK2 and the battery BY2; the latter is held against the side of the box with a simple metal clip. Two holes are cut in the box for SK1 and SK2, and two smaller holes (in the right-hand side) for the preset controls VR1 and VR2.

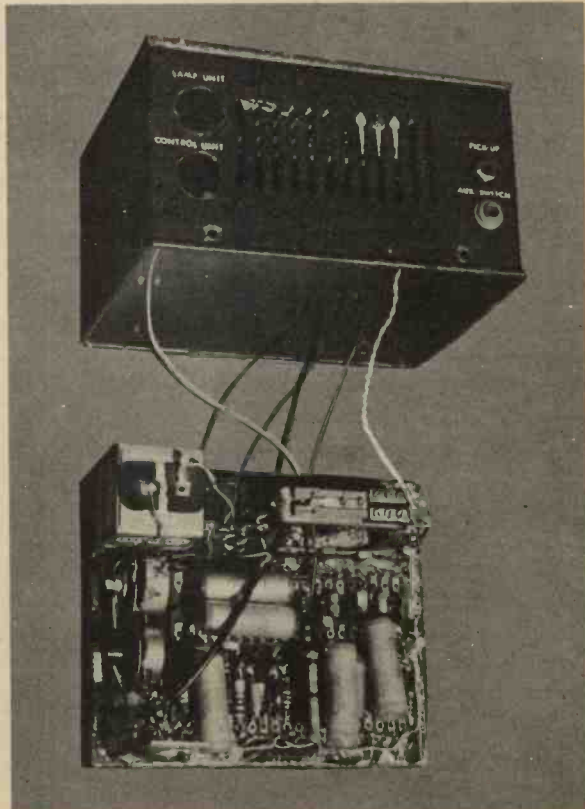
The cable running to the control unit can be several yards long, so the control unit can be some distance away if required.

The control unit made by the author utilises a small ex-G.P.O. telephone switchboard, as can be seen from Fig. 5 and Fig. 8. Such switchboards are often available on the "surplus market". It is not essential to use this particular unit, of course, and any "discrete" switches, either of the rotary or toggle kind, would serve equally well. The warning lamps, which form part of the telephone switchboard unit, could be dispensed with or, alternatively, individual lamp holders could be installed and wired up, one in association with each switch.

The size of the front panel is 12in  $\times$  4in. A view of this panel was given in Fig. 5 last month. Layout of components and wiring of the control unit is given in Fig. 8.

The 16-way group board shown to the right of the control unit in this figure contains the components of the "memory latch"—an optional extra which was described last month.

The power supplies for the memory latch can be separate batteries as indicated in Fig. 3 and Fig. 8, or those used for the main unit could also serve this additional unit. The memory latch was built into the control unit, as shown in the illustrations. It could, however, be incorporated in the basic unit if preferred.



The basic unit

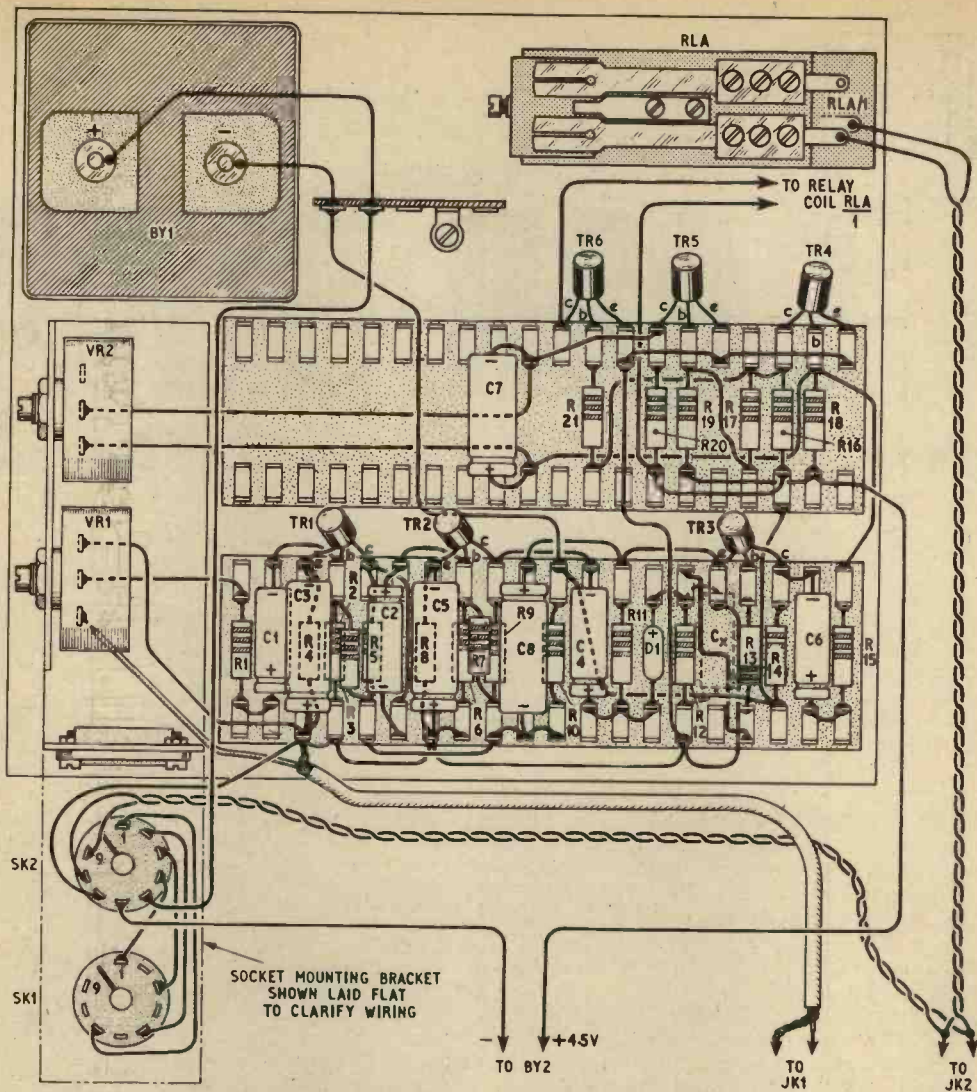


Fig. 6. Component layout and wiring for the basic unit

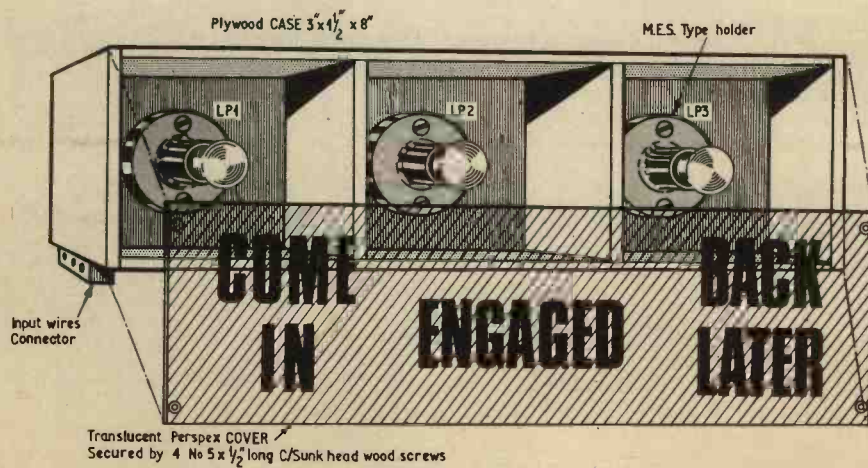


Fig. 7. The lamp unit

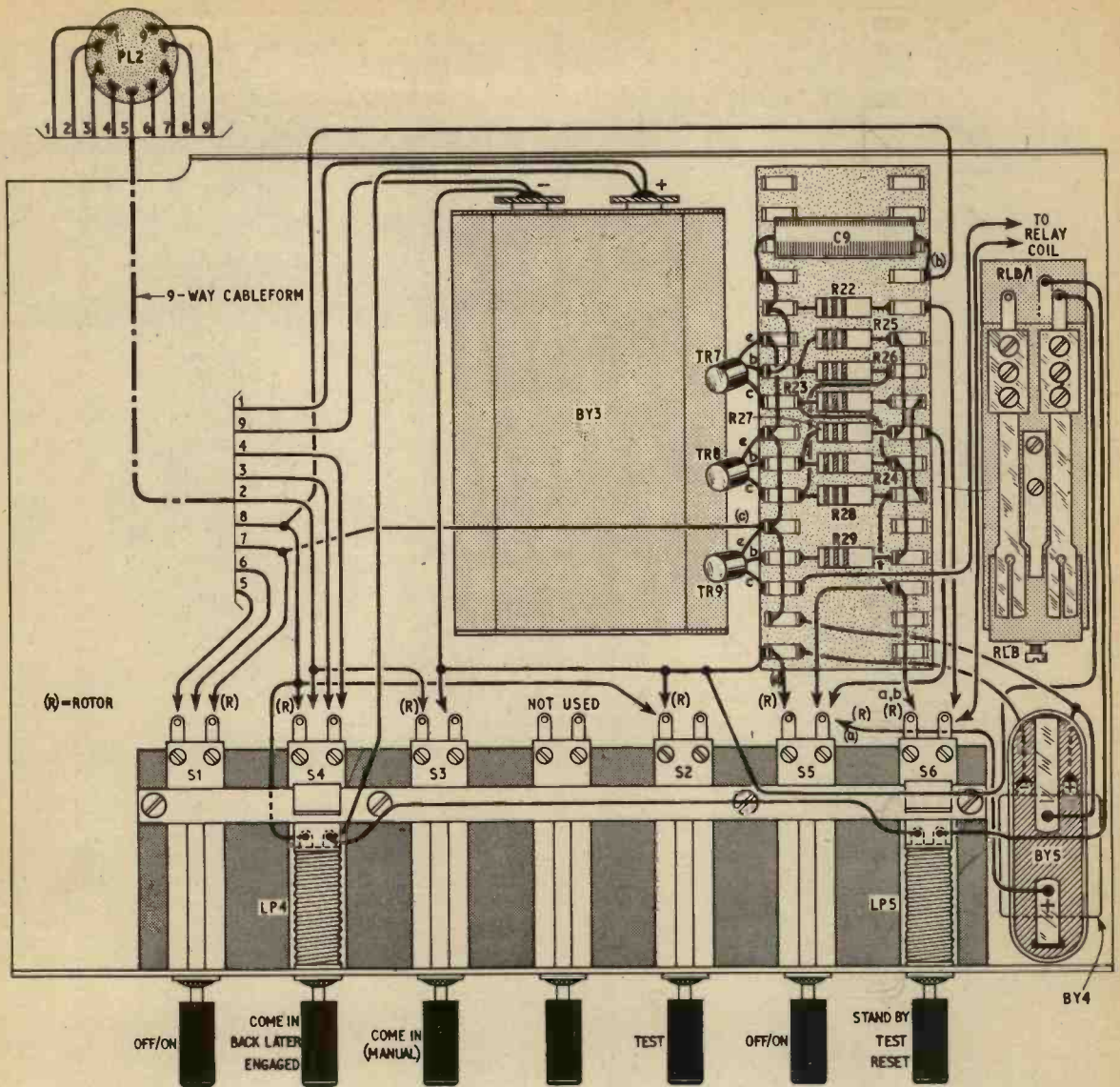


Fig. 8. Component layout and wiring for the control unit.

## Components . . .

Resistors		MEMORY UNIT		Relay	
R22	2.2k $\Omega$	R27	6.8k $\Omega$	RLB	500 $\Omega$ coil. One make-break contact
R23	1k $\Omega$	R28	1k $\Omega$		
R24	4.7k $\Omega$	R29	3.3k $\Omega$		
R25	6.8k $\Omega$			<b>Switches</b>	
R26	4.7k $\Omega$			S5	Double pole on/off
All $\pm 10\%$ , $\frac{1}{4}$ W carbon				S6	Double pole 3-way
<b>Capacitors</b>				<b>Lamp</b>	
C9	0.01 $\mu$ F paper			LP5	6V 0.3A
<b>Transistors</b>				<b>Batteries</b>	
TR7-9	OC71 (3 off)			BY4	9V
				BY5	4.5V
				One 16-way group board	

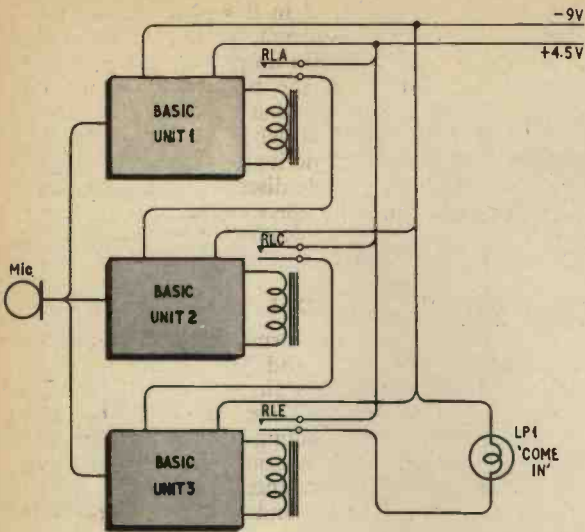


Fig. 9. A possible system for "coded knocking"

The lamp unit can also take any convenient form, one suggested pattern is given in Fig. 7. This is a three compartment box made of plywood and measures 3in by 1½in by 8in. The front panel consists of a piece of opaque plastic with the appropriate legends printed on the inside.

### SETTING-UP PROCEDURE

When setting the pre-set controls it is best to adjust first the flip-flop bias control VR2. This has an effect on the length of time that the flip-flop remains in the triggered state. With VR2 turned to maximum resistance TR4 will be unable to conduct any of the time and the circuit will remain permanently in the triggered state. If VR2 is set to minimum then TR4 will conduct heavily all the time and applying a trigger pulse will have no-effect on it. Between these two extremes there is a point where triggering the circuit causes TR5 to begin conducting and continue to do so for 3-5 seconds. The most convenient way of triggering the circuit at this stage is to short briefly the emitter and base leads of TR4 with the metal blade of a screw-driver.

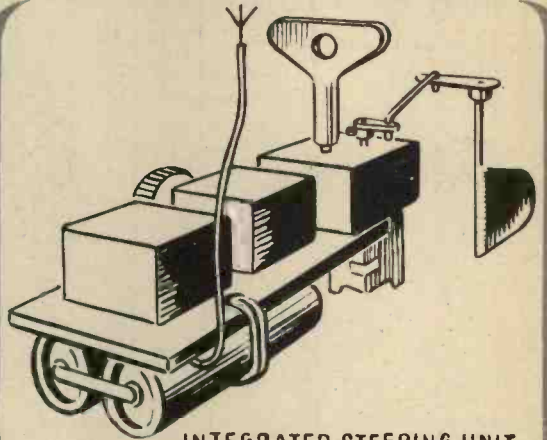
The sensitivity control VR1 is adjusted so that the appropriate loudness of knock causes the circuit to operate. If the sensitivity is too high then other sounds can trigger the circuit at the wrong time.

### CODED KNOCKING

A more elaborate version of the Door Slave uses several basic units and illuminates the "Come In" lamp only if a certain sequence of knocks is heard. One version of this is given, in block diagram form only, in Fig. 9. Three basic units are used and the output relay of each of the first two units supply power to the next one; only the third one lights a lamp. With this arrangement the lamp will light only if three knocks are heard in quick succession. Other systems of connection will make the arrangement respond to other types of coded knocks. There is obvious scope here for further development of the system so that even more complicated "knocking" procedures are needed to operate the device. ★

# Next Month!

## MODEL CONTROL INSTALLATIONS



INTEGRATED STEERING UNIT

This special article shows how to get the best from P.E. miniature radio control modules by combining them to make a complete control system with an escapement mechanism.

### 2 Projects using Sealectro 'Press-Fit' Wiring Systems

#### TRANSISTOR C.R.O. TRACE DOUBLER

To extend the capability of a single-beam oscilloscope to display two waveforms.

#### VIDEO PATTERN GENERATOR

For testing video stages of television receivers, transmitters and monitors.

Plus  
PRACTICAL APPLICATIONS OF F.E.T.S.

PRACTICAL JUNE ISSUE ON SALE MAY 12  
**ELECTRONICS**

● IMPORTANT! Are you getting 'Practical Electronics' every month? If not, place a regular order with your newsagent today.



# BASS GUITAR

By

S. Simpson



THE bass guitar described in this article is not particularly difficult to construct, but the author would point out here that the strain on parts of a bass guitar is very great and, while the prototype has proved highly satisfactory both for tone and keeping in tune, the success is attributed largely to the method and materials used in its construction.

And now, having probably discouraged a few would-be bass guitarists and doubtless whetted the eagerness of many others more venturesome, we will see how the guitar is made.

## GENERAL DESCRIPTION

The body of the guitar is formed from two sheets of  $\frac{3}{8}$ in blockboard, the neck and head is one piece of solid oak, the fingerboard is  $\frac{1}{4}$ in mahogany-faced plywood, and the "trimmings" are  $\frac{1}{8}$ in white Perspex. The metalwork is mainly aluminium and duralumin; the bridge adjusting screws are mild steel. The pick-up is a "bought-in", high impedance component.

Other components are standard items, obtainable anywhere.

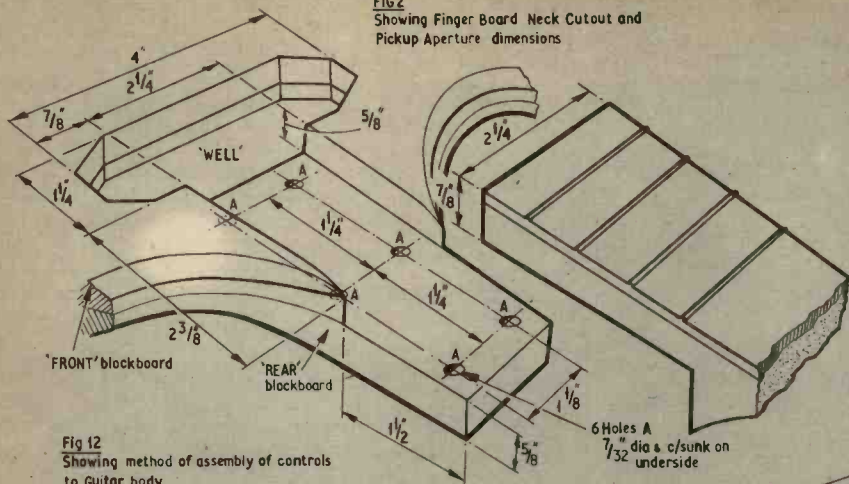
The strings are a standard set and the maximum string length from bridge to nut or string spacer (where the neck becomes the head) has been set at 30 $\frac{1}{2}$ in. A longer span gives a tighter E string with less likelihood of "rattle", but, unless the neck is reinforced by a steel truss, the neck will yield and become permanently distorted. The present model will rattle if it is played violently, but the output from this guitar, *played normally*, has proved ample in quite "noisy" conditions.

All materials and items required are specified in the Parts List.

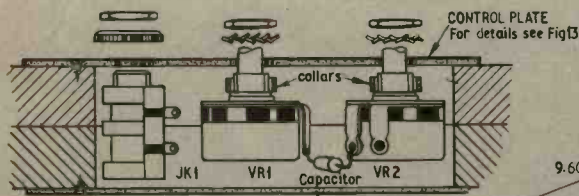
No attempt will be made to estimate costs, as prices for these materials may vary quite widely throughout the country. The most costly item, of course, is the pick-up and will probably run to 6gn approximately. As stated earlier, intending constructors may have their own ideas, enabling them to use materials at hand; the following instructions, in such cases, should serve as a reliable guide to what is necessary.



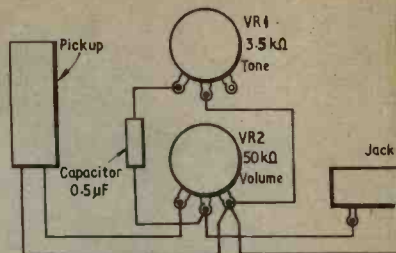
**FIG 2**  
Showing Finger Board Neck Cutout and  
Pickup Aperture dimensions



**Fig 12**  
Showing method of assembly of controls  
to Guitar body

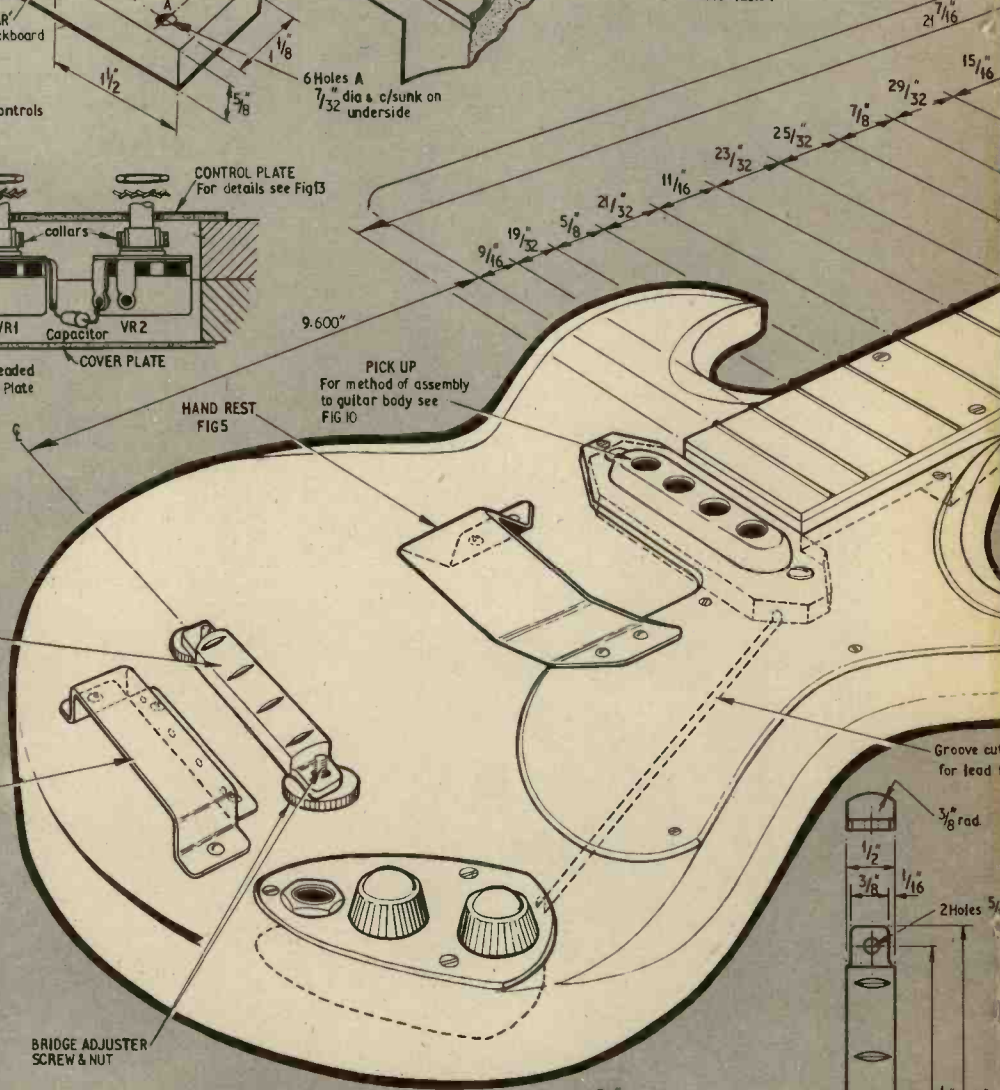


Additional collars to be used if threaded bush projects to far above Control Plate

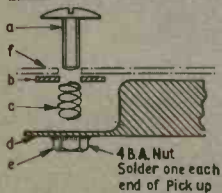


**FIG 11**

For cumulative decimal dimensions  
from centre line (C) of BRIDGE (FIG 7)  
see Table I

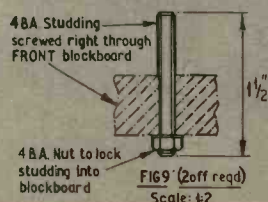


**FIG 10** Pick up adjuster assembly



- a) Height adjustment screw
- b) Perspex washer
- c) Compression spring
- d) Pick up fixing lug
- e) 4 B.A. Nut
- f) Guard Plate

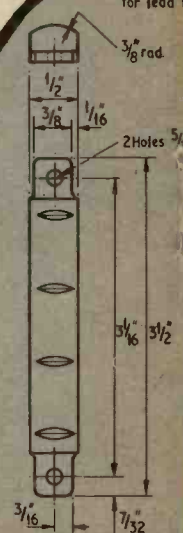
**BRIDGE ADJUSTER SCREW & NUT**



**FIG 9** (2 off reqd)  
Scale: 1:2



**FIG 8** (2 off reqd)  
Scale: 1:2  
Material: White Perspex

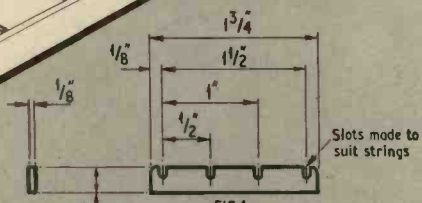
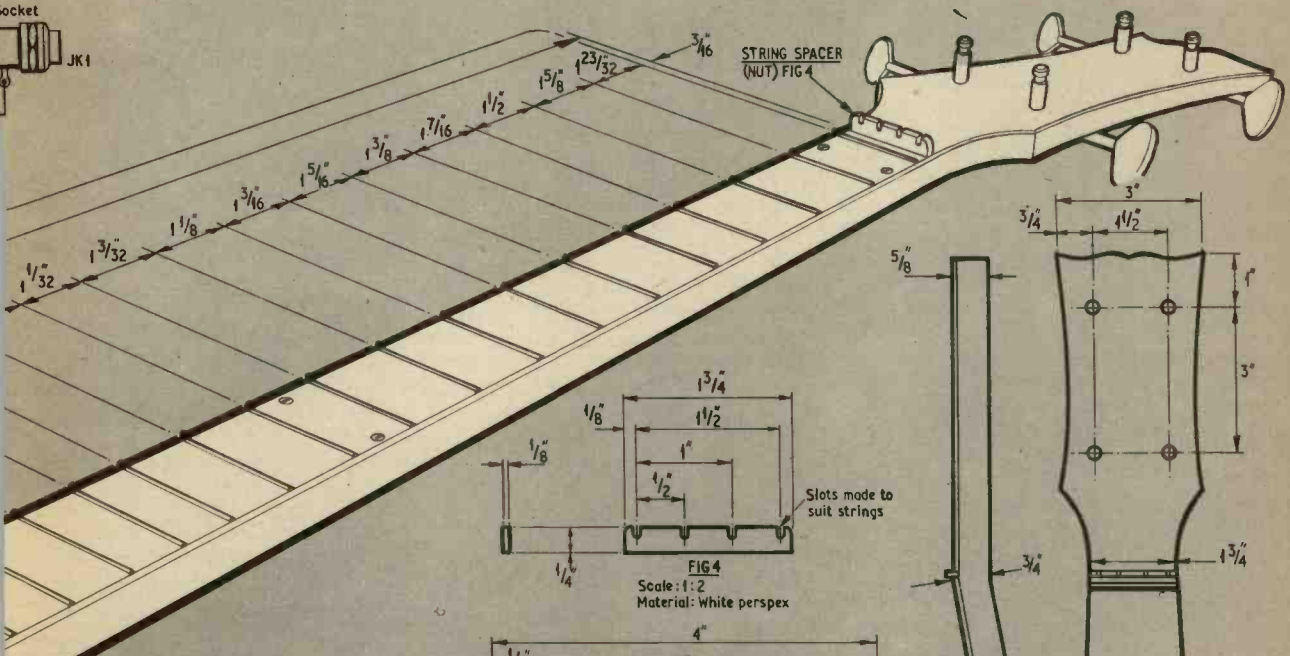
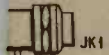


# BASS GUITAR

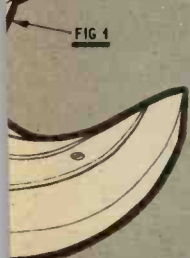


# CONSTRUCTIONAL DETAILS

Socket



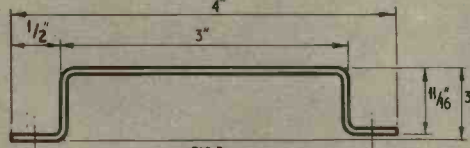
**FIG 4**  
Scale: 1:2  
Material: White perspex



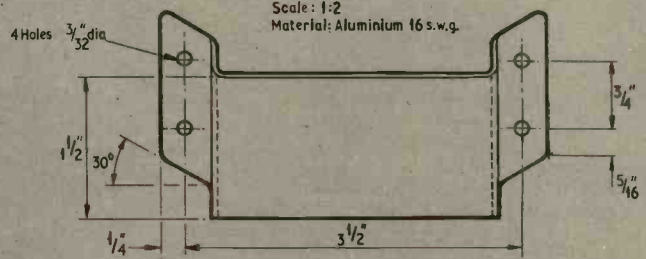
in rear face of FRONT blockboard  
on Pickup to Control Panel



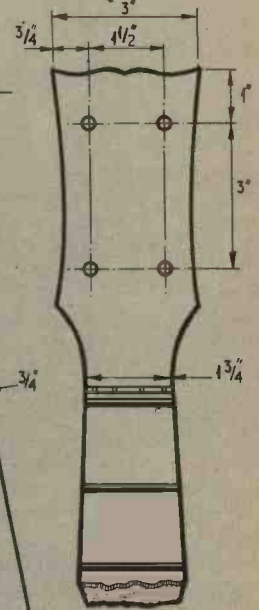
**FIG 7**  
Scale: 1:2  
Material: Aluminium Bar



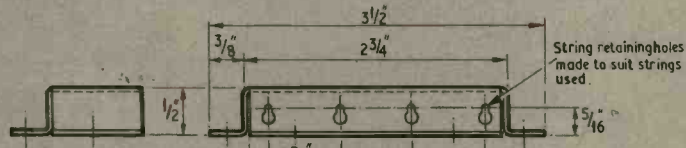
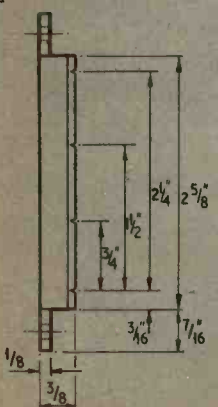
**FIG 5**  
Scale: 1:2  
Material: Aluminium 16 s.w.g.



**FIG 6**  
Scale: 1:2  
Material: Aluminium 18 s.w.g.



**FIG 3**  
Scale: 1:4  
Material: Oak with Mahogany faced plywood on upper surface



String retaining holes  
made to suit strings  
used.

## MAKING THE BODY

Begin by marking out one piece of blockboard to the pattern shown in Fig. 13, which is a half-scale drawing of the body. Using a coping saw, cut out the shape; again using the coping saw, cut the bevel shown down to  $\frac{1}{4}$ in from the underside of the work-piece. Finish off, using a rasp to begin with and progressing through fine, to very fine, glasspaper.

Treat the second piece of blockboard in the same way, then, first protecting the surfaces of the two pieces, clamp them in a vice, ensuring that the edges match as nearly as possible. Finish off the shaping with the pair thus matched. These two body pieces will be subsequently referred to as the "front" and the "back", respectively.

## CUTTING THE APERTURES

Separate the two body pieces; lay the "back" piece aside meantime.

Study Fig. 2 in relation to Fig. 1 and note how the aperture for the pick-up and the slot for the neck are cut in one process. The entire thickness of the "front" is removed and a "well" will be cut from the "back" later on to accommodate the depth of the pick-up. The neck will fit on to the upper surface of the "back", and be snugged between the walls of the cutaway in the "front", as described in detail under "The neck and head".

The dimensions given in Fig. 2 suit the Burns "Tri-sonic" pick-up; if a different pick-up is to be used, these dimensions will change, of course, and probably the well in the "back" also. All cutting must be accurate, especially where the neck is to fit.

No dimensions are given here for the aperture to accommodate the volume control, tone control, and output socket, as these depend upon the items obtained. Approximate positions for them are shown in Fig. 1. The piece is removed from "front" and "back"; the controls will be concealed by a Perspex plate providing access to the controls for maintenance. The controls should not be crushed needlessly; in any case, room for rotation of knobs and clearance for the output cable will partly determine the spacing of the controls and socket.

A groove, shown as a dotted line in Fig. 1, accommodates the twin lead from the pick-up to the volume control. This should be cut into the underside of the "front" and extend from the pick-up aperture to the volume control aperture.

The "back" must be recessed where the pick-up will lie; only enough material should be removed to provide the necessary depth.

This completes the preliminary work on the body, which can now be enamelled and left to dry.

## THE NECK AND HEAD

The shape of the neck is shown in Figs. 1 and 3. In the prototype, the angle at the head was obtained by using a milling machine; if this is not possible, it must be cut by a coping saw, shaped by a rasp, and smoothed off, using various grades of glasspaper. Dimensions of the stub fitting into the channel already cut in the body are given in Fig. 2. The stub should be a tight fit.

The head can be drilled to take the pegs of the machine heads at the points indicated in Fig. 3, but the heads themselves should not be fitted until the neck and head have been enamelled (or finished in some other way).

TABLE 1

Distance from Datum (centre line of bridge) 9-6in

Fret No.	Fret No.	Fret No.
1 10.17in	8 15.25in	15 22.84in
2 10.77in	9 16.15in	16 24.20in
3 11.42in	10 17.11in	17 25.64in
4 12.38in	11 18.13in	18 27.17in
5 13.11in	12 19.21in	19 28.78in
6 13.58in	13 20.35in	20 30.50in
7 14.39in	14 21.56in	

## THE FINGERBOARD

The fingerboard can now be attended to. Cut the plywood to the dimensions shown in Figs. 1, 2 and 3. Note that the top fret is set  $\frac{1}{8}$ in from the end of the board, then mark off for fret positions at the distances quoted in Fig. 1 and Table 1. Cut to the depth of the tongue on the fret-wire, using a fine saw-blade such as the "Junior" hacksaw, or a fret-saw. If the cutting is very carefully done, so that the frets are a tight push-fit, no adhesive will be necessary as the strings themselves will hold the frets quite firm. Cut and fit the frets, then attach the fingerboard to the neck, using "Evostik".

## THE NUT OR STRING SPACER

The nut or string spacer is cut from white Perspex to dimensions given in Fig. 4. The channels to hold the strings are of various widths and should be a fairly close fit. When prepared, put the nut aside for assembly later.

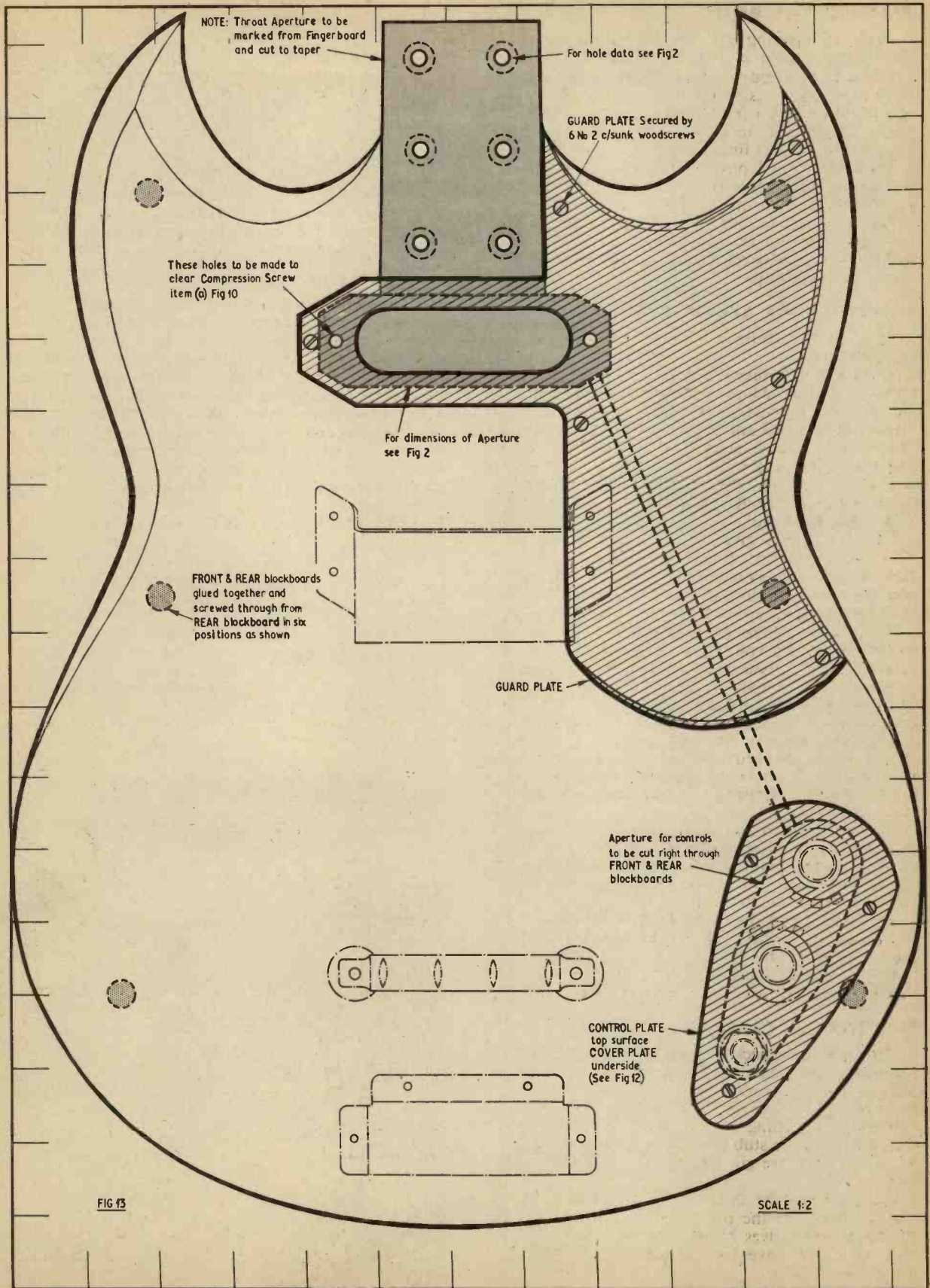
## THE HAND REST

The hand rest is cut from 16 s.w.g. sheet aluminium to the shape shown in Fig. 5, then drilled and bent to the shape shown. It will be secured to the body by four  $\frac{1}{2}$ in No. 2 round head plated woodscrews.

## THE BRIDGE

The bridge can be fashioned from either  $\frac{1}{2}$ in diameter duralumin, if milling is available, or from  $\frac{1}{2}$ in square stock if to be filed to shape. (If the reader cannot operate a milling machine, but knows someone who







can, he should show the person the drawing given in Fig. 7, which is adequate for an experienced machinist.)

*Dimensions must be strictly adhered to, otherwise the string spacing may make fingering difficult.* The bridge will be secured to the body by two specially-made screws described in the next section.

### BRIDGE ADJUSTER SCREWS AND NUTS

The bridge adjuster screws are fashioned from two lengths of 4B.A. studding screwed right through the "front" blockboard, Araldited, and locked on the rear face with a 4B.A. nut (Fig. 9).

The adjuster nuts are made from white Perspex discs,  $\frac{3}{4}$ in diameter and  $\frac{1}{8}$ in thick. The rims of the discs are serrated with a fine saw. A hexagonal hole is made in the centre and a 4B.A. nut is firmly Araldited in place, see Fig. 8. (First drill a  $\frac{1}{4}$ in hole in the disc and then file out the hexagonal shape.)

### THE STRING ANCHORAGE

The string anchorage is also manufactured from 18 s.w.g. aluminium as shown in Fig. 6. The string anchorage will be secured to the body by four  $\frac{1}{4}$ in No. 2 plated screws, *provided the material used for the body is hard*; if soft, a longer screw must be used.

### GUARD PLATE, CONTROL PLATE AND COVER PLATE

The guard plate, control plate, and cover plate are cut from white Perspex to the shapes shown in Fig. 13, or to the reader's own liking.

The only particular part is that surrounding the pick-up aperture and, here again, the pick-up obtained will determine the shape of the guard plate. The control plate shape will be determined by the type of components used, as also the cover plate to be fitted at the back of the instrument directly above the controls. Those shown in Figs. 1, 12 and 13 are typical readily available items.

### ASSEMBLING THE GUITAR

Have at hand the two parts of the body, the guard plate, the pick-up, the tone control and volume control, the output socket and the pick-up height adjuster screws and compression-springs shown in Fig. 10. It is assumed that the pick-up already has threaded holes in the lugs; if not, a 4B.A. nut should be soldered to the underside of each lug, as shown in Fig. 10, first removing any plating on the surface to be soldered. As most metals transmit heat rapidly, the nuts should be fitted by a person experienced in *quick* soldering; damage to the pick-up might ensue if the application of heat is prolonged.

Fit the pick-up to the guard plate as shown in Fig. 1, gently compressing the springs meantime. Lay the pick-up into the aperture in the body "front", then screw down the guard plate, using small plated countersunk woodscrews.

Fit the tone control, volume control and socket to the controls assembly plate. Connect the wiring as shown in the circuit, Fig. 11, and the "back" and "front" may then be assembled by glueing and screwing, using six 1in No. 6 c.s.k. woodscrews in the positions indicated in Fig. 13. Check that the wiring is still intact, then fit the cover plate over the aperture at the controls (looking at the "back" of the instrument).

The neck should now be fitted and attached by six  $1\frac{1}{4}$ in No. 6 woodscrews (no glue is used, thus allowing for packing pieces to be inserted if necessary to clear the pick-up polepieces; the screw adjustment at the bridge should, however, take care of clearance if all cutting and shaping has been done accurately).

Summing up; so far we now have the head and neck (complete with fingerboard and frets) assembled to the body (complete with pick-up, controls and socket). At this stage the neck and head can be enamelled, or polished as the reader desires, then the final assembly items can be fitted.



## MACHINE HEADS

The machine heads must be strongly built. The author found that right-hand heads appear to be sturdier than "lefts" (for no known reason) and he eventually converted two "rights" to form two "lefts". The method was quite simple and obvious. Advice should be obtained from the dealer regarding heads.

Having converted two of the machine heads, all four should now be fitted.

## STRINGS AND POSITION OF ANCHORAGE

Have the nut or string spacer (Fig. 4) close at hand. Pass the No. 1 string and No. 4 string through the anchorage and attach each to its respective machine head. Tighten both until the strings are just taut when the anchorage is held at its allotted position (Fig. 1). Set the nut under the string at the head, then laterally adjust the anchorage so that each string lies approximately central about its polepiece on the pick-up. (Do not bother about clearance just yet: lateral position is the matter in hand.) Having set the anchorage, mark through the fixing holes. Slack off the strings and screw down the anchorage.

## THE BRIDGE

Tighten the strings just taut, then insert the bridge under the strings at a point 9-60in from the nearest fret. If cutting and slotting have been accurate, the strings should accept the bridge without movement across the polepieces. Mark through the bridge fixing holes, then slack off the strings and remove the bridge. Drill for the bridge screws (remember that these *must* be a tight drive-fit) and fit the screws quite vertically. A block of hardwood will protect the screws when fitting them.

Fit the adjusters and run them down to the bottom of the threaded screws. Fit the bridge, then pass the remaining strings through the anchorage, and the bridge, over the nut and on to the machine heads. Set the strings just taut and check clearance at the pick-up when each string is pressed against the fret nearest the pick-up. Adjust for minimum clearance by screwing the adjusters upward on the bridge screws. Note that the bridge can be set at a small angle from horizontal to allow for the considerable difference and thickness between No. 1 and No. 4 strings. The nut should remain quite firm without any fixative and is, in fact, better free as this allows the strings to take up a "natural" position.

The hand rest can now be fitted over the strings as shown in Fig. 1 and this completes the assembly of the guitar.

## TRYING OUT THE GUITAR

Tune the strings against another guitar, or by piano or other instrument. Insert the output cable and connect it to a suitable amplifier either known to the reader, or in the care of someone who does know the control functions. Switch on the amplifier at low volume, and normal tone. Set the tone control at half-traverse and the volume control likewise. Pluck the No. 4 string and check that the loudspeaker responds.

Continue plucking, meanwhile turning the volume control clockwise; check that the loudspeaker output increases. If it *diminishes*, the volume control *outer* connections at the guitar must be changed over, but before doing so, check that the tone becomes less deep as the tone control is turned anticlockwise. If it

## MATERIAL REQUIRED

- 2 pieces blockboard, 18in × 18in ×  $\frac{3}{8}$ in
- 1 piece oak, 30in × 3in × 2in
- 1 piece high-quality  $\frac{3}{8}$ in plywood, 30in × 2 $\frac{1}{2}$ in (mahogany finish)
- 1 piece 4B.A. studding, 3in long
- 1 piece duralumin, 4in long ×  $\frac{3}{8}$ in diameter. (This may be 4in long ×  $\frac{1}{2}$ in square; see text under heading "The Bridge")
- 1 piece 16 s.w.g. sheet aluminium, 5 $\frac{1}{2}$ in × 2in
- 1 piece 18 s.w.g. aluminium, 4 $\frac{1}{2}$ in × 2in
- 1 piece white Perspex, 1 $\frac{1}{2}$ in ×  $\frac{1}{4}$ in ×  $\frac{1}{16}$ in thick
- 1 piece white Perspex, 8in × 8in ×  $\frac{1}{16}$ in
- 1 piece white Perspex, 1in × 2in ×  $\frac{1}{8}$ in
- 1 set (four) heavy duty machine heads ("string winders"), all metal
- 1 set bass guitar strings for electronic guitar
- 4ft length of T-section fret-wire for bass guitar
- 8  $\frac{1}{2}$ in No. 2 round head woodscrews, preferably plated
- 12  $\frac{1}{2}$ in No. 2 csk woodscrews, preferably plated
- 6  $\frac{3}{8}$ in No. 10 csk woodscrews
- 6 1 $\frac{1}{2}$ in No. 6 csk woodscrews
- 6 1in No. 6 csk woodscrews
- 4 4B.A. full nuts and 2 washers
- Quantity "Evostik"
- White undercoat paint
- White brushing Belco (or a similar self-spray enamel)

## CIRCUIT COMPONENTS

- VR1 3,500Ω potentiometer (tone control)
- VR2 50,000Ω potentiometer (volume control) both preferably semi-miniature, 1in dia.
- CI 0.5μF 150V working. (The working voltage is not important; small physical size matters)
- XI Four-pole pick-up. (Prototype incorporates a Burns "Tri-sonic" which is very satisfactory for operation with a high-impedance, high-power amplifier)
- JK1 single-pole jack socket (Belling)
- PL1 single-pole jack plug to suit JK1 (Belling)
- Two control knobs, to fit volume control and tone control

becomes *deeper*, the *outer* connection on the tone control must be changed over to the (at present) unused outer connection. Return the tone control to mid-position.

If all is well, try out the No. 1 string, increasing volume carefully. When at maximum setting on the guitar, gently increase volume at the amplifier. At some point, the loudspeaker may "break" from a clear string note to a rattle. This is just beyond the maximum setting the amplifier can take; reduce the control slightly.

Now check the effect of tone controls by adjusting anticlockwise to increase depth, still striking No. 4 string. At some point, rattle may again be encountered and two remedies are possible—(a) reduce volume at the amplifier or (b) reduce depth at the tone control on the guitar. (This is the "getting to know" process.) Volume and depth should be very much more than ample before these limiting conditions are reached.

Now strike the string with the No. 4 string pressed to the bottom fret (nearest pick-up). Check that, when strongly struck, it does not vibrate against the pick-up. If it does, the bridge adjusters must be raised slightly (this will probably entail a small increase of volume control setting to obtain maximum permissible volume).

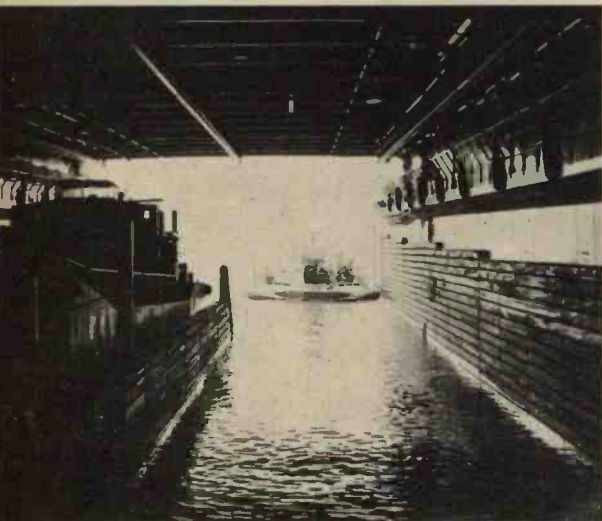
A little practice along these lines should quickly enable the guitarist to set his instrument against any other high impedance amplifier he may encounter in travelling from one group to another. ★

# ELECTRONORAMA



## New Assault Ship has Docking Eyes

THE latest Royal Navy assault ship, due to serve East of Suez in September, has massive docking facilities for landing barges, hovercraft, helicopters, tanks, and



armoured vehicles. This ship, H.M.S. *Intrepid* (above), carries a comprehensive communications network which is necessary for co-ordinating the activities of about 590 officers and men of the Royal Navy, Royal Marines, and the Army. Up to 700 troops can be carried in addition.

One essential feature of interest is the use of closed circuit television cameras in the docking area and decks to ensure maximum packing of the various vehicles. H.M.S. *Intrepid* is to relieve H.M.S. *Fearless*, a similar ship whose docking area is shown on the left with a landing barge and hovercraft.

Four *Seacat* guided missiles and two 40mm guns are fitted armaments on *Intrepid*, which was built and commissioned at John Brown's shipyard, Glasgow.

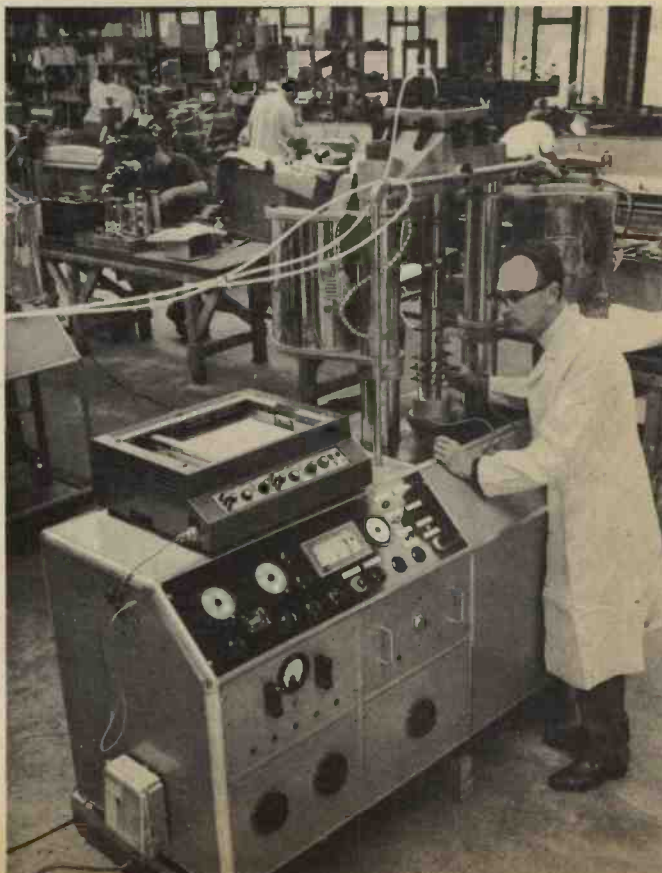
## Plotting Strain in Tensile Testing

RECORDING and measuring strain in conjunction with tensile testing machinery is one of the many operations which was a problem until the introduction of compact, highly sensitive and extremely accurate XY Plotters. The problems arose out of the fact that materials are tested in both tension and compression, often at temperatures in excess of 700°C.

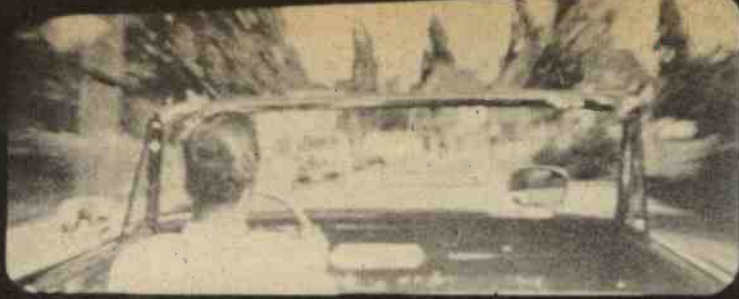
Measuring equipment which is capable of plotting a load/strain diagram and of detecting fractional movement of the test specimen with complete accuracy, thus has an indispensable role in tensile testing.

In this photograph (right) we show a combination of a Mand High Strain Fatigue Machine and a Bryans 20000 series XY Plotter.

The machine has a fully automatic push/pull testing facility, capable of applying cyclic modes of up to 25,000lb on either tension or compression and at temperatures of up to 750°C.







### Driver Teaching System

**A** NEW system for teaching people to drive was introduced in March when the first "Dryotrainner" school was opened in Nottingham.

The method of teaching involves watching the actions of the driver on the screen, and then later the pupils looking straight through the windscreen and completing the actions themselves. In each film there is a test period, during which time an electronic machine records all the movements of each pupil. After the films have been shown the instructor can point out to the class everyone's mistakes.

### Cables Down Under

**B**ELOW the London underground railway, is a complex of tube tunnels probably unknown to many people. Built on similar principles to the railway tube, this system of tunnels holds the secret to telephone communications in London.

A lift shaft takes engineers 100ft below ground at the Post Office Tower to a surprisingly clean and odourless environment to instal cables between main exchange centres. Our picture below shows an electric tractor, 18in wide, pulling a long cable off a drum and through the tunnel, to be lifted on to the side carrier arms later.

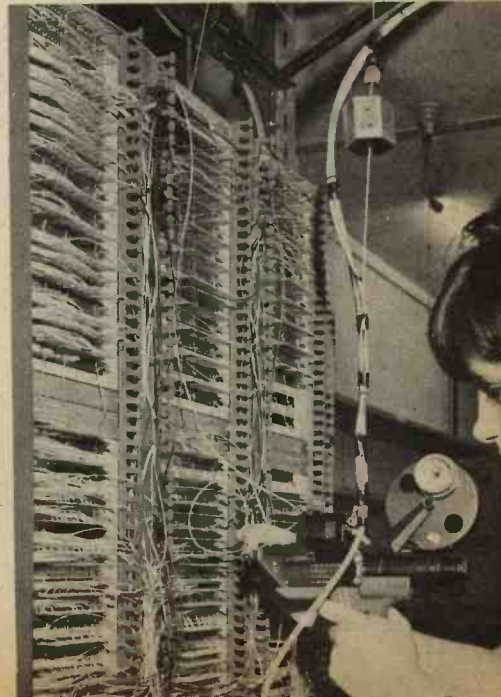


### Mechanical Wiring Gun

**A** quick and effortless method of making wire connections to tags is the "Termi-Point" system of solderless connections.

The picture (below) shows an operator using the A-MP Termi-Point gun to make a connection on a digital logic box that may require as many as 800 connections to the square foot.

Based on the standard Termi-Point gun, which is pneumatically powered and uses a magazine to contain a supply of connectors in continuous reel, LDEP Industrial Automation have developed a technique of presenting the wiring instructions to the operator by the use of tape recordings.





## AUDIO FAIR SPECIAL

**N**EW products for the delectation of audio enthusiasts appear in above average variety at this time of the year. The reason, of course, is the Audio Festival and Fair, held from March 30 to April 2 in London. This annual event marks the unveiling of interesting developments to which manufacturers have been putting finishing touches during the late winter months. This article, largely devoted to components and systems prepared for introduction at the exhibition, is necessarily a *preview* because this issue went to press before the doors opened.

In some instances full specifications were not available in advance of the exhibition; this is true of hi fi units by Armstrong, further details of which will follow as soon as possible. This firm has introduced a completely new range, the Series 400, comprising a transistor tuner and tuner-amplifier as well as a stereo amplifier. The whole series is designed for either shelf-mounting or easy cabinet fitting. Amplifier power outputs are about 15 watts per channel. A transistor decoder is available for stereo radio.

### SILICON TRANSISTOR UNITS

Indeed, stereo radio and transistor applications are major talking points this year. Both these subjects are within the province of firms such as Ferranti who are concerned to promote the use of silicon transistors. This particular company has prepared a book of audio circuits for amateur and professional users; one design shown is an f.m. stereo tuner which uses low cost epoxy resin encapsulated transistors. Enquiries should be addressed to the company at Gem Mill, Oldham, Lancs.

Truvox now use silicon transistors in their Series 100 equipment, which includes several tape recorders as well as the TSA100 amplifier and FM100 tuner. Other firms going ahead with transistors include Radford and Goodmans. The latter now offer a stereo a.m./f.m. tuner, the "Stereomax," to match the Maxamp 30 amplifier.

Units bearing the "Arena" trademark are made in Denmark and imported by Highgate Acoustics of London. Several new arrivals include the T2500H stereo receiver with a pre-selection f.m. tuner coupled to 15 watt power amplifier channels. This model sells at £90 8s 7d plus 6 gns for a stereo decoder. Rather similar is the T2500F which, at £84 1s is presented as a tuner-amplifier without speakers.



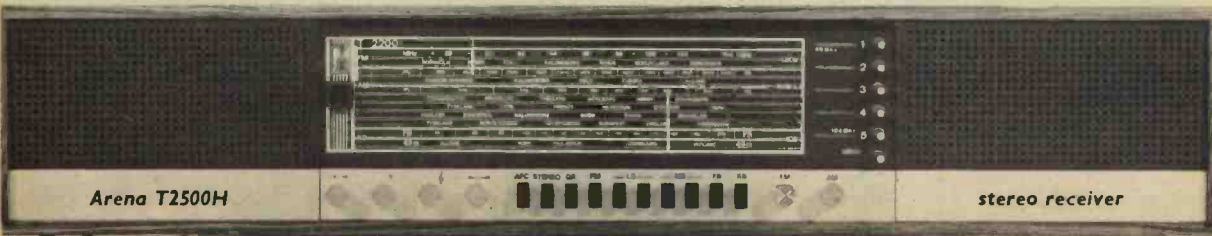
Armstrong 426 tuner-amplifier

Model F210 stereo amplifier by Arena, priced at 36 gns and rated at 10 watts per channel, is an encased unit finished in teak. It has input arrangements for magnetic pick-up (3mV sensitivity), radio tuner, tape recorder and crystal pick-up (the latter despite the preponderance of ceramic types now used for hi fi). As usual with Continental amplifiers, the output impedance is low (4 ohms in this instance) but Arena market a wide range of matching speaker systems.

Stereosound, who some time ago introduced a low cost stereo outfit with separate speakers, have now added a one-piece instrument which sells at 63 gns. Known as the SS16, this model has an output of 8 watts per channel and incorporates a speaker system comprising a bass unit in each end of the cabinet plus a pair of front-facing tweeters. These units are isolated within their own enclosures. This outfit, which employs the B.S.R. UA70 player, will also be available in a version with a.m./f.m. tuner, stereo facilities being provided if required.

### SPEAKER SYSTEMS

A new medium-sized system, the Sarabande by Richard Allan Radio, houses three drive units. The aim of no-compromise bass reproduction down to 30Hz is realised, the firm claims, by using a 15in unit in a 4 cu ft enclosure. The rest of the range is covered by a mid-range and tweeter assembly of modular type complete with crossover filter. Enclosure dimensions

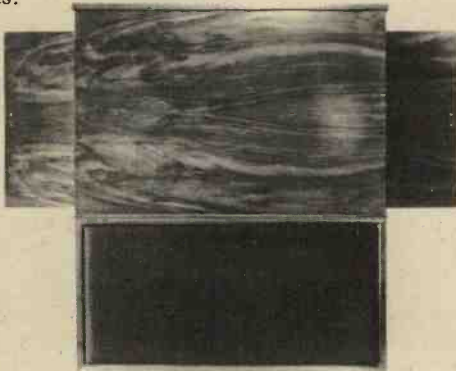


are 33in × 20in × 14in and the price is in the £40 region.

Celestion introduce the Ditton 15, a 1 cu ft model which they describe as something different in compact speakers. It is a three-unit system incorporating a new type of low frequency drive unit—the “auxiliary bass radiator.” This is claimed to provide deeper, cleaner bass, in the important lowest octave from 30 to 60Hz, than is ordinarily obtained from sealed enclosures of comparable size. Other units in the enclosure are a new 8in mid-range speaker and the HF1300 Mk2 tweeter.

K.E.F. Electronics also add to their range a new miniature system called the “Cresta.” The drive units are entirely new designs: the 5in bass unit has a synthetic rubber surround, nylon rear suspension and a cone of specially developed material; the h.f. unit employs a ¾in Melinex plastics diaphragm which gives smooth response and a broad polar radiation pattern. Thus directional output is avoided. Enclosure size is only 13in × 9in × 7in and speaker impedance is 4 to 8 ohms, chosen to suit transistor amplifiers.

The Jordan-Watts 6in square metal cone module is used as a building brick for a number of speaker systems which include reflex, sealed-box and folded horn types. The latest development is a compact one-piece stereo speaker called the Stereola. In adopting this approach, involving the use of two acoustic channels in one assembly, Jordan-Watts say their aim is to produce a superior blending of both stereo outputs.



Jordan-Watts Stereola speaker system

## TAPE EQUIPMENT

Equipment by Akai of Japan is marketed by Pullin Photographic, a company in the Rank Organisation. New arrivals include the X2000, a four-track stereo recorder with a most comprehensive specification and the correspondingly high price of 150 gns. This solid-state instrument has four speeds (15in/sec is the highest) and records and plays back in either tape direction. Features include 20 watts output on each channel, two V.U. meters, sound-on-sound facilities, bass and treble controls and built-in monitoring speakers.

The same company is introducing the AA7000 stereo tuner-amplifier which features silicon transistors in all circuits and an output of 40 watts per channel. Equipped for stereo, the a.m./f.m. tuner section has a tuning sensitivity indicator, muting switch and moveable a.m. ferrite aerial.

Said to be ideal for the hi fi enthusiast, the new “Scotch” C60 compact tape cassette is loaded with “Superlife” tape which is claimed to reduce oxide



Cartridges for the Acos “Ninety” series

rub-off and promote improved frequency response and tape life. Other recent items from this source are leatherette bound albums and self-threading spools in 5½in and 7in sizes. The spool is designed to utilise centrifugal force to grip the end of the tape and ensure quick and smooth take-up.

## P.A. and CARTRIDGES

Lustraphone now offer a portable P.A. system which enables a lecturer to take with him, in convenient form, his own sound-reinforcement equipment for use in small halls lacking such facilities. This ingenious solution to an old problem comprises a desk type housing containing a transistor amplifier, batteries and horn speaker, together with a ribbon microphone on a flexible tube stand. The housing is of “lectern” shape, surmounted by the microphone, and is simply placed on a desk or table so that the loudspeaker grille faces the audience.

The Acos “Ninety” series by Cosmocord includes pick-up cartridges which have been designed to suit all types of disc equipment. For example, the GP91-1 is a mono crystal cartridge giving 200mV average output and provided with a dual stylus assembly for l.p. and 78. The GP92-1 is in some respects similar to the GP91 cartridges but is a ceramic mono type. The GP93-1 and GP94-1 are stereo versions, and the GP96 is a ceramic stereo cartridge intended for 33 and 45rev/min discs only.



Stereosound SS16 stereo record reproducer

**D**ESIGNED originally to eliminate the human element in timing car driving tests, this equipment is equally suitable for operating a stopwatch for many other sporting events.

The major design criteria were absolute reliability regardless of weather conditions during operation; positive operation for battery voltages down to 10.5V; total current consumption is not above 2A including the lamps; simple installation and operation on site.

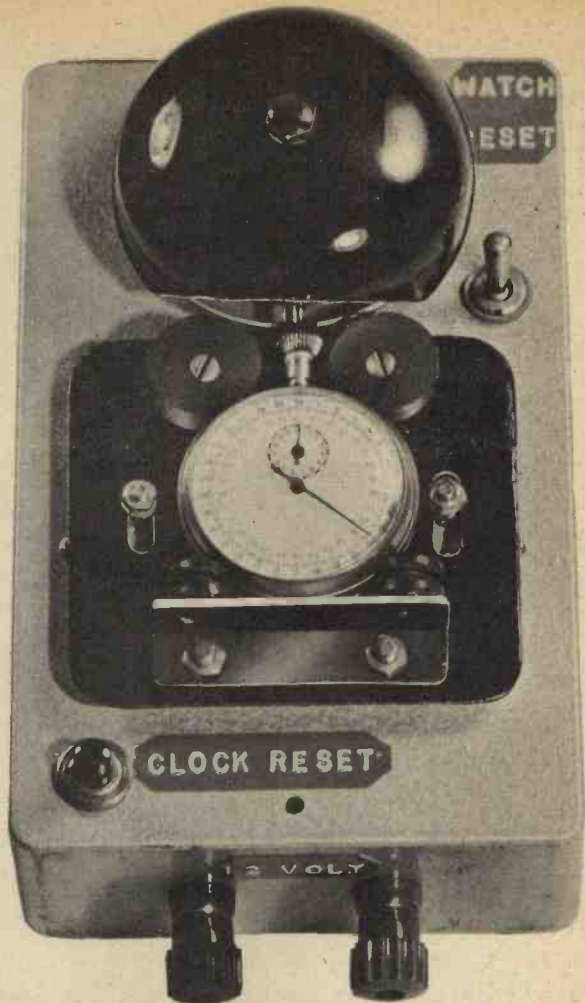
The final version described here met these conditions admirably. The essential operating element is a light dependent resistor (l.d.r.) controlling a transistor with a relay in its collector circuit. This relay in turn controls a solenoid in the master unit which starts and stops the stopwatch. There are, however, several novel ideas which have been devised in the light of experience and incorporated in the design.

In the block diagram (Fig. 1) it will be seen that a beam unit and a light are positioned so that the vehicle (or person) breaks the beam of light at the start. This immediately operates the stopwatch on the master control unit. A second beam unit and light are placed at the end of the course; when the beam is interrupted the master control unit stops the watch. The time can be read off by the operator who then presses a non-locking switch to reset the watch for the next operation.

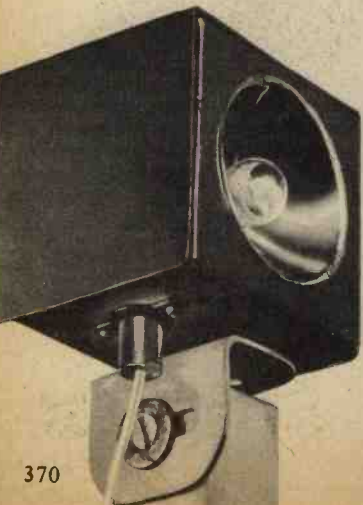
A secondary feature of this equipment is that it is designed to be used on its own or in conjunction with a large electronic clock indicator such as the one described in the May 1965 issue of PRACTICAL ELECTRONICS. This provides considerable spectator interest at sporting events.

#### BEAM UNITS

The lights are 12 volt 6 watt car side lamp bulbs mounted in reflectors taken from cycle lamps. Originally



# LIGHT OPERATED



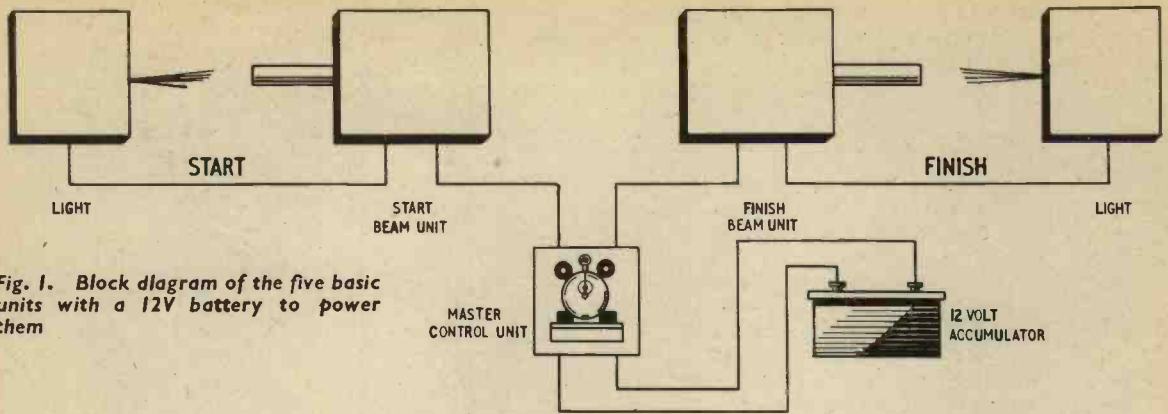


Fig. 1. Block diagram of the five basic units with a 12V battery to power them

2.2 watt screw-in bulbs were tried but were found to be of too low a power rating for reliable operation. With the 6 watt lamps and reflectors (no lenses) the units operate satisfactorily when spaced up to 30ft apart. It is possible to operate over several hundred feet using a 35 watt spot lamp, but this is rarely of any practical use and in any case is very heavy on battery consumption.

To reduce the cable runs—and so facilitate installation—each lamp takes its supply via its associated beam unit. For convenience all connections are plug-in. The lights are housed in small square metal boxes, but there is nothing critical in the design and any arrangement which will permit mounting in such a way to allow adjustment in any direction will do. For use on grass tracks, lengths of slotted angle iron provide the best support for the units; for hard ground small

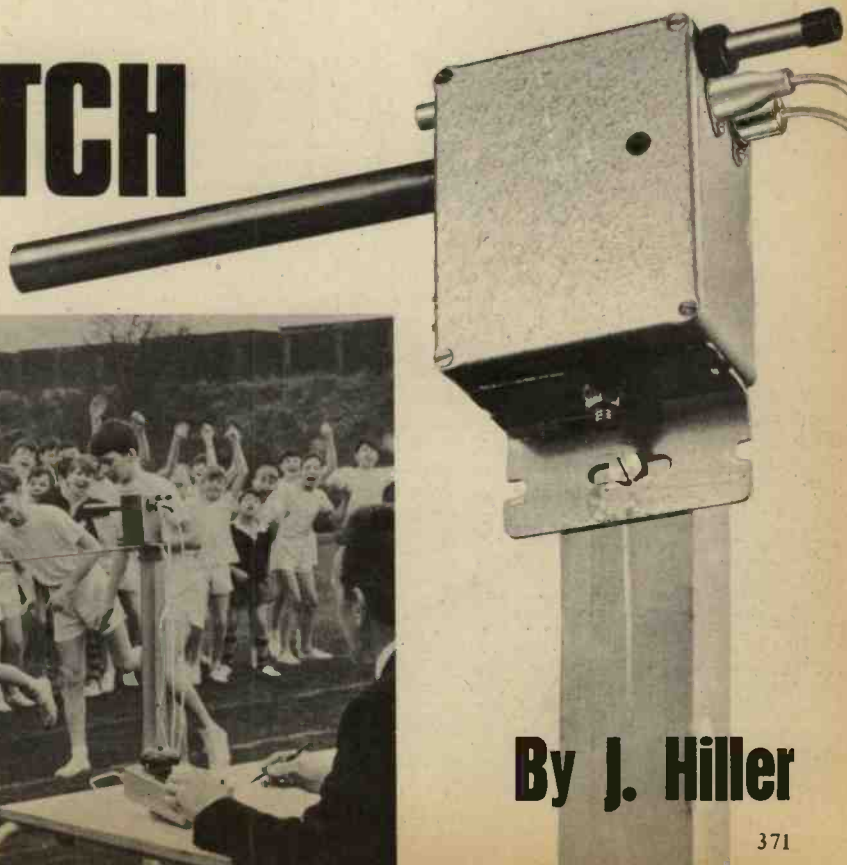
wooden stands can be made. All beam units and lamps should be rigidly mounted so that they do not move under the influence of strong winds.

Start and finish beam units are identical in construction and in circuitry except for the wiring to the relay contacts. In the start unit the relay contacts switch on when triggered, in the finish unit they switch off (see Fig. 2).

#### CONTROL OPERATION

Component values have been arrived at by a combination of calculation and practical experience. Originally a variable sensitivity control was incorporated in the top section of the base bias network of the transistor but experience proved this to be more a liability than an asset. Fixed resistors are more stable in operation and have operated satisfactorily.

# STOPWATCH



By J. Hiller

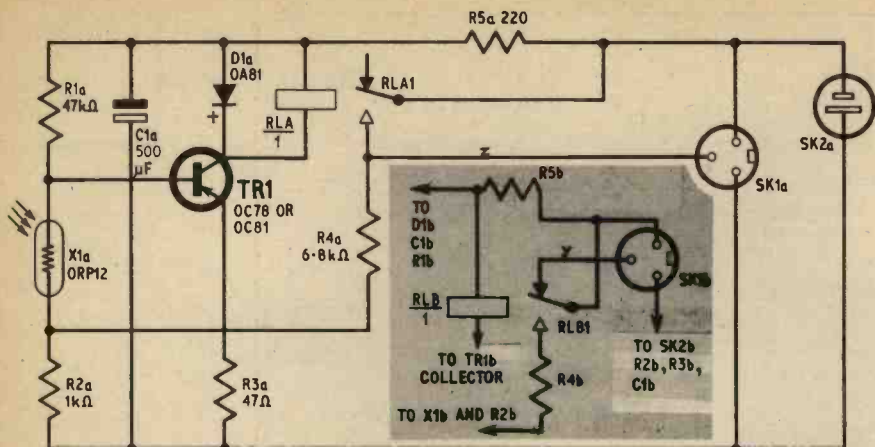


Fig. 2a. Circuit diagram of the "start" unit. The "finish" unit is identical except for the wiring to the relay contacts which is drawn in the grey panel

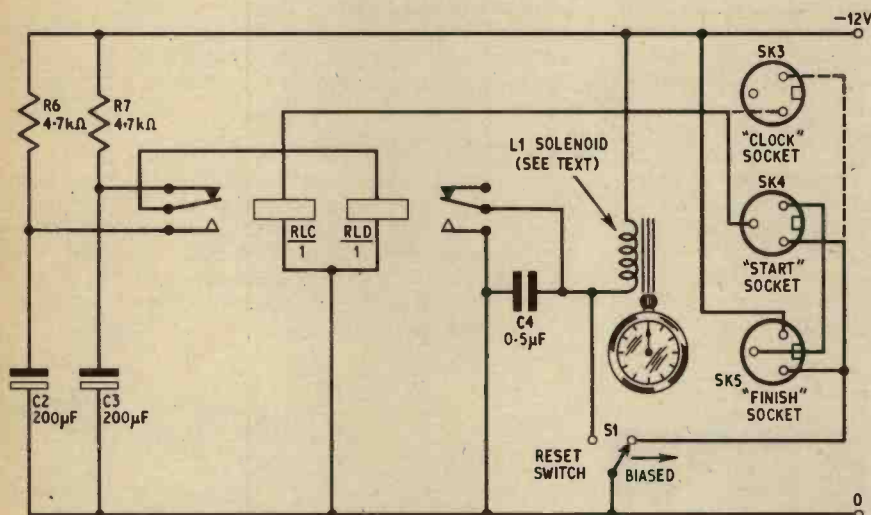


Fig. 2b. Circuit diagram of the "master control" unit

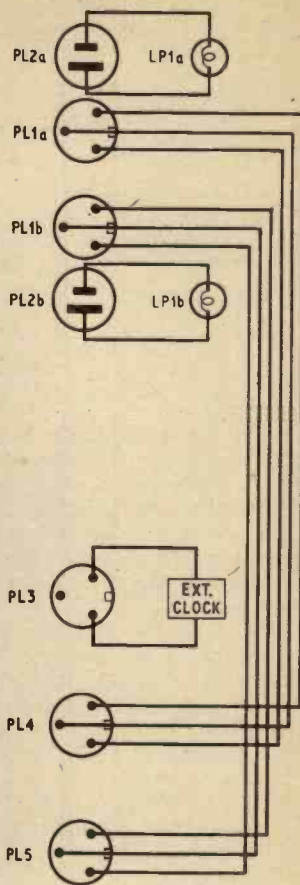


Fig. 2c. Wiring of the plugs to match the appropriate sockets alongside

The type of transistor used in the circuit is not critical and both OC78 and OC81 have been employed successfully. Probably any other similar power types would also serve. Although heat sinks are used these are only for providing a good mechanical mounting for the transistors. Heat dissipation is negligible. As there may be slight variation in different transistors, it may be necessary to try one or two values for R1 to achieve best results. Too low a value will cause the equipment to operate without breaking the beam, while too high a value may make triggering unreliable. In practice, various values from 22 kilohms to 68 kilohms were tried and found to work.

Referring to the circuit diagram, operation is as follows. Light falling on the l.d.r. reduces its resistance to around 1 kilohm. As this component is in the lower leg of the base bias network of TR1 the transistor is cut off; in this condition the relay in its collector is not energised. When the light beam is interrupted the resistance of the ORP12 immediately increases causing TR1 to conduct and operate the relay. The relay contact feeds 12 volts back long a

control line to the master unit where it causes the mechanism to operate the stopwatch. This same 12 volt supply may be utilised to operate the large clock for the spectators.

It is necessary to ensure that once the start relay is energised it locks into this position automatically until reset by the operator. This locking action is accomplished by resistor R4 which provides a holding bias and keeps the transistor conducting regardless of any further changes in the resistance of the l.d.r.

As quite high voltage pulses may appear across the relay winding when the transistor cuts off, a diode is included in the circuit to suppress them and prevent damage to the transistor.

Resistor R5 and capacitor C1 perform a dual function. Firstly, they decouple the supply line and prevent variations in supply voltage affecting the operating of the light beam units. Secondly, and more important, they provide the necessary delay for resetting the units at the end of each sequence. Resetting is carried out by switching off the supply to the start and finish units at the master control and then restoring

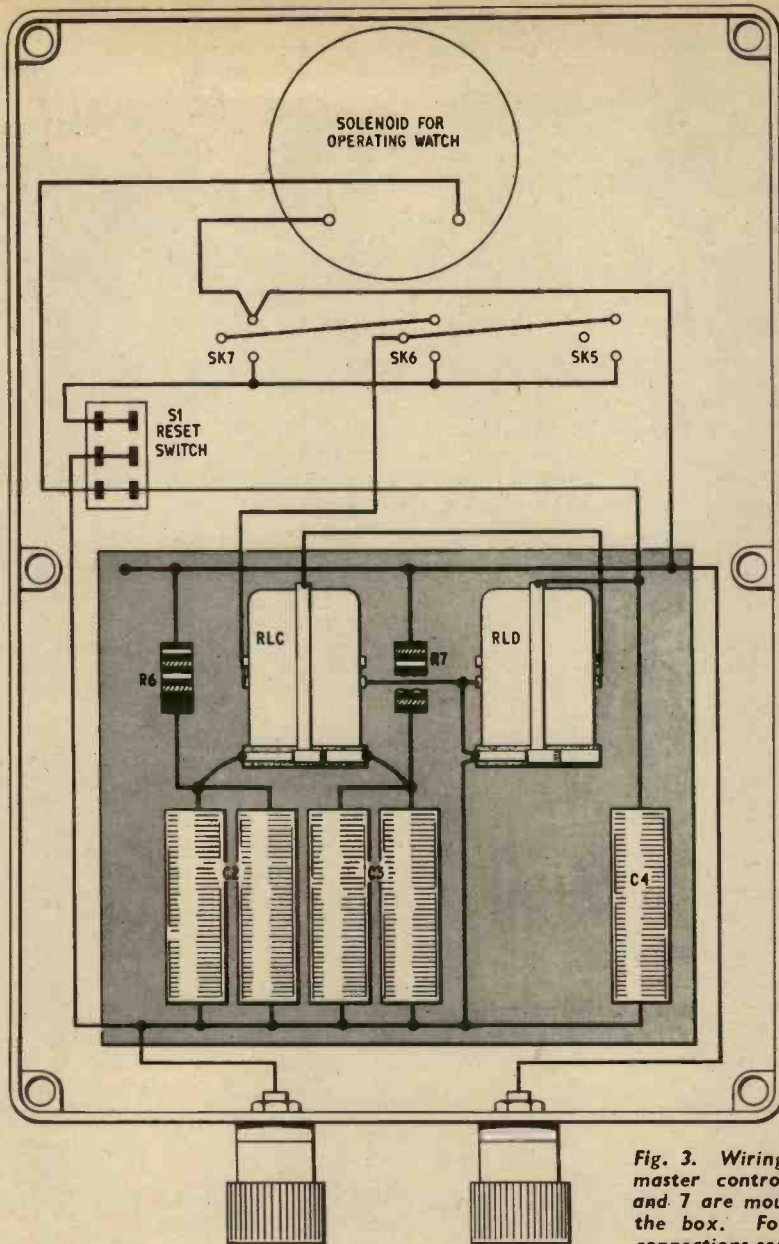


Fig. 3. Wiring on the inside of the master control unit. Sockets SK5, 6 and 7 are mounted on the top end of the box. For identification of relay connections see photographs

it again. This process releases the relays ready for the next timing sequence.

However, as the lights also go out when the supply is cut, it is possible that, when switched on again, the electronic circuits would trigger before the lamps reach sufficiently high intensity to hold the transistors off. The slight delay introduced by R5 and C1 overcomes this difficulty.

### TRIGGERING THE WATCH

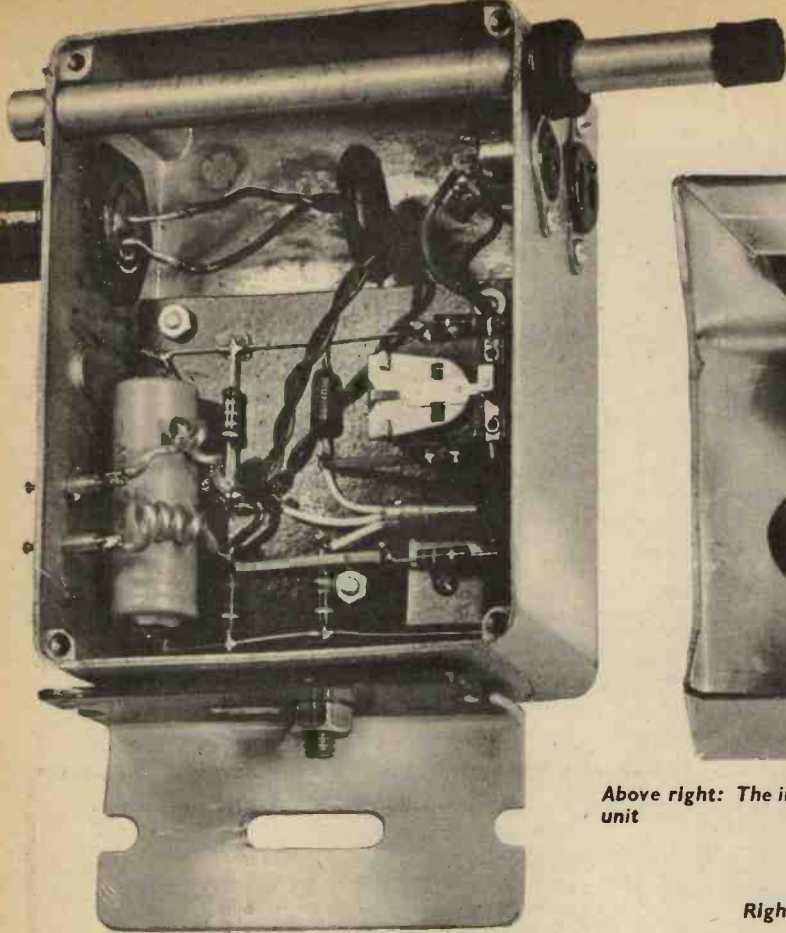
To operate a stopwatch, the simple switch-on action of the start unit has to be converted into an on-off pulse because unless the watch button is released it cannot be pressed again to stop.

This action is carried out automatically in the master control unit. In the "rest" position, as shown in Fig. 2, capacitor C2 quickly charges up to the full supply voltage through resistor R6. Capacitor C3 on

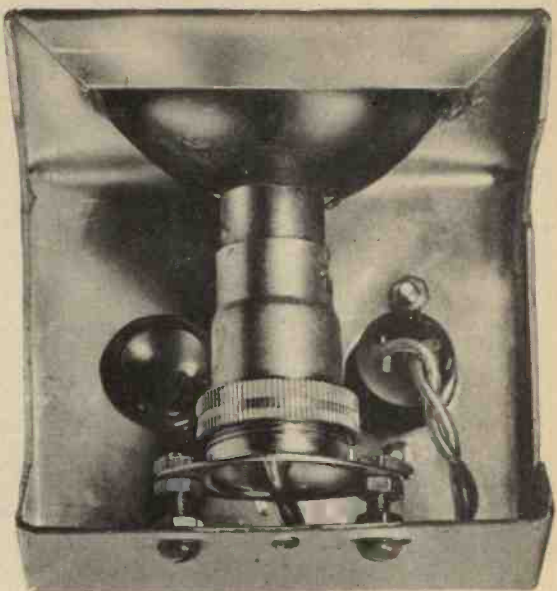
the other hand has very little charge on it since it leaks away continuously through the coil of relay RLD. The actual current flowing through RLD in this condition is limited by resistor R7 to about 2mA, not enough to operate the relay.

When the relay in the start unit closes it completes the circuit, and energises RLC whose contacts then change over. This switches the fully charged C2 across the coil of relay RLD. This causes RLD contacts to close and remain closed until the charge on C2 is exhausted. In practice RLD contacts remain closed for about one second and then open again. This section operates the solenoid to start the watch and then releases ready for the stop impulse.

Relay RLC remains closed during the timing of the event and this allows C3 to charge up to the full supply voltage. When the relay operates in the finish light beam unit, it cuts off the supply to RLD and contact

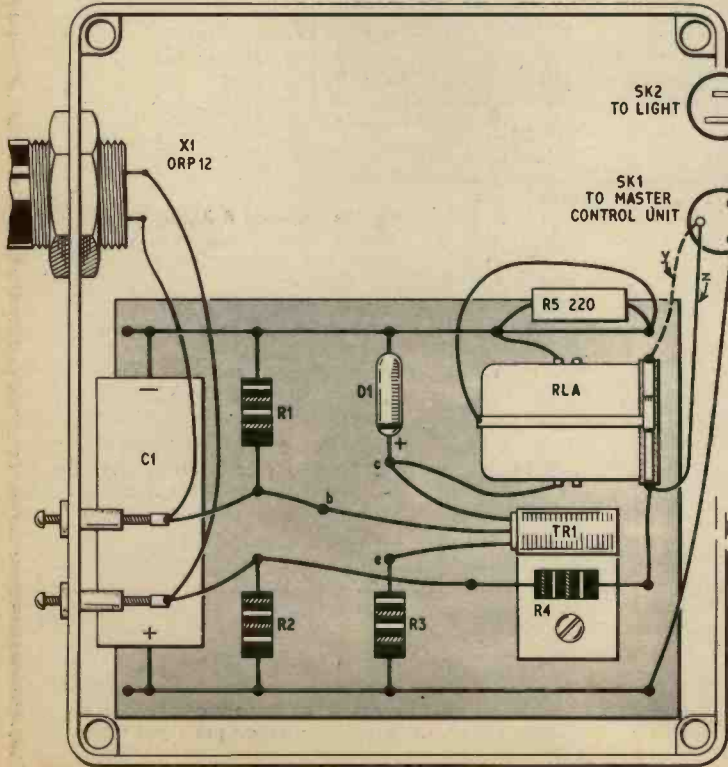


Left: Inside of the "finish" unit. The l.d.r. is held in the tube on the left by the grommet which has been moved here for clarity

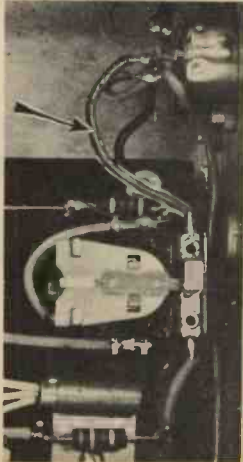


Above right: The inside of one lamp unit

Fig. 4 (below). Wiring inside the "start" unit (wire "y" is not used)



Right: Start unit relay



In the "finish" unit wire "y" is used and wire "z" is omitted. This is shown in the photograph on the right. Otherwise the two units are identical

Right: Finish unit relay



RLC1 returns to its rest position. Thus C3 immediately discharges through the coil of RLD to provide another one-second pulse to stop the watch.

When the operator has noted the time from the watch, switch S1 is depressed for a moment and then released. This returns the stopwatch to zero and sets the start and finish units ready for the next competitor. To reduce sparking caused by the inductive load of the solenoid the contacts of RLD1 are shunted by a capacitor C4.

## CONSTRUCTION

The diagrams and photographs give details of the construction of the prototype units. Building is quite straightforward and layout is not in any way critical, neither is there any need for miniaturisation.

The units are built into small diecast boxes but the stopwatch is best mounted on a separate panel so that it can be adjusted to the best position. If it is too close to the plunger of the solenoid there will not be enough power to operate the watch; if it is too far away the watch button will not be pressed far enough. If the mounting holes for the stopwatch panel are slotted, then the best position can be determined by

# COMPONENTS . . .

## MASTER CONTROL UNIT

### Resistors

R6 4.7k $\Omega$  R7 4.7k $\Omega$   
Both 10%,  $\frac{1}{2}$  watt carbon

### Capacitors

C2 200 $\mu$ F elect. 15V  
C3 200 $\mu$ F elect. 15V  
C4 0.5 $\mu$ F polyester or paper 150V

### Relays

RLC and RLD type B14/12 (B and R Relays Ltd.  
Temple Fields, Harlow, Essex)

### Solenoid

L1 Moving slug solenoid in 4.5V a.c./d.c. bell (see text) (Gents)

### Switch

S1 Single-pole changeover toggle switch, spring biased

### Plugs and Sockets

PL3 and SK3 }  
PL4 and SK4 } 3-way D.I.N. pattern (3 sets)  
PL5 and SK5 }

### Miscellaneous

Eddystone 845 diecast box  
Stopwatch (minutes and seconds)  
Screw terminals for battery supply (2 off)  
S.R.B.P. sheet 4in  $\times$  3 $\frac{1}{2}$ in  
Turret tags  
Mounting plate and rubber cushions for holding stopwatch (see text)

## LAMP UNITS

(Two of each item are required)

### Lamps

LP1a and b 12V 6W double contact m.b.c. side lamp bulbs

### Lampholders

Miniature bayonet cap double contact

sliding the panel to the best position, then screwing down firmly.

Part of the bell gong is cut away to allow the solenoid slug to strike the control knob on the watch. The make and break mechanism in the bell is partly removed leaving just one return spring. Using a 12V d.c. supply, the force exerted by the solenoid is quite high, but since it operates for only about one second at a time, there is no trouble with overheating. Care should be taken when initially testing to ensure the solenoid is not left permanently in the on position as this could burn out the winding.

Wiring between the units consists of a three-core cable between master control unit and each light beam unit, and a two-core cable between light beam units and lamps. As far as the operation of the equipment is concerned there is no limit to the distance between the start and finish of the race, but installation is easier and takes less cable if organisers can be persuaded to keep them reasonably close. Staggered starts on field tracks will need one set of beam units for each lane.

The stop watch is firmly held on the master control box panel by rubber knobs; a thin sheet of rubber can be positioned underneath the watch to help to cushion it.

## (a) START BEAM UNIT (b) FINISH BEAM UNIT

Two sets (a) and (b) of identical components

### Resistors

R1a and b 47k $\Omega$  R4a and b 6.8k $\Omega$   
R2a and b 1k $\Omega$  R5a and b 220 $\Omega$   
R3a and b 47 $\Omega$   
All 10%,  $\frac{1}{2}$  watt carbon

### Capacitors

C1a and b 500 $\mu$ F elect. 15V

### Light Sensitive Resistor

X1a and b ORP12

### Transistors

TR1a and b OC78 or OC81

### Relays

RLA and RLB Type B14/9 (B and R Relays Ltd.)

### Diode

D1a and b OA81

### Plug Sockets

PL1a and b, SK1a and b 3-way D.I.N. pattern (2 sets)  
PL2a and b, SK2a and b 2-way non-reversible (2 sets)

### Miscellaneous

Eddystone 650 diecast boxes (2 off)  
Conduit pipe or tube  $\frac{3}{8}$ in diameter  $\times$  8in (2 off)  
 $\frac{3}{4}$ in diameter  $\times$  6in (2 off)  
S.R.B.P. sheet 3in  $\times$  2 $\frac{1}{2}$ in (2 off)  
Turret tags

### Boxes

Made from 20 s.w.g. tinned iron sheet or hardboard mounted on angle iron or wooden posts (see text)

## BEAM UNIT ALIGNMENT

The light cell is mounted at the end of a long tube (in the prototype—conduit) to shield it from extraneous light. The secret of successful operation of this type of equipment lies in precise alignment of the light beam and the cell tube. This is a fairly easy task inside a workshop but it can be almost impossible to do outside on a sunny day unless provision is made for this. In the equipment described, a simple and effective method of alignment has been evolved.

A second tube, thinner than the light cell tube, is fitted in the beam unit as a sighting tube. It is parallel with the main tube and by looking through it the unit can be aligned on to the centre of the lamp. This operation does not ensure that the light beam is shining directly into the cell tube, so a further adjustment is required to set the lamp correctly. For this adjustment the properties of the light cell itself are used.

On the beam unit two connections are brought out through insulated tags on the box; inside the unit they connect to the l.d.r. A clip-on extension lead is connected temporarily between these tags and an ohmmeter placed near the lamp. It is now possible to set the direction of the lamp precisely by adjusting to the position giving the lowest reading on the meter.

When carrying out this adjustment it is advisable to disconnect the equipment from the battery and run the lamp from an independent supply. The beam unit does not require any power for this operation. The reading will vary depending on which way round the ohmmeter is connected due to the action of the  $500\mu\text{F}$  capacitor across the supply. The correct way to connect the meter is the one which gives the greatest variation of reading between light and dark. The swing is typically from about 1 kilohm to 50 kilohms or more.

For car events the beam units are about 18 inches above the ground but it is important that all units are the same height so that whichever part of the car starts the timing operation so the same part will stop the watch.

If there is any choice it is usually better to have the light beam units facing the sun and the lights shining in the same direction as the sun. This avoids the possibility of erratic triggering due to reflections from light coloured objects nearby.

Although no difficulty has been experienced in strong sunlight, it is a good idea to fit a small shield, like a camera lens hood, over the end of the light cell tube to shield it from full sunlight. One advantage of having the light units facing towards the operator is that this gives a quick check that the equipment is ready for use since both lights should be on in this condition.

In wet weather a polythene bag is usually slipped over the units, leaving the light tube exposed of course. Avoid the immediate proximity of flags or bunting near the light beam units. If it is a breezy day and bunting waves across the path of the light beam some erroneous times will be registered. ★

## Meetings . . .

### SOCIETY OF ELECTRONIC AND RADIO TECHNICIANS

#### SOUTHAMPTON

*Date:* April 20  
*Title:* Hospital Broadcasting  
G. A. Allcock  
*Time:* 7.30 p.m.  
*Address:* College of Technology, East Park Terrace, Southampton

#### CARDIFF

*Date:* April 20  
*Title:* U.H.F. Tuners  
B. M. Goodwin  
*Time:* 7.30 p.m.  
*Address:* Llandaff Technical College, Western Avenue, Cardiff

#### LONDON

*Date:* April 21  
*Title:* The Fleming Memorial Lecture  
"The Strange Journey from Retina to Brain"  
Dr. R. W. G. Hunt, B.Sc., F.R.P.S., D.I.C., A.R.C.S.  
*Time:* 7 p.m.  
*Address:* Royal Institution, Albemarle Street, London, W.1.  
Admission to this lecture is by ticket only. Tickets are obtainable from The Secretary, 166, Shaftesbury Avenue, London, W.C.2.

### THE INSTITUTION OF ELECTRICAL AND ELECTRONICS TECHNICIAN ENGINEERS

#### DURHAM

*Date:* April 26  
*Title:* Post Office Tower  
T. Kilvington, B.Sc.(Eng.), C.Eng., F.I.E.E.  
*Time:* 7.30 p.m.  
*Address:* Science Laboratories, University of Durham, South Road, Durham.

### JOINT MEETINGS

#### LONDON

*Date:* May 10  
*Title:* The Education of Computer Engineers  
*Time:* 6 p.m.  
*Address:* London School of Hygiene and Tropical Medicine, Keppel Street, London, W.C.1.  
(Sponsored by the I.E.E. and I.E.R.E.)


#### BRISTOL

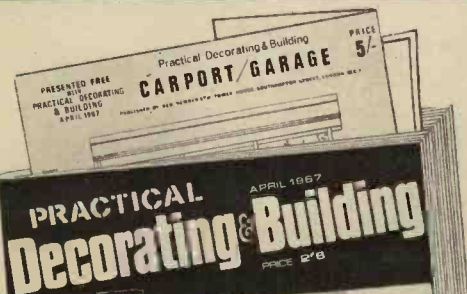
*Date:* April 26  
*Title:* Super Conductivity  
Dr J. G. C. Milne  
*Time:* 7 p.m.  
*Address:* University of Bristol, University Walk, Clifton, Bristol, 8.  
(Sponsored by the I.P.P.S. and I.E.R.E.)

#### PLYMOUTH

*Date:* May 2  
*Title:* Microelectronics  
Dr. S. S. Forte  
*Time:* 7 p.m.  
*Address:* Plymouth College of Technology, Plymouth  
(Sponsored by the I.E.E. and I.E.R.E.)



**Make sure of  
No 2**   
**OF THIS GREAT NEW PRACTICAL**



**FREE!**  
**INSIDE**

- 2** DOUBLE-SIDED  
**DESIGN PLANS**  
FOR BUILDING
- 1** Carport/  
Garage
- 2** Bedroom  
Floor-to-Ceiling  
Storage  
Unit



**EXTRA!**  
8-Page Supplement  
**ALL ABOUT**  
**BRICKS & MORTAR**

*Other Outstanding Features:*

- SELF-BUILD 4-BEDROOM HOUSE**
- PUTTING IN A RING MAIN**
- DECORATING A STEAMY KITCHEN**
- RIDDING A ROOF OF PESTS**

**PRACTICAL  
Decorating & Building**

APRIL ISSUE OUT NOW 2/6

# EXCEL

*in*

# ELECTRONICS

**Through this ICS  
3-way Training Method:**

- 1** MASTER THE THEORETICAL SIDE  
From basic principles to advanced applications, you'll learn the theory of electronic engineering, quickly and easily through ICS. That's because each course is set out in easy-to-understand terms.
- 2** MASTER THE PRACTICAL SIDE  
ICS show you how to develop your practical abilities in electronic engineering—*alongside* your theoretical studies. It's the only sure way to success. All training manuals are packed with easy-to-follow illustrations.
- 3** MASTER THE MATHEMATICAL SIDE  
To many this aspect is a bitter problem. Even more so because no electronic engineer is complete without a sound working knowledge of maths. But new ICS teaching makes mathematics easier to learn.

Wide range of courses available include:  
Radio/T.V. Engineering and Servicing, Closed Circuit T.V.,  
Electronics, Electronics Maintenance, Instrumentation and  
Servomechanisms, Telemetry, Computers, etc.  
**NEW!** Programmed Course on Electronic Fundamentals

- EXPERT COACHING FOR:**
- INSTITUTION OF ELECTRONIC AND RADIO ENGINEERS
  - CITY AND GUILDS TELECOMMUNICATION TECHNICIANS
  - CITY AND GUILDS SUPPLEMENTARY STUDIES
  - R.T.E.B. RADIO/T.V. SERVICING CERTIFICATE
  - RADIO AMATEURS' EXAMINATION
  - P.M.G. CERTIFICATES IN RADIOTELEGRAPHY

And there are practical "learn as you build" radio courses as well.

Member of the Association of British Correspondence Colleges

FOR **FREE** HANDBOOK POST THIS COUPON TODAY

I.C.S., Dept. 151, INTERTEXT HOUSE,  
PARKGATE ROAD, LONDON, S.W.11

NAME .....

ADDRESS .....

OCCUPATION..... AGE..... 5/67

**INTERNATIONAL CORRESPONDENCE SCHOOLS**

# Field Effect

# TRANSISTORS



## PART ONE

By G. B. Clayton, B.Sc., A.Inst.P

**F**IELD effect transistors (f.e.t.) are not new devices; as early as 1935, O. W. Heill took out a patent on what would be now called a field effect transistor. The semiconducting materials available in those days were very limited and Heill's device was never commercially developed. In post-war years the principles of f.e.t.s were developed further, but it was not until comparatively recently that the advances in the various semiconductor technologies culminated in the production of practical and viable field effect devices.

### MAIN FEATURES

Commercially available types may be used together with conventional transistors and for certain applications they possess definite advantages over conventional types. The most marked difference between f.e.t.s and conventional transistors is their much greater input impedance, resembling thermionic valves in this respect.

On first acquaintance with a device it is necessary to become familiar with the terms used to describe various features of it. The operating principles and electrical characteristics of f.e.t.s differ from conventional transistors but a correlation may be found between the familiar terminals of a valve, a conventional transistor, and an f.e.t. The f.e.t. has three terminals: source, gate and drain, corresponding to the emitter, base and collector of a conventional transistor, and to the cathode, grid and anode of a triode valve.

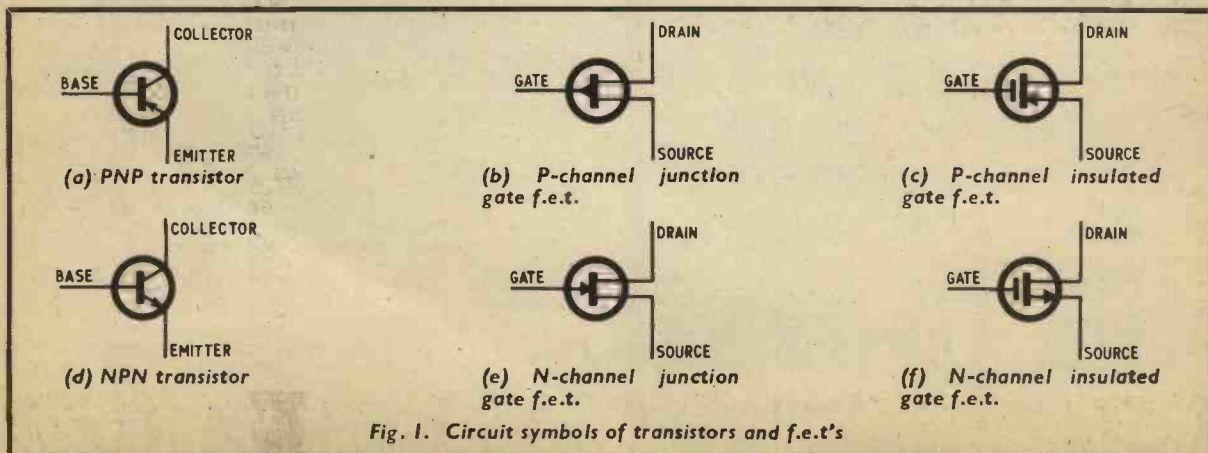
Fig. 1 shows the conventional circuit symbol for f.e.t.s. There are two different types commercially available: the junction gate f.e.t. (reverse-biased diode

f.e.t.) and the insulated gate f.e.t. (metal-oxide semiconductor transistor, m.o.s.t.). As *pnp* and *npn* transistors are available, so are *p* and *n* channel f.e.t.s.

The gate terminal of an f.e.t. takes extremely small currents (about  $10^{-10}$  A for a junction gate f.e.t. and  $10^{-13}$  A for an insulated gate f.e.t.). Its potential controls the current between source and drain. There is a close similarity here to the action of the control grid in a thermionic valve, and a marked difference from the action of the base in a conventional transistor, for in this device it is the base current which is normally thought of as controlling the collector current.

The characteristic curves of junction gate f.e.t.s and insulated gate f.e.t.s are similar and resemble the anode characteristics of a pentode valve. Typical characteristics are illustrated in Fig. 2 with those of a pentode valve shown for comparison purposes. Beyond the "knees" of the characteristics, any increase of voltage produces little change in current in both the f.e.t. and the pentode. This region of the f.e.t. characteristic is referred to as the "pinched-off" region, the significance of this term will be discussed later. Below the "knees" the pentode curves tend to run into one another but those of the f.e.t. are quite distinct.

The non-pinched-off characteristics (those for small values of drain voltage) are illustrated in Fig. 3. They are almost linear and in this region the f.e.t. acts as a resistor whose magnitude is determined by the gate voltage. There are interesting applications of f.e.t.s as voltage dependent resistors, such applications are of course not possible with conventional transistors. Some of these applications will be discussed later.



# For your Car and Casual Wear



## THE "COASTA" CAR COAT

100% Coated Bri-Nylon cloth. Super lightweight and quilted. Knitted Collar. With the new front-buttoned Yoke. Spacious pockets and in-breast pocket. Multi-coloured quality lining. In the new smoky black. Matching buttons. A high grade leisure jacket for car and every outdoor occasion.  
**PRICE £8 19s. 6d.**

## ALL-WOOL SCOTTISH TWEED SPORTS JACKET

Choose from two in tweed woven by Ballantyne of Peebles, Scotland. "MIDLOTHIAN" in traditional lovat green overcheck or "GRAMPIAN" in brown lovat overcheck. Fashionable centre vent at back. 3-button single breasted, Cross pockets and breast pocket. Inside pocket. A jacket of good taste.  
**PRICE £7 19s. 6d.**

Superbly Tailored  
 but at Ready-to-  
 Wear Prices

QUALITY means everything in men's wear, and the new season's Car Coat, Tweed Sports Jacket and Lovat Tailored Trousers shown here will always look "right", last for years and years. Select what you want for the months ahead and you can be sure of tailoring and cloth of high standard.



## STYLISH TERYLENE WOOL-WORSTED TROUSERS

In "YORK" lovat green or "CHESTER" brown lovat. Will tone with Car coat or Sports Jacket, but available separately if desired. 55% Terylene, 45% Wool Worsted. Will not shrink or wrinkle. Self supporting and adjustable waistband. Turn-ups. Semi-cross side pockets and hip pocket. Button-fly. Long life guaranteed.  
**PRICE £5 12s. 6d.**



## HOW TO ORDER NO POSTAGE TO PAY

Choose garment or garments you wish to have:—

<b>"COASTA" CAR COAT</b>	SMALL (up to 36" chest)	MEDIUM (38"-40")	LARGE (42"-44")
<b>SPORTS JACKET</b>	CHEST SIZE: 34" 36" 38" 40" 42" 44"		
	COLOUR: "MIDLOTHIAN" (lovat green overcheck) "GRAMPIAN" (brown lovat overcheck)		
<b>TROUSERS</b>	WAIST SIZE: 30" 32" 34" 36" 38" 40" 42" 44"		
	INSIDE LEG: 29" 30" 31" 32" 33"		
	COLOUR: "YORK" (lovat green) "CHESTER" (brown lovat)		

Write or tick on coupon where required.

Add your name and full address (in block letters), and send with remittance to: Mr. John Best, W.S.R. Ltd. (E.1), 15-17 Long Acre, LONDON, W.C.99. Cheques, postal orders and money orders should be made payable to W.S.R. Ltd. and crossed "& Co.". If sending cheque write name and address on back. You are guaranteed money refunded if not completely satisfied. Provided garment or garments returned in absolutely new and unworn condition within 7 days of despatch to you. This offer does not apply in Eire or Overseas.

## ORDER BY POST NOW

To Mr. Jn. Best, W.S.R. Ltd. (E.1) 15-17 Long Acre, LONDON, W.C.99

Please send me Quality Men's Wear in sizes and colours as indicated:—

"COASTA" CAR COAT SMALL  MEDIUM  LARGE   
 £6 19s. 6d. (Tick clearly the one required)

SPORTS JACKET CHEST SIZE  
 £7 19s. 6d. COLOUR: LOVAT GREEN  Tick One  BROWN LOVAT

TROUSERS WAIST SIZE INSIDE LEG SIZE  
 £5 12s. 6d. COLOUR: LOVAT GREEN  Tick One  BROWN LOVAT

I enclose Postal Order, Money Order, Cheque VALUE: £ s. d. No.:

NAME \_\_\_\_\_

ADDRESS \_\_\_\_\_

BLOCK LETTERS

(E.1)

**GUARANTEED QUALITY MEN'S WEAR BY W.S.R. LTD.**

# DE LUXE PLAYERS

4-Speed Players 2-tone Cabinets 17" x 15" x 8 1/2". High flux loudspeaker and High Quality Amplifiers ready built. Quality output. Volume and Bass controls. Special instructions enable assembly in 30 minutes, only 5 wires to join. 12 months' guarantee.



## TO BUILD YOURSELF

Post 2/6 per item.

- PORTABLE CABINET AS Illustrated.** To fit standard player. 69/6
- ROTOR AMPLIFIER** 3 WATT. Ready made and tested with UCL82 triode pentode valve. Volume and tone controls with knobs. Quality loudspeaker. 59/6
- SINGLE PLAT UNITS**
- AUTOCHEANGE UNITS**
- Garrard SP12 £41.9.6
  - Garrard SP25 101.19.6
  - Phillips AG1018 £12.9.6
  - Garrard AT0 £19.19.6
  - Garrard LAB80 £24.19.6
  - Garrard 401 £29.19.6

- SUPERIOR AMPLIFIER.** Ready made and tested. Guaranteed better sound! Fully isolated AC mains Transformer. 4 watt output. ECL86 triode pentode valve. Volume and tone controls with knobs. Quality Loudspeaker. 89/6
- BSS Superslim** £5.19.8
- Garrard 1000** £5.19.8
- Garrard 2000** £8.19.8
- Garrard 3000** £8.9.6
- Garrard AT80 with diecast turntable** £10.19.8

## GARRARD TEAKWOOD BASE W.B.1 Ready to mount for 1000, 2000, 3000, SP25, AT80.

**INTEGRATED STEREO AMPLIFIER** 4 watt per channel. A splendid example of functional design and value. Grey/Silver Crackle cabinet size 10 x 6 1/2 x 3 in. 200-250V. A.C. Separate Gram and Tuner inputs. Self-contained pre-amp. and controls. Post 2/6 £10.10.0

## Q MAX CHASSIS CUTTER

Complete: a die, a punch, an Allen screw and key

- tin. 14/8 tin. 15/9 tin. 18/11 tin. 20/6 2 1/2 tin. 37/8
- tin. 14/8 tin. 18/11 tin. 18/11 tin. 22/6 2 1/2 tin. 44/3
- tin. 15/6 1 1/2 tin. 11 tin. 20/1 tin. 34/3 tin. 51/6

**BARGAIN XTAL PICK-UP ARM** Complete with ACOS LP-78 Turnover Head and Stylus 20" Stereo 30". SPEAKER FRET Tygan various colours, 5 1/2 in. wide from 10"-11". 2 1/2 in. wide from 5 1/2". SAMPLES S.A.E.

**EXPANDED METAL GRID** or Silver 12 x 12 in. 6 p.

**NEW GARRARD GRAM MOTORS** 100-130V. A.C. 16/- pair for 200/250V. (in series), or 10/- each Post 2/6.

**FULL WAVE BRIDGE SELENIUM RECTIFIERS:** 2, 6 or 12 v. outputs, 1 1/2 amp. 8/9; 2 a. 11/3; 4 a. 17/6.

**CHARGER TRANSFORMERS.** P. & P. 2/6. Input 200/250 v. for charging at 2, 6 or 12 v., 1 1/2 amps. 17/6; 2 amps. 21/-; 4 amps. 25/-.

**Circuit free. Ammeter 0 to 5 amp. 10/6.**

- MOVING COIL MULTIMETER TK 25.** 47/6
- 0-1,000V. A.C./D.C. ohms 0 to 100k. etc.
- MOVING COIL MULTIMETER EP10K.** 79/6
- 0-1,000V. A.C./D.C. ohms 0 to 3 meg. etc.
- MOVING COIL MULTIMETER EP20K.** 99/6
- 0-2,500V. D.C. 20,000 ohms per volt. 0-1,000V. A.C. Ohms 0 to 6 meg. 50 Microamps full scale.

## NEW MULLARD TRANSISTORS

OC71 6/-; OC72 7/6; OC81D 8/-; OC81 8/-; AF115 8/-; AF114 8/8; OC44 8/-; OC43 8/-; OC171 9/-; OC170 9/6; AF117 7/-; OC26 12/6; AD140 15/-; OC35 15/-; Holders 10/6

**ARDENT TRANSISTOR TRANSFORMERS**

- D3055. 7.3 CT. 1 Push Pull to 3 ohms for OC72, OC81 11/-
- D3054. 1.75 : 1 CT. Push Pull Driver for OC72, OC81 11/-
- D3058. 11.5 : 1 Output to 3 ohms for OC72, OC81 11/-

**TRANSISTOR MAINS ELIMINATORS.** FAMOUS "POWER MITE". 9 VOLT. SAME SIZE AS PPB BATTERY. FULLY SMOOTHED. 150mA. FULL WAVE CIRCUIT. 45/-

## WEYRAD P50 - Transistor Coils

RA2W 6 in. Ferrite Aerial with car aerial coil. 12/6

Driver Trans. LFDT4. 9/6

One P50/1AC 5/4

Printed Circuit, PCA1. 9/6

3rd I.F. P50/3CC 6/7

Weyrad Booklet 2/-

## Volume Controls

- Long spindles. Midget Size 5 K. Ohms to 2 Meg. LOG or L.N. L/3 3". D.P. 5/-
- STEREO L/S 10/6, D.P. 14/6
- COAXIAL PLUG 1/4". PANEL SOCKETS 1/4". LINE SOCKETS 2/4. OUTLET BOXES. SURFACE OR FLUSH 4/6
- BALANCED TWIN FEEDERS 1/4". 80 or 300 ohms
- TELESCOPIC CHROME AERIALS. 8 in. extends to 23 in. 6/6 each. CAR AERIAL PLUGS 1/6. Sockets 1/3.

**80 Ohm Coax 6d** yd. Semi-air spaced Cable 40 yd. 17/6. 60 yd. 25/-

**FRINGELOSS 1/6** yd. Ideal 625 lines

## TV REMOTE CONTROL

For PHILIPS 19T1111A, 121A, 125A, 142A, 23T1111A, 113A, 121A, 131A, STELLA ST1033A 39A, 43A, 53A



**PHILIPS PR13A 3 gns. Price 12/6 Post 2/6**

Brand New. Includes 11ft. 7-way cable, MULLARD OA81 2 pots., 3 switches, 5 resistors

## RETURN OF POST DESPATCH RADIO COMPONENT SPECIALISTS

Post and Packing 1/6 unless otherwise stated. C.O.D. 5/- extra. Full List 1/-. CALLERS WELCOME

# STELLA RECORD PLAYER AMPLIFIER

4 watt, 2 stage, 3 to 7 ohm. Neck feed back. UCL82, UY85. 200-250V. A.C. Tapped input. Chassis size 8 x 2 1/4 x 4 in. High Gold/Walnut knobs. Volume and Tone controls on separate Polished Wood Panel 6 x 2 in. Brand new with makers' guarantee. BARGAIN PRICE P. & P. 2/6. 78/6

NEW TUBULAR ELECTROLYTICS	GAN TYPES
2/350 v. . . . 2/3 100/25 v. . . . 2/-	8/800 v. . . . . 9/6
4/350 v. . . . 2/3 250/25 v. . . . 2/8	16/800 v. . . . . 12/6
8/450 v. . . . 2/3 500/25 v. . . . 3/-	16+16/500 v. . . . 7/6
16/450 v. . . . 3/- 8+8/450 v. . . . 3/6	32+32/450 v. . . . 6/-
32/450 v. . . . 3/9 8-16/450 v. . . . 3/9	50+50/350 v. . . . 7/-
25/25 v. . . . 1/9 16-16/450 v. . . . 4/3	80+100/350 v. . . . 11/6
50/50 v. . . . 2/- 32+32/350 v. . . . 4/8	100+200/275 v. . . . 12/6

## PAPER TUBULARS

350v.-0.1 9d., 0.5 2/6; 1 mid, 3/-; 2 mid, 150v. 3/-.  
500v.-0.001 to 0.05 9d.; 0.1 1/1/-; 0.25 1/6; 0.5 3/-.  
1,000v.-0.001, 0.002, 0.0047, 0.01, 0.02, 1/6; 0.047, 0.1 2/6.  
E.H.T. CONDENSERS. 0.001mtd., 2kV., 6/6; 20kV., 10/6.

**SUB-MIN. ELECTROLYTICS.** 1, 2, 4, 5, 8, 16, 25, 30, 50, 100, 250 mfd. 15v. 2/6; 500, 1000 mfd. 15v. 3/6; 2000 mfd. 25v. 7/6.  
GERMIO. 500 v. 1 pF. to 0.01 mfd. 9d. Discs 1/-.  
**SILVER MICA.** Close tolerance (plus or minus  $\pm$  pF.). 5 to 47 pF. 1/-; ditto 100 1/2 to 800 pF., 1/-; 1,000 to 5,000 pF. 2/-.  
**TWIN GANG.** "0-0" 208 pF. +178 pF. 10/8; 365 pF. miniature 10/-; 500 pF. standard with trimmers, 9/-; 5000 pF. midget less trimmers, 7/6; 500 pF. slow motion, standard 9/-; small 3-gang 500 pF. 16/8. Single "0" 365 pF. 7/6. Twin 10/-.  
**RECTIFYING WAVE.** Single 10 pF. 50 pF., 75 pF., 100 pF., 160 pF., 5/8 each. Can be Ganged. Couplers 9d. each.  
**TUNING.** Solid dielectric. 100 pF., 300 pF., 500 pF., 3/6 each.  
**TRIMMERS.** Compression ceramic 30, 50, 70 pF. 9d.; 100 pF., 150 pF., 1/3; 250 pF., 1/6; 800 pF., 750 pF., 1/8.  
250v. RECTIFIERS. Selenium 1/2 wave 100mA 5/-; BY100 10/-; CONTACT COOLED 1/2 wave 60mA 7/6; 85mA 9/8.  
Full wave 75mA 10/-; 150mA 18/6; T.V. rect. 10/-.

## SPECIAL OFFER! NEW B.A.S.F. TAPE

7 in. L.P. 1,800 ft. (Cat. LGS35) 45/-  
7 in. D.P. 2,400 ft. (Cat. LGS26) 70/-

Spare Spools 2/6. Tape Splicer 5/-. Leader Tape 4/6.  
Tape Heads: Collaro 2 track 28/6 pair. B.S.R. 4 track 99/6

## MAINS TRANSFORMERS

250-0-250 80 mA. 6.3 v. 3.5 a., 6.3 v. 1 a., or 5 v. 2 a. 29/6  
160-0-160 88 mA. 6.3 v. 3.5 a., 6.3 v. 1 a., or 5 v. 2 a. 29/6  
MT. 310/300-0-310 120 mA., 6.3 v. 4 a. . . . . 29/6  
MINIATURE 200 v. 20 mA., 6.3 v. 1 a. . . . . 10/6  
MIDGET 220 v. 45 mA., 6.3 v. 2 a. . . . . 15/6  
SMALL 250-0-250 50 mA., 6.3 v. 2 a. . . . . 19/6  
HEATER TRANS. 6.3 v. 1 a., 8/6; 6.3 v. 4 a. . . . . 10/6  
Ditto tapped sec. 1.4 v., 2, 3, 4, 5, 6.3 v., 1 1/2 amp. 10/6  
GENERAL PURPOSE LOW VOLTAGE. Outputs 3, 4, 5, 6, 8, 9, 10, 12, 15, 18, 24 and 30 v. at 2 a. 29/6  
1 amp., 5, 10, 15, 20, 25, 30, 35, 40, 55, 60, 29/6; 2 a., 47/6  
AUTO TRANSFORMERS 0-115-230 v. Input/Output, 150w. 25/-; 500w. 92/6; 1000w. 175/-.

## CRYSTAL MIKE INSERTS

1 1/2" tin. 6/8; B.M3 1" tin. 7/8; ACOS 1 1/2" tin. 8/6  
TANCO CARBON MIKE with Switch . . . . . 5/6  
MOVING COIL MICROPHONE 100 ohms (at 6.3 v.) 12/6  
H.R. HEADPHONES 2000 ohms 12/8, 4000 ohms 15/-  
H.R. HEADPHONES 2000 ohms Super Quality . . . . . 25/-



1967 GRAM CHASSIS

Post 5/-  
Three Wavebands: Five Valves: ECH81, EF89, Long., Med., Short. Gram. EC81, EL84, E280,  
12 month guarantee. A.C. 200-250 v. Ferrite Aerial 5 watts 3 ohm. Chassis 13 1/2" tin. x 5 in. dial size 13 in. x 4 in. Two pilot lamps. Four Knobs.  
Aligned calibrated Chassis isolated from mains £10.10.  
DE LUXE STEREO GRAM CHASSIS V.H.F., MW, SW 19-50m, SW 60-180m. Magic eye, push buttons: £19.19  
6 valve plus rect. Size 15" x 7 1/2" x 8 1/2" high

**HIGH GAIN TV. PRE-AMPLIFIER BAND I B.B.C.** Tunable channels 1 to 5. Gain 18 db. ECC84 valve. Kit price 32/6 or 55/- with power pack. Details 6d.

**BAND III I.P.T.A.** - same prices. Tunable channels 7 to 13. Band I or III. Coils and circuit only, 9/6. Chassis 4/8 1/2.  
**B.B.C. 2 SUPER BOOSTER** transistor model. Ready built 75/-.

**ALUMINIUM CHASSIS.** 18 s.w.r., 2 1/2 in. sides. 7 x 4 in. 5/6; 9 x 7 in. 6/8; 11 x 3 in. 6/8; 11 x 7 in. 7/8; 13 x 9 in. 9/8; 14 x 11 in. 12/6; 15 x 14 in. 15/-.

**ALUMINIUM PANELS 18 s.w.r. 12 x 12 in.** 5/8; 14 x 9 in. 4/8; 12 x 8 in. 3/8; 10 x 7 in. 2/8; 8 x 6 in. 2/1; 6 x 4 in. 1/8.

**ALL PURPOSE TRANSISTOR PRE-AMPLIFIER** Gain 14: 1, 250v. or 9v. input. Ready built with Mu Metal input transformer for Miles, Pick-Up. Tuners. 15/-  
Instructions and circuit supplied. Post 2/6.



**THE INSTANT BULK TAPE ERASER AND RECORDING HEAD DEMAGNETISER**

200/250 v. A.C. Leaflet S.A.E. Post 35/-

# BAKER 12 in. STANDARD

The ideal High Fidelity Loudspeaker. Now with built in high efficiency tweeter cone.

Voice Coil impedance 15 ohms.  
Max. Power . . . . . 20 watts  
Bass Res. . . . . 40/50 cps.  
Flux . . . . . 14,000 gauss.  
Voice Coil diameter . . . . 1 1/2 in.  
Voice Coil material . . . . . Copper  
Response . . . . . 40-14,500 cps.  
Magnet material . . . . . Alcomac  
Overall dia. . . . . 12 in.  
Overall depth . . . . . 6 in.



PRICE £8 POST FREE

## CATALOGUE S.A.E. GROUP MODELS FOR VOCALS

BASS, LEAD AND RHYTHM GUITARS  
30-10,000 cps. Voice Coils 15 ohms. Heavy duty

'Group 25' 12in. 5gns.  
'Group 35' 15in. 8gns.  
'Group 50' 15in. 18gns.

**LOUDSPEAKERS P.M. 3 OHMS.** 2 1/2 in., 3 in., 4 in., 5 in., 7 in. x 4 in., 16/8 each; 8 in., 22/6; 6 in., 18/6; 10 in., 30/-; 12 in., 50/-; 15 ohms 35/-; 10 x 6 in. 30/-; 8 x 6 in. 21/-; E.M.I. Double Cone 13 1/2" x 8 in. or 15 ohm models, 45/-; W.B. 10 in. HF1012. £5.10.0; 8 in., HF812, £4.10.0 Crossover 35/-; Horn Tweeters 3-16 Kcs. 10 w 29/8; 20 w 20 Kcs. 99/6.  
**CRACK SOCKETS Std.** open circuit 2/6, close-circuit 4/6.  
**Chrome Lead Sided.** DIN 3-pin 1/3; Lead 3/8.  
**Phono Plugs 1/4." Socket 1/4." Banana Plugs 1/4." Sockets 1/4."**  
**JACK PLUGS.** STANDARD, Chrome 3/6. DIN 3-pin 3/8.  
**WAVE-CHANGE SWITCHES WITH LONG SPINDLES.** 2 p. 2-way, or 2 p. 6-way, or 3 p. 4-way 3/6 each. 1 p. 12-way, or 4 p. 2-way, or 4 p. 3-way, 3/6 each.  
Wavechange "MAKITS" 1 p. 12-way, 2 p. 6-way, 3 p. 4-way 4 p. 3-way, 6 p. 2-way. Prices include click spindles, adjustable stops, spaces, etc., 1 wafar, 10/6; 2 wafar, 15/-; 3 wafar, 19/6.  
TOGGLE SWITCHES, sp. 2/-; sp. at. 3/6; dp. 3/6; dp. at. 4/6.

## DE LUXE TAPE SPLICER

Guns, trims, joins for editing and repairs. With 3 blades. 14/6

**4 CHANNEL TRANSISTOR MICROPHONE MIXER.** Add musical amplifiers and effects to recordings. Will mix Microphone, records, tape and tuner with separate controls into single output. 59/6

**PRIMO A.13 TRANSCRIPTION TONE ARM.** Complete with tracking template and two plug-in shells suitable for mounting any cartridges. Moving Coil Stereo Diamond Cartridge 20-18,000 cps. 5 gns. 5 gns.

**FM TUNER 88-108 Mc/s Six Transistor.** Superhet. Ready built. Printed circuit. Calibrated slide dial tuning. Size 6" x 4" x 2 1/2". £8.10.0

**3 WATT QUALITY AMPLIFIER.** 4 Transistor Push-Pull Ready built, with volume control 75/-

## NEW MANUFACTURERS SUPERLUH UHF BBC 2 AERIALS

BBC 2 Double Gole Ring Set Top Model . . . . . 22/6  
BBC 2 Five Element Loft Model . . . . . 32/6; Outdoor 42/6

## \* RADIO BOOKS \* (Postage 9d.)

- High Fidelity Speaker Enclosures and Plans . . . . . 5/6
- Transistor Superhet Commercial Receivers . . . . . 7/8
- Mullard Audio Amplifier Manual . . . . . 8/8
- Radio Valve Guide, Books 1, 2, 3, or 5 . . . . . each 5/6
- Practical Radio Inside Out . . . . . 4/8
- Transistor Audio Amplifier Manual . . . . . 3/6
- Shortwave Transistor Receivers . . . . . 5/8
- Transistor Communication Sets . . . . . 6/6
- International Radio Stations List . . . . . 2/6
- Modern Transistor Circuits for Beginners . . . . . 7/8
- Practical Shortwave Transistor Receivers . . . . . 9/8
- Wireless World Radio Valve Data . . . . . 9/8

At a glance valve equivalents . . . . . 6/6

**RESISTORS.** Preferred values, 10 ohms to 10 meg. 1 w., 1/2 w., 1 w., 20 watt; 4d., 1 1/2 w., 8d., 2 w., 1/-; 1/2 w. 10% 6d. HIGH STABILITY. 1/2 w. 1% 2/- Preferred values. 10 ohms to 10 meg. Ditto 5%, 10 ohms to 22 meg. 9d. 5 watt 0.5 to 3.2 ohm 3 w. 10 watt 10 ohms to 6,800 ohms 1/8

15 watt WIRE-WOUND RESISTORS 1/9  
10K, 15K, 20K, 25K, 68K, 10W. MAINS DROPPERS. Midget. With sliders. 0.3 a., 1 K., 0.2 a., 1.2 K., 0.15 a., 1.5 K., 6/- each. LINE CORD 100 ohms it. twin plus resistance. 1/- 1/2.

**WIRE-WOUND 3-WATT** WIRE-WOUND 4-WATT  
POTS. T.V. Type. Values STANDARD SIZE POTS. 10 ohms to 30 K., 5/3. LONG SPINDLE VALUES Carbon 30 K. to 2 meg., 3/-. 50 OHMS to 100 K., 7/6.

**VALVE HOLDERS.** Int. Oct. 6d. Mazda Oct. 6d., BT7, B8A, B8G, B9A, Moulded 9d. Ceramic 1/1. B70, B9A Cans 1/1. Valve base plugs B70, B9A, Int. Oct., 2/3.

**C.R.T. BOOSTER TRANSFORMERS** for heater cathode short or tailing emission. 25% and 50% optional boost, 200/250V. AC input. State tube voltage required, 2 or 6 or 13 v. Post 2/6. 15/6

**BRAND NEW QUALITY EXTENSION LOUDSPEAKER**



In tough cream plastic cabinet with 20ft. lead and adapters. For any transistor radio, intercom, mains radio, tape recorder, etc. 3 to 15 ohm matching Size: 7 1/2" x 5 1/2" x 3" 30/- Post 2/6

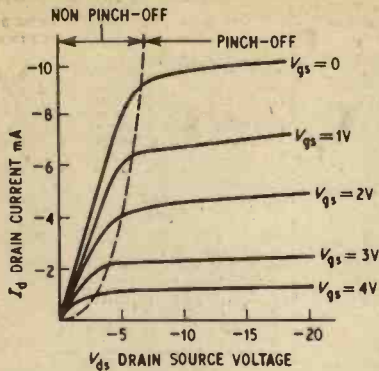


Fig. 2a. Drain characteristics of p-channel junction gate f.e.t.

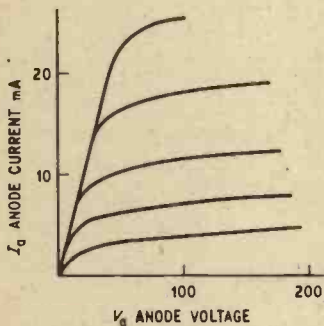


Fig. 2b. Anode characteristics of pentode valve

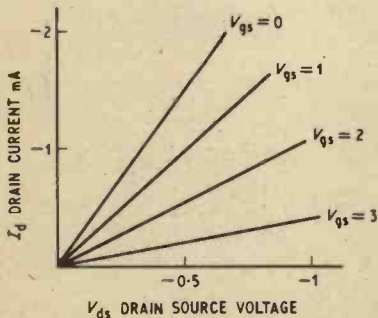


Fig. 3. Drain characteristics for low values of  $V_{ds}$ .

### CONDUCTION IN SOLIDS

Before considering the theory of operation of an f.e.t. it is useful to review very briefly the nature of the conduction process in semiconductors and the conditions that exist at the junction between a  $p$  and  $n$  type semiconductor.

In order that a solid should be a conductor of electricity it is necessary for it to contain mobile charges; an electrical field applied to the solid will then be able to superimpose a drift motion on top of the random thermal motion of these mobile charges. Such a drift of charges through a solid constitutes the electric current in the solid. An insulator contains no mobile charges, all charges in it are "bound" and cannot move under the action of an applied electrical field.

In  $n$ -type semiconductors the mobile charges are predominantly negatively charged electrons. These electrons are given ("donated") to the solid by suitable impurity atoms (donor impurities) which are introduced into the material. The impurity atoms are fixed in the crystal structure of the solid and when they have lost one of their electrons they have an excess positive charge.

In a  $p$ -type semiconductor the mobile charges are predominantly mobile positive holes. The presence of these positive holes is primarily due to impurities that are present in the solid. The impurity atoms are of a different type to the donor impurities in an  $n$ -type semiconductor and are called "acceptor" impurities. These acceptor atoms capture electrons from neighbouring valency bonds between atoms of the solid and thus create vacancies in these bonds. It is these vacancies that have an excess positive charge associated with them that are mobile and constitute the positive holes. The acceptor atoms are fixed in the crystal structure and when they have captured an electron they then have an excess negative charge.

### BEHAVIOUR OF PN-JUNCTIONS

The conditions that exist at a junction between a  $p$ - and  $n$ -type semiconductor may be conveniently visualised by imagining the two materials initially separated being brought into contact (Fig. 4). The random thermal motion of electrons and holes will result in a diffusion of electrons from the  $n$ - to the  $p$ -type material and of holes from the  $p$ - to the  $n$ -type material.

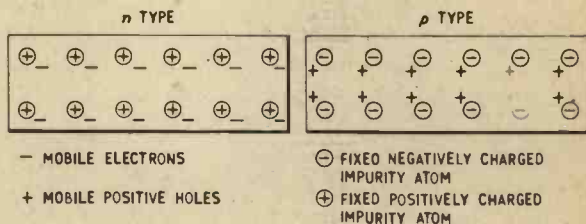


Fig. 4a.  $N$ - and  $p$ -type semiconductors before contact

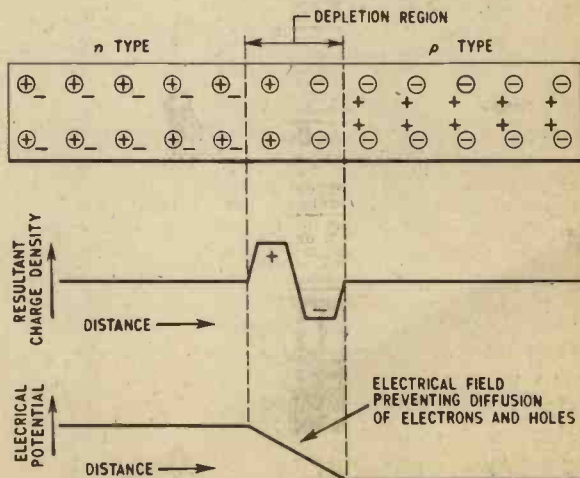


Fig. 4b.  $N$ - and  $p$ -type semiconductors after contact equilibrium conditions

In the immediate vicinity of the junction recombination of electrons and holes will "uncover" (leave unneutralised) the charges on the impurity atoms that are fixed in the material. A double layer of unneutralised charge will thus exist at the junction in a region containing very few mobile charges.

The double layer of charge will produce an electrical field in this region which will sweep electrons and holes out of the region and tend to prevent diffusion of electrons and holes across the junction. This region at the junction is called a depletion region because it contains very few current carriers.

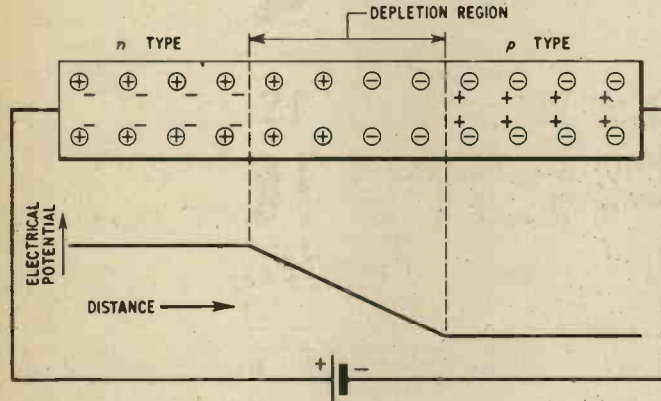


Fig. 5. P- and n-junction with reverse bias

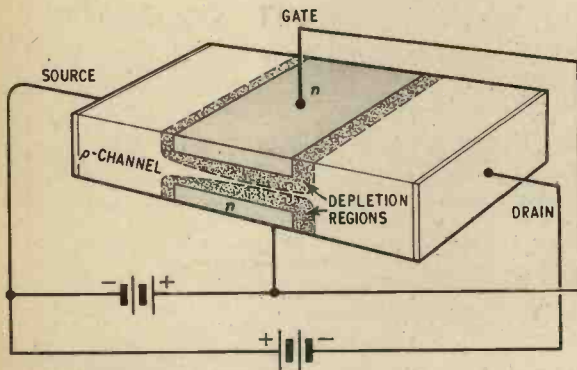


Fig. 6. P-channel junction gate f.e.t.

The rectifying action of a junction depends on the presence of a depletion region. A reverse bias applied to the junction (*p*-type made negative with respect to *n*-type) pulls electrons and holes away from the junction and increases the thickness of the depletion region (Fig. 5). The extremely small currents that pass through such reversed biased junctions are carried by electron-hole pairs created by thermal vibrations of the atoms of the material, they depend markedly on the temperature.

## JUNCTION GATE F.E.T.

### Reversed-biased diode f.e.t.

In its simplest form a junction gate f.e.t. consists of a semiconductor bar as shown in Fig. 6 with ohmic contacts at both ends. One of the contacts is called the source, the other is called the drain. The current

carriers (positive holes in the case of a *p*-channel device), pass through the bar from source to drain. At the middle part of the bar, regions of opposite conductivity type to the bar are formed and a contact is made to them called the gate.

In use the *pn*-junctions thus formed are reverse biased by a voltage applied to the gate. The thickness of the depletion regions associated with the *pn*-junctions is varied by varying the gate voltage. The depletion regions extend into the channel and restrict the effective cross section through which the channel current can pass, the gate voltage thus controls the drain current.

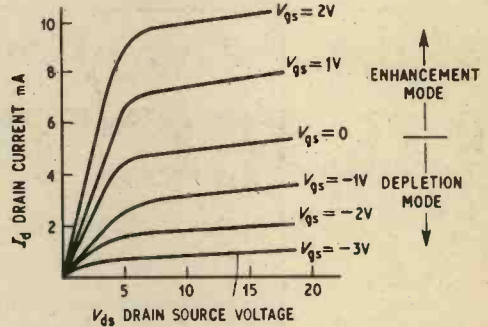


Fig. 7. Drain characteristic of depletion type n-channel m.o.s.t.

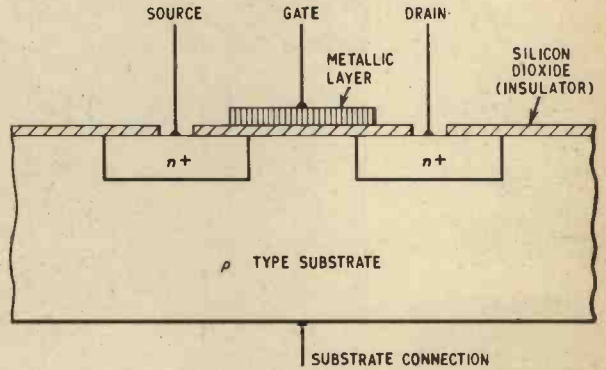


Fig. 8. Insulated gate f.e.t. structure of n-channel enhancement device

The control voltage applied between gate and source is effectively applied to a reverse biased diode and this accounts for the extremely small value of the gate current.

The depletion regions are thickest nearest to the drain because it is here that the greatest reverse bias exists across the junctions. If the gate voltage is held constant and the voltage between source and drain increased, the two depletion regions eventually meet, restricting the drain current to a near constant value. This is called the pinch-off condition.

Junction gate f.e.t.s are called "depletion mode" devices because a voltage must be applied to the gate terminal in order to turn them off. Insulated gate f.e.t.s are available as either "depletion mode" or "enhancement mode" devices. An enhancement mode device needs a voltage applied to its gate terminal before any drain current can pass (see Fig. 7).

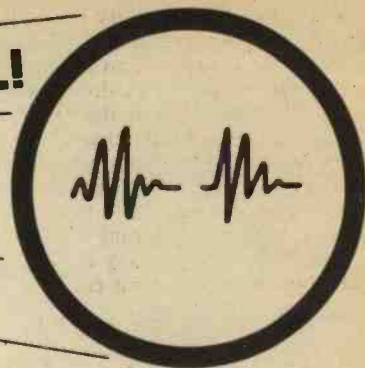


# LOOK!

**PRACTICAL!**

**VISUAL!**

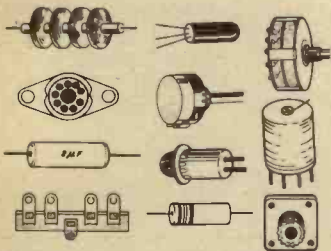
**EXCITING!**



a new 4-way method of mastering  
**ELECTRONICS**  
 by doing — and — seeing . . .

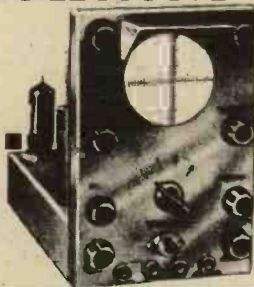
**1 ▶ OWN and HANDLE a**

complete range of present-day **ELECTRONIC PARTS** and **COMPONENTS**

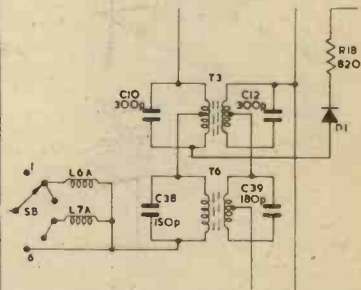


**2 ▶ BUILD and USE**

a modern and professional **CATHODE RAY OSCILLOSCOPE**



**3 ▶ READ and DRAW and UNDERSTAND CIRCUIT DIAGRAMS**



**4 ▶ CARRY OUT OVER 40 EXPERIMENTS ON BASIC ELECTRONIC CIRCUITS AND SEE HOW THEY WORK . . . INCLUDING . . .**

- VALVE EXPERIMENTS
- TRANSISTOR EXPERIMENTS
- AMPLIFIERS
- OSCILLATORS
- SIGNAL TRACER
- PHOTO ELECTRIC CIRCUIT
- COMPUTER CIRCUIT
- BASIC RADIO RECEIVER
- ELECTRONIC SWITCH
- SIMPLE TRANSMITTER
- A.C. EXPERIMENTS
- D.C. EXPERIMENTS
- SIMPLE COUNTER
- TIME DELAY CIRCUIT
- SERVICING PROCEDURES

This new style course will enable anyone to really understand electronics by a modern, practical and visual method—no maths, and a minimum of theory—no previous knowledge required. It will also enable anyone to understand how to test, service and maintain all types of Electronic equipment, Radio and TV receivers, etc.

**FREE** POST NOW  
 for  
**BROCHURE**

or write if you prefer not to cut page

To: **BRITISH NATIONAL RADIO SCHOOL, READING, BERKS.** Please send your free Brochure, without obligation, to: we do not employ representatives

NAME..... BLOCK CAPS

ADDRESS..... PLEASE PE 5

# VARIABLE VOLTAGE TRANSFORMERS



**PORTABLE TYPE**  
£8. 10. 0.



**4 50 AMPS**

INPUT 230/240v. A.C. 50/60—  
OUTPUT VARIABLE 0-260v.  
**BRAND NEW Carriage Paid.**  
Buy direct from the importer,  
keenest prices in the country.  
All Types (and Spares) from  
1/2 to 50 amp. from stock.  
**OPEN TYPE (Panel Mounting)**  
1/2 amp, £3. 3. 0. 1 amp, £4. 10. 0.  
2 1/2 amps, £5. 12. 6.  
**SHROUDED TYPE**  
1 amp, £4. 10. 0. 2.5 amps,  
£5. 17. 0. 4 amps, £8. 7. 6.  
5 amps, £9. 0. 0. 8 amps,  
£13. 10. 0. 10 amps, £17. 0. 0.  
12 amps, £19. 10. 0. 15 amps,  
£22. 0. 0. 20 amps, £32. 10. 0.  
37.5 amps, £65. 0. 0. 50 amps,  
£85. 0. 0.  
1.5 amp. portable fitted metal case  
voltmeter, lamp, switch, etc. £8.10.0  
P. & C. 10/- Similar to above 2.5  
amp. £9.17.6 P. & C. 10/-

## LIGHT SENSITIVE SWITCH

Kit of parts, including ORP12 Cadmium Sulphide Photocell, Relay, Transistor and Circuit, etc., 6-12 volt D.C. op. price 25/- plus 2/6 P. & P. ORP 12 including circuit, 10/6 each, plus 1/- P. & P.

**A.C. MAINS MODEL** Incorporates Mains Transformer, Rectifier and special relay with 3, 5 amp mains c/o contacts. Price inc. circuit 47/6 plus 2/6 P. & P.

## UNISELECTOR SWITCHES

75 ohm coil 24 v. D.C.  
6 Bank 25 position, 5 non-bridging 1 Bridging Wiper  
5 Bank 25 position, 4 non-bridging 1 Bridging Wiper  
6 Bank arranged to give 3 bank, 50 positions  
8 Bank arranged to give 4 bank, 50 positions  
These switches have been carefully removed from equipment.  
All at 35/- each. P. & P. 2/6.

## BRAND NEW 4 Bank 25

Way Uniselector, 3 Bank + Homing 25 ohm coil. 12-24v. D.C. operation £417.6 plus 2/6 P. & P.

## SOUND POWER OPERATED EX-ADMIRALTY HEAD AND BREAST SETS

Two such sets connected up will provide perfect intercom. No batteries required. Will operate up to 1/2 mile. Price 17/6 each plus P. & P. 3/- or 32/6 per pair. P. & P. 5/6.

## 100 WATT POWER RHEOSTATS (NEW)

AVAILABLE IN THE FOLLOWING VALUES

1 ohm, 10 a.; 5 ohm, 4.7 a.; 10 ohm, 3 a.; 25 ohm, 2 a.; 50 ohm, 1.4 a.; 100 ohm, 1 a.; 250 ohm, .7 a.; 500 ohm, .45 a.; 1,000 ohm, .280 ma.; 1,500 ohm, 230 ma.; 2,500 ohm, .2 a. Diameter 3 1/2 in. Shaft length 3/4 in., dia. 3/8 in. All at 27/6 each. P. & P. 1/6.

## 25 WATT POWER RHEOSTATS

10 ohm, 1.5 a.; 25 ohm, 1 a.; 50 ohm, .75 a.; 100 ohm, .5 a.; 250 ohm, .3 a.; 500 ohm, .2 a.; 1,000 ohm, .15 a.; 1,500 ohm, .12 a.; 2,500 ohm, .1 a.; all at 14/6. P. & P. 1/6.

## "CABY" MULTI-RANGE TEST METER

Model B40. D.C. volt, 0.5 v., 2.5 v. at 10,000 ohm per volt. Ideal for transistor circuit testing. A.C. and D.C. volt, 10 v., 50 v., 250 v., 500 v., 1,000 v. at 4,000 ohm per volt. Resistance, 2 K ohm, 200 K ohm, 2 meg., 20 meg. Repair service available. Price includes Test Leads, Battery, Instruction book, Packing and Post (U.K.). £6.2.6. 3 additional models available from 54/- to £14.14.0. Leaflet gladly sent on request.

## 5amp AC/DC VARIABLE VOLTAGE OUTPUT UNIT

Input 230v. AC  
Output 0-260v. AC  
Output 0-240v. DC  
Fitted large Scale  
Ammeter and Voltmeter. Neon Indicator, Fully Fused. Strong attractive metal case 15" x 8 1/2" x 6". Weight 24lbs. Infinitely Variable, smooth stepless Voltage Variation over full range. Price £30. C. & P. £2.



## 36 VOLT 30 AMP AC or DC VARIABLE LT SUPPLY UNIT

Low voltage supply. Fully isolated. Fitted in robust metal case with Voltmeter, Ammeter, Panel Indicator and Chrome Handles. Input and Output fully fused. Ideally suited for Lab. or Industrial use. £55 -- 40/- Cap. Similar in appearance to above.

## CONSTANT VOLTAGE TRANSFORMER

Input 185-250 v. A.C. Output 230 v. A.C. Capacity 250 watt. Attractive metal case. Fitted red signal lamp. Rubber feet. Weight 17 lbs. Price £11.10.0. P. & P. 15/-.



## UNIVERSAL DEMONSTRATION TRANSFORMER

Stenzyl Type  
A complete composite apparatus, comprising a Transformer and electromagnet with removable coils and pole pieces. Coil tapped for 230v, 220v, 110v, 115v; 6, 12, 36, 110v. A.C. These coils are also used for D.C. experiments. Complete with all accessories as shown. £17 + 15/- carriage. Leaflet on request.

## WIMSHURST ELECTROSTATIC GENERATORS

£13/17/6, carr. U.K. (B.R.S.) 10/-. Leaflet on request.

## ULTRA VIOLET BULBS

Easy to use source of U.V. for dozens of practical and experimental uses. 12 volt 36 watt A.C./D.C. SBC 6/6. 12 volt 60 watt A.C./D.C. SBC 8/6. P. & P. 1/- on above. Transformer to suit the above. Input 200-240 v. A.C., 12 volt 36 watts, 21/- P. & P. 2/6. Input 200-240 v. A.C. 12 volt 60 watt, 27/- P. & P. 3/6.

Set of 4 Colours FLUORESCENT PAINT. Red, yellow, green and cerise. In 1/2 oz. tins. Ideal for use with the above Ultra Violet Bulbs. 11/-, plus 2/6 P. & P.

## COMPACT HEAVY DUTY 6V DC RELAY

6-9 volt DC operation 30 ohm coil 2 x 10 amp c/o contacts, will handle up to 250 volt AC. Size 1 1/2" high x 2 1/2" x 1 1/4". Price 7/6 plus 1/6 P. & P. 3 for 20/- post paid.

## DOUBLE WOUND VARIABLE TRANSFORMERS

Fully isolated low tension secondary winding. Input 230 v. A.C. Output continuously variable 0-36 v. A.C.  
0-36 Volt at 5 Amp. £8.10.0. P. & P. 8/6.  
0-36 Volt at 20 Amp. £19.10.0. P. & C. 15/-.  
These fully shrouded Transformers designed to our specifications are ideally suited for Educational and Industrial Laboratory use.

## L.T. TRANSFORMERS

All primaries 220-240 volts.

Type No.	Sec. Taps	Price Carr.
1	30, 32, 34, 36 v. at 5 amps.	£3.5.0 7/6
2	30, 40, 50 v. at 5 amps.	£5.5.0 9/-
3	10, 17, 18 v. at 10 amps.	£3.10.0 7/6
4	6, 12 v. at 20 amps.	£4.17.6 7/6
5	17, 18, 20 v. at 20 amps.	£5.12.6 10/6
6	6, 12, 20 v. at 20 amps.	£5.5.0 9/-
7	24 v. at 10 amps.	£3.15.0 7/6

# SERVICE TRADING CO

All Mail Orders—Also Callers—Ample Parking Space  
57 BRIDGMAN ROAD, LONDON, W.4 Phone 995 1560  
SHOWROOM NOW OPEN CLOSED SATURDAY

Personal callers only  
9 LITTLE NEWPORT ST.  
LONDON, W.C.2. Tel. GER 0576

## NEW 1967 Edition

# WORLD RADIO TV HANDBOOK

32/-

Postage 1/-

**TV FAULT FINDING**, a Data Pub. 8/6. Postage 6d.

**SHORT WAVE LISTENING**, by J. Vastenhou. 12/6. Postage 1/-.

**HOW TO TEST ALMOST EVERYTHING ELECTRONIC**, by J. Darr. 23/- Postage 9d.

**LOUDSPEAKERS & LOUDSPEAKER CABINETS**, by P. W. Van Der Wal. 15/- Postage 1/-.

**QUESTIONS & ANSWERS ELECTRONICS**, by C. Brown. 8/6. Postage 9d.

**RADIO VALVE DATA** Compiled "WW" 8th ed. 9/6. Postage 9d.

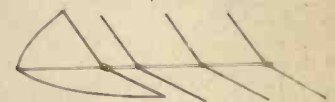
**QUESTIONS & ANSWERS RADIO & TELEVISION**, by H. W. Hellyer. 8/6. Postage 9d.

**UNDERSTANDING TELEVISION**, by J. R. Davies. 37/6. Postage 2/6.

## THE MODERN BOOK CO.

BRITAIN'S LARGEST STOCKISTS  
of British and American Technical Books  
**19-21 PRAED STREET**  
**LONDON, W.2**  
Phone: PADDINGTON 4185  
Closed Saturday 1 p.m.

## NEW HI-GAIN EXPORT VHF/FM AERIALS FOR MONO/STEREO



- Full band width spacing
- High forward gain
- High front to back ratio
- Fibreglass moulding
- Universal clamp for up to 2 1/2" masts
- The perfect answer to Mono/Stereo FM reception
- HGFM/3 3 element 60/-
- HGFM/4 4 element 75/- (Illustrated)

## ALSO HIGH PERFORMANCE UHF 625 COLOUR AERIALS

Type C 500 3 element	25/-
Type C 570 7 element	32/6
Type C 510 10 element	40/-
Type C 514 14 element	47/6

- Full range of masts and fittings on request
- State channels required when ordering
- C.W.O. or C.O.D. p. & p. 4/6d.

## "C" AERIALS LTD.

14-15 QUARRY STREET, GUILDFORD, SURREY  
TEL: GUILDFORD 67704

## BATTERY ELIMINATORS

The ideal way of running your TRANSISTOR RADIO, RECORD PLAYER, TAPE RECORDER, AMPLIFIER, etc. Types available: 9v; 7 1/2v; 6v; 4 1/2v (single output) 39/6 each. P. & P. 2/9. 9v + 9v; 6v + 6v; or 4 1/2v + 4 1/2v (two separate outputs) 42/6 each. P. & P. 2/9. Please state output required. All the above units are completely isolated from mains by double wound transformer ensuring 100% safety.

R.C.S. PRODUCTS (RADIO) LTD.  
(Dept. P.E.), 11 Oliver Road, London, E.17

## INSULATED GATE F.E.T.

### Metal-oxide semiconductor transistor, m.o.s.t.

The input resistance of the insulated gate f.e.t. is even higher than that of the junction gate f.e.t. because its gate terminal is insulated from the semiconducting material by a thin layer of insulating material. Two very rich  $n$  regions (sometimes called  $n^+$  regions) are diffused on a  $p$ -type silicon substrate as shown in Fig. 8. These regions form the source and drain contacts and are very close together.

The structure shown is that of an  $n$ -channel enhancement device. Under conditions in which no voltage

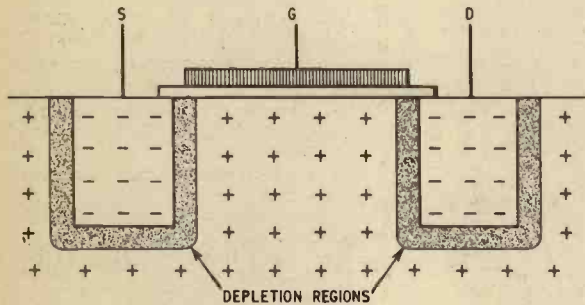


Fig. 9a. Equilibrium situation, no voltage applied

Even though the substrate is doped with acceptor type impurities, there are always some electrons present in it that have been generated by thermal energy; these are attracted to the surface by the positive gate to give region (2). It is called an inversion layer. A voltage applied between source and drain can now produce a current carried by electrons through the inversion layer.

As the drain voltage is increased the electrical field attracting electrons to the surface of the substrate becomes less near the drain and the conducting  $n$  channel decreases in thickness here (Fig. 9d), eventually becoming pinched off. The drain current then remains

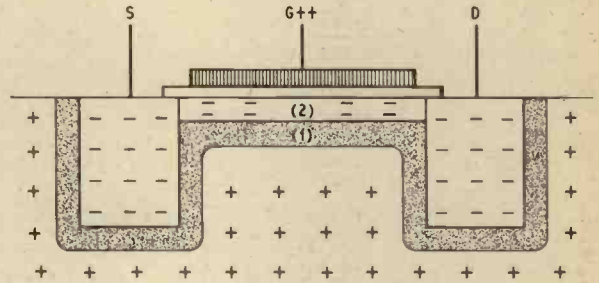


Fig. 9c. Gate made more positive, inversion layer (2) formed

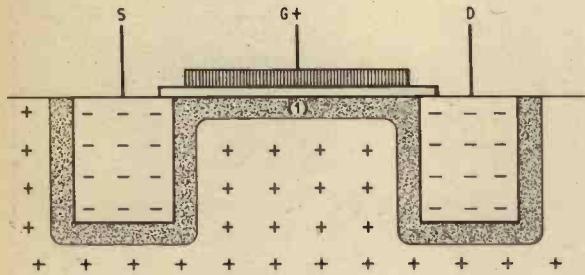


Fig. 9b. Gate made slightly positive

is applied to the gate, the source-channel-drain circuit is equivalent to two  $pn$  junctions back to back. No  $n$  channel in fact exists between source and drain and no drain current can flow whatever the magnitude or polarity of the applied drain-source voltage. (This is true up to the point at which one of the junctions breaks down.)

A simplified theory of the operation of the device is illustrated in Fig. 9 (not to scale). Fig. 9a shows the equilibrium situation with no voltages applied. If a small positive voltage is applied to the gate the action of the electrical field produces a depletion region (1) just below the surface of the substrate (Fig. 9b). In Fig. 9c an increase in gate voltage extends region (1) deeper into the bulk of the semiconductor and produces region (2). In this region the electron density actually becomes greater than the hole density; it behaves as if it were  $n$ -type material.

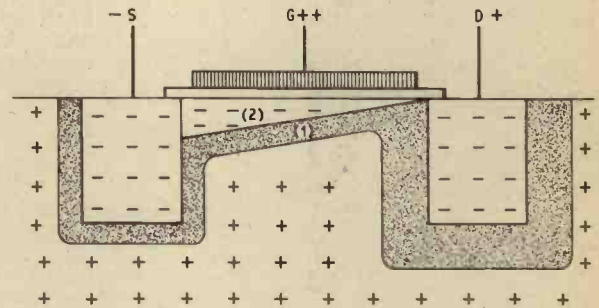


Fig. 9d. Voltage applied between source and drain

almost constant as the drain voltage is increased

Some insulated gate f.e.t.s are made with a layer of  $n$ -type material formed at the surface of the substrate under the gate and connecting source and drain. Conduction is then possible between source and drain through this layer even though no gate voltage is applied. A negative gate voltage has to be applied to deplete this region of electrons in order to cut off the drain current.

Devices such as this are working in the depletion mode, although they can also be made to work in the enhancement mode by the application of a positive gate voltage.

The treatment that has been given has referred to an  $n$ -channel insulated gate f.e.t.;  $p$ -channel devices are also available. The explanation of the theory of action of these devices is similar to that for  $n$ -channel devices with the polarity of all voltages reversed. ★

# MARKET PLACE

Items mentioned in this feature are usually available from electronic equipment and component retailers advertising in this magazine. However, where a full address is given, enquiries and orders should then be made direct to the firm concerned.

## RESISTORS AND CAPACITORS

New resistors and capacitors are always being introduced each month, as more stringent specifications and processes are being implemented. A new range of miniature low value wirewound resistors, types TW and TP, especially developed to meet the requirements of modern transistor equipment, is the latest product from the Resistor Division of the Plessey Components Group.

Finished in green silicon cement, type TW and TP resistors have an overall resistance range from 0.22 ohms to 6.8 kilohms at 1 watt rating. Available with both wire and printed circuit terminations these resistors are scaled down versions of this Company's proven glassfibre cored resistors.

The Davall Type 72 miniature moulded track potentiometer is claimed to offer a substantially longer life than conventional sprayed track potentiometers now in use.

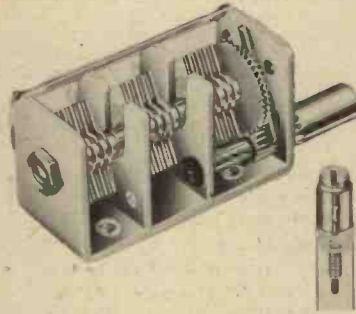
The type 72 has the insulating base, solid carbon track and terminals moulded into a single solid integrated unit. The potentiometer has a power rating of 0.5W (linear) and 0.25W (non-linear) at 55 degrees centigrade and a resistance range of between 50 ohms and 2 megohms. The maximum working voltage is 500V d.c.

Just one of the many new capacitor ranges is the Erie 801 Series of Disc Ceramics which measure 0.36in maximum diameter. The 500V working standard version is available in 24 individual ceramic bodies to suit all applications, has an overall capacitance range of 6pF to 7,000pF and is obtainable in either the conventional wire termination form or the Erie "Pluggable" form for printed circuits.

Specially designed for printed circuit mounting is a new piston-type trimmer introduced by Wingrove & Rogers Ltd., Polar Division, 75, Uxbridge Road, Ealing, London, W.5. The trimmer, type S60-01, has an overall diameter of 0.25in with 0.2in fixing centres and is variable from 2pF to 25pF by

means of a screwdriver slot in the rotor. These trimmers are available in polystyrene dielectric or p.t.f.e. dielectric for operation in extreme temperatures.

Another new type is the CG80-03, a miniature three-gang capacitor designed for v.h.f. receivers. Each section has a capacitance of from 2.5pF to 17pF. An internal gear and pinion drive gives a 3:1 reduction. High-grade ceramic posts insulate the stator from the frame, and the capacitor is 1.5in long, 0.65in wide and 0.85in high overall.



The CG80-03 and the S60-01 capacitors from Wingrove and Rogers

## GOOD BUYS

The Testmaster is a new mains tester screwdriver (price 7s 6d) from Vitrex (Sales) Ltd., 457-463 Caledonian Road, London, N.7. This screwdriver differs from others in that it has a cartridge fuse testing socket as well as the usual neon mains tester.

Most mains cartridge fuses have opaque tubes and it is practically impossible to tell visually whether the fuse has blown. But by inserting the suspect fuse in the fuse socket in the head of the Testmaster, and following the instructions as indicated on the card provided, it becomes a simple process to test the fuse.

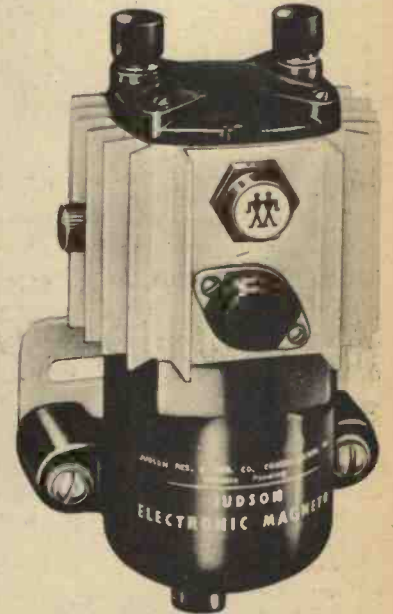


Vitrex Testmaster Screwdriver

The handle is moulded tough nylon, has high voltage insulation properties and is fitted with a high intensity neon and plated chrome vanadium blade. The fuse socket in the handle houses a spare fuse.

Beulah Electronics Ltd. have been appointed sole U.K. distributors of an electronic ignition system from Judson Research and Manufacturing Corporation of America. Known, in the U.K., as the Beulah-Judson Electronic Magneto it costs £21, uses a silicon transistor, is fully protected by zener diodes and components are completely sealed to prevent corrosion.

It is not uncommon for temperatures of up to 200°F to exist under the car bonnet and it is for this reason that most manufacturers of transistor ignition systems, particularly those using germanium transistors, recommend that the transistor should not be mounted in the engine compartment. The Beulah-Judson Magneto uses a silicon



Ignition System imported by Beulah Electronics

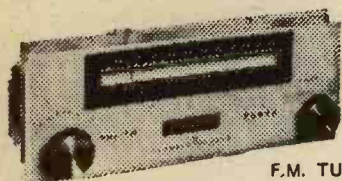
transistor which will continue to function at 420°F; high engine temperatures are no problem.

The system is one complete unit and it is simple to instal by transposing three wires from the present ignition coil and connecting one additional wire to ground; it is simple to revert back to the old system by replacing the three leads.

Tests have been carried out over a period of two years in the U.S.A. on cars and boats; it carries a three year warranty regardless of mileage or hours placed on the engine. The same unit may be used on 6 or 12 volt systems, single or dual point ignition distributors, and will not interfere with radio reception. Two models are available, for either negative or positive "earth" systems.

# PEOPLE PREFER MARTIN

FOR RELIABILITY, FOR QUALITY, FOR ADD-ON-ABILITY, FOR ECONOMY



F.M. TUNER



STEREO CONTROL ASSEMBLY

MARTIN AUDIOKITS are available for Mono, and can be doubled up for stereo, or as complete stereo units. 3 ohm and 15 ohm systems are available. There is a special pre-amp for low output pick-ups and escutcheon panels to suit the arrangement you choose. The tuner is styled to match.

- 5-stage input selector £2.76
- Pre-amp/vol. control £1.17.6
- Pre-amp/tone controls £3.2.6
- 10 watt amp. (3 ohms) £5.12.6
- 10 watt amp. (15 ohms) £6.12.6
- Mains power supply £2.15.0
- F.M. Tuner £12.17.6

Trade enquiries invited

From Radio and Hi-Fi Stockists

**MARTIN ELECTRONICS LTD.**

154/5 HIGH STREET, BRENTFORD  
MIDDLESEX. ISLeworth 1161/2

so that your installation is always up to date. Most important of all is the power and quality which MARTIN Audiokits give you. Their sturdy construction assures compactness without sacrifice to quality or efficiency. They offer excellent value, are very easily installed and will give years of unflinching service. That is why people prefer MARTIN — it's simple to instal, good to listen to, and looks completely professional.

**AMPLIFIER SYSTEMS • TUNERS • RECORDERS**

## MARTIN ELECTRONICS

154 High Street, Brentford, Middlesex  
Please send Recordakit/F.M. Tuner/Audiokit  
Hi-Fi Leaflets. (Strike out items not wanted)

Name .....

Address .....

PE57

## Get these ALL-PURPOSE casuals!

*Specially made for hard-wear indoors and out*

Whether you're up and doing as a handyman or just at leisure you need these "WINWEAR" all-purpose trousers. In pure combed cotton and with superior tailoring they will give you years of service — plus comfort and fit.

**PRE-SHRUNK • DRIP DRY • TURN-UPS  
SELF-FITTING • PRACTICAL SIZE  
POCKETS • BACK POCKET AND FLAP  
IN SANDY FAWN or LIGHT NAVY**

**ONLY 47<sup>6</sup>/<sub>6</sub> POST PAID**

### HOW TO ORDER

Available in these sizes:  
WAIST: 30" 32" 34" 36" 38" 40" 42" 44" 46"  
INSIDE LEG: 29" 30½" 32"  
COLOURS: SANDY FAWN or LIGHT NAVY  
Write on coupon your waist and inside leg size, and tick colour required. Add your name and full postal address (In block letters) and send with remittance 47s 6d to:

**Mr. JOHN BEST, W.S.R. LTD. (E.2)**  
15-17 LONG ACRE, LONDON, W.C.99  
Cheques or postal orders should be made payable to W.S.R. Ltd. and crossed " & Co." If sending cheque please write your name and address on back.

You are guaranteed money refunded if not completely satisfied, provided the garment is returned in absolutely new and unworn condition within 7 days of despatch to you. This offer does not apply in Eire or Overseas.



**POST NOW** to: Mr. Jn. Best, W.S.R. Ltd. (E2)  
15-17 Long Acre, London, W.C.99

Please send me the "WINWEAR" all-purpose trousers in size:

WAIST.....ins.      INSIDE LEG.....ins.

COLOUR: SANDY FAWN  **TICK ONE**  LIGHT NAVY

I enclose { Postal Order/Cheque  
VALUE 47s 6d      No.....

If sending cheque write your name and address on back  
**WRITE IN BLOCK LETTERS**

NAME .....

ADDRESS .....

(E.2)

**QUALITY MEN'S WEAR BY W.S.R. LTD.**

# BI-PAK SEMICONDUCTORS

(DEPT. E)

8 Radnor House  
93/97 Regent St.  
London, W.1



BRAND NEW—FROM USA  
SCOOP PURCHASE—8 LEAD  
EPOXY CASE—LOW COST—

μ L 900 "Buffer" 19/6  
μ L 914 "Gate" 19/6  
μ L 923 "J.K." 35/-

COMPLETE  
DATA AND  
CIRCUITS SEND  
1/6 OR FREE  
WITH ALL IC  
ORDERS

THESE  
DEVICES OPEN UP A WHOLE NEW CON-  
CEPT IN THE WORLD OF ELECTRONICS

## INTEGRATED CIRCUITS

Our vast stocks change daily with hundreds of Semi-  
conductor bargains becoming available. Just send  
2/6 to cover 3 months mailing of our latest stock lists,  
eqvt. charts, circuits, etc.

Minimum Order 10/- CASH WITH ORDER  
PLEASE. Add 1/- postage and packing per Order.  
GUARANTEED by return postal service. Overseas  
add extra for Airmail.

### VALUE PAKS FOR '67

NEW UNTESTED

120 GERM. SUB-MIN. DIODES 10/-

20 ALL TYPES MIXED VOLTS ZENERS 10/-

25 SIL. NPN 200 M/cs TRANSISTORS 10/-

20 1 Amp. GERM. up to 300 PIV RECTIFIERS 10/-

60 SILICON 200 mA DIODES 10/-

16 SILICON 750 mA TOP-HAT RECTIFIERS 10/-

50 MIXED GERM. TRANSISTORS 10/-

10 STUD. 2 AMP SILICON RECT. 10/-

10 SCR's UNMARKED, UNTESTED VOLTAGE RANGE 1 Amp 50-400 PIV 20/-

### SCR's (THYRISTORS) LOWEST PRICE YET LARGEST RANGE EVER

PIV	1 AMP (TO-5 can)	7 AMP (STUD)	16 AMP (STUD)	30 AMP (STUD)
25	—	7/6	—	30/-
50	7/6	8/6	10/6	35/-
100	8/6	10/-	15/-	45/-
200	12/6	15/-	20/-	55/-
300	15/-	20/-	25/-	—
400	17/6	25/-	35/-	80/-
500	—	30/-	45/-	95/-
600	—	40/-	50/-	—

### NEW SILICON RECTIFIERS TESTED

PIV	750 mA	3 AMP	10 AMP	30 AMP
50	2/-	3/-	4/6	9/6
100	2/3	3/6	6/-	15/-
200	2/6	4/6	6/6	20/-
300	3/-	4/9	8/-	22/-
400	3/6	6/-	9/-	25/-
500	4/-	6/6	9/6	30/-
600	4/3	7/-	10/-	37/-
800	4/9	8/-	15/-	40/-
1000	6/-	10/-	17/6	50/-

750 mA TOP HAT TYPE 3, 10 & 30A STUD STPE



### NEW—SILICON BRIDGE RECTIFIERS —TESTED

600 PIV 2 Amp at 55°C 25s. each.  
800 PIV 2 Amp at 55°C 30s. each.

### TUNNEL DIODES

AEY11 Full Data 15/- each  
STC 1050 m/cs

### TRANSISTOR MANUAL

647 PAGE, BY G.E. (USA) CIRCUITS, APPLICATIONS CHARACTERISTICS THEORY

(30/- EACH) P.P. 2/6

ALL THE INFORMATION YOU NEED 7TH EDITION

AND APPLICATIONS ALSO COVERING A WHOLE RANGE OF RECTIFIER COMPONENTS

S.C.R. MANUAL BY G.E.

409 PAGES

3RD EDITION

### NEW TESTED VALUE PAKS

3 OC139 Trans. NPN Mullard	10/-
2 Drift Trans. 2N1225 100 M/Cs PNP	10/-
6 Matched Trans. OC44/45/81/81D	10/-
4 OA10 Diodes Mullard	10/-
15 Red Spot AF Trans. PNP	10/-
16 White Spot RF Trans. PNP	10/-
4 Sil. Rects. 3A 100/400 PIV	10/-
4 NPN Trans. Switching	10/-
2 10 Amp. Sil. Rect. 50/100 PIV	10/-
8 Diodes 4 OA70, 4 OA79	10/-
1 5 AMP SCR 100 PIV	10/-
3 Sil. Trans. 2S303 PNP	10/-
5 GET884 Trans. Eqvt. OC44	10/-
10 Assorted Computer Diodes	10/-
4 Zeners 5, 12 Vlt Mixed	10/-
4 20417 Trans. Eqvt. AF116/117	10/-
2 200 M/Cs Sil. Trans. BSY26/27	10/-
2 Bi-directional Trans. A8Y66	10/-
4 High Current Trans. OC42	10/-
2 Power Trans. OC28/35	10/-
5 Sil. Rects. 400 PIV 250mA	10/-
3 OC71 Trans. Mullard	10/-
3 OC75 Trans. Mullard	10/-
3 NPN Sil. Trans. 70 M/Cs	10/-
1 Power Trans. OC20 100 Vlt	10/-
5 OA47 Gold Bonded Diodes	10/-
4 OA202 Sil. Diodes Sub-Min	10/-
3 OC77 Trans. Mullard	10/-
8 OA81 Diodes CV448	10/-
3 Sil Rects. 400 PIV 500 mA	10/-

FREE One 10/- Pack of your own choice free with orders valued £4 or over FREE

3 High vlt. AF Trans. PNP ACY17	15/-
3 BSY96A Sil. Trans. STC	15/-
3 Sil. Trans. OC200 Mullard	15/-
2 Sil. Power Rect. 6 Amp. 200 PIV BYZ13	15/-
1 AF139 GERM. Trans. 1500 M/Cs	15/-
1 Sil. Power Trans. 100 M/Cs TK201A NPN	15/-
6 Zener Diodes 3-15 vlt. Mixed 400mW	15/-
5 OA5 Gold Bonded Diodes Mullard	15/-
1 2N1132 PNP PLANAR Trans. Sil	15/-
2 2N697 NPN PLANAR Trans. Sil	15/-
4 GERM. Power Trans. eqvt. OC16 Mullard	15/-
1 UNIJUNCTION Trans. 2N2846 G.E	15/-
2 Sil. Trans. 60Vcs 200 M/Cs ZT83/84	15/-
1 Sil. PLANAR Trans. BBY25 NPN 1000 M/Cs	15/-
1 Sil. Trans. 18104 150 M/Cs HFE 200 NPN	15/-
2 SCR's 50 PIV 1 Amp. TO-5 can	15/-
1 Tunnel Diode IN3720 (TD-5) G.E	15/-
1 2N2160 UNIJUNCTION Trans. TO-5 can	15/-
2 Sil. Rect. 5 Amp. 400 PIV Stud	15/-
2 GERM. Power Trans. OC28/29	15/-
2 ZENERS 25 Watt 15 & 22 Vlt	15/-
6 Sil. Rect. Type BY100 800 PIV 500mA	20/-
8 Sil. Rect. 400 PIV 200/500mA	20/-
26 Mixed Sil. & GERM. Trans. New Marked	30/-
40 Mixed Semiconductors New Marked	40/-
1 Logic Module Handbook & Catalogue	17/6



BI-PAK GUARANTEE SATISFACTION OR MONEY BACK

# detached particles

JOHN VALENCE

## COLOUR ARRIVES

What the Postmaster General has described as "the biggest single technical step forward which British TV has ever taken" is about to be made . . . colour comes to BBC2 in the autumn and to BBC1 and ITV during the course of the next three years.

Welcome news, especially to the TV receiver manufacturers and the retailers. Just the shot in the arm they need, because this particular section of the electronics industry has been almost moribund for the last 12 months or more.

The long drawn out discussions over the choice of a colour system, and then the long awaiting for the final go ahead signal from the government have exasperated many folk both within the industry and outside. After all, it has been pretty galling to watch the progress of other nations in the field of colour while this country which pioneered TV broadcasting in 1936 remained immobilised at the starting line.

Come to think of it, I suppose there is a compensatory side of the coin. We at any rate do start off with the benefit of much accumulated experience to draw upon. Highly satisfying though it may be to pioneer a new field, there are nevertheless certain penalties to be suffered ultimately, witness the original choice of a 405 line standard. This has not been favoured by any other country and with the advent of colour is now conceded to be obsolescent.

The move up into the ultra high frequency band is almost obligatory on technical grounds. It does, however, fill me with some trepidation concerning the kind of reception many a viewer will get. Blanket coverage of the country is definitely out on u.h.f. The behaviour of these frequencies cannot be predicted with any certainty for any given location; as experience with the present BBC2 transmissions indicates, "blind spots" are likely to occur which no elaborate aerial array, no matter how pains-takingly orientated, will overcome.

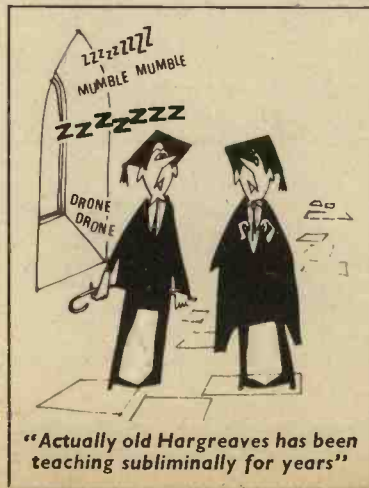
I hope I am not being too pessimistic, but surely it will be only prudent to have a proper survey and field strength tests carried out in our homes before we invest in a £300 colour receiver! A Technicolour snowstorm may be somewhat enthralling to watch—but even this spectacle is likely to pall very quickly, particularly when we recall the cost!

Is it not likely that we shall see more and more "piped" TV than the "wireless" variety in the future? The vagaries of u.h.f. signals may indeed accelerate this development.

## PREP WITHOUT TEARS

That wonderful assembly of electronics sometimes referred to by the more vulgar types as the goggle box, and nowadays taken so much for granted, has made a tremendous impact upon our everyday lives (yes, even in glorious black and white). One of the problems it has introduced into many a domestic scene is due to the magnetic attraction it holds over younger members of the family. This is often to the detriment of their homework and other studies.

Despairing parents can take heart. It seems that our old friend the electron in yet another of his varied guises may provide the answer to this vexed problem.



Subliminal teaching aids are now being made for use in residential schools for sleep-learning. Some equipment of this kind I have been reading about is marketed by a firm called Inductive Learning. Either disc or tape recordings can be used and one unit will feed up to 20 pillow speakers. The equipment can be set to repeat time and time again the recorded "lesson".

Well, what is good enough for the school boarder should be good enough for the day boy. So just install this prep machine in young Johnnie's bedroom and let him gaze at the one-eyed monster till close down, if he wishes. This way you will achieve domestic peace, while retaining a clear conscience as a dutiful parent.

## PROGRAMME MUSIC

Getting down to silicon diodes, computers for all their outward air of sophistication actually lead quite prosaic lives. Their working hours are normally spent disgorging a flood of figures—all very important to those directly concerned, but not frightfully exciting to the outsider.

But now and again we hear of a computer indulging in some frolic or other with the connivance of its (or should it be *his* or *her*) human attendants. Such fun-and-games antics, like playing chess or picking out compatible couples, seem to endow the machine with almost human-like qualities.

If any of these machines have any pretensions to musical artistry, now's the time to get flip-flopping. The International Federation for Information Processing has just announced a competition for a piece of music forming an artistic whole and composed by a computer. Medals will be awarded for the three best compositions which will be performed, it is hoped, in Edinburgh during the 1968 Congress of the IFIP.

Messrs. Mozart, Beethoven, Tchaikovsky, and the rest didn't know how fortunate they were living in the pre-electronic era.

# Readout —

## A SELECTION FROM OUR POSTBAG

### Let's be square!

Sir—Though I agree with your comments regarding the use of Hz instead of c/s (see March 1967 Editorial), I feel that your description of the continental resistor symbol as “a rectangular nonentity”, or “an empty block”, to be a trifle erroneous. Some continental manufacturers use a code to fill the symbol, this enables one to determine the rating and tolerance of the component at a glance. The same sort of system is used for capacitors; this saves a lot of time in searching through a parts list to determine a component's characteristics.

Also spare a thought for the electronics draughtsmen; no more patiently drawn “zig-zags”, and inductor symbols, as used at present.

S. A. Hardy,  
Chippenham,  
Wilts.

### Stay British

Sir—I was shocked by your support of the Hertz as a replacement for the c.p.s. or c/s which we are all used to. Can you give any logical reason for this change? There are many reasons in my mind why Hertz should not be used, perhaps the most sensible one being: we've managed without it up to now! Why make things awkward by introducing meaningless symbols?

If these new symbols made life easier then I would support the proposed move. As this does not seem the case it can only make things more difficult.

Later on in the same editorial you write: “Why discard a symbol which is the acme of perfection, explicit, simple to draw (or print) and economical in space . . .”

May I ask you the same question, WHY?

You've got the guts to dig your feet in on the question of whether it should be a simple zig-zag or a rectangle, then dig your feet in on the question of simple c/s or

confusing Hertz, this “move” is more important to us who try to keep up with your magazine, than to anyone else as far as you are concerned.

If you wish to change over then do so. I can't, and about 95 per cent of your readers will probably agree.

Up to the March 1967 issue I have enjoyed the articles and have been able to understand them. I don't want to give up taking P.E. but Mr Hertz might make me.

Dig your feet in, throw them both out, let's stay British.

E. Davies, G3PGM,  
Reading,  
Berks.

### Continental origin

Sir—Of course you are right to resist those little empty boxes of continental origin, for the internationally recognized traditional resistance symbol has no equal on all the counts that matter. The experts of the I.T.C. have become too arbitrarily-minded once again.

Frankly, I am all with those journals in other countries which have already rejected the Hears—sorry!—Hertz (including U.S.A.—despite their N.B.S.) and have declared their adherence to c/s— or better still, the symbol “~”. This beats everything else for conciseness, simplicity and unmistakability, it is universally accepted—and has always been widely used by German Industry itself!

I am appalled by the weak attitude of the B.S.I. and the number of British firms which have readily accepted this push-over. Would they jump at using M Om. for megohm instead of MΩ in the same way? To be logical they would have to; the symbol Ω is merely a letter of lingual antiquity, not a contraction of Ohm's name, and conveys no technically self-evident meaning, whereas ~ decidedly does—and everyone knows it.

We have never been a nation of dupes before—and we don't have to be now. Not even about pedantic trifles. The procurement

of international standards is a laudable motive as such, but if it means retrogression we are better off without it, as left to itself, good sense tends to emerge unassisted.

J. R. C. Moore,  
Little Melton,  
Norwich.

### Duty to readers

Sir—I feel that I must protest about your decision to adopt the symbol Hz as the unit of frequency in place of the excellent c/s.

It seems strange that you should adopt this controversial symbol without any prior warning to your readers and yet reject the rectangular box symbol for a resistor, which has been officially recognised by the British Standards Institute.

Do not think though that I am in favour of the adoption of the rectangular box symbol. I reject it on the same grounds as your magazine appears to, but why confine these grounds only to the box symbol, surely the same applies to the symbol Hz?

I feel, however, that you have a duty to your readers and that if you, or your staff, have a leaning towards the intruder “Hertz” then the fairest way to decide the issue is to have a ballot among your readers and let the majority vote dictate the action of your magazine.

Normally your magazine maintains a very high standard in policy and productions, but here I think you have slipped, and slipped badly.

D. Newman,  
Leicester.

### Still waiting!

Sir—In your March issue you published a letter from a Mr H. M. Sherry, complaining of lack of attention from advertisers.

As a newcomer to the fascinating science which you propagate in your excellent monthly, I must agree with your correspondent. I am amazed at the indifference and lack of courtesy shown by some dealers. Three weeks after sending cash I'm still waiting. Surely, after a fortnight it would not be too much trouble to send a card explaining the delay.

Like Mr Sherry, I'm learning, and have begun a process of elimination.

C. G. Thorne,  
Sutton Coldfield,  
Warks.



### QUICK CUPPA

Mini Immersion Heater  
350w. 200-240v. Boils  
full cup in about two  
minutes. Use any socket or  
lamp holder. Have at bed-  
side for tea, baby's food,  
etc. 19/6, post and insur-  
ance 1/6.



### 9 VOLT PRECISION MOTOR

Intended for driving battery operated tape recorders and record players. Laminated. Pole Armature with Brush Gear and Rapid start switch. Normally 25/- . Our Price 7/8 plus post and insurance 1/6.



### CAPSTAN DRIVEN TAPE RECORDER



This is a truly portable self-contained instrument with built-in microphone and loudspeaker using a 7 transistor amplifier with P.P. output and suitable for operation from mains or by chargeable batteries. Tape capacity is 25 minutes on easily change spools. A tape position indicator gives quick reference to any part of dictation. Recording level is automatically preset during dictation and can be adjusted to suit operator. Interlock prevents unintentional erasures. Tape speed controlled by fly wheel driven capstan. Very portable in neat case with carrying handle, overall size of which is approximately 8 1/2 x 7 1/2 x 2 1/2. Price with tape and mains unit but less batteries, £5.18.6 (rather less than 1/3 original price). Postage and insurance 7/8. Unusual and in perfect working order.

### OZONE AIR CONDITIONER

For removing smells and generally improving oppressive atmosphere. In neat hammer finish box. Uses Philips ozone lamp and mains unit. Lamp easily replaceable. Only 39/6 plus 6/6 carriage and insurance.



### See in the Dark INFRA-RED BINOCULARS



These infra-red lit from a high voltage source will enable objects to be seen in the dark, providing the objects are in the rays of an infra-red beam. Each eye tube contains a complete optical lens system as well as the infra-red cell. These optical systems can be used as lenses for T.V. camera-light cells, etc. (details supplied). The binoculars form part of the Army night driving (Tabby) equipment. They are unused and believed to be in good working order, but sold without a guarantee. Price £3.17.6, plus 10/- carr. and ins. Hand-book 2/6.

### FLUORESCENT LIGHT KITS

Comprising choke, lampholders, starter and two chrome tube clips. 20 watt 19/6, 40 watt 11/6, Super Silent 40 watt 17/6, 80 watt 17/6, 65 watt 19/6. All 4/6 P. and F.

### THERMOSTATS

Type "A" 15 amp. for controlling room heaters, greenhouse, airing cupboard. Has spindle for pointer knob quickly adjustable from 30-80°F., 9/6, plus 1/- post. Suitable box for wall mounting, 5/- . P. & P. 1/-.

Type "B" 15 amp. This is a 17in. long rod type made by the famous Swissvic Co. Spindle adjusts this from 60-550°F. Internal screw alters the setting so this could be adjustable over 30° to 1000°F. Suitable for controlling furnace, oven, kiln, immersion heater or to make flamestart or fire alarm 8/6, plus 2/6 post and insurance.

Type "D" We call this the Ice-ast as it cuts in and out at around freezing point 2/5 amps. Has many uses, one of which would be to keep the loft pipes from freezing, if a length of our blanket wire (16 yds. 10/-) is wound round the pipes, 7/6. P. & P. 1/1.

### TRANS/CEIVERS

Communicate without connecting wires. Wonderful present for child. All transistor, crystal controlled with telescopic aerial and push button operation. Uses P.P.3 batteries. Pair of instruments, complete and ready to use £5.8.6 the two plus 5/- post and insurance. These cannot be used in U.K.



### SUPPRESSOR CONDENSER

Stop your drill or other appliances interfering with your or your neighbours' radio or television. Simple instructions given, 1/6 each. 12/- dozen.

### MAINS TRANSISTOR POWER PACK

Designed to operate transistor sets and amplifiers. Adjustable output 5v. 9V. 12 volts for up to 500 mA (class B working). Takes the place of any of the following batteries: PP1, PP3, PP4, PP6, PP7, PP9, and others. Kit comprises: mains transformer-rectifier, smoothing and load resistor, 5,000 and 500 mfd. condensers, Zener diode and instructions. Retail snip at only 14/6, plus 3/6 postage.

PP3 Eliminator—play your pocket radio from the mains! Save 2's. Complete component kit comprises 4 rectifiers—mains dropper resistances, smoothing condenser and instructions. Only 6/6 + 1/- post.

**NO SOLDERING POCKET 3**  
Lots of fun to build and good results when finished—complete kit with detailed instructions and crystal earpiece. Batteries, 1/2 extra. £5 value only 19/6, plus 3/- post & insurance.



### SILICON RECTIFIERS

Tested and guaranteed

750mA 100v. 1/3	1 Amp 100v. 3/-
200v. 1/6	200v. 4/6
400v. 3/6	400v. 6/-
3A 100v. 3/6	10 Amp 100v. 9/6
200v. 5/-	200v. 12/6
400v. 7/6	400v. 14/6
800v. 9/6	

Sub-miniature glass enclosed—only approx. 1/3in long wire ended.

750mA	50v. 1/6	100v. 2/6
	200v. 4/6	800v. 6/6

Where postage is not definitely stated as an extra then orders over £3 are post free. Below £3 add 2/6.

### MINIATURE WAFER SWITCHES

	2	3	4	6	12
1 pole	3/6	3/6	3/6	3/8	3/8
2 pole	3/8	3/8	3/8	3/8	3/8
3 pole	3/8	3/8	3/8		
4 pole	3/8	3/6			

Any 12 switches ordered together 36/-.

### GANGED POTS

Standard type and size with good length of spindle—made by Morganite. List-price is 10/- each but if you act quickly you can have them at 12/- doz. (or 1/6 each if less than doz.) Following values in stock all 1/1n — 5K + 5K — 10K + 10K — 100K + 100K — 500K + 500K all new and unused. Post 2/9 on 1st doz. then 1/- per doz. 6 doz. or more post free.



### ROLLER BEARINGS

You will find plenty of uses for these under anything which has to be moved, trolleys, sliding trays, etc. Made by Hoffman, approx. 2 1/2in. o.d. Offered at 4 for 10/-, post 4/6 extra.



### VACUUM CLEANER FLEX

Non-kinkable ribbed rubber, most pliable but very tough. 24/36 Cores. Normally 1/9 per unit, offered at £3 per 100 yard coil, post and insurance 8/6.

### SUB-MINIATURE SILICON DIODES

General purpose type with gold plated leads. 1/- each, 10/- per dozen.

### 20W. SPEAKER (BRITISH RATING)

This is a beautifully made Hi-Fi reproducer with heavy duty 10,000 line magnet and 3in. voice coil, gives really fantastic results. In maple veneered enclosure £7.15.0 plus 10/- carriage and insurance. Guitar model in fabric covered carrying case £7.15.0. Either speaker supplied less enclosure, £4.19.6 plus 10/- carriage and insurance.

### TWIN TWISTED 14/36 FLEX CABLE

Maroon cotton covered still the best for lighting drops. 50 yard coil 15/-, post 4/6.

### BUILDING SOMETHING?

This may save you a lot of time and money. Ex Redline Noise Limiter Unit has most useful power pack with 250-0-250v. 100 m.a. H.T. plus 250-0-250-3v. secondary, primary windings and standard primary fused and with adjustment 200-250v. H.T. is provided by EZ80 rectifier and 4 smoothing condensers. The power unit is housed in the very nice houred metal cabinet, size approximately 10in. x 10in. x 7in. on the front is a 2in. flush moving coil meter scaled d.b. Also five pre-set controls behind a removable panel. Within the unit is a 10in. x 10in. chassis on which the power pack is mounted. There are also five valve holders, but a lot of clear space for anything you want to fit. Below the chassis there is an assortment of tag, nuts and components. All new and unused, offered for less than the value of the power pack alone, 49/6 plus 10/- carriage and insurance.

### SEMI-CONDUCTOR BARGAINS

Type	No.	Price	Type	No.	Price
2N172	15/-		MAT101	8/6	
2N1728	10/-		MAT120	7/6	
2N1742	25/-		MAT121	8/6	
2N1747	25/-		OA5	5/-	
2N1748	10/-		OA10	8/6	
AC107	9/-		OA47	3/-	
AC121	9/-		OA70	2/6	
ACV17	8/6		OA79	2/6	
ACV18	5/6		OA81	2/6	
ACV19	6/6		OA85	2/6	
ACV20	5/6		OA90	2/6	
ACV21	6/-		OA91	2/6	
ACV22	4/6		OC200	3/6	
AF12	7/-		OC202	4/6	
AF115	6/6		OC220	3/6	
AF116	7/-		OC23	17/6	
AF117	5/-		OC24	15/-	
AF118	10/-		OC26	7/6	
AF139	12/6		OC28	15/-	
AF186	17/6		OC29	7/6	
AFZ12	15/-		OC35	12/6	
ASZ21	15/-		OC36	15/-	
BC107	14/6		OC42	6/6	
BY100	4/6		OC44	4/6	
BY213	7/6		OC45	3/6	
MAT100	7/9		OC70	4/-	
			OC71	3/6	
			OC72	5/6	
			OC75	6/6	
			OC76	5/6	
			OC77	7/6	
			OC78	5/6	
			OC78D	5/6	
			OC81	5/6	
			OC81D	5/6	
			OC82	5/6	
			OC83	5/6	
			OC84	6/6	
			OC139	8/6	
			OC140	12/6	
			OC170	5/6	
			OC171	6/6	
			OC200	9/6	
			OC201	12/6	
			OC202	13/6	
			OC203	12/6	
			OC271	15/-	
			ORP12	8/6	
			ORP60	5/6	
			8B078	6/6	
			8B305	8/6	
			8B251	10/-	



### DRILL CONTROLLER

Correct drill speed electronically without loss of power. Complete kit, case, thyristor, rectifiers, wire wound pot, etc.

ONLY 19/6. P. & P. 2/6

### 750 mW TRANSISTOR AMPLIFIER

4 transistors including two in push-pull input for crystal or magnetic microphone or pick-up—feed back loops—sensitivity 5 m/v. Price 19/6. Post and insurance 2/6. Speakers 3in. 12/6; 8in. 13/8. 6in. x 4in. 14/6.

### SCR'S (THYRISTORS)

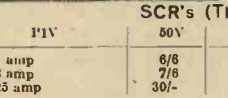
PIV	50V	100V	300V	400V
1 amp	6/6	7/8	12/6	15/-
3 amp	7/6	8/8	14/6	17/-
25 amp	30/-	35/-	47/6	60/-

### HALF PRICE—Proprietary Tapes

brand new, unused and guaranteed perfect and not second in any way—a connoisseur's tape on normal spools and in normal boxes.

Standard Play 5in.	600ft	9/-	Long play 5in.	900ft	11/6
	5 1/2in.	900ft.	11/6	5 1/2in.	1,200ft.
	7in.	1,200ft.	16/-	7in.	1,800ft.

£3 post free otherwise add 2/- post and insurance.



## ELECTRONICS (CROYDON) LIMITED

(Dept. PE), 102/3 TAMWORTH RD., CROYDON, SURREY (Opp. W. Croydon Stn.)  
also at 266 LONDON ROAD, CROYDON, SURREY

# Practical Electronics Classified Advertisements

The pre-paid rate for classified advertisements is 1/- per word (minimum order 12/-), box number 1/6 extra. Semi-displayed setting £3.5.0 per single column inch. All cheques, postal orders, etc., to be made payable to PRACTICAL ELECTRONICS and crossed "Lloyds Bank Ltd." Treasury notes should always be sent *registered post*. Advertisements, together with remittance, should be sent to the Advertisement Manager, PRACTICAL ELECTRONICS, George Newnes Ltd., Tower House, Southampton Street, London, WC2, for insertion in the next available issue.

## TAPE RECORDERS, TAPES, ETC.

**TAPES TO DISC**—using finest professional equipment—45 r.p.m. 18/- S.A.E. leaflet. DERROY, High Bank, Hawk Street, Carnforth, Lancs.

**20% CASH DISCOUNT** on most famous makes of Tape Recorders, Hi-Fi equipment, Cameras, etc. Join England's largest Mail Order Club now and enjoy the advantages of bulk buying. Send 3/- for membership card, catalogues, price lists and ask for quotation on any item. C.B.A. (Dept. A18), 370 St. Albans Road, Watford, Herts.

**SAVE UP TO 20%** on most new, guaranteed, Hi-Fi and Tape Recorders. Large s.a.e. details. MICROSERVICE, Fourways, Morris Lane, Hulsall, Leuca.

## FOR SALE

**SEE MY CAT.** for this and that. Tools, materials, mechanical and electrical gear—lots of unusual stuff. This Cat. is free for the asking. K. R. WHISTON (Dept. CPE), New Mills, Stockport

**FOR SALE.** Oscilloscopes — Galvanometers — Evershed & Vignoles Meggers. Also other items and components. Free list. Stamp please. R. & E. MART, Box 9, G.P.O., Tunbridge Wells, Kent.

## MINI-ANALOG COMPUTER

Another I-COR first

I-Cor Systems, who introduced Britain to Digi-Comp, have now developed MAC-1, an electrical analog computer. With this desk-top instrument you multiply and divide, take square roots and powers, and do log operations. Computing principles and techniques are not difficult to grasp; with classrooms and workshops in mind, *simplicity and quality* were primary considerations in the design of MAC-1. Apart from the obvious relevance to general maths problems, the Instruction Manual covers applications in electronics and physics, engineering and trigonometry. Complete in kit form, MAC-1 is 3 gns.—or £3 13s. 6d. built and ready for use. (For either please add 6/- carriage.) Or send 4d. stamp for details.

**I-COR SYSTEMS (PE5)**

18 STAMFORD HILL, LONDON, N.16

## FOR SALE

(continued)

**100 PAGE** illustrated catalogue No. 17 of Government and manufacturers' electronic and mechanical surplus, also a complete new section of the latest semi-conductors and miniature components, includes a credit voucher for 2/6. Send for your copy now. Price 3/- Post Free. ARTHUR SALLIS (RADIO CONTROL) LTD., 93 North Road, Brighton.

## HAMMERITE

HAMMER PATTERN BRUSH PAINT FOR PANELS, METALWORK

**3/6 TIN • JUST BRUSH ON • WITHSTANDS 150°C, OIL, WATER, Etc.**

2 1/2 oz. tins	3/6	1 gallon	35/-*
1 pint	7/6	1 gallon	58/-*
	15/-	(* sent by road)	

Carriage: Orders up to 5/- 9d; up to 10/- 1/9; over 10/- 3/-. Colours: Blue, Silver, Black or Bronze. Return of post service, Monday to Friday. From your component shop or direct from the manufacturer: **FINNIGAN SPECIALITY PAINTS (PE)** Mickley Square, Stocksfield, Northumberland Tel. Stocksfield 2280

**CRACKLE PAINT.** Black or Grey, 1/2 pint tins 4/-, post 6d. from the component specialists. **SERVIO RADIO**, 156-8 Merton Road, Wimbledon, London, S.W.19.

## MORSE MADE!

**FACT NOT FICTION.** If you start right you will be reading amateur and commercial Morse within a month. Using scientifically prepared 3-speed records you automatically learn to recognise the code RHYTHM without translating. You can't help it, it's as easy as learning a tune.

For full explanatory booklet enclose 6d. in stamps to: **G3CHS/E**, 45 Green Lane, Purley, Surrey. S.T.D. 01-660 2896

## MISCELLANEOUS

**ALUMINIUM CHASSIS, PANELS, Etc.** Quick service. 'One-offs' welcome. Send sketch for quotation (Stamp please), Trade Supplied. **FAIRISGRADES LTD.**, Barling, Nr. Southend, Essex.

**CONVERT ANY TV SET** into an Oscilloscope. Diagrams and Instructions, 12/6. **REDMOND**, 42 Dean Close, Portslade, Sussex.

## BERNIESOUND (AUDIO ENGINEERS)

Design-Build-Repair-Modify  
All types of Electronic Equipment  
For estimates write to:—  
Mr. Brown, 1 Effie Place, London, S.W.6.

**NEW (BBC2) CONVERSION KITS** for Phillips and associate models, including tuner, IF panel, 7 valves, instructions, guarantee card, etc. **£3.10.0** p/p 6/6, c.o.d. add 2/6. 60 Wellesley Avenue, Norwich, Norfolk.

## BOOKS AND PUBLICATIONS

### SURPLUS HANDBOOKS

19 set Circuit and Notes	4/6 P.P. 6d
1155 set Circuit and Notes	4/6 P.P. 6d
H.R.O. Technical Instructions	3/6 P.P. 6d
38 set Technical Instructions	3/6 P.P. 6d
46 set Working Instructions	3/6 P.P. 6d
88 set Technical Instructions	5/- P.P. 6d
BC. 221 Circuit and Notes	3/6 P.P. 6d
Wavemeter Class D Tech. Instr.	3/6 P.P. 6d
18 set Circuit and Notes	3/6 P.P. 6d
CR.1000 (31 set) Circuit & Notes	3/6 P.P. 6d
CR.100/B.28 Circuit and Notes	8/6 P.P. 9d
R.107 Circuit and Notes	5/- P.P. 6d
A.R.88D. Instruction Manual	15/- P.P. 1/6
62 set Circuit and Notes	4/6 P.P. 6d
52 set Sender & Receiver Circuits	6/-, post free
Circuit Diagrams 3/- each post free.	
R.1116/A, R.1224/A, R.1355, R.F. 24, 25, & 26.	
A.1134, T.1154, CR.300, BC.342, BC.312.	
BC.348, J.E.M.P. BC.624, 22 set.	

Resistor colour code indicator, 1/6 P.P. 6d. S.A.E. with all enquiries please. Postage rates apply to U.K. only. Mail order only to: **Instructional Handbook Supplies** Dept. P.E., Talbot House, 28 Talbot Gardens Leeds 8

## EDUCATIONAL

**ELECTRONIC EXPERIMENTS.** The practical way of mastering electronics. Complete experiment kits with instructions, components, circuits, tabulation and graph sheets, etc. Write for **FREE** booklet. **ELECTRONIC EXPERIMENTS**, 49 Heath Lane, Brinklow, Rugby.

**HOME STUDY COURSES** in Practical Electronics. Free Brochure without obligation from: **BRITISH NATIONAL RADIO SCHOOL**, Reading, Berks.

## TELEVISION SERVICING RADIOTELEGRAPHY RADAR MAINTENANCE

Full and Part-time Training Courses

Apply:—Director, British School of Telegraphy, 20 Penywern Road, Earls Court, London, S.W.5

A.M.S.E. (Elec.), City & Guilds, G.C.E., etc., on "Satisfaction or Refund of Fee" terms. Wide range of Home Study Courses in Electronics, Computers, Radio, T.V., etc. 132-page Guide—**FREE**. Please state subject of interest. **BRITISH INSTITUTE OF ENGINEERING TECHNOLOGY** (Dept. 124K), Aldermaston Court, Aldermaston, Berks.

**CHAMBERS GUIDE (New).** Details of 293 Careers and spare-time Business, Technical and Examination Courses. A Mine of friendly "know-how" for go-aheads. For free copy write—**CHAMBERS COLLEGE** (Dept. 856K), 148 Holborn, E.C.1.

## EDUCATIONAL

(continued)

**ALDERMASTON COURT POSTAL TRAINING** for B.Sc. (Eng.) Part 1, A.M.I.E.R.E., A.M.S.E., City & Guilds, G.C.E., etc. prepares you privately for high pay and security as Technician or Technologist. Thousands of passes. For details of Exams and Courses in all branches of Engineering, Building, Electronics, etc. (including latest information on C.Eng.), write for 132-page Handbook—FREE. Please state interest. **BRITISH INSTITUTE OF ENGINEERING TECHNOLOGY**, (Dept. 125K), Aldermaston Court, Aldermaston, Berks.

**STUDY RADIO, TELEVISION & ELECTRONICS** with the world's largest home-study organisation. I.E.R.E., City & Guilds, R.T.E.B., etc. Also practical courses with equipment. No books to buy. Write for FREE prospectus stating subject to I.C.S., Intertext House, Parkgate Road (Dept. 577), London, S.W.11.

## APPOINTMENTS

**TECHNICIANS/JUNIOR TECHNICIANS** required; (a) experienced in electronics and preferably with ability in the use of machine tools for applied acoustics research laboratories, and (b) to do interesting work for research laboratories, including photographing and electronic assembly. Salary Junior Technician £366-£624 p.a., Technician £698-£1,078 depending of qualifications and age. Application forms obtainable from Superintendent of Laboratories, Physics Department, **CHELSEA COLLEGE OF SCIENCE AND TECHNOLOGY**, Manresa Road, London, S.W.3. Tel. FLA. 6421, ext. 28.

## SITUATIONS VACANT

### RADIO TECHNICIANS

A number of suitably qualified candidates are required for permanent and pensionable employment (mostly in Cheltenham, but from time to time there are some vacancies in other parts of the U.K. including London). There are also opportunities for service abroad.

**Applicants** must be 19 or over and be familiar with the use of Test Gear, and have had practical Radio/Electronic workshop experience. Preference will be given to candidates who can offer "O" Level GCE passes in English Language, Maths and/or Physics, or hold the City and Guilds Telecommunications Technician Intermediate Certificate or equivalent technical qualifications.

**Pay** according to age, e.g. at 19—£747, at 25—£962 (highest age pay on entry) rising by four annual increments to £1,104.

**Prospects** of promotion to grades in salary range £1,032—£1,691. There are a few posts carrying higher salaries.

**Annual Leave** allowance of 3 weeks 3 days, rising to 4 weeks 2 days. Normal Civil Service sick leave regulations apply.

Application forms available from:

Recruitment Officer (RT)  
Government Communications Headquarters  
Oakley  
Priors Road  
CHELTENHAM, Glos.

## SITUATIONS VACANT (continued)



## TEST ENGINEERS

### PYE TELECOMMUNICATIONS LTD.

### CAMBRIDGE

Due to rapid expansion of this Company in the communication field and the progressive promotion within the organization, a number of vacancies exist for engineers.

Ideally we are looking for men capable of fault finding and checking to an exacting specification V.H.F. and U.H.F. communication equipments involving valve and transistor circuitry. Training will be given to all applicants with the right background.

Suitable applicants will join our permanent staff and will enjoy the benefits of a Company which is offering first class financial rewards and rapid advancement within the organization.

Apply to:

The Personnel Manager,  
Pye Telecommunications Ltd.,  
Newmarket Road,  
Cambridge.

Phone: Cambridge 61222.



# TECHNICAL TRAINING by

# ICS IN RADIO, TELEVISION AND ELECTRONIC ENGINEERING

First-class opportunities in Radio and Electronics await the ICS trained man. Let ICS train YOU for a well-paid post in this expanding field.

ICS courses offer the keen, ambitious man the opportunity to acquire, quickly and easily, the specialized training so essential to success. Diploma courses in Radio/TV Engineering and Servicing, Electronics, Computers, etc. Expert coaching for:

- INSTITUTION OF ELECTRONIC AND RADIO ENGINEERS.
- C. & G. TELECOMMUNICATION TECHNICIANS' CERTS.
- C. & G. SUPPLEMENTARY STUDIES.
- R.T.E.B. RADIO AND TV SERVICING CERTIFICATE.
- RADIO AMATEURS' EXAMINATION.
- P.M.G. CERTIFICATES IN RADIOTELEGRAPHY.

Examination Students Coached until Successful.

**NEW SELF-BUILD RADIO COURSES.**

Build your own 5-valve receiver, transistor portable, signal generator and multi-meter—all under expert tuition.

**POST THIS COUPON TODAY** and find out how ICS can help YOU in your career. Full details of ICS courses in Radio, Television and Electronics will be sent to you by return mail.

MEMBER OF THE ASSOCIATION OF BRITISH CORRESPONDENCE COLLEGES.

**INTERNATIONAL  
CORRESPONDENCE  
SCHOOLS**

**A WHOLE WORLD  
OF KNOWLEDGE  
AWAITS YOU!**

International Correspondence Schools  
(Dept. 152), Intertext House, Parkgate Road,  
London, S.W.11.

NAME .....

Block Capitals Please

ADDRESS .....

5.67

## RECEIVERS AND COMPONENTS

**BC107, BC108, BC109 Transistors** 6/9 each. S.A.E. for details or cash with order. P. B. ELECTRIC, 17 Bronson Road, London, S.W.20.

## R. & R. RADIO & TV SERVICE

Dept. P.E.  
44 Market Street, Bacup, Lancs. Tel. 465

Salvage Valves	Good Emission Guaranteed	
EF80 1/6	30P4 7/-	30FL1 5/-
ECC82 3/-	EB91 1/-	PL82 4/6
ECL80 3/6	EF85 5/-	PL36 7/-
30F5 5/-	30PL1 5/-	
PCF80 4/-	EY86 4/-	PCC84 4/-
PL81 5/-	6U4GT 5/-	PY81 3/6
PZ30 5/-	PY33 6/-	U301 6/-

**SPEAKERS** Ex TV 3 ohm imp, 5" Rnd, and 6" X 4" 3/6. 8" Rnd. 6/- Post 2/6.  
BY100, Rectifiers complete with 10 watt res. 6/- Post 6d. Fireball Tuners, less cover cans 9/- post paid.  
Ekco line o/p trans, U26 type 35/- post paid. Ferg line O/P 406T 30/-, Ferg 306 type, New, 70/-, Cydon type 'C' tuners 15/- post 2/-.  
S.A.E. with all enquiries.  
9 X 4 Envelope for lists.

2N2026 3/6, OC71 3/6, OA81 1/9, 850V, 1A. Rectifiers 4/7, 1W 5 1/2, H.S. resistors 4d. add 6d. pp. Discount on 10 and up. A. P. ROBSON, 41 Thunder Lane, NORWICH.

### NEW COMPONENTS

★ ASSORTED TRANSISTORS—6 Tested A.F. Devices ..... 9/6

★ ASSORTED RESISTORS—Hi-5tab. 300 oh (5%, 1/4, 1/2, 3 watt, worth £3) ..... 15/-

★ SLIDER SWITCH—Quality Miniature 2 pole changeover ..... 3/-  
Subminiature 4 pole changeover ..... 5/-

★ TRANSISTORS—Matched Output Kit: OC81D and 2-OC81 ..... 9/6  
R.F. Kit: OC44 and 2-OC45 ..... 9/6  
OC44, 45, 70, 71, 72, 81 and 81D Equivalent, each ..... 3/-

(P. & P. 1/6 per order, C.W.O.)

**ELMBRIDGE INSTRUMENTS LTD.**  
Island Farm Avenue, West Molesey, Surrey

### MARKET CENTRE FOR SEMICONDUCTORS

AC126 8/-	BCY31 16/-	OC71 4/-
AC128 4/-	BFY51 9/6	OC73 3/-
AC176 6/-	OC28 15/-	OC76 3/-
AF115 4/-	OC29 19/-	OC81 3/-
AF116 4/-	OC35 12/-	OC81D 3/-
AF117 4/-	OC36 20/-	OC82 4/6
BC107 7/9	OC41 3/6	OC83 4/6
BC108 7/6	OC42 4/-	OC170 4/-
BC109 8/3	OC44 3/-	OA5 4/6
BCY30 8/3	OC45 3/-	OA10 3/-
Full Mullard range in stock. See our Cat. 1/-		OA81 1/6
		OA200 4/-

SAVE £££ WITH OUR BARGAIN PACKS:

4 BY100 Sil. Rectifiers	13/-
4 OA210 Sil. Rectifiers	12/-
4 OC81 Mullard	10/-
2 OC45 + 1 OC44 RF set	8/6
3 2N2926 Planars (Yellow)	11/-
12 OC45 equivalents (2G345B)	20/-
2 Complementary Power AD161/2	10/-
2 OC81 Matched + 1 OC81D	7/-
15" Veroboard 36 square inches	10/-
4 pieces 2 Amp. 100 pin Sil. Rectifiers	10/-
150 yards PVC wire 4 colours	11/-

RECENTLY SPECIFIED TYPES:

2N2160 15/-	2N3228 19/-	NKT274 3/6
2N3528 19/-	2N2147 17/-	NKT0013 12/-

Postage 9d. Callsers Welcome  
**L.S.T. COMPONENTS**  
23 New Road, Brentwood, Essex

## RECEIVERS AND COMPONENTS

(continued)

**GENERAL PURPOSE TRANSISTORS** type GET3, for switching, multi-vibrators, AF, 8/6 for 10. PP. £2.10.0 100, post 1/6. ZR10 rectifiers, 2/6. 12V 5% zeners 3/6 PP. 300V De/Mc FR panel meters 6", full glass dials, basic approx 3.5 m/A, 15/- each. Post 6/-. J. COOPER, 13 Churchfield Road, Outwell, Wisbech, Cambs.

## BARGAINS! BARGAINS!

Ex Government Equipment

HRO's, AR88's, 19 SETS and EQUIPMENT, 31 SETS, B44's, 88, 38 and 18 SETS and miscellaneous equipment.

Complete List 1/- (S.A.E.)

**A. J. THOMPSON (Dept. P.E.)**  
Elling Lodge, Codicote, Hitchin, Herts.

Tel.: Codicote 242

**TRANSISTORS.** BC107 7/6, BC108 7/6, NKT217 8/-, NKT0013 (NKT20329) 10/6, BFY 8/6, BCY31 13/6, 1B40K 10 30/-, 2N3819 25/-, 2N2147 16/-, AU10 40/-, ACY22 4/-, NKT274 3/6, NKT675 4/8, NKT773 5/-, Brand new, P.P. 6d. C.W.O. Mail only. M. HARVEY, 29 The Drive, Potters Bar, Herts.

## TAPES AND TRANSISTORS

Best quality recording tape at cheapest prices in U.K.

	Std.	LP.	DP.	ER.
7 in.	1200' 7/9	1800' 12/-	2400' 20/3	2/3
5 1/2 in.	900' 6/9	1200' 8/9	1800' 15/3	2/-
5 in.	600' 5/6	900' 7/3	1200' 11/3	2/-
3 in.	150' 2/3	225' 3/9	300' 4/9	9

**Tested and Guaranteed Transistors**

3/- each OC44, OC46, OC70, OC71, OC72, OC75, OC76, OC78, OC78D, OC81, OC81D, OC82, OC82D.

4/- each AF114, AF115, AF117, AF118, AF125, AF127, OC77, OC170, OC171, OC172, AC127, AC128.

4/6 each AF119, BY100, OC84, OC139, OC169, TK22C, TK28C.

8/- each OC22, OC23, OC25, OC26, OC28, OC123, AC107, AD140.

### Special Offers

2/6 each OC45, AC126, AF116, OAS.  
5 x OC45 10/-.  
BCY33, BCY34, BCY38, BY133, BFY50 6/6 each.  
Money refunded in full if not satisfied.  
Post and Packing. Tape 2/9 per order.  
Transistors 1/- d. per order.

**A. MARSHALL & SON (London) LTD.**  
28 Cricklewood Broadway, London  
Dept. P.E.12 01-452 0161 N.W.2

## SILICON PRODUCTS

2N3053. NPN. 60V. IW. 10/6  
2N3055. NPN. 100V. .65W. 21/6  
Unijunction 2N2646 13/6  
Computer Diodes 1/-

**PREMMIT LTD., Components Div.**

31 Queen Anne's Gate  
London, S.W.1

C.W.O. Add 1/- P. & P.

## RECEIVERS AND COMPONENTS

(continued)

'X' LINE	Modules you can open !!	
X-161	2 Watt Amplifier	35/-
X-191	Guitar Amplifier	35/-
X-141	Record Player Amp.	35/-
X-151	Intercom.	35/-
X-481	Audio Booster	30/-
X-461	Siren	35/-
X-471	Burglar Alarm	35/-
X-661	Metronome	30/-
X-761	Morse Oscillator	20/-
X-671	Lamp Flasher	32/6
X-691	Lamp Flasher (Double)	30/-
X-261	Mic. FM Transmitter	35/-
X-271	Telephone Transmitter	35/-
X-241	R/Player Transmitter	35/-
X-291	Guitar Transmitter	35/-
X-371	Wireless Sentry	35/-



Send a S.A.E. for details to:  
**L.S.T. COMPONENTS**  
23 New Road, Brentwood, Essex

2N3054 21/- BC107 7/9 FET-2N3819 25/-  
2N3055 22/6 BC108 7/6 FET-2N3820 25/-  
2N3702 5/6 BC109 7/6 ALL-2N2926 4/-  
2N3704 5/6 ME301 2/6 SCR-2N3525 25/-  
ME4001 4/6 ME301 2/6 UJT-T1543 13/-  
ME4002 4/9 OC83 4/6 T.D. IN-3716 25/-  
ME4003 5/3 N-TYPE ECONOMY FET 14/-

MILLTRENDS  
1 ULLSWATER ROAD, LEVERSTOCK GREEN  
HEMEL HEMPSTEAD, HERTFORDSHIRE  
C.W.O. Post Free S.A.E. List Mail Order Only

## ECONOMY SEMICONDUCTORS

New Triacs (SCR's for a.c.)  
400V, 5A, 45/-, for lamp dimming, speed control, etc.  
All voltages 2.7 to 33V, 5% tolerance, 400mW, 6/- each.

**Zener Diodes**  
Germanium Transistors  
AC17, 8/6. ACY18, 5/6. ACY19, 6/6. ACY20, 5/-, ACY21, 6/-, ACY22, 3/6. NKT21, 5/-, NKT22, 4/9. NKT23, 4/9. NKT24, 3/9. NKT25, 9/-, NKT27, 7/-, 2N1304, 4/3. 2N1305, 4/3. 2G301, 4/6. 2G302, 5/5. 2G308, 6/9. 2G309, 8/-.

**Silicon Transistors**  
BC107, 7/-, BC108, 6/3. BC109, 7/3. 2N3241A, 7/3. 2N3242A, 9/9. 2N3053, 11/6. 2N3702, 4/9. 2N3706, 4/6. 2N3709, 3/3. 2N3711, 5/-, 2N2926 all colours, 4/- each. 40319, 13/6. 2N3055, 23/-.

**Complementary Matched Pairs**  
2N1304/2N1305, 9/-, 2N2926/2N3702, 9/-, 2N3705/2N3702, 11/2. 2N3053/40319, 25/6.  
Over 100 popular types in stock. Over 1,000 types listed on short delivery. Send for catalogue giving data, equivalents and other useful information, 6d.

**Resistors**  
Carbon film low noise. 1W, 10%, 2/- doz., 15/- 100. 1/4W, 5%, 2/3 doz., 17/3 100. Large quantities stocked. 47Ω to 10MΩ, your choice (12 preferred values per decade only).

**Skeleton Presets**  
100Ω, 250Ω, 500Ω, etc., to 10MΩ. Horizontal or vertical mounting, 1/-.

**Disc Ceramics**  
330pF 500V, 5d. 470pF 500V, 5d. 1000pF 500V, 5d. 0.01μF 50V, 5d. 150pF 500V, 6d. 220pF 500V, 6d. 220pF 500V, 6d. 330pF 500V, 6d. 0.02μF 50V, 6d. 0.05μF 50V, 6d. 4700pF 500V, 7d.

**Polyester Capacitors**  
0.1μF 250V, 10d.

**Cir-Kits**  
No. 3 Pack, 15/-.

**Peak-Sound**  
Stereo Amplifier kit, £12 19s. 6d. Power Supply kit, £3 15s. 0d. P. & P. 5/6d.  
Discount of 10% on orders over £3

## ELECTROVALUE

6 Mansfield Place, ASCOT, Berkshire

## RECEIVERS AND COMPONENTS

(continued)

**REPANCO** Transistor Coils and Transformer. for the Constructor. Send stamp for lists **RADIO EXPERIMENTAL PRODUCTS LTD., 33 Much Park Street, Coventry.**

### CLEARANCE OFFER! UNREPEATABLE BARGAINS! LIMITED QUANTITIES!

Industrial 1" Digital Recording Heads,  
10-track, Record/Replay/Erase. Cost  
over £200 ..... £10

#### HY-GRADE RELAYS

OCAL base, 24v. removable cover,  
2 pair c/o contacts rated 2A ..... 5/6 each  
Chassis mounting, 24v. sealed, 3 pair  
c/o contacts rated 5A ..... 6/6 each  
Hi-speed, P.O. type, 500Ω coil,  
2 pair c/o contacts rated 1A ..... 4/6 each

Panel mounting switches, 30A, 250v.  
D.P. .... 6/- each  
3000µf, 15VDC Electrolytics ..... 2/9 each  
50-50µf, 275VDC Electrolytics ..... 2/8 each  
16µf, 350VDC Electrolytics, can type ..... 2/3 each  
25µf, 100VDC paper ..... 9d. each  
.01µf, 500VDC paper ..... 7d. each  
220pf, 350V polystyrene ..... 5d. each  
10Ω w.w. Miniature Potentiometers ..... 1/2 each  
Turret Tags 1in., to fit 2in. hole ..... 5/6 gross  
Porcelain Beads, 4in. hole ..... 4d. doz.

#### SPECIAL BARGAIN

Quartz Crystals, 57.6kc ..... 12/6 each  
Post and Packing 1/6d.

**DORIC TRADING COMPANY**  
19 HIGHER HILLGATE  
STOCKPORT, CHESHIRE

#### TRANSISTOR PANELS

New boxed, size 9" x 6" x 1 1/2" with "Valvo"  
transistors type OC45 or similar, with full  
length leads, also an equal number of OA85  
diodes, H/S resistors, etc. Built on perforated  
board in a metal frame.

Panel of 20 transistors, diodes, etc. 20/-  
30 - 25/- 60 - 40/- 90 - 100 - £3  
40 - 30/- 70 - 45/-  
50 - 35/- 80 - 50/-

Postage 2/- per panel.

Polystyrene Capacitors, 350v. 680, 820, 1,800,  
2,200, 2,700, 5,600, 6,800, 0.018, 0.022, 0.033,  
125v. 1,000, 1,200, 1,500, 1,800, 3,300, 3,900,  
4,700, 8,200, 0.01, 0.012, 0.015, 2/- dozen any  
selection. Heat Sinks 10W finned, 5/-. Miniature  
Relays, 1" x 1" x 1", 950 ohm, 2 pole  
change over 10/-. Electrolytics, 5,000 MFD,  
50v. 6/6. 1,000 MFD, 60v. 5/-. 1,000 MFD,  
30v. 4/-. 3,000 MFD, 10v. 2/-. Gold Bonded  
Diodes, 75v. P.I.V. 75mA. cards of 25, 18/-  
Wire Wound Pots 5, 10, 25, 50, 100, 250, 500,  
1k, 2k, 2.5k, 5k, 10k, 20k, 25k, 50k, 100k, not  
presets, 2/- each. Minimum order 5/-, post 1/-.

**NEW CROSS RADIO**  
6 OLDHAM ROAD, MANCHESTER 4

### COMPONENTS FOR A.C. POWER CONTROL

Silicon Bridge Rectifiers 1A 400PIV encap-  
sulated in cylinder 1 cm. by 1 cm. ....  
15/6 p.p. 6d.

Unijunction Transistors 2N2646 suitable for  
firing SCR's. .... 12/- p.p. 6d.

The above are first grade components, not  
seconds or rejects.

\*'Cir-kit' for instant printed circuits without  
messy etching processes Kit, No. 3. ....  
15/- p.p. 6d.

SCR's (thyristors) also available 400PIV 1A 10/-,  
400PIV 3A 13/- p.p. 6d. Fully tested.

**NESLO ELECTRONICS**  
53 GROSVENOR PLACE  
NEWCASTLE UPON TYNE 2

## RECEIVERS AND COMPONENTS

(continued)

### TRANSISTORS, ETC.

#### MIN TRANSISTOR CONDENSERS

1MFD 12V, 1/- 0.25MFD, 1/3  
10MFD 12V, 1/3 0.5MFD, 1/3  
30MFD 12V, 1/3 0.01, 0.02, 7d. each  
50MFD 12V, 1/3 0.04, 0.05, 8d. each  
100MFD 12V, 1/4 0.1, 9d. each  
Plus 4d. p.p. any quantity.

4 transistor amplifier push pull output 200  
mW/att, 30/- post paid.

#### TRANSISTORS

Special offer 1 OC44 + 2 OC45 + 1 OA81 +  
1 OC81D + 2 OC81, 12/6 + 4d. p.p. 1 OC82D  
+ 2 OC82, 7/6 p.p., OC71, 2/6 ea. + 4d. p.p.  
any quantity. OC44, OC45, OC72, OC81D,  
OC81, 3/- ea. OC83 5/6 + 4d. p.p. any quantity.  
AF116, AF117, OC170, 3/6 each. OC26 7/6,  
OC82D 3/-. AF114, AF115, 3/9 each. OA81,  
OA79, OA91 Diodes, 1/6 each. + 4d. p.p. any  
quantity.

#### SILICON RECTIFIERS

BY100 5/- + 4d. p.p. any quantity. BYZ19  
200 P.I.V. 6 amps. 5/4 each p.p. BYZ15 200  
P.I.V. 40 amps £2 17s. Od. each. 800 P.I.V.  
400M/A 4/- each + 4d. p.p. any quantity.  
800 P.I.V. 5 amps, 6/6 each p.p. 50 P.I.V.  
20 amps, 12/6 p.p.

#### TEXAS TRANSISTORS (GRADE 1)

2N1302 - ASY28, 6/6 each. 2G339A -  
AC127, 2/6 each. 2G374 = OC75, 2/4 each.  
25301 Audio, 2/6 each. GM0290 cut of  
freq., 700 M/c/s. 19/6 each.

#### NEWMARKET TRANSISTORS (GRADE 1)

NKT271, 8/-. NKT773, 10/-. NKT278, 6/6.  
NKT713, 12/6. NKT279A, 3/6. NKT214, 6/6.

#### ACOS RECORD PLAYER CARTRIDGE

Suitable for Collo, Grand, BSR, etc., with  
needles, 12/6 p.p. Mullard AF186, u.h.f.  
transistors, cut of freq., 800 M/c/s, 27/6 each  
p.p. Transistor T.V. Amplifiers, £3 15s. Od.  
Please state channels.

#### TRANSISTOR POCKET RADIOS

From £3, s.a.e. for details. ORP12 Cadmium  
Sulphide Cells, 7/9. Denco Technical Bulletin,  
2/4 p.p. Radio Television Industrial Tube,  
Diode Transistor Equivalents Manual, 10/6 +  
6d. p.p.

#### MAT TRANSISTORS

MAT101, 8/6. MAT121, 8/6. MAT100, 7/9.  
MAT120, 7/9. NKT219 = AC126, 6/6 each.

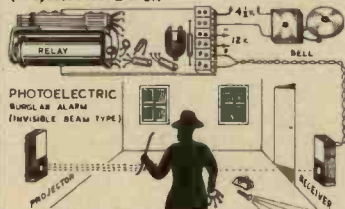
#### J. ROBINSON (RADIO TV)

4 HIGHCLIFFE ROAD, BLACKLEY  
MANCHESTER 9 Mail Order Only

## PHOTOELECTRIC KIT

Build 12 EXCITING  
PHOTOELECTRIC DEVICES  
on a Printed Circuit Chassis

CONTENTS: 2 P.C. Chassis Boards, Chemicals  
Etching Manual, Infra-Red Sensitive Photocell,  
Latching Relay, 2 Transistors, Resis. Cond.  
Pot. Terminal Block, Elegant Case, Screws,  
etc. In fact, everything you need to build a  
simple but efficient Photo-Switch/Burglar  
Alarm/Counter, etc. (Project No. 1) which can  
be modified for modulated light operation  
(Projects Nos. 2 & 3).



Also Essential Data, Circuits and Plans for  
building 12 PHOTOELECTRIC PROJECTS. (1) Simple  
Photo-Switch. (2) Modulated Light  
Alarm. (3) Long Range Strobe-Light Alarm. (4)  
Relay-less Alarm. (5) Warbling-Tone Alarm.  
(6) Closed-Loop Photoelectric Alarm. (7) Proj-  
ector Lamp Stabiliser. (8) Electronic Projector  
Modulator. (9) Mains Power Supply Unit. (10)  
Automatic Car Parking Lamp Controller. (11)  
Super Sensitive Relay-Less Modulated Light  
Alarm. (12) Car Automatic Headlamp Dipper.  
Basic Kit: 39/6. Post and Packing 2/6 (U.K.)

#### OPTICAL KIT

Everything needed (Except plywood) for build-  
ing 1 Folded-Beam Projector and 1 Photocell  
Receiver to suit PHOTOELECTRIC PROJECTS.  
CONTENTS: 2 lenses, 2 mirrors, Infra-Red  
Filter, 2 45 deg. Blocks, Projector Lamp  
Holder and Bracket, Plans, etc. Optical Kit:  
19/6. Postage and Packing 1/6.

Send S.A.E. for details and photographs  
**YORK ELECTRICS, 333 York Rd. S.W. 11**

## RECEIVERS AND COMPONENTS

(continued)

### AT LAST! THOSE HARD TO GET MICROMINIATURE MICROPHONES

Sensitive dynamic type. Size approx. 1/4"  
square by 1/8" thick. Impedance approx. 1K.  
Ideal for external or built in application.  
LIMITED STOCKS AT ONLY 28/6 postfree.  
C.W.O.

#### MICRO DATA SYSTEMS

30 Baker Street, London, W.1

#### SILICON PRODUCTS

2N696 6/6	2N697 7/-
2N706 4/6	2N3702 4/6
2N3704 5/6	2N3708 4/6
2N3053 11/-	2N3055 22/-

#### FULL WAVE BRIDGES

100PIV 6 amps 50/-	200V 60/-
100PIV 10 amps 65/-	200V 75/-

#### RECTIFIERS 1 AMP

50V 6/6	100V 7/-	400V 9/-
	800V 14/6	

#### RECTRA COMPONENTS LTD.

25 Victoria Street  
LONDON, S.W.1

C.W.O. add postage

## SPECIAL OFFER

1 Watt S.T.C. 300 MC/S N.P.N.  
Silicon Planer. Transistors. With  
data. Limited Stocks. £1 for 6.

3/- each. OC44, OC45, OC70,  
OC71, OC81, OC81D, OC200,  
Get 16, Get 20.

4/- each. AF114, AF115, AF116,  
AF117, OC170, OC171.

5/- each. OC139, OC140, Get  
7, Get 8, Get 9, XCI41, BY100,  
OA211.

#### ZENER DIODES

3.9v. to 26 volt, 1/4w. 3/6 each,  
1.5w. 5/-, 7w. 6/- each.

Send 6d. for full lists: inc. S.C.R.  
Zeners.

BSY 27, 7/6 each. OC20, 10/-  
each.

## Cursons

78 Broad Street  
Canterbury  
Kent

#### SERVICE SHEETS

**SERVICE SHEETS** for all makes Radio, T/V,  
Tape Recorders, 1925-1967. Prices from 1/-.  
Catalogue 6,000 models, 2/6. Free fault-  
finding guide with all sheets. Please send  
stamped addressed envelope with all orders/  
enquiries. HAMILTON RADIO, Western Rd.,  
St. Leonards, Sussex.

## SERVICE SHEETS

(continued)

**SERVICE SHEETS**, Radio, TV, 5000 models. List 1/6. S.A.E. enquiries. TELRAY, 11 Maudland Bank, Preston.

**RADIO TELEVISION**, over 8,000 Models. JOHN GILBERT TELEVISION, 1b Shepherds Bush Rd., London, W.6. SHE 8441.

T.V. Fault finding guide and unique testing device with servicing instructions. Faults found in minutes 15/-. With service sheets 4/- each extra. Service sheets with guide only 7/6. Radio sheets 3/- all P.P. State model Nos. **ELECTRONIC SUPPLIES AND SERVICES (I.W.)**, 16 Gordon Road, Newport, I.W.

# ELECTRONICS GALORE! IN THE NEW dca CATALOGUE

THE CONVENIENT WAY TO SHOP FOR ALL YOUR ELECTRONIC NEEDS.

EVERYTHING FROM SINGLE COMPONENTS TO COMPLETE EQUIPMENT ALL AT BEST VALUE PRICES.

SEND 1/6d. NOW FOR YOUR COPY TO:—Dept. PE/6

**dca ELECTRONICS LIMITED**  
28 UXBRIDGE ROAD, EALING, W.5

**HIGH SPEED-MAGNETIC COUNTERS** (4 × 1 × 1 1/2 in.). 4 digit. 12/24/48V. (state which) 6/8 each. P. & P. 1/-.

**RE-SET H.S. MAGNETIC COUNTERS** (3 × 1 × 1 1/2 in.). 3 digit. 12/24/48V. (state which) 32/8 each. P. & P. 2/6.

**COPPER LAMINATE BOARD** (8) × 6 1/2 × 1/2 in. 2/6 each. 5 for 10/-.

**PRINTED CIRCUIT CONNECTORS**, 13 way 'in-line', Gold Plated Pins. 4/6 Pr. P. & P. 6d.

### BULK COMPONENT OFFERS

100 Capacitors (latest types) 50pF to 5μF.

250 Carbon Resistors 1/2 & 1W. (Transistor types).

250 Carbon Resistors 1/2 & 1W.

150 High-Stab Resistors 1/2, 1/4 & 1W.

100 Ceramic Capacitors 2—1000 pF.

25 Vitreous W/W Resistors (5%).

12 Precision Resistors (1%).

25 Close Tolerance Caps. (2%).

ANY ITEM 10%-. ANY 5 ITEMS £2.

**SILICON CONTROLLED RECTIFIERS**, CRS 1/30 (360 P.I.V. 1 amp) 7/6 each. CRS 3/40 (460 P.I.V. 3 amp) 10/- each.

**PHOTOFLASH ELECTROLYTIC** 2000μF, 275V. 17/8, P. & P. 2/6.

**ELECTROLYTICS** 100μF, 60V. 2/8; 200μF, 250V. 3/8; 100 & 400μF, 275V. 6/8; 500μF, 100V. 4/-; 1000μF, 50V. 5/-; 3000μF, 100V. 7/6; 5000μF, 50V. 7/6. P. & P. 2/6 in £1.

**PATRICK & KINNIE**  
81 Park Lane  
Romford, Essex  
ROMford 44473

## SERVICE SHEETS\* (continued)

### SERVICE SHEETS

4/- each, plus postage.

We have the largest supply of Service Sheets for all makes and types of Radios and Televisions, etc. in the country. Speedy Service.

To obtain the Service Sheet you require, please complete the attached coupon:

From:

Name: .....

Address: .....

.....

.....

### To: S.P. DISTRIBUTORS

35/36 Great Marlborough Street, London, W.1

Please supply Service Sheets for the following:

Make: .....

Model No.: ..... Radio/TV

Make: .....

Model No.: ..... Radio/TV

Make: .....

Model No.: ..... Radio/TV

I also require the new 1967 list of Service Sheets at 1/6 plus postage. (please delete items not applicable)

I enclose remittance of .....

which includes postage

MAIL ORDERS ONLY May PE

## MODERN DICTIONARY OF ELECTRONICS 50/-

AUTHORITATIVE, COMPREHENSIVE, COMPLETELY UP TO DATE, by GRAF. POSTAGE 4/6.

**Tape Recorder Servicing Manual**, by Hellyer. 67/6.

**Colour T.V. Servicing Handbook**, by Hartwich. 51/6.

**101 Ways to use your Oscilloscope**, by Middleton. 22/-.

**Having fun with Transistors**, by Buckwalter. 22/-.

**Transistor Electronic Organs for the Amateur**, by Douglas. 19/-.

**Computers, self taught through experiments**, by Brayton. 31/-.

**Transistor Specification and Substitution Handbook**, by Techpress. 22/6.

**Hi-Fi Year Book**, by Miles Henslow. 16/3.

**Transistor Technology**, by Middleton. 31/-.

**Questions and Answers on Transistors**, by Brown. 9/3.

All prices include U.K. postage

Where possible 24-hour service guaranteed

## UNIVERSAL BOOK CO.

12 LITTLE NEWPORT ST., LONDON, W.C.2

(Leicester Square Tube Station)

## CRESCENT RADIO LTD.

ELECTRONIC COMPONENT SPECIALISTS  
40 Mayes Road, Wood Green, N.22

Telephone: BOWes Park 3206

### A.M. RADIO TUNER, MW/LW

2 valve with ferrite rod aerial, 11 in. X 4 1/2 in. front panel. Complete with dial. Power required: 240 volt @ 20 ma, 6.3 volt @ 1 amp. PRICE ONLY £4.0.0. No Postage.

### THYRISTOR

S.C.R. 400 volt @ 3 amp., 6/- each.

### TRANSISTOR BARGAINS

V30/30p	6/- each
2G339/A	1/6 each
2G339/B + matched 2G378/B	4/- the pair
AC127	3/- each
GET/114	1/6 each

<b>SILICON EPITAXIAL TRANSISTORS</b>	
5T/140	4/- each
5T/141	6/- each

### SPECIAL LINES

Silicon Rectifiers 125 volt @ 250 ma	2 for 2/6
65 pf Air Spaced Capacitor with Spindle	1/- each
Luminescent Mains Indicators, RED, YELLOW, GREEN (7/8 Round Fixing)	3/9 each
DEAC CELL 2.44 volt (2 @ 1.22 volt)	6/- the pair
7 way Group Panels	6d. each
4 to 21 pf Trimmers	3d. each
1 mfd Paper Capacitors	9d. each
ORP12	10/- each

### SPEAKERS

3 in. @ 20 ohm	9/6 each
6 1/2 in. @ 35 ohm	17/6 each
7 in. X 4 in. @ 25 ohm	15/- each

### TWEETERS

3 in. @ 6 ohm	13/6 each
---------------	-----------

### PRINTED CIRCUIT BOARD

9 in. X 5 in.	1/11 each
12 in. X 4 in.	1/6 each

We have a large stock of electric components and feel that a visit to our premises would be to your advantage. Send 1/- for our catalogue. Please include postage with orders.

## NEW RANGE U.H.F. AERIALS FOR BBC 2 (625) line transmissions

All U.H.F. aerials now fitted with tilting bracket and 4 element grid reflectors.

**Loft Mounting Arrays**, 7 element, 35/-; 11 element, 42/6; 14 element, 50/-; 18 element, 57/6. **Wall Mounting with Cranked Arm**, 7 element, 60/-; 11 element, 67/-; 14 element, 75/-; 18 element, 82/6. **Mast Mounting with 2in. clamp**, 7 element, 42/6; 11 element, 55/-; 14 element, 62/-; 18 element, 70/-.

**Chimney Mounting Arrays, Complete**, 7 element, 72/6; 11 element, 80/-; 14 element, 87/6; 18 element, 95/-.

Complete assembly instructions with every unit. **Low Loss Cable**, 1/6 yd. U.H.F. Pre-amps from 75/-.

State clearly channel number required on all orders.

### BBC · ITV · F.M. AERIALS



**BBC (Band 1)**, Telescopic loft, 21/-; External S/D, 30/-; "H", £2.10.0.

**ITV (Band 3)**, 3 element loft array, 25/-; 5 element, 35/-; Wall mounting, 3 element, 35/-; 5 element, 45/-.

**Combined BBC/ITV**, Loft 1+3, 41/3; 1+5, 48/8; Wall mounting 1+3, 56/3; 1+5, 63/8; Chimney 1+3, 63/8; 1+5, 71/3. VHF transistor pre-amps from 75/-.

**F.M. (Band 2)**, Loft S/D, 12/6; "H", 30/-; 3 element, 52/6. External units available. Co-ax cable, 8d. yd. Co-ax. plugs, 1/3. Outlet boxes, 4/6. Diplexer Crossover Boxes, 12/6. C.W.O. or C.O.D. P. & P. 5/-. Send 6d. stamps for illustrated lists. **Quotations for special arrays available on request**

### K.V.A. ELECTRONICS (Dept. P.E.)

27 Central Parade, New Addington  
Surrey—CRO-OJB  
LODGE HILL 2266



for quick  
easy faultless  
soldering

Containing 5 cores of non-corrosive flux, instantly cleaning heavily oxidised surfaces. No extra flux required. Ersin Multicore Savbit Alloy reduces wear of copper soldering iron bits.

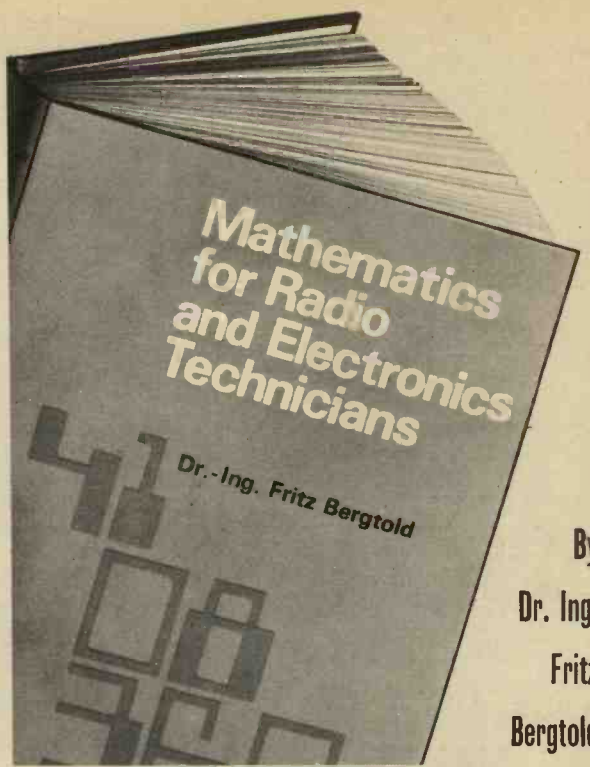
**SIZE 5  
HANDY SOLDER  
DISPENSER**  
Contains 12 ft. coil of 18 s.w.g. Ersin Multicore Savbit Alloy. 2/6 each

**SIZE 15**  
21 ft coil of 60/40 Alloy, 22 s.w.g. in a dispenser. Ideal for small components, transistors, diodes, etc. 3/- each

**SIZE 12**  
Ideal for home constructors. Contains 102 ft. of 18 s.w.g. Ersin Multicore Savbit Alloy on a plastic reel. 15/- each

**BIB MODEL 8  
WIRE STRIPPER  
AND CUTTER**  
Strips insulation without nicking the wire, cuts wire and splits plastic twin flex. Plastic cushioned handles. 8/6 each

From Electrical or Hardware shops. If unobtainable write to:  
Multicore Solders Ltd., Hemel Hempstead, Herts.



By  
Dr. Ing.  
Fritz  
Bergtold

## MATHEMATICS FOR RADIO AND ELECTRONICS TECHNICIANS

This book begins with the most simple of equations and basic methods of calculations and gradually works its way through the various branches of mathematics which will be required by the radio and electronics technician. The material is presented in an easy step-by-step method.

The subjects covered are involution, curves, arrangement, transformation, and solution of equations, the slide rule, logarithms, the treatment of trigonometrical functions, Fourier and other series, differentiation and Integration, polar co-ordinates and the Gaussian plane, vectors and calculation with complex values.

This teaching book will prove invaluable to all engaged or embarking on a career in radio and electronic engineering.

320 pages, line illustrations. 50s.

**Buy this book NOW at your bookseller, W. H. Smith, Boots, Wyman or Menzies branches— or fill in and post the coupon below—**

To: Odhams Books, Dept. SAC 337  
Basted, Sevenoaks, Kent.

Please send me.....copy/ies of  
**MATHS FOR RADIO  
AND ELECTRONICS TECHNICIANS (50s./52s. 6d. by post)**

Name .....

Address .....

I enclose remittance of £ : s. d. **Published by  
NEWNES**

## TECHNICAL TRADING Co.

All items previously advertised available, also see items advertised in Practical Wireless. Huge Hi-Fi and Components stocks at all branches.

**JASON TAPE** Top British mylar/P.V.C.

Standard Play		Double Play	
3"	180ft. 2/3	3"	300ft. 4/-
4"	300ft. 4/8	4"	800ft. 8/-
5"	600ft. 7/8	5"	1200ft. 18/-
5 1/2"	900ft. 10/8	5 1/2"	1800ft. 19/8
7"	1200ft. 13/8	7"	2400ft. 27/-
Long Play		Triple Play	
3"	225ft. 2/9	4"	900ft. 13/-
4"	450ft. 5/6	6"	1800ft. 25/-
5"	900ft. 10/6	5 1/2"	2400ft. 34/-
5 1/2"	1200ft. 13/-	7"	3600ft. 44/-
7"	1800ft. 18/6		
	Post 1/-	Quadruple Play	
		3"	600ft. 8/-

**ROBOPHONE ORDERS**  
Your C.O.D. order exceeding 1£ can be telephoned to  
BRIGHTON 680722  
at any time day and night

10 TOTTENHAM COURT RD., LONDON, W.1 Tel.: MUS 2639  
350/352 FRATTON RD., PORTSMOUTH, Tel: 22034  
72 EAST STREET, SOUTHAMPTON, Tel: 25851  
132 MONTAGUE STREET, WORTHING, TEL: 2585  
ALL MAIL ORDER AND RETAIL SHOP  
**PARK CRESCENT PLACE, BRIGHTON**

## YUKAN SO PROFESSIONAL THE YUKAN SELF-SPRAY AEROSOL WAY -

Get these AIR DRYING GREY **HAMMER**  
or **BLACK WRINKLE (CRACKLE)** Finishes

Yukan Aerosol spraykit contains 16 ozs. fine quality durable easy instant sprav. No stove baking required. Hammers available in grey, blue, gold, bronze. Modern Eggshell Black Wrinkle (Crackle) all at 14/11 at our counter or 15/11, carriage paid, per push-button self-spray can. Also Durable, heat and water resistant Black Matt finish (12 ozs. self-spray cans only) 13/11 carriage paid.  
**SPECIAL OFFER:** I can plus optional transferable snap-on trigger handle (value 5/-) for 18/11, carriage paid. Choice of 13 selfspray plain colours and primer (Motor car quality) also available.

Other Yukan Air Drying Aerosols include:  
Zinc Chromate Primer.  
Clear Lacquer.  
Anti-Tarnish Gold and Metallic Finishes.



Please enclose cheque or P.O. for total amount to:  
YUKAN, Dept. PE/5, 307a Edgware Rd., London W.2.  
Open all day Saturday. Closed Thursday afternoons.

# PRE-PAK SEMICONDUCTORS EXCLUSIVELY BY DAVIS & WHITWORTH LTD.

222-224 WEST ROAD, WESTCLIFF-ON-SEA, ESSEX  
PHONE: SOUTHEND (0502) 46344

PRE-PAK FOR QUALITY			PRE-PAK FOR VALUE			PRE-PAK FOR SERVICE			
No.	Description	PRICE	TRANSISTORS	PRICE	TRANSISTORS	PRICE	No.	PRICE	
A1.	6—Silicon Rectifiers BY100 type	20/-	AC107	6/-	OC81D	2/-	C1.	15—50 volt. trans., germ switching	15/-
A2.	10—Relays, mixed types and voltages	20/-	AC126	2/6	OC83	4/-	C2.	1—Uni junction, 2N2160 or equiv.	15/-
A3.	20—Mixed, marked and tested trans.	20/-	AC127	2/6	OC139	2/6	C3.	5—Audio kit, NKT278/275/271/773 + diode	15/-
A7.	1—500 Mc/s epitaxial mesa. PNP 2N700	20/-	AC128	3/-	OC140	5/-	C4.	2—RF power trans., OC22 and BUY11	15/-
A8.	6—Sub. min. zeners, 3—6—15V, 400mW	20/-	ACV17	5/-	OC170	2/6	C5.	2—Sil. power recs. 200PIV, 6 amp	15/-
A9.	1—2N174 real power trans. 80V, 150W	20/-	AF114	4/-	OC171	4/-	C6.	5—Sil. recs. 1/2 amp, 100/200PIV	15/-
A12.	1—High power, high volts, 25024, 100V 100W	20/-	AF115	3/-	OC200	5/-	C9.	2—100/60V, sil. trans., 200Mc/s, T784/86	15/-
A13.	25—Assorted trans. and diodes, all new	20/-	AF116	3/-	OC201	8/-	C14.	2—3 watt planar, 2N1613, 2N1893	15/-
A14.	4—2N601 p/trans. germ. 30V 10Mc/s	20/-	AF117	4/-	2G301	2/6	C15.	4—Sil. pnp trans., in the 5300 series	15/-
B1.	50—Unmarked, untested, trans. new	10/-	AF118	3/6	2G302	2/6	C16.	1—Sil. power 85 watts, 25721 series	15/-
B2.	4—Solar cells, inc. Book of ins.	10/-	AF119	3/6	2N697	5/-	C17.	2—60v. 150 Mc/s TO-18, 25103/4	15/-
B3.	4—OA5 gold bonded diodes, Mullard	10/-	AF178	10/-	2N706	5/-	C18.	1—2N1132 sil. planar pnp trans.	15/-
B5.	7—Matched set, OC44/45/81/0/81 + diode	10/-	AS566	2/-	2N711	10/-	C20.	3—Germ. NPN trans., 2N1302/4/8	15/-
B8.	2—Power trans. OC26/35 type	10/-	BCZ11	5/-	2N1302	4/-	C21.	3—Germ. pnp trans., 2N1303/5/7/9	15/-
B9.	1—Light sensitive cell, ORP12 type	9/-	BFY50	15/-	2N1303	4/-	C22.	1—300Mc/s germ. AS221, Mullard	15/-
B11.	2—Comp. pair, AC128, AC176	10/-	BSY25	10/-	2N1304	4/-	C25.	2—Power trans., germ., OC28/29 type	15/-
B13.	7—BA115 G.B. diodes T.V. video	10/-	BSY26	5/-	25303	2/6	C27.	4—800PIV, 500mA, sil. recs., 5TC	15/-
B15.	8—Bi-directional trans., ASY66	10/-	BSY27	5/-	OC20	10/-	C28.	5—Sil. recs., 400PIV, 1/2 amp	15/-
B20.	4—Assorted NPN trans., TO-5, TO-18	10/-	BSY28	5/-	OC23	10/-	C29.	1—200Mc/s low noise trans., AFZ12	15/-
B32.	4—1 amp. recs. 200/300PIV	10/-	BSY29	5/-	OC25	8/-	C30.	2—Sil. trans., narrow gain spread	15/-
B33.	10—Germ. diodes, assorted types	10/-	BSY95A	5/-	OC26	5/-	C31.	4—Sil. recs. 800 PIV, 1/2 amp	15/-
B34.	8—Silicon diodes, assorted types	10/-	GET102	4/-	OC28	7/6	D1.	25—1W hi-stab. resistors mixed	5/-
B35.	2—2 zener diodes 11V., 7 and 10 volts	10/-	GET114	2/6	OC36	10/-	D3.	3—Germ. diodes, OA70, OA79, OA81	5/-
B36.	10—Gold bonded, diodes, assorted	10/-	NKT213	2/6	OC36	10/-	D4.	2—Sil. recs., Sub. min., 400/600PIV 400mA	5/-
B41.	3—2G339A NPN audio, texas	10/-	OC41	2/6	AAY42	2/-	D7.	2—Zener diodes, 5-1v., 250mW	5/-
B42.	5—TK22C germ. switching trans.	10/-	OC44	2/6	OA10	2/-	D9.	10—Assorted capacitors, all types	5/-
B43.	4—SI100 sil. recs. 100 PIV, 1/2 amp	10/-	OC45	2/6	OA70	1/9	D10.	20—Transistor heat sink	5/-
B44.	1—Tunnel diode AEY11, 1050Mc/s	10/-	OC71	2/6	OA79	1/9	D14.	3—Low imp. earphones, less plugs	5/-
			OC72	2/6	OAB1	1/9	E1.	2—2N458 matched power trans., 150V., 80W	30/-
			OC73	5/-	OA182	2/-			
			OC81	2/6	IN914	1/6			

**'FREE' ★ ★** THE LARGEST RANGE OF LOW PRICED SILICON CONTROLLED RECTIFIERS (THYRISTORS) IN G.T. BRITAIN.

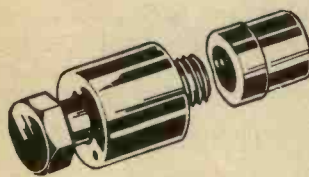
amp (TO 5 can)	3 amp (stud)	7 amp (stud)	16 amp (stud)
PIV each	PIV each	PIV each	PIV each
100 9/6	50 7/6	100 10/6	100 16/6
400 25/-	100 10/-	200 15/-	200 25/-
	200 12/6	300 25/-	300 30/-
	300 17/6	400 30/-	400 40/-
		500 40/-	500 50/-
		600 45/-	600 55/-

★ ★ **'FREE'** FREE SCR literature including circuit diagrams for light dimmers, speed controllers, AC power switch, etc., with all SCR orders or on request

**FIRST EVER LOGIC KITS.** Learn for yourself how computers work, even make one for yourself. Full instructions for a noughts and crosses machine, binary counters, timers, etc. L.1. 5 gms. L.2. 10 gms. No need to purchase both kits, you can start with L.2. which incorporates L.1. **DETAILS FREE.**

**MAKE A REV. COUNTER FOR YOUR CAR.** THE 'TACHO BLOCK'. This encapsulated block will turn any O-1mA meter into a perfectly linear and accurate rev. counter for any car. State 4 or 6 cylinder. **20/-each**

**NO CONNECTION WITH ANY OTHER FIRM.** MINIMUM ORDER 10/- CASH WITH ORDER PLEASE. For complete lists and substitution charts send 1/- in stamps, add 1/- post and packing per order. OVERSEAS ADD EXTRA FOR AIRMAIL.



**The PUNCH you need!**

**HOLE PUNCHES**

Instant Type		
3/8" diameter	6/10 ea.	
<b>Screw-up Type</b>		
1 1/2" diameter Toggle switch	8/6	..
" " B7G	8/6	..
" " B8A, B9A	9/-	..
" " "	9/6	..
" " "	10/2	..
" " "	10/8	..
" " "	11/8	..
1 1/4" diameter Int. Octal	13/4	..
" " "	16/2	..
" " "	18/10	..
" " B9G	21/8	..
" " "	24/4	..
2 1/2" " Meter	33/2	..

Complete Set £9.3.6.

No extra charge for postage and packing in the U.K.  
Now supplied by:

**TOMPKINS & LONGMAN LTD.**  
237 GIPSY ROAD  
WEST NORWOOD, S.E.27  
Tel.: Gipsy Hill 5000

**Laboratory Components**

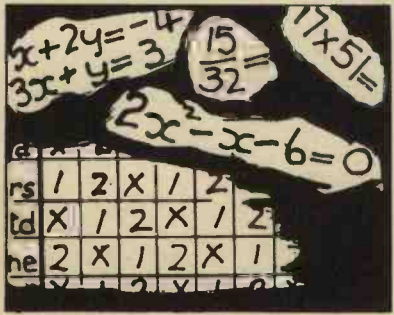
**Resistors.** 1/2W. 10% High Stab. Class 1. Low Noise 3/- per Doz.

**Capacitors.** Min. Electrolytics, Ass or Single value 9/- per Doz. Polystyrene sub-min. 25V. 10% Ass. 6/- per Doz.

**Transistors.** BC108 5/8 each  
Matched Output Kit, OC81D + 2 x OC81 7/6 per set  
Germanium, Ass. PNP, NPN AF Types 10/8 per doz.  
Germanium, Low Leakage, RF Types 12/- per doz.  
Type 1020, PNP, Germanium, AF, 50mW 8/- per Doz.  
Type 1021, PNP, Germanium, AF, 200mW 12/6 per Doz.  
Type 1024, PNP, Low Leakage, RF.  
4mc/s Type 17/6 per Doz.  
OC44, OC46, OC70, OC71, ACX22, OC81D 2/3 each  
**Power Transistors.** (OC26 7/6) (OC25 8/6) (OC36 10/-)

For complete list of Laboratory Components send S.A.E. to:

**LABORATORY EQUIPMENT (ELEC)**  
38 Crawford St., London, W.1  
All goods C.W.O. and P.P. 1/6



Simple Electrical Analogue circuits to solve the above, 4/6d.

**PLANET INSTRUMENT CO.**  
25 (E), DOMINION AVE., LEEDS 7

**4-STATION INTERCOM**



£6/9/6

Solve your communication problems with this 4-Station Transistor Intercom system (1 master and 3 Subs), in de-luxe plastic cabinets for desk or wall mounting. Call/talk/listen from Master to Subs and Subs to Master. Ideally suitable for Business, Surgery, Schools, Hospital, Office and Home. Operates on one 9V battery. On/off switch. Volume control. Complete with 3 connecting wires each 66ft. and other accessories. P. & P. 6/6.

**INTERCOM/BABY ALARM**



Usually ~~£8/6~~  
Our Price ONLY **49/6**

Modernize business or home with this new two-way Portable Transistor Intercom, consisting of Master and Sub, in strong plastic cabinets with chromium stands. Designed as a two-way instant communication system. Call/talk/listen from Master to Sub and Sub to Master. Operates on one 9V battery. Complete with 60 ft. wire and battery. P. & P. 2/6

**Transistor TELEPHONE AMPLIFIER 55/-**



Why not boost business efficiency with this incredible De-luxe Telephone Amplifier. Take down long telephone messages or converse without holding the handset. A status symbol? Yes, but very useful one. On/off switch. Volume Control. Operates on one 9V. battery supplied for 2/6 extra. P. & P. 2/6.

Full price refunded if not satisfied in 7 days.

**WEST LONDON DIRECT SUPPLIES (P/5)**  
169 KENSINGTON HIGH STREET, LONDON, W.8



# YOURS FREE FOR 7 DAYS

The New 'Picture - Book' way of learning

# BASIC

**ELECTRICITY (5 Vols)**  
**ELECTRONICS (6 Vols)**  
**ELECTRONIC CIRCUITS (2 Vols)**  
**INDUSTRIAL ELECTRICITY (2 Vols)**  
**SYNCHROS & SERVOMECHANISMS (2 Vols)**

You'll find it easy to learn with this outstandingly successful new pictorial method—the essential facts are explained in the simplest language, one at a time; and each is illustrated by an accurate cartoon-type drawing.

The books are based on the latest research into simplified learning techniques. This has proved that the Pictorial Approach to learning is the quickest and soundest way of gaining mastery over these subjects.

The series will be of exceptional value in training mechanics and technicians in electricity, Radio and Electronics.

## WHAT THIS MONTH'S ENTHUSIASTIC READERS SAY

- ... These Manuals have played an important part in my career ...  
K.W., WEST DRAYTON
- ... These books create a sound basis on which to build a successful future ...  
R.G., LOWESTOFT
- ... I am well pleased with the series. Everything is well set out in self-explanatory diagrams ...  
D.D., WEST HAM
- ... A really brilliant series ...  
T.L., NEWCASTLE

TO SELRAY BOOK CO.  
 60 HAYES HILL, HAYES, BROMLEY, KENT

Please send me Without Obligation to Purchase, one of the above sets on 7 Days Free Trial. I will either return set, carriage paid, in good condition within 7 days or send the following amounts. Basic Electricity 70/- Cash price or Down Payment of 15/- followed by 4 fortnightly-payments of 15/- each. Basic Electronics 82/- Cash Price or Down Payment of 15/- followed by 5 fortnightly payments of 15/- each. This offer applies to U.K. only. Overseas customers cash with order.

Tick set required (only ONE set allowed on free trial)

BASIC ELECTRICITY 70/-       BASIC ELECTRONICS 82/-   
 BASIC ELECTRONIC CIRCUITS 40/-   
 BASIC INDUSTRIAL ELECTRICITY 40/-   
 BASIC SYNCHROS & SERVOMECHANISMS 38/-   
 ALL PRICES INCLUDE POSTAGE

1P 5

Signature ..... (If under 21, signature of parent or guardian)

NAME ..... BLOCK LETTERS BELOW

FULL POSTAL ADDRESS .....

**POST NOW FOR THIS OFFER!**

## FANTASTIC

## SELL-OUT SALE

## FANTASTIC

OWING TO THE EVER-INCREASING DEMAND FOR A LARGE SELECTION OF SEMICONDUCTORS WE ARE CLOSING OUR COMPONENT SECTION. THIS ENABLES US TO OFFER THESE FANTASTIC BARGAIN PACKS TO YOU. DON'T MISS THEM ORDER NOW!

- 25 ASSORTED TRANSISTOR ELECTROLYTICS POPULAR VALUES.
- 100 ASSORTED HI-STABILITY RESISTORS 0-1%, 1%, 2%, 5%.
- 200 ASSORTED  $\frac{1}{2}$ ,  $\frac{1}{4}$ ,  $\frac{1}{10}$  WATT RESISTORS, P.C. TYPES INCLUDED.
- 100 SILVER MICA AND CERAMIC CAPACITORS POPULAR VALUES.
- 12 ASSORTED POTENTIOMETERS, INC. TANDEM, W.W., PRESET, ETC.

ALL PACKS 10/- EACH

**WENTWORTH RADIO**

### FREE FREE FREE

WITH ANY SIX PACKS ORDERED ONE SUPER BARGAIN PACK INC. TAG STRIPS, TAG BOARDS, PRINTED CIRCUITS, KNOBS, TERMINALS, TRANSFORMERS, PLUGS, SOCKETS, RECTIFIERS, TRIMMERS, FERRITE RODS, COILS, BULBS, ETC., ETC.

POST AND PACKING 1/3 PER PACK

1a WENTWORTH COURT, ALSTON ROAD, BARNET, HERTS.

- 10 ASSORTED SWITCHES, INC. SLIDER TOGGLE, PUSH BUTTON, ROTARY, ETC.
- 100 ASSORTED WIREWOUND AND CARBON RESISTORS, 1 WATT-5 WATT.
- 100 ASSORTED PAPER AND POLYESTER CAPACITORS. 125 vwg-500 vwg.
- 12 MAGNETIC MINIATURE EARPIECES WITH LEAD.
- 10 ASSORTED TV AND RADIO ELECTROLYTICS INC. 8 MFD, 16 MFD, 32 MFD, ETC.

ANY 10 PACKS P. & P. FREE



**WELCOME LIGHT**

With a SELCON Automatic Photo Electric Control Switch. Safety-security-convenience. Lights automatically on at sundown — off at dawn. Selcon gives SOLAR-control for garage and porch lights, in nurseries, shop windows, etc. 200/250v. A.C. Comparable controls cost double.

ONLY 49/6 p. & p. 2/6

PHOTAIN CONTROLS LTD. (K) Randalls Road, Leatherhead, Surrey

Now available - free revised catalogue of the widest range of Lenses, Prisms, Graticules, Flats, etc.

from Dept. No. P.E. 1

**UNITED TECHNICAL SUPPLIES LTD**

29 TOTTENHAM COURT ROAD LONDON W1

Phone LAN 1116/7





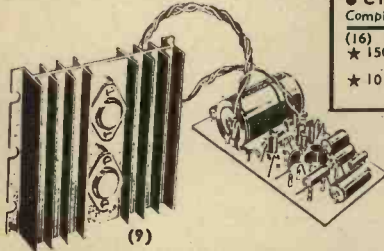
(14)



(12)



(10)



(9)

**HENRY'S RADIO LTD.**  
303 EDGWARE RD., LONDON, W.2  
PADdington 1008/9 (STD: 01-723 1008)  
Open Mon. to Sat. 9-6. Thurs. 1 p.m.  
Open all day Saturday

**12 AND 20 WATT MONO AND STEREO TRANSISTOR AMPLIFIERS**

(9) **POWER AMPLIFIERS.** 12 watts RMS output, 100mV input, 30 c/s to 20 k/c/s  $\pm$  1dB. 6-Transistor Push-pull. Panel size 4 X 2 1/2 X 1 in. H/S 4 X 4 in. Leaflet on request.  
MPA10/3 3-5 ohm spkr. £4.10.0, p.p. 2/6  
MPA10/15 8-16 ohm spkr. £5.5.0, p.p. 2/6  
(Mains unit 1 or 2 amplifiers, 59/6, p.p. 2/6)

**The Finest High Fidelity at Unbeatable Prices**

**25 WATT AMPLIFIER**  
8-Transistor design. Push-pull output for 7 1/2 to 16 ohm speaker. 150mV input, 30c/s to 20k/c/s  $\pm$  1dB. For use with valve or transistor pre-amplifiers as item (10) above.  
**PRICE BUILT £7.19.6 P.P. 3/-**  
**AND TESTED**  
(Mains unit 79/6, p.p. 2/6)

(13) **MULTI-METERS SCOPE**  
PT34 1kV 39/6 EP30k 30kV £6.10.0  
TPI0 2kV 75/- EP50k 50kV £9.19.6  
ITI-2 20kV 69/6 500 30kV £8.17.6  
TP55 20kV £5.19.6 EPI00k 100kV £10.10.0  
● CT52 Scopes £22.10.0, p.p. 10/-  
Complete range of test equipment in stock

(16) **NOMBREX TEST UNITS**  
★ 150 kc/s—350 mc/s RF Generator £10.10.0. All Transistor.  
★ 10 c/s—100 kc/s Transistor. £16.19.6 Audio Generator.

(15) **GARRARD BATTERY 2-SPEED TAPE DECK**  
Brand New with R/P head, erase/osc. head, tape cassette. Specifications and osc. circuits. 2 speed 2-track 9 volt operated. List Price 13 gns.  
**PRICE £8.19.6 P. & P. 3/6**

**COMPONENTS AND EQUIPMENT.** The largest range in the country, 8/6 buys 1967 200-page catalogue with discount vouchers.

(10) **PREAMPLIFIERS.** 8 input selector. Treble, bass, volume, filter controls. 1 1/2 mV to 100mV inputs. Battery operated or from Mains Unit. Output up to 150mV. LEAFLETS ON REQUEST.

MP2 Mono 9 1/2 X 2 1/2 X 2 in. £5.10.0, p.p. 2/6 (grey and gold front panel 8/6).  
SP4 Mono/Stereo, 9 X 3 1/2 X 1 1/2 in. £10.19.6, p.p. 3/6 (front panel plate 12/6)  
● ALL UNITS BUILT AND TESTED

(12) **MW/LW QUALITY TRANSISTOR RADIO TUNER**  
Fully tunable superhet with excellent sensitivity and selectivity. Output up to 1/2 volt peak. Complete with front panel, etc. 9 volt operated. For use with any amplifier or tape recorder.  
**TOTAL COST TO BUILD £3.19.6 P.P. 2/6**

(14) **VHF FM TUNER**  
Supplied as 2 Preassembled Panels, plus metal work Superhet design, 88-108 Mc/s, 9 volt operated. 6 Mullard Transistors. Total cost to assemble £12.17.6, p.p. 2/6

**STABILISED POWER SUPPLY**  
Two outputs. 3.6 volt and 9.6 volt up to 250mA each. Transistorised and Zener stabilised. 110 to 250 volt mains input. In case with leads. PRICE 67/6, p.p. 2/6.

(17) **5 WATT AMPLIFIER**  
6-Transistor Push-pull, 3 ohms. 6mV into 1K. 12/18V supply, 2 1/2 X 2 X 1 1/2 in.  
**BUILT AND TESTED 69/6 P.P. 2/-**  
(optional mains units 54/-)  
1 1/2 watt version 59/6.  
Matching Pre-amplifier, 6 inputs, treble/bass/selector/volume controls. 6-10mV o/p. 9-18V supply. 79/6, p.p. 2/-.  
For use with any Transistor Amplifier LEAFLET ON REQUEST.

FMT41 FM TUNER. 6-transistor, 3 diode design. Com-pletely built and tested £8.10.0 P.P. 2/-  
(19) AMT31. Med. Wave Tuner. Built ready to use. 79/6, p.p. 2/-.



(16)



(17)



(13)



(15)

**SEE BACK COVER FOR MORE ITEMS OF INTEREST**

**MAKE 5 DIFFERENT RADIOS FOR 39/6**

Amazing Radio Construction Set! Become a radio expert for 39/6. A complete Home Radio Course. No experience needed. Parts including Instructions for each design. Step-by-Step plan, all Transistors, loudspeaker, personal phone, knobs, screws, etc., all you need. Box size 14" X 10" X 2" (parts available separately). Originally £8. NOW 39/6 plus 4/6 P. & P.

Frustrated Import Shipment Offered BELOW HALF PRICE to Clear 500 Only Five Transistor

**PERSONAL TRANSCIEVER SETS** Our Price **£6. 18. 11**

You've heard about them—now you've read about them. NOW YOUR CHANCE TO OWN THEM. Highly sensitive two-way transistor transceiver sets have individual volume control and talk-listen switch. Teleopic aerial picks in the voice from the other set over tremendous distances—no wires—a genuine transceiver as used by official bodies and forces, 500 sets only at £6.18.11, including accessories, batteries etc. Plus 4/7 p.p. These cannot be used in U.K.

**UNIQUE NEW PORTABLE RADIOS FULLY TRANSISTORISED READY BUILT**

with Full Variable waveband. NOW A FRACTION OF THE NORMAL PRICE **29/6** WHY PAY MORE?

All the latest refinements are packed into this new MULTI-STATION ALL Transistor radio—the internal aerial picks up even the remote stations and the powerful built-in speaker gives room filling volume. Individual tuning, first-class reception. Purchase with confidence—packed in original manufacturer's cartons. (Personal carpiece and battery 4/6). Send 29/6 plus 4/6 p. & p.

**AMAZING No soldering CIGARETTE RADIO ONLY 25/-**

Yes, a perfectly ordinary packet of cigarettes! But watch your friends' astonishment on hearing its range of stations loud and clear. Holds 10 cigarettes—yet conceals sensitive, fully transistorised circuit (including tiny battery). A young boy can assemble it in 2 hours. No soldering. Only 16 connections to make. ALL PARTS including semi-conductors, ABC Plans, etc. ONLY 25/- plus 2/6 P. & P. Parts available separately.

**CONCORD ELECTRONICS LIMITED (Dept. P.E. 31) 77 NEW BOND STREET LONDON, W.1. Mail Order Only**

**BAKER 12in. STANDARD**  
Now with built-in concentric tweeter cone

The ideal High Fidelity Speaker for use where higher outputs are desired in the home, public address, schools, theatres, etc.

Maximum Power	20 watts	Available from all Radio & Hi-Fi Dealers <b>£8</b> Post Free
Bass Resonance	40-50 c.p.s.	
Flux Density	14,000 gauss	
Voice coil diameter	1 1/2"	
Voice coil impedance	15 ohms	
Voice coil material	Copper	
Useful response	40-14,500 c.p.s.	
Cone surround	Roll	
Chassis material	Alcomac	
Overall diameter	12 1/2"	

Send for New catalogue and enclosure plans

**Baker Reproducers Ltd.** (DEPT. P.E.17)  
Bensham Manor Road Passage, Thornton Heath, Surrey. THO 1665

**YOU CAN AFFORD! AN INDIVIDUALLY MANUFACTURED ENGRAVED FACIA PANEL**

WE OFFER A COMPLETELY NEW SERVICE TO ELECTRONIC ENTHUSIASTS WHO WISH TO MAKE THEIR APPARATUS INDISTINGUISHABLE FROM THE MOST EXPENSIVE PROFESSIONALLY MADE EQUIPMENT.

FOR FREE QUOTATION AND FURTHER INFORMATION SEND S.A.E. AND WORKING DRAWING OF APERTURES AND WORDING REQUIRED TO:—  
**GREYMEI LTD., 34 PANGRAS RD., LONDON, N.W.1**

# VALUABLE NEW HANDBOOK FREE TO AMBITIOUS ENGINEERS

Have you had your copy of "Engineering Opportunities"?

The new edition of "ENGINEERING OPPORTUNITIES" is now available—without charge—to all who are anxious for a worthwhile post in Engineering. Frank, informative and completely up to date, the new "ENGINEERING OPPORTUNITIES" should be in the hands of every person engaged in any branch of the Engineering industry, irrespective of age, experience or training.

## On 'SATISFACTION OR REFUND OF FEE' terms

This remarkable book gives details of examinations and courses in every branch of Engineering, Building, etc., outlines the openings available and describes our Special Appointments Department.

## WHICH OF THESE IS YOUR PET SUBJECT?

### ELECTRONIC ENG.

Advanced Electronic Eng.—  
Gen. Electronic Eng.—  
Applied Electronics—  
Practical Electronics—  
Radar Tech.—  
Frequency Modulation—  
Transistors.

### ELECTRICAL ENG.

Advanced Electrical Eng.—  
General Electrical Eng.—  
Installations—  
Draughtsmanship—  
Illuminating Eng.—  
Refrigeration—  
Elem. Elec. Science—  
Elec. Supply—  
Mining Elec. Eng.

### CIVIL ENG.

Advanced Civil Eng.—  
General Civil Eng.—  
Municipal Eng.—  
Structural Eng.—  
Sanitary Eng.—  
Road Eng.—  
Hydraulics—  
Mining—  
Water Supply—  
Petrol Tech.

### RADIO ENG.

Advanced Radio—  
General Radio—  
Radio & TV Servicing—  
TV Engineering—  
Telecommunications—  
Sound Recording—  
Automation—  
Practical Radio—  
Radio Amateurs' Examination.

### MECHANICAL ENG.

Advanced Mechanical Eng.—  
Gen. Mech. Eng.—  
Maintenance Eng.—  
Diesel Eng.—  
Press Tool Design—  
Sheet Metal Work—  
Welding—  
Eng. Pattern Making—  
Inspection—  
Draughtsmanship—  
Metallurgy—  
Production Eng.

### AUTOMOBILE ENG.

Advanced Automobile Eng.—  
General Auto. Eng.—  
Auto. Maintenance—  
Repair—  
Auto. Diesel Maintenance—  
Auto. Electrical Equipment—  
Garage Management.

WE HAVE A WIDE RANGE OF COURSES IN OTHER SUBJECTS INCLUDING CHEMICAL ENG., AERO ENG., MANAGEMENT, INSTRUMENT TECHNOLOGY, WORKS STUDY, MATHEMATICS, ETC.

Which qualification would increase your earning power?  
A.M.I.E.R.E., A.M.I.Mech.E., A.M.S.E., A.M.I.C.E., B.Sc.,  
A.M.I.P.E., A.M.I.M.I., A.R.I.B.A., A.I.O.B., A.M.I.Chem.E., A.R.I.C.S.,  
M.R.S.H., A.M.I.E.D., A.M.I.Mun.E., C.ENG., CITY & GUILDS, GEN.  
CERT. OF EDUCATION, ETC.

BRITISH INSTITUTE OF ENGINEERING TECHNOLOGY  
316A ALDERMASTON COURT, ALDERMASTON, BERKSHIRE

## THIS BOOK TELLS YOU

- ★ HOW to get a better paid, more interesting job.
- ★ HOW to qualify for rapid promotion.
- ★ HOW to put some letters after your name and become a key man . . . quickly and easily.
- ★ HOW to benefit from our free Advisory and Appointments Depts.
- ★ HOW you can take advantage of the chances you are now missing.
- ★ HOW, irrespective of your age, education or experience, YOU can succeed in any branch of Engineering.

132 PAGES OF EXPERT CAREER - GUIDANCE

### PRACTICAL EQUIPMENT

Basic Practical and Theoretical Courses for beginners in Radio, T.V., Electronics, Etc., A.M.I.E.R.E. City & Guilds Radio Amateurs' Exam. R.T.E.G. Certificate P.M.G. Certificate Practical Radio Radio & Television Servicing Practical Electronics Electronics Engineering Automation

### INCLUDING TOOLS

The specialist Electronics Division of B.I.E.T. NOW offers you a real laboratory training at home with practical equipment. Ask for details.

## B.I.E.T.

You are bound to benefit from reading "ENGINEERING OPPORTUNITIES"—send for your copy now—FREE and without obligation.



## POST NOW!

TO B.I.E.T., 316A ALDERMASTON COURT, ALDERMASTON, BERKSHIRE.

3d. stamp if posted in an unsealed envelope.

Please send me a FREE copy of "ENGINEERING OPPORTUNITIES." I am interested in (state subject, exam., or career).

NAME .....

ADDRESS .....

WRITE IF YOU PREFER NOT TO CUT THIS PAGE

**THE B.I.E.T. IS THE LEADING INSTITUTE OF ITS KIND IN THE WORLD**

**HR**

# 1967 CATALOGUE 200 PAGES PLUS!

**COMPLETELY NEW EDITION — HUNDREDS OF NEW LINES**

● Contains the largest and most comprehensive range of components and equipment available. Over 5,000 stock lines with more data more stock lines. Information and illustrations. Hundreds of bargain lines. You cannot afford to be without a copy of this catalogue. Supercedes all previous editions.  
**MORE THAN A CATALOGUE—A COMPLETE REFERENCE**

Price 7/6, p.p. 1/-.

● **5 FREE VOUCHERS**  
 Total value 10/- for use on purchases. Pays for catalogue after use.

● **Unbeatable value — 200 packed pages — 10/- value discount vouchers** ●

**MARRIOT TAPE HEADS**  
 † Track R/RP/3 Med z. 7/8. R/RP/1 High x. 8/- R/RP/1 High z + R/E/1 erase on block. 19/6. † Track L/RPS/12 High z. 15/- L/RPS/7 Med z. 19/6. L/ES/9 erase. 12/8. Also HR-RP single track Rec/Play Med z. 6/6

**DEAC RECHARGEABLE BATTERY**  
 ● 9.6 volt 225mA/H ... 20/-, P.P. 1/6

**DEAC CHARGER**  
 To charge 3.6 volt and 9.6 volt packs. Fully mains isolated **45/-** P.P. In moulded case. 2/-

(4) **BUILD A QUALITY 2 OR 4 TRACK TAPE RECORDER**

3-speed version using '363' decks  
 ● **TWO-TRACK.** Deck £10.10.0. Martin Amplifier. £14.19.6. Cabinet and speaker 7 gns. Complete kits with FREE 7in. 1200ft. tape, spare spool. Today's Value **£45. 27 gns.** P.P. 15/-

● **FOUR-TRACK.** Deck £13.10.0. Martin Amplifier £15.19.6. Cabinet and speaker 7 gns. Complete kits with FREE 7in. 1200ft. tape, spare spool. Today's Value **£50. 30 gns.** P.P. 15/-

(6) **GARRARD DECKS—BRAND NEW FULLY GUARANTEED**

1000 mono	£5 19 6	SP25 stereo	£10 19 6	401 less cart./Arm	£27 10 0
AT5 mono	£8 9 6	SP26 Derain	£13 19 6	AT6 mono Mk. II	£8 19 6
2000 mono	£8 9 6	AT80 less cart.	£10 19 6	AT6 stereo Mk. II	£9 10 0
2000 stereo	£8 19 6	AT80 mono	£11 10 0	AT6 Derain	£11 19 0
3000 1 in stereo	£7 19 6	AT80 stereo	£11 19 6	Decadec Mk. II	£17 17 0
SP25 less cart.	£9 19 6	AT80 Derain	£9 19 6	A70 less cart.	£17 17 0
SP25 mono	£10 10 0	L.A.B90 less cart.	£25 0 0	(P. and P. 5/- any type)	

All other makes of decks and cartridge in stock

(7) **GLOBEMASTER MW/LW/SW PORTABLE RADIO TO BUILD**

Full 3-waveband tuning. Pushbutton wave-change. Superhet printed circuit design. Black-chromed cabinet 11 x 7 1/2 x 3 1/2in. (SW 17-50 metres). Ear/Record sockets. 1 watt Push/Pull output. 6 Mullard Transistors. Handbook **TOTAL COST £7.19.6** P.P. on request **TO BUILD 3/6**

**SCR'S (THYRISTORS)**  
 ● **1 AMP SERIES WIRE LEADS**  
 50PIV ... 7/8 100 PIV ... 7/6  
 200 PIV ... 12/8 300 PIV ... 15/-  
 400 PIV (280V Rms) ... 17/8  
 100 PIV, 3 Amp Stud Type ... 9/6  
 400 PIV, 7 Amp (280V Rms) Stud Type 25/-  
 400 PIV, 3 Amp (280V Rms) ... 20/-

**FM STEREO DECODER**  
 7 Mullard Transistors. Printed Circuit Design with Stereo Indicator. For use with any valve or transistor FM. Uses pot cores to Mullard design and ger. and silicon transistors. Leaflet on request Complete Kit Price **£5.19.6** P.P. 2/-

(5) **VHF FM TUNER TO BUILD**  
 37/105 Mc/s Transistor Superhet. Geared tuning. Terrific quality and sensitivity. For valve or transistor amplifiers. 4 x 3 1/2 x 2 1/2in. Complete with dial plate. 5 Mullard Transistors (FM Decoder Kit **£5.19.6** P.P. 2/-). **TOTAL COST £6.19.6** P.P. **TO BUILD 2/6**

(Cabinet Assembly 20/- extra)

**RADIO CONTROL RECEIVER**  
 "TINYTONE" 27 Mc/s band receiver. Printed circuit construction. Sensitive 4-transistor design. Size only 2" x 2" x 1". Complete with circuit and instructions. **TOTAL COST 55/-** P.P. **TO BUILD 1/6**  
 (Circuit etc. 1/3 separately.)

**TUNNEL DIODES**  
 1mA 22/6; 5mA 15/-; 15mA 12/6. Brand new at fraction of normal price. Free Specs. supplied.

**TRANSISTOR CATALOGUE**  
 Completely new 24-page 11x7 inch. Hundreds of new types with details. The largest range available with data, information, illustrations, etc. Send 1/- for your copy.

**INVERTOR KITS**  
 12 volt input. Output 230 volts, 50 c/s.  
 ● 15 watt ... 87/6 P.P. 3/6  
 ● 40 watt ... 87/6 P.P. 6/6

(1) **REGENT-6 MW/LW POCKET RADIO TO BUILD**  
 6-Transistor superhet. Geared tuning. Push-pull speaker output. Moulded cabinet 5 x 3 x 1 1/2in. None socket. **TOTAL COST 69/6** P.P. **TO BUILD 2/-**  
 Full tuning on both bands

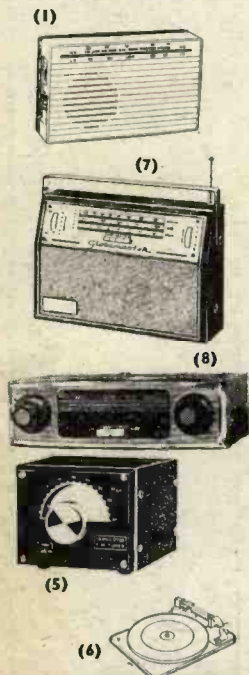
**HI-FI EQUIPMENT** from stock: **ARMSTRONG QUAD** Complete range in stock. Send list of requirements for special price quote. **THEORENS GOODMAN'S GOODMANS WHARF/RECORD CELESTION GOLDBRING ROGERS, TRJVOX, LEAK ETC.**

**WE CAN SUPPLY FROM STOCK MOST OF THE PARTS SPECIFIED ON CIRCUITS IN THIS MAGAZINE. SEND LIST FOR QUOTATION.**

**OR BETTER STILL—BUY THE NEW 1967 CATALOGUE. EVERYTHING YOU NEED IS AVAILABLE FROM STOCK.**

## HENRY'S RADIO LTD.

303 EDGWARE RD., LONDON, W.2  
 P.A. Ddington 1008/9 (STD 01-723 1008)  
 Open Mon. to Sat. 9.5. Thurs. 1 p.m.  
 Open all day Saturday



**CAR MONO/STEREO AND MONO TAPE PLAYERS—TERRIFIC QUALITY**

**NEW!** 12 volt pos. or neg. earth operated. Uses Musicassettes. Either your own recordings or EMG/Philips prerecorded tapes. Fits any car. Full range of controls bass/treble/volume. Provides 50 mins. from one tape. Supplied complete with speakers, fixing kit, instructions and 50 min. prerecorded tape.

Prices. Mono **26 gns.** Mono/Stereo **32 gns.** Leaflet on request. British Made.

**SUPPLIERS OF QUALITY COMPONENTS AND EQUIPMENT FOR MORE THAN 20 YEARS**

## ★ MAYFAIR PORTABLE ELECTRONIC ORGAN—

**Build the World's first All-Transistor Portable Electronic Organ Kit**

● Plug-in printed circuits ● 170 transistors and devices ● 10 selected tone colours ● Fully sprung keyboard ● Vibrato ● 6 Octaves of generators ● Simple locked-in tuning ● 110/250 volt mains unit ● Cabinet size 30 1/2" x 15 1/2" x 9" ● Weight 35 lb. Cabinet with detachable legs, music stand and foot swell pedal ● Fully detailed building manual with photos, drawings and full circuits.

**START BUILDING FOR AS LITTLE AS £5—BUILD THE MAYFAIR A SECTION AT A TIME**

**REVERBERATION**  
 Transistorised mains operated unit for use with any organ or audio equipment. 18 GNS.

**TO BUILD YOURSELF IN EASY STAGES ALL PARTS AVAILABLE SEPARATELY**

★ COMPLETE KIT 99 gns. (Carr. 30/-).  
 ★ DETAILED LEAFLET ON REQUEST  
 ★ HP FACILITIES AVAILABLE.  
 ★ COMPLETE RANGE OF ORGAN COMPONENTS IN STOCK.

Designed by L. W. Roche



**ORGAN COMPONENTS FROM STOCK**

- ★ Gold clad wire and Rhodium bars
- ★ Chokes
- ★ Panels
- ★ Pedal Boards
- ★ Amplifiers
- ★ Reverberation Equipment
- ★ Stop Units
- ★ Key Boards
- ★ Pedal Switches
- ★ Expression Pedals
- ★ Relay Units
- ★ Coupler Switches
- ★ Etc. etc.

**LIST ON REQUEST**

● **SEE FOR YOURSELF CALL IN FOR DEMONSTRATION**

**NEW!** VHF FM plus MW and Longwave Car Radio. 3 watts O/P. Pos. or neg. earth 12 volt. British Made. Complete with speaker, etc. **25 gns.**

← See page 400 for more stock items

Britain's best selling Hi-Fi transistorised 5, 12 and 25 watt amplifiers and preamplifiers—AM and FM Tuners—New catalogue is a must—Order Yours NOW!