

7206 79

Personal Computer

World July 1983 85p

Canada \$2.75/US \$2.50/FF 18.50/FL 8.15/SFr 8.00/IR £1.23/BFr 94.00/
Lire 4,700/DKr 24.00/NKr 14.55/DM 9.5.

QX-10 -
IS EPSON
IN BUSINESS?

BRITAIN'S LARGEST SELLING MICRO MAGAZINE

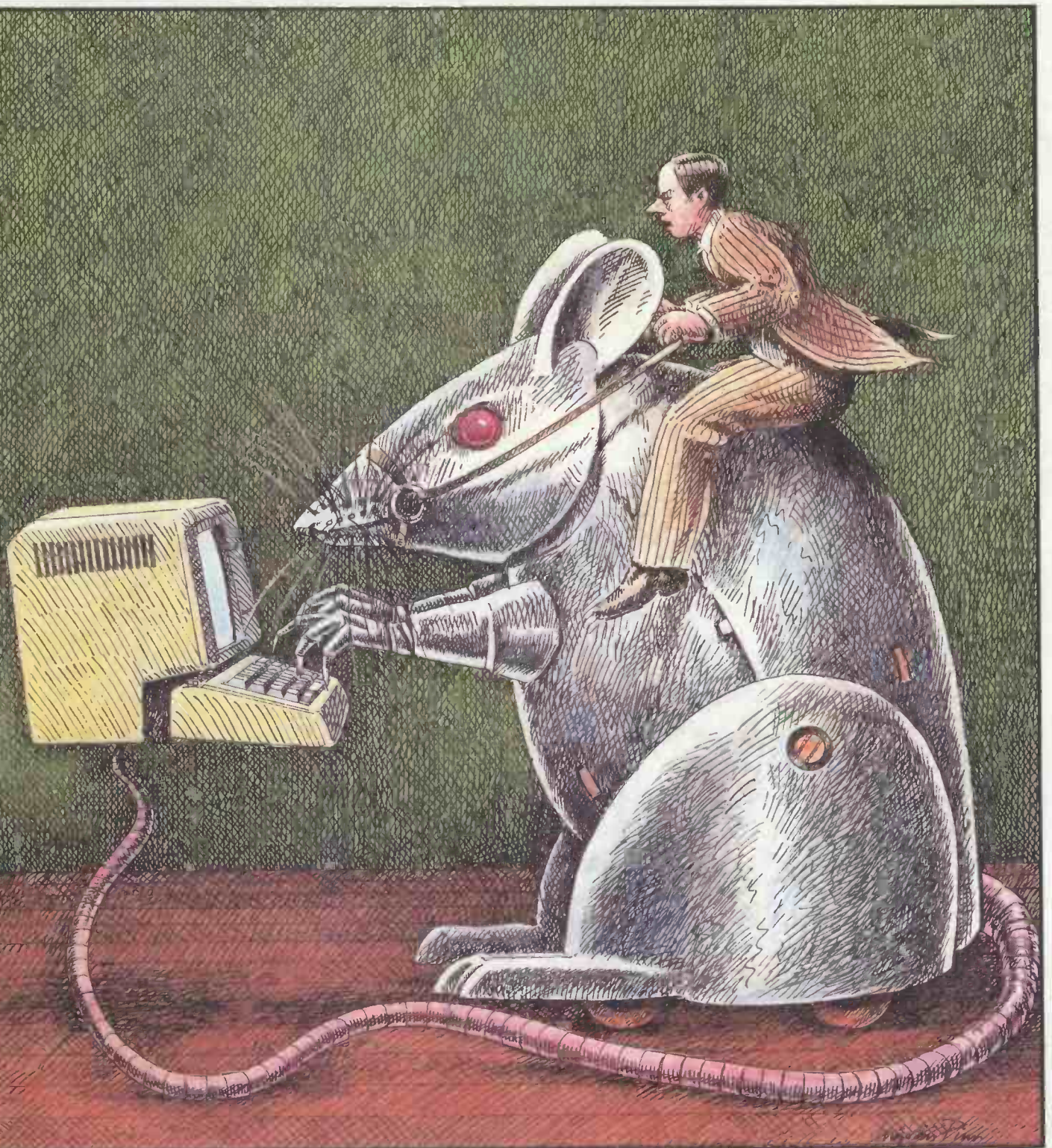

ENTER THE ERA OF THE MOUSE
Exclusive full Benchtest of Lisa

**NEW
MODEL**

**LOWER
COST**



Cromemco System One

MicroCentre introduce Cromemco's new System One computer, available with an integral 5 megabyte Winchester hard disk, at a new low price.

The System One supports the full range of Cromemco interface cards, including high resolution colour graphics, and software packages. The choice of operating systems includes CDOS, CP/M and CROMIX—Cromemco's answer to Unix.

Call MicroCentre for  Cromemco

MicroCentre Ltd
(Complete Micro Systems)

**Britain's independent
Cromemco importer**

**30 Dundas Street
Edinburgh EH3 6JN
Tel: 031-556 7354**

CONTENTS

Vol 6 No 7 July 1983

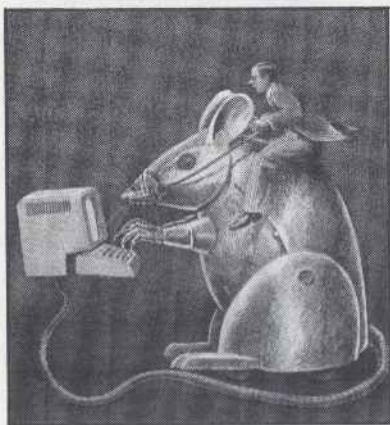

Cover illustration by Ingram Pinn

BENCHTESTS & REVIEWS

MEDDLING WITH MICROTAX 130

Using this package with the Dragon 32 perhaps you too could be equal to the mysterious methods of the Inland Revenue? Tony Harrington investigates.

OMNIS 138

A UCSD-p data management system which claims to be the most portable of all. Kathy Lang examines this assertion.

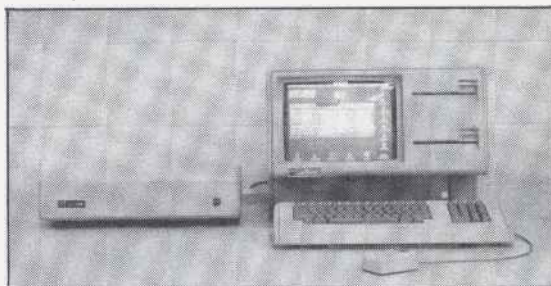

APPLE LISA 146

PCW flew Robin Webster to California to put the first full commercial Lisa system through its paces, and to talk to its design engineers.



ECALC FOR EPSON 164

Is the portable HX-20 a suitable vehicle for spreadsheets? Mike Liardet gives it a fair trial.

EPSON QX-10 168

This machine signals Epson's launch into desk top micros. Peter Rodwell's findings look good.

EPSON FX-80 174 ▶

And while he's at it, Peter gives a new dot matrix printer the once over, too.

OSBORNE EXECUTIVE 176

An old hand at the Osborne, Guy Kewney, puts the new model under scrutiny.

FEATURES

CTUK! NEWS 119

Computertown Thanet reports on an open day aimed at bringing microcomputers to the community.

DISKOGRAPHY 162

Jane & John Shemilt give helpful information on choosing suitable disks for your computer.

MICRONET 800 184

Maggie Burton asks whether this Prestel-based dial-up computer club and magazine renders the old forms of communications obsolescent.

TOP SECRET 190

Is this the code to end all codes? Cryptography by George Sassoon.

Founder Angelo Zgorelec Editor Jane Bird Assistant Editor Maggie Burton Home Computing Editor Steve Mann Programs Editor Surya Sub Editor Ginny Conran Consultant Editors Peter Rodwell, David Tebbutt, Dick Pountain Editorial Secretary Tracy Dear Art Editor Phoebe Creswell-Evans Design Assistants Nikki Rechal, Safu-Maria Gilbert Typesetters Jane Hannell, Anne Ashby Publishing Manager Fiona Collier Group Advertisement Manager John Cade Advertisement Manager Patrick Dolan Assistant Advertisement Managers Peter Goldstein, Herbert Wright Sales Executives Jan Martin, Gill Harrison, Sarah Alexander, Michael Clarke, Caroline Shepherd, Joe Harrower Micromart Gaye Collins Advertisement Assistant Priscilla Senior Group Production Manager Laura Cade Advertisement Production Tony Keefe Production Assistant Lezley Hannibal

1983 READER SURVEY 195

Your chance to win a Sharp MZ-711 micro, and to shape the future of PCW while you're at it!

IBM COMES FORTH 198 ▶

Dick Olney gives the first UK review of the multi-tasking PolyForth compiler for the IBM PC.

A PSYCHOLOGICAL APPROACH? 207

The first in a four-part series about the Warnier Orr method of structured programming by Paul Overaa.

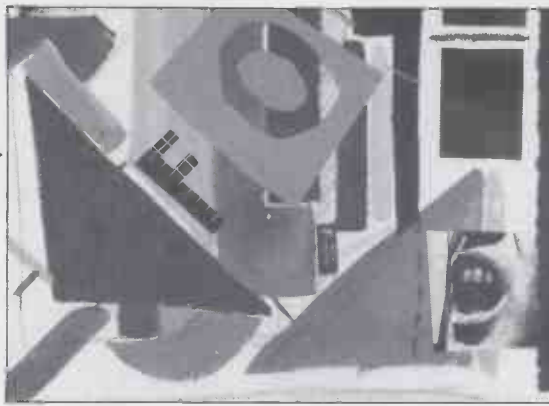

REGULARS

NEWSPRINT 106

Guy Kewney keeps you posted on the news and gossip in the micro world, delivered in his inimitable style.

COMMUNICATIONS 116

We like to keep in touch with our readers – so you keep in touch with us! Send the letters rolling in be they never so rude.

BANKS' STATEMENT 120

Martin gets lachrymose lamenting the passing of once-loved hardware.

**TJ'S WORKSHOP 122**

Jamboree bag of tips and tip-offs from readers.

PORTABLE COMPUTER WORLD 133

Amanda Parfitt gives hints on how to use the six function keys of the Sharp PC 1500.

YANKEE DOODLES 134

Continuing our monthly package of hot news and rumour from Sol Libes in the US.

BRAIN DUMP 144

It's Maggie's turn to sound off this month. Her subject: how myths are exploited in the computer world.

SCREENPLAY 160

Ms Burton again... this time looking at games for the Colour Genie.

NUMBERS COUNT 167

Last month it was U-sequences, this month it's n-tuples. Mike Mudge presents another batch of mathematical mind-benders.

COMPUTER ANSWERS 180

Agony Uncle Len Warner concentrates his expertise on solving your problems.

MICRO CHESS 182

Tony Harrington puts the Phantom from Milton Bradley under the spotlight. David Levy adds notes on strategy.

SUBSET 188

Alan Tootill provides another bumper pack of assembler subroutines.

SUBSCRIPTIONS 208

How to ensure your next issue arrives while you're lying prostrate in the sun on holiday. You give us the cash first!

DIRECT ACCESS 210

Includes In Store, ACC News, Computer Town Centres, Networks, Diary Data.

BEGINNERS START HERE 222

This is where we explain the opaque jargon bandied about the rest of the magazine.

PROGRAMS 224

Surya presents a round-up of programs for the BBC, Atom, ZX81, Spectrum, Genie, MZ-80K, TRS-80 and Apple II micros.

LEISURE LINES 243

JJ Clessa hooks you with more brain teasers for fast thinkers.

BACK ISSUES 244

Keep them for posterity.

CHIP CHAT 352

A private eye and a candid camera ever watchful for the industry's biggest blunders.

BLUDNERS 352

Blunders of our own... not wishing to be outdone.

Subscriptions Enquiries Stuart Cruickshank Subscription Rates UK: £12.50, Overseas £27.50 Subscription and mail order address 53 Frith Street, London W1A 2HG, tel: 01-439 4242. © Computing Publications Ltd. 1983. Editorial and advertising address 62 Oxford Street, London W1A 2HG, tel: 01-636 6890. No material may be reproduced in whole or in part without written consent from the copyright holders. Printed by Chase Web Offset, St Austell, Cornwall. Distributed by Seymour Press, 334 Brixton Road, London SW9, tel: 01-733 4444.

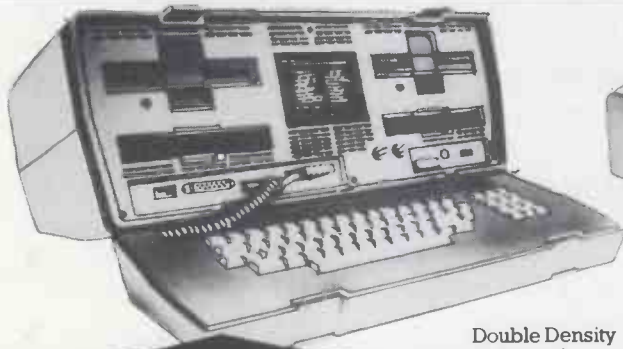

Double Density
Osborne 1
(New Style)

£949 + VAT



TEC FP 1500-25
Daisy Wheel Printer
25 CPs fully Wordstar
compatible with
Sheetfeeder and
Tractor
Option.

SPECIAL OFFER!

EPSON Rx-80 100 characters per
second, dot addressable graphics,
condensed and double width
printing.

Fx-80 160 characters per
second, proportional spacing,
quick forms tear
off, and many
other
features.

SPECIAL OFFER!



COMPUTERS

Britain's No. 1.

Southampton House, 192-206 York Road, London SW11 3SA

TELEX: 8954575 CTCLDN

BRITAIN'S No.1. OSBORNE DEALER!

DATA BASE II
Ashton-Tate Data Base II gives your Osborne mainframe power.

SPECIAL OFFER!

Facilities: Address lists, Sales ledgers, Time Sheets, Inventory control etc.

OSBORNE 80/104 Column Card
We recommend *only* the OSBORNE 80 column because it also allows you the flexibility of 52 card and 104 card function - unlike other 80 column adapts on the market!

SPECIAL OFFER!

When you buy an Osborne at 01 Computers you also benefit from the kind of back up you would expect from Britain's No. 1 Osborne Dealer.

- * User training for you and your staff.
- * Easily arranged credit terms.
- * Sophisticated technical and service back up.

We would welcome a visit from you, to our showrooms where we can offer you coffee, an informal atmosphere and of course a personal demonstration of the incredible OSBORNE I.

* N.B. We are open until 6.30 pm weekdays and 10 am - 1 pm Sat. & Sun.

Call us for an appointment, sales/mail order, or simply drop in!

01-228 2207

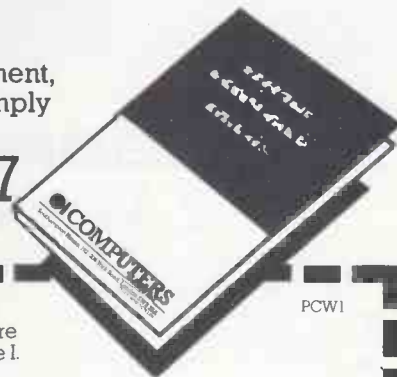

**WE'RE CENTRAL
AND EASY TO
FIND!**

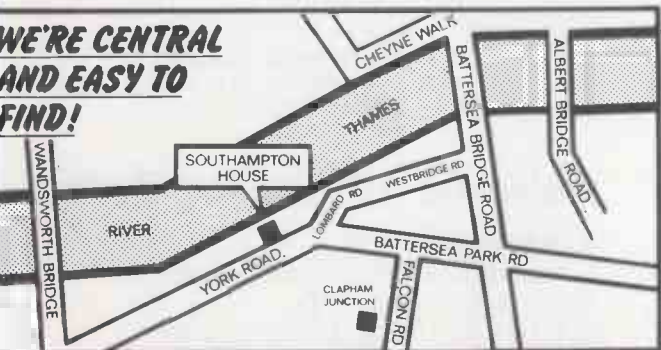

Please send me a copy of your introductory brochure and details of the Osborne I. PCW1

Name _____

Address _____

_____ Tel No: _____

Occupation _____

Southampton House, 192-206 York Road, London SW11 3SA

— STOCK — — CLEARANCE — — SAVE £600 —

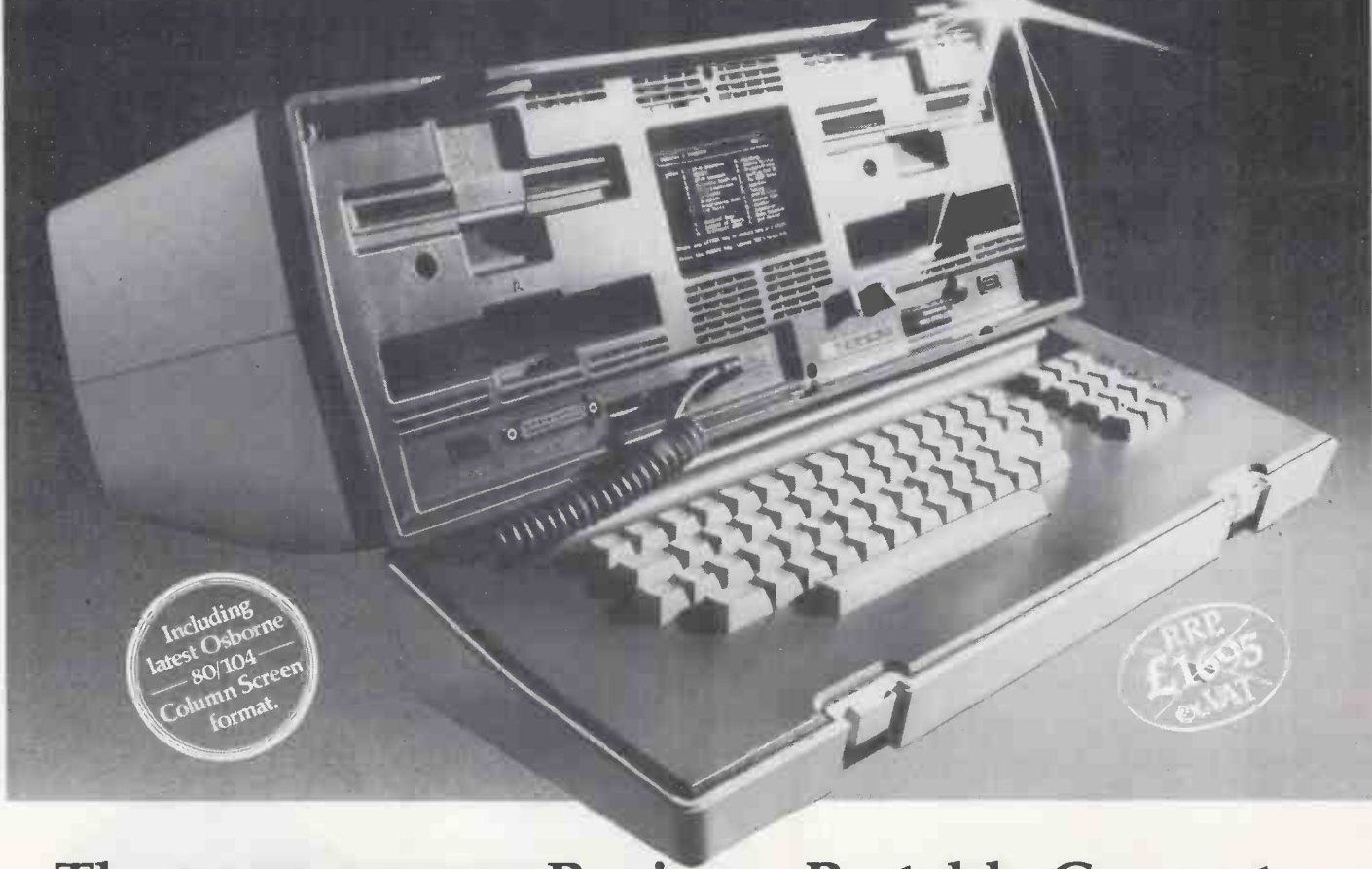

The **OSBORNE** Business Portable Computer
ZAK clearance price £1,095* ex. VAT.
whilst stocks last

*** Inclusive Software:-**

- WORDSTAR word processing
- MAILMERGE mail list etc.
- SUPERCALC electronic spreadsheet
- CBASIC programming language
- MBASIC programming language
- CP/M operating system

FULL 12 MONTHS GUARANTEE
Our special price includes the 12 months
parts and labour Osborne warranty.



ZAK Computers.

Osborne Authorised Dealer

Zak Computers Ltd.,
Churchill House, 88/92 Talbot Rd.,
Manchester M16 0PD.
Tel: 061-872 7818. Telex: 665449

SILICON VALLEY

The best value in the city for . . .



ACT Sirius 1

This high speed 16 bit business computer from ACT is the best selling micro of its kind. Available from Silicon Valley from £2,395 or lease from £12.98 per week.

1.2K ● 2.4K ●

10 Mbyte (Winchester) Accounting systems installed and supported by Chartered Accountants

For these products

- We are established main dealers
 - We give the best support
 - We give the advice
 - We supply the software
- And we are always in stock!!

Silicon Valley has on site Chartered Accountants, management consultants specialist, computer engineers to discuss and recommend solutions. We offer full training and maintenance - **TRY US OUT**

THE COMPLETE BUSINESSMANS PACKAGE

- Sirius 128K computer
- Epson Matrix Printer
- Exact - stock, sales, invoicing, sales ledger & purchase ledger
- All cables, consumables, installation and on site training - £2,999



EPSON QX10

THE UP-MARKET MICRO with power, compatibility and add-on versatility. **First** for educational applications ● Unbeatable for graphics ● Easiest to use software ● CP/M and all its systems ● Full battery back up. All for **£1,735**

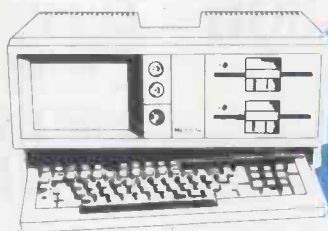

Hyperion

IBM Compatibility
Hyperion runs all the popular programs written for the IBM Personal Computer.

Eg: Visicalc, Wordstar, DBASE II, Advanced Disc BASIC, MULTIPLAN ● IN:SCRIBE

TORCH
OSBORNE



London
Suite 104/5
Hatton Square
16 Baldwins Gardens
London EC1N 7RJ
01-242 2803

Manchester
12 Lever Street
Piccadilly
Manchester
061-228 1686
061-792 2723

**A GOOD DEAL MADE
A GOOD DEAL BETTER**

Telex: 8813271 GECOMSG
Tel: 01-242 2803

The Permanent Computer Show

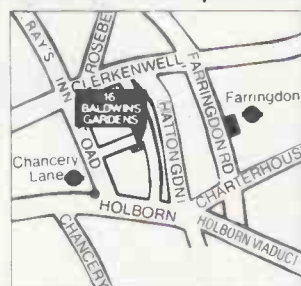

SILICON
VALLEY
COMPUTER
CENTRE

NEVER UNDERSOLD!

SPECIAL SPRING OFFER

IBM PC

128K RAM complete with Dual
320Kb Drives, Keyboard,
Monochrome Display, Printer
Adaptor, Asynch Comm.
Adaptor.

LIST £2929.00

ADS PRICE £2400.00

SIRIUS 1

Dual 1.2 Mb Drives, 128K RAM

LIST £2395.00

ADS PRICE £1995.00

SIRIUS 1

10Mb Winchester, 1.2 Mb
floppy, 128K RAM

LIST £3995.00

ADS PRICE £3495.00

SHARP MZ80B

Dual floppy drives 560Kb,
CP/M.

LIST £1709.00

ADS PRICE £1295.00

**All equipment ex-showroom stock – available immediately
Plus all peripherals, software etc. All prices are plus VAT**

ATLANTA DATA SYSTEMS

350/6 Old Street London EC1V 9DT

01 729 1411

NETWORKING!

If you wish to interface any computer to almost any other computer or peripheral O.E.M. NETWORKS are probably the only company in the U.K. that have a working solution

NOW!

(not next quarter).

We have developed the new *INTERNET IV* (any 2 machines/peripherals networking) and the new *MULTINET 2000* range (6 to 120 machines/peripherals networked). Each port is programmable and we can link variable networks together on:—

MICRO'S

MINI'S

MAINFRAMES

So, if you are drowning in this pool:

ASCII, EBCDIC, Baudot, Hexadecimal codes, Asynchronous, Binary Synchronous transmission modes, Baud rates from 50 to 19200, X-on/X-off, ENQ, ACK, EOL Handshakes, odd/even parity, 2780/3780, 3270, CO3, MCP, DOS, RSTS/E, GCOS, OS1100, MVS, HASP, PRIMOS, VRX, EXEC8, RDOS

WE CAN SAVE YOU!

Call our hotline on 748 8404

PLUS! — IBM PC/SIRIUS 1® with up to 50 terminals.

Transfer of data files and programme files from almost any machine to any machine.

Come to our King Street showrooms to discuss your application and have a demonstration on:

IBM
Personal Computer



ACT
SIRIUS 1



olivetti M20



apple®

OSBORNE 1



and a whole range of printers.

OEM TOMORROW'S TECHNOLOGY TODAY

OEM NETWORKS
150-152 KING STREET, LONDON W.6.

PCW7
Tel. 01-741 7383

Please send me information/quote on:

I am an End User Dealer Urgent

I have a requirement for 1 system 2-9 systems

10 or more systems

I will be purchasing within

1 month 3 months 6 months or more

My budget is £

Name _____ Title _____

Company _____

Address _____

Postcode _____

Phone _____ Extension _____

The Extraordinary Epson Computer Family

QX10



A fully integrated Desktop Microcomputer system that takes the hardwork out of using software. An incredible new member of the Epson family.

Features:

- ★ Z80A CPU, VDU, and Keyboard units in modern lightweight, functional design.
- ★ 192K memory upgradeable to 256K RAM.
- ★ RS232C and parallel interfaces with multi-font BASIC as standard.
- ★ 5 optional interface card slots for Cassette, Barcode, Joystick, Sound Generator, Omninet™ facilities. Also available is a universal interface card for developing your own interfaces.
- ★ 80 col x 25 lines screen with full bit image control.
- ★ 640 x 400 resolution graphics with 16:1 ZOOM and special effects including split screen facility.
- ★ Clock and calendar with battery back-up.

™ Omninet is a registered trade mark of Corvus Computers.

HX20



The full function, truly portable computer that slips into your briefcase, incorporating an LCD screen, full typewriter keyboard, printer and optional microcassette.

Features:

- ★ 20 character by 4 lines LCD screen.
- ★ A built in 24 column dot matrix impact microprinter.
- ★ 16K RAM which is optionally expandable to 32K, ROM expandable to 64K
- ★ RS232C and serial interfaces.
- ★ Full size ASC II Keyboard.

STC Multicomponent can also offer a full range of accessories and several software packages in microcassette or pre-programmed ROM format.

RX80 & FX80 PRINTERS



Two exciting new printers that have the usual Epson qualities like reliability, modern styling and speed — and successfully surpass the performance of earlier machines.

The RX80 Features:

- ★ 100 character per second
- ★ Dot addressable graphics.
- ★ Condensed and double width printing.
- ★ Tractor feed for exact alignment.

The FX80 Features:

- ★ 160 characters per second.
- ★ Proportional spacing, quick form tear off, superscripts, and down loadable character set.

Both printers have standard Centronics parallel interface with IEEE 488, RS232C etc optional interfaces.

MX 100 III

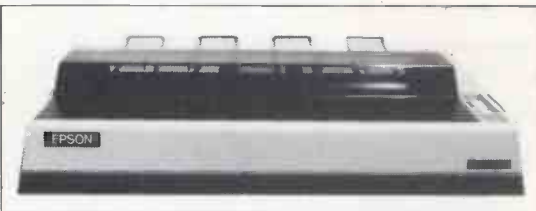

Another stylish and versatile printer from the Epson family.

Features

- ★ 100 characters per second
- ★ Wide 15" carriage.
- ★ Bit image printing.
- ★ 32 print codes standard.
- ★ Full 96 ASCII with decenders, 8 international character sets.
- ★ Standard Centronics parallel interface with a variety of optional interfaces including RS232C, TRS 80 Model I, and Apple II intelligent parallel interface.

From An Extraordinary Distributor



WATFORD ELECTRONICS

33 (PCW) Cardiff Road, Watford, Herts, England
Tel: Watford (0923) 40588. Telex: 8956095

ALL DEVICES FULLY GUARANTEED. Send Cheque, P.O.s, Cash, Bank Draft with Orders. ACCESS/MASTER CHARGE Accepted. GOVERNMENT & EDUCATIONAL ESTABLISHMENTS OFFICIAL ORDERS WELCOME. P&P add 60p to all Cash Orders. OVERSEAS Orders postage at cost.

VAT ALL PRICES ARE EXCLUSIVE OF VAT. PLEASE ADD 15% TO THE TOTAL COST INCLUDING P&P. SHOP HOURS: 9.00am-6.00pm MONDAY TO SATURDAY. AMPLE FREE CAR PARKING SPACE AVAILABLE. FOR QUANTITY PRICES PHONE WATFORD(0923) 40588

| Computer IC's | FD1781 | £15 | TTL74 | 4068 | 14 | 4412 | 790 | 4585 | 60 |
|---------------|------------|------|-------|------|------|------|------|------|-------|
| 1802CP | FD1791 | £22 | 7400 | 11 | 4070 | 13 | 4450 | 350 | 4597 |
| 2114L-200n | FD1793 | £23 | 7402 | 11 | 4076 | 50 | 4451 | 350 | 4598 |
| 2147-3 | FD1795 | £28 | 7410 | 14 | 4077 | 13 | 4490 | 350 | 4601 |
| 2532-450n | IM6402 | 380 | 7411 | 15 | 4078 | 15 | 4500 | 675 | 4605 |
| 2564 | INS8060N | 1050 | 7420 | 18 | 4081 | 13 | 4504 | 75 | 4610 |
| 2708 | T85154N | 309 | 7421 | 18 | 4093 | 20 | 4505 | 185 | 4612 |
| 2716-5V | MC1488 | 55 | 7422 | 15 | 4099 | 75 | 4508 | 130 | 4618 |
| 2732-250n | MC1489 | 55 | 7422 | 20 | 4160 | 95 | 4511 | 46 | 46114 |
| 2764-250n | MC14411 | 690 | 7427 | 18 | 4161 | 99 | 4519 | 30 | 46163 |
| 27128-250 | MC14412 | 725 | 7430 | 14 | 4162 | 99 | 4528 | 50 | 46244 |
| 27128-400 | MC3446 | 215 | 7432 | 31 | 4163 | 99 | 4549 | 375 | 46245 |
| 3242 | MC3447P | 315 | 7447 | 40 | 4174 | 99 | 4569 | 175 | 46373 |
| 4116-200 | MC6846 | 625 | 7448 | 40 | 4175 | 105 | 4583 | 90 | 46374 |
| 4116-200 | MM5280D | 695 | 7473 | 24 | 4411 | 690 | 4584 | 40 | 45106 |
| 4116-250 | MM5303 | 635 | 7474 | 20 | | | | | |
| 4164-200 | MM5307 | 1275 | 7475 | 25 | | | | | |
| 4632-3 | MM5387A | 475 | 7485 | 25 | | | | | |
| 4816A-100nS | MM5817A | 700 | 7486 | 20 | | | | | |
| 5101 | RC-3-2513L | 250 | 7489 | 170 | | | | | |
| 6116-150 | RO-3-2513U | 600 | 7490 | 20 | | | | | |
| 6116L-120nS | SFF96364E | 800 | 7491 | 35 | | | | | |
| 6117-100n | SP0256AL2 | £18 | 7492 | 25 | | | | | |
| 6187 | TMS2716-3 | 725 | 7493 | 20 | | | | | |
| 6502A | TMS4145-15 | 475 | 74100 | 80 | | | | | |
| 6502 CPU | TMS4500 | £14 | 74116 | 50 | | | | | |
| 6503 | TMS5100 | 600 | 74121 | 25 | | | | | |
| 6521 | TMS6011 | 365 | 74122 | 35 | | | | | |
| 6522 VIA | TMS927 | 600 | 74126 | 35 | | | | | |
| 6530 RRIOT | TMS9929 | £16 | 74143 | 210 | | | | | |
| 6532 RIOT | TMS9995 | £12 | 74148 | 60 | | | | | |
| 6545 CRTC | ULN2003 | 75 | 74151 | 40 | | | | | |
| 6551 ACIA | UPD7002 | 425 | 74153 | 40 | | | | | |
| 6592 PC | Z80 | 875 | 74154 | 50 | | | | | |
| 6800 | Z80CPU2.5 | 260 | 74186 | 470 | | | | | |
| 6802 | Z80ACPU | 300 | 74188 | 250 | | | | | |
| 6803 | Z80B | 875 | 74383 | 99 | | | | | |
| 6804 | Z80CTC | 250 | | | | | | | |
| 6805 | Z80ACTC | 260 | | | | | | | |
| 6808 | Z80DART | 495 | LS02 | 11 | | | | | |
| 6809 | Z80ADART | 495 | LS02 | 11 | | | | | |
| 6810 | Z80DMA | 675 | LS04 | 12 | | | | | |
| 6821 | Z80DMA | 675 | LS08 | 12 | | | | | |
| 6840 | Z80P10 | 260 | LS10 | 12 | | | | | |
| 6843 | Z80AP10 | 275 | LS11 | 12 | | | | | |
| 6845 | Z80S10 | 850 | LS13 | 15 | | | | | |
| 6847 | Z80S10 | 850 | LS14 | 26 | | | | | |
| 6850 | ZN419 | 180 | LS19 | 18 | | | | | |
| 6852 | ZN423E | 138 | LS20 | 13 | | | | | |
| 6854 | ZN424E | 130 | LS22 | 12 | | | | | |
| 6854 | ZN425E-8 | 345 | LS22 | 12 | | | | | |
| 6875 | ZN426E-8 | 300 | LS27 | 12 | | | | | |
| 68000 | ZN427 | 130 | LS30 | 12 | | | | | |
| 74C322 | ZN427E-8 | 590 | LS42 | 28 | | | | | |
| 8080A | ZN428E | 220 | LS47 | 35 | | | | | |
| 8085A | ZN429E-8 | 210 | LS48 | 35 | | | | | |
| 8088 | ZN459 | 570 | LS63 | 120 | | | | | |
| 81LS95 | ZN1034C | 200 | LS73 | 18 | | | | | |
| 81LS96 | ZN1040 | 660 | LS75 | 18 | | | | | |
| 81LS97 | ZN423AE | 850 | LS82 | 42 | | | | | |
| 81LS98 | LS85 | 42 | LS86 | 16 | | | | | |
| 8118-10 | 74500 | 30 | LS90 | 24 | | | | | |
| 8123 | 74502 | 30 | LS91 | 60 | | | | | |
| 8155 | 74503 | 32 | LS92 | 32 | | | | | |
| 8156 | 74504 | 30 | LS93 | 23 | | | | | |
| 8202 | 74505 | 30 | LS125 | 24 | | | | | |
| 8205 | 74506 | 40 | LS126 | 24 | | | | | |
| 8212 | 74510 | 40 | LS128 | 25 | | | | | |
| 8214 | 74527 | 40 | LS139 | 28 | | | | | |
| 8215A-300 | 74527 | 40 | LS148 | 70 | | | | | |
| 8216 | 74527 | 40 | LS153 | 40 | | | | | |
| 8224 | 74532 | 70 | LS156 | 36 | | | | | |
| 8226 | 74534 | 80 | LS157 | 25 | | | | | |
| 8228 | 745112 | 80 | LS158 | 20 | | | | | |
| 8228 | 745132 | 110 | LS156 | 36 | | | | | |
| 8243 | 745133 | 60 | LS157 | 25 | | | | | |
| 8250 | 745138 | 100 | LS158 | 20 | | | | | |
| 8251 | 745139 | 115 | LS175 | 36 | | | | | |
| 8253 | 745155 | 39 | LS240 | 55 | | | | | |
| 8255 | 745158 | 195 | LS241 | 95 | | | | | |
| 8256A | 745175 | 260 | LS242 | 55 | | | | | |
| 8257 | 745188 | 140 | LS243 | 55 | | | | | |
| 8259 | 745189 | 140 | LS244 | 50 | | | | | |
| 8271 | 745194 | 195 | LS273 | 70 | | | | | |
| 8279 | 745201 | 250 | LS273 | 70 | | | | | |
| 8282 | 745225 | 240 | LS373 | 60 | | | | | |
| 8283 | 745240 | 390 | LS374 | 55 | | | | | |
| 8284 | 745241 | 250 | LS393 | 42 | | | | | |
| 8285 | 745244 | 290 | LS471 | 629 | | | | | |
| 8287 | 745257 | 170 | LS640 | 180 | | | | | |
| 8288 | 745260 | 50 | LS641 | 180 | | | | | |
| 8288A | 745262 | 850 | LS645 | 180 | | | | | |
| 8272 | 745262 | 850 | LS648 | 125 | | | | | |
| 8278A | 745278 | 225 | LS669 | 120 | | | | | |
| 8278 | 745288 | 210 | LS670 | 100 | | | | | |
| 8195N | 745289 | 200 | LS673 | 550 | | | | | |
| 8197N | 745301 | 000 | | | | | | | |
| 9364AP | 745365 | 000 | | | | | | | |
| 9602 | 745374 | 365 | | | | | | | |
| AM28LS3172 | 745470 | 620 | 4000 | 40 | | | | | |
| AY-3-1015 | 745471 | 620 | 4001 | 10 | | | | | |
| AY-3-1270 | 745472 | 1150 | 4002 | 12 | | | | | |
| AY-3-8910 | 745475 | 25 | 4009 | 24 | | | | | |
| AY-5-1013 | 745571 | 620 | 4010 | 24 | | | | | |
| AY-5-1350 | | | 4011 | 10 | | | | | |
| AY-5-2376 | | | 402 | 2 | | | | | |
| AY-5-3600 | 75159 | 125 | 4017 | 32 | | | | | |
| COM8017 | 751078 | 95 | 4018 | 45 | | | | | |
| COM8116 | 751509/54 | 125 | 4023 | 13 | | | | | |
| DM8131 | 751514 | 125 | 4025 | 13 | | | | | |
| DP8304BN | 75182/3 | 99 | 4027 | 20 | | | | | |
| DS3691N | 75188/9 | 55 | 4034 | 140 | | | | | |
| DS88LS120N | 75188/9 | 55 | 4034 | 140 | | | | | |
| DS8820 | 7532 | 140 | 4040 | 40 | | | | | |
| DS8830 | 75450 | 60 | 4051 | 60 | | | | | |
| DS8833 | 75451/2 | 52 | 4052 | 60 | | | | | |
| DS8831 | 75454 | 70 | 4053 | 50 | | | | | |
| E9365/6 | 75491/2 | 65 | 4066 | 24 | | | | | |

| Computer IC's | FD1781 | £15 | TTL74 | 4068 | 14 | 4412 | 790 | 4585 | 60 |
|---------------|------------|------|-------|------|------|------|------|------|-------|
| 1802CP | FD1791 | £22 | 7400 | 11 | 4070 | 13 | 4450 | 350 | 4597 |
| 2114L-200n | FD1793 | £23 | 7402 | 11 | 4076 | 50 | 4451 | 350 | 4598 |
| 2147-3 | FD1795 | £28 | 7410 | 14 | 4077 | 13 | 4490 | 350 | 4601 |
| 2532-450n | IM6402 | 380 | 7411 | 15 | 4078 | 15 | 4500 | 675 | 4605 |
| 2564 | INS8060N | 1050 | 7420 | 18 | 4081 | 13 | 4504 | 75 | 4610 |
| 2708 | T85154N | 309 | 7421 | 18 | 4093 | 20 | 4505 | 185 | 4612 |
| 2716-5V | MC1488 | 55 | 7422 | 15 | 4099 | 75 | 4508 | 130 | 4618 |
| 2732-250n | MC1489 | 55 | 7422 | 20 | 4160 | 95 | 4511 | 46 | 46114 |
| 2764-250n | MC14411 | 690 | 7427 | 18 | 4161 | 99 | 4519 | 30 | 46163 |
| 27128-250 | MC14412 | 725 | 7430 | 14 | 4162 | 99 | 4528 | 50 | 46244 |
| 27128-400 | MC3446 | 215 | 7432 | 31 | 4163 | 99 | 4549 | 375 | 46245 |
| 3242 | MC3447P | 315 | 7447 | 40 | 4174 | 99 | 4569 | 175 | 46373 |
| 4116-200 | MC6846 | 625 | 7448 | 40 | 4175 | 105 | 4583 | 90 | 46374 |
| 4116-200 | MM5280D | 695 | 7473 | 24 | 4411 | 690 | 4584 | 40 | 45106 |
| 4116-250 | MM5303 | 635 | 7474 | 20 | | | | | |
| 4164-200 | MM5307 | 1275 | 7475 | 25 | | | | | |
| 4632-3 | MM5387A | 475 | 7485 | 25 | | | | | |
| 4816A-100nS | MM5817A | 700 | 7486 | 20 | | | | | |
| 5101 | RC-3-2513L | 250 | 7489 | 170 | | | | | |
| 6116-150</ | | | | | | | | | |

MICRO COMPUTER CONSULTANTS LTD



ASCOTT HOUSE, 227 ELLIOTT ST., TYLDESLEY, MANCHESTER M29 8DG
TEL: ATHERTON (0942) 892818

**YOU CAN DO ALL THIS ON AN
APPLE IIe
PERSONAL COMPUTER?**



Editing and word processing · Graphics presentations · Financial modelling · Data base and file management · Sales forecasting · Budget planning · Electronic mail and data base access · Small business accounting · Project management · Teaching and training

INCREDIBLE OFFERS ON THE REVOLUTIONARY APPLE IIe AND APPLE III SYSTEMS

APPLE IIe STARTER SYSTEMS from only £1057

MATRIX PRINTERS from as little as £289
DAISY WHEEL PRINTERS from only £425
ALL PRODUCTS CARRY A 1 YEAR WARRANTY
OVERSEAS ORDERS A SPECIALITY

Call 0942-892818 for full details

While stocks last

APPLE II+48K for only £499 (+VAT)

PROFILE VIDEO LTD

TEL. 062-85-29721

Ferguson Tx Rec. with R.G.B.

| | |
|-----|------|
| 14" | £240 |
| 18" | £315 |
| 22" | £340 |

OTHER SIZES
AVAILABLE.

Epson Printers

| | |
|--------|------|
| RX 80 | £279 |
| FX 80 | £379 |
| MX 100 | £410 |

ALL CONNECTION LEAD
AVAILABLE PRICE ON
REQUEST.

Computer Tables

| | | |
|---------|-----------|-----|
| C.T. 20 | 20" × 26" | |
| | 20" × 14" | £50 |
| C.T. 40 | 40" × 26" | |
| | 40" × 14" | £75 |



Computers

| | |
|-------------------------|-------|
| Epson HX 20 C-W case | £400 |
| Cassette unit for above | £75 |
| Osborne 1 D.D. Jersin | £1275 |

ALL PRICES SUBJECT TO V.A.T.

CARRIAGE CHARGE EXTRA.

INTERESTED IN LANGUAGES?

FRENCH RUSSIAN GERMAN
(coming soon)

EDUCATIONAL LANGUAGE SOFTWARE
on Cassette for
BBC Micro (32K) and soon for Spectrum (48K)

Master the most vital part of grammar with our

IRREGULAR VERB SERIES

Easy to use, attractive and fully comprehensive programs for
ALL levels of ability.

Immediate access to THOUSANDS of verb forms from over
150 mainly IRREGULAR verbs in ALL their tenses.

TEST Yourself BROWSE at random Use as a REFERENCE

- * Menu Driven
- * Test with time limit
- * English meanings
- * Choice of tense(s)
- * Full character sets
- * Multiple levels
- * Attractive colour format
- * Full form generation
- * Vetted by native speakers
- * Five operation modes

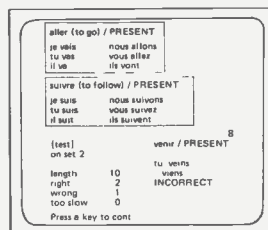

FRENCH

Fully accented characters; Eight tenses/moods. Includes
virtually all types of stem and ending mutation **£19.30 incl**

RUSSIAN

Cyrillic character set; Optional stress accenting.
Aspect pairs at key press. **£21.50 incl**

These sophisticated programs actually generate each verb
form as and when required.

Prices include VAT and P&P

Direct Order or SAE for further details to:

CARSONDALE ENTERPRISES LIMITED

44 KINGSWAY, STOKE-ON-TRENT, Staffordshire, ST4 1JH

QUALITY SOFTWARE FOR THE DRAGON 32K

HOME FINANCE:- A useful program to help you
manage your money. **£7.00**

MISSILE DEFENDER:- Good colours and graphics.
Save the world – if you can!! **£6.25**

GOLDEN APPLES:- Steal the apples, then defeat
the warlock **£8.45**

PLANETARY TRADER:- Choose your cargo, then
deliver it – if you can **£5.95**

SURPRISE:- Spells, giants, a magic ring – but not
another 'Lord of the Ring' **£8.45**

NEW SOFTWARE FOR THE SPECTRUM (7.95 EACH)

STAR FIRE (48K only):- Rid the galaxy of the Xtardan battle
cruisers, a game of strategy and skill

GOLF:- (16K & 48K):- Who's the Champion, then?

YOMPER (16K & 48K):- Command the Paras and complete the
impossible

SHEEPWALKER (48K only):- Sheepdog trials in your living room

Mail order only. Price includes U.K. postage only

ALL TAPES GUARANTEED

TAPESOFT (Dept PCW)
55 Morley Road, Twickenham, TW1 2HG.

ATARI COMPUTERS

| | |
|---------------------------------------|--------|
| AM 400 16K RAM Computer | 125.95 |
| A800 48K RAM Computer | 329.95 |
| A850 Interface Module | 109.95 |
| A410 Programs Recorder | 42.95 |
| CX86 Printer Cable | 24.95 |
| CX88 RS232 Cable | 21.75 |
| CO1655 Technical Users Notes | 17.00 |
| CXL4018 Pilot Language | 78.29 |

Selection of educational, graphic games software available.



BBC MICROCOMPUTERS

| | |
|---|--------|
| BBC Micro Module B | 399.95 |
| Model A to Model B Upgrade Kit | 49.95 |
| Games Paddle | 11.30 |
| Prestel Adaptor | 129.95 |

Selection of educational, graphic games software available.



COMMODORE MICRO COMPUTERS

| | |
|------------------------|--------|
| Commodore VIC 20 | 79.00 |
| Commodore 64 | 279.95 |

Selection of educational, graphic games software available.

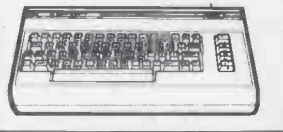

CASIO POCIET COMPUTERS

| | |
|-----------------------|--------|
| FX802 | P.O.A. |
| FX 3600P | 19.95 |
| FX 602P | 43.95 |
| FX 700P | 69.55 |
| PB 100 Computer | 43.45 |



SHARP PORTABLE COMPUTERS

| | |
|-------------------------|--------|
| PC 1251 | 64.95 |
| CE 125 | 79.95 |
| PC 1500 Colour | 139.95 |
| CE 150 Printer | 124.95 |
| CE 152 (4K RAM) | 29.95 |
| CE 153 | 69.56 |
| CE 155 8K Battery | 78.25 |
| CE 158 RS232 | 130.45 |



EPSON HX-20 PORTABLE COMPUTER

Portability for programmability anywhere. Diminutive fully featured business computer, that is small and light enough to slip into a briefcase. Specifications include integrated LED screen, printer and micro-cassette, 16K RAM expandable to 32K, and its own rechargeable power supply. Ideal for people on the move.

Epson HX-20 16K P.O.A.

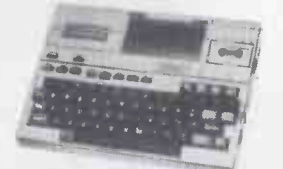

HEWLETT PACKARD

| | |
|-------------------------------|--------|
| HP-32E Pre-programmed | 44.26 |
| HP-10C Programmable | 47.67 |
| HP-11C Programmable | 61.29 |
| HP-15C Advanced Program | 81.72 |
| HP-16C Programmable | 81.72 |
| HP-12C Financial | 87.45 |
| HP-41C Computer | 125.37 |
| HP-41CV Computer | 176.81 |
| Memory module | 16.88 |
| Quad memory | 50.67 |
| Extended functions | 50.67 |
| Card Reader | 125.37 |
| Printer | 247.53 |
| Digital Cassette Drive | 294.21 |



SINCLAIR ZX COMPUTERS

| | |
|---------------------|--------|
| Spectrum 16K | 86.95 |
| Spectrum 48K | 112.95 |
| ZX81 Computer | 34.80 |
| 16K RAM | 19.95 |
| 32K RAM | 49.95 |
| 64K RAM | 79.00 |
| ZX Printer | 34.75 |



SHARP MZ-80A

| | |
|--------------------------------|--------|
| 48K Computer | 434.95 |
| MZ-80 SFD D/Drive | 285.00 |
| MZ-80 FB Dual D/Drive | 529.00 |
| CP/M-MZ-80A | 64.95 |
| MZ-80TU Assembler | 44.95 |
| MZ-8AD0Z FDOS | 41.95 |
| MZ-80AEO Expansion Unit | 99.95 |
| MZ-80AMD Master Diskette | 29.95 |
| MZ-80P4 Printer | 649.00 |
| MZ-80P5 Printer | 289.95 |
| MZ-80P6 Printer | 320.00 |



EPSON QX-10

THE QX-10. A fully integrated Desktop Microcomputer system that takes the hard work out of using software.

More Power for money, 192k up-gradable to 256k R.A.M., incredible graphics capability, with zoom facility, RS232C and parallel interfaces and multi-font BASIC as standard. Compare that with systems costing twice the price.

80 col. x 25 lines screen with full bit image control, 640 x 400 resolution for greater definition. 16:1 zoom and special effects as well as unique split screen facility allowing different typestyles and graphics to be shown together for educational applications.

196K RAM £1735.00



BOOKS

At DEANS we stock a complete range of books for computer users. Whether you want to learn about machine-language or BASIC, games programs or business programs, we probably have the book for you.

Why don't you come in and have a look at our fine selection? If you're out of town, or can't get to Kensington, then send us an S.A.E. and we'll rush you our books catalogue.

Remember: it's books for learning, and it's DEANS for the best in computer books!

VDU's & MONITORS

| | |
|---------------------------------|--------|
| Sony 20" RGB Monitor | P.O.A. |
| 12" Green Kaga Monitor | 99.00 |
| 12" Black Kaga Monitor | 99.00 |
| 12" Amber Kaga Monitor | 99.00 |
| Kaga Colour RGB | 259.95 |
| 12" Green Hitachi Monitor | 99.00 |
| Sony 12" TV | 229.95 |

PRINTERS-IMPACT

| | |
|----------------------------------|--------|
| EPSON MX100 FT Type III | 430.00 |
| FX80 FT 160 cps | 428.00 |
| RX80 100 cps | P.O.A. |
| Apple Dot Matrix | 425.00 |
| SEIKDSHA GP100A | 199.00 |
| GP100VC | 219.95 |
| Paper Tiger | 299.95 |

PRINTERS-DAISY WHEEL

| | |
|----------------------------|---------|
| Apple letter quality | 1350.00 |
| FEC F10 | 1285.00 |

LYNX

48K R.A.M. expandable to 96k or 128k. You can start off using your cassette recorder for program and data storage. Lynx will accept a wide range of add on equipment, disc drives, printers ranging from low cost dot matrix to letter quality CP/M compatibility.



OLIVETTI M20 16-BIT MICRO

- Engineering
- Business
- Education
- Science

only
2395.00

or LEASE from 17.68 per week

● FREE SONY C6 VIDEO



RANK XEROX 820-II



Wordprocessing
Forecasting
Budgeting
Planning

only 2100.00 or LEASE from
£17.68 per week.

For the businessman looking for a superb business-oriented microcomputer system.

DEANS

of Kensington

191, Kensington High Street
London W8
200 Yards from High Street Kensington
Underground Station

Send orders with cheque payable to
DEANS. State goods required.
SECURICOR delivery add £6.00

Prices are subject to change without
notice. Add 15% VAT.

Tel 01-937-7896/938-1588 Ext 6

**Top specification.
High quality. Reliable.
Outstanding value.**



£319
+ VAT
Recommended introductory price.

The new Lucas LX80 printer

Here's a new dot matrix printer that you will want to see and try – if only to confirm that what we claim for it is true.

The LX80 is ideally suited to educational, scientific and personal applications in conjunction with the Lucas Nascom 3 micro, and similar machines.

Phone your nearest Lucas Logic stockist listed below – or if in difficulty phone us on 0926 59411.

We're adding to our dealer list, daily.



FEATURES:

- 80 characters per line, 10 characters per inch ● 80 characters per second bi-directional printing ● Dot matrix print using 7 x 8 dots in an 8 x 9 matrix ● 228 ASCII character set includes normal and italic scripts ● Full graphics facilities – semigraphic characters and 640 bit-addressable dots per line, or compressed 1280 dots per line (7.5 inches) ● Software selection of print – normal, compressed (142 characters per line), double width (40 characters per line) and compressed double (71 characters per line) ● Subscripts, superscripts, underlining, emphasised and double print software selectable ● Vertical and horizontal tab control, including variable line spacing, automatic form feed to preset length and perforation skip ● Backed by Lucas

Microcomputers for education, science and business.

Lucas Logic Limited, Welton Road, Wedgnock Industrial Estate, Warwick CV34 5PZ

LUCAS LOGIC STOCKISTS – Aberdeen: MicroComms, 0224 633385. Amersham: Amersham Computer Centre, 02403 22307. Bedford: Kempston News, 0234 857601. Bristol: Target Electronics, 0272 421196. Cardiff: Llandaff Radio & Television, 0222 563760; Steve Computer Services, 0222 41905. Crewe: Mid-Shire's Computer Centre, 0270 211086. Egham: Electrovalue, 0784 33603. Esher: Northamber, 0372 62071. Huntingdon: JPS, 0487 840710. Ipswich: M.D.W. Electronics, 0473 78295. Kenilworth: Business & Leisure Microcomputers, 0926 512127. Leeds: Leeds Computer Centre, 0532 458877. London: Henry's Radio, 01-724 3564; Off Records, 01-223 7730. Manchester: E.V. Computing, 061-431 4866. Newcastle-under-Lyme: Micro-Print, 0782 616481. N. Ireland: Newburn Electronics, 09603 78330. Norwich: Anglia Computer Centre, 0603 29652. Nottingham: Skytronics, 0602 781742. Plymouth: S. R. Brewster, 0752 665011. Poole: Parkstone Electronics, 0202 746555. Stroud: Zeta Computers, 045382 2444. Torquay: Crystal Computers & Components, 0803 22699. Watford: Computer Centre, 0923 50123; SRS Microsystems, 0923 26602. Witham: Selven Systems, 0376 519413.



ACT SIRIUS I SEEING IS BELIEVING!

The Act I Sirius I is a *revolutionary* concept in personal computing for business, bringing a new meaning to the term Price/Performance.

It offers users the 16 Bit performance normally associated with minicomputers but at a microcomputer price.

And it's backed up by the kind of 01 expertise and service that has made 01 one of Britain's top microcomputer Dealers.

Call us *first* on 01-228 2207, for a personal demonstration of the Act Sirius I. Remember, seeing is believing!

* ACT Sirius 1 128K RAM with 1.2Mb S/S Disks including CP/M-86, MS-DOS, (Run-time versions) & Microsoft Basic 86 £2,395

* ACT Sirius 1 128K RAM with 2.4Mb D/S Disks including CP/M-86, MS-DOS, (Run-time versions) & Microsoft Basic 86 £2,895

* ACT Sirius 1 256K RAM with 2.4Mb D/S Disks including CP/M-86, MS-DOS, (Run-time versions) & Microsoft Basic 86 £3,195

* ACT Sirius 1 128K RAM with 10Mb Winchester and 1.2Mb D/S Disk including MS-DOS, (Run-time version incorporating CP/M-86 emulator) & Microsoft Basic 86 £3,995

* ACT Sirius 1 256K RAM with 10Mb Winchester and 1.2Mb D/S Disk including MS-DOS, (Run-time version incorporating CP/M-86 emulator) & Microsoft Basic 86 £4,295

* Full Peripheral & Software Portfolio in stock

Call us for an appointment, sales/mail order, or simply drop in!

01-228 2207

* N.B. We are open until 6.30pm weekdays and 10am 1pm Sat & Sun

FROM
£2395+VAT

01 COMPUTERS

Britain's No.1

Southampton House, 192-206 York Road, London SW11 3SA
TELEX: 8954575CTCLDN

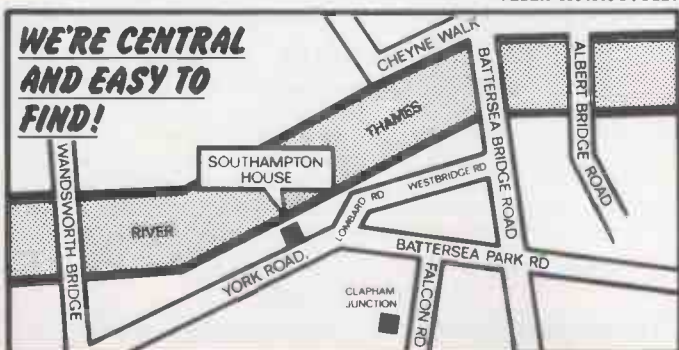

**WE'RE CENTRAL
AND EASY TO
FIND!**



Please send me a copy of your introductory brochure and details of the Act Sirius I.

PCW1

Name _____

Address _____

Tel No: _____

Occupation _____

Southampton House, 192-206 York Road, London SW11 3SA

Gemini

more programs

GEMINI SPECIAL FREE OFFERS

3 for the price of 2 – SAVE £19.95!
 5 for the price of 3 – SAVE £39.90!
 7 for the price of 4 – SAVE £59.85!
 (CASHBOOK & FINAL ACCOUNTS NOT INCLUDED)



CASH BOOK ACCOUNTS PROGRAM FOR BBC 32K, TORCH, SPECTRUM 48K
NEW £59.95

J. B. SHOOKER TIA P01 BLACK

TRAIL BALANCE AT 31/12/81

| ACCOUNT | DEBIT | CREDIT |
|-------------------------|--------|--------|
| 1 Sales £11 | | 60070 |
| 2 Sales £11 | | 49071 |
| 3 Discount Sales & Inv | 3000 | |
| 4 Purchases 102 | 31400 | |
| 5 Purchases 27 | | 37150 |
| 6 Discounts Sales & Inv | | 5000 |
| 7 Bank of England | | 700 |
| 14 Assets | 6430 | |
| 15 Assets | 1700 | |
| 16 Assets & Res | 1875 | |
| 17 Assets & Res | 675 | |
| 18 Expenses | 1870 | |
| 19 Expenses | 241 | |
| 20 Expenses | 780 | |
| 21 Assets & Res | 613 | |
| 24 Profit & Res | 800 | |
| 25 Profit & Res | 150 | |
| 26 Profit & Res | 150 | |
| 27 Profit & Res | 150 | |
| 28 Profit & Res | 150 | |
| 29 Profit & Res | 150 | |
| 30 Profit & Res | 150 | |
| 31 Profit & Res | 150 | |
| 32 Profit & Res | 150 | |
| 33 Profit & Res | 150 | |
| 34 Profit & Res | 150 | |
| 35 Profit & Res | 150 | |
| 36 Profit & Res | 150 | |
| 37 Profit & Res | 150 | |
| 38 Profit & Res | 150 | |
| 39 Profit & Res | 150 | |
| 40 Profit & Res | 150 | |
| 41 Profit & Res | 150 | |
| 42 Profit & Res | 150 | |
| 43 Profit & Res | 150 | |
| 44 Profit & Res | 150 | |
| 45 Profit & Res | 150 | |
| 46 Profit & Res | 150 | |
| 47 Profit & Res | 150 | |
| 48 Profit & Res | 150 | |
| 49 Profit & Res | 150 | |
| 50 Profit & Res | 150 | |
| 51 Profit & Res | 150 | |
| 52 Profit & Res | 150 | |
| 53 Profit & Res | 150 | |
| 54 Profit & Res | 150 | |
| 55 Profit & Res | 150 | |
| 56 Profit & Res | 150 | |
| 57 Profit & Res | 150 | |
| 58 Profit & Res | 150 | |
| 59 Profit & Res | 150 | |
| 60 Profit & Res | 150 | |
| TOTALS | 114800 | 114800 |

One of the most innovative business programs on the market. Replaces a manual cash book system, e.g. Simplex and 'All-in-One'. Written by practising Chartered Accountants, this practical program is simple to use and will replace your manual cash and bank records. By giving you access to vital management information as and when you want it, it will enable you to keep more positive financial control of your business.

The software is extremely well and lucidly documented, and Gemini provide a full technical back-up and product up-date policy. Take a look at the information this program will provide:

- Summary of VAT information for VAT returns
- Cumulative receipts and payments report analysed over the standard

profit and loss and balance sheet headings • Option for departmental analysis of sales and purchases • Audit trail printout of all transactions. • Journal routine for entering transfers between accounts and year end adjustment for debtors, creditors etc. • Trial balance at any interval • Interfaces to 'Final Accounts' program to produce balance sheet and trading and profit/loss account etc. • Spectrum version may be used with Sinclair OR 80 column printer.

FINAL ACCOUNTS PROGRAM FOR BBC 32K, TORCH, SPECTRUM 48K £59.95

Requires Cash Book module. This program will take your cash book data to the logical conclusion of balance sheet, trading and profit/loss account and notes to the accounts i.e. fixed assets, land and buildings and capital accounts. Final accounts (BBC version) links to 'Beebplot' for graphic data presentation.

Format: Torch disk, BBC disk/cassette, Spectrum cassette.
Special Offer – Cash Book and Final Accounts together – £95

J. B. SHOOKER TIA P01 BLACK

BALANCE SHEET AT 31/12/81

| ACCOUNT | DEBIT | CREDIT |
|-------------------------|--------|--------|
| 1 Sales £11 | | 60070 |
| 2 Sales £11 | | 49071 |
| 3 Discount Sales & Inv | 3000 | |
| 4 Purchases 102 | 31400 | |
| 5 Purchases 27 | | 37150 |
| 6 Discounts Sales & Inv | | 5000 |
| 7 Bank of England | | 700 |
| 14 Assets | 6430 | |
| 15 Assets | 1700 | |
| 16 Assets & Res | 1875 | |
| 17 Assets & Res | 675 | |
| 18 Expenses | 1870 | |
| 19 Expenses | 241 | |
| 20 Expenses | 780 | |
| 21 Assets & Res | 613 | |
| 24 Profit & Res | 800 | |
| 25 Profit & Res | 150 | |
| 26 Profit & Res | 150 | |
| 27 Profit & Res | 150 | |
| 28 Profit & Res | 150 | |
| 29 Profit & Res | 150 | |
| 30 Profit & Res | 150 | |
| 31 Profit & Res | 150 | |
| 32 Profit & Res | 150 | |
| 33 Profit & Res | 150 | |
| 34 Profit & Res | 150 | |
| 35 Profit & Res | 150 | |
| 36 Profit & Res | 150 | |
| 37 Profit & Res | 150 | |
| 38 Profit & Res | 150 | |
| 39 Profit & Res | 150 | |
| 40 Profit & Res | 150 | |
| 41 Profit & Res | 150 | |
| 42 Profit & Res | 150 | |
| 43 Profit & Res | 150 | |
| 44 Profit & Res | 150 | |
| 45 Profit & Res | 150 | |
| 46 Profit & Res | 150 | |
| 47 Profit & Res | 150 | |
| 48 Profit & Res | 150 | |
| 49 Profit & Res | 150 | |
| 50 Profit & Res | 150 | |
| 51 Profit & Res | 150 | |
| 52 Profit & Res | 150 | |
| 53 Profit & Res | 150 | |
| 54 Profit & Res | 150 | |
| 55 Profit & Res | 150 | |
| 56 Profit & Res | 150 | |
| 57 Profit & Res | 150 | |
| 58 Profit & Res | 150 | |
| 59 Profit & Res | 150 | |
| 60 Profit & Res | 150 | |
| TOTALS | 114800 | 114800 |

"Gemini's range of software is in the vanguard of the releases for 'serious' micro users..."
 (WHICH MICRO AND SOFTWARE REVIEW)



INVOICES AND STATEMENTS . . . £19.95

Compatible with most micros. See table. Ideal for the small business. A complete suite of programs together with generated customer file for producing crisp and efficient business invoices and monthly statements on your line printer. All calculations include VAT automatically, and the program allows your own messages on the form produced. This program gives you superb presentation and saves time on one of the most tedious tasks in the office.



COMMERCIAL ACCOUNTS . . . £19.95

Compatible with most micros. See table. A gem of a program, all for cassette, with the following features: Daily Journal. Credit Sales. Cash Sales. Credit Purchases. Purchases—other. Sales Ledger. Purchase Ledger. Bank Account. Year to date summary. A fully interactive program suitable for all businesses. Files can be saved and loaded and totals from one file carried forward to another on cassette. Particularly useful from a cash flow point of view, with an immediate accessibility to totals for debtors and creditors. Bank totally supported with entries for cheque numbers, credits and, of course, running balance.



MAILING LIST . . . £19.95

Compatible with most micros. See table. A superb dedicated database to allow for manipulations of names and addresses and other data. Gemini's unique 'searchkey' system gives you a further ten 'user-defined parameters' to make your own selections. Features include the facility to find a name or detail when only part of the detail is known, it will print labels in a variety of user specified formats.



DATABASE . . . £19.95

Compatible with most micros. See table. The program that everyone needs, the most valuable and versatile in your collection. Facilities include sort search, list print if required. Can be used in place of any card index application; once purchased you can write your own dedicated database to suit your particular needs with a limitless number of entries on separate cassettes.



STOCK CONTROL . . . £19.95

Compatible with most micros. See table. Dedicated software with all that's necessary to keep control of stock. This program will take the tedium out of stock control and save time and money. Routines include stock set up, user reference number, minimum stock level, financial summary, line print records, quick stock summary, add stock, delete/change record and more.



HOME ACCOUNTS . . . £19.95

Compatible with most micros. See table. Runs a complete home finance package for you with every facility necessary for keeping a track of regular and other expenses, bank account, mortgage, H.P., etc. This program also allows you to plot graphically by Histograms your monthly outgoings.



WORD PROCESSOR . . . £19.95

Compatible with most micros. See table. This program features routines found in much larger and more expensive packages with a typical word length of 5-6 letters it allows for around 1000 words in memory at one time. Ideal for the user who requires a simple program to write letters on his computer. Features include. block delete. block insert. search and replace. edit text. display text and more.

"Simple to use"
"Ideally suited to the way most offices run....."
 PERSONAL COMPUTER NEWS

ns for more computers!



SPREADSHEET ANALYSIS BEEBCALC £19.95 DRAGONCALC £19.95

NEW FOR BBC AND DRAGON 32. Spreadsheet processors have proved to be important tools for using micros in business, scientific and domestic financial applications.

| POSITION | A1 | RC | SPACE | 5185 | T |
|----------|--------------------------------|----|-------|-------|---|
| II | A | A | II | B | C |
| 1 | - J.B. SNOOKER T/A POT - BLACK | | | | |
| 2 | PROJECTED CASH FLOW | | | | |
| 3 | | | YEAR | ENDED | |
| 4 | | | Oct. | Nov. | |
| 5 | | | £ | £ | |
| 6 | INCOME | | | | |
| 7 | Sales | | | | |
| 8 | | | 11786 | 10944 | |
| 9 | REVENUE EXPENDITURE | | | | |
| 10 | Purchases | | | | |
| 11 | | | 500 | 500 | |
| 12 | Advertising | | | | |
| 13 | | | 1596 | 1596 | |
| 14 | Director's salary | | | | |
| 15 | | | 2216 | 2216 | |
| 16 | Rent | | | | |
| 17 | | | | 300 | |
| 18 | Telephone | | | | |
| 19 | | | | 200 | |
| 20 | Insurance | | | | |
| | | | | 400 | |
| | Printing, stationary | | | | |
| | | | | 60 | |
| | Repairs & renewals | | | | |
| | | | | 60 | |
| | Hire of equipment | | | | |
| | COMMAND BCDEFGPRSTW** | | | | |

BEEBLOT & SPECTRUMPLOT £19.95 NEW

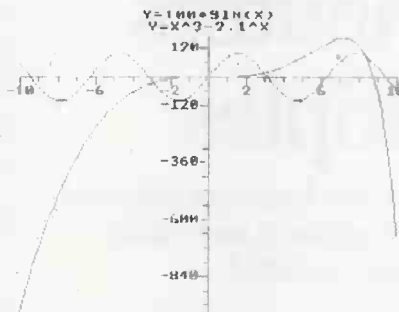
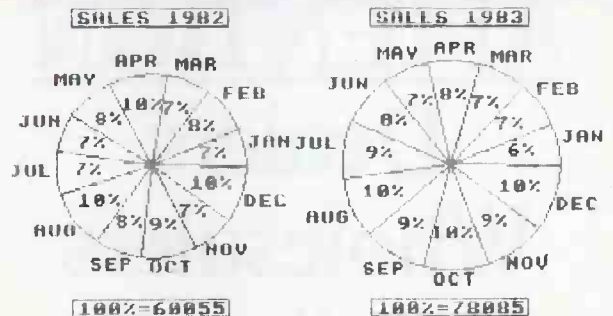

Important new additions to the Gemini family. Present numeric and string data together in easily-understood pie chart, histogram or graph format. Beebplot has a built-in interface to Beebcalc, and both Beebplot and Spectrumplot have built in interfaces to the Final Accounts program of Cashbook. The facility for mathematical function

plotting is also provided. The BBC version has a high resolution 'screen dump' for the Epson or CP-80 printers, and the Spectrum version dumps to the Sinclair printer via the 'copy' key. A very useful program that will give superb results either from direct input of data from the keyboard or via simple access to other software data files. A must for business and education.

Dealer/Trade enquiries invited - generous trade discounts for quantity.
Special ACCESS card instant sales hotline for prompt despatch... 24 hr Ansaphone Service.
All enquiries other than credit card sales to 03952-5832

Tel: 03952 5165

Gemini. Functional Software Specialists. 9, Salterton Road, Exmouth, Devon. EX8 2BR

Program Availability Chart:-

| | Database | Stock Control | Mailist | Invoices & Statements | Spread sheet Analysis | Cashbook Accounting | Word processor | Home Accounts | Commercial Accounts | Pilot | Final Accounts |
|------------------------------|----------|---------------|---------|-----------------------|-----------------------|---------------------|----------------|---------------|---------------------|-------|----------------|
| Sinclair Spectrum 16k or 48k | ● | ● | ● | | | ● | | ● | ● | ● | ● |
| Dragon 32k or 64k | ● | ● | ● | ● | ● | | | ● | ● | ● | ● |
| VIC 20 (16k +) | ● | ● | ● | ● | | | | ● | ● | ● | |
| Sinclair ZX81 (16k +) | ● | | | | | | | | | | |
| Grundy Newbrain | ● | | ● | | | | | | | | |
| Sharp M280A | ● | ● | ● | ● | | | | ● | ● | | |
| Sharp M280K | ● | ● | ● | ● | | | | ● | ● | | |
| Sharp M280E | ● | ● | ● | ● | | | | ● | ● | | |
| BBC Micro model A or B 32k | ● | ● | ● | ● | ● | ● | ● | ● | ● | ● | ● |
| Atari 400/800 | ● | | | | | | | | | | |
| Torch | ● | ● | ● | ● | ● | ● | ● | ● | ● | ● | ● |
| Epson HX-20 | ● | ● | ● | ● | | | | | | | |
| Commodore 64 | ● | | ● | | | | | ● | | | |

PLEASE SEND URGENTLY

(Please note: Items as priced except BBC/TORCH DISKS: please add £4 extra for 40 track and £5 for 80 track format)

Name _____

Address _____

Machine Type _____ Memory Size _____

I enclose _____

Make cheques and postal orders payable to Gemini Marketing Ltd.

Access Number _____

Signature _____ PCW/07/83

ACCESS ONLY

GEMINI
MARKETING LIMITED

Gemini. Functional Software Specialists,
9 Salterton Road, Exmouth, Devon EX8 2BR

GEMINI

ATTENTION

Dealers Wholesalers Distributors Multiples

The demand for serious/business software for the microcomputer is inevitably increasing rapidly!

Take a look at our exciting range of quality software. Interested? Then talk to us about our advantageous terms and ask for our dealer pack, or a visit by one of our qualified sales staff.

For a full description of our product range see previous two pages.

ACT NOW!

FULL DEALER LIST NEXT MONTH.

GEMINI

MARKETING LIMITED

Functional Software Specialists,

9 Salterton Road Exmouth Devon
EX8 2BR Tel: 03952 5832

VISION PROBLEMS?

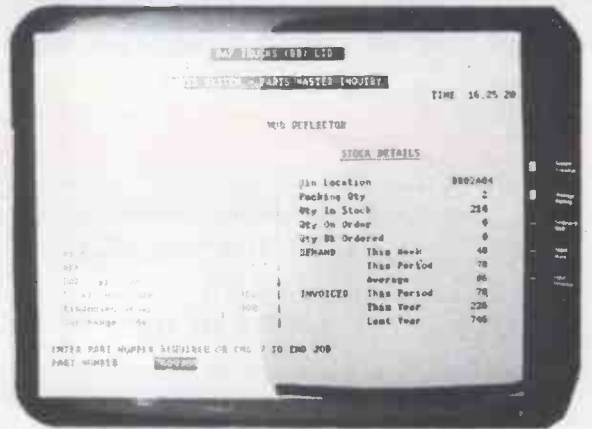

Our range of products is designed to increase productivity by solving the problems associated with working with VDUs.

For example, reducing glare and reflections results in fewer complaints of eyestrain, fatigue and stress as reported by What Micro?

For further details, telephone 06285 29997/29859 or send for our free brochure by simply filling in the coupon below NOW.

Name.....
Company..... Position.....
(if any)
Address.....
Tel:.....

To: VISION PRODUCTS (A DIVISION OF BEDBROOK LTD)
UNIT 10, WESSEX ROAD, BOURNE END, BUCKS.

*3M Formed Panel Film.

Trade Enquiries Welcome

NEW FROM BRAINWAVE BRAINWRITER

A SUPERB WORD PROCESSOR
FOR YOUR NEWBRAIN COMPUTER

THIS IS THE ONE YOU HAVE BEEN WAITING FOR!!!

JUST LOOK AT THE FEATURES:-

- Two separate pages to write on; (3 on EPROM)
- Copy part or all of page 1 to page 2;
- Block Move to same page;
- Block Move to next page;
- Send any required code to Printer;
- Instant Move between pages;
- Automatic Word Wrap at end of line;
- Document Formatting;
- Document Reformatting, allowing change of page size;
- User Selectable Printer Speeds;
- Text Search & Highlighting of chosen words;
- Text Search & Replacing of chosen words;
- Optional Right Justification;
- Shift Lock Facility;
- User Selectable Tabs at all character positions;
- Character Insertion & Deletion;
- Character & Line Position Indicator;
- Move Line or Part of a line;
- Documents may be saved on tape or disc;
- Documents may be loaded from tape or disc;
- Over 20 Easy to remember Control Codes;
- An 8 page Manual is included.

REMEMBER - THIS ONE WORKS ON TAPE OR DISC
(GRUNDY CP/M)

BRAINWRITER IS AVAILABLE ON CASSETTE TAPE -
OR ON AN EPROM TO BE INSERTED IN
THE GRUNDY ROM BOX - THIS USES NO RAM

BRAINWRITER IS NOW IN STOCK
PRICE * TAPE 34.50 * ROM 41.40

THE ABOVE PRICE INCLUDES
FIRST CLASS POST & PACKING

BRAINWAVE SOFTWARE LTD
TILBURY-JUXTA-CLARE * GT. YELDHAM
NR. HALSTEAD * ESSEX
TELEPHONE 0787-237831

FREE SONY C6

WITH EVERY PURCHASE OF AN APPLE II EXECUTIVE OR APPLE III BUSINESS SYSTEM DEANS ARE GIVING AWAY A FREE SONY C6 VIDEO.

Apple IIe EXECUTIVE SYSTEM

| | |
|-----------------------------------|-----------------|
| Apple IIe 64K | 845.00 |
| Disk Drive + Controller | 345.00 |
| Disk Drive only | 245.00 |
| Monitor | 170.00 |
| 80 Col Card | 80.00 |
| MULTIPLAN | 185.00 |
| <hr/> | |
| RRP of units bought separately | 1870.00 |
| DEANS Price | £1699.00 |



Apple III BUSINESS SYSTEM

Apple III 256K
 Apple Dot Matrix Printer
 Apple Writer III
 VISICALC III
 Self TRAINING Manual

DEANS Price **2995.00**

The personal computer



*Apple III will also run many Apple II programs and has CP/M compatibility.

Prices exclude delivery and VAT and are correct at time of going to press. Apple reserves the right to change specifications without notice. All offers subject to availability.

DEANS

of Kensington

191, Kensington High Street
 London W8. Tel 01-938 1588 ext 5
 200 Yards from High Street Kensington
 Underground Station

To DEANS of Kensington, 191 Kensington High St, London W8.

Please tell me more about the special offer

Name Company

Address

..... Tel No

OWING TO EXPANSION DAVINCI COMPUTERS HAVE OPENED THEIR GIANT COMPUTER STORE IN NORTH LONDON

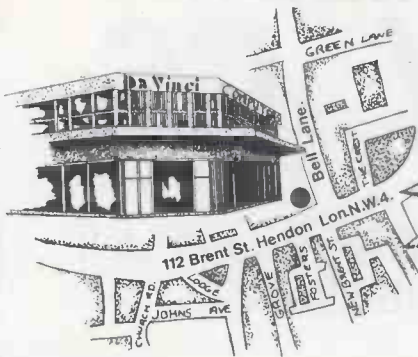

OPENING SALE

UP TO 20%
On Selected
Computers

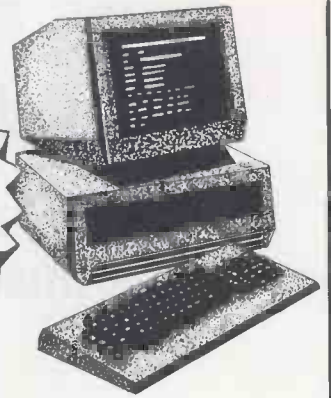

COMPUTERS

Systime
Sirius
Commodore
Osborne
Apple
BBC
Commodore 64
VIC 20
Sinclair

- + Book & Magazine Department
- + All Accessories
- + Media & Stationery Supplies
- + Computer Furniture
- + 2nd Hand & Ex-Demo Computers
- + Maintenance Contracts
- + Installation & Training
- + Finance Facilities
- + Mail Order

PRINTERS

Epson
Ricoh-Flowriter
Brother
Olympia
Olivetti
Seikosha
Anadex
Toshiba

SOFTWARE

Accounting
Payroll
Incomplete Records
Solicitors Accounting
Financial Packages
Time Recording
Invoicing
Stock Control
Data Base
Spread Sheets
Word Processing
Graphics
Educational
Games

Professional Advice Given

Official Orders Welcome



112 Brent Street
Hendon NW4 2DT

Tel 01-202 2272

Open Mon-Fri 9.00 to 5.30
Sat 9.30 to 5.00

B/Card
Access

Easy Parking at rear car park

No.1 BEST SELLERS

Sirius + Epson
FX80 = £2395

Sirius + Tec
Daisywheel
and Wordstar
= £2795

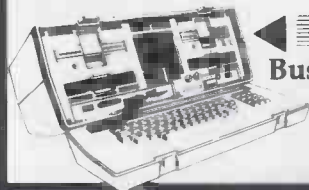
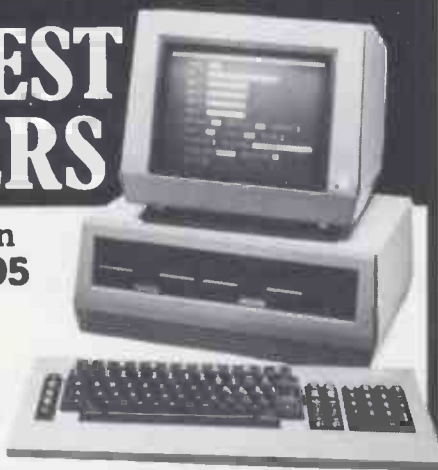

OSBORNE
Business Portable Computer

Dual Density (80 column) = £1095
Single Density = £895
D/D+Daisywheel Printer = £1495
D/D+Epson RX80 = £1345

Dial-a-Deal: 061-872 7818

ZAK
Computers.

Zak Computers Ltd.,
Churchill House, 88/92 Talbot Road,
Manchester M16 0PD. Telex: 665449.

SIANDA SOFTWARE SERVICES STOP!!!

IF YOU ARE LOOKING FOR A QUALITY BRITISH MICROCOMPUTER THEN LOOK NO FURTHER



The LSI system M-FOUR is a powerful BRITISH microcomputer that combines both 8 bit & 16 bit processors to give multi user and multi tasking with up to 256k and 22Mbyte of disk store

SIANDA SOFTWARE SERVICES can supply and support a full range of software for the M-FOUR, including:-

- * ACCOUNTING * WORD PROCESSING * FINANCIAL PLANNING
- * TRAVEL AGENTS * JOB COSTING * ACCOUNTANTS
- * STOCK CONTROL * INSURANCE BROKERS * DOUBLE GLAZING
- * PRODUCTION CONTROL * DATA MANAGERS

For further details and price list, contact

SIANDA SOFTWARE SERVICES
7, Lansdowne Terrace, Gosforth, Newcastle Upon Tyne
Tel 0632 856707

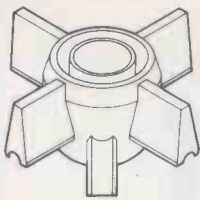

Isoframe[®]

SPACEFRAMES

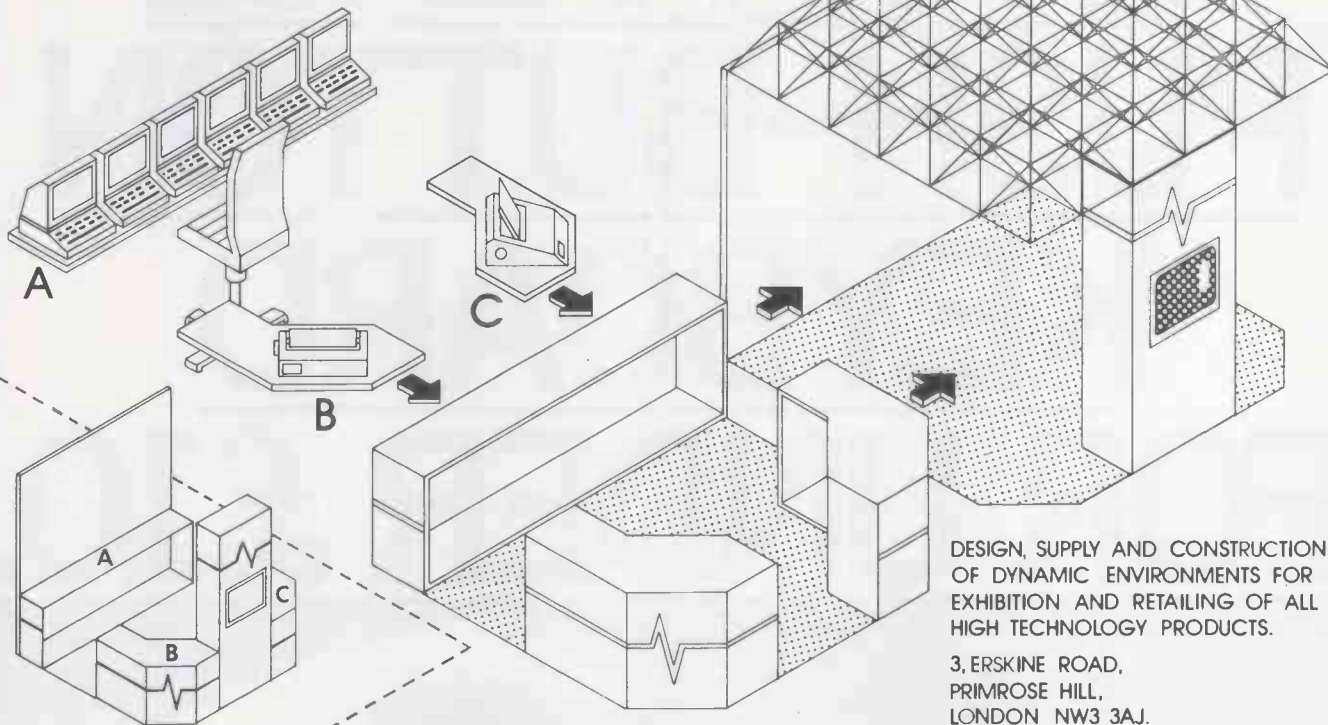

DESIGN, SUPPLY AND CONSTRUCTION OF DYNAMIC ENVIRONMENTS FOR EXHIBITION AND RETAILING OF ALL HIGH TECHNOLOGY PRODUCTS.

3, ERSKINE ROAD,
PRIMROSE HILL,
LONDON NW3 3AJ.
TEL: 586 7720



Everything for the Acorn and BBC microcomputer user.

ACORN USER EXHIBITION

Cunard International Hotel

Hammersmith,
25-28 August 1983

The Acorn User Exhibition at the Cunard, Hammersmith will house the largest display of Acorn products ever assembled under one roof. It will be four days of non-stop entertainment and education for parents and children alike.

The new Electron, the second processors for the BBC micro, the BBC Buggy, all the new software and hardware will be on show. There'll be competitions, prizes, Acorn experts to answer your technical questions, demonstrations and lots and lots of bargains.

If you are an Acorn owner, or just thinking about being one, you can't afford to miss it.

Opening hours: August 25th-27th, 10am-7pm; August 28th, 10am-4pm.

Admission charges: Adults £2 per ticket, Children £1 per ticket.

We have arranged for nearly every exhibitor to redeem the cost of your ticket when you buy something from their stand.

Group rates: 10% discount for parties of 10 or more.

Buses: Frequent services from central London.

Tubes: Hammersmith Broadway – Metropolitan, District and Piccadilly lines.

Car Parking: Several car parks in the immediate area.

For details of exhibition stands and advance ticket sales contact Computer Marketplace Ltd, 20 Orange Street, London WC2H 7ED. Tel: 01-930 1612.

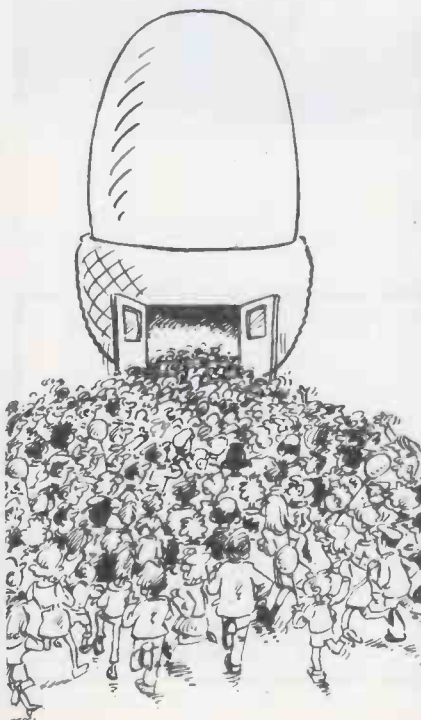

ADVANCE BOOKING COUPON Miss the queue – buy your tickets in advance.
Computer Marketplace Ltd, 20 Orange Street, London WC2H 7ED.

Please send _____ Adult tickets at £2 _____ Childrens tickets at £1

I enclose a cheque/postal order value £ _____ payable to Computer Marketplace Ltd.

Name _____

Address _____

PCW/7/83

NOW. A ZX81 PUSH-BUTTON KEYBOARD FOR UNDER £10.

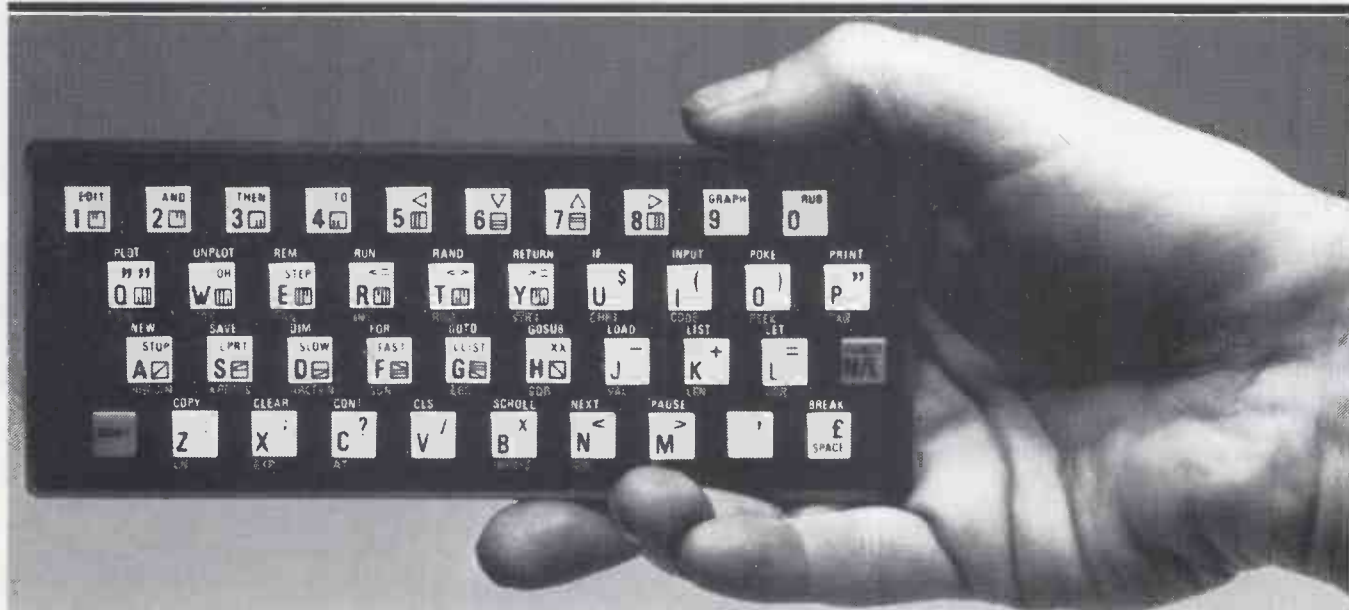

1. Make sure the original keyboard is clean and check that all the keys function.



2. The Buttonset is held in place by self adhesive pads.



3. So all you do is remove the protective backing.

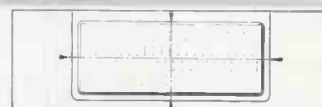

4. And place it centrally on your ZX81.

At last there's a really cheap but efficient way of ironing out the ZX81's only real bug: its keyboard. The Filesixty Buttonset offers:

- A full-travel calculator-type moving keyboard for only £9.95.
- Installed in seconds. The peel-off adhesive backing means you just register into position and press.
- No messy labels, dismantling or soldering.
- 3 groups of colour keys to pick out shift, numerals and newline.
- Precision moulded in ABS to match your ZX81, with contrasting legends for maximum legibility.

Filesixty Ltd., 25 Chippenham Mews, London W9 2AN, England.
Tel: 01-289 3059. Telex: 268 048 EXTLDN G 4087.

Orders to Filesixty Ltd., FREEPOST, London W9 2BR.

Cheques/PO made payable to Filesixty Ltd.

Please send me _____ (qty) Buttonset(s) at £9.95 each (including VAT and P&P).

Total £ _____ BLOCK CAPITALS

Name _____

Address _____

PCW.7.83

FILESIXTY

WHEN IT COMES TO MICROCOMPUTER SOFTWARE WE WROTE THE BOOK

How do you stay up-to-the-minute with the rapidly changing world of microcomputer software? Get the Lifeboat Catalogue.

The latest innovations The new Lifeboat Catalogue is packed with the latest state-of-the-art software. And if we publish a new program after the latest catalogue has gone to press, we enclose a flash bulletin in your copy.

The greatest selection

Because Lifeboat is the world's largest publisher of microcomputer software, our catalogue offers you the greatest selection of programs for business, professional and personal use. Our more than 200 programs range from the integrated accounting and professional practice systems to office tools for book-keepers and secretaries to sophisticated tools for programmers. Included are business systems, word processors, programming languages, database management systems, application tools and advanced system utilities.

We specialise in software that runs on most small business computers. Our more than 60 media formats, including floppy disks, data cartridges, magnetic tape and disk cartridges, support well over 100 different types of computer.

Get full service We give the crucial dimension of after-sales service and full support to everything we sell.

That includes:

- An update service for software and documentation.
- Telephone, telex and mail-order services in the London office and at overseas offices in the United States, France, Switzerland, West Germany and Japan.
- Subscriptions to Lifelines™, the monthly magazine that offers comparative reviews, tips, techniques, identified bugs and updates that keep you abreast of change.

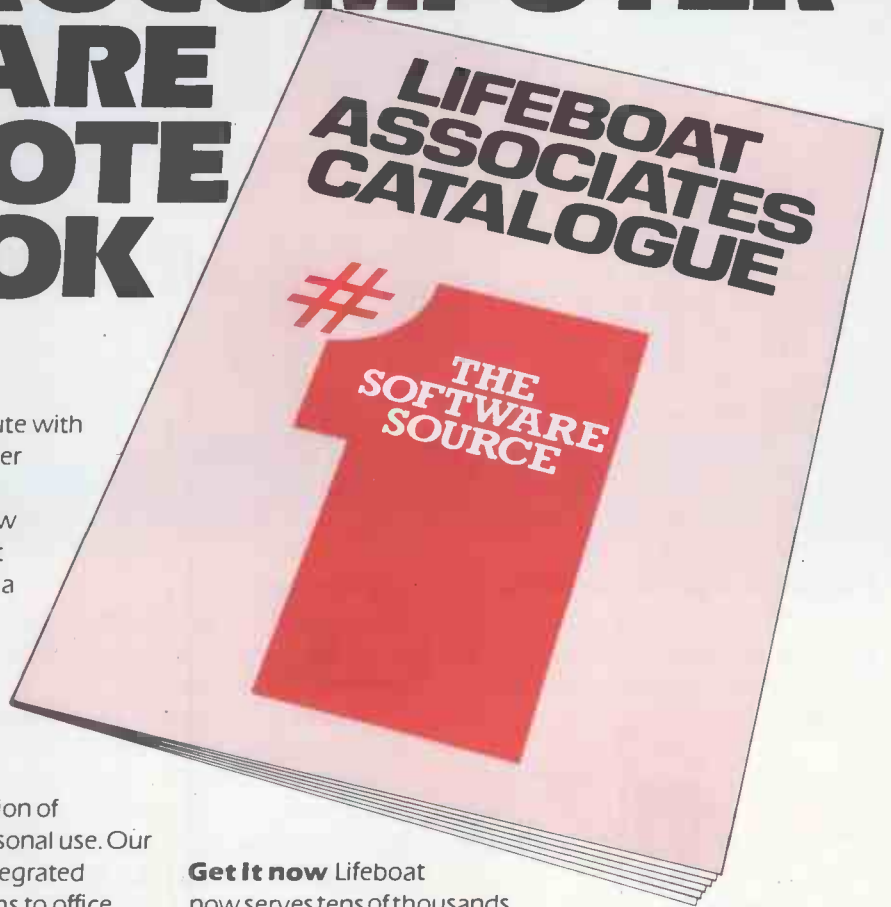

Get It now Lifeboat now serves tens of thousands of satisfied customers with our breadth of up-to-date, fully tested, fully supported and competitively priced software.

You may not need all we offer, but we offer just what you need. After all, we wrote the book.

#1 Lifeboat Associates
World's foremost software source

Mail coupon to: Lifeboat Associates

PO Box 125, London WC2H 9LU or call 01-836 9028

Please send me a free lifeboat catalogue.

Name

Title

Company

Address

Postcode

Copyright © 1981, by Lifeboat Associates.

PCW/7/83

Lifeboat Worldwide offers you the world's largest library of software. Contact your nearest dealer of Lifeboat.

USA Lifeboat Associates 1651 Third Ave. New York NY 10028 Tel [212] 860-0300 Telex 640693 (LBSOFT NYK) TWX 710 581-2524 JAPAN Lifeboat Inc. OK Bldg. 5F 1-2-8 Shiba-Daimon Minato-ku Tokyo 105 Japan Tel 03-437-3901 Telex 2423296 (LBJTYO) ENGLAND Lifeboat Associates Ltd PO Box 125 London WC2H 9LU England Tel 01-836 9028 Telex 893709 (LBSOFTG) SWITZERLAND Lifeboat Associates GmbH Hinterbergstrasse Postfach 251 6330 Cham Switzerland Tel 042-36-8686 Telex 865265 (MICO CH) W GERMANY Intersoft GmbH Schlossgartenweg 5 D-8045 Ismaning W. Germany Tel 089-966-444 Telex 5213643 (ISOFD) FRANCE Lifeboat Associates SARL 10 Grande Rue Charles de Gaulle 92600 Asnieres France Tel 1-733-08-04 Telex 250303 (PUBLIC X PARIS)

System Saver™

The most important peripheral for your Apple II and IIe.

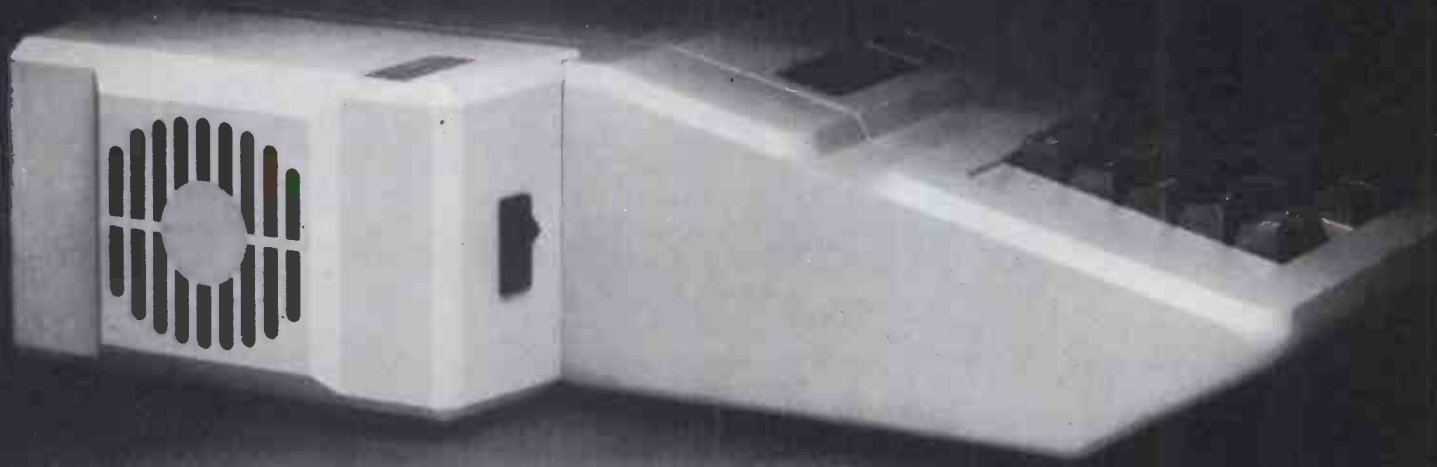

For Line Surge Suppression

The SYSTEM SAVER provides essential protection to hardware and data from dangerous power surges and spikes.



By connecting the Apple II power input through the SYSTEM SAVER, power is controlled in two ways: 1) Dangerous voltage spikes are clipped off at a safe 130 Volts RMS/175 Volts dc level. 2) High frequency noise is smoothed out before reaching the Apple II. A PI type filter attenuates common mode noise signals by a minimum of 30 dB from 600 khz to 20 mhz, with a maximum attenuation of 50 dB.

For Cooling

As soon as you add 80 columns or more memory to your Apple II you need SYSTEM SAVER.

Today's advanced peripheral cards generate more heat. In addition, the cards block any natural air flow through the Apple II creating high temperature conditions that substantially reduce the life of the cards and the computer itself.

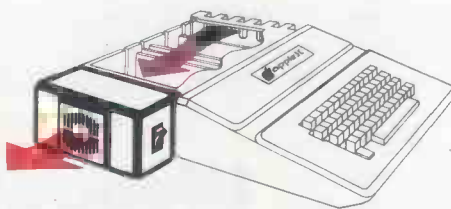

SYSTEM SAVER provides correct cooling. An efficient, quiet fan draws fresh air across the mother board, over the power supply and out the side ventilation slots.

For Operating Efficiency

SYSTEM SAVER contains two switched power outlets. As shown in the diagram, the SYSTEM SAVER efficiently organizes your system so that one convenient, front mounted power switch controls SYSTEM SAVER, Apple II, monitor and printer.

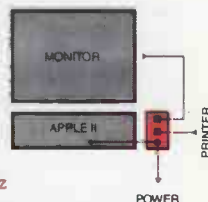

Available in 220/240 Volt, 50 Hz

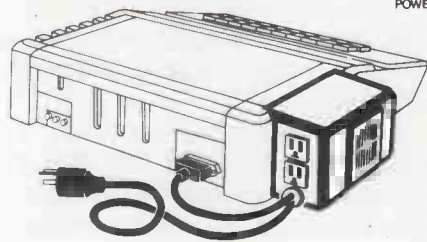

The heavy duty switch has a pilot light to alert when system is on. You'll never use the Apple power switch again!

Easy Installation

Just clips on.
No mounting or hardware required.
Color matched to Apple II.

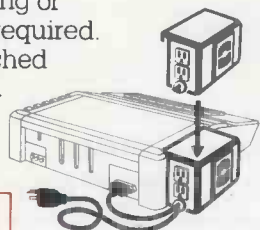

PATENT PENDING

Compatible with Apple Stand



All these features have made System Saver the top selling Apple II and IIe peripheral in America. Now available at your local dealer. If yours doesn't stock System Saver yet, have him contact our distributor, Softsel Computer Products 01 844-2040.

Kensington Microware Ltd.
919 Third Avenue, New York NY 10022
(212) 486-7707 Telex: 236200 KEN UR

 **KENSINGTON
MICROWARE**

SMORGASBOARD™

The only board your IBM Personal Computer may ever need.

SMORGASBOARD from Kensington Microware is a multi-function board for your IBM Personal Computer that greatly increases the capabilities of your PC while only using one expansion slot. SMORGASBOARD is completely hardware and software compatible with the PC. SMORGASBOARD combines the following 8 functions to enhance your IBM PC.

256K RAM MEMORY EXPANSION from 64K to 256K bytes in 64K byte increments. Additional memory enhances many software packages, including financial spreadsheets such as 1-2-3, VisiCalc and MultiPlan.

SERIAL PORT connects modems, letter quality printers and other serial devices. The serial port may be configured as COM1 or COM2. IBM PC communications software is fully supported.

PARALLEL PRINTER PORT Centronics compatible parallel printer interface, is identical to IBM's Parallel Printer Adapter and may operate as LPT1, LPT2 or LPT3. This interface is plug compatible with standard printer cable. It can also be configured as a bidirectional SASI interface.

CLOCK/CALENDAR so you no longer have to input the time and date each time you reboot your PC. SMORGASBOARD's chronograph always keeps your system's clock/calendar up to date.

GAME PADDLES/JOYSTICK INTERFACE for attaching up to four game paddles or two joysticks to the PC.

SPOOL software package uses part of the system's memory as a print buffer. You no longer have to wait for your printer.

SOFTDISK program allocates a portion of the system's memory as a super fast electronic disk drive. Store important information there for speedy access.

SMORGASBOARD PIGGYBACK offers even more expandability. With it another 256K bytes RAM and a 2nd Serial Port become available.

INCREDIBLE LOW PRICE: £299 with 64K installed; £399 with 128K; £499 with 192K and £599 with 256K. SMORGASBOARD comes with a one year warranty and is documented in English, French and German.

SEE IBM DEALERS EVERYWHERE. If yours doesn't stock SMORGASBOARD yet, have him contact Kensington Microware or one of our distributors—Ferrari Software 01 751-5791 or Softsel Computer Products 01 844-2040. Kensington Microware Ltd. 919 3rd Avenue NYC, NY 10022 Tel. 212 486 7707 Telex. 236200 KEN UR

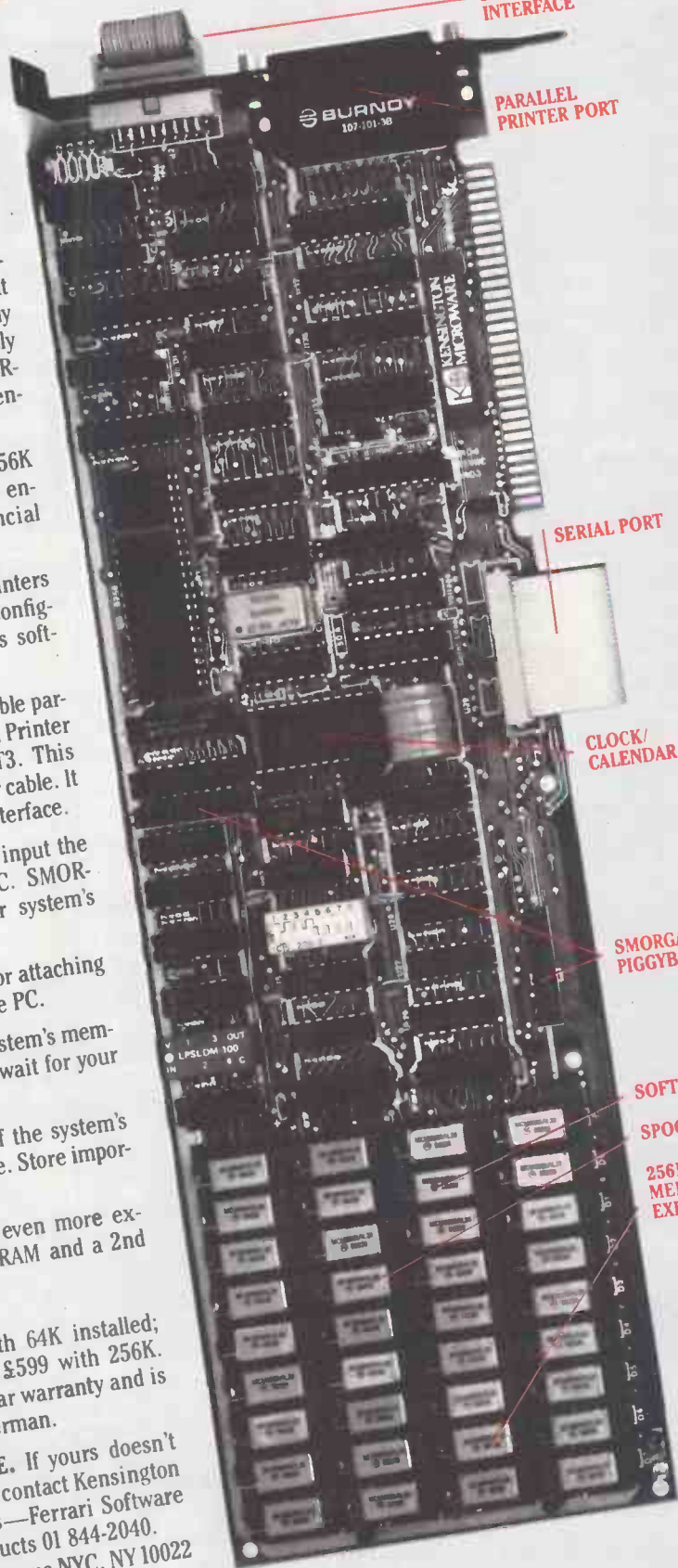

GAME PADDLES/
JOYSTICK
INTERFACE

PARALLEL
PRINTER PORT

SERIAL PORT

CLOCK/
CALENDAR

SMORGASBOARD
PIGGYBACK

SOFTDISK
SPOOL

256K RAM
MEMORY
EXPANSION

 KENSINGTON
MICROWARE

SPECTRUM

NEWS from SPECTRUM Sensational TEXAS OFFER!

Fantastic reductions & offers on the TEXAS TI-99/4A see our ad. on next double page for details.

PRESTEL

See PRESTEL Page 600181 for up to date information from SPECTRUM

NEW SPECTRUM MEMBERS

Check our address page! - there are many new SPECTRUM dealers throughout the UK so there's a good chance there'll be a SPECTRUM centre near you.

VIC-20 Package Offer!

A sensational package offer on this top selling micro. A complete computer system for only £139.99 - see our advertisement for full details.

AFTER SALES CARE

SPECTRUM service centres will ensure that should your machine 'go down' we will get it running again as quickly as possible. We also offer extended warranties at reasonable prices too! - ask your SPECTRUM HOME COMPUTER CENTRE for full details.

COMPUTER DEALERS

The SPECTRUM dealer list is virtually closed. If your area is free and you'd like to join the waiting list, please write to MIKE STERN, Spectrum (U.K.) Ltd, Burrowfields, Welwyn Garden City, Herts.

BBC Model 'B' MICRO

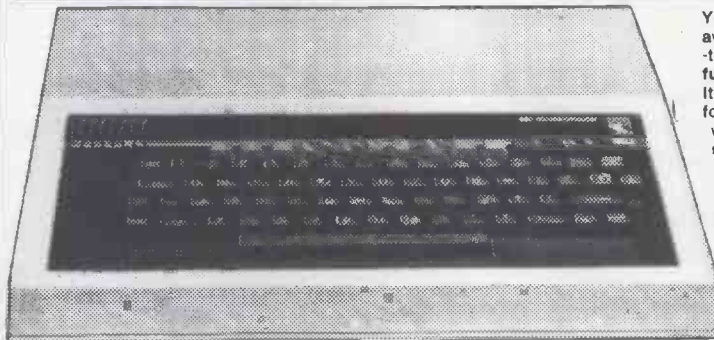

Yes, this top selling Micro system is available from your local SPECTRUM dealer - the BBC Model 'B' offering 32K RAM plus full back-up of peripherals & software. It's an infinitely expandable machine, for the home or business and is already widely used for educational purposes in schools - so the chances are your child may already be well familiar with operation, which must make it the first choice for the home too! So if you're thinking of buying a micro you must look at the BBC at your SPECTRUM dealer NOW! - but just a word of warning, initially stocks were limited and demand is bound to be great, so please 'phone to check stock position before making a journey.

BBC 'B' with Disk Interface
£470.50

BBC Disk Interface Kit
£95.00

BBC Single Disk Drive 100K
£265.00

BBC Dual Disk Drive 800K
£803.85

BBC Tape Recorder
£29.90

BBC Acorn Software Cassette based from
£9.95

BBC Disk based software
£11.50

Spectrum Price

£399.00

INC. VAT

Please Note!

We regret that there is a tremendous shortage on all BBC equipment - please phone your nearest store before making a journey to check stock position.

SHARP MZ-80A



FREE!
£75 WORTH
of software
with every MZ80A
purchased

Desk top genius! The all-in-one SHARP MZ-80A. Ready to run the moment you get it home. Built-in keyboard. CRT. 9" display and cassette data storage with 48K RAM. The BASIC with extra useful additions, offers quite a powerful micro for the home or business. ■ 4K Byte ROM 48K Byte RAM · 2K Byte Video RAM ■ ASCII profiled keyboard · numeric pad ■ 2page Video RAM allows screen to be scrolled up or down. ■ CP/M available.

Spectrum Price

£546.25
Inc. VAT

Floppy Disks and Accessories for MZ80A
Twin Floppy Disk unit (inc. 1/0 Card, Disk, Cable).....£856.75
Twin Disk Unit (only).....£678.50
Single Floppy Disk Unit.....£460.00

Cable for F/0 Drive.....£29.79
Printers and Accessories for MZ80A, MZ80B & MZ80K
80 Col Tractor Feed Printer inc. Cable, 1/0 Card & Rom.£477.25

ORIC-1



A superbly designed and engineered micro and great value-for-money from SPECTRUM. Offering 48K RAM Colour - (8 foreground background can be displayed at same time) High resolution graphics User definable Graphics. Full sound (6 octaves controllable sound) Easy to use keyboard with moving Standard Centronics parallel interface allows easy connection a wide range of printers etc

Spectrum Price

£169.99
Inc. VAT

SPECTRUM FACTS

Maximum user RAM 47,870 Bytes
Text screen 2 Lines
High Resolution 240 Lines
Cassette Lead Incl

The powerful and infinitely expandable

LYNX

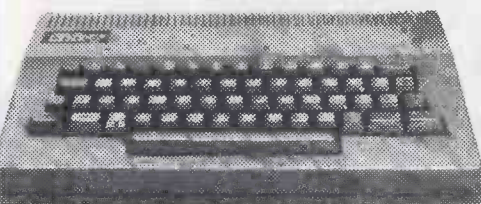

Take a look at this super new LYNX Micro - an incredible 16K & 32K video ram and that's expandable up to or beyond 96K. For just £225.00 INCLUDING VAT the LYNX is exceptionally versatile. All LYNX's 'add-on' connections are standard types. The high definition colour graphics make it a top value choice for the home or office (with expansion, the LYNX can become an 80 characters-per-line word processor!) Take a look at the LYNX - a memorable bargain from SPECTRUM. But please come to check stock position before making a journey as this machine is bound to be in great demand.

Spectrum Price

£225.00 Inc. VAT

DISCOUNT - Teach yourself LYNX BASIC £6.95

SPECTRUM FACTS

Maximum user RAM..... 13,700 Bytes (approx)
Text Screen..... 24x30
High Resolution..... 265x248
Cassette Lead..... Included

COLOUR GENIE



A truly reliable micro and highly recommended by SPECTRUM featuring powerful and sophisticated COLOUR GRAPHICS, allowing you to create full 8-colour Games, Diagrams and charts quickly and simply. Powerful 16K RAM memory (expandable internally to 32K) for FULL COLOUR video games and POWERFUL COMPUTING with a full range of inexpensive accessories: 16K RAM pack, Joysticks for TV games, Light Pen, Disk Drive and a Printer. The superb Colour Genie is at SPECTRUM now - check it out and see the Genius at work!

NEW Low Price £194.00 Inc. VAT

COLOUR GENIE ACCESSORIES

Joysticks..... £49.49
16K RAM..... £38.50
Printer Interface..... £39.95
DISCOUNT Teach yourself Colour..... £6.95
SPECTRUM FACTS
Maximum user RAM..... 14,200 Bytes (approx)
Text screen..... 24x40
High Resolution..... 320 x 192
Cassette Lead..... Included

SINCLAIR ZX SPECTRUM



Yes, this top selling micro is now available from Spectrum in both 16K and 48K RAM. So now there's no need to send by Mail Order - just call into your local SPECTRUM dealer and pick one up. But just one word of warning: with this added availability advantage, stocks are bound to sell fast - so make it soon!

SINCLAIR ZX SPECTRUM 16K - £99.95
SINCLAIR ZX SPECTRUM 48K - £129.95

Spectrum Computer Centres have no connection whatsoever with the ZX-Spectrum Computer manufactured by Sinclair Research Ltd.

SINCLAIR ZX-81

SINCLAIR ZX . . . £49.95
16K RAM pack . . . £29.95
ZX Printer . . . £39.95

Computer Bookshop INC.
Software for Sinclair VAT
Computers
Bumper 7 1K ZX81..... £5.95
1K Super Tilo ZX81..... £7.95
Labyrinth 16K ZX81..... £5.95
Nightmare Park/Music 16K ZX81..... £6.95
Computacalc 16K ZX81..... £7.95
Personal Banking System
16K ZX81..... £11.44
Space Invaders/Rescue
16K ZX81..... £6.95
Breakout 16K ZX81..... £5.95
Mugsy 16K ZX81..... £5.95
Mergatroyds 16K ZX81..... £5.95
Progmerge 16K ZX81..... £5.95
Football Manager 16K ZX81..... £7.95
Cassettes for ZX81 Type-10
6 Games..... £3.95

Junior Education..... £3.95
Business & Household..... £3.95
Skill & Judgement Games..... £3.95
Junior Education..... £3.95
Family Quiz..... £3.95
Type-20
Fantasy Games..... £4.75
Space Raiders & Bombers..... £4.75
Type-30
Super Programs Nos. 1-8..... £4.95
Type-40
Backgammon..... £5.95
Flight Simulation..... £5.95
Type-50
English Literature 1..... £6.95
English Literature 2..... £6.95
Geography..... £6.95
History 1..... £6.95
Maths. 1..... £6.95



ZX-PANDA
16K RAM PACK
ONLY £24.95

OKI MICROLINE Printers

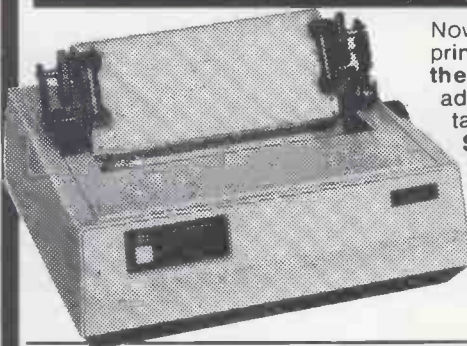

Now from SPECTRUM - this top selling range of printers renowned throughout the world for their quality and reliability. If you're thinking of adding a printer to your micro then you must take a look at the MICROLINE range at SPECTRUM -NOW! they're fantastic value-for-money

Models available

MICROLINE Model 80 £259.90
MICROLINE Model 82A £455.40
MICROLINE Model 92P £585.35

EPSON



The new EPSON RX-80 and FX printers now available—check with your local SPECTRUM dealer NOW!
FX-80 Spectrum Price £503.70
RX-80 Spectrum Price £332.35

SEIKOSHA



GP-100A
Now a top quality graphic printer at a price you can afford. Centronics interface connects easily with most micros.
Spectrum price £229.94 Inc. VAT
Cables & Interfaces available for most micros

SMITH CORONA

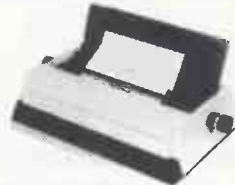

Model TP-1
Microprocessor controlled, high quality daisy wheel printer at a LOW cost from SPECTRUM. Serial, Parallel or IEEE Interface.
Spectrum LOW price **£557.75** Inc. VAT

SELECTION FROM THE COMPUTER BOOKSHOP
30 Hour Basic for the BBC Micro..... £5.95
Let your BBC Micro Teach You to programme..... £6.45
BBC Micro Revealed..... £7.95
Over the Spectrum..... £6.95
60 Games and Applications for the ZX Spectrum..... £4.95
Programming the 6502..... £9.95
Programming your ZX Spectrum..... £6.95
ZAP Pow Boom for the Vic 20..... £7.95
The ZX Spectrum Explored..... £5.95
Vic Innovative Computing..... £6.95
Mastering Machine Code on your ZX81..... £7.50

BOOKS



The ZX Spectrum and how to get the most from it..... £5.95
Easy Programming for the ZX Spectrum..... £5.95
30 Programmes for the BBC Micro..... £4.95
CPM Handbook..... £11.50
Programming the Z80..... £11.95
20 Best Programmes for the ZX Spectrum..... £5.95
Getting acquainted with your Vic 20..... £6.95
Machine code and Better Basic..... £7.50
The Cambridge Colour Collection (Spectrum)..... £5.95
Vic Revealed..... £10.00
De RE Atari..... £17.00
ATARI Operating system listing..... £10.43

MORE SPECTRUM LOW PRICES

Spectrum

A truly amazing offer on this expandable & Comprehensive top-of-the-line Micro.

Yes, now from SPECTRUM the fabulous TEXAS TI-99/4A Home Micro at a super NEW LOW PRICE - Plus! a super FREE! offer too! When you return your FREE OFFER VOUCHER obtainable at time of purchase to TEXAS INSTRUMENTS they will send you absolutely FREE! a PAIR OF JOYSTICKS - worth £24.95. A beginners BASIC TUTOR PROGRAM -Worth £9.95 and a CONNECT 4 PROGRAM - Worth £15.95. TOTAL VALUE £50.85 (which means you're effectively only paying £99.10 for your TEXAS TI-99/4A micro.) A fantastic offer - HURRY to your local SPECTRUM dealer NOW and see for yourself just what great value this really is. Offer closes June 30th.

Plus!
FREE!
Goods worth £50.85
FREE! Pair of Joysticks worth £24.95
FREE! Beginners BASIC Tutor program worth £9.95
FREE! Connect Four program worth £15.95
With every TEXAS TI-99/4A purchased. See opposite for details.

Super NEW LOW PRICES on TEXAS SOFTWARE from Spectrum too!



TEXAS TI-99/4A - just part of a complete system.

The TEXAS T1-99/4A is just part of a complete system which can be expanded simply & easily with optional peripherals (disk drives, printers etc.) and easy-to-use Solid State Software modules. A system which will meet your needs today & tomorrow - a system you can grow with as and when the needs arise. It can use up to 4 different programming languages and more than 600 software programs are available worldwide. Last but not least-it comes from the people with the greatest experience in microprocessors-the inventors themselves: so if you're considering buying a home micro you must take a look at the TEXAS TI-99/4A at your local SPECTRUM dealer NOW - it really is a terrific buy!

The Spectrum top 30

| | | |
|---------------------------|---------------------------|----------------------------|
| Connect Four..... £15.95 | Oldies but Goodies £12.95 | Adventure & Pirate. £29.95 |
| Zero Zap..... £15.95 | Soccer..... £24.95 | Adventure Land.... £19.95 |
| Attack..... £15.95 | Tomb Stone City... £24.95 | Mission Impossible £19.95 |
| Blasto..... £15.95 | Munchman..... £29.95 | Voodoo Castle..... £19.95 |
| Hustle..... £15.95 | Chess..... £39.95 | The Count..... £19.95 |
| Yahtzee..... £15.95 | Parsec..... £29.95 | Strange Odyssey £19.95 |
| Hangman..... £15.95 | Alpiner..... £29.95 | Mystery Funhole... £19.95 |
| T.I. Invaders..... £19.95 | EDUCATIONAL GAMES | Pyramid of Doom... £19.95 |
| A-maz-ing..... £19.95 | Dragon Mix..... £27.95 | Ghost Town..... £19.95 |
| Wumpus..... £19.95 | Aligator..... £27.95 | Golden Voyage.... £19.95 |
| Carwars..... £19.95 | ADVENTURE PROGRAMS | |

PLUS!

FREE!

SPEECH SYNTHESIZER or TI CASSETTE RECORDER each worth £49.95

When you buy any 6 Texas Software modules.

An additional BONUS OFFER from SPECTRUM! Purchase 6 (or more) TEXAS software modules - send your receipt to TEXAS INSTRUMENTS and you'll receive a FREE SPEECH SYNTHESIZER or a TEXAS TI CASSETTE RECORDER each worth £49.95 -ask your local SPECTRUM for details NOW!

Unbelievable but true!

TEXAS

TI-99/4A Micro Offer!

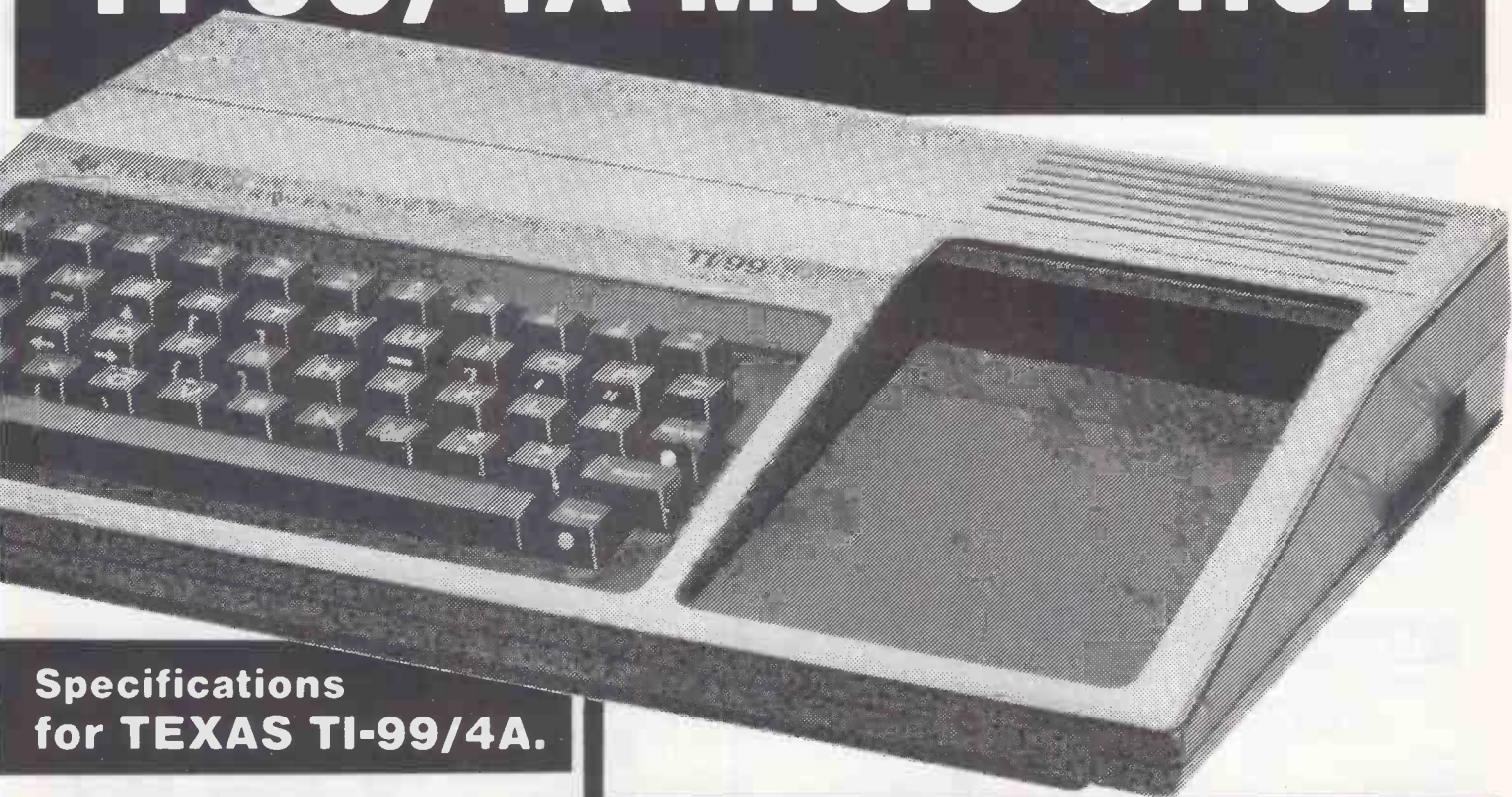

Specifications for TEXAS TI-99/4A.

Console CPU: 9900 Family, 16-bit microprocessor, plus 256-byte scratchpad RAM.

Memory: Total combined memory capacity: 110 KBytes. Internal ROM memory supplied: 26 KBytes. External ROM memory: (Solid State Software® command modules) up to 36 KBytes each.

RAM memory supplied: 16 KBytes (Expandable to 48 KB).

Keyboard: 48 key QWERTY with control and function keys (user definable), full upper and lower case capability, alpha lock, auto repeat.

Sound: 5 octaves, 3 simultaneous tones plus noise generator. Each tone controllable in 1Hz steps from 110 Hz to beyond the audible range.

Colours: 16 foreground and background colours.

Video resolution: 192 x 256 (24 x 32 characters).

Power: 240V - 50Hz - 25W in separate power supply unit.

I/O: UHF modulated PAL colour signal for UK TV receivers.

I/O: UHF modulated PAL-Colour signal for connection to your own T.V. Interface for up to 2 domestic audio cassette recorders. 44-pin peripheral connector-up to 3 peripherals attached simultaneously. System memory and address signals available at peripheral connector. Interface for 2 Wired Remote Controllers.

Built in Software: 14 KByte BASIC interpreter. Internal Graphics Language interpreter, not user accessible. Internal 4.4 KByte monitor (not user accessible).

SPECTRUM SENSATIONAL PRICE - NOW ONLY

£149.95

INC.
VAT

MORE SPECTRUM LOW PRICES 

SPECTRUM

A few examples from our
SOFTWARE Selection
from independent software houses

| THORN EMI | |
|---------------------------|----------|
| Software for Atari | Inc. VAT |
| Submarine Commander | £34.44 |
| Jumbo Jet Pilot | £34.44 |
| Soccer | £29.84 |
| Kickback | £29.84 |
| Home Financial Management | £19.49 |
| Darts | £19.49 |
| Snooker & Billiards | £19.49 |
| Pool | £19.49 |
| Cribbage & Dominoes | £19.49 |
| Cupute 4 & Reversi | £14.89 |
| Mutant Herd | £24.25 |
| Software for Commodore | £25.24 |
| River Rescue | £25.24 |
| Vic Music Composer | £25.24 |

| GEM | | KUMA | |
|--|----------|-----------------------------------|--------|
| Software for ZX81, Dragon and Spectrum | Inc. VAT | Software for Sharp Electron 22622 | £9.20 |
| Monster Mine (for ZX81) | £4.95 | Cribbage | £12.08 |
| Monster Mine (for Spectrum) | 4.95 | Adventure | £12.08 |
| Monster Mine (for Dragon) | 7.95 | Chess | £16.68 |
| Space Mission (for ZX81) | £4.95 | | |
| Space Mission (for Spectrum) | £4.95 | | |
| Space Mission (for Dragon) | £7.95 | | |
| Dragon Golf | £7.95 | | |
| Dragon Character Generator | £9.95 | | |

| SALAMANDER | | AUDIOGENIC | |
|---------------------|----------|-------------------------|----------|
| Games for Dragon 32 | Inc. VAT | Programs for VIC-20 | Inc. VAT |
| Dragon Trek | £9.95 | Amok | £6.95 |
| Wizard War | £7.95 | Allen Blitz | £7.95 |
| Vulcan 0 | £7.95 | Golf | £7.95 |
| Games Compendium 01 | £7.95 | Spiders of Mars | £19.95 |
| Golf | £7.95 | Satellite & Meteorites | £19.95 |
| | | Bonzo | £7.95 |
| | | Trashman | £19.95 |
| | | Boss | £14.95 |
| | | Tank Attack | £19.95 |
| | | Word Craft | |
| | | Word Processing package | £125.00 |

| RABBIT | |
|------------------------------|----------|
| Software for Commodore VIC20 | Inc. VAT |
| Space Storm | £6.99 |
| Ski Run | £4.99 |

ACCESSORIES
SANYO Colour Monitor
CDD3125NB
£286.35

| | | | |
|--|----------|---|---------|
| SANYO | Inc. VAT | Single part 11" x 9 1/2" printer paper, box of 2,000 sheets | £13.05 |
| SANYO 12" green monitor | £113.85 | VIC Accessories from Viscount | |
| Slim 3G Cassette Recorder | £29.95 | Motherboard without Buffer | £24.95 |
| C12 Cassettes | £0.50 | Motherboard with Buffer | £29.90 |
| Single sided double density disks (Box of 10) | £21.25 | 16K RAM Pack | £43.95 |
| Double sided, double density disks (Box of 10) | £33.81 | 32K RAM Pack | £66.95 |
| Disk head cleaner | £16.10 | 64K RAM Pack | £114.94 |
| | | Adman Chatterbox | |
| | | Voice Synthesiser | £57.45 |

Plus many more at your local SPECTRUM dealer - call in now and see!

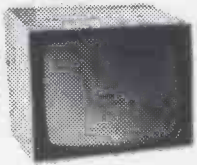

ATARI 800

Now this proven and tested machine has been upgraded to a massive 48K RAM and it's still at the amazing LOW price of £399.99 from SPECTRUM. It's an ideal Home Micro for graphics, educational and personal finance etc. use it and it will take you from learning up to a small business use. You can add printers, program recorders, disk drives and more, to expand your micro as and when you want, suit your needs. So if you're looking for a top of the line micro you must see the ATARI 800 with 48K at SPECTRUM - NOW!

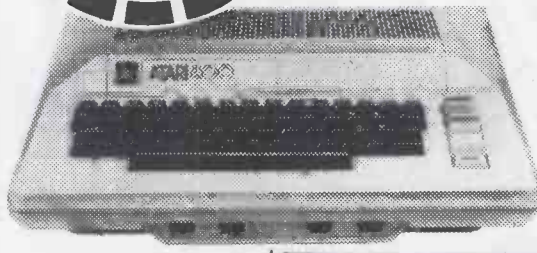

Sensational Price
£299.95
INC. V.A.T.
SPECTRUM FACTS
Maximum user RAM 37,899 Bytes
Text Screen 24 x 24
High Resolution 320 x 192
Cassette Lead Needs own Recorder

ATARI 400

16K RAM



NOW ONLY
£149.95
INC. VAT

including FREE Programming Kit
BASIC cartridge extra
£39.99 inc. VAT
(£34.77 ex. VAT)

SPECTRUM FACTS

Maximum user RAM 13,323 Bytes (with basic Cartridge)
Text Screen 24 x 40
High Resolution 320 x 192
Cassette Lead Needs own Recorder

ATARI DISK DRIVE
£299.00 INC. VAT

DRAGON

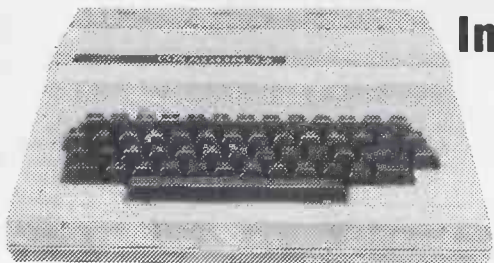

Incredible Value for Money

Extensive facilities include highly advanced colour graphics. Powerful standard 32K RAM (expandable to 64K Bytes). 9 Colour 5 resolution Display • Extended Microsoft colour BASIC (as standard) • Advanced sound with 5 octaves -255 tones.

SPECTRUM FACTS
Maximum user RAM 29,679 Bytes
Text Screen 16 x 32
High Resolution 256 x 192
Cassette Lead Includes
VISCOUNT Teach yourself Dragon Basic
£6.95

Spectrum Price only
£175.00
INC. VAT

Commodore VIC-20 'Package Deal'

SENSATIONAL VALUE!

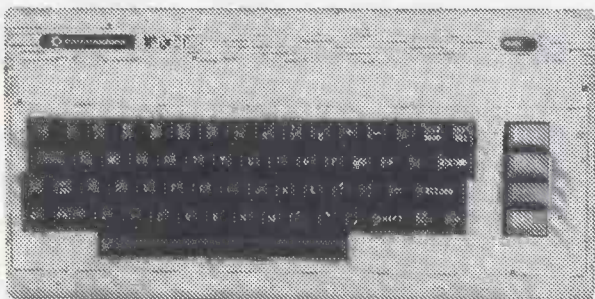

A complete computer system including the VIC-20 Computer, a Cassette Unit, Introduction to BASIC part 1 - a simple explanation of computer programming. A tape of four computer programs - Blitz, Type-A-Tune, Race & Hoppit. A fantastic deal! and great value-for-money - check it out at your local SPECTRUM dealer NOW!! But Hurry! this is a limited offer only while stocks last!

SPECTRUM PRICE ONLY
£139.99

COMMODORE 64

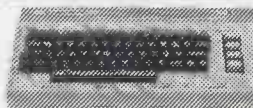

Powerful 64K RAM
40-colour displays to monitor TV. High resolution graphics and 3-dimensional effect capability, music synthesiser. Z80 addition processor option.

Spectrum Price
£345.00
INC. VAT

There's a Spectrum Centre near you ...

ABERYSTWYTH

AberData at Galloways,
23 Pier St. 0970 815522

ABINGDON

Ivor Fields Computers,
21 Stert St. 0235 21207

ACCRINGTON

PV Computers, 38A Water St.
0254 36521/32611

ALDERSHOT

David Saunders Computer
Centre, 51 Station Rd.
0252 20130

ALFRETON

Gordon Harwood, 69/71 High
St. 0773 832078

BANBURY

Computer Plus, 2 Church Lane.
(0295) 55890

BARROW-IN-FURNESS

Barrow Computer Centre,
96 Church St. 0229 38353

BASILDON

Godfrey's, 28-32 East Walk.
Town Centre. 0268 289379

BASINGSTOKE

Fisher's, 2/3 Market Place.
0256 22079

BATH

Software Plus, 12 York St.
0225 61678

BEDFORD

Stead Ltd., 115 Midland Rd.
0234 49341

BELFAST

Arthur Hobson Ltd.,
37 Great Victoria St. 0232 246336

BIRMINGHAM

Sherwoods, Great Western
Arcade. 021 236 7211

BOSTON

Fotosound Computers,
19 Dolphin Lane. 0205 64781

BRADFORD

Erricks Foto-Sonic House,
Rawson Square 0274 309266

BRIGHTON

Capricorn, 1 Queens Rd.
0273 29634

BRISTOL

Brensal Computers Ltd.,
24 Park Row, 0272 294188

BURNLEY

IMO Computer Centre,
39-43 Standish St., BB11 1AP
0282 54299

BURY (Lancs.)

Micro-North, 7 Broad St.
Tel. 061-797 5784

BURY ST. EDMUNDS

Bury Computer Centre,
Tel. 061-797 9764

CAMBERLEY

Camera Arts (Micro Computer
Division), 36 High St.
(0276) 65848

CAMBRIDGE

KP Ltd., 12a Kings Parade.
0223 68087

CANTERBURY

Kent Micro Systems, Conquest
House, 17 Palace St. 0227 50200

CARDIFF

Randall Cox, 18-22 High St.
Arcade. 0222 31960

CHELMSFORD

Maxton Hayman Ltd.,
5 Broomfield Rd. (0245) 354595

CHERTSEY

Chertsey Computer Centre,
1, Windsor Street. 09328 64663

CHESHAM

Read Photography &
Computers, 113 High St.
0494 783373

CHESTER

Oakleaf Computers Ltd.,
100 Boughton. 0244 310099

COVENTRY

Coventry Micro Centre,
33 Far Gosford St. (0203) 58942

CREWE

Microman, Unit 2, 128 Nantwich
Rd. 0270 216014

CROYDON

Cadcom Ltd, 96 Whitgift Centre
(Next door to MacDonald's)
01-686 8393

DARLINGTON

McKenna & Brown,
102 Bondgate. (0325) 59744

DERBY

CT Electronics, at Camera
Thorpe, The Spot. 0332 360456

DUMFRIES

Vennals, 71 English St.
0387 4547

DUNSTABLE

Dormans, 7-11 Broad Walk.
0582 65515

EDGWARE

Breaker 1-4, 130 High Street,
01-952 7488/8880

EDINBURGH

The Silicon Centre, 6-7 Antigua
St. 031 557 4546

EVESHAM

Tecnicare, The Lodge,
Bricklin St., 0388 41484

EXMOUTH

Open Channel, 30 The Strand,
03952 4408

GLASGOW

Victor Morris Ltd., 340 Argyle
St. 041 221 8958

GLOUCESTER

The Model Shop, 79-81 Northgate
St. (0452) 410693

GRANTHAM

Oakleaf Computers Ltd,
121 Dudley Rd. 0476-76994/70281

GRIMSBY

R. C. Johnson Ltd.,
22 Friargate, Riverhead Centre.
0472 42031

GUERNSEY

Gruet's, 3-5 The Pellet,
St Peters Port. 0481 24682

GUILDFORD

The Model Shop, 23 Swan Lane.
(00772) 0483 39115

HAMILTON

Tom Dickson Computers, 8-12
Cadzow St. 0698 283193

HARROW

Camera Arts (Micro Computer
Division), 24 St. Ann's Rd.
01-427 5469

HATFIELD

Microworld, 2 Crawford Rd.
(07072) 64137

HEMEL HEMSTEAD

Faxminster Ltd. Computer &
Electrical Discount Centre,
25 Market Square. 0442 55044

HEREFORD

Melgray Hi-Tech Ltd, 49 Broad
St. 0432 275737

HESWALL

Thorngard Computer Systems
46 Pensby Rd. 051-342 7516

HITCHIN

Camera Arts (Micro Computer
Division), 68A Hermitage Rd.
0462 59285

HULL

The Computer Centre
(Humber-side) Ltd., 26 Anlaby
Road (0482) 26297

ILFORD

Prot Enterprises, 1 Centreway,
(next to Sainsburys)
High Rd. 01-553 0144

IPSWICH

Brainwave, 24 Crown St.
0473 50965

ISLE OF MAN

T. H. Colebourn Ltd., 57-61
Victoria St., Douglas. 0624 3482
(Just Opening)

JERSEY

Audio & Computer Centre
7 Peter St.,
St. Helier. 0534 74000

KILMARNOCK

Vennals, 49 Foregate
0568 32175

KIRCALDY

R. Kilpatrick, 254E High St.
Tel. T.b.a.

LEAMINGTON SPA

IC Computers, 43 Russell St.
0926 39244 (Opening Soon)

LEEDS

Bass & Bligh, 4 Lower Briggate.
0532 454451

LEICESTER

Youngs, 40-42 Belvoir St.
0533 544774

LEIGHTON BUZZARD

The Computer Centre at
Milton Keynes Music,
17 Bridge St.
0525 382504/376622

LINCOLN

MKD Computers, 24 Newland
Street. 0522 25907

LITTLEHAMPTON

Alan Chase Ltd., 39 High St.
09084 5674/4545

LIVERPOOL

Beaver Radio,
20-22 Whitechapple.
051-709 9898

LONDONDERRY

Foyle Computer Systems
3 Bishop St. 0504-68337

LIVERPOOL (Aintree)

Hargreaves, 31/37 Warbreck
Moor. 051-525 1782

LONDON E8

McGowans, 244 Graham Rd.
Hackney. 01-533 0935

LONDON EC2

Devron Computer Centre,
155 Moorgate. 01-638 3339/1830

LONDON SE1

Vic Odden's, 6 London Bdg. Walk
01-403 1988

LONDON SE9

Square Deal, 375 Footscray Rd.,
New Eltham. 01-859 1516

LONDON SE15

Castlehurst Ltd., 152 Rye Lane,
Peckham. 01-639 2205

LONDON SW6

Chelsea Micros Ltd.,
14 Jerden Place. 01-385 8494

LONDON N1

ASP Micro Systems, 185 Upper
St. Islington. 01-359 9095

LONDON N14

Youngs Electronic t/a
Fieldmaster, 19 The Broadway,
The Bourne, Southgate
01-882 5579

LONDON N.20

Castlehurst Ltd., 1291 High Rd.
01-446 2280

LONDON NW9

Moviescope, 459 Kingsbury Rd.,
London NW9. 01-204 6352

LONDON W1

Devron, 4 Edgware Road.
01-724 2373

LONDON W1

Computers of Wigmore Street,
87 Wigmore St. 01-486 0373

LONDON W1

Sonic Foto & Micro Center,
256 Tottenham Court Rd.
01-580 5826

LONDON W3

Colormatic Computers, 44
High St., Acton. 01-992 7611

LONDON W11

Electroleisure, 120 Notting Hill
Gate. 01-221 7029

LOUGHTON

Micro & Movie Channel
309 High Rd.
01-508 1216

LOWESTOFT

John Wells, 44 London Rd.
North. 0502 3742

LUTON

Terry-More, 49 George St.,
0582 233912

MACCLESFIELD

Camera & Computer Centre,
118 Mill St. 0625 27468

MANCHESTER

Lomax Ltd., 6 Exchange St.,
St. Ann's Sq. 061 832 6167

MANCHESTER GTR.

Mr. Micro Ltd., 69 Partington
Lane, Swinton. 061 7282282
open Thurs.-Fri.-Sat. till 8 p.m.

MANCHESTER GTR

PASE, 213-215 Market St., Hyde.
061-366 5935 Telex: 665845

MANCHESTER GTR

Wilding Ltd., 23 Oeansgate,
Bolton. 0204 33512

MANCHESTER GTR

Home & Business Computers
4 Northway, Eccles Precinct,
061-707 2004

MARKET HARBOROUGH

Harborough Home Computers,
7 Church Street. 0858 63056

MIDDLESBROUGH

McKenna & Brown,
190 Linthorpe Rd. 0642 248345

NEWCASTLE-ON-TYNE

Newcastle Camera
& Computer Mart, 16 Northum-
berland Ct. 0632 327461

NEW MALDEN

Surrey Micro Systems,
31 High St. 01-942 0478

NEWPORT (Gwent)

Randall Cox, 118 Commercial
St. 0633 67378

NORTHAMPTON

Basic Computers & Systems
Ltd., 72 Kingsthorpe Hollow,
0604 710740

NORTHWICH

Camera & Computer Centre,
3 Town Sq. (0606) 45829

NORWICH

Sound Marketing,
52 St Benedicts St. 0603 687725

NOTTINGHAM

Camo Computers, 8/9/10
Trinity Walk. 0602 42912

NOTTINGHAM

Baslc
39-41 Trent Boulevard,
West Bridgeford 0602 819713

OLDHAM

Home & Business Computers
Ltd., 54 Yorkshire St.,
061-633 1608

OXFORD

Ivor Fields, 7 St Ebbes Street.
0235 21207

PAIGNTON

Devon Computers, 81 Upper
Manor Rd. (0803) 526303

PEMBROKE

Randall Cox, 19 Main St.,
084 688 2876

PETERBOROUGH

Peterborough Communications
91 Midland Rd.
0733 41007

PETERHEAD

North East Computers
1-3 Ellis St. 0779 79900

PORTSMOUTH

Computer Corner, 261
Commercial Rd. 0705 833938

PORTSMOUTH

Waterlooville
GB Microland, 7 Queens Prde
07014 59911

PORT TALBOT

Micro Gen. 6 Royal Buildings,
Talbot Road, 0639 887730

POTTERS BAR

The Computer Shop, 197 High
Street. 0707 44417

PRESTON

Wilding's, 49 Fishergate.
0772 556250

RAINHAM

Microway Computers, 39 High
Street. 0634 376702

Introducing Perfect Software.™

Now, put the power of our remarkable new programs to work for you!

If you've been looking for powerful, flexible software that's also easy to use, take a close look at what we've got to offer.

An integrated product line with the state-of-the-art features and common-sense prices you're probably looking for.

Perfect Writer™

Perfect Calc™

Perfect Filer™

Perfect Speller™

Whether you're interested in one or all four of our revolutionary products, you owe it to yourself to find out what we have to offer:

Perfect Writer.

The most powerful and versatile word processing software for microcomputers available anywhere. Features include Virtual Memory, multiple editing of up to 7 files at once, dual display windows, automatic footnotes, table of contents and indexing.

Perfect Calc.

You get 17 application programs that are ready to use for

any planning and financial control task. Plus multiple editing of up to 7 files at once and dual display windows.

Perfect Filer.

This incredible double data base management system produces personalized standard letters and versatile sort menus for generating lists or invoices. It prints labels, envelopes and more. It can even handle accounting functions!

Perfect Speller.

Now, get a 50,000 word dictionary that checks over 4,000 words a minute. It even locates and corrects document design errors!

Take a look at what you get:

- Britain's first fully-integrated product line. Learn only *one* set of logical commands.
- Easy-to-use, user-friendly features that are unmatched in the industry.
- Interactive teaching disks make Perfect Software easy-to-learn.
- Available for both 8 and 16 bit micros, CP/M™ operating systems and the IBM PC.
- All programs maximize virtual memory architecture for all applications and multiple file display.
- True ASCII files for powerful communication capability.
- And lots, lots more.

Perfect Software, Inc.™

To order or find out more, contact:

Pete & Pam Computers
Telephone: 0706 227011
Telex: 635740 PETPAM G

Transam Microsystems Limited
Telephone: 01-405 5240/2113
Telex: 24224 (Ref. 1422)

Tamsys Limited
Telephone: Windsor 56747
Telex: 849462 TELFAC G

Software Limited
Telephone: 01 387 8832
388 9927

Telex: 21879

Hotel Microsystems Ltd.
Telephone: 01 328 8737
Telex: 266828

Interam Computer Systems Ltd.
Telephone: 01 622 9373
Telex: 925859

Attention Dealers/Distributors
All inquiries are invited. Contact your UK Sales Representative:
Micro Marketing International
2936 Domingo Avenue
Suite 5
Berkeley, California, U.S.A. 94705
Telephone: 415 658-5548
644-0205

Telex: 171 596 AAA SCOM SUVL
© 1983 Micro Marketing International
CP/M is a trademark of Digital Research, Inc.

If you're serious about your BBC Micro... get some serious Software!



Microcomputers weren't created just to play arcade games or to be left unused once you've learnt the basics of computing. Micros are amazing machines and have many serious uses, but they are only as efficient as the software you run on them.

Psion are one of Europe's largest producers of microcomputer software with sales now exceeding one million packages. Our policy is to create quality software that takes full advantage of the processing power of your microcomputer and uses its capacity to the full.

The Versatile Spreadsheet Program

Vu-Calc is a powerful program that constructs a spreadsheet for generating and calculating large tables of interdependent text, data and formulae.

A 'window' for viewing the spreadsheet can be scrolled in any direction so that the effects of new figures and formulae on all the other data can be observed.

Vu-Calc is supplied with a clear and detailed 16-page user manual, and its hundreds of applications include:-

- Cashflow Projections • Home Finance Management • Engineering and Statistical Tables • Investment Forecasting • Business Planning • Profit and Loss Statements • Break Even Analysis, and other complex calculation models

£14.95

The Complete Filing System

Vu-File is a powerful data base management system that turns your microcomputer into a sophisticated general purpose filing system for manipulating information of all kinds.

Vu-File can be used to create dedicated data bases to suit your most varied needs. Features such as order, sequence, search, list and copy make Vu-File the most essential data handling software package available for microcomputer owners. Vu-File is supplied with a clear and detailed 16-page user manual, and its infinite applications include:-

- Catalogues of stamps, coins, books, records etc.
- Names and Addresses • Mailing Lists
- Customer Accounts • Estate Agents Lists
- Medical Records • Club Memberships
- Records and Lists of all kinds.

£14.95

We have now rewritten two of our most popular programs for use on the BBC Microcomputers (Model B or Model A with 32K RAM). *Vu-Calc* and *Vu-File* are powerful software packages that make practical and serious use of your microcomputer.

Supplied on cassette, they are designed for use with cassette or disk systems, and each program comes with a detailed user manual. *Vu-Calc* and *Vu-File* constitute essential software that no serious microcomputer user should be without.

To the Retailer

Contact Psion to find out details of substantial discounts for trade orders of our best selling computer software.

Order Vu-Calc and/or Vu-File by using your Access or Barclaycard or send cheque/postal order for £14.95 per package to:-
BBC Software Psion Ltd.,
2 Huntsworth Mews, Gloucester Place,
London NW1 6DD.

Enquiries can also be made at W.H. Smith or your local retailer.

Please make cheques and postal orders payable to Psion Ltd., and allow 14 days for delivery.

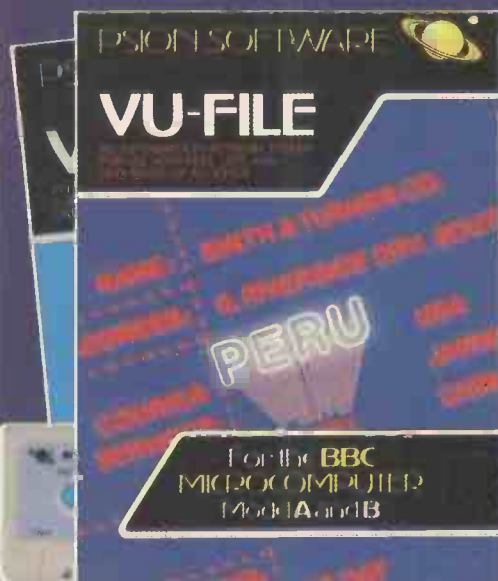

TO: BBC Software,
Psion Ltd., 2 Huntsworth Mews,
Gloucester Place, London NW1 6DD.

Please send me the following Software packages at £14.95 per package.

Vu-Calc (£14.95 inc. p&p and VAT)

Vu-File (£14.95 inc. p&p and VAT)

*I enclose a cheque/postal order for £ _____ made payable to Psion Ltd.

*Please charge my Access/Barclaycard Account Number _____

Signature _____

NAME _____

ADDRESS _____

*Delete as appropriate

For those that do,

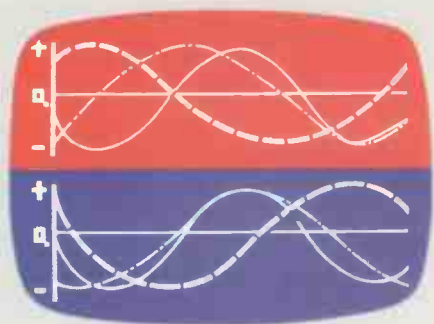

$$a \frac{dy}{dx} - by = f(x)$$
$$a \frac{d^2y}{dx^2} - b \frac{dy}{dx} + cy = f(x)$$

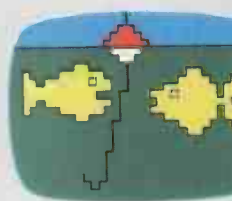

those that don't



The do's and don'ts of the new CGL M5 home computer reveal why it is such a remarkable family computer. Unrivalled in its range.

For those family members that do revel in creating their own personal computer programmes the M5 will test all their abilities. And teach them many more.

Alternatively for those that don't want to become so involved in programming the M5 couldn't be more fun.

How can one computer be all things to all users — from a sixty year old to a six year old?

Simply because the CGL M5 has been developed in Japan as a sophisticated 'add-on' computer system. With the back up of a unique software system.

As your computer abilities grow so the CGL M5 will expand to meet them. One of the first things you'll discover about the M5 is its amazing colour and graphic reproduction, whether it's bringing life to your own animation or pre-programmed cassettes and cartridges.

The graphic modes capability of the M5 is just one of the features that sets this computer in a class of its own.

It also incorporates a mini-synthesiser. Slot in the Basic G cartridge and you can compose to your ears' delight.

The addition of a Basic F cartridge lets you do more complicated scientific, technical and arithmetical applications. There's also the FALC cartridge which gives you an easy to use data management and family accounting package.

And the CGL M5 is still growing. With an ever expanding library of cassettes and cartridges.

Do yourself and your family a service — don't buy a home computer until you've found out more about the remarkable CGL M5.

CGL M5
HOME COMPUTER

and those that might.

For full details and a technical specification of the new CGL M5 send us this completed coupon. Apart from the full-colour brochure we'll also rush you the address of your nearest stockist. Be sure to see a demonstration.

The CGL M5. It might be the best family decision you'll make for years.

Name _____

Address _____

Tel. No. _____

Post the completed coupon to Computer Games Limited, CGL House, Goldings Hill, Loughton, Essex IG10 2RR.

THE BATTLE IS OVER...

"MS-DOS has become the dominant 16-bit operating system . . ."

Computing, 17th February '83

". . . now it is clear that MS-DOS is the runaway winner."

Weekly Micro Bulletin, 21st February '83

"MS-DOS . . . has virtually stopped the runaway success of Digital Research's CP/M in its tracks."

Infomatics Daily Bulletin,
14th January '83

"Digital Research . . . may be too late to stop the landslide."

Personal Computer News, 20th May '83

"In quick succession, more than 50 other computer hardware manufacturers picked Microsoft's operating system. As a result, MS-DOS has virtually shut CP/M out of the market for newer, more powerful microcomputers."

Business Week, 21st February '83

MS-DOS

The industry standard 16-bit OS

MICROSOFT®

Microsoft Ltd,
Bulbourne House, Gossoms End, Berkhamsted, Herts HP4 3LP

When it's time to stop playing games and get down to business...

Unfortunately, many of today's desk top computers are designed with too much emphasis on home use. That's fine, if you want to balance your checkbook, play "space war" or draw pictures. But when you have serious business requirements for a computer, you want one designed specifically for business.

The RAIR Business Computer is just that. A computer designed specifically for business applications, incorporating a host of features—optimised for the business environment. 8- and 16-bit microprocessors allow users to run available 8-bit—plus newer 16-bit—applications software simultaneously. And an integral high-capacity Winchester disk drive—plus provision for additional hard disk support—provides sufficient on-line storage for virtually any business application.

Advanced communications software allows the RAIR Business Computer to connect to mainframe systems and networks. And expanded RAM memory supports simultaneous access from up to four user workstations, each including an ergonomically designed, detached keyboard, high-resolution colour display, and optional workstation printer.

So if you're serious about a computer for business, call RAIR for details about our Business Computer. We're not playing games.

RAIR Limited

6-9 Upper St. Martins Lane

London WC2H 9EQ

Phone (01) 836 6921, Telex 298452

SYSTEM SPECIFICATION

Microprocessors: Concurrent 16-bit 8088 plus 8-bit 8085
RAM Memory: 256 kbytes expandable to 1024 kbytes
Integral Disk Storage: 19-Mbyte Winchester drive plus 1-Mbyte floppy drive
Storage Options: Up to 4 add-on Winchester drives plus streaming tape backup
Communications: 4 workstation ports (RS-422-compatible), plus 2 synchronous/asynchronous programmable RS-232 ports

WORKSTATIONS (up to 4)

Keyboard: Ergonomic, low-profile, 83 keys, 10 programmable function keys, 10-key numeric keypad (with cursor/editing functions)
Color Display: High-resolution, 80 characters x 25 lines, upper and lower case, 8 programmable foreground/background colors
Printer: Bidirectional, 160 characters-per-second, friction and tractor feed

SOFTWARE

Operating System: User-friendly, multi-tasking, CP/M, MP/M, PC-DOS compatible
Languages: BASIC, COBOL, Pascal
Applications: Spreadsheet, Database, Text Processing, Communications

CP/M and MP/M are trademarks of Digital Research
PC-DOS is a trademark of IBM

the RAIR Business Computer.



Sinclair ZX Spect



The growing range of Spectrum Software



You'll know already that the Spectrum has generated an enormous range of peripherals and independent software. Our own range is growing very fast and is shown in the Sinclair Software Catalogue - free with every ZX Spectrum.

um-news!

**16K now
£99.95**
Previously £125.

**48K now
£129.95**
Previously £175.



**ZX Printer now
£39.95**
Previously £59.95

How to order your ZX Spectrum
Access, Barclaycard or Trustcard holders
- call 01-200 0200 24 hours a day, every
day. By FREEPOST - use the coupon
below. Please allow up to 28 days for
delivery. 14-day money-back option.

**sinclair
ZX Spectrum**

Sinclair Research Ltd., Stanhope Road,
Camberley, Surrey, GU15 3PS.
Tel: 0276 685311. Reg. no: 1135105.

...last, a 16K colour computer
...th graphics for under £100!
...Why have we done it?
...Partly because the sheer
...volume of Spectrums sold (over
...100,000 so far) has brought
...down unit production costs.
...And partly, of course,
...because we hope you'll buy a
...Sinclair computer - and not
...some competitor's promise!
...We've all heard about colour
...computers breaking the £100
...barrier. Here's the computer
...that's done it. A colour computer
...with advanced graphics that's
...fully supported, and widely
...available.

Right now, you can order a
Sinclair Spectrum at these
prices direct from Sinclair on
the order form below. And to
make it even easier to handle
high-level computing at the

lowest possible price, we've
cut the cost of the printer, too.
At £39.95, it's almost
unbelievable!

At prices like these, there's
really no reason to wait.

| To: Sinclair Research, FREEPOST, Camberley, Surrey, GU15 3BR. | | | | Order |
|---|--|------|-----------------|---------------|
| Qty | Item | Code | Item Price £ | Total £ |
| | Sinclair ZX Spectrum - 16K RAM version | 3000 | 99.95 | |
| | Sinclair ZX Spectrum - 48K RAM version | 3002 | 129.95 | |
| | Sinclair ZX Printer | 1014 | 39.95 | |
| | Printer paper (pack of 5 rolls) | 1008 | 11.95 | |
| | Postage and packing: orders under £90 | 0028 | 2.95 | |
| | orders over £90 | 0029 | 4.95 | |
| | | | | Total £ _____ |

Please tick if you require a VAT receipt

*I enclose a cheque/postal order payable to Sinclair Research Ltd for £ _____

*Please charge to my Access/Barclaycard/Trustcard account no. _____

*Please delete/complete as applicable. _____

Signature _____ PLEASE PRINT

Name: Mr/Mrs/Miss _____

Address _____

_____ PCW 907

FREEPOST - no stamp needed. Prices apply to UK only. Export prices on application.

EPSON HX-20

at

VISION STORE

NOW!

Vision Store now have in stock the fantastic Epson HX-20, the totally portable computer that slips easily into a briefcase and yet incorporates its own LCD screen, full typewriter keyboard, printer and microcassette. It runs for over 50 hours on its own power supply, which can be easily recharged overnight, for use anywhere. Come in and try the Epson HX-20 at Vision Store today.

EPSON HX-20 COMPUTER SYSTEM

HX-20 UA The HX-20 portable computer complete with integral printer and display
with transit case **£411.00**
without transit case **£402.00**

HX-20 MC-SA Optional Microcassette drive for HX-20 **£75.00**

HX-20 EU-SA Expansion unit for HX-20 contains 16 KB of RAM, or may be used with up to 32K ROM **£80.00**

HX-20 RC-SA optional ROM cartridge for HX-20 may contain 8K pre-programmed ROM (not supplied) **£45.00**

EPSON HX-20 ACCESSORIES

HOO-AAU Spare mains adaptor **£8.50**

HOO-RP Paper rolls for HX-20 pack of 5 **£2.60**

HOO-CR-RA Cartridge ribbons for the HX-20 (each) 1,000,000 character life **£2.20**

HOO-CT EPSON MC-30 Microcassette tapes **£1.60**

EPSON HX-20 LEADS & CABLES

702 Cable to connect an external audio cassette **£5.70**

714 Cable to connect an external EPSON terminal printer (serial) **£15.00**

716 Cable to connect 2 HX-20 computers using 8 pin RS232 sockets **£15.00**

717 Cable to connect 2 HX-20 computers using the High Speed serial interface (5 pin sockets) **£15.00**

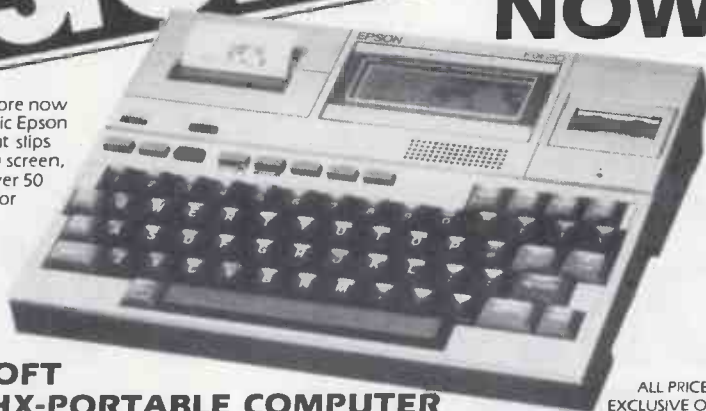

EPSONSOFT EPSON HX-PORTABLE COMPUTER

| | | Microcassette | Pre Programmed ROM |
|--------------------------|--|---------------|--------------------|
| D.I.Y. | A programme generator system, for the user who wishes to write data capture and data handling systems without learning BASIC | £30 | £75 |
| EPSON SIMPLICALC | A spread sheet system to create financial reports and forecasts from complex formulae | £30 | £85 |
| THE PERSONAL OFFICE | This suite of programs provides a 3 month rolling diary. A card index system, including a standard form and graphics option | £20 | £75 |
| CORRESPONDENT | A powerful word processing system, specifically designed for the HX-20, may be linked to an external printer, text files are stored on microcassette | £50 | £105 |
| MLIST | A complete mailing list system, including a selection code, complete with a link into the Correspondent system | £25 | £75 |
| SALES ORDER ENTRY SYSTEM | Allows the collection of sales orders and the downloading of a stock file from a central computer. | £40 | N/A |
| COMMUNICATION | | N/A | £30 |

ALL PRICES ARE EXCLUSIVE OF VAT

VISION STORE

3 Eden Walk Precinct, Kingston-on-Thames, Surrey
Tel: 01-546 8974

How fast is FAST?

Micro-computers don't hang about—and neither do we. We like to move as fast as the products we handle. When you deal in computers you need a distribution system to match the product.

That's where we have the edge. Located at the centre of the country's communications network we can get anywhere in the UK—Fast!

Phone in your order now, we'll get the system moving!

EPSON Extraordinary products. Exceptional quality - from



The fastest movers around!

116-118 Tennant Street, Birmingham B15 1EY. Telephone: 021-643 4419.

**Westwood
Distribution
Limited**

SIMPLY MORE

VHA
CO1, CO3 ICL Comms
0532-747475

MOM
Condor Database
0474-57746

Biodata
Microlink-Computer
Interface
061-236 1283

Padmede
Nominal Ledger
02514-21892

Graffcom
IBSF-W
Business Controller
01-727 5561

Comshare
Microconnect
021-704 4151

Sosoft
Tomorrows Office
0202-735656

Millhouse Designs
Comms Processor
0420-84517

M.P.S.L.
BOS Autoclerk
01-831 8811

Sapphire Systems
Stock Control
Invoicing
01-554 0582

Management
Accounting
01-0585

Pulsar
Pulsar Range
021-454 8585

UC
02

We felt it was time we stopped telling you about ourselves and said a few words about the massive commitment which over 100 software organisations have made to the ACT Sirius 1. On these pages are just a few of more than 400 packages now available for the Sirius 1, Britain's best-selling 16-bit personal computer.

The packages range from traditional accounts programs to sophisticated computer-aided design systems and there is a whole host of software for specific industries and professions.

If you're looking for a computer solution to match your business requirements, then 'phone one of the numbers above, before you look any further. They're all convinced that the ACT Sirius 1 is the best machine of its kind in the country – and they have the software that will make it work for you. And if you don't see what you want, just clip the coupon for details of more than 400 products designed for the ACT Sirius 1.

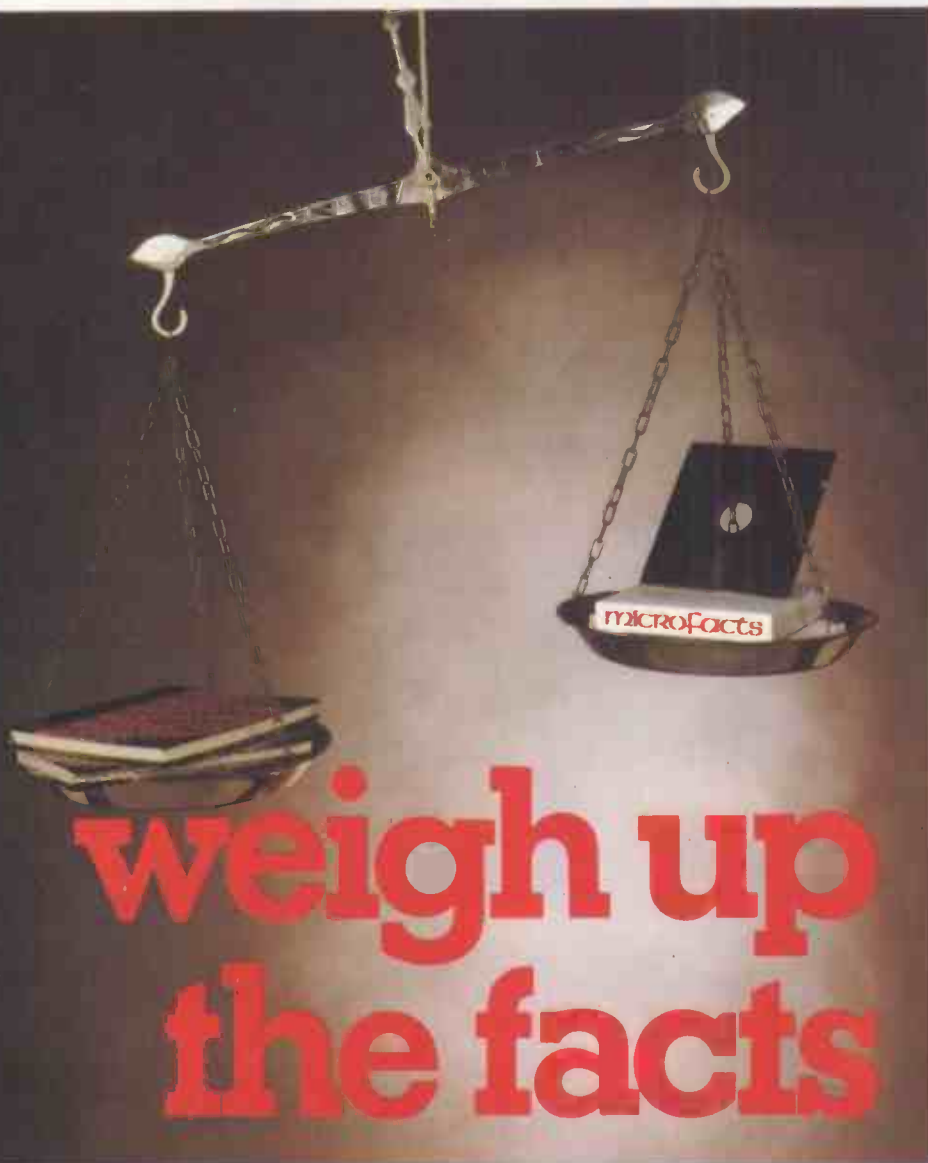

On balance, is too much of your valuable time and effort taken up by mundane and repetitive statistics and bookkeeping?

The MICROFACTS integrated accounting system is already helping hundreds of users of microcomputer small business systems to manage their businesses more effectively and profitably, giving them time to make the crucial decisions.

Don't you think your business could benefit from tighter credit control, rapid and accurate financial reporting, reduced stock holding, comprehensive job costing, better customer service and many other advantages?

Make the right decision NOW. Find out how MICROFACTS can help YOU and take some of the stress out of your life.

**Now available for
Commodore 700 Series.**

microfacts

Facts Software Ltd.



For further information and details of your local dealer please complete the coupon and mail to the address below.

Name _____

Position _____

Company _____

_____ Tel. No. _____

Address _____

County _____

Postcode _____

**Facts Software Ltd.
Ketwell House
75-79 Tavistock Street
Bedford MK40 2RR
Telephone (0234) 218191**

SOFTWARE

Computing
System
449

D.L.A. Computers
Off-line telex
preparation
01-847 2331

Vuman
Symbolex-Scientific
Word Processor
061-273 3333

Praxis
Praxistock Modelling
08926-61261

Heronview
IEEE488 Driver
01-628 5423

Interdata
Telex-simulation
01-761 4135

Abtex
Micronet
Project Planning
0224-647074

Micro Supplies
Dairy Herd
Management
0262-77115

Busisoft
Spellbinder
01-381 4337

TABS
Fast Data Entry
0264-58933

Pegasus Software
Invoicing
0536-522822

l.
System
2796

Bristol Software
Factory
Silicon Office
0272-277135

Distinct
Coach
0937

Please send me
the Registered Product Brochure,
listing over 400 Hardware and
Software products for the ACT Sirius 1.

Name _____

Position _____

Company _____

Address _____

Telephone _____



ACT SIRIUS 1

A new star is born



pulsar

16 BIT BUSINESS SOFTWARE



PULSAR business software is the creation of ACT – the company behind the Sirius I and recognised leader in 16-bit personal computing.

The new PULSAR range, developed by ACT at a cost in excess of £1 million, takes full advantage of the power and expandability of 16-bit computers.

It is inherently faster and more powerful than traditional 8-bit software.

And it is a true 16-bit range, designed and developed by ACT's own software engineers.

PULSAR offers more of all the key requirements in business software:

MORE PORTABILITY

Written throughout in machine-independent portable languages to protect your software investment.

LONGER PEDIGREE

ACT has more than 17 years experience in developing business software. Thousands of companies throughout the world use ACT packages.

GREATER INTEGRATION

All the PULSAR packages are designed to share information, avoiding duplication of files and eliminating re-entering of data.

MORE USER-FRIENDLY

ACT's unique UFO (user-friendly origination) routines allow even the inexperienced user to quickly and easily configure a PULSAR system to precise requirements.

BETTER TRAINING

Two training centres, in London and Birmingham are open to all PULSAR users.

MORE SUPPORT

A 'hot line' telephone support scheme to instantly resolve any operating queries.

PULSAR SOFTWARE CENTERS

Only PULSAR is available through the unique network of PULSAR Software Centers. These are hand-picked computer dealers who handle a range of personal computers but who specialise purely in PULSAR to meet all business needs.

THE PULSAR RANGE

| | | | |
|-----------------|------|-------------------|------|
| Sales Ledger | £195 | Informer Database | £295 |
| Purchase Ledger | £195 | Micromodeller | £595 |
| Nominal Ledger | £195 | SuperCalc™ | £150 |
| Payroll | £195 | MultiPlan™ | £159 |
| Stock Control | £195 | WordStar™ | £295 |
| Invoicing | £195 | Select™ | £295 |
| Data Analysis | £195 | MailMerge™ | £95 |
| | | d Base II | £395 |

AVAILABLE NOW FOR SIRIUS – IBM PC and DEC Rainbow coming soon.



For more information on the new PULSAR Range clip the coupon and return to

**ACT (Pulsar) Ltd
FREEPOST,
Birmingham B16 1BR
or call
021-454 8585**

Please send me further details of the new PULSAR Range.

Name _____

Position _____

Company _____

Address _____

Tel _____

SCI

™ indicates registered trade mark. Ownership details on request. ALL prices exclude VAT.

Welcome to the ICE Age

ICE



5 1/4 in. Winchester Sub Systems with a tape streamer back up
From 3 to 42 Megabyte configurations

Compatible with

Apple II • Apple III • Superbrain • Sirius/Victor • I.B.M.P.C. • S100 • Z80 based Systems

Tapestreamer backup now available for Profile. Apple III hard disc.

For further information or a demonstration contact:--ICE 16/18 Littleton Road, Ashford, Middlesex TW15 1UQ. Telephone Ashford (07842) 47271/47171 Telex 8952042 (DPCUST G)

from £1350



The box is not always black ...

At Rair we're continually enhancing and upgrading our Black Box microcomputer range to meet the ever-changing, ever-growing needs of our customers.

That's why you'll often find our systems turning up under different names, different colours – not always black.

Our current Black Box range includes 8- and 16-bit microprocessors, that can be configured from simple

single-user floppy disk systems right up to powerful multi-user systems with Winchester hard disks and tape backup.

So next time you're choosing a microcomputer for a new application, remember to call us first.

With Rair, you can have any colour you like, including black.

RAIR

United Kingdom RAIR Limited 6-9 Upper St Martins Lane London WC2H 9EQ Telephone (01) 836 6921 Telex 298452

France RAIR Sarl 90 Avenue Champs Elysées 74008 Paris Telephone 010 331 225 4401 Telex 290177

West Germany RAIR Computer GmbH Clemensstrasse 5-7 5000 Köln 1 Telephone (0221) 219811 Telex 8881915

United States RAIR Microcomputer Corp. 4101 Burton Drive Santa Clara CA 95050 Telephone (408) 988-1790 Telex 677038

Peachtree Software

The gilt-edged investment for your microcomputer



You need to be sure that the application software you choose carries the hallmark of stability and reliability and will be a sound investment for the future. It should enhance the value of the microcomputer you select to solve your business problems.

The Peachtree Portfolio of Application Software meets this need. The range provides for simple book-keeping (*Peachtree Basic Accounting Systems*), comprehensive accounting (*Peachtree Business Management Systems*) and integrated office automation (*Peachtree Office Productivity Systems*).

Peachtree is part of the world's largest Application Software company. We have over 20 years experience helping users of large and small computers get the full value from the computerisation of their business.

A nationwide network of independent computer retailers offers our portfolio of products on many different types of microcomputer. These companies provide the local support you want - backed up by Peachtree.

Major microcomputer manufacturers and distributors have made their investment in Peachtree Software for their computers.

They include:

IBM, DIGITAL, BRITANNIA,
RANK XEROX, PHILIPS, OSBORNE,
POSITRON, OEM, EPSON,
GRUNDY, WANG, MEMORY,
SAMURAI (distributed by Micronetworks)
SANYO and ALTOS (distributed by Logitek)

Peachtree Software is available for these machines through their own distribution networks - backed up by Peachtree.

THE SOFTWARE THAT WORKS FOR YOU.

Peachtree Software International Limited
43-53 Moorbridge Road, Maidenhead,
Berkshire SL6 8LT, United Kingdom
Telephone: Maidenhead (0628) 32711.
Telex 849000



SEND FOR THE PEACHTREE PORTFOLIO:

Clip the coupon to your card or
letterhead and mail it today.

My Company: _____

My Name: _____

My Computer: _____



PCW 5

A Subsidiary of Management Science America AN  COMPANY

Multi-Index from Bonsai.

The first Integrated Accounting Software for micros designed for real world business.

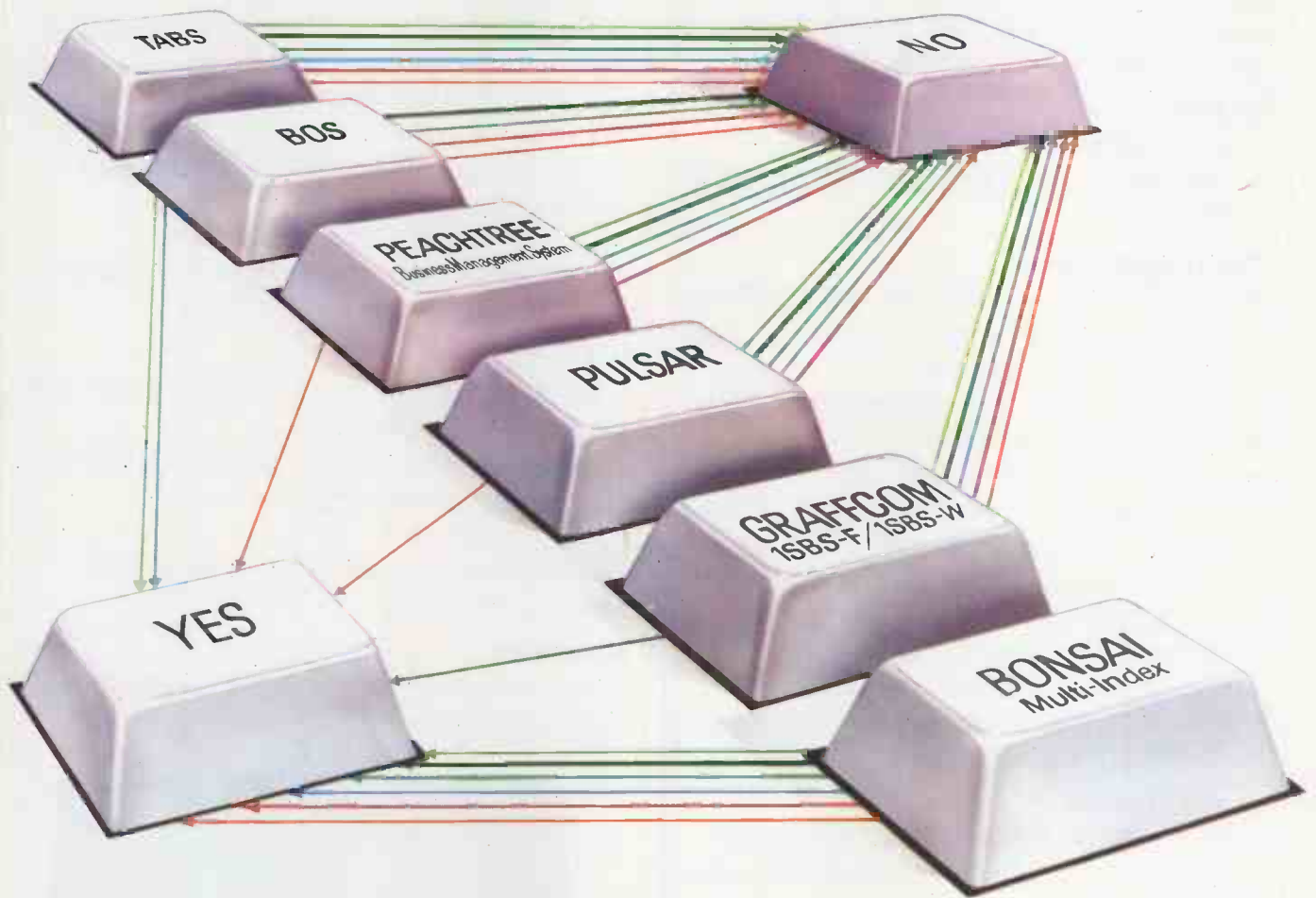

Multi-Index is a new generation of sophisticated Accounting Software. A completely integrated system written entirely in RM/COBOL, a professional business oriented language. It makes systems written in BASIC look pretty basic.

Multi-Index consists of seven fully integrated modules: Sales, Purchase, VAT and Nominal Ledgers, Stock Control, Order Entry/Invoicing and Sales Analysis, with several additional modules to be released soon. Multi-Index provides the ultimate combination of sophistication and ease-of-use. Entirely menu driven, easy to follow screen displays lead inexperienced operators step by step through all procedures so Multi-Index is quick and painless to learn.

Multi-Index presents features up to now only available on mainframes. Features like:

- ➡ Up to 13 open accounting periods with full detail accessible throughout the year.
- ➡ A financial statement report generator producing all statements including Sources & Applications of Funds, Balance Sheet, P & L and supporting schedules to *your own format*.

- ➡ Multiple-location stock control among unlimited branches with full stock transfer support.
- ➡ Access to customers, suppliers and stock items by name if the account or stock number is not known.
- ➡ Flexible price discount schedules, plus automatic calculation of salesmen's commissions, settlement discounts and finance charges.

➡ No time-consuming sorts anywhere in the system.

Feature for feature Multi-Index beats all other micro accounting packages hands down. It is available *now* for many 8, 16 and 32-bit microcomputers running CP/M-80, CP/M-86, MS-DOS and Unix including the latest hardware like the IBM Personal Computer.

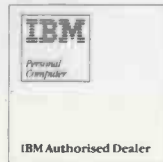

See Multi-Index running on the new IBM PC XT

Bonsai[®]
MICROCOMPUTER SYSTEMS
FOR PEOPLE IN BUSINESS.

Bonsai Limited, 112-116 New Oxford Street,
London WC1A 1HJ. (01) 580-0902.

Please (Tick as appropriate) Contact me to arrange a Multi-Index demonstration.
 Send me your Multi-Index information pack. Send details of your next Multi-Index seminar. Send information on the RM/COBOL programming language.

Name _____
 Company _____
 Position _____
 Address _____
 Phone _____
 OEM and Dealer Enquiries Invited.

Although the NewBrain is conceived as a total system, the unexpanded Processor itself has a great deal to offer. It is available in two forms: Model AD, shown below, with a built-in line display; and Model A, without the line display. Both models can operate with a monitor or a television set.

MEMORY

- 24K bytes of ROM;
- 32K bytes of RAM, at least 28K of which is available to the user.

THE SCREEN DISPLAY

- 40 or 80 characters to the line – without affecting the 28K bytes of RAM at your disposal;
- 24 or 30 lines to the screen;
- well-formed characters, with true descenders;
- a full European character set;
- normal or reverse video, high resolution graphics on screen of controllable size, 256, 320, 512 or 640 horizontal resolution by 250 vertical lines;
- a facility to set up a “page” of up to 255 lines, with the screen acting as a “window” to display it;
- ability to maintain several such pages simultaneously, and to switch rapidly between them;
- text may be used on graphics screen as well as on parts of the video screen not used by graphics.

CHARACTER SET

- 512 characters, including the full ASCII set, all European accented characters, Greek and graphics symbols.

GRAPHICS

- 20 powerful graphics commands;
- all text characters usable on the graphics screen;
- variable-sized graphics screen, with the rest of the screen available for text – for versatility and to save memory.

SOFTWARE

Enhanced ANSI BASIC; screen editor (32 commands); mathematics package (10 significant figures); graphics commands.

- a very friendly screen editor – a delight to use and readily adapted to text processing;
- arithmetic to 10 significant figures;
- very controllable output formatting of numbers – invaluable for accounting, statistics, and scientific applications;
- a powerful, much enhanced BASIC;
- a very flexible operating system, which allows any data stream to be opened to any device.

INTERFACES

- two tape cassette ports built into the processor unit;
- a built-in printer interface;
- a built-in communications interface (V24/RS232);
- a video monitor interface;
- a TV interface;
- an expansion interface for NewBrain system expansion modules.

KEYBOARD

- standard typewriter pitch, action, layout and size, with editing control and graphics keys.



*CP/M IS A REGISTERED TRADE MARK OF DIGITAL RESEARCH INC.

You can get everything in the box on the

If you understand the facts and figures on the left you'll soon realise that NewBrain has to be one of the most powerful micros around.

However, if you find the box on the left a little hard to follow, don't worry.

We've got over 120 dealers nationwide who've got all the answers at their fingertips.

Either way you'll discover that NewBrain is the kind of micro that will stop the competition getting a look in.

At £269 it starts off with twice as much memory as most of its competitors and can expand to over thirty times that amount. So there's no chance of being left behind in the micro race.

It comes with a very powerful language (enhanced ANSI BASIC) and it'll take CP/M, so it'll work on the same system as similar big business micros, giving you the capacity to use an almost limitless variety of tried and tested software.

But most of all NewBrain is a machine that can expand.

It's designed to take disks, printers and memory expansion modules (up to 2M bytes) plus anything else you'd expect a professional business micro to handle.

So, whether you understand the box on the left or not, pay a visit to someone in the know on the right.

They'll answer all your questions and give you a full demonstration.

NewBrain

Grundy Business Systems Ltd., Grundy House,
Somerset Road, Teddington.

DEALER NETWORK

| | | |
|---|---|---|
| ALTRINGHAM PHARMACY COMPUTER SYSTEMS (061 928 0087) | GREAT YARMOUTH KAYE ELECTRONICS LIMITED (0493 52967) | NEWCASTLE-UPON-TYNE MICROCORE COMPUTERS (0632 617077) |
| BARNISLEY BROOK OFFICE SUPPLIES LTD (0226 88916) | GUILDFORD M C D LTD (0483 574659) | NEWARK DATA BASE (0638 667311) |
| BARNSTAPLE LANDREY-NEWLAND (0271 77883) J & A CAMERAS (0271 75037) | HAMILTON STRATHCLYDE MICRO CENTRE (03552 22517) | NOTTINGHAM MICRO-C (NOTTINGHAM) (0602 412455) |
| BEDFORD MICROPOWER BUSINESS APPLICS (0234 213571) | HARPENDEN CONSULTANTS IN OFFICE POWER (0582 76911) | NOTTINGHAM LASKYS (NOTTINGHAM) (0602 415150) |
| BIRMINGHAM CALISTO COMPUTERS LTD (021-632 6458) | HASTINGS THE COMPUTER CENTRE (BMS) LTD (0424 439190) | ORMSKIRK MALHOUSE COMPUTERS LTD (0695-78 901) |
| LASKYS (BIRMINGHAM) (021-632 6303) | HEREFORD HONEYSETT COMPUTERS LTD (0432 279404) | PETERBOROUGH LASKYS (PETERBOROUGH) (0733 31313) |
| MICRO-C (BIRMINGHAM) (021-633 1105) | HERTFORD RMR COMPUTER SERVICES (0992 56160) | PLYMOUTH DISHWISE LTD (0752 267000) |
| TYPEWRITER CENTRES (021-622 5385) | HIGH WYCOMBE SUM-IT COMPUTER SYSTEMS LTD (0494-827 238) | POTTERS BAR POTTERS BAR COMPUTERS (0707 59669) |
| BOURNE MICRO-C (LINCOLNSHIRE) (077 82 4566) | HUNTLY I C E (ELECTRONICS) (0466-88 337) | PRESCOT MICROSYS LTD (051-426 7271) |
| BRADFORD NORTHWAY COMPUTER SERVICES (0274 588236) | ISLE OF WIGHT VICTUS COMPUTER SERVICES (0983 528345) | PRESTON LASKYS (PRESTON) (0772 59264) |
| BRIGHTON LASKYS (BRIGHTON) (0273 725625) | KIDDERMINSTER MICRO-MART (0562 742142) | READING LASKYS (READING) (0734 595459) |
| BRISTOL ELECTROPRINT COMPUTERS (0272 292375) | KINGSTON LASKYS (KINGSTON) (01-546 1271) | RICHMOND TANTUS MICROSYSTEMS LTD (01-940 7299) |
| LASKYS (BRISTOL) (0272 20421) | LEAMINGTON SPA WARWICKSHIRE COMPUTER CENTRE (0926 311873) | ROYSTON CORNIX MICRO (0763 44766) |
| MICRO-C (BRISTOL) (0272 650501) | LEEDS MICRO-C (LEEDS) (0532 446601) | RUGBY OEM COMPUTER SYSTEMS (0786 705224) |
| COLSTON COMPUTER CENTRE LTD (0272 276619) | MICROCELL COMPUTER SYSTEMS (0532 681366) | SARISBURY GREEN WENDMORE MANAGEMENT SERV LTD (04895 6318/9/0) |
| BROMLEY LASKYS (BROMLEY) (01-464 7829) | LEICESTER TILLEY COMPUTER SYSTEMS (0533 553984) | SHEFFIELD T A EDUCATION LTD (0742 618539) |
| BUCKNELL BORDER COMPUTING & PROGRAMMING (05474 368) | LINGFIELD SNOBEECH MICRO CENTRE (0342 832476) | LASKYS (SHEFFIELD) (0742 750971) |
| CAMBERLEY ASYST SYSTEMS CONSULTANTS LTD (0276 28397) | LIVERPOOL LASKYS (LIVERPOOL) (051-236 2828) | SOUTHAMPTON MICRO-C (SOUTHAMPTON) (0703 29676) |
| CAMBRIDGE CAMBRIDGE COMPUTER STORE (0223 65334) | LONDON DIXONS PHOTOGRAPHIC (UK) LTD (01-491 7376) | GODWIN ELECTRICAL LTD (0703 783322) |
| G C C (CAMBRIDGE) LTD (0223 835330) | BEAUCHAMPEL COMPUTER SYSTEMS LTD (01-584 8203) | ST HELIER THE PROCESSOR CENTRE (JERSEY) (0534 77070) |
| CANTERBURY M D WRIGHT DATA SERVICES LTD (0227 69090) | LION MICRO COMPUTERS (01-580 7383) | (JERSEY) LTD (0534 71219) |
| CANNEY ISLAND MERCURY MICROSYSTEMS LTD (0268 696263) | MICRO-C (LONDON NW1) (01-387 9275) | ST PETER PORT THE PROCESSOR CENTRE (GUERNSEY) (0481 28827) |
| CARDIFF LASKYS (CARDIFF) (0222 374893) | TRANSAM MICROSYSTEMS LTD (01-405 5240) | STOCKPORT DISKWISE COMPUTER CENTRES LTD (061-477 5931) |
| CHALFONT ST GILES PRINITIVITY LTD (02407 4906) | LASKYS (QUEENSWAY) (01-229 6425) | STROUD THE MODEL SHOP (045-36 5920) |
| CHATHAM MEDWAY COMPUTERS (0634 826080) | LASKYS (TOTTENHAM COURT ROAD) (01-836 0845) | SURBITON COMPUTASOLVE (01-390 5135) |
| CHELSEA COMPUTER SHACK LTD (0242 584343) | LASKYS (OXFORD STREET) (01-493 4623) | SWANLEY PETER RALPH (82 62230) |
| CHESTER BELLARD ELECTRONICS LTD (0244 380123) | OFFICE INSTALLATIONS LTD (01-579 6771) | TEDDINGTON AM PROGRAMMERS LTD (01-943 2266) |
| LASKYS (CHESTER) (0244 317667) | TREND VIDEO & HI-FI LTD (01-521 6146) | STAG TERMINALS LTD (01-943 0777) |
| COLCHESTER CROPPERIN COMPUTER CENTRE (0206 331168) | M R DEAN & SONS LTD (01-723 4630) | TEIGNMOUTH QUESTEL COMPUTERS (062 672258) |
| CORK C O S COMPUTING LTD (0002 23922) | WELBROOK VIDEO (01-486 3783) | THIRSK AMPLAN MANAGEMENT SYSTEMS (0845 597330) |
| CORRINGHAM C & L COMPUTERS LTD (0375 67 5656) | RICHBY COMPUTER SERVICES (W2) (01-723 1382) | THORNTON HEATH CROYDON COMPUTER CENTRE (01-889 1290) |
| COVENTRY COVENTRY MICROCENTRE (0203 58942) | AUDIO MARKETING (UK) LTD (01-580 2554) | TUNBRIDGE WELLS RICHBY COMPUTER SERVICES (KENT) (0892-86 2060) |
| CROYDON LASKYS (CROYDON) (01-681 3027) | LOUGHBOROUGH DATA ONE SYSTEMS LTD (0509 37281) | UXBRIDGE J B MICRO (0895 57908) |
| DARLINGTON DARLINGTON COMPUTER SHOP (0325 487478) | MICRO-C (LOUGHBOROUGH) (0509 37367) | WALTON ON THAMES PMFS (58 22895) |
| DERBY FIRST BYTE COMPUTERS (0332 49672) | LUTON LASKYS (LUTON) (0582 425079) | KEY COMPUTER CENTRES LTD (58 4277/8) |
| DUBLIN 4 THE E C L GROUP OF COS (0301 603497) | MAIDENHEAD KUMA COMPUTERS LTD (0628 71778/9) | WAREHAM GAMES & COMPUTERS (09295 51383) |
| DUNFERMLINE ANDREW THOMSON (0383 724541) | MAIDSTONE LASKYS (MAIDSTONE) (0622 678165) | WARRINGTON NORTHERN COMPUTERS LTD (0928 35110) |
| EDGWARE CITADEL PRODUCTS LTD (01-951 1848) | MANCHESTER H S C COMPUTER SHOPS LTD (061-832 2259) | WATFORD LASKYS (WATFORD) (0923 47488) |
| EDINBURGH LASKYS (EDINBURGH) (031-556 2914) | MICRO-C (MANCHESTER) (061-834 0144) | WELWYN ANGLA ENTERPRISES (0438 812439) |
| JOHN MENZIES PLC (EDINBURGH) (031-225 8555) | LASKYS (MANCHESTER) (061-832 6087) | WENDOVER TARACE LTD (0296 623965) |
| ELSTREE ELSTREE COMPUTER CENTRE (01-953 6921) | LOMAX LTD (061-832 6167) | WINDSOR CASTLE COMPUTERS (95 58118) |
| GILLINGHAM MEDWAY MICRO COMPUTERS LTD (0634 576764) | MIDDLESBROUGH MICRO-TECHNIC COMPUTER SYSTEMS (0642 221501/2) | YORK LASKYS (YORK) (0904 641221) |
| GLASGOW VICTOR MORRIS (AUDIO VISUAL) (041-221 8958) | MILTON KEYNES MILTON KEYNES COMPUTER CENTRE (0908 668811) | MITREFINCH (0904 52995) |
| LASKYS (GLASGOW) (041-226 3349) | HAILESEA BYTE MICRO COMPUTING CENTRE (0272 851337) | |
| GLoucester MILEQUIP COMPUTERS (0452 411010) | NEW MILTON SNIPE COMPUTERS LIMITED (0425 617477) | |

left from anyone in the box on the right.

Keep on running

The name on the world's best selling dot matrix printers is Epson. That's because more and more people every year are proving for themselves that Epson printers are the cost performance leaders.

R & D commitment

It's the research and development Epson put behind every machine, using only the latest micro technology, with fewer moving parts, that has made their printers world beaters for performance plus reliability.

And that's backed by a 12 month guarantee for real peace of mind.

RX 80 – the personal printer

The new Epson RX 80 takes the proven MX series technology even further, setting the pace once again in fast 100cps printers with features that make its low price tag look even smaller.

Bit image graphics, a wide variety of programmable character sets and print styles, and a selectable

50cps quiet mode make the RX 80 a printer advanced enough for any office, yet affordable enough for the personal computer budget.

FX 80 – the versatile printer

If you need even faster hard copy, the Epson FX 80 will give you all you need in a dot matrix printer.

With print speeds of up to 160cps, with a 80cps quiet mode, the versatile FX 80 will power through all your printout with ease. But that's not all. Versatility means being able to handle up to 256 user defined characters, variable line spacing that's switchable or programmable, and a choice of typefaces.

And that makes the FX 80 a printer that's way ahead of its class at any price.

Fast response too – from Midlectron

Fast selling printers like these need a distributor like Midlectron – because we hold enough stocks to deliver off the shelf, with a nationwide dealer network so you won't have to go far to get your hands on an Epson.

For your nearest dealer, technical support or OEM pricing, phone Midlectron today.

FX80

Epson reliability Ex-stock from...

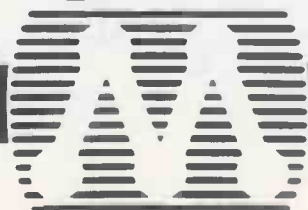

MIDLECTRON DISTRIBUTION

Southern Office:

N.E.C. World Trade Centre, St Katherine's Dock, London, E1 9AA.
Tel: (01) 481 9919 Telex: c/o NEC 884671

Northern Office:

Midlectron House, Nottingham Road, Belper, Derby, DE5 1JG.
Tel: (077 382) 6811 Telex: 377879.

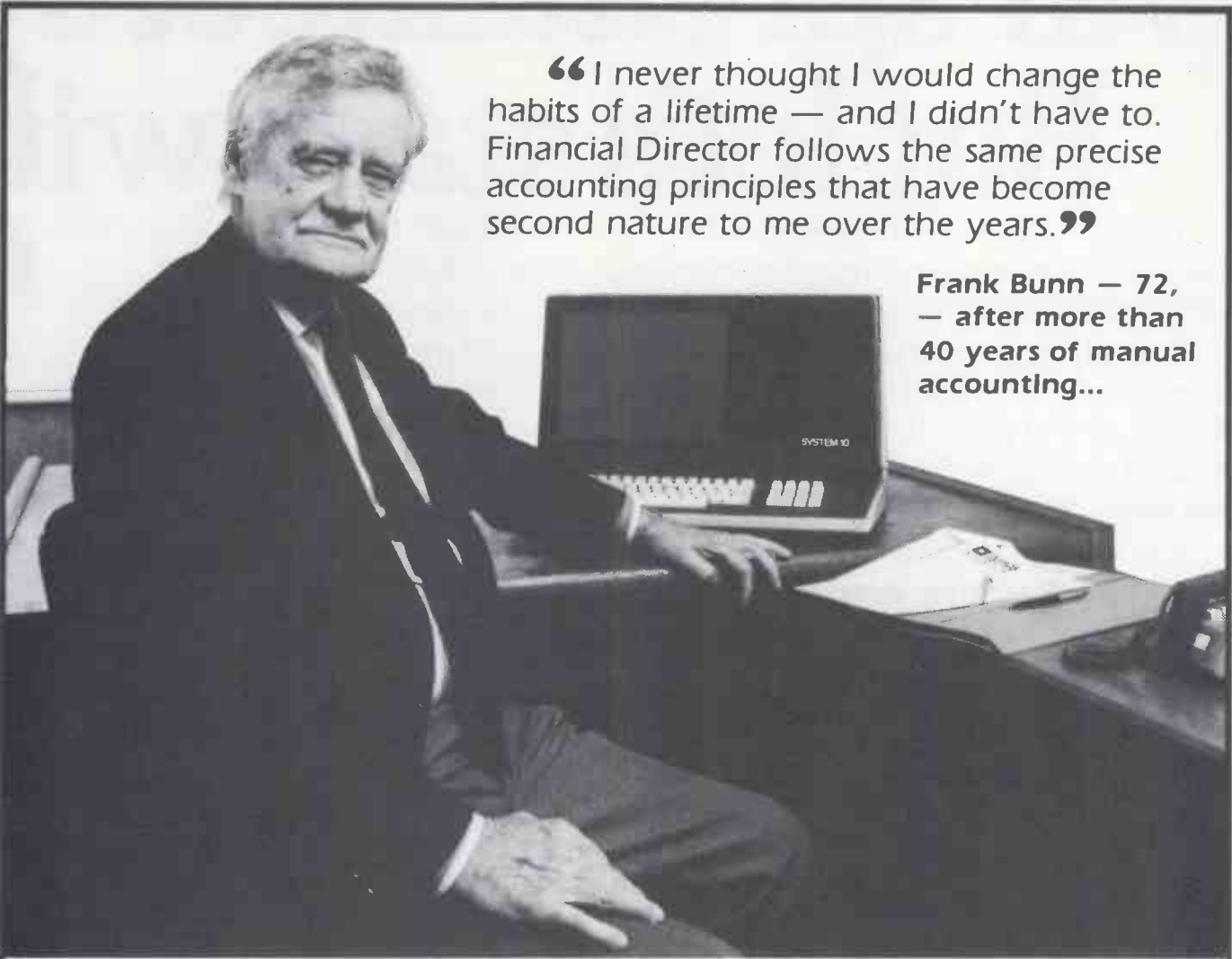

“I never thought I would change the habits of a lifetime — and I didn't have to. Financial Director follows the same precise accounting principles that have become second nature to me over the years.”

Frank Bunn — 72,
— after more than
40 years of manual
accounting...

More and more people are finding FINANCIAL DIRECTOR is Right for their Business

Financial Director is a complete business book-keeping and accounting software package for small and medium-sized businesses and proven in two years' field testing.

Financial Director has been designed by professional Accountants and conforms exactly to British Accounting principles with essential items such as automatic double entry and a complete audit trail which are fundamental to successful computer accounting.

Financial Director has been described as the 'accountant in a briefcase' — partly due to its unique presentation, partly because it provides the financial control skills of the professional accountant and enables the businessman to keep totally up-to-date with the progress of his business.

Financial Director works on most business micro's and is available from good computer dealers all over the country.

We recommend that you consult your accountant and implement your computer accounting system with professional assistance.

For full information and details of our training schemes and dealer network — call today.



**THE
FINANCIAL
DIRECTOR
SOFTWARE
LIMITED**

Asphalte House,
Palace Street,
London SW1E 5HS
Tel: 01-828 4377. Telex: 913001.

Our spreadsheet system But let's start with

Today, computers, micros and more importantly business planning systems are no longer considered luxuries.

They allow you to make better decisions by providing better information on budgeting, cash flow, project profitability, Acquisition Appraisal, Lease vs Purchase analysis and much more.

You stay one step ahead of your business and your business stays one step ahead of the competitors.

But which system should you buy? Surely no one system can meet the needs of all businesses?

Fortunately Comshare is not like most companies. We see the need for different systems to suit different people.

NEW USERS START HERE

PlannerCalc at £85.00* is now accepted as the first choice for people new to financial planning.

Designed for 8-bit micros, it boasts the kind of features that you'd expect to pay twice as much for. (Buy PlannerCalc's nearest rival and you'll have to.)

Unlike all other 'calc' products it allows you to enter calculations in a language you understand. Plain English.

For example:

LINE 1 SALES=100,150,175,210
 LINE 2 EXPENSES=GROW 70 BY 15% FOR 4
 LINE 3 NET=SALES-EXPENSES
 LINE 4 CSALES=CUM SALES
 COLUMN 5 YEAR=SUM OF COL 1 THRU COL 4

So it's much easier to use.

It uses the popular "spreadsheet" approach with a window that can be rolled in all directions.

Which means you can enter new figures and rules and

immediately see their effect on everything else in the model.

It comes with the best manual on the market and it's suitable for most micros with a TMCP/M 2.2 operating system, 64K of memory, giving at least 900 cells, minimum screen width of 80 characters and 2 floppy disc drives.

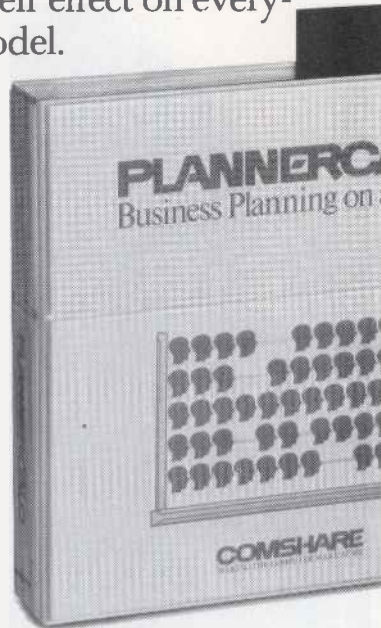

MUCH MORE POWER, NOT MUCH MORE MONEY

MasterPlanner is the most powerful spreadsheet system currently available with its increased matrix size, 2000-3000 cells on most 64K micros. (But at £245* it certainly isn't the most expensive.)

Consolidation of models, allows you create separate plans for each department and then combine them into an overall comparison.

COMSHARE DEALERS

Aberdeen
Abernet Ltd
(0274) 647074

Aldershot
EAS (UK) Ltd
(0252) 313551

Altrincham
Mercator Tech
Services Ltd
(061) 941 4225

Ardsley
Holtstar Systems Ltd
(0296) 630364

Barnsey
Brook Office Supplies Ltd
(0276) 89916

Bedford
HSC Wiltand Ltd
(0234) 50260

Berkeley
Conquest Computer Sales Ltd
(037 45) 59861

Birmingham
Accountancy & Computer
Consultants
(021) 236 3455

Bristol
CPS (Data Systems) Ltd
(0274) 707 3866

Blackburn
BEC Systems
Services Ltd
(0294) 677215

Bolton
TDS Bus Systems Ltd
(0274) 676915

Bradford
The Soft Option U.K. Ltd.
(0274) 668890

Brighton
Rams Computers Ltd
(0274) 306566

Bristol
Aron Microcentre
Systems Ltd
(0272) 277774

C C C (Europe Ltd)
(0454) 321088

Mercator Computer
Systems Ltd
(0272) 730079

Trarstec Ltd
(0272) 277462

Bury St. Edmunds
S.J.R. C.S. Ltd
(0284) 82022

Cambridge
Alexander Systems Ltd.
(0276) 28971

Cambridge
Business Computers
(Cambridge) Ltd
(0273) 357130

Canterbury
Kent Micro Systems
(0272) 52000

Canterbury
Jutee Ltd
(0272) 830083

Cardiff
Bourlamps Computer
Services Ltd
(0222) 36875

Charham
Midway Computers Ltd
(0634) 826090

Chesham
Nestar Computer Systems
(0246) 207048

Cleveland
Bard Computer
Systems Ltd
(0272) 878 157

Cranebrook
The Soft Option U.K. Ltd.
(058080) 310

Doncaster
Branstar Computer
Centre
(0302) 67135

Dublin
Transic Ltd
(001) 718521

Farnham
Electronics Ltd
(0329) 230670

Gosport
Vaurebury Ltd
(0329) 235846

Harpenden
Irration Ltd
(05827) 62421

Hastings
BHS Computer
Services Ltd
(0424) 439190

Hatfield
Honeywell Computers Ltd
(0432) 279404

Hickin
McVigh Business Systems Ltd
(0462) 50386

Huddersfield
Micrologica Systems
(0484) 47450

Isleworth
Anglo Microsystems
(0459) 740046

Leamington Spa
Worts Ltd
(0563) 32029

Leicester
Locustar Micro Centre
(0533) 551869

Lisburn
MMK Electronic Ltd
(08462) 3184/3665

Liverpool
BEC (Liverpool) Ltd
(051) 263 5738

London
BD Computer Systems
01 435 4442

Business Information
Systems
01 373 3113

Detapower Ltd
01 437 5994

Clentia Computer
Systems Ltd
01 670 4202

Corporate Modelling
Consultants
01 628 4107

Dartford Ltd
01 519 7004

DNR Computer
Systems Ltd
01 439 4354

Equinox Computers Ltd
01 739 2387

Ferrari Software Ltd
01 751 5791

Interfax
01 943 0968

Jarragat Ltd
01 671 6321

Ludlow Computing Ltd
01 679 4321

Malmes Electronics Ltd.
01 373 6607

Mayfair Business
Systems Ltd
01 688 3836

MGE Systems Ltd
01 439 9617

Microcom Systems Ltd
01 263 6926

Nokua (UK) Ltd
01 900 0421

Pinewood Computers Ltd
01 504 0403

P.W. Hare & Associates
01 551 1988

San Business
Services Ltd
01 735 7949

Transam Computers Ltd
01 402 8137

Whisper Ltd
01 556 9151

Leath
Compu-A-Crop
(05074) 604271

Malvern
Malvern Micro Systems
(06845) 68500

Meltham
Ciler Systems Ltd
(0225) 706361

RCEN Ltd
02255 702133

Midhurst
Woodhill Automation Ltd
(073881) 6641

Millom Business
Systems Ltd
(0908) 614242

Nevan
S. Triple S Ltd
(046) 20472

Northampton
Micropeople Ltd
(06074) 69117

Oxford
Choice Business
Systems
(049161) 2697

Rayleigh
V. J. Parkes Associates
0268 743928

Rodcar
Applislop
(0642) 474707

Richmond
Tritech Computer Services
01 948 4213

Rutland
Microspec Ltd
(0572) 2528

Stough
RGB Micros Ltd
(75) 38581

Southampton
Kain Systems Ltd
(0703) 38140

St Albans
St Albans Computer
Services Ltd
(0727) 77700

St Helier
The Processor Cent
(0534) 77070

Thomas & Company
(0534) 77700

West Byfleet
Ferguson Computer
Ltd
(91) 41810

West Drayton
Frogers Ltd
(0334) 77070

Weston-Super-Mare
Eastons Ltd
(0934) 41834E

Weybridge
Kewill Systems Ltd
0932 52046

Winchester
Modular Office
Systems Ltd
(0962) 55759

Yatton
Grove Business Ma
0934 835222

Yeovil
Dale Computer
Systems Ltd
(0915) 22000

Systems start at £85.00. Why you need one.

plan. Data transfer to word processing and other systems lets you incorporate figures in reports and output to a data base. It also has extensive formatting facilities which means you can produce reports that wouldn't look out of place in the board room.

It can store up to 25 standard reports to run when you need them. It's got full WHAT IF? analysis and direct editing of both spreadsheet and logic display.

JUST AS EASY TO USE

All this increased power doesn't mean you'll need a degree in advanced computing to understand MasterPlanner.

It works on exactly the same system as PlannerCalc and models written on PlannerCalc run without modification on MasterPlanner.

16 BIT VERSION

A new version of MasterPlanner has been specifically designed for the 16 bit micros like the Sirius 1 under TMCP/M-86 or the IBM personal using either CP/M-86 or TMMS DOS 1.1. With a vast matrix size of over 7000 cells on 128K and even more with larger memory, you'll at last be able to make the most of your micro.

ULTIMATE POWER

Fastplan is the top Comshare micro planning system.

It's file-based, allowing development of large scale models; with a staggering 18,000 cell matrix; full financial functions plus backwards iteration, file input and output; and much more. Yet, because it can be menu driven it is easy to use. For the full story, tick the Fastplan box when you return the coupon.

OVER 10 YEARS EXPERIENCE

When you invest in MasterPlanner or PlannerCalc you're not just getting the best software money can buy.



You're also getting the kind of back up and after-sales service that only a company of Comshare's track-record can guarantee.

If you'd like to know more about any product, call in at your local dealer or fill in the coupon and send it to us.

*Plus VAT and post & package.

COMSHARE

Making the computer make sense.

*CP/M and TMCP/M-86 are the registered trade marks of Digital Research Inc. Comshare Ltd., 32-34 Great Peter Street, London SW1P 2DB. Telephone: 01-222 5665.

To: Department PCW7 Comshare Ltd., 32-34 Gt. Peter Street, London SW1P 2DB.
Please send me:

| Qty | Product | Micro | Op System | Disc Size | K | Amount £ | p. |
|-----|---|--------|------------|-----------|---|-------------|----|
| | PlannerCalc @ £99.50 (8 bit only) | | CP/M 2.2 | 8"/5¼" | | | |
| | MasterPlanner @ £282.95 | | CP/M 2.2 | 8"/5¼" | | | |
| | MasterPlanner | IBM PC | MS DOS 1.1 | 8"/5¼" | | | |
| | MasterPlanner | | CP/M-86 | 8"/5¼" | | | |

All prices include VAT and postage & packing **TOTAL**

Please send me information about Fastplan

I enclose a cheque/postal order for £_____ made payable to Comshare Ltd.

Please debit my Access Card No. _____ for £_____



Barclaycard No. _____ for £_____

Signature _____

Name _____

Address _____

Tel. No. _____

Please allow 28 days for delivery. VAT No. 238418649. Registered No. 980406.

Comshare reserve the right not to accept any orders. Any acceptance will be subject to Comshare's terms and conditions.

THE FIRST OF THE SECOND GENERATION

Earlier this month *Tomorrow's World* carried its first ever news story about a piece of software. Whilst not of earth shattering importance to the man in the street, this event marks the beginning of a quiet revolution that the experts have been predicting for months. The time has come when standardisation is forcing hardware into the background, leaving the spotlight on software.

Whether you use a micro for playing games, running a business or just learning about computers, the software you buy and use will make or break your relationship with your machine.

And just how well do the existing micro magazines serve your needs once you face that fact? Not very well at all.

That's why we're launching SOFT, a brand new monthly magazine that is totally committed

to software. Totally committed to reviewing more software, in greater depth, than any other magazine. And totally committed to facing up to the role that software plays — where it matters — at the man/machine interface.

As the publishers that took *Personal Computer World* to the number one slot in the market and that

launched the market-leading trade paper *MicroScope*, we can promise the first radically new approach to micro magazines in five years.

Just as we led the first generation, we intend to lead the second.

The first issue of SOFT will be on sale at all good newsagents from 20 May.

And we are offering very special subscription rates to charter subscribers who apply before the end of June.

CHARTER SUBSCRIPTION OFFER

I would like to apply for a charter subscription to SOFT for one year (12 issues)
I understand that this entitles me to 12 issues for the price of 10.

UK £10.00

Rest of the world £23.00

I enclose a cheque made payable to
SportsScene Specialist Press Ltd.

Please charge my American Express/
Barclaycard/Access
(Delete where not applicable)

Signed Credit Card No.

Name

Address

Please send the completed form with your payment to:

SOFT, Subscriptions Department, Freepost 7, London W1E 4EZ.

If you prefer you may submit your application on a photocopy of this coupon.

SOFT

PCW 1



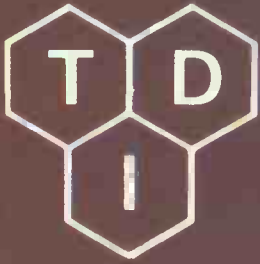

SAGE
COMPUTER TECHNOLOGY

THE WISE MAN'S CHOICE

THE SAGE family of computers is expanding! Added to the exciting SAGE II is the new SAGE IV. Both machines provide power from the Motorola 68000 chip which is a true 16 bit processor (some even call it 32 bit) and give new levels of performance in personal computers.

With the addition of the new machine SAGE now covers the complete range of business micro-computers. Configurations now extend from memory of 128K to a massive 1 Megabyte, and storage systems from 640K to potentially 200 Megabytes of Winchester disk.

SAGE software is expanding! There is now a choice of four operating systems for the machines. The standard UCSD p-System (complete with Pascal, FORTRAN, and BASIC compilers) is now available in a multi-user form for the SAGE IV which has ports for six users.

For the user who prefers a COBOL environment 'MPSL' now offer the 'BOS' system (CAP Micro-Cobol) together with their large range of multi-user application software. With the implementation of RAMDISK, BOS runs twice as fast! on the SAGE as any previous machine, and the list includes some sizeable mini computers!

CPM is available. What more to say except that Digital Research now give their blessing to SAGE with their CPM68K system. This comes complete with a 'C' compiler and will allow UNIX software to be compiled and run under the CPM environment.

SAGE Application software is expanding! Many of the major Apple Pascal system houses have opted for the SAGE as their development machine (remember it goes 14 times as fast as an Apple), and our software directory is getting very large, with a choice of Accounting programs, Modelling programs, Database programs, Project monitoring systems, and a host of software for specialist applications. As we say it's rather hard for anyone developing software to look away from SAGE because it makes other so-called 16 bit computers look pedestrian.

SAGE draws pictures! An interface to the PLUTO graphics system gives superb high speed, high resolution graphics in eight colours.

MicroAPL offer their MIRAGE APL system on SAGE computers, and again the SAGE delivers performance only previously found on mainframe or timesharing systems.



Every SAGE shipped is complete with ONE YEARS ON-SITE SERVICE from GCS Engineering who have over 120 field engineers, so 24 HOUR CALLOUT means just that.

SAGE is affordable! SAGE prices start at under £3000 and a typical 4 user system complete with Winchester disc AND terminals is under £7500.

Wise men need to be convinced! Call your local dealer today.

TDI LIMITED, 29 ALMA VALE ROAD, BRISTOL BS8 2HL. TEL: 0272-742796

DISC CHANGER'S ELBOW?



HAL Apple compatible sub systems—the cure

Up to 30 Mb capacity, volume sizes up to 7 Mb, back up to floppy disc or integral streaming tape and fully plug compatible under DOS 3.3, CPM and Pascal.

Winchester speeds and capacities to match the demands of your business, plus the security you need for serious applications. HAL, Aquarius and Capricorn Subsystems will run virtually any business application software including: TABS, Vlasak, Padmede, Systematics, Blythe Computers, Ashton Tate, etc., etc.

Cure disc changer's elbow and get serious with your Apple. HAL subsystems—much more for much less.

For full information and your nearest dealer call our telesales department on 0252 517171.



**SO MUCH SPACE,
WE'RE OUT OF
THIS WORLD**

HAL Computers Ltd
Invincible Road
Farnborough
Hampshire
GU14 7QU
Telex
858404

HAL

COMPUTERS LIMITED

From the
publishers of
Personal Computer World

SLAYS INFERIORS

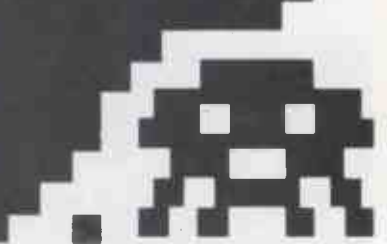

lots of micro magazines pretend to take computer games seriously. But seriously, as a person with the perspicacity to read this magazine, you know better. Yet you still want to play games with your micro, rather than let your micro play games with you. So that's why from July onwards, you can buy a special magazine

published by VNU called 'Personal Computer Games' which will help you do just that. No matter what micro you own, 'Personal Computer Games' will tell you everything you've ever needed to know about the games you can play with your micro. And the wherewithal of playing them. Make sure you don't miss out. Shoot on down to your newsagent, or use the coupon below to order your copy. Now! And start winning, winning, winning.

- I enclose my cheque made payable to Personal Computer World for £1.35 (P & P inclusive)
- I enclose my postal order payable to Personal Computer World for £1.35
- Please debit my American Express/Access/Barclaycard (delete where not applicable)

Account no. _____

Signed _____

Name _____

Address _____

Please send this order, with your remittance to: Personal Computer World, Circulation Dept., Freepost 38, London W1E 6QZ.

only
85p

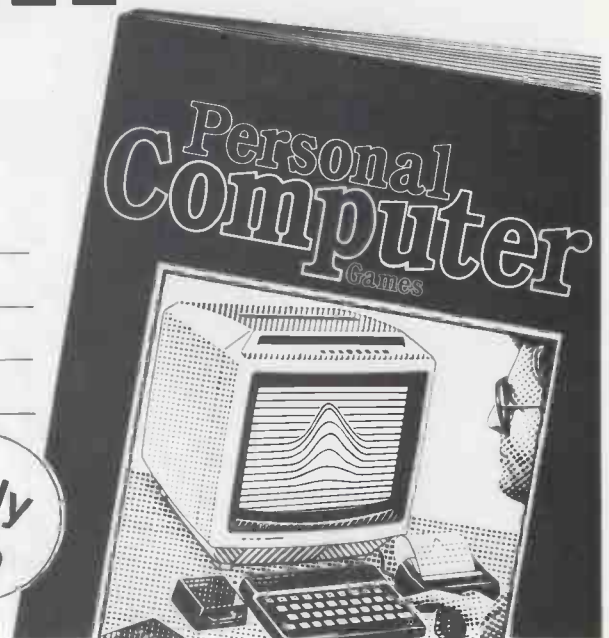

The **APPLE**cation of applications software

HAL'S Winchester subsystems allow you to truly utilise your business applications software. Volumes up to 7 Mbytes with the speed and accessibility of Winchester technology. Our Apple compatible subsystems offer full DOS 3.3, CPM and Pascal compatibility for any software, including:

- Systematics Financial Controller
- TABS Accounting Business Systems
- Padmede Business

Control System • Vlasak Orbit • Blythe Computers Omnis • Stoneware db Master • Ashton Tate d base II. In fact any package that will run under standard operating systems will run on our drives.

Capricorn—up to 30 Mb and back up to floppy disc and streaming tape.

Aquarius—up to 15 Mb with integral streaming tape drive.

Systems for Apple II and IIe, Superbrain, TRS 80 and more to come.

Full one year warranty and local dealer support. For full information and your nearest dealer call our telesales department on 0252 517171.

HAL Computers Limited
Invincible Road, Farnborough
Hampshire, GU14 7QU
Telex 858404

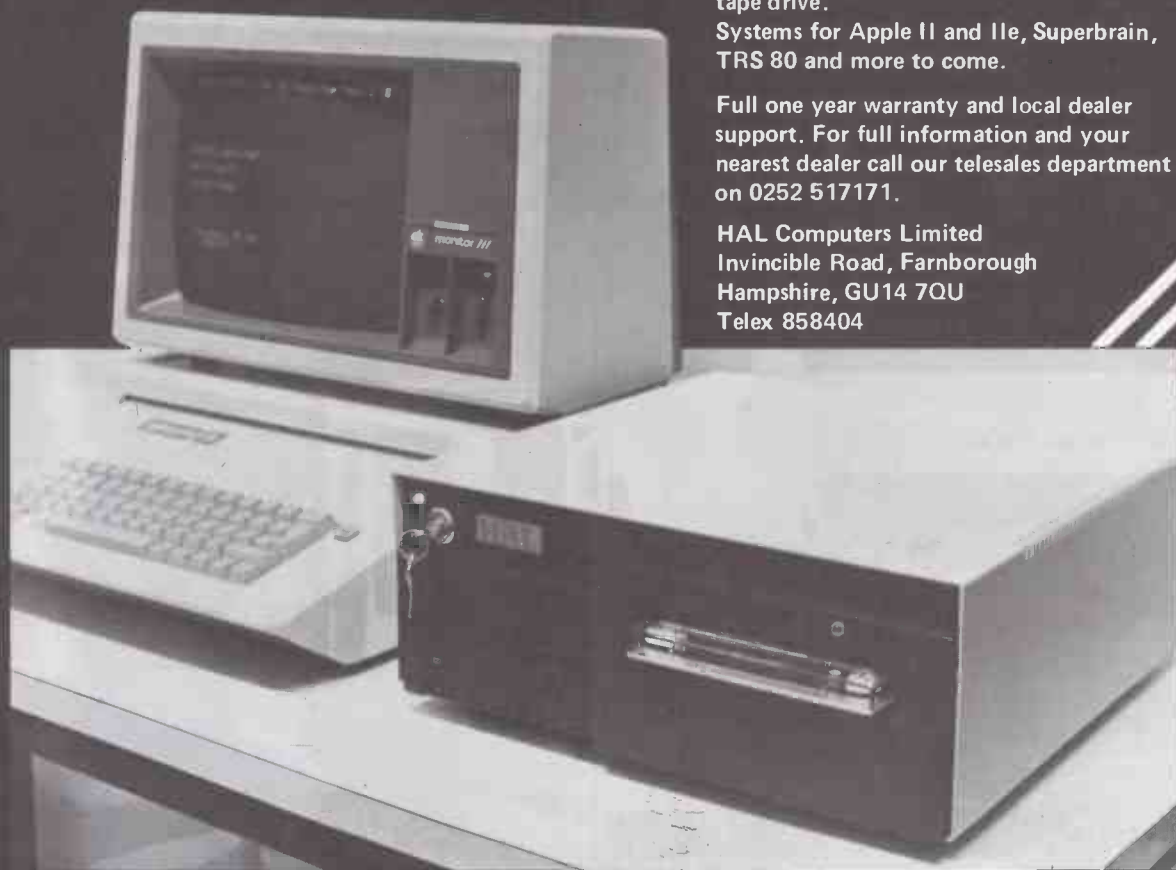

**SO MUCH SPACE,
WE'RE OUT OF
THIS WORLD**

HAL

COMPUTERS LIMITED



MAPLIN

HARDWARE

Atari 400 with 16K RAM (AF36P) £199.95
 Atari 400 with 48K RAM (AF37S) £299.00 ★
 Atari 800 with 48K RAM (AF02C) £399.00 ★
 All above with BASIC and handbooks
 Atari Cassette Recorder (AF28F) £50.00
 Atari Disk Drive (AF06G) £299.95
 48K RAM for Atari 400 (AF44X) £99.95
 48K Upgrade for 400 (AF45Y) £99.95
 Commodore 64 (AF56L) £339.00 ★
 16K RAM for VIC20 (AF53H) £59.95
 Commodore Cassette (AF48C) £44.95
 Commodore Disk Drive (AF50E) £299.99
 Dragon 32 (AF57M) £199.50
 Dragon Joystick (BC30H) £19.95
 Cassette Cable for Dragon (BC31J) £2.95
 Epson Printer MX80F/T (AF40T) £447.35
 MENTA (XG28F) £115.00
 Floppy Disk (YX87U) £2.50
 5 C12 Data Cassettes (AF61R) £1.99
 Joystick Controller (AC53H) £7.50
 Joysticks (Pair) (AC37S) £13.95
 Le Stick (AC45Y) £24.95
 Full details all above in MAPLIN catalogue.
 ★ Delivery next day by Datapost

SELECTED SOFTWARE

ATARI
 Attack At Ep-Cyg-4 -1E-16K-KF54J £34.95
 Baja Buggies -1C-16K-KB74R £22.95
 Candy Factory -1D-32K-KF53H £21.95
 Claim Jumper -1E-116K-KB67X £34.95
 Defender -1E-16K-KF10L £29.95
 Forth -1D-24K-YL29G £62.95
 Frogger -1C-16K-KB68Y £22.95
 Galaxian -1E-16K-KF11M £29.95
 Gorf -1E-16K-KB44X £34.95
 Hellfire Warrior -1C-32K-KF02C £27.45
 K-razy Shootout -1E-8K-BO63T £34.95
 Moon Shuttle -1C-16K-KF22Y £27.50
 Pac-Man -1E-8K-BO71N £29.95
 Paint -1D-48K-KB22Y £29.95
 Picnic Paranoia -1E-16K-KF13P £34.95
 Preppie -1C-16K-KB07H £21.95
 Qix -1E-16K-KF16S £29.95
 SAM Speech Synth -1D-32K-KB15R £47.19
 Shamus -1E-16K-KB90X £34.95
 Softporn Adventure -1D-40K-BO93B £20.64
 Starcross -1D-32K-KB37S £29.95
 Synassembler -1D-48K-KB83E £38.95
 Zaxxon -1C-16K-KF20W £31.50
 Zork I -1D-32K-BO94C £29.95
 Zork II -1D-32K-BO95D £29.95
 Zork III -1D-32K-KB31J £29.95
 *3D-Supergraphics -1C-40K-BQ29G £31.95
 Plus over 280 other titles for Atari.

COMMODORE 64
 Temple Of Apshei (Part 1) -1D-BC57M £27.45
 Upper Reaches (Part 2) -1D-BC58N £13.80
 Curse Of Ra (Part 3) -1D-BC59P £13.80
 Sword Of Fargoal -1D-BC60Q £20.75
 Crush, Crumble & Chomp -1D-BC61R £20.75
 Jump Man -1D-BC62S £27.45
DRAGON
 Berserk -1E-BC32K £19.95
 Black Sanctuary -1C-BC78K £7.95
 Dragon Trek -1C-BC82D £9.95
 Galax Attax -1E-BC79L £19.95
 Quest -1C-BC41U £7.95
 Wizard War -1C-BC83E £7.95
 Plus 30 other titles for Dragon
SPECTRUM
 The Hobbit (48K) -1C-BC88V £14.95
 Timegate (48K) -1C-BC89W £6.95
 Space Intruders (16K) -1C-BC90X £4.95
 Meteor Storm (16K) -1C-BC91Y £4.95
 Chess Player (48K) -1C-BC92A £6.95
 Speakeasy (48K) -1C-BC93B £4.95

VIC20
 Crush, Crumble & Chomp (+16K) 1C-KK10L £20.75
 Invasion Orion (+16K) -1C-KK13P £13.80
 Monster Maze -1C-KK12N £17.25
 Plattermania -1E-KK11M £27.45
 Princess & Frog -1E-KK14Q £27.45
 Rescue At Rigel (+16K) -1E-KK16S £29.95
 Ricochet (+8K) -1C-KK08J £20.75
 Sword Of Fargoal (+16K) -1C-KK15R £13.80
 Tank Arcade -1C-KK09K £20.75
 Plus 80 other titles for VIC20

* Disk versions also available though price and memory size may be different.

Send sae now for our new software leaflet with details of all programs added since Maplin catalogue.
 Order As XH52G Issue 4.



MICROWRITER

The new hand-held word processor that eliminates the need for a typist. You can learn the Microwriting technique in less than an hour and produce perfectly typed text the same day.

Microwriter (AF62S) £485 + £72.75 VAT ★
 Complete Word Processor Package (Microwriter, printer and lead) (AF63T) £1,205 + £180.75 VAT ★
 Available ONLY by mail order or from WESTCLIFF shop.

★ Delivery next day by Datapost



If your order contains over £120 worth of computer hardware apply now for interest free credit by telephoning: Mail-order: (0702) 552911. London Shop: 01-248 0926. Birmingham Shop: 021-356 7292. Southend shop: 0702 554000 or write to P.O. Box 3, Rayleigh, Essex SS6 8LR.
 You pay 10% down, then 10% per month for a further nine months (to nearest penny).

Credit quotations on request. This offer subject to approval which can take up to 48 hours (APR = 0%).

The brilliant new colour computer SORD M5

A superb new home computer with one of the most powerful colour video processors available. An incredible 32 sprites simultaneously and 16K of RAM dedicated to graphics alone. Powerful Z80A (3.5MHz) main processor. Three tone generators and noise generator all with envelope control like a mini-synthesiser. Complete with BASIC and superb handbooks for beginners. All this for just £189.95 (AF64U)



Mapsoft full colour catalogue. Price £1 incl. post. Maplin catalogue contains full details of all hardware and lots of software. On sale now in all branches of W. H. Smith, price £1.25 or £1.50 incl. post from PO Box 3, Rayleigh, Essex.



Maplin Electronic Supplies Ltd., Mail Order: P.O. Box 3, Rayleigh, Essex SS6 8LR. Tel. Southend (0702) 552911 (Sales).
 Demonstrations at our shops NOW.
 159-161 King St., Hammersmith, W6. Tel. 01-748 0926. 284, London Road, Westcliff-on-Sea, Essex. Tel. (0702) 554000. Lynton Square, Perry Barr, Birmingham. Tel. (021) 356 7292.
 All goods delivered in UK mainland carriage paid, but add 50p if total order less than £5 except catalogues. Orders including items marked ★, delivery next day by Datapost.
 Subject to availability. All prices include VAT unless shown. Prices correct at time of going to press.

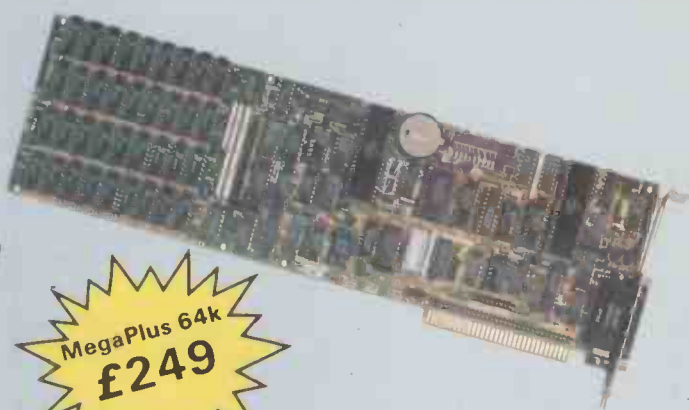

I/O-Plus 2
£115

MegaPlus 64k
£249

Now you can buy a QUAD function IBM PC board without having to buy more memory.

MegaPlus™ and I/O-Plus-2™ are the ultimate add-on products you will need to expand your IBM PC and XT. Which board you decide on will depend on where you are heading. To take full advantage of your IBM PC and XT beyond 256k, you will want to expand with the MegaPlus™. It's features include two asynchronous ports, clock/calendar, printer port, and up to 512k of memory expansion. But what if you already have all the memory you need? The I/O Plus-2™ gives you all the features of MegaPlus™ to operate your printers, plotters and modems, set your time and date automatically with the clock/calendar, without adding memory. Also a special game adapter is available, but more about that later. Both boards include SuperDrive™ disk emulation and SuperSpool™ print buffer software.

MEGA WITH MEMORY

The MegaPlus™ has three functions standard: Parity checked and fully socketed memory up to 256k in 64k increments; clock/calendar with battery back-up for automatic loading of time and date when the computer is turned on; and an asynchronous communication port (RS232C serial) which can be used as COM1 or COM2, (DTE for a printer, or DCE for a modem). Optional is a 100% IBM compatible parallel printer port, and a second asynchronous port for another £30 each. The MegaPak™ option plugs onto your MegaPlus™ "piggyback" style to give you 512k of additional memory. Now you can create disk drives in memory up to 360k, set aside plenty of space for print spooling, and still have memory for your biggest programmes.

I/O-PLUS 2 WITHOUT MEMORY

The I/O-Plus 2™ comes standard with a clip-on battery powered clock/calendar, and asynchronous communication port (RS232C serial). Optional is a second asynchronous port (DTE for a printer, or DCE for a modem), a parallel printer adapter, and the best game paddle adapter on the market. What's so special about our game adapter? Not only is it an IBM standard game port, but it can also use low cost, widely available Apple compatible paddles and joysticks. If you already have sufficient memory the I/O-Plus 2™ gives you all the input and output ports you might need for less than the cost of most single function boards.

FREE SOFTWARE

SuperDrive™ disk emulation software creates "disk drives" in memory which access your programmes at the speed of RAM memory. SuperSpooler™ print buffer software allows the memory to accept data as fast as the computer can send it and frees your computer for more productive work. Some manufacturers sell hardware print buffers that do only this for hundreds of pounds. SuperSpooler™ eliminates the need for these slot robbing products. Both of these powerful pieces of software can be used with any expansion memory for your IBM PC or XT.

CHEAP SOFTWARE TOO

What good is great hardware without some great software to use it with? We offer some terrific prices on some of the popular programmes you will want to use your board with. How about the cream of the spreadsheet programs, SUPERCALC, for just £129, or SUPERWRITER for £199. If you are looking for data base management you can get dBASE II by Ashton-Tate for £369.

WHY BUY IT FROM US?

Because we provide the service and support most companies just talk about. Each board is fully tested and burned in prior to shipment. We realize how integral this board is to the use of your computer. What good is a warranty if it takes weeks for repairs to be made? We offer 48 hour turnaround or a replacement board on all warranty repairs. Do you hear anyone else making this promise? If you still are not convinced, and want to compare prices, remember we don't charge extra for credit cards, shipping, or COD fees. We think the ultimate testimony to our good service and high quality is that one of our largest customers is none other than IBM! If you still want to buy elsewhere, ask any competitor if they will face the acid test.

THE ACID TEST

Qubie' (say que-bee-A) gives you a 30 day satisfaction guarantee on all board purchases. If you are not completely satisfied we will refund the entire cost of your purchase. If you can get one of our competitors to give you the same guarantee, buy any other board you think compares and

return the one you don't like. We're not worried because we know which one you will keep. We also offer a one year parts and labor warranty. An additional one year extended warranty is available for £35.

TO ORDER BY MAIL SEND:

- your name and delivery address
- board type, size, and options requested
- daytime phone number
- UK Residents add 15% for VAT
- Company check or credit card number with expiration date (personal checks take 10 days to clear)



PRICES:

I/O-Plus 2™ with Clock/calendar, asynchronous communication adapter, SuperDrive™ and SuperSpool™ - **£115**

MegaPlus™ with memory, clock, async, SuperDrive™ and SuperSpool™ software:

| | | | |
|------|------|------|------|
| 64k | £249 | 256k | £399 |
| 128k | £299 | 512k | £698 |
| 192k | £349 | | |

OPTIONS:

| | |
|----------------------------------|------|
| Parallel Printer Port | £30 |
| Second Async Port | £30 |
| Game Adapter (I/O-Plus 2 only) | £30 |
| MegaPak™ with 256k of memory | £299 |
| Cable to parallel printer | £30 |
| Cable to modem or serial printer | £20 |
| Memory Diagnostics Program | £7 |
| SUPERWRITER by Sorcim | £199 |
| SUPERCALC II by Sorcim | £129 |
| dBASE II by Ashton-Tate | £369 |

SHIPMENT

We pay postage charges. Credit card or bank check orders shipped next day.

QUBIE' DISTRIBUTING LTD.

Tempo House
15 Falcon Road, London SW11, UK
Telephone (01) 223-7662
(01) 223-4569

DEALER ENQUIRIES INVITED

£1,495*

The MIMI 803 is a supreme example of high quality British engineering. It is a truly professional microcomputer that really does meet all the criteria of a sophisticated business machine - at a price you can afford.

Our competitors expect you to make do with the basics and then buy expensive extras in order to fulfil your needs. The MIMI 803 has all the 'extras' as standard - so when you buy a MIMI you really are getting a microcomputer that will do the job from the outset.

The MIMI's operating system OS/M[†] is fully compatible with CP/M[‡] 2.2 in all system calls and functions. This ensures that you have access to the comprehensive range of Software currently available in the open market.

During the next few months we will be announcing the availability of TROJAN - a major software innovation that totally simplifies the learning process and use of micros, and dramatically eases the creation of new applications software in record time - so we can guarantee its performance.

Don't settle for less... contact us or one of our dealers now.

Features include:

- Z80A at 4MHz
- 64K dynamic RAM, plus additional 16K RAM for the graphics
- Integral D/S - D/D 5¼ ins floppy discs - 800Kb.
- Full RS232C and Centronics parallel ports.
- 96 Key ASCII keyboard - colour coded.
- 17 programmed function keys.
- Elegant compact and light - 24 lbs.
- OS/M[†] operating system - CP/M[‡] compatible.
- Disc format conversion facility.
- Wide range of software, utilities and languages.
- Super high resolution graphics (512 x 256 pixels).

And now with:

- Winchester disc option.
- Choice of orange or green display.

MONITOR SUPPLIED BY PHILIPS

NOW ALL OTHER MICROS ARE LESS THAN PERFECT

† OS/M is the trademark of Scifax Microsoftware.

‡ CP/M is the registered trademark of Digital Research Inc.

*Monitor extra, from £142.

Some of our dealers

Apollo Information Systems Ltd
13 Southend Road Grays Essex RM17 5NH
Tel: (0375) 33088
Contact: Ronald Burrell

Broadway Systems (BCSS) Ltd
5-7 Mariner Street Swansea W Glam Wales SA1 5BA
Tel: 0792 462279/474598 01-997 4764/0498
Contact: Philip Gittoes

City Microsystems Ltd
65 London Wall London EC2
Tel: 01-588 7272
Contact: Anthony Coulson

B & D Computing
8 Sheep St. Highworth Swindon Wilts
Tel: 0793 762449
Contact: David Wakley

Business Data Capture
262 Regents Park Road London N3 3HN
Tel: 01-349 4095
Contact: Peter Klein

John Elmer Office Equip
32 Victoria Road Burgess Hill Sussex
Tel: 04446 5670/5791
Contact: John Elmer



BRITISH MICRO

Penfold Works Imperial Way Watford Herts. WD2 4YY Tel: Watford (0923) 48222/43



A Hegotron Group Company



Kyle Data Services Ltd
7 High Street Ayr Scotland KA7 1LU
Tel: (0292) 285411
Contact: Alex Gardiner

Leicester Micro Centre
59 Regent Road Leicester
Tel: 0533 551869
Contact: Ray Beresford

Anita Electronic Services
34 Musters Road West Bridgford Notts
Tel: 0602 813240
Contact: Steve Conroy

Dantre Business Systems
7 High St. Daventry Northants NN11 4BQ
Tel: 03272 77239
Contact: Mike Griffin

Malvern Micro Systems
Wych Cutting Upper Colwall Malvern Worcestershire
Tel: (06845) 68500
Contact: Barry Lewis

Computer Graphics Workshop
38 Ullett Road Sefton Park Liverpool 17
Tel: 051 733 9604
Contact: Noel Runnels-Moss

Tel: 946024 Contact: Julie Hissey

MIMI 803

Silver-Reed-Right!

THE DAISY PRINTER OFFERING UNBEATABLE PRICE/PERFORMANCE PLUS COMPATIBILITY WITH MOST POPULAR WORD-PROCESSING PACKAGES.

Superbly engineered, the Silver-Reed EXP550 provides the widest range of word-processing functions at a true entry-level price. Features include single pcb electronics and low compo-

nent count for ultimate reliability, and industry standard interfaces.

All backed by X-Data's renowned customer support service.

- 16 cps bi-directional
- up to 17in paper width
- quiet operation for office environment
- original plus four copies
- easy-load cartridge ribbon

Perfect print at a price you can afford.



X-DATA

Equipment Wholesalers

For more information telephone Slough (0753) 72331

X-Data Limited, 750-751 Deal Avenue, Slough Trading Estate, Slough, Berks, SL1 4SH.



1 Operating Systems

| | | |
|-----------|------------------|-----|
| CP/M V2.2 | Digital Research | 121 |
| CP/M-86 | Digital Research | 201 |
| CP/NET | Digital Research | 149 |
| MP/M V2.0 | Digital Research | 339 |

2 High Level Languages

| | | |
|----------------------|------------------|-----|
| CBASIC V2.08 | Digital Research | 90 |
| CBASIC COMPILER | Digital Research | 366 |
| PL/1-80 | Digital Research | 370 |
| FORTH | MPI Ltd | 100 |
| CIS COBOL | Micro Focus | 425 |
| LEVEL-2 COBOL | Micro Focus | 965 |
| CORAL-66 | Micro Focus | 825 |
| BASIC-80 V5.21 | Microsoft | 241 |
| BASIC COMPILER V5.3 | Microsoft | 272 |
| FORTRAN-80 V3.44 | Microsoft | 344 |
| COBOL-80 V4.60 | Microsoft | 516 |
| muLISP/muSTAR V2.12 | Microsoft | 138 |
| muMATH/muSIMP V2.12 | Microsoft | 180 |
| PASCAL MT | Digital Research | 242 |
| PASCAL MT - SPP | Digital Research | 173 |
| PASCAL MT - WITH SPP | Digital Research | 346 |

3 Low Level Languages

| | | |
|----------------|-----------------------------|-----|
| MAC | Digital Research | 73 |
| MACRO-80 V3.44 | Microsoft | 138 |
| PASM | Phoenix Software Associates | 100 |

4 Utilities/System Tools

| | | |
|--------------------------------------|-----------------------------|-----|
| THE OPERATING GUIDE | Decision Systems | 45 |
| BT-80 | Digital Research | 194 |
| DESPPOOL | Digital Research | 37 |
| SID V1.4 | Digital Research | 59 |
| XLT86 | Digital Research | 111 |
| ZSID V1.4 | Digital Research | 76 |
| dUTIL (FOR DBASE-II) | Fox & Geller | 76 |
| CLIP | Keelie Codes | 80 |
| SPOOFER | KLM Systems | 97 |
| CPMSIM | Magic Circle Software | 166 |
| ANIMATOR | Micro Focus | 225 |
| FILESHARE | Micro Focus | 250 |
| FTNUMB | Micrology | 50 |
| PLINK | Phoenix Software Associates | 100 |
| BUG | Phoenix Software Associates | 100 |
| PDEVELOP | Phoenix Software Associates | 267 |
| PLINK-2 | Phoenix Software Associates | 256 |
| DISKORG | Slogger Software | 50 |
| LEVEL-2 ANIMATOR | Micro Focus | 475 |
| DISKMAN | Slogger Software | 65 |
| DISKED-2 | Slogger Software | 65 |
| DISKTOOLS-1 (DISKMAN & DISKORG) | Slogger Software | 90 |
| DISKTOOLS-2 (DISKTOOLS-1 & DISKED-2) | Slogger Software | 145 |

5 Sorting

| | | |
|----------------------|-----------|-----|
| SUPERSORT | Micropro | 145 |
| SUPERSORT (APPLE II) | Micropro | 139 |
| MSORT V1.012 | Microsoft | 134 |

6 Code Generators

| | | |
|---------------------------------|---------------------|-----|
| THE LAST ONE | D.J. 'Al' Systems | 330 |
| QUICKCODE (FOR OBASE-II) | Fox & Geller | 215 |
| QUICKSCREEN (FOR MBASIC) | Fox & Geller | 121 |
| QUICKSCREEN (FOR CBASIC) | Fox & Geller | 121 |
| FORMS-2 | Micro Focus | 110 |
| PEARL-3 | Pearl International | 295 |
| AUTOCODE | Stemmos | 220 |
| THE LAST ONE DEMONSTRATION PACK | D.J. 'Al' Systems | 50 |
| LEVEL-2 FORMS-2 | Micro Focus | 110 |

Telecommunications/Conversions

| | | |
|--|------------------------------|-----|
| BSTAM | Byrom Software | 139 |
| BSTMS | Byrom Software | 139 |
| BISYNC-80/3780 (EBCDIC) | Micro Integration | 525 |
| BISYNC-80/3780 (ASCII) | Micro Integration | 525 |
| BISYNC-80/3270 (BSC) | Micro Integration | 525 |
| BISYNC-80/HASP | Micro Integration | 975 |
| REFORMATTER CP/M ↔ IBM | Microtech Exports | 173 |
| REFORMATTER CP/M ↔ DEC | Microtech Exports | 173 |
| BACSCOPY | Comley Computer Services Ltd | 150 |
| BACDEBIT | Comley Computer Services Ltd | 150 |
| ICL CO3 EMULATION (Interactive) | Synchro Systems Ltd | 600 |
| ICL CO3 EMULATION (Bulk) | Synchro Systems Ltd | 600 |
| ICL CO3 EMULATION (Interactive & Bulk) | Synchro Systems Ltd | 900 |

Word Processing/Text Editing/Editors

| | | |
|-------------------------|-----------------------------|-----|
| TEX V3.0 | Digital Research | 78 |
| PARAGRAB | Focus | 75 |
| WORDSTAR | Micropro | 295 |
| MAILMERGE | Micropro | 145 |
| WORDSTAR & MAILMERGE | Micropro | 390 |
| SPELLSTAR | Micropro | 145 |
| WORDMASTER | Micropro | 90 |
| WORDSTAR (APPLE II) | Micropro | 260 |
| MAILMERGE (APPLE II) | Micropro | 87 |
| SPELLSTAR (APPLE II) | Micropro | 136 |
| EDIT-80 V2.02 | Microsoft | 83 |
| LEXICON (WORD ANALYSIS) | Microtek | 200 |
| PEDIT | Phoenix Software Associates | 100 |
| PMATE | Phoenix Software Associates | 139 |

Databases/Data Management Systems

| | | |
|----------------------------|---------------------|-----|
| dBASE-II | Ashlon Tale | 438 |
| ADDRESS BOOK | Decision Technology | 90 |
| RESCUE | MBS | 295 |
| RESCUE DEMONSTRATION | MBS | 35 |
| SELECTOR-V | Micro-Ap | 380 |
| DATASTAR | Micropro | 175 |
| DATASTAR (APPLE-II) | Micropro | 205 |
| PERSONAL PEARL | Pearl International | 180 |
| INFOSTAR | Micropro | 295 |
| ADDRESS BOOK DEMONSTRATION | Decision Technology | 30 |

Financial Accounting/Business Applications

| | | |
|----------------------------------|---------------------------|------|
| TYPING MASTER (BASIC VERSION) | Anthony Ashpitt | 50 |
| TYPING MASTER (BUSINESS VERSION) | Anthony Ashpitt | 125 |
| PAYROLL | MPI Ltd | 500 |
| INCOMPLETE RECORDS | MPI Ltd | 1200 |
| CASHBOOK | Microtek | 225 |
| SOLICITOR'S TIME RECORDING | Microtek | 600 |
| DOMESTIC CONTRACTORS' ESTIMATING | Microtek | 1500 |
| CP/M TUTOR | Syntax Software Ltd | 55 |
| POLICY MASTER (MULTI-USER) | CSA Micro Systems | 1600 |
| POLICY MASTER (SINGLE-USER) | CSA Micro Systems | 960 |
| SINGLE TO MULTI UPGRADE | CSA Micro Systems | 800 |
| POLICY MASTER DEALER DEM PACK | CSA Micro Systems | 125 |
| SOLICITOR'S DATABASE | Microtek | 350 |
| SALES/DEBTORS LEDGER SYSTEM | Padmede Computer Services | 249 |
| SALES INVOICING | Padmede Computer Services | 249 |
| STOCK CONTROL SYSTEM | Padmede Computer Services | 249 |
| PURCHASE/CREDITORS LEDGER SYSTEM | Padmede Computer Services | 249 |
| NOMINAL/GENERAL LEDGER SYSTEM | Padmede Computer Services | 249 |
| PADMEDE BUSINESS CONTROL SYSTEM | Padmede Computer Services | 1245 |

Financial Modelling/Problem Solving

| | | |
|------------------------------------|--------------------------------|-----|
| dGRAPH | Fox & Geller | 215 |
| MATHSPACK | MPI Ltd | 120 |
| STATSPACK | MPI Ltd | 120 |
| CALCSTAR | Micropro | 120 |
| CALCSTAR (APPLE II) | Micropro | 136 |
| MULTIPLAN | Microsoft | 189 |
| MILESTONE | Organic Software | 263 |
| SAPPHIRE MARS | Sapphire Systems | 395 |
| SAPPHIRE MARS DEMONSTRATION SYSTEM | Sapphire Systems | 50 |
| LINEAR & GOAL PROGRAMMING | Electronic Accounting Services | 200 |

* Asterisk indicates price different from that shown

MEDIA AND FORMATS

| | | | | | | | |
|------------------------------|----|----------------------|----|-------------------------------|----|-------------------------------|----|
| Altos | A1 | EKO | A1 | Exidy Sorcerer - CP M-80 | O2 | Exidy Sorcerer Exidy CP M-80B | A1 |
| APPLE CP M-80 13 Sector | RE | Fair 96TPI SS DD | NS | Health HB H47 | A1 | Hewlett-Packard 125 Bin | A1 |
| APPLE CP M-80 16 Sector | RE | IBM 3740 B SS DD | C1 | IBM PC-DOS 55 DD | O2 | IBM PC-DOS 55 DD | C1 |
| Blackhawk Micropolis Mod II | O2 | IBM PC-DOS DS DD | C2 | IBM CP M-86 SS DD | C3 | IBM CP M-86 OS DD | C4 |
| British Micros Mini | RK | IBM CP M-86 OS DD | C3 | ICOM 3712 | A1 | IMS41 VDP-80 | A1 |
| California Computer Sys 8 in | A1 | ICL DRX Series | RE | Industrial Microsystems 5000 | RA | Industrial Microsystems 8000 | A1 |
| CDS Versatile 4 | O2 | Intel MDS 50 | A1 | Intercor Superbrn SS DD | RK | Intercor Superbrn SS DD | RK |
| Columbia Data Products 8 in | A1 | Intercor Superbrn OD | RS | ISC InterColor 8063 8360 8963 | A1 | ITT 3030 DSDD | N6 |
| Comart Communicator CP50 | P2 | Intercor Superbrn OD | RS | ITT 3030 DSDD | N6 | Microcamation | R1 |
| Comart Communicator CP100 | P2 | Intercor Superbrn OD | RS | Microcamation | R1 | Micropolis Mod II | O2 |
| Comart Communicator CP200 | P2 | Intercor Superbrn OD | RS | Morrow Discus | A1 | Morrow Discus | A1 |
| Comart Communicator CP500 | P2 | Intercor Superbrn OD | RS | Mostek | A1 | Multi-Tech 1 | O2 |
| Compaq 80 | Q2 | Intercor Superbrn OD | RS | Multi-Tech 2 | O2 | Nascom (Gemini Drives SS DD) | O2 |
| CPT 8000 | A1 | Intercor Superbrn OD | RS | Nascom Lucas | R1 | Nascom (Gemini Drives SS DD) | O2 |
| Cromemco System 3 | R6 | Intercor Superbrn OD | RS | NCR 8140 9010 | A1 | NCR M505 | RB |
| Cromemco System 2 55 SS | R6 | Intercor Superbrn OD | RS | NCR 8140 9010 | A1 | NCR M505 | RB |
| CSSN Backup | A1 | Intercor Superbrn OD | RS | NCR 8140 9010 | A1 | NCR M505 | RB |
| Cyber 8 | A1 | Intercor Superbrn OD | RS | NCR 8140 9010 | A1 | NCR M505 | RB |
| Datapoint 1550 2150 | N6 | Intercor Superbrn OD | RS | NCR 8140 9010 | A1 | NCR M505 | RB |
| Dec Rainbow SS DD | N6 | Intercor Superbrn OD | RS | NCR 8140 9010 | A1 | NCR M505 | RB |
| Dec VT 180 SS DD | N6 | Intercor Superbrn OD | RS | NCR 8140 9010 | A1 | NCR M505 | RB |
| Delta Systems | R1 | Intercor Superbrn OD | RS | NCR 8140 9010 | A1 | NCR M505 | RB |
| Direct 48TPI DS DD | R2 | Intercor Superbrn OD | RS | NCR 8140 9010 | A1 | NCR M505 | RB |

ORDER INFORMATION

When ordering software please specify the format you require. All software items are subject to VAT. Please add £3.75 (plus VAT) for postage and packing for the first item purchased, and then £1.15 for each extra item. For overseas please add £6.50 per item and then £1.50 for each extra item required. Most software in this advertisement is available from stock and a 72 hour return service is offered on most prepaid orders. These details and prices are all current as of May 1983. (Telephone at time of purchase to confirm latest prices.) All payments must be in Sterling and drawn against a U.K. bank.

MAIL ORDER · TELEPHONE ORDER · VISIT **Retailer and OEM terms available**
Access & Visa accepted

THE New APPLE II E

FROM

SIMMONS MAGEE



- 64K Expandable to 128K
- Upper & Lower Case
- Much Improved Keyboard
- Built In PAL Encoder
- Runs Apple II Software
- Eight Built-In Expansion Slots

SPECIAL ONLY £999

(VALID UNTIL 30th JUNE)

APPLE II E 64K
MONITOR 12"
DISK DRIVE WITH CONTROLLER
80 COLUMN CARD

YES! £999 for the above

Or Items may be purchased individually

| | |
|-------------------------------|------|
| Apple II E 64K | £645 |
| Disk Drive + Controller | £280 |
| Disk Drive Without | £200 |
| 80 Column Card | £70 |
| 80 Column + 64K | £150 |
| Monitor III + Stand | £140 |
| Multiplan Spreadsheet | £175 |
| Quick File II E | £60 |
| Apple Writer II E | £119 |
| Microsoft CP/M Card | £200 |

PRINTERS

AT LOW, LOW PRICES

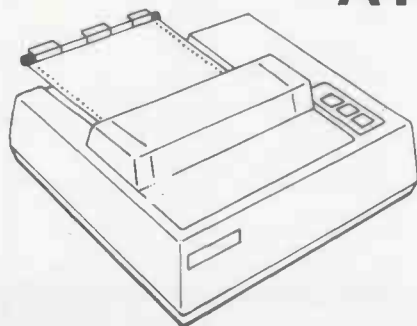

* PRICES DO NOT INCLUDE INTERFACE CABLES

OK1

| | |
|---------------------|------|
| Microline 80 | £215 |
| Microline 82A | £339 |
| Microline 83A | £539 |
| Microline 84 | £821 |

EPSON - TYPE III

| | |
|--------------|------|
| MX 100 | £405 |
| FX 80 | £399 |
| RX 80 | £280 |

ALL PRICES EXCLUSIVE OF VAT
 SHOWROOMS OPEN MON-FRI 9-5PM
 SAT 9-1PM

SIMMONS MAGEE

TWICKENHAM

SIMMONS MAGEE COMPUTERS LTD. 13 YORK ST. TWICKENHAM, MIDDX. 01-891 4477

WILDING

Electronic Typewriter Centres

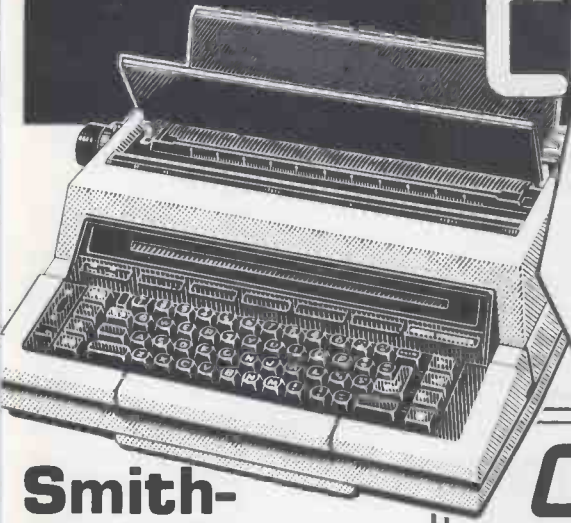

£50 of Goods FREE
From our shelves when you buy the TW2500.



Smith-Corona TW2500

A built-in interface allows the TW2500 typewriter to be used as a letter quality computer printer. Word processing can be fed directly to the office typewriter. The TW2500 can be used as a computer printer without switching or software. Allows use of all typewriter characters and features. Combines word processing with quality printing. **£465 + VAT**

Computer Interfaced Typewriters & Printers

Smith-Corona TP-1

A microprocessor controlled high quality daisy wheel printer which delivers fully formed executive quality printout at a speed of 120 words per minute. The TP-1 can be utilized with word processing systems, micro-computers, small business systems, or in any environment which requires high quality printing. Serial or parallel interfaces. **£425 + VAT**

Brother CE-60



Complete with a Brother Plug-in Interface, the CE 60 is a very versatile compact office typewriter which will perform every function you require from a quality printer, yet retaining all its typewriter features: 13" carriage, one line correction memory, 10, 12 and 15 pitches, cassette type daisy wheel, cassette ribbon, automatic relocation, decimal tab, plus many other features. **£525 + VAT**

Olivetti Praxis 41



Complete with an Olivetti Plug-in Interface, this light duty office compact can be used as a personal computer console; a low volume quality printer; a typewriter/communications terminal. Features 13" carriage, 3 typing pitches [10, 12 and 15], 10 character memory correction and daisy wheel printing element. **£495 + VAT**

Phone 04024 48629 and quote your Access/Barclaycard No for immediate POST FREE despatch (24hr answering service)

- | | | | |
|---|--|--|---|
| ★ CENTRAL LONDON 278 High Holborn 157 Moorgate, EC2 275 Regent Street | Tel: 01-405 9052/9104 Tel: 01-528 0501 Tel: 01-499 2836 | ★ LEEDS 38 Eastgate ★ LUTON 25 Wellington Street ★ MAIOSTONE 88 King Street ★ MANCHESTER 125 Oldham Street | Tel: 0532 468118 Tel: 0582 26476 Tel: 0622 52726 Tel: 061-834 5682 Tel: 0603 666011 |
| ★ BOLTON 38 Great Moor St ★ BRISTOL 10-11 Denmark St ★ CAMBRIDGE 2 Sussex Street ★ COLCHESTER 103 High St ★ CROYDON 18 St. Georges Walk | Tel: 0204 386937 Tel: 0272 277396 Tel: 0223 65714 Tel: 0206 46768 Tel: 01-686 4957 | ★ NORWICH 12 Queens Road ★ PUTNEY 339 Putney Bridge Road ★ SLOUGH 261 High Street ★ SOUTHEND 26 Alexandra St ★ SWINDON 47-48 Havelock St ★ WALTHAM CROSS 91 High Street | Tel: 01-788 3452 Tel: 0753 39356 Tel: 0702 331876 Tel: 0793 33111 Tel: 0992 764200 |
| ★ GLOUCESTER 4 Grosvenor House, Station Road ★ HIGH WYCOMBE 12 Church Street ★ ILFORD 531-535 High Road ★ IPSWICH 16 Carr Precinct, Carr Street ★ KINGSTON 26 Castle Street | Tel: 0452 23111 Tel: 0494 36378 Tel: 01-514 1525 Tel: 0473 57469 Tel: 01-549 9461 | ★ WATFORD 15 Queens Road ★ WODLWICH 21 Thomas St | Tel: 0923 32121 Tel: 01-855 0631 |
- HEAD OFFICE
531/535 High Road, Ilford, Essex Tel: 01-514 1525

Order any item POST FREE

To: Wilding, 196 High Street, Hornchurch, Essex.
Tel: 04024 48629

Please send me Wilding's Catalogue

Please supply [add 15% VAT to prices shown]

I enclose cheque/PO for £.....
or charge my Access/Barclaycard No.

Name..... Signature.....
Address.....

PCW7/83



Easier commuting to computing...

THE NEW ADDRESS OF LEEDS COMPUTER CENTRE IS 55 WADE LANE LEEDS.

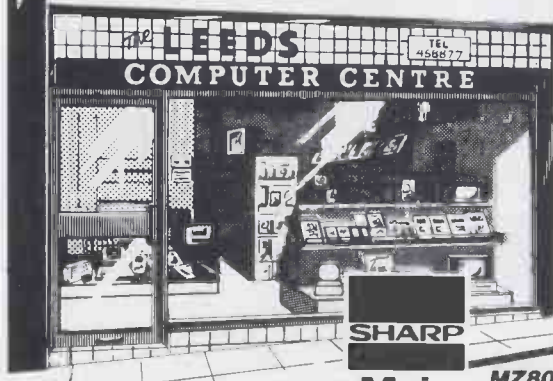

In the spacious new showrooms of the Leeds Computer Centre you will be welcome to browse through a most comprehensive range of microcomputers, peripherals, books and media. Our aim is to provide the finest service possible for personal, educational, O.E.M., industrial and business users.

We offer expertise gained from years on the microcomputer scene. Also product knowledge stemming from dealerships in NASCOM, SHARP, EPSON, TEXAS, GEMINI, QUANTUM, ORIC and DRAGON which we have held ever since they first came onto the market. You will find just the help you need at the Leeds Computer Centre.

SHARP
Main Dealer

MZ80A (48k) PERSONAL COMPUTER FREE SOFTWARE INCLUDED
£549.00 inc VAT

TWIN DISK SYSTEM MZ80A **£879.75 inc VAT**
SHARP F/T P6 PRINTER **£488.75 inc VAT**



Either of the above options require an expansion unit on the MZ80A **£115.00 inc VAT**

PC3500 BUSINESS COMPUTER

MONOCHROME **£2064.25 inc VAT**
FULL COLOUR **£2518.50 inc VAT**
640 x 400 HIGH RES. OPTION **£299.00 inc VAT**

Prices include:-
128K RAM; CPU; Keyboard;
Display Unit: SHARP FDOS
MBASIC; CP/M 2.2;
PEACHCALC

PEACHTREE BUSINESS PACKAGES ARE AVAILABLE FOR SALES, PURCHASE, NOMINAL, STOCK, PAYROLL, WORD PROCESSING etc.

Full range stocked. Full technical support. Full range of software

POCKET COMPUTERS & PERIPHERALS

- PC1251 WALLET SIZE POCKET COMPUTER **£79.95 inc VAT**
- CE125 PRINTER & MICROCASSETTE **£99.95 inc VAT**
- 12A 19 STATISTIC & GAMES PROGRAMS **£14.00 inc VAT**
- 12B 20 ENGINEERING & GAMES PROGRAMS **£14.95 inc VAT**
- 12C 20 MATHEMATICS & GAMES PROGRAMS **£14.95 inc VAT**
- PC 1500 PORTABLE COMPUTER **£169.95 inc VAT**
- CE 150 X.Y. PLOTTER & PRINTER **£149.95 inc VAT**
- CE152 CASSETTE RECORDER **£39.95 inc VAT**
- CE15A APPLICATIONS TAPE **£14.95 inc VAT**



80-BUS NAS-BUS LUCAS NASCOM GEMINI

- NASCOM from LUCAS LOGIC **£304.75 inc VAT**
- NASCOM 2 MICROCOMPUTER **£631.35 inc VAT**
- NASCOM 3 MICROCOMPUTER (48k) **£172.44 inc VAT**
- NASCOM ADVANCED VIDEO CARD from **£540.50 inc VAT**
- NASCOM DISK SYSTEMS **£69.00 inc VAT**
- NASCOM DISK OPERATING SYSTEM **£143.75 inc VAT**
- NASCOM CP/M 2.2 **£143.75 inc VAT**

NEW! LUCAS LX MATRIX PRINTER INTRODUCTORY PRICE
£366.85 inc VAT

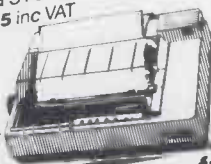

GEMINI MICROCOMPUTERS LTD

- GM811 CPU CARD **£143.75 inc VAT**
- GM813 CPU CARD plus 64k RAM **£258.75 inc VAT**
- GM802 64k DYNAMIC RAM **£143.75 inc VAT**
- GM812 INTELLIGENT VIDEO CTRL. **£143.75 inc VAT**
- GM829 FLOPPY DISK CONTROLLER **£166.75 inc VAT**
- GM827 87 KEY KEYBOARD from **£97.75 inc VAT**
- GM825 DISK DRIVE from **£402.50 inc VAT**



This is only a small selection from our extensive stocks!

PRINTER INTERFACES

- CENTRONICS CABLE **£17.25 inc VAT**
- BBC CABLE **£17.25 inc VAT**
- DRAGON CABLE **£17.25 inc VAT**
- ORIC CABLE **£17.25 inc VAT**
- MZ80K CENTRONICS INTERFACE **£80.00 inc VAT**
- MZ80A CENTRONICS INTERFACE **£97.75 inc VAT**
- MZ80B CENTRONICS INTERFACE **£97.75 inc VAT**

PRINTERS

- SEIKOSHA GP 100A **£247.25 inc VAT**
- LUCAS LX80 **£366.85 inc VAT**
- NEC 8023 **£447.35 inc VAT**
- EPSON FX80 **£503.70 inc VAT**
- BROTHER HR-1 **£747.50 inc VAT**

EPSON HX20 THE PORTABLE MIRACLE from **£462.30 inc VAT**



Stop Press...

NEW! SHARP CASSETTE BUSINESS SOFTWARE NOW IN STOCK for the MZ80A
These packages run on the standard MZ80A with cassette. This means a complete business system, including printer, can cost £1000.00 plus VAT.

Packages are: DIRECTORY, PRICE LIST, SALES LEDGER, PURCHASE LEDGER, INVOICING AND STOCK CONTROL.

The system can be expanded to disks without the loss of data.

NEW! SHARP PC3500 BUSINESS COMPUTER AVAILABLE FROM STOCK

Full range of PEACHTREE ON DEMO

NEW! LUCAS LX80 80 COLUMN DOT MATRIX PRINTER. EXCELLENT VALUE

FREE! DESK DATA SOFTWARE WORTH £46 WITH EVERY EPSON HX20

FREE! Printer Lead with any printer

SHARP MZ80K HI RES GRAPHICS FROM QUANTUM MICROS £115.00 inc VAT

SUPERBRAIN. IF YOUR SUPERBRAIN NEEDS TRUE DESCENDERS. WE HAVE THE ANSWER FOR £23.00 inc VAT.

NASCOM 2 GRAPHICS ON YOUR NASCOM 1 FOR ONLY £23.00 inc VAT.

BITS & PCS
COMPUTER PRODUCTS LTD

Trading as Leeds Computer Centre.
Please call or write for full details
Leeds Computer Centre, 55 Wade Lane,
Merrion Centre, Leeds
LS2 8NJ. Tel. 0532 458877



Genie SuperCare

2 year
Extended
Guarantee

Why should I bother with insurance?

Genie SuperCare is the first plan that can protect you for two years against breakdown repair cost. Today, high technology repairs can get alarmingly expensive. Skilled technicians with a first-class training are needed. Diagnostic service centres and special equipment do not make the bills any smaller!

Now, in the very unhappy event of a Genie breakdown, you can protect yourself against possible costly repair bills for 2 years.

And have the option to extend cover for a further period if you wish.



Colour Genie
Genie SuperCare
£16.50
Extended
Guarantee



Genie I
Genie SuperCare
£16.50
Extended
Guarantee



Genie II
Genie SuperCare
£16.50
Extended
Guarantee



Genie III
Genie SuperCare
£60.00
Extended
Guarantee

*Please note: the policy does not cover overhaul, modification, repairs to finish or cosmetic trim, damage caused by willful act or neglect, or loss of the insured product or consequential loss of any kind

Worry-free

Genie SuperCare lifts the worry right off your shoulders and places it back where it belongs. You will not get any invoices, nor any re-imbursment paperwork. Just take your Genie to your specialist Genie dealer and he will handle it all, direct. (Remember to keep the protective packing!)

Prepared by experts

The plan has been prepared by Lowe Computers, who distribute every Genie product in the U.K. from their extensive service and training centre in Matlock, Derbyshire.

In home electronics, they are the leaders. The plan is underwritten by Domestic and General Insurance Co. Ltd. They are the most senior in this field of insurance and are members of the British Insurance Association, your assurance of reliability.

What is covered?

Labour and parts for electrical, electronic and mechanical breakdown*, carriage by Securicor between your dealer and Lowe Computers or, in the event of a write-off, re-imbursment at cost.

Introductory offer: Backdated Guarantee

Until July 31, 1983, Genie SuperCare will apply to all Colour Genie and Genie III purchases, whenever you bought the computer.

Genie I and II will be eligible if purchased on or after January 1, 1983.

From the last day of July, only new purchases will be eligible - so, if you are a Genie owner, you owe it to yourself to act now!

This offer can never be repeated again, so contact your dealer at once, and spread the word to your friends.

Underwritten by:

Domestic & General Insurance Co. Limited

Swan Court, Mansel Road, Wimbledon,
London SW19 4AA

**SPECIAL
BACKDATED
OFFER**

There's a huge choice of micros around. Each with a different 'reason to buy'.

One might have fantastic graphics, but with a sound output like a pebble in a tin can.

Another may win every brownie point in the book on games. But with programming difficulties that make your brain ache (let alone your finger tips)...

For your micro, it's no good having one star in the team. You need all-round performance that wins with flying colours (all 16 of them!). And backed by a knowledgeable dealer network that will help you explore the exciting world of micros.

THAT'S COLOUR GENIE

Owning one means that when you want to do something new, you won't have to throw away

months or years of experience. And you'll find that for whatever reason you first buy a micro - you'll develop new interests immediately!

It means that once started, you can progress to be an experienced programmer. From fantastic games, to professional program applications.

SOUNDS CHALLENGING?

It's meant to! Because Colour Genie is fast and powerful enough to offer you the most exciting challenges in entertainment and education, at home and at work.

PROGRAMMABLE

Fast Z-80 chip with very programmable Microsoft* BASIC Extended held in 16K ROM.

128 programmable characters with programmable screen for text and display. Plus 128 pre-set graphics on the keyboard.

4 programmable function keys in each shift plus auto-repeat on all 63 keys.

And to help cure any of your programming bugs - Colour Genie has a full, powerful editing facility!

MEMORABLE

On 16K RAM, virtually 90% is available for you to use. Rising to a staggering 95% with the 32K RAM option. That indicates design efficiency and some very experienced programming.

It's not RAM size that counts - it's the usable RAM that matters!

ADAPTABLE

Screen text display is a full 40 across x 24 down. In this mode you can build highly complex graphics. Using the highest screen resolution of 320 x 192 with both text and graphics.

With up to 16 colours on screen (8 colours and 8 hues), get the shapes to 'move' over the screen with a 3D effect. Or you can use full-screen high graphics resolution at 160 across x 96 down in 4 colours with background colour. In both modes you have the facility of 128 pre-programmed graphic 'building blocks' plus 128 more that you can create yourself.

Colour Genie

Quite simply, More . . . able

Available, and affordable!

Only **£194**

(including VAT)

Send **NOW** for full details.



LEARNABLE

Colour Genie even comes with 2 manuals. A beginner's guide, and one to take you through the first steps of BASIC, the English 'shorthand' that the computer understands (shown here with optional joystick controllers).

SOFTWARE AVAILABLE

Find the Diamond of Balmarion
The Vegan Incident
Enchanted Garden (requires 32K)
Toad Mania!
Space Fighters
Racing Driver
Mysterious Adventure Series (7 programs)
Invaders from Space
The Chomper
Cosmic Attack
Zen Editor/Assembler/Debugger
Genmon
Fortress of Evil
The Exterminator
The Graphics Master
The Deep
Double Agent
Electric Etch
Skramble
Kong!!
Blitz
Windscare
Pantoon
Snake
Music
Electronic Organ
Break-Out (Joysticks)
Morse Code Trainer
Rodeo

Lifeboat & Noughts and Crosses
Round Table (Adventure)
Murder at Gosforth Hall (Like Cluedo)
Missile Strike
Galactic Attack
Mousemaze
Asteroid Mission
CSAVERS (Genie 1 to 4 Basic Trans.)
Monitor 3

File Handling
C.G. Copy
Maths Practice Program
CORPLAN (Business and Educational Software)
Character Generator (2 games on reverse side)
Word Processing
Wolf Tracks -

COMMANDABLE

SHAPE, SCALE, COLOUR, PAINT, CIRCLE, FILL, PLOT – the list goes on with more than 80 others.

Add more than 40 graphic, arithmetic and other functions. You can see the power behind Colour Genie.

COMPOSABLE

Outstanding facility with 3 sound generation channels. Independent or simultaneous with a full range of 8 octaves on each channel to give the synthesized sound of instruments such as drums, flute and harpsichord. A bomb, a car or a bird!

Programmable pitch, duration and volume.

White noise. Special effects.

Full enveloping. Plays through your TV or Hi-Fi (with picture on TV).

SOUND AND PLAY commands.

USEABLE

There's no shortage of action-packed games available now. But as your expertise develops, you'll find Colour Genie software to meet your growing skills. From some of the best writers around.

Education, music, business and many other applications.

Regular software update lists.

Backed by Lowe Soft, the special Lowe Computers software service. All you need to get the most from your Colour Genie.

ENJOYABLE

Your optional Colour Genie joysticks must be the best in the business!

Slam them hard for explosive screen action. Touch them gently for slow precision. They each use a 6-bit chip and convert from normal analogue to digital response.

And each stick has a built-in numeric pad to help build exciting two player applications.

SHARE-ABLE

The National Colour Genie Users' Group welcomes you! Free magazine every month for the beginner and the pro. Where to get software. Its own software library. User experiences, and the opportunity to sell your software on the Group's own label.



GUARANTEE-ABLE

Our optional 2-year breakdown guarantee underlines the reliability of Colour Genie. Only £16.50 from date of purchase.

UNDERSTANDABLE

For everybody new to computers, all the technical words are a bit of a mystery. But for Colour Genie, you'll find excellent books which take you from wiring in the plug to how to get the best from the computer!

Give us a call and we can update you on current titles.

Happy computing!

LOWE
COMPUTERS

Lowe Computers, Lowe Electronics Ltd., Chesterfield Road, Bentley Bridge, Matlock, Derbyshire DE4 5LE

Telephone: (0629) 4057, 4995. Telex: 377482 LOWLECG

*Microsoft is a registered trademark of Microsoft Incorporated

✂ CLIPABLE Please send me full Colour Genie details, software list and the address of my nearest specialist Dealer.

Name _____

Address _____

Postcode _____

Lowe Computers, Lowe Electronics Ltd.,
Chesterfield Road, Bentley Bridge,
Matlock, Derbyshire DE4 5LE
Telephone: (0629)
4057, 4995.

PCW

GALAXY 2 COMPUTER SYSTEM



WHATEVER REQUIREMENTS YOU HAVE



GM813 - CPU/ 64K RAM Board

- ★ 4 MHz Z80A CPU
- ★ 64K Dynamic RAM
- ★ RS232 Serial Interface
- ★ Two 8-Bit I/O Ports
- ★ 1200 Baud Cassette Interface
- ★ Extended and Page Addressing Modes

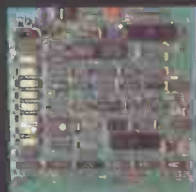

GM812 - IVC Board

- ★ 80x25 Display Format
- ★ On-board Z80A Microprocessor
- ★ Buffered Keyboard Input
- ★ Programmable Character Generator
- ★ 160x75 Pixel Graphics
- ★ Light Pen Input



GM 829 - FDC/ SASI Board

- ★ Single/Double density operation
- ★ Single/Double sided drive operation
- ★ Up to 3 mixed 3.5", 5.25" and 8" drives
- ★ Industry Standard SASI hard-disk interface

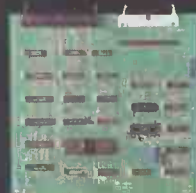

**TWO
SPARE
SLOTS**

The cost-effective solution to your computer needs for only **£1,495***

For just £1,495 the Galaxy 2 provides the basic requirements for a small business system:

- **Central Processor Unit with 64K of RAM**
- **Twin disk drives (400K storage per drive)**
- **Keyboard and 12" monitor**

But unlike many other small-business systems the Galaxy System is specially designed for expansion and flexibility to meet changing requirements. It uses the world's best selling micro processor, the Z80A, and is based on industry-standard 80-Bus boards. The business system uses only 3 boards in the 5 spaces available, so extra cards can be "plugged-in" to expand the system; for example to expand the memory, or to give a colour facility, or to develop the Galaxy for the particular requirements of education, research, software development etc.

It has a CP/M operating system which gives access to the largest range of software available for any machine. In particular, Gemini can offer QUIBS; a small-business package developed especially for the Galaxy.

The Galaxy has industry-standard interfaces (parallel and serial), and Gemini Microcomputers can supply a full range of compatible hardware including a Winchester sub-system and printer.

The Galaxy offers the most cost-effective way of obtaining a basic unit which is capable of developing to meet your particular requirements; now and tomorrow.

Features include:

- Twin Z80 Processors
- 64K Dynamic RAM
- 800K Disc Based Storage
- 80 x 25 Screen Format
- Dual Printer Interfaces
- Modular Design
- Extra Disc Drives Easily Added
- Winchester Expansion Available
- Net Working System Available
- Additional Slots for 2 Cards
- 12" Green or Amber Monitor



*Price is exclusive of VAT



Gemini Microcomputers

18 Woodside Road, Amersham, Bucks HP6 5EQ. Tel: (02403) 28321.



DUPLEX

SUSS BOX

The DUPLEX SUSS-BOX and DUPLEX SUSS-ADAPTOR have been designed to enable the less skilled computer user to have a better understanding of the correct working connection between a computer and a peripheral, such as a printer. This is achieved by using the commonly used signals (wires) of the RS232C serial data cable specification, a matrix-block and special connector pins.

By inserting the connector pins into the SUSS-BOX's matrix-block at the axis of two incoming signals the user can quickly establish a firm connection. The signals are routed into the SUSS-BOX by two 25 way D type connectors; 1 x female, 1 x male. The SUSS-BOX also provides a lamp for each signal to show its condition when connected in-line, ie High or Low.

JUMPERING:

Jumpering between two or more signals is possible by using three SEPARATE jumpering lines also available on the SUSS-BOX & ADAPTOR matrix-blocks, thus each of the incoming 25 way connectors can be jumpered independently.

WIRES ROUTED THROUGH THE MATRIX-BLOCK:

On each connector, pins - 2, 3, 4, 5, 6, 8 & 20. All remaining pins are wired through.

Lines for jumpering - J1, JA2, JA3, & JB1, JB2, JB3. All separate lines.

SUSS BOOK

If the user specifically wishes to connect a microcomputer to the OCTET or HERMIT typewriter/printers then refer to DUPLEX's SUSS-BOOK for details on various microcomputer cable 'Pin-outs'.

£49.95
+ VAT

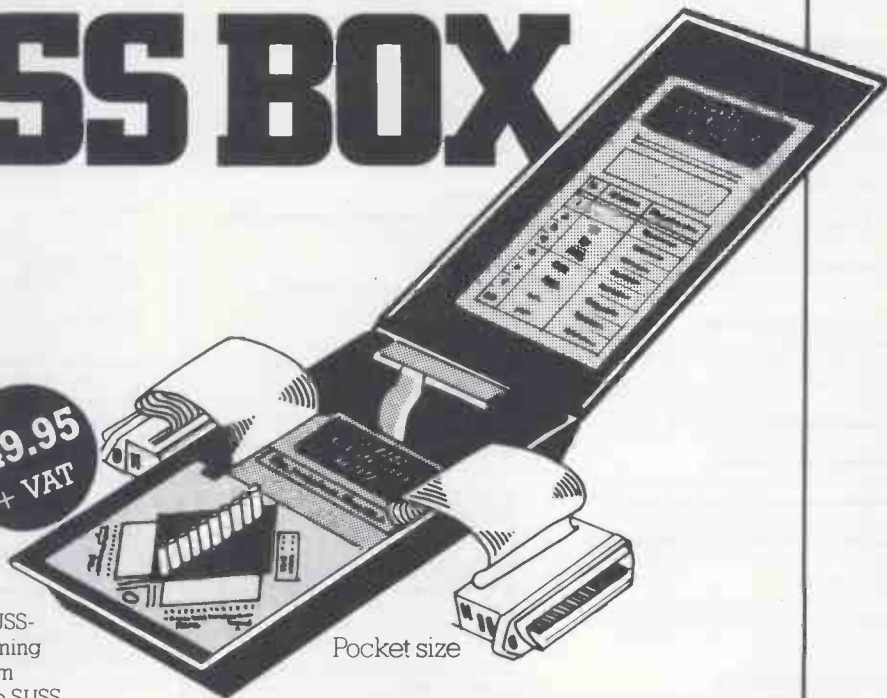

Pocket size

SUSS-ADAPTOR

When the user has achieved the correct 'Pin-out' between a micro computer and a printer the DUPLEX SUSS-ADAPTOR should be used as a permanent means of connection. This is done by 'transposing' the correct matrix-block pin-layout already established with the SUSS-BOX onto the matrix-block of the SUSS-ADAPTOR, and then installing the SUSS-ADAPTOR in between the computer and printer.

£29.95
+ VAT

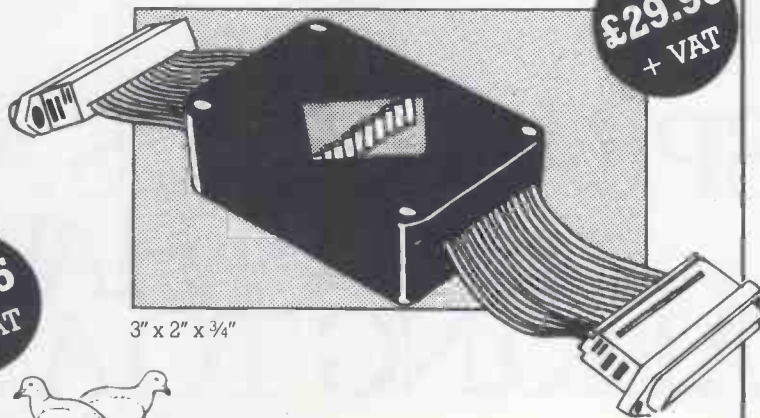

3" x 2" x 3/4"

£3.75
+ VAT



DUPLEX
Communications Ltd.

The Interface People

All prices are based on cash-with-order terms

Midlands/North - 2 Leire Lane, Dunton Bassett, Nr. Lutterworth, Leicestershire LE17 5JP. Tel: 0455 209131
South - 52 High Street, Stock, Essex CM4 9BW. Tel 0277 841011

ENGLAND

AVON

Datalink Microcomputer Systems
BRISTOL (0272) 213427
Dowco Information Systems
BRISTOL (0272) 23352

BEDFORDSHIRE

Computopia Limited
LEIGHTON BUZZARD (0525) 376600
The Bedford Microcentre
BEDFORD (0234) 215015

BERKSHIRE

Cascade Computers
NEWBURY (0635) 201591
Data Supplies Ltd.
SLOUGH (0753) 823820
Decision Support Systems Ltd.
MAIDENHEAD (0628) 76887
Lynx Computers Ltd.
WINDSOR (07535) 56322
M E Electronics
READING (0734) 669480/667463
Thames Valley Systems
READING (0734) 581829

BUCKINGHAMSHIRE

Action Data Ltd.
HIGH WYCOMBE (0494) 716171
Bits & Bytes Ltd.
BOURNE END (06285) 26535/26754
Computer Modelling Ltd.
PENN (049481) 6181
Debug Data Services
HIGH WYCOMBE (0494) 448777
Milton Keynes Computer Centre Ltd.
MILTON KEYNES (0908) 668811
Neath Hill Professional Workshop
MILTON KEYNES (0908) 660364
Tarace Ltd.
WENDOVER (0296) 623965
Viasak Computer Systems
HIGH WYCOMBE (0494) 448633

CAMBRIDGESHIRE

Eicon Research Ltd.
CAMBRIDGE (0954) 81825
QIS Computer Services Ltd.
PETERBOROUGH (0733) 47191

CHESHIRE

3SL System Support Services
SANDBACH (09367) 3842/61249
Fairhurst Instruments Ltd.
WILMSLOW (0625) 525694
Fairhurst Instruments Ltd.
WOODFORD (0625) 527146
Fairhurst Instruments Ltd.
HANDFORTH (0625) 533741
Mid-Shires Computer Centre
CREWE (0270) 211086
Northern Computers
FRODSHAM (0928) 35110

U-Microcomputers Ltd.
WARRINGTON (0925) 54117
Umbra Software Ltd.
STOCKPORT (061) 4778177

CUMBRIA

Carlisle Computer Centre
CARLISLE (0228) 48345
Radex-Visionscan
KENDAL (0539) 22559

DERBYSHIRE

Donnington Computers
DERBY (0332) 43090/49672
Impact Micro Computer Services
ALFRETON (0773) 831547

DEVON

Keel Data Systems Ltd.
EXETER (0392) 215666
Southern Computer Systems
TORQUAY (0803) 212957

DORSET

Deverill Computer Services Ltd.
POOLE (0202) 684441

ESSEX

Colin Grace Associates Ltd.
SAFFRON WALDEN (0799) 22532
Compuskill Ltd.
ROMFORD (0708) 751906
Essex Computer Centre Ltd.
CHELMSFORD (0245) 358702
Microcore Ltd.
CHELMSFORD (0245) 64230
Strident Computer Services Ltd.
COLCHESTER (0206) 49581

GLOUCESTER

The Business House
GLOUCESTER (0452) 424411

GREATER MANCHESTER

Micro Computer Consultants Ltd.
TYLDESLEY (0942) 892818
Technique Ltd.
MANCHESTER (061) 872 3601
The Microsystem Centre Ltd.
MANCHESTER (061) 834 0234

HAMPSHIRE

A J Hales Computers
EASTLEIGH (04215) 62366
G & M Management Services Ltd.
SOUTHAMPTON (0703) 30664
Grist Business Services Ltd.
SOUTHAMPTON (0703) 39061/2
Grist Business Services Ltd.
PORTSMOUTH (0705) 829228/829283
Mitron (Electronics) Ltd.
WINCHESTER (0962) 55612

HERTFORDSHIRE

Data Efficiency Ltd.
HEMEL HEMPSTEAD (0442) 60155
H G Services Ltd.
ST ALBANS (0727) 30129

Local Business Technology Ltd.
HODDESDON (0992) 466650/466157
Potters Bar Computers
POTTERS BAR (90) 59404
Tesco Business Centre
WELWYN GARDEN CITY
(07073) 39333

HUMBERSIDE

Microware Computers Ltd.
HULL (0482) 562107
Saville Data Systems
HULL (0482) 446707

KENT

Bromley Business Computers
BROMLEY (01) 460 6226
Emetco Ltd.
FOLKESTONE (0303) 57171
Freetime Computers
ASHFORD (0233) 38488
M D Wright Data Services Ltd.
CANTERBURY (0227) 69090
Microspot
MAIDSTONE (0622) 858753

LANCASHIRE

Access Computer Services
ROCHDALE (0706) 358131/57308
AIDS Data Systems Ltd.
BURNLEY (0282) 56065
Lancaster Computing Ltd.
LANCASTER (0524) 69095
Ormskirk Computers Services
ORMSKIRK (0695) 77043
Pete & Pam Computers
ROSSENDALE (0706) 212321/227011
Style Systems
BLACKBURN (0254) 51051

LEICESTER

Leicester Computer Centre Ltd.
LEICESTER (0533) 5562/68
Tilley Computers
LEICESTER (0533) 553984

LINCOLNSHIRE

Computer Facilities Ltd.
LINCOLN (0522) 30433

LONDON

Advanced Micro Products Ltd.
LONDON SE9 (01) 850 8280
Advanced Micro Products Ltd.
LONDON SE1 (01) 928 0372
Albion Computer Co
LONDON W1 (01) 636 8284
Applitek
LONDON W4 (01) 995 5446
CSS (Systems) Ltd.
LONDON E8 (01) 254 9293
City Computer Centre
LONDON EC1 (01) 588 5537
Computacenter
LONDON EC2 (01) 638 4274
Deans of Kensington
LONDON W8 (01) 937 7896/938 1588

General Microcomputer Systems Ltd.
LONDON W4 (01) 995 4998
Informex
LONDON SE13 (01) 318 4213
Komputation Automation Information
LONDON NW6 (01) 328 3968/7038
Personal Computers
LONDON EC2 (01) 377 1200
Pete & Pam Computers
LONDON SW16 (01) 769 1022
Planning Consultancy Ltd.
LONDON SW1 (01) 839 3143
Stirling Microsystems
LONDON NW1 (01) 486 7671
System Logic Ltd.
LONDON E2 (01) 981 7311
The West London Micro Centre
LONDON W12 (01) 743 9000
Tap Micros Ltd.
LONDON EC4 (01) 242 4706
Wason Microchip Ltd.
LONDON N18 (01) 807 1756/1558

MERSEYSIDE

Liverpool Computer Centre
LIVERPOOL (051) 236 2000
Rockliff Micro Computers Ltd.
LIVERPOOL (051) 227 2568
Technique Ltd.
BIRKENHEAD (051) 653 4343

MIDDLESEX

Data Profile
HOUNSLOW (01) 572 0678
Fletcher Dennys Systems Ltd.
HOUNSLOW (01) 570 8999
Hexagon Services
HILLINGDON (0895) 36832
Microsolve Computer Services Ltd.
EDGWARE (01) 951 0218/9
Ozwise Computers
HARROW (01) 429 1060
Simmons Magee Computers Ltd.
TWICKENHAM (01) 891 4477

NORFOLK

Anglia Computer Centre
NORWICH (0603) 667031/2/3
Jarrod Office Equipment
NORWICH (0603) 660661

OXFORD

Cyberpress Ltd.
WALLINGFORD (0491) 39538
Micromark Ltd.
HENLEY-ON-THAMES (04912) 77926
Oxford Software Ltd.
HEADINGTON (0865) 60777
Rocon Ltd.
ABINGDON (0235) 24206

SHROPSHIRE

Cressage Computer Services
SHREWSBURY (0743) 69834

SPEAK TO US AND WE'LL SOON HAVE YOU TALKING TO A NEW APPLE

The above are just a selection of the many helpful Apple dealers around the country.

Most offer training courses as well as a complete back-up service, and many will lease you an Apple for as little as £70 a month.

Remember, whatever you do you'll do it better with Apple. And with a dealer network like ours it's easy and convenient to get started.

Everybody should have a friend like Apple.

Apple is a trademark of Apple Computer Inc., USA.



SOMERSET
Markes Industrial Agencies
BRIDGE (0934) 732681/732435

SUFFS
Micro Applications Ltd.
WYFFORD (0785) 43414

SUFFOLK
Anderson Gardiner Computers Ltd.
LIXSTOWE (0394) 77964
Stram Computers
WYRY ST EDMUNDS (0284) 705808

SURREY
IL
RNHAM (0252) 722139
C London Ltd.
RLEY (01) 668 0683
Argusson Computers Ltd.
ALTON-ON-THAMES (09322) 41692
D Financial Advisors
ALTON-ON-THAMES
9322) 47888

Micro Facilities Ltd.
HAM (0784) 31333
Microlines Computers Ltd.
NGSTON-UPON-THAMES
) 546 9944
Northwell Data Systems Ltd.
AMBERLEY (0252) 519441
Orrey Micros Ltd.
MILDFORD (0483) 66111/62942
Orga Computers Ltd.
ROYDON (01) 656 8431/8432

SUSSEX
Commercial & Professional
Computers
HICHESTER (0243) 787123
High O'Neill Computers
HICHESTER (0243) 605856
Southern Micro Computers Ltd.
WHAVEN (07912) 4724
The Computer Centre (MS) Ltd.
ASTINGS (0424) 439190

SWYNDEN AND WEAR
Microcore Computers
NEWCASTLE-UPON-TYNE
632) 617077

Newcastle Computer Services Ltd.
NEWCASTLE-UPON-TYNE
(0632) 761168/9
System 800 Computers Ltd.
NEWCASTLE-UPON-TYNE
(0632) 681611

WEST MIDLANDS
ABM Computers
BIRMINGHAM (021) 707 1822
Camden Computer Systems Ltd.
BIRMINGHAM (021) 771 3636
Mercla Computer Systems
COVENTRY (0203) 78652
Micro Applications Ltd.
WALSALL (0922) 644234
Second City Software
BIRMINGHAM (021) 606 8739
Stewart Computer Services Ltd.
BIRMINGHAM (021) 632 4822
Westwood Computers
BIRMINGHAM (021) 632 5824

WILTSHIRE
Computacentre
SWINDON (0793) 612341/2

WORCESTER
Data Design
STOWPORT-ON-SEVERN
(02993) 6277
Nestern Ltd.
WORCESTER (058-470) 487

YORKSHIRE
Autosystems Ltd.
HUDDERSFIELD (0484) 665111
Catel Computer Systems Ltd.
HARROGATE (0423) 65165
Computerways
KEIGHLEY (0535) 64171/2
Lysis Computers Ltd.
NORTHALLERTON (0609) 6374
Microware Computers Ltd.
LEEDS (0532) 434377
Pennine Computer Co Ltd.
HALIFAX (0422) 41719
Ram Computers Services Ltd.
BRADFORD (0274) 391166
Saville Data Systems
YORK (0904) 37700

Spot Computer Systems Ltd.
DONCASTER (0302) 25159
Wharnclyffe Business Systems
BARNSELY (0226) 298501

NORTHERN IRELAND

Cem Micro Computer Services Ltd.
BELFAST (0232) 244111/243564
Medical & Scientific Computer
Services
LISBURN (08462) 77533

SCOTLAND

BORDERS
McQueen Systems Ltd.
GALASHIELS (0896) 4866

GRAMPIAN
Ablex Computer Systems
GRAMPIAN (0224) 647074

HIGHLANDS
Black Isle Systems Ltd.
INVERNESS (0381) 20276

LOTHIAN
McQueen Systems Ltd.
EDINBURGH (031) 225 2774

STRATHCLYDE
Gate Microsystems Ltd.
GLASGOW (041) 221 9372
Masons Computers & Business
Equipment
KILMARNOCK (0563) 20985/44167

TAYSIDE
Gate Microsystems Ltd.
DUNDEE (0382) 28194

WALES

CLWYD
Rockliff Micro Computers Ltd.
MOLD (0352) 59629

GLAMORGAN
Croeso Computer Services
SWANSEA (0792) 61555

Lawson Computers
SWANSEA (0792) 474939
South Wales Computers Ltd.
CARDIFF (0222) 490512

GWYNEDD
IDC Computer Services
LLANGEFNI (0248) 724282

The following branches of
BEAM BUSINESS CENTRES
BRISTOL (0272) 290391
CHELTENHAM (0242) 45414
LONDON W1 (01) 380 0388
MANCHESTER (061) 831 7066
WARLEY (021) 4201631

LASKY'S
LONDON W1 (01) 493 4623
LONDON W1 (01) 536 0845/6/7/8/9
LONDON W2 (01) 229 6425
BIRMINGHAM (021) 632 6303
BRIGHTON (0273) 725625
BRISTOL (0272) 20421
BROMLEY (01) 464 7829
CARDIFF (0222) 374893
CHESTER (0244) 317667
CROYDON (01) 681 3027
EDINBURGH (031) 556 2914
GLASGOW (041) 226 3747
KINGSTON (01) 546 1271
LIVERPOOL (051) 235 2828
LUTON (0582) 38302
MANCHESTER (061) 832 6087
MAIDSTONE (0622) 678165
NOTTINGHAM (0602) 415150
PRESTON (0722) 59264
PETERBOROUGH (0733) 313513
READING (0734) 595459
SHEFFIELD (0742) 750971
YORK (0904) 641221

MICRO-C
BIRMINGHAM (021) 233 1105
NOTTINGHAM (0602) 412455
SOUTHAMPTON (0703) 29676
LUTON (0582) 425079
LEEDS (0532) 446601
MANCHESTER (061) 834 0144
LEICESTER (0533) 546224
LONDON NW1 (01) 387 9275

The Dealer list above is not a list of all authorised Apple Dealers.
For a complete list write to Apple Computer (UK) Limited, Eastman Way,
Hemel Hempstead, Herts, HP2 4BR, FREEPOST.



No 1 source for software

SOFT OPTION SOFTWARE CENTRE

When you're thinking software, think Soft Option first. Chances are we'll have the right product, in the right format, on the shelf in quantity.

We despatch fast from stock. We also offer a dealer pricing system to suit individual needs with cumulative discounts available.

Finally, we *know* about software—we can give you technical support when it's needed.

So make Soft Option your first call. We'll soon become your first choice.



and IBM PC Software



SOURCES INCLUDE:

We hold stocks of most software manufacturers including:

MICROPRO
MICROSOFT
DIGITAL RESEARCH
SORCIM
IUS
ASHTON TATE



MACHINE FORMATS INCLUDE:

Software can be made available in 8 BIT or 16 BIT formats to suit most micro-computers currently on the market including:

Superbrain
North Star Horizon
North Star Advantage
Columbia PC • IBM PC
Televideo • Apple
CP/M 8" • Rair • Sirius



PROGRAMS INCLUDE:

Our complete list of software is too long to publish and changes by the hour but here are a few examples to whet your appetite.

| | |
|--------------------|--|
| WORDSTAR | MICROPRO's comprehensive word processing system. |
| PL/I-80 | DIGITAL's PL/I Compiler. |
| BASIC-80 | MICROSOFT's popular and powerful basic Interpreter. There is a Compiler too. |
| FORTTRAN-80 | Fortran Compiler to ANSI X3.9 1966 except COMPLETE data. |
| SUPERCALC | SORCIM's spread sheet and modelling system. |
| EASYFILER | Data Recording System for the IBM PC from IUS. |
| dBASE II | Relational Database Management from Ashton Tate. |

RING THE SOFTLINE Grantham (0476) 860171

All products are supplied complete with full originator's documentation. Please send large s.a.e. for full details. TRADE ENQUIRIES WELCOME.



Soft option

SOFTWARE CENTRE

The Soft Option (UK) Ltd. Home Farm House Colsterworth
Grantham Lincolnshire NG33 5HZ Tel: Grantham (0476) 860171

COMPSOFT'S DMS – winner
of the 1982 **RITA** Awards,
'Software Product of the Year'.

Now Compssoft announce
Delta – the very powerful, very
friendly database* that the
world has been waiting for.

* For micro computers with CP/M, MP/M or MSDOS operating systems. Including IBM PC.

Compssoft Training Centre

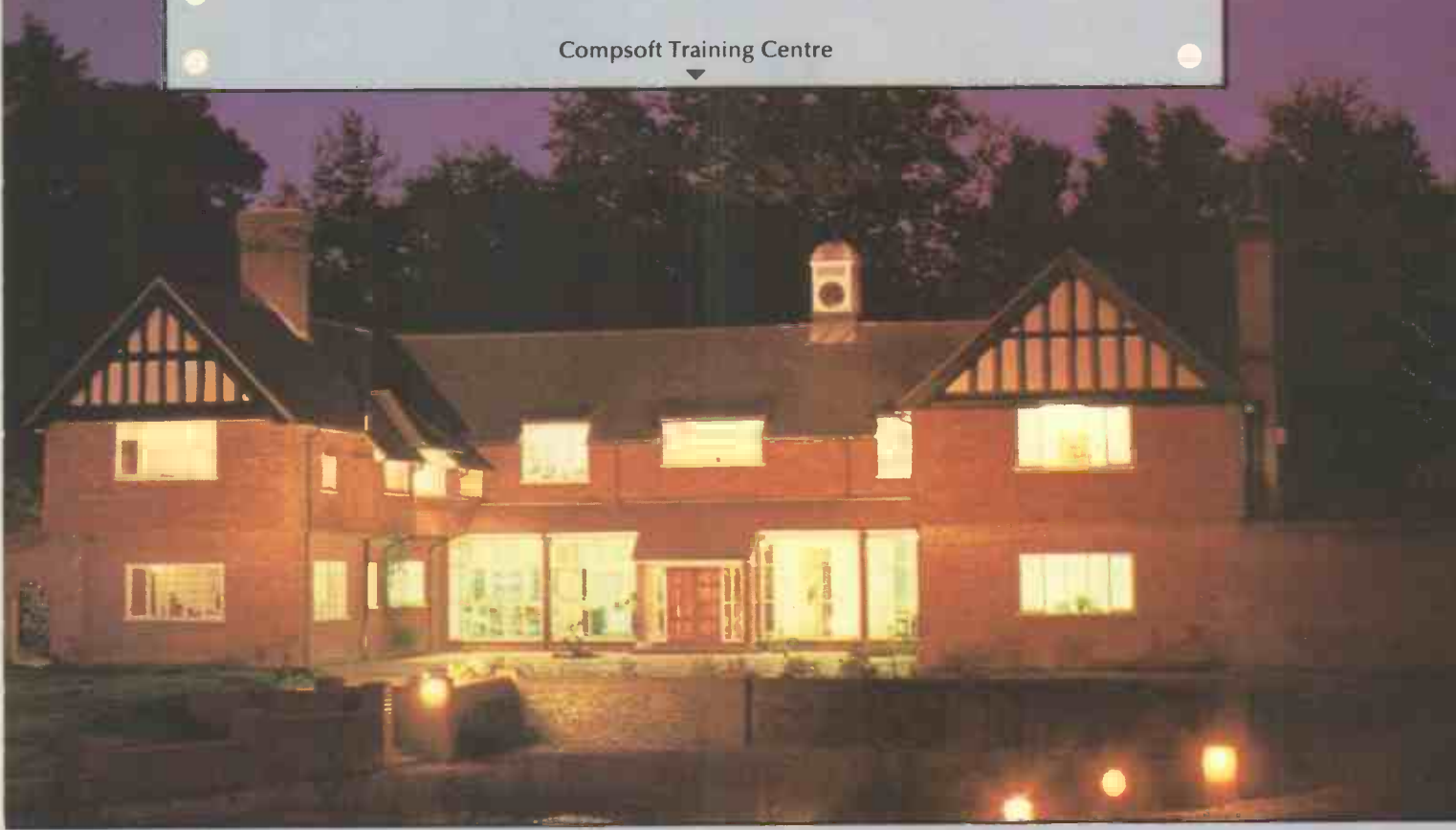

If part of your microcomputer's job is to store information, you need Compssoft's software.

Compssoft DMS is already Britain's No. 1 record keeping program. And with 4000 users to our credit, we can honestly say we know more about information storage & retrieval than anyone else. We listen to your comments & requests and now we've produced a world first – the Delta – a true transactional database.

If you'd like to know more, we have general brochures, full technical specifications & free

guides to DMS handling a multitude of business situations from order processing, invoicing & stock recording, through to library, personnel & hospital record management.

Find out more about the database revolution. Either telephone the office or clip the coupon now.

Compssofts Delta – taking microcomputers into the third dimension.

Compssoft Limited
Hallams Court
Shamley Green
Nr Guildford, Surrey
England GU4 8QZ

Telephone: Guildford (0483) 898545
Telex: 859210 CMPSFT



Please send me further details

Company

Contact

Address

PCW/7/83

Tel No.

You were impressed by the unique portable Epson Computer that fits into your briefcase.



Now take a look at the one that sits on your desk.

The QX-10. A fully integrated Desktop Microcomputer System. A new member of the Epson family.

But there's more to the functional and stylish lines of this remarkable machine (just to prove that beauty isn't only skin deep).

The lightweight CPU, monitor and Keyboard units are very easy to use - even for a first time operator. You could say that our system takes all the hard work out of using software, and once used...you probably will.

What's more, when it comes to cost you'll find there's more power for your money.

Just look at these qualities.

192k upgradable to 256k RAM, Z80A CPU, RS-232C and parallel interfaces. CP/M and multifont BASIC comes as standard.

The QX-10 offers an incredible graphics capability. The 80 columns x 25 line display has 640 x 400 resolution and full bit image control for greater definition, 16:1 zoom and special effects.

QX-10

THE HUMAN COMPATIBLE BUSINESS MICRO

EPSON

Extraordinary product. Exceptional quality.

Epson (UK) Limited, Freeport, Wembley, Middlesex HA9 6BR. Freephone: 2730. Telex: 8814169

Not to mention a unique split screen facility enabling different typesyles and graphics to be shown together. A major first for educational applications.

For even more power - simply slot in up to 5 optional interface cards for cassette, bar code reader, joysticks, sound generator, plus a Universal Interface card for developing your own interfaces. Clock, calendar and full battery back-up complete the system.

As with all the other respected Epson products, you are assured of high quality. (We even manufacture the slim line disc drives ourselves.)

So, at last there's a desktop microcomputer system that really works together. To really work for you.

See it soon. We know you'll be impressed.

- I would like a demonstration of the QX-10.
- Please send me details and the name of my local stockist.

Name _____

Position _____

Company _____

Address _____

Tel: _____

THE WORLD'S LEADING MICROS AT PRICES YOU CAN AFFORD!

OEM offer one of the most comprehensive ranges of business micros in the U.K. — so come to our King Street showrooms where you can discuss your application and have a demonstration on:



From £12.98 p.w.

IBM
Personal Computer



From £13.98 p.w.

olivetti M20

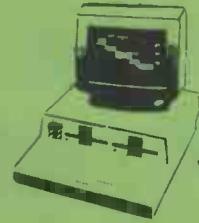

From £12.98 p.w.

apple III



From £12.98 p.w.

OSBORNE 1



From £7.98 p.w.

apple IIe

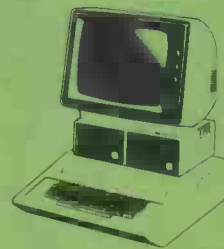

From £4.58 p.w.

Also Canon Photocopiers *from* £3.48 p.w. Call our hotline 01-748 8404 for some of the keenest prices in Britain!

PLUS! Epson — Ricoh 1600 Flowriter — Facit — Qume — Praxis 35 — and a whole range of dot matrix and daisywheel printers and peripherals.

As one of Britain's foremost companies in the field of high technology as well as one of the leading micro computer outlets in the U.K., OEM offer as part of our all round expertise:—

TRAINING

Our monthly training courses cover most leading software packages but must usually be booked 4 weeks in advance!

SUPPORT

Our customer support department is second to none!

NETWORKING

Our Multinet 2000 range interfaces almost any computer to any other computer/peripheral whether main-frame, mini or micro.

BUSINESS PACKAGES

A wide range including accounts, word processing and spreadsheet programs!

SOFTWARE DEVELOPMENT

Software written to your needs and specification.

HARDWARE DEVELOPMENT

Our team of engineers will design and build any system/peripheral you require!

MAINTENANCE

We will repair/maintain/service most micros whether purchased from us or not.

WEEKLY BARGAINS!

Every Friday evening we change our **showroom** demonstration models — which you can pick up (only one week old) at vastly reduced prices!

To: **Office Efficiency Machines Ltd.**
150-152 King Street,
London W.6.

PCW7

Tel: 741 7383/4/5/6

Please send me information/quote on:

I am an End User Dealer Urgent

I have a requirement for 1 system 2-9 systems
 10 or more systems

I will be purchasing within

1 month 3 months 6 months or more

My budget is £

Name _____ Title _____

Company _____

Address _____

Postcode _____

Phone _____ Extension _____



OFFICE EFFICIENCY MACHINES LTD

150-152 King Street, London W.6.

Tel: 01-741 7383/4/5/6 Telex 263559 MICRO G

NOTE TO EXHIBITORS

1982: 47,543 reasons to be at
the 5th PCW Show



1983: 20 chances to be at the 6th

Six months before the doors open on the 6th *PCW* Show, Britain's number one micro event, only 20 stands* are available for allocation. Need we say more...?

To discuss stand availability today, phone Timothy Collins on 01-486 1951.
For exhibitor list and further information write to Montbuild Ltd, 11
Manchester Square, W1M 5Ab, Telex 24591.

* correct at 20.4.83

BARBICAN CENTRE, CITY OF LONDON
28 September — 2 October 1983

FREE

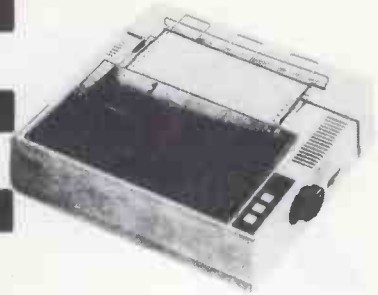

EPSON RX80 PRINTER

A business micro for as little as £1695.00
with a printer supplied - FREE!

- LOW PRICE** -£1695 with a printer FREE.
- POWER** -64K RAM expandable to 1MB and RAM DISK is available.
- SPEED** -30% faster than most micro.
- O/S** -CP/M 2.2 or UCSD PASCAL SYSTEM.
- STORAGE** -400K + 400K twin floppy with TEAC SLIMLINE drives and up to 10MB version available.
- NETWORK** -Available with RECORD LOCKING, and capable of linking up to 30 users.
- SCREEN** -Memory mapped 12" non-glare screen (80 by 24).
- KEYBOARD** -Detached keyboard with function keys.



- WARRANTY** -1 year warranty and less than £250.00 per annum for service contract by Olivetti.
- SERVICE** -After sales service and advice by our hardware and software engineer.

| MODEL | STORAGE | PRICE |
|-------|------------------------------|-------|
| BC2 | 400K+400K floppy | £1695 |
| BC4 | 800K+800K floppy | £2125 |
| HD5 | 5MB hard disk + 400K floppy | £3185 |
| HD10 | 10MB hard disk + 800K floppy | £3795 |

transtec computers

FOR FURTHER DETAILS PLEASE RING: 01-567 0154

MAGNUM

MAGNUM COMPUTERS LTD. 156 Northfield Avenue, Ealing, London W13 9SB

NOW WITH CPM86 SUPPLIED FREE!



CPM86 and MSDOS and CPM exclusively from EuroMicro on the Z100 Computer

Just look at these features:

- * Dual processor 8085/8088
- * Full 640 x 225 dot 8 colour graphics
- * Floppy/Winchester drives
- * 4 x S100 Expansion slots
- * Disk format compatible with IBM PC
- * Available as low profile or "all in one"

**Suitable for all applications.
Runs 8 bit & 16 bit software**

Call 01-341 2447 today for full literature package and prices.

EuroMicro™

EuroMicro Limited
EuroMicro House, Coleridge Lane, London N8 8ED, England
Telephone: 01-341 2447

EuroMicro is the Trademark of EuroMicro Inc

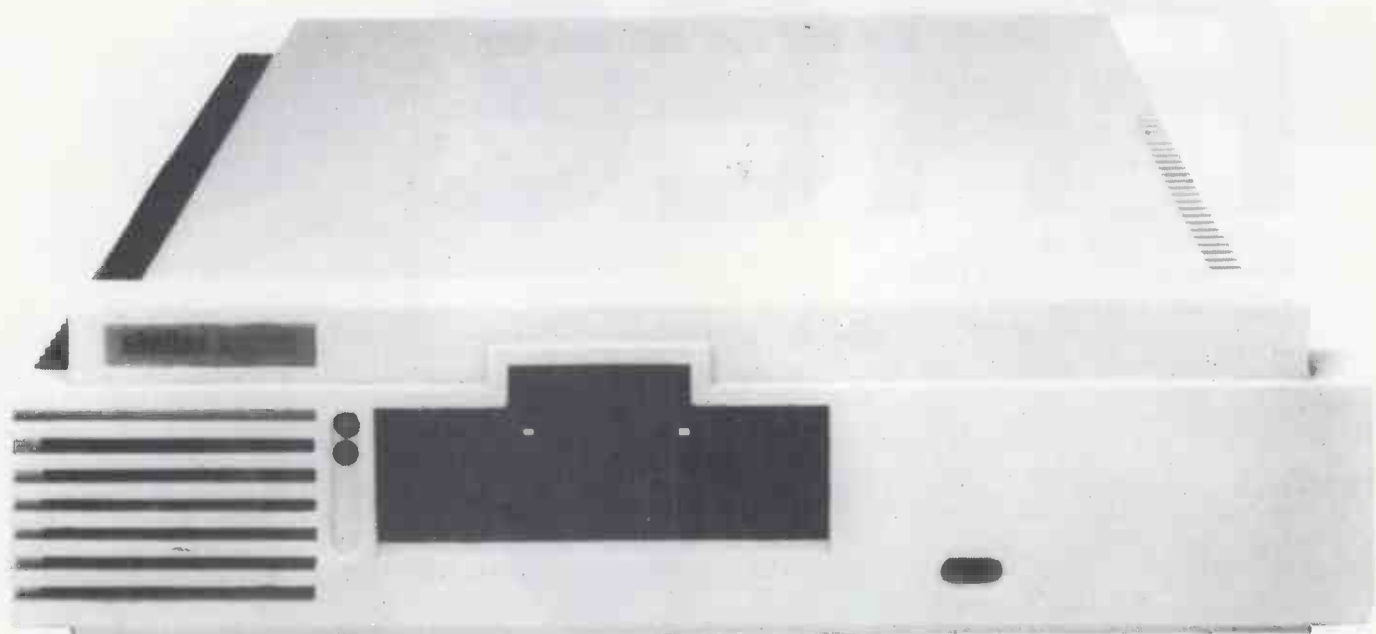

SIG/NET- OFFERING DEALERS A GREAT DEAL

If you are an experienced dealer in the South-East looking for the right micro to handle, you will find it with Sig/net.

At DPLC, the South-East distributor for Sig/net, we feel that we offer dealers the perfect package: a micro system with limitless potential, at a very competitive price with generous dealer discounts and margins, combined with full hardware and marketing support. In return we expect our dealers to be skilled in the installation of packages — either for specific vertical markets or general business applications.

Sig/net 2 is a modular system, housed in a compact unit, to which a wide range of peripherals can be attached. A system may start with a single workstation with floppy disc and be expanded to a multi-user system with virtually no restriction to the number of workstations and hard disc capacity. There are already more than 1,000 users in the UK.

Because the Sig/net operating system is CP/M compatible, it enables you to provide bespoke software easily, in addition to the very wide range of proven business software already available on CP/M.

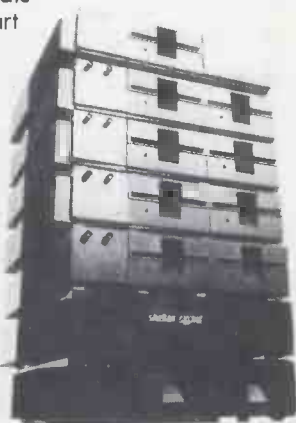

The successful British manufacturer, Shelton Instruments, is undertaking a programme of advertising, PR and exhibitions. Enquiries generated in the South-East from these promotional activities are passed on to the dealers, through DPLC. Comprehensive product brochures are also available.

To complement the Sig/net, we offer a range of terminals and printers. And there are appointed national and local organisations to provide after-sales maintenance to your customers.

To find out more details about a Sig/net dealership, fill in the coupon and return it to: DPLC Limited, 8A Walpole Street, London SW34QP. Telephone: 01-730 2890.

Please send me further details of the Sig/net dealership.

Name _____ Position _____

Company _____

Address _____

DPLC DPLC Limited,
8A Walpole Street,
London SW3 4QP.
Telephone: 01-730 2890.

SOFTWARE

ORIC-1

LYNX

JUPITER ACE

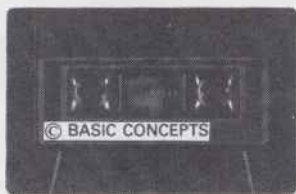

SOFTWARE

COLOUR GENIE

SPECTRUM

DRAGON

TEACH YOURSELF BASIC

ORIC-1

LYNX

COLOUR GENIE

SPECTRUM

DRAGON

BBC 'B'

TEACH YOURSELF GRAPHICS

ORIC-1

COLOUR GENIE

DRAGON

LEARN FORTH

JUPITER ACE

HAPPY LANDINGS

ORIC-1

LYNX

COLOUR GENIE

SPECTRUM

DRAGON

* WATCH THIS SPACE FOR NEW SOFTWARE
COMING SOON *

ALL CASSETTES £6.95 + 30p pack & post

BASIC CONCEPTS

PO BOX 46 0372 - 378694

LEATHERHEAD

SURREY

KT22 7XF

DEALER ENQUIRIES WELCOME

NewBrain

Buy from the NewBrain Specialists

NewBrain Models A and AD
Expanded NewBrain systems } call for prices
All the leads, cables etc.
Software Technical Manual £50

Printers Epson FX80, RX80, Shinwa CP80, Juki 6100 etc.
From £289 + VAT.

Recorder Sanyo DR 101 Data Recorder £39 + £5.85 VAT.

NewBrain Software Selection

BRAINZAP ASSEMBLER (W) An interactive assembler/editor opening up the world of Z80 machine language £9.95
MONITOR (W) The memory manager. Examine, alter, fill, move, dump, save, load, run, print, convert, etc. £8.00
DISASSEMBLER (W) Unravel the secrets of the NewBrain's ROM £9.95
DATABASE (G) Includes sort and search on any field, and many other useful features £19.95
CHESS (Gr) The one you've been waiting for! £14.95
LIFE SEARCH (W) (Adventure) Fills the NewBrain and can take two lifetimes to solve! £9.95
BRAINTEXT (W) An easy-to-use and very practical W/P. £12.00
STAR TREK (W) Rid the Galaxy of the Klingon menace – if you can! £9.00
QUADRAX/SPACE BATTLE (Gr) Two for the price of one. £9.95
BRAINWRITER (B) All the W/P features you've been waiting for! £34.50

Key to Software suppliers:

B = Brainwave, G = Gemini, Gr = Grundy, W = Watkiss Computers

Please write/phone for full lists of NewBrain hardware & software etc.

AUTHORS – DO YOU HAVE A PROGRAM WE MIGHT SELL?

MAIL ORDER – Free delivery for orders over £5.

To obtain your NewBrain etc., ring us on Stevenage (0438) 812439 (Access accepted) or send cheque/PO/Access number to:

ANGELA ENTERPRISES

4 Ninnings Lane, Rabley Heath,
Welwyn, Herts AL6 9TD

Tel: Stevenage (0438) 812439



AT LAST

A WORKSTATION
THAT WILL HOUSE
ALL YOUR
MICRO EQUIPMENT
HOME ELEGANCE
COMMERCIAL
RUGGEDNESS



STANDARD FEATURES

- * Unique cable tray eliminates all untidy cables
- * Built in 4 way 13 amp power block – only one mains cable runs to your wall point
- * Lower shelf for printer tray + storage
- * Permanent housing for all your micro equipment – eliminates expensive de-plugging and replugging damage
- * Adjustable feet
- * Compact design – 9.25 sq ft shelf area within neat 36" x 20" dimension
- * Durable & stylish satin white melamine in tough satin black frame
- * Tried, tested & approved by micro users

ALL FOR £90.00

EXTRAS TO YOUR CHOICE

- Additional 4 way 13 amp block fitted £8.00
- Special power track mains connector for up to 6 units with special plugs – this is neat (in place of power block). Track £2.50, special plugs £5.00 each.
- Rugged 2" castors in place of adjustable feet – for complete mobility. Per set £7.50.

Add 15% VAT to total order value. Delivery FREE in UK.
Send orders with remittance to:

CALANCRAFT LTD 134 St Johns Rd,
Woking, GU21 1PS. Telephone: Woking (04862) 68139

Or write or telephone for leaflet and order form.
Additional trade distributors wanted in most areas.
Special designs built for private and commercial customers – ask for quotation.

...MORE TO EXPLORE

with EE computer "add-on" projects...

NEW SERIES STARTS THIS MONTH

MICROCOMPUTER INTERFACING TECHNIQUES

Peripheral Circuits and Software

A series of articles to help the electronics experimenter build and use a range of simple peripheral units, which can be interfaced with 6502 closed microcomputers.

EE knows how to make
circuit building easy

* JULY ISSUE
on sale June 17 – 85p

EVERYDAY ELECTRONICS and computer PROJECTS

* Available from your local newsagent. In case of difficulty send £1 to:
Post Sales Dept., IPC Magazines Ltd., Lavington Street, London, SE1 0PF.

THE HR1 THE FINEST PRINTER/TYPEWRITERS MONEY CAN BUY.

Only £650 + VAT



The HR1

Bi-directional – 17 CPS – some features as below, but without keyboard and lift off facility.

CROWN RANIER – The leader of all interfaced daisy wheel printer/typewriters. Here's why:

The unbeatable Crown Ranier is the only heavy duty daisy wheel printer/typewriter which runs on a linear motor – no belts or cables to break, stretch or wear – and uses the IBM ribbon and lift off correctors. The reliability has become legend in these days of expensive electronic typewriter breakdowns.

CENTRONIC – IEEE – RS232 INTERFACES – No external boxes – interchangeable daisywheels – variable pitch – three free daisy wheels – automatic whole line correction – easily copes with standard printed forms – 195,000 characters per ribbon (at least twice the average character length) – standard lift off correctors – a printer/typewriter at the flick of a switch.

Perfection as a typewriter (now used by local authorities and multi-nationals), perfection as a printer.

Beware of lightweight, low cost machines – these can never give long term reliable service. **THIS MACHINE WILL!!** The professional machine.

Ask you local computer or office equipment dealer for further information. **EX STOCK DELIVERY.**

Compatible with
**SHARP
OSBORNE
APPLE II
APPLE III
TELEVIDEO
TANDY
BBC
MIMI
TEXAS 30/30
PET
HEWLETT PACKARD
SUPERBRAIN
SIRIUS
XEROX
IBM**

In fact most computers!

THE CROWN RANIER ONLY £795 + VAT

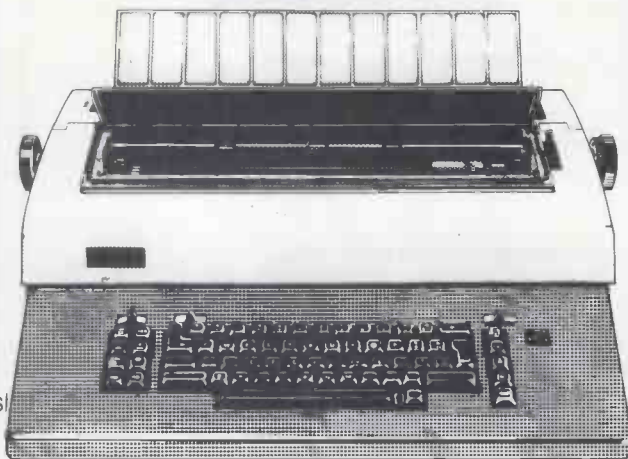

SOLE UK DISTRIBUTOR. TRADE ENQUIRIES INVITED



CROWN BUSINESS CENTRE

**56-58 SOUTH ST., EASTBOURNE,
SUSSEX. (0323) 639983.**

Knights guarantee lowest prices on Sharp & Atari

DEAL A36+2 £419 SHARP MZ-80A, 36 programs + BASIC & PASCAL languages.

DEAL A40+3 £439 MZ-80A, 40 programs + BASIC, PASCAL & FORTH languages.

DEAL A40+4 £449 MZ-80A, 40 programs + 4 languages – BASIC, PASCAL, FORTH & **KNIGHTS EXPERT MACHINE CODE.**

DEAL A113+4 £475 MZ-80A with 4 languages – BASIC, PASCAL, FORTH, and **MACHINE CODE** + 113 programs.

DEAL B3 £747 MZ-80B 76K total memory, BASIC, **MACHINE CODE** & **ASSEMBLER.**

DEAL B3+75 £859 MZ-80B with BASIC, **MACHINE CODE**, **ASSEMBLER** & **16 DIGIT DOUBLE PRECISION BASIC** + 75 programs.

DEAL P5+KA1 £363 complete SHARP P5 printer system with all cables, character generator, interface card for MZ-80A or K + **KNIGHTS COMMANDER.**

DEAL P6+KA1 £418 MZ-80K or A P6 printer system + **KNIGHTS COMMANDER.**

DEAL MZ-80FD+A1 £657 complete MZ-80A or K dual floppy system with Master Disk, manuals, card & cables + **KNIGHTS EXPERT MACHINE CODE.**

DEAL MZ-80A SYSTEM £1575 complete A system, micro, dual disks, printer, expansion unit, all cards, cables, manuals, 4 languages + 150 programs.

DEAL MZ-80A SYSTEM + 152 £1750 A system as above + disk programs for 2000 item **STOCK CONTROL** & 2000 name **MAILING LIST.**

DEAL MZ-80B SYSTEM £1899 complete B system, micro, printer, dual disks, BASIC, **MACHINE CODE**, **ASSEMBLER** + 70 programs.

DEAL MZ-80B SYSTEM + 73 £2050 B system as above + 3 **DISK PROGRAMS** – **STOCK 2000**, **MAIL LIST 2000**, & **DATA PROCESSING.**

ATARI 400 £138 26K memory + 61 programs.

ATARI 800 £299 with 58K memory + 61 programs.

ATARI 810 DISK UNIT £259 with 61 programs.

BASIC CARTRIDGE for above ATARI 400 R ATARI 800 micros £33.90.

*All prices exclude V.A.T. but include 48hr U.K. Securicor delivery.
No surcharge on ACCESS or VISA.*

This is our 9th year of selling Sharp without ever having charged to repair a Sharp product.

Ring or write for our newsletter & software catalogue which details our 600 programs.

Scandinavian versions of our Sharp software are available at LASEN-KNIGHT, STRANDGADE 22, 1401 Copenhagen K.

Knights Computers
108 Rosemount Place, Aberdeen Tel: 0224 630526

NEW FOR NASBUS/GEMINI The MAP V.F.C.

80 Column x 25 line screen, and Floppy disk controller on a single 8" x 8" professionally built plug-in card. Fully compatible with the current range of NASCOM and GEMINI products.

FEATURES: 80 x 25 paged memory mapped screen
Flicker free display
Standard ASCII character set
128 graphic chars or inverse video
Onboard software
Video switch & keyboard port options
5 1/4" floppy disk controller

Available separately as kits or built boards

| | | |
|------------------------|----------|------------|
| VIDEO CARD | £89 KIT | £110 BUILT |
| FLOPPY CONTROLLER | £95 KIT | £115 BUILT |
| VIDEO & FLOPPY | £165 KIT | £199 BUILT |
| OPTION & EXPANSION KIT | POA | |

We are pleased to announce that we are supporting our new VFC with a 5 1/4" floppy disk drive system using 96 TPI, SS/DD Teac half height drives, in a slim case complete with power supply and all cables.

| | |
|---|------------|
| SINGLE DRIVE SYSTEM (500Kb) | £299 BUILT |
| DOUBLE DRIVE SYSTEM (1Mb) | £499 BUILT |
| 256K RAM CARD - 64K Ver | £105 KIT |
| (Expandable to 256K - expansion kits POA) | £150 BUILT |

SOFTWARE - We can support most systems with CP/M software - Ring for details.

ALL PRICES EXCLUDE P&P (£1.50) & VAT

MAP 80 SYSTEMS LTD

OPENING EARLY APRIL. COME AND SEE US AT OUR NEW SHOP:
CHERTSEY COMPUTER CENTRE, 1 WINDSOR STREET
CHERTSEY Tel (09328) 64663

A LOW COST, HIGH-QUALITY DAISYWHEEL PRINTER FOR YOUR WORD PROCESSING SYSTEM



Based on the Olivetti PRAXIS 35, the TP35L operates as a high quality printer with centronics parallel input or as an electric typewriter. The TP35L printer has no messy wires or black boxes to get in your way. The parallel interface is fitted inside the printer with a neat little socket into which you plug your computer. Disconnect the computer and you have a magnificent portable typewriter.

The TP35L printer with parallel input Price £350
Available soon:

The TP35M with microprocessor control.
Parallel input, 2K BUFFER as standard, supports KB2 chars. Price £450

Also the TP35M-S as per TP35M but serial input.
Price £500

Prices are exclusive of CARRIAGE and VAT.



Z.E. SYSTEMS

481 BIDEFORD GREEN,
LEIGHTON BUZZARD, BEDS LU7 7TZ.
0525 378664

Computers for Export

Sinclair
Spectrum

Sinclair
ZX81

ORIC-1

Dragon 32

Jupiter Ace

Commodore
VIC-20



Commodore
64

Commodore
500

Commodore
700

Atari 400

Atari 800

Epson
HX-20

Plus Printers, Disc Drives, Memory Expansion, Software

Quantity discounts available

No tax charge for equipment shipped abroad

Write for our price list or call our 24hr answer phone

01-549 8229

**Galaset Ltd, 30 Bayford Road,
Littlehampton, West Sussex,
England. Telex. 8954018 Acurat G**

SINCLAIR OWNERS READ THIS FROM



You've probably heard about MACHINE CODED PROGRAMS and thought "so what! How can they help me?"

Well now you can find out and taste the very real difference by purchasing our latest MACHINE CODED programs. These emulate features of the most modern professional computers (12 years writing machine coded programs for IBM, ICL, UNIVAC and Sinclair means we know what we're talking about).

Just read the specification and you'll see what we mean.

MACHINE CODE TEST TOOL

The ultimate professional tutor and de-bug program, we wrote this to help us write our own programs.

- TEST and display machine code instructions as they're written.
- IDEAL for both the novice and the expert
- FULLY documented with a 32 page tutorial
- HEX/DECIMAL conversion as standard.
- CHARACTER GENERATOR - of unbelievable quality

Supplied free with the Spectrum version.
Available for the 16K ZX81 and 16/48K Spectrum.

SPECTRUM CHESS Dare you face The Turk

The original Turk was an eighteenth century automaton, a life-size mechanical figure resplendent in Turkish costume and seated behind a wooden cabinet on which a chess board and pieces were placed.

OCF now offer you the twentieth century equivalent of that Turk - a chess-playing computer program. The Turk challenges you to a game of chess!

MANY OPTIONS INCLUDE:

- 6 LEVELS OF DIFFICULTY
- DEMONSTRATION MODE
- BOARD EDITOR
- GAMES PRINTOUT FACILITY
- BLITZ CHESS AGAINST THE CLOCK
- TWO PLAYER MODE
- UNFINISHED GAMES CAN BE STORED
- RECOMMENDED MOVE

FULL INSTRUCTIONS PROVIDED

ADDRESS MANAGER.....

Works on the 16K and 48K Spectrum. In 48K it will store, file, select and retrieve over 400 full addresses (over 1500 individual names); Dynamic Memory Management and compression techniques makes all this possible and there's a lot more.

- FULL SCREEN INPUT and EDITING - see it as a page as it happens with insert, delete and TAB Commands.
- MULTIPLE INDEXING - 3 way user-defined index enables you to define, catalogue, select and print entries as needed, (essential for the more sophisticated applications.)
- INSTANT RESPONSE - yes, this program is very very fast.
- SUPER FRIENDLY - crash-proof, extremely easy to use and efficient in a way that BASIC can never be.

MANY USES

- AT HOME - (storing addresses, printing out Xmas Card lists etc.)
- AT WORK - for mail-order work, internal telephone directory, sorting customers into types, areas, size ... you choose.
- CLUBS - print-out members list, sort different categories etc.

MACHINE CODE.. IT MAKES ALL THE DIFFERENCE.....

Post order to: Oxford Computer Publishing Ltd., P.O. Box 99, Oxford.
Please rush me: Address Manager at £8.95 each. Spectrum only.

Chess The Turk at £8.95 each. Spectrum only.
Machine Code Test Tool at £9.95 each.

Tick box for edition required: ZX81 Spectrum
Send cheque, postal order or ACCESS No. to above address. Or telephone order with ACCESS No. to (0753) 888866

NAME:

ADDRESS:

POSTCODE:

Available from most branches of W H SMITH and other retailers

PCW/07/83

Value - MicroValue - Micro

COMPUTERS

Gemini Galaxy 2

"I would place the Galaxy at the top of my list"
(Computing Today, April 1983)

- *Twin Z80A Processors
- *CP/M 2.2 Operating System
- *64K Dynamic RAM
- *800K Disk Capacity
- *80x25 Video Display
- *Serial and parallel printer interfaces
- *Cassette and light pen interfaces
- *User definable function keys
- *Numeric key pad
- *12" Monitor included

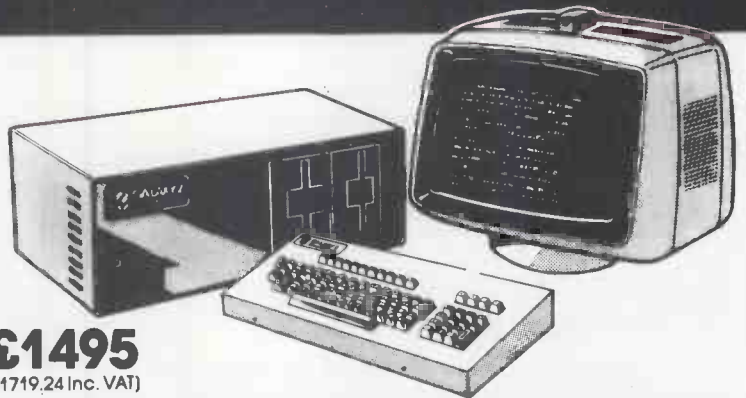

£1495
(£1719.24 Inc. VAT)

Total support for Gemini & nascom Products

nascom 3 available from MicroValue

Based around the successful Nascom 2 computer, this new system can be built up into a complete disk based system. Supplied built and tested complete with PSU, Nas-Sys 3 and Nas-Gra.

48K System
£549 (£631.35 Inc. VAT)

CP/M 2.2
£100 (£115 Inc. VAT)

NASCOM 2 KIT
£225 (£258.75 Inc. VAT)

Built & Tested
£285 (£327.75 Inc. VAT)



80x25 Video for nascom

£125
(£143.75 Inc. VAT)

Nascom owners can now have a professional 80x25 Video display by using the Gemini G812 Intelligent Video Card with on-board Z80A. This card does not occupy system memory space and provides over 50 user controllable functions including prog character set, fully compatible with Gemini G805 and G815/809 Disk Systems. Software supplied on Gemini system disks. Built and tested.

The **Microvector 256A** is a high performance graphics display interface on an 80-BUS and NASBUS compatible card. Various graphic primitives such as vector and character generation are executed in hardware by a Thompson EF9356 Graphic Display Processor. Plotting rates are typically 1 million pixels per second giving full animation capability. Various vector and character types can be selected. Characters can be scaled to give 256 different sizes. MV 256A Suitable for TV use (PAL-UHF) **£199.00 + VAT**
MV 256B Suitable for TV or RGB monitor **£220.00 + VAT**

SHARP MZ80A

£475
(£546.25 Inc. VAT)

Electronic magnificence from Sharp

Z80A C.P.U. · 48K RAM · 4K ROM · Industry standard Qwerty keyboard with numeric pad · 9" GREEN C.R.T. · 1200 baud cassette · Music and sound · Real time clock · Enhanced BASIC · Full editing facilities · Internal expansion.

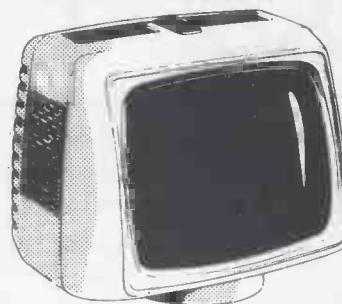

Phoenix P12 Monitor

A high quality data display monitor, ideal for all Nascom and Gemini systems. 20MHz resolution. Available in amber or green phosphor.

£110
(£126.50 Inc. VAT)

PRINTERS

Epson FX80
£436 (£501.40 Inc. VAT)

Epson RX80
£298 (£342.70 Inc. VAT)

Epson MX100 Type III
£496 (£569.95 Inc. VAT)

NEC 8023A
£339 (£389.95 Inc. VAT)

SEIKOSHA GP100A
£215 (£246.95 Inc. VAT)

Daisy Wheel Printer:

Smith-Corona TP-1 **£485** (£557.75 Inc. VAT)

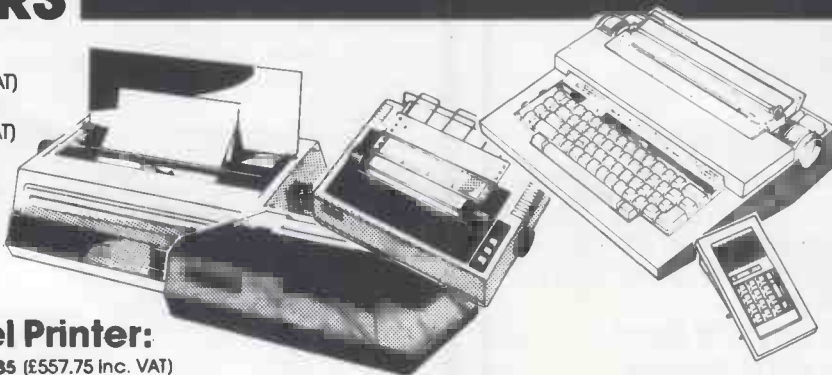

Olivetti Praxis 41

Complete with RS 232 interface and numeric key pad. This module enables the Praxis 41 to be used as:

- * a Personal Computer console
- * a quality, low volume printer
- * a typewriter communicating point-to-point, or via modem, or acoustic coupler.

£595 (£684.25 Inc. VAT)

Value - MicroValue - Micro

LOW COST SYSTEMS

NEW Micro Professor MPF II 64K

MPF II is a most exciting addition to our range. Based on 6502 microprocessor this machine offers 64K of RAM, high resolution 6 colour graphics, and sound. Standard BASIC interpreter is Applesoft compatible, allowing MPF II to read and write tapes in Apple format. Complete with excellent 600 page manual.

- * Micro Professor **£233.92** (£268.99 inc V.A.T.)
- * Joystick **£13.00** (£14.95 inc V.A.T.)
- * MPF II printer **£161.53** (£185.75 inc V.A.T.)
- * Software Cassettes **£4.34** (£4.99 inc V.A.T.)



**BUY FROM THE
COMPUTER
PROFESSIONALS**

Dragon 32

A powerful colour computer for under £200.

- * 32K RAM
- * 6809E Microprocessor
- * Extended Microsoft Colour BASIC
- * 9 Colour, 5 Resolution Display
- * Sound through TV 5 octaves, 255 tones Inc. VAT)
- * Advanced Graphics

Full range of Dragon software available.

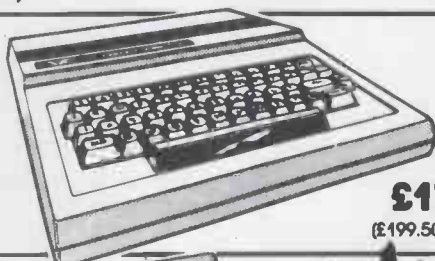

£173.47
(£199.50 inc. VAT)

Sinclair ZX81

Now available through MicroValue—
a real computer for less than £50!

- * Sinclair ZX81 Computer **£43.43** (£49.95 inc. VAT)
- * Sinclair ZX Printer **£34.74** (£39.95 inc. VAT)
- * ZX81 Learning Lab **£17.35** (£19.95 inc. VAT)
- * Software for Sinclair **from £3.43** (£3.95 inc. VAT)



**SPECIAL
OFFER**
16K RAM PACK
for ZX81
£17.17 + VAT

Sinclair ZX Spectrum

NEW LOW PRICES

Colour, sound and high resolution
graphics from only £125

- * 16K ZX Spectrum Microcomputer **£86.92**
(£99.95 incl. VAT)
- * 48K ZX Spectrum Microcomputer **£113.00**
(£129.95 incl. VAT)
- * Sinclair ZX Printer **£34.74** (£39.95 Inc. VAT)

Expand
your Spectrum
to 48K with our
new RAM PAK
£34.73 + VAT



Texas TI99-4A

Colour, sound and a typewriter type
keyboard for under £160

A truly expandable microcomputer system
with a wide range of educational and
games software.

- * Texas TI99-4A Microcomputer 16K
£139.08 (£159.95 incl. VAT)
- * Voice Synthesiser Unit **£43.43**
(£49.95 incl. VAT)
- * Peripheral Expansion Unit **£130.39** (£149.95 incl. VAT)
- * Disk Drive **£278.21** (£319.95 incl. VAT) * Disk Control board (for above) **£165.70** (£189.95 incl. VAT)



ORIC 1 ORIC 1 when used with the ORIC MODEM will allow access to PRESTEL-Vlewdata, which has 200,000 pages of interactive information covering sport, travel, hotel bookings, games, etc.



- * ORIC 1 48K Microcomputer
£147.79 (£169.95 incl. VAT)
- * ORIC 1
Communications
Modem **£68.69**
(£79.00 incl. VAT)

MICROVALUE DEALERS:

AMERSHAM, BUCKS
Amersham Computer Centre,
18 Woodside Road,
Tel: (02403) 22307

BRISTOL
Target Electronics Ltd.,
16 Cherry Lane.
Tel: (0272) 421196

EGHAM, SURREY
Electrovalue Ltd.,
28 St. Judes Road,
Englefield Green.
Tel: (07843) 3603

IPSWICH
MDW (Electronics),
47/49 Woodbridge Road East.
Tel: (0473) 78295

LONDON W2
Henry's Radio,
404 Edgware Road.
Tel: 01-402 6822

LONDON SW11
OFF Records,
Computer House,
58 Battersea Rise,
Clapham Junction.
Tel: 01-223 7730

MANCHESTER M19
EV Computing,
700 Burnage Lane.
Tel: 061-431 4866

NOTTINGHAM
Computerama,
(Skytronics Ltd.)
357 Derby Road.
Tel: (0602) 781742

Telephone orders
welcome



MicroValue

REAL value – from the Professionals

The Plug says 'No' to dirty power.

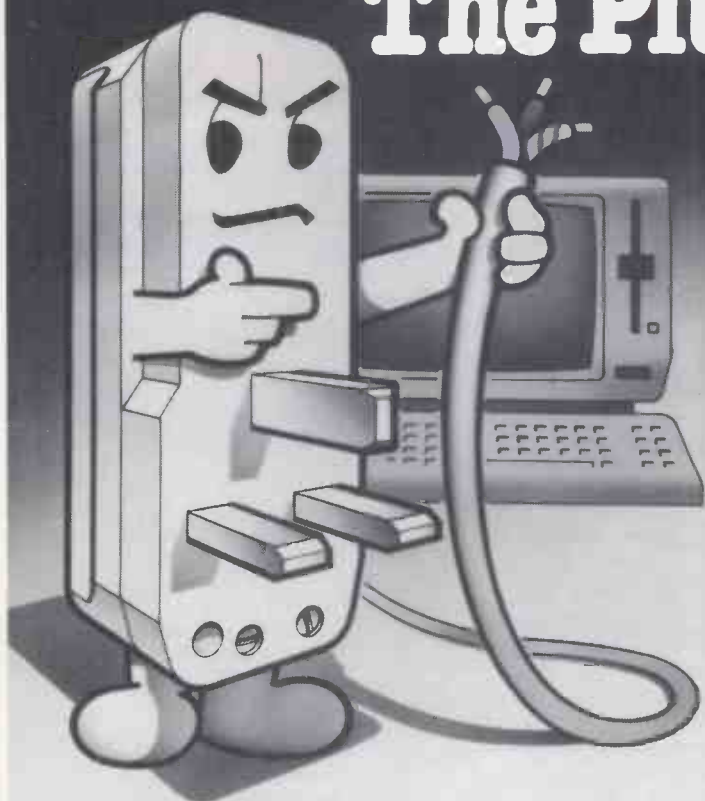

WARNING: Unfiltered power can damage your computer's health.

WHY

Because dirty power is the most likely cause of the unexplained errors and circuit malfunctions which can upset all micro based products and their users.

HOW

The Plug with its own built in filter and transient suppressor reduces the effect of electrical noise and spikes and increases the reliability of both hardware and software.

Protect your computer from unnecessary power problems, say 'No' to dirty power.



R.R.P. £15.50 including p.p.
Dealer enquiries welcome.

The Plug is available from dealers or direct from the manufacturer

FOR FURTHER INFORMATION CONTACT:

Power International Limited 2A Isambard Brunel Road,
Portsmouth, Hampshire. PO1 2DU. Tel. (0705) 756715

MAILBOX

Inter User Communication for both CP/M and MP/M (Digital Research)

| Features | CP/M | MP/M |
|---|--------------------|---------------------|
| Time and Date Stamping Message, Length (Lines or files) | As Input <64000 | Automatic <64000 |
| Text File Inclusion | Yes | Yes |
| Specific or All Users | Yes | Yes |
| Multi-Disk Access | Yes | Yes |
| Record Locking | N/A | Yes |
| Multi-user Access | N/A | Yes |

Available in 8" Single Density and many other Formats

£48.00p

VAT & Postage already included. Send cheque or use VISA/Barclaycard



Starwest
Computer Services
Limited

20 Lime Street, Bedford
Tele: (0234) 213547

THINKING ABOUT A COMPUTER FOR BUSINESS OR PERSONAL USE?

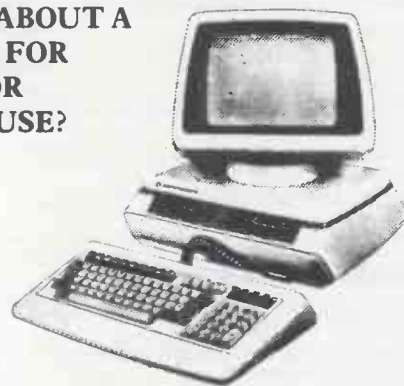

PPM have been supplying them for 5 years which makes us one of the most experienced companies in a young business.

To discuss your requirements 'phone David Chester on Brookwood (04867) 80111.

STOP PRESS !

In addition to the full range of Commodore equipment we have been appointed area distributor for the new ZORBA professional portable computer.

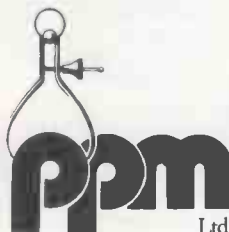

Hermitage Road St Johns
Woking Surrey GU21 1TZ

Ltd.

MicroSight

Use your BBC Model B as an image analyser with :-

MicroSight I

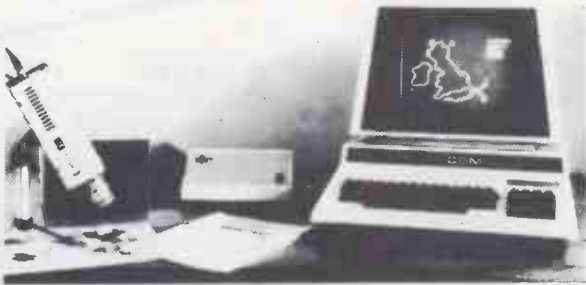

Available on BBC, Apple, Commodore, Research Machine, Sirius, etc, Includes Camera, cables, interface, software and documentation.

£495.00 + VAT

MicroScale.

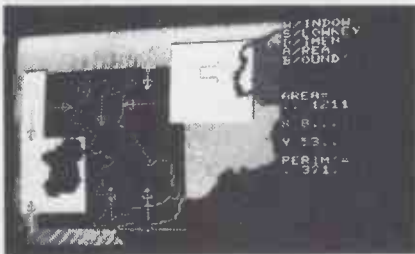

Image processing software to calculate area and perimeter of objects within a specified window also to dimension features. Disk and printer dumps of binary and grey scale data.

£295.00 + VAT

MicroEye Vision Interface.



256 x 256 pixel resolution with 255 grey levels per pixel comes complete with software and documentation. Can be used for video tape digitising Satellite picture analysis etc. Available for BBC, Apple, Commodore, Research Machine, Sirius etc.

£295.00 + VAT

DIGITHURST

Digithurst Ltd.

Leaden Hill, Orwell, Royston,
Herts. SG8 5QH

Tel: (0223) 208926

FOR BBC MICROCOMPUTER

Software

FORTH ROM & documentation £34.72 + VAT
Manual (for newcomers to FORTH) ... £6.75
STATISTICS PACKAGE £19.75 + VAT
(on 5 1/4" Disc)

Hardware & Accessories

TORCH drives & operating system ... £780.00 + VAT
Printers, drives etc (please phone for quote)

FOR EPSON HX20

Software

FORTH ROM + documentation £34.72 + VAT
(Manual available shortly)

Hardware & Accessories

EXPANSION UNIT, USV Interface etc
..... Please phone for quote

COMING SOON FOR BBC MICRO

FORTH FLOATING POINT EXTENSION (ROM)
COMPUTER AIDED LEARNING PACKAGE

OTHER MACHINES:

Dragon 32, Colon Genie, Apple, SWTPc

H.C.C.S. Associates

533 Durham Road, Low Fell
Gateshead, Tyne & Wear NE9 5EY
Tel: (0632) 821924

FACIT 4510

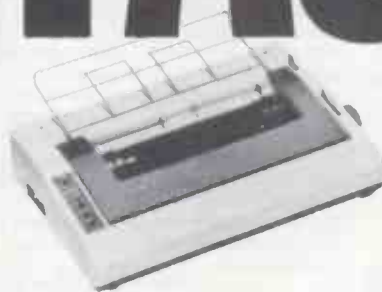

The Facit 4510 Low Cost 80-column Serial Matrix Printer is a thoroughbred micro printer.

Engineered for quality and professional computer outputs. Smart, versatile, three way paper handling, block and pin graphics secure optimum system performance.

FACIT DATA PRODUCTS

Facit Data Products Division
Maidstone Road, Rochester, Kent. ME1 3QN
Telephone: Medway (0634) 40172/7

CASTING YOUR VOTE FOR THE BYTE SHOPS IS A DECISION YOU'LL NEVER REGRET.



BBC MICROCOMPUTER

Acornsoft in stock

| | |
|--|--------|
| BBC Micro Model B | 364.00 |
| Microvitec 14" Colour Monitor inc. | |
| Cables | 249.00 |
| 12" Monochrome Monitor | 90.00 |
| Single Disk Drive 100K | 199.00 |
| Dual Disk Drive 200K | 369.00 |
| Dual d/s Disk Drives 800K | 619.00 |
| Torch Z80 Disk Pack inc. CP/M | |
| Compatible Op. System 96K RAM | 780.00 |
| Disk Interface | 95.00 |
| Disk Cable | 15.00 |
| Format Disk and Doc | 15.00 |
| Epson RX / 80 | 289.00 |
| Games Paddles | 11.30 |
| Selection of business, educational, graphics and games software available from | 3.50 |
| Selection of teach yourself BBC publications | |



EPSON HX-20 PORTABLE COMPUTER

Diminutive fully featured business computer that is small and light enough to slip into a briefcase. Specification includes integrated LCD screen and printer, 16K RAM expandable to 32K and its own rechargeable power supply. Ideal for people on the move - data can be subsequently 'down loaded' on to a larger machine when you return to base. Optional microcassette available.

402.00 ex. VAT



Epson HX Executive in stock 610.00

CROMEMCO C-10 PERSONAL COMPUTER

A full feature personal business computer system including software - for the price of a VDU. Also the entry point into the renowned Cromemco range.

1350.00 ex. VAT

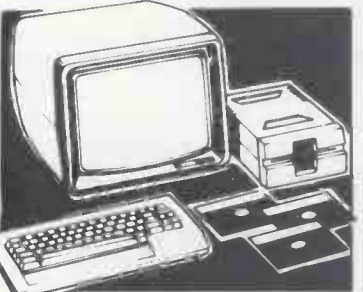

C-10 SP Personal Computer Superpak Inc Z80A Processor, 64K Memory Single 5 1/4" 390K Byte Floppy Disk 24 x 80 Screen, CKBA Keyboard CP/M Compatible Operating System plus Word Processing, Financial Planning & 32K BASIC Software 1350.00
Additional 5 1/4" Floppy Disk Drive 510.00

OSBORNE

See also System Spotlight
Osborne Portable Computer inc. Standard Software - Wordstar Mailmerge, Supercalc, MBASIC, CBASIC, CP/M: Double Density Version 1495.00
Double Density Upgrade inc. Fitting 175.00
Screen Pack 80 Column Upgrade 225.00
Screen Pack and Double Density Upgrade inc. Fitting 350.00
Osborne to Epson Cable 24.00
Special Offer on Personal Pearl I - see system spotlight. See CP/M listing for Osborne Software

PRINTERS - DAISY WHEEL

| | |
|------------------------------|---------|
| Brother HR 1 | 650.00 |
| Crown Ranier - Brother 19CPS | 795.00 |
| Diablo 620R0 25CPS | 1195.00 |
| Diablo 630R0 | 1995.00 |
| Smith Corona TP 1 | 475.00 |

IBM PC-XT

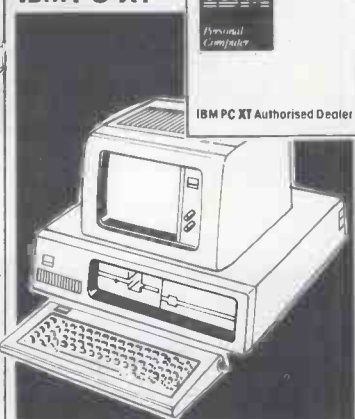

The XT is the new high performance, high speed version of the universally acclaimed IBM PC. Features include integrated 10 Megabyte hard disk drive plus 320 / 360Kb disk drive, 128K bytes of user memory and asynchronous communications as standard. The new DOS 2.0 operating system allows easier filing and access to files plus tree structured directories and is upward compatible with DOS 1.1. Also available are 10 Megabyte fixed disk expansion units for the XT and Personal Computer. As a result of 8 expansion slots allied to IBM hardware and Tecmar add on's, you have the ability to boost storage to 20 plus Megabytes (11,000 double spaced typed written pages) shared between four users. See the machine that takes a winning formula further at your local Byteshop now.

4440.00 ex. VAT

| | |
|--|---------|
| IBM PC Dual 320K Byte Disk Drives 64K Byte RAM UK Keyboard and Screen | 2477.00 |
| IBM PC Dual 320K Byte Disk Drives 128K Byte RAM UK Keyboard and Screen | 2820.00 |
| IBM Colour Adapter Card | 216.00 |
| IBM Printer inc. Stand and Cable | 509.00 |
| MICROVITEC Colour Monitor High Res | 550.00 |
| KAGA Colour Monitor Med Res | 335.00 |
| EPSON FX80 PRINTER inc. cable | 478.00 |

SOFTWARE FOR THE IBM PC

| | |
|---|--------|
| 123 Business Management Package | 359.00 |
| BSTAM Byrom Communications Package | 115.00 |
| CBASIC Compiler (C886) D/R Basic Language | 377.00 |
| CBASIC / 86 Digital Research Language | 142.00 |

PRINTERS - IMPACT

| | |
|---|---------|
| Anodex DP9500A 150CPS Matrix Printer with Graphics, Law Noise | 1215.00 |
| Anodex DP9501A As DP9500A with High Density Graphics | 1215.00 |
| Anodex DP9620A 200CPS Matrix Printer, Law Noise 100 COS in Enhanced Mode | 1295.00 |
| Anodex DP9625A As 9620A. Double Pass Correspondence Quality Mode at 50 CPS | 1450.00 |
| Anodex WP6000 Dual Mode Printer 150 / 180 CPS Correspondence Quality, 200 / 330CPS Draft and Graphics Mode. Diablo 630 Protocol Emulation | 2275.00 |
| Epson MX100FT/3 Friction and Tractor 100CPS | 499.00 |
| Epson FX / 80 160CPS | 438.00 |
| Epson RX / 80 New Model | 289.00 |

CP/M - 86 Digital Research Concurrent

| | |
|---|--------|
| CP/M Operating system | 248.00 |
| CP / M86 For IBM PC D/R Operating System | 43.00 |
| CARDBOX Caxton Database | 155.00 |
| DBASE II Ashton-tate Database Package | 437.00 |
| EASYFILER IUS Database Package | 258.00 |
| EASYPLANNER IUS Financial Planning Package | 161.00 |
| EASYSPELLER II, IUS Word Processing Package | 81.00 |
| EASYWRITER II, IUS Word Processing Package | 226.00 |
| FLIGHT SIMULATOR Microsoft Training / Games Package | 34.00 |
| MAILMERGE Micro Pro Word Processing Enhancement | 145.00 |
| MARS Sapphire Business System | 395.00 |
| MICROSTAT Ecosoft Statistics Package | 195.00 |
| PASCAL MT + 86 Digital Research Language | 377.00 |
| SPELLSTAR Micro Pro Word Processing Enhancement | 145.00 |
| SUPERCALC Sorcim Financial Planning Package | 190.00 |
| WORDSTAR Micro Pro Word Processing Package | 295.00 |
| WS + MAILMERGE Micro Pro Word Processing Package | 390.00 |
| WS + SPELLSTAR Micro Pro Word Processing Package | 415.00 |
| WS + MM + SP/S Micro Pro Word Processing Package | 510.00 |

See also CP / M86 software listing.

TECMAR PC MATE ADD ON'S AND ADD IN'S FOR THE IBM PC

| | |
|---|---------|
| TECMAR Winchester Share / 10 Expansion 10M Byte, H / D with shared system adapter for upto 4 x IBM PC's inc. expansion unit | 2295.00 |
| TECMAR First Mate, Five in one card, 64K Byte dynamic memory card c/w serial and parallel ports, clock and calendar | 320.00 |
| TECMAR Dynamic Memory 64K Bytes | 230.00 |
| TECMAR Dynamic Memory card 256K Bytes | 390.00 |
| TECMAR Scribe Tender with one serial and parallel cable | 175.00 |
| TECMAR High Res. Colour Graphics | 520.00 |
| TECMAR IEEE488 Interface | 295.00 |
| TECMAR DADIO Digital to Analog Converter | 295.00 |

The above is just a small selection from the 60 plus Tecmar IBM PC compatible add in's and add on's and specialist interfaces that we offer. There are data storage expansion units; industrial, scientific and laboratory interfaces; extended input/output expansion cards; general support; communications and software utilities. Please contact us for a full listing. Our Microservice Centres in all our stores can offer full maintenance and service facilities for the IBM PC & Tecmar PC add on's.

COMART COMMUNICATOR

Clearly the most price competitive modular computer system on the market with built-in expandability - inside and out.
Inc. CP/M From 1895.00 ex. VAT

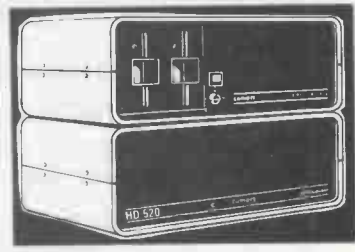

COMART COMMUNICATOR Z80A MODULAR SYSTEMS

| | |
|---|---------|
| Comart CP100 'Communicator' Micro Computer Z80A Processor, 64K Byte Memory, Dual 5 1/4" Floppy Diskette Drives each storing 390K Bytes of Data. Dual Serial and Parallel Ports. 10 Slot S100. Bus CP/M Version 2 included | 1895.00 |
| Comart CP200 as CP100 except Dual 790K Byte Diskette Drives | 2195.00 |
| Comart CP500 as CP100 except one 790K Byte Diskette Drive and one 5" Winchester Drive having 4 8M Bytes of Formatted Data | 2995.00 |
| Comart CP520 as CP100 except one 790K Byte Diskette Drive and one 5" Winchester Drive having 19M Bytes of Formatted Data | 3995.00 |

COMART COMMUNICATOR 8086 MODULAR SYSTEMS

| | |
|---|---------|
| Comart CP1100 Communicator Micro Computer 6MHz 8086 Processor, 128K Byte Memory with Parity, Dual 5 1/4" Floppy Disk Drives each storing 390K Bytes. Dual Serial and Parallel Printer Ports 10 Slot S100 Bus inc. CP/M86 & MS-DOS | 2295.00 |
| Comart CP1202 As CP1100 except Dual 790K Byte Diskette Drives with 256K Byte Memory | 2745.00 |
| Comart CP1522 As CP1202 except 1 x 790K Byte Diskette Drive and 1 x 5" Winchester Disk having 19M Bytes of Formatted Data with 256K Byte Memory | 4545.00 |

UPGRADE SERVICE KITS

Wide range of factory fitted 8 to 16 Bit and floppy to hard disk upgrade kits available for communicator systems.

BYTESHOP FOR THE PROFESSIONAL

There are so many micro computers on the market that choosing the right one is far from easy. And if it isn't made any easier when you find the one that fits your needs, hi-fi and a host of other electrical equipment. What you need is someone that is single minded. And that means us. Byteshops are totally dedicated to microcomputers. So, not surprisingly, we can offer you a wider range because we sell nothing else. Our prices are keener too. So are our staff. Each one is an expert who can make sure you get the computer that's exactly right for you - whether it's a home micro or a £20,000 business system.

What's more we'll freely advise you on expanding or upgrading your system as your knowledge grows or your requirements change. While our Microservice Centres offer full service and maintenance on site and at our shops. And our product support specialists are your assurance of our total commitment to after sales service. After all, we are the UK's longest established microcomputer specialists. Come and see us soon.

COMART SUBSYSTEMS

PRICES EXCL. VAT

Comart CB200 Cartridge Tape Back-Up Subsystem for Hard Disk... 2495.00
 Comart HD520 5" x 20M Byte Hard Disk Subsystem (requires HDCONT or can be added to a CP520 or CP 1520)... 2395.00
 Comart HDCONT Winchester Disk Controller for 2, 20M Byte Drives... 195.00
 Comart FD800 8" Floppy Single Disk Drive Subsystem; Single Sided, Single Density IBM 3740 Compatible (requires C-IFDC)... 995.00

COMART MULTI USER CONFIGURATIONS

Comart CP520/M CP520 Communicator System with 256K Byte Memory and 6 Serial Interfaces Includes CP/M and MP/M II... 4995.00
 Comart CP 1525/M CP1520 Communicator with a total of 512K Byte Memory and 10 Serial Interfaces Includes CP/M86 and MP/M86... 5995.00

COMART MULTI PROCESSOR CONFIGURATION

Comart CP500/M CP500 Communicator System with 256K Byte Memory & 6 Serial Interfaces inc. CP/M & MP/M II... 3995.00
 CP520 MP Multi Processing Communicator System c/w 1 x Z80A main and 5 x Z80A slaves. 64K Byte main memory + 5 x 64K Bytes, 1 x 790K Byte Diskette Drive + 1 x 5" 20 Mega Byte Winchester Disk Drive, 12 Serial & 6 Parallel Interfaces. inc. CP/M & Multi processing system software, £6995

\$100 BOARDS

Comart CRAM64 64K Byte Dynamic RAM with Bank Select... 200.00
 Comart CMPU Multi-Processing Add-In Card with Z80A Slave Processor, 64K Byte Dynamic RAM 2X Serial & 1X Parallel Interface... 495.00
 Comart CRAM256 256K Byte Dynamic RAM with Parity, 8 and 16 Bit Data. IEEE696 Compatible. Also supports 8 Bit Bank Switching... 550.00
 Comart C-CPU86 8086 Processor Card, with Dual Serial and Parallel Ports. Monitor in 8K EPROM and 4K RAM... 300.00
 Comart C-IFDC Intelligent Diskette Drive Controller with Z80A Processor... 295.00
 Comart C-CPU Z80A system Processor Board incl. 2 Serial / 1 Parallel Port... 200.00
 Comart 4S 10 4 Channel Synch/Asynch Interface Board... 250.00
 Cromemco IOP I/O Processor Board with Z80A, EPROM, RAM and C-BUS 'Off Card' Interface... 425.00
 Cromemco QUADART 4 Channel ASYNCH / SYNCH Interface Board (Requires IOP)... 510.00
 Cromemco Single Card Computer Z80A, SCC, EPROM, RAM, Serial & Parallel Ports... 425.00
 Dual Systems CEM32 32K CMOS Battery Supported Memory... 1350.00
 RTC1 Real Time Clock Card / Prototype Board... 150.00

CROMEMCO 68000/Z80A SUPER MICRO SYSTEMS

Cromemco CS 1D2 System 1 inc. Dual 390K 5" Floppy Disks, DPU, 256KZ and 16 FDC Cards in 8 Slot S100 Card, Table Top Enclosure... 3730.00
 Cromemco CS1 HD2E System 1 Including Single 390K 5" Floppy Disk, 5.5M Byte 5" Winchester Disk, DPU, MCU, 256MSU, 16FDC, WD12... 6345.00
 Cromemco CS 1HD2 As System 1 except 256KZ Memory without MCU... 5970.00
 Cromemco CS 1HD5E as CS1 HD2E but with 512MSU... 7090.00

CROMEMCO SOFTWARE FOR 68000/Z80A SERIES

Cromemco CRO-D Cromix Multi-User/Multi Tasking (Unix Based) Operating System 445.00
 Cromemco FOR-D Fortran '77... 445.00
 Cromemco PAS-D ISO Pascal... 445.00
 Cromemco ASM-D 68000 Macro Assembler... 445.00
 Cromix (CRO-D). All Software is available on 5" or 8" Floppy Disks - Please specify. All 68000 Languages require Cromix.

VDU'S & MONITORS

Comart WY100 Visual Display Terminal, Green Display, 24 x 80 and Status Lines. Detached 105 Key Keyboard with Numeric Pad, Function, Cursor and Editing Controls. Swivel and Tilt Display... 725.00
 Comart WYSEWORD Wordstar option... 30.00
 Volkercraig 4404... 595.00
 Volkercraig 4404WS... 695.00
 12" Green Screen Monitor... 99.00

BOOKS

Very wide range of computer books stocked at all shops.

DISKETTES

Byteshop 5 1/4" Single Sided, Single Density... 1.70ea
 Byteshop 5 1/4" Double Sided, Double Density... 2.13ea
 Dyan 5 1/4" Double Sided, Double Density... 4.70ea
 Dyan 8" Double Sided, Double Density... 5.80ea
 Full range of Dyan 5 1/4" & 8" Diskettes in stock

HOME COMPUTER SOFTWARE

Available for IBM PC, VIC, BBC, ZX81. Spectrum. Call for availability.

CP/M SOFTWARE

BASCOM Microsoft Basic Compiler... 272.00
 BASIC-80 Microsoft Basic Interpreter... 241.00
 BAZIC Micromikes Basic Language... 120.00
 BSTAM BYROM Software Communications Package*... 130.00
 BSTMS BYROM Software Communications Package... 130.00
 C-86 D/R C Language with UNIX Version 7 Compatible Run Time Library... TBA
 CALCSTAR Micropro Financial Planning Electronic Spread Sheet Package... 90.00
 CARDBOX Caxton Store/Search... 155.00
 CB80 Digital Research Basic Compiler... 355.00
 CB86 D/R Basic Compiler... 426.00
 CBASIC Digital Research Basic Language... 106.00
 CBASIC/86 D/R Basic Language*... 231.00
 CIS COBOL Microfocus COBOL Language*... 425.00
 COBOL-80 Microsoft COBOL Compiler... 516.00
 CP/M-86 DISPLWR Digital Research Operating System... 231.00
 CP/M-86 + CBASIC 86DW Digital Research Operating System + Language... 430.00
 DATASTAR Micropro Database Package... 175.00
 DBASE II Ashton-Tate Relational Database + ZIP... 437.00
 FILESHARE (CIS) Microfocus Utility... 250.00
 FILESTAR Microsec's Disk Reformatter CP/M to IBM, DEC, Motorola and Intel Formats... 110.00
 FMS-80 DJR Assoc. Database/FM... 650.00
 FMS-81/82... 350.00
 FORMS 2 Microfocus Table Maker*... 110.00
 FORTRAN-80 Microsoft FORTRAN Compiler... 344.00
 GBS Bytesoft General Business System 795.00
 INFOSTAR Micropro Database Reporter 295.00
 ISL Bytesoft Accounting Package... 1095.00
 LEVEL II COBOL Microfocus Language* 965.00

SYSTEM SPOTLIGHT



Present this voucher at time of purchase of your Osborne System and we will allow you £100 off the price of the Personal Pearl Database/FM Software Package. (value £110)

OSBORNE MICRO SYSTEM

Buy the world's best selling portable business computer from any Byteshop and we'll give you a massive £100 discount off the price of the Personal Pearl Database/FM Software Package. The Osborne 1 is the personal small computer system that is housed in a durable but lightweight 'snap together' case. Features embrace 64K RAM, dual floppy disk drives and we also throw in 100 sheets of paper so that you can start work straight away! The price also includes the following comprehensive business software programmes:
 • SUPERCALC for electronic spreadsheets.
 • WORDSTAR for word processing with MAILMERGE.

• CP/M the control programme that gives you access to the world's biggest library of software options.
 • CBASIC and MBASIC for programming.

1,495.00 ex VAT

Also special Osborne 1 package including the new Epson RX80 Printer. 1,695.00 ex VAT

• Double Density
 NB. The voucher on the corner of this magazine must be presented at time of purchase to ensure a £100 discount off the price of the Personal Pearl Software Package. Offer valid until 31st July, 1983.

PRICES EXCL. VAT

MACRO-80 Microsoft Macro Assembler... 137.00
 MAILMERGE Micropro Wordprocessing Enhancement to link with WORDSTAR* 145.00
 MARS Sapphire Business System*... 395.00
 MICROSTAT Ecosoft Statistics Package 210.00
 MILESTONE Organic Software Critical Path Package*... 250.00
 MULTIPLAN Microsoft Financial Planning Package... 189.00
 PASCAL/MT + D/R Pascal Language with Speed Programming Tool... 248.00
 PASCAL/MT + 86 Digital Research Pascal Language for 16 Bit Systems... 426.00
 PEACHTREE Basic Accounting System per module... 325.00
 PEACHTREE Business Management System per module... 600.00
 PERSONAL PEARL Pearl Data Base/FM 185.00
 PL/1-80 Digital Research Language... 390.00
 PL/1-86 Digital Research Language... 532.00
 REPORTSTAR Micropro Reporter... 210.00
 RESCUE MBS Database... 295.00
 SPELLSTAR Micropro Proofreading Utility to link with WORDSTAR*... 145.00
 SUPERCALC Sorcim Financial Planning/Budgeting Spread Sheet Package*... 190.00
 SUPERSORT Micropro Sort Utility... 145.00
 SUPERVYZ Epic Application Control... 97.00
 T/MAKER II Lifeboat Associates Financial Planning/Spread Sheet Package... 195.00
 WORDSTAR Micropro Wordprocessing Package* Also available with Mailmerge and Spellstar... 295.00
 WP WORKSHOP MAC Ltd Training Guide for WORDSTAR or MAILMERGE... 75.00
 X BASIC Xitan Language... 185.00
 X BASIC 86 Xitan Language... 250.00
 X CP/M Xitan/DR Operating System... 130.00

Many Utilities, Programming Tools and Training Packages available. Also extensive range of diskette formats. Prices include configuration on machines supplied by ourselves. We are totally committed to after sales service and future support.
 * These software packages are available for both CP/M and CP/M86.

ALL PRICES EXCLUSIVE OF VAT
 • Barclaycard Visa & Access cards taken in payment.
 • Shop opening hours 9-5.30, check individual shops for details of Saturday opening times.
 • Phone Mail Orders accepted. Please contact nearest shop for P.P. & Delivery Rates. Regret no C.O.D.

Some Items may be subject to a dollar surcharge if the dollar exchange rate changes more than 5 cents. Prices will be adjusted in line with the rate prevailing at the time of purchase.
 • Prices subject to change without notice E.&O.E. and are valid for the cover date life of this magazine (July 83)
 • Whilst we carry a vast range of stock, we cannot guarantee that every advertised item will be available in each shop.
 • All goods are new and include factory warranties.
 • No refunds on opened software.
 • Orders from Government Depts., Colleges & BFPD addresses welcome for orders above £25.
 • Leasing & HP facilities available - apply for written details.
 • Detailed prices available on request.



BYTESHOP FOR THE BUSINESSMAN
 You wouldn't go to a lawyer for medical advice, or take your tax problems to a doctor. It's just as illogical to talk computers to anyone but a computer expert.
 Every Byteshop is a specialist computer store. In it you will find nothing but computers and computer people. There is nothing else to distract you. Every Byteshop can show you the very latest personal computer systems and provide solutions to both specific and specialist requirements. Word processing, production control, accounts financial planning and data bases are just a few of the most popular applications.
 We can also offer everything allied to micro-computers, such as stationery, diskettes, boards, ribbons for your printer, books, tapes and print wheels.
 Just as important, you will have the undivided attention of a computer expert. Our staff have been trained on all our machines and peripherals and can give you sound advice and assistance with complete impartiality.
 Even if you have to travel a few extra miles it will certainly pay to come to the experts.

THE BYTESHOP

Your Specialist Computer Centre

LONDON
 The Byteshop,
 324 Euston Road NW1 3BG
 Tel: 01-387 0505

BIRMINGHAM
 The Byteshop,
 94-96 Hurst Street, B5 4TD.
 Tel: 021-622 7149

GLASGOW
 The Byteshop,
 266 St. Vincent Street, G2 5RL.
 Tel: 041-221 8202

MANCHESTER
 The Byteshop, 11 Gateway House,
 Piccadilly, Station Approach,
 M1 2GH. Tel: 061-236 4737

NOTTINGHAM
 The Byteshop,
 92a Upper Parliament Street,
 NG1 6LF. Tel: 0602 40576

SOUTHAMPTON
 Also at XITAN systems,
 23 Cumberland Place, SO1 2BB.
 Tel: 0703 334711

THE EPSON QX-10 FROM TRANSAM

- Multi-font Basic, supports 16 character Fonts on screen
- 192k Ram expandable to 256k supplied as standard
- Clock and calendar with battery back-up
- New slimline disc drives
- Unique split screen facility
- Unique price

£1735 plus VAT

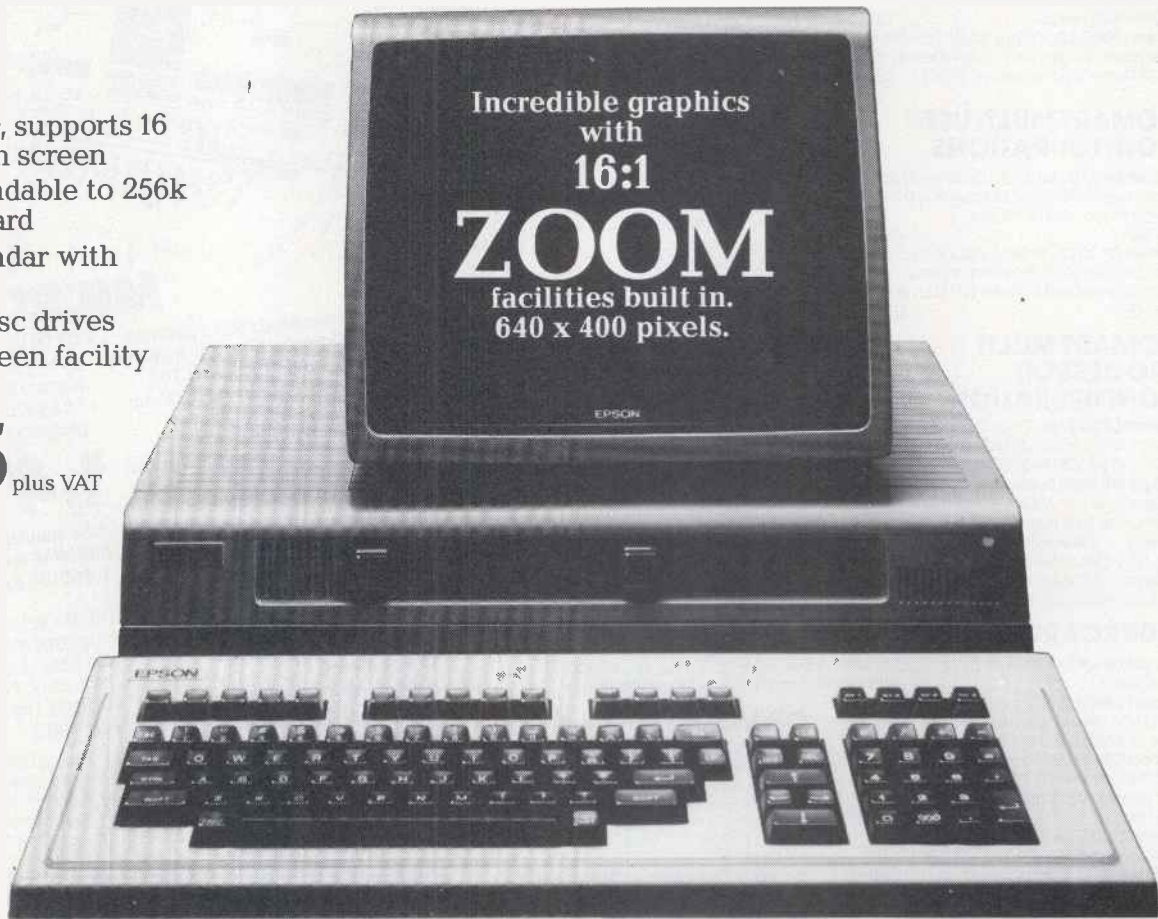

A FULLY INTEGRATED DESKTOP MICROCOMPUTER SYSTEM.

The QX-10. A fully Integrated Desktop Microcomputer system that takes the hard work out of using software. An incredible new member of the Epson family, emphasising cost effective computing on your desk. The QX-10 gives you a lot more for your money.

Lightweight, Z80A CPU, VDU and Keyboard units in modern functional design.

Very easy to use - specially for the first time operator.

More Power for your money. 192k upgradable to 256k RAM. Incredible graphics capability with zoom facility, RS-232C and parallel interfaces and multi-font BASIC as standard. Compare that with systems costing twice the price.

Add-on power. Simply slot in up to 5 optional interface cards for the following facilities:-

| | |
|-----------------|--------------------------|
| Cassette | Omninet |
| Bar code reader | Universal interface card |
| Joysticks | for developing your own |
| Sound generator | interfaces |

80 col. x 25 lines screen with full bit image control, 640 x 400 resolution for greater definition. 16:1 zoom and special effects as well as unique split screen facility allowing different typestyles and graphics to be shown together for educational applications.

TCL SOFTWARE - the software division of Transam, offer complete CP/M software support for the QX-10 and a professional software service to guide you through all the available options.

Combining the resources of Transams experience with CP/M Based systems and software with Epson innovation and reliability means we can offer you your best buy in 1983.

The QX-10 personally packaged by Transam.

THE HUMAN COMPATIBLE MICRO

We also stock the new range of Epson RX and FX printers.

Please send me further information on the QX-10 and software products by return.

Name

Company

Address

Tel. Interest



Tel. Orders Accepted on VISA and ACCESS, or visit our London Showroom.

Transam
MICROSYSTEMS LIMITED

59/61 Theobalds Road, London WC1.
Telephone: 01-405 5240/2113

WITH TOTAL SUPPORT FROM TCL SOFTWARE

TCL Software, a division of Transam, offers one of the most comprehensive ranges of CP/M based software. We support most of the popular microcomputers available which gives us the strength, in depth, to identify the best.

We offer the professional system solution.

PERFECT SOFTWARE FOR QX-10

Introducing the PERFECT SOFTWARE range of office software. Available now for QX-10 as well as other CP/M based micros.

| | |
|----------------------|------|
| Perfect Writer | £215 |
| Perfect Speller..... | £75 |
| Perfect Calc | £165 |
| Perfect Filer | £215 |

Perfect Writer re-thinks the whole approach to word processing. All the standard features plus split screen editing on two files or two parts of a single file. Automatic footnotes, indexing, page referencing and paragraph numbering facilities. One set of commands common to all Perfect Software packages and links directly with Perfect Speller, Calc and Filer. Perfect Calc supports up to seven worksheets on line at once and split screen editing. Functions and formulae can be defined by the user. Files can be associated and re-calculated in order of dependency. Perfect Calc also links with Perfect Filer, to fetch data and to Perfect Writer to create reports. Please contact us for further information.

| | |
|-----------------------|------------------------|
| GENERAL OFFICE | Survey Analysis |
| Wordprocessing | Mathematical |
| Card index | Estate Agents |
| Databases | Authoring |
| Mailing | Time Tabling |
| Reports | OTHER LANGUAGES |
| BUSINESS | TCL Pascal |
| Accounting | C Compiler |
| Payroll | CIS Cobol |
| Stock Control | COBOL 80 |
| Job Costing | Comal |
| Bookkeeping | Forth |
| Financial Modelling | Fortran |
| Time Recording | COMMUNICATIONS |
| PROFESSIONAL | DEVELOPMENT |
| Scientific | AND UTILITY |
| Statistics | PROGRAMS |
| Planning | |

THE EPSON HX20 PORTABLE COMPUTER **£402**

+ VAT

As a stand alone portable or linked to your CP/M based computer, the HX-20 takes computing a step further. Unlimited horizons on a limited budget.

Transams portable computer centre offers a wide choice of portable equipment and software. The HX-20 has taken pride of place. Software now available includes:-

| | |
|--|--------|
| CARD INDEX - System/Data Base..... | £25.00 |
| DIARY - 3 month rolling diary..... | £25.00 |
| DIY - Do it yourself system generator..... | £30.00 |
| SALES ORDER ENTRY - For Travelling Reps..... | £40.00 |
| EPSON CALC- Financial spreadsheet/reports..... | £30.00 |
| COMMUNICATIONS ROM - ISO Standard..... | £30.00 |
| CORRESPONDENT 20 - Portable Word Processor ... | £25.00 |
| MAILING LIST - and label printing..... | £30.00 |
| GAMES 1 + 2 - a selection of games, each..... | £18.00 |



A computer small enough to fit into a briefcase yet with a full size typewriter keyboard, LCD virtual screen, printer and microcassette facility actually built in. High speed serial communication with other computers plus the Epson reliability - a world beater.

| CODE | | PRICE |
|-----------|--|------------------|
| HX20UA | Portable Micro Unit with Operating Manual Vinyl Case | £402.00 £9.00 |
| HX20MC-SA | Microcassette Drive | £75.00 |
| HX20EU-SA | Expansion Unit | £80.00 |
| H00BR-JA | Bar Code Reader | £82.00 |
| HX20RC-SA | ROM Cartridge | £45.00 |
| H00AAU | Spare Mains Adapter | £8.50 |
| SHX700 | Sendata Acoustic Coupler | £220.00 |
| CAB 702 | External Cassette Cable | £5.70 |
| CAB 705 | Acoustic Coupler Cable | £15.00 |
| CAB 714 | Terminal Printer Cable | £15.00 |
| CAB 716 | Local Network Cable HX20/HX20 | £15.00 |
| CAB 717 | Serial Interface Cable | £15.00 |
| THX01 | Parallel Interface Unit | £85.00 |
| H00RP | Paper Rolls (5) | £2.60 |
| H00CR-RA | Printer Ribbons | £2.20 |
| MC-TAPES | Microcassette Tapes | £1.60 |

NEW INTELLIGENT TERMINAL EMULATION AND TEXT EDITOR.

New from Transam, the software (in ROM) allows your HX-20 to interface with any computer and act as a terminal to transmit and receive with 'off line' editing. Full screen editor for text preparation.

Plug in ROM and documentation **£45.00** plus VAT.
Sendata acoustic coupler **£220.00** plus VAT.



Construction Costs Profile

A - Materials (24%)
B - Overhead (33%)
C - Land (27%)



The new TI Professional Computer. If you want the business edge, it's the answer.



Today's business manager is faced with a world of questions, often tough. Questions about productivity. Cost control. And the bottom line.

To help you come up with sharper answers and alternatives, to give you the business edge, we introduce the new Texas Instruments Professional Computer. The one with the power, the expandability, the easiest-to-use keyboard, extremely high resolution graphics, and a broad array of software.

All the leading operating systems and programming languages are available. You can use many

popular application programs from the best software suppliers to help you create spread-sheets, do word processing, construct graphics, communicate with other data bases or create your own.

All of which lets you control assets, manage your time, and make projections for tomorrow's performance—today.

And for a clear "hard copy" printout of information, you can rely on the new 850 Series printers, made by Texas Instruments especially for the new TI Professional Computer.

The TI Professional Computer

helps you make better business decisions based on better information. With the performance and reliability you expect from TI.

In short, it's the answer.

For full information phone 0234 223000 or write to Texas Instruments, Manton Lane, Bedford MK41 7PA.



TEXAS INSTRUMENTS

Creating useful products
and services for you.

SPECIFICATIONS

System Unit

16-bit, 8088 microprocessor
64K byte RAM, expandable to 256K bytes
4K byte graphics display memory
5-slot expansion bus

Keyboard

Specially designed low profile
Popular typewriter layout
97 keys, including 12 function keys
Separate numeric keypad and cursor control clusters
Tactile response, for quick positive entry
Upper- and lower-case letters

Display Units

12-inch monochrome (green phosphor) or
13-inch full-colour, 25 lines x 80 columns
High resolution, 720 x 300 pixels

Mass Storage

Built-in 320K byte diskette standard
Additional internal storage of 320K byte
diskette, or 5 or 10 Mbyte Winchester disks
optional

Communications Options

TTY, 3780
3270 SNA stand-alone
3270 BSC and SNA cluster

Operating Systems

MS™ -DOS, Digital Research™ CP/M-86®,
and Concurrent CP/M-86™ UCSD p-System™

Languages

BASIC, COBOL, FORTRAN, Pascal

Applications Software

Over 100 programs available from the most
popular software vendors such as Microsoft,
Ashton-Tate, Micro-Pro, IUS, Sorcim, MPSP,
Lifeboat and others

Printers

150-cps TI 850 Series for most applications

FOOTNOTES: MS-DOS is a trademark of Microsoft Corporation. CP/M-86 and Concurrent CP/M-86 are trademarks of Digital Research Inc. UCSD p-system is a trademark of the Regents of the University of California

Let  **PHILIPS** put a word in
for your business (or thousands of words)

The P2000 word processing system

... lets even one finger typists turn out secretary-perfect letters. Time after time after time.

And it costs from under
£2000 complete with
letter quality printer!

The P2000 system brings word processing power within the reach of practically any small business. Accountants, small contractors, solicitors, sole traders. In fact anyone who needs to put out letters, quotations, invoices, etc. quickly, neatly and accurately.

No more hasty alterations giving your letters that 'amateur' look. No more frantic retyping when you realise you need to make a change just before last mail collection. You can change text, correct errors, add or delete words or paragraphs, all at the touch of a few keys.

If you want more than one original it's no problem. You can even send the same letter to all your mail list, each individually titled. You'll soon find that the P2000 pays for itself in time saved, not to mention what it does for your business image.

Of course, the P2000 will do more if you want it to. For relatively small extra cost it will handle book-keeping, statistics, record filing and all those other office chores.

And all underwritten by the Philips' reputation for quality and reliability. It's simply for everyone.



Philips Micro-Computer

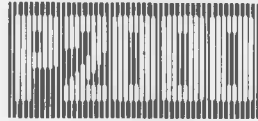

Simply for everyone.

**TO FIND OUT HOW
PHILIPS CAN PUT A WORD IN FOR
YOUR BUSINESS, CONTACT:**

Technical

| | |
|-----------------------------------|--|
| Screen | : 12" non-reflective green screen. 24 lines of 80 characters. |
| Keyboard | : Full typewriter style. Numeric/ function keypad. |
| CPU | : Z80 2.5 MHz. 48K RAM. |
| Disks | : Two built-in 140K mini-floppy drives as standard. : Optional two drive expansion chassis. |
| ROM | : Programs loaded by inserting 16K ROM modules. |
| Printer | : Philips P2121 daisy wheel printer, 25 cps. |
| Basic WP package (under £2000) | : Computer with 48K RAM. Two floppy drives. Word processing ROM. P2121 daisy wheel printer. |

pd MICRO
DESIGN

DEALER ENQUIRIES WELCOME

Oakfield House, 56 Crewe Road, Sandbach
Cheshire CW11 0NN

Tel: (09367) 61231 Telex: 36690 Ref: 505

PLAY THE NUMBERS GAME WITH DIGITAL SOLUTIONS!

Undoubtedly the most flexible promotion ever—with a guarantee of total support.

EXAMPLE OFFER:

SIRIUS HARD DISK SYSTEM£3995
includes over £1000 of equipment from our extensive range

Such as—PULSAR SALES Value £195
PULSAR PURCHASES £195
PULSAR NOMINAL £195
SMITH-CORONA TP1 £485

Total £1070 FREE!!

OTHER EXAMPLES (There are too many to list them all)

SIRIUS 1.2 Mb, 128K RAM DUAL FLOPPY£2395
includes £600 of free equipment

SIRIUS 2.4 Mb, 128K RAM DUAL FLOPPY£2895
includes £700 of free equipment

SAGE 1.3 Mb, 512K RAM DUAL FLOPPY£3995
includes £600 of free equipment; free maintenance for 12 months

(All other SAGE models available)

FORTUNE 5 Mb HARD DISK, 800Kb FLOPPY, FULL WORD-PROCESSING, 256K RAM£5995
includes £1100 of free equipment

(All other FORTUNE models available)

DEC, IBM etc ... coming soon.

All cables, 48 hr delivery, 90 day warranty, installation, advice etc ... FREE ...

PERIPHERALS AND SOFTWARE:

| Sell at | | Sell at | | Sell at | | Sell at |
|--|-----|-----------|---------------|----------------|------|---------|
| EPSON RX-80 £265 | OKI | M80A £235 | PULSAR | Informer Dbase | £295 | |
| FX-80 £365 | | M82A £379 | Nominal | Micromodeller | £595 | |
| | | M83A £535 | Sales | Supercalc | £150 | |
| | | M84A £949 | Purchases | Multi-Plan | £159 | |
| OLIVETTI JP-101 | | | Payroll | Wordstar | £295 | |
| £320 | | | Stock Control | Select | £295 | |
| 5 other matrix printer ranges available | | | Invoicing | Mailmerge | £95 | |
| SMITH-C TP1 £415 | | | Data Analysis | Dbase 2 | £395 | |
| EL2000 £619 | | | | | | |

12 other daisywheel ranges available

**MOST OTHER SOFTWARE PACKAGES AVAILABLE
ALL MACHINE UPGRADE COMPONENTS AVAILABLE
MAINTENANCE CONTRACTS ARRANGED**

CALL FOR A QUOTE ON PERIPHERALS & SOFTWARE WITHOUT MACHINE PURCHASE.

CALL OR WRITE TODAY:

DIGITAL SOLUTIONS LTD.

88 WAVENEY RD
ST. IVES
CAMBS

HUNTINGDON (0480) 300728

BBC Micro Computer System

OFFICIAL DEALER. Please phone for availability

BBC COMPATIBLE DRIVES SINGLE;
DUAL:
DRIVE CABLES:
 Single £8 Dual £12
 Disc Manual & Formatting Diskette £17.50



BBC Model B £399

(inc. VAT) Carr. £8

Model A to Model B upgrade kit £50

Fitting charge £15

Partial Upgrades also available

TORCH Z80 DISC PACK

£780

TELETEXT ADAPTOR
£195

BUSINESS EDUCATION AND FUN SOFTWARE IN STOCK

BBC WORD PROCESSOR 'VIEW'
 16K ROM £52
 WORDWISE 8K ROM £39

All mating Connectors with Cables in stock.
 Full range of ACORNSOFT, PROGRAM POWER & BUGBYTE SOFTWARE AVAILABLE.

BBC FLOPPY DISC DRIVES

FD INTERFACE £95 INSTALLATION £20
 Single Drive 5 1/4" 100K £235 + £6 carr.
 Dual Drive 5 1/4" 800K £799 + £8 carr.

BBC COMPATIBLE DRIVES

These drives are self powered and supplied in BBC matching colour cases.
 SINGLE 100K £180; 200K £250; 400K £330
 DUAL 200K £350; 400K £475; 800K £590

Phone or send for our BBC leaflet.

RUGBY ATOMIC CLOCK

This Z80 micro controlled clock/calendar receives coded time data from NPL Rugby. The clock never needs to be reset. The facilities include 8 independent alarms and for each alarm there is a choice of melody or alternatively these can be used for electrical switching. A separate timer allows recording of up to 240 lap times without interrupting the count. Expansion facilities provided. See July/August ETI for details. Built and tested. £145 + £2 p&p.

MONITORS

MICROVITEC 1431 14" Colour Monitor £249 + £8 carr.
 MICROVITEC 2031 20" Colour Monitor £319 + £8 carr.
 KAGA 12" Colour Monitor RGB £255 + £8 carr.
 Lead for KAGA/SANYO RGB £10
 SANYO HIRES GREEN MONITOR £99 + £6 carr.
 SANYO HIRES RGB MONITOR £445 + £8 carr.

BBC BOOKS (No VAT)

Basic on BBC £5.95 30 House Basic £5.95
 Programming the BBC Micro £6.50
 BBC Micro An Expert Guide £6.95
 Assyl Lang Prog. for BBC £8.95
 6502 Machine Codes for Beginners £6.95

NEC PC 8023 BE-C

100CPS, 80 cols. Logic Seeking, Bidirectional, Forward and Reverse Line Feed, Proportional Spacing, Auto Underline, Hi-Res and Block Graphics, Greek Char. Set. Only £345 + £8 carr.

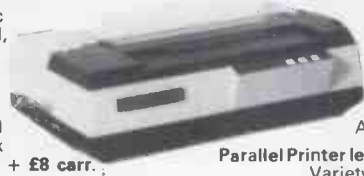

PRINTERS

SEIKOSHA GP 100A

80 Cols 30 CPS
 Full ASCII & GRAPHICS
 10" WIDE paper
 Now only £180 + £6 carr.
 GP250A £235 + £8 carr.
 Ask for details on GP 250A

Parallel Printer lead for BBC/Atom to most printers £13.50
 Variety of interfaces, ribbons in stock
 2,000 fan fold sheets 9 1/2" x 11" £13.50 + £3 p&p

EPSON RX80 and FX80

RX80 100CPS 80col
 Tractor Feed £298

FX80 160CPS 80col
 F & T Feed £389

MX100 F/T3 £425
 (£8 carr./printer)

Full Specifications on request

DISC DRIVES FOR THE FORTH COMPUTER

5 1/4" Teac FD55 Slim Line Mechanisms
 FD55A 40 track SSD 250kbytes unformatted.
 Bare: £135. Cased: £155
 2 x FD55A 40 track SSD 500kbytes unformatted.
 Cased + psu £350
 FD55E 80 track SSD 500kbytes unformatted.
 Bare: £180. Cased: £205
 2 x FD55E 80 track SSD 1 Mbyte unformatted.
 Cased + psu £475
 5 1/4" Mitsubishi M4853 Slim Line mechanism
 80 track DSD 1 Mbyte unformatted.
 Bare: £225. Cased: £245
 2 x M4853 2 Mbytes. Cased + psu £590
 Single drive cable £8. Dual drive cable £12.

Other parts for FORTH COMPUTER available.
 Send SAE for details.

SOFTY II INTELLIGENT PROGRAMMER

The complete micro processor development system for Engineers and Hobbyists. You can develop programs, debug, verify and commit to EPROMS or use in host computer by using softy as a romulator. Powerful editing facilities permit bytes, blocks of bytes changed, deleted or inserted and memory contents can be observed on ordinary TV. Accepts most +5v Eproms. Softy II complete with PSU, TV Lead and Romulator lead £169.

UV ERASERS

UVIB up to 6 Eproms £47.50
 UVIT with Timer £60.00
 UV140 up to 14 Eproms £61.50
 UV141 with Timer £78.00

(Carr £2/eraser)

All erasers are fitted with mains switches and safety interlocks

'WIRELESS WORLD' PROJECTS

Semi conductors inc I.C.s.
 Transistors, Displays, Connectors, and Sockets for most projects are stocked by us.

BBC COMPATIBLE CASSETTE RECORDER WITH COUNTER & REMOTE CONTROL £26.50 SANYO DATA RECORDER MODEL DB1101 £39.00. Carriage £1.50 each.

CONNECTOR SYSTEMS

I.D. CONNECTORS

(Speed Block Type)

| | St. Pin | Recap- tacles | Edge Conn. |
|--------|---------|------------------|---------------|
| 10 way | 90p | 85p | 120p |
| 20 way | 145p | 125p | 195p |
| 26 way | 175p | 150p | 240p |
| 34 way | 200p | 160p | 320p |
| 40 way | 220p | 190p | 340p |
| 50 way | 235p | 200p | 390p |

JUMPER LEADS

24" Ribbon Cable with Headers

| | 14 pin | 16 pin | 24 pin | 40 pin |
|------------|--------|--------|--------|--------|
| Single End | 145p | 165p | 240p | 380p |
| Double End | 210p | 230p | 345p | 540p |

| | 20 pin | 26 pin | 34 pin | 40 pin |
|---------------------------|--------|--------|--------|--------|
| Ribbon Cable with Sockets | 160p | 200p | 280p | 300p |
| 1 end | 160p | 200p | 280p | 300p |
| 2 ends | 290p | 370p | 480p | 525p |

AMPHENOL CONNS

| | |
|--|-----------|
| 36 way plug Centronics Parallel Solder £5.25 | IDC £4.95 |
| 36 way socket Centronics Parallel Solder £5.50 | IDC £5.20 |
| 24 way plug IEEE Solder £5.00 | IDC £4.75 |
| 24 way Solder Plug (IEEE type) | 500p |
| 24 way Solder Socket | 500p |
| 24 way IDC Plug | 485p |

RIBBON CABLE

| | (Grey/meter) |
|--------|--------------|
| 10 way | 40p |
| 16 way | 60p |
| 20 way | 85p |
| 26 way | 120p |
| 34 way | 160p |
| 40 way | 180p |
| 50 way | 200p |
| 64 way | 280p |

D CONNECTORS

No. of Ways

| | 80p | 105p | 160p | 250p |
|--------|------|------|------|------|
| Solder | 80p | 105p | 160p | 250p |
| Angled | 150p | 210p | 250p | 365p |

| | 105p | 160p | 200p | 355p |
|--------|------|------|------|------|
| Solder | 105p | 160p | 200p | 355p |
| Angled | 165p | 215p | 290p | 440p |
| Hoods | 90p | 85p | 90p | 100p |

IDC 25 way plug 385p Socket 450p

TEST CLIPS

| | | | |
|--------|------|--------|----|
| 14 pin | 275p | 40 pin | £6 |
| 16 pin | £3 | | |

RS 232 CONNS

(25 way D)

| | |
|-----------------------|-------|
| 24" Single end Male | £5 |
| 24" Single end Female | £5.25 |
| 24" Female-Female | £10 |
| 24" Male-Male | £9.50 |
| 24" Male-Female | £9.50 |

DIP HEADERS

| | Solder | IDC |
|--------|--------|------|
| 14 pin | 40p | 120p |
| 16 pin | 50p | 140p |
| 24 pin | 100p | 200p |
| 40 pin | 200p | 225p |

EUROCONNECTORS

| | PLUG | SKT |
|----------------------|------|------|
| DIN 41617 | 160p | 165p |
| 21 way | 170p | 170p |
| 31 way | | |
| DIN 41612 | | |
| 2x32 way St. Pin | 220p | 275p |
| 2x32 way Ang. Pin | 275p | 320p |
| 3x32 way St. Pin | 260p | 300p |
| 3x32 way Ang. Pin | 375p | 350p |
| IDC Connector | | 475p |
| A+B | | |
| IDC Connector | | 525p |
| A+C | | |
| 2x32 way U Connector | £15 | |

(please specify a+b or a+c)

EDGE CONNECTORS

| | 0.1" 0.156 |
|------------|------------|
| 2x18 way | 140p |
| 2x22 way | 190p |
| 2x23 way | 175p |
| 2x25 way | 225p |
| 2x28 way | 190p |
| 1x43 way | 260p |
| 2x43 way | 395p |
| 1x77 way | 600p |
| 5100 Conn. | 600p |

TEXTOL ZIF DIL SOCKETS SWITCHES

| | | | |
|--------|-------|--------|------|
| 24 pin | £5.75 | 4 way | 70p |
| 28 pin | £8.00 | 6 way | 85p |
| 40 pin | £9.75 | 8 way | 90p |
| | | 10 way | 140p |

SPECIAL OFFER

| | |
|----------|------|
| 2532 | 350p |
| 2732 | 350p |
| 2764-25 | 450p |
| 27128-25 | £25 |
| 4116-2 | 80p |
| 4164-2 | 450p |
| 6116P | 350p |

BAUD RATE GENERATORS

| | |
|----------|------|
| 4702B | 750p |
| COM 8116 | 700p |
| MC 14411 | 675p |

CPU's

| | |
|---------|------|
| 1802CE | 650p |
| 2650A | £12 |
| 6502 | 350p |
| 6502A | 500p |
| 6800 | 225p |
| 6802 | 225p |
| 68802 | 700p |
| 6809 | 650p |
| 68809 | £12 |
| 6809E | £12 |
| 8035 | 350p |
| 8039 | 300p |
| 8080A | 250p |
| 8085A | 450p |
| INS8060 | £11 |
| TMS9980 | £20 |
| 8086A | £22 |
| 8748 | £18 |

COMPONENTS

| | |
|----------|------|
| TMS9995 | £12 |
| Z8 | £24 |
| Z80 | 290p |
| Z80A | 320p |
| Z80B | £12 |
| Z808 | £18 |
| 8250 | 8250 |
| 8251 | 8251 |
| 8255 | 8255 |
| 8278 | 8278 |
| 8289 | 8289 |
| 8297 | 8297 |
| Z80P10 | 250p |
| Z80AP10 | 280p |
| Z80CTC | 230p |
| Z80ACTC | 280p |
| Z80ADART | 700p |
| Z80ADMA | £10 |

SUPPORT DEVICES

| | |
|-------|------|
| 2651 | £12 |
| 6520 | 280p |
| 6522 | 310p |
| 6532 | 550p |
| 6551 | 650p |
| 6821 | 100p |
| 68B21 | 220p |
| 6854 | 770p |
| 68B54 | 800p |

CRT CONTROLLER

| | |
|----------|------|
| CRT6545 | 900p |
| CRT 5027 | £18 |
| CRT 5037 | £18 |
| EF9365 | £36 |
| EF9366 | £36 |
| 6845 | 650p |
| 6847 | 650p |
| TMS 9927 | £18 |
| TMS 9928 | £20 |
| TMS 9929 | £20 |
| EF 9364 | £9 |

TECHNOMATIC LTD

MAIL ORDERS TO: 17 BURNLEY ROAD, LONDON NW10 1ED
 SHOPS AT: 17 BURNLEY ROAD, LONDON NW10
 (Tel: 01-452 1500, 01-450 6597. Telex: 922800)
 305 EDGWARE ROAD, LONDON W2

PLEASE ADD 40p p&p & 15% VAT
 (Export: no VAT, p&p at Cost)

Orders from Government Depts. & Colleges etc. welcome.



Detailed Price List on request
 Stock items are normally by return of post.



THE AUTUMN
COMPUTER TRADE FORUM
 4th-7th October, 1983
 National Exhibition Centre, Birmingham,



Sound business sense for volume buyers

The Autumn Computer Trade Forum is the UK's largest and most successful trade event and the only show that fully understands the needs of volume buyers.

It offers you a comprehensive display of minis, micros, software and peripherals in an environment that's specially made for volume business.

Who is CTF for?

Distributors. Dealers. Software houses. Systems integrators. Retailers. OEM's. In fact anyone who makes a living buying and selling computers, software and peripherals. So whether you're new to DP/WP or know the business backwards, CTF is the event you mustn't miss.

How can CTF help you sell more?

The exhibitors at the Computer Trade Forum understand your needs. That means they'll be talking your language. Quantity terms. Discounts. Marketing support programmes. Delivery schedules. The whole range of services to help you sell more.

Who will be at CTF?

Texas Instruments. Logica. DEC. Systime. DRG. Zygol. Motorola...and many more! And for every name you know there'll be many you don't—with products that could well be your next year's big seller.

Why CTF is different!

The Computer Trade Forum is the only show that understands what volume buying really means. The atmosphere, the choice of exhibitors, the absence of

razmatazz are all designed for profitable business.

CTF has been specifically designed for you and as a proven, established national event it offers you even more with the support of leading UK suppliers.

Post the coupon today

The general public is not invited to CTF. The emphasis is on volume business. And for you it's free! Just fill in the coupon and we'll send you free tickets (worth £3.00 each) by return of post.

If you need to know more, call 01-747 3131.



Computer Trade Forum
 232 Acton Lane, London W4 5DL

Please send me free tickets for myself and colleagues.

Name _____

Position _____

Company _____

Address _____

I am interested in exhibiting at CTF
(No one under 18 admitted)

FREE SHOW TICKETS

PCW1

OPUS SUPPLIES "SUMMER SAVERS"

NEW TEAC DISC DRIVES

- * TEAC 55F Mini D/S 80 Track. Formatted single density 400K Byte. Double density 800K Byte. Only £229.00.
- * Case to hold 2 disc drives with power supply only. Only £39.95.
- * (If you buy the case without the drives the case is £45.00).
- * Ribbon Lead - single to connect to the BBC. £12.00.
- * Dual Lead £15.00. * Power Lead £5.00.
- * Ideal with BBC Micro
- * Full warranty
- * Low power consumption
- * Slimline - latest technology

8" DISC DRIVES - SHUGART COMPATIBLE

FD514 S/S Dual Density. Formatted 600K Byte. Only £149.00.
 FD650 D/S Dual Density. Formatted 1.2M Byte. Only £199.

★ PERTEC ★ 90 DAY WARRANTY ★

Case to hold 2 Drives - complete with power supply & fan. Only £99.95.

'NASHUA' FLOPPY DISCS

With full 5 year Warranty. All discs have hub rings and Minis have a Free Plastic Library Case.

| Minis | | 8" Discs | |
|--------------|---------------|----------|---------------|
| S/S/D | £16.95 for 10 | S/S/D | £17.95 for 10 |
| S/D/D | £19.95 for 10 | S/S/D/D | £23.95 for 10 |
| D/S/D/D | £22.95 for 10 | D/S/D/D | £24.95 for 10 |
| S/S 80 Track | £24.95 for 10 | | |
| D/S 80 Track | £26.95 for 10 | | |

CANON DISC DRIVES

MDD 6106 5¼" S/S 40 track. Formatted single density 100K/double density 200K. Only £129.95.
 * Case to hold one drive £9.95.
 * Leads available as TEAC

12" GREEN SCREEN MONITOR

Only £69.95. 1 year warranty.
 Video Response 18 MHz.
 Composite video/phono connector to computer.

STOP PRESS

14" Colour Monitor. Available Soon - ring for details.

STOP PRESS DOGFIGHT

2 player game for BBC Micro 32K. 8 levels of difficulty.
 Become a flying Ace with this new and exciting game. £8.65.

LOOK VIEWDATA TERMINALS NEW

We have available a limited quantity of these superb terminals built to Industrial Specification by a World famous Manufacturer. Featuring:

- ★ Prestel ★ Built in Modem. Receive at 1200 Baud, Transmit at 75 Baud ★ G.P.O. Approved ★ 7" Green anti reflective screen
- ★ Angled display for desk top viewing
- ★ Page format - 24 lines/40 characters
- ★ Security lock
- ★ Slimline.

only
£199.00

BRAND NEW 14" CASED RGB COLOUR MONITOR SCOOP OFFER

Medium resolution £199
 High resolution £299
 Manufactured by J.V.C.
Stop Press
 As this is a new line please ring for further details as spec-sheet.

NEW THE 'ORGANIZER'

At least a Desk designed for the personal computer user.

* Suitable for use with all leading micros.

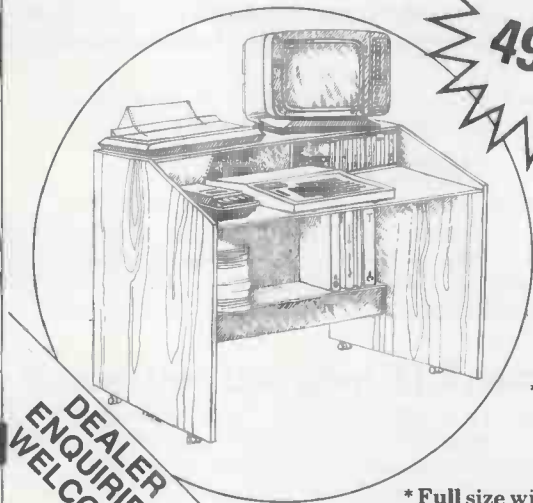

£
49.50

DEALER ENQUIRIES WELCOME

- * Teak finish
- * On casters for ease of movement
- * Self assembly
- * Top shelf, large desk top surface and bottom shelf

* Full size with ample room in front of lower shelf for you to sit comfortably

TEC STARWRITER ONLY £499.00

TEC Starwriter, FP1500-25. Friction feed, serial interface

To Order: Add Carriage at the following rates:
 Discs 85p, All Other Goods £7.00. Add VAT at 15% to total and send your order to:

OPUS SUPPLIES 158 Camberwell Road, London SE5 0EE

Tel: 01-701 8668 (3 lines); 01-703 6155/6/7

GOVERNMENT/EDUCATIONAL & OFFICIAL ORDERS WELCOME



EPROM PROGRAMMERS

2K-4K-8K

BBC - PET - VIC - APPLE - ACORN

BBC - PET - VIC - APPLE - ACORN

MODEL A 2716, 2516, 2532, 2732, 2732A, 2764, 2564, 25128, 27128
MODEL B 2716, 2516, 2532
MODEL C 2716, 2516, 2732
BBC MODEL A. PET MODEL A.B. or C. ACORN MODEL A.B. or C.
APPLE MODEL A. VIC MODEL A.B. or C.
MODEL A £110.00
MODEL B £ 53.50
MODEL C £ 53.50
* All Programmes can Read/Programme/Verify/Copy
* Full Software Tapes supplied for your computer.
* Pet owners free programme for making your own character sets.

PET SUPERBOARD 40 or 80 column only £52.50

- * Select upto 8 Rom/Eprom, Ram/Rom 6 from any available Rom socket.
- * No wires, switches or soldering required.
- * Plugs onto your pet expansion port leaving the port still available.
- * Will except any combination of 2K pr 4K Rom/Epoms, Ram/Roms.
- * Can also be plugged into the character generator giving you 8 character sets.

APPLE VIA BOARDS communicate with the outside world.

- * Each via board contains 1 or 2 6522 via's
- * Each 6522 contains;
- * 2x8 Bit programmable I/O Ports.
- * 1x8 Bit shift register for serial output.
- * Four handshaking lines CA1, CB1, CA2, CB2.
- * Two programmable timers.
- * Plugs into any available slot.
- * Full 6522 Data Sheets Supplied.
- Single via £27.90 Double £36.60

ACORN MONITOR CHIP

- * 10 commands to simplify machine code programming. £10.50
- * Full screen editor.
- * Repeat key and auto entry.
- * Flashing cursor Tape Verify.
- * Slow scroll, memory fill etc.
- * Supplied on 2K Eprom

CONNECTORS

| | |
|--|---------------|
| Pet IEEE User Port | + Hood £ 5.65 |
| Vic User port | + Hood £ 5.65 |
| Vic Games Port | + Hood £ 5.65 |
| Acorn Expansion Port | + Hood £ 7.00 |
| Pet Cassette Port (crimp) on orders of 100 or over | £ 1.00 |

C10 Cassettes (pack of 10) £ 5.00

| | |
|--------------------------|--------|
| 2716 Eprom (2K) | £ 4.00 |
| 2532 Eprom (4K) | £ 6.50 |
| 2746 Eprom (8K) | £ 8.00 |
| 6116 P.3 (2K) Static Ram | £ 4.50 |
| 6522 Via's | £ 6.50 |

New pet character sets made to order £15.00

| | |
|----------------------------|--------|
| Eprom Eraser with Timer | £50.00 |
| Eprom Eraser without Timer | £40.00 |

ALL THESE PRICES INCLUDE VAT AND P&P

Coming Soon

PET IEEE PRINTER BUFFER

- Free your pet from printing
- Data is sent to the 14K Buffer in seconds. Then returns you to your computer so you can type your next letter.
- * 14K Printing Buffer
- * Full IEEE to IEEE and IEEE to CENTRONICS
- * IEEE to RS232c optional extra

SAE FOR DETAILS.

PLEASE ADD 15% VAT PLUS £2.50 P&P TO YOUR ORDERS.

DEALERS ENQUIRIES
OFFICIAL ORDERS
WELCOME

CID COMPUTER INTERFACE DESIGNS

4 ALBERT RD. WESTBROOK. MARGATE. KENT. (0843) 294648

Apple and IBM PC users,

Wizard

performance products add
magic to your computer

The finest of plug-in performance products for your Apple II and Aple IIE personal computer.

WIZARD-80

80-Column Card

Lets you see exactly what you will get when typing/editing 80-column format. Displays upper/lower case. Compatible with CP/M, word processors, modems, software and all current Apple II expansion boards. £190

WIZARD-16K

16K RAM Memory Card

Expands your memory . . . Adds 16K bytes of RAM. Compatible with Z-80 cards for CP/M. Runs with all Apple languages. £76

WIZARD-BPO (for Serial & Parallel Printers)

Buffered Printer Output Card

Lets you continue using your Apple while the printer prints. Contains 16K byte "Character Buffer" expandable to 32K bytes full graphics included. £153 (parallel)
£183 (serial)

WIZARD-IPI

Smart Printing at a Smart Price

The Wizard Intelligent Printer Interface for parallel printers (complete with cable). It offers not only text printing, but enhanced text formatting such as: line length, left and right margin, page length, software control of automatic line feeds and perforation skips.

Graphics too - hi-res screen dump, alternate hi-res screen dump, 90 degree rotation, inverse video, double-size picture, left margin alignment . . . all done with single-key commands. £69

For your IBM Personal Computer:

WIZARD-SPOOLER (Both parallel and parallel/serial versions)

Contains 16K byte character buffer expandable to 64K bytes. Enables you to use your IBM PC while the printer is printing. The parallel/serial version allows you to switch from parallel to serial so that you can run either of two printers from your personal computer. £222 (parallel)
£268 (parallel/serial)

WIZARD-MEMORYCARD

Will expand the memory capacity of your IBM PC in 64K increments up to a maximum of 256K bytes. £330 (64K version)

For your EPSON Printer

WIZARD-EBI

Up to 64K of Buffering in your Epson MX Series Printer

The Wizard Epson Buffered Interface mounts completely inside any MX Series printer. It provides up to 64K characters of buffering in steps of 8, 16, 32 or 64K, and offloads the time-consuming printing task from the computer to the buffer.

Use your computer for the next task while the printer prints the previous one. The Wizard-EBI, with its on-board 5 volt regulator will never overload the Epson 5 volt supply as others do. £69

ABOVE PRICES ARE EXCLUSIVE OF UK V.A.T.

NEW DEALER ENQUIRIES WELCOMED
- SUBSTANTIAL DISCOUNTS AVAILABLE

COMPUTRONIX

14, THE RIDINGS, FRIMLEY
CAMBERLEY, SURREY GU16 5RA

Telephone: Camberley (0276) 682422 Telex: 858306

EUROPEAN DISTRIBUTORS:

| | | |
|-------------------------|----------------------------|----------------------------|
| AUSTRIA (03144) 2293 | DENMARK (01) 185100 | FINLAND (90) 641233 |
| SWEDEN (08) 7169460 | SWITZERLAND (01) 520355 | W. GERMANY (089) 984263 |

Visit us on Stand 18 at the Apple '83 show Fulcrum Centre, Slough on June 3rd, 4th, 5th.

Dealer enquiries welcome from bona fide computer dealers

WE HAVE THE LARGEST COLLECTION FOR APPLE, IBM PC, HX20 AND

TRIPLE YOUR DISK ACCESS SPEED
No hardware modification required
FastDOS
Fast Disk operating system for Apple II computers
Completely compatible with DOS disks
Loads and saves standard DOS files
Completely compatible with all DOS/APPLESOFT programs that access DOS through standard hooks, including FID and MUFFIN
Executes all standard DOS commands

| Comparative timings: | DOS | FastDOS |
|------------------------------|--------|---------|
| Booing integer basic | 13 sec | 3 sec |
| Cataloging a 12 file disk | 2 sec | 1 sec |
| Saving a 10 sector program | 6 sec | 2 sec |
| Saving a 100 sector program | 34 sec | 7 sec |
| Loading a 100 sector program | 24 sec | 7 sec |

Requires 48K
£19.95



LOW COST PLOTTING with SWEET-P

AN INCOMPARABLE GRAPHIC PLOTTER AT £595
Works on all Micros with a suitable parallel interface for all your Graph Processing, Chart Processing, Engineering Graphics and Overhead Transparencies. Just take a look at this comparison with the Strobe Plotter:-

| Compare | Strobe | Sweet-P | Compare | Strobe | Sweet-P |
|----------------------------|--------|---------|-------------|-----------|------------|
| Will Paint OEM Colours | No | Yes | Interfacing | Special | Centronics |
| Int. Letter Size Generator | No | Yes | | | Parallel |
| Self Test | No | Yes | Size | 16½x8½x3½ | 14x8½x3 |
| Pause Key | No | Yes | Weight | 8lbs | 5½lbs |
| Enter Key | No | Yes | Speed | 3" Sec | 6" Sec |
| Transparencies | Yes | Yes | Res. | | |
| Software | Yes | Yes | Steps/Inch | 500 | 250 |
| Plot Commands built in | None | 19 | Plot Area | 8"x10" | 8"x128" |

★ SWEET-P SOFTWARE AVAILABLE FOR APPLE, IBM PC, OSBORNE AND XEROX 820 ★
ADDITIONAL SOFTWARE:

SWEET PLOT I - APPLE TUTORIAL GRAPHICS - £75 (Also for IBM PC)
BPS - APPLE - COMPLETE BUSINESS GRAPHICS £139
BPS - IBM PC COMPLETE GRAPHICS £265

ANNOUNCING... Sprinter

RING US TODAY - GET YOUR PRINTER TOMORROW!

We stock the following printers:

- Tec/Itoh F10/40cps £1,285
- Tech/Itoh F10/50cps £1,675
- Epson MX100 F/T III £499
- Epson MX82T Graphic Ptr. £369
- Epson FX80 T/T III £438
- NEC 8023B Dot Matrix £399
- OKI Microline 80 £226
- OKI Microline 82A £390
- OKI Microline 83A £566
- OKI Microline 84 Parallel £906
- OKI Microline 84 H.S. Serial ... £1,011
- Olympia ESW3 with KB £1,098
- Olympia ESW102 (RO) £836
- Smith Corona
- TP1 D/W Serial £485
- Smith Corona
- TP1 D/W Parallel £485
- QUME Sprint II £1,580

*NEW
EPSON RX 80 £298
Dealer Prices available on request

NEW PRINTER BROCHURE
Gives details of over 20 printers
- Write Today -

★ BOOKS ★
SEND NOW FOR OUR NEW CATALOGUE OF OVER 600 COMPUTER RELATED BOOKS

Now you can HIRE Computers from PETE & PAM.

YES, IN ANSWER TO TERRIFIC RECENT DEMAND, PETE & PAM COMPUTERS HAVE OPENED UP A HIRE DEPARTMENT AT THEIR LONDON OFFICE.

Commercial rates have been pegged at a very reasonable 10% of the equipment's retail value per week's hire, or 20% for the first month, and 10% per subsequent month. Hire charges for specific system requirements are available on application.

CALL DAVID PHILLIPS TODAY - 01-769 1022

MACHINE CARE - DUST COVERS

| | | | |
|------------------------|--------|------------------------|--------|
| Decca RGB Monitor | £9.95 | Apple II | £8.95 |
| Sirius Keyboard | £5.95 | Apple & 2 Discs | £8.95 |
| Sirius Proc & Monitor | £10.95 | Apple & 12" Monitor | £8.95 |
| Prism Printer 580 | £8.45 | Apple 2 KD&12" Monitor | £9.95 |
| Anadex 9080 Series | £8.95 | Apple 2 DK&9" Monitor | £8.95 |
| ABC Computer | £8.95 | Single Disc | £3.45 |
| IBM PC Monitor & Cover | £9.95 | 2 Stacked Discs | £4.45 |
| IBM PC Keyboard | £4.95 | 9" Monitor | £5.95 |
| NEC 8023B-C Printer | £8.45 | Epson MX80/70 | £5.95 |
| Pet 4023/8023/8098 | £9.45 | Paper Tiger 446/60 | £7.45 |
| Pet 4040/8050 Disc | £8.95 | MX100 | £9.95 |
| 9080 Hard Disc | £8.95 | Qume 5 W/Tractor | £10.95 |
| Pet 4022P Printer | £5.95 | Nec 12" Monitor | £7.45 |
| Pet 8023P Printer | £7.45 | Hitech 12" Monitor | £7.45 |
| Pet 8300P Printer | £8.45 | | |

UP TO 652K DISK STORAGE ON AN APPLE II



THE ELITE SERIES OF DISK DRIVES FROM RANA SYSTEMS

More juice on Apple's inferiority.

Rana has an advanced write protect feature which makes it impossible to lose your information. A simple touch on the front panel's membrane switch gives you failsafe control. Apple of course only has a notch or tab, which gives you only minimal protection. With the superior Elite controller card you can control up to four floppy disks on only one slot. With Apple's you can only have two. Of course, you can still plug into Apple's controller card, but down the line you'll want to switch to Rana's and save yourself a slot.

Elite also gives you more byte

Even our most economical model, the Elite One, gives you 14% more storage than Apple's 163K versus Apple's 143K. With our Elite Two offering 326K and our top-of-the-line Elite Three offering a 356% storage increase at 652K. That's almost comparable to hard disk performance, all because of our high density single and double sided disks and heads.

We put our heads together to give you a superior disk drive.

We designed the Elite Three to give you the hard disk capacity with all the advantages of a minifloppy system. The double sided head operates on 80 tracks per side giving you a capacity of 652K bytes. It would take 4½ Apples to give you that!

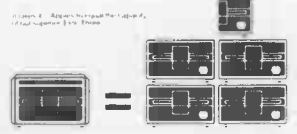

The Elite Two offers an impressive 326K bytes and 40 tracks on each side. This drive is making real hit with users who need extra storage, but don't require top-of-the-line capacity.

- ELITE One £2
- ELITE One & Controller £3
- ELITE Two (2 x 40 Track) £4
- ELITE Two & Controller £4
- ELITE Three (2 x 80 Track) £5
- ELITE Three & Controller £6
- RANA Controller card for 4 Drives £

WIDENED RANGE OF PRODUCTS C/PM COMPUTERS IN THE UK!

Goods listed in this advertisement are available from our dealers throughout Europe

RANDOM ACCESS IN A PRINTING BUFFER?



ES! PipeLine Random Access Printing Buffer

- Random Access printing—stores paragraphs or pictures for printing in any order—any number of times.
- FIFO Printing—conventional first-in, first-out "dumb buffer" operation.
- Bypass Printing—Lets you interrupt a long print to do a short, urgent print.
- Compression of data for efficient utilization of memory space.
- Simple erase feature to clear buffer.
- Automatic duplication capability. Prints copies without using your computer.
- Easily expandable by you, from 8K Bytes to 128K Bytes.
- Stand-alone unit—does not use up your computer's power or expansion slot space.

From £179



You'll love the view with ULTRATERM from VIDEX

The revolutionary new video display card that gives extraordinary new powers to Apple II, Apple IIe & Apple III computers. Setting new standards for versatility, Ultraterm allows you to choose the number of columns and lines you want displayed across your screen. Add to that an incredible clarity of character display and a refreshing ease of use.....
and you have ULTRATERM!

RETAIL PRICE £299.00



NOW AVAILABLE FOR

- EPSON MX100 £4.45
- EPSON FX80 £3.95
- EPSON MX80 £3.95

When ordering please state printers model



SAVES TIME

Imagine the time, energy, and frustration you could save by boosting your Apple's speed from 1 Mhz to 3.58 Mhz. That's 3 1/2 times faster than normal, making the Apple II Plus arguably the fastest Micro on the market.

How is it possible? It's all down to ACCELERATOR II. This new plug-in board from Pete & Pam Computers contains a 6502C Processor and 64K of memory. The board runs all native Apple II software, including programs written in Applesoft, Integer, Machine Code, Pascal, Apple Fortran 77 and Forth.

Amongst the many thousands who could benefit from ACCELERATOR II are users of Visicalc, DB Master, Micro Modeller, Multiplan Tabs, and Systematics.

SUPER FAST

In November 1982, PCW published a bumper round up of all the Benchmark Timings since PCW began. The Olivetti M20 came out top of the 'league' with an average Benchmark timing of 11.5. Running the same Benchmark test programs,

the Apple II Plus with Accelerator II averages a timing of 8.58 — that's an incredible 25% faster than the Olivetti M20.

We have reproduced some of PCW's findings, incorporating Benchmark Timings for the Apple II Plus with Accelerator II.

| Machine | BM1 | BM2 | BM3 | BM4 | BM5 | BM6 | BM7 | BM8 | Average |
|-----------------------------------|-----|------|------|------|------|------|------|------|---------|
| Apple II Plus with Accelerator II | 0.3 | 2.4 | 4.5 | 5.0 | 5.5 | 8.2 | 12.9 | 2.98 | 8.6 |
| Olivetti M20 | 1.3 | 4.0 | 8.1 | 8.5 | 9.6 | 17.4 | 26.7 | 1.6 | 11.5 |
| IBM Personal Computer | 1.5 | 5.2 | 12.1 | 12.6 | 13.6 | 23.5 | 37.4 | 3.5 | 17.6 |
| Osborne 01 | 1.4 | 4.4 | 11.7 | 11.6 | 12.3 | 21.9 | 34.9 | 6.1 | 19.9 |
| Intertec Superbrain | 1.6 | 5.2 | 14.0 | 13.9 | 14.8 | 26.3 | 43.2 | 5.6 | 21.9 |
| Apple III | 1.7 | 7.2 | 13.5 | 14.5 | 16.0 | 27.0 | 42.5 | 7.5 | 24.7 |
| ACT Sirius 1 | 2.0 | 7.4 | 17.0 | 17.5 | 19.8 | 35.4 | 55.9 | 4.3 | 24.8 |
| Xerox 820 | 1.7 | 5.5 | 15.5 | 15.1 | 16.2 | 28.9 | 46.1 | 8.0 | 26.1 |
| Apple II | 1.3 | 8.5 | 16.0 | 17.8 | 19.1 | 28.6 | 44.8 | 10.7 | 30.4 |
| Commodore CBM 8032 | 1.7 | 10.0 | 18.4 | 20.3 | 21.9 | 32.4 | 51.0 | 11.9 | 34.3 |

So don't wait — start to save time now. Contact your local dealer, or call us on (0706) 212321, or, in London on 01-769 1022. A faster, easier computing life is on its way.

LPS II

Light Pen System for Apple II™ Computers

The LPS II is the only true High Resolution Light Pen System with full software support for the Apple II. High Resolution pictures, diagrams and other graphics can be easily drawn on the screen.

- LPS II FEATURES INCLUDE**
- PENTRAX Machine Language Software.
 - PENPAINTER Software system with area fill/re-fill
 - 4 Complete Hi-Res Drawing Systems.
 - Menu Selection Programs.
 - Hi-Res Text Generator.
 - LPS II by GIBSON LABORATORIES — £249.00

SPRING CLEARANCE SALE ASK FOR LATEST LISTS AND DETAILS OF MANY ITEMS AT MUCH REDUCED PRICES.

Bag of Tricks A Review

£25.95

Bag of Tricks

By Don Worth and Peter Lechner **CS** QUALITY SOFTWARE

GAMES GALORE

BUY 3 — Save 15%

SPECIAL OFFER

| NAME | PRICE | NAME | PRICE |
|-------------------------------------|--------|-------------------------------|--------|
| High Orbit | £24.95 | Cannon Ball Blitz | £24.95 |
| Soft Porn Adventure | £19.95 | Lappak | £24.95 |
| Cross Fire | £19.95 | Lunar Leeper | £19.95 |
| Jaw Breaker | £19.95 | Sneakers | £19.95 |
| Mission Asteroid | £13.95 | Gorgan | £24.95 |
| Mystery House | £17.95 | Bandits | £21.95 |
| Ulysses and the Golden Fleece | £22.95 | The Blade of Blackpoole | £21.95 |
| Wizard & Princess | £22.95 | Free Fall | £21.95 |
| Marauder | £22.95 | Apple Panic | £19.95 |
| Granston Manor | £22.95 | Pegasus | £19.95 |
| Threshold | £27.95 | Prisoner II | £22.95 |
| Mouse attack | £22.95 | Phazer Fire | £21.95 |
| Ultima II | £29.95 | Scrabble | £24.99 |
| Frogger | £21.50 | Gamma Goblins | £19.95 |
| | | Borg | £19.95 |
| | | Epoch | £21.95 |

Pete & Pam Computers

New Hall Hey Road, Rossendale, Lancs., B84 6JG
 Phones: (0706) 227011 & 212321
 Telex: 635740 Petpam G.

Norwegian Agent:
 The Norwegian Software House
 Address: Okernveien 145
 Oslo 5
 Telephone 47 2 84 55 77

103-5 Biegborough Road, London, SW16 6DL
 Phones: 01-769 1022/3/4
 Telex: 923070 PCOMP G

removapple

Prices do not include VAT please add 15% to your remittance
 Postage and Packing FREE



Guy Kewney delivers his monthly package of micronews.

Private Eye

Some time last year, a deal was concluded between a computer maker and a shop, which is now attracting the attention of the police.

It involved the maker setting up a 'front' for mail order purposes, because it didn't want its dealers to know that it was indulging in mail order.

In order not to upset the police, I'll keep the story anonymous. As I am not God, however, I cannot be sure whether people are telling me the truth. I can, therefore, only present the story with the facts that have been made known to me.

First of all, the computer company was in difficulty. It had signed big deals with retail chains, promising to deliver computers (which it had not yet made) too cheaply: that is, at a price which would not have provided it with more than pennies in profit.

The company itself was in debt, and the bank — presented with this deal as evidence of its bright future — had become so alarmed that it began taking steps to wind up the company. So the company, which from now on we will give the name R Souls, began looking for a deal which was obviously much more profitable.

But you can't do that, after having just told a major chain like W H Greenson that you can only supply them with 1000 computers (when they wanted 10,000.) If you do, it will come back and demand that you supply the requested number, and do not divert its products directly into the postbags of customers.

So R Souls decided to disguise the operation. The idea was to set up an associated company which would print the advertising

under its own name.

To do this, it needed a handy fool who would set up N D Fule Ltd — a dealer — and advertise his shop and also offer mail order computers and software. Then, if W H Greenson were to complain, R Souls would be able to throw up its little hands in despair, and say: 'It's awful, isn't it, but what can we do?'

The reason that R Souls needed a fool for this was simple. To make its profits, mail order people have to accept machines at a very high price — so if they cost £100, they have to pay £95 (or more). They have to be too dim to see that — as a dealer — he could get them at dealer price — and if R Souls refused to give him a dealer price direct, he could get machines through friendly arrangements with other dealers.

Look at the arithmetic. R Souls pays for the advertising, and prints N D Fule's address. A hundred people write in and pay £100 each, and a mere 15 people walk in through the door, and buy them off the shelf. (That makes 115 computers.)

But N D Fule then rings up R Souls, and plaintively says: 'The response has been awful; I've only sold 20. Oh, and I'll need 95 machines for my shop, at £60.' (That, oddly enough, also makes 115 computers.)

He then flogs the machines to his hundred mail order customers at the high-profit rate, when his shop only had 15 customers through the door. Instead of making 100 times £5 (plus the retail of 15 times £40) he makes a thumping lot more.

This simple dodge doesn't appear to have occurred to the chief of R Souls, nor to the N D Fule man. They signed a deal, which I've seen,

setting all that out in terms obviously designed only to make lawyers rich.

Of course, the deal didn't work. Primarily (I think) it didn't work because the wretched factory at R Souls was not making any machines. That is to say, it was making them by the hundred, all bar one small chip which the chip maker had neglected to inform it was not quite ready — and didn't work. So the computer didn't work.

At this point, R Souls set up a subsidiary, which we will call Flybynight Systems, and gave this new company the rights to make the Soul computer. Then it raised enormous City finance, and told N D Fule that his contract was no longer valid because he hadn't stuck by the contract. And anyway, his contract wasn't with Flybynight, was it?

The way in which he had broken his contract is interesting.

He had been told to put all mail order money in a special 'escrow' account in R Souls' bank, and to send out products direct to mail order buyers.

But the bank, (I think, quite reasonably) felt — since it was just about to wind up the company for its indebtedness — opening a new account was just not on. So N D Fule couldn't pay it into its joint account so, obviously he was breaking the contract.

At that point, fiction has obviously entered the scene. It gets worse from here on.

According to R Souls, there had never been a mail order deal. That is, it was revoked before it was signed. It continued to pay for N D Fule's advertising, and check the artwork for the advertisements, but there was nothing R Souls could do about the fact that he was offering mail order. He was a dealer after all — except he had to pay cash with order

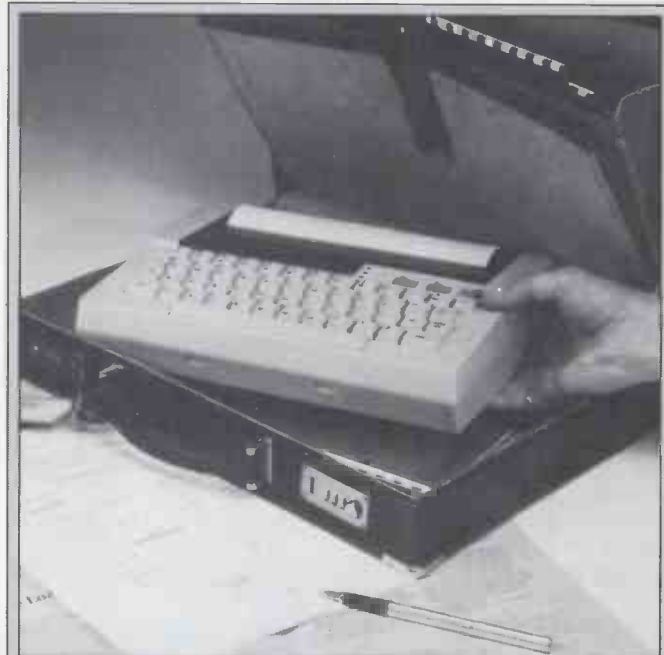

Unlike most portable micros you may meet, this Texas model 709 has a full width printer. Unlike most computers, however, this model 709 has no data processing power. Eventually, says Texas Instruments, it is proposed to provide 'solid state software' (that is, plug-in cartridges) to make it do some of the things that a computer could do — such as automatically dial up a computer and provide the user's log-on sequence. At £800, I should jolly well hope so, too.



For people who don't like reaching behind their computers to unplug the printer before connecting the modem, or putting the daisy-wheel on, or whatever, the T-switch (T for Transfer) from Inmac costs £135 for a two device switch, £175 for four, or £215 for six devices. Other configurations to suit every taste: details on Runcorn (09285) 64321.

because he wasn't creditworthy.

He swears he sent the £9700 he received to R Souls (as Flybynight strangely renamed itself). It says he sent no money, but did pay cash for his retail sales. He denies this — claiming his deal said he didn't have to pay in advance of getting machines. He sent the mail order cash. He couldn't send the retail cash, because he was going bust. It says he wasn't entitled to machines in advance, because there had never been any deal. And it says that it will lose £20,000 because of it, refunding customers their money or supplying machines and software.

At the end of the day, one good thing has emerged: one customer, brighter than the rest, refused to accept R Souls' assurances that N D Fule was not its agent, and threatened to sue them jointly — and was given his product ('without prejudice'). Shortly after, out of the goodness of its heart, R Souls decided to supply the machines and software to anybody who could prove they had sent money to N D Fule.

Fortunately, I don't have to make up my mind whether any of the three bumbling twits involved was actually a crook.

But the law says that you can't take money for goods you can't supply, whether you do it on purpose, or by accident. And so at least one man out of three bumbling twits is very likely to spend a few months in prison 'on

remand' waiting to be tried for fraud, and possibly a few years serving a sentence. Somehow, that spoils the joke.

I wish the police joy of it.

For any customers of mail order computer firms who have had similar experiences, the lesson is simple; it isn't: Don't buy mail order — because most people who do have no other choice. It is: Do not accept the assurances from supplier and dealer that 'you have to sue the other one'. Threaten to sue them jointly; this will magically change the supplier's attitude from 'get lost, sucker,' to 'you poor, poor dear, you really deserve a machine to console you, and here is one, out of the goodness of our hearts.'

Make sure you get the full warranty, in writing.

Brainy deal

The Newbrain portable micro is about to change the meaning of the word 'cheap' on systems using CP/M as the operating system.

By August, the plan is to supply a Newbrain with CP/M, with a single 200 kbyte floppy disk, display monitor and printer for £700 or less. The printer will probably be the cheap Oki model.

This package will be upgradable to a 96 kbyte system with twin floppy disks of 800 kbyte each, plus monitor and printer, for £1200.

To go with this new system, Newbrain's parent company

Grundy has signed a software contract with Peachtree: Peachtree has implemented virtually the entire product range on the Newbrain.

That will be marketed along with the Newbrain CP/M system — the extra 64 kbyte expansion module.

Anybody needing a CP/M system this month should ignore this announcement — because you won't be able to get one for a little while.

Production has already begun, but order backlogs and other prior bulk commitments will take a fairly sizeable chunk of time. Expect to see computers in high street stores in August.

Grundy has also done an interesting deal on maintenance: it has signed a contract with the Thorn EMI subsidiary, Software Science.

This means that the dealers and Grundy will act as brokers for the Software Science maintenance facilities on a nationwide basis — there are ten branches around the country. This deal will not just cover the Newbrain itself, but expansion modules and peripherals, too.

At first, the new expansion system is expected to be clumsy-looking. As an interim measure, Newbrain will provide a metal case racking unit with built-in, heavy duty

power supply (able to drive the whole lot). Eventually the company will design and develop a packaged unit for desk-top work. The Newbrain itself can always be unplugged from the system, and carried home.

Details from dealers.

Going cheap

Scanty details of the Advance 86 — to be launched shortly by Dixons — indicate a frightening change in the price structure of 16-bit micros.

For £400, including VAT, this machine (without disks) will provide an 8086 processor (that is, the proper 16-bit chip of which the 8088 in the Sirius and IBM machines is the little brother), plus 128 kbytes of internal memory.

Owing to the 8086, it runs at around 40 per cent faster than the IBM micro, but the builders say it will be almost totally compatible.

The system will apparently have colour display, the MS-DOS operating system, an IBM standard tape cassette interface, and a detachable keyboard.

I'm told it will take IBM personal computer cards, including the standard £200 IBM disk controller card. And



Sending data down a phone line to a computer involves rather more than the modem to connect your own processor to the phone: there is the small matter of persuading the receiving computer that what is coming down makes sense.

Specialist in computer communications, Albetros, has produced a package called Semaphore, which takes into account all the file handling eccentricities of either computer.

That is, as long as the computers fall into the categories for which it has a list of eccentricities: namely any CP/M or CP/M-86 system; or any MS-DOS computer; or Digital Equipment's minis; Data General's Eclipses; or Prime and IBM minis and mainframes.

Cost of the software on diskette starts at £125. Details on (0256) 57551.

when the computer is fitted with diskette drives, they will read IBM PC-DOS diskettes.

The price of a complete system isn't easy to work out from that information, so I've been told to quote a price of £1425 for a complete system with one five megabyte hard disk, one 329 kbytes floppy drive, and the operating software.

Bill Gates, head of Microsoft, says that his big test of whether a computer is compatible with IBM's personal computer is: 'Will it run Flight Simulator?' (a game which displays an immensely complex screen of aircraft controls and outside scenery) — and further says that the Advance 86 will, indeed, do so. He has been working closely with the designers, getting MS-DOS running properly.

At this stage of the project, details like 'How many are going to be made?' and 'When will they be available in Dixons shops?' are unanswerable. But the news is obviously worth passing on to your own dealer next time he tries to sell you an ordinary American eight-bit system with ordinary CP/M for around £2000.

Anyone going down?

You will have noticed that the price of ZX81s, Commodore VICs, Texas Instruments 99/4As and ZX Spectrums are all down.

The ZX81 has come down to £40, the Spectrum to £100 (£130 for the bigger version with 48 kbytes of memory); the VIC 20 is approx £85, and the Texas machine £100 — without the trimmings.

It's interesting to try to work out why; but before looking at that, there is something else that is even more interesting. That is: spot the odd ones out.

The obvious one, the BBC Micro, hardly need explaining. Acorn can sell every BBC Micro it can build, and Acorn's dealers are frantic to get hold of add-ons like games, joysticks, disk interfaces, second processors, or just anything at all. And when the Electron starts appearing in September, things

will not get any easier with the BBC Micro, because there are enormous differences, and because nobody who can afford the one will be satisfied with the other.

It isn't the Dragon, either. That and the Lynx both sell in the £200 price range, and all the price-drop machines are well below that level.

No, the interesting omission is the Commodore 64.

The 64 still costs £300 in this country. Astonishingly, it costs around \$300 in America.

Once, there was a tradition that gave us lots of prices like this in the UK, but these days an imbalance as big as all that cannot last. It is a warning that it will soon change.

As things stand today, the 64 looks (on paper at least) like a computer roughly equivalent to the BBC Micro. It is £100 cheaper, but needs a special tape recorder, and has a noticeably inferior Basic which can be upgraded to something at least comparable by plugging in a special purpose cartridge.

This cartridge, Simons Basic, is spoken of very highly inside Commodore, but less so by programmers with whom I have discussed it. A matter of taste, perhaps, but in any event, not a clear advantage over the BBC Micro, and nothing like the publicity that the BBC can generate to back it, while it does make the two prices very similar.

So, expect Commodore to cut the price of the 64. When, I wouldn't like to say. Probably around August, and possibly not by a straight price cut — something more like the VIC move.

The VIC's price cut has been engineered by supplying the special tape recorder, the 'Teach Yourself Basic' programming course, and four games, all for £140.

On the 64, anything could happen for a package deal. It might be software and tape, it might be a special disk, or it might even be a colour monitor thrown in free. Whatever it is, the effective price of a 64 will be down to £200 long before Christmas.

Now: as to why the prices fell, the answer is easy. They were too high.

The VIC has been selling for a lot less in America than the UK, for months. So has the Texas machine.



For those of you who felt ignorant and uninformed when I referred to CP/M hard disk systems for £4000 that didn't have printer or software, gaze enraptured at the Cifer Cub. It is a 'low-cost winchester-equipped micro priced at only £3395', with five megabytes.

You don't even get CP/M Plus: just a nice, ordinary version 2.2. Details on (0225) 706361.

Commodore had planned to sell 10,000 VICs per month, and the only reason the actual figure was 7000 was that the factory in Germany couldn't make them that fast, and so there wasn't any point in reducing the price, except to eat into the Spectrum market — and since Sinclair couldn't make enough Spectrums either, nobody cut any prices.

But the high UK computer prices made Japanese and American inventors look greedily at the market here. The Humdinger was just the first of many machines prepared for export to Europe; others will appear over the next few months — Panavision, Mattel Aquarius, Sord M5, and so on.

So Sinclair boss Nigel Searle was persuaded to lower the Spectrum price to discourage the importers, and VIC and Texas had to keep in step.

Then, the unforeseen factor arose, W H Smith, with 20,000 black ZX81s in its warehouse (so people say) did a little arithmetic. A Spectrum with 16 kbytes costs £99. But a ZX81 with an add-on 16k costs £80.

Panic. Cut the price of the ZX81 by £10.

Smith's own version of the story is that they decided to lower the price a week earlier than Sinclair 'so that customers could benefit over the May Day bank holiday' — an idea which struck me as absurd. The big 'Sale' signs

go up *after* the holiday, not before, as any Christmas student knows.

Behind the times

British micro builder Casu after years of near invisibility to the average UK buyer — except those inside British Telecom (who bought most of the production) — has stepped into stage centre with the daring innovation of a five-inch diskette.

Anybody who wants to explain the company's strategy, please do so.

At a time when IBM is selling a system worth £2300 for over £3000, Casu has released a system with the same chip, same operating systems, a bit more memory (and a lot more disk) for £4000 including printer.

At a time when everybody else is starting to decide which three-inch diameter diskette to use, Casu is stubbornly sticking to the eight-inch diameter standard — it has announced upgrades for all its old Z80, MP/M micros, now also available with winchester disks of 20 or 40 megabytes.

It must leave Apple, Osborne and Sirius absolutely quaking in their boots at what we clever UK computer people are going to do next. Why, Casu has sold nearly 3000 systems (since 1976), whereas by the end of this

year, IBM will be making a mere 12,000 PCs per week.

I wouldn't mind, really I wouldn't, even with the bee I have in my bonnet about wanting to see a strong British computer industry, if the people who do this sort of thing (and that includes 'quality' micro builders like Pericom, Sintrom and Rair) weren't so obviously pleased with the wizardry of their growth.

Casu sent me 28 pages of information on these poor-man's minicomputers, ending up with a three page soliloquy on the subject of their 'planned growth' from a garage in 1976, with a turnover rising to £5m last year.

In the motorbike industry, this would be phenomenal. In the computer business, comparison with another micro company that was in a garage in 1976 shows just what an opportunity we are all missing.

Just in case you didn't know from the financial press, Apple is in the Fortune 500 — the list of the 500 biggest US companies, as compiled by the magazine Fortune, each year.

It's all right for you. You don't have to go to press conferences while important executives from ICL harangue you about how IBM has got it all wrong by failing to design a multi-user micro, and how Apple has taken a very silly risk by trying to launch Lisa. I do.

Tardy Tandy

Were it not for one little detail, I would have been planning to spend \$800 as soon as I reached America for the National Computer Conference (that was at the beginning of May, in Los Angeles) on a Tandy model M100.

The M100 is a portable computer which knocks spots off the Epson HX-20. It has a similarly nice, typewriter style keyboard, is very much the same size, and weighs around the same.

But the Tandy machine (built by Japanese firm Kyocera) has a display which is almost twice the size of the Epson. And it has text processing software by Microsoft, based on that company's new

Multi Tool word processor (silly name isn't it? Nobody explained British slang to them, you see).

The \$800 system gives only 8 kbytes of memory: up to 32 kbytes can be added.

The drawback is actually one of its biggest advantages: a built-in modem. In America, this allows the computer to be plugged into a phone, to transmit text to any other computer with a standard 300 bits per second 'answer' modem. In Britain, it is so much useless silicon, because our CCITT standard modems can't understand a note that American Bell standard modems can whistle.

This idiotic lack of common standards mean that I'll just have to wait until the UK half of Tandy gets its act together with the British Telecom people, and develops, then gets approved, a UK type modem.

The processor inside this marvel is a special CMOS silicon which uses almost no power at all — but which behaves like an Intel 8085, which is a CP/M family processor. Unlike most portable computers, however, this one also has CMOS process in its memory and other chips. So it really can do a lot of work from four pen cell batteries.

And where things like Osborne, Kaypro, Compaq and so on will fit under most airline seats (but not the window seats, nor the aisle seats of DC9 type aircraft, because I've tried), this one will sit on your lap, and let you get on with your work.

I wish I thought Tandy UK would have it out before Christmas.

Expensive claims

A computer called the Kaypro II, designed to be an 'improved' version of the portable Osborne 1 but to sell for the same price, has been launched in the UK by a new company called CK Computers.

Unfortunately, the new company has neglected to take the important step of making the price in the UK the same as Osborne's UK price.

The man behind the deal is Michael Kilmartin, who was

previously famous in the business because he set up DRG as a rival to ACT, importing the Victor (which is the Sirius 1 in a different colour box) as a rival to the Sirius.

He is repeating a claim I've heard a lot in America, to the effect that the Kaypro (because it has a bigger display screen than the five-inch Osborne screen) is outselling the Osborne.

Like the Osborne, the Kaypro II is a good, standard CP/M workhorse, and I might leave it there, if the 'outsell' claim hadn't been made several times, quite publicly.

I may be biased by my fondness for the Osborne, but there are several reasons why I find this particular claim unconvincing.

First, the maker of the Kaypro II, a company called Non-Linear Systems, is known to have been looking

for a buyer for its computer business, which is something of a sideline.

Second, a very big dealer in Los Angeles, Jade, assures me that it is doing a great deal of Kaypro business, but not more than Osborne business — despite the fact (it says) that it knows more about fixing the machine than Non-Linear Systems does.

In the words of one senior Jade executive at the recent West Coast Faire: 'The machine was designed by an outside circuit design consultant, and Non-Linear Systems has a very rudimentary idea of what can go wrong with it.'

Third, the machine carries the same Microsoft MBasic interpreter as the Osborne. According to Microsoft head, Bill Gates, information available to him doesn't appear to support the Kaypro II claim. I presume it pays

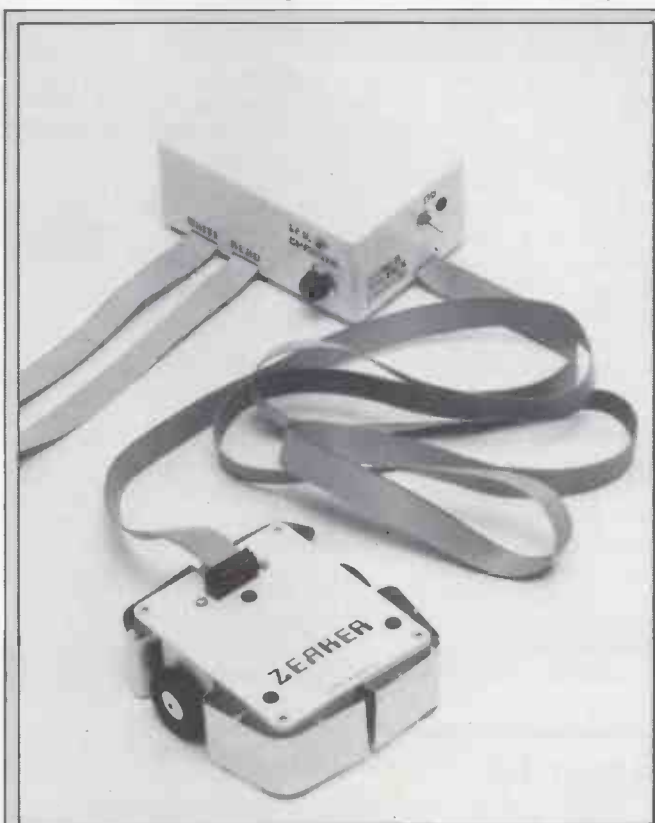

The Logo turtle, made famous by a television programme on Seymour Papert (the South African inventor of the language Logo) is a bit on the costly side for many children. And children are the prime targets of Logo as a teaching language.

Colne Roberts has released this Zeaker Micro-Turtle, at £52 (plus VAT) for the kit, or £69.50 (plus VAT) ready-built. Any computer with a bi-directional, eight-bit port (often called 'parallel') can drive it, as can the Spectrum or ZX81 (for which Colne has special interfaces).

Under it is a retractable pen; its two wheels are separately controllable, and software supplied with it will enable it to learn its way around an area, dodging obstacles. But you don't get Logo with it.

Details on 01-892 8197.



This picture of BBC TV man Kenneth Kendall was sent by Acorn to illustrate the fact that it has used his voice as the basis of its voice synthesiser chip.

This is very silly of it. Everybody who saw the BBC programme in which this chip spoke for the first time will recall that it sounded like a damaged recording of a four-foot jews-harp being buzzed by a timbermill bark-stripper, through a helicopter-mounted carbon microphone, down a faulty telephone line.

Even the programme presenter, Mike McNaught Davis, proudly and triumphantly asked by his assistant to guess whose voice it was, could not be persuaded to agree that it sounded human, never mind like Kenneth Kendall. Maybe it was meant to be his voice after getting the illustrated chip stuck in his throat.

him the correct royalties.

All of which is, perhaps, quite irrelevant compared to the fact that the machine seems nice, has a clear display, a good keyboard, and is portable with a good bundle of software including Perfect Writer, Filer, Calc, Speller and others.

Integrity

Long ago, when I was a little lad, and wanted my mother to buy a book which we couldn't afford, she took me to the local public library and suggested I borrow the thing for as long as it took to read.

My puritan nature was revolted. If everybody could get books from libraries without paying, what would happen to the book shops? And without bookshops, what would happen to books? Was the magic world of reading

going to collapse overnight?

When I grew up and started working in the publishing world (I'm sorry, the nostalgia has to go on, just a little more), I found myself either working for 'controlled circulation' papers which were given away free, and paid for by advertising, or on high quality newspapers, which were only partly paid for by advertising.

And whenever I went to interview a software producer, he would always have ready for me a file of useful information about his company, including Xerox copies of press reports. On his desk would be a single copy of at least one newspaper like *Electronics Weekly* or *Microscope* or *The Economist*, and attached to that newspaper would be a piece of paper with ten or twenty names on it. People who had read it would cross

their names off, and pass it on.

Some of these software producers sell complex programs, like database managers. Some of them are good, some of them are too clever for me, and some of them are useless to man or beast — though there is no way of finding this out until you've used them for a week or two, filled them with information, and found that it won't come out again.

One such producer of software, a very good friend indeed, recently accused a local bunch of children of 'stealing' software because the five of them clubbed their pocket money together to buy a program they couldn't otherwise afford.

This man is perfectly rational. He would never dream of trying to close down public libraries in order to boost authors' fees, nor would he imagine that closing down libraries would have any such effect. Yet he is firmly convinced that if he can only find a way to make software uncopyable, everybody who 'steals' software will instantly go into the nearest shop and buy the programs they have borrowed.

His latest idea is to make sure that every computer has a serial number, and that software sold to me will only run on my computer. This would prevent me from lending it to my friends.

Quite apart from the problem of what happens

when (in two years' time) we are all on local networks getting our software from the central disk, and linking our networks (in five years' time) to each other via 64000 bits per second data lines, I can think of only one program that would have been sold in large numbers if only one person could use it, and that is VisiCalc.

And all the best-selling programs I know are *completely* copyable. Yes, there are three copies in existence for every one sold, but there are three times as many sold as the rival program can claim.

There is a lesson to be learned there. It has to do with 'pigs in pokes' and it has to do with advertising by word of mouth. But you need not expect to see the lesson learned by most software producers — they are too close to the problem.

My good friend was once reduced to an almost frothing rage by my careless mention of the fact that one of his programs could be easily duplicated by following the instructions in his manual. I didn't even repeat the instructions.

I have even sold copies of his program by lending it to friends (copies, of course) to try out. He actually tells a lovely story of a programmer who wanted him to publish a program and insisted on having a binding contract that it would be published before



The reason the word 'easy' is displayed in two-inch high letters is that the operator is partly blind. The ViewScan system uses the Epson micro and a little camera to expand the word from paper, or from the computer.

It isn't a giveaway but there is a special £500 discount to mark the launch of the computer based system.

Details on (0602) 814673.



Looking like a glass elbow over a map, the Versawriter connects to the IBM micro as a way of feeding drawings into the computer memory. It costs £200, and is available from Pete & Pam on (0706) 212321.

even saying what sort of program it was. He actually gives away a very useful version of one of his programs, in the hope that you may like it enough to come back and buy the full version.

But talk about software libraries, and you will have to survive without his excellent companionship for weeks.

In general, I have learned that you should not expect sense from a smoker about health, or logic from the IBA about contraception, or a warm welcome from Digital Equipment if you're a friend of mine.

It is a year since ex-software publisher Julian Allason told an excited world that tape duplicating 'has destroyed the computer games software business' rather than admit that his Petsoft programs were all out of date — and yet games software writers, even of totally copyable Spectrum tapes, are earning £35,000 at the age of 17 and getting invited to dinner with Margaret Thatcher.

These are facts.

But don't discuss them with software publishers. They won't understand.

Fruitful promises

The UK importer of the Sirius, ACT, has announced that it is building a new design of personal business computer.

The announcement came in the course of a financial deal which raised £6 million to pay for the development of the computer. It will be called the Apricot, will be broadly compatible with the IBM Personal Computer — but portable and more powerful — and is promised for this year.

Actually, the question of when it will be available is a matter of guesswork. In May, ACT executives admitted that they didn't yet know of working prototypes, but still said they would let software houses start work on 'pre-production models'. That began in June.

I don't doubt their sincerity, but I do doubt their judgement. I've seen more experienced hardware designers than ACT take more than a year from where they are now to the point where people could walk into shops and buy computers.

Look for your first Apricots in January.

Narcissistic tendencies

It is an old rule that when people tell you how amazingly cheap a system is, but don't actually quote a price, you can be sure it isn't cheap.

In the case of the Dutch Tulip micro, a beautiful yellow-coloured IBM-like system with the more powerful 8086 and 8087 (arithmetic) processors, knowing the price might be a letdown. It would

have to match up to this: 'For it is CompuData which has developed the Fourth Generation Microcomputer, going by the striking name of Tulip System I. Its introduction worldwide was carefully prepared to ensure maximum impact: with the advent of the Tulip System I, the fastest genuine 16-bit microcomputer is a fact.'

After that low-key, modest introduction, the style of the announcement warms up a bit, mentioning a 'truly unparalleled combination of advanced technological features', and climaxing triumphantly with 'The know-how that CompuData has gathered, and which many companies view with awe, constitutes the basis on which the future of CompuData, its dealers, and the European micro electronic industry will be built.'

The technical data sheet, which accompanied this awesome megalith of technological buzz-wordery, went on to detail a perfectly ordinary micro running perfectly ordinary programs like WordStar, SpellStar, dBase II, Multiplan and MailMerge (all optional).

Anyone who is interested, says CompuData, can obtain more information from them on 073-422045. I'm fairly sure I didn't get this one on April 1st.

The knowledge

Spend five minutes trying to explain local area networks to a taxi driver one day, and you will learn two things.

One, you cannot explain them to anybody who doesn't know what computers, disks, storage, printers, files, displays and data rates are already. And two, what you are trying to do is actually easier than installing one.

The news that American firm 3Com has successfully persuaded 25 retail stores to stock its line of EtherSeries add-ons for the IBM PC, shows what a lot that company has achieved in its short life.

It is easy enough to persuade a manager, who has ten colleagues, all wanting a three megabyte hard disk at around £800 each, that he really wants one 80 megabyte drive at £2500 and a few network connections. It is



This happy family photograph shows Epson distributors. The man to look out for is called Carl Tayfour, head of Informex — one of 11 Epson distributors dropped just before this meeting. (He isn't in the picture).

Epson's larger-than-life sales manager, John Patterson, explained the dropping of the eleven with the tactful comment: 'Let's be honest, we want distributors who are going to commit to us in the long term, and not just make a fast buck at someone else's expense.'

Epson subsequently let it be known it was taking legal action to get £100,000 which, it claims, Informex owes them.

I think Tayfour may have taken this somewhat to heart. He was last seen talking to lawyers about £500,000 he reckons Epson owes his company. 'We were one of its' biggest distributors. We made it what it is today in the UK,' he told the trade paper Microscope recently.

You see; now that the hardware side of this business is getting to be all boring old IBM look-alikes, the trade side is getting to be more fun than ever.

quite another to get him to buy the network.

The 3Com trick is a little box, with an IBM PC plug-in card, and a length of coax cable — TV cable by appearances. In the box are full instructions — the card costs £700 or so — and you can do it yourself.

Just in case the prices look a little too close, they also have a lovely range of networked software. There is Ethermail, where all the users in the artwork club can swap memos instantly, and there is a networking game, Etherman (no, nothing like Pac-man) and lots of other useful and envy-producing things.

Details on (415) 961 9602.

Autocode

Programmers who find it easy to write programs with dBase II or Cobol will probably dismiss Autocode as the sort of thing for weaklings who are afraid of cold baths.

It does most of the hard work of converting untrained

ideas into dBase II specifications and commands, or Cobol statements, and it costs £220.

Its inventors, working for a company called Stemmos, say it's the most powerful software of its kind — that kind being program generators — in the world. I suspect them of bias, but they claim 2000-plus customers, so far, and are reckoning to sell another 10,000 copies by the end of the year. So maybe the bias is justified.

Details on 01-740 9444.

Well researched homework

One side effect of the success of the BBC micro (over 100,000 sold in May) has been the growth of people using them in classroom networks. Most use the Acorn Econet, since it comes virtually built into the computer.

Now a way of linking Z80 based micros into Econets has

been launched by S J Research (of Cambridge, where else?) starting with the Research Machines 380Z — also used in many schools.

The most obvious use of the interface is to share 380Z disks. Typically, schools have only one 380Z but with reasonably large disks, whereas the more numerous BBC's disks are still more like hen's teeth than computer peripherals.

Price for software and hardware to do this is £500: to connect a Z80 system to an Acorn network, however, is rather cheaper at £153 (VAT extra).

Details on (0223) 69927.

Crossword Magic solutions

For all the crossword fanatics who read June *PCW*, here are the answers to the puzzle printed as part of the Crossword Magic Checkout (page 198).

| Across | Down |
|-----------------|---------------|
| 1. Silent | 1. Sun |
| 8. Orbit | 2. Lid |
| 9. Lead | 3. Nefarious |
| 10. Own | 4. Traitor |
| 11. Be | 5. Pi |
| 13. Sagacious | 6. Oak |
| 15. Strap | 7. Constant |
| 16. Obligatory | 9. Lease |
| 18. Me | 12. Oxo |
| 19. Ant | 14. Capital |
| 22. Intent | 17. Bumblebee |
| 24. Tab | 20. Reason |
| 26. Story | 21. Ko |
| 28. Onus | 23. Nun |
| 29. Pseudo | 25. Bap |
| 32. Insane | 27. Rip |
| 34. Per | 30. Or |
| 37. Necromancer | 31. Sensible |
| 39. Vile | 33. Norm |
| 40. Egg | 34. Present |
| 41. Ebullient | 35. Broken |
| 43. Blessing | 36. Best |
| 44. Tern | 38. Mint |
| 45. Scene | 39. Vicious |
| 47. Use | 42. Line |
| 48. Enter | 46. No |

Catch 22

You have got the program running on your BBC micro, and you want to send it in to us. So you SAVE it on tape, and then you read our

instructions, which clearly state that we want a direct printout. But you can't afford the printer until we publish your program!

What you need is a friend with a BBC and a printer. Failing that, try Beebprint, a company in West Sussex set up by enthusiast Bob Sampson, who has a printer, and will charge you £2 or so per program up to 32 blocks long. He will even do a screen dump of whatever part of the program you want to have printed for 50p extra (if you include a line saying VDU2:CALL & DOO:VDU3 at the appropriate point).

Details on (0273) 833397.

Showtime

Last month we gave everyone the tiniest peek at what will be in store at the 6th *PCW* Show. For those who haven't yet heard, the Show is from 28 September to 2 October, but members of the public should remember that the first day is a trade day — nobody outside the computer business will be admitted — but there are still four other days to choose from...

Last year the Scrabble contest was run using just the Apple II. This year games mogul John Baldachin of Little Genius will be presenting the Scrabble program on the Spectrum, T199/4A and one other micro — so you can choose your favourite.

Entering the contest will be much like last year — you go along, fill in a card and wait to play. The four prizes will be presented at the end of the last day. All winners will receive a Chambers' Dictionary and the first three prize winners will also be awarded a different computer each — we don't know what they are yet because it's a secret.

It's quite a challenge, though — last year the computer was, in score terms, the undisputed winner, with 503 points. Bearing in mind that competitors will only have two minutes to move, this is pretty hard to beat. Dealers in the Show will be selling the program, which is not available from the Scrabble feature itself.

Regular readers of Tony Harrington's Chess column will no doubt be looking forward to the Chess tournament.



Take a 16-bit processor, 80k RAM (32k user) standard and expandable to 512k, a 3in 320k (formatted) Hitachi drive, built-in 66 col x 8 line LCD display, touch-sensitive 'mouse' plate, integral modem, two operating systems, MBasic and a selection of software in ROM capsules — all as standard in a machine expected to retail at around £3000. Add a 50cps letter-quality thermal-ribbon printer at £700 and a second disk drive at around £500. Now picture the whole system, including printer and single drive, weighing less than 15lbs, running on rechargeable batteries and fitting comfortably into a standard sized briefcase. You've got a Gavilan 'Mobile Computer', available in Britain from October (says Gavilan). The software is IBM compatible and is available in five languages to match the six different keyboards available. Dealers haven't been appointed as yet, but the number to ring for information is 01-353 8807.

Surya

Business Computers you can afford.



At last here's a range of true business computers at realistic prices. Sanyo desk top micros give you a choice of 8-bit, 64K RAM or 16-bit 128K RAM, expandable up to 512K. Sanyo's reputation for quality products, thoroughly pre-tested for reliability, is backed up by Logitek's experience and service.

Logitek has a strong reputation for reliable products and a high level of customer support. 100 Logitek dealers are backed up by a national maintenance service, and in-house support on operating systems and applications software.

Logitek are the top distributor for Altos micros, and Peachtree software and the new Landmark multi-processor

micro complete the range with full compatibility of operating systems and applications software.

Here are real business computers at an affordable price - get one on your desk now.

- Choice of 8-bit or 16-bit
- 320-640 Kbytes on floppy disc
- Expandable up to 1.2 Mb
- True 8086 16-bit processor
- Peachtree accounting software
- CP/M, CP/M-86, MS-DOS operating systems
- Price from £1195 to £2450

Sanyo technology plus Logitek support

LOGITEK

Logitek, Logitek House, Bradley Lane,
Standish, Greater Manchester, WN6 0XQ. Tel. 0257 426644
Logitek, London
30, Brook Mews North, London W2 3BW. Tel. 01-723 0012

Send to: Logitek, Bradley Lane, Standish, Gtr. Manchester, WN6 0XQ

NAME _____ TITLE _____
 COMPANY _____
 ADDRESS _____
 TEL. _____ PCW1716

ASHTON-TATE ■ dBASE II

The world's leading micro database package can now be enhanced with 3 new products

Fox & Geller, the world's largest suppliers of dBASE II add-ons, are now established in the UK to supply and support

QUICKCODE™

The dBASE II program generator. QUICKCODE writes concise programs to set up and maintain any type of database. You still have all the power of dBASE II and there is no programming required. Draw your data entry form on the screen and you're in business - it's that simple. The most powerful program generator available. And the easiest to use. **QUICKCODE makes dBASE II easy.**

dUTIL™

The dBASE II utility program. dUTIL automatically combines your dBASE II command files, saving disk access time and speeding up your programs. dUTIL makes your listings more readable by automatically indenting and aligning command sequences. Makes debugging that much faster. dUTIL also cuts out repetitive programming. Simply type your instruction sequence into a standard text file - then INCLUDE it in as many dBASE II command files as you wish. **dUTIL makes dBASE II faster**

dGRAPH™

The dBASE II graphics system. Now you can bring your dBASE II database to life! Produce pie charts and bar or line graphs in minutes and with ease. Advanced features make dGRAPH as powerful as it is easy. Features like autoGRAPH which will automatically load dBASE II data, compute scales, draw grid lines and label charts. Then there's automatic shading and overlay graphs. And more.



Easy to use dGRAPH makes dBASE II better to look at

Dealers - contact your Fox & Geller distributor for more details:

| | | | |
|------------|---------------|---------------|-----------------|
| Encotel | 01-680 6040 | Software Ltd. | 01-833 1173 |
| Ferrari | 01-751 5791 | Soft Option | (0476) 860171 |
| Midlectron | (077382) 6811 | Tamsys | (Windsor) 56747 |
| Pete & Pam | 01-769 1022 | Tradesoft | 01-627 1800 |
| | | Xitan | (0703) 334711 |



Fox & Geller (UK) Ltd
17 Wigmore Street
London W1.
Tel: 01-580 5816

FOX & GELLER

QUICKCODE, dGRAPH, dUTIL and autoGRAPH are trademarks of Fox & Geller. dBASE II is a trademark of Ashton-Tate.



This will be the 4th European Microcomputer Chess Championship.

Many of last year's exhibitors will again be taking part, among them ACT, Acorn, Pete and Pam Computers, Peachtree Software, Sinclair, Atari, DEC, Computers, Microwriter and Sharp. New exhibitors will include Oric Products, Psion, Mattel (probably exhibiting its micro, the Aquarius) Micronet 800, and several more new and hitherto unheard-of companies who will no doubt be displaying interesting software, add ons, books and all known paraphernalia for your micro or the one you might just buy at the Show.

Don't forget that we've only listed a minority of the exhibitors — there will be many more to see. All in all, it looks like visitors to the PCW Show will find just about anything they could want for whatever micro they may have. See you there (if we're not hiding in the lounge again)...

Micronode launch

The UK office systems company Xionics has announced Micronode, a network of local area networks (LANs). Each Micronode processor can support between two and eight users sharing winchester, floppy and printer, the maximum number of linked Micronodes being unlimited for all practical purposes.

The LAN is via Xionics' own Xinet, and Micronodes are linked to each other by a public switched telephone network (PSTN). The main selling point of the system is the library of communication protocols which will enable it to talk to other machines including IBM, ICL and DEC mainframes, Viewdata and Telex Message Switches, together with selected word processors and micros. The IBM PC is scheduled to be the first. These protocols will allow a Micronode workstation to emulate whatever it happens to be plugged into — be it a humble word processor or an IBM mainframe.

The operating system that achieves these minor miracles is being kept a closely-guarded secret, and managing director

Mike Bevan wouldn't so much as tell me the name of his OS. The company will, we are assured, be making an announcement 'shortly'.

An entry level system costs under £10,000, for which you get a Micronode, software and two workstations. Details on 01-636 0105.

Surya

Golden opportunities

On 22 March, 1982, Telecom Gold was launched to market British Telecom's Dialcom Electronic Mail Service.

Telecom Gold — now in its second year — has become firmly and successfully established with some 175 client accounts, who together constitute a user population in excess of 2500 mailboxes.

The success of Telecom Gold to-date has been based primarily on the Mail service, the store-and-retrieve mailbox capability. This however, is only one of a number of services offered by Telecom Gold through its London-based computer timesharing service.

The Dialcom Electronic Mail software extends, in fact, to cover products for calendar/diary scheduling; notice/bulletin board; database management systems; phone messaging; forms design and processing and across user 'chat' facilities.

Most significant has been the development of software providing interworking capability from Mail to such British Telecom services as Telex, Telemessage and Radiopaging. All these interworking products are currently completing their trials and final market tests. Early commercial release of these additional interworking products is planned.

For further information, contact: Sales Administration, Telecom Gold Ltd, 42 Weston Street, London SE1, tel 01-403 6777.

Dragonalia

Come August those McCaffrey Dragon freaks among you will be able to buy a game of the Dragon civilization of Pern to play on your home computer.



Transtec Computers has just announced its new range of micros: the Krypton series. The standard micro is a 64k, Z80-based, CP/M machine with a memory-mapped 80-column display, user-definable characters and 17 fully programmable function keys. Options include CP/M Plus and USCD-p operating systems, floppy and hard disks and a choice of either a 128k or 256k RAM disk. The operating software supplied with the RAM disk is CP/M transparent and the disk is accessed as drive E. As an indication of its speed, MBasic loads in approximately 0.5 seconds. This, says Transtec, makes it ideal for storing overlay files, where the time taken to access floppies can be extremely irritating. The availability of Telemaintenance, a remote hardware and software diagnostics facility using an acoustic coupler, is being heavily stressed by the company. The basic machine costs £1695, and the RAM disk is £325 for 128k and £450 for 256k. Details on Dublin (0001) 718521.

Surya

Anne McCaffrey has just given games manufacturer Epyx the licence to market a game incorporating the two-stomached, firestone-eating, phosphane-breathing dragons. It will run on machines from Apple, Atari, Commodore, IBM and Tandy, and will cost \$29 or the UK equivalent.

The game is set on the feudal planet Pern, where the dragons and their human riders live, and which is subject to invasion by worm-hatching spores.

Anne admits that she doesn't have a world monopoly on dragons, only on firestone-eating, phosphane-breathing ones. She is extremely circumspect about to whom she grants licences, and the Epyx deal follows unsuccessful attempts to sign her dragons up by Atari and other games manufacturers. She feels very personally attached to her dragons and won't authorise any games which aren't in the true spirit of the Pern civilisation.

Ten million of Anne's Dragon books have now been sold. She awoke one morning

at a convention in Baltimore, Maryland and discovered she was a cult figure. People at the convention were singing dragon songs and wearing dragon costumes. Now there is a whole subculture of 'dragonalia'.

Anne has just finished a new dragon story 'Moreta, Dragon Lady of Pern', scheduled for launch in October.

Jane Bird



I would like to address this convention on: 'Anne McCaffrey, Myth or Legend?'

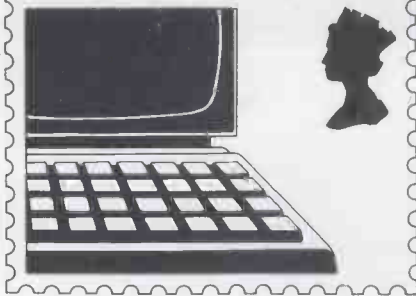

PCW welcomes correspondence from its readers but we must warn that it tends to be one way! Please be as brief as possible and add 'not for publication' if your letter is to be kept private. Please note that we are unable to give advice about the purchase of computers or other hardware/software — these questions must be addressed to Len Warner (see 'Computer Answers' page). Address letters to: 'Communications,' Personal Computer World, 62 Oxford Street, London W1A 2HG.

What's in a name, sir?

Dear World,
I address you, as such as your editor, or at least the individual responsible for the letters page, seems to have taken to (very rudely) addressing correspondents solely by their surnames. While I appreciate that there are probably a lot of wallies who write to you, surely it is not too much to be polite to your correspondents if you are going to publish their letters and your replies? I have to say that I have detected more than a little arrogance and 'in-crowd' attitude creeping into your magazine of late. At risk of being thought over sensitive, may I suggest that this will probably not do very much for your circulation figures?

Yours faithfully
Dr J B Brooke (or to you, my boy, Brooke),
Nottingham

Humblest apologies! Grovel, grovel — Ed.

Bad example

Your office pedant, Steve Mann, done it on purpose, didn't he? You know, wot he wroat about us illiterates. (If in doubt GOTO page 183, May 1983 *PCW*.) It were good on him to rush to the defence of...

Excuse me, does the 'its' refer to the English language, the losing battle or the computer industry?

Let me rush over the five (or is it six?) cliches in the first paragraph because I see in the middle column 'at most, a couple of sheets or a cassette insert'. If the 'couple of sheets' is 'at most' can the 'cassette insert' also be at most? Isn't the one more 'at most' than the other?

Yes again my attention is

distracted by 'riddled with errors'. What a lovely picture — or perhaps 'riddle' here is not rhyming slang for 'leak'. I must consult the dictionary. *Riddle = question, etc, designed to test ingenuity.* It is doing that. *Riddle = coarse sieve; to sift.* Neither of those seems to fit. What's this? *Filled with holes.* That's better — he's talking about punched cards. No, wait a minute — *filled with faults.* So the document is filled with faults, with errors. (My dictionary has an entry for 'riddling', that is, puzzling: that's no lie.)

We are told that 'children can only learn by example'. Quick, someone, and tell the government that all this money they are spending on computers is not needed — we have the authority of *PCW* for that.

'This is the case...'; 'this is not the case...'; 'in most cases...': we have enough cases to overload a forklift truck or a court calendar. 'True' or 'false' gives that 'clarity of meaning' (tautology) that is 'the one factor of prime importance' (tautology again) that Mr Mann seeks.

I have lost count of the number of cliches and of that unpardonable offence, the ambiguous pronoun, seen in the sub-title and near the end where an 'it' is parted from its noun by fourteen words.

At first I thought Mr Mann was showing us by example what happens to a pedant compelled to read too many 'computer-related products'. (Those are the black lines on the coffee jar, I suppose.) Then I read the next article.

'Shirt Pocket Casio' sounded more intimate than user-friendly. 'At the top end of the portable computer' was as far as I read before I was attracted to the heading 'Documentation'. In that I read '... the normal flimsy affair...' is '... quite complete'. Is it complete or not? Mr Pountain presumably compared the

Japanese and English texts to be able to justify his 'better translated' accolade but what does he mean by 'translated on average'?

Is the 'sizeable pocket book' measured in metres or inches?

'It (presumably the small program library at the end) is quite readable' which is more than I can say for Mr Pountain's review. Then, as if he has been hypnotised by the manual (or paperback or program library), he writes '... is slightly stilted in prose style'.

Several of your contributors complain, with justification, about the quality of paperware supplied with hardware and software. A higher editorial standard in *PCW* might educate the industry. RIRO (or do you prefer GIGO?) applies to writers as much as to computers. Mr Mann's comments about the education of children are more pertinent to the industry than to schools. In theory schools have teachers to correct mistakes.

H J M Langshaw BSc MIS-TC, Technical Author,
Dartford, Kent

Oversight

I started reading with interest Mike Liardet's article on Microsoft's Multiplan (*PCW* April 1983) and was greatly surprised to find that there was no mention of one of the very first micros to adopt Multiplan, the Olivetti M20 (although using a different operating system). This is even more surprising when one recalls the fact that the M20 passed *PCW*'s benchmark tests with flying colours — evidence of this was produced by the *PCW* benchmarks' summary in the December issue, when the Olivetti M20 was top of the list out of 63 machines tested.

The M20 is also conspicuous in the absence of any reference to it, except when British Olivetti or an indepen-

dent dealer decides to place an advertisement in your otherwise very informative magazine. I wonder why!
Brian J Darmanin, Sliema, Malta.

*No discrimination intended here — although the M20 is enjoying a big ride on the back of the *PCW* benchmarks — Ed.*

Universal disappointment

I sympathise with B Kemp's letter 'Bad bugs bite back' (May 1983) concerning the trials and tribulations of Bug-Byte's 'Space-Warp'. I have this tape and am bitterly disappointed.

The graphics are almost non-existent; the space craft on the cover only appearing as a file at the end of the tape.

The space craft tends to fly wherever it wants, especially when flying at warp speeds.

Your score only appears on your destruction, a rare occurrence due to the limited number of foes. It can be very frustrating, flying about an empty universe! B Kemp should think himself lucky that he never received a working copy.

Andrew Hardy, Bingley, West Yorkshire

Useful tip

I recently ordered the language 'Lisp' from Acornsoft for my BBC Model A. When it finally arrived I was most disappointed to find out that it apparently did not work. Upon further investigation I discovered that if the interpreter is loaded into a Model A machine, the text window set by the usual Acornsoft header page is not reset, and so, although the interpreter is working, the text window is so small as to disguise this fact.

The solution I employed was to alter line 120 on the second Lisp program to:
 120 PROC oscli ("LOAD IMAGE" + STR\$ — (imbot % *&100)):IF HIMEM< &7C00 THEN mode % = 7:GOTO 150.

I hope that this will be of some use to your readers.
G Philip, Bangor, Gwynedd

Reader's digest

We were interested to see the use of biotechnology in computing. In fact HCCS Associates (*PCW* April 1983, page 317) seems to have a really 'gutsy' machine with its 'Colon Genie'.

DCE Kennils, Biology Laboratory, Old Swan Technical College, Liverpool

TRS-80 forum

I have a TRS-80 colour and DMP 100 printer to which (all being well) I will add disk drives by the end of this year.

I am very pleased with the system and unlike your unfortunate reader Mr H J Leckie in the May 1983 issue, I am very satisfied with the service that I receive from my local branch here in Brussels. If I ask for something not in stock I normally have it within five to seven days. One example was that I asked for the printer on a Thursday evening around 6.30pm and I took delivery on the Saturday. The only thing it has fallen down on is getting me an assembler/editor pack as there are none in Belgium at the moment.

The thing that I find strange is that I have not seen any programs in your program section for the TRS-80 colour. No, I am not mistaken; I have just completed checking all the issues I have, so the question arises 'why?', as I find it a reasonably versatile low cost system which I use in numerous ways for my personal entertainment and self-education of programing as well as the primary function my business needs for reports, files, etc. Admittedly the process is a bit slow at the moment without disks, but it is certainly not stopping me.

I would be interested in hearing from other TRS-80 colour owners as I get the impression that it is a system

being left out in the cold in favour of bigger names such as Apple, ZX81, BBC micro etc.

I would also be interested in your comments as a leading computer publication.
W J Brown, Brussels.

See page 231 The Domain of the Djinn, but why don't you send PCW some TRS-80 programs? — Ed.

Future plans

Now that the Spectrum has come down in price, is Sinclair planning to launch another colour moving-keyboard computer? Could it possibly be a 16-bit IBM compatible? If so, my wallet is ready. Can you please find out?

CC Kuan, London

Over to you Sinclair — Ed

Tandy feedback

Mr Leckie (May 1983) asked if his problems with getting spares for a Tandy computer are normal. I have been in charge of a lot of Tandy computers which take a battering at the hands of school children and I have a love-hate relationship with Tandy. The good part is that if you have a serious problem, you know that Tandy will fix it quickly and at a reasonable cost. If it is an obscure fault that is difficult to find, then it seems to replace the whole motherboard for a reasonable price and save the expensive labour costs. Even one that went up in smoke, after the best part of a glass of coke had gone inside, came back the following week with an affordable bill. On the other hand the company charges the earth to fit a lower/case chip which costs a few pounds from an independent supplier, and its official memory expansion is based on the times when chips cost four times as much as at present.

Tandy seems to fall over backwards to protect its customers from themselves, and this is the root cause of its disclaimer on CPUs that have been opened by the user. It is also true that the UK company is out of step with the

USA head office. Parts that are not available over here can be obtained from the USA by return of post.

So, Mr Leckie, you can at least thank your lucky stars that you have a TRS-80 and that Tandy only lost your letter. I sent a BBC computer back and it lost the computer for weeks.

Derek Tomkins, Maidstone, Kent

Epson praise

Late last year after reading various reviews including one in *PCW*, I bought the Epson HX-20. I was very pleased with it and after writing the two programs which I wanted for the computer, I awaited eagerly the Epson programs and interface to a TV. (I remembered that the programming instructions in the manual mentioned various instructions to a TV monitor.)

As far as I can see, and having discussed the matter with Epson, the TV interface is nothing more than a figment of the company's imagination. I think the advertising authorities should be made aware of Epson's practice of advertising items which simply do not exist.

While waiting for the Epson programs, namely, 'Correspondent' and 'ECalc', I tested a program called 'Intext'. This is a text editor from Talbot Offset in Bournemouth. Unfortunately, I obtained an early version of this program and on using it with the expansion memory of the computer it caused all sorts of problems. I found that I could not even re-set the computer at one point and had to disconnect the battery to regain control of the computer. It also used only twenty columns of the Epson screen which made tabulating columns of figures very difficult. Also controls could be inserted to underline and centre, but I found these extremely difficult to use.

The program also had a welcome feature enabling the width and length of the paper to be set.

Having recently contacted Talbot Offset I was assured that the newer version of the program has been improved and that the controls are easier, but I have yet to try them.

At last I have obtained ECalc and Correspondent 20. These programs, I think, must rate as the biggest insult to the Epson name.

ECalc is a program written in Basic which endeavours to emulate VisiCalc. It is so slow as to be almost unusable. Its other faults are that the user has to be extremely careful as there is no way one can retract a miskey to an option. It is also sadly missing the feature @SUM [. . .]. In ECalc to obtain a list of additions into a cell one must define all the other cells. The program did request the printer controls, but only a maximum of eighty columns, thus not using the feature on some printers to print in excess of eighty columns. A page selected in excess of eighty columns is wrapped around, thus making reading difficult. However, as the program is written in Basic, it is very easy to correct this deficiency.

Going back to the matter of time taken on replication or recalculation: to copy the formula A4=A1+A2+A3 to columns B and C takes over a minute and in serious use replication can take between five and ten minutes! This makes nonsense of using a computer to do work which can be done faster by hand. Even though the Epson is smaller than say the PET or Apple, the capacity is almost the same with the expansion memory fitted and thus I can only attribute these deficiencies to a badly written program. (I appreciate that tape storage is slower than disk.)

Regarding Correspondent 20, this is the Epson text editor which uses a page, sixty lines by sixty columns. The screen operates similarly to a piece of paper in a typewriter. A bleep sound is heard indicating that the end of a line is approaching and the operator has to make the necessary adjustments to the text. The result is that while editing the text, all the adjustments previously made are non effective and then every line has to be checked, correcting where the words are split or where unwanted paragraphs have occurred because a sentence has been lengthened. If editing is this difficult, it could be advisable to use a portable typewriter

like the Brother. There is no centering or underlining facility and neither is there any right justification.

The version I had was on a ROM cartridge and, as the control to the RS232 was fixed, only by altering the program each time could I make my printer operate.

A pleasant feature of the Correspondent 20 is the way the keys are used to search and move within the screen, a directory is created at the beginning of the microcassette and all the filing of the texts is carried out automatically by the program. Unfortunately even this has a draw back in that the tape duly initialised with the directory must be inserted before even a letter entered into memory can be printed; if this is not done the text is lost.

All in all Epson has a good product but with little decent software to use its potential. I suppose I'll just have to wait for other people to write sensible and well thought out programs which work.

J G Feingold, Salford, Lancs

For more comments on ECalc see Mike Liardet's review on page 164 — Ed.

Short supply

I am writing to bring to the attention of your readers the current situation regarding the supply of software for my machine the Acorn Atom.

I ordered the cassettes advertised for Forth and Forth utilities from Acornsoft on 19 November, 1982. Here I am six months on, and no sign of the order being fulfilled. My letters to Acornsoft are answered promptly, but they always say the same thing that they are waiting for supplies.

Thinking that Acorn dealers would be able to help, I found on contacting several that there is a widespread problem in obtaining software and hardware, particularly hardware peripherals for the BBC machine.

My experience of this situation in other walks of life usually indicates that a company that cannot meet demand, and is unable to make improvements is in financial difficulty.

It occurs to me that as the

Atom is likely to be phased out, it may be deliberate policy to neglect software to encourage Atom owners to buy BBC machines.

It would be helpful to readers if you could get a statement from Acorn on its policy on software for past, current, and future machines. In my opinion, the companies that will survive in this business will be the ones who demonstrate their continuing support for their customers.
John Ferguson, Chelmsford, Essex

What's the score then Acorn? — Ed.

Communicating by sound

As originator (and now managing director) of Head-Line Communication — the company responsible for the 'Sound Training' packs, I was naturally very interested in the Steve Harris feature 'Learning by Ear' (May 1983).

But before commenting on your review of our 'WordStar' Sound Training product, I would like to clear up a possible misunderstanding. The retail cost of the Sound Training pack is not £23 as you reported but £33.50 plus VAT. All Sound Training products are in fact available from sole distributors, Newtech Publishing, 8 Camp Road, Farnborough, Hants.

So much for the 'commercial'. In the cause of making some interesting and often valid observations, your review suggests that our selection of 'help level zero' is too low and that it should have been possibly pitched at 'help level three' which would be rather more practical. While taking the point, I still believe that selecting 'zero' is correct for our planned training approach. I would, however, like to point out that the Sound Training pack which you kindly reviewed was, in fact, an 'original proof package'. Since then, the product has been considerably revamped and hopefully most of the comments of both reviewers and early users have been taken into consideration and amendments made.

The sales success of the Sound Training approach cer-

tainly confirms our basic belief that the interactive training method is not only different from all others, but is one which is increasingly meeting the needs of the first time or inexperienced user.

Hopefully PCW will be prepared to 'plug in your tape recorder, sit back and listen' to our latest product, the Sound Training 'MailMerge' pack. Here, I hope you will agree we have taken a rather imaginative approach to what is a somewhat complex and often intangible software product.

As Maggie Burton comments in the same issue, 'Audio courses are an easier option than reading a book', or as we would add, following the manual.

John Campbell, Managing Director, Head-Line Communication, Hereford

Legal defence

I was amazed to read the letter from Brian Hurley (Communications May 1983) where he goes on at great length about copyright infringement and the rights and wrongs of copying programs, then he admits to having no legal background, and no connection with the authors of the book in question. It seems quite obvious that he has no connection with the Sharp MZ-80K either, because some of the tips which prompted his irate letter simply do not do what they were intended to do — as Anthony Newgrosh got some of his addresses wrong. Surely if one is going to make such a stand for what is right, one should at least have a little knowledge on the subject to start with. Does Mr Hurley actually own an MZ-80K, or indeed any micro, or is he just one more person wanting to jump on the software piracy bandwagon.

If Mr Hurley really wants to know about software piracy, I'll show him how to get a listing of a commercially integrated accounts package in MBasic which would cost anything up to a thousand pounds; or how to make as many copies as he wants of those commercial MZ-80K tapes.

My point being that anyone can find out such tricks of the trade, but that doesn't mean

we are out to make money by copying other people's software. I say 'good luck' to the Anthony Newgroshs of the world; at least they get pleasure from their micros.

The information regarding PEEKs and POKEs on the MZ-80K can be found in numerous computer magazines dating back to the day the machine was first put on the market; or as your reply rightly pointed out by simple experimentation.

Come on Mr Hurley, stick to enjoying computing and leave legal matters to legal minds.

Peter Paton, Burnley, Lancs

PS... Computer jargon definition: Endless loop = an argument about software copyright.

Arcadian delights

Steve Mann expressed in 'Screenplay' (PCW May 1983) his disbelief that anybody could reach level 53 on 'Arcadia'. I would like to report that I have reached level 173, gaining a score of 199,292, with only five ships provided initially. I would also like to report the first recorded case of what I am sure will soon be a common complaint 'Arcadian wrist'.

One point not explained by 'Imagine' in the documentation for the game, is the names of the various species of 'Atarian' attackers. To remedy this I would like to suggest the following names, which are now in common usage in this household. They are, in order of levels (level one first): Arrows, Bow-Ties, Round-Shouldered, Dancing Hurtles, Walking Sticks, Birds, Boxes, Eiffel Towers, Flower Pots, Octopuses, Singing Blacks, Boomerangs and Balloons.

Finally, I would just like to say what excellent value 'Arcadia' is; I would recommend it to anybody owning a Spectrum.

Ivan Mactaggart, Yeovil, Somerset



From its humble origins CTUK — Thanet has grown into a thriving success. Peter Kiff, its organiser, gives a synopsis of how and where it all began.

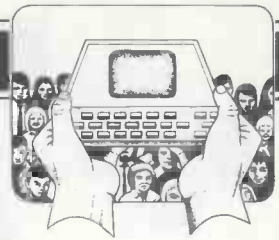

CTUK — bringing computer literacy to the whole community. It was only when we sat down and considered that aim that we realised what an enormous job it would be. We would surely fall short of our objective. Besides, we asked ourselves, what exactly was meant by computer literacy? Did it mean learning to program computers? Did it mean learning how computers work? Or was it rather finding out about the role of the computer in our fast-changing society? Probably it involved all of these and many more aspects beside. Then again, did the whole community want to be made computer literate? Would it not be possible for other organisations with more money, time and expertise than us to do the job more efficiently?

It was with some feelings of trepidation but lots of enthusiasm that we expressed our wish through the CTUK page of PCW to form CTUK — Thanet serving the island and its seaside towns of Margate, Ramsgate and Broadstairs. We received a few letters expressing interest in reply, not exactly an overwhelming response, but one was just what we were looking for. The local area librarian had spotted our announcement and had decided that computer literacy had a place in Thanet's libraries. Thus began a very fruitful partnership in which we have had every encouragement and lots of friendly co-operation from the library staff.

It was decided that we would hold meetings every Friday evening in Broadstairs Library, which is a fairly central venue for the Thanet community. We had the choice of

using the large entrance foyer or an upstairs exhibition room and decided upon the former, since this would mean that everyone entering or leaving the library had to walk past our computers.

Soon we had a group of people who were expressing an identifiable need, and posing questions such as: How can the computer help my business? How can the computer help my child's education? What can the computer do for me now that I'm retired? They wanted to learn more. At that time no adult education classes were available locally in either computer appreciation or programming. We realised that we had to run our own.

We began a ten week course in Basic; we kept it simple, we moved forward slowly, we always tried to link programming concepts with wider computer applications. We were helped once more by the library staff who provided another room for our courses while our other CTUK activities continued in the foyer.

We continued in this manner for the first 18 months of our operation. Towards the end of this period we realised that there was a need to change our mode of operation. Things were moving swiftly in the world of microcomputers. High Street stores were beginning to stock the machines; the merely curious could drop into the shops on a Saturday morning in between buying the groceries and ordering a lunchtime pint. The local Adult Education Centre began running programming courses. We found that our Friday evening sessions were being attended by the same people each week — mainly



'Computers in Education' day at Broadstairs' Library

youngsters who regarded our set-up as a club. It was always a pleasant beginning to the weekend but not what we had set out to do.

We mulled the problem over and discussed possibilities with the librarian. Eventually we decided, somewhat reluctantly, to abandon our weekly sessions and, instead, begin running all-day Saturday events about once every six weeks. Each of these was to be on a different theme. We felt now that our job was to demonstrate to people how micros could be useful in the home, at school and at work. Owing to the fact that we only needed to organise one session every six weeks, we could concentrate upon providing a really good display of equipment and software. Our thematic approach would give us an opportunity to explore various areas in some depth.

We decided upon 'Computers in Education' for our first Saturday session. It was the beginning of a new school year and the Department of Industry scheme was just being extended to primary schools. We gathered together appropriate hardware:

Research Machines 380zs, BBCs and Spectrums. We collected as much educational software as possible: The local bookshop put on a display of books. It looked impressive, but would anyone come? There were a few tense moments as we waited for the library doors to open. Then in they poured — teachers,

children and parents. From 9.30am until we closed the doors at 4pm, there was a constant flow of people. It was hectic but we coped and we dropped exhausted at the end of the day, tired but satisfied with our efforts.

Since then we have run sessions on 'Computers in the Home' and 'Computers for Small Businesses', both of them very successful in terms of numbers attending and, we hope, in getting the message across. Our next session will be an even grander affair. We are leaving our friends at the library temporarily because we need more space, and this the local technical college is providing. Our exhibition there will cover many different aspects of microcomputing. However, we shall be back at the library in September for another Education Day and then I think, since micros are getting cheaper every day, we shall need a 'what low-cost micros can do for you' kind of day, round about Christmas time.

I think we have learnt two important things from running CTUK — Thanet. Firstly, in the fast-moving world of computing one has to be prepared to change to suit the circumstances. Secondly, whatever your locality you need a CTUK centre.

Note: Peter Kiff, organiser of CTUK — Thanet has moved. He is now at Flint Cottage, 2 Ranelagh Grove, St Peter's-in-Thanet, Broadstairs, Kent CT10 2TE.

END

Computer Town UK! is a rapidly expanding network of computer literacy centres where members of the public are given free access to all sorts of computer equipment. This is courtesy of those willing to offer time/resources. You can find a Computer Town anywhere — they're often in libraries or schools. The aim is to make micros enjoyable and non-threatening, so axe-grinding of any sort is banned. Guidelines are available for those interested in starting up their own 'Towns. Write to: CTUK!, PCW, 62 Oxford Street, London W1A 2HG. Remember to enclose an A4 SAE for your reply. Please don't ring PCW for information as CTUK! is entirely a spare time activity.



BANKS' STATEMENT

ANY OLD JUNK?

Martin Banks rambles retrospectively on the ephemerality of computer hardware.

I woke up this morning and looked at my reflection in the mirror, counted the odd new wrinkle or two that had appeared since the last time I had been brave enough to attempt this feat, and asked myself a question: 'Is it all passing you by, Banksey boy?'

Having decided that it probably was (and I hope at this point that you are beginning to feel slightly sorry for me), I asked myself how this could be. The answer, I decided, was that although I could remember the great events in my life — many of the personal computers I had seen, played with and/or written about in my time as a journalist — there was in the end little tangible evidence of these events.

Unlike some of my compatriots, I never bothered to acquire specimens of these machines as and when they had appeared on the market. Now they are gone, lost to the ravages of time.

Of course some of those machines are better lost to time than attempting to reside here in the present world as working systems. But even they have had their place in the great scheme of things, if only because they were such excellent demonstrations of how personal computer systems should *not* be designed, built and sold. There are others that could have been successes if only all the factors had been right. If only, for example, the people with the finance a few short years ago could have had the vision and courage that they are starting to show today, now that there is a track record of success to demonstrate.

A further thought occurred to me as I gazed at the vision of loveliness in the mirror (look, I'm writing this, so I'll choose my own adjectives, even if they are pure sophistry). The thought was that, even in the short history of the personal computer, it has built up a tradition and a folklore that are, in their own way, as important and fundamental to the path of development of the industry and products, as Spotted Dick and Morris Danc-

'...if we lose sight of the tradition of the personal computer industry, we will be continually selling ourselves on the next technological gizmo...'

ing are to the way the English are now.

In a world of sanitated, greasy Yuk-burgers and two-dimensional French flies — sorry, fries —, Spotted Dick still seems remarkably real and wholesome,

something to be relied upon. It's probably what made the British great. Without it, we might just slide away forever into some fast food shop's chip pan to be processed, sanitated, re-processed and re-sanitated for ever.

In the same way, if we lose sight of the tradition of the personal computer industry, short in history though it may be, we will be continually selling ourselves on the next technological gizmo, purely because it *is* the next technological gizmo, and for no other reason: setting ourselves up to be processed, and re-processed, throwing away perfectly good products that actually serve our needs just because they have committed the final, cardinal sin. That sin, of course, is to become 'old' or obsolete.

What actually started off this train of thought occurred back in April. It was the London Computer Fair, a small show organised by the Association of London Computer Clubs. I went along to this affair, not to hunt out new and startling products, for I knew that such discoveries would be rare at such an event. No, instead I went to see if any old friends from the business were around, and to sniff the air among such a large collection of dedicated personal computer users.

I found some old friends to be sure, but I also met up with something else. This was a stand at the show taken by a company calling itself the Computer Junk Shop. At first I thought this was just another fun name for a company, but on investigation found that it was exactly what it stated, a company dedicated to selling old computer junk.

It was then that I thought 'here is history, and it's being knocked down at only a few pounds a time.'

To be fair, the stuff they actually had on the stand was not part of the essential folklore of the personal computer business. Some of it came close though, and it was all interesting. There were, for example, some old ICL 7500 series terminals going for around £40; there was even a Computer Automation mini-computer (definitely not part of the PC tradition) marked at £500, and an early Video Genie (definitely in as part of the tradition) on sale for £195.

There was nothing on the stand at the show that was earth-shattering or of immense historical importance, but there could have been. What if I had spotted an early Altair or Imsai on sale. Closer to home, what if there had been an old Scamp computer.

Hands up those who remember the Scamp? I suspect that there are probably quite a few of you out there, but many more will know nothing about the

machine. It was made by a company now long defunct (long at least in personal computer terms). The company was Bywood, the brainchild of the late, and lamented, John Miller Kirkpatrick. Today, the Scamp would be laughed at for masquerading as a computer, but with some better backing and some reasonable financial support, Kirkpatrick could have beaten Clive Sinclair at his own game!

He didn't of course, so perhaps it is no good crying over spilt milk, but Kirkpatrick and his Scamp computer have a place in the history of the personal computer business. I feel sure that many of the people presently working in the industry got their early experience on such a machine.

What is needed, therefore, is a museum, a place where all these artifacts of the business can be brought together for the interested to see and study. There are such museums elsewhere — for example, the Digital Equipment Corp has one in the USA — but there is nothing here, and we have contributed at least as much to the development of the

'Much more of what has appeared in the personal computer business should be saved for posterity.'

industry and its products as any one else.

There are, to be fair, some individual collections of such artifacts in this country. For example, journalist and writer Robin Bradbeer has one that he has assembled over the years — though, because it has come from his own pocket, or from what he could beg borrow or steal (in the nicest possible way, of course), it is far from complete in its coverage of the industry and its products.

Much more of what has appeared in the personal computer business should be saved for posterity, I feel. It should be kept together in one place where those that are interested in how the products and the industry developed can study the subjects at their leisure.

Ideally, of course, such a museum should be a national archive, though this perhaps is an unlikely hope. I know that the Science Museum carries some displays of this type, but these are far from complete, for the museum has to cover many other areas of science. Indeed, if Robin Bradbeer is to be believed (and why not?), a fair amount of what has been exhibited there has come from the man's own collection. (Perhaps we could start by saving Bradbeer for the nation!)

Failing that, it does seem to me that a



o Museum of Old Computers



magazine of some standing in the business — such as *Personal Computer World* — could easily be the benefactor of such a museum, especially if some college or university were to provide the important facility of a place to keep the exhibits.

But why, I hear a voice enquire, should we bother with what has gone before when there is so much currently happening on the scene that is new and exciting. Answer: precisely because there is all this new stuff. The pace of development in personal computers means that

some systems — especially those that take their time in actually appearing after their announcement — run the grave risk of being superseded. They are becoming obsolete before they ever appear on the market. They may never have a place to rest except in a museum!

This is certainly the case in the area of whizz-bang technology, where business machines have grown from 8-bit machines driving 4k of memory to 16-bit machines running 256k in about seven years, and where home computers have gone from having 1k to 48k in under

three years. In each case, the unit price has barely changed.

I'm not saying for one second that this development is in any way bad, but I do feel that when a home computer, offering 16-bit processing, 128k of memory and hi-res graphics on the TV, will probably appear with a price tag of under £150 by the end of this year, it is time to start keeping a sense of proportion. By charting what has been, both good and bad, we will be able to work out better whether, and how, such developments have any real value. **END**



Our monthly pot-pourri of hardware and software tips for the popular micros. If you have a favourite tip to pass on, send it to 'TJ's Workshop', PCW, 62 Oxford Street, London W1A 2HG. Please keep your contributions as concise as possible. We will pay £5-£30 for any tips we publish. PCW can accept no responsibility for any damage caused by using these tips, and readers should be advised that any hardware modifications may render the maker's guarantee invalid.

BEEB'S SECRET COLOURS

Here is a simple program to display some of the numerous shades of colour which can be obtained using the BBC micro. Colours are mixed by drawing parallel lines close together; the distance between these lines being determined by the step size in line 50.

All the effects are obtained using a two-

colour model! Mode 5 would enable up to four colours to be mixed at once.

```
10 MODE 0
20 FOR C=7 to 0
  STEP 1
30 FOR K=0 to 7
40 VDU
  19,0,C,0,0,0,19,1,K,0,0,0
50 FOR X%=0 TO 1280
  STEP 8
60 MOVE X%, 0
70 DRAW X%, 1023
80 NEXT X%
90 NEXT K
100 NEXT C
Vin Riley
```

KEY SAVER

I am tired of seeing Basic programs designed solely to set up the function keys on the BBC micro, when there's a far simpler, faster and more efficient method to save the soft key buffer itself.

The function keys should be set up as usual, then the command: *SAVE"FILENAME" BOO BFF should be entered. This will save Page OB of the memory, where the soft

key buffer is situated. The buffer can then be reloaded with:

*LOAD

This will not affect a program that is already in the memory, nor will it clear any variables. The buffer loads up to five times faster than an equivalent Basic program, an important factor for those of us not yet blessed with disk drives.

D Alderson

PET TAPE APPEND

A routine to APPEND sub-routines or to incorporate parts of other programs into a resident program is one of the most useful routines in any Toolkit — indeed one wonders how one ever managed without it. There are occasions, however, when a TAPE-APPEND can be very useful, eg, if your PET does not have a Toolkit-type ROM installed or, if like myself, you have decided to upgrade your Toolkit by installing a chip such as COMMAND-O, only to discover that the APPEND function will now only append from disk and not from tape.

There are at least two popular ways of APPENDING tape program files but they are both a little 'messy' in their own ways: (i) The Butterfield MERGE routine in which the sub-routine to be appended is converted first into an ASCII file and then read back as if they were being entered via the keyboard. As a MERGE routine this is fine but it does have the disadvantage that subroutines

have to undergo a conversion process first. (ii) Machine-code APPEND (such as detailed in Raeto West's *Programming the PET/CBM*) operates by loading machine code, then loading the program to be appended, then 'hoisting' it into high memory, then loading the 'main' program and finally 'appending' the first program by bringing it down from high memory to tag on to the tail of the main program. If one is working from disks, this is fine as access time is quick but in tape the process is very much slower and prone to error.

The routine to be developed here works in the way that you might expect it to work, ie, with a program already held in memory it is possible to APPEND another program straight on to the end of it as though one were using the Toolkit type APPEND. The routine is compact (some five or six lines of Basic) and can be entered in direct mode if necessary. To explain exactly how it works a little knowledge of tape headers is required.

When programs are

stored on tape, the program header has the structure as shown in Fig 1.

Locations 635-636 in the first cassette buffer store the 'start' address for the load and this is usually 01 and 04 (=1025 decimal, ie, start of Basic program area). Locations 637-638 store the 'end' address for the load. It is possible to examine the header for any tape without loading the main program by typing OPEN 1 (or more fully, OPEN 1,1,0"PROGRAM NAME") and then examining the bytes in the monitor (SYS 4 and then M 027A-029A).

This tape-append routine works by opening the file of the sub-routine and recomputing new 'start' and 'addresses' for the load so that the sub-routine will tag onto the 'tail' of the resident program.

Explanation of the program:

Line 4 : As Basic programs end with three zero bytes, this routine works through the link pointers to ascertain the position of the middle zero byte. This is the 'start'

position of the new program.

Line 5 : Requests the name of the sub-routine (in A\$), copies it into B\$. Note the three shifted spaces and three cursor lefts in the input string so that a null return will result in A\$ holding a *shifted* space (ASCII 160) and therefore not dropping into direct mode. If the tape to be appended is at a known position one can utilise this by pressing RETURN only.

Line 6 : OPENS the tape header of the named (or next) tape-file and prints out (in reverse) APPENDING (PROGRAM NAME). The new 'end' address is computed and the low and high bytes of the new 'start' address are poked into position.

Line 7 : The low and high bytes of the new 'end' address are POKEd into position and the end-of-Basic pointers updated so that the composite program can be saved if necessary.

Lines 8-9 : Enters a ROM



SHARP LOWER CASE

One of the prices to be paid for the Sharp MZ-80K's excellent set of graphics characters, which makes some of the new generation games machines look stupid, is a hideously deformed set of lower case ASCII character codes. This can make such things as driving printers and communicating with other micros much more complicated than they need be. Fortunately, the MZ-80K is provided with an extra character set, the display code or graphics set. Although they are not in the same place, this set at least has the lower case letters in the right

order. Occasionally, you see enormous programs to convert from one character set to the other. These are completely unnecessary, as the MZ-80K monitor (SP-1002, I don't know about earlier versions) provides the conversion routines itself, 'ADCN' and 'DACN' at 0BB9H and 0BCEH respectively. Therefore, to convert Sharp ASCII to Standard ASCII, and vice versa, all that is necessary is to transfer and adjust.

This subroutine takes a Sharp ASCII lower case letter in the accumulator and converts it to a standard ASCII lower case letter in A:-
 CD B9 0B NONSTA:CALL 0BB9H ;Sharp ASCII — Display code

D6 20 SUB 20H ;Display code — Standard ASCII
 C9 RET

And this one take a Standard ASCII lower case letter in A and converts it to Sharp ASCII:-
 C6 20 STANON:ADD A,20H ;Standard ASCII — Display code

CD CE 0B CALL 0BCEH ; Display code — Sharp ASCII
 C9 RET

A simple routine will be needed to check that the character being treated is — in actual fact — a lower case letter.
 Stephen Morris

KEY-IN

Following all the interest that seems to have been generated by possible uses of the user defined keys on the BBC micro, here is a short program which can be saved and loaded in the normal way and does save a lot of time and frustration:-

10* TV 255
 20* KEY 0 OLD : M
 MODE 7 : M : N
 LIST : M

30* KEY 1 CLS : M RUN : M

40* KEY 2 MODE 7 : M LIST

Obviously this can be changed and extended to suit any particular user's needs but all of the keys must be loaded on separate basic lines as the computer does not respond to colons when it is working in the operating system.

John Carey

routine to complete the load (the headers having been adjusted) and another routine to re-chain the program lines (versions for Basic4 and Basic2). If your version is only going to be used on one version of Basic, then one of these lines can be dispensed with. The CLR and END statements are important! Basic 1 (Old ROMs) should substitute SYS 62403: SYS 50227.

Notes:

- Line 3 is included so that the newly augmented program will skip the APPEND routine and go direct to line 10. It can be added later if you wish. If you include line 3 then activate the APPEND with RUN4.
- Your sub-routine should start at line 10, preferably with a REM. If you leave a line 10 REM in your APPEND program and later APPEND another line 10, the program will finish with two line 10 REMs. Deleting line 10

(a) CLR:A=1025:B=256:FORJ=1TO1E6:L=PEEK(A)+B*PEEK(A+1):A=L:IFL<>0THENE=L:NEXT
 (b) OPEN 1 (or OPEN 1,1,0,"PROGRAM NAME") *NB tape must be positioned!
 (c) N=PEEK(637)+B*PEEK(638)+E-1025:POKE635,EAND255:POKE636,E/B:POKE637,NAND255
 (d) POKE638,N/B:POKE42,PEEK(637):POKE(637):POKE43,PEEK(638):SYS?????:SYS?????:CLR
 The SYS calls are (Basic1)SYS62403:SYS50227: (Basic2) SYS62393:SYS50242
 (Basic4)SYS62456:SYS46262

Fig 2

will delete the first of these leaving the (newly appended) line 10 in place.
 3 Your APPEND routine can be used as many times as you like to append further sub-routines. The responsibility is yours, however, to ensure that the numbers are in ascending order before the process is started.

To APPEND in direct mode is fairly easy but you must be exact! (a), (b), (c), (d) represent lines typed in direct mode assuming a program resident in memory: see Fig 2.

Disk APPENDS are documented in *Commodore Computing* (July 1982) p4 for Basic2; *Commodore Computing* (October 1982) p4 for Basic4.

M Hart

| | | | | | | | | | | | |
|--------------------|---------------|-------------|--|---------|----|---------|----|----|----|----|----|
| 01 | 01 | 04 | 10 | 04 | 4E | 41 | 4D | 45 | 20 | 20 | 20 |
| 634 | | 635 636 | | 637 638 | | 639 640 | | | | | |
| Identif-ication no | Start Address | End Address | Name (16 characters long or name + space = \$20) | | | | | | | | |

Fig 1

```

3 GOTO10:REM NEW PROGRAM STARTS AT 10
4 A=1025:B=256:FORJ=1TO1E6:L=PEEK(A)+B*PEEK(A+1):
  A=L:IFL<>0THENE=L:NEXT
5 INPUT"APPEND NAME ████":A$:B$=A$:IFASC(A$)=160
  THENA$="":B$=""
6 OPEN1,1,0,A$:PRINT"APPENDING "B$:N=PEEK(637)
  +B*PEEK(638)+E-1025:POKE635,EAND255:POKE636,E/B
7 POKE637,NAND255:POKE638,N/B:POKE42,PEEK(637):
  POKE43,PEEK(638):IF PEEK(144)=46 THEN9
8 SYS62456:SYS46262:CLR:END:REM BASIC4
9 SYS62393:SYS50242:CLR:END:REM BASIC2
10 REM
11 REM*****
12 REM*
13 REM* VARIABLE LIST *
14 REM* ===== *
15 REM*
16 REM* A=LOW BYTE (BECOMES LINK) *
17 REM* B=HIGH BYTE MULTIPLIER *
18 REM* L=LINK ADDRESS *
19 REM* E=END OF RESIDENT PROGRAM *
20 REM* (BECOMES NEW START ADDRESS)*
21 REM*
22 REM* A$=NAME OF PROGRAM TO APPEND *
23 REM* B$=COPY OF A$ *
24 REM*
25 REM*
26 REM*
27 REM* LINE 8=LOAD & RECHAIN *
28 REM* (BASIC 4) *
29 REM*
30 REM* LINE 9=LOAD & RECHAIN *
31 REM* (BASIC 2) *
32 REM*
33 REM*****

```

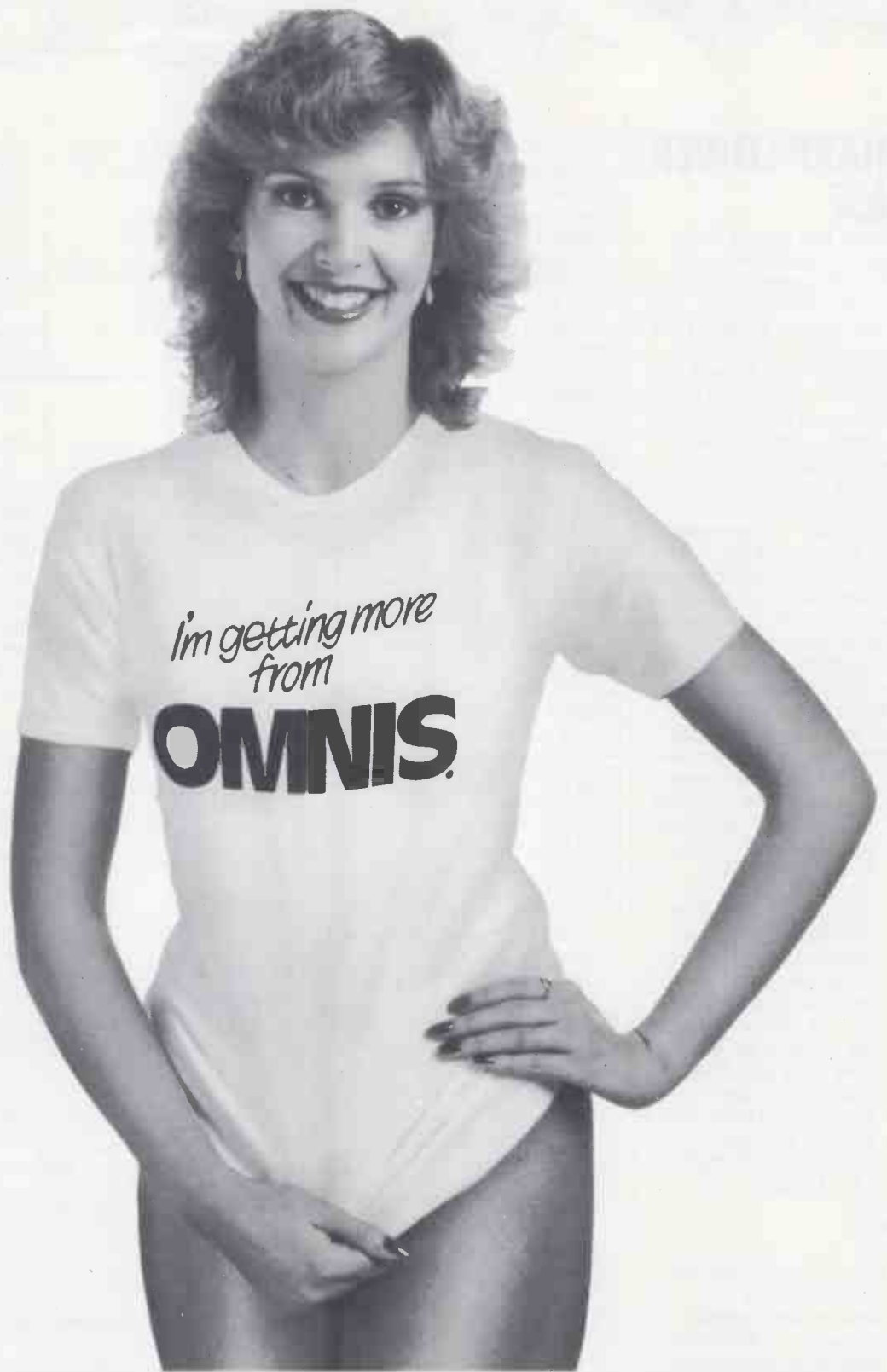

IT'S attractive, IT'S friendly, If handled correctly IT'S very responsive and of course IT'S extremely versatile. IT'S a great deal faster than most others! IT'S flexibility is envied by all. We are, of course, referring to our OMNIS Information Management Program, and it really is all that we have said about it! For what other database program has the ability to produce letters from within a very powerful, and fast, record keeping function, not to mention its network and calculating capability! Telephone Brigit and she will explain its features in more detail to you.

**BLYTH
COMPUTERS**

Wenhaston, Halesworth, Suffolk. IP19 9DH. Telephone: (050 270) 371

OMNIS. YOU'LL GET MORE FROM IT!

BETTER PET GRAPHICS

As a teacher of science, one of the major facilities which I require from a microcomputer is that of graph plotting. It is also most useful to be able to label and put scales on

graph axes.

This facility is most important, both in the context of simulated experiments (eg, simulation of the decay of radioactive isotopes), and in direct experimental applications. An example of the latter might be taking readings from a temperature probe

connected to the micro-computer via an A-D converter, and plotting the results in graphical form. (I feel sure that other microcomputer users can instance many important applications of graph plotting other than in science teaching.)

The science department at Earl Shilton College owns a PET 4016 computer. Other PET users will know that one of its major drawbacks is its limited graphics. The PET Basic provides only the TAB function for use in graphical displays. The usual solution to this problem is to plot the graph with the Y axis across the top of the screen and then plot the X axis and the graph points together, line by line, down the screen; an altogether unsatisfactory procedure (see Fig 3).

Labelling and putting scales on the axes is even more unsatisfactory. (Try it for the function above).

How much simpler this whole business would be if the PET was equipped with the PLOT and PRINT AT functions which are now available on some other, often less expensive, microcomputers.

Of course these facilities are available for the PET (as, too, are high-resolution graphics) at a price. However, one is loath to spend extra money, especially at a time when school funds are under considerable pressure.

After hearing of my dissatisfaction, Graeme, a former student of the college waiting to go to university, took two days to come up with two Basic routines which, when included in program, give the PET a full PLOT facility and a full PRINT AT facility. At the same time, the plotting density of the screen is doubled, ie, the 40 x 25 screen is converted to an 80 x 50 plotting area with full cursor mobility. The Basic versions of these

two routines are listed below.

PET double density plotting routine (Basic): The variables XX and YY hold the x and y co-ordinates respectively of the point to be plotted.

The co-ordinates (0,0) lie at the bottom left of the screen and the x and y co-ordinates must lie in the ranges of 0 to 79 and 0 to 49 respectively on a small-screen PET. If co-ordinates outside these ranges are supplied to the routine, it will simply return them to the main program without attempting to plot them.

Before the routine can be used in a program it must be initialised by performing a GOSUB to line 50090. This need only be done once, before the routine is used for the first time

The routine itself is accessed by setting up the XX and YY variables and executing a GOSUB to line 50000.

As a simple example, the program below plots a vertical line UP the screen from (5,0) to (5,49). (see Fig 4).

PET "PRINT AT" routine: A much more straightforward, but nevertheless useful little facility. This now returns to the normal screen size of 25 lines (0 to 24) and 40 columns (0 to 39) with (0,0) at the top left-hand corner; for example, this program prints EARL starting at line 20 column 12 (see Fig 5).

The only disadvantage of the PLOT routine is that being in Basic it is rather slow. Graeme soon became dissatisfied with this and within another two days had produced a machine-code version of the routine and a version in data statements.

Gerry Spalton and
Graeme Baird

```
10 REM THIS PROGRAM PLOTS A MEDIOCRE
    GRAPH
20 REM PLOTTING A GRAPH OF Y=2*X
30 FOR Y=0 TO 30
40 PRINT "  ";
50 NEXT Y
55 PRINT
60 FOR X=1 TO 15
70 PRINT TAB (0) "I" ; TAB (2*X-1) "*" ;
80 NEXT X
```

Fig 3

```
10 REM DOUBLE DENSITY PLOTTING
20 GOSUB 50090
30 XX=5
40 FOR YY = 0 TO 49
50 GOSUB 50000
60 NEXT YY
70 REM ** THE NEXT 13 LINES DO
    ALL THE WORK **

49999 STOP
50000 IF XX <0 OR XX>79 OR YY<0 OR YY>49
    THEN RETURN
50010 VA = 33728 - INT (YY/2) * 40 + INT(XX/2)
50020 VB = 2 ^ ((YY - INT(YY/2)*2)
    + XX - INT(XX/2)*2)
50030 PP = PEEK (VA) : VC = 1
50040 IF PP = SY (VC) THEN PP = VC : GO TO
    50070
50050 VC = VC + 1 : IF VC < 16 THEN 50040
50060 PP = 0
50070 POKE VA, SY (PP OR VB)
50080 RETURN
50090 DIM SY (15) : FOR VC = 1 TO 15 : READ SY
    (VC) : NEXT VC
50100 RETURN
50110 DATA 123, 108, 98, 126, 97, 127, 252, 124,
    255, 225, 254, 226, 236, 251, 160
```

Fig 4

```
10 GOSUB 55030
100 AX = 12
110 AY = 20
120 GOSUB 55000
130 PRINT "EARL" ;
55000 IF AX<0 OR AX>39 OR AY<0 OR AY>24
    THEN RETURN
55010 PRINT "cursor home"; LEFT $ (AT$,AY) ; TAB
    (AX) ;
55020 RETURN
55030 AT$ = "24 cursor downs"
55040 RETURN
```

Fig 5



**ACT
sirius 1**

authorised dealer

**exparam 128
£256**

**£175 + VAT
£260 + VAT**

high quality expansion memory card

- fully selectable address
- 128 user upgradable to 256
- on-board refresh

dealer enquiries welcome

dio 86

£185 + VAT

plug in expansion card for digital I/O and clock

- six 8 bit I/O ports
- calendar clock updates MS-DOS
- six interval timers

analogue 1208

£249 + VAT

the photonic designed and built analogue 1208 is a separately boxed analogue data acquisition interface using the sirius control port

- 8 differential/16 single ended channels
- 12 bit/0.025% resolution
- software programmable sensitivity

PHOTONIC

Electronic Design Consultants

EDC PHOTONIC LTD

061-973 8367

Tector House
103 Washway Road
Sale Cheshire

Selling the outside
is one thing . . .
knowing the inside
is something else.

The IBM Personal Computer is a very special micro. Here is a machine of technical excellence – a standard which others will be measured against. It's not surprising that such a product demands professional sales and service back-up.

Zynar is well established at the forefront of personal computing. Our network systems lead the field in Europe and the USA – our design group networked the Personal Computer even before its UK debut. We are professionals, having worked for many years in the computing and 'chip' industries.

Zynar will help you optimize the easy-to-use hardware and lead you to the best software solution: tailored, off-the-shelf, simple or sophisticated.

The Personal Computer has been worth waiting for. You will know it. IBM knows it. And we know it – inside-out.

Please phone/send literature
Name.....

Company.....

Address.....

Tel No.....

Application: word processing
accounts/financial planning
general PCW 2

Position.....

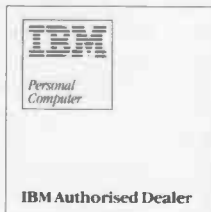

ZYNAR

Authorised dealer serving London & the Home Counties

Zynar Ltd (PC Systems Division)
122/3 Uxbridge High Street
Uxbridge, Middx
Tel: (0895) 59836 Telex: 896607



BEEB TELETEXT CONTROL CODES

Mode 7 is the most useful mode for displaying title pages and instructions which do not require hires but can benefit from colour. The problem with mode 7 is the difficulty of putting the control codes which create all the special effects into PRINT statements. There are two ways in which this can be done, either with CHR\$ or by using the red f-keys to produce the codes for direct inclusion inside quotes. Both have their disadvantages: CHR\$ takes up a lot of time and space; direct inclusion can make editing confusing. In mode 7 the control codes take effect and in other modes they merely appear as spaces invisible to both the programmer and the COPY key.

That's the problem... now (for owners of OS1.00 or better) the solution! First, the easy bit — making all the codes directly available from the keyboard. *FX227,140 and *FX228,150 will do this (see below). Second, how to make editing in modes 0 to 6 easy. It is possible to redefine the appearance of the characters 128 to 159 in modes 0 to 6 without giving up any extra memory (&COO to &CFF have already been

| | | | | | | | | | |
|---------------------------------|----------------------------------|----------------------------------|---------------------------------|------------------------------------|--------------------------------|-----------------------------------|---------------------------------|---------------------------------|-----------------------------------|
| <input type="checkbox"/> Cyan 6 | <input type="checkbox"/> White 6 | <input type="checkbox"/> Conceal | <input type="checkbox"/> Joined | <input type="checkbox"/> Separated | <input type="checkbox"/> Red 6 | <input type="checkbox"/> Black Bk | <input type="checkbox"/> New Bk | <input type="checkbox"/> Held 6 | <input type="checkbox"/> Unheld 6 |
| <input type="checkbox"/> Normal | <input type="checkbox"/> Double | <input type="checkbox"/> Red | <input type="checkbox"/> Green | <input type="checkbox"/> Yellow | <input type="checkbox"/> Blue | <input type="checkbox"/> Magenta | <input type="checkbox"/> Cyan | <input type="checkbox"/> White | <input type="checkbox"/> Flash |
| <input type="checkbox"/> | <input type="checkbox"/> | <input type="checkbox"/> | <input type="checkbox"/> | <input type="checkbox"/> | <input type="checkbox"/> | <input type="checkbox"/> | <input type="checkbox"/> | <input type="checkbox"/> | <input type="checkbox"/> |

f-key overlay

set aside for them). Since these are the same codes as the teletext control codes, it is possible to arrange things so that teletext control codes appear as symbols relevant to their function: eg, a small underlined R for red. The VDU statements in the program below set up such a set of characters shown on the f-key overlay.

If you intend to use these codes often the character definitions should be included in your key-define program (assuming you have one (!BOOT on disk)). The two *FX commands should be included in the *KEY10 (BREAK) definition. The character definitions may be stored on files in four ways:

- 1 As a Basic program
- 2 As a *SPOOL file of VDU statements.
- 3 As a *SPOOL file of the output of the VDU statements (as created by the example).
- 4 As a *SAVE file of the memory from &COO to &CFF inclusive.

Brian McCauley

f-key definitions

| | Normal Definition | After °FX227&228 °KEY string |
|---------------|-------------------|------------------------------|
| Unshifted | ASCII 128 to 137 | ASCII 128 to 137 |
| Shift | ASCII 144 to 153 | ASCII 140 to 149 |
| Control | Nothing | ASCII 150 to 159 |
| Control/shift | Nothing | Nothing |

Note: codes 138 and 139 do nothing so their omission is unimportant.

```

10*SPOOL CODES
20VDU23,128,0,0,0,0,0,0,0,0,0
30VDU23,129,124,102,124,108,102,0,126,0
40VDU23,130,62,96,110,102,60,0,126,0
50VDU23,131,102,102,60,24,24,0,126,0
60VDU23,132,124,102,124,102,124,0,126,0
70VDU23,133,99,119,127,107,99,0,127,0
80VDU23,134,60,102,96,102,60,0,126,0
90VDU23,135,99,107,127,119,99,0,127,0
100VDU23,136,126,96,120,96,96,0,126,0
110VDU23,137,62,96,60,6,124,0,126,0
120VDU23,138,0,0,0,0,0,0,0,0,0
130VDU23,139,0,0,0,0,0,0,0,0,0
140VDU23,140,102,118,126,110,102,0,126,0
150VDU23,141,124,102,102,102,124,0,126,0
160VDU23,142,0,0,0,0,0,0,0,0,0
170VDU23,143,0,0,0,0,0,0,0,0,0
180VDU23,144,0,0,0,0,0,0,0,0,0
190VDU23,145,124,102,124,108,102,0,102,0
200VDU23,146,62,96,110,102,60,0,102,0
210VDU23,147,102,102,60,24,24,0,102,0
220VDU23,148,124,102,124,102,124,0,102,0
230VDU23,149,99,119,127,107,99,0,99,0
240VDU23,150,60,102,96,102,60,0,102,0
250VDU23,151,99,107,127,119,99,0,99,0
260VDU23,152,60,102,96,102,60,0,0,0
270VDU23,153,62,12,12,108,56,0,102,0
280VDU23,154,62,96,60,6,124,0,102,0
290VDU23,155,0,0,0,0,0,0,0,0,0
300VDU23,156,255,131,153,131,153,131,255,0
310VDU23,157,255,153,137,129,145,153,255,0
320VDU23,158,102,102,126,102,102,0,102,0
330VDU23,159,102,102,102,102,60,0,102,0
340PRINT"*FX227 140"
350PRINT"*FX228 150"
360*SPOOL
  
```

ERROR TRAP

I have written a pair of subroutines for 3000 and 4000 series PETs, which provide an error trapping facility. They work by storing a command in the keyboard buffer, which is executed after an error, in this case causing a jump to line 12000. The interrupt routine is disabled when the trap is enabled, to prevent the user overwriting the command in the keyboard buffer. This also disables the

clock, the stop key, and the cassette motor. The trap must therefore be disabled before getting data from the keyboard, or using the cassette system. The routine clears the screen when an error occurs. To enable the trap use 'GOSUB 10000', and to disable it use 'GOSUB 11000'. The routines set 'ER' to -1 when the routine is enabled, and to zero when it is disabled. Your routine to deal with the error should start at line 12000, and its first

action should be to disable the trap. Although variable values are preserved, the contents of

the stack are lost, so you cannot continue a FOR-NEXT loop or subroutine. Robert Oakeshott

```

10000 REM ERROR TRAP ENABLE
10010 POKE 59411,60:REM DISABLE KEYBOARD
10020 ER$="JGF12000"+CHR$(13)
10030 POKE 158,LEN(ER$):REM NO. OF CHARACTERS IN KEYBOARD BUFFER
10040 FOR I=1 TO LEN(ER$)
10050 POKE 622+I,ASC(MID$(ER$,I,1))
10060 NEXT
10070 ER=-1
10080 RETURN
11000 REM ERROR TRAP ENABLE
11010 POKE 59411,61:REM KEYBOARD ENABLE
11020 POKE 158,0:REM CLEAR KEYBOARD BUFFER
11030 ER=0
11040 RETURN
12000 REM ERROR CAUGHT
12010 GOSUB 11000:REM ERROR TRAP DISABLE
12020 STOP
  
```

THE TIGER

The Right Product at the Right Price

The TIGER is the most unique and powerful microcomputer in its price range, exceeding the capabilities of any other micro in its class.

Designed for ease of use, convenience and to a price, TIGER will perform for a one person office, small to medium size business operations, and with its versatility and flexibility, the TIGER is ideal also for the large corporate user.

Comprehensive Software, Documentation and Support

Look at the TIGER specification. Impressive? Yes! But, all these features count for nothing unless you have reliable software, good documentation and the right level of professional support. TIGERBYTE® software includes Peachtree – one of the world's biggest and most experienced software specialists. In addition to these basic accounting and office productivity programs, TIGERBYTE® provides proven communications and graphics software. With excellent documentation and nationwide service back-up, HH provide the dealer with total product and support.

Designed for the Market

The TIGER was designed with the user in mind. Apart from its obvious aesthetically pleasing appearance and excellent use of ergonomics, the TIGER performs. The price and performance meets the



THE COMPLETE TIGER
DESKTOP SYSTEM – £2,795

needs of the smaller business but, because of its built-in modem and immediate access to Prestel, the TIGER is a powerful communications tool. Comprehensive interfacing ports mean TIGER can support advanced data communications to other terminals, minicomputers, and large corporate mainframes. With outstanding colour graphics, the TIGER is a compelling selling proposition.

HH® – The Company

The TIGER comes from a well-established British company renowned for its high quality electronics and marketing skills. We have an impressive list of clients worldwide supported by over 600 dealers in 48 countries. We'll be here tomorrow.

The Future Today and Tomorrow

The TIGER'S design is based on a combination of some of the most advanced microprocessors available, providing significantly better performance than any other micro in its price class, so it won't be obsolete tomorrow.

Invest in the Future Today

Innovation, quality and service. That's HH. We are now looking for the best 100 dealers in Britain. That could be you. Contact HH now for a dealer pack.

End-user enquiries welcomed

COMPARE THESE SPECIFICATIONS

Unique Three Processor System

Tiger's advanced pipe-lined architecture is based on the 7220, 6809 and Z80A microprocessors.

Memory: 7220: 96K RAM
Z80A: 64K RAM

Expansion bus allows virtually unlimited extra RAM, I/O devices or disk controller connection.

16K ROM provision if used without disks.
Standard 2K ROM.

6809: 2K RAM

Expansion bus allows extra RAM, I/O devices or disk controller connection.

16K ROM
256 x 4 bits parameter RAM with battery.

Disk Capacity: Two 5¼" double sided, double density, drives giving total 2.0MB.

Operating System: CP/M® Industry Standard.

Colour Graphics: 14" High resolution colour display. Dedicated 7220 processor with 96K RAM generates –
• High resolution colour 512x512 Pixels, with High Speed vector, arc and figure drawing. Features hardware Pan and Zoom, also animation.

- Text mode resolution 640x256, 80 characters x 24 lines.
- Prestel mode 40 characters x 24 lines.
- Display writing speed 1 million pixels per second.

Features Built-in

- Modem – with auto-dial, auto-answer facility
 - Cassette Port
 - Security Switch
ID Codes.
 - Reset Switch
 - Light Pen Port
 - Video Drive (TTL Level)
 - Disk Port
 - IEEE-488 Port
 - Printer Port
 - RS232
 - Network Data Link
 - Internal Loudspeaker
 - Keyboard – Expanded QWERTY, non reflective key-caps, numerical pad and cursor controls. Ten coloured definable function keys. Special ergonomic design.
 - Disk Expansion – Disk controller card. Connectors for additional two 5¼" drives and two 8" drives.
 - UHF Pal Encoder Module – option
- ® registered trade mark of Digital Research Inc.

HH® is a registered trademark.

* Price includes hardware and systems software only (excl. VAT).



FROM

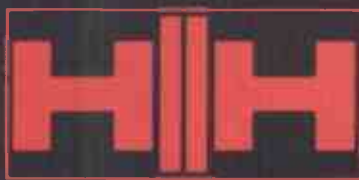

I am interested in a dealership. Please send me

full details and contact me:

Name: _____

Address: _____

Telephone No: _____

H/H Microcomputers Viking Way, Bar Hill, Cambridge CB3 8EL Telephone: Crafts Hill (0954) 81140 (15 lines)
Telex: 817515 HHELECG Telegrams: Electronic Cambridge.

PCW/7/83



MEDDLING WITH MICROTAX

Is Microtax the long-awaited solution to make light work of those formidable tax return forms? Tony Harrington discusses some of its benefits.

The first thing to be said about Microtax is that it is a serious venture. A lot of work has gone into producing it, and the initial impression is that not much has been taken for granted.

Anyone who has loaded games cassettes onto the Dragon, and that includes most Dragon owners, will know that instructions for a specific program can usually be found in the tape cassette folder. My first reaction, coming to the Dragon from disk based applications, was to look for the loading instructions in the Guide that comes with the cassette. This was a mistake.

The 'Guide', as it says on the cover, is a separate work from the program and is in no sense a reference manual for it. Although the program frequently sends the user back to the Guide, it is always for a more in-depth explanation of the UK tax system, never for additional information on how to operate the program itself.

In other words, the 'Guide' is in no sense an operating manual for the program.

Microtax is somewhat handicapped in its serious aims by the fact that the Dragon has not yet worked out how one program can be loaded and automatically run from another program. Using the remote jack plug that comes with the Dragon, it should, in theory, be possible for the program itself to load the next section of the program at the appropriate time, but the user still has to type in 'run', and press enter.

The tape contains half a dozen different programs on each side. The first program consists of a number of messages on the screen to guide you through the initial familiarisation stage. I had nothing against these, as a little too much advice is better than leaving the user to flounder around alone. Incidentally, it is worth noting that Side A, at least, of the tape will not accept decimal places, so amounts have to be rounded down to the nearest pound.

Since my remote jack-plug connection didn't seem to work, it was not possible for me to test the effectiveness of the program's ability automatically to call in the next routine. It flashed a message on the screen saying it was searching for the next program, but since the tape recorder remained motionless, I figured that the message was a little optimistic.

I opted for CLOADing from the beginning of the next program section. This was

Microtax is supplied by Tax and Financial Planning Ltd. It is designed to calculate income tax liability and tax payable for the year ended 5 April 1983, but it also assists with the completion of the 1983/84 tax return. It runs on the Dragon 32. The complete package consists of a 1982/83 UK income tax guide and a cassette containing a number of programs.

quite easy to do, but it made me long for a disk based system, with all the access facilities of disk. And it raises the question of how seriously one can take even the most efficiently designed tape-based program when it gets to this kind of size. It needs an enthusiast to go to some time and trouble doing this sort of thing. Most people, even those with a tax problem, don't want to be bothered.

Familiarisation

The introduction starts off simply enough by asking whether you have a printer to work with the program. I didn't, and was immediately advised by a neatly printed message (black on a green background) to take notes!

The 137-page Guide is long and comprehensive. Like encyclopaediae, you are not expected to read all of it, just the sections the program states are relevant for your needs. This comes as something of a relief since most ordinary users will not want to plough their way through 137 pages on the intricacies of the UK tax system.

Right at the start you are warned that if you are married and both you and your husband/wife work as employees, the tape will have to be run through twice. There was no explanation as to why the program couldn't handle both simultaneously, but within the limited capabilities of 16k, processing the values for one person's income and tax was probably as much as could be expected.

Pressing 'break' on the Dragon does dreadful things to a sequence of programs like this. So although the program uses the 'press any key' technique to move you on to the next screenful of information, it is thoughtful enough to add 'press any key but the break key...', which I found a nice touch. There is probably a potential user

out there who would have pressed it without this warning. There is doubtless one who will press the break key even with the warning, but there is not much a program designer can do about such folk.

The other point to bear in mind is that you cannot simply sit down with this package and bang out your income tax. Before you sit down to it you need to put in a bit of work gathering the necessary documents. The program tells you as much before you get very deeply into it: 'Before commencing we suggest that you gather together as much of the information as possible as listed in Appendix A.'

You also need to establish your domicile and residence status. These delays before you begin working out your tax are inevitable if the matter is going to be treated seriously. Nobody wants to get their tax into a muddle.

Documentation

The documents you require are: your tax return, as completed last year; your present tax return; your P60 form (the one given to you by your employer showing earnings for the year, your pension contributions and your tax deductions). Then you need the P11D and the P9D, which is the form returned by your employer, giving details of 'benefits in kind' (a company car is the prime example).

Other documents you need — or might need under certain circumstances — are your assessment for the past year; details of the number of days you spent working abroad; details of building society rates paid in 1983 in respect of your house, and details of other loan interest for which you know you get relief; dividend vouchers; share transactions and contract notes; tax deduction certificates in respect of any pensions received; vouchers from building societies, banks and so forth; as well as deeds of covenants made. Armed with all these you are ready to begin.

Well, almost ready to begin. One of the problems with this kind of program is that there are so many factors which have to be taken into account. The program cannot just assume that users will know definitely one way or another whether they should in fact pay UK tax.

The fact that Microtax asks questions

about domicile and residence seriously is evidence that the package is intended for serious use.

Problems

But there is a problem. Domicile is a thorny question. As the Guide points out, this is a problem of general law, not just of tax law. If you are new to the country or uncertain about your status, it might be possible to work out your tax obligations from the notes given in section A5 of the Guide. But I wouldn't advise it. The Guide itself points out that 'it is not possible to list all the factors that are considered in determining whether a person is domiciled in a particular country'. So if you are in doubt, get expert advice.

When you have sorted that one out and are in the position to give a confident 'yes' or 'no' to the question: 'Are you domiciled in the UK, yes or no?', you reach the next murky area, namely, questions about residence.

If you have never thought about your residence or domicile status before, it probably means that you don't have to. In that case, this section of the program will strike you as a little quaint. It has to be worked through all the same, but that only takes a moment or two. The real test of the program at this point is how well it serves those who might have a problem in this area.

About the best it can hope to do is to indicate what are the problems connected with being 'resident' or 'ordinarily resident' (the two are not quite the same) in the UK. And it does this reasonably well. You can omit the residence questions altogether if you are sure (as most users will be) that you are a resident.

If you do want advice here, the first thing the program tells you is that it is not really competent to deal with residence questions. 'These residence questions (on your screen) are not exhaustive. Please read the manual where advised to do so and seek professional advice if in doubt,' it says.

But it gives a sound idea as to what would make one a non-resident. Going abroad under a full-time contract of employment which is still in force is an excellent way of being non-resident (though you might still have to settle your current tax bill first, depending on when you plan to leave).

The program also asks you whether you have been physically present in the UK for 183 days in the 82/83 tax year. An extended holiday abroad can have great implications for your tax status.

Having answered all these questions you get a comforting message up on the screen asserting 'You are resident and ordinarily resident in the UK' — and so, by implication, it will be worth your while continuing with the Microtax program.

Tax jargon

As this is a serious tax program, from time to time it has to use the language of the Inland Revenue and of tax law. This language has nothing in common with the language of everyday. This means that the user must be prepared to go backwards and forwards between the program and the

tax guide.

An instance of this occurs when you begin the tax program proper, having answered all the preliminary questions. The screen asks: 'Do you have any earnings which arise from an office or employment in 82/83. See B.2.' In ordinary language, this does not make much sense. Earnings which arise from an office you might suppose to refer to earnings which you get from working in one. You'd be wrong.

Turning up the Guide you will discover that neither 'office' nor 'employment' have been defined in tax law. An office is usually referred to as 'an existing permanent substantive position which has an existence independent of the person which fills it, and which is filled in succession by successive holders'.

When you work your way through that one you might realise that earnings from an office means holding a company directorship or the like. Employment, on the other hand, arises when there is a contract of service as opposed to a contract for service. If you are paid under the PAYE system where you receive your pay net of tax, then you can be relatively certain that your earnings arise from a contract of employment.

By now it will have struck most users that they are discovering a great deal about tax law that they do not really need to know in order to fill out their income tax returns. It might have taken the more curious among them some time to reach this point in the program. And still not a line of their tax return has been filled in. One way of looking at this program — for all its seriousness — is to see it as another elaborate question and answer computer game. That is why it strikes me that whatever the supplier's intentions, the program will appeal most of all to enthusiasts who want to get the feeling that they are doing something useful with their home computers.

The program goes on to ask whether your earnings are accessible as earnings under Schedule E, or as profits of a trade or profession under Schedule D. Most users who get this far on the Dragon will know from past history whether they fall under PAYE or not. If you don't know, the program won't be able to help you. It will simply bring you up short at this point.

Microtax can deal with up to five separate contracts of employment. Most people only hold one (nearly four million don't hold any, but that is beside the point since they won't be buying this package).

Having answered all the domicile and residence questions and decided that you do fall inside the PAYE NET, there is still one more barrier to cross before you start work on your tax. The program wants to know whether your employer is resident in the UK or not (the employer company, that is).

As the Guide points out, the residence of the employer is an ill-defined term under current tax law. You might have to go to your employer's accountant to find out if your contract of employment is with a non-resident employer. Once again, this is not a point that most users need bother with. But it does have important implications for your

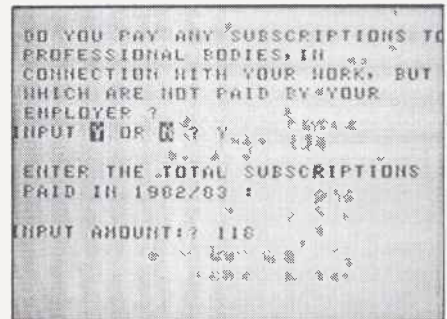
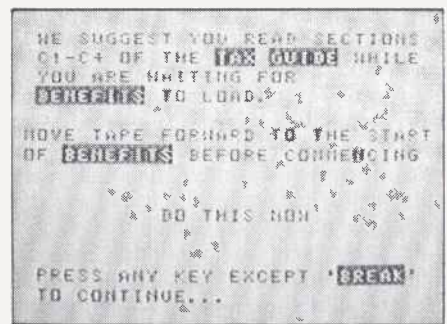
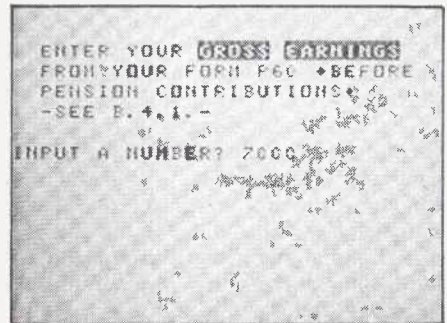
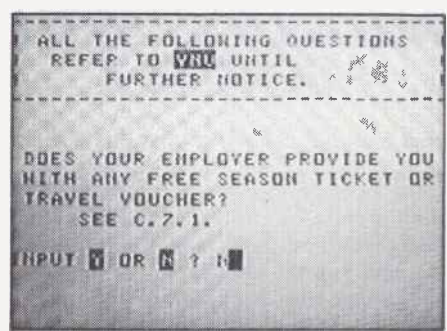

Lucid and comprehensive instructions on the screen.

tax if, by some chance, your employer is not a resident UK company.

A large number of expatriates from abroad working temporarily in the UK will be put on the payroll of a non-resident company in order to reduce their tax liability. As the rest of the world has noticed, UK tax rates tend to be unusually high.

Comprehensive cover

Once through that, you are finally ready to begin. It sounds like an awful lot of work, but the program has had to foresee every eventuality. The sensible user should have skipped through everything to this point. But if you are the least bit adventurous, be warned. Filling in your tax return using this package is going to take you into some very strange waters.

The first value you are asked to put in is

MEDDLING WITH MICROTAX

your gross pay. That is an easy one, since if you don't know that, you are going to be in a pretty poor position to work out your tax! But the naive user will stumble again once he comes across Benefits-in-Kind (sections C.1 to C5 of the Guide).

You can omit the Benefits-in-Kind section altogether, or omit it for selective contracts of employment (if you have more than one). For those who need it, it is a vital section of the program, since working out what you owe the taxman for your company car can be a real headache.

The Car Benefit program is a separate program on the tape and has to be loaded separately. Theoretically, as I've said, the program can call up the next routine automatically. This didn't work for me since I had a rather elderly tape recorder. But loading each additional program was no real problem.

This section is designed to take you through all the details that the Inland Revenue needs to know in order to assess the taxable value to you of having a company car. The questions it asks include: how many cars were available to you; whether you changed the car during the year; whether it was more than four years old; what cylinder capacity it had and the number of days it was available to you.

It also wants to know the business mileage through the year. At the end of entering all the information — and this is true of all the following sections where you enter information — you get a chance to rerun the section, without reloading the program, to change any details you want.

When you have finished, the program comes up with a pound value of the benefit to you. Where the program gets this value from is not at all obvious, as it is based on the intricacies of what the Inland Revenue has laid down. Unless you are a tax expert yourself, you will simply have to take the program on trust here.

The rest of the Benefits-in-Kind section is contained in the next program on the tape. It deals with things like free season tickets; travel vouchers; credit cards, etc, living accommodation (explained in the Guide); heating, lighting, repair bills, etc, paid on this accommodation by your employer; and so forth. Once again, gathering all this information, if it applies to you, could be tricky, but it is information you would have to supply to the taxman anyway. If it doesn't apply to you, it can be whisked through fairly quickly.

Profit sharing schemes have become more popular recently, and the Benefits-in-Kind program includes a section on these.

Next comes the Expenses program. All the expenses reimbursed or paid to you have to be taken into account, and the program is at least useful in reminding you of this fact. These can include motoring, travelling, entertaining, mileage allowance, subscriptions, round sum expenses and so on. Free medical expenses, loans from your employer at an interest rate of under 15 per cent and getting goods or services below the

market rate are also taxable expenses.

Then the program goes on to ask about things like pension contributions paid by you through the year. Most of this kind of information you could get off your P60.

This is followed by another program called Working Abroad — a question and answer session designed to see to what extent you have escaped the PAYE net by working abroad through the year. If you have or think you might have been out of the country during the periods from the 6/4/81 to 5/4/83 or will be between 6/4/83 and 5/4/84 then this is the program for you.

Then comes a section on Compensation. The number of people who will buy this program and who will receive compensation for one reason or another through the year can probably be counted on two fingers. But if you need it, it is there. The final section on Side A of the tape is a summary section which totals all the values you have input so far. It tells you a) that you are domiciled in the UK (or not); b) what your company car and benefits-in-kind are worth if you have them; and c) what your expenses are worth. Having done all this, you then have to put Side B on and only at this point are you ready to begin actually filling out your tax return!

Form filling

Side B reminds you once again of the documents you need. Then it works through a maze of questions of the sort that you will find on your tax return form anyway. For example, were you married and living with your spouse during the tax year in question? Did your husband die during the tax year? and so on. It also tells you to do helpful little things such as entering the name and address of your employer on your tax form.

You would have done all this anyway without the program, but since part of its function is to tell you how to fill in your tax form these little prompts could hardly be left out. I found them pretty pointless, but there might be those who find them helpful. Remember, the tax form itself tells you to fill in this kind of information.

The next five sections in the program, headed Return 1 — 5, work through each of the sections of the tax return form, telling you to put in crosses, values and so forth.

Some of these sections are more com-

plicated than others — for example, entering the total value of life assurance premiums paid by yourself through the year is fairly simple; working out the tax due on rents from furnished or unfurnished property, on dividend payments and so on, is not. Once again, you are free to move quickly through the sections that do not interest you.

I was reasonably convinced that all the things that one would normally be caught out by in completing a tax form were included in the program. This includes everything from building society interests, to alimony payments, to supporting a permanently disabled child who has passed the home leaving age.

Return No 5 adds up all the information that you have put in on Sides A and B and lists everything. It also lists the personal allowances (£2445 as the married man's allowance).

The last program deals with the computation of your tax. At this point you are finally in a position to receive all those good things that Microtax promises you on the cover wrapping. It does a little calculation to see whether you would be better off as a married couple electing for separate assessments. It also tells you whether you have overpaid your tax.

Conclusions

My feeling as I came to the end of the program was one of immense relief. If I had been using it to fill in a tax return, instead of simply reviewing it, I would have switched it off shortly after starting. But then, in my days as an employee, not having too much by way of dividend income or benefits-in-kind, and not having any handicapped relatives to support, filling in my tax return was always a rather simple business.

The program will be helpful, though, to the employee with all sorts of factors to take into account. (Microtax has promised that a program designed to meet the needs of the self-employed will be out shortly.)

So if you live in a house provided by the company, pay a minimum rent, have a company car and are blind, receive income from earnings abroad, have a profit sharing scheme and a couple of thousand shares in various companies, then this is the package for you. Alternatively, you might buy it for the joy of running a program that actually relates to the real world instead of to some programmer's fevered dreams of alien invaders.

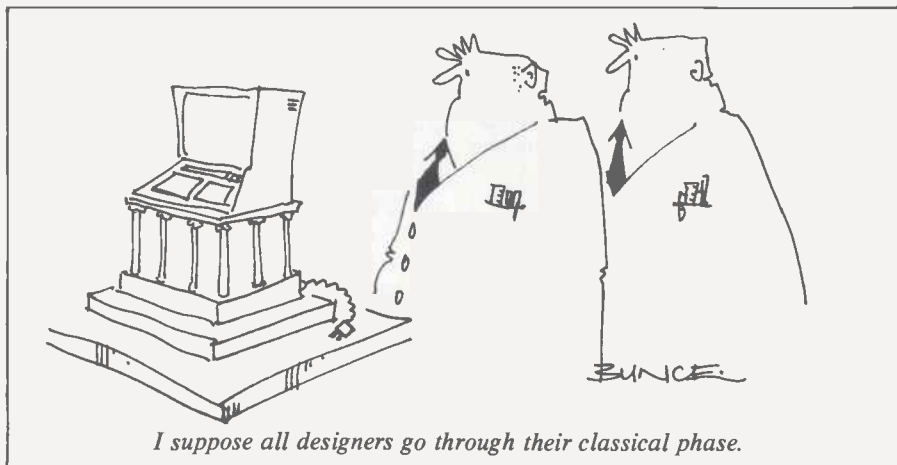



Random rumours

Rumours persist that IBM will soon announce its 'peanut' 16-bit portable computer, with flat panel display, 64 or 128k of RAM and an expected price between \$700-900. The unit is expected to be offered to mass merchandisers. . . IBM is said to be studying the possibility of adding the Pick operating system to its repertoire of operating systems for the PC. . . Microsoft is reportedly close to releasing its word processor package and is beta testing a user shell for its MS-DOS to integrate its Multiplan and word processor packages in much the same manner as Lotus 123 and VisiOn. . . In the meantime rumour has it that VisiOn deliveries have been pushed back to August/September.

Random news bits

Microsoft has introduced a \$195 mouse device (made in Japan) with demo software. . . CBS has formed a division to publish personal computer software. . . Bill Synes, the chief designer of the IBM PC and an 18-year IBM veteran, has left IBM to join Franklin Computer (an Apple look-alike maker). . . Cannon Inc, Tokyo, a major supplier of calculators to the US, will shortly begin shipping personal computers. . . California Software Products Inc, Santa Ana, CA, has released a package that enables the PC to run IBM System/34 applications soft-without modification. They call it 'Baby/34'.

Big blue report

IBM has reorganised its marketing of the PC and XT

Sol Libes presents his monthly batch of juicy snippets from the Big Apple.

by giving its own direct sales force greater latitude. Discounts offered by IBM salespeople have been increased and they are now being permitted to accept orders on individual units (previously they were limited to accepting orders for 20 or more units). IBM itself is offering discounts of five per cent on 3-10 machines, eight per cent on 11-19, 12 per cent on 20-49, 16 per cent on 50-149 and 20 per cent on 150-249 units. IBM now has 770 dealers including 40 IBM product centers, 45 Sears Business Centers, 330 Computerland outlets, 350 independent retailers and nine value-added dealers.

Microsoft to offer Xenix via retailers

Xenix, the Microsoft implementation of Unix disk operating systems for microcomputers has until now only been available as a product bundled with a hardware system. Microsoft will now be selling a simplified version through computer stores. Initially a version for the Apple Lisa will be offered to be followed with an IBM PC version. It will include a hardware card which must be installed into the machine.

Commodore shipping new computers

Commodore has made initial shipments of three new micros to dealers: the B500, C128 and PET 64. Two more machines — the trans-portable SX100 and a Z8000-based 16-bit Lisa-like system — are expected within 90 days. The SX100 is expected to have a 5in screen and retail for under \$1000. A \$1500 colour version is expected to follow. The Z8000 machine is expected to sell for less than \$3000 and will include monitor and 896k of RAM.

The C128 (at \$795) uses the 6509 processor, has a 40 character-wide screen, sup-

ports full colour and is expandable to 896k of RAM. It is the first Commodore machine with a true RS232 port. The B500 (at \$895) is an 80-column black and white business oriented version of the C128. An Intel 8088 plug-in board with MS-DOS and CP/M-86 is expected as an option. The PET 64 is designed for educational use and will sell for \$695.

Two more business-oriented machines (B700 and BX700) are expected later. The BX700 is expected to have three processors: the 6509, Z80 and 8088, with the ability to switch back and forth between them. Also expected is a machine to be called the 'Executive 64' which will include 128k of RAM and bundled software.

Electronic software delivery

As if computer stores were not having enough competition in selling software from bookstores, they are now getting competition from radio, cable and timesharing companies. These companies have introduced electronic delivery of software (currently mostly games). PlayCable, a joint venture of Mattel Inc and General Instrument Corp, is currently sending video game software to cable TV subscribers in three cities. National Public Radio has received permission from the Federal Communications Commission to broadcast software in an unused portion of the FM radio band. And CompuServe Inc, a timesharing service for personal computer users, has initiated a service whereby users can download software and have it billed to their charge card.

Notebook portables arrive

The true portable computer market is off to a fast start with notebook-sized products from Tandy, Epson and NEC. IBM (see 'Random rumours' section) is expected to enter

shortly as is Commodore, Osborne and Apple. Commodore, which announced the HHC-4 hand-held computer back in January has announced that it has cancelled the project. The unit was to have had a 24 character LCD display and other features now considered too limiting in this new emerging market.

Tandy is expected to be the front-runner in this market for this year. Tandy expects to sell 100,000 portables (100 million dollars worth) this year alone. NEC, with a unit very similar to the Tandy unit, is expected to be second with Epson third. Epson is expected to introduce a new Z-80 based unit with 80-column display this summer to replace their current unit. Prices should start dropping by Christmas.

The portable computer market appears to be the first segment of the personal computer market in which the Japanese will assume a prominent position.

Home computers — a marketing game

The home computer market is behaving in a manner akin to the calculator field of the early 70s with prices dropping monthly. Home computers are no longer being sold by independent computer stores but rather are the staple of mass merchandisers and catalog sales organisations. The thing that is expected to save computer makers from pricing themselves out of business is the aftermarket for products such as peripherals and software.

Timex/Sinclair, Texas Instruments and Commodore are in a neck-and-neck price race, with Atari running a close fourth. The Timex 1000 (Sinclair ZX81) can now be purchased on sale for under \$40, the VIC 20 for under \$85 and the Atari 400 for under \$100. And there are rumours that we may see the VIC 20 go as low as \$29.95 and the Commodore 64 as low as \$199 by Christmas.

YANKEE DOODLES

The Commodore 64 is currently selling for as low as \$288 (including a \$100 rebate), which is half of what it was selling for last September. The Atari 800 is now selling for \$388 (with a \$100 rebate).

Atari is going through a reorganisation, moving manufacturing to the Far East to reduce cost and going into the chip manufacturing business to integrate vertically in an attempt to remain in the race. Tandy, despite the selling of over 300,000 colour computers, is now a distant fifth in the field and will most likely drop further back as game makers such as Mattel and Coleco step up their marketing efforts.

One drop-out already is the decision of TI to drop its new 99/2 computer, after test marketing the unit for under \$100. The basic problem is that the current 99/4 computer is now selling for under \$100.

The desk-top microcomputer market has also been the scene of price slashing. In response to IBM's 15 per cent decrease in the price of the PC, Apple cut 20 per cent from the Apple III, Texas Instruments cut 15 per cent from its Professional, Xerox

cut the price of the 820-II by 26 per cent and Zenith cut its Z-100 price by 12 per cent.

Book publishers move into computer book publishing

Doubleday, one of the largest book publishers in the country, recently gave an author a \$1.3 million advance (a new record) on a book to be titled *The Whole Software Catalog*. Virtually every major book publisher now has a computer book division and computer books are staples in almost every book store. Several of the book publishers have also begun software publishing operations as more and more book stores have begun to carry software on their shelves.

Zilog to release Z800

Zilog has finally officially

released the Z800 microprocessor, although samples will not be available until the fall. Production is expected in the first quarter of 1984. The Z800 is a greatly enhanced Z80 — Zilog claims five times greater performance. The Z800 will include a memory manager (for up to 16 Mbytes), DMA controller, counter/timers, serial I/O, 256 byte cache memory, interrupt controller, four additional addressing modes, four additional registers (including a second stack pointer) and memory refresh logic. It has a clock rate of 10-25 Mhz (Z80 current maximum is 8 Mhz).

The added functions include instructions for hardware multiply/divide, 16-bit arithmetic, 16-bit load, system/user calls (for multiuser/multitasking) and test/set (for multiprocessing). A floating point math co-processor (Z8070) was also announced. The Z800 will come in four versions (see below).

| Prices | I/O | Pins | Address | Lines | Price in \$ |
|--------|--------|------|---------|-------|-------------|
| Z8108 | 8 bit | 40 | 19 | | 40 |
| Z8116 | 16 bit | 40 | 19 | | 48 |
| Z8208 | 8 bit | 64 | 24 | | 60 |
| Z8216 | 16 bit | 64 | 24 | | 72 |

The 8-bit I/O versions interface directly with Z80 peripheral chips while the 16-bit I/O versions work with Z8000 family of devices and have about twice the throughput. The 40 pin devices will omit circuitry such as serial I/O and DMA controller.

FCC fines microcomputer makers

Forty four manufacturers of personal computers and electronic games have been notified by the Federal Communications Commission that their equipment does not comply with FCC standards on radio frequency interference (RFI). Of 317 devices checked, the FCC found that almost 30 per cent were in violation.

CROSS-FIGURES

For those among you who were unable to come up with all the answers for our Cross Figures Puzzles last month, here are the solutions.

Solution 'Cross figure puzzles'

| | | |
|---|---|---|
| 1 | 8 | 2 |
| 0 | | 8 |
| 7 | 4 | 9 |

The clue for A-down is redundant.

| | | |
|---|---|---|
| 5 | 6 | 7 |
| 2 | | 7 |
| 9 | 8 | 7 |

All four clues are needed.

| | | |
|---|---|---|
| 3 | 6 | 1 |
| 2 | | 9 |
| 7 | 2 | 9 |

The clue for B-down is redundant.

Solution 'Theatre' clue

The year was 1576 (see library ref. books!). A-ac must be between 1000 and 1999. So C-dn (twice A-ac) must be between 2000 and 3998, ie, C-dn begins with 2 or 3. But 1st digit of C-dn is also last digit of A-ac, and C-dn is twice A-ac, so twice that digit must give a 6 for the last digit of C-dn: $2 \times 2 = 4$ no; $2 \times 3 = 6$. OK! So first digit of C-dn is 3, and C-dn is between 3000 and 3999.

| | | |
|---|---|-----|
| 1 | | 2-3 |
| | 5 | |
| | | 7 |
| | | 6 |

So A-ac (half of C-dn) must be at least 1500, ie, 2nd digit of A-ac is 5, 6, 7, 8 or 9. Now let's look at the clue for A-dn: $5 \times 5 = 25$, so last digit of A-dn is 5. Remember that 2nd digit of A-

dn must be same as 1st digit of D-ac. Now some calculator work... Set 55 in calculator as first trial value of B-dn. Try values of D-ac starting at 15:

| | | |
|---|-----|---|
| 1 | 5-9 | 3 |
| | 5 | |
| | | 7 |
| 5 | | 6 |

D-ac * 5
xB-dn * 5-9 5
A-dn 1 * * 5

55 x 15 = 825 too small
55 x 25 = 1375 no
55 x 35 = 1925 no
55 x 45 = 2475 too big — try 65

65 x 15 = 975 too small
65 x 25 = 1625 no
65 x 35 = 2275 too big — try 75

75 x 15 = 1125 yes! But check all values:

75 x 25 = 1875 no
75 x 35 = 2625 too big. Try 85 and 95: no, no.

| | | |
|---|---|---|
| 1 | 7 | 3 |
| 1 | 5 | |
| 2 | | 7 |
| 5 | | 6 |

So only one possibility: $75 \times 15 = 1125$

The digits of A-ac total 19. We have 1, 7 and 3, adding up to 11. So remaining digit must be 8, giving A-ac as 1783. So C-dn (twice 1783) is 3566. That gives 76 for E-ac, and the square of 76 is 5776, giving F-ac. And that's it!

| | | | |
|---|---|---|---|
| 1 | 7 | 8 | 3 |
| 1 | 5 | | 5 |
| 2 | | 7 | 6 |
| 5 | 7 | 7 | 6 |

To find solution without knowing the actual 'theatre year' (the first digit must be 1, of course!), you need a list of squares (from calculator or maths table) and determination! Clue for A-ac is important. Happy hunting.

Solution 'Common factor'

| | | | |
|---|---|---|---|
| 5 | 5 | 8 | 6 |
| 4 | | 4 | 9 |
| 8 | 3 | | 7 |
| 1 | 8 | 6 | 2 |

Four of nine clues are redundant.

Three out of every four computers going into schools are BBC Micros.

Is there a lesson to be learned by every user?

As part of the current government subsidised scheme aimed at introducing micros to schools, the Department of Industry undertook a survey of machines available and made recommendations to education authorities all over the country.

The BBC Micro met their priorities exactly: it is economical yet fast and powerful, and it can justify the investment involved, through its capability to grow with the needs of the user and with the rapid changes in technology.

Teachers and education authorities agreed, and today it represents over three-quarters of all micros being ordered for schools across the country under the DOI scheme.

The BBC's choice too.

In choosing a machine to put their name to for their massive Computer Literacy Project, the BBC had the same set of priorities as the DOI. The BBC Micro is now an integral part of that project, which includes books, software, courses and a number of major television series, one of which, "Making the Most of the Micro" is now being broadcast.

All this for only £399.

The BBC Micro is light and compact. It generates high resolution colour graphics, and is capable of synthesising music and speech using its own internal speaker. The keyboard uses a conventional layout and typewriter feel.

The most sophisticated version (called

Model B) is available for only £399. (There is also a basic model available, the Model A, at £299.)

Designed to grow.

Last year the magazine "Which Micro?" said that the most attractive and exciting feature of the BBC Microcomputer was its 'enormous potential for expansion'.

This is indeed one of the features that sets it aside from the competition.

For example, as well as interface sockets to allow you to connect to a cassette recorder, and to your own television, you can also use video monitors, disc drives, printers (dot matrix and daisy wheel) and paddles for games or laboratory use.

You can also plug in ROM cartridges containing games with specialist application programs.

The Tube. A unique feature.

The Tube, which is unique to the BBC Micro, provides for the addition of a second processor via a high speed data channel. The possibilities are enormous. For example, the addition of a second

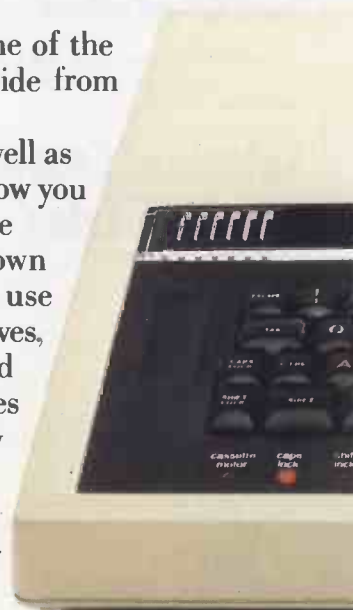

3MHz 6502 processor with 64K of RAM doubles processing speed. While a Z80 with 64K of RAM opens the door to a fully CP/M* compatible operating system, with all the benefits for business applications.

Linking up with other computers.

The BBC Micro also offers a facility of immense potential value to schools, colleges and businesses. It's called Econet® – a system which uses telephone cable to link with other BBC Micros. A number of machines can then share the use of expensive disc drive and printer facilities.

Make full use of Prestel & Teletext.

With special adaptors you will not only be able to turn your TV set into a Prestel terminal and teletext receiver, but you can also take data and programs direct from these services. (The programs, which are known as telesoftware, are already being broadcast by BBC's Ceefax service.) This is another first for the BBC Micro.

BASIC plus.

A sophisticated version of BASIC has been chosen for the BBC Micro, which incorporates features normally found only in more advanced high level languages. However, there is also a facility allowing access through a simple command to another language – for example, PASCAL, FORTH and LISP.

*Trademark of Digital Research.

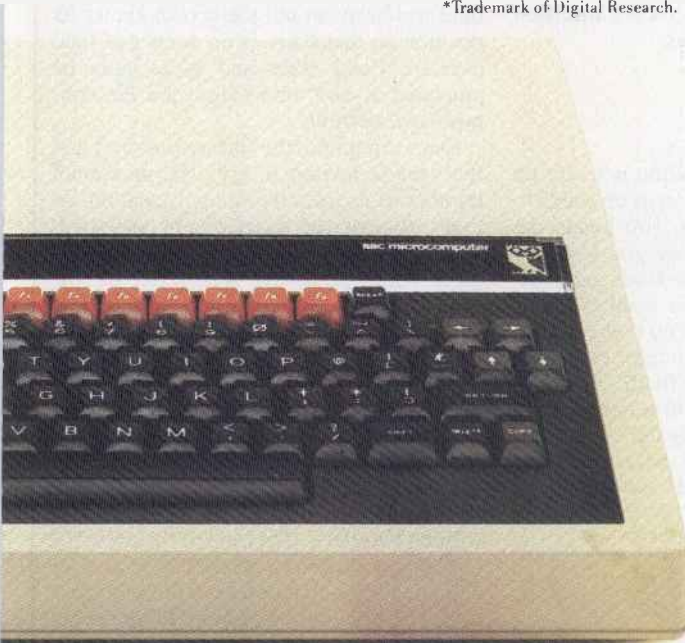

A full range of software.

Applications software for the BBC Micro already cover a very wide field. Packages covering games, education and business applications are available on cassette. All developed to the same high standards set by the hardware.

The best possible back-up.

Your BBC Micro comes with the backing of the BBC and an extensive dealer and service network. Each approved dealer is able to offer advice and carry out expansion work and repairs.

| |
|---|
| BBC Microcomputer – Model A and Model B. |
| 2MHz 6502A Processor. |
| 32K ROM; 16K RAM Model A, 32K RAM Model B. |
| Full QWERTY keyboard with 10 user-definable function keys. |
| Mixed high resolution graphics and upper and lower case text. |
| 300 baud and 1200 baud interface for standard cassette recorders. |
| Three-voice music synthesis with full envelope control feeding internal loudspeaker. |
| Interface sockets (Model B only) – RS423, for analog inputs centronics and user port. |
| 6502, Z80, 16032 second processors. |
| Single and Dual Disc Drives with 100 and 800 K-bytes storage. |
| Teletext unit. |
| Speech synthesis. |
| Networking facility – via Acorn Econet® |

How to buy your BBC Micro.

If you are a credit card holder and would like to buy a BBC Micro B, or if you would like the address of your nearest stockist, just phone 01-200 0200.

Alternatively, you can buy a Model B directly by sending off the order form below to: BBC Microcomputers, c/o Vector Marketing, Denington Estate, Wellingborough, Northants, NN8 2RL.

All orders are despatched by fully insured courier and come complete with easy to follow 500 page User Guide and Welcome cassette.

 01-200 0200 credit card holders.

To BBC Microcomputers, c/o Vector Marketing, Denington Estate, Wellingborough, Northants NN8 2RL. Please send me _____ BBC Model B Microcomputers at £399 each, inc. VAT and delivery. I enclose PO/cheque payable to Acorn Computers Limited Readers A/C or charge my credit card.

Card Number _____
Amex/Diners/Visa/Access (Delete)

Name _____

Address _____

_____ Postcode _____

Signature _____

PCW7
Registered No. 140 3810 VAT No. 215 400220

The BBC Microcomputer System.

Designed, produced and distributed by Acorn Computers Limited.



SOFTWARE DATABASE BENCHTEST

OMNIS

A universal data management package? Kathy Lang determines whether OMNIS lives up to expectations.

In this series so far, the great majority of systems reviewed have been for the CP/M and MS-DOS operating systems, which are very commonly available, and similar to one another to the point where MS-DOS disks can convert files from CP/M formats. This month the subject is a data management system which runs under UCSD-p — the Pascal operating system which claims to be the most portable of all. Certainly OMNIS runs on a very wide variety of systems, from Apple II through Z-80 based systems such as SuperBrain and Osborne to 16-bit systems like Sirius, IBM PC, DEC and SAGE II. In each case it uses the 'native' processor so that you don't need to install a Z-80 card to run the system. Here I shall be looking at how such a system, which almost any disk-based micro can use, compares with others which are more system specific.

OMNIS records are of fixed structure and length; the first field in each record must be a key field, and up to nine others may also be indexed. These indexes are all kept up-to-date. File structures can be changed only by copying the file out to a plain text format and back into OMNIS again. You cannot link one data file directly to another. Any record or group of records can be retrieved either via indexed key fields, or (more slowly) by selecting records which match criteria based on any fields. The package uses menus to get down to the level at which the user's records are displayed on the screen. When processing individual records, commands are used, but

you can ask for a list of those available to be displayed on the screen. Quite extensive security facilities are provided to ensure that users have access only to appropriate parts of the system, and to the information which the Master user thinks they need.

Constraints

The main constraints on the use of OMNIS are shown in Fig 1. The most significant for many applications is the restriction to a maximum of 79 characters in a text field — that is, each field must fit within a single line of an 80-column screen. On the plus side, you need not have all your data on a single screen — fields of a records may span up to ten screens in record insertion and amendment operations.

File creation

The first stage in file creation is to set up formats for one or more screens on which to enter records. To do this, you locate the cursor in the position where you want the field label to begin, type the label, and position the cursor where you want the field contents display to start. You then press an ESCape sequence to go into command mode to give details of the field. The first is the name by which the field is to be known to OMNIS (not necessarily the same as the 'label' displayed on the screen, as the OMNIS name is restricted to seven charac-

ters). You can include the same named field several times — for instance, a reference number once on each screen for applications where a record spans several screens. (That invaluable facility is not documented in the present manual, and can therefore provide an unnerving surprise if you type an existing name by mistake.) Other attributes to be supplied include the length and type of the field, whether it is to be indexed or not, and some additional optional characteristics such as the permitted range of values (which can include 'wild' codes), the precision of display of numeric fields, and, for calculated fields, the nature of the calculation to be performed. There is no provision for echoing, for instance, the value of the same field in the preceding record. When a field has been set up, the screen shows its position so that there is no danger of field overlap. Field sizes and types may be amended at any time before the file contains real records.

Once complete, the format is stored and the user is invited to give the maximum number of records the file will contain, so that sufficient disk space can be allocated. This took six minutes for a 1200-record file on a single Sirius disk. The space can be allocated on one or more disks. The OMNIS/UCSD-p volume assignments seem to use the Apple conventions. Being unused to these I found this part of the package a little confusing, but managed to set up the file for my Benchtest data correctly by carefully re-reading the manual.

Once a file structure has been set up, and records stored in it, it cannot be altered within OMNIS — not even to the extent of changing the fields to be used as keys. Nor can you decide that you need more records than you originally expected. (The details of screen display can, however, be altered — see below.) If you need to change field lengths, add extra fields, define more or different key fields for indexing, or increase the maximum number of records allowed, you must write the file out to a plain text file in DIF™ format (see below, under 'Links with Outside'), redefine the file format, and read the records back into OMNIS. This is a very slow process — see Fig 2 for my benchmark timings. Many packages have

| | |
|---------------------|---|
| Max file size | 32,767 records, not limited to one disk |
| Max no records | as file size |
| Max size record | 1023 characters |
| Max no fields | 120 |
| Max field size | 79 characters |
| Max no index fields | 10 |
| Max no sort fields | 10 |
| Calculation limits | 5 levels of brackets, 120 calc fields in reports |
| Report limits | 240 rows by 240 columns |
| Field types | character, numeric, data (day/month/year — stored as 6 chars) |
| Field modifiers | upper case conversion, protection, decimal places to display |

Fig 1 Constraints

this inflexibility over changing record structures, but few take it to the point of restricting changes to key field definitions, or to the maximum number of records, to such a procedure.

Data input and updating

Record insertion and amendment is carried out via the maintenance function on the main menu. Once this function has been requested, you have a number of commands available, including 'I' for insert a record, and 'E' for edit (the current) record. The commands are activated by pressing the ESC key — once or twice, depending on your system — followed by the command letter. To retrieve a record for editing, you can specify the value of any of the key fields. The procedure is to issue the 'find' command, which results in a screen display of the record in the format set up at creation time, with the cursor on the first field. By pressing the RETURN key, the cursor is moved from one key field to the next until the desired field is reached, when the data to be matched is entered. Once the field value is entered, pressing RETURN again instructs OMNIS to search for the nearest match. Alternatively, pressing CTRL/N will request an exact match. I found this an acceptable compromise method of retrieval, and quite quick to use (see Fig 2 for times). Records can also be retrieved for editing with the 'select' command, about which I shall say more later.

Once a record has been found and displayed, you can either issue the 'edit' command, or ask for the 'next' in sequence (of the field used to select the record for display). So you can scroll forward through records with identical values for the key field. You can't, however, scroll backwards. Data editing is carried out by direct screen editing, using the cursor movement keys in the usual way. Deletion involves pressing CTRL/D once for each character to be inserted, and then typing in the insertion over the spaces. You can also move backwards and forwards among the screens of data for one particular record, using commands. Since records are stored to the file after being added or edited, the indexes which give access through the key fields are automatically kept up-to-date.

Displaying data on the screen

The screen formats set up when the file is created are always used to display records when accessed by the 'find' or 'select' commands. Screen display can include not only the data items themselves — which incidentally may be shown left or right justified or centred within the space for the field — but also features such as lines drawn to make the display more readable. The screen format creation section includes some commands to make this an easy feature to use. You can mark a rectangle on the screen and then ask OMNIS to draw a line round the rectangle with user-specified

characters. In addition, the order in which fields are displayed need not be the same as their order in the stored record, so although the first field in the record must be a key field, it does not have to be displayed as the first field on the screen.

The restriction to a single overall display format for 'find' and 'select' access means that you cannot vary the way the data is displayed for editing according to the needs of different applications. You can, however, restrict the display so that particular fields are not shown if you don't want the user to have access to them. So it is possible, for instance, to permit a clerk to update staff names and addresses without also permitting that person to see, still less change, staff salaries. It is also possible to display data in a variety of different formats if the need is for viewing only, and no changes or updates are required. This is achieved by the 'report' function, as any report may be shown on the screen instead of being printed. So if you simply wanted to view a few fields from selected records on the screen together, listing them one line at a time, you would have to set up a report format for that function.

OMNIS also has two features which permit repetitive amendment. A group of records meeting certain criteria can be deleted 'at a stroke' with the 'zap' command. A group of records can also be amended by the 'multiple update' command, allowing such useful actions as increasing all prices by five per cent, or upgrading salaries for all individuals in a particular staff grade by £500. The criteria for selecting records to be deleted or amended are set up in the same way as criteria for use by the 'search' command, described later under 'Selection'. The calculation facilities in 'multiple update' are the same as those permitted during data entry, which are described later under 'Calculation'.

Printed reports

The provisions for printed reports in OMNIS are extremely powerful, but quite complex in their use and explanation. The format itself is designed in a very similar fashion to the screen display format, using a mainly 'paint-a-screen' approach which I personally find quite helpful. But the way in which sections of the report are specified is less easy to understand. Each report may have up to 12 sections — one detail section, a heading and a totals section, and up to nine sub-totals sections deriving their values from fields specified as sort fields. Instead of some form of labelling of these sections on the report, they are separated from one another by a single exclamation mark, so that only by counting can one identify (when designing the format) the detail, total and other sections. Any field for which a sub-total is calculated may, if desired, force a page-break when its value changes.

In addition to field values from the record, any section can include calculated values — up to 120 variables may be defined, calculated from field values and/or constants. You can also include the page number, a count of the number of records processed so far, or the current date. Report

formats can subsequently be modified (but I couldn't find a way within OMNIS to keep a previous version of a format and also use it as a basis for constructing a new stored format). The formatting of the 'detail' section is sufficiently flexible to allow inclusion of enough text to write personalised letters including OMNIS information. This is a big advantage, and not very commonly found in data management systems. However, don't expect full-blown word processing capability — for instance, you can specify that a field in a letter is to be of varying length, so that the rest of the line is moved over to close up the gap, but remaining lines stay in place rather than the whole of the rest of the paragraph being moved up in WordStar/Mail-Merge fashion.

The paper layout is specified by a separate menu option, so that you can control numbers of lines on the paper, margins and line spacing. You can also vary the number of records printed across the page, to permit the printing of mail labels which may be 'two-up' or more (up to six in OMNIS). If you only want totals printed, you can at this stage suppress the printing of the detail line. You can also specify pausing at the end of a page, in case it is necessary to print a report on single sheets rather than on continuous stationery. If the report is displayed on the screen, OMNIS pauses at the end of each screenful of information.

In addition to formatted reports, it is also possible to 'dump' a copy of the screen to the printer while editing.

Selection

For screen display, records may be selected either by the 'find' command which I talked about before, or by the 'select' command. This allows you to set up to ten criteria, which will be tested to see if a record meets the search requirements. The setting up process involves filling in up to ten lines of a form displayed on a separate screen, rather than by building up a single combined command. Fields may be tested for equality, less than, greater than, not equal, starting with or containing a constant value. (Matching against another value in the same or another record is not permitted.) If more than one test is employed, the results are 'ANDed' together, so that a record only passes the test if it meets all the criteria — this is to a large extent a consequence of the method used to set up searches. Searches may be executed immediately, or stored in a file for subsequent retrieval. Once a record has been retrieved through the 'search' command, it can be edited just as if it had been retrieved with 'find'.

Stored searches set up through the 'search' command may be used to control the retrieval of records for printed reports; this may be tied to the report format if a report always involves a particular selection, or activated dynamically when the report is invoked.

Sorting

If you retrieve records with the 'find' command, and then issue 'next' commands to

OMNIS

browse forward through the data, the file will appear to be sorted in the order of the field used for retrieval. To get records sorted in order using more detailed sequencing, you must use the 'sort' facility within the 'report' function. This allows sorting on up to nine fields, each of which may be in ascending or descending order. Once sorted, records can be displayed either on the screen or on the printer as described in the 'report' section above.

Calculation

At input and during multiple updating, you can specify calculations based on constants or field values, combined with the conventional arithmetic operators. No memory variables are available for storing intermediate results, but at the expense of disk space you could allow an extra field or two in the record itself for this. The number of data fields allowed is quite generous. Order of execution of arithmetic statements may be modified by using brackets, which can be nested up to five levels deep. During the preparation of reports, up to 120 calculation fields may be defined, using the same features. These calculation features are relatively powerful, and should, with the provisions for totalling and sub-totalling, cater for most needs.

Multiple files

OMNIS can handle only one file at a time. However, communication between two files can be achieved through converting to DIF™ format and writing out again — see 'Links with Outside'.

Tailoring

Within its own provisions, OMNIS is a flexible package, and it permits the storage of search sequences and of report formats (including sorting and selection criteria) for subsequent use or modification. But it doesn't provide the ability to set up a sequence of operations which combine the use of several commands in a predefined sequence, to permit full tailoring to a particular application.

Security

Protection against ill-considered or unauthorised use of OMNIS is provided in a variety of ways. When the screen format for data entry is set up, fields may be protected; a record which contains one or more protected fields may not be deleted in normal operations. This provision applies to any user. An extensive set of facilities control the extent to which individual users or classes of user (four 'users' plus the Master user, each identified to the system by a password typed in when the system is started up) may access OMNIS functions, and

fields within records. Control may be very detailed, but the principle is that users can be given full access, allowed to modify and add data but not amend or create file structures. They can be permitted just to see records but not change them. Control over access to individual fields could be particularly useful in environments, such as hospitals or personnel offices, where information tends to be a mixture of the public and the confidential.

Housekeeping

Access to the housekeeping facilities of UCSD-p is included within OMNIS, so that by using an option given when the system is started, you can copy, delete or rename files. You can't at the moment format disks in this way, although by the time you read this article, OMNIS should include a formatting facility.

Links with outside

The link between OMNIS and the outside world is provided by the ability to read and write files in DIF™ format. This is a format devised by Software Arts to allow exchange of data in plain text form between packages. In the full form as used by OMNIS it includes the specification of field names, which makes it possible to use the format to bring back into OMNIS a file whose format needs to be modified, for instance by the addition or deletion of fields or by defining different key fields. It is relatively easy, if rather tedious, to create records in the DIF™ format in most programming languages. In addition, a number of other packages, notably VisiCalc, can read files in DIF™ format. The processing of DIF™ files within OMNIS is, however, extremely slow. I stopped my Benchtest 6, which usually imports 1000 records from an external file (DIF™ format in this case) after 800 records and 2 hours 45 minutes of continuous disk activity, to save further wear on my disks. I didn't carry out Benchtest 1, which involves adding one new data field to each record, as this would have taken the time to write a DIF™ file out from OMNIS, plus at least the time for Benchtest 6 to read the records back into OMNIS using the new record format.

Whether this slowness is a serious problem depends very much on your application.

User image of the software

As is so often the case, OMNIS is a mixture of good and bad in its ease of use. The blend of menus and commands is sensible. It uses menus to get down to the record handling level, and then commands to handle the individual records. The ability to show available commands on the screen on request is very valuable. On the other hand, I thought the menu arrangement unimaginative: in particular, all the record handling — insertion, amendment, selection for screen display — is covered by one main menu option called 'Maintenance', so that you would almost always have to call up the next level of menu to carry out the most frequently used operations. And the report formats were extremely complex to set up, although less difficult in practice than the current manual makes it seem. In particular, the method of numbering the fields on the screen, and the instructions for displaying sub-totals, were in my view very confusing. The report facilities do include the ability to test the format before live printing, a very valuable but necessary feature.

The users of OMNIS to whom I spoke were very happy with the package — one went so far as to say 'I don't know what we'd do without it'. The ability to span several screens, the power of the calculations, and the flexibility of reporting were features which were particularly mentioned.

Documentation and support

The documentation for my review system consisted of an A5-sized manual, which is in two parts: a tutorial section and a reference section. There is no summary of reference material — including commands — nor is there an index. So although the manual is much smaller and less intimidating than most, it is quite difficult to find exactly what you need to know. I also found the style rather dense and a bit sententious,

| | | |
|------|--|----------------------------|
| BM1 | Time to add 1 new field to each of 800 records | NT — see text |
| BM2 | Time to add 50 records interactively | 2 sec/record |
| BM3 | Time to add 50 records 'in a batch' | NT — only via DIF™ file |
| BM4 | Time to access 50 records from 800 sequentially selecting on one field | 20 mins 50 secs |
| BM5 | Time to access 50 records from 800 by index on 25-character field | 4 mins 35 secs + scrolling |
| BM6 | Time to index 800 records on 25-character field | NA — updated |
| BM7 | Time to sort 800 records on 5-character field | 22 mins 25 secs |
| BM8 | Time to calculate on 1 field per record and store result in record | 25 mins 10 secs |
| BM9 | Time to total 3 fields over 800 records | 26 mins 15 secs |
| BM10 | Time to import a file of 800 records | 2 hours 45 mins |

Notes: NT=Not Tested NA=Not Applicable — indexes kept up-to-date, new index fields not allowed

Fig 2 Benchmark times

Sage for those who demand more and more and more....

If your application is too demanding for small-fry microcomputers, if it looks as though only a mainframe will do – think SAGE and save money.

If your BOS accounting system is too much for your IBM Series I or DEC PDP 11/34, think SAGE and get more power at less cost.

SAGE is simply the most powerful microcomputer – nearly 2½ times as fast as a PDP 11/34 minicomputer running Microcobol bench tests. *Its 32 bit Motorola 68000 processor runs at 8 MHz and executes 2 million instructions per second. It can address up to 16 million bytes of memory. It runs four operating systems – BOS, Mirage, P System and CP/M 68 – with the Unix-like IDRIS due shortly. You can program in Pascal, Basic, Cobol, Forth, Fortran 77, APL, OCCAM, Expert, Modulla II and “C”.

C/WP Computers, Britain's leading microcomputer dealer, now offers SAGE systems with full technical support. C/WP can supply you with terminals, printers, Winchester disks, tape drives, graphics devices, network multiplexors and communications equipment for your SAGE. All SAGE systems are covered by a free 12 months, on-site 24-hour callout maintenance service. Free delivery in the UK within 20 days of order.

SAGE II, 128k RAM, two 640k floppy drives, one terminal (two may be fitted) £3,990

SAGE IV, 1024k RAM, one 640k floppy drive, 10 Mbyte Winchester drive, six terminals £9,365

For full details and price list write or telephone C/WP Computers, 01 630 7444

*Tested by MicroProducts Software Ltd using SAGE II



C/WP

C/WP Computers
108 Rochester Row, London SW1P 1JP
Telephone: 01-630 7444

OMNIS

and the structure (with the chapter numbering continuous through both tutorial and reference sections) confusing. On the other hand, the tutorial section does give page numbers for the reference section showing where further information is to be found. The manual included all the major features of OMNIS itself, with some minor omissions. But I was sorry that it lacked a description of the DIF™ format, to ease the problems of people trying to get information into OMNIS from other packages, or out to other processing programs.

The disks as distributed include some example data files, which are very valuable for trying out the system to start with. Not all the examples in the manual had been tried out on the sample data, though. The example given of selecting a field from the same data file used in the manual specifies a search for which there are no matches in the sample file. . . It is to be hoped that this and other deficiencies will be remedied by the revised version of the manual, which I am told includes a complete rewrite of the tutorial section, and which Blyth Computers Ltd (suppliers of OMNIS) says should be available by the time you read this. But, as with any other package, you should make a point of looking carefully at the manual before buying.

Support for OMNIS is provided both by dealers and by Blyth direct, which has a support person working full-time on a 'hot line' for dealers and registered users. Customers speak well of Blyth's support — 'Blyth has been extremely helpful,' was a typical comment.

Conclusions

OMNIS is a powerful and flexible package, which is available on a wide variety of sys-

tems under UCSD-p, and is well-liked by its users. It can cope with quite large records, and its files can span more than one floppy disk. The calculation features are good. Its retrieval facilities are less flexible than some — the ability to combine selections only with AND would be a disadvantage to many — and it can cope with only one file at a time. The reporting is extremely powerful, but some of its features are not very easy to use. This is in contrast to the rest of the package, where by and large the mixture of menus, commands and direct screen entry using cursor movement was quite successful. If the other software you are using is not running under UCSD-

p, you would be limited to translating files across disk formats using the UCSD-p Xenophile utility.

The package is competitively priced, but its performance, as shown by my benchmark (Fig 2), is not particularly fast relative to other packages I've tested, except when retrieving records directly by key. In summary, OMNIS is well worth looking at for handling information with a fixed structure, especially if you are looking for a package running under UCSD-p. But make sure you take a good look at the manual, and see the package working on a size of file comparable with those you will be using.

Summary

| | |
|----------------|--|
| Package Type | Data management: single file, fixed length records. |
| Facilities | Selection, ordering by indexes kept up-to-date automatically, powerful calculation in records and reports, good reporting, important export of files in DIF™ format, password protection on functions and fields, 'paint-a-screen' formats for screen display and printed reports. Changes to structure and max number records only by copying records out and back. |
| Ease of Use | Good, with exception of reporting. |
| Error messages | Clear when provided — some non-vital omissions. |
| Documentation | Not very clear, sententious, some omissions, no index or reference summary. Being rewritten. |
| Costs (ex VAT) | £195 for Apple II; £295 for Sirius, IBM PC single-user systems; includes 'hot-line' telephone support. Updates £15 per release. Special prices for networked systems. |
| Supplier | Blyth Computers Ltd, Suffolk. Tel: (050270) 371. |

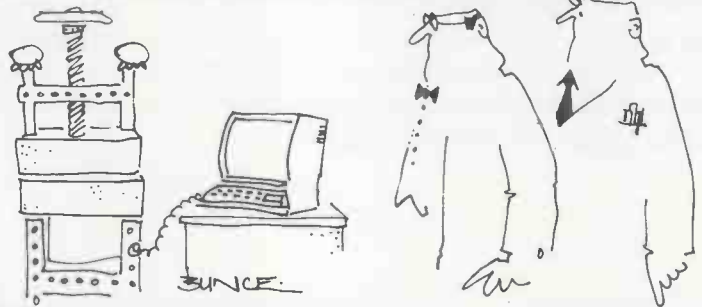

'It's on loan from the printer company until the new models come in.'

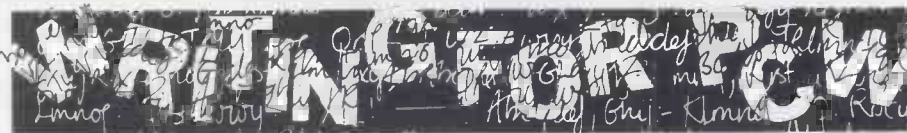

PCW welcomes approaches from would-be writers, even those who have never appeared in print before. In this game it's often those with practical experience who have important things to say so we don't mind if your prose is less than perfect — providing submissions have a sensible structure and follow a logical sequence, we can take care of the polishing.

If your article is already written, send it in — taking care to ensure that your name and address, together with a daytime phone number if possible, appears on both the covering letter and the manuscript. Manuscripts should, preferably, be typed or printed out (dot matrix output is quite acceptable) but *must* be double line-spaced with ample margins top and bottom and on each side. Make sure you keep a copy of *everything* you send us.

We can now accept articles on a limited number of disk formats: standard IBM 3740 single-sided, single-density 8in, and the following 5¼ in formats: Superbrain

SSDD 35-track; RML 380Z SSSD; Sharp MZ-80K/A DSSD, Cromemco SSSD, Nascom DSSD, Rair/ICL DSDD, SD Sales SSSD, Triton 35 track SSDD and ACT Sirius 1 (CP/M-86 or MS-DOS) single-sided. By prior arrangement we can accept stuff over the phone by modem using BSTAM at 300 baud but as we can only do this during office hours (10am to 6pm) it's not exactly a cheap way of getting your article to us! In the near future we hope to be able to accept material by The Source and Rewtel. Please note that if you want to send your article in this way, it should be as an ASCII file rather than as a 'work file' for any one type of word processor — ie, use your word processor to print the text to disk instead of to paper.

Please note that we cannot undertake to return manuscripts, diagrams and photographs, although we always try to return the latter. We can only return disks if they are accompanied by adequate postage and packaging.

If you have an idea for an article or a series, write us a letter outlining your ideas. A one- or two-page synopsis giving the proposed structure, sequence and content is what we're looking for. But before you send anything to us, take a good look through PCW to see what sort of articles get published and to see what style of writing we prefer (basically, avoiding promiscuity at one extreme and flippancy at the other). Also take a look through the Back Issues advert to see what sort of things we have already published — no point in re-inventing the wheel.

Once you've sent off your article or proposal, please don't hassle us for a decision. We receive far more submissions than we can ever use and it takes us a while to sort through them, acknowledge receipt and give an opinion one way or the other. Please be sure to tell us if you've sent the article to another magazine — it would be very awkward indeed if the same article appeared simultaneously in two publications! Frankly, we're more likely to accept something which has been offered exclusively to us.

Finally, we do pay for published work but please be patient! Payment *normally* follows about 4-6 weeks after publication.

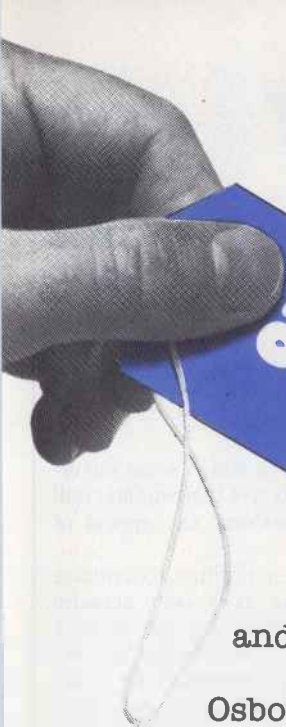

LOOK WHAT "O" DID FOR OSBORNE

O-Computers has done wonders for Osborne I. We call it Super Osborne. We added refinements and lowered prices to make it the best value-for-money microcomputer you can find. For £1499 + VAT we'll sell you our Super Osborne I with double density disks (normally £1495 on its own) and all of Osborne's free software, a 12 inch green or amber screen monitor (RRP £99) and a built-in 80 column adaptor (estimated value £175) plus the brilliant new Star DP510 100 cps matrix printer (RRP £289) with cable. Or if you prefer, for £100 more, the Silver Reed portable daisy wheel printer (RRP £485) which can also be used as an electronic typewriter.

WE GAVE IT 80 COLUMNS

Yes, our Super Osborne allows you to see lines of 80 characters on the screen. You can say goodbye to all that juggling with sideways scrolling that ordinary Osborne users do. Our design engineers have developed a circuit which fits inside the Osborne and provides video to British standards. You can plug any British monitor into your Super Osborne and get a rock steady message 80 columns wide.

WE GAVE IT A WINCHESTER

And while we were about our redesign, we added to the 80 column circuitry some further cleverness to allow the Super Osborne to use a CONTOUR Winchester disk. That means that when the time comes you can plug in a CONTOUR and suddenly the world is yours with up to 21 million characters of storage. A 5 million character CONTOUR, baby of the range, costs £1195 + VAT.

WE MAKE YOU AN EXTRAORDINARY OFFER

Use the Osborne in your office and bask in the luxury of the CONTOUR Winchester disk's massive story capacity. Come Friday, copy the files you need onto Osborne's new double density floppies, unplug the CONTOUR and carry your Osborne Electronic Office home for a weekend's work. Or use it with its portable electronic printer to catch up on your private correspondence.



O-COMPUTERS

A member of the C/WP Group
108 Rochester Row, London SW1
Telephone: 01-828 9000

Take advantage of our £1499 introductory offer. Add a 5 megabyte CONTOUR for £1195, 10 megabytes for £1495, 21 megabytes for £1995. But hurry. Offer ends 31 July 1983.



THE DREAM MACHINE

A profitable use of myths? Maggie Burton asks whether the computer user is being exploited.

Two well worn stereotypes spring to mind when computers are brought into conversation. One is the huge laboratory filled with the requisite ingredients of germanic scientists, odd tubes and flasks full of bubbling noxious liquids and, of course, our old friend the computer with its whirring tape reels, bleeping noises and flashing lights.

The other is the 'open the pod door, Hal' Star Trek animal, as characterised in the film 2001. It knows where the space heroes are going, knows the sound of their voices and probably knows what will happen in the future. Again, all the bright lights, odd pictures on screens and huge tape reels are still there.

The supercomputer as immortalised in films and books for the past twenty years has not changed fundamentally since its conception. What has changed are the voices — they're more human; the lights — more aesthetically pleasing; and the shape, which is now more likely to be hexagonal or otherwise polygonal (witness the CPU of a Cray-1) than the wall-to-wall valves of sixties sci-fi.

Why am I talking about fantasy computers? The answer is this: the fantasy colours people's attitude to the fact. The advertisements perpetrate the myths. Users learn to exploit the myths for personal gain. Bureaucrats and banks hide their incompetence in the data banks of their mainframes. Fantasy computers have apparently random wiles and predilections. They have minds of their own and they can possess the minds of humans. They may make profound and unauthorised governmental decisions. They argue. They might let off nuclear rockets of their own will. On the bright side, they are mentors and encyclopaediae to their users. I read a story when I was about fourteen about a computer which was so powerful it could turn itself off and on at will — and thus could not be shut down by anybody. The machine took over the running of the government who installed it, and effectively scuppered the whole country's essential services. Another recently published novel depicts the tale of the little boy whose best friend is his little computer. Some of these fictional machines are credited with intelligence far greater than that of their human creators.

Now computers are in millions of people's homes throughout the world. They run many office services and are in use in medicine, science and law. But the myths live on.

The myths live on because the adverts tell you you can do anything with a computer; you ought to have one, it'll solve all your problems. The myths are also perpetuated because there's so much destruc-

tive publicity and so much bungling surrounding computers. Stories about computers messing things up are rife — apocryphal tales have won a permanent place in our culture and are in popular circulation. Computers do seem to have an almost human ability to make mistakes, and in this they are as human as the programmers who fit them for their work. But people still come out with nonsense like 'our computer won't allow that', and so on.

The myths live on because the adverts tell you you can do anything with a computer; you ought to have one, it'll solve all your problems.

In the Colour Genie software review on page 160 I tried to picture the disillusionment which must be felt by many home computer users when they get their machine home only to find it won't load a cassette. The reason for this sort of thing is good old time honoured human stupidity (on the part of the manufacturers, that is). It is reflected now everywhere you look in the computer industry — in marketing policy, in product quality and availability and in support. Particularly, in support.

In the case of cassette loading, I know some companies make cassettes which load far better than those of their competitors — and sell them for roughly the same price.

How, furthermore, can a micro be deemed an educational tool when there is no teaching software available for it? It is only educational as a micro to teach you about micros then, and you can bet your life your kids will be great at little more than playing space invaders or donkey kong after it's been in the house a while. It will not be truly worthwhile having a computer in the home (or in business for that matter), until its limitations are widely acknowledged. The machine can in no way do everything and we have a long way to go before computers are as useful as they might be.

There are still a large number of people of sound (even superior) intellect who hardly know what a micro looks like, never mind what it can do. Buyers are buyers because they 'ought to get one', because 'everybody else has one', because 'computers can make life easier'. They are still buyers in the dark, surrounded by a feeble lack of initiative and imagination and an oily sea of competing adverts. Try looking into what some of these ads must mean —

and the idiotic way in which some advertisements even try to give their square, dull coloured, sterile products sex appeal of all things!

I may not be in a position to criticise advertising (as long as it isn't actually lying) but I can say this: you can no more teach a goat to talk than you can educate your children using a computer for which the only available software is Asteroids, Adventure, Pacman or downright unfriendly. A lot of imagination, coupled with a lot of revamping of other, older bits of imagination, goes into computer games. Sooner or later it will have to be realised that there ought to be as much genuinely useful software as there are games. While the myths live on, the computers sell — there's no need to worry if there's no software for them. And next year today's popular small micros will inevitably be replaced by a bunch of new ones — with little more software than we know on our micros now.

The sum of all these points is simple: were it not for the myths and fantasies home computers would not sell to anyone who wasn't an enthusiast.

The end product of making computers available to the man on the Clapham omnibus has simply been to add to the confusion and, in many ways, to make even more difficult the integration of these machines into working and home life. I enjoy my computer; but I know what can go wrong. Afficionados can see the pitfalls into which the inexperienced may fall. There is such a rush to get people to buy and not enough of a rush to help them use and benefit from their computers. Money is made overnight. Some have become millionaires but not by being honest with their customers or by supporting their products — quite the opposite. As we have already seen, the trend is to keep a computer on the market for a year and then scrap it almost completely in favour of another one which offers twice the capability at half the price. The computer industry should offer at least the support we have come to expect of the motor industry — and this is often not enough. It is high time it was acknowledged that these machines need not be toys which are outgrown in six months — you can buy a video cartridge machine to do that. They have a whole lot of potential which is totally unexploited. Software (again!) should be written to stretch a computer and not hurriedly upgraded from a program written on an older and inferior beast. Is it too much to expect that users — even totally inexperienced ones — might one day get the best from their machines rather than be subjected to money making ploys?

END



GOOD MORNING CORTEX

C/WP CONTEXT has changed its name to CORTEX – but it's still the same powerful, cost effective, easy-to-use twin-processor microcomputer (faster in basic bench marks than IBM PC* or Sirius). CORTEX has superb graphics and C/WP's new version WordStar – best of the word processing software.

AN OFFER FOR EARLY BIRDS

C/WP makes you this extraordinary offer to celebrate the dawn of CORTEX. For £1895 you receive a 104k CORTEX with IBM-style keyboard, twin double density disk drives, CP/M operating system, the new Star 510 matrix printer, WordStar, Mailmerge and dBase II (the ultimate database system) with Autocode I automatic program generator – a present worth £2588.

Offer extended to 5.30pm 15 July 1983.

C/WP CORTEX

C/WP Computers, 108 Rochester Row, London SW1. Tel: 01-828 9000

APPLE LISA

Robin Webster and Leslie Miner give their exclusive report on Lisa. Here they weigh up whether or not Apple has succeeded in its aim of providing an integrated office system for the single user.

Not all traditional computer users will be happy with the new Lisa Office System from Apple Computer.

It is an indication that something serious has happened in the industry when people get opinionated or unusually picky about the suspected shortcomings of a product.

As the following review indicates, the Lisa represents a vast improvement in the ways in which users interact and the results they achieve with conventional systems. At \$10,000 Apple's new system is not low-cost, but it is powerful. While the hardware is state-of-the-art in complexity, everything else has been uniquely designed for one purpose: to simplify the interaction for the single-user. The ideal is that the machine, as one of its designers said, 'is finally cut from its roots in accounting and becomes primarily an extension of the user's ability to get results'.

With the mouse, a desktop interface, integrated software applications, and a high-resolution, multi-window display, the Lisa represents a new alternative: the office computer made as personal as possible.

In fact Apple has daringly and effectively cut across many perceived industry trends.

The feeling within Xerox, the company which did a lot of the conceptual work on window displays and icons with the Smalltalk software system and Star hardware, is reported as being, 'We blew it...'

The kind of response that Apple has had from its potential customers indicates an untapped demand for a Lisa-like machine. And since Apple is now ranked at 411 in the Fortune 500 (one of the youngest companies to attain the honour), it could be ideally placed to provide the right kind of computer solutions to its peer group.

In taking on John Scully as president and chief executive officer — replacing Mike Markkula, one of the co-founders — Apple has sharpened its marketing prowess, too. Scully, has already demonstrated his abilities by turning around the ailing international division of the Pepsi company, for which he was vice-president.

We had access to a Lisa for just a short time. Maybe Apple has gambled its corporate future on the roll of a dice, or maybe it has made a dramatic shift from being the company that started micro-computing with the Apple II, to the company that started it all over again with the Lisa.

SOFTWARE

This review of Lisa took place at Apple's Lisa division building located in Cupertino, California, in what had come to be known as the 'sneak room' — an area with six or so Lisas on permanent display to visiting Fortune 500 managers.

On entering the room, I placed some of my papers down on a table next to a Lisa which appeared to be switched off, and was surprised to see the screen suddenly glimmer. No keys had been pressed, the fact that I had inadvertently jostled the machine's mouse was enough to make it come to life.

Then the screen, sensing that no activity had occurred within a pre-set time, automatically dimmed. This is just a simple demonstration of Lisa's software capabilities.

The designers at Apple confessed that what they had held at the back of their minds was a 'vision' or central concept. This vision was the ideal user interface,

around which a whole new machine would have to be built, possibly a whole new genre of machines. Indeed, it would probably turn out to be the very machine that they themselves would prefer to use.

The result of this work is a far better understanding (as far as Apple is concerned) of how people interact with computer systems, and notably, a Lisa-like machine. To make absolutely sure that they were on the right track, Lisa's designers arranged with the company's personnel department that all new recruits into the Lisa division should be asked to act as test subjects on the prototype machines. These recruits first indicated the level of computer experience they had, and were then let loose on a machine. Careful monitoring of their responses in specific situations gave the design team a wealth of information.

The typical user interface (that is, the

operating system command line interpreter or shell) nurtures a small group of people who view computing as a challenge — a bit like bronco-busting in fact. They succeed more by conquering the command line interpreter than by using it to achieve results.

But even understanding how a conventional system functions doesn't guarantee that you will always be able to predict how it will perform. Disk errors, system lock-outs, incoherent error messages can destroy the work of even the best user. There's an ever-present fear of losing important data; a lack of reliability. This is what the Lisa team set out to conquer.

Not only is it visually clear where the Lisa user's data has come from and what's being done to it, but there is virtually no fear that any information will be 'lost' in the system.

With features like 'Undo Last Command', it can only get as bad as watching

Tom & Jerry ... after Tom is demolished in some way, you know that he'll reappear intact in the next frame.

Icons

Returning to the Lisa that automatically switched its screen on, let's examine what happens the moment a user begins to interact with the machine.

The first thing he sees is a blank screen except for a group of 'desktop' items that are at his disposal — a clock, calculator, clipboard, trash-can, and two special items called the 'ProFile' and 'Preferences' — see Figs 1 and 2.

The clock is used to set the system's time and date information; the calculator is actually represented on the Lisa screen as a full-function calculator and can be used as such; the clipboard is used for the temporary storage of information; while the trash-can is used as a hold area for unwanted files (the last item thrown into the trash-can can always be retrieved).

'ProFile', being the 5 Mbyte hard disk, is equivalent to a filing cabinet, while 'Preferences' is provided as a means of tailoring the Lisa's capabilities to individual requirements.

These screen images are called icons. In addition other icons can be generated; for example, if you wish to put a new file onto your desktop from a floppy disk, then a floppy disk icon will appear on the screen, with the document name beneath it once everything is loaded.

Even at this stage, there are those who are critical of the fact that such icons are used to depict 'real' objects, and they are critical of the specific icons that have been chosen.

We think that this is beside the point because the icons could be modified and improved upon if necessary. The real question is: 'Are icons a better method of interacting with a system than straight keyboard entry and special function keys?' Moreover, are they useful, and specifically, are they useful to Apple's target users?

What do you do with an icon? This is where the mouse comes in.

The Mouse

The mouse controls the screen cursor which can be moved directly to any icon. The icon can then be selected by pressing the mouse button once. Once selected, the icon changes into a negative image (that is, from a black outline on a white background to a white outline on a black background). The user can now act upon the icon by moving the mouse/cursor to a one-line menu bar across the top of the Lisa screen.

Menus

One-line system command menus are not new. The Lisa version seems to have some of the characteristics of the UCSD p-System menu. When you change from the top-level compile and execute menu on the p-System and go into the program edit level, the menu options change in

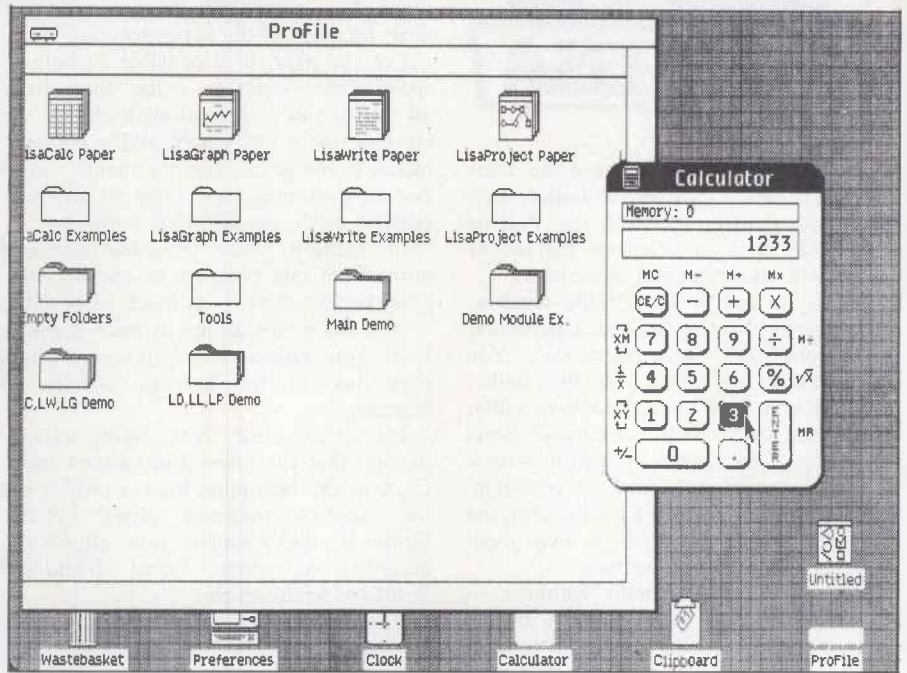

Fig 1 'ProFile' is equivalent to a filing cabinet.

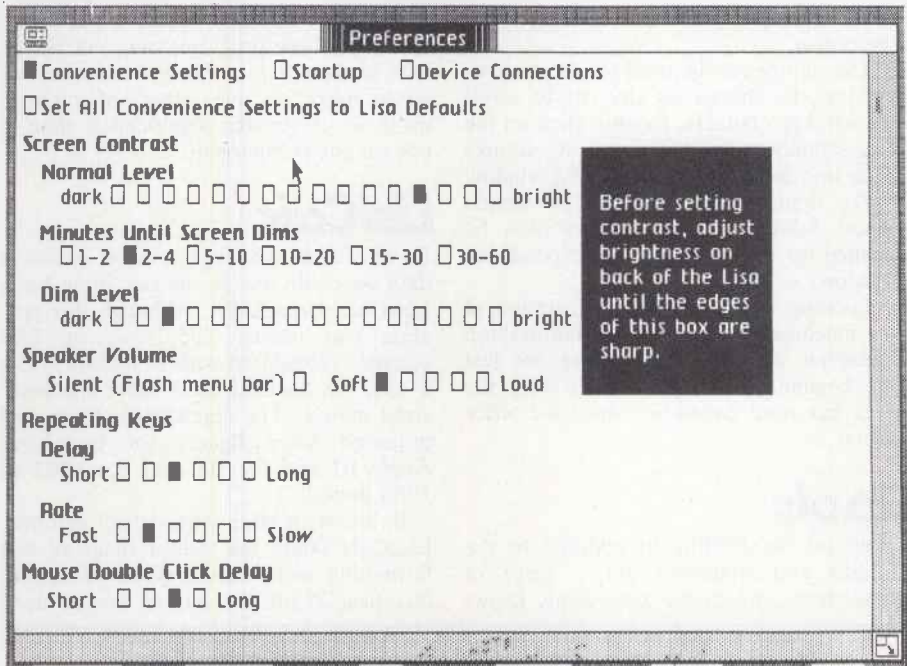

Fig 2 'Preferences' allows Lisa to be tailored to individual requirements.

keeping with the mode. It's no use having the 'Compile' option while you are still using the screen editor, to create code. The Lisa menu does change as well, not in terms of the mode (because Lisa genuinely is a modeless system), but simply to keep track of the applications currently in use.

If you are using the spreadsheet tool you are given a menu which reads: File/Print, Edit, Type Style, Page Layout, Format, Protect, Calculate. If you simply start at your desk and wish to see what's stored on your ProFile hard disk, you select 'View' from a simpler general menu: File/Print, Edit, View, Disk. By selecting View from the menu while holding the mouse button down, a range of more specific options are revealed in the form of a pop-out or pull-down menu.

'View' gives you three ways in which you can display the ProFile contents: Pictorial, Alphabetical, Chronological. Keeping the mouse button depressed,

you simply 'pull' the cursor down over the options and once the relevant one is backlit, let go of the button.

If 'Alphabetical' or 'Chronological' are chosen from the pull-down menu, the user is given a very recognisable directory listing which includes file names, file sizes, and the time and date they were created.

If 'Pictorial' is chosen, the user gets a first introduction to the Lisa's 'window' concept. An actual window opens up on the screen with the title ProFile. In the window are all the files on the disk represented pictorially as folders. New, unused files, seen as pads of stationery, are present too. The pads and folders are also icons and can be acted upon in the way described above.

Short-cut

For those readers who want to cut right through the menu selection route, there is

APPLE LISA

a much quicker way to achieve the same result. In order to open a folder, say, within the ProFile, or even the ProFile icon itself, clicking twice on the mouse button will also open and close icons.

Once you are in the Profile window, suppose you want to look at a particular folder entitled 'Correspondence'. You again place the cursor on the folder, select it with one click, and then either click again or go to the command menu at the top of the screen to open it. A new window appears out of the Correspondence icon, and ends up overlapping the ProFile window — much as two documents would on a real desktop.

Note that although many windows — up to 20 or so — could be open on the desktop at one time, only one window can be active. If you want to look at a window lying beneath the currently active one, you must first select it with the cursor.

The mouse can be used to select either window, to change its size, or to scroll the window contents. Double click on the Correspondence folder and it shrinks back into its icon in the ProFile window — or double click on, say, an annual report folder, and its window will be opened up on top of the Correspondence window.

Looking at the graphics orientation of the machine — the windows, the desktop metaphor and the icon images are just the beginning — you can see why the Lisa has been called 'intuitive' for office users.

Tools

Held on the ProFile in addition to the folders and stationery are a range of other icons, which the user simply knows

'Lisa will be considered successful if the user can accomplish something unaware of the complex underlying engineering'

as 'Tools'. These are the six application programs, whose integration is a key feature of the Lisa system. To the user this means that he can use any tool on almost any document, at any time, just as he would at his desk.

The six packages are:-

LisaCalc — a spreadsheet program.
LisaWrite — a word processing program.
LisaDraw — a very impressive drafting/freeform drawing program that can be used in its own right, or to enhance the output from other Lisa Tools.
LisaGraph — generates all popular format graphs from LisaCalc or keyboard entered data.
LisaProject — generates a PERT-like project management schedule or flowchart, juggling tasks and resources. It is unique to Lisa.

LisaList — a personal database management program of the list processing kind.

For the user, it is possible to build a spreadsheet, generate a pie chart from all, or part, of it, immediately change the pie chart to a bar graph, add a personal memo to the graph, edit the memo, add a free-hand drawing, and then get an exact printout of the composite document.

In addition, while the Lisa user can move from one program to another with ease, he also uses — as much as possible — the same operations in each application. This reduces the amount of time that has to be devoted strictly to learning.

It's pretty clear from asking various people, that the name Lisa wasn't much more in the beginning than a project tag for Apple's personal office system. However, the company now allows the acronym to mean Local Integrated Software Architecture.

The following is a description of how we created quickly quite reasonable output illustrating some of the above programs — particularly LisaCalc, LisaGraph, LisaDraw, and LisaProject. Although these programs may not be the best in their fields, the fact that they all go to make up one integrated environment is of greater significance than a one-on-one comparison.

LisaCalc

First, we decided upon some fictitious data we could use as the raw input for a LisaCalc spreadsheet. Although this program can handle 255 rows by 255 columns (compared with Multiplan's 255 x 63), we decided on a more modestly sized matrix. The spreadsheet topic was projected sales figures for the Lisa, Apple III and the IIe over the 1983 to 1985 period.

In line with other spreadsheet systems, LisaCalc offers the user a range of cell formatting and formula creation/copying facilities. While the mouse can be used

to select cells for data entry, the cursor control buttons on the numeric pad can prove just as handy. There are two nice features about this program. It shows which cells are being changed during a 'what if?' calculation by shading them grey. And if you want to format, say, a money value, the exact way it will appear is controlled by the contents of the 'Format' pull-down menu. So, if you want your dollar amounts to be preceded by a dollar sign, and show commas for thousands, you would use the mouse to select the '\$1,235' option. If you wanted it to appear with cent amounts, you would choose the '\$1234.56' option.

Special cell features include cell lock, circle missing values (this highlights those cells referenced by a formula but which contain no valid data), 'Undo'

(can usually cancel the effects of the latest operation), and 'Revert To Previous Version' (this very useful feature can get you out of many sticky situations by dumping everything out and reloading the last saved version of a spreadsheet). Since LisaCalc can manipulate a 255 x 255 matrix, the multiple window feature — up to six horizontal or vertical splits can be made per spreadsheet — is also a necessity.

For the Lisa, we decided to show sales increasing over the three year period from \$100 million, through \$400 million, and reaching \$600 million in 1985. Figures for the Apple III were \$250 million, \$350 million, and \$500 million, while for the Apple IIe sales jumped up from \$700 million to \$1000 million and then on to \$1400 million. By entering a formula for the first column of data we obtained the total income figure of \$1050 million for 1983. This formula, which merely added the amount of each product's sales in 1983 together, was then copied over to the 1984 and 1985 columns.

The next step in the procedure was to select the six sales cells (the total income figures were not included) from the spreadsheet and place them on the clipboard icon for temporary storage. This can be achieved by clicking on the relevant cells, and then using the COPY function available from the Edit menu.

LisaGraph

To put the LisaCalc data into LisaGraph, we had to open up the LisaGraph icon. Once this was open, we used the 'Paste' option from the Edit menu to transfer the LisaCalc sales information from the clipboard to the graph. Almost immediately, we obtained the bar graph shown in Fig 3. By simply choosing one of the menu options the bar graph could rapidly be changed into one of the following: line, mixed bar line, pie, and scatter graphs.

Other features of LisaGraph are that data changes are replotted instantly in a 'what if?' manner; the screen size of the graph can be enlarged or compressed; graphs can be printed out in four different sizes — ¼ page, ½ page, ¾ page, and full-page — and graph areas can be shaded in many different patterns. Also, in keeping with the concept of integration, certain functions, such as the selection of numerous typestyles and combinations of typestyles for titles, Undo Last Command and Revert to Previous Version are ever-present.

At this point, we printed our LisaCalc/LisaGraph work out on a dot matrix printer and switched to LisaProject.

LisaProject

LisaProject enables a manager visually to map the progress of a project. Individual activity, or task boxes, are created by the user and linked to form a schedule of activities leading to a goal.

For review purposes, we decided to create a simple 'Apple Team Project' chart using somewhat makeshift data

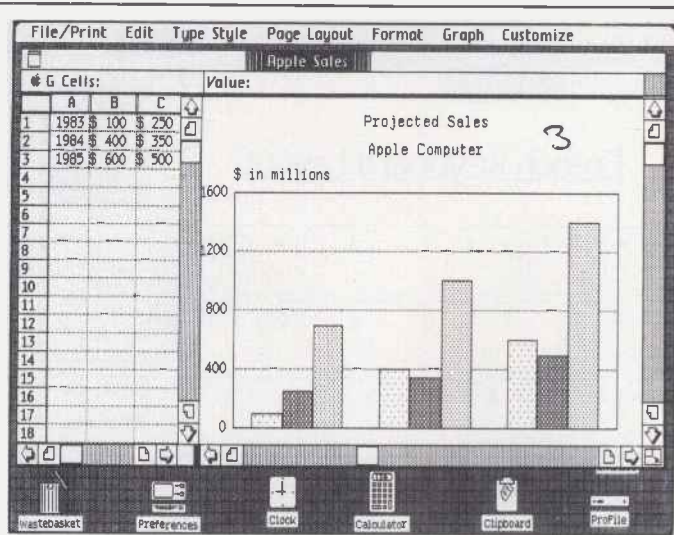

Fig 3 LisaGraph generates bar line, pie and scatter charts.

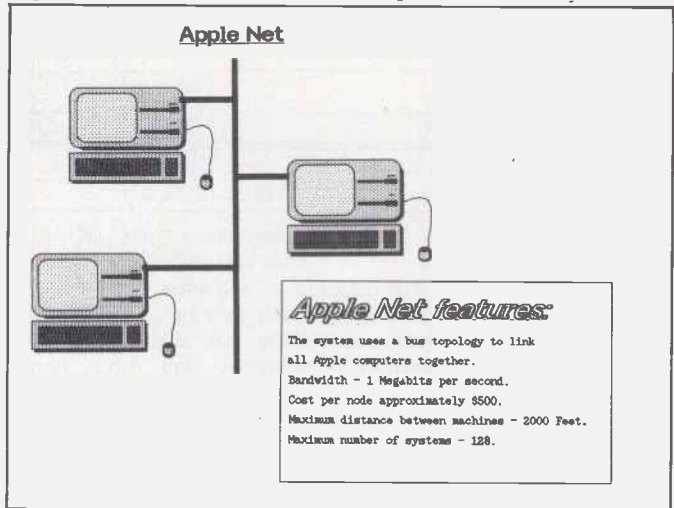

Fig 6 The Lisa drawing was composed with shapes from the palette, then shaded and cloned.

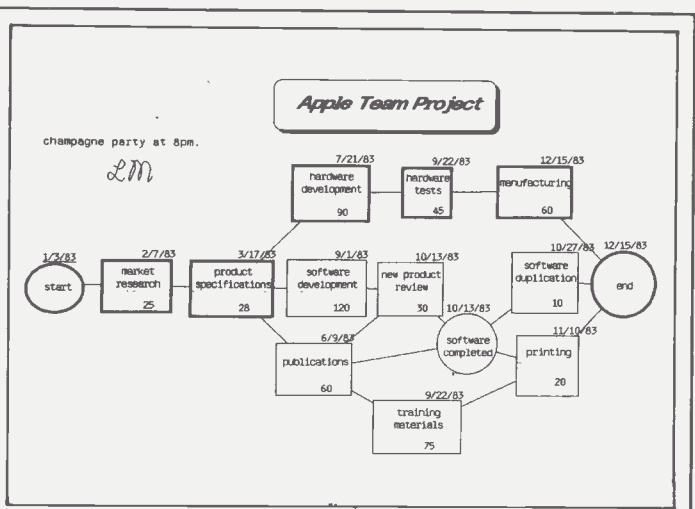

Fig 4 LisaProject automatically calculates completion dates for stages of the project and incorporates a 'what if?' facility.

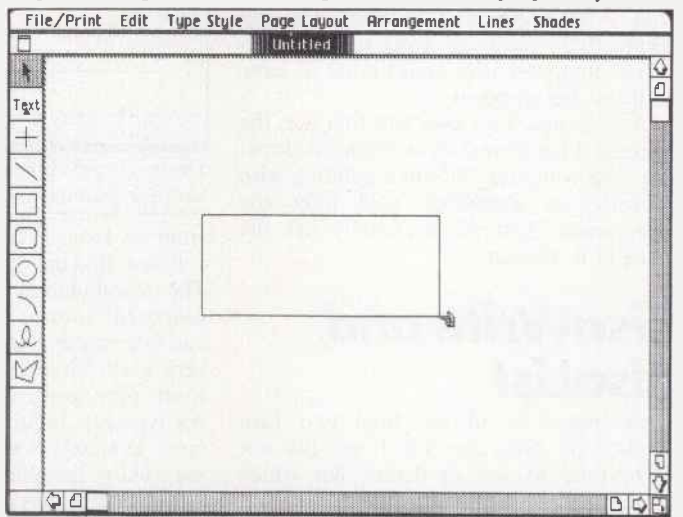

Fig 5 The ten options of the LisaDraw palette are displayed vertically on the left of the screen.

based on the Lisa project itself.

Every LisaProject chart has at least two 'milestones' (Start and End) which are displayed as circles. The specific activity boxes, such as the market research task and the connecting lines between them, are easy to draw with one movement of the mouse.

It is equally easy to add a box — like that marked 'training materials' — and to reduce the chart to a one-page display by selecting the relevant pull-down menu option from the 'Customise' command above (see Fig 4).

After each box is drawn a small cursor appears within it, signalling the user to insert text. This would be the name of the activity, its duration, and, perhaps, the particular staff member responsible for it. When we inserted the Start date within the left-most circle, LisaProject automatically calculated the completion dates for each activity and the End of project; it also highlighted the so-called Critical Path, the route along which any delays would delay the total project.

One of the major achievements of the Apple software designers is that they have brought the same 'what if?' scenario flexibility demonstrated in the LisaCalc and LisaGraph to LisaProject. Alter the data in any given activity box or boxes, and LisaProject will propagate this change through the chart.

This is not all. It is also possible for

the user to visualise project tasks and resources in two other forms besides the schedule chart reproduced below.

There is a Task Chart and a Resource Chart; the latter is a kind of personnel availability calendar, looking a bit like those holiday charts used in offices. The former, while it resembles the Resource Chart, displays projects tasks in the order in which they will be performed.

LisaDraw

Now here comes the fun ... We took our LisaProject schedule and pasted it into a LisaDraw window, so enabling us to enhance the diagram for use in a presentation.

A LisaDraw palette with ten options is displayed vertically down the left of the screen (Fig 5). Besides various shapes and lines, there is a free-hand symbol and a 'Text' option. Selecting the Text option, we first added a small memo (champagne party at 8pm) and then signed initials via the freehand line draw. We then gave the title a new typestyle, decided to reposition it, and put a box around it. Further enhancements to the text were always possible since there are eleven typestyles and other possibilities such as: Bold, Outline, Shadow, Italic, Hollow, Underlined, or any practical combination of these.

While the above is an example of

LisaDraw used to enhance something from another program, the next illustration was created entirely within the LisaDraw environment.

Again, the document was fictitious in nature (only the Apple Net specifications box is completely accurate). Using the Text option, the memo heading and other text was entered onto a piece of blank LisaDraw paper — no attention was paid to typestyle at this point. By selecting various primitive, or ready-made, objects from the palette (a rounded corner rectangle for the system unit, another for the screen, a right-angled rectangle for the keyboard, and so on) the Lisa drawing was put together. The mouse was a small box, but its lead, or tail, was drawn freehand (Fig 6).

The disk drive slots were drawn in under 30 seconds using lines of various thicknesses. At no time was there any fear of making a terrible mistake since all the lines and boxes could have been squashed to make them smaller, stretched to make them larger, or, if you really got into trouble, the Undo Last Command would come to the rescue.

Just to show how it would look, we then selected three different shades from a total pattern selection of 36, and placed each in a different part of the Lisa drawing. Then, the original drawing was copied twice and the two LisaClones were positioned on the memo sheet. The

APPLE LISA

box around the text at the bottom right was put there by again selecting the right-angle rectangle from the palette.

The titles 'Apple Net Features', 'Apple Net', and 'Memo' were then all customised using the timesteps option. The signature, on the other hand, was a bit more difficult.

Although we were the proverbial naive users, the main memo design work took about ten minutes (it could have been done much faster, and much better). Owing to unfamiliarity with the system, the freehand signature took maybe that much time again. There is no doubt that LisaDraw is the most visually impressive piece of software that an office computer user could hope to have at his or her disposal.

As any new Lisa user will find out, the hardest thing to master is freehand drawing with a mouse. 'It's like painting with a rock' as somebody said after the experience. You do eventually get the hang of it, though.

LisaWrite and LisaList

This brings us to the final two Lisa application programs which we did not have time to use in detail, but which should be covered briefly.

LisaWrite, the word processing pro-

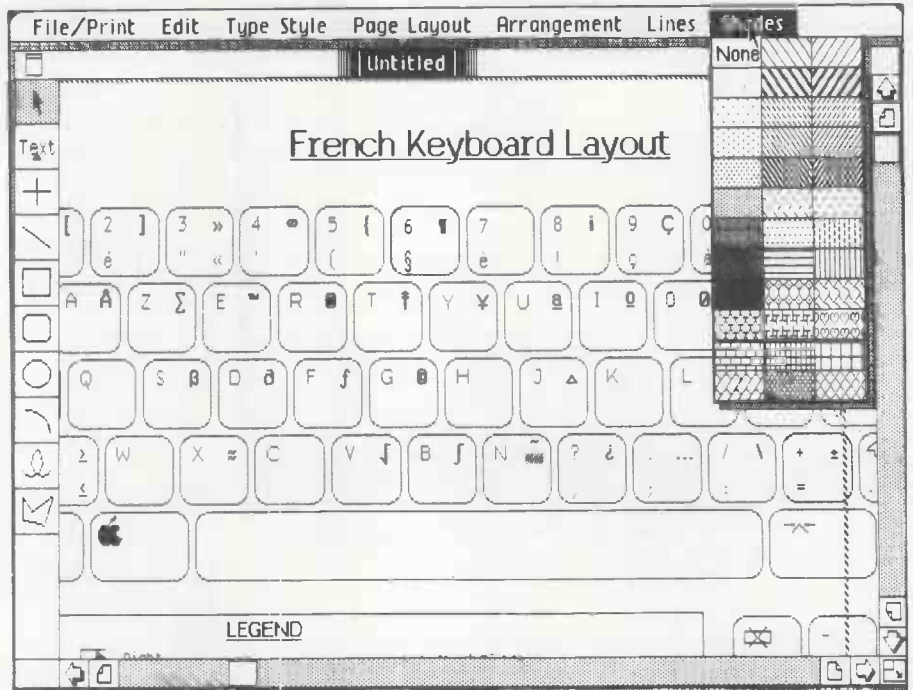

There are 36 different patterns for shading. This French keyboard was created with the palette; freehand drawing with the mouse is the hardest to master.

gram on Lisa, is probably the best 'what you see is what you get' editor around. The combination of the mouse and keyboard allows fast selection, editing and reformatting of text. Block moves are very easy, for example, and all standard word processing features are provided. All typestyle, editing and Undo type features available with the other programs are used to their fullest in LisaWrite.

LisaList is described as being a personal database system. Essentially, it lets

a user input personal types of information — phone lists, customer lists, personnel details — and then sorts them by some specific attribute or combination of attributes. There are eight data field types: text, numbers, date, time, phone number, social security number, zip code, and money.

It comes with a file-recovery system that helps rebuild damaged databases in case of system or software malfunction. This should be welcomed by users since

Dialogue boxes (error messages)

Typical error messages, as you know and hate them, can be a pain to deal with. This is either because they are of the 'YXXE/2345.B, Diskerr...' type or they are crushingly blunt: 'Fatal error on system disk...'

If you are lucky, the manufacturer of the machine or the software vendor will have moved one step ahead by basing error codes on a numbering system. So, if you have a disk error, the system generates a particular code number and you look in the manual to see what action should be

taken.

The Lisa, we think is way ahead in this field. Instead of error messages *per se*, the Desktop Manager communicates problems and warnings to users by the means of dialogue boxes. These dialogue boxes make use of familiar road sign shapes, so they are both visually obvious and unambiguous.

The messages included in the boxes do more to calm the user than quicken the pulse. The writing style is very casual, yet precise, and the boxes are big enough to

allow complete paragraphs of text, the dialogue road sign, and a menu selection area for the user. Cancelling a dialogue box cancels the command that brought it forth; selecting whatever other options may be offered will have a similarly logical effect.

Not once during the many hours we spent on the Lisa did anything catastrophic happen to data we were working on. Unlike the general type of error message, the Lisa version does not elbow aside your work just to make itself known.

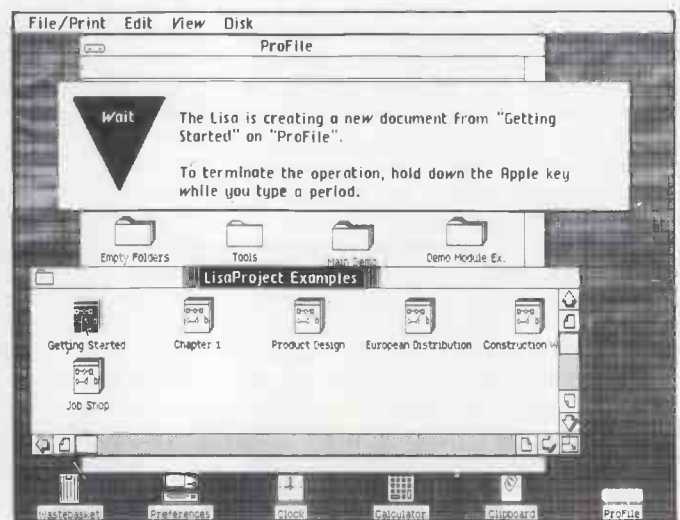

LisaList can handle up to about 600,000 bytes (say, a 6000 x 100 character list) of data.

The main point about all of these integrated software programs is that they are designed to be understandable. They are not primarily designed for specialist tasks, but to make people feel comfortable rather than hesitant in their everyday office work.

The icons, windows and error messages (which appear as large road signs) are common to all programs, and are symbols of a physical world to which people can relate. The supposition is that people want to feel in total control of a concrete (rather than an abstract) manipulation of data for their concrete, real-world, projects.

As one of the designers told us, Lisa will be considered successful if the user can accomplish something without being aware of the underlying complex engineering that went into making the product reliable.

Lisa communications

Since the corporate office structure tends to be distributed both in a local and remote sense, Apple has had to devise a method of linking its Lisa equipment up into networks while at the same time keeping additional customer costs to the minimum.

The first communications product to come out on the Lisa will be Lisa Terminal. It will be another Software Tool and, as such, will be accessible through its own individual icon and tear-off stationary pad. LisaTerminal will provide TTY, Digital Equipment VT52 and DEC VT100 terminal emulation capabilities. The first release will not be able to handle sophisticated Lisa/host computer interactions; the uploading and downloading of text created in LisaWrite or LisaCalc is likely to be the major initial component.

Sometime later this year various IBM emulation programs will be released, putting the Lisa into an entirely different kind of ball park. There will be 3270/3271 Systems Network Architecture (SNA) support, 3780 Remote Job Entry support, and 3278 terminal emulation.

In a deal with Cullinet, formerly Cullinane, Apple will also be able to offer that company's Information Database product. This will allow Lisa users to top information stored on IBM mainframes in Cullinet's IDMS/R relational database product.

Also due for release this year is Apple Net — a low-cost, low-speed (1 Megabits per second) local area network system that can be installed at a cost of approximately \$500 per user connection, or node. This will link all of Apple's products — the Apple IIe, Apple III, and Lisa — together. It features the Carrier Sense, Multiple Access/Collision Detection (CSMA/CD) transmission protocol as used on the Ethernet system.

Up to 128 Apple machines can be supported on an Apple Net network which may use up to 2000 feet of coaxial cable.



Clear instructions.

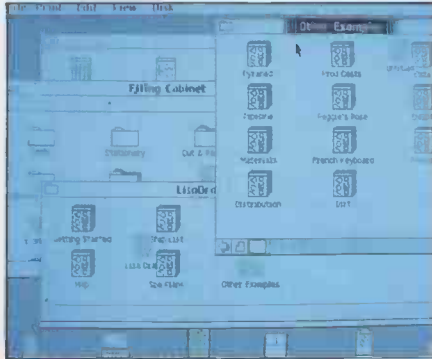

Comprehensive choice.

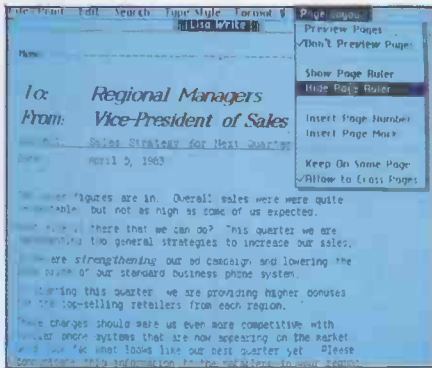

Laying out a memo.

For those who want something more, Apple has arranged a deal with US company 3Com whereby 3Com will supply interface boxes that will tie Apple equipment into an Ethernet network (which has a 10 Megabit per second transmission capability).

The changing Lisa cursor

One nice touch about the Desktop Manager system on Lisa is that it has been programmed to take account of what might at first seem to be a trivial display aspect.

Although the main cursor is always shown as a slightly inclined arrow (↖), there are in fact six other cursor styles the user will discover. Within the matrix of a LisaCalc spreadsheet the cursor becomes a hollow 'plus' sign (+); in LisaWrite it becomes an I-beam (⌵) to allow the user to carry out precise selections, such as a full point or inter-character space, during editing work; in LisaDraw it takes on the shape of very small crosshairs (+) and the grab-hand shown in Fig 5. While the Lisa is doing a processing task that will take more than a few seconds, it also displays an hour-glass symbol, informing the user that it is busy.

The Application

Developer's

Toolkit

If the Lisa depends on any one thing in particular, it is the Application Developer's Toolkit (ADT) — the key method by which independent software companies will be able to create applications that make full use of the Lisa's mouse/screen/Desktop Manager.

The ADT has been under development for the last nine months and is now undergoing tests. The project was headed up by Larry Tesler, a key man in the overall Lisa project who originally worked on the Star system at Xerox. He has the honour of being one of the people who showed Apple staff members, including chairman Steve Jobs, the Star's abilities, an event which was to lead to a \$50 million, three-year project that came up with Lisa.

Independent software is already being put onto the Lisa; Xenix is expected to be available this month and CP/M-68k shortly thereafter. But it will not make full use of the Lisa's Desktop Manager. The user will get some fancy graphics, but not the cut and paste type of operations.

What the ADT does is to give the software designer direct access to a framework Desktop Manager — windows can be displayed as a matter of course, but the interactions possible and the types of data they will contain is left open. Essentially, the programmer fills the empty Desktop Manager with his own data control code. The ADT is a kind of Software Workshop. Problems like, 'how do you best represent an accounts receivable package with an icon?' are still not completely answered, though.

Apple research has shown that traditionally trained software people can take six months to get up to speed in terms of writing code for the Lisa, so the ADT will obviously be of benefit here. To make sure that they are not too strained, though, the ADT project workers have actually gone as far as extending the Pascal language so that classes of objects can be more easily referred to, but the code is still recognisably Pascal. Apple's Pascal with extensions is called Clascal and will most probably be made available as a separate product, outside of the ADT, at some future date.

As an added incentive to interested software companies, Apple is also offering selected organisations significant discounts on the Lisa (with a maximum of two machines per company) plus hotline support. Response has been high and machines are being shipped out. Companies like Digital Research and Microsoft have had machines for quite a while.

Apple states definitely that it does not want to get into the operating system or software development market. 'Six years from now there will be the same six applications from Apple and hundreds developed by independents' said one manager.

APPLE LISA

HARDWARE

Reviewing the Lisa in terms of what its hardware looks like and can do is rather misleading since there is no one part of the system which can be described as truly stand-alone. The integrated Desktop Manager software/the high-resolution screen/the mouse/the so-called Software Tools, and the CPU all work together in a highly coordinated manner. To force a distinction between 'the hardware' and 'the software' really overlooks the purpose of an integrated user environment.

At the very least, though, a description of the hardware will give you an idea of what it takes to make such a 'new wave' machine perform.

First of all, there are a couple of things to point out.

There is no such thing as a 'standard' Lisa in the conventional use of the phrase. Look at most computer manufacturers price lists and you will come across this mythical machine.

It always comes with too little main (RAM) memory; there probably isn't any disk storage included but, if there is, it will most likely be one drive; the video display will only provide the user with the simplest level of character generation; and, generally, no software will be present — except that locked in to boot ROM.

By the time you have purchased enough 'option' cards to make the thing do more or less what you want, the stan-

dard machine price has long receded into the distance and you really have made a capital investment. (Apple is a major offender here.)

This marketing approach, while comfortable for many manufacturers, tends to start customers off on the road to being something akin to system builders — they continually come across obstacles that can only be overcome by going out and buying more add-on equipment.

Such a situation is totally unsuitable for the professional/business customer, who is simply looking for methods of improving working practices. With this in mind, I'll give a quick overview of what the hardware looks like and then move

on to specifics.

For \$9995 a customer gets a complete Lisa system. This consists of the six integrated Lisa programs; the system box containing a 12in video display, the 68000 CPU, 1 Mbyte of RAM, and two of the Apple designed floppy disk drives; a 5 Mbyte ProFile hard disk; an IBM Selectric style keyboard; and, of course, the mouse.

The System Unit: Lisa's case is made of moulded plastic and, while pleasingly compact, is smaller than one might imagine from photos. The 12in video screen is placed over on the left, while the two floppy drives are immediately over to the right. A nice touch is the hollowed-out area underneath the display and drives. Since the mouse is used for a majority of file and data manipulation tasks, this is used as a storage bay for the now under-used keyboard. Tucked almost out of sight to the right of this bay is the Lisa's shut-down key. Shut-down rather than on/off switch because the Lisa is designed to ensure that all open files are closed (that is, returned to



All 76 keys are programmable but the mouse is used to issue most commands.



The system unit is compact, incorporating 12in screen on the left and storage for the keyboard underneath.

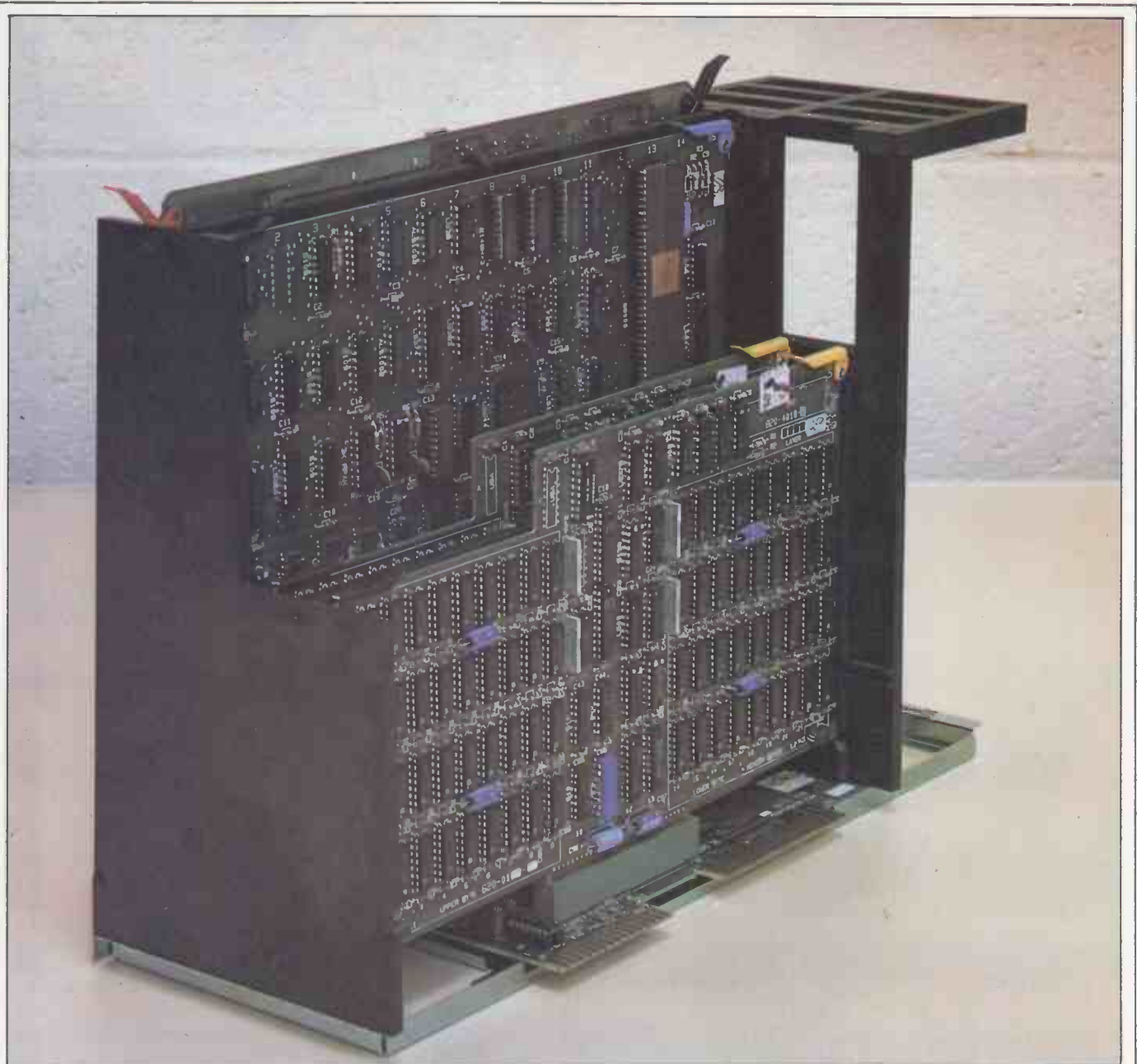

A user can completely dismantle a Lisa into serviceable modules.

their relevant folders) before powering-down. This is a very powerful example of the interdependence between Lisa hardware and software.

One might imagine that because there is nothing but heavy disk drives and video equipment towards the front of the system unit, the Lisa might have a tendency to tip forwards. Apple designers overcame the problem by placing a couple of Sphinx-like paws on either side of the keyboard bay. Cooling vents are situated around the top, back and sides of the casing. All I/O connections are sited along the lower back.

Display

Having seen high-resolution systems such as the Three Rivers/ICL Perq and Apollo Domain, it wasn't too surprising to see a 720 x 364 bit-mapped video display which did a marvellous job of impersonating a piece of paper. The surprise is that it is now available on a commercial office product, using more or less standard chip technology, offering a set of six integrated software programs for

under \$10,000. Apple managed to keep the hardware costs lower than they might have been by deciding to use a 12in (half-page) screen format rather than the giant full-page (1024 x 900 pixel, or thereabouts) monitors supported by the Perq and similar devices. Also, since the screen is bit-mapped (each addressable picture element, or dot, can be represented by one or more bits in a reserved sector of memory), the smaller screen requires less attention from the CPU. The Lisa team decided not to use a graphics chip to handle the screen display (because they felt it might actually slow things down...) so the Motorola 68000 CPU currently timeshares cycles between main processing and the video memory map processing.

Mouse

A pointing device has now replaced keyboard input as the prime method of issuing commands to a system (see box for a discussion of mouse technology). Apple has trademarked the phrase Graphics Mouse Technology, which might suggest

to some that it is the first company to come up with a successful version of the device. This is not absolutely true. There have been many previous mice — some that were like enormous flywheels and just kept going in one direction. There are mice of various sizes, colours and complexity, including the three-button

**'Like a jet engine,
it can't turn a car into
an aeroplane'**

'Rolls-Royce' of mice made by a US company called Hawley. At the recent West Coast Computer Faire, a recent entrant — with just two buttons — could be seen controlling editing functions on an IBM PC. What Apple has done is to streamline the device, going for reliability and ease of use. While manipulating the palm-sized mouse is simple, its integration with the Lisa software (something which does not have to be obvious to the user) is very complex. Not just any mouse will do — end users should be

APPLE LISA

wary of advertisements and mouse manufacturers' suggestions of what their product can do. Like a jet engine, it can't turn a car into an aeroplane.

Keyboard

The Lisa keyboard is a standard, Selectric style version with 76 keys — all of them are programmable. Since the mouse has been given the main burden of issuing commands and manipulating objects and data, the keyboard does not come with row upon row of special function 'headstones'. To the left of the keyboard is the main section of the qwerty and multi-character keys (special symbols such as omega, mu, epsilon and pi, and other unusual characters are selected by the correct use of the shift key). To the right is an 18-key numeric pad which has the four left/right/up/down cursor control markings sharing key-top space with the '+', '/', '**', and ';' symbols. Although Apple decided against straight, one-punch, function keys, it is possible for the more experienced user to generate a wide range of special effect codes from the keyboard. For example, at certain stages while using LisaDraw it is possible to erase selected portions of an object by pressing the 'Apple' key (it has an Apple logo on it) and the 'Clear' key, rather than selecting the object with the mouse and then going to one of the pull-down menus to select a similar procedure. Both the keyboard and mouse are controlled by a COPS processor on the I/O board.

That's the quick overview; now we should turn our attention to more specific aspects of the Lisa hardware.

Inside

Getting into the machine is no problem since there is both a back and front cover. No special tools are needed for their removal. This design philosophy has been carried right through to the point where a user can completely dismantle a Lisa into its serviceable modules — the twin disk unit, circuit board carrying frame, power supply, and even single boards — in a matter of minutes (for the full implications of this, see 'Conclusion'). The only non-user accessible unit is the high-voltage video circuitry and monitor.

Inside the machine to the left there are three empty expansion slots. Currently, the indication is that Apple will not rush to fill these, rather, it will encourage independent hardware vendors to offer their products. From the hardware engineers' point of view, the expansion slots provide a very simple means of attaching all sorts of devices to the Lisa. Simple, because the slots provide add-on cards direct memory access (DMA) instead of routing signals via the CPU.

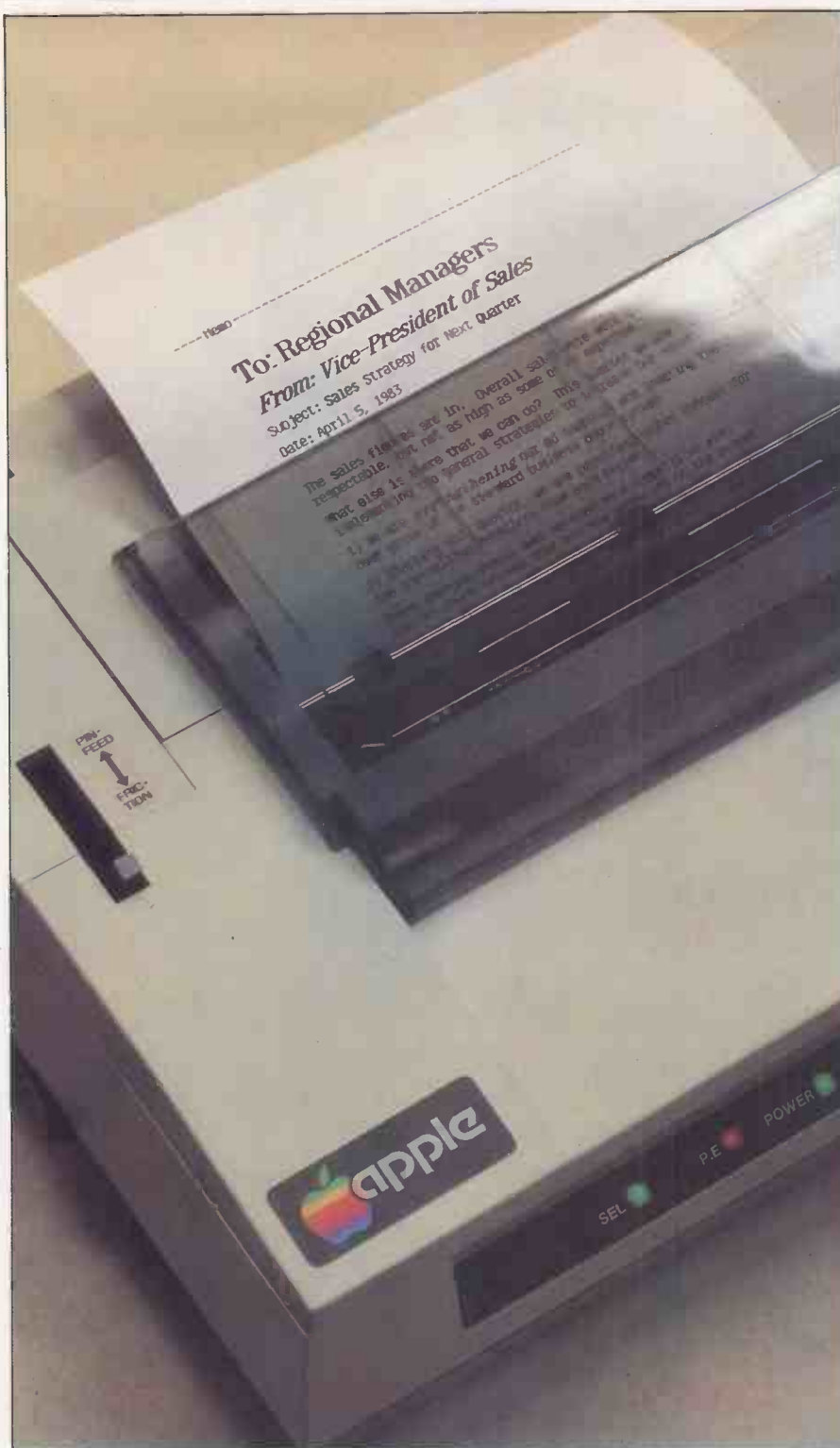

Apple has made the dot-matrix printer respectable.

Printers

It's nice to see that Apple has made the poor man's printer — the dot matrix system — respectable. To get the high-quality graphics printouts reproduced in this review, Apple had to inform the Japanese printer company, C Itoh, that its printer *could* produce the required quality. The printer, which now has a ROM chip customising it to the Lisa, 'paints' a piece of paper with dots. In low-resolution mode, the output is quite good; in high-resolution mode the output is of presentation quality. Most of the screen dumps reproduced in these examples were done in the low-resolution mode.

Reluctant to leave well alone, Apple decided that the Lisa user must have the option of a letter-quality daisy wheel printer as well — but it had to be able to do graphics. To achieve this, Apple created a completely new 130-spoke print wheel for a printer from Qume. It will reproduce all the special symbols, including foreign variations, and allow a single printout to combine various typestyles (such as standard mixed with bold and italics). Graphics output, using special dot symbol spokes, can cope with Lisa screen dumps, but they are not really as good as the dot matrix version.

Apple's only current exception to the 'no add-on cards' rule is a parallel interface board (\$195) which is needed to help manage the generation of high-quality output on a specially redesigned dot matrix printer from the Japanese company C Itoh. While this does take up one of the three expansion slots, Apple is working on a serial version of the matrix printer which will use one of the two RS232 ports on the Lisa.

All circuits boards, expansion slots, and even the I/O connections, are held in a specially designed slip-out carriage. This board holder is a novel method of securely retaining a lot of hardware in its place, while at the same time making access extremely easy.

Since the holder is only connected to the main system box by gold-plated edge connectors, simply tugging it towards you makes it glide out smoothly. If you ever ripped yourself to pieces trying to remove a board from an old terminal (the soldered side was usually loaded with razor-sharp objects right where you had to grip it), or ever found out too late that you had put the CPU board into the wrong slot, you'll appreciate what Apple has done for the user in this area. Every board has been supplied with colour-coded grips and unique edge connector layouts so that it is impossible to damage yourself or a board.

Although I mentioned earlier that the Lisa has a shutdown button, the machine is never completely off. A battery pack located on the I/O board maintains the system in a kind of slumber, waiting for some one to come along and press a key to reactivate it. This is rather like the temporary display blanking that some calculators use to conserve on energy while retaining numbers to be eventually used in a calculation.

Motorola 68000

Having conceived a complex software environment for the user, Apple designers were aware, even at the theory stage, that a fairly powerful processor would be required to cope with the kind of activity that would be required of the Lisa.

There are a couple of reasons why the Motorola 68000 was chosen.

This 32/16-bit chip (almost all its internal CPU registers are 32-bit while the external data paths, along which data is fetched and sent back out, have a 16-bit transmission capacity) has been the choice of many specialist multi-user system builders for the last few years. Only recently has it been receiving the kind of general attention it warrants.

Sage Computer Technology chose the chip as a powerplant for the Sage II. It is also the featured chip in the Corvus Concept, the Tandy TRS-80 Model 16, the Fortune 32:16, the Wicat and the somewhat intriguing IBM 9000 scientific system.

Apple adopted the 68000 because it was the best advanced chip available in sufficient quantities at the time the Lisa project began (1979).

Early samples were used for prototyping, but it was not until Motorola could give assurances that 5 Mhz versions would be available in production quantities that Apple made the commitment.

While offering the power of a true 16-bit chip, assisted by its 32-bit internal structure, the 68000 couldn't give Apple's software designers one much-needed break. Sitting inside the Lisa is about 2.5 Mbytes of object code which makes up the Desktop Manager system. Add to this the code which makes up the various Software Tools — LisaCalc, LisaWrite, LisaDraw, LisaGraph, LisaList, LisaProject range in size from 200k to 400k — and you have an enormous problem shifting that number of

area are the cooling fan and the disk drives. This first problem was overcome in the Lisa by devising a passive, or convection, cooling system. Since warm air rises, the designers arranged for all the main circuit boards to be held upright in a special carrier frame. As the boards begin to generate heat, it is taken in by the surrounding air which then escapes through vents positioned at the top, back and sides of the casing.

It seems to work well as there were no signs of internal overheating during the review sessions. Nor did it get perceptibly warmer around the machines.

The second potential source of noise, the disk drives, never had to be dealt with. The 5 Mbyte ProFile disk (which

'Apple designers were aware, even at the theory stage, that a fairly powerful processor would be required'

bytes around in a reasonably professional manner.

Memory management facilities developed by Apple for the 68000 make the software handling task much simpler because it offers the ability to relocate blocks of code in memory — virtual memory in fact. To quote the Lisa specification sheet, the memory management system on the machine allows for the 'segmentation (of memory) into 128 variable-length blocks dynamically controlled by memory map table'. That's 16 Mbytes of virtual memory.

In addition to having an Apple-added virtual memory facility, the Lisa can do multi-tasking and lock out bad memory cells. While one job is being printed, a user can go ahead and use the LisaCalc program, or whatever. If memory errors occur, the system will not halt all processing until repairs take place. Rather, the parity checking system will steer all operations away from the faulty sector(s) and so allow Lisa to continue processing.

Diagnostics

Keeping with recent industry trends, the Lisa comes with built-in diagnostics that go into action when the machine is fully powered up. The user is given a set of visual symbols denoting which piece of the system Lisa is currently testing, and, if everything goes well, tick-marks appear in each symbol field. There is a full 64k of diagnostic code held in ROM (remember, that's the size of many standard personal computer main memories) and if the display is not working, the Lisa emits specific groups of tones from its internal speaker that can be understood easily by a user.

Noise

Noise can be a problem in an office environment and, as many personal computer users would testify, their machines are not always as quiet as they might be.

The biggest traditional culprits in this

was originally built for the reasonably successful Apple III) has always operated with a minimum decibel output. Most of the Lisas have ProFile placed conveniently out of the way on the main system unit. Although this is not a prerequisite, it certainly reduces space requirements on a desk.

Disks

Most floppy disk drives are worth just a quick look to see if all the bits and pieces are there and how much storage they provide. If you're really lucky, you might even find out that the machine you're thinking of buying can read disks of different formats.

In the case of the Lisa's drives, it's worth devoting more time, since by standards, they are excellent.

While the ProFile gives 5 Mbytes of storage — a common enough amount by today's standards if you look at computers like the IBM XT, ACT Sirius 1, and Wang Personal Computer which come with, or can be configured to have, 10 Mbyte drives — the two floppy drives cope with 860k formatted (1.4 Mbytes unformatted) storage each. Therefore the total removable storage is over 1.7 Mbytes...

Here's how Apple managed to create such a dense packing of data on a 5¼in disk.

Traditional double-sided disks rotate at about 300rpm and store somewhere in the region of 200k to 400k — a notable exception to the rule being the 600k+ drives of the Sirius 1. The Sirius 1 uses multi-speed drives that can spin standard disks at up to 350rpm when necessary.

Apple decided that rather than stay with commercially available drives, which didn't offer the kind of functionality or reliability the Lisa demanded, a totally new unit using a totally new 5¼in disk would have to be built.

A Synertek 6504, which is not too far off from the 6502 chip that has kept the

APPLE LISA

Apple II running and running, is dedicated to each of the Lisa drives, acting as smart interfaces with the main system. One of the jobs the 6504 has is to vary the speed of the drive in keeping with the position of the track it is reading or writing so that data is laid down in a regular density of 10,000 bits/65.4 tracks per inch.

Since ordinary drives rotate at one speed at all times, regardless of where the recording head is located, data is more densely packed on the tracks closer to the disk centre (where the disk surface is travelling more slowly than at the outer edge) and relatively sparsely elsewhere.

The internal set-up of the Lisa drive is also very different from other double-sided units. Rather than having both heads

positioned so that the disk media is pinched between them, increasing wear, the Apple drives have offset heads and special opposing pressure pads that access the disk surface through two cut-outs in the disk jacket. In the early development days of the Lisa project, having such unique disks was a definite advantage because even if a prototype machine had been stolen, illegally borrowed, or whatever, the fact that virtually all disks were kept safely locked up meant that no harm could be done.

Now that the Lisa is ready for the market, one wonders what kind of production arrangements Apple has made. Certainly, at the time of this review, no one at the company could give me any details on pricing, etc.

Security

We're not yet finished with the disks, because there are two remaining features that must be covered — data integrity and data protection by means of automatic

disk retention.

Files stored on a disk are located by means of a directory set up on a particular grouping of tracks. If this map-like data should be corrupted in some way — either by software or system failure — it is not always possible to recover all the lost data held on the disk. The Lisa drives, however, are made to lay down a special block of 24 bytes per each 512 byte disk sector. Contained in these 24 bytes is a description of which file the block belongs to and where in the file it should appear. Further pointers to disk space allocation are also held within files themselves and in the main directory. Inevitably, some information will be lost, but it will have to be precipitated by something fairly catastrophic.

If you've read something about the Lisa you will already know that its disk drives do not have the conventional flip-down doors which can be opened at any time, regardless of what is going on. Instead, the drives have an automatic lock and load feature made possible by automatic 'disk present'

The Mouse

The difference between the traditional keyboard and a mouse is essentially the difference between sending morse code signals down a wire or using a telephone. While the telegraph and telephone achieve more or less the same result, the speed of interaction, and what might be called the 'fluidity' of communication, are just not comparable.

People first interacted with computers via teletypewriters — electromechanical devices that generated printed text either from an attached keyboard or in response to computer output. So it is not unnatural that they should have become used to dealing with line by line printouts that were issued in true typewriter fashion. If they wanted to leave blank lines on a printout they had to hit the 'line feed' key the required number of times. If they wanted to write something only at the end of a line, they might use the space bar, or tab key, to move the print-head over to the right.

Things remained pretty much the same even when paper was replaced by cathode ray tubes (CRTs, VDUs, or whatever you like to call them) as the prime method of displaying user input and computer output. The print head was replaced by a flashing or solid cursor (an underline, or solid square), but the user could still only move around the screen in discrete up/down/left/right movements. Cursor addressing, a facility made more accessible by the higher-level languages, was used but this was handled strictly at the program level.

The mouse unlocks the cursor from its straight-line existence and instead gives the user total control of its positioning. Connected to a computer by a thin cable (the tail), the mouse consists of a palm-sized package of electronics and mechanical/electrical/optical equipment which converts analog movements (drawing of a circle, for example) into digital signals. These digital signals are then acted upon by the relevant onboard processor, and a circle appears on the display.

Apple's mouse is probably one of the

simplest to use. Where others come with up to three control buttons, Apple's has only one for all actions. The multi-button mice have a sense of function keys about them — you push this one to do action number one, then you push the other to do action number two. This is because they are generally used with far simpler software than that supplied with the Lisa. The Apple mouse demands only that a user follow the simple rule: if you press the button twice to open one icon, you do exactly the same for another icon, independent of the program or stage you are at; if you want to select something from the pull-down menus you always click the button once after the required option is backlit.

Of course, there are times when the mouse becomes clumsy or redundant and that's why there are still cursor control and special escape keys/key sequences on the Lisa keyboard.

Lisa's engineers are sometimes criticised for selecting the mouse rather than other quick data input devices — notably the trackball, touch-screen and light-pen.

They point out that the trackball (which can be thought of as an upside-down mouse) requires two quite distinct operations. First you use your fingers to roll the cursor control ball as is necessary, then you have to reach over and press a command button. The mouse user can both move the device and press a button at the same time, so maintaining smooth movements.

The touch-screen and light-pen both have the limitation that the user must first identify the location that has to be touched, and then a physical movement has to be made to identify or select an object. Delay and arm fatigue can be a problem here. Also, touch screens do get fingermarked and light-pens have a limited resolution. If there are two option boxes placed very close together on the screen the pen might only be able to straddle them, and not deal with them as two distinct objects.

The Lisa mouse is simply built. All the



A replacement for the keyboard?

electronics are held on one small internal circuit board, and there are only a few moving parts. One is the teflon-coated metal ball which partially protrudes out of the bottom of the mouse casing. There are also the rollers, placed at right angles to each other, which translate mouse movements into x/y coordinates. The rollers touch the teflon-coated ball and move in accordance with it. Depending upon the skill of the user, such mouse-controlled movements can be made highly accurate — it doesn't take much time to be able to pick out a specific pixel with the cursor. Since the office environment poses a lot of potential hazards to mouse mechanisms — cigarette ash, abrasive paper fibres from lots of paper shuffling, and even the left-over debris from eat-in lunches abound — Apple has made its product user-serviceable. By unscrewing a black plastic retaining ring, the teflon ball can be tipped out and both it, and the mouse insides, given a clean-up.

During this review, we found the mouse to be a truly natural method of interaction. The only problems were freehand drawing in the LisaDraw program and the fact that you had to keep your desktop neat — something managers may find difficult.

**TWO VERY SPECIAL DAISYWHEEL PRINTERS ★★★★★
 ★★★★★★ AT TWO VERY SPECIAL PRICES**

ESW 100 RO

17-24 CPS
 10, 12 15 CPI
 CENTRONICS INTERFACES
 WIDE RANGE OF DAISY
 WHEELS AVAILABLE

= **£498 Ex VAT**
C.W.O.

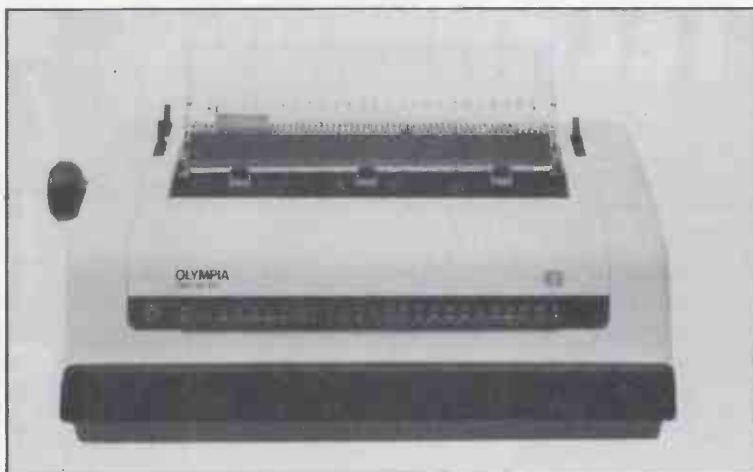

**WORD PROCESSING AT
 INTELLIGENT
 PRICES**

ESW COMPACT

DAISYWHEEL TYPEWRITER
 AND COMPUTER PRINTER
 10. 12. 15. C.P.I.
 14 CPS
 RS232 INTERFACE

= **£498 Ex VAT**
C.W.O.



(TRADE ENQUIRIES WELCOME)

**FOR MORE DETAILS OF THESE AND OTHER PRINTERS AVAILABLE,
 PLUS THE II64 & II128K PRINTER BUFFERS RING OR FILL IN COUPON
 BELOW AND POST TO**



**INTELLIGENT
 INTERFACES**

18 Central Chambers
 Wood Street
 Stratford on Avon
 WARKS CV37 6JQ
 0789 296879

Name

Business Address

.....

Tel. No: PCW 7/83

OFFICIAL TRADE DISTRIBUTOR OF ESW PRINTER PRODUCTS

BEHAVIOUR & INFORMATION TECHNOLOGY

This new quarterly journal began publication in March 1982. It deals with the interaction of human behaviour and information technology, focusing on research and development in the human sciences relevant to the design, use and impact of information technology in the short and long terms. It draws on a wide range of disciplines including psychology, sociology, ergonomics, computer science, management science and economics.

Published quarterly, £37.00, \$90.00, DM175.00.

For further information and/or free specimen copy please write to the Marketing Manager, Taylor & Francis Ltd, Rankine Road, Basingstoke, Hampshire, RG24 0PR, England.



Taylor & Francis Ltd

4 JOHN STREET, LONDON WC1N 2ET
Tel: 01-405 2237/9 Telex: 858540

ENGINEERING PACKAGES FOR THE APPLE II/IIe

SOFTWARE

TUTSIM A low cost dynamic simulation system

- Powerful machine language
- Fully interactive graphics output

ALL FEATURES OF A LARGE ANALOGUE COMPUTER AND MORE. IDEAL FOR PROCESS CONTROL, ELECTRO-MECHANICAL, PHYSIOLOGICAL AND ECONOMIC MODELLING. £250 COMPLETE

- OTHER CONTROL ENGINEERING SOFTWARE. SEND FOR DETAILS.

HARDWARE

APPLESCOPE Digital memory storage oscilloscope

- Plug into any two slots in Apple II/IIe
- 2 channels plus trigger
- 0.286 μ seconds sampling division
- 1K buffer on board
- Full software library including fourier transforms, correlation etc.

£695 COMPLETE

- OTHER HARDWARE ADD ONS INCLUDE FUNCTION GENERATORS, WAVE FORM GENERATORS, AND LOGIC ANALYSERS.

FOR MORE DETAILS CONTACT

MICROPACS

A Division of Process Automation and Computer Systems Ltd
Graphics House, 50 Gosport Street
Lymington, Hampshire SO4 9BE
Tel. (0590) 73503



CONCORDIA THE EXPERTS

FOR YOUR

EPSON QX10

The simple to use QX 10 computer. Ideal for the first time user, it also has the power and facilities to satisfy the most demanding expert. The price includes CP/M, MFBASIC, twin double sided double density disk units, high resolution VDU, 192k RAM, a music generator and interfaces for RS232, Centronic parallel, and a light pen.

Of course the QX 10 has 16 BIT precision, High resolution graphics, keyboard graphics, and many function keys. It also gives you 16 type faces to choose from and they all print out on the FX 80 printer.

In fact there are so many new facilities on the QX 10 and so many high quality programs to choose from that CONCORDIA have written a booklet to tell you about them.

To get one ring 01 337 4541 (Day or night).

Concordia (Est 1971), give after sales support

6 CENTRAL ROAD, WORCESTER PARK,
SURREY, KT4 8HZ

PHONE 01 337 4541

TELEX 929980

CORRESPONDENCE COURSE IN BASIC

TIME IS MONEY !....



SM - UNITEXT
the "go-anywhere"

SM - UNITEXT utilises the full size keyboard of the EPSON HX-20 to give full size text processing:-

- full screen editing
- variable page width up to 80 columns
- auto return
- remote transmission
- text blocks
- line / character insert delete
- print out on built-in miniprinter or full size external printer
- word break suppression
- right hand justification
- integrates with SM - UNIVERSE (data base) and other products

SM - UNITEXT
£90

EPSON
HX - 20

SPECIAL OFFERS
for combined hardware / software packages

ASK YOUR EPSON DEALER FOR A DEMONSTRATION - OR CONTACT US DIRECT

SM Software (UK) Ltd., Raglan House, 56 Long St., Durley, Glos. 0453-46065

APPLE LISA

sensors. If you want the disks back for some reason, you cannot just yank them out. To the right of each drive there is a disk request button which signals to the CPU that you want to remove a disk.

Before anything else is done, the Desktop Manager checks to see what files are open and then sets about closing them. Once everything is cleared from the desktop the disks are automatically ejected.

Having visited an office shortly after somebody lost 20 pages of WordStar text by removing the disks and resetting the system without doing the hallowed ^KD, I think there are many people out there who would consider the wait a reasonable price to pay as an insurance against going into a sudden state of speechless shock at losing an afternoon's hard work. And, anyway, what are you going to do with the disk if all your work hasn't been saved on it?

Documentation

During the review, provisional documentation only was available for use — the exception being a proof copy of the LisaDraw user's manual. The provisional material was more than adequate, but the LisaDraw manual — in fact it was more like a commercially published book — was probably the best.

It was properly typeset on good quality paper and there were many photographs and high quality prints of the Lisa and its display to provide visual backup. Contents and page number information was also

included. If all the documentation is of this quality, there won't be many complaints.

In addition to the manuals, Apple has written LisaGuide, an interactive guide on using the Lisa. It is quite a major achievement in itself since it avoids being condescending where it easily could be so. It makes full use of the display's high-resolution and the mouse, so helping novices quickly through the acclimatisation process.

Service

Apple is offering various levels of service for the Lisa.

The ordinary user will be able to take advantage of the Apple Care Carry-In service whereby the machine is handed to a local dealer who will swop out the faulty part and replace it. Dealers will carry stocks to cover most component failures.

Bigger users can take out a contract with Apple whereby RCA will send a service person to the site.

At the top end, Apple will provide in-house training so that Fortune 500 users can do all but the most major repairs themselves.

There is also a hot-line direct support service permanently available by telephone.

Discounts

Against the high single unit price of the Lisa, Apple is setting a series of discounts for customers prepared to sign 12-month contracts.

If you are prepared to show a definite interest in buying a few machines over the next 12 months then you can gain a 10 per cent reduction in the cost price per machine.

A customer which will commit to buying 275-549 units in the coming year can obtain 15 per cent discount. For 550-999 units the discount increases to 18 per cent.

At the top end, 1000 definite orders will yield a 20 per cent discount rising to 28 per cent for even greater volumes. International companies can gain these price reductions on a worldwide basis.

Prices

Lisa: \$9995 (UK price around £8500) — includes main unit, 1 Mbyte of RAM, display, system/applications software, keyboard, mouse, and 5 Mbyte ProFile hard disk unit.

Dot Matrix Printer: \$695

Daisy-wheel printer: \$2100

Languages: Basic Plus: \$395

Pascal: \$595

Cobol: \$795

Conclusions

Really to get an idea of what has happened, you mustn't compare the Lisa directly with other machines such as the IBM PC, the DEC Professional, or the Sirius 1. If you do the sums, they actually show that the Lisa is competitive in terms of price, and totally unapproachable in terms of integration (once all storage, software and necessary add-on boards have been accounted for).

Certainly, the recent announcement that Digital Research would be aiding and abetting Visicorp in implementing the mouse-controlled, window-oriented VisiOn product in the CP/M environment is significant. So too, is the fact that IBM, DEC and Texas Instruments have all said they will support the VisiOn package on their relative machines.

Microsoft, with its MultiTool word processing system, has also adopted the mouse as a viable alternative to laborious keyboard commands. The product has windows, and is modelled after the company's Multiplan spreadsheet program.

Both packages will be moderately priced — a few hundred dollars each — and this will obviously meet a vast number of users' needs. But consider that we're talking about different leagues here.

VisiOn and other similar products waiting in the wings, run on a range of manufacturers' machines that have not been optimally designed for such products. The keyboards are still the unhappy mixture of qwerty and dp functions; the mice are add-ons rather than a fundamental part of the computer's design philosophy; reliability in the software may not be mirrored by reliability in the hardware.

In summary, the hardware/software division is still maintained. Obviously, events in the next six months are going to provide some answers to such thoughts — but our feeling is that there is room in the market for both approaches.

Technical Specifications

| | |
|----------------------|--|
| CPU | 32/16-bit Motorola 68000 running at 5MHz. |
| Other Processors: | SCC chip in keyboard and NatSemi COPS on I/O board to handle keyboard and mouse. |
| RAM: | Presently 2 x 512k boards or the option of 2 x 1 Mbyte boards — to be introduced shortly — that will fit in the same slots. |
| Diagnostic ROM: | 64k start-up diagnostic code checks out disks, memory, etc. Capable of generating audio backup if the display fails. |
| Display: | Crisp, black on white background, video generation. 12 inch diagonal, 720 x 364 pixels, bit-mapped in upper area of RAM memory. |
| Keyboard: | IBM Selectric style, 76 keys (no straight function keys) including numeric pad. |
| Mouse: | One button, see and point operation. Accurate for cursor positioning down to individual pixels. |
| Floppy disk storage: | Two 860k, 5¼in, floppy drives integral to system unit. Unique twin access windows in disk envelope because of offset drive heads. |
| Hard disk storage: | 1 x 5 Mbyte ProFile hard disk, as originally designed for the Apple III. More than one can be connected. |
| I/O ports: | Two RS232 ports, one parallel interface port. |
| Expansion slots: | Three empty slots are available. |
| System Software: | Desktop Manager operating environment, and six Lisa specific application programs: LisaCalc, LisaList, LisaWrite, LisaProject, LisaDraw, and LisaGraph. Others, including LisaTerminal, will follow. |
| Languages: | Basic Plus, Cobol, Pascal. Others are under development, including the Smalltalk language/environment. |
| Printers: | Dot Matrix graphic printer (parallel) and letter quality daisy wheel (serial) printers. |

SCREENPLAY

Maggie Burton looks at games software for the Colour Genie

The Colour Genie is a very puzzling animal indeed. Writing good software for it demands considerable expertise, especially in the area of machine code.

In the Colour Genie Benchtest last month I concluded that great things are possible from the Genie if software is properly written. The machine includes a very powerful sound generator, good screen handling in spite of the unchangeable low-res background, and the power to give very fine shape definition when user-defined characters are used.

Oddly, though, cassette handling is not as good as I had thought. It is only after spending a great deal of time playing with different programs from different manufacturers that you can begin to get an accurate idea of how well a machine loads cassettes.

Machine code programs load fairly well using the SYSTEM command to enter a rudimentary monitor (it seems to be designed purely for the loading of machine code). Basic is loaded using the more conventional CLOAD command. You are told when a program is loading by the appearance of two asterisks in the top right-hand corner of the screen. The rightmost one flashes as blocks of data are fed into the computer's memory.

Basic does not seem to load at all well. After much fiddling and swearing I was able to load just two Basic programs

out of six — the others were abandoned when all the different volume levels had been tried. All of the cassettes were loaded from the Genie cassette recorder.

Loading is very error-prone; often the machine will load a program and run it even though the load is bad — the result is often chaotic, with odd characters appearing all over the place, controls refusing to work and screens filling with garbage. An error is indicated when the leftmost loading asterisk is replaced with a 'C'. Some machine code programs seem to cause unexplained corruptions when they are part-loaded. The most common was getting the response 'Syntax error' from the command NEW, even though the command worked. A lot of them disable the reset keys, making it impossible to empty memory without switching the machine off.

What is even odder is that the Genie seems to load better when it has only just been switched on. Once it has been running for an hour or so, and has got really warm, loading becomes progressively more unreliable.

Having now experienced the cassette loading/saving capabilities (or lack of them) on most home machines, there is only one thing which can be said. Almost without exception they are awful. This statement is not addressed at one manufacturer more than any other. Most

computers have some problems loading cassettes. The only one which rarely does is the Sharp MZ-80A, which has an integral cassette recorder anyway. While unsuccessfully trying to load programs I have often put myself in the place of the first time user. This person has proudly bought a machine and some software, gone home, set the machine up, and fiddled around for ages to get it tuned into the TV. Our unfortunate individual then decides to load his programs and try them out. He tries once. It doesn't work. He changes the volume level (if the manual tells him to, which some don't) and tries again. Eventually, after trying several times, not knowing how long to wait, not being quite sure what to expect, the program loads — by which time all the fun has gone from it. How many people, I wonder, have had that experience? It's a shame, in this age of microtechnology, that a better solution cannot be found than this.

The Genie software library is quite big. Most of the titles, unsurprisingly, are games. The seemingly impressive list of packages soon deteriorated into a very run-of-the-mill set of programs indeed. Some programs, though, are of a very high standard, as shall be seen from their reviews.

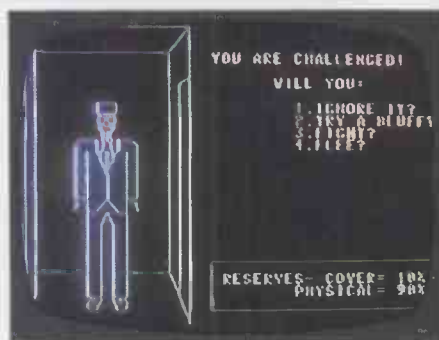
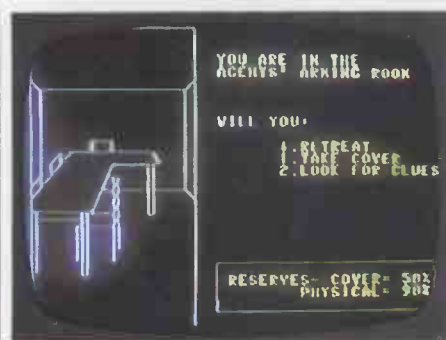

DOUBLE AGENT

Supplier: Algray Software
Price: £12.95

Fed up with traditional adventure games? Graphics? Sound? Role-playing? It's all here. Double Agent is positive proof that the Genie is capable of great things. It took me ages to load it like all the other games, but I wasn't at all disappointed. The plot is a very simple one. You are a double agent (one of 200 different characters, in fact, which you choose at the beginning of the game) in disguise, looking though a building seeking stolen documents.

In choosing your disguise you must consider your appearance and character so that you look the part. You are then entitled to carry some items as part of your disguise, which can prove useful later. You are also allowed to select some weapons from a short list, all of which will make your cover less convincing.

What is so good about this game is the graphic and sound effects. You actually walk around the building, open doors (or force them with a bang if they are locked), meet little men who look like traffic wardens and challenge you and discover objects which may or may not relate to

what you are looking for. You really feel as though you are the character you are playing. There is, though, what must be a bug in the game. If you turn left or right immediately at the entrance to the building, you become trapped in a location which probably should not exist and cannot get out. The screen becomes garbled and parts of the text are lost. The only way to get out of this trap is to restart the game.

On balance, though, old and young alike will love playing this game. It is well thought out and presented and is a definite step nearer to what adventures ought to be.

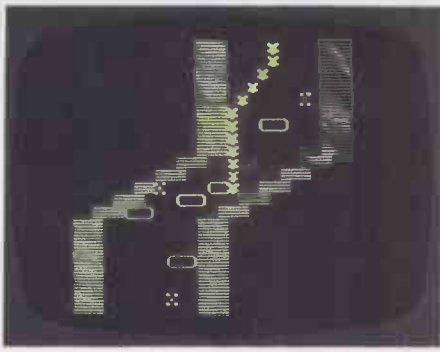

RACING DRIVER

Supplier: Molimerx
Price: £10.06

There are some really excellent Grand Prix programs around. Some of them are in 3D, other have lots of cars to control, bright colours, good sound effects. I mean no offence to Molimerx, but I've seen better games on a ZX81. Keyboard response is bad, shapes are poor, sound is boring and monotonous and all the graphics are in the same colour. The fact that it's in Basic is no excuse — the game is no good at all.



EXTERMINATOR

Supplier: Algray Software
Price: £7.95

This is a very fast moving game indeed. Your aim is to destroy some birds while avoiding a deadly indestructible missile which zaps towards you at every opportunity. When you have done all this you go on to the second phase — grabbing eggs (while avoiding more aliens) and putting them in an incinerator.

It's not a very spectacular game at all but it does include a 'hall of fame' of the best five high scores.



ROCKFALL

Supplier: MCE Software
Price: £5.95

Here's another (perfectly playable) game into which very little imagination has gone. The idea of the game is to catch Martian bombs (poor Martians — what have they done to deserve such a reputation?) and thus defend your cities. You do not fire or zap through millions of light years in time/space. It's a thoroughly two-dimensional game and a little too fast to be really enjoyable.



INVADERS FROM SPACE

Supplier: Molimerx
Price: £9.20

We'd probably better resign ourselves to the fact that Space Invaders (to give a dog a name) is here to stay. It's a horrible old game but once it was really good, because it was the only video game around.

With so much computing power around it seems idiotic that software suppliers still go on producing version after version of this derisory little scenario.

What I will say here is that this version is as good as a version of space invaders can be. It is colourful, keyboard response is good and it is true to the arcade original — ie, it leaves nothing out. Interestingly it includes a facility to freeze the game and start it again. Using it you can often get out of difficult situations by freezing and then using one of the cursor keys to move out of the way of falling bombs before they have time to drop on you. The instructions seem to be wrong in their explanation of this — they tell you to press break/clear to resume the game, which doesn't work; it should be one of either left/right arrows.

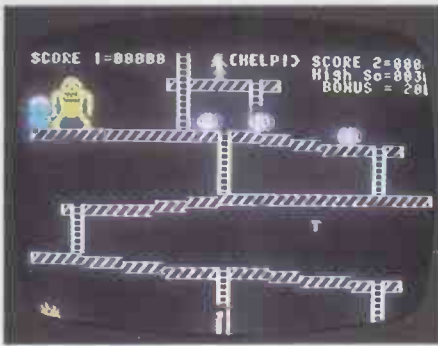

KONG

Supplier: Algray Software
Price: £8.95

Before I review this game I'd like to say that gorillas are charming creatures; very gentle and far more civilised than humans. It is a little unfair that they are often portrayed as vicious, woman-stealing, dangerous animals, but perhaps that's human nature.

Kong is also a version of an arcade game. Sound and graphics are very good but as far as I can see the game is nearly impossible. Basically, you have to climb up a building, avoiding the rocks the gorilla at the top will roll at you, and kill him with a hammer which you pick up at the beginning. Then you rescue the dame to win.

This is all lots of fun (apart from the abiding insult to the character of the gorilla) but sometimes you are killed for no apparent reason and you always die if you hit a ceiling when you jump — which makes it impossible to jump, most of the time, to avoid the rocks. At the best of times it's a hard game to play and really shouldn't be made any harder by bad debugging.



SKRAMBLE

Supplier: Algray Software
Price: £8.95

Algray seems to have got the hang of it on this machine. Skramble is one of the games I played again and again, but it's by no means original.

It's a version of the arcade game 'Scramble', and it's a very faithful one. It's also one of the few games which uses the Genie's excellent joysticks as an option. Those unfamiliar with Scramble will need to know that the game involves flying a little rocket over a varied landscape, killing alien ships and bombing fuel dumps until you fly through a long maze and come to a landing pad, where, logically, you must land to finish the game. It's a difficult game to play but lots of fun and quite picturesque.

This version is good but poorly debugged. You can explode on your own bombs, fly underground or impale yourself on your own lasers and exploding aliens.

If you're greedy and avaricious, you'll be pleased to know that Algray is offering a £100 prize to the first person to reach the end of the game.

DISKOGRAPHY

A BRIEF GUIDE TO FLOPPY DISKS

Jane and John Shemilt offer their advice on purchasing the correct disks for your computer.

This article is a short guide to the various types of floppy disk on the market and attempts to explain why it is important to buy the correct type of disk for your machine. It does not make any comparisons between disks from different manufacturers, so no 'best buys' are recommended.

There are two standard floppy disk sizes commonly in use: five and a quarter inch (mini) and eight inch (standard). Both these types have a similar construction, the heart of which is a mylar disk on which is deposited a metal oxide layer. The mylar disk is held in a sealed protective envelope with a soft inner lining including a cutaway for head access (see Fig 1). The disk has a large hole in the centre which fits onto the disk drive hub, which centres and rotates the disk inside the stationary envelope in the drive during use. There is at least one other hole in the mylar disk (the index hole) which lines up with the index/sector hole in the envelope once per revolution. If the disk is *soft-sectored*, there are no more holes in the mylar disk, but if it is *hard-sectored* it will have more holes in the disk which line up with the index/sector hole once each revolution. In this case, the disk is divided into sectors, ie, wedges or slices, by a series of holes (one hole per sector) in addition to the index hole. (Whether the division of the disk into sectors is hardware or software controlled will depend on the disk controller used by your computer.)

For eight inch disks, the index/sector hole in the envelope is in one of two positions depending on whether the disk is *double-sided* or *single-sided* while, for five and a quarter inch disks, the position of the index/sector hole in the envelope is always the same. The only other hole in the disk envelope of importance to the user is the write protect notch. Usually, on eight inch disks when the notch is uncovered, the disk may not be written to *write protect mode*, although on five and a quarter inch disks

this notch must be covered up by an opaque material to *write protect* the disk.

The label on the disk envelope usually has a large number '1' or '2' on it, followed possibly by a large letter 'D'. The number '2' indicates that the disk is double-sided, ie, both sides of the mylar disk have a metal oxide layer which can be written to, while a '1' denotes a single-sided disk. In fact, most single-sided disks are actually manufactured as double-sided where the oxide layer on one side of the mylar has failed on inspection. It is generally *not* a good idea to use single-sided disks in a double-sided disk drive as they can cause damage to the magnetic recording heads if used frequently. However, double-sided five and a quarter inch drives can be used on single-sided five and a quarter inch drives, but only as single-sided disks and the second side of the disk may be damaged if it is used this way frequently. It is possible to buy double-sided disks with two index/sector holes in the envelope so that both sides can be used, but only one at a time, in single-sided drives by turning the disk over to *change sides*. Unfortunately these disks, when turned over, rotate in the opposite direction to their previous motion so that all the dirt and loose oxide particles, which have collected on the liner by the side of the head access slot, are dislodged and deposited on the disk surface. This debris is wiped off on the recording head and pressure pad of the disk drive and can cause damage. Also, in this case, the pressure pad on the single-sided drive is in contact with a disk surface, which is used for writing to and reading from, and can damage this surface leading to the loss of data on the disk; usually the pad presses on the unused face of a single-sided disk.

Another special eight inch double-sided disk can be obtained where both the single-sided and double-sided index/sector holes are cut out in the envelope, so that the disk can be used as a single-sided disk on a single-sided drive and as a double-sided

disk on a double-sided drive. Of course, the index/sector hole which is not applicable should be covered up while using the disk. The main use of these special disks is in the transfer of software between different disk drives but, as most eight inch double-sided drives will also read and write to single-sided disks, these make a more readily available medium to transfer software.

The disk label also specifies the recording technique for which the disk is suitable. The standard recording technique of Frequency Modulation (FM) records a flux reversal on the disk at every clock pulse (4 microseconds) to produce *bit cells*. The data is recorded serially in the form of another flux reversal in the centre of the bit cell to record a '1' bit or no flux reversal for a '0' bit. (see Fig 2a). A disk capable of being used with this recording method is called a *single density disk*. In order to double the amount of data stored on the disk, a technique called Modified Frequency Modulation (MFM) is used. In this method (see Fig 2b), the clock frequency is doubled giving a 2 microsecond bit cell. However, there are normally no flux reversals recorded on the disk at clock pulses so that only data generated flux reversals (denoting '1' bits) are recorded. This could lead to synchronisation problems if a group of '0' bits happened to be recorded in sequence and, therefore, if one '0' bit is followed by another '0' bit a flux reversal is inserted at the clock pulse (see Fig 2b). Disks suitable for MFM recording are called *double-density* disks. The actual frequency of recording in MFM is not increased over FM (single-density) technique but this double-density recording is more susceptible to the quality of the disk. A double-density disk may be formatted and used in a single-density drive but a single-density disk should not be formatted for double-density as it is prone to errors. (In practice it is often possible to get away with formatting a single-density disk as a double-density one.) The letter 'D' following the '1' or '2' on the disk label implies that the disk is of double-density quality. Even though the recording technique used by a machine may not be FM or MFM, the disk type specified for use on the particular machine will be specified as 'single' or 'double' density.

For eight inch disks that completes the story but, for five and a quarter inch disks, there is one more option to consider when.

GOTO page 240

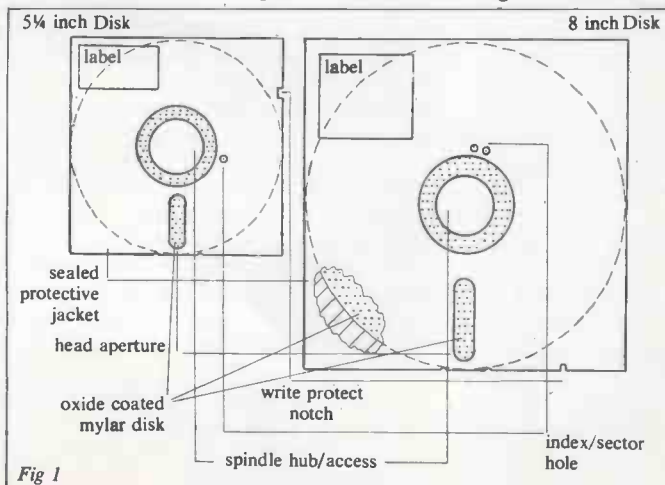

Fig 1

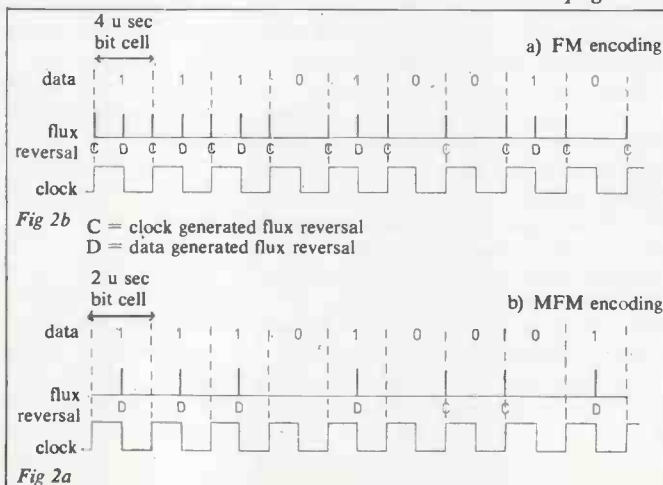
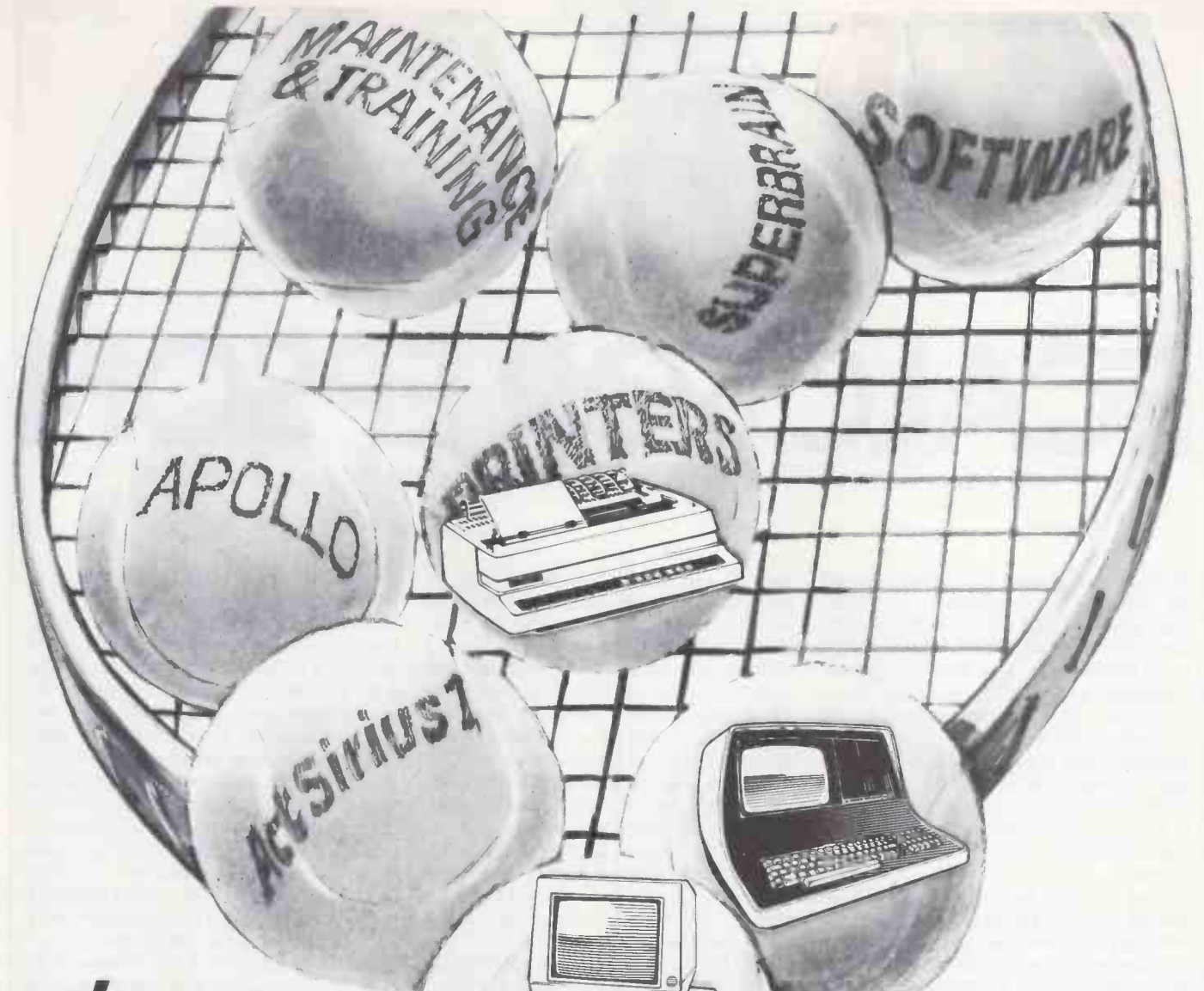

Fig 2b C = clock generated flux reversal
D = data generated flux reversal

Fig 2a



It's our service!

Whether your applications involve simple financial procedures or complicated R & D Graphics (or a myriad of techniques in between) KGB have the system for you.

With the right software packages to go with it. And all at sensible competitive prices.

But we go further still. We can help with finance and leasing. We provide sound system training. And comprehensive maintenance.

So send for our literature. Have a look at the KGB service - and find out how you can win Game, Set and Match!



Micros for the Business, Commercial and Technical user - Stand Alone and Multi-user Systems.

**See us at the
COMPUTER FAIR,
Earls Court,
16th-19th June,
Stand N0235**

KGB

MICROS LIMITED

word processing + accountancy + financial modelling + calculation + record keeping + sales office management + accounts + payroll + graphics + engineering + communications + languages + solicitors + CAD

14 Windsor Road, Slough SL1 2EJ. Tel: Slough (0753) 38581/38319. Telex: 23152 KMICRO and in Scotland: Micro Change Ltd. Telfer House, 74/80 Miller Street, Glasgow. Tel: 041-204 1929



ECALC FOR EPSON

Mike Liardet takes a look at ECalc — a spreadsheet system for the Epson HX-20.

In the last three years Epson has achieved an extremely good reputation as a hardware manufacturer with its highly reliable range of printers for micros. More recently, it has joined the growing band of Japanese companies exporting micros to the West.

The first of its micro product line to arrive in the UK was the HX-20, a portable computer only slightly bigger and heavier than this magazine (reviewed in December 82 *PCW*). This has now been joined by the QX-10, a more conventional desk-top micro (reviewed in this issue) running CP/M.

True to the industry norm, the HX-20 arrived on the scene to great acclaim, but with very little software to run on it. Now six months on, a trickle of software is becoming available, including a word processor called Intext, and ECalc, a spreadsheet system which is the subject of this article. To date, all Epson's offerings have served to reinforce the excellent Japanese reputation in electronics manufacturing. Now we have a first opportunity to see if it has software skills to match.

Back to Basic(s)

My complete review package, including all hardware, software and manuals, arrived in a neat cardboard box about the same size and weight as a briefcase. In fact, if you are not image-conscious, you could just about use it as a briefcase, since Epson has thoughtfully fitted a rugged plastic handle to the top.

Quickly opening it, I unearthed the HX-20 itself, with a mains adaptor, micro-cassette drive, two manuals and, of course, the ECalc package.

The first task was to fit the micro-cassette drive. Once fitted, it becomes an integral part of the body of the HX-20, with no trailing wires or other encumbrances. The cassette is actually held in place by a clamping lever, and there is absolutely no need to fiddle with screwdrivers or jack-plugs, or get involved in any wiring-up. The whole operation takes less time than I have taken to describe it!

As the HX-20 comes supplied with a rechargeable battery, it is not necessary to

use the mains adaptor. The battery is reputed to run for 50 hours without recharging. Since the adaptor did not have a mains plug, I opted to 'leave it for the time being'. I subsequently regretted this, when the battery died on me at a critical moment in the Benchtests, and long before 50 hours had elapsed. Presumably it was already greatly discharged when the system arrived. Anyway, I was able to resume work immediately the adaptor was connected, since it simultaneously powers the machine and recharges the battery. In spite of the power failure, the Epson had managed to retain the ECalc software in RAM, but I was unable to recover the spreadsheet model itself, and had to re-enter it all.

The ECalc package is attractively presented in a shiny blue paperback-sized box, holding the micro-cassette and slim spiral bound manual. (ECalc is also available, at a greater price, on a ROM cartridge.) Both the box and manual cover label the package 'Epson Calc' (for the sophisticated punter at the Derby?!), but the software and documentation refer to it as 'ECalc'. Presumably the marketing and technical departments have got their wires crossed on this one.

Before doing anything, I had to get the software on the micro-cassette read into the machine. In fact, once there, it stays almost indefinitely, surviving all switch-offs and low battery levels, somewhat lessening the advantages of the ROM cartridge. Of course it can always be explicitly erased to make room for another program perhaps,

and also it does get lost if you remove or really abuse the battery.

Anyway, I experienced a few initial difficulties loading the cassette, although it is actually a fairly straightforward procedure once you know what to do. Firstly, my review copy was unlabelled, so I was unsure which way to insert it in the drive and my initial guess turned out to be wrong. Further confusion arose when I missed a vital bit in the ECalc manual telling me that the HX-20 must be in Basic programming mode before the cassette drive commands will operate. However, after consulting the programming and hardware manuals and applying a bit of guess-work, I got the cassette drive reading the tape.

After a minute or so, I was informed of an 'I/O error', usually a sign that the tape or cassette drive is duff, though the ECalc manual had nothing to say on this matter. Trying again, I got the same message, and then — on my third attempt — it worked! Subsequent experiments failed to repeat the I/O error, so possibly it was caused by a speck of dust on the tape. Whatever the cause, the manual had no advice on the matter.

Having successfully read the tape, I still did not have an up and running spreadsheet system, being in Basic programming mode. Eventually I tracked down the instructions in the ECalc manual. It transpires that it is necessary to type RUN to get ECalc going. This is the usual command to run a Basic program. Could it be that ECalc is written in Basic? Well, somewhat to my surprise, I

Benchmarks and other measurements

Maximum number of columns: 14 (26 with 16k expansion unit).

Maximum number of rows: 15 (35 with 16k expansion unit); numeric precision: 7 digits; fixed column width: 8 characters.

As mentioned in the article, the formulae used in the Benchtests were slightly modified to comply with ECalc's formula syntax requirements. (Refer to *PCW*'s Feb '83 issue for more information on these tests.)

Benchmark 1 — to test calculation speed and capacity: (a) 9 rows (b) and (c) both 450 seconds, ie, 50 seconds per row (d) vertical scrolling speed: 18 seconds for 9 rows, ie, 2 seconds per row. Horizontal scrolling speed: 30 seconds for 13 columns, ie, 2 seconds per column.

Benchmark 2 — 15 rows (this fills every single cell with text).

Benchmark 3 — 15 rows (this fills every single cell with numbers).

Cassette benchmark: the 9 row calculation benchmark took 90 seconds to save, approximately one cell per second.



verified that it is. Basic, with its comparatively slow speed of execution is not normally the preferred language for implementing time-critical spreadsheet systems. The benchmark timings (see below) testify to this.

Putting it in perspective

The original motivation for spreadsheet systems was to provide a facility to help with pencil/paper/calculator operations. They ran on expensive (compared to a calculator, that is) micros. Although in one sense, the HX-20 can be regarded as an

extraordinarily cheap and portable computer, we can also view it as a rather large and expensive super-calculator. Thus ECalc is one of the first of, what I expect will become, a growing number of inexpensive calculator spreadsheet systems — taking the spreadsheet back to its roots.

It must be remembered that any spreadsheet system on the HX-20 is bound to be limited by the small screen display available: only 20 characters across by four rows down. Similarly the standard HX-20 comes with just 16k of RAM to hold both program and spreadsheet data.

Both of these hardware facts of life contribute to the attractive price and portability of the machine, but also affect the sophis-

tication of the software written for it. So it's really within this context that we must look at what Epson can provide.

Using ECalc

Once ECalc is running, the display clears to reveal the top-left hand corner of an empty spreadsheet. Just four spreadsheet cells can be accommodated in the display, two columns by two rows. The display's left-hand margin is reserved for the row numbers, and the top row has the column identifiers (letters A,B, etc). Thus ECalc uses the standard 'Visicalc style' for identifying cells on the spreadsheet; the first row of cells being A1, B1, etc, and the second

ECALC

being A2, B2, and so on. Of course, the display has no room for long-winded prompts, or copyright messages. The fourth and bottom line of the display are left blank, being used as 'input lines' displaying what has been typed at the keyboard. Fig 1 gives an actual size (with respect to character count) typical display.

Moving around the spreadsheet is very simple. The 'current cell' is marked by an underline cursor character. In fact this is redundant since the current cell is always the top left-hand cell on display. Anyway, the keyboard has two keys each labelled with two arrows, and each pointing in a different direction. Using these keys with and without the 'shift' key provides the four different key strokes necessary to move the current cell to the one above, below or to left or right.

After each keystroke the display is redrawn, so that the newly current cell appears in the top left hand position. The display is liquid crystal, and 'redraws' are slower than a video display would be, but because it's a small area being redrawn, this does not greatly inhibit the speed of moving around the spreadsheet.

Moving far enough to the right and down we reach the outer limits of ECalc's spreadsheet: 14 columns wide by 15 rows down. This is quite a small area but, unlike many spreadsheet systems, this is not simply a theoretical limit, since in most cases each and every one of these cells can be used without running out of memory. (In fact only the 'formula Benchtest 1' filled up all available memory before all the cells had been used.) The HX-20 also has an optional 'expansion unit', with another 16k of memory, which extends the limits to 26 columns by 35 rows. As the review system

did not have the extra 16k, I have only tested the smaller size spreadsheet.

Entering text, numbers and formulae follows the standard drill: move to the cell to be changed and type in whatever is required. To enter a formula, first press the '@' key to select 'formula mode' or else it will be treated as ordinary text. Similarly, numeric input is preferable in formula mode, since then the formatting is handled automatically. Formula syntax is rather more limited than usual: only simple arithmetic (+ - * /) can be used, and no parentheses. For some formulae this involves a little extra thought. For example, one formula used in the Benchtests (see *PCW*, Feb 83) is: $(12*(A1-1)/12)+2$. For ECalc this had to be converted to: $12*A1-12/12+2$. Note that ECalc evaluates from left to right, ignoring the normal algebraic precedence conventions. For example, ECalc would evaluate $3+4*5$ as 35 and $4*5+3$ as 23. It is easy to work out what is happening if you (mentally) add parentheses from left to right: $((12*A1)-12)/12+2$, $(3+4)*5$ and $(4*5)+3$ in the examples I have given.

ECalc does not automatically recalculate after every entry. This has to be forced by pressing the 'recalculate' (control-R) key, but once pressed the spreadsheet is completely updated to reflect all changes. However, recalculation is probably the weakest aspect of the system, since it takes an excessively long time, even for quite small spreadsheet models (see Benchtests below).

Other features

Apart from the basic facilities described above, ECalc has the following features:

- * Row and column totals. The last column and row of the spreadsheet can be used for row and column totals. This compensates somewhat for ECalc's lack of SUM function, available on most larger spreadsheet systems.

- * Display format control. The numeric display can be either integer (ie, no decimal point) or decimal (a decimal point and two digits after the decimal). The format control is global and cannot be used selectively on specified cells. In either format, very large numbers are displayed in 'exponential form', for example, 123456789123 is displayed as 1.2E+12.

- * Replication. Formulae, numbers and text can all be replicated along a single row or column, but not into an area. Specifying replication into an area (an area would be 'A1 TO F6' whereas a row would be 'A1 TO F1') produces a terse error message: 2D NO GO.

Replication of formulae can be in both relative or absolute mode. Absolute replication copies the formula faithfully, and relative replication modifies it according to where it will be placed. Relative replication is used when a formula has been set up to calculate, say, January profits, and it's to be copied along the row, into February to December columns. Clearly references to January cells in the January formula should become references to February cells in the February copy, and so on. Relative replication ensures that this happens.

Another nice feature of replication is the ability to move the cursor in mid-formula entry. As only four cells are on view at one time, it is easy to get confused when entering a complex formula. By moving the cursor the required cell can be located, then simply pressing '@' enters its identifier directly into the formula.

- * Printing. The HX-20 comes complete with an integral printer, using cash-till roll paper, and also an interface for an external printer. ECalc provides facilities for printing a specified area of the spreadsheet to either. The integral printer can only print 24 characters across: enough for just two columns of the spreadsheet, and wider reports are automatically broken into sections by the program, two columns at a time. For such a small device the printer is surprisingly noisy, and would doubtless cause a bit of a stir when used in a public place. Needless to say, being an Epson, the print quality is very good.

- * Saving and loading data. ECalc provides a fairly sophisticated cassette filing system. Before loading, the tape can be fast-wound (all under program control) to a numbered position, thus reducing search-times. Spreadsheets are saved with an eight character name, so it's possible to save more than one per side of tape, without getting them mixed up. And every time a save is made, the program prints out its position on tape with its name and the date, providing a hard-copy record for future reference. (By the way, the HX-20 has its own clock with calendar software, so it's not necessary to enter the date every time you use it.) Saving one of the benchmarks, just over 100 cells of 13 character formulae took 90 seconds, which seemed a fairly respectable speed for a cassette.

Missing features

It should be clear by now that ECalc is a fairly simple spreadsheet system. Of course it lacks consolidation facilities, split

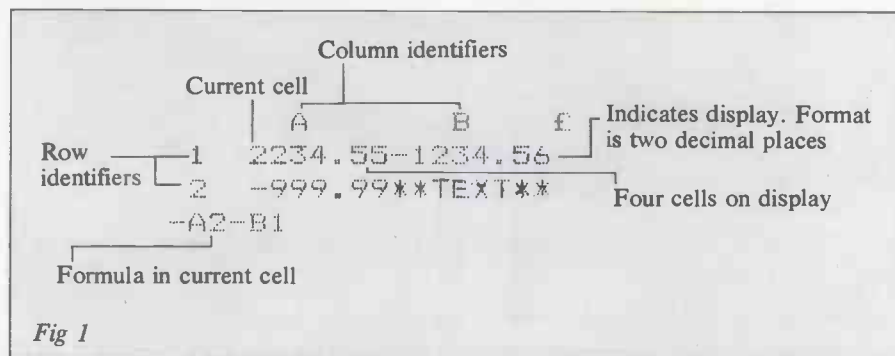

Fig 1

Checklist

Documentation: attractively packaged 32-page manual with tutorial, reference and index.

User-friendliness: relatively easy to use, but slow calculation speed, and limited help prompts.

Error handling: a few terse error messages.

Facilities: + - * / row and column sum. Can be configured as a turnkey system. Replication into rows or columns but not areas. Only three display formats: integer, two decimal places and exponential. Fixed column widths.

Manual recalculation only. 'GOTO' cell facility.

Supplier and prices (exclusive of VAT): £30 on cassette (and cassette drive costs £75). £85 on ROM cartridge. 16k memory expansion unit costs £75 and the HX-20 itself is £402. Contact Epson (UK) Ltd, Freepost, Wembley, Middlesex HA9 6BR. Freefone 2730.

screens and other sophistications, but these are hardly fair criticisms for a package in this context, so I will not dwell upon them.

However, it does also lack a few features of basic human engineering which, if present, would greatly contribute to user-friendliness. For example, there is no command to clear the spreadsheet, and there are no instructions on how to do it, either. In fact the spreadsheet can be fairly quickly cleared by exiting then re-running, a matter of a few keystrokes. Another source of annoyance was that it was impossible to abandon a menu option once selected, for example, once replication is selected you must go through with it, even if you hit the wrong key by accident. Also for some reason, the delete key did not operate in text entry under the menu options.

Although it is difficult to run out of memory before every cell available is in use, it would appear that there is no proper error-recovery if this does happen. When running the calculation benchmarks, the system simply 'died' if too many formulae were entered.

Of course more extensive arithmetic and faster recalculation times would also be desirable, along with improved editing facilities and row and column deletes. Particularly lacking was a flexible formatting facility. If working with small quantities it could be possible to squeeze four or five spreadsheet columns onto the display, but with ECalc's fixed column widths there is no facility to do this. Obviously, with just 16k of RAM, the implementors had to draw the line somewhere, since lots of facilities would mean no room for spreadsheet!

The manual

The manual is well presented: 32 glossy pages with information on getting started,

basic facilities, several tutorial examples and an index. Most of the instructions give a key by key account of what to do with all the keystrokes given in emphasised type, and keystrokes using special keys (like 'control' and 'return') printed in inverse, white on black. This is not quite as effective as it could be since emphasised type is also used wherever the product name appears, and in other instances as well. Thus it is still necessary to hunt through the text for which keys to use. Most of my initial problems with cassette loading stemmed from being unable to find information that was *actually* there, but obscured by inconsistent type-faces.

The content of the manual is passable, but not as clearly written as I would have liked. Possibly it lost a little elegance in its translation from Japanese, or alternatively it's always been in English but was not brilliantly written in the first place! Certainly it's better than some Japanese translations, in fact better than Epson's own printer manuals, but I did find it necessary to re-read most of the instructions before I could mentally digest them.

There are several tutorial exercises, including a December cash-flow problem for a certain Mr Fawkes of the 'Big Bang Firework Co' — a refreshing change from the 'Acme Widget' example that seems to pepper most of the American manuals.

Conclusion

Frankly, I was a little disappointed with ECalc. Of course, knowing the hardware limitations of the HX-20 I was not expecting a product in the Multiplan class (reviewed in *PCW*, April 83), but it would not be going into the realms of fantasy to expect a greater range of arithmetic functions and a more respectable calculation speed. After all, the HX-20 does have an

excellent Basic interpreter written by Microsoft — fully equipped with all the usual trigonometry and arithmetic functions. So all that software is already there, just waiting for connection to a spreadsheet system, and Epson failed to make use of it.

Curiously enough, I was not greatly troubled by the small scale display. Obviously a bigger display would be preferable, and Epson have plans for an external 32 by 16 character add-on, but it certainly did not render the system unusable. A particularly nice feature was the ability to move the cursor during formula entry, thus enabling the right cell reference to be found even if it was off-screen at the start of the formula entry.

The integral narrow width printer (24 characters) was just about adequate to the task, but a fair bit of cutting and pasting would be needed to fit together a wide report. As compensation, the HX-20 has good facilities for connecting to larger external printers and ECalc itself can optionally make use of them.

After some initial teething troubles the cassette behaved itself very well, with some fairly sophisticated facilities for loading and saving the spreadsheets, and at quite a reasonable speed (for a cassette) as well.

So all things considered, Epson have succeeded in implementing a usable spreadsheet system on their hand-held portable computer. It's a system that can support only fairly lightweight applications, partly because it's on lightweight hardware (for which the implementors cannot be blamed), and partly because of the software design (for which they can). Nonetheless, hand-held micro owners are not exactly spoiled for choice in this area at the moment, and so ECalc should prove of interest to the growing band of HX-20 users beavering away on buses, planes and trains.

END

NUMBERS COUNT

Mike Mudge presents another batch of mathematical mind-benders.

n-TUPLES OF ASSOCIATED n-TUPLES

A triple of positive integers is defined to be (a,b,c) where a, b and c are chosen from 1, 2, 3, ... The order of occurrence of a, b and c is not significant.

Two such triples are said to be associated if they have a common sum $a + b + c$ and also a common product $a \times b \times c$. We shall write, for example, (14,50,54)(a)(15,40,63) since $14+50+54=15+40+63=118$ and $14 \times 50 \times 54 = 15 \times 40 \times 63 = 37800$; (a) being read 'as associated with'.

Computational problems

(i) Determine the smallest common sum of four associated triples. Believed to be 118.

(ii) Determine the smallest common product of four associated triples. Believed to be 25200.

(iii) Discover any quintuples of associated triples.
(6,480,495)(a)(11,160,810)(a)(12,144,825)(a)(20,81,880)(a)(33,48,900).

(iv) Investigate empirically the existence of larger sets (n-tuples $n > 5$) of associated triples.

(v) Investigate empirically the existence of n-tuples of associated m-tuples for computationally feasible m and n.

Note: There are mathematical problems relating to infinite families of associated triples such as:-

(16ka, bc, 15d)(a)(10ka, 4bc, 6d)(a)(15kb, a d, 16c)(a)(6kb, 4ad, 10c) where $a = k + 2$, $b = k + 3$, $c = 2k + 7$, $d = 3k + 7$, $k = 1, 2, 3, \dots$ due to J G Mauldon but these

are essentially outside the scope of this article.

Readers are invited to submit a program, or suite of programs, which investigate the above problems. All submissions should include program listings, hardware descriptions, run times and output; they will be judged for accuracy, originality and efficiency (not necessarily in that order). A prize of £10 will be awarded to the 'best' entry received.

Entries, to arrive by 1 September, to: Mr M R Mudge BSc FIMA FBCC, Room 560/A, Department of Mathematics, The University of Aston in Birmingham, Gosta Green, Birmingham B4 7ET.

Note: Submissions will only be returned if suitable stamped addressed envelopes are included.

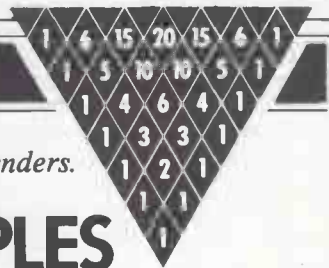

EPSON QX-10

Having made its name as a printer manufacturer, Epson took the world by storm with its portable micro, the HX-20. Will its desk-top machine have a similar impact? Peter Rodwell investigates.

Epson makes more dot matrix printers than all the other manufacturers put together and has an enviable reputation for producing well-made and reliable products. As well as selling its printers under its own brand name, it seems to have done deals with nearly every big name in the micro world to supply printers in any colour or casing with anyone else's name on the outside — even IBM uses Epson printers for its PC.

As part of the giant Seiko electronics group, it was perhaps inevitable that Epson would develop its own computers and this it has done, achieving an instant success with its HX-20 portable machine. The QX-10 is a 'grown-up' desk-top microcomputer which has already been available in Japan and the USA for some time but which has only just appeared in this country. It received rave reviews in the States and I'll say right now that this review will be of the same ilk — it's a nice machine.

Another thing which must be said right at the start is that the QX-10 goes completely against the current trend by being an 8-bit microcomputer, not 16-bit. But this is no ordinary, boring Z80-based, twin disk, CP/M-based machine. Yes, it's based on a Z80; yes, it has twin disks; and yes, it's a CP/M-80 machine, but unlike just about every other micro in this category, there's a lot more to it than this. Epson must, of course, be working on a 16-bit desk-top micro (it will certainly bring out a 16-bit portable before too long) but in the meantime, apparently dissatisfied with the state of 16-bit computing, it has chosen to put a lot of careful thought and ingenuity into considerably refining and developing the good old 8-bit formula.

On the printer front, Epson has enjoyed resounding success with its MX range of dot matrix printers. These have now been replaced by two new machines, the RX-80 and FX-80; the latter offering all the features of the top-of-the-line MX-80 but with plenty of extra bells and whistles, too. It seemed logical to evaluate this new printer at the same time, so you'll find a Checkout of it tacked onto the end of this Benchtest.

Hardware

The QX-10 follows the now conventional 'three box' design philosophy, which allows the user to devise whatever



Light, positive — and 103 keys!

relative positioning of screen and keyboard is most comfortable.

The main box houses the electronics and disk drives and, at 510mm wide by 340mm deep, is roughly the same size as an IBM PC box; it is, however, much lower, at 100mm or so, and this is achieved by the use of two low-profile disk drives. The box is in fact very slightly higher than the FX-80 and slightly less deep.

Apart from the disk drives, the only features on the front of the box are a small power light, a reset button deeply recessed into the lower edge of the moulding, and the socket for the keyboard cable, similarly hidden. The power switch is on the right hand side towards the back.

The rear of the machine has quite a few holes in it. From left to right, as you look at the back, these are: power connector, light pen socket, a socket

carrying video and power for the monitor, a row of DIP switches which configure the system's RAM, a tiny volume control knob for the internal speaker, a parallel Centronics printer interface, an RS232 interface and a series of snap-off plastic covers — the purpose of which we'll come to soon.

The keyboard unit is the same width as the main box but is only 50mm high. It connects to the main unit through a neat, coiled cable and recessing in both units allows you to push the keyboard right up against the main box, with the cable neatly hidden, out of the way. The 103 keys have a very light but positive feel, just right for very fast typing. All the main alphanumeric keys auto repeat if held down for more than a second or so. Across the top of the keyboard are ten programmable function keys, a block of four keys labelled 'Break', 'Pause', 'Help' and 'Screen dump', the functions of



Neat and stylish — the three-box system.

which are exactly as stated except for the Help key, which merely produced the characters '^@' on the screen. There are another four keys, each with a built-in LED indicator, labelled 'SF1' to 'SF4' at the right hand top of the keyboard; these allow you to alter the character set, as we'll see later. The main qwerty block is standard, but has a caps lock key with built-in LED at one end of the space bar and a graphics shift key at the other. This graphics key allows you to type in graphics symbols directly from the keyboard, using the main alpha keys; the symbols provided include the usual lines, boxes and shades as well as a little person, a tiny car, an unstable-looking aircraft and a half-full wine glass. There's also an odd one which may or may not be a telephone receiver.

Full cursor control is provided by four keys to the right of the main block, and this section also has a cursor home,

screen clear, insert and delete keys. At the far right is a numeric pad which includes a return key, all arithmetic symbols and a '000' key. All the main keys on the keyboard are a tasty plain chocolate brown, with subsidiary keys a lighter colour. And — a nice touch — the 10 function keys and the Break, etc, keys have removable transparent covers so you can put your own labels on them. It can surely be only a matter of time before Epson — or a similar company — produces function keys with dot matrix LCD displays built in, so that key labels as well as functions can be changed under software control.

The keyboard can be used in two positions — lying flat on the table top or tilted up by pulling out the two rear feet and turning them to lock them into the extended position.

The display unit simply sits on top of the main box; you can therefore swivel it

around but there's no way to adjust its tilt, which is a little odd although, in practice, I found it to be at the right angle anyway. Both power and video signals are carried along the same rather short cable. The only user control on the VDU is a brightness knob at the back although there's also a deeply recessed focus adjuster, for which you need a long screwdriver. The display is monochrome with sharp, green characters on a black background.

Overall, the QX-10 looks neat and stylish and takes up commendably little space on the desk. It's not too heavy — 18kg, in fact — to move around the office, either.

A closer look at, and inside, the main box shows that the machine is built to the very high standard we have come to expect from Japanese manufacturers. Undoing two philips screws at the rear allows you to lift off a small cover to the

EPSON QX-10

left of the main box as you look at it from the front. Inside, you have easy access to an area of the main PCB where all the RAM chips are housed — there are two groups each of 64k on the standard machine and sockets for another 64k to be added. And there are five sockets for expansion cards, one of which was occupied on the test machine with the multi-fonts card, supplied as standard equipment in this country. Each expansion card fits into a slot at one end and has a small 'foot' which engages in a hole in the PCB at the other, thus holding it perfectly steady, unlike the free-flapping arrangements found in some other machines. At the rear of the case is a panel of four snap-off covers which can be replaced by connectors for the expansion cards and there's also a tiny plastic cover hiding a DIN-sized hole for a connector to the fifth card — presumably this would be for something like a colour monitor connector.

Two screws are visible inside this area: they obviously hold down the rest of the cover, but at first sight there seems to be no access to the remaining cover screws. A closer inspection reveals two tiny plastic removable squares on the cover top; levering these up with a screwdriver reveals the other two cover screws, an impressively neat piece of design work. The two disk drives are fixed into the cover itself and with their leads unplugged — two easy-to-get-at connectors and an earthing strap — the

whole lot lifts off. Inside, there's a vertically-mounted power supply at one end of the machine and the whole of the rest of it is taken up with a gigantic PCB, crammed with components and beautifully made. Crammed though it is, though, there still wasn't room for everything and another, smaller board is piggy-backed on top of it. The standard of construction is very high and could act as a lesson for quite a few European and American manufacturers: everything is neatly arranged, there are no wires floating around, all the important chips are socketed and the whole thing has clearly been designed not only for efficient manufacture but for easy servicing, too.

The CPU chip is in fact a Japanese Z80A equivalent, a uPD780-1. The system contains a DMA controller, two counter-timers, a clock/calendar chip with battery back-up, Centronics parallel, RS232 serial and light pen interfaces and five expansion card slots — expansion cards can be inserted in whichever slot takes your fancy.

The system comes with 192 kbytes of RAM as standard, expandable to 265k. A 64k area is designated as the main bank and operates just like a normal CP/M-based system — see the Memory Map. Another bank, of 56k, is labelled 'BIOS' in the manual and appears to be reserved for the expanded CP/M used in the machine. Two further 56k banks are also available; Bank 1 comes with the standard machine and is used by the Multi-font Basic or can be accessed from CP/M as a 56k capacity memory disk called Drive F. You can use this just as



Rear view with snap-off covers



Low-profile disk drives



Expansion sockets.

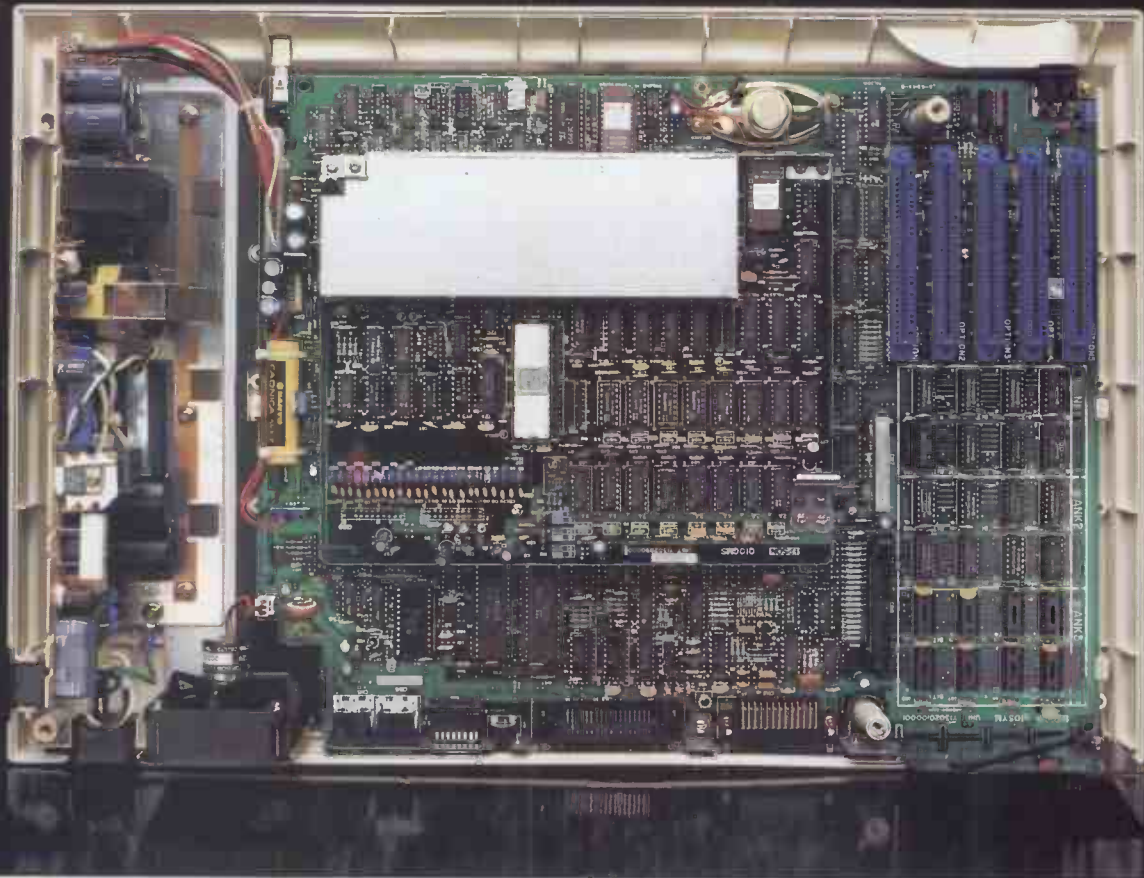

Interior shows neat design: crammed with components and easy to service.

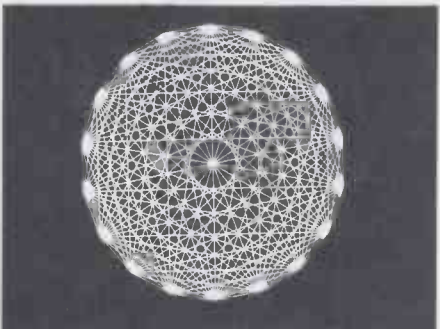
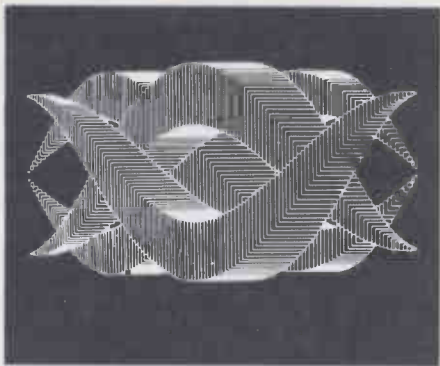

Hi-res and fancy fonts.

though it were an actual disk drive, and expanding the memory to the full 256k gives a second RAM disk, designated Drive E, also of 56k capacity.

A further 32k of video RAM is provided and a diagram in the manual seems to suggest that this can be expanded to 128k, although nowhere is this mentioned in the text; I assume this refers to the colour display option. The screen displays 25 lines of 80 characters normally, each character being formed on a 7 x 13 matrix. Curiously, the standard character set has virtually no descenders but is nevertheless very attractive and easy to read — the descenders in fact project below the line by a single dot. Using MFBASIC, you have either 20 lines of 80 characters or 20 lines of 40 characters — the latter being used for the fancy fonts. Graphics resolution is a very good 640 dots horizontally by 400 vertically.

The QX-10 system diagram in the manual also shows 2 kbytes of CMOS RAM with battery backup, although its purpose isn't very clear from the manual.

The double-sided, double-density 5¼in real disk drives have a formatted capacity of 278 kbytes per disk after the directory and operating system have taken their share of disk space; this is fairly low by today's standards.

In use

Setting up the machine is simplicity itself — insert the power lead, plug in the screen and keyboard, and you're ready to go. Switching on produces a quiet rushing sound from the cooling fan and the words 'INSERT DISKETTE' appear in the centre of the screen, with the LED on the left-hand drive lighting up to indicate which drive expects the disk. The low-profile drives are very, very quiet and hum slightly while the head is being moved across the disk. The QX-10 appears to go through some sort of diagnostics or configuring routine initially, which involves flashing all the LEDs on the keyboard, one at a time and then all together in a most festive manner. This all takes several seconds, during which time nothing appears on the screen to tell you what's happening, but eventually you get the CP/M copyright sign and prompt.

System software

The QX-10 comes with a considerably modified version of CP/M-80 2.2, allowing complete control over all of its fancy features. At boot-up, the 10 function keys are configured to provide all the most useful CP/M commands at a single keystroke: DIR, TYPE, LOAD, DDT, PIP, DUMP, SAVE, SUBMIT, and MFBASIC.

Most users will probably want to customise the system's configuration first, though, using the CONFIG program. This alters the system configuration information held as a file on disk and read during the boot-up process. It allows you to set up the machine for any of Epson's printers — but there's no option to allow you to specify another manufacturer's printer — which are assumed to be attached to the parallel port. The options included all the MX and FX models. The serial port can be set up for baud rates from 50 to 9600 and for all the usual framing possibilities (number of stop bits, parity, etc). If you need faster serial communications, you'll

have to install an option serial card which allows baud rates up to 19,200 baud. CONFIG then allows you to set the date and time for the clock/calendar chip before offering you a choice of eight 'language' options, which are in fact the possible character sets: standard ASCII, French, German, English, Danish (sic), Swedish, Italian or Spanish. Keyboards are available to use all of these characters, by the way, another lesson many Americans could learn.

A utility called CHARADEF allows you to create your own character sets of up to 66 characters and store them on disk. These can be accessed by applications programs and displayed on the screen, and provided you are using a suitable printer, they can also be printed out. The function keys can be re-programmed using a utility called PFKSET; this allows whole strings to be assigned to each key and files of these stored on disk. You can modify the table of strings used by the machine as standard settings and you can create your own tables; these can be loaded from disk and activated with the same program. This can happen automatically, if required, using the AUTOST program, which allows you to define a program for automatic execution when the system is turned on.

The QX-10 can be used as either a terminal to another computer or as a host computer with the TERM program. You can also alter the RS232 port settings with this utility. This would appeal to owners of both a QX-10 and an HX-10; the latter could be used 'in the field' for data collection, and the data could then be loaded into the QX-10 back at the ranch.

Other utilities, apart from the standard CP/M ones, include DISKCOPY, which transfers the entire contents of a disk from one drive to another and which can also be used with the RAM disks; FORMAT, which formats a disk; and DIRINIT, which initialises the directory of a disk and, effectively, erases anything on it in the process — this is useful for cleaning up the RAM disk after MFBASIC has cluttered it up.

Some very considerable extensions have been added to those already in CP/M. These are concerned with screen handling, dumping the screen's contents to a printer, serial port handling (both the built-in port and extra ones), reading and setting the clock/calendar chip, using the light pen interface, handling interrupts and the function keys and dealing with the memory system. This last includes routines for switching between RAM banks, transferring data between banks and using software at a specified address in a specified bank. These will all provide hours of harmless fun for the serious assembler language programmer but of course mean that any programs using them will be totally non-standard and unusable on other CP/M-based machines. This shouldn't be too great a discouragement, I feel. One would expect any sensible programmer to have long ago built a good degree of adaptability into his programs to take advantage of

Memory map

| Main bank | | | | |
|-----------|-------------------|-------------|-------------------------|-------------------------|
| E000H | CP/M | System bank | User bank 1 | User bank 2 |
| | Program area | BIOS | User area or RAM disk F | User area or RAM disk E |
| 100 H OH | Reserved for CP/M | | | |

Provided on basic 192k machine

With expansion to 256k

EPSON QX-10

the advanced features now appearing on CP/M micros, and to have catered for the inclusion of these sorts of facilities in his software.

Character fonts

The QX-10 can display 16 different built-in character fonts, a feat unrivalled by any other CP/M-80 micro as far as I am aware. Yes, there are machines around which will allow you to generate your own fonts but none, to the best of my knowledge, come with them *built-in*, not only to the system but to the operating system, too, so that using them is actually easy.

The hard work is done by the MultiFont character generator card, supplied with the standard machine, which occupies one of the expansion bus slots. The card contains six 128 kbit ROMs full of character data and has its own 8-bit 8039 slave CPU, plus control firmware in a 2716 PROM.

A utility program, MFONT, activates the card from CP/M. You can then select whichever font you require with the four 'SF' keys at the top right of the keyboard. Fonts are selected by pressing these keys in various combinations, the activated combination being shown by the little LEDs built into these keys. With four keys you have 15 combinations plus the standard one used by the system normally. The penalty you pay for typographical fun and games, though, is that you can only display 40 special characters per line with these fonts, instead of the 80 per line with the standard character set. This is a shame, for one or two of the fonts are much more attractive than the standard one and come with normal and italic versions, which would look nice for word processing. Most of the fonts are, however, decorative rather than practical and you would only want to use them for headings, etc, rather than whole blocks of text. Needless to say, the font generator can be controlled by CP/M applications programs, through what seems a complex series of commands; time just didn't allow me to experiment with this facility and I confined my font fun to playing with it from Basic instead.

My immediate reaction to the fonts facility was that it would make a superb tool for layout artists, but although the manual speaks of proportional spacing possibilities, I couldn't quite work out how it could be done. If the fonts were typographically accurate from the spacing point of view, word processor output could be displayed on the screen in its typeset form; this could also be dumped to a printer for rough layouts, although it naturally wouldn't be in a camera-ready condition — Epson dot matrix printers aren't *that* good!

The fonts provided are Bodoni, Old English, Flash Bold, Commercial Script, Helvetica light, Helvetica light italic, Helvetica medium italic, Broadway,

American typewriter medium, Light italic, Helvetica medium, Bodoni italic, sans-serif shaded, Microgramma Extended and Old Germany.

MF Basic

First the bad news: MultiFont Basic is an extended version of Microsoft Basic. Now the good news: the extensions are fantastic. As its name implies, it's designed to take full advantage of the multi-fonts facility and in addition it has comprehensive graphics abilities to make really good use of that superb 640 x 400 high-resolution screen.

But first I've just got to tell you about the editing facility. Anyone who has tried to write programs with standard Microsoft Basic must, like me, have been occasionally reduced to tears of rage and frustration at the appalling, horrible, unfriendly, fiddly editing arrangements for correcting all your mistakes. I hate it (and so does everyone else I know who is familiar with it and has seen the screen editing supplied on some machines). Well, Epson obviously hated it, too, because it has been swept aside on the QX-10 with a proper screen editor.

Let me explain this for those of you unfamiliar either with Microsoft's so-called editor or with proper screen editors. The Microsoft editor treats the screen as though it were a piece of paper emerging from a printer. To correct a wrong line, you type EDIT 15230, say, and you get the line number with the cursor next to it printed on the screen. Pressing the space bar moves you along the line, displaying each character one at a time. You thus have to position yourself just before the wrong character (which you can't see, of course) and then use special commands to insert or delete whatever's wrong with the line. There is a command which will display the line and put you at the start of a new copy of it but the whole process is too much hassle — I can never remember the commands for moving back and forth along the line and I always end up re-typing the line to the accompaniment of much swearing.

Even the original Commodore PET had a better arrangement than this. You LIST your program — or section of it, or

Benchmark timings

| | |
|-----|------|
| BM1 | 2.3 |
| BM2 | 6.4 |
| BM3 | 15.8 |
| BM4 | 15.8 |
| BM5 | 16.5 |
| BM6 | 31.9 |
| BM7 | 52.9 |
| BM8 | 65.8 |

All timings in seconds. For an explanation and listings of the Benchmark programs, see PCW Vol 5 No 11, November 1982.

one line — on the screen, move the cursor to it, along it, back and forth, whatever, until you find your mistake. You can overtype, insert or delete (using 'insert' and 'delete' keys) and as you change what appears on the screen, so the program in RAM is changed. The only restriction found on some machines, including the Epson, is that changes are only accepted if you move to the end of the corrected line and press RETURN. Needless to say, I was immensely pleased to discover that I could edit programs using the Epson's cursor control, insert and delete keys. The last time I asked anyone at Microsoft when they were going to do something about their stupid editor I received some mumbled comments about hardware difficulties and a swift change of subject. Full marks, then, to Epson, for doing something about it.

Having raved about the editor, I must now confess to being able to say little more about MFBasic, as a manual was not supplied with the machine and requests for one didn't produce the goods in time for this Benchtest. It does appear to support standard Microsoft Basic, though and this would make it 'upwards compatible' — a program written in standard Microsoft on one machine should run on the QX-10 but one written on the QX-10 and using the machine's special features obviously wouldn't work on some other computer.

Loading MFBasic automatically activates the multi-font card and you can access the fonts directly from MFBasic. It also reconfigures the function keys so

GOTO page 240

Technical specifications

| | |
|------------------|--|
| CPU: | Z80A-compatible |
| RAM: | 192k main memory, expandable to 256k; 32k video RAM; 2k CMOS RAM. |
| Display: | 25 lines x 80 characters in CP/M; 20 x 80 or 20 x 40 in MFBasic; 640 x 400 graphics resolution; 8 national versions of standard character set; 15 additional character fonts available from CP/M and MFBasic. |
| Keyboard: | 103 keys including 10 programmable function keys, full cursor control, font change keys and numeric pad. |
| Disks: | Twin 5¼in floppy, capacity 278k per disk. |
| I/O: | 1 Centronics parallel printer port, 1 RS232 port with software-controlled baud rates (50-9600 baud) and framing, light pen interface; 5 internal expansion slots (1 occupied by MF card) for optional IEEE-488, RS232, Omninet and fibre optic interfaces. |
| System software: | Enhanced CP/M 2.2 |
| Languages: | Multi-font Basic (enhanced Microsoft) |
| Applications: | Optional Peachtree accountancy and word processing. |

DRAGON 32 OWNERS

NEW FROM MICRODEAL

The Producers of TELEWRITER

REGISTERED TRADE MARK

TELE-TUTOR 1



SPELLING TEST

This programme is designed to give a standard oral spelling test, using the sound track of the tape-recorder, to dictate either single words or words and sample sentences. The responses are then typed using the keyboard, which will subsequently be displayed on the screen and, if required, can be kept as a permanent record using a printer.

WORD DRILL

This programme is designed to give a multiple choice vocabulary quiz. Words and their definitions are entered into the programme using the keyboard or from a previously prepared tape file. The computer will then display randomly selected definitions with a choice of eight words. The correct word must be chosen before the preset timer reaches zero. This programme could be used for words and definitions, a geographical quiz, chemical formulae, etc.

Tele-Tutor costs £25 on cassette and is

AVAILABLE FROM DRAGON 32 DEALERS NATIONWIDE OR DIRECT FROM:

MICRODEAL

14 TRURO ROAD, ST. AUSTELL, CORNWALL, PL25 5JE. TEL: 0726-67676.

MATHS DRILL

This programme is designed to help children practise addition, subtraction, multiplication and division.

- Programmed for up to 6 students
- Answers are written as on paper
- Division can be written showing "remainder"
- Ten different skill levels
- "Smiley" face and graphics used as rewards
- Skill levels adjust to ability
- Problems timed
- Correct answers are displayed if error made
- Full report at end of test

ESTIMATE

This programme is designed to help children practice their mental arithmetic. A selection of addition, subtraction, multiplication and division is given.

- Programmed for up to 5 students
- Five skill levels
- Time taken to answer is recorded
- Correct answers are displayed if error made
- Full report at end of test

AN INSTRUCTION MANUAL IS INCLUDED IN THIS PACKAGE SUITABLE FOR CHILDREN AGED FIVE TO ADULT

ALONG WITH OUR PRESENT RANGE OF SOFTWARE:

| | |
|-----------------------------|-------|
| ALCATRAZ..... | £8.00 |
| BACKGAMMON..... | £8.00 |
| COSMIC ZAP..... | £8.00 |
| DEFENSE..... | £8.00 |
| DRAGON INVADERS..... | £8.00 |
| ESCAPE..... | £8.00 |
| FLIPPER..... | £8.00 |
| GALACTIC AMBUSH..... | £8.00 |
| INVADERS REVENGE..... | £8.00 |
| JERUSALEM ADVENTURE 2..... | £8.00 |
| KATERPILLAR ATTACK..... | £8.00 |
| MANSION ADVENTURE 1..... | £8.00 |
| PHANTOM SLAYER..... | £8.00 |
| PLANET INVASION..... | £8.00 |
| PROGRAM PACK 1..... | £8.00 |
| PROGRAM PACK 2..... | £8.00 |
| PROGRAM PACK 3..... | £8.00 |
| PROGRAM PACK 4..... | £8.00 |
| PROGRAM PACK 5..... | £8.00 |
| RACER BALL..... | £8.00 |
| SCARFMAN..... | £8.00 |
| SPACE MONOPOLY..... | £8.00 |
| SPACE WAR..... | £8.00 |
| STORM..... | £8.00 |
| TALKING ANDROID ATTACK..... | £8.00 |
| THE KING..... | £8.00 |
| WILLIAMSBURG | |
| ADVENTURE 3..... | £8.00 |
| ULTIMATE ADVENTURE 4..... | £8.00 |

| | |
|---------------------|--------|
| TELE-WRITER | |
| WORD PROCESSOR..... | £49.95 |
| TELE-TUTOR..... | £25.00 |

HARDWARE

| | |
|-------------------------|--------|
| JOYSTICKS pair..... | £19.95 |
| LIGHT PEN WITH PROGRAMS | |
| £12.00 | |

TELE-TUTOR IS AVAILABLE FROM
SELECTED **John Menzies** SHOPS





your word processor can handle it, but of course there shouldn't be too much problem if you're using some other suitably configured software).

Graphics

A hefty section of the printer's thick, spiral bound manual is given over to its graphics capability. Again, a variety of modes are possible: 576, 640, 720 and 1920 horizontal dots, with variable line spacing to obtain just the effect required. Note that one mode gives the same horizontal dot resolution — 640 — as the Epson QX-10, Benchtested in the

preceding pages, and naturally the two are completely compatible. Seizing this fact, I cheated to produce the graphics shown below by dumping from the QX-10's screen to the FX-80.

Of course a major advantage of the dot graphics is that you can define your own character sets and produce all sorts of fancy effects, although the FX-80 has such versatility in its built-in character sets that I'd be hard put to find a use for any more which would justify the effort of designing and programming my own fonts. Still, if you want to do so, the manual gives full instructions. The manual, by the way, is clearly and con-

cisely written, with full details of how to set up the machine plus extensive examples, in standard Microsoft Basic, of how to send the character control codes. There are also complete diagrams of all the character sets and permutations possible on the machine.

Conclusions

The FX-80 has got to be another winner for Epson, even though a cheaper machine is being marketed — it wins on the massive range of facilities, which should be enough for anybody's uses. The only problem you might face is in interfacing it to your software; the range of facilities and the codes required to control them vary so much between manufacturers that it's extremely difficult for standard software packages to cater for all possibilities.

Although the FX-80 is slightly noisier than its predecessors, it is twice as fast and this makes a tremendous difference if you have lots of stuff to print out. As an all-round printer selling at a reasonable price, it definitely is worth seriously considering.

This is the FX-80's standard font
 This is normal but it's underlined
 and here is the italics version of the standard font
 This is the emphasised version of the standard font
 This is double-strike printing
 This is double-width
 This is what the condensed face, giving 132 columns, is like
 and it has an enlarged version, too
 This is printed in the elite face - 12 chars per inch
 This is proportionally spaced - it's automatically emphasised
 The FX-80 can also handle ^{superscripts} and _{subscripts}

Some of the FX-80's built-in fonts

SuperCalc AnswerKey (ta) Entry/Edit mode

The first character determines whether you are entering a formula or a text string (label). A quote mark (") starts a text string. An apostrophe (') starts a repeating text string. Any other character starts a formula.

While entering data, the arrow keys (which normally scroll around the worksheet) become "editing" keys:

Left arrow (or CTRL/B) --) Backspace one character
Right arrow (or CTRL/D) --) Move right one character
Up arrow (or CTRL/E) --) Insert one blank
Down arrow (or CTRL/X) --) Delete one character

Press any key to continue

The seven inch screen displays 80 characters per line

cessor as the Osborne 1, running at a perfectly ordinary 4 Mhz — which means that its performance on running program instructions in Basic is almost identical to its predecessor.

However, there are differences between one CP/M system and the next — depending on the way the processor board is constructed — and the Osborne 1 was relatively quick at running Microsoft Basic.

One factor which can affect benchmark timings is the number of 'wait states' that the processor gets caught up in, when signals are expected from its subordinate chips, and take longer than the Z80 would ideally like.

The operating system for the pre-production model supplied is CP/M Plus, which differs enormously from CP/M in several ways: one of these is the way it handles disks, and another is the way it extends memory.

The Executive has 124 kbytes of memory. Theoretically, under CP/M Plus, this could be extended in 'banks' of 48 kbytes, all of which share the same memory contents for the top 16 kbytes. On the Executive this theoretical expandability has been ignored, on the grounds (I think, spurious) that there simply isn't room in the case or power in the power supply for another memory board.

As to the power supply, the company may have a point. This system, like most modern desk-top micros, needs a fan to keep it cool. The vent at the front is obvious. At the back, there is a closable hatch over the fan — with it closed, the fan will have no effect except to generate a certain amount of extra heat. On the top, there is a larger ventilation hatch, identical to that on the newer, cased version of the Osborne 1, where simple convection was more than enough to cool it down.

There was a plan (still not rejected) to put a switch into the system, so that the fan only worked when the computer got hot. On the test machine, this heat sensing had not been included, so the noise of the fan simply had to be tolerated — and the noise, I'm afraid, did betray the fact that the power supply finds the disks a bit of a strain, because the note of the fan hum drops quite noticeably when they come on. It must also be pointed out that the power is much beefier than the Osborne 1 could put out, and this machine can operate both disks together — the old one would have blown a fuse.

Total memory in the Executive is 124 kbytes (see memory map diagram) with 60 kbytes of this available as the 'transient program area' — transient programs being things like SuperCalc and WordStar.

The machine can be connected to printers, terminals, modems and other peripherals through two RS232 ports, or a Centronics port which can be re-programmed as a universal HP interface bus (IEEE 488 standard). Invisible to the user but available to the system designer



Superficially the Executive is not dissimilar to the Osborne 1 but refinements have been incorporated.



NO TWO-BIT COMPUTER.

You're looking at the new true 16-bit MBC4050 microcomputer from Sanyo. Just one of a new range of machines designed to make your life easier.

With features like the 8086CPU, 128 KBytes RAM expandable up to 384 KBytes, twin 5¼" slim type double sided double density double track 640 KBytes per drive mini floppy disk drives giving more than 1.2 MBytes storage capacity, the CP/M-86 operating system, interfaces for Centronics - compatible printers and RS-232C communications port, you can see that the MBC4050 is something of a star performer.

As with all Sanyo products, the attention to detail will make the MBC4050 an even more attractive proposition. Thoughtful features like a built-in palm rest on the detachable keyboard, coiled cable and tilt display option for flexibility and ease of operation, and the versatility of 15 programmable function keys.

For further information regarding the many new bits in the Sanyo Computers range for 1983, contact our distributors, Logitek, at Logitek House, Bradley Lane, Standish, Greater Manchester or telephone them on 0257 426644.

Alternatively, clip the coupon below and return it to Sanyo. We'll send you information on any of our business machines, all designed to mind your business more efficiently.

Please provide me with further information on the Sanyo 1983 Business Machines Range. I am particularly interested in (please tick):

Microcomputers Calculators Telephone Answering Machines

Electronic Cash Registers Dictating and Transcribing Machines

Name _____

Company _____

Address _____

Position _____

Return to Marketing Dept., Sanyo Marketing (UK) Ltd., Watford Road, Watford, Herts, or Tel Watford 46363

Tel (Day) _____

SEE SANYO, THEN DECIDE

 **SANYO**

THE OSBORNE EXECUTIVE

or the clever add-on merchant, there is a direct memory access (DMA) port.

The serial ports are considerably upgraded on the originals, being programmable to run at any baud rate from 50 to 9600. The Centronics port on the old machine was just an edge connector, which meant considerable trouble in tracing a suitable cable. On this one it is still not absolutely standard as a Centronics plug because it lacks the little wire 'hooks' that lock the cable in place. However, any Centronics cable will plug firmly enough into it. And it is, apparently, a 'standard IEEE socket'.

The Direct Memory Access port is of no interest to anybody who is not planning to upgrade the Executive into a 16-bit processor with the add-on 8088 card. No more need be said of it at this stage, since it isn't available.

The diskettes, apart from being half-height, offer no surprises to Osborne 1 users, nor to anybody else. The slightly disappointing surprise is that they are still only single-sided, double density, with a maximum capacity of 200 kbytes.

Against that, they are pretty clever, being able (used with care) to get data off the Digital Equipment Robin (VT180) CP/M kit, the Xerox five-inch disk format, the Cromemco minidisk, and the IBM (CP/M-86 only) double density, as well as from earlier Osborne diskettes. That is all without loading any special program.

With the use of specially bought programs, these drives can be used not only to read, but to format, and to write, for some 20 other five-inch formats, since the operating monitor program does not force user programs to go through CP/M disk handling routines, but offers the alternative of direct access.

Software

Standard software supplied with the machine is:

UCSD P-system (Pascal interpretative run-time operating software) and CP/M Plus as operating systems; CP/M utilities, and Osborne utilities for programming the machine or for changing its operating characteristics; Executive Data Base Manager; Supercalc 1.12; WordStar 3.4 (with Mail-Merge) and Microsoft 5.3 disk Basic (interpretative) with CBasic 2.37 (compiled) as programming languages.

Total shop value of that lot would be around £1500.

The utilities are worth a more detailed mention, because all too many CP/M systems skimp on these. This system comes with almost as full a set as one could wish.

In particular, the old insistence on supplying only standard CP/M programs that would work on any CP/M system has been dropped; and the assembler program ASM has been replaced by MAC. The difference is simple enough: MAC can cope with the extra instructions of the

Z80, whereas ASM.COM could produce only 8080 code.

The CP/M utilities are nice; but it is the Osborne utilities that make the machine. They get a special section to themselves, below, in the 'machine under test' section.

As on the Osborne 1, all the numeric keys are programmable to send a string of characters to the console, or to any other CP/M 'logical' device. There are a total of 288 memory locations in memory, set aside to store these strings, more than twice the limit on the Osborne 1. In addition, the cursor arrow keys can be directly programmed — on the original system, there was merely a choice of 'WordStar' or 'CP/M' standard control characters.

The screen is the first piece of hardware to show a definite reduction, rather than increase, over the Osborne 1.

Adam Osborne has said that the seven-inch screen was the right size improvement — that most people felt it was 'a lot bigger' than the old five-inch screen, whereas a nine-inch screen didn't offer much over the seven-inch.

But where the old five-inch screen displayed only 52 characters per line (and this new seven-inch screen displays 80), it actually was capable of showing you 128 characters, with a little clever scrolling.

That has gone (see above), and its loss will disappoint Osborne fans.

The Executive under test

Testing the machine was a challenge which I happily dodged. I am prepared to make slight apologies for not trying out the database or the program generator, or the terminal emulation facilities, each of which warrants a full software text on its own. WordStar version 3.4 is very well known; Supercalc is a spreadsheet which needs introduction only to those who don't know what spreadsheets are; and the assembly level utilities are of interest only to the user who has had the machine for some time, or for the systems software professional (who knows them all backwards anyway).

What I did test was the new Setup and character generation utilities, SETUP.COM and CHARGEN.COM.

Chargen is a character generator. It shows you a grid of pixels, and you can load existing characters in for alteration, or develop your own from scratch. Having gone right through the dot matrix for each letter, you can end up with a character set on disk, automatically loadable, which will give serifs for each letter. Or you can write in Greek. All you need is disk space to store the characters.

Setup does almost anything. It will program one user port to use the ET/ACK protocol, at 9600 baud; the next to do XON/XOFF, at 50 baud; or both; or neither. It can set the cursor to be visible or invisible, blinking or steady, block or underline, or any combination (though obviously not invisible blinking anything) and can change screen attributes to flash, underline, inverse, half-bright or graphics.

It can even be programmed to avoid 50/

60 Hz mains flicker. That is one of the more irritating things that can happen on US built machines, where the frequency of the screen refresh can often clash with the UK mains frequency, producing wobble, flicker and other eye-irritating nasties. On the Executive, Setup can be told what the mains frequency is, and will adjust the screen frequency to avoid these problems.

But one thing Setup cannot do is edit the programmable function keys. Nor, infuriatingly, can it be programmed to send two 'ESCAPE' characters (Hex 1B) after each other.

The most obvious use of Setup for programming function keys lies in telecommunications, where logging on to remote computers can be a matter of typing up to 30 characters in batches of 10 (or so) — any one of which, if mistyped, can force you to start again. Press the 'control' key and one of your pre-programmed function keys, and the whole string will go out perfectly.

I find this invaluable on WordStar, where quite complex sequence of multi-key commands can be transmitted with one finger. The trouble is that when you come to alter a sequence, you have to type in the new sequence from the start — you cannot just change the offending character. It may seem a small quibble, but when you have WordStar loaded, a file ready to save and find that you've accidentally left out the letter S in a complex save and print sequence, tempers can wear thin.

Since there is no editor, when typing in programmable sequences there has to be some way of telling Setup that you have finished. Osborne chose two ESCAPE characters as the indication. So you cannot program your telecom system to send two ESCAPE characters sequentially — which is something you have to do, using Osborne's own approved Amcall program, in order to transmit an ESCAPE to the remote computer. A silly oversight, and definite proof that nobody at Osborne uses Comshare electronic mail.

One other thing that Setup cannot do is change the screen width.

It is perfectly possible, with the Osborne 1, to set up the machine (using the SETUP.COM program) so that no user is ever aware that he has 128 characters, or that there is any scrolling ability. There were reasons why this wasn't done — principally, the 80-column WordStar menu displays, which would have been illegible.

But none of these apply to the Executive.

The designers have thrown that nice wide screen away. With automatic 'scrolling' off, the machine set to have a logical screen width of 80 columns and standard software running, no one would ever be troubled by screen flicker, or horizontal scrolling jump. The only possible drawback would be that since the new screen actually needs 12-bit memory, it would use up quite a few memory chips to do this — but with only 4 kbytes devoted to video memory, the extra involved could hardly be seen as prohibitive.

This is particularly irritating when you switch to WordStar.

GOTO page 242

Send your queries to Len Warner, 35 St Julian's Road, St Albans, Herts. Please note that Len cannot answer questions on an individual basis, so please don't send an SAE with your query.

Scientist's dilemma

I am looking for a cheaper alternative to the Hewlett Packard HP85 for use as a scientist's personal computer. The Newbrain is attractive for its graphics, and low price, while the BBC Model B is attractive for its faster Basic, and expansion capability.

The PCW review of the Newbrain suggests that a program will be executed faster on subsequent runs than on the first, as it only needs to be compiled the first time. If this is so, how much faster?

How complicated would it be to have a sub-routine to dump the contents of the screen to a printer with either of these machines?

How difficult would it be to use one of these micros plus a video monitor as a terminal to a mainframe?
J R Senna, London

The Newbrain 'compiler' compiles each line into a 'tokenised' form as it is entered. This tokenised version of the program is then run in an interpretative manner each time the program is run. There is thus no dramatic speed-up in execution, such as that associated with true compilers.

The ability to allocate 'devices' to 'data streams' on the Newbrain should make it relatively easy to copy the screen to a printer. On the BBC micro, the VDU command allows the screen and printer to display the same text when required, and routines have been published by Beebug and others to dump the high-res graphics screen to a matrix printer.

There should be no problems using either of these machines as terminals to a mainframe. The wide range of interfaces on the Newbrain and the power of the data

stream concept should take care of this. Equally, the RS423 port and the operating system commands of the BBC make this relatively easy.

P L McIlmoyle

Time to switch off?

I want to use my micro as a timeswitch to turn mains powered equipment on and off. Can you give me details on how to switch mains circuits from a computer?

P Halsey, Birmingham

There are several vital safety aspects to consider, and I advise you not to construct any mains unit unless your wiring skill, attention to detail, and electrical knowledge are of a high standard.

First, all low-voltage circuits must be properly isolated from the mains. This is to protect the users and, less important, the computer. The simplest way to accomplish this is to use a Solid State Relay to switch the power.

Second, the micro and all other equipment must be safe to leave switched on unattended.

Third, the equipment should be operationally safe. It should not present a hazard to people who do not know it is automatically controlled. Heaters and moving machinery might be a problem. What happens if your control program crashes and leaves strange combinations of units on?

These two products will solve the mains isolation problem:-
Gem Systems Ltd, 2 Crawford Road, Hatfield, Herts, tel 66148, supplies a Power Switch Box ready built, which will switch 3A per channel. The computer interface is Centronics or VIC 20. Four channels cost £69.95, and the system is expandable in modules to over 1800 channels.

TK Electronics, 11 Boston Road, London W7, tel 01-579 9794, offers the XK112 Mains Wiring Transmitter/Receiver kit. This controls appliances remotely by signals transmitted over the mains wiring. The interface is five lines driving opto-isolators. The two channel kit costs £42, and independent 2KW channels are allowed.

Len Warner

Bigger and better

Please can you tell me how to obtain enlarged characters, condensed characters, and all the other styles that the Epson MX80 allows. I am using a BBC micro and have tried sending control codes to no avail.

Joseph Thompson, Edgeware
Control codes sent to the printer are removed by the operating system on the BBC micro. You will be aware that to send output to the printer you must use VDU 2, and to stop output going to the printer you send VDU 3. For example:-
10 PRINT"APPLE"
20 VDU 2
30 PRINT "ORANGE"
40 VDU 3
will print APPLE and ORANGE on the screen, but only ORANGE on the printer. To send any single character (even control codes) you use VDU 1. The '1' must be repeated before each character sent. For example:-
10 UDU 2
20 PRINT"APPLE"
30 VDU 1,14 :REM enlarged
40 PRINT"ORANGE"
50 VDU 1,20 :REM enlarged off
60 VDU 1,271,69 :REM emphasised
70 PRINT"PEAR"
80 VDU 3
will print in normal, enlarged and emphasised mode in turn, and leave the emphasised typeface selected but printer

output off. Line 60 is the way to send 'escape'+ 'E'. One VDU command can contain the VDU 2 function, several VDU 1 codes, and the VDU 3 function, if required.

Sheridan Williams, Beebug

Spectrum machinations

I have recently purchased a Spectrum and have been experiencing difficulties in moving a number of things on the screen at the same time, which obviously needs machine code to make the speed acceptable. The Spectrum books I have seen shy away from the problem or give brief and poorly explained examples. I am looking for a book with a series of Basic examples of all the Spectrum functions with equivalent machine code routines to do the same job. What can you recommend?

B T Izzard, Chelmsford
I don't think you will find the book you ask for, because the time wasted in Basic is largely in scanning the program and data areas to find the right program line and variables. The function finally executed is in machine code and fairly efficient. A machine code program scores by using fixed areas of memory for program and data and by making direct calls to ROM routines. Sometimes machine code can eliminate lots of unproductive Basic internal housekeeping operations, eg, in a routine which is moving data with a loop containing PEEKs and POKEs.

The solution is to learn machine code and the architecture of your micro, so that you can choose the most direct way to carry out a task. I think you will find *40 Best Machine Code Routines for the Spectrum* by Hardman and Hewson very useful,

because it teaches machine code with a set of routines — which should be useful building blocks for later programs — and concentrates on screen handling problems.

It is available from MoI, 1 Francis Avenue, St Albans, Herts, tel (0727) 52801 for £6.90 post paid.

Len Warner

Engineering calculator

I would like to purchase either a small computer or a programmable calculator capable of dealing with engineering problems such as pipe-sizing, heating and cooling loads, etc. I have no knowledge of computers, and hence would be looking for a machine easily mastered by the layman. What would you advise?

P Bagnall, Riyadh

Assuming that you just want the right answer fast, and are not concerned either with having a detailed printout, or with writing your own programs, then I personally think there is a lot to be said for a dedicated electronic calculator for your application. This would seem to be especially so in your case, as there would be no moving parts to get sand into them, and no need for a mains power supply, which might be subject to voltage variations, etc.

The Hewlett Packard, Texas Instrument, and Casio ranges, should be able to offer what you need. The HP calculators tend to provide a range of programs by the use of magnetic cards which need to be fed into the machine. There could be advantages for you in the TI range, which use interchangeable plug-in ROM packs, providing TI have the programs you need in ROM.

P L McIlmoyle

Track record

Over the last few months I've been trying to work out how a trackball works. I've talked to my A level physics teachers and they haven't any ideas on the subject. The only way I can think of is by using changing magnetic fields. Is this correct? If it isn't, how do they work?

John Benfield, Hemel Hempstead

I confess, I have been intrigued by this too, and I don't know. However, let me suggest two feasible methods, and perhaps someone will write in and tell me if I am near the mark.

A trackball is a position controller similar to a joystick, except that you can rotate the ball continuously through as many degrees as you like by rubbing with the hand. So the problem is to resolve and measure the X and Y motions without being able to put a shaft through the ball. One way would be to have two small disks with their edges on the ball and mutually at right angles, so that one rotates for X motion and slips for Y, and vice-versa. The movement could be read by a shaft encoder, giving very low friction and direct digital output.

Another way would be to have a metal ball and five small solenoids with their poles forming the pattern of a cross at the ball's surface. The central pole would be energised with an AC bias, and the four surrounding poles would pick up equal signals with the ball still. If the ball moves, it will drag the eddy current pattern round and upset the signal balance. A differential amplifier, rectifier and a voltage to frequency converter for each axis would give a pulse signal proportional to movement.

Len Warner

Filing task

We have a collection of some 3600 photographic transparencies, and are looking for a micro-computer system to index and cross-reference these, perhaps by a keyword system. We would want to be able to find which slides showed which subject or combination of subjects, as well as a 40-character description of each subject. Is this possible on any of the cheaper (BBC 'B' or less) micros?

G Jenkins, West Lothian

The problem of attempting to use a machine such as the BBC Model B, or a similarly priced unit, for an application such as yours, is the large amount of data you wish to handle. Your application, as

described, would take up some 150 kbytes just for the 40-character descriptions. It is not really satisfactory to handle amounts of data such as this with an ordinary cassette recorder. Normally, I would strongly recommend disks for such work. Indeed, all the database systems with which I am familiar for such applications are disk-based, and typically cost £200-£600 for the software alone!

An alternative would be to use the system with Philips mini-cassettes for storage of data, as these run faster than ordinary audio-cassette systems. The Hobbit has been available for the Nascom for a long while, and the new BBC version has been receiving good reviews. Another possibility is the Sinclair Microdrive, when it becomes readily available.

It may be some time before many database packages are marketed for these tape systems.

If you do take the plunge with disks (with a minimum cost of £1000 to £1500 for hardware) then I would be thinking in terms of DMS, or possibly DataStar plus SuperSort, for your application.

P L McIlmoyle

Hold your tongue!

The Namal Supertalker produces speech from a 550 word dictionary in its internal ROM, and I have been able to write programs which use the ROM but I am unable to use the exten-

ded dictionary facility to add to the unit's vocabulary. According to the instruction booklet it is necessary to POKE the new words into addresses 12288 onwards. I have found it impossible to do this because these addresses are 'unPOKEable' on the Spectrum. I am obviously doing something silly and I would be very pleased if you could put me right.

W Cooksey, Cambridge

The ZX81 and Spectrum versions of the Supertalker have RAM space from 12288 for extending the dictionary. In the ZX81, this lies in the reflection of the 8k Sinclair ROM, so the ZX81 Supertalker switches this out using ROMCS. Hence ZX81 users can use Basic or machine code to POKE new words.

However, in the Spectrum this area is occupied by the 16k Sinclair ROM, so it is not POKEable from Basic. The Spectrum Supertalker has a memory bank switch to alternate between the Sinclair ROM and the dictionary RAM. You *must* use a machine code routine like the one in the booklet in order to swap these sections of memory in and out properly. Interrupts are temporarily disabled, then banks switched by an OUT instruction. Unfortunately the mnemonic code version of the routine and the denary machine code disagree about the port address, but since you have been able to use the ROM vocabulary I assume it is 127 = 7Fh and not 128 = 80h. A quick experiment will tell you which is right.

Len Warner





PHANTOM MOVES

Tony Harrington provides an insight into the seemingly magical effect of a chess computer, known as the 'Phantom', which mysteriously moves its own pieces.

For your true chess enthusiast, once the game has well begun the best that can be said about the materials, with which the game is played, is that they should cause as little of a distraction as possible. A chess board that draws attention to itself by its fluorescent colouring or any other oddity is simply an irritant. Similarly, an ornamental chess set modelled on the Chinese Mandarins of the tenth century might be a wonder in a showcase, but a pain in the neck to play with.

Much the same is true of chess computers. Once the game is under way, it really does not matter how the computer signals its move, so long as it does so clearly and concisely. Like most chess players, I've got used to the quiet flashing of a couple of LED lights, accompanied by a demure 'beep' whenever the machine has found its move.

So when I was given the opportunity to look at the Milton Bradley machine, which rejoices in the mysterious name 'The Phantom', I had my doubts. The marvellous feature of this machine, I was told, is that it moves the piece itself. It has a reasonable program, but that is almost beside the point — the point was that progress had been made in the direction of the magical.

The usefulness of a machine that could literally make its own moves was not clear to me. Why should it be a significant advance on existing machines which simply sit there, lighting up their LEDs in a friendly sort of way and waiting patiently for you to do the decent thing by them?

I sat down before the Phantom with some scepticism. Following the great — and now almost forgotten Bobby Fisher's dictum — I opened with the king's pawn. What followed is hard to describe. A motor started into life, rather audibly, and Black's king's pawn slid firmly out to e5 and stopped. So did the motor, and I was left in a deepening silence to think about my next move.

I brought the king's knight out to f3. The motor rasped into action and Black's pawn on f7 slid a fraction of an inch to one side. For a moment I thought the machine had slipped a gear, or sprung a solenoid or something. Then its knight moved majestically through the gap created between the pawns on f7 and g7 to take up its station on f6. 'What about the touch move rule?' I said to my absent opponent. But then, no-one had touched a piece, so I suppose it didn't apply. A pity, I hate playing against the Petroff.

More surprising things were to come a

few moves later when I took Black's pawn on d5 with my e pawn. There were several possibilities for Black, and I was brooding over a few of them when my e pawn, now on d5, suddenly sidled off the board and stood out of play. I was left staring at the blank square and wondering what it was going to recapture with. The pause could only have been a half second or so, but it produced a distinctly odd feeling.

The game itself was not particularly memorable, but it was interesting in its own right. As it developed it began to seem more like a game of chess than the circus performance it had seemed at the beginning. As a marketing gimmick, I think that Milton Bradley has hit on something rather special. My only hope is that the company doesn't put a voice chip in the blasted thing, or you may as well call the neighbour over and play a human being.

Now for the origins of the machine. Milton Bradley rang up Intelligent Software in June 1981 while David Levy and his colleagues were still hard at work on programs for SciSys. According to Levy, whoever spoke to him simply said that he wanted some advice on chess computers. They phoned from the States and asked Levy to go and see them at their East Longmeadow, Massachusetts offices.

'When I arrived they showed me into a room and, after asking me to sign the traditional non-disclosure agreement, they put a machine on the table, switched it on, and a pawn moved — as if by magic — from e2 to e4 — without any human intervention or any visible, physical device for making it move. I was fascinated,' Levy said.

This was the idea they wanted to develop: that is, they wanted the mechanism that had just moved the pawn developed to the point where it would be reliable enough to be used in a consumer product. And they wanted a chess program that would work with this mechanism.'

Levy phoned the technical director of Intelligent Software from Milton Bradley's offices and told his colleague about this new machine. After a brief huddle, they decided that this was very much the sort of project they wanted to get involved in. In Levy's words: 'It was the most exciting chess product that we had been faced with and we could not resist the challenge.'

All the chess programming that Levy and Intelligent Software had previously

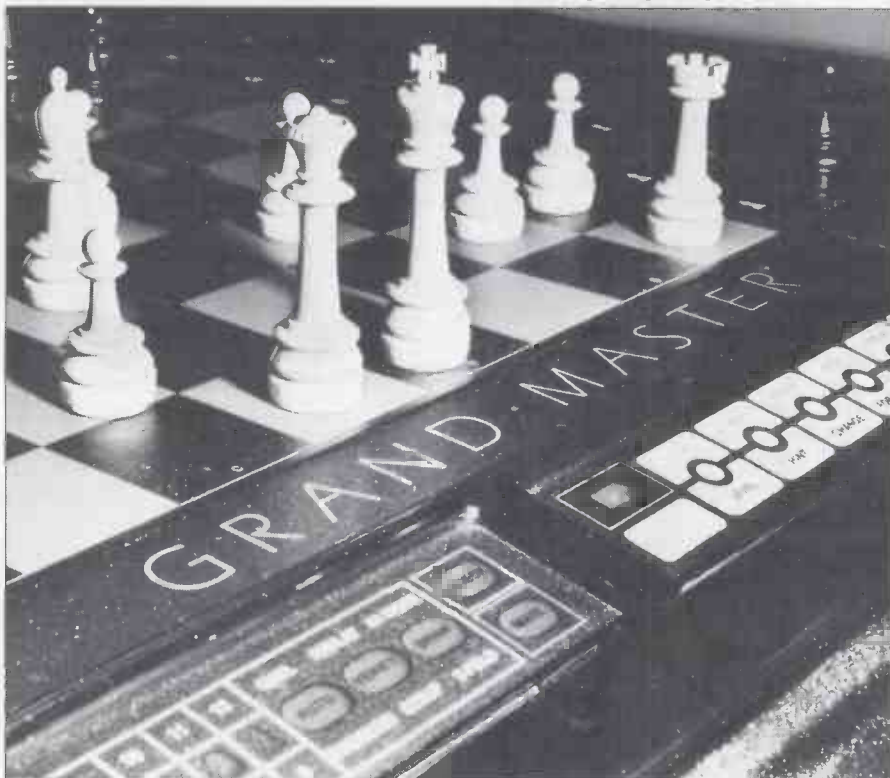

A side view of the 'Phantom', known in the US as 'Grand Master'.

been involved with had been straightforward software programming. This was the first time that they had to get involved with electro-mechanical technology.

Despite this, they undertook to write the chess program and the software to control the electro-magnetic system which moved the pieces. Levy reckons that when he was first shown the machine it worked to the point where it was possible to demonstrate the idea, but there was still quite a way to go before it could be turned into a reliable product which would stand up to the rigours of life in the average home.

So how does the machine move its pieces? The idea is basically simple. There is a solenoid (an electro-magnet) underneath the playing surface. This is connected to a mechanism which moves on two axes, consisting of two metal bars. The one can move down the length of the board, while the other moves down the width of the board.

The solenoid is fixed onto the one axis and is constrained to move by the other axis so that it is always at the centre of the cross-hairs formed by the intersection of the two axes. The bars are controlled by two belts (with teeth), which go round two wheels (also with teeth). A photosensitive device counts how many teeth on each of the wheels move past a certain point. So by counting how many fractions of a turn each wheel has made, the program is able to tell exactly where the solenoid is located under the chess board.

Each piece has a permanent magnet in its base, and when the Phantom wants to move, it first moves the solenoid to the exact position of the piece on the board (all the pieces are of course tracked by the program). It switches on, detects that there is indeed a piece on that square, and then moves to the target square — 'dragging' the chess piece with it.

In the case of captures, it first moves the captured piece from its square to a place at the side of the board, off the playing surface, set aside for it. The surface of the board is a touch sensitive surface, much like that of the Sensory Nine. When the player captures one of the computer's pieces, that piece has to be placed at the side of the board as well, and there is a symbol for every piece set out in two lines on the right and left hand sides of the chess board.

One of the quirks that fascinated me was the fussiness of the machine. Each time I captured one of its pieces and put it down on its square, there was the audible sound of its motor starting up as the solenoid rushed over to check that I had placed the piece correctly on the square appointed for it. According to Levy, if I had put the knight down on a square reserved for a queen, the machine would have immediately moved it — by the shortest possible route (no inefficiency here, please) — to the right square.

As with the Sensory Nine, when the player makes a move, it is necessary to press down lightly on the square of the piece that you are moving and on the square that you are moving to. Levy reckons that the program has an approximate rating of 1550. This is considerably weaker than that of La Regence,

Intelligent Software's own machine, released last December (which has an estimated rating of 1750).

The explanation for this is that La Regence was designed after the Phantom, and with a more leisurely research and development period. Levy's brief was to produce a program stronger than the Sargon 2 running on the Apple computer. The processor involved was the 6502A processor with 2k of RAM and 16k of ROM.

'The rating of 1550', he said, 'comes from 40 games played against the Sensory Nine and the Sargon 2.5, both of which were chosen as adversaries because they have already been rated by the United States Chess Foundation. Thirty games against rated players or rated machines are enough to get a statistically reliable result,' Levy said. 'We played 40 in order to gain even greater confidence.'

'We had never done anything using electro-mechanical devices before. When we first discussed the machine in the company's offices, I was asked how long I thought the job would take. More specifically, I was asked if we could do the work within five months. When I phoned our technical director I didn't tell him the time period Milton Bradley was considering. I just asked him how long he thought it would take. He said: 'five months...'

My guess is that with Intelligent Software already marketing a machine with a stronger program than the Milton Bradley machine, it won't be too long before the Phantom gets a program worthy of its mechanical dexterity.

Games section

White: Fidelity Sensory 9 (level 3);
Black: Phantom (level 10); Pirc Defence;
Notes by David Levy.

| | | |
|---|--------|--------|
| 1 | e2-e4 | d7-d6 |
| 2 | d2-d4 | Ng8-f6 |
| 3 | Nb1-c3 | g7-g6 |
| 4 | f2-f4 | Nb8-c6 |
| 5 | Bf1-b5 | |

(Unusual and rather pointless. The pin on Black's knight is of no consequence and the bishop would be better placed on almost any other square.)

| | | |
|---|---------|-------|
| 5 | ... | a7-a6 |
| 6 | Bb5xc6+ | b7xc6 |

(Black has an isolated pawn (a6) and doubled pawns (c7 and c6) but despite having made these concessions in its pawn structure, the Phantom actually has the better long-term prospects. This is partly because White has ceded bishop for knight; partly because of the attacking prospects along the b-file; and partly because White's impressive looking pawn centre might eventually prove vulnerable to pressure.)

| | | |
|---|--------|--------|
| 7 | Ng1-f3 | Bf8-g7 |
| 8 | 0-0 | 0-0 |
| 9 | Bc1-d2 | |

(A poor square for the bishop, but 9 Bc1-e3 accomplishes nothing after 9...Nf6-g4. Perhaps White should have tried 9 h2-h3 and 10 Bc1-e3.)

| | | |
|----|--------|--------|
| 9 | ... | Ra8-b8 |
| 10 | Ra1-b1 | Bc8-e6 |
| 11 | Qd1-e2 | |

(Otherwise...Bc6-c4 might be embarrassing, and now White threatens 12 Qe2xa6.)

| | | |
|----|---------|--------|
| 11 | ... | Rb8-b6 |
| 12 | e4-e5 | Nf6-g4 |
| 13 | h2-h3 | Ng4-h6 |
| 14 | Nf3-g5 | Be6-f5 |
| 15 | Bd2-e3? | |

(Too slow. I would have tried 15 g2-g4, when 15...Bf5xc2 16 Rb1-c1 Rb6xb2 17 Bd2-e3 wins a piece (17...Bc2-d3 is best met by 18 Qe2xb2 Bd3xf1 19 Rc1xf1, rather than 18 Qe2xd3 d6xe5 19 f4xe5 Bg7xe5!).

Since Black cannot capture on c2 after 15 g2-g4, play might continue 15...Bf5-d7 16 Qe2-f2, with an eventual Qf2-h4 and f4-f5, attacking Black's king.

The move played in the game hands the initiative to Black.)

| | | |
|----|--------|--------|
| 15 | ... | Qd8-b8 |
| 16 | g2-g4 | Bf5-d7 |
| 17 | e5xd6? | |

(A serious positional error. White weakens itself on the a1-h8 diagonal. Better would have been 17 Nc3-d1, followed by Qe2-f2 and Qf2-h4.)

| | | |
|----|-----|-------|
| 17 | ... | e7xd6 |
|----|-----|-------|

(More dynamic than the obvious looking 17...c7xd6. Black now has the possibility of play along the e-file.)

| | | |
|----|--------|--|
| 18 | Nc3-a4 | |
|----|--------|--|

(Putting the knight offside. White's only chances lie on the K-side, so again 18 Nc3-d1 was called for.)

| | | |
|----|--------|--------|
| 18 | ... | Rb6-b5 |
| 19 | c2-c4 | RB5-a5 |
| 20 | Na4-c3 | Rf8-e8 |
| 21 | b2-b4 | |

(Further weakening White's position.)

| | | |
|----|---------|--------|
| 21 | ... | Ra5-a3 |
| 22 | Qe2-b2? | |

(22 Qe2-d2 was essential.)

| | | |
|----|-----|---------|
| 22 | ... | Re8xe3! |
|----|-----|---------|

(A simple combination which wins material.)

| | | |
|----|--------|--------|
| 23 | Qb2xa3 | Bg7xd4 |
|----|--------|--------|

(The point. As a result of the numerous threats created by the discovered check (if Black moves the rook from e3), White has no time to defend the c3 knight.)

| | | |
|----|--------|---------|
| 24 | Kg1-h1 | Re3xc3 |
| 25 | Qa3xa6 | Bd7-c8! |

(Winning another pawn, since 26 Qa6xc6 loses the queen to 26...Bc8-b7.)

| | | |
|----|--------|--------|
| 26 | Qa6-a4 | Rc3xc4 |
|----|--------|--------|

(Black has a significant material advantage (two bishops and a pawn for a rook), and its king is much safer than White's, so the result of the game is hardly in doubt.)

| | | |
|----|--------|--------|
| 27 | Rf1-e1 | Bc8-d7 |
| 28 | Re1-e7 | Qb8-d8 |
| 29 | Re7-e4 | |

(If 29 Rb1-e1 Bd4-c3, threatening...Bc3xe1, ...Rd4xb4 and ...Rd4xf4.)

| | | |
|----|--------|--------|
| 29 | ... | f7-f5 |
| 30 | Qa4-a6 | d6-d5 |
| 31 | Ng5-e6 | Bd7xe6 |
| 32 | Re4xe6 | f5xg4 |
| 33 | Rb1-e1 | |

(Threatening to win Black's queen by 34 Re6-e8+.)

| | | |
|----|--------|-------------|
| 33 | ... | Kg8-f7 |
| 34 | f4-f5 | Nh6-f5 |
| 35 | h3xg4 | Qd8-h4+ |
| 36 | Kh1-g2 | Qh4-f2+ |
| 37 | Kg2-h3 | Qf2-g3 mate |

MICRONET 800

AN ELECTRONIC MAGAZINE?

Maggie Burton explores the derivation and growth of the viewdata service, Micronet 800.

Micronet 800 is the new approach to Prestel. It's a subscribers' viewdata service which allows micro users to link their computers into the large Prestel network through its own database of micro tips and information.

Prestel was the first ever public teledata service. Run by Buzby's 'Politburo', it was quickly found to be a rather expensive prospect — what with subscription fees, special television sets, page charges and phone bills. From the start, the user base

was small, and it still is. Promotion has always been virtually nil, and people often do not realise how much valuable information is contained within its pages.

Well-intentioned though it may be, Prestel has previously been little more than



Micronet software display



News reporter Sid Smith in his free-format office



Reporter Dave Babsky chases a runaway mouse

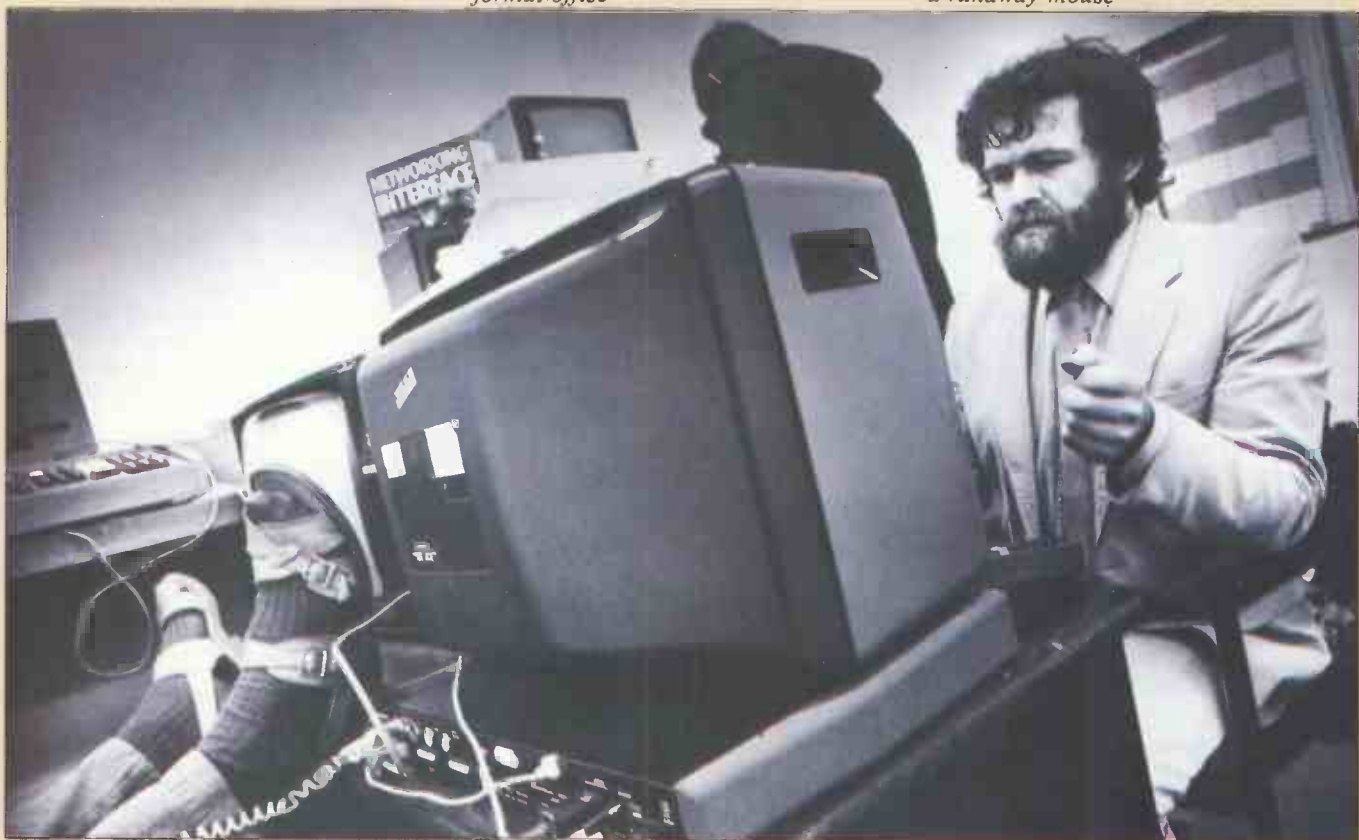

Babsky contemplates news copy: Smith's feet indicate a higher degree of relaxation.

Photography by Tony Sleep



The Spectrum with modem attached and the Micronet acoustic coupler.

an 'executive toy', a plaything of company directors. Now perhaps that is changing, thanks to Micronet 800 which combines the speed and efficiency of the teledata system with the hard-won views of the printed media.

Origins

Micronet began as EMAP's (East Midlands Allied Press) venture into information provision for Prestel. Information providers have to make their services pay in some way, either to offset Prestel charges or, if they're selling something through it, to make a profit. EMAP's venture was a loss-making one. Richard Hease, the owner of ECC (publisher of *Educational Computing*), had become involved with EMAP following the sale of some of ECC's computer publications to EMAP. He was working as a consultant in the area of computer publishing when EMAP asked him to look into the Prestel venture and, literally, either to make it work or close it down.

Hease became interested in the idea of telesoftware. Coincidentally, a competition was being run in *Sinclair User* to design a cheap, reliable Prestel adaptor. 'I thought the only way Prestel was going to work was to make it possible to link micros into it and develop a database micro users would want,' he says. Realising that his idea would need sound financial backing, Hease decided to seek it out.

The idea of a computer users' database — combining free telesoftware, news and on-line shopping facilities — was presented to Prestel. Prestel liked the idea and invested in it. The Department of Industry also moved in with financial backing.

'Both Prestel and the DoI,' says Hease, 'moved faster than I've ever seen a government or bureaucratic organisation

move. Within weeks we had everything sorted out.'

Provisions

Micronet was first presented to the public last summer. Advertisements invited enquiries and, on the basis of the replies, the first users accessed the database in March this year.

The variety of information and services is already considerable and, by the end of the year, should be even greater. At present, Micronet has a large news section, updated daily by intrepid reporters (*the end of the weekly is nigh — Ed*), free programs which can be downloaded straight into a micro, onscreen games which are resident in Micronet, product news and facts from companies like Sinclair, a teach-yourself Basic course, Computer-mart: second-hand micro advertising (and jobs too), a mailbox, problem page (Agony aunt's 'Elpful Area), quizzes, reference lists . . .

These are all great if you happen to have a micro or an interest in micros. Micronet offers educational value and, because the screens are bright and often very funny (the Computer Club title frame depicts a row of micros leaning on each other, all wearing boots), kids should like it and learn from it. Some of the onscreen games (that is, those which you don't have to load first) offer prizes for the winners. A version of adventure offers a prize draw between users who solve it.

Following Micronet is a little bit like playing an adventure game, but easier. It's a big, cheerful, Alice-in-Wonderland database and, if you haven't seen it before, it can be both confusing and fascinating. 'Something new is always just around the corner,' explains one satisfied user.

Micronet, besides being a large computer information service (it has a capacity to support 30,000 frames and is at present big using half that), seems to have become something of a hobby in itself for some of its users.

One of the obvious but largely unspoken aims of the editorial team is to make it into a communication base of computer users all over the country. Every Micronet subscriber has his/her own personal mailbox number, through which he/she can send messages both to Micronet itself and to other users. In this way people so inclined can set up a soapbox and pontificate, or can make micro-friends. It's unlikely to develop overnight into a substitute for the good old postage stamp, though, because the person to whom you are sending a letter needs to be a Micronet subscriber and you need to know his/her mailbox number. Besides, you do expect people to open their post. Some users may not access their mailboxes for weeks.

Hardware

The hardware involved is both easy to use and inexpensive. For the BBC Computer, an acoustic modem has been produced but this is now being pushed out in favour of a direct connect one. Present users can buy a modem from £49 plus VAT — the price depends on the computer and includes software and a manual. Direct connect modems cost £69.95 plus VAT. At present the BBC micro is the main computer for which Micronet caters — simply because it was the first one for which the modem was developed. A special unit for the Spectrum, a little black box which clips neatly underneath it, will be available very soon. Other micros which will be able to access Micronet are the

THE ULTIMATE MICRO PRINTING MACHINE



**The one machine solution
to every application.**

*For word processing, plotting
and just plain printing.*

Save the expense of a costly daisywheel. Eliminate the limited capability of cheap matrix printers. And get plotting in the process. Look at the advanced MT160 80 column and MT180 132 column multi-functional microprinters. You'll be amazed that such small printers can house so many facilities as standard.

Capability? You name it, these printers have got it. A report package puts you in the word processing world... letter quality characters, proportional spacing, margin justification, auto centering. A graphics package lets you plot whatever your micro wants to portray. The standard print mode lets you generate reports fast at speeds

up to 160 cps, and when it does this you have 8 different character widths to choose from.

There's more. Clip-on paper handling attachments let you use fan-fold forms, letterhead or continuous roll paper. The control panel has a "menu select" for machine configuration and the MT160/180 are plug compatible to most micros. After all they have parallel and serial interfaces as standard.

In short, the MT160/180 are at the forefront of engineering excellence.

Give us a ring for full details or ask your regular microcomputer dealer for a demonstration



**MANNESMANN
TALLY**

Mannesmann Tally Limited, Molly Millars Lane, Wokingham, Berkshire RG11 2QT. Tel: (0734) 788711. Telex: 847028.



Note to microcomputer dealers — if you would like to handle these products then ring Geoff Thomas or Terry Bell on the M-T Direct lines — Wokingham (0734) 791619 and 791533.

MICRONET 800

TRS.80 models I and III, RML 380Z and 480Z, PET (3,4 and 5 series), Apple II, Oric and, hopefully, ZX81 (a solution is being sought to the inevitable problems with the ZX81).

The Spectrum unit is rather neat. It eliminates the problem of noise interference caused through having to leave the phone off the hook by forming a 'bridge' between telephone line and TV through itself and the computer. This means that, as the call is taken from the line before it reaches the phone, you can hang up after you've got through. If you talk down a phone while it is transmitting data, you will get a screen full of garbage — it takes a lot less than that to interfere with data on a smaller scale.

The Lynx and Atari will not, at this time, be added to the Micronet list. 'The user base isn't big enough at present,' according to Robin Wilkinson, Editor-in-Chief.

One of the nice things about the Micronet modem is that it will conform to the Prestel standard of 1200/75 baud (1200 transmitting speed, 75 receiving) while allowing for 1200/1200 communication as well, which means you could use one of these modems to talk to your mate's computer over the phone. The modems are made by Prism Microproducts, Sinclair, Atari and Texas's distributor, a company in which Richard Hease is a partner.

Micronet itself also allows subscribers full access to Prestel. The subscription fee to Micronet includes the Prestel cover charge, which is £5 per quarter. Micronet is £8 per quarter. This means a total subscription cost of £52 per year.

The first 10,000 users are entitled to a special offer which includes a free jack plug installation within 72 hours of joining Micronet. The price of the modem will probably have to rise after this number have been sold.

Unfortunately cost does put the service out of some people's range. When you add the price of the modem and all the phone

calls you'll make over a year it does mount up. At present accesses to Micronet are very high — in April they were over one million — but it has been suggested that this will drop when people get their phone bills!

Usage

The way in which the 'have and have not' element could possibly be solved is by having Micronet in schools. Certainly it is educational in itself. Just in case there's any doubt as to its value in this area, part of the service is an educational branch. It includes educational programs, directories of educational software suppliers, computer courses and diary events and information from the Microelectronics Education Programme.

But there are practical problems with putting something like this in a school — you could only really have one terminal in a classroom (many more would be far too expensive to set up), and how many classrooms provide telephone lines? It is possibly the sort of thing which will appear in special rooms in some schools.

Plans for the future include business Micronet, which is already in its beginning stages. One feature of this service will be telex, enabling business users to send messages to each other without the receiver having to access Micronet to see it.

Business users can buy areas of Micronet and keep them closed from other users, thereby enabling confidential information to be transmitted over long distances secretly, and very quickly.

The teleshopping area of Micronet will grow bigger as suppliers overcome their preoccupation with the novelty of it and begin to act more adventurously. Telesoftware will expand and — before too long — there could be a Hong Kong Micronet, one in Australia and one in Boston, provided by clubs there using their own computer. The Boston scheme

is in the pilot stages.

The target for subscriptions is 12,000 by the end of the year. 'What really surprised us was the interest,' says Hease. The initial interest has been followed up by the rapid growth of an enthusiastic following. Jeremy Dredge, an estate agent, was Micronet's first ever user. 'It's opened the door to Prestel,' he said. 'I'm delighted with it'. He feels the friendly attitude of Micronet is what makes it such a success — and successful it is. Over 2000 subscriptions in two months and a 50 per cent reply rate on promotional mailings could hardly be called a failure.

Hease also agrees that Micronet's friendliness is a big part of its popularity. The chattiness is a conscious (but not forced) approach. 'We try to inject a bit of friendliness and fun into the whole thing,' he says.

Other users also enjoy Micronet. Hilary Brindley, who has been accessing the database for about a fortnight, says she enjoys being able to download programs and explore Prestel as well.

Conclusions

So people are having fun with it and learning from it. But does it actually bring people nearer to taking teledata into their homes, or is it simply another toy, confined to micro enthusiasts instead of company directors? Some Micronet subscribers feel that they would not be interested in Micronet or Prestel if they were not aware of microcomputing as well. It's also felt that big steps still have to be taken in this area before it is truly universal. There is a lot of potential in what Micronet represents which could be applied to other hobbies or businesses — especially those which need the transmission of large amounts of information. The closed areas available on Prestel offer businesses a step into electronic mail which could make communication far more efficient and far less wasteful than it is at present — imagine having your old bulky filing cabinet transformed into a neat screen and keyboard.

Micronet, as it stands now, represents good value for money for all types of computer user and enthusiast. Some reservations have been expressed about the originality of the games supplied free, but there is the promise that more programs are being added all the time. It is very like a magazine in its approach (but not, by necessity, in its structure), and keeps up to date with the news much faster because it is updated rapidly and is available instantly. Since information is left in the database for some time users don't generally miss anything.

It's to be hoped that Micronet 800 will continue to grow and develop, possibly spreading a little out of the computer market and further into Prestel's idea of a universal information database. Certainly its friendly approach, and the amount of useful and regularly updated information within it, makes it an example which other viewdata services and information providers could do a lot worse than follow.



Technical manager Mike Brown knows his way round.

END

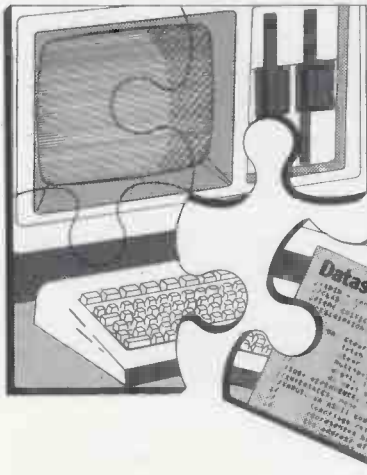

PCW SUBSET

Alan Tootill and David Barrow present more useful assembler language subroutines. This is your chance to help build a library of general-purpose routines, documented to the standards we have developed together in this series. You can contribute a Datasheet, improve or develop one already printed or translate the implementation of a good idea from one processor to another. PCW will pay for those contributions that achieve Datasheet status. Contributions (for any of the popular processors) should be sent to SUB SET, PCW, 62 Oxford Street, London W1A 2HG.

UNSPECIFIED 8085 INSTRUCTIONS

Concerning the unspecified 8085 op. codes reported by Jonathan Marten (PCW February), and Peter Caunt last month, Mark Hammes of

Loughborough finds, as did Peter, that 10 hexadecimal on his processor executes a 'SRA HL', a 16-bit arithmetic shift right, retaining the sign in bit 15.

Z80 CUBE ROOTS

Last month we printed John Kerr's lucid account of root extraction, carrying on from Steven Weller's square root programs (PCW August, 1982). Now that you have all

had a chance to apply this thinking to some code of your own, here — as promised — are John's own Z80 cube root routines CURT1 and CURT2.

DATASHEET

```

;=CURT1 - 16-bit unsigned integer cube root
;/CLASS: 1
;/TIME CRITICAL?: No
;/DESCRIPTION: Calculates the cube root (integer part) of a 16-bit
unsigned binary number, giving remainder
;/ACTION: Clear 16-bit accumulators for result, remainder & subtrahend
Repeat six times: Shift left input into accumulator (3 bits)
IF accumulator > current subtrahend
THENaacc := acc - subtr - 1; rotate '1' into result LSB;
shift left subtr (2 bits) & add in 18 * result.
ELSE rotate '0' into result LSB
shift left subtr (2 bits) & subtract 6 * result.
;/SUBr DEPENDENCE: None
;/INTERFACES: None
;/INPUT: BC holds 16-bit unsigned binary input number
;/OUTPUT: BC = 6-bit cube root; HL = 13-bit remainder
;/REGs USED: BC,HL
;/STACK USE: 6
;/LENGTH: 64
;/T-STATES: 1509 max
;/PROCESSOR: Z80

CURT1: PUSH AF ; Save registers, F5
PUSH BC ; getting input C5
EX (SP),IX ; into IX DD E3
PUSH DE ; D5
LD A,+6 ; A is loop counter 3E 06
LD BC,+0 ; Clear three 01 00 00
LD D,C ; accumulators 51
LD E,C ; 59
LD H,C ; 61
LD L,C ; 69
JR START ; Single bit shift 1st time 18 08
REPEAT: ADD IX,IX ; Then shift three bits DD 29
ADC HL,HL ; of input number ED 6A
ADD IX,IX ; into accumulator DD 29
ADC HL,HL ; ED 6A
START: ADD IX,IX ; DD 29
ADC HL,HL ; ED 6A
RL C ; Assume subtract will fail CB 11
SCF ; Take (subtrahend + 1) 37
SBC HL,DE ; from accumulator, and ED 52
JR C,ADBAK ; if result nonnegative 38 0A
INC C ; then set new bit 0C
EX DE,HL ; Subtrahend into HL EB
ADD HL,BC ; effectively multiplied 09
ADD HL,BC ; by four, and 09
ADD HL,BC ; 18 * current result 09
ADD HL,BC ; added in to obtain 09
ADD HL,HL ; new subtrahend 29

```

```

ADD HL,BC ; 09
JR SHIFT ; Continue 18-09
ADBAK: ADC HL,DE ; Subtraction did fail; ED 5A
EX DE,HL ; restore accumulator EB
OR A ; New subtrahend is B7
SBC HL,BC ; 4 * old value, minus ED 42
ADD HL,HL ; 6 * current result 29
SBC HL,BC ; ED 42
SHIFT: ADD HL,HL ; Done; now restore 29
EX DE,HL ; remainder to HL and EB
DEC A ; continue with next three 3D
JR NZ,RPEAT ; bits of input 20 D5
POP DE ; Restore all D1
POP IX ; registers DD E1
POP AF ; F1
RET ; End of CURT1 C9

```

DATASHEET

```

;=CURT2 - 32-bit unsigned integer cube root
;/CLASS: 2 (flags not preserved)
;/TIME CRITICAL?: No
;/DESCRIPTION: Calculates the cube root (integer part) of a 32-bit
unsigned binary number, giving remainder
;/ACTION: Clear 24-bit accumulators for remainder (A,HL) and subtrahend
(C,DE); clear stack top to hold result
Repeat eleven times: Shift left input into A,HL (3 bits)
IF A,HL > C,DE
THEN A,HL := A,HL - (C,DE + 1); rotate '1' into LSB of
(SP); let C,DE := 4*C,DE + 18*(SP).
ELSE (SP) := 2*(SP); C,DE := 6*(SP).
;/SUBr DEPENDENCE: Local SLEFT
;/INTERFACES: None
;/INPUT: BC,DE holds 32-bit unsigned binary number
;/OUTPUT: BC,DE = 11-bit cube root; A,HL = 23-bit remainder
;/REGs USED: AF,BC,DE,HL
;/STACK USE: 8
;/LENGTH: 97
;/T-STATES: 5480 max
;/PROCESSOR: Z80

CURT2: PUSH BC ; Move input into C5
EX (SP),IX ; index registers, DD E3
PUSH DE ; saving their D5
EX (SP),IY ; original contents FD E3
LD BC,OBOOH ; Loop counter B = 11; 01 00 0B
LD A,C ; clear 79
LD D,C ; all 51
LD E,C ; other 59
LD H,C ; registers 61
LD L,C ; and 69
PUSH HL ; stack top E5
JR BEGIN ; Skip one shift 1st time 18 03
AGAIN: CALL SLEFT ; Then shift three bits CD YY YY
BEGIN: CALL SLEFT ; of input number CD YY YY
CALL SLEFT ; into A,HL CD YY YY
SCF ; Take (subtrahend + 1) 37
SBC HL,DE ; from accumulator A,HL ED 52
SBC A,C ; but jump to restore 99
JR C,NOSUB ; if now negative 38 15
EX (SP),HL ; Subtraction successful; E3
ADD HL,HL ; new result bit 29
INC L ; is '1' 2C
PUSH HL ; save new result and E5
ADD HL,HL ; multiply 29
ADD HL,HL ; by four; 29
EX DE,HL ; add this into EB
ADD HL,DE ; subtrahend 19
JR NC,NOINC ; 30 01
INC C ; 0C
NOINC: ADD HL,HL ; Double 29
RL C ; subtrahend CB 11
POP DE ; Retrieve saved result D1
ADD HL,DE ; & add into subtrahend 19
JR NC,NEXT3 ; 30 16
INC C ; 0C
JR NEXT3 ; 18 13
NOSUB: ADC HL,DE ; Subtraction didn't go; ED 5A

```

| | | | |
|------------|----------|---------------------------|-------|
| ADC | A,C | ;restore accumulator | 89 |
| EX | (SP),HL | ;Shift left result-so-far | E3 |
| ADD | HL,HL | ;new result bit is '0' | 29 |
| EX | DE,HL | ;Subtract | EB |
| SBC | HL,DE | ;result | ED 52 |
| JR | NC,NODEC | ;from | 30 01 |
| DEC | C | ;subtrahend | 0D |
| NODEC: ADD | HL,HL | ;Shift left | 29 |
| RL | C | ;subtrahend | CB 11 |
| SBC | HL,DE | ;Repeat last two | ED 52 |
| JR | NC,NEXT3 | ;operations | 30 01 |
| DEC | C | ; | 0D |
| NEXT3 ADD | HL,HL | ;In either case, the | 29 |
| RL | C | ;correct new subtrahend | CB 11 |
| EX | DE,HL | ;has now been calculated. | EB |
| EX | (SP),HL | ;Restore operands and go | E3 |
| DJNZ, | AGAIN | ;back for next 3 bits. | 10 C2 |
| POP | DE | ;Final result into BC,DE | D1 |
| LD | C,B | ; (top word BC cleared) | 48 |
| POP | IY | ;Restore index | FD E1 |
| POP | IX | ;registers | DD E1 |
| RET | | ;End of CURT2 | C9 |
| SLEFT: ADD | IX,IX | ;Local subroutine shifts | DD 29 |
| ADC | HL,HL | ;one bit of input number | ED 6A |
| RLA | | ;into accumulator A,HL | 17 |
| ADD | IY,IY | ; | FD 29 |
| RET | NC | ; | D0 |
| INC | IX | ; | DD 23 |
| RET | | ;End | C9 |

CASE OF MISSING INFORMATION

Apologies for the fact that 6502 processors across the globe have lain idle for three months while their owners contemplated CASEOF (as

mentioned in April *PCW*). Below is the missing information to get those processors up and running again...

6502 CASEOF

Most readers of Sub Set will be familiar with the idea of the 'case' structure in which control is passed to different parts of the program depending on the match of a variable with associative keys.

Peter Villadsen of Copenhagen in Denmark provided Sub Set with a 6502 'case' routine, CASEOF. CASEOF searches through a table of addresses to routines, each of which has an associative key. If a match is found between the input variable in the X register and any key byte in the table, then a jump is made to the location whose address is held in the two bytes immediately following the matched key. If after a complete search of the table no match is found then CASEOF causes a jump to a location whose address could be an error message handler or other such routine to deal with no match.

The return address to the instruction following JSR

CASEOF remains on the stack for control to be passed back to the calling program after the requested routine has been executed.

CASEOF needs the base address of the table to be in page zero memory before it is called and uses another two bytes of page zero memory to store the found address. By transferring the address to page zero in this way, control can be passed to the subroutine by means of an indirect jump.

The routine is not limited to any one table but the maximum table size it can manage is 84 cases. Using indexed addressing, no more than 256 bytes can be addressed and each case takes 3 bytes; one byte for the key and two for the address. Still, there can be very few programs that require case structures of greater dimensions.

The table format for CASEOF is shown in Fig 1.

| | | |
|-------|-----------|----------------------------------|
| TABLE | | : number of keys * 3 (ie, 3n) |
| TABLE | +1, 2 | : address of action 0 (no match) |
| TABLE | +3 | : key 1 |
| TABLE | +4, 5 | : address of action 1 |
| TABLE | +6 | : key 2 |
| TABLE | +7, 8 | : address of action 2 |
| • | | • |
| • | | • |
| TABLE | +3n | : key n |
| TABLE | +3n+1, 2: | address of action n |

Fig 1

Z80 CASEOF

Andrew Bain of Welwyn Garden City who benefitted enormously from Peter Villadsen's ideas (see above) has sent in three Z80 routines along the same lines as CASEOF.

We give here two of them, CASOFZ and CASTXT. The first one, CASOFZ performs an identical task to CASEOF and uses a table format which differs from that used by CASEOF only by requiring the first table byte to give the number of keys in the table rather than the number of bytes.

CASTXT doesn't match single byte keys but whole strings using the concepts of Simon Sellick's routine CPSTR (*PCW* November, 1981) and, according to Andrew, could be used in writing a Basic interpreter. The table format differs in that the address is given first, followed by a byte giving the string length, then the string to match. The final address (of the 'no match' routine) is followed by a zero or null byte and always 'matches' if no other match is found.

DATASHEET

```

;-CASOFZ - Single byte key Case handling routine
;/CLASS: 2
;/TIME CRITICAL?: No
;/DESCRIPTION: Branches to action associated with matched key
                or "no match" action if no match found.
;/ACTION: Until match OR end of table
                Move pointer to next key and compare with input key
                If end of table then reset pointer to table start
                Increment pointer to associated address and transfer
                address on to stack, and "return" to required action.
;/SUBr DEPENDENCE: None
;/INTERFACES: None
;/INPUT: Key to match in A
;/OUTPUT: Branch to required action effected
;/REGs USED: A
;/STACK USE: 8
;/LENGTH: 30
;/TIME STATES: Match: 158 + 38 * key position
                No Match: 182 + 38 * no. of keys
;/PROCESSOR: Z80
TABLE: DEFB NN ;no. of keys
        DEFW NOMTCH ;address of no match action
        DEFB KEY1 ;1st key
        DEFW ACTN1 ;address of action for match on key 1

;table continued for all keys
CASOFZ: PUSH HL ;save registers
        PUSH DE ;
        PUSH BC ;
        PUSH AF ;
        LD HL,TABLE ;HL = table pointer
        LD B,(HL) ;B = no. of keys
        LD DE,+3 ;DE = no. of bytes each case
LOOP: ADD HL,DE ;move pointer to next key
        CP (HL) ;test for match of input key
        JR Z,IN ;and exit loop if found
        DJNZ LOOP ;else repeat
OUT: LD HL,TABLE ;start of table for no match
IN: INC HL ;pick up address associated with
        LD C,(HL) ;matched key, or no match address,
        INC HL ;in HL
        LD H,(HL) ;
        LD L,C ;
        POP AF ;restore all registers
        POP BC ;putting address
        POP DE ;of required
        EX (SP),HL ;action on stack
        RET ;and "return" to it.

```

DATASHEET

```

;-CASTXT - String key Case handling routine
;/CLASS: 2
;/TIME CRITICAL?: No
;/DESCRIPTION: Branches to action associated with matched string
;/ACTION: Read address of associated action and key string length
                Until end of string OR corresponding bytes don't match
                Compare action key string with string-to-match
                If no match then loop back and do again for next key
                If match then branch to associated action
;/SUBr DEPENDENCE: None
;/INTERFACES: None
;/INPUT: DE is pointer to string-to-match
;/OUTPUT: Branch to required action effected
;/REGISTERS USED: DE
;/STACK USE: 10
;/LENGTH: 40
;/PROCESSOR: Z80
TABLE: DEFW ACTN1 ;address of action for match on key 1
        DEFB NN ;byte length of key string 1
        DEFM ;key string 1
;table continued in like manner for all keys, then:
        DEFW NOMTCH ;address of no match action
        DEFB 0 ;zero length string to ensure "match"

CASTXT: PUSH HL ;save registers
        PUSH BC ;
        PUSH AF ;
        LD HL,TABLE ;HL = table pointer
NXTKEY: LD C,(HL) ;transfer next routine address
        INC HL ;to stack via BC
        LD B,(HL) ;
        INC HL ;moving HL to point to length byte
        PUSH BC ;
        LD A,(HL) ;A = length of string to match
        OR A ;test for null length = end of
        JR Z,DONE ;table and exit if so

```

TOP SECRET

George Sassoon explores the code of public-key cryptography.

A few years ago, there were curious happenings at a meeting of a learned mathematical society. Armed security men burst into the lecture hall; fist-fights broke out around the podium; equations were hastily rubbed off the blackboard. The cause of it all? Someone had finally invented what security agencies dread most: the unbreakable cipher.

But all these efforts were in vain. The secret was out; and the basic principle of the cipher is so simple that one kicks oneself for not having thought of it first. Credit for that must go to three workers at the Massachusetts Institute of Technology, Messrs Rivest, Shamir and Adleman. From their initials, the cipher is known as the RSA public-key cryptosystem. Why 'public-key'? The reason is that the key comes in two parts: the encryption key, which is made public, enabling anybody to encipher messages; and the decryption key, which is kept secret, enabling only the originator of the cipher to decode messages.

Until the invention of public-key sys-

tems, the only really secure cipher was the so-called 'one-time pad'. This is simply a pad printed with random numbers. If each sheet of the pad is used only once, then the system is 100 per cent secure; problems arise, though, in the distribution of the pads, which must be done by trusted couriers. If a pad is lost or copied en route to an agent in, say, Moscow, then the whole pad is compromised and must be replaced. The RSA system, with its two-part key, avoids this difficulty; the encryption key could be published in the Moscow telephone directory without compromising the system!

The separation of encryption and decryption is achieved by means of modulo arithmetic. The modulo function amounts to dividing one number by another, throwing away the quotient, and keeping the remainder. Thus 11 mod 3 is equal to 2, the remainder when 11 is divided by 3. Supposing that the original message, the plaintext, was '11', and the ciphertext was '2', the codebreaker has

no way of working backwards from '2' to '11'; the original message could have been 2,5,8,11,14. . . The RSA system uses this principle, but with very large numbers. In my implementation, the modulus is not 11, but a number in excess of 2^{240} , or about 1.77×10^{72} . The text is divided into blocks of 30 ASCII characters, each block being enciphered as a unit. Thus if the message is: 'ABCDEF. . .', it would be expressed for encryption as the number:

$65 + 66 * 256 + 67 * 65536. . .$
the final result being a number 240 bits (or 30 bytes) long. This is known as the plaintext number P.

The next step in the RSA system is to turn the plaintext number P into the ciphertext number C. This is done as follows:

$$C = P^E \text{ mod } N$$

Where E, the encryption exponent, and N, the modulus, are the public part of the key, E is usually a prime number less than 20, and N is a very large number, in my case greater than 2^{240} , which must be the product of two primes. The plaintext is thus multiplied by itself a number of times, and at each stage about half the number is thrown away. The result is the ciphertext. This is more or less equivalent to turning the message into alphabet soup, pouring it into a bucket, and then stirring it with a digital wooden spoon, spilling about half the soup with each stir. On the face of it, it would seem impossible to get back to the original message from the resulting mess of random-looking numbers. This is in fact true; it is impossible to work backwards to the original message, but it is possible to work forwards, using some mathematical trickery and the secret decryption exponent D. This can be illustrated by the simple example in Fig 1.

In this example, N is chosen to be 35, which is the product of 7 and 5, two primes. There are thus 35 possible 'messages', the numbers 0 and 34. The encryption exponent is chosen as 5, so each possible message is raised to the fifth power, being reduced modulo 35 at each multiplication. Some of the resulting ciphertext messages are unchanged, those adjacent or equal to exact multiples of 7, but the rest are thoroughly scrambled.

Decryption is then carried out according to the formula:

$$P = C^D \text{ mod } N$$

That is, the ciphertexts are raised to power D, the decryption exponent, also modulo N. In this simple example, D is also equal to 5. The result of this opera-

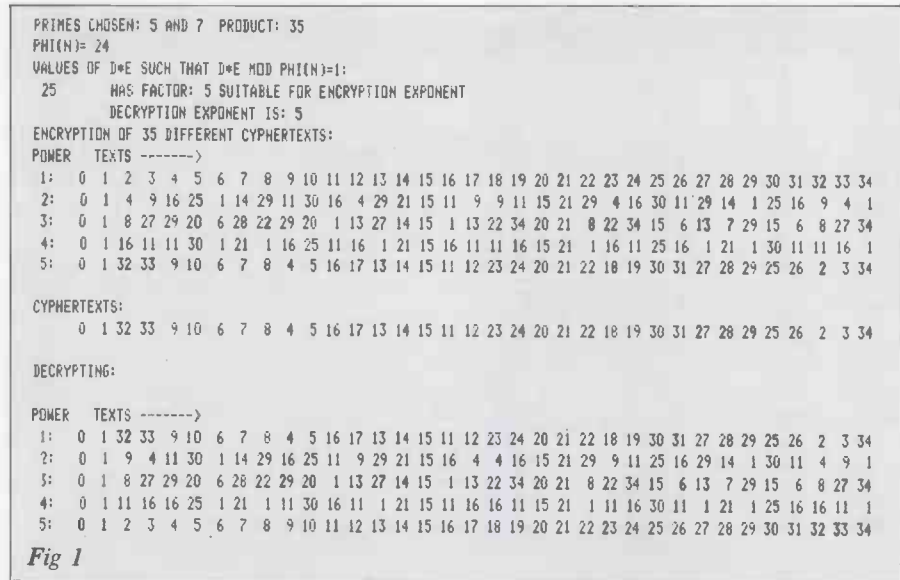

Fig 1

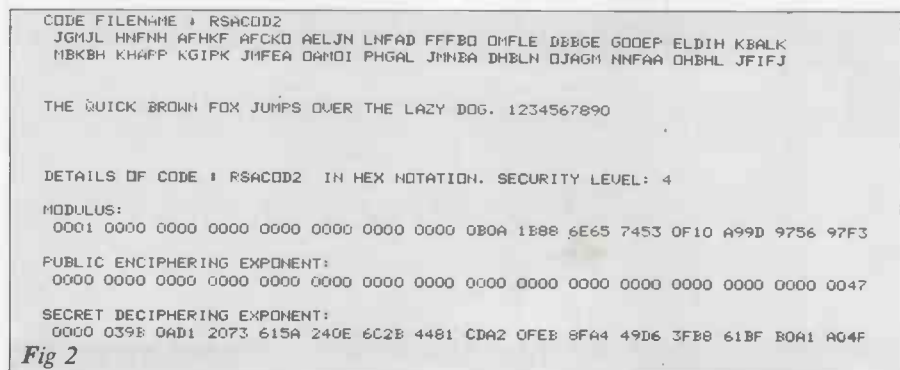

Fig 2

tion is to restore the original messages 0 - 34.

This example is clearly trivial, but it illustrates how the original messages can be restored in spite of the modulo operation at each multiplication. All that needs to be done is to use the same principle for very large numbers, and then the system becomes a usable cipher.

Choice of exponents

In Fig 1, both encryption and decryption exponents were taken as equal to 5. These figures were arrived at by making use of one of the rules of modulo arithmetic. This states that when working modulo N, exponents are multiplied modulo phi(N), phi(N) being the Euler totient function of N. In normal arithmetic, for successive exponentiation, the exponents are simply multiplied. Thus:

$$(X^E)^D = X^{D \cdot E}$$

But in modulo arithmetic, the following rule applies:

$$(X^E \bmod N)^D \bmod N = X^{D \cdot E \bmod \phi(N)}$$

where phi(N) is the fearsome-sounding Euler totient function of N. The function is in fact very simple; it is the number of integers not exceeding N which are relatively prime to it. For prime numbers, the only such number not relatively prime to N is N itself, so for primes phi(N)=N-1. It can be shown that if N is the product of two primes P1 and P2, then phi(N)=(P1-1)*(P2-1).

In the example of Fig 1, the primes are 7 and 5, and phi(N) is 24. Now it is a basic truth that any number raised to the power of 1 is the number itself. So to select the encryption and decryption exponents, we need to select E and D such that:-

$$D \cdot E \bmod \phi(N) = 1$$

Possible values of D*E are:

25: equal to 5 * 5

49: equal to 7 * 7

73: prime

97: prime

121: equal to 11 * 11

145: equal to 5 * 29

169: equal to 13 * 13

etc.

Any of these pairs of factors would do for the encryption and decryption exponents. For demonstration, 5 and 5 were chosen, but in practice a small value for E and a large value for D would be chosen.

It will be seen that the exponents D and E are interchangeable, that is, you could equally well encrypt with the decryption exponent and decrypt with the encrypting one. This leads to another important feature of the RSA system, which is authentication of messages. Supposing our London office sends a message to their agent in Moscow, how can he be sure that it comes from London and not from Dzerzhinsky Square down the road? This is easily confirmed if the London office appends a block to the message which is encrypted using D, the secret decryption exponent. The man in Moscow can decrypt it using E, the public encryption exponent. If it makes sense, then he can be sure that the

message came from someone in possession of the secret exponent D, which can only be the London office.

Implementation of the system

The first requirement is for multiple-precision arithmetic routines, capable of handling very long numbers. Z80 routines were written, which can handle unsigned integers up to 2^{256} (over 10^{77}). Double this length is required for multiplications, so that each number occupies up to 64 bytes of memory. All the usual arithmetic functions are implemented, with the addition of 'powermod', used for evaluating the

expression:

$$Y = X^Q \bmod N$$

When Q is very large, it is not practical to do this with successive multiplications. Instead, Q is expressed as a binary number, and X is squared mod N for each bit of Q; if the bit is 1, then the result Y is multiplied by X. Thus to evaluate X^{11} , $Y = X^1 * X^2 * X^8$.

With this system, decryption of a 30-byte cipher block takes about five minutes, using a bog-standard Z80 running at under 2 Mhz clock rate.

But before there can be any encryption and decryption, ciphers must be created. Two prime numbers must be found, whose product is in excess of 2^{240} , and

GOTO page 204

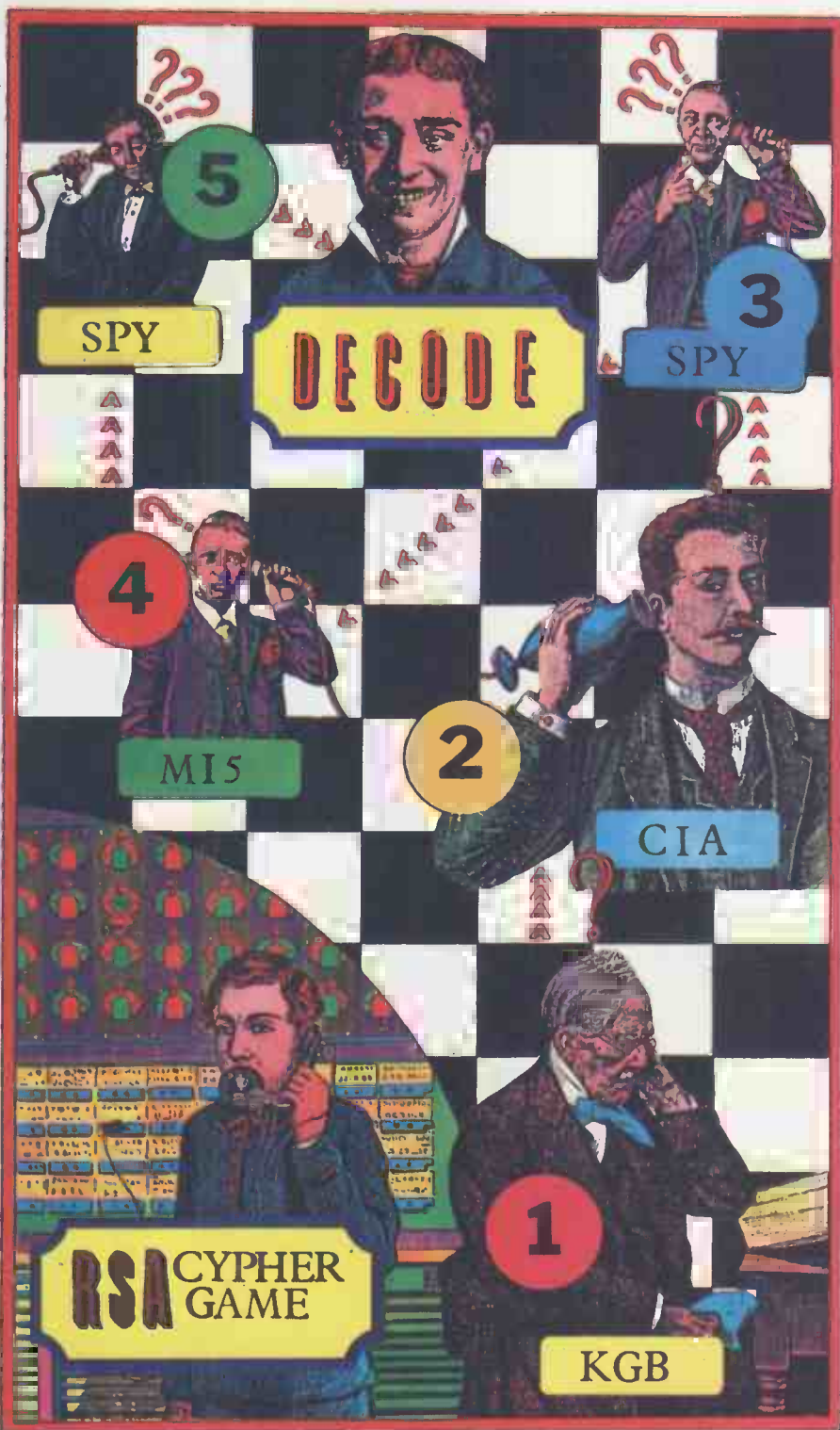

Illustration by Mike Liberland



**Just how big a difference is there
between Digital and other
personal computer manufacturers?**



The gap, believe us, is wide.

And the confusion surrounding personal computers, widespread. Because the term 'personal' computer now stretches to include a multitude of machines, with a diverse range of functions and capabilities.

So let's set the record straight. And get down to business. Over the past quarter century Digital's main objective has been to personalise the computer. Permitting direct access to *real* computing power to whoever wants it.

And in that time Digital have introduced minicomputer power into banks, mines, steel plants, farms, refineries, aviation, broadcasting, universities and assembly lines to name but a few.

Digital were also the first company to mass produce minicomputers, and the PDP-11 is, in fact, the world's most popular minicomputer today.

A fact that makes Digital the world's largest manufacturer of minicomputers. Which, in turn, makes it less of a surprise that Digital have now developed a range of personal computers unrivalled in their ability to meet today's professional requirements. From the dual micro-processor Digital Rainbow to the highly advanced Digital Professionals, the first personal computers with the ability to perform numerous functions at once, there's a Digital personal computer to suit practically any need.

And the Digital difference becomes even wider when you consider Digital's unique service back-up, which includes access to our Customer Information Centre, service support, software services and maintenance. And in the unlikely event of anything going wrong, Digital guarantee to deal with any problem, on site, within 8 working hours anywhere on the UK mainland.

Plus you automatically get a free 12 month warranty to cover all our hardware and software.

It's a service record that is, in fact, unrivalled by any.

If you'd like further information about Digital professional personal computers ring Digital on Basingstoke (0256) 59200 or contact any of the Dealers shown overleaf, then compare the facts with any other machines to see just how wide that chasm of difference really is.

You'll end up on our side every time.

Doing more. The Digital difference.

digital

Where to find your nearest Digital Authorised Personal Computer Dealer.

LONDON

Beauchamp Computer Systems Ltd.,
115 Fulham Road, London SW3.
Tel: 01-581 8134.

The Computer Terminal, 44 Cathedral Place,
London EC4. Tel: 01-236 2187.

Demotab Ltd.,
99-101 Regent Street, London W1.
Tel: 01-439 3971.

(Market Research & Advertising Agencies)*

Guestel Ltd., 8-12 New Bridge Street,
London EC4. Tel: 01-583 2255.

Matmos Electronics Ltd.,
14-16 Child's Place, London SW5 9RX.
Tel: 01-373 6607.

(Opticians & Ophthalmologists)*

Micro Business Systems PLC, Cannon Street,
London EC4. Tel: 01-621 1122.

Personal Computers Ltd., 220-226 Bishopsgate,
London EC2M 4JS. Tel: 01-377 1200.

Planning Consultancy Ltd., 46/47 Pall Mall,
London SW1Y 5JG. Tel: 01-930 5274.

Rank Xerox (UK) Ltd., The Xerox Store,
84 Piccadilly, London W1V 9HE.
Tel: 01-629 0694/5.

The Xerox Store, 110 Moorgate,
London EC2M 6SU. Tel: 01-588 1531/2.

The Xerox Store, 76-77 Holborn,
London WC1V 6LS. Tel: 01-242 9596/7.

Software Sciences, Thorn (EMI) House,
14 Old Park Lane, London W1. Tel: 01-499 7099.

Software Sciences, 88 Old Street,
London EC1. Tel: 01-253 1480.

Sumlock Bondain Ltd., 263-269 City Road,
London EC1V 1JX. Tel: 01-250 0505.

Sytec Products Ltd.,
25 Bruton Lane, London W1. Tel: 01-409 1244.
(Pressure Vessel Design, Surveying,
Structural Analysis)*

HOME COUNTIES

Dataview Ltd., Portreeves House, East Bay,
Colchester, Essex CO1 2XB. Tel: 0206 865835.

Ferrari Software Ltd., 683 Armadale Road,
Feltham, Middlesex. Tel: 01-751 5791.

GSI Ltd., Stanhope Road, Camberley, Surrey.
Tel: 0276 62282.

(Motor Dealers & Manufacturers)*

Key Computer Centres, Enterprise House,
Terrace Road, Walton-on-Thames, Surrey.
Tel: 09322 42777.

Micro Business Systems PLC,
119-120 High Street, Eton, Berkshire.
Tel: 07535 55211.

Microfacilities Ltd., 7-9 Church Road,
Egham, Surrey. Tel: 0784 31333.

Rank Xerox (UK) Ltd., The Xerox Store,
3/4 William Street, Slough, Berkshire SL1 1XY.
Tel: 0753 76957.



STC Micros, West Road, Harlow,
Essex CM20 2BP. Tel: 0279 443421.

Sytec Products Ltd., Cord House,
The Causeway, Staines, Middlesex.
Tel: 0784 63911.

SOUTH/SOUTH EAST

Bartholomews Business Systems Ltd., Portfield,
Chichester, Sussex. Tel: 0243 775111.
(Agricultural Suppliers, Farming)*

Computerland
(Sperrings Computer Shops Ltd.),
Spencer House, 12-14 Carlton Place,
Southampton. Tel: 0703 39571.

Software Sciences, Abbey House,
282-292 Farnborough Road, Farnborough,
Hants. Tel: 0252 544321.

South East Computers Ltd.,
Unit 2, Castleham Road,
Castleham Road Industrial Estate,
Hastings, Sussex. Tel: 0424 426844.

South East Computers Ltd., 29 High Street,
Maidstone, Kent. Tel: 0622 681263

SOUTH WEST

Computacenter, Theatre Square, Swindon,
Wiltshire SN1 1GN. Tel: 0793 612341/2.

Rank Xerox (UK) Ltd., The Xerox Store,
Bristol & West House, Broad Quay,
Bristol BS99 7AX. Tel: 0272 277828.

15 Castle Street,
Software Sciences, Unit 39, Southfield Road,
Nailsea, Nr. Bristol. Tel: 0272 851462/3.

South Coast Computers Ltd.,
South Coast House, Wimbourne Road,
Ferndown, Dorset. Tel: 0202 893040.

Whymark Computing, 20 Milford Street,
Salisbury, Wiltshire SP1 2AP.
Tel: 0722 331269.

MIDLANDS

4B Microcentres Ltd., 13/14 North Bar, Banbury,
Oxon OX16 0TF. Tel: 0295 66555/50796.

Micro Business Systems PLC, Wirksworth,
Derbyshire. Tel: 062-9823120.

MMS Ltd., Ketwell House,
75-79 Tavistock Street, Bedford MK40 2RR.
Tel: 0234 40601.

Zygal Dynamics PLC, Zygal House,
Telford Road, Bicester, Oxon OX6 0XB.
Tel: 08692 3361.

NORTH EAST

Microware Computers Ltd., Diamond House,
Whitelock Street, Leeds. Tel: 0532 434377.

Microware Computers Ltd., Priors House,
1133 Hesse High Road, Hull HU4 6SB.
Tel: 0482 562107.

Whessoe Technical & Computing Systems Ltd.,
Brinkburn Road, Darlington,
Co. Durham DL3 6DS. Tel: 0325 60188.

NORTH WEST

Cytek (UK) Ltd., Sandringham House,
9 Warwick Road, Old Trafford,
Manchester M16 0QQ. Tel: 061-872 4682.

Micro Business Systems PLC,
Birchwood Science Park, Warrington.
Tel: 0925 822261.

Rank Xerox (UK) Ltd., The Xerox Store,
Pearl Assurance House, Derby Square,
Liverpool L2 9QR. Tel: 051-236 7512.

WALES

Rank Xerox (UK) Ltd., The Xerox Store,
South Gate House, Wood Street,
Cardiff CF1 1EW. Tel: 0222 40118.

Sigma Systems Ltd., 266 North Road,
Cardiff CF4 3BL. Tel: 0222 34865/69.

SCOTLAND

Micro-Centre (Complete Microsystems) Ltd.,
30 Dundas Street, Edinburgh EH3 6JN.
Tel: 031-556 7354.

Micro Business Systems PLC,
Turnhouse Airport, Edinburgh.
Tel: 031-333 1000.

Pilgrim Business Machines Ltd.,
28 Walker Street, Edinburgh.
Tel: 031-226 5528.
(Solicitors)*

Pilgrim Business Machines Ltd.,
Northfield Place, Aberdeen. Tel: 0224 645104.

Rank Xerox (UK) Ltd., The Xerox Store,
166 Hope Street, Glasgow G2 2TG.
Tel: 041-333 0495.

NORTHERN IRELAND

Systems Plus Ltd., 19 Glengormley Park,
Newtownabbey, Northern Ireland.
Tel: 023-134 2117.

DIGITAL UK HEADQUARTERS

Digital Equipment Co. Limited, P.O. Box 110,
Reading RG2 0TR. Tel: 0734 868711.

*Vertical market application speciality.



1983 READER SURVEY

YOUR CHANCE TO WIN A SHARP MZ-711

Yes, once again it's time for the *PCW* Reader Survey, and once again we have a sparkling new micro to give away to the first name out of the hat! The star prize is a Sharp MZ-711 personal computer. It has 64k of RAM and it's one of the latest MZ-700 series announced by Sharp. A further ten lucky readers will receive a year's free subscription to the best micro mag on the market! Don't worry if you already have a subscription — we'll simply extend it for a further year.

The reason we have these annual surveys is to keep us in touch with what you want from the magazine. We do meet readers from time to time, of course, and obviously we receive a lot of letters, but this Survey gives us the chance to analyse the views of as many readers as possible. If there's anything you particularly love or hate about *PCW*, new ideas you'd like to see included or regular items you think we should drop like a hot brick, here's your chance to let us know.

The Survey is used to plan the future of *PCW*, so this is your chance to take an active part in choosing the direction we're going to be moving in over the next year or so. The prize draw will take place in mid-August so the questionnaire should be returned as quickly as possible. Our thanks to Sharp for providing the prize and to you for completing the questionnaire.

Please use **BLOCK CAPITALS** throughout and/or tick appropriate boxes

- Name: _____
- Address: _____

Did you buy this issue of *PCW*? Yes/No (delete where applicable).

- Age: Under 15 ¹ 15-18 ² 19-30 ³ 31-45 ⁴ 46-65 ⁵ over 65 ⁶
- Sex: M ¹ F ²
- Occupation: (*Please give precise title*) _____
- If you work full-time in the computer industry, please complete the following, otherwise GOTO question 8:
Please indicate your main area of involvement: Mainframes ¹ Minis ² Micros ³
- If you ticked 'micros' above, please complete the following, otherwise GOTO question 8:
Sales ¹ Servicing ² Support ³ Other ⁴ (*Please give details*) _____
- Which of the following publications do you read?

| | Regularly | Sometimes | Please indicate which one you think is best | | Regularly | Sometimes | Please indicate which one you think is best |
|-------------------------|---------------------------------------|---------------------------------------|---|------------------------------|---------------------------------------|---------------------------------------|---|
| Personal Computer World | <input type="checkbox"/> ¹ | <input type="checkbox"/> ² | <input type="checkbox"/> ¹ | What Micro? | <input type="checkbox"/> ¹ | <input type="checkbox"/> ² | <input type="checkbox"/> ¹¹ |
| Practical Computing | <input type="checkbox"/> ¹ | <input type="checkbox"/> ² | <input type="checkbox"/> ² | Your Computer | <input type="checkbox"/> ¹ | <input type="checkbox"/> ² | <input type="checkbox"/> ¹² |
| Computing Today | <input type="checkbox"/> ¹ | <input type="checkbox"/> ² | <input type="checkbox"/> ³ | Home Computing | <input type="checkbox"/> ¹ | <input type="checkbox"/> ² | <input type="checkbox"/> ¹³ |
| Which Computer? | <input type="checkbox"/> ¹ | <input type="checkbox"/> ² | <input type="checkbox"/> ⁴ | Weekly | | | |
| Computer Answers | <input type="checkbox"/> ¹ | <input type="checkbox"/> ² | <input type="checkbox"/> ⁵ | Popular Computing | <input type="checkbox"/> ¹ | <input type="checkbox"/> ² | <input type="checkbox"/> ¹⁴ |
| Computer & Video Games | <input type="checkbox"/> ¹ | <input type="checkbox"/> ² | <input type="checkbox"/> ⁶ | Weekly | | | |
| Micro Decision | <input type="checkbox"/> ¹ | <input type="checkbox"/> ² | <input type="checkbox"/> ⁷ | Computing | <input type="checkbox"/> ¹ | <input type="checkbox"/> ² | <input type="checkbox"/> ¹⁵ |
| Personal Computing | <input type="checkbox"/> ¹ | <input type="checkbox"/> ² | <input type="checkbox"/> ⁸ | Computer Weekly | <input type="checkbox"/> ¹ | <input type="checkbox"/> ² | <input type="checkbox"/> ¹⁶ |
| Today | | | | Datalink | <input type="checkbox"/> ¹ | <input type="checkbox"/> ² | <input type="checkbox"/> ¹⁷ |
| Personal Computer News | <input type="checkbox"/> ¹ | <input type="checkbox"/> ² | <input type="checkbox"/> ⁹ | Computer Talk | <input type="checkbox"/> ¹ | <input type="checkbox"/> ² | <input type="checkbox"/> ¹⁸ |
| Which Micro? & Software | <input type="checkbox"/> ¹ | <input type="checkbox"/> ² | <input type="checkbox"/> ¹⁰ | Infomatics | <input type="checkbox"/> ¹ | <input type="checkbox"/> ² | <input type="checkbox"/> ¹⁹ |
| Review | | | | Other (<i>state which</i>) | _____ | | |

- Please indicate your interest in the following sections of *PCW*: _____

| | A lot | Some | Little | None | | A lot | Some | Little | None |
|--------------------|---------------------------------------|---------------------------------------|---------------------------------------|---------------------------------------|---------------|---------------------------------------|---------------------------------------|---------------------------------------|---------------------------------------|
| Newsprint | <input type="checkbox"/> ⁴ | <input type="checkbox"/> ³ | <input type="checkbox"/> ² | <input type="checkbox"/> ¹ | ACC News | <input type="checkbox"/> ⁴ | <input type="checkbox"/> ³ | <input type="checkbox"/> ² | <input type="checkbox"/> ¹ |
| Communications | <input type="checkbox"/> ⁴ | <input type="checkbox"/> ³ | <input type="checkbox"/> ² | <input type="checkbox"/> ¹ | Computer Town | <input type="checkbox"/> ⁴ | <input type="checkbox"/> ³ | <input type="checkbox"/> ² | <input type="checkbox"/> ¹ |
| Banks' Statement | <input type="checkbox"/> ⁴ | <input type="checkbox"/> ³ | <input type="checkbox"/> ² | <input type="checkbox"/> ¹ | Networks | <input type="checkbox"/> ⁴ | <input type="checkbox"/> ³ | <input type="checkbox"/> ² | <input type="checkbox"/> ¹ |
| Computer Answers | <input type="checkbox"/> ⁴ | <input type="checkbox"/> ³ | <input type="checkbox"/> ² | <input type="checkbox"/> ¹ | Diary Data | <input type="checkbox"/> ⁴ | <input type="checkbox"/> ³ | <input type="checkbox"/> ² | <input type="checkbox"/> ¹ |
| <i>PCW</i> Sub Set | <input type="checkbox"/> ⁴ | <input type="checkbox"/> ³ | <input type="checkbox"/> ² | <input type="checkbox"/> ¹ | Programs | <input type="checkbox"/> ⁴ | <input type="checkbox"/> ³ | <input type="checkbox"/> ² | <input type="checkbox"/> ¹ |

1983 READER SURVEY

| | | | | | | | | | |
|-------------------|---------------------------------------|---------------------------------------|---------------------------------------|---------------------------------------|-------------------|---------------------------------------|---------------------------------------|---------------------------------------|---------------------------------------|
| Portable Computer | <input type="checkbox"/> ⁴ | <input type="checkbox"/> ³ | <input type="checkbox"/> ² | <input type="checkbox"/> ¹ | Leisure Lines | <input type="checkbox"/> ⁴ | <input type="checkbox"/> ³ | <input type="checkbox"/> ² | <input type="checkbox"/> ¹ |
| World | | | | | Chip Chat | <input type="checkbox"/> ⁴ | <input type="checkbox"/> ³ | <input type="checkbox"/> ² | <input type="checkbox"/> ¹ |
| TJ's Workshop | <input type="checkbox"/> ⁴ | <input type="checkbox"/> ³ | <input type="checkbox"/> ² | <input type="checkbox"/> ¹ | Benchtests & | <input type="checkbox"/> ⁴ | <input type="checkbox"/> ³ | <input type="checkbox"/> ² | <input type="checkbox"/> ¹ |
| Micro Chess | <input type="checkbox"/> ⁴ | <input type="checkbox"/> ³ | <input type="checkbox"/> ² | <input type="checkbox"/> ¹ | Reviews | | | | |
| Beginners Start | <input type="checkbox"/> ⁴ | <input type="checkbox"/> ³ | <input type="checkbox"/> ² | <input type="checkbox"/> ¹ | Hardware Features | <input type="checkbox"/> ⁴ | <input type="checkbox"/> ³ | <input type="checkbox"/> ² | <input type="checkbox"/> ¹ |
| Here | | | | | Software Features | <input type="checkbox"/> ⁴ | <input type="checkbox"/> ³ | <input type="checkbox"/> ² | <input type="checkbox"/> ¹ |
| In Store | <input type="checkbox"/> ⁴ | <input type="checkbox"/> ³ | <input type="checkbox"/> ² | <input type="checkbox"/> ¹ | Advertisements | <input type="checkbox"/> ⁴ | <input type="checkbox"/> ³ | <input type="checkbox"/> ² | <input type="checkbox"/> ¹ |
| Packages | <input type="checkbox"/> ⁴ | <input type="checkbox"/> ³ | <input type="checkbox"/> ² | <input type="checkbox"/> ¹ | | | | | |

9a Is there any feature which, if removed, would stop you buying *PCW*? _____

10. What other topics would you like to see in *PCW*? _____

11. What topics would you like to see deleted? _____

12. What other comments (if any) would you like to make about *PCW*? _____

13. Do you own a microcomputer?
Yes ¹ No ² If yes, which make and model? _____

14. Do you own disk drive(s)?
Yes ¹ No ² If yes, which make? _____

15. Do you own a printer?
Yes ¹ No ² If yes, which make & model? _____

16. Do you intend buying a microcomputer in the next 12 months?
Yes ¹ No ² If yes, which make and model is your current choice? _____

17. Do you intend buying separate disk drive(s) in the next 12 months?
Yes ¹ No ² If yes, which make & model? _____

18. Do you intend buying a printer in the next 12 months?
Yes ¹ No ² If yes, which make and model? _____

19. What is your intended total budget for the above purchases?
Under £199 ¹ £200-£499 ² £500-£999 ³ £1000-£1999 ⁴
£2000-£2999 ⁵ £3000-£3999 ⁶ £4000-£4999 ⁷ £5000-£10,000 ⁸
over £10,000 ⁹

20. Do you intend to buy software?
Yes ¹ No ²

What type of software do you intend to buy?
Games ¹ Business ² Education ³ Systems ⁴ Software ⁵

What operating system(s) do you use?
CP/M Family ¹ MS-DOS ² Other (state which) _____

21. What is your total budget for software?
up to £24 ¹ £25-£49 ² £50-£99 ³ £100-£249 ⁴ £250-£499 ⁵
£500-£999 ⁶ over £1000 ⁷

22. Do you intend to buy blank cassettes during the next 12 months?
Yes ¹ No ² How many? _____

23. Do you intend to buy disks?
Yes ¹ No ² How many? _____

24. Do you intend to buy computer stationery?
Yes ¹ No ² Value? _____

25. Do you buy computer books?
Regularly ¹ Occasionally ² None ³

26. What do you use your micro for (please tick the main use only)?
Home use/games ¹ Business ² Scientific/Engineering ³ Education ⁴ System
Development ⁵ Other (state which) _____

27. Apart from yourself, how many other people read your copy of *PCW*? _____

28. Do you object to your name and address being placed on a mailing list:
For *PCW* use only? Yes ¹ No ²
For other commercial users? Yes ¹ No ²

Moore on Kuma



Forth First

Kuma believes it is the first in the world to offer a 68000 based Forth which includes an assembler.

This professional software product is written by Kuma and we fully support it all the way. It comes complete with a floating point package and an assembler for £385 plus VAT, for the Sage II.

Forth is a high level language particularly suited for machine control. Its "self-extending" facility allows you to custom build your own language by permanently embedding routines in the software.

Having mastered the Sage Forth we are interested in implementing this on other 68000 based machines.

Forth on MSDOS

With the trend away from CP/M 86 to MSDOS, has meant that we have now implemented our Forth for Sirius 1 on MSDOS.

Centronics Interface

A special interface is available from Kuma to convert the RS232C serial interface on the NewBrain to Centronics. So if you have a Centronics printer, you can now interface it with the NewBrain without any problems. Price is £99.50 plus VAT.

Similar interfaces (serial to Centronics) for other machines are in the pipeline and will be announced shortly.

Sage & CBM64 Franchises

Kuma is now a franchised dealer for the 68000 based Sage and the Commodore CBM64. Now you can not only buy the hardware from us but look forward to the high level of software support we give all our machines.

Sharp Colours

For just over £2000 plus VAT, Kuma can offer you the exciting MZ3541 colour machine. A twin disk, CP/M computer with 128K of main memory and a large spread sheet calculator capability. It's every bit as good as you expect from Sharp.

Pascal Update

HiSoft Pascal for Sharp MZ80A is up to version 1.5 with the notable inclusion of printer drivers. To update your existing cassette-based Pascal compiler return to us with a cheque or P.O. for £3 plus VAT.

News Bits

- * An assembler written in machine code is available from Kuma for the NewBrain.
- * Our June NewBrain catalogue is ready. It's free and contains details on the new assembler and other utilities.
- * The popular 4D game has been computerised for the Sharp. More details in our new MZ80A brochure.
- * We have a very useful program called TX for transferring CP/M files. It runs under CP/M on Sirius 1, Osborne 1 and MZ80B.
- * MZ80A and B users can have the new Kuma dual port RS232 interface card for £130 plus VAT.

HX-20 User Graphics

Special characters for mathematical and scientific symbols, foreign letters, etc, can now be defined by the Epson HX-20 user easily and quickly with a £17.50 (plus VAT) package from Kuma.

After defining, the characters can be directly used or saved to tape for transfer to other programs.

Low Cost Word Processor

Kuma's WDPRO word processing package continues to be our top selling program for the Sharp MZ80A. For £39.50 or £79.95 plus VAT respectively for the cassette and disk versions, you have a superb low cost word processor. And the recent addition of MAILPRO means names and addresses can be merged with WDPRO created documents.

New for HX20

Get our new programs in the DESK MASTER series.

They are a Data Base (16K or 32K versions), Mailing List, and Labelling packages.

Other items in the successful DESK MASTER series are a Spreadsheet Calculator and Word Processing Packages (both of which are now market leaders for this machine); Office Aid; Friendly Terminal; and Decision Maker. The last is a selection aid where multi-parameters with different weightings are applied, eg in staff selection.

Last but not least, there is the DESK MASTER editing terminal on the HX20. We are now leading Electronic Mail Box proponents so if you want to talk to us digitally, dial up "KUMA" on the BL Comet service and we can't fail to listen.

Kuma Computers Limited



A Combination of Soft & Hardware



SIRIUS 1

SAGE

SHARP

EPSON

NewBrain

Commodore

OSBORNE 1

Kuma has over 500 software programmes covering - utility, educational, entertainment, word processing and other business requirements.

KumaComputers are backed with many years of direct experience.

PHONE NOW or SEND FOR DETAILS

MAIDENHEAD (0628) 71778

Kuma Computers Ltd. 11 York Road,
Maidenhead, Berks SL6 1SQ

Please tick box for information required, and send coupon to:
Kuma Computers, 11 York Road, Maidenhead, Berks SL6 1SQ

| HARDWARE | SOFTWARE | HARDWARE | SOFTWARE |
|--------------------------------------|--------------------------|---------------------------------------|--------------------------|
| <input type="checkbox"/> SAGE | <input type="checkbox"/> | <input type="checkbox"/> NEWBRAIN | <input type="checkbox"/> |
| <input type="checkbox"/> SIRIUS-1 | <input type="checkbox"/> | <input type="checkbox"/> COMMODORE 64 | <input type="checkbox"/> |
| <input type="checkbox"/> SHARP A | <input type="checkbox"/> | PRINTERS: | |
| <input type="checkbox"/> OSBORNE-1 | <input type="checkbox"/> | <input type="checkbox"/> MATRIX | |
| <input type="checkbox"/> EPSON HX-20 | <input type="checkbox"/> | <input type="checkbox"/> DAISY WHEEL | |

NAME

ADDRESS

POST CODE

IBM COMES FORTH

An exclusive review of PolyForth as presented by Dick Olney

As the popularity of Forth among micro users increases so, too, does the number of compilers available. The problem is that either they are cassette-based or they run under one of the standard operating systems, both of which situations disguise the language's full potential.

PolyForth, from Forth Inc of California, is unique in providing a stand-alone multi-tasking operating system and an overwhelming selection of extensions and utilities for a mere £250. It was designed to run on an IBM PC with at least one single-sided disk drive. A conversion utility is included which allowed me quickly to reconfigure the software and make full use of the dual 320k drives installed in the machine I was using.

The PC automatically boots up the PolyForth when it's switched on, whereupon a title and date appear in the top left-hand corner of the screen together with the word 'HI'. At this point the Forth 'nucleus', that is, those words which are precompiled on the system disk, is already in place and most of the major features have been loaded (like any good Forth all the non-standard extensions are supplied as source). Typing 'HI' at this stage loads a further selection of utilities and displays a help screen containing brief details of a selection of useful commands.

MS-DOS users might be rather disturbed at this point to find the cursor and edit controls on the numeric pad completely disabled (the keys always echo their number value). This is because these functions — like the rest of the keyboard — are dealt with in software. In fact the Forth has a keyboard interpretation chart residing in block 0 of the system disk. The version I used was still configured to a US keyboard. The " and @ symbols were reversed and the £ returned a #. Comsol, the European distributor of this product, is working on a UK conversion utility to be included in the package. It is possible to use all of the special keys but you'll need to develop your own routines to handle their functions. The ten keys labelled F1 to F10 can be attached to a word simply by naming it with the legend on the key as in: F1." This is Function F1"; which will cause the embedded text to print out whenever the F1 key is depressed. For other keys, however, such as CTRL and ALT you'll need to test for ASCII values in a special input routine.

The basic system includes most standard Forth words and much more besides. One omission which might surprise Fig Forth users is VLIST (giving a listing of the dictionary). It's easy to test for the

existence of a word and the command LOCATE will automatically display the source of any word loaded from disk not contained in the object nucleus — an invaluable debugging aid. A full selection of 32-bit maths operators is included as well as an 8088 assembler — written in Forth — and a standard line editor.

As is usual the assembler and editor words are held in discrete vocabularies which must be declared before they are used. A further 5 user vocabularies can be added. The system keeps track of these using an array called GOLDEN which contains the start (or end, depending on how you look at it) of the dictionary lists. At any one time up to four vocabularies can be current, with the compiler following a pre-specified search sequence determined by the contents of the variable CURRENT. Used in conjunction with the turnkey compiler (see below) this enables the programmer to create a self-loading application where the user can only access an appropriate selection of high level commands.

A copy of the GOLDEN array, called CONTEXT, has its link addresses updated as new words are added to the various vocabularies. The word EMPTY copies the contents of GOLDEN into CONTEXT, thereby erasing from the dictionary any entries compiled since its previous execution. The source for this reads GOLDEN CONTEXT 20 MOVE. The reversed phrase CONTEXT GOLDEN 20 MOVE re-initialises GOLDEN thus protecting all currently compiled words from the use of EMPTY. In this way applications can be efficiently re-compiled during development and protected after successful debugging using a technique which is much more controlled than the traditional FORGET.

All dates in the system, including today's, are held as 16-bit numbers described as 'modified Julian dates' giving the number of days which have elapsed since 1 January, 1900. They use a compact representation which allows arithmetic to be performed on the date directly. Two formats are provided for input and output of which examples are 14 MAY 1983 or 5/14/83. Little effort has been put into conversion for the British market though it would be no problem to develop your own routines using the existing low level words.

Multi-tasking

Multi-tasking is probably the most exciting feature of PolyForth not least

because of its ease of use. It relies upon a tiny (25 bytes) core routine called PAUSE. When executed in a program this word passes control to an idle loop which runs around a circular chain of addresses called a 'round robin' searching for the next task ready to be activated. New background tasks are created using three programmer-supplied values. The first of these represents the 'user area' in which key variables may be protected from other tasks. Such variables are defined in the format:

offset USER name

where the offset is added to the task's base address to give the address of the variable. Each task maintains its own parameter and return stack, and the other two values represent the byte sizes of these. To define a background task the command is:

user parameter return BACKGROUND name

which constructs a table to be used when the task is initialised with the word BUILD, whereupon it is linked into the round robin.

Once a task has been defined and created it can be activated by any program using the following convention:

word task-name ACTIVATE (words executed by task);

There are, however a number of vital restrictions of which the programmer must be aware if this is to be successful. First a background task cannot perform terminal I/O and is thus unable to issue error messages, so if anything goes wrong the whole system will crash. A similar effect occurs if the task is allowed to reach the semi-colon, and it must therefore be explicitly terminated with the word STOP.

The reason that a background task cannot perform terminal I/O is that such a potential demands the ability to vector to unique routines when executing words like TYPE and CR. It is possible to overcome this by moving text directly into screen memory, but you'll need to develop your own routines in assembler to access memory above 64k. The two predefined tasks called OPERATOR and TYPISIT are, of course, capable of terminal I/O since they control screen and printer respectively. This means that screen activity remains relatively unaffected when the printer is active.

Although the multi-tasking facility is simple and effective much of its operation depends on the programmer. Remember that in reality only one task is actually active at any one time, and it is therefore essential in both foreground and back-

Illustration by Donna Muir and Su Huntley

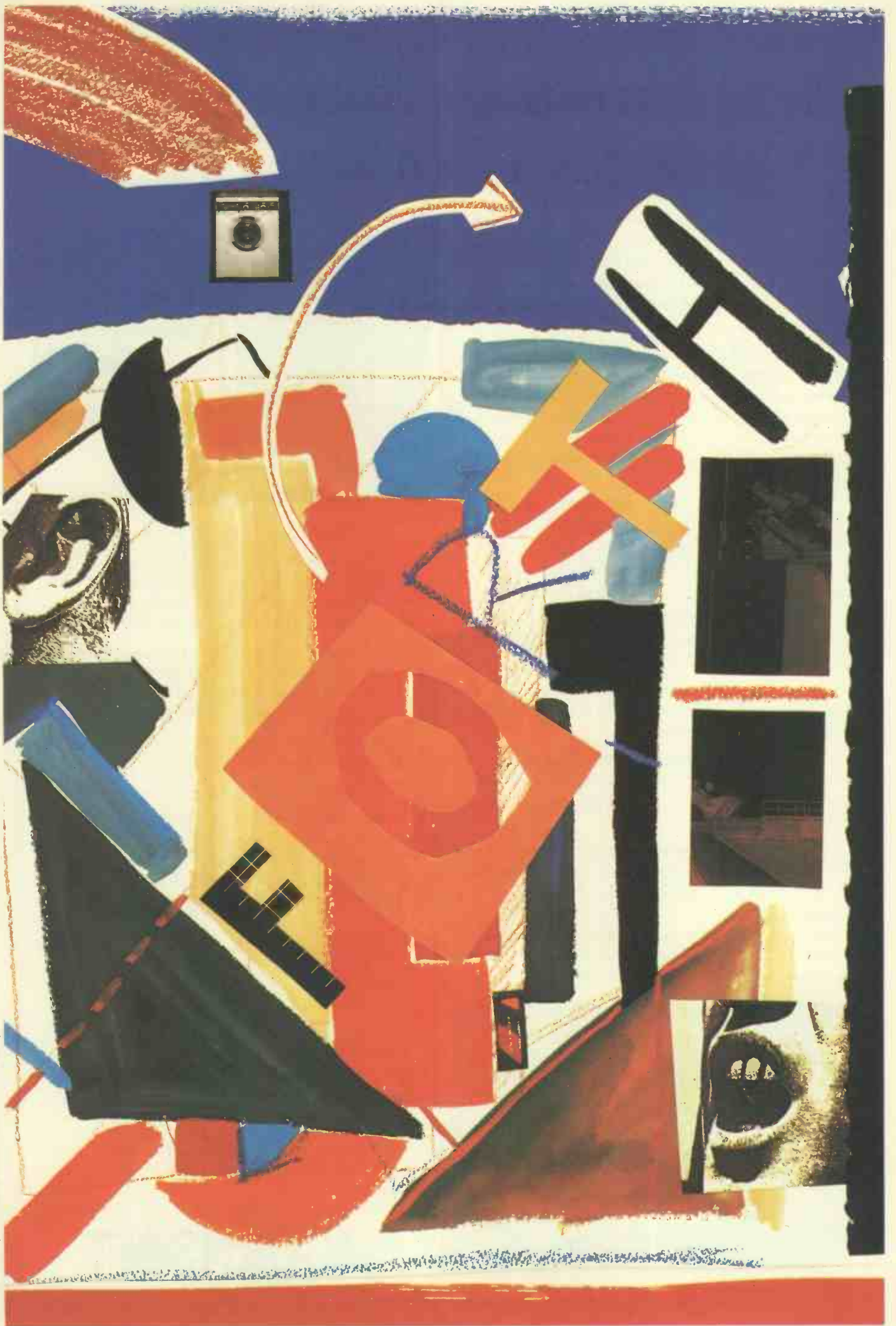

Announcing more exciting programs for the BBC.

Acornsoft is the software division of Acorn Computers, the company that designed and built the BBC Microcomputer. Here are four more exciting programs, all designed to get the most from your BBC Micro.

Starship Command (£9.95) is a demanding high-resolution graphics game in which you command a starship against attacking alien ships. You control the forward drive and rotational thrust of your ship, which is equipped with shields, long and short-range scanners and a sector display of the stars and alien ships.

Countdown to Doom (£9.95) is a race against time as you strive to repair your damaged space ship in the corrosive atmosphere on the planet Doomawangara (Doom). Beat the clock or resign yourself to a life in the wilderness of Doom.

Business Games (£9.95) is a cassette containing two games designed for economics, business or general studies teaching.

In **Stokmark**, up to eight players compete in buying and selling shares aided by a screen display of relevant market information.

In **Telemark**, players compete to dominate in the manufacture and sale of televisions. The winner is the one who makes the largest profit or controls over half the total market.

Jars (£11.90) is an educational cassette suitable for 7-13 year olds. The objective of the program is to present, what are usually thought of as purely numerical problems, in a visual way. Jars of liquid are used to visualise volume estimation and fraction problems. Success, partial success or failure is noted by a scoring system and suitable comments.

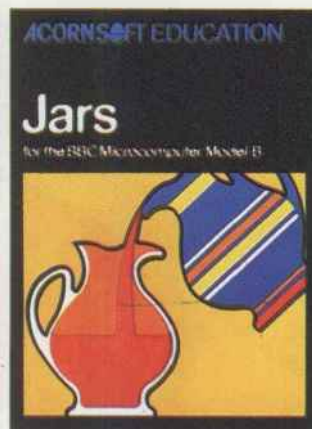
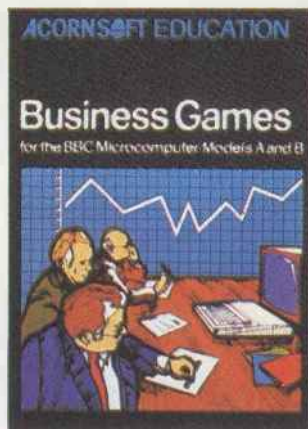

How to get Acornsoft programs.

If you're a credit card holder and would like to buy cassettes of the programs shown in this advertisement, or if you would like to know the address of your nearest stockist, just phone 01-200 0200.

Alternatively, you can buy the cassettes directly by sending off the order form below to: Acornsoft, c/o Vector Marketing, Denington Estate, Wellingborough, Northants NN8 2RL.

Also use this form if you would like to receive the current free Acornsoft catalogue.

Please allow 28 days for delivery.

☎ Credit Card Holders. Telephone 01-200 0200.

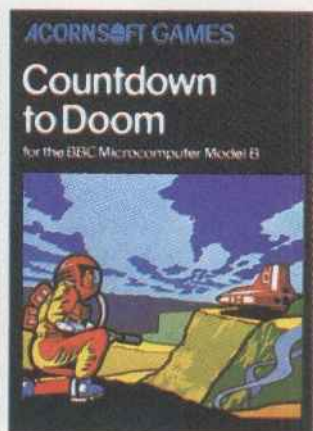

To: Acornsoft, c/o Vector Marketing, Denington Estate, Wellingborough, Northants NN8 2RL.

Please send me the following:-

| PROGRAM | PRICE | QUANTITY | TOTAL | (Code Acornsoft use only) |
|-------------------|--------|----------|-------|---------------------------|
| Starship Command | £9.95 | | | SBG22 |
| Countdown to Doom | £9.95 | | | SBG19 |
| Business Games | £9.95 | | | SBE03 |
| Jars | £11.90 | | | SBE15 |
| TOTAL | | | | |

I enclose PO/cheque payable to Acornsoft Ltd.
Or charge my credit card.

Card Number _____
(Amex/Diners/Visa/Access (Delete))

Please send me the Acornsoft brochure

Name _____

Address _____

Postcode _____

Signature _____

PCW 7/83

Registered No. 1524763. VAT No. 215 8123 85

ACORNSOFT

IBM COMES FORTH

ground tasks to use PAUSE in a fashion most appropriate to the application. In addition the use of any shared resources, such as the disk buffers, must be carefully monitored and, if necessary, controlled using special routines. Note that, once built into the round robin task, definitions cannot be erased from the memory by EMPTY or FORGET and any attempt to do so has dire consequences.

Despite the vulnerability of the PolyForth multi-tasking, it does give this system an immediate lead over most of the more conventional operating systems currently available. Used properly with careful and extensive debugging it could provide the basis for many impressive applications.

Programmer Utilities

The initialisation of diskettes and the manipulation of data on them is fundamental to any disk-based operating system.

In this system these functions are grouped in a utility dubbed 'Disking'. All the standard commands are provided including initialisation, backup, and block copying as well as disk diagnostics. One command that is particularly useful is MATCHES, which is not used to activate an optional cigarette lighter, but to compare the contents of two specified ranges of blocks and report any discrepancies.

The most common criticism of Forth is that the source is unreadable to anyone but the originator. Forth Inc has attempted to counter this with a facility called 'shadow documentation'. Two disks are supplied with the package, the system disk which resides in drive 0, and a documentation disk for use in drive 1. The documentation or shadow disk contains brief descriptions of all the words existing as source on the system disk. To access the shadow blocks you must first LIST the relevant source; at this point the command Q will toggle the display between the source and its associated documentation. This idea is that shadow documentation is written at the same time as the source to assist in any future modification or debugging.

The printing utility makes use of the shadow documentation by allowing double-sided printing. With careful positioning of the paper the source and shadow blocks can be printed so as to appear opposite each other when filed in an A4 binder. Alternatively, source without shadow documentation can be laid out with alternate pages on different sides of the paper to give a similar effect.

Printing is initialised by preceding any valid words with the command PRINT. This literally sends the rest of the input stream to the TYPIST terminal task. Because of its mode of operation, however, this word cannot be used inside colon definitions, where TYPIST ACTIVATE performs a similar function. The system gives full support for the standard IBM (Epson) parallel printer, though you need to write your own control functions using EMIT and the ASCII values

given in the IBM Guide to Operations.

Additional Options

To complete the image of this package as a powerful software development tool, a number of additional support features have been included. One of the most exciting of these, especially bearing in mind the multi-tasking capability, is the colour graphics option. Unfortunately, I do not have access to a colour display so I was unable to use this facility, though I did see a demonstration on one of IBM's machines which drew some fairly convincing square spirals. The option allows basic point plotting in medium-resolution (200 x 320) colour mode. From the manual I would guess it's fairly primitive but, like the rest of this system, I'm sure it could be extended into a powerful vocabulary.

Another option is the screen editor, which uses all the IBM function keys, and which I used to write this review. It's better than using my old typewriter but lines do not run on, neither do blocks, so it's hardly a word processor. Nevertheless it serves its purpose and perusal of the source reveals an interesting definition of a word named :K which reads: :K (k) : LAST @ @ CFA 2+ SWAP 'FUNCTION ;

The colon within this definition means that upon execution :K will itself cause a new word to be compiled from the input stream, and it is at this time that the colon is presented with a matching semi-colon. When :K encounters the latter compilation ceases and the rest of the code is executed. The technique is used here to place the execution address of a colon definition into a function table at the time it is compiled, thereby facilitating vectored execution. The word :K expects the offset in the table for the new word to be on the stack. An example of its use is:

```
71 :K HOME 0 C# ! 0 L# !;
```

where HOME places the cursor at the first position on a block by zeroing the column and line counts.

Although IBM apparently does not support it, there is a spare socket on the system board for an 8087 maths processor, and the PolyForth manual gives full instructions for installation and details of an extensive supporting vocabulary. The conditions of sale from IBM, however, suggest that such a modification would render the warranty invalid, so I resisted the temptation to test out this option.

If applications are to be written in Forth, then sooner or later they are bound to be presented with files created under PC DOS, and the next option on the list is PC DOS file handler. All this really does is to take care of the DOS sectoring and provide for basic file manipulation. Actually to access data in applications you'd need to extend considerably the vocabulary. Still, the basis of it is there and it would be fairly easy to impose your own data structures over the DOS format.

Last, but not least, is the turnkey compiler which allows self-booting application disks to be created. This is achieved by first EMPTYing the dictionary then loading up your applications, followed by the

turnkey utility. At this point a controlling application word to be executed on entry can be specified together with any blocks to be loaded from disk at that time. The word PROGRAM then transfers a custom bootstrap dictionary to an initialised diskette in drive 1 (instructions are also provided for generating turnkey diskettes on single drive machines). Applications, using a startup program in conjunction with sealed vocabularies or closed program loops, can effectively deny a user access to the Forth itself, even though the core code is resident in the application. If Forth Inc is convinced that you've done this properly then the company won't claim for any copyright payments.

Benchmark timings

| | |
|-------------------|------|
| magnifier | 1.7 |
| do-loop | 5.8 |
| literal | 6.6 |
| literal-store | 11.3 |
| variable | 7.4 |
| variable-fetch | 9.6 |
| constant | 7.8 |
| dup | 9.6 |
| increment | 9.4 |
| test> | 12.7 |
| test< | 12.7 |
| while-loop | 14.4 |
| until-loop | 13.4 |
| dictionary-search | 5.7 |
| arithmetic | 4.1 |
| mixed maths | 5.3 |

I timed the PolyForth using the Forth benchmark programs published in the January issue of PCW. To do this I had to write an assembler routine to reset the stack pointer, which luckily turned out to be very simple (my assembler is limited to say the least!) and my version of SP! reads:

```
CODE (SP!) S POP NEXT
: SP! SO @ 2 - (SP!) ;
```

Having checked the reliability of the system clock I decided to let the machine time itself and printed out the contents of the system variable TICKS at the beginning and end of the multiplier routine. Remember that the timing for this word is subtracted from the other values to give the true figure so it doesn't matter that my version takes slightly longer.

The results are the fastest recorded Forth benchmarks, particularly the arithmetic program which this system runs four times faster than its nearest competitor. An additional test of my own, using double-number and mixed operators, ran almost as fast as the original arithmetic program. There's no doubt that if it's speed you're after then this is the package for you. (For 'mixed maths' benchmarks, see below.)

Mixed maths benchmarks

```
1
2: mixed-maths .TICKS 1000 1D0
3 900 900 M* 9 M/ 0 90000 D+
90000 D-
4 SP! LOOP .TICKS ;
```

More K's.



ATARI 800™ no price increase, upgraded from 16K to **48K RAM.**

Less £'s.



ATARI 400™ reduced from £199.99 (SRP inc. VAT) to **£159.99.**

It's hard to know which set of figures is more attractive. Certainly the ATARI 800™ Computer, upgraded by an astonishing 32K without any increase in price, will have its admirers.

However, £40 off the ATARI 400™ Computer makes it remarkable value for money, particularly when you take into account its 16K RAM (on some computers you'll be charged extra to upgrade to 16K).

It's even more remarkable when you look at our computers feature by feature.

The Family Computer.

Before we designed them, we thought about who was actually going to use them.

One day our computers might be playing games; next, they're wrestling with household budgets; teaching geography to an 8-year-old; or printing letters.

In other words, we designed our computers and software for as many applications as a family has ideas. (Now the ATARI 800 Computer has 48K RAM, there's even more memory for even more applications.)

Next we built in high-resolution graphics. Inside our computers, we have a microprocessor whose only job is to operate our graphics.

(All told, you can choose up to 16 different colours in 16 intensities, which gives you a spectrum of 256 different shades.)

In fact, our computers divide the screen up into 60,000 tiny points, each one of which can be changed without affecting the other.

A friend not a fiend.

We also looked at ways to make computers rather friendlier.

On the ATARI 400 Computer, we've incorporated touch-sensitive keys with ridges, so fingers won't slip; on the ATARI 800 Computer, we have keys much as you'd find on a standard typewriter.

You can talk to your computer in a choice of languages (five for the Atari 400, nine for the Atari 800), including ATARI BASIC, using software which you load in on cartridge, cassette, or disk.

For our computers, we have one of the largest software libraries in the world: everything from speech synthesis to sophisticated data management.

No doubt you know all about our famous games such as PAC-MAN†, SPACE INVADERS‡ and STAR RAIDERS§,™ winner of the 1982 Game of the Year Award.

However, we also boast home and office application software as well



Atari 400 and 800 Home Computer Technical Specifications.

Colour Capabilities: Choose from 16 colours, and 16 intensities (up to a total of 256 shades).

Sound: Four independent sound synthesisers for musical tones and games sounds. Three and one half octaves. Variable volume and tone for each voice.

Display: Three text modes: 24 lines of 40 characters, double-width characters, or double-height, double-width characters. Nine graphic modes: from 40 columns by 24 rows up to 320 columns by 192 rows.

Memory: Includes a built-in 10K Read Only Memory (ROM) Operating System with 48K Random Access Memory (ATARI 800) and 16K Random Access Memory (ATARI 400).

C.P.U.: 6502B Microprocessor 0.56 micro-second cycle. 1.8Mhz.

Special Features: Three customised integrated circuits.

Extended Graphics Functions: High-resolution graphics. Multi-coloured character set. Software screen switching. Mixed text and graphics modes.

Multiple re-defined character sets. Player missile (sprite) graphics. Fine screen scrolling in any direction. Changeable colour registers. Smooth character movement.

Peripherals: A range of peripherals and accessories that are available now.

as educational programs to satisfy the most enquiring mind.

You can learn French, Spanish, German or Italian on our computers and through our unique 'sound through' system you'll hear the language and learn it the way you learnt your mother tongue. (Other computers will leave you speechless.)

You can teach yourself touch typing, compose and play your own music or teach a child the alphabet.

On another program you can find out if your current mortgage is giving you the best value for money; while yet another program will answer a question that has vexed mankind for generations: "Where does all my money go?"

At the same time, the outstanding VisiCalc program is available for the ATARI 800 Computer.

Write your own programs.

As if all that isn't enough, through Atari's Program Exchange (APX), you can have access to a wide range of the most imaginative programs written by our users.

Or you can learn to write your own programs with the help of our 'Invitation to Programming'™ series, using our unique 'sound through' system.

Surprisingly, you won't have to plough through a small library of manuals to do so, since most of the series is on software, not in hard books. Of course, we've always had just about everything you're looking for in computers.

From today, we've got even more.

More of what home computers are for.

IBM COMES FORTH

Documentation

Very sensibly Forth Inc has used the superb *Starting Forth* as one of the manuals for its PolyForth. This book has become the Forth programmer's bible, providing the beginner with a detailed overview of the language and many useful examples. The other manual supplied with the package, held in a solid foam-backed binder, contains general details of specific features, though really to understand how everything works you'll need to read the shadow documentation as well. Everything is covered and the manual includes an excellent index and glossary, as well as full source and shadow listings.

Expandability

Level 2 PolyForth is at the bottom end

of a range of three products. Level 3, which costs £490, includes a database system and support for multi-terminal tasking and networking. It also includes a much more detailed manual. The most expensive system, Level 4, adds a target compiler and carries full source listings of all words. It costs £2750, but this buys you certain rights of reproduction as well. Unfortunately, you get no discount on Level 3 if you've already got a Level 2, though full discount is offered when upgrading from Level 3 to Level 4. It is, however, possible to write most of the features included in Level 3 with the facilities available in Level 2.

Conclusion

As you may have guessed, I was extremely impressed with this package. Forth remains (in this country at least) relatively unexploited as a serious software development tool, partly because

many of the compilers available are simply not suitable for this purpose. Level 2 PolyForth is a quality product aimed at the professional or semi-professional programmer (at a price that should present no problem to anyone who can afford an IBM PC!). How successful it is in competing with the mainstream languages and operating systems will depend to some extent on the marketing, an area about which Comsol is still hazy, though it has been submitted to IBM for approval. I do know that the company plans to go all out in the autumn, and is looking for big sales to make the venture worthwhile.

Enquiries should be directed to: Computer Solutions Ltd, Treway House, Hanworth Lane, Chertsey, Surrey KT16 9LA. Tel: Chertsey (09328) 65292.

END

TOP SECRET

continued from page 191

the exponents E and D selected. Primes are found using the so-called probabilistic prime test, which can find a suitable pair in the region of 2^{120} in an hour or two. Exponents E and D are then selected according to the procedure outlined above. Fig 2 gives details of one cipher, RSACOD2. The ciphertext is in alphahex code, where the letters A-P represent the numbers 0-15; two letters of ciphertext corresponding to one ASCII symbol of plaintext. Thus a 30-byte block of plaintext enciphers as 12 five-letter alphahex groups. The plaintext may include carriage-returns and other control characters.

Security aspects

To break an RSA code, it is necessary to find the factors of the public-key modulus, N. When the factors are known, the Euler totient function $\phi(N)$ can be calculated, and the decryption exponent D. Finding the factors of very large numbers is extremely time-consuming if there are only two large factors. By comparison, finding large primes is very easy. Thus the present system can find primes in the region of 10^{34} in an hour or so, yet it took over 48 hours to find the factors of a number in the region of 10^{21} using the efficient Monte Carlo method.

As the numbers get larger, the difficulty of finding factors increases as the 0.25th power of the number, but the difficulty of finding primes only as much as the cube of the log of the number.

So, the longer the numbers, the greater becomes the difference in computing power needed between creating a code and breaking it. Hellman has estimated that with N in the region of 200 decimal digits, the best computers in the world would take over a billion years to break it. The present Z80-based system could easily be adapted to accommodate numbers that length, at a cost of a 30-fold increase in encryption and decryption times.

There is also the brute-force approach to breaking the code, which consists of trying every possible plaintext input and seeing which one gives the known ciphertext output. Even with the present system, trying 10^{12} plaintexts per second would take about 10^{52} years to work through all possible combinations. Despite intensive world-wide efforts, no easy way of cracking RSA ciphers has been found, and it seems unlikely that one will ever be found.

There has recently been controversy as to how unbreakable this code really is. PCW would be interested to hear actual experiences of breaking it.

Applications

Up until the present, the use of ciphers has been confined to military and

diplomatic circles but, as Hellman points out, the proliferation of electronic communications has led to more and more confidential information being transmitted over insecure channels. It is easier to tap into a telephone line than to open a sealed letter without detection. Due to this, it is likely that more and more private individuals and organisations will resort to the use of ciphers, and if this happens then RSA ciphers and microcomputers will be sure to play a large part.

Acknowledgement

I am greatly indebted to Robert Macmillan of the University Mathematical Laboratory, Cambridge for helpful advice and for having sent me a draft copy of his dissertation.

References

- Hawker, Pat. Electronic Cryptography. *Wireless World*, Sept 1980.
- Hellman, Martin E. Mathematics of public-key cryptography. *Scientific American*, Aug 1979.
- Macmillan, Robert J. The implementation of a program which factorises large integers on the IBM 370/165. Cambridge University dissertation (in preparation).

END

PCW SUBSET

continued from page 189

Andrew suggests that the routine CASTXT might be improved by replacing the POP DE immediately prior to DONE with a POP BC. This gets rid of the old value of DE

(the first byte of the test string) and DE then passes the address of the byte following the string where there may be parameters for use by the associated action.

END

| | | | | |
|--------|------|---------|------------------------------------|-------|
| | LD | B,A | ;else move length to B and pointer | 47 |
| | INC | HL | ;to 1st byte of key string | 23 |
| | PUSH | DE | ;save test string pointer | D5 |
| CPSTR: | LD | A,(DE) | ;compare test byte against | 1A |
| | CP | (HL) | ;key string byte | BE |
| | JR | NZ,NEXT | ;go next key if no match | 20 09 |
| | INC | DE | ;else increment both pointers | 13 |
| | INC | HL | ;to next bytes and repeat until | 23 |
| | DJNZ | CPSTR | ;end of string or no match | 10 F8 |
| | POP | DE | ;matched, so restore pointer | D1 |
| DONE: | POP | HL | ;HL = required routine address | E1 |
| | POP | AF | ;restore registers | F1 |
| | POP | BC | ;putting address of required | C1 |
| | EX | (SP),HL | ;action on stack | E3 |
| | RET | | ;and "return" to it | C9 |
| NEXT: | LD | C,B | ;BC = string bytes left | 48 |

Ordered yesterday...

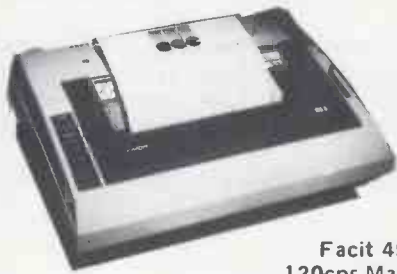

Facit 4510
120cps Matrix
*Buy from £433
Rent from £28 per month.

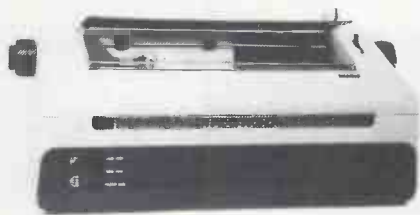

Facit 4560 22cps Daisywheel Printer
*Buy from £740
Rent from £43 per month.

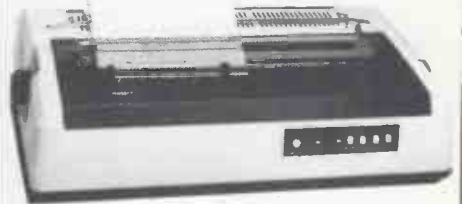

Facit 4565 40cps Daisywheel Printer
Qume compatible
*Buy from £1095
Rent from £65 per month.



Qume 11 Plus —
40 & 55cps Daisywheel Printer
*Buy from £1275
Rent from £76 per month.



NDR Series 8820 150-240cps Matrix
*Buy from £795
Rent from £55 per month.



Print Swiss Matrix 110cps KSR
and RO 24hr. duty cycle
*Buy from £1184
from £91 per month.
Also available for
Burroughs and
Univac Systems.

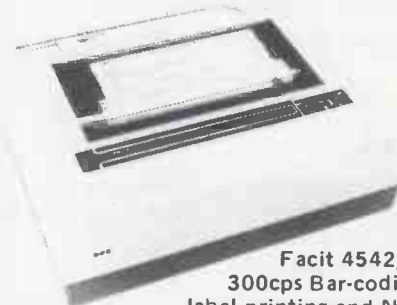

Facit 4542/44
300cps Bar-coding,
label printing and NLQ
24 hour duty cycle
*Buy from £1948
Rent from £111 per month.

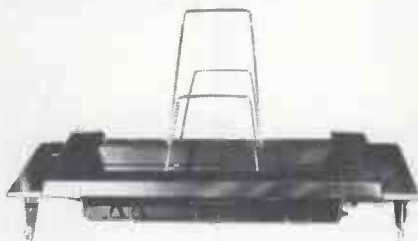

Rutishauser Cut Sheet Feeders
*Buy from £457
Rent from £29 per month.



Qume VDU Model
QVT 100 series
Various emulations
available
*Buy from £569
Rent from £33
per month.



Facit 4420-31 VT52
and VT100+
*Buy from £800
Rent from £46

Rent or buy at really competitive prices from

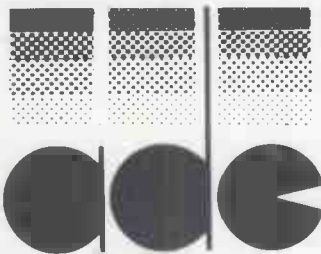

*Prices quoted do not include VAT or delivery and are subject to variation depending on currency exchange rates.



Anderson Jacobson
Model A-J 211
*Buy from £270
Rent from £15
per month.

delivered today!

Access Data Communications Ltd.,
Unit 17, Eskdale Road, Uxbridge Industrial Estate,
Uxbridge, Middlesex UB8 2RT. Tel: (0895) 59781 (10 lines). Telex: 267336.

512 x 512 GRAPHICS

Digisolve offer you a way to increase your graphics speed and resolution. Using a high speed graphics processor, our cards draw lines and characters FAST. The graphics processor works in parallel to the host machine, and gives you the power of using a co processor specifically designed for graphics. With drawing rates of up to 1,500,000 pixels per second, lines appear instantly to speed up your plotting.

With the resolution, we offer new possibilities for software and systems. No longer is it necessary to consider one of the new 16 bit personal computers because of their better graphics. Digisolve offer a card designed for the Apple II to give 512 x 512 monochrome graphics. With the development of an 80 x 57 line Visicalc and Applewriter pre-boot, serious business users are no longer finding 80 column cards good enough. We also offer a colour unit designed to connect to any computer to give the same resolution but with 64 colours.

Digisolve are committed to the development of graphic systems and character display equipment and have a rapidly growing software base to help you use better graphics.

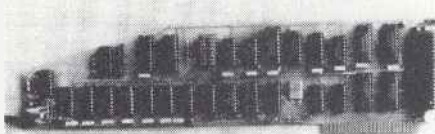

APPLE II CARD

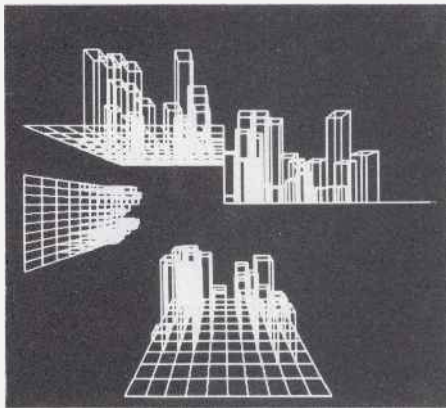

APPLE II

Digisolve's Apple II High Resolution Vector Graphic Processor Card quadruples the screen resolution and saves using up your Apple's memory space. The enhanced Applesoft support disc supplied with our card provides the powerful graphics functions and simplifies the conversion of existing software.

- * Draws vectors at up to 1,500,000 pixels per second
- * 512 x 512 pixels resolution
- * Graphics and characters mixed, allows proportional spacing and up to 85 characters by 57 lines of text
- * 64K bytes of on board memory will store two pictures for animation or have one text and one graphics page
- * 4 different line types for clarity
- * Blocks of variable sizes may be drawn to speed up area filling
- * Read modify write mode for drawing cursors
- * Screen read mode for dumping drawings to a printer
- * £399 + VAT + P&P

SOFTWARE: Visicalc and Applewriter pre-boot. Architectural Design & Modelling. Kitchen Design. Draughting. Report Presentation.

Turtle Graphics, TASC & Apple Soft software support.

VGP 64

Digisolve offer you high resolution colour graphics too. Designed to plug into any computer with a bus host adapter. The VGP 64 gives you 512 x 512 pixels in 64 colours. With its own vector processor and 384 K bytes of memory your computer can become a sophisticated graphics system.

- * 64 colours that may be expanded with a palette or extension video RAM card
- * 512 x 512 pixels resolution with fast vector processor
- * 384 K bytes of video RAM on board
- * 2 pictures may be stored simultaneously in full colour for animation
- * In monochrome 12 pictures may be stored and selected for display under software control individually or for animation
- * Available as a boxed unit complete with power supply, or in board form to OEM customers
- * Will plug into Apple, Commodore, IBM, Sage, S100 systems, PDP11 or any computer with a bus
- * Available in several versions: 8 colour £799 64 colour £899

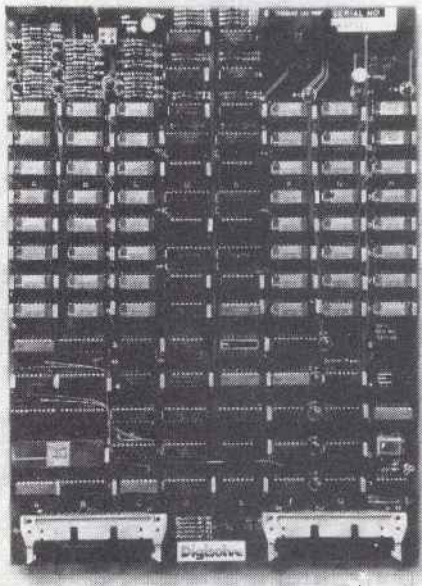

VGP64

Digisolve

AIRE & CALDER WORKS
CINDER LANE, CASTLEFORD
WEST YORKSHIRE
TELEPHONE: (0977) 513141 or 513382
TELEX: 557661 AGRAM
A MEMBER OF THE LAMBSON GROUP

VDU BOARD

COMING Digisolve offer you the cheapest way to make a scrolling VDU with our intelligent 80 x 24 VDU card. With over 50 control functions the card works at up to 19.2 K baud.

- * 80 Characters x 24 lines of text
- * Characters are properly formed with descenders
- * Block graphics option
- * Fully scrolling at 19.2 K baud
- * Keyboard and RS232 data input

COMING SOON: Terminal emulations including TEK 4010 in monochrome and colour. Character displays 80 x 24 and A4 size

★ SEE YOU
AT
APPLE '83

APPLE II is the Trade Mark of Apple Computers Inc.

A PSYCHOLOGICAL APPROACH?

Paul Overaa introduces a four-part series on programming with an analysis of the more modern ideas and approaches in problem-solving.

There are so many methodologies scattered around under the terms 'structured approaches to problem solving' or 'structured programming techniques' that we are all apt to look upon new ideas and thoughts on how we should program with a certain amount of contempt. Frequently such contempt is justified because writers often rehash the work of others using a different terminology, or an alternative name simply for the sake of doing so. When I first thought of preparing this series I was motivated primarily by the desire to collect together some of the more important ideas that have appeared over the last few years. It is my opinion that there is not enough emphasis placed on how these newer techniques are evolving to form a consistent framework within which many of the older concepts are finding new life.

There is always a tendency for ideas, once useful, to be pushed both theoretically and practically to their limit. This is a good thing at times but I suspect that very often the initial simplicity of an idea becomes 'clouded'. People unfamiliar with the original thoughts have difficulty working out the basic concepts. In programming, and computing in general, this constitutes a major obstacle. So it is appropriate to take stock of the various developments in a way that can provide a general picture.

We can start by examining some very general points that are closely related to the field of computer programming. They are concerned with how we think and solve problems. More importantly they give some clues about how we react or behave when we encounter difficulties.

Solving problems

Motivation is one key to accomplishment. Another way to learn about any new subject is to 'break it up into manageable pieces'. Each piece is then far less formidable and consequently far easier to get to grips with.

Inherent in this idea is the implication that an ordered or 'structured' approach exists that enables our understanding of the lesser problems to be integrated into our understanding of the original, more complex, ideas and problems.

The microcomputer has brought us sophisticated computing power. No longer are computers the 'gods in the sky' to be admired with awe. The computer is now a readily available tool that can be used by all of us irrespective of our professions. It can save us time, increase our productivity or

allow us to indulge our own creativity 'just for the fun of it'.

So you have a computer, or access to one; you have instruction manuals and books that explain how you physically program your computer; you start learning by 'hands on' experience — writing programs and experimenting with problems and uses that interest you. Gradually you come to terms with the vocabulary of the subject and you become aware of what a powerful tool you are working with. Such awareness serves to increase your desire to learn, to increase your motivation to master a seemingly complex subject.

As you start to tackle larger problems you will have become aware that difficulties arise. These difficulties are solved with much effort and diligence (yes, it is quiet in the early hours of the morning). As frequently as not you find yourself looking over large amounts of coding in an attempt to locate a 'bug' that is preventing your program from working. If you are examining a program that you wrote some time ago, the problem is even more exasperating — especially if you did not document it properly. In more unfortunate cases you get involved with trying to understand programs that have been written by other peo-

'People unfamiliar with the original thoughts have difficulty working out the basic concepts.'

ple. I'm sure that many of you will have come to the conclusion either that every programmer is a latent masochist or that there must a better approach to use.

Emphasis on 'structured programming' is an important step in the right direction but it is not in itself the complete solution. This is owing to a serious fundamental error continually made by both professional and amateur programmers alike. The difficulties in programming a computer to solve a particular problem consist of two very distinctly different parts.

Failure to appreciate the difference between the inherent logical basis of the problem, and the completely separate problem of how to code it, is one of the major causes of bad programming. It is one of the reasons why so many people run into problems as they start to tackle larger projects.

The point made in the previous paragraph has a clear corollary:

Any envisaged use of computers to solve a problem requires that you find a logically correct solution before you make any attempt to involve yourself with the problems of actually coding your computer solution, that is, you should not try to solve the quite separate difficulties together.

It has consistently been found easier to tackle each part in turn. The isolation of a logical program design produces a logical solution that is portable. It is independent from the computer hardware and software on which it will be implemented.

My concern then is about the techniques of solving problems and designing the logical solutions needed to produce efficient and well structured programs in any language you care to name. If you are a newcomer to microcomputing, then take heart. Although some of the ideas may take a certain amount of time to digest, they are fundamentally simple. Be patient and think about the concepts. Apply them to problems of your own choosing and you will achieve a real and useful understanding.

Iconic modelling

The way in which we approach a problem plays an important role in determining how successful or not our solution will be. In the last twenty years much work has been done by psychologists to try and discover the basic mechanisms we use when we solve a problem. In general, what mechanisms do we use to come to terms with our intellectual and physical environment?

Jerome Bruner has attempted to describe and characterise the ways in which young children react when confronted with a problem. He was able to identify three broad stages in the problem-solving experience. The words used by Bruner — *enactive*, *iconic* and *symbolic* — can be thought of as keywords for a basic problem-solving framework. This framework is applicable to adult as well as children's patterns of thought.

Enactive: relates to the use of physical models and the ability and confidence to manipulate them. One of the characteristics of this enactive level is an inability to describe the situation — that is, the inability to communicate effectively without resorting to actual demonstration.

Iconic: the second recognisable stage is the use of diagrams or pictures to represent the 'enactive elements' of the problem. This has been called the iconic stage and is sometimes seen as the initial stage of abstraction, that is, separating the physical or real problem into a 'modelling situation'.

SUBSCRIBE TO PERSONAL COMPUTER WORLD



**AND
SAVE £2
ON THE PRICE
OF A BINDER**

Let's face it, what can £12.50 a year buy you these days? Three or four visits to the cinema, a modest meal for two including a carafe of 'house' wine, two and a half albums from Virgin Records, a single ticket to the opera. Not a very impressive list is it?

On the other hand, £12.50 could guarantee that you will receive twelve issues of Britain's largest selling microcomputing magazine. If you are already a subscriber then send your £12.50 anyway, and we'll add another dozen issues to those you still have due on your current subscription.

As an added bonus to every person subscribing to *PCW* this month (whether a new subscription, a

renewal or an extension to your existing subscription), we will send you a voucher worth £2 off the cost of a *PCW* binder.

To qualify for this voucher you must use the subscription card stuffed inside this issue. Send it today. It's true you can't eat it, watch it in the dark, drink it or smoke it, but we reckon if you're interested in microcomputing in any shape or form, £12.50 for 12 issues of *PCW* delivered to your office or home is excellent value.

Lastly, 'thank you' to all our existing subscribers and regular readers. The most recent figures from the Audit Bureau of Circulation shows that *PCW* is currently outselling its nearest rival by more than 12,000 copies. So we must be doing something right — but feel free to let us know if you think otherwise.

| | | |
|------------------------------------|--------|---|
| 1 Year Subscription (U.K. only) | £12.50 | We send you 12 issues of <i>PCW</i> hot off the press direct to your door. |
| 2 Year Subscription (U.K. only) | £21.50 | You receive 24 issues saving yourself £3.50 off the full current subscription price. Plus you protect yourself against future increases in cover prices and postal rates which will save you £££'s over the period. |
| 3 Year Subscription (U.K. only) | £32.50 | You receive 36 issues saving yourself £5.00 off the full current subscription price. Plus you protect yourself against future increases in cover prices which will save you £££'s over the period. |

PLUS

We have now arranged for special 'first-off-the-press' copies to be mailed direct to subscribers which will ensure that they arrive either on the same day or one or two days in advance of national distribution in the U.K.

PLUS

Existing subscribers can take advantage of any of the offers above. Just tick the 'this is an extension subscription' box on the coupon and enclose your payment. The additional copies will be added to your existing subscription automatically. You do not have to wait until it is time to renew (by which time this offer will probably have been withdrawn). Save money by extending your subscription today!

PLUS

We have completely reorganised our Subscription Department and any problems, change of address, special requests etc etc will be promptly dealt with by an extremely 'user-friendly' human being should you need to write to us.

PLUS

We send subscription copies of *PCW* in a tough polythene wrapper. It will reach you promptly every month, unfolded and in good condition.

PLUS

You can pay for your subscription to *PCW* by cheque, postal order or by using Barclaycard (Visa)/American Express or Access. And you don't even need a stamp for your envelope. Use the coupon on the right.

**Why do more people read *PCW* than
any other microcomputer magazine in Europe?
Subscribe today!**

A PSYCHOLOGICAL APPROACH?

It is to be hoped that such a model will embody all the enactive elements of the problem in a form that is easier to translate into totally abstract form.

Symbolic: the use of signs and symbols, previously defined to produce an abstract version of the problem. This characterises the symbolic level of confidence in problem solving.

Mathematics is typical of symbolic abstraction, and it is commonly recognised that difficulties associated with learning and understanding mathematics frequently stem from a lack of confidence in symbol manipulation.

In children these stages can be identified by the way that simple problems are tackled. Of equal importance is how the approach changes as a child gets older:- Given a dozen bricks a very young child, if asked how many he would get if he had to share his bricks with two other children, will resort to physically sharing the bricks. At a later stage he might solve such a problem by drawing three boxes and placing dots in them to represent bricks. He will be able to deduce from his iconic model that each child will receive four bricks. Later still, developing his confidence at the symbolic level will enable him to write $12 \div 3 = 4$ without hesitation.

'The way in which we approach a problem plays an important role in determining how successful or not our solution will be.'

In many situations these three levels of confidence occur simultaneously; they should not therefore be thought of as being physically distinct. The distinction to make is that the stages are conceptually different. We will often be able to look at particular lines of reasoning and identify areas that are causing problems as being symbolic as opposed to iconic or enactive.

This framework is equally recognisable in adult thinking, and the various levels of confidence can often be identified. An important point is that, when we have difficulties in tackling a problem, we frequently fall back to a lower level of problem representation in an attempt to achieve a better understanding.

Think how many times you have been presented with a mathematical problem to solve in which you plunged straight in with some symbolic argument only to find you got 'stuck' and rapidly resorted to a graph or diagram, that is, an iconic model, in order to get a better understanding of the problem itself.

These ideas produce some interesting generalities which have implications of particular benefit to us in our quest for better methods of designing and writing computer programs. It would appear, for instance, that most of us benefit by having an iconic

model to fall back on while we are coming to grips with difficult or unusual problems. Some people are able to work at a symbolic level almost immediately. Such confidence is rare and those who can do this often have great difficulty in explaining to others how they arrived at a particular approach or why it was obvious to them but not to others.

So, there are two key points. Firstly, when you solve programming problems you are frequently solving other people's problems. You may very often need to explain your solutions and your lines of reasoning to others. There is a need to ensure proper communication of your ideas (often to non-technical people). Secondly, the problems you examine will often be ill or imprecisely defined. Frequently, restrictions will be

the logical from the practical difficulties. In addition to this the diagrams provide an iconic level with which to examine a problem. In an earlier article (*PCW* January 1983) you will have seen that it is easy to cope with changes even when you are in the middle of a solution. The very nature of the technique enables us to split a problem 'as we go' into easily handled sections while maintaining a coherence between these sections.

Next month I shall discuss the implications of regarding programming as a means of operating on 'sets' of data. This, and the concept of 'Normalisation' of a data set, provides a useful approach that enables us to avoid some of the pitfalls that have been found to cause many problems in real life applications.

The following references will be of use for people who would like to examine some of the published works related to the work of Jean Dominique Warnier:

Logical Construction of Systems by Jean Dominique Warnier. Pub. Van Nostrand Reinhold Company. ISBN 0-442-22556-3.

Logical Construction of Programs by Jean Dominique Warnier. 3rd edition trans. B M Flanagan. Pub. Van Nostrand Reinhold Company.

Practical LCP by Albert C Gardner. Pub. McGraw Hill Book Co (UK) Ltd. ISBN 0-07-084561-1. This is useful but Gardner's description tends to deviate from Warnier's in what appears to be an unnecessary way. The diagrammatic notation is not as clear as the original Warnier method. This disturbs the clarity of an otherwise good interpretation.

Structured Systems Development by Keneth T Orr. Pub. Youden Press New York. ISBN 0917072-06-5. A good non-theoretical introduction. Ken Orr's works are always very readable and he knows a lot about the practical uses of Warnier's work.

Structured Requirements Definition by Keneth T Orr. Pub. Ken Orr & Associates Inc, Topeka, Kansas. Again this is useful as an introduction. It contains many of the fundamental definitions that one comes across with the newer approaches to programming.

Personal Computer Word

* October 1981 issue contains a short introduction describing in simple terms some of the main advantages and some fundamental conventions that are used.

* April 1982 issue contains a Microsoft Basic implementation of a screen-form program. The use of the Warnier approach for program design is illustrated. This program was actually written as a 'halfway stage' before a full 8085 assembler version was prepared.

* January 1983 issue contains an 8085 assembly language program called DUMP. The complete design and implementation technique is given.

Byte Magazine. Various authors.

added to the problem while you are in the middle of finding a solution ie, the problem will change. During this time you will regularly come across quite severe difficulties. If you are working at a purely symbolic level you may conclude that some particular difficulty is insurmountable. Providing you have an 'iconic model' to fall back on you are more likely to come to terms with the new restraints.

The way, or ways, in which we describe a problem becomes important as we attempt to conceptualise and solve problems. It is also important because of the ease or difficulty with which we can convey our ideas and thoughts to others.

One of the techniques that capitalises on the above ideas is the 'Warnier diagram'. The power of using such diagrams to design programs is due in part to the separation of



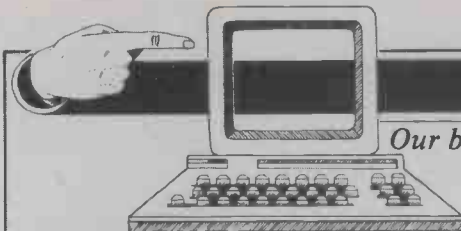

IN STORE

Our bi-monthly guide to microcomputing systems. Updates should be sent to:
Dick Olney, PCW, 62 Oxford Street, London W1A 2HG.

| Machine (Price from) | Main Distributor/s (No. of Dealers) | Hardware | Software | Miscellaneous (Documentation) |
|----------------------------------|--|---|--|---|
| ABC 26 (£4500) | AI 09237-70578(19) | 64k RAM: Z80A: dual 8" F/D (2.3Mb): 12", 24 x 80 VDU: 2 x RS232 ports: 3 x P/P | CP/M: <i>MP/M Basic:</i> <i>Cobol: Fortran: Pascal.</i> | Options: 10Mb H/D £4000. BT 4/81 (S). |
| ABC 80 (£738) | Datormark Ltd: 97 44896 | 16-40k RAM: Z80A: C: 12", 16 x 40 b&w VDU: 4680 bus: IEE 488: RS232 port. | DOS Basic (16k ROM): <i>Fortran: Pascal: A:</i> <i>Multi user Basic.</i> | Colour video graphics with UHF output. Viewdata compatible. Loudspeaker. Numeric keypad. Options: dual 5 1/4" F/D (320k) £895: dual 8" F/D (2 Mb). BT 1/80. (I) |
| Acclaim (£3650) | Country Computers 0527 29826 | 64k RAM: Z80: 24x80 VDU: single 5 1/4" F/D (140k): 5 MB H/D: RS232 port. Option: P/P | CP/M: <i>Basic: Cobol:</i> <i>Fortran: Pascal</i> | Various integral H/D options up to 21MB (£4450) |
| ACT Sirius I (£2395) | ACT 021 501 2284 (50) | 128-512k RAM: 8088: dual 5 1/4" F/D (1.2M): 12", 25 x 80 VDU: 2 x RS232 ports: 2 x P/P | CP/M 86: U: <i>Basic 86</i> <i>Cobol: Fortran: Pascal</i> | High res graphics. Options: 10 Mb H/D: dual 5 1/4" F/D (2.4 M) BT 2/82.(S) |
| Adler Alphatronic (£1895) | Adler 01-250 1717 | 48-64k RAM: 8085A: dual 5 1/4" F/D (1Mb): 12", 24 x 80 VDU: S/P: P/P | CP/M: <i>Basic: CBasic:</i> <i>Fortran: Cobol</i> | With 80 cps printer and dual F/D £2345 (inc CP/M). (S) |
| Altos ACS 800-2 (£2995) | logitek: 0257 426644 (33) | 64k RAM: Z80A: dual 8" F/D (1 Mb): 2 x RS232 ports: 2 P/P. | CP/M: <i>Basic: CBasic:</i> <i>Cobol.</i> | Single user. Options: DMA. Floating point processor. Phototyping board. |
| Altos ACS 800-10 (£6675) | As above. | 280k RAM: Z80A: single 8" F/D (500k): 10 Mb H/D: 6 x RS232 ports: P/P: network RS422 port: DMA | CP/M: <i>MP/M: Basi:</i> <i>Cobol: Fortran: APL:</i> <i>Pascal.</i> | Multi-user/multi tasking. Up to 4 users. Options: 10 Mb: mag tape backup (S + H). |
| APL Signet (£1750 or £130pm) | Micro APL: 01-834 2687 | 64k RAM: Z80A: dual 5 1/4" F/D (380k): 2 x RS232 ports. | CP/M: <i>APL: Basic: U:</i> <i>Fortran: Cobol: Algol:</i> <i>Forth</i> | Desktop APL computer with self teaching course. (S) |
| Apple II (£695) | Apple (UK) 0442 60244 (200 +) | 16-48k, RAM: 6502: 8 I/O slots. | OS: <i>Basic: Pascal:</i> <i>Fortran: Cobol: Pilot</i> | 280 x 192 high resolution graphics: Option: single 5 1/4" F/D (116k) £349. |
| Apple III (£2496) | As above | 128-256k RAM: 6502B: dual 5 1/4" F/D (286k): 12", 24x80 VDU: RS232 port: P/P. | SOS: <i>Basic: Pascal:</i> | Options: single 5 1/4" F/D (143k) £384: 5Mb H/D £2256. (E) BT 5/82 |
| Atari 400 (£200 inc VAT) | Atari UK: Slough 33344 | 16k RAM: 6502: C int: cartridge slot: 24 x 40 TV int: touchpad k/b: Opt: C £50 | OS (10k ROM): <i>Basic (8k ROM).</i> <i>Pilot: A:</i> | High resolution colour graphics. 4-channel sound. Four games controller/light pen sockets. BT 10/80. (I/B). |
| Atari 800 (£500 inc VAT) | As above. | 16-48k RAM: 6502: C int: 2 x cartridge slots: 24 x 40 TV int: Opt: single 5 1/4" F/D (90k) £300: 16k RAM £65. | OS(10k ROM) Basic (8k ROM): <i>Pilot</i> <i>A: Forth: MBasic</i> (I/B). | As above. Software & RAM on cartridge modules. Up to 4 disk drives RS232C int £135. BT 10/80. |
| Atom (£120) | Acorn: 0223 245200 (160) | 2-12k RAM: 8-16k ROM 6502: Full K/B: C int: TV int: 20 I/O lines: 1 P/P. Options: 80 col printer £199, Prestel adaptor £120. | Basic in 8k ROM: A Cass O/S: <i>Lisp:</i> <i>Forth</i> | High resolution graphics on bigger model: Single 5 1/4" F/D £297 B/ 7/80 (B) |
| BASF 7120 (£4400) | BASF: 01-388 4200 (12) | 88k RAM: 2xZ80A: 3 x 5 1/4" F/D (480k): 12", 24 x 80 VDU: RS232 port: P/P | DOS: <i>(OASIS) Ex Basic:</i> <i>Cobol U. A: CP/M</i> | H/D available. Also 7125 with 960k F/D £4900 and 7130 with single F/D (430k) & 5Mb H/D £6300. Disk controller has own Z80A. BT 9/80 |
| BBC Micro (£299 inc VAT) | BBC Micro Systems 0933 79300 | 16-32k RAM: 32k ROM 6502: C int: TV int: RS423 port: P/P: Option: single 5 1/4" F/D (100k) £230 | MOS: <i>Basic A: Pascal</i> <i>Logo: Forth: Lisp</i> | Video text & second processor int. 32k model with Econet and disk interface £399. BT 1/82 (I) |
| Bonsai SM3000 (£1995) | Bonsai 01-580 0902 | 64k RAM: Z80: dual 5 1/4" F/D (700k): 12", 24x80 VDU: RS232 port: P/P | CP/M: <i>Basic: Cobol:</i> <i>Pascal: Fortran</i> | Many floppy and hard disk option Applications software avail. from Bonsai. |
| Computers Lynx (£225 inc VAT) | Computers Ltd 0223 315063 (TBA) | 48-192k RAM: Z80A: 24x40 TV int: C int: RS232 port | Basic | 248 x 256 colour graphics (8 colour). CP/M compatible 5 1/4" F/D & printer avail soon. (B) |
| Canon BX-3 (£3000) | Canon 01-680-7700. | 32k RAM: 6809: dual 5 1/4" F/D (640k): 28 char display: 80 cps printer: 3 x RS232 port: P/P. | OS: <i>Basic: A.</i> <i>Cobol: Pascal</i> | Fully integral unit. Extensive applications support offered on all Cannon Machines. Options: dual dual 5 1/4" F/D (640k) £1500. |
| Canon CX-1 (£2500) | As above. | 32k RAM: 6809: dual 5 1/4" F/D (640k): 12", 24 x 80 VDU: 3 x V24 ports: P/P: light pen. | OS: <i>Basic: A: Cobol:</i> <i>Pascal</i> | Price includes installation & training. Extensive application support offered. Options: dual 8" F/D (1Mb) £3300.(S) |
| Canon TX-25 (£1450) | As above. | 16-32k RAM: 6809: C: 20 char display: 26 col, 2.4 lps printer. Option: 2 x RS232 port. | Basic: A | Fully integral unit. Cassette is Cannon's own design (8k). Can be used with communications. (S). |
| Cleno Pronto (£2825) | Cleno Computing Systems Ltd: 01-670 4202 (TBA) | 64k RAM: Z80: dual 8" F/D (1 Mb): 3 S/P: 2 P/P. | CP/M: <i>CBasic-2:</i> <i>Pearl 1: U Fortran:</i> <i>Cobol: Pascal</i> | With 2.4Mb F/D £3105. Also H/D systems with 5-20 Mb H/D & tape drive £5430. |

List of Abbreviations

A Assembler
BT Bench Tested
C Cassette
E Extensive
F/D Floppy disk

G/C Graphics card
H Hardware
H/D Hard disk
I Introductory
Int Interface

M/A Macro assembler
N/A Not available
N/P Numeric pad
O/S Operating system
P/P Parallel port

S Software
S/P Serial port
T/E Text editor
TBA To be announced
U Utility

Please note: Software items listed in *italic* are not included in the basic price of the equipment. All prices are *exclusive* of VAT.

IN STORE

| Machine (Price from) | Main Distributor/s (No. of Dealers) | Hardware | Software | Miscellaneous (Documentation) |
|--|--|---|---|--|
| Cleno Table Top 525 (£1750) | As above | 64k RAM; Z80 dual 5 1/4" F/D; 2xS/P | CP/M; MBasic; W/P | Wordstar & Logicalc included in price. Many options |
| Colour Genie (£200 inc VAT) | Lowe Electronics 0629 2430 (100+) | 16-32k RAM; Z80; 16k ROM; C int: 24x40 TV int; Audio port; RS232 port; P/P | ExBasic | 160x96 colour graphics. 16k RAM £30. Many options inc joysticks and light pen. F/D avail soon. (B) |
| Columbia PC (£2800) | Icarus 01 485 5574 (50) | 128k RAM; 8088; dual 5 1/4" F/D (640k); 24x80 VDU; 2xRS232 ports; P/P; 8 expansion slots | MS-DOS; CP/M 86; Basic; Cobol; Fortran; Pascal | IBM PC compatible. With integral H/D (5 Mb) £4200 or (10 Mb) £4550 (S) |
| Comart Communicator (£1895) | Comart 0480 215005 (25) | 64k RAM; Z80A; dual 5 1/4" F/D (780k); 2 S/P; P/P. | CP/M; MP/M Basic; Cobol; Fortran; Pascal | With 1.5 Mb F/D £2195. With 4.8 Mb H/D & 790k F/D £2995. Option: 18 Mb H/D. £3895 Also CP100 range with 8086 & 128k-1Mb RAM from £2295. Expandable to multiuser/multitasking. (S). |
| Commodore PET 16k, & 32k (£550, £695) | Commodore: 0753 79292 (150) | 16-32k RAM; 6502; C: 12" 25x40 VDU; IEEE-488 port; Options: dual 5 1/4" F/D (343k) £695; same but (1018k) £895 | O/S: Basic (in 8k ROM); Forth; Pilot; Pascal; Comal; Lisp; A | CBM 8032 with 80-col screen (32-96k) BT 12/80. £895 Field service avail. (1). |
| Commodore Vic 20 (£200 inc VAT) | Commodore: 0753 79292 (150) | 5-32k RAM; 6502; Cint: 22 x 23 TV int; S/P; P/P; Games int. | Basic | Graphics 3 tone sound generator. Will interface to PET. Option: single 5 1/4" F/D (170k). BT 9/81(S). |
| Commodore 500 Series (From £659) | As above | 128-896k RAM; 6509; 25x40 TV int; P/P | O/S: Basic; CP/M; Pascal; Forth; Cobol; Fortran | High res. 16-colour graphics. Second processor option: Prestel facility avail. |
| Commodore 700 Series (From £995) | As above | 128-896k RAM; 6509; 24x80 VDU; Option: dual 5 1/4" F/D (1Mb); IEEE-488 port; RS232C port. | As above | 8088 or 280 second processor option Tilt and swivel screen. |
| Commodore 64 (£299) | As above | 64k RAM; 6509; 25x40 TV int; C int; RS232 port; P/P | Basic | Second processor option. 320x200 colour graphics. Option: Joystick; Light pen |
| Compucorp 625 (£6000) | Compucorp: 01-907 0198 (17) | 48-60k RAM; Z80; dual 5 1/4" F/D (630k); 9". 16x80 VDU; 40 col printer; RS232 port; P/P. | Basic; A; Fortran; Pascal; U | IEEE-488 Controller and S100 int. Many applications packages avail. (E). |
| Compucorp 655/665/675/685 (from £5050) | As above | 60k RAM; Z80; Up to 4x5 1/4" F/D (160k-2.4 Mb); 9", 20x80 or 12" 20x80 or 20" 60x80 VDU; 40-col printer; RS232 port. | As above | Prices incl installation and training. Opt: 10-20 Mb H/D |
| Cromemco System Zero/DDF, System 2, System 3, System Z2H. (£1975/£3095/£4495/£6585). | Datron: 0742 585490. Comart: 0480 215005 (25) MicroCentre: 031-556 7354 (18) | 64k RAM; Z80; dual 5 1/4" F/D (390k) on System Zero, System 2 & Z2H; dual 8" F/D (1.2 Mb) on Sys 3; 10 Mb H/D on Z2H; S/P; P/P. | CDOS; Basic; Cobol; Fortran; RPG II; Lisp; A; W/P; Multi-user Basic; Cromix; CP/M | System 2 & 3 expandable to Multi-user (max 7) Also 'D' series with 6800/ Z80A dual processor from £3620. Options: dual 8" F/D (996k); 11.2Mb H/D. BT 10/79 (E). |
| DAI (£595) | Data Applications (UK): 0285 2588 (7) | 48k RAM; 8080; C int; 24x60 VDU int; RS232 port; over 20 industrial fints. option: dual 5 1/4" F/D £595 | Basic (ROM); U | Colour graphics up to 255 x 335; 3 notes & noise generator; PAL O/P to TV; Paddle int; H maths option. (1). BT 10/80. |
| Diablo 3000 (£6250) | Business Computers Ltd: 01-207 3344 | 32k RAM; 8085; dual 8" F/D (1.3 Mb); 12", 24x80 b&w VDU; 45 cps printer. | DOS; Basic; DACL; A; U. | Selection of business packages included (S). |
| Digital Microsystems DMS-3 (£3530) | Digital Microsystems 0734 343885 (14) | 64k RAM; Z80A; dual 8" F/D (1.14Mb); 3xRS232 ports; 1xRS422 port; P/P. | CP/M; CBasic; Cobol; Fortran; Pascal; PL/I | Expandable to multi-user system with 10-28 Mb H/D. Extensive software avail. (S). |
| Digital Microsystems DMS-4 (£4395) | As above | 128-512k RAM; Z80A; single 8" F/D (500k); 11 Mb H/D; 4x RS232 ports; P/P. | CP/M; Basic-E; CBasic; Cobol; Fortran; Pascal. | Port expander to enable up to 10 workstations under M/PM. Options: 128k RAM £1295; up to 96Mb H/D. (H). |
| Dragon 32 (£200 inc VAT) | Dragon Data 0792 580651 (50+) | 32-64k RAM; 6809E; 16x32 TV int; C int; P/P | Basic | 9 colour 256x192 high resolution graphics. Option: Joysticks BT 8/82 |
| Durango F-85 (£4995) | Comp Ancillaries: 0784 36455 (12) | 64k RAM; 8085; dual 5 1/4" F/D (1 Mb); 9", 16x64 green VDU; 132 col 165 cps printer; N/P. | O/S; D Basic; CP/M; CBasic; Micro Cobol. | Up to 5 work stations; fully integrated system. Options: additional dual 5 1/4" F/D (1 Mb); 12-24 Mb H/D.(S). |
| Eagle II, III and IV (from £2350) | Mediatech Bus Syst 01 903 4372 | 64k RAM; Z80A; dual 5 1/4" F/D (768k and 1.5Mb) or single 5 1/4" F/D (784k) with 10Mb H/D; 2xRS232 ports; 2 x P/P | CP/M; CBasic; Cobol; Pascal; Fortran | Many different configurations available. Full range of applications software |
| Epson HX20 (£402) | Epson | 16-32k RAM; 32k ROM; Twin 6301 CPU; 20x4 LCD; RS232 port; Micro dot matrix printer | E Basic | Display gives 120 x 32 dot graphics. Options: TV int; micro-cassette drive; expansion module. BT 12/82 |
| Equinox 200 (£7500) | Equinox: 01-739 2387 (N/A) | 64-512k RAM; Z80; 10 Mb-1200 Mb H/D; 6xS/P; 1 P/P. | CP/M; CBasic; Cobol; Fortran. | Multi-user MVT/FAMOS available in place of CP/M. 16-bit version (Equinox 300) £10,000. (S&H). |
| Fortune 32:16 (£4375) | Fortune Systems 01 938 1721 | 256-512k RAM; MC 68000; dual 5 1/4" F/D (800k); 12", 25x80 VDU; S/P; P/P | FOS; CP/M; Basic; Pascal; Cobol; Fortran; C | Expandable to full multi-user system. High res colour graphics |
| Gecac 64/2 (£3305) | Gecac Micros 01 629 3758 | 64k RAM; Z80A; dual 8" F/D (2.4 Mb); S100 bus. | CP/M; Cobol; Basic Pascal Fortran | Up to 4.8 Mb F/D. Expandable to multi-user/multitasking system. |

List of Abbreviations

| | | | |
|-----------------|-------------------|----------------------|---------------------|
| A Assembler | G/C Graphics card | M/A Macro assembler | S Software |
| BT Bench Tested | H Hardware | N/A Not available | S/P Serial port |
| C Cassette | H/D Hard disk | N/P Numeric pad | T/E Text editor |
| E Extensive | I Introductory | O/S Operating system | TBA To be announced |
| F/D Floppy disk | Int Interface | P/P Parallel port | U Utility |

Please note: Software items listed in *italic* are not included in the basic price of the equipment. All prices are *exclusive* of VAT.

ARCADE COMPUTERS

2ND FLOOR, 37/38 THE SILVER ARCADE, LEICESTER

Opening times 9.30-5.30

Tel (0533) 532991



We stock

ORIC 48K

COLOUR GENIE also available – 16K Ram expansion, Printer Interface Joystic Controllers, Cassette player etc.

MONITORS 12" & 9" Green or Amber, Hi-resolution

PRINTERS Sekoisha Range, Microline Range

SOFTWARE BBC, Dragon, Vic20, ZX, Spectrum, Colour Genie, Oric.

BOOKS Selection of Various Books.

We also stock, Printer Ribbons, Computer Cassettes, Floppy Disks etc.

Mail order, Price lists and brochure available

We will also help you with sales service and advice

ANY ITEMS CONCERNING COMPUTERS, WE CAN HELP YOU WITH



EPSON
HX-20

Missing something?

If you have been looking for a compact Micro-computer designed with the business man in mind, then the EPSON HX-20 will meet your requirements.

For further information on this and other EPSON products including A.P. unique word processing and business software contact:
A.P.SYSTEMS LTD., 90-100 Brighton Road, Surbiton, Surrey, KT6 5PP. Tel: 01-399 1257

APS

EPSON QX-10

BUSINESS MICRO-COMPUTER

with

EPSON FX-80

FULL FEATURE PRINTER

plus

Free!

- memory upgrade to full 256K
- £100 software Voucher

for only **£2173** + VAT

SOFTWARE AVAILABLE NOW!

- * MULTIPLAN £179 * WORDSTAR £295 *
- * dBASE II £375 * dBASE ACCOUNTS £600 *
- * FULL PEACHTREE RANGE from £175 *

- Prices exclude VAT and carriage -

DATA BASE

147 All Saints Road Newmarket
Newmarket 667311

IN STORE

| Machine (Price from) | Main Distributor/s (No. of Dealers) | Hardware | Software | Miscellaneous (Documentation) |
|--------------------------------|---|---|---|--|
| Gemini Multiboard (£500) | Micro Value 02403 28321(7) | 64k RAM: Z80: 25 x 80 VDU int (with Z80): Option: dual 5 1/4" F/D £690. | CP/M: <i>Basic Cobol: Pascal Fortran AP/L:</i> | Modular system. Other options inc ROM board & EPROM programmer. BT 2/82 (H&S). |
| Gemini Galaxy 2 (£1495) | As above | 64k RAM: Z80A: dual 5 1/4" F/D (800k): 12", 25x80 VDU: RS232 port: P/P: C int | CPM: <i>Basic: Cobol: Fortran: Pascal: AP/L: A</i> | Options: dual 5 1/4" FD (800k): dual 8" F/D (2.4Mb) |
| Gimix System 68 (£2000) | SEED: 05433 78151: Windrush 0692 505189 | 16-64k RAM: 6800/6809: dual 5 1/4" F/D (500k): 2xRS232 ports. | OS-9: <i>Flex Basic: Pascal: A: Dis A: T/E: U</i> | With dual 8" F/D (2 Mb) £2900. Designed as development system for industrial control. (H). |
| Genie I (£299) | Lowe Electronics: 0629 2430 (N/A) | 16k RAM: Z80: 500bps C: 16 x 64 TV int: extra C int: 1 P/P | Basic (12k ROM): <i>Pascal: A M/A: Fortran</i> | Options: single 5 1/4" F/D (184k) £220; dual 5 1/4" F/D (368k) £375 (I) Also Genie II with numeric keypad and function keys but no cassette (same price as I). |
| Genie III (£1900) | As above (26) | 64k RAM: Z80A: dual 5 1/4" F/D (1.25 Mb): 24x80 VDU: RS232 port: P/P | NewDOS 80: <i>CP/MZ: Basic: Cobol: Fortran Pascal</i> | System complete with business applications software, maintenance contract and choice of printer £3250 (S). |
| Grundy 8200 (£1850) | M-Tech Comp Serv: 0603 870620 | 64-256k RAM: Z80A: dual 8" F/D (2MB): 24x80 VDU: RS232 port: P/P | CP/M: <i>Basic: Cobol: Fortran: Pascal: Forth: PL/I: Ada</i> | Various hard disk options up to 26MB |
| Haywood 9000 Composite (£1795) | Haywood: 01-428 0111. (TBA) | 64-192k RAM: Z80A: dual 5 1/4" F/D (640k): RS232 port: P/P: 15" 28x80 VDU. | CP/M: <i>Basic: Cobol: Fortran: Pascal: W/P.</i> | Graphics avail. Expandable to 18 Mb H/D. Networking version planned (H&S) |
| Haywood Hinet (£7500) | As above | 64k RAM: Z80A: dual 8" F/D (2Mb): 11Mb H/D: RS232 port: RS422 port: P/P: 24x80 VDU | CP/M: <i>HiNet: Basic: Cobol: Fortran: Pascal</i> | Local area network, up to 32 users. Range of H/D avail. Local disks & printers if required. Work station £2050 (H&S) |
| HP 75C (£728) | As above | 16-24k RAM: 48k ROM: CPU: 32 char display: mag card reader | Basic | 8k RAM £142. Video interface £221. Thermal printer £371. (E) BT 11/82 |
| HP 85 (£2013) | Hewlett Packard Ltd: 0734 784774 (16) | 16-32k RAM: C.P.U.: 5", 16x32 VDU: C(200k). 64 cps printer: 4 P/P. Options: dual 5 1/4" F/D (540k) £1610: fusi 8" F/D (2.4 Mb) £4108. | Basic (ROM) | Full dot matrix graphics. Complete range of interfaces, peripherals and application packages avail. 16k RAM £142. (S). |
| HP86 (£1314) | As above | 80k RAM: C.P.U.: 48k ROM. Options: 12", 24x80 VDU £238: 9", 16x80 VDU £216: 5 1/4" F/D (207k) £622 | ExBasic | Many expansion possibilities including CP/M module (£362), RS232 port (£289) and up to 576k user RAM. 400x240 graphics. BT 10/82 (E) |
| HP 125 (£2479) | As above | 64k RAM: 2xZ80A: 12", 24x80 VDU 2xRS232 ports: HP-1B port. Options: dual 5 1/4" F/D (500k) £1693 | CP/M: <i>Basic: Cobol: Fortran: Pascal</i> | Integral thermal printer £629. Also available with dual 8" F/D (2 Mb). (S). BT 3/82 |
| IMS 5000 (£1500) | Equinox: 01-739 2387 (20) | 16-56k RAM: Z80: dual 5 1/4" F/D (320k): 2xS/P: 1 P/P: | CP/M: <i>C/Basic: Cobol, Fortran.</i> | 3 drives option: (S&H). |
| IMS 8000 (£2500) | As above | 64-256k RAM: Z80: dual 8" F/D (1 Mb): 2xS/P: 1 P/P | CP/M: <i>CBasic: Cobol: Fortran: MicroCobol.</i> | Multi-user MVT/FAMOS available in place of CP/M. (S&H). |
| Jupiter Ace (£90 inc VAT) | Jupiter Contab, | 3k RAM: 8k ROM: Z80A; 24x32 TV int; C int: loudspeaker. | Forth | Has 140 Forth words defined in ROM. |
| Kemitron K2000 E (£2300) | Kemitron 0244 21817 (3) | 64k RAM: Z80A: single 5 1/4" F/D (150k): 12", 24x80 VDU: 2xS/P: P/P | CP/M: <i>Basic: Cobol: Fortran Pascal: A</i> | Extensive range of support cards and industrial interfaces. |
| Kemitron K3000 E (£3300) | As above | 64k RAM: Z80A: dual 8" F/D (2Mb): 2xS/P: P/P | CP/M: <i>MP/M: Basic: Cobol: Fortran: Pascal: A</i> | Up to four screens and four printers can be attached. Options: 10Mb H/D. |
| LSI M-Two (£6000) | LSI Computers 04862 23411 (20) | 64-128k RAM: 8085A: dual 8" F/D (1.2 Mb): 12", 24x80 VDU: 60 cps printer | Elsie: <i>CP/M: Basic: Cobol: Fortran: Pascal: A: U</i> | Max 8 VDUs and 4 printers. Many applications packages available. Option: 10 Mb H/D £2600. (S). |
| LSI M-Three (£1700) | As above | 64k RAM: Z80A: dual 5 1/4" F/D (350k): 12", 24x80 VDU: RS232 port: P/P | CP/M: <i>Basic: Cobol: Fortran: Pascal: A</i> | Option: Dual 8" F/D, 10 Mb H/D (E) |
| LSI M-four (£2175) | As above | 128-256k RAM: Z80B: 8088: dual 5 1/4" or 8" F/D 3xRS232 ports: RS422 port: P/P 12", 24x80 VDU | MS-DOS: <i>CP/M-86 Basic: Cobol: Fortran: Pascal: MP/M-86</i> | Operates on either 8-bit or 16-bit applications software. Option: 10 Mb H/D |
| Macro 1 (£3950 or £294 pm). | Micro APL Ltd. 01-834 2687 (TBA) | 64k RAM: Z80A: dual 8" F/D (1 Mb): 4xRS232 ports. | CP/M: <i>APL: U: Basic: Fortran: Cobol: Wordstar Algo: Pascal: Forth.</i> | Designed as timesharing replacement. Macro 2 with 2 Mb F/D £4750 or £334 pm. |
| Marinchip M9900 (£4990) | Microprocessor Eng. 0703 775482 | 128k RAM: 9900: dual 8" F/D (2Mb): 4xRS232 ports. | NOS: <i>Basic: Pascal: W/P: SPL: Forth: Meta</i> | Multi-user/multi-tasking OS. Options: H/D up to 120 Mb. |
| Micro Trainer 1 (£650) | Hewart: 0625 22030 (N/A) | 16-32k RAM: 6800/6809: 10" 16x24 VDU: 2xC int: Opt: dual 5 1/4" F/D (160k) £595: 8k RAM £17. | Basic: <i>Pascal: PL/M: W/P</i> | SS50-based system. Graphics avail. Int card with real time clock £17. (I). |
| Millbank Sys 10 (£2395) | Millbank: 01-891 4691(6). | 65k RAM: Z80: dual 5 1/4" F/D (700k): 12", 24x80 VDU: 2x RS232 ports: RS449 port: P/P. | CP/M: <i>Basic: Cobol: Fortran: Pascal: PLI: W/P.</i> | 12-month warranty. Main-frame comm. package. Maintenance contracts. Options: 1.6 Mb F/D. 5-50 Mb H/D. (S&H) |
| Munroe EC8800 (£2150) | Fi-Cord Int. 061 445 7716 | 128k RAM: Z80A: single 5 1/4" F/D (320k): 3xRS232 ports: P/P | Munroe Multitasking System: <i>CP/M: Basic: Cobol: Fortran: Pascal</i> | High res colour graphics. Option: single 5 + " F/D. (320k). £495 |

List of Abbreviations

| | | | |
|-----------------|-------------------|----------------------|---------------------|
| A Assembler | G/C Graphics card | M/A Macro assembler | S Software |
| BT Bench Tested | H Hardware | N/A Not available | S/P Serial port |
| C Cassette | H/D Hard disk | N/P Numeric pad | T/E Text editor |
| E Extensive | I Introductory | O/S Operating system | TBA To be announced |
| F/D Floppy disk | Int Interface | P/P Parallel port | U Utility |

Please note: Software items listed in *italic* are not included in the basic price of the equipment. All prices are *exclusive* of VAT.

MAKE YOUR SPECTRUM WORK FOR YOU!

Connect to professional printers with this Centronics interface.

£39.95
inc.VAT



ZX Lprint interface will enable your Spectrum computer (16 or 48K) to print on any dot matrix or daisywheel printer with 'Centronics' input (e.g. Seikosha, all Epsoms, Star, Shinwa, Oki Microline and many others). Just plug ZX Lprint in and LPRINT and LLIST commands will work. And because NO additional software is needed all of your RAM is free to take professional word processing programmes such as Tasword 2. High resolution screen dump can be done on many printers using optional 'COPY' software.

- WORD PROCESSING
- HIGH RESOLUTION GRAPHICS PRINTING
- SPREAD SHEET PRINTOUT
- ADDRESS LABELS AND ENVELOPES
- CORRESPONDENCE ● PROGRAM LISTINGS

EURO ELECTRONICS

26 Clarence Square, Cheltenham, Glos, GL50 2JP

ORDER: To EURO ELECTRONICS, 26 Clarence Square, Cheltenham, Glos. GL50 2JP Tel: (0242) 582009

From: Name: _____

Address: _____

This order is for: _____ (Quantity)

ZX LPRINT interface at £39.95 _____

Interconnecting Cable at £11.95 _____

COPY software at £5.00 _____

Please specify make of your printer _____

Cheques/PO payable to _____ Please add £1.45 p&p.

EURO ELECTRONICS please. Amount £ _____

Barclaycard/Access _____

THE OSBORNE SPECIALISTS

For all things OSBORNE

NEW ERAC SOFTWARE:

- 'CASHMASTER' – Analysed Cash Book & Nominal Accounting system. £150
Unique, easy-to-use, professionally approved for the small business.
- 'ADMASTER' – Publicity & Advertising Text Display system for the Retail or Exhibition environment. £52
- 'CLUBMASTER' – The complete Golf Club system, now installed at 14 U.K. Golf Clubs.

All standard Osborne and other software available

ACCESSORIES:

ERAC ADAPTOR for Multiple TV/Monitor Display
PRINTER LEADS, KEYBOARD EXTENSIONS and
TRAINING TEMPLATES at competitive prices

REPAIRS & MAINTENANCE:

Complete Osborne repair services

ERA Consultants Ltd.
127a, Wellington Road South,
STOCKPORT
Tel: 061 480 8927



TAKE AWAY BUSINESS SYSTEMS

FARMER OR
BUSINESSMAN
WE HAVE
THE
ANSWERS.

OSBORNE



SPECIAL PACKAGE

1A + Sage or Farmfax +
Microline 80 Printer

£1999
+ VAT.

OAKLEAF COMPUTERS LIMITED



121, Dudley Road,
Grantham,
Lincs.
0476 76994/70281

100, Boughton,
Chester,
Cheshire.
0244 310099

IN STORE

| Machine (Price from) | Main Distributor/s (No. of Dealers) | Hardware | Software | Miscellaneous (Documentation) |
|--|---|--|--|---|
| Munroe OC8820 (£2990) | As above | 128k RAM: Z80A: dual 5 1/4" F/D (640k): 9", 24x80 VDU: 3xRS232 ports: P/P | As above | 5MB H/D avail soon. BT 4/82. |
| Nascom 3 (£549) | Lucas Logic 0926 59411 | 48-60k RAM: Z80: dual 5 1/4" F/D (700k): RS232 port: P/P. | Basic: <i>Pascal: A: CP/M: Cobol Fortran</i> | Options dual 5 1/4" F/D (700k) £685: 48k RAM £130. |
| NEC PC 8001 (£599) | IBR 0734 664111 | 32k RAM: Z80A: P/P Option: dual 5 1/4" F/D (326k) £699 | Basic N: (24k ROM) <i>CP/M: Fortran: Cobol: Pascal.</i> | Colour monitor £359 (low res) or £579 (high res) both 12", 25x80 many expansion units avail. (E) BT 6/81 |
| Newbrain Model A (£199) | Grundy: 0223 350355 (TBA) | 32k-2 Mb RAM: Z80A: Nat 420: 2xC int: TV int: 2xV24 ports. | CBasic (29k ROM): A. | Graphics. Battery or mains. Options: 1/2 Mb RAM £450. Also Model AD £299. (E). |
| North Star Horizon (£1975) | Comart: 0480 215005. (25) Trader Comp. 01-328 3484 (60) | 32-64k RAM: Z80A: dual 5 1/4" F/D (360k): 15", 24x80 VDU: 150 cps printer: 2 S/P: 1 P/P. | DOS: Basic: CP/M: <i>Cobol: Fortran: Pascal.</i> | Options: 5-18 Mb H/D, Multi-user. |
| North Star Advantage (£2195) | As above | 64k RAM: Z80A: dual 5 1/4" F/D (720k): 12", 24 x 80 VDU: S/P. | GDOS: CP/M: <i>CBasic: MBasic: Fortran: Cobol: Pascal</i> | Price includes business graphics & demo software. |
| Oki if 800 (£3000) | Encotel. 01 686 9687 | 64k RAM: Z80A: 2k ROM: dual 5 1/4" F/D (768k): 12", 24x80 VDU: 80 col printer: loudspeaker: RS232 port: 20k ROM cartridge. | Basic: A: <i>CP/M Cobol: Fortran:</i> | Fully integral unit. Graphics. Options: dual 5 1/4" F/D (560k): RS232 port: PP. (1). BT 10/81 |
| Olivetti M20 (£2395) | Olivetti 01 785 6666 | 128k-512k RAM: Z8001: 2-8k ROM: dual 5 1/4" F/D (640k): RS232 port: P/P | Basic: <i>PCOS: A</i> | Alternative 8086 processor board to run CP/M86 & MS-DOS. Options: 11 Mb H/D (integral): printer £738. (S) B/T 9/82 |
| Onyx C8000 (£6875) | Onyx Dist Ltd. 09066-5432 (TBA) | 64k RAM: Z80: 12 Mb Cartridge: 10 Mb H/D: 4 S/P: P/P | CP/M: <i>MP/M Oasis: Unix: Fortran: Pascal: W/P</i> | C8001 with 128k RAM £8220. Multi-user version avail. using Oasis. (E) BT 3/81. |
| Oric 1 (£100 inc VAT) | Oric Products Int 0990 27641 | 16-48k RAM: 6502A: 28x40 TV int: C int: S/P: P/P: Loudspeaker | Basic (16k ROM): <i>Forth</i> | With 48k RAM and Forth on cassette £170 inc VAT. 240x200 colour graphics. Micro disk and modem avail soon. Viewdata compatible. |
| Osborne 1 (£1250) | Osborne 0908 615274(40) | 64k RAM: Z80A: dual 5 1/4" F/D (200k): 5", 24x52 VDU: RS232 port: P/P | CP/M: W/P: <i>Cobol Fortran: Pascal CBasic: MBasic: Wordstar: Mailmerge: Supercalc Forth</i> | Integral system in weatherproof carrying case. Will run on battery pack. Option: dual 5 1/4" F/D (400k). BT11/81. |
| Oscar (£2560) | JDS Ltd: 0908 313997(30) | 64k RAM: Z80: dual 5 1/4" F/D (800k): 12", 25x80 VDU: RS232 port: 1 P/P | CP/M: <i>Basic: Pascal Fortran: Cobol: W/P:A</i> | Also avail. with dual 5" F/D (1.6Mb) £2905 and 8 1/2" F/D (2 Mb) £3380. Advanced video board. S&H) |
| Panasonic JD 800M, JD850M (£3300, £4350) | Panasonic Business Equipment: 0753 75841 (10 regional dist) | 64k RAM: 8085A: 4k PROM: dual 8" F/D JD800M (500k): JD850M (2 Mb): 12", 24x80 VDU: 3xRS232 ports. P/P | CP/M: Basic: A <i>Micro-Cobol.</i> | Option: 8.4 Mb H/D £2725 (up two). BT3/80(S). |
| Pascal Microengine (£2295) | Pronto Electronic Systems Ltd: 01-554 6222 | 64k RAM: MCP 1600: 2x RS232 ports: 2 P/P. | Pascal. | CPU instruction set is P-code: no interpreter needed. Available with dual 8" F/D (2 Mb) £3900. |
| Pasca 640 (£1900) | Westrex Ltd: 01-578 0957 (TBA) | 64k RAM: Z80A: dual 8" F/D (512k): 12", 24x80 VDU: RS232 port: P/P | CP/M: <i>Basic: Cobol: Fortran: Pascal: A: W/P: U</i> | Maintenance contracts avail. Option: 5-20 Mb H/D. (S) BT 5/18 |
| Philips P2000 (£2444) | Philips Data | 16-48k RAM: Z80: dual 5 1/4" F/D (140k): 12", 24x80 VDU: RS232 port. | PDOS: UCSD p-system: <i>Pascal: Basic Fortran:A.</i> | With 48k RAM, Pascal and Basic £3300: BT 12/81.(S). |
| Position 900 (£1950) | Position Comp. 09252 29741 (10) | 64-512k RAM: 6809: 4xRS232 ports: IEEE-488 port: 1200 band C: dual 5 1/4" F/D (720k) | OS-9: Basic 09: <i>Pascal C: A: Cobol: U FLEX O/S</i> | Supports 4 users, expandable to 8. Networking allows 28 users on 7. Options dual: 5 1/4" F/D (1.4 Mb): 5-40 Mb H/D (E) |
| Position 9000 (£1536) | As above | 64-512k RAM: 6809: 4xRS232 ports: IEEE-488 port: 1200 band C. | OS-9: Basic 09: <i>Pascal C: A: Cobol: U</i> | 240x240 high res colour graphics. Viewdata compatible. Disk options as above. Supports 5 users. Networking allows 35 users on 7 systems (E) BT 10/82. |
| Prince (£3045) | Digico: 04626 78172 (50) | 64k RAM: 3xZ80A: dual 5 1/4" F/D (800k): 2xRS232 port: P/P/A2", 25x80 VDU | CP/M: <i>Basic: Pascal: Fortran: Cobol: W/P:A: T/E:U</i> | High res graphics. Options: single 5 1/4" F/D (400k) £600: dual 8" F/D (2 Mb) £2000 5-10Mb H/D. Rentals avail. (S). |
| Quantum 2000 (£2250) | Quantum Comp Sys 0532 458877 | 64k RAM: Z80A: dual 8" F/D (2.4Mb): 12", 24x80 VDU. C int: P/P | CP/M <i>Basic: Cobol: Fortran: Pascal: A</i> | Many expansion boards avail inc high res colour graphics. Option: 5-10Mb H/D. |
| Rair Black Box 3/30 (£3750) | Rair: 01-836 6921 (N/A) | 64-512k RAM: 8085: dual 5 1/4" F/D (500k): 6 Mb H/D: 2xRS232 ports. | CP/M: Basic: Cobol: Fortran: M/A | 64k RAM expansion £500. 256k RAM £1250. Up to 16 RS232 ports. |
| Research Machines 380Z (£1867) | Research Machines: 0865 249866 (N/A) | 32-56k RAM: Z80A: dual 5 1/4" F/D (300k) RS232 port. P/P. | ExBasic: A: T/E: U: <i>CP/M: Fortran: Cobol: Algol: Pascal.</i> | High res colour graphics. Many possible systems. With 56k RAM & dual 8" FD (1 Mb) £3347. |
| Research Machines Link 480Z (£560) | As above | 32-64k RAM: Z80A: C: 2xS/P: P/P | Basic: T/E | High res colour graphics. Network station. |

List of Abbreviations

A Assembler
BT Bench Tested
C Cassette
E Extensive
F/D Floppy disk

G/C Graphics card
H Hardware
H/D Hard disk
I Introductory
Int Interface

M/A Macro assembler
N/A Not available
N/P Numeric pad
O/S Operating system
P/P Parallel port

S Software
S/P Serial port
T/E Text editor
TBA To be announced
U Utility

Please note: Software items listed in *italic* are not included in the basic price of the equipment. All prices are *exclusive* of VAT.

IN STORE

| Machine (Price from) | Main Distributor/s (No. of Dealers) | Hardware | Software | Miscellaneous (Documentation) |
|-------------------------------------|---|--|---|--|
| Sage II (£2870) | TDI 0272 742796 | 128-512K RAM: 68000: single 5¼" F/D (320k); VDU int: RS232 port: P/P | UCSD p-System: Pascal Basic: Fortran: M/A | Price includes 1 year service. With 512k RAM and dual 5¼" F/D (1MB) £4594 BT 2/83 |
| SEED System 1 (£1900) | Strumech: 05433 78151 (5) | 32-56k RAM: 6800: various disk options: 12", 24 x 80 VDU: RS232 port: P/P | DOS: Basic: M/A: CBasic: A: T/E | Graphics. PROM programmer Also system 19 multi-user (£3000). (E). |
| Sharp MZ-80K (£460-34k) | Sharp Electronics (UK) Ltd: 061-205 2333 (22) | 6-48k RAM: Z80: C: 10" 24 x 40 VDU: Option: dual 5¼" F/D (289k) £695 | Basic, A. CP/M: Pascal: Fortran: Forth | Graphics: loudspeaker. BT 10/79 (B) |
| Sharp MZ80A (£549) | Sharp Electronics (UK) Ltd 061 205 2333 (22) | 48k RAM: Z80: 25x40 VDU: C: P/P. Options: single 5¼" F/D £400: dual 5 + " F/D £590: RS232 port | Basic: CP/M: A: Pascal: Fortran: Cobol | Expansion unit needed for disks (£100) Low res (80x50) graphics. Loudspeaker Numeric pad (B) |
| Sharp MZ-80B (£1095) | As above | 64k RAM: Z80A: C: 9", 25 x 80 VDU: RS232 port: P/P. | Basic: A: Pascal: FDOS | High res graphics. Options: dual 5¼" F/D (560k) £800: 80 cps printer £415. (S) |
| Sharp PC1500 (£150) | As above | 3-11k RAM: CPU: 16k ROM: 26 char LCD: | Basic | Full system with dual cassette int. and miniature four colour plotter £375. RS232 port avail. soon. (B) BT 6/82 |
| Sharp PC3201 (£2995) | As above CP/M: Cobol | 64k RAM: Z80A: dual 5¼" F/D (500k): C int: 12", 25 x 80 VDU: 70 lpm printer. | DOS: U: Basic: CP/M: Cobol. | Various expansion cards avail. BT 7/81 (I&B) |
| Sharp PC1251 (£80) | As Above | 3k RAM: 8-bit CPU: 24 char LCD | Basic (24k ROM) | Portable. Printer/cassette unit £100 BT 2/83 |
| Sig/Net 100ZS (£1299) | Shelton 01 278 6273 (5) | 64k RAM: Z80A: dual 5¼" F/D (400k): 2xRS232 ports | CP/M: Basic: Cobol: Fortran: Pascal | Various disk options, up to 16 Mb H/D |
| Sinclair ZX81 (£50 inc VAT) | Sinclair: 0276 66104 (300 +) | 1-16k RAM: Z80A: C int: TV inb: full K/B: 44-pin expansion port. | Basic (8k ROM). | Advanced 4-chip design. Printer now avail. BT 6/81 |
| Sinclair ZX Spectrum (£125 inc VAT) | Sinclair: 0276 685311 | 16-48k RAM: Z80A: 16k ROM: T.V. int: C int | Basic | Options: 32k RAM £60. RS232 port and microdrive disks avail soon BT 6/82 |
| Smoke Signal Chiefan (£1800) | Windrush 0692 405189: (TBA) | 32-64k RAM: 6800/6809: dual 5¼" F/D (500k): 2 x RS232 port. | DOS: 68/FLEX: Basic: Fortran: Cobol: A: Disc A: Pascal: U. | With dual 8" F/D (2 Mb) £2600. Designed as development system for industrial control. (H). |
| Sorcerer (£790) | EMG 0293 519211 (27) | 48k RAM: Z80: RS232 port: 1 P/P: S100 connector: 30x64 VDU int. N/P. | O/S: Basic (ROM): A: Algol: Fortran: MBasic: ExBasic: 80. Pascal: W/P. | High-resolution graphics capability: user programmable character set, Option: single 5¼" F/D (316k) £600 Video disk unit (1.5Mb) £1890 |
| Sord M100 ACE (£2339) | Midas Computer Services Ltd: 07917 64686 (10) | 48k RAM: Z80: 8k ROM dual 5¼" F/D (245k): 24 x 64 green VDU: RS232 port: N/P | O/S: Basic: A: Fortran: Pascal. | Up to 3 drives possible. Colour graphics avail. Option S100 bus. (I) |
| Sord M223 Mk II-VI (£4078) | As above | 64k RAM: Z80: 8k ROM: dual 5" F/D (700k): 12", 24 x 80 green VDU: RS232 ports: S100 bus: N/P | O/S: Ex Basic: CBasic: Multi-User Basic: Fortran: Cobol | Expandable to 4 Mb F/D. 32 Mb, H/D, 5 screens, 2 printers. M243 with 192k RAM & 1.4 Mb F/D £5087. |
| SPC/1 (£3140) | Digital Data: 01-573 8854 | 96-1056k RAM: 8085 A-2: dual 5¼" F/D (280k): 12", 24 x 80 VDU: 2 x RS232 ports: Option: Up to 106 Mb H/D | Mikados, Comal: Pascal: A. | Expandable to multi-user system (8 users). BT 7/80 (S). |
| Superbrain (£1750) | Icarus: 01-485 5574 (45) | 64k RAM: 2 x Z80: dual 5¼" F/D (320k): 12" 25 x 80 VDU: 2 x RS232 port. | CP/M: A: Basic: Cobol: Fortran: APL: Pascal | Limited graphics, Mainframe int avail. With 676k F/D £2090, 1.5Mb £2345. With 5Mb H/D & single 338k F/D £3950. BT 8/80. (S&H) |
| SWTPc/09 (£3850) | SWTP Ltd 0733 234433 | 64k RAM: 6809: dual 5¼" F/D (1.5MB) 2 S/P: P/P: 12", 24 x 80 VDU | Flex O/S: Basic: A: T/E | Expandable to 768k RAM |
| SWTPc S/09 (£7000) | As Above | 128k RAM: 6809: dual 8" F/D (2.5MB) 2 S/P: 1 P/P | Uniflex O/S: Cobol: Basic: Fortran: C. Pascal: A: Pilot: Forth. | Up to 80MB H/D. Multi-user, multi-tasking, up to 18 users |
| System 10 (£2995) | Millbank 01-788 1083 (TBA) | 64k RAM: Z80: dual 5¼" F/D (700k): 12", 24 x 80 VDU: 2 x RS232 port: P/P | CP/M: Basic: Fortran: Pascal: Cobol: PL/1: W/P | 12 month warranty. Maint. contracts. Applications packages avail. Choice of high level language in price. (E) |
| Tandberg EC10 (£3250) | Tandberg: 0532 774844 (N/A) | 64k RAM: 8080 A: single 8" F/D (250k): 12" 25 x 80 VDU: 7 x RS232 ports: printer int. | CP/M: Ex Basic (24k) Multi-user Basic: Pascal: Cobol: A: U: | Up to 7 terminals. Includes V28 comms port. (S&H) |
| Tandy PC-2 (£179 inc VAT) | As above | 3-11k RAM: CPU: 16k ROM: 26 char LCD | Basic: | System with dual cassette int. and miniature four colour plotter £338 inc VAT. RS232 port avail. soon. (B) |
| Tandy TRS-80 Model I (£174) | Tandy: 0922 648181 (200) | 16-48k RAM: Z80: C: 12", 16 x 64 VDU: RS232: P/P | Basic (12k ROM): A. | Fully expandable. Option: single 5¼" F/D (175k) £320 (up to 4). Many extras available. 32k RAM £260. (I) |
| Tandy TRS-80 Model II (£2347) | As above | 64k RAM: Z80: single 8" F/D (500k) 12" 24 x 80 VDU: 2 x RS232 port: P/P | Basic M/A Fortran: Cobol 3-32 Mb H/D | Option: single 8" F/D (500k) £782 (subsequent £391, up to 4). 8-32Mb H/D |
| Tandy TRS 80 Model 3 (£434-£1477) | As above | See Model I Levels I and II | | Fully integral unit. Up to 2 integral and 2 external 5¼" F/D. BT 8/81 |

List of Abbreviations

A Assembler
BT Bench Tested
C Cassette
E Extensive
F/D Floppy disk

G/C Graphics card
H Hardware
H/D Hard disk
I Introductory
Int Interface

M/A Macro assembler
N/A Not available
N/P Numeric pad
O/S Operating system
P/P Parallel port

S Software
S/P Serial port
T/E Text editor
TBA To be announced
U Utility

Please note: Software items listed in *italic* are not included in the basic price of the equipment. All prices are *exclusive* of VAT.

IN STORE

| Machine (Price from) | Main Distributor/s (No. of Dealers) | Hardware | Software | Miscellaneous (Documentation) |
|--|--------------------------------------|--|--|--|
| Tandy TRS-80 Colour (£209) | As above | 16-32k RAM: 6809; 8-16k ROM: C: 16 x 32 TV int: RS232 port. | Colour Basic. | With 16k RAM, 16k ROM & Extended Colour Basic £261 (I). BT 9/81. |
| Tandy TRS-80 Model 16 (£3651) | As above | 128-512k RAM: Z80A 68000: dual 8" F/D (1-2Mb): P/P: 2xRS232 port. | TRSDOS: A: <i>Cobol Basic</i> | Will run all Model II software. System with single 5 1/4" F/D (600k) and 8Mb H/D £5911. Options: 8Mb H/D £2173 (up to four): 640x240 high res graphics: Multi-user system avail. soon. (S) |
| Tele Video TS800 (£3100) | Colt 01-577 2686 | 64k RAM: Z80A: dual 5 1/4" F/D (700k): P/P: S/P: 24x80 VDU: 80 cps printer. | CP/M: <i>Basic: Cobol: Fortran: Pascal</i> | Fully expandable to local area network with 16 users. 8 and 16 bit versions avail. and full set of application software. (S) |
| Terodec PBM-1000 (£4020) | Terodec: 0734 664343 (40) | 80k RAM: Z80A: single 5 1/4" F/D (819k): 6Mb H/D: 2xS/P: P/P | CP/M CP/Net CBasic: <i>Fortran: Pascal: Cobol</i> | System with Okidata 80 printer: TV1 910 VDU: W/P and various application packages £5995 (S&H) |
| TI 99/4A (£199 inc VAT) | TI: 0234 67466 (TBA) | 16-48k RAM: 26k ROM: 9900: 2 x C int: 24 x 32, 16 colour TV int: 3 tones & noise: P/P. | OS: <i>Basic.</i> | 12 month guarantee. Options 32k RAM: 2 x RS232: 3 x 5 1/4" F/D (92k each): Speech Synthesiser. |
| Torch (£12795) | Torch Comp. 0223 841000 (30) | 64k RAM: Z80A: dual 5 1/4" F/D (800k): 12", 24x80 colour VDU: RS232 port: P/P: Modem | CPN: BBC Basic: | O/S is CP/M compatible. With 21MB HD and single F/D £5495. B/T 1/83 |
| Tuscan CP/M Starter (£999) | Transam: 01-405 5240 (N/A) | 24k RAM: Z80: single 5 1/4" F/D (190k): Cint: TV int: RS232 port: P/P: N/P. | CP/M: <i>Basic: Fortran: Pascal: Cobol:</i> | Options: single 5 1/4" F/D (190k) £155: single 5 1/4" F/D (370k) £285: 16k RAM £162: 3 Mb H/D £1450: 20 Mb H/D £2970 (S&H) |
| Tuscan Starter Kit (£299) | As above | 8k RAM: Z80: Cint: 56-key K/B Options: Case £110: 5 x S100 sockets £20: TV int £3.50 | 8k Basic | Fully assembled version £499 BT 1/81 (H&S) |
| Vector MZ (£2650) | Almarc: 0602 52657 (3) | 56k RAM: Z80A: dual 5 1/4" F/D (630k): 3 S/P: 2 P/P. | CP/M: <i>Basic: Algol: Cobol: Pascal: Fortran: Coral: CBasic: A.</i> | High resolution graphics. Also system B with video board & terminal £3450. (E) |
| Vector System 2800 (£4600) | As above | 56k RAM: Z80A: dual 8" F/D (2.4 Mb): 3 S/P: 2 P/P | As above | High-res graphics. Many Options. Fully expandable to 5005 multi-user system (max 5) £5400. |
| VIP (£2650) | Almarc 0602 52657 (3) | 64k RAM: 3k ROM: Z80B: single 5 1/4" F/D (630k): 12", 24 x 80 VDU: RS232 port, 3 x P/P | CP/M: <i>Basic: forttran: Cobol: Pascal: A.</i> | Up to 3 additional F/D drives. Options: dual 8" F/D (2 Mb) £1063, 32 Mb H/D (TBA). (H&S). BT2/81 |
| Windrush 6809 (£2418) | Windrush 0692 405189 | 56k non-volatile CMOS RAM: 6809: 2xRS232 port. 2xP/P: dual 5 1/4" F/D (700k) | OS-9: <i>Flex: Uniflex Basic: A: PL9: SPLM: Cobol: Fortran: Pascal</i> | Designed as development system for industrial control/computer station for commercial OEM's. With dual 8" F/D (2 Mb) £2953. (E) |
| Xerox 820 (£1845) | Business Comp Sys 01 207 3344 | 64k RAM: Z80: single 5 1/4" F/D (162k): 12", 24 x 80 VDU: 2 x RS232 ports: P/P | Monitor: <i>CP/M: Basic: Cobol: Fortran: Pascal.</i> | With 8" F/D (500k) £2250. CP/M £95. BT 1/82 (S + H) |
| Zenith WH-11A (£2673) | Zenith Data Systems 0452 29451 (TBA) | LSI 11: 16-32k RAM: 25 x 80 VDU: S/P: P/P. | O/S: <i>Basic, Fortran: A: U.</i> | PDP 11-compat. Option: 2 x 8" F/D (1 Mb). £1717 (S&H). |
| Zenith Z89 £1570-£1710 | As above | 16-48k RAM: Z80: single 5 1/4" F/D (102k): 12" 24 x 80 b&g vdu: RS232. | <i>Basic: A: HDOS: CP/M: MBasic: CBasic: Fortran.</i> | 3 x 5 1/4" F/D possible. Options: dual 8" F/D (1 Mb) £1717, 20 Mb H/D. |
| Zilog MCZ 1/05 (portable): MCZ 1/20A (£3250) | Thames Systems: 084421 5471 (N/A) | 64k RAM: Z80: dual 8" F/D (600k): RS232 port: MCZ1/20A only 1 P/P: Option: 10 Mb H/D £7100 | RIO: O/S: <i>Cobol: Basic: Fortran: Pascal: M/A: U.</i> | Available desk top or rack mounted. Debug in 3k PROM. 1/20A runs multi-user Cobol, up to 5 terminals with 40 Mb H/D. (S&H). |

TRANSACTION FILE

Readers will be pleased to know that, due to our clever layout ideas, the Transaction File is up-to-date and waiting cut down considerably. Ads are accepted only on the form below for a flat fee of £2.50. Please don't specify issues as we can't oblige. Ads cannot be repeated unless separate forms are sent in. We will only accept entries from non-commercial readers. Thank you for cooperating.



- Sharp MZ-80K 48k-RAM complete with Basic, manual, green screen, games and dustcover. Excellent condition, guarantee until December. Also Micro magazines and desk included £275. Tel: Wigan (0942) 714694
- Newbrain A.32k, 3 months old. Very light use + Database + manuals + Sharp CE-152 cassette recorder £200. Complete. Tel: 352-1099
- Texas 990/4 16bit mini with 16k words RAM, with 733ASR keyboard printer terminal with twin 1200B digital cassettes. Offers to 0934 412178.
- Must sell! ITT 2020. Twin disk drives + controller, paddles, TV colour modulator, manuals, many useful programs. £900. Warrington 35953. Ex 3659A (daytime) Droitwich 775615 eve.
- ITT 2020 64k, twin Dos 3.3 drives. Joystick, paddles, amplifier, Pascal, Fortran, toolkit, Appletree, software. All manuals. Jailbreak +TV. Modulator fitted. Apple II compatible. £900 ono Mike 01-505 5001.
- Aculab floppy tape and ten wafers. Hardly used. No interface required, plugs straight into the Video Genie. Upgrading to disks hence £70, for quick sale. Carlo 639-4353, ext 267 or 732 6456.
- Sinclair Spectrum users! Non-commercial venture to help buy, sell, and exchange programs, for all Spectrum users. Send SAE for details. The Secretary, VGES, 25 Rona Road, London NW3 2HY.
- Sharp MZ80-P5 printer, as new condition £215. Sharp MZ80B, FDOS, Pascal and double precision Basic. £50. Parish 2, Collyers Close, Hurworth, Darlington, Co Durham DL2 2ES. Letters only.
- Sharp MZ-80K 48k. First class cond. Inc word processor and database games, accounts, etc. Also Epson MX80T and Sharp interface. Both items £550. Tel: Ingatestone, eve 02775 2256.
- MZ-80K programs, very fast machine code, Basic Froggo game. Features high score board + music accompaniment whilst you play. Also fast shooting game. Both programs £7. Tel: 0288 3225.
- TRS80 Model I, Level II, drive 26-1160 £175. TRSDos drive 26-1161, £150. Montiro £65, 32k expansion int £150. Microsoft editor, assembler + £15. Owner upgrading. Tel 0268 743967 after 6.
- S100 Z80 complete system, Midas cable, CP/M Dos, with many available extras. A bargain at £900 (but no VDU). Offers accepted. Tel: 0829 70737 eve or w/ends please. Ted.
- Microintel Prestel television adaptor. Almost new, complete and with built in microcomputer interface socket, documentation and Apple II interface software, on diskette. £95 ono. Tel 0829 70737 eve please. Ted.
- PET 3032 with cassette, toolkit, superchip, arrowchip, sound including music monitor, light pen, reset button, books and 50 cassettes inc, Chess, Drafts, Papermate, Adventure games. £375. Tel: Gresford 2741.
- Commodore system comprising PET 3032, 3040 disk drive, 3022 printer. £1500 ono. Sunbury (09327) 87846.
- Atari 400 16k + recorder + J/ sticks + paddles worth £250+. Cartridge, cassette s/ware worth £500+. Books worth £90+. All £500 ono. Tel: Jeff, 0903 64783, eve except Monday, Wednesday, Friday. Free TI59 included.
- TRS80, model III, level II, 48k, built in VDU, 1 year old. Light hobby use only, £550. Tel: Poulton (Glos) 421.
- Double sided, double density, 2 megabyte Z/80 CPM2.2 + E&bit screen, Micromation Z-plus computer. New in 1980. Cost £4,500. Accept £1,500. Tel: Brandon Solicitor 603-5545 or 603 5955.
- Sharp MZ80B 64k with expansion unit, extension graphics and printer interface, £550 ono. Also selection MZ80B disk software, cheap. Tel: Reading 664559. Can deliver.
- Sharp MK-80A 48k + Basic interpreter, manuals, education, games (10), Home Finance, Basic Tutorial, Database, cassette programs, + Peeking and Poking manual, all 3 months old. Accept £475 ono. Lancing 767702.
- UK101 cased 8k RAM with Cegmon and Basic 5 300/600 baud cassette interface. Manuals, Assembler and games tapes included £100. Tel: 0455 30186.
- Nascom 2, power supply and 48k memory board with 16k RAM. Includes graphics ROM, Sargon, Chess, Games and Assembler. £200 ono. Tel: 061 969 7065.
- Apple II Z80-card. 80-column card, CP/M system disk, the lot for £195. Printer (Centronic) interface card and cable, £65 ono. Osborne I computer £850 ono. Tel: Anthony 01-440 2403 or 01-690 6871.
- Probably the only building, small works estimating programme around. Including bill head. Printout designed for Apple but easily adaptable for most micros £300. Tel: Reading 0734 663026 after 6.
- Newbrain. Wordprocessor, Options include save/load to tape, paged organisation, directory look-up, full error detection, efficient text packing, most normal W/P functions, manual cassette, £5. K. Polston, 19 Marshalls Drive, Romford, Essex RM1 4JR.

3D COMPUTERS

THE LATEST CHAIN OF
HOME COMPUTER SPECIALIST SHOPS
IN THE U.K.

Easy Parking at all Branches

BBC MICRO MODEL B
£399

commodore 64
£343.85

DRAGON 32 £199.99

ORIC-1 £159.95

SHARP 48K MZ-80A
NEW SHARP CASSETTE BASED
BUSINESS SOFTWARE NOW AVAILABLE

SOFTWARE
PROGRAM POWER
BUG-BYTE
SUPERIOR SOFTWARE
A+F
SIMON HESSEL
MOLIMERX
PHOTRONICS
ACORNSOFT

PERIPHERALS
DISCS SINGLE/DUAL
TORCH Z80 DISCS
CUMANA DISCS
PRINTERS
JOYSTICKS
MONITORS b&w/colour
LIGHT PENS
BBC BUGGY

LARGE RANGE OF BOOKS,
DISKETTES, CASSETTES &
PRINTER PAPER ALWAYS
IN STOCK

TOLWORTH
230 Tolworth Rise South
Tolworth, Surbiton
Surrey KT5 9NB
Tel: 01-337 4317

SUTTON
30 Station Road
Belmont, Sutton
Surrey SM2 6BS
Tel: 01-642 2534

EALING
11A Gunnersbury Avenue
Ealing
London W5 4HB
Tel: 01-992 5855

RICKMANSWORTH
Greystone Works
The Green, Croxley Green
Rickmansworth
Herts WD3 3AJ
Tel: (0923) 779250

MILTON KEYNES
Unit 1, Heathfield
Stacey Bushes
Milton Keynes MK12 6HP
Tel: (0908) 317832

NEWBURY
26 Stanley Road
Newbury
Berks RG14 7PB
Tel: (0635) 30047

Disk storage Labels Paper
Ribbons Furniture
cleaning kits
Binders
Disks

Quality Computer Media

at discount prices

come to Password



Uncertain about the disk or ribbon for your machine Call Password for online advice.

Verbatim Datalife
The industry standard.
All mini disks are double
density with hub rings

| | | | | |
|-------|-------|----|----------|---------|
| 5 1/4 | MD525 | SS | 40 track | £18.95* |
| | MD550 | DS | 40 track | £24.95* |
| | MD577 | SS | 77 track | £26.95 |
| | MD557 | DS | 77 track | £34.95 |

| | | | | |
|---|--------|------|--|--------|
| 8 | FD1500 | SSSD | | £22.95 |
| | FD9000 | SSSD | | £28.95 |
| | FD8000 | SSDD | | £29.95 |
| | DD4001 | DSDD | | £34.95 |

* Single density compatible

◆ Disk storage

| | | |
|-----------------------|---------------------------|------------------------|
| Egly | Plastic flip top | |
| Plastic library cases | large storage easy access | |
| 5 1/4" holds 10 | £2.00 | 5 1/4" holds 30 |
| 8" holds 10 | £2.20 | 8" holds 60 (lockable) |
| | | £18.95 |

◆ Professional ribbons from GEHA

| | | |
|---------------------|-----------|-------|
| Richo RP 1600 | M. Strike | £3.36 |
| NEC Spinwriter | M. Strike | £3.32 |
| Microline | Nylon | £1.32 |
| Seikosha GP 100 | Nylon | £6.25 |
| Epson MK80 | Nylon | £5.32 |
| Commodore PET | Nylon | £5.32 |
| Sharp CE/MZ | Nylon | £5.32 |
| Centronics zip pack | Nylon | £2.69 |

We have ribbons for most popular machines

All disks
come with
Factory guarantee
10/16/32 sectors
available at the
same price

BASF Disk Media
These disks are high
quality at low prices

| | | |
|-------|------|--------|
| 5 1/4 | SSSD | £15.00 |
| | SSDD | £19.00 |
| | DSDD | £24.00 |

| | | |
|---|----------------|--------|
| 8 | SSSD | £21.90 |
| | SSDD | £25.90 |
| | DSDD | £28.80 |
| | SSSD 32 sector | £27.35 |

◆ Cassettes (C12)

Manufactured especially for Micros
Bulk tested. Error free operation
No more drop outs
Packaged in boxes of 10 £5.75

◆ Verbatim Disk Drive Head Cleaning Kit

Now anyone can clean heads safely and quickly
No messy fluids use as a normal disk
Cleaning Kit £6.25
Extra Disks (10) £11.50 Specify 8 or 5 1/4

◆ Printout binders

| | | |
|-----------------|--------|------------|
| Width | Vinyl | Pressboard |
| 7 1/2 - 12 | £18.50 | £17.20 |
| 12 3/4 - 15 1/4 | £22.90 | £19.50 |

All prices are for 10 packs. Other sizes available



cheap paper can damage your printer

Our stationery is superior heavyweight low dust paper
We have over 30 formats to choose from
Labels available on request

- ◆ One part music ruled 65gsm
2000 11 x 9 1/2 £10.95
2000 11 x 14 1/2 £12.90
2000 11 x 15 5/16 £13.50

- ◆ New mini packs for the small user
Plain 70gsm with perforated edges
(72 cuts/inch gives ultra smooth edge)
Ideal for letters/forms and archive listings

| | |
|-----------------|-------|
| 1000 11 x 9 1/2 | £8.36 |
| 1000 12 x 9 1/4 | £8.67 |

UK postage and packing

Disks 8 £1.30 each pack 5 1/4 £0.95 each pack
Library cases (EGLY) £0.50 each (30) £2.60 each
(60) £2.60 each Cassettes £0.95 each pack
Ribbons £0.35 each Binders £2.60 each box
Paper (1000) £2.60 each box (2000) £3.50 each box
Cleaning kit £0.50 each

Add 15% VAT to total price Cheques, Postal Orders to

Password Electronics Ltd
62 Normandy Street,
Alton,
Hampshire, GU34 1DE
Tel: 0420 86977

FREEPOST
ALTON, HANTS GU34 1BR



ACC NEWS

Rupert Steele presents his monthly round-up of news from the Amateur Computer Club.

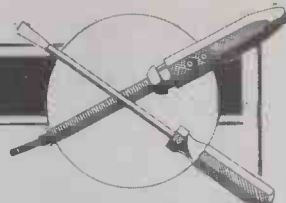

The ACC club bulk membership scheme has been revised, in order to tailor it more accurately to the requirements of local clubs.

The members of ACC, who can take part in the election of the committee, come from two sources: direct members who have paid the subscription fee to ACC, (currently £5 or £2.50 for under 16s and OAPs), and club affiliate members, who belong as a result of their membership of a local computer club.

This is how you go about starting a bulk membership of your club. Get together the members of your club who require ACC membership, and send their names to me, with a fee calculated as follows:

Each of the first 50 members (minimum: 10 members): £3
Each of the next 50: £2.75
Each subsequent member: £2.50

There are lots of things you can do with this scheme; perhaps your local club would like to beef up its regular news sheet by distributing ACCumulator as well (this is usually cheaper than producing a similar news sheet yourselves). Alternatively, ACC membership could be an optional part of your club subscription.

Clubs

I have had a letter from the Society of Genealogists, which is very interested in the application of computers in genealogy. So if your family tree is so complicated that you need a computer to unravel it, then you should contact David Hawgood of 26 Cloister Road, London W3 ODE who is setting up a genealogy club.

A chap called Chris

Wallwork tells of a 'Tonbridge Wells Area Computer Society', which meets twice per month, on the first and third Thursdays. Give him a ring on Tonbridge Wells 37682. If you can't get through, try Colin Turner on Ton Wells 21120.

Also around here is the SOBAT computer club, its aims, according to the Chairman, Mr T Kayani, are to provide an opportunity for micro owners to discuss their problems, exchange wants and exchange (public-domain) software. It is also building up a growing library of games and educational programs for the use of its members. The club caters for East London, mainly Leyton, Ilford and East Ham. Contact: Mr T Kayani, Berridge House, Hillfield Road, London NW6 or phone (weekends) 01-556 5423.

Over to the west of town, Steve Ward of 28 Brodie Road, Enfield EN2 OEU writes to tell me of the 'Brigadier Computer Club'. This meets monthly on the first and third Monday from 7.30 to 10pm at the Brigadier Youth Centre, Brigadier Hill, Enfield. The subscription is £2, with a meeting fee of 25p. It is a general club, catering for novice and expert alike.

Mr Ken Ward of 45 Coleburn Road, Lakenham, Norwich NR1 2NZ writes to tell me of his proposed club in Norwich — he seems to be mainly Atari based, but if you have another system or interest, do contact him.

Dashing a few hundred furlongs to Newmarket, we meet 'Newbyte' — a catchy acronym. The secretary, John Smyth of 5 New River Green, Exning, Newmarket, Suffolk

CB8 7HS writes to tell me that it is a general club with a range of different machines. Most of the members are fairly new to micros, so there is no need to be intimidated — just race to the telephone and get John on Exning 8100.

Down on Canvey Island, I have had letters from two club contacts, namely Paul Sida of 3 Tewkes Road, Canvey Island, Essex and Dean Williams of 17 Mornington Road, Canvey Island, Essex SS8 8AT. The latter club is for any machine, although it has a minimum age of 14 for its members. As to whether these two clubs are actually the same, 'I'm sorry, I haven't a clue...'

Remaining in island vein, there is the Jersey Computer Association. The man to contact is Michael Murphy, PO Box 441, St Helier, Jersey, Channel Islands (I wonder what it's like to live in a PO box — pretty rough I imagine). You can also phone him in working hours on (0534) 78399. Anyway, the Jersey Computer Association is a general group with many machine interests, including both business and home applications. The subscription varies from £2 to £16 depending on who you are.

Meanwhile, up in sunny Merseyside, we have the Liverpool BBC and Atom Group, which now meets twice monthly, on the first Thursday of the month at the Old Swan Technical College (Rm C33) and on the third Thursday at Birkenhead College. For more info, contact Nik Kelly on 051-525 2934.

Also in the Liverpool area, a Mr Gary Metcalfe of 24 Marlston Avenue, Irby,

Wirral, Merseyside L61 3XU writes to tell me of his new computer club. This will be a general club, including Atari, VIC, Commodore 64, BBC, Spectrum and Dragon users — with more on the way.

Going east I find Ian White, who tells me of the South Trafford Microcomputer Club (South Manchester). This group has been running for almost two years and meets once a fortnight. The members possess a wide range of micros, and they publish a monthly newsletter, including teaching material in Basic and machine code. Contact Ian on 061-969 2080 or write to him at 16 Leicester Avenue, Timperley, Altrincham WA15 6HR.

Further east still, I find James Bridson of Barnsley Co-Operative Computer Club, 39 Keresforth Hall Road, Kingstone, Barnsley, S Yorks S70 6NF. It holds its meetings on co-op premises which are provided free (hence the name of the club). So if you're clubless of Barnsley, you know who to talk to.

And finally, a Mr Illegible writes from Italy to tell me of its ZX users club. It calls itself Sinclair Club, and its address is: /o Arrigo Bomdi, via Molino Vecchio 10/F, 40026 Imola, Italy. So if you want to brush up your Italian, while learning about the fantastico ZX81, then you know what to do.

* For more information on the ACC, Club Spot 800, or any of the points mentioned above, contact: Rupert Steele, St John's College, Oxford OX1 3JP or phone (0865) 512811. Please note that this address and phone number will be changing shortly.

CTUK! CONTACTS

For further information on ComputerTown UK! see 'CTUK News' or Prestel page *800803 #

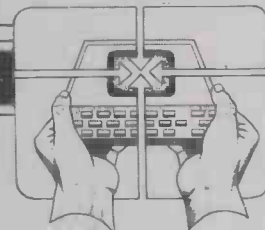

E N Ryan
15 Queens Square
Eastwood
Nottingham
NG16 3BJ

Peter J Kiff
52 Stone Road
Broadstairs
Kent CT10 1DZ

John Stephen Bone
2 Claremont Place
Gateshead
Tyne & Wear
NE8 1TL

Andrew Stoneman
135 Birchdale Avenue
Newcastle-Upon-Tyne
Tyne & Wear

Derek Knight or Bob Carter
Rayners Lane Library
Imperial Drive
Rayners Lane
Middx

Christopher Bates
Ashford Main Library
Church Road
Ashford Kent

Paul Maddison
Gardenways
Chilworth Towers
Chilworth
Southampton SO1 7JH

Chris Cooper
110 Church Road
Hanwell
London W7

Brian Taylor
Tonbridge Area Library
Avebury Avenue
Tonbridge
Kent

Bill Gibbings
2 Longholme Road
Retford
Notts DN22 6TU

CTUK! CONTACTS

Ray Skinner
62 Central Avenue
Billingham
Cleveland TS23 1LN

Philip Joy
130 Rush Green Road
Romford
Essex

Peter Herring
Ordnance Road Library
Ordnance Road
Enfield Middx

Derrick Daines
18 Cuttings Avenue
Sutton in Ashfield
Notts

Patrick Colley
52 Queensway
Caversham Park Village
Reading
Berks RG4 0SJ

J M A Kilburn (Headmaster)
Shawfield Norden
Community Middle School
Shawfield Lane
Norden
Rochdale OL12 7QR

Robin Bradbeer
Polytechnic of North London
Holloway Road
London N7

Derek Moody
2 Victoria Terrace
Dorchester
Dorset DT1 1LS

Pam Pollicott
South Ruislip Library
Victoria Road
South Ruislip
Middx

Rex Shipton
17 Woodlands Avenue
Eastcote
Middx

Susan Kelly
Head of Reference Services
PO Box 4
Civic Centre
Harrow
Middx

Andrew Holyer
10 Masons Road
Mannings Heath
Horsham
Sussex RH13 6JP

Ted Ellerton
25 Beachdale
Winchmore Hill
London N21

R L Saunders
14 St Nicholas Mount
Hemel Hempstead
Herts

Brigitte Gordon
18 Purbright Crescent
New Addington
Croydon CR0 0RT

Richard Powell
22 Downham Court
South Shields
Tyne & Wear

Peter Earthy
46 High Street
Church Stretton
Shropshire SY6 6BX

Alan Sutcliffe
4 Binfield Road
Wokingham
Berks RG11 1SL

Allan Porten
14 Foxmede
Rivenhall End
Witham
Essex

David Sharp
5 Bridgenhall Road
Enfield
Middx

Keith Taylor
Carter Hydraulic Works
Thornbury
Bradford BD3 8HG

Alan Hooley
21 Brammay Drive
Tottington
Bury BL8 3HS

Vernon Quaintance
50 Beatrice Avenue
Norbury
London SW16 4UN

BJ Candy
9 Oakwood Drive
Gloucester GL3 3JF

Roger Shears
18 Woodmill Lane
Bitterne Park
Southampton SO2 4PY

Chris Woodford
31 Hopley Road
Anslow Burton-On-Trent
Staffordshire

Mike Perry, Steve Collas
or Dave Lee
The Library
Ealing Road
Wembley
Middlesex HA0 4BR

Tony Cartmell
54 Foregate Street
Worcester WR1 1DX

Lyn Antill
1 Defoe House
Barbican
London EC2

Peter Jarvis
c/o Health Dept
Corporation of London
Guildhall
London EC2

Vernon Gifford
111 Selhurst Road
Croydon
London SE25 6LH

Peter Stone or
Alan Strangman
Computing and Maths Dept.
The Polytechnic
Wulfruna Street
Wolverhampton WV1 1LY

J G Batch
Central Library
Clapham Road
Lowestoft NR32 1DR

John Byfield
Moonrakers
The Rutts
Bushey Heath
Herts WD2 1LH

NETWORK NEWS

These are all the European networks of which we're aware. Most are free — but phone them for details.

Forum-80 Hull ... (Forum-80 HQ)
Tel: 0482 859169, System operator:
Frederick Brown. International
electronic mail, library for
up/down-loading software.
Forum-80 Users Group, Pet Users
section shopping list system hours,
7 days a week midnight to 8.00am,
Tues/Thurs 7.00pm to 10.00pm
Sat/Sun 1.00pm to 10.00pm

Forum-80 London ... Tel: 01-747
3191. System operator: Leon Jay.
Electric Mail, library for
downloading. System hours:
Tues-Fri/Sun 7.00pm to 11.00pm.

Forum-80 Holland ... Operator:
Nico Karssemeyer, Tel: 01/313 512
533. Facilities: electronic mail,
program up/downloading,
shopping list. Hours; Tues-Sat
1800-0700 nightly, continuous from
1800 Sat-0700 Tues

CBBS London ... Operator: Peter
Goldman, Tel: 01-399 2136.
Facilities: electronic mail, program
downloading. Hours: Wed
0700-0930 & 1900-2200, Fri
1900-2200, Sun 1600-2200.

Forum-80 Milton ... (TRS-80
Users Group 80-Nett) Tel: 0908

566660. System operators: Leon
Heller and Brian Pain. Electronic
mail, library, newsletter, TRS-80
information system hours: 7 days a
week 7.00pm to 10.00pm.

Mailbox-80 Liverpool ... 051-428
8924. System operator: Peter
Toothill, Electronic mail, down-
loading TRS-80 information.

ACC ... members bulletin board,
Peter Whittle (0908 44262).

ABC-80 ... Stockholm (Sweden).
Tel: 010-468 190522.

University Research Computer ...
Sweden. Tel: 010-468 23660, guests
use password "66,66" for access.

Elfa ... Sweden 010-468 7300 706.

Tree Tradet ... Sweden 010-468
190522.

Rewtel ... (Radio &
Electronics World's bulletin
board) 24 hour service 7 days a
week. Packed with useful and
interesting information, etc.
Subscription fee £10 pa. Non-
subscribers may have 8 mins
free. Hardware required: 300
baud full duplex. Standard
page: 64 characters by 16
inches. Tel: (0277) 232628.

DIARY DATA

Readers are strongly advised to check details with exhibition organisers before making arrangements to avoid wasted journeys due to cancellations, printer's errors, etc.

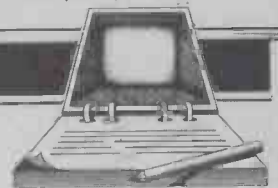

| | | |
|------------|--|----------------|
| London | (Earls Court) Computer Fair. Contact: Reed Exbns, 01-643 8040 | 16-19 June |
| Manchester | (Belle Vue) Compec, Comp Professionals Exbn. Contact: Reed Exbns, 01-643 8040 | 21-23 June |
| Leeds | (John Taylor Teachers Centre) Educational Computing & S/W Fair. Contact: Mr Creighton, 53 Headingley Lane, LS6 1AA | 22 June |
| Cologne | Mini Comp show for Office, Home, Hobby. Contact: German Chamber of Industry & Commerce, 01-930 7251 | 23-26 June |
| London | (Barbican) Times & Sunday Times Business to Business Exbn. Contact: Silver Collins & Co Ltd, 01-729 0677 | 26-29 June |
| London | (West Centre Hotel) DeXPO Europe, Digital Equip H/W + S/W. Contact: Interco Bus Consultants Ltd, 01-948 3111 | 29 June-1 July |
| London | (Wembley Conf Centre) IBM Users Conf & Exbn. Contact: Online Publications Ltd, 09274 28211 | 12-14 July |
| London | (Royal Lancaster Hotel) Nat Conf & Exbn of Computers in Personnel. Contact: Peter Mirrington Exbns, 0277 232030 | 12-14 July |

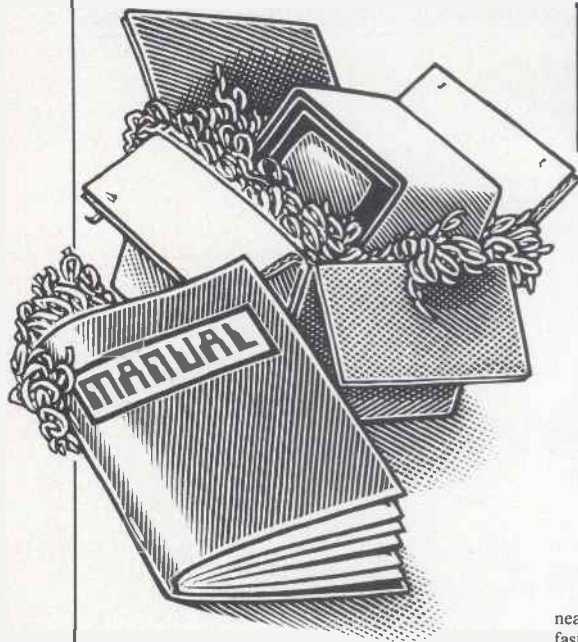

NEWCOMERS START HERE

This is our unique quick-reference guide, reprinted every month to help our readers pick their way through the most important pieces of (necessary) jargon found in PCW. While it's in no way totally comprehensive, we trust you'll find it a useful introduction. Happy microcomputing!

Welcome to the confusing world of the microcomputer. First of all, don't be fooled; there's nothing complicated about this business, it's just that we're surrounded by an immense amount of necessary jargon. Imagine if we had to continually say 'numbering system with a radix of 16 in which the letters A to F represent the values ten to 15' when instead we can simply say 'hex'. No doubt soon many of the words and phrases we are about to explain will eventually fall into common English usage. Until that time, PCW will be publishing this guide — every month.

We'll start by considering the microcomputer's functions and then examine the physical components necessary to implement these functions.

The microcomputer is capable of receiving information, processing it, storing the results or sending them elsewhere. All this information is called **data** and it comprises numbers, letters and special symbols which can be read by humans. Although the data is accepted and output by the computer in 'human' form, inside it's a different story — it must be held in the form of an electronic code. This code is called **binary**. Binary is a system of numbering which uses base 2 instead of the more familiar decimal — or, to be more accurate, denary-system of base 10. In binary notation there are only two digits — 0 and 1 — which the computer recognises as the absence or presence of an electric current. The easiest way to visualise this is to think of each binary digit (**bit**) as being a switch which can be either off or on. Each binary digit stands for a power of 2. The right-most digit, the least significant, is $2^0=1$, the next $2^1=2$, then $2^2=4$, $2^3=8$, $2^4=16$, $2^5=32$, $2^6=64$, $2^7=128$, $2^8=256$. So decimal 24, for example, is represented in binary as 00011000. A set of eight bits is known as a **byte** and, to make things easier for humans, a third system of numbering, **hexadecimal** or **hex** for short, is used as a sort of 'halfway house' between binary and denary. Hex uses numbers to base 16, with denary numbers between 9 and 16 represented by the letters A-F. The hex equivalent of a byte is obtained by giving each half a single character code: 0=0000, 1=0001, 2=0010, 3=0011, 4=0100, 5=0101 ... E=1110 and F=1111. Our example of 24 is therefore 18 in hex.

To simplify communication between computers, several standard coding systems exist, the most common being **ASCII** (American Standard Code for Information Interchange). This allocates a numerical code to each digit and letter. For example, the number 5 is given the ASCII code 35 hex, 53 decimal, whereas a capital A is represented by ASCII 41 hex, 65 decimal.

The computer processes data by reshuffling, performing arithmetic on, or by comparing it with other data. It's the latter function that gives a computer its apparent 'intelligence' — the ability to make decisions and to act upon them. It has to be given a set of rules in order to do this and, once again, these rules are stored in **memory** as bytes. The rules are called **programs** and while they can be input in binary or hex (**machine code** programming), the usual method is to have a special program which translates English or near-English into machine code. This speeds programming considerably; the

closer the **programming language** is to English, the faster the programming time. On the other hand, program execution speed tends to be slower.

The most common microcomputer language is **Basic**. Program instructions are typed in at the keyboard, to be coded and stored in the computer's memory. To run such a program the computer uses an **interpreter**, which is usually built into the machine's ROM (see later paragraph on this page). The interpreter picks up each Basic instruction, translates it into machine code and then feeds it to the **processor** for execution. It has to do this each time the same instruction has to be executed. A much faster method is to use a **compiler**, which accepts each instruction in turn, waits until the program has been entered, then turns each instruction into machine code before running the program. This means that each instruction has to be translated once only — consequently the speed of execution is considerably improved.

Two strange words you will hear in connection with Basic are **PEEK** and **POKE**. They give the programmer access to the memory of the machine. It's possible to read (PEEK) the contents of a byte in the computer and to modify a byte (POKE).

Moving on to **hardware**, this means the physical components of a computer system as opposed to **software** — the programs needed to make the system work.

At the heart of a microcomputer system is the central processing unit (**CPU**), a single microprocessor chip with supporting devices such as **buffers**, which 'amplify' the CPU's signals for use by other components in the system. The packaged chips are either soldered directly to a printed circuit board (**PCB**) or are mounted in sockets.

In some microcomputers, the entire system is mounted on a single, large PCB; in others a **bus system** is used, comprising a long PCB holding a number of interconnected sockets. Plugged into these are several smaller PCBs, each with a specific function — for instance, one card would hold the CPU and its support chips. The most widely-used bus system is called the **S100**.

The CPU needs memory in which to keep programs and data. Microcomputers generally have two types of memory, **RAM** (Random Access Memory) and **ROM** (Read Only Memory). The CPU can read information stored in RAM — and also put information into RAM. Two types of RAM exist — **static** and **dynamic**; all you really need know is that dynamic RAM uses less power and is less expensive than static, but it requires additional, complex, circuitry to make it work. Both types of RAM lose their contents when power is switched off, whereas ROM retains its contents permanently. Not surprisingly, manufacturers often store interpreters and the like in ROM. The CPU can only read the ROM's contents and cannot alter them in any way. You can buy special ROMs called **PROMs** (Programmable ROMs) and **EPROMs** (Erasable PROMs) which can be programmed using a special device; EPROMs can be erased using ultra-violet light.

Because RAM loses its contents when power is switched off, **cassettes** and **floppy disks** are used to save programs and data for later use. Audio-type tape recorders are often used by converting data to a series of

audio tones and recording them; later the computer can listen to these same tones and re-convert them into data. Various methods are used for this, so a cassette recorded by one make of computer won't necessarily work on another make. It takes a long time to record and play back information and it's difficult to locate one specific item among a whole mass of information on a cassette; therefore, to overcome these problems, **floppy disks** are used on more sophisticated systems.

A floppy disk is made of thin plastic, coated with a magnetic recording surface rather like that used on tape. The disk, in its protective envelope, is placed in a disk drive which rotates it and moves a **read/write head** across the disk's surface. The disk is divided into concentric rings called **tracks**, each of which is in turn subdivided into **sectors**. Using a program called a **disk operating system**, the computer keeps track of exactly where information is on the disk and it can get to any item of data by moving the head to the appropriate track and then waiting for the right sector to come round. Two methods are used to tell the computer where on a track each sector starts: **soft sectoring** where special signals are recorded on the surface, and **hard sectoring** where holes are punched through the disk around the central hole, one per sector.

Half-way between cassettes and disks is the **stringy floppy** — a miniature continuous loop tape cartridge, faster than a cassette but cheaper than a disk system. **Hard disk** systems are also available for microcomputers; they store more information than floppy disks, are more reliable and information can be transferred to and from them much more quickly.

You, the user, must be able to communicate with the computer and the generally accepted minimum for this is the visual display unit (**VDU**), which looks like a TV screen with a typewriter-style **keyboard**; sometimes these are built into the system, sometimes they're separate. If you want a written record (**hard copy**) of the computer's output, you'll need a **printer**.

The computer can send out and receive information in two forms — **parallel** and **serial**. Parallel input/output (**I/O**) requires a series of wires to connect the computer to another device, such as a printer, and it sends out data a byte at a time, with a separate wire carrying each bit. Serial I/O involves sending data one bit at a time along a single piece of wire, with extra bits added to tell the receiving device when a byte is about to start and when it has finished. The speed that data is transmitted is referred to as the **baud rate** and, very roughly, the baud rate divided by ten equals the number of bytes being sent per second.

To ensure that both receiver and transmitter link up without any electrical horrors, standards exist for serial interfaces; the most common is RS232 (or V24) while, for parallel interfaces to printers, the **Centronics** standard is popular.

Finally, a **modem** connects a computer, via a serial interface, to the telephone system, allowing two computers with modems to exchange information. A modem must be wired into the telephone system and you need British Telecom's permission; instead you could use an **acoustic coupler**, which has two obscene-looking rubber cups into which the handset fits, and which has no electrical connection with the phone system — British Telecom isn't so uppity about the use of these.



Software News



**INNOVATIVE
TRS 80-GENIE SOFTWARE**

from the professionals

£250 REWARD

Below you will find described a new program entitled Enigma. It is a true simulation of the German wartime cypher machine of that name. It will encipher messages which may be communicated to third parties by any means who, assuming they have the key, will be able to use their Enigma program to decipher.

We will pay the sum of £250 to anyone [who has purchased the program] who can demonstrate an infallible method of deciphering the coded message supplied in the program's instructions. We consider Enigma to be the best program of its kind on the U.K. or U.S. market; contestants may therefore use any orthodox means to crack the code, including microcomputer programs other than Enigma.

The original message and keys will be lodged with our Solicitors for safe keeping in a sealed envelope. In the [hopefully] unlikely event that the code is cracked by more than one person, the reward will be paid to the first customer who demonstrates to us that he has succeeded.

MOLIMERX LTD.

During the 1939/45 war the German Army and Intelligence used a deciphering machine called Enigma. It was a fascinating machine and the stories that have surrounded it are equally interesting. There have been some four or five books written about the machine, and with regard to the way in which the British counter intelligence managed to crack the code.

That they did so was the culmination of some fortuitous circumstances, a lot of luck, but mainly it was due to the fact that the people who did it were extremely clever mathematicians. The fact that it took so much brain power, plus a rudimentary type of computer and a specimen of the machine in order to crack the code is an indication of how complex that code is.

The Enigma microcomputer program that we are selling is a simulation of the original machine, together with one or two improvements which were suggested by Gordon Welchman, who wrote the book "The Hut Six Story" last year and was also the leader of the team that cracked the code.

Although the machine and, therefore, the program is so complicated, its use is amazingly simple. One simply inputs a key and a message and the code is supplied. To decipher, the message is input again with the key and if the key is correct then the decoded message is displayed. With the cassette version it is necessary to input from the keyboard but with disks both inputs and outputs may be to disk files if required. A printer is of course supported.

The code may be transmitted in any way which the written word can be transmitted. Companies who wish to fully protect their communications will no doubt have the program generate the code and then tap it into a telex. Tape users will have to send either the output from their printer or write down the code direct from the screen.

Enigma is a fascinating program designed, not only for those people who are interested in encryption professionally or as a hobby, but also for companies or private persons who wish to communicate with others in an entirely secure manner. As is shown by the above Reward Notice, we have great faith in the powers of this piece of software.

ENIGMA (Tape) ... £17.25
ENIGMA (Disk) ... £23.00
Inclusive of V.A.T. P&P 75p

TEL: [0424] 220391/223636

MOLIMERX™ LTD
A J HARDING (MOLIMERX)

TELEX 86736 SOTEX G

1 BUCKHURST ROAD, TOWN HALL SQUARE, BEXHILL-ON-SEA, EAST SUSSEX.

TRS-80 & VIDEO GENIE SOFTWARE CATALOGUE £1.00 plus £1 postage.

ASCII Keyboards



- Upper & Lower Case plus Control
- Low Power Consumption
- Shift & Alpha Lock
- Autorepeat (Model 777)
- Parallel Data Output
- Metal Mounting Frame
- Suitable for Tuscan, Tangerine etc.

| | | |
|--------------|-------------|--------|
| Model KB756A | 56 key | £44.50 |
| KB710 | Numeric Pad | £ 7.50 |
| KB771 | 72 key | £57.50 |
| KB777 | 77 key | £65.00 |

Accessories available include:-

| | |
|--------------------|--------|
| Metal Case | £15.95 |
| Edge Connector | £ 2.25 |
| DC to DC Converter | £ 5.50 |

(for operation off single 5V supply)

High Performance Monitor



MONITOR

- 12" Green P31 Phosphor
- MULLARD C.R.T.
- 80 Character Line Capability
- 24MHz Video Bandwidth
- 240V AC Input
- Toroidal Transformer
- Composite Video Input
- Ideal for Apple, B.B.C. Micro, Gemini, Nascom, Tuscan, Newbrain etc.

MODEL 101 £89.50

NewBrain



| | | |
|----------|---------|-------------------------------------|
| Model A | £189.00 | 200K |
| Model AD | £219.00 | Drive, boxed with Floppy Controller |
| | £120.00 | power supply |

£220.00

ZX Spectrum Series 2 - CP48 32K Memory Extension

Gives total of 48K. Simply fits internally with no soldering. Only full spec. components used £20.95.

VIC 20 16K RAM Cartridges

For 8 and 16K Programmes £25.00.
For 3, 8 and 16K Programmes, switchable £33.00.

U.K. Orders add 15% VAT on order total. Overseas Orders add £6.50 to cover part cost postage and documentation. Delivery all items ex stock.

Citadel Products Ltd

Dept. PCW, 50 High Street, Edgware, Middlesex, HA8 7EP. Tel: 01-951 1848

PROGRAMS

PCW is interested in programs written in any of the major programming languages for all home and small business micros. When submitting programs to PCW please include the following:-

- (a) A cassette or disk of the program
- (b) A listing on plain, white paper (typewritten if no printer available).
- (c) Comprehensive but brief documentation.
- (d) A suitable sae if you would like your materials to be returned after use.

Please mark (a), (b) and (c) with your name, address, program title, machine (state minimum RAM where appropriate) and — if possible — a daytime phone number. All programs must, please, be fully debugged. Programs are paid for at the rate of £40 per page of published listing, plus a £100 bonus for the Program of the Month. Send contributions to: Surya, PCW Programs, 62 Oxford Street, London W1A 2HG.

I'll do my best to acknowledge receipt of programs as quickly as possible, but following this acknowledgement it will usually be some time before a decision can be made, so please be patient! Generally speaking, programs which are rejected for any reason are returned fairly quickly, so 'no news ...'

Note: Due to industrial action at Rathbone Place Sorting Office, London, W1, programs — along with all our other mail — are subject to delay.

Oric 1 owners will, by now, be tearing out their hair and banging their heads against the nearest wall ... the corrections to the corrections to the errors in the 'Bug Eater' listing are included in this month's 'Bludners'. This program will now work (he says confidently). Could A Roe, author of 'BBC Balloons', please give me a ring — I've lost your address. And lastly, authors will be pleased to note that the new Programs rate is £40 per page with a £100 bonus for the author of Program of the Month. And now to this month's contributions ...

BBC TV Test

by Q A Rice

For someone with the necessary technical knowhow, TV Test should provide all the information needed to set up a tv or monitor correctly. The program makes use of the BBC's high-resolution graphics to simulate a pattern generator, offering a crosshatch, dot pattern, colour bar, colour matrix, focus grid and test card. I don't know enough about pattern generators to comment on the quality, but our

referee (a lecturer in physics who presumably *does* know about pattern generators) seemed suitably impressed. You'd be hard-pressed to find a pattern generator selling at much below the price of a BBC Model A — besides, you can't play PAC-MAN on a pattern generator. The program runs on either model, and is menu-driven. Pressing the space bar returns you to the menu.

DRAGON 32 / TANDY COLOR

Now 4 — yes 4 — fabulous magazines just for you!!

"RAINBOW"
"COLOR COMPUTER NEWS"
"COLOR COMPUTER MAGAZINE"
"HOT CO-CO"

all plus EXCLUSIVE U.K./European Supplement & Free advisory service

Send £2.25 (+57p s.a.e.) for sample copy to

ELKAN ELECTRONICS (Dept PCW)
FREEPOST, 11 Bury New Road, Prestwich
Manchester M25 6LZ Tel. 061-798 7613

HOBBYIST LIMITED

Open 6 days 10am-7pm
Wednesday and Saturday 5.30pm

Authorised Apple Service Centre

Apple IIe, Epson HX20 Portable Computer and Epson RX80, FX80 Printers all now in stock. Also wide range of supporting peripherals and books.

3 The Broadway, Manor Hall Road
Southwick, Brighton BN4 4ND

Tel: 0273 593345

PROGRAMS

```

10MODE7
20VDU23,224,85,170,85,170,85,170,85,170
30VDU23,225,51,51,204,204,51,51,204,204
40VDU23,226,15,15,15,15,240,240,240,240
50VDU23,227,85,87,80,95,64,127,0,255
60VDU23,228,85,213,21,245,5,253,1,255
70VDU23,229,0,127,64,95,80,87,84,85
80VDU23,230,1,253,5,245,21,213,85,85
90VDU23,231,0,255,0,255,0,255,0,255
100VDU23,232,85,85,85,85,85,85,85,85
110MODE7:PRINT""T.V. TEST PATTERNS""1.CROSSHATCH""2.DOT PATTERN""3.COLOUR
BARS<1>""4.COLOUR BARS<2>""5.FOCUS GRID""6.TEST CARD"
120PRINT""TO RETURN TO MENU HIT ANY KEY""
130INPUT"ENTER CHOICE "CH
140NCH GOTO150,180,280,290,300ELSEGOTO130
150MODE4:FOR I=0TO1200 STEP 64:MOVEI,0:DRAWI,1024:NEXT
160FOR I=0TO1024 STEP 64:MOVE0,I:DRAW1200,I:NEXT
170GOTO390
180MODE4:FORI=0TO1270:PRINT":NEXT
190GOTO390
200MODE2:FORI=0TO1120STEP160:READK
210GCOLOR,K:MOVEI,0:MOVEI,1024:PL0T85,I+160,1024:MOVEI,0:PL0T85,I+160,0:NEXT
220RESTORE:GOTO390
230MODE2:FORI=0TO1120STEP160:READK
240GCOLOR,K:MOVEI,0:MOVEI,1024:PL0T85,I+160,1024:MOVEI,0:PL0T85,I+160,0:NEXT
250RESTORE:FORI=0TO896STEP128:READK:GCOLOR,K
260MOVE0,I:MOVEI200,I:PL0T85,1200,I+64:MOVE0,I:PL0T85,0,I+64:NEXT:RESTORE
270GOTO390
280MODE5:FORI=0TO639:PRINTCHR<225>:NEXT
290GOTO390
300MODE2:PROCPRINT<1,10,1,30,226>
310PROCPRINT<3,16,6,25,225>
320PROCPRINT<6,13,11,20,224>
330T=0:FORX=-4TO4:W=X*8
340PROCPRINT<1,10,15,16,231>
350PROCPRINT<9,10,3,28,232>
360PRINTTAB<9,15>:CHR<228>:PRINTTAB<10,15>:CHR<227>:PRINTTAB<9,16>:CHR<230>
:PRINTTAB<10,16>:CHR<229>
370FORI=0TO7:READK:COLOUR120+K:FORJ=0TO1:PRINTTAB<I*2+J,J>:"":PRINTTAB<I*2+
2,30+J>:"":NEXTJ,I:RESTORE
380FORI=0TO7:READK:COLOUR120+K:FORJ=0TO2:PRINTTAB<0,I*3+J+4>:"":PRINTTAB<10,
I*3+J+4>:"":NEXTJ,I:RESTORE
390VDU30:X=GET:GOTO40
400DEFPROCPRINT<A,B,C,D,E>
410FORI=A TO B:FORJ=C TO D
420PRINT TAB<I,J>:CHR<E>:NEXTJ,I
430ENDPROC
440DATA0,4,1,5,2,6,3,7
    
```

Atom Four-stroke Cycle

by Jonathan Empson

'Four-stroke Cycle' is a simple graphical demonstration of the workings of a four-stroke internal combustion engine. The program, intended for use as a visual aid in a physics or general science lesson, shows the movement of the piston

together with the operation of the inlet and exhaust valves. The display freezes after each cycle and waits for a key press before continuing. This program requires the Ross utility ROM.

```

10 LINK 44992
20 CLEAR4
30 R=40
40 FOR A=1 TO 2
50 MOVE 87,55
60 FOR X=-40 TO 40 S.4
70 Y=SQR<R+R-X*X>
80 IF A=2 Y=-Y
90 DRAW <127+X>,<55+Y>
100 N.
110 N.
120 *RES.470
130 *READ B,C
140 MOVE B,C
150 DO
160 *READ B,C:IF B=-1 G.190
170 IF B=-2 G.210
180 DRAW B,C
190 U. B=-1
200 G.130
210 *STRG 20,170,"Intake valve"
220 *STRG 160,170,"Exhaust valve"
230 *STRG 110,190,"Spark"
    
```

COLOUR PRINTING FOR WORDSTAR
A Patch is available for operating the PRISM colour printer from inside Wordstar III, providing control over ALL colour options, SPEED and PITCH. Easily installed HEX listing supplied £35.00., + VAT (CWO).

DUST COVERS

| | |
|----------------|-------|
| SUPERBRAIN | £5.50 |
| PRISM 80 | £3.50 |
| PRISM 132 | £4.50 |
| TELEVIDEO 800A | £5.50 |
| TELEVIDEO 802 | £5.50 |
| TELEVIDEO 806 | £5.50 |

Prices ex-VAT. Add 50p postage and packing. Dealer and Quantity discount available.
021 643 1609 JAEMMA LIMITED 021 643 1609
UNIT 24, LEE BANK HOUSE, HOLLOWAY ROAD
BIRMINGHAM B1 1HR

COMMODORE 64

At last! "BC BASIC", the new ultra-powerful Basic Extension for the 64, is available now at the unbelievable price of **£19.95**

JUST LOOK AT THESE FEATURES:
GRAPHICS: Full HI RES, including PLOT and DRAW. 320x200 2-colour, 160x200 4-colour plotting. Two 9K graphics screens stored simultaneously, but leaves 33K free for BASIC! Colour ANDing, ORing and XORing, and POINT (x,y). Very powerful! Also includes sprites and user-defined characters. SOUND: 18+ commands and functions, like PITCH, ADSR, WAVEFORM, RINGMOD, SYNC, FILTER, FMODE & many more. OTHERS: include IF... THEN... ELSE, REPEAT... UNTIL, & % for hex and binary numbers, HIMEM, PRINT AT, INK/PAPER/BORDER, 2-byte Peek/Poke - the list goes on!!!
Many more features than those listed above. Send cheque/PO for £19.95 payable to B C COMPUTERS for cassette and manual, or SAE for full details, to: B C COMPUTERS, 31A GROSVENOR AVENUE, LONG EATON, NOTTINGHAM NG10 3FQ

MICROMART

BUFFERS

add high-speed memory to your system and cut print processing time

... for EPSON users

- MICROBUFFER (Practical Peripherals) for EPSON MX/RX/FX and IBM PC Printers
- Ex-stock - Serial 8K, Parallel 16K £125 + VAT, total £143.75

... for APPLE users

- ORANGE MICRO Bufferboard for Apple II & III, 16K parallel £109 + VAT, total £125.35. Expansion available.

All our prices are post-free
Cash with order please

A>Line Computer Systems

24 Horsendale Avenue, Nuthall
Nottingham NG16 1AN
Tel. (0602) 276445

PET DISK REVEALED!

That's right - with SUPERSOFT'S new DISK REVEALED program, you can examine any track or sector on your PET disk - even if the disk gives read errors! Whether you use DISK REVEALED to recover lost data, create protection systems, or in an attempt crack security on the DISK REVEALED disk, you'll find it excellent value at £25 plus V.A.T.

64 OWNERS - A version for the 1541 drive is on the way!

In the many pages of SUPERSOFT'S winter '82 catalogue (no we don't have a new one yet, but then it still seems like winter '82), you'll find innovative PET products like MATRIX BASIC (£75) and INFINITE ARITHMETICALLY minded. There's BACKGROUND music (£18), for the musically minded, and the bloody minded, a whole range of adventure games that will tax your persistence and test your sanity. For only £8 you can choose from a large range of arcade games including CRAZY KONG, SUPER GLOOPER, MANGROVE, or two games for the price of one, CLOUDHOP and BREAKOUT. Spend a little more (£10) and you can buy SCRAMBLE - it's ace!

We reckon that only 25% of PET owners in the UK are on our mailing list. Come on the rest of you let's have your name and address pronto. Though more and more of our advertising is aimed at 64 owners we're not going to discontinue our 300 PET programs, accessories and peripherals.
ADD 15% V.A.T. TO ALL PRICES - POSTED FREE-PHONE FOR A FREE CATALOGUE

SUPERSOFT

Winchester House, Canning Road, Wealdstone,
Harrow, Middlesex, HA3 7SJ, England.
Telephone: 01-861 1166

OSBORNE 1

TRY US FIRST!

£949 + VAT

COMPUTERS

01-228 2207
Southampton House, 192-206 York Road, London SW11 3SA

MZ80 GAMES

INTERESTED !!

For further information write to

STEVE BROWN
3 PRIESTLEY GARDENS
ROMFORD
ESSEX

BBC MICRO

also VIC, DRAGON, TANDY, etc

DEALER ENQUIRIES WELCOME

An expansion console which gives your micro the professional look. Protects your micro with room for dual disc drives or drive plus teletext adapter or second processor. All wiring out of sight within the console made of aluminium and textured sprayed in cream colour. Coming soon a bolt on extra module for extra expansion options. Yes this console will grow with you. Basic BBC console as shown £39.99 plus £4.00 P/P. Please add VAT at 15% or for more information enclose sae to SILENT COMPUTERS, 27 Wycombe Rd, London N17 9XN.

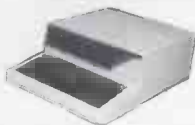

Mail order only. Viewing by arrangement.
24 hour ansaphone 801 3014

NASCOM UK101 TRS 80 All single board computers. Computer cases for your micros plus up to two disc drives with room for expansions are still available. SAE for details.

DRAGON/ATOM/ORIC-1 ADD LOW-COST I/O POWER WITH A VIA BOARD

Drive extra I/O devices, from LEDs & switches to extra peripherals. Link 2 micros for data/program transfer, spool listings to a second micro to print/save etc. (see TEVLINK below).

HARDWARE: 6522 VIA provides 16 I/O lines + control, serial port 2 timers, interrupt register, VD, voltage & interrupt lines taken to 26-way IDC plug for easy connection to peripherals etc. Connectors available for Dragon, Atom, Oric 6522A version should be out soon. The Board may be interfaced to most other 6502/6809 micros, and may be shared between m/c's by changing the plug-in connector.

SOFTWARE: 'TEVLINK' package provides 2-machine parallel link (2 Boards needed), overall speed about 8K DATA bytes/second with error checking.

A PRINT SPOOLER is included (only 1 Board needed): connect printer port to VIA board on receiving micro and use normal LIST/PRINT etc.
Assembled board + Atom connector £16.50
Assembled board + Dragon connector £18.75
Assembled board only - for your interface £14.00
Atom connector £4.00 Dragon connector £6.00
Cable: Printer port to VIA (state m/c) £7.00
TEVLINK Board Board cable £4.50
TEVLINK's 'ware': Dragon/Atom cassette £7.75
Blank cassettes (cased): 10 x C10 for £5.75

OTHER SOFTWARE:
CAVE QUEST: Underground quest for the ring of power: Dragon/Atom/Oric cassette £2.30
LASER INVADERS: Dragon joystick game £2.30
TEVROG'S KINGDOM: A real-time quest for magic powers (and survival): Dragon/Oric £5.75

Other software and hardware available soon
WANTED!! Good software (games & serious) for royalties or outright purchase. Send for details

MAIL ORDER ONLY. SEND FOR LISTS/DETAILS
All prices fully inclusive of VAT, P/P etc.

Tevward Microtech Ltd. (Dept PCW)
403 Dallow Road, Luton LU1 1UL
Tel. (0582) 418906

PROGRAMS

```

240 *BLOCK 1 105,86,45,30
250 *STRG 110,182,"plus"
260 G=1:H=1:*#140="COMPRESSION"
270 GOS.a:GOS.u
280 #140=" Ignition "
290 GOS.a
300 *STRG 124,155,"*"
310 #140=" POWER "
320 GOS.a:*STRG 124,155," ":GOS.d
330 G=3:*#140=" EXHAUST "
340 GOS.a:GOS.u
350 G=1:H=3:*#140=" INTAKE "
360 GOS.a:GOS.d
370 G.260
380aLINK #FFE3
390 *BLOCK G 145,150,4,5
400 *BLOCK H 105,150,4,5
410 *BSTRG 1,95
420 IF G=1:*STRG 160,160,"SHUT"
430 IF G=3:*STRG 160,160,"OPEN"
440 IF H=1:*STRG 20,160,"SHUT"
450 IF H=3:*STRG 20,160,"OPEN"
460 RET.
470 *DATA 103,86,103,150,105,150,105,170,-1,-1
480 *DATA 110,170,110,150,120,150,120,155,124,155,124,170
490 *DATA 130,170,130,155
500 *DATA 130,170,130,155
510 *DATA 134,155,134,150,144,150,144,170,-1,-1
520 *DATA 149,170,149,150,151,150,151,86,-2,-2
530uFOR F=86 TO 117
540 MOVE 105,F:PLOT 3,44,0
550 MOVE 105,(F-30):PLOT 1,44,0
560 IF G=1 PLOT 13,(A.R.*44+105),(A.R.*30+117)
570 N.:R.
580uFOR F=147 TO 116 S.-1
590 MOVE 105,F:PLOT 3,44,0
600 MOVE 105,(F-30):PLOT 1,44,0
610 IF H=3 PLOT 13,(A.R.*44+105),(A.R.*30+117)
620 N.:R.
    
```

ZX81 Spectrum Least Squares

by Neil J Marshall

'Least Squares' is a linear regression fitting program for the 16k ZX81, and either Spectrum. Given a set of (x,y) coordinates, the program uses the method of least squares to calculate the equation of the best straight line through the given points. It uses a parallelogram of errors to calculate the expected errors in gradient and constant, as well as giving two widely-spaced coordinates to facilitate easy plotting of the line.

Subject to the amount of memory

available, the program will allow any number of coordinates to be entered, although it must obviously be given a minimum of two. The coordinates may be entered in any order and the program does work for a perfectly straight line. For those of you who get some kind of perverse pleasure out of confusing poor, defenceless micros, you can defeat this one by entering coordinates of either the x or y axis: the only cases where the program falls down.

```

100 PRINT "THIS PROGRAM WILL GI
VE THE EQUATION OF THE BEST
STRAIGHT LINE THROUGH ANY SET
OF POINTS USING THE LEAST SQUA
RES METHOD."
110 PRINT
120 PRINT "THE POINTS MAY BE EN
TERED IN ANY ORDER. THE COMP
UTER WILL ALSO GIVE THE COORDI
NATES OF TWO WELL SEPARATED POINT
S ON THIS BEST STRAIGHT LINE T
O FACILITATE PLOTTING THIS STRAIG
HT LINE ON A GRAPH. THE COMPUTER
ALSO GIVES THE STANDARDISED ERR
ORS IN BOTH THE GRADIENT OF THE
GRAPH AND IN THE CONSTANT, PROVID
ED THAT THESE ERRORS ARE NOT
ZERO."
130 PRINT
140 PRINT "PRESS ANY KEY TO CON
TINUE."
150 IF INKEY$="" THEN GOTO 150
160 CLS
170 PRINT "HOW MANY PAIRS OF PO
INTS ? ";
180 INPUT N
190 IF N<=1 THEN GOTO 180
200 PRINT N
210 DIM X(N)
220 DIM Y(N)
    
```

MONITOR & PRINTER STANDS



- Handsomely crafted in 6mm tinted Perspex
- PSS model for Microline 80/82/83, Epson MX-80, Sheiksha GP100 etc. 15" x 12" x 4.5" £18.95 + VAT
- PSL for Microline 84, Epson MX82 etc. 17" x 14.5" x 3.75" £19.95 + VAT
- MSB monitor stand for BBC £19.95 + VAT.
- POT Printer Output Tray for 11" fanfold paper £18.95 + VAT
- PSC-3 for Epson MX-100 £22.95 + VAT

Packing + Postage
£3.50



CAMBRIDGE MICROELECTRONICS LTD
One Milton Road Cambridge CB4 1UY
(0223) 314814

HIGH QUALITY SOFTWARE FOR TRS80 MODEL 2

FULLY INTEGRATABLE BUSINESS SYSTEMS

Standard Features:

- ★ Modular design means that you can build as you grow.
- ★ Very easy to use - requires no previous computing experience.
- ★ Many advanced features such as high speed incremental backup are built in as standard

CHECKOUT THIS EXCITING NEW DEVELOPMENT

MECTRONICS LTD

Contact Paul Hiles · Tel 0272 674635
Tower Lane (a), Tower Road North,
Warmley, Bristol

PROGRAMS

```

230 PRINT
240 LET L=2
250 FOR I=1 TO N
260 PRINT "POINT ";I;TAB 10;"X-
COORDINATE ? ";
270 INPUT X(I)
280 PRINT X(I)
290 PRINT TAB 10;"Y-COORDINATE
? ";
300 INPUT Y(I)
310 PRINT Y(I)
320 PRINT
330 LET L=L+3
340 IF L<=18 THEN GOTO 370
350 CLS
360 LET L=0
370 NEXT I
380 LET SX=0
390 LET SY=0
400 LET SXY=0
410 LET SX2=0
420 LET SY2=0
430 FOR I=1 TO N
440 LET SX=SX+X(I)
450 LET SY=SY+Y(I)
460 LET SXY=SXY+X(I)*Y(I)
470 LET SX2=SX2+X(I)*X(I)
480 LET SY2=SY2+Y(I)*Y(I)
490 NEXT I
500 LET S=N
510 LET MX=((SX*SY)-(S*SXY))/((
SX*SX)-(S*SX2))
520 LET CY=((SY*SXY)-(S*SY2))/
((SX*SX)-(S*SX2))
530 LET MY=((SX*SY)-(S*SXY))/((
SY*SY)-(S*SY2))
540 LET CX=((SY*SXY)-(S*SY2))/
((SY*SY)-(S*SY2))
550 LET CY=-CY/MY
560 LET MY=1/MY
570 LET M=(MX+MY)/2
580 LET C=(CX+CY)/2
590 LET L=1E10
600 LET L2=1E10
610 LET B=-1E10
620 LET B2=-1E10
630 LET R=-1E10
640 FOR I=1 TO N
650 IF X(I)<L THEN LET L2=Y(I)
660 IF X(I)<L THEN LET L=X(I)
670 IF X(I)>B THEN LET B2=Y(I)
680 IF X(I)>B THEN LET B=X(I)
690 IF ABS (Y(I)-(M*X(I)+C))>R
THEN LET R=ABS (Y(I)-(M*X(I)+C))
700 NEXT I
710 LET L1=M*L+C
720 LET B1=M*B+C
730 LET DM=0
740 LET DC=0
750 IF N<=2 THEN GOTO 780
760 LET DM=(ABS (((B2-L2+2*R)/(
B-L))-M))/SQRT (N-2)
770 LET DC=R/SQRT (N-2)
780 CLS
790 PRINT "THE EQUATION OF THE
BEST STRAIGHT LINE THROUG
H ALL THE POINTS IS
",,"Y=";
800 IF M<>1 THEN PRINT M;
810 PRINT "X";
820 IF C<0 THEN PRINT "-";ABS C
830 IF C>0 THEN PRINT "+";C
840 IF C=0 THEN PRINT
850 IF DM=0 THEN GOTO 870
860 PRINT ", "THE STANDARDISED E
RROR IN THE GRADIENT IS +/-";D
M
870 IF DC=0 THEN GOTO 890
880 PRINT ", "THE STANDARDISED E
RROR IN THE CONSTANT IS +/-";D
C
890 PRINT ", "TWO POINTS ON THIS
LINE ARE X=";L,"Y=";L1,"X="
;B,"Y=";B1
900 STOP
    
```

BBC Mickey

by Q A Rice

'Just for fun. This proves Disney's original idea for drawing Mickey Mouse using only circles and ellipses really works. Originally written on a minnie computer using Pluto graphics board'

explains the author. Let it be known that there's an inverse relationship between the number of puns of that quality and your chances of getting paid, Mr Rice.

```

10MODE1
20VDU19,0,4;0;19,2,0;9;:PROCRAYS
30PROCCIRC(700,400,250,2)
40PROCCIRC(650,750,150,2)
50PROCCIRC(1050,550,150,2)
60PROCCIRC(570,470,100,3)
70PROCCIRC(700,440,100,3)
80PROCCIRC(820,300,100,3)
    
```

pet/vic printer.

For £79.90 (inc. VAT)

Put a ZX Printer (£59.95 from Sinclair) on your PET/VIC using the SOFTEX PRINTERFACE - costing only £19.95 plus £1 p&p.

- * Very high-resolution graphics
- * Full VIC/PET characters
- * 42 column printer with superb formatting facilities
- * Use as normal PRINT/LIST syntax

Send orders/enquiries to

SOFTEX COMPUTERS,
37 Wheaton Road, Bournemouth BH7 6LH
Telephone 0202 422028

Please state exact computer model.

INSURE YOUR COMPUTER

Impact damage, Fire, Theft & Transit Insurance for your Computer Equipment:

| | | |
|--------------------|-----------|--------------|
| £1 to £1,500 cover | £8.00 pa | £10 (excess) |
| £1,500 to £2,500 | £16.00 pa | £15 (excess) |
| £2,500 to £8,000 | £16.00 pa | £25 (excess) |
| £10,000 | £20.00 pa | £25 (excess) |

Ask for details

KGJ Insurance Brokers
6 Hagley Road, Stourbridge
West Midlands DY8 1QG
Tel (03843) 5333/2545

MICROMART

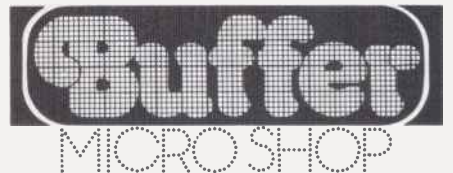

**ZX81·ZX SPECTRUM·
DRAGON 32·VIC·20·BBC**

The very best mail order items 'over the counter'
Games, Keyboards, Serious Programs, Rams,
Books, Peripherals and much, much more!

FAST MAIL ORDER SERVICE PHONE 01-769 2887
WITH ACCESS/VISA (24hr Ansafone)
or send large S.A.E. for catalogue (state which computer)

Open 10.30 - 5.30 Tues. to Sat. (closed Mondays)
310 STREATHAM HIGH ROAD, LONDON SW16

BRAIN SURGEON

Anita Electronic Services (London) Ltd are specialists in the repair and service of Superbrain I and II and associated printers including Apple silent type, Centronic, Anadex, NEC, QUME, Ricoh and Empson.

We also specialise in the repair of Commodore, Apple, Sirius, Osborne, Alpha Tronic, and Adler computers.

We offer a fast on-sight service or alternatively repairs can be carried out at our workshops should you wish to bring in your machine.

Maintenance contracts are available at very competitive prices. Trade enquiries welcome.

For further information telephone or write to:

MR D. WILKINSON
Anita Electronic Services Ltd.,
15 Clerkenwell Close,
London E.C.1.
01-253 2444

ELECTRONIC
klik keyboard
AN ALTERNATIVE NOT AN ADD ON
FOR ZX81

£24.95
INC VAT
P+P £1.00

KEMPSTON
MICRO ELECTRONICS
Dept . 180a Bedford Road, Kempston, Bedford MK42 8BL

OSBORNE 1

TRY US FIRST!

£949 + VAT

COMPUTERS
01-228 2207
Southampton House, 192-206 York Road, London SW11 3SA

BUSINESS SOFTWARE

INTEGRATED ACCOUNTS
Prepares daybooks, cash books, sales, purchase, nominal ledgers, trial balance, profit and loss accounts.
Normal price £1200.
SPECIAL OFFER £895.

PAYROLL

All valid PAYE codes are catered for. Facilities for different companies and branches. Cash analysis, payslips, P45 P60 etc. Normal price £500.
SPECIAL OFFER £395.

HARDWARE

North Star Horizon and Advantage Superbrain. All hardware and software are under warranty for 12 months.

MICROSYS LTD.
58 High Street, Prescot L34 6HQ
051-426 7271/051-430 6650

northern computers
THE COMPUTER CENTRE OF THE NORTH



THE showroom for all the leading micros

easy parking off the M56 (junc 12) • Vic 20 • Vic 64
BBC micros • Newbrain • Acorn Atom • Books
Apple 11e, 111 • Dragon • Electron • Games
Sinclair Spectrum, * IBM P.C.
Secondhand computers • EASY PAYMENTS
ALL ACCESSORIES SALES AND SERVICE

northern computers Churchfield Road, FRODSHAM Cheshire WA6 6RD

TEL: FRODSHAM (0928) 35110
* UNBEATABLE PRICES *

WE WILL PURCHASE AND PUBLISH YOUR PROGRAMS. Call Steve Rhodes for details

Programming & Consultancy Service

We can help with...

Programming • system design • user manuals • technical training • hardware and software selection.
We are at home on micros, minis and mainframes — in all major languages.

Mike Lewis Consultants Ltd
48 Willoughby Road
London NW3
tel: 01-794 3886

PROGRAMS

```

90GCOL1,0:FORI=2.6 TO 5.5 STEP .2
100MOVE700,400:PLOT85,700+(COS(I)*250),400+(SIN(I)*250):GCOL0,3:NEXT
110PROCCIRC(670,250,120,3)
120PROCCIRC(670,250,100,2)
130PROCELL(450,300,200,-.2,130,3)
140GCOL1,0:FORI=4 TO 6 STEP .1
150MOVE550,450:PLOT85,550+(COS(I)*250),450+(SIN(I)*250):GCOL0,3:NEXT
160PROCELL(270,450,90,-.5,90,2)
170PROCELL(230,500,20,-.5,20,3)
180PROCELL(530,400,40,.3,60,2)
190PROCELL(660,450,50,.4,60,2)
200PROCELL(670,210,25,.6,25,1)
210PROCELL(710,210,25,.6,25,1)
220PROCELL(600,200,40,0,25,1)
230PROCELL(670,210,10,.6,10,3)
240PROCELL(710,210,10,.6,10,3)
250GCOL0,3:MOVE530,400:MOVE600,500:PLOT85,600,460
260GCOL0,3:MOVE660,450:MOVE720,470:PLOT85,720,430
265PROCHAIT(200)
270PRINTTAB(3,2);"MICKEY MOUSE MICROS PRESENTS....."
275PROCHAIT(400)
280T=6:REPEAT READ A#:PROCHAIT(50):PRINT TAB(1+RND(3),T);A#:T=T+1
290UNTIL T=22
300VDU30
310END
320DEFPROCCIRC(A,B,C,D)
330GCOL1,0:FORI=0TO2.1*PI STEPPI/10
340MOVEA,B
350PLOT85,A+(COS(I)*C),B+(SIN(I)*C)
360GCOL0,D:NEXT:ENDPROC
370DEFPROCELL(A,B,C,D,E,F)
380GCOL1,0:FORI=0TO2.1*PI STEPPI/10
390MOVEA,B
400PLOT85,A+(COS(I)*C),B+(SIN(I)*D)*E)
410GCOL0,F:NEXT:ENDPROC
420DEFPROCHAIT(X)
430TIME=0:REPEATUNTILTIME>X:ENDPROC
440DEFPROCRAYS
450GCOL0,1:FORI=1TO3*PI STEPPI/40
460MOVESIN(I)*100+700,COS(I)*100+400
470 DRAW SIN(I)*1500+600,COS(I)*1500+500
480NEXT:ENDPROC
490DATAK,R,A,Z,Y, ,K,O,M,P,U,T,E,R,S,I
    
```

Genie SLC-2

by E F Grimes

The Video Genie's ability to load from and save to an external cassette-player is primarily intended for file-handling, but can also come in useful when a cassette refuses to load from the built-in unit. There is, however, no facility for loading SYSTEM tapes from an external cassette-player, hence this routine.

Once entered into the computer, the routine is available to the user even after typing new since it is stored above user-RAM. To load a SYSTEM tape from an

external cassette-unit, type 'LOAD'. This will give you a modified system prompt, namely 'SYSTEM LOAD -2-'. The filename is now entered in the usual way.

SLC-2 is stored in the communications area of RAM normally used by the disk operating system. This means that the routine is incompatible with disk-based Genies, but since it is specifically designed to overcome cassette loading problems, this is of no consequence.

```

100 CLEAR 100
110 POKE 16866,195 : POKE 16867,62 : POKE 16868,64
120 POKE 16776,195 : POKE 16777,62 : POKE 16778,64
130 CLS:PRINT TAB(7);"SLC2 - TO LOAD SYSTEM TAPES FROM CASSETTE £-2."
140 PRINT TAB(7) STRING$(46,61)
150 PRINT
160 PRINT"THE PROMPT IS MODIFIED TO READ :-";STRING$(10,32);"SYSTEM LOAD £-2"
170 PRINT STRING$(43,32);" *? ";CHR$(95)
180 PRINT
190 PRINT"IT SHOULD BE ANSWERED BY THE FILENAME IN THE USUAL WAY.THE TAPE"
200 PRINT "WILL THEN LOAD FROM CASSETTE £-2."
210 PRINT "ONCE LOADED, SLC2 MAY BE RE-ENTERED FROM BASIC AT ANY TIME BY"
220 PRINT "TYPING 'LOAD' & THEN 'NEW LINE'."
230 PRINT"(SLC2 RESIDES IN A SECTION OF MEMORY UNUSED BY LEVEL II, SO A"
240 PRINT"SYSTEM TAPE CAN BE LOADED ANYWHERE IN FREE MEMORY).":PRINT CHR$(10)
250 FOR N=0 TO 65
260 READ D : POKE 16446+N,D
270 NEXT N
280 SYSTEM
290 DATA62,201,50,226,65,33,110,64,205,117,43,49,136,66,205,254,32,62,42,205,42
300 DATA3,205,179,27,218,204,6,215,202,151,25,254,47,202,29,3,62,17,205,18,2,205
310 DATA150,2,195,209,2,83,89,83,84,69,77,32,76,79,65,68,32,35,45,50,0,0,0
    
```

C12/15 CASSETTES

SUITABLE FOR PROGRAMMING
DIRECT FROM MANUFACTURER,
COMPLETE WITH LABELS AND
LIBRARY CASE.
COMPETITIVE PRICES, DISCOUNTS
ON BULK PURCHASES

LEEHOLME AUDIO SERVICES LTD
MANUFACTURERS OF
HIGH QUALITY BLANK CASSETTES
350-4 LEABRIDGE ROAD, LEYTON
LONDON E10
TEL: 01-556 4748

Graphics
FOR ROM
SUPERBRAIN II
ALSO YOUR ROMS
PRODUCED TO ORDER
£13 +VAT
MICROMODS LTD
53 ACTON RD. LONG EATON NOTTINGHAM
NG10 1FR TEL: 06076 64264

PROGRAMS

MZ-80k Forth Interpreter

by J C Lea

This Sharp MZ-80k program requires 'Basic Extensions' or a similar extended Basic supporting full string comparisons: it will *not* run under the Basic SP-5025 supplied with the machine (cf *PCW*, March 83, pp 178-181).

The program is a simple Forth 'pseudo-interpreter' written in Basic. Although slow and somewhat limited, the interpreter does provide an effective introduction to the language. The following keywords and functions are supported:

+ , * /
> , > = , = , < > , < , = < (operators)
DUP , SWAP , OVER , ROT , DROP , UP (stack manipulators)
DEF , VARIABLE , ! , @ , FORGET (assignment)
IF-ELSE-ENDIF , DO-LOOP , REPEAT-UNTIL , BEGIN-WHILE-AGAIN (control structures)
, , CLEAR , INPUT , PEEK , POKE , RAND , LIST , EXAM (general)

LIST is used to display dictionary entries — either a single named entry or, in default, the whole dictionary. EXAM lists the values of the stack. Note that 'DEF' is used in place of ':' since we cannot include a colon as part of a

DATA statement in the Basic program.

Once you've typed in the interpreter, try the following simple Forth program:
4 6 * .
DEF SQUARE DUP * ;
4 SQUARE .
VARIABLE SHARP
8 SHARP !
DEF CUBE DUP SQUARE * ;
SHARP @ CUBE .
20 1 DO DUP . LOOP
FORGET CUBE
5 CUBE .
DEF DEC SHARP @ 1 - SHARP ! ;
REPEAT SHARP @ . DEC SHARP @ 1 UNTIL
BEGIN 10 RAND DUP . 5 WHILE .
'TESTING' CR AGAIN

'Forth Interpreter' doesn't in any way set out to teach Forth, so you'll need some kind of introductory text if you're new to the language. There are plenty of books around, and your local computer shop and/or library should be able to help. The program does allow you to gain hands-on experience of the language to enable you to judge whether it's to your taste before spending your hard-earned cash on a fully-fledged interpreter.

'Forth Interpreter' doesn't in any way set out to teach Forth, so you'll need some kind of introductory text if you're new to the language. There are plenty of books around, and your local computer shop and/or library should be able to help. The program does allow you to gain hands-on experience of the language to enable you to judge whether it's to your taste before spending your hard-earned cash on a fully-fledged interpreter.

MICROMART

NEW FOR YOUR UNEXPANDED VIC 20

Paratrooper, the catch pakacuda, crazy kong, critters race fun, anti natter splatter, english invaders escape M.C.P. cyclons, all at £5.50 each. For any Vic at only £5.25 each. Wacky waiters arcadia, catcha snatcha, new for your 64, Startrek, panic 64, frogger 64, at only £6.95 each. Escape M.C.P. cyclons, annihilator only £5.50 each. Graphics editor, grave robbers, moonbase alpha, monopole, at only £7.25 each.

ALL PRICES INCLUDE POST & PACKING — OVERSEAS ORDERS PLEASE ADD 65p P&P. AND YOU MAY PAY BY STERLING MONEY ORDER (FROM YOUR BANK) OR YOUR OWN U.S. \$ CHEQUE. ALL CUSTOMERS MAY DEDUCT THE FOLLOWING DISCOUNTS: ORDERS £10-£19.99: -5% £20-£29.99: -7½% £30 and over: -10%. ALL ORDERS DEALT WITH ON DAY OF RECEIPT. VIC HARDWARE — E.G. Vic 20+ Cassette Deck + Joystick ONLY £180 (plus £3.50 p.p.) Full lists on application. SOFTWARE HOUSES please send us your samples.

BYTEWELL,
203, Court Rd., Barry, S. Glam.
Tel: (0446) 742491.

A BASIC COURSE FOR EVERYONE

Carrbridge Hotel, Inverness-shire BY SPEYSIDE SYSTEMS, CARRBRIDGE

We are holding 5-day Residential Courses in the heart of Speyside, 6 miles from Aviemore. The course includes your own use of a new microcomputer with excellent tuition booklets and on-hand instruction. The course is designed for those involved in micros for personal and business use. As well as the intensive BASIC course you will have full board and lodging. Arrangements can be made to stay over the weekend and allow extra use of the computer. Numbers are restricted to six.

5 DAY COURSE plus food and board £250

Tuition undertaken by experienced personnel. Dates are 18th to 22nd July and Sept 26th to 30th.

Further dates can be arranged on demand, also weekend residential courses. Please send for our brochure. Details:

Mrs. Linda Anderson M.A. Speyside Systems Carrbridge, Inverness-shire. Phone Carrbridge 689.

PRINTERS FOR SHARPS

Most dot matrix and daisy wheel printers available for MZ80K & MZ80A.

Our package includes printer, cable, interface and software. Centronics for RS232, automatic conversion of Sharp codes to standard ASCII. All printer control codes can be used with BASIC. Other boards available include EPROM memory storage and programmers, ADC's etc.

Details from:-
PETERSON ELECTRONICS LTD
Academy Street
Forfar
Angus DD8 2HA
Telephone Forfar (0307) 62591

OSBORNE 1

TRY US FIRST!

£949 + VAT

ICOMPUTERS
01-228 2207
Southampton House, 192-206 York Road, London SW11 3SA.

THE POWER BANK

sealed for life, batteries included

system compatible sine wave output

The Uninterruptable Power Supply which will:

- Continue to operate your Micro Computer System when the mains electricity supply fails
- Suppress dangerous spikes and surges
- Stabilise voltage and frequency to your sensitive equipment

Operate your Micro/Disk/Printer System from a Power Bank and forget about a disabling break in the electricity supply. 120 VA UNIT £360. 250 VA UNIT £495.

Please contact: Power Testing (Sales) Ltd, on 0277 233188. Telex: 24224 Monref G (ref 586), 65a Sherfield Rd, Brentwood, Essex CM15 8HA

THE 'BIG' O

FREE SPECIAL

3-year Warranty with all systems until 31st May 1983

OSBORNE

4B microcentres Ltd

Telephone (0295) 67551

North Bar, Banbury, Oxon. OX16 0TF

**ORIC-1 48K TI 99/4A
LINX NUTIME BBC 'B'
SPECTRUM DRAGON**

THREE GAMES FOR CHILDREN

Education games for young children making imaginative use of colour graphics and sound to encourage children to learn counting, spelling and use of text and shapes.

All machines £7.95.

DRAGON ISLE

Can you recover the fabled dragon gold. Beware, it is well protected. Choose your spells well and pray for luck. A combined graphic and text adventure.

Spectrum 48K, TI99/4A £6.95.

SQUADRON LEADER

Select your planes, judge the effect of wind, defeat the enemy defenses and destroy your target. Full use of graphics and sound.

TI99/4A £6.95.

All games include comprehensive instruction booklet. Prices include P&P.

Send now stating game and machine to

NUTIME
220 London Road
Stoke on Trent
Staffs

S.A.E. for full product list

SCIENTIFIC SUBROUTINE LIBRARY

VOLUME 1 — STATISTICS AND FITTING FUNCTIONS

Mean, SD, normal distribution, partial expectation, Chauvenet's criterion, least squares fit to polynomial and arbitrary function, repetitive least squares fits, covariance matrix, chi-squared statistic, matrix inversion, solution of simultaneous equations.

VOLUME 2 — LINEAR PROGRAMMING

Reduction of a Simplex tableau, integer programming, partial integer programming, conversational linear programming system, least cost mix problem.

VOLUME 3 — FURTHER STATISTICS

Ranking, quantiles, frequency, 2-way table, correlation coefficient, T, chi-squared and F distributions and their inverses, T test, chi-squared test, Wilcoxon test, linear and multiple regression, ANOVA 1-way and 2-way.

VOLUME 4 — TRANSFORMATIONS & SORTING ALGORITHMS

Fourier, FFT, Laplace, numerical integration and differentiation. Exchange sort, Quicksort, Shell sort, Tree sort.

Manuals including full source listings with implementation notes and documentation —

BASIC £25 per volume

PASCAL £30 per volume

Software in CP/M (8" SSSD) or DEC RT-11 (RXOI) formats — £75 + VAT per volume.

CP/M TO DEC FILE TRANSFER

Software to read and write RT11 format RXOI diskettes under CP/M. Supplied on 8" SSSD diskette — £25 + VAT.

MICRO LOGIC CONSULTANTS LTD.
57, Station Rd., Southwater, Horsham,
W. Sussex.

Telephone: 0403 731818

MAKE MONEY MAKE MONEY MAKE MONEY MAKE

TO ALL HOME MICRO USERS

Your Micro/W.P. can earn up to

£500 PER MONTH

in your spare time!

Send £3.00 for the new sensational booklet:

MICRO (C-D-S) ENTREPRENEURS

To:

C.D.S. (UK) MICRO

89 Hexthorpe Road, Doncaster DN4 0BE
START YOUR OWN C.D.S. BUSINESS

MAKE MONEY MAKE MONEY MAKE MONEY MAKE

PROGRAMS

```

400 D*(0)=D*(0)+E":N=N0:S(N)=0:S(N+1)=0:L1=L0
410 C=S(N):D=S(N+1)
420 C=C+1:V$=MID$(D$(D),C,1):IFV$="E"THEN500
430 IFV$="I"THEN$1=S1+1:S(S1)=VAL(MID$(D$(D),C+1,2)):C=C+2:GOTO420
440 IFV$="H"THEN$1=S1+1:S(S1)=VAL(MID$(D$(D),C+1,5)):C=C+5:GOTO420
450 IFV$="R"THEN$1=VAL(MID$(D$(D),C+1,2)):C=C+2:GOTO1000+X*100
455 REM GOTD DEFINED WORD AFTER SAVING LAST POINT ON STACK
460 IFV$="D"THEN$1=VAL(MID$(D$(D),C+1,2)):C=C+2:S(N)=C:S(N+1)=D:N=N+2:GOTO480
470 PRINT"ERROR":GOTO100
480 D=X:IC=VAL(LEFT$(D$(D),1))+3:GOTO420
495 REM TEST FOR END OF INSTRUCTIONS
500 H=N-2:IFH<N0THEN900
505 PEM DROP BACK TO PREVIOUS WORD
510 GOTO410
900 PRINT"O.K.":GOTO100
990 IF$1<50THENPRINT"STACK UNDERFLOW ABORT":GOTO900
1000 GOTO420
1099 PEM "/
1100 IFMID$(D$(D),C+1,1)="/"THEN1120
1110 X=S(S1):S1=S1-1:PRINTX:GOTO990
1120 C=C+1
1130 C=C+1:V$=MID$(D$(D),C,1):IFV$="/"THEN1000
1140 PRINTV$:GOTO1130
1199 REM "+
1200 X=S(S1)+S(S1-1)
1209 REM REPLACE OPERANDS WITH RESULT
1210 S1=S1-1:S(S1)=X:GOTO990
1299 REM "-
1300 X=S(S1-1)-S(S1):GOTO1210
1399 REM "*"
1400 X=S(S1)*S(S1-1):GOTO1210
1499 REM "/"
1500 X=INT(S(S1-1)/S(S1)):GOTO1210
1599 REM "<"
1600 X=(S(S1-1)>S(S1)):GOTO1210
1699 REM ">"
1700 X=(S(S1-1)<S(S1)):GOTO1210
1799 REM "<="
1800 X=(S(S1-1)<=S(S1)):GOTO1210
1899 REM ">="
1900 X=(S(S1-1)=S(S1)):GOTO1210
1999 REM "<>"
2000 X=(S(S1-1)<>S(S1)):GOTO1210
2099 REM "="
2100 X=(S(S1-1)=S(S1)):GOTO1210
2199 REM "DUP"
2200 X=S(S1)
2209 REM PUTS RESULT ON TOP OF STACK
2210 S1=S1+1:S(S1)=X:GOTO990
2299 REM "SWAP"
2300 X=S(S1-1):S(S1-1)=S(S1):S(S1)=X:GOTO120
2399 REM "OVER"
2400 X=S(S1-1):GOTO2210
2499 REM "ROT"
2500 X=S(S1-2):S(S1-2)=S(S1-1):S(S1-1)=S(S1):S(S1)=X:GOTO120
2599 REM "DROP"
2600 S1=S1-1:GOTO990
2699 REM "UP"
2700 S1=S1+1:GOTO1000
2799 REM "EXAM"
2800 FORX=S0TOS1:PRINTS(X):NEXT:GOTO1000
2899 REM "CLEAR"
2900 PRINT"0":GOTO1000
2999 REM DEFINE WORD
3000 V$="E"
3010 X$=MID$(D$(D),4,LEN(D$(D))-4)+V$
3020 FORX=1TO100:IFD$(X)="/"THEN3040
3030 NEXT:PRINT"WORD BUFFER FULL":GOTO900
3040 IFX=DWTHENDW=X
3050 D$(X)=X$:GOTO900
3099 REM FORGET WORD AND WORDS USING WORD
3100 X$=MID$(D$(D),4,3):X=VAL(RIGHT$(X$,2)):D$(X)="" :FORX=1TODW
3110 L=LEN(D$(X)):FORV=1TOL-4:IFMID$(D$(X),V,3)=X$THEND$(X)="" :V=L
3120 NEXTV,X:GOTO900
3130 NEXTV
3150 NEXTX:GOTO900
3199 REM DEFINE VARIABLE
3200 V$="00000":GOTO3010
3299 REM STORE
3300 V$=STR$(S(S1-1)):X=LEN(V$)
3310 IFX<5THENFORV=XTO4:V$="0"+V$:NEXT
3320 D$(S(S1))=LEFT$(D$(S(S1)),LEN(D$(S(S1)))-5)+V$:S1=S1-2:GOTO1000
3399 REM FETCH
3400 S(S1)=VAL(RIGHT$(D$(S(S1)),5)):GOTO1000
3499 REM INPUT
3500 INPUT X:IFINT(X)<>XTHENPRINT"INPUT NOT INTEGER":GOTO900
3510 GOTO2210
3600 PRINT:GOTO1000
3699 REM TEST IF
3700 V=S(S1)+S1=S1-1:IFXTHEN1000
3710 C=C+1:X$=MID$(D$(D),C,3):IF(X$="R29")+X$="R28")THENC=C+2:GOTO1000
3720 GOTO3710
3799 REM SKIP ELSE LOOP
3800 GOTO3710
    
```

RANA'S SHACK

SHARP



LOW COST HIRE OF QUALITY GAMES, LANGUAGES AND UTILITIES FROM 50P A WEEK.

DON'T DELAY JOIN US NOW — MEMBERSHIP £5

HIRE MORE! PAY LESS!

SEND NOW FOR FREE OFFICIAL CATALOGUE.

RANA'S SHACK
206 SOUTH LAMBETH ROAD,
LONDON SW8 1UX



THE 'BIG' O

FREE! D BASE II still available
whilst stocks last phone NOW

OSBORNE

Telephone (0295) **67551**
North Bar, Banbury, Oxon. OX16 0TF

4B microcentres ltd

PROGRAMS

```

3899 REM SKIP ENDIF
3900 GOTO1000
3999 REM SET UP DO LOOP
4000 L1=L1+2:S(L1)=C:S(L1+1)=D
4010 REM TEST END OF LOOP
4020 IFS(S1-1)=S(S1)THEN1000
4030 C=C+1:IFMID$(D$(D),C,3)="R31"THENC=C+2:L1=L1-2:S1=S1-2:GOTO1000
4040 GOTO4030
4099 REM LOOP BACK
4100 C=S(L1):D=S(L1+1):S(S1)=S(S1)+1:GOTO4020
4199 REM REPEAT-UNTIL LOOP
4200 L1=L1+2:S(L1)=C:S(L1+1)=D:GOTO1000
4299 REM UNTIL TEST
4300 S1=S1-1:IFS(S1+1)THENL1=L1-2:GOTO1000
4310 C=S(L1):D=S(L1+1):GOTO1000
4399 REM BEGIN-WHILE-AGAIN LOOP
4400 GOTO4200
4499 REM WHILE TEST
4500 S1=S1-1:IFS(S1+1)THEN1000
4510 C=C+1:IFMID$(D$(D),C,3)="R36"THENC=C+2:L1=L1-2:GOTO1000
4520 GOTO4510
4599 REM LOOP FROM AGAIN
4600 GOTO4310
4699 REM LIST DEFINED WORDS
4700 IFLen(D$(0))=4THEN 4710
4705 X=VAL(MID$(D$(0),5,2)):GOSUB4750:GOTO900
4710 Y=-10
4715 Y=Y+10:FORX=Y+1TOY+10:IFX=DMTHEN900
4720 PRINTX:" ";:GOSUB4750:NEXT
4725 PRINT"MORE?"
4730 GETK$:IFK$=""THEN4730
4735 IFK$="Y"THEN4715
4740 IFK$="N"THEN900
4745 GOTO4730
4749 REM DECODE FOR USER LISTING
4750 C=1
4755 C=C+1:V$=MID$(D$(X),C,1):PRINTY$:" IFV$=" "THEN4765
4760 GOTO4755
4765 C=C+1:V$=MID$(D$(X),C,1):IFV$="E"THENPRINT:RETURN
4770 IFV$="N"THENZ=VAL(MID$(D$(X),C+1,5)):PRINT"Z:"Z:C=C+5:GOTO4765
4775 IFV$="%"THENZ=VAL(MID$(D$(X),C+1,5)):PRINTZ:RETURN
4780 Z=VAL(MID$(D$(X),C+1,2)):C=C+2:IFV$="R"THENPRINTR$(Z)::GOTO4765
4785 Z=1:X$=D$(X)
4790 Z=Z+1:V$=MID$(X$,Z,1):PRINTY$:" IFV$=" "THEN4765
4795 GOTO4790
4799 REM PEEK
4800 S(S1)=PEEK(S(S1)):GOTO120
4899 REM POKE
4900 POKES(S1-1),S(S1):S1=S1-2:GOTO120
4999 REM RAND
5000 S(S1)=INT(RND(1)*S(S1))+1:GOTO1000
9999 END
10000 DATA ., +, -, *, /, >, <, =, <, >, =, DUP, SWAP, OVER, ROT, DROP, UP, EXAM, CLEAR, DEF
10010 DATAFORGET, VARIABLE, !, @, INPUT, CR, IF, ELSE, ENDIF, DO, LOOP, REPEAT, UNTIL
10020 DATABEGIN, WHILE, AGAIN, LIST, PEEK, POKE, RAND
    
```

★★ Program of the month ★★

TRS-80/Video Genie Domain of the Djinn

by David Marsh

'Domain of the Djinn' is a well-written and thoroughly absorbing adventure game for a Video Genie/TRS.80 with at least 12k RAM.

The Domain is a six-storey building, each floor consisting of a maze of rooms and passages. Along with either one or two friends, your task is (surprise, surprise!) to find the treasure hidden in one of these rooms. To do this, you and your team wander through the Domain picking up the odd artefact along the way and generally being nosy.

The Domain, naturally enough, is inhabited by an assortment of zombies,

trolls, ogres, dragons and other dodgy types who make it their business to lurk in dark corners — doing whatever it is mythical monsters do in dark corners. On meeting one or more of the Domain's tenants, you have a number of options; including striking up a friendly conversation, and, very sensibly, getting the hell out of it! For braver souls, you also have the option to pick a fight in order to claim the contents of the room, but I should warn you that some of the occupants have distinctly violent tendencies. Also, you shouldn't be too surprised if the room turns out to be empty after

M & J SOFTWARE

DRAGON COMPANION BOOK £4.95
If you are bored with games and Basic and want to learn more about your machine, this is the book for you. Includes disassembler listing and many useful routines.

DRAGON fig-FORTH £10
Faster than Basic and easy to use. Fully documented.

FORTH ASSEMBLY LISTINGS each £7
6502, 8080, 280, 6809, 6800, 9900, 8086/8088, 68000, PDP-11, 1802. These are standard fig-FORTH assembly listings.

INSTALLATION MANUAL £5
Necessary for implementing FORTH and its editor.

6502 MACRO ASSEMBLER £5
This program is written in fig-FORTH and is a structured one-pass assembler. It will work on any fig-FORTH implementation with only one alteration. Control structures include: BEGIN, END, AGAIN, IF, THEN, ELSE, ENDF, REPEAT, UNTIL, WHILE.

All prices inclusive of postage and packing. Cheques and POs to.

M & J SOFTWARE, Dept 6, 34 Grays Close Scholar Green, Stoke-on-Trent ST7 3LU. Tel. (0782) 517876

DEALER ENQUIRIES WELCOME

SHARP MZ 80A

CASH FLOW & MODELLING

Do you have problems controlling your cash flow? Then you need this menu driven program

FACILITIES INCLUDE:

Setting up historic data · Monthly input of data
Examining/amending data · Displaying data
Modelling data · Reading/saving data
Year end routine (36 periods)

Available now for the Sharp MX 80A
£12.00 including documentation, p&p.

S.A.E. for details

S. Lester, 219 Uxbridge Road
Harrow Weald, Middx HA3 6TW

MICROMART

CHESTER COMPUTER SCHOOL

Modular training courses for office
personnel: Managers
Technicians
Professionals of all kinds

Learn to program in
Dbase II
Stock Systems
Accounting Systems
Payroll
Management Information
Systems
Learn Systems, Thinking and
analysis
and much more.

One, two and three day courses. Three week executive courses include group project and practical work experience.

Students can also correspond to increase their skills to a commercial level.

All students receive course certificates. Fees from £20 per day. Details and application forms from:

The Principal
Chester Computer School
7 Stanley Place
Chester
Tel: 0244 318959

DEPARTMENT OF EXTRA-MURAL STUDIES University College of Wales 9 Marine Terrace, Aberystwyth

THE MICROCOMPUTER REVIEWED

A course aimed at a more practical understanding of Microcomputers

19-23 Sept. '83 · Aberystwyth

Further details from above address
(Tel. 617616)

NewBrain

EDITOR adds extra commands to the machine CHANGE, FIND, GET, INSERT, DELETE, MOVE, VALUE, ORGANISE, CENTRE & RIGHT JUSTIFY TEXT.

Can be used as a word processor database or program editor, handling up to 24k on a 32k machine. The files created are in ASC11 format. £15

RENUMBER can be used independently or in conjunction with EDITOR. All or part of a program may be renumbered with update of GOTO/GOSUB/THEN/RESUME statements. £6

MONITOR produces machine code programs on tape. Input, display, record, & test code hard copy feature. Input/output is in HEX or ASC codes. £15

Microplot

19 The Earls Croft, Chylesmore, Coventry CV3 5ES
phone 0203-503038

OSBORNE 1

TRY US FIRST!

£949 + VAT

COMPUTERS
01-228 2207
Southampton House, 192, 206 York Road, London SW11 3SA
Britain's No. 1

MICROMART

SEARCHING FOR 'BEST PRICE'

FOUND 'BEST PRICE'... GOTO

| PET | TAPE | RRP |
|------|------|-------|
| C2N | | £55 |
| CBM | 64K | £299 |
| 4032 | 32K | £695 |
| 8032 | 32K | £895 |
| 8096 | 96K | £1195 |

Our own transport delivers nationwide weekly. All you need is our Best Price Quotation. Contact us Now! For Super Service.

DISK DRIVES

| | | |
|------|------|-------|
| 2031 | 170K | £395 |
| 4040 | 343K | £695 |
| 8050 | 1M | £895 |
| 8250 | 2M | £1295 |
| 9060 | 5M | £1995 |
| 9090 | 7.5M | £2495 |

PRINTERS

| | | |
|-------|--------|-------|
| 4022P | 80COL | £395 |
| 8023 | 136COL | £895 |
| 8300 | DAISY | £1395 |

VAT TO BE ADDED @ 15%

CARRIAGE - £5 PER ITEM

IF YOU KNOW WHAT YOU WANT WHY WAIT?

THESE ARE THE PRICES YOU NEED

ORCHARD COMPUTER SERVICES

Orchard House, 21 St Martins St
Wallingford, Oxon

Tel: Wallingford (0491) 35529

Open 6 days per week



PET HI-RES!

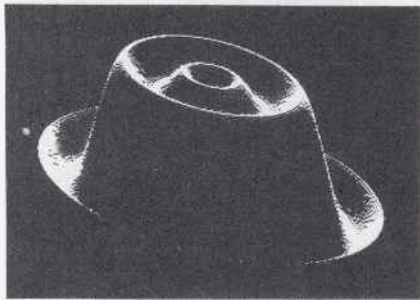

£149 plus VAT brings you 320 by 200 dot resolution on your PET/CBM screen. No soldering is necessary - SUPERSOFT graphics boards just plug in!

Three models are available: for 80-column machines specify the HR80 board; large screen 40 column machines need the HR40B board; for other machines (except very early PETs with no Rom sockets) order the HR40 board. All three boards add 8k of RAM and include GRAPHIX machine code utility software in EPROM. Over 500 boards have been installed in the UK - by schools, colleges, hospitals, learned establishments, even home users - and hundreds more are being exported worldwide.

SUPERSOFT are Commodore specialists. We have a large range of software, accessories, and supplies for existing COMMODORE machines and will be supporting new machines as they are launched. Our 20 page catalogue is free to owners and users of PET/CBM machines - but here's a selection of products to whet your appetite! Add 15% VAT to all prices.

BUSICALC (FINANCIAL SPREADSHEET) £39.00
PAPERMATE PLUS (WORD PROCESSOR) £45.00

SUPERSOFT

Winchester House, Canning Road, Wealdstone, Harrow Middlesex, HA3 7SJ, England, Telephone 01-861 1166

USED COMPUTER EQUIPMENT

Register your need to buy or sell with us - we will provide up to five contacts.

BUYERS - free service!
SELLERS - we charge only £20 + 1% declared value

Send full details to:

EXCEL SERVICE

31 Goldington Road, Bedford, MK40 3LH

Or 'phone (0234) 40722 for recorded further details

PROGRAMS

you've gone your ten rounds with a hungry goblin.

Movement through the maze is by use of the N, S, E and W keys to represent the four points of the compass. When you come across some stairs, you can go either up (U) or down (D) (logical enough). It should be noted, however, that things can get distinctly hairy down in the lower regions.

Your chances of coming out of a confrontation with an irate centaur - with the same number of limbs as when you entered the room - depend on the relative strengths of your team and that of your opponent. These strengths are measured in terms of four factors: survival, battle, magic and communication. Initially, you have to choose your team to obtain what you feel to be the optimum combination of these factors. During your journey, the more fights you win, the more monster-types you manage to convert to your noble cause (getting rich quick), and the greater the area of the maze you manage to explore, the greater your party's strength.

Survival is a measure of fighting power. Running out of survival points is not recommended since your life runs out with them. Battle points are a measure of your fighting skills - the more points you have, the less likely your opponents are to see your body as a convenient place to stick their swords. Communication points measure your ability to sweet-talk yourself out of tricky situations ('there, there, nice dragon' - that sort of thing). Magic points measure, well, magic.

Game points are awarded for various reasons: the acquisition of gold,

platinum, jewels, artefacts and killing the Djinn who, incidentally, are neither poor nor defenceless - so don't waste any sympathy on them! The artefacts referred to include such things as Rhombs - handy-sized hyperspace units enabling you to jump from one place to another instantly.

However, they only work on the level you're on.

In dire emergency, you can effect a hasty exit by pressing the panic button. Since this key is noticeably lacking on the TRS-80 keyboard, SHIFTEd E has to serve. This does get you out of whatever mess you've got yourself into, but at a price: you lose all your treasure to a hyperspace junkyard. You're also liable to end up just about anywhere and you can't rely on this feature too often.

Before you begin your epic voyage into the unknown, take a bit of time to choose your team carefully. Magicians rate highly on communication and magic, but they don't make particularly good 'minders'; fighters are good in battle but have the IQ of educationally sub-normal carrots. Our referee also recommends staying well clear of the lower levels until you have some strong fighters on your side!

In case all this sounds complicated, it is. It's not the sort of game you can master in ten minutes and wonder what to do next. The menus and input prompts are all quite straightforward, though, so you shouldn't have any problems running it. All in all, an addictive game - I'd certainly like to see more programs of this standard being submitted to PCW Programs. Now you're not going to take a challenge like that lying down, are you?

```

1 RANDOM:GOTO5000
10 E=INKEY$:RT=0:AR="":FORU=1TOD500:NEXT:CLS:PRINT@60,L1:FORU=0TOD19:FORV=0TOD6:S=V
AL(RIGHT$(STR$(N(L,U,V)),2)):PRINT@U*3+V*12B,A(S):NEXTV,U
25 RU=RU-1:FORU=0TOD19:RESE(U,0):RESE(U,41):NEXTV:FORV=0TOD41:RESE(0,V):RESE(
119,V):NEXTV:PRINT@896,CHR$(31);:GOSUB200:ET="":ET=INKEY$:IFET<>" "THEN30ELSEFORU
=1TOD30:FORV=X1*6+2TODX1*6+3:RESE(V,Y1*6+2):SET(V,Y1*6+2):NEXTV,U
30 PP=0:E=INKEY$:IFE=" "ANDE=" "THEN30ELSESEE=LEFT$(E+ET,1):PRINT@896,CHR$(31);:IFE
=" "THEN30ELSEIFE="S"THEN40ELSEIFE="e"THEN160ELSEIFE="e"THEN45ELSEIFE="W"THEN50
ELSEIFE="A"THENPP=1:GOTO100ELSEIFE="U"THEN20ELSEIFE="D"THEN24ELSE30
35 IFY1=0THEN30ELSEIFPOINT(X1*6+2,Y1*6+1)=0THEN30ELSEIFN(L,X1,Y1-1)=0THENGOSUB70:N
(L,X1,Y1-1)=PP
36 PRINT@X1*3+(Y1-1)*12B,A(VAL(RIGHT$(STR$(N(L,X1,Y1-1)),2))):IFPOINT(X1*6+2,6*
Y1-1)=0THENBOELSEX2=X1:Y2=Y1:L2=L:Y1=Y1-1:GOTO100
40 IFY1=19THEN30ELSEIFPOINT(X1*6+2,Y1*6+5)=0THEN30ELSEIFN(L,X1,Y1+1)=0THENGOSUB70
:N(L,X1,Y1+1)=PP
41 PRINT@X1*3+(Y1+1)*12B,A(VAL(RIGHT$(STR$(N(L,X1,Y1+1)),2))):IFPOINT(X1*6+2,Y1
*6+6)=0THENBOELSEX2=X1:Y2=Y1:L2=L:Y1=Y1+1:GOTO100
45 IFX1=19THEN30ELSEIFPOINT(X1*6+5,Y1*6+2)=0THEN30ELSEIFN(L,X1+1,Y1)=0THENGOSUB70
:O(N(L,X1+1,Y1))=PP
46 PRINT@X1+1)*3+Y1*12B,A(VAL(RIGHT$(STR$(N(L,X1+1,Y1)),2))):IFPOINT(X1*6+6,Y1
*6+2)=0THENBOELSEX2=X1:Y2=Y1:L2=L:X1=X1+1:GOTO100
50 IFX1=0THEN30ELSEIFPOINT(X1*6,Y1*6+2)=0THEN30ELSEIFN(L,X1-1,Y1)=0THENGOSUB70:N
(L,X1-1,Y1)=PP
51 PRINT@X1-1)*3+Y1*12B,A(VAL(RIGHT$(STR$(N(L,X1-1,Y1)),2))):IFPOINT(X1*6-1,Y1
*6+2)=0THENBOELSEX2=X1:Y2=Y1:L2=L:X1=X1-1:GOTO100
70 PP=11*(RND(2)-1):IFRND(5)=1THENPP=PP+5+RND(6)ELSEPP=PP+RND(5)
71 RETURN
    
```

OPEN HOUSE FOR COMPUTER NOVICES

Choose your time - day or evening.
Learn at your own pace on Apple, PET or CP/M
Computers BASIC programming and
Business Packages includes
D base II, wordstar, supercalc

Brochure from:
MICROCOMPUTER ADVISORY
CENTRE

Polytechnic of the South Bank, Borough Road
London SE1 0AA
Tel: 01-928 8989 Ext. 2468

BUSINESS & SPECIAL SOFTWARE
LOGIC PLUS LUTON 594539
STANDARD PACKAGES AVAILABLE

PROGRAMS

```

80 PRINT@B96,CHR$(31);:PRINT@B96,"DEAD END";:GOTO25
100 IFVAL(RIGHT$(STR$(N(L,X1,Y1)),2))>1THEN$O0ELSE25
200 MM=0: SX=VAL(RIGHT$(STR$(N(L,X1,Y1)),2)): IFSX>11THENRETURNESEIFN(L,X1,Y1)>10
0THENMM=INT(N(L,X1,Y1)/100):GOTO210ELSER=NRD(8):IFR=2ANDL=6THENMM=10ELSEIFR=1
THENMM=11ELSEIFR=2THENMM=12ELSEIFR=3THENMM=13ELSEMM=10
201 N(L,X1,Y1)=N(L,X1,Y1)+MM*100
210 IFMM=10THENRETURNESEIFMM=11THENE="UP"ELSEIFMM=12THENE="DOWN"ELSEIFMM=13THEN
E="UP AND DOWN"
220 PRINT@B96,CHR$(31);:PRINT@B96,"STAIRS ";:E:RETURN
230 IFMK<11ANDMM<13THEN$O0ELSEMA=2:L2=L:X2=X1:Y2=Y1:L=L-1:IFL=0THEN$O0ELSEIFN(L,X1,Y1)=0THEN$O0SUB70:N(L,X1,Y1)=PQ:IFPD>11THENRU=1
231 GOTO250
240 IFMK>12ANDMM<13ORL=6THEN$O0ELSEMA=1:L2=L:X2=X1:Y2=Y1:L=L+1:IFN(L,X1,Y1)=0TH
ENG0SUB70:N(L,X1,Y1)=PQ:IFPD>11THENRU=1
250 NA=N(L,X1,Y1):S=VAL(RIGHT$(STR$(NA),2)):IFS>11THEN10ELSEIFNA<99THENH(N,L,X1,Y1)
)=NA+100*(10+MA):GOTO10ELSEIFINT(NA/100)=10THENH(N,L,X1,Y1)=NA+MA:GOTO10ELSE(L,N,X1,Y1)=1300+S:GOTO10
300 BRZ=0:TZ=INT(N(L,X1,Y1)/100):IFTZ=10ORRND(2)=2THENPRINT@B96,CHR$(31);:PRINT@
B96,"AN EMPTY ROOM";:N(L,X1,Y1)=N(L,X1,Y1)+1000*(1-TZ/10):GOTO25ELSESRN=RND(15+L)
:IFRN>15THENGOTO6000
305 RA=RND(10):TW=VAL(MID$(B(RA),9,1)):IFTW>LTHEN$O0ELSENEM=(L-TW+1)*RND(3):IFNM=
OORNM>9THEN$O0ELSEEZ="":FORU=1TOB:E=MID$(B(RA),U,1):IFE<>"":THENEZ=E+*E:NEXTU
306 FORU=1TONM:FORV=1TO4:VL=VAL(MID$(B(RA),9+V,1)):Z(U,V)=RND(2*(L-1)*VL)+2*(L-1)
)*(RND(9)-1)*VL*(VL+1):NEXTV,U:SS=0:FORU=1TONM:SS=SS+Z(U,1):NEXTU
309 FORO=1TOR:FORO1=1TO4:H(O,O1)=0:NEXTO1,Q:GOSUB8000:GOSUB11000
330 MR=0:SR=0:FORU=1TONM:MR=MR+Z(U,3):SR=SR+Z(U,2):NEXTU:GOTO400
400 PRINT:PRINT"MAGIC ADJUSTMENTS":PRINT"YOUR PARTY LOSES A TOTAL OF"MR" MAGIC F
ACTORS":MS=INT(MR/R):FORU=1TOR:H(U,3)=G(U,3)-MS:NEXTU
401 FORU=1TOR:FORHJ=1TO4:IFHJ=3THENNEXTHJELSEH(U,HJ)=G(U,HJ)+H(U,HJ):NEXTHJ,U:GO
TO440
405 FORU=1TOR:IFH(U,3)<1THENGOTO430ELSEPRINT:PRINTC(U);:("";H(U,3));:FORV=1TO
R:PRINT"DO YOU WANT TO GIVE";C(V);" ANY FACTORS"(Y/N)";:GOSUB10000:IFE<>"Y"THEN
430
410 J=0:IFH(U,3)=0THEN430ELSEINPUT"S";:J:IFJ<0ORJ>H(U,3):GOSUB10ELSEH(V,1)=H(V,1)+
J:H(U,3)=H(U,3)-J+G(U,3)=G(U,3)-J:G(V,1)=G(V,1)+J
412 J=0:IFH(U,3)=0THEN430ELSEINPUT"B";:J:IFJ<0ORJ>H(U,3):GOSUB11ELSEH(V,2)=H(V,2)+
J:H(U,3)=H(U,3)-J
414 J=0:IFH(U,3)=0THEN430ELSEINPUT"C";:J:IFJ<0ORJ>H(U,3):GOSUB14ELSEH(V,4)=H(V,4)+
J:H(U,3)=H(U,3)-J
430 IFH(U,3)=0THENNEXTU,UELSENEXTU
440 IFPP=1THEN10ELSEFORNM=1TO699:NEXTNN:CLS:PRINTTAB(18)"YOUR OPTIONS:--":PRINT:P
RINT"1) ATTACK"PRINT"2) COMMUNICATE"PRINT"3) RUN"PRINT"4) USE AN ARTIFACT":PR
INT"5) REVIEW TROOPS":PRINT"6) SHARE MAGIC":PRINT"7) LOOK":PRINT:PRINT"WHICH?";
450 UD=NM:NM=7:GOSUB9000:J=UM:NM=UD:IFJ=7THENGOSUB11000:GOTO40ELSEJGOTO800,60
0,700,1000,7000,405
460 IFZ(1,4)=0THENPRINT"COMMUNICATION IMPOSSIBLE":GOTO40ELSEFC=0:FORU=1TOR:FC=FC
+H(U,4):NEXTU:FD=0:FORU=1TONM:FD=FD+Z(U,4):NEXTU:IFNM>RDR2+R0<RNMTHENPRINT"TH
EY ATTACK":GOTO800ELSEIFFD+RND(6)>FCTHENPRINT"THEY ATTACK":GOTO800
610 PRINT"THE ";EZ;:IFNM>1THENPRINT"S";
620 PRINT" WILL JOIN YOUR PARTY":FORU=1TONM:FORV=1TO4:G(R+U,V)=Z(U,V):NEXTV:G(R+
U,0)=RA+3:C(R+U)=E+STR$(U):NEXTU:R=R+NM:GOTO900
700 IFRU=0THENPRINT"RUNNING IS IMPOSSIBLE":GOTO40ELSEX1=X2:Y1=Y2:L=L2:GOTO10
800 WF=0:FORU=1TOR:P(U)=0:NEXTU:IFR=1THEN$3ELSEPRINT"HOW MANY WILL FIGHT?";:UD=N
M:NM=R:GOSUB9000:UN=UM:NM=UD:IFUN=RTHEN$3ELSEPRINT"NAME(S)";:FORU=1TONM
805 INPUT:FORU=1TOR:IFC(V)=E+THEM(V)=1:NEXTUELSEXTV:PRINT"WHO";:GOTO805
808 CLS:FORU=1TONM:IFZ(U,1)<1THENNEXTUELSEPRINT#4*U,U;:NEXTU
810 FORU=1TOR:IFP(U)=0THENNEXTU:GOTO830ELSEU=0:FORV=1TO200-12*L:NEXTV:PRINT#640
,CHR$(31);:PRINT#640,C(U);" WHICH DO YOU ATTACK?";:GOSUB9000:HF=H(U,2)+RND(4*INT
(L/2))-3*L:IFHF<Z(U,2)THENPRINT"MISS":NEXTU:GOTO830
811 PRINT" HIT ":PL=L*(HF-Z(U,2)):PM=Z(PL-(PL-14))*SGN(INT(PL/14)):UY=RND(PM-(PM-
32760)*SGN(INT(PM/32760))):Z(U,1)=Z(U,1)+UY:IFZ(U,1)>0THENNEXTU:GOTO830ELSE
PRINT"DEAD":PRINT#4*U*U,"":IFEZ="DJINN"THENNDJ=1ELSEIFEZ="GIANT"THENFORWC=1TONM:
Z(WG,3)=0:NEXTW
820 FORU=1TO200:NEXTW:FORV=1TONM:IFZ(V,1)>0THENNEXTUELSEXTV:CLS:PRINT"YOU WIN"
:FORU=1TO4:SR=0:FORV=1TONM:SR=SR+Z(V,U):NEXTU:SR=SR/Z(L+1):R:FORV=1TOR:G(V,U)=G
(V,U)+SR*Z(L+1)*ABS(U-2ANDG(V,0)=1ORU=3ANDG(V,0)=2):NEXTU,U:GOTO900
830 FORU=1TONM
832 IFZ(U,1)<0THENNEXTU:GOTO840ELSESRH=RND(R):IFP(RH)=0THEN$3ELSEFORO=1TO200-(L
+NM)*S:NEXTO:PRINT#640,CHR$(31);:PRINT#640,EZ;:ATTACKS";:C(RH):HF=Z(U,2)+RND(9
+4*INT(L/2)):IFHF<H(RH,2)THENPRINT"MISS":NEXTU:GOTO840ELSEPRINT" HIT ":UY=2*RND(HF
-H(RH,2))
834 H(RH,1)=H(RH,1)-UY:G(RH,1)=G(RH,1)-UY:IFH(RH,1)<1THENPRINTC(RH);" IS DEAD":G
OSUB4100ELSEPRINTC(RH);" HAS" H(RH,1)" S-FACTORS LEFT"
836 IFR>0THEN$40ELSECLS:PRINT"YOUR TEAM IS ALL DEAD":PRINT:PRINT:PRINT"THE DJINN
HAS BEATEN YOU":PRINT:INPUT"DO YOU WANT ANOTHER GO (Y/N)";:E:IFE="N"THENENDELSER
UN
838 FORU=1TOR:P(U)=1:NEXTU:GOTO808
840 FORU=1TO500-25*L:NEXT:IFRU=0THEN$0ELSEPRINT"DO YOU WANT TO RUN?";:GOSUB1000
0:IFE="Y"THEN700ELSEIFU>NMTHEN$0ELSENEXTU:GOTO808
900 SS=SS/Z(L+1):R:FORU=1TOR:G(U,1)=G(U,1)+SS:NEXTU:FORU=1TO500-20*L:NEXT:PRINT
:PRINT"TREASURE":":PRINT:TA=RND(INT(L/2)+1):TY=RND(15):IFTY<6THENPRINT"THE SACK
S ARE EMPTY":GOTO950ELSEIFTY=6THENAT="JEWELS"ELSEIFTY<13THENAT="GOLD"ELSEAT="PLA
TINUM"
910 PRINT"THE SACKS CONTAIN"AT;" UNIT";:IFTA>1THENPRINT"S";
920 PRINT" OF "AT:IFAR<>"":THENPRINT"YOU MAY ALSO TAKE THE "AR
930 PRINT:PRINT" WILL YOU TAKE ANYTHING?";:GOSUB10000:IFE="N"THEN10ELSEGOSUB4500:
FORU=1TOR:PRINT:PRINTC(U);" HOW MUCH ";AT;"?";
940 GOSUB9100:IFTT=0THENNEXTU:GOTO944ELSEFORV=1TOT:TA=TA-1:IFTA<0THEN950ELSEIFA
T="JEWELS"THENCA(U)=CA(U)+CHR$(30):WB(U)=WB(U)+1
941 IFAT="GOLD"THENCA(U)=CA(U)+CHR$(28):WB(U)=WB(U)+1ELSEIFAT="PLATINUM"THENCA(U)
)=CA(U)+CHR$(29):WB(U)=WB(U)+1
942 IFAT<0THEN944ELSEPRINTC(U)
944 PRINT:FORU=1TOR:MS=0:MP=0:MJ=0:IFWB(U)=1+INT(G(U,1)/3)THEN944ELSEPRINTC(U)
";" IS OVERLOADED":FORV=1TOLEN(CA(U)):TH=ASC(MID$(CA(U),V,1)):IFTH=28THENMS=MS+1E
LSEIFTH=29THENMP=MP+1ELSEIFTH=30THENMJ=MJ+1
945 NEXTV:PRINTMS;"GOLD";:MP;"PLATINUM";:MJ;"JEWELS":PRINT"LOSE WHAT?(G/P/J)";:G
OSUB9200:EL=E="":FORV=1TOLEN(CA(U)):WG=ASC(MID$(CA(U),V,1)):IFWG=28ANDH="G"O
RWG=29ANDH="P"ORWG=30ANDH="E"THEN946ELSENEXTV:PRINT"YOU HAVE NONE":GOTO944

```

MICROMART

: GO FORTH & ★ :

Laboratory Microsystems Z-80 FORTH
Version 2.0 now includes multi-tasking, editors, assemblers, utilities, good manual and games.
CP/M 8" ... £45+VAT CP/M 5" £60+VAT
CP/M 8" ... £95+VAT IBM PC or SIRIUS £95+VAT
Floating point package - includes both hardware and software support with trig. routines £95 with Z-80 FORTH above £125
Cross-compilers - ultimate FORTH tool £230
Choose target from - 6502, 8080, Z-80, 8086/8088, 68000, LSI-11, 1802 - others to come.
Additional targets £100

FORTH is available on disc, cartridge, or cassette for most machines inc. BBC, DRAGON, VIC ...

DIY FORTH kits
Installation manual £7
How to do it + model + definitions + editor
Source code listing for one processor £7
6502, 6800, 6809, 8080/Z80, 8086/8088, 9900 1802, 68000, Z8000, VAX, Apple II, LSI-11, Eclipse

FORTH books - range includes:
'Starting FORTH' by Brodie £15 inc. p+p
'Systems Guide to fig-FORTH by Ting £25inc. p+p
JUPITER ACE - a very nice FORTH micro ... £78+VAT



MicroProcessor Engineering Ltd
21 Hanley Road Shirley
Southampton SO1 5AP
Tel: 0703 775482

Micro-Pac

NO HIDDEN EXTRAS
YOU PAY THE PRICE YOU SEE

| | | PRICE PER PAC | | |
|--------------------------------|-----------------------------|---------------|-------|-------|
| | | 1-3 | 4-7 | 8+ |
| 5.25" FLOPPY DISKS - PAC OF 10 | VERBATIM SSSD Soft/Hard Sec | 17.30 | 16.74 | 16.53 |
| | SSDD Soft/Hard Sec | 17.30 | 16.74 | 16.53 |
| | DSDD Soft/Hard Sec | 26.60 | 25.80 | 25.50 |
| | SSGD Soft/Hard Sec | 24.27 | 23.49 | 23.19 |
| | DSGD Soft/Hard Sec | 33.00 | 31.93 | 31.52 |
| | NASHUA SSSD Soft/Hard Sec | 16.57 | 16.00 | 15.47 |
| 8" | SSDD Soft/Hard Sec | 17.07 | 16.51 | 16.19 |
| | DSDD Soft/Hard Sec | 20.14 | 19.44 | 18.80 |
| | SSGD Soft/Hard Sec | 24.40 | 23.61 | 23.31 |
| | DSGD Soft/Hard Sec | 27.92 | 26.96 | 26.06 |
| | SSSD Soft/Hard Sec | 23.18 | 22.35 | 21.58 |
| | DSDD Soft/Hard Sec | 24.00 | 23.14 | 22.34 |
| DSDD Soft/Hard Sec | 25.55 | 24.64 | 23.80 | |
| LISTING PAPER (500 SHT PAC) | | 1-2 | 3-4 | 5+ |
| 9.5" x 11" Side Micro Perfs | | 4.39 | 3.50 | 2.75 |
| 14.5" x 11" Music Ruled | | 5.33 | 4.70 | 4.00 |
| MICRO LABELS (250 PAC) | | 1-2 | 3-4 | 5+ |
| 4.5" x 1 7/16" 2 wide | | 4.41 | 4.05 | 3.95 |
| Fits 9.5" Tractor Feed | | | | |

COMPAC LTD (Micro-Pac Division)
Commerce House, Stuart Street,
Luton LU1 5AU, Bedfordshire.
Tel: (0582) 452580.

MEMOREX FLOPPY DISC

FULLY GUARANTEED

Sample Prices for 5 1/4" (per box of 10)

| | | |
|--------------|--------|------------------|
| SS 48 t.p.l. | £20.90 | Cash with order* |
| DS 48 t.p.l. | £26.90 | Add £1 p&p |
| SS 96 t.p.l. | £27.90 | + VAT at 15% |
| DS 96 t.p.l. | £34.90 | per box |

We supply disks for a full range of m/s e.g. * IBM PC * Sirius
Millbank * Apple * Wang * Burroughs * DEC * IBM * AES
Call us for your particular requirements

Fan-fold Kleen-edge Letterheads for Wordprocessing
from £35.00 per 1000 sheets

Contact
Forte Computer Supplies, 4 Newman Passage,
London W1 Tel: 01-636 1023/1025
(DIVISION OF FDS)

OSBORNE 1

TRY US FIRST!

£949 + VAT

COMPUTERS

01-228 2207
Southampton House, 192-206 York Road, London SW13 9SA

HORSE RACING

Professor Frank George's program is a serious punter's aid to sensible betting. Data is entered from a sporting newspaper and the program produces betting recommendations.

Available for:
Apple II, Pet, Video Genie, TRS-80, Spectrum, ZX81, BBC 'B', NewBrain, Sharp MZ80k, Sharp MZ80A

From: Bureau of Information Science
Commerce House, High Street,
Chalfont St. Giles, Bucks.
Football Forecast available.

Splice Video

FOR
CUMANA & MICROVITEC
1431/MS Monitor £245 + VAT
Dual Disc Unit for BBC Micro
£345 + VAT

ACCESS AND VISA CARDS WELCOME

Telephone 01-845 6705

PROGRAMS

```

4)=0:FORU=1TOR:IFRND(18)>=3+L THENNEXTUELSEST(U)=1:NEXTU
6062 CLS:FORU=1TOR:IFST(U)=0 THENNEXTU:RETURNELSEPRINT"THE FOLLOWING ARE PETRIFIED
D":FORU=1TOR:IFST(U)=0 THENNEXTU:PRINTC(U):NEXTU
6064 FORU=1TOR:FORV=1TOLEN(CA(U)):IFASC(MID$(CA(U),V,1))<>13 THENNEXTV,U:PRINT"YOU
ARE NOT CARRYING A CURE POTION,SO THEY ARE DEAD":FORU=1TO1900:NEXT:FORRH=1TOR
:IFST(RH)<>1 THENNEXTRH:RETURNELSESEGDSUB4100:NEXTRH:AS:FORRH=1TOR:IFST(RH)=1ANDC
6066 INPUT"WHO WILL YOU SAVE WITH YOUR CURE POTION":AS:FORRH=1TOR:IFST(RH)=1ANDC
(RH)<>ASTHENGOSSUB4100
6068 NEXTRH:FORU=1TOR:ST(U)=0:NEXTU:RETURN
6080 IFL<SANDMJ=0 THEN6000ELSEZ="GIANT":NM=RND((L+1)/2):FORU=1TONM:Z(U,1)=RND(2(
(L-1)*30):Z(U,2)=RND(2((L-1)*30):Z(U,3)=9999:Z(U,4)=0:NEXTU:RETURN
7000 CLS:PRINT"NAME":TAB(10)"S":TAB(20)"B":TAB(30)"M":TAB(40)"C":TAB(50)"TYPE":P
RINT:FORU=1TOR:PRINTC(U):FORV=1TO4:PRINTTAB(10*V)H(U,V):NEXTV:PRINTTAB(50)D(G
(U,0)):NEXTU:PRINT"PRESS ANY KEY TO CONTINUE"
7010 E=INKEY$:IFE=" " THEN7010ELSE440
8000 FORRH=1TOR:IFG(RH,1)<1 THEN6080SUB4100
8100 NEXTRH:IFR<0 THENRETURNELSECLS:GOTO836
9000 EY=INKEY$:IFEY=" " THEN9000ELSEIFASC(EY)<49ORASC(EY)>48+NM THEN9000ELSEPRINT:U
M=VAL(EY):RETURN
9100 EY=INKEY$:IFEY=" " THEN9100ELSEIFASC(EY)<48ORASC(EY)>48+TATHEN9100ELSESET=VAL(
EY):RETURN
9200 EY=INKEY$:IFEY="DREY<>"B"ANDEY<>"P"ANDEY<>"J" THEN9200ELSEBEH=EY:RETURN
9300 EY=INKEY$:IFEY="DREY<>"B"ANDEY<>"D" THEN9300ELSESEE=EY:RETURN
10000 ES=INKEY$:IFES=" " ORES<>"Y"ANDES<>"N" THEN10000ELSESEE=ES:RETURN
11000 CLS:PRINT"THE ROOM CONTAINS"NM;" ";E;
11010 IFNM>1 THENPRINT"S";
11020 IFAR<>" " THENPRINT",A ";AR;
11030 PRINT" AND SOME SACKS":RETURN
    
```

BBC Cross-hair Cursor

by David Ingram

BBC graphics enthusiasts should find the following procedures a useful, if simple, addition to their library of subroutines. Both routines use a joystick to move a cross-hair cursor and will work with either BBC machine.

The first listing moves the cursor around the screen without adding anything to the display, while the second

allows the user to 'mark' points on the screen using the joystick button which the program then joins with a straight line.

Although intended for use with joysticks, the routines should be fairly straightforward to adapt for keyboard use.

```

1 REM CROSS-HAIR CURSOR (A)
10 MODE 1:GCOL 3,1
20 X=-20:Y=-20
30 PROCcursor
40 GOTO 30
6000 DEF PROCcursor
6010 LOCAL X1,Y1,F
6020 X1=(4095-ADVAL(1)/16)*(1279/4095)
6030 Y1=(ADVAL(2)/16)*(1023/4095)
6040 IF ABS(X-X1)<5 AND ABS(Y-Y1)<5 THEN ENDPROC
6050 FOR P=1 TO 2
6060 MOVE X-20,Y: PLOT 1,10,0
6070 MOVE X,Y-20: PLOT 1,0,10
6080 MOVE X+10,Y: PLOT 1,10,0
6090 MOVE X,Y+10: PLOT 1,0,10
6100 X=X1:Y=Y1
6110 NEXT P
6120 ENDPROC
    
```

```

1 REM CROSS-HAIR CURSOR (B)
10 MODE 1:GCOL 3,1
20 X=-20:Y=-20:CURFLAG=0
30 PROCcursor
40 IF (ADVAL0 AND 1)=1 AND CURFLAG=0 MOVE XN,YN: X2=XN: Y2=YN: CURFLAG=1
50 IF (ADVAL0 AND 1)=1 MOVE X2,Y2: DRAW XN,YN: X2=XN: Y2=YN
60 GOTO 30
6000 DEF PROCcursor
6010 LOCAL P
6020 XN=(4095-ADVAL1/16)*(1279/4095)
6030 YN=(ADVAL2/16)*(1023/4095)
6040 IF ABS(X-XN)<5 AND ABS(Y-YN)<5 THEN ENDPROC
6050 FOR P=1 TO 2
6060 MOVE X-20,Y: PLOT 1,10,0
6070 MOVE X,Y-20: PLOT 1,0,10
6080 MOVE X+10,Y: PLOT 1,10,0
6090 MOVE X,Y+10: PLOT 1,0,10
6100 X=XN:Y=YN
6110 NEXT P
6120 ENDPROC
    
```

HOME COMPUTER CENTRE

| | | | |
|---------------|---------|--------------|---------|
| ATARI 400 16K | £159.99 | SPECTRUM 16K | £99.95 |
| ATARI 800 48K | £399.00 | SPECTRUM 48K | £129.95 |
| SINCLAIR ZX81 | £45.95 | DRAGON 32K | £199.95 |
| ORIC-1 48K | £169.99 | COMMODORE 64 | £343.50 |
| BBC 'B' 32K | £399.00 | VIC 20 | £129.95 |

Plus printers, cassette recorders, RAM packs, accessories etc., etc. Extensive software stocks.

SCREENS MICROCOMPUTERS

Open 6 days a week.

Mail order - phone
Northwood 20664,
free lists & prices.

Access, Barclaycard,
American Express.

6 MAIN AVENUE, MOOR PARK,
NORTHWOOD, MIDDLESEX

MICROMART

MICRO COMPUTERS

NEC
ORIC
New Brain

DANNY
O'SULLIVAN
SIMON MILNER

TELEPHONE
37281/2



DATA ONE SYSTEMS

LIMITED
MAKING COMPUTER TECHNOLOGY WORK FOR YOUR
BUSINESS

Prudential Chambers, Market Place, Loughborough
Telephone (0609) 37281/2 Telex 342351 TRANSO

SHARP MZ 80A



THE INTEGRATED
SMALL BUSINESS
COMPUTER WITH
INTEGRATED
ACCOUNTS PACKAGES

WRITE OR CALL FOR DETAILS

**WEST COAST
PERSONAL COMPUTERS**

47 KYLE STREET, AYR HA7 1RS

32K BBC users,

Can you make back up copies of all your software?
Can you copy any program that you would like to buy
but it is too expensive?

Can you copy any machine code program or data
file?

If the answer is no then you need the Protonsoft
Master Copy program. This is the program that the
serious software collector can't be without.

Also still available is our excellent Star Trek game.
Full colour high resolution graphics and excellent sound
effects make this game the best of its type available. We
can assure you that you won't be disappointed.

Both programs available separately on high quality
computer cassette with full documentation for £5.55 inc
P&P.

Cheques to Mark Smith

Send to

PROTONSOFT, 10 Dewey Avenue,
Liverpool L9 0LU. Phone 051-525-9188.

OSBORNE 1

TRY US FIRST!

£949 + VAT

COMPUTERS

01-228 2207
Southampton House, 192-206 York Road, London SW11 3SA

MICROMART

SHARP **PC-1500** TANDY **PC-2**

SOFTWARE

3D Plotter Graphics with rotation and perspective. Mathematical shapes. LURGO featuring Gnat. Graphics and SCRAMBLOID - the finest arcade game ever! Intelligent Noughts & Crosses, Special Colour Effects and lots more - to run on expanded/unexpanded machines.

PRICE: £6.75 inclusive.

Send Cheque/P.O. payable to

D.D.D.

150 High Street, Twerton
Bath. BA2 1BY

ALL ORDERS DESPATCHED WITHIN 24HRS.



PROGRAMMERS

For the APPLE, ORIC, and BBC

Are you green with envy when you read about the wealth other people have gained through programming?

NOW IT'S YOUR CHANCE!!

Turn your dreams into a reality

We at KNIGHTS SOFTWARE offer you 30% royalties or a lump sum for YOUR programs. For more information phone or write to:

KNIGHTS SOFTWARE

14 Knights Court, Knights Park
Kingston Surrey KT1 2QL
01 549 3045

CASSETTE DUPLICATION SERVICE

Need cassette copies in a hurry?
We can provide a super-fast service using only the latest studio equipment.
Why wait weeks or months for your copies and pay high prices?
Average price per copy 34 p.(C12) + vat.
On body printing and inlay cards to your spec.

No order too large or too small.

JLC

49 Castle St.,

Barnsley, South Yorkshire, S70 1NT
Phone: 0226 87707

As we try to maintain a fast service and for security reasons visitors will only be seen by prior arrangement. Telephone enquiries Preferred after 6pm weekdays or anytime weekends and holidays.

JOYSTICKS from £4.50 each DIRECT FROM OUR FACTORY

IN KIT FORM: kit contains 1 switched joystick assembly, 2 moulded case halves, fire button, 1.5 metres 5 core + screen cable, fixing screws

£4.50 per KIT

READY BUILT with 9 way 'D' socket - suit Atari or Vic 20..... £5.95 each

FEW ONLY with potentiometers and 5 way din socket to suit Dragon £5.00 each

CONNECTORS

'D' connectors 9 way female plug or 15 way male plug complete with hoods

£1.75

Din plug 5 way 240 deg. 50p

AERIAL SPLITTER SWITCHES £2.50

(Saves unplugging T.V. Aerial to connect computer)

Cheque or PO with order. Prices quoted INCLUDE VAT. 1st Class Post. immediate despatch - 7 day money back guarantee.

VOLTFACE LTD., PARK DRIVE, BALDOCK, HERTS.

Callers welcome Monday to Friday.

Telephone: (0462) 894410



PROGRAMS

Apple II Menucreate

by Jim Hawkins

'Apple II Menucreate' is a utility routine designed to generate menu procedures in Pascal. The program was written in Apple/UCSD Pascal but should adapt easily to other implementations.

The program requests details of the items to be included in the menu and the desired layout, before generating a text file of the appropriate Pascal procedure. This text file may be either 'Copied' straight into a program or simply called by the compiler as an 'Include' file. The resultant procedure checks for a valid response, sounding the bell in case of invalid input. It should be noted, however, that the program does not generate error messages. The example menus require some dummy procedures;

the procedure 'Testbed' (see listing below) is used to generate these.

The menu procedure can be given any name and uses no global variables so that an unlimited number of menus can be called. The program will also, if required, produce the text of a dummy program in order to show the menu as it will appear on the screen. Care must be taken when entering the listing to get all the commas and inverted commas correct, otherwise a stream of 'STRING CONSTANT MUST NOT EXCEED ...' messages will be produced.

Besides being a useful and neatly-written Pascal program, 'Menucreate' also serves to illustrate the way in which program generators work.

```

VAR
PTEXT:TEXT; (* DISK FILE FOR TEXT OF PROCEDURE *)
LEFTMARGIN,GAP,CHOICES,X:INTEGER;
INVC,OUTFILENAME,PROCNAME,MENUNAME,UNDERLINE:STRING;
MENOPT,PROCLIST:ARRAY[1..9] OF STRING;
CH:CHAR;
EIGHTY:BOOLEAN;

PROCEDURE FIRST;
BEGIN
INVC:=''; (* MAKES PASCAL INVERTED COMMAS EASIER TO USE *)
PAGE(OUTPUT);
WRITELN(' INCLUDE FILE NAME FOR MENU ON DISK ');
WRITE(' -> ');
READLN(OUTFILENAME);
IF POS('.',TEXT,OUTFILENAME)=0 THEN OUTFILENAME:=CONCAT(OUTFILENAME,'.TEXT');
REWRITE(PTEXT,OUTFILENAME); (* OPEN FILE FOR TEXT *)
WRITELN(' FILE OPENED');
WRITE(' MENU PROCEDURE NAME->');

(* TO BE CALLED BY MAIN PROGRAM
TO DISPLAY MENU - MIGHT JUST
BE "MENU" OR "MAINMENU" *)

READLN(PROCNAME);

(* NOW WE START TO WRITE PROCEDURE
TEXT TO DISK FILE *)

WRITELN(PTEXT,'PROCEDURE ',PROCNAME,',');
WRITELN(PTEXT,'VAR RESPONSE:CHAR;');
WRITELN(PTEXT,'COUNT:INTEGER;');
WRITELN(PTEXT,'BEGIN');
WRITELN(PTEXT,'PAGE(OUTPUT);');
WRITE(' MENU HEADING->');

(* MENU TITLE TO BE PRINTED AT THE
TOP OF THE SCREEN *)

READLN(MENUNAME);
MENUNAME:=CONCAT(INVC,MENUNAME,INVC);
WRITE(' TAB POSITION FOR MENU ITEMS: ');

(* WHERE WE WANT THE MENU ITEMS TO
BE PLACED LEFT TO RIGHT *)

READLN(LEFTMARGIN);

(* NOW ASK IF WE WANT 80 COLUMNS OF
UNDERLINE FOR TITLE - ANSWERING
'N' WILL DEFAULT TO 40 *)

WRITE(' 80 COLUMNS? <Y/N> ');
REPEAT
READ(KEYBOARD,CH)
UNTIL CH IN ['Y','y','N','n'];
EIGHTY:= ( CH IN ['Y','y'] );

WRITELN;
X:=LEFTMARGIN + 5;
WRITELN(PTEXT,'GOTOXY('',X'',1);WRITELN('',MENUNAME,'');
    
```

NEWBRAIN RENUMBER

A resident machine code program which renumbers all or part of BASIC programs. Allows moving of lines from one region to another. Lists new line-number and new references (with type), to screen or printer. Lists and originally modifies references to non-existent lines. Helps keep your programs tidy.

£15.00 inc. P&P. for tape and user guide.

Contact:
Ian Barnard
46 Bribeck Place
Sandhurst
Camberley
Surrey
Tel: Camberley (0276) 33938

PROGRAMS

```

WRITELN(PTEXT, 'WRITELN:');
UNDERLINE:= '_____';
WRITELN(PTEXT, 'WRITE(' ,INVC, UNDERLINE, INVC, ');');
IF EIGHTY THEN WRITELN(PTEXT, 'WRITE(' ,INVC, UNDERLINE, INVC, ');');
END;

PROCEDURE SECOND;
BEGIN
WRITE(' NUMBER OF MENU CHOICES? ');
(* ALLOWS 1..9 CHOICES. IF MORE
DESIRED PATCH INPUT TO USE
READLN AND USE NUMERIC VARIABLE
INSTEAD OF CHARACTER. WITHOUT
ELABORATE ERROR CHECKING THIS
IS EASIER FOR USERS TO CRASH,
HOWEVER *)
READLN(CHOICES);
IF CHOICES>5 THEN GAP:=1 ELSE GAP:=2;
(* THIS LINE DOUBLE-SPACES
SMALL MENUS *)
WRITELN('ENTER THE TEXT YOU REQUIRE FOR');
WRITELN('EACH MENU CHOICE. ');
WRITELN;
(* NOW GET THE SCREEN TEXT FOR
EACH OPTION AND THE PROCEDURE
IN THE USER PROGRAM THAT WILL BE
CALLED IF THAT OPTION IS PRESSED *)
FOR X:=1 TO CHOICES DO BEGIN
WRITE(' CHOICE ' ,X, ' ->');
READLN(MENOPT(X));
WRITE(' PROCEDURE TO CALL FOR THIS CHOICE->');
READLN(PROCLIST(X))
END;

FOR X:=1 TO CHOICES DO BEGIN
MENOPT(X):=CONCAT('> ' ,MENOPT(X), INVC, ');');
WRITELN(PTEXT, 'GOTOXY(' ,LEFTMARGIN, ' ,',GAP*X+4, ');WRITELN(' ,X, MENOPT(X));
END;
END;

PROCEDURE THIRD;
(* COMPLETE THE FILE CREATION *)

BEGIN
WRITELN
(PTEXT, 'GOTOXY(' ,LEFTMARGIN, ' ,22);WRITE(' ,INVC, 'PRESS SELECTION :');');
WRITELN(PTEXT, 'REPEAT');
WRITELN(PTEXT, 'READ(KEYBOARD, RESPONSE);');
WRITELN
(PTEXT, 'IF NOT ( RESPONSE IN {' ,1, ' ,INVC, ' ,.. ,INVC, CHOICES, INVC, '}) ');
WRITELN(PTEXT, 'THEN WRITE(CHR(7));');
WRITELN(PTEXT, 'UNTIL RESPONSE IN {' ,1, ' ,INVC, ' ,.. ,INVC, CHOICES, INVC, '});');
WRITELN(PTEXT, 'COUNT:=ORD(RESPONSE)-48;');
WRITELN(PTEXT, 'WRITELN;');
WRITELN(PTEXT, 'CASE COUNT OF');
FOR X:=1 TO CHOICES DO
WRITELN(PTEXT, ' ' ,X, ' : ' ,PROCLIST(X), ' ');
WRITELN(PTEXT, 'END;');
WRITELN(PTEXT, 'END;');
WRITELN(PTEXT, 'END;');
WRITELN(' MENU TEXT FILE CREATED');
CLOSE(PTEXT, LOCK);

END;

PROCEDURE TESTBED;
(* CREATE A DUMMY PROGRAM ON
THE BOOT DISK USING THE
MENU PROCEDURE AS AN INCLUDE
FILE. MUST BE COMPILED
AND THEN EXECUTED *)

BEGIN
REWRITE(PTEXT, 'TESTBED.TEXT');
WRITELN(PTEXT, 'PROGRAM TESTBED;');
WRITELN(PTEXT);
FOR X:=1 TO CHOICES DO
BEGIN
WRITELN(PTEXT);
WRITELN(PTEXT, 'PROCEDURE ' ,PROCLIST(X), ' ');
WRITELN(PTEXT, 'BEGIN');
WRITELN(PTEXT, 'GOTOXY(' ,LEFTMARGIN+1, ' ,',GAP*X+4, ');');
WRITELN(PTEXT, 'END;');
END;
WRITELN(PTEXT, '(*$I', OUTFILENAME, '*');');
WRITELN(PTEXT, 'BEGIN');
WRITELN(PTEXT, 'PROCNAME);');
WRITELN(PTEXT, 'END. ');
CLOSE(PTEXT, LOCK);
WRITELN; WRITELN;
WRITELN(' TO SEE THE MENU C(OMPILe TESTBED');');
WRITELN(' TO TESTBED AND THEN X(ECUTE IT. ');');
END;

BEGIN

```

MICROMART



FINANCIAL MODELLING COURSES

'Hands On' Practical Microcomputer Modelling

- 1 DAY COURSE VISICALC
- 1 DAY COURSE ADVANCED VISICALC
- 3 DAY COURSE MICROMODELLER

CONSULTANCY

Model Design, Writing, Support

- VISICALC
- MICROMODELLER
- PROSPER STAR
- PROSPER +
- MARS
- FCS/EPS



VAL WARDEN CONSULTANTS

110 Western Road,
Tring, Herts. HP23 4BJ
Tel: Tring (044 282) 6774/5

SILICON OFFICE USERS!

FULLY QUALIFIED PROGRAMMER
NOW AVAILABLE

Low Rates

Phone Antony Stecker on

01-242 9493

for an unobligatory discussion

MICRO USER T-SHIRTS

| | | |
|---------------|-------------------------------|-------------------------|
| EPSON ZX81 | SHARP SPECTRUM SIRIUS 1 | SORD ORIC 1 APPLE |
|---------------|-------------------------------|-------------------------|

MICRO FUN T-SHIRTS

"I'M USER FRIENDLY"
"HAVE YOU SEEN MY PERIPHERALS?"
Available in white, blue and red,
small, medium, large and x-large sizes
CLUB T-SHIRTS ALSO PRINTED
£3.25 EACH INCLUSIVE
Mail Order only from
ONE PER CENT SCREENS
UNIT 12, STAR LANE INDUSTRIAL ESTATE
GREAT WAKERING, ESSEX.

TOP
QUALITY

FLOPPY DISKS

- * Three year guarantee
- * All manufacturer tested
- * Immediate dispatch
- * All prices inclusive of library cases. 10 per box

£14.90 = 5 1/4" single sided, single density

£15.90 = 8" single sided, single density

- * Full range of floppy disks available
- Please add 15% VAT and £1.00 p&p per order

ARAN COMPUTER SUPPLIES

47, Longmeads, Tunbridge Wells, Kent.
TN1 1BA. Tel: (0892) 24300

RS 232/423
OLIVETTI
PRAXIS 35
INTERFACE
£72 inc.

MICRO PROCESSOR
CONTROLLED UNIT
Turns your Praxis 35 into a high quality (12 cps)
Daisy Printer. Boxed, tested, with complete installa-
tion instructions (2 sets of 13 easy soldering joints).
Great for BBC, CP/M systems etc. 300 Baud.
Also available fitted for £430

TIMTOM MICRO
9 ILTON RD
PENYLAN
CARDIFF

Also suitable for
Praxis 30
S.A.E. for details



OSBORNE 1

TRY US FIRST!

£949 + VAT

ICOMPUTERS

01-228 2207
Southampton House, 192-206 York Road, London SW11 3SA

MICROMART

*** For the Best Prices Ever ***
STOP & PHONE US NOW * 01-683 1181 (PBX)

Croydon Micros

THE MICRO-COMPUTER PROFESSIONALS

Computers:
Sharp MZ80B £869 Osborne 1 £1206
Sharp MZ80A £434 IBM PC £2620

Printers:
Seikosha GP 100 £176 Smiths Corona TP1 ... £430
Epson MX80FT3 £325, MX82FT £355, MX100 £420
OK1 80 £210, 82A £299, 83 £431, 84A £795

RICOH Flowriter £1350 TEC Starwriter F10 ... £950

Cables:
Standard £20 Special £35

Drives: 5 1/4" Top Quality
SS 48 tpi £137.50
DS 48 tpi £162.50
SS 96 tpi £187.50
DS 96 tpi £200.00
Cases and PSU available
Please ring for prices

Please add V.A.T. and delivery:
Computers £15.00
Printers £10.00
Paper (Box) £2.00
Disks (Box) £1.50

*Wide range of paper, diskettes and software available *
for immediate delivery on MAIL ORDER

Ring now for help

Croydon Micros

Cheques to: 20-26 Whitehorse Road
Croydon, Surrey CR9 2HQ
Showroom open: Tuesday to Saturday 10 to 1 & 2 to 6pm
Proprietor: Frontrealm Ltd (T/A)
Incorporated in England No: 1593574

VISA ACCESS
AMEX DINERS

PET PET PET PET PET PET PET

**** HI RESOLUTION GRAPHICS ****

A high resolution graphics board that gives a 64,000 dot (320 x 200) resolution. Versions available for any dynamic ram Pet, BASIC 2.3.4, FAT40 & 80 columns. No soldering or track cutting required, supplied complete with fast GRAPHIX software in ROM and full fitting & operating instructions. £149.00

**** SUPER ROM-SELECTOR ****

A high quality printed circuit board giving 64K of utility ROM space, software selectable!!! Allows 16 x 4K ROMs/EPROMs to reside in the expansion area of your PET. One 'POKE' enables any two ROMs at a time. Suitable for bank-switched software. £75.00

**** PET UPGRADES ****

WHITE-U-WAIT service! (Dynamic ram pets only!)
Memory expansion: 8K - 32K £59.90
16K - 32K from £48.70
8K - 16K £38.26

40 column (12" VDU only) to 80 column conversion
40 to 80 column £89.00
40 to 80 column switchable (two machines in one!) £105.00
Full keyboard functions: i.e. TAB, ESC, REPEAT, SCROLL up/down, define WINDOW, lower case/graphics mode & DELETE from/to cursor. All available in direct or program mode.

NEW! Now available 40/80 column switchable conversion for 9" machine £149.00

**** REPAIRS AND SERVICING ****

Fast and efficient repairs to all Commodore computers at reasonable prices. WHITE-U-WAIT service whenever possible.

Please add VAT to the prices shown at the current rate

Telephone Mick Bignell for more details at:

MICROPORT

7 Clydesdale Close, Borehamwood, Herts. WD6 2SD
Tel: 01 953 8385

USED SUPERBRAINS
Bought and Sold
Also part exchanged against
most new 16 bit micros

INTERLEX LTD
Imperial House
Lower Teddington Road
Kingston KT1 4EP

Contact Mike Lane on
01-943 0968

PROGRAMS

```

• FIRST;
• SECOND;
• THIRD;
• PAGE(OUTPUT);
• WRITE(' DO YOU WANT A TEST PROGRAM FOR THIS MENU? ');
• READ(KEYBOARD,CH);
• IF CH IN ['Y','y'] THEN TESTBED;
• WRITELN;
• WRITELN('FINISHED. ');
• END.
    
```

Oric 1 Word Scrambler Conversion

by Ian Collins

You may remember the TRS-80 Word Scrambler program published in the April issue (pp 229-230). Ian Collins has written in to say that only two lines need to be modified in order for the program

to run on an Oric. These are:-
10 CLS: CLEAR: DIM P\$(999): M=1:
N=1
200 R=INT(RND(1)*L+1)

BBC Quadsolve

by I Kingston

'Quadsolve' is a neat and straightforward program for solving quadratic equations.

The user enters the values of a, b and c in the equation $ax^2+bx+c=0$. The program attempts to solve the problem first, by factorising, and then — if this is not possible — by using the quadratics formula. Since each line of the working is displayed along with the final solution, the program makes a useful teaching aid as well as being ideal for doing your maths homework!

When entering the program, note that the ASCII character 'i' should be entered as '[' when typing in the listing: the lines to watch out for are 420, 540, 630, 770

and 820. Line 40 selects green as the text colour. Unless you have a monitor (as opposed to a tv set), this can look distinctly nauseating, so you may like to experiment with other colours (like white, perhaps?).

User-defined characters are used to provide the correct mathematical notation for square, square root, divided by, plus-or-minus and factorises to. For this reason, mode 6 is used rather than the usual mode 7 since the latter has no facility for non-standard characters.

The program requires a model B and was tested under the 1.2 OS.

```

10 REM"QUADSOLVE"
20 REM By Ian Kingston, Dec 1982.
30 MODE6
40 VDU19,1,2,0,0,0
50 VDU23,240,96,144,16,96,128,240,0,0
60 VDU23,241,16,8,252,0,252,8,16,0
70 VDU23,242,0,16,0,254,0,16,0,0
80 VDU23,243,16,16,124,16,16,0,124,0
90 VDU23,244,7,4,8,8,8,144,80,32
100 PRINT"TAB(15):"QUADSOLVE"
110 PRINT"This program will solve any quadratic equation entered in the form"
120 PRINTTAB(12);"ax";CHR$(240);"+bx+c=0""where a is the coefficient of x";CHR$(240);"
130 PRINTTAB(6);"b is the coefficient of x";TAB(2);"and c is a numerical constant."
140 PRINT"wherever possible the roots will be derived by factorising the equation."
150 PRINT"if this is impossible then the formula""x=-b";CHR$(243);CHR$(244);"b";CHR$(240);"
-4ac)"" will be used"
160 PRINTTAB(2);"-----"
170 PRINTTAB(7);"2a"
180 PRINT"TAB(5):"Press SHIFT KEY to continue"
190 REPEATUNTILINKEY(-1)
200 VDU12
210 PRINT"Coefficient of x";CHR$(240);:INPUTAX
220 INPUT"Coefficient of x";B%
230 INPUT"Value of constant";C%
240 PRINT
250 IFAX=0 THENVDU7:PRINT"Not a quadratic"";GOTO210
260 IFB%<=0 ANDC%<=0 THENVDU7:PRINT"Clever...0=0!!";GOTO210
270 PROCdisc%
280 PRINT"The equation you entered is:"
290 Q$=""
300 IF%>1 THENQ$=STR$(%)+(" "
310 IFSGN(AZ)=-1 THENQ$=Q$+"-"
320 IFABS(AZ)>1 THENQ$=Q$+STR$(ABS(AZ))
330 IF AZ THENQ$=Q$+"x"+CHR$(240)
340 IFB% THENQ$=Q$+CHR$(43-2*(SGN(BZ)=-1))
    
```



Holiday weekend for two in a delightful Cotswold hotel (four poster honeymoon bedroom).
WITH EACH OSBORNE SYSTEM
Relax away from it all — renowned for good food, friendly company and pleasant atmosphere.



DP System £1550 plus V.A.T.
WP System £1850 plus V.A.T.

Banbury Computer Centre
17 Westbar, Banbury, Oxon
Tel: Banbury (0295) 65023

EPSON FX80
£379+VAT

EPSON RX80
279+VAT

MICRO-AID
Micro-Aid, 25 Fore Street
Praze, Camborne, Cornwall
Tel: 0209 831274

PROGRAMS

```

350 IFABS(B%) > 1 THENQ=Q#+STR*(ABS(B%))
360 IFB% THENQ=Q#+X"
370 IFC% THENQ=Q#+CHR*(43-2*(SGN(C%)=-1))+STR*(ABS(C%))
380 IFF% > 1 THENQ=Q#+I"
390 Q=Q#+=0"
400 PRINTTAB(22-LEN(Q));Q#
410 IFF% > 1 THENQ=MID$(Q,3,LEN(Q)-5)+RIGHT$(Q,2)
420 IFF% > 1 THENPRINTCHR*(241);TAB(22-LEN(Q));Q#;TAB(25);";CHR*(242);" by ";f"
430 CLEAR
440 Z=0
450 IFC% THENPROCfactorise ELSEK%=1:L%=0:M%=A%:N%=B%:Z=2
460 DNZ=1:BOT0800,470,700
470 Q#="("
480 IFSN(K%)=-1 THENQ=Q#+-#
490 IFABS(K%) > 1 THENQ=Q#+STR*(K%)
500 Q#="Q#+CHR*(43-2*(SGN(L%)=-1))+STR*(ABS(L%))+)" ("
510 IFSN(M%)=-1 THENQ=Q#+-#
520 IFABS(M%) > 1 THENQ=Q#+STR*(ABS(M%))
530 Q#="Q#+X"+CHR*(43-2*(SGN(N%)=-1))+STR*(ABS(N%))+)"=0"
540 PRINTCHR*(241);TAB(22-LEN(Q));Q#;TAB(25);";factorise"
550 IFSN(K%)=-1 THENQ#="-ELSEQ#="";IFABS(K%) > 1 THENQ=Q#+STR*(ABS(K%))
560 Q#="Q#+X"+CHR*(43-2*(SGN(L%)=-1))+STR*(ABS(L%))+)"=0 or "
570 IFSN(M%)=-1 THENA#="-#
580 IFABS(M%) > 1 THENA#="A#+STR*(ABS(M%))
590 A#="A#+X"+CHR*(43-2*(SGN(N%)=-1))+STR*(ABS(N%))+)"=0"
600 PRINTCHR*(241);TAB(22-LEN(A#));Q#;TAB(25);";"
610 Q#="X"+STR*(LEN(SGN(K%))+)" or "
620 A#="X"+STR*(LEN(SGN(M%))+)"
630 PRINTCHR*(241);TAB(22-LEN(A#+Q#));Q#;TAB(22-LEN(A#));A#;TAB(25);";solved"
640 K%=ABS(K%);M%=ABS(M%)
650 IFC% > 1 THENPRINTTAB(22-LEN(A#)-5);"-";
660 IFM% > 1 THENPRINTTAB(21);"-#
    
```

Newbrain GENIN

by S E H Fellowes

GENIN is an acronym for 'general input' routine and is intended to be used as a sub-routine in programs where a significant amount of input is required. The routine is designed to be completely crashproof (I said 'designed to be' — there are no prizes), rejecting invalid input while allowing the use of insert, delete and left and right cursor movement.

The routine checks that string length is less than or equal to the value of 1, and that each character within the string is within the ASCII range defined by i\$; these values to be set by the programmer earlier in the program. To accept only four letter

words, for example, 1 should be set to 4 and i\$ set to 'az'. In the listing given below, a sample calling routine is given in lines 10 and 20.

A carriage return returns the string without trailing spaces and CONTROL/CR pads the string with spaces to the string length set by 1. The input is returned as in\$. If you are dealing in numeric input, then add one further line: 925 in=val(in\$).

To date, this is the one and only Newbrain program I've received: Newbrain programmers, where are you? Haven't you noticed our new rates?

```

10 PUT31:PRINT"name [      ]"
20 l=8:i1$=" z":PUT22,7,0:GOSUB500:PRINT:PRINTin$:END
500 REM ** genin **
510 IFLEN(i1$) < 2 THENPRINT"no i1$":RETURN
520 OPEN#5,5:PUT21:GET#1,y1:f1=0:f2=0:in$=""
530 l1=0:PUT6:l0=ASC(LEFT$(i1$,1)):hi=ASC(RIGHT$(i1$,1)):IFl0>hi THENRETURN
540 GET#5,s$:IFs$="" THEN540
550 s=ASC(s$)
560 IFS=13 THEN900
570 IFS=3 THENf2=1:GOTO900
580 IFS=8 THENf1=0:GOTO690
590 IFS=26 THENf1=0:GOTO670
600 IFS=17 THENf1=1:GOTO540
610 IFS=24 THEN800
620 IFS<32 THEN540
630 IFS<l0 ORs>hi THEN540
635 IFF1=1 THENGOSUB730:GOTO540
640 PRINTs$:l1=l1+1:IFl1=1 THENl1=11-1:PUT8
650 GOTO540
660 REM ** right cursor **
670 IFl1=11-D THEN540
680 GOTO640
690 REM ** left cursor **
700 IFl1=0 THEN540
710 l1=11-1:PUT8:GOTO540
    
```

OSBORNE 1

Plus the last one £1475.00 + V.A.T.

We Also Stock:-

NEC

NMR
COMPUTERS

COMPUTERS
PRINTERS
MONITORS

Tel: Huddersfield
(0484) 682905

BCPL FOR THE BBC

The most powerful language for the BBC Microcomputer, includes a full screen editor and assembler. Language ROM, 450 page Manual, Utility disk. Published by Acornsoft £99.65
also BCPL for any CP/M £172.50

Richards Computer Products Ltd

Brookside, Blewbury, Didcot,
Oxon OX11 9QA
Telephone 0235-850218

MICROMART

WANTED DISTRIBUTORS AND RETAILERS

For a new range of DRAGON and ORIC games. Including

FOR THE DRAGON BUMPER BRICKS

One of those rapid reflex games that looks so easy... until you try it.

FOR THE ORIC (16K or 48K) BLOCKBUSTER

A demolition game that can go in five different directions at once. Very fast and very difficult.

Both games feature 'self play modes'.

Leave them running and they sell themselves.

Good discounts available for quantity. Also available mail order £6 each. (A version of BLOCKBUSTER is available for ACORN ATOM).

QUODLIBET

QUODLIBET
2, Victoria Terrace,
Dorchester,
DORSET DT1 1LS



BBC CHARACTER GENERATOR

Menu driven facilities include reflect, invert and 3 rotates. Display is on grid for multi-character pictures. Full load and save etc.

£9.95 P&P FREE
CHEQUES TO

VISCOUNT SERVICES LTD
2A Boulton Road, Southsea, Hants.
NOFUSS GUARANTEE 0705-833633

- BORGPROGZZ -

present NEW for

nascom

NASCOM 2 FAST MACHINE CODE GAMES

| | | |
|-------------------|-----|-----|
| POW R. TOCH | 18K | £10 |
| WALL RACERS | 10K | £8 |
| FOREST FIRE | 18K | £8 |
| BELCHMAN | 18K | £10 |

BASIC PROGRAM PACKS, £5 per pack

- 1) Battleships, Asteroids, Wrgls
- 2) Bomb New York, Alien, Grand Prix

Prices inclusive
SEND FOR DETAILS TO:

BORGPROGZZ

39 Priests Lane, Brentwood, Essex CM15 8BU

OSBORNE 1

TRY US FIRST!

£949 + VAT

ICOMPUTERS
01-228 2207
Southampton House, 192-206 York Road, London SW11 3SA

MICROMART

alphaSyntauri

QUITE SIMPLY THE BEST APPLE MUSIC SYNTHESIZER AVAILABLE

Standard featured include:

- 5 octave velocity sensing keyboard
- 8 voice polyphonic
- Up to 8 way keyboard split
- Full sounds designed software with 16 track polyphonic recording
- Up to 8 voice layering
- Full auto-transcribing facilities are optional

**QUITE SIMPLY THERE'S
NO COMPETITION!**

Further details from:

Computer Music Studios

62 Blenheim Crescent, London W11 1NZ.
Tel: 01-229 2597/01-969 5822

SUPERBRAIN

10 MB Compustar £1600.00
VPU 4 (DQD) £1600.00
+ VAT

Hardly used, with five months contract.

CAMBRIDGE DATA
4 Somerset Gardens
Highgate
London
N6 5EQ

Telephone: 01-348 3298

Peanut Price Breakthrough

Apple II+ compatible Disc Drives
APPLEMATE £179.50
SLIMLINE SUPER 7 £189.50

Free Joystick with every order

Peripheral Cards
for Apple II+

| | |
|----------------------------|--------|
| Disc Controller | £27.95 |
| Z80 CP/M | £46.50 |
| Printer (Centronics) | £33.75 |
| RS 232C | £38.25 |
| Language (16K) | £37.12 |
| Eprom Writer | £38.25 |
| 80 Column | £37.12 |
| Integer Basic | £34.87 |
| Games Joystick | £11.95 |

All cards fully assembled and tested.

MONEY BACK GUARANTEE

Carriage: under £100 add £3; over £100 add £5. Add 15% to all orders for VAT. Cash, cheques, P.O.'s payable to

PEANUT COMPUTER
Dewsbury, W. Yorks., WF13 3LX.
Tel: (0924) 499366

PROGRAMS

```

720 REM ** insert **
730 PUT7:FORs=x1+1-2TOx1+11STEP-1:PUT22,s,y1,20:GETch
740 PUT22,s+1,y1,ch:NEXTs:PUT22,s+1,y1,s:PUT8,6
750 RETURN
800 PUT7:IF11=0THEN850
810 fi=x1+1-1:FORs=x1+11TOfi:PUT22,s,y1,20:GETch
820 PUT22,s-1,y1,ch:NEXTs:11=11-1
830 PUT22,fi,y1,32:PUT22,x1+11,y1,6:GOTO540
850 FOR s=x1TOx1+1-2:PUT22,s+1,y1,20:GETch
860 PUT22,s,y1,ch:NEXTs:PUT22,x1+1-1,y1,32
870 PUT22,x1,y1,6:GOTO540
900 PUT7:FORs=0TO1-1:PUT22,x1+s,y1,20:GETch:
    in$=in$+CHR$(ch):NEXTs
910 IFF2=1THEN930
920 IFRIGHT$(in$,1)=CHR$(32)THEN1=1-1:in$=LEFT$(in$,1):
    GOTO920
930 CLOSE#5:RETURN
    
```

DISKOGRAPHY A BRIEF GUIDE TO FLOPPY DISKS

continued from page 162

purchasing. This is the number of tracks on the disk, ie, the number of concentric rings on the disk on which data may be recorded. On eight inch disks there are always 77 tracks but for five and a quarter inch disks, there is a choice of 35, 40 or 80 tracks. Both 35 and 40 track disks are recorded at 48 tracks per inch ("TPI") but 35 track recording uses less of the disk surface to write to

than 40 track recording. Therefore, a 40 track disk can be used on a 35 track drive but not the other way round. 80 track disks are recorded at 98 TPI (half the distance between tracks) and, although 80 track disks are sold, I have never had any problems reformatting double-density 40 track disks for use on an 80 track drive. Of course, 80 track disks can be reformatted as 40 track or 35 track disks if required.

That completes this summary of the physical differences between the various floppy disks on the market. Of course, data can be written to disks, even physically identical disks, in many different formats but that is another story. **END**

EPSON QX-10

continued from page 172

that all the important Basic commands are available at a single stroke. To display characters in a particular font, you'd use the command PRINT " with the machine's normal font and then select the new font by pressing the SF keys in the appropriate combination. You then type the words in the selected font, and go back to the standard font for the rest of the program line. SAVEing the program, LOADing it again and LISTing it reveals that the fancy font parts are always retained in their proper format — when you LKIST the program, there they are, in their special fonts, just as you typed them in.

Provided you have the correct type of Epson printer, you can also produce

these fonts on paper — see the listing and printout in Checkout. This is done automatically from MFBASIC using the printer's bit image graphics facility and very nice it looks, too. It's certainly a fun way to liven up otherwise boring documents like invoices and grovelling letters to the bank manager.

MFBASIC also provides good graphics capabilities to take advantage of the machine's excellent 640 x 400 display. A perusal of the demonstration program listing revealed that it is all easy and straightforward and programmers should have no difficulty in producing some very impressive business graphics packages with this Basic.

The benchmark timings show MF Basic

ORIC GAMES ARE HERE!

1. **THE PITS** — The deepest fantasy game you have ever played. 500+ rooms and many, many hazards!
2. **S.A.S.** — A multi-part action game.
3. **ACTION 6** — Starshoot, Amaze, Tron, Bomber, Starchaser, Headbang.
4. **MIND 6** — Swappers, Squares, Hexpawn, 4 in a Row, Bite, Slide.
5. **GRAPHICS** — Includes the most flexible character generator on the market.
6. **CONTRACT BRIDGE**

£5 each from
Touchstone
61 Highfield Road,
Saxilby, Lincoln LN1 2QJ.



THE 'BIG' O

★ ★ ★ FREE ★ ★ ★
SPECIAL
3-year Warranty with all
systems until 31st May 1983

OSBORNE

4B
microcentres ltd

Telephone (0295)
67551
North Bar, Banbury,
Oxon. OX16 0TF

to be respectably quick, putting the machine well into the upper third of our rankings table (see *PCW* November 1982).

Expansion and potential

The five expansion slots inside the machine indicate that a variety of interesting extras should be on their way and indeed they will be here shortly, most of them. These will include an IEEE-488 interface, an extra RS232 board, joysticks, a light pen, an acoustic coupler and a prototyping board. Local area networking capabilities will be catered for with an Omnet interface while for high-speed communications a fibre optic interface will also be available. At the time of writing, availability dates and prices had not been fixed by Epson (UK) for any of these.

The extra memory expansion will take the form of chips to plug into the spare sockets; it is expected that many customers will buy the machine already configured with the full 256k RAM but that dealers will be able to upgrade 192k machines for about £50 or so.

A colour display system, with the same 640 x 400 resolution as the monochrome display, is currently being evaluated by Epson (UK) and sounds very nice indeed. Again, availability and pricing had not been decided by the time this went to press and Epson was uncertain whether it would be offered as an upgrade to existing machines or in the form of a colour QX-10.

My single criticism of the machine concerns its disk capacity, although maybe, as a Sirius owner, I am a little spoilt in this respect. In any case, a hard disk option is a probability but there are no further details on this at the moment.

Documentation

The review machine came with a thick, just-smaller-than-A4, spiral bound QX-10 *Operations Manual*. This is properly typeset and well laid out, with an index, and covers a wide range of topics about the machine, from how to set it up and switch it on to handling disks carefully, through the intricacies of the fonts system to full details of all the CP/M system calls, both standard and extra. Full details are given of all the machine's features and a section contains careful instructions on using all the CP/M

utility programs, with plenty of screen pictures to show you what should happen. The manual is clearly and concisely written in flawless American English with none of the hilarious mistranslations which livened up some earlier examples of Japanese documentation. As mentioned earlier, I was not supplied with the MFBasic manual but I would confidently expect it to be to the same standard. The manual should be very useful for both the computer-naive business person and the experienced programmer looking for solid technical details.

Applications

The basic machine comes with no applications software at all. Epson (UK) has, however, done a deal with Peachtree so that all that company's accountancy and office productivity software, including the Peachtext (*nee* Magic Wand) word processor, a much nicer thing than the universal WordStar as far as I am concerned. Epson is also making Personal Pearl available and other third-party vendors are being encouraged to put their software onto the QX-10; certainly Caxton has made Cardbox available on the machine, and no doubt we'll be hearing of others joining in pretty quickly.

An American company has produced a system called Valdox based on the QX-10. I've heard wonderful things about this package: it's supposed to be a complete business system not dissimilar in some ways to Apple's Lisa software and includes what has been described to me as a very good word processor. But it won't run on a standard QX-10 as it requires considerably modified hardware and, although there is what Epson describes as a 'very good chance' that it will be sold here some day, this depends very much on pricing and whether or not the Valdox system is fully debugged — apparently it isn't yet.

Conclusions

This is the best 8-bit CP/M computer I've yet seen. It is beautifully and robustly made: a lot of careful thought has gone into the design of the system, in terms of the facilities put into it and into the production engineering aspect. It is intended as a serious business computer and has all the facilities built in to fulfil this role perfectly — within the constraints of CP/M, of course. The ergonomics are excellent (apart from the lack of screen tilting) and the keyboard is a joy to use.

Compared to many 8-biters now on

MICROMART

The SATURDAY dBASE II INTRODUCTORY COURSE

This course enables a rapid grasp to be gained of using database packages, in particular dBASE II (TM: Ashton Tate), on micros under CP/M. It is planned for those who have little or no prior knowledge of data base systems on computers, or dBASE II, and starts virtually from scratch covering:

- Introduction to Micros & CP/M
- Databases on Microcomputers
- Introduction to dBASE II
- Hands on use of dBASE II
- System design for dBASE II
- Programming in dBASE II
- Practical work on dBASE II
- Programming aids & style

Numbers are strictly limited to not more than 20 delegates. Registration is at 0900-0915, lunch 1300-1415, and conclusion at 1800. Several micros are used for hands on work including: Osborne, Sirius, Televideo, Galaxy, etc. Four lecturers are present so as to ensure that every delegate receives individual help in the practical sessions.

The next course is on Saturday JUNE 4th. Currently planned dates are for the following SATURDAYS at a West London hotel:

| | |
|-----------|-----------|
| June | 4, 18 |
| July | 2, 16, 30 |
| September | 10, 24 |
| October | 15, 29 |

Cost: £90 + VAT payable in advance but with scaled refunds if cancellation within specified notice periods. Cost includes course material, meals and refreshments, and a copy of Arthur Green's book: "dBASE II User's Guide". Payment by Cheque, PO, Access or VISA. Detailed explanatory leaflet available with fuller description. To make a booking or to obtain further details, telephone or write to: Steve Conlon at:

AQUA COMPUTING LTD

(Dept PW5), 10 Barley Mow Passage,
London W4 4PH

(Phone: 01-994-6477)

If interested
in advertising
in
Micromart
please call
01-636 6890

OSBORNE 1

FREE Osborne 80/104 column card +
FREE D Base II. When you
purchase your Osborne from

£1 COMPUTERS: Osborne Specialist

Southampton House, 192-206 York Road
Battersea, London SW11 3SA

Tel: 01-228 2207

(300 hundred yards from Wandsworth
Bridge roundabout)

LONDON'S APPLE CENTRE

With any one of our Apple Computer Packages you can greatly increase your business efficiency or improve your leisure time activity.

Come in and talk to us today. We can help you choose the right system and demonstrate it to you. Our prices are highly competitive and include a 12 month parts and labour guarantee and full after sales service. And, because we are specialists in Apple Computer Systems and software, we can provide proven packages for every business or pleasure need. Here are some examples:

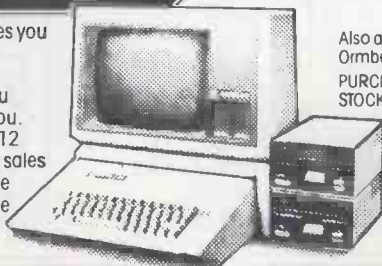

BUSINESS SYSTEMS

Apple IIe Computer, 80 Column Card, Monitor, 2 Apple Disk Drives, Dot Matrix Printer, Sales Ledger Programme.

£2288.00 + VAT

Also available with a variety of Apple and Orbeta software programmes including:

PURCHASE LEDGER, NOMINAL LEDGER,
STOCK CONTROL, WORD PROCESSING,
SALES FORECASTING,
BUSINESS GRAPHICS,
DATA BASE MANAGEMENT.



NEW LOW PRICE PACKAGE

Apple IIe Computer, 64K, Apple Disk Drive with Controller, Zenith Monitor.

£1049.00 + VAT

Plus a full range of business and leisure software. All for immediate delivery.

STIRLING MICROSYSTEMS

THE MICRO COMPUTER STORE

241 BAKER STREET, LONDON NW1. 01-486 7671
Open Mon-Sat 9.30am-6.00pm. Please send for free price list

MICROMART

FIG-FORTH

Insulation Manual and 1 assembler listing
£12.50

Extra assembler listings £6.50

Assembly listings available for the following
CPU's:

8080/Z80, 6052, 6800, 68000, 6809, PDP-11/
LSI-11, 8" CP/M Disc systems £25.00

8080 SMALL C COMPILER

This compiler is available as CSource, on 8"
CP/M discs for only £25.00

Also available fully working under CP/M
(includes free 8080 assembler) £45.00

CONGUIN SOFTWARE

14 Goodwood Close, London Road, Morden, Surrey SM4 5AW

the market, it may at first seem rather expensive. But of course the price does include a good-quality display and there are all those lovely frills. Epson has proved beyond all doubt that, just because there are lots of 16-bit microcomputers around, we shouldn't write off the 8-bit CP/M-80 machine as a dodo. Far from it: there's still a lot which can be done to make this type of machine a valuable and versatile business tool.

The time is fast approaching when I will have to buy a second 'grown-up' computer to supplement my Sirius. I had more or less resigned myself to buying an IBM on the grounds that, overpriced

though it undoubtedly is, the vast flood of software about to hit us from the States would make it more or less compulsory for someone in my line of work. Having now seen the QX-10, I have changed my mind. The Americans can damn well adapt their 16-bit software to the Sirius if they want it evaluated!

Prices

QX-10 with 192k RAM, twin disks,
MF card, MFBasic and manuals:

£1735.00 excl VAT

65k memory upgrade: £50 (estimated)

Peripherals and add-ons: £TBA

OSBORNE EXECUTIVE

continued from page 179

Most users of the Osborne 1 queue up for a neat little patch to WordStar, which stops that program pretending that it is sending display characters down a serial line to a dumb terminal, and makes it print them direct on the screen.

WordStar normally sends cursor address signals to the screen handling routines of the Console Command Processor in CP/M, which then moves the cursor, then comes back for the character, then asks for the cursor position, and so on. Cut that out, and the result is that Osborne 1 WordStar is one of the quickest text editors you ever saw, because it can update a screen faster than you can see.

It also gave its users the option of a 128 column display (only 52 visible at any one time. If and when you produced a document that was over 79 columns wide, you could see it exactly as it would print out, whereas normal WordStar users would have to put up with lines that took two lines on screen).

For this version of WordStar, MicroPro spotted that this was daft, and produced a system of horizontal scrolling *exactly like the Osborne horizontal scroll* so that, as you typed across the screen, the whole screen moved to the left.

But it did this with cursor addressing, You can go mad, watching a horizontal scroll; but you can go mad in spades watching it happen, line by line, with cursor addressing.

If horizontal scrolling is bad, why use WordStar's latest version? And if it's good, why throw it away?

CP/M plus

Most changes from ordinary CP/M to CP/M Plus are ones which the user won't notice — bar one. There will be no more moments of 'Horrors, Bdos Error!' because it automatically logs onto a diskette as soon as it goes into the drive.

Most improvements to CP/M Plus lie in the speed and sophistication of diskette handling. This is not the moment for an explanation of what one means by 'hashed directory access', or 'least recently used sector buffering' or 'multi-sector 1/0 primitive', beyond saying that they can enormously speed up programs that use the disks a lot, and they are all features of CP/M Plus.

It can also speed up the way the system handles the screen, and the way programs and program overlays are loaded.

However, it is clear that programs designed for the larger memory space, better screen handling and faster disk abilities of this operating system, will absolutely walk over those that are built round CP/M 2.2. In particular, when hard disks are more available, the ability to have files of 32 megabytes on disks of up to 512 megabytes capacity will enormously improve database managers.

In the circumstances, I found it easy to agree to Osborne engineers' requests not to run the benchmarks. Their objections were on the grounds that the performance improvement in MBasic programs might not be shown on the final production machines, if somebody puts more 'wait states' into the circuit board. My objec-

Every computer needs a
CHATTERBOX!
"OK Spock, you win this time..."

NEW! SAVE ££££ ONLY **£49**

for **ZX81 SPECTRUM**
NASCOM, VIC, PET, BBC, APPLE, TRS80, IBM, CRAY, ETC.
(Please state)

At last! Genuine phonetic synthesis at a sensible price. Gives your computer an *unlimited* vocabulary (nothing more to buy!). Self contained speaker/amplifier, Sinclair connector etc, **PLUS** Expansion socket for **BIG EARS AND** Monitor socket for Music Board. Full instructions, technical notes and programme examples supplied with this outstanding educational unit.

OR COMPLETE D.I.Y KIT **£39**
DEALER ENQUIRIES WELCOME

As seen on BBC TV "Computer Programme"
BIG EARS STOP! GO! LEFT RIGHT

SPEECH INPUT FOR ANY COMPUTER

Hugely successful Speech Recognition System complete with microphone, software and full instructions. **BUILT TESTED & GUARANTEED** ONLY **£49**
PLEASE STATE COMPUTER: UK101 SPECTRUM, ATOM, NASCOM2, Vic 20, Micron, ZX80/81, PET, TRS80, MZ80K, APPLE II, BBC MICRO
NEW FAST MACHINE CODE FOR ZX81 SPECTRUM £7.40

ZX81/SPECTRUM
MUSIC SYNTHESISER (STEREO)
+ 16 LINE CONTROL PORT

Play 3-part music, sound effects, drums etc. Full control of attack, decay and frequency. Input/Output lines provide control and monitor facility for Home Security, Robot Control, Model Railway etc. etc. Works with or without 16K RAM.

Add keyboard to make a live performance polyphonic synthesiser! Full instructions/software included.

AMAZING VALUE AT ONLY £19.50 (KIT)
Extra 23 way connectors at £2.60
£25.50 (BUILT)

THE COMPOSER
Music Programme for above synthesiser.
Enter and play 3 part harmony.
Includes demonstration tunes. Recommended **£7.40**

COLOUR MODULATOR KIT **£15**
RGB in, PAL/UHF out (not for ZX) BUILT **£20**

SPECIAL OFFER I.C. **£18**
SPEECH OUTPUT CHIP SX-01
Phoneme Speech Processor DATA **£0.60**

Please add VAT at 15% to all prices.
Barclay/Access orders accepted by telephone

All enquiries S.A.E. please

WILLIAM STUART SYSTEMS Ltd
44 Bedford Gardens, Kensington, London W8 7EH
Tel: 01-221 1131 (sorry no callers)

APPLE I/O EXPANSION

IEEE 488 GPIB Interface card.

Test equipment control.

Interfaces directly with Basic. £189.00
inc. V.A.T. and p&p.

32 Channel I/O control card.

With 2 x 6522 V.I.A. £44.50 inc. V.A.T. and p&p.

Hawk Electronic Test Equipment

Bircholt Road

Parkwood Industrial Estate

Maidstone, Kent

Tel: 0622-686811

SPECIAL OFFER

NASHUA DISKETTES

*** 5 YR WARRANTY**
*** PLASTIC LIBRARY CASE FREE**
WITH BOTH SIZES

| 5 1/4" | 8" |
|---------------|---------------|
| ss,ss | ss,ss |
| ss,dd | ss,dd |
| ds,dd | ds,dd |
| ss (80 track) | ss (80 track) |
| £16.32 | £20.25 |
| £19.00 | £23.10 |
| £21.40 | £24.55 |
| £23.65 | |

For complete list and details of other products (tapes, cartridges, disk packs) send S.A.E. (add 15% VAT and £1 p&p/box) cheques & postal orders to:

HAMILTON DATA

11 Brackenhill, Melkirk Earnock, Hamilton, Lanarkshire
ML3 8AY Tel: 0698 457608

tions to the project were simpler: a) the MBasic interpreter is identical; b) there was obviously no change in the approximate speeds (a two per cent speed increase was indicated, which is not enough to write home about); and c) it would be a complete waste of an afternoon's hard graft with stopwatch and keyboard, because it totally ignored all the new go-faster features of the machine, in favour of testing a language which is very little used for commercial applications.

Overall impressions

This is the year of the IBM personal computer, 16-bit software, and MS-DOS.

As eight-bit systems go, the new Osborne — to be launched this month although shipping to the UK will not start until September — offers a lot of software for a reasonable price — and several performance improvements over standard CP/M systems. But it does remain disappointing in terms of what one might

have expected.

Quite what the 16-bit version will be like, only time will tell. All we know at the moment is that it will offer colour, probably an extra application package (like Lotus 123 or VisiOn) and two 16-bit operating systems. We also know that a company called Personal Computer Products has just announced a deal with Osborne, to design the 8088 co-processor card for the Executive II.

By the time that machine is ready, there will be more than one portable on the market capable of running IBM personal computer software. One of them may even be an IBM machine.

On the positive side, the machine answers most criticisms of the Osborne 1, and looks good value for money — the UK tag is expected to be £2000 or so. And Osborne is now established with enough dealers, and in enough corporate buying plans, that the upgrade will probably be a noticeable success.

All it needs, really, are double-sided diskettes, and a 132 column scrollable 'window' screen.

LEISURE LINES

by J J Clessa

Quickie

What gets longer the more you cut it at the ends?

Prize Puzzle

Susan's perfect man has black hair, brown eyes, and is tall and slim.

Susan knows four men — Arthur, Bill, Charles and Dave — only one of which has all the characteristics that Susan requires.

- 1 Arthur and Bill have the same colour eyes.
- 2 Only one of the men has both black hair and brown eyes.
- 3 Bill and Charles have the same colour hair.
- 4 Only two of the men are both tall and slim.
- 5 Charles and Dave have different builds.
- 6 Only two of the men are both tall and dark-haired.
- 7 Dave and Arthur are the same height.
- 8 Only three of the men are both slim and brown-eyed.

Which is Susan's perfect man?

April Prize Puzzle

One hundred and twenty-eight entries — but since twenty-nine of these were not on postcards, they were immediately disqualified. This left 99 possibles — most of which contained the right answer.

The winning entry — selected at random — came from George Sassoon of Warminster, Wilts. Congratulations Mr Sassoon, your prize is on its way.

The answer is that 89 or 98 requires the greatest number of operations, 24 in all, before a palindromic number is reached.

Several of you have pointed out that we frequently omit the closing date for entries, and the address to which they should be sent. We will try to rectify this in future, but just for the record:-

Closing date for all entries is the last day of the month of the magazine issue. Mark your entries with the puzzle date, for example, 'Prize Puzzle (month) 83', and send them to Leisure Lines, PCW, VNU Publications, 62 Oxford St, London, W1, Keep puzzling.

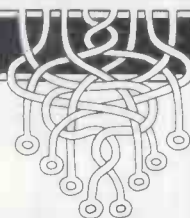

MICROMART

COMMODORE COMPUTERS

SOUTHAMPTON

HIRE Commodore equipment by the week, all including manuals, cassette deck, media etc.

4032 £25, 4040 Disk or 4022 Printer £25

Exdemo equipment available with guarantee
8032 £600, 4032 £475, 4022 £295, Vic 20 £65,
CBM 64 £235

Also secondhand equipment, 4032 with Hi-Res Board and C2N Cassette £450, 2031 Disc unit £250

Sell us your unwanted equipment, 700 series computer available June. Ask for brochures and price list.

10% discount for orders received up to August 31st. Repairs to Commodore equipment.

ALL PRICES ARE CASH-AND-CARRY AND EXCLUDE VAT

OFFICIAL COMMODORE DEALER

SUPER-VISION

13 St James Road, Shirley, Southampton
Telephone: (0703) 774023
After hours: (0703) 554488

MICRO-COMPUTER INSURANCE

- ★ All Risks Cover (incl. Transit) — up to £8,000 for £20

- ★ Increased Cost of Working — to reinstate lost data

- ★ Breakdown & Derangement — alternative to maintenance agreement

Comprehensive cover at a reasonable premium:-

Talk to us before taking a Maintenance Contract

Write with details of equipment and value to:-

Geoffrey Hoodless & Associates
Freepost (no stamp required)
Woking, Surrey GU21 4BR

Tel: Woking (04862) 61082 Answering Service.

OSBORNE 1

FREE Video Recorder when you purchase your Osborne from:

#1 COMPUTERS: Osborne specialist

Southampton House
192-206 York Road
Battersea, London SW11 3SA
Tel: 01-228 2207

(300 hundred yards from Wandsworth Bridge Roundabout)

THE NATIONAL 6809 CENTRE

Stirling Microsystems is the country's leading '6809' Centre where you can get professional advice and practical demonstrations of one of the widest ranges of '6809' based hardware and software. Take the Positron 9000 System with 64K - 256K RAM, it offers true multi-tasking with multi-user capabilities. One of the most powerful '6809' development systems available today running OS-9 or FLEX operating systems. Complete Positron Systems available from £2050.00 + VAT.



Send for full details of DENNIS (77-C9), the ECM High-Res Graphics Computer Project based on the '6809'.

Flex Operating System Software for 6809 on 5" or 8" disks. EX. VAT

| | |
|---|--------|
| Configurable Flex with Editor & Assembler | 120.00 |
| Debug Package | 56.00 |
| Sort/Merge Package | 56.00 |
| Disk Utilities | 56.00 |
| Disk & Memory Diagnostics | 56.00 |
| Text Processor | 56.00 |
| 68000 Cross Assembler | 200.00 |
| Relocating Assembler/Linking Loader | 115.00 |
| Extended Basic | 75.00 |
| Extended Basic Pre-Compiler | 37.50 |
| Pascal - 6809 Source Compiler | 150.00 |
| Fortran 77 | 320.00 |

| | |
|---------------------------|---------|
| DRAGON 32 | EX. VAT |
| Dragon 32 Colour Computer | £173.48 |
| Joysticks (pair) | £16.96 |

| SOFTWARE | |
|--|--------|
| Dragon Mace Editor & Assembler | £26.04 |
| Compuserve DASM Editor & Assembler | £16.00 |
| SM SAM Cassette Assembler Disassembler | £10.43 |
| Compuserve High Res. 52 x 24 Display | £21.30 |
| Dialog Cassette Data Base | £15.65 |

STIRLING MICROSYSTEMS

THE MICRO COMPUTER STORE

241 BAKER STREET, LONDON NW1. 01-486 7671
Open Mon-Sat 9.30am-6.00pm. Please send for free price list



Mail Order enquiries welcome. Please add 75p p&p per item

BACK ISSUES SERVICE

Here is a complete guide to all available back issues of *PCW*. A quick guide to their contents is shown below. Check the coupon overleaf for the issues you require.

Volume 1 No 1, 1978

The 77-68/Practical hints on kit building/Nascom 1/Charity case study/Flowcharting/Pontoon flowchart.

Volume 1 No 2 1978

Kit building Basic — first steps/Case study — a software house/PET 2001/Research machines 380Z/School computing/E78 — Europa Bus.

Volume 1 No 3, 1978

More efficient programs/Cosmac 1802/The PDP11 Part 1/Small business computing — an approach/The Z80/EPROM programmer construction.

Volume 3 No 6

June 1980
Benchtest: Tandy TRS-80 Model II/
Benchtest: Sintrom Peniflex 630/48/
Staff case study/Checkout: Sofy Intelligent EPROM Programmer/
Checkout: Exatron Stringy Floppy/
Practical examples of the IEEE48 bus use/Programs: Naming Nascom files/380Z Pictures/Fuel tank calculations — PET/PET large numerals/PET tank battle/Basic string handling.

Volume 3 No 12

December 1980
Benchtest: Microwriter/
Printerfacing: Series — Part 1/Sharp PC-1211 speed-up/Programs: TRS-80 Tarot, PET Cat & Mouse, PET Rebound, MZ-80K Alligator Swamp, PET Connect, UK101 Minefield, PET Simon Benchtest: Raand SP1

January 1981

Benchtest: Transam Tuscan/Real-time control using trains — part 1/Recover from a data tape disaster/PET Music Multi-user systems — part 1/Programs: TRS80 Four in a row, TRS80 Target Practice, PET Convoq, PET Wire, PET Maze Chase, PET Android Attack, PET Anagram

Volume 4 No 3

March 1981
Benchtest: Onyx C8002/Benchtest: Bigboard/Micro music software package/ALC circuit/Commons report/HP 43C/Programs: TRS80 Show Jumping, PET Grand Prix, PET Aircraft landing, PET Bouncy.

Volume 4 No 5

May 1981
Benchtest: Pascal 640/WP Benchtest: Magic Wand/PET colour/Low-cost digital tape system/Using calculator printers on micros/Apple music-making/Multi-user Benchtest: MVT-Famos/Programs: PET Grand Prix, PET Aircraft Landing, PET Bouncy, report/Radio Teletype/WP Benchtest: Wordpro 4 plus/Budget tape interface/Further Casio quirks/Programs: UK101 Zor, PET



Volume 4 No 6

June 1981
Benchtest: NEC PC-8001/Multi-user Benchtest: MP/M/Benchtest: Sinclair ZX81/West Coast Faire



Volume 4 No 8

August 1981
Benchtest: Tandy Model III/
Viewdata update/WP Benchtest: Spellbinder/Printer survey/
Microholism/Programs: ZX80 Othello, Easter Sunday, Apple Mondrian, MZ-80K Duck Shoot, PET Gomoku, MZ-80K Football.



Volume 4 No 7

July 1981
Benchtest: Sharp PC-3201/Multi-user Benchtest: Acorn Econet/Case study: Accident investigation on TRS-80/Zilog Z8 family/WP Benchtest: Format-80/Pascal Benchmarks: readers letters/Quicker Casio computations/Programs: ZX80 Sliding letters, UK101 Car Rally, TRS-80 Calendar, UK101 m/c code to Basic converter, PET Exam Questions, MZ-80K Designer, ZX91 Sketch Pad.



Vol 4 No 12

December 1981
Benchtests: Sharp MZ-80B Philips P2000/School network/BBC Micro Inside story/'Turtle' Graphics for Apple/Forth language/Curve fitting/Calc corner: HP14C review/programs: PET Fantasy, ZX81 Battleships and cruisers.



Vol 5 No 1

January 1982
Benchtests: BBC Micro Xerox 820/Frames of Reference (new series)/ZX81 printer Checkout/
Digital Drummer for PET/Calc Corner: benchmarks/Programs: MZ-80K Fortune, TRS-80 Reaction Timing, ZX80 Laybrinth, Apple Letters.



Vol 5 No 3

March 1982
Benchtests: Texas Instruments 99/4A, Hewlett-Packard 125/Choosing a Database/Compsort DMS REVIEWED/Screenplay (new series)/Calc Corner: Hewlett-Packard Interface Loop/Programs: TRS-80 Solitaire, TRS-80 Ducks, Nascom Business Documents, MZ-80K Race Chase, ZX81 Graphplot.



Volume 5 No 4

April 1982
benchtest: Monroe OC8820/DB Benchtest: FMS-80/Checkout: Sid 1/Generating screen forms/Comal/Logo/Brain Dump-New series/Calc Corner: Casio FP-10 printer/Programs: TRS-80 Maths & Trig, PET Boot the Cat, ZX81 Resistor & Res code.



Vol 5 no 6

June 1982
Benchtests: Sharp MZ-80A/ZX Spectrum/Database Benchtest: DBMS2/West Coast Fire Report/Lisp/VIC 20 games/Calc Corner: Sharp PC1500/Programs: RML Altered Basic/VIC-20 Large Characters/BBC Breakout/VIC20 Trailblazer/MZ-80K Next-to-Last One/MZ-80K Tarot.



Vol 5 No 7

July 1982
Benchtests: Mimi 801/Newbrain/Database Benchtest: Silicon Office/UCSD p-System/BBC Computer-in-Depth/Apple II games/Calc Corner: T188/Programs: ZX81 Hypocycloids/BBC Character Generator/TRS-80 Truth/PET Doc/TRS-80 Screen Dump/UK101 Screen Converter/PET boxes/Atari Earth.



Vol 5 No 8

August 1982
Benchtests: Sort M23/Dragon 32/Database Benchtest: Cardbox/Preview: Sony SMC-70/UCSD p-System/RS232 Interface/Sirius graphics/NCC Show report/ZX81 Speech Checkout/Calc Corner: Casio fx602p/Programs: TRS-80 Quadrangle/UK101 Conversion of units/PET Mopup/Apple Lifespan/Apple Trees/Nascom Snail Racing/UK101 Long Multiplication & addition.



Vol 5 No 9

September 1982
Benchtest: Olivetti M20/Word Processor Benchtest: Select for NEC/Database Benchtest: Aquila/Checkouts: Microwriter Revisited, E40 Data Compression/Screenplay: ZX81 Pt II/DIY Logo/P for Perfect/Beeb Colour Hi Res/RS232/Calc Corner: HP15 and 16C reviewed/programs: Video Genie Extended Basic, ZX81 Alphabetising, PET File Comparison, BBC Music Player, PET Virus, BBC Radar, PET German Game, TRS-80 Cardshuffler.

PCW SPECIALS

1983 Microcomputer Benchtest Special. 20 leading micros reviewed by the *PCW* team. Desk Top Computing £2.25. Comprehensive guide to using micros to help you in your business.

BINDERS

Keep your copies in order with these strong, attractive yellow binders. £3.95 each (inc P&P)





Vol 5 No 10
October 1982
 Benchtests: HP-86; Positron 9000/
 Database Benchtest; Personal Pearl/
 3D Graphics for BBC
 Computer/Hashing Techniques/
 Designing your own Database/CP/
 M-86 v MSDOS/Clock-Calendar
 Card for Apple II/Calc Corner:
 hints for Sharp PC122/Programs:
 ZX81 Star Trek; PET Knockout;
 PET Trains.

Vol 5 No 11
November 1982
 Benchtests: Canon CX-1; Hewlett
 Packard HP75/Database Benchtest:
 Condor/Apple II Clock Calendar
 Card Part — Algebra checking/
 Benchmarks summary/Bit Stik
 graphics for Apple/Calc Corner —
 HP41C, Casio fx702p programs/
 PCW Show report/Tiny printing on
 Centronics 739/Screenplay — Acorn
 Atom/Programs: Apple Piano;
 Apple Moon Module; PET Letter-
 writer; UK101 Logic; Atari Walls;
 Sharp MZ80K Area-filling; RML
 380Z Restore.

Volume 6 No 1
January 1983
 Benchtests: Jupiter Ace/Torch/
 Database Benchtest: Superfile/
 Warmier-Orr programming
 techniques/Expert systems/Tokyo
 Data Show report/Forth
 Benchmarks/Digital Video/The
 Nearly Man — Charles Babbage/
 Portable Computer World — Con-
 tinued Fractions/Micro
 Chess/Screenplay — Spectrum/
 Programs: VIC Connect-4/
 VICMon/Atari character set
 mover/VIC UFO/PET Forth
 Teacher/VIC Doppler/BBC
 Gomoku.

Volume 6 No 2
February 1983
 Benchtest: Sage/Database
 Benchtest: BusiPost/Which
 Spreadsheet — new series/Networks
 — new series/Expert systems/BBC
 graphics revealed/Logo Turtle/
 Micro Chess — Fidelity's Prestige/
 Portable Computer World — Sharp
 PC1251 Benchtested/Numbers
 Count/Screenplay — BBC games/
 Programs — UK101 Vocabulary
 Test/PET Race Chase II/Apple
 Character Plotter/Variable
 Checkchart/ZX81 hex calculator/
 Atom Backgammon/Video Genie
 Aircraft Lander/Atari Flashback/
 MZ Text Analysis.

Volume 6 No 3
March 1983
 Benchtests: Corvus Concept,
 Computers Lynx/Database
 Benchtest: DataPrism/Which
 Spreadsheet? — Prophet II/IBM
 9000 Instrumentation Computer/
 Apple Word Handler/Networks —
 Part II/ZX81 Graphics
 Module/Sharp MZ-80k
 Enhancements/Micro Chess — the
 Conchess range/Screenplay — Atari
 800/Portable Computer World —
 hex listings for Casio fx602p and
 Sharp PC1211/Programs: Atari
 Animation/Chinese Horoscopes/
 PET Patience.

BACK ISSUES CENTRE

We have a complete selection of all available PCW back numbers in our flashy new Back Issues Centre in the West End of London, just half a minute's walk from Oxford Street (close to Tottenham Court Road tube station). Of course, you could order them from our excellent mail order service using the coupon below, but by visiting in person you save on postage costs. The Back Issues Centre also often has back numbers of PCW on sale which we cannot offer through the mail order service because of shortage of stock. Our receptionists will also be happy to sell you a set of binders to take your subscription. And there's a range of interesting computer books on sale as well. Drop by next time you're in the West End. We're open Monday to Friday, 10am to 6pm. The address is 14 Rathbone Place, London W1P 1DE.

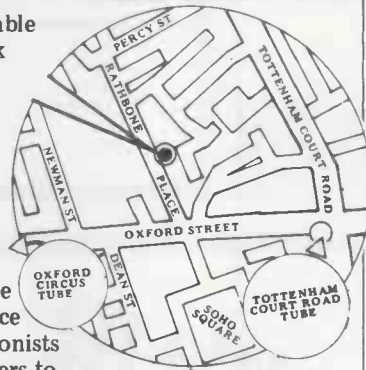

Vol 6 No 4
April 1983
 Benchtests: Oric-1, LSI M-Four/
 Database Benchtest: Rescue/Which
 Spreadsheet? — Multiplan/Networks
 — Part 3/Shelton Signet/A Look at
 C/Interfacing the BBC Micro/
 Screenplay — Dragon 32/Petsped
 compiler/Speech on the BBC/Dork
 program generator/Micros in
 dentistry/Genealogy — Coding
 family relations/Portable Computer
 World — Tax tables on Casio/
 Chess — Intelligent Software/
 Programs: BBC Bigprint/PET
 Billy/BBC Engine Failure/ZX81
 Molecular Weight/IK Adventure/
 Beebdump/TRS-80 Word Scrambler.



Vol 6 No 5
May 1983
 Benchtests: Commodore 64, TI
 Professional/Database Benchtest:
 MicroPen/Which Spreadsheet? —
 PlannerCalc/Word Processor —
 MicroScript/Audio training
 packs/Reliable Code/Centronics
 Hook-Up/BBC Music/MS-DOS 2/
 Lisp/Screenplay — 2X Spectrum/
 Portable Computer World — Casio
 PB100/Chess — Mephisto/
 Programs: Oric Bug Eater/Spectrum
 Big Print/MZ-80k Mole Man/BBC
 Paintbox/MZ-80k Terrapin/MZ-80k
 Double Trouble/Tandy Colour
 Demos.



Come up and see us...
Mon-Fri
10am-6pm
Saturday
11am-6pm

CHANGE OF ADDRESS

Readers should note that all mail order subscriptions, binders and back issue enquiries must now be addressed to 55 Frith Street, London W1.

However, for personal callers only, a selection of PCW back issues, binders, micro-computing books etc can be purchased from the shop at 14 Rathbone Place, London W1.

Any one issue £1.50; all additional issues £1.00 each.
 Benchtest special £1.80. Desktop Computing £2.25.
 Binders £3.95 each. All prices include post and package.
 *Overseas orders requiring Air Mail postage add £1.00 per copy. Cheques/P.O. payable to Computing Publications Ltd,

53/55 Frith Street, London W1A 2HG Please allow up to 3 weeks for delivery and don't forget to state your name and full address with your order. Please send me the following copies of PCW. I enclose a cheque/P.O. for £. . . Please tick appropriate boxes.

| | | | | | |
|---|-----------------------------|---|--|---|---|
| Volume 1 | Volume 3 | Volume 4 | Volume 5 | Volume 6 | Benchtest Special <input type="checkbox"/> |
| 1 <input type="checkbox"/> 2 <input type="checkbox"/> | 6 <input type="checkbox"/> | 1 <input type="checkbox"/> 3 <input type="checkbox"/> 5 <input type="checkbox"/> 6 <input type="checkbox"/> | 1 <input type="checkbox"/> 3 <input type="checkbox"/> 4 <input type="checkbox"/> 6 <input type="checkbox"/> 7 <input type="checkbox"/> | 1 <input type="checkbox"/> 2 <input type="checkbox"/> | Desk Top Computing <input type="checkbox"/> |
| 3 <input type="checkbox"/> | 12 <input type="checkbox"/> | 7 <input type="checkbox"/> 8 <input type="checkbox"/> 12 <input type="checkbox"/> | 8 <input type="checkbox"/> 9 <input type="checkbox"/> 10 <input type="checkbox"/> 11 <input type="checkbox"/> | 3 <input type="checkbox"/> 4 <input type="checkbox"/> | Binder <input type="checkbox"/> |

Name _____ Address _____

CHALLENGE!!

CAN YOU FIND A KEYBOARD SKILLS PACKAGE WHICH

- Teaches you thoroughly and
- Gives Instant Feedback and
- Offers a Money-Back Guarantee and
- Has more Program material than Wordstar and
- Is Easy to Install on almost all Mircros using CP/M and
- Costs just £29.00?

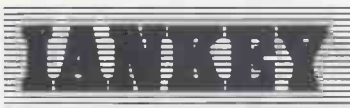

All this and much more besides . . .

Order from your Dealer or, in case of difficulty, direct from:

IANSYST LTD (PCW5), Omnibus Building,
41 North Rd, London N7 9DP Tel (01) 607 0187

CLWYD PERSONAL COMPUTERS

Unit 19, Daniel Owen Pricinct, Mold, CH7 1AP.
Telephone: Mold 56842



SPECTRUM 16K & 48K

Commodore 64

VIC 20 & ORIC 1

PACKAGE £139.99

Software by:

Quicksilver

BUG-BYTE

IMAGINE

Over 200 Software in Stock

PLEASE SEND ME _____
CHEQUE ENCLOSED, VALUE _____
NAME _____
ADDRESS _____
POSTCODE _____

*cut &
post
now*

PCW/7/83

PUT A CLIP IN YOUR WINCHESTER

CLIP — Compressed Library Interchange Program

CP/M MS DOS CP/M-86 £95 RTII £150

- Backs up a Winchester on to floppies.
- Compresses text or data to less than half size
- Large files can span multiple discs
- Selective backup or retrieval, on an inclusive or exclusive basis.

CLIP has no equal in reputation, convenience, power or economy. **CLIP** comes standard with the **CIFER** Business Management System, and with all Winchester systems supplied by **COLT & TRIUMPH ADLER (UK)**.



KEELE CODES LTD

University of Keele, Keele, Staffordshire, U.K. Tel: (0782) 629221 Telex: 36113
24-hour telephone service: Access accepted.

CLIP offers effortless backup. It will also take care of most of the chores in building an ordered file library, and can make notes of its own operations. The user can set up his own housekeeping procedures in a few minutes. Thereafter, to repeat any function just type e.g. 'BACKWIN' 'VIEWTOPS' 'RESTORE'.

With **CLIP's** powers of selection and compression, the user can expect a four-to-one saving over global copying, with no effort except to feed discs on cue. Or, **CLIP** can select just the new/updated files and reduce the backup load still further.

All prices excl. VAT, post free in U.K.
Most popular disc formats from stock.

WORD PROCESSOR?

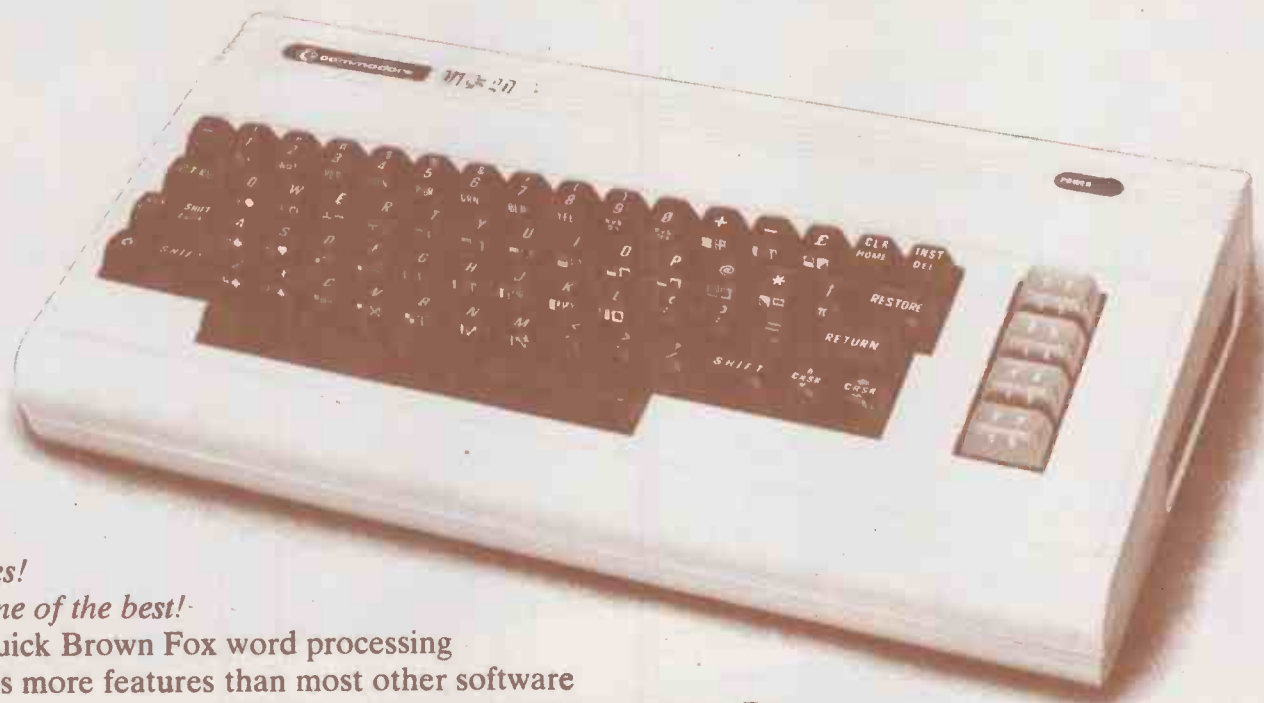

Yes!
One of the best!
Quick Brown Fox word processing has more features than most other software and runs on your VIC-20 or Commodore 64 computer. Put yourself in league with industry standards like WORDSTAR, SCRIPTSIT, WORDCRAFT and WORDPRO. We can supply you with a complete first-class word processor for less than £1,000 – this includes computer, additional memory, 80 column display monitor and a daisy-wheel typewriter which doubles as a computer printer.

It all starts with the Quick Brown Fox software at £60

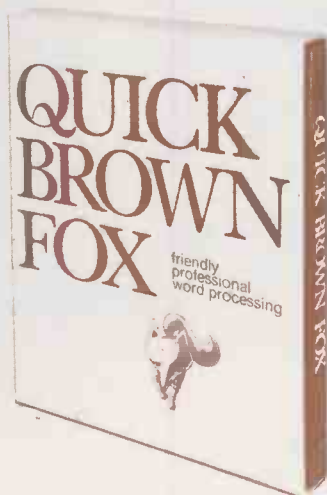

(all R.R.P. excluding VAT)

Further information from:

SPT

or

SPT

Electronics Limited, Tollesbury, Essex, CM9 8SE, England
Telephone: Maldon (0621) 868484. Telex: 995358

Benelux B.V., Wilhelminastraat 1, 3961 AG Wijk bij Duurstede,
Holland
Telephone: 03435-5741

(Dealer enquiries also welcome)

Designed to



The All-Purpose Computer

The MTX500

The MTX500 is a new departure in micro-computer technology. Whether your needs as a user are for personal programming, games playing, scientific or process control, educational or business use the MTX500 is already capable or very easily adaptable to almost every application. Glance through the standard features below - you'll see what we mean.

Software

The MTX500's 16k ROM contains several languages and routines which enable the novice or the experienced programmer to make full use of the machine. Standard languages are MTX BASIC, LOGO and NODDY. ROM routines include an ASSEMBLER/DISASSEMBLER with screen display of the Z80 CPU registers, memory and program which can be manipulated from the keyboard. Machine code programs can be stepped through one instruction at a time, and easily called from within BASIC

programs. A further feature is the Virtual Screen facility which enables the programmer to define sections of the screen to work independently whilst maintaining all full screen facilities. Pascal is available as an add-on ROM pack.

Hardware

As standard - 32k of user RAM expandable to 512k plus 16k of dedicated video RAM. Sixteen colours, 40 column text, 256 x 192 high resolution graphics with all sixteen colours available and easily moveable user defined graphics (Sprites) combine to make effective screen displays quick and simple to achieve. Standard outputs are centronics printer

Perform

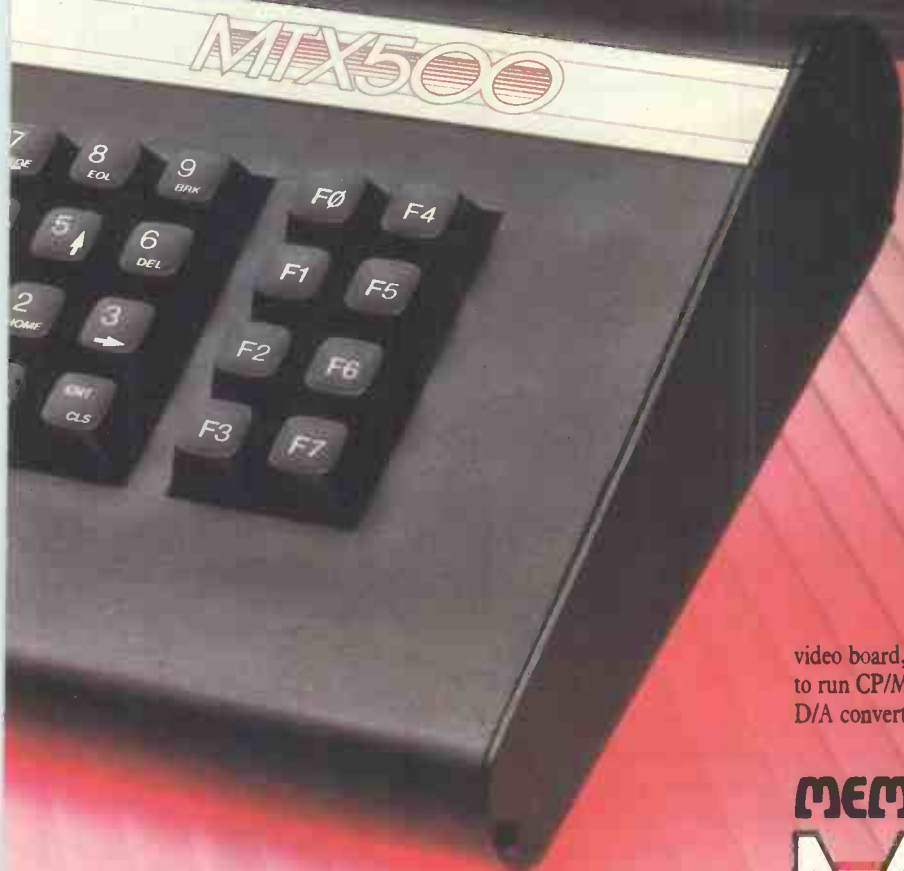

port, two joystick ports, an uncommitted I/O port, 2400 Baud Cassette port, separate TV and Video Monitor ports, 3 voice sound with hifi output plus a dedicated games cartridge port. Other standard features include the Z80A processor running at 4MHz, real time clock, full moving key keyboard with 79 keys including eight function keys and separate numeric pad. Optional expansions include 80 column colour

video board, twin RS232 interfaces, 5¼ and 8 inch floppy disc interfaces to run CP/M, Node interface to enable ring system, plus an A/D and D/A convertors.

MEMOTECH
MTX500

For further information, please write to:
Sales Dept. Memotech Limited, Station Lane Industrial Estate,
Witney, Oxon. OX8 6BX. Telephone Witney (0993) 2977.



ANDROMEDA

FROM **£1595** + VAT
+ SOFTWARE VOUCHER
FROM **£500** to **£2250**
included in purchase
price.

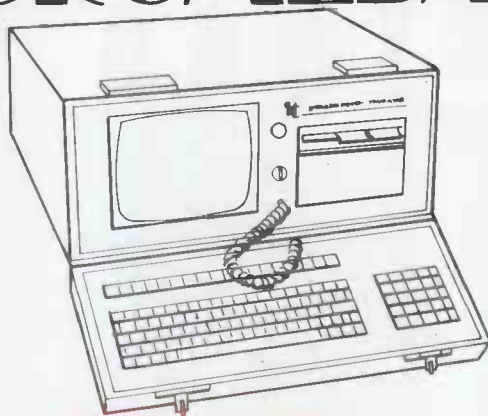

Choose from:

- * **D BASE II** – Ashton data
- * **WORDSTAR** – Micropro
- * **SAPPHIRE MARS**
- * **PADMEDE ACCOUNTS**
- * **INCOMPLETE RECORDS**
- * **APPROVED SOFTWARE**
- * **REAL LEATHER EXECUTIVE CASE**
- * **ZIPPED POUCH FOR BUSINESS PAPERS**

10" Video, Z80A MultiProcessor, 128K RAM, Real Time Clock, Floppy or Winchester Storage – CP/M*

ITCS, The British Microcomputer Manufacturer with a range of Portable and Desktop Systems, Printers and Media.

For a solution which expands with your growth.

PORTABLE BUSINESS COMPUTING – ZITA

ZITA-E

– Executive System with up to 3 Mbyte Storage – 128K, from **£1595** Software Voucher from **£500** included.

ZITA-EW

– Winchester based up to 24 Mbyte – from **£3695** Software Voucher from **£1500** included.

ZITA-P

– Waterproof, Sturdy System up to 3Mbyte Storage – 64K, from **£1595** Software Voucher from **£500** included.

ZITA-PW

– Winchester protected from the shocks, up to 24 Mbyte, from **£3695** Software Voucher from **£1500** included.

DESKTOP BUSINESS COMPUTING SYSTEM – ALFA

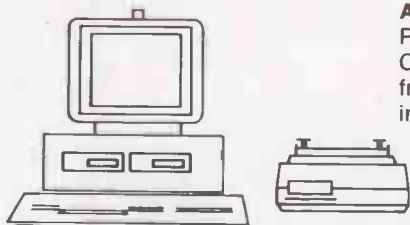

ALFA Systems include Monitor, Central Processor, Dual Disc drives or Winchester, Correspondence Quality Printer and Software from **£1995** + VAT complete – No hidden extras, includes **£500** software voucher.

Call our main Distributor to Rent or Buy
MBS Personal Computers Ltd
119/120 High Street, Eton, Windsor,
Berkshire
Tel: 07535 68171 or 01-621 1122
or contact
ITCS for your nearest dealer
Tel: 07342 47371-4

- * Dealer enquiries contact 07342 47375
- * Export enquiries contact 07342 47371 ext. 200

CP/M is a registered trade mark of Digital Research. Andromeda & ITCS is a registered trade mark.

EXCITING NEW ZITA-E

THE ITCS EXECUTIVE PORTABLE BUSINESS COMPUTER

– Optional **INTEGRAL
WINCHESTER**

Software:

Choose from the comprehensive software list, included in the purchase price.

Hardware:

Select your business system by matching the processing, storage, printer and communications criteria to an Andromeda solution.

Training:

Application and System courses undertaken On-Site or by arrangement at the ITCS Training Centre.

Customer Support:

Nationwide On-Site or return to dealer software and maintenance service 8 or 24 hours, or sooner if required.

Warranty:

All ITCS Systems carry a 12 month warranty, including printers when purchased as a system.

Upgrade:

If you outgrow your processing or storage capacity your Andromeda computer can be upgraded by ITCS. Generous allowances are given to assist you financially.



16-18 Littleton Road
Ashford, Middlesex TW15 1UQ

HAPPY MEMORIES

| Part type | 1 off | 25-99 | 100 up |
|-------------------------|-------|-------|--------|
| 4116 200ns | .90 | .81 | .78 |
| 4816 100ns For BBC comp | 2.20 | 1.95 | 1.85 |
| 4164 150ns | 3.99 | 3.56 | 3.42 |
| 2114 200ns Low power | 1.15 | 1.00 | .90 |
| 2114 450ns Low power | .95 | .85 | .80 |
| 4118 250ns | 3.95 | 3.55 | 3.40 |
| 6116 150ns CMOS | 3.35 | 3.00 | 2.85 |
| 2708 450ns | 3.25 | 2.85 | 2.75 |
| 2716 450ns 5 volt | 2.35 | 2.10 | 2.02 |
| 2716 450ns three rail | 5.75 | 5.00 | 4.65 |
| 2732 450ns Intel type | 3.50 | 3.15 | 3.00 |
| 2532 450ns Texas type | 3.70 | 3.30 | 3.00 |
| 2764 250ns | 4.45 | 4.00 | 3.85 |

| | | | | | |
|----------|-------|----------|-------|----------|-------|
| Z80A-CPU | £3.95 | Z80A-P10 | £2.99 | Z80A-CTC | £2.99 |
| 6522 PIA | £3.70 | 7002 A-D | £4.60 | 3691 | £2.75 |
| 88LS120 | £2.20 | 7805 reg | .50 | 7812 reg | .50 |

| | | | | | | | | | |
|------------------------------|---|----|----|----|----|----|----|----|----|
| Low profile IC sockets: Pins | 8 | 14 | 16 | 18 | 20 | 22 | 24 | 28 | 40 |
| Pence | 9 | 10 | 11 | 14 | 15 | 18 | 19 | 25 | 33 |

Soft-sectored floppy discs per 10 in plastic library case:

| | | | | | |
|-------------|--------|-------------|--------|-------------|--------|
| 5 inch SSSD | £17.00 | 5 inch SSDD | £19.25 | 5 inch DSDD | £21.00 |
| | | 5 inch DSQD | £26.35 | | |
| 8 inch SSSD | £19.25 | 8 inch SSDD | £23.65 | 8 inch DSDD | £25.00 |

74LS series TTL, large stocks at low prices with DIY discounts starting at a mix of just 25 pieces. Write or 'phone for list.

Please add 50p post & packing to orders under £15 and VAT to total
Access & Visa welcome, 24hr service on (054 422) 618
Government & Educational orders welcome, £15 minimum.
Trade accounts operated, 'phone or write for details.

Happy Memories (PCW),

Gladestry, Kington, Herefordshire. HR5 3NY.

Tel: (054 422) 618 or 628



The Wizard's Warriors

MICRO COMPUTERS at CHANNEL ISLAND PRICES (NO V.A.T.)

| | |
|--------------|---------|
| C.B.M. 64 | £299.96 |
| NEWBRAIN | £199.00 |
| ATARI 400 | £143.00 |
| ORIC I | £147.00 |
| VIC-20 | £147.82 |
| SPECTRUM 48K | £113.00 |

Telephone orders accepted with
Access or Barclaycard numbers.
24 hour ansaphone service.
Stock items dispatched by return
post.

MICROVIA
6 BELMONT ROAD
ST HENER · JERSEY
TEL 0534 77404

THE WIZARD'S WARRIORS: A fast moving game that matches developments in your skill as a player by becoming increasingly more devious. By offering to you the full range of options you can choose how to control your warrior throught the maze. A full implementation of this program enables such features as a continuous series of sound effects, arcade quality graphics, double-point scoring, and-for the very artful-bonus lives
FORTH: A full implementation. Ideal for writing fast moving arcade type games. Allows the full colour and sound facilities of the Spectrum to be used. Future Microdrive enhancements will be made available.

Spectrum
£4.95

ADVENTURE ONE: Features a save game routine as the game can take months to complete.

ZX81 £5.95

'A remarkably good version . . . well worth the money.' . . . Sinclair User...

MAZEMAN: A fast action m/c game that reproduces the spirit of the original '...is very accurate and fast.' ...Which Micro?...

Spectrum
£4.95

ZX81 £4.45
ZX81 £5.95

CHES 1.4: Ten levels of play with this m/c program.

Good graphic screen display.
'In a class of it's own.' ...Your Computer...

INVADERS: Very fast m/c action. Includes mystery ship and increasingly difficult screens.

ZX81 £4.45

7 MAES AFALLEN, BOW ST., DYFED,
SY24 5BA

24hr Ansaphone 0970 828851



PLUTO

A BREAKTHROUGH IN COLOUR GRAPHICS

PLUTO is an intelligent, high performance colour display controller that is both compact and affordable:

Technical Profile:-

- 8" x 8" PCB
- 640 (H) x 288 (V) x 8 colours
- 16 bit Intel 8088 microprocessor
- 192 Kbytes of dual ported memory
- Fast parallel I/O interface for connection to most computers

Use PLUTO with any machine

PLUTO'S in built software gives fast access to a comprehensive command set:-

- High level software protocol.
- High speed vector drawing. (over 150,000 pixels per sec.).
- Built-in character display freely mixable with graphics.
- On-board storage of user-defined symbols.
- Complex polygon flood fill

An extended command set ROM is available providing the following functions:-

- Raster operations with rotation in multiples of 90°.
- Complex polygon colour and pattern fills.
- Circles and arcs, etc.

Prices:-

| | |
|----------------------------|------------|
| PLUTO | £399 + VAT |
| BABY PLUTO (320x288) | £299 + VAT |
| DOUBLE RES. OPTION | £50 + VAT |
| 8 MHz PROCESSOR OPT ... | £50 + VAT |
| EXTENDED COMMAND ROM... | £60+VAT |
| MANUAL | £6 ONLY |

(OEM Discounts Available)

i research ltd.

6 Laleham Avenue · Mill Hill London NW7 3HL
Telephone: 01-959 0106

BUY THE BEST

TWILLSTAR COMPUTERS



BBC

BBC MOD A 299.00
BBC MOD B 399.00
DISK DRIVES 100K ONLY £195.00+VAT
DISK INTERFACE ONLY £95.00+VAT



ORIC-1

THE REAL COMPUTER SYSTEM
48K ONLY £155.00 INC VAT

BBC Software from: Acorn Soft, Gimini, Bugbyte, IJK, Superior Software, Program Power, MP Software



Dragon 32 ONLY £195.00 INC VAT

NEW

EPSON FX80 ONLY £395+VAT
EPSON MX100 ONLY £395+VAT
SEIKOSHA GP100A ONLY £185.00+VAT
SEIKOSHA GP250X ONLY £230.00+VAT

NEW SPECIAL OFFER

Now connect a Daisywheel Typewriter/Printer to your BBC
SILVER-REED EX44 ONLY £395.00+VAT (inc Interface)



commodore COMPUTERS

Printer Cables, Leads, Disks, Stationery, Cassettes, Ribbons, Dust Covers and Wide Range of Software for all Computers.

COLOUR MONITORS
14" Microvitek £250.00
GREEN MONITOR
Zenith £95.00 inc VAT

COMPUTER BOOKS & ELECTRONIC MAGAZINES
SOFTWARE, HARDWARE SUPPORT/SERVICES/RENTALS

CALL IN FOR FURTHER DETAILS

TWILLSTAR COMPUTERS LTD

17 REGINA ROAD, SOUTHALL, MIDDX

TEL: 574-5271 (24 hours)

OPEN 10am-8pm SIX DAYS A WEEK



LOW DISKETTE PRICES

| | Wabash | Datalife | Nashua |
|----------------------------|--------|----------|--------|
| 8" DISKETTES | | | |
| Single Side/Single Density | 20.00 | 27.60 | 20.80 |
| Single Side/Double Density | 24.00 | 26.10 | 22.10 |
| Double Side/Single Density | 25.00 | 31.00 | - |
| Double Side/Double Density | 30.00 | 31.00 | 23.40 |
| 5 1/4" DISKETTES | | | |
| Single Side/Single Density | 17.50 | 19.70 | 15.60 |
| Single Side/Double Density | 20.00 | 19.70 | 16.90 |
| Double Side/Double Density | 21.50 | 28.50 | 19.50 |
| Single Side/Quad Density | 27.00 | 25.80 | 24.70 |
| Double Side/Quad Density | 32.00 | 36.00 | 26.00 |

All prices per box of 10 disks, exclusive of VAT (15%) and carriage (£1 per box). Prices correct at time of going to press. Cash with Order/Trade accounts only. Please contact us for Discounts. (5+ boxes).

We stock the full range of Wabash, Verbatim and Nashua diskettes, Ribbons for most printers and other products for Mini, Micro and W.P. systems. Mail Order only.

CONWAY COMPUTER SERVICES LTD.

39 Conway Road, London N15 3BB 01-800 1796

AS POWERFUL AS A MAINFRAME

Now
in
stock!

It's
a
Gift!

Memory
Expansion
2MB

All sorts
of
Printers

To NEWBRAIN a
Disc Drive and all
the CP/M Software
that goes with it.

Storage
Expansion
18MB

Wordstar
Supercalc
Database etc. Managing Direc

"MBA's promise
to look after you
after you've
gone home..."

DISC DRIVE AND CP/M FOR NEW BRAIN

CLIP THE COUPON AND SEND IT TO:-

M. FORD, MBA LTD., TAVISTOCK HOUSE, 34-36 BROMHAM ROAD, BEDFORD MK40 2 QD. TEL: (0234) 213571

A 64K TWIN DISC DRIVE CP/M SYSTEM £1500*

PLEASE CONTACT ME
 I WOULD LIKE TECHNICAL ADVICE
 SEND ME DETAILS
 NAME
 POSITION
 ADDRESS

 POSTCODE
 TELEPHONE

I ENCLOSE CHEQUE/POSTAL ORDER TO THE VALUE £.....
 MADE PAYABLE 'MBA NEWBRAIN'

PLEASE DEBIT MY ACCESS ACCOUNT FOR THE AMOUNT £.....

EXPIRY DATE CARD MEMBER ACCESS NO.

* ALL PRICES ARE EXCLUSIVE OF VAT.
 ITEMS SUBJECT TO AVAILABILITY.

| DESCRIPTION | PRICE* | QTY | VALUE |
|----------------------------------|---------|-----------------------|-------|
| NEWBRAIN MODEL 'A' | £234.00 | | |
| NEWBRAIN MODEL 'AD' | 260.00 | | |
| MONITOR 12" | 100.00 | | |
| WALTER 2000 PRINTER | 439.00 | | |
| EXPANSION MODULE (INCL. 64K) | 200.00 | | |
| FLOPPY CONTROLLER | 120.00 | | |
| FLOPPY DISC 200 K SS DD 40 TRACK | 195.00 | | |
| FLOPPY DISC 800 K DS DD 80 TRACK | 355.00 | | |
| CP/M LICENCE (INCL. DISC) | 29.00 | | |
| | | SUB-TOTAL | |
| | | ADD 15% VAT | |
| | | ADD POSTAGE & PACKING | |
| | | SALES TOTAL | |

PCW/3 **MBA**

New Brain

ALLOW 28 DAYS DELIVERY

MBA

ALGOTEK

The name in **BBC** computers

SPECIAL OFFERS!

BBC Model 'B'
word processing pack

BBC MODEL 'B'
DISK INTERFACE
WORDWISE
SMITH CORONA DAISY-
WHEEL PRINTER
FLOPPY DISK DRIVE
UNIQUE LOW PRICE
£1119.99 carr. £15
including VAT £1251.15



| | | | | |
|---------------------|-----|---------|--------------------|------|
| BBC Model A | 16K | £399 | BBC Model B | 32K |
| £299 | | inc VAT | | |
| TELETEX ADAPTOR | | | | £196 |
| DISK INTERFACE KITS | | | | £95 |
| PRESTEL ADAPTORS | | | | £90 |

PRINTERS

| | |
|--------------|---------|
| MX 100 FT3 | £448.00 |
| FX80 | £394.00 |
| SMITH CORONA | £438.00 |
| carr. | £7.00 |

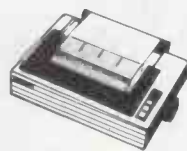

SOFTWARE FOR BBC

(ALL PRICES INCLUDE VAT)

| | |
|-----------------------------------|---|
| BUSINESS: | WORD PRO £19.95; disk £23.95 |
| CASSETTE. | BEEB CALC £19.95; disk £23.95 |
| DATABASE £19.95; disk £23.95 | GAMES: |
| MAILIST £19.95; disk £23.95 | CENTIPEDE, cass. £6.50; disk £9.90 |
| INVOICE & STATEMENT £19.95; | INVADERS, cass. £6.50; disk £9.90; |
| disk £23.95 | SPACE FIGHTER, cass. £6.50; disk £9.90 |
| PAYROLL £11.90; disk £23.95 | GALAXIAN, cass. £6.50; disk £9.90 |
| STOCK CONTROL £19.95; disk £23.95 | FRUIT MACHINE, cass. £6.50; disk £9.90 |
| HOME ACCOUNTS £19.95; disk £23.95 | DROPOUT, cass. £6.50; disk £9.90 |
| | COMMERCIAL ACCOUNTS £19.95; disk £23.95 |

CANON BBC DISK DRIVE UNITS

| | | |
|--------------------|---------------------|---------------------|
| Single Side | Double Sided | Double Sided |
| 40 track | 40 track | 80 track |
| £189.00 | £235.56 | £283.56 |
| carr. £3 | carr. £3 | carr. £3 |

Disk drives include cables and formatting disks. Case to hold one drive. £8.00
Colourmatch to BBC Micro Case to hold Dual Drive £9.00

Power supply units 25VA for single £15.75
Power supply units 50VA for dual £16.50
All prices except BBC Software Special Offer & Models A & B exclusive of VAT.



ALGOTEK

93 WESTGATE, TRANMERE PARK,
GUISELEY, LEEDS LS20 8HH. Tel: 0943-74861

IRVINE BUSINESS SYSTEMS LTD.

A SINGLE CARD COMPUTER FROM ONLY ★

★
£99.95
+ POST
+ VAT

BARE BOARD SEND

| | |
|--------------|----------------|
| COST | £99.95 |
| P/P | 2.00 |
| VAT | 15.24 |
| TOTAL | £117.24 |

ASSEMBLED & TESTED

| | |
|--------------|---------------|
| COST | £475.00 |
| P/P | 5.00 |
| VAT | 72.00 |
| TOTAL | 552.00 |

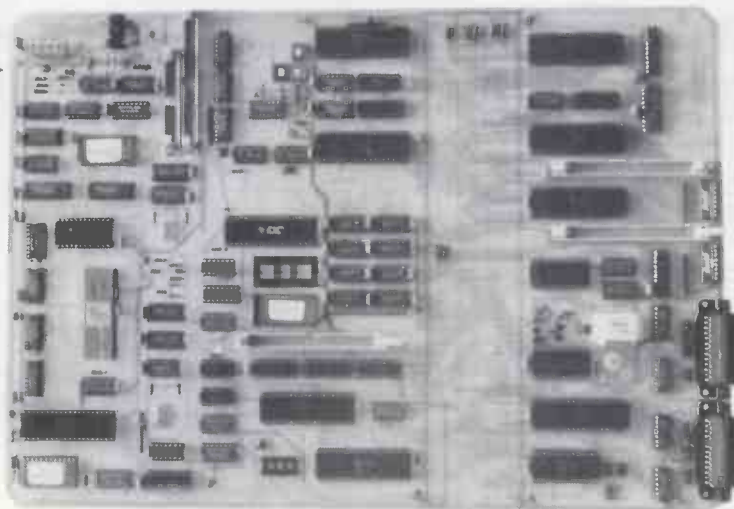

- ★ 4 MEG Z80 CPU
- ★ 64K RAM
- ★ 16K PROM
- ★ 5" & 8" DISK CONTROLLER
- ★ 80x24 VIDEO GEN
- ★ 2xSERIAL I/O
- ★ 4xPARALLEL I/O
- ★ IEEE 488 INTERFACE
- ★ KEYBOARD PORT
- ★ HARDWARE RTC
- ★ MONITOR IN PROM

THE **IBS 750** S.B.C.

IRVINE BUSINESS SYSTEMS LTD, 1 MONTGOMERY PLACE, IRVINE, Ayrshire KA12 8PN.
0294 75000/73333

MADE IN IRVINE SCOTLAND BY IRVINE BUSINESS SYSTEMS LTD.

NOW . . . FOR ZX SPECTRUM USERS EVERYWHERE THE FULLER BOX . . .



A NEW DIMENSION IN SPECTRUM CAPABILITY

It's easy to see why the ZX Spectrum is outselling all the other small colour computers, it really is a marvel of new technology.

Equally marvellous is the new 'Fuller Box' for your Spectrum.

Sound Quality is improved enormously with the built in *Audio Amplifier* which works with all Spectrum programs. *The Sound Synthesiser* will make any sound you want to design: explosions, laser blasts, trains, birds etc. It's based on the popular G1-AY-3-8912 chip, and is supplied with a demo program.

Finally, the *Joystick Port* enables you to use any low-priced Atari/Commodore joysticks with your programs.

The Fuller Box fits neatly on to the back of your ZX Spectrum, and does not interfere with any peripherals, including the new Spectrum microdrives.

PRICE (INC. VAT)

£29.95 + 80p p&p

But the story doesn't end there! The Fuller Box has been designed to perform many other functions, and extra, expanded versions are already available.

The Master Unit The Ultimate Games Unit Provides all the requirements for the serious Spectrum games enthusiast. It contains the Fuller Orator, Joystick port, sound synthesiser, and audio amplifier. The Master Unit also provides endless scope in application via its duplicate user port.

£54.95 + 80p p&p (inc. VAT)



The Fuller FD Printerface

RS 232 Version (lead not inc)

£34.95

Centronic Version (lead not inc)

£39.95

Dual Version

£45.50

The Fuller Orator

An amazing Speech Synthesiser which can be programmed to say anything you command

£39.95

+ 80p p&p (inc VAT)

Fuller FD42 System NOW FOR ZX81 or ZX SPECTRUM



This famous, best selling product immediately converts your ZX Computer into a sturdy,

attractive and professional unit, with full size typewriter keyboard. A tough plastic case encloses the keyboard, P.C.B. and power supply. It has

42 keys including all the ZX81/Spectrum graphic characters printed on them. The full travel key switches have gold plated contacts and guaranteed life of 10⁶ operations. IT'S SO EASY TO INSTALL! You simply unscrew the ZX PCB from its case, screw it to the FD case, and plug in the keyboard. No soldering or technical knowledge required.

NOW ALL ONE PRICE! £29.95 (inc. VAT) + £2.50 p&p
16K ZX81 Expansion Module - to fit into back of Fuller case - **£24.95 (inc. VAT & p&p).**

RAM Adaptor Board - enables you to fit 16K Expansion inside Fuller case - **£9.75 (inc. VAT & p&p).**

Fuller FDS Keyboard for the ZX81 or ZX Spectrum

Our new advanced keyboard has the same, fine specifications as the FD42 system, but with a new, re-designed case, space bar and double-sized shift and enter keys. A must for the discerning ZX81 or Spectrum user.

SPECIAL LOW PRICE £39.95 (inc. VAT) + £2.50 p&p.

Fuller ZX Spectrum Upgrade Pack

16K Spectrum owners - upgrade to 48K with a Fuller Spectrum Upgrade Pack - Complete with full assembly instructions. Model 2 or 3 only. **£34.95 (inc. VAT) p&p FREE!**

COMPUTER DEALERS!

Contact us for a Special Fuller Introductory Pack. We are looking for dealers throughout the U.K!

Fuller MICRO SYSTEMS

Mail to: **FULLER MICRO SYSTEMS,**
The ZX Centre, Sweeting Street, Liverpool 2.
Telephone: 051-236 6109

Please supply the following items:

| ITEM | QUANTITY | PRICE | POSTAGE | TOTAL |
|------|----------|-------|---------|-------|
| | | | | |
| | | | | |
| | | | | |

I enclose cheque/p.o.

Or, please debit my Access/Barclaycard No. _____

Name _____

Address _____

Please send me further details. I enclose S.A.E.

PC.W.783

**Style and sophistication
combined with modern technology
has produced...**



**A 14" British colour monitor at a price
you really can afford. £199.50 plus VAT.**

 **CABEL**
electronic

19 High Street, Tewkesbury, Gloucestershire GL20 5AW
Telephone: 0684 298840 Telex: 339671 ALO FAB



DRAGON 32 OWNERS
 Shoot your mouth off in... *Talking*
Android Attack

Another great game from Microdeal the first of a new generation of fast action, talking arcade games. At the start of each frame the computer warns the androids of an intruder "Intruder Alert"!! Now you can either run for the nearest doorway, escape and be called a "Coward", or chase, shoot and try to wipe out the androids, however, if you hit one it will turn into a GHOST ANDROID, capable of wandering thru walls — which of course are electrified with a fatal effect on you when touched!! Should you clear the screen the computer sneers "I'll get you next time". Will it?



All Cassettes £8 each (including VAT & Postage)
 AVAILABLE FROM DRAGON 32 DEALERS NATIONWIDE OR ORDER DIRECT

SEND 1st CLASS STAMP FOR OUR FREE SOFTWARE LISTS FOR DRAGON 32 & TANDY RANGE OF COMPUTERS.

MICRODEAL

14 TRURO ROAD, ST. AUSTELL, CORNWALL, PL25 5JE. TEL: 0726-67676.

AVAILABLE FROM SELECTED
 and **Boots**
 John Menzies





Geophysical Systems Limited

CALL THE MICRO SPECIALISTS

★ GSL offer 10,000 times increase in capacity NOW!

With the new GSL Winchester interface the memory capacity of the BBC-Acorn Model B Micro can be enlarged up to 340Mbyte.

WINCHESTER SYSTEM'S FOR ACORN M/c. A FIRST FOR GSL

COMPRISING: Power supplies
Interface Board
Controller Board
Software suitable for
BBC Acorn Micro.

- * 5 mb
- * 10 mb
- * 20 mb
- * 85 mb
- * Up to 340 mb
- * Tape Streamer 20 mb backup.

Ring For
Competitive
Quotes

| | |
|---------------------------|---------|
| 8271 Disc controller chip | £ 45.00 |
| 2764-200n's Eproms | £ 7.50 |

★ BBC Dealers ★

| | |
|---|----------|
| BBC Model A | £ 260.00 |
| BBC Model B | £ 347.00 |
| BBC Model B with disc interface | £ 408.00 |
| BBC Electron | £ 150.00 |
| Coming Soon Orders Taken Now for the Electron Joysticks | £ 11.30 |
| All Machines ex stock | |

A-B Upgrade £ 75.00

Disc Upgrade £ 95.00

ALSO:-

| | |
|-------------------------------|----------|
| View Word Processor | £ 45.21 |
| Wordwise Word Processor | £ 39.00 |
| Teletext Receiver | £ 195.65 |
| Speech Interface Inc. Fitting | £ 47.82 |

OTHER MISCELLANEOUS

| | |
|---|----------|
| ORIC 1 48K | £ 147.78 |
| TORCH 280 Disc Pack | £ 780.00 |
| TORCH Colour M/c Twin 400K Disc | £2795.00 |
| TORCH Colour 10 meg Hard + twin discs | £4995.00 |
| TORCH Colour M/c 21 meg Hard + twin 400K discs | £5495.00 |

Disc Drives

WE BELIEVE WE ARE THE CHEAPEST!
All compatible to the BBC MICRO

- ★ Shugard 5¼" metal cased ⅓ and ½
height to match the BBC
FM MFM
- ★ 100K/200K SA200 £147.00
- ★ 200K/400K SA 455 £250.00
- ★ 400K/800K SA 465 £300.00
- ★ 800K Dual £580.00

PRINTERS

| | |
|-----------------|---------|
| NEC 8023 BE-C | £320.00 |
| SEIKOSHA 250 GP | £260.00 |
| EPSON FX80 | £438.00 |

MONITORS

| | |
|----------------------------|---------|
| Microvitec 1431 Colour 14" | £249.00 |
| Kaga Green 12" | £105.00 |

SOFTWARE

Screen dump software
Acorn/Software various
Monsters, Snapper, Frogger,
Painter etc. & Other titles incl.
Business & Educational.

BEEBSCOPE

Enables the BBC Model B to
function as a two channel, Large
screen, storage oscilloscope. For
scientific, educational or home
use. PRICE £299.00 SYSTEM PRICE
AVAILABLE

* We pride ourselves on service
come and see it running before
you buy in our extensive show-
room *

We are Acorn Dealers/Service Centre

★ Dealer enquiries/discount available ★

Max 48 hour delivery on all Stock items

The above are just some items of our range.

All prices exclude carriage & V.A.T.



Geophysical Systems Limited

2 North Way
Walworth Industrial Estate
Andover, Hants SP10 5AZ
Tel (0264) 58744 51699
Telex 47166

THE BROTHERS BROTHER

**WP
PRINTER**



HR15

RIGHT PRICE

RIGHT PERFORMANCE

RIGHT OPTIONS

UNDER £550 RETAIL

13 CPS, CARTRIDGE DAISY WHEEL & RIBBON, 2 COLOUR PRINTING, PROPORTIONAL SPACING, GRAPHICS ETC.

SINGLE SHEET FEED, TRACTORS SERIAL/PARALLEL INTERFACES

BROTHER DEALERS:

| | | | | | |
|----------------------------------|----------------------------|-------------|--------------------------|--|--------------|
| London WC2 | Digitus Ltd. | 01 379 6968 | Essex | Essex Computer Centre | 0245 358702 |
| London WC1 | Bonsai Ltd. | 01 580 0902 | South | Brian Bass Ltd. | 02514 23900 |
| London EC1 | City Computer Centre | 01 588 5537 | Kent/East Sussex | Crown Business Centre Ltd. | 0323 20496 |
| London South | The Lyndon Co. | 01 788 1234 | Hampshire | Basingstoke Computer Centre | 0256 52203 |
| London South East | Bennett Electronics | 01 692 4941 | Avon | Data Link Ltd. | 0272 213427 |
| London South West | Twickenham Computer Centre | 01 892 7896 | South West | Southern Computer Systems and Services | 0803 212957 |
| London West | Interlex Ltd. | 01 943 0968 | South Wales | Penny Computer Systems | 04465 4539 |
| London North | Lion House Retail | 01 580 7383 | North Wales | Technologic Ltd. | 0978 263618 |
| North Middx | Davinchi Computers | 01 952 0526 | South Midlands | Daventry Computer Centre | 03272 78058 |
| Wildings Office Equipment Group: | | | East Midlands | Leicester Typewriters | 0533 24848 |
| Ilford | | 01 514 1525 | Birmingham | Q-Com Systems | 021 622 7165 |
| Holborn WC1 | | 01 405 8052 | North Midlands | Skytronics Ltd. | 0602 781/42 |
| Moorgate EC2 | | 01 628 0501 | Manchester | Doxiver Ltd. | 061 962 9418 |
| Buckinghamshire | Christie Computers | 0494 775999 | Merseyside & North Lancs | Agri-Plan Computer Systems | 0774 733714 |
| Buckinghamshire | Fraser Associates | 0280 816087 | South Yorks | Intac Ltd. | 0709 547179 |
| Berkshire | Computer 100 | 0734 584545 | West Yorks | Leeds Computer Centre | 0532 458877 |
| Oxfordshire | 4B Microcomputers | 0295 67551 | North East | Microcomputing Ltd. | 0632 476018 |
| Thames Valley | Bits and Bytes | 06285 26535 | Scotland East | Computer Services Scotland | 0592 773710 |
| South East | Amplicon Micro Systems Ltd | 0273 608331 | Scotland West | Sculthorps Ltd. | 06285 26535 |
| East Anglia | Anglia Computer Centre | 0603 667031 | | | |

UK DISTRIBUTOR



**THAME
SYSTEMS
LTD.**

TELEPHONE: 084 421 5471
TELEX: 837508
THAME PARK INDUSTRIAL ESTATE
THAME, OXON OX9 3RS

COMPUTER NETWORKS – Ungermann-Bass
MICROCOMPUTERS – Rair, Onyx, Zilog
GRAPHICS SYSTEMS – Terak
DISK PRODUCTS – Adaptec, Archive, Heurikon, NEC, Quantum, SMS
PERIPHERALS – Axiom, Brother, Hazeltine, NEC, Toshiba

SIMPLE PLUG-IN CENTRONICS INTERFACE



For ZX
Spectrum

ONLY
£45
inclusive

- Recognises LLIST and LPRINT which allows programs to be listed directly from your Spectrum
- Also allows printout direct from BASIC listings without the need for special user calls
- Completely self contained with 1 metre of ribbon cable and connectors
- Works with any Centronics printer including all Epsoms, Seikosha 100A, OKI Microline 80 etc
- Includes driving software which allows up to 128 characters per line
- Full range of business software available
- Fully tested and guaranteed for 12 months

Trade Enquiries
Welcome

KEMPSTON

MICRO ELECTRONICS

180a Bedford Road, Kempston, Bedford, MK42 8BL

I wish to order:

| Quantity | Item | Price |
|----------|--|----------------------|
| | Centronics interface (r £45.00) | |
| | Cheques/Postal orders should be made payable to Kempston Micro Electronics Ltd | Post & Package £1.00 |
| | | Total (VAT inc) |

For Access/Barclaycard please give your card number and signature

Card No _____

Signature _____

Address _____



Please post to Kempston (Micro) Electronics, Dept PCW/7
180a Bedford Road, Kempston, Bedford MK42 8BL

THOUSANDS OF PEOPLE FROM HUNDREDS OF PLACES WILL VISIT



You should be there, too, if you're looking to make the most of the pre-Christmas selling period.

Because the thousands of visitors who will come to the first major personal computer and leisure technology show to be held in the West of England will be Christmas computer shoppers, with money to spend on the latest computers and electronic innovations which will be on show.

So if you manufacture or supply computers, software, books, video games or other accessories make sure you exhibit at HomeTech '83.

And have yourself a very merry Christmas.

Bristol Exhibition Centre 11th-13th November, 1983

HOME TECH 83

organised by
**Tomorrow's World Exhibitions
Limited,**

9 Park Place, Clifton, Bristol. BS8 1JP
Telephone (0272) 292156/7

VOICE MACHINE COMMUNICATIONS, INC.

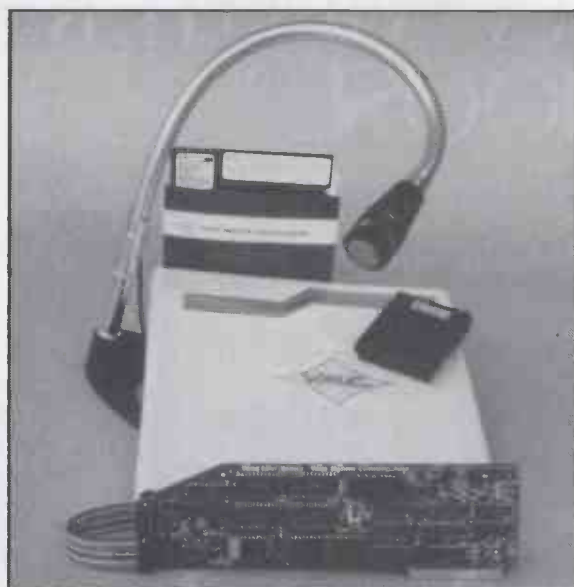

The VIM converts spoken words to commands or data for your application programs. The Voice Input Module has unexcelled spoken word recognition accuracy at an unmatched price.

DESCRIPTION:

VIM FOR APPLE II CONTAINS:

Voice Input Module 2020C with:

16 channel audio spectrum analyzer
6803 high speed microcomputer
8K Bytes of RAM, 4K Bytes of ROM

Voice Utility Diskette with:

Vocabulary builder/editor
Prompting vocabulary trainer
Recognition software
Vocabulary tester
Merge vocabularies
Change vocabulary
11 Application vocabularies

Microphone, Users Manual and all necessary cables and connectors

Deluxe model & options available
VISA - MASTERCARD

VOICE MACHINE COMMUNICATIONS, INC.
1000 S. Grand Avenue, Santa Ana, CA 92705.
Phone: (714) 639 6150



®TRADEMARK

Announcing
SPEECH RECOGNITION

VOICE INPUT MODULE

FOR APPLE II® & APPLE II-E®

FEATURES:

No application programming necessary
Near perfect recognition 98%+
Unlimited vocabulary using eighty word/phrase subsets
Recognizes anybody's voice easily
Multi-lingual recognition
Allows simultaneous input of voice and keyboard

APPLICATIONS:

The VIM is designed to add voice input to any existing Apple II application:

Graphics
Word Processing
Data Input and Retrieval
Education
Business
Industrial Automation
Programming
Testing & Measurement
Control Systems
Games & Entertainment
Handicapped — Environmental Control

£899 inc VAT

CASCADE GRAPHICS DEVELOPMENT

185 Lower Richmond Road
Richmond, Surrey
Phone: 01 878 7661

WHICH OF THESE TWO TOP PORTABLE COMPUTERS WILL YOU CHOOSE?

OSBORNE

5" monitor
 200K or 400K storage
 No Winchester
 2 free software packages
 Plastic case

KAYPRO II

9" monitor
 400K or 800K storage
 Winchester disk available
 5 free software packages and 10 games
 Metal case



The Kaypro II features should make the choosing easy. If you're interested in finding out all about this ultra-reliable, top selling U.S. system, call us today. Kaypro II. Powerful, portable, affordable.

Please send me full details of the Kaypro systems.

Name

Address

Telephone

Sales Enquiries: (0934) 516246
 CK Computers Limited
 Estover Close
 Estover Industrial Estate
 Plymouth
 Devon PL6 7PL
 Telephone: (0752) 780311 Telex: 45786

CK Computers Limited



comart communicator

PROGRESS REPORT



...now the pedigree really shows

**NOW
AVAILABLE
WITH
8086 16 Bit Processor**

How has Comart's controlled, down to earth development strategy kept Communicator a firm favourite in the UK, and the leading candidate to reverse the tide of microcomputer imports?

New Range Additions The Communicator range has broadened to add a new 20 Megabyte 5" Winchester Hard Disk Drive System to the already well established 5 Megabyte and floppy diskette models. Another new system offers 8" floppy disk drives for compatibility of data transfer. With the associated tape and additional Winchester back up systems that adds up to eight basic models – all in the same neat, stackable, casing – all based on S100 bus construction to keep future options in memory, users, peripherals and Interface requirements wide open.

New System Additions Communicator operating systems continue to broaden both in options and facilities. An improved CP/M offers enhanced diagnostics, for example, and auto boot from Hard Disk. These basic improvements are reflected in the now tried and tested Communicator multi-user MP/MII™, which also provides for full CP/M™ compatibility.

New Communications Options Communicator now offers CP/Net™ and RBTE communications protocols. Individual Communicator



Systems can now operate as intelligent information terminals, integrated with either existing mainframe or mini computer installations, or be part of a shared resource or communications network.

New Range of Terminals Find out more about Comart's new smart VDU. It's a new advanced ergonomically designed unit. It has a 105 keyset detached keyboard, soft green phosphor tilt screen, and a low profile foot. Its a perfect complement to the Communicator in both styling and performance.

Some things don't change Communicator still has Comart's established dealer network and nationwide after sales service back up, supporting thousands of Communicators already at work throughout the UK.

And in the Future? Behind all these innovations are advanced programmes of research and development. Soon Comart will be bringing you 16 bit, multi processor and distributed processing systems. This is your guarantee that Communicator will continue to keep pace as microcomputer technology progresses.

To find out more about Communicator today, call us now on 0480 215005.

Main Dealers

Birmingham The Byteshop 94/96 Hurst Street Tel 021-622 7149
Dublin Lendac Data Systems 8 Dawson Street Tel 0001 372052
Glasgow The Byteshop Magnet House 61 Waterloo Street
Tel 041-221 7409 Leeds Holdene Bray House Leicester Place
Tel 0532 459459 London The Byteshop 324 Euston Road NW1
Tel 01-387 0505 Digitus Lading House 10/14 Bedford Street Covent
Garden WC2 Tel 01-379 6968 Jarogate 197/213 Lyham Road Brixton
SW2 Tel 01-671 6321 Manchester The Byteshop 11 Gateway House
Piccadilly Station Approach Tel 061-236 4737 Nottingham
The Byteshop 92a Upper Parliament Street Tel 0602 40576
Southampton Xitan Systems 23 Cumberland Place Tel 0703 38740

A member of the Comart Group of Companies

comart
SPECIALISTS IN MICROCOMPUTERS

Comart Limited, Little End Road,
Eaton Socon, St Neots, Cambs PE19 3JG
Tel: 0480 215005 Telex: 32514 Comart G

Dealers

Aberdeen MOM Offshore Tel 0224 22863 Bedford Remdex Bradley Tel 93 58581
Cambridge Cambridge Computer Store Tel 0223 85334 Edinburgh Holdene
Microsystems Tel 031 557 4060 Glenrothes Computer Services (Scotland) Tel 0592
773710 Blackpool Western Computers Tel 0253 404676 Manchester NSC Computers
Tel 061 832 2269 Norwich Anglia Computer Centre Tel 0603 29652 Worthing Ace
Computing Services Tel 0903 354111 Middlesbrough Aztech Tel 0642 222621 Barking
Mokdavia Tel 01-591 6511 Belfast Cardiac Services Co Tel 0232 625566 Wilmslow
Holdene Tel 0625 529486 Colchester Eurotec Consultants Tel 0206 72538
Huntingdon Westcom Tel 0480 217217 Luton M E Marketing Tel 0582 31806
Middlesex/Berks Newbury Data Recording Tel 0784 61141 Sheffield Hallam
Computer Systems Tel 0742 863125 Watford Lux Computer Services Tel 0232 29513
Aylesbury J K Wakeford Assoc Tel 0296 27473

CP/M, MP/MII and CP/Net are all trademarks of Digital Research Inc.

DON'T JUST STAND THERE...



USE THE FAST LANE

28th September-2nd October Barbican Centre, City of London

The PCW Show is Britain's most popular micro event. Hardly surprising, with over 200 exhibitors showing an exciting range of micros, software and peripherals — for business and commerce, education, science, industry and the home.

But if you use a micro at work

(or are thinking of buying one) you can avoid the crush. Just clip the coupon below and send it with your business card and a cheque for £2.00 (normal price £3 at the door!). We'll send you a special "Fast Lane" ticket. And you won't have to play the waiting game.



28th September-trade only
Entrance by invitation

THE FAST LANE

Please send me one "Fast Lane" ticket to the 6th PCW Show.

I enclose my business card and a cheque for £2.00 made payable to the "Personal Computer World Show".

NAME.....

ADDRESS.....

.....

Send to Amanda Stephens
PCW Show, 11 Manchester Square
London W1M 5AB

NEWBRAIN SOFTWARE

From the software house of Elstree Computer Centre
A superb range of easy to use programmes
Purpose made and designed for the
fabulous Newbrain Computer

- Word Processor £35.00
- Database £25.50
- Invoice and credit note programme £59.50
- Invoice and credit note review £22.50
- Sales Ledger £65.00
- Stock Control £29.50
- Customer Information File £32.00
- Bank and Cash balance £29.00
- Inventory £29.50
- Mailing List £29.00
- Home Expenses £25.00
- Product Costing £22.50
- Sales Analysis £23.50
- Inventory Analysis £23.50
- Business ratios, for Investment, Sales, Turnover etc £19.50
- Calculate for Costing, Bidding (with your mark-up) £27.50
- Two programs: Mortgage repayment and property investment £21.50
- Address Book £25.00
- Business Expenses £29.50

VAT @ 15% should be added to each of the above
(include 90p P&P per program)
Phone for your nearest dealer

Send large S.A.E.
for complete range of programs
ELSTREE COMPUTER CENTRE

32 DEACONS HILL ROAD, ELSTREE, HERTS WD6 3HL

Tel: (01) 953-6921

EXPORT AND DEALER ENQUIRIES WELCOME

NEWBRAIN SOFTWARE

NEWLY RELEASED PROGRAMS

- HOTEL BOOKINGS £35.75
- PHARMACEUTICAL LABELLING £38.75
- APPOINTMENTS DIARY £25.00
- STATEMENTS £39.00

* NEWBRAIN MODEL A *

ELSTREE COMPUTER CENTRE £199.50

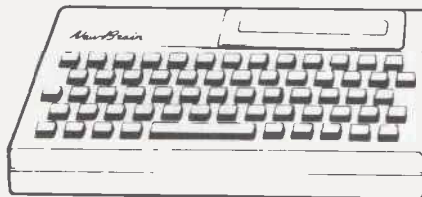

MODEL A.D.

- 80 CHARACTER DISPLAY PER LINE
- 4 CHARACTER SETS
- VERY FAST: ACCURATE KEYBOARD
- IDEAL FOR BUSINESS USE

AD £229 A £199 p&p £2.75

PLUS SPECIAL OFFER

☆ SOFTWARE JUST RELEASED. SEE LIST ASIDE.

A FULL RANGE OF PRINTERS AND MONITORS
ESPECIALLY FOR THE NEWBRAIN A & AD IN STOCK

OFFICE HOURS 9-6 MON-FRI.

☆ TAPE RECORDER MODIFIED ESPECIALLY FOR THE
NEW BRAIN MODEL A AND AD NOW IN STOCK
£29.75+ VAT

FREE

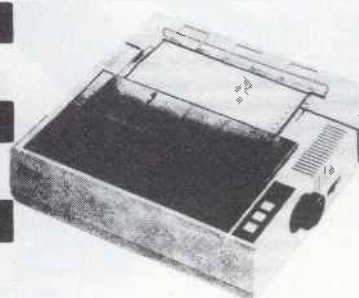

EPSON RX80 PRINTER

A business micro for as little as £1695.00
with a printer supplied - FREE!

- LOW PRICE** -£1695 with a printer FREE.
- POWER** -64K RAM expandable to 1MB and RAM DISK is available.
- SPEED** -30% faster than most micro.
- O/S** -CP/M 2.2 or UCSD PASCAL SYSTEM.
- STORAGE** -400K + 400K twin floppy with TEAC SLIMLINE drives and up to 10MB version available.
- NETWORK** -Available with RECORD LOCKING, and capable of linking up to 30 users.
- SCREEN** -Memory mapped 12" non-glare screen (80 by 24).
- KEYBOARD** -Detached keyboard with function keys.



- WARRANTY** -1 year warranty and less than £250.00 per annum for service contract by Olivetti.
- SERVICE** -After sales service and advice by our hardware and software engineer.

| MODEL | STORAGE | PRICE |
|-------|------------------------------|-------|
| BC2 | 400K+400K floppy | £1695 |
| BC4 | 800K+800K floppy | £2125 |
| HD5 | 5MB hard disk + 400K floppy | £3185 |
| HD10 | 10MB hard disk + 800K floppy | £3795 |

transtec computers

FOR FURTHER DETAILS PLEASE RING: 01-567 0154

MAGNUM

MAGNUM COMPUTERS LTD. 156 Northfield Avenue, Ealing, London W13 9SB

QUESTION

WHERE CAN I BUY

| | | |
|----------------------------|-----|---------|
| NEWBRAIN 'A' 32K | FOR | £268.00 |
| NEWBRAIN 'AD' 32K | FOR | £298.00 |
| SINCLAIR ZX81 1K | FOR | £48.00 |
| SINCLAIR SPECTRUM 16K | FOR | £99.00 |
| SINCLAIR SPECTRUM 48K | FOR | £129.00 |
| ORIC-I 48K | FOR | £168.00 |
| SINCLAIR ZX PRINTER | FOR | £39.00 |
| SINCLAIR ZX81 RAM PACK | FOR | £28.50 |
| SEIKOSHA GP-250X PRINTER | FOR | £260.00 |
| SEIKOSHA GP-100A PRINTER | FOR | £215.00 |
| SANYO SCM12H GREEN MONITOR | FOR | £100.00 |
| SANYO SCM12N GREEN MONITOR | FOR | £85.00 |

CARRIAGE: 1 item £4.00, 2 items £3.50 each, 3 items £3.00 each, 4 or more FREE

ANSWER:-



**WHY NOT COME IN AND SEE US
AT OUR NEW SHOP
44 NEW BRIGGATE, LEEDS 1
NEXT TO THE GRAND THEATRE**

MICROCELL COMPUTER SYSTEMS

New Brain
APPOINTED STOCKIST

FOR ACCESS PHONE ORDERS, PLEASE RING (0532) 681366

MICROCELL COMPUTER SYSTEMS, 44 NEW BRIGGATE, LEEDS 1, YORKSHIRE

| | | | |
|--------------------------------------|---------------------------|------------------|--|
| NAME _____ | | PLEASE SEND ME | |
| ADDRESS _____ | | | |
| _____ | | | |
| SIGNED _____ | | | |
| FOR OUR COMPLETE PRICE LIST | | TOTAL £ | |
| | | + CARRIAGE £ | |
| | | TOTAL ENCLOSED £ | |
| PLEASE TICK <input type="checkbox"/> | PLEASE DEBIT MY ACCESS NO | | |

VIDEO GENIE & TRS80 MODEL I

DP2000

**DIRECT FROM
THE MANUFACTURER**

The DP2000 combines a **CANON 6106 Disk Drive** with **disk controller, parallel printer interface and power supply** in a sleek but sturdy steel case. (Extra disk drives can be connected)

**A DISK DRIVE THAT
PLUGS DIRECT TO THE
KEYBOARD FOR ONLY**

★ **£220.00** ★

With a **FREE parallel
printer interface**

DP2000
**NO EXPANSION INTERFACE
REQUIRED**

All you need is
your computer and a
Disk Operating System
We even include a 13amp plug!
(Extra drives can be connected)

PLUG-IN POWERFUL SOFTWARE

This small unit plugs into the edge connector at the back of your computer. (You do NOT need to open your computer). By using a "splitter-cable" you can have this unit as well as an expansion interface.

Feature **ROM "A"** provides single key commands, flashing cursor, repeating characters, machine code monitor and editor, load and save system programs.

Feature **ROM "B"** provides single key commands, flashing cursor, lower case inverter, BASIC line re-number/program merge/compress memory saver, screen print.

Features **ROM "A" or "B"** complete:

| | |
|----------------------|--------|
| Video Genie | £29.95 |
| TRS80 | £34.50 |
| Splitter Cable | £14.50 |

PARALLEL PRINTER INTERFACE WITH DISK CONTROLLER

Plugs **DIRECT** to the keyboard

DP1000 **£76** only
Comes complete with power supply in
sleek sturdy steel case

MEMORY EXPANSION TO 48K

£43.50

Easily fitted inside the keyboard unit
No expansion interface required

fig. FORTH disk

| | |
|---|--------|
| Operating System | £25.00 |
| Discover FORTH book by Thos Hogan | £11.95 |

COMPUTERS

| | |
|--------------------------------------|---------|
| Genie I | £287.00 |
| Genie II with numeric keypad | £260.00 |
| Genie I with 48K internal RAM | £318.00 |
| Genie II with 48K internal RAM | £297.00 |
| Colour Genie 16K | £168.70 |

PRINTERS

| | |
|---|---------|
| EACA EG 3085 (120cps dot matrix) | £357.00 |
| EG 603 (Genie microprinter) | £200.00 |
| Brother HR1 (low cost, reliable daisywheel) | £630.00 |

DISK DRIVES

| Teac | Single | Dual |
|-----------------------|--------|------|
| 40 Track | £185 | £330 |
| 80 Track | £245 | £399 |
| 80 Track double-sided | £359 | £675 |

| CANON slim drives | Bare Drive | P.S.U. | With case & |
|--------------------|------------|--------|-------------|
| 6106 40 Track S.S. | £139 | £169 | |
| 6108 40 Track D.S. | £169 | £199 | |
| 120 80 Track S.S. | £189 | £219 | |
| 220 80 Track D.S. | £229 | £259 | |

ALL PRICES ARE EXCLUSIVE OF VAT & CARRIAGE. (TELEPHONE FOR FURTHER DETAILS).

**CREDIT
FACILITIES
AVAILABLE**



GENERAL NORTHERN MICROCOMPUTERS LTD.

8 WHITWORTH ROAD, SOUTH WEST INDUSTRIAL ESTATE, PETERLEE, Co. DURHAM SR8 2JJ
TELEPHONE: PETERLEE (0783) 860314



LONDON COMPUTER CENTRE

EPSON QX10

the revolutionary **Small
Business Computer with
256K RAM at no extra cost**

£1730

SOFTWARE AVAILABLE

CP/M 2.2, Peachtree, Wordstar, Spellbinder,
SuperCalc, Dbase II, Communications etc. etc.

All prices are Exclusive of VAT and Delivery. Dealer Enquiries invited on all Products.
Large range of CPM Software available. Please phone for Prices.

Demonstrations on all models.

43 GRAFTON WAY, LONDON W1P 5LA (Opposite Maples)
OPENING HOURS: 11-7 MON-FRI 12-4 SAT Tel: 388 6991/2
24 hour answer phone: 01-388 5721

4 WAYS TO GET MORE FROM APPLE.

1 HARDWARE

We have a range of New Products for Apple, a few are listed below.

1. XAD1-low cost Analogue to Digital Converter
 - 4 channels analogue, 0.5V, 12 bit
 - 4 reed relay outputs.
 - Real Time Clock.
2. XAD2-low cost Analogue to Digital Converter
 - 3 channels analogue, 0.5V, 12 bit
 - 2 channels programmable gain analogue
 - 2 reed relay outputs.
3. XBUB1-Bubble Memory Module for APPLE
 - Non-volatile
 - High reliability
 - Fast
 - Cold Boot from Apple...
4. XROM1-PROM System for APPLE
 - Put your BASIC Programs into ROM
 - Cold Boot from APPLE
 - I/O facilities on card
5. XCOUNT-6 channel pulse counter/timer
 - 4 counters up to 500kHz
 - 2 up to 4MHz
 - Interrupt at overflow
 - Frequency Comparison.

2 SOFTWARE

We can provide a high degree of programming support for all industrial, technical and professional applications, from machine code through to high level.



3 SYSTEMS

Xcalibur is a systems house specialising in the application of small computers to Industrial and Technical areas. We are able to provide full systems support on Apple and other small computers.



For further information contact.

Xcalibur Computers Ltd.
Spencer House
3 Spencer Parade
Northampton NN1 5AB
Tel: (0604) 21051/4 Telex: 31612

4 PACKAGING

NEW — Merlin package for APPLE II. Accepts IIE and II+ processor boards and keyboards. 19" rack, free standing or portable according to your choice.

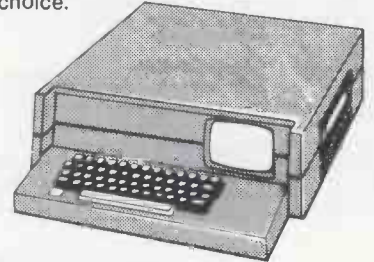

xcalibur

DATA*TRANS™

*Fast, Reliable, Versatile and Easy-to-use
Apple II Communications Software*

MICRO-MINI-MAIN FRAME INTERCONNECTION

Enables your Apple computer to communicate with virtually any other computer:
Time-sharing main frames, Minicomputers, and other Microcomputers.

| | | | |
|-------------------------------------|--------------|------------------------------|-----------|
| Automatic logon access | ALL SERVICES | Auto-answer: # re-calls | NO LIMIT |
| Transmission baud rate | 300/1200 | Simultaneous Copy/List/Print | ALL THREE |
| Time to load 18K textfile from disk | 21 sec. | Remote control of Apple | YES |
| Quick scan of textfile on disk | YES | # Phone numbers | NO LIMIT |
| Converts data for VisiCalc | YES | Menu Access Delay | 0 sec. |
| Maximum # of lines | NO LIMIT | Frequency of Menu change | FEW |
| Line/Memory counters | BOTH | Displays control characters | YES |
| # Text Editor commands | 9 | Prompted transmission | YES |

ABT DATA*TRANS ONLY £79.95

Send you CASH/CHEQUE/POSTAL ORDER with order to:

Martin Cooper Associates
Appletree House, Woodlands Way, Westfield,
East Sussex, TN35 4RG, U.K.

MASTER

MASTER is a totally new concept... a complete package for program development. Used by top professionals in the USA and Europe, MASTER has everything you need to write your own software, to the highest professional standards... up to 85 new commands that work with CBM Basic IV... and just one command can replace whole paragraphs of Basic code. That's why Master is...

a new concept in CBM Basic

MASTER has 17 DISK HANDLING commands (both keyed and sequential access, masked retrieval, batch operation, existence tests, etc)... 12 INPUT MANAGEMENT commands (input/output screen zones, with alpha, numeric and date formatting, etc)... 8 SCREEN MANAGEMENT commands (with screen pages loadable from disk or memory)... 10 commands for REPORT MANAGEMENT (with disk-loadable report formats)... 18 BUSINESS BASIC commands (with 20-place arithmetic, data compression, automatic date control etc)... and on the CBM 8096, all the features of PM96 (46K for programs, 26K for variables, as well as 17 BASIC UTILITY commands).

now available for the CBM 64

... including the full CBM Basic IV command set, and all the MASTER features listed above! Supplied on a CBM 1541 diskette, with a cassette port security key, MASTER 64 is the most powerful software utility ever offered to personal computer users! MASTER also supports CBM/PET models 4032, 8032, 8096, (and 8032 with CP/MAKER), as well as the CBM 4040, 8050 and 8250 floppy disks, plus the CBM 9060 or 9090 hard disks, and is supplied with a User Reference Manual, Quick Reference Guide, Installation Guide, Demo Disk, and with a security key for either cassette port.

PM 96 for the CBM 8096

CBM 8096 users can at last make full use of their 64K Expansion Memory... with PM96, the only product that offers sophisticated, yet simple, dynamic memory management... as well as 17 extra commands that work with CBM Basic IV. 82K of memory is available to the user, with 56K for programs (up to 16 together!), and 26K for variables (maintained even while editing or loading!). The new Basic commands include all the TOOLKIT functions, plus PRINT USING, IF-THEN-ELSE, STOP KEY disable, HARDCOPY screen dump, CALL, FETCH, PLOT (50 by 150), WINDOW, and more. PM96 comes with a User Reference Manual, Quick Reference Guide, Disk with demo programs, and UD11 Support Rom.

New prices and products!

MASTER 64 FOR THE CBM 64 INTRODUCTORY OFFER £125.00
 MASTER FOR ALL BASIC IV CBM/PETS £295.00
 PM96 MEMORY MANAGEMENT + EXTRA BASIC FOR CBM 8096 .. £99.50
 KRAM KEYS DISK ACCESS, FOR ALL BASIC II/IV CBM/PETS £99.50
 KRAM + PM96 COMBINED SPECIAL OFFER £150.00
 COMMAND-O 39 COMMANDS FOR CBM BASIC IV ... PRICE NOW £39.95
 DISK-O-PRO ADDS BASIC IV (AND MORE) TO BASIC II £29.95
 SPACEMAKER 4-ROM ADAPTOR (NOT FOR 8096) £34.95
 VISICALC 32K/96K RRP NOW £175.00 SPECIAL OFFER £140.00
 IBM VSI-SERIES SPECIAL OFFER ON IBM VSI-PRODUCTS .. 20% OFF

SUPERSCRIP I FOR ALL BASIC II/IV CBM/PETS £249.00
 SUPERSCRIP 700 (INCLUDES SUPERSPELL)..... £450.00
 SUPERSPELL FOR ALL BASIC II/IV CBM/PETS £150.00
 SUPERSCRIP I EDUCATIONAL PRICE (SEND OFFICIAL ORDER) £100.00
 SUPERBASE 700 THE DEFINITIVE INFORMATION MANAGER ... £450.00
 SUPERBASE 64 THE PERSONAL DATA BASE £100.00
 VIZAWRITE 64 THE PERSONAL WORD PROCESSOR' £69.00
 VIZASPELL 64 DISK DICTIONARY/SPELLING CHECKER £59.00
 VIZAWRITE 700 (INCLUDES VIZASPELL) EPOA

ORDERING INFORMATION: ADD 15% VAT TO QUOTED PRICES. ORDER BY POST/TELEPHONE/PRESTEL, USING CHEQUE, ACCESS, BARCLAY CARD OR OFFICIAL ORDER. TELEPHONE 01-546-7256 FOR SAME-DAY DESPATCH. POSTAGE IS FREE EXCEPT ON CREDIT OR OVERSEAS ORDERS. (REF A14)

Calco Software

LAKESIDE HOUSE, KINGSTON HILL, SURREY KT2 7OT TEL 01-546-7256

Better books from Sunshine

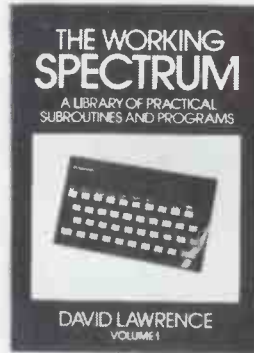

A collection of sophisticated Basic programs and subroutines including Unifile, Renumber (handles Gotos and Gosubs) education, accounts, games and scores of essential routines. Put your Spectrum to work with what must be the most comprehensive Spectrum book. 248pp **£5.95***

Some of the more advanced programs in this collection include a word processor and text editor, a music and sound synthesiser, a sprite editor and a program which allows you to enter high resolution graphics mode. This is not available in the standard Basic. 160pp **£5.95***



The Working Dragon 32



This computer has capabilities far beyond most other computers in this price bracket. With this collection of Basic programs and routines David Lawrence introduces word processing, music and shows you how to mix text and high resolution graphics. As with the other books in this series, each program is built up out of re-usable subroutines. 160pp **£5.95***

*Available through W. H. Smith's and computer dealers

Trade/dealer enquiries welcome



SUNSHINE

Please send me

The Working Spectrum at £5.95 each

The Working Commodore 64 at £5.95 each

The Working Dragon 32 at £5.95 each

I enclose a cheque/ postal order for £ _____ payable to **Sunshine Books** 19 Whitcomb Street, London WC2 7HF.

Name _____

Address _____

Signed _____

We can normally deliver in four to five days

the amazing adventures of

MICROMITE

SOMEWHERE IN THE CITY



TIRED, OVERWORKED
MICROS. UNABLE
TO TALK TO EACH
OTHER.
SLOW.
NON CO-OPERATIVE.
HOW CAN THEY BE
MADE MORE
POWERFUL?
HOW CAN THEY
WORK TOGETHER?
THIS IS
UNDOUBTEDLY A
SOCIAL AND
TECHNOLOGICAL
ROLE FOR..

MICROMITE!!



WITHIN SECONDS



SEE THE DIFFERENCE TO
THESE MICROS. FASTER,
MORE POWERFUL, ALL
LINKED TO THE
MICROMITE THROUGH
A SINGLE CABLE.

**A JOB
WELL
DONE**

QUICKER THAN YOU CAN SAY
MEGABYTE, MICROMITE LINKS UP
ALL THE UNCOMMUNICATIVE MICROS,
GETS THEM WORKING TOGETHER. LOOKING
AFTER THEIR FILES CENTRALLY WITH THE
MICROMITE'S ENORMOUS DISK STORAGE
CAPACITY - YET ALLOWING THESE FILES TO
BE SHARED BUT SECURE.

MICROMITE FILESERVER - THE LOCAL AREA NETWORK
SYSTEM FOR CP/M* BASED MICROS.
SEND FOR DETAILS AND LIST OF INTERNATIONAL STOCKISTS.



*Trademark of Digital Research Inc.

Micromite Computers, Regency House, 2 Rockstone Place, Southampton
SO1 2EP, England. Tel: (0703) 334144. Telex: 477575 sharet g

Distributors in USA, Germany, Portugal, Spain, Holland, Italy, Denmark.

Please send me details and list of international stockists.

Name _____
Position _____
Company _____
Address _____
Tel _____
PCW17

Professional
standard
micronetwork
system

U-NET

Shared Resources Network

- Open network: Apple II+ and IIe and BBC Micro now others later.
- Low cost but with sophisticated user facilities: real printer spooling, highly secure files, message switching, shared files.
- Proven reliability.
- Hardware freedom: choice of serial or parallel printers, choice of disk storage, choice of network host.

Available from selected dealers.

* Send for detailed data pack!

U-MICROCOMPUTERS

U-Microcomputers Ltd,
Winstanley Industrial Estate
Long Lane, Warrington,
Cheshire, WA2 8PR, England.
Telephone 0925 54117
Telex 629279 UMICRO G

USA subsidiary—
U-Microcomputers Inc
300 Broad Street, Stamford,
Connecticut 06901, USA.
Telephone 203 359 4236
& Toll Free (800) 243 2475
Telex 965999 O&S STD

'make it easy on yourself'



Choose from the Sunshine range of Spectrum Software

Bring some Sunshine into your life



Cruising
Behind the wheel of your machine. Cruising on Broadway. You look mean. People stop to stare. Suddenly a black-and-white pulls onto the Broadway behind — its light flashing and siren wailing. The chase is on! Cruising on Broadway is a tyre-burning fast machine-code game for the 16 & 48K Spectrum. The further you can get the more difficult it becomes — cash prizes are being offered each month for the highest scores. £4.95*

Androids
Trapped in an endless maze populated only by vicious androids your only objective — survival. You have a lazer of course and can withstand a few blows, but you'd better be quick on the draw, these guys are designed to kill. Maybe you can find an exit — but escape is impossible and your replenished resources won't last long. The fastest, most head-spinningly demanding game you'll ever play. £5.95



Swordfight at Midnight
More like a simulation than a game, Swordfight at Midnight presents you with a duel to the death between two swordsmen — play against a friend or against the computer. Not a program whose possibilities will be exhausted in a day or even a week. What it has in common with arcade space games is a demand for quick reactions to attack but it adds to this necessary ingredient subtleties of skill and tactics that will open up endless new ways of approaching the duel. An important aid to learning these skills is a "playback" facility which enables you to watch the game that has just taken place and spot your errors. £5.95*

Blind Alley
A deadly duel, deep in space, Blind Alley is what passes for sport in the year 3017. Your craft must use strategy to outwit and corral the opponent — in this crazy development of the pursuit games of the late 2600s. After each round in the enclosure game more players are sent against you to test your skill and agility. Blind Alley is the machine-code action of the future — now! For the 16 & 48K Spectrum. Blind Alley can be played with a Kempston Joystick. £4.95*

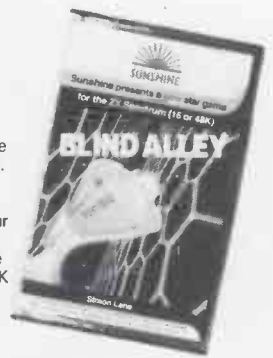

Galaxy Attack
An amazing three part hybrid of adventure and arcade action. Your task will take you through the depths of space to a crash landing on a far flung planet where you race against time to repair your crippled ship before the walkers get you. You probably won't make it but if you do the third and final part of your incredible journey will begin... the assault on the alien mothership itself. Galaxy Attack is the acid test — the ultimate game — think you're up to the challenge? Then now's the time to try... Galaxy Attack is totally machine coded and will only work on the 48K Spectrum. £5.95

SPECIALLY FOR THE DRAGON USER

Cruising
Quick thinking and dexterity are required to master this high speed chase game. Use the keyboard to travel around a maze — try to cover it all before the chaser gets you. All you have to help you is the ability to make a gap in the track which may slow your enemy up a bit but watch out — things only get tougher — the mazes get harder and more chasers appear. A high speed all machine code challenge guaranteed to raise your Adrenalin to new heights — no-one has yet mastered the highest levels. £6.95

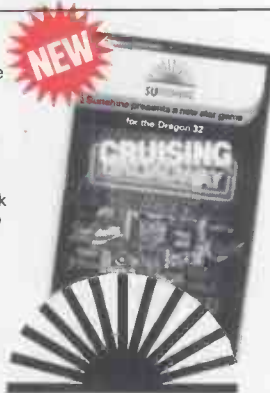

NEW DRAGON USER

Dragon User — the new independent monthly magazine dedicated to putting the Dragon through its paces. Available through your newsagent for 60p, or take out a subscription for 12 issues for £8.

SUNSHINE

*Available through W. H. Smith's and computer dealers.

Trade/dealer enquiries welcome.

Please send me

Cruising on Broadway at £4.95 each Swordfight at Midnight at £5.95 each Blind Alley at £4.95 each

Androids at £5.95 each Galaxy Attack at £5.95 each Cruising (Dragon) at £6.95 each

Dragon User Magazine at £8 for 12 issues

I enclose a cheque/ postal order for £ _____ payable to Sunshine
19 Whitcomb Street, London WC2 7HF.

Name _____

Address _____

Signed _____

We can normally deliver in four to five days.

**BUDGET
MICROS?**

**ORIG-NEW BRAIN-LYNX
ZX81-BBC MICRO-SPECTRUM**

together with an exceptional range of larger microcomputers—OSBORNE, SIRIUS, H-P, TRS 80, APPLE, TORCH and COMMUNICATOR plus peripherals and media.

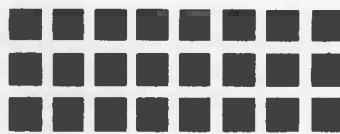

Cambridge Computer Store

1 Emmanuel Street
Cambridge CB1 1NE
Telephone (0223) 358264/65334
(closed 12.30 — 1.15 except Saturday)

SOLVE ALL YOUR MAINS INPUT POWER PROBLEMS WITH

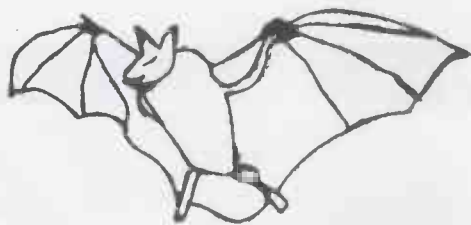

BATTPOWER

300, VA output, Quartz Frequency control, regulated sine wave output, interchangeable Battery pack, Toroidal transformers Technology. Easy to install.

Cost: £635.00 plus VAT – for one hours backup. Please ring us for a detailed leaflet.

Software now available for Commodore 64 from Speeder Software.

Machine Code Monitor – tape – £19.95 inc. VAT.

Programmers Tool Kit – tape – £17.95 inc. VAT.



ECCLESTON ELECTRONICS

8 LEGGE LANE, BIRMINGHAM B1 3LG.
TELEPHONE: 021-236 6220/1226

Micropoint

SALE

Even at sale time everything at Laskys remains the same – except the price. You get the same wide range of top name models and the unique opportunity to test and compare them side by side, with specialist advice.

Just look at these savings on the widest range of top name models available in the High Street. Whether for home, hobbyist or business use.

Names like; Atari, Commodore, Sinclair, Oric, Jupiter, New Brain, Apple, Sharp and Osborne, plus a comprehensive selection of compatible software and peripherals.

And with our 14 day exchange, up to £1,000 Instant Credit,* two years free guarantee ^ and the back-up of Laskys service engineers, the Micro-point Sale has to be the place to buy your micro.

APPLE



**SAVE
£120**

Prev. Price
~~£969.00~~
Sale Price
£849.00

APPLE II E Powerful 64K memory with excellent colour graphics and sound.

| | Prev. Price £ | Sale Price £ |
|--------------------------------|---------------|---------------|
| Apple Disk Drive | 299.00 | 249.00 |
| Apple Disk Drive + Controller | 359.00 | 329.00 |
| Apple A3 Disk Drive | 449.00 | 399.00 |
| Apple Dot Matrix Printer | 489.00 | 459.00 |
| Apple II Europlus 48K Computer | 649.00 | 599.00 |

ATARI

ATARI 400 Home computer with 16K memory. Sound generator. Good graphics and colour. Includes 'Basic' kit.

| | Prev. Price £ | Sale Price £ |
|---|---------------|---------------|
| ATARI 800 48K Home Computer | 399.00 | 279.00 |
| Atari 822 Printer | 249.00 | 179.00 |
| Atari 810 Disk Drive (only compatible with Atari 800). | 329.00 | 279.00 |

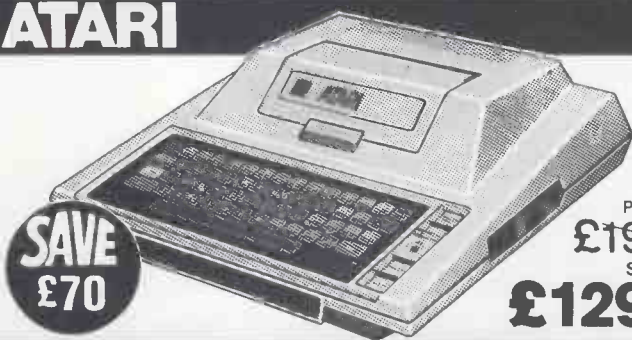

**SAVE
£70**

Prev. Price
~~£199.90~~
Sale Price
£129.90

SHARP

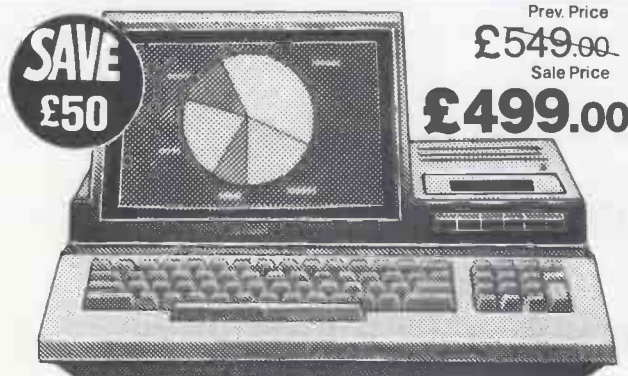

**SAVE
£50**

Prev. Price
~~£549.00~~
Sale Price
£499.00

SHARP MZ80A Powerful compact personal 48K computer, designed for any environment, always ready to run. Built-in monitor and cassette deck.

| | Prev. Price £ | Sale Price £ |
|----------------------------------|---------------|---------------|
| Sharp CE 122 Printer | 89.90 | 59.90 |
| Sharp PC 1500 hand held Computer | 189.90 | 149.90 |
| Sharp MZ80 P5 Printer | 379.00 | 339.00 |
| Sharp MZ80 SFD Disk Drive | 449.00 | 399.00 |
| Sharp MZ80 FB Disk Drive | 689.00 | 649.00 |

at Laskys

COMMODORE

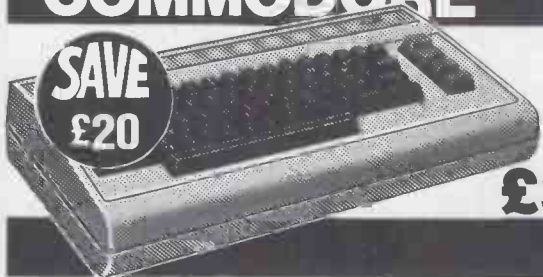

**SAVE
£20**

COMMODORE 64 A home computer with a full size keyboard. Powerful 64K memory, sprite graphics, colour and sound.

Prev. Price
~~£339.00~~
Sale Price
£319.00

Prev. Price £ Sale Price £

| | | |
|-----------------------------|------------------|--------------|
| 3K RAM Expansion for VIC 20 | 29.90 | 26.90 |
| 8K RAM Expansion for VIC 20 | 46.90 | 39.90 |

SINCLAIR

SINCLAIR SPECTRUM 48K with full colour and sound. High resolution graphics.

| | Prev. Price £ | Sale Price £ |
|---------------------------|-------------------|--------------|
| Sinclair Spectrum 16K | 124.00 | 99.90 |
| Sinclair Spectrum Printer | 52.00 | 39.90 |

Prev. Price
~~£169.00~~
Sale Price
£129.90



**SAVE
£40**

ORIC



**SAVE
£20**

Prev. Price
~~£169.90~~
Sale Price
£149.90

ORIC 48K A home computer with 48K RAM. Ergonomic keyboard with 57 moving keys. Colour, sound and a hi fi sound output. Teletext/Viewdata compatible graphics.

NEWBRAIN

NEWBRAIN MODEL AD An ideal personal/small business computer 32K memory, excellent graphics and character set. Built-in one line display.

| | Prev. Price £ | Sale Price £ |
|------------------|-------------------|---------------|
| Newbrain Model A | 269.00 | 219.00 |

Prev. Price
~~£299.00~~
Sale Price
£249.00



**SAVE
£50**

OSBORNE

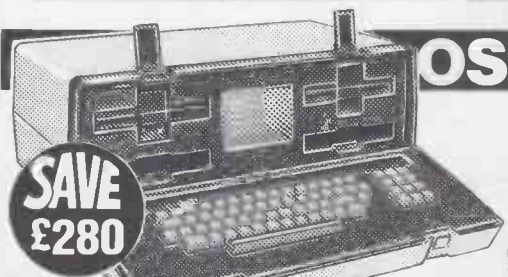

**SAVE
£280**

Prev. Price
~~£1579.00~~
Sale Price
£1299.00

OSBORNE 1 DOUBLE DENSITY A portable business computer with built-in screen and two disk drives. Powerful 64K memory. Comes complete with a comprehensive business application programme.

UP TO £1000 INSTANT CREDIT*

CHECK OUT OUR HUGE SELECTION OF
COMPATIBLE SOFTWARE AT SALE PRICES

SALE STARTS 17th JUNE

The Retail Division of The Ladbroke Group



▲ Computers/V.D.U. monitors normal domestic use 2 years (business use 1 year). Programs/Peripherals normal domestic use 1 year (business use 6 months). Pre-recorded cassettes and programs will only be exchanged if proven faulty and then only for same cassette/program. All offers subject to availability. Prices include VAT and are correct at time of going to press 25.5.83 but may be subject to variation thereafter. Some of these models shown need a separate TV or monitor. Microspot has a complete range of suitable models from £59.90 (B/W) or £198.90 (Colour)



* All credit offers subject to acceptance. Laskys Credit brokers. Please ask for written details. APR 29.3%



A service provided in association with Unicredit Finance Ltd. Please ask for written details APR 29.8% if you pay by Bankers Order (34.3% for other methods of payment)

Full stock available at these branches:

LONDON
42 Tottenham Court Road, W1
471-3 Oxford Street, W1
7-9 Queensway, W2
ALSO OPEN SUNDAY 11am-7pm
BROMLEY 22 Market Square
KINGSTON Eden Street

LUTON 192 Arndale Centre
READING Friar Street
MAIDSTONE 79-81 Week Street
BRIGHTON 151-2 Western Road
BRISTOL 16-20 Penn Street
GLOUCESTER 25 Eastgate Street
BIRMINGHAM 19-21 Corporation St.

CHESTER 7 The Forum
MANCHESTER Arndale Centre
NEWCASTLE-UPON-TYNE
6 Northumberland St.
NOTTINGHAM 1-4 Smithy Row
PETERBOROUGH Queensgate Centre
PRESTON Guildhall Arcade

SHEFFIELD 58 Leopold Street
YORK 10a Coney Street
LIVERPOOL 33 Dale Street
EDINBURGH 4 St. James' Centre
GLASGOW 66-70 Buchanan Street
CARDIFF 122 Queen Street

A range of home/hobbyist computers with peripherals and programs, are available from these branches.

LONDON
257 Tottenham Court Road, W1
382 Edgware Road, W2
152 Fleet Street, EC2
Golders Green Road, NW11
COLCHESTER 13 Trinity Square
CROYDON Whitgift Centre

SLOUGH Queensmere Centre
WATFORD Charter Place
CHATHAM 8 The Pentagon
ROMFORD South Street
SOUTHEND 205-206 Churchill West
LEICESTER 45 Market Place South

NORTHAMPTON
78 Abington Street
OXFORD 16 Westgate
WOLVERHAMPTON
30 Wulfrun Way

COMPUTER WAREHOUSE

THE 'ALADDIN'S' CAVE OF COMPUTER AND ELECTRONIC EQUIPMENT

HARD DISK DRIVES

Fully refurbished Diablo/DRE Series 30 2.5 mb hard disk drive for DEC RK05, NOVA, TEXAS etc.
Front load £550.00 - Top load £295.00
PSU type ME3029 for 2 drives £125.00
DRE 44A/4000A/B 10 mb 5+5 all configurations from £995.00. Call sales office for details.

5 AMP MAINS FILTERS

Cure those unerving hang ups and data glitches caused by mains interference. Matchbox size - Up to 5 amp 240 v load. As recommended by the ZX81 newsletter. Suppression Devices SD5A £5.95.

COOLING FANS

Keep your hot parts COOL and RELIABLE with our range of BRAND NEW professional cooling fans.

ETRI 89XU01 Dim. 92 x 92 x 25 mm. Miniature 240 v equipment fan complete with finger guard. £9.95.
GOULD JB-3AR Dim. 3" x 3" x 2.5" compact very quiet running 240 v operation. NEW £6.95
BUHLER 69.11.22. 8-16 v DC micro miniature reversible fan. Uses a brushless servo motor for extremely high air flow, almost silent running and guaranteed 10,000 hr life. Measures only 62 x 62 x 22 mm. Current cost £32.00. OUR PRICE ONLY £12.95 complete with data.
MUFFIN-CENTAUUR standard 4" x 4" x 1.25" fan supplied tested EX EQUIPMENT 240 v at £6.25 or 110 v at £4.95 or BRAND NEW 240 v at £10.50. 1000's of other fans Ex Stock. Call for Details. Post & Packing on all fans £1.60

DISTEL ©

The UK's FIRST free of charge, 24 hr. public access data base. Get information on 1000's of stock items and order via your computer and credit card. On line now, 300 baud. CCITT tones, full duplex, fully interactive.

DON'T MISS THOSE BARGAINS CALL NOW, IT'S FREE!

01-683 1133 7 days per week 24 hrs per day

8 BIT WORD - NO PARITY

COMPUTER 'CAB'



All in one quality computer cabinet with integral switched mode PSU, Mains filtering, and twin fan cooling. Originally made for the famous DEC PDP8 computer system costing thousands of pounds. Made to run 24 hours per day the PSU is fully screened and will deliver a massive +5v DC at 17 amps, +15v DC at 1 amp and -15v DC at 5 amps. The complete unit is fully enclosed with removable top lid, filtering, trip switch, 'Power' and 'Run' LEDs mounted on Ali front panel, rear cable entries, etc. Units are in good but used condition - supplied for 240v operation complete with full circuit and tech. man. Give your system that professional finish for only £49.95 + Carr. Dim. 19" wide 16" deep 10.5" high. Useable area 16" w 10.5" h 11.5" d. Also available LESS PSU with internal dim. 19" w, 16" d. 10.5" h. £19.95". Carriage & Insurance £9.50.

8" FLOPPY DISK DRIVES



Unbelievable value the DRE 7100 8" floppy disk drives utilise the finest technology to give you 100% bus compatibility with most drives available today. The only difference being our PRICE and the superb manufacturing quality!! The 7100 single sided and 7200 double sided drive accept hard or soft sectoring IBM or ANSI standard formats giving a massive 0.8 MB (7100) 1.6 MB (7200) of storage. Absolutely SHUGART, BASF, SIEMANS etc. compatible. Supplied BRAND NEW with user manual and full 90 day warranty. Carriage and Insurance £9.75.

7100 Single sided £225.00 + Carr. 7200 Double sided £295 + Carr.

Optional accessories: Full technical manual £20.00 alone. £10.50 with drive. Refund of difference on drive purchase. DC and AC power connector and cable kit £8.45. 50 way IDC connector £5.50. 50 way ribbon cable £3.20 per metre.

RECHARGEABLE BATTERIES

CYCLON type D001 sealed lead acid maintenance free 2v 2.5 ah. will deliver over 300 amps on short circuit!! Brand new at only £2.95

VIDEO MONITORS

12" CASED. Made by the British KGM Co. Designed for continuous use as a data display station, unit is totally housed in an attractive brushed aluminium case with ON-OFF, BRIGHTNESS and CONTRAST controls mounted to one side. Much attention was given to construction and reliability of this unit with features such as internal transformer isolated regulated DC supply, all components mounted on two fibre glass PCB boards - which hinge out for ease of service, many internal controls for linearity etc. The monitor accepts standard 75 ohm composite video signal via SO239 socket on rear panel. Bandwidth of the unit is estimated around 20 Mhz and will display most high def graphics and 132 x 24 lines. Units are secondhand and may have screen burns. However where burns exist they are only apparent when monitor is switched off. Although unguaranteed all monitors are tested prior to despatch. Dimensions approx. 14" high x 14" wide by 11" deep. Supplied complete with circuit. 240 volt AC operation. ONLY £45.00 PLUS £9.50 CARR.

24" CASED. Again made by the KGM Co with a similar spec as the 12" monitor. Originally used for large screen data display. Very compact unit in lightweight alloy case dim. 19" H x 17" D x 22" W. All silicon electronics and composite video input make an ideal unit for schools, clubs, shops etc. Supplied in a used but working condition. ONLY £55.00 PLUS £9.50 CARR. 6 INS.

14" COLOUR superb chassis monitor made by a subsidiary of the HITACHI Co. Inputs are TTL RGB with separate sync. and will plug direct into the BBC micro etc. Exceptional bandwidth with good 80 col. definition. Brand new and guaranteed. Complete with full data & circuit. 240 v AC working. Dim. 14" x 13" x 13". ONLY £199.00 PLUS £9.50 CARR.

SEMICONDUCTOR 'GRAB BAGS'

Mixed Semis amazing value contents include transistors, digital, linear, I.C.'s triacs, diodes, bridge recs, etc. etc. All devices guaranteed brand new full spec. with manufacturer's markings, fully guaranteed, 50+ £2.95 100+ £5.15.
TTL 74 Series A gigantic purchase of an "across the board" range of 74 TTL series I.C.'s enables us to offer 100+ mixed "mostly TTL" grab bags at a price which two or three chips in the bag would normally cost to buy. Fully guaranteed all I.C.'s full spec. 100+ £6.90 200+ £12.30 300+ £19.50

CALLING DEC USERS

Brand new and boxed RSX11M 3.2 Documentation kits, fill 3 feet of your bookshelf! Under half price only £120.00 carr. £6.50 0 vat on manuals. We are always keen to buy all types of used or surplus DEC equipment.

SUPER DEAL? NO - SUPER STEAL!!

The FABULOUS 25CPS TEC Starwriter Daisy wheel printer at a fraction of its original cost.

BRAND NEW AT ONLY £499 + VAT

Made to the very highest spec the TEC Starwriter FP1500-25 features a heavy duty die cast chassis and DIABLO type print mechanism giving superb registration and print quality. Micro-processor electronics offer full DIABLO/QUME command compatibility and full control via CPM Wordstar etc. Many other features include bidirectional printing, switchable 10 or 12 pitch, full width 381 mm paper handling with upto 163 characters per line, friction feed rollers for single sheet or continuous paper, internal buffer, standard RS232 serial interface with handshake. Supplied absolutely BRAND NEW with 90 day guarantee and FREE daisy wheel and dust cover. Order NOW or contact sales office for more information. Optional extras: RS232 data cable £10.00. Tech manual £7.50. Tractor feed £120.00. Spare daisy wheel £3.00. Carriage & Ins. (UK Mainland) £10.00.

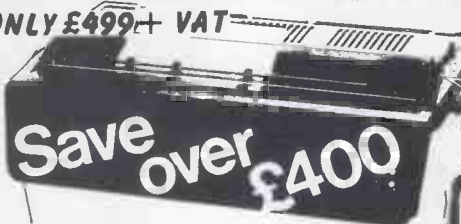

TELETYPE ASR33 I/O TERMINALS

FROM £195 + CAR + VAT Fully fledged industry standard ASR33 data terminal. Many features including ASCII keyboard and printer for data I/O auto data detect circuitry. RS232 serial interface, 110 baud, 8 bit paper tape punch and reader for off line data preparation and ridiculously cheap and reliable data interface. Supplied in good condition and in working order. Options: Floor stand £12.50 + VAT. KSR33 with 20ma loop interface £125.00 + Sound proof enclosure £25.00 + VAT

SOFTY 2

The amazing SOFTY 2. The complete "toolkit" for the open heart software surgeon. Copies, Displays, Emulates ROM, RAM and EPROMS of the 2516, 2532 variety. Many other features include keyboard, UHF modulator. Cassette interface etc. Functions exceed capabilities of units costing 7 times the price! Only £169.00 pp £1.95 Data sheet on request

DATA MODEMS

Join the communications revolution with our range of EX TELECOM data modems. Made to most stringent spec and designed to operate for 24 hrs per day. Units are made to the CCITT tone spec. With RS232 i/o levels via a 25 way 'D' s't. Units are sold in a tested and working condition with data. Permission may be required for connection to PO lines.
MODEM 13A compact, async, same size as telephone base. Up to 300 baud, full duplex over 2 wires, but call mode only £75.00
MODEM 2B/C Fully fledged, up to 300 baud async, ANSWER & CALL modes, auto answer, auto switching, ideal networks etc. Just 2 wire connection to comms line. £85.00
MODEM 20-1 Compact unit for use with PRESTEL or full duplex 2 wire link 75 baud transmit - 1200 baud receive. Auto answer. £130.00
MODEM 20-2 same as 20-1 but 75 baud receive 1200 baud transmit. £130.00
MODEM 20-3 Made for data rates up to 1200 baud in full duplex mode over 4 wire circuit or half duplex mode over 2 wires. £130.00 Carriage. 13A £4.50. 2B/C & 20.95.00
DATA PUMP MODEM compact unit upto 1200 baud full duplex over 4 wires or half duplex over 2 wires. BELL specification with data i/o via RS232 25 way D socket, remote test etc. 240 v operation. Supplied complete with data £65.00 carr. £4.50.
For more information or details of other types of ex. stock modems contact sales office.

8" WINCHESTER price SLASH

Worldwide purchasing brings you two amazing Winchester SCOOPS at prices that will likely NEVER be repeated.
BASF 6172 8" 24 Mb. Complete unit consists of micro-processor controlled logic on 3 PCBs for all read/write and servo control functions. Fast data transfer is by the BASF 'Disk Bus' interface on a single 40 way multiplexed i/o bus. Units have been carefully removed from believed working equipment, but at the staggering price of ONLY £99.00 are sold without guarantee. Supplied complete with 200 page + tech. Manual. Dim 45 x 22 x 11 cm. DC requirements +5v, +12v, +24v. Carriage and ins. £10.00
S100 Bus 19 Mb. Subsystem. A cancelled order and change of policy by a major British disk drive manufacturer enables us to offer you 'last year's model' at a plug in and ready to go SUPER LOW PRICE. Our own custom controller pugs direct into the S100 bus and will control 2 disk drives, offering a total storage of OVER 36 Mbs! and at data transfer rates in excess of 7 Mb/sec seeing is believing!! Supplied complete with user configurable BIOS etc. Save a fortune, Limited quantity only.
3100 19 Mb. Disk drive £499.00 PSU unit £165.00
CD1100 controller & BIOS £345.00 PSU extension cable £9.95
Full tech Manual £20.00
Special SUBSYSTEM prices. 1 x 3100 disk + PSU + Controller £799.00
or 2 x 3100 disks + 2 PSU + Controller £1295.00
All prices + VAT and carriage. 90 day guarantee. Data on request.

ALL PRICES PLUS VAT

All prices quoted are for UK Mainland, paid cash with order in Pounds Stirling PLUS VAT. Minimum order value £2.00. Minimum Credit Card order £10.00. Minimum BONA FIDE account orders from Government depts., Schools, Universities and established companies £20.00 Where post and packing not indicated please ADD 60p + VAT Warehouse open Mon-Fri 9.30 - 5.30. Sat. 10.15 - 5.30. We reserve the right to change prices and specifications without notice. Trade, Bulk and Export enquiries welcome.

DISPLAY
-ELECTRONICS-

64-66 Melfort Road, Thornton Heath, Near Croydon, Surrey
01-689 7702 - 01-689 6800 Telex 27924



Summer Sale

at Computer Plus

Why not call into Computer Plus and talk to friendly and professional staff who will guide you through our wide range of computers and accessories. There are a number of other exciting offers in our "Summer Sale" including Sinclairs, Sharps, BBC, Vic, plus many software items

COMMODORE
64 inc.
£275 VAT

EPSON
RX80 PRINTER
inc.
£299 VAT

DRAGON
32 inc.
£187 VAT

SANYO
12" MONITOR
inc.
£79 VAT

SHARP
M280A
inc.
£479 VAT

SENSORY 9
CHESS COMPUTER
inc.
£135 VAT

Suppliers:

Sharp • Acorn • BBC • Apple • Commodore • Dragon • Sinclair • Victor • Man Tally • Microvitec • Seikosha • Smith Corona • Vebatim • Basf • Bugbyte • Fidelity • Computer Concepts • Program Power • CGL • Epson and many others.

Computer Plus

47 Queens Rd, Watford, Herts. Tel: WATFORD (0923) 33927

32K Rampack For Your Vic 20 Special Offer

Choose any of the following Gemini software cassettes requiring 32K memory.

- | | |
|------------------|------------------------|
| 1. Database | 4. Invoice Statements |
| 2. Stock Control | 5. Home Accounts |
| 3. Mailing List | 6. Commercial Accounts |

And add a 32K Rampack by Plus 80
(Recommended Retail Price £69.95 for both)

SPECIAL PRICE £59.99 (Inclusive)

Send to: PLUS 80, 31-33 LOWER ROAD, HARROW, HA2 ODE.

SOFTWARE 1. 2. 3. 4. 5. 6.
32K RAMPACK ON ITS OWN £49.99
16K RAMPACK ON ITS OWN £37.99

INDIVIDUAL SOFTWARE
PACKAGES £19.95 1. 2. 3. 4. 5. 6.

Name Address.....

Tel. No:.....

Allow 10-14 days delivery.

(Please tick appropriate boxes)

Generous Dealer Discounts

PCS

PEDRO COMPUTER SERVICES

BBC MODEL 'B'
ORIC I
SPECTRUM
ZX 81
VIC 20
VIC 64
OSBOURNE

CONTINUOUS STATIONERY
DISKETTES
PRINTER RIBBONS
CASSETTE RECORDERS
BOOKS
VARIOUS ADD-ONS
BLANK CASSETTES

PRINTERS
RGB MONITORS
GREEN SCREEN MONITORS
DISK DRIVES
PET TV INTERFACE
PET EDGE CONNECTORS
MORE PET ADD-ONS

PRINTER LEADS
MALE - FEMALE
FEMALE - FEMALE
SIRIUS - PARALLEL
OSBOURNE - PARALLEL
IBM - PARALLEL
T-SWITCH - switches
between two devices

BBC SOFTWARE
ACORN SOFTWARE
PROGRAM POWER
BUG BYTE
GEMINI
VIC SOFTWARE (20/64)
ZX81 - SPECTRUM

IN HOUSE MAINTENANCE OF:
PET's
BBC
OSBOURNE
APPLE
PRINTERS AND
MONITORS

We export to Europe, Africa and Asia. Access and Barclay cards welcome.

Address:- 43/44 Hoxton Square, London N1.
Telephone:- 01 - 729 4100

ORIC Software



For the superb ORIC-1 The finest software, ORIC SOFTWARE

Fast-load action, taking ORIC's colour, graphics and sound capabilities to new frontiers. Carefully designed and selected to match ORIC's quality and quest for timeless technology.

The ever growing range includes programs for Business, Education and In-home entertainment, so whether you want a total business system or 'edge of the chair' arcade excitement, choose ORIC - The new experience in micro-software.

Part of the growing selection includes:-

FOR HOME

BACKGAMMON - CHESS
FLIGHT - ZODIAC - AIRLINE
DALLAS

FOR BUSINESS

ORIC PAY - ORICINV - ORIC STOCK - ORIC CALC -
ORIC TYPER - AUTHOR **PLUS** ORIC BASE and
ORIC FORTH languages

Real computer software from

ORIC



ORIC PRODUCTS INTERNATIONAL LTD, COWORTH PARK, LONDON ROAD, ASCOT, BERKS

JUST LAUNCHED

ORIC TREK SPACE ADVENTURE GAME

You are in command of the Federation's most powerful starship the USS Enterprise. Armed with your phasers and photon torpedoes, your task is to patrol the furthest reaches of the Galaxy, protecting Federation space against the forces of invading Klingons. Your ultimate mission is to rid the Galaxy entirely of the Klingon menace...before they destroy you. Your crew awaits you aboard the Enterprise. Starfleet Command wishes you Bon Voyage and Good Hunting!

**ORIC products available from:-
WHSMITH • DIXONS • GREENS
LASKYS • MICRO'C' • MICRO
PERIPHERALS • SPECTRUM
COMPUTERS FOR ALL
And hundreds of independent
dealers.**

Critical review?



“The sound commands on the Oric 1 are, for a computer of this price, very sophisticated. Three music channels, and one noise channel, mean that you can program some fairly complex sounds.”

POPULAR COMPUTING WEEKLY

“Oric is everything you hoped it would be. Alive with colour, and zapping with built-in sound effects, the Oric looks like a match for any machine now selling for less than £200”

YOUR COMPUTER

“The 16k Oric – fighting the 16k Spectrum – is £25 cheaper. It feels a good deal more ‘professional’ than the home-appeal Sinclair. Oric’s sound is extremely versatile, and well up to the standard of the £300 or £400 BBC microcomputer made by Acorn.”

WHICH MICRO?

“Oric was over twice as fast as the Spectrum. Surprisingly perhaps the Oric, which initially seemed only faster when performing the simplest of calculations, has come back to beat the Spectrum by a small amount. As the problems get more complex the Oric comes into its own. One final point – in entering the benchmark tests – the Oric was certainly the easiest to handle.”

WHICH MICRO?

“This slope coupled with the design of the keys makes the Oric an easy machine to touch-type on. All keys have auto-repeat and there are four keys dedicated specifically to cursor control. It is certainly easier to type on than any of Sinclair’s offerings.”

YOUR COMPUTER

“Oric will soon be selling a Modem so that Prestel will become available. Owners will be able to accept telesoftware – programs loaded straight down the phone line – eventually electronic mail could come into the home by the same route, and with the addition of a tape recorder the Oric with its Modem could become a telephone answerer and message taker.”

YOUR COMPUTER

“When compared to the stogginess of the Spectrum’s keyboard this is certainly an improvement. I can’t see any Orics failing through bad assembly. If only the £2400 IBM were so easy to use.”

WHICH MICRO?

“Instead of the Spectrum’s 28 look-up single-character error reports, the Oric has 18 self-explanatory messages. If you actually want to do computing, rather than just exploring the world of off-the-shelf games programme entertainment the Oric will be a better buy.”

WHICH MICRO?

“One good feature of the Oric is an on-screen reminder in the top right hand corner to show that you’ve engaged all-capitals mode. So much better than the BB’s variety of lights in the corner of the keyboard. The Oric is sound, simple to get along with and offers great expansion potential.”

WHICH MICRO?

“A good speaker and built-in noises get the Oric’s sound off to a good start. Typing Zap, Ping, Shoot or Explode produces convincing ‘arcade game noises which can easily be incorporated into any program.”

YOUR COMPUTER

“The modem is certainly unusual in a machine of this price. Together with the other peripherals, when finally available, it should make for an attractive package for a small business... surely a match for machines costing much more.”

POPULAR COMPUTING WEEKLY

ORIC-1

The Real Computer System

ORIC PRODUCTS INTERNATIONAL LTD, COWORTH PARK, LONDON ROAD, ASCOT, BERKS

available from... **WHSMITH ● DIXONS ● GREENS
LASKYS ● MICRO‘C’ ● MICRO PERIPHERALS
SPECTRUM ● COMPUTERS FOR ALL
And hundreds of independent dealers.**

MICRO NETWORKS NEW BABY – FROM NISSEI SANGYO/HITACHI
SAMURAI S16-BIT MEGA MICRO

'Simply' more power,



more
 reliability,
 more performance,
 more flexibility, more
 quality, more speed,
 more storage, more
 compatibility...



S16-Bit Mega Micro

TECHNICAL DATA

Processor: 16-Bit 8086, cycle time 215 Nano Seconds. **Architecture:** DMA Bus based, true 16-Bit. **Speed:** DMA @ 6MB/sec; Disc transfer @ 3MB/sec. **Memory (RAM):** 128KB standard, expandable to 640KB. **Screen:** High resolution green; anti-glare optical filter. Colourgraphics optional extra. **Discs:** Two 8" DS/DD giving 2.36 MB usable. IBM compatible. **Interfaces:** 2 RS 232 communications interfaces. Plus: Centronic printer interface. **Operating Systems:** MS-DOS CP/M-86. 8-bit software emulator. **Languages for 16-bit:** Basic, Cobol, Pascal, Fortran, PL/1, BCPL compilers and interpreters available. **Customising:** with logo, namestyle and house colours, can be arranged. "So simple to operate" – and don't forget, the S16-bit Mega Micro is built to military standards with laboratory-level quality control for complete dependability.



NISSEI SANGYO MICRO NETWORKS S16 MEGA MICRO

The symbols that guarantee your business computing success. The S16-bit Mega Micro is a product from Nissei Sangyo, a subsidiary of Hitachi. (In a word, reliability). Micro Networks Limited is a fast growing company backed by a powerful financial consortium, dedicated to the marketing of proven high quality Computer equipment, at the right prices!

NATIONWIDE MAINTENANCE – the most comprehensive after sales service on the market. Our qualified engineers give a 24 hour working day calling service.

WARRANTY – Free for a 12 month period.

GUARANTEED – of course, but also a guaranteed no quibble replacement.

TRAINING – comprehensive training schemes available.

SUPPORT – from our fully trained dealer network.

SOFTWARE *Universal availability of business software. All MS-DOS and CP/M-86 software will run on the S16, which means a comprehensive library of business/technical applications packages are available to you.*

... so much more –
£2,395
 for so little!

What are your business computer requirements?

Business Systems? Specialist Systems? Are you a first time buyer? Single user? Looking for a replacement for obsolete equipment? Or, do you want a main frame link-up system? The S16-bit Mega Micro is the *powerful, reliable answer* and can be tailored to your exact needs now, with flexible, expandable options in the future.

A CHALLENGING INVITATION!

Compare the S16-bit Mega Micro with other 16-bit micros, including the PCW Benchtest winner 1982 (the Olivetti M20). We know what the results will be, new Benchtests prove it!

Before you make a decision to buy a micro computer – and maybe make a costly error –

01-602 7405

for more information about the S16-bit Mega Micro. One of our qualified Sales Executives will give you friendly, helpful advice and if required, arrange a non obligatory demonstration. Call into our London offices – or, fill in the coupon for immediate response.

To: **MICRO NETWORKS LIMITED**
 382 Kensington High Street, London W14 8NL

- Please send me your colour brochure, full details of the S16-BIT MEGA MICRO and the name of my local dealer.
- I would like a representative to call me today. PLEASE TICK

Name _____

Position _____

Company _____

Address _____

Telephone _____

PCW/7/83

FRASERS

Professional Micro Systems from the computer professionals

OSBORNE 1

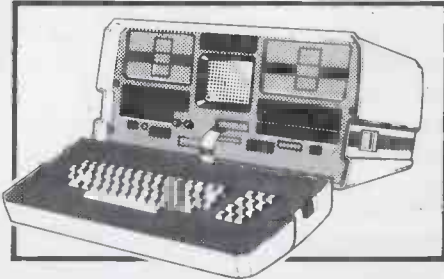

Includes £800 worth of **FREE SOFTWARE** – Wordstar, Mailmerge, Supercalc, Basic, Disc capacities to 1.2M Byte or Winchester

ACT SIRIUS 1



The most popular 16 BIT system

EXACT BUSINESS SYSTEMS

SALES LEDGER
POINT SALE INVOICING
STOCK CONTROL
PURCHASE LEDGER
NOMINAL LEDGER

ALL FOR ONLY

£400 + VAT

Ex demonstration units available at giveaway prices.

91 Station Road, West Drayton, Middlesex UB7 7LT
Telephone: West Drayton 41731

Which PRINTER FOR What COMPUTER?

Micro General the specialists for Printer Selection
Contact us for our expert advice on all your Interfacing problems

It's not just a question of plug in and lets go. There are now over 200 different connector situations. How do you know that your computer will accept the printer of your choice? We at Micro General do not sell boxes off the shelf. As computer engineers we help you to choose and install the right printer for your computer. The advice is free and it could save you some embarrassing mistakes – Buy from us for peace of mind.

EPSON MATRIX PRINTERS

From **£298 +vat**

| | | |
|-------|--------------|----------|
| RX80 | Tractor only | |
| | 100cps | £298+vnt |
| FX80 | 160cps | £438+vnt |
| MX100 | 100cps | |
| | full width | £499+vnt |

INTERFACES AVAILABLE FROM SPECTRUM, VIC 20, AND COMMODORE 64

NEW RX-80 FX-80 MODELS NOW AVAILABLE

MICROLINE RANGE

From **£211 +vat**

| | | |
|---------------|---------|----------|
| Microline 80 | 80 cps | £211+vnt |
| Microline 82A | 120 cps | £370+vnt |
| Microline 83A | 120 cps | £529+vnt |
| Microline 84 | 200 cps | £847+vnt |

(The M84 has High Res. Graphics plus Near Letter Quality print)

NEW ADDITIONS TO THE MICROLINE FAMILY (All with Near Letter Quality printing and High Resolution Graphics)

| | | |
|--------------|----------------------------------|----------|
| Microline 92 | 160 cps | £476+vnt |
| | (80 cols. at 10 cpi) | |
| Microline 93 | 160 cps | |
| | Full Width (136 cols. at 10 cpi) | £688+vnt |

TRIUMPH-ADLER TRD 170S DAISY WHEEL PRINTER

£695 +vat

HIGHLY RECOMMENDED LOW COST QUALITY PRINTER

- Amazingly quiet for the office environment.
- Serial or Parallel Interface.
- Tractor Feed & Single Sheet Feeder available.
- Character Pitch 10, 12, 15 cpi & Proportional.

Micro General

Always call for the best possible price Access/Visa

(Dept PCW7) 6 The Birchwoods, Tilehurst, Reading, RG3 5UH Tel: 0734 25226

WHAT GIVES A STAR THE EDGE OVER RIVALS?

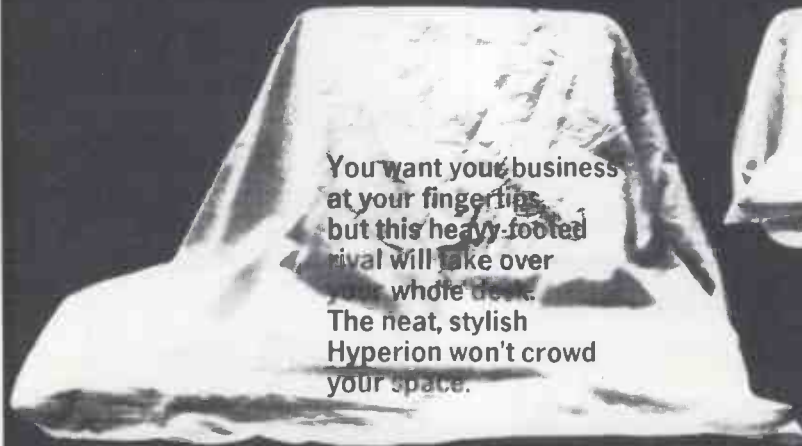

You want your business at your fingertips, but this heavy-footed rival will take over your whole desk. The neat, stylish Hyperion won't crowd your space.

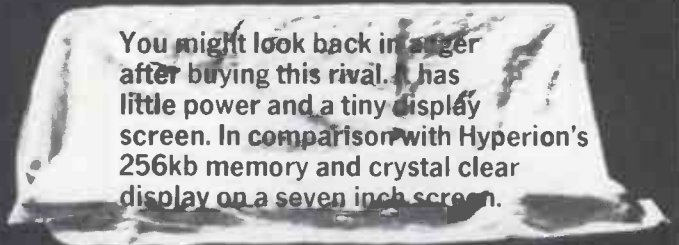

You might look back in anger after buying this rival. It has little power and a tiny display screen. In comparison with Hyperion's 256kb memory and crystal clear display on a seven inch screen.

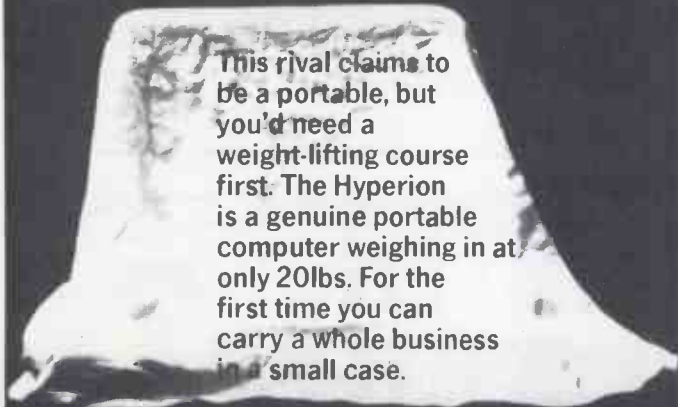

This rival claims to be a portable, but you'd need a weight-lifting course first. The Hyperion is a genuine portable computer weighing in at only 20lbs. For the first time you can carry a whole business in a small case.

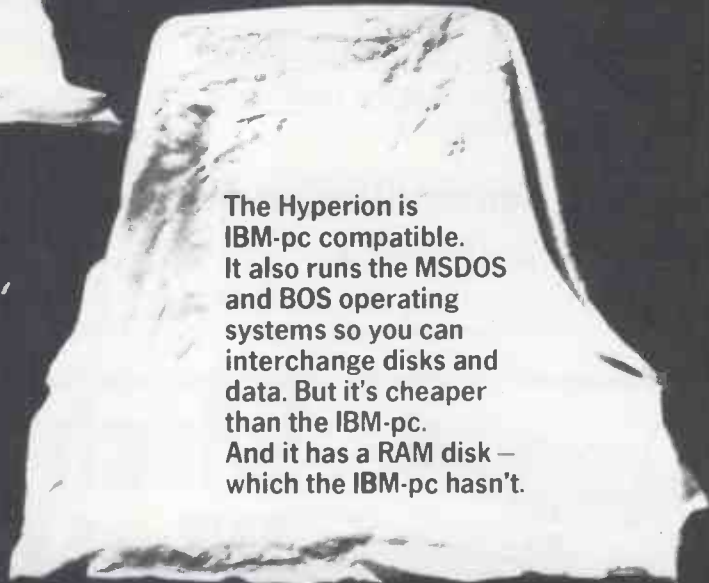

The Hyperion is IBM-pc compatible. It also runs the MSDOS and BOS operating systems so you can interchange disks and data. But it's cheaper than the IBM-pc. And it has a RAM disk — which the IBM-pc hasn't.

In business you need an edge. So it makes sense to choose the portable computer with the edge over its rivals. It's what makes Hyperion the world's major star.

For more information just fill in the coupon below and send it to Gulfstream Technology Limited, Unit 3A, Tunnel Estate, 726 London Road, West Thurrock, Grays, Essex RM16 1LS. Telephone (04026) 4926. Telex: 894222 Gulfs

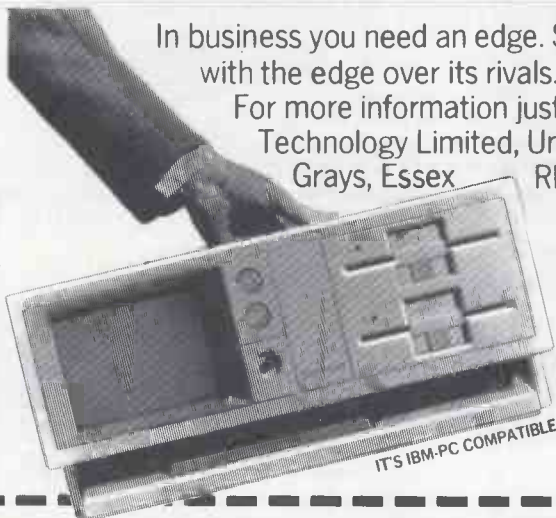

IT'S IBM-PC COMPATIBLE

Hyperion

the world's most powerful portable computer

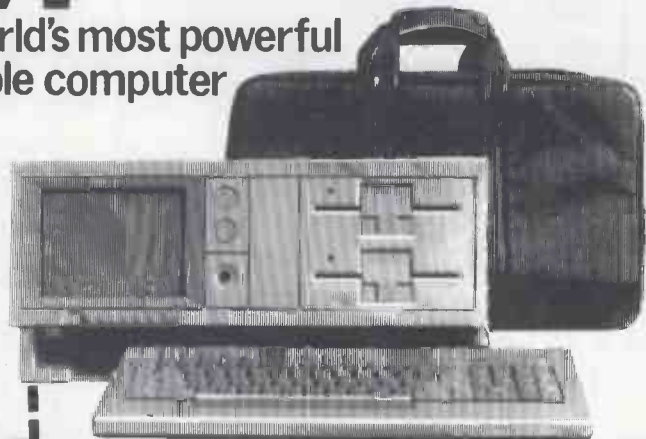

GULFSTREAM TECHNOLOGY LIMITED Unit 3A, Tunnel Estate, 726 London Road, West Thurrock, Grays, Essex RM16 1LS. Telephone: 04026 4926
Please send me full colour brochure of the Hyperion Portable Computer
Please send me details on how I can become a Hyperion Portable Computer Dealer A MEMBER OF THE BYTEC GROUP 

My name is: _____

Company _____

Address _____

Telephone _____

PCW 783

MOST SUPPORT STORIES START WITH A WIFE AND SIX KIDS.

This is one about a microprocessor and its peripherals. They can be even more costly to maintain when things go wrong. However don't despair—with our help it may never happen.

Digital Computer Services is an independent maintenance support service for users, manufacturers and dealers of mini and microcomputer systems. From centres throughout the country DCS offers a fast off – and on – site service. No more worries about the various equipment in your system. DCS has the experience and the facilities to maintain a wide range of hardware.



**TOTAL MINI/MICROCOMPUTER
MAINTENANCE SUPPORT**
Digital Computer Services Limited,
76-78 Wallgate, Wigan, WN1 1BA. Tel: 0942 321153

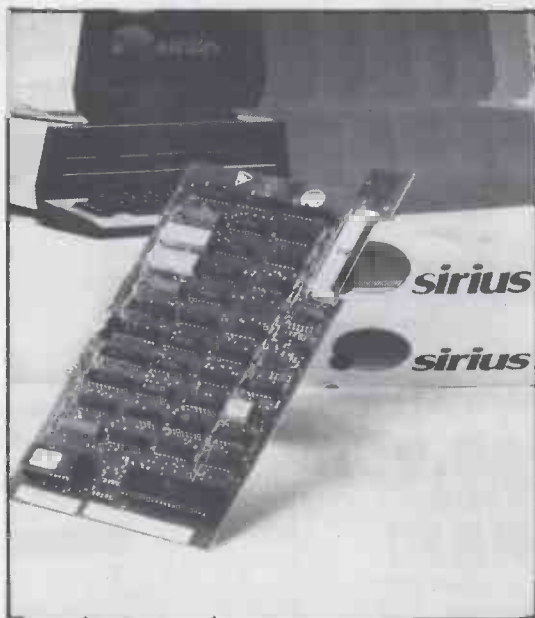

SIRIUS 80 CARD

CP/M-80 for the Sirius 1

The SIRIUS 80 Card now manufactured by Sirius Systems Technology under licence for Small Systems Engineering adds a new dimension to the capabilities of the Sirius 1. Simply plugging in the card and typing "80" opens the door to the world's most popular operating system, CP/M-80, giving access to thousands of application packages, languages, compilers, development tools and programming aids.

- A copy of true CP/M-80—*not an emulation*—is included with every card.
- A single command is all that's needed for the system to alternate between CP/M-80 and CP/M-86. Files generated under either operating system are identical in structure, providing compatibility between the two.
- Drive 'M' RAM disk facility enables areas of RAM to function as high speed disk drives.
- Corvus hard disk drive interface allows up to 64 Sirii to share the same 6, 10 or 20 Mb drive, with high speed video tape back-up.
- I.O. address selection ensures complete compatibility with other Sirius plug-in cards.
- Full 6 MHz operation with its own 64K of RAM.
- Comprehensive documentation is included, and a complete set of programming utilities, including Corvus drivers for MS-DOS.
- The simple-to-fit Sirius 80 Card has over 2000 installations world-wide.

£365

 **sirius**
Sirius Approved Product



small systems engineering limited

2-4 Canfield Place, London NW6 3BT. Telephone: 328 7145 Telex 264538



THE euribon GROUP

A single source of supply for all computer consumables; computer services and mini-computers

- Continuous stationery • continuous labels
- pre-printed stationery • printer ribbons for line printers • printer ribbons for mini-computers and word processors • magnetic tapes and discs • digital cassettes
- all leading makes of floppy discs • over 500 different ribbons and ribbon cassettes in stock.

euribon

Customer Service Dept., The Euribon Organisation, Euribon House, King's Place, Nottingham NG1 1LJ. Tel: Nottingham 0602 57676 Telex: 377510

Proven over many years of service

Applestop Ltd

HELP!

HELP SCREEN UTILITY FOR THE APPLE II and IIe.

Allows help screens to be created and easily displayed at any time from within a program. Can also be used to provide menus and other instructions, data lists etc. Supports multiple screens within a single program. Access time 1/8 0.05 sec. via simple 'call'. Original text screen replaced unchanged after help screen display. Easy to use - example program provided. Supplied on DOS 3.3 diskette.

£18.95 inclusive of V.A.T. and postage.

BIG FILE

ALLOWS 370K + DOS TEXT FILES!!

Allows a single DOS text file to be spread over two or three disks. No changes to existing programs are necessary and records are accessed as normal in a random access text file.

£12.95 inclusive of V.A.T. and postage.

PRO-FORMA

Allows the design, printing and completion of any type of form - e.g. application forms, reports, returns, etc. Forms may be designed and the format, titles, other text and data information saved to disk.

Any form can be completed, whether it is designed using the system or is an existing internal or external forms, with the user being prompted by field name for the data to be inserted in each position. All data entered is checked for validity and size. Multiple copies of blank or completed forms can be printed.

£21.95 inclusive of V.A.T. and postage.

Available from: **Applestop Limited**
17 Fulford Grove
New Marske, Redcar, Cleveland TS11 8JZ
Tel. 0642 474707

MASSIVE DEMAND

AND TECHNICAL SUCCESS FOR THE SP48

Memory prices down!

With an increasing demand for our ZX Spectrum accessories we invite you to share in our success, with a special price reduction.

| | |
|--|--|
| <p>SP48 32K MEMORY EXTENSION (giving you the standard 48K) £23</p> | <p>SP80 64K MEMORY EXTENSION (giving a massive 80K paged!) £46</p> |
|--|--|

Both the SP48 and the SP80 fit inside the Spectrum case, are fully compatible with all Sinclair add-ons (ZX Printer, RS232, Microdrive etc.), are very low in power consumption, require no soldering, are easy to fit and remove and carry our full warranty.

ZX SLOWLOADER £10
Transfers contents of ZX 81 tapes on to your Spectrum in minutes. Ready for SAVEing and EDITing. Send s.a.e. for details.

If you cannot identify whether you hold issue 1 or issue 2 Spectrum, please contact us for confirmation.

FIT & TEST SERVICE. Available on all memories. For personal callers while-you-wait £3. 2-5pm Mon-Fri, or by return registered post £7.

Please send me by return the following items (tick products required)

| Quantity | £ | p |
|--|-----|---|
| <input type="checkbox"/> SP48 issue 1 | £35 | |
| <input type="checkbox"/> SP48 issue 2 | £23 | |
| <input type="checkbox"/> SP80 issue 1 | £50 | |
| <input type="checkbox"/> SP80 issue 2 | £46 | |
| <input type="checkbox"/> ZX Slowloader | £10 | |

p&p 65p

I enclose cheque/P.O. payable to East London Robotics Ltd. for £
Send s.a.e. for FREE catalogue. Same day despatch for telephoned
ACCESS and VISA orders.

Prices include VAT. Please tick if you require VAT receipt

Name _____
Address _____

EAST LONDON ROBOTICS
GATE 11, ROYAL ALBERT DOCK, LONDON E16.
24 HOUR INFORMATION SERVICE TEL: 01 474 3308
24 HOUR ACCESS AND VISA ORDERING TEL: 01 474 4715
SPECIAL ENQUIRIES TEL: 01 474 0430

All products advertised are in stock at the time of going to press.

Vic Odden's of London Bridge

Sensational offer on the TEXAS TI-99/4A

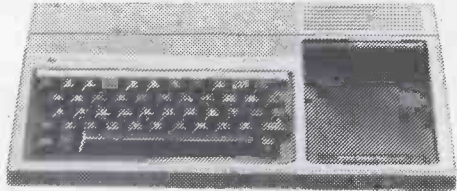

NOW ONLY £149.95 PLUS FREE!

- Pair of Joysticks
- Beginners BASIC tutor programme
- Connect four program

Worth £50.85
Please ask for details. We are members of the SPECTRUM group of micro dealers - see SPECTRUM'S ad's in this issue for further details.



TWO'S COMPANY TEN'S a hole in your pocket



As a home personal computer user, you don't always want to buy your floppy disks in 10-packs. But you do want high quality media. So Verbatim offer you Datalife in a twin-pack.

Two 5 1/4" Datalife minidisks in a convenient pack, complete with labels and read/write protect tabs. Available from all Verbatim authorised retailers, or call

01-773 1115 for your nearest stockist.

The new Datalife™ minidisk Twin-Pack.

 Verbatim®

Verbatim Ltd. Mint House, 6 Stanley Park Road, Wallington, Surrey SM6 0HA. Tel: 01-773 1115 Telex: 892757

SuperSoft®

ScratchPad 3.0

CP/M®, CP/M-86®, MS DOS, IBM PC DOS

NEVER SEE "OUT OF MEMORY" AGAIN

ScratchPad 3.0 is at the forefront of electronic spreadsheet development. Its advanced features and capabilities make it a powerful tool for business planning, "what if" analyses, financial modelling and decision making.

ScratchPad's matrix of rows and columns gives you complete control over the entry, cross-referencing, and mathematical analyses of data of all kinds.

ScratchPad 3.0 supports many advanced features not found on lower quality spreadsheets. These features include:

- **Flexible Spreadsheet**

A ScratchPad innovation. Now you can design the spreadsheet to fit your application, rather than redesigning your application to fit the spreadsheet. The matrix dimensions are up to you.

- **Virtual Memory**

You can now use every cell in the spreadsheet. Don't be misled, other spreadsheets tell you how "big" the matrix is, but you can only use a very small portion. With Scratchpad's virtual memory feature you can use EVERY CELL up to maximum 25,000 entries.

- **Consolidation**

This allows you to combine values from many different spreadsheets into a new "master" spreadsheet that contains either the sum or the average of the others. For example, monthly sales figures from several spreadsheets can be consolidated into one yearly spreadsheet. This feature is invaluable to businesses of any size.

- **Merge**

Spreadsheets saved on disk can be merged with the current spreadsheets to give you greater use of previously recorded data.

- **Unlimited Window Splitting**

A ScratchPad exclusive! This helps you quickly understand the results of "what if" analyses by keeping your screen movement to a minimum.

- **If/Then**

Allows the use of conditional statements.

- **Automatic or Manual Calc Modes**

Lets you decide when recalculations will occur.

- **Format Control**

Lets you format numbers globally or at specific locations, commas, or (in the case of intermediate values) invisible format.

- **Print**

You can specify rows and columns to be printed and printout to either printer or disk.

- **Replicate the contents of Rows, Columns, or Points**

- **Zero the contents of Rows, Columns, or Points**

- **Vary Column Width**

- **Delete or Insert Rows or Columns**

- **Erase Spreadsheet**

- **Jump between windows**

ScratchPad also has a complete complement of built in functions, including:

ABS, ATN, AVG, CHOOSE, COS, COUNT, EXP, FAC, IF/THEN, INT, LOG, LOOKUP, MAX, MIN, PI, SIN, SQR, SUM, TAN

Arithmetic functions have 13 DIGIT BCD PRECISION.

| Formula: 017(004,1,007)FORM 010-043 | | calc on 03 | |
|-------------------------------------|--|----------------------------|--|
| Entry: | | Entry: | |
| 1 Monthly Budget For 1982 | | 20 Monthly Budget For 1982 | |
| 2 | | 21 | |
| 3 Salary: 1,500 10,000 | | 22 Salary: 1,300 | |
| 4 | | 23 | |
| 5 Expenses | | 24 Expenses | |
| 6 | | 25 | |
| 7 Food: 150 | | 26 Food: 120 | |
| 8 car: 225 | | 27 car: 225 | |
| 9 gas: 100 | | 28 gas: 90 | |
| 10 rent: 300 | | 29 rent: 325 | |
| 11 | | 30 | |
| 12 total: 625 | | 31 total: 760 | |
| 13 | | 32 | |
| 14 left: 675 | | 33 left: 500 | |
| 15 | | 34 | |
| 16 | | 35 | |
| 17 | | 36 | |
| 18 | | 37 | |
| 19 | | 38 Savings | |
| 20 | | 39 Per year: 2,100 | |
| 21 | | 40 | |
| 22 | | 41 | |

SuperSoft®

FIRST IN SOFTWARE TECHNOLOGY

European Agents: MICRO TECHNOLOGY SOFTWARE SYSTEMS.
51 THE PANTILES, TUNBRIDGE WELLS, KENT TN2 5TE.
TELEPHONE: (0892) 45433. TELEX: 95441 MICRO G.

SuperSoft®

DISK DOCTOR

DISK DOCTOR £66.66 requires 48K CP/M

Two drives are needed for complete operation, Disk Doctor was not designed for use with double sided or hard disks.

DIAGNOSTICS II £83.33 requires 32K CP/M

DIAGNOSTICS II CP/M-86 £83.33

DISK EDIT £66.66 requires 32K CP/M

DISK EDIT CP/M-86 £66.66

| | |
|----------------------------------|---------|
| ADA | £200.00 |
| C | £183.33 |
| C CP/M-86 | £333.33 |
| C MSDOS | £333.33 |
| Corrector (Z80 only) | £166.66 |
| Elink | £166.66 |
| FORTTRAN (Z80 only) | £283.33 |
| FORTTRAN CP/M-86 | £283.33 |
| FORTTRAN MSDOS | £283.33 |
| FORTH Z80 | £133.33 |
| FORTH 8080 | £133.33 |
| IBM PC Personal Database | £83.33 |
| LISP | £100.00 |
| Ratfor (ALL FORTRANs) | £66.66 |
| Scratchpad 3.0 requires 48K CP/M | £196.66 |
| Scratchpad 3.0 CP/M-86 | £196.66 |
| Scratchpad 3.0 MSDOS | £196.66 |
| Star Edit | £150.00 |
| Star Edit CP/M-86 | £150.00 |
| Star Edit MSDOS | £150.00 |
| Stats-graph | £133.33 |
| System Checker | £50.00 |
| Term II | £133.33 |

All products will work with 8080 CP/M unless otherwise stated.

These and many other SUPERSOFT products are available from our Distributors Software Ltd. 01-387 8832 MPI 01-591 6511

DDL Systems Ltd. (North Star and others) 0435-830680

Anglsea Ltd. (SIRIUS FORMATS) 0735-292496.

In case of difficulty they are available direct from Microtechnology Software Systems in IBM PC, 8", OSBOURNE and other formats.

Please add £3.00 p.p. per product plus V.A.T. on total, cash with order only.

FOR MORE TECHNICAL INFORMATION OR ENQUIRIES, PLEASE CONTACT RICHARD ASHTON (0892) 45433

IBM PC Authorised Dealer.
MICROTECHNOLOGY
EUROPEAN AGENTS FOR SUPERSOFT INC.

51 THE PANTILES, TUNBRIDGE WELLS, KENT TN2 5TE.
TEL: 0892-45433 TELEX: 95441 MICRO-G.

OPUS DESKING

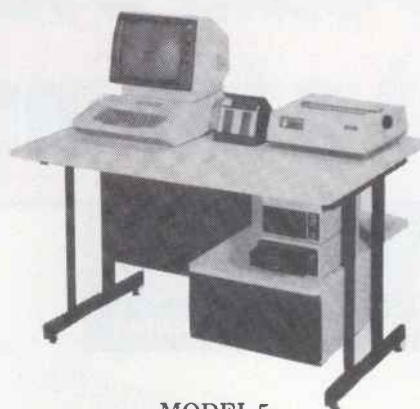

MODEL 5

10 MODELS AVAILABLE

COLOUR LITERATURE AVAILABLE

LOWER SHELF FOR DISC DRIVES

COMPETITIVE PRICES

DEALER ENQUIRIES WELCOMED

SCRATCH RESISTANT SURFACES

CASTORS WITH LOCKABLE BREAKS AVAILABLE

GENEROUS DESK TOP AREA

ATTRACTIVE BROWN & CREAM FINISH

EX STOCK DELIVERY

DRAWER FOR DISC STORAGE

MADE IN BRITAIN

For further information please contact

OPUS SUPPLIES, 158 Camberwell Road, London SE5 0EE
Tel: 01 701 8668 (3 lines) or 01 703 6155/6/7

SPECTRUM BBC DRAGON

Make the most of your microcomputer with these tested books from the Tim Hartnell *Success in the Fast Lane* computer series.

- () PROGRAMMING YOUR ZX SPECTRUM — 230 pages, 100 plus programs, Tim Hartnell and Dilwyn Jones — £6.95.
- () BEYOND SIMPLE BASIC — DELVING DEEPER INTO YOUR ZX SPECTRUM — Dilwyn Jones — £7.95.
- () 60 GAMES AND APPLICATIONS FOR THE SPECTRUM — David Harwood — £4.95.
- () CREATING ARCADE GAMES ON THE ZX SPECTRUM — Daniel Haywood — £3.95.
- () INSTANT BBC MACHINE CODE — Jeremy Ruston — tape and book, enter program in BASIC, program changes it instantly to machine code — £34.95.
- () LET YOUR BBC MICRO TEACH YOU TO PROGRAM — Tim Hartnell — £6.45.
- () THE BBC MICRO REVEALED — Jeremy Ruston — £7.95.
- () MAKING THE MOST OF YOUR DRAGON 32 — Clive Gifford — more than 150 programs, explores all the Dragon's resources — £5.95.
- () DYNAMIC GAMES FOR THE DRAGON 32 — Tim Hartnell and Robert Young — 30 great games, including Asteroid, Space Search, Reversi/Othello and Cubik's Rube — £4.95.

Interface Publications, Dept. PCW2, 44-46 Earls Court Road, London, W8 6EJ.

Please send me the books indicated above. I enclose £_____.

Name _____

Address _____

*(reg. TM)

The Juki 6100 printer. It should cost a lot more than £399*

JUKI MODEL 6100
LETTER QUALITY DAISYWHEEL PRINTER

EX-STOCK
£399 + VAT
FREE 24 HR.
DELIVERY



- ★ "Drop in" Daisywheel Triumph Adler compatible
- ★ IBM Selectric Ribbon
- ★ Compatible Centronics Interface and Industry standard control codes makes the 6100 ideal for: BBC, Dragon, Oric, Apple, Newbrain, Sirius and others.

The new Juki model 6100 letter quality daisy wheel printer has full features you'd expect to find on a more expensive printer.

It can support word processing and graphic functions, print 18CPS, and use a simple drop-in daisy wheel.

The 6100 has 10/12/15 pitch, proportional spacing, utilizes standard IBM Selectric typing ribbons, has 2K buffer memory, parallel interface, and both tractor feed and serial interface are available as options.

That's only the beginning. Best of all, the low-noise Juki model 6100 is extremely reliable.

You can pay more, *but you can't buy better* — the JUKI MODEL 6100.

NO DELAY — TELEPHONE YOUR CREDIT CARD No. TODAY AND YOU CAN START PRINTING TOMORROW, AND IF YOU'RE NOT SATISFIED, RETURN WITHIN 14 DAYS FOR A FULL REFUND.

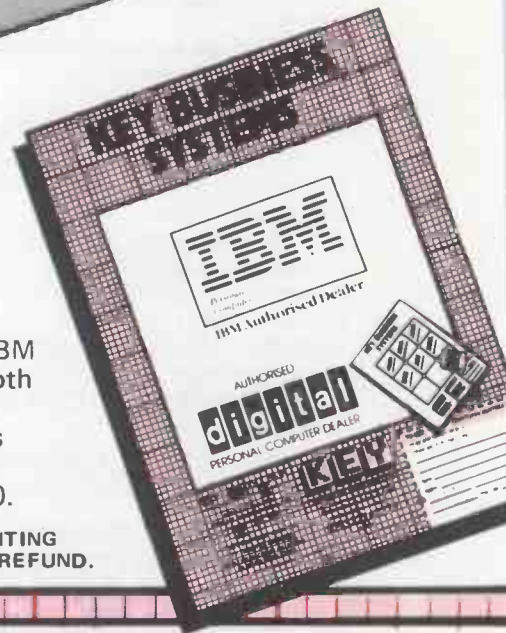

HAMPTON COURT **KEY** WALTON

OPEN 6 DAYS A WEEK
Mon-Sat 9am-7pm (6pm Sat)
Prices quoted ex. VAT @ 15%
Can be delivered within 24 hrs from stock.



H.P. facilities arranged



KEY COMPUTER CENTRES LTD
Enterprise House, 44 Terrace Road
Walton-on-Thames, Surrey, KT12 2SD
Tel: 09322 42777 (4 lines)

To: Key Computer Centres Ltd
Please send me FREE print out samples and literature.

Name.....
Address.....
Post Code.....



**Your IBM PC: A GUIDE TO THE
IBM PERSONAL COMPUTER
BY LYLE J GRAHAM**

Packed with information and resources, this book is written for both beginning and experienced computer users and will serve as a day-to-day guide and as a reference. For beginners it provides an overview of personal computer hardware and software, clear step-by-step operating instructions, and where appropriate, detailed explanations of the computer's internal operations. For the more experienced user, the author covers advanced IBM BASIC programming, DOS, graphics and sound, the printer interface and the I/O interface, machine language and the monitor. This is an indispensable book for all IBM PC users.
093198885 3 £12.95

**Data Base Management
Systems: A GUIDE TO
MICROCOMPUTER SOFTWARE
BY DAVID KRUGLINSKI**

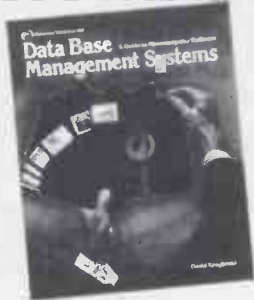

You'll be able to evaluate and select a data base management system to meet your particular business requirements after reading *this* book. It defines the capabilities of the 3 categories of data base management systems: File, Relational and Network/Hierarchical and examines many of the more popular packages, some of which run under the CP/M

operating system, including: Condor Series 20, dBase II, FMS-80, DataStar and others. With the facts in this book, any microcomputer owner can make intelligent decisions about data base management systems for their business.
093198884 5 £12.95

**Learning with Logo
BY DANIEL WATT**

Logo is a fascinating new computer language. This comprehensive guide is written to be useful to children as young as 9 years old, as well as adults. Many pictures and examples, clear descriptions of commonly experienced bugs and pitfalls, and sample projects such as simple and complex turtle drawings in black and white and colour, animated computer games, word games, quizzes, conversations, and text editing are featured. This book offers fascinating insight into this language for anyone interested in learning or teaching logo.
07 068570 3 £16.50



**Word Processing Buyer's Guide
BY ARTHUR
NAIMAN**

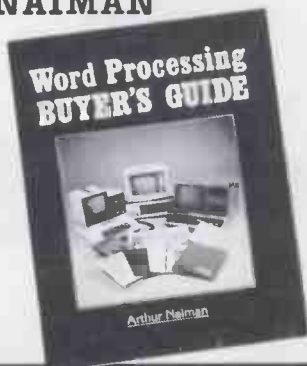

Filling the need for a word processing buyer's guide that is neither too complex nor too superficial for the experienced computer user, this thorough guide shows how word processors enable all kinds of writers to edit, rearrange, reformat and print their documents electronically with dazzling speed and efficiency. It examines such areas as letter-quality printers, storage systems, terminals, keyboards and video monitors. Helpful appendices feature conversion tables, a bibliography and an extensive word processing glossary, and so make this an invaluable guide to the prospective word processor owner.
07 045869 3 £13.50

**Make the
most of
Your Micro -**

WITH THESE GREAT BOOKS FROM MCGRAW HILL

**Vic 20 User Guide
BY JOHN HEILBORN**

Whether you're using your VIC 20 for entertainment or practical applications, this book will help you enjoy your computer more as you build your computer skills. For beginning programmers there are tutorials in VIC 20 BASIC, complete with instructions for colour graphics and sound. For experienced programmers, the book includes detailed coverage of VIC 20 BASIC statements and functions, including a chapter on advanced colour graphics. Filled with comprehensive reference material and tutorials, the VIC 20 User Guide is the definitive source for complete information on the VIC 20.
093198886 1 £10.95

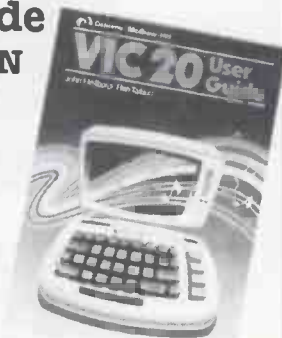

**ZX81 / TS1000
Programming for Young
Programmers (UK)
BY LINDA HURLEY**

The ZX81 computer is becoming evermore popular both in schools and homes, but in order to teach youngsters the techniques required to become proficient in programming the ZX81, they need instruction that will hold their interest and provide entertainment. This book, to be published in July, teaches young programmers from 9 years upwards the fundamentals of BASIC programming, in a way they'll find both educational and exciting. A software cassette to accompany the book is also available. This contains listings in the book, plus ideas for routines that will help the adventurous programmer design and write their own simple games programs. Also included are 3 games not contained in the book. The cassette will be available in July.
07 084595 6 (Book) £4.95
07 084700 2 (Cassette) £5.95



**How to order these
books - simple!**

Just tick the titles you require, fill in your name and address, and send this advert (or a copy of it) with your cheque or postal order to: Marketing Services Department, McGraw-Hill Book Company (UK) Limited, FREEPOST, Maidenhead, Berkshire, SL6 2BU.

Name: _____

Address: _____

PCW K1

All McGraw-Hill Computing books are also available through all good bookshops.

Byrom Software

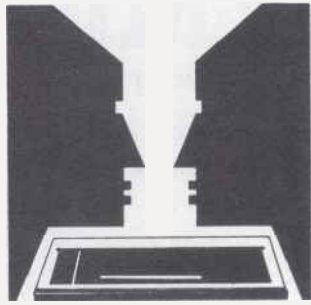

CONVERSATION PIECE

Get micro's talking to each other ... and to mainframes ... with Byrom Software's communications packages.

BSTAM

Micro to micro transmission of all CP/M* files, regardless of size.

- full wildcard expansions to send *.COM etc.
- full speed data transfer without hex conversion
- direct 9600 baud linking with UARTS, or via phone lines using modems
- reliable error detection and automatic retry

BSTMS

TTY emulation facility for communicating with remote time-sharing systems via phone lines. Osborne version available.

Terminal mode runs your computer like a TTY, and File mode lets you send and receive files to and from the Host Computer.

- interactive mode
- expand and compress programs translating binary to character files and vice versa.
- files received to and transmitted from disk

For your nearest supplier, see our main advertisement (Pages 100 and 101)



Xitan Systems Ltd. 23 Cumberland Place
Southampton SO1 2BB Tel. 0703 334711

*CP/M is a Trademark of Digital Research Inc.

Best Buy Crofton

MONITORS

IT'S A BETTER BUY THAN MOST AT
LESS THAN £4 PER MHZ.

THE PRICE IS AS CRISP AS THE IMAGE.
ORDER TODAY - WE'LL SHIP RIGHT AWAY.
All major Credit Cards accepted.

Phone for details of cased and open
frame monitors.

CROFTON ELECTRONICS LTD.

35 GROSVENOR ROAD, TWICKENHAM, MIDDX 01-891 1923/1513 Telex 295093

THE ZYGON COMPUTER STAND.



New,
purpose built
stand, suits most home
computers. BBC,
Spectrum, Vic, Dragon,
Acorn, Electron,
Commodore, Genie, Ace,
Oric, Lynx.
Packs maximum units
into minimum area.
Lower shelf slideaway
keyboard protection.
Basic unit
grows with
your system.
New feature extension
shelves accommodate
printers, disc drives, etc.

ZYGON STAND
just **£59** plus VAT
(extension shelves extra)



To: Zygon Products, FREEPOST, 9 Sheredes Drive,
Hoddesdon, Herts EN11 8BR. (No stamp required). Tel: 0992 466259
Please send full details of the Zygon Stand

Name.....
Address.....

PCW 7

Fun Mathematics on Your Microcomputer

CZES KOSNIOWSKI

This entertaining, original book shows how to use a personal computer for recreational mathematics, providing an endless source of ideas for the personal computer user. Learn some fascinating mathematics, play some intriguing games and develop your computing skills. Find out about 'making snowflakes' and about 'confused but loving husbands', discover 'polar honey bees' and play Treasure Hunt. Each chapter introduces an important part of mathematics, explains the fundamental ideas and incorporates them into computer programs. All the programs are written in BASIC and are readily adaptable to individual computers.

£4.95 net

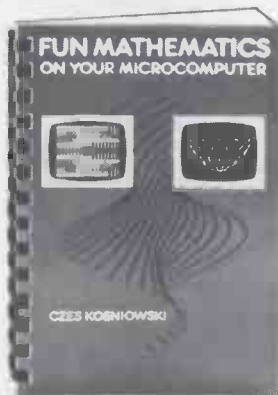

CAMBRIDGE UNIVERSITY PRESS

Linsac's ZX Companion series has received excellent press reviews:

"Far and away the best" — *Your Computer*

Thoughtfully written, detailed and illustrated with meaningful programs ... outstandingly useful" — *EZUG*

'The Spectrum Games Companion' is the latest addition to the series and is aimed at the games player and programmer alike. Twenty-one games designed specifically for the ZX Spectrum are included, with clear instructions on entry and play. Each program is explained fully with complete details on how it is designed and written. Introductory chapters show how to set up and use the Spectrum and how to create your own games. Later sections cover number games, word games, board games, simulation games, dice games, card games and grid games. If you want to enjoy your ZX Spectrum and learn its secrets at the same time then this is the book for you!

Bob Maunder is co-author of 'The ZX80 Companion' and author of 'The ZX81 Companion'. He is a Senior Lecturer in Computer Science at Teesside Polytechnic, holds an MSc degree in Computer Science, and is a Member of the British Computer Society.

The Spectrum Games Companion is available from good book shops, or send £5.95 to:

THE
SPECTRUM
GAMES
COMPANION

Bob Maunder

LINSAC

ONLY
£5.95

LINSAC, (P.C.W.) 68 Barker Road,
Middlesbrough, Cleveland TS5 5ES

Postage is free within the U.K. —
add £1 for Europe or £2.50 outside Europe.

ISBN 0 907211 02 X

The INCREDIBLE NEW SIRIUZ 80 only £169.87

+ VAT

- RUNS THOUSANDS OF LOW COST CP/M 80†2.2 PROGRAMS ON SIRIUZ 1.
- USERS REPORT COST RECOVERED ON 1 STANDARD SOFTWARE PACKAGE ALONE.
- ALL BRITISH HARDWARE/SOFTWARE SOLVING THE 16 BIT SOFTWARE SHORTAGE.
- EXPANDED CP/M 80 COMPATIBLE OPERATING SYSTEM INCLUDED WITH EVERY SIRIUZ 80.
- MANY WELL KNOWN PROGRAMS ACTUALLY RUN FASTER THAN THEIR HIGHER PRICED 16 BIT TRANSLATIONS.

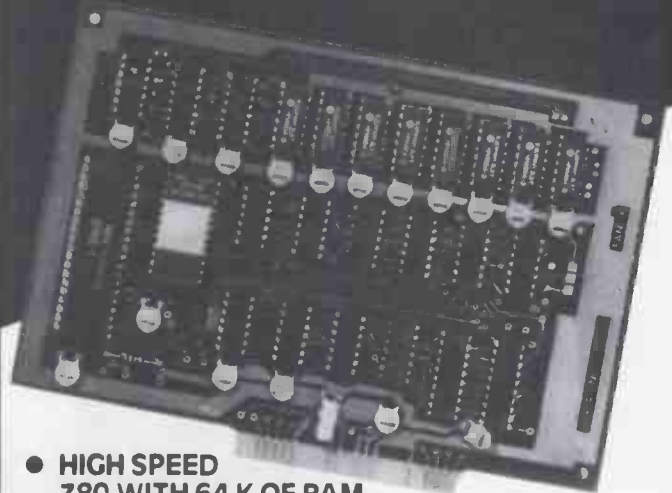

- HIGH SPEED Z80 WITH 64 K OF RAM
- SYNCHRONOUS SIRIUS INTERFACE
- EASY 5 MINUTE FITTING (FIXINGS PROVIDED)
- HIGH NOISE IMMUNITY CONSTRUCTION
- 2 YEAR HARDWARE WARRANTY
- FREE SOFTWARE UPDATES

† TM DIGITAL RESEARCH INC.

Inpholink

LIMITED

FRONT STREET WEST, BEDLINGTON,
NORTHUMBERLAND NE22 5UB.

TELEPHONE: BEDLINGTON (0670) 829009/827480.

PLEASE RUSH ME _____ SIRIUZ 80 PACKAGES ON 21
DAYS APPROVAL AT £197.08 INC. VAT AND £1.50 P&P

NAME _____

ADDRESS _____

CHARGE TO MY ACCESS
ACCOUNT



NO _____



VISA PLEASE PHONE.

DEALER ENQUIRIES INVITED.

Cumana

Model III Winchester

the finest drive in the West!



With the quality Rodime RO200 Series of 5¼" Winchester Drives Cumana gives TRS-80 Model III owners high capacity at low cost. Internally mounted hard disks offer storage capacities from 5.25 M.B. to 21 M.B. The internal kit is comprised of mounting frame, hard disk, power supply unit, controller and fan. The mounting frame also allows for the installation of either one or two slimline floppy disk drives.



For Model III owners who already have internal floppy disk drives we can supply an externally boxed unit at the same prices as those charged for the internal kits.

Disk operating systems are obtainable from Molimerx (L.DOS)0424-220391 & Microfirm (DOS Plus) 0454- 322260.

| | |
|--------------------------|------------------------------|
| 5.25 M.BYTE (Formatted) | £1395 |
| 10.5 M.BYTE (Formatted) | £1745 |
| 15.75 M.BYTE (Formatted) | £1885 |
| 21.0 M.BYTE (Formatted) | £2195 |
| (internal or external) | (Add V.A.T. to above prices) |

CUMANA LTD

The Pines Trading Estate, Broad Street,
GUILDFORD, Surrey GU3 3BH. Telex: 859380 Tel. (0483) 503121.

For further details complete & return this coupon

Name

Address

Tel. No.

Interests: Dealer Education Business Home Use

NOTE if Dealer please attach this form to your Company letter head.

Please send: Brochure Data Sheets Dealer Address List

LOOK! ... FOR ALL YOUR



apple ACCESSORIES



All items fully guaranteed for one year
 Free postage and packing within UK

Immediate delivery
 Many more items available

| BUSINESS SOFTWARE | NET | INC. VAT |
|---|--------|----------|
| Access | 162.00 | 186.30 |
| Business Forecasting Model (Reqs.) | | |
| Visicalc | 69.00 | 79.35 |
| Calcostar (CP/M) (80 column spread sheet) | 69.00 | 79.35 |
| dBase II (CP/M) | 325.00 | 373.75 |
| Data Star (CP/M) (powerful data entry) | 122.00 | 140.30 |
| Data Perfect | 67.00 | 77.05 |
| D.B. Master (version 3.02) | 119.00 | 136.85 |
| D.B. Master statistics | 62.00 | 71.30 |
| D.B. Master utilities (links with vists) | 62.00 | 71.30 |
| Desk Top Plan II | 89.10 | 102.35 |
| Dutil (for dBase II) | 65.00 | 74.75 |
| Graphmagic (bar graphs, pie charts, etc) | 59.00 | 67.85 |
| Mathemagic | 59.00 | 67.85 |
| Msort-80 (stand alone CP/M sort) | 125.00 | 143.75 |
| Multiplan (Microsofts superior spreadsheet) | 155.00 | 178.25 |
| Omnis (also for Ile) | 195.00 | 224.25 |
| PFS Filing system | 68.00 | 78.20 |
| PFS Graph | 68.00 | 78.20 |
| PFS Report | 53.00 | 60.95 |
| Quick Code (for dBase II) | 189.00 | 217.35 |
| Supersort (CP/M) | 99.00 | 113.85 |
| The General manager (ver 2.0) | 135.00 | 155.25 |
| The Last One (programme generator) | 185.00 | 212.75 |
| Versaform (form generator in Pascal) | 192.00 | 220.80 |
| Visicalc | 122.00 | 140.30 |
| Visi + (visicalc consolidation) | 19.45 | 22.37 |
| Visicalc utilities | 34.00 | 39.10 |
| Visidex | 135.00 | 155.25 |
| Visifile | 135.00 | 155.25 |
| Visiplot | 135.00 | 155.25 |
| Visitrend/plot | 155.00 | 178.25 |
| WORD PROCESSING | | |
| Applewriter Ile | 115.00 | 132.25 |
| Applewriter II | 83.00 | 97.75 |
| Executive Secretary | 149.00 | 171.35 |
| Executive Speller | 49.00 | 56.35 |
| Format 80 | 195.00 | 224.25 |
| List Handler (Mailer & Form Letter) | 69.00 | 79.35 |
| Pie Writer (40/80 columns) | 87.00 | 100.05 |
| Sensible Speller (new fast proof reader) | 69.00 | 79.35 |
| Sensible Speller (CP/M) | 69.00 | 79.35 |
| Screenwriter II (70 col w/out 80 col card) | 75.00 | 86.26 |
| Super Text 40/80 | 114.00 | 131.10 |
| Word Handler (does not req. 80 col. card) | 99.00 | 113.85 |
| Zardax (40/80 & inc form letter) | 139.00 | 159.85 |
| PRINTERS | | |
| Epson RX-80 (100 cps tractor feed) | 275.00 | 316.25 |

| | | |
|---|---------|---------|
| Epson FX-80 (160 cps & prop. spacing) | 399.00 | 458.85 |
| Epson MX100FT-3 (100 cps & wide carriage) | 449.00 | 516.35 |
| Mannesmann Tally MT120 L (160 cps) | 525.00 | 603.75 |
| Strobe Graphics Plotter | 545.00 | 626.75 |
| Nec 8023 (100 cps & prop. spacing) | 339.00 | 389.85 |
| TEC1500-25 (25 cps daisy wheel) | 599.00 | 688.85 |
| Tec Starwriter F10-40cps | 1099.00 | 1263.85 |

PRINTER INTERFACE CARDS

| | | |
|--|--------|--------|
| Aristocard Parallel | 69.00 | 79.35 |
| Aristocard Serial | 75.00 | 86.25 |
| Asynch Serial I/Face (7710A) | 119.00 | 136.85 |
| CPS Multifunction Card (inc real time clock) | 119.00 | 136.85 |
| Digitek Printmaster (BASIC/CPM/PASCAL) | 69.00 | 79.35 |
| Grappler + (Epson/Anadex/Cent/Nec) | 98.00 | 112.70 |
| IPB-16K (serial/parallel card & buffer) | 129.00 | 148.35 |
| MBP-16K (Epson 16K buffer) | 96.00 | 110.40 |
| Microbuffer | 95.00 | 109.25 |

80 COLUMN CARDS & ACCESSORIES

| | | |
|---|--------|--------|
| Softswitch (for Videx Videoterm) | 24.95 | 28.69 |
| U-Term (inc shift mod. & font editor) | 127.00 | 146.05 |
| Videx Enhancer II | 83.00 | 95.45 |
| Videx Inverse Eprom | 18.45 | 21.22 |
| Videx Utility Disc (inc font editor etc) | 27.00 | 31.05 |
| Videx Videoterm | 175.00 | 201.25 |
| Visicalc preboot disc (80 col with videx) | 32.00 | 36.80 |
| Vision-80 (incs softswitch & inverse) | 185.00 | 212.75 |

MONITORS/COLOUR CARDS

| | | |
|--|--------|--------|
| Digitek Colour Card (excellent colour on TV) | 95.00 | 109.25 |
| D.M.S. R.G.B. Colour Card | 88.00 | 92.00 |
| Kaga 12" Green Screen | 105.00 | 120.75 |
| Microvitec colour monitor | 275.00 | 316.25 |
| Microvitec colour card (use with above) | 35.00 | 40.25 |
| Zenith 12" Green screen (very good value) | 89.00 | 102.35 |

GRAPHIC UTILITIES & MUSIC

| | | |
|---|--------|--------|
| Arcade Machine (game designer) | 42.00 | 48.30 |
| Bit Stik (Robocom) | 245.00 | 281.75 |
| Complete Graphics System (Penguin) | 65.00 | 74.75 |
| Digitizer II | 189.00 | 217.35 |
| E-Z Draw 3.3 (excellent graphic utility) | 32.00 | 36.80 |
| Graforth (fast 3D utility plus music) | 46.00 | 52.90 |
| Graphics Magician (Penguin) | 39.00 | 44.85 |
| Graphic package Sublogic (detailed 3D pack) | 74.75 | 85.96 |
| Higher Text II (many diff fonts, sizes, cols) | 25.45 | 29.27 |

| | |
|--|--------|
| Pascal Animation | 41.00 |
| Pilot Animation tools | 41.00 |
| Special Effects (Penguin) | 27.00 |
| The Artist | 55.00 |
| Versawriter (graphic digitizer) | 179.00 |
| Versawriter expansion pac 1 | 25.00 |
| Zoom Grafix (similar to zoom on Bit Stick) | 23.95 |
| Audex | 18.95 |
| Electric Duet (creates 2 part music) | 21.00 |
| Forte (4 voices & 9 octaves) | 15.95 |
| S.A.M. (software automatic mouth) | 75.00 |
| Zapple Sound Effects & Music Board | 56.00 |

UTILITIES

| | |
|---|--------|
| Aplus (Applesoft structured Basic) | 18.95 |
| Appleguard (provides software protection) | 185.00 |
| Apple Mechanic (Beagle Brothers) | 25.00 |
| Assembly lang. Dev. (6502, Z80 or 8080) | 75.00 |
| Bag of Tricks | 24.95 |
| B.E.S.T. (Enhanced Software Tool) | 23.95 |
| Build Using (Provides 'print using' command) | 23.95 |
| Copy II Plus | 35.00 |
| Disc Doctor (CP/M disc recovery) | 89.00 |
| Disc Library (incl CP/M & Pascal) | 34.95 |
| DOS 3.3 Tool Kit | 41.00 |
| Dos Boss (modifies Dos Commands) | 15.00 |
| Edit Soft (powerful macro line editor) | 19.95 |
| Fast DOS | 19.45 |
| Global Program Line Editor (supports 80 col.) | 35.50 |
| Image Printer-Epson (flexible hi-res dump) | 32.00 |
| Lisa (Assembly lang. dev. system) | 57.00 |
| Lisa (Educational system) | 75.00 |
| List Master (inc. smart renumbering) | 23.95 |
| Locksmith 4.1 (bit copier for most discs) | 61.00 |
| Merlin Macro Assembler (editor & utilities) | 42.00 |
| Munch A Bug | 32.00 |
| Printographer (supports almost any printer) | 28.95 |
| Speed Star (compiles 1200 lines per min.) | 75.00 |
| Super Disc Copy III | 25.00 |
| Tasc Compiler (handles v. large programs) | 105.00 |
| The Bug (Assembly Language debugger) | 35.00 |
| The Inspector (disc snooper, needs 16K cd) | 35.00 |
| The Routine Machine (mach. lang. routines) | 45.00 |

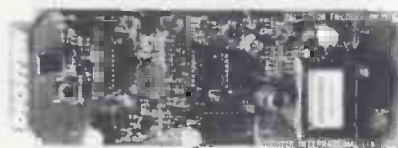

DIGITEK COLOURCARD

This amazing card gives high quality colour and includes a wide band modulator, simply plug in your TV or Pal monitor. £95.00 + VAT.



THE BIT STIK GRAPHICS SYSTEM

A large smooth tracking hemisphere with adjustable back pressure, and probably the most powerful Microcomputer graphics software available. £245 + VAT.

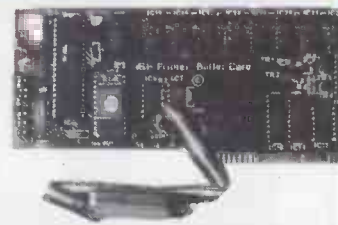

IPB-16K SERIAL/PARALLEL INTERFACE & BUFFER

Now you need only one interface to support both your daisywheel and matrix printers plus the benefits of buffer to speed things along. £129 + VAT.



STROBE GRAPHICS PLOTTER

Create superb hardcopy graphics directly from your Apple at a fraction of the cost of most other systems. A4 size or transparencies. £545.00 + VAT.



MICROVITEC 14" COLOUR MONITOR

Besides offering a crystal clear display in either text, hi-res. or low-res modes. It also includes the following features, 16 text colours, b/grd colours, 80 column card compatibility. A superb colour monitor for £275.00 + VAT.



12" KAGA MONITOR

Features 24 M/Hz bandwidth, giving clear display, and contained in a neat compatible case. Green screen £105 + VAT.

Home Computer - Starter Packs

THE BEST PRICE & ADVICE FOR THE BEGINNER

COMMODORE 64

● 64k RAM ● 16 colours

★ Commodore 64 – £343.85

1541 Disk Drive – £299.99

1525 Printer – £230.00

Cassette Unit C2N – £44.95

Floppy Disks (Box 10) – £27.50

Starter Pack 1 64k + Cassette + 10 x C12 – £389.00

Starter Pack 2 64k + Disk Drive + Printer + Disks + Paper – £899.00



VIC 20

SUPER STARTER PACK

VIC 20 + C2N Cassette + Intro to Basic + 4 Cassette Games (Blitz, Hoppit, Race, Strategic Advance).

Current RRP £249.99

SPECIAL PRICE - £139.95

1540 Disk Drive - £299.00, 1525 Printer - £230.00, Cassette Unit C2N -

£44.95, Also available - extra RAM, hi-res cartridge Joysticks, Paddles.

ALL PRICES INCLUDE VAT

BBC

BBC Model A - 16k – £299.00

BBC Model A - 32k – £349.00

BBC Model B – £399.00

Upgrade A to B – £95.00

Cassette – £29.95

Disk S/S 100k – £265.00

Disk Interface – £100.00

Dual Disk 800K – £829.00

Disk TEAC single – £199.00

Disk TEAC twin – £399.00

1.2k ROM – £11.50



Microvitec 14" Colour RGB TTL – £299.00

Also Available – BBC Econet system

SINCLAIR

ZX81 – £49.95



ZX Printer – £59.95 16k RAM – £29.95

ZX Spectrum 16k – £99.95

ZX Spectrum 48k – £129.95

Cassette – £29.95 Paper (5 rolls) – £11.95

HUGE SELECTION OF GAMES, CASSETTES, BOOKS FOR ALL MACHINES

ORIC1



● 8 Colours

● 40x28 or 240x200 display

● 96 User Graphics

● 6 Sound octaves

* ORIC 48K – £ 169.95 *

DRAGON

● 6809E Processor

● 32k RAM

● Advanced Graphics and Sound

● 9 Colours

● Professional Quality Keyboard

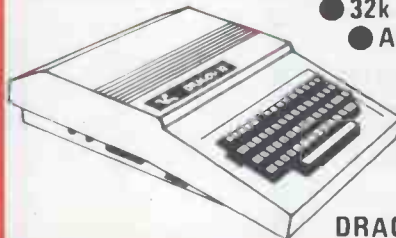

DRAGON 32k – £199.00

FULL RANGE OF PRINTERS, MONITORS, JOYSTICKS, PERIPHERALS & STATIONERY

ATARI

AM 400 – £159.00

AM 800 – £399.00

Cassette Deck – £49.95 Disk Drive – £299.00

Basic – £39.95 Thermal Printer – £199.00

Starter Pack 1

AM400 + Cassette + 10xC12 – £199.00

Starter Pack 2

AM400 + Cassette + Basic + 10xC12 – £239.00

EXPORT

SINGLE or QUANTITY EXPORT orders welcome. NO VAT. Experience of exports worldwide - full documentation.

TERMS. U.K. - Payment with Order.

Overseas - Cheque in sterling drawn on British Bank. Carriage.

Please check for carriage.



CASTLE ELECTRONICS

(0424) 437875

CASTLE ELECTRONICS Dept. PCW.
7 CASTLE STREET, HASTINGS, E.SUSSEX

Our Sister Company SOUTH EAST COMPUTERS, is No.1 in the South for Business Systems

LONDON COMPUTER CENTRE

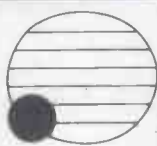

ACT Sirius 1

1.2 Mb Disk Storage £2395
2.4 Mb Disk Storage £2895

Now available
Z 80 CP/M Add-on board
to run all CP/M 8 bit or
16 bit software

NEW

**Sirius
Hard Disk 10 Mb
Available Now! £3995**

Wordstar Magic Wand Spellbinder
Spellstar D Base II T/Maker Calcstar
Milestone Datastar Microstar
Fortran Cobol Pascal or any CP/M
software

NEW



EPSON QX10

the revolutionary
small Business
Computer

CP/M 2.2
196K RAM
£1730

TELE-VIDEO SINGLE-USER TO MULTI-USER



CP/M Software

Wordstar £235
Spellstar £134
Grammatik £75
Foot Note £75
CPM/IBM £99
CPM/DEC £99
T Maker II £150
D Base II £325
Autocode £195
Milestone £195
Task £195

NEW

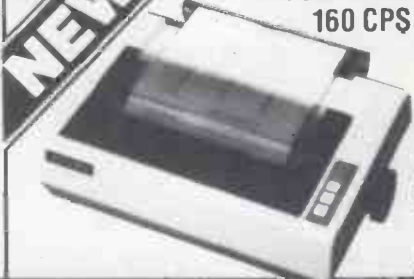

EPSON FX-80
160 CPS

EPSON HX20
the Portable
Computer from £402



NEW



Tele-Video
803
£1850

**AUTO SHEET
FEEDER £580**
New! 12" Wide
Automatic
Sheet Feeder
fits all below

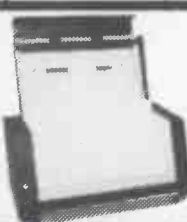

NEW

AUTHORISED TANDY DEALER
11 Mb Hard Disk model 11/16
runs CP/M & TRS DOS £1895

Model 16
128K
from £3129

Model II
with TRS DOS
and CPM at
no extra charge
from £1995

Model III
16K £599
48K £649
48K with 2 disk
drives £1395

**Osborne
£1350**

**DAISY WHEEL
PRINTERS
LETTER QUALITY
PRINTING.**



FLOWRITER RP 1600 CPS
£1500.

* **TEC 40.40 CPS**
JAPANESE DIABLO 630 uses Diablo
Daisy Wheel & Ribbons £1135.
CP 80 DOT MATRIX 80 CPS

Toshiba P1350

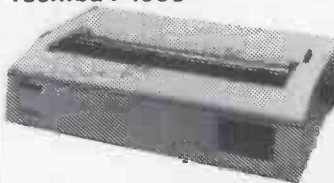

24 Pin Matrix offers High speed drafts 190 CPS
Letter Perfect Printing (Daisy Wheel Quality) 100 CPS
and addressable Pin graphics £1225.
Options: Tractor £87
Automatic Sheet Feeder £250

HARD DISKS for Superbrain,
TRS 80 Model II, Apple

Model 6 6 Mb Formatted £1595
Model 12 11.5 Mb Formatted £1895
* Specially designed Hybrid
heavy duty power supply
* Data Error Recovery



All prices are Exclusive of VAT and Delivery. Dealer Enquiries invited on all Products.
Large range of CPM Software available. Please phone for Prices.
Demonstrations on all models.

43 GRAFTON WAY, LONDON W1P 5LA (Opposite Maples)
OPENING HOURS: 11-7 MON-FRI 12-4 SAT Tel: 388 6991/2
24 hour answer phone: 01-388 5721

Adman
ELECTRONICS



**Add on
the Adman way**

The Vic 20 really can speak...but only if you use an **ADMAN SPEECH SYNTHESISER**. It's word power is endless as there is no set vocabulary. Yet operation is simple. The 64 elements of English speech are pre-programmed to let you put your own words together as soon as you switch on. Just imagine...program adventure games with characters that can actually talk!

Also for your Vic 20 there are 8K and 16K RAM PACKS and the **ADMAN 3 PORT EXPANSION MOTHERBOARD**. With proven designs of the highest quality they are the best value for money around.

**The Vic 20
speaks out!**

Available from Spectrum, Dixons and other major computer accessory shops

Prices around:

- 8k Ram Pack £39.95
- 16k Ram Pack £49.95
- Motherboard. £19.95
- Speech Synthesiser . . £49.95

To find out more about these products, why not take a lead from our speech synthesiser...go to your local dealer and ask for it! Or post the coupon.

Dept. C, Adman Electronics Ltd., Ripon Way,
Harrogate, N.Yorks, HG1 2AU. Tel. 0423 62642

Adman Electronics Ltd. is a member of the Adam Leisure Group PLC

Please send me information on Adman Vic 20 Accessories

Name _____

Address _____

PCW/7/83



helistar
SUPERBRAIN SOLUTIONS



Repairs • Maintenance • Software
Graphics • Printers • Disks

10MB WINCHESTER HARD DISKS

Software written in Z80 Assembler, COBOL and BASIC; CP/M operating systems modified; interfacing and software transfers carried out; hardware designed and modified.

HELISTAR SYSTEMS LTD

150 Weston Road, Aston Clinton,
Aylesbury, Bucks. HP22 5EP.
Telephone: Aylesbury (0296) 630364/631446

LONDON COMPUTER CENTRE

8/16 bit SOFTWARE

The comprehensive range includes

WORDSTAR £235
SUPERCALC £165

D BASE II £325
MAILMERGE £134

WORD PROCESSING £

- SpellBinder 290
- Magic Wand 226
- Spellstar 134
- Proofreader 60
- Grammatik 75

LANGUAGES £

- MBasic 195
- MBasic Compiler 215
- Fortran 80/86 325
- Cis Cobol/Forms2 399/105
- Pascal M 250
- Pascal MT+ /SSP 350

FINANCIAL PLANNING

- Calcstar 85
- Multiplan 165
- Plannercalc 75
- T/Maker III 175
- Microplan 200

ACCOUNTING

- SGS from 250
 - Peachtree from 325
 - Tabs from 199
 - Exact 500
 - Pulsar 395
- COMMUNICATIONS**
- Bstam 130
 - Crosstalk 135
 - Moveit 80/86 90/105

D BASE CORNER

- Autocode 195
- Quickcode 205
- D Base Window 150

UTILITIES

Sid £60, ZSid £70, Mac £70

FORMATS: Superbrain, Televideo, Sirius, Sanyo, Osborne Northstar, 8" SD, DEC, Epson QX-10, IBM

All prices are exclusive of VAT

Software



43 GRAFTON WAY, LONDON W1P 5LA (Opposite Maples)
OPENING HOURS: 11-7 MON-FRI 12-4 SAT Tel: 388 6991/2
24 hour answer phone: 01-388 5721

NEW SLIMLINE MITSUBISHI

Disc Drive double sided double density, 80 tracks in a specially designed case for the BBC Microcomputer complete with cables and utility disc (400K capacity).

Price £239 + VAT = £274.85

Switchable between 40 and 80 track

Price £249 + VAT = £286.85

PLEASE PHONE FOR FURTHER INFORMATION

Double sided/double density Double Tracks 5 1/4" Disk Drives

This is the latest addition to our range of disk drives. The capacity is 1 MEGA BYTES (unformatted) per drive, the track density is 96TPI. Track to track access time is 3 msec. These are compatible with Shugart SA460 (ANSI standard interface). Compatible with BBC COMPUTER, ATOM, NASCOM and lots of other computers.

One disk drive only £239 + VAT = £279.85
Two disk drives £469 + VAT = £539.35
Single boxed with power supply £274 + VAT = £315.10
Dual boxed with power supply £509 + VAT = £585.35
DS/DD 96TPI diskettes £3.95 + VAT = £4.54 each
Two drive cable £15 + VAT = £17.25

PROFESSIONAL MONITORS

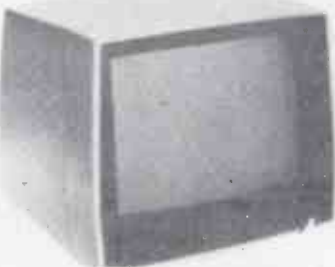

• **GREEN MONITOR** 12" green monitors with composite and sync input. Suitable for most computers.
Hitachi MM1216 £89 + VAT = £102.35
SM12H 18MHZ monitor £89 + VAT = £102.35
SM12N 15MHZ monitor £69 + VAT = £79.35

• **COLOUR MONITORS** 14" colour monitors, RGB or composite and sync input.
SCM14N Normal-res 400 dots £239 + VAT
SCM14M Medium-res 600 dots £339 + VAT
SCM14H High-res 800 dots £499 + VAT

KDS 7362 VDU

80 charac x 24 lines
25th status line, RS
232C/20mA current
loop interfaces,
128 displayable
characters, reverse
video, blink,
blank, underline,
half intensity,
detachable keyboard
with 101 keys.

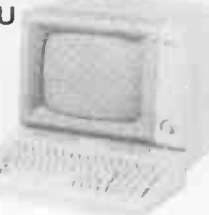

AS USED WITH ICL PERSONAL COMPUTER

Our Price..... £449 + VAT = £513.35

ATARI HOME COMPUTERS

ATARI 400 — £159
ATARI 800
£399
Prices include
VAT



BBC MICROCOMPUTER

OFFICIAL BBC DEALER

BBC Microcomputer Model B £348 + VAT = £399
Model B + Econet Interface £389 + VAT = £446
Model B + Disk Interface £409 + VAT = £469
Model B + Econet + Disk Interfaces £450 + VAT = £516
Single disk drive (100K) £230 + VAT = £264
Torch Dual Disc Drive (800K) with Z80 processor 64K of RAM and CPN operating system £779 + VAT = £895
Parallel printer cable £12 + VAT = £103
Games Paddles (per pair) £11 + VAT = £12.65
Second Processor Z80 £195 + VAT = £224.25

SOFTWARE FOR BBC COMPUTER

Desk Diary (Two programmes) £8.65 + VAT = £9.95
Algebraic manipulation package £8.65 + VAT = £9.95
BBC Peeko Computer £8.65 + VAT = £9.95
BBC FORTH language £14.50 + VAT = £16.67
BBC LISP language £14.50 + VAT = £16.67
BBC word processing package (view) £52 + VAT = £59.80
Printer Driver Cass £8.65 + VAT = £9.95



TEXAS INSTRUMENTS HOME COMPUTER SYSTEM

T199/4A 16 BIT MICROPROCESSOR
FREE CASSETTE LEAD SUPPLIED

FREE CASSETTE LEAD

T199/4A

£149.95 inc VAT

This microcomputer is based on TMS9900 16 bit microprocessor. It includes 16K RAM, 16 colour high resolution graphic (192x256). The screen display is 32 characters, 24 lines TI-BASIC. Full size keyboard. For Software there are about 1000 Programs to choose from. There are a lot of peripherals available e.g. Disk Drives, Disk Interface, Speech Synthesizer, Extra RAM, Additional Languages (PASCAL, TI-LOGO, ASSEMBLER). Prices: TI Home Computer £149.95; Peripheral Expansion System £149.95; Disk Controller Card £144.95; Disk Drive £199.95; Speech Synthesiser £41.95. All prices inclusive of VAT. Please send large SAE for full price list.

GUARANTEED LOWEST PRICES

We guarantee that our prices are the lowest on the market. If you can find any item advertised and in stock at less than our price we will match that price.

NEW EPSON TYPE 3 PRINTERS

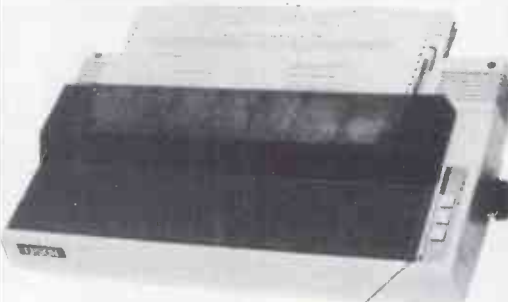

NEW FX 80 80 column, 160 CPS
£379 + VAT = £435.85

MX 100-3

136 columns, 100 CPS, all other features of MX80 plus true descenders, adjustable paper width up to 15 inches, friction or tractor feed, centronic parallel interface.

Price: £429 + VAT = £493.35

DRAGON 32

£169 + VAT = £194.35
INCLUDING A FREE CASS LEAD



This is a powerful new microcomputer specially designed for the family and small business use. It has 32K Bytes of Ram (expandable to 64K), 16K Byte Microsoft Colour Basic. High-res, colour graphic and very good sound features. It has full size professional keyboard and comes complete with power supply and a built-in centronic parallel printer interface. Send SAE for lists.

CASIO CALCULATORS

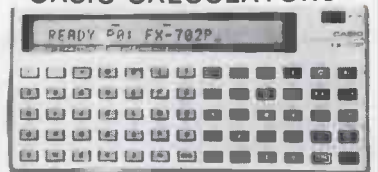

*FX-702P the casio pocket computer/calculator, basic programmer, 55 scientific functions, up to 1,680 program steps.

Special Price..... £61 + VAT = £69.95
*FX-602P programmable calculator 50 scientific function and 512 programme steps.

Price £46 + VAT = £52.90

*FA-2 cassette interface for FX-702 and FX-602.

Price £16 + VAT = £18.40

*FX-10 Mini printer for FX-702 and FX-602

Price £37 + VAT = £42.55

*PB-100 pocket computer with qwerty keyboard.

Price £39 + VAT = £44.85

*FX700 Scientific pocket computer

Price £47 + VAT = £54.05

SEIKOSHA GP SERIES GRAPHIC AND TEXT PRINTERS

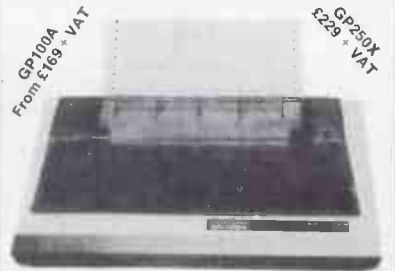

GP-100A 50CPS, 80 column Hi-res graphic line repeat function, adjustable up to 10" paper width, tractor feed, 5 x 7 dot matrix GP-100A centronic parallel interface, 50 CPS £189 + VAT = £217.35
GP100A 30 CPS £169 + VAT = £194.35

GP-250X New 50 CPS, 80 column tractor feed true descenders, 64 user defined characters, double height and/or double width characters, 5 x 7 dot matrix parallel and serial (RS232) interface

GP-250X £229 + VAT = £263.35

STAR DP PRINTERS

The most cost effective quality matrix printers to be launched this year. DP510 and DP515 features include friction and tractor feed and roll holders as standard. 100 CPS print speed bi-directional logic seeking 9 x 9 matrix gives true descenders. 2.3K buffer as standard. Hi-res bit image plus block graphics, sub and super script, italic printing, auto underlining, 2K user definable memory, vertical and horizontal tabulation, left and right margins set, skip over perforation, back space and self test.

Star DP510 10" carriage 80 columns
Price £279 + VAT = £320.85

Star DP515 15" carriage 136 columns
Price £379 + VAT = £435.85

FAST 100 CPS NEC 8023 PRINTER

NEC 8023BE-C



This is a high speed printer using bi-directional logic seeking operation, 7x9 matrix for alphanumeric, 8x8 for graphics and bit image printing. Programmable paper feed, original plus three copies, Greek characters and high resolution graphics. The print quality is exceptional, and the price is affordable.
Price £299 + VAT = £343.85

AKHTER INSTRUMENTS LTD.

DEPT CT, UNIT 19, ARLINGHYDE ESTATE, SOUTH ROAD, HARLOW, ESSEX, U.K. CM20 2BZ
PCW 7/83 TEL: HARLOW (0279) 412639 TELEX: 995801 — A18

ORDERING INFORMATION All orders which accompany a cheque or cash are CARRIAGE FREE (UK only) On all other orders a carriage charge of 3% of invoice total is applicable

OPENING HOURS: Mon-Fri 9am-5.30pm, Sat 10am-2pm

After bath. After shave.

After you with the Epson.

**Epson HX-20.
The most complete portable
computer you can lay your hands on.**

A complete portable computer with full size typewriter keyboard, LCD Virtual Screen, printer, microcassette facility and rechargeable power source all built-in.

Yet a precision machine so small, so lightweight, so portable - you can take it anywhere. To readily use it anywhere. The Epson HX-20.

The HX-20 is different. Because it is designed and built to be different.

And because it thinks bigger than the others.

Just take a look at the facts.

Uses full extended version of Microsoft BASIC with 16k RAM optionally expandable to 32k, and 32k ROM expandable to 64k, RS-232C and Serial interfaces.

The ASCII typewriter keyboard and five programmable keys offer no less than ten program functions.

A unique LCD screen that enables you to carry out word processing or data entry as if you were using a large screen.

24 column dot matrix impact micro-printer offering 42LPM for hard copies.

Runs on its own power for over 50 hours and can be easily recharged overnight or whilst in use - with the ability to retain information in memory even when switched off.

Simply add on a wide range of peripherals to include bar code readers and acoustic couplers for total capability.

Various software applications are available too.

You know the name. Epson quality is already world renowned for desktop computers and a superb range of quality printers. And now our new remarkable machine is raising more than just a few eyebrows wherever it's seen.

Clip the coupon opposite and we'll tell you the full story, or call us for the name of your local stockist, so you can experience the HX-20 first hand.

After everything else - it's got to be the most complete portable computer you are likely to lay your hands on.

Epson (UK) Limited, Freepost, Wembley, Middlesex HA9 6BR.
Sales Enquiries: Freefone 2730.
General Enquiries: 01-900 0466/01-900 0988 or 01-903 3722. Telex: 8814169.

EPSON Extraordinary product.
Exceptional quality.

I would like to see a demonstration of the HX-20 Portable Computer.

Please send me further details.

Name _____

Company _____

Address _____

Telephone _____

SOLVE THE “WHICH MICROCOMPUTER TO BUY” PUZZLE IN SIX EASY MOVES

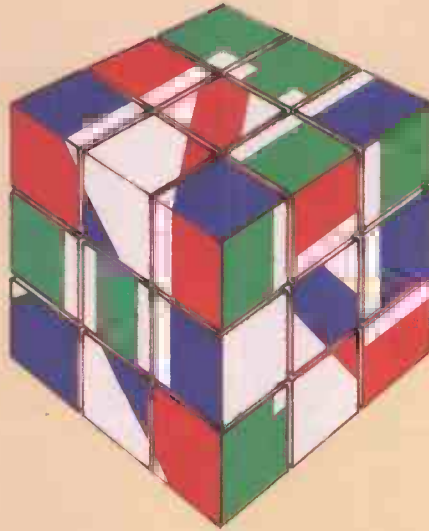

1. 16 BIT MICROPROCESSOR
2. 128K RAM
3. DUAL FLOPPY DISKS
4. 12 INCH MONOCHROME VDU
5. MSDOS OPERATING SYSTEM
6. APPROXIMATELY £1400 (EX. VAT)

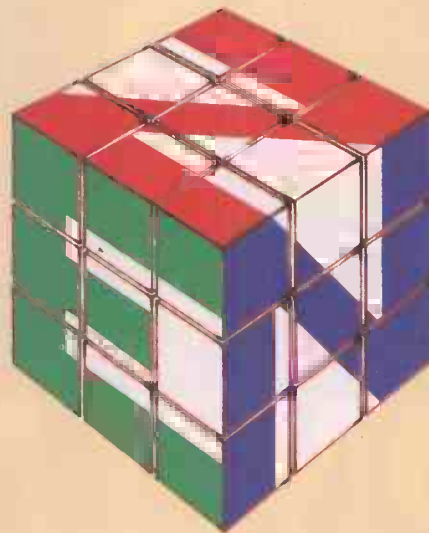

ZEN MICROCOMPUTERS LTD.

Please write for further details to:
ZEN MICROCOMPUTERS LTD, 5 ENGAINE, ORTON, LONGUEVILLE, PETERBOROUGH PE2 0QA

Name

Company

Address

Tel:

THE
MIRACLE

IS

COMING



PORTICO TE

It's the micro you've been waiting for.

A computer that's equally at home as a big-screen portable or as a compact, stylish desk-top business machine.

With the power you are looking for, at a price that's a breakthrough in value.

Incorporating all the latest developments to give it the specifications you want.

And a performance way ahead of the crowd.

Because every Miracle comes with more than a thousand pound's worth of integrated software – word-processing, data management, financial planning, communications – all the software you need, in fact, to use the Miracle as a complete business system without spending another penny.

So if you're in the process of buying a micro, a word of advice.

Wait for the Miracle to happen.

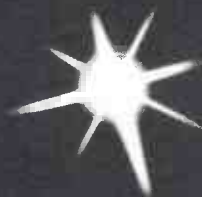

It won't be long.

And it'll be well worth the wait.

TECHNOLOGY LTD.



If you want to know which computer to buy, ask your expert.

You knew it would happen some day. Some day, your child would become smarter than you.

What you didn't expect was that it would happen so soon. To you, computers are a mystery from the future.

But to your children, they are a real source of excitement. And they're happening now.

THE FIRST FAMILY COMPUTER.

So what will this young expert say when you ask which computer to buy? First, make sure that you have sufficient power for your needs. That your computer is easy to learn, and easy to use. And that it has a challenging, entertaining and expanding range of software.

The Dragon 32 is the first computer specifically designed for the family. And as such, we feel that it meets even our young expert's stringent criteria.

The Dragon offers a truly massive 32K RAM memory - harnessed by the advanced 6809E microprocessor. This is quite simply more than you're ever likely to need - but it does mean that your computer's capabilities can respond to

your increasing ability as you learn your way around.

And how quickly you'll learn. The Dragon's easy-to-follow instruction manual helps. But what will really get you going is the fact that you'll be enjoying every minute.

And when it comes to ease of use, the Dragon's professional-quality keyboard makes your computer as familiar as a typewriter.

SOFTWARE TO MATCH.

Dragon software offers a great range of games - but that's not all. You'll find educational programs. Programs to help you plan your money. Even programs which teach you how to program.

And whether you're playing or working, you'll be

learning more and more about this increasingly important new technology.

The Dragon 32 costs just £175.00*. For that, you get all the features that your child could ask for - which means just one thing. It's a very grown-up computer indeed.

SPECIFICATIONS

6809E MICROPROCESSOR. The most powerful eight bit processor available.

32K RAM (as standard). At least twice the memory of most similarly priced machines.

EXTENDED MICROSOFT COLOR BASIC (as standard). Featuring: ADVANCED GRAPHICS (set, line, circle, paint, print, draw, rotate and print using). ADVANCED SOUND 5 octaves, 255 tones. AUTOMATIC CASSETTE RECORDER CONTROL. FULL EDITING with INSERT and DELETE.

PRINTERPORT (Centronics parallel).

9 COLOUR, 5 RESOLUTION DISPLAY.

USE WITH ANY U.H.F. TV and/or separate P.A.L. monitor.

PROFESSIONAL QUALITY KEYBOARD. Typewriter feel. Guaranteed for 20 million depressions.

JOYSTICK CONTROL PORTS.

*TV not included in price.



DRAGON 32
The first family computer.

SEARCH NO FURTHER FOR XITAN COVERS THE

NATIONWIDE DISTRIBUTION

Xitan Systems Ltd. are long-established software distributors, maintaining close links with the principal U.S. software houses and supplying a nationwide network of approved dealers: whatever your software requirements, particularly in the professional sector, it makes sense to talk to a Xitan dealer.

SCOTLAND

GRANITE CHIPS
21 Bon Accord Street
ABERDEEN AB1 2EA
Tel: 0224 22520

BYTESHOP (GLASGOW) LTD
266 Vincent Street
GLASGOW G2
Tel: 041 221 8202

IRELAND

O. & M SYSTEMS
95 Dublin Road
BELFAST
Northern Ireland
Tel: 0232 249440

NORTHERN ENGLAND

WESTERN COMPUTERS LTD
Blackpool Airport
BLACKPOOL, Lancs
Tel: 0253 404676

ENTERPRISE SOFTWARE PRODUCTS LTD
40 West Street
CREWE, Cheshire
Tel: 0270 215984

REAL-TIME COMPUTER SYSTEMS LTD
28-32 Mill Street
CREWE, Cheshire CW2 7AN
Tel: 0270 256142

HOLDENE

Bray House
Leicester Place
LEEDS

Tel: 0532 45945
COMPUTER GRAPHICS WORKSHOP

38 Ullet Road
LIVERPOOL 17

Tel: 051 733 9604
KBS COMPUTER SERVICES

State Insurance Bldg.
14 Dale Street
LIVERPOOL L2 4TH

Tel: 051 236 8333
BYTESHOP (MANCHESTER) LTD

11 Gateway House
Piccadilly Station Approach
MANCHESTER

Tel: 061 236 4737
NSC COMPUTERS LTD
29 Hanging Ditch
MANCHESTER MA 3ES

Tel: 061 832 2269

MICROFACTOR COMPUTER SYSTEMS LTD

61 Bridge Street
MANCHESTER M3 3BQ
Tel: 061 832 2685

COMPENTIAL

118 St Anne's Road
Prestwich
MANCHESTER M25 8GJ
Tel: 061 773 8243

DATRON MICRO CENTRES

2 Abbeydale Road
SHEFFIELD
W. Yorkshire S7 4FD

Tel: 0742 585490

THOMSON COMPUTER SERVICES

56 Micklegate
YORK
N. Yorks YO1 1LF
Tel: 0904 35833

MIDLANDS

BYTESHOP (BIRMINGHAM) LTD

94/96 Hurst Street
BIRMINGHAM
West Midlands B5 4TD
Tel: 021 622 7149

CAMBRIDGE COMPUTER STORE

1 Emmanuel Street
CAMBRIDGE CB2 1NE
Tel: 0223 65334

HERALD COMPUTERS LTD

93 East Road
CAMBRIDGE
Tel: 0233 215862

BYTESHOP (NOTTINGHAM) LTD

92A Upper Parliament Street
NOTTINGHAM
Notts NG1 6LF
Tel: 0602 40576

PLUME COMPUTER SERVICES LTD

11 Newark Street
LEICESTER LE1 5SS
Tel: 0533 559711

LONDON & THE SOUTH

DATAVIEW SYSTEMS LTD

Portejees House
East Bay, COLCHESTER
Essex CO1 2XB
Tel: 0206 265835

SYSTEMATIC BUSINESS COMPUTERS LIMITED

45 Woodbridge Road
GUILDFORD
Surrey GU1 4RN
Tel: 0483 572222

VAUNTERRY LTD.

9 Wych Lane
Bridgemaury, GOSPORT
Hants. PO13 0SU
Tel: 0329 235846/7

BASYS LTD.

191-195 Shenley Road
BOREHAMWOOD
Herts. WD6 1AW
Tel: 01 953 7303

TELESYSTEMS

P O Box 12
GREAT MISSENDEN
Bucks HP16 9DD
Tel: 02406 5314

MICROTEK

15 Lower Brook Street
IPSWICH, Suffolk
Tel: 0473 50125

ALBION COMPUTER CO. LTD

79-83 Great Portland Street
LONDON W1
Tel: 01 580 9611

BYTESHOP (LONDON) LTD.

324 Euston Road
LONDON NW1 3BG
Tel: 01 387 0505

HOTEL MICROSYSTEMS LTD

69 Loudoun Road
LONDON NW8 0DQ
Tel: 01 328 8737

JAROGATE LTD

197-213 Lyham Road
Brixton
LONDON SW2
Tel: 01 671 6321

OEM LTD.

1 Lochaline Street
LONDON W6 9SJ
Tel: 01 748 8404

SMALL TURNKEY SYSTEMS

31 Parolles Road
Upper Holloway
LONDON N19 3RE
Tel: 01 272 3530

TOUCHSTONE COMPUTERS LTD.

319 City Road
LONDON EC1V 1LJ
Tel: 01 278 5708

4C's LTD

P O Box 24, 1 Avondale
MAIDENHEAD
Berks SL6 6SE

Tel: 0628 34562

ROUNDHILL COMPUTER SYSTEMS LTD

Axholme, London Road
MARLBOROUGH, Wiltshire
Tel: 0672 54675

XITAN SYSTEMS LTD

23 Cumberland Place
SOUTHAMPTON
Hants SO1 2BB

Tel: 0703 334711

LUX COMPUTER SERVICES

Colonial Way
WATFORD
Herts WD2 4AT

Tel: 0923 47367

SERVICE AND EXPERTISE

Every Xitan dealer is backed by Xitan's service and expertise, so that you can buy with confidence.

Established dealers interested in becoming registered Xitan Software Dealers are invited to write or phone for full details.

N.B. Although most products are available off the shelf, not all dealers carry the complete range, and some may specialize in turnkey systems rather than retailing individual products. Also, some dealers may carry other software not supplied by Xitan.

While every effort has been made to ensure the accuracy of the information provided, Xitan are unable to accept any responsibility for errors.

SOFTWARE COUNTRY

| | | CP/M-80 | CP/M-86 | PC-DOS |
|---|------------------|---------|---------|--------|
| Word Processing | | | | |
| WORDSTAR | MicroPro | □ | ● | ** |
| MAILMERGE | MicroPro | □ | ● | ** |
| SPELLSTAR | MicroPro | □ | ● | ** |
| EASYWRITER II | IUS | | | ** |
| EASYSPELLER II | IUS | | | ** |
| Data Bases And File Management Systems | | | | |
| DASTAR | MicroPro | □ | | |
| DBASE II | Ashton-Tate | □ | ● | ** |
| EASYFILER | IUS | | | ** |
| FMS-80, 81, 82 | DJR Assoc | □ | | |
| INFOSTAR | MicroPro | □ | | |
| PERSONAL PEARL | Pearl Software | □ | | |
| REPORTSTAR | MicroPro | □ | | |
| RESCUE | MBS | □ | | |
| Business Systems, Financial Planning, Accounting | | | | |
| CALCSTAR | MicroPro | □ | | |
| EASY PLANNER | IUS | | | * |
| MULTIPLAN | MicroSoft | □ | | |
| SAPPHIRE MARS | Sapphire Systems | □ | ● | |
| SUPERCALC | Sorcim | □ | ● | * |
| MILESTONE | Organic Software | □ | ● | |
| GBS (General Business System) | ByteSoft | □ | | |
| ISL (Integrated Stock & Ledger) | ByteSoft | □ | | |
| Statistics | | | | |
| MICROSTAT | Ecosoft | □ | | * |
| Training Packages | | | | |
| HANDS-ON CP/M | MicroCal | □ | ● | |
| HANDS-ON COBOL | MicroCal | □ | ● | |
| WP WORKSHOP | MAC | □ | | |
| FLIGHT SIMULATOR | MicroSoft | | | * |
| Languages | | | | |
| BASIC COMPILER | MicroSoft | □ | | |
| BASIC INTERPRETER | MicroSoft | □ | | |
| BAZIC | MicroMikes | □ | | |
| CBASIC | Digital Research | □ | ● | |
| CBASIC COMPILER | Digital Research | □ | ● | |
| CIS COBOL | MicroFocus | □ | ● | |
| COBOL | MicroSoft | □ | | |
| FORTRAN | MicroSoft | □ | | |
| LEVEL II COBOL | MicroFocus | □ | ● | |
| MULISP/MUSTAR | MicroSoft | □ | | |
| MUMATH/MUSIMP | MicroSoft | □ | | |
| PASCAL/MT | Digital Research | □ | ● | |
| PASCAL/MT & SPP | Digital Research | □ | ● | |
| PL/1 | Digital Research | □ | ● | |
| XBASIC | Xitan | □ | | |

| | | CP/M-80 | CP/M-86 | PC-DOS |
|---|------------------|---------|---------|--------|
| Programming Tools (inc. Cross Assemblers) | | | | |
| ACCESS MANAGER | Digital Research | □ | | |
| ANIMATOR | MicroFocus | □ | ● | |
| EDIT | MicroSoft | □ | | |
| BT-80 | Digital Research | □ | | |
| DISPLAY MANAGER | Digital Research | □ | | |
| FORMS 2 | MicroFocus | □ | ● | |
| LINK-80, PL1L1B | Digital Research | □ | | |
| MAC | Digital Research | □ | | |
| MACRO | MicroSoft | □ | | |
| RMAC, LINK & XREF | Digital Research | □ | | |
| SID | Digital Research | □ | ● | |
| SPP | Digital Research | □ | ● | |
| WORDMASTER | MicroPro | □ | ● | |
| XASM18 (1802) | Avocet | □ | | |
| XASMF8 (F8/3870) | Avocet | □ | | |
| XASM65 (6502) | Avocet | □ | | |
| XASM68 (6800/01) | Avocet | □ | | |
| XASM48 (8048/8041) | Avocet | □ | | |
| XLT86 | Digital Research | □ | | |
| ZSID | Digital Research | □ | | |
| Operating Systems | | | | |
| CP/M | Digital Research | □ | ● | |
| CP/M PLUS | Digital Research | □ | | |
| CP/NET & CP/NOS | Digital Research | □ | | |
| MP/M II | Digital Research | □ | ● | |
| CONCURRENT CPM-86 (IBM PC) | Digital Research | □ | ● | |
| Utilities | | | | |
| COPYALL | MicroMikes | □ | | |
| DESPOOL | Digital Research | □ | | |
| FILESHARE | MicroFocus | □ | | |
| FILESTAR | MicroSec | □ | | |
| MUCOPY | Wheatcroft Hards | □ | | |
| SORT | MicroSoft | □ | | |
| SUPERSORT | MicroPro | □ | | |
| SUPERVYZ | Epic | □ | | |
| SDISK (Silicon Disk) | Xitan | □ | | |
| Communications | | | | |
| BSTAM | Byrom Software | □ | ● | * |
| BSTMS | Byrom Software | □ | | |
| Graphics | | | | |
| GSX | Digital Research | □ | ● | |
| GSS- Kernel | Digital Research | □ | | |
| GSS- Plot | Digital Research | □ | | |
| GSS- 4010 | Digital Research | □ | | |
| WATCH THIS SPACE | | | | |
| Xitan Systems Ltd. are continually adding new software to their range: check the listing every month to keep up with exciting new developments. | | | | |



LARGE RANGE

Xitan are main U.K. distributors for Digital Research Inc., MicroPro Inc., Microsoft, Ashton-Tate, Sorcim and IUS, and suppliers of a large range of software from other leading software houses such as Byrom and Ecosoft. Most software can be supplied in a comprehensive range of formats.

Looking After our Dealers - so You Know Where to Look

OKI rules, OK!

Quality, reliability and unbeatable price performance are the hallmarks of the Oki Microline family. The only truly complete range of low-cost printers.

Exciting recent additions to the family are the Microline 92 and Microline 93 (80 and 132 column respectively). These feature NLQ print, 160 cps print speed and high resolution graphics.

With these additions the family covers the broadest possible range of capabilities. From the small but very efficient 80-column, 80 cps Microline 80, to the top-of-the-range

Microline 84. This sophisticated and professional machine offers speeds up to 200 cps, NLQ print and pin-addressable graphics.

All Microlines are made to Oki's exacting quality specifications, and all are backed by X-Data's high-level technical support capability.

Whatever your print needs, there will be an Oki printer to fit your bill. And at astonishingly low cost.



X-DATA

The authorised OKI distributor

For more information telephone Slough (0753) 72331

X-Data Limited, 750-751 Deal Avenue, Slough Trading Estate, Slough, Berks. SL1 4SH.

NOMINATIONS FOR BEST PRINTER AWARDS 1983

Best Star — STAR DP510/DP515 Matrix Printers

available for around **£289 and £399 ex VAT**

- ★ 80 Column (DP510), 136 Column (DP515)
- ★ 100 CPS, Bi-Directional Logic Seeking
- ★ Friction, Tractor and Roll Holder as standard
- ★ Full standard features including 2.3k Buffer

Best Performer — JUKI 6100 Daisywheel

available for around **£399 ex VAT**

- ★ 18CPS — Bi-Directional Logic Seeking
- ★ 10, 12, 15 CPI + Proportional Spacing
- ★ "Drop in" Daisywheel — Triumph Adler Compatible
- ★ Supports all Wordstar features
- ★ Diablo protocols — IBM Selectric ribbon
- ★ 2k Buffer as standard — 100 character Daisywheel

Best Newcomer — SHINWA - CTI CP80 Matrix Printer

available for around **£289 ex VAT**

- ★ 80 CPS — Bi-Directional Logic Seeking 80 Column
- ★ Friction and Adjustable Tractor Feed
- ★ Patented Square Needles up to 9 x 13 matrix
- ★ Hi-Res Graphics and Block Graphics

Best Producer — HERMES 612 WPQ Printer

available from around **£1950 ex VAT**

- ★ Up to 400CPS and Word Processing Quality at 120 CPS
- ★ 10, 12 or 15 CPI — programmable to 1/360" spacing
- ★ 132 column at 10 CPI

All now on general release — see them at your local dealer

Best Distributor:-

Micro Peripherals Ltd

69 The Street, Basing, Basingstoke, Hants. RG24 0BY
TEL: (0256) 3232 (12 lines) TELEX: 859669 MICROP G

ONE YEAR GUARANTEE

ONE YEAR GUARANTEE

ONE YEAR GUARANTEE

ONE YEAR GUARANTEE



star

★ NOW ON RELEASE ★



JUKI

★ NOW ON RELEASE ★



SHINWA - CTI

★ NOW ON RELEASE ★

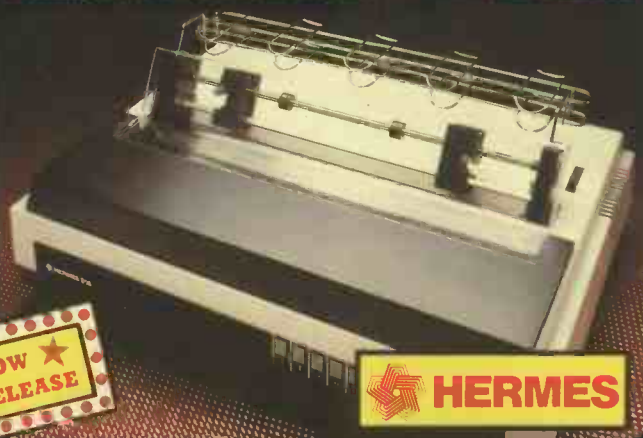

HERMES

★ NOW ON RELEASE ★

Please send technical details, printout samples and local dealer details to:-

Name: Position

Company:

Address:

DEMYSTIFY DISC COPYING

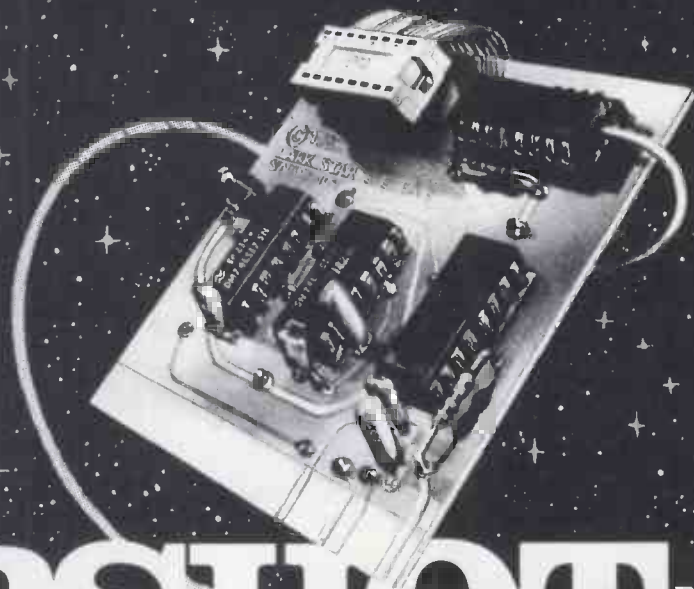

«SNAPSHOT» TWO

The Ultimate Unlock System

The disc copy card with all the great features of SNAPSHOT, plus:

WIDER COMPATIBILITY: Works with virtually any 16K card

EASIER TO USE: Just press the trigger on the attached extension cable. Never open your Apple's cover. Simple 1-2-3 copy procedure. Copies most programs in 30 seconds.

PEELINGS 11 magazine (Feb 1983) compares SNAPSHOT with Wild Card and Crack-Shot:

"Overall, with one of the supported RAM cards, SNAPSHOT is the best buy."

"The copy procedure is perhaps the easiest and clearest of the three cards."

SNAPSHOT will copy any memory-resident program that runs on the 48K Apple. SNAPSHOT uses your 16K RAM card* to interrupt a running program and dump the entire contents of 48K and registers to an unprotected backup disc. SNAPSHOT backs up programs that baffle nibble copiers like Locksmith without any complex parameter changes or trial-and-error hassle. And SNAPSHOT is still more effective, less expensive and easier to use than its imitators.

- ★ You have full, normal use of other hardware and software.
- ★ Ideal for debugging or analyzing programs.
- ★ Freeze-frame your game! Print the graphics on your printer and resume play.

- ★ Shooting down space invaders and the phone rings? Interrupt your game until later, or tomorrow. Save your high scores!
- ★ Repeatedly interrupt and resume running programs.
- ★ Faster and easier to use than nibble copiers or other copy cards.
- ★ Full monitor capabilities to examine, modify, trace, single-step or disassemble any interrupted program.
- ★ Suspend work with one program while you use another (for instance, interrupt word-processing a letter to look up an address in a database, then resume the letter exactly where you left off).
- ★ Move protected programs to hard disc or 8" disk; copy several programs onto the same disk.
- ★ List "unlistable" Basic programs; make custom modifications. Backups run without SNAPSHOT present; most run without 16K card.

And there's more! Write or ring for complete technical information.

PRICE: £95.00* from your local dealer or Dark Star Systems

Terms: Payment with order. Add 19% VAT. P&P included. VISA/ BARCLAYCARD and Am Ex accepted. Dealer enquiries invited. Foreign: No VAT. Add £2 postage to Europe, £7.00 elsewhere.

* Apple II or II+ or Franklin, one drive and Language Card/16K required. Works with most popular cards, including Apple, Microsoft, Computer Stop, Merton, Ramex, Digitex, MPC, RH Electronics, Orange, Franklin, etc. Other brands: specify when ordering. Graphics dump requires graphics interface card and printer. Version for Apple II E available soon. ENQUIRE NOW!



DARK STAR SYSTEMS

78 Robin Hood Way,
Greenford, Middlesex. UB6 7QNW
Telephone: 01-900 0104

If your software's not on the menu, they won't be ordering it.



How would you like to sell your programs to thousands of genuine, enthusiastic and committed users?

If you're a professional supplier, how would you like to get rid of all those merchandising headaches on your general and games software?

And how would you like to do all this from just one cassette?

Micronet 800 makes all this possible.

When this huge database for microcomputers was launched just a few months ago, it attracted thousands of enquiries from educational, business and home users. Users who could see the huge new vistas opened up by linking them with Micronet 800...an 'Aladdin's Cave' of hundreds of programs which can be downloaded to machines like the BBC Micro, ZX Spectrum, ZX81, Apple II, Tandy TRS80, and PET...hundreds of thousands of pages of news, reviews, product data and prices from the computer world and from *Prestel*...and an electronic mailbox for exchanging messages and ideas with other users right across the country.

All this for around a modest 15p a day. Subscribers are linked by telephone through a modem...making it the fastest and most direct means of selling your software downline to genuine and serious buyers.

Right now, Micronet 800 is looking for further general and games software to add to its enormous library. This is an opportunity which authors and suppliers, professionals and hobbyists, simply can't afford to ignore.

Get on-line today and find out what you stand to gain from Micronet 800.

Phone Robin Wilkinson, Software Manager on Peterborough (0733) 237111, or send your disk or cassette together with the coupon to Micronet 800 to the address below.*

micronet
800

Micronet 800
Bushfield House
Orton Centre
Peterborough PE2 0UW

| |
|---|
| Name _____ |
| Address _____ |
| _____ |
| _____ Tel: _____ |
| Name of Program _____ |
| Type of Program _____ Type of Micro _____ |
| <input type="checkbox"/> Please tick box if you are interested in becoming a Micronet 800 subscriber. |

PCW/7/83

*We cannot return cassettes or disks unless a stamped addressed envelope is enclosed.

How to make work like a

First, neatly cut out the "370" label.

Now, when nobody's looking, nonchalantly tape it to your terminal, just under the "IBM," as if it really belonged there.

Then wait for your chance and quickly slip a dBASE II™ disk into your main drive.

That's it.

Your IBM Personal Computer is now ready to run a relational database system, the kind that IBM has

on their mainframes. And you're ready with more data handling power than you would have dreamt possible before dBASE II.

You'll wonder how you managed without it.

You'll find that dBASE II, because it's a relational database management system (DBMS), starts where file handling programs leave off. dBASE II handles multiple databases and simplifies everything from accounting to department staffing to monitoring rainfall on the Upper Volta.

With a word or two, you CREATE databases, APPEND new data instantly, UPDATE, MODIFY, and REPLACE fields, records and entire databases. Organize months worth of data in minutes with the built-in REPORT. Do subfield and multi-field searches, then DISPLAY some or all of the data for any condition you want to apply.

And you've just begun to tap the power of dBASE II.

Easy to look at, easy to use.

Input screens and output forms couldn't be easier — just "paint" your format on the screen

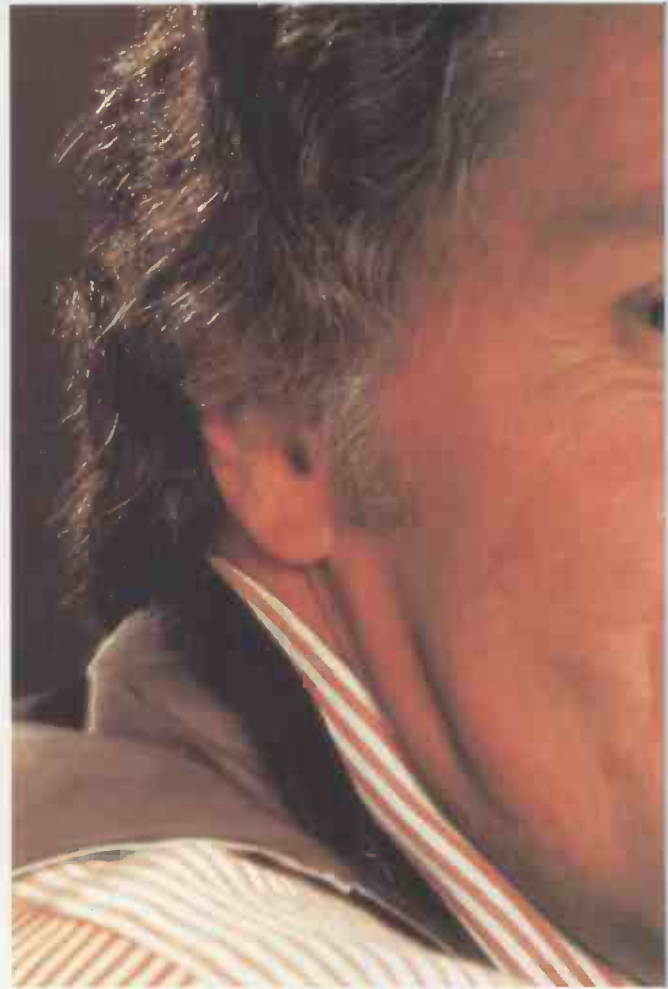

and what you see is what you'll get.

You can do automatic calculations on fields, records and databases, accurate to 10 digits.

And you can use dBASE II interactively for answers right now. Or save your instructions, then repeat everything with two words: DO Manhours, DO Project X, DO whatever has to be done.

Use dBASE II to help make your choice:

Instead of just poring over a manual, you can check out dBASE II by running it on your own system free for 30 days.

e your micro mainframe.



Visit your dealer and run through a hands-on demonstration. Then buy a package and use it on your IBM PC, Sirius or CP/M computer. If you don't like it, return it and you'll get your money back, no questions asked.

But if you do that, you'll have to remove that label. Because nothing short of a mainframe works like dBASE II.

For the name of your nearest dealer, contact one of our distributors: Encotel Systems 01-686 9687. Ferrari Software 01-751 5791. Interam 01-675 5325. Pete & Pam (0706) 227011. Software Ltd 01-387 8832.

Soft Option (0476) 86017. Tamsys Windsor 56747. Xitan Systems (0703) 334711. ACT (Pulsar) 021-454 8585. Druvic International 01-226 8809.

Ashton-Tate

dBASE™



©1983 Ashton-Tate
dBASE II is a registered trademark of Ashton-Tate
CP/M is a registered trademark of Digital Research

MIKRON

NORTH LONDON'S LEADING
COMPUTER STORE OFFER YOU
AN UNBEATABLE OFFER!

COMPUTERS

| | |
|-----------------------|--------|
| BBC A | 299.00 |
| BBC B | 399.00 |
| DRAGON 32 | 199.00 |
| COLOUR GENIE | 199.00 |
| COMMODORE 64 | 345.00 |
| MICRO PROFESSOR | 269.00 |
| ATARI 400 | 160.00 |

PRINTERS

| | |
|--------------------|--------|
| OKI 80 A | 229.00 |
| SEIKOSHA | 220.00 |
| STAR DP 8480 | 243.00 |
| STAR DP 8240 | 251.00 |

MONITORS

| | |
|------------------------|--------|
| KAGA 12" GREEN | 129.95 |
| SANYO COLOUR | 269.00 |
| PHEONIX | 99.00 |
| PRINCE 12" GREEN | 99.00 |

SOFTWARE

| | |
|-----------------|-------|
| BBC | _____ |
| ORIC | _____ |
| ATARI | _____ |
| DRAGON | _____ |
| GENIE | _____ |
| RABBIT | _____ |
| MICRODEAL | _____ |

PHONE
FOR PRICES

ORIC-1



JUST £169.00

INC VAT WITH 2 FREE GAMES

BOOKS

OVER 300 TITLES TO
CHOOSE FROM FOR
BEGINNER TO EXPERT

MAIL ORDER:



FOR COMPUTERS,
PRINTERS & MONITORS
ADD £1.00 p+p

PRINTER & VIDEO LEADS

| | |
|----------------------|-------|
| BBC | 14.50 |
| ORIC | 14.50 |
| DRAGON | 14.80 |
| APPLE 2 | 18.95 |
| SIRIUS | 18.95 |
| VICTOR | 18.95 |
| IBM PC | 18.95 |
| 25 WAY D-25 | 18.95 |
| 36 WAY CENT-36 | 18.95 |
| ZAPPLER PARR | 14.25 |
| ZAPPLER SERIAL | 14.50 |
| RS 232 C | 15.95 |
| 380 Z SERIAL | 14.50 |
| 480 Z SERIAL | 11.25 |
| BBC RGB VIDEO | 10.35 |
| PHONO PHONO | 2.95 |
| BNC PHONO | 3.95 |
| BNC-BNC | 4.95 |
| DIN-PHONO | 3.50 |
| HX.20 LEAD | 11.25 |

PRICES INCLUDE VAT
+ CARRIAGE

MIKRON

11 WESTERN PARADE
BARNET, HERTS
01-449 3476

DATEX DX3 Computer Cassette Recorder

AVAILABLE TO TRADE ONLY

- 1) Record Button (REC)
- 2) Play Button (▶)
- 3) Fast Forward Button (▶▶)
- 4) Rewind Button (◀◀)
- 5) Stop/Eject Button
- 6) Carrying Handle
- 7) Cassette Cover
- 8) Mains Socket (240v AC ~50Hz)
- 9) Battery Compartment
- 10) Earphone Jack (EAR)
- 11) Remote Control Microphone Jack
- 12) Auxillary Microphone Jack
- 13) Volume Control
- 14) Condenser Microphone
- 15) Record LED Indicator
- 16) Tape Counter
- 17) Din Jack

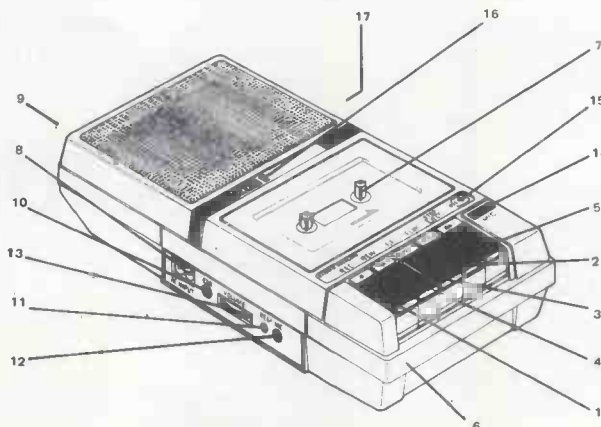

WE
OFFER THE
BEST
TRADE
PRICES

EEC DISTRIBUTION
SERVICES LTD.
14, WESTERN PARADE,
BARNET, HERTS.
EN5 1AD.
TEL: 01 441 1590/1722
TELEX: 295749 EEC05

★ **PRINTER & CASSETTE LEADS ALSO SUPPLIED**

G. W. COMPUTERS LTD

TEL: 01-636 8210

LONDON'S WEST END - NATIONWIDE OVERNITE SERVICE
 MORE PRODUCT RANGES
 PROBABLY THE WIDEST SELECTION OF NETWORKS...MICROS...
 AND PRINTERS ON DISPLAY

WE OFFER ONE OF THE BEST 'SYSTEM DEALS' IN THE UK (Save £1500.00+)
****** THE NEW DBMS III.7 (series III of the world's first 'task-robot-programs') ******
****** FEATURES ******

14 files multi-user accessible
 1400 character record sizes
 mathematical scratchpad
 record relational indexes
 translateable to any language
 User-definable reporting
 field protection/classification
 either-or, same as, greater, smaller
 sorts 'alpha or numeric' any window

12 online file architectures
 240 fields using cross-referencing
 cross-record calculations
 'Jump-to' any record in 12 files
 User-definable files/field words/sizes
 32000 records per filename
 20 main/200 sub fields per record
 field and record related formulae
 'Jump-to' any of 32000 records per file

random/binary/key/multiple field search
 'if-then' questioning
 file protection/password entry
 range match, not match, integer match
 sort speed 500 records per 20 seconds
 endless 'either-or' matching
 formulate/recall on selection criteria
 13 interrogation question types
 short filing output/audit trails
 Word-star & Mbasic compatible

DBMS III.7 new switch mode facility enables you to cross up to 12 different files (32000 records per file) pre-selecting any of up to 20 fields per record/file for display/print output (240 fields) in all. One massive enquiry can pass through 384,000 records.

You might have two files whose records are directly related to each other, so that the first file (say containing names and addresses) refers to the second file (say financial and other information relating to the same record numbers if the first file) directly. Then you can simply choose that in file 1 you are interested in just the name and telephone numbers, whereas in file two, you are interested in the income, trading period and number of branches, information. Your enquiry can then pass through both files highlighting that information only. Actually there doesn't need to be a strict correlation between the same record numbers in different files, and you can also on just one JUMP command go to any record in any of the 32000 records in any of the twelve files and carry on cross-referencing from there onwards.

DBMS'S MACROS WORK FROM THE MOMENT YOU INSERT THE 'TASK DISK' IN THE COMPUTER

Simply design your file, give its fields your words, setup your report mask, and then enter your records. Switch to 'automatic drive' and formulate any task you wish the program to fulfill, the task is stored as a macro. Take a copy of the program on another 'task disk' and from then on, the task disk will function without a single keystroke. Think of a number of such 'task disks' such as 'stock-re-order reports'; 'stock-valuation reports'; 'analysis'; 'patient history analysis'; 'research-analysis'; 'budgetting'; 'plus more?'

Not only does this program surpass most of its kind that you might buy elsewhere, but if you buy the hardware from us, then you get it - FREE...

DBMSII (WITHOUT MACROS) AND DBMS III ARE FULLY IMPLEMENTED UNDER CPM-86 (tm) AND MS-DOS (tm) ie: <SIRIUS/VICTOR/IBM> DBMSII IS 395.00 (or 250.00 by mail order ex. training). DBMSIII is 575.00 (or 295.00 by mail order ex. training).

MICRO-COMPUTERS

PRINTERS

SOFTWARE

Contains the highest state of the art software available today
FORMS/TEST/CALC/DBMS - ALL IN ONE PROGRAM THE "KEY" @ 675.00

When you budget for a complete system of software you eventually end up with a host of packages like: Sales, Purchases, Nominal, Data, Text, Calc, Mailshot, Invoice, Order, Workflow, Personnel, and so on. The list is endless and the outlay several thousands of pounds.

Features: Design a form as wide as a window of 250 characters, long as needed. Cursor movements are 'left, right, up, down, delete left, delete right, tab right-left-up-down'. Paint your form as you like directly on the screen. (Order/Invoice/Budget/Indent etc).

Text: Write a letter as you see it on the screen, edit it then simply enter 'P' to print.

Calc: Set into the form, your data fields, 'EEEEEE' and specific file-related activities, formulae and validation checks. Enter values and see the spreadsheet calculate itself.

Database: Search files for data to be inserted to fields specified. All the features of DBMS III, explained elsewhere in our ad.

Here's an example of an invoice you might design for your stationery... You could design your own spreadsheet, order form, statement, wage docket, or any other kind of form that is required to fit your existing stationery.

INVOICE 00000000000000000000

| | |
|-----------------------------|------------------------|
| To: 01-00000000000000000000 | From: G.W. Ltd |
| 02-00000000000000000000 | 55 Bedford Court Mans. |
| 03-00000000000000000000 | Bedford Avenue |
| 04-00000000000000000000 | London WC1 |
| 05-00000000000000000000 | Tel: 01-636 8210 |

| | | | | |
|-------------------|-------------------------|-----------------|---------------|--------|
| Date: 06.00.00 | Tax point: 07.00.00 | Agent: 08.00.00 | | |
| Quantity | Description | Cost | Tax | Total |
| 09.000 | 10.00000000000000000000 | 11.00 | 12.00 | 13.000 |
| 14.000 | 15.00000000000000000000 | 16.00 | 17.00 | 18.000 |
| | and so on... | | | |
| Total...19.000000 | | | Tax...20.0000 | |

?? Items 01 to 05 Internal command to request name input, and then search an address file for details.
 ?? Items 06 to 07 request date input and validate.
 ?? Item 08 request agent number and validate range.
 ?? Item 09 request quantity, validate range.
 ?? Item 10 request description, search file, accept, and calculate fields 01, 02, 03, if finished invoice then calculate fields 09 and 20.

Now comes the more valuable facility, you can provide the 'FORM' with file-related instructions, not only to request a 'console' input for a file search against names, and stock, but after the invoice is finished the fields you have selected may be passed to relate files.
 eg: Send fields 00, 01, 06, 07, 011, 012, 013, 019, 020 to a sales ledger.
 Then send fields 09, 10, 11 to produce analysis file.
 Then send fields 00, 01, 07, 019, 020 to VAT file.
 Then send fields 10, 11, 12, 13 to Nominal Ledger.

SYSTEM DEALS
(Our Speciality)
SAVES YOU 1500.00 +

Buy any computer, any printer and 150 value diskettes
 add 85.00 for cables and testing.
 add 10% for return to base warranty for 1 year (optional)
 add 110.00 for delivery & installation (optional)
 training optional extra 120.00

and get completely ****FREE****
 cpm handbook . . 50 basic exercises . .
 2000 sheets paper
 DBMS III.7 magic wand w/proc magic calc
 mbasic 80 diagnostics msort/dsort
 recover autoload instant basic
 library boxes disk/games DT/AS/NS sorts
 ****total value 1525.00****
 Based on 8 bit hardware, 16 bit software varies!

Here's a typical example of a complete system deal

| | |
|---|---------|
| 1. Sirius 128k ram/1.2 megabyte disks | 2395.00 |
| 2. OKI microline 80 printer | 295.00 |
| 3. Cables and testing | 85.00 |
| 4. Diskettes | 150.00 |
| 5. Price differential on magic/wand for word-star | 100.00 |
| Software described above | FREE |
| | 3025.00 |

We specialise in 'STANDARD MICRO-PRINTER SYSTEMS' as well as 'NETWORK SYSTEMS BASED ON A SHARED HARD DISK'.

The range of computer products (mostly ex stock) includes the most popular brands of micro-computers, printers, modems, buffers, spoolers and software.

- MICROS** - SIRIUS/VICTOR/IBM/DEC/EPSON/NORTH-STAR/SANYO/SUPERBRAIN/COMPUSTAR/ALTOS/APPLE/LISA/TELEVIDEO
- PRINTERS** - NEC/QUEM/DIABLO/OKI/EPSON/OLYMPIA/RICOH/TEXAS/DRE/ANADIX
- OTHERS** - CORVUS/COMPUSTAR/HARD DISKS NETWORKS AND MULTIPLEXORS/SPOOLERS/MODEMS/BUFFERS/MOST OF THE BEST KNOWN BRANDS OF SOFTWARE

TERMS & ETC

G. W. Computers Ltd [Grama (Winter) Ltd]
 55 Bedford Court Mansions
 Bedford Avenue
 London WC1 England.
 Tel: 01-636 8210, 01-631 4818. Telex: 892031 TWC G
 Boston office telex: 94-0890
 24 hour answerphones - leave address for 'infopacks'
 We do not operate a reader's reply card service.
 Terms: C.W.O. or C.O.D. Prices exclude VAT...
 but include all non-credit discounts available.
 No dealers. The above lists are not exhaustive.
 Please call at our showroom only by prior appointment.

24 hour answerphones leave address for infopacks

Unless expressly agreed, all warranties are commercial 90 days return to base for parts and labour.
 Annual warranties and maintenance facilities available nationwide through closely related third parties.

THE BEST SELLER OF 1982



In 1982 the RICOH 1600S outsold every other comparable printer because of its speed, reliability, intelligence, flexibility and sophistication.

Because it is compatible with all known systems and software packages.

Because of the 12 month warranty that Micropute offer.

Because Micropute are a company who care, who are constantly aware of changing needs and who can fulfill any special requirements.

Not least of all, because of the price

In 1983, there will be thousands more satisfied customers.

We hope that you will be one of them.

ONLY MICROPUTE GIVE YOU SUPERCOVER

As an extra bonus Micropute Supercover will provide a 12 month on site maintenance for only £99.00 parts and labour.

**DON'T
FORGET THE
RICOH 1300S**

...a little bit slower but
every bit as clever.

Please send details of the RICOH 1600S
and 1300S

Name: _____

Position: _____

Company: _____

Address: _____

Telephone: _____

RP2

MICROPUTE

Micropute, Catherine Street, Macclesfield,
Cheshire SK11 6QY. Tel: (0625) 615384.

Grundy Computers 8200 Series WORD PROCESSOR

- A> Flexible Dedicated Keyboard
- A> 64-256K Internal Memory
- A> Low Maintenance
- A> Factory Upgrade to Hard Disk
- A> British Made Quality System



CALL

CEEDATA Ltd Manufacturer
DIRECT 01-941-2231/4889

The 8200 Series Word Processor starts from £2400.00 complete with Daisy Wheel printer & Software.

MICRO-RENT[®] from KEYBOARD HIRE

OSBORNE 1



apple



IBM



SIRIUS 1



MR

01-607 8797-8

Totally flexible rentals of OSBORNE, APPLE, IBM and SIRIUS hardware, software and peripherals from under £3.50 per day (3-month rental, Osborne)

KEYBOARD HIRE LIMITED 176 BARNBURY ROAD LONDON-N1 0ER

HOME COMPUTERS

AQUARIUS

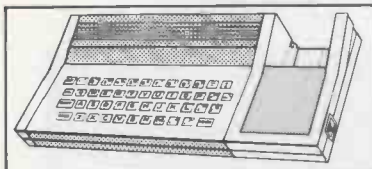

AQUARIUS: The brand new Aquarius Personal Computer is part of Mattel Electronics latest developments in advanced technology and offers full home computing facilities, as well as extensive game play, using a very wide range of plug in cartridges. Since Aquarius is a Mattel Electronics product, it benefits by the company's wide experience of producing high technology equipment, as well as their game programming expertise which is evident from the advanced games which have been produced for the Intellivision. Aquarius costs £79 and comes with microsoft basic built in. It is so simple to use that you'll be writing your first programs within minutes of taking the machine out of its box. You can even record the programs on your own cassette recorder at home, so you can use them again at a later date. Most available domestic tape recorders are compatible with the Aquarius.

A POWERFUL MACHINE: For all its simplicity, it is also very sophisticated. It has a Z80A processor and 8K of built in ROM as well as 4K of RAM, which is user expandable to 52K. It has a display of 40x24 characters, and a graphic resolution of 320x192 with a total character set of 256 (including the complete ASCII set with upper and lower case letters, numbers and additional graphic symbols). The keyboard has 49 full stroke moving keys, unlike some of the cheaper machines which have membrane keyboards. The size of the machine (excluding any of the additional peripherals), is 13" x 6" x 2".

PERIPHERALS: It is very easy to increase the capabilities of your Aquarius as all the peripherals plug straight into one another. You can add a Printer, a Modem, a Data Recorder, Mini Expander and other items. All of the peripherals are very easy to install and what is more, they're easy to use. But the best news of all is, they're easy to afford.

CPM OPERATING CAPABILITY: The Aquarius is capable of being expanded to 52K RAM and later in 1983 a disk drive will be available for it, with the commercial CPM business operating system. This will allow you access to one of the largest software libraries in the world, with literally hundreds of programs available for you to use.

CARTRIDGES: Various sophisticated programs will be launched on plug in cartridges such as a Visicalc type spreadsheet and a word processor. In addition there will be dozens of games and utilities and alternative languages such as Logo, which combined with the built in microsoft basic gives an unbeatable combination of high quality programming ability.

MATTEL AQUARIUS - £68.70 + VAT = £79

ATARI 400/800



NEW LOW PRICES

ATARI 400/800: With the Atari Personal Computers, you can play the ultimate T.V. games, teach yourself new subjects or skills, balance budgets, and even write your own computer programs in Basic.

SPECIFICATIONS: Both the Atari 400 and 800 can display in up to 16 colours each with 16 intensities. They have independent sound synthesizers for multiple game sounds, giving four octaves with variable volume and tone control on your T.V.'s speaker. The display graphics

are of amazing quality, having a detailed resolution of 320 x 192, comprising 24 lines of 40 characters. Atari personal computers have a standard 10K ROM operating system. In addition the standard Atari 400 (£149) comes with 16K of RAM, and the expanded version with 48K (£198). The Atari 800 (£299) comes with 48K as standard. Both the 400 and 800 are now supplied with a FREE E40 Basic Programming Kit, which includes the Basic Programming Cartridge, as well as a 120 page Basic Reference Manual and a 184 page Self Teaching Manual by Bill Carris called 'Inside Atari Basic', so you can be programming straight away, without buying any 'extras'. Even a mains plug is supplied.

OVER 500 PROGRAMS AVAILABLE: The Atari computers are supported by well over 500 programs available for your use, a larger selection than you will find on any other television game or home computer! The wide selection puts Atari way ahead of the competition. Just fill in the coupon and we will be pleased to send you a full price which gives details of our range of software available for entertainment, home education programming and home office use. We think you'll agree when we say it's quite impressive.

100 FREE PROGRAMS FROM SILICA SHOP: If you buy your Atari Home Computer from Silica Shop, you will receive a FREE presentation pack of 6 cassettes, containing 100 programs including games, utilities and demonstrations. A 16 page booklet giving the details of all of these programs is available on request. If you have already purchased your computer elsewhere you can buy the set of 6 cassettes for £30. What's more, Silica Shop offer a two year guarantee on all computers as well as a FREE joystick. This is up to a great offer that we believe can't be beaten or matched by any of our competitors.

ATARI 400 16K - £129.57+VAT=£149
ATARI 400 48K - £172.17+VAT=£198
ATARI 800 48K - £260.00+VAT=£299

COLECOVISION



THE SYSTEM: The CBS Colecovision offers new standards in video game play. The excellent graphics are well implemented with arcade titles such as Zaxxon, Lady Bug, Gorf, Wizard of Wor, Carnival, Mouse Trap and the lovable Smurfs. The console comes supplied with a three screen arcade quality version of DONKEY KONG. Parker and other companies have also announced ranges of cartridges for Colecovision, to further enhance the wide range of quality titles available for this new television games machine.

THE CONSOLE: The CBS Colecovision video games system has advanced technology which produces superlative graphics resolution and excellent sound effects. The styling of the console and hand controllers has been carefully researched; the console is designed to complement modern hi-tech equipment, and has clear features for easy operation. The hand controllers allow fingertip control via the 8 direction joystick, and feature 2 independent fire buttons. The push button keyboard is used for game selection and for game control with some cartridges. The hand controllers are detachable and are connected to six feet of telephone coil cable, storing neatly away in the console when not in use.

ATARI EXPANSION MODULE: The Atari converter module allows Atari VCS software cartridges to be played on the Colecovision console, allowing owners the freedom to purchase from the extensive range of Atari compatible cartridges. It also means that existing Atari owners can buy the CBS Colecovision games system without discarding their software library. Silica Shop offer part exchange facilities if you wish to upgrade.

TURBO EXPANSION MODULE: The Turbo Driver Expansion Module allows you to actually drive the vehicle that appears on your T.V. screen. The module consists of a steering wheel, dashboard and accelerator pedal. One hand controller is mounted on the dashboard to provide a gear change unit. The module comes complete with a Turbo Driver cartridge, the first of several cartridges to make use of the module, which provides all the action of sitting in the driving seat. This facility is unique to CBS Colecovision.

HOME COMPUTER EXPANSION MODULE: The Home Computer Module scheduled for late 1983, allows conversion of the games unit into a sophisticated Home Computer. This flexibility of design is an important feature of the CBS Colecovision System.

COLECOVISION - £127.82 + VAT = £147

VECTREX



THE SYSTEM: Vectrex is a totally unique Home Arcade System, which has been exclusively designed and engineered to duplicate real arcade game play. Complimented with its own monitor display, Vectrex won't cause arguments over the use of the family's television because it has its own built in screen.

THE SCREEN: Vectrex does not use ordinary display techniques, instead it uses vector scanning to control images on the screen. With this scanning method, the gun only updates the area of the screen that has changed whereas a normal T.V. re-transmits the ENTIRE screen 50 times a minute. It is this that gives Vectrex its speed and means that very little computer power is required for screen control, and the results provide very responsive and clear images. These 'Vector Graphics' are used in several arcade games such as Asteroids and Battlezone, to give you incredibly high resolution quality. Vectrex brings all of this from the arcade right into your living room. The Vectrex screen is capable of displaying 80 columns by 40 lines, which is significant to the extensive developments planned for the system.

EXCITING SOUNDS AND ELECTRONICS: Vectrex has an advanced microprocessor with more speed and power and exciting effects than many home video games systems.

REAL ARCADE CONTROLS: Vectrex has a unique control panel, similar to those used in many real arcade games, with 4 concave action buttons and a full 360° self centring joystick. This control panel has a 4 foot detachable cord for maximum player freedom.

REAL ARCADE GRAPHICS: Vectrex has its own 9 inch vertical screen and unlike conventional T.V. screen, uses advanced display technology to achieve brilliant, high resolution imagery and superb game play never before possible. The Vectrex display provides special effects too, such as 3-D rotation and zooming in and out, which regular T.V. cannot match. Using a black and white monitor, each Vectrex game comes supplied with its own coloured plastic screen overlay to add to the excitement of game play. The range of Vectrex cartridges (£21.95 each), gives a good selection of arcade games such as Berzerk, Scramble, Rip-Off and Bomber Attack. Vectrex comes complete with a fast paced 'Minestorm' game built into memory.

VECTREX: Vectrex has an advanced state-of-the-art microprocessor with more speed than other T.V. games.

VECTREX - £129.57 + VAT = £149.00

WHO ARE SILICA SHOP?

Silica Shop are one of the leading specialist suppliers of Video Games & Personal Computers. We consider that our service, to those who already own or to those who are interested in any products in our range, cannot be matched by any other supplier. Just look at what we have to offer:

- **SHOP DEMONSTRATION FACILITIES** - we provide full demonstration facilities at our shop in Sidcup, so that you can get hands on experience of our range.
- **SHOP OPENING HOURS** - we are open from Monday to Saturday 9 am - 5:30 pm, but close at 1 pm on Thursday's and 8 pm on Friday's.
- **MAIL ORDER** - we are a specialist mail order company and are able to supply goods direct to your door at no extra cost.
- **FREE FIRST CLASS DELIVERY** - all orders are sent Post and Packing FREE, most of them being despatched by FIRST CLASS POST within 24 hours of us receiving your order details. If you require overnight delivery, this can be arranged, at a charge of £3 for items under £50, or alternatively £5 for items over £50.
- **MONEY BACK GUARANTEE** - if you are totally dissatisfied with your purchase, you may return it to us in good condition within 15 days for a full refund.
- **PART EXCHANGE** - we will offer you up to one third of our current selling price in part exchange on your old Mattel Intellivision or Atari console (and related cartridges), if you decide to buy a new video game or personal computer from us.
- **SECONDHAND GOODS** - we sell second hand Mattel & Atari consoles/cartridges (with a full 1 year guarantee), at two thirds of our normal retail price.
- **COMPETITIVE PRICES** - both our prices and services are very competitive. We are never knowingly undercut and will normally match any bona fide price quoted by our competitors, providing they actually have the goods in stock. We will also send the order to you post and packing free!
- **HELPFUL ADVICE** - our specialist sales staff are always available to give you advice on the suitability of various computers or T.V. games.
- **SERVICE/REPAIRS** - are available on all machines in our range, often utilising our in house service facilities. We will support your machine long after you buy it.
- **ATARI SERVICE CENTRE** - we are now an authorised Atari service centre and can therefore accept repairs on all Atari equipment (TV Game and Computers) even if you did not originally purchase it from Silica Shop. All repairs during the manufacturer's 18 month warranty period will be completed FREE OF CHARGE.
- **2 YEAR GUARANTEE** - we offer a 2 year extension on some manufacturers 12 month guarantee, including Atari Personal Computers.
- **VIDEO GAMES AND COMPUTER CLUBS** - we offer a full information service on all video games and computers in our range. Advanced information on many new developments is often included, so you are always kept informed. We now issue regular newsletters on software releases to make sure that you join our club.
- **OVERSEAS ORDERS** - we regularly send goods overseas and use various dispatch services. Please let us know your requirements and we will give you a quotation.
- **PAyment** - we accept Barclaycard/Visa/American Express/Deiners Club credit cards, as well as cash, cheques, postal orders, COD or Post Office Transfers.
- **CREDIT FACILITIES** - we also offer credit facilities with varying payment over 12, 24 or 36 months. Please send for our FREE literature and a written quotation.

01-309 1111

**SILICA SHOP LIMITED, Dept ZPCW 0783,
 1-4 The Mews, Hatherley Road, Sidcup, Kent, DA14 4DX
 Telephone: 01-309 1111 or 01-301 1111**

VIDEO GAMES

ATARI

ATARI VCS (2600) - THE NO 1 BRAND LEADER IN THE U.K.

ATARI: The Atari Video Computer System known as the Atari VCS or the 2600 has now become the T.V. game brand leader. In the U.K. there are over 700,000 owners of the VCS with access to a range of over 200 different plug in cartridges, each having a multitude of different variations and difficulty levels. Every system comes complete with the main console, two individual joystick controllers, a pair of paddle controllers, aerial splitter, mains adaptor and a 27 game Combat cartridge. It gives you bright crisp graphics, realistic sound effects and even specially designed circuits for the protection of your Television Set.

SECONDHAND GAMES: We currently have several secondhand Atari VCS units in stock which we are selling for only £49 (inc VAT). This price includes the Console, with Combat Cartridge and all the accessories, as well as a 12 month guarantee. We also have stocks of several secondhand cartridges many at half price (all with 12 months guarantee). We will normally buy back secondhand units and cartridges at one third of our standard price.

£49

EXTENSIVE CARTRIDGE RANGE: The Atari VCS is so popular that in addition to Atari's own cartridges, there are over 150 compatible cartridges, produced by at least a dozen different third party manufacturers. Silica Shop has one of the largest cartridge selections available in the U.K. Our range of over 200 titles (printed either side of this column), includes items in stock now, as well as many of the new releases for later in 1983.

SILICA ATARI CLUB: Silica Shop has over 20,000 Atari VCS club members registered on our computer. As a specialist company we are able to obtain advance information about new developments and send detailed catalogues to all of our club members, enabling them to evaluate new products before they buy. This is a totally FREE service, to receive your copies complete the coupon below.

SERVICE CENTRE: Atari International (UK) Inc has recently appointed Silica Shop as an authorised Atari Service Centre. This means that we can now service your Atari VCS or 400/800 (under guarantee if applicable), whether or not you purchased it from us.

VCS COMPUTER KEYBOARD: A keyboard will soon be launched to convert the VCS into a fully programmable home computer. For further details, join our club by completing the coupon below. We will then let you know when further information is available.

STARPATH SUPERCHARGER: The supercharger plugs into the cartridge socket of your VCS and expands its RAM almost 50 fold, from 128 to 6,272 bytes. This increased memory adds vivid high resolution graphics capabilities and significantly lengthens the game playing time. Supercharger has a range of multi-load games (at £19.45 each), these offer the facility to play a game in several distinct parts (great for adventures), the next section being loaded when you have completed the previous one, thus enhancing the game play. For further information please complete the coupon below.

£79

ATARI VCS CONSOLE- With Combat Cart & Accessories £68.70+VAT = £79.00

- | | |
|--------------------|---------------------|
| ATARI/Cont | PARKER/Con |
| Super Breakout | Emp Strike Bk |
| Surround | Frogger |
| Swordquest E | Incredible Hulk |
| Swordquest F | James Bond 007 |
| Tennis (1/pt) | Jedi Arena |
| Vanguard | Lord of Rings |
| Volleyball (r/s) | Popeye |
| Warlords | Q-Bert |
| Yars Revenge | Reactor |
| | Rtn of Jedi 1 |
| | Rtn of Jedi 2 |
| BOMB | Sky Skipper |
| Assault | Spiderman |
| Great Escape | Splinterman |
| Splendour | Super Cobra |
| Wall Defender | Tutankham |
| Z-Track | |
| SPCTRVISION | |
| Chall of Nexar | |
| China Syndrome | |
| Cross Force | |
| Donkey Kong | Gangster Alley |
| Gorf | Galactic Tactic |
| Mousetrap | Master Builder |
| Smurf | Planet Patrol |
| Solar Fox | Tape Worm |
| Turbo | |
| Venture | |
| Wizard of Wor | SUPERCHARGER |
| Zaxxon | Communist Mut |
| | Dragonstmp |
| | Escape from M |
| | Fire Ball |
| IMAGIC | Killer Satellite |
| Atlantis | Phaser Patrol |
| Cosmic Ark | Suicide Mission |
| Dem. Attack | |
| Dem. Attack II | TELEYS |
| Dragonfire | Coconuts |
| Fire Fighter | Cosmic Creeps |
| No Escape | Demolition Herby |
| Riddle of Spx | Fast Food |
| Scuba | Ram - It |
| Sternum | |
| Star Voyager | TIGERVISION |
| Trick Shot | Jawbreaker |
| Zone | Kong King |
| | Marauder |
| M-NETWORK | Miner 2049er |
| Adv of Tran | |
| Alt riders | Polaris |
| Burger Time | River Patrol |
| Comp Revenge | Pizza Chef |
| Frog & Flies | Threshold |
| Intnl Soccer | ZIMAC |
| Lock 'n' Chase | Cosmic Corridor |
| Space Attack | Oshister |
| Tron Dilyc Disc | Immiss & Aggs |
| Winter Olymp | Isant my Mom |
| | Pizza Chef |
| PARKER | Quest for Gold |
| Action Force | Tally Ho |
| Amidar | Tanks no Tanks |



- | | |
|---------------------|------------------|
| ACCESS Atari | ATARI |
| Aerial Splitter | 3-D tile tac toe |
| Joysticks | Adventure |
| Keyboards | Air/Sea Battle |
| Mains Adaptor | Asteroids |
| Paddles | Backgammon |
| | Basic Math |
| ACCESS 3rd P | Basic Program |
| Ext'n Lead | Basketball |
| Joysticks (r/s) | Basketball (r/s) |
| Le Stick | Berzerk |
| Pointmaster | Bowling |
| Quick Shot | Brain Games |
| Reckball | Breakout |
| Starfighter | Casino |
| Straight Stick | Centipede |
| Trackball | Checkers |
| Triple Command | Chess |
| Video Command | Circus |
| Wicos | Codbreaker |
| Zircon | Combat |
| | Concentration |
| ACCESS Mix | Defender |
| Video Storage | Demons/Oriams |
| Units | Dig Dug |
| | Dodge 'em |
| ACTIVISION | E.T. |
| Barroom | Football/accr |
| Boxing | Fun with Nos |
| Bridge | Galaxian |
| Chopper Cmd | Golf |
| Dolphin | Gravitar |
| Drifter | Hangman |
| Enduro | Haunted Hse |
| Flaming Drby | Human Cann |
| Freeway | Hunt & Score |
| Grand Prix | Indy 500 |
| Ice Hockey | Jungle Hunt |
| Kaboom | Kangaroo |
| Keystin Capers | Krull |
| Laser Blast | Math G Prix |
| Megamania | Maze Craze |
| Onik | Min Golf |
| Pirfall | Misile Cmd |
| Plaque Attack | Ms Pac-Man |
| River Raid | Night Driver |
| Robotank | Olympics |
| Seaquest | Othello |
| Skating | Outlaw |
| Sky Jinks | Pac-Man |
| Spider Fighter | Phoenix |
| Stampeed | Pinball |
| Starstrater | Pole Postn |
| Tennis | Raiders of LA |
| | Sky Diver |
| APOLLO | Slot Racers |
| Lost Luggage | Soccer |
| Racquetball | Space Invaders |
| Shark Attack | Star Wars |
| Skeet Shoot | Star Raiders |
| Space Cavern | Street Racer |
| Space Chase | Superman |

ACCESSORIES

We stock a wide range of accessories for the Atari VCS and 400/800 personal computers. The same accessories can be used on the Commodore VIC range of computers. The Wico range can also be used with the Texas Instruments computers on purchasing a special adaptor. To give you an idea of the range available, just take a look at the following list:



Trackball with Wico

LE STICK: A mercury filled joystick specially made for one handed operation, with thumb fire button.

QUICK - SHOT: This joystick features a contoured handle grip, thumb trigger and optional base fire button. It is supplied with 4 sure foot suction grips.

STARFIGHTER: Neat and compact with a small direction stick. Metal interior for added strength.

VIDEO COMMAND: With a tapered handle, this joystick is for one handed use. It has a directional control which is similar to a jet fighter joystick.

WICO RED-BALL: An arcade type joystick with a red ball handle, it features 2 fire button locations, one at the base and one on the stick. It comes supplied with 4 grip pads for easier table top use.

WICO STRAIGHT - STICK: The main feature of this joystick is its arcade style, bat handle grip. It also has 2 fire buttons. Four grip pads included for table top use.

WICO TRACKBALL: A true arcade style trackball for use with your Atari or Commodore VIC. This product is designed to give arcade control in your living room.

12' EXTENSION LEAD: A 12' extension for Atari and Atari compatible joysticks for greater player freedom.



Wico Straight Stick with Stick Fire Button

MATTEL INTELLIVISION

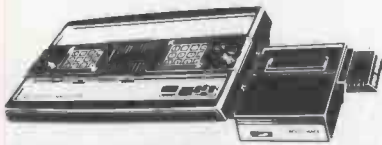

MATTEL INTELLIVISION: The Mattel games unit is a most versatile T.V. game which offers 3-D graphics quality for only £98. Each cartridge comes with 2 overlays which fit over the unique hand controller giving easy directions for game play. Using the handset's control disc, objects

can be moved accurately in 16 directions giving a realistic simulation of lifelike movement.

VOICE SYNTHESIS: The Intellivision unit, price £49, is used with special cartridges where high quality synthesised male and female voices feature as part of the game play.

NEW MATTEL CARTRIDGE RELEASES: Why not complete the coupon below and join the Silica Mattel Owners Club and receive our FREE news bulletins and 16 page catalogues detailing new Mattel releases. There will soon be over ninety cartridges available for the Mattel, and a small selection from these is listed below:

MATTEL: Arctic Squares, Burger Time, Buzz Bombers, Chess, Cloudy Mountain, Loco Motion, Mission X, Mystic Castle, Sharp Shot, Solar Sailor, Space Shuttle, Vectron, Winter Olympics. **ACTIVISION:** Happy Trails, Pirfall, Stampeed. **C.B.S.:** Blue Print, Carnival, Donkey Kong, Gorf, Mousetrap, Smurf, Solar Fox, Turbo, Venture, Wizard of Wor, Zaxxon. **IMAGIC:** Bezerk, Dracula, Ice Trek, Nova Blast, Safecracker, Swords & Serpents, Tropical Trouble, White Water. **PARKER:** James Bond 007, Lord of the Rings, Popeye, Q-Bert, Spiderman, Star Wars, Super Cobra, Tutankham.

COMPUTER KEYBOARD: In July/August 1983, Mattel will be launching their new £89, 49-key computer keyboard attachment called 'Lucky' which is fully programmable and has microsoft basic built in. It will transform your Master Component into a home computer. The adaptor also accepts a 6 note polyphonic music synthesiser and full size 49-key piano keyboard that will make learning music as easy as playing games.

MATTEL CONSOLE £85.22 + VAT = £98.00

£98

VIDEO GAME CLUB

In a fast moving market like video games, it is difficult to keep up to date with all the developments that take place. With new programmes and accessories being introduced at a fast rate by several different manufacturers, it is impossible to get all the information you require from one manufacturer alone. It is for this reason, that we have set up owners clubs for the more popular video games and home computers, to keep you fully up to date with what is going on with your particular machine. As far as we know, Silica Shop are the only company to offer such clubs, but that is not surprising since we are the specialists. We currently have FREE clubs for the Atari VCS, Atari 400/800 home computers, and Mattel Intellivision. Soon we will have clubs for Colecovision, Aquarius and Vectrex. So if you own one of these machines, fill in the coupon opposite, and we will enrol you FREE OF CHARGE in the club relevant to your computer or video game.

01-309 1111

SILICA SHOP

SILICA SHOP LIMITED, Dept ZPCW 0783,
1-4 The Mews, Hatherley Road, Sidcup, Kent, DA14 4DX
Telephone: 01-309 1111 or 01-301 1111

FREE LITERATURE

FREE LITERATURE - Please send me your FREE LITERATURE and catalogues on the following items:

OWNERS CLUB - I already own the following products, please enrol me in your FREE club:

Mr/Mrs/Miss: Initials: Surname:

Address:

Postcode: ZPCW 0783

FREE LITERATURE

Rayman Electronics

124 BROOMSPRING LANE, SHEFFIELD S10 2FD. TEL: 71860
59 MAIN STREET, SHIREBROOK, MANSFIELD. TEL: 748129

IS YOUR COMPUTER STILL RUNNING ON LOW TECHNOLOGY

Your computer system may be all High Technology but the mains supplying it is low technology.

Interference and spikes transferred through the mains can cause data loss, software corruption, hardware damage and system crashes. High voltage spikes can also reduce the life of your computer.

NOW you can raise your Mains Technology with the DATA BLOC PROFESSIONAL mains filter.



This piece of computer hardware will:-
★ PROTECT 4 ITEMS OF EQUIPMENT UP TO A TOTAL OF 1000 WATTS
★ MAKES SPIKES AND INTERFERENCE HARMLESS
★ GIVES RFI/EMI PROTECTION
★ INTEGRAL PLUG WITH QUICK RELEASE FUSE
PRICE £39.50, p&p £1.00

Also available DATA BLOC STANDARD mains filter. Offers:-

- ★ 4 WAY PROTECTION
 - ★ SUPPRESSES SPIKES
 - ★ INTEGRAL PLUG WITH QUICK RELEASE FUSE
- PRICE £29.50, p&p £1.00

Please write for a complete list of our products enclosing a stamped addressed envelope to:

Rayman Electronics,
124 Broomspring Lane, S10 2FD.
Or phone 0623 748129.

TRADE ENQUIRIES WELCOME

IF ORDERING ALLOW 28 DAYS FOR DELIVERY

GEM SOFTWARE



UNIT 'D' THE MALTINGS STATION ROAD
SAWBRIDGEWORTH HERTS

for

LYNX, DRAGON, SPECTRUM & ZX81 Software

MONSTER MINE by W. E. MacGowan.

Escape from the mine with as much money as you can, but don't get closed in or caught by the prowling monsters. An addictive machine code game, with superb graphics and save facility.

Price.....(LYNX & DRAGON).....£7.95
Price.....(SPECTRUM & ZX81).....£4.95

SULTAN'S MAZE by Christopher Hunt.

Enter the 3D Maze in search of the Sultan's jewels, but beware, your strength may run out, or you may come face to face with the Mad Guardian. A multi-difficulty game with fantastic graphics and sound.

Price.....(LYNX & DRAGON).....£7.95

SPACE MISSION by W. E. MacGowan.

Launch from lunar base, fight your way through the asteroid belt to do battle with the enemy fleet. Multi-level space combat game, sets new standards in graphic excellence and attention to detail.

Price.....(DRAGON).....£7.95
Price.....(SPECTRUM & ZX81).....£4.95

CHARACTER GENERATOR by John Line.

A program for the programmer, allowing creation and saving of character sets/shape tables and subsequent inclusion into user's basic program. Demonstration program and full ASCII character set included.

Price.....(DRAGON).....£9.95

GEMPACK IV by W. E. MacGowan.

Two great machine code games, with full colour graphics.

In **Sea Harrier** you must land your plane on the aircraft carrier, after dispersing the clouds with chemical bombs, but don't hit the ship!

In **Sub Chase** you must depth charge the wolf pack without being sunk.

Both with 4 levels of play from easy to kamikaze!
Price.....(LYNX & DRAGON).....£7.95

ALIEN BLITZ by Peter Chase.

Your craft is running low of fuel and you must land! You have to use your bombs to clear a space amongst the skyscrapers, but beware of craters! A superb multi-level action game for the Dragon, with superb sound and graphics.

Price.....£7.95

FUNMATHS I by Peter Chase.

Improve your maths while you play these five great games! In **Number Race** you must beat the computer, or a friend, to exactly 100 by eating the numbers. **Maths Maze** asks questions as you work your way around the maze. **Chemist** is a game of ratios, where you mix two chemicals, trying not to get blown up! **Dragon** exercises your skill at expressing co-ordinates — you have to find the Dragon, hidden in a grid. Last, but by no means least, **Simon** tests your memory for tunes/colours/numbers.

Price.....(DRAGON).....£9.95

All titles available mail order or Access. All cassettes despatched by return of post.

GEM SOFTWARE

UNIT D, THE MALTINGS, SAWBRIDGEWORTH, HERTS.
Telephone: (0279) 723567

TRADE ENQUIRIES WELCOME — PLEASE RING FOR DEALER PACK.

IBM PC
VERSION NOW AVAILABLE

APPLE USERS

BACK UP VISICALC AND ALL YOUR VISIS QUICKLY AND SIMPLY

Copy II Plus is a versatile software back-up system, capable of backing up all visis, as well as most other protected software.

Its fast — only 45 seconds for Fast Copy, less than three minutes for Bit Copy.

Its simple — menu driven for ease of use with full instructions on backing up dozens of popular programs.

Its comprehensive — it includes all the file handling and DOS utilities you will ever need.

Its priced right — at around half the cost of similar competing products.

Copy II Plus — only £35 + V.A.T.

COPY II PLUS
COPY
COPY
COPY

ORCHARD
SOFTWARE

Send cash with order, or quote your Access or Diners card number to:

Orchard Software, 17, Wigmore Street, London W.1. Telephone 01-580-5816. Dealer enquiries welcome.

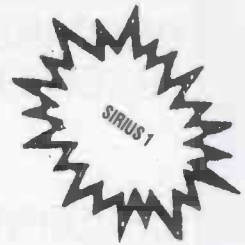
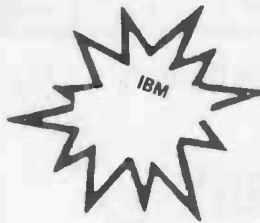

MICROCOMPUTER SALES, LEASE OR RENTAL AND OTHER SERVICES

A comprehensive rental/hire service, featuring the ACT Sirius 1, the SUPERBRAIN, BBC, ICL, APPLE & IBM range of microcomputers. **PLUS** a full range of PRINTERS & SOFTWARE.

- Short term rental available • Rental fee refundable against purchase • Very competitive costs • Plus our own low cost 24 hour maintenance service • Phone 01-458 5845 or write to our central office for details.

ACT SIRIUS 1



- THE COMPLETE BUSINESS MACHINE
- CALL FOR PRICES
- FULL SUPPORT OF THE PULSAR SOFTWARE

PRINTERS

New EPSON Type III Series



- Available for Apple, BBC, Tandy, PET NASCOM, Sorcerer & other Micros.
- MX80F/T₃ = £310
- MX 100 = £425

OTHER MODELS AVAILABLE

| | |
|--|--------------------------------|
| £175 Silentyte 80-Col Graphics Printer | £460 Paper Tiger 455 |
| £1300 Flowriter 1600 RP | £560 Paper Tiger 460 |
| £795 ET121 KFR Olivetti Daisy Wheel printer includes parallel RS232 & IEEE 488 | £725 Paper Tiger 560 |
| £1050 QUME 35 KSR | £760 Anadex DP9500 |
| £110 QUME Form Tractor TEC | £795 Anadex DP9001 |
| £1000 Starwriter 70/40 | £900 Anadex DP9501 |
| | £1200 Colour Prism 132 Printer |

CP/M SOFTWARE – Available for both ACT Sirius 1 & Superbrain

| LANGUAGES | STANDARD | ACCOUNTANCY |
|------------|-------------|--------------------|
| PASCAL | WORDSTAR | INCOMPLETE RECORDS |
| FORTRAN | MDBSIII | INTEFR ACCOUNTS |
| CIS-COBOL | DBII | SALES LEDGER |
| COBOL | MAILMERGE | PURCHASE LEDGER |
| FORTRAN | DATASTAR | NOMINAL LEDGER |
| MBASIC | SUPERSOFT 1 | INVOICING |
| CBASIC 86 | SUPERCALC | PAYROLL |
| APL | MULTIPLAN | STOCK CONTROL |
| MPM | OASIS 16 | OS |
| C | | PULSAR SOFTWARE |
| MS-DOS | | |
| CPM 86, 80 | | |

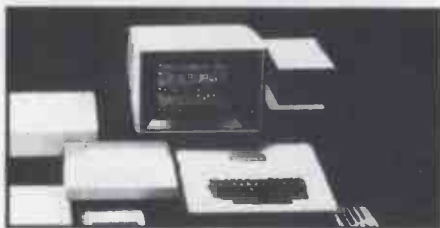

HARDWARE AVAILABLE • Call for Prices



Details of IBM & ICL range of P.C. and expansion hardware, software, ring for sales or lease or short term rentals.

For all Mail Orders, Rental Orders, Price Details or Further Information — Contact our Central Office:

MICROCOMPUTER SPACEDROME

3 WESTHOLM, HAMPSTEAD, LONDON NW11 Tel: 01:458 5845

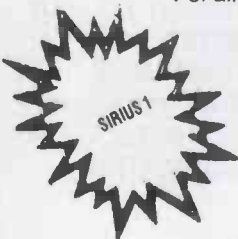

OSBORNE

OSBORNE Double Density
EPSON FX80

£1425*

OSBORNE
80 Column
Double Density

EPSON FX80
£1625*

*Prices + VAT
& Delivery

CARDBOX DATABASE PACKAGE FREE

NOW
FREE DATABASE
PACKAGE FOR ALL
ORDERS RECEIVED
BY JULY 31st

AUTHORISED OSBORNE
MAIN DEALERS

Fraser Associates Ltd.
1 Bristle Hill Buckingham Bucks MK18 1EZ
Tel. Buckingham (0280) 816087

ANSWER PHONE? ENHANCE YOUR RESPONSE!

For only £10.00 You can have:-
Jack Nicholson, James Bond, Kirk
Douglas, Woody Allen and many
other notable mega stars answering
your telephone.

Not only will it encourage people to
actually leave a message; but will
also attract more callers ... which
could mean more business!

For a demonstration of
"STARCALLS"
Phone - 01-748 8075

Available from
SCREENCHANCE

P.O. Box 4NL

83/84 Berwick Street, London W1

DON'T LEAVE IT TO CHANCE !

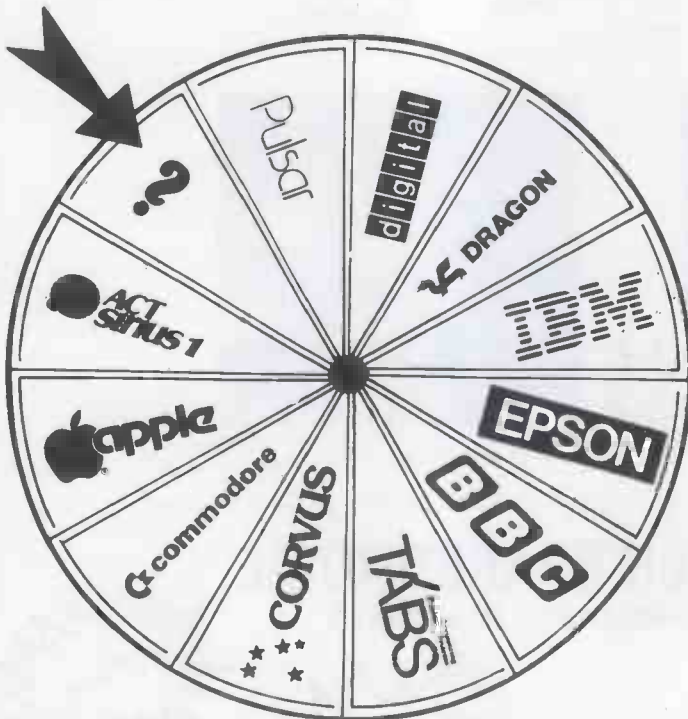

LET US TAKE THE RISKS OUT OF CHOOSING YOUR SYSTEM

- Established six years
- Professional experience
- Free consultations
- Bespoke software
- Delivery and installation
- Full after sales support
- Computer courses

Plus

Call us now for an invitation to our
Micros and the Businessman
Seminars, our special offers and
details of the latest product releases.
And don't forget if a software package
doesn't suit we'll write something
that will.

 **ozwise computers**

236 Imperial Drive, Rayners Lane, Harrow, Middlesex. Tel 01-429-1060

LOW COST BUSINESS SOFTWARE

ZX81 16K

ACCOUNTS PREPARATION

Produces printouts of all prime entries, nominal ledger, profit and loss account and balance sheet. Has 31 nominal ledger accounts.

Sole Trader - £17.50 Limited Company - £17.50
(Combined Price - £25.00)

SALES AND PURCHASE LEDGERS

Produces day book, sales/purchases and VAT analyses, debtors/creditors listings and statements. 50 accounts and 200 monthly transactions.

Sales - £20.00 Purchases - £20.00
(Combined Price - £25.00)

SPECTRUM 48K

ACCOUNTS PREPARATION

Produces printouts of all prime entries, nominal ledger, trial balance, profit and loss account and balance sheet with supporting schedules. Has 73 nominal ledger accounts and automatically calculates VAT.

Sole Trader/Partnership (up to 4) - £25.00
Limited Company - £25.00
(Combined Price - £35.00)

SALES AND PURCHASE LEDGERS

Produces day book, sales/purchases and VAT analyses, debtors/creditors listings and statements. 250 accounts and 1000 monthly transactions. Automatically calculates VAT. £25.00.

All programs have been professionally developed and are being used by practising accountants and small businesses. Supplied on cassette with operating instructions.

Full details from

HESTACREST LIMITED

P.O. Box 19, Leighton Buzzard, Beds. LU7 0DG
Tel: 052-523-785

THE CHEAPEST IN THE WORLD?

apple II COMPATIBLE

48K
Numeric Keypad
Upper/Lower case



RAM II

£250
INC. FREIGHT TO LONDON

MONEY-BACK GUARANTEE

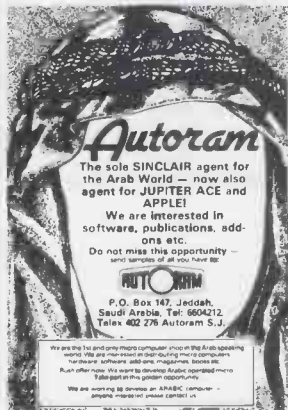

Autoram

PO Box 147, Jeddah
Saudi Arabia Tel. 660 4212
Telex 402 276 AUTORAM SJ

Sole SINCLAIR agent for
The Arab World

UK INFORMATION CENTRE
0923-771306

A NEW STAR IS BORN

FROM THE LARGEST RETAILER IN THE UK OF STAR PRINTERS COMES THE:

NEW STAR DP 510/515

EX STOCK

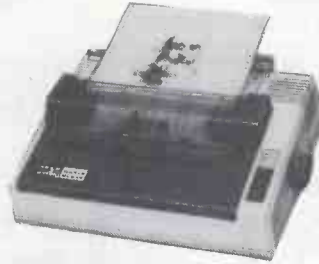

One Year Warranty, True Descenders 9x9 Matrix, 100 CPS Bidirectional & Logic seeking, 5, 6, 8, 5, 10, 12, 17 cpi 40, 48, 68, 80, 96, 136 cpi, Italics, Emphasized, Double strike, Super & Sub Scripts, Hi-Resolution & Block Graphics Continuous Underline, Backspace, Vertical & Horizontal Tabs Friction, Tractor Feed or Paper Roll (Roll holder standard) 2.4K Buffer Standard Centronics Interface Standard others available
DP 510 Accepts 10 Inch Paper
DP 515 Accepts 15 Inch Paper

DP 510 £310.00 + £46.50 VAT = £356.50

DP 515 £425.00 + £63.75 VAT = £488.75

PACKAGE PRICE for BBC MICRO/DRAGON/ORIC
STAR DP 510 + Cable + Delivery & VAT £375.00
STAR DP 515 + Cable + Delivery & VAT £510.00



SPECIAL

NEW LOW PRICE ON STAR DP8480

EX STOCK

DP 8480 £217.39 + £32.61 = £250.00

RS232 Interface as standard 5, 6, 8, 5, 10, 12, 17 cpi 40, 48, 68, 80, 96, 136 cpi
7 Needle Head 7x9 Character Matrix Block Graphics or Optional Hi-Res Graphics
80 cps Bidirectional & Logic Seeking Friction & Tractor Feed accepts up to 10 inch Paper

| | |
|--|---------|
| Hi-res Graphics option for DP8480 | £15/£20 |
| BBC Package (Star DP8480 + Hi-res option + Cable + Delivery & VAT) | £260.00 |
| Printer Cables | |
| BBC to 36 Way Centronics Type Connector | £17.50 |
| Dragon to 36 Way Centronics Type Connector | £17.50 |
| Oric to 36 Way Centronics Type Connector | £17.50 |
| Torch to 36 Way Centronics Type Connector | £20.00 |
| BBC to 25 Way D Type (For use with RS423) | £9.50 |
| BBC to 40 Way Edge Connector (Centronics 737/739) | £20.00 |

| | |
|----------------------|--------|
| Full A>B Upgrade Kit | £60.00 |
| Ram Upgrade Kit | £23.00 |

Disk Drives From £190.00

Including Case, Cables, Utilities Disk & VAT. Delivery £4.00

Blank C15/C30 Cassettes Ten for £4.50 ANY MIX

Send SAE for Full Price List of:-

Books : Software : Leads (Cassette, Monitor, Data & Specials) : Upgrade Kits & Components

Postage 50p per order or as stated
24 hr Securicor Delivery for Printers/Disk Drives £8.00

C. J. E. NEW SHOP NOW OPEN

Microcomputers

Dept PCW, 78, Brighton Road
Worthing, West Sussex
Tel: (0903) 213900

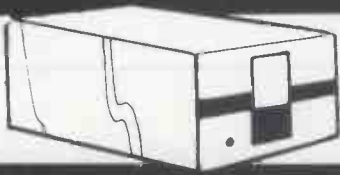

FLOPPY DISC DRIVES

SINGLE AND DUAL DISC DRIVES
40 OR 80 TRACK FOR BBC MICRO

includes utility disc and Dos Manual Phone for prices :-

BBC MICRO

BBC COMPUTER MODEL 'A' £262.00 + VAT
BBC COMPUTER MODEL 'B' £349.00 + VAT
BBC COMPUTER WITH DISC £410.00 + VAT

MONITORS

High resolution 18 MHZ 12"
Green Phosphor Monitor

£99.00 + VAT

Includes Cable

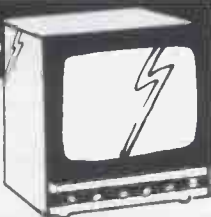

OTHER ITEMS AVAILABLE FOR THE BBC MICRO

Books, Cables, Joy Sticks, Cassette Decks, Dust Covers, Teletext Adaptor, Speech Upgrade.

SEND FOR PRICE LIST

SEIKOSHA GP-100A

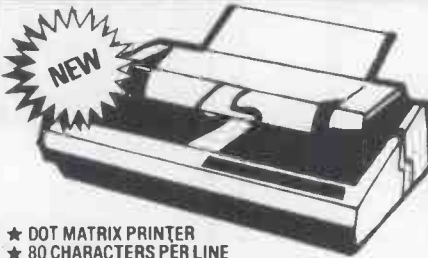

- ★ DOT MATRIX PRINTER
- ★ 80 CHARACTERS PER LINE
- ★ 30 CHARS/SEC
- ★ FREE HI-RESOLUTION 'DUMP OUT' LISTING

£179 + VAT. Carr £5

BBC Printer Cable £16 + VAT

BBC MICRO

WORD PROCESSOR
ROM £46.00

| | |
|-----------|--------|
| CHESS | £11.50 |
| ASTEROIDS | £ 8.95 |
| GLAXIAN | £ 8.95 |
| BILLIARDS | £ 8.50 |
| FROGGER | £10.00 |
| GOLF | £ 8.00 |



BBC MICRO MICRO UPGRADES

RAM KITS: Upgrades the Model 'A' to 32K RAM
Supplied with full fitting instructions. £29.90 + VAT
ANALOGUE KITS: Suitable for adding joysticks,
controllers etc. £15.00 + VAT
PRINTER INTERFACE & I/O PORT: Enables a
Centronic Interface printer to be attached ... £16.00 + VAT

MODEL 'A' TO MODEL 'B' UPGRADE

£89.00 + VAT (fitted)
DISC EXPANSION £80.00 + VAT
DISC DRIVES from £179.00 + VAT
COLOUR MONITORS from £229.00 + VAT
Send for details on other items, cables, cassettes, plugs,
software etc.

WHY NOT SEND YOUR MACHINE TO US FOR UPGRADING?

PRINTERS

EPSON FX80 - The printer recommended for the BBC Microcomputer

- ★ Dot Matrix Printer
- ★ 80 Cps
- ★ Hi-Resolution Graphics
- ★ Bi-directional Printing

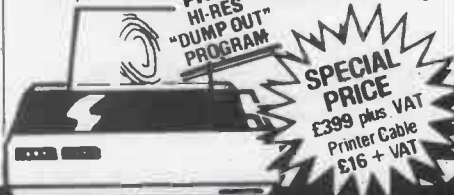

Telephone STD (0438) 65385
2 Daltry Close, Old Town, Stevenage.



CRYSTAL RESEARCH LTD

XTAL BASIC 3

A Z80 based Interpreter. Disc and Cassette versions including CP/M are available now or in the near future.

FEATURES

- Has over 110 Commands and Functions and is user extendable.
- Xtal BASIC 3 incorporates its own editor that is independent of VDU or terminal being used but appears to have the facilities of the most sophisticated direct screen editing, in brief the editor contains the following:
Lines of 127 characters (can be extended up to 254)
Full on screen editing, up, down, left, right.
Auto insertion of lines.
HOME CURSOR, CLEAR SCREEN, DELETE LEFT, DELETE RIGHT, INSERT CHARACTER, ERASE WHOLE LINE, ERASE TO END OF SCREEN, PRINT SCREEN CONTENTS TO PRINTER, and ABANDON LINE. A LINE EDIT MODE IS INCLUDED AS STANDARD.
- Variables can be of any length. First five characters used to distinguish one variable from another. Multi-dim arrays, string arrays and integer arrays.
- Full Tape and Disc file handling.
- 32 standard error messages and traps. Ability to trap **BREAK KEYS**. Error table is extendable.
- Possible to run programs larger than memory capacity.
- Special features allow transfers of programs from machine to machine.
- Xtal BASIC 3 is designed to be compatible with most available BASICS and a program is supplied for many BASIC to BASIC conversions.
- The manual, consisting of over 100 pages, includes full description of the BASIC, sample programs, useful Machine Code Subroutines in Xtal BASIC 3, examples of extra commands and functions.
- SIZE 12K to 14K depending on the System.
- Available on **Cassette** and/or **Disc**. Please contact Crystal Research Ltd., for availability on your particular machine.
- On Cassette **£40.00 + VAT** On Disc **£60.00 + VAT**
OEM and Manufacturers are invited to contact Crystal Research Ltd., for licence details.

Open 0930-1200 1300-1730 except Saturday & Sunday
40 Magdalene Road, Torquay,
Devon, England Tel: 0803 27890
Access and Barclaycard



TRIONIC

For The Attention of : All budding Computer Freaks
We Stock : Atari 400/800 - £149.99/£299.99
: VIC 20/Commodore 64
- £139.99/£344.99/£349.99

Home Computers and support these with an extensive range of Utilities; Software; firmware; peripherals and add-ons. We are probably the largest stockists of 3rd party Atari & Vic Software in London.

SUMMER SPECIAL OFFERS

- ★★★ Sony CHF C30 Tapes £7.50 (Box of 10) ★★★
- ★★★ Memorex SSD5 5 1/4" Disks £25.00 (Box of 10) ★★★
- ★★★ Atari Disks £15.00 (Box of 5) ★★★

Now Available:

EPSON PRINTERS -

RX80 £299.99 · FX80 £439.99 · MX100III £499.99

OPEN 10am-8pm Mon-Sat. Tel: 01 861 0036

TRIONIC LIMITED 144 Station Road, Harrow, Middlesex

DEALER ENQUIRY WELCOME

TABS PEACHTREE DBASE II

Rolled into one
gives you

UNEK

A BUSINESS SOLUTION WITH A DIFFERENCE !

"Unek" offers you one of the most comprehensive suits of CPM based integrated business systems. Only with "Unek" can you customise a package to any degree without one programme change.

Using the "Unek Modifier", systems can be totally tailored or created in a matter of hours; in fact you'll wonder why you ever bothered with other software.

"UNEK" TURNS YOUR SOFTWARE NIGHTMARES INTO DREAMS

APPLICATIONS COVERED:

PRICES FROM: £225

Sales Ledger with Invoicing
Purchase Ledger
Nominal Ledger
Management Accounts
Incomplete Records
Sales Order Processing
Stock Control
Clothing Import/Export
Motor Dealers Package
Freight Forwarding Accounting

TELEPHONE 01-486 7498

SGS SOFTWARE PRODUCTS LIMITED 66 MARYLEBONE LANE,
LONDON W1

NOW AVAILABLE
UNDER 16 BIT
MS DOS



GREAT NEW SOFTWARE DEAL

Buy 'n Try - the sensible way to shop for software. Simply buy any item from our software range. Try it out at home. If it's not exactly what you expected, then we'll buy it back for a full 80% of the price you paid against another purchase of equivalent or greater catalogue value any time within 1 month of purchase.

Which means you can keep right up to date with the latest software and games releases without making costly mistakes.

How it Works

Example: Buy a game for £10. If it's not as good as you thought, then we'll buy it back for £8 against your choice of another game worth £10 or more. Just send us the difference. There's just one simple rule we can only agree to buy back software that's in working order.

Look at our super selection and complete the order form to take advantage of the hottest software deal ever, or telephone your order to Software Centre on 01-487-5974, quoting your Access/Barclaycard number (24-hour telephone service).

B.B.C. MICRO

| | Mem | Regd | Supplier | Code No | Price |
|------------------------|--------|-----------------|----------|---------|--------|
| Space Pirates | 16K | Bug | Byte | 02B001 | £8.00 |
| Space Warp | 32K | Buy | Byte | 02B002 | £9.00 |
| Golf | 32K | Bug | Byte | 02B003 | £5.50 |
| Dragon Quest 1 | 16K | Bug | Byte | 02B004 | £11.50 |
| Fruit Machine | B | Bug | Byte | 03B006 | £5.50 |
| B.B.C. Airlift | B | Bug | Byte | 02B007 | £5.50 |
| Polaris | 32K | Bug | Byte | 02B008 | £5.50 |
| B.B.C. Chess | 32K | Bug | Byte | 02B009 | £8.00 |
| B.B.C. Backgammon | A/B | Bug | Byte | 02B010 | £8.00 |
| B.B.C. Multifle | 16K | Buy | Byte | 02B011 | £15.00 |
| B.B.C. Micro Derby | A/B | Bug | Byte | 02B012 | £5.50 |
| Swoop B/A | 32K | Micropower | | 24B029 | £7.99 |
| Alien Destroyers | 32K | Micropower | | 24B030 | £7.99 |
| Galactic Commander | 32K | Micropower | | 24B031 | £7.99 |
| Timetrek | 32K | Micropower | | 24B032 | £7.99 |
| Laser Command B/A | 32K | Micropower | | 24B033 | £7.99 |
| Astro Navigator B/A | 32K | Micropower | | 24B034 | £5.70 |
| Chess B/A | 32K | Micropower | | 24B035 | £7.99 |
| Footer B/A | 32K | Micropower | | 24E036 | £7.99 |
| Adventure | | Micropower | | 24B037 | £7.99 |
| Cowboy Shootout | 32K | Micropower | | 24B038 | £6.85 |
| Munchyman | | Micropower | | 24B039 | £6.85 |
| Seek | | Micropower | | 24B040 | £6.85 |
| Eldorado Gold B/A | 32K | Micropower | | 24B041 | £6.85 |
| Roulette B/A | 32K | Micropower | | 24B042 | £5.70 |
| Reversi 2 B/A | 32K | Micropower | | 24B043 | £5.70 |
| Filer | | Micropower | | 24B044 | £10.30 |
| Micro Budget | | Micropower | | 24B045 | £7.99 |
| Constellation B/A | 32K | Micropower | | 24B046 | £6.85 |
| Disassembler | | Micropower | | 24B047 | £6.85 |
| World Geography | 32K | Micropower | | 24B048 | £6.85 |
| Where B/A | 32K | Micropower | | 24B049 | £6.85 |
| Junior Maths Pack | 32K | Micropower | | 24B050 | £6.85 |
| Star Trek/Candyfloss | A or B | I.J.K. Software | | 33B001 | £6.50 |
| 6 Games | A or B | I.J.K. Software | | 33B002 | £4.50 |
| Mutant Inv/Breakout | A or B | I.J.K. Software | | 33B003 | £6.50 |
| Beep Beeb B or A | 32K | I.J.K. Software | | 33B004 | £4.50 |
| Beebmunch B or A | 32K | I.J.K. Software | | 33B005 | £6.50 |
| Super Hangman B or A | 32K | I.J.K. Software | | 33B006 | £4.50 |
| 3D Maze B or A | 32K | I.J.K. Software | | 33B007 | £4.50 |
| Invaders A | | I.J.K. Software | | 33B008 | £5.50 |
| Invaders B or A | 32K | I.J.K. Software | | 33B009 | £7.50 |
| Wordpro B or A | 32K | I.J.K. Software | | 33B010 | £10.50 |
| Atlantis/Scramble | 32K | I.J.K. Software | | 33B011 | £7.50 |
| Flags | 32K | I.J.K. Software | | 33B012 | £4.50 |
| Hyperdrive | 32K | I.J.K. Software | | 33B013 | £6.50 |
| Strato Bomber | 32K | I.J.K. Software | | 33B014 | £7.50 |
| Creative Graphics | A/B | Acomsoft | | 53B051 | £9.95 |
| Arcadians | B | Acomsoft | | 53B052 | £9.95 |
| Sliding Block Puzzles | B | Acomsoft | | 53B053 | £9.95 |
| Snapper | B | Acomsoft | | 53B054 | £9.95 |
| Desk Diary | A/B | Acomsoft | | 53B055 | £9.95 |
| Cube Master | B | Acomsoft | | 53B056 | £9.95 |
| Tree of Knowledge | B | Acomsoft | | 53B057 | £9.95 |
| Lisp | A/B | Acomsoft | | 53B058 | £16.85 |
| City Defence | | Bug Byte | | 02B059 | £7.50 |
| Space Invaders | | Bug Byte | | 02B060 | £7.50 |
| Galaxy Wars | | Buy Byte | | 02B061 | £7.50 |
| Asteroid Belt | | Comp. Concept | | 60B073 | £7.80 |
| Space Hawks | | Comp. Concept | | 60B074 | £7.80 |
| Golden Baton | | Digit. Fantasia | | 61B075 | £10.30 |
| Time Machine | | Digit. Fantasia | | 61B076 | £10.30 |
| Arrow Death 1 | | Digit. Fantasia | | 61B077 | £10.30 |
| Arrow Death 2 | | Digit. Fantasia | | 61B078 | £10.30 |
| Pulsar 7 | | Digit. Fantasia | | 61B079 | £10.30 |
| Circus | 32K | Digit. Fantasia | | 61B080 | £10.30 |
| Feasibility Experiment | 32K | Digit. Fantasia | | 61B081 | £10.30 |
| Frogger | | I.J.K. | | 33B088 | £7.50 |
| Croaker | | Micropower | | 24B108 | £7.99 |
| Dragon Rider | | Salamander | | 62B109 | £7.95 |

B.B.C. MICRO cont.

| | Mem | Regd | Supplier | Code No | Price |
|----------------------------|------------|------------|------------|---------|--------|
| Tanks | | | Salamander | 62B110 | £24.95 |
| Companies & Statements | | | Gemini | 63B115 | £19.95 |
| Home Accounts & Budget | | | Gemini | 63B116 | £19.95 |
| Decision Maker | | | Gemini | 63B117 | £5.95 |
| Stock Control System | | | Gemini | 63B118 | £19.95 |
| Selective Mailing List | | | Gemini | 63B119 | £19.95 |
| Commercial Accounting | | | Gemini | 63B120 | £19.95 |
| BBC Word Processing | 32K A or B | | Gemini | 63B121 | £19.95 |
| Beebcalc | | | Gemini | 63B122 | £19.95 |
| Moonraider B/A | 32K | Micropower | | NEW | £7.99 |
| Galactic Commander B/A | 32K | Micropower | | NEW | £7.99 |
| Spacemaze B/A | 32K | Micropower | | NEW | £6.85 |
| Maze Invaders B/A | 32K | Micropower | | NEW | £5.70 |
| Startrek A or B | | Micropower | | NEW | £5.70 |
| Killer Gorilla B/A | 32K | Micropower | | NEW | £7.99 |
| Croaker B/A | 32K | Micropower | | NEW | £7.99 |
| Barrage B/A | 32K | Micropower | | NEW | £7.99 |
| Labyrinths of LaCoshe B/A | 32K | Micropower | | NEW | £7.99 |
| Painter B/A | 32K | Micropower | | NEW | £6.85 |
| Caveman Adventure | A or B | Micropower | | NEW | £6.85 |
| Yahtzee B/A | 32K | Micropower | | NEW | £5.70 |
| Wall B/A | 32K | Micropower | | NEW | £5.70 |
| Mastermind | A or B | Micropower | | NEW | £4.55 |
| Music Processor B/A | 32K | Quicksilva | | NEW | £14.95 |
| Algebraic Manipulation B/A | 32K | Acomsoft | | NEW | £9.95 |
| Arcade Action B/A | 32K | Acomsoft | | NEW | £11.65 |
| Cube Master B/A | 32K | Acomsoft | | NEW | £9.95 |
| Forth B/A | 32K | Acomsoft | | NEW | £16.85 |
| Word Hunt B/A | 32K | Acomsoft | | NEW | £11.90 |
| Sphinx Adventure B/A | 32K | Acomsoft | | NEW | £9.95 |
| Peeko Computer B/A | 32K | Acomsoft | | NEW | £9.95 |
| Rocket Raid B/A | 32K | Acomsoft | | NEW | £9.95 |
| Meteors B/A | 32K | Acomsoft | | NEW | £9.95 |
| Missing Signs B/A | 32K | Acomsoft | | NEW | £11.90 |
| Number Balance B/A | 32K | Acomsoft | | NEW | £11.90 |
| Sentence Sequencing B/A | 32K | Acomsoft | | NEW | £11.90 |
| Planetoid B/A | 32K | Acomsoft | | NEW | £9.95 |
| Super Invaders B/A | 32K | Acomsoft | | NEW | £9.95 |
| Painting B/A | 32K | BBC Soft | | NEW | £10.00 |
| Fun Games B/A | 32K | BBC Soft | | NEW | £10.00 |
| Music B/A | 32K | BBC Soft | | NEW | £10.00 |
| Beebmon | A or B | Micropower | | NEW | £10.30 |
| Draw | A or B | Micropower | | NEW | £10.30 |
| Chemistry | A or B | Micropower | | NEW | £6.85 |
| World Geography | A or B | Micropower | | NEW | £5.95 |
| Physics | A or B | Micropower | | NEW | £6.85 |

COMMODORE 64

| | | | |
|---------------------------------|--------------|--------|--------|
| Monopole | Rabbit | 13K002 | £9.99 |
| Grave Robbers | Rabbit | 13K003 | £9.99 |
| Sprite Editor/Graphic Generator | Rabbit | 13K004 | £9.99 |
| Adventure Pack 1 | Rabbit | 13K005 | £9.99 |
| Attack on Mutant Camels | Llamasoft | 52K006 | £8.50 |
| Rox 64 | Llamasoft | 52K007 | £4.95 |
| Gridrunner | Llamasoft | 52K008 | £8.50 |
| Colonels House | Rabbit | 13K009 | £9.99 |
| Grand Master Chess | Audiogenic | 16K012 | £17.95 |
| Renaissance | Audiogenic | 16K013 | £8.95 |
| Motor Mania | Audiogenic | 16K014 | £8.95 |
| Super Skramble | Terminal | NEW | £9.95 |
| Star Trek | Interceptor | NEW | £7.00 |
| Panic 64 | Interceptor | NEW | £7.00 |
| Frogger 64 | Interceptor | NEW | £7.00 |
| Centropods | Rabbit | NEW | £5.99 |
| Pakacuda | Rabbit | NEW | £5.99 |
| Escape MCP | Rabbit | NEW | £5.99 |
| Cyclons | Rabbit | NEW | £5.99 |
| Lunar Lander | Channel 8 | NEW | £9.95 |
| Superfont | English Soft | NEW | £6.95 |
| Spritemaker | English Soft | NEW | £6.95 |
| Vixplode - 64 | Albraso | NEW | £8.50 |

NB. Software Centre is not a software library.

DRAGON 32

SINCLAIR SPECTRUM

| Mem Req'd | Supplier | Code No | Price |
|----------------------------|-----------------|---------|--------|
| Host Attack (cart) | Dragon Data | 17C007 | £24.95 |
| Ave Hunter (cart) | Dragon Data | 17C008 | £24.95 |
| Tarship Chameleon (cart) | Dragon Data | 17C009 | £24.95 |
| Hess (cart) | Dragon Data | 17C011 | £24.95 |
| Ragon Selection One | Dragon Data | 17C012 | £7.95 |
| Ragon Selection Two | Dragon Data | 17C013 | £7.95 |
| Personal Finance | Dragon Data | 17C016 | £7.95 |
| Graphic Animator | Dragon Data | 17C017 | £7.95 |
| Omputa Voice | Dragon Data | 17C018 | £7.95 |
| Typing Tutor | Dragon Data | 17C022 | £7.95 |
| Catraz | Microdeal | 21C028 | £8.00 |
| Defense | Microdeal | 21C029 | £8.00 |
| Ragon Invaders | Microdeal | 21C030 | £8.00 |
| Escape | Microdeal | 21C031 | £8.00 |
| Insion Adventure | Microdeal | 21C032 | £8.00 |
| Jerusalem Adventure | Microdeal | 21C033 | £8.00 |
| Williamsburg Adventure | Microdeal | 21C034 | £8.00 |
| Ultimate Adventure | Microdeal | 21C035 | £8.00 |
| Hantom Slayer | Microdeal | 21C036 | £8.00 |
| Planet Invasion | Microdeal | 21C037 | £8.00 |
| Games Pack 1 | Microdeal | 21C038 | £8.00 |
| Games Pack 2 | Microdeal | 21C039 | £8.00 |
| Games Pack 3 | Microdeal | 21C040 | £8.00 |
| Acner Ball | Microdeal | 21C041 | £8.00 |
| Carfman | Microdeal | 21C042 | £8.00 |
| Pace Monopoly | Microdeal | 21C043 | £8.00 |
| Pace War | Microdeal | 21C044 | £8.00 |
| Storm | Microdeal | 21C045 | £8.00 |
| Invaders Revenge | Microdeal | 21C046 | £8.00 |
| Monkey King | Microdeal | 21C047 | £8.00 |
| Slipper | Microdeal | 21C048 | £8.00 |
| Waterpillar Attack | Microdeal | 21C049 | £8.00 |
| Strategic Command | Romik | 10C050 | £9.99 |
| Adventure 2 | Microdeal | 21C055 | £8.00 |
| Adventure 3 | Microdeal | 21C056 | £8.00 |
| Eight Pens | Microdeal | 21C060 | £8.00 |
| Snake | Salamander | 62C061 | £9.95 |
| Lizard War | Salamander | 62C062 | £7.95 |
| Ulcans O's & X's | Salamander | 62C063 | £7.95 |
| Games Compendium | Salamander | 62C064 | £7.95 |
| Wolf | Salamander | 62C065 | £7.95 |
| Grand Prix | Salamander | 62C066 | £7.95 |
| Star Trek | P.S.S. | 64C067 | £7.95 |
| Star | P.S.S. | 64C068 | £12.95 |
| Tragbug | P.S.S. | 64C069 | £12.95 |
| Attack | P.S.S. | 64C070 | £7.95 |
| Atlantian | P.S.S. | 64C071 | £12.95 |
| Osmic Zap | Microdeal | 21C072 | £8.00 |
| Android Attack | Microdeal | 21C073 | £8.00 |
| L Diablero | Dragon Data | 17C074 | £7.95 |
| Database Management System | Gemini | 63C075 | £19.50 |
| Home Accounts & Budget | Gemini | 63C076 | £19.95 |
| Ragon Calc | Gemini | 63C077 | £19.95 |
| Monster Mine | Gem Software | NEW | £7.95 |
| Ultan's Maze | Gem Software | NEW | £7.95 |
| Wolf | Gem Software | NEW | £7.95 |
| Pace Mission | Gem Software | NEW | £7.95 |
| Men Blitz | Gem Software | NEW | £7.95 |
| Character Generator | Gem Software | NEW | £7.95 |
| Games Pack I | Gem Software | NEW | £7.95 |
| Games Pack II | Gem Software | NEW | £7.95 |
| Games Pack III | Gem Software | NEW | £7.95 |
| Tempack IV | Gem Software | NEW | £7.95 |
| Duquiz I | Gem Software | NEW | £9.95 |
| Duquiz II | Gem Software | NEW | £9.95 |
| Unmaths I | Gem Software | NEW | £9.95 |
| Hateau | Gem Software | NEW | £7.95 |
| Family Programs | Shards Software | NEW | £6.95 |
| Fun and Games | Shards Software | NEW | £6.95 |
| Live and Learn | Shards Software | NEW | £6.95 |
| City Defence | Shards Software | NEW | £5.75 |
| Rate | Abrasco | NEW | £8.50 |

| Mem Req'd | Supplier | Code No | Price |
|-----------------------------|----------------|---------|--------|
| G2: Games 2 | ICL | 27D009 | £4.95 |
| G3: Games 3 | ICL | 27D010 | £4.95 |
| G4: Games 4 | ICL | 27D011 | £4.95 |
| G5: Games 5 | ICL | 27D012 | £4.95 |
| Pastimes 1 | ICL | 27D013 | £4.95 |
| Pastimes 2 | ICL | 27D014 | £4.95 |
| Space Raiders | Psion | 27D015 | £4.95 |
| Planetoids | Psion | 27D016 | £4.95 |
| Hungry Horace | ICL | 27D017 | £5.95 |
| Biorhythms | ICL | 27D018 | £6.95 |
| History 1 | ICL | 27D019 | £6.95 |
| Geography 1 | ICL | 27D020 | £6.95 |
| Inventions 1 | ICL | 27D021 | £6.95 |
| Music 1 | ICL | 27D022 | £6.95 |
| English Literature | ICL | 27D023 | £6.95 |
| Chess | 48K Microgen | 06D024 | £7.95 |
| Flight Simulation | 48K Psion | 28D025 | £7.95 |
| VU-CALC | Psion | 28D026 | £8.95 |
| VU-FILE | Psion | 28D027 | £8.95 |
| VU-3D | Psion | 28D028 | £9.95 |
| Acadia | Imagine | 05D029 | £5.50 |
| Scramble | Micro Gen | 06D030 | £5.50 |
| Master Chess | Micro Gen | 06D031 | £6.95 |
| Sorcerers Castle | Micro Gen | 06D032 | £5.50 |
| Cosmic Raiders | Micro Gen | 06D033 | £5.95 |
| Krazy Kong | 48K Cotech | 07D034 | £5.50 |
| Spectral Invaders | Bug Byte | 02D037 | £5.00 |
| Spectres | Bug Byte | 02D038 | £8.00 |
| Aspect Editor | Bug Byte | 02D039 | £9.00 |
| Nightflite | 16/48K Hewson | 70D042 | £5.95 |
| Speak Easy | 48K Quicksilva | 12D046 | £4.95 |
| Time Gate | 48K Quicksilva | 12D047 | £6.95 |
| Chess Player | 48K Quicksilva | 12D048 | £6.95 |
| Space Intruders | 16K Quicksilva | 12D049 | £4.95 |
| Meteor Storm | 16K Quicksilva | 12D050 | £4.95 |
| Meteoroids | DK Tronics | 09D063 | £4.95 |
| 3D Tanx | DK Tronics | 09D064 | £4.95 |
| Centipede | DK Tronics | 09D065 | £4.95 |
| Ground Force Zero | DK Tronics | 09D066 | £5.00 |
| Football Manager | 16K Addictive | 50D070 | £6.95 |
| Gobbleman | 16/48K Artic | 25D071 | £4.95 |
| Invasion Force | 16/48K Artic | 25D072 | £4.95 |
| Frog/Showdown | 16/48K Artic | 25D073 | £4.95 |
| Spectrum Assembler | 48K Artic | 25D074 | £9.95 |
| Voice Chess | 48K Artic | 25D075 | £9.95 |
| Schizoids | Imagine | 05D076 | £5.50 |
| Ah Diddums? | Imagine | 05D077 | £5.50 |
| Adventure A | Artic | 25D078 | £6.95 |
| Adventure B | Artic | 25D079 | £6.95 |
| Adventure C | Artic | 25D080 | £6.95 |
| Adventure D | Artic | 25D081 | £6.95 |
| Invaders | Artic | 25D083 | £4.95 |
| Galaxians | Artic | 25D084 | £4.95 |
| Bug 1 | Artic | 25D085 | £2.50 |
| Bug 2 | Artic | 25D086 | £7.00 |
| Forth | Artic | 25D087 | £29.95 |
| Micro Chess | Artic | 25D088 | £6.95 |
| Chess | Artic | 25D089 | £9.45 |
| Krakit | Artic | 25D090 | £9.95 |
| Arcadia | J.K. Greye | 32D091 | £4.95 |
| Penetrator | Melbourne H. | 65D092 | £6.95 |
| Hobbit | Melbourne H. | 65D093 | £14.95 |
| Spectrum 1 | Melbourne H. | 65D094 | £5.95 |
| Spectrum 2 | Melbourne H. | 65D095 | £5.95 |
| Spectrum 3 | Melbourne H. | 65D096 | £5.95 |
| Mined Out | Quicksilva | 12D097 | £4.95 |
| Ground Force | Titan | 22D098 | £5.00 |
| Mad Martha | Microgen | 06D099 | £6.95 |
| Mines of Saturn | Microgen | 06D100 | £5.95 |
| M Coder | P.S.S. | 64D101 | £8.95 |
| Ghost Hunt | P.S.S. | 64D102 | £4.95 |
| Maze Death Race | P.S.S. | 64D103 | £4.95 |
| Database Management Systems | Gemini | 63D104 | £19.50 |
| Home Accounts & Budget | Gemini | 63D105 | £19.95 |
| Decision Maker | Gemini | 63D106 | £5.95 |
| Stock Control System | Gemini | 63D107 | £19.95 |
| Selective Mailing List | Gemini | 63D108 | £19.95 |
| Commercial Accounts | Gemini | 63D109 | £19.95 |
| Monster Mine | Gem Software | NEW | £7.95 |
| Space Mission | Gem Software | NEW | £7.95 |



**FOR USE ON VIC20 + 16K,
DRAGON, COMMODORE 64,
ORIC 1, SINCLAIR ZX81 + 16K.**

CENTRESPREAD SC

A fast flexible spread-sheet program. Set up the spread and test 'what-if' options. Centrespread calculates formulae on columns and lines. Superb forecasting and planning aid. **£19.95**

DATABASE SC

A powerful database management program to select and sort complex data from any of twelve fields. Ideal for records, home accounts, mail lists, stock lists etc. **£19.95**

NB When ordering please state computer model

THE BEST WAY TO BUY
Software Centre's great Buy 'n' Try deal stops costly mistakes by making sure you only keep what you really want.



SINCLAIR SPECTRUM

| | | | |
|--------------------|-----------|--------|-------|
| Planet of Death | Artic | 25D001 | £6.95 |
| Witch Curse | 48K Artic | 25D002 | £6.95 |
| Ship of Doom | 48K Artic | 25D003 | £6.95 |
| Espionage Island | 48K Artic | 25D004 | £6.95 |
| Reversi/Othello | Moi | 26D005 | £7.95 |
| Club Record Contrl | 48K ICL | 27D006 | £9.95 |
| Collectors Pack | 48K ICL | 27D007 | £9.95 |
| 1: Games 1 | ICL | 27D008 | £4.95 |

SOFTWARE CENTRE 24 HOUR HOT-LINE ORDER SERVICE 01-487-5974

SINCLAIR ZX81

| | | | |
|------------------------|--------------|--------|-------|
| Space Invaders | Microgen | 06E001 | £3.95 |
| Breakout | Microgen | 06E002 | £3.95 |
| Bomber | Microgen | 06E003 | £3.95 |
| ZX Chess | Microgen | 06E004 | £6.50 |
| Sorcerer's Castle | Microgen | 06E005 | £3.95 |
| 1K ZX Chess | Sinclair | 20E006 | £2.95 |
| Thro the wall/Scramble | Psion | 28E007 | £4.95 |
| Super Gloop/Frogs | 16K Psion | 28E008 | £4.95 |
| 1K Games Pack | Sinclair | 20E009 | £5.95 |
| Planet of Death | 16K Artic | 25E010 | £5.95 |
| Inca Curse | 16K Artic | 25E011 | £5.95 |
| The Ship of Doom | 16K Sinclair | 20E012 | £5.95 |
| Espionage Island | 16K Sinclair | 20E013 | £5.95 |
| Toolkit | 16K Sinclair | 20E014 | £5.95 |
| Reversi/Othello | 16K Moi | 26E015 | £6.95 |

COPYRIGHT WARNING: IT IS AGAINST THE LAW TO COPY SOFTWARE PURCHASED FROM US

SINCLAIR ZX81 cont.

| | Mem Req'd | Supplier | Code No | Price |
|----------------------------|-----------|--------------|---------|--------|
| Games 1 | | ICL | 27E016 | £3.95 |
| Junior Education 2 | | ICL | 27E017 | £3.95 |
| Business & Household 3 | | ICL | 27E018 | £3.95 |
| Games 4 | | ICL | 27E019 | £3.95 |
| Junior Education 5 | | ICL | 27E120 | £3.95 |
| Family Quiz 6 | | ICL | 27E121 | £3.95 |
| G12 Fantasy Games | | Psion | 28E122 | £4.75 |
| G13 Space Raiders | | Psion | 28E123 | £4.75 |
| G1 Super Program 1 | | ICL | 27E124 | £4.95 |
| G2 Super Program 2 | | ICL | 27E125 | £4.95 |
| G3 Super Program 3 | | ICL | 27E126 | £4.95 |
| G4 Super Program 4 | | ICL | 27E127 | £4.95 |
| G5 Super Program 5 | | ICL | 27E128 | £4.95 |
| G6 Super Program 6 | | ICL | 27E129 | £4.95 |
| G7 Super Program 7 | | ICL | 27E130 | £20.95 |
| G8 Super Program 8 | | ICL | 27E131 | £4.95 |
| G10 Backgammon | | Psion | 28E132 | £5.95 |
| G14 Flight Simulation | | Psion | 28E133 | £5.95 |
| E1 English Lit. 1 | | ICL | 27E134 | £6.95 |
| E2 English Lit. 2 | | ICL | 27E135 | £6.95 |
| E3 Geography | | ICL | 27E136 | £6.95 |
| E4 History | | ICL | 27E137 | £6.95 |
| E5 Maths 1 | | ICL | 27E138 | £6.95 |
| E6 Music 1 | | ICL | 27E139 | £6.95 |
| 7 Inventions 1 | | ICL | 27E140 | £6.95 |
| E8 Spelling 1 | | ICL | 27E141 | £6.95 |
| G11 Chess | | Psion | 28E142 | £6.95 |
| G9 Biorhythms | | Sinclair | 20E143 | £6.95 |
| B3 VU-CLAC | | Sinclair | 20E144 | £7.95 |
| B4 VU-FILE | | Sinclair | 20E145 | £7.95 |
| B1 Collectors | | Sinclair | 20E146 | £9.95 |
| B2 Club Records | | Sinclair | 20E147 | £9.95 |
| QS Scramble | 16K | Quicksilva | 12E148 | £3.95 |
| QS Invaders | 16K | Quicksilva | 12E149 | £3.95 |
| QS Asteroids | 16K | Quicksilva | 12E150 | £3.95 |
| QS Defenda | 16K | Quicksilva | 12E151 | £3.95 |
| Mazogs | 16K | Bug Byte | 02E175 | £10.00 |
| Invaders | 16K | Bug Byte | 02E176 | £4.00 |
| Adventure | | Bug Byte | 02E177 | £8.00 |
| ZXAS Assembler | | Bug Byte | 02E178 | £5.00 |
| ZXTK Toolkit | | Bug Byte | 02E179 | £6.00 |
| ZXDB D/smbler & Debugger | | Bug Byte | 02E180 | £6.50 |
| Damsel and the Beast | | Bug Byte | 02E181 | £6.50 |
| Dictator | | Bug Byte | 02E182 | £9.00 |
| Star Trek | | Bug Byte | 02E183 | £5.00 |
| Constellation | | Bug Byte | 02E184 | £8.00 |
| Multifile | 16K | Bug Byte | 02E185 | £17.50 |
| Awari | | Sinclair | 20E186 | £6.95 |
| Games Pack 1 | | Sinclair | 20E187 | £4.75 |
| Games Pack 2 | | Sinclair | 20E188 | £4.75 |
| Asteroids | | Sinclair | 20E189 | £4.95 |
| Centipede | | Sinclair | 20E190 | £4.95 |
| Defender | | Sinclair | 20E191 | £4.95 |
| Space Invaders | | Sinclair | 20E192 | £4.95 |
| Games 1 10 Games | | | | |
| Games 2 Starfighter | 1K | J K Greye | 32E001 | £3.95 |
| Artist | 1K | J K Greye | 32E002 | £3.95 |
| Games 3 Catacombs | 16K | J K Greye | 32E003 | £4.95 |
| Games 4 3D Monster Maze | 16K | J K Greye | 32E004 | £4.95 |
| Games 5 3D Defender | 16K | J K Greye | 32E005 | £4.95 |
| Football Manager | 16K | Addictive | 50E193 | £5.95 |
| Gobblerman | 16K | Artic | 25E194 | £3.95 |
| Namir Raiders | 16K | Artic | 25E195 | £3.95 |
| Galaxy Warrior/Star Trek | 16K | Artic | 25E196 | £6.50 |
| Invasion Force | 16K | Artic | 25E197 | £3.95 |
| Assembler | 16K | Artic | 25E198 | £9.95 |
| Chess 11 | | Artic | 25E199 | £9.95 |
| Chess | 1K | Artic | 25E200 | £2.95 |
| Krakit | | Artic | 25E201 | £9.95 |
| Galaxians | | Artic | 25E206 | £3.95 |
| Games | 1K | Artic | 25E207 | £6.00 |
| Sword of Peace | | Artic | 25E208 | £6.50 |
| Toolkit | | Artic | 25E209 | £5.95 |
| Forth | | Artic | 25E210 | £14.95 |
| Bug | | Artic | 25E211 | £7.00 |
| Assembler | | Bug Byte | 02E212 | £5.00 |
| Invaders | | Bug Byte | 02E213 | £4.00 |
| Adventure | | Bug Byte | 02E214 | £8.00 |
| Mazogs | | Bug Byte | 02E215 | £10.00 |
| Pilot | | Hewson | 70E216 | £5.95 |
| Puckman | | Hewson | 70E217 | £5.95 |
| Games | | Microgen | 06E218 | £3.95 |
| Scramble | | Microgen | 06E219 | £3.95 |
| Frogs | | Microgen | 06E220 | £3.95 |
| Paintmaze | | Microgen | 06E221 | £3.95 |
| Asteroids | | Microgen | 06E222 | £3.95 |
| Tempest | | Microgen | 06E223 | £3.95 |
| Games | 1K | Microgen | 06E224 | £3.95 |
| Debug | | Microgen | 06E225 | £3.95 |
| Asteroids | | Quicksilva | 12E226 | £3.95 |
| Croaka Crawl | | Quicksilva | 12E227 | £3.95 |
| Munchees | | Quicksilva | 12E228 | £3.95 |
| Trader | | Quicksilva | 12E229 | £9.95 |
| Starquest | | Quicksilva | 12E230 | £3.95 |
| Super Nine | | Quicksilva | 12E231 | £9.99 |
| Database Management System | | Gemini | 63E232 | £7.95 |
| Decision Maker | | Gemini | 63E233 | £5.95 |
| Monster Mine | | Gem Software | NEW | £4.95 |
| Space Mission | | Gem Software | NEW | £4.95 |

BUY 'N TRY MEANS 80% OFF YOUR SECOND PURCHASE

*** Personal callers welcome come along see our super selection!**

VIC 20

| | Mem Req'd | Supplier | Code No | Price |
|----------------------------------|-----------|------------|---------|--------|
| Vic Forth (cart) | | Adda | 01V001 | £38.95 |
| Vic Stat (cart) | | Adda | 01V002 | £28.95 |
| Vic Graph (cart) | | Adda | 01V003 | £28.95 |
| Facemaker | 16K | A.S.K. | 14V004 | £8.95 |
| Twister | 16K | A.S.K. | 14V005 | £8.95 |
| Number Chaser | 8K | A.S.K. | 14V006 | £8.95 |
| We Want to Count | 16K | A.S.K. | 14V007 | £8.95 |
| Frogger | 3K | Rabbit | 13V008 | £9.95 |
| Space Storm | | Rabbit | 13V010 | £6.95 |
| Rainbow Towers | | A.S.K. | 14V012 | £8.95 |
| Number Gulper | | A.S.K. | 14V013 | £8.95 |
| Super Worm | | Rabbit | 13V014 | £4.99 |
| Night Flight | 3K | Rabbit | 13V015 | £4.99 |
| Rabbit Writer | 16K | Rabbit | 13V016 | £19.95 |
| Rabbit Base | 16K | Rabbit | 13V019 | £14.99 |
| Home Office | 8K | Navajo | 18V020 | £12.95 |
| Decision Maker | | Creative | 19V021 | £14.95 |
| Loan Analyser | | Creative | 19V022 | £14.95 |
| Car Costs | | Creative | 19V023 | £14.95 |
| Home Inventory | | Creative | 19V024 | £14.95 |
| Household Finance | | Creative | 19V025 | £14.95 |
| Forth (cart) | | Audiogenic | 16V026 | £24.95 |
| Monitor (cart) | | Audiogenic | 16V027 | £19.95 |
| Bonzo | 8K | Audiogenic | 16V028 | £7.95 |
| Tomb of Drewan | 16K | Audiogenic | 16V029 | £12.95 |
| Trashman (cart) | | Audiogenic | 16V030 | £19.95 |
| Pit | 3K | Audiogenic | 16V031 | £7.95 |
| Astro Blitz (cart) | | Audiogenic | 16V032 | £19.95 |
| Boss | 8K | Audiogenic | 16V033 | £14.95 |
| Tank Attack (cart) | | Audiogenic | 16V034 | £19.95 |
| Outworld (cart) | | Audiogenic | 16V035 | £19.95 |
| Blockade | | Audiogenic | 16V036 | £6.95 |
| Amok | | Audiogenic | 16V037 | £6.95 |
| Vicalc | | Audiogenic | 16V038 | £8.95 |
| Alien Blitz | | Audiogenic | 16V039 | £7.95 |
| Sky Math | | Audiogenic | 16V040 | £6.95 |
| Space Division | 3K | Audiogenic | 16V041 | £6.95 |
| The Allen | 3K | Audiogenic | 16V042 | £7.95 |
| Vicat | 3K | Audiogenic | 16V043 | £8.95 |
| Hangman/Hang Math | | Audiogenic | 16V044 | £7.95 |
| Math Hurdler/Monster Maze | | Audiogenic | 16V045 | £7.95 |
| Sea Wolf/Bounce Out/Vic | | Audiogenic | 16V046 | £8.95 |
| Code Maker/Code Breaker | | Audiogenic | 16V047 | £7.95 |
| Kosmic Kamikaze | 3 or 8K | Audiogenic | 16V048 | £7.95 |
| Minikit | | Audiogenic | 16V049 | £7.95 |
| Golf | | Audiogenic | 16V050 | £7.95 |
| Spiders of Mars (cart) | | Audiogenic | 16V051 | £19.95 |
| Cloudburst (cart) | | Audiogenic | 16V052 | £19.95 |
| Renaissance (cart) | | Audiogenic | 16V053 | £19.95 |
| Satellites and Meteorites (cart) | | Audiogenic | 16V054 | £19.95 |
| Meteor Run (cart) | | Audiogenic | 16V055 | £19.95 |
| Magnificent Seven | 3K | Audiogenic | 16V056 | £4.95 |
| Mikro Assembler (cart) | | Audiogenic | 16V057 | £48.95 |
| Wacky Waiters | | Imagine | 05V149 | £5.50 |
| Catcha Snatcha | | Imagine | 05V150 | £5.50 |
| Arcadia | | Imagine | 05V151 | £5.50 |
| Castlemath | 16K | Audiogenic | 16V058 | £8.95 |
| Arcadia | | Imagine | 05V059 | £5.50 |
| Martian Raider | | Romik | 10V072 | £9.99 |
| Mind Twisters | | Romik | 10V073 | £9.99 |
| Shark Attack | | Romik | 10V074 | £9.99 |
| Multisound Synthesizer | | Romik | 10V075 | £9.99 |
| Sea Invasion | | Romik | 10V076 | £9.99 |
| Space Attack | | Romik | 10V077 | £9.99 |
| Chess | 16K | Bug Byte | 02V078 | £7.00 |
| Asteroids | | Bug Byte | 02V079 | £7.00 |
| Another Vic in the Wall | | Bug Byte | 02V080 | £7.00 |
| Panic | | Bug Byte | 02V081 | £7.00 |
| Cosmiads | | Bug Byte | 02V082 | £7.00 |
| Backgammon | 3K | Bug Byte | 02V083 | £7.00 |
| Scramble | | Bug Byte | 02V084 | £7.00 |
| Blitz | | Commodore | 04V103 | £4.99 |
| Hopbit | | Commodore | 04V104 | £4.99 |
| Race | | Commodore | 04V105 | £4.99 |
| Strategic Advance | 16K | Commodore | 04V106 | £4.99 |
| Simplicalc | 16K | Commodore | 04V107 | £19.95 |
| Vic Stock Control | 8K | Commodore | 04V108 | £19.95 |
| Vic Writer | 8K | Commodore | 04V109 | £19.95 |
| English Language | 8K | Commodore | 04V110 | £9.99 |
| Maths 1 | 8K | Commodore | 04V111 | £9.99 |
| Maths 2 | 8K | Commodore | 04V112 | £9.99 |
| Biology | 8K | Commodore | 04V113 | £9.99 |
| Chemistry | 8K | Commodore | 04V114 | £9.99 |
| Physics | 8K | Commodore | 04V115 | £9.99 |
| Apple Tree Birds | 3K | Commodore | 04V116 | £4.99 |
| Engine Shed | 3K | Commodore | 04V117 | £4.99 |
| Lighthouse & Subtraction | 3K | Commodore | 04V118 | £4.99 |
| Quizmaster | 8K | Commodore | 04V119 | £9.99 |
| Know your own I.Q. | 8K | Commodore | 04V120 | £9.99 |

CALLING DEALERS

If you want a bit of the action and a share of the success ... call us right away.

COPYRIGHT WARNING: ALL LISTED PROGRAMS ARE PROTECTED BY COPYRIGHT

VIC 20 cont.

| | Mem Req'd | Supplier | Code No | Price |
|--------------------------------|-----------|-------------|---------|--------|
| Know your child's I.Q. | 8K | Commodore | 04V121 | £9.99 |
| Know your own personality | 8K | Commodore | 04V122 | £9.99 |
| Robert Carrier Menu Planner | 8K | Commodore | 04V123 | £9.99 |
| Vic Money Manager | 8K | Commodore | 04V124 | £9.99 |
| Vic Road User & Highway Code | 8K | Commodore | 04V125 | £9.99 |
| B.B.C. Mastermind | 8K | Commodore | 04V126 | £9.99 |
| Type & Tune | | Commodore | 04V135 | £4.99 |
| Programmers Aid Cart. | | Commodore | 04V136 | £34.95 |
| Machine Code Monitor Cartridge | | Commodore | 04V138 | £34.95 |
| Missile Panic | | Titan | 22V141 | £6.00 |
| Road Runner | | Titan | 22V142 | £5.00 |
| Android Attack | | Titan | 22V143 | £5.00 |
| Space Hopper | | Titan | 22V144 | £5.00 |
| Star Wars 2 | | Titan | 22V145 | £5.00 |
| Mawai Attack | | Titan | 22V146 | £5.00 |
| Space Wars/Battle Zone | | Titan | 22V147 | £5.00 |
| Space Fortress | | Romik | 10V135 | £9.99 |
| Space Attack | | Romik | 10V136 | £9.99 |
| Innovative 1 | | Melbourne H | 65V149 | £5.95 |
| Innovative 2 | | Melbourne H | 65V150 | £5.95 |
| Innovative 3 | | Melbourne H | 65V151 | £5.95 |
| Wizard & Princess | | Melbourne H | 65V152 | £5.95 |
| Tornado | | Quicksilva | 12V153 | £5.95 |
| Harvester | | Quicksilva | 12V154 | £7.95 |
| Pixel Power | | Quicksilva | 12V155 | £7.95 |
| Trader | | Quicksilva | 12V156 | £14.95 |
| Subspace Striker | | Quicksilva | 12V157 | 7.95 |
| Starquest | | Quicksilva | 12V158 | £7.95 |
| Moons of Jupiter | | Romik | 10V159 | £9.99 |
| Grand Master Chess | 8K | Audiogetic | 16V160 | £17.95 |
| Choplifter (cart) | | Audiogetic | 16V161 | £24.95 |
| Apple Panic (cart) | | Audiogetic | 16V162 | £24.95 |
| Serpentine (cart) | | Audiogetic | 16V163 | £24.95 |
| Mangrove | | Audiogetic | 16V164 | £7.95 |
| Country Garden | 8K | Audiogetic | 16V165 | £7.95 |
| Kaktus | 8K | Audiogetic | 16V166 | £7.95 |
| Rabbit Call | | Rabbit | 13V167 | £19.99 |
| Abductor | | Llamosoft | 52V168 | £6.00 |
| Blitzkrieg | | Llamosoft | 52V169 | £4.95 |
| Gridrunner | | Llamosoft | 52V170 | £6.00 |
| Andres Attack | | Llamosoft | 52V171 | £8.00 |
| Database Management System | | Gemini | 63V172 | £19.50 |
| Invoices & Statements | | Gemini | 63V173 | £19.95 |
| Home Accounts & Budget | | Gemini | 63V174 | £19.95 |
| Decision Maker | | Gemini | 63V175 | £5.95 |
| Stock Control System | | Gemini | 63V176 | £19.95 |
| Selective Mailing List | | Gemini | 63V177 | £19.95 |
| Commercial Accounting | | Gemini | 63V178 | £19.95 |
| Critters | | Rabbit | NEW | £5.99 |
| Anti Matter Splatter | | Rabbit | NEW | £5.99 |
| Skramble | | Rabbit | NEW | £5.99 |
| English Invaders | | Rabbit | NEW | £5.99 |
| Pakacuda | | Rabbit | NEW | £5.99 |
| Escape MCP | | Rabbit | NEW | £5.99 |
| Cyclons | | Rabbit | NEW | £5.99 |
| The Catch | | Rabbit | NEW | £5.99 |
| Paratroopers | | Rabbit | NEW | £5.99 |
| Vixplode | | Abrasco | NEW | £8.50 |
| Android Attack | | Abrasco | NEW | £9.50 |
| Fly Snatcher | | Abrasco | NEW | £7.50 |
| Alien Hunter | | Abrasco | NEW | £7.50 |
| Double Trouble | | Abrasco | NEW | £9.50 |
| Catcha Troopa | | Abrasco | NEW | £7.50 |
| Skramble | | Sumlock | NEW | £7.95 |
| Jumpin Jack | | Sumlock | NEW | £7.95 |
| Triad | | Sumlock | NEW | £7.95 |
| Griptrap | | Sumlock | NEW | £7.95 |
| Astro Fighters | | Sumlock | NEW | £6.95 |
| Chopper | | Sumlock | NEW | £6.95 |
| Destroyer | | Sumlock | NEW | £7.95 |
| Gunfight | | Sumlock | NEW | £6.95 |
| Space Rescue | | Sumlock | NEW | £6.95 |
| Space Bomber & Man on the Run | | Sumlock | NEW | £6.95 |
| Puzzle Pack | | Sumlock | NEW | £9.95 |
| Starship Escape | | Sumlock | NEW | £8.95 |
| Data Pack | | Sumlock | NEW | £7.95 |
| Scorpion | | Sumlock | NEW | £7.95 |
| Multitron | | Sumlock | NEW | £5.95 |
| At the Circus | | Sumlock | NEW | £5.95 |

ATARI

| Mem Req'd | Supplier | Code No | Price |
|-----------|----------|---------|--------|
| | | 34G052 | £21.99 |
| | | 34G053 | £17.99 |
| | | 34G054 | £21.99 |
| | | 34G055 | £25.49 |
| | | 34G056 | £25.49 |
| | | 34G057 | £17.99 |
| | | 35G058 | £29.75 |
| | | 35G059 | £14.75 |
| | | 35G060 | £18.50 |
| | | 35G061 | £29.75 |
| | | 35G062 | £14.75 |
| | | 35G064 | £14.75 |
| | | 35G065 | £14.75 |
| | | 35G067 | £22.00 |
| | | 35G068 | £29.75 |
| | | 35G069 | £22.00 |
| | | 35G070 | £14.75 |
| | | 35G072 | £29.75 |
| | | 35G073 | £29.75 |
| | | 35G074 | £29.75 |
| | | 36G075 | £22.00 |
| | | 36G076 | £22.00 |
| | | 36G077 | £22.00 |
| | | 37G078* | £33.25 |
| | | 37G079* | £33.25 |
| | | 38G080 | £31.00 |
| | | 38G081 | £31.00 |
| | | 39G082* | £29.50 |
| | | 39G083* | £33.00 |
| | | 40G084 | £22.00 |
| | | 40G085* | £22.00 |
| | | 41G086* | £29.50 |
| | | 42G087* | £29.95 |
| | | 42G088 | £23.55 |
| | | 43G089 | £31.40 |
| | | 43G090 | £31.40 |
| | | 44G091 | £22.00 |
| | | 45G092 | £19.95 |
| | | 46G093 | £22.00 |
| | | 47G094 | £27.50 |
| | | 47G095* | £29.95 |
| | | 47G096 | £27.50 |
| | | 47G097* | £29.95 |
| | | 47G098 | £27.50 |
| | | 47G099* | £29.95 |
| | | 47G100 | £27.50 |
| | | 47G101* | £29.95 |
| | | 47G102 | £27.50 |
| | | 47G103* | £29.95 |
| | | 47G104 | £27.50 |
| | | 47G105* | £29.95 |
| | | 48G106* | £27.50 |
| | | 48G107 | £18.50 |
| | | 48G108* | £26.75 |
| | | 48G109 | £18.50 |

* Denotes cartridge

BUY WITH CONFIDENCE TRY AT YOUR LEISURE

When we send your software order, you'll find a return address label and a list of the buy-back prices for each item ordered.

Remember, we are pledged to buy back your software against a new purchase of equivalent or greater catalogue value, provided you purchase it from us. And you get a full month to decide whether to keep your software or benefit from the buy-back option.

Of course, if you wish to return two or more software items against the purchase of a more expensive item ... then provided that their initial purchase price does not exceed that of the new program you want ... we'll be happy to help.



SOFTWARE CENTRE 128 WIGMORE STREET LONDON W1 Tel 01-487-5974

BRANCHES: LEICESTER
30 New Walk Leicester.
Tel (0533) 532704.

ILFORD
426 Cranbrook Road,
Gants Hill, Ilford, Tel 01-554-6574.

SOUTHAMPTON
The Software Centre, 112 East Street,
Southampton, S01 1HD, Tel 0703-24703.

Please rush me the following programs, and put me on the Software Centre mailing list for program up-dates and great special purchase offers. I confirm that I shall not attempt to copy any program bought from Software Centre.

Name Code No Price

Name Code No Price

Name Code No Price

Cheque () Postal order () enclosed. **Total order value £**

Please debit my Access () Barclaycard () in the sum of £ Account no.

My computer is (make) Model

Memory Peripherals

Name

Address

Post code Customer Tel. No

Signed Please allow up to 14 days for delivery.

SEND TO:
SOFTWARE CENTRE
128 WIGMORE STREET
LONDON W1
01-487-5974
OR YOUR NEAREST BRANCH.

Buy an off-the-peg personal computer for your business and the results should hardly surprise you.

Because too many manufacturers turn out a standard model, and that's your lot.

The ICL Personal Computer, however, is far more personalised.

Not too big for your immediate needs, yet designed never to cramp your style – it grows with you.

Storage and disc facilities can be increased up to 16 and 30



times, running up to four VDUs. And there's a vast catalogue of software for you to choose from.

The experts in our Trader Point network will get the measure of your needs and put together a total package to cover them—then let you try the whole thing on for size.

As you may have guessed, we think you'll find it a perfect fit.

To find out more, just dial 100 and ask for Freefone ICL.

We should be talking to each other.

ICL





**ORIC
SOFTWARE**

TANSOFT

NEW

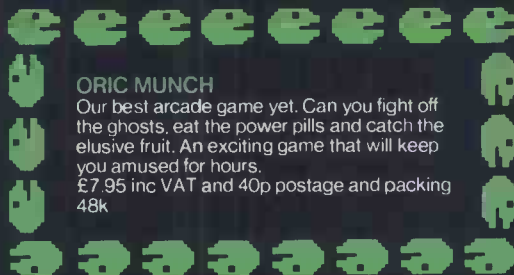

ORICMON

A complete machine code monitor including mnemonic assembler/disassembler, block move and verify, trace and slow-motion run and full cassette handling, plus manual.
Price: £15.00 inc VAT and 90p postage and packing 16k or 48k

ORIC MUNCH

Our best arcade game yet. Can you fight off the ghosts, eat the power pills and catch the elusive fruit. An exciting game that will keep you amused for hours.
£7.95 inc VAT and 40p postage and packing 48k

3D LINK 4

A set of new exciting and challenging games. Hangman, Moonlander, Substrike, Roadrace and 3D Noughts and Crosses.
£6.90 inc VAT and 40p postage and packing 48k

HOUSE OF DEATH

If you were baffled by Zodiac you will be terrified by House of Death. Can you discover the secret of the haunted house and escape with your life?
£9.99 inc VAT and 40p postage and packing 48k

ORIC BASE

This is a database system used for the maintenance of personal and small business information. It is supplied on cassette with a comprehensive manual. A sophisticated query language is used to manipulate data and allow reports to be printed, data to be sorted or moved about and running totals to be kept. A Macro command facility allows the creation of application specific command strings which can be used easily by non-technical personnel. Requires a 48k machine.
Price: £14.50 including VAT and 90p postage and packing.

ZODIAC

A traditional adventure game in which the player has to find the 12 cunningly hidden signs of the Zodiac which lead him to greater treasures. The player manipulates objects through simple sentences which the program can understand and can ask for his score at any time. A save game feature is also included. Requires a 48k machine.
Price: £9.99 including VAT and 40p postage and packing.

ORIC-CHESS

Using high resolution graphics to display the chess board this package will play a challenging game of chess with five levels of skill. The computer looks ahead for its own moves plus its opponent's. The skill level dictates how far the computer looks ahead although at the expense of more time. All chess rules including Castling and En Passant are obeyed. Requires a 48k machine.
Price: £9.99 including VAT and 40p postage and packing.

ORIC FORTH

This is a cassette-based implementation of FIG-FORTH, the language distributed by the Forth Interest Group in the United States. It has been extended to utilise the graphics and sound capabilities of the Oric. It is supplied with an editor and a full Forth assembler. A 96-page manual is included in the package. A demonstration music program is also supplied. Requires a 48k machine.
Price: £15.00 including VAT and 90p postage and packing.

ORIC OWNER MAGAZINE, £10

Why should you subscribe to *ORIC OWNER*? Your Oric 1 is one of the most powerful low-cost computers on the market today. *Oric Owner* is the only magazine totally dedicated to the Oric and its supporting hardware and software. From issue to issue *Oric Owner* is able to bring you in-depth information on the Oric, advance news on the latest add-ons, superb programs to try and 'behind the scenes' interviews with the engineers who designed it. If you wish to keep ahead of the latest developments and news on the Oric then *Oric Owner* is essential. At only £10 for a year's subscription of 6 issues (£15 for overseas readers) can you afford to be without *Oric Owner*? **SUBSCRIBE TODAY!**

Calling all Software Writers.

If you can write top quality games, business or utility software we want to hear from you. Haven't got an Oric? Convince us of your capability and we will supply one!

Dealer Enquiries Welcome

| Please send me | Quantity | Total |
|---------------------|-----------|-------|
| ORIC FORTH | at £15.00 | |
| ORIC BASE | at £14.50 | |
| ZODIAC | at £ 9.99 | |
| ORIC-CHESS | at £ 9.99 | |
| ORICMON | at £15.00 | |
| HOUSE OF DEATH | at £ 9.99 | |
| 3D LINK 4 | at £ 6.90 | |
| ORIC MUNCH | at £ 7.95 | |
| ORIC OWNER MAGAZINE | at £10.00 | |
| TOTAL | | |

● Please Include money for postage.

This amount varies with each item.

Please allow 28 days for delivery

All cheques payable to:

TANSOFT LTD

3 CLUB MEWS

ELY

CAMBS

CB7 4NW

Please send me latest price list.

Name

Address

Apple® users read on

LCC Lower Case Chip. Adds the full lower case set to your Apple II, complete with clip-on shift key mod. Lower case letters have true descenders. Available in most European & USA languages (please state which). **£34.00 + VAT**

LCC 8132 Epson Eprom. Provides owners of EPSON 8132 parallel card with the means to upgrade their existing card to accept conventional Apple printer card commands. Pascal & CP/M compatible. **£18.00 + VAT**

Developer. Developer speeds up the program development cycle by providing facilities to make rapid local and global changes to program text. Once installed Developer is completely transparent and does not interfere with DOS or Applesoft. **£19.95 + VAT**

Matrix Basic. Statisticians, Engineers, Scientists need MATRIX and ARRAY instructions normally found only on Main Frame computers NOW available for your Apple II. **£29.95 + VAT**

Visiplot Driver Routines. Allows users of Visiplot and an intelligent printer card such as Grappler WIZARD, Printmaster, Epson 8132, to send their graphs directly to the printer using all the features of the printer card. **£19.95 + VAT**

Tridee. The Tridee system for 3D graphics on an Apple II computer is a complete system for scientific-engineering and educational use. Useable by those with Pascal programming experience and those who wish to use it as a tool for 3D design and visualisation. Compatible with Apple FORTRAN. **£49.95 + VAT**

Supermon. Extends the facilities of the resident Apple II monitor to give several new commands to aid the machine code programmer in debugging his programs and in understanding others. **£19.95 + VAT**

Statsease. A set of seven interactive programs developed at Nottingham University using the Apple II for analysing data (up to 4000 entries) and for teaching statistics single disk with instructions. **£75.00 + VAT**
Back-up disk (can only be purchased with main disk). **£5.00 + VAT**

Visicalc Utilities. This program gives you - Visiform, enabling you to list out on your printer or VDU all the worksheet formulae, allows you to display or print those formulae too wide for Visicalc display area. Visiprint, reformat the printout of your worksheets with variable column widths, additional text headings, dates, page control and numbering. If you have a clock card, date and time are automatically included in your print-out. **£39.99 + VAT**

Omnibus. A powerful, general non parametric statistical tool, developed and tested over six years by Dr. R. Meddis, University of Technology, Loughborough. Omnibus has been written with a wide range of users in mind. It is equally suitable for undergraduates and experienced statisticians. The program is accompanied by a substantial handbook with examples to illustrate all the experimental designs within its range. **£95.00 + VAT**

Send for LCC Fact Sheets giving further details.
System Requirements: 48K Apple II or Apple //e.

LEICESTER
computer centre limited
67 Regent Road, Leicester LE1 6YF.
Tel: 0533 556268

apple computer
Sales and Service

COMPUTER BONANZA!

COMPUTERS
AT UNBEATABLE PRICES



EPSON HX20

Portable Computer **All prices + VAT**
With carry case **£385.00**
Without carry case **£380.00**
Micro-cassette Drive **£71.50**
1 Year Guarantee Parts and Labour.



All prices + VAT
ACT SIRIUS 1 128K with 1.2mb S/S Disks **£2025**
ACT SIRIUS 1 128K with 2.4mb D/S Disks **£2525**
ACT SIRIUS 1 128K with 1.2mb D/S Disks
and 10mb Winchester **£3975**
10mb Hard Disk **£2525**
128K Extra Memory **£340**
384K Extra Memory **£775**



90 Days Guarantee Parts and Labour.
Add **£3.00** to delivery charge for system.

Payment by Cheque, Access, Visa etc
All prices Apply to 30th June 1983.



Shipments throughout UK by TNT. We can export to most countries in the world. Please phone for Access or Visa buying details.

**IMMEDIATE
DELIVERY**

Micro-Spares

We cannot and will not be beaten on Price!

Note our change of address
104-106 Hanover Street, Edinburgh EH2 1DR
031-226 3345

SYSTEM SCIENCE CP/M SOFTWARE

FROM SOFTWARE TOOLWORKS

C/80 Compiler Ver 2.0 **£50.00**
Conforms to Kernighan & Richie. Lacks long and floating data types.
Generates .REL files. Needs 48K.

SPELL **£50.00**
Fast, easy to use spelling error detection program. Effective dictionary of up to 50,000 words. 48K RAM.

RATFOR **£42.00**
Pre-processor for FORTRAN-80. Many 'Software Tools' programs inc.

LISP/80 Interpreter **£42.00**
For A1 with examples. Requires 48K RAM.

TEXT-formatter **£45.00**
With many sophisticated features, including mail list, file inclusion, table of contents.

UVMAC-Z80 macro assembler **£35.00**
Generates absolute code.

AUTO DIFF **£40.00**
Smart file comparator - works with both text and binary files.

LABORATORY MICROSYSTEMS

Z80 FORTH Development System **£50.00**
Includes 90 page Manual and screens of software. Floating point version. **£120**

LYNX **£230**
Friendly overlay linking loader Fortran-80.

All of the above on 8" SSSD disc. Enquire for other formats

FOR THE OSBORNE

MYCHESS - Chess program **£35.00**
Pack and Crypt - file compression and encryption **£30.00**
MUNCHKIN and ADVENTURE each **£30.00**

Please send cheques or PO (add VAT - £2.00 postage)

SYSTEM SCIENCE

54 Enfield Cloisters, Fanshaw St, London N1 Tel: 01-739 0540

MICROAGE ELECTRONICS

THE NUMBER ONE COMPUTER DEALER.

MICROAGE HAVE DONE IT AGAIN! In our constant quest to bring you only the top computer equipment in the market, we now expand our range to include the Oric I, Spectrum and Sord. Of course we are still London's premiere BBC Micro dealer with a full range of Acorn Products and peripherals.

COME AND SEE US AT
Computer Fair June 16-19
 Stands 405/407
Acorn User August 25-28
 Feature Area A
PCW Show Sept. 28-Oct. 2
 Stand 230

BBC MACHINES

| | |
|--|-------------|
| Model A 32K + 6522 | £329.00 |
| Model B | £399.00 |
| Model B + Disk Interface | £494.00 |
| BBC Compatible Single Disk Drive* (100 K) | £235.00 |
| BBC Compatible Dual Disk Drive* (200 K) | £389.00 |
| BBC Dual Slimline Disk Drive* (Double sided & density 800 K) | £799.00 |
| Dust covers | £3.95 |
| 24 hour disk interface fitting | £95.00 |
| Official Joysticks | £13.00 |
| | + £1.30 p&p |

*All drives include manual & utility Disk.

SAVE £149.80!
 BBC, 800K Drive,
 Word processing ROM,
 Epson and extras.
Our price £1599.00
FREE COURIER.



Microage
 will soon
 be armed with
SORD

PERIPHERALS

Microage Cassette
 Suitable for most computers, includes tapecounter, lead, battery mains **£29.95**

PRINTERS

| | |
|------------------------|------------------|
| Seikosha AP 80* | £189.00 |
| Seikosha AP 100* | £215.00 |
| Brand new Epson FX 80* | £465.00 |
| | (incl. courier.) |
| Spectrum Printer | £39.95 |

*Suitable for all machines

MONITORS

| | |
|-------------------------------------|---------|
| 14" RGB Microvitec Colour Monitor* | £284.00 |
| Microvitec High Res. Colour Monitor | £575.00 |
| 12" Zenith High Res. Green Screen | £95.00 |

*Suitable for the Oric.
 Prices include cables.



sinclair

| | |
|----------------------|---------|
| Sinclair ZX Spectrum | £129.95 |
| 48K RAM | |
| Sinclair ZX81 | £49.95 |

SOFTWARE AND BOOKS

We have a complete range of Acornsoft, large stocks of Spectrum software and a wide range of Oric software. Books for all machines available in great quantities. Please phone for further details. (All items subject to availability.)

ORIC-1

Massive 48 K Ram, 16 colours,
 High resolution graphics **£169.00**



POSTAGE RATES

Books, software, dust covers for all machines: 1 item **£1**, 2 or more items 50p per unit.

BY COURIER TO YOUR DOOR

Computers, Monitors, Drives etc.
 1 item **£7**, 2 items **£10**, 3 or more **£13**
 (these offers are not available for the Sinclair hardware.)

We accept official orders from education establishments Credit card holders—phone for express despatch.
 Send large S.A.E. for lists and info pack.
 Barclaycard and Access welcomed.
 All prices include VAT.

Contact us for more information on the
Microage Discount Card.

Please rush me details of the Computer Users Data File.

Name _____

Address _____

Barclaycard and Access
 welcomed.



**ALL PRICES INCLUDE VAT. FOR FURTHER
 DETAILS AND MAIL ORDER LIST SEND LARGE S.A.E.**
 Open Mon - Sat 9.15 am - 6.00 pm. Thurs 9.15 am - 1.00 pm.

MICROAGE ELECTRONICS
 135 HALE LANE EDWARE MIDDLESEX HA8 9QP
 TEL: 01-959 7119 TELEX 881 3241

SALES, RENTAL and LEASE

and other services

Sirius 1, IBM, Apple, BBC, Superbrain, Osborne, ICL, Zenith

Extremely low introductory prices available on all Micros
All CP/M software available; Languages, Accounts Packages, Database, Standard CP/M ie. Wordstar, Supercalc

EPSON PRINTERS MX 80 F/T 3 £310
MX 100 3 £440

Delivery in London free of charge
Elsewhere £5 delivery
Disk drive with control card £260

Full range of Video monitors, Hardware
Software, Documentation, Printers, cards and accessories.

MAIL ORDER TO CENTRAL OFFICE

Send for further details on rest of our excellent range of software hardware
★ All prices ex. V.A.T. ★ Our own low cost maintenance 24 hrs. service ★ Please ask for other brands of software and hardware

MICROCOMPUTER HIRE SERVICE

A TRIAL PERIOD FOR YOUR COMPUTERISATION
A COMPREHENSIVE SERVICE FOR RENTALS
SIRIUS 1, IBM Superbrain with application packages. Apple System, PET, Tandy, Sorcerer, Horizon, Sirius 1, IBM, Osborne Printers, BBC (b), ICL, Zenith
Short Term Rental Available

CENTRAL OFFICE:

Microcomputer Spacedrome, 3 Westholm, Hampstead, London NW11.
01-458 5845

PRINTER BONANZA!

EPSON

PRINTERS AT UNBEATABLE PRICES

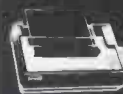

EPSON RX80 £275 + VAT
EPSON FX80 £365 + VAT
STAR 510 £299 + VAT
STAR 515 £389 + VAT
CP80 £299 + VAT

THE NEW 'STAR' AND 'CP' PRINTERS -
AS GOOD AS EPSON

STAR & EPSON - THE BEST ON THE MARKET.



All printers carry a 1 Year Guarantee and come with paper. Shipment is by TNT Overnight Express to your door - Please add £7 + VAT carriage.

Payment by Cheque, Access, Visa etc.
All prices Apply to 31st July 1983.

Shipments throughout UK. We can export to most countries in the world.

Please phone for Access or Visa buying details.



IMMEDIATE DELIVERY.

Micro-Spares

We cannot and will not be beaten on Price!

Note our change of address
104-106 Hanover Street, Edinburgh EH2 1DR
031-226 3345

EPSON

RX-80 & FX-80
now in stock

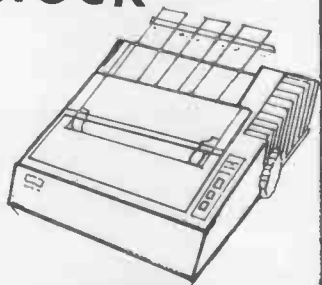

RX - 80 £275 + VAT
100cps

FX - 80 £398 + VAT
180 cps

All printer products supplied carry a full, no nonsense 12 month warranty.

TELEPHONE ORDERS ANYTIME - WE DO THE REST

Nationwide delivery by Securicor

KINDLEGLLEN LTD
Computer Supplies
66 Brookside Road
Brangsgore
Christchurch
Dorset BH23 8NA

Tel No: 0425 73278

TOP VALUE AND LOWER PRICES AT LOMAX NEW COMPUTER CENTRE

(Est 1927)

The BBC Microcomputer System MODEL B £399
(cassette lead £4.50)

SHARP MZ80A £499
(incl £75.00 of FREE software)

BBC COLOUR MONITOR £287

NEW LYNX - 48 £225

SINCLAIR ZX-81 £45.95

ORIC - 1 48K NOW AVAILABLE £169.95

SINCLAIR 16K RAM Pack £29.95

GENIE 2000 (COLOUR) £199

PACKAGE PRICE (Save £5.00) £69.95

NEW BRAIN Model A £243

SINCLAIR SPECTRUM 16K £99.95

NEW BRAIN Model AD £269

SPECTRUM 48K £129.95

ATARI 800 £299

Free Post & insurance on above items

PRINTERS SEIKOSHA GP 100A £215

ATARI 400 £149.95

ACORN AP 100A PRINTER £214

DRAGON 32 £175

MONITORS from £79.95

SOFTWARE AVAILABLE FOR ACORN (BBC) ATARI. DRAGON. BUG-BYTE. RABBIT. COMMODORE. UK.

CASSETTE RECORDERS from £29.95

Send S.A.E. for our Computer News Sheet For Insurance & Postal charges ADD £5 for Hardware £1 for Software

ACORN SOFTWARE MONSTERS, ARCADIAN, SUPER INVADERS SNAPPERS, METEORS plus many more £9.95 each
Also available for BBC BUG-BYTE SOFTWARE

For MAIL ORDER Phone your ACCESS / VISA on our HOT LINE 061-832 6345 or send cheque P.O. Payable to LOMAX LTD for IMMEDIATE ATTENTION NO EXTRA CHARGE ON CREDIT CARDS

LOMAX (Computer Division)
8 EXCHANGE ST (St Anns Sq) MANCHESTER M2 7HL

Calc Result™

3-D Budgetting out of this world

Spread sheet programs have been available for a number of years. The knowledge and experience gained through the use of these led to a demand for a tool that is easier to use, easier to understand and more powerful than contemporaries. The result is Calc Result — a powerful yet low cost '3D' spread sheet for the Commodore 8000 and 64.

- * Three dimensional format
- * Up to 32 pages with consolidation
- * Horizontal and vertical page split
- * View part of up to 4 pages at one time
- * Powerful editing facilities
- * Compare budgets with "What if . . ." facility
- * "if . . . then . . . else" choice of calculation
- * Graphics output on screen and printer
- * Miserly use of memory
- * 'Help' functions on screen
- * Multi user capabilities and hard disk support
- * Ability to load VisiCalc™ files

Machine capability

CalcResult is currently available on Commodore Business machines as follows:

8032 and 8096 computers — including the SK series — on 8250 or 8050 disk units. It can also be used in multi-user situations and with Commodore 9060 and 9090 hard disks.

Commodore 64 — a single disk version for the 1541 disk unit, and serial printer.

Price

For 8000 series £149 (plus VAT)
For Commodore 64 £109 (plus VAT)

THE
SPREAD
SHEET

KOBRA

Micro Marketing
PO Box 28, Henley-on-Thames, Oxon, RG9 1PF.
Telephone 04912 2512

Available from: W.H. Smith, The Xerox Stores, Currys Micro C and leading Commodore dealers.



BEST OF BRITISH

16 Bit Microcomputers

THE CAL PC



Unbeatable on Price

IBM PC Compatible

Will Also Run 8 Bit

CPM Software

THE ORION

Multi-User,
Concurrent Tasks,
inc. Telex

Outstandingly Fast

(Practical Computing)
May 1983

The System You Can
Really Talk Business
With



And the Best of British Support!

**YOU WON'T BEAT OUR PRICE OR BACK-UP ON
EITHER MACHINE**

Microtrol Engineering Design Ltd
11 Church St, Kidderminster, Worcs. DY10 2AH
Tel: 0562-742244

MED

OSBORNE

**OSBORNE Double Density
EPSON FX80**

£1425*

**OSBORNE
80 Column
Double Density**

**EPSON FX80
£1625***

*Prices + VAT
& Delivery

NOW

FREE DATABASE

PACKAGE FOR ALL

ORDERS RECEIVED

BY JULY 31st

**AUTHORISED OSBORNE
MAIN DEALERS**

Fraser Associates Ltd.

1 Bristle Hill Buckingham Bucks MK1B 1EZ
Tel Buckingham (0280) 816087

you can take it anywhere



.....but so what!

The EPSON HX-20 is the first complete briefcase - portable computer. It has a full - size typewriter keyboard, four line screen, printer, microcassette drive, rechargeable batteries - all in a lightweight package the size of a phonebook.

SO WHAT can it do for you?

Its Word Processing enables you to note down ideas anywhere: on a plane, in a meeting, in a hotel room. Letters or reports can be typed in silently whilst on the move and then printed out back at base.

Its Database System means you can store customer details, pricing information, or stock data and retrieve or print out selectively at the customers office - here or anywhere in the world.

Its ECALC Spreadsheet gives you financial modelling so you can prepare business or personal budgets at work, at home or on the train between the two.

Its Communications link you with your larger computer, with various printers, with the telex network or with the resources of the Onestop Business Centres.

Diary, adding machine, payroll, salesman's package, games.....the list is growing daily.

SO WHERE can you get your HX-20? From Integra and Onestop - the HX-20 specialists. Here you receive excellent back up and support from a growing network of business centres. These centres provide you with the greater computer storage and printing power - but you only pay for what you use.

the EPSON HX-20

from
Integra

& ONESTOP



Call Integra to discuss your requirements on:-
01-935 0685 (West End) or (04862) 22450 (Woking).

Or drop into your nearest Onestop Business Centre at:-
Victoria: 11 Gillingham Street, London SW1. 01-828 5425
Croydon: 9 Essex House, College Road. 01-688 7481
Reading: 11 Duke Street. (0734) 591888

MOST OF THE PEOPLE READING THIS AD SHOULDN'T BE READING THIS AD...

Unless, that is, you're over 18 and a bona fide computer retailer or distributor or thinking of becoming one. If so, you're invited to **MICROTRADE 83** at London's Barbican Centre from 6-8 July.

MICROTRADE 83 is unique. Not only because there will be many new products and services on display, from Act, Burroughs, Logica, Portico and Sharp, amongst others, but because it's the only microcomputer show for the trade alone.

Which means everyone will be speaking the same language – with exhibitors looking for retailers and distributors and visitors talking availability, margins and support.

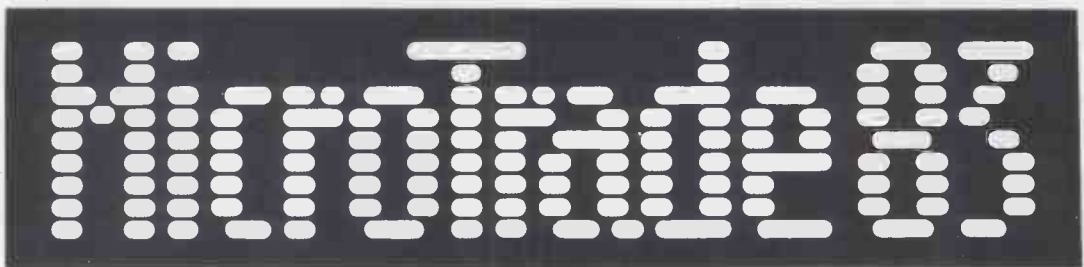

**SPONSORED BY MICROSCOPE
BARBICAN CENTRE, LONDON.
6-8 JULY.**

Make a stake in the future. Phone Timothy Collins on 01-486 1951 for your free invitation, or send your letterhead or business card marked 'MICROTRADE' to Montbuild Ltd 11 Manchester Square London W1M 5AB (01-486 1951)

MICROTRADE 83 is a trade-only show. No-one under 18 admitted
For special **MICROTRADE** travel and accommodation arrangements contact:
Pharoah Hughes Associates – 01-995 8995.

ADVERTISERS INDEX

| | | | | | | | | |
|-----------------------------------|---------------|---------------------------------|----------|--------------------------------------|---------------|--------------------------------|--------------------------------|----|
| A | | Daystar Computers Ltd | 303 | L | | PCW Show | 266 | |
| Apple Computer (UK) Ltd | 76/77 | DPLCLtd | 84 | Lowe Electronics Ltd | 71/72/73 | Password Electronics | 218 | |
| Ashton Tate | 114, 316/317 | Digitihurst Ltd | 91 | Logitek | 113 | Q | | |
| Acorn Computers Ltd | 136/137 | Digital Solutions Ltd | 99 | Laskys | 276/277 | Qubie Distributing Ltd | 63 | |
| ACT Computers | 42/43/44/45 | Deans of Kensington | 13, 19 | Linsac | 293 | Q-Tek Systems Ltd | 328 | |
| Acornsoft | 200 | Da Vinci Computers Ltd | 20 | Level 9 Computing | 297 | R | | |
| Atari | 202/203 | Data Stream | 251 | London Computer Centre | 300/301 | Rair Ltd | 37, 47 | |
| Access Data Communications Ltd | 205 | Database | 212 | Lucas Logic Ltd | 14 | Rayman Electronics | 324 | |
| Applestop Ltd | 286 | E | | Lifeboat Associates | 23 | S | | |
| Adman Electronics Ltd | 301 | Epson (UK) Ltd | 80, 304 | London Computer Centre | 269 | Soft Magazine | 56/57 | |
| Akhter Instruments Ltd | 302 | EEC Distribution Services Ltd | 318 | Lowmack | 339 | Simmons Magee Computers | 68 | |
| Angela Enterprises | 85 | EDC Photonic Ltd | 126 | Leicester Computer Centre | 337 | The Soft Option (UK) Ltd | 78 | |
| Atlanta Data Systems | 8 | Eccleston Electronics | 275 | M | | SM Software (UK) Ltd | 158 | |
| Acorn User Magazine | 21 | The Euribon Organisation | 286 | Midlectron | 52 | Sinclair Research Ltd | 38/39 | |
| Abersoft | 251 | East London Robotics | 286 | Maplin Electronic Supplies Ltd | 62 | Sanyo Marubeni (UK) Ltd | 178 | |
| Algotek Computer Company | 254 | EuroMicro Ltd | 83 | Microcomputer Products International | 67 | Sunshine Books | 271, 274 | |
| ABT | 270 | Everyday Electronics Magazine | 85 | Micro Peripherals Ltd | 313 | Small Systems Engineering Ltd | 285 | |
| AP Systems | 212 | Elstree | 267 | Micronet 800 | 315 | Satellite Services Ltd | 299 | |
| Arcade Computers | 212 | ERA Consultants Ltd | 214 | Micropute | 320 | Swanley Electronics | 303 | |
| Autoram | 327 | Euroelectronics | 214 | Microdeal | 173 | IFC | Starwest Computer Services Ltd | 90 |
| Apple Orchard | 324 | F | | Microcentre Ltd | | Silicon Valley Computer Centre | 7 | |
| B | | Financial Director Software Ltd | 53 | Microsoft Ltd | 36 | STC | 10 | |
| Bonsai | 49 | Facts Software Ltd | 41 | Mannesman | 186 | Sianda Software Services | 20 | |
| British Micro | 64/65 | Frasers | 326 | Micro Networks Ltd | 282 | Spectrum | 26-31 | |
| Bits & PC's Computer Products Ltd | 70 | Facit Data Products | 91 | Micro General | 283 | SPT Electronics Ltd | 247 | |
| Blyth Computers | 124 | Filesixty Ltd | 22 | Micro Technology Software Systems | 288/289 | Silica Shop | 322/323 | |
| Basic Concepts | 85 | Fuller Micro Systems | 255 | McGraw Hill Book Company (UK) Ltd | 291 | Software Centre | 330/331/332/333 | |
| The Byte Shop | 92/93 | Fraser Associates | 334, 341 | Magnum Computers Ltd | 83, 267 | SGS Software | 329 | |
| Bedbrook Ltd | 18 | G | | Map 80 Systems | 87 | System Science | 337 | |
| Brainwave Software Ltd | 18 | Grundy Business Systems | 50/51 | Microvalue | 88/89 | Starcalls | 326 | |
| Beebug | 261 | Gemini Microcomputers Ltd | 74 | Micro Design | 98 | T | | |
| Bunch Books | 342 | Grama Winter Computers Ltd | 319 | Micro Computer Consultants Ltd | 12 | TDI Ltd | 58 | |
| C | | Gulfstream Technology Ltd | 284 | Memotech | 248/249 | Taylor & Francis Ltd | 158 | |
| Comshare | 54/55 | Galaset Ltd | 87 | MBA | 253 | Transam Microsystems Ltd | 94/95 | |
| Compsoft Ltd | 79 | Gemini Marketing Ltd | 16/17/18 | Microdeal | 257 | Texas Instruments | 96/97 | |
| C/WP Computers | 141, 143, 145 | Geophysical Systems Ltd | 259 | Microtek | 258 | Technomatic Ltd | 100 | |
| Concordia | 158 | General Northern Micros Ltd | 269 | Microcell | 268 | Tapesoft | 12 | |
| Computer Games Ltd | 30, 34/35 | Gem Software Ltd | 324 | Micromite | 268 | Twillstar | 252 | |
| Cambridge Computer Store | 275 | H | | Molimerx Ltd | 272 | Thame Systems Ltd | 260 | |
| Computer Plus | 279 | Hal Computers Ltd | 59, 61 | Microspares CIEL | 335, 337, 339 | Tomorrows World Exhibitions | 262 | |
| Crofton Electronics Ltd | 292 | H/H Microcomputers | 128/129 | Microage Electronics | 338 | Three D Computers | 218 | |
| Cambridge University Press | 293 | Hclistar Systems Ltd | 301 | Microcomputer Space Drome | 325 | Tansoft | 336 | |
| Cumana Ltd | 294 | HCCS Associates | 91 | MED | 341 | Trionic | 328 | |
| Castle Electronics | 298 | Happy Memories | 251 | N | | U | | |
| Clearsons Ltd | 303 | Hestacrest Ltd | 327 | Oric Products International Ltd | 280/281 | U-Microcomputers Ltd | 273 | |
| Calanraft Ltd | 85 | I | | Opus Supplies | 101, 289 | UTS | 258 | |
| Crown Business Systems | 86 | Intelligent Interfaces Ltd | 157 | Office Efficiency Machines | 9, 81 | V | | |
| Computer Trade Forum | 101 | ICE | 46 | Oxford Computer Publishing Ltd | 87 | Vergecourt Ltd | IBC | |
| Computer Interface Designs | 103 | Interface Publications | 289 | Oi Computers | 4/5, 15 | Vision Store | 40 | |
| Computronix | 103 | Inpholink Ltd | 293 | Oakleaf Computers | 214 | Vic Odden's | 286 | |
| Caxton Software Ltd | 1 | Isoframe | 21 | Ozwise Computers | 326 | Verbatim Ltd | 287 | |
| Carsondale Enterprises Ltd | 12 | Iansyst | 246 | P | | W | | |
| Clwyd Personal Computers | 246 | ITCS | 250 | Personal Computer Games Magazine | 60 | Wilding Office Equipment | 69 | |
| Conway Computer Services | 252 | IO Research Ltd | 252 | Portico Technology Ltd | 306/307 | Westwood Distribution Ltd | 40 | |
| Cabel Electronics | 256 | Irvine | 254 | Process Automation | 158 | Watford Electronics | 11 | |
| Cascade Graphics Development | 263 | lbek | 261 | Personal Computers | OBC | X | | |
| CK Computers Ltd | 264 | ICL | 334/335 | Psion Ltd | 33 | X-Data Ltd | 66, 312 | |
| Comart | 265 | Integra | 341 | Peachtree Software International Ltd | 48 | Xitan Systems | 292, 310/311 | |
| Calco Software | 271 | K | | Pedro Computer Services | 279 | Xcalibur Computers Ltd | 270 | |
| Crystal Research | 328 | KGB Micros Ltd | 163 | Plus 80 | 279 | Y | | |
| CJE Microcomputers | 327 | Kuma Computers Ltd | 197 | Pacc Software Supplies | 296/297 | Z | | |
| C-Data | 321 | Key Computer Centres Ltd | 290 | Power Testing (Sales) Ltd | 299 | Zen Microcomputers Ltd | 305 | |
| D | | Knights Computers | 86 | Personal Computer World Show | 82 | Zynar Ltd | 126 | |
| Duplex Communications Ltd | 75 | Kensington Microware | 24/25 | Power International Ltd | 90 | Zygon Products | 292 | |
| Dragondata | 308/309 | Keelecodes | 246 | PPM Ltd | 90 | Z. E. Systems | 87 | |
| Dark Star Systems | 314 | Kempston Microsystems | 262 | Pete & Pam Computers | 104/105 | Zak Computers Ltd | 6, 20 | |
| Digital Equipment Co Ltd | 192/193/194 | Keyboard Hire Ltd | 321 | Profile Video Ltd | 12 | | | |
| Digisolve | 206 | Kindleglen | 339 | Perfeet Software Inc | 32 | | | |
| Display Electronics | 278 | Kobra | 340 | Phoenix Publishing Associates | 258 | | | |
| Digital Computer Services Ltd | 285 | | | Pinner Wordpro | 258 | | | |
| DJ 'AI' Systems Ltd | 295 | | | | | | | |

CHIP CHAT

Portable problem

It is something of a mystery how the same micro can be sold by its manufacturer and a separate distributor under different names.

It can cause severe hostility between the two companies involved and the motivation behind it must surely contain an element of greed — that is to say, the manufacturer notices 'it's selling at lot of them. Why don't we sell it too and cash in — after all we built the thing in the first place.'

Actually the root of this little story is rather less simple, but the end result is just as unnecessary.

Readers may have heard of the Ajile portable. They may also have heard of the Hyperion. The two are one and the same. The Ajile is sold by Anderson Jacobson, which also makes acoustic couplers and other communications devices, and the Hyperion is sold by its manufacturer Bytec, through a subsidiary, Gulfstream Technology.

The original manufacturer, Canadian company Dynalogic, had concluded an OEM agreement with Anderson Jacobson before it sold out to Bytec — unknown to the latter. Upon hearing that Gulfstream would also be selling the machine in the UK,

Anderson Jacobson's PR firm Patria Design sent out a press release under the heading 'Ajile versus Hyperion' which was allegedly authorised by AJ's marketing manager Mike Parrish.

The communication claimed that AJ was 'undaunted' by competition from Gulfstream because AJ, unlike Gulfstream, 'can guarantee a reliable countrywide field service'. Talk about goading an ox...

The release, coupled with a flyer to AJ customers offering a 20 per cent discount on the Ajile, incurred the wrath of Gulfstream and led to Patria Design losing the AJ account. A release from Patria insists that the PR outfit was instructed to issue the offending missive and that the subsequent sacking was 'the easy way out' for AJ's managing director Brian Warrington. AJ now denies authorising the release although, according to Patria Design, the 'unauthorised' release was discussed between Mike Parrish and a journalist. Patria's Jennifer Morbey believes she has been turned into a scapegoat to cool AJ's blushes.

So the sum total of this little storm in a teacup is that, because someone jumped the gun, a PR firm lost an account and two companies look very silly indeed. We are now told that the two companies do not want to tread on each other's toes and wish to co-operate.

But how can they, selling the same computer under rival trademarks?

Snippets

A symposium of eminent American psychologists, says *The Times*, 24 May, has recently held a forum entitled 'Donkey Kong, Pacman and the meaning of life'... A press release about a software company, Pegasus Software, which arrived in the ivory tower early in May, was titled 'Pegasus — a synonym for success'. Could this mean that the word Pegasus will soon be integrated into modern language as such? Soon we may well be referring to 'a really pegasusful young executive' or the computer that was 'never much of a pegasus'... What with Miss World assisting in promotions in her charming way, Epson is going a long way towards buttering up the press as we all know that revered profession deserves. Now it's doing the same thing for its distributors with a free, all-expenses-paid golfing weekend in Cornwall. We're told that this trip 'reflects Epson's move towards a fully committed distributor force...' Hippie types, gurus and trendies who read the Whole Earth Catalog will be edified to know that there is also a Whole Earth Software Catalog. This is published by Point Foundation and licensed by Doubleday & Co of New York. Knowing the content of the Whole Earth Catalog makes the mind boggle with respect to its silicon stablemate — could make interesting reading... Remember

the Statutory Sick Pay packages? If not, in May Chip Chat it was mentioned that wastebins were stuffed full of press releases from large numbers of software houses all having had the same idea — SSP Software. A recent report in *Computing*, the well known computer trade journal, explains that some of these packages may be causing companies to lose vast amounts of money in sickness benefit which is not due. This is apparently caused by a package's inability to allocate sick pay to specific days of the year. Some of the systems are also incapable of holding enough details on an employee. At least twelve weeks of details, says Mike Copleston of IMS, a consultancy firm, should be kept at any one time. One wonders if IMS is selling its own SSP package?

STOP PRESS...

In order to keep delivering our monthly package of news, views and useful info about the micro world *PCW* is in need of a **FEATURES EDITOR**.

We are looking for somebody with a keen grasp of the industry, a lively interest in micros, writing skills and no mean wit.

The **FEATURES EDITOR** will play a key role in our small team and the job will include commissioning and writing articles.

Salary in accordance with experience.

If this sounds like you please write with CV to The Editor, Jane Bird, *PCW*, VNU Business Publications, 62 Oxford St, London W1A 2HG.

BLUDNERS



Let's try again with Oric Bug Eater. In lines 1085 and 1105, the pound sign (£) should be entered as a hash (#) — SHIFTed 3. This applies to any program listing unless the pound sign is inside quotation marks. Line 8066 has closing quotes missing after the full

stop. Line 11076 should read as follows: 11076 L=0: N\$="" : K\$=KEY\$: I\$="" . If you have a 16k Oric, insert the following line: 3 HIMEM 13311 and then edit line 1020 to read: 1020 READ DA: POKE 13312+D+8*ASC (""), DA

If, on the other hand, you have a 48k machine, leave line 1020 alone and don't even think about adding line 3: simply delete line 2 instead. Ok so far? Good. The following modifications apply to both 16 and 48k machines: 1111 :PAPER(F-1) AND 7: INK(F+1) AND 7, 1170 X=20: Y=24: T=0: H=1:

PLOT X,Y,"\$", 10090 K\$=KEY\$: WAIT 100.

Moving onto the MZ-80K Pascal program, we told you that the program was written under the Hi-Soft Pascal 3, but the title of the program disappeared somewhere along the line. We were in fact referring to MZ-80K 'Double Trouble'.

There were two omissions in 'Spectrum Blaster'; one in the listing and one in the description. The line 35 LET SS=450 is missing and the 'A' in lines 160 and 212 are graphics characters.

Yet another correction to a correction! Last month, we

gave two lines missing from PET Billy. These lines were in fact slightly wrong. In both lines, there should be five, not three, spaces after the cursor-control at the beginning of the line, and you should also add five cursor-lefts to the end of each line.

Finally, two lines were inadvertently omitted from the Lisp database (June *PCW*, page 150). Fig 9 should commence (DEF MY (YOUR 2 ((YOUR @ MFBS / FAMILY) (HOW WELL DO YOU AND YOUR = /FAMILY GET ON ?))

For those with no ^{money} time to waste.

"What if" VISICALC had variable column widths, Protected Fields, Tabbed Fields, Password Protection and a Whole series of enhanced format commands such as negatives in brackets, Cr, Dr & % symbols as formats, the ability to add a 'Dm or Bf' (Deutschmark or Belgian Frank) or any combination of 2 characters as a Prefix to a numeric entry and if this was only an indication of what was possible then your VISICALC would have taken on a new lease of life.



If we then told you that your model could be as large as 255K and it was possible to 'Save' it to disk in only 45 secs (136K in 20 Secs) you might think we were talking about the IMPOSSIBLE!

The Super Expander 80.2 is a REALITY, manufactured by Vergecourt for use with a standard VISICALC on the Apple II Plus or Apple IIe and requires at least one Ramex 128 Expansion Board to be fitted to the System.

All other expansions cost MORE for LESS so contact your dealer without delay.



| | |
|---------------------|---------|
| RAMEX 128 | £295.00 |
| SUPER EXPANDER 80.2 | £ 80.00 |
| SUPER EXPANDER 80 | £ 60.00 |
| SUPER EXPANDER | £ 40.00 |

Generous Dealer/Distributor Discount

VERGECOURT LTD

Lydean House, Queens Road
Brighton, East Sussex BN1 3XB
Telephone: (0273) 728551
Telex: 877083 VERGCT

Apple II is the trademark of Apple Computers Inc. Visicalc is the trademark of Visicorp

You can tell by the companies we keep...

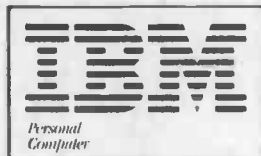

IBM Authorised Dealer



We are very pleased to announce that we have been chosen by three of the best companies to bring you their personal computer products. They think we are pretty good — why not come and see for yourself?

Personal Computers

218 & 220/226 Bishopsgate, London EC2M 4JS. Tel. 01-377 1200