

electronics today

INTERNATIONAL

JANUARY 1983 85p

BUYER'S GUIDE TO CONQUERING THE UNIVERSE: VIDEO GAMES FROM BOTH SIDES OF THE SCREEN

© 1982
WALT DISNEY
PRODUCTIONS

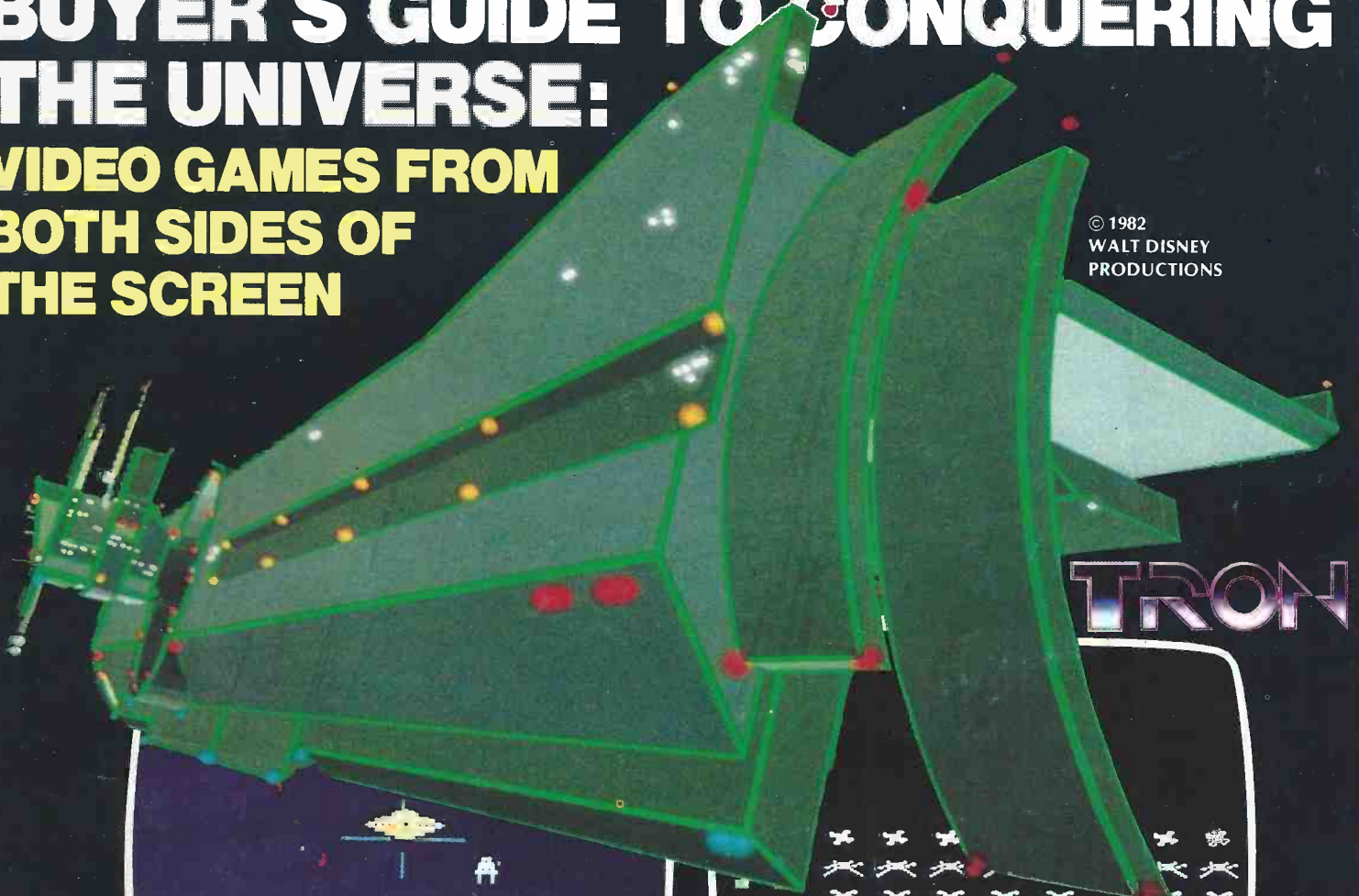

TRON

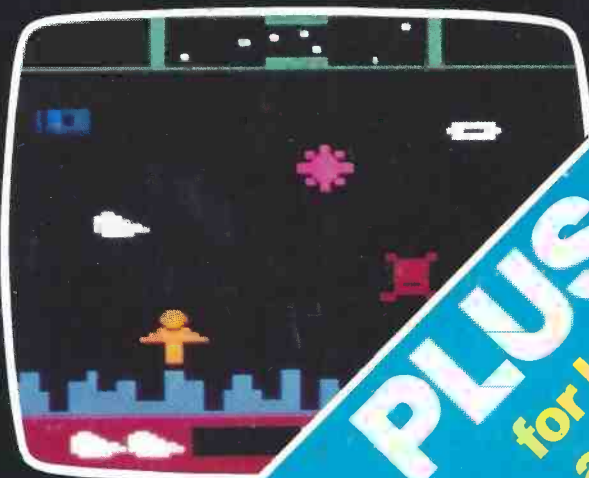

PLUS SPECIAL
for home, stage
and workshop

... AUDIO COMPUTING MUSIC RADIO ROBOTICS ...

MAN-MADE
MUSIC AT ITS
VERY FINEST
— MORE KITS
INSIDE BACK
COVER



T20 + 20 — Designed by Texas Engineers, this 20 watt amplifier gives Hi Fi performance at low cost. Many up-dated features and the ideal beginners kit. Complete kit £29.50 plus VAT (30 watt version — Complete kit £34.50 plus VAT)



LINSELY HOOD 75 DE LUXE — 75watt amplifier with superb performance (less than .01% distortion). Easy construction with virtually no wiring. Complete kit £75.00 plus VAT.

Man-made music at it's very finest.....

TRANSCENDENT SOUNDS by POWERTRAN

For over 2000 years man has entertained himself and his friends with music played upon instruments he has fashioned with his own hands. From the earliest pipes of hollow reed in the cradles of civilisation, the brazen trumpets of ancient Rome, to the subtle strings of renaissance Europe. Pleasure in the making — Pleasure in the playing and Pleasure in the listening.

Now — in the 1980's its the turn of the electronics age, the age of Powertran.

In our twelve years of research and development we have introduced probably the most comprehensive and sophisticated range of synthesisers and supporting equipment ever offered to the music making, home-constructor.

Each kit is a perfect example of how craftsman-made components, ingenious design technology, originality of concept — and rigid quality and price control — combine together in kits that are both fascinating and satisfying to construct. Our clear step by step instruction manuals ensure that the kits are well within the capability of the first time builder as well as the dedicated enthusiast.

Once you've made your Transcendent Synthesiser you will be able to make the music of all the ages — from the earliest sounds of the simple pipe, through the most complex harmonies, to the most modern tonalities of Stockhausen or Steel Eye Span!

TRANSCENDENT POLYSYNTH — A four octave polyphonic synthesiser with outstanding design characteristics and versatility and performance to match. Complete kit £275.00 plus VAT (single voice) Extra voice (up to three more) £42.00 plus VAT

EXPANDER — A new matching 4 voice expander to team up with your polysynth for even a greater range and capability. Complete kit £249.00 plus VAT

TRANSCENDENT DPX — Offers a five octave keyboard with power to match. Two audio outputs (can be used simultaneously) to give harpsichord and piano/honkytonk or reed with strings/brass and both are fully polyphonic. Other features include switchable touch sensitivity and a chorus ensemble unit with strong/mild effect switching. An advanced design made simple with our clearly laid out instruction manual. Complete kit £295.00 plus VAT

TRANSCENDENT 2000 — Although only a 3 octave keyboard the '2000' features the same design ingenuity, careful engineering and quality components of its larger brethren. The kit is well within the scope of the first time builder — buy it, build it — play it! You will know you have made the right choice. Complete kit £165.00 plus VAT

1024 COMPOSER — Come right up to the minute with this new design. It will control your synthesiser with a sequence of up to 1024 notes — or an equal selection of shorter sequences. The Composer is mains powered with automatically charged battery to preserve your programme after switch-off. Complete kit £85.00 plus VAT

DEMONSTRATION TAPE — Demonstration tape now available of all three kits (30 minutes) £2.00

POWERTRAN
WORLD LEADERS IN ELECTRONIC KITS



PORTWAY INDUSTRIAL ESTATE
ANDOVER, HANTS. SP10 3NM
TELEPHONE
(0264) 64455

- **PRICE STABILITY:** Order with confidence irrespective of any price changes we will honour all prices in this advertisement until the end of the month following the month of publication of this issue (Errors and VAT rate changes excluded)
- **EXPORT ORDERS:** No VAT. Postage charged at actual cost plus £1 handling and documentation.
- **U.K. ORDERS:** Subject to 15% surcharge for VAT, or at current rate if changed. No charge is made for carriage. Cheques, Access, Barclaycard accepted.
- **SECURICOR DELIVERY:** For this optional service (U.K. mainland only) add £2.50 (VAT inclusive) per kit FREE ON ORDERS OVER £100
- **SALES COUNTER:** If you prefer to collect kit from the factory, call at Sales Counter. Open 9a.m. — 12 noon, 1 — 4.30p.m. Monday — Friday.



USE OUR EASY ORDER SERVICE
SIMPLY PHONE US ON 0264 64455
Tell us the kit you want and just quote
your Access or Barclaycard number —
and leave the rest to us.
(40 page catalogue free on request)



electronics today

INTERNATIONAL JANUARY 1983 VOL 12 NO 1



Dave Bradshaw: Editor
Peter Green: Assistant Editor
Rory Holmes: Project Editors
Phil Walker: Project Editors
Gary Price: Advertisement Manager
Ron Harris B.Sc: Managing Editor
T.J. Connell: Managing Director

PUBLISHED BY:
 Argus Specialist Publications Ltd.,
 145 Charing Cross Road, London WC2H 0EE.
DISTRIBUTED BY:
 Argus Press Sales & Distribution Ltd.,
 12-18 Paul Street, London EC2A 4JS
 (British Isles)
PRINTED BY:
 QB Limited, Colchester.
COVERS PRINTED BY:
 Alabaster Passmore.

OVERSEAS EDITIONS and their EDITORS
 AUSTRALIA — Roger Harrison
 CANADA — Halvor Moorshead
 GERMANY — Udo Wittig
 HOLLAND — Anton Kriegsman

ABC Member of the Audit Bureau of Circulation

Electronics Today is normally published on the first Friday in the month preceding cover date. □ The contents of this publication including all articles, designs, plans, drawings and programs and all copyright and other intellectual property rights therein belong to Argus Specialist Publications Limited. All rights conferred by the Law of Copyright and other intellectual property rights and by virtue of international copyright conventions are specifically reserved to Argus Specialist Publications Limited and any reproduction requires the prior written consent of the Company. ©1982 Argus Specialist Publications Ltd □ All reasonable care is taken in the preparation of the magazine contents, but the publishers cannot be held legally responsible for errors. Where mistakes do occur, a correction will normally be published as soon as possible afterwards. All prices and data contained in advertisements are accepted by us in good faith as correct at time of going to press. Neither the advertisers nor the publishers can be held responsible, however, for any variations affecting price or availability which may occur after the publication has closed for press.

□ Subscription Rates. UK £13.15 including postage. Airmail and other rates upon application to ETI Subscriptions Department, 513 London Road, Thornton Heath, Surrey CR4 6AR.

EDITORIAL AND ADVERTISEMENT OFFICE

145 Charing Cross Road, London WC2H 0EE. Telephone 01-437 1002/3/4/5. Telex 8811896.

FEATURES

DIGEST 11
 In News at 11 this month we have items to amaze you and amuse you, items to thrill you and chill you — oh, enough of the hype, just get wise and read it (or vice versa).
TRON 16
 This will probably be the smash hit of the Christmas movie glut, and deservedly so, too. A film by computers and about computers, we look at what was done, how it was done, and the ideas and thoughts of the man who did it.



DESIGNING MICRO SYSTEMS . . . 31
 Now we get to the man-machine interface, which sounds very deep but just means VDUs, printers and joysticks.

CONQUERING THE UNIVERSE . . . 52
 Kerpow! Peeooooom! Vrooosh! Your intrepid star warrior cum hack has been boldly splitting infinitives which no man has split before in an attempt to review the state of the videogame market.

TECH TIPS 69
 This month our regular readers' design page includes a RAM-to-ROM converter for micros and an improved version of our loudspeaker protector.

CONFIGURATIONS 77
 In which we take a look at the granddaddy of the IC family, the op-amp, and discuss some of the fundamentals about its operation.

PROJECTS

STAGE LIGHTING UNIT 22
 Presenting Part the First of a project that will provide you with digital control of your theatrical lighting set-ups, with programmable scene changes and fades and brightness and stuff.

CORTEX PART 3 42
 The final part of the constructional information provides you with the PSU and keyboard details.

FUEL GAUGE 46
 You mean a hip, up-to-the-minute guy like you still has a meter on his dashboard? Look, build this electronic one before anyone notices and it'll just be our little secret.

ZX ADC 61
 Here's a project of unparalleled excellence: an eight-channel, eight-bit analogue-to-digital converter that plugs into your 81 or Spectrum and lets you do all kinds of wonderful things.

WAVEFORM MULTIPLIER 71
 Does your synth sound weak and thin? Fret no more, this ETI wonder cure will give you a much richer sound without making you poorer.

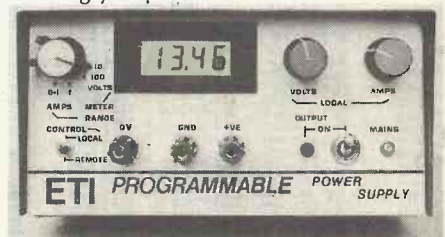

PROGRAMMABLE PSU 83
 Power supplies are very popular with our readers. So are computers. That should ensure the success of this project since it's a precision supply that can have its voltage and current limit controlled manually or by a micro.

FOIL PATTERNS 93

INFORMATION

NEXT MONTH'S ETI 7
LONDON HOME
COMPUTER SHOW 39

SUBSCRIPTIONS 7
HAM RADIO TODAY 41
PCB SERVICE 91

NEXT MONTH

electronics today

INTERNATIONAL

THE ETI ORGAN

Here's a major project for all you budding musicians — a two-manual and bass pedals organ. This design has a single main board that does all the usual organ stuff and also includes a very realistic-sounding multi-voice rhythm module. Sounds expensive, doesn't it? Wrong. The start-up kit to build one keyboard will cost less than £100, while a full kit (excluding cabinet) will be available for under £300. A fully-built version will also be available, still at well under the price of organs with an equivalent performance.

ZX81 ENHANCEMENT

Here's a very cheap little project for anyone who owns a ZX81 and sometimes feels like breaking it by hitting it with the cassette recorder. Yes, we've got details on how you can solve all the legendary problems this computer has with SAVEing programs, and very cheap it is too!

LOGIC PROBE

Not another logic probe? Yes, here's one that's a little more complex than before, which will give you an indication of pulse presence and polarity besides the usual high and low indications.

CRYOGENIC COMPUTERS

Do you get cold feet when you think about electronics? IBM's design engineers took it a stage further, and next month we'll be telling you what they're up to.

DESIGN COMPETITION

There's one group of people who'll be camping outside the newsagents next month: the ones who entered our Design competition. The next issue will reveal the name of the person who won the £100 prize for the best design based on free PCB we gave away with the October issue. We've also decided to publish one or two runners-up.

**LOOK OUT FOR THE
FEBRUARY ISSUE ON
SALE 7th JANUARY**

Articles described here are in an advanced state of preparation. However, circumstances may dictate changes to the final contents.

SUBSCRIPTION ORDER FORM

Cut out and SEND TO:
Electronics Today International,
513, LONDON ROAD,
THORNTON HEATH,
SURREY,
ENGLAND.

Please commence my personal subscription to Electronics Today International with the issue.

SUBSCRIPTION RATES

(tick as appropriate)

£13.15 for 12 issues

UK

£16.95 for 12 issues

overseas surface

£36.95 for 12 issues

Air Mail

I am enclosing my (delete as necessary)
Cheque/Postal Order/International Money
Order for



£.....



(made payable to A.S.P. Ltd)
OR

Debit my Access/Barclaycard*
(*delete as necessary)

.....

Please use BLOCK CAPITALS and include post codes.

Name (Mr/Mrs/Miss)

delete accordingly

Address

Signature

Date



SUBSCRIPTIONS

The magazine you hold in your hand is the biggest seller in the UK electronics field. Why risk your newsagent running out? Take out a subscription using the form provided, and make sure of getting the next 12 issues. Don't you *deserve* not to miss out on the best?

CRICKLEWOOD ELECTRONICS LTD.

40 CRICKLEWOOD BROADWAY, LONDON NW2 3ET. Tel: 01-452 0161. TELEX: 914977 CRKEL G

SUPERIOR QUALITY CARBON FILM RESISTORS, HI STAB LOW NOISE		Grade One Single Sided 178 x 240mm		2N2714 12p		2N2900 25p		2N5210 25p		40625 1.60		8C178 16p		8C175 30p		8C174 30p		8C173 30p		8C172 30p		8C171 30p		8C170 30p		8C169 30p		8C168 30p		8C167 30p		8C166 30p		8C165 30p		8C164 30p		8C163 30p		8C162 30p		8C161 30p		8C160 30p		8C159 30p		8C158 30p		8C157 30p		8C156 30p		8C155 30p		8C154 30p		8C153 30p		8C152 30p		8C151 30p		8C150 30p		8C149 30p		8C148 30p		8C147 30p		8C146 30p		8C145 30p		8C144 30p		8C143 30p		8C142 30p		8C141 30p		8C140 30p		8C139 30p		8C138 30p		8C137 30p		8C136 30p		8C135 30p		8C134 30p		8C133 30p		8C132 30p		8C131 30p		8C130 30p		8C129 30p		8C128 30p		8C127 30p		8C126 30p		8C125 30p		8C124 30p		8C123 30p		8C122 30p		8C121 30p		8C120 30p		8C119 30p		8C118 30p		8C117 30p		8C116 30p		8C115 30p		8C114 30p		8C113 30p		8C112 30p		8C111 30p		8C110 30p		8C109 30p		8C108 30p		8C107 30p		8C106 30p		8C105 30p		8C104 30p		8C103 30p		8C102 30p		8C101 30p		8C100 30p		8C99 30p		8C98 30p		8C97 30p		8C96 30p		8C95 30p		8C94 30p		8C93 30p		8C92 30p		8C91 30p		8C90 30p		8C89 30p		8C88 30p		8C87 30p		8C86 30p		8C85 30p		8C84 30p		8C83 30p		8C82 30p		8C81 30p		8C80 30p		8C79 30p		8C78 30p		8C77 30p		8C76 30p		8C75 30p		8C74 30p		8C73 30p		8C72 30p		8C71 30p		8C70 30p		8C69 30p		8C68 30p		8C67 30p		8C66 30p		8C65 30p		8C64 30p		8C63 30p		8C62 30p		8C61 30p		8C60 30p		8C59 30p		8C58 30p		8C57 30p		8C56 30p		8C55 30p		8C54 30p		8C53 30p		8C52 30p		8C51 30p		8C50 30p		8C49 30p		8C48 30p		8C47 30p		8C46 30p		8C45 30p		8C44 30p		8C43 30p		8C42 30p		8C41 30p		8C40 30p		8C39 30p		8C38 30p		8C37 30p		8C36 30p		8C35 30p		8C34 30p		8C33 30p		8C32 30p		8C31 30p		8C30 30p		8C29 30p		8C28 30p		8C27 30p		8C26 30p		8C25 30p		8C24 30p		8C23 30p		8C22 30p		8C21 30p		8C20 30p		8C19 30p		8C18 30p		8C17 30p		8C16 30p		8C15 30p		8C14 30p		8C13 30p		8C12 30p		8C11 30p		8C10 30p		8C9 30p		8C8 30p		8C7 30p		8C6 30p		8C5 30p		8C4 30p		8C3 30p		8C2 30p		8C1 30p	
1/4W 10% 100Ω 5% E24	2p	Veroboard 0.1"	2p	2N2714	12p	2N2900	25p	2N5210	25p	40625	1.60	8C178	16p	8C175	30p	8C174	30p	8C173	30p	8C172	30p	8C171	30p	8C170	30p	8C169	30p	8C168	30p	8C167	30p	8C166	30p	8C165	30p	8C164	30p	8C163	30p	8C162	30p	8C161	30p	8C160	30p	8C159	30p	8C158	30p	8C157	30p	8C156	30p	8C155	30p	8C154	30p	8C153	30p	8C152	30p	8C151	30p	8C150	30p	8C149	30p	8C148	30p	8C147	30p	8C146	30p	8C145	30p	8C144	30p	8C143	30p	8C142	30p	8C141	30p	8C140	30p	8C139	30p	8C138	30p	8C137	30p	8C136	30p	8C135	30p	8C134	30p	8C133	30p	8C132	30p	8C131	30p	8C130	30p	8C129	30p	8C128	30p	8C127	30p	8C126	30p	8C125	30p	8C124	30p	8C123	30p	8C122	30p	8C121	30p	8C120	30p	8C119	30p	8C118	30p	8C117	30p	8C116	30p	8C115	30p	8C114	30p	8C113	30p	8C112	30p	8C111	30p	8C110	30p	8C109	30p	8C108	30p	8C107	30p	8C106	30p	8C105	30p	8C104	30p	8C103	30p	8C102	30p	8C101	30p	8C100	30p	8C99	30p	8C98	30p	8C97	30p	8C96	30p	8C95	30p	8C94	30p	8C93	30p	8C92	30p	8C91	30p	8C90	30p	8C89	30p	8C88	30p	8C87	30p	8C86	30p	8C85	30p	8C84	30p	8C83	30p	8C82	30p	8C81	30p	8C80	30p	8C79	30p	8C78	30p	8C77	30p	8C76	30p	8C75	30p	8C74	30p	8C73	30p	8C72	30p	8C71	30p	8C70	30p	8C69	30p	8C68	30p	8C67	30p	8C66	30p	8C65	30p	8C64	30p	8C63	30p	8C62	30p	8C61	30p	8C60	30p	8C59	30p	8C58	30p	8C57	30p	8C56	30p	8C55	30p	8C54	30p	8C53	30p	8C52	30p	8C51	30p	8C50	30p	8C49	30p	8C48	30p	8C47	30p	8C46	30p	8C45	30p	8C44	30p	8C43	30p	8C42	30p	8C41	30p	8C40	30p	8C39	30p	8C38	30p	8C37	30p	8C36	30p	8C35	30p	8C34	30p	8C33	30p	8C32	30p	8C31	30p	8C30	30p	8C29	30p	8C28	30p	8C27	30p	8C26	30p	8C25	30p	8C24	30p	8C23	30p	8C22	30p	8C21	30p	8C20	30p	8C19	30p	8C18	30p	8C17	30p	8C16	30p	8C15	30p	8C14	30p	8C13	30p	8C12	30p	8C11	30p	8C10	30p	8C9	30p	8C8	30p	8C7	30p	8C6	30p	8C5	30p	8C4	30p	8C3	30p	8C2	30p	8C1	30p

**64K RAM
— AS STANDARD!**

**POWERTRAN
COMPUTING TODAY
ELECTRONICS TODAY INTERNATIONAL**

COMBINE THEIR TALENTS TO BRING YOU

CORTEX



**SELF-ASSEMBLY KIT
£295
+ VAT
CARRIAGE FREE**

**READY BUILT
£395
+ VAT
CARRIAGE FREE**

CORTEX WITH OPTIONAL DISC DRIVES FITTED

16 BIT COLOUR COMPUTER

ALL THESE FEATURES PROVIDED AS STANDARD!

- High speed 24K byte extended basic interpreter
- Powerful TMS9995 16 bit microprocessor
- 48 bit floating point gives 11 digit accuracy
- High resolution (256 x 192) colour graphics
- Memory-mapped video controller for 3D simulation
- Independent 16K video RAM
- 16 colours available on the screen together in Graphic mode
- Fast line drawing and point plotting basic commands
- High speed colour shape manipulation from basic
- Full textural error messages
- String and Array size limited only by memory size
- Real time clock included in basic
- Interval timing with 10mS resolution via TIC function
- Named load and save of basic or machine code programs
- Auto-run available for any program
- Powerful machine code monitor

- Assembler & Disassembler
- Auto line numbering facility
- Full renumber command
- Simple but powerful line editor
- Buffered i/o allows you to continue executing the program while still printing
- Flexible CALL statement allows linkage to machine code routines with upto 12 parameters
- Basic programs may contain spaces between keywords to make programs readable without using more memory
- 64K RAM using latest technology 64K DRAMS
- Over 34K bytes available for basic programs even when extended basic includes IF-THEN-ELSE
- Supports up to 16 output devices
- Screen and cassette included as standard
- Supports bit manipulation of variables from basic
- Error trapping to a basic routine included
- Basic supports Hexadecimal numbers

OPTIONAL EXTRAS

- RS232C interface kit£9.20
- Floppy disc interface£86.50
- Pair of 5¼" disc drives & hardware kit ..£366.00

READY BUILT

- CORTEX B — Basic machine + RS232C£410.00
- CORTEX C — As above + disc drives£895.00

All items carriage free — prices exclusive of VAT

ULTRA POWERFUL 24K BASIC

COMMANDS	LOG	KEY	?	RANDOM	SGET
RUN	SQR	STATEMENTS	UNIT	ENTER	MAG
SIZE	SYS	IF	BAUD	LIST	TOF
CONT	TIC	ELSE	CALL	PURGE	TON
MON	SON	ON	DATA	NUMBER	DIM
	BIT	GOTO	READ	RENUM	DEF
FUNCTIONS	CRB	GOSUB	RESTOR	BOOT	NEW
ABS	CRF	POP	RETURN	GRAPH	END
ADR	MEM	REM	STOP	TEXT	BIT
ASC	MWD	FOR	TIME	PLOT	CRB
ATN	LEN	NEXT	WAIT	UNPLOT	CRF
SIN	MCH	ERROR	SAVE	COLOUR	MEM
COS	POS	INPUT	LOAD	CHAR	MWD
EXP	COL	PRINT	ESCAPE	SPRITE	BASE
FRA	MOD		NOESC	SHAPE	
INT	RND			SPOT	

To: Powertran Cybernetics, Portway Industrial Estate, Andover, Hants. SP10 3NM. 0264 64455

Please send me:

I enclose a cheque for

Please charge to my Access/Barclay Card no

Name

Address



THE NEW MAPLIN CATALOGUE FOR 1983

**BRINGS YOU
RIGHT UP-
TO-DATE IN
ELECTRONICS
& COMPUTING**

Nearly 400 pages of all the most useful components and a whole big new section devoted to home computers and personal software. As always the catalogue keeps you up-to-date with the latest technology — even our ordinary miniature resistors are now superb quality 1% tolerance metal film, yet they're still only 2p each. As well as our usual quality products at low prices, now we're offering quantity discounts too. So pick up a copy of our catalogue now — it's the biggest *and* the best!

**ON SALE IN ALL
BRANCHES OF WHSMITH**
FROM 18th NOVEMBER 1982
PRICE £1.25

Send now for an application form — then buy it with MAPCARD. MAPCARD gives you real spending power — up to 24 times your monthly payments, instantly.



Post this coupon now for your copy of our 1983 catalogue, price £1.25 + 25p p&p. If you live outside the UK send £1.90 or 10 International Reply Coupons. I enclose £1.50.

Name

Address

.....

.....

ET1 1/83

MAPLIN

ELECTRONIC SUPPLIES LTD

P.O. Box 3, Rayleigh, Essex SS6 8LR.

Telephone: Southend (0702) 552911/554155

Shops at:

159-161 King Street, Hammersmith, London W6 Tel: (01) 748 0926

Lynton Square, Perry Barr, Birmingham. Telephone: (021) 356 7292

284 London Road, Westcliff-on-Sea, Essex. Tel: (0702) 554000

All shops closed Mondays

DIGEST

New Logic Probes and Pulsers

Two new products are now available from the OK Machine & Tool (UK) Ltd. The PRB-1 Digital Logic Probe detects pulses as short as 10 nS, has a frequency response of better than 50 MHz and an automatic pulse stretching to 50 nS but is competitively priced at £33.24. It is compatible with RTL, DTL, HTL, TTL, MOS, CMOS and microprocessor logic families and also features 120k impedance, power lead reversal protection and over-

voltage protection to 200V (+V-V). Supply voltage range is 4-15V but a PA-1 adaptor can be supplied for use with voltages from 15-25V.

The PLS-1 for £43.13 is a pocket-sized, multi-mode, high-current pulse generator that will superimpose a dynamic pulse train (20pps) or a single pulse onto the circuit node under test, without having to unsolder pins or cut printed circuit traces, even when these nodes are being clamped by digital outputs. It can source or sink sufficient current to force saturated output transistors in digital circuits into the opposite logic state. OK Machine & Tool (UK) Ltd, Dutton Lane, Eastleigh, Hants SO5 4AA. Tel: 0703 610944.

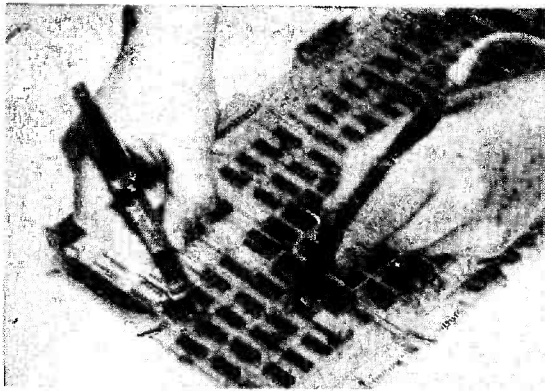

The VDU Approaching Platform

6. . . .

Jasmin Electronics have won important contracts to supply British Rail (London Midlands Region) with their new Information Display System, which utilises a new Character Generator to give the unique choice of presenting the same information in up to seven different formats on television screens — but only having to generate it once.

St. Pancras Station (London) and Preston Station are the first to

order this new model which will become operational in the new year. Similar systems are in use for many applications in the UK and overseas, particularly at airports. More stations are expected to adopt this information system as a key part of London Midland Regions' improvements in passenger information facilities.

The versatility of the design means that the same basic system can be very easily adapted to differing requirements of other stations while still gaining the benefits of standardisation. For each station, an important feature is the capacity to modify or extend the system without major re-design. Jasmin Electronics Limited, St. Matthews Way, Leicester LE1 2AA. Tel: (0533) 58128.

3 1/2 Digit Panel Meter

A new 3 1/2 digit DPM recently announced by Lascar Electronics can be operated by 5 V DC, 110-120 V AC or 220-240 V AC. The meter fits into a standard DIN cut-out and will replace many existing types, but offers improved performance with very low cost. Standard features include 0.43" (11mm) high efficiency LED's, Auto-zero, Auto-polarity, bandgap reference, polarised filter and programmable decimal points. The meter is capable of single ended, ratio-metric or differential measurements. Although offered in a



standard FSD of 200 mV, the meter can be easily programmed by the user to read many other engineering units, such as current, resistance, temperature, etc. Lascar Electronics Limited, Oakland House, Reeves Way, South Woodham Ferrers, Chelmsford, Essex CM3 5XQ. Tel: Chelmsford (0245) 329797.



High-Rise RAM

High speed erasing, writing, modifying and reading of non-volatile data is made possible for software engineers by the MEMIC model T by Camel Products. Two kilobytes of fast access, low power static CMOS RAM is built into a 'Tower block' unit needing no more real estate than the 24 pin IC socket it plugs into. Even when plugged into a ROM socket, the flylead provided allows write operations. Hi-K Lo-K or 2K operation is switch selectable. A power down switch permits months of non-volatility off NiCd batteries. At £29.95 (incl.) the ready to use unit comes with clear and easy user notes. Cambridge Microelectronics Ltd, 1 Milton Road, Cambridge CB4 1UY. Tel: 0223 314814.



Inside-Out TV

Philips' new CTX small-screen colour TV, the 14" CT2006, turns on itself to show what makes this advanced receiver tick: a single board with a third less parts than previous sets.

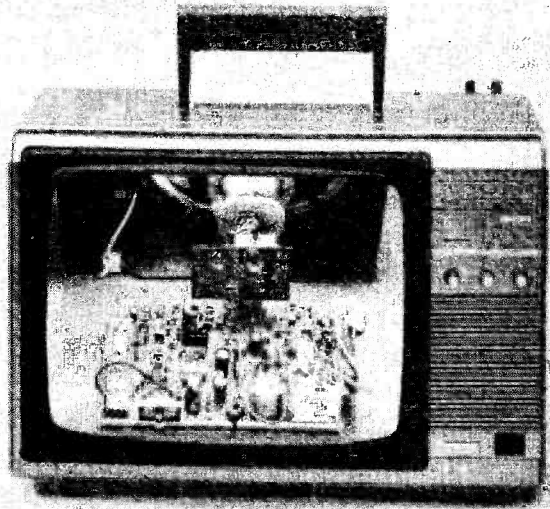



MULLARD SPEAKER KITS

Purposefully designed 40 watt R.M.S. and 30 watt R.M.S. 8 ohm speaker systems recently developed by MULLARD'S specialist team in Belgium. Kits comprise Mullard woofer (8" or 5") with foam surround and aluminium voice coil. Mullard 3" high power domed tweeter. B.K.E. built and tested crossover based on Mullard circuit, combining low loss components, glass fibre board and recessed loudspeaker terminals. SUPERB SOUNDS AT LOW COST. Kits supplied in polystyrene packs complete with instructions.

8" 40W system - recommended cabinet size 240 x 216 x 445mm
Price £14.90 each + £2.00 P & P.
5" 30W system - recommended cabinet size 160 x 175 x 295mm
Price £13.90 each + £1.50 P & P.

Designer approved flat pack cabinet kits, including grill fabric. Can be finished with iron on veneer or self adhesive vinyl etc.
8" system cabinet kit £8.00 each + £2.50 P & P.
5" system cabinet kit £7.00 each + £2.00 P & P.

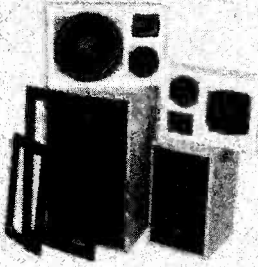

STEREO CASSETTE TAPE DECK MODULE.

Comprising of a top panel and tape mechanism coupled to a record/play back printed board assembly. Supplied as one complete unit for horizontal installation into cabinet or console of own choice. These units are brand new, ready built and tested.

Features: Three digit tape counter. Autostop. Six piano type keys, record, rewind, fast forward, play, stop and eject. Automatic record level control. Main inputs plus secondary inputs for stereo microphones. Input Sensitivity: 100mV to 2V. Input Impedance: 68K. Output level: 400mV to both left and right hand channels. Output Impedance: 10K. Signal to noise ratio: 45dB. Wow and flutter: 0.1%. Power Supply requirements: 18V DC at 300mA. Connections: The left and right hand stereo inputs and outputs are via individual screened leads; all terminated with phono plugs (phono sockets provided). Dimensions: Top panel 5 1/4" x 11 1/2". Clearance required under top panel 2 1/2". Supplied complete with circuit diagram and connecting diagram. Attractive black and silver finish.

Price £29.70 + £2.50 postage and packing.
Supplementary parts for 18V D.C. power supply (transformer, bridge rectifier and smoothing capacitor) £3.50.

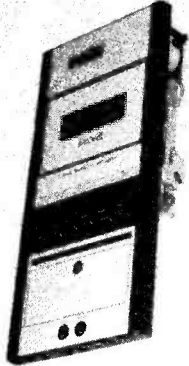

6 piano type keys

NEW RANGE QUALITY POWER LOUD-SPEAKERS (15", 12" and 8"). These loudspeakers are ideal for both hi-fi and disco applications. Both the 12" and 15" units have heavy duty die-cast chassis and aluminium centre domes. All three units have white speaker cones and are fitted with attractive cast aluminium (ground finish) fixing escutcheons. Specification and Price:-

15" 100 watt R.M.S. Impedance 8ohm 59 oz. magnet, 2" aluminium voice coil. Resonant Frequency 20Hz. Frequency Response to 2.5KHz. Sensitivity 97dB. Price £32 each £3.00 Packing and Carriage each.

12" 100 watt R.M.S. Impedance 8 ohm, 50 oz. magnet, 2" aluminium voice coil. Resonant Frequency 25Hz. Frequency Response to 4KHz. Sensitivity 95dB. Price £23.70 each. £3.00 Packing and Carriage each.

8" 50 watt R.M.S. Impedance 8 ohms, 20 oz. 1 1/2" aluminium voice coil. Resonant Frequency 40Hz. Frequency Response to 6KHz. Sensitivity 92dB. Also available with black cone fitted with black metal protective grill. Price: White cone £8.90 each. Black cone/grill £9.50 each. P & P £1.25 each.

PIEZO ELECTRIC TWEETERS - MOTOROLA

Join the Piezo revolution. The low dynamic mass (no voice coil) of a Piezo tweeter produces an improved transient response with a lower distortion level than ordinary dynamic tweeters. As a crossover is not required these units can be added to existing speaker systems of up to 100 watts (more if 2 put in series). FREE EXPLANATORY LEAFLETS SUPPLIED WITH EACH TWEETER.

TYPE 'A' (KSN2036A) 3" round with protective wire mesh, ideal for bookshelf and medium sized Hi-fi speakers. Price £3.45 each.

TYPE 'B' (KSN1005A) 3 1/2" super horn. For general purpose speakers, disco and P.A. systems etc. Price £4.35 each.

TYPE 'C' (KSN6016A) 2" x 5" wide dispersion horn. For quality Hi-fi systems and quality discos etc. Price £5.45 each.

TYPE 'D' (KSN1025A) 2" x 6" wide dispersion horn. Upper frequency response retained extending down to mid range (2KHz). Suitable for high quality Hi-fi systems and quality discos. Price £6.90 each.

TYPE 'E' (KSN1038A) 3 1/4" horn tweeter with attractive silver finish trim. Suitable for Hi-fi monitor systems etc. Price £4.35 each.

TYPE 'F' (KSN1057A) Cased version of type 'E'. Free standing satellite tweeter. Perfect add on tweeter for conventional loudspeaker systems. Price £10.75 each. P&P 20p ea. (or SAE for Piezo leaflets).

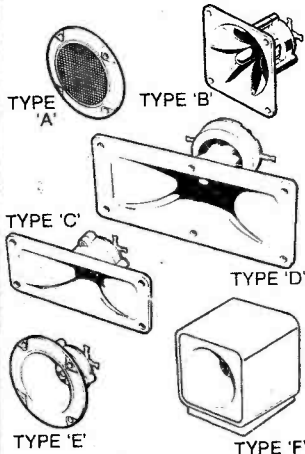

1000 MONO DISCO MIXER

A superb fully built and tested mixer/pre-amp with integral power supply. 4 Inputs 2 turntables (ceramic cartridge). Aux. for tape deck etc., plus Mic. with override switch, all with individual level controls. Two sets of active tone controls (bass and treble) for Mic. and main inputs. Master volume control. Monitor output with select switch and volume control.
Outputs Main 750 mV Monitor 500 mV into 8 ohms. Supply 220/240V AC50/60Hz. Size 22 1/2" x 4 1/2" x 2 1/2" price £39.99 + £2.50 P&P

1K.WATT SLIDE DIMMER

- Controls loads up to 1KW
- Compact size
- 4 1/2" x 13" x 2 1/2"
- 16



- Easy snap in fixing through panel/cabinet cut out
 - Insulated plastic case
 - Full wave control using Ramp triac
 - Conforms to BS800
 - Suitable for both resistance and inductive loads
- Innumerable applications in industry, the home, and discos/theatres etc.

Price: £11.70 each + 50p P&P (Any quantity)

BSR P256 TURNTABLE

P256 turntable chassis ● S shaped tone arm ● Belt driven ● Aluminium platter ● Precision calibrated counter balance ● Anti-skate (bias device) ● Damped cueing lever ● 240 volt AC operation (Hz) ● Cut-out template supplied ● Completely manual arm. This deck has a completely manual arm and is designed primarily for disco and studio use where all the advantages of a manual arm are required.

Price: £28.50 + £2.50 P&P



MEMBRANE KEYBOARDS manufactured from a tough polycarbonate film mounted on 1mm glass fibre printed circuit board assembly incorporating silver plated contacts.

16 way numeric keyboard Standard keyboard providing 0-9 and A-F functions. Size: 100mm x 100mm x 2mm. Price: £5.99 + 35p p&p
Alpha Numeric Keyboard Full size 55 key non encoded keyboard with the commonly required functions in a Qwerty array. Matrix output via a 18 pin DIL socket. Size: 350mm x 100mm x 2mm. Price: £13.99 + 50p p&p

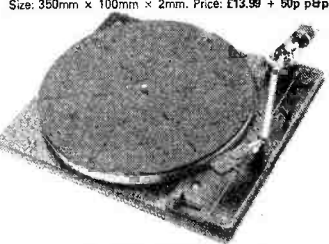

POWER AMPLIFIER MODULES

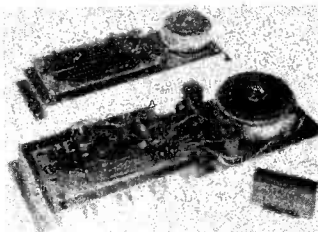

100 WATT R.M.S. AND 300 WATT R.M.S. MODULES

Power Amplifier Modules with integral toroidal transformer power supply, and heat sink. Supplied as one complete built and tested unit. Can be fitted in minutes. An LED Vu meter is available as an optional extra.

SPECIFICATION:
Max Output Power: 110 watts R.M.S. (OMP 100) 310 watts R.M.S. (OMP 300)
Loads: Open and short circuit proof. 4-16 ohms.
Frequency Response: 20Hz - 25KHz ±3dB.
Sensitivity for Max. Output: 500mV at 10K (OMP 100) 1V at 10K (OMP 300)
T.H.D.: Less than 0.1%
Supply: 240V 50Hz
Sizes: OMP 100 360 x 115 x 72mm
OMP 300 460 x 153 x 66mm
Prices: OMP 100 £31.50 each + £2.00 P&P
OMP 300 £28.00 each + £3.00 P&P
Vu Meter £5.50 each + 50p P&P

Matching 3-way loudspeakers and crossover

Build a quality 60watt RMS system 8ohms
Build a quality 60 watt R.M.S. system

- ★ 10" Woofer 35Hz-4.5KHz
- ★ 3" Tweeter 2.5KHz-19KHz
- ★ 5" Mid Range 600Hz-8KHz
- ★ 3-way crossover 6dB/oct 1.3 and 6KHz

Recommended Cab-size 26" x 13" x 13"
Fitted with attractive cast aluminium fixing escutcheons and mesh protective grills which are removable enabling a unique choice of cabinet styling. Can be mounted directly on to baffle with or without conventional speaker fabrics. All three units have aluminium centre domes and rolled foam surround. Crossover combines spring loaded loudspeaker terminals and recessed mounting panel.
Price £22.00 per kit + £2.50 postage and packing. Available separately, prices on request

12" 80 watt R.M.S. loudspeaker.
A superb general purpose twin cone loudspeaker. 50 oz. magnet. 2" aluminium voice coil. Rolled surround. Resonant frequency 25Hz. Frequency response to 13KHz. Sensitivity 95dB. Impedance 8ohm. Attractive blue cone with aluminium centre dome.
Price £17.99 each + £3.00 P&P.

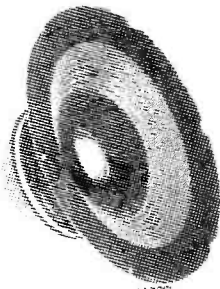
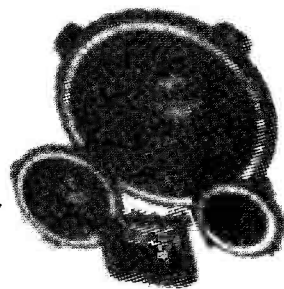

B.K. ELECTRONICS

37 Whitehouse Meadows, Eastwood, Leigh-on-Sea, Essex SS9 5TY

★ SAE for current lists. ★ Official orders welcome. ★ All prices include VAT. ★ Mail order only. ★ All items packed (where applicable) in special energy absorbing PU foam. Callers welcome by prior appointment, please phone 0702-527572.



Compact Speakers with Sealed Mylar Diaphragm

New from G. English Electronics is a series of dynamic mylar audio speakers designed for use in all types of portable industrial and domestic receiving or reproduction equipment. Introduced as the DSH Series, these highly compact dynamic mylar speakers are claimed to provide

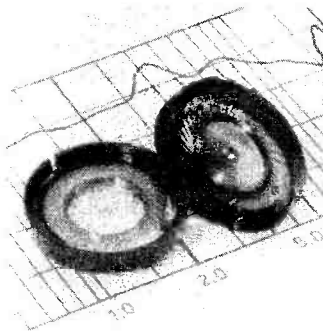

sound reproduction of exceptional quality, combining good bass response with low distortion and smooth upper frequencies. They are designed for use with amplifiers of 8-ohm to 200-ohm output impedance, and have an impedance tolerance of $\pm 20\%$. Their sensitivity at 1.5mm is 108 dB/mW at 1 kHz, and claimed frequency response is 20 Hz to 20 kHz. The rated and maximum inputs of the DSH Series are 30 mW and 100 mW, respectively.

An important feature of these miniature speakers is that they may be supplied with special terminations to meet individual application requirements. This means that they can be incorporated, without modification, into an extremely wide range of equipment, typically portable transceivers, headphones, domestic and office audio reproduction systems, etc. Their dimensions vary according to their rated output, from 27.1mm dia. \times 14.3mm up to 45.0mm dia. \times 8.2mm. G. English Electronics Ltd, 34 Bowater Road, Woolwich, London SE18 5TS. Tel: 01 855 0991.

Design Teaching Aid

The Research Machine 380Z can now be interfaced to the E & L Instruments AID-1, Analogue Interface Designer. Developed by Imperial College of Science and Technology with supporting educational text written by Edward James, the system provides an introduction to A/D and D/A conversion, and enables the stu-

dent to have an understanding of the relationship between the computer and control applications. The AID-1 is complete with electric motor, sensors for temperature, position, light meter digital inputs/outputs with LED indications. Other interfaces are also available for TRS-80 and AIM 65. E & L Instruments Ltd, Whitegate Industrial Estate, Whitegate Road, Wrexham, Clwyd LL13 8UG. Tel: 0978 263030.

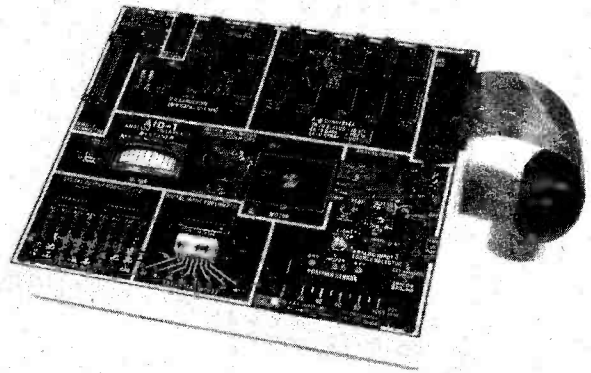

Shorts

● CUB miniature counters are now available with a new range of converter modules that allow count inputs to be taken from solenoids, contactors, logic sources, and sensors with triac outputs. The modules are protected against dirt, oil, water and most chemicals by PVC encapsulation. Eurovector Ltd, Wessex House, Silchester Road, Basingstoke RG26 6PX. Tel: 07356 3693.

● Motorola have announced several new products including: a plastic-packaged (T0220) 40 A (RMS) thyristor with 400 A surge capability; 'medium' current (up to 100 A!) power darlington transistors capable of switching 25k VA, the MJ10040 series; and, in the next few months, a series of gate arrays in ECL, ALS and CMOS. Motorola Ltd, York House, Empire Way, Middlesex HA9 0PR.

● Ross Electronics have launched a range of micro speakers and booster amplifiers for personal stereos. Ross Electronics, 49/53 Pancras Road, London NW1 2QB.

● Texas Instruments claim to be producing the first single-chip dual peripheral drivers with single-saturating transistors capable of outputting up to 500 mA. Designated the SN75407 (NAND inputs) and the SN75408 (NOR inputs), the 100-off price will be around 55p. Texas Instruments Ltd, Manton Lane, Bedford MK41 7PA.

● Also available from Texas is a new handbook covering information and instruction on microprocessor systems, called (original title!) 'Software Development'. The book is aimed at both software learners and

experienced engineers, and Texas say that it covers the basic steps in the software development process. It costs £12.90 (plus £1.50 p&p) and is available from Texas Instrument Ltd, PO Box 50, Market Harborough, Leicestershire.

● Zilog are at it again, this time with a new data book describing their full range of microprocessor products. Available from Zilog distributors, it costs £3, which looks like a bargain for 643 pages of information. Zilog (UK) Ltd, Zilog House, Moorbridge Road, Maidenhead, Berks SL6 8PL.

● A little more expensive than the Zilog book is a new publication from Granada Publishing Ltd, PO Box 9, St Albans AL2 2NF, called the Microprocessor Data Book, by S A Money. It doesn't sound that thick at 288 pages, but believe us, when it landed on our desk it nearly carried on going — it's in a large format, so it is heavily laden with facts. If we ever manage to plough through it all, we will give you a more considered opinion on all 1.4kg of it!

● Bradford & Ilkley Community College, Great Horton Road, Bradford, West Yorkshire will be running a course to prepare for the morse examination in the Radio Amateurs 'A' Licence. The one year course will commence on 12th January, with classes on Wednesday evenings from 1900 to 2100 hrs. (Note: if other colleges are running similar courses, we and our colleagues on 'Ham Radio Today' would be most interested to hear about them with a view to publishing details.)

● New products from Raytheon Semiconductor, Howard Chase, Pippis Industrial Area, Basildon, Essex SS14 3DD: a 10-bit 85 nanosecond D to A (that's fast enough

for a video signal!) called the DAC-10; and 16 and 32K PROMs and SPROMs in 24-pin 0.3" packages.

● Ground Control (they really are called that, we have the letterhead to prove it), of Alfredda Ave, Hullbridge, Essex SS5 6LT, are producing a RAM pack for the ZX81 that, they claim, eliminates the disconnection problems that can occur with other RAM packs. They claim that you can pick up your ZX81 and shake it without a crash occurring. The basic unit costs £19.95, or £24.95 with an added keyboard sounder (prices include VAT and p&p).

● Looking for a 2A or 6A high-efficiency diode with a recovery time of 25 (or 30) ns? Then contact Power Technology Ltd, Boulton Road, Reading, Berks RG2 0LT, because they've just started selling some devices made by Varo Semiconductor that may fill the bill.

● We don't know what has gone wrong this month, as we have heard of only one new multimeter being launched — must be the time of year. This one is from Keighley Instruments Ltd, 1 Boulton Road, Reading, Berks RG2 0NL (must be next door to Power Technology), and it's called the 132. It's unusual in that it's a hand-held instrument with true RMS AC ranges and a temperature range (somebody at Keighley must have been reading Tim Orr's series on measurement techniques...).

● A four-wheeled motor-driven chassis that might form the basis of a small robot (the chassis measures approx 10" \times 6" \times 3") is available for less than £40 from DRJ Electronics, PO Box 394, London SE6 1TR (catalogue 60p).

● Ambisonics is not dead, but are

keeping a low profile of late after all the 'hype' several years ago. Minim Audio, of Lent Rise, Burham, Slough SL1 7NY, are hoping to their bit to bring it back to the public eye with their AD2 surround sound decoder module. The module costs £49.95, and will, when mounted in a 'host' amplifier, decode UHJ-encoded recordings as well as enhancing normal stereo recordings.

● The BBC has published its plans for direct broadcasting by satellite in a booklet called (wait for it) 'Direct Broadcasting by Satellite — the BBC's Plans'. A limited supply of these will be available on a first-come first-served basis from the Engineering Information Department BBC, Broadcasting House, London W1A 1AA (large A4 size stamped addressed envelope required).

● Connectors' Corner — we seem to have more new connectors this month than anything else. Semiconductor Specialists (UK), of Carroll House, 159 High Street, Yiewsley, West Drayton, Middlesex UB7 7BX have introduced the '400' range of dual-beam (thought they were 'scopes) DIP sockets; BFI Electronics Ltd, 516 Walton road, West Molesley, Surrey KT8 0QF have a new snap-in connector range called the Series 600 that's already in use in the French telephone industry; BICC-Vero Connectors, Parr St, St Helens, Merseyside have introduced the M50 series fixed-pitch (1.27mm) flat-cable connecting system with a wide range of different connectors; and finally, Davico Industrial Ltd, Charles Street, West Bromwich, West Midlands have issued what they claim is the definitive catalogue of electrical terminals, connectors and cable ties.

ETI

CASIO MAGIC FOR 1983

ELECTRONIC DICTIONARIES — OLE!

**TR-6000
TRANSLATOR
CALCULATOR**
6,000 words
and phrases
£29.95

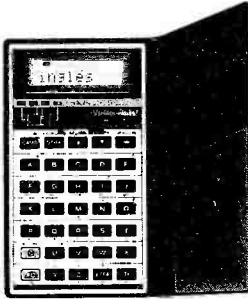

This English-Spanish/Spanish-English translator is a must for next year's holiday and, naturally, the alpha-numeric keyboard doubles as a calculator to help you work out your pesetas.

**TE-2500
DICTIONARY**
£39.95

Dictionary mode
1,711 words in both
English and Spanish.

**5-language
translation mode**
36 basic sentences for
daily conversation in
English, Japanese, Spanish,
French and German.

Backward/forward search buttons with rapid search.

World time mode Displays all 24 time zones.
Daily alarm, hourly chimes, calendar, stopwatch.
**Surely this amazing piece of science fact must
be the most versatile watch ever created**



UNDERSTAND COMPUTERS

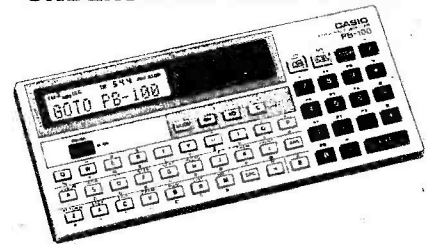

PB-100. LEARN AS YOU GO FOR £69.95
Everyone can join the new world of computers with this easy-to-understand teaching system. **LEARN** with the beginners manual "An easy-to-follow introduction to the Personal Computer". **FOLLOW** the step by step examples and **USE** the programs supplied, or develop your own for business or home, including exciting games. QWERTY keyboard. Upper/lower case dot matrix display. Up to 544 program steps/94 memories, expandable to 1,568 steps/222 memories, all protected. A truly pocketable 9.8 x 165 x 71mm. Weight 116g. 360 hours battery life.
OR-1 1K RAM expansion module. £11.95. FA-3 cassette interface £22.95.

BEST SELLING WATCHES

with alarm, hourly chimes and stopwatch



TS-1000
£24.95



**AX-250
PRICEBEATING**
£21.50

TS-1000 World's first thermometer watch with high and low temperature thermo alarms, daily alarm, stopwatch and world time mode. 100 metre water resistant resin case.

TS-2000 Non W/R metal version **£29.95**
AX-250 10 alternative displays. Over 60 functions.

100 metre water resistant

with countdown alarm timer for dinghy racing etc.



**W-300
Resin**
£17.95



**W-450
All S/S**
£22.95

Two of our most popular watches and rightly so. One lithium battery lasts 5-7 years.

Latest Models



**CS-821
Calculator**
£24.95



**GG-9
Golf Watch**
£17.95

CS-821 A really beautiful ultra-slim (6.6mm) calculator watch. One battery lasts 15 months.
GG-9 Golf stroke counter. 9 hole golf game.

We stock over 30 Casio watches, including game, joggers, divers and ladies models

See our catalogue in last month's ETI, or send for further copies

PRICEBEATERS

We believe we are the **ONLY** authorised Casio dealer currently advertising in ETI. Our prices are the lowest we are allowed to charge. Although grey imports are **NOT** guaranteed by Casio, we will nevertheless **BEAT** any lower price **AND** give you a **VALID** Casio guarantee. Our **PRICEBEATERS** from last month's ETI are as follows:

Watches
CS-821 **£24.95**. CA-851 **£24.95**. AX-250 **£21.50**
WS-70 **£18.95**. A-656 **£8.50**. F-85 **£7.25**
Calculators
FX-702P Computer **£69.95**. FX-602P Program **£62.50**
FP-10 Printer **£39**. FA-Z Interface **£18.50**
FX-100 College **£13.50**. FX-7 **£9.95**
MG-777 **£13.50**. MG-880 **£10.25**. MG-888 **£10.25**

**IF YOU SEE A BETTER OFFER
WE WILL BEAT IT!**

PORTABLE COMPUTERS

FX-801P

ONLY £349
**THE FUTURE
IS HERE TODAY**

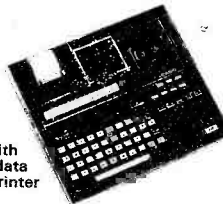

High speed computer with integral micro-cassette data control and hard copy printer monitoring.

Everything you need, in an area smaller than this page. This truly portable **SYSTEM** needs no peripherals on lengths of wire. Batteries last 250 hours (only display) or 5,000 lines (display and printing). Typewriter style QWERTY keyboard, plus all the advanced functions of the FX-702P.

FX-700P
£79.95

**Truly pocket
size**



BASIC programming. QWERTY keyboard. Up to 1,568 program steps, up to 222 memories, up to 10 program areas, all protected.

Upper/lower case dot matrix display. Powerful editing functions. 25 scientific functions. Subroutines. 8 levels. FOR/NEXT loops, 4 levels. 9.8 x 165 x 71mm. Weight 118g. 300 hour battery life approx.
FA-3 cassette interface **£22.95**. FP-12 printer **£49.95**.

SOUNDS SENSATIONAL

Free vouchers, supplied on request with your order, may be exchanged for accessories or goods.

DIGITAL SYNTHESISER
CT-1000P



£325

PLUS £45 VOUCHER

10 preset voices and 1,000 switchable sounds, with a protected memory for your 10 favourites. 5-octave split keyboard; programmable arpeggio/real time sequencer; transposition. 4 7/8 x 36 x 14 1/8 inches. 22.5lbs.

BAR-CODE PROGRAMMABLE TEACHING KEYBOARDS

CT-701

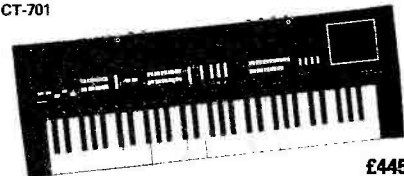

£445

5 octave, split keyboard. 20 preset sounds with variable vibrato and sustain. Fingered or auto chords with bass and arpeggio. 16 rhythm accompaniments with fill-in. Two sound effects. 5 x 37 1/2 x 12 1/2 inches. Weight 27.6lbs.

PORTABLE MINI KEYBOARDS

Battery or mains. Mains adaptor optional extra.

MT-70



£199

PLUS £30 VOUCHER

A portable mini keyboard version of the CT-701. 4 octave (not split) keyboard. 10 rhythm accompaniments. Without the two sound effects, it is otherwise very similar to the CT-701. Battery or mains powered, with optional mains adaptor. 2 1/2 x 25 x 7 1/4 inches. Weight 6lbs.

MT-60. 25 voices, 8 rhythms, Easy-Play auto chords, bass and arpeggio. With £20 voucher . . . **£149**

CHRISTMAS DELIVERY: Orders received by the 18th December will normally be delivered in time for Christmas, subject to availability.

Price includes VAT and P&P
Send cheques, P.O. or phone your
ACCESS/VISA card number to:

TEMPUS

Dept. ETI, 34 Burleigh Street,
Cambridge CB1 1DG
Telephone: 0223 312866

TRON

One of the most imaginative and innovative films for some time has just been released, and it uses computers in a way never seen before. Peter Green has seen the film; now read the article.



All photographs © 1982 Walt Disney Productions

Far above the infinite Sea of Simulation which resembles shifting, multicoloured graph paper, a jewelled ship flies on butterfly wings down a channel of pure light. Its path takes it over gridded fields populated by strange spiderlike creatures and through vast canyons with faceted, metallic cliffs that pulse with an eerie, sombre light.

A group of crouching warriors are surrounded by skeletal 'blueprints' which solidify into futuristic lightcycles and speed forwards toward each other, trailing impenetrable coloured walls in their wake. The cycles snap into right-angled turns, courting collision and slowly covering the playing area with a complex maze of walls. Suddenly a warrior miscalculates a turn: he is destroyed in an explosion of light and his wall disappears with him.

A huge battleship thunders across the landscape, the ultimate weapon of the tyranny that has taken over this world. Slowly, along a plane that sweeps over the craft from front to rear, it fades into a transparent, skeletal outline that continues on its journey towards a distant citadel as if nothing had happened.

This is the world of *Tron*. It is like no film you have seen before. And it was made as no film has been before — or will be again.

Game For A Death

Most of the standard subject matter for science fiction has been done to death — albeit in a pretty spectacular manner, given the skills of the modern special effects team. *Tron* is fresh and different because its director has combined two modern phenomena that have become big business: the use of high-res computer graphics for leisure, in the guise of video games, and the use of high-res computer graphics as a tool for industry. One forms the backdrop to the plot for the film, the other the means of its making. Most of the film takes place in an imaginary world inside the computer, and all the major actors have two roles, one on either side of the video screen.

Tron starts in the real world, where Flynn (Jeff Bridges, playing the sort of laconic rogue I first warmed to in *Thunderbolt and Lightfoot*) is running a seedy videogame arcade, and beating everyone else's maximum score to



The computer-generated face of the computer.

boot. Flynn used to be the top programmer at ENCOM, a communications conglomerate, until he wrote five crack videogames. An unscrupulous colleague, Dillinger (David Warner), steals the games from the company computer, presents them as his own, and on the strength of their success gets promoted to Managing Director; Flynn gets the elbow.

A trifle miffed at this, Flynn spends his evenings on a home computer terminal upstairs from the arcade, trying to break into the ENCOM computer and gather evidence of Dillinger's dirty work. Unfortunately for Flynn the whole system is now being run by the artificial intelligence of Dillinger's Master Control Program (MCP), which monitors the intrusion and shuts down all access by group seven users (Flynn's security rating). This has the added bonus to the MCP of preventing Alan Bradley (Bruce Boxleitner) from completing work on *TRON*, an independent security program that would monitor the ENCOM computer and reveal the embarrassing fact that, no longer under Dillinger's control, it is tapping into the computers of other companies, not to mention the Pentagon and the Kremlin (most readers will have spotted that *TRON* is the BASIC command for *TRace ON*). Other ENCOM employees to have their work halted are Gibbs and his assistant Lora (Cindy Morgan), who've been working on a project to disassemble objects with a laser, store the information in a computer, then reassemble it ("Beam me up, Scotty").

Alan and Lora guess that Flynn's been meddling, pay him a visit, get the whole story and decide to help him. That night they break into ENCOM; Flynn will forge a new security access so that Alan can complete his work on *TRON*. But Flynn is using Lora's terminal, right next to the experimental laser; the MCP fights back by disassembling Flynn and sucking him inside the computer. Flynn wakes up in an alternative universe where the inhabitants are 'Programs', electronic alter-egos of the 'Users' who wrote them. The cruel tyrant ruling this world is the MCP, aided by his henchman Sark (Warner again), who flies around in his giant carrier putting down rebellion. Any program that's useful is absorbed by the MCP; the rest are trained as gladiators and fight on the Game Grid, where videogames become a life-and-death reality. Flynn is sentenced to fight until he dies, and finds he needs all his skills to stay alive against the complex games that he himself has written.

Here Flynn meets Tron (Boxleitner), mightiest of the warrior programs and still fighting for the Users against the MCP. Tron is adept in the use of his 'identity disc', which doubles as an information store, and a personal weapon à la Frisbee. Tron and Flynn manage to escape from the Game Grid on their lightcycles and being a long journey to sabotage the MCP. Separated from Flynn by Sark's tanks, Tron meets Yori (Morgan again), a simulations program, who helps him steal her Solar Sailer project. Meanwhile Flynn has stolen a Recognizer, a vehicle used by Sark's

guards. Tron manages to contact Alan Bradley via an input output tower and his identity disc is coded with the information required to destroy the MCP. Eventually the trio meet up again on the home ground of the MCP and prepare for the final battle that will decide all their fates.

The Pong Plot

As you can see, the plot is innovative to say the least. So are the techniques used to film it. And the whole thing is the result of the drive and vision of the director, Steven Lisberger. I spoke to him during his recent visit to London to promote the film and though we started talking about *Tron*, he ended up leaping from subject to subject like a gazelle. For example, if you're planning to play Zaxxon, the new arcade game that's been appearing in pubs over here, be gentle with it — apparently the joystick is badly designed and machines are breaking down regularly in the USA.

Lisberger first conceived *Tron* in 1977 while he was directing a couple of animated TV specials called *Animalympics*: the inspiration was the lowly Pong, father of arcade games as we know them today. Originally the film was to have been animated entirely by computer, and as Lisberger began checking into the techniques he met many people in the industry who gave him ideas for the plot. The theme of the parent company ripping off the inventions of its employees was one, inspired by stories from people it had actually happened to.

By 1980 Lisberger and his producer, Don Kushner, had honed the script into its final form and were hawking it around the major studios. The screenplay now contained extensive scenes using live actors and conventional animation, all of which had to be carefully combined with the computer-generated footage. Within a week of being offered the project, Walt Disney Productions had, in keeping with their tradition of gambling on the success of some pioneering technique, expressed an interest and put up \$50,000 for test footage.

Lisberger And Chips

The computer-generated sequences in *Tron* occupy about 20 minutes of the 75 spent in the fantasy world — primarily they are scenes involving the lightcycles, the tanks and Recognizers, the Solar Sailer, Sark's carrier and the face of the MCP. Three main companies were involved in the work: Digital Effects Inc, who did the opening shot of a man forming out of energy and Flynn's 'pet', Bit; the Mathematical Applications Group Inc, or MAGI; and Information International Inc, known as Triple-I or III for short. MAGI and III use completely different approaches to computer image generation and worked on separate areas of the film.

The MAGI Synthavision system (you may have seen it used in the film *Demon Seed* on TV recently) is unique in that it uses subroutine programs; a selection of about 50 solid geometric shapes are stored in the computer as building blocks. To generate the required images, the basic shapes may be added or subtracted from one another until the correct result is obtained. For example, to make the lightcycle you might start with a pair of

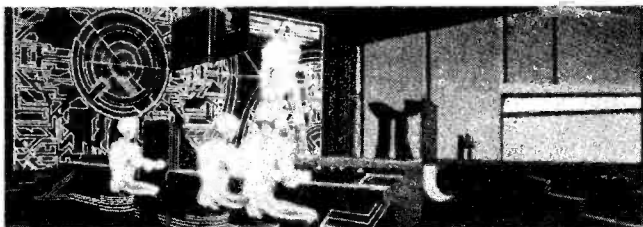

The spacious control room of Sark's battlecruiser.

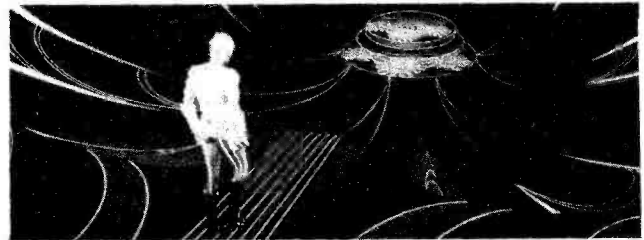

Tron approaches the platform of the I/O tower.

spheres and remove cylindrical cores to give the tyre shapes, then add a smaller central sphere for the hubcap. MAGI were responsible for the lightcycles, tanks, Recognizers and so on. The company uses a Perkin Elmer System 3240 computer for the graphics calculations, using two megabytes of MOS memory and two 80 megabyte disc drives. The pictures are actually generated on a monitor by a second computer, a Celco DFR 4000. As MAGI are located in New York, all their work for the film was sent down the telephone lines via modem to the Disney Studios in California, where the animators studied the results on their monitors and called back with any corrections needed.

III uses a completely different system, in which the blueprints for the required object are digitized on a 40" by 60" Taylos graphics tablet and fed into a custom-built one-off computer they call the Foonley F-1. The computer uses the digital information to define the points of the surface, which is then coloured and shaded. This method is better for complex, irregular shapes because it doesn't rely on regular-shaped, geometric building blocks. Hence III are responsible for the 'human' face of the MCP as it communicates with Sark, and also the delicate Solar Sailer.

Eventually, when the scenes have been choreographed to the satisfaction of the animators (and using computers means that changes to the action can be made in only 20-30 minutes), the images are transferred to movie film by photographing them frame by frame from the screen of a high resolution cathode ray tube. The resulting quality is superb: each frame can contain up to two million pixels and the resolution of some of the images is 2000 lines, higher than that of the film stock being used. So don't try looking for the little squares, because you won't see them.

Seeing Things In Black And White

Equal care and quality went into the filming of the live action scenes, and equally innovative techniques were used. All the denizens of the computer world wear costumes with constantly flickering bands of light — none of which existed in reality. The actors' costumes were white with black patterns and were filmed on black-and-white film against black backdrops. The film was 70mm — rare in itself these days — and provided big negatives for the post-production work. In fact both MAGI and III had to change their equipment to VistaVision. Once the actors had been filmed, the special effects team made a series of 'mattes' and 'reveals' for each frame of film. These are masks and counter masks that allow various sections of each negative to be lit separately from below by coloured lights and rephotographed on colour stock to give the finished film frame. Most frames had to be rephotographed at least 12 to 15 times (and some as many as 45 times) to produce the required effects using eye reveals, face reveals, costume reveals and so on. The live action was then combined with backgrounds which had been either computer-generated or drawn by conventional animators. Of the 1100 special effects shots in *Tron*, over 700 involve composite shots with actors.

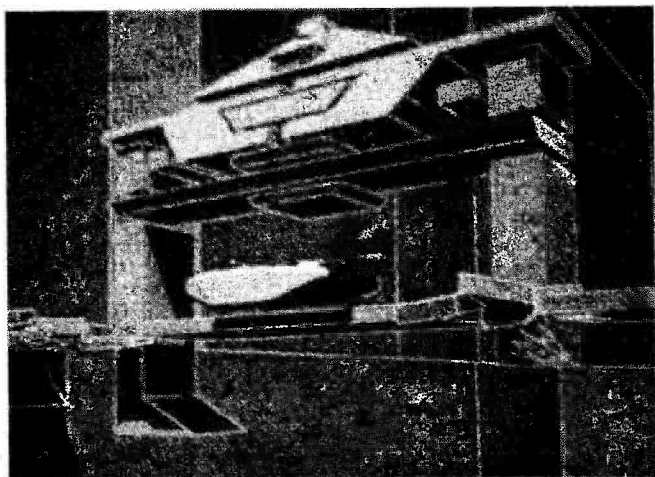

L-driver Flynn crashes his Recognizer into a bridge — a remarkable piece of special effects work.

This may seem like a stupendous amount of effort but the quality of the result is worth it. Normally a film shot using the conventional 'blue screen' matting techniques gives spaceships and actors with a noticeable line round them. This is the system where the actors or spacecraft are filmed against a bright blue background, which can then be photographically 'removed' and replaced with a different background, such as a star field or planet. Even *Star Wars*, which used a greatly improved version of this technique, had scenes in which it was possible to 'see the join'. Since *Tron* doesn't have any mattes in the conventional sense, there are no matte lines. Conventional matting will also give errors in perspective, since it's almost impossible to merge film of models shot at different locations and different times and get things dead right. *Tron* uses no models: everything exists only in the computer's memory and the perspective is always perfect.

One particular scene demonstrates this well. Recognizers are composed of various elemental blocks and Flynn has stolen a wrecked one by using his User powers to hold it together. But his steering's not too good and the machine hits a bridge, sending the component blocks twisting and tumbling in all directions. Flynn exerts his will and draws them together from their random trajectories, spinning and rotating back into place with perfect precision. This scene alone would have taken a team of conventional animators years to perfect.

The Digital Editor

Even the level of technology used in *Tron* is only the beginning. The next step is to scan the live action footage and digitize it so that it, too, may be completely manipulated within the computer. The live action can be coloured, distorted, combined with other objects, again without matte lines. In effect the computer will become a digital film printer and the optical printer will become obsolete. According to Lisberger, this sort of equipment will arrive in a couple of years — just in time for *Tron II*, perhaps?

Looking even further ahead, I asked how soon he thought it would be before computer graphics could simulate real scenes, such as the *Star Trek* episode "Court Martial" in which a disgruntled crewman fakes the computer log tape to incriminate Kirk. "I've seen sample reels where objects are indistinguishable from photos, but to simulate people will take a long time — 10-15 years," he estimates.

After *Tron*, our discussion turned to the videogames that the film is based on. Lisberger is a videogame buff and feels that they are a Good Thing for society. "This

technology is here to stay, and the kids who are playing these games, now will grow up into adults who are familiar with it. This has got to be helpful to their development". But he's less happy about the way the big money-spinning games like *Space Invaders* and *Pacman* are licenced by the Japanese, who rake in the millions of dollars of profit each year. "It doesn't say much for American enterprise" he comments sadly. His opinion of Atari suing left, right and centre over *Pacman* copyright infringement is that it's a load of b*ll***t, and he feels they're really just testing out laws which are too vague. "I think the tendency in future will be towards more lenient copyright laws, but big companies like Atari will probably still try to bring lawsuits against smaller companies just to be a nuisance. It's scary that the threat is more powerful than the law itself."

Raiders Of The Lost Arcade

I wish I'd said that; but it's what *Tron* was dubbed in the USA when it was released. Oddly enough, when I first saw the film the only two actors I'd heard of were Bridges and Warner: since then Bruce Boxleitner and Cindy Morgan have appeared on the ITV network in a series called *Bring 'Em Back Alive*, which is a thinly-disguised rip-off of *Raiders*, even down to the theme tune — and what's more, one of the characters is called Flynn! The incestuous plagiarism of the US film and TV industry never ceases to amaze me . . .

I also spotted a few cinematic references in *Tron*, although Lisberger is as much a film buff as he is a video buff and these are obviously a homage to some great classics. The most blatant one is Alan Bradley's poster reading "GORT KLAATU BARADA NIKTO", the famous line from *The Day The Earth Stood Still*. Flynn's journey across the electronic landscape when he is atomized by the MCP echoes Bowman's journey over the weird planet at the end of *2001*, and surely the scene when the Solar Sailer escapes from its hanger, pursued by Sark's giant warship and watched by the helpless guards on the ground is straight out of *Star Wars*? Perhaps I'm wrong, but in any case *Tron* has sufficient action and witty dialogue of its own. For example, when Dillinger reminds the MCP that he programmed it, it replies "I've gotten 2,415 times smarter since then": though I did cringe a bit when Sark orders the destruction of an electronic barrier with the words "Bring up the logic probe!"

Tron is already showing in London and will be on general release by Christmas. It cost \$22 million to make and has already grossed \$30 million in the USA, salvaging the reputation of Disney which suffered badly from the appalling *Black Hole*: a film which Lisberger admits might make people wary of *Tron*. Other problems he was worried about were Britain's poor cinema audiences — "Your TV is too good" — and the imminent release of *ET*. However, there are queues outside the cinema down the road from us and *Tron* is already the top film after being out for a fortnight, so Lisberger's fears are probably unfounded.

Strangely enough, *ET* is the sort of film that Disney themselves might once have made, although Lisberger isn't too impressed with it. "*Tron* has a moral, that we have to watch out for big business and guard against its excesses. I don't know what sort of message you could take home from *ET*, except maybe be kind to your pet". I'll buy that; and I'll also buy a ticket to see *Tron*, despite sitting through two press showings already. It's brilliant, and I thoroughly recommend it. It establishes computers as a powerful new tool for the cinema industry, and Lisberger as a major young talent to join the ranks of Spielberg, Lucas et al.

END OF LINE.

ETI

ETI JANUARY 1983

30 Solderless Breadboard Project — Book 1

Recommended By BICC VEROB PA PENFOLD

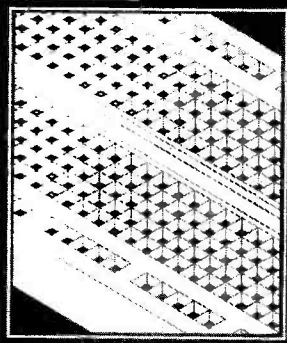

BRAND NEW VEROBLOC KIT!!!

Just published by Babani, Mr. R.A. Penfold's new book, "30 SOLDERLESS BREADBOARD PROJECTS" — this book features 30 different projects for assembly on a Verobloc, and the kit contains all parts necessary to make:

- Audio Amplifiers
- Light & Dark Activated Switches & Alarms
- Timers
- Metronome
- Oscillators & Tone Generators.
- Warbling Door Buzzer
- Two-Tone Train Horn
- Touch Switch
- Reaction Game
- Sound Activated Switch
- Radio Receivers
- Fuzz Unit
- ... + lots more!!

The introduction shows all the different components and explains how to use the breadboard. The Verobloc layout is shown for every project together with the circuit diagram and an explanation of how it works. Ideal for beginners in electronics, but also suitable for more advanced students.

The complete kit is contained in an attractive plastic case, which can be divided up into 15 compartments in which your components may be stored.

Complete Kit, including book, Verobloc & all parts £24.95; Book only £2.25; Kit without Verobloc £20.45.

NEW GOODIES JUST ARRIVED!!!

- C12 BDX88A Darlington Power TO3 PNP
60V 12A 117W Hfe 750 @ 6A 75p
- C13 Nixie — Siemens ZM1336K, 14mm digit height, overall 25mm. Wire ended 50p
- C14 8Y122-750 power switching rect, 800V 4A, 4 for £1.50
- C15 GR05R 50V switching rect, 4 for 50p
- C16 21PT5 50V 20A rect 75p
- C17 KBL04 4A 400V bridge 50p
- C18 BS1 1A 100V bridge 5 for £1

1982/3 CATALOGUE

- Bigger! Bigger! Buy one!!
 - Only 75p inc. post — Look what you get!!
 - # Vouchers worth 60p
 - # 1st class replay paid envelope
 - # Wholesale list for bulk buyers
 - # Bargain List with hundreds of surplus lines
 - # Huge range of components
 - # Low, low prices
- Sent free to schools, colleges etc.

LAST MONTHS NEW ITEMS

- N1 8085A CPU £3.50
- N2 MC14175 50p
- N3 LM390 50p
- N4 1000uF 18V Ax. 15p
- N5 6850 100p
- N6 MM5290 50p
- N7 MM2114 2 60p
- C1 7912CK (TO3 Case) 75p
- C2 3.579545MHz Xtal HC6U case 50p
- C3 40 DIL LP skts 10/£2 100/£16
- C4 25 way screened cable 7.0/2.50p/metre
- C5 Reed switches, 20mm body SP make 20/£1
- C6 12V reed relay, SP break 40p
- C8 68A00 CPU £1.50
- C9 UDN6116A display driver 50p
- C10 Speedlock ribbon cable: 10 way 30p/m; 20 way 60p/m; 40 way £1.20/m

10 W AMP PANEL

Neat board 115 x 62mm with Class B output. Uses 2 x 2N5293, 2 x BFY50, BFY23. Supply can be either 36V or 18-0-18V input sensitivity 1V for 10W output. Small H/S on board; £2.95. Suitable transformer, bridge rect, smoothing and o/p capacitor. £5.50. Supplied with circuit/connection data.

'COMPUTER BATTLESHIPS'

Probably one of the most popular electronic games on the market. Unfortunately the design makes it impractical to test the PCB as a working model, although it may well function perfectly. Instead we have tested the sound chip, and sell the board for its component value only (PCB may be chipped or cracked): SN76477 sound IC; TMS1000 u-processor; batt clips, R's, C's etc. Size 160 x 140mm. Only £1.50. Instruction book and circuit 30p extra.

TIL302 7-SEG DISPLAY

C11 0.27in red common anode. Only 8p

1N4007 1000V 1A RECTS

Motorola banded/lowest ever price!! 100 £2.95; 300 £8.50; 1k £27; 3k £72; 10k £220

5mm RED LED SCOOP

Another company gone bust — to your advantage!! We've bought all their 5mm red LEDs — GI type MV5754, and offer them as follows:

25 £1.95; 100 £6.00; 250 £13.50; 1k £39.50; 5k £185. Add 30% for 2-part clip if required.

LIE DETECTOR

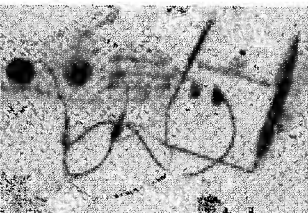

Not a toy, this precision instrument was originally part of an "Open University" course, used to measure a change in emotional balance, or as a lie detector. Full details of how to use it are given, and a circuit diagram. Supplied complete with probes, leads and conductive jelly. Needs 2 4V batts. Overall size 155 x 100 x 100mm. Only £7.95 — worth that for the case and meter alone!!

1000 resistors £2.50

We've just purchased another 5 million preferred resistors, and can make a similar offer to that made two years ago, at the same price!! MS23 — 1000 mixed 1 and 1W 5% carbon film resistors, preferred for PCB mntg. Enormous range of preferred values. 1000 for £2.50; 500 £10; 20k £36

ELECTRO-DIAL

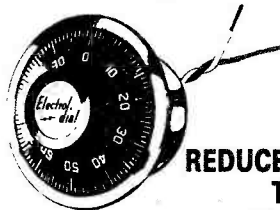

REDUCED TO £3.95

Electrical combination lock — for maximum security — pick proof. 1 million combinations!! Dial is turned to the right to one number, left to a second number, then right again to a third number. Only when this has been completed in the correct sequence will the electrical contacts close. These can be used to operate a relay or solenoid. Overall dia. 65mm x 60mm deep. Only £3.95

PACKS PACKS PACKS

K517 Transistor Pack. 50 assorted full spec marked plastic devices PNP NPN RF AF. Type numbers include BC114, 117, 172, 182, 183, 198, 239, 251, 214, 255, 320, BF198, 255, 394, 2N3904 etc etc. Retail cost £7 +. Special low price 275p

K620 Switch Pack. 20 different assorted switches — rocker, slide, push, rotary, toggle, micro etc. Amazing value at only 200p

K622 Copper clad board. All pieces too small for our etching kits. Mostly double sided fibre-glass. 250g (approx 110 sq ins) for 100p

K641 It's back!! Our most popular pack ever — Vero offcuts. This has been restricted for some time, but we have now built up a reasonable stock and can once again offer 100 sq ins of vero copper clad offcuts, average size 4 x 3". Offered at around 1/2 the price of a new board 320p

SOLENOID AND RELAYS

W921 Solenoid rated 48V @ 25% duty cycle, but work well on 24V (700gm pull, 10mm travel) push or pull 27 x 18 x 15mm 55p

W922 Mains 240V ac solenoid, 10% duty cycle, push or pull, 16mm travel 50 x 20 x 16mm. Only £1.50

W895 9V DC relay 500R SPCO 28 x 24 x 19. 50p

W733 11 pin plug in relay, 240V ac, 3PCO 5A contacts £2.50. Base 36p

W838 700R 24V 4PCO "continental" relay 35 x 30 x 18mm, only 84p, 10/£7.00

W847 37R 5-10V relay, SP 3A contact, PCB mntg 11 x 33 x 20. 36p 10/£7.50

W893 Omron LY4 mains relay, 4PCO 5A contacts. £2.50

W925 6V DIL reed relay, SP make 75p

W924 6V reed relay, 500R coil, DP break contacts, 60p

W928 24V Omron relay type G2L 113P, PCB vert mntg, 28 x 25 x 10mm 75p

POWERFET AMPLIFIERS

NEW DESIGNS

With the introduction of four new boards PANTECHNIC have pushed forward the performance and reliability of their powerfet amplifiers. Four key improvements have been incorporated in these second generation modules —

- 1.) The use of H-PAK powerfets, resulting in improved thermal efficiency and consequently enhanced power output capabilities.
- 2.) Low COB drivers now in power transistor packages, maintaining the superb HF performance and improving driver reliability.
- 3.) Separate driver and input supply rails allowing a 10% increase in available output power by increasing output stage efficiency.
- 4.) Bridge mode input pin allowing instant bridging between any two amplifiers without the need for extra circuitry.

PFA100 Specification

Bandwidth 10Hz-100KHz ± 1dB
Output Power into 8Ω 100W (Vs ± 55V)
THD (20Hz-20KHz) <0.008%
THD (1KHz at 100W) 0.004% typ.
SNR 120dB
Slew rate >30 V/μS
Gain x 23
Rin 30K
Vs max ± 70V

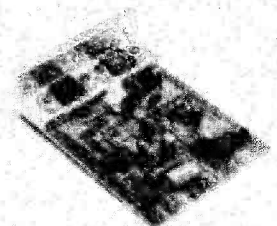

Price
£17.35 (Built & Tested)
£15.17 (Kit)

PFA100 120W into 8Ω

PFA200 Specification

Bandwidth 10Hz-100KHz ± 1dB
Output power into 8Ω 150W (Vs ± 60V)
THD (20Hz-20KHz) <0.005%
THD (1KHz at 150W) 0.002% typ.
SNR 120dB
Slew rate >30 V/μS
Gain x 23
Rin 30K
Vs max ± 70V

PFA200 180W into 8Ω
300W into 4Ω

Price
£23.87 (Built & Tested)
£21.70 (Kit)

And for those with a taste of power . . .

PFA500 Delivers 475W into 4 ohms and 600W into 2ohms. These highly current capable units can deliver 25amps continuous into a load, whilst maintaining the excellent performances figures of the smaller units£42.00 (built & tested)

PFA/HV A very special module aimed at digital audio and wide dynamic range programme material. Delivery 300W into 4ohms and 8ohms on a continuous basis, it will peak for musically significant periods of time at up to 5dBs above this. The PFA/HV is the widest dynamic range power amplifier currently available£34.30 (built & tested)

The Heat Exchanger Other people sell heatsinks. Pantechnic design, manufacture, and sell heatexchangers. Re-examination at the heat transfer process has resulted in a radically new design possessing greatly improved efficiency. The unit 7" x 4" x 2" handles PFAs up to 300W or 1.2KW when blown.....£7.50

POWER SUPPLY COMPONENTS

Toroidal Mains Transformers

Voltage	160VA	225 VA	300 VA	500 VA	625 VA
40-0-40	9.50	11.20	12.00	—	—
45-0-45	—	11.20	12.00	15.50	—
50-9-50	—	—	—	15.50	18.15

Special low flux windings. Carriage + VAT included

25A 400PIV Bridge rectifier	£2.00	For the PFA/HV 625VA	70/0/70
10,000uF 80V Electrolytics	£4.00		£18.15
30,000uF 75V Electrolytics	£10.00	10,000uF 100V electrolithic	£5.50

Phone or write for advice on selecting the right components for your particular application.

All prices excl. VAT. Carriage 75p. Trade lists available

Ask about our preamps, protection boards and active crossovers

THE POWERFET SPECIALISTS

pantechnic

(incorporating J.W. Rimmer)

Mail order only to:

Dept ETI 1 148 Quarry Street, Liverpool L25 6HQ

Telephone: 051 428 8485

Technical enquiries:

367 Green Lanes, London N4 1DY. Tel: 01-800 6867

ALL PRICES INCLUDE VAT; JUST ADD 50p POST

GREENWELD

443A Millbrook Road Southampton SO1 0HX

GET BIG POWER

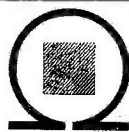
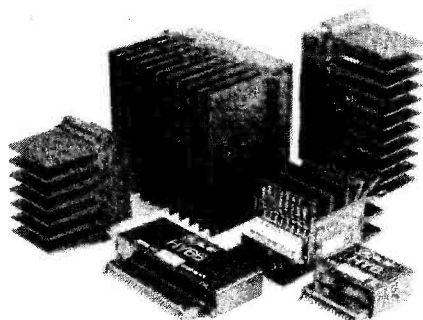

Modular Amplifiers the third generation

Due to continuous improvements in components and design ILP now launch the largest and most advanced generation of modules ever.

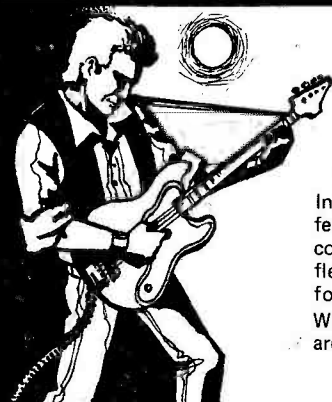

WE'RE INSTRUMENTAL IN MAKING A LOT OF POWER

In keeping with ILP's tradition of entirely self-contained modules featuring, integral heatsinks, no external components and only 5 connections required, the range has been optimized for efficiency, flexibility, reliability, easy usage, outstanding performance, value for money.

With over 10 years experience in audio amplifier technology ILP are recognised as world leaders.



BIPOLAR MODULES

Module Number	Output Power Watts rms	Load Impedance Ω	T.H.D. Typ at 1KHz	I.M.D. 60Hz/7KHz 4:1	Supply Voltage Typ	Size mm	WT gms	Price inc. VAT
HY30	15	4-8	0.015%	<0.006%	± 18	76 x 68 x 40	240	£8.40
HY60	30	4-8	0.015%	<0.006%	± 25	76 x 68 x 40	240	£9.55
HY6060	30 + 30	4-8	0.015%	<0.006%	± 25	120 x 78 x 40	420	£18.69
HY124	60	4	0.01%	<0.006%	± 26	120 x 78 x 40	410	£20.75
HY128	60	8	0.01%	<0.006%	± 35	120 x 78 x 40	410	£20.75
HY244	120	4	0.01%	<0.006%	± 35	120 x 78 x 50	520	£25.47
HY248	120	8	0.01%	<0.006%	± 50	120 x 78 x 50	520	£25.47
HY364	180	4	0.01%	<0.006%	± 45	120 x 78 x 100	1030	£38.41
HY368	180	8	0.01%	<0.006%	± 60	120 x 78 x 100	1030	£38.41

Protection: Full load line. Slow Rate: 15v/ μ s. Rise time: 5 μ s. S/N ratio: 100db. Frequency response (-3dB) 15Hz - 50KHz. Input sensitivity: 500mV rms. Input Impedance: 100K Ω . Damping factor: 100Hz >400.

PRE-AMP SYSTEMS

Module Number	Module	Functions	Current Required	Price inc. VAT
HY6	Mono pre amp	Mic/Mag. Cartridge/Tuner/Tape/Aux + Vol/Bass/Treble	10mA	£7.60
HY66	Stereo pre amp	Mic/Mag. Cartridge/Tuner/Tape/Aux + Vol/Bass/Treble/Balance	20mA	£14.32
HY73	Guitar pre amp	Two Guitar (Bass Lead) and Mic + separate Volume Bass Treble + Mix	20mA	£15.36
HY78	Stereo pre amp	As HY66 less tone controls	20mA	£14.20

Most pre-amp modules can be driven by the PSU driving the main power amp. A separate PSU 30 is available purely for pre amp modules if required for £5.47 (inc. VAT). Pre-amp and mixing modules in 18 different variations. Please send for details.

Mounting Boards

For ease of construction we recommend the B6 for modules HY6-HY13 £1.05 (inc. VAT) and the B66 for modules HY66-HY78 £1.29 (inc. VAT).

POWER SUPPLY UNITS (Incorporating our own toroidal transformers)

Model Number	For Use With	Price inc. VAT
PSU 21X	1 or 2 HY30	£11.93
PSU 41X	1 or 2 HY60, 1 x HY6060, 1 x HY124	£13.83
PSU 42X	1 x HY128	£15.80
PSU 43X	1 x MOS128	£16.70
PSU 51X	2 x HY128, 1 x HY244	£17.07

Model Number	For Use With	Price inc. VAT
PSU 52X	2 x HY124	£17.07
PSU 53X	2 x MOS128	£17.86
PSU 54X	1 x HY248	£17.56
PSU 55X	1 x MOS248	£19.52
PSU 71X	2 x HY244	£21.75

Model Number	For Use With	Price inc. VAT
PSU 72X	2 x HY248	£22.54
PSU 73X	1 x HY364	£22.64
PSU 74X	1 x HY368	£24.20
PSU 75X	2 x MOS248, 1 x MOS368	£24.20

Please note: X in part no. indicates primary voltage. Please insert "0" in place of X for 110V, "1" in place of X for 220V, and "2" in place of X for 240V.

MOSFET MODULES

Module Number	Output Power Watts rms	Load Impedance Ω	T.H.D. Typ at 1KHz	I.M.D. 60Hz/7KHz 4:1	Supply Voltage Typ	Size mm	WT gms	Price inc. VAT
MOS 128	60	4-8	<0.006%	<0.006%	± 45	120 x 78 x 40	420	£18.69
MOS 248	120	4-8	<0.006%	<0.006%	± 55	120 x 78 x 80	840	£38.41
MOS 364	180	4	<0.006%	<0.006%	± 55	120 x 78 x 100	1030	£38.41

Protection: Able to cope with complex loads without the need for very special protection circuitry (fuses will suffice).

Slow rate: 20v/ μ s. Rise time: 3 μ s. S/N ratio: 100db

Frequency response (-3dB): 15Hz - 100KHz. Input sensitivity: 500mV rms

Input impedance: 100K Ω . Damping factor: 100Hz >400.

'NEW to ILP' In Car Entertainments

C15

Mono Power Booster Amplifier to increase the output of your existing car radio or cassette player to a nominal 15 watts rms.

Very easy to use.

£9.14 (inc. VAT)

Robust construction.

Mounts anywhere in car.

Automatic switch on.

Output power maximum 22w peak into 4 Ω .

Frequency response (-3dB) 15Hz to 30KHz, T.H.D. 0.1% at 10w 1KHz

S/N ratio (DIN AUDIO) 80dB, Load Impedance 3 Ω .

Input Sensitivity and impedance (selectable) 700mV rms into 15K Ω 3V rms into 8 Ω .

Size 95 x 48 x 50mm. Weight 256 gms.

C1515

Stereo version of C15.

£17.19 (inc. VAT)

Size 95 x 40 x 80. Weight 410 gms.

WITH A LOT OF HELP FROM



PROFESSIONAL HI-FI THAT EVERY ENTHUSIAST CAN HANDLE...

Unicase

Over the years ILP has been aware of the need for a complete packaging system for its products, it has now developed a unique system which meets all the requirements for ease of assembly, adaptability, ruggedness, modern styling and above all price.

Each Unicase kit contains all the hardware required down to the last nut and bolt to build a complete unit without the need for any special tools.

Because of ILP's modular approach, "open plan" construction is used and final assembly of the unit parts forms a compact aesthetic unit. By this method construction can be achieved in under two hours with little experience of electronic wiring and mechanical assembly.

Hi Fi Separates

UC1 PRE AMP UNIT: Incorporates the HY78 to provide a "no frills", low distortion, (<0.01%), stereo control unit, providing inputs for magnetic cartridge, tuner, and tape/monitor facilities. This unit provides the heart of the hi fi system and can be used in conjunction with any of the UP Unicase series of power amps. For ultimate hum rejection the UC1 draws its power from the power amp unit.

POWER AMPS: The UP series feature a clean line front panel incorporating on/off switch and concealed indicator. They are designed to compliment the style of the UC1 pre-amp. Performance for each unit which includes the appropriate power supply, is as specified on the facing page.

Power Slaves

Our power slaves, which have numerous uses i.e. instrument, discotheque, sound reinforcement, feature in addition to the hi fi series, front panel input jack, level control, and a carrying handle. Providing the smallest, lowest cost, slave on the market in this format.

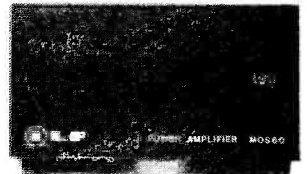
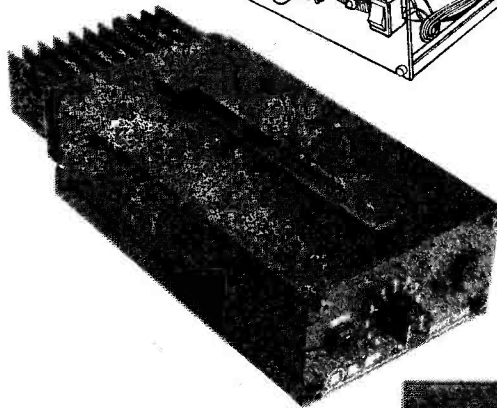
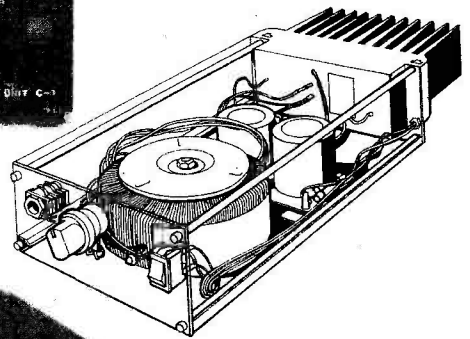

UNICASES

HiFi Separates					Price inc. VAT
UC1	Preamp				£29.95
UP1X	30 + 30W/4-8Ω	Bipolar	Stereo	HiFi	£54.95
UP2X	60W/4Ω	Bipolar	Mono	HiFi	£54.95
UP3X	60W/8Ω	Bipolar	Mono	HiFi	£54.95
UP4X	120W/4Ω	Bipolar	Mono	HiFi	£74.95
UP5X	120W/8Ω	Bipolar	Mono	HiFi	£74.95
UP6X	60W/4-8Ω	MOS	Mono	HiFi	£64.95
UP7X	120W/4-8Ω	MOS	Mono	HiFi	£84.95
Power Slaves					
US1X	60W/4 Ω	Bipolar	Power	Slave	£59.95
US2X	120W/4 Ω	Bipolar	Power	Slave	£79.95
US3X	60W/4-8Ω	MOS	Power	Slave	£69.96
US4X	120W/4-8Ω	MOS	Power	Slave	£89.95

Please note X in part number denotes mains voltage. Please insert 'O' in place of X for 110V, '1' in place of X for 220V (Europe), and '2' in place of X for 240V (U.K.) All units except UC1 incorporate our own toroidal transformers.

TO ORDER USING OUR FREEPOST FACILITY

Fill in the coupon as shown, or write details on a separate sheet of paper, quoting the name and date of this journal. By sending your order to our address as shown at the bottom of the page opposite, with FREEPOST clearly shown on the envelope, you need not stamp it. We pay postage for you. Cheques and money orders must be crossed and made payable to I.L.P. Electronics Ltd. if sending cash, it must be by registered post. To pay C.O.D. please add £1 to TOTAL value of order.

PAYMENT MAY BE MADE BY ACCESS OR BARCLAYCARD IF REQUIRED



Post to: ILP Electronics Ltd., Freepost 4, Graham Bell House, Roper Close, Canterbury CT2 7EP, Kent, England. Telephone: (0227) 54778. Technical: (0227) 64723. Telex: 965780.

Please send me the following _____

Total purchase price _____

I enclose Cheque Postal Orders Int. Money Order

Please debit my Access/Barclaycard No. _____

Name _____

Address _____

Signature _____

PROGRAMMABLE STAGE LIGHTING

Tis the season to be jolly, and put on pantos. And make yourself a nervous wreck trying to control the stage lighting. This programmable lighting control unit should solve your problems. Design by David Colven and Ian Cleverley.

Is your lighting of Christmas productions a pain? Is your director always shouting at you in the lighting gantry about a missing spot, wrong light level or jerky fades? Do you need three hands with six fingers each during complex scene changes? Worry no more, here is a circuit that does it all for you.

Over many years of school productions the authors have come to the conclusion that a system capable of remembering scene changes and fading stage lights at pre-set rates would be a great boon. The 'computer' we developed even (eventually) met the exacting standards of our stage director.

HOW IT WORKS — KEYPAD AND BUFFER

The various output lines are normally held low by resistors R1-4. When any numbered key is pressed the strobe line (KS) is taken high by one of the diodes D1-8, which triggers monostable IC1a via Q1. The monostable is necessary to debounce the keyboard. At the same time the other diodes in the keypad, D9-20, encode the numbered key into parallel binary on lines KD0-2. This parallel data is presented to the inputs of the dual two-bit latches IC6-9. Each successive key-press/monostable pulse clocks on IC2, a 4017 decade counter whose outputs go high in turn and provide the latching pulse to the required latches. The latching pulses are fed to IC6-9 via AND gates IC3a-d, 4a, whose other inputs are taken from the output of IC1a via R5.C3. These components delay the latching pulse until IC2's outputs have had a chance to settle, avoiding any problems due to double latching. One point to note is that the first digit of the light number is temporarily stored in IC8 by the first key-press before being transferred into IC6 by the second key-press.

The data must be input in a fixed order and the contents of the buffer are decoded and displayed on seven-segment common anode displays by IC10-13.

The unit will control up to 16 light channels of up to 2 kilowatts maximum each. It can pre-set each channel to one of 16 different light

levels and fade each channel up and down at 32 different speeds. Up to 99 different scene changes can be programmed into the unit as

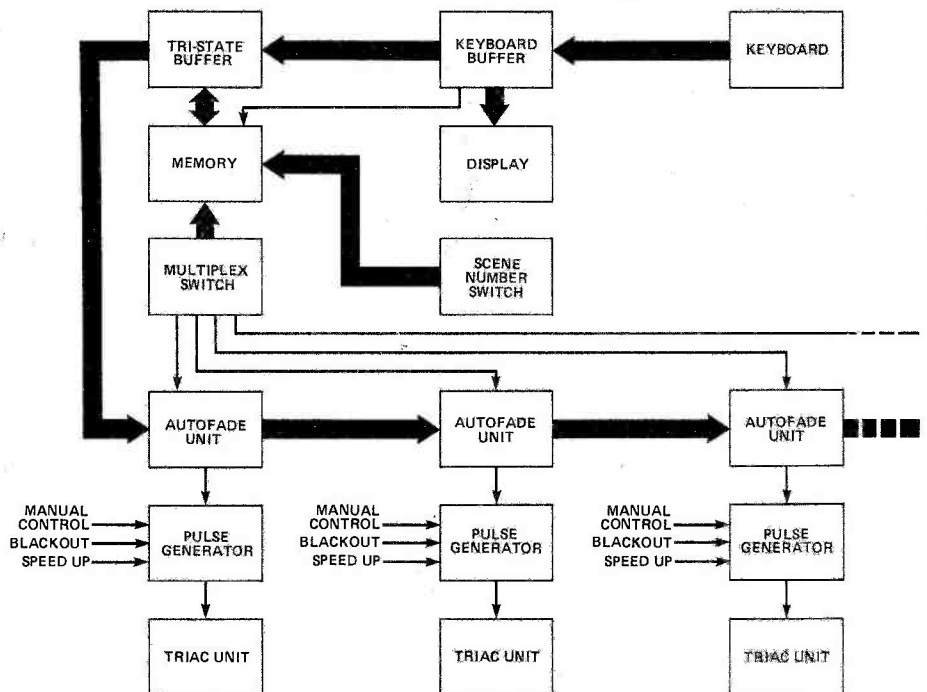

Fig. 1 Block diagram of the stage lighting unit. Up to 16 auto-fade/pulse generator/triac units may be controlled.

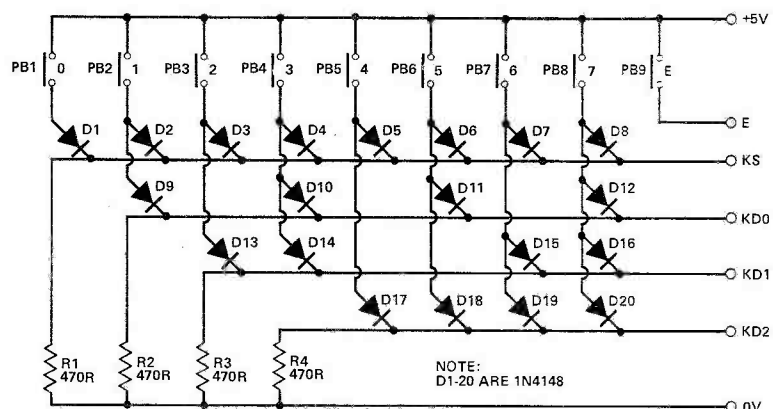

Fig. 2 Circuit diagram of the keypad unit.

described, but this can easily be extended by using extra memories and addressing circuitry to meet any requirements without theoretical limit. Eight different light levels have been found to be quite sufficient for stage use, and fade times of up to about one minute are possible. Longer fade times can be accomplished by programming in multiple scene changes. Individual blackout, master blackout, manual operation and fade speed-up controls are available.

The Light Fantastic

The light control circuits themselves are designed in such a way as to be easily driven from a microcomputer with two eight-bit user output ports. We felt, however,

that the expense of a micro-computer dedicated for some weeks to this single purpose could not be justified; in any case, we had enough hardware problems without adding software ones as well.

All the lighting changes are stored in RAM (a 6116 2K × 8 low power memory) and are stored in octal. This cuts down on the complexity and expense of the circuit and makes the most efficient use of the store. It is worth it even if it means spending some time teaching your director or lighting man about number bases!

One final virtue of this unit is that by using external control voltages, one can produce many special effects and you could easily have a 32 kW, 16-channel sound-to-light unit!

Module Mode

A modular design has been used for ease of construction and these modules are housed in two units. The main control console contains the memory section, separate auto-fade units for each light channel, the phase switching pulse generators and the power supply. The front panel controls include a calculator-sized keypad for programming the information and a pair of rotary switches for selecting the scene number: the manual override controls, blackout and speed-up switches are also located on this unit.

If a touch of luxury is desired, there's no reason why the keypad and scene select switches shouldn't be mounted separately in a small hand-held unit so that the lights can

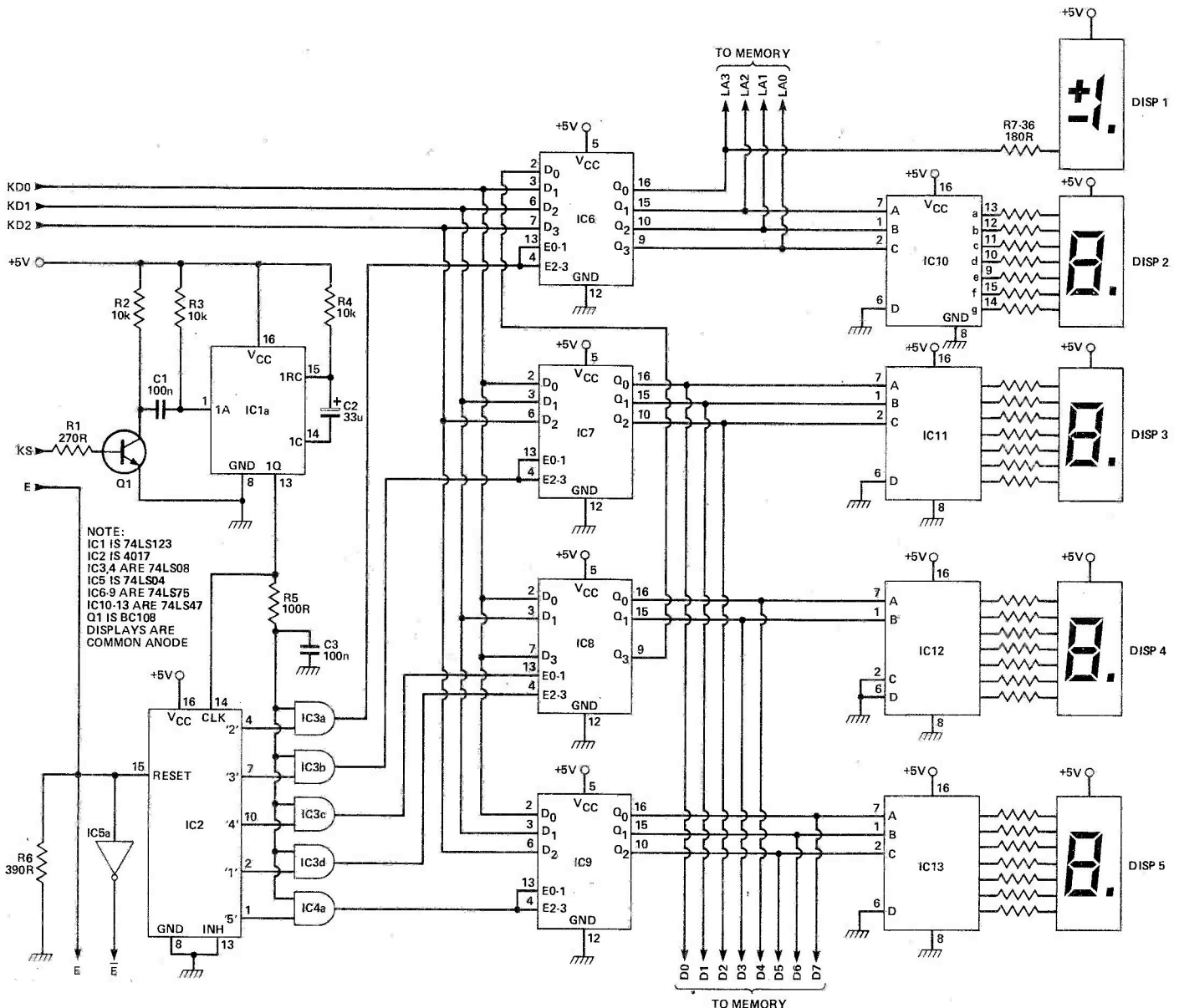

Fig. 3 Circuit diagram of the keyboard buffer and data display circuitry.

HOW IT WORKS — MAIN MEMORY

Once the data has been latched into the buffers it is transferred into the main memory by pressing the ENTER (E) key on the keypad. This provides the E and \bar{E} signals (the latter being generated by IC5a). Several things now happen at once. IC2 is reset to '0' and the output of IC14 is set to the contents of the first buffer, IC6, which contains the light number. This forms the four least significant bits of the address for IC22, the memory IC. The seven most significant address bits are set by the scene address switches. The monostable IC1b provides a write pulse to the memory and the eight data bits from the buffer are transferred into IC22 via the tri-state bidirectional buffers IC23,24.

When the enter key is released, the tri-state buffers are set to output data from the memory to the data bus for the auto-fade units, and the memory is set to read. Nothing else is affected.

The multiplexing of the data to the individual auto-fade units during the 'replaying' of the scene information

after programming is carried out by ICs 14-19. A standard clock oscillator formed by IC5b,c and their associated components has its output squared up by IC5d. The signal clocks a J-K flip-flop, IC20a, and the Q and \bar{Q} outputs of the flip-flop are NANDed with the signal to give alternate clock pulses at PC and DC, provided SW1 (the scene change switch) is switched to the clock. If SW1 is earthed then DC remains high. The signal PC clocks the counter IC14 and causes the lower four address lines (A0-A3) to ripple through a 16-byte block. These address lines are also decoded by IC19 (a 4-to-16 line decoder) to give a low voltage on the appropriate output. If SW1 is in the depressed position then the DC signal is clocking and the output of the NOR gate selected by IC19 will go high, i.e. one of the latch enables LE0-15 will go high. This causes the data on the data bus to be latched into the corresponding auto-fade unit.

Data is thus alternately fetched from the memory and sent to the appropriate

fader unit as long as SW1 is not earthed. Therefore it is necessary to hold this switch depressed for at least 16 clock cycles to effect a transfer of all the data for one scene change.

The higher address lines for the memory, A4-10, are selected by two rotary switches, SW2 and SW3. One switch represents the units and the other the tens — the scene number may be set from 0 to 99. The number set is encoded to binary by the diode matrix and the appropriate bit pairs are summed by adders IC25,26.

The circuitry around Q2 is an auto battery back-up. When the console PSU is supplying power, Q2 is held on by R40,41,ZD1, and the chip select pin of the memory is held low, enabling the memory. When the console is switched off, Q2 turns off, the CS pin goes high and the memory goes to standby mode. B1 supplies the very small quiescent current required by the RAM (via D21), thus allowing the RAM to retain the data.

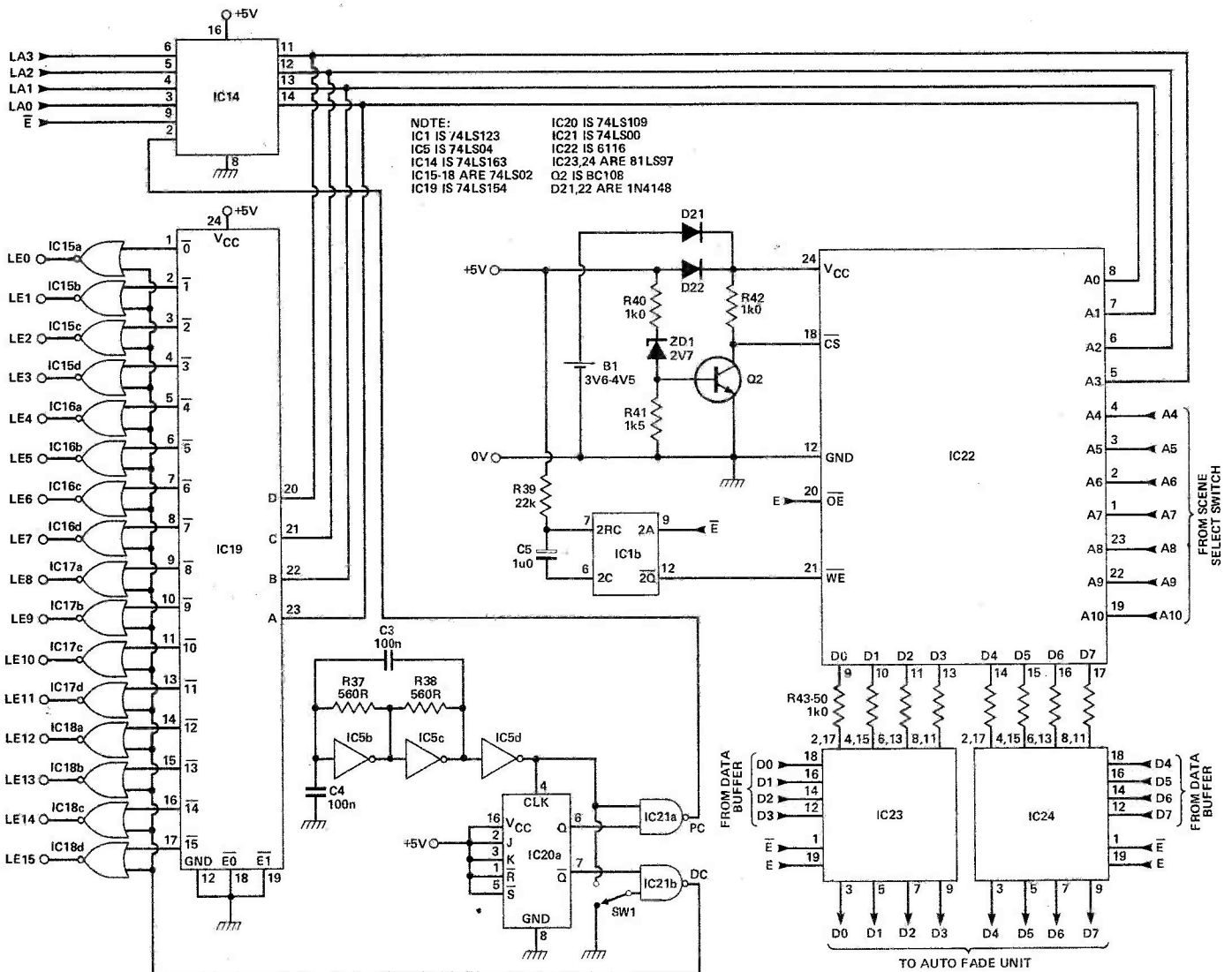

Fig. 4 Circuit diagram of the main memory section. This has an auto de-select and battery back-up system so that data is retained without mains power.

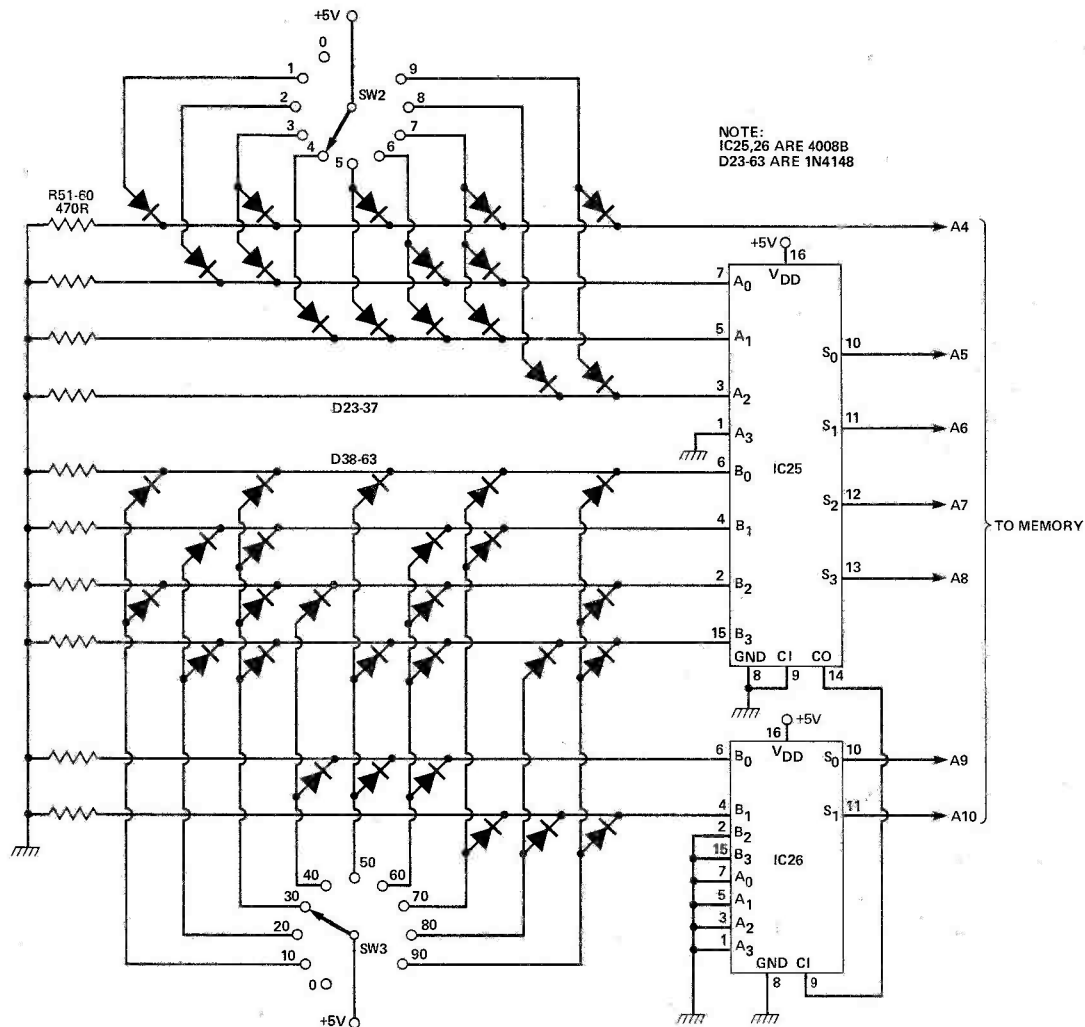

Fig. 5 Circuit diagram of the scene number selector.

be programmed from the auditorium with the stage in full view. The advantage of this arrangement is that setting-up can be done from any part of the theatre without having to lug round the main console and all its power cables, but the hand unit will require a sizeable length of multiway cable and with the prices these days we doubt whether anyone's budget will stretch that far.

The second unit contains the triac power circuits and can be permanently wall mounted with a suitable single-phase mains supply (up to 140 A may be drawn!). The pulses from the console are fed to opto-isolators in this unit and control the various lights.

The Keypad And Memory Buffer

This has eight numbered keys (0-7) plus a data entry key. A three-bit parallel code is produced along with a strobe signal. The data from the keyboard is held in a temporary buffer store whose contents are

displayed on seven segment displays. The channel number to be programmed takes the first two keystrokes (any initial zeroes required must be entered) and requires four bits (00 to 17 octal). The next keystroke enters the light level (0 to 7) and the next two the fade rate (00 to 37 octal). The light number will be used as part of a memory address and the other eight bits are the data to be stored.

The Main Memory

When the enter key is pressed the data held in the buffer is placed in the main RAM and the buffer is reset. The eight data bits are stored in a memory location which depends on the light number and the scene number: the latter is set using a pair of rotary switches. The memory is structured in 16 byte blocks, each block representing one stage lighting change. The data for each light channel is stored in numerical order and is recalled in order before being latched into the autofade units. This transfer of data

is activated by a single switch, which is held depressed for 16 cycles of the master clock.

The two 10-pole rotary switches which comprise the scene number switch are encoded to binary by diodes; the units and tens are then summed to give a seven-bit parallel address, the most significant bits of the address.

We've used a 6116 CMOS memory IC so that the lighting information may be retained even when the console is powered down. When this occurs the 6116 is forced into its quiescent mode and is supplied by its own private battery. The chip is automatically enabled as soon as the console is turned on again.

Auto-fade Circuits

Any number of auto-fade circuits up to a maximum of 16 may be connected to the memory module. The data for each channel for the current scene is held in an eight-bit latch/buffer. Three of the data bits are converted to a voltage

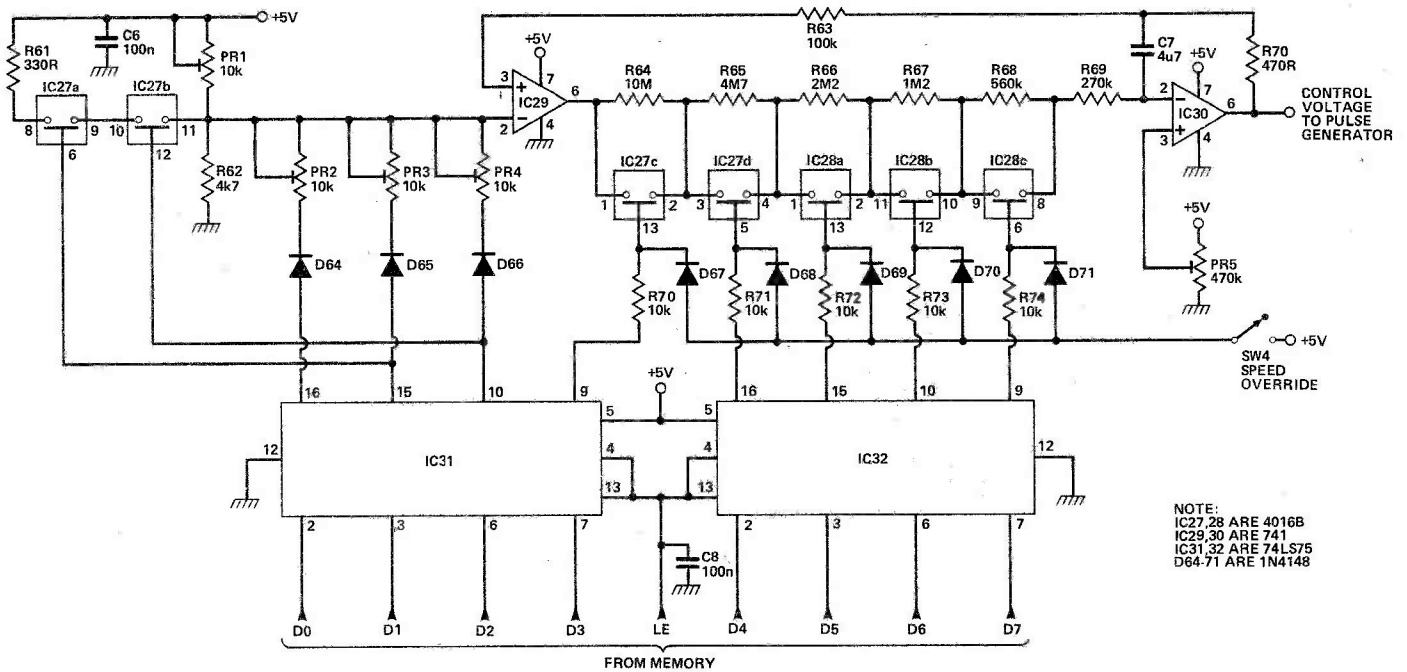

Fig. 6 Circuit diagram for one of the auto-fade units.

HOW IT WORKS — AUTO-FADE UNIT

The data buffer/latch in each of the possible 16 auto-fade units consists of two four-bit D-type bistables, and their contents control the light channel behaviour. Three of the bits from IC31 (those output on pins 16, 15 and 10) are used as inputs to a digital-to-analogue converter, which gives a voltage level that controls the final brightness of the channel. With phase-switching control this voltage has to increase rapidly at low lighting levels, then more slowly and finally rapidly again. The currents from PR1-4 are fed into a low value resistor R62. To accomplish the high brightness boost, two analogue switches, IC27a,b, are used to deliver extra current into this part of the circuit when the data reads 110 or 111 (ie light levels 6 and 7). Table

1 summarises the conversion in order of increasing brightness.

The analogue voltage generated is fed to a voltage comparator, IC29. The output of this comparator is integrated by IC30 and the resulting ramp voltage is compared with the analogue voltage at the DAC. The output of the integrator will ramp up or down until it reaches a set multiple of the input voltage and then it will hunt imperceptibly until the input voltage is changed again.

Five more analogue switches (IC27c,d, IC28a,b,c) are used to control the ramp rate of the integrator depending on the data stored in the other five bits of the buffer/latch. The slowest rate is produced when all the resistors R64-69 are in series: this corresponds to

a data input of 00000 octal. As the stored number increases in magnitude, various resistors will be shorted by the appropriate analogue switches and the ramp rate will increase, until for 11111 octal all the switches are closed, all the resistors are shorted and the maximum ramp rate is achieved.

PR5 gives a reference voltage for the integrator so that it will ramp up and down at the same rate. This voltage will be approximately 3V7 as the output from the voltage comparator will be either about 5 V or about 2V3.

If a high voltage is applied to the diodes D67-71, the data in the buffer will be overridden, all the analogue switches in the chain will close, and the ramp rate will increase to maximum.

which is integrated by a second circuit. The integrator ramps up or down until it reaches a level set by the input voltage, at a rate controlled by the other five bits stored in the buffer.

The actual work of regulating the power of the lights is done by the switching pulse generator: this works by sending mains-synchronised pulses to the triac power unit. The phase control is accomplished by a standard 'ramp and pedestal' UJT circuit. The ramp rate is set by the voltage from the auto-fade circuit and the sooner it reaches the pedestal trigger voltage the earlier in the mains half cycle the triac is triggered and the brighter the lamp will be.

Instead of using the auto-fade output voltage, the control for the pulse generator can come from a manually operated potentiometer, a

blackout control or from an external sound-to-light or flasher circuit. Each pulse generator has its own pedestal zener diode to eliminate interaction between channels, and the pulse generators are connected to the power-controlling triacs by opto-isolators.

Triac Control Circuit

As mentioned above, opto-isolators are used for safety (the prototype has suffered a few disasters which would have melted down the whole of the control unit if these hadn't been fitted). They also allow the control unit to be earthed while the triac trigger pulse is referenced to the neutral line.

The opto-isolator transistor drives a transistor switch and amplifier that pulses the gate of the triac negative via a resistor.

Power Supplies

These may seem to be a bit over-designed but this is necessary. The first of them supplies the +5 V for the main logic and memory boards and the autofaders: two independent 5 V rails are generated in order to prevent stray pulses on the auto-fade supply doing horrible things to the memory.

The second PSU provides the supply rail for the pulse generator circuits, together with a totally unsmoothed output of about 33-36 V which is fed to the zeners in each pulse generator to produce the pedestal voltage (which drops to 0 V twice each mains cycle). The input buffer amplifier transistor can suffer from thermal drift despite the resistor values around it being chosen to minimise the problem: this results in all the light levels increasing gradually after switch-on.

PROJECT: Stage Lighting

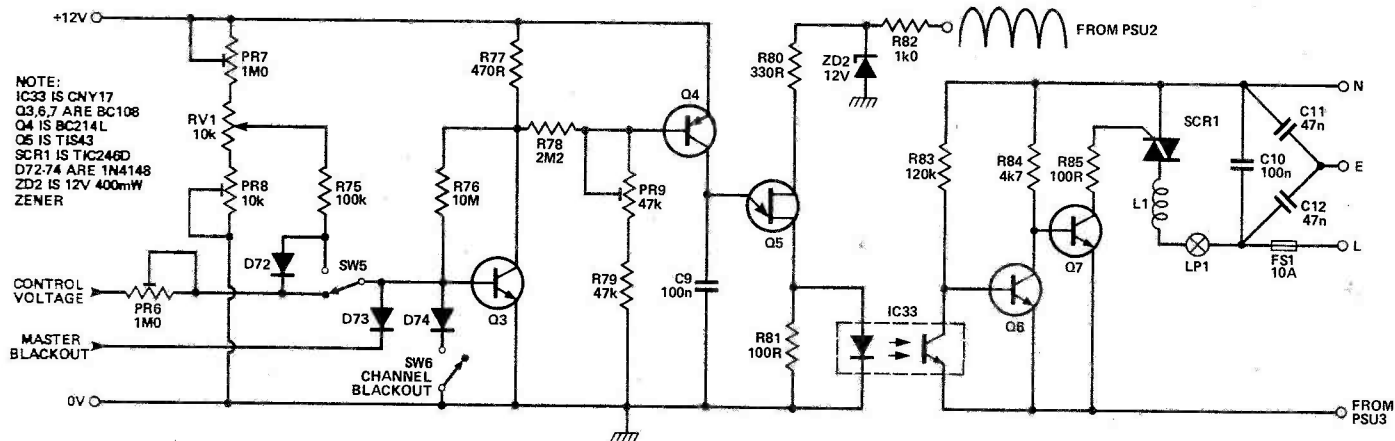

Fig. 7 Each auto-fade unit requires one of these pulse generator and triac circuits.

TABLE 1

LEVEL	CODE	CURRENT SOURCES	TYPICAL VOLTAGE
0	000	PR1	1V75
1	001	PR1, PR2	2V5
2	010	PR1, PR3	2V75
3	011	PR1, PR2, PR3	2V85
4	100	PR1, PR4	3 V
5	101	PR1, PR2, PR4	3V15
6	110	PR1, PR3, PR4, R61	4 V
7	111	PR1, PR2, PR3, PR4, R61	4V25

To correct this tendency, should it be present, the output voltage of the second PSU is made variable so that compensation may be made for any residual drift.

The third PSU is located in the triac power control unit and does not require regulation. It is capable of driving all the triac channels and has its positive rail connected to the neutral line as a reference for the triac gate.

Next month we give the constructional details of the Stage Light Dimmer.

HOW IT WORKS — PULSE GENERATOR

The input voltage to the pulse generator, either from the auto-fade unit or the manual control pot, is amplified and buffered by Q3. Q4 acts as a constant current source which charges up capacitor C9 at a rate that depends on the input voltage: PR9 and R79 set the minimum charge rate. The voltage on the emitter of the unijunction transistor Q5 will rise as C1 charges until it reaches the trigger voltage. The UJT then conducts, discharging C9 through R81 and the LED in IC33, the optoisolator. This sends a trigger pulse to the triac. As C9 is discharged at the end of each half-cycle (when the b1/b2 voltage falls), this pulse is synchronised with the mains zero-crossing point. The delay is set by the rate at which C9 charges and hence the power level supplied to the lamp is varied.

The manual control RV1, working through D73, will override the auto-fade unit if the pot voltage is increased above the auto-fade voltage, allowing special effects. SW5 switches between auto and manual modes and SW6 can black out the channel by pulling the base of Q3 to earth. All the channels can be blacked out if the master blackout line is taken low.

When the optoisolator is fired Q6 is switched off because its base is pulled negative. This allows Q7 to turn on, giving a negative voltage pulse via R85 to the triac gate which turns on the triac (if it isn't already on). The delta capacitor network C10-12 together with L1 help to minimise mains-borne interference caused by switching transients. A 10 A fuse affords some protection for the triac in the event of a fault occurring.

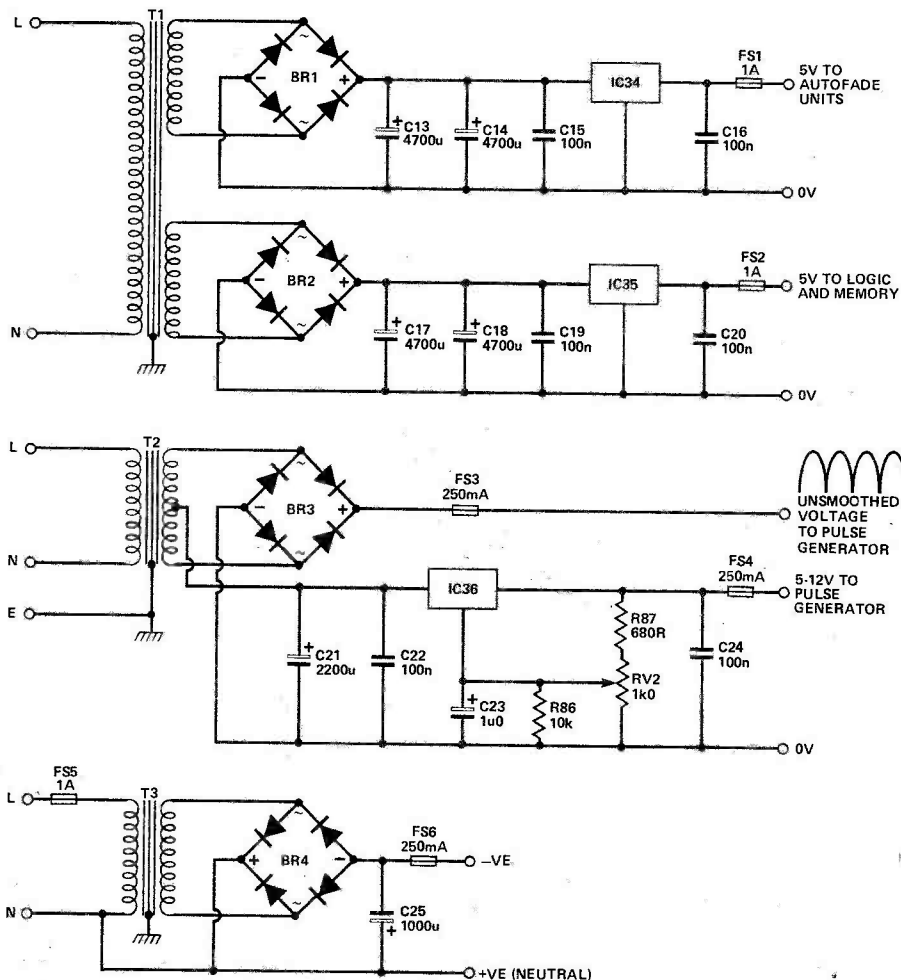

Fig. 9 Circuit diagram for the power supplies required by this project.

BBC Micro Computer
Please phone for availability



BBC Model A £299
BBC Model B £399
(incl VAT) Carr £8/unit

Model A to Model B
upgrade kit £50
Fitting charge £15

MEMORY UPGRADE
8 x 4816 AP-3 100ns £21.60
F.D. INTERFACE KIT
IC 77-78 £70.00

ANALOGUE PORT KIT
IC 73, SK6 £7.30
RS423 & VDU Port Kit
£10.80

PRINTER & USER PORT KIT
IC 69, 70, 71 PL9, 10 £9.50
Bus & Tube Port Kit £6.50

All mating Connectors with Cables in stock. Full range of ACORNSOFT, PROGRAM POWER & BUGBYTE SOFTWARE AVAILABLE

Phone or send for our BBC leaflet

BBC FLOPPY DISC DRIVES

Single drive 5 1/4" 100K £235 + £6 carr.
Dual drive 5 1/4" 800K £799 + £8 carr.

BBC COMPATIBLE DRIVES

These are drives with TEAC FD50 mechanism and are complete with power supply
SINGLE: 100K £190; 200K £260; 400K £340
DUAL: 200K £360; 400K £490; 800K £610

OFFICIAL **BBC** DEALER

CASSETTE RECORDER

Ferguson Cassette Recorder
£240 + £1.50 carr.
Cassette leads £3.50
Computer Cassette £0.50 ea. £4.50 for 10 + £1 carr.

MONITORS

BMC BM 1401 14" Colour Monitor
RGB Input 18MHz Bandwidth
£240 + £8 carriage
Hi Res Green Monitor
Antiglare screen £99 + £6 carr.

MICROVITEC 1431 M/S 14"
Colour Monitor RGB input
£269 + £8 carr.
RGB lead for BMC £8
Composite Videolead £3.50

ACORN ATOM

Basic Built £135 Expanded £175 (carr £3 per unit)
Atom Disc Pack £299 + £6 carr
3A 5V Regulated PSU £26 + £2 carr.
Phone or send for our BBC Atom list.

NEC PC 8023 BE - C

100CPS, 80 cols
Logic Seeking,
Bidirectional, Forward and
Reverse Line Feed,
Proportional Spacing, Auto
Underline, Hi-Res and Block
Graphics, Greek Char. Set.

Only £320
+ £8 carr.

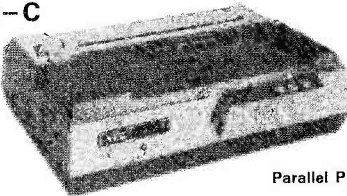

PRINTERS

SEIKOSHA GP 100A

80 Cols 30 CPS
Full ASCII e GRAPHICS
10" Wide paper
Now only £175 + £6 carr.
Ask for details on GP 250A

Parallel Printer lead for BBC/Atom to most printers £13.50
Variety of interfaces, ribbons in stock
2,000 fan fold sheets 9 1/2" x 11" £13.50 + £3 p & p

EPSON MX 80 and 100F/T3

MX 80 80CPS 80 cols
MX 100 100CPS 136 cols
Logic Seeking, Bi-
directional, Bit Image
Printing, 9 x 9 Matrix
Auto Underline
MX 80 F/T3 £325
MX 100 F/T3 £430
(£8 Carr/Printer)

RUGBY ATOMIC CLOCK

This Z80 micro controlled clock/calendar receives coded time data from NPL Rugby. The clock never needs to be reset. The facilities include 8 independent alarms and for each alarm there is a choice of melody or alternatively these can be used for electrical switching. A separate timer allows recording of up to 240 lap times without interrupting the count. Expansion facilities provided. See July/August ETI for details. Complete Kit £120 + £2.00 p&p

MICROTIMER

6502 Based Programmable clock timer with
★ 24 switching times/week cycle
★ 24 hour 7 day timer
★ 4 independent switch outputs directly interfacing to thyristor/triacs
★ 6 digit 7 seg. displays to indicate real time, ON/OFF and Reset times
★ Output to drive day of week switch and status LEDs.
Full details on request. Price for kit £57.00

I.D. CONNECTORS

(Speedblock Type)			
No of ways	Header	Recept.	Edge Conn.
10	90p	90p	200p
20	145p	125p	240p
26	175p	150p	300p
34	200p	160p	380p
49	220p	180p	500p
50	235p	200p	500p

CONNECTOR SYSTEMS

JUMPER LEADS

24" Ribbon Cable with headers			
14 pin	18 pin	24 pin	40 pin
1 end 145p	165p	240p	380p
2 ends 210p	230p	345p	540p
24" Ribbon Cable with sockets			
20 pin	26 pin	34 pin	40 pin
1 end 160p	210p	270p	300p
2 ends 290p	365p	480p	540p
24" Ribbon Cable with D. Conn.			
25 way Male 500p Female 550p			

AMPHENOL CONNECTORS

36 way Solder Type Plug (centronix type)	550p
36 way Solder Socket (centronix type)	550p
36 way IDC Plug (centronix type)	500p
24 way Solder Plug (IEEE type)	500p
24 way Solder Socket	500p
24 way IDC Plug	485p

RIBBON CABLE (Grey)

10 way	60p
14 way	80p
16 way	90p
20 way	105p
25 way	140p
34 way	220p
40 way	255p
50 way	330p
64 way	370p

D-CONNECTORS

9 way 15 way 25 way 37 way			
MALE			
Solder	90p	130p	160p 250p
Angled	160p	230p	285p 425p
FEMALE			
Solder	110p	160p	210p 350p
Angled	175p	240p	310p 500p
Hood	95p	95p	95p 125p

RS232 CONNS (25 way D)

24" Single end Male	£5.50
24" Single end Female	£6.00
24" Female-Female	£11.00
24" Male-Male	£10.00
24" Male-Female	£11.50

DIL HEADERS

Pin	Solder	IDC
14 pin	40p	100p
16 pin	50p	110p
24 pin	100p	150p
40 pin	200p	225p

EURO CONNECTORS

(Indirect Edge Conn.)		
DIN STD	Plug	Sket
41617 21 way	170p	170p
41617 31 way	180p	180p
41612 2 x 32 way	250p	320p
Angled 2 x 32 way	325p	375p
41612 3 x 32 way	275p	380p
Angled 3 x 32 way	400p	400p
2 x 32 way IDC a-b	525p	525p

(for 2 x 32 way specify a-b or a-c)

EDGE CONNECTORS

0.1" 0.156"	
2 x 18 way	140p
2 x 22 way	200p 170p
2 x 23 way	210p
2 x 25 way	225p 220p
2 x 43 way	260p
2 x 43 way	395p
2 x 50 way	—
1 x 77 way	700p
ST100 Conn.	800p

MICRODOCTOR

This is not a logic analyser or an oscilloscope. It tests a microsystem and gives a printed reprint on RAM, ROM and I/O — it will print memory map, search for code, check dataline shorts and operates peripherals
Microdoctor complete with PSU, Printer, probe cable and two configuration boards. £295.

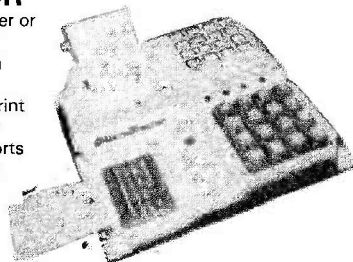

SOFTY II INTELLIGENT PROGRAMMER

The complete micro processor development system for Engineers and Hobbyists. You can develop programs, debug, verify and commit to EPROMS or use in host computer by using softy as a ramulator. Powerful editing facilities permit bytes, blocks of bytes changed, deleted or inserted and memory contents can be observed on ordinary TV. Accepts most +5v Eproms.
Softy II complete with PSU, TV Lead and Ramulator lead £169

SPECIAL OFFER

2114L	80p
2718 (+5v)	250p
2532	350p
4116-2	80p
4164-2	450p
6116P-3	350p

UV ERASERS

UVIV up to 6 Eproms £47.50
UVIT with Timer £60.00
UV140 up to 14 Eproms £61.50
UV141 with Timer £78.00
(Carr £2/eraser)
All erasers are fitted with mains switches and safety interlocks

TRAINER KITS

6502 Junior Computer £85.00
6802 Nancomp I £80.00
6809 Nancomp II £80.00
1802 Micro Trainer £64
E80 Manta £115
Z80 Manta £115
(fully built and documented)
Full details on request

BOOKS (No VAT p&p £1)

CMOS Cook Book £7.75
CRT Controller H/Book £5.95
Programming the Z80 £11.50
Z80 Microcomp. handbook £5.95
Programming the 6502 £10.25
6502 Assy. Lang. £12.10
6502 Applications £10.20
6502 Software Design £9.05
6502 Games £10.52
Large selection of databooks, interfacing books, books on BBC, etc in stock. As for our list.

PLEASE SEND SAE FOR PRICE LIST

DESIGNING MICRO SYSTEMS PART 6

The previous article explained how the computer handles input and output of data but how many of us read and write in binary? This month Owen Bishop explains the operation of more user-friendly interfaces.

Quite a number of electronic circuits produce their output in analogue form, and it is beyond the ability of a computer to read such data unless it is first converted to digital form. Examples of devices with analogue outputs are electronic thermometers, pressure transducers, audio amplifiers (for speech recognition etc) and indeed any device which produces an output voltage varying over a predefined range. Even a simple carbon pot can be included in this list. The Games Controller of the Apple II, for example, uses a 150k potentiometer (there is also a push-button connected to a memory-mapped latch, but this is a digital input). The position, or setting, of the potentiometer is the analogue quantity to be measured. The computer has a quadruple timer IC and, when the Games Controller is plugged in to the computer board, the pot becomes part of the RC circuit of the timer. When the MPU is to read the setting of the Controller, it first triggers the timer (the trigger input is memory-mapped) then measures the length of pulse produced. It does this by reading the memory-mapped output over and over again, counting how many times it reads 'high' until it eventually reads a 'low'. The number of 'high' reads is approximately proportional to the angular setting of the control knob. The analogue-to-digital conversion is crude and far from linear, but certainly good enough for its intended application.

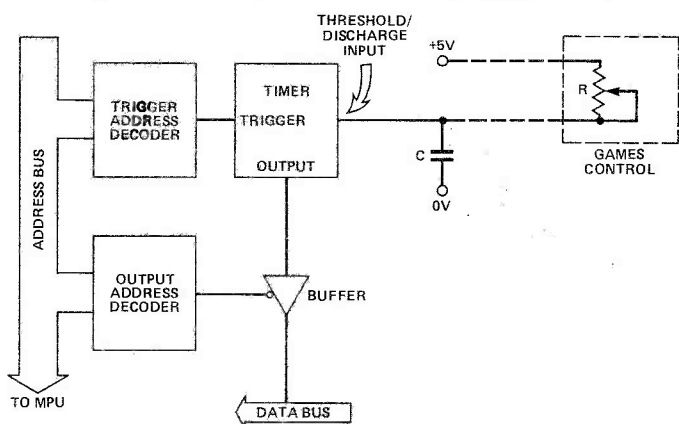

Fig. 1 Analogue-to-digital conversion for a games controller.

A-to-D Conversion . . .

Many computers have on-board A-to-D ICs such as the National Semiconductor ADC0801 (Fig. 2). This converts any input voltage in the range 0 V to 5 V to digital output in the range 0 to 255 (00 to FF in hex). The heart of the IC is a chain of resistors in series, with 5 V across the ends of the chain.

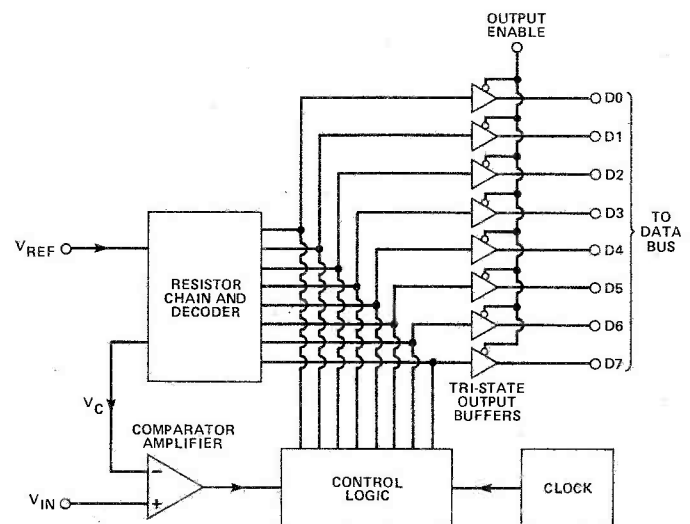

Fig. 2 Simplified block diagram of an A-to-D converter such as the ADC0801. V_{REF} is an on-chip or external reference voltage. V_C is the output voltage from the resistor chain, which is compared with V_{IN} , the analogue voltage which is to be converted.

Internal logic controls CMOS analogue switches which switch resistors into or out of the chain, so producing a voltage (V_C) which can range from 0 V to 5 V in 256 steps. At each stage a comparator matches the output of the chain against the analogue voltage (V_{IN}). The largest resistor is switched in and out first, to determine if the input is less than or greater than $2V_5$. Then the next largest resistor is switched in and out to narrow the possible range to within $1V_{25}$. At each stage the chain output and analogue input are matched more and more closely. After eight attempts the closest match will have been found. The logic signals which have produced the match are then used to set the eight output buffers to one of the 256 possible combinations which can be read as a byte (0 to 255) by the computer. This IC converts the voltage with true linearity, with an accuracy of half a step in 256 steps and takes only a few hundred microseconds to do so. If we want greater accuracy, there are similar A-to-D ICs with a 12-bit output. Note that it is the converter which does the work: the MPU only has to read the result. We do not need to write software to instruct the MPU to measure pulse lengths as with the Games Controller. This saves time and simplifies programming.

Most A-to-D ICs have ways of altering the span of the input range, so that voltages from, say, 0 V to 2 V produce the full-scale output range, 0 to 255. In addition you can

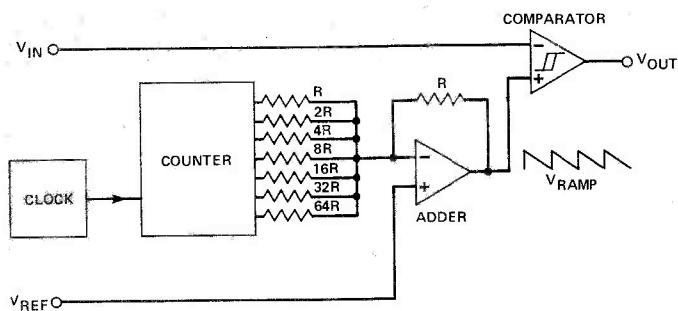

Fig. 3 Simplified block diagram of a simple A-to-D converter, the 507C. V_{REF} is an on-chip or external reference voltage. V_{IN} is the analogue voltage to be converted; V_{OUT} is the square wave output.

adjust the offset so that, for example, you obtain a reading of 0 when the input is 10 V and reading of 255 when the output is 12 V.

As might be expected, a A-to-D IC is a sophisticated circuit and is correspondingly expensive. If an application requires several analogue inputs and high conversion time is not of paramount importance, the inexpensive 507C IC provides linear conversion in 1 mS with seven-bit resolution. This has a resistor ladder (Fig. 3), and the counter supplies current to each resistor in binary sequence. The op-amp adds the currents and the result is that the output ramps down a voltage from $0.75 \times$ supply voltage to $0.25 \times$ supply. If the enable input is high, the comparator gives a high output whenever the ramp voltage exceeds the analogue input voltage; thus the length of time the output is low is a measure of the analogue voltage (Fig. 4). The MPU can find this time by using a program like that described for the Games Controller.

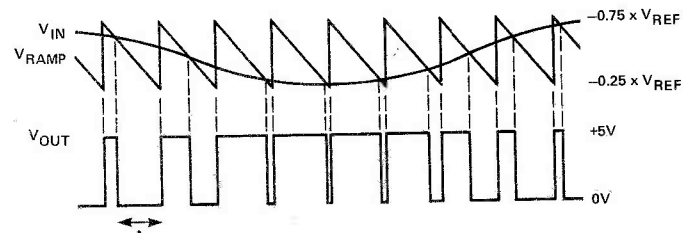

Fig. 4 The input and output voltages of the 507C A-to-D converter. The computer measures t , which is proportional to V_{IN} .

... And The Converse Conversion

If a peripheral needs an analogue signal to control it (eg controlling the speed of a motor), we need circuits which can convert the digital output of the computer into its analogue equivalent.

The ZN425 D-to-A converter makes use of an R-2R ladder (Fig. 5). The switches are under the logical control of the eight-bit input. As the count increases, the output voltage increases in proportion (see panel). To drive a low impedance device the output must be buffered by an operational amplifier.

This IC may also be used for A-to-D conversion, using its binary counter. The counter is clocked by an external pulse generator, and as it counts the pulses, switches controlling the R-2R ladder are closed and opened in a binary sequence. The output is a staircase ramp of 256 steps. An external amplifier compares the output from the ladder with the analogue voltage which is to be converted. When the ramp output equals the analogue voltage, the output from the amplifier inhibits the clock. At this point the logic output which controls the switches can be read as an eight-bit equivalent of the analogue input.

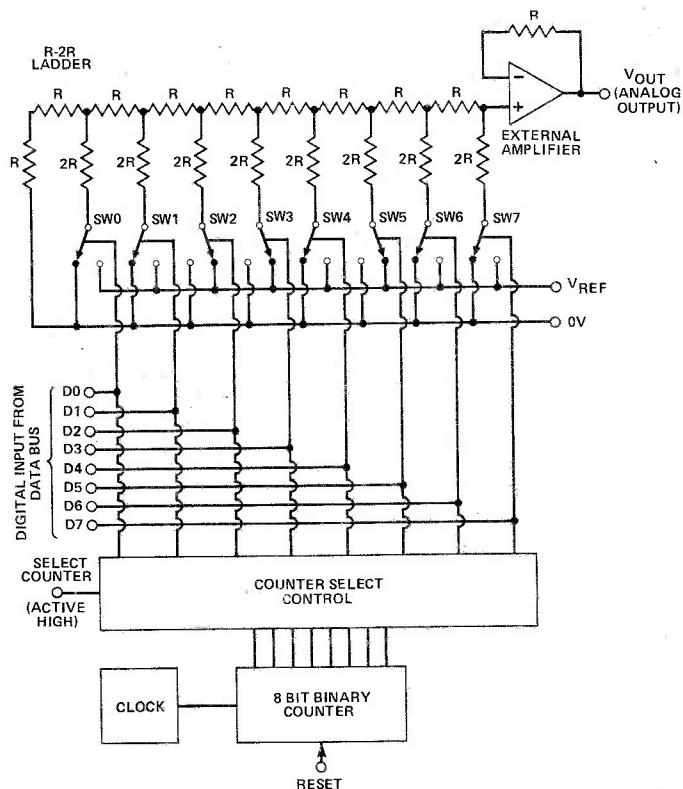

Fig. 5 Block diagram of the ZN425E D-to-A converter. V_{REF} is an on-chip or external reference voltage. The amplifier is not on the chip but is an external op-amp (eg 741).

Screens And Printers

The way most owners receive information from their micros is through the screen. This may be a domestic TV set or a monitor unit specially designed for the purpose. Those whose main interest lies in arcade games, adventures, and the like usually need no more than the screen, but anyone with an interest in programming soon finds that the screen alone is not enough. There is the tedium of copying long listings of favourite programs from the screen, and the frustration of being able to see only a few lines of program at any one time. Sooner or later, the serious programmer adds a printer to the system. This month we shall deal with both these ways of receiving information from the micro.

The fact that the technology of high-speed (for the time) printing was already available in the form of teletype machines, lead to the early mainframe computers having a printer but usually no screen. We are reminded of this early use of teletypes by some of the curious control codes which abound in the ASCII character set (see last month's article). The screen of the early mainframe computers, if any, was often a CRT in which the X and Y deflection plates were under the direct control of the computer. It was a kind of high-grade oscilloscope, with the computer using the electron beam to 'draw' an image on the screen. This was suitable for displaying charts and graphs, but not much use for text.

With a modern computer, the electron beam scans a rectangular area on the end of the CRT, in the same way as a TV set. The field (or **raster**) consists of a large number of horizontal lines (the number varies according to the system) placed close together (Fig. 6). Each line is scanned in turn, from the top to the bottom of the screen. Most TV systems have an interlaced raster in which the beam first scans alternate lines down the screen and then returns to scan the ones between the first set. As the beam scans, its intensity (and hence the brightness of the glow produced

HOW THE R-2R LADDER WORKS

Assume all switches are set to 0 V. The three left-hand resistors are equal to 2R and 2R in parallel, and so can be replaced by a single R resistor. Thus the four resistors shown are equivalent to 2R switched to 0 V. We can carry this reasoning all along the ladder, until we reach a switch that is not set to 0 V.

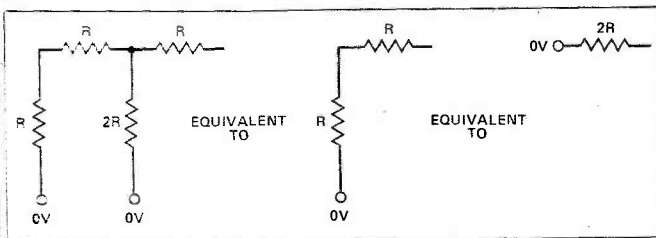

If all except SW7 are set to 0 V, and SW7 is set to V (the reference voltage), we can consider all resistors to the left as equivalent to a single 2R resistor, switched to 0 V. We have a potential-divider, and $V_0 = V/2$. This corresponds to the expected output, since $128/256 = 1/2$.

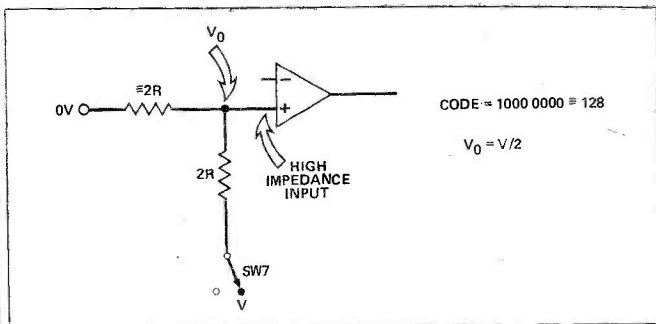

If all except SW6 are set to 0 V and SW6 is set to V, we can consider all resistors to the left to be replaced by a single 2R resistor, switched to 0 V.

$$I_0 = V/3R; \quad I_1 = (V - V_1)/2R; \quad I_2 = V_1/2R$$

By Kirchoff's Law (sum of currents entering a point must equal sum of currents leaving a point):

$$I_0 = I_1 - I_2, \text{ so}$$

$$V_1/3R = (V - V_1)/2R - V_1/2R, \text{ giving}$$

$$2V_1 = 3V - 3V_1 - 3V_1$$

$$V_1 = 3V/8$$

Now we can calculate V_0 :

$$V_0 = 2V_1/3 = V/4$$

This corresponds to what is expected since $64/256 = 1/4$.

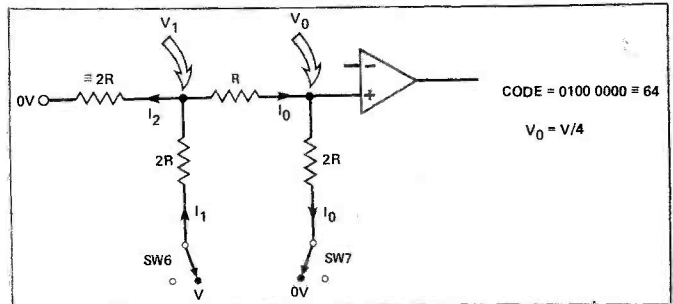

Here both SW6 and SW7 are switched to V.

$I_0 = (V - V_1)/3R$ but I_1 and I_2 are as above.

$$I_2 = I_0 + I_1, \text{ so}$$

$$V_1/2R = (V - V_1)/2R + (V - V_1)/3R,$$

which simplifies to $V_1 = 5V/8$.

Now $V_0 = V_1 + (V - V_1)/3 = 5V/8 + V/8 = 3V/4$.

This is what we expect, since $192/256 = 3/4$.

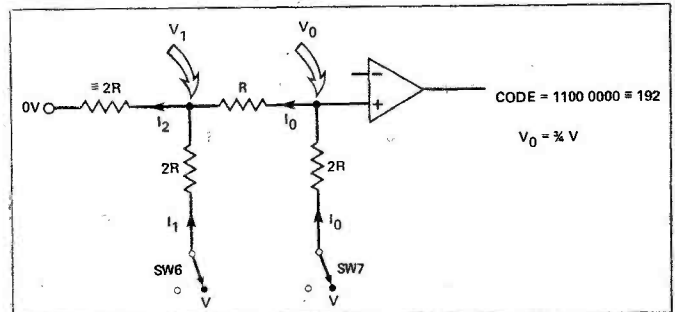

This kind of reasoning can be repeated all along the chain, getting more and more complicated, but with the same kind of result. If all the switches are set to V, the maximum V_0 is obtained, ie $255/256V$.

on the screen) is modulated. If the beam is strongly modulated, so that it produces either bright light or none, we can use it to produce a textual display of good contrast. Fig. 7 shows how a line of text can be built up from dots of light in seven successive scans. These are followed by a number of lines in which the beam is blanked (off) to provide spacing between rows of text. This process is repeated all the way down the screen.

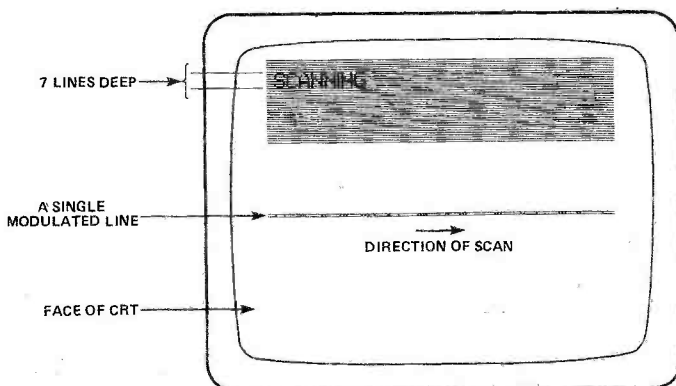

Fig. 6 How text is displayed on a TV screen.

As Fig. 7 shows, it is possible to build up well-defined alphabetic characters from a 7×5 matrix of dots. Numeric characters, punctuation marks and various other symbols can also be built up in this way. We will now look in more detail at what the computer has to do in order to produce such a display. Visual displays are a field in which microcomputer designers have felt themselves free to use their inventiveness. Consequently, there are almost as many ways of producing the display as there are makes of microcomputer. Our discussion will therefore deal only with the main principles which are common to most micros.

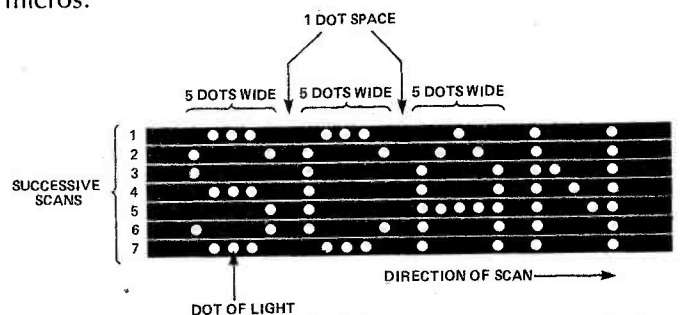

Fig. 7 Enlarged view of the first few letters shown in Fig. 6.

The Writing's On The Screen . . .

Figure 8 shows the signal which is fed to the grid of the CRT to modulate the beam to produce scan 5 of Fig. 7. The length of a single dot-producing pulse is of the order of 15 μ s. This waveform is produced by a circuit like that shown as a block diagram in Fig. 9. Most micros have what is termed a **memory-mapped display**. A certain block of memory addresses is set aside for holding the text. Normally it requires one byte of data for each character. For example, if the screen has 16 lines, with 64 characters per line, the memory area must consist of 1024 bytes, or 1 kilobyte. Whenever text is to be displayed, the CPU stores the ASCII codes corresponding to each character in the appropriate memory cell.

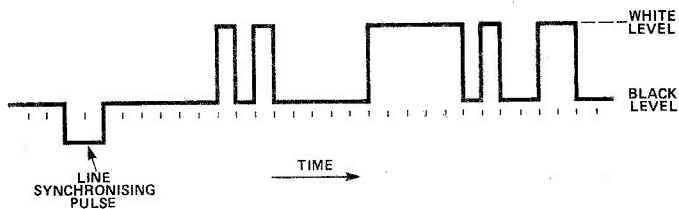

Fig. 8 The signal required to produce the fifth scan of Fig. 7.

The **video RAM**, as this section of memory is usually called, is read in sequence by the video circuitry. Although video RAM can be addressed by the MPU like any other part of RAM, in some micros it has its own control signals and its own data bus to connect it with the video circuit. For most of the time it operates independently of the microprocessor. The ASCII code for each character in turn is transferred to the data latch. It is held there while the next code is being fetched. The output from the latch goes to a **character generator IC**. This is a special kind of ROM (see *Designing Micro Systems*, ETI October 1982) which converts an ASCII code into the corresponding pattern of dots. It has inputs from the latch to tell it which character is to be generated, and from the synchronising circuit to tell it which one of the seven lines of dots is to be generated. It has five outputs that indicate which dots are to be displayed as white and which will be black.

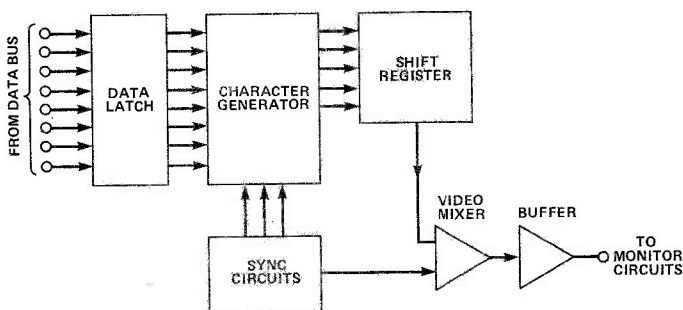

Fig. 9 Block diagram of the circuit for displaying text.

The output from the character generator is converted from parallel to serial form by the shift register. This produces a train of pulses, some high, some low, like those shown in Fig. 8. These are fed to a video mixer circuit where line synchronising pulses and frame synchronising pulses are added. The combined video signal is then passed through a buffer circuit to the monitor.

Such a signal is not suitable for sending to a domestic TV set. The TV is expecting a UHF carrier signal from an aerial, modulated by the video signal. So, if a TV is being used, the signal from the video mixer must first go to a modulator. This produces a UHF carrier signal (usually on

Channel 36) with the video signal imposed on to it. When the TV receives this signal it demodulates it, recovering the original video signal that it then uses to produce the display. The additional processes of modulation and demodulation inevitably lead to distortion; consequently, the resolution obtainable on a TV is inferior to that obtained on a proper monitor screen. A TV is acceptable when there are 40 or fewer characters per line, but when there are 60 characters or more the use of a monitor is much to be preferred.

Graphics Galore

The variety in methods of producing textual displays is exceeded by the variety of techniques used for producing graphics. A few micros (eg ZX81 and PET) use the character generator to produce geometrical shapes and other designs and symbols. These can be combined on the screen to produce designs of almost infinite complexity. This technique exploits one of the useful features of character generators: they can be programmed to produce any or all of the possible patterns on a 5x7 (or larger) matrix. For example, we can have them programmed for different styles of letter or for special letters for different languages. There 2^{35} permutations of dots, far more than can be accommodated within a single IC, so the snag of this method is that the user is limited to the range of symbols selected by the manufacturer. If you are writing programs for playing Bridge or Blackjack, the hearts and clubs symbols will be useful but, if your interests lie in cash account programs, they are a waste of space on the chip.

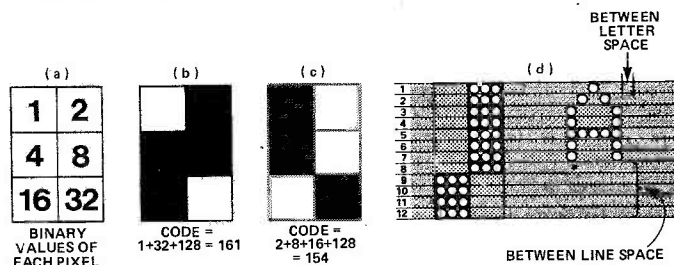

Fig. 10 Graphics blocks, as used in the TRS-80 Model I. (a) Each pixel has the binary value shown. (b) and (c) The sum of values of 'on' blocks plus 128 gives the code. (d) How a block is displayed by scanning (letter A for comparison of sizes). The blocks are displayed on a 6x12 matrix, leaving no space between adjacent blocks.

Many computers use graphics blocks (Fig. 10) as a means of constructing displays. A block may consist of six sub-blocks (or **pixels**, which is the name used for picture elements). Designing displays by this method involves interpreting your picture six blocks at a time and programming the computer with the corresponding code. The codes are stored in video RAM, as with text. Separate circuits are used in place of the character generator to convert the code to the corresponding set of video signals and feed them to the shift register. If the designs required are regular (such as decorative borders), programming is simple but it becomes very time-consuming if you want to draw complicated pictures.

A third approach to graphics is to deal with each pixel separately, and allocate one bit in video RAM to each pixel. If the value of the bit is '0', the corresponding pixel is 'off' (black screen). If it is '1', the pixel is 'on' (white screen). A medium-resolution graphics display, for example MODE 5 on the BBC Microcomputer, has 256 lines, each with 160 pixels. This gives a total of 40960 pixels. Allotting one bit per pixel, the video RAM must provide 5 kilobytes. If the display is to be in colour, an

additional 5K bytes are required to indicate colour information for four colours, or an additional 15K for 16 colours. With the high-resolution display on the BBC Microcomputer (MODE 0) there are 640 pixels per line, requiring 20K, but allowing for only two colours. It can be seen that high resolution graphics, and particularly high-resolution *colour* graphics, require a very extensive video RAM. The cost of RAM has fallen in recent years, making it feasible to provide micros with good high-resolution colour graphics at relatively low cost. But, unless special 'paging' address circuitry is introduced, a micro with a 16-bit address bus is limited to 64K of memory, into which ROM, program RAM and the video RAM must be fitted. Consequently, an increase in the size of the video RAM means a decrease in the address space left for program RAM. If video RAM is physically a section of RAM itself, instead of being a separate entity as in some micros (see above), this section of RAM can be used for video when a program is to have plenty of graphics in colour, but can be turned over to program or data storage when graphics are not required. This is the system generally adopted in micros with high resolution graphics.

A Colourful PAL

In the PAL system of colour television, used in most European countries, colour transformation is transmitted by modulating the luminance (brightness signal) with a very high frequency chrominance (colour) signal. The way in which the chrominance signal is derived and subsequently decoded in the TV set is too complex to go into here. The final result is that three separate signals are derived to control the red, green and blue guns of the colour tube.

The output from a computer to an RGB colour monitor consists of four signals, on separate lines. The 'sync' signal provides the pulses needed for synchronising scanning with the reading of video RAM. The other three signals (R, G and B) control the three electron guns of the colour tube. Whenever there is a pulse on R, a red dot is produced on the screen. Whenever there is a pulse on G, we obtain a green dot. In either case only one kind of phosphor (red or green) is made to glow. If there are pulses on R and G at the same time, both electron guns are activated. A red dot and a green dot are produced in the same region of the screen. From the normal viewing distance it appears that there is a yellow dot on the screen. All colours are produced by mixing red, green and blue in various combinations and proportions.

The availability of separate signals for the red, green and blue guns means that excellent colour rendering with full saturation may be readily obtained on an RGB monitor. For those who wish to use a domestic colour TV, micros with colour graphics usually have a TV output. In the video mixer circuit the RGB signals are combined with the luminance signal before modulation and the composite signal is sent to the TV set. As with monochrome TVs, losses of signal quality occurring during demodulation and decoding mean that resolution and colour rendering is not as good as with a monitor.

High resolution colour graphics can give an intricate picture but, with so many pixels to be individually dealt with, one might think that programming would be too laborious for the average user. In fact, high resolution graphics may be easier to handle than the graphics blocks or generated characters described earlier. Since there is only one shape (a dot) instead of dozens or hundreds, we avoid the need to specify which shape is to be displayed. Since each pixel can be specified solely by its X and Y coordinates of the screen, the basis of pixel graphics is mathematical and it lends itself readily to mathematical

treatment. It is easy to write routines for drawing lines, circles, or triangles, and for filling in areas with solid colour. The high-level language may include commands such as DRAW, PLOT, and CIRCLE, which perform these functions automatically, leaving the user to supply only the parameters. Graphs, bar charts, clock faces and all kinds of designs which are composed of reasonably simple geometrical shapes can be programmed in a few lines.

Getting Into Print

Controlling a printer is very different from controlling a monitor or TV. When controlling a monitor, the computer is responsible for all the timing and signal generation. The monitor merely transfers this signal to the screen as a raster of lines, varying in brightness along their length. Once the data has been transmitted, there are no further problems for the computer, for the monitor is able to work fast. The signals it receives are almost immediately translated into a pattern on the screen.

A printer takes a much larger share of the work on itself. The computer simply tells the printer which letter is to be printed next. Then the printer works out how and where to print the letter, or when to feed the paper on to print the next line. It can even organise itself to save time by printing alternate lines from right to left! In order to do this the printer needs an elaborate logic circuit. This may often include a microprocessor specially devoted to managing its activities. If the printer is of the dot-matrix type, it also needs a character generator to tell it which combinations of printing needles to fire at the ribbon (Fig. 11).

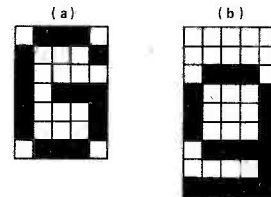

Fig. 11 Dot-matrix printers use a matrix of printing needles. If a needle is fired it hits the ribbon and makes a dot on the paper. In (a) a capital G is produced on a 5x7 matrix. In (b) a lower-case g is produced with a tail beneath it using a 5x9 matrix. In general, printers with few rows are not able to offer descenders like this.

The main disadvantage of a printer compared with a screen is that it deals with data much more slowly. There is a physical limit on how rapidly we can accelerate and then decelerate the appreciable mass of the print head (be it a matrix of needles or a daisywheel) and the rollers or sprockets which feed the paper to it. By contrast, the beam

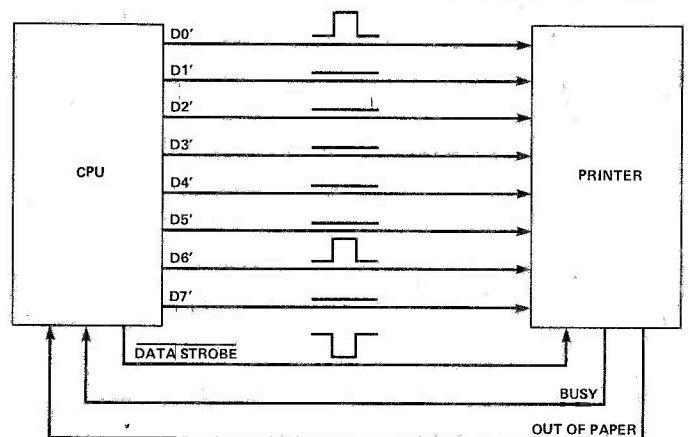

Fig. 12 Parallel data transfer between computer and printer.

of electrons in a CRT is virtually massless and can be directed and modulated almost instantly.

There are two main ways in which a computer and printer may be connected. The parallel transfer of data is illustrated in Fig. 12. An example of this system is the Centronics interface, originally devised by manufacturers of Centronics printers but now adopted by many other manufacturers. The first point to note is that there is two-way communication, in contrast with the one-way communication between computer and monitor. This is a consequence of the relatively slow speed of a printer. A computer can instruct a printer far faster than the printer can print. Rather than have the computer waste its valuable time waiting for the printer to operate letter by letter, we let the computer send a long string of commands to the printer in rapid succession. Since there are eight data lines, the computer can send a byte at a time. This is normally the ASCII code for the letter required. The printer can also interpret ASCII control characters for operations such as line feed (LF) and carriage return (CR). Whenever the computer is outputting data it makes the DATA STROBE line low. This has the same function as the WR control line used internally, and is derived almost directly from it. Similarly, the data lines are separated from the data bus of the computer only by latches, which hold the data long enough for the printer to be able to receive it. In some micros a general-purpose I/O device is used for this purpose (see Designing Micro Systems, ETI December 1982).

The I/O device or the buffers leading to the printer data lines need only one decoding circuit to enable them. Thus a printer needs to have only one address in RAM allocated to it. In comparison with the video screen, the printer makes minimal demands!

Printer Buffer

When data is received by the printer it is stored in a small RAM, called the **holder buffer**. This holds the codes for about 80 characters (maybe more), which is enough to print one line of text. It stores codes as they come in, then reads out codes previously stored and prints the characters they represent. When the computer sends a long string of codes the buffer is likely to become full. Also the printer has occasionally to stop printing to move on the paper to the next line. Again, codes will accumulate in the buffer. At this stage the printer puts a signal on the BUSY line. The effect of this is to interrupt the computer and make it stop sending any more data. When the printer has printed all that it has stored and its buffer is empty, the BUSY signal is taken off the line and the computer is free to send the next batch of data. On some interfaces there is also an acknowledge line (ACK), a handshaking line by which the printer informs the computer that it has done whatever it was told to do and is awaiting fresh instructions. There may be an OUT OF PAPER line for

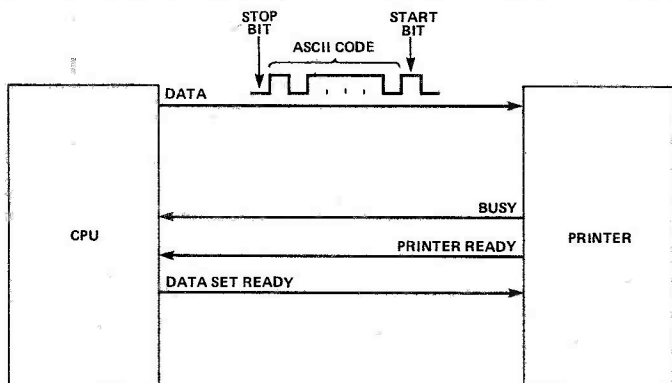

Fig. 13 Serial transfer of data between computer and printer.

signalling this fact to the computer. The level on this line is usually controlled by a micro-switch connected to a lever which is in contact with the paper. An OUT OF PAPER signal causes the computer to send no more data until the normal level is restored.

Are You Being Serialized?

The alternative way of sending data to a printer is to transmit a series of pulses along a single line. This has obvious advantages in that only a single data line is required instead of eight. The most frequently used system of serial data transfer is known as the RS232C standard. The standard specifies voltage levels and rates of data transfer and the system to be used for coding the data. The standard also covers the types of connector to be used so that any pair of devices employing RS232C may be coupled together and expected to communicate reliably.

In Fig. 12 the pulses drawn above the parallel data lines indicate that the computer is sending 0100 0001 (or 65 decimal, the ASCII code for 'A'). In Fig. 13 the same ASCII code is being sent serially along one data line. Sending eight bits one after another is obviously slower than sending them in parallel, a byte at a time, as in Fig. 12, but since printers are relatively slow this is not a great disadvantage.

There are various ICs available for converting parallel data to serial data. A simple parallel-in-serial-out (PISO) shift register such as the 74LS166 will do the job, but ICs specially designed for computers do it better. A universal asynchronous receiver transmitter (UART) is an example of such an IC. This provides two-way communication, being able to receive parallel data from the CPU and transmit it as serial data, and to receive serial data from a peripheral and pass it to the CPU as parallel data. The latter function is not required for use with a printer, but would be used, for example, when two computers are required to communicate with each other. Not only does the UART convert from parallel to serial (or the other way about) but it takes the parallel data, makes it into a train of eight pulses, and adds a 'start' pulse and a 'stop' pulse to the beginning and end of the train.

Correcting The Errors

Since it requires only one data line, serial data transmission is suited for long distance. Parallel data transmission is rarely used under such circumstances. The longer the line, the greater the chance of stray electromagnetic interference finding its way on to the line and into the data receiving circuit. This is why the train of pulses often includes an extra pulse known as the **parity bit**. The idea of this is to allow the receiving device to check that no spurious pulse has been added as a result of interference during transmission. The parity bit is calculated by the UART before the data is transmitted, and is added to the end of the train of data pulses, then followed by the stop bit or bits. The value to be given to the parity bit is found by counting how many 1s are present in the data. If the number is even, the parity bit is made 1, so the total number of 1s becomes odd. If the number of 1s in the data is already odd, the parity bit is made 0, so retaining the odd number of 1s. At the receiving end the UART simply has to count the number of 1s in the train. If it is odd, all is well and it then sends on the train (minus the parity bit) to be decoded. If the number of 1s is even, a transmission error has occurred and the device or its operator can be alerted. This system is not absolutely error-proof for two errors could occur which would be self-cancelling. However, if the average rate of error is, say 1 in 100,000 bits on any occasion, the chance of two errors occurring on that occasion is 1 in

10,000,000,000 bits, which can be fairly safely disregarded.

The system described above is known as **odd parity**. It is also possible to work with **even parity**, in which the parity bit makes up the 1s to an even number. Most UARTs can be programmed to deal with either type of parity.

It's Your Timing That's Crucial

Figure 10 shows the train of pulses required to transmit the ASCII code for 'A' serially. It includes an even parity bit. The voltage level specified for signalling 0 is $-3V$ or more, while the level for 1 is any voltage lower than $-3V$. The interval between successive groups of pulses can be as long as necessary. The receiver waits until a start bit arrives and then decodes the nine or so bits which follow. There is no interval between successive pulses. The sequence of five 0s, for example, is received as one long high pulse. It follows that the transmitter and receiver must both have a method of timing the duration of pulses. Both circuits have oscillators or clocks built in to them to fix the rate at which they work. When two devices are coupled both clocks must operate at the same frequency. To assist standardisation, a number of frequencies have been selected for use with RS232C interfaces.

The rate of transmission of data is expressed in **baud**. This unit, named after a French engineer, J. M. E. Baudot, is equal to the number of bits transmitted per second. Standard rates are 110, 150, 300, 600, 1200, 2400, 4800, 9600 and 19200 baud, though the higher ones are not included in the RS232C standard. To simplify circuit design there are baud rate generator ICs. These are driven by a high frequency crystal oscillator circuit; the high

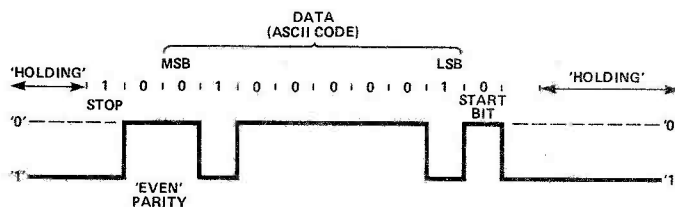

Fig. 14 The waveform of a serial signal (see text). There may be one or two 'stop' bits. The holding period between successive signals may be any length, which is why the system is called asynchronous.

frequency is divided by internal counter circuits to produce a range of output frequencies at standard baud rates. A UART may be connected to one or other of these outputs, depending on which baud rate is to be used. An interface usually has the facility for switching the UART to any one of the generator outputs, so that the rates on transmitter and receiver may be matched.

Since this is an asynchronous system, matching of timing does not have to be of high precision. Timing at the receiver begins when a start bit is received. The clock at the receiver has to remain in phase with the transmitting clock only for the duration of 10 to 11 pulses. The receiving clock probably runs slightly slower or faster than the transmitting clock, but this does not matter. It can get only a fraction of a pulse out of phase in such a short time, and this is not enough to cause errors in decoding. When the next train of pulses arrives, timing begins all over again from the arrival of the start pulse. Any discrepancies of timing which might have accumulated between trains are eliminated.

ETI

MODULES FOR SECURITY & MEASUREMENT

AS FEATURED IN PRACTICAL ELECTRONICS

INTRUDER ALARM CONTROL UNIT CA 1250

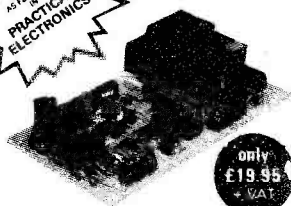

This exciting new module offers all the possible features likely to be required when building an intruder alarm system. Whether used with only 1 or 2 magnetic switches or in conjunction with several ultrasonic alarm modules or infra-red units, a really effective system can be constructed at a fraction of the cost of comparable ready-made units. Supplied with a fully explanatory Data Sheet that makes installation straight forward, the module is fully tested and guaranteed.

- Built-in electronic siren drives 2 loud speakers
- Provides exit and entrance delays together with fixed alarm time
- Battery back-up with trickle charging facility
- Operates with magnetic switches, u/sonic or I.R. units
- Anti-tamper and panic facility
- Stabilised output voltage for external units
- 2 operating modes - full alarm/anti-tamper and panic facility
- Screw connections for ease of installation
- Separate relay contacts for switching external loads
- Test loop facility

only £19.95 + VAT

available in kit form £16.95 + VAT

DIGITAL VOLTMETER MODULE DVM 314

Fully built & tested



- Positive & negative voltage with an FSD of 999mV which is easily extended
- Requires only single supply 7-12V
- High overall accuracy - 0.1% + 1 digit
- Large bright 0.43" LED displays
- Supplied with full applications data

only £11.95 + VAT

With this fully built and calibrated module a wide range of accurate equipment such as multimeters, thermometers, battery indicators etc. can be constructed at a fraction of the cost of ready-made units. Full details are supplied for extending the voltage range, measuring current, resistance and temperature. Fully guaranteed, the unit has been supplied to electricity authorities, Government departments, etc.

Temperature Measurement Kit DT.10

£2.25 + VAT

Using the I.C. probe supplied, this kit provides a linear output of 10mV/°C over the temperature range from 10°C to +100°C. The unit is ideal for use in conjunction with the DVM module providing an accurate digital thermometer.

Power Supply PS.209

£4.95 + VAT

This fully built mains power supply provides two stabilised isolated outputs of 9V, 250mA each. The unit is ideally suited for operating the DVM at Temperature Measurement module.

ULTRASONIC ALARM MODULE

US 4012 Fully built & tested



Adjustable range from 5ft. to 25ft.

A really effective fully built module containing both ultrasonic transmitter and receiver and circuitry for providing false alarm suppression. This module, together with a suitable 12V power supply and relay unit as shown, forms an effective though inexpensive intruder alarm. Supplied with comprehensive Data Sheet, it is easily mounted in a wide range of enclosures. A ready-drilled case and necessary hardware is available below.

only £10.95 + VAT

Power Supply & Relay Units PS 4012

£4.25 + VAT

Provides a stabilised 12V output and relay with 3A contacts. The unit is designed to operate one or two of the above ultrasonic units. Fully built and tested.

Hardware Kit HW 4012

£4.25 + VAT

A suitable ready-drilled case with the various mounting pillars, mains switch socket and nuts and bolts. Designed to house the ultrasonic alarm module together with its power supply. Size: 153mm x 120mm x 45mm.

Siren Module SL 157

£2.95 + VAT

Produces a loud and penetrating sliding tone operating from 9-15V. Capable of driving 2 off 8 ohm speakers to SPL of 110db at 2M. Contains an inhibit facility for use with shop lifting loops etc. or other break to activate circuits

* ACCESSORIES *

- 3-position Key Switch for use with CA 1250 supplied with 2 keys £3.43
- Magnetic switch (with magnet) £1.17
- 5" Horn speaker for use with CA1250 and SL157 £4.95

Add VAT & 50p post and packing to all orders.

Shop hours 9.00-5.30 p.m.

(Wed. 9.00-1.00 p.m.)

Units on demonstration — callers welcome. S.A.E. with all enquiries

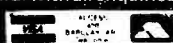

RISCOMP LIMITED

Dept: ETI/13

21 Duke Street,

Princes Risborough, Bucks.

Princes Risborough (08444) 6326

Telephone Orders Welcome

Jupiter ACE

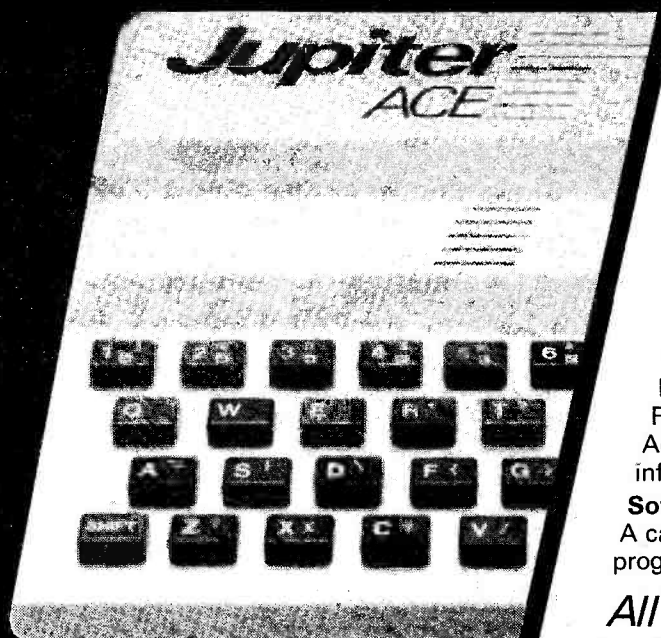

only
£89.95

The Jupiter Ace uses FORTH

The Jupiter Ace personal computer runs in FORTH, an easily understood language, typically four times as compact and ten times as fast as BASIC. Before the Ace all personal computers used BASIC and FORTH was only available to a privileged few. The Jupiter Ace also features a full-size moving-key keyboard, high-resolution graphics, sound, floating point arithmetic, a fast and reliable cassette interface and 3K of RAM.

Available soon

Plug-on parallel printer interface.

For around £20.00 this will connect your Jupiter Ace to anything from high-speed dot matrix to letter-quality daisy wheel printers.

Plug-on 16K Memory Expansion

For around £30.00 you will increase the memory of your Jupiter Ace to 19K giving you instant access to enormous amounts of information.

Software

A catalogue will be sent with every machines, and includes, initially, programs for education and entertainment.

All inclusive price

For £89.95 you receive your Jupiter Ace, a mains adaptor, all the leads needed to connect to most cassette recorders and T.V.s (colour or black and white), a software catalogue and a manual.

The manual is a complete introduction to the world of personal computing and a course in FORTH programming on the Ace.

Even if you are a complete newcomer to computers, the manual will guide you step by step from first principles to confident programming.

The price includes postage, packing and V.A.T.

The Jupiter Ace is backed by a full 12 month-warranty.

The Jupiter Ace is available only by mail order.

Please allow up to 28 days for delivery.

Send cheque or postal order with the form to:—

JUPITER CANTAB, 20 FOXHOLLOW
BAR HILL, CAMBRIDGE CB3 8EP

Technical Information

Hardware

Z80A running at 3.25 MHz.
8K bytes ROM
3K bytes RAM

Keyboard 40 Moving-key keyboard with auto repeat on every key and Caps Lock.

Screen Memory mapped 32 (column x 24 line flicker-free display with upper and lower case ascii character set.

Graphics Chunky graphics (64 x 46 pixels) may be plotted, unplotted or over-plotted (XOR operation). Also, the entire character set (128 characters and their video inverses) may be redefined allowing intricate shapes to be drawn with a resolution equivalent to 256 x 192 pixels.

Sound Internal loudspeaker may be programmed to operate over the entire audio spectrum.

Cassette Programs and data in the compact dictionary format may be saved, verified, loaded and merged. Blocks of memory can be saved, verified, loaded and relocated. All tape files are named. Running at 1500 baud, the Ace will connect to most portable tape recorders.

Expansion Port Contains D.C. power rails and full Z80 Address, data and control signals. May be used to connect extra memory and other peripherals. IN and OUT words allow port-based peripherals to be addressed.

Data Structures Integer, Floating point and String data may be held as constants, variables or arrays with multiple dimensions and mixed data types. There are no restrictions on names.

Control Structures IF-ELSE-THEN, DO-LOOP DO-+LOOP, BEGIN-WHILE-REPEAT, BEGIN-UNTIL, all may be mixed and nested to any depth.

The Jupiter Ace closely follows the FORTH 79 standard with extensions for floating point, sound and cassette. It has a unique and remarkable editor that allows you to list and alter words that have been previously compiled into the dictionary. This avoids the need to store screens of source, allowing the dictionary itself to be saved on cassette. Comprehensive error checking removes the worry of accidentally crashing your programs.

Designed by Jupiter Cantab

Computer Designers Steven Vickers and Richard Altwasser played a major role in creating the ZX Spectrum and then formed Jupiter Cantab to develop advanced ideas in personal computing. The Ace is the result, another all-British computer to lead the world.

ORDER NOW!

Please send me:—

JUPITER ACE MICROCOMPUTER(S) @ £89.95.

Name. Mr/Mrs/Miss

Address

ETI

Go on a computer date

(and take along the wife and kids)

Have you ever fancied spending the day playing with an Atari, or a Sinclair, or an Apple computer?

Well, these plus a complete cross-section of the hard and software available to the home user, will be on display at the London Computer Show.

The emphasis is on the lower end of the price bracket, with computers from £50-£300.

You will be able to chat to the manufacturers and play with the computer before you buy.

So bring along the wife and kids (who'll probably be more of an expert on what you're buying than you).

And if you're a party of 20 or more, there's a 25% discount.

Friday 7th January '83

(10.00am-6.00pm)

Saturday 8th January '83

(10.00am-6.00pm)

Sunday 9th January '83

(10.00am-4.00pm)

THE LONDON HOME COMPUTER SHOW.

Royal Horticultural Society's Old Hall, Vincent Street,
London SW1.

**For advanced bookings for parties of 20 or more, please send
cheques payable to Argus Specialist Publications Ltd. (Dept.
LHCS), 145 Charing Cross Road, London WC2H 0EE.
Telephone 01-437 1002.*

SAVE 50p

Present this token duly completed when buying your ticket for a
50p reduction. Only 1 token allowed per person.

Name Mr/Mrs/Miss

Address

Signature ETI

HOME LIGHTING KITS

These kits contain all necessary components and full instructions & are designed to replace a standard wall switch and control up to 300W. of lighting.

TDR300K Remote Control Dimmer **£14.30**
MK6 Transmitter for above **£ 4.20**

TD300K Touchdimmer **£ 7.00**

TDE/K Extension kit for 2-way switching for TD300K **£ 2.00**

LD300K Rotary Controlled Dimmer **£ 3.50**

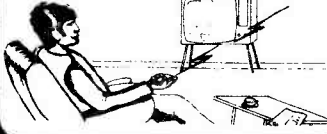

HOME CONTROL CENTRE

This New Remote Control Kit enables you to control up to 16 different appliances anywhere in the house from the comfort of your arm chair. The transmitter injects coded pulses into the mains wiring which are received by receiver modules connected to the same mains supply and used to switch on the appliance addressed. Receivers are addressed by means of a 16-way keyboard, followed by an on or off command. Since pushing buttons can become rather boring, the transmitter also includes a computer interface so you can programme your favourite micro to switch lights, heating, electric blanket, make your coffee in the morning, etc., without rewiring your house. **JUST THINK OF THE POSSIBILITIES.** The KIT includes all PCBs and components for one transmitter and two receivers, plus a drilled box for the transmitter. **£42.00**
Order as XK112.

Additional Receivers XK111 **£10.00**

ELECTRONIC LOCK KIT XK101

This KIT contains a purpose designed lock IC, 10-way keyboard, PCBs and all components to construct a Digital Lock, requiring a 4-key sequence to open and providing over 5000 different combinations. The open sequence may be easily changed by means of a pre-wired plug. Size: 7 x 6 x 3 cms. Supply: 5V to 15 V d.c. at 40uA. Output: 750mA max. Hundreds of uses for doors and garages, car anti-theft device, electronic equipment, etc. Will drive most relays direct. Full instructions supplied.

ONLY £10.50

Electric lock mechanism for use with latch locks and above kit **£13.50**

THE MULTI-PURPOSE TIMER HAS ARRIVED

Now you can run your central heating, lighting, hi-fi system and lots more with just one programmable timer. At your selection it is designed to control four mains outputs independently, switching on and off at pre-set times over a 7 day cycle, e.g. to control your central heating (including different switching times for weekends), just connect it to your system programme and set it and forget it—the clock will do the rest.

FEATURES INCLUDE:-

- 0.5" LED 12 hour display.
- Day of week, am/pm and output status indicators.
- 4 zero voltage switched mains outputs.
- 50/60Hz mains operation.
- Battery backup saves stored programmes and continues time keeping during power failures. (Battery not supplied).
- Display blanking during power failure to conserve battery power.
- 18 programme time sets.
- Powerful "Everyday" function enabling output to switch every day but use only one time set.
- Useful "sleep" function—turns on output for one hour.
- Direct switch control enabling output to be turned on immediately or after a specified time interval.
- 20 function keypad for programme entry.
- Programme verification at the touch of a button.

(Kit includes all components, PCB, assembly and programming instructions). **ORDER AS CT5000**

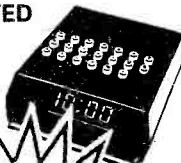

NOW ONLY £39 WITH SO MANY EXTRA FEATURES. OPTIONAL BLACK PLASTIC CASE. READY DRILLED £2.50

FREE SHORT FORM CATALOGUE - send SAE (6" x 9"). We also stock Vero, Books, Resistors, Capacitors, Semi-Conductors etc.

CHRISTMAS PRESENTS GALORE



3-NOTE DOOR CHIME
Based on the SAB0600 IC the kit is supplied with all components, including loudspeaker, printed circuit board, a pre-drilled box (95 x 71 x 35mm) and full instructions. Requires only a PP3 9V battery and push-switch to complete. **AN IDEAL PROJECT FOR BEGINNERS.** **£5.00**
Order as XK102.

LIGHT DIMMER KIT
Contains all components, including front panel and knob, to make a dimmer for lights up to 300W. **£3.50**

MW RADIO KIT
Based on 2N414 IC, kit includes PCB, wound aerial and crystal earpiece and all components to make a sensitive miniature radio. Size: 5.5 x 2.7 x 2 cms. Requires PP3 9V battery. **IDEAL FOR BEGINNERS.** **£5.00**

LCD 3 1/2 DIGIT MULTIMETER
16 ranges including DC voltage (200 mv-1000 v) and AC voltage, DC current (200 mA-10 A) and resistance (0.2 M) + NPN & PNP transistor gain and diode check. Input impedance 10M. Size 155x88x31 mm. Requires PP3 9V battery. Test leads included. **ONLY £29.00**

STOCKING FILLERS

- PACK (1) 650 Resistors 47 ohm to 10 Mohm - 10 per value **£4.00**
PACK (2) 40 x 16V Electrolytic Capacitors 10uF to 1000uF - 5 per value **£3.25**
PACK (3) 60 Polyester Capacitors 0.01 to 1 uF/250V - 5 per value **£5.55**
PACK (4) 45 Sub-miniature Presets 100 ohm to 1 Mohm - 5 per value **£2.90**
PACK (5) 30 Low Profile IC Sockets 8, 14 and 16 - pin - 10 off each **£2.40**
PACK (6) 25 Red LEDs (5mm dia.) **£1.25**
PACK (7) 20 BC182 NPN General Purpose Transistors **£1.20**
PACK (8) 20 BC212 PNP General Purpose Transistors **£1.20**

All full spec. branded devices

BUY ANY 5 PACKS AND WE WILL SEND YOU 10 RED LEDs FREE



ALL PRICES EXCLUDE VAT

DVM/ULTRA SENSITIVE THERMOMETER KIT

This new design is based on the ICL7126 (a lower power version of the ICL7106 chip) and a 3 1/2 digit liquid crystal display. This kit will form the basis of a digital multimeter (only a few additional resistors and switches are required—details supplied), or a sensitive digital thermometer (-50°C to +150°C) reading to 0.1°C. The basic kit has a sensitivity of 200mV for a full scale reading, automatic polarity indication and an ultra low power requirement—giving a 2 year typical battery life from a standard 9V PP3 when used 8 hours a day, 7 days a week.

9949

Price £15.50

DISCO LIGHTING KITS

DL 1000K
This value-for-money kit features a bi-directional sequence, speed of sequence and frequency of direction change, being variable by means of potentiometers and incorporates a master dimming control. **£14.60**

DL2100K
A lower cost version of the above, featuring unidirectional channel sequence with speed variable by means of a pre-set pot. Outputs switched only at mains zero crossing points to reduce radio interference to a minimum.

Optional opto input DLA1 **Only £8.00**
Allowing audio ("beat")—light response.

DL3000K
This 3 channel sound to light kit features zero voltage switching, automatic level control & built in mic. No connections to speaker or amp required. No knobs to adjust—simply connect to mains supply & lamps. **Only £11.95** (1Kw/Channel)

"OPEN-SESAME"

The XK103 is a general purpose infra-red transmitter/receiver with one momentary (normally open) relay contact and two latched transistor output. Designed primarily for controlling motorised garage doors and two auxiliary outputs for drive/garage lights at a range of up to 40 ft. The unit also has numerous applications in the home for switching lights, TV, closing curtains, etc. Ideal for aged or disabled persons.

The Kit comprises a mains powered receiver, a four button transmitter, complete with pre-drilled box, requiring a 9V battery and one opto-isolated solid state switch kit for interfacing the receiver to mains appliances. As with all our kits, full instructions are supplied.

ONLY £23.75

REMOTE CONTROL KITS

MK6 SIMPLE INFRA RED TRANSMITTER
Pulsed infra red source complete with hand-held plastic box. Requires a 9V battery **£4.20**

MK7 INFRA RED RECEIVER
Single channel, range approx. 20ft. Mains powered with a triac output to switch loads up to 500W at 240V ac. **£9.00** (PC500K—Special Price for MK6 and MK7 together **£12.50**)

MK8 CODED INFRA RED TRANSMITTER
Based on the SL430, the kit includes all components to make a coded transmitter and only requires a 9V (PP3) battery and keyboard. 8 x 2 x 1.3cms **£5.90**

MK10 16-WAY KEYBOARD
For use with MK8 and MK18 to generate 16 different codes for decoding by the ML928 or ML926 receiver (MK12) kit. **£5.40**

MK11 16-Channel + 3 Analogue o/p IR Receiver
Based on ML922 decoder IC. Functions include on/standby output, toggle, control of volume, tone and lamp brightness. Includes its own mains supply. **£12.00**

MK12 16-CHANNEL IR RECEIVER
For use with MK8 kit with 16 on/off outputs, which with further interface circuitry, such as relays or triacs, will switch up to 16 items of equipment on or off remotely. Latched or momentary outputs—please specify when ordering. Includes its own mains supply. **£11.95**

MK13 11-WAY KEYBOARD For use with MK8, MK18 and MK11 kits. **£4.35**

MK16 Mains Powered IR Transmitter
Mains powered for continuous operation—single channel, for applications such as burglar alarms, automatic door openers, etc. Range approx. 6 ft. **£2.50**

MK17 12V d.c. IR RECEIVER
For use with MK6 or MK18. Relay output with DP 3 Amp change-over contacts, may be used as latched, momentary or "break beam" receiver. Operates from 6-13V d.c. **£9.50**

MK18 HIGH POWER IR TRANSMITTER
Similar to MK8 but with range of approx. 60ft. **£6.20**

Ancillary Kits: **MK2 Solid State Relay**
Opto-isolated with zero voltage switching. No. triac supplied. **£2.80**

MK15 DUAL LATCHED SOLID STATE RELAY
Comprises 2 x solid state relays and latch for use with momentary version of the MK12. 2 output triacs required (not supplied). **£4.50**

24 HOUR CLOCK/APPLIANCE TIMER KIT

Switches any appliance up to 1kW on and off at present times once per day. Kit contains: AY-5-1230 IC, 0.5" LED display, mains supply, display drivers, switches, LEDs, triacs, PCBs and full instructions.

CT1000K Basic Kit **£14.90**
CT1000K with white box (56/131 x 71mm) **£17.40**
(Ready Built) **£22.50**

Add 55p postage & packing +15% VAT to total.
Overseas Customers:
Add £2.50 (Europe), £6.00 (elsewhere) for p&p.
Send S.A.E. for further STOCK DETAILS.
Goods by return subject to availability.

OPEN 9am to 5pm (Mon to Fri)
10am to 4pm (Sat)



FAST SERVICE - TOP QUALITY - LOW LOW PRICES

No circuit is complete without a call to -

ETI

ELECTRONICS ETI

11 Boston Road
London W7 3SJ



TEL: 01-567 8910 ORDERS
01-579 9794 ENQUIRIES
01-579 2842 TECHNICAL AFTER 3PM

Amateur radio will become much clearer after 3rd Dec.

The radio market has become more complex. Things have become more confused.

Wires get crossed as new equipment floods onto the market.

At the end of the day, even the most avid enthusiast spends more time trying to find out about new equipment than on the airwaves using it.

As for the novice?

They stand little chance of picking anything up at all.

So we've decided to clear things up.

On December 3rd our new magazine Ham Radio Today begins.

Not a magazine you need a degree in electronics to decipher.

Or one that still calls your gear a wireless.

Rather a magazine that simply clarifies the vast range of electronic gadgetry available.

Lists new equipment, analyses its performance.

Thorough reviews, special features, news items and constructional projects.

In a clear and concise way that will give everyone a perfect 5 + 9.

Ham Radio Today.

Tomorrow... tune in and find out, 73.

**HAM
RADIO**

Published by
Argus Specialist Publications Ltd.

TODAY

CORTEX PART 3

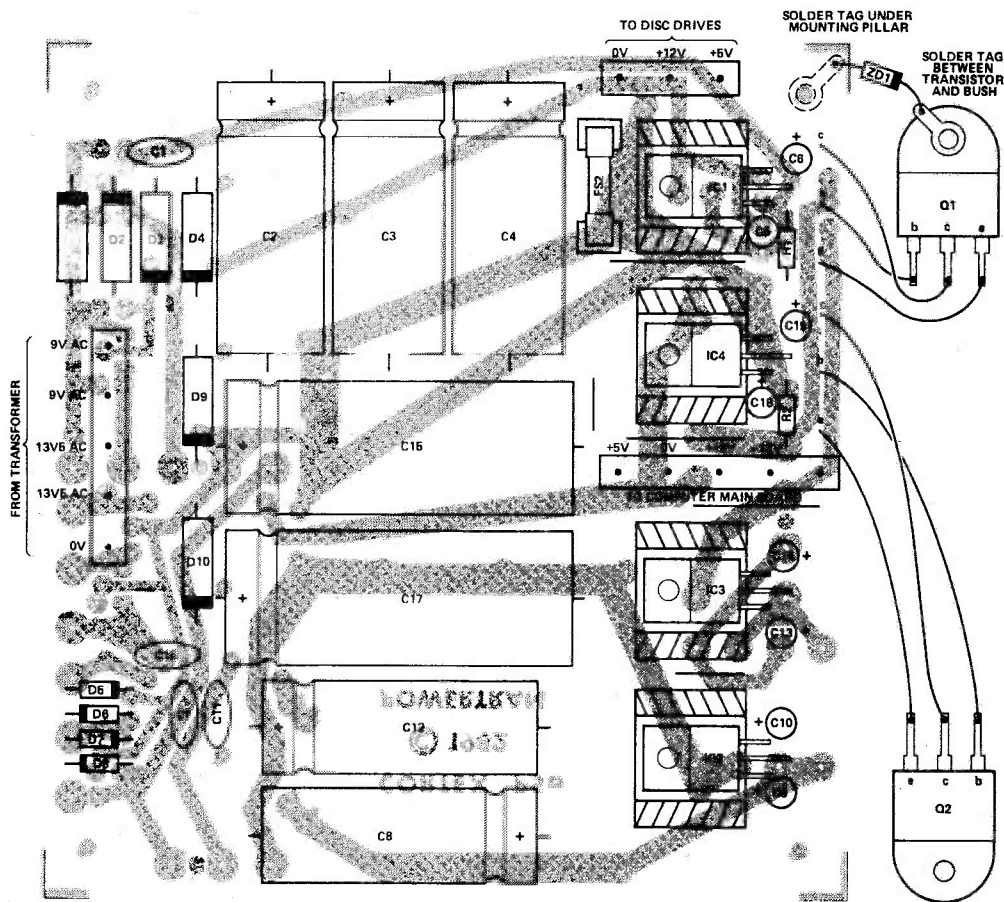

Fig. 1 Component overlay for the power supply.

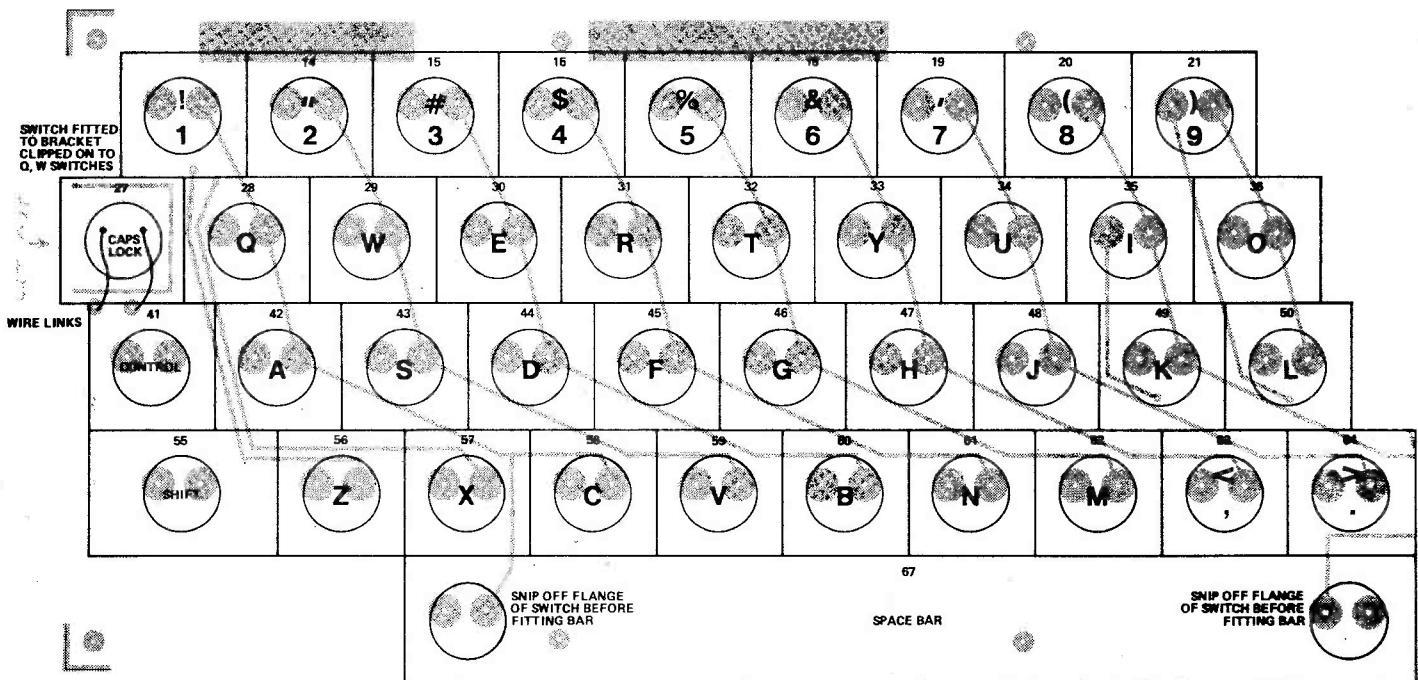

Fig. 2 The keyboard overlay, in two halves so it doesn't get stapled into illegibility.

PARTS LIST

POWER SUPPLY
Resistors (all 1/4W, 5%)
R1,2 10R

Capacitors
C1,7,11,15 100n polyester
C2-4 4700u 16 V axial electrolytic
C5,6,9,10,13,14,18,19 1u0 35 V tantalum
C8,12 2200u 25 V axial electrolytic
C16,17 4700u 25 V axial electrolytic

Semiconductors
IC1 7805
IC2,4 7812
IC3 7912
Q1,2 TIP2955

D1-4,9,10 1N5402
D5-8 1N4002
ZD1 BCW70 5V6

Miscellaneous
PCB (see Buylines); one off three way connector; two off five way connectors; transformer (13.5-0-13.5 V at 3 A, 9 V at 4 A; fuseholder clips; four off TV5 heatsinks.

KEYBOARD
Resistors (all 1/4W, 5%)
R1,2,6,8 4k7
R3 18k
R4 12k
R5 680k
R7 100k

Capacitors
C1,2,5 220n 35 V tantalum
C3,4 4u7 16 V tantalum
C6 4n7 ceramic
C7 33p ceramic

Semiconductors
IC1 74LS123
IC2 74LS08
IC3 74LS157
IC4 2376
Q1 BC182L

Miscellaneous
PCB (see Buylines); 67 off momentary push-to-make switches; one off latching push-to-make switch; set of 67 double shot moulded key tops; IC sockets; switch mounting bracket; mounting pillars etc.

The CAPS LOCK switch is physically different from the rest and is wired in with wire links. Press this switch into its bracket together with the Q and W switches before fitting to the board. It is most important that the switches fit squarely on the board. The best way to be sure of this is to solder only one pin of each switch and then holding the board, press in turn each of the switches while reheating the soldered joint. If any are misaligned this will correctly position them. The key tops can now be pressed on and the remaining pins soldered.

The power supply is on a single-sided PCB with six wire links and it is best to fit these before any components. Connections to and from this board are made via connectors and to ensure that their

pins are soldered in squarely, fit the sockets on to them during soldering. The power supply is all on the back panel and the power transistors use this as a heatsink, being fitted to it with mica insulating washers.

As well as holding the input and output sockets, the rear panel has provision for a cooling fan and one should be fitted when disc drives are used.

The disc drives pass through the front panel and are screwed onto a mounting plate. Plates on the sides of the drives press against the panel, thereby making a rigid sub-assembly which fits into the cover of the computer. The standard kit has a panel with no cut-outs for disc drives and a new panel is provided with the drives when purchased.

There are two positions in which the main board can be fitted.

The board has provision for a Eurocard connector for expansion purposes and there is a cut-out in the side of the computer through which the connector passes; for external expansion the board fits at the far right hand side. However, if the add-on units are to be fitted internally then the position to the left is used.

BUYLINES

Powertran are supplying complete kits of parts and component packs for the Cortex. A complete 64K Cortex kit will cost £295 plus VAT, carriage free. A ready-built 64K Cortex will cost £395 plus VAT, carriage free. Prices for add-ons (eg floppy discs, RS232C interface, memory expansion etc) and for component packs (eg PCB, semiconductors etc) can be found in Powertran's brochure. Powertran Cybernetics, Portway Industrial Estate, Andover, Hants SP10 2NM. Telephone 0264 64455.

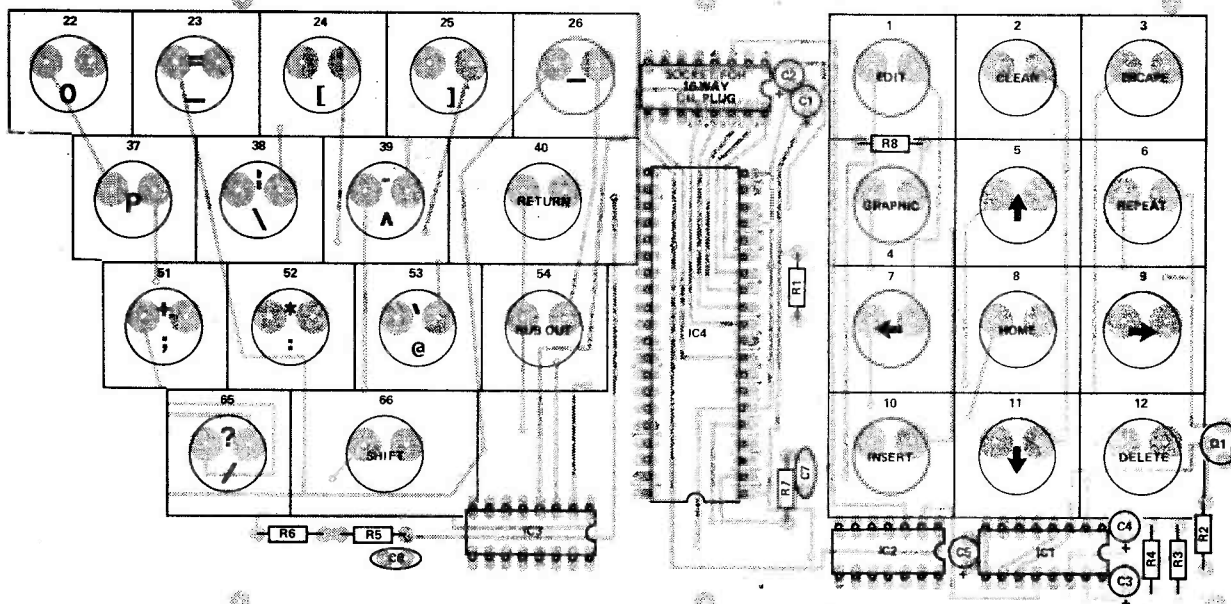

ETI

BRADLEY MARSHALL LTD.

SPECIALIST ELECTRONIC COMPONENT DISTRIBUTORS

325 Edgware Road, London W2 1BN Telephone: 01-723 4242 Telex: 295441 BUSY B

1983 CATALOGUE NOW AVAILABLE

Probably the largest stock of ICs and Transistors in the South —
TRY US FIRST!

SEND LARGE SAE & 75p TO ADDRESS BELOW

Crimson Elektrik

PROFESSIONAL AMPLIFIER MODULES

CODE	DESCRIPTION	Less VAT £	VAT £	INC £	WT (Kg)
CE 608	Power Amplifier Module	18.26	2.74	21.00	0.16
CE 1004	Power Amplifier Module	21.30	3.20	24.50	0.20
CE 1008	Power Amplifier Module	23.90	3.60	27.50	0.21
CE 1704	Power Amplifier Module	30.43	4.57	35.00	0.22
CE 1708	Power Amplifier Module	30.43	4.57	35.00	0.22
CE 3004	Power Amplifier Module	42.60	6.40	49.00	0.40
BD 1	Bridge Driver Module	7.13	1.07	8.20	0.06
TR 80	Toroidal Transformer 80VA	18.00	2.70	20.70	2.00
TR 150	Toroidal Transformer 150VA	20.07	3.01	23.08	2.35
TR 250	Toroidal Transformer 250VA	25.43	3.81	29.24	3.35
TR 250Q	Toroidal Transformer (low noise)	33.20	4.98	38.18	2.80
B 6	Bridge Rectifier (6 amp)	0.99	0.15	1.14	0.02
B12	Bridge Rectifier (12 amp)	1.80	0.27	2.07	0.03
C4700/40	Reservoir Capacitor and Clip	1.91	0.29	2.20	0.09
C4700/63	Reservoir Capacitor and Clip	2.40	0.36	2.76	0.11
C4300/63	Reservoir Capacitor and Clip	2.60	0.39	2.99	0.11

CPS 80	Power Supply	22.82	3.42	26.24	2.10
CPS 80D	Dual Power Supply	27.63	4.14	31.77	2.25
CPS 150	Power Supply	25.86	3.88	29.74	2.50
CPS 150D	Dual Power Supply	31.65	4.75	36.40	2.60
CPS 250	Power Supply	32.03	4.80	36.83	3.50
CPS 250D	Dual Power Supply	39.43	5.91	45.34	3.65
TS 70	Thermal Switch 70°C	1.92	0.29	2.21	0.02
HS 50	50mm Heatsink	1.60	0.24	1.84	0.15
HS 100	100mm Heatsink	2.60	0.39	2.99	0.30
HS 150	150mm Heatsink	3.65	0.55	4.20	0.45
FM 1	Fan Mounted on 2 × HS 100	32.13	4.82	36.95	1.20
FM 2	Fan Mounted on 2 × HS 150	36.10	5.42	41.52	1.50
CPR 1X	Pre-Amplifier Module	31.30	4.70	36.00	0.15
MC 2	Moving Coil Pre-Pre-Amplifier Module	20.00	3.00	23.00	0.07
REG 1	Regulated Power Supply	8.09	1.21	9.30	0.07
TR 6	6VA Mains Transformer	2.87	0.43	3.30	0.21
XO 2	2 Way Crossover Module	17.39	2.61	20.00	0.07
XO 3	3 Way Crossover Module	26.09	3.91	30.00	0.07
MU 1	Muting Circuit for XO 2 or XO 3	8.35	1.25	9.60	0.04
CK 1010	Complete Pre-Amplifier Kit	78.26	11.74	90.00	2.50
CK 1040	Complete 40 Watt Power Amplifier Kit	103.48	15.52	119.00	7.30
CK 1100	Complete 100 Watt Power Amplifier Kit	129.56	19.44	149.00	7.30
MC 2K	Add On Moving Coil Kit	21.74	3.26	25.00	0.12
PSK	Pre-Amplifier Power Supply Kit	17.39	2.61	20.00	0.75

SOLE DISTRIBUTION BRADLEY MARSHALL LTD.
325 EDGWARE ROAD, LONDON W21 BN. TEL: 01-723 4242

E.T.I. KITS

ALL KITS
INCLUDE PCBs

Full kits include printed circuit boards, components, hardware, I.C. sockets, cases etc. unless stated (not batteries). If you do not have the issue of E.T.I. which

includes the project — you will need to order the instruction reprint at an extra 45p each. PCBs included. Reprints available separately 45p each + p&p 45p.

SPECTRACOLUMN DEC 82, Less case and lights £34.85p

PLAYMATE Aug/Sept 82, less optional foot pedal + mains unit	£39.98	RECHARGEABLE BATTERY extra	£19.98
PEST CONTROL Feb 82	£28.42	HANDCLAP SYNTHESIZER Aug 81	£32.98
DUAL LOGIC PROBE Sept 82	£14.99	WAH PHASE June 81, Less pedal	£14.78
AUTO VOLUME CONTROL Sept 82 £4.26 less case	£17.57	LED JEWELLERY June 81, Cross	£2.98
INSULATION TESTER May 82	£17.57	Star £8.91 Spiral £7.98	
AUTORANGING CAPACITANCE METER Mar/April 82	£71.99	GUITAR NOTE EXPANDER April 81	£17.99
HIGH QUALITY PHONO AMPLIFIERS Feb 82, Less case	£43.98	DRUM MACHINE April 81	£65.97
MOVING COIL STAGE	£19.75	ENGINEERS STETHOSCOPE Mar 81	£20.98
MOVING MAGNET STAGE	£19.69	SOUND PRESSURE LEVEL METER Feb 81	£43.98
PEST CONTROL Feb 82	£7.46	INFRA RED ALARM Feb 81	£59.98
GUITAR TUNER Jan 82	£31.87	4 INPUT MIXER Dec 80	£21.74
COMPONENT TESTER Dec 81	£8.78	MUSICAL DOORBELL Dec 80	£12.77
CAR ALARM Nov 81	£19.77	METRONOME Nov 80	£6.58
ENLARGER TIMER	£29.25	ULTRASONIC BURGLAR ALARM Aug 80	£29.50
SOUND BENDER Oct 81	£22.84	CAPACITANCE METER Aug 80	£22.28
WATCHDOG SECURITY ALARM Aug 81	£47.86	CMOS LOGIC TESTER Aug 80	£11.98
		CLICK ELIMINATOR April 79	£67.70 Or less case £49.98

ADVENTURES WITH DIGITAL ELECTRONICS

New book by Tom Duncan in the popular 'Adventures' series. This book of entertaining and instructive projects is designed for hobbyists, and students. It provides a stepping stone to the microprocessor.

The first part deals with the properties of some basic ICs used in digital electronics. The second part gives details of how to build eight devices — shooting gallery, 2 way traffic lights, electronic adder, computer space invaders game, etc. For each project there is an explanation of 'how it works' and also suggestions for 'things to try'.

No soldering — all circuits built on 2 Bimboard 1 breadboards. Adventures with Digital Electronics book £3.25. Component pack £42.50 ref. ETDC. All the components needed including 2 breadboards and hexadecimal keyboard. Available less breadboards £29.98 ref. ETDF. Both less battery.

MAGENTA ELECTRONICS LTD

EW23, 135 HUNTER ST., BURTON-ON-TRENT, STAFFS

DE14 2ST 0283 65435. MON-FRI 9-5. MAIL ORDER ONLY

ADD 45p P&P
TO ALL ORDERS

ACCESS and BARCLAYCARD (VISA)
ORDERS ACCEPTED BY PHONE OR
POST.
SAE ALL ENQUIRIES.

Prices inc. VAT
OFFICIAL ORDERS WELCOME
OVERSEAS Payment must be in sterling.
IRISH REPUBLIC and BFPO UK
PRICES EUROPE — UK PRICES +10%
ELSEWHERE — Write for Quote.

Desk-top Ten Way Manual Exchange (key & lamp unit)
£8 + £1.80 P&P

Recent Style P.O. Telephones
£4.75 + £1.80 P&P
2 for £9 + £2.50, 5 for £20 + £5

Older style black telephones, £3, p&p as above. Our leaflet explains how to use G.P.O. phones in home intercom systems.

Operator's Headset with Mic. & 4 Pole Jack
£2.75

5 Digit Counters 48V coil. Non resettable
75p

UNISELECTORS, 50v, 4 Bank +, Homing Bank, 25 way £3.50

D CONNECTOR SOCKETS with cover, 50 way
£2

50V 8A TRANSFORMER. Ideal for big power supply unit or amplifier £12 inc. p&p. BEAT THAT!

Various stabilised power supplies available — Excellent prices send for details.

FREE on request — Leaflet "D.I.Y. Telephone Systems and Automatic Exchange Design"

LOW-COST, RUGGED

TEMPERATURE CONTROL

HIGH QUALITY

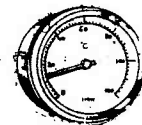

TEMP. GAUGE 0° - 120°C
Remote sensor on 38" capillary, panel mounting dial 55mm. dia.

ONLY £2.50

16A 240V RANGE THERMOSTAT

Wide control range (low room temp. to over boiling point) Sensor on 22" capillary. £2.30, including control knob

RANCO THERMAL CUT-OUT 100°C

15A 240V. Sensing coil on 41in. capillary panel mounting with reset button £1.20

BUY ONE EACH OF ABOVE FOR £5.50

LIGHT DEPENDENT RESISTORS in plastic housing with window, heavy-duty lead. Similar to ORP 61. You normally pay well over double for resistor alone. Only 30p or £2.35 for 10.

GEARED Synchronous motor, 8 r.p.m., 240V A.C. 3 Watt £2.

SOLENOID GAS VALVE, 240V A.C. 5 P.S.I. suitable for non-corrosive fluids. £2.20

BULGIN 3 pin free plug & panel socket. 2A 240V 50p

AUTOMATIC DIAL UNIT. (mains powered). These units connect into a telephone and dial a number when a punch-card is inserted. Card & instructions supplied. Cards readily available. Many uses. Only £8 + £1 p&p



L.E.M. SERVICES
22 Emscote Road,
Warwick,
Warwickshire

ADD 50p P&P
ORDERS OVER
£7.50 POST FREE
unless stated otherwise

ALL ITEMS — MONEY BACK IF NOT DELIGHTED.

The WERSI Concept...

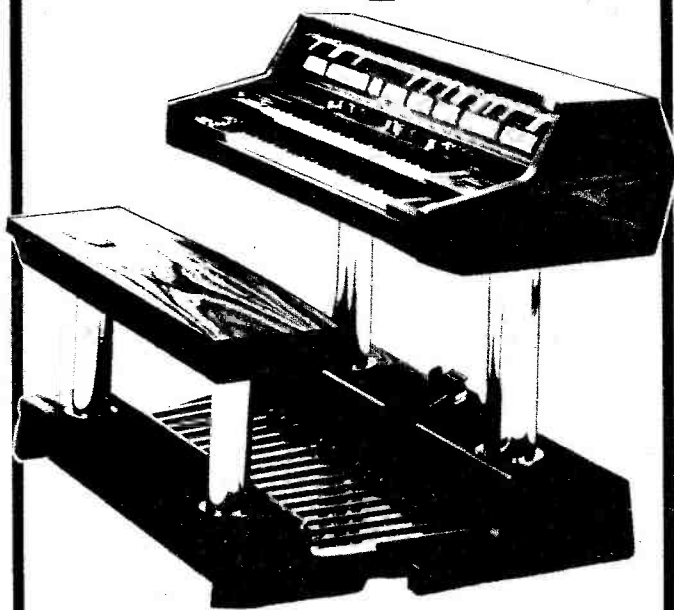

Now you can indulge your ambition to spend more time playing music. At the same time you can build a superb organ at home, yourself, and it will cost you less than half the ready assembled price. You need no previous experience in electronics or carpentry — WERSI makes it easy.

Do you have to be a virtuoso or a music lover to benefit from building a WERSI organ? No . . . this would mean failure to recognize the sense of the hobby. Even after your project is completed you will be able to discover new excitement from the world of music. Whether you play haunting blues stomping disco, liturgical hymns or classic renditions the new generation of WERSI organs will make your life more enjoyable. Want to know more? Just fill in the coupon below, and we'll send you all the information.



WERSI ORGANS & PIANOS LTD
14-15 Royal Oak Centre, Brighton Road,
Purley, Surrey. Tel: 01-668 9733.

PLEASE SEND ME FURTHER DETAILS OF THE WERSI RANGE

NAME

ADDRESS

Send to WERSI ORGANS & PIANOS LTD.,
14-15 Royal Oak Centre, Brighton Road, Purley, Surrey

WERSI... are growing! HERE'S WHERE...

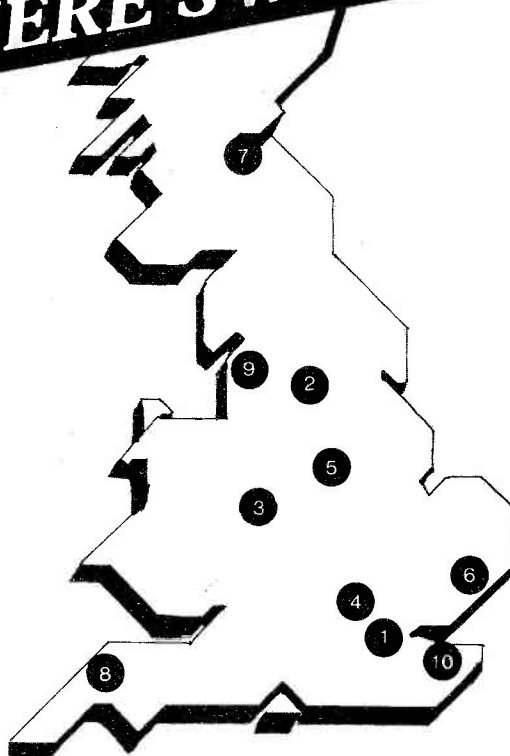

There are now TEN retail outlets for WERSI ORGANS and kits and there's a friendly welcome awaiting you at all the showrooms listed below. We offer free demonstrations and a technical support service second to none. Pop in and discover The World of WERSI for YOURSELF.

- 1 AURA SOUNDS LTD
14-15 Royal Oak Centre, Brighton Road, Purley, Surrey 01-668 9733
- 2 AURA SOUNDS LTD
17 Upper Charter Arcade, Barnsley, S. Yorks. 0226 5248
- 3 AURA SOUNDS LTD
1729 Coventry Road, South Yardley, Birmingham 021-707 8244
- 4 ELECTRO VOICE SALES LTD
Maple Cross Industrial Estate, Denham Way, Rickmansworth, Herts. Tel. Rickmansworth 75381
- 5 ELECTRO VOICE SALES LTD
389 Aspley Lane, Nottingham 0602 296311
- 6 ELECTRO VOICE SALES LTD
488 Felixstowe Road, Ipswich, Suffolk 0473 710051
- 7 ELECTRO VOICE SALES LTD
626 Lanark Road, Juniper Green, Edinburgh 14 031-441 4248
- 8 MICRO DIY CENTRE LTD
Albany Road, Newquay, Cornwall 063 73 5953
- 9 TWS LTD
185 Walton Summit Centre, Bamber Bridge, Preston, Lancs. 0772 37249
- 10 WAVEBAND LTD
29 Oxford Street, Whitstable, Kent 0227 262006

Want to know more about WERSI? Look for the other advertisement in this issue and send the coupon to the Head Office address below—we'll send you free details.



WERSI ORGANS & PIANOS LTD
14-15 Royal Oak Centre, Brighton Road,
Purley, Surrey. Tel: 01-668 9733

FUEL GAUGE

Moving coil meters? How passé. If Ford is prepared to spend millions of pounds on computer-aided design and robot assembly, the least you can do is fit your car with an electronic fuel gauge. Design by A. M. Smithers.

The standard petrol gauge, as fitted to most cars, is of a primitive 'hot-wire' design, the gauge responding to the heating effect of the current through it, which in turn varies with the resistance of the fuel gauge sender unit located in the fuel tank. The chief disadvantage of such a gauge is the inaccuracy of reading. Running out of petrol is advantageous only in certain circumstances and even then it would be nice to know exactly when it was going to occur!

A far more elegant, and indeed, much prettier solution would be a bargraph type display which could be accurately calibrated. With the help of the LM3914 bargraph display driver this can easily be effected. The standard sender unit in the tank is retained, but the petrol gauge is disconnected at the instrument panel and the sender unit is, instead, connected to the input. R2 provides the current source for the sender unit previously obtained from the gauge itself. Please note that considerable adjustment is provided on the circuit resulting in the value of R2 and, indeed, the resistance of the sender unit being not at all critical.

The voltage developed across the sender unit of the car in which the prototype was fitted varied from around 10V when empty to around 2V when full. A 741 operational amplifier is used to invert this signal by comparing it with a 5V reference provided by R4 and R5. The output of the op-amp varies from about 0V5 when the tank is empty to about 8V when it is full. This output is now of the correct sense to be fed to a standard LM3914 expanded scale voltmeter. The potential divider formed by R7 and PR1 provides a full scale adjustment which may be calibrated against a brimming full petrol tank. Similarly PR2 provides a zero adjustment for calibration against an empty tank.

Construction

The circuit is relatively simple and may be constructed on Veroboard or the PCB design as illustrated. IC sockets are recommended, particularly to novice constructors, as LM3914s do not come cheap and removing an 18-pin IC is no easy task in any case. The LEDs may be soldered directly to the board as shown or may be mounted remotely, for instance on the car dashboard with flying lead connections to the PCB. If mounting the LEDs on the board specified, please note that 0.125" LEDs must be used as 0.2" types will not fit!

R2, the 100R 2W resistor is not of a critical value and to save costs, on the prototype this component was made up of 4x470R 1/2W resistors in parallel. Any similar combination resulting in a power handling of 1W5 or more may be used.

Provision is made on the PCB for converting the circuit to dot-mode display. Although this modification would not be advantageous for a fuel gauge, the project can of course be used for

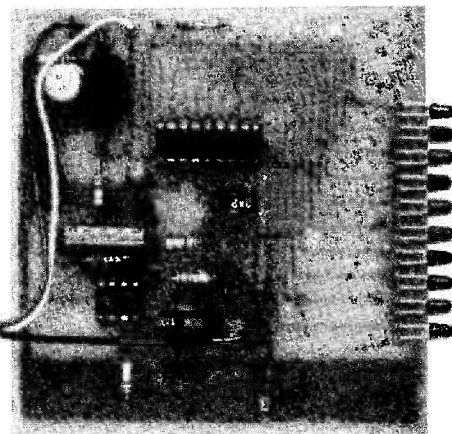

HOW IT WORKS

A current source for the fuel gauge sender unit is provided by R2. A voltage proportional to the resistance of the sender is therefore developed between the input and ground. In a typical vehicle this voltage will vary from 2V when full to around 9V when empty. This variable input is inverted around a reference voltage derived from R4 and R5 by a unity gain inverter consisting of IC1, R3 and R6. C1 is deliberately larger than is normal for frequency compensation to slow down the response of the circuit, thus providing a far more static display, free from annoying flicker. A variable potential divider formed by R7 and PR1 sets the FSD of the LM3914 bargraph display driver.

PR2 serves two purposes: the setting of this pot adjusts the zero level of the voltmeter, while the value sets the LED current. A value of 2k2 was chosen to give an LED current of around 7 mA according to the formula:

$$I_{LED} = \frac{1.2(10 + R)}{R}$$

where R is the value of PR2 in kilohms. A current of 6 mA per LED with all LEDs illuminated corresponds to a maximum dissipation in IC2 of around 600 mW which is inside the rated maximum of 660 mW.

The components ZD1, R1 and Q1 form a simple stabilised power supply of around 10V. This value allows for a weak battery while still maintaining accuracy.

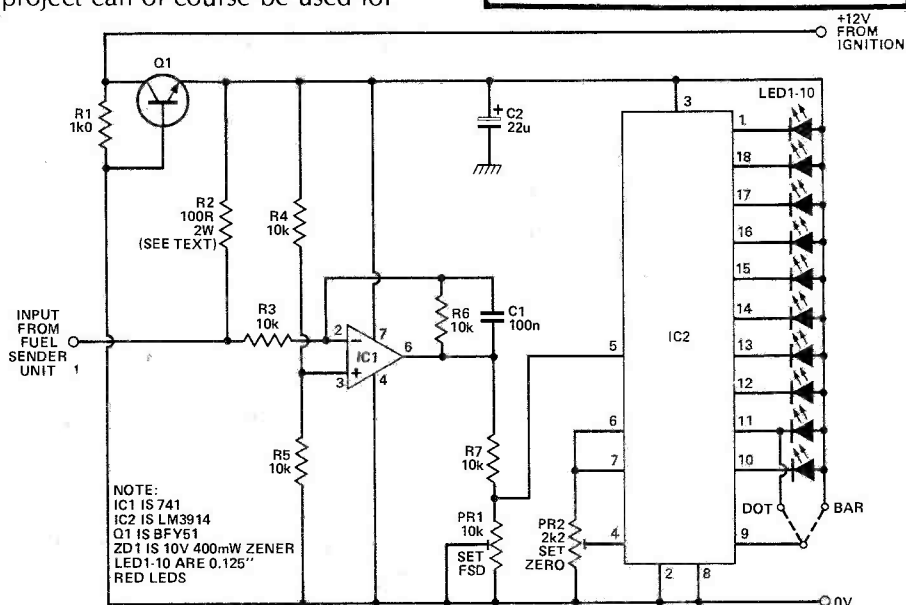

Fig. 1

any purpose requiring a monitor with a response that is inversely proportional to a linear input.

Testing And Calibration

After assembly of all components, connect the unit to a 12V supply and short the input terminal temporarily to 0V. It should be now possible by adjustment of PR1 to obtain a full 10 LED display with adjustment to at least half FSD. With the input shorted to +10V PR2 should adjust for no LEDs illuminated, again with considerable adjustment both ways. If the unit fails to function check for solder shorts, misfitted components, broken PCB tracks and faulty components — in that order.

To calibrate the unit it is obviously necessary to have access to the car with fuel tank full and empty; we recommend that the following procedure is adopted. Run the car until the tank is nearing empty. Drain the tank into a suitable container by disconnecting the fuel line at the pump and refill the tank with about 2-3 pints of fuel to allow a certain safety margin even when the gauge registers empty. Connect the unit temporarily to the car and after allowing the tank contents to settle, accurately measure the voltage at the input and record this value. Replace the tank contents, drive to a garage and fill the tank completely with fuel. Again accurately measure the voltage at the input.

Remove the unit to the test bench, apply power and connect a low value potentiometer between the input and ground. Now using the recorded values, the unit may be calibrated on the bench by applying the correct voltages by adjustment of the potentiometer. This method of calibration is necessary because the two adjustments are highly interactive and calibration would otherwise entail filling and draining the fuel tank several times, which would be time-consuming and possibly expensive. When calibration is complete, seal the presets with wax or nail varnish and finally install the unit in the car. Take care not to allow the track around the edge of the PCB touch the chassis when mounting the unit — this is the +10V rail and blown fuses will result.

The display brightness is set by the value of PR2. This value is chosen to give a current of about 6 mA per LED which corresponds to a dissipation of around 600 mW in the LM3914 when all LEDs are

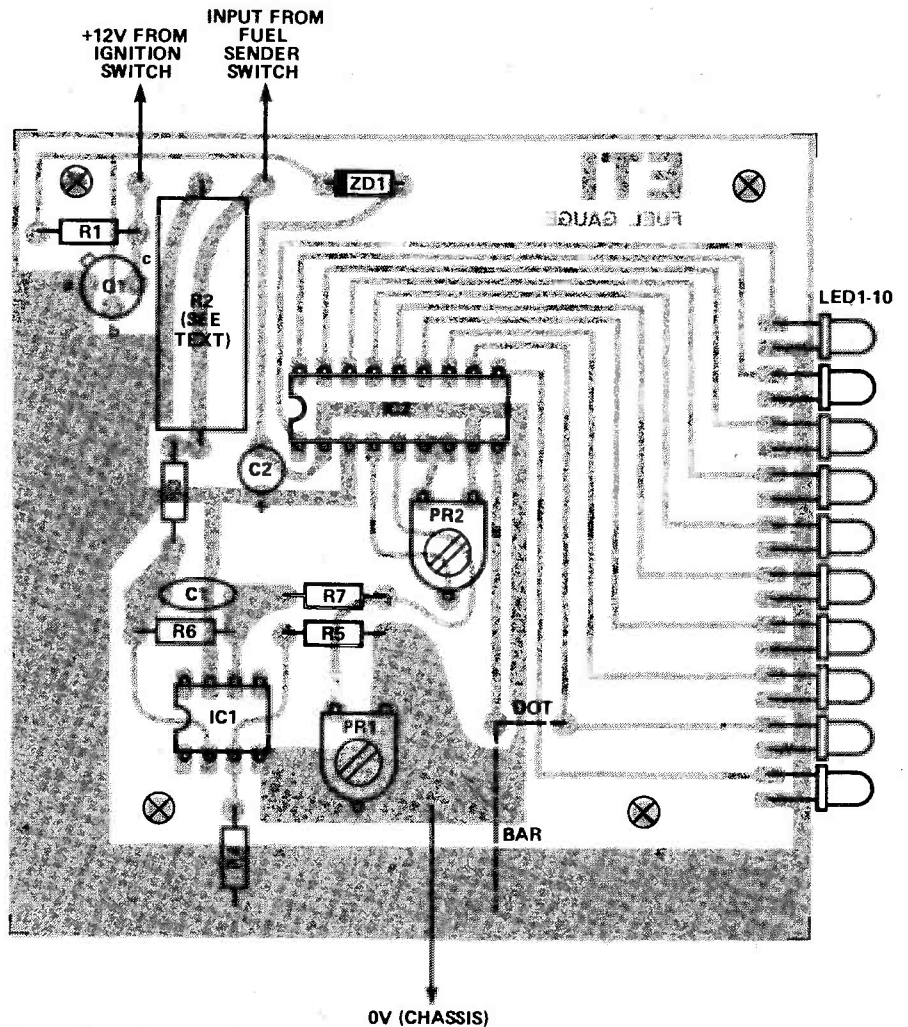
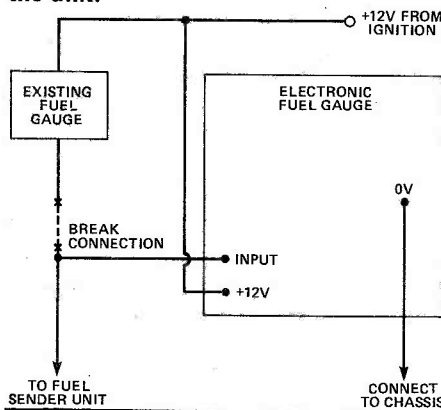

Fig. 2 (Above) Component overlay. This is slightly altered from the prototype shown.

Fig. 3 (Below) Connection details for the unit.



illuminated. As the maximum allowable dissipation of the device is 660 mW, on no account should the value of PR2 be reduced.

A design point is that the display is of 10 LEDs and most modern cars have tank capacities of around 10 gallons. Thus an approximate direct readout of 'gallons remaining' is obtained and a fair estimation of fuel consumption may be made.

PARTS LIST

Resistors (all $\frac{1}{4}$ W, 5% except where stated)
 R1 1k0
 R2 100R 2 W (see text)
 R3-7 10k

Potentiometers
 PR1 10k miniature horizontal preset
 PR2 2k2 miniature horizontal preset

Capacitors
 C1 100n polyester or polycarbonate
 C2 22u 16V tantalum

Semiconductors
 IC1 741
 IC2 LM3914
 Q1 BFY51 or similar
 ZD1 10V 400mW zener
 LED1-10 0.125" red LEDs

Miscellaneous
 PCB (see Buylines); hardware for mounting

BUYLINES

No problems with any of the components here; everything should be sold by everybody, and most of it could be found in your junk box. The PCB can be obtained using the PCB Service order form on page 91.

Sinclair ZX Spectr

**16K or 48K RAM...
full-size moving-
key keyboard...
colour and sound...
high-resolution
graphics...**

**From only
£125!**

First, there was the world-beating Sinclair ZX80. The first personal computer for under £100.

Then, the ZX81. With up to 16K RAM available, and the ZX Printer. Giving more power and more flexibility. Together, they've sold over 500,000 so far, to make Sinclair world leaders in personal computing. And the ZX81 remains the ideal low-cost introduction to computing.

Now there's the ZX Spectrum! With up to 48K of RAM. A full-size moving-key keyboard. Vivid colour and sound. High-resolution graphics. And a low price that's unrivalled.

Professional power – personal computer price!

The ZX Spectrum incorporates all the proven features of the ZX81. But its new 16K BASIC ROM dramatically increases your computing power.

You have access to a range of 8 colours for foreground, background and border, together with a sound generator and high-resolution graphics.

You have the facility to support separate data files.

You have a choice of storage capacities (governed by the amount of RAM). 16K of RAM (which you can update later to 48K of RAM) or a massive 48K of RAM.

Yet the price of the Spectrum 16K is an amazing £125! Even the popular 48K version costs only £175!

You may decide to begin with the 16K version. If so, you can still return it later for an upgrade. The cost? Around £60.



Ready to use today, easy to expand tomorrow

Your ZX Spectrum comes with a mains adaptor and all the necessary leads to connect to most cassette recorders and TVs (colour or black and white).

Employing Sinclair BASIC (now used in over 500,000 computers worldwide) the ZX Spectrum comes complete with two manuals which together represent a detailed course in BASIC programming. Whether you're a beginner or a competent programmer, you'll find them both of immense help. Depending on your computer experience, you'll quickly be moving into the colourful world of ZX Spectrum professional-level computing.

There's no need to stop there. The ZX Printer – available now – is fully compatible with the ZX Spectrum. And later this year there will be Microdrives for massive amounts of extra on-line storage, plus an RS232 / network interface board.

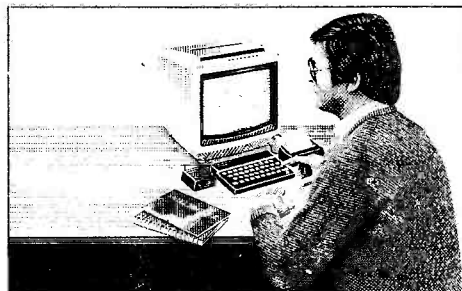

Key features of the Sinclair ZX Spectrum

- Full colour – 8 colours each for foreground, background and border, plus flashing and brightness-intensity control.
- Sound – BEEP command with variable pitch and duration.
- Massive RAM – 16K or 48K.
- Full-size moving-key keyboard – all keys at normal typewriter pitch, with repeat facility on each key.
- High-resolution – 256 dots horizontally x 192 vertically, each individually addressable for true high-resolution graphics.
- ASCII character set – with upper- and lower-case characters.
- Teletext-compatible – user software can generate 40 characters per line or other settings.
- High speed LOAD & SAVE – 16K in 100 seconds via cassette, with VERIFY & MERGE for programs and separate data files.
- Sinclair 16K extended BASIC – incorporating unique 'one-touch' keyword entry, syntax check, and report codes.

um



The ZX Printer - available now

Designed exclusively for use with the Sinclair ZX range of computers, the printer offers ZX Spectrum owners the full ASCII character set - including lower-case characters and high-resolution graphics.

A special feature is COPY which prints out exactly what is on the whole TV screen without the need for further instructions. Printing speed is 50 characters per second, with 32 characters per line and 9 lines per vertical inch.

The ZX Printer connects to the rear of your ZX Spectrum. A roll of paper (65ft long and 4in wide) is supplied, along with full instructions. Further supplies of paper are available in packs of five rolls.

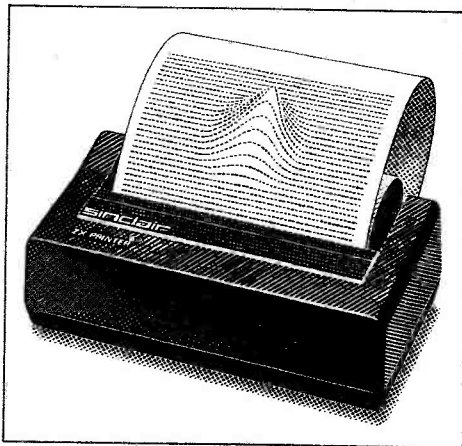

The ZX Microdrive - coming soon

The new Microdrives, designed especially for the ZX Spectrum, are set to change the face of personal computing.

Each Microdrive is capable of holding up to 100K bytes using a single interchangeable microflop.

The transfer rate is 16K bytes per second, with average access time of 3.5 seconds. And you'll be able to connect up to 8 ZX Microdrives to your ZX Spectrum.

All the BASIC commands required for the Microdrives are included on the Spectrum.

A remarkable breakthrough at a remarkable price. The Microdrives are available later this year, for around £50.



ZX Spectrum software on cassettes - available now

The first 21 software cassettes are now available directly from Sinclair. Produced by ICL and Psion, subjects include games, education, and business/household management. Galactic Invasion... Flight Simulation... Chess... History... Inventions... VU-CALC... VU-3D... 47 programs in all. There's something for everyone, and they all make full use of the Spectrum's colour, sound and graphics capabilities. You'll receive a detailed catalogue with your Spectrum.

RS232/network interface board

This interface, available later this year, will enable you to connect your ZX Spectrum to a whole host of printers, terminals and other computers.

The potential is enormous. And the astonishingly low price of only £20 is possible only because the operating systems are already designed into the ROM.

sinclair

Sinclair Research Ltd, Stanhope Road,
Camberley, Surrey GU15 3PS.
Tel: Camberley (0276) 685311.

How to order your ZX Spectrum

BY PHONE- Access, Barclaycard or Trustcard holders can call 01-200 0200 for personal attention 24 hours a day, every day. **BY FREEPOST**- use the no-stamp needed coupon below. You can pay by cheque, postal order, Access,

Barclaycard or Trustcard.

EITHER WAY- please allow up to 28 days for delivery. And there's a 14-day money-back option, of course. We want you to be satisfied beyond doubt - and we have no doubt that you will be.

To: Sinclair Research, FREEPOST, Camberley, Surrey, GU15 3BR.

Order

Qty	Item	Code	Item Price £	Total £
	Sinclair ZX Spectrum - 16K RAM version	100	125.00	
	Sinclair ZX Spectrum - 48K RAM version	101	175.00	
	Sinclair ZX Printer	27	59.95	
	Printer paper (pack of 5 rolls)	16	11.95	
	Postage and packing: orders under £100	28	2.95	
	orders over £100	29	4.95	
				Total £ _____

Please tick if you require a VAT receipt

*I enclose a cheque/postal order payable to Sinclair Research Ltd for £ _____

*Please charge to my Access/Barclaycard/Trustcard account no. _____

*Please delete/complete as applicable _____

Signature _____

PLEASE PRINT

Name: Mr/Mrs/Miss _____

Address _____

ETI 901

FREEPOST - no stamp needed. Prices apply to UK only. Export prices on application.

MEMOTECH



MEMOPAK 16K For those just setting out on the road to real computing, this pack transforms the ZX81 from a toy to a powerful computer. Data storage, extended programming and complex displays become feasible. For even greater capacity, memory packs can be added together (16 + 16 + 16K or 16 + 32K). The MEMOPAK 32K and the MEMOPAK 64K offer large memories at economical prices.

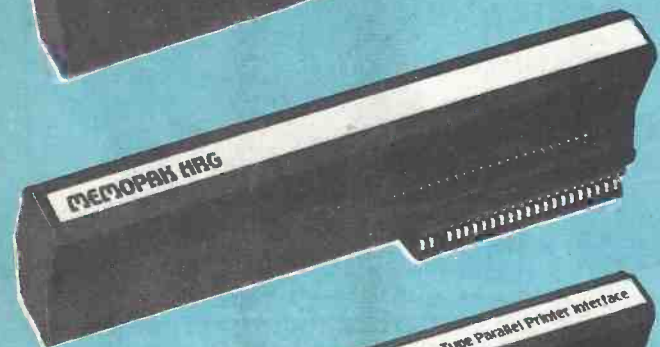

MEMOPAK HRG This pack breaks down the constraints imposed by operating at the ZX81 character level and allows high definition displays to be generated. All 248 x 192 individual pixels can be controlled using simple commands, and the built in software enables the user to work interactively at the dot, line, character, block and page levels. Scrolling, flashing and animation are all here.



MEMOPAK Centronics I/F The BASIC commands LPRINT, LLIST and COPY are used to print on any CENTRONICS type printer. All ASCII characters are generated and translation takes place automatically within the pack. Reverse capitals give lower case. Additional facilities allow high resolution printing. The full capabilities of your printer are now under the control of the ZX81.



MEMOCALC The screen display behaves as a 'window' on a large sheet of paper on which a table of numbers is laid out. The maximum size of the table is determined by the memory capacity, and with a MEMOPAK 64K a table of up to 7000 numbers with up to 250 rows or 99 columns can be specified. Each location in the table can be either a number which is keyed in or a formula which generates a number. Every time the command to 'calculate' is given, all the formulae in the table are re-evaluated. Spreadsheet analysis started as an aid to cash-flow analysis, but this powerful tool has now been generalised and MEMOCALC with its special ability to perform iterative calculations is invaluable in the performance of numerical tasks.

- 16K £26.00 + £3.90 VAT £29.90
- 32K £43.43 + £6.52 VAT £49.95
- 64K £68.70 + £10.30 VAT £79.00
- HRG £34.70 + £5.20 VAT £39.90
- CI/F £34.70 + £5.20 VAT £39.90
- MEMOCALC £26.00 + £3.90 VAT £29.90
- KEYBOARD WITH INTERFACE
£43.43 + £6.52 VAT £49.95

Memotech products are available at larger branches of WHSMITH

realises the ZX81 potential

The Memotech approach to microcomputing is to take the well-proven and popular ZX81 as the heart of a modular system. This small computer houses the powerful Z80A processing unit and acts as the central processor module through which the MEMOPAKS operate.

Memotech has a reputation for professional quality, producing units which are designed to fit perfectly, to look well-balanced, and to work efficiently and reliably.

The modular approach gives ZX81 owners the freedom to design the system they really need. Furthermore, the intercompatibility of the modules ensures that later additions will click straight in, to give you a system that grows with your ambitions and abilities.

To ensure that your expectations are realised, care is taken at every stage to design features into the system to anticipate your frustrations and to forestall them. For example:

A) Memories are cumulative e.g. 16K and 32K can be added to the MEMOPAK 16K or even to the Sinclair 16K RAM pack.

B) The HRG firmware allows commonly used constructions (such as scrolling, shading and labelling graphs), which might otherwise be beyond the user's programming capabilities, to be evoked by a few simple commands.

C) The Centronics I/F converts ZX81 character codes into ASCII and extends the print line to the width of the printer, still using the LLIST, LPRINT and COPY commands.

As one example, a system with 16K of memory and MEMOCALC is all that is required to perform sophisticated numerical calculations giving the same results as a computer at 10 times the price. The problem may be as complicated as a cash flow or production schedule, or as simple as household accounts or pocket money budgeting. If the bank manager wants to see the cash flow, then a single print instruction to the Centronics I/F will give a printout which is more than acceptable to any bank.

The example system which is shown below, on the other hand, would satisfy the needs of someone who wanted to enter data via a light-touch keyboard, construct and label graphs, and then copy the screen to an 80-column printer. Only 16K of memory is used here but with additional memory, more than one video page can be stored. Up to 7 successive pages can be displayed cyclicly to give animated displays.

Looking forward, Memotech will continue to back the ZX81 through 1983 with fast storage devices, pressure sensitive electronic drawing boards and more software packs including a wordprocessor, an RS232 interface and a Z80 assembler.

MEMOPAKS may be ordered by post (cheque, Access/Barclaycard quoting number) or by telephone. Please make cheques payable to Memotech Ltd. and please include £2.00 per unit for packaging and postage inland (overseas £3.00).

We want to be sure you are satisfied with your Memopak - so we offer a 14-day money back guarantee on all our products.

MEMOTECH LIMITED
3 COLLINS STREET
OXFORD OX4 1XL ENGLAND

TEL. 0865 722102
TELEX 837220 ORCHID G



BUYER'S GUIDE TO CONQUERING THE UNIVERSE

Only a few shopping days to Christmas, and we're full of goodwill to all men and xenophobia towards aliens. Peter Green has been killing as many as possible (aliens, that is), and this is how he got on.

No doubt you all think it's a pretty cushy job, playing video games day after day and getting paid for it too. That's because you're not sitting here trying to type this article with the twin ailments of Intellivision Thumb and Atari Cramp. The former is caused by excessive pressure on the direction disc through sheer panic when you're trapped by a falling boulder in *Astrosplash*. The second is the result of trying to keep a firm grip on the joystick while throwing the USS Enterprise all over the known universe.

Which brings me to my first complaint. Oh great video game companies, when are you going to produce a decent hand controller? The offerings of the two giants leave a lot to be desired. The Atari controller needs a lot of force on the joystick if you're to be certain you've closed the switches, and as a result the left hand which is gripping the controller base starts to go numb quite quickly: especially when you have to tighten your hold because you're starting to sweat and lose your grip. On the Intellivision the flat direction disc is, I think, a lot easier to use (although there are many in the office who'd dispute that), but I still find that in the excitement of a game I'm pressing too hard, which quickly makes the end of the thumb sore. I suppose the real answer is to cultivate a calm attitude during play, but this is almost impossible (maybe we should produce a book on Zen and the Art of Videogames!).

By far the worst problem with the Intellivision is the fire buttons on the sides of the Controller. These need a ridiculous amount of pressure to push them in, which isn't so bad when they have to be momentarily pressed; but in one game which required continuous pressure for rapid firing, I ended up dead because my hand simply couldn't grip the controller any longer. So loosen your springs, gentlemen!

The next problem was actually getting hold of anything to review! At this time of year it seems everyone has the same idea, and time after time I was told by the PR companies that they had nothing for me because everything was out on loan and none of the journalists would return it. This explains the lack of reviews for the Atari VCS in particular, and as for the Philips G7000 — I never managed to lay my hands on one.

Maybe I should propose a new video game in which a screenful of journalists acquire video games and when

they've had them for a certain length of time you can blast them with a 30 kW X-ray laser . . .

Eventually I managed to get a reasonable selection together, though, and play-testing began. It became apparent that there are three broad categories of game: ones where you have to kill an infinite series of strange things and get the highest number of points, those where you have to kill a finite number of strange things in the fastest possible time, and those that simulate some real human activity. The success or failure of any of these types depends mostly on how well the designer has struck the balance between challenge and skill level. If a game is so easy you can master it after playing it once, it's a bad game; so, too, is one that kills you off within 30 seconds no matter how much you practise. The ideal game is fairly easy at the lower levels but increases in difficulty at just the right pace to keep step with your increasing familiarity with it. It should be possible to play it again and again and always find that extra challenge that brings you back for more: unfortunately few games can achieve this.

One of the best guides to the success of the game, I found, was the number of people that started looking over my shoulder while I was playing, and how many of them fought to take my place when I went to the loo! There are a lot of dedicated gamers in our office and the highest scores that we give are not necessarily mine (in fact they're rarely mine!).

Star Raiders (Atari 400)

This is one of the best Star Trek simulations you can buy. The TV shows the view through the viewscreen of the Enterprise, with stars drifting past very realistically, and an array of readouts at the bottom giving co-ordinates, energy left, number of kills and so on. The joystick is used to steer the ship and aim and fire the photon torpedoes, while the keyboard gives functions such as forward and aft view, shields on/off, long range scan, galactic chart, attack computer on and hyperspace controls. Basically the idea is to protect your starbases by locating your enemy (and there's a lot of them) on the galactic chart, travelling to their location by hyperspace (a spectacular effect as you storm through the starfield) and kill all the aliens you find there. Simple, huh? Until you discover that the controls work as they would in real life so that when the joystick is pushed forward the ship's bow drops and the view

through the screen rolls up. Ditto left and right movements. This topsy-turvy system takes a bit of getting used to, and the only course is to stick at it until your brain finally clicks. Once you get the knack of steering you still have to cope with the fact that your photon torpedoes move with true perspective and dwindle in size, so aiming is an acquired art too. Mastering all this is quite satisfying, but once you've beaten the basic game and try to move up you find that the difficulty leaps enormously: your shields are no longer impervious, you quickly take a lot of damage and die fairly rapidly. This assumes you actually found any aliens in the first place, because on the higher levels you have to steer through hyperspace and this is damned difficult. No-one in the office has beaten this game on anything other than novice level, and our highest rating so far is Lieutenant Class 4.



Missile Command (Atari 400)

Another cracker for the 400, this is the one where a central missile base is trying to defend the cities on either side by shooting down the aircraft, satellites and nuclear warheads which are doing their best to decimate the landscape. The catch is that you have to position your target cursor just the right distance in front of the enemy because they only detonate if they fly into the explosion of your missile and it takes a finite time for your missile to reach its target. And don't miss — most of the warheads are Multiple Independent Re-entry Vehicles, so if you don't knock them out fast you suddenly find they split into half-a-dozen or so. Bonus points are awarded each time you clear the screen for cities saved and missiles not used, and the amount you score increases as the game progresses, but after a certain point the nasty smart bombs appear. These don't fly blindly into your fireballs, but will always dodge them if possible. This means you either have to lay a pattern of charges around them, or get good enough to hit them spot on. Tricky. Our maximum is 74,420, and we can recommend this as a good game.

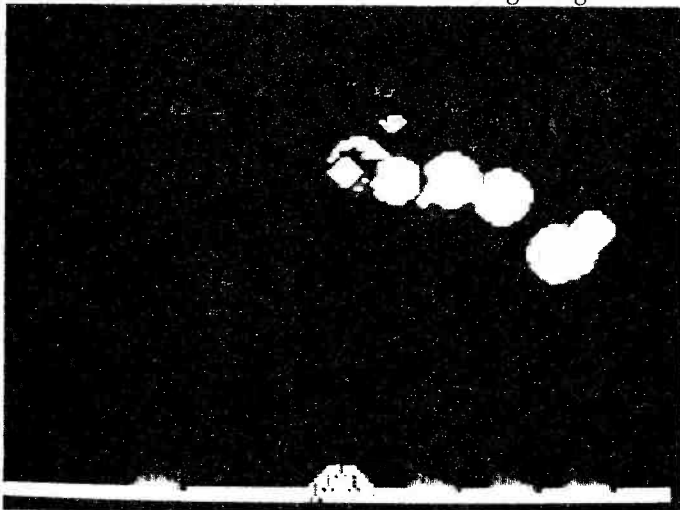

Space Invaders (Various)

Here I have to admit that I've never been able to understand the runaway success of this game — it bores me rigid. Anyway, what can I say? Everyone's seen this and knows that there's a screenful of aliens who fly in gradually descending rows while you try to stop them doing same by shooting upwards with your laser. Whoopee. Since I can't get up the enthusiasm to practise this one my score is derisory, but my brother-in-law's sister is so good she can get the score on a VCS up to all nines and then clock it round to zeroes. It's safe to say that if you can manage that you're not doing too badly.

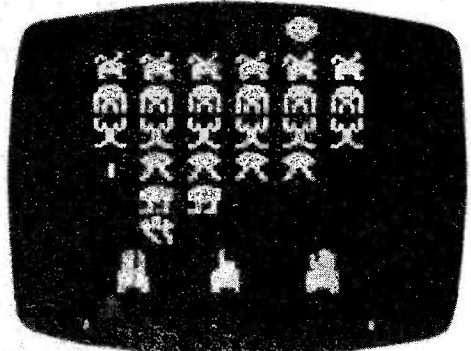

Defender (BBC Model B)

Possibly the best simulation of an arcade game on a micro that we've seen yet. Full colour, excellent high-resolution graphics, all the sound effects you could ask for and a fast, challenging game. Acornsoft have definitely come up with the goods on this one. The game follows the standard Defender format: your spaceship is flying over the surface of a planet populated by little men who are prone to being kidnapped by alien landers. Your task is to prevent this antisocial behaviour by lasering the alien ships before, during but not after — because if they complete their task by reaching the top of the screen, they turn into very fast mutants which plough straight into you. Extra points are awarded if you can rescue a human in mid-air, and even more if you land him safely. Once you've cleared the first wave things turn progressively nastier, with bombers, pods, swarms and other whatsits all after your blood. This is when you really need your smart bombs, which instantly detonate everything on screen: very useful in a tight corner. There are seven control keys for various functions so just getting yourself co-ordinated takes a while, but it's worth persevering. I started out by getting maximum scores of 450 (by ramming three landers!) but after a couple of hours I was soon getting respectable totals. Current office maximum resides with a colleague on Personal Computing Today, who racked up 54,350.

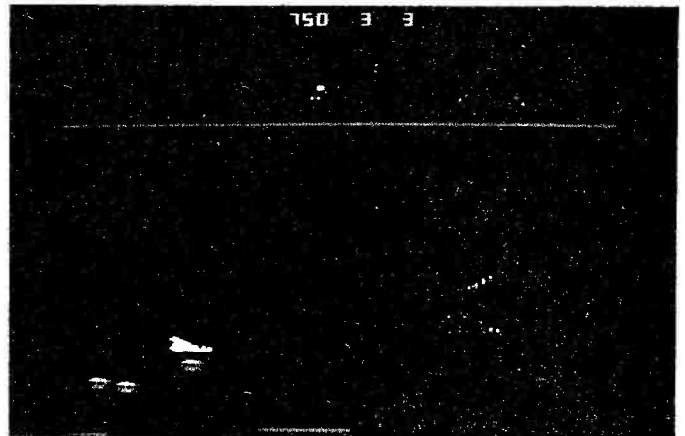

The Empire Strikes Back (Atari VCS)

This is one of the new releases for Christmas from Parker and quite good it is too. The game recreates the battle from the film of the same name, in which Luke Skywalker and his pals take on the Imperial Walkers in their snowspeeders on the ice planet Hoth. You are the pilot of a snowspeeder trying to prevent a line of walkers from reaching the right-hand side of your TV. The action actually takes place over an area eight screens wide, and a small radar view at the bottom of the screen tells you exactly where you are in the larger scheme of things. Walkers are tough critters — you have to hit them 48 times in the body to destroy them, whereas they can take you out with five shots or fewer. This would make the game almost impossible but for two things. The first is that for every two minutes you can keep the snowspeeder alive, you get 20 seconds of the Force being with you, which makes you invincible; as soon as this happens you can just sit there blasting away and ignoring enemy missiles. The second thing is the occasional appearance of very small 'bomb hatches' on the body of the walker; if you can get a laser bolt into one it destroys the walker immediately. The bad news is that if you play the harder games, these bomb hatches will often launch homing smart bombs which chase you for a considerable time (of course there's bonus points in it if you can shoot them down). There's an infinite sequence of walkers, and they get faster and more accurate as time goes on, so this game ends when your last snowspeeder has been destroyed, the object being to score as highly as possible. On game 13, the hardest (smart bombs and solid walkers that destroy you if you fly into them), the current maximum is 5,562.

Yar's Revenge (Atari VCS)

Now most of the time you can play a video game and when someone asks what you're doing, you can give a coherent answer. But when you reply that you're a Yar who's trying to kill the deadly Qotile with your Zorlon cannon, you tend to get forehead-tapping and pitying looks. Well, ignore the infantile plot and concentrate on the game: which isn't one of the most gripping we've played. You're a sort of intelligent space-going housefly (stop laughing at the back there) and your enemy, the Qotile, is hiding behind a shield. Your job is to break through the shield, either by shooting out cells from a distance or getting in close and eating them. Eating a cell or touching the Qotile loads your Zorlon cannon, which is the only thing which will destroy the Qotile (tough things, Qotiles). Shoot through the gap in the shield and pow! Exit one Qotile and enter another. To give some added spice the Qotile periodically turns into a spinner and fires itself

across the TV at you. Possibly a good game for the kids but it won't keep you engrossed for long. Our maximum score on the normal game with maximum difficult setting was 116,923. If you're interested, Yar's Revenge is the second game from the right on the top row at the end of Atari's TV ad.

Starstrike (Intellivision)

Now you've all seen this one — it's in the Mattel TV adverts. It doesn't take too much intelligence to figure out that this is meant to be as close to the Death Star canyon sequence from Star Wars as Mattel can get without breaching the copyright laws. Your ship is flying above a trench (actually your ship stays stationary and the trench rotates beneath you). You can manoeuvre about but you have to be careful not to hit any part of the enemy space station or the game's over. You can judge your position and height by the shadow under your craft. The score starts at 8000: it decreases steadily as time goes on and increases every time you shoot down the enemy ships which fly down the trench at you. The object of the game is to successfully bomb the five red targets that appear over the horizon and pass beneath your ship (if you haven't got out of position by chasing aliens). Get killed or fail to hit all five targets before your score reaches zero and it's bye-bye Earth — the red thingies take off and decimate the ol' home planet. The idea isn't bad, but the balance of the game could do with a bit of work: it's too easy to beat on the lowest level and too fast to beat at the higher ones. Our maximum — 6462 on level 1. There's a good video game lurking in the Death Star sequence, but this isn't it.

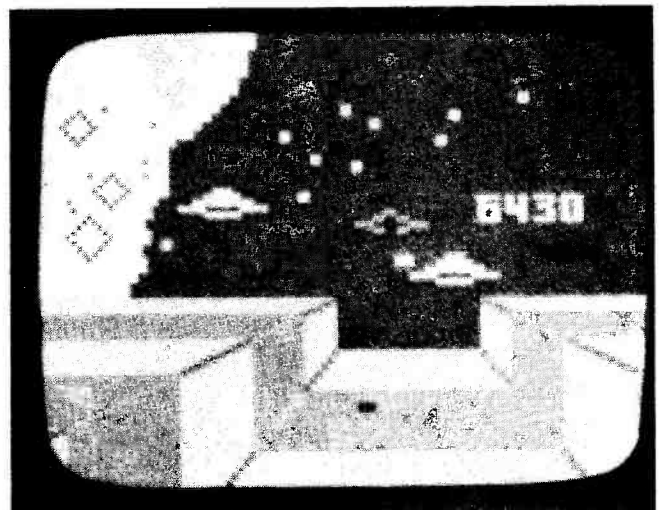

Astrosplash (Intellivision)

Superficially this seems almost identical to Space Invaders, and yet I found it a lot more to my liking. You have a laser base at the bottom of the screen which you can move right and left, and which fires upwards at all sorts of space debris which is dropping out of the skies towards you. Every time you hit an object, it explodes (and if you're lucky it detonates another piece which was flying too close): every time an object hits the ground, you lose points. Now and again large or small white 'spinners' start falling — you must hit these or you lose a base when they land. As your score goes up you can score points faster, but the action speeds up and you then get guided missiles which home in on your laser and attack UFOs which fly across the screen lobbing huge bombs at you. The main trick with this game is to get a good rapid-firing technique established, but as pointed out earlier, the stiffness of the

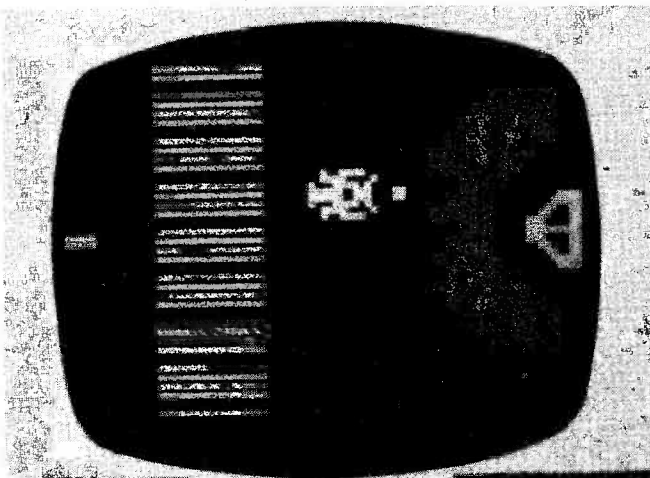

Mattel push-buttons gets you cramped very quickly. At least Mattel have had the decency to provide a pause facility on this game, so you can loosen up your fingers before carrying on. As is usual in games of this type, the various scoring levels are indicated by the background changing colour and some of them make the targets a bit harder to see; I'm not sure if this is deliberate obstruction or not! Not a bad game at all, and worth trying to beat our maximum of 23,190.

Skiing (Intellivision)

Not a bad little simulation, this, though if I were programming it I think I'd alter the rates of acceleration and deceleration which seemed a bit exaggerated to me. There's a choice of two courses, downhill or slalom, 15 degrees of mountain slope, and up to six different skiers so you can make it a team event with your friends. The difference between the two courses is that the downhill course is designed for speed, with a fair distance between gates (and mounds of snow to jump over), while the slalom requires some precision skiing with tight turns (which were a bit beyond my abilities!). The game is improved immensely by the excellent detail of the skiers (Mattel have always been best at this aspect of graphics) and by the sound effects, which include realistic thumps as you collide with the trees and a cheering crowd as you pass the finish line. Unfortunately I didn't seem to be able to complete the course in less than a minute (best time was 64.6 seconds, making me a hot-dogger), but I'll keep trying. Now where's that wax . . . ?

SNAFU (Intellivision)

Peculiar name for a game (especially if you know what it stands for — and we can't print it here), but quite good fun to play. There are four snakes on the screen, two controlled by the computer and two which can be steered using the hand controllers. There are various types of game based on two basic ideas: trap games and bite games. In the former the trail grows continuously so that a complex maze develops on the screen, and the object is to force your opponents to trap themselves and crash into a wall. The other type involves snakes of a finite length, the trick being to run your head over your opponent's tail and gradually eat him away. Some permutations allow the possibility of diagonal movement, some have obstacles which must be avoided. Once the number of snakes on the screen has been reduced to two, the computer takes it upon itself to play one of two rather catchy little tunes, just to make things a bit more entertaining. There's no score of ours to beat, since all the games involve you against an opponent. A good game when you're fed up with killing aliens.

Utopia (Intellivision)

Now here's an unusual one: this is a sort of graphics-based version of Kingdoms, where you rule an island community and score points by maximising the well-being of your people. Tyrants need not apply. You can play against an opponent, who takes the other island, or simply try to beat your previous best score. As head of the Treasury you can decide whether to buy fishing boats or PT vessels, crops, houses, schools, factories, forts, or hospitals: you decide whether to co-operate with your neighbour or wage war on him. Natural hazards include storms and hurricanes: unnatural hazards include pirate ships who sink your fishing vessels. The game consists of a number of rounds from 30 seconds to 2 minutes, after which you are told how many points you scored, how much your population has increased (or decreased), and the amount of gold in the treasury. I liked it.

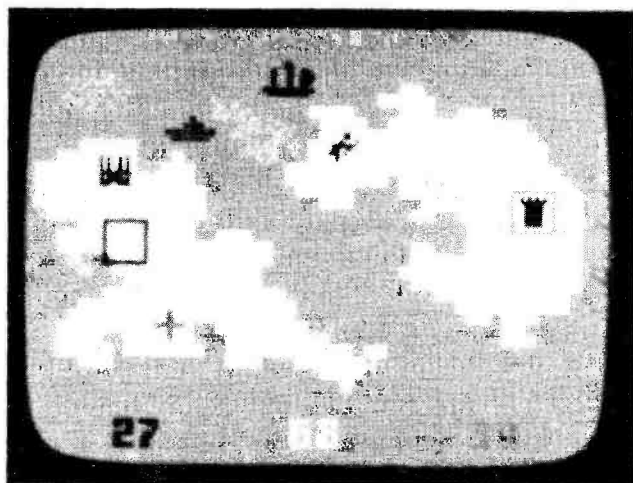

Dungeons And Dragons (Intellivision)

This is great! I've always been a fantasy lover and this is a really different type of computer game. Set off across the mountainous terrain towards Cloud Mountain, with the ominous snoring of the fearsome Winged Dragons in the background as they wait for their next meal — you. Plan your route carefully, as some mountains are impassable while the rest have caves containing arrows, tools, and fierce monsters to guard them. The caves and tunnels only light up as you pass along them so you have to become adept at tracking your prey. Some monsters leave visual clues to their presence (though what I thought were dragon droppings turned out to be something else) and some can be heard as you approach. It's up to you to learn the various signs and strengths of the foe, because the manual won't help you: in fact it was a long time before I realised what made the spiders dangerous. If you can keep at least one of your three men alive to the end, you get to find the two halves of the Crown of Kings, although when you do the finale is something of an anticlimax. There are four skill levels, sightseer, weekend adventurer, seasoned adventurer and hero, and I finally managed to reach hero, despite the incredible speed of the baddies and the paucity of arrows on this level. Who is this Conan chap anyway? One of Mattel's better games.

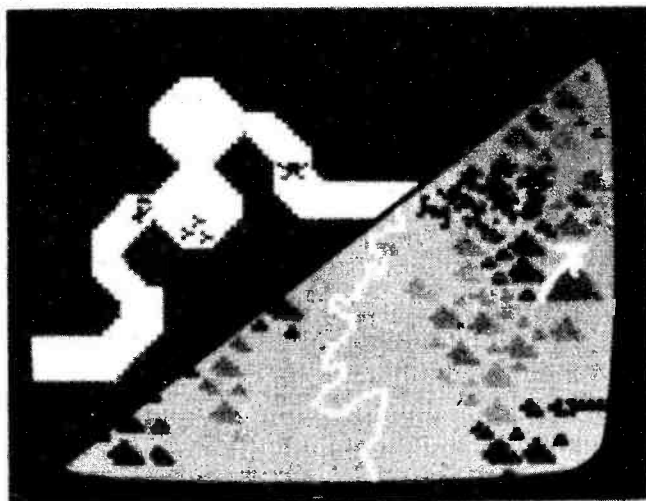

Tron — Deadly Discs (Intellivision)

Mattel have managed to tie up the licence for the home video game market from Disney (there are also Tron arcade games on the way), and this first cartridge is based on the Frisbee fights from the film (see the review on page 16). You take the part of Tron, facing three opponents on

the Game Grid in a duel using identity discs. You can move about, throw your disc in any of eight directions (judging the lead on your moving target if you don't want to miss), or block your opponents' disc when they aim at you. The bad guys enter the arena through doors which you can jam open — get two opposite each other and you can teleport through from side to side, giving strategical superiority as well as allowing you to recover one hit (three hits and you're dead). Should you clear the screen, however, one of Sark's Recognizers appears to repair the jammed doors. Knock out its robot eye, a devilishly tricky manoeuvre, and you get 10 times warrior value bonus points. Watch out after 10,000 points, though: your scoring rate has increased considerably but your opponents are faster and more accurate at aiming. Sometimes you'll get dark blue Leaders, who can carry homing discs or discs that count as two blows; the purple Bulldog warriors are slower but need two hits to kill them. After you reach a million points (and by now I've played enough to believe it's possible), the computer switches tactics and sends on orange guards with paralyzer sticks, which need four blows to kill them and can end the game simply by touching you. My new ambition is to get up to this stage of play: I've already racked up 242,500, and a curse on the homing disc that got me just short of reaching the quarter million! The only way to score highly, by the way, is to learn to use the hand controller by feel alone. If you keep looking down to see which button to push, you aren't going to last very long. This gets my vote as favourite game of the article.

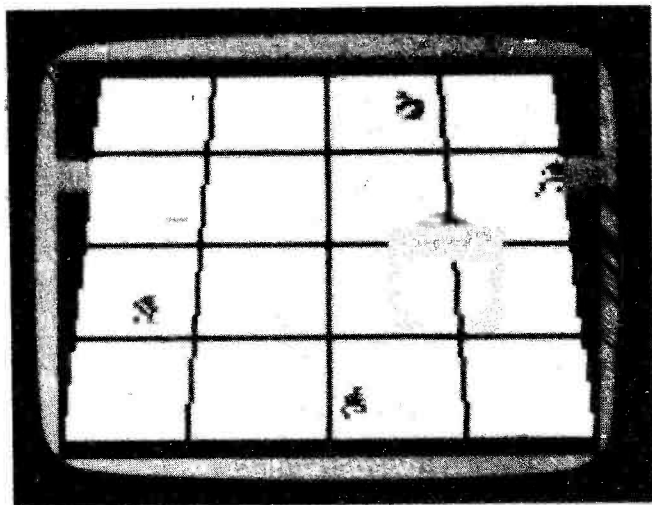

Preppie (Atari 400)

And this gets my vote as the best-written piece of 'non-alien' games software yet published. The game is based on the arcade game of Frogger, and the playing area is a golf course. Preppie is the American for caddie, and the poor soul has to retrieve a series of lost golf balls in a fixed time limit. The problem is that he has to traverse a fairway being criss-crossed with lawnmowers, golf carts, and on the harder levels, bulldozers (don't ask me what they're doing on a golf course), then leap from log to log, barge and alligator to cross a river. All the time you're playing, the computer is serenading you with a selection of catchy tunes in three-part harmony, and the graphics are quite superb. We particularly liked the bit where the caddie gets flattened out after hitting a lawnmower — sadists that we are. There are 10 difficulty levels, and no-one here has yet succeeded in surviving level 6 (it's the killer frog on the towpath that causes the problems). Our high score is 14,730. Very highly recommended, despite its rather frightening price tag of £23 (this is a tape, not a cartridge).

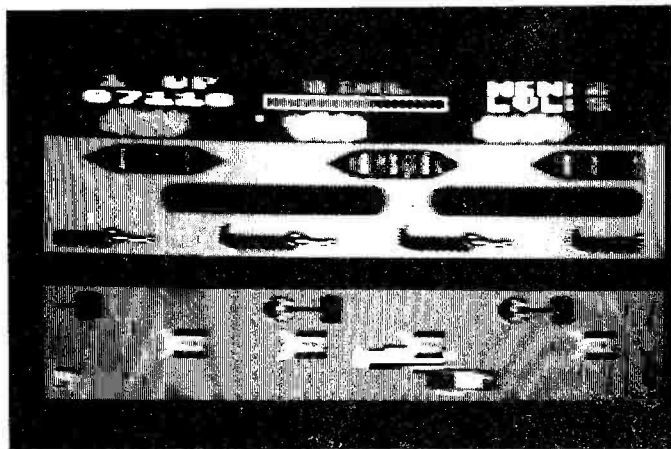

B-17 Bomber (Intellivoice)

The first of the games for the Intellivision that requires the use of the add-on Intellivoice module. You are flying a bombing mission over Europe during the Second World War, and throughout the flight you're getting a series of comments and warnings in a (pretty appalling!) Texan drawl. "Bandits at six o'clock", it announces, and you switch to the view from that gunnery position to shoot down der Luftwaffe. Sometimes this doesn't work, because there's a line of bullet holes across the canopy and your gunner is dead! Once you've reached your target, you can sight through the bomb doors and release your thousand-pounders ("Bawmbs awaay...") and hopefully hit something ("That was awn tarrgit..."). The cockpit displays leave a lot to be desired, considering the sort of quality you can get out of an Intellivision: just a green horizon wobbling about as you try to dodge the flak. Not a bad game, but I think I'd want to see some better software than this before I went out and bought an Intellivoice.

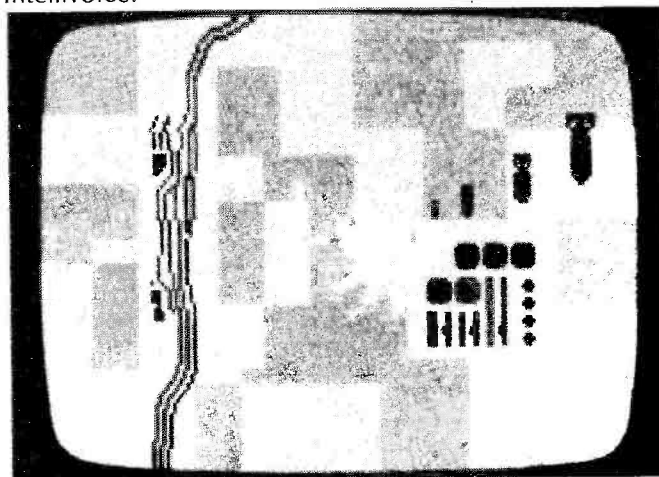

Cloudburst (VIC 20 cartridge)

We've included this one for people who aren't very good at Space Invaders etc. Basically it's just sheer carnage, with enemy practically throwing themselves onto your laser bolts. At some unspecified future time, the Earth's atmosphere has become so polluted that mutant creatures have spawned in the acid clouds and are creeping down amidst acid rain to ravage the planet. Your laser gun can fire up, or to the left and right to slaughter any creatures making their way across the surface after landing. The screen colours are restful tints of pink, red and blue, to counterpoint the machine-gun speed of your laser fire and the ferocity with which the mutants hurl themselves at you. In between games the VIC plays you a snatch of rather incongruous 12-bar boogie. The easiest

level is damn fast, and anyone who claims he can survive longer than 10 seconds on level 9 is a liar.

Jumbo Pilot/Sub Commander (Atari 400)

Here are two especially for those of you with very poor reflexes. You require the reaction time of a corpse to play these because they are 'real-time simulations' ie pretty slow. In Jumbo you have to take off, fly across country and land. It takes 11 minutes or so just to taxi into position and lift off, and you can then spend anything up to two hours watching the dials in the cockpit do very little, until you attempt to land and plough into the tarmac. Then all you can do is start again. Frustrating, huh? The least the author could have done was to include an option

to practise landing without going through the rest of the game. Our highest score is zero, since no-one's been able to land yet; but one of us did manage to do a barrel roll successfully!

Sub Commander is a simulation of World War Two submarine combat against shipping convoys in the Mediterranean. You have all mod cons like sonar, periscope, hydrophones and torpedoes, plus a satellite reconnaissance of the Med (in WW II? Oh well . . .). You stalk the ships, aim through the periscope and hopefully torpedo them before they blow you out of the water with depth charges. Rather more action in this game, but still a bit slower than my tastes run to. Highest score so far is 10,420.

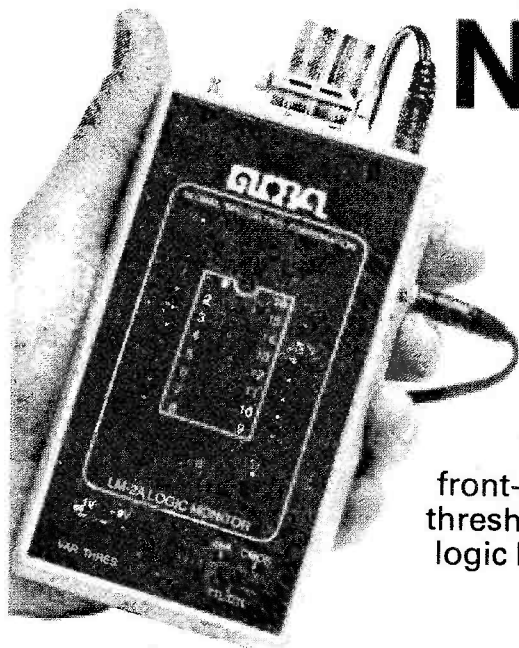
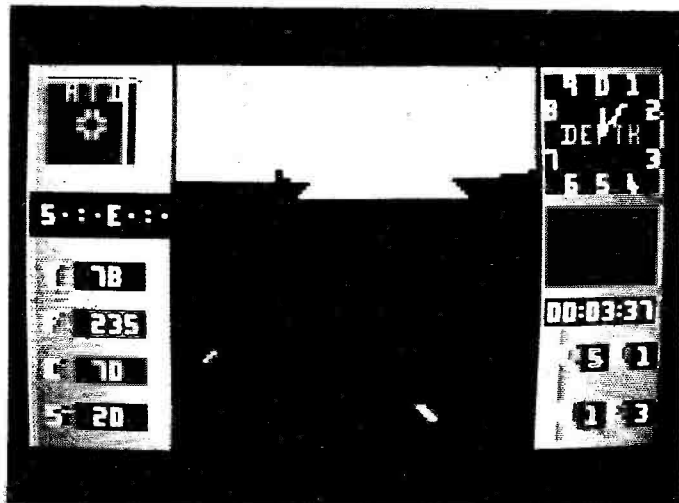
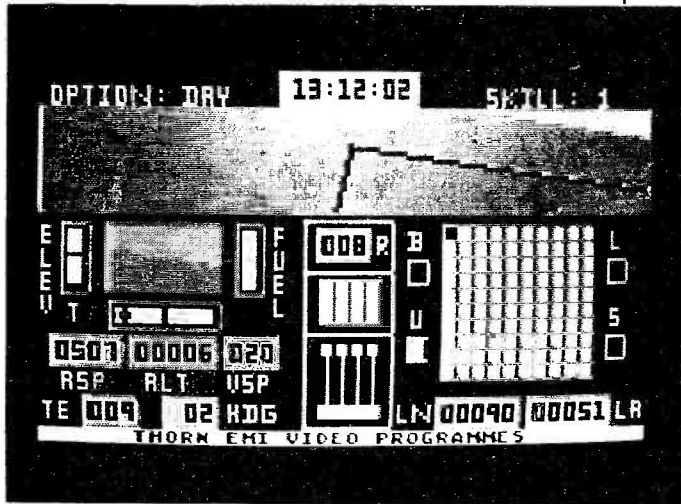

Now, really reason with IC's

With the new LM2A logic monitor from GSC, you can see just what's going on in an integrated circuit for only £87* The LM2A's sixteen LED indicators show the static and dynamic logic states of all the pins on 14 or 16-pin IC packages, and GSC's unique Proto-Clip provides rapid, reliable contact with the circuit.

You can use the LM2A with different logic families, too. A front-panel switch lets you select TTL or C-MOS, and a variable threshold control covers any voltage from +1V to +9V for other logic levels. It's small and light enough to hold in the hand, and operation is simplicity itself.

Take the logical course of action – fill in the coupon now.

* Price excluding P&P and 15% VAT.

GLOBAL SPECIALTIES CORPORATION



G.S.C. (UK) Limited, Dept 9L,
Unit 1, Shire Hill Industrial Estate,
Saffron Walden, Essex CB11 3AQ.
Telephone: Saffron Walden (0799) 21682.
Telex: 817477.

G.S.C. (UK) Ltd., Dept 9L, Unit 1, Shire Hill Industrial Estate, Saffron Walden, Essex CB11 3AQ			
Model LM2A	LOGIC MONITOR	Unit price inc. P&P 15% VAT £102.35	Qty. Reqd.
Name _____			
Address _____			
I enclose cheque/P.O. for £ _____ or debit by Barclaycard/Access/ American Express card no. _____ exp. date _____			
FOR IMMEDIATE ACTION – The G.S.C. 24 hour, 5 day a week service. Telephone (0799) 21682 and give us your Barclaycard, Access, American Express number and your order will be in the post immediately.			For FREE catalogue tick box <input type="checkbox"/>

CALCULATORS

CASIO SUPER DEALS



CASIO FX601P/602P
10+2 digit dot matrix, full alpha numeric upper and lower case, 50 functions. Up to 512 steps/88 memories. (601P up to 128 steps/11 memories.)
FX602P **£63.00** FX601P **£37.00**

FA2 CASSETTE INTERFACE **£19.00**

FP10 PRINTER FOR 602/702 **£40.00**

CASIO FX702P

dot matrix display basic language.
Up to 1880 steps/226 memories
Now only
£71.00

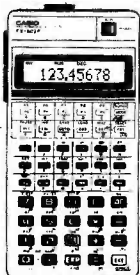

AX250
Multi function, dual display, dual time zones, 12/24 hour display. Versatile alarm/chronograph
£23.00



£21.00



£15.00

SHARP



EL5100

EL5100 61 functions, 24 digits, 10 memories, 80 steps **£49.95**
EL5103 63 functions, dot matrix, 6 memories, 80 steps **£29.95**

HP HEWLETT PACKARD ULTRA HIGH QUALITY CALCULATORS

HP11C SUPER DEAL PRICE
203 program lines, 21 addressable memories
NOW ONLY **£89.95**

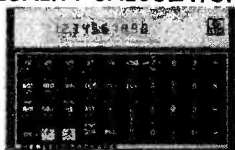

HP10C New Model **POA**

HP16C New Model **£119.95**

HP12C financial/stats **£119.95**

HP41C **£182.95**

HP15C New Model **£109.95**

HP41CV 5 times 41C memory **£237.95**

HP41C/41CV Software Modules, All Subjects **£25.95**

NEW TI 57 LCD 50 functions/8 memories. 10 digit LCD **£21.95**

NEW TI 55-II LCD 122 functions, linear regression, up to 56 steps/8 memories. 10 digit LCD **£32.95**

NEW TI Programmer Essential tool for programmer **£44.95**

TI 58C 172 functions, up to 480 steps/60 memories **£64.95**

TI 59 With magnetic card reader up to 960 steps/100 memories **£119.95**

PC 100C Printer for TI58/58C/59 **£179.95**

TI 58/58C/59 Software modules. All subjects **£35.95**

FP 10 Scientific/Statistical Print + Display **£69.95**

Full range of Canon, Casio, Hewlett Packard, Sharp, and Texas Calculators and accessories supplied
Large SAE with all enquiries please

Export less 10% — All payments in £ sterling
All prices include post, packing, VAT, 12 months guarantee
Payment with order, Cash, P.O., Cheque or Access

CALCULATOR SALES & SERVICE

Freepost (no stamp required UK),
PO Box 13, Redditch, Worcs B98 0BR
Telephone Redditch (0527) 43169



Post & Packing, 50p for KS kits, 75p for UK kits, £1.00 for cabinets. Send S.A.E. for catalogue of our extensive range of kits & cabinets. Trade, Educational & Export enquiries welcome.

7, Hughenden Road,
Hastings, Sussex,
TN34 3TG
Telephone: Hastings
(0424) 436004

ELECTRONIC KITS

<p>KS 100 Mini VHF Super-regenerative receiver 88-108 MHz 9V D.C. £9.27 inc. V.A.T.</p>	<p>KS 130 2 Channel audio mixer, 20V D.C. Max £4.21 inc. V.A.T.</p>	<p>KS 160 Dark room timer. Timing range 1-99 secs. £11.58 inc. V.A.T.</p>
<p>KS 200 Mini F.M. transmitter 88-108 MHz 9V D.C. (Not licensable in U.K.) £7.37 inc. V.A.T.</p>	<p>KS 238 3 channel microphone operated sound to light. 300W per channel, 240V A.C. £11.58 inc. V.A.T.</p>	<p>KS 240 3 channel sound to light. output 3 x 1KW 240 V. £12.63 inc. V.A.T.</p>
<p>KS 250 12V-0.5A stabilized power supply £7.37 inc. V.A.T.</p>	<p>KS 490 Nicad battery charger, 10-20-45-150 mA, 15V D.C. max 240V A.C. £8.42 inc. V.A.T.</p>	<p>UK 380 Digital tuning indicator £37.88 inc. V.A.T.</p>
<p>KS 390 Stereo pre-amp, treb-bass-midd loudness & volume control 18-25V D.C. £15.79 inc. V.A.T.</p>	<p>UK 713 5 channel microphone mixer, A.C. 240V operated. £20.00 inc. V.A.T.</p>	<p>KS 410 Car mounted digital clock, 12V D.C. £16.84 inc. V.A.T.</p>
<p>KS 440 Universal anti-theft alarm £10.52 inc. V.A.T.</p>	<p>KS 450 Anti-theft alarm for motorcycles, 6-15V D.C. £9.48 inc. V.A.T.</p>	<p>KS 500 Go-No-Go transistor tester, 5V or 4.5V battery £5.27 inc. V.A.T.</p>
<p>KS 430 Digital D.C. voltmeter, 999MV-999V, 0.5V D.C. £17.89 inc. V.A.T.</p>	<p>UK 108 Miniature F.M. transmitter, Not licensable in U.K. £9.46 inc. V.A.T.</p>	<p>UK 113/U 10W integrated circuit amplifier £6.31 inc. V.A.T.</p>
<p>UK 232 Antenna amplifier for AM/FM £5.27 inc. V.A.T.</p>	<p>KS 260 3 channel chase light, 1KW per channel, 240V A.C. £10.52 inc. V.A.T.</p>	<p>KS 300 Westminster chimes, (Big Ben) £9.48 inc. V.A.T.</p>
<p>UK 562 Transistor and diode tester £14.73 inc. V.A.T.</p>	<p>UK 716 Three-way stereo mixer £24.21 inc. V.A.T.</p>	<p>UK 882 Centralized anti-theft alarm £33.67 inc. V.A.T.</p>

PLASTIC CABINETS

MODEL	OUTSIDE DIMENSIONS						PRICE INC
	WIDTH		HEIGHT		DEPT		
	INCH	mm	INCH	mm	INCH	mm	VAT
OO/3001.00	7.54	191.4	1.81	46	6.89	175	£4.21
OO/3001.02	7.54	191.4	2.36	60	175	175	£4.21
OO/3001.04	7.54	191.4		74	6.89	175	£5.27

CLEF ELECTRONIC MUSIC



ELECTRONIC PIANOS

SPECIALISTS SINCE 1972
Clef Pianos adopt the most advanced form of Touch Sensitive action which simulates piano Key inertia using a patented electronic technique.

7 1/4 OCTAVE DOMESTIC MODEL COMPONENT KIT £266

Two Domestic Models are available including the 88 note full size version. Four intermixable Voice Controls may be used to obtain a wide variation of Piano tone, including Harpsichord.

Both Soft and Sustain pedals are incorporated in the Design and internal Effects are provided in the form of Tremolo, Honky Chorus, and Phase Flanger.

A power amplifier integrates into the Piano top which may be removed from the Base for easy transportation.

SIX OCTAVE DOMESTIC MODEL COMPONENT KIT £234

Component Kits include Keyboard, Key switch hardware, and all electronic components and may be purchased in four stages at no extra cost.

Complete Kits further contain Cabinets, wiring harness, Pedals and in the case of Domestic Models both Power Amplifier and Speaker.

The Six Octave Stage Piano has the same range of Voices and Effects and is designed for use with an External Amplifier and Speaker.

SIX OCTAVE STAGE MODEL COMPONENT KIT £234

MANUFACTURED £80

AMDEK Kits

Distortion	£32
Compressor	£36
Phaser	£40
Tuning Amp	£36
Metronome	£36
Flanger	£63
Chorus	£54
St. Mixer	£90
Graphic	£72
Delay	£130
Percussion	£54
Rhythm	£90

by ROLAND



COMPLETE KIT £283

MICROSYNTH THE COMPACT MUSIC SYNTHESIZER

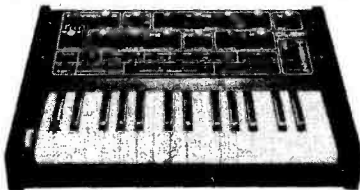

COMPLETE KIT £129.00

- SWITCH ROUTING
- THUMBWHEEL

- 2½ OCTAVES
- 2 OSCILLATORS
- 2 SUB-OCTAVES

STRING ENSEMBLE

A very popular Keyboard Synthesizer Kit for Group or Home use. Four Octave polyphonic instrument with split Keyboard facility. Cabinet requires control panel (not supplied) to be fitted to side of keyboard.

COMPONENT KIT £197.50
CABINET £41.40

ROTOR-CHORUS

Comprehensive two speed organ rotor simulator plus a three phase chorus generator.

COMPONENT KIT £98.00

KEYBOARDS

Our Square Front Keyboards
88 NOTE (A-C) £62.67
73 NOTE (F-F) £51.75
FIVE OCTAVE £41.97
FOUR OCTAVE £31.82

Since 1972 Clef Products have consistently produced leading designs in the field of Electronic Musical Instruments, many of which have been published in technical magazines. With musical quality of paramount importance, new techniques have been evolved and the latest musically valid technology has been incorporated into projects which have been successfully completed by constructors over a wide range of technical capability. Back up TELEPHONE advice is available to all our customers. All instruments are on show.

PRICES INCLUDE VAT, UK CARRIAGE & INSURANCE (CARRIAGE EXTRA ON MFD PIANOS). Please send S.A.E. for our complete lists, or use our telephone VISA/ACCESS Service. Competitive quotations can be given for EXPORT orders — in Australia please contact JAYCAR in Sydney. Visit our showroom.

CLEF PRODUCTS (ELECTRONICS) LIMITED

(Dept. ET1), 44A Bramhall Lane South, Bramhall, Stockport, Cheshire SK7 1AH 061-439 3297

"THE COMPUTER BAND-BOX"

COMPLETE KIT £235

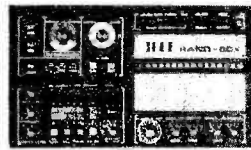

£320 MANFD.

(MASTER RHYTHM ALSO REQUIRED)

A revolution in the field of Computer Music Generation!

A musicians instrument for vocal & instrumental soloists practice — live performance — recording

The BAND BOX provides an Electronic Backing Trio consisting of Drums, Bass, and a Chord Instrument (one of 16 Waveform/Envelope combinations), with the capacity to store over 3,000 User Programmable Chord Changes on more than 120 different Chords. Using advanced Microprocessor technology, Playback of 50-100 Scores can be executed in any Key and at chosen Tempo. Complete Music Pad is electronically Indexed and stored on secondary battery back-up. Facility exists for composition of Intro, Repeat Chorus, and Coda sections including Multiple Score Sequences. Sockets are provided for Volum Pedal and Footswitch plus separate and mixed instrument Outputs. Total size 19" x 11" 4 1/2" incorporating Master Rhythm.

THE Programmable DRUM MACHINE

EIGHT TRACK PROGRAMMING/ TWENTY-FOUR PATTERNS/ TWELVE INSTRUMENTS/ SEQUENCE OPERATION. COMPLETE KIT £79



MANFD. — £119

The Clef Master Rhythm is capable of storing 24 selectable rhythmic drum patterns, invented, modified, and entered by the Operator on to Eight Instrumentation tracks. A three position Instrumentation control expands the number of instruments available to twelve, grouped into sounds typical of playing with Drumsticks, Brushes, or Latin American Bongos and Claves. Sequence operation allows two rhythm sections to be coupled with the second (B) section appearing at four, eight or sixteen Bar repetition. All drums can be adjusted for level and resonance on internal controls to suit individual taste, thus producing good musical sounds on a battery driven unit 8 1/2" x 5" x 2 1/2".

Interak 1

HOME COMPUTERS DO NOT WORK!

You've already got a "home" computer — am I right? You may be anyone — a Hospital Electronics Workshop, a University Computer Dept., an Electronics Research Establishment, or you may be just plain Joe Soap.

Either way round — you're fed up with the boss, or your wife (may be the same thing), always asking you — "Very nice, but what does it do?" I know you can make it do things, so you must be pretty clever, but what a mess. What's that heap of junk plugged in the back — talk about spaghetti!

They look lovely, home computers, don't they — until you bolt on all the things round the back that the designer couldn't (or wouldn't) include.

I think we both know what is needed: A "rack and card" build it yourself system (Interak 1!). Something like Acorn's and Tangerine's original plug in systems, before they went on to more profitable things, but you don't want it 8502-based — Interak 1 uses the Z80A, (doesn't everybody who has any sense?).

If you use Interak 1, the Z80A CPU is on one card, the VDU Interface is on another, Dynamic RAM on another, and so on. Very tidy, and very modular because "any card fits in any slot". And that ugly expansion adaptor, and the special box of bits you've got sticking out of the back, can be neatly re-packaged and slid into the spare slots in Interak 1.

I've got no space to say more (this advert's cost a few hundred pounds already!), so send me a stamp (20p) and/or SAE, or neither, or 'phone if you prefer, and I'll send you the 38-page low-down.

David Parkins

P.S. Although this advert may sound a bit corny (we have to get your attention somehow) Interak 1 really is a serious, sensible system with thousands of cards sold, and in daily use. Cards, Manuals, all available separately inc. circuit diagrams.

GREENBANK

Greenbank Electronics (Dept. T12E), 92 New Chester Road, New Ferry, Wirral, Merseyside L62 5AG
Telephone: 051-645 3391

SC110A FULLY PORTABLE OSCILLOSCOPE

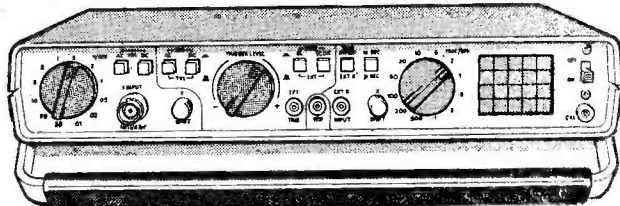

The new THANDAR SC110A represents a break through in Oscilloscope development. The SC110A is only 2" thick and weighs under 2 lbs yet it retains the standard features of a bench oscilloscope.

FULL-SIZED PERFORMANCE

- 10MHz band width
- 10mV per div. sensitivity
- Full trigger facilities are provided including bright line and auto, with T.V. line and frame filtering
- RUNS ON ORDINARY HP11 (four) batteries or rechargeables
- Basic price — £170 UK Post free

Optional extras

- AC Adaptor £5.69; Rechargeable batteries £8.63; X1 Probe £8.05; X10 Probe £9.20; X1/X10 Switched Probe £10.90; Carry Case £8.86.

PFM200A FREQUENCY METER

- Pocket size ● 8-Digit LED display ● Frequency range 20Hz-200MHz ● Resolution 0.1Hz ● Sensitivity typically 10mV rms
 - Timebase accuracy 2ppm ● Battery life 10 hours ● Frequency: 2 ranges, 4 gate times
 - Price £67.50 UK Post free
- Optional extras — AC Adaptor £5.69

LARGE S.A.E. Brings details of: Oscilloscope, Frequency Meters, Signal Generators, Function Generators, Pulse Generators, Analogue and Digital Multimeters; Digital Thermometer, C.R.T. Tester, Logic Analyser etc.

All prices include VAT. Official orders welcome. Mail order only, or callers by prior appointment. Barclaycard/Access welcome. Cash/cheque, etc., with order. Government and Educational Establishments official orders welcome.



B.K. ELECTRONICS

37 Whitehouse Meadows, Eastwood, Leigh-on-Sea, Essex SS3 6TY
Tel: Southend 527572

NEW PRINTED CIRCUIT PRODUCTS

EXCLUSIVE MAIL ORDER FOR PRICE CONSCIOUS ENTHUSIASTS

Kelan Engineering, established for over 12 years as manufacturers of high Quality Printed Circuit boards and the original innovators of the Positive Photo Resist System NOW INTRODUCE.

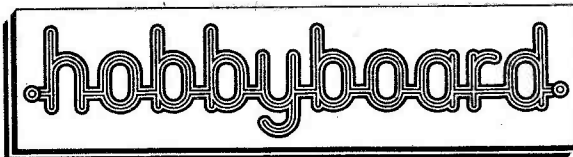

the complete Printed Circuit Workshop

- ★ Copper Clad Boards ★ Veroboards
- ★ Breadboards ★ Artwork materials
- ★ Hobbyboard Photo Resist System the simplest, cleanest method ensuring high quality PCB's EVERYTIME.
- ★ Plastic & Die Cast Boxes & Cases
- ★ Connectors ★ Sockets
- ★ Terminals ★ Screws, Nuts, Spacers etc. ★ Workshop Tools
- ★ Drills & Machines.
- ★ ZX81 & SPECTRUM INTERFACING SYSTEMS AND ACCESSORIES.

SPECIAL OFFER

Complete - low cost introductory Hobbyboard Photo Resist Kit includes UV exposure lamp & full instructions for DIY UV unit - all artwork, board & chemical requirements + "Introduction to Circuit Making"

Please send me details of:-

- Hobbyboard mail order catalogue
- Hobbyboard Photo Resist System
- Hobbyboard ZX81/SPECTRUM SYSTEM
- Hobbyboard special offer

NAME
ADDRESS

I have completed electronic projects during the past 12 months



KELAN (Hobbyboards) LTD
North Works, Hookstone Park,
Harrogate, North Yorkshire.
☎ 0423-883672

ETI/183

AUDIO ELECTRONICS SALE SALE SALE

ALL PRICES INCLUDE VAT

EXCLUSIVE OFFERS!

FREE bonus for all orders received by 28/2/83.

MULTIMETERS

 £10.95 £7.95 (UK c/p 65p)	 £21.50 £15.95 (UK c/p 65p)	 £26.95 £18.95 (UK c/p 65p)
FREE with SG402 below.	FREE with CS1566A below.	FREE with CS1820 below.

FREE BONUS

Mini stereophones with every 7206/7081/2050 (State 3 1/2mm or 1/4" jack plug)

TRIO 20 MHZ DUAL TRACE SCOPES

140mm Tube. DC to 20 MHZ. 5mV sensitivity. CH2 Invert
CS1820 Delayed sweep. 0.2-µsec to 0.5 sec Sweep. Modes CH1, CH2, DUAL and ADD. List Price **£539.00** Inc. VAT.
 Our Price **£420** inc. VAT (UK c/p £4)

CS1566A NOR. AUTO. VIDEO. 0.5-µsec Sweep. Modes CH1, CH2, ALT, CHOP and ADD. List price **£368.00** inc. VAT.
 Our Price **£299** inc. VAT (UK c/p £4)

PLUS FREE METER! See above

SAVE £119
SAVE £69

(Optional probe X10 £9.45)

SPEAKERS & TWEETERS

 HIF20ESM 8 ohm 30/50 watt Bass/Midrange B" £5.95 (UK c/p £1.20)	 HIF20ESM 4 ohm Version B" £4.95 (UK c/p £1.20)	 HIF87BSM 4" 8 Ohm 30/50 watt midrange £4.95 (UK c/p 65p)	 PH30 3" 8 ohm 15 watt tweeter £2.20
 HT25 2 1/2" 8 ohm 15 watt tweeter £1.95	 CN38 3 way 8 ohm 15 watt crossover £1.25 (UK c/p Tweeters & Crossovers 65p per 1-3 items)	 SN300 40 watt version £1.75	 HT315F 5" x 3 1/2" 8 ohm 30 watt tweeter £3.95

FREE Mini stereophones as above for purchases of £10.00 or more from this advertisement.

STEREOPHONES • MEGAPHONES • P.A. HORNS

 331S 10 watt megaphone with siren £41.95 £32.95 (UK c/p £1.05)	 331 without siren £28.95 (UK c/p £1.05)	 M112 Stereophones padded earpieces: mono/stereo switch; vol. controls £6.45 £3.95 (UK c/p 65p)	 CH66 6" 10 watt 8 ohm PA Horns £8.95 £6.95 (UK c/p 65p)
 CR8520 10 to 20 watts 5" Tapped 4 and 8 ohm 20oz £13.95 £7.95 pair (UK c/p £1.05)	 CR880 20oz 8 ohm £11.95 £7.50 (UK c/p £1.05)	 700 Mains TV boosters back of set £7.95 £5.95 (UK c/p 65p)	 TMB Masthead (2 TV's) £16.95 £12.95 (UK c/p 85p)

SG402 100KHZ to 30 MHZ
 6 band Trio RF Generator int/ext. mod. variable o/p to 100mV. AM int 400 HZ mod.
 List price **£71.00** inc. VAT
 Our Price **£59.95** Inc. VAT (UK c/p £2)

DON'T FORGET TO CLAIM YOUR FREE BONUS

ORDER BY POST OR PHONE OR CALL IN AND SEE FOR YOURSELF WELL WORTH A VISIT! ALL OFFERS LIMITED QUANTITIES E & DE

AUDIO ELECTRONICS

Cubegate Limited ALL PRICES INCLUDE VAT

TEL: 01-724 3564
 301 EDGWARE ROAD, LONDON W2 1BN.
 ALSO AT HENRYS RADIO,
 404/406 EDGWARE ROAD, LONDON W2

Order by Post with CHEQUES - ACCESS VISA or Telephone your order. Allow up to 10 days for delivery (unless advised)

ZX ANALOGUE-TO-DIGITAL CONVERTER

Expand the consciousness of your computer and let it sample the delights of the real world with this low-cost ADC. Design by Rory Holmes.

How about a fast, eight-channel, eight-bit analogue-to-digital converter, all in one small box that plugs neatly onto the back of your Sinclair computer and costs about £15? A rhetorical question, really, because that's what we're presenting in this article. The applications for this project are numerous since A-to-D converters allow your computer access to the 'real world': and the real world, as the data acquisition experts call it, is anything which varies smoothly and continuously, such as temperature, sound level, voltage, position, speed and so on. Eight channels of analogue input data, each with a resolution of one part in 256, will open up a whole new field of applications for your computer and programs. For example, some of the things you might consider include real-time graphs for multi-variable displays, eight-channel spectrum analysers (or even Spectrum

analysers!), VU meters for recording work, process control programs, central heating control, potentiometer-type joystick inputs (up to four sets of two axes), weather station computers, waveform analysis by computer, aircraft simulations and so on. You might even be able to make good Uncle Clive's boast that the ZX81 could control a power station!

The ADC IC

Our analogue-to-digital converter is based around the new 7581 IC, a complete data acquisition system on a chip with some very handy features. The best of these features concerns the way in which data is made available to the host computer: by using a 'dual port RAM' and internal scanning logic the conversion process is made completely transparent to the user. Basically this means that the microprocessor need do nothing:

the latest analogue data is always available and may be read from a small memory-mapped region of the computer's address space (eight consecutive bytes).

The chip will convert each channel in 50 microseconds and performs a complete conversion update of all eight channels in 400 microseconds. The analogue input voltage range is 0-10 V and these limits will correspond to 00 and FF Hex respectively.

The unit plugs into your computer via a double-sided edge connector, and, if you want, you can include a switch to enable the unit to switch between the ZX81 and the Spectrum port configurations. The eight analogue inputs enter the unit via a 15-way 'D' type connector. The system derives its low-current 5 V supply directly from the expansion bus, so it will start functioning as soon as the computer is switched on,

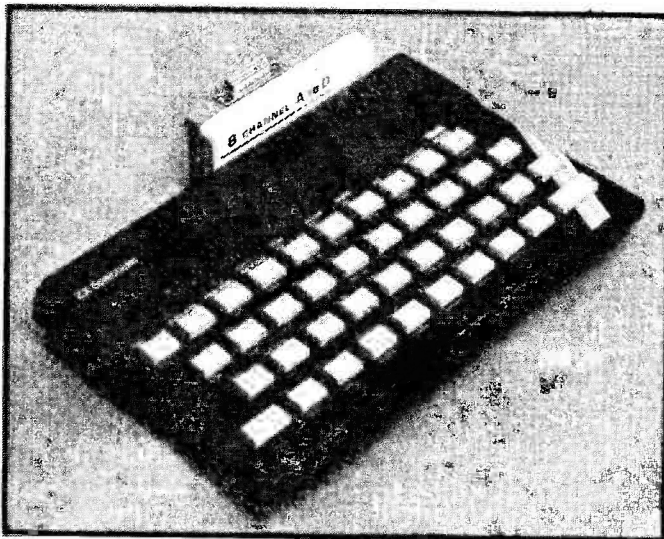

The ADC plugs on like a commercial unit.

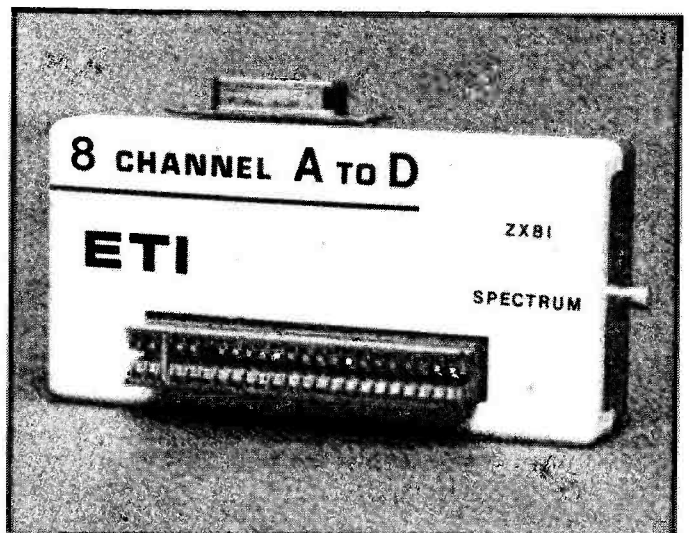

Here you see the protruding edge socket.

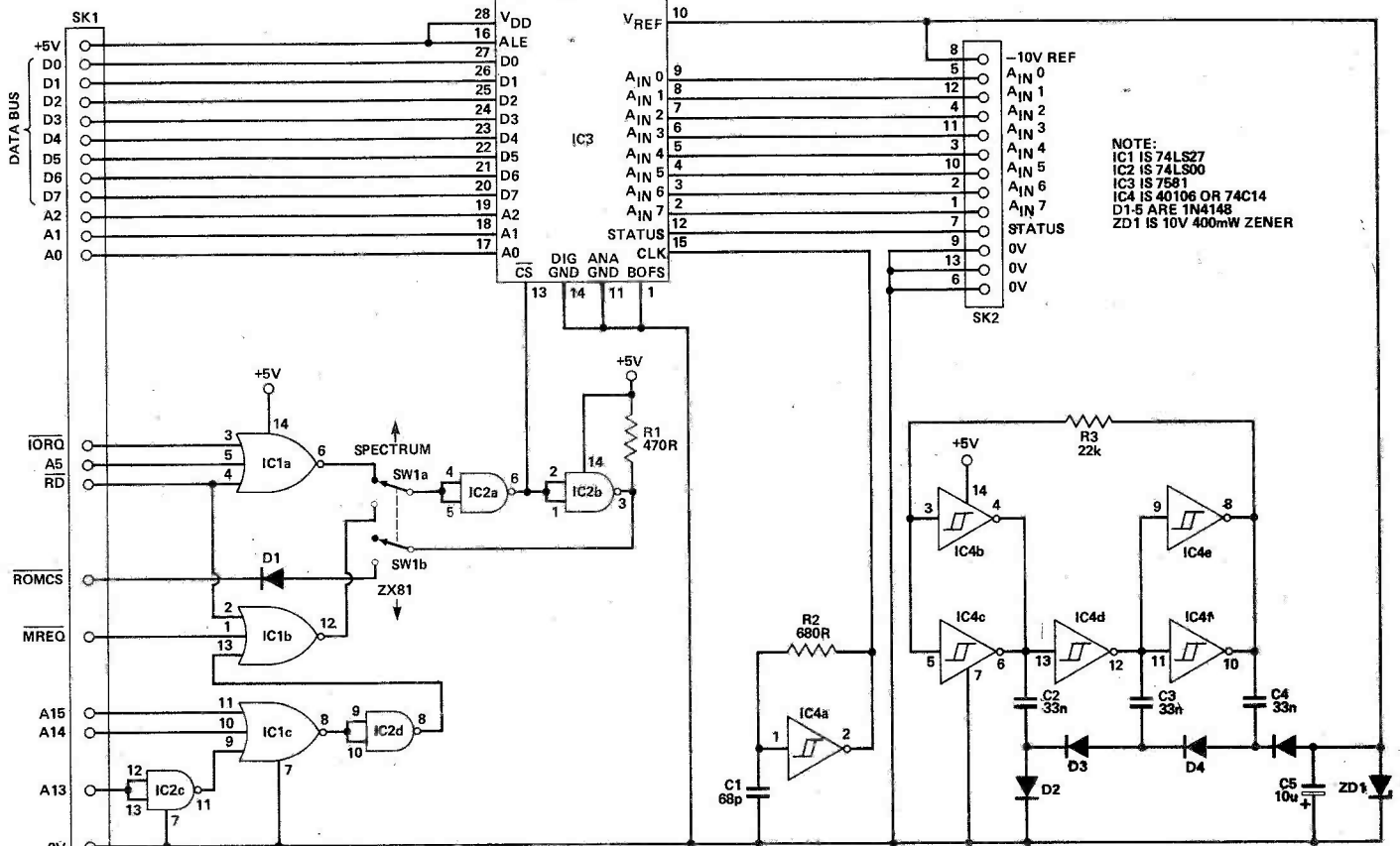

Fig. 1 Circuit diagram.

HOW IT WORKS

Figure 1 shows the complete circuit of the eight-channel analogue-to-digital converter. There are four separate parts to this circuit: the main converter device IC3, the master clock oscillator (a single CMOS gate), a negative voltage reference generator, and the address decoder. The 7581 (IC3) is a complete eight-bit, eight-channel data acquisition system, designed for direct interface to microprocessor buses. The 7581 accepts eight analogue inputs and sequentially converts each input into an eight-bit binary word using the successive approximation technique. Results from the conversions are stored in an internal eight-bit eight-word 'dual port RAM'. The dual port RAM allows a microprocessor to access the analogue data independently of the internal updates; all the data acquisition is therefore transparent to the programmer. The analogue data appears to be permanently available in eight successive 'read only' RAM locations — you cannot write to these addresses.

The converter requires a master clock for its scanning logic and this is provided in our circuit by IC4a, a Schmitt inverter gate wired as a 1.6 MHz oscillator. Conversion of a single channel takes 80 clock periods, with a complete scan through all eight channels taking 640 clock periods. At 1.6 MHz this corresponds to 50 μ s and 400 μ s respectively.

The converter is wired in our circuit for simple unipolar conversion using a -10 V reference supply. In this case the eight-bit word covers an analogue range of 0-10 V as illustrated in the transfer characteristic diagram of Fig. 2. The actual analogue input circuitry is shown in Fig. 4. An R-2R resistor ladder forms a multiplying DAC to perform the A-to-D

conversion. Each input, including the reference input, has an impedance of about 20k. A status output is also available which allows an external device to identify which channel is being updated at a given moment: it provides a signal, synchronised to the master clock, which follows the scanning logic and pulses low for channel 0. The status signals as related to the master clock are shown in Fig. 5.

The reference voltage generator that provides -10 V for IC3 is based on the voltage multiplier principle and allows a single 5 V supply to power the entire unit. The voltage tripler is constructed using CMOS Schmitt trigger inverters, and a capacitor-diode multiplier chain formed by C2-4 and D2-5. The inverters are connected as a self-oscillating ring running at several kilohertz to provide the AC square wave to the voltage multiplier. The tripler should give 15 V at the negative side of the smoothing capacitor C5 but due to diode and impedance losses this is reduced to about 12 V. The zener diode ZD1 is then used to clamp this voltage to the 10 V reference level.

The address decoding is performed using the same system we designed for the Message Panel Interface (why reinvent the wheel?). IC1 and IC2 perform the address decoding and the slide switch SW1 selects either memory-mapped decoding for the ZX81, via IC1b, or I/O-mapped decoding for the ZX Spectrum via IC1a. When the decoder is switched for the Spectrum the states of the bus lines \overline{IORQ} (I/O request), A5 (address bit 5), and \overline{RD} (the read signal) are continuously monitored for logic lows. If they all go low together, then the Spectrum is performing an IN addr, X command, and the output of

NOR gate IC1a will go high. This output is inverted by IC2a, which in turn takes the chip select pin of the converter (pin 13) to logic low. As the chip select goes low the data from IC3's internal memory (addressed by the three lower address bits A0, A1 and A2) is made available to the data bus for the read operation. Thus any of the eight-bit data words may be read at any time.

The rest of the gates in the decoder section are effectively ignored, and as far as the Spectrum is concerned the A13, A14 and A15 inputs are connected to the wrong bus pins anyway.

When plugged into a ZX81, however, with the selector switch in its other position, these other gates become usefully active. With IC2c wired as an inverter, address bits A14 and A15 must be high and A13 low in order to take the output of IC1c to logic high: this means the second 8k address block is being selected. The output of IC1c is inverted by IC2d and fed to one input of IC1b, a NOR gate. The other two inputs of this gate monitor logic low states on the \overline{MREQ} (memory request) and \overline{RD} bus lines.

Thus the output of IC1b will only go high when the ZX81 is performing a memory read operation at a location between 8192 and 16383. The output of IC1b is fed to the chip select pin of IC3 via the selector switch and inverter as before. IC2b inverts and buffers the enable signal to drive the ROMCS line (linked via SW1b): consequently this line will go high through diode D1 whenever the interface is addressed and switch off the 8k ROM in the ZX81.

The 15 mA or so supply current for the TTL and CMOS is taken directly from the 5 V supply rail on the ZX bus.

NOTE:
IC1 IS 74LS27
IC2 IS 74LS00
IC3 IS 7581
IC4 IS 40106 OR 74C14
D1-5 ARE 1N4148
ZD1 IS 10V 400mW ZENER

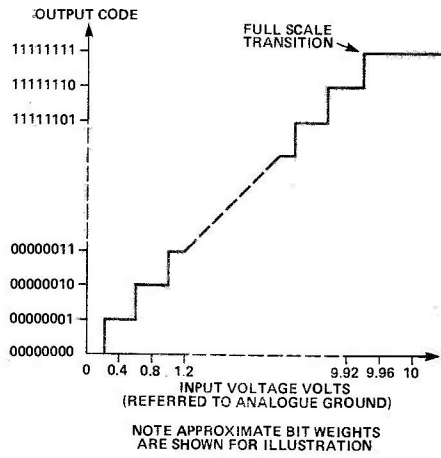

Fig. 2 Transfer characteristic diagram.

updating the analogue data at the chosen memory locations ready for PEEKing or machine code access.

There's no reason why this device couldn't be used with any other computer. All you have to do is find a handy unused hole in your system's address space and design suitable circuitry to decode the chosen range of addresses. This circuitry will replace the section of our circuit involving IC1 and 2.

Construction

The entire eight channel converter is built into a plastic Verocase to form a very neat and solid unit which plugs directly into the Sinclair expansion connector,

either on the ZX81 or the Spectrum. A standard 15-way 'D' type socket allows access to the eight analogue inputs and a few other internal connections. This is a right-angled PCB-mounting type which is soldered directly to the track side of the PCB to reduce interwiring. Since the wire-wrap edge connector socket is also soldered to the PCB, the only part external to the PCB is the selector switch, which is optional. If you anticipate using only one computer then wire links can be used to replace the switch contacts at the appropriate overlay points.

The PCB should be assembled first, following the overlay diagram of Fig. 6. Don't forget the six wire links and take care over the orientation of all the diodes and ICs. The 23-way edge connector must be mounted the right way round and with the polarizing key at position three. The edge socket must have long wire-wrapping pins so that when mounted it will protrude through the front of the box as illustrated by our prototype (see the photograph). The socket is mounted from the component side, and the pins should protrude about 2 mm through the track side for subsequent mounting of an optional edge connector plug (to allow other ZX add-ons to be plugged in). Ensure that the socket is square and parallel to the PCB before soldering the pins. A 43-way edge connector could also be used, provided it is sawn off at either end to leave the polarizing key at position three.

The 'D' type socket should be left until last, when its right-angled pins can be inserted from the track side of the board and pushed home as far as possible. The soldering of this component is difficult but not

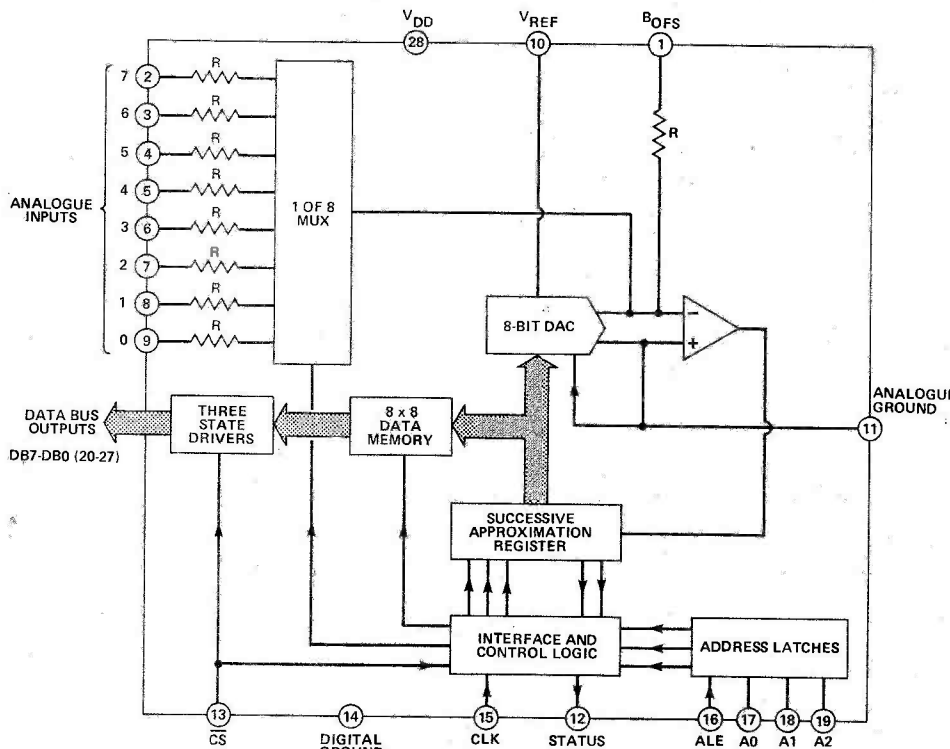

Fig. 3 Internal block diagram of the 7581.

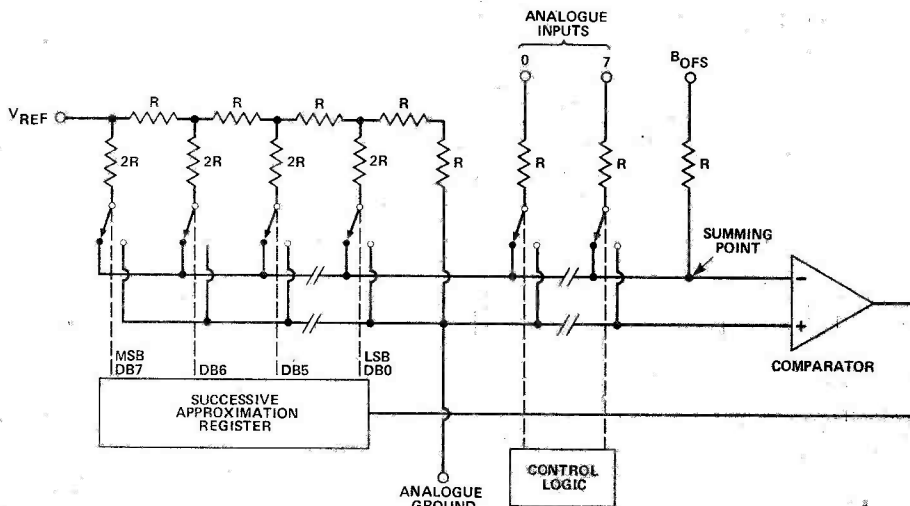

Fig. 4 The analogue input circuitry of the 7581.

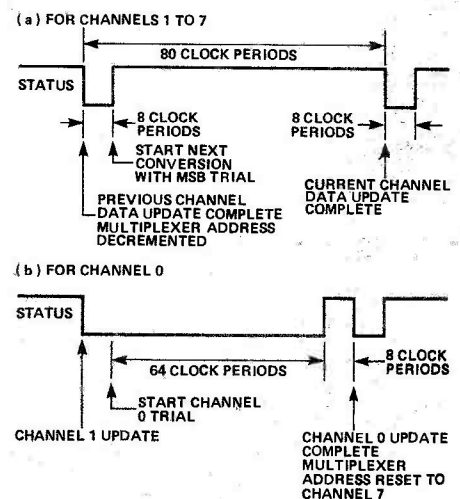

Fig. 5 Status signals.

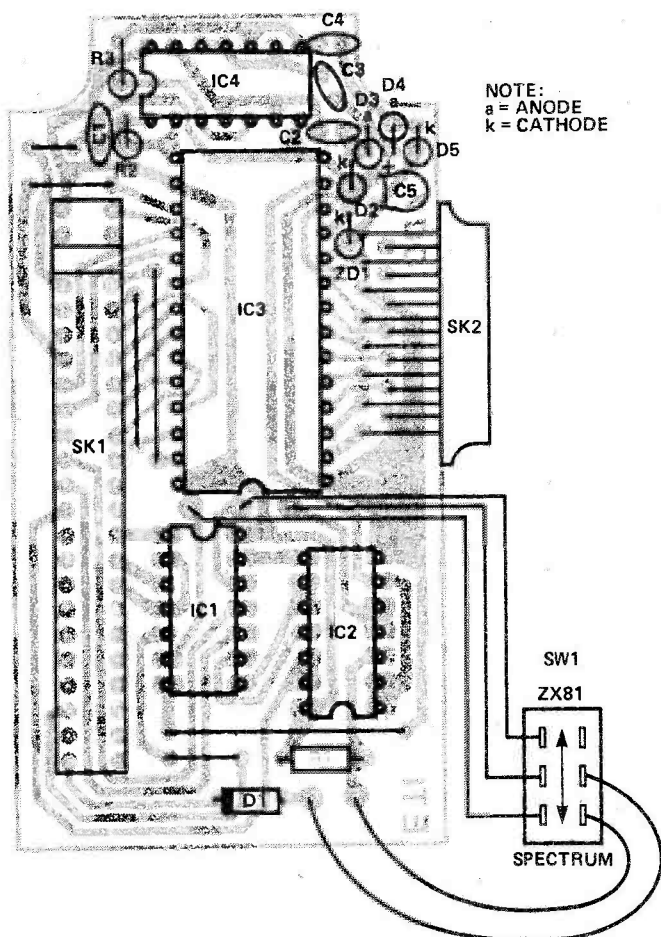

Fig. 6 Component overlay.

PARTS LIST

Resistors (all 1/4W 5%)	
R1	470R
R2	680R
R3	22k
Capacitors	
C1	68p ceramic
C2-4	33n ceramic
C5	10u 16 V tantalum
Semiconductors	
IC1	74LS27
IC2	74LS00
IC3	7581
IC4	40106B or 74C14
D1-5	1N4148
ZD1	10 V 400 mW zener
Miscellaneous	
SW1	DPDT miniature slide switch
SK1	23-way double-sided edge connector
SK2	15-way right-angled PCB-mounting 'D' type cannon socket
PCB (see Buylines); case, Vero order code 65-2514F.	

impossible, providing a small soldering bit is used.

The PCB should be filed to the shape shown in the overlay diagram, since it has to fit into the lid section of the case: the two corner pillars which take the main case bolts will also need to be filed

away slightly. At this stage, a slot should be cut in the appropriate position to take the connector socket so the assembled PCB can be fitted into the lid. It should sink down until the tops of the ICs touch the inside of the lid. The edge connector should now be almost clear of the slot and the diodes and capacitors should just clear the filed-down case pillar.

By mating up the two case halves, you can find the position for an appropriate slot to be cut in the base of the case to clear the 'D' type socket. If a switch is to be fitted this should be glued, using cyanoacrylate or epoxy glue, to the side of the base section as shown in our internal photographs: the switch contacts will just clear the PCB. On our prototype we fixed three large stick-on rubber feet into the base of the Verobox; these support the PCB at the correct height, and when the case halves are screwed together, they will hold the PCB firmly in place.

The diagram of Fig. 7 shows the pinout connection for the 'D' type socket; it's a good idea to draw this along with the corresponding address locations onto an adhesive

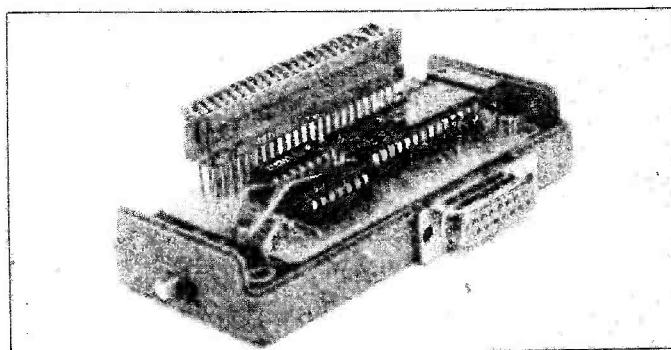

The socket is raised off the PCB like this.

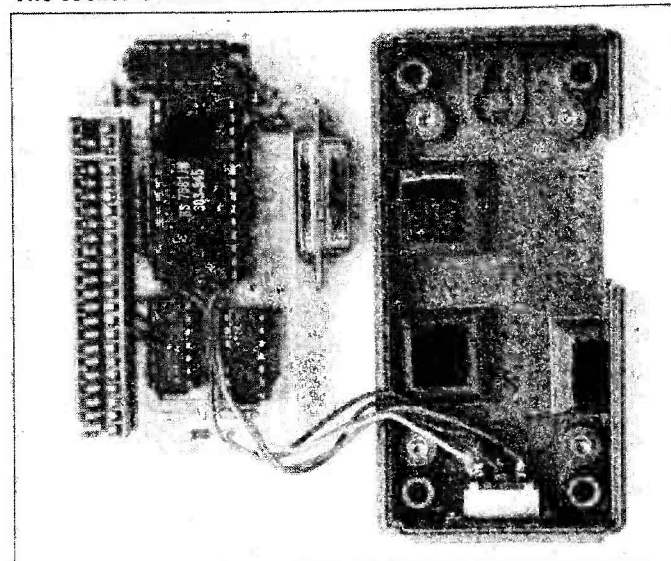

Rubber feet help secure the PCB.

BUYLINES

The 7581 analogue-to-digital converter chip can be obtained from Technomatic Ltd for about £8. Technomatic also stock the other semiconductors and the 'D' type connector: check their advert for prices and ordering details. The special wire-wrap 23-way edge connector for use with ZX computers can be obtained from Timedata, 57 Swallowdale, Basildon, Essex: alternatively you could get hold of a 40-way version and cut it to size as described in the main text. The PCB Service advert is on page 91 for those unable to etch their own boards. The joystick units mentioned in the text are available from Remcon Ltd, 1 Church Road, Bexley Heath, Kent (telephone no. 01-304 2055).

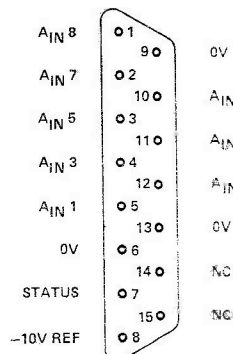

Fig. 7 Pinout for the 'D' type connector we used.

TABLE 1

CHANNEL	ADDRESS LOCATIONS	
	ZX81	SPECTRUM
8	8199	65503
7	8198	65502
6	8197	65501
5	8196	65500
4	8195	65499
3	8194	65498
2	8193	65497
1	8192	65496

label, which can then be stuck onto the back of the box. There are two unconnected pins on the socket which could be connected (using insulated wire links) to any other two signals, say +5 V and the master clock.

Having completed the assembly, the A-to-D converter may be plugged into a Sinclair computer and tested. One of the analogue inputs may be wired up to the simple pot circuit shown in Fig. 8 and the corresponding address location can be looked at via the computer. Table 1 shows the address locations for each input; the command PEEK addr is used for the ZX81 and the command IN addr for the Spectrum. For a 0 V input the memory byte will contain 0 while

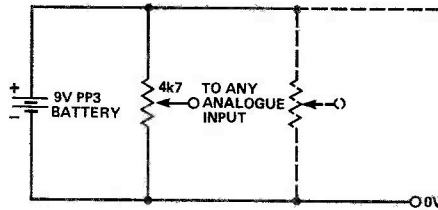
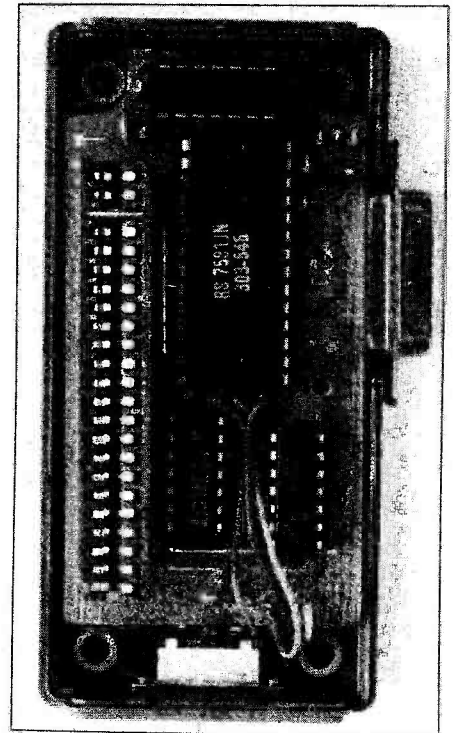

Fig. 8 How to connect pots for testing and when using the unit as a joystick port.

for the full 10 V input it will contain 255 or FF in Hex. The number (in eight-bit binary) will vary proportionately for all the voltages in between. A small program to continuously print out the value of all eight memory locations would help in the testing procedure.

After you are satisfied that the unit is working the programming options are practically limitless; eight real time voltage inputs continuously available to either BASIC or machine code programs! Dedicated games players who want to use the unit to interface joysticks to the computer will find a suitable source of two-axis joysticks fitted with 4k7 pots listed in Buylines. Figure 8 shows how they should be wired up.



Using the case specified will tax your construction skills but it is possible to get everything in!

ETI

LB ELECTRONICS

DISC DRIVE BONANZA

PERTEC FD650 8" DSDD... £199 + VAT
 PERTEC FD250 52" DSDD... £145 + VAT
 PERTEC FD200 5 1/4" SSDD... £100 + VAT

**BRAND NEW AND BOXED
 PLUS DATA P & P AT COST**

INTERSCAN ACOUSTIC COUPLER

10" x 4" x 5" WITH ELECTRONICS, SOUND TIGHT UNIT, FOR STANDARD GPO HAND SET.
 NO DATA — £10.00 (INC VAT) P & P £1.75

LB ELECTRONICS

11 HERCIES ROAD,
 HILLINGDON,
 MIDDLESEX UB10 9LS,
 ENGLAND
 TEL: UXBRIDGE 55399

A LIGHTING REVOLUTION!

● DIRECT FROM THE MANUFACTURERS COMES A BREAKTHROUGH IN LIGHTING TECHNOLOGY AND PRICE!

THE MINI-12
 Compact 2-preset
 blue/black desks.

**SYSTEMS FROM
 JUST £214**

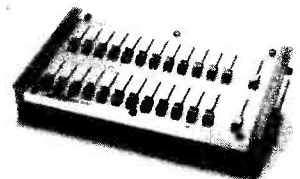

- 6 channel hand held controller£70
 - 12 channel 2 preset desks£180
 - 18 channel 2 preset desks£260
 - 6 channel 13A power packs£120
 - 10 metre multi-core cables£12
- (prices do not include VAT and delivery)

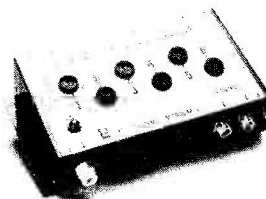

THE MICRODIM PACK

An ideal method of providing 6 channels that plug easily and quickly to your lamps, the mains and the desk. Can be free-standing or wall mounting. Complete with 10M mains lead.

After extensive research MJL have arrived at a means to provide the complete lighting versatility you require, at a price you can afford. ITS CALLED DIGI-DIM TECHNOLOGY. Out goes the expensive voltage control method and in comes the micro-chip. If your requirement is for amateur or professional theatre, mobile or fixed lighting rigs, rock bands, or simply general purpose, then waste no more time and phone or write for FREE information to:

MJL SYSTEMS LTD. (Dept A)
 45 Wortley Road, W. Croydon, Surrey CR0 3EB, U.K.
 Tel: 01-689 4138
 Our sales desk is open Mons to Frids 9.30-5.30

New Products



HIFI STEREO AMPLIFIER KITS

From one of Britain's leading esoteric amplifier manufacturers comes an exciting new package of stereo amplifier kits, designed to offer all the advantages of true high fidelity but without the usual price penalty.

These new kits offer the choice of moving magnet or moving coil inputs, 40 to 100 watts per channel, in fact, everything that made the previous models so popular is included but with added style, easier construction and a full two year warranty.

The new range consists of The CK 1010 Stereo Pre Amplifier, The CK 1040 WPC Power Amplifier, The CK 1100 WPC Power Amplifier.

CK 1010

This kit contains all the necessary parts to build a complete pre-amp. The main PCB is ready assembled and tested therefore construction is simply a matter of point to point wiring and mechanical assembly of the connections and controls to the pre punched chassis.

The CK 1010 takes its DC supply from the CK 1040, 1100 or, if using a different power amplifier a PSK power supply kit. Inputs for disc, tuner and tape are provided and an optional add-on moving coil input can be fitted to extend its versatility. (MC2K)

CK 1040

This is a nominal 40 watt per channel power amplifier kit which features our dual power supply and the DC output for the CK 1010. All components such as heatsinks, wire and connectors are included and protection is provided from short circuit outputs.

CK 1100

Similar to the CK 1040 this model provides a nominal 100 watts per channel with extra heatsinking and thermal cutouts are provided as standard.

When correctly assembled these kits are guaranteed for two years.

"It would seem then that Crimson have maintained their position at the top of the commercial kit-build field. There is no oriental amplifier I know of that can better the sound of this combination overall at any price and only a few — such as the KA-1000 (£500+) — are of comparable standard. . . . I can say no more than that for £250 it (CK 1010/MC2K/1100) is a bargain and one that becomes the reference point for kit amplifiers from now on."

PRICES CK 1010 — RRP £92.00; CK 1040 — RRP £121.00; CK 1100 — RRP £151.00; MC2K — RRP £25.00; PSK — RRP £20.00

Barclaycard or Access accepted, otherwise send C.W.O. C.O.D. £1.00 extra. All prices include P&P to anywhere in the U.K. Export: Write for pro-forma

SEND FOR FULL DETAILS ON OUR HIFI KIT PRODUCTS BY WRITING TO FREEPOST ADDRESS BELOW

**FREEPOST, 9 CLAYMILL ROAD
LEICESTER LE4 5ZD. ENGLAND
TEL. 0533 761920, TLX 34694**



MICRO-PROFESSOR

YOUR GUIDE TO THE WORLD OF MICROPROCESSORS

A low cost tool for learning, teaching & prototyping.



(by phone or post)

Complete the coupon today!

Please allow 28 days for delivery.

Please send me:	Price	Qty	p&p
Micro-Professor	£79.95		£2.95
SSB-MPF board	£69.95		£2.95
EPB-MPF board	£84.95		£2.95
PRT-MPF board	£74.75		£2.95
		Total	

I enclose cheque/P.O. for £.....

Name

Address

.....

.....

.....

Micro-Professor is a low-cost Z80 based microcomputer which provides you with an interesting and inexpensive way to understand the world of microprocessors and utilise their unlimited potential.

Micro-Professor is a complete hardware and software system whose extensive manual gives you detailed schematics and examples of programme code. A superb learning development tool for students, hobbyists and microprocessor engineers, as well as an excellent teaching aid for instructors of electrical engineering and computer science courses.

Technical specification

Z80 CPU, 2K RAM, 2K monitor, 24 1/0 lines, LED display, cassette interface, CTC/PIO facility, 2.25" speaker, three manuals, 36 keyboard. Options include: EPROM board, speech board and printer board.

Please send or telephone for full details.

£79.95 + p&p

Now includes 2K BASIC

FLIGHT ELECTRONICS LTD. Flight House, Quayside Rd, Southampton, Hants SO2 4AD. Tel: (0703) 34003/27721. Telex: 477793.

Mail order only • Trade enquiries welcome • Bulk order discounts • Prices include VAT

TECH TIPS

RAM To ROM Converter

A. Whitaker, Grimsby

How many times have you experimented with machine-code on an MZ-80 computer or similar system where the monitor is loaded off tape into RAM, and crashed it by accidentally re-writing the monitor? Faced with the same problem on a Z80-based system I am planning to build, I devised a method of turning RAM into ROM under software control. The idea is really very simple — after the monitor or desired language has been loaded from tape into the computer, an OUT instruction is used to program the inputs of a bank of OR gates. Whether the OR gates are inside a chip or made from two diodes and a resistor, by considering one input as an enable, we see that if the enable goes high (logic 1) the output must also go high, irrespective of the data on the other input. This can be used to disable the WRITE line going to a RAM board. When the enable input is low (logic 0) the OR gate acts as a buffer and lets the data on the other input through, so the WRITE line is unaffected. By disabling the WRITE pin on a RAM chip, the RAM is turned into a Read Only Memory — obviously this will not stop your RAM

from losing its contents as soon as the power is turned off, but can prevent loss of data due to the odd bug in a user's program.

Although the basic idea was just to protect the language loaded off tape, special areas of memory can be protected by using address decoding or simply interrupting the WRITE line going to individual RAM chips. Using one of these methods, OUT statements could be used before running a program to disable most of the RAM, leaving only workspace and/or the screen (video) RAM to be corrupted by the user's program.

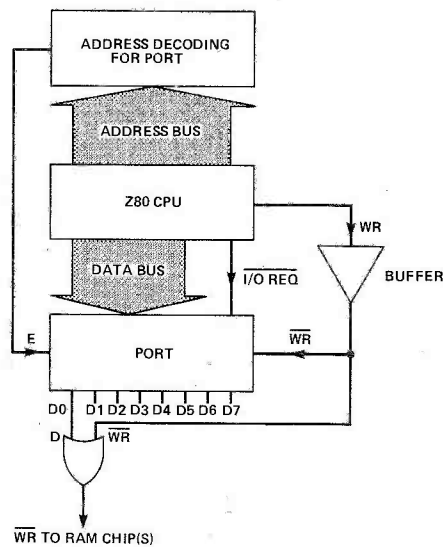

Modified Loudspeaker Protection Module

A. Calderhead, 62 Hayfield Terrace, Denny, Stirlingshire

Having built the Audiophile 4000 system and installed the speaker protector as published in ETI July 1980, my main misgiving with this arrangement was that I had to open up the power amp case to check or change the battery; it also meant that the amplifier was connected to the speakers via two relays.

I have since built the System A amplifier and installed this modified version of the protection circuit. This uses the two spare inverters in the 4049B and gives a 2-4 second switch-on delay. The output of IC1f is at logic 1 until C4 charges up, holding IC1e's output low. Q1 is therefore turned off for this period and the loudspeakers are not connected. Q2 is biased on and LED1 lights up to indicate that the speakers are disconnected. Note that in this case, the speakers must be wired through the normally-open contacts on the relay rather than the normally-closed contacts as in the original design: this gives the added advantage that the circuit fails safe.

The whole lot is powered from the System A preamp supply, which is regulated to 5 V to power IC1.

PS. If any readers from my neck of the woods want to hear the System A they can drop a line to the above address.

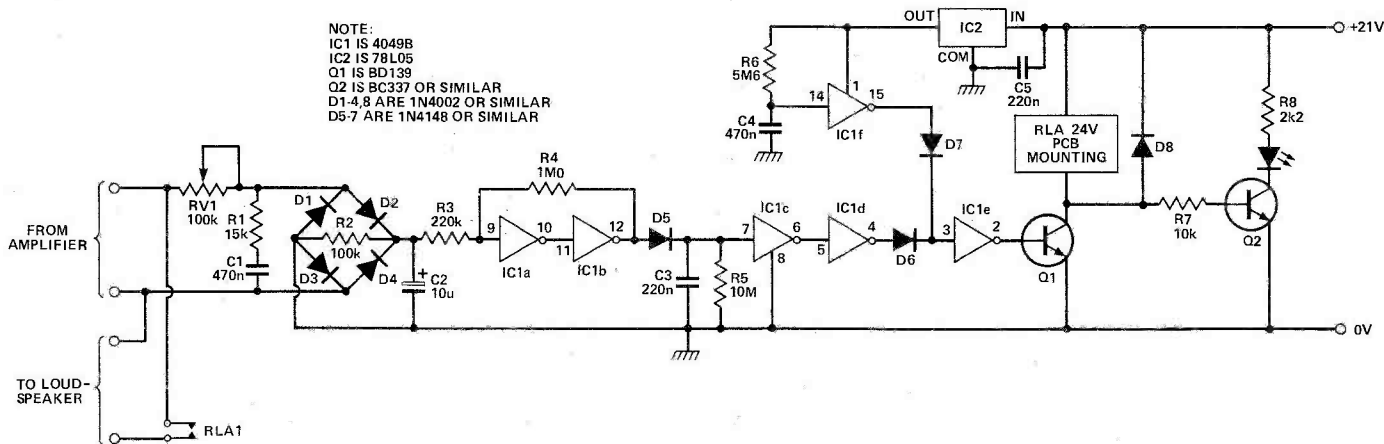

Tech-Tips is an ideas forum and is not aimed at the beginner. We regret we cannot answer queries on these items. ITI is prepared to consider circuits or ideas submitted by readers for this page. All items used will be paid for at a competitive rate. Drawings should be as clear as possible and the text should be typed. Text and drawings must be on separate sheets. Circuits must not be subject to copyright. Items for consideration should be sent to ETI TECH-TIPS, Electronics Today International, 145 Charing Cross Road, London WC2H 0EE.

WAVEFORM MULTIPLIER

A single VCO on a synth is, to be honest, pretty boring. Generate rich multiple oscillator sounds by hooking it up to one of our multiplier boards. Design by David Ward-Hunt.

Many synthesisers, both mono and polyphonic, utilise two or more VCOs, slightly detuned, to generate a rich chorus sound. Chorus or phasing treatment of a single VCO can go some way towards livening up the sound, but these tend to suffer from a rather repetitive sweep and on some units a considerable amount of background noise during periods of silence — not to mention aliasing when used with high frequency high harmonic content waveforms which any decent synthesiser is capable of producing.

The beauty of using two or more slightly detuned oscillators is that in addition to producing a full chorus sound, the problems of background noise and bandwidth are eliminated. However, multiple VCOs don't come cheap! An alternative method of achieving a 'multiple oscillator sound' is to generate additional waveforms from the existing VCO output. If each of these 'new' waveforms is out of phase with the original and with each other, then a fuller sound will be heard. However, the richness of the sound from multiple oscillators comes not from the fact that they are out of phase with each other, but from the fact that the phase difference is continually changing — the ear perceives phase *change* rather than phase difference. Therefore it is necessary not only to have additional out-of-phase waveforms, but their phase differences should be continually moving with respect to each other and the original.

A Passing Phase

The circuit described here does just that. It will accept sawtooth, triangle or sine wave inputs, though with the latter two the output will bear little resemblance to the original waveform due to the circuit action: however, they are still useful



The picture shows how the prototype was mounted in a Teko Alba A23 case, but this is not essential and most people will build the boards into their synth.

sounds to experiment with. The circuit has been used successfully to treat the VCO sawtooth outputs from a number of synthesisers including the Transcendent, Digisound '80 and PE Minisonic; it has also been used with a Korg Sigma and Roland SH02 (see the interfacing notes below). The one disadvantage of the circuit (there has to be one, doesn't there?) is that for setting-up purposes, constructors will need access to a scope or a second VCO with which to adjust the circuit to produce the correct waveforms.

Using The Multiplier

The multiplier board is fed with the output from your existing VCO. With a sawtooth waveform fed to the circuit, the output is a series of six sawtooth waveforms each individually phase modulated and mixed with the original sawtooth from the VCO. One multiplier PCB (generating six 'new' waveforms) is used with each VCO. If you do have two or more VCOs each feeding a separate multiplier board the effect is outstanding, especially when the VCOs are tuned to form a

chord. The output from the multiplier(s) is then fed back to the synthesiser and treated by the VCF and VCA in the normal way.

Construction

The project consists of two PCBs. The first holds the modulation oscillators for phase modulating the multiplier; the second PCB holds the multipliers and associated circuitry. The reason for splitting the project into two PCBs is that one modulation PCB is sufficient to drive up to four multiplier PCBs. (In fact there is no reason why it wouldn't drive more; however, we believe that if you intend to use more than four multiplier boards, the small additional expense of another modulator is well worth it for adding an even richer sound.)

All the components are mounted on the two PCBs with the exception of two diodes which are mounted on a switch (thereby saving two wires from the PCB to the switch). The only external connections required are the VCO input and the output from the unit plus the power supply connections (see below) which ideally should

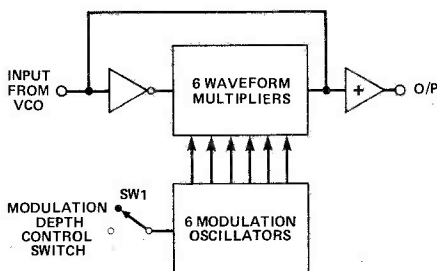

Fig. 1 Block diagram of the ETI Waveform Multiplier. Should you require an even richer sound, there's no reason why more than six multipliers shouldn't be used.

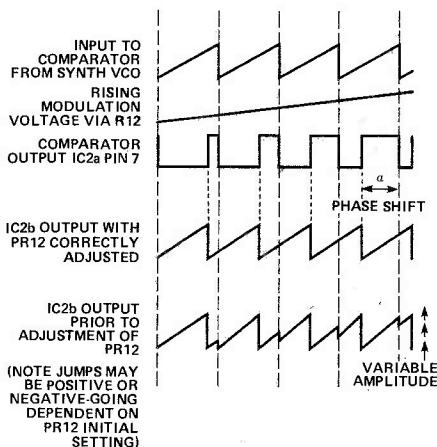

Fig. 2 The waveforms associated with various sections of the circuit. This indicates the operation of the unit and will also guide those people who are setting up the unit with an oscilloscope.

come from the same power supply as the VCO being input to the unit.

Interwiring between the PCBs should be clear from the diagram, as should the wiring up of the switch with its associated zener diodes. The switch is a DPDT with centre off and it is essential (for setting-up purposes if nothing else) to have this 'off' position (see Buylines).

A note is in order here about the component numbering. In order to make the numbering clearer and logically the same for each of the six multipliers on the PCB, each resistor or preset is designated by a two-figure number. The first figure indicates which of the six multipliers it is associated with, and the second is the 'relative number' of the component. For example, R11 is 'R1' on the first multiplier, R21 is 'R1' on the second multiplier, R35 is 'R5' on the third multiplier and so on.

With regard to the modulation PCB, though all the capacitors are of the same value, take care not to mix up the resistors associated with the two oscillators, as each oscillator should have all three of its resistors the same value. If not, the modulation output waveform will take on a pulse form at the output associated with the first op-amp in each oscillator.

PARTS LIST

MODULATION BOARD

Resistors (all 1/4W, 5%)
 R1-3 1M8
 R4-6 2M2
 Capacitors
 C1-8 100n polyester

Semiconductors

IC1 LM324
 IC2 LM1458
 ZD1,2 6V2 400 mW zener

Miscellaneous

SW1 DPDT with centre off (see Buylines)
 PCB (see Buylines)

MULTIPLIER BOARD

Resistors (all 1/4W, 5%)
 R1-3, 11,12,13,14, 15,16,21,22, etc to 66 100k (39 in total)
 R4 18k

Potentiometers

PR11-61 100k miniature horizontal preset (six in total)
 PR12-62 220k miniature horizontal preset (six in total)

Capacitors

C1,2 47u 16 V PCB electrolytic
 C3-6 100n polyester

Semiconductors

IC1 LM1458
 IC2-4 LM324
 D1-6 1N4148

Miscellaneous

PCB (see Buylines); case to suit (Teko Alba A23); sockets to suit.

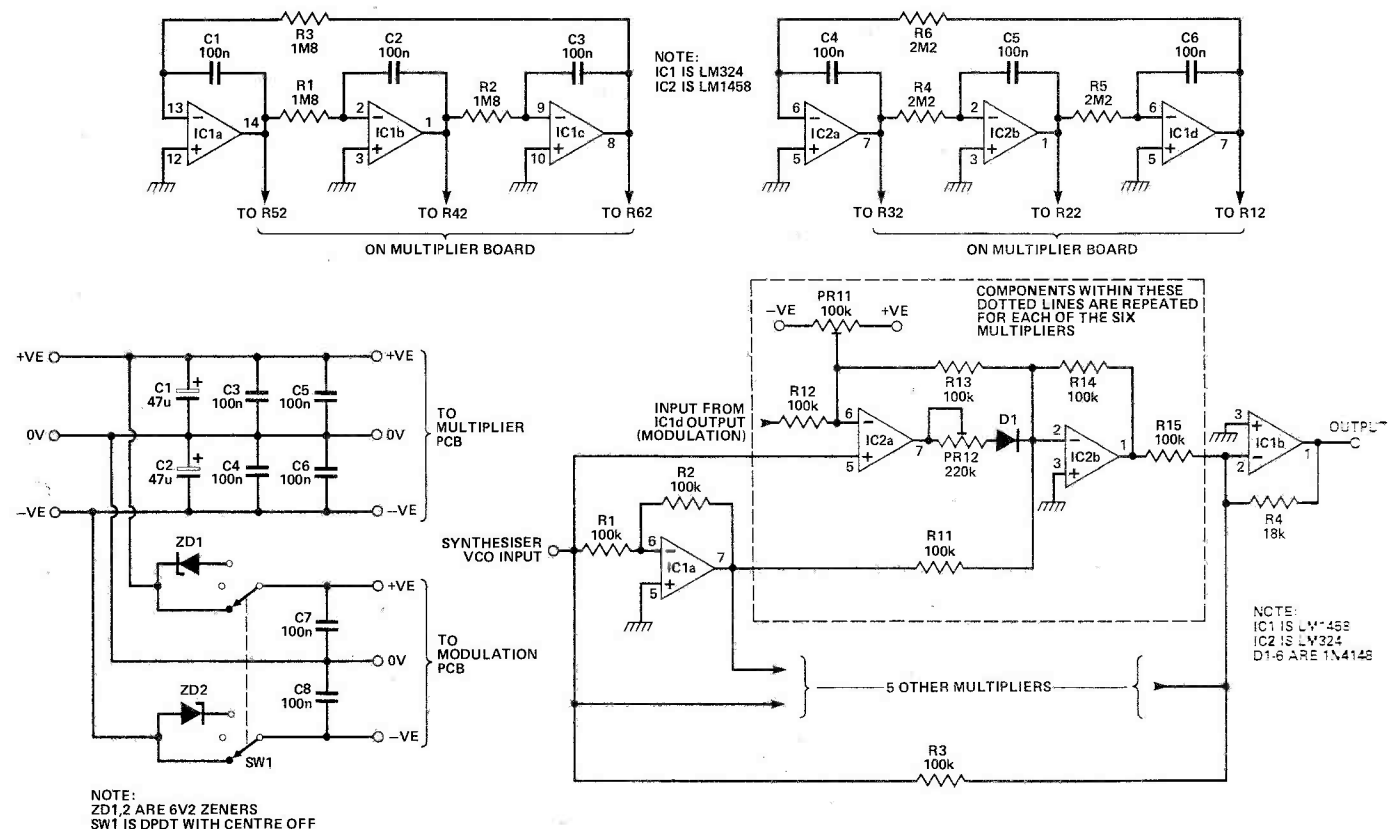

Fig. 3 Complete circuit diagram of the Waveform Multiplier.

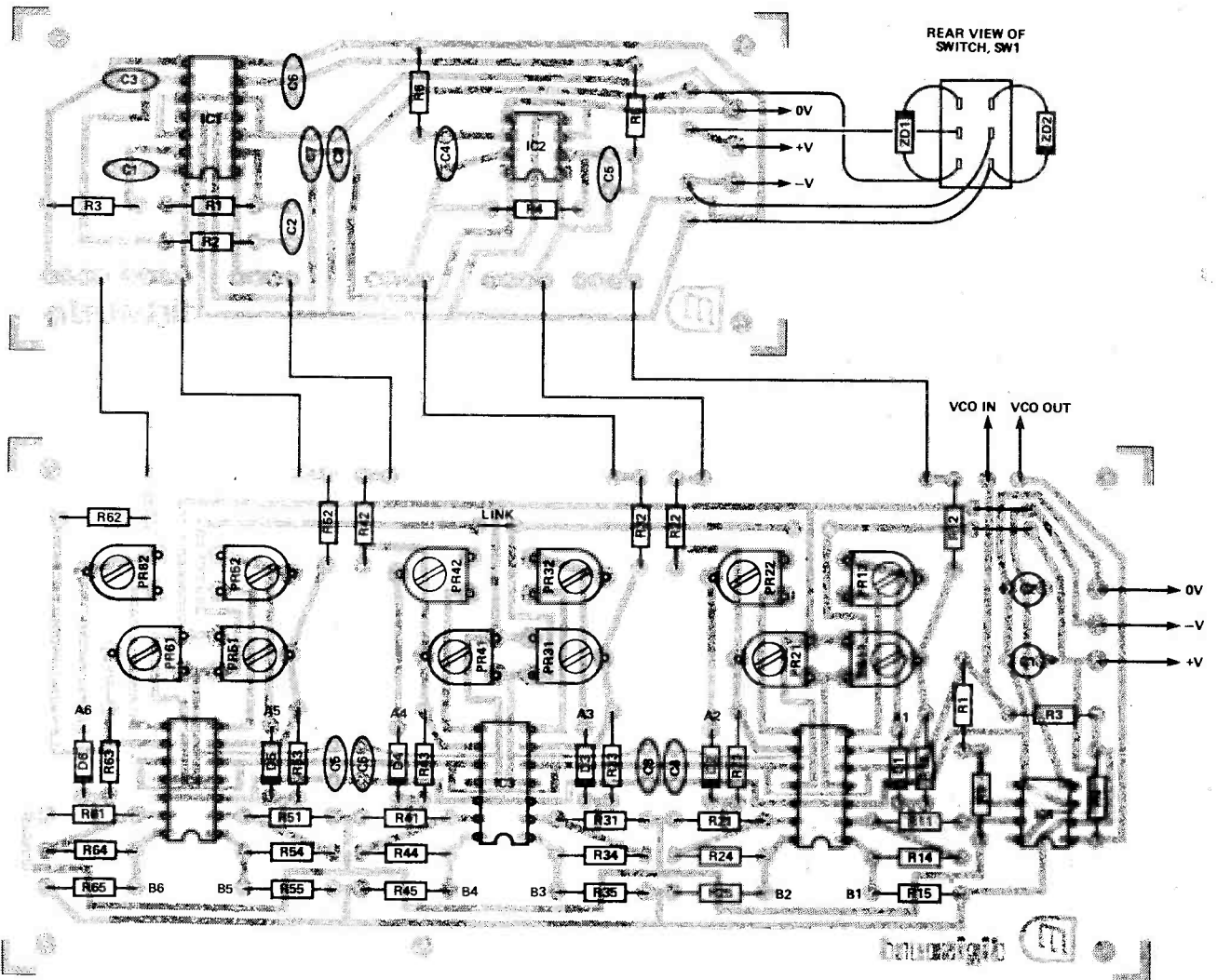

Fig. 4 Component overlays for the modulator board (top) and the multiplier board (bottom), and the interwiring required. Several multiplier boards may be driven from one modulator board.

HOW IT WORKS

The modulation oscillators are based on a standard three phase oscillator; two of these are used. Each of the three integrators in the loop outputs a waveform that is one-third of a cycle behind the others. The speed of the two oscillators is set at about 0.6 Hz and 0.4 Hz respectively. This modulation rate was found to give the best simulation of a number of oscillators running in free phase over a wide keyboard span.

It should be noted that the output of these oscillators is, in fact, a trapezoid shape waveform and it might be thought that some filtering would be required to produce a waveform more akin to a sine wave. This was tried in the development stage, but in practice the trapezoid waveform gave a better randomness to the overall output, whereas with a sine wave modulation a more definite sweep could be detected on long sustained notes.

Referring now to the multiplier circuit, the output from the synthesiser VCO is taken to IC1a configured as an inverter/buffer; the VCO waveform also goes to one input of the comparator IC2a. The other input of the comparator is fed with a voltage set up on PR11 together with the modulation voltage via

R12. With a positive-going sawtooth, the point at which the comparator goes high is determined by the sum of the fixed voltage from PR11 and the modulating voltage via R12. As shown in the waveform diagram, with a rising modulation voltage the width of the pulse at the comparator's output increases. However, the comparator will, of course, always reset at the same moment as the sawtooth. Thus the comparator's reset is synchronised with the original sawtooth, whereas its positive-going excursion can be voltage-controlled to any point within one cycle of the input waveform.

The output of the comparator is rectified by D1 and summed with the inverted sawtooth from IC1a via R11. These voltages (actually currents) result in a new sawtooth whose reset point is determined by the positive-going edge of the comparator. Thus, as shown in the waveform diagram, this new sawtooth is phase-shifted from the original and the amount of phase shift is dependent on the comparator pulse width. The output of the summing amplifier IC2b is taken via R15 and mixed with the other multiplier outputs plus the original sawtooth (via R3), where IC1b acts as the mixing amplifier.

Setting Up

As stated earlier in the article, setting up requires access to an oscilloscope; you should have two VCOs and some method of listening to their output, but hopefully these requirements will not be a problem for most constructors.

Once all the components have been installed, ensure that the ICs, diodes and the two polarised capacitors are correctly orientated. All the ICs should be facing the same way and the diodes mounted on the PCB should have their band pointing towards pin 1/pin 14 of the ICs. Turn all the presets to their mid-position.

The setting up procedure is reasonably straightforward, though repetitive, since each of the six multipliers has two presets which need to be adjusted; however, your efforts will be rewarded! Constructors with access to a scope will find it easier to use the scope to see the various waveforms mentioned in the text. Those of you

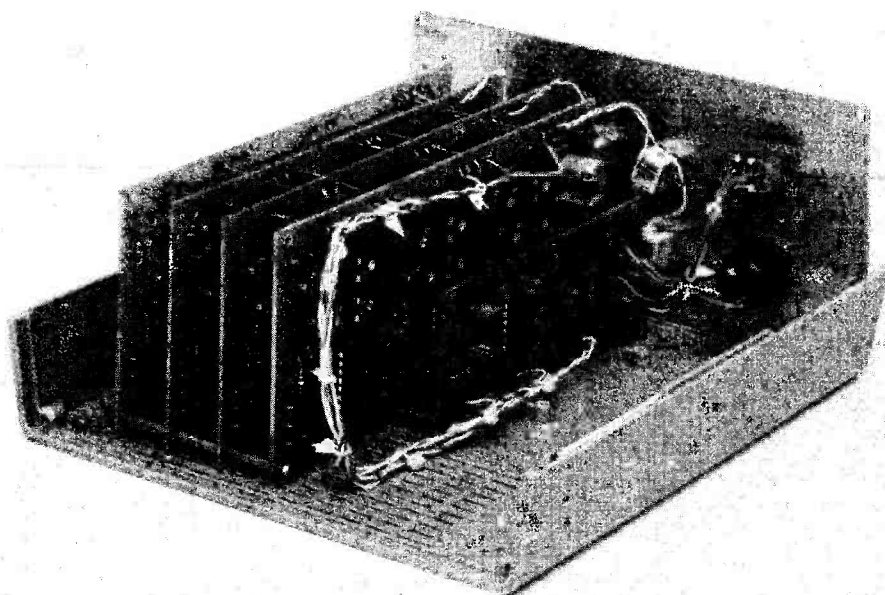

A view inside the prototype showing how it is configured to provide four independent channels driven by one modulator board. Miniature jack sockets are used for input and output (see also the lead photograph).

without a scope will be using your ears rather than your eyes, so make sure you have some means of listening handy. Either an amplifier and speakers, or headphones of reasonable quality will do, but remember we are listening to a 'raw' signal so don't stick it straight into your favourite hi-fi amp!

The first step is to power up the circuit and apply a VCO sawtooth waveform running at about 500 Hz (for ease of listening — so with a scope it doesn't matter). Ensure that the modulation switch is in the off position. Attach a lead to the output of IC1b (junction of pin 7 and R2). This should be outputting the VCO sawtooth (inverted). Next move the scope probe or audio lead to the junction of D1 and PR12 (marked A on the component overlay). This is the comparator output from which we want to get an approximate square wave output. At first you may hear no sound at all, but as PR11 is rotated you should hear a square wave break in with the pulse width varying as you turn the preset. Adjust PR11 for an approximate 50% duty cycle. (For

those unfamiliar with this sound, adjust PR11 for the 'loudest' sound. When the duty cycle is less than about 30% or more than about 70% a 'thin' spiky sound predominates, so set PR11 midway between these two — an accurate 50% is not important.) Repeat this step on each of the five other multipliers.

With the comparators now set up, we need to adjust the presets on the comparator outputs so as to give a smooth sawtooth waveform. PR12 is the preset associated with this adjustment. Attach your lead to the output of IC2b (junction of pin 1 and R15 — point B on the overlay). Until PR12 is correctly adjusted the sawtooth will contain a jump in it as shown in the waveform diagram. Using a scope, all you need to do is turn PR12 until this jump is smoothed out. Without a scope you will need two VCOs in order to accomplish this adjustment.

First, slow down the VCO which is connected to the circuit, to its lowest setting (somewhere around one cycle per second is fine). Now attach a lead from the aforementioned junction of pin 1 and R15 (point B) and run it to the FM input of your second VCO. If you now listen to the output of this second VCO it will be frequency-modulated by the sawtooth wave that we need to smooth out. So all you need to do now is turn PR12 until this second VCO gives a smooth upward frequency sweep followed by a sudden return to the starting frequency. This may sound difficult to perform but in fact it is surprising how easily the ear can detect any jumps in the modulating

waveform. However, if you are unsure of what a VCO sounds like when it is being frequency-modulated by a slow running sawtooth, listen to this effect on its own before trying to set up PR12.. Again this adjustment is carried out on each of the six multipliers.

With all the multipliers now set up, speed up the VCO connected to the circuit, attach a lead to the output and you should see/hear a multiple sawtooth waveform. Now switch the modulators on (either setting of SW1) and you should hear a 'phasing' sound as the modulation builds up. Finally, check that the two 'on' positions of SW1 give different depths of modulation.

If, when the modulation switch is set to 'full' you find you can hear a distinct pause or break in one of the new waveforms, this indicates an incorrect setting of the preset associated with the comparator. To determine which one needs a finer adjustment, check each of the six multipliers by attaching an audio lead or probe to point B and adjust PR11, 21, 31 etc as appropriate, so that even with full modulation depth the comparator (and thus the sawtooth) remain within the range of one full cycle of the original sawtooth.

Interfacing Notes

The original circuit was developed for a Digisound 80 modular synthesiser; this has $\pm 15V$ supplies and a positive-going 0-10V VCO output. However, the circuit is fairly tolerant of a wide range of conditions and can be adapted to almost any synth with possibly some small additional components. The most likely problem concerns the ratio of the VCO output amplitude when compared with the voltage supply rails. The minimum and maximum supply voltages to the circuit described are $\pm 5V$ to $\pm 16V$. Bearing in mind these two limits, the waveform to be treated should be equal to or greater than one-third the sum of the voltage rails.

If the input waveform does not meet these requirements the obvious course is to add an op-amp to the front end of the circuit to bring the waveform up to the required level. For instance, with the PE Minisonic, which is pretty much a worst case, the power supply is $\pm 9V$, the VCO output is 1V peak-to-peak. In this case a simple $\times 6$ amplifier would do, but so as to allow plenty of headroom a $\times 8$ amplifier was made up. **ETI**

BUYLINES

A kit of parts for this project, comprising glass fibre PCB and all electronic components, is available from Digisound Ltd, 14-16 Queen Street, Blackpool, Lancs FY1 1PQ. The prices, inclusive of VAT and postage, are £10 for the multiplier and £6.05 for the modulator. Housing the project is entirely up to you and most people will simply fit the boards inside their synth, but we put ours into a Teko Alba A23 case to match the rest of the Project 80 modules. If you want to do likewise, the case is available from West Hyde, Unit 9, Park Street Industrial Estate, Aylesbury, Buck.

B.N.O.S. ELECTRONICS

Don't miss the Christmas rush. Don't waste your money on throw away Dry cell batteries. Buy Ever Ready RECHARGEABLE Nicad Batteries. Run your toys, radios, cassettes or even kitchen equipment. Each charge lasts as long as a dry cell, but you can re-charge them up a 1,000 times or more. So think of the money you can save at 1p a charge.

BUY NOW
and have a set charged ready for Christmas.
(Available in four standard sizes)

NI-CAD	DRY CELL		1.9	10-24	24-100
	EQUIVALENT	CAPACITY			
'AA'	HP7	0.5AH	0.90	0.85	0.82
'C'	HP11	2.2AH	2.40	2.30	2.20
SUB 'D'	HP2	1.5AH	2.30	2.15	2.00
'D'	HP2	4.0AH	3.40	3.20	3.05
PP3	PP3	0.11AH	3.90	3.65	3.40

Ni-Cad Battery Chargers

Type AC1 charges up to 4 x AA cells at a time.....**£5.90**

Type MC2 charges up to 4 x AA, C, D cells & also PP3's..**£8.50**

Postage FREE on Mainland UK orders

SEND NOW your cheque/postal orders to

B.N.O.S. ELECTRONICS Dept. ETI,
GREENARBOUR, DUTTON HILL,
GT DUNMOW, ESSEX CM6 3PT
TEL: 0371 84767

Also ACCESS and VISA cards welcome

MARCO TRADING

Primary	Secondary	Current	1+	10+	100+
240V	4.5-0-4.5V	400m/a	50p	45p	35p
240V	6-0-6	100m/a	58p	52p	43p
240V	6-0-6	500m/a	65p	60p	48p

Manufacturers note: We can supply OFF THE SHELF 1000+ quantities of the above transformers.

These high quality British made European Adaptors are ideal for driving radio's, cassette recorders, TV games, calculators etc etc.

These adaptors fit the UK shaver socket.

			1+	10+	100+
E08	4.5V DC	200m/a	50p	45p	32p
EM3	6V DC	200m/a	£1.00	80p	55p
E09	6V DC	400m/a	£1.50	£1.25	85p

UK POWER SUPPLY/CHARGER. Input 240V. Output 9V 200m/A. Fully Regulated and Stabilised. Complete with Reversible 4 Way Plug.
Price £2.95 + 75p p&p + VAT

MULTIMETER SPECIAL

Russian type U4324 20,000 O.P.V.
DC Voltage: 0.6, 1.2, 3, 12, 30, 60, 120, 600, 1200.
AC Voltage: 3, 6, 15, 60, 150, 300, 600, 900.
DC Intensity M/A: 0.06, 0.6, 6, 60, 600, 3000
AC Intensity M/A: 0.3, 3, 30, 300, 3000.
DC Resistance: 0.2, 5, 50, 500, 5000K.
ge level dB: 10 to + 12.

Special Price £15.00 inc p/p and VAT

Send 25p Now for our latest Catalogue. Fantastic Value it includes capacitors, diodes, resistors, transistors, LEDs, boxes, cable, prepaid envelopes and much, much more.

Please add 35p postage and packing and 15% VAT to all orders.

Send orders to:

MARCO TRADING (Dept ETI/1)

The Maltings, High Street,
Wem, Shropshire SY4 5EN
Telephone: WEM (0939) 32763

Every order receives our latest special offer lists. Or send SAE.

All orders despatched by return of mail.

CENTRONICS 306



Superb professional quality fast compact line-printer 80 columns 120 char/sec. Parallel I/F. Beautiful quality at a silly price. Vertical format unit. To include copy of operations manual. ONLY £149.00 Carriage (England) £17.50. Tech manual (230 pages) £10.00.

DISC DRIVE

Memorex 550 8" Floppy drive, mounted in case with power supply and fan. Room for second drive. Only £225 + £7.50

SHUGART 801 8" Floppy - 2 only at £250 + £7.50
DRE 4000A (258-9901) Hard disc - 1 only £300.

BASF 6172 24 Mega byte Winchester with TSU - 1 only £700

69 Key keyboard 5 volt CMOS - believed ASCII but no data hence £20

Multi Rail PSU 5 volt at 4 amp. 12 volt at 2.5A, 12 volt at 350 mega Amps only £17.50 + £1.80

5 V, 5 amp Regulator module £2.50 + 50p.

Data dynamic RO390 printers 110 Baud ASCII RS232 - 20 mega amps £75

MAWSON ASSOCIATES

124 Lennard Rd, Beckenham, Kent BR3 1QP

01-778 3800

Callers welcome by appointment and all 2nd hand goods sold as seen working but unguaranteed

WE ALSO BUY
SELECTED
COMPUTERS
AND COM-
PUTER
PERIPHERALS

WHY USE STRIPBOARD?

Make your own PCB. It's easy:

"GET YOU STARTED" KIT

12V Mini Drill (takes 1/2 A).

1mm Bit.

25 sq. ins. Copper Clad.

PCB Etchant for 1/2 ltr.

Tweezers and Dish,

Fine Etch Resist Pen

Instructions. Only £6.00

"SUPER" KIT As above with:

3 pens, Fine-Med.-Thick.

75 sq. ins. Copper Clad.

3 Sheet Transfers - Etch Resist.

Only £8.50.

SIMPLE PCB DRILL

12V Motor with chuck attached with 3 collets 0.8 to 2.0mm. £4.50.

PCB ETCHANT

Double strength to make 1/2 ltr. solution. 90p.

ETCH RESIST PENS

Set of 3, Fine-Med.-Thick. £1.80

Callers Welcome 9am to 5.30pm

Prices are inclusive but add 60p P & P to each order.

Cheques & P.O.'s payable to POPS Components.

POPS COMPONENTS

38 Lower Addiscombe Rd,
Croydon CR0 6AA
Tel No: 688 2950

LOW COST PROFESSIONAL TEST INSTRUMENTS

sabtronics
FREQUENCY METERS
100MHz, 600MHz, and 1GHz Models
from £67

Belemic
Hand Held
Analogue and
Digital
Multimeters
16 Models
from £18.75

Belemic

- ★ FREQUENCY METERS
- ★ ANALOGUE MULTIMETERS
- ★ DIGITAL MULTIMETERS
- ★ FUNCTION GENERATOR
- ★ OSCILLOSCOPES
- ★ POWER SUPPLIES
- ★ LOGIC PROBE
- ★ SCOPE PROBES

Write or phone for illustrated test instrument catalogue and price list

Black Star Ltd.
9A, Crown Street
St. Ives, Huntingdon
Cambs. PE17 4EB
Tel: (0480) 62440 Telex 32339

CONFIGURATIONS

And so to op-amps, the most venerable members of the linear IC family. Ian Sinclair traces their ancestors, descendents and lifestyle.

Before the reason for the name becomes shrouded in the mists of history, perhaps it's just as well to look at the origins. Operational amplifiers were designed for analogue computers, which are machines used for solving mathematical equations. They do so, not by using binary arithmetic as digital computers do, but by connecting up a network of components which represents either a mathematical relation or an equation. In the case of a mathematical relation (eg, $y=x^2$) the circuit will have an input, x , and an output, y , that will vary according to the relation set up and according to the value of x . Equations can be either ordinary (eg, $x^2+4x+3=0$) or differential (eg, $d^2y/dx^2+x=0$); the circuit will be connected in a loop, and in the case of the ordinary equation it will give an output that represents the solution (or one of the solutions) to the equation. The solution to a differential equation is itself a mathematical relation (in the case of the example given above, $y=Asinx+Bcosx$), so the circuit will have an input and an output (the coefficients of the equation, A and B , will be determined by the initial values of the circuit voltages, but that takes us a bit beyond the present scope of this article).

An essential part of representing a mathematical operation in electrical terms is an amplifier with very high gain whose frequency response can be modified by using negative feedback. Typical operations that can be simulated by amplifiers of this sort include the mathematically important ones of differentiation and integration (Fig. 1), and the amplifiers which were designed for these purposes very reasonably became known as operational amplifiers.

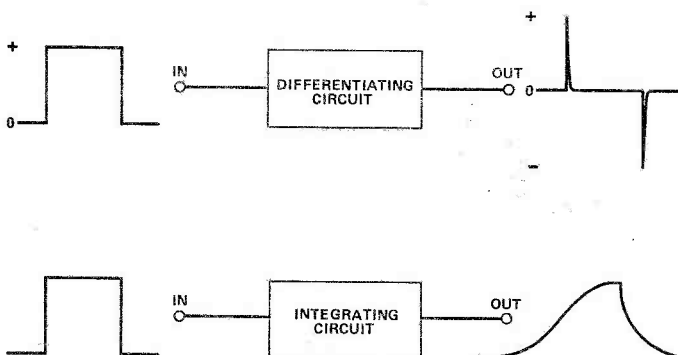

Fig. 1 The operations of differentiation and integration performed on a square wave.

The Perfect Specimen

The specification for a perfect operational amplifier was that it should have infinitely high gain, infinitely high input resistance, zero output resistance, and as much bandwidth as was needed — it was particularly important to have the gain maintained right down to DC. Analogue computers are still produced, though they don't have the

importance they once had, and the operational amplifiers which were once made using valves, and then transistors, are now made as ICs. The requirements are still pretty much the same, because our definition of an operational amplifier nowadays is as a high gain DC-coupled amplifier whose behaviour can easily be controlled by using negative feedback. Since the behaviour (gain, bandwidth, shape of gain-bandwidth curve) is so easily modified by the use of negative feedback, the operational amplifier is the nearest thing we have to an all-purpose amplifier, and that's why operational amplifiers were among the first linear ICs that were produced.

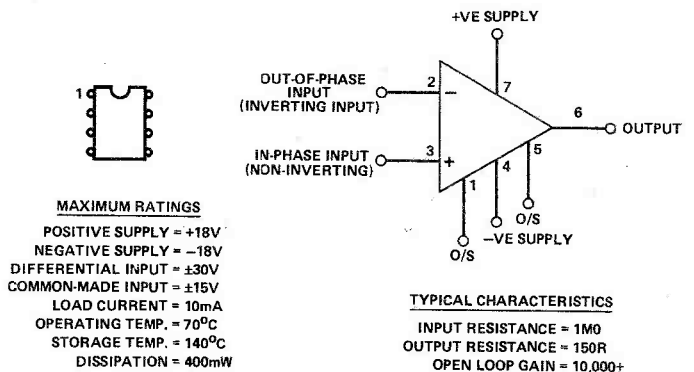

Fig. 2 Part of the specification for the 741 op-amp.

To start with, consider the typical specification of one of the best-known op-amps, the 741. This is illustrated in Fig. 2, to show how close we can get to the ideal specification. One point of importance is the bandwidth. If you use a 741 at its full gain, you must expect the bandwidth to be very severely limited — less than 100 Hz at maximum gain. Some care has to be taken if 741s are used in audio circuits, because in some feedback circuits that include filtering the chip may be working at a very high gain at the ends of the bandwidth, even though its midband gain is low.

Offset Problems

Getting down to configurations, the main point about op-amp circuits is how to bias them. Very few applications call for the 741 to be operated as a differential DC amplifier at full gain, but for these applications a balanced power supply is needed. Additionally, some form of input offset balancing will be needed. This is necessary because there are bound to be some very small mis-matches between the resistors and transistors that make up the two input circuits (see later). The gain of the op-amp is so high that any imbalance will be amplified up, so that with both inputs tied to zero, the output of the op-amp will not be zero by quite a margin.

Manufacturers usually specify typical and maximum *input offset voltage* and *input offset current*. These are the *differences* between the input voltages and the input

currents (with both inputs very close to zero volts) needed to obtain an output voltage of zero. With the 741 and many other op-amps there are offset trim connections that allow you to trim out the voltage offset. A circuit for the 741 is shown in Fig. 3. However, the input currents will still be slightly different, and there may be the odd circuit

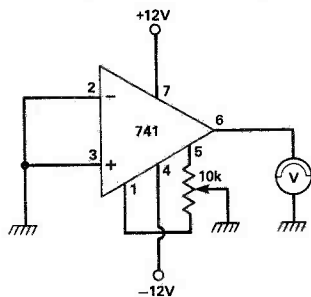

Fig. 3 Using the offset adjustment to balance out the internal currents.

for which this will need to be taken into account.

The offset adjustment will have to be repeated at intervals, because the settings *drift*. The effect of temperature and time conspire to make the output voltage change (drift) away from zero, so that an op-amp at full gain is a rather unstable device which needs frequent checking. Fortunately, we seldom need to make use of the full gain of the op-amp, and most of the circuit configurations make use of feedback bias circuits.

Figure 4 shows one of the most common bias methods. The circuit uses a balanced power supply, and bias is obtained by connecting a resistor between the output and the out-of-phase or inverting input (marked as -). The in-phase or non-inverting input (+) is connected to earth, so that the output voltage will be almost zero, just enough to apply the correct offset voltage (which is usually less than a millivolt) to the inverting input. The gain of this circuit depends on the resistance of the signal source. If we represent this as a resistor in series with the input, R1, then the gain is simply $-R2/R1$ (the - sign indicates that the signal is inverted).

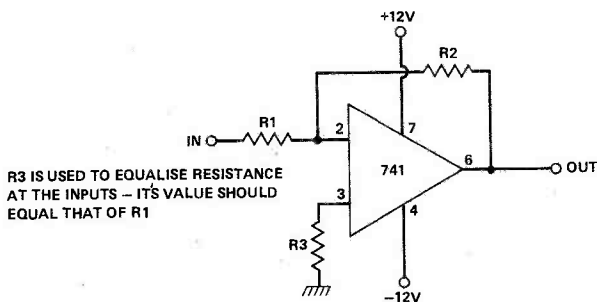

Fig. 4 The feedback bias system in a circuit which uses the out-of-phase, or inverting input for signals.

This circuit is DC-coupled throughout, but if we do not need DC gain, then a single-ended supply version can be constructed, as indicated in Fig. 5. Capacitor coupling must then be used to avoid shorting out the bias voltage, choosing capacitors with low leakage, and the supply voltage must be adequate — the quoted minimum voltage across the chip is 3V.

When this configuration is used, the inverting input voltage remains practically constant when a signal is applied. When a balanced power supply is used, in fact, the inverting input is virtually at earth voltage, and this 'virtual earth' effect means that signals applied to the input terminal (one end of R1) are flowing through R1 to a point

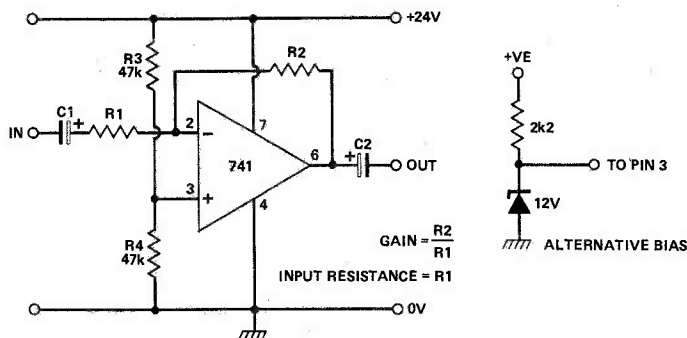

Fig. 5 A single-ended power supply version of the Fig. 4 circuit.

which is as good as earthed as far as signals are concerned. This makes the input resistance of the circuit equal to the value of R1, and it limits the application of the circuit to some extent, because if the input resistance is to be reasonably high, then the feedback resistor R2 will have to be of an unreasonably high value to achieve a modest gain. If the feedback resistor has too high a value (in the megohm region), then the bias currents at the input of the chip, typically 200 nA, will cause voltage drops which we can't ignore without making our calculations go considerably astray. The input resistance of the op-amp itself is large, but the use of negative feedback to the same input as the signal makes the input resistance low because of the 'virtual-earth' effect.

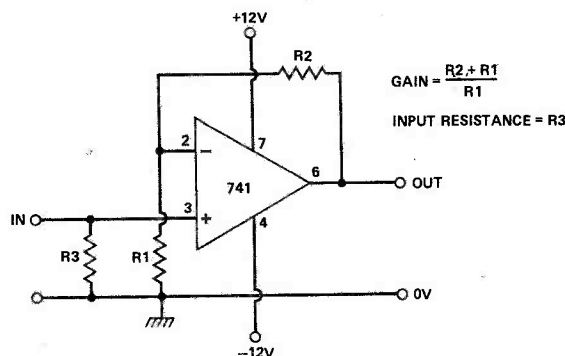

Fig. 6 Using signal input to the in-phase, or non-inverting input of the 741.

Improved Impedances

Another configuration of the op-amp is illustrated in Fig. 6. This time the input is taken to the non-inverting input, and the inverting input is used only for the feedback. In this balanced version of the circuit, the input resistance can be higher, because the resistance R3 does not control the gain of the amplifier, and the source resistance is of no interest unless it is unusually high. The gain is given by $(R2 + R1)/R1$.

It's quite straightforward to combine the biasing arrangements of Fig. 5 with the non-inverting circuit of Fig. 6. However, a word of caution: all those resistors and all those capacitors combine to form low-pass filters, and at frequencies around their cut-offs, these will all produce considerable phase-shifts, and this may lead to what you've designed as an amplifier actually turning out to be an oscillator!

Slewing About

The 741 type of operational amplifier has a lot of merits, but it is a design which is now showing its age. Much more recent designs have, in particular, wider

INTRODUCING TWO NEW HANDHELD DIGITAL MULTIMETERS

200 μ A — 10 AMP AC-DC

MODEL 6010

DC accuracy 0.5%

£29.95
plus VAT

MODEL 7030

DC accuracy 0.1%

£35.95
plus VAT

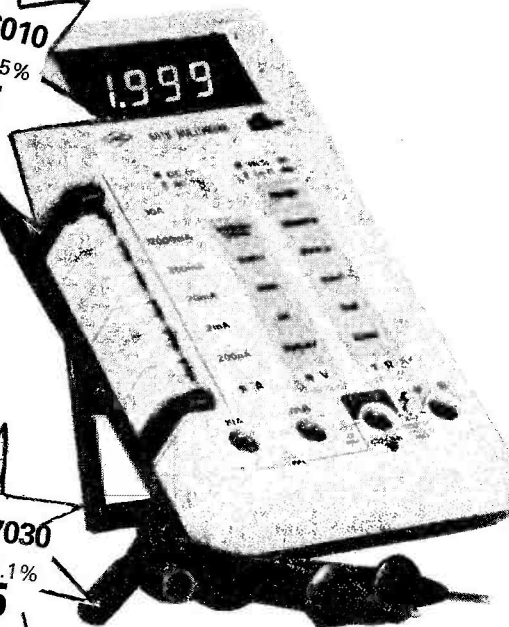

SPECIFICATION 6010 & 7030

BATTERY: Single av dry cell

BATTERY LIFE: 200 hours

DIMENSIONS: 170 x 89 x 38mm

WEIGHT: 400g inc battery

MODE SELECT: Push button

AC DC CURRENT: 200 μ A to 10A — 6 Ranges

AC VOLTAGE: 200mV to 750V — 5 Ranges

DC VOLTAGE: 200mV to 1000V — 5 Ranges

RESISTANCE: 200 Ω to 20M Ω — 6 Ranges

INPUT IMPEDANCE: 10M Ω

DISPLAY: 3½ Digit 13mm LCD

O/LOAD PROTECTION: All ranges

OTHER FEATURES:

Auto polarity. Auto zero. Battery-low indicator.
Strong ABS plastic case with tilt stand.
Battery and test leads included.
Optional carrying case.

Please add 15% to your order for VAT. Postage & Packing is free of charge. Trade enquiries invited.

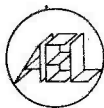

ARMON ELECTRONICS LTD.

Cottrell House, 53-63 Wembley Hill Road, Wembley, Middlesex HA9 8BH, England

Telephone: 01-9024321 (3 lines)

TELEX No. 923985



TURNTABLE KITS

FROM

INPUT DESIGN LTD

THE LEADING MANUFACTURERS OF
TURNTABLES IN KIT FORM

KITDECK 2 NORMAL PRICE £115.00

**SPECIAL
CHRISTMAS
OFFER TO
READERS
OF ETI**

£99

inc. VAT
(P + P £3.00)

**HOME CONSTRUCTOR TURNTABLE KIT
NOW £49.50 (P + P £1.95)**

5 YEAR GUARANTEE

MONEY BACK IF NOT SATISFIED

Pay by Barclaycard, Access or CWO. Export: Write for Pro-forma

PALACE STREET,
BIGGLESWADE,
BEDS. SG18 8DP

Telephone:
0767 316655
Telex: 826671

PRACTICAL DESIGN OF DIGITAL CIRCUITS

Ian
Kampel

Practical Design of Digital Circuits will instruct the reader who is familiar with basic electronic principles but with no previous knowledge of digital electronics in the practical aspects of digital design. It should appeal particularly to engineers and enthusiasts wishing to expand their knowledge in practical rather than theoretical directions.

The book is divided into three main parts covering: the principles of digital electronics and the wide range of devices available; how to use these devices in cost-effective designs, including two detailed examples; microprocessors, showing them to be particularly versatile and sophisticated devices.

0 408 01183 1 324 pages
£9.95

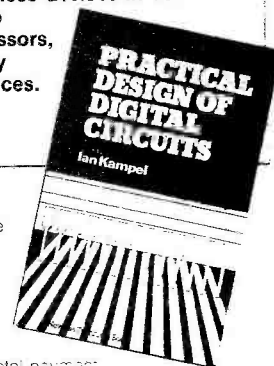

**ORDER NOW from your
local Bookseller**

In case of difficulty this coupon can be returned to Shirley Godden at the address below.

Please send me _____ copy/ies of
Practical Design of Digital Circuits
(Kampel) 0 408 01183 1 @ £9.95

I enclose cheque/PO for £ _____ in total payment

FROM _____

ADDRESS _____

Newnes Technical Books
AN IMPRINT OF BUTTERWORTHS, BOROUGH GREEN,
SEVENOAKS, KENT TN15 8PH

ETI 17/82



TARGET ELECTRONICS

16 Cherry Lane, Bristol BS1 3NG
Telephone: 0272 421196

Panel Meters

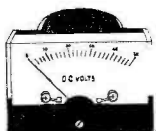

Dims:- 110 x 82 x 35mm. Require 58mm dia. cut out
FINE QUALITY -

043	0-30 UA
045	0-50 UA
0410	0-100 UA
0420	0-200 UA
0450	0-500 UA

£5.50

40p p&p + VAT
10 Plus 10% Discount



Dims:- 60 x 47 x 33mm. Require 38mm dia. cut out
FINE QUALITY -

T21	0-50 UA
T22	0-100 UA
T23	0-500 UA
T24	0-1 MA
T25	0-5 MA
T26	0-10 MA
T27	0-50 MA
T28	0-100 MA
T29	0-500 MA
T30	0-1 AMP
T31	0-2 AMP
T32	0-25 Volts
T33	0-50v AC
T34	0-300v AC
T35	"Ω"
T36	"VU"
T40	50-0-50 UA
T41	100-0-100 UA
T42	500-0-500 UA
T43	0-30v DC

£4.80

40p p&p + VAT
10 plus 10% Discount

Illuminating kit for meters

1pc 80p + 15% VAT



Dims:- 52mm(H) x 58mm(W) x 43mm(D)
44mm dia. cut out.

ref.	icat.	F.S.D.	Int. Resistance
DC MICROMETERS			
XME18	MU45	0-50 uA	3500 ohms
XME19	MU45	0-100 uA	3500 ohms
XME20	MU45	0-500 uA	430 ohms
DC GALVANOMETERS			
XME21	MU45	50-0-50 uA	3500 ohms
XME22	MU45	100-0-100 uA	1450 ohms
DC MILLIAMMETERS			
XME23	MU45	0-1 ma	200 ohms
XME24	MU45	0-5 ma	8 ohms
XME25	MU45	0-10 ma	3 ohms
XME26	MU45	0-50 ma	1.5 ohms
XME27	MU45	0-100 ma	0.8 ohms
XME28	MU45	0-500 ma	0.2 ohms
DC AMMETERS			
XME29	MU45	0-1 amp	0.1 ohms
XME30	MU45	0-2 amp	0.4 ohms
XME31	MU45	0-5 amp	0.02 ohms
DC VOLTMETERS			
XME32	MU45	0-25 volts	1000 ohms
XME33	MU45	0-50 volts	1000 ohms
VU METER			
XME34	MU45	1.228 VAC (OVU)	---

£3.00

40p p&p + VAT
10 Plus
10% Discount

KD25C LCD DIGITAL MULTITESTER

0.4" (10 mm) 3½ digit (1999) LCD display. Automatic zero and polarity. Full overload protection. Complete with hand strap, battery, test probes, spare fuse and CARRYING CASE.
Input Impedance: DC 10M ohms, AC 1K ohms

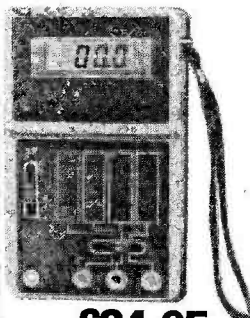

measurement	ranges
DC VOLTS	0-2V 0-20V 0-200V 0-1000V
AC VOLTS	0-200V 0-500V 0-2mA
DC CURRENT	0-20mA 0-20mA
RESISTANCE	0-2K ohm 0-20K ohm 0-200K ohm 0-2M ohm

Dims: 138 x 86 x 36mm

£24.95

£1.50 P&P
+ 15% VAT

Official Orders Welcomed, GVT/Educational Dept etc



We can offer you Barclaycard or
Access facility, just telephone your card number to
place an order.



ambit's new autumn/winter catalogue

is OUT NOW!



70p

ALL THE 'USUAL' BITS (Rs, Cs, Tr's, ICs etc) + ALL THE TRICKY BITS

at all good
newsagents
or direct

- * TOKO COILS, INDUCTORS, LC FILTERS
- * PCM FILTERS, VHF/UHF HELICAL FILTERS
- * UNELCO CAPACITORS
- * PCI INTELLIGENT LCD MODULES
- * TOKO SWITCHES : F SERIES/R7000 SERIES
- * ALPS POTENTIOMETERS AND KEYSWITCHES
- * TOYO-TSUSHO COAX RELAYS FOR TX/RX
- * CRYSTAL FILTERS, CERAMIC FILTERS
- * WELLER SOLDERING IRONS
- * COOPER TOOLS
- * TEST EQUIPMENT
- * BOOKS, MANUFACTURERS' HANDBOOKS
- * HARDWARE, CASES, PANELWARE, ETC.
- * MODULES, R&EW KITS
- * RF POWER DEVICES

ORDERS SUBMITTED USING STOCKCODES
DESPATCHED WITHIN 8 WORKING HOURS

* PHONE ORDER SERVICE - (NO MACHINES!)

PLEASE NOTE OUR NEW PHONE SYSTEM AUTOMATICALLY STACKS CALLS
IN ORDER OF ARRIVAL SO PLEASE WAIT IF NOT ANSWERED IMMEDIATELY

8 AM - 7 PM MON - SAT
0277 230909

* COMPUTER ORDER SERVICE - 'REWTEL'

6 PM - 9 AM 300 BAUD/RS232
(IT MAY BE 24 HRS BY THE TIME YOU READ THIS)
0277 230959

ambit INTERNATIONAL

200, NORTH SERVICE ROAD
BRENTWOOD, ESSEX
CM14 4SG
Telephone : (0277) 230909
Telex : 995194 AMBIT G

**3 x £1
DISCOUNT
VOUCHERS**

ambit's new
autumn/winter
catalogue
is
**OUT
NOW!**



**128
PAGES**

70p

ALL THE 'USUAL' BITS
(Rs, Cs, Tr's, ICs etc)
+ ALL THE
TRICKY BITS

at all good
newsagents
or direct

- * TOKO COILS, INDUCTORS, LC FILTERS
- * PCM FILTERS, VHF/UHF HELICAL FILTERS
- * UNELCO CAPACITORS
- * PCI INTELLIGENT LCD MODULES
- * TOKO SWITCHES : F SERIES/R7000 SERIES
- * ALPS POTENTIOMETERS AND KEYSWITCHES
- * TOYO-TSUSHO COAX RELAYS FOR TX/RX
- * CRYSTAL FILTERS, CERAMIC FILTERS
- * WELLER SOLDERING IRONS
- * COOPER TOOLS
- * TEST EQUIPMENT
- * BOOKS, MANUFACTURERS' HANDBOOKS
- * HARDWARE, CASES, PANELWARE, ETC.
- * MODULES, R&EW KITS
- * RF POWER DEVICES

ORDERS SUBMITTED USING STOCKCODES
DESPATCHED WITHIN 8 WORKING HOURS

*** PHONE ORDER SERVICE — (NO MACHINES!)**

PLEASE NOTE OUR NEW PHONE SYSTEM AUTOMATICALLY STACKS CALLS
IN ORDER OF ARRIVAL SO PLEASE WAIT IF NOT ANSWERED IMMEDIATELY

8 AM — 7 PM MON — SAT
0277 230909

*** COMPUTER ORDER SERVICE — 'REWTEL'**

6 PM — 9 AM 300 BAUD/RS232
(IT MAY BE 24 HRS BY THE TIME YOU READ THIS)
0277 230959

ambit INTERNATIONAL

200, NORTH SERVICE ROAD
BRENTWOOD, ESSEX
CM14 4SG
Telephone : (0277) 230909
Telex : 995194 AMBIT G

TRAIN FOR SUCCESS

in Television, Radio & Electronics

ICS have helped thousands of ambitious people to move up into higher paid more secure jobs in the field of electronics — now it can be your turn. Whether you are a newcomer to the field or already working in the industry, ICS can provide you with the specialised training so essential to success.

Personal Tuition and Guaranteed Success

The expert and personal guidance by fully qualified tutors, backed by the ICS guarantee of tuition until successful, is the key to our outstanding record in the technical training field. You study at the time and pace that suits you best and in your own home. In the words of one of our many successful students: "Since starting my course, my salary has trebled and I am expecting a further increase when my course is completed."

City and Guilds Certificates

Excellent job prospects await those who hold one of these recognised certificates. ICS can coach you for:

Basic Electronic Engineering (C&G/ICS)
Radio Amateurs

Certificate Courses

- TV & Audio Servicing
 - TV, Radio and Audio Engineering
 - Radio & Amplifier Construction
 - Electronic Engineering*
 - Computer Electronics*
 - Industrial Electronics*
 - Radio Frequency Electronics*
 - Introduction to Microprocessing*
 - Electrical Engineering*
 - Electrical Contracting & Installation
- *Qualify for IET Associate Membership



Approved by CACC



Div. National Education Corporation



Member of ABCC

POST OR PHONE TODAY FOR FREE BOOKLET

FREE BOOK

Please send your FREE School of Electronics Prospectus

Subject of Interest _____

Name _____

Address _____



Dept. C265
ICS School of Electronics
180 Stewarts Road,
London-SW8 4UJ



01-622 9911
all hours

PROGRAMMABLE POWER SUPPLY

We hear a lot these days about computing power but here it is, literally. With this PSU plugged into a suitable port on your micro you can control your voltage and current bit by bit. There's manual control, too. Design by Phil Walker.

This versatile piece of equipment is basically a programmable power supply. It allows you to set the output voltage and/or current to very close limits by means of your computer keyboard without actually touching the unit itself. Even more useful, in some cases, is that a sequence of voltage and/or current levels can be programmed in advance. The unit has a range of 0–25V5 in 100 mV steps and 25 mA to 1A6 in 25 mA steps.

The prime controlling element in the power supply section is an LM317 integrated voltage regulator device. In this project it is used as a high-gain self-protecting power transistor. In order to get the rated output from the device under all operating conditions, two power rails are used. The lower one, 17 V, is used while the required output is less than 12 V, the higher supply rail of 34 V is used when the required output is greater than 12 V. The purpose of this configuration is to keep the dissipation in the LM317 as low as possible. This is necessary because the LM317 will not allow the full 1A6 output to flow if there is more than about 17 V across it.

The reduced power dissipation in this circuit arrangement allows us to have a constant current output characteristic over the whole range instead of a 'foldback' limiting circuit.

Construction

The project was constructed in the specified Newrad case, but it's a fairly tight fit and it may well be easier to use the next size up (S2/38) to allow more elbow room. Construction of the PCB is straightforward so long as polarity of components is observed where relevant. We used PCB plugs and sockets for the digital input as this is



The handsome face of the ETI Programmable power supply.

most convenient. IC8, Q3, D4 and D5 are mounted on the heatsink and wired through a grommet in the rear panel. It makes things easier here if some PTFE insulators are used to hold the diodes and connecting wires. Use insulating mica washers with heatsink compound under IC8 and Q3 to conduct the heat away while preventing unwanted short circuits. Together with the heatsink, the mains switch, fuse, mains cable and control input socket are all mounted on the rear panel.

It will help considerably if the front and rear panel components

BUYLINES

Not too much in the way of unusual components for this project: the ZN428 and D-range connector may be hard to track down but Technomatic can supply both parts. The case we used is available from Newrad Instrument Cases Ltd, Tip-toe Road, Wootton, New Milton, Hants BH25 5SJ, telephone New Milton 615774; the PCB can be obtained, as usual, from our PCB Service as advertised on page 91. The optional DVM module, the DPM05, is stocked by Lascar Electronics, Oakland House, Reeves Way, South Woodham Ferrers, Chelmsford, Essex CM3 5XQ, telephone 0245 329797.

are fitted and wired as far as possible before the chassis is finally fitted. Make sure, however, that you leave enough room to insert the chassis afterwards. Note that R4, 25, 27 to 31 are mounted on their associated front panel components, though we did find room on the PCB for R4 after the prototype was completed, and it is shown thus on the overlay.

The transformer, main capacitors, bridge rectifier and PCB together with D6 and R26 are mounted on the chassis supplied with the case. Some solder tags and tagstrip will be useful for mounting the smaller components and connecting to the capacitors. The large capacitors used in the prototype were mounted horizontally using two clips each.

Setting Up

Having constructed the project and checked for wiring errors very carefully, put RV1 and RV2 to minimum, close SW3 and set SW2 to local. Switch on and check that the voltages on C1, C2 and C7 are +34, +17, and -34 (± 5 V or so). If not, check the wiring again. Now make sure that the +5V and -5 V

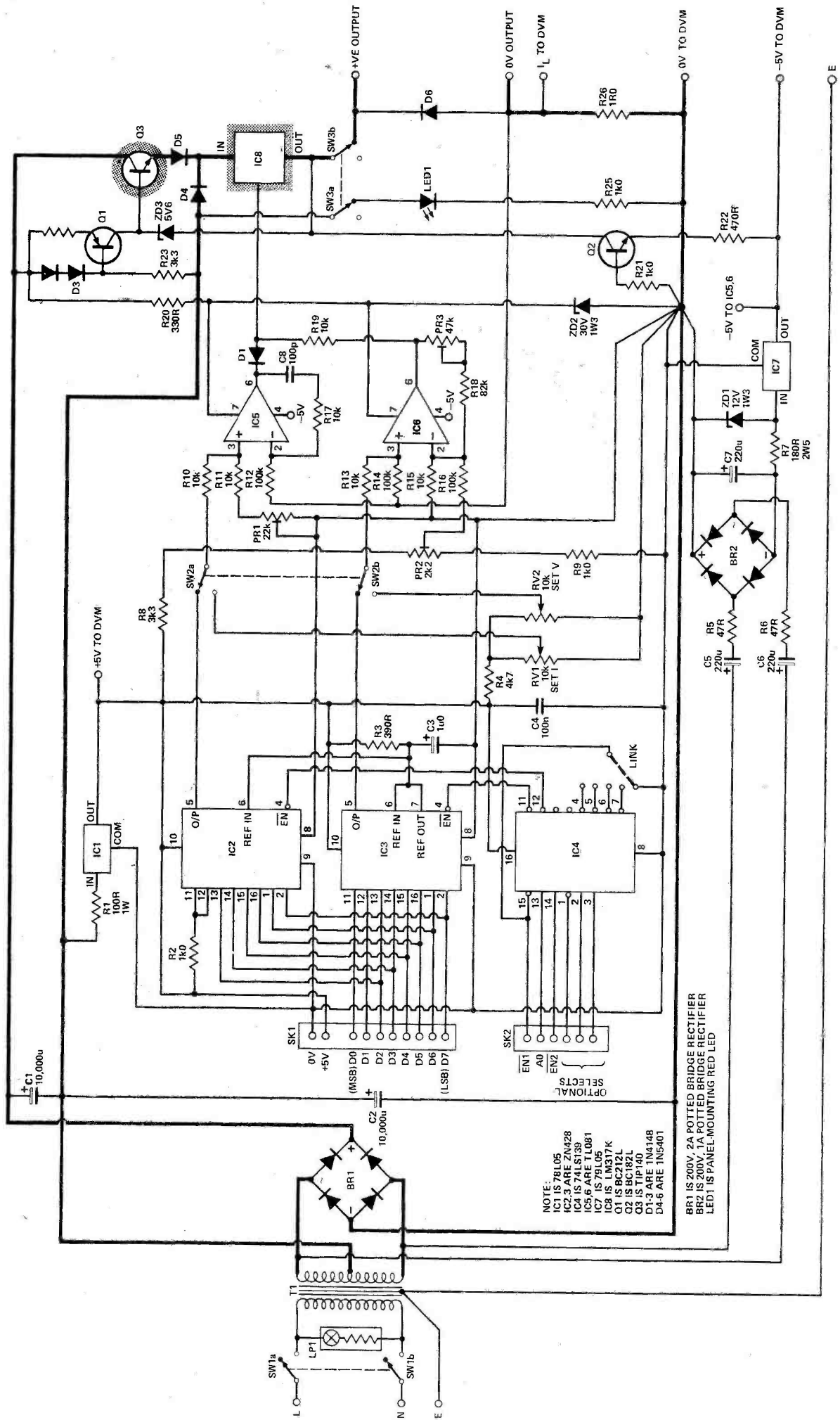

Fig. 1 Circuit diagram for the power supply. The heavier tracks carry the high current. Note the central earthing system.

HOW IT WORKS

POWER REGULATOR STAGE

The 12-0-12 V from the transformer is rectified by BR1 and smoothed by C1 and C2. This is connected to give a 0 V rail, a 17 V and 34 V positive supply rails. Also driven from the transformer, BR2, C5, C6, C7, R5 and R6 act as a full wave voltage doubler to provide a negative supply rail for the control circuitry.

The 17 V rail is connected to the input side of the LM317 via D4 while the 34 V rail is connected to the same point via Q3 and D5. Q1, R24, D2, 3 and R23 form a simple constant current source which tends to turn Q3 on. ZD3 acts to maintain the base of Q3 at 5V6 above the output level. By emitter follower action in Q3, the input to the LM317 will be maintained at about 5V6—1V8 higher than the output terminal. However, this is only true while D5 is forward biased, i.e. while $V_{out} \times (5.6 - 1.8)$ is greater than 17 V. When the output voltage is less than the level required, current will no longer be supplied via Q3 and D5 but will come via D4.

AUXILIARY SUPPLIES

The op-amps are supplied from +30 V and -5 V to enable them to cover the output voltage range while staying within their absolute maximum supply capability. These voltages are generated by a resistor and zener diode combination for the 30 V supply and an IC regulator for the -5 V supply. This latter device is preceded by a resistor and zener diode combination to drop the output from the voltage doubler circuit down to a safer level. The logic circuitry is supplied with +5 V from IC1.

THE VOLTAGE REGULATOR CIRCUIT

IC8 is the main regulator device in this project; it is treated as a self-protecting transistor except that its 'base' voltage is about 1V2 below the output level. The current into or out of this terminal is very small. IC6 is connected as an amplifier with a gain of 10. It also removes the effect of the current sense resistor R26 on the final output, and allows the output to be set to 0 V out for 0 V in by means of PR2.

The input to IC6 is selected by SW2 and is a 0 to 2V55 variable DC level from either RV2 for local (manual) control or from IC3 for remote (programmable) control. The output from IC6 goes via R19 to the common terminal of IC8; the

voltage at this point determines the output voltage from the unit.

THE CURRENT REGULATOR CIRCUIT

IC5 is the circuit element which detects the voltage generated by the output current flowing through R26. This voltage is compared with the current limit input voltage selected by SW2 and if the current limit is exceeded, the output of IC5 is driven towards the negative rail. This eventually pulls the common terminal of IC8 low enough via D1 to stabilise the current at its preset limit.

R10, T1 and PR1 set the sensitivity of the circuit while R12, 17 and C8 reduce the high frequency gain of the circuit to help stability.

THE PROGRAMMABLE INPUT SECTION

IC2 and 3 are eight bit A-to-D converters with internal latches, although only six bits of IC2 are programmable as greater resolution was not felt to be usable without greater complexity in the current limit circuit. This also means that the unit is not completely off under any circumstances. All eight bits are available in IC3 for setting the output voltage. R3 and C3 supply the reference voltage generator in IC3 which in turn supplies the D-to-A converters in both IC2 and 3. Address decoding and device selection is available in IC4 which is a dual 1-of-4 selector. Two outputs from one section of this IC drive the enable inputs of the DACs and the three inputs to this section can be used on their own with external address decoding or in conjunction with an output from the other section (selected by a suitable link on the PCB) if required.

THE PANEL METER MODULE

This optional part of the circuit allows the user to monitor the output voltage or current from the unit: SW4 is used to select the mode and range required. R27 to 31 form a divider network to scale the meter to the correct measuring range. The module used has a nominal input of 100 mV for a reading of 1000. It also has provision for selecting the decimal point position and this is made use of by a section of SW4. It is necessary to use +5 V and -5 V to supply the meter as it will not read correctly if the input terminals are at or near the negative supply. The module has its own internal band-gap voltage reference and if accurate resistors are used for the divider network a highly accurate readout will be obtained.

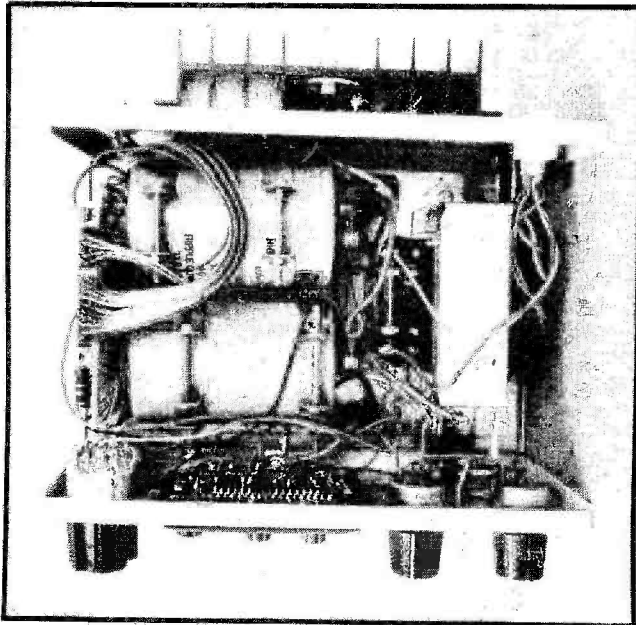

This is how we packed everything into the case specified in Buylines but it's pretty tight! You may wish to use the next size up.

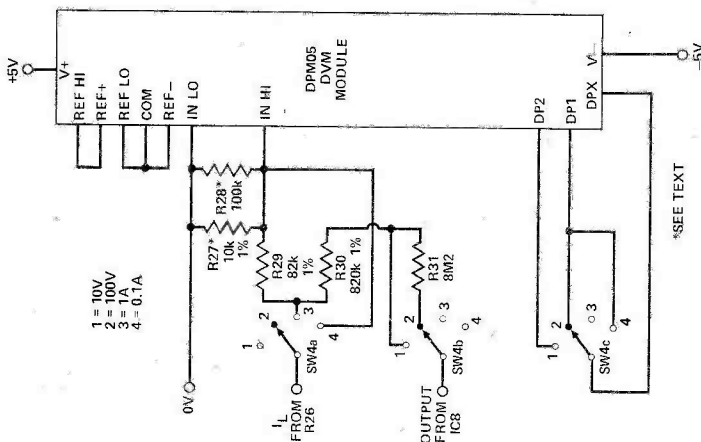

Fig. 2 Circuit for the optional DPM.

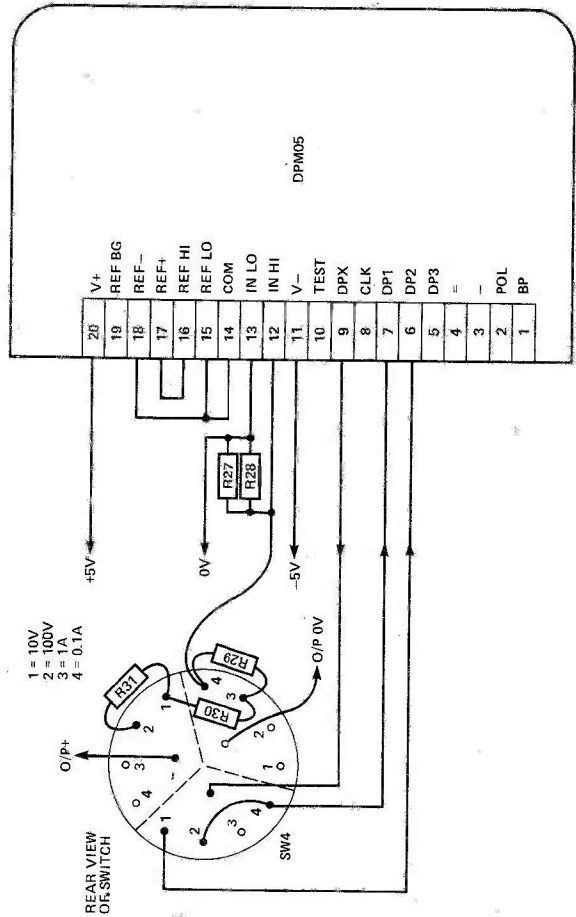

Fig. 3 How to wire up the range switch and its resistors to the DPM.

PARTS LIST

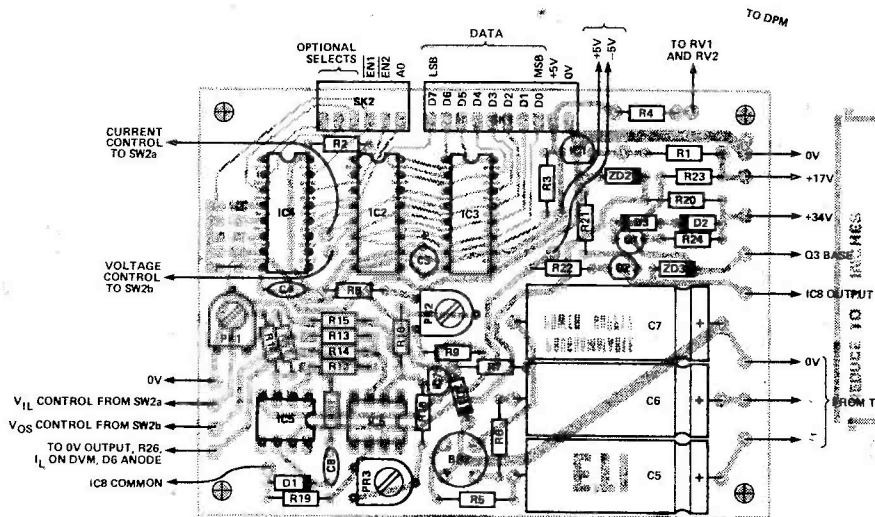
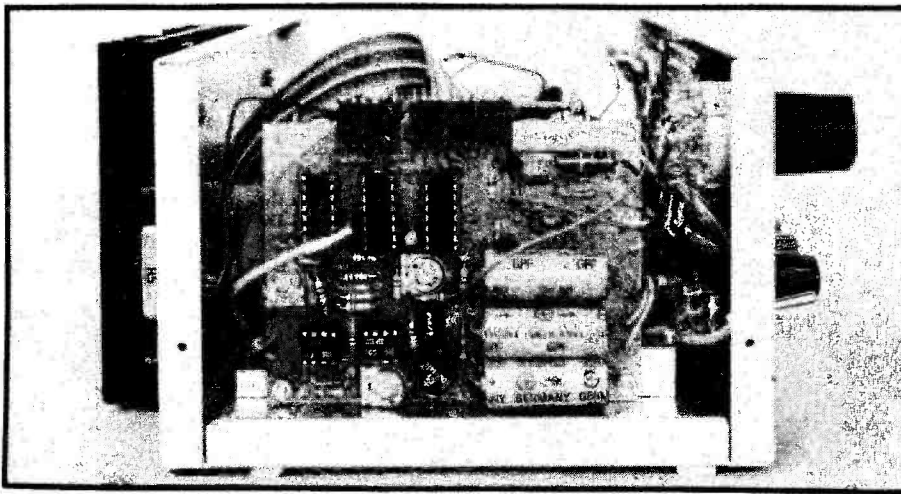

Fig. 4 Component overlay. Note some components are mounted off-board.



A side view showing the construction of the PCB.

rails are correct on the PCB. If not, check component polarities and placement. Rotate SW4 through all its positions and check that it reads at or somewhere near zero in all positions. With SW4 in the 10 V range (or a 10 V meter connected at the output) adjust PR2 for 0 V output. Connect a voltmeter to RV2 wiper and adjust RV2 until it reads 2V55 with respect to the 0 V rail. Adjust PR3 until the output reaches 25V5 (SW4 in 100 V position).

Now connect the voltmeter to RV1 wiper and adjust RV1 until it reads 2V55. Turn RV2 to minimum and connect an ammeter to the output terminals. Advance RV2 a little and a current of between 1 and 2 amps should flow. Adjust PR1 until this current is 1A6.

If all these steps have been accomplished without smoke, the supply should be operational. The only thing left to check is the digital control section. Connect all the data inputs on SK1 to 0 V and connect EN1 to 0 V using the link indicated beside IC4 in Fig. 4. Now, with A0 at 0 V take EN2 low momentarily. Repeat this with A0 high. Now

check that the outputs from IC2 and 3 are at 0 V (IC2 will be 30 mV or so positive). Set SW2 to 'remote' and readjust PR2 if necessary.

Set all the data inputs to +5 V and latch in this new information using A0 and EN2 as in the previous paragraph. Readjust PR3 and (with care) PR1. The unit should now be ready for use. Note, when doing the above procedures it may be advisable to provide pull-up resistors on unconnected inputs.

The A0 line selects the voltage D-to-A converter when low and the current D-to-A converter when high. EN1 could be the select line while EN2 would be the R/W on 6502-type systems, or WR on the Z80 etc. For most applications it is advisable that there should be some means of isolation between the control processor and this unit to prevent earth loops and other undesirable effects; this may well be in the form of opto-isolators. Pads are provided to allow the EN1 link to be repositioned to use the other section of IC1 and gain extra decoding capability, should this be necessary.

Resistors (all 1/4W, 5% except where stated)

R1	100R 1 W
R2,9,21,25	1k0
R3	390R
R4	4k7
R5,6	47R
R7	180R 2W5
R8,23	3k3
R10,11,13,15,17,19	10k
R12,14,16	100k
R18	82k
R20	330R
R22	470R
R24	120R
R26	1R0 2W5
R27*	10k 1%
R28*	100k
R29	82k 1%
R30	820k 1%
R31	8M2 5% or better

*R27 and R28 may be replaced with a single 9k1 1% resistor

Potentiometers

RV1,2	10k linear
PR1	22k miniature horizontal preset
PR2	2k2 miniature horizontal preset
PR3	47k miniature horizontal preset

Capacitors

C1,2	10,000u 25 V can electrolytic
C3	1u0 35 V tantalum
C4	100n ceramic
C5-7	220u 63 V axial electrolytic
C8	100p ceramic

Semiconductors

IC1	78L05
IC2, 3	ZN428
IC4	74LS139
IC5,6	TL081
IC7	79L05
IC8	LM317K
Q1	BC212L
Q2	BC182L
Q3	TIP140
D1-3	1N4148
D4-6	1N5401
ZD1	12 V 1W3 zener
ZD2	30 V 1W3 zener
ZD3	5V6 400 mW zener
LED1	panel-mounting red LED
BR1	200 V, 2 A potted bridge rectifier
BR2	200 V, 1 A potted bridge rectifier

Miscellaneous

SW1	two-pole mains-rated on-off rocker switch
SW2	two-pole miniature changeover toggle switch
SW3	two-pole on-off toggle switch (5 A @ 30 V)
SW4	three-pole four-way rotary switch
FS1	20 mm 1 A fuse
T1	0-12, 0-12 V, 50 VA mains transformer
LP1	mains neon indicator

PCB (see Buylines); DPM05 LCD DVM module (see Buylines); PCB plugs and sockets if required (one off 10-way and two off three-way); 15 way D-range connector (see Buylines); three off screw terminals; three knobs; can capacitor clips; tag strip; transistor mounting kits and heatsink compound for LM317 and TIP140; heatsink (2.0° C/W); cable and hardware; case, Newrad type S2/37 (see Buylines).

POWER DIMMER MODULES

A range of electronic modular dimmers designed to suit your custom channel and facility requirement

- Considerable saving over commercial equipment
- All the commercial facilities and more
- Compatible special effects
- Preset/remote/master
- Easily installed and wired

"SUPER DISCOUNTS"
Contact our Sales Desk and save a further 20% on certain dimmer items NOW!

SPC — Simple but effective 1000W controller	£15.70
SPU — Used in conjunction with RS units for Remote desks in 1000 and 2000W versions	£11.90
MC — Master dimmer for SPC/RS units	£23.90 (2K)
RS — Remote controller for SPU/SPC Units	£7.90
SUP/REF — Supply/signals for up to 50 modules	£9.40
Discounts on above only (order £100 to £199 15% £200 to £299 20% £300+ 25%)	£20.00
EFFECTS ACCESSORIES	
MXSL — Four channel sound to light	£36.90
MXLS — Four Channel Sequencer	£23.70
MXLS-S Four channel sound chaser	£26.70
MXECF — Dip/Dipless Electronic Crossfade	£31.90

3 CHANNEL SOUND/LIGHT CHASER £35.70



A high performance sound to light providing bass, mid and treble separation, employing active filters. Automatic switching to chase in the absence of a music signal 1000W chaser.

3 CHANNEL SOUND/LIGHT LB31000SL



£22.70

All the advantages of the SLC without chase. Controls: bass/mid/treble/master sensitivity.

STEREO DISCO MIXER/PREAMP

LBPA3
M — Magnetic
C — Ceramic

Main supply £7.20
PFL supply £1.00



£36.70

Magnetic or ceramic deck versions — please state
All the requirements of a stereo disco preamp on one board, left and right deck mixers/tones controls/misc. mixer/tones/mic. auto fade over decks/and P.F.L. The unit can be used with virtually any power amp.

AND MORE!

- * 4 CHAN S/L AUTO CHASER
- * 4 CHAN MULTI SOUND CHASER
- * 4 CHAN SEQUENCER
- * 4 CHAN SOUND CHASER
- * FASCIA PANELS

Active Crossovers £17.90 (supply £7.20)
(3-way 300Hz/3kHz)

Don't hesitate to write or phone for immediate information. All prices include VAT. Please include 75p post except power dimmer (£1.75). Cheques/PO/COO/Access all welcome

Tel: 01-640 6053 (Mon to Fri 9 to 4.30)

L & B ELECTRONIC 34 Oakwood Ave, Mitcham, Surrey CR2 1AQ

HAPPY MEMORIES

Part type	1 off	25-29	100 up
4116 200ns	0.83	0.72	0.66
4116 250ns	0.75	0.65	0.60
4816 100ns For BBC comp	2.45	2.10	1.95
4164 200ns	4.95	4.55	4.20
2114 200ns Low power	1.15	1.00	0.90
2114 450ns Low power	0.95	0.85	0.80
4118 250ns	3.25	2.85	2.65
6116 150ns CMOS	3.70	3.20	2.95
2708 450ns	2.60	2.25	2.10
2716 450ns 5 volt	2.60	2.25	2.10
2716 450ns three rail	5.75	5.00	4.65
2732 450ns Intel type	3.75	3.25	3.00
2532 450ns Texas type	3.75	3.25	3.00

Z80A-CPU £4.35 Z80A-PIO £3.25 Z80A-CTC £3.25
6522 PIA £3.98 7805 res 0.50 7812 res 0.50

Low profile IC sockets:

Pins	8	14	16	18	20	22	24	28	40
Pence	9	10	11	14	15	18	19	25	33

Soft-sectored floppy discs per 10 in plastic library case:
5 inch SSSD £17.00; 5 inch SSDD £19.25; 5 inch DSDD £21.00; 8 inch SSSD £19.25; 8 inch SSDD £23.65; 8 inch DSDD £25.50

74LS series TTL, large stocks at low prices with DIY discounts starting at a mix of just 25 pieces.

Write or phone for list.

Please add 30p post & packing to orders under £15 and VAT to total. Access & Barclaycard welcome. 24 hour service on (054 422) 618. Government & Educational orders welcome, £15 minimum. Trade accounts operated, phone or write for details.

HAPPY MEMORIES (ETI)

Gladestry, Kinston, Herefordshire HR5 3NY

Telephone: (054 422) 018 or 628

ALARMS

FREE CATALOGUE!

OUR GREAT NEW ILLUSTRATED CATALOGUE IS PACKED WITH INFORMATION ON SUPERB QUALITY, PROFESSIONAL BURGLAR ALARM EQUIPMENT



AT UNBEATABLE PRICES!



SEND S.A.E. OR PHONE NOW FOR YOUR COPY

THIEFCHECK BURGLAR ALARM D-I-Y SYSTEM



A.D. ELECTRONICS DEPT. ET11

217 WARBRECK MOOR
AINTREE LIVERPOOL
L9 0HU/051 523 8440

PARNDON ELECTRONICS LTD.

Dept. No. 23, 44 Paddock Mead, Harlow, Essex CM18 7RR. Tel. 0279 32700

RESISTORS: 1/4 Watt Carbon Film E24 range ± 5% tolerance High quality resistors made under strictly controlled conditions by automatic machines. Banded and colour coded.

£1.00 per hundred mixed. (Min 10 per value)

£8.50 per thousand mixed. (Min 50 per value)

Special stock pack. 60 values. 10 off each £5.50



DIODES: IN4148 3p each. Min order quantity — 15 items
£1.60 per hundred

DIL SWITCHES: Gold plated contact in fully sealed base solve those programming problems.
4 Way 86p each 6 Way £1.00 each 8 Way £1.20 each



DIL SOCKETS: High quality, low profile sockets
8 pin — 10p. 14 pin — 11p. 16 pin — 12p. 18 pin — 19p. 20 pin — 21p.
22 pin — 23p. 24 pin — 25p. 28 pin — 27p. 40 pin — 42p.

ALL PRICES INCLUDE V.A.T. & POST & PACKING — NO EXTRAS
MIN ORDER — U.K. £1.00 OVERSEAS £5 CASH WITH ORDER PLEASE

MONITORS

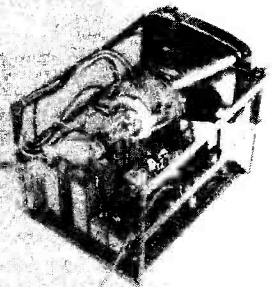
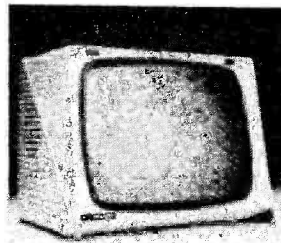

HIGH RESOLUTION ~ AND LOW COST!

Either cased or open frames to OEM's. The specification is right, the price is even better.

Phone or write to our Sales Manager, Richard Cox, for immediate action.

CROFTON ELECTRONICS LTD

35, Grosvenor Road, Twickenham, Middx, TW1 4AD.

Telephone: 01-891 1923/1513 Telex: 295093 CROFTN G



Constructor Series Speakers

IT'S SO EASY

Have fun, save money, building a Kef design with a Wilmslow Audio CS Total kit. No electronic or woodworking knowledge necessary and the end result is a proven top-quality design that you'll be proud of.

Each kit contains all cabinet components, accurately machined for easy assembly, speaker drive units, crossovers, wadding, grille fabric, terminals, nuts, bolts, etc.

The cabinets can be painted or stained or finished with iron-on veneer or self adhesive woodgrain vinyl.

Easy foolproof assembly instructions supplied. Set of constructor leaflets sent free on receipt of large S.A.E.

Prices: CS1 (As 101)	£110	pr. inc. VAT, plus carr./ins. £ 5.50
CS1A (simplified LS3/5A)	£103	pr. inc. VAT, plus carr./ins. £ 5.50
CS3 (as 103.2)	£129	pr. inc. VAT, plus carr./ins. £10.00
CS5 (as Carlton II)	£192	pr. inc. VAT, plus carr./ins. £15.00
CS7 (as Cantata)	£250	pr. inc. VAT, plus carr./ins. £18.00



0625 529599

35/39 Church Street, Wilmslow, Cheshire SK9 1AS

Catalogue — £1.50 post free



Lightning service on telephoned credit card orders!



NEW T.V. SOUND TUNER BUILT AND TESTED

In the cut-throat world of consumer electronics, one of the questions designers apparently ponder over is "Will anyone notice if we save money by chopping this out?" In the domestic TV set, one of the first casualties seems to be the sound quality. Small speakers and no tone controls are common and all this is really quite sad, as the TV companies do their best to transmit the highest quality sound. Given this background a compact and independent TV tuner that connects direct to your Hi-Fi is a must for quality reproduction.



£22.95 + £2.00 p&p.

This TV SOUND TUNER offers full UHF coverage with 5 pre-selected tuning controls. It can also be used in conjunction with your video recorder. Dimensions: 11 3/4" x 8 1/4" x 3 1/4" E.T.I. kit version of above without chassis, case and hardware. £12.95 plus £1.50 p&p.

PRACTICAL ELECTRONICS STEREO CASSETTE RECORDER KIT COMPLETE WITH CASE

SPECIAL OFFER!

ONLY £31.00 plus £2.75 p&p.

• NOISE REDUCTION SYSTEM. • AUTO STOP. • TAPE COUNTER. • SWITCHABLE E.Q. • INDEPENDENT LEVEL CONTROLS. • TWIN V.U. METER. • WOW & FLUTTER 0.1%. • RECORD/PLAYBACK I.C. WITH ELECTRONIC SWITCHING. • FULLY VARIABLE RECORDING BIAS FOR ACCURATE MATCHING OF ALL TYPES.

Kit includes tape transport mechanism, ready punched and back printed quality circuit board and all electronic parts, i.e. semiconductors, resistors, capacitors, hardware, top cover, printed scale and mains transformer. You only supply solder & hook-up wire. Featured in April P.E. reprint 50p. Free with kit.

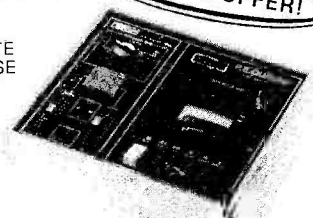

P.E. STEREO TUNER KIT

This easy to build 3 band stereo AM/FM tuner kit is designed in conjunction with Practical Electronics (July '81). For ease of construction and alignment it incorporates three Mullard modules and an I.C. IF System.

FEATURES: VHF, MW, LW Bands, interstation muting and AFC on VHF. Tuning meter. Two back printed PCB's. Ready made chassis and scale. Aerial: AM - ferrite rod, FM - 75 or 300 ohms. Stabilised power supply with 'C' core mains transformer. All components supplied are to P.E. strict specification. Front scale size 10 1/2" x 2 1/2" approx. Complete with diagram and instructions.

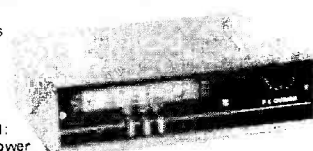

£17.95 Plus £2.50 p&p.

Self assembly simulated wood cabinet sleeve to suit tuner only. Finish size: 11 1/4" x 8 1/2" x 3 1/2". £3.50 Plus £1.50 p&p.

125W HIGH POWER AMP MODULES

The power amp kit is a module for high power applications - disco units, guitar amplifiers, public address systems and even high power domestic systems. The unit is protected against short circuiting of the load and is safe in an open circuit condition. A large safety margin exists by use of generously rated components, result, a high powered rugged unit. The PC board is back printed, etched and ready to drill for ease of construction and the aluminium chassis is preformed and ready to use. Supplied with all parts, circuit diagrams and instructions.



ACCESSORIES: Suitable mains power supply kit with transformer: £8.50 + £2.00 p&p. Suitable LS coupling electrolytic. £1 + 25p p&p.

SPECIFICATIONS: Max. output power (RMS): 125 W. Operating voltage (DC): 50 - 80 max. Loads: 4 - 16 ohms. Frequency response measured @ 100 watts: 25Hz - 20KHz. Sensitivity for 100w: 400mV @ 47K. Typical T.H.D. @ 50 watts, 4 ohms: 0.1%. Dimensions: 205x90 and 190x35mm.

KIT £10.50 +£1.15 p&p. BUILT £14.25 +£1.15 p&p.

BSR RECORD DECK

Manual single play record deck with auto return and cueing lever. Fitted with stereo ceramic cart-ridge 2 speeds with 45rpm spindle adaptor ideally suited for home or disco.



£12.95 + £1.75 p&p. 13" x 11" app.

SPECIAL OFFER! Replacement Stereo cassette tape heads — £1.80 each. Mono: £1.50 each. Erase: £0.70 each. Add 50p p&p to order.

SPEAKER BARGAINS

2 WAY 10 WATT SPEAKER KIT

8" bass/mid range and 3 1/2" tweeter. Complete with screws, wire, crossover components and cabinet. All wood pre-cut — no cutting required. Finish - chipboard covered wood simulate. size 14 1/2" x 8 3/4" x 4". PAIR for ONLY

£12.50 plus £1.75 p&c.

All mail to: 21 E HIGH STREET, ACTON, W3 6NG. Note: Goods despatched to U.K. postal addresses only. All items subject to availability. Prices correct at 30/10/82 and subject to change without notice. Please allow 7 working days from receipt of order for despatch. RTVC Limited reserve the right to update their products without notice. All enquiries send S.A.E. Telephone or mail orders by ACCESS welcome.

ALL CALLERS TO: 323 EDGWARE ROAD, LONDON W2. Telephone: 01-723 8432. (5 minutes walk from Edgware Road Tube Station. Now open 6 days a week 9 - 5.7.82. No. 1252 A)



ELKAN ELECTRONICS

Make the most of your pocket computer

new software for SHARP PC1500

World Exclusive! NEW Business Programs

from GEMINI..... Silicon Notebook £19.95

Executive Suite (6 programs)..... £29.95

new books..... for DRAGON 32

101 program tips & tricks..... £6.95

55 programs home/school/office..... £6.95

color computer graphics..... £7.95

Add 50p per book post & packing (max. £1.50)

New Idea..... Ideal Gift

At last - no more tape-loading problems!

SHARP CE152 cassette tape recorder

purpose built for computers only £39.93

Send cash, cheque, Access or Visa Card No. Ask for our New FREE pocket brochure. Trade enquiries welcome anytime.

ELKAN ELECTRONICS (Dept. ETI)

FREEPOST, 28 Bury New Road, Prestwich, Manchester M25 6LZ or telephone 061-798-7613 (24 hr. service). See full list on Prestel 258-2022.

We specialise in pockets!

Step-by-step fully illustrated assembly and fitting instructions are included together with circuit descriptions. Highest quality components are used throughout.

Sparkrite

BRANDLEADING ELECTRONICS

NOW AVAILABLE IN KIT FORM

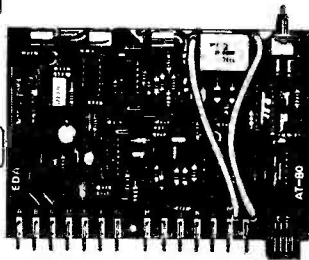
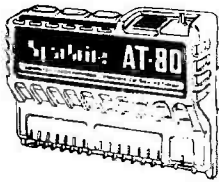

AT-80 Electronic Car Security System

- Arms doors, boot, bonnet and has security loop to protect fog/spot lamps, radio/tape, CB equipment
- Programmable personal code entry system
- Armed and disarmed from outside vehicle using a special magnetic key fob against a windscreen sensor pad adhered to the inside of the screen
- Fits all 12V neg earth vehicles
- Over 250 components to assemble

VOYAGER Car Drive Computer

- A most sophisticated accessory. • Utilises a single chip mask programmed microprocessor incorporating a unique programme designed by EDA Sparkrite Ltd. • Affords 12 functions centred on Fuel, Speed, Distance and Time. • Visual and Audible alarms, warning of Excess Speed, Frost/Ice, Lights-left-on. • Facility to operate LOG and TRIP functions independently or synchronously
 - Large 10mm high 400ft-L fluorescent display with auto intensity. • Unique speed and fuel transducers giving a programmed accuracy of + or - 1%. • Large LOG & TRIP memories. 2,000 miles. 180 gallons. 100 hours. • Full Imperial and Metric calibrations. • Over 300 components to assemble
- A real challenge for the electronics enthusiast!

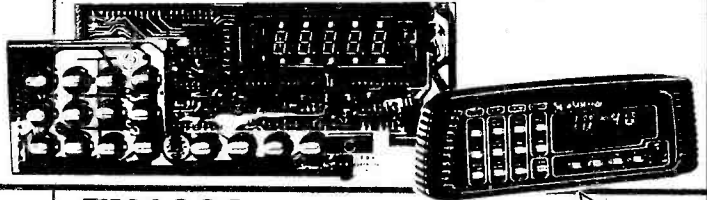

SX1000 Electronic Ignition

- Inductive Discharge
- Extended coil energy storage circuit
- Contact breaker driven
- Three position changeover switch
- Over 65 components to assemble
- Patented clip-to-coil fitting
- Fits all 12v neg. earth vehicles

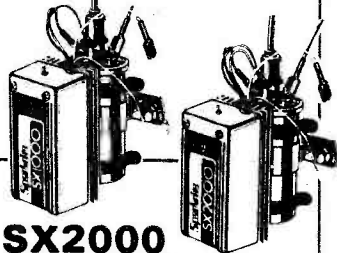

TX1002 Electronic Ignition

- Contactless or contact triggered
- Extended coil energy storage circuit
- Inductive Discharge
- Three position changeover switch
- Distributor triggerhead adaptors included
- Die cast weatherproof case
- Clip-to-coil or remote mounting facility
- Fits majority of 4 & 6 cyl. 12V. neg. earth vehicles
- Over 145 components to assemble.

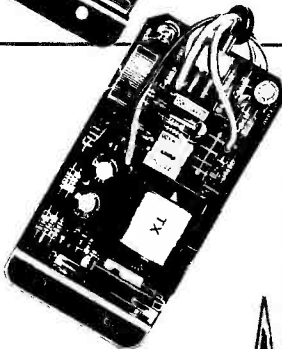
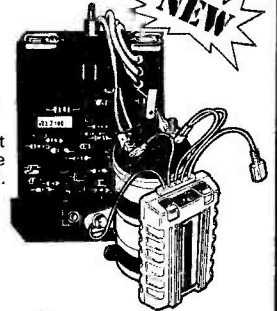

SX2000 Electronic Ignition

- The brandleading system on the market today
- Unique Reactive Discharge
- Combined Inductive and Capacitive Discharge
- Contact breaker driven
- Three position changeover switch
- Over 130 components to assemble
- Patented clip-to-coil fitting
- Fits all 12v neg. earth vehicles

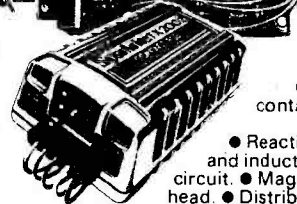

TX2002 Electronic Ignition

- The ultimate system
- Switchable contactless.
- Three position switch with Auxiliary back-up inductive circuit.
- Reactive Discharge. Combined capacitive and inductive.
- Extended coil energy storage circuit.
- Magnetic contactless distributor triggerhead.
- Distributor triggerhead adaptors included.
- Can also be triggered by existing contact breakers.
- Die cast waterproof case with clip-to-coil fitting
- Fits majority of 4 and 6 cylinder 12v neg. earth vehicles.
- Over 150 components to assemble

All SPARKRITE products and designs are fully covered by one or more World Patents.

SPECIAL OFFER

"FREE" MAGIDICE KIT WITH ALL ORDERS OVER £45.00

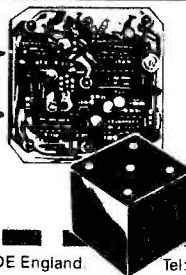

MAGIDICE Electronic Dice

- Not an auto item but great fun for the family
- Total random selection
- Triggered by waving of hand over dice
- Sleeps and flashes during a 4 second tumble sequence
- Throw displayed for 10 seconds
- Auto display of last throw 1 second in 5
- Muting and Off switch on base
- Hours of continuous use from PP7 battery
- Over 100 components to assemble

SPARKRITE 82 Bath Street, Walsall, West Midlands, WS1 3DE England

Tel: (0922) 614791 Allow 28 days for delivery

	SELF ASSEMBLY KIT
SX 1000	£12.95
SX 2000	£19.95
TX 1002	£22.95
TX 2002	£32.95
AT 80	£32.95
VOYAGER	£64.95
MAGIDICE	£9.95

PRICES INC. VAT. POSTAGE & PACKING

NAME _____ ETI.1
ADDRESS _____

I ENCLOSE CHEQUE(S)/POSTAL ORDERS FOR

£ _____ KIT REF. _____

CHEQUE NO. _____

PHONE YOUR ORDER WITH ACCESS/BARCLAYCARD
SEND ONLY SAE IF BROCHURE IS REQUIRED

BRANDLEADING BRITISH ELECTRONICS
CUT OUT THE COUPON NOW!

electronize

ELECTRONIC IGNITION KITS OR READY BUILT

IS YOUR CAR AS GOOD AS IT COULD BE ?



- ★ Is it **EASY TO START** in the cold and the damp? Total Energy Discharge will give the most powerful spark and maintain full output even with a near flat battery.
- ★ Is it **ECONOMICAL** or does it "go off" between services as the ignition performance deteriorates? Total Energy Discharge gives much more output and maintains it from service to service.
- ★ Has it **PEAK PERFORMANCE** or is it flat at high and low revs. where the ignition output is marginal? Total Energy Discharge gives a more powerful spark from idle to the engines max. (even with 8 cylinders).
- ★ Is the **PERFORMANCE SMOOTH**. The more powerful spark of Total Energy Discharge eliminates the 'near misfires' whilst an electronic filter smooths out the effects of contact bounce etc.
- ★ Do the **PLUGS and POINTS** always need changing to bring the engine back to its best. Total Energy Discharge eliminates contact arcing and erosion by removing the heavy electrical load. The timing stays "spot on" and the contact condition doesn't affect the performance either. Larger plug gaps can be used, even wet or badly fouled plugs can be fired with this system.

Most **NEW CARS** already have **ELECTRONIC IGNITION**. Update **YOUR CAR** with the most powerful system on the market - 3½ times more spark power than inductive systems - 3½ times the spark power of ordinary capacitive systems, 3 times the spark duration.

Total Energy Discharge also features:
EASY FITTING, STANDARD/ELECTRONIC CHANGE-OVER SWITCH, LED STATIC TIMING LIGHT, LOW RADIO INTERFERENCE, CORRECT SPARK POLARITY and DESIGNED IN RELIABILITY.

- ★ **IN KIT FORM** it provides a top performance system at less than half the price of competing ready built units. The kit includes: pre-drilled fibreglass PCB, pre-wound and varnished ferrite transformer, high quality 2µF discharge capacitor, case, easy to follow instructions, solder and everything needed to build and fit to your car. All you need is a soldering iron and a few basic tools.

FITS ALL NEGATIVE EARTH VEHICLES
6 or 12 volt, with or without ballast.

OPERATES ALL VOLTAGE IMPULSE TACHOMETERS:
(Older current impulse types need an adaptor).

STANDARD CAR KIT £15-90
Assembled and Tested £26-70

TWIN OUTPUT KIT £24-55
For Motor Cycles and Cars with twin ignition systems
Assembled and Tested £36-45

PLUS
P. & P.
£1 (U.K.)

Prices
include
VAT



ELECTRONIZE DESIGN

Dept. D · Magnus Rd · Wilnecote
Tamworth · B77 5BY
tel: 0827 281000

The basic function of a spark ignition system is often lost among claims for longer "burn times" and other marketing fantasies. It is only necessary to consider that, even in a small engine, the burning fuel releases over 5000 times the energy of the spark, to realise that the spark is only a trigger for the combustion. Once the fuel is ignited the spark is insignificant and has no effect on the rate of combustion. The essential function of the spark is to start that combustion as quickly as possible and that requires a high power spark.

The traditional capacitive discharge system has this high power spark but, due to its very short spark duration and consequential low spark energy, is incompatible with the weak air/fuel mixtures used in modern cars. Because of this most manufacturers have abandoned capacitive discharge in favour of the cheaper inductive system with its low power but very long duration spark which guarantees that sooner or later the fuel will ignite. However, a spark lasting 2000µS at 2000 rev/min. spans 24 degrees and 'later' could mean the actual fuel ignition point is retarded by this amount.

The solution is a very high power, medium duration, spark generated by the **TOTAL ENERGY DISCHARGE** system. This gives ignition of the weakest mixtures with the minimum of timing delay and variation for a smooth efficient engine.

- ★ **SUPER POWER DISCHARGE CIRCUIT** A brand new technique prevents energy being reflected back to the storage capacitor, giving 3½ times the spark energy and 3 times the spark duration of ordinary C.D. systems, generating a spark powerful enough to cause rapid ignition of even the weakest fuel mixtures without the ignition delay associated with lower power 'long burn' inductive systems.
- ★ **HIGH EFFICIENCY INVERTER** A high power, regulated inverter provides a 370 vdt energy source - powerful enough to store twice the energy of other designs and regulated to provide sufficient output even with a battery down to 4 volts.
- ★ **PRECISION SPARK TIMING CIRCUIT** This circuit removes all unwanted signals caused by contact volt drop, contact shuffle, contact bounce, and external transients which, in many designs, can cause timing errors or damaging un-timed sparks. Only at the correct and precise contact opening is a spark produced. Contact wear is almost eliminated by reducing the contact breaker current to a low level - just sufficient to keep the contacts clean.

TYPICAL SPECIFICATION

	Total Energy Discharge	Ordinary Capacitive Discharge
SPARK POWER (Peak)	140W	90W
SPARK ENERGY	36mJ	10mJ
STORED ENERGY	135mJ	65mJ
SPARK DURATION	500µS	160µS
OUTPUT VOLTAGE (Load 50pF, equivalent to clean plugs)	38kV	26kV
OUTPUT VOLTAGE (Load 50pF + 500k, equivalent to dirty plugs)	26kV	17kV
VOLTAGE RISE TIME TO 20kV (Load 50pF)	25µS	30µS

TOTAL ENERGY DISCHARGE should not be confused with low power inductive systems or hybrid so called reactive systems.

ETI PCB SERVICE

Up until now PCBs were always the hardest component to obtain for a project. Of course you could make your own, but why bother anymore?

Now you can buy your boards straight from the designers — us! As of this issue all (non-copyright) PCBs will be available automatically from the ETI PCB Service. Each board is produced from the same master used to build our prototypes, so you can be sure it's accurate and will be finished to the high standard you would expect from ETI.

In addition to the PCBs for this month's projects, we are making available some of the more popular designs from our recent past. See the list below for details. Please note that **NO OTHER BOARDS ARE AVAILABLE**. If it's not listed, we don't have it!

- | | | | | | | | | | | |
|--|--|--|--|--|--|---|--|---|--|--------|
| <input type="checkbox"/> APRIL 79 | <input type="checkbox"/> Guitar Effects Unit | £2.64 | <input type="checkbox"/> LED Jewellery: Cross | £1.47 | <input type="checkbox"/> MAY 82 | <input type="checkbox"/> DV Meg | £2.92 | | | |
| <input type="checkbox"/> Click Eliminator | £6.64 | <input type="checkbox"/> Spiral (two boards) | £2.64 | <input type="checkbox"/> Analogue PWM | £3.37 | <input type="checkbox"/> Slot Car Controller | £4.96 | | | |
| <input type="checkbox"/> JUNE 79 | <input type="checkbox"/> Accentuated Beat Metronome | £3.60 | <input type="checkbox"/> Waa-phase | £1.53 | <input type="checkbox"/> Wattmiser | £4.53 | <input type="checkbox"/> Sound Effects Board | £2.40 | | |
| <input type="checkbox"/> FEBRUARY 80 | <input type="checkbox"/> Tuning Fork | £2.64 | <input type="checkbox"/> JULY 80 | <input type="checkbox"/> System A A-MM/A-MC | £2.65 | <input type="checkbox"/> June 82 | <input type="checkbox"/> Ion Generator (two boards) | £6.22 | | |
| <input type="checkbox"/> MARCH 80 | <input type="checkbox"/> Signal Tracer | £2.27 | <input type="checkbox"/> System A A-PR | £5.17 | <input type="checkbox"/> Ion 'Blinker' | £2.60 | <input type="checkbox"/> MOSFET Amp Module | £6.99 | | |
| <input type="checkbox"/> AUGUST 80 | <input type="checkbox"/> CMOS Logic Tester | £2.64 | <input type="checkbox"/> Smart Battery Charger | £1.97 | <input type="checkbox"/> MOSFET Amp Module | £6.99 | <input type="checkbox"/> Logic Lock | £3.41 | | |
| <input type="checkbox"/> Capacitance Meter | £2.93 | <input type="checkbox"/> AUGUST 81 | <input type="checkbox"/> System A Power Amp (A-PA) | £4.77 | <input type="checkbox"/> Digital PWM | £3.84 | <input type="checkbox"/> Optical Sensor | £1.98 | | |
| <input type="checkbox"/> Ultrasonic Burglar Alarm | £2.87 | <input type="checkbox"/> Flash Sequencer | £3.44 | <input type="checkbox"/> Hand-clap Synthesiser | £3.97 | <input type="checkbox"/> Stylus Tensor | £2.98 | <input type="checkbox"/> Oscilloscope (four boards) | £13.19 | |
| <input type="checkbox"/> OCTOBER 80 | <input type="checkbox"/> Cassette Interface | £2.93 | <input type="checkbox"/> Heartbeat Monitor | £1.83 | <input type="checkbox"/> Oscilloscope (four boards) | £13.19 | <input type="checkbox"/> JULY 82 | <input type="checkbox"/> Mike Switching Unit | £2.04 | |
| <input type="checkbox"/> Fuzz/Sustain Box | £3.27 | <input type="checkbox"/> Watchdog Home Security (two boards) | £5.31 | <input type="checkbox"/> SEPTMBER 81 | <input type="checkbox"/> Mains Audio Link (three boards) | £7.35 | <input type="checkbox"/> TV Bargraph (main board) | £4.85 | | |
| <input type="checkbox"/> NOVEMBER 80 | <input type="checkbox"/> Touch Buzzer | £1.93 | <input type="checkbox"/> Laboratory PSU | £4.53 | <input type="checkbox"/> OCTOBER 81 | <input type="checkbox"/> Enlarger Timer | £3.40 | <input type="checkbox"/> TV Bargraph (channel card) | £2.44 | |
| <input type="checkbox"/> Light Switch | £1.93 | <input type="checkbox"/> OCTOBER 81 | <input type="checkbox"/> Sound Bender | £2.65 | <input type="checkbox"/> Thermal Alarm | £2.63 | <input type="checkbox"/> Hotwire | £2.99 | | |
| <input type="checkbox"/> Metronome | £1.93 | <input type="checkbox"/> Enlarger Timer | £3.40 | <input type="checkbox"/> Thermal Alarm | £2.63 | <input type="checkbox"/> Bridging Adaptor | £2.74 | <input type="checkbox"/> AUGUST 82 | <input type="checkbox"/> Playmate (three boards) | £7.92 |
| <input type="checkbox"/> 2W Power Amp | £1.93 | <input type="checkbox"/> Sound Bender | £2.65 | <input type="checkbox"/> Thermal Alarm | £2.63 | <input type="checkbox"/> Kitchen Scales | £2.70 | <input type="checkbox"/> SEPTMBER 82 | <input type="checkbox"/> Auto Volume Control | £2.07 |
| <input type="checkbox"/> RIAA Preamplifier | £1.93 | <input type="checkbox"/> Thermal Alarm | £2.63 | <input type="checkbox"/> Micropower Pendulum | £2.21 | <input type="checkbox"/> Sound Track | £4.38 | <input type="checkbox"/> Dual Logic Probe | £2.31 | |
| <input type="checkbox"/> Audio Test Oscillator | £3.13 | <input type="checkbox"/> Micropower Pendulum | £2.21 | <input type="checkbox"/> NOVEMBER 81 | <input type="checkbox"/> Voice-Over Unit | £3.97 | <input type="checkbox"/> OCTOBER 82 | <input type="checkbox"/> Message Panel (one card) | £9.66 | |
| <input type="checkbox"/> DECEMBER 80 | <input type="checkbox"/> Musical Doorbell | £2.80 | <input type="checkbox"/> Car Alarm | £2.81 | <input type="checkbox"/> NOVEMBER 81 | <input type="checkbox"/> Car Alarm | £2.81 | <input type="checkbox"/> NOVEMBER 82 | <input type="checkbox"/> Spectrum Analyst (3 boards) | £16.29 |
| <input type="checkbox"/> Bench Amplifier | £2.53 | <input type="checkbox"/> Voice-Over Unit | £3.97 | <input type="checkbox"/> Phone Bell Shifter | £2.96 | <input type="checkbox"/> Phone Bell Shifter | £2.96 | <input type="checkbox"/> Pulse generator | £6.09 | |
| <input type="checkbox"/> Four Input Mixer | £2.64 | <input type="checkbox"/> Phone Bell Shifter | £2.96 | <input type="checkbox"/> DECEMBER 81 | <input type="checkbox"/> Alcohometer (two boards) | £5.32 | <input type="checkbox"/> Message panel interface | £2.27 | | |
| <input type="checkbox"/> JANUARY 81 | <input type="checkbox"/> LED Tacho | £4.13 | <input type="checkbox"/> DECEMBER 81 | <input type="checkbox"/> Alcohometer (two boards) | £5.32 | <input type="checkbox"/> NOVEMBER 82 | <input type="checkbox"/> Spectrum Analyst (3 boards) | £16.29 | | |
| <input type="checkbox"/> Multi-Option Siren | £3.20 | <input type="checkbox"/> Bodywork Checker | £1.97 | <input type="checkbox"/> Bodywork Checker | £1.97 | <input type="checkbox"/> Pulse generator | £6.09 | <input type="checkbox"/> DECEMBER 82 | <input type="checkbox"/> ELCB | £2.54 |
| <input type="checkbox"/> Universal Timer | £3.31 | <input type="checkbox"/> Component Tester | £1.49 | <input type="checkbox"/> Component Tester | £1.49 | <input type="checkbox"/> Message panel interface | £2.27 | <input type="checkbox"/> Servo Interface (two boards) | £5.99 | |
| <input type="checkbox"/> FEBRUARY 81 | <input type="checkbox"/> Infra-red Alarm (four boards) | £6.64 | <input type="checkbox"/> JANUARY 82 | <input type="checkbox"/> Parking Meter Timer | £2.37 | <input type="checkbox"/> DECEMBER 82 | <input type="checkbox"/> ELCB | £2.54 | | |
| <input type="checkbox"/> Pulse Generator | £3.57 | <input type="checkbox"/> Parking Meter Timer | £2.37 | <input type="checkbox"/> Infant Guard | £1.80 | <input type="checkbox"/> Servo Interface (two boards) | £5.99 | <input type="checkbox"/> Spectracolumn | £5.48 | |
| <input type="checkbox"/> MARCH 81 | <input type="checkbox"/> Engineer's Stethoscope | £2.65 | <input type="checkbox"/> Infant Guard | £1.80 | <input type="checkbox"/> Guitar Tuner (two boards) | £5.97 | <input type="checkbox"/> Spectracolumn | £5.48 | | |
| <input type="checkbox"/> APRIL 81 | <input type="checkbox"/> Musical Box | £2.64 | <input type="checkbox"/> Guitar Tuner (two boards) | £5.97 | <input type="checkbox"/> FEBRUARY 82 | <input type="checkbox"/> Ripple Monitor | £2.08 | <input type="checkbox"/> Signal Line Tester | £1.78 | |
| <input type="checkbox"/> Drum Machine (two boards) | £5.60 | <input type="checkbox"/> Ripple Monitor | £2.08 | <input type="checkbox"/> Pest Monitor | £1.85 | <input type="checkbox"/> JANUARY 83 | <input type="checkbox"/> Fuel Gauge | £3.21 | | |
| <input type="checkbox"/> Guitar Note Expander | £3.20 | <input type="checkbox"/> Pest Monitor | £1.85 | <input type="checkbox"/> I Ching Computer (two boards) | £5.31 | <input type="checkbox"/> ZX ADC | £2.39 | <input type="checkbox"/> Programmable PSU | £3.21 | |
| <input type="checkbox"/> JUNE 81 | <input type="checkbox"/> Mini-drill Speed Controller | £2.93 | <input type="checkbox"/> Moving-magnet stage | £3.80 | <input type="checkbox"/> Moving-coil stage | £3.80 | | | | |
| <input type="checkbox"/> Antenna Extender | £3.20 | <input type="checkbox"/> Moving-coil stage | £3.80 | | | | | | | |

How to order: indicate the boards required by ticking the boxes and send this page, together with your payment, to: ETI PCB Service, Argus Specialist Publications Ltd, 145 Charing Cross Road, London WC2H 0EE. Make cheques payable to ETI PCB Service. Payment in sterling only please. Prices subject to change without notice.

Total for boards £
 Add 45p p & p 0.45
 Total enclosed £

Signed
 Name
 Address

MASTER ELECTRONICS NOW!

The PRACTICAL way!

This new style course will enable anyone to have a real understanding of electronics by a modern, practical and visual method. No previous knowledge is required, no maths, and an absolute minimum of theory.

You learn the practical way in easy steps mastering all the essentials of your hobby or to start or further a career in electronics or as a self-employed servicing engineer.

All the training can be carried out in the comfort of your own home and at your own pace. A tutor is available to whom you can write personally at any time, for advice or help during your work. A Certificate is given at the end of every course.

You will do the following:

- Build a modern oscilloscope.
- Recognise and handle current electronic components
- Read, draw and understand circuit diagrams
- Carry out 40 experiments on basic electronic circuits used in modern equipment
- Build and use digital electronic circuits and current solid state 'chips'
- Learn how to test and service every type of electronic device used in industry and commerce today. Servicing of radio, T.V., Hi-Fi and microprocessor/computer equipment.

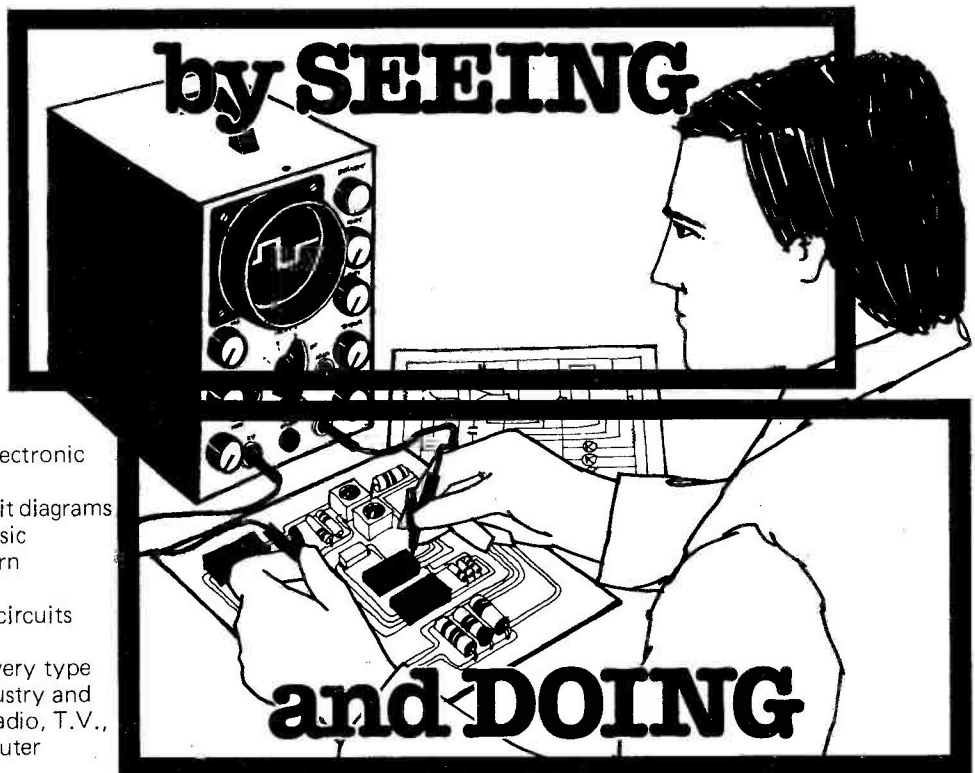

New Job? New Career? New Hobby? Get into Electronics Now!

FREE!

COLOUR BROCHURE



POST NOW TO:

Please send your brochure without any obligation to

I am interested in:

ETI/1/820

NAME _____

ADDRESS _____

- COURSE IN ELECTRONICS as described above
- RADIO AMATEUR LICENCE
- MICROPROCESSORS
- LOGIC COURSE

OTHER SUBJECTS _____

BLOCK CAPS PLEASE _____

British National Radio & Electronics School Reading, Berks. RG1 1BR.

PCB FOIL PATTERNS

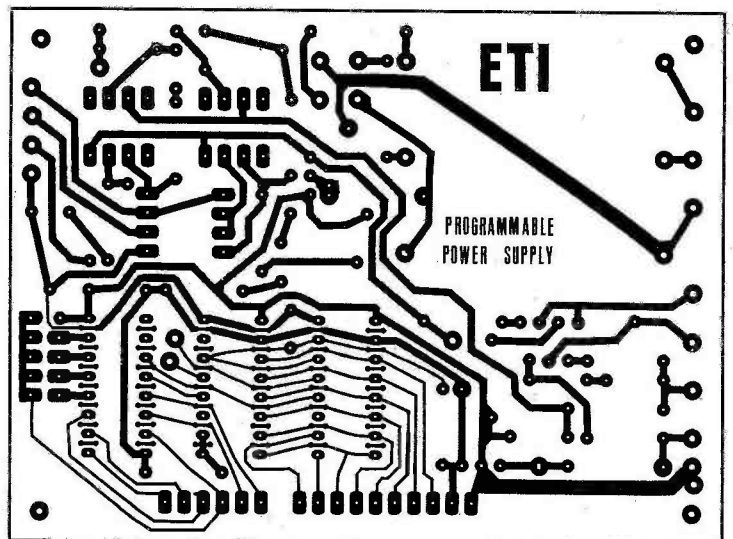
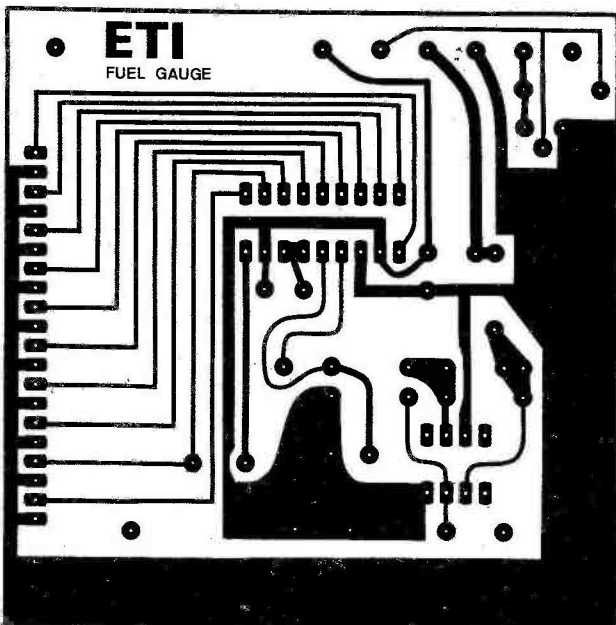
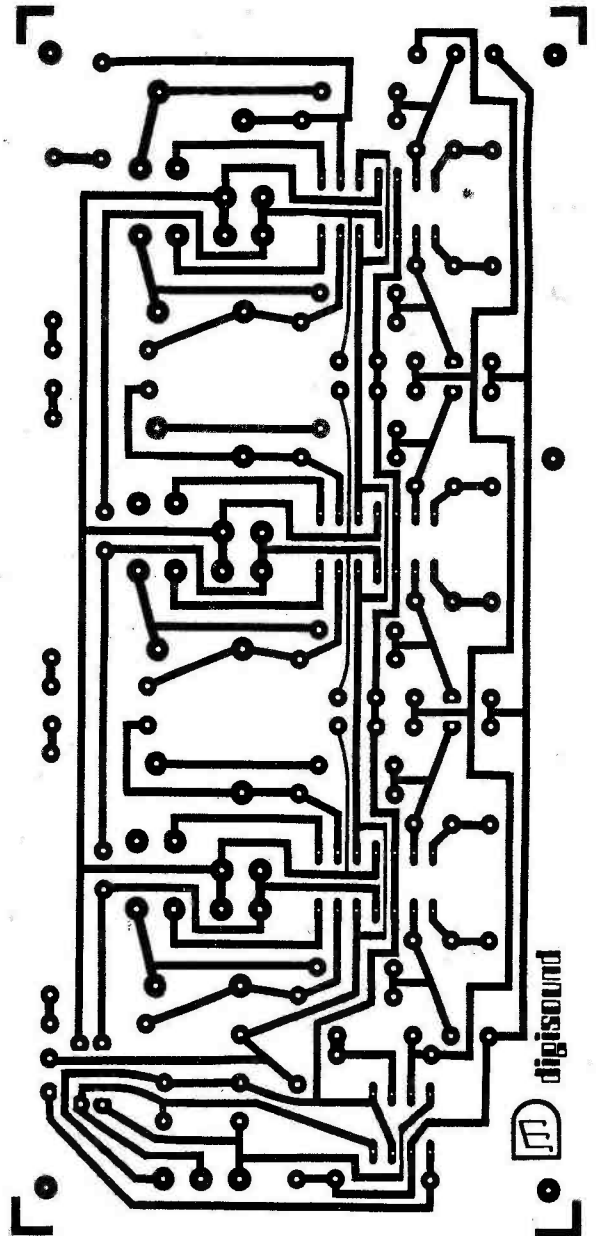
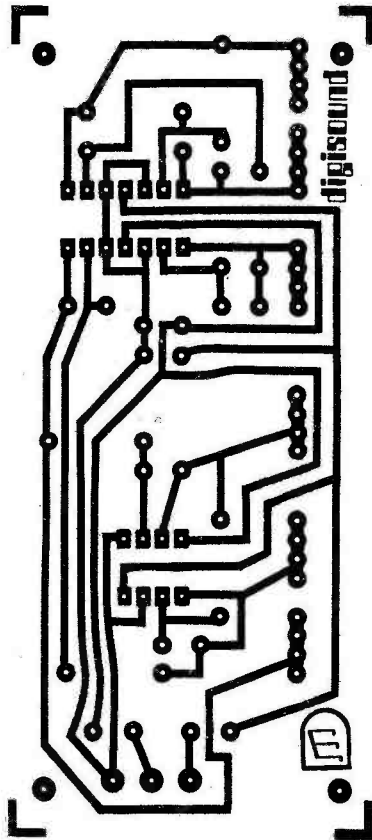
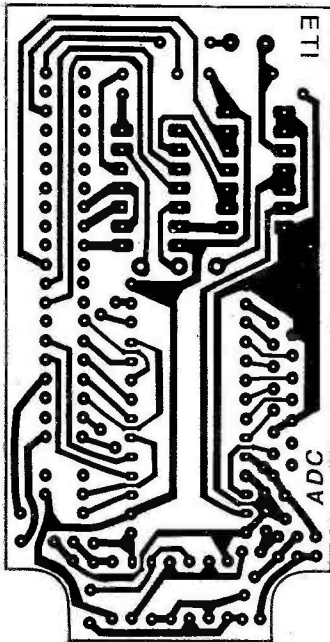

19" RACK MOUNTING CABINET. £23.95
 Front Panel 480x150mm Rear Case 425x250x140mm **£19.50**



Or Free Standing
Brushed Ali Front
 with
'CHROME HANDLES'

This is a professional rack mounting cabinet that will allow you to get your equipment off the bench. Rack mounting provides security for your equipment and easy access for maintenance. This Precision rack mounting cabinet has all of the features you would expect from a professional unit.

★ Top, bottom and rear cover removable for access ★ Plates have heavy duty grey paint finish ★ Front panel is heavy gauge - 3mm aluminium ★ Strong, screwed, construction throughout - screws included ★ Heavy gauge chassis mounting plate is pre-drilled and has four mounting positions to choose from ★ Front panel is of brushed aluminium finish enhanced with heavily chromed handles ★

19" ENCLOSURES EURO SIZES £3.95
 AT LOW COST
 1u. ± 44mm
 Special Sizes Made To Suit REQUIREMENT

2u	£17.50
3u	£18.50
4u	£22.75
5u	£26.95
6u	£35.25

Rear Case h = u size less 10mm
 425w250d

28 SLIDING SWITCHES TOGGLES PUSH ROCKERS R.R.P. £9.50 Offer - £3.95

ADD V.A.T AT STD RATE & ORDERS UNDER £5.00. P&P 50p. ABOVE ITEM £2 P&P

'metal cabinets'

These are beautifully manufactured cabinets with an aluminium base and 18 gauge steel covers. They come fitted with rubber feet (to please the wife!), loured for ventilation and finished in an attractive tone finish. They make excellent cabinets for power supplies, remote control units and many more projects.

a - 102(d) x 66(h) x 83(w)mm	a. £1.70
b - 150(d) x 61(h) x 103(w)mm	b. £2.55
c - 150(d) x 76(h) x 134(w)mm	c. £3.04
d - 184(d) x 70(h) x 160(w)mm	d. £4.08

Ask for our **FREE Catalogue.**

'TRADE' PRICES ON QTY ORDERS

SOLDERING IRON 30 W £1.75
 RELAY-A-QUIP, Moat Lodge, Stock Chase, Maldon, Essex. phone 0621-57242

VISA
 11am 8pm MON-SAT

TIME WRONG?

MSF CLOCK is ALWAYS CORRECT — never gains or loses, SELF SETTING at switch-on, 8 digits show Date, Hours, Minutes and Seconds, auto GMT/BST and leap year, also parallel BCD output (including Weekday), receives Rugby 60KHz atomic time signals, built-in antenna, 1000Km range, GET the TIME RIGHT, £69.60.

60KHZ RUGBY RECEIVER, as in MSF Clock, serial data output for computer etc, decoding details and ZX81 fittings for LOCAL, GMT and SIDEREAL time, £22.20.

LOSING DX? Antenna Fault? Check FAST with an Antenna Noise Bridge, MEASURE resonance 1-150MHz and radiation resistance 2-1000 ohms, £18.60.

Each fun-to-build kit includes all parts, printed circuit, case, postage etc, money back assurance so GET yours NOW.

CAMBRIDGE KITS
 45 (TN) Old School Lane, Milton, Cambridge.

Universal Ni-CAD, battery charger. All plastic case with lift up lid. Charge/Test switch. LED indicators at each of the five charging points.

Charges:- PP3 (8V), U12 (1.5V penlite), U11 (1.5V "C"), U2 (1.5V "D"), Power:- 220-240V AC, Dims:- 210 x 100 x 50mm. Knock down price only while stocks last.

Only £5.00
 Order No. MW 398

Multitester & Transistor Tester
 DC volts 0-1v-5v-2.5v-10v-50v-250v-1000v ±3%
 AC volts 0-10v-50v-250v-1000v ±3%
 DC current 0-50uA-2.5mA-25mA-0.25A ±3%
 Resistance:
 Minimum 0-2-2-200-200k ohms
 Midscale 20-200-20k-200k ohms
 Maximum 2k-20k-2m-20m ohms

As a transistor tester
 Leakage current 0-150uA at Z1k range
 0-15mA at X10 range
 0-150mA at X1 range

PLEASE ADD 15% VAT & £1 P&P

Only £11.95
 Order No. HT 320

ENFIELD ELECTRONICS 208 BAKER ST., ENFIELD, MDDX. Tel: 01-366 1873

WILMSLOW AUDIO
 The firm for Speakers

Bigger and Better
 the colourful Wilmslow Audio brochure
 — the definitive loudspeaker catalogue!

Everything for the speaker constructor — kits, drive units, components for HiFi and PA.

50 DIY HiFi speaker designs including the exciting new dB Total Concept speaker kits, the Kef Constructor range, Wharfedale Speakercraft, etc.

Flatpack cabinet kits for Kef, Wharfedale and many others.

- ★ Lowest prices — Largest stocks ★
- ★ Expert staff — Sound advice ★
- ★ Choose your DIY HiFi Speakers in the comfort of our ★ two listening lounges (Customer operated demonstration facilities) ★ Ample parking ★

Send £1.50 for catalogue (cheque, M.O. or stamps — or phone with your credit card number)

- ★ Access — Visa — American Express accepted ★ also HiFi Markets Budget Card.

WILMSLOW AUDIO
 The firm for Speakers

0625 529599

35/39 Church Street, Wilmslow, Cheshire SK9 1AS

Lightning service on telephoned credit card orders!

CNC 10 PCB HOLDER

Ideal for small scale production, testing, research, service engineers, education and the home constructor.

The CNC 10 has a board capacity of 8" x 8" and longer boards (maximum 8" wide) may be accommodated since they can project beyond the ends of the rails. Adjustment of the board rails is extremely simple and they are locked in the desired position by one central locking clamp. A further clamp enables the PCB, when in position, to be rotated through 360 degrees and locked in the required position.

An optional foam pad is available which enables a number of components to be inserted prior to soldering. Pad size 8" x 8".

CNC 10: £16.10 INC. VAT
 FOAM PAD & CLIP: £5.64 INC. VAT

Please add £1.50 to cover postage.
 Available direct from the manufacturer:

CARLTON NICHOL & CO. LTD.,
 GOLDKEY INDUSTRIAL ESTATE,
 KELVEDON, COLCHESTER, ESSEX

SAVE £££'s ON HOME HEATING BILLS

UNIQUE DIGITAL THERMOSTAT
 POSSIBLE FUEL SAVINGS OF UP TO 25%

Normally manufactured exclusively for the trade. Features: ● Continuous readout of ambient temp via 3 digit 7 segment display ● LED indicates when pump is in operation ● 0.2°C Hysteresis ● 240v 3A control contacts ● Switched set temperature ● Freeze protection setting

High specification — Simple to calibrate — Connect in place of existing thermostat — Requires 240v 2VA supply — Kit includes all necessary components, Enclosure, diagrams* and instructions.

Kit price only £39.90. Assembled Price £49.90
 Prices include P&P and VAT

Send cheque or PO to: **DICON ELECTRONICS LIMITED** Bond Street, Bury, Lancs BL9 7DU Tel 061-797 5666 Telex 665362

ELECTROMART

**MONTHLY IN
ELECTRONICS TODAY —
YOUR OWN 'WHERE TO
BUY IT' GUIDE**

AVON

ANNLEY ELECTRO

190 Bedminster Down Road
Bedminster Down, Bristol
Tel: 0272 632622
Open: Mon-Sat 9am-6.30 pm Wed 9am-2pm

BEDFORDSHIRE

BROADWAY ELECTRONICS

1 The Broadway, Bedford,
Tel: 0234 213639
Open: 6 days 9-5.30. ½ day Thur.
lunch 1.30-2.30.
Specialists in electronic components and
Acorn computers.

DORSET

D.J. ELECTRONICS
64 Ensbury Park Road,
Bournemouth.
Tel: (0202) 515073.
Open: Mon-Sat 9am-6pm.

HERTFORDSHIRE

GODDARDS COMPONENTS
110 London Road, St. Albans.
Tel: St. Albans 64162
Open: Mon-Sat 9.30am-5.30pm
(½ day Thur)

**LOOKING FOR
COMPONENTS! HARDWARE!
CASES! TRY YOUR LOCAL
LISTED STOCKIST**

LANCASHIRE

ETESON ELECTRONICS

E.E. 15B Lower Green,
Poulton-le-Fylde, Blackpool
Tel: (0253) 885107
Open: 9.30am-12.30, 1.30-5.30. Closed Wed & Sun.
Electronic Component Specialists.

MERSEYSIDE

MYCA ELECTRONICS

2 VICTORIA PLACE
SEACOMBE FERRY SQUARE
WALLASEY L44 6NR
Tel: 051 638 8847
Open: Mon-Sat 10am-5.30pm

W. MIDLANDS/WARCS

WAVEBANDS

103 Coventry St., Kidderminster
Components, computers, car radios,
C.B.'s, amateur radio
and all electronic hobby equipment
Open: Mon-Sat 9-6, Sun 10-2
TEL: 0562 2179

STAFFORDSHIRE

TP ELECTRONIC SUPPLIES 105 High St.,
Wolstanton,
Newcastle
Tel: 0782 636904
Open: Mon-Wed 9-6, Thurs 9-12 & 5-7,
Fri & Sat 9-9, Sun 11-2

**FOR YOUR BUSINESS TO
BE INCLUDED, CALL
ELECTROMART ON
01-437-1002.**

S. WALES

CARDIGAN ELECTRONICS

Chancery Lane, Cardigan,
Tel: Cardigan (0239) 614483
Open: Mon-Sat 10am-5pm. Closed Wed.
Electronic components &
Acorn computer stockist.

STEVE'S ELECTRONIC SUPPLY CO. LTD.

45 Castle Arcade, Cardiff
TEL: 0222 41905
Open: Mon-Sat 9-5.30
For components to computers

WARWICKSHIRE



Charlotte St. Rugby. Tel: Rugby 78138
Open 5 Days 10-6 (closed Wed)
Wide range of components and R.S. stockists.
1983 Mail Order Catalogue 75p

YORKSHIRE



ACE MAILTRONIX LTD.
3A Commercial Street,
Batley. Tel: (0924) 441129
Open: Mon-Fri 9am-5.30pm. (Sat 1pm)
Retail and wholesale.

Please include my business details in the next available issue of **ELECTRONICS TODAY INTERNATIONAL**:

BUSINESS NAME:

ADDRESS:

TEL. NO.:

OPENING HOURS:

RETAIL WHOLESALE MAIL ORDER (Please tick)

CONTACT: (FOR OFFICE USE ONLY)



BARCLAYCARD

VISA

ACCESS

CLASSIFIED

THE PATH TO
SUCCESSFUL SALES!

01-437 1002
Ext 213

ADVERTISEMENT RATES

Semi-Display (min 2 cms)

1-3 insertions £10.00 per cm
4-11 insertions £9.00 per cm
12+ insertions £8.00 per cm
Lineage 35p per word (min 15 words)

Box Nos. £2.50

Closing date 1st Friday in the month preceding publication date.

All advertisements in this section must be prepaid. Advertisements are accepted subject to the terms and conditions printed on the advertisement rate card (available on request)

Send your requirements and cheque / P.O. to:

E.T.I. CLASSIFIED ADVERTISING,
145 CHARING CROSS RD, LONDON
WC2H 0EE

CLOSING DOWN SALE

V. BANSAL

14 DAVIDGOR ROAD, HOVE, E. SUSSEX

All components are new. Minimum order £20.00.
Free postage. No V.A.T.

C-Mos	10p	4017	30p	4019	25p
4012	40p	4023	10p	4024	20p
4025	10p	4048	20p	4071	12p
4076	45p	4081	10p	4518	35p
4520	45p	4528	40p	4557	222p
NE567	8p				
TTL					
7400	9p	7404	13p	74161J	14p
7495	45p				

AERIAL AMPLIFIERS Improve weak television reception. Price £6.70, S.A.E. for leaflets. Electronic Mailorder, Ramsbottom, Lancashire BLO 9AGH.

SPECTRUM VENTURE. Exciting new game for the Spectrum (7 games in 1). In colour, with sound and fantastic screen effects, 16K and 48K version supplied on one cassette for £6. Bobker, 29 Chadder-ton Drive, Unsworth, Bury, Lancs.

MONITOR YOUR PHONE

Our unique telephone monitor kit connects between the phone line and any cassette recorder and automatically records all incoming and outgoing phone calls - unattended - 24 hours a day.

Use it to record important or interesting phone calls, to detect and trace unauthorised phone use, to analyze phone usage, etc.

The kit comes complete with all components, leads, plugs, PCB, and attractive case. Send only £9.95 to:

UNITECH (Midlands) Dept ETI

FREEPOST

Sutton Coldfield, West Midlands B74 2BR

(No stamp required)

(Not British Telecom Approved)

PRINTED CIRCUITS. Make your own simply, cheaply and quickly! Golden Fotolac 'light-sensitive lacquer - now greatly improved and very much faster. Aerosol cans with full instructions, £2.25. Developer 35p. Ferric Chloride 55p. Clear acetate sheet for master 14p. Copper-clad fibreglass board, approx. 1mm thick £1.75 sq. ft. Post/packing 75p. White House Electronics, Castle Drive, Praa Sands, Penzance, Cornwall.

PARAPHYSICS JOURNAL (Russian translations); Psychotronic Generators, Kirliano-graphy, gravity lasers, telekinesis. Details: SAE 4 x 9". Paralab, Downton, Wilts.

BURGLAR Alarm Equipment. Please visit our 2,000 sq.ft showrooms or write or phone for your free catalogue. C.W.A.S. Ltd, 100 Rooley Avenue, Bradford BD6 1DB. Telephone 0274 308920.

BIG BARGAIN BOX

Our Big Bargain Box contains over a thousand components - resistors, capacitors, pots, switches, diodes, transistors, panels, bits and pieces, odds and ends. All useful stuff - would cost many times the price we are asking if bought separately. Approx. weight 4lbs.

ONLY £5.00 inc. post - you're bound to come back for another!!
ESP

147A FOUNDRY LANE, SOUTHAMPTON SO1 3LS
Lots of surplus bargains on our latest list - send an SAE for your copy now.

CIRCUIT DESIGN, Prototype construction, analogue or Digital, Single Circuits or Complete Instruments/Systems. Write A. J. ATTWOOD, C.Eng., MIERE, Heathercote, Heatherton Park, Taunton, Somerset, TA4 1ET, or Phone Bradford-on-Tone (082-346) 536.

ATTENTION ELECTRONIC ORGAN KIT BUILDERS

Shop soiled 60 note plastic keys £17.25

30 note all timber pedal boards £86.25

Few only! Mini consoles oak or mahogany

£195 ex works including V.A.T.

George Sixsmith organ builders,
Hillside Organ Works, Carrhill Rd.,
Mossley, Nr. Ashton-u-Lyne, Lancs.

Tel: Mossley 3009

PACK OF TWO BNC 75R PLUGS £1.20, 27vdc 4 Pole (Mains 'Continental' type) change over relay £1.20. Coax change over relay 9vdc £4. All prices include VAT & postage. Send SAE for list AFR Electronics, School Lane, Moulton, Northampton.

T. & J. ELECTRONICS COMPONENTS - Quality components, competitive prices. Illustrated catalogue 45p. 98 Burrow Road, Chigwell, Essex.

'STEREOPOWER' - 120 WATT - £10.85. Case + Stereo Controls + Sockets + Data!! Kia, 8 Cunliffe Road, Ilkley. MERRY CHRISTMAS.

WILDERN ELECTRONICS LTD for all microprocessor-based system designs, GPIB interfaces/software, S100 systems using our own CPU (also sold separately). Instrumentation systems, peripheral interfacing. Test/Control equipment, Established 1977, MAPCON consultants. Contact Mr Priestley, Portsmouth 831041.

LYNX AUDIO PROCESSORS. The Great New Name in Electro-music. Revers £29.95. Fuzz/Sustains £19.95. Programmable Drum Synthesizers (dual channel) £59.95. Autowahs, Phasers and Custom-Built Multi-music Processors. S.A.E. for Brochure to: Lynx Audio Processors, 26 Aldingbourne Close, Ifield, Sussex.



A really compact high performance CCTV camera for only £130.00 plus VAT plus P/P, Total £152.95. Size 3"x3"x9". 240v operation. 1v p-p output. Lens extra.

CROFTON ELECTRONICS LIMITED

35 GROSVENOR ROAD, TWICKENHAM,
MIDDLESEX TW1 4AD

Telephone 01-891 1923/01-891 1513

Telex 295093 CROFTN G

DIGITAL WATCH REPLACEMENT parts batteries, displays, backlights etc. Also reports publications, charts. S.a.e. for full list Profords Conersdrive, Holmergreen, Bucks, HP15 6SGD

PSU's 5V3 £19.99. 5V5A £26.99. 1-30V 1.5A £26.99. 5A £32.99. inc. p&p. S.A.E. Lists. Edwards Electric, Unit 3, Mill Lane, Bridgwater, Somerset.

EPROMS. Small Surplus Quantity of 2532 Eproms. Brand new, full spec. devices. £3.25 each or £2.95 each for quantities of 10 or more. Please make cheques payable to 'A1 Systems'. Apply Box No. ET1203. Asp Ltd., 145 Charing Cross Road, London WC2.

HAVEN HARDWARE. Spectrum Fruit Machine £4.95. UK101/Superboard products still available. ZX kits: Repeat Key £3.95. Inverse Video £3.45. S.A.E. for built prices/beeper/keyboard/software details. 4 Asby Road, Asby, Workington, Cumbria.

Save money on drawer sets with the **BITSABOX**

12 drawer white cardboard bench set for your bits and pieces
Drawer size 140 x 50 x 37mm

ONLY £2.20 + 90p P&P

Cheques/PO to: DMW Boxes, 81 Somerset Road London E17, Prop. R.E. Davidson
PERSONAL CALLERS & TRADE ENQUIRIES WELCOME

FOR SALE Taylor Instrument. AM Signal Generator Model 68A/17. Hardly used. Offers. Lymm 3127 evenings.

CABINET FITTINGS

Fretcloths, Coverings, Handles, Castors, Flight Case Locks & Parts, Jacks, XLRs, Bulgins, Reverb Trays, P & N mic Stands, ASS Glassfibre Horns, CELESTION POWER Speakers.

ADAM HALL SUPPLIES LTD.

Send 30p cheque/PO for illustrated catalogue: Adam Hall (ET Supplies), Unit B, Carlton Court, Grainger Road, Southend-on-Sea.

CENTURION ALARMS

We manufacture, you save £££'s
Send s.a.e. or phone for our Free list of professional D.I.Y. Burglar Alarm Equipment and accessories.
Discount up to 20% off list prices, e.g. Control Equipment from £15.98. Decoy Bell Boxes from £5.95 inc.

TRADE ENQUIRIES WELCOME
0484-21000
or **0484 35527** (24 hr. ans.)
CENTURION ALARMS (HE)
1265 Wakefield Road, Huddersfield HD5 9BE, W. Yorkshire
Access B Visa Orders Welcomed

STOCK CLEARANCE. Wirewound Resistors C7, C14, FA75, W24, AW1602, 16ER. Cannon Plugs Sockets JP12, JS12. 74S133, 8284A, 74193, 7483, 74120. Diode 12F40. Static Ram 2102. Amphenol Connectors MS3102A-20-24S, MS3106A-20-24P, MS3106A-20-29P. For prices contact Pat Critchfield, Posidata Limited. Telephone 0256 52741.

COPPER CLAD Double Sided Fibreglass, 12" x 8". 10 sheets £6. 5 sheets £4. Davron, Box No. E.T.I.202, Asp Ltd., 145 Charing Cross Road, London WC2.

BRYSTEP ELECTRONICS

10 Camphill Industrial Estate West Byfleet, Surrey KT14 6EW
Tel: Byfleet (09323) 51676

Many, many other items held in stock. S.A.E. for full stock and price list. Also separate list of items which are Surplus/Liquidator stock, at bargain price. We fully guarantee your money back in FULL if any item fails, whether old or new, provided it is returned within 28 days of receipt. We have never had to return money yet.

CMOS
4001 £0.10
4007 £0.15
4008 £0.47
4011 £0.11
4012 £0.16
4013 £0.22
4015 £0.50
4016 £0.19
4017 £0.38
4018 £0.46
4021 £0.40
4022 £0.48
4023 £0.16
4024 £0.32
4025 £0.16
4028 £0.48
4040 £0.48
4042 £0.48
4047 £0.58
4049 £0.22
4050 £0.22
4066 £0.29
4069 £0.15
4070 £0.15
4078 £0.18
4081 £0.14
4083 £0.25
4503 £0.35
4508 £1.44
4510 £0.48
4511 £0.45
4512 £0.50
4514 £1.19
4515 £1.20
4516 £0.59
4518 £0.35
4520 £0.59
4528 £0.64
4529 £0.70
4531 £0.65
4534 £3.98
4541 £0.98
4586 £0.98

D Connectors (Cannon Type)

9 Way	£0.80	£0.95	£0.90
16 Way	£1.10	£1.20	£0.92
25 Way	£1.50	£2.00	£0.92
37 Way	£2.20	£3.25	£1.28

Rt Angle P.C.B. Mtg

9 Way	£1.17	£1.80
16 Way	£1.53	£2.32
25 Way	£2.20	£2.20
37 Way	£2.57	£4.20

Volt Regulators

7805	£0.39	IN4002	£0.04
7815	£0.39	IN4148	£0.02
LM309K	£1.30	IN5401	£0.15
LM323K	£4.88	IN5406	£0.16

Diodes

FREE With every order: 1 pack of 15 1/2 watt carbon film resistors

Sorry: MAIL ORDER ONLY
Please add £0.30 p&p and V.A.T. @ 15%

SPECIAL OFFER FOR THIS ISSUE
LM323K £3.95 (1-24) £3.75
(25+) £2.76 (1+5) £2.15 (1-24)
£2.00 (25+) £2.72 £3.50 (1-24)
£3.45 (25+)

DON'T MISS THE FEBRUARY ISSUE OF E.T.I.

ON SALE JANUARY

THE 7th FOR YOUR CLASSIFIED ADVERTISEMENTS RING BRIDGETTE ON 01-437 1002

£6.50 Post 65p MINI-MULTI TESTER
Deluxe pocket size precision moving coil instrument. Impedance & Capacity - 4000 o.p.v. Battery included. 11 instant ranges measure: DC volts 5, 25, 250, 500. AC volts 10, 50, 500, 1000. DC amps 0.250µa; 0.250ma. Continuity and resistance 0 to 600K ohms.

De-Luxe Range Doubler Model, 60.000
o.p.v. £18.50. 7 x 5 x 2 1/2in. Post £1.

NEW PANEL METERS £4.50
50µa, 100µa, 500µa, 1ma, 5ma, 50ma, 100ma, 25 volt.
VU Meter. 500ma, 1 amp, 2 amp.
Facia 2 1/2 x 2 x 1 1/2in. Post 65p.

FAMOUS LOUDSPEAKERS

Make	Model	Size	Watts	Ohms	Price
Seas	Tweeter	4in	50	8	£9.50
Audax	Tweeter	4in	30	8	£6.50
Audax	Mid-Range	4in	50	8	£7.50
Seas	Mid-Range	4 1/2in	100	8	£12.50
Seas	Mid-Range	5in	80	8	£12.00
Goodmans	Woofers	8in	25	4 or 8	£6.50
Audax	Woofers	8in	40	8	£14.00
Audax	Woofers	10in	50	8	£16.00
Goodmans	8inB	8in	60	8	£12.50
Rigonda	Full-Range	10in	15	8	£5.00
Baker Hi-Fi	Deluxe	12in	15	8	£14.00
Baker Hi-Fi	Major	12in	30	4/8/16	£14.00
Baker Hi-Fi	Superb	12in	30	8/16	£24.00
Baker P.A.	Group 45	12in	45	4/8/16	£14.00
Baker Hi-Fi	Auditorium	12in	45	8/16	£22.00
Baker Hi-Fi	Auditorium	15in	60	8/16	£34.00
Baker P.A.	Group 75	12in	75	4/8/16	£18.00
Goodmans	GR Group	12in	90	8/16	£27.50
Baker P.A.	Group 100	12in	100	8/16	£24.00
Baker P.A.	Disco 100	12in	100	8/16	£24.00
Baker P.A.	Disco 100	15in	100	8/16	£32.00
Baker P.A.	Disco 100	15in	100	8/16	£32.00
Goodmans	HPD Disco	12in	120	8	£29.50
EMI	450	13 x 8in	10	3/8	£8.00
Goodmans	HP Bass	18in	230	8	£80.00

R.C.S. LOUDSPEAKER BARGAINS

3 ohm, 5 x 3in, 7 x 4in, £2.50; 8 x 5in, 8 1/2in, £3; 8in, £4.50; 10in, £5.
3 ohm, 2in, 2 1/2in, £2.00; 3in, 5 x 3in, 6 x 4in, 7 x 4in, £2.50
3 1/2in, £3; 8in, £3; 10in, £5; 12in, £6
15 ohm, 3in, 5 x 3 1/2in, 6 x 4in, 5in, £2.50, 6 1/2, 8 x 4in, £3.
25 ohm, 3in, 5 x 3in, 7 x 4in, £2.50; 120 ohm, 3 1/2in. dia. £1.50.

BATTERY ELIMINATOR MAINS TO 9 VOLT DC
Stabilised output, 9 volt 400 m.a. UK made with terminals. Overload cut out. 5 x 3 1/2 x 2 1/2in. Transformer Rectifier Unit. Suitable Radios. Cassettes. £4.50. Post 50p.

LOW VOLTAGE ELECTROLYTICS

1, 2, 4, 5, 8, 16, 25, 30, 50, 100, 200mF 15V 10p.
500mF 12V 15p; 25V 20p; 50V 30p;
1000mF 12V 50p; 25V 35p; 50V 50p; 1200mF/75V 80p.
2200mF 6V 25p; 25V 42p; 40V 80p; 2000mF/100V £1.20.
2500mF 50V 70p; 3000mF 25V 50p; 50V 65p.
3300mF 63V £1.20; 4700mF 63V £1.20; 2700mF/76V £1.
4700mF 40V 85p; 1000mF 100V £1.

HIGH VOLTAGE ELECTROLYTICS

8/450V	45p	8 + 8/450V	75p	50 + 50/300V	50p
16/350V	45p	8 + 16/450V	75p	32 + 32 + 32/325V	75p
32/350V	75p	20 + 20/450V	75p	100 + 100/275V	65p
50/350V	80p	32 + 32/350V	85p	150 + 200/275V	75p
50/450V	95p	32 + 32/500V	£1.80	220/450V	95p

TRIMMERS 30pF, 50pF 10p, 100pF, 150pF 15p, 500pF 30p.
CONDENSERS VARIOUS. 1pF to 0.01mF 350V 5p.
400V.0.001 to 0.05 5p; 01 15p; 0.25 25p; 0.47 35p.
1000V.0.1mF 25p; 0.22mF 30p; 0.47mF 60p; 1750V.0.22mF 50p.
WAFER SWITCHES. 1 pole 12W, 2 pole 6W, 3 pole 4W, 4 pole 3W, 2 pole 2W, 4 pole 2W 60p ea.
TWIN GANGS 120pF £1; 500 + 200pF £1.
SINGLE SOLID DIELECTRIC 100pF, 500pF £1.50.
GEARED TWIN GANGS 25pF 95p; 365 + 365 + 25 + 25pF £1.
SLOW MOTION DRIVE 6:1 90p; REVERSE VERNIER 60p.
VERNIER DIALS 36mm £2.25, 50mm £2.75.
SPINDLE EXTENDERS 60p, COUPLERS 40p.
NEON PANEL INDICATORS 250V. Red 1/2 x 1/2 45p, Round at 40p.
RESISTORS. 100 to 10M, 1/2W, 1W, 20% 2p, 2W 10p.
HIGH STABILITY. 1/2W 2% 10 ohms to 1 meg. 10p.
Ditto 5%. Preferred values 10 ohms to 10 meg. 3p.
WIRE WOUND 10 ohm to 10K 5 watt 20p.
BLANK ALUMINIUM CHASSIS. 6 x 4 - £1.45; 8 x 6 - £1.80
10 x 7 - £2.30; 12 x 8 - £2.60; 14 x 9 - £3.00; 16 x 6 - £2.90
16 x 10 - £3.20. All 2in. 18 swg. **ANGLE ALI.** 6 x 4 x 1/2in. 25p.
ALUMINIUM PANELS - 18 swg. 6 x 4 - 45p; 8 x 6 - 75p;
14 x 3 - 75p; 10 x 7 - 95p; 12 x 8 - £1.10; 12 x 5 - 75p;
16 x 6 - £1.10; 14 x 9 - £1.45; 12 x 12 - £1.50; 16 x 10 - £1.75.
PLASTIC box with aluminium fascia 6 1/2 x 4 1/2 x 2in. £1.50.
ALUMINIUM BOXES WITH LIDS
3 x 2 x 1 £1.4
4 x 2 x 2 £1.4
4 x 4 x 2 1/2 £1.35
6 x 4 x 2 £1.60, 7 x 5 x 3 £2.40, 8 x 6 x 3 £2.50.
10 x 7 x 3 £3, 12 x 6 x 3 £2.75, 12 x 8 x 3 £3.60.
BRIDGE RECTIFIER 200V PIV 1/2 amp 50p, 2 amp £1.00.
4 amp £1.50, 8 amp £2.50. **DIODES** 1a, 10p; 3a, 30p.
TOGGLE SWITCHES SP 40p, DPST 50p, DPDT 60p.
MINIATURE TOGGLES SP 40p; DPDT 60p.

THE "INSTANT" BULK TAPE ERASER
Suitable for cassettes and all sizes of tape reels.
A.C. mains 200/240V.
Ideal all Recorders, Tapes, Discs, Cassettes, Computers.
£9.50 Post 95p
HEAD DEMAGNETISER PROBE £5.00.

MAINS TRANSFORMERS

	Post		Post
5-8-10-16V, 1/2A	£2.50	24V 2 1/2A Twice	£8.00
6V 1A	£2.00	20V 1A	£3.00
6-0-5V, 1 1/2A	£3.50	20-0-20V 1A	£3.50
9V 250ma	£1.50	20/40/60V 1A	£4.00
9V 3A	£3.50	25-0-25V 2A	£4.50
9.0-9V 50ma	£1.50	28V 1A Twice	£5.00
10-0-10V 2A	£3.00	30V 1 1/2A	£3.50
10-30-40V	£2.50	30V 5A and 17.0-17V 2A	£4.50
12V 100ma	£2.00	35V 2A	£4.00
12V 3A	£3.50	35-29-0-29-34V 6A	£12.00
12-0-12V, 2A	£3.50	0-12-27V 2A	£3.50
15-0-15V 2A	£3.75		

RADIO COMPONENT SPECIALISTS

DEPT. 6, 337 WHITEHORSE ROAD, CROYDON, SURREY, U.K. TEL: 01-684 1685

Post 50p Minimum. Callers Welcome. Closed Wed. Same day despatch. Access-Barclay-Visa. Lists 31p.

USE ELECTRONICS TODAY INTERNATIONAL'S CLASSIFIED

(35p per word, minimum 15 words. Box Nos. £2.50 extra or £10.00 per single column centimetre (min. 2cms) — all prepaid

Just write the details on the form below and send it with your cheque, made payable to A.S.P. Ltd, to Electronics Today International Classified, 145 Charing Cross Road, London WC2 0EE

1.	2.	3.	4.	5.
6.	7.	8.	9.	10.
11.	12.	13.	14.	15.

Please place my ad in the next available issue of E.T.I.:

Name

Address

Tel. No.

I enclose my cheque/P.O. for the value of £

Electronic kits for the thrifty!

Build 50 Interesting Projects on a PC Chassis with surplus components from your 'Spares Box'.

EXPERIMENTERS' PRINTED CIRCUIT KIT

Contents: 4 assorted boards to suit the enclosed designs. Etching Powder, Resist Paint, Solvent, Degreaser and Etching Instructions; also 50 Circuit diagrams, Chassis Plans and Layouts for simple Crystal Sets, Transistor Radios, Transmitters, Amplifiers, Intercoms, Radio Control, Metal Detector, Photoelectric and Ultrasonic Alarms, 'Perpetual Motion', Light Beam Telephone Instruments, Testers, Gadgets, etc. You can build at negligible cost with 'Surplus' or reclaimed parts and transistors you already have.

Price: £2.50. Postage and Packing 50p

PHOTOELECTRIC KIT

A kit of basic parts to build a simple Infra-Red Sensitive Photoelectric Switch. Contents: Phototransistor, Transistors, Diode, Resistors, Connector, Latching Relay, Chassis Board, Case, Screws and Instructions.

Price: £4.50. Postage and Packing 50p

OPTICAL KIT

A kit of parts to build an IR folden-beam Projector and Receiver to suit the above kit. Contents: 2 Lenses, 2 Mirrors, 2-45° blocks, Infra-Red Filter, Lampholder, Building Plans.

Price: £3.70. Postage and Packing 30p

Both kits together make an excellent Invisible-Beam Burglar Alarm.

EXPERIMENTAL ELECTRONICS

335 Battersea Park Road, London SW11 4SL

Tel: 01-720 2683

Send SAE for full details of all kits and circuits

**Please mention
E.T.I.
when replying
to all adverts**

ADVERTISERS INDEX

Ad Elec	87	Happy Memories	87
Akhter Inst	67	ICS	82
Ambit Int	81, 82	KP	20, 21, 79
Amtron	58	Input Design	80
Armon Elec	80	Jupiter Cantab	38
Audio Elec	60	Kelen Eng	60
Aura Sounds	46	L&B Elec	87
Bi-Pak	70	LB Elec	88
BK Elec	12, 59	LEM Services	44
Black Star	76	Magenta	44
BNRS	92	Maplin	100
BNOS	76	Marlo Trading	76
Bradley Marshall	44	Manson	76
Calculator Sales & Service	58	Memotech	50, 51
Cambridge Kits	94	Midwich Co	30
Carlton Nichol	94	M.J.L.	88
Centemp	66	Newnes Tech Books	80
Clef Products	59	Pantechnic	19
Cricklewood	8, 9	Parnoon Elec	87
Crimson Elektric	68	Pops Components	76
Crofton	87	Powertran	2, 10, 66, 99
Dicon Elec	94	Rapid Elec	6
Display Elec	75	Relay A Quip	94
Electrovalle	15	Riscomp	37
Electriize Design	90	R.T.V.C.	88
Elkan Elec	88	Sinclair Research	48, 49
Enfield Elec	94	Sparkrite	89
Europa	66	Target Elec	81
Experimental Elec	98	Technomatic	28, 29
Flight Elec	68	Tempus	14
Globin Spec Corp	57	TK Elec	40
Greenbank	81	Watford Elec	4, 5
Greenweld	19	Wilmslow Audio	88, 94

POWER PLUS PERFORMANCE

MAN-MADE
MUSIC AT IT'S
VERY FINEST
—
SEE OUR GREAT
SYNTHESISERS
INSIDE
FRONT COVER

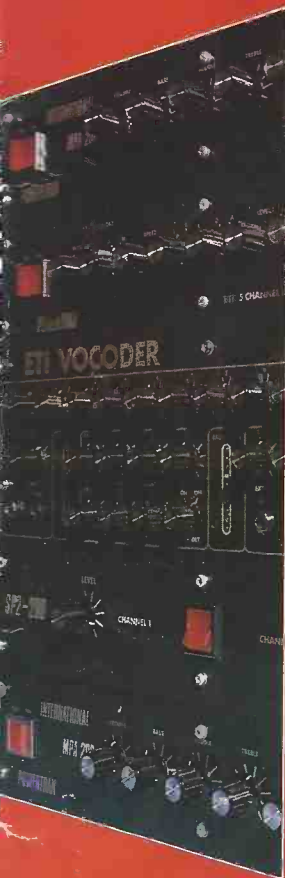

MPA 200 is a low price, high power 100W amplifier, its smart styling, professional appearance and performance make it one of our most popular designs. With adaptable inputs the mixer accepts a variety of sources yet straightforward construction makes it ideal for the first-time builder.

Complete kit £49.90 + VAT



CHROMATHEQUE 5000 — a 5-channel lighting system powerful enough for professional discos yet controllable for home-effects. Sound to light, strobe to music level, random or sequential effects — each channel can handle up to 500W yet minimal wiring is needed with our unique single board design.

Complete kit £49.90 + VAT



ETI VOCODER — 14 channels, each with independent level control, for maximum versatility and intelligibility; Two input amplifiers — for speech/excitation — each with level control and tone control. The Vocoder is a powerful yet flexible machine that is interesting to build and thanks to our easy to follow construction manual, is within the capability of most enthusiasts.

Complete kit £175.00 + VAT



SP2 200 twice the power with two of the reliable, durable and economic amps from the MPA 200; fed by separate power supplies from a common toroidal transformer. Superb finish and quality components throughout — up to (even over!) the standard of high priced factory-built units.

Complete kit £64.90 + VAT



DJ90 Stereo Mixer — this is a really versatile new mixer that enables the constructor DJ to produce a professional performance every time. There are two stereo inputs for magnetic cartridges, a stereo auxiliary input and mike input.

Other 'plus' features are auto-panning for fast or slow slider controls, multi-mixing, ducking, interrupt, input modulation, in short everything ... the whole works

— AND — under £100 complete!

(We have illustrated the DJ90 teamed in our own console with the Chromatheque and an SP2 200 and speakers. — Console only available as Sales Counter purchase.

Complete Kit — £97.50 + VAT

NEW Digital Delay Line

Our latest kit! With its ability to give delay times from 1.6 mSecs to up to 1.6 secs. Many powerful effects including phasing, flanging, A.D.T., chorus, echo & vibrato are obtained. The basic kit is extended in 400 mS steps up to 1.6 secs. Simply by adding more parts to the PCB.

Compare with units costing over £1,000!

Complete kit (400 mS delay) £130 + VAT.

Parts for extra 400 mS delay £9.50p.



POWERTRAN

WORLD LEADERS IN ELECTRONIC KITS



PORTWAY INDUSTRIAL ESTATE
ANDOVER. HANTS. SP10 3NM

TELEPHONE
(0264) 64455

- **MONEY BACK GUARANTEE:** — if you are not completely satisfied with your Powertran Kit return it in original condition within 10 days for full refund.
- **FREE SOLDERING PRACTICE KIT:** — To assist the beginner we will supply, on request with your first kit order, a free soldering practice kit with useful tips and illustrations.
- **COMPONENT PACKS:** — Most kits are available as separate packs (e.g. PCB component sets, hardware sets etc). Prices in our FREE catalogue.
- **ORDERING:** — Full ordering details, delivery service, and sales counter opening — inside front cover of this issue.

USE OUR EASY ORDER SERVICE
SIMPLY PHONE US ON 0264 64455
Tell us the kit you want and just quote
your Access or Barclaycard number —
and leave the rest to us.
(40 page catalogue free on request)
FULL ORDERING INFORMATION
INSIDE FRONT COVER.

VISA