

# electronics today

ISSN 1074

INTERNATIONAL

NOVEMBER 1980 60p

## SPACE INVASION!

First ever DIY project -  
easily converted to a  
home computer!

## DMMs AT HOME

A market  
survey

## DESIGNING REGULATORS

## VERSATILE TEST OSCILLATOR

## RADIOACTIVITY EXPLAINED

**5** PROJECTS  
TO BUILD  
WITH OUR

**INSIDE:**

WORTH  
**£1!**

### 8K ON BOARD MEMORY!

5K RAM 3K ROM or 4K RAM, 4K ROM (link selectable) Kit supplied with 3K RAM 3K ROM System expandable for up to 32K memory

### 2 KEYBOARDS!

56 Key alphanumeric keyboard for entering high level language plus 16 key Hex pad for easy entry of machine code

### GRAPHICS!

64 character graphics option — includes transistor symbols! Only £18.20 extra!

### MEMORY MAPPED

high resolution VDU circuitry using discrete TTL for extra flexibility Has its own 2K memory to give 32 lines for 64 characters

### KANSAS CITY

low error rate tape interface

### 2 MICROPROCESSORS

Z80 the powerful CPU with 158 instruction, including all 78 of the 8080 controls the MM57109 number cruncher Functions include + — % / squares, roots, logs, exponentials, trig functions, inverses etc Range 10<sup>99</sup> to 9 x 19<sup>99</sup> to 8 figures plus 2 exponent digits

### EFFICIENT OPERATION

Why waste valuable memory on sub routines for numeric processing? The number cruncher handles everything internally!

### RESIDENT BASIC

with extended mathematical capability Only 2K memory used but more powerful than most 8K Basics!

### 1K MONITOR

resident in EPROM

### SINGLE BOARD DESIGN

Even keyboards and power supply circuitry on the superb quality double sided plated through-hole PCB

**PSI comp 80**  
Z80 Based powerful scientific computer design as published in **WIRELESS WORLD**



**COMPLETE KIT**  
**NOW ONLY**  
**£225 + VAT**

Cabinet size 19.0" x 15.7" x 3.3"

Television not included in price

The kit for this outstandingly practical design by John Adams published in a series of articles in Wireless World really is complete. Included in the PSICOMP 80 scientific computer kit is a professionally finished cabinet, fibre-glass double sided, plated-through-hole printed circuit board. 2 keyboards PCB mounted for ease of construction, IC sockets, high reliability metal oxide resistors, power supply using custom designed toroidal transformer. 2K Basic and 1K monitor in EPROMS and, of course, wire, nuts, bolts, etc.

### KIT ALSO AVAILABLE AS SEPARATE PACKS

For those customers who wish to spread their purchase or build a personalised system the kit is available as separate packs eg PCB (16" x 12.5") £43.20, Pair of keyboards £34.00, Transformer or EPROMS £30.00, Toroidal transformer and power supply components £17.60, Cabinet (very rugged, made from steel, really heavy-duty finished) £26.50, P.S. Wd greatly enhance any other single board computer including DMH SUPERBOARD for which it can be readily modified. Other packs listed in our FREE CATALOGUE

### PSI COMP 80 Memory Expansion System

Expansion up to 32K all inside the computer's own cabinet!

By carefully thought out engineering a mother board with buffers and its own power supply (powered by the computer's transformer) enables up to 3 8K RAM or 8K ROM boards to be fitted neatly inside the computer cabinet. Connections to the mother board from the main board expansion socket is made via a ribbon cable

<b>Mother board:</b>	Fibre glass double sided plated through hole PCB 8 7" x 3 0" set of all components including all brackets, fixing parts and ribbon cable with socket to connect to expansion plug	<b>£39.90</b>
<b>8K Static RAM board</b>	Fibre glass double sided plated through hole PCB 5 6" x 4 8" Set of components including IC sockets, plug and socket but excluding RAMs 2114L RAM (16 required) Complete set of board components 16 RAMs	<b>£12.50</b> <b>£11.20</b> <b>£5.00</b> <b>£89.50</b>
<b>8K ROM board</b>	Fibre glass double sided plated through hole PCB 5 6" x 4 8" Set of components including IC sockets, plug and socket but excluding ROMs 2708 ROM (8 required) Complete set of board components 8 ROMs	<b>£12.40</b> <b>£10.70</b> <b>£6.00</b> <b>£68.50</b>

AS FEATURED  
LAST MONTH

## ★ ETI VOCODER ★



Panel size 19.0" x 5.25" Depth 12.2"

**14 CHANNELS!**  
**NOISE GENERATOR!**  
**LED PPM METERS!**  
**SLEW RATE CONTROL!**

**2 OSCILLATORS!**  
**VOICED/UNVOICED DETECTOR!**

**COMPLETE KIT ONLY £195 + VAT**

Kit includes FREE foot control and test oscillator!

Like all our kits the ETI VOCODER really is complete — fully finished metal work, professional quality components (all resistors 2% metal oxide), nuts, bolts, etc. — even a 13A plug! Kits also available as separate packs — See our Free Catalogue.

# POWERTRAN

OUR CATALOGUE IS FREE! WRITE OR PHONE NOW!  
**POWERTRAN ELECTRONICS**  
PORTWAY INDUSTRIAL ESTATE  
ANDOVER  
ANDOVER, HANTS SP10 3NM  
(STD 0264) 64455

**PRICE STABILITY:** Order with confidence. Irrespective of any price changes we will honour all prices in this advertisement until December 31, 1980, if this month's advertisement is mentioned with your order. Errors and VAT rate changes excluded.

**EXPORT ORDERS:** No VAT. Postage charged at actual cost plus £1 handling and documentation.

**U.K. ORDERS:** Subject to 15% surcharge for VAT. No charge is made for carriage, or at current rate if changed.

**SECURICOR DELIVERY:** For this optional service (U.K., mainland only) add £2.50 (VAT inclusive) per kit.

**SALES COUNTER:** If you prefer to collect kit from the factory, call at Sales Counter, Open 9 a.m. - 12 noon, 1-4.30 p.m. Monday-Thursday.

**MANY MORE KITS ON PAGE 8**



ETI versus the Universe p. 65



Millions of meters (nearly) p. 91



one of the many p39

# electronics today

NOVEMBER 1980 VOL.9 NO.11 INTERNATIONAL

## FEATURES

NEWS	8	Read it first in ETI
EMP	15	The debate continues
MICROBASICS	20	Memories are made of this
AUDIOPHILE	32	Sony competition results
TECH TIPS	43	Readers' designs
ASTROLOGUE	52	The Space Shuttle saga
SPOT DESIGNS	60	Tried and tested circuits
DESIGNER'S NOTEBOOK	76	Zero-voltage switching
RADIOACTIVITY	86	Brush up your alpha, beta, gamma
DMM SURVEY	91	Digital multimeter bazaar
REGULATOR DESIGN	99	Keep your volts under control

## PROJECTS

AUDIO TEST OSCILLATOR	27	Make waves with our test gear
RIAA PREAMP	39	Moving coil matchmaker
TOUCH BUZZER	48	Simply a touch noisy
METRONOME	56	Raise a rhythm or two
SPACE INVASION GAME	65	A microprocessor marvel
POWER AMPLIFIER	72	A two watts winner
LIGHT SWITCH	81	Light dependent switching
FOIL PATTERNS	109	We have designs on your copper

## INFORMATION

NEXT MONTH'S ETI	17	The last one in 1980
NEXT MONTH'S CT	25	Computing tomorrow
NEXT MONTH'S HE	85	Inside Hobby Electronics
SUBSCRIPTIONS	97	Get ETI the easy way
HI-FI SYSTEM OFFER	104	A complete system under £300
ETIPRINTS	108	Foil pattern prints
BOOK SERVICE	113	The ETI technical library

### EDITORIAL AND ADVERTISEMENT OFFICE

145 Charing Cross Road, London WC2H 0EE. Telephone 01-437 1002/3/4/5

Ron Harris B.Sc. Editor  
 Ian Graham B.Sc. Assistant Editor  
 Tina Boylan Editorial Assistant  
 Paul Wilson-Patterson Group Art Editor  
 Paul Edwards Drawing Office Manager  
 Ray Marston Project Editor  
 Christopher Surgenor Group Advertisement Manager  
 Steven Rowe Advertisement Manager  
 Roy Perryment Advertisement Representative  
 T.J. Connell Managing Director

OVERSEAS EDITIONS and their EDITORS  
 AUSTRALIA - Roger Harrison  
 CANADA - Halvor Moorshead  
 GERMANY - Udo Wittig  
 HOLLAND - Anton Kriegsman



Member of the Audit Bureau of Circulation



PUBLISHED BY Modmags Ltd., 145 Charing Cross Road, WC2  
 DISTRIBUTED BY Argus Distribution Ltd. (British Isles)  
 12-18 Paul Street, London  
 Gordon & Gotch Ltd. (Overseas)  
 PRINTED BY QB Limited, Colchester

Electronics Today is normally published on the first Friday in the month preceding cover date. ©MODMAGS LTD 1980. All material is subject to worldwide copyright protection. All reasonable care is taken in the preparation of the magazine contents, but the publishers cannot be held legally responsible for errors. Where mistakes do occur, a correction will normally be published as soon as possible afterwards. All prices and data contained in advertisements are accepted by us in good faith as correct at time of going to press. Neither the advertisers nor the publishers can be held responsible, however, for any variations affecting price or availability which may occur after the publication has closed for press. Subscription Rates UK £10 including postage. Airmail and other rates upon application to ETI Subscriptions Service, PO Box 35, Bridge Street, Hemel Hempstead, Herts.

# MITRAD

The premier mail order house specialising in quality products and superior after-sales care.

## SEIKO QUARTZ LCD MEMORY-BANK CALENDAR WATCH

SPECIAL PRICE **ONLY £49.95**  
plus 85p p&p. Usually £89 or over.

Displays hour, minute, second, month, day of the week and date in 12 hour indication – or 24 hour at the touch of a button.

● Button touch also displays month and year and dates for a designated month with Sunday dates flashing.

Stores dates in memory up to 11 ahead, flashes 'MEMO' on designated dates.

Illuminated time and calendar display.

Display flashes when battery nears life end.

Stainless steel case and wrist strap (adjustable).

In presentation case with instructions.

### A LIFETIME WATCH AT A BARGAIN-OF-A- LIFETIME PRICE

Full refund if not completely satisfied.

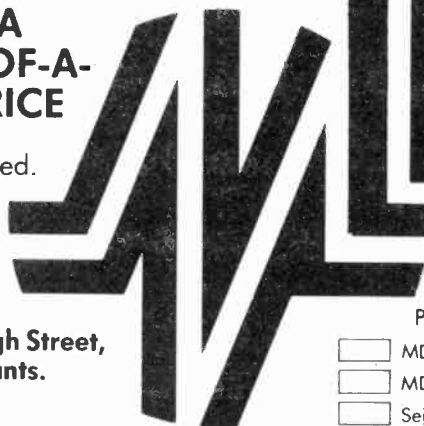

Mitrad, 68-70 High Street,  
Kettering, Northants.  
Tel: 0536 522024

This is a representative selection from the collection of guaranteed leading make and own brand watches offered through Mitrad's 7 day distribution system and backed by Mitrad's own service organisation. For complete product range, ring or write for catalogue. Trade price list available for bulk orders.

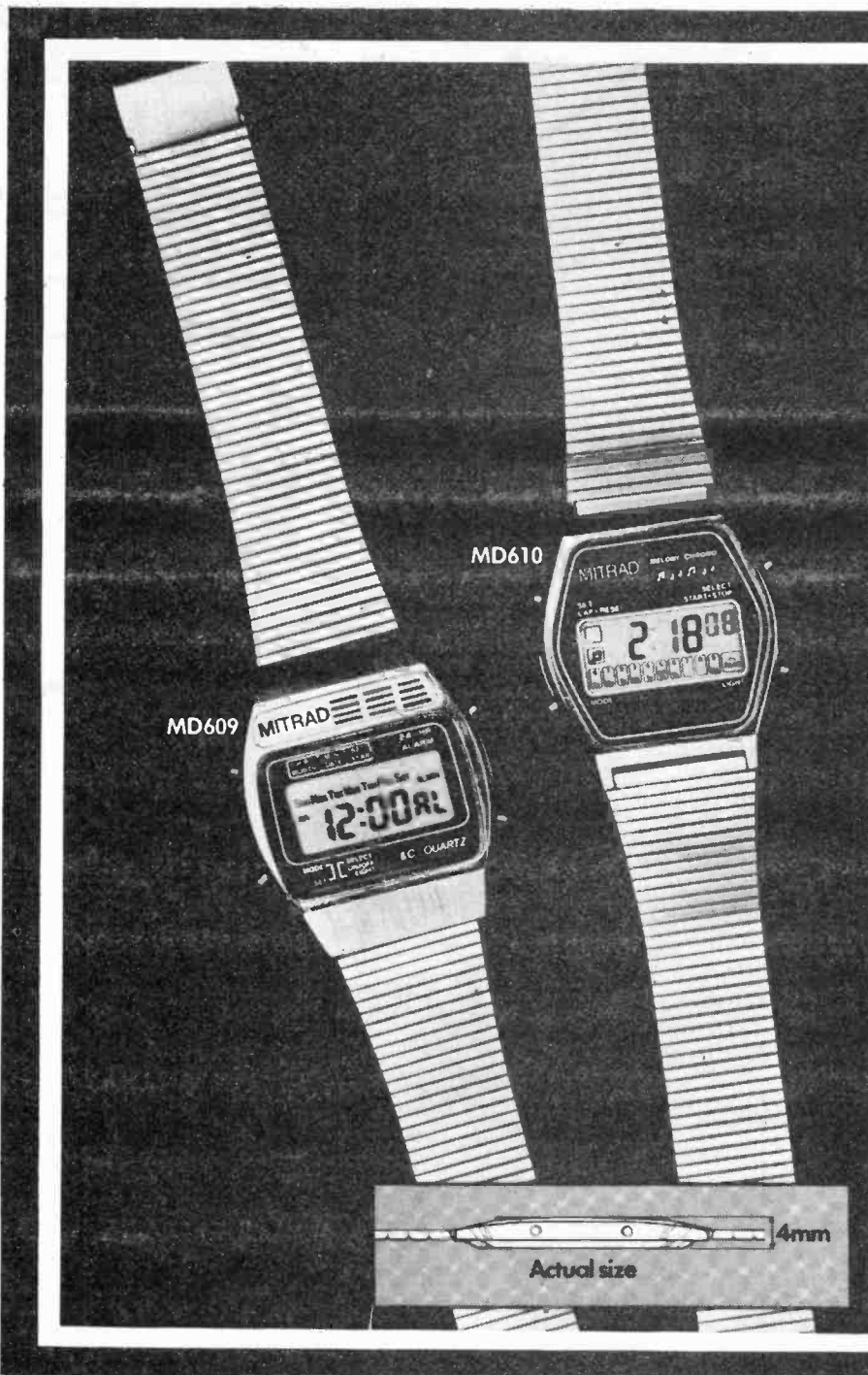

To Mitrad, 68-70 High Street, Kettering, Northants.  
Please send me:

- MD609 watch(es) at £11.80 inc p&p  
 MD610 watch(es) at £17.80 inc p&p  
 Seiko Quartz watch(es) at £50.80 inc p&p  
 MD605 watch(es) at £12.80 inc p&p

- MD606 watch(es) at £10.80 inc p&p  
 MD607 watch(es) at £10.80 inc p&p  
 MD608 watch(es) at £16.35 inc p&p

Total value of my order £ \_\_\_\_\_

I enclose cheque/PO or debit my Access/Barclaycard No. \_\_\_\_\_

Name \_\_\_\_\_ Signature \_\_\_\_\_

Address \_\_\_\_\_ (block letters please)

☎ Credit Card holders may telephone (0536) 522024 24 hours a day stating Card Number for immediate attention. All orders despatched within seven days, subject to availability. Full refund if not completely satisfied.  
 Mitrad Registered in England No. 2554356.



ETI

ETI NOVEMBER 1980



**MD609** Gentleman's **super slim** flag date alarm. Only 4mm case thickness. Continuous display of hours, minutes, seconds and day; optional display of date, month, year. 24 hour alarm, alarm mode indication. Back light. Infinitely adjustable stainless steel strap. Very latest technology.  
**£10.95 + 85p p&p**

**MD610** Gentleman's dual time melody alarm chrono. Only 5mm case thickness. Continuous display of hours, minutes, seconds plus date and mode indications. 'Running horse' chrono to 1/10 sec, 12 hour alarm plays 30 seconds of 'Yellow Rose of Texas'. Infinitely adjustable stainless steel strap.  
**£16.95 + 85p p&p**

**MD605** Ladies musical alarm chrono. Continuous display of hours, minutes, seconds; optional display of day, date, month. Auto calendar. Chronograph with lap timing facilities, to 1/10 sec. 24 hour alarm plays 30 seconds of Beethoven's 'Fur Elise'. Back light. Infinitely adjustable stainless steel strap.  
**£11.95 + 85p p&p**

**MD606** Ladies five function fashion LCD watch with 3 year battery. Continuous display of hours and minutes, with month/date and date/seconds available. Auto calendar. Only 6mm case thickness. Back light. Infinitely adjustable stainless steel strap.  
**£9.95 + 85p p&p**

**MD607** Ladies slim 'sugar coated' dress watch. Continuous display of hours and minutes; optional display of month and date. Auto calendar. Back light. Integral watch and strap. In gold or silver finish.  
**£9.95 + 85p p&p**

**MD608** Gentleman's musical alarm chrono. Continuous display of hours, minutes, seconds, plus day indication. Also month and date. Chronograph with lap timing facilities, to 1/10 sec. 24 hour alarm plays 30 seconds of Beethoven's 'Fur Elise' or can be set to awaken to a single note. Back light. Infinitely adjustable stainless steel strap.  
**£15.50 + 85p p&p**



## COMPUTER CORNER

- **SUPERBOARD II** Ready-built and tested. Only £150
- **PSU 5V/3A** (for above incl. RF Modulator) £25
- **610 Expansion Board** (BK RAM) expandable to 24K £150
- **CHALLENGER 1P** (Superboard cased with PSU) £188
- **Extra 4K RAM** (8x2114) £18
- **Plastic Case** Black, fits UR101 Superboard, NASCOM II etc £25
- **SUPERPRINT 800**, 80 column High Performance Impact Printer. Ideal for PET, NASCOM, UK101, Superboard, TRS80 etc. only £325
- **VIDEO GENIE** based on TRS80. Utilises Z80, 12K level II Basic 16K RAM incl. Cassette Deck £290
- **STRINGY FLOPPY**, Combines economy of Cassette with speed & reliability of DISC (incl. 20 wafers) £169
- **SOFTY**, Intelligent EPROM Programmer. Connects directly to TV. Develop. copy. Burn EPROMS Kit £99
- Ready-built and tested £120
- PSU for above (Built) £20
- **UHF Modulators 6MHz** 280p
- **UHF Modulators 8MHz** 450p
- **KEYPADS** 4 x 4 matrix 350p
- **Full ASCII** coded 56 Key Keyboard Mod. 756 £40
- **10x C12 Cassettes** in Rack £5.50 (P&P is extra on all items). Call in at our shop for Demo or write in for leaflets.

**SWITCHES**  
TOGGLE: 2A 250V 32p  
SPST 34p  
DPST 44p  
DPDT 54p  
4 pole on/off 54p

**SUB-MIN TOGGLE**  
SP changeover 55p  
SPST on/off 54p  
SPST biased 85p  
DPDT 6 tags 70p  
DPDT centre off 79p  
DPDT biased 115p

**SLIDE 250V:**  
1A DPDT 14p  
1A DPDT c/over 15p  
1/2A DPDT 13p  
4 pole 2-way 24p

**PUSH BUTTON**  
DPDT Black Body  
Red, Blue, Grn., Yell.  
SRL Latching 125p  
SRM Momentary 125p

**MINI Non Locking**  
Push to Make 15p  
Push Break 25p

**DIL SWITCHES**  
(SPST)  
4 way 85p, 6 way 95p, 8 way 115p

**ROTARY:** Make your own multiway Switch. Adjustable Stop Shafting Assembly. Accommodate up to 6 Wafers 90p  
Mains Switch DPST to fit 40p  
Break Before Make Wafers 1 pole/12 way, 2p/6 way, 3p/4 way, 4p/3 way, 6p/2 way 56p  
Spacer and Screen 6p

**ROTARY: (Adjustable Stop)**  
1 pole/2 to 12 way, 2p/2 to 6 way, 3 pole/2 to 4 way, 4 pole/2 to 3 way 43p  
**ROTARY:** Mains 250V AC, 4 Amp 52p

**'D' CONNECTORS (Cannon type)**  
Plugs Sockets Covers  
9way 95p 128p —  
15way 135p 195p 150p  
25way 188p 284p 170p  
37way 290p 398p 185p

**CRYSTALS**  
100KHz 323  
455KHz 383  
1MHz 323  
1.008M 395  
1.28MHz 392  
1.6MHz 323  
1.9MHz 323  
1.8432MHz 362  
2.4576MHz 362  
3.2768M 323  
3.57954M 195  
4.000MHz 195  
4.032MHz 323  
4.433619M 230  
5.0MHz 355  
5.185M 323  
5.24288M 425  
6.0MHz 323  
6.5536M 200  
7.680M 392  
8.0MHz 392  
8.08333M 362  
8.867237M 362  
9.375M 323  
10.0MHz 323  
10.7MHz 323  
12MHz 392  
14.31818M 362  
18MHz 323  
18.432M 323  
20.0MHz 323  
21.648M 323  
38.6667M 350  
48.0MHz 323  
100.00MHz 323

**TRANSFORMERS** (Mains Prlm. 220-240V)  
6-0-6V: 9-0-9V; 12-0-12V 100mA 95p  
3VA: 0-6V 0-6V (PCB mounting) 150p  
6VA: 6V: 5A 6V: 5A 9V: 4A 9V: 4A 12V: 3A 150p  
12V: 3A 15V: 2.5A 15V: 2.5A 215p  
12V: 4.5V: 1.3A 4.5V: 1.3A 6V: 1.2A 6V: 1.2A 235p (30p p&p)  
12V: 1.5A 12V: 1.5A 15V: 8A 15V: 8A 20V: 3A 235p (30p p&p)  
24VA: 6V: 1.5A 6C: 1.5A 9V: 1.1 3A: 4x4x1 1/2" 75  
12V: 1A 12V: 1A 15V: 8A 15V: 8A 20V: 3A 235p (30p p&p)  
50VA: 6V: 4A 6V: 4A 9V: 2.5A 9V: 2.5A 12V: 2A 12V: 2A 15V: 1.5A 15V: 1.5A 20V: 1.2A 20V: 1.2A 25V: 1A 25V: 1A 30V: 8A 30V: 8A 95p (60p p&p)  
100VA: 12V: 4A 12V: 4A 15V: 3A 15V: 3A 20V: 2.5A 20V: 2.5A 30V: 1.5A 30V: 1.5A 40V: 1.25A 40V: 1.25A 50V: 1A 50V: 1A 60p (74p p&p). (NB: p&p charge to be added above our normal postal charge.)

**ALUM. BOXES WITH LID**  
3x2x1" 55  
2 1/2x5 1/2x1 1/2" 75  
4x4x1 1/2" 75  
4x2 1/2x1 1/2" 75  
4x5 1/2x1 1/2" 100  
4x2 1/2x2" 80  
5x4x2" 107  
6x4x2" 110  
7 1/2x2 1/2" 185  
8x6x3" 185  
10x7x3" 240  
10x4 1/2x3" 228  
12x5x3" 230  
12x8x3" 275

**PANEL METERS**  
FSD  
60x46x35mm  
0-50µA 40p  
0-100µA 2p/5  
0-500µA 0-5mA  
0-1mA 0-5mA  
0-10mA 0-50mA  
0-100mA 0-500mA  
0-1A 250  
0-2A 250  
0-25V 445p each  
0-50V AC 0-300V AC  
"S" 445p each  
4 1/2x3 1/2x1 1/2" 0-50µA  
0-100µA  
0-500µA  
159p each

**VOLTAGE REGULATORS**  
1A TO3 +ve -ve  
5V 7805 145p 7905 220p  
12V 7812 145p 7912 220p  
15V 7815 145p  
10 78WZ 181p 7818 145p  
1A TO220 Plastic Casing  
5V 7805 60p 7905 65p  
12V 7812 60p 7912 65p  
15V 7815 60p 7915 65p  
18V 7818 60p 7918 65p  
24V 7824 60p  
100mA TO92 Plastic Casing  
5V 78L05 30p 79L05 65p  
6V 78L02 30p  
8V 78L02 30p  
12V 78L12 30p 79L12 65p  
15V 78L15 30p 79L15 65p

**OPTO**  
LEDs with Clips  
TIL209 Red 13  
TIL211 Grn 17  
TIL212 Yel 18  
TIL220 2" Red 14  
2" Green, Yellow or Amber 18  
7 Segment Displays  
TIL307 675  
TIL312 3" CA 105  
TIL313 3" CC 105  
TIL321 5" CA 115  
TIL322 5" CC 115  
DL77 8" CA 99  
DL707 3" CA 99  
DL747 6" CA 180  
8" Orange CA 250  
LS400 255 FND357 Red 120  
OCP71 120 FND500 115  
ORP12 63 3" Green CA 150  
ORP61 85 6" Green CA 215  
2N5777 45 3" 1 Red CA 150  
3" 1 Green CA 150

**ISOLATORS**  
IL74 55 DVM176 1885  
TIL111/2 85 LCD 3 1/2 Digits 775  
TIL114 85 LCD 4 Digits 975  
TIL117 110 LCD 6 Digits 950

**ETI Projects: Parts available for:**  
Digital Test Meter, DM900, 60W Amplifier System. Send SAE plus 5p for list.

LS245 450	LS373 180	4015 85	4053 80	4174 130	4521 250
LS247 135	LS374 180	4016 82	4054 130	4175 120	4522 150
LS248 135	LS375 150	4017 82	4055 135	4176 125	4526 150
LS249 135	LS377 199	4018 28	4056 135	4408 790	4527 160
LS251 130	LS378 185	4019 48	4057 2650	4409 790	4528 120
LS253 130	LS379 215	4020 99	4059 575	4410 790	4529 175
LS257 115	LS384 50	4021 105	4060 130	4411 1020	4530 89
LS258 120	LS385 420	4022 95	4061 1225	4412F 1520	4531 165
LS259 180	LS386 85	4023 25	4062 995	4412V 1520	4532 140
LS261 450	LS390 140	4024 75	4063 120	4415F 850	4534 575
LS266 75	LS393 140	4025 25	4066 58	4415V 850	4536 395
LS273 180	LS395 210	4026 180	4067 430	4419 320	4538 160
LS276 320	LS396 199	4027 48	4068 26	4422 570	4539 135
LS278 88	LS398 235	4028 82	4069 26	4432 1050	4541 150
LS279 250	LS399 230	4029 105	4070 30	4435 1050	4543 175
LS283 190	LS445 140	4030 60	4071 25	4440 999	4549 296
LS290 130	LS447 195	4031 225	4072 25	4450 350	4553 440
LS293 130	LS490 150	4032 125	4073 25	4451 350	4554 175
LS295 215	LS868 105	4033 175	4074 95	4452 25	4555 85
LS298 215	LS869 105	4034 210	4076 99	4490F 750	4556 75
LS299 420	LS870 270	4035 125	4077 48	4490V 750	4557 425
LS300 175	LS873 750	4036 365	4078 30	4501 28	4558 130
LS302 175	LS874 850	4037 115	4081 28	4502 125	4559 290
LS320 270		4038 118	4082 28	4503 75	4560 235
LS323 450		4039 360	4085 90	4506 75	4561 95
LS324 200		4040 105	4086 90	4507 60	4562 595
LS325 320	4000 18	4041 80	4089 150	4508 325	4566 190
LS326 330	4001 18	4042 80	4093 89	4510 99	4568 299
LS327 315	4002 24	4043 95	4094 240	4511 150	4569 250
LS346 185	4006 92	4044 95	4095 105	4512 99	4572 48
LS347 150	4007 22	4045 175	4096 105	4513 225	4580 595
LS348 190	4008 82	4046 110	4097 350	4514 265	4581 350
LS352 85	4009 40	4047 98	4098 115	4515 299	4582 150
LS353 185	4010 48	4048 65	4099 190	4516 120	4583 125
LS355 65	4011 24	4049 45	4160 125	4517 450	4584 64
LS366 65	4012 24	4050 48	4161 125	4518 105	4585 140
LS367 65	4013 85	4051 80	4162 125	4519 70	44016 95
LS368 65	4014 85	4052 80	4163 125	4520 115	

### CMOS

# All these advantages...

- Instant all-weather starting
- Smoother running
- Continual peak performance
- Longer battery & plug life
- Improved fuel consumption
- Improved acceleration/top speed
- Extended energy storage

## ..in kit form

SPARKRITE X5 is a high performance, top quality inductive discharge electronic ignition system designed for the electronics D.I.Y. world. It has been tried, tested and proven to be utterly reliable. Assembly only takes 1 1/2 hours and installation even less due to the patented 'clip on' easy fitting.

The superb technical design of the Sparkrite circuit eliminates problems of the contact breaker. There is no misfire due to contact breaker bounce which is eliminated electronically by a pulse suppression circuit which prevents the unit firing if the points bounce open at high R.P.M. Contact breaker burn is eliminated by reducing the current by 95% of the normal. There is also a unique extended dwell circuit which allows the coil a longer period of time to store its energy before discharging to the plugs. The unit includes built in static timing light systems function light, and security change-over switch. Will work all rev counters.

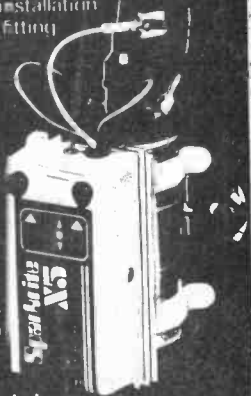

**Fits all 12v negative-earth vehicles with coil/distributor ignition up to 8 cylinders.**

**THE KIT COMPRISES EVERYTHING NEEDED**  
Die pressed case. Ready drilled aluminium extruded base and heat sink, coil mounting clips and accessories. All kit components are guaranteed for a period of 2 years from date of purchase. Fully illustrated assembly and installation instructions are included.



Roger Clark the world famous rally driver says "Sparkrite electronic ignition systems are the best you can buy."

# Sparkrite

HIGH PERFORMANCE ELECTRONIC IGNITION

Electronics Design Associates, Dept. ET1/11, 2 Bath Street, Walsall, WS1 3DE. Phone: (0922) 614791

Name \_\_\_\_\_  
Address \_\_\_\_\_

Phone your order with Access or Barclaycard I enclose cheque/PO's for  
Inc. V.A.T. and P.P. QUANTITY REQ'D.  
**X5KIT £16.95**  
ACCESS OR BARCLAY CARD No. \_\_\_\_\_  
Cheque No. \_\_\_\_\_  
Send SAE if brochure only required.

# DIGEST

## High Level Control

A system for regulating the level of the Royal Military Canal in Kent has been installed by Shepway District Council. The fully automatic system was devised and commissioned by Rotork Retrofit of Bath and utilises a pressure transducer which senses a predetermined water level and initiates the raising of the water gates to allow water to flow beneath and so maintain a safe level. The electronic control system is housed in a weatherproof cabinet on the site and is programmed to provide four stages of control in winter

and three in summer. In summer a high level is maintained to cater for the needs of pleasure boats and anglers. The automatic control ensures that this high level is maintained even in times of heavy rainfall to prevent fish being lost out at sea, which occurred before. During the winter the canal is tidelocked during high tide conditions and this has led in the past to incidents of flooding. Previously the gates had to be left in a partly open position and this necessitated having staff 'on call' day and night to adjust them manually whenever tide or weather caused problems. The new system saves time, money and staff inconvenience.

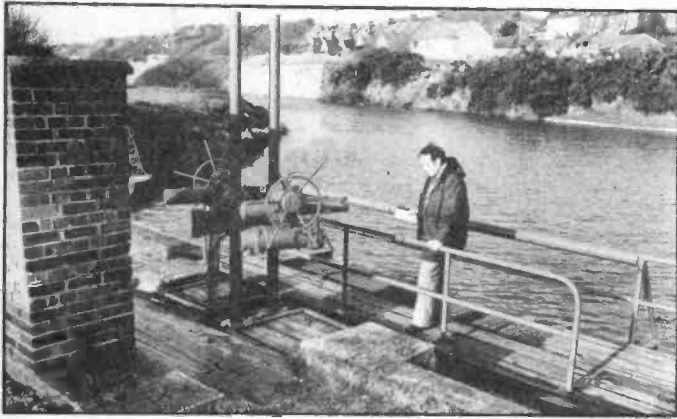

## Cassette Interface PCB

We omitted to include a Buy-lines section in the Cassette Interface project published last

month. Jayman Electro Devices, 15 Ash Grove, Springhead, Oldham, Lancs OL4 4RP will supply a PCB for £4 all inclusive or a complete kit (including PCB) for £13.50 including post and VAT.

## Getting It Taped

Mitsubishi Electric have launched their new metal tape cassette deck, the DT-530. For £122.00 you can enjoy such features as soft touch operation

and one-touch recording, together with Dolby noise reduction and peak level indicators for accurate reading. Fifteen LEDs per channel provide an easy-to-read scale from -20 dB to +5 dB and at 0 dB the scale colour changes from green to red. The cassette housing on the front loading deck is air-damped and

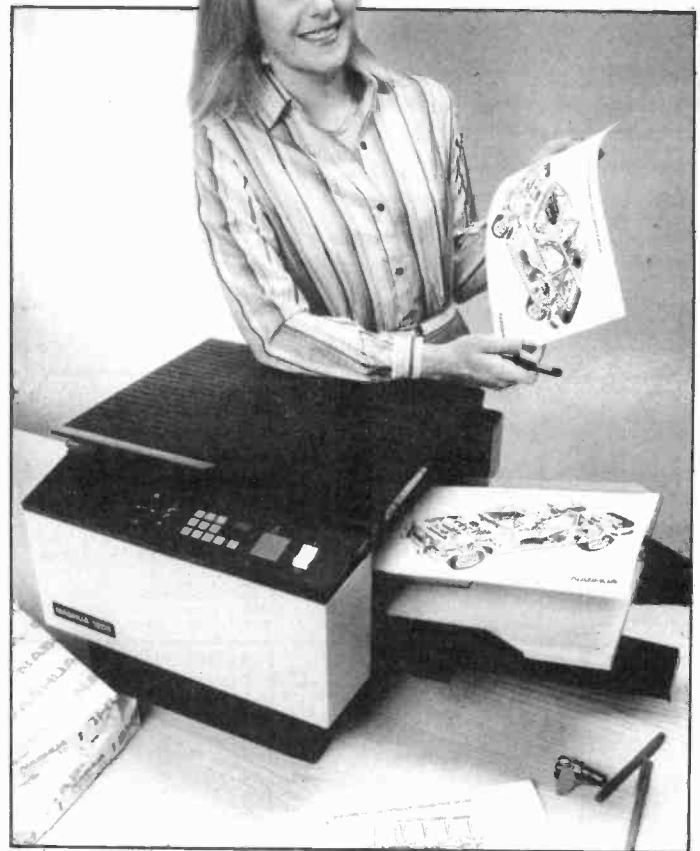

## Copycat

Nashua have introduced what they consider to be the smallest plain paper copier in the world. Measuring only 18" x 18" x 13", the Nashua 1205 will make its UK exhibition debut at the London Business Show on September 23-26. It is designed for the small business where inexpensive decentralised copying is required. The 1205 utilises fibre optics combined with a miniaturised development of Nashua's micro-processor controlled Liquid Toner Transfer system to achieve its

small size. The first copy is ready in 7 S, subsequent copies at 12 per minute and the single paper tray can hold a range of paper from A5 to 8.5" x 14.0". There is an automatic shut-off 60 S after the last copy is produced and the toner/developer is held in self-contained cartridges. The machine also has improved copy (especially blue response), adjustable exposure control and a touch-tone keyboard with a digital readout to keep track of copy countdown. For further information contact Nashua Copycat Ltd, Cory House, Bracknell, Berkshire, RG12 1ET.

## 24 Hour Fone Machine

Most telephone answering machines lie redundant in the office all day, only bursting into action when everyone has gone home. The Ansafone 6A has been designed to be useful 24 hours a day.

In addition to providing telephone answering and simple announcement facilities, the 6A doubles as a simple-to-use dictation machine. It can also be used as a music cassette player for background music.

Ansafone 6A is available on rental from £2.35 per week from Ansafone, Lyon May, Frimley Road, Camberley, Surrey GU16 5EY.

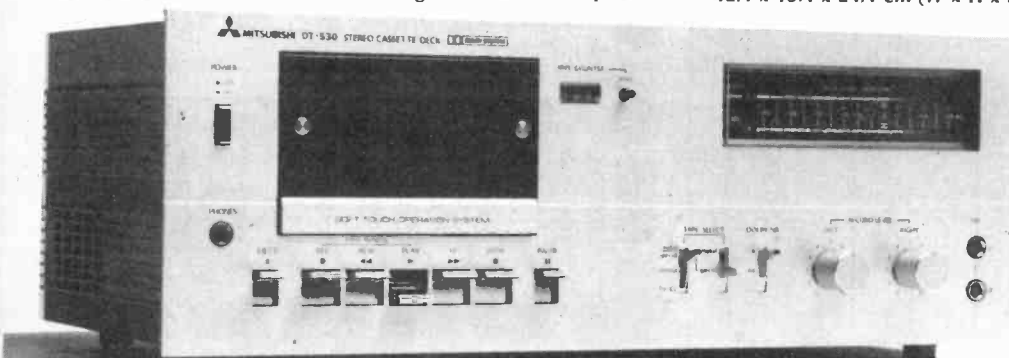



# TRANSCENDENT DPX

DIGITALLY CONTROLLED, TOUCH SENSITIVE, POLYPHONIC, MULTI-VOICE SYNTHESIZER

Another superb design by synthesizer expert Tim Orr — published in Electronics Today International

The Transcendent DPX is a really versatile new 5 octave keyboard instrument. There are two audio outputs which can be used simultaneously. On the first there is a beautiful harpsichord or reed sound — fully polyphonic, i.e. you can play chords with as many notes as you like. On the second output there is a wide range of different voices, still fully polyphonic. It can be a straightforward piano or a honky tonk piano or even a mixture of the two! Alternatively you can play strings over the whole range of the keyboard or brass over the whole range of the keyboard or should you prefer — strings on the top of the keyboard and brass at the lower end (the keyboard is electronically split after the first two octaves) or vice-versa or even a combination of strings and brass sounds simultaneously. And on all voices you can switch in circuitry to make the keyboard touch sensitive! The harder you press down a key the louder it sounds — just like an acoustic piano. The digitally controlled multiplexed system makes practical touch sensitivity with the complex dynamics law necessary for a high degree of realism. There is a master volume and tone control, a separate control for the brass sounds and also a vibrato circuit with variable depth control together with a variable delay control so that the vibrato comes in only after waiting a short time after the note is struck for even more realistic strong sounds.



Cabinet size 36.3" x 15.0" x 5.0" (rear) 3.3" (front)

**COMPLETE KIT ONLY £299 + VAT**

To add interest to the sounds and make them more natural there is a chorus/ensemble unit which is a complex phasing system using CCD (charge coupled device) analogue delay lines. The overall effect of this is similar to that of several acoustic instruments playing the same piece of music. The ensemble circuitry can be switched in with either strong or mild effects. As the system is based on digital circuitry digital data can be easily taken to and from a computer (for storing and playing back accompaniments with or without pitch or key change, computer composing, etc., etc.) Although the DPX is an advanced design using a very large amount of circuitry, much of it very sophisticated, the kit is mechanically extremely simple with excellent access to all the circuit boards which interconnect with multiway connectors, just four of which are removed to separate the keyboard circuitry and the panel circuitry from the main circuit in the cabinet. The kit includes fully finished metalwork, solid teak cabinet, professional quality components (all resistors 2% metal oxide), nuts, bolts, etc., even a 13A plug!

## POWERTRAN

MANY MORE KITS ON PAGE 116. MORE KITS AND ORDERING INFORMATION ON INSIDE FRONT COVER

## TRANSCENDENT 2000 SINGLE BOARD SYNTHESIZER

LIVE PERFORMANCE SYNTHESIZER DESIGNED BY CONSULTANT TIM ORR (FORMERLY SYNTHESIZER DESIGNER FOR EMS LIMITED) AND FEATURED AS A CONSTRUCTIONAL ARTICLE IN ELECTRONICS TODAY INTERNATIONAL.

The TRANSCENDENT 2000 is a 3 octave instrument transposable 2 octaves up or down giving an effective 7 octave range. There is portamento, pitch bending, a VCO with shape and pitch modulation, a VCF with both low and high pass outputs and a separate dynamic sweep control, a noise generator and an ADSR envelope shaper. There is also a slow oscillator, a new pitch detector, ADSR repeat, sample and hold, and special circuitry with precision components to ensure tuning stability amongst its many features. The kit includes fully finished metalwork, fully assembled solid teak cabinet, filter sweep pedal, professional quality components (all resistors either 2% metal oxide or 1/2% metal film) and it really is complete — right down to the last nut and bolt and last piece of wire! There is even a 13A plug in the kit — you need buy absolutely no more parts before plugging in and making great music! Virtually all the components are on the one professional quality fibreglass PCB printed with component locations. All the controls mount directly on the main board, all connections to the board are made with connector plugs and construction is so simple it can be built easily in a few evenings by almost anyone capable of neat soldering! When finished you will possess a synthesizer comparable in performance and quality with ready-built units selling for many times the price.

**COMPLETE KIT  
ONLY  
£168.50 + VAT!**

Comprehensive handbook supplied with all complete kits! This fully describes construction and tells you how to set up your synthesizer with nothing more elaborate than a multi-meter and a pair of ears!

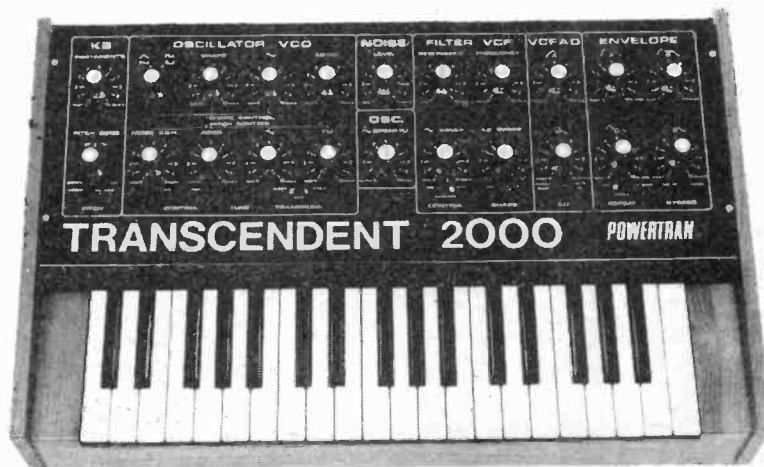

Cabinet size 24.6" x 15.7" x 4.8" (rear) 3.4" (front)



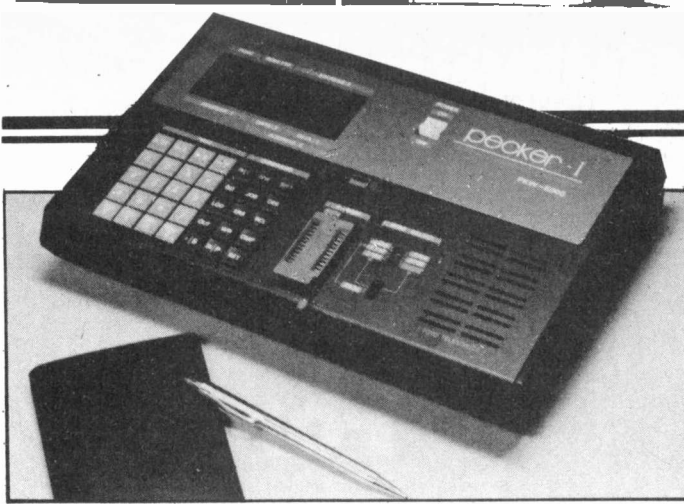

## Keep Your Pecker Up

Chiptech have just introduced a new portable EPROM programmer based on the Z80 microprocessor. The PKW5000 is capable of programming devices up to 32K bits, including the 2708, 2716, 2732, 2516 and 2532 EPROMs. Keyboard function commands such as load, write, erase, check, compare and buffer clear as well as data entry and various editing functions through the RAM buffer are available.

A 16 digit hex display shows address and data information and also the EPROM type selected. An audible warning confirms the key-

in operation, programming completion and error occurrence.

In addition to its programming capability, the PKW5000 may be used to run and debug Z80 programs with readout of all registers and insertion of up to two breakpoints. An optional I/O card will allow the unit to be interfaced with a 150 CPS tape reader, a 20 mA current loop or RS232C serial interface. The option also contains sockets which can accept preprogrammed EPROMs containing an assembler, debug program or BASIC.

For further information on the PKW5000 get in touch with Chiptech Ltd, Unit One, Tewin Court, Welwyn Garden City, Hertfordshire AL7 1AU.



## Test Points

Vero Electronics can now supply a range of high quality, low cost probe pins for testing bare or component-loaded boards, wire-wrap boards or backplanes.

The pins come in two parts — the receptacle, which is available in either minwrap or solder termination, and the spring contact, which can have any one of three tips. The serrated tip will cut into flat pads to enable readings to be taken; the conetip can be used to probe plated-

through holes; the cup can be used for wire wrap boards or backplanes.

The pin constituents are a veritable tour of the periodic table. The spring contact probes have heat treated beryllium copper plungers plated with rhodium over nickel and the phosphor bronze receptacles and nickel silver contact shells are plated with gold over nickel.

For further details of these low cost probe pins contact Vero Electronics Ltd, Industrial Estate, Chandlers Ford, Eastleigh, Hampshire SO5 3ZR.

## APOLOGY

On page 84 of the September issue of Electronics Today International we published an advertisement placed by Tempus which stated that Zeon had gone into voluntary liquidation. This statement referred to Zeon Products Limited and was not intended to reflect in any way on Zeon Limited.

The advertisement was phrased in such a way that it may have been detrimental to Zeon watches. No criticism of the watches sold by Zeon Limited under the "Zeon" trade mark was intended. Furthermore, we are informed that Zeon Limited have taken over the service obligations entered into by Zeon Products Limited, thereby providing continuing service.

We wish to apologise to Zeon Limited for any embarrassment which the advertisement may have caused.

## Microbasics

We've had a few inquiries about the subject of the photo we used to start off Microbasics in September. It was one of the first all-transistor computers, built at Harwell between 1952 and 1954. In the 1950s, CADET (the reversed initials of Transistor Electronic Digital Automatic Computer) was thought of as a mini compared to the vast valve complexes of the day.

CADET was used for several years at Harwell. The UK nuclear programme and Harwell's involvement generally in electronics and instrumentation benefitted from the experience gained from the design, construction and use of CADET. You may have seen some of its original circuit panels at the 'Challenge of the Chip' exhibition at the Science Museum in London.

## Home Computing

A new computerised garage door which has achieved great success in the States, is now being sold in the UK. It is being introduced to builders' merchants, hardware, electrical DIY and car accessory retailers. The NuTone garage door operates from the greater than normal distance of 400 yards, has a computer that makes its own adjustments and is simple to instal. Whilst it is a convenience to the ordinary motorist it is also useful for elderly or handicapped drivers. The hand-held radio control unit is fitted with British-made electronics and is Home Office approved. Additional units can be purchased as well as an alternative key-operated opening

device which can be fitted to the gatepost or a site convenient to the garage entrance. Inside the home a push button switch (this is included) can be installed to operate the NuTone door.

A built-in light is also included to switch on once the door is opened. Should the door be obstructed as it tries to close, the motor will automatically reverse until the door is fully open. In the event of an obstruction as it opens, the motor will stop. The garage door operator costs £229 including VAT. The radio receiver, transmitter and aerial costs £75; the key switch system £9.25; a manual release button £14.85; additional transmitters £28.25 and pushbuttons 85p. A Haos service agent will confirm whether or not a garage door can accommodate the unit. The Haos Company Ltd are at The Built-In Centre, 32 Letchworth Drive, Bromley, Kent.

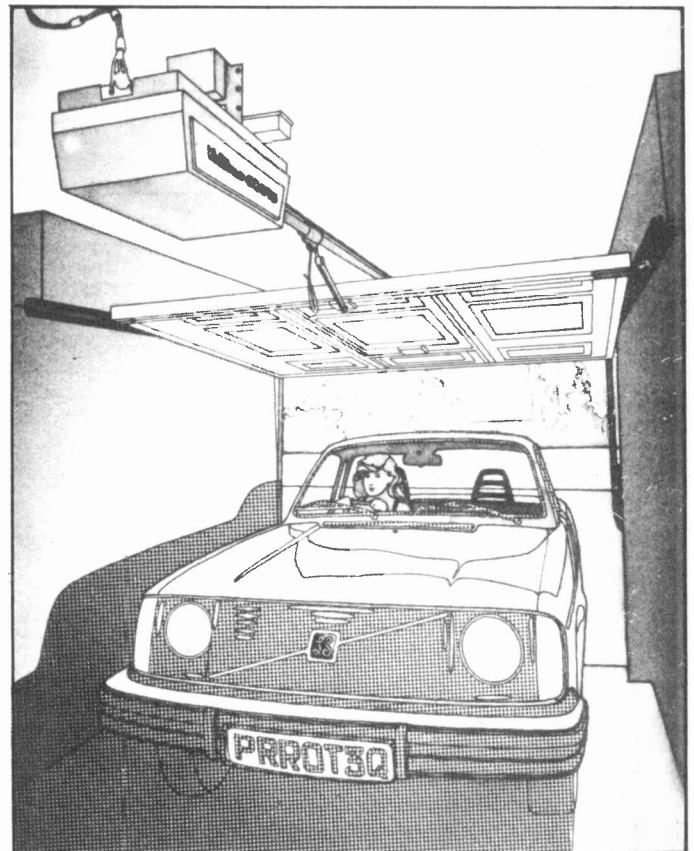

**DMM  
BREAKTHROUGH**

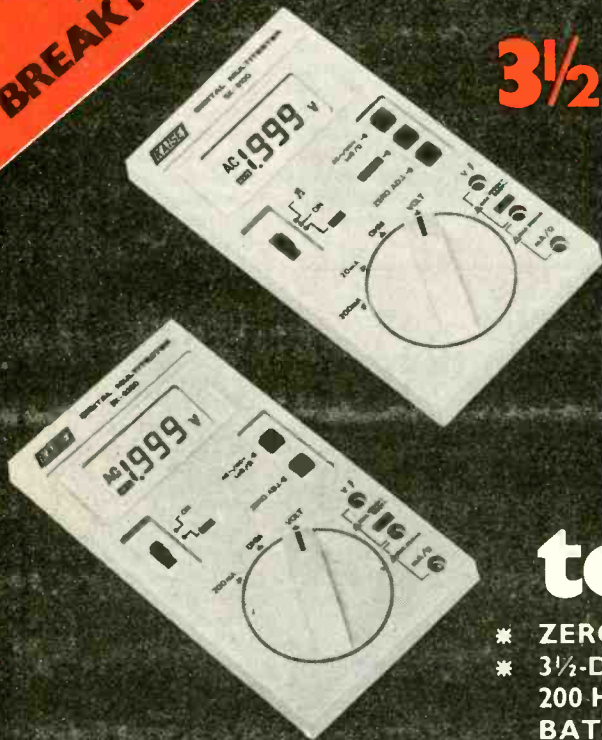

# If you want an Autoranging 3½-digit LCD DMM For only

# £39.95

(inc VAT)

## We've got to hand it to you!

- \* ZERO ADJUSTMENT
- \* 3½-DIGIT LCD WITH 200 HRS CONTINUOUS BATTERY LIFE
- \* AUTO 'BATT' WARNING
- \* FULL AUTORANGING
- \* AUTO UNIT DISPLAY
- \* CONTINUITY TEST (6110 and 6100 only)
- \* 10 AMP AC/DC (6110 and 6220 only)

Introducing the latest professional state-of-the-art 3½-digit DMM – at really old-fashioned prices! From just an unbelievable £39.95 inc. VAT, plus £1.15 p&p!

	6100	6110	6200	6220
RESOLUTION	1mV, 10µA; 0.1Ω on all models			
FULL AUTO RANGING	✓	✓	✓	✓
RANGE HOLD	✓	✓	✓	✓
UNITS OF MEASUREMENT DISPLAYED	mV, V, mA	mV, V, mA, A	mV, V, mA	mV, V, mA, A
FUNCTIONS DISPLAYED	Ω, KΩ, AUTO, BATT, ADJ, LO, - and AC			
MEASURES DC VOLTAGE TO	1000V	1000V	1000V	1000V
MEASURES AC VOLTAGE TO	750V	750V	750V	750V
MEASURES AC DC CURRENT TO	200mA	10A	200mA	10A
ZERO ADJUSTMENT	Zeros out minute test-lead resistances for precise measurements			
ACCURACY	0.5%	0.5%	0.8%	0.8%
LOW POWER OHM RANGES	For in-circuit resistance measurements on all models			
BUZZER – Continuity Test	✓	✓	✓	✓
BUZZER – Over Range Indicator	✓	✓	✓	✓
COMPLETE WITH	Batteries, pair of Test Leads, Spare Fuse, One Year's Guarantee			
PRICE	ONLY £64.95	ONLY £74.95	ONLY £39.95	ONLY £49.95
p&p	£1.15	£1.15	£1.15	£1.15

Why such a low, low price? Because the A/D converter and display are custom built! This is a genuine top-spec DMM. Check these features for unbeatable value – you won't find a hand-held DMM with these features at these prices again!

I believe you! Please send me the DMM/s as marked.

\_\_\_\_\_ 6200 @ **£41.10** each, inc. VAT, p&p. Total price £\_\_\_\_\_

\_\_\_\_\_ 6220 @ **£51.10** each, inc. VAT, p&p. Total price £\_\_\_\_\_

\_\_\_\_\_ 6100 @ **£66.10** each, inc. VAT, p&p. Total price £\_\_\_\_\_

\_\_\_\_\_ 6110 @ **£76.10** each, inc. VAT, p&p. Total price £\_\_\_\_\_

Total cash/cheque enclosed £\_\_\_\_\_

Cheques payable to  
Maclin-Zand Electronics Ltd., please

Available exclusively from the company that gives you tomorrow's technology today.  
38 Mount Pleasant, London WC1X 0AP.  
Tel. 01-278 7369/01-837 1165

ACCESS orders taken. Please write card no: and signature.

ACCESS NO \_\_\_\_\_ 

Name \_\_\_\_\_

Address \_\_\_\_\_

Signed \_\_\_\_\_

To: Maclin-Zand Electronics Ltd., 38 Mount Pleasant, London WC1X 0AP.  
Despatch by return. For overseas orders, please add £5 to cost of total order package.

**ME**

# Maclin-Zand

Making state-of-the-art affordable.

2ETI



## New Records

Digital recording techniques are taking off in a big way at EMI's Abbey Road studios in London. The result of a four year R&D programme is EMI's first digitally recorded classical album — Debussy's 'Images' played by the London Symphony Orchestra conducted by André Previn. This has won three major awards since its release in December 1979.

EMI has been using five SE7000M units for its experimental recordings, which were primarily designed for laboratory standard scientific and engineering instrumentation and data recording applications. They were selected for use by EMI for their high quality performance and ability to withstand rigorous use. The advantages of digital recording are that it provides audio engineers with the ability to eliminate all extraneous background noise and distortion problems associated with conventional recording techniques.

Analogue recording is

susceptible to equipment noise and non-linear recording characteristics as well as many other factors. Digital recording gives the ability to store and subsequently edit signals so that the sound remains distortion-free throughout the various production processes. The resultant sound has far greater clarity and freshness.

Each of the recording systems being used at Abbey Road comprises a single encoder and decoding unit interfaced to an SE7000M recorder. The complete system is trolley mounted to facilitate movement around the studios and for location work. At Abbey Road they can be moved to various locations within the building, although they will mainly be used in the larger Studio One for orchestral productions. However, they are also required for location work in Europe and America and have been shipped for recording sessions as far apart as Berlin, Philadelphia, Vienna and Amsterdam.

All material is recorded on standard 10½" reels of 1" magnetic tape running at 30

inches per second. Currently only two channels of sound can be processed digitally, using two tracks per channel to store data at the very high density level of 25 k/bits per inch. The outstanding quality of recordings is achieved due to this and an extremely sophisticated error-correction system to counteract drop-out or blemishes on the tape. For recording sessions, two digital systems are normally used together to provide a back-up facility. At Abbey Road they can interface with the mixing consoles in any of the three studios.

At present, editing of the digital material is carried out on the computer-controlled prototype equipment at the Central Research Laboratories. This function will soon be undertaken at Abbey Road itself.

By the end of 1980 virtually every classical record produced at Abbey Road will be digitally recorded. 'Middle of the road' and 'pop' discs generally rely on multi-track facilities, but even these can be produced using a mixture of analogue and digital recording processes. The final product will still offer improved reproduction quality.

## Sound and Vision

Thorn Television Rentals and Magnetic Video, a subsidiary of 20th Century Fox, have reached an agreement in which Thorn will market through its TV rental outlets VHS video cassettes of 43 film titles. The range includes 'Butch Cassidy and the Sundance Kid', 'The Poseidon Adventure', 'Cleopatra', 'M.A.S.H.', 'Patton', 'The Sound of Music', 'The French Connection', 'Hello Dolly', 'Gentlemen Prefer Blondes', 'Soldier Blue' and 'Von Ryan's Express'. Initially they will be available on a test market basis through rental showrooms and later in the year through all 1,200 outlets of the Thorn Rental Group. This will be the first time that major film titles will be available on a rental basis to the general public. Rates will be £5 for hire over three days.

## EMPerative

If you wish to protect your telecommunications equipment or other information transmission system from the effects of EMP, the M-O Valve Co. has something for you. They have introduced a fast acting gas-filled surge arrester, type E3465. Conventional gas-filled surge arrestors designed for lightning protection do not give adequate protection against EMP. The E3465 is a sub-miniature metal ceramic device which, when used in conjunction with a suitable holder can provide protection on a nanosecond time scale. It has a maximum surge strike voltage of 1 kV at 1 kV/nS rate of rise and a maximum capacitance of 4 pF, whilst retaining the normal advantages of gas-filled arrestors of high current capability and low discharge voltage. For further information contact the M-O Valve Co, Brook Green Works, London W6.

For further news of ETI's pursuit of the EMP phenomenon turn to page 15!

## Sounding Board

Sirius Cybernetics can now supply a programmable sound synthesiser board for the SWTPC S50 bus 6800 and 6809 computers. For £60 (including post, but excluding VAT) you get an assembled and tested slot printed circuit board and driving software.

The package enables the 16 internal registers of the sound synthesiser chip to be programmed either from assembly language or BASIC.

Three independently controlled sound channels producing a tone and white noise can generate a variety of sound effects or music.

Two bi-directional 8-bit ports are also provided on the board for, amongst other things, the connection of keyboard or games paddles to the host computer. The board even has its own on-board power amplifier. Just connect a loudspeaker.

The 6800/6809 S50 bus Sound Synthesiser board is available from Sirius Cybernetics Ltd, 7 Euston Place, Leamington Spa, Warwickshire CV32 4LN.

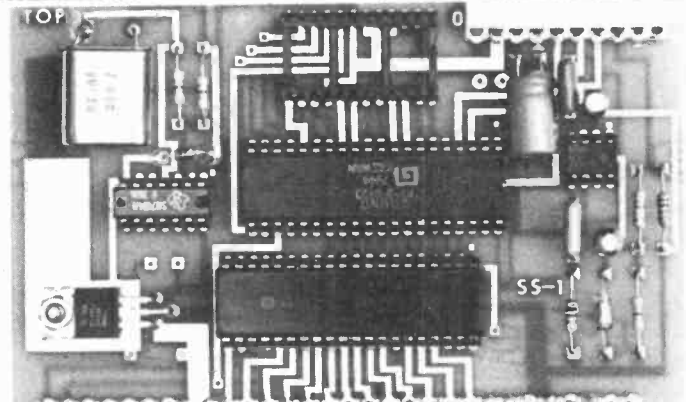

The NEW

# VIDEOTONE

YOU CANNOT BUY CHEAPER - YOU CAN ONLY GET LESS FOR YOUR MONEY!

## Introduces DIRECT SELLING - the Ultimate Discount!!!



DISCOUNT SELLING PRICE  
**£50.00**

### LOUDSPEAKERS

The complete fully reviewed range of Videotone Speakers which dominate within their class. Now at lowest ever prices.

D 100	£38
Minimax 11	£44
GB3	£50
GB2	£60
GBS	£207
D 93	£40



DISCOUNT SELLING PRICE  
**£68.00**

DISCOUNT SELLING PRICE  
**£75.00**

### ELECTRONICS

This new range of Electronics from Videotone redefines the words quality and value for money to a new high.

30 watt amp MC input SA4130	£75.00
Stereo Tuner ST4120	£68.00
Cassette full features SC3200	£98.00
50 Watt amplifier WA7700	£77.00
20 Watt amplifier LA2020	£58.00



DISCOUNT SELLING PRICE  
**£9.69**

### HEADPHONES

HP 90 Headphone	£12.65
HP 80 Headphone	£9.69

Superbly made with top flight performance.

## VIDEOTONE

**ALL PRODUCTS ON DISPLAY & CONTINUOUS DEMONSTRATIONS**

ALL PRICES INCLUDE VAT

### CORAL CARTRIDGES

Fast becoming one of the top names

#### MOVING COIL

UK's No. 1 Cartridge

MC 81	£48.87
777EX	£35
777E	£25

#### MOVING MAGNET

555SX	£7.28
555E	£14.22
666E	£32.48



#### HEAD AMP

H300	£51.75
T100	£24.75

#### HEADSHELLS

S100	£6
S101	£7
S200	£4



### MICROPHONES

MU 105-22	£29.30
MU 105-12	£22.25
MU 25 C	£17.39

### TURNTABLES

Sansui SR222 Mk2	£69.00
JVC LA 11	£64.00
JVC SLQ 3	£140.00

## A MESSAGE FROM VIDEOTONE

*Dear Customer*

You will find that the products advertised on this page are the best possible value for money. They are only low in price because we have eliminated large amounts of selling costs that other brands have to suffer. These savings are passed directly on to you. We have full brochures on any specific item you may be interested in and a competent realistic staff of engineers at our London Showrooms to help you in your choice. Our consumer protection packages are comprehensive and we offer every form of financing you may require. We carry out our own servicing and are dedicated to giving Value for Money. We are confident our products are unbeatable. You may purchase with confidence because our Engineers have specially selected them from competitive sources throughout the world and we import them directly ourselves. Remember, you have 21 days trial period on all products. That is the measure of our confidence.

*Bill Hardcastle*  
Managing Director

### SEND FOR OUR LATEST FREE BROCHURE

AND DETAIL LIST OF LOCAL SALES OUTLETS IN THE U.K.



VIDEOTONE  
98 CROFTON PARK ROAD,  
CROFTON PARK, LONDON SE4  
Tel: 01-690 8511/2

Please send me your Direct Selling Brochure and list of sales outlets.

Name \_\_\_\_\_

Address \_\_\_\_\_

E.T.I. 11/80

# EMP

Following ETI's article on EMP, Tina Boylan has been finding out what's going on in the country to protect us in a nuclear war.

In the event of war our protection will depend mainly on local councils and this is the area that we have explored to find out exactly what is going on. Local councils will be in charge of re-organising the survivors in their area in the aftermath of a nuclear strike. This will basically mean local groups providing food, medical help and checking damage. As far as their radio communications are concerned, equipment at this local level has no special, built-in protection against EMP other than those in the Home Office's standard specification. How effective this will be is something no-one really seems to know.

The only other protection this equipment will have is either that at the 'four minute warning' the radios will be switched off at the mains and have their aerials removed, or that a back-up system will remain 'frozen' until the danger of EMP has passed. Standard procedure will then be followed. After 24 hours the equipment will be switched on again and broadcasts will be tried on frequencies 1-10 (is there anybody out there?); after 36 hours frequencies 10-20 will be tried, etc, until either something is located or until someone realises that the equipment is useless. In the meantime, according to one man "there'll be a lot of telephoning around". Perhaps someone forgot to tell him that EMP will almost certainly destroy all telephone communications!

This method of 'protection' of equipment relies heavily on the assumption that 1) there will be a four minute warning and, 2) that the enemy hasn't made a nuclear detonation over somewhere like the North Sea, which will knock out these communications anyway.

## Us and Them

Strangely enough, local as well as national Government has known about the EMP effect for between four and six years, since its discovery during nuclear tests in the Pacific, but they have not considered it to be of interest to the general public. With this long-standing knowledge perhaps something more tangible should have been done, but again, it's the same old story; finance — or rather lack of it — has prevented much action being taken.

Until recently, civil defence in general has not appeared on the local council list of priorities. But since the Afghanistan crisis reared its ugly head, a more careful study of the country's state of readiness for war has been made. The results of this investigation prompted Mr. Whitelaw, the Home Secretary to make a statement in the House of Commons on August 7th this year. There is a firm belief that any war is likely to start conventionally and escalate into nuclear exchange.

The main points of Mr Whitelaw's speech were that the UK monitoring and warning organisations would modernise their equipment and that the associated communications network responsible for wartime broadcasting would be improved, so that it can continue public broadcasting even after a large scale attack.

As far as local defence plans are concerned he had this to say:

*"A great deal of civil defence work must be done at local level, and the Government propose to double the money available for this purpose. We shall consult the*

*local authority associations about the allocation of additional resources for planning and training, and the adaptation of premises by district councils to complete the pattern of local authority wartime administrative headquarters and communications. Effective civil defence arrangements depend upon co-operation between central Government and local government. I know that concern has been expressed about variations in civil defence arrangements in different parts of the country. I am satisfied that the Government have adequate powers to ensure that proper standards of protection are provided throughout the country, and it will naturally be our aim, with the local authorities, to see that this is done."*

## Cut-Backs

It is understood that by 1984 civil defence spending will have risen by 60%. This additional cost will be covered by "re-allocation of resources within existing programmes without adding to the total of public expenditure". This means that local government will have to find the money out of their existing budgets, already tightly squeezed by cut-backs. In one county at least, civil defence was described 'second to bottom on the list of priorities'. So even if there is extra cash allocated to it, there are no plans at present for further expenditure on communications in particular. The main priorities are to improve training of volunteers and if possible choose various leading members of the community to help with reorganisation after the holocaust. The consensus of opinion is that if nuclear war, as opposed to conventional war, breaks out, there is little that can be done to prevent huge numbers of casualties. The only course of action therefore, that local government can (reasonably) take is to provide a well trained reorganisation force to help the survivors. However, as one spokesman said, and this must be ETI's quote of the month, "after all, life goes on, you know". I somehow think he won't be standing at ground zero!

So it seems to be largely up to the public themselves to find out what should be going on, then try to do something about it. The 'men from the ministry' whom I contacted, seemed rather upset that the great British malaise is apathy. It generally takes two forms. Firstly, that we believe we will be looked after completely by the Government, something similar to what happened during the Second World War with plenty of shelters and ARP/Home Guard types. Secondly, there is the pacifist attitude that "honour will prevail" and common sense and negotiation will prevent war.

After the Afghanistan crisis the local authorities were bombarded with telephone calls from people either willing to offer their services or simply wanting to find out how to protect themselves. If you want to find out who is in charge of your local defence plans, simply telephone the Home Office in London on 01-213 3000. They were able to supply us with the names, addresses and telephone numbers of all civil defence organisations, or you can contact your local council. For 50 pence you can also obtain the government leaflet 'Protect and Survive' which certainly prompted us to ask a few questions! Keep sending the letters.

ETI





**NEXT  
MONTH**

# electronics today

INTERNATIONAL

Look out for the December issue  
on sale November 7th.

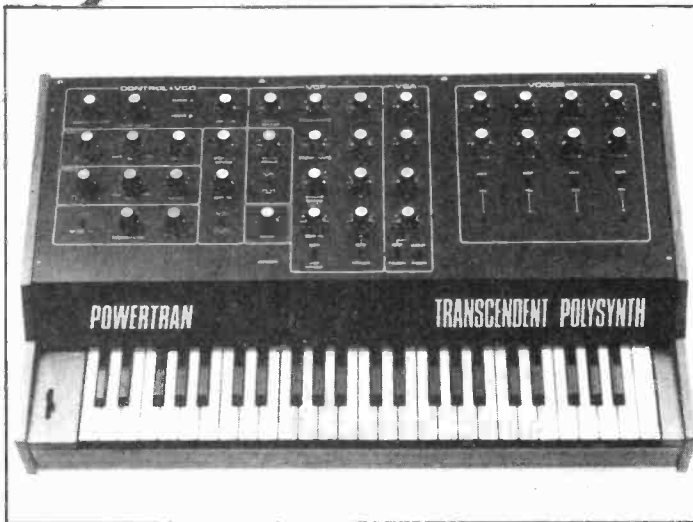

## TRANSCENDENT POLYSYNTH

Transcendent, a name familiar to ETI readers, turns up next month in the shape of our latest keyboard instrument project. The Transcendent Polysynth, designed by Tim Orr, is a polyphonic music synthesiser. It can be operated with one, two, four and even eight voices. Each voice is a synthesiser in itself, containing two VCOs, two ADSR units, one VCA and one VCF. The design features all the usual synthesiser functions — pitch bend, portamento, noise source, modulation oscillators, etc.

## FOUR INPUT MIXER

Looking for the right musical mixture? Balance your decibels with the ETI four input mini mixer. It may be small, but size isn't everything (as a theatrical lady once said to a clergyman). Our box of tricks will mix it with the best of them.

## PROGRAMMABLE DOORBELL

Variety's the spice of life — even where doorbells are concerned. If you've had enough of that boring old 'ding dong' noise coming from your front door, swap it for our programmable doorbell design. It doesn't use complex microprocessor control or expensive PROMs for storing tunes. It's simple to build, based on inexpensive and readily available components.



A useful addition to your test bench - the ETI Bench Amplifier

## MUSICAL ALARM CLOCK

This battery-powered design is more than a mere alarm clock. To keep construction simple the clock section is based on a ready-built module. Although it's an electronic clock, we've included a sound generator to produce the comforting 'tick tock', just so you know that it's still there. The tick rate and volume are adjustable. Naturally it has all the usual alarm clock features — ten minute snooze function, backlight, etc. When the alarm condition is selected, it doesn't make a monotonous buzzing noise. A clever little chip in the innards can generate 24 different tunes — three groups of eight. You select which of the three groups you want and it randomly selects a tune to alarm you with.

Articles described here are in an advanced state of preparation. However, circumstances may dictate changes to the final contents.

# Britain's first com computer kit.

## The Sinclair ZX80.

# £79.95

Price breakdown  
ZX80 and manual: £69.52  
VAT: £10.43  
Post and packing FREE

Please note: many kit makers quote VAT-exclusive prices.

You've seen the reviews... you've heard the excitement... now make the kit!

This is the ZX80. 'Personal Computer World' gave it 5 stars for 'excellent value.' Benchmark tests say it's faster than all previous personal computers. And the response from kit enthusiasts has been tremendous.

To help you appreciate its value, the price is shown above with and without VAT. This is so you can compare the ZX80 with competitive kits that don't appear with inclusive prices

### 'Excellent value' indeed!

For just £79.95 (including VAT and p&p) you get everything you need to build a personal computer at home... PCB, with IC sockets for all ICs; case; leads for direct connection to a cassette recorder and television (black and white or colour); everything!

Yet the ZX80 really is a complete, powerful, full-facility computer, matching or surpassing other personal computers at several times the price.

The ZX80 is programmed in BASIC, the world's most popular computer language for beginners and experts alike.

The ZX80 is pleasantly straightforward to assemble, using a fine-tipped soldering iron. It immediately proves what a good job you've done; connect it to your TV... link it to an appropriate power source\*... and you're ready to go.

#### Your ZX80 kit contains...

- Printed circuit board, with IC sockets for all ICs.
- Complete components set, including all ICs—all manufactured by selected world-leading suppliers.
- New rugged Sinclair keyboard, touch-sensitive, wipe-clean.
- Ready-moulded case.
- Leads and plugs for connection to domestic TV and cassette recorder. (Programs can be **SAVEd** and **LOADed** on to a portable cassette recorder.)
- FREE course in BASIC programming and user manual.

#### Optional extras

- Mains adaptor of 600 mA at 9 V DC nominal unregulated (available separately—see coupon).
- Additional memory expansion boards allowing up to 16K bytes RAM. (Extra RAM chips also available—see coupon).

\*Use a 600 mA at 9 V DC nominal unregulated mains adaptor. Available from Sinclair if desired (see coupon)

### The unique and valuable components of the Sinclair ZX80.

The Sinclair ZX80 is not just another personal computer. Quite apart from its exceptionally low price, the ZX80 has two uniquely advanced components: the Sinclair BASIC interpreter; and the Sinclair teach-yourself BASIC manual.

The unique Sinclair BASIC interpreter offers remarkable programming advantages:

- **Unique 'one-touch' key word entry: the ZX80 eliminates a great deal of tiresome typing. Key words (RUN, PRINT, LIST, etc.) have their own single-key entry.**
- Unique syntax check. Only lines with correct syntax are accepted into programs. A cursor identifies errors immediately. This prevents entry of long and complicated programs with faults only discovered when you try to run them.
- Excellent string-handling capability—takes up to 26 string variables of any length. All strings can undergo all relational tests (e.g. comparison). The ZX80 also has string input to request a line of text when necessary. Strings do not need to be dimensioned.
- Up to 26 single dimension arrays.
- FOR/NEXT loops nested up to 26.
- Variable names of any length.
- BASIC language also handles full Boolean arithmetic, conditional expressions, etc.
- Exceptionally powerful edit facilities, allows modification of existing program lines.
- Randomise function, useful for games and secret codes, as well as more serious applications.
- Timer under program control.
- PEEK and POKE enable entry of machine code instructions.USR causes jump to a user's machine language sub-routine.
- High-resolution graphics with 22 standard graphic symbols
- All characters printable in reverse under program control
- Lines of unlimited length.

### Fewer chips, compact design, volume production—more power per pound!

The ZX80 owes its remarkable low price to its remarkable design: the whole system is packed on to fewer, newer, more powerful and advanced LSI chips. A single SUPER ROM, for instance, contains the BASIC interpreter, the character set, operating system, and monitor. And the ZX80's 1K byte RAM is roughly equivalent to 4K bytes in a conventional computer—typically storing 100 lines of BASIC. (Key words occupy only a single byte.)

The display shows 32 characters by 24 lines.

And Benchmark tests show that the ZX80 is faster than all other personal computers

No other personal computer offers this unique combination of high capability and low price.

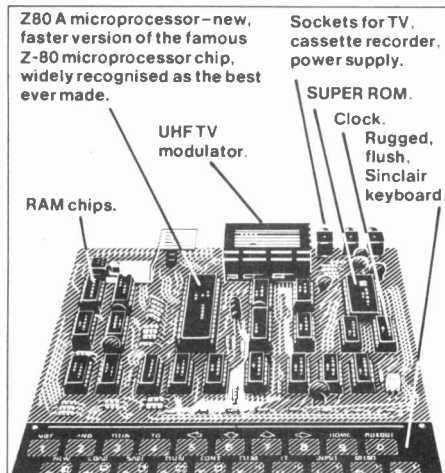

# plete



### The Sinclair teach-yourself BASIC manual.

If the specifications of the Sinclair ZX80 mean little to you - don't worry. They're all explained in the specially-written 128-page book *free* with every kit! The book makes learning easy, exciting and enjoyable, and represents a complete course in BASIC programming - from first principles to complex programs (Available separately - purchase price refunded if you buy a ZX80 later.) A hardware manual is also included with every kit

### The Sinclair ZX80. Kit: £79.95. Assembled: £99.95. Complete!

The ZX80 kit costs a mere £79.95. Can't wait to have a ZX80 up and running? No problem! It's also available, ready assembled and complete with mains adaptor, for only £99.95

Demand for the ZX80 is very high, use the coupon to order today for the earliest possible delivery. All orders will be despatched in strict rotation. We'll acknowledge each order by return, and tell you exactly when your ZX80 will be delivered. If you choose not to wait, you can cancel your order immediately, and your money will be refunded at once. Again, of course, you may return your ZX80 as received within 14 days for a full refund. We want you to be satisfied beyond all doubt - and we have no doubt that you will be

# sinclair

# ZX80

Science of Cambridge Ltd  
6 Kings Parade, Cambridge, Cambs., CB2 1SN  
Tel 0223 311488

## ZX80 software - now available!

See advertisements in Personal Computer World, Electronics Today International, and other journals.

New dedicated software - developed independently of Science of Cambridge - reflects the enormous interest in the ZX80. More software available soon - from leading consultancies and software houses.

Quantity	Item	Item price £	Total £
	Sinclair ZX80 Personal Computer kit(s) Price includes ZX80 BASIC manual, excludes mains adaptor	£79.95	
	Ready-assembled Sinclair ZX80 Personal Computer(s) Price includes ZX80 BASIC manual and mains adaptor	£99.95	
	Mains Adaptor(s) (600 mA at 9 VDC nominal unregulated)	8.95	
	Memory Expansion Board(s) (each one takes up to 3K bytes)	12.00	
	RAM Memory chips - standard 1K bytes capacity	16.00	
	Sinclair ZX80 Manual(s) (manual free with every ZX80 kit or ready-made computer)	5.00	
<b>TOTAL</b>			<b>£</b>

*NB Your Sinclair ZX80 may qualify as a business expense*

I enclose a cheque/postal order payable to Science of Cambridge Ltd for £ \_\_\_\_\_  
Please print  
Name Mr/Mrs/Miss \_\_\_\_\_  
Address \_\_\_\_\_

ETI/11/80

# MICROBASICS

Remember, remember ETI November. Henry Budgett explains how microprocessors ROaM round the RAM chips. It's all a question of memory.

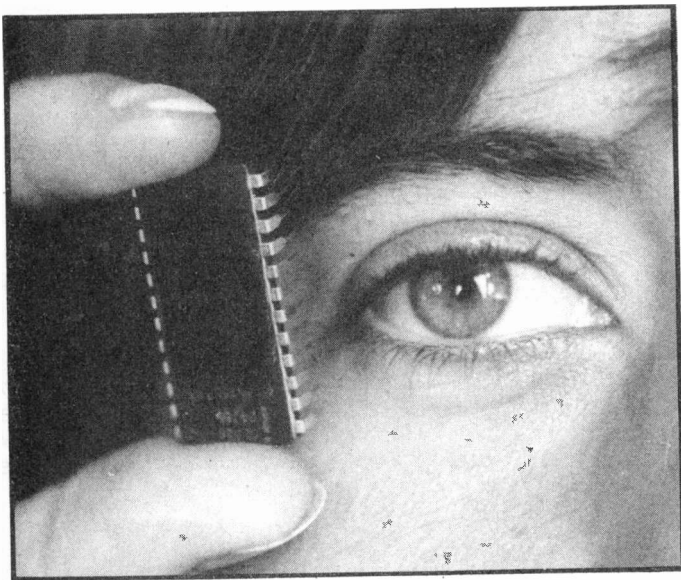

It is doubtful if even the legendary skills of the elephant could cope with the vast and bewildering array of memory devices that are currently offered with each and every microprocessor. Would you choose dynamic or static; is there any difference between on-line and off-line storage; do bubbles really bubble and many other similar questions often crop up in reader's enquiries and only go to show that the fundamental topic of computer storage is in dire need of a bit of explanation. To that end let's go right back to the fundamentals and take it from there.

## The Elemental Store

Computers of digital type work on the binary system — they process information that occupies one of two states. The commonest logical element that can occupy one of two states is the bistable and, in simple terms, all computer memory can be regarded as constructed of simple bistable elements. We need not concern ourselves with the history of memory devices (it will only serve to confuse the issue), so let's start off with semiconductor devices such as Random Access Memory and Read Only Memory, RAM and ROM to use the common acronyms.

In virtually all computer designs RAM is the fundamental storage system for the user to put his instructions into. Within this family of circuits there are two sub-groups, static and dynamic, but the simplest element is the common bistable. Static RAM is really a vast number of bistables arranged in a special fashion. Some popular arrangements are 1024 by 1, 2048 by 1, 1024 by 4 and many, many others. The numbers specify the way the device is used, for example if you wish to

construct a memory card that could hold 1K bytes of program you would need eight of the first kind of chip or two of the third kind.

## Amnesia

Because these static elements are based on simple logic gates, they will lose their contents when turned off, just as any logic will, but they do have a number of advantages. Once the desired information has been loaded into the memory (more on that later) it will stay there until either it is altered or someone turns the computer off. The disadvantage of this is that it requires the power to be constantly maintained within the chip and thus the current consumption of these devices is high. You do get a good, high-speed response in exchange, though. It is common to find that within the structure of a single microcomputer both static and dynamic RAM devices are used, with the static providing the workspace or 'scratchpad' area for the CPU and the dynamic providing the bulk user RAM and hence saving power.

The fundamental difference between dynamic and static devices is that dynamic devices will lose the stored information if they are not 'refreshed' every so often. The reason for this is that they are based on MOS technology and store the information on tiny capacitors as a charge. This charge will leak away after a finite time and thus has to be constantly topped up. This process

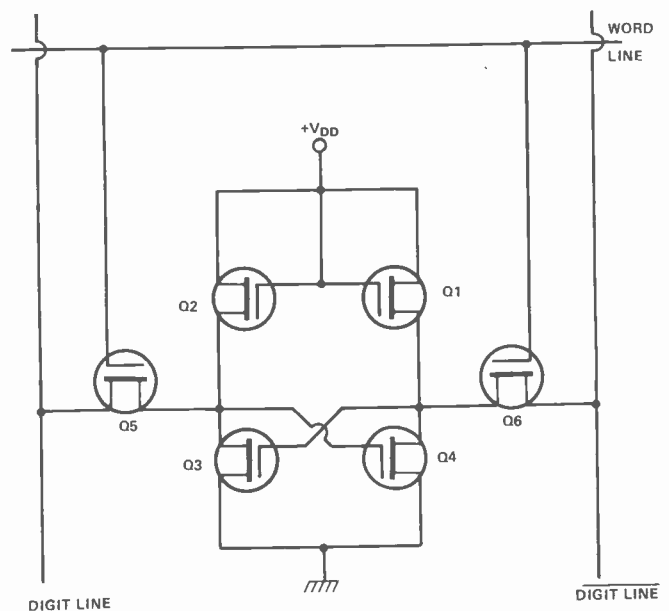

Fig.1 MOS static memory cell.

can either be performed within the chip or by some special circuitry on the memory board or, in the case of the Z80 CPU, by the micro itself. Typical refresh times are between 1 and 2 mS and woe betide the designer who tries to cut it fine because increases in temperature have very undesirable effects that compound the problem.

In summary, therefore, RAM is used by the micro as its immediate store and is based around the humble bistable type of logic element. In strong contrast we have the ROM memories which as their name implies, can only be read and hence are used as permanent stores.

## Memories Are Made Of This

It is worth taking a few minutes to inspect the internal architecture of both static and dynamic devices at the storage element level. Figure 1 shows the equivalent circuit for a static MOS memory cell. Transistors within the chip are all made as MOSFETs which, although slower than bipolar transistors, consume less power and hence allow greater packing densities. Q1 and Q2 are actually being used in this circuit as resistors to bias the bistable element made from Q3 and Q4. The transistors Q5 and 6 act as switching gates to allow information to be read or written to the cell. To read a cell the word line is set to logic one which will turn on either Q5 or Q6 depending on the contents of the cell. To write the word line is again set to logic one but the appropriate digit line is set so that the cell contents are toggled to the correct value.

The dynamic MOS element shown in Fig. 2 uses the technique of stored charge to represent information. To write new information to the cell the row line is set to logic one and the appropriate data is set onto the data line. Reading the cell is performed by setting the row select high and inspecting the state of the data line.

## A Family Affair

If you thought that having two types of RAM was quite enough to cope with then ROM will try your mental processes even more. The original ROMs are truly Read Only in that the user buys them pre-programmed to a specification and there is no way that he can alter the contents. Computer monitor programs are commonly based in ROM, but with the high cost of producing the original 'mask', (that's the pattern to which they are made), several companies are turning to other devices such as the EPROM. The internal arrangement of a ROM chip is not dissimilar to that of a RAM chip except that each and every element is 'hard wired' to either logic '1' or logic '0'. It would obviously be nice if the user could program in his own pattern and try it out and to this end the PROM device emerged. This is a ROM with each element uncommitted, but with a tiny piece of 'fuse wire' called a fusible link fitted to each element. If you wish to select that as a logic '0' you leave it as it is, if you want it to be a logic '1' then you have to 'blow' the fuse, usually with a high voltage pulse.

All very well but once you've cooked it you're stuck with it, or are you? The designers found that if you didn't burn the link away thoroughly enough it started to grow back, embarrassing! This gave rise to the EAROM or Electrically Alterable ROM which allows you to erase the content of the device and later re-program it. It also gave birth to the most common type of device, the EPROM or Erasable Programmable ROM, which uses a

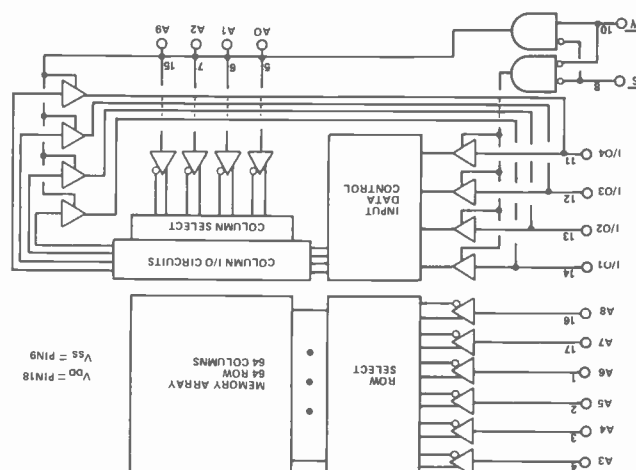

Fig.2 Dynamic memory cell.

slightly different internal structure and can be 'wiped' with ultraviolet light of a certain frequency — the contents of an EPROM will naturally self-erase after about one hundred years anyway!

The programming of these devices requires a special piece of equipment called, not surprisingly, a Programmer. These vary from the very crude to the amazingly sophisticated professional models that allow full program editing and verification and can handle many of the different types.

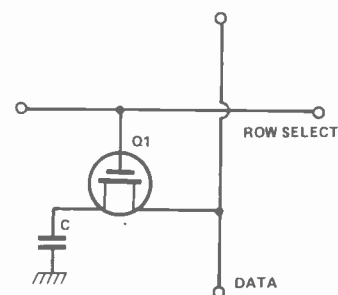

Fig.3 The internal layout of a 4096 bit static RAM device. Compare the architecture of this 1024 by 4 layout to that in Fig.4 of a dynamic 4096 bit device organised by 4096 by 1.

We can now introduce a new term which nicely classifies the two types of computer memory. RAM is called volatile memory; the contents 'evaporate' when the power is removed; ROM is non-volatile because it retains the information. Interestingly, the much-vaunted successor to RAM, the bubble memory device, is a non-volatile store, because it works on magnetism (much like the old-fashioned core memory).

## Reads And Writes

Getting information into and out of memory devices is, generally, a straightforward process. With an eight bit microprocessor which has a 16 bit address bus the maximum amount of memory that you can directly address is  $2^{16}$  or 65536 locations. Because we are working in binary and cannot have nice 'round' numbers this is referred to as 64K where one 'K' is 1024 locations. Each location contains eight bits of data, one byte, and can be uniquely addressed by the 16 address lines. The CPU determines whether the required access is a READ, taking information out of memory, or a WRITE, which puts information into memory by setting a control line to

either a logic one or a logic zero. This line is taken to all the memory devices and, appropriately gated, enables the required area of memory. Figures 3 and 4 show the internal structure of two typical devices.

Once the specified location has been opened, the data stored there is either transferred onto the data bus, in the READ situation, or is overwritten by the information on the data bus, the WRITE situation. It is important to note that the information is overwritten, so saving you the job of clearing out the previous contents.

There is a further control pin on many memory devices called Chip Select. This is set to either logic one or zero (depending on the device) when that memory area is required for use and this prevents possible accidents such as overwriting data in another part of the memory to that which you actually wanted. How can this happen if you have a unique addressing system? In most small computers you only have a small area of memory on the actual CPU card, the actual memory cards hold the bulk of RAM and ROM. Because of this the address bus is not decoded into specific areas; the Microtan 65 is a good example. Now, when you are using

refresh information during the correct cycle time.

The latest versions of dynamic RAM are being equipped with the capability of on-chip refresh. This means that to the outside world they look just like a static device, indeed they are sometimes called 'pseudo-static', and thus save all the problems of timing that are associated with the procedure.



Fig.5 A simple memory map created by allowing the address lines A<sub>14</sub> and A<sub>15</sub> to select the appropriate memory areas. This causes the contents of the selected chip to be 'reflected' through the entire section of memory, but this does not matter provided that you only access the addresses which are connected to a device.

## Banking On A Solution

In some situations 64K of memory is not enough, believe it or not. It is possible to access more by using a technique known as bank selecting. The required extra memory is treated as a peripheral device and accessed through the data bus, each extra board of memory occupying the same address area but having a unique code that selects it. The NASCOM 2 system is set up to allow up to four 48K RAM cards, that's nearly two hundred thousand bytes of memory to be plugged in. The technique does have another use in the field of Teletext and Prestel information. Here each page must be loaded into memory as it is received, with only 64K you'd soon run out. The technique is to allocate pages of memory to the received information and then to access that information from the paged memory as though it were a peripheral device.

One other technique that is very important, especially when you move into the realms of discs is that of Direct Memory Access (DMA). Because the time taken for the processor to read information from a fast peripheral such as a disc is slow, the disc controller takes command of the processor bus by asserting a control signal. The CPU goes into a high impedance stage, effectively it is disconnected, and the information is passed directly to the memory area specified.

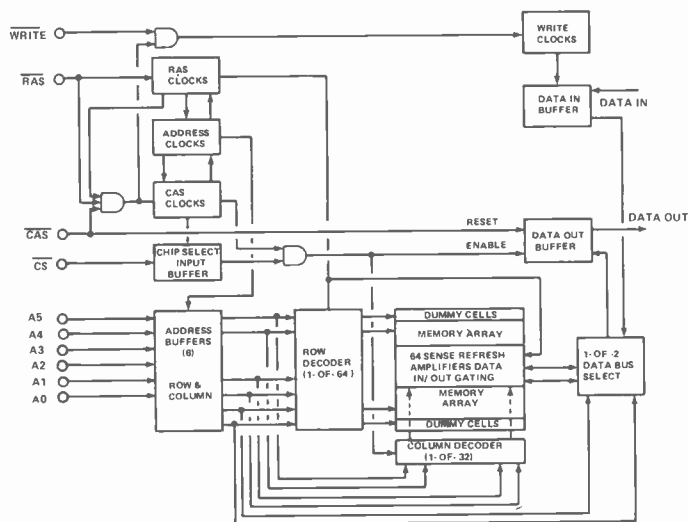

Fig.4 A 4096 bit dynamic RAM device. Compare with Fig.3.

only a small amount of memory you don't bother to decode all the addresses, you merely use, say, A<sub>15</sub> to operate the Select on the monitor ROM, A<sub>14</sub> to control the I/O area and A<sub>13</sub> to enable the RAM. This leads to repeating address inside the memory space, but this doesn't matter, because there are no devices physically occupying those actual locations. The trouble starts when you expand and forget to eliminate all these 'reflected' areas. The diagrams in Fig.5 and 6 show the case on the Microtan before and after memory mapping has been done and illustrates the problem admirably.

## Dynamic Stuff

Because of the different technology used in the consideration of dynamic memory devices, allowing many more locations to be put onto one chip, one finds that, given a sixteen pin package, you don't have enough pins to supply all the necessary signals. This is solved by multiplexing the address bus and supplying the row address first and then the column address. The row address is stored internally, hence giving a complete matrix address and allowing the information to be accessed. The row address is also used to carry the

MEMORY ADDRESS	FUNCTION	
FFFF FC00	1K ROM (TANBUG)	64k
FBFF F800	(TANBUG REFLECTED—1K)	63k
F7FF F000	4KROM ON TANEX	62k
EFFE E800		
DFFF E000	10KBASIC INTERPRETER ON TANEX	58k
OFFF 0000		
CEFF C000		
BFFF BC00	BFFF MICROTAN 65 I/O SPARE I/O PORTS	48k
BBFF	40K(DECIMAL) TANRAM	47k
2000		
1FFE	7K RAM ON TANEX	8k
0400		
03FF	1K RAM ON MICROTAN 65	1k
0000		
		0k

Fig.6 A typical system memory map showing the areas used by the system firmware and the spaces left for the user RAM.

ETI

## DIGITAL VOLTMETER MODULE



Fully built and tested, ONLY

**£11.95** VAT

- ★ Reads positive and negative voltages with a sensitivity of 0 - +999mV and 0 - -99mV
- ★ Requires only single supply between 7 & 12 volts (220mA)
- ★ High accuracy +0.1% +1 digit
- ★ Large bright 0.43" high efficiency displays
- ★ 4 readings per second sampling rate
- ★ Size only 41 x 95 x 10mm
- ★ Supplied with full data & applications information

This brand new, quality module manufactured by Autona Limited (who are one of the U.K.'s largest module manufacturers) means you can build accurate test equipment, multi-meters, thermometers, etc. easily and at a fraction of the cost of ready-made equipment. Full details are provided showing how to measure A.C. voltage, current, resistance and temperature.

Send your cheque or P.O. (£11.95 + £1.79 V.A.T. + 50pp. & p. = £14.24) now to:-

**Dept. ET12  
RISCOMP LIMITED**  
21 Duke Street  
Princes Risborough  
Bucks. HP17 0AT

**BUCKINGHAMSHIRE'S NEW  
ELECTRONICS CENTRE**  
8 miles off the M40  
50 minutes from London  
Telephone: (084 44) 6326

EX-STOCK DELIVERY

## IONISER KIT

This negative ion generator gives you power to saturate your home or office with millions of refreshing ions. Without fans or moving parts it puts out a pleasant breeze. A pure flow of ions pours out like water from a fountain, filling your room. The result? Your air feels like fresh ocean air, pure crisp and wonderfully refreshing.

All parts P.C.B. and full instructions £10. A suitable case including front panel, neon switch, etc. Available at £8 extra.

## H.E. KITS

**Car Booster ZD50 £18; Multi Option Siren ZD36 £10.50; Car Equaliser ZD52 £13.30; Envelope Generator ZD20 £11.79; R/C Speed Controller ZD3 £9.60; White Noise Effects Unit ZD18 £16.85; Track Cleaner ZD12 £7.75; Drill Speed Controller ZD21 £7.**

All Hobby Kits supplied cases except ZD3. All kits contain components as specified plus Texas I.C. sockets where required. Also connecting wire. Special introductory offer to E.T.I. readers, a pack of nuts, bolts, washers, self-cutting, self-tapping screws supplied with each kit.

## SPECIAL OFFERS

<b>Texas / I.T.T. 1N4148, 100 for £1.50.</b>	
<b>Fairchild FLV ISO Red '2 LEDs 10 for £1; 100 for £7.50.</b>	
Mullard Computer Electrolytics S/T 21,000 U.F. 40V	£3.50
Daly Electrolytic Capacitors 2000µF, 100V	£1.50
I.T.T. BCY 72 Transistors leads pre-formed	10 for 50p
Varicap Tuners ELC1042	£6.00
Varicap Tuner ELC1043	£6.00
Philips Scope Tube 5" CV2191 / DG-13-2	£10.00
Thorn-Sylvania Scope Tube 5" SE5J	£17.50 (Callers only)
Toshiba 12" TV Tube 310GAB4	£12.50 (Callers only)

If you do not have the issue of H.E. which contains the Project, we can supply a reprint at 40p extra orders. Please add 30p post and packing. Add 15% VAT to total order.

Callers please ring to check availability of Kits.

# T. POWELL

306 ST. PAUL'S ROAD  
HIGHBURY CORNER, LONDON, N.1.  
TELEPHONE: 01-226 1489

Access/Visa accepted

Shop hours: Mon. to Fri. 9-5.30 Sat. 9-4.30

## Base 2

MODEL 800MST 80 COLUMN HIGH PERFORMANCE  
IMPACT PRINTER

- suitable for most Micros.

JUST LOOK AT THESE STANDARD FEATURES:-

\* RS-232, 20mA, IEEE 488 and Centronics I/O  
\* 15 Baud rates to 9,600 \* 100 Chrs. per second -  
Bidirectional \* 6 print densities 60, 72, 80, 96,  
120 or 132 Chr/line \* Self test switch \* 96 Chrs.  
ASC II Standard \* Auxilliary User Defined Ch.  
set \* Tractor and fast paper feed/graphics  
\* 2k Buffer \* Accepts 8½" max. paper pressure  
feed and 9½" max. paper tractor feed.

FREE  
INTERFACE  
CABLE  
WORTH  
£25

ONLY  
£359 + VAT

VERBATIM 5¼" DISCS £1.85 each (min. 10) + VAT STATIC RAM 2114 1-12 £3 each + VAT 13+ £2.50 each + VAT

## Compukit UK101 DISC DRIVES

with up to 32k RAM expansion

free  
games  
disc

NEW

\* 9 Digit extended Basic  
\* Plugs straight into 8k Compukit requires  
no hardware mods. (5v.5A required for 610)

610 Expansion (8k) ONLY £159 + VAT  
Disc Drive with DOS ONLY £285 + VAT

## EXATRON Stringy Floppy

COMBINES ECONOMY OF CASSETTE  
WITH SPEED & RELIABILITY OF DISC

16k loads in approx. 24 secs. - Wafers to  
75ft (48k approx.)



ONLY  
£188  
+ VAT

Versions for  
PET  
APPLE  
TRS80

Stringy Floppy with 10 Wafers (Tapes)  
BUS EX. 2 for 1. Machine Lang. Monitor

## Ohio Superboard II & Challenger IP with FREE RAM

- the no fuss start to Micro's.

\* Ready Built \* 8k Microsoft in ROM, 6 digit floating  
point basic plus full features. 4k RAM - expandable to 32k



FREE  
ADDITIONAL  
4k RAM with  
SII & CI  
WORTH £24

All 50Hz  
operation

SUPERBOARD II (24x24 format) £159 + VAT  
SUPERBOARD II (48x32 format) £199 + VAT  
POWER SUPPLY 5v.3A. . . . . £27 + VAT  
CASE . . . . . £29 + VAT  
CHALLENGER 1P (24x24 format) £219 + VAT  
CHALLENGER 1P (48x32 format) £259 + VAT  
(Superboard is used in Challenger)

# Mighty Micro

for a Mighty good deal !!!

Please add V.A.T. at 15%. Carriage extra, will advise at time of order. Official orders welcome.

61 NEWMARKET SQUARE, BASINGSTOKE, HAMPSHIRE. RG21 1HWE  
Telephone: Basingstoke (0256) 56468 and 56417

Buy in confidence. If on receipt of your order the goods do not meet with your satisfaction,  
return within 7 days for full refund. Credit facilities arranged.





# COMPUTER WAREHOUSE

**NOW OPEN**  
**MONDAY-SATURDAY**  
**9.30-5.30**

## SCOOP PRINTER PURCHASE

PROFESSIONAL EQUIPMENT AT HOBBYIST PRICES  
SO LOW EVEN OUR COMPETITORS GASP!

In stock now test equipment, microprocessors, teletypes, transformers, power supplies, scopes, sig. gen's, motors, peripheral equipment, I.C.'s, tools, components, variacs, keyboards, transistors, microswitches, V.D.U.'s sub-assemblies + thousands of other stock lines. Just a mere fraction of our vast range, is displayed below. 100's of bargains for callers.

### TELETYPE ASR33 I/O TERMINALS



£235 + CAR + VAT

Fully fledged industry standard ASR33 data terminal. Many features including: ASCII keyboard and printer for data I/O, auto data detect circuitry, RS232 serial interface, 110 baud, 8 bit paper tape punch and ready for off line data preparation and ridiculously cheap and reliable data storage. Supplied in good condition and in working order. Options: Floor stand £12.50 + VAT  
Sound proof enclosure £25.00 + VAT

### ICL TERMIPRINTER 300 BAUD TERMINALS



£325 + CAR + VAT

Made under licence from the world famous GE Co. The ICL Termiprinter is a small attractive unit with so many features it is impossible to list them in the space available! Brief spec. as follows: RS232 serial interface, switchable baud rates 110, 150, 300, (30 cps), upper and lower case correspondence type face, standard paper, almost silent running, form feed, electronic tab settings, suited for word processor applications plus many more features. Supplied in good condition and in working order. Limited quantity.

### MAKE YOUR COMPUTER TALK!!!

#### VIA OUR EX-GPO MODEM UNITS

Well, not exactly talk, but communicate over a standard dial-up G.P.O. line with any other modem. The modem unit 2A is housed in an attractive fibre glass case measuring only 15" w x 13" d x 5" h, inside are the electronics and mains power supply which enable serial duplex data communication between terminal/computer etc. at any speed up to and in excess of 250 baud (300 at a push). Made to the most stringent, exacting specification for the G.P.O. These units feature Modular plug in P.C.B.'s, internal test points, Standard tone frequencies, Configurable to terminal or computer end, Auto unattended answer, RS232/V24 interface on standard 25 way 'D' socket, etc. etc., supplied complete with diags., at a fraction of their original cost at only **£55.00 + £4.50 CARR.**

NOTE: Units believed working, but untested, unguaranteed. Permission may be required for connection to G.P.D. lines.

### EX STOCK SOFTY

#### SOFTWARE DEVELOPMENT SYSTEM, INVALUABLE TOOL FOR DESIGNERS, HOBBYISTS ETC.

Enables "open heart surgery" on 2708, 2716, etc. Blows, Copies, Reads EPROMs or emulates EPROM/ROM IN-SITU whilst displaying contents off ROM/RAM on a domestic TV receiver. A host of other features.

Write or phone for more details.

**£115 + VAT & CARR**

You'll never regret buying a SOFTY!

### THE CHIPS ARE DOWN MOSTEK, INTEL, NEC, MOTOROLA I.C. PRICES SLASHED!

A massive purchase of brand new "state of the art" data processing equipment enables us to offer the following chips at never, and we mean never to be repeated prices.

8085A	Central Processor	£11.99
8155C	256x8 Static Ram	£8.95
8253C	Programmable Interval Timer	£8.95
8255A	Programmable Peripheral Interface	£9.95
8259A.8	Programmable Interrupt Control	£4.75
8755A	2Kx8 Eprom 16 1/0 Lines	£34.50
MC6850P	ACAI	£3.75
2652	MPCC Comms. Controller	£24.00
2102 1K	Static 650ns Rams 8 for	£5.25
1702	256x8 Eprom	£3.75
5101L-1	256x4 Static Ram 450ns	£4.95

And Remember All Chip Prices Include V.A.T.

All above I.C.s are brand new or removed from new unused socketed P.C.B.'s. Eproms supplied washed.

All full spec. and guaranteed

### SEMICONDUCTOR 'GRAB BAGS'

Amazing value mixed semiconductors, include transistors, digital, linear I.C.'s, triacs, diodes, bridge recs. etc. All devices guaranteed brand new, full spec. with manufacturers markings, fully guaranteed. 50 + BAG £2.95 100 + BAGS £5.15

### MUFFIN FANS

Keep your equipment Cool and Reliable with our tested ex equipment "Muffin Fans" almost silent running and easily mounted. Available in two voltages. 110 V.A.C. £5.05 + pp 65p OR 240v A.C. £6.15 + pp 65p DIMENSIONS 4 1/2" x 4 1/2" x 1 1/2"

### ELECTRONIC COMPONENTS & EQUIPMENT

# 66%

DISCOUNT

Due to our massive bulk purchasing programme which enables us to bring you the best possible bargains, we have thousands of I.C.'s, Transistors, Relays, Cap's, P.C.B.'s, Sub-assemblies, Switches, etc. etc. surplus to our requirements. Because we don't have sufficient stocks of any one item to include in our ads., we are packing all these items into the "BARGAIN PARCEL OF A LIFETIME" Thousands of components at giveaway prices! Guaranteed to be worth at least 3 times what you pay plus we always include something from our ads. for unbeatable value!! Sold by weight

2.5kls £ 4.75+pp £1.25    5kls £ 6.75+pp £1.80  
10kls £11.75+pp £2.25    20 kls £19.99+pp £4.75

### SHUGART SA800 ★ 8" Floppy Disk Drives as new £225.00 + VAT

### ★ RAM AND EPROM STAR OFFERS ★

2716 Single 5v rail EPROMS	£10.25
2716 Three rail EPROMS	£ 8.50
2708 EPROMS	£ 4.95
4116 16k x 1200 n s RAMS 8 for.....	£28.50

### 32K x 8 DYNAMIC/STATIC RAM CARDS

A masterpiece of electronic engineering and our own advantageous buying enables us to bring you a complete memory system at a giveaway price. Originally made for a large processor the RAM card has many features, including on board refresh, internal parity generation and checking. Standard TTL inputs/outputs, +5, +12, -15v supply rails and its effective STATIC capability make it useable with many CPU's. A fast cycle time of approximately 400ns make this a snip at only **£90.00 + £3p & p.** Supplied complete with circuits.

### DISPLAY I.C. AND TRANSISTOR BARGAINS NEVER CHEAPER

All I.C.'s and Transistors by well known manufacturers and fully guaranteed. No fall outs. Comprehensive data on I.C.'s 15p per type.  
2N4351 N channel MOS FET  
2N4352 P channel MOS FET  
60p each £1.00 per pair  
**HIGH VOLTAGE NPN POWER SWITCHING** transistors BVcbo 600v BVceo 500v BVebo 15v 1c 5 amps Pc 125 watts HFE 60 typ ft 2.5 mhz ideal invertors. etc. T03 £1.60 each 4 for £5.40  
BF258 NPN 250v @ 200ma 45p each 3 for £1.08  
1.R. BS01 2.5 amp 100v bridge rec. P.C. mount long leads 35p each 4 for £1.08  
IN4998 4 amp 100v P.C. mount diodes long leads 14p each 10 for £1.10  
LM309K + 5v 1.2 amp regulator £1.10 each 6 for £5.35  
AGFA C10 computer grade cassettes complete with library cases 68p each, 10 for £5.50  
IN4004 SD4 1 amp 400v diodes 7p each 18 for £1.00  
1.R. 12 amp BRIDGE RECS. 400 volt £1.25 each

**POWER OARLINGTON SCOOP!**  
MJ1000 NPN 60v 90w 8 amps T03 95p each  
2N6385 NPN 80v 100w 10 amps T03 £1.25 each  
MJ4030 NPN 60v 150w 16 amps T03 £2.75 each

**S.C.R.'s**  
2N3001 30v 350 ma T018 22p each 6 for £1.00  
2N5061 60v 800ma T018 27p each 4 for £1.00  
2M4441 50v 9 amps T0220 45p each 10 for £4.00  
C10601 400v 5 amps T0202 55p each 10 for £5.00

**TRIACS**  
G.E. 12 amp 600v T0220AB 95p each 10 for £8.75  
A.E.I. 10 amp 400v ready mounted on 2 1/2" x 2 1/2" heatsink £1.00 each 4 for £3.75

**LOW PROFILE I.C. SOCKETS**  
8 D.I.L. 10p each 12 for £1.00  
14 D.I.L. 14p each 8 for £1.00  
16 D.I.L. Gold Plated mil. grade 22p each 6 for £1.00  
22 D.I.L. 27p each 5 for £1.00  
24 D.I.L. 35p each 3 for £1.00  
40 D.I.L. 60p each 2 for £1.00

**OTHER GOODIES**  
2N3055 (R.C.A) 65p each  
2N5943 R.F. output 40 volts 1 watt up to 1000MHZ T.O. 55p each 10 for £5.00  
2N4304 W/1720 F.E.T. transistor 37p each 3 for £1.00  
LM3800/SL6051 14 D.I.L. 2 watt A.F. amp 80p each 8 for £6.00  
CA3028B DC 120 MHZ differential/cascode amp £1.00 each 3 for £2.50  
CA3014 20 MHZ wideband amp T099 case 65p each 2 for £1.00  
TMS3114 OVAL MDS 128 bit static shift reg. DC 25 MHZ £1.50 each 4 for £4.25  
NE555 27p each. 10 for £2.50  
GE424 zero voltage switch, triac SCR relay driver T05 can £1.10 each 7 for £6.50  
LM384 5 Watt audio I.C.s £1.50 each 10 for £11.00  
FP03725 4 NPN 50v 500ma transistors in 14 D.I.L. pack 70p each 2 for £1.00

### SUPERVALUE P.C.B. SPECIAL

Another great buy. Board contents include 62 Digital I.C.'s all located in 14 pin D.I.L. sockets. Original cost over £90, our price only **£4.95 + pp 65p**

### 5v D.C. POWER SUPPLIES

Following the recent "SELL OUT" demand for our 5v 3 amp P.S.U. we have managed to secure a large quantity of ex-computer systems P.S.U.'s with the following spec.: 240 or 110v A.C. input. Outputs of 5v @ 3-4 amps, 7.2v @ 3 amps and 6.5v @ 1 amp. The 5v and 7.2v outputs are fully regulated and adjustable with variable current limiting on the 5v supply. Unit is self contained on a P.C.B. measuring only 12" x 5" x 3". The 7.2v output is ideal for feeding "on board" regulators or a further 3 amp LM323K regulator to give an effective 5v @ 7 amp supply. Supplied complete with circuit at only **£10.95 + £1.75pp.** Believed working but untested, unguaranteed.

### KEYBOARDS ★ LOW PRICE CHASSIS ★

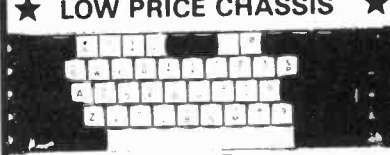

A special bulk purchase enables us to offer the above keyboard at a lowest ever price. 49 coded keys encoded into a direct TTL compatible 7 bit output. Features such as delayed strobe, 5 volt O.C. single rail operation and rollover protection make this an absolute must for the MPU constructor! Supplied complete with connection diagram and edge connector. At a secondhand price of only **£20.00 + P.P. £1.60**

"no time to test" price of only

**£27.50 + P.P. £1.85**

### TOROIDAL TRANSFORMERS

PR 240v pri. sec. 15 0 15 @ 2 amps dimensions 3" x 2 1/2" £4.95 + p.p. 99p  
TM 240v/110v pri. sec. 15 0 15 8VA dimensions 2 1/2" x 1" £1.95 + p.p. 30p  
All voltages measured off load.

### Plugs, Sockets & Connectors Cannon 'D' Range

Ways	Plug	Socket
9	£1.03	£1.26
15	£1.17	£2.01
25	£1.72	£2.58
37	£2.35	£4.14
50	£2.90	£5.46

2E way ex-equip. plug or socket £1.25  
Edge connectors, gold plated

0.1" DS	40 way	£2.45
0.1" DS	85 way	£3.99
0.15 DS	56 way	£3.25
0.156DS	36 way	£2.00

All connectors easily cut to size  
1000's of other connectors ex stock

### BARGAINS GALORE! In our walk round Warehouse NOW open Monday to Saturday 9.30-5.30



## ELECTRONICS

Dept. E.T.I. 64-66 Melfort Rd., Thornton Heath, Croydon, Surrey. Tel: 01-689 7702 or 01-689 6800

**MAIL ORDER INFORMATION**

Unless otherwise stated all prices inclusive of VAT. Cash with order. Minimum order value £2.00. Prices and Postage quoted for UK only. Where post and packing not indicated please add 40p per order. Bond Fide account orders minimum £10.00. Export and trade enquiries welcome. Orders despatched same day where possible. Access and Barclaycard Visa welcome.



# computing today

What to look for in the  
November issue  
on sale October 10th.



We present the definitive article on just how all those graphics games make things move around. All the programs given are specially designed to allow their use as examples on any memory mapped system provided you know a couple of details. How do you find these details? Read our companion article of course. . . . .

## INTERACTIVE GRAPHICS

## GRAPHIC DETAILS

CT starts an ongoing situation with a set of standard graphics maps for many popular machines together with vital details as to their screen layouts etc., so you can change games from system to system by looking up a simple code. Couldn't be easier, could it?

We present a general purpose plotting program for Apple owners. Display your functions using this powerful and adaptable piece of software. Owners of other systems that allow high resolution plotting such as the 380 Z might pick up a trick or two as well.

## GRAPH PLOTTER

## THE ULTIMATE GAME

Yes, it's a game that depends on graphics. Yes, it's a game that *everyone* wants but no-one has! Until next month's CT that is! Buy next month's CT and make sure you don't miss out on this, the ultimate, games implementation on a micro!

As a companion to our series on interfacing techniques we present a high quality analogue to digital converter suitable for connection to any system with an eight bit parallel port. Sample programs for the PET are given along with full circuit and functional descriptions.

## THE REAL WORLD

All articles mentioned herein are in an advanced state of preparation. However, circumstances may dictate changes to the final contents.

# I.L.P. Toroidal TRANSFORMERS



We use advanced winding technology to make our toroidal transformers. They have only half the weight and height of their laminated equivalents and are appreciably more efficient. Our toroidals cost virtually the same as their now-outdated laminated equivalents and hum is down to a negligible tenth of what it used to be. Supplied with rigid mounting kit with centre bolt, two neoprene and one steel washer. Available so far in a range of 37 sizes with more to come.

TYPE	VA	SECONDARY RMS VOLTS	SECONDARY RMS CURRENT	DIA. x HT in mm	WEIGHT	PRICE
2X010	50	6+6	4.16	80 x 35	0.9	EACH <b>£5.40</b> + £1.10 P&P + 98p VAT
2X011		9+9	2.77			
2X012		12+12	2.08			
2X013		15+15	1.66			
2X014		18+18	1.38			
2X015		22+22	1.13			
2X016	25+25	1.00				
3X010	80	6+6	6.64	90 x 30	1.0	EACH <b>£5.76</b> + £1.20 P&P + £1.04 VAT
3X011		9+9	4.44			
3X012		12+12	3.33			
3X013		15+15	2.66			
3X014		18+18	2.22			
3X015		22+22	1.81			
3X016		25+25	1.60			
3X028		110	0.72			
3X029		220	0.36			
3X030		240	0.33			
4X010	120	6+6	10.00	90 x 40	1.2	EACH <b>£6.72</b> + £1.30 P&P + £1.20 VAT
4X011		9+9	6.66			
4X012		12+12	5.00			
4X013		15+15	4.00			
4X014		18+18	3.33			
4X015		22+22	2.72			
4X016		25+25	2.40			
4X028		110	1.09			
4X029		220	0.54			
4X030		240	0.50			
5X016	160	25+25	3.20	110 x 40	1.8	EACH <b>£8.88</b> + £1.40 P&P + £1.54 VAT
5X017		30+30	2.66			
5X028		110	1.45			
5X029		220	0.72			
5X030		240	0.66			
6X016	300	25+25	6.00	110 x 50	2.6	EACH <b>£12.27</b> + £1.50 P&P + £2.07 VAT
6X017		30+30	5.00			
6X018		35+35	4.28			
6X026		40+40	3.75			
6X025		45+45	3.33			
6X028		110	2.72			
6X029		220	1.36			
6X030		240	1.25			

## CHOICE OF 3 PRIMARY INPUTS

I.L.P. Toroidal Transformers are available in choice of 110V, 220V, 240V, coded as follows: (Secondaries can be connected in series or parallel)

For 110V Primary insert 0 in place of "X" in type number.  
For 220V Primary insert 1 in place of "X" in type number.  
For 240V Primary insert 2 in place of "X" in type number.

Example - 120VA 240V 15+15V. 4A = 42013.

\* TYPES TO SPECIFICATION CAN BE SUPPLIED TO ORDER IN QUANTITY, AGENCIES IN CERTAIN COUNTRIES AVAILABLE ENQUIRIES INVITED

## FREEPOST facility.

We pay postage on U.K. enquiries and orders. Simply address envelope to FREEPOST T5 to address below. NO STAMP REQUIRED.

**TO ORDER** Enclose cheque/Postal Order/Money Order payable to I.L.P. Electronics Ltd or quote your ACCESS or BARCLAYCARD account No. To pay C.O.D. add £1 extra to TOTAL value of order.



FREEPOST T4 GRAHAM BELL HOUSE ROPER CLOSE  
CANTERBURY CT2 7EP Phone (0227) 54778 Telex 965 780



# MUSICAL MICRO 24 TUNE DOOR BELL

## BUILD THE WORLD FAMOUS CHROMA-CHIME

Give your friends a warm welcome. Yes, think how delighted and amazed they will be to hear the musical Chroma-Chime play when they press your button!

The Chroma-Chime uses a microcomputer to play 24 well-known tunes. The kit is simplicity itself for ease of construction. Absolutely everything needed is supplied, including:

- ★ Resistors, Capacitors, Diodes, Transistors, I.C. Socket and all hardware
- ★ Texas Instruments TMS 1000 microcomputer
- ★ Comprehensive kit manual with full circuit details
- ★ Ready drilled and legended PCB included



Plays 24 well-known tunes including:

Star Spangled Banner, William Tell Overture, Greensleeves, Rule Britannia, Colonel Bogey, Oh come all ye faithful, plus many other popular tunes.

- ★ No previous microcomputer experience necessary
- ★ All programming retained is on chip ROM
- ★ Fully guaranteed
- ★ Ideal present any time

## TMS 1000N



MP0027A Micro-computer chip available separately if required. Full 24 tune spec device fully guaranteed.

This unique chip can be used not only for electronic door chimes.

but for other projects requiring musical output.

Car Horns Musical Boxes Alarms

Amusement Machines Public Address etc

**£4.95**

ALL CHROMATRONICS PRODUCTS SUPPLIED WITH MONEY BACK GUARANTEE

Please send me:

TO: CHROMATRONICS, EIVER WAY, HARLOW, ESSEX  
Telephone (0279) 418611

Name .....

Address .....

I enclose cheque/PS value £

or debit my ACCESS/BARCLAYCARD account no.

Signature .....

# CHROMATRONICS

# AUDIO OSCILLATOR

A testing time for ETI. This unit features sine and square outputs, from 30 Hz to 60 kHz, each with its own level control. Circuit design by Ray Marston. Project development by Steve Ramsahadeo.

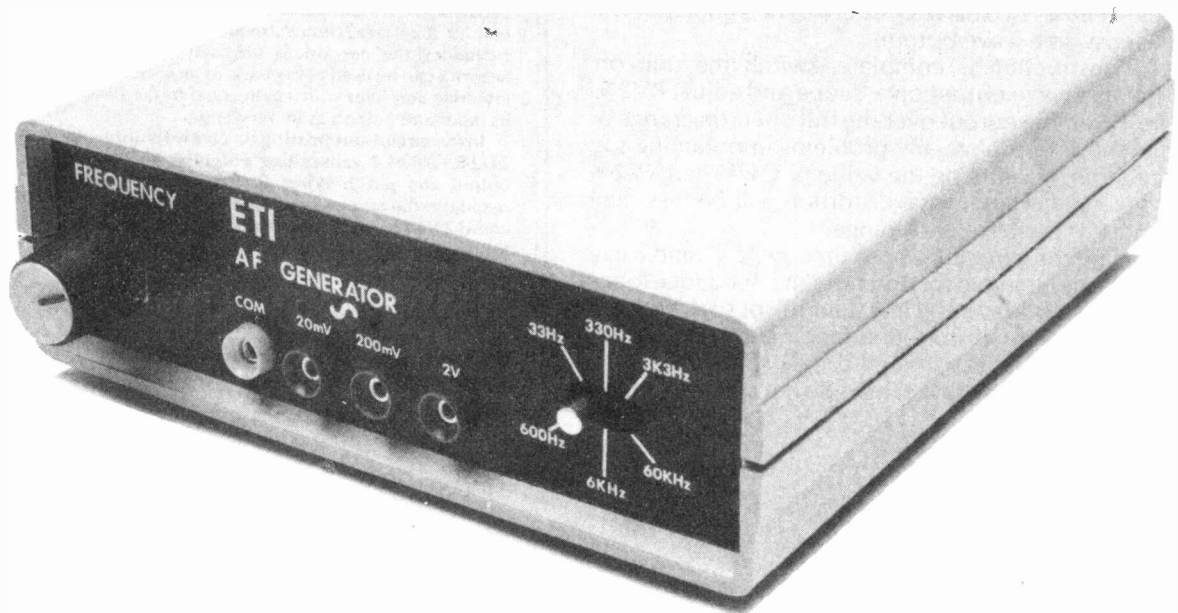

Good quality sine/square generators, giving very low sine/wave distortion, are invaluable pieces of test gear but tend to be rather expensive. For the vast majority of practical applications, such as gain and frequency response testing, function checking and sound generation, etc, the expensive 'very low distortion' sine wave characteristic is, however, superfluous, since distortion factors up to several percent are quite acceptable in such applications.

With these points in mind, we've set out to design a really inexpensive and easily built, but genuinely useful,

sine/square generator. Our generator covers the frequency range 30 Hz to 60 kHz in three switch-selected bands. Sine and square outputs are simultaneously available, each with their own independent level controls.

Automatic sine wave amplitude regulation is achieved in the circuit via a pair of back-to-back zeners in a control loop. This method of regulation is very inexpensive but has the great advantage of enabling range-sweeping to be achieved without amplitude bounce. Sine wave output distortion is typically less than 5% over most of the frequency range.

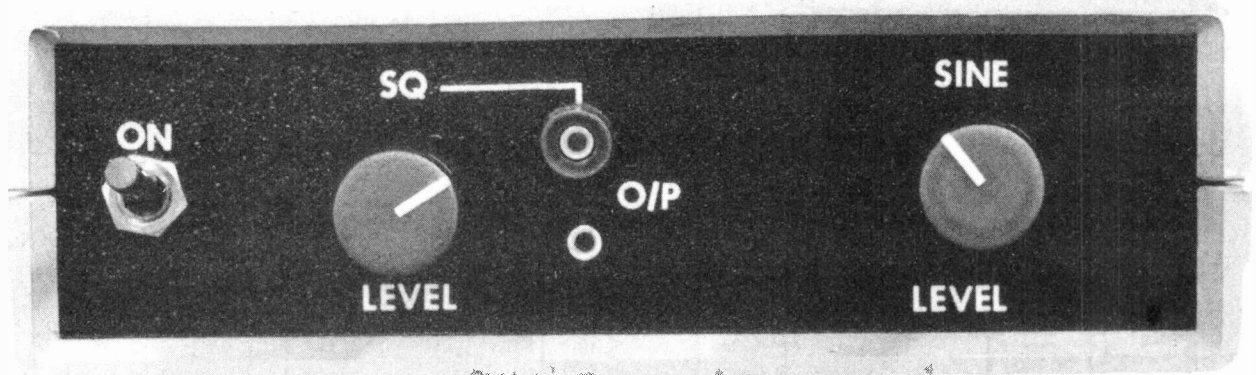

# Construction

The circuit is very simple and construction should present few problems. We decided to construct our prototype unit as a miniature 'squirr box', with an uncalibrated frequency dial. If you decide to follow our method of construction, note that we have fitted the two frequency controls (RV1 and SW1) and the sine wave output terminals to the front panel of our unit and all remaining controls (RV3, RV4 and SW2) and the square wave output terminals to the instrument rear panel. Our unit is powered by two PP3 batteries.

Whatever form of construction you decide to use, note that timing capacitors C1-3 should all be 5% or better types and that RV1 should be a good quality stereo pot, with good tracking between its two halves. Failure to fit a good pot will result in a lousy sine wave output.

When construction is complete, switch the unit on, monitor the sine wave output on a 'scope and adjust RV2 to give the best possible output over the full operating range of the instrument. If you have any problems in obtaining top range oscillation, try altering the value of C4. When RV2 is correctly set, typical sine wave distortion will be less than 5% over most of the frequency range.

When using the generator, note that the '2 V' sine wave output terminal is intended for driving high impedance loads only. If this output is loaded by less than 10k or so the output will become severely distorted under maximum output conditions, due to the very limited drive capability of IC1. The '200 mV' and lower output ranges do not suffer from this loading restriction.

## HOW IT WORKS

The heart of the unit is the Wien bridge oscillator designed around IC1. The Wien network comprises a series C-R network (R1-RV1a and C1a/C2a/C3a) and a parallel C-R network (R2-RV1b and C1b/C2b/C3b) connected in series. Input signals are applied to the top of this network from the output of IC1 and the output of the network is applied to input pin 3 of IC1.

The main feature of the Wien network is that the phase relationship of its output to input signal varies from  $-90^\circ$  to  $+90^\circ$  and equals zero only at a certain 'centre' frequency ( $f = 1/6.28CR$ ). At this centre frequency the network is precisely symmetrical. Thus, the Wien network can be used as the basis of an oscillator by connecting a non-inverting amplifier with a gain equal to the Wien loss factor between its input and output, as in our design.

In our circuit, automatic gain control is obtained by wiring the ZD1-ZD2-RV2-R3-C4 gain-setting potential divider between the op-amp output and pin 2. When RV2 is correctly adjusted, this network maintains the output amplitude of the IC1 signal virtually constant (at about 2 V RMS) over the entire frequency range of the unit (30 Hz to 60 kHz) and results in a typical distortion factor of less than 5% on its sine wave output. The amplitude of the final sine wave output signal is variable via RV3 and the simple R4-R5-R6 attenuator network.

The direct sine wave output of IC1 is fed, via R7, to the input of IC2. This IC is wired as a simple voltage comparator and converts the sine wave input signal to a square wave output. The amplitude of the final square wave output is variable via RV4.

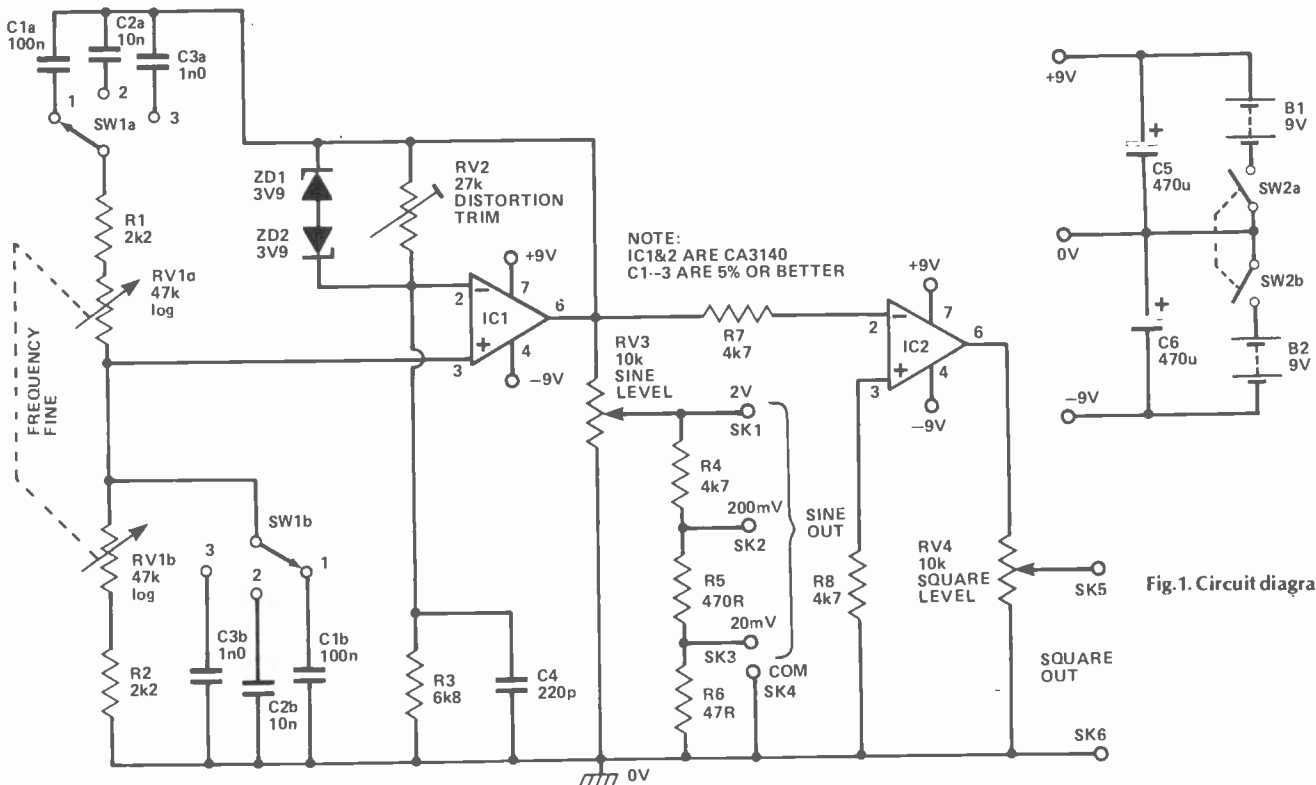
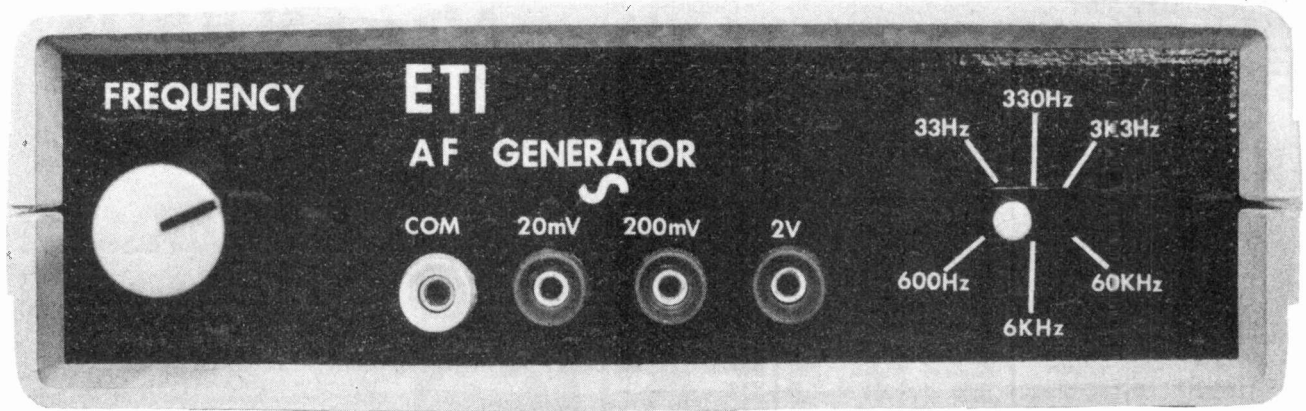

Fig.1. Circuit diagram.



A simple front panel layout for ease of operation.

## BUYLINES

There should be no problems in obtaining any of the components used in the AF generator as all are common types.

The case we used for the project is available from O.K. Machine & Tool Ltd. Order as CM5-125. Phone 0703-610944.

Fig.2. Component overlay.

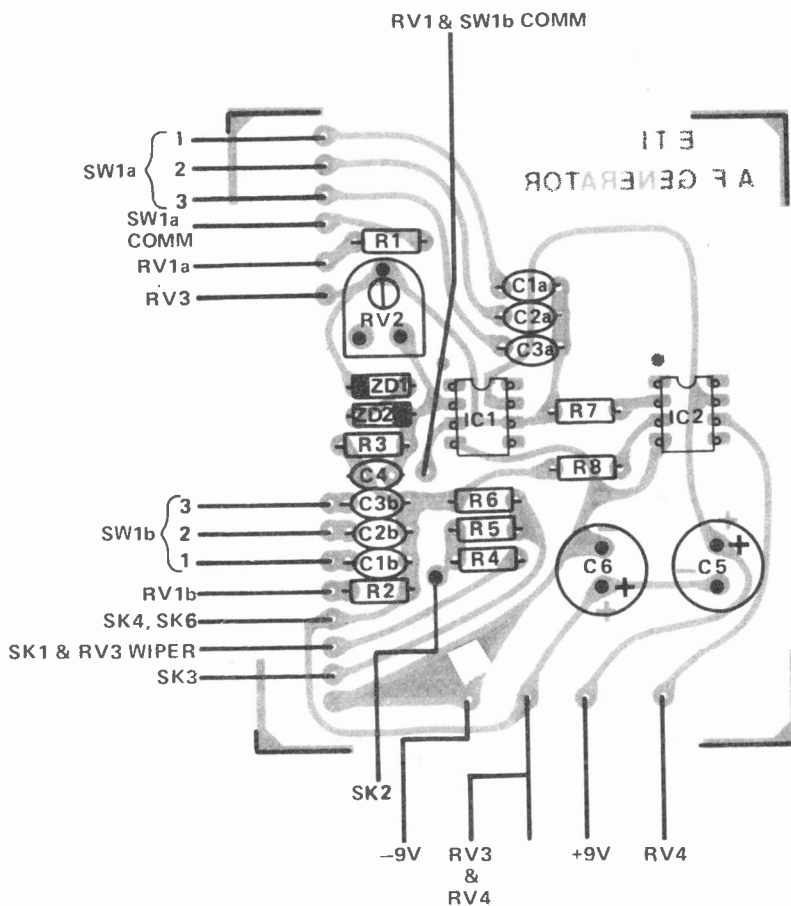

## PARTS LIST

### AF Generator

Resistors all 1/4W 5%

R1,2	2k2
R3	6k8
R4,7,8	4k7
R5	470R
R6	47R

### Potentiometers

RV1	47k logarithmic dual gang
RV2	22k horizontal miniature
RV3,4	10k linear

### Capacitors

C1a,b	100u 5% polycarbonate
C2a,b	10u 5% polycarbonate
C3a,b	1u0 5% polycarbonate
C4	220p ceramic
C5,6	470u 25V electrolytic PCB type

### Semiconductors

IC1,2	CA 3140
-------	---------

### Miscellaneous

SW1 2 pole 3 position slide switch, SW2 DPDT miniature toggle, SK1-6 to suit, case (see Buylines), PCB.

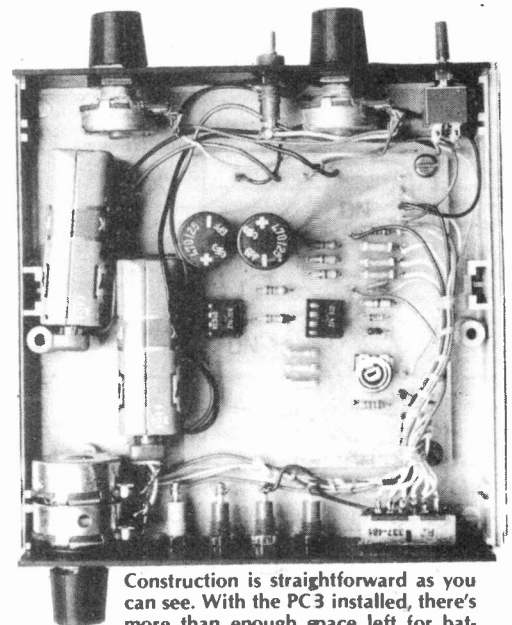

Construction is straightforward as you can see. With the PCB installed, there's more than enough space left for batteries.

ETI



# IS THERE AN ALTERNATIVE TO SPENDING MORE AND MORE ON LP'S AND TAPES?



## YES!

# THE WILSON STEREO LIBRARY

As a music lover, you know just how much new records and cassettes cost. Now, by hiring your recordings from The Wilson Stereo Library you can save yourself a lot of money. Borrow from our vast collection of classical, opera, jazz, rock and pop recordings, for as little as 6p a day for stereo discs, and 5p for cassettes. Keep them for as long as you like. Change them as often as you like. And then, if you want to buy a particular disc, on hire, you can — and at a very advantageous price!

**FOR BORROWERS**, the choice is wide open. Almost every recent worthwhile classical, popular or jazz recording — record or cassette — can be sent to you in prime condition; or mint condition and even totally unplayed for a small extra charge.

To find out just how good our selection of recordings is, why not buy our Record or Cassette Catalogue, or both, before even becoming a member. To get your copy, simply complete and post the coupon. And remember, the cost of the Catalogue is refunded when you join.

**TO JOIN THE LIBRARY**, your annual subscription for records is £3.90; or £3.75 annually for cassettes. **There is no deposit at all to pay.**

**A FULL LIBRARY CATALOGUE** is sent to you the day you join. From this, you make your choice and your first selection of records or cassettes will be dispatched by return of post in a special container designed to give full protection. You only pay the hire charge on returning the recordings.

**FOR NEW RECORDS AND CASSETTES AT CUT PRICE**, join the WSL "Records at Cost Service". The annual subscription is £3.50, enabling you to buy any brand new record or tape at cost price, plus a nominal handling charge of 25p.

**TO BUY USED RECORDS OR SPECIAL OFFERS OF BRAND NEW RECORDS AT BARGAIN PRICES**, you pay an annual subscription of £1.90. For this, you get a monthly list of slightly used records, tapes and special brand new records offered at enormous savings.

**BORROW OR BUY,  
THERE'S NO BETTER WAY**

**THE WILSON  
STEREO  
LIBRARY LIMITED**

TO: The Wilson Stereo Library Limited, 54 Sea Road, Bexhill, East Sussex. TN40 1JP.

Please send me:

- Free booklet 'The Wilson Stereo Library', which gives full details of all W.S.L. services (and accessories).
- W.S.L. Catalogue of stereo and quad recordings. I enclose £1.25\* plus 20p post and packing.
- W.S.L. Catalogue of stereo cassettes. I enclose 80p\* plus 15p post and packing.

\* I understand that this will be credited to me in full, should I decide to become a member of either the Cassette or Record Library, or both.

Name .....

Address .....

Total Sum Enclosed £ .....

The Wilson Stereo Library Ltd., 54 Sea Rd., Bexhill, East Sussex TN40 1JP

ETI 11/80

# AUDIOPHILE

Disguised as Father Christmas, Ron Harris presides over our Sony competition Prize Day, finds a sticky mat to play with and casts a critical eye over a budget box of tricks.

Competition results time again. A few Audiophiles ago I ran that appalling, tasteless and thoroughly despicable Sony publicity photo for the 'Stowaway' portable tape player and asked for your captions . . . As usual you did not disappoint me. Six million pieces of paper later I think we have a winner. Well, almost. In fact, two winners, as I was unable to make up my mind between two very witty submissions.

Mr B. D. Barrett of Pickering, Yorkshire and C. R. Thorn of Gloucester (who did not bother to define gender more closely) are, therefore, declared joint 'Wit of the Month' and duly rewarded a year's subscription to ETI. Anyone who thinks second prize is two year's subscription to ETI had better leave now, lest he lose his vitals.

There were many more worthy attempts, but by far the most popular line was "O.K. Scotty, beam us up" which lost by sheer weight of numbers! I have given a few of the better efforts below, the winners first:-

Left: the great Sony picture show which started all this lunacy.

Joint Winners: "Are you sure this will stop me getting pregnant?" Mr R.D. Barrett, Pickering

"Darling — I know it's cheaper than a choir, but this is our wedding . . ." C. R. Thorn, Churchdown

Also worth an honourable mention or three:

"His equipment is so tiny . . . but I love the performance". Mr J Wakewell, Shirley, Surrey.

A final chord in this symphony of corn and photographic pap. Just to prove that PR agencies are capable of exhibiting bad taste on a worldwide scale, I reproduce below the hand-out photos for the Stowaway from Japan and the USA . . .

No words of mine could do them justice, therefore — no comment.

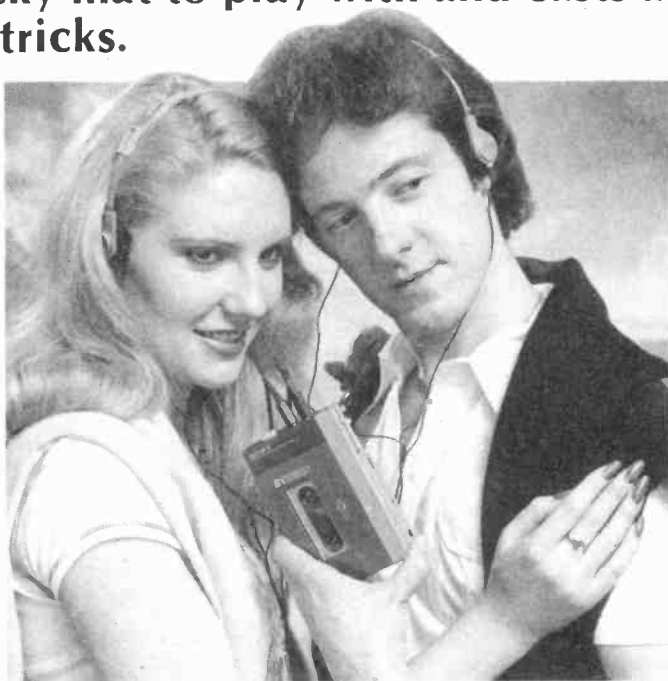

"Here — can you do this with your thumb?" Un-named of Maidstone. (Blew it, didn't you?)

"So this is where you keep the spare batteries . . .". J. Clarke, Sutton Coldfield.

"Darling are you sure your pacemaker's working O.K.?" S. McKinty, Co. Down.

"Step two: place your right hand on your partner's left . . ." P. Skinner, Derby

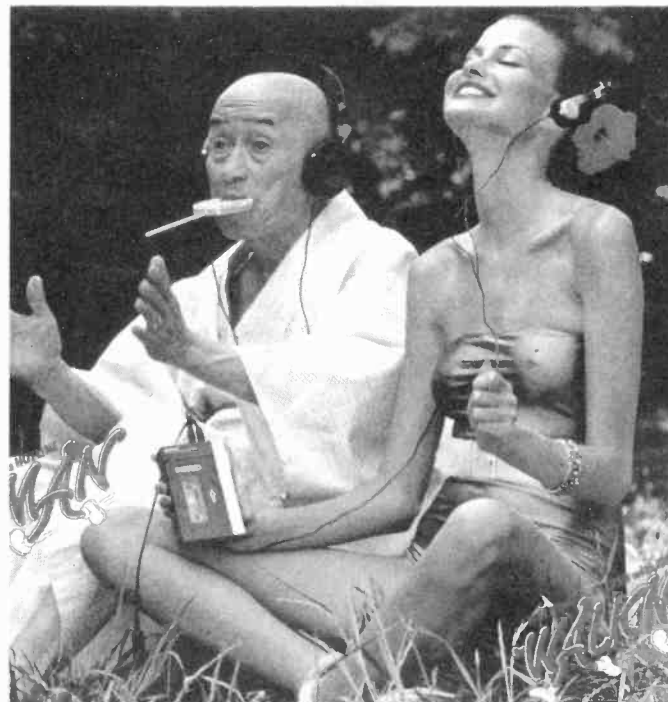



## On The Mat

Following on from last month's review of the Thorens TD160S turntable, I have more news of the 'conversion' kit to upgrade other models to a similar performance. Similar, but not equal. It seems that most

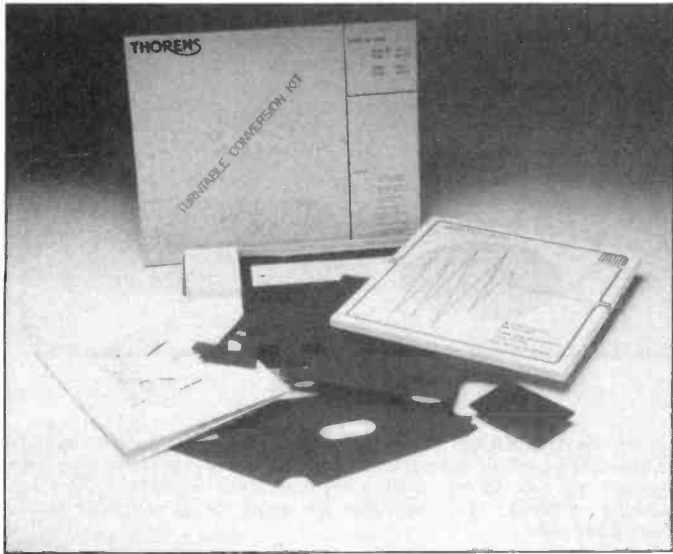

Thorens conversion kit includes self-adhesive damping material to improve the sub-chassis behaviour under resonant conditions. A new arm-board and turntable mat is also included.

of the changes to the standard 160 which were made to create the 160S are the brainchild of Cambrasound (a merged version of Metrosound and Cambra International) Thorens UK importer.

One point of difference exists, however, over the turntable mat. Thorens went their own way and produced a very heavy and sensible specimen which resides in the 160S production model. Metrocare have their own mat — and it is this that is included in the conversion kit. As this item is marketed separately, as a general application turntable mat, I thought it worth a closer look.

It is formed from a silicon elastomer, which is virtually 100% pure polymer. That description makes about as much sense to me as the Arabian Daily News. The material has a very high surface tension — higher on the face which will be in contact with the turntable.

Practically this means it is "sticky" to the touch and bonds very well to the metal surface. The record is effectively held across its entire surface, with no room for air gaps.

## Resonant Peaks

Metrocare claim the biggest benefit lies in the reduction of those resonances which are inherent in all cast platters and cite an improved upper-bass and mid-range reproduction as the audible return for the £16.75 retail price.

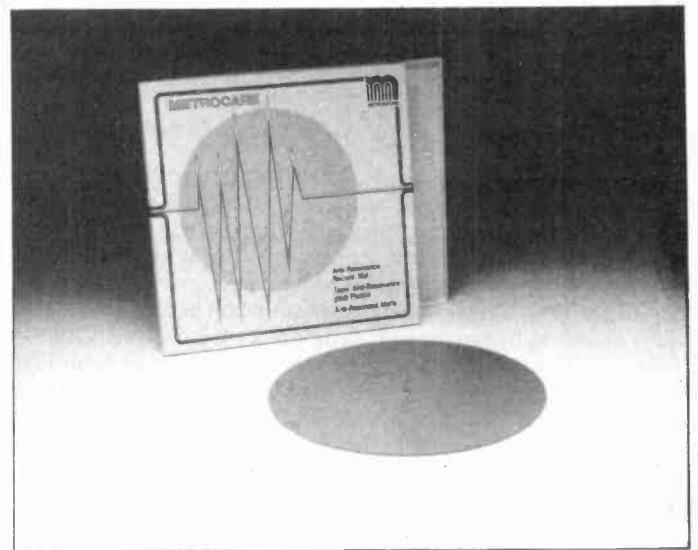

Above: the very persistent Metrocare turntable mat, as fitted to the Thorens conversion kit, but not to the production 160S decks. A very high surface tension endows it with considerable LP holding qualities.

Because of the mat's amazing ability to hold dust, the Metrocare must be kept clean — and the deck covered at all times when not in use. Removing records from the mat has to be done carefully as the bonding is not just good, it is excellent. LPs are somewhat loathe to leave.

Having tried the Metrocare on a few decks, including the TD160S, I can confirm that it is indeed a worthy effort. Compared to Thorens' own creation it displays an improved mid-range and tighter control of the bass. Subtle changes, but clearly audible nonetheless. I cannot understand why Thorens would not accept the whole of the advice offered, and fit Metrocare to the TD160S production model. Swiss independence, I suppose. Ah well.

Trying the Metrocare on other decks, including some budget machines, suggested that it has much to offer most hi-fi users in that an audible improvement was obtained on all the decks we dropped it on. It is probably the only one of these "super-mats" that can claim such universal application. ➔





## Budget Trio

In response to readers' calls for budget hi-fi reviews (and because someone told me Felicity Kendal had a Trio hi-fi) I have been taking a look at the new KA-300 from Trio, a 30 + 30 low price amplifier which will retail at somewhere in the region of £80-£90.

Facilities offered are not at all bad for this price area and dubbing between two tape decks is possible. One set of tape sockets (phono) is included in the front panel for ease of access. Not a bad idea if you can hide them somehow with one of those flaps the Japanese are so enamoured of, but a little ugly otherwise. In fact the KA-300 is anything but pretty all round! The controls are well sited and smooth to operate, but the appearance is downright ugly in my opinion. The black plastic ribbing which pops up all over the front panel gives a very strange look to the whole thing.

Individual is perhaps the kindest label to hang there!

On test the Trio acquitted itself well, exceeding the spec on every feature and giving a very competent electrical performance. Power available was somewhere around the 35 W a channel mark and this is well maintained across the audio spectrum. Noise ratios were commendably low for the price and distortion was at a level where it would not be a problem. The test results give you the details, if you're interested.

TABLE ONE

Output Power	; 40Hz - 20kHz	; 25W
Power Bandwidth	; at 0.01% THD	; 10Hz - 45kHz
S/N Ratio, unweighted	; phono	; 60dB
	aux, tuner, tape	; 65dB
Damping Factor	; 8R 40Hz - 20kHz	; 60
Input Sensitivity	; phono	; 2mV at 50K
	aux etc	; 130mV at 27K
Distortion	; THD 1kHz at 20W;	0.1%
	intermodulation	; 0.05%

Test results for the Trio KA300 amplifier. Noise ratios are excellent. The impedance on the aux input is, however, somewhat less than excellent! A minimum of 50K is to be preferred.

Above: the Trio KA300 budget amplifier. The appearance is certainly striking and bereft of superfluous controls. Loudness could have been disposed of, too, in my opinion without much weeping wailing and gnashing of teeth. Tape facilities are good for an amplifier in the under £300 class.

## Listen with Trio

It is always difficult to decide exactly how to audition budget equipment. Do you hook it onto a top flight set-up, in order to exactly determine its strengths and weaknesses, or use the type of system it is designed to run with and accept that you are only able to judge it comparatively against a rival unit?

My own approach is simply to do it both ways! Never one to make things less complex, if at all possible. Hence the Trio was substituted into my reference system (driving Kef 105 IIs at one point!), first of all to try to get an absolute idea of performance before moving on. I might add that the Seoum amplifier on offer elsewhere in this issue was also put to the test and used throughout as a comparison to the Trio. Final listening was carried out with reference to a friend's system using the NAD 3020, which is perhaps the best sounding unit in this price bracket.

Having now heard the KA-300, I think that NAD have little to worry about. On an absolute basis the Trio has poor bass control and a tendency to "harden" on complex material. The Seoum sounded a good deal clearer and coped with most material well, although the noise was higher than with the Trio.

On the 'plus' side, the KA-300 is possessed of a good signal-to-noise ratio on both phono and tape and is well engineered. Against that, it has a good sound quality that is bettered by competitors, such as the NAD 3020 and the Seoum, and a highly individual appearance that you will either love or hate.

Sorry Trio, I can't recommend this one at all.

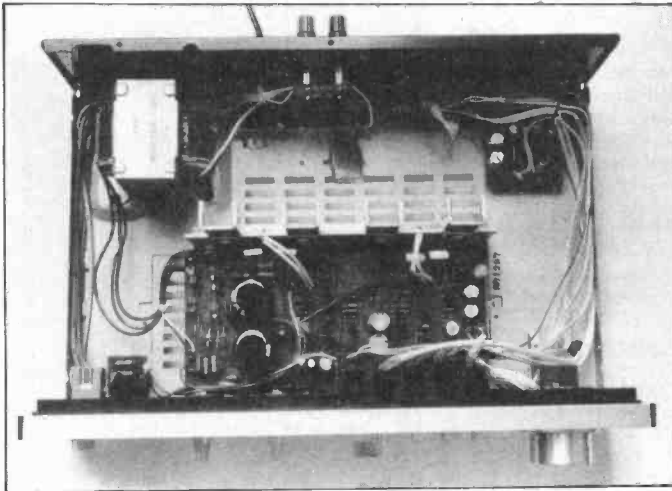

Above: an internal view of the Trio KA300. Lots of space is there not? Surely a smaller cage could have been found without jeopardising the signal to noise ratios too much?

Will readers using the Audiophile hi-fi enquiries service please remember to quote full details of the hi-fi system they are using. It is of great value to me in trying to sort out problems to know what it is I'm trying to sort out!

## Letters Pray

Dear Sir,

I am upgrading my system and have been told that what I ought to change next is the turntable. This is a Thorens TD150 and an SME 3009 and a Shure M75ED cartridge. Amplifier: Armstrong 621. Speakers KEF Cadenzas.

My friend told me to buy a Linn as this will improve my system more than anything else. But this will cost me over £300 and this is more than I paid for the whole system, I wanted to be sure. What would you suggest I do?

Yours sincerely

F. Kendal

London

Hang on whilst I recover from the heart-attack that that name and address induced... People with *that* name should make it clear at the start who they are *not* — not who they are!... Come on heart, don't fail me now... you can make it...

Anyway, Mr Kendal, the first thing I would advise you to do is take your 'friend' on a one way trip to the docks in brand new cement shoes. It is about all he deserves. If your TD150 is in good condition, a Linn will make little, if any, difference to your system. A better immediate upgrade would be to change the cartridge. If you like the Shure sound then the V15 IV is an excellent buy. If you fancy a change then give the Goldring G900 IGC or Empire 600 LAC a try. After that both the amp and speakers could well be replaced — in fact, the deck is the last thing to change!

ETI

**video**  
**TODAY**  
OCTOBER 1980  
60p

Philips' V2020 - European Video Takes On Japan

Video Discs LP Records With Pictures

Vision Mixing At Home For £70

The Best Hi-Fi Amplifier Yet

NEW PRE-RECORDED REVIEWS AND DETAILS OF EVERY MAJOR VIDEOCASSETTE AVAILABLE

**NEW**  
With Unique 22 Page Video Check List!

AT YOUR LOCAL NEWSAGENTS

# NOW!

or direct from us, add 25 pence p&p

For a mere 60p you can sample the delights of our new Modmags publication VIDEO TODAY.

If your interests include hi-fi, films and video equipment of all descriptions, this magazine can fill the void in your life.

Finding yourself with nothing to do with your leisure hours? VIDEO TODAY can supply loads of new ideas.

Features include film reviews as well as video machines, vision mixing and hi-fi amplifiers.

THE entertainment magazine for the home!



# KEELMOOR Quality..

Keelmoor Ltd is a company which has been established for a long time - we supply the products you have often bought from other companies. Our precision watches and electrical goods are renowned for their superb quality and reliability. We differ from other companies in that we import direct world-wide - that difference is passed on to you at unbeatable prices. You receive the goods faster and we provide a service and no catch guarantee of which we are justly proud. We employ experts world-wide whose job it is to seek out products of the highest quality at the lowest possible prices. Illustrated here is just a tiny selection of our comprehensive range. Just compare these items with those seen elsewhere - we are confident the prices will amaze you. You can save ££££'s.

## GENTS 5 FUNCTION LCD

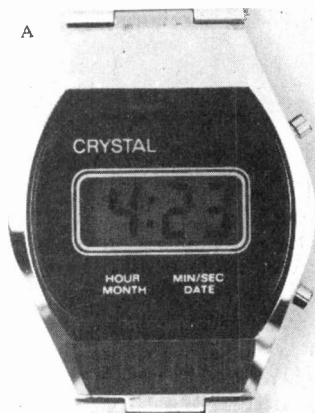

This is the foundation of our range and is ideal for the man requiring the basic functions of hours, minutes and seconds, with month and date. A backlight is included and the stainless steel strap provided is fully adjusted to suit any size of wrist. Guaranteed for one year, this watch represents fantastic value at only

**£4.95p**

**ILLUSTRATED BELOW IS THE LADIES 5 FUNCTION LCD.** This watch has the same time and auto calendar functions as the basic gents model described above, together with backlight and adjustable strap to suit the daintiest of wrists. It's compact, pleasing appearance makes it a very practical day watch and it is also often used for boys and girls. Available in black or white face.

These are just a few of our fantastic offers remember. A free colour catalogue is posted with every order.

**£5.95p**

or just send large S.A.E. and we'll send you one.

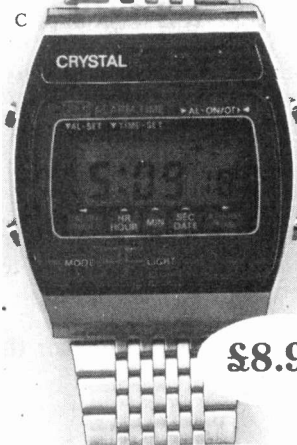

## GENTS LCD ALARM WATCH

This model represents fantastic, incredible value for money. The 6 digit display continuously shows hours, minutes and seconds, or may be changed at will to hours, minutes and date. Its effective alarm is extremely useful and may be set to any time within a 24 hr. period. In addition, there is an alarm indicator, 4 year calendar and snooze repeater.

**£8.95p**

### FULLY GUARANTEED

We must emphasize all these items are fully guaranteed for one year. All electronic goods come complete with demonstration batteries which cannot be guaranteed. New batteries are available for only 60p.

**BARCLAYCARD AND ACCESS CARD WELCOME. SEE COUPON.**

## HERE IS THE AMAZING 12/24 HOUR ALARM/CHRONOGRAPH



Along with the usual time and date displays, this multi-functional timepiece has a 24 hour alarm and a 1/2 second stopwatch. The time may be set to operate in 12 or 24 hour mode and the date can be in English or American format. The day of the week is continuously indicated and the stopwatch display may, on command, be frozen to show split/laptime while the stopwatch continues to run. Stopwatch operation does not effect normal time keeping. £12.95 only for this model. Also available with solar energy panel to conserve energy during daylight hours for £14.95

FROM **£12.95p**

From Watches to Clocks, from Calculators to Radios, from Binoculars to Tool Kits - **KEELMOOR is the name for the right quality at the right price. Your personal catalogue will tell you more - free with every order.**



## LADIES QUARTZ LCD DRESS WATCH

This attractive ladies model with the standard 5 functions of hours, minutes, seconds, month and date has literally sold in tens of thousands. Available in gold or silver colours with 'sugar coated' finish. Please state first and second choice of square, round or oval design.

**£8.95p**

## THE ULTIMATE GENTS LCD CALCULATOR/ALARM WATCH

If you want a watch from the top end of the market this is the one for you. Full calculator functions plus memory and percentage are combined with time and alarm functions to make this item an outstanding buy. Manufactured in Japan at the same factory that produces models for probably the most famous name in the watch business, this device represents sheer quality at an unbelievable price. Comes complete with backlight and button operating tool carried in the strap clasp. We advise you to order quickly whilst stocks last.

**£39.95p**

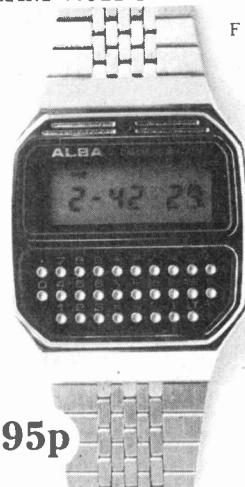

# at Keener Prices

**FREE**  
With every order.  
Big colourful  
Keelmoor catalogue  
featuring hundreds of  
products at bargain  
prices.

We don't think you'll find items of this quality anywhere else at the price we offer. Order now, Christmas is round the corner and this is the way to make gift buying easier – and cheaper too.

WE ARE PROUD TO INTRODUCE THE AMAZING MELODY ALARM CHRONOGRAPH



**ACTUALLY  
PLAYS**  
**THE YELLOW  
ROSE OF TEXAS**  
BUT AS YOU CAN SEE  
FROM THE DETAILS BELOW  
THIS CHRONOGRAPH IS NO  
MERE NOVELTY

Today's technology has produced this fine watch which incorporates a musical alarm which plays a complete verse of 'The Yellow Rose of Texas'. Other functions included are as for model number 1. With stop watch.

**£14.95p**

NEW TO OUR RANGE, WE COMBINE PRECISION AND STYLE IN THIS – THE SUPER SLIM GENTS 5 FUNCTION CHRONOGRAPH



JUST TO GIVE YOU AN IDEA OF THE ULTRA SLIMNESS OF THESE WATCHES WE HAVE ILLUSTRATED A SIDE VIEW OF THE SUPERSLIM DIGITAL. BELOW, WE HAVE ELABORATED ON SOME OF THE TECHNICALITIES:—

These watches need no special functions to make them stand out in a crowd – their slimness serves that purpose. If you've been put off digital quartz watches in the past because you require an ultra-slim design, now is the time to change. Is equipped with standard 5 functions and backlight.

**£9.95p**

**Keelmoor Ltd.**  
78 Castle Street, Derbyshire DE7 1DY

**MAINS DIGITAL ALARM CLOCK**

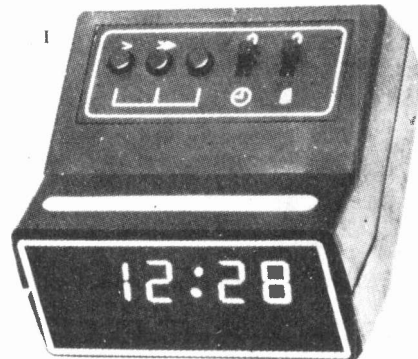

A very practically sized mains operated digital alarm clock – this item is extremely well finished and looks equally at home by the bedside or in the living room. With snooze/repeater alarm you could not even buy the components to build your own for this price. Available at the amazingly low price of only

**£8.95p**

AND FINALLY, WHAT MUST BE THE ULTIMATE IN SQUEEZING A QUART INTO A HALF PINT POT! THE INCREDIBLE MINIATURE LCD TRAVEL/ALARM CLOCK



**£10.95p**

As you can see from the photograph above this device is tiny and yet it continuously displays hours and minutes with auto calendar and night light. Invaluable for the busy traveller or simply for use in the modern home, it comes complete with its own travelling case and can easily be carried in top pocket or the smallest of handbags. It has even got a stand for upright position on table, shelf or sleeping compartment. An unusual gift to yourself or others at only £10.95.

Every order dispatched by return, and is sent by recorded delivery. That is Keelmoor's Promise To You.

**THE KEELMOOR PROMISE**

Keelmoor have a tremendous reputation to uphold, both in the retail and wholesale trades and so, with every product sold, we automatically give the Keelmoor Promise. This includes:—

- **NO RISK GUARANTEE.** Try any of these items for 15 days and if you are not completely satisfied with the quality and value simply return it for a complete refund.
- **ONE YEAR'S FULL GUARANTEE** on all products
- **BACK UP SERVICE** second to none

**15 DAY TRIAL COUPON.**

To Keelmoor Ltd, 78 Castle Street, Melbourne, Derby DE7 1DY  
Please send me the items indicated in the boxes below. I understand that if I am not completely satisfied, I may return the goods undamaged within 15 days and my money will be refunded in full

A	B	C	D	E	F	G	H	I	J	Just indicate with a tick, item required, if more than one required tick plus number - i.e. ✓ 1
										TOTAL AMOUNT = 5

NAME Mrs Miss Ms Mr  
ADDRESS

POST CODE

Enclose a cheque PO to KEELMOOR LTD  
Or charge my Access or BARCLAYCARD (tick as applicable)

No. TOTAL — 5 + 50 per item P&P  
The advertisements to watch for quality precision at the right price.  
All goods dispatched by return.

ETI

# MONITORS MONITORS MONITORS

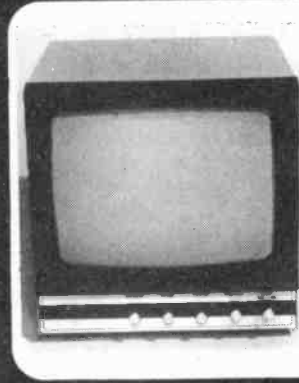

Uncased from 3" to 12"  
Cased from 5" to 20"

Semi professional or professional available from stock.

Monitor PCB's including Transformers and Tubes also in stock.

TRS8-80 Software available.

Send for details.

## CROFTON ELECTRONICS

Crofton Electronics Limited  
35 Grosvenor Road, Twickenham, Middx.  
Tel: 01 891 1513

## BUILD YOUR OWN METAL DETECTOR VLF/TR VCO/TR IB/TR BFO . . .

Pre-aligned search heads — test equipment not required. Literature available in return for SAE. Manuals and parts sold separately: write or phone for price. Export welcome: write for quote.



**Shadow VLF/TR.** Full specification discriminator, not just ferrous/nonferrous indication. It works by measuring the conductivity of the target; now you can reject naila bottle caps even aluminium foil and ring pull tabs! Full ground effect: exclusion over normal or high permeability soils. The head is thermally and capacitively shielded. 4 modes: deepseeking VLF plus 3 TR discriminating ranges. Push button "memory" tuning. Performance equals commercial detectors costing £200! As described in ETI. Complete kit now only £87.87 inc. VAT & post!

**Shadow TR/1B**

**Individual parts:** Search head £21.33 PCB £6.80 Case £5.33 Adjustable shaft assy. £5.10. LM393 £1.12. Manual (gives more info. than ETI article — and extra function) £1.12. All inc. VAT & post! (Other parts also available separately)

**Shadow TR/1B (illustrated).** A true transmit receive/induction balance detector at a budget price for anyone who doesn't need discrimination. Waterproof and thermally insulated search head. Good sensitivity. Built-in speaker and headset jack. Complete kit £33.60 inc. VAT and Post.

**Shadow TR/VCO.** An advanced version of the TR/1B. Use as a sensitive 1B machine or switch to VCO mode when the sound changes to a varying pitch, allowing easier use over mineralised ground and enabling detection of negative, high permeability anomalies. Kit price £38.87 inc. VAT and Post.

Matching stereo headphones for all Shadow models £5.85 inc. VAT and Post.

**Shell Kit.** Consists of the (hard to find) hardware items, for detectors of your own design. Fully adjustable shaft with handle, search head mouldings (int. diam. 185mm) with hinge assembly, special clips to mount your own control housing (any box is suitable). Completely non-metallic and undrilled. With assembly instructions £14.45 inc. VAT and Post.

## ALTEK (ETI), 1 Green Lane Walton-on-Thames Surrey

Order by post or phone (24 hours). Access & Visa Cards quote number. Callers by appointment only please. Phone (093 22) 44110 anytime!

# 110 projects in every book!!

The '110' books have been acclaimed by enthusiasts, students and engineers. Each contains 110 different circuit applications. Use them as project books or as source books for circuit ideas.

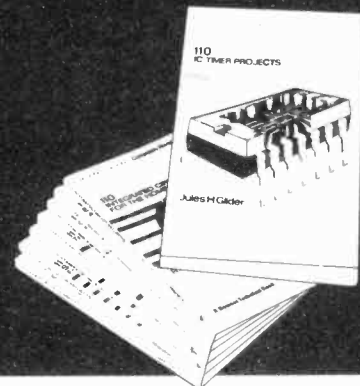

110 CMOS Digital IC Projects for the Home Constructor  
R. M. MARSTON 0 408 00216 6 £3.95

110 Electronic Alarm Projects for the Home Constructor  
R. M. MARSTON 0 408 00269 7 £3.95

110 IC Timer Projects for the Home Constructor  
JULES H. GILDER 0 408 00480 0 £3.95

110 Integrated Circuit Projects for the Home Constructor —  
Second Edition  
R. M. MARSTON 0 408 00309 X £3.95

110 Operational Amplifier Projects for the Home Constructor  
R. M. MARSTON 0 408 00153 4 £3.95

110 Semiconductor Projects for the Home Constructor  
Second Edition  
R. M. MARSTON 0 408 00322 7 £3.95

110 Thyristor Projects using SCRs and Triacs  
R. M. MARSTON 0 408 0074 5 £3.95

110 Waveform Generator Projects for the Home Constructor  
R. M. MARSTON 0 408 00353 7 £3.95

Available from your bookshop or in case of difficulty direct from the publishers.

## Newnes Technical Books

Borough Green, Sevenoaks, Kent TN15 8PH

# RIAA PREAMP

Sounds amazing. Listen to your magnetic cartridge burst into life with our RIAA equalised preamp, designed for the ETI Multi-Option Board. Circuit design by Keith Brindley.

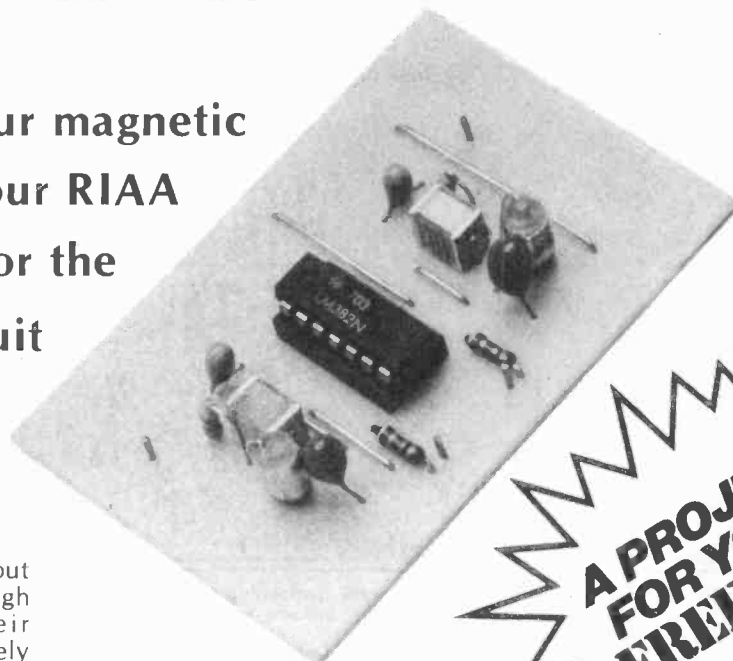

**M**agnetic cartridge pick-ups have very low output levels and consequently require low noise, high gain preamplifiers to boost their signals. Op amps for this application are relatively abundant nowadays. But, things aren't quite that simple — not only is the output level of a magnetic pick-up low, but it varies with frequency. At the top end of the audio spectrum (ie 15-20 kHz) the signal is about 40 dB up, (ie 100 times) that of the lowest end of the range.

The Record Industry Association of America (RIAA) laid down the rules for the frequency response curve, so that when designing such a preamp stage the engineer has only to calculate suitable values for the components in an op amp feedback loop. What is needed is an amplifier response which *diminishes* with increasing frequency over a range of 40 dB, to compensate for the response of the cartridge and give an overall flat output. Given a microcomputer, a sharp pencil and a bottle of vodka it should take him — ages. But why bother, it's all done nowadays (as it often is!) on one chip — the LM382.

## Cue Cavalry

National Semiconductor came to the rescue with the introduction of this device, a wide-range supply voltage (9-40 V) preamp which, with only a handful of other components, gives an RIAA preamp featuring low noise, high gain and the required frequency response.

## Construction

The only components which need correct polarisation are the four tantalum capacitors and the IC, so check the overlay carefully before soldering them into position on the ETI Multi-Option Board.

The input and output connections should be made with screened lead, the screen being taken to 0 V. The only thing to note here is that the input leads must be as short as possible, because the high gain involved in any preamp circuitry makes them very susceptible to hum and noise pickup. Short screened leads help to minimise this problem.

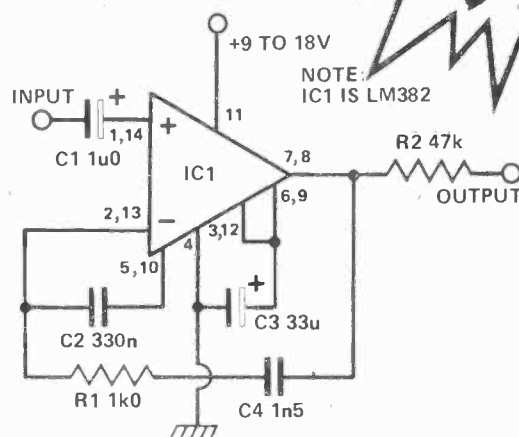

Fig. 1. Circuit diagram of one channel of the preamp.

## HOW IT WORKS

The feedback loops in any RIAA amplifier are fairly conventional and apart from different component values, any one circuit is similar to another. What makes the LM382 novel is the internal resistor matrix available on the chip. This enables an exceptionally low number of external components.

For the technically minded the RIAA transfer function of such an amplifier can be stated as:

$$G = \frac{(1 - jf_2/f)}{(1 - jf_1/f)(1 + jf/f_3)}$$

where  $f_1 = 50$  Hz,  $f_2 = 500$  Hz and  $f_3 = 2.12$  kHz.

This defines the corner frequency exactly and also the various slopes of the frequency response. It just so happens that capacitor/resistor feedback combinations can be used to achieve the required amounts of gain, corner frequencies and roll-offs. The internal resistor matrix of the LM382 simply allows us to use fewer external components in the circuit.

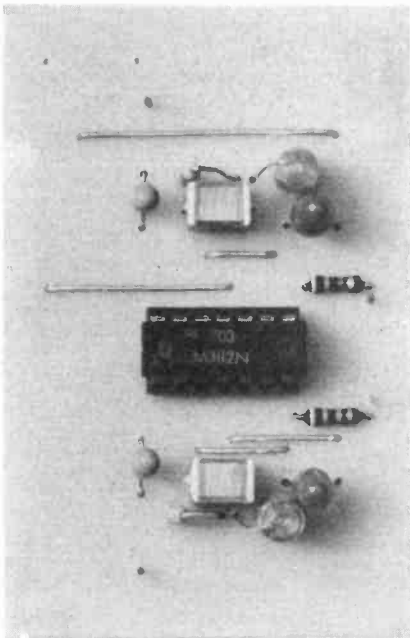
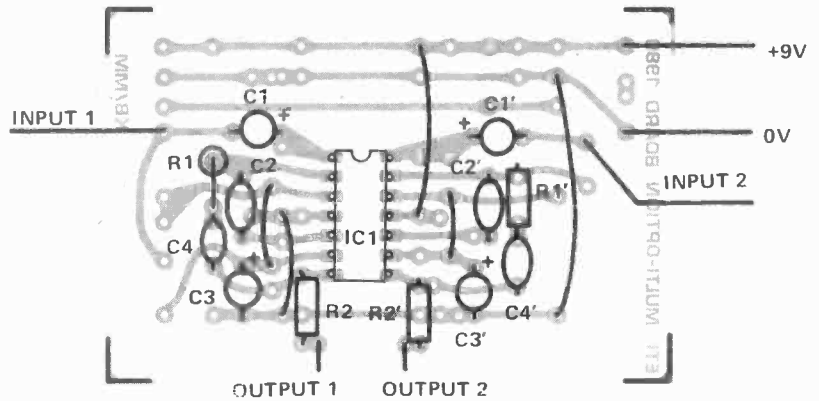

Fig. 2. (below) Component overlay of the stereo preamp fitted onto the Multi-Option PCB.



## PARTS LIST

Resistors all 1/4 W 5%

R1 1k0  
R2 47k

Capacitors

C1 1u0 35 V electrolytic  
C2 330n polycarbonate  
C3 33u 10 V electrolytic  
C4 1n5 polystyrene

Semiconductors

IC1 LM382

Miscellaneous

ETI Multi-Option PCB

## BUYLINES

The one chip and handful of components used should not present any problems. They should be readily available from suppliers advertising in this issue.

ETI

### ULTRA SLIM ALARM - CHRONOGRAPH

WITH 12/24 HOUR DISPLAY  
Only 6.5mm thick including a special battery hatch. Normal display is Hours, mins, secs, day of the week and p.m. indication. Display mode can be either 12 or 24 hour cycle. Other features include 24 hour alarm, 1/10th sec chrono with lap time and backlight. (Chrome colour).



A201S £13.50 ▶

### DUAL TIME ALARM CHRONOGRAPH

Incredible value for money. Sold elsewhere for £19.95. Normal display is Hours, mins, secs, or date, day of the week, PM and alarm indicator. Other features include, 2nd time zone, 1/10th sec chrono, backlight and 24 hours alarm. Buy now while the stock lasts. (Chrome colour).



◀ LM20 £10.95

### MYSICAL ALARM CHRONOGRAPH

Normal display is Hours, mins, secs, day of the week and Alarm and indicator. Other features include, 1/10th sec chronograph with lap time facility, month, date, backlight, 24 hours musical alarm. Plays FUR ELISE.

Case similar to model LM20



A205S £13.50

As illustrated in the picture

A202S £14.50

As illustrated but with Dual Time (Plays YELLOW ROSE OF TEXAS)

LM101 £15.95



### GENTS 6 DIGITS ALARM WITH DAY OF THE WEEK

Normal display is Hours, mins, secs, day of week, PM indicator and Alarm indicator. (Model A203L has extra large digit for better readability). It has a very useful 24 hour repeat alarm and 4 year auto calendar. (Chrome colour).

◀ A203S £8.50

### LADIES SNOOZE ALARM

Exceptionally good value for money. Normal display is Hours, mins, PM and Alarm on indications, other features include, 4 year auto calendar, backlight, 24 hour alarm with Snooze facility. Fully adjustable, stainless steel bracelet (Chrome colour).



LM102 £9.50 ▶

### LADIES SUGAR COATED DRESS WATCH

Ladies 9 function LCD watch. Hours, mins, secs, month, date, backlight. Auto date/time display mode, 4 year auto calendar. This watch has an optional auto date/time display mode. In this mode time and date is alternatively displayed every 2 secs. (Chrome or gold).



LM39 £8.95 ▶

### LADIES COCKTAIL WATCH

Ladies 9 functions LCD watch. Hours, mins, secs, month, date, backlight, auto date/time display mode, 4 year auto calendar. This watch has an optional auto date/time display mode. In this mode time and date is alternatively displayed every 2 secs. (Chrome colour).



◀ LM38 £5.95

- \* ULTRA SLIM DUAL TIME MUSICAL ALARM CHRONO. Only 7mm thick. Plays "YELLOW ROSE OF TEXAS". A204S £14.95
- \* VIDEO MASTER. 24-tune Doorchime £13.95
- \* VIDEOMASTER COMPUT-A-TUNE: 2 octave keyboard, replay with added musical effects. £19.95

#### GUARANTEE:

We will refund your money if not satisfied with our goods (return goods within 10 days in good conditions). All our products are guaranteed for one year. All prices include postage, packing and insurance. But if you require your watch in a felt presentation case please add 70p per watch to cover cost of extra postage and packing.

**AKHTER INSTRUMENTS LTD.**  
11-15 BUSH HOUSE  
HARLOW, ESSEX CM1B 6NS  
Tel: 0279 414464



# Buy a microcomputer for under £1,000 and you could be on your own! Unless it's a Commodore PET.

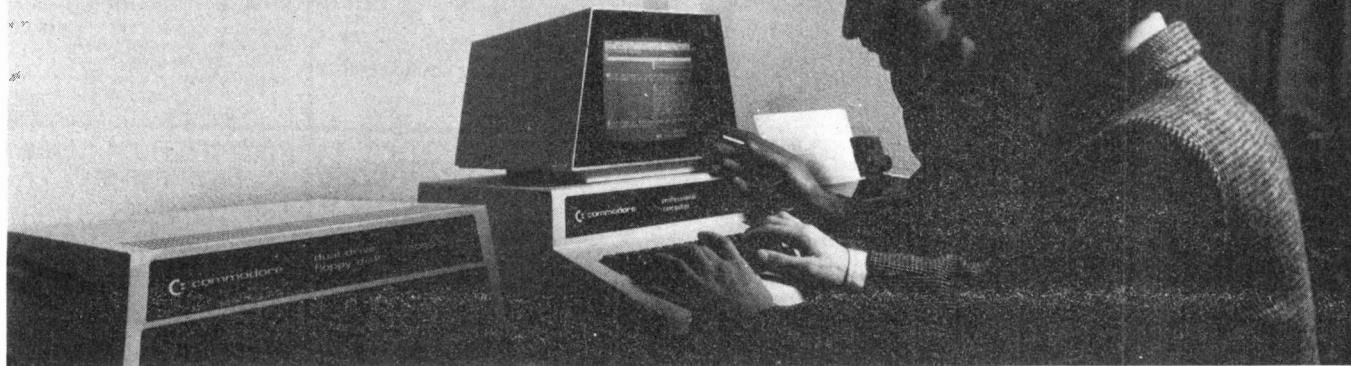

Commodore produce Britain's number one microcomputer. But we don't stop there. We also insist on providing comprehensive support throughout our national dealer network.

Our dealers can examine your needs and demonstrate which hardware and software will suit you best. Their trained engineers are always at hand and a 24-hour field maintenance service is available. Your local dealer can tell you more about the following Commodore Services.

## **C** The Commodore PET

The Commodore PET computer range covers everything from the self-contained unit at under £500 to complete business systems at under £2,500.

## **C** Commodore Business Software and Petpacks

Our software range covers hundreds of applications. Business software includes Sales and Purchase Ledgers, Accounting, Stock Control, Payroll, Word Processing and more. In addition over 50 Petpacks are available covering such titles as Strathclyde Basic Tutorial, Assembler Development System, Statistics, plus our Treasure Trove and Arcade series of games.

## **C** Commodore Approved Products

Compatible products of other manufacturers with Commodore's mark of approval are also available.

## **C** Commodore Courses

Commodore offer a range of residential training courses and one day seminars. An excellent start. And when you have installed your system the PET User's Club Newsletter can keep you informed of new ideas and latest developments.

### LONDON AREA

Adda Computers Ltd.  
W5. 01-579 5845  
Advanced Management Systems.  
EC2. 01-638 9319  
Byteshop Computerland.  
W1. 01-636 0647  
C.S.S. (Business Equipment) Ltd.  
E8. 01-254 9293  
Capital Computer Systems.  
W1. 01-636 3863  
Centralex-London Ltd.  
SE13. 01-318 4213  
Cream Microcomputer Shop.  
HARROW. 01-863 0833  
Da Vinci Computer Shop.  
EDGWARE. 01-952 0526  
L & J Computers.  
NW9. 01-204 7525  
Home and Business Computers.  
E12. 01-472 5107  
Merchant Systems Limited.  
EC4. 01-353 1464  
Metycleam Ltd.  
SW1. 01-828 2511  
Micro Computation.  
N14. 01-882 5104  
Micro Computer Centre.  
SW14. 01-878 3206  
Sumlock Bondain Ltd.  
EC1. 01-250 0505  
Sumlock Bondain Ltd.  
EC4. 01-626 0487  
T.L.C. World Trading Ltd.  
WC2. 01-839 3894  
TOPS TV LTD.  
SW1. 01-730 1795

### HOME COUNTIES

G. M. Marketing.  
ANDOVER. 790922  
HSV Microcomputers.  
BASINGSTOKE. 62444  
MMS Ltd.  
BEDFORD. 40601  
Elex Systems Ltd.  
BRACKNELL. 52929  
DDM Direct Data Marketing Ltd.  
BRENTWOOD. 229379  
Amplicon Micro Systems Ltd.  
BRIGHTON. 562163  
RUF Computers (UK) Ltd.  
BURGESS HILL. 45211  
T & V Johnson (Microcomputers  
Etc) Ltd. CAMBERLEY. 20446  
Cambridge Computer Store.  
CAMBRIDGE. 65334  
Wego Computers Ltd.  
CATERHAM. 49235  
Dataview Ltd.  
COLCHESTER. 78811  
South East Computers Ltd.  
HASTINGS. 428844  
Alpha Business Systems.  
HERTFORD. 57423  
Brent Computer Systems.  
KINGS LANGLEY. 65056  
Isher-Woods Business Systems.  
LUTON. 416202  
South East Computers Ltd.  
MAIDSTONE. 681263  
Micro Facilities Ltd.  
MIDDLESEX. 01-979 4546  
J.R. Ward Computers Ltd.  
MILTON KEYNES 562850  
Sumlock Bondain (East Anglia) Ltd.  
NORWICH. 26259  
T & V Johnson (Microcomputers  
Etc) Ltd. OXFORD. 721461  
H.S.V. Microcomputers.  
SOUTHAMPTON. 22131  
Super-Vision.  
SOUTHAMPTON. 774023  
Xitan Systems Ltd.  
SOUTHAMPTON. 38740  
Stuart R Dean Ltd.  
SOUTHEND-ON-SEA. 62707  
The Computer Room.  
TUNBRIDGE WELLS. 41645  
Orchard Electronics.  
WALLINGFORD 35529

Petallect Ltd.  
WOKING. 63901  
Oxford Computer Systems.  
WOODSTOCK. 811976

### MIDLANDS AND SOUTH HUMBERSIDE

Byteshop Computerland.  
BIRMINGHAM. 622 7149  
CPS (Data Systems) Ltd.  
BIRMINGHAM. 707 3866  
Camden Electronics.  
BIRMINGHAM. 773 8240  
Computer Services Midlands Ltd.  
BIRMINGHAM. 382 4171  
Catlands (Computers) Ltd.  
BURTON-ON-TRENT. 812380  
Ibek Systems.  
COVENTRY. 86449  
Jondane Associates Ltd.  
COVENTRY. 564400  
Davidson-Richards Ltd.  
DERBY. 366803  
Caddis Computer Systems Ltd.  
HINCKLEY. 613544  
H.B. Computers.  
KETTERING. 83922  
Taylor-Wilson Systems Ltd.  
KNOWLE. 6192  
Machsize Ltd.  
LEAMINGTON SPA. 312542  
Office Computer Techniques Ltd.  
LEICESTER. 286 31  
Lowe Electronics.  
MATLOCK. 2817  
Betos (Systems) Ltd.  
NOTTINGHAM. 48108  
Byteshop Computerland.  
NOTTINGHAM. 40576  
Keen Computers Ltd.  
NOTTINGHAM. 583254  
Tekdata Computing.  
STOKE-ON-TRENT. 813631  
Systems Micro.  
TELFORD. 460214  
McDowell Knaggs & Associates.  
WORCESTER. 427077

### YORKSHIRE AND NORTH HUMBERSIDE

Acrolyd Typewriter & Adding  
Machine Co. Ltd. BRADFORD. 31835  
Allen Computers.  
GRIMSBY. 40568  
Microware Computers Ltd.  
HULL. 562107  
Microprocessor Services.  
HULL. 23146  
Holdene Ltd.  
LEEDS. 459459

South Midlands Communications Ltd.  
LEEDS. 782326  
Yorkshire Electronics Services Ltd.  
MORLEY. 522181  
Computer Centre (Sheffield) Ltd.  
SHEFFIELD. 53519  
Electronic Services.  
SHEFFIELD. 668767  
Hallam Computer Systems Ltd.  
SHEFFIELD. 663125

### NORTH EAST

Dyson Instruments.  
DURHAM. 66937  
Currie & Maughan.  
GATESHEAD. 774540  
Wards (Office Supplies) Group.  
GATESHEAD. 605915  
Elfton Ltd.  
HARTLEPOOL. 61770  
Fiddes Marketing Limited.  
NEWCASTLE. 815857  
Newcastle Computer Services.  
NEWCASTLE. 615325  
Format Micro Centre.  
NEWCASTLE. 21093  
Tripart Associated Systems  
Consultants Ltd.  
SUNDERLAND. 73310

### SOUTH WALES AND WEST COUNTRY

Radan Computational Ltd.  
BATH. 318483  
Computer Corner.  
SHROESBURY 59788  
Bristol Computer Centre.  
BRISTOL. 23430  
C.S.S. (Bristol) Ltd.  
BRISTOL. 779452  
T & V Johnson (Microcomputers  
Etc) Ltd. BRISTOL. 422061  
Sumlock Tabdown Ltd.  
BRISTOL. 26685  
Sigma Systems.  
CARDIFF. 34869  
Office and Business Equipment  
(Chester) Ltd. DEESIDE. 817277  
A.C. Systems.  
EXETER. 71718  
Micro Media Systems.  
NEWPORT 59276  
J.M. Computer Services Ltd.  
NEWQUAY. 2863  
Devon Computers.  
PAIGNTON. 526303  
J.A.D. Integrated Services.  
PLYMOUTH 62616  
Business Electronics.  
SOUTHAMPTON. 738248  
Computer Supplies (Swansea).  
SWANSEA. 290047

### NORTH WEST AND NORTH WALES

Tharstern Ltd.  
BURNLEY. 38481  
B + B (Computers) Ltd.  
BOLTON. 26644  
Preston Computer Centre.  
PRESTON. 57684  
Catlands (Computers) Ltd.  
WILMSLOW. 527166

### LIVERPOOL

Aughton Microsystems Ltd.  
LIVERPOOL. 548 7788  
B.E.C. Computers.  
LIVERPOOL. 263 5738  
Rockcliff Brothers Ltd.  
LIVERPOOL. 521 5830

### MANCHESTER AREA

Byteshop Computerland.  
MANCHESTER. 236 4737  
Computastore Ltd.  
MANCHESTER. 832 4761  
Cytek (UK) Ltd.  
MANCHESTER. 872 4682  
Executive Reprographic Ltd.  
MANCHESTER. 228 1637  
N.S.C. Computer Shops Ltd.  
MANCHESTER. 832 2269  
Sumlock Electronic Services  
(Manchester) Ltd.  
MANCHESTER. 834 4233  
Professional Computer Services Ltd.  
OLDHAM. 624 4065  
D. Kipping Ltd.  
SALFORD. 834 6367  
Automated Business Equipment Ltd.  
STOCKPORT. 061-432 0708

### SCOTLAND

Holdene Microsystems Ltd.  
EDINBURGH. 668 2727  
Microcentre.  
EDINBURGH. 556 7354  
Aethorol Consultancy Services.  
GLASGOW. 641 7758  
Byteshop Computerland.  
GLASGOW. 221 7409  
Robox Ltd.  
GLASGOW. 221 5401  
Mac Micro.  
INVERNESS. 712203  
Thistle Computers.  
KIRKWALL. 3140

### IRELAND

Softech Ltd.  
DUBLIN. 784739  
Medical & Scientific Computer  
Services Ltd. LISBURN. 77533

To: Commodore Information Centre,  
360 Euston Road, London W1 3BL. 01-388 5702

Please send me further information about the Commodore PET.

Name \_\_\_\_\_

Position \_\_\_\_\_

Address \_\_\_\_\_

ETI D 2

Intended application \_\_\_\_\_

Do you own a PET? YES  NO

**commodore**

This list covers dealers participating in our advertising.



# TECH TIPS

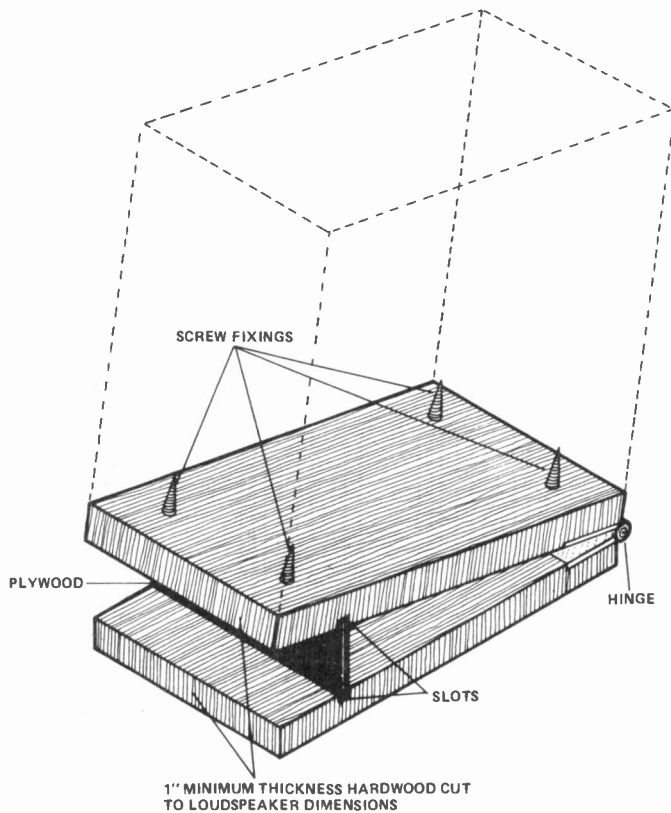

## Getting off the ground — cheaply

G. Adams, Poole.

The cost of loudspeaker stands prohibit many from buying them, although they are important to floor-standing arrangements for two reasons. They reduce possible colouration via floorboards etc. and, more importantly, they effectively heighten floor-standing loudspeakers so that the sound from each is directed where it should be, to one's ears, *not* to the upholstery and one's ankles!

With the latter problem particularly in mind, this design was finally decided upon. It is rather uniquely versatile, in that by using different sizes of plywood any degree of lift may be obtained. However, a lift of around 10° is considered a useful stone upon which to build.

## High Quality Headphone Amplifier

A. J. Jones, Cobridge

This circuit is capable of high performance using low cost, readily available components. The class A amplifier is designed to drive efficient, high impedance headphones of 150R and above, although it will drive 8R headphones with reduced performance.

Feedback is applied by R1,2 and gain with the specified components is 11. For maximum output the input sensitivity is 0 dB. Q3,4 and C4 form a gyrator circuit and present a high impedance to AC signals. This gives the circuit a high open-loop gain.

Quiescent current is set by R9 (approximately 60 mA).

Performance is good with distortion and noise measured on Radford test kit at less than 0.01%

for maximum output. Noise is less than -80 dB unweighted. Power bandwidth is less than 10 Hz to over 50 kHz. Slew rate is greater than 5 V/uS.

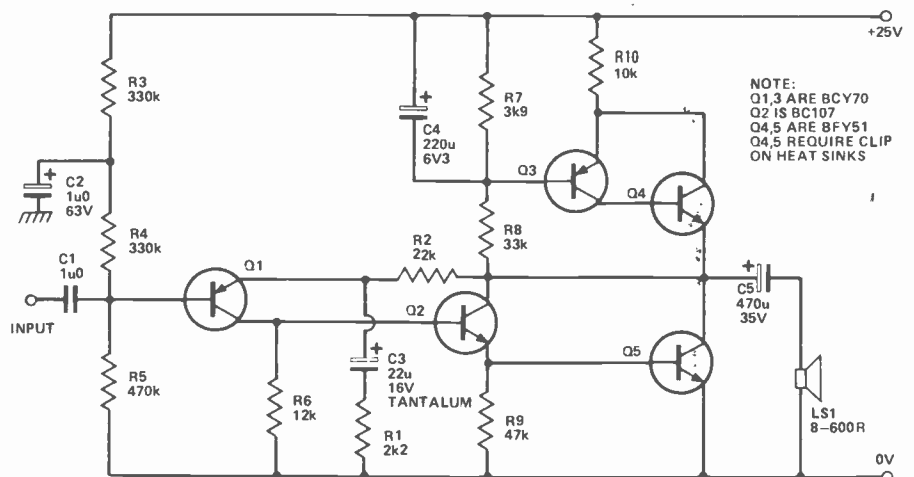

Tech-Tips is an ideas forum and is not aimed at the beginner. We regret we cannot answer queries on these items. ETI is prepared to consider circuits or ideas submitted by readers for this page. All items used will be paid for. Drawings should be as clear as possible and the text should preferably be typed. Circuits must not be subject to copyright. Items for consideration should be sent to ETI TECH-TIPS, Electronics Today International, 145 Charing Cross Road, London WC2H 0EE.

# Efficient P.A. Amplifier

N. D. Sheldon, High Wycombe

The efficiency of this amplifier is so high that an output of 3 W can be obtained with a BC107 used as the output transistor, even without a heatsink.

The amplifier consists of a voltage controlled pulse width oscillator working at about 6 kHz, driving a class D output stage. Since the output transistor is either hard on or completely off, the dissipation is minute — hence the high efficiency. The output waveform bears no resemblance to the input, but the integral of the output waveform is proportional to the integral of the input waveform, both with respect to time.

A table of component values has been given in order that any amplifier with an output of between 3 W and 100 W can be constructed. Still higher powers up to 1 kW can be obtained.

The drawback is that it produces about 30% distortion and can, therefore, be used for sound reinforcement only. It is especially suitable for public address systems, as speech is completely intelligible.

POWER (W)	R4	R5	Q3	HEATSINK	SUPPLY/V	O/P TRANSFORMER
3	1k5	390R	BC107	50 C/W	15	—
10	1k5	390R	BFY51	22 C/W	24	15R:8R0
30	1k0	270R	BD139	10 C/W	40	22R:8R0
100	820R	180R	BD139	5 C/W	60	35R:8R0

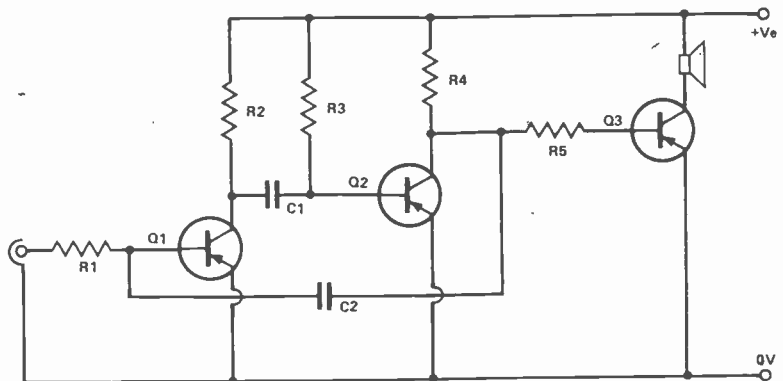
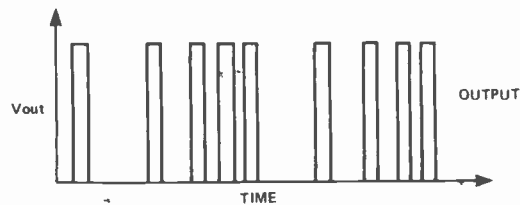
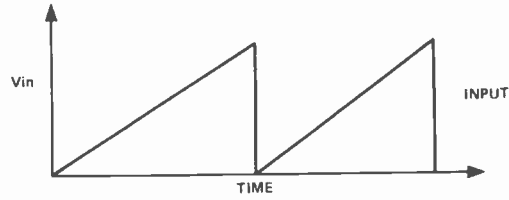

R1 27k	C1 1n8	Q1 BC107
R2 1k5	C2 1n8	Q2 BC107
R3 180k		

# Digital Op-Amp

K. Wood, Leicester

One half of a 4013 package may be used as an amplifier, if one doesn't mind a digital output whose duty cycle is proportional to the expected output voltage. This could always be filtered to recover an analogue output.

Clock pulses have to be applied as indicated and these should be considerably higher in frequency than the required bandwidth. Gain is  $R2/R1$  and the time constant  $R1R2C/(R1 + R2)$  should be longer than the period of the clock pulses.

Uses of the circuit include the following:

1. Take pulses from the zero

crossing point of the mains, drive a triac with the output and you have proportional power control without RFI.

2. Switch driver transistors with the output using a fast clock and you have a high efficiency PWM audio amplifier.

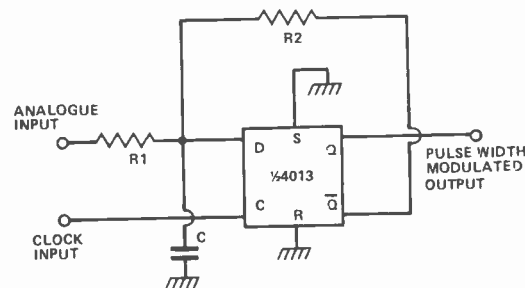

## Interior Light Delay

S.A. Johnson, Newcastle

The circuit shown will delay the car interior light by about 10-15 S, depending upon the time constant of R2-C1.

One big fault with most delay units is that the delay is so long that the light is still on when you drive away, which can be very annoying at night. This unit, however, will extinguish the light either 10-15 S after the door is

closed, or when the engine is started, whichever occurs first. The unit may be fitted without running any extra wires to it and may be fixed behind the interior light.

Capacitor C1 charges up through R2; thus turning Q1, Q2, RL1 and Q3 off after 10-15 S. When the door is opened C1 is discharged by the opto-isolator and begins to charge up after the door is closed.

If, however, the engine is started before 10-15 S the supply voltage will drop sufficiently to de-energise RL1, (approx 3V) and give C2 a positive pulse via Q3 which will charge C1 up sufficiently to switch Q1 off. **NOTE:** The value of C2 and ZD1 may need to be altered to get this effect.

The unit draws very little current when not in use and has only ten components.

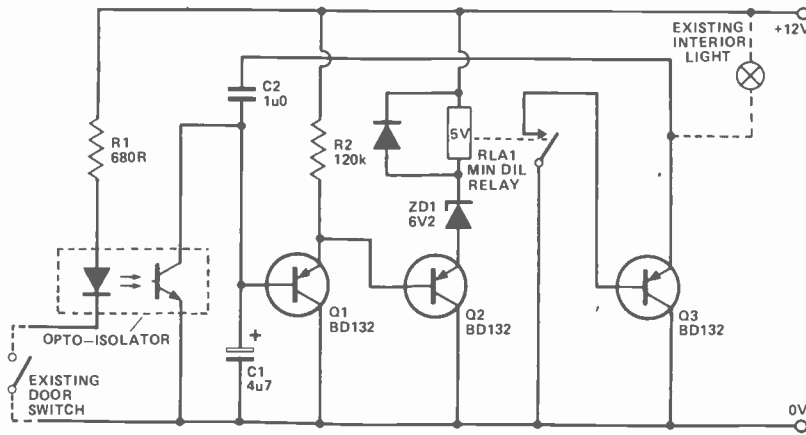

## Multivibrator

E. Vaughan, High Wycombe

The frequency of a conventional multivibrator is controlled by the R-C times constant of its feedback loops. This circuit has fairly good rise and fall time and will operate at repetition rates as high as 10-15 MHz. The disadvantage of this kind of circuit is poor frequency stability. Also, the frequency can be affected by temperature, voltage variations, and variation (within tolerance ranges) between capacitors and resistors in the feedback loops, the latter affecting not only frequencies, but waveform symmetry.

With the circuits shown, all these disadvantages can be eliminated and the advantages of a conventional multivibrator will not be lost. The same number of components are required as the crystal or crystals replace the capacitor in one or both feedback loops. The resistor value in the feedback is not critical. As it is used with a crystal it no longer controls the time constant.

Both CT cut or AT cut crystals are suitable. The circuit in Fig. 1 uses a crystal of 7 MHz with a low activity. Crystal activity was down to about one tenth of its 7MHz value when in the circuit, so it was not possible for it to operate below 750 kHz. To get below this a higher activity crystal would have to be used. Varying the feedback

resistor in a conventional multivibrator changes the frequency. This had no effect on the frequency the crystal controlled circuit. Then the capacitance of the 7MHz and 3.5MHz crystals in Fig. 2 were measured and came out as 13pF and 12pF respectively.

These capacitors are not in the range that create an R-C time constant that permits the circuit to work at the above frequency, so there is no doubt the crystal was controlling the frequency. With a crystal the circuit operates only at its rated frequency. Frequency tolerances in the order of 0.001 to 0.0001 percent can be obtained with this circuit. The 2N2475 used is a very fast switch. If another transistor is used it need not be as fast,

but should have a switching time that will permit operation at the desired frequency.

The circuit (Fig.1 modified) controls symmetry by employing different frequency crystals in the two feedback loops. R3 and R4 were changed to 10k and X2 to 3.5 MHz. The 7 MHz crystal remained in the second feedback loop. All other values are the same as shown in Fig. 1. This produces a symmetry of 2:1, but maintained a frequency stability of 0.007 percent with a 20 percent supply voltage variation. This modification has other advantages. It can be used to produce an extremely stable asymmetrical square wave. Crystals for this type of operation must have a harmonic relationship.

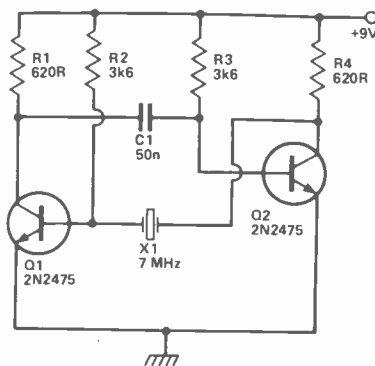

Fig. 1.

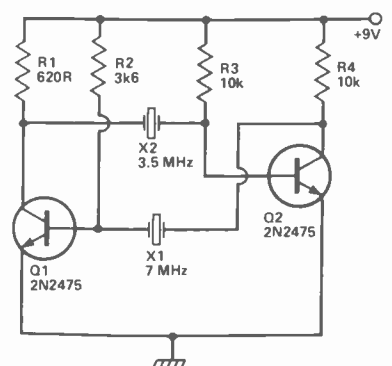

Fig. 2.

**CHOOSE FROM OVER  
20 TOP QUALITY  
MODULES**

**HIGHEST QUALITY**

BI-PAK Audio Modules are famous for their variety, quality of design and ruggedness. For over 10 years BI-PAK have been suppliers to manufacturers of high quality audio equipment throughout the world — to date, well over 100,000 modules have been sold — this is why discerning amateur enthusiasts insist on using BI-PAK modules in their equipment. They know that every item is designed and tested to do the job for which it is intended before it leaves the factory. Whatever you are building, there is a kit or module in the BI-PAK range to suit your every need from 5 watts to 125 watts, from amplifiers to equalisers. AND if you cannot see what you require in this advertisement, just write or phone us — we are waiting to help you!

# build a "tailor-made"

**WORLDWIDE  
SUPPLIERS OF  
AUDIO  
EQUIPMENT FOR  
OVER 10 YEARS**

**DESIGNED AND MADE  
IN BRITAIN**

**COMPLETELY  
GUARANTEED**

## **AL250** POWER AMPLIFIER 125 Watts r.m.s.

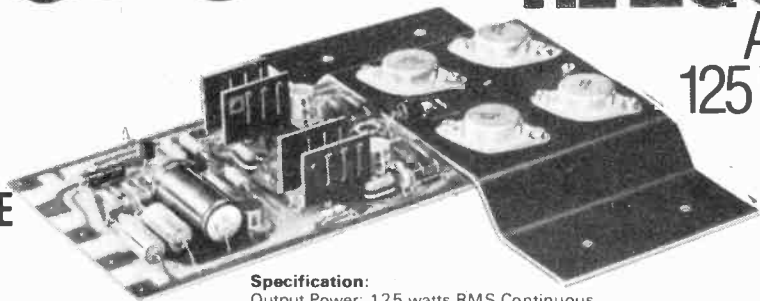

SPECIALLY DESIGNED  
FOR USE IN — DISCO  
UNITS, P.A. SYSTEMS,  
HIGH POWER HI-FI,  
SOUND REINFORCEMENT  
SYSTEMS

**Specification:**

Output Power: 125 watts RMS Continuous.  
Operating voltage: 50-80. Loads: 4-16 ohms.  
Frequency response: 25Hz-20kHz **Measured at 100 watts**  
Sensitivity for 100 watts output at 1kHz: 450mV  
Input impedance: 33K ohms. Total harmonic distortion:  
50 watts into 4 ohms: 0.1%  
50 watts into 8 ohms: 0.06%  
S/N ratio: better than 80dBs. Damping factor: 8 ohms: 65.  
Semiconductor complement: 13 transistors, 5 diodes. Overall  
size: Heatsink width 190mm, length 205mm, height 40mm.

**ONLY  
22.54  
£**

**AMPLIFIERS**

AL10. 3 watt Audio Amplifier Module 22-32v supply **£3.63**  
AL20. 5 watt Audio Amplifier Module 22-32v supply **£4.11**  
AL30A. 7-10 watt Audio Amplifier Module 22-32v supply **£4.78**  
AL60. 15-25 watt Audio Amplifier Module 30-50v supply **£5.92**  
AL80. 35 watt Audio Amplifier Module 40-60v supply **£9.28**

AL120. 50 watt Audio Amplifier Module 50-70v supply **£15.11**  
AL250. 125 watt Audio Amplifier Module 50-80v supply **£22.54**

**STEREO PRE-AMPLIFIERS**

PA12. Supply voltage 22-32v input sensitivity 300mv. Suit: AL10/AL20/AL30 **£9.83**  
PA100. Supply voltage 24-36v inputs: Tape, Tuner, Mag P.U. Suit: AL60/AL80 **£20.30**

PS200. Supply voltage 35-50v inputs: Tape, Tuner, Mag P.U. Suit: AL80/AL120/AL250 **£20.98**

**MONO PRE-AMPLIFIERS**

MM100. Supply voltage 40-65v inputs: Tape, Mag P.U. Microphone Max output 500mv **£14.29**  
MM100G. Supply voltage 40-65v inputs: 2 Guitars, Microphones Max output 500mv **£14.29**

## BI-KITS

**STA5.** 5 watts per channel Stereo Amplifier Kit consisting of: 2 x AL20 amplifiers, 1 x PA12 pre-amplifier, 1 x PS12 power supply, 1 x 2036 transformer and necessary wiring diagram **£22.14**

**STA10.** 10 watts per channel Stereo Amplifier Kit consisting of 2 x AL30 amplifiers, 1 x PA12 pre-amplifier, 1 x PS12 power supply, 1 x 2036 transformer and necessary wiring diagrams **£23.72**

**STA15.** 15 watts per channel Stereo Amplifier Kit consisting of: 2 x AL60 amplifiers, 1 x PA100 pre-amplifier, 1 x SPM80 power supply, 1 x 2034 transformer, 2 x coupling capacitors for 8 ohms 470mfd 30v and necessary wiring diagram **£42.27**

## BI-KITS

**STA25.** 25 watts per channel Stereo Amplifier Kit consisting of: 2 x AL60 amplifiers, 1 x PA100 pre-amplifier, 1 x SPM120/45 power supply, 1 x 2040 transformer, coupling capacitors for 8ohms, 470 mfd. 45v, 1 x reservoir capacitor, 2200mfd 100v and necessary wiring diagram **£46.58**

**STA35.** 35 watts per channel Stereo Amplifier Kit consisting of: 2 x AL80 amplifiers, 1 x PA100 pre-amplifier, 1 x 2035 transformer, 2 x coupling capacitors 470mfd at 50v for 8ohms, 1 x reservoir capacitor 2200mfd 100v and necessary wiring diagram **£52.62**

## BI-KITS

**STA50.** 50 watts per channel Stereo Amplifier Kit consisting of: 2 x AL120 amplifiers, 1 x PA200 pre-amplifier, 1 x 2041 transformer, 2 x coupling capacitors 1000mfd 63v, 1 x reservoir capacitor 3300mfd 100v and necessary wiring diagram **£68.87**

**STA100.** 100 watts per channel Stereo Amplifier Kit consisting of: 2 x AL250 amplifiers, 1 x PA200 pre-amplifier, 2 x SPM120/65 power supplies, 2 x 2041 transformers, 2 x coupling capacitors 1000mfd 100v and necessary wiring diagram **£97.38**

# hi-fi system with bi-pak!

### POWER SUPPLIES

PS12. 24v Supply. Suit: 2 x AL10, 2 x AL20, 2 x AL30 & PA12/S.450 **£1.90**

SPM80. 33v Stabilised supply. Suit: 2 x AL60, PA100 to 15 watts **£5.57**

SPM120/45. 45v Stabilised supply. Suit: 2 x AL60, PA100 to 25 watts **£7.34**

SPM120/55. 55v Stabilised supply. Suit: 2 x AL80, PA200 **£7.34**

SPM120/65. 65v Stabilised supply. Suit: 2 x AL120, PA200, 1 x AL250 **£7.34**

SG30. 15-0-15 Stabilised power supply for 2 x GE100MK11 **£4.37**

### MISCELLANEOUS

MPA30. Stereo Magnetic Cartridge Pre-Amplifier — input 3.4mv Output 100mv **£3.76**

S.450. Stereo FM Tuner Supply Voltage 20-30v — Varicap tuned **£29.40**

STEREO 30. Complete 7 watt per channel Stereo Amplifier Board — includes amps, pre-amp, power supply, front panel, knobs etc — requires 2050 Transformer **£24.25**

BP124. 5 watt 12v max. — Siren Alarm Module **£4.43**

GE100MK11. 10 channel mono-graphic equaliser, complete with sliders and knobs **£26.45**

VPS30. Variable regulated stabilised power supply 2-30v 0-2 amps **£8.74**

PS250. Consists — 1 capacitor & 4 diodes for constructing unstabilised power supply for AL250 to 125 watts **£3.78**

### TRANSFORMERS

2034. 1.7 amp 35v. Suit SPM80 **£5.40**

2035. 2 amp 55v. **£6.35**

2036. 750mA 17v. Suit PS12 **£3.20**

2040. 1.5 amp 0-45v-55v. Suit: SPM120/45, SPM120/55v **£5.20**

2041. 2 amp 0-55v-65v. Suit: SPM120/55, SPM120/65v **£6.80**

2050. 1 amp 0-20v. Suit Stereo 30 **£3.25**

1725. 150mA15-0-15v. Suit SG30 **£1.77**

### ACCESSORIES

139. Teak Cabinet. Suit: Stereo 30, 320x235x81mm **£6.45**

140. Teak Cabinet. Suit: STA15, 425x290x95mm **£9.77**

FP100. Front Panel for PA100 & PA200 **£1.80**

BP100. Back Panel for PA100 & PA200 **£1.60**

GE100FP. Front Panel for one GE100MK11 **£1.75**

2240. Kit of parts including Teak Cabinet, chassis sockets, knobs, to build 15 watt stereo amplifier **£19.95**

**Full data sheets are available FREE on request, please enclose a S.A.E.**

Access and Barclaycards accepted — just telephone our Orderline — Ware (STD 0920) 3182.

All prices include V.A.T., add 50p postage per order. C.W.O., cheques, Postal Orders payable to Bi-Pak at address below

# BI-PAK

## SEMICONDUCTORS

Dept. ETI.11, P.O. BOX 6, WARE, HERTS.

Tel. Ware (STD 0920) 3442. Telex: 817861.

Giro No. 388006.

Visit our shop at: 3 Baldock Street, Ware, Herts.

BARCLAYCARD



# TOUCH BUZZER

Buzz off to your heart's content with our simple touch operated buzzer. Circuit design by Keith Brindley.

Versatility is the name of the game — modern day electronics is no exception. In the jungle of electronic components only the fittest and most adaptable survive — the rest fall by the wayside. You need only cast your mind back two or three years to the days of the dedicated TV games chips which played table tennis or perhaps squash if you were lucky. They have been forgotten now with the advent of programmable games units which have recently reached the stage of very realistic 3-D effects.

## What About The Workers?

The 555 is a worker! It is adaptable to a wide variety of ideas and designs. It can operate on a power supply of 5 to 18 V. It can sink or source currents up to 200 mA.

The 555 has, therefore, been with us as a field leader for the ten years since Signetics first introduced it and you would be correct in assuming that it will be around for a while longer yet.

The ETI Touch Buzzer uses the dual version of the 555, which is designated the number 556. It is, of course, constructed on the ETI Multi-Option Board given away free with this issue and is extremely simple to build. You can utilise it as a rather clever VAS (Visitor Announcement System — otherwise known as a doorbell) or you can dream up your own uses for a very adaptable project. For instance, the output of the first half of the circuit from pin 5 of the 556 (see How It Works for circuit explanation), can be used to operate a low voltage relay to turn on and off other items of equipment and the circuit now operates as a touch switch.

## Construction

No problems with this project — just be careful to get the two tantalum capacitors and the IC in the right way round and you can't go wrong. The overlay shows the position of all components and interconnections so study it carefully. The touch controls can be any suitable pieces of conductive plate which may be at hand.

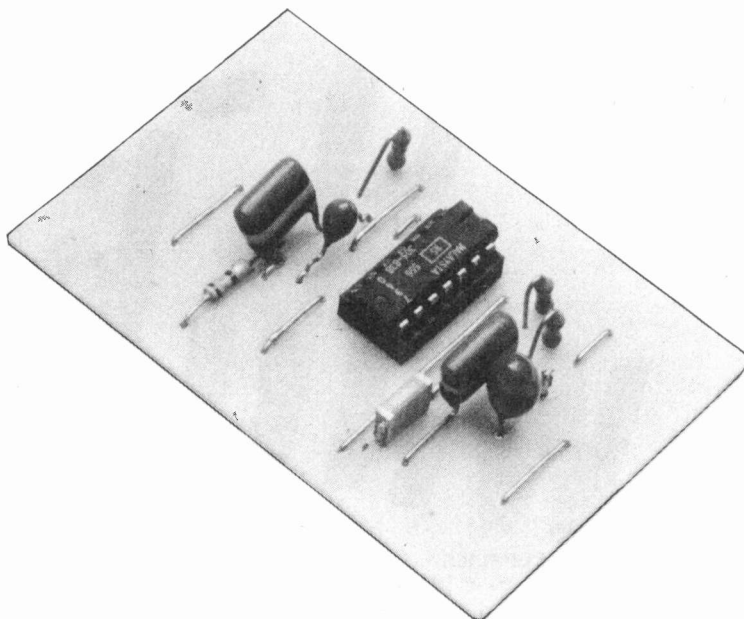

## HOW IT WORKS

The 556 is divided internally into two separate multivibrator circuits — a monostable followed by an astable. The monostable is triggered when the voltage at pin 6 of the IC is taken below one-third supply voltage. Normally pin 6 is held high by R2, a 2M7 resistor. However, when a finger is placed over the touch plates the skin resistance takes the voltage low.

The timing period of the monostable is given by the formula  $T = 1.1 \times R1 \times C1$ , which as all you budding mathematicians know (using the values of 100k and 10uF for R1 and C1 respectively) works out to be approximately 1 S. So every time the touch contacts are bridged the output (pin 5) of the monostable stays on (high) for about 1 S afterwards. The output is connected to the reset input (pin 10) of the second half of the chip, wired as an astable. The astable is prevented from oscillating when pin 10 is low and is allowed to oscillate when pin 10 is high. Thus, touching the contacts enables the astable to oscillate for about a second.

The timing components in the astable are set for a frequency of about 500 Hz.

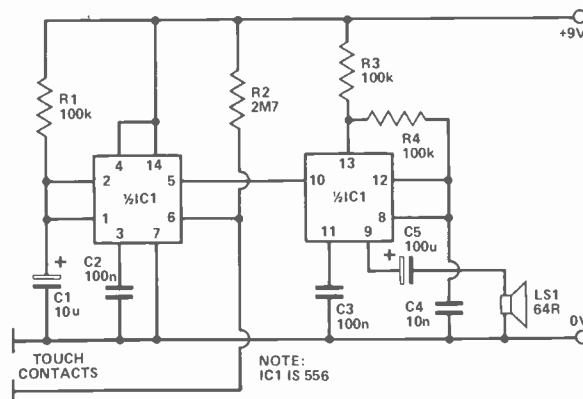

Fig 1. Circuit diagram.



**A PROJECT  
FOR YOUR  
FREE PCB**

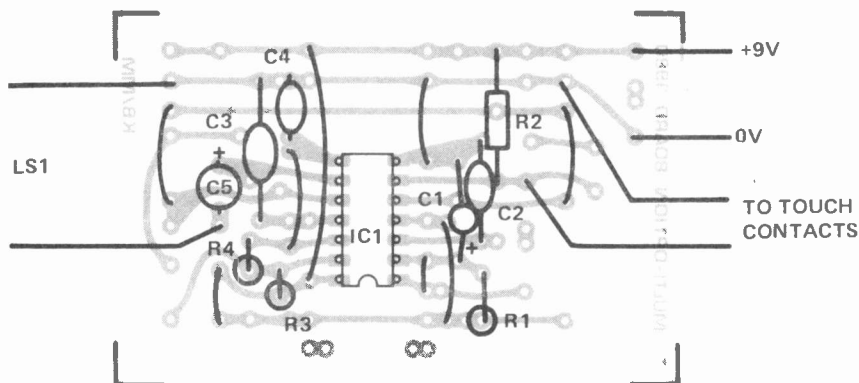

Fig 2. Component overlay. The touch contacts can be any available piece of conductor.

**PARTS LIST**

<b>Resistors All ¼ W 5%</b>	
R1, 3, 4,	100k
R2	2M7
<b>Capacitors</b>	
C1	10u 10 V tantalum
C2, 3	100n polyester
C4	10n polycarbonate
C5	100u 10 V tantalum
<b>Semiconductors</b>	
IC1	556
<b>Miscellaneous</b>	
LS1	64R miniature speaker
ETI	9 V battery and connector
Touch contacts	multi option board

**BUYLINES**

All of the components used in this project should be available from the usual mail order companies who advertise in the magazine.

ETI

# Conquer the chip.

Be it a career, hobby or interest, like it or not the Silicon Chip will revolutionise every human activity over the next ten years.

Knowledge of its operation and its use is vital. Knowledge you can attain, through us, in simple, easy to understand stages.

Learn the technology of the future today in your own home.

## MASTER ELECTRONICS LEARN THE PRACTICAL WAY BY SEEING AND DOING

- Building an oscilloscope. ● Recognition of components.
- Understanding circuit diagrams. ● Handling all types Solid State 'Chips'.
- Carry out over 40 experiments on basic circuits and on digital electronics.
- Testing and servicing of Radio, T.V., Hi-Fi and all types of modern computerised equipment.

## MASTER COMPUTERS

LEARN HOW TO REALLY UNDERSTAND COMPUTERS, HOW THEY WORK - THEIR 'LANGUAGE' AND HOW TO DO PROGRAMS.

- Complete Home Study library. ● Special educational Mini-Computer supplied ready for use. ● Self Test program exercise.
- Services of skilled tutor available.

## MASTER THE REST

- Radio Amateurs Licence. ● Logic/Digital techniques.
- Examination courses (City & Guilds etc.) in electronics.
- Semi-conductor technology.
- Kits for Signal Generators - Digital Meters etc.

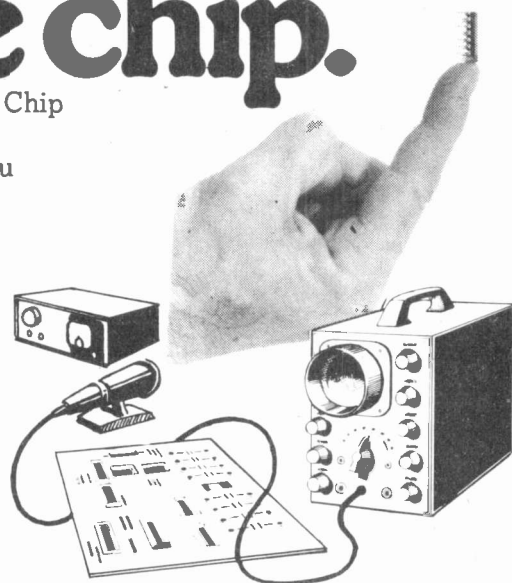

Please send your **FREE** brochure without obligation -

Name

Address

BLOCK CAPS PLEASE

I am interested in -

PRACTICAL ELECTRONICS.....

COMPUTER TECHNOLOGY.....

OTHER SUBJECTS.....  
(please state your interest)

**BRITISH NATIONAL RADIO & ELECTRONICS SCHOOL**  
4 CLEVELAND ROAD, JERSEY, CHANNEL ISLANDS. ETI/11/813

**SIMPLY AHEAD**  
and staying there

# The range grows bigger... better...

## New Profile Amplifiers - Two New Series

### MOSFET

CHOOSE AN I.L.P. MOSFET POWER AMP when it is advantageous to have a faster slew rate, lower distortion at higher frequencies, enhanced thermal stability, the ability to work with complex loads without difficulty and complete absence of cross-over distortion. I.L.P.'s exclusive encapsulation technique within fully adequate heatsinks has been taken a stage further with specially developed computer-verified 'New Profile' extrusions. These ensure optimum operating efficiency from our new MOSFETS, and are easier to mount. Connection is via five pins on the underside. **I.L.P. MOSFETS ARE IDENTICAL IN PERFORMANCE TO THE COSTLIEST AMPLIFIERS IN THIS EXCITING NEW CATEGORY BUT ARE ONLY A FRACTION OF PRICES CHARGED ELSEWHERE.**

Model	Output Power RMS	Distortion Typical at 1KHz	Slew Rate	Rise Time	Signal/Noise Ratio DIN AUDIO	Price & VAT
MOS120	60W into 4-8 $\Omega$	0.005%	20V/ $\mu$ s	3 $\mu$ s	100dB	£25.88 + £3.88
MOS200	120W into 4-8 $\Omega$	0.005%	20V/ $\mu$ s	3 $\mu$ s	100dB	£33.46 + £5.02

### BIPOLAR

CHOOSE AN I.L.P. BIPOLAR POWER AMP where power and price are first consideration while maintaining optimum performance with hi-fi quality and wide choice of models. From domestic hi-fi to disco and P.A., for instrument amplification, there is an I.L.P. Bipolar to fill the bill, and as with our new Mosfets, we have encapsulated Bipolars within our New Profile extrusions with their computer-verified thermal efficiency and improved mounting lugs. Connections are simple, via five pins on the underside and with our newest pre-amps and power supply units, it becomes easier than ever to have a system layout housed the way you want it.

Model	Output Power RMS	Distortion Typical at 1KHz	Slew Rate	Rise Time	Signal/Noise Ratio DIN AUDIO	Price & VAT
HY30	15W into 4-8 $\Omega$	0.015%	15V/ $\mu$ s	5 $\mu$ s	100dB	£6.34 + 95p
HY60	30W into 4-8 $\Omega$	0.015%	15V/ $\mu$ s	5 $\mu$ s	100dB	£7.24 + £1.09
HY 120	60W into 4-8 $\Omega$	0.01%	15V/ $\mu$ s	5 $\mu$ s	100dB	£15.20 + £2.28
HY200	120W into 4-8 $\Omega$	0.01%	15V/ $\mu$ s	5 $\mu$ s	100dB	£18.44 + £2.77
HY400	240W into 4 $\Omega$	0.01%	15V/ $\mu$ s	5 $\mu$ s	100dB	£27.68 + £4.15

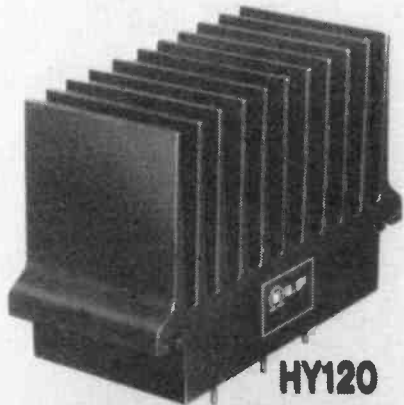

I.L.P. POWER AMPS ARE ENCAPSULATED FOR THERMAL STABILITY AND LONGER LIFE

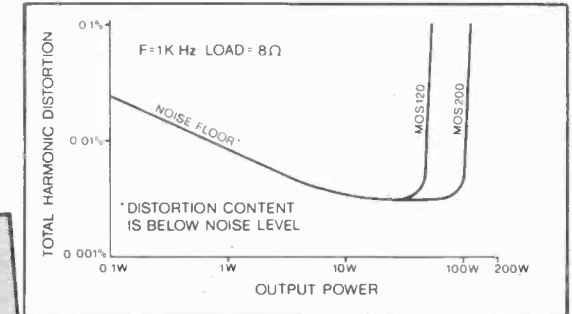

Load impedance both models 4 $\Omega$  -  $\infty$  Input sensitivity both models 500mV Input impedance both models 100K $\Omega$  Frequency response both models 15Hz-100KHz - 3dB

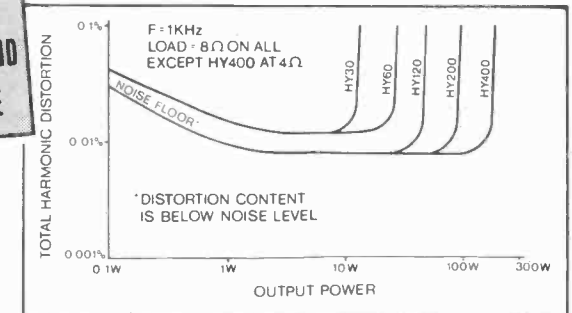

Load impedance all models 4 $\Omega$  -  $\infty$  Input impedance all models 100K $\Omega$  Input sensitivity all models 500mV Frequency response all models 15Hz-50KHz - 3dB



#### THE NEW PROFILE EXTRUSIONS

The introduction of standard heatsink extrusion for all I.L.P. power amplifiers achieves many advantages: - Research shows they provide optimum thermal dissipation and stability. Slotted shoulders allow easy mounting; standardisation enables us to keep our prices competitive. Surfaces are matt black, anodised for lower thermal conductivity. Extrusions vary in size according to module number.

# NEW PRE-AMPS

COMPATIBLE  
WITH ALL  
ILP MODULES

**HY6** (mono) and **HY66** (stereo) are new to I.L.P.'s range of advanced audio modules. Their improved characteristics and styling ensure their being compatible with all I.L.P. power-amps both MOSFET and BIPOLAR, giving you chance to get the best possible reproduction from your equipment. HY6 and HY66 pre-amps are protected against short circuit and wrong polarity. Full assembly instructions are provided. Mounting boards are available as below.

Sizes - **HY6** - 45 x 20 x 40 mm. **HY66** - 90 x 20 x 40 mm. Active Tone Control circuits provide  $\pm 12$ dB cut and boost.

**Inputs Sensitivity** - Mag. PU. -3mV; Mic - selectable 1-12mV; All others 100mV. **Tape O/P** - 100mV; **Main O/P** - 500mV. **Frequency response** - D.C. to 100KHz - 3dB.

**HY6** mono £5.60 + 84p VAT Connectors included  
**HY66** stereo £10.60 + £1.59 VAT Connectors included  
**B6** Mounting Board for one HY6 78p + 12p VAT  
**B66** Mounting Board for one HY66 99p + 15p VAT

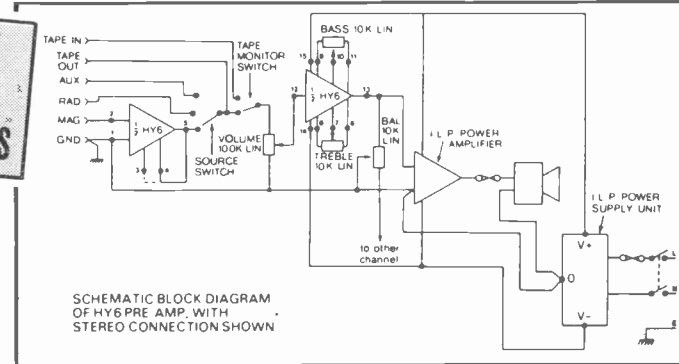

- DISTORTION TYPICALLY 0.005%
- S/N RATIO - 90dB (Mag. P.U. - 68 dB)
- 38 dB overload margin on Mag. P.U.
- LATEST HIGH QUALITY CONNECTORS
- ONLY POTS, SWITCHES AND PLUGS/SOCKETS NEED ADDING
- NEEDS ONLY UNREGULATED POWER SUPPLY  $\pm 15$  to  $\pm 60$ v

# NEW POWER SUPPLY UNITS

IN A RANGE OF 11 MODELS USING  
LATEST TOROIDAL TRANSFORMERS

Of the eleven power supply units which comprise our current range, nine have toroidal transformers made in our own factory. Thus these I.L.P. power supply units are space-saving, more efficient and their better overall design helps enormously when assembly building. All models in the range are compatible with all I.L.P. amps and pre-amps with types to match whatever I.L.P. power amps you choose.

- PSU30**  $\pm 15$ V at 100mA to drive up to 12 x HY6 or 6 x HY66 £4.50 + 0.68p VAT
- THE FOLLOWING WILL ALSO DRIVE I.L.P. PRE-AMPS**
- PSU36** for 1 or 2 HY30's £8.10 + £1.22 VAT
- PSU50** with toroidal transformer for 1 or 2 HY60's £9.75 + £1.46 VAT
- PSU60** with toroidal transformer for 1 HY120 £9.75 + £1.46 VAT
- PSU65** with toroidal transformer for 1 MOS120 £9.75 + £1.46 VAT
- PSU70** with toroidal transformer for 1 or 2 HY120's £13.61 + £2.04 VAT
- PSU75** with toroidal transformer for 1 or 2 MOS120 £13.61 + £2.04 VAT
- PSU90** with toroidal transformer for 1 HY200 £13.61 + £2.04 VAT
- PSU95** with toroidal transformer for 1 MOS200 £14.75 + £2.21 VAT
- PSU180** with toroidal transformer for 1 HY400 or 2 HY200 £23.02 + £3.45 VAT
- PSU185** with toroidal transformer for 1 or 2 MOS200 £24.20 + £3.63 VAT

## 1971-1980 TEN YEARS OF PLANNED PROGRESS

When, as a young man in 1971, Ian L. Potts founded his now world-famous company, he realised the need for a different and more rational approach to exploiting to the maximum, the potential of modular construction. New thinking was badly needed. The result was a range of modules completely revolutionary in concept. The rightness of Ian Potts' thinking is shown in the size of the company today, its new factory, its vast exports, its acceptance by constructors as the modules to build with. The range grows bigger and better. New lines (in no way replacing existing ones) are well past drawing board stage. This is why I.L.P. are simply ahead and staying there - we don't rest on our laurels.

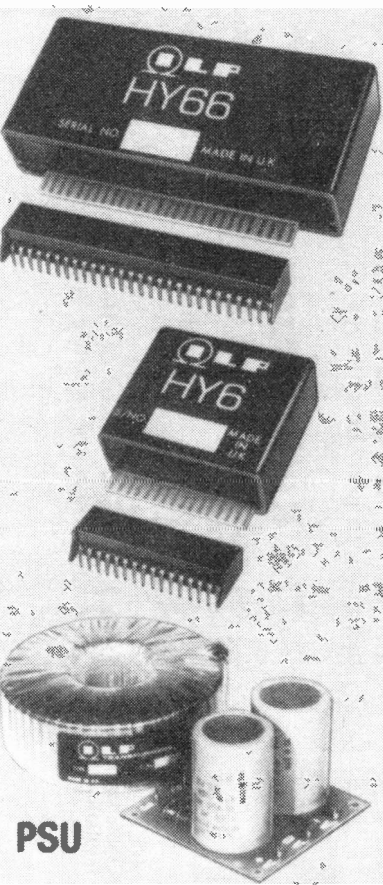

**NO QUIBBLE 5 YEAR GUARANTEE**  
**7-DAY DESPATCH ON ALL ORDERS**  
**BRITISH DESIGN AND MANUFACTURE**  
**FREEPOST SERVICE**

★ **Freeport facility**  
 When ordering or writing about I.L.P. products, you do not need to stamp the envelope. Mark it FREEPOST plus the code shown in the address below. We pay the postage for you

★ **TO ORDER** Send cheque or money order payable to I.L.P. Electronics Ltd and crossed. Or pay by ACCESSOR BARCLAYCARD. Cash payments must be in registered envelope, if C.O.D. payment is wanted, please add £1.00 to TOTAL value of order.

## BRITAINS FASTEST GROWING MODULE SUPPLIERS

To: I.L.P. ELECTRONICS LTD, CANTERBURY CT2 7EP

Please supply .....

..... Total purchase price £.....

I enclose Cheque  Postal Orders  International Money Order

Please debit my Access/Barclaycard Account No. ....

NAME .....

ADDRESS .....

Signature .....

**I.L.P. ELECTRONICS LTD.**

FREEPOST 4 Graham Bell House, Roper Close,  
 Canterbury, Kent CT2 7EP.  
 Telephone (0227) 54778 Telex 965780

Available also from MARSHALLS, WATFORD ELECTRONICS and certain other selected retailers

**ALL U.K. ORDERS  
 DESPATCHED  
 POST FREE**

# ASTROLOGUE

The Farnborough Air Show opened its doors to the public again this year. Ian Graham reports on the Show with the latest news on the Space Shuttle.

The Space Shuttle was born in the heady days of the Apollo moon-landings, when America was the undisputed leader in the high-technology stakes. However, spaceflight gradually became 'ordinary', Press coverage waned, America's national pride took a couple of severe knocks and the world started downhill towards its worst post-war recession. These factors conspired to influence the Office of Management and Budget to cut the NASA Shuttle budget by thousands of dollars a year.

## Going, Going, Wrong...

The earliest failures were in the main engine. Because of underfunding, NASA departed from its usual practice of proving each component separately before it was integrated into the complete system. The Shuttle main engine was tested as a whole. Consequently, some minor failures were accompanied by major engine damage. The first flight back-up engine was recently shut down automatically ten seconds into a 100 S burn. A defect in the operation of the high pressure liquid oxygen turbopump started a fire, damaging the turbopump, the main engine controller and some oxygen piping.

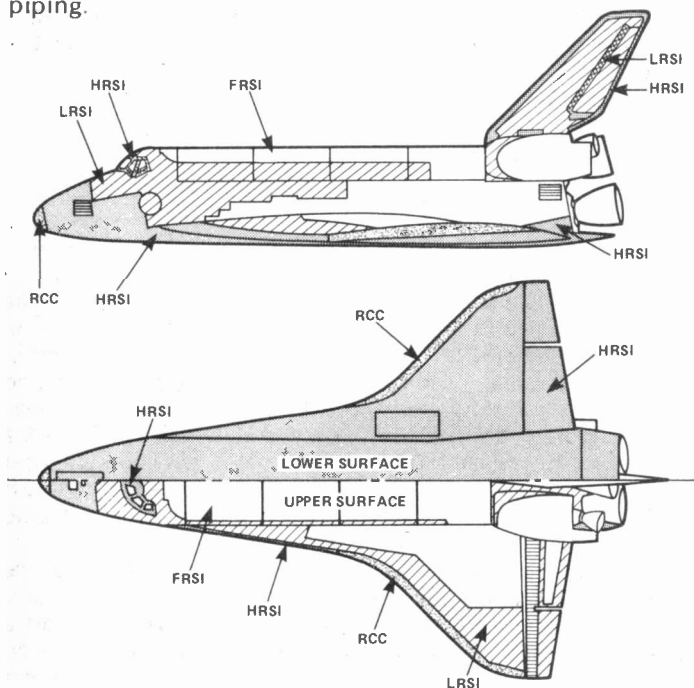
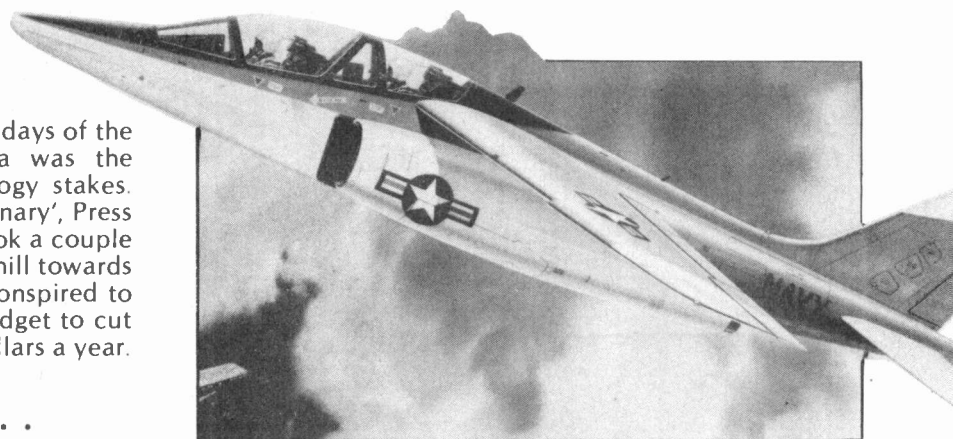

Fig. 1 The Space Shuttle's Thermal Protection System. RCC — reinforced carbon-carbon; HRSI — high temperature, reusable surface insulation; LRSI — low temperature, reusable surface insulation; FRSI coated Nomex felt, reusable surface insulation.



An artist's impression of Lockheed's new Alpha Jet during its three week tour of American military bases. The aircraft is competing for selection as a new advanced training aircraft for the US Navy.

## Fact Or Fiction

The heat shield material used on Mercury, Gemini and Apollo was unsuitable for the Space Shuttle, because it could only be used once. On re-entry it slowly boiled off, dissipating the air friction heat. Heat conduction in the silicate developed for the Shuttle was almost zero. (You may remember the alarming photograph published at the time of a technician holding a tile at one corner while the centre glowed red hot).

The process of bonding the tiles to the Shuttle's aluminium skin was not researched as extensively as the tile thermal behaviour. Indeed, air friction alone was sufficient to strip some of the tiles off during a short flight on the back of its 747 carrier aircraft. Several thousand more may have to be removed, strengthened and replaced.

Unfortunately there wasn't a Space Shuttle at the Air Show, but there was a Press conference dealing with NASA's plans for the 1980s. Naturally, though, most interest was focused on the Space Shuttle.

The first launch is still expected by next March. Although we have become accustomed to taking revised launch dates with a pinch of salt, March 1981 *does* seem to be more definite than the others. Some of those involved in making preparation at the Cape are beginning to get 'launch fever'.

## The Retile Trade

November 23rd should see the completion of tile replacement work. I was given a rather distressing demonstration of the mechanical properties of the thermal tiles. A piece of tile material was held up and snapped between two fingers like a piece of polystyrene foam. The endurance of the tiles in service will determine when the Shuttle finally goes operational.

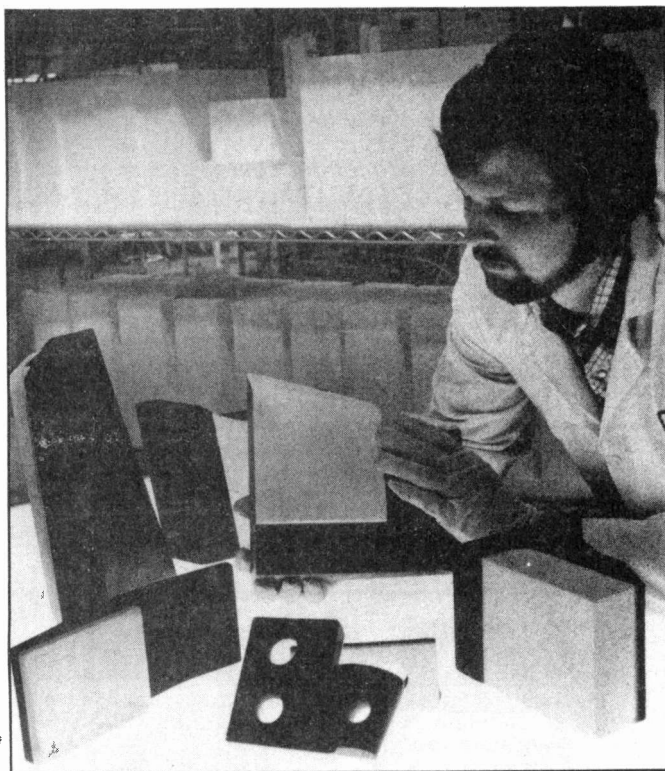

At the Lockheed plant in Sunnyvale, California, a technician examines some of the silica tiles manufactured for the Space Shuttle. As each tile is shaped to fit only one spot on the spacecraft, no two tiles are the same.

That is planned for the fifth flight in September 1982. However, if large numbers of the tiles have to be removed and replaced between flights, the operational date will have to be put back.

Shuttle flights are all booked up until 1986. Therefore, conventional Delta and Atlas-Centaur launchers will continue to fly until at least 1985.

The Shuttle's thermal protection is far from satisfactory. However, the production of the current series of Orbiters is so far advanced that no major hardware changes can now be implemented.

For equatorial flights, the Shuttle will be launched from Cape Canaveral. For polar flights, it will be launched from Vandenberg Air Base. The work necessary to prepare Vandenberg for the Shuttle should be finished in 1984.

## Outdoors

The highlight of the Show was the flying display. I was deafened and delighted by a cross-section of the world's civil and military aircraft. The Shorts Skyvan demonstrated its short (and I mean *short*) take-off and landing capability. Lulled into a false sense of security by the Canadair Challenger and Shorts displays, I was deafened by the Dassault military aircraft. An Alphajet, Mirages and a Falcon screamed around the airfield.

Five Westland helicopters approached the airfield from all angles. Each entertained the land-bound throng and 'parked' in the air in line with its predecessor. The line of aircraft hung in the air for a moment in silent salute and then made off. The British Army have ordered 100 Lynx helicopters. The Royal Navy have ordered 70 to replace Westland Wasps. Total Lynx orders are currently approaching 300.

Stars of the display were the American fighters — General Dynamics' F-16 and McDonnell Douglas' F-15A and F-18. The US Air Force plans to buy no less than 1400 F-16s. The 200th was delivered recently. More than 500 F-15A Eagles have also been delivered. Each has a maximum speed of more than Mach 2.5.

The US Navy needs 1377 F-18 Hornets. Each has a maximum speed in excess of Mach 1.8.

## Optica

The Optica, designed by John Edgley was, perhaps, the oddest participant in the Show. The Bug-eyed EA7 Optica made its first flight from Cranfield Institute of Technology last Summer. It is designed to be used as a three seat observation aircraft. The cabin is mounted in front of the engine, a 180 HP Lycoming IO-360, which drives a ducted propulsor instead of a conventional propeller. The floor area can be modified to carry vertical mounting cameras. It is claimed to be a quiet machine both inside and outside. From the ground, it was certainly one of the quietest craft in the display.

## Cosmic Traffic Jam

We've always thought of space as limitless. However, it is most useful to place a satellite in a geostationary (or geosynchronous) orbit about the equator. That is, the satellite appears to be stationary in the sky — it is orbiting as fast as the Earth is turning. That particular orbit is now becoming overcrowded. Looking towards the 1990s, NASA is carrying out research into new telecommunications techniques to allow fewer satellites to carry greater workloads. In future, tracking and data relay satellites will also replace some ground stations.

NASA may co-operate with the European Space Agency (ESA) to fly a satellite to Halley's comet. ESA is committed to sending the satellite and has offered NASA experimental space on-board. NASA may provide the launcher.

## Indoors

NASA, ESA, satellites...in fact spaceflight in general constituted a very small part of the Show. The two spacious exhibition halls were packed with just about everything with anything to do with aviation and avionics. The main feature of Plessey's stand in the North Hall was a new, fully-equipped production version of a Transportable Air Defence Processing and Control Cabin. It houses the signal processing equipment and displays for the Plessey AR3D Long Range Radar system. The Radar and P & C Cabin provide ground forces with a mobile, autonomous radar command and control post capability. The post can automatically track 40 aircraft and carry out eight interceptions. The AR3D's electronic countermeasures can also be selected.

Ferranti announced the development of a miniature inertial navigation system (FIN2000) for use in military aircraft. Positional data is presented to the pilot on a control and display unit and is typically accurate to within 1 nm/hr of operation. The modular system features extensive built-in test and self-calibration facilities for easy maintenance and enhanced reliability. Pre-production models will shortly begin flight trials at the Royal Aircraft Establishment.

ETI

World famous for quality, reliability and value for money. 20,000,000 customers can't be wrong!

Now Casio, the new technological leaders, take a giant step forward in time with

# THE ULTIMATE WATCHES



**Analogue Display**



**Digital Display**

You have to hand it to Casio for the best of both worlds!  
AA81 LCD ANALOGUE/DIGITAL ALARM CHRONOGRAPH

- **LCD Analogue.** Independent display of hours and minutes, with synchronous digital seconds, can be used as a dual time.
- **Digital.** Independent display of hours and minutes, synchronous seconds, day and date.
- **Auto calendar.** Four year calendar is set for 28 days in February.
- **Professional stopwatch.** Measures net, lap and 1st & 2nd place times in units 1/100 second to 12 hours. A signal confirms start/stop operation and sounds at 10 minute intervals.
- **Daily reminder alarm.** Sounds at the pre-set time and an amazing "Star Burst" display flashes for 30 seconds. "Alarm on" symbol.
- **Countdown alarm.** Measures normal and net times from 1 minute to 60 minutes. 30 second alarm and "Star Burst" display. 10 minute signal. Star/stop signal.
- **Time signal.** Every half hour on the half hour. Every hour on the hour. Two tones.
- **Tone control.** Tone pitch can be varied in 10 steps.
- **Lithium battery.** Approx. 18 months life using alarm for 90 seconds and nightlight for 3 seconds daily.  $\pm$  15 secs/month accuracy. "Merry-go-round" demonstration display. Water resistant case 8.65mm thick. Mineral glass. Matching stainless steel bracelet.

**ONLY £29.95 for around 40 functions. RRP £34.95**

*Sent 20-10-80*

Tune in to Casio. 12 melodies will alarm you — the price won't!

**12 MELODY ALARM CHRONOGRAPHS with countdown; date memories**

- **Time display.** Hours, minutes, seconds, am/pm. 12 or 24 hour format.
- **Calendar.** Day, date and month auto 4 yrs. calendar.
- **Daily alarm.** 7 melodies, one for each day of the week, including "American Patrol."
- **Hourly time signal.** With "Big Ben" type tune. When date memories are set, the chosen melody is played instead of the time signal. Easily switched on or off.
- **Date memory.** Select "Trinkled" or "Wedding March" to be played instead of hourly chimes on the set day. Press the calendar button for additional renditions.
- **Birthday memory.** "Happy Birthday" is played instead of hourly chimes, or when the calendar button is pushed. The message "Happy" is also displayed.
- **Christmas memory.** On December 25th "Jingle Bells" is played instead of the hourly chimes, or when the calendar function is selected.
- **Countdown alarm.** From 1 second to 1 hour. At zero a chime sounds for 10 seconds and the count continues positively for 1 hour.
- **Stopwatch.** Net, lap and 1st & 2nd place times from 1/10 second to 1 hour. A signal confirms start/stop operation. A signal sounds at 1 minute intervals.

Picturesque moving display of every note played. One touch melody demonstration. Built-in speaker. Backlight. 2 year battery. Mineral glass. Water resistant case.

**M-12** Resin case and strap, S/S trim. **M-1200** All stainless steel. 9.0mm thick case.



**M12**  
(£26.95)  
**£24.95**



**M1200**  
(£34.95)  
**£29.95**



**W100**  
**£19.95**

**W150C**  
**£25.95**  
**100 METRE WATER RESISTANT**

**W150B**  
**£32.50**

Get in the swim with Casio — 300 feet down!  
**100 METRE WATER-RESISTANT ALARM CHRONOS with countdown**

- **Amazing FIVE YEAR battery life.** Around 30 functions
- **Timekeeping mode.** Continuous display of hours, minutes, seconds, am/pm, day date and month. 12 or 24 hour mode. Time is always visible, regardless of the display modes. Auto 4 year calendar set at 28 days for February.
- **Professional stopwatch.** Net, lap and 1st & 2nd place times from 1/100 second to 1 hour. A signal confirms start/stop operation, and sounds at 10 minute intervals.
- **Daily reminder alarm.** Sounds for 30 seconds at the pre-set time. "Alarm on" symbol.
- **Time signal.** Sounds every half hour on the half hour, and every hour on the hour. (Two tones). The time signal, with symbol, can be switched on or off.
- **Lithium battery.** Approx. 5 years life, using alarm for 100 seconds and nightlight for 3 seconds per day.  $\pm$  15 seconds per month accuracy. Mineral glass.
- **100 METER WATER RESISTANT CASES.** **W-100** Resin case 9.65,, thick, resin strap. **W-150C** Metal case, resin strap. **W-150B** Metal case and S/S bracelet.

**See also A250 on opposite page**

Price includes VAT and P&P. Send your company order, cheque, P.O. or phone your ACCESS or BARCLAYCARD number to:

# TEMPUS

Dept. ETI, FREEPOST, 164-167 East Road, Cambridge CB1 1DB. Tel: 0223 312866

# JOIN THE KEYBOARD REVOLUTION!

## WITH THE AMAZING NEW CASIOTONE 201

The natural fidelity of 29 instruments, preserved on one keyboard. Not an organ or synthesizer. The Casiotone 201 is a remarkable new concept in electronic keyboard instruments, using a totally new technology to reproduce an astonishing variety of musical sounds.



**ONLY £245 (RRP £285)**  
Wait till you get your hands on it

The future of music, for home or stage. As used by the internationally famous DOOLEYS

Pitch, timbre and harmonics of 29 instruments have been measured, digitalised and stored in electronic chip memory for faithful reproduction. A 4-sound memory function allows you to change between any 4 pre-selected instruments at a touch. In all modes this professional multi-instrument is polyphonic — it can play full chords of up to 8 notes together. The 29 white and 20 black keys span four octaves. The simple-to-use control panel has a 4-position Instrument Memory selector, Vibrato switch, Tone switch, and Volume control. Integral speaker. LINE OUT, AUX IN, ECHO TO and ECHO FROM Jacks. FOOT VOLUME pedal and SUSTAIN pedal options. Velvet black or Woodgrain. Dimensions: 3x33½x9½ inches. Weight: 15lbs. AC only.

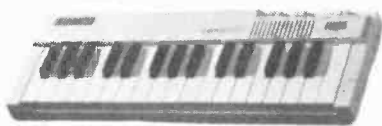

**CASIOTONE M-10. Four instruments on the move!**  
An instrument of the new age, encompassing the finest of the old. 8-note polyphonic playing of piano, organ, violin and flute. 32 keys. 19 white and 13 black. span two and a half octaves. Instrument selector switch. Vibrato switch. Volume control. Integral speaker. Output jack for external amplifier, headphones etc. Mains/battery capability. 2x16½x5½ inches. 3.5 lb.

RRP £79. ALL THIS FOR **ONLY £69**

Casio means digital music!

# SEIKO

## DUO DISPLAY

Independent analogue display of hours and minutes, with sweep-second hand. Digital display of hours, minutes, seconds, am/pm (1/2 or 24 hour format). Day and date auto 4 year calendar function. 24 hour alarm with "alarm on" symbol and hourly chimes. 1/100 second stopwatch to 1 hour, normal and net. 2 year battery with battery life indicator. Stainless steel. Water resistant. Hardlex glass.

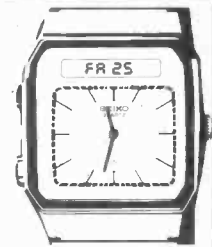

**JET 010** (illustrated)  
Equivalent to HV013

**ONLY £62.50**

**JET 018** (Equivalent to HV011)  
**JET 028** (Equivalent to HV005)  
**JET 994** Gold plated, champagne dial  
**JES 994** (Equivalent to HX008)

**£62.50**  
**£62.50**  
**£92.50**  
**£67.50**

## DFT 048

ALARM CHRONOGRAPH

Countdown timer.

Hours, minutes, seconds, alpha day and date. 24 hour alarm and hourly time signal. Stopwatch times in units of 1/100 second to 12 hours, net, lap and 1st & 2nd place. Countdown alarm timer up to 1 hour. Backlight. Stainless steel. Hardlex glass. Water resistant.

**ONLY £37.50**

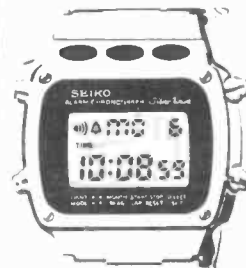

## DFT 038

100 METRE

Water resistant

Suitable for swimming, water skiing etc.

Functions as DFT 048 above.

**£49.95**

## DER 048

ALARM CHRONOGRAPH

Solar powered

Weekly alarm

Countdown alarm

Hours, minutes, seconds, day, date and month. Weekly programmable alarm. Hourly chimes. Interval countdown alarm timer from maximum of 16 hours. Stopwatch times in 1/100 up to 20 minutes, then in seconds to 12 hours. Net, lap, 1st & 2nd place timing. Double display function. Stainless steel. Hardlex glass. Water resistant.

**ONLY £52.50**



## DER 018

100 METRE

Water resistant

Suitable for swimming, water skiing etc.

Functions as DER 048 above.

**£69.95**

All Seiko watches have an international 12-month guarantee.

## CASIO LADIES WATCHES

Hours, minutes, 10-seconds, seconds (by flash) am/pm. Day, date month calendar. Stopwatch. Dual time.

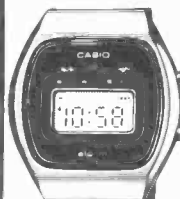

LA550  
Alarm  
**EP.O.A.**



87QL-19B  
Stainless Steel  
**£29.95**



87QL-18B  
**£27.95**



87QL-13B  
Chrome  
**£16.95**



L-20  
Chrome  
**£14.95**



L-10  
Sports  
**£10.95**

## WATCH THIS SPACEWAR

The bored room calculator CASIO MG-880

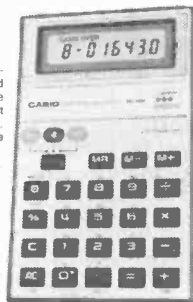

An ordinary calculator?? Absolutely enthralling. Action-packed speed game. You against the spaceships. Beat the highest score! 11-note melody maker, pre-programmed "When the Saints Go Marching In". Full memory, %, auto-power off. 1½x2½x4½ inches.

(£12.95) **£10.95**

12 Pre-programmed melodies  
MELODY 90 (ML-90)

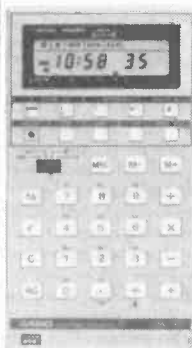

Clock, calendar, stopwatch, calculator, 11-note melody maker, %, square roots. Alarm 1-7 tones, one for each day. Alarm 2. A fixed tune. Date Memory, four anniversary tunes. Kiss touch keys. 1 year battery life. 7/32x2½x4½ inches.

(£22.95) **£19.95**

MELODY 81 (ML-81) RRP £22.95 **£19.95**

Clock, calendar, 2 melody alarms, countdown alarm, stopwatch, 11-note melody maker, calculator, %, square roots. 5/16x4½x2¼" 14 months batteries.

All other Casio Calculators. P.O.A.

## A250 Alarm chronograph

The same module as W-100 and W-150 watches but in a standard water resistant case.

RRP £T.B.A.

**ONLY £T.B.A.**

## S220 Chronograph

Very similar to A250 but with dual time facility in lieu of alarms and chimes. Countdown timer with repeat function. 7 YEAR BATTERY.

**ONLY £25**



A250

## F-300 Sports chronograph

Hours, minutes, seconds, am/pm, day and date. 4 year calendar (28 days for Feb.) Stopwatch measures in 1/100 second to 12 hours, net, lap, and 1st & 2nd place times. 2 year lithium battery. Resin case/straps. S/S trim. Mineral glass. Water res.

(£14.95) **£12.95**

## 110QS-37B

As F-300 but chrome plated case. S/S bracelet.

(£19.95) **£17.95**



## F-80E Alarm chronograph

Hours, minutes, seconds, date, am/pm, or hours, minutes, alpha day, date, am/pm. 24 hour alarm, hourly chimes. Stopwatch from 1/10 second to 12 hours, net, lap and 1st & 2nd place. Nightlight. Resin case/strap. Mineral glass. Water resistant. 3 YEAR BATTERY.

(£17.95) **£15.95**

## 83QS-41B

As F-80 but stainless steel encased S/S bracelet.

(£22.95) **£19.95**



ALL OTHER CASIO WATCHES  
Prices on application

See opposite page for ordering details

# METRONOME

A PROJECT  
FOR YOUR  
FREE PCB

We couldn't design five projects for our free Multi-Option Board without one based on the versatile 555. Circuit design by Keith Brindley

The 555 is such an adaptable integrated circuit that no home can afford to be without at least one. As a timer IC it does its job magnificently, working in a variety of monostable and astable multivibrator modes with just a handful of additional passive components, and its timing period is adjustable from literally just a fraction of a fraction of a second through to hours, simply by selection of one resistor and one capacitor.

## Metro Gnome

Our chosen design using the 555 is a metronome. Before the advent of relatively cheap solid-state electronic components such devices were clockwork. Because of this they had a tendency to start off at a high speed and as the spring slowly wound down they got slower and slower. A completely electronic metronome does not suffer from this problem and yet can be far cheaper than a clockwork counterpart.

The circuit is simply an astable multivibrator. Increasing either the resistors or the capacitor values, or both, the timing period can be lengthened, decreasing the frequency and vice versa.

## Applications

At audio frequencies, ie 30 Hz to 16 kHz, the 64R loudspeaker is an adequate transducer, but outside this range other transducers can be utilised to suit. For instance, if the frequency of the astable is increased to 40 kHz by choosing suitable component values and the loudspeaker replaced by an ultrasonic transducer, then the circuit can be converted into an ultrasonic transmitter. It couldn't be simpler.

## Combinations

You could use the astable as a clock generator for digital circuits, or you could combine this circuit with that of the 2 W Power Amplifier to make a loud siren. The choice is yours.

## Construction

None of the components are at all critical and if you can't obtain exactly the right component value, don't worry. Anything remotely close to the specified values will get your device off the ground and operational.

If your capacitor value is too high, simply use a lower value resistor combination and vice versa. Six links are required to complete the circuit, then you can connect your battery and go.

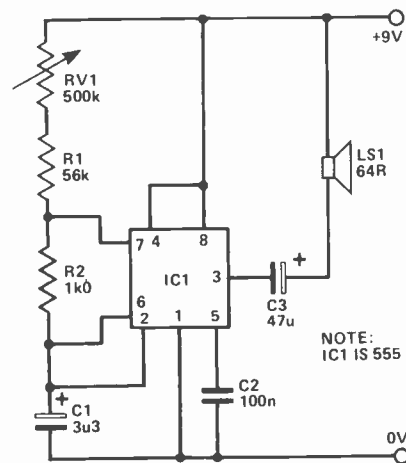

Fig.1. Full circuit diagram of the Multi-option Metronome.

## HOW IT WORKS

The circuit is a standard 555 astable multivibrator which means that the device operates in a free run oscillating mode and the output from pin 3 is constantly switching between 0 V and 9 V at a rate determined by the components in the circuit. This switching output is coupled to the loudspeaker via C3.

The multivibrator mark/space ratio is deliberately kept uneven to provide short, sharp pulses to the loudspeaker, instead of the more usual square-wave normally associated with an astable. This, of course, produces a more pronounced click from the speaker to duplicate the tick of the metronome.

The mark/space ratio is adjusted by changing the values of RV1 and R1 along with R2. Capacitor C1 charges up toward supply voltage through RV1, R1 and R2 and the output of the 555 is low for this period. When the voltage at pin 6 (ie the voltage across this capacitor) reaches approximately two-thirds supply an internal switch operates, sending the output high. In going high, the output takes pin 7 to 0 V internally, which discharges the capacitor through R2 only. When the capacitor voltage falls to about one-third supply, the internal switch changes state again to take the output low. This action repeats itself ad infinitum.

From this you can see how different mark/space ratios are possible — the charge rate (off time) must be greater than the discharge rate (on time) by the ratio:—

$$\frac{RV1 + R1 + R2}{R2}$$

For example, with RV1 in minimum position the ratio is:

$$\frac{56k + 1k\Omega}{1k\Omega} = 57:1$$

In other words the off time is 57 times as long as the on time.



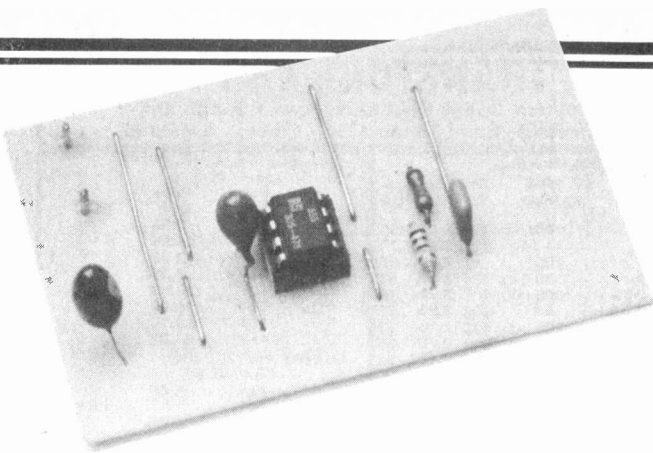
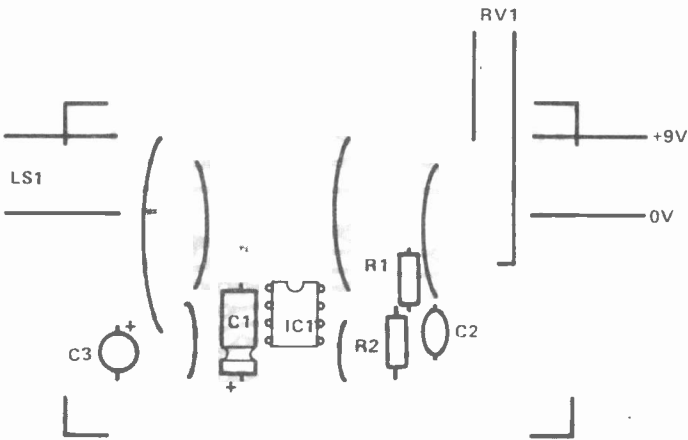

Fig.2. Component overlay for the Metronome. For once you'll have to ignore the unused locations on the PCB.



BUYLINES

The ETI Multi-Option Board Metronome uses standard components, readily available from suppliers advertising in this issue.

PARTS LIST

Resistors All 1/4 W, 5%	
R1	56k
R2	1k0
Potentiometers	
RV1	500k linear
Capacitors	
C1	3u3 10 V electrolytic
C2	100n ceramic
C3	47u 10 V tantalum
Semiconductors	
IC1	555
Miscellaneous	
ETI Multi-Option Board	
64R speaker	

ETI

QUESTION?

1. Is your hobby home computing or electronics?
2. Do you understand the application of IC's, Transistors, Diodes, etc?
3. Have you used or applied analogue or digital techniques?
4. Are you applying TTL Logic to your home computer?
5. Are you programming your home computer using simple software techniques?

If the answer is YES to any of these questions then why not consider turning your hobby into a career — applying your knowledge to servicing electronic equipment ranging from basic terminals and data processing machines through to advanced micro-processor systems.

We will train you through to advanced technology at the company training school, fitting the individual in at their own level.

We have vacancies over the whole of the U.K. especially in the London area, with the successful applicants working from home, usually in a radius of no more than 60-70 miles.

We supply all tools and test equipment, plus a company car which is available for private use.





If you are interested, then why not contact **Mr. C. Marklew on 0249 813771** to discuss your own career opportunities in confidence, or write to:

**KODE SERVICES LIMITED**  
Station Road, Calne, Wiltshire

NEED ENCLOSING?

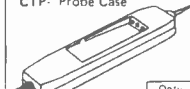
Now, CSC are really in the hardware business, with a series of plastic cases ideally suited to applications ranging from hand-held probes to hi-fi equipment. CSC cases are moulded in robust plastic and come with all the necessary screws, covers and, where appropriate, battery compartments, connectors and transparent panels for displays. And CSC can provide customer-specified variations for large-quantity orders. Fill in the coupon for more details.

CSC (UK) Ltd, Unit 1, Shire Hill Industrial Estate, Saffron Walden, Essex CB11 3AQ. Telephone: (0799) 21682. Telex: 817477.

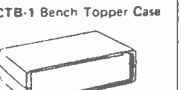
<p>CTP - Probe Case</p>  <p>Qty</p> <p>(£2 30 Nett) £3.50</p>	<p>DMC-2 Design-Mate Case</p>  <p>Qty</p> <p>(£3 85 Nett) £5.29</p>	<p>CBP-1 Portable Case</p>  <p>Qty</p> <p>(£5 75 Nett) £7.76</p>
<p>CTH-1 Handheld Case</p>  <p>Qty</p> <p>(£3 00 Nett) £4.31</p>	<p>DMC-1 Design-Mate Case</p>  <p>Qty</p> <p>(£4 25 Nett) £5.75</p>	<p>CTB-1 Bench Topper Case</p>  <p>Qty</p> <p>(£7 15 Nett) £9.37</p>

Bold prices include P & P and 15% VAT. Please deduct £1 postage from each additional order.

I enclose cheque/PO for £.....  
or debit my Barclaycard, Access, American Express card  
No..... Exp. date.....  
or Tel: (0799) 21682 with your card number and your order will be in the post immediately.

NAME.....

ADDRESS.....

CONTINENTAL SPECIALTIES CORPORATION



FREE catalogue tick box

Continental Specialties Corporation (UK) Limited, Dept. 9MM  
Unit 1, Shire Hill Industrial Estate, Saffron Walden, Essex CB11 3AQ.

**TOMORROW'S TOOLS TODAY**



# MINIATURE KEYBOARDS

**SPECIAL OFFER**

**RAPID TURNAROUND  
CUSTOM DESIGN IS  
OUR SPECIALITY**



Apex is manufacturing miniature keyboards in volume for the T.V. and Computer Industries. Substantial cost savings have been made and these are now being offered to the end user in this Introductory Special Offer. Ideal for interfacing to micro based systems via an 8 bit ASCII data bus or a serial 20mA/RS232 port these attractively styled keyboards have all the features of full sized units at a fraction of the cost.

- |                                 |          |               |
|---------------------------------|----------|---------------|
| * Miniature ASCII keyboard      | MKBOI    | <b>£40.00</b> |
| * Cased ASCII Keyboard          | MKBOIC   | <b>£45.00</b> |
| * Serial Cased Keyboard (20mA)  | MKBOICMA | <b>£65.00</b> |
| * Serial Cased Keyboard (RS232) | MKBOICRS | <b>£65.00</b> |
| * BCD Encoded Hex Pad           | MHPOI    | <b>£17.95</b> |
| * Ribbon Cable and Connector    | RCC20    | <b>£2.50</b>  |

When ordering serial interfaces please specify Baud Rate.

**APEX MICROSYSTEMS LTD. 06333 69169**  
Unit 22, Springvale Industrial Estate  
Cwmbran, Gwent

## TRANSFORMERS

Panel Meters, Bridge Rectifiers, Power Supply Units  
Multimeters - Semi Conductors - Timers - Safebloc

Minimum & Sub Miniature				
Volts	Milli-amps	Ref. No.	Price £	P&P
3-0.3	200	238	2.55	.65
0.6, 0.6	1A 1A	212	2.95	.70
9-0.9	100	13	2.25	.65
0.9, 0.9	330 330	235	2.10	.65
0.8-9, 0.8-9	500 500	207	2.70	.70
0.8-9, 0.8-9	1A 1A	208	3.80	.70
0.15, 0.15	200 200	236	2.10	.65
0.20, 0.20	300 300	214	2.70	.85
20-120-12-20	700(DC)	221	3.45	.85
0.15-20, 0.15-20	1A 1A	206	4.55	1.00
0.15-27, 0.15-27	1500 500	203	4.00	.85
0.15-27, 0.15-27	11A, 1A	204	6.05	1.00

12 AND/OR 24 VOLT Pri: 220-240 Volts				
12v	24V	Ref. No.	Price £	P&P
0.5	0.25	111	1.25	.70
1.0	0.5	213	2.70	.85
2	1	71	3.20	.85
4	2	18	4.00	.85
6	3	70	5.55	.90
8	4	108	7.40	1.15
10	5	72	8.20	1.15
12	6	116	8.80	1.15
16	8	17	10.80	1.25
20	10	115	13.80	1.45
30	15	187	16.80	1.45
60	30	226	33.30	1.75

30 VOLT (Pri: 220-240V) Sec: 0-12-15-20-24-30V				
Amps	Ref. No.	Price £	P&P	
0.5	112	2.80	.85	
1.0	79	3.55	.85	
2.0	3	5.55	1.00	
3.0	20	6.25	1.15	
4.0	21	6.55	1.15	
5.0	51	9.55	1.15	
6.0	117	11.05	1.15	
8.0	88	14.30	1.45	
10.0	89	16.55	1.45	

50 VOLT (Pri: 220-240V) Sec: 0-19-25-33-40-50V				
Amps	Ref. No.	Price £	P&P	
0.5	102	3.55	.85	
1.0	103	4.55	1.00	
2.0	104	7.25	1.15	
3.0	105	8.55	1.15	
4.0	106	10.80	1.25	
6.0	107	15.05	1.45	
8.0	118	20.15	1.65	
10.0	119	24.05	2.15	

60 VOLT (Pri: 220-240V) Sec: 0-24-30-40-48-60				
Amps	Ref. No.	Price £	P&P	
0.5	124	3.80	.85	
1.0	126	5.55	1.00	
2.0	127	7.50	1.15	
3.0	125	11.05	1.25	
4.0	123	12.30	1.45	
5.0	40	14.10	1.55	
6.0	120	17.55	1.55	

AUTO TRANSFORMERS Input/Output Tapped 0-115-210-240V				
VA (Watts)	Ref. No.	Price £	P&P	
20	113	2.60	.85	
75	64	4.05	.85	
150	4	5.55	1.00	

Input/Output Tapped 0-115-210-220-240V				
VA (Watts)	Ref. No.	Price £	P&P	
300	53	10.05	1.15	
500	67	10.80	1.45	
1000	84	18.55	1.55	

Also 1500/2000/3000VA MAINS ISOLATING (Centre Tapped & Screened) Pri: 120/240V Sec: 120/240V				
VA (Watts)	Ref. No.	Price £	P&P	
60	149	6.55	1.00	
100	150	7.55	1.25	
200	151	11.05	1.25	
250	152	13.25	1.45	
350	153	16.25	1.55	
1000	156	27.05	3.15	

Please add VAT at 15%  
Barclaycard and Access facilities  
available  
Trade and Education Welcome

**BAYDIS** 7a William Street  
Herne Bay, Kent  
Herne Bay 64586

# It's easy to complain about advertisements.

Every week, millions of advertisements appear in the press, on posters or in the cinema.

Most of them comply with the rules contained in the British Code of Advertising Practice and are legal, decent, honest and truthful.

But if you find one that, in your opinion, is wrong in some way, please write to us at the address below.

We'd like you to help us keep advertising up to standard.



**The Advertising Standards Authority.**  
**If an advertisement is wrong, we're here to put it right.**

A.S.A. Ltd., Brook House, Torrington Place, London WC1E 7HN.

# SUPER OFFER

to  
ELECTRONICS TODAY INTERNATIONAL  
Readers

# mini 20 multimeter only £19.50

**INCLUSIVE OF POST & PACKAGE  
AND V.A.T.**

The Mini 20 Multimeter is an ideal instrument for the constructor.

This Special Offer is a wonderful opportunity to acquire an essential piece of test gear with a saving of nearly £10 on the normal retail price.

The 21 ranges cover all likely requirements. Operation is straight-forward, just turn the 22-position selection switch to the required range.



Sensitivity 20k $\Omega$ /V d.c. 4k $\Omega$ /V a.c.  
 Ranges extend from  
 100mV to 600V d.c. 30mA to 3A a.c.  
 15V to 1,500V a.c. 0 to 2k $\Omega$   
 50 $\mu$ A to 600mA d.c. 0 to 2M $\Omega$

Movement protected by internal diode and fuse.

The instrument is supplied complete with case, leads and instructions.

Please complete both parts of the coupon in **BLOCK CAPITALS**

Name .....

Address .....

.....

.....

From: Alcon Instruments Ltd. (ETI Offer)

19 Mulberry Walk, London, SW3 6DZ

To: Alcon Instruments Ltd. (ETI Offer)  
 19 Mulberry Walk, London SW3 6DZ  
**Mail order only**

Please send me ..... meter/s at £19.50 each

I enclose P.O./Cheque No. .... Value .....

Name .....

Address .....

.....

Please allow 28 days for delivery

# SPOT DESIGNS

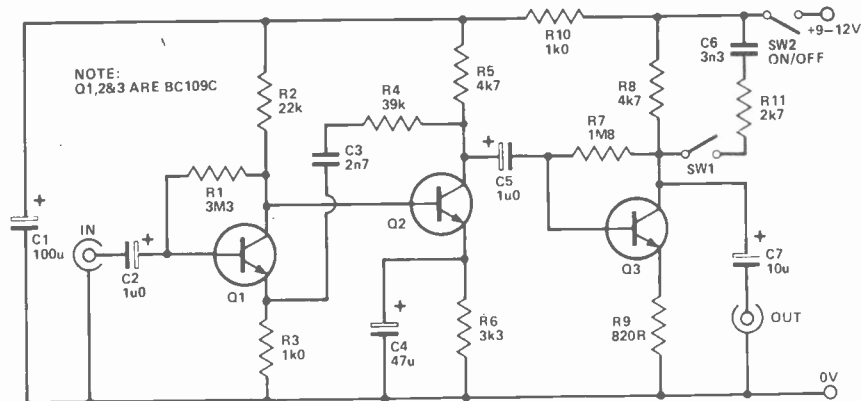

## Cassette Preamplifier

Used in conjunction with one of the cassette mechanisms currently available on the surplus market (or a mechanism removed from an old recorder or player) this preamplifier circuit makes an inexpensive but useful cassette player for use with a hi-fi system. The circuit is for a mono player, but for a stereo unit it is, of course, merely necessary to make one preamplifier for each channel.

The output signal level from a cassette tape head is typically about 500  $\mu$ V or so at middle audio frequencies for a mono head and only about half this level for a stereo type. The preamplifier must, therefore, provide a considerable amount of voltage gain in order to match this to a hi-fi amplifier, since these require a signal level of about 1,000 times higher than this. It is also necessary for the preamplifier to provide equalisation, because the output from a tape head rises with frequency at a rate of 6 dB per octave. However, at higher audio frequencies tape heads are not very efficient and require a much lesser degree of roll off.

Q1 and Q2 are used in a conventional two stage, direct coupled, common emitter amplifier and the frequency-selective negative feedback through C3 and R4 provides the appropriate equalisation.

These also set the midband voltage gain of the input stages at about 46 dB (200 times). With such a low input signal level it is obviously necessary to use low noise transistors (such as the BC109C) in order to obtain good results. Running Q1 at a low collector current of about 200  $\mu$ A also helps to give a low noise level.

Q3 is used as a low gain common emitter stage, which provides the additional amplification needed to give a suitably high output level. R9 introduces negative feedback, which controls the voltage gain of Q1 and the specified value gives a gain of about 14 dB (five times). For a stereo unit R9 should be reduced to 390R in order to give increased gain to compensate for the lower output of a stereo tape head.

When playing a Dolby B encoded cassette SW1 can be closed. This gives a small degree of treble cut which provides a reasonably flat overall response, with a small excess of treble at low signal levels and a slight deficit at the highest levels. A useful level of noise reduction is obtained, although only about half that provided by a proper decoder.

The circuit is capable of excellent results and the output quality is largely dependent on the quality of the tape head, the tape used in the cassette and so on.

## Flash Slave Unit

The photocell used in this circuit is a photo-Darlington transistor. This gives a fairly fast operating speed and high sensitivity. In fact the sensitivity is rather too high, making it likely that the cell would saturate in only moderately light conditions. Its base terminal is, therefore, connected to the negative supply rail to give a suitable reduction in sensitivity. R1 and RV1 form the collector load resistance for photocell Q1 and RV1 acts as a sensitivity control. With RV1 at a low resistance, the increase in the current passed by Q1 when it picks up the pulse of light from the primary flashgun will produce a fairly small voltage spike across the load resistance. With RV1 set at a high resistance, a similar current pulse would produce a much larger voltage spike across the load and high sensitivity is obtained.

One problem with equipment of this type is that under bright conditions the photocell can saturate, preventing the circuit from functioning. When used indoors, saturation is unlikely to occur even with RV1 set for maximum sensitivity. The sensitivity of the unit should be so high that it will trigger reliably even if the primary flashgun and Q1 are aimed in opposite directions. When used outside in bright conditions it would be advisable to back off RV1 and the aim of Q1 and the flashgun will inevitably be more critical (there will probably be less reflected light to trigger the unit in addition to the reduction in sensitivity).

C2 couples the output from Q1's collector to the input of a common emitter amplifier using Q2. This is biased by R2 so that there is a quiescent collector voltage of only about 1 V. Q3 is an emitter

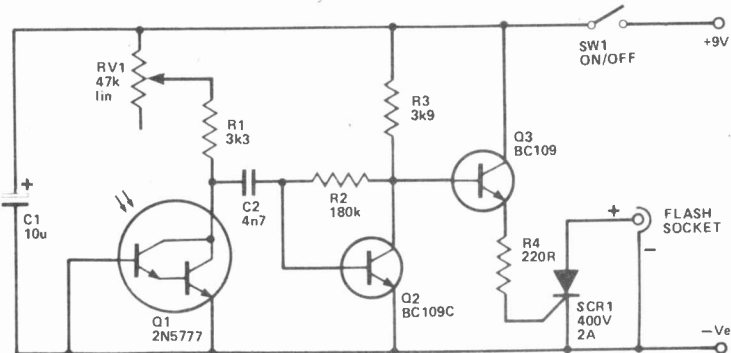

follower buffer stage which is used to drive the gate of SCR1 from Q2's collector. The quiescent voltage at Q3's emitter is insufficient to activate the thyristor, but when Q2 receives the negative voltage spike from Q1 it switches off and the emitter potential of Q3 rises to a high enough level to trigger SCR1 and fire the second flashgun. R4 is a current limiting resistor which prevents Q3 from passing an excessive current.

The current consumption of the circuit is about 2 mA. Note that the flash lead must be connected to SCR1 with the correct polarity or the unit will not operate.

## AF Signal Generator

Although the 8038CC is not capable of generating an extremely pure sine wave, it is capable of producing an output of high enough quality for general audio testing. The simple circuit shown here covers the audio frequency spectrum in three ranges — less than 20 Hz to more than 200 Hz; less than 200 Hz to more than 2 kHz; less than 2 kHz to more than 20 kHz. The output amplitude is continuously variable up to a maximum of about 550 mV RMS and is from a low impedance source.

The 8038CC oscillates by first charging a capacitor via a constant current source and then discharging it through another constant current generator. It thus generates a triangular waveform. This is then fed to a trigger circuit to generate a squarewave signal and to a

non-linear amplifier which "rounds off" the signal to give a sine wave output of reasonable purity. C2 to C4 give the three ranges. R1, RV1 and R2 form a potential divider circuit, which is used to control the charge and discharge currents of the timing capacitor. RV1 thus acts as the fine frequency control. PR1, R3, R4 balance the charge and discharge currents, so that a symmetrical output is obtained. PR2 is part of the sine wave shaping circuitry and is adjusted for maximum purity.

The sine wave output at pin 2 of IC1 is at a high impedance and is, therefore, coupled to the output via an emitter follower buffer stage using Q1. RV2 is the output level control, and C2 provides DC blocking at the output. Current consumption is approximately 9 mA.

With the unit adjusted for a fairly low frequency output (about 50-200 Hz), it should be possible to hear the main fundamental frequency plus the higher frequency harmonic signals. The output can be monitored using a crystal earphone or amplifier/loudspeaker. PR1,2 are adjusted to minimise the harmonics.

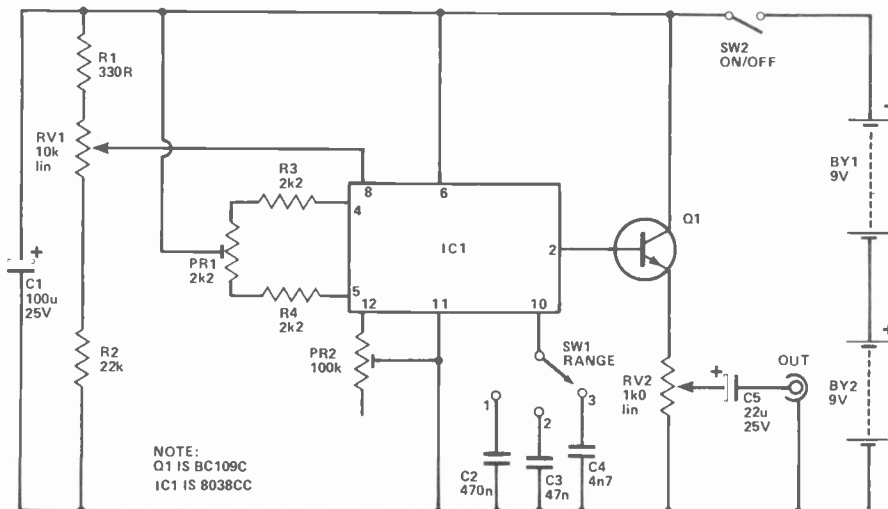

## Waa-Waa Unit

An unusual feature of this circuit is that the Waa-Waa effect is obtained by operating a foot-switch, rather than the more usual method of operating a potentiometer via a pedal mechanism. This method is slightly less versatile than a proper Waa-Waa pedal, but is far simpler for the home constructor to build since it avoids the need for any pedal mechanics.

The basic Waa-Waa circuit uses a quite conventional arrangement based on common emitter amplifier, Q1. Frequency selective negative feedback is provided by C3, 4. These provide little feedback at a certain frequency. A peak in the response of the amplifier is produced at this frequency, as the lack of feedback enables virtually the full voltage gain of Q1 to be realised. The actual frequency at which the peak is produced can be controlled by means of a resistance between the junction of C3, 4 and the negative supply rail. With a high resistance here the peak is produced at a high frequency. By varying the control resistance the peak can be swept up and down the audio frequency spectrum, producing the familiar Waa-Waa effect.

The control resistance is formed by the collector to emitter impedance of Q2. Under quiescent conditions Q2 is switched off and the peak is at such a low frequency that it is effectively non-existent. If PB1 is operated, C5 charges up via R5 and, as the voltage across C5 increases, Q2 is biased harder into conduction by the base current it receives through R4. This causes the peak to be swept up through the

audio band until C5 becomes fully charged. If PB1 is then released, C5 gradually discharges through R4, Q2 and R6, causing the bias on Q2 to decrease and the peak to be swept down the audio spectrum. Thus the required effect is produced by closing and opening PB1. The Waa-Waa frequency is partially controlled by the frequency at which PB1 is operated, but C5 restricts the range of frequencies that can be obtained in practice. However, the value of C5 can be altered to suit individual requirements, or several switched components of different values could be used.

SW1 enables the Waa-Waa circuit to be quickly and easily bypassed. R1 is needed to reduce the gain of the unit which would otherwise be excessive. Current consumption is about 2 mA.

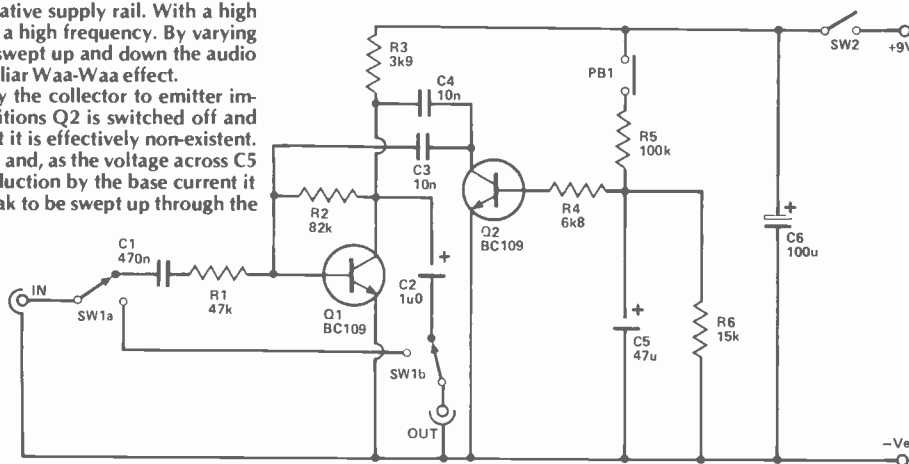

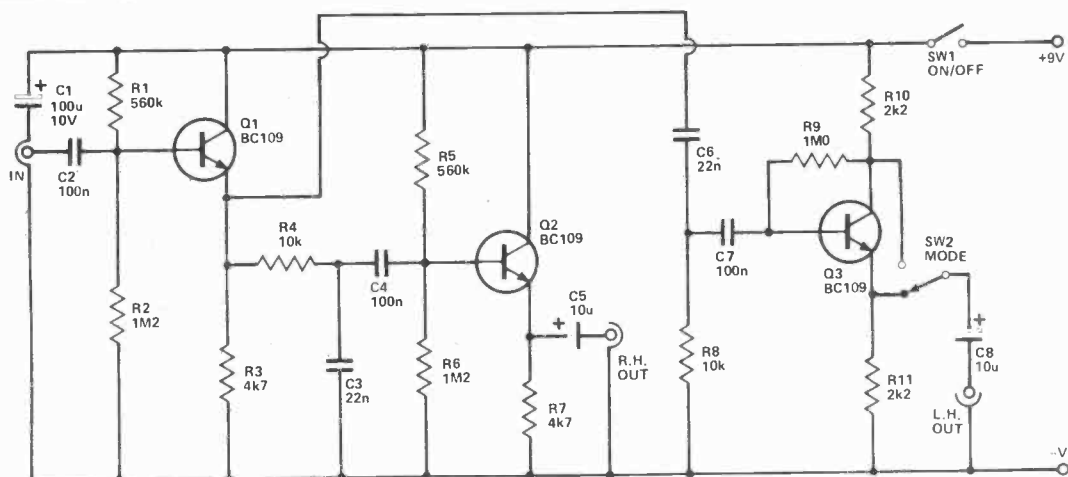

### Stereo Synthesiser

There are two common methods of producing a pseudo stereo effect from a mono signal; playing the mono signal from the two speakers in antiphase and the use of frequency selective techniques, which normally consists of directing lower frequency signals into one channel and higher frequency signals into the other. This circuit uses the second technique, but can additionally give antiphase signals which can give a better effect, especially when using headphones.

Q1 is used as an emitter follower buffer stage which ensures that the two filter networks fed from its output are driven from a low impedance source. If these were driven direct from the input, it is quite possible that they would be fed from a source impedance of a few kilohms or more, which would be quite sufficient to alter their effective characteristics.

The two filters are formed by R4 and C3 (low pass), and C6 plus R8 (high pass). A high roll off rate is by no means essential in this application and the 6 dB per octave attenuation rate of simple RC filters such as these is perfectly adequate. The -3 dB point of each filter is at approximately 800 Hz and the combined output of the

filters, therefore, gives a virtually flat response with no significant peaks or troughs.

Q2 is connected as an emitter follower buffer stage and this ensures that there is minimal loading on the low pass filter. Q3 similarly ensures that there is minimal loading on the high pass filter, but this device is used as a phase splitter. With SW2 switched to take the output from Q3's emitter, Q3 effectively operates as an emitter follower and gives no phase inversion. With SW2 switched to take the output from Q3's collector, Q3 then effectively acts as a common emitter stage with 100% negative feedback (and unit voltage gain) due to R11. It also provides a 180° phase shift so that the two output signals are in anti-phase. An in-phase relationship is needed to give a good central stereo image and the use of anti-phase signals tends to give an impression of increased channel separation.

In a stereo orchestral recording it is normal for the violins to come from the left hand channel, with the cellos and basses from the right hand channel. Therefore, the high frequency signals are fed to the left channel and the low frequency signals are fed to the right channel so that the unit provides a similar effect (although it will obviously function properly with the outputs connected either way).

The current consumption of the circuit is about 3 mA.



NOTE:  
Q1 & 2 ARE BF244B  
T1 IS DENCO D.P. BLUE AERIAL COIL, RANGE 4  
T2 IS DENCO MW5FR FERRITE AERIAL  
T3 IS DENCO WHITE OSC COIL, RANGE 4

### Short Wave Converter

This SW converter tunes over 5 to 15 MHz approximately and also enables an ordinary MW broadcast receiver to pick up stations operating on the 19, 25, 31, 41 and 49 m broadcast bands.

Signals picked up by the telescopic aerial are directly coupled into the aerial tuned circuit as these signals will be quite weak, necessitating a tight coupling. CV2 is the main tuning capacitor for the aerial tuned circuit and CV1 is the aerial trimmer control. The signals selected by the tuned circuit are coupled directly into the gate of mixer transistor Q1, no coupling winding being needed here due to the use of a JFET transistor with a very high input impedance. The drain load for Q1 is a MW ferrite aerial, but it is used in reverse in this application and is used to radiate the 1.6 MHz IF output of the converter. This is picked up by the MW radio, which is placed near

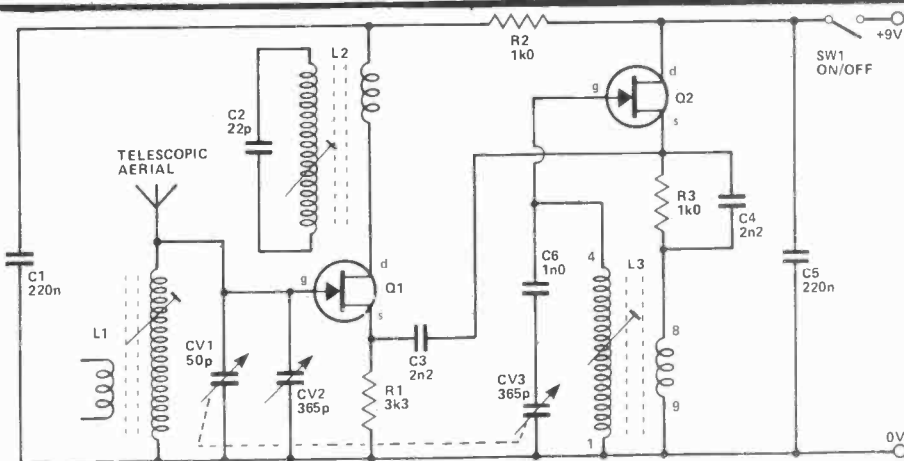

the converter and tuned to a quiet spot on the band in the vicinity of 1.6 MHz. The position of the coil on the ferrite aerial is adjusted to resonate L2 at the appropriate frequency and effect optimum signal transfer.

The oscillator uses JFET device Q2 in the source follower mode, with positive feedback provided by L3. At the resonant frequency of L3 there is sufficient feedback to cause oscillation and CV3 tunes the oscillator over a frequency range which is 1.6 MHz higher than the range of the aerial tuned circuit so that the required difference frequency of 1.6 MHz is produced at the output. C6 is a padding capacitor which gives reasonably good tracking between the aerial and oscillator circuits. Perfect tracking is not required since CV1 can be used to keep the unit peaked for optimum results. C3 is used to couple the output from the oscillator to the input of the mixer stage. The circuit has a current consumption of only 4 mA.

**WERSI**

*Aura Sounds are the first company to successfully market Wersi Organs and Kits in the United Kingdom. Operating from modern Showrooms, we offer a complete, unique evening and weekend telephone support advice. We pride ourselves on our friendly and individual service. We market Wersi products because we feel they are simply the best, both in terms of quality and reliability. These factors, together with a fresh approach, are what have made Wersi one of the leading organ manufacturers in the world today. AURA SOUNDS AND WERSI – THE WINNING COMBINATION. Illustrated below are just a few of the wide range of organs in stock.*

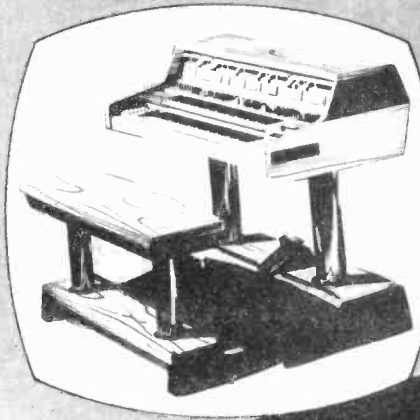

**The SATURN W3T.**

*The ultimate transportable organ, featuring sophisticated rhythm unit and built-in WERSI Voice. 30 or 61 note Keyboards and 30 pedals.*



**The COSMOS W5S**

*The baby of the range, a great instrument at a great price. There are many optional extras and Cosmos can be easily assembled at home by the average handyman.*

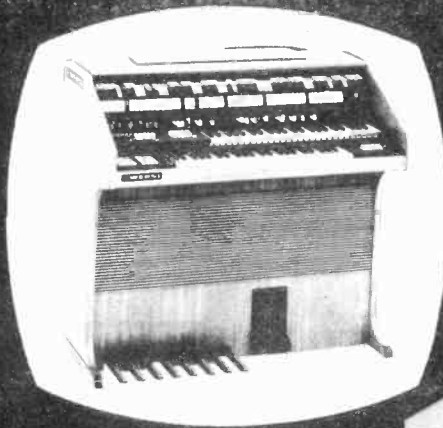

**The HELIOS.** *For home or professional use. Available as a transportable model with various options including 25-pedal clavier.*



**The GALAXY.**

*The top model of the range with 3 full manuals and a 30 note pedalboard. For looks and sound, the effects are first class.*

**IMPORTANT**

AURA SOUNDS have just been appointed marketing agents for the range of Heath Electronic Kits in the U.K. This exciting range of 'up-market' Kits makes AURA SOUNDS, more than ever before, the company to come to for advice and product choice.

AURA SOUNDS 14-15 Royal Oak Centre, Brighton Road, Purley, Surrey. Telephone 01-668 9733 and at 17 Upper Charter Arcade, Barnsley, West Yorks. Telephone (0226) 5248  
**THE PROFESSIONALS**

Please send me the 104 page colour WERSI catalogue plus the NEW HEATHKIT BROCHURE & price lists I enclose a cheque/P.O. for £1.00

Name \_\_\_\_\_

Address \_\_\_\_\_

Send to Aura Sounds Ltd. 14/15 Royal Oak Centre, Brighton Road, Purley, Surrey.

# POWERFET AMPLIFIERS

Some day all power amps will be made this way!

Very high quality 80 watt and 120 watt designs (by Hitachi) offering wide bandwidths and very low distortions. Both are conservatively rated and can be used with supplies up to  $\pm 65V$ . One P.C.B. serves both designs, and an 80 watt unit can be upgraded by the simple addition of components.  
All units come with substantial heatsink / mounting brackets.

**PFA80**  
80W into 8 $\Omega$  ( $V_s = \pm 50V$ )  
 $\uparrow THD \leq 0.008\%$   
S/N 120dB.

**PFA120**  
120W into 8 $\Omega$  ( $V_s = \pm 55V$ )  
 $\uparrow THD \leq 0.005\%$   
S/N 120dB.

**KIT £11.95. BUILT £13.95**

$\uparrow$  from 1W to rated output at all audio frequencies. PFA120.

recommended for 4 $\Omega$  loads.

45v-0-45v. 300Va Toroidal Transformer-£15 (£2 p&p)

CHAN	VDS max V	ID max A	PDISS max W	Price
BD512	P	60	1.5	10
BD522	N	60	1.5	10
VMP4	N	60	2.0	25
VN10KM	N	60	0.5	1.0
VN64GA	N	60	2.5	80
VN67AF	N	60	2.0	15
2SJ49	P	140	7.0	100
2SK134	N	140	7.0	100

CA3080E	TLOB1	29p
	TLOB2	55p
CA3140E	2102	80p
	2114	340p
DAC08EN	4001B	17p
	4011B	17p
DM2502	4013B	40p
	4016B	40p
LM3900	43p	709
MC3401	30p	710
NE529	145p	733
NE555	25p	741
SAD1024	78L05	29p
	78L12	29p
	1050p	

$\uparrow$ /p protected. four selection. VN/VM. 96-page Design Cat. 20p. Heat clips/sink T0202 12p. T092 8p. T03 35p.

### HI-FI ON TWO CHIPS

HA12017 (Preamp 0.001% distortion 83dB S/N in phono application) 80p. HA1397 (Poweramp 20 watts in 8 $\Omega$ . 0.02% distortion (typ) 195p.

Both with data and circuits.

**VCA** High quality design offers attenuation from 0dB to -90dB. S/N 90dB, THD 0.01%, 8.W. DC to 100KHz. Complete component set and circuit £2.50.

### I.C. Sockets (low prof.)

8 pin 10p, 14 pin

12p, 16 pin 13p.

Low noise Resistor

set 10 off each

E12, value from

10R to 10M 730.

1/4W, 5% CF resistors

650p.

### SCOPE TRACE DOUBLER P.C.B.

Built. C/W shift, chan select, choprate controls and instructions. Useful display from DC to 10MHz. Runs from 9v battery £9.95.

2 $\mu$ S ADC chip set (DAC08, DM2502, NE529) with data £9. HA388 (Bridge amp. 18w from car battery). With data 195p. HA1388 (Bridge amp. 18w from car battery). With data 195p.

30p post and packing. Mail order only to

**J. W. RIMMER**

148 Quarry Street  
Liverpool L25 6HQ  
Tel. 051-428 2651

Technical enquiries to: 367 Green Lanes, London N4 1DY.  
Telephone. 01-800 6667

# X10 Battery Tester Charger

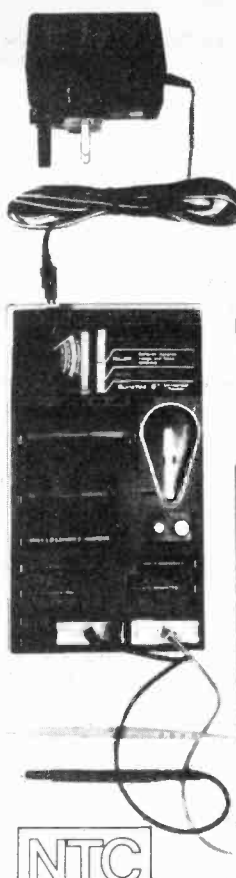

Tests all sizes of batteries including watch and camera types. Also tests lamps, fuses and continuity. The addition of a 4.5 to 9, volt DC adaptor converts the X10 into a useful charger for all sizes of NICAD batteries.

Complete with test leads, instructions and 9 volt battery.

**£13.55**  
incl postage and VAT

Suitable AC/DC adaptor

**£3.95**

N.T.C. SERVICES  
331 East Prescott Road  
Liverpool L14 2DD  
051 228 4690

NTC

# Marshall's

A. Marshall (London) Ltd., Kingsgate House,  
Kingsgate Place, London NW6 4TA  
Industrial Sales: 01-328 1009

Mail Order: 01-624 8582 24hr. service

Also retail shops: 325 Erdware Road, London W2  
40 Crickwood Broadway, London NW2 85 West Regent St. Glasgow  
108A Stokes Croft, Bristol

We now supply the extremely reliable and cost conscious LEADER range of testgear.

SINGLE TRACE OSCILLOSCOPES	
LBO 510A 5" 4MHz 20mV	£125.00
LBO 512A 5" 10MHz 10mV	£170.00
LBO 513A 5" 10MHz 10mV	£215.00
LBO 507A 5" 20MHz 10mV	£239.00

DUAL TRACE OSCILLOSCOPES	
LBO 308S 3" 20MHz 2mV	£419.00
LBO 508A 5" 20MHz 10mV	£229.00
LBO 520A 5" 35MHz 5mV	£475.00
LNO 514 5" 10MHz 5mV	£259.00

T.V./RADIO TEST GEAR	
LSG 16 Signal Generator	£ 49.00
LSG 231 FM Stereo Signal Generator	£169.00
LCG 392U PAL B Pattern Generator	£189.00

AUDIO TEST GEAR	
LAG 26 Audio Generator	£ 60.00
LAG 120A Audio Generator	£119.00
LDM 170 Distortion Meter	£225.00
LFM 39A Wow/Flutter Meter (Dm)	£249.00
LFM 39A Wow/Flutter Meter (Dm)	£299.00
LAV 191 Audio Tester	£249.00
LAG 125 Low Distortion Audio Generator	£229.00

GENERAL TEST GEAR	
LCR 740 LCR Bridge	£135.00
LTC 906A Transistor Checker	£ 90.00
LVT 72 Fet Transistor Checker	£119.00
LTC 907 Transistor Checker	£139.00
LAT 47 Attenuator	£135.00
LAT 45 Attenuator	£ 75.00
LFG 1300 Sweeter/Function Generator	£299.00

AMATEUR RADIO	
L0M 815 DIP Meter	£ 43.00
LIM 870A Antenna Impedance Meter	£ 41.00
LPM 880 RF Power Meter	£ 69.00
LPM 885 SWR/Watt Meter	£ 44.00
LAC 895 Antenna Coupler	£ 85.00
LAC 896 Antenna Coupler	£ 41.00
LAC 897 Antenna Coupler	£ 41.00

Please send large SAE for special catalogue. All prices exclusive VAT/carriage.

The new Marshall's 80/81 catalogue is now available. A veritable treasure house of components, test gear, tools, etc.



Lots of old friends, but also many new products including leader test gear, Crimson Hi Fi Modules, Rechargeable Ni Cad batteries and chargers (very competitive). More components including SN74ALS series, new tools etc.

Available by post, UK 75p post paid; Europe 95p post paid; Rest of world £1.35 post paid.

### SINCLAIR INSTRUMENTS

Digital Multimeter	
"	PDM35 £ 34.50
"	DM235 £ 52.50
"	DM350 £ 72.50
"	DM450 £ 99.00
Digital Frequency Meter	
	PFM200 £ 49.80
Low Power Oscilloscope	
	SC110 £139.00

### NEW

TF200	Frequency Meter	£145.00
TGF105	Pulse Generator	£ 85.00

### CRIMSON ELEKTRIK HI FI MODULES

CE608	Power Amp	£20.09
CE1004	"	£23.43
CE1008	"	£26.30
CE1704	"	£33.48
CE1708	"	£33.48
CPS1	Power Unit	£19.52
CPS3	"	£23.52
CPS6	"	£30.00
CPR1	Pre Amp	£32.17
CPR1S	Pre Amp	£42.52

All Prices + VAT + postage/packaging

Don't forget! We also carry an impressive range of semi-conductors, passive components, electro-mechanical components, tools etc.



# SPACE INVASION GAME

You've heard of the beer you drink at home — now ETI is doing its bit to clear the pubs with the Space Invasion game you play at home. Will the social life of England ever be the same?

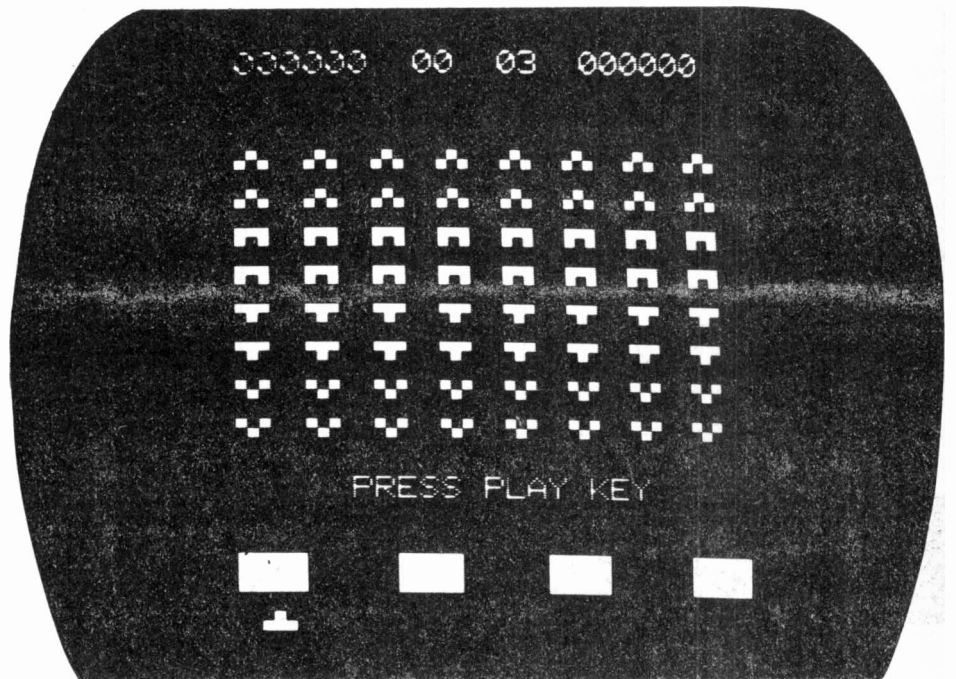

Hardware design by Paul Johnson. Software by Mike Rose.

One of the fastest growth industries of the last few years must be the production of video games. Only a couple of years ago we were pushing our five pence coins into the slot to play what was laughingly known as tennis (two oblong 'bats' and a blob that bounced all over the screen). Nowadays we can pilot starcruisers into the uncharted depths of space and zap the enemy with laser bolts, launch rescue missions to the Moon, and engage in dogfights with agile aliens who can fly rings round a cathode ray tube. Of course it costs more than fivepence too! Video games have probably led the field in showing the public that the microprocessor is capable of better things than frightening Clive Jenkins.

Life would be a lot better if you didn't have to keep feeding the coin slot to stay in practice, though, and as usual ETI comes to the rescue. Yes, for the first time anywhere we present a home-built version of the country's most popular pastime (all right, second most popular). Before you glance across to Buylines and decide we've got peculiar ideas about how to save you money, it should be pointed out that you get more than just a TV game. A TV game requires a microprocessor, some memory, a graphics generator, a keypad and a UHF output suitable for plugging into your television set. Amazingly enough these are also what you need for a home computer. Once you have the basic Space Invasion game, you can expand it at very little expense into just such a computer, designed by Tangerine Computer Systems.

## Playing the Game

The game follows a fairly standard format. Eight columns of eight saucers fly backwards and forwards across the TV screen and slowly descend while you take potshots at them from your laser base at the bottom of the screen. The base may be moved to left and right to aim at the enemy and to dodge the bombs they are dropping on you. If they hit you, your base is destroyed, but there are defences for you to hide under — these are gradually whittled away by the alien barrage. (Your laser bolts can cancel bombs as they fall.) Everything gets faster as the number of aliens decreases, and when they've all been wiped out, lo! another fleet appears.

Scoring is as follows: Top two rows — 50; Next two — 40; Next two — 30; Bottom two — 20. Every time you blast a saucer, its score is added to your total. Occasionally a huge saucer flies across the top of the screen; it doesn't drop bombs and hitting it scores 100 points. There are four numbers displayed at the top of the screen, and from left to right they are: score this game, number of saucers left on screen, number of bases you have left and highest score during this session. You start off with three bases and are awarded an extra one for every two thousand points, but you can't have more than four at once.

The switches are provided to select one of four levels of difficulty — these are set to either 0 V or 5 V and provide a binary input, 00 for easiest level (slow) and 11 for expert (very fast). →

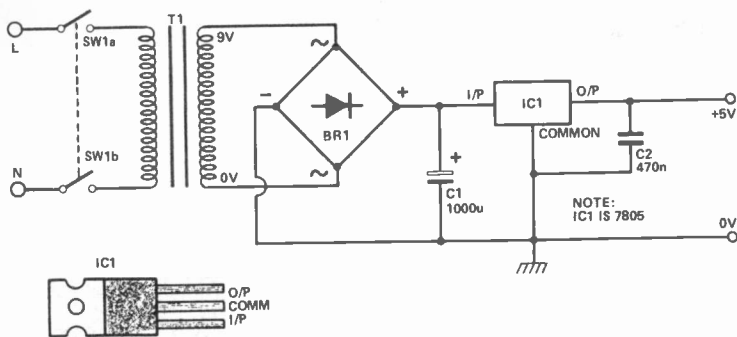
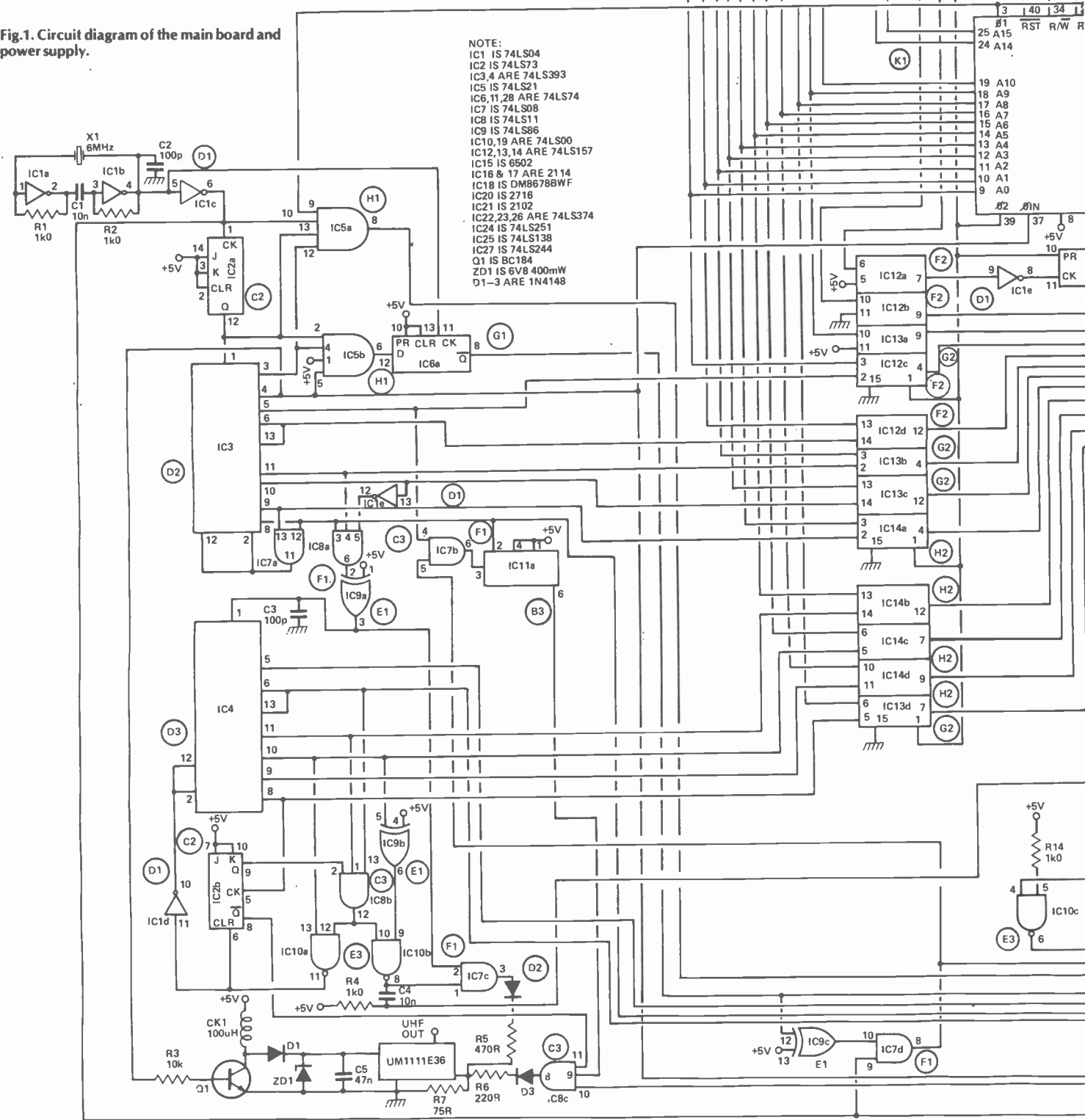
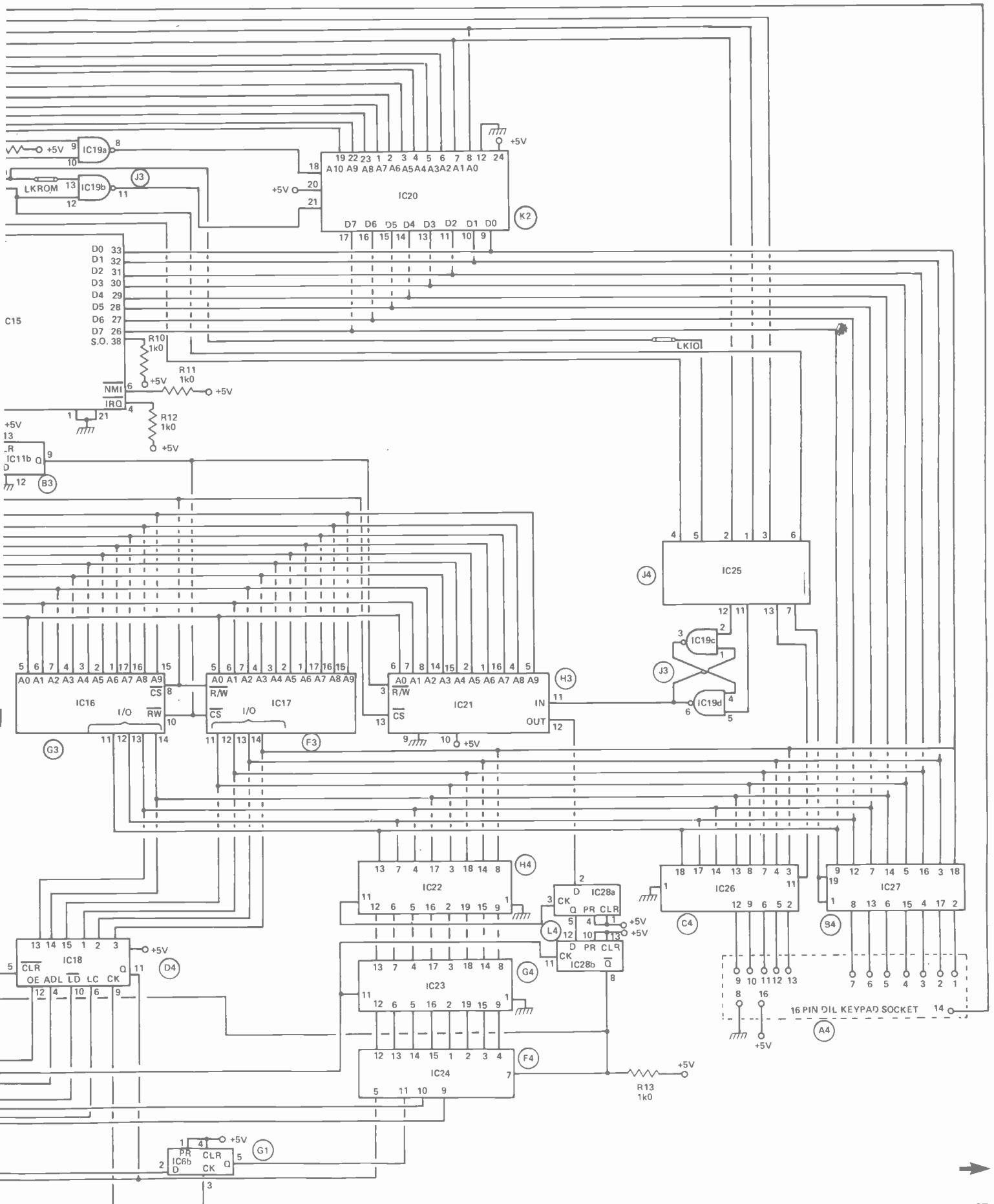
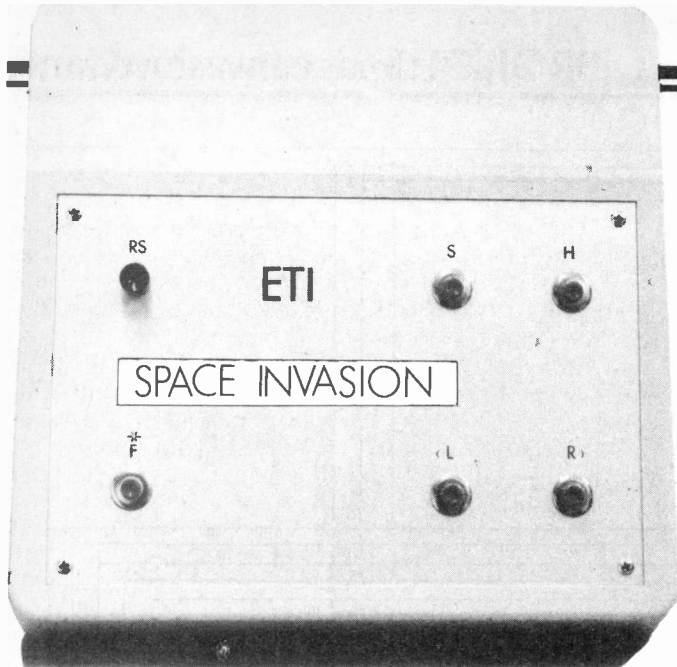

Fig.1. Circuit diagram of the main board and power supply.

NOTE:  
 IC1 IS 74LS04  
 IC2 IS 74LS73  
 IC3,4 ARE 74LS393  
 IC5 IS 74LS21  
 IC6,11,28 ARE 74LS74  
 IC7 IS 74LS08  
 IC8 IS 74LS11  
 IC9 IS 74LS86  
 IC10,19 ARE 74LS00  
 IC12,13,14 ARE 74LS157  
 IC15 IS 6502  
 IC18 & 17 ARE 2114  
 IC18 IS DM8678BWF  
 IC20 IS 2716  
 IC21 IS 2102  
 IC22,23,26 ARE 74LS374  
 IC24 IS 74LS251  
 IC25 IS 74LS138  
 IC27 IS 74LS244  
 Q1 IS BC184  
 ZD1 IS 6V8 400mW  
 D1-3 ARE 1N4148







The face of the Space Invasion. The simple controls are reset, start (play), hold, fire, left and right.

## HOW IT WORKS

Although the circuit diagram looks hideously complex, it falls quite naturally into various basic blocks which can be examined separately. The heart of the system is IC15, a 6502 microprocessor. This can be seen at top centre of the circuit, surrounded by its memory and address decoding chips. Below these are the chips that generate the graphics for the display. The I/O port for connecting the main board to the keyboard and sound generator circuitry is on the right. Finally, the entire section on the left produces the timing signals required by the microprocessor, as well as all the synchronising signals which must be mixed with the video information before it is passed to the UHF modulator.

The master oscillator is formed by three of the inverters in IC1; the frequency of operation is set at 6 MHz by crystal X1. IC2, IC3 and IC4 form the complete counter chain for generating all the timing signals and refresh addresses — the various additional gates and flip-flops decode the counter outputs to provide these signals as follows.

IC3 is reset by the output of IC7a; this controls its count length. Three of the outputs of IC3 are decoded by IC8a and IC9a to produce the line sync pulse, which also clocks the line counter IC4. The line blanking pulse is produced at pin 6 of IC11a. The count length for IC4 is controlled by the reset pulse derived from IC10a, and IC10b produces the frame sync pulse. The frame blanking pulse is produced at pin 8 of IC2b. The frame sync and line sync pulses are mixed in IC7c; the frame blanking and line blanking pulses are mixed in IC8c with the video information from the character generator circuitry.

The timing signals for loading the character generator IC18 are produced by IC5 and IC6.

The line blanked and frame blanked video is mixed with the sync pulses by diode 'OR' gate D2, D3. R5, R6 and R7 ensure that the various parts of the composite signal have the correct relative amplitudes before being fed to the input of the UHF modulator. The modulator requires a supply voltage higher than the 5 V that powers the other circuitry — this is derived from chopper transistor Q1 which is driven by one of the outputs of counter IC3. D1, ZD1 and C5 regulate the voltage from Q1 collector to 6V8.

IC12, IC13 and IC14 form the address and control signal selector for the memory. This switches over at the processor clock rate and allows both screen refresh and microprocessor access to occur at full speed without mutual interference. IC20 is the ROM chip; the RAM is provided by IC16, IC17, and IC21. The data output of the RAM is processed by IC22, IC23 and IC24 to produce the graphic pixel cells. IC28 selects either graphics or alphanumeric mode for a particular character cell position.

IC26 and IC27 provide the I/O port to read the paddle switches and drive the sound generator.

A unique feature of this game is the provision of a hold switch. If you want to go to the loo, or answer the phone, you can freeze the action in the middle of the game and carry on where you left off when you get back.

## Objects and Computers

The object of the game is to score 999,999 points! If you manage it a suitable message appears on the screen but we're not going to tell you what it is — play the game and find out for yourself, if you can. You lose if:

- 1) You lose all your bases before reaching 999,999;
- 2) An invader touches your laser base;
- 3) An invader lands on the baseline.

If you already own a Microtan 65 computer than it isn't necessary to build all the hardware for this project — you simply run the Space Invasion software on your existing machine. Sound effects are optional and require the additional circuitry shown in the diagram. The special hardware may be added by connection to the cable socket. All the possible configurations for getting Invasion onto your TV screen are given below.

- 1) Invasion PCB + Hex keypad + Invasion PROM
- 2) Invasion PCB + special Key Unit + Invasion PROM
- 3) Microtan 65 + Tanex + Invasion PROM (in position E2) + Hex keypad
- 4) Microtan 65+ Tanex + Invasion PROM + special Key Unit
- 5) Microtan 65 + Tanex + 2K RAM + keyed-in software + Hex keypad
- 6) Microtan 65 + Tanex + 2K RAM + keyed-in software + Key Unit.

Note the use of a Hex keypad — this project will *not* run with an ASCII keyboard.

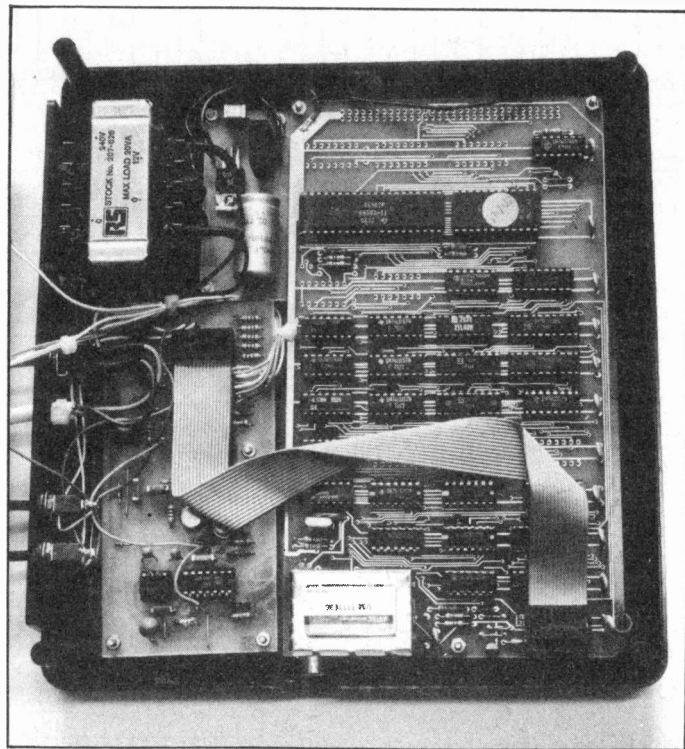

Inside the box, the main board is fitted into the right hand side, connected to the sound effects board on the left by ribbon cable. The power supply board is squeezed in next to the transformer. The two switches on the rear panel select the level of difficulty.

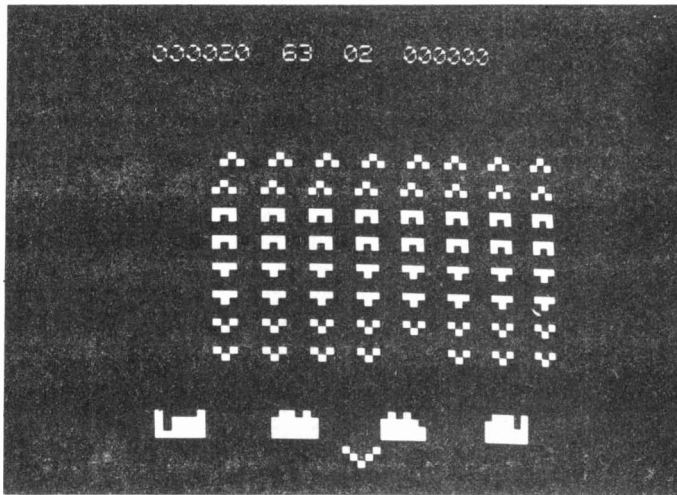

The screen display. This unfortunate space traveller has just been zapped by an alien.

## Construction

Tricky bit first. The main board is double-sided but it isn't necessary to solder components on both sides because the holes are plated through (sighs of relief). Fit the links and the discrete components first, being careful with the polarity where necessary, then solder all the IC sockets in the positions shown in the overlay diagram. You'll find there are more spaces for sockets than there are sockets but don't panic — this is to allow for later expansion into a computer as mentioned earlier. The UHF modulator is fixed to the PCB by soldering the case tags to the large pads provided — make sure it's the right way round. Now, double-checking both device type and orientation very carefully, plug the ICs into their sockets. Fit two lengths of wire for the power supply connections (these solder directly to the copper track) and the main board is complete. Check it again.

Well, there's still a long way to go. We have a score of 480 with 49 aliens still coming and no bases left. But we did better than the last astrogamester. He only scored 20.

With a flying saucer zooming across the top of the screen, one alien has just launched a missile. Hit your left or right button quick! Or try to blow his (its) missile off the screen.

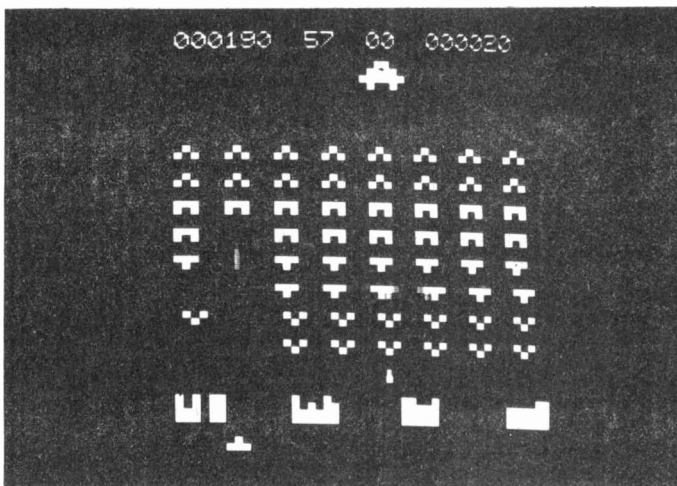

## Operating Differences

The UHF modulator for either version of the game is pre-tuned to Channel 36. Plug into the aerial socket, select a channel and adjust the tuning until the picture appears. If the game has been switched on without 'Reset' being operated, the screen will contain garbage.

If you are using the basic Invasion PCB, then operating the Reset switch brings the system into the 'ready-to-play' condition. If you are running the software on the Microtan 65, use Reset to gain access to TANBUG. The PROM is assembled to live at E800 (Hex), and the listing for the RAM version is assembled to live at 400 (Hex). So for the PROM version, typing GE800 brings the game to readiness by moving to the start address. With the software keyed into RAM, type G400.

If you are using the Hex keypad, the following keys are equivalent:

0 = PLAY

4 = BASE RIGHT

8 = BASE LEFT

C = FIRE

SHIFT = HOLD

Hitting any of the keys except HOLD removes hold.

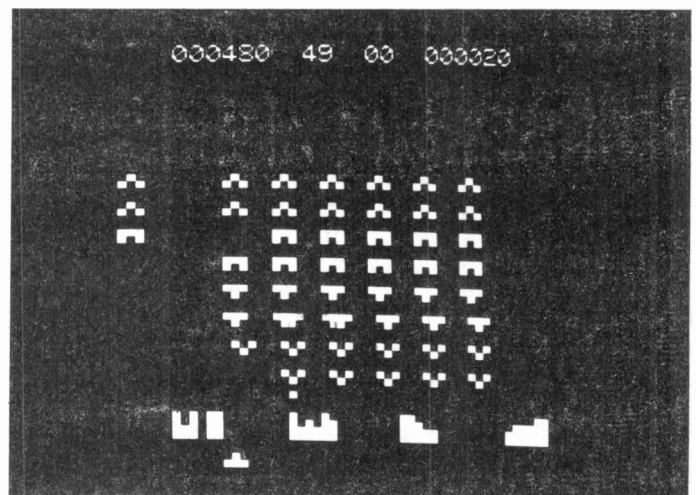

Now you can sit in front of your telly and make your living room a safe haven for the human race. For details of the modifications to produce a home computer, watch this space!

## BUYLINES

Tangerine Computers Ltd can supply the 'ETI Space Invasion project built for £99.85 all inclusive (or £80.85 in kit form). The sound generator and keypad section is available built for £20.55 all inclusive (or £15.38 in kit form).

If you want to shop around for your own components you can get the main Space Invasion PCB only for £21.15 all inclusive and the sound generator board for £5.60. The ROM is available for £17.75 all inclusive.

A case with internal PSU will be available from Tangerine soon. Contact them for the latest information on availability and price. Tangerine Computers Ltd, Forehill, Ely, Cambridgeshire.

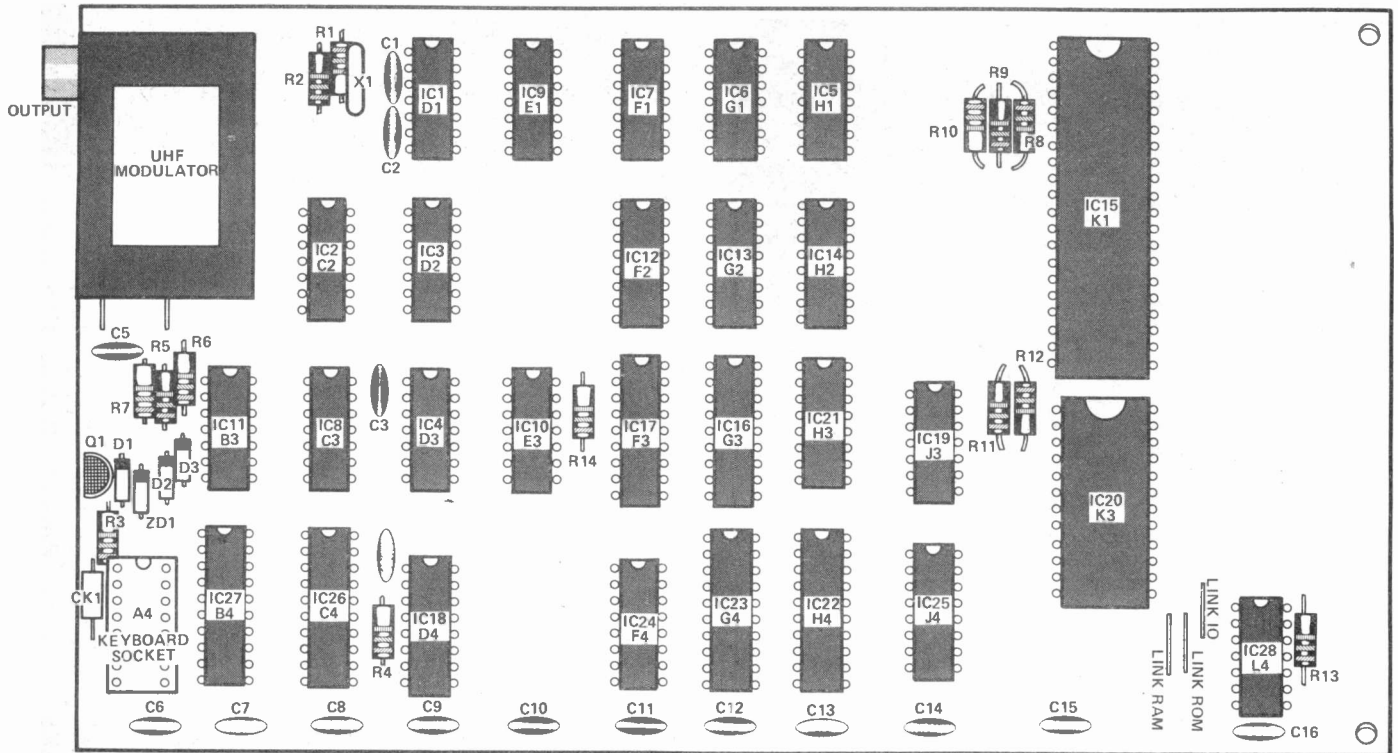

Fig.2. (above) Component overlay for the main board. All the chips face the same way.

## PARTS LIST

Resistors all 1/4 W 5%  
 R1,2,4,8,9,10,11,12,13,14 1k0  
 R3 10k  
 R5 470R  
 R6 220R  
 R7 75R

Capacitors  
 C1,4 10n ceramic  
 C2,3 100p ceramic  
 C5,6-16 47n disc ceramic  
 C6-16 are decoupling components, one for each column of ICs.

Semiconductors  
 IC1 74LS04  
 IC2 74LS73  
 IC3,4 74LS393  
 IC5 74LS21  
 IC6,11,28 74LS74  
 IC7 74LS08  
 IC8 74LS11  
 IC9 74LS86  
 IC10,19 74LS00  
 IC12,13,14 74LS157  
 IC15 6502  
 IC16,17 2114  
 IC18 DM8678BWF  
 IC20 2716  
 IC21 2102  
 IC22,23,26 74LS374  
 IC24 74LS251  
 IC25 74LS138  
 IC27 74LS244  
 Q1 BC184  
 ZD1 6V8 400 mW  
 D1-3 1N4148

Miscellaneous  
 CH1 100 uH choke  
 X1 6 MHz crystal  
 UHF modulator UM1111E36  
 PCB, case, 14-pin DIL socket (x13), 16-pin DIL socket (x8), 18 pin DIL socket (x2), 20 pin DIL socket (x4), 24 pin DIL socket, 40 pin DIL socket.

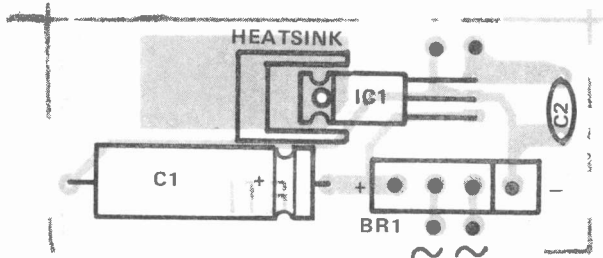

Fig.3. Component overlay of the power supply circuit. The heatsink is a type TV4, available from Watford Electronics.

## PARTS LIST

Capacitors  
 C1 1000u 25 V electrolytic  
 C2 470n polycarbonate

Semiconductors  
 IC1 7805  
 BR1 1.6 A 'In-Line' package

Miscellaneous  
 T1 0-9 V @ 1 A  
 SW1 DPDT miniature toggle  
 heatsink

Next month, we conclude the ETI Space Invasion Game with constructional details of the sound effects board.

ETI

# DORAM

DORAM ELECTRONICS LTD

Fitzroy House, Market Place,  
Swaffham, Norfolk, PE37 7QH.

TEL: (0760) 21627 TELEX: 817912  
VAT Reg: 324 5604 75

## PROJECT PACKS

### Projects for beginners

Clap switch (79026) Responds from a hand clap to switch on an electrical appliance	£6.60
Simple Sound effects (79077) Strange noises from a very simple circuit, loudspeaker included.	£5.70
Pools predictor (79053) An analogue computer that may win you a fortune.	£8.15
Talk Funny (80052) A ring modulator circuit that produces very strange results when fed with a human voice.	£9.60
Pest Pester (80130) An electronic insect repellent.	£2.35
Steam train sound effects (80019) Simulates the sound of steam and whistle.	£6.50
Electronic Nuisance (80016) Makes an annoying noise, but only in the dark!	£3.85
Cackling Egg timer (9985) An egg timer with a difference, it clucks like a hen.	£7.20

### New projects

Melody Maker (80502) An electronic musical box that can play 27 tunes with organ or piano like quality.	£23.50
Transistor Curve Tracer (80128) Interface with your scope to display Ic/Vce characteristics on the screen.	£2.40
Linear Thermometer (80127) Simple but effective meter reading thermometer using a diode as sensor.	£13.45
Precision Power Unit (80514) Produces accurate reference voltages at presettable current limits up to 2 Amps.	£48.65
8K RAM + EPROM card (80120) Various versions with up to 16K of EPROM.	POA

### Audio projects

Top-preamp (80031) Mini, all IC preamplifier for use with most power amplifiers.	£34.40
Topamp (80031) Hybrid audio power amplifier uses Philips modules for high fidelity performance. Two power levels: OM931 (output 30 Watt)	£18.50
OM961 (output 60 Watt)	£33.40
Stentor (79070) A high power portable amplifier for PA use.	£30.00
Assistant (79071) A preamplifier designed for Stentor which can also be used as a speech compressor for radio transmission.	£7.00
Parametric Equalizer (9897) A modular system of construction to suit your equalisation requirements. Filter section (9897-1)	£6.45
Tone section (9897-2)	£5.20
Elektornado (9897) A single board design that can be used as either a single 100 Watt amplifier or two 50 Watt amplifiers.	£19.50
UAA180 LED meter (9817) A two channel voltage display unit.	£13.00
Peak Programme Meter (9860) To be used with UAA180 LED meter to give PPM display.	£3.70
Audio Analyser (9932) An analyser that can pin point the deficiencies in an audio chain.	£14.80
Stereo dynamic Preamp (80532) A low noise high quality disc preamplifier.	£5.20
STAMP (80543) Super tiny amplifier with up to 1 Watt output.	£3.75
Consonant (9945) A high quality audio control amplifier.	£34.65
Preconsonant (9954) A preamplifier for the disc input of the Consonant.	£5.75
Luminant (9949) A two channel LED display designed to show output levels in the Consonant system.	£20.70

### Car projects

Car Battery Charger (79517) Reliable and safe charger for all types of lead-acid batteries.	£21.70
Transistor Ignition (80082) The most significant advantages of other systems combined in one.	£20.45
Dipstick Probe (80102) Direct warning of high oil temperature. State long or short dipstick required.	£11.25
Intelligent Wiper Delay (80086) Can be set to produce delayed wipes at any predetermined interval.	£15.85
Battery Protection (80109) Automatically switches off the head lamps of a parked car.	£5.15
Battery Voltage Indicator (80101) LEDs indicate the condition of your battery.	£6.85
Active Car Aerial (80018) Improves the sensitivity of AM and FM radio reception in your car.	£13.85

### Music projects

Chorosynth (80060) A cheap mini synthesizer. Send for details.	£57.90
Elektor Vocoder (80060) The first Vocoder designed to be built in kit form. 10 Channel modular construction.	£162.50
Analogue Reverberation Unit (9973) Uses a SAD1024 which can produce a delay up to 100ms.	£27.70
Guitar Preamp (77020) With three tone controls.	£6.50

### Projects for the home

Touch Dimmer (78065) Room lighting controlled by a single touch.	£6.80
Ioniser (9823) Produces a high concentration of negative ions.	£9.55
Loudspeaking telephone amplifier (9987) Amplifies without direct connection.	£11.50
Proximity Detector (9974) Detects by electric field change movement in a room.	£9.80

Our Project Packs include the electronic components, the PCB, sockets and solder together with assembly instructions. Cases, knobs etc can be supplied as extra items if required. This is only part of our wide range of projects. See our catalogue for details of other projects that we can supply. You can also ring our number between 12.30 p.m. and 1.30 p.m. any weekday for a recorded announcement of any new items we have available.

Send 40p for catalogue

#### HOW TO ORDER

Send a cheque or postal order to DORAM ELECTRONICS LTD or write or ring with your Access account number. All our prices include VAT. Overseas customers please deduct 15%. Please add 40p to your order for postage and packing. An answering service is available to take your orders outside our normal office hours. Mail Order service only.

a de boer company



NAME \_\_\_\_\_

ADDRESS \_\_\_\_\_

# 2W POWER AMPLIFIER

A PROJECT  
FOR YOUR  
FREE PCB

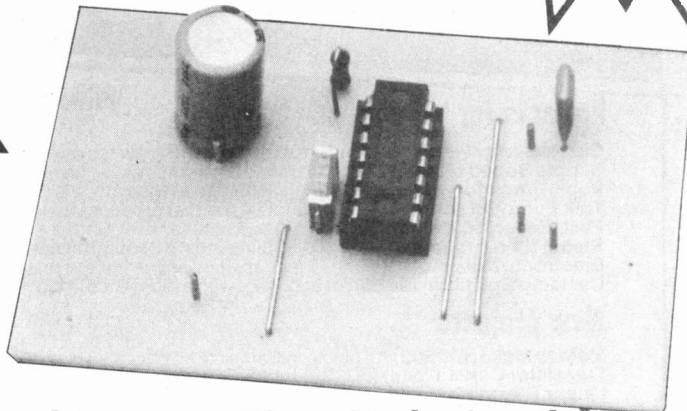

This must be just about the simplest power amplifier that you're likely to come across — a few components and a free PCB. No excuses for not building this one. Circuit design by Keith Brindley.

If you need a simple-to-build, inexpensive power amplifier and you've got 15 minutes to spare, unpack your soldering iron and ETI Multi-Option Board. That's all it'll take to get your ETI 2 W Power Amplifier up and running.

We aren't claiming total originality for this circuit. The donkey work, of course, is all done by the well known and loved LM380 power amplifier IC. This chip eliminates the need for preset adjustments of any kind, and distortion and output noise are so low as to render the circuit virtually in the "High Fidelity" category.

Only four other components are needed to complete the amplifier, which will provide the builder with a fine device, needing only a power supply of between about 9-18 V DC (ideal for battery operation) to get things going.

For those interested in technical specifications,

you'll want to know that the IC features an internally fixed gain of 50 (34 dB) and an output which automatically centres at half supply voltage. The output stage is short-circuit current-limited and thermal shutdown in the chip prevents overheating-to-damage point — it turns itself off if it runs a temperature, takes two aspirins and calls you when it cools off again. So, it's safe to assume that the amplifier is just about idiot-proof!

## Construction

Nothing much to comment on here. It's all straightforward. Just make sure the chip is the right way round, as should be the power connections (shown on the overlay).

## HOW IT WORKS

The whole IC can be regarded as a simple op amp with a power output stage tagged on at the end. Pin 2 is the inverting input and pin 6 the non-inverting input. To these can be added the usual feedback connections to tailor gain and frequency response as required, but internal resistors tie what would be the open loop gain to a flat ratio of 50. So with no feedback resistance, a fixed gain of 34 dB occurs whatever the input.

The output stage is a class AB, quasi-complementary pair, emitter-follower. This keeps crossover distortion to a minimum whilst also maintaining quiescent current at less than 15 mA. This latter fact allows satisfactory battery operation, with low distortion.

R1 and C2 form a Zobel network, which effectively suppresses a possible 5 to 10 MHz small amplitude oscillation which can occur during the negative swing into the load. Obviously the oscillations are not in the audio range nor will they pass through the speaker (due to coil reactance), but nevertheless they can cause power loss and other problems in an RF sensitive environment.

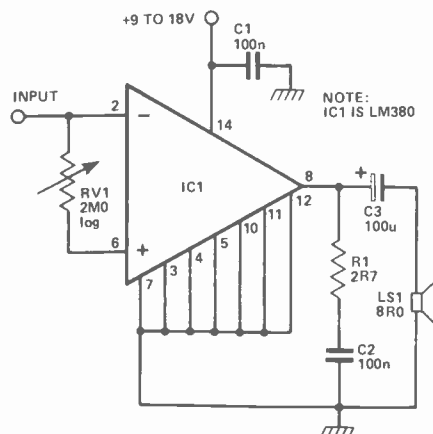

Fig.1 Circuit diagram. Pins 3,4,5,10,11 and 12 are joined internally.



PARTS LIST

Resistor ¼ W 5%	
R1	2R7
Potentiometer	
RV1	2M0 logarithmic
Capacitors	
C1,2	100n polycarbonate
C3	100u 16 V electrolytic
Semiconductor	
IC1	LM380
Miscellaneous	
LS1	8R0 Loudspeaker
ET1 Multi-Option PCB	

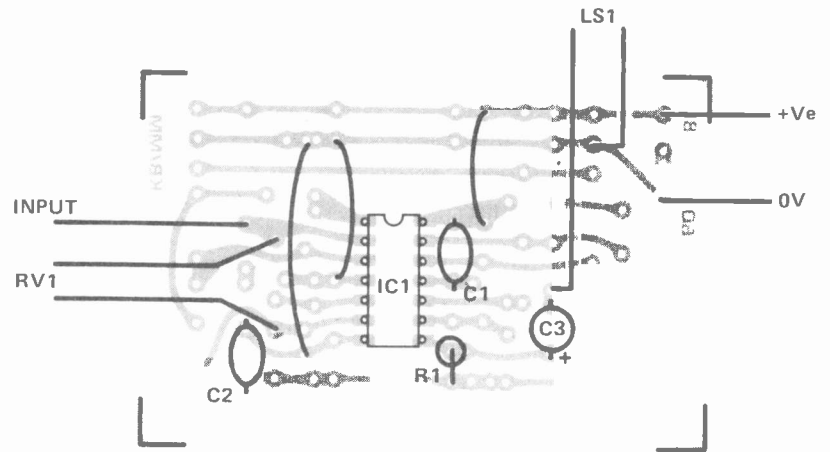

Fig.2 Component overlay.

BUYLINES

A simple project with few components. You shouldn't meet with any difficulty in obtaining the components. Have a look at the major suppliers advertising in this issue.

ETI

# Guess who builds this great

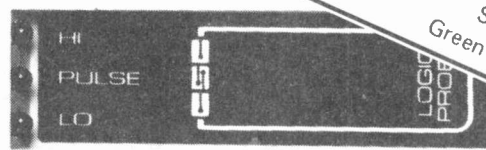

See us on STAND 826, Green Hall at INTERNEPCON

# Logic Probe...*YOU!* for only **£11.92**

With this easy-to-build Logic Probe Kit from CSC and just a few hours of easy assembly—thanks to our very descriptive step-by-step manual—you have a full performance logic probe.

With it, the logic level in a digital circuit is indicated by light from the Hi or Lo LED; pulses as narrow as 300 nanoseconds are stretched into blinks of the Pulse LED, triggered from either leading edge. You'll be able to probe deeper into logic with the LPK-1, one of the better tools from CSC.

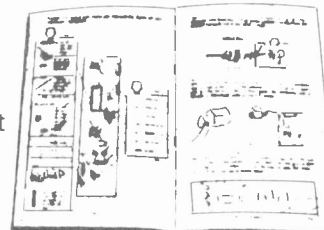

Complete, easy-to-follow instructions help make this a one-night project.

CONTINENTAL SPECIALTIES CORPORATION

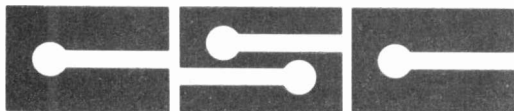

**C.S.C. (UK) Limited**, Dept. 9Z  
 Unit 1, Shire Hill Industrial Estate,  
 Saffron Walden, Essex. CB11 3AQ.  
 Telephone: Saffron Walden (0799) 21682  
 Telex: 817477.

CONTINENTAL SPECIALTIES CORPORATION. DEPT. 9Z  
 Unit 1, Shire Hill Industrial Estate, Saffron Walden, Essex.

Name \_\_\_\_\_  
 Address \_\_\_\_\_  
 Inc P&P and 15% VAT  
**LPK-1 £14.86** I enclose cheque  
 PO for £ \_\_\_\_\_ FREE Catalogue  
 Phone your order with Access, Barclaycard tick box   
 or American Express Card No. \_\_\_\_\_ Expiry date \_\_\_\_\_

# interface components

ALL PRICES ARE EXCLUSIVE OF VAT

## TRANSISTORS

AC128	15p	BCY71	12p
AC187K	30p	BCY72	12p
AC188K	30p	BF179	25p
ACY17	90p	BF183	25p
AD149	55p	BF200	29p
AF127	35p	BF336	33p
ASZ17	120p	BFX30	32p
AU113	150p	BFX86	26p
BC107	7p	BFX88	22p
BC108	7p	BFY50	13p
BC108A	7p	BFY51	13p
BC108C	7p	BFY64	28p
BC136	15p	BFY90	56p
BC140	28p	BSX19	80p
BC141	30p	BSY95A	16p
BC142	25p	BU204	149p
BC143	28p	BU208	150p
BC147	6p	OC29	89p
BC147B	6p	OC43	50p
BC149	7p	2N696	15p
BC149C	7p	2N930	20p
BC159	9p	2N1132	19p
BC160	35p	2N1304	40p
BC167A	10p	2N1613	12p
BC178	12p	2N1711	15p
BC179	12p	2N2217	20p
BC182	8p	2N2219A	20p
BC182L	9p	2N2221	18p
BC183	9p	2N2368	15p
BC183L	9p	2N2369	14p
BC184L	9p	2N2894A	20p
BC186	20p	2N2904	15p
BC212	9p	2N2904A	15p
BC212L	9p	2N2905	15p
BC213B	9p	2N2906	15p
BC327	13p	2N2926Y	10p
BC328	13p	2N2926O	10p
BC337	16p	2N2926R	10p
BC338	11p	2N3442	102p
BC440	32p	2N3702	8p
BC547	9p	2N3704	8p
BC548	9p	2N3705	8p
BC550	14p	2N3708	8p
BC558	12p	2N3709K	8p
BCY33	99p	2N3866	35p
BCY34	99p	2N3906	10p
BCY39	229p	2N4058	12p
BCY58	16p	2N4427	60p
BCY70	12p	Add VAT	

## REGULATORS

7805	80p
7812	80p
7815	80p
7824	80p
7905	105p
7912	105p
7915	105p
7918	105p
7924	105p
LM309K	105p
LM320T5	105p
LM320T12	105p
LM320T15	105p
LM320T18	105p
LM323K	450p
LM340T5	80p
LM340T12	80p
LM340T15	80p
LM340T18	80p

74175	63p	4022	79p
74180	84p	4023	16p
74181	151p	4024	49p
74191	80p	4025	17p
74192	80p	4026	129p
74193	80p	4027	39p
74194	80p	4028	59p
74LS00	11p	4029	89p
74LS01	11p	4030	49p
74LS02	12p	4034	189p
74LS03	12p	4035	99p
74LS04	12p	4042	69p
74LS10	19p	4043	86p
74LS11	20p	4044	83p
74LS20	18p	4046	109p
74LS30	18p	4049	45p
74LS32	24p	4050	63p
74LS42	89p	4051	69p
74LS51	24p	4052	69p
74LS55	28p	4053	69p
74LS74	39p	4066	49p
74LS75	46p	4069	17p
74LS76	39p	4070	17p
74LS85	99p	4071	17p
74LS90	36p	4072	17p
74LS93	79p	4073	17p
74LS114	49p	4075	19p
74LS122	65p	4076	75p
74LS123	65p	4077	35p
74LS124	115p	4081	19p
74LS132	89p	4082	17p
74LS139	79p	4160	105p
74LS151	89p	4161	105p
74LS155	91p	4162	105p
74LS156	89p	4163	105p
74LS157	69p	4402	36p
74LS165	69p	4404	110p
74LS168	139p	4412	86p
74LS174	99p	4445	174p
74LS175	99p	4446	148p
74LS190	110p	4502	99p
74LS192	115p	4511	89p
74LS194	115p	4512	89p
74LS195	115p	4514	229p
74LS196	95p	4515	229p
74LS197	125p	4516	99p
74LS257	99p	4520	70p
74LS260	99p	4522	129p
74LS273	199p	4526	125p
74LS367	59p	4531	125p
74LS378	159p	4555	92p
		4556	69p
		4581	269p
		4582	115p
		4584	59p
		4585	99p

## TTL

7400	9p
7401	9p
7402	9p
7403	9p
7404	10p
7405	14p
7406	30p
7407	30p
7408	17p
7409	17p
7410	12p
7412	17p
7413	25p
7414	45p
7416	25p
7417	25p
7420	14p
7427	28p
7430	14p
7432	22p
7438	26p
7442	48p
7447	50p
7450	15p
7451	15p
7470	30p
7472	25p
7474	20p
7475	27p
7480	40p
7482	60p
7486	25p
7491	63p
7492	35p
7493	28p
7494	63p
7495	63p
74100	110p
74107	30p
74121	25p
74122	36p
74123	44p
74145	72p
74154	80p
74157	60p
74161	85p

## CMOS

4000	14p
4001	14p
4002	14p
4006	69p
4007	16p
4008	79p
4009	36p
4010	36p
4011	19p
4012	16p
4014	59p
4015	73p
4016	42p
4017	79p
4018	79p
4019	45p
4020	89p
4021	83p

## DIL SOCKETS

8 pin	10p
14 pin	12p
16 pin	13p
20 pin	25p
24 pin	30p
40 pin	40p

## MEMORIES

21L02	60p
2114	300p
4027	275p
4116	500p
4118	1250p

## EPROMS

2708	750p
2716	1500p
2732	4850p

## CPU'S

Mk 3880	950p
Mk 3881	625p
Mk 3882	625p

All advertised items available for immediate despatch while stocks last

## DIODES

AA119	10p
BA154	9p
BA156	9p
IN4001	4p
IN4002	4p
IN4003	5p
IN4005	5p
IN4006	6p
IN4007	6p
IN4148	5p
IS44	3p

## TRIACS

4A 400V	54p
4A 600V	60p
6A 400V	60p
6A 600V	66p
8A 400V	66p
8A 600V	72p
10A 400V	72p
10A 600V	84p
15A 400V	108p
15A 600V	126p

## OPTO

Leds	
125 Red	8p
125 Green	12p
125 Yellow	12p
2 Red	10p
2 Green	10p
Displays	
704	110p
741	160p
747	160p
750	160p

## BRIDGE RECTIFIERS

50V	100V	200V	400V	600V
1.5A	34p	36p	38p	40p
4A	40p	42p	44p	48p
6A	48p	50p	54p	60p
25A	130p	140p	150p	170p

### RETAIL SHOP AND MAIL ORDER WE STOCK A WIDE RANGE OF

★ Semiconductors ★ Resistors ★ Capacitors ★ Soldering Irons & tools ★ VERO products ★ OK Machine Tool Co. Products ★ Microcomputers & Peripherals including Nascom, PET, Sharp. 35p P & P. VAT additional  
★ Large range of Microcomputer books

### INTERFACE COMPONENTS LIMITED

OAKFIELD CORNER, SYCAMORE ROAD, AMERSHAM, BUCKS HP6 6SU  
TELEPHONE: 02403 22307. TELEX: 837788

Write, telephone or call. Access or Barclaycard accepted

## Quantum Electronics



### PRE-amp MODULE £63.50, BUILT £92.00

The most cost-effective pre-amplifier available. It provides a perfect match for any cartridge, moving coil or magnetic and also accepts auxiliary and 2- or 3-head tape machine with outstanding technical performance from an elegant circuit configuration. We also have separate mains supplies for the pre-amplifier in kit form and ready-built and module/hardware for moving coil head amps.

★ COMING SOON: ACTIVE CROSSOVER ★

### POWER AMPS: KITS FROM £100.50 BUILT £151.00

There are stereo and mono 'domestic' power amplifiers from 45W to 200W/8 ohms, ready built or in kit form. The kits use built and tested printed circuit boards and require only simple assembly and point-to-point wiring.

Exemplary specification includes t.h.d. less than 01% at 1kHz, slew rate greater than 30V/μS, noise greater than 110dB, fully protected against overload, unconditionally stable.

45W channel: kit, P2, £100.50; built, 202D £151.00  
110W/channel: kit, P4, £126.00; built, 204D £185.00

### POWER AMP MODULES AND SUPPLIES

QE 1708, 1704, £31.96  
QE 1004, £20.69

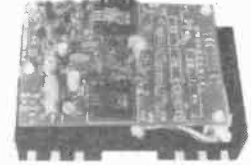

M1504, 1508, £35.79 M2603, £50.28  
M854, £26.00 M2308, £53.96

We offer a wide range of power amplifier modules to suit virtually any application with a performance that is unbeatable at the price. Using circuitry basically identical to our widely acclaimed amplifiers above, they are available in both the popular 'L' bracket versions for 60 to 170W 'module rating' for medium duty use and also in high dissipation formats using separate heatsinks for ultimate reliability at up to 260W r.m.s. Matching power supplies using toroidal transformers (available separately up to 500VA!) are available.

### ★ EXCELLENT TRADE PRICES ★

We also build rack mounting power amplifiers, sub-assemblies and special modules to individual specifications. Please telephone with your enquiry.

### NEW DELUXE SPEAKER KITS

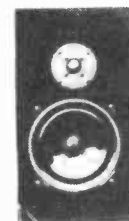

SYSTEM 1  
£69.00

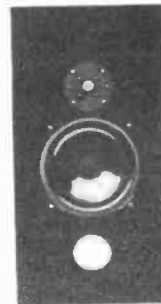

SYSTEM 2  
£89.00

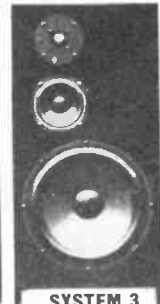

SYSTEM 3  
£159.00



SYSTEM 4  
£359.00

#### PRICES PER PAIR INC. BAFFLES

Have you wondered why the existing sources of speaker kits offer a bewildering choice of systems, particularly combinations of 200mm bass unit and tweeter? Don't they know which ones are best? If so, why bother with the rest! Well we have sorted out these super kits so you can order in confidence, knowing you get our full endorsement of their performance and value. The kits incorporate professionally finished front baffles with the drive units already mounted so all the fiddly work is done for you. All that is left to do is to make a simple box. Crossover networks, foam and terminals are included. Systems 1 and 2 use a 200mm bass and 25mm dome tweeter from Son Audax. System 2 being a reflex design that we enthusiastically recommend. System 3 is a competitive 3-way I.B. using Seas bass and mid with a Son Audax tweeter, cleverly incorporating a stand at the bottom of the enclosure, as does System 4, undoubtedly the best kit on the market, using a Volt 250mm bass driver with a 250mm ABR on the rear baffle (also supplied), a modified Peerless mid and Son Audax tweeter. We will also be retailing selected drive units at competitive prices, e.g. Son Audax 200mm bass, 20B25J4 £13.50; 25mm tweeter, HO100025, £9.00.

All our prices include V.A.T. and delivery. Export no problem — please send for a specific quote by return. All equipment can be wired for 110V mains. Please send a large S.A.E. or dollar bill for our full information and review reprints.

PLEASE NOTE THE ADDRESS OF OUR NEW LARGER PREMISES:  
**8 ALBION STREET, LEICESTER**  
Tel: (0533) 546198

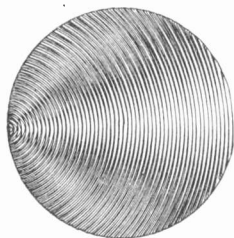

# B.K. ELECTRONICS

## A SOUND CHOICE

★ PROMPT DELIVERY ★ PRICES INCLUDE V.A.T. ★ AMPLE STOCKS  
A PERSONAL SERVICE FROM A SMALL EXPANDING COMPANY

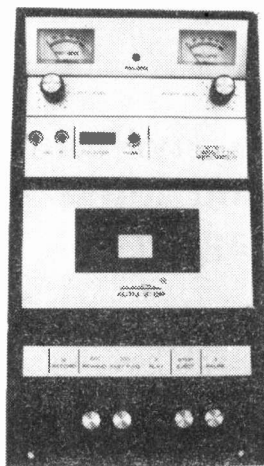

6 piano type keys

**STEREO CASSETTE TAPE DECK ASSEMBLY.** Comprising of a top panel assembly and tape mechanism coupled to a record/play back printed board assembly. For horizontal installation into cabinet or console of own choice. Brand new, ready built and tested. **Features:** Pause control, auto stop, 3 digit tape counter, illuminated twin VU meters with individual level controls, twin mic, input sockets, AC erase system, LED record indicator. (Separate power amplifier required.) **Input Sensitivity:** 6 MV (with level control set at max). **Input Impedance:** 47 kOhms. **Output Level:** To both left and right hand channels 150 MV. **Output Impedance:** < 10k. **Signal to noise ratio:** 45 dB nominal. **Power Supply Requirements:** 12V AC at 300M/A. **Connections:** All connections to the unit are via a wander lead terminated with a nine pin plug (socket provided). **Dimensions:** Top panel — 11 1/2 in x 6 1/2 in. Mechanism fits through a cut out 5 3/4 in x 10 1/2 in. Clearance required under top panel 2 1/4 in. Supplied complete with circuit diagram etc. **Price £30.50** plus £2.50 postage and packing. Suitable mains 12-volt transformer, **£3.00.**

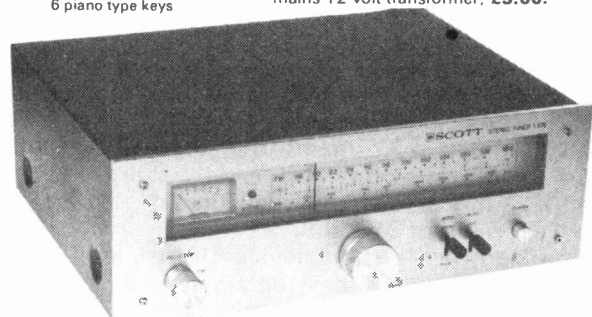

**SCOTT AM/FM STEREO TUNER MODEL 516.** This Scott tuner is one of the top American makes and is offered at a very realistic price. Features: ★ FM tuning range 87.5 to 108 MZ ★ AM tuning range 535 to 1605 kHz ★ Usable FM sensitivity 6.2dBF 2.2μV ★ 300 ohm & 75 ohm Aerial inputs for FM ★ Signal strength tuning meter ★ Stereo beacon indicator ★ Ferrite aerial for AM ★ Mute switch, 10 diodes, 9 transistors and 3 ICs. Size: Height 5in, Width 14 1/2 in, Depth 12in. Silver front panel. Black body. Modern stacking format. Suitable for 240-volt 50Hz AC operation. Special Price **£40** postage free.

### PIEZO ELECTRIC TWEETERS — MOTOROLA

Join the Piezo revolution. The low dynamic mass (no voice coil) of a Piezo tweeter produces an improved transient response with a lower distortion level than ordinary dynamic tweeters. As a crossover is not required these units can be added to existing speaker systems of up to 100 watts (more if 2 put in series). **FREE EXPLANATORY LEAFLETS SUPPLIED WITH EACH TWEETER.**

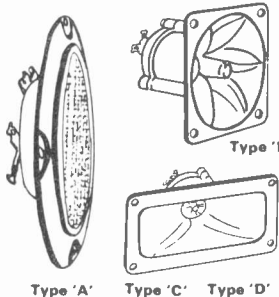

**Type 'A'** 3in round with removable wire mesh. Ideal for bookshelf hi-fi speakers. **Price (Type 'A')** **£3.75 each**;

**Type 'B'** 3 1/2 in super horn. For general purpose speakers disco and PA systems, etc. **Price £4.60 each.**

**Type 'C'** 2in x 5in wide dispersion horn. For hi-fi systems and quality disco etc. **Price £6.20 each.**

**Type 'D'** 2in x 6in wide dispersion horn. Frequency response extending down to mid-range (2000 c/s) suitable for hi-fi systems and quality disco. **Price £9 each.**

Post and Packing, all types, 15p each (or SAE for Piezo leaflets).

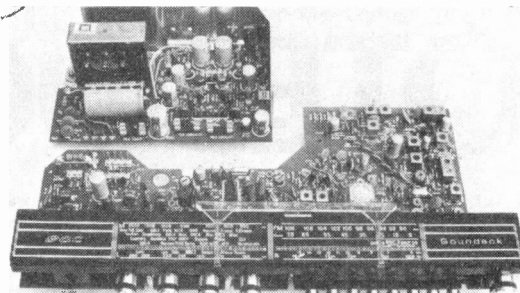

**GEC AM/FM STEREO TUNER AMPLIFIER CHASSIS.** Originally designed for installation into a music centre. Supplied as two separate built and tested units which are easily wired together. **Note:** Circuit diagram and interconnecting wiring diagrams supplied. **Rotary Controls:** Tuning, on/off volume, balance, treble, bass. **Push-button controls:** Mono, Tape, Disc., AFC, FM (VHF), LW, MW, SW. **Power Output:** 7 watts RMS per channel, at better than 2% THD into 8 ohms. 10 watts speech and music. **Frequency Response:** 60Hz-20kHz within ± 3dB.

**Tape Sensitivity:** Output — typically 150 mV. Input — 300 mV for rated output. **Disc Sensitivity:** 100mV (ceramic cartridge). **Radio:** FM (VHF), 87.5MHz — 108MHz. Long wave 145kHz — 108kHz. Medium wave. 520kHz — 1620kHz. Short wave. 5.8MHz — 16MHz. **Size:** Tuner — 2 3/4 in x 15 in x 7 1/2 in approx. Power amplifier — 2 in x 7 1/2 in x 4 1/2 in approx. 240V AC operation. Supplied complete with fuses, knobs and pushbuttons, and LED stereo beacon indicator. **Price £21.50** plus £2.50 postage and packing.

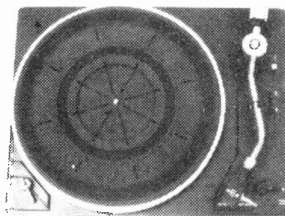

**JVC TURNTABLE.** JVC Turntable supplied complete with an Audio Technica AT10 stereo magnetic cartridge. ★ 'S' shaped tone arm. ★ Belt driven. ★ Full size 12in platter. ★ Precision calibrated counterbalance weight (0-3 grms.) ★ Anti-skate (bias) device. Nylon thread weight. ★ Damped cueing lever. ★ 240V AC operation, (50Hz). ★ Cut-out template supplied. Size — 12 3/4 in x 15 3/4 in (approx). **Price £28.50** plus £2.50 postage and packing.

### DE-SOLDERING PUMP



This de-soldering pump made to a very exacting specification is ideal for the removal of small components from printed circuit boards, etc. Comes complete with spare PTFE tip **£5.30** post free

### FIRE ALARM CENTRAL CONTROL UNIT (S.T.C.)

Ideal for Fire or Burglar Alarm Systems

- ★ Responds to normally open or closed switches (or smoke detectors etc.)
- ★ Complete with an internal EXIDE lead acid accumulator (dry charged) as a back-up for mains failure. This is trickle charged
- ★ 6v-2 amp output for Fire/Burglar alarm, etc
- ★ Re-set button for silencing Fire/Burglar alarm.
- ★ Internal buzzer which sounds if re-set button if pressed until initiating switch is cleared
- ★ Wall mounting, complete with red case, approx. 11" x 7 1/2" x 4"
- ★ 240v AC operation

### LOUDSPEAKER

High quality full range 8" loudspeaker. 10 watts RMS. 80HM Rolled surround with aluminium centre dome **Price £3.75 each** + 75p Postage and Packing each.

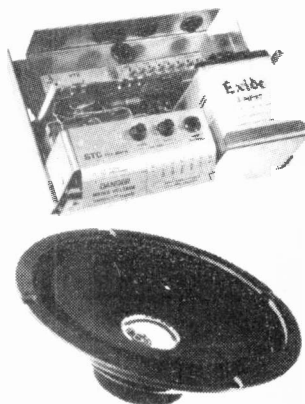

# B.K. ELECTRONICS

37 Whitehouse Meadows, Eastwood, Leigh-on-Sea, Essex SS9 5TY

★ SAE for current lists. ★ Official orders welcome. ★ All prices include VAT. ★ Mail order only. ★ All items packed (where applicable) in special energy absorbing PU foam. Callers welcome by prior appointment, please phone 0702-527572.



# DESIGNER'S NOTEBOOK

In this month's 'Notebook' Ray Marston explores the mysterious depths of 'zero-voltage switching' of mains power and looks at some practical applications of the CA3059 'zero-voltage' IC.

There are two basic ways of switching mains power to a load — either via a mechanical switch or via a solid state switch such as a triac. Mechanical switches are fairly slow acting devices: they suffer from severe arcing at the moment of switching and generate a great deal of RFI (radio-frequency interference) at switch-on and switch-off. This RFI can often be heard on domestic radio and TV sets and can cause malfunctioning of delicate electronic equipment.

Triac switches are fast acting devices and do not suffer from arcing problems. Nevertheless, they are still capable of generating considerable RFI at switch on. Why? As the triac turns on, the load current may rise from zero to several amps in a mere couple of microseconds: since this current flows through the mains wiring, the wiring may radiate a great 'splurge' of RFI in response to this heavy surge current. The magnitude of the RFI is proportional to  $di/dt$  and can be reduced by

either reducing the surge current amplitude or increasing the surge current rise time, or possibly both: once the triac has turned on, the subsequent large 'rise time' of the 50 Hz mains signal causes virtually zero RFI even when load currents of tens of amps are being drawn.

## Zero-Voltage Switching

Thus, the degree of triac switch-on RFI is proportional to the value of instantaneous mains voltage at the moment of triac turn-on. If a 100R load is being driven from 230 V AC mains, the surge current will be 3A25 if switch-on occurs at a 'crest' value of 325 V, or mere 32.5 mA if switch-on occurs at a 'near zero-crossover' value of 3V25.

Triacs are self-latching devices. If they are turned on by a brief gate signal, they remain on until their main-terminal currents fall below a minimum 'holding' value

Fig. 1 Internal circuit and minimum external connections of the CA3059 zero-voltage switch.

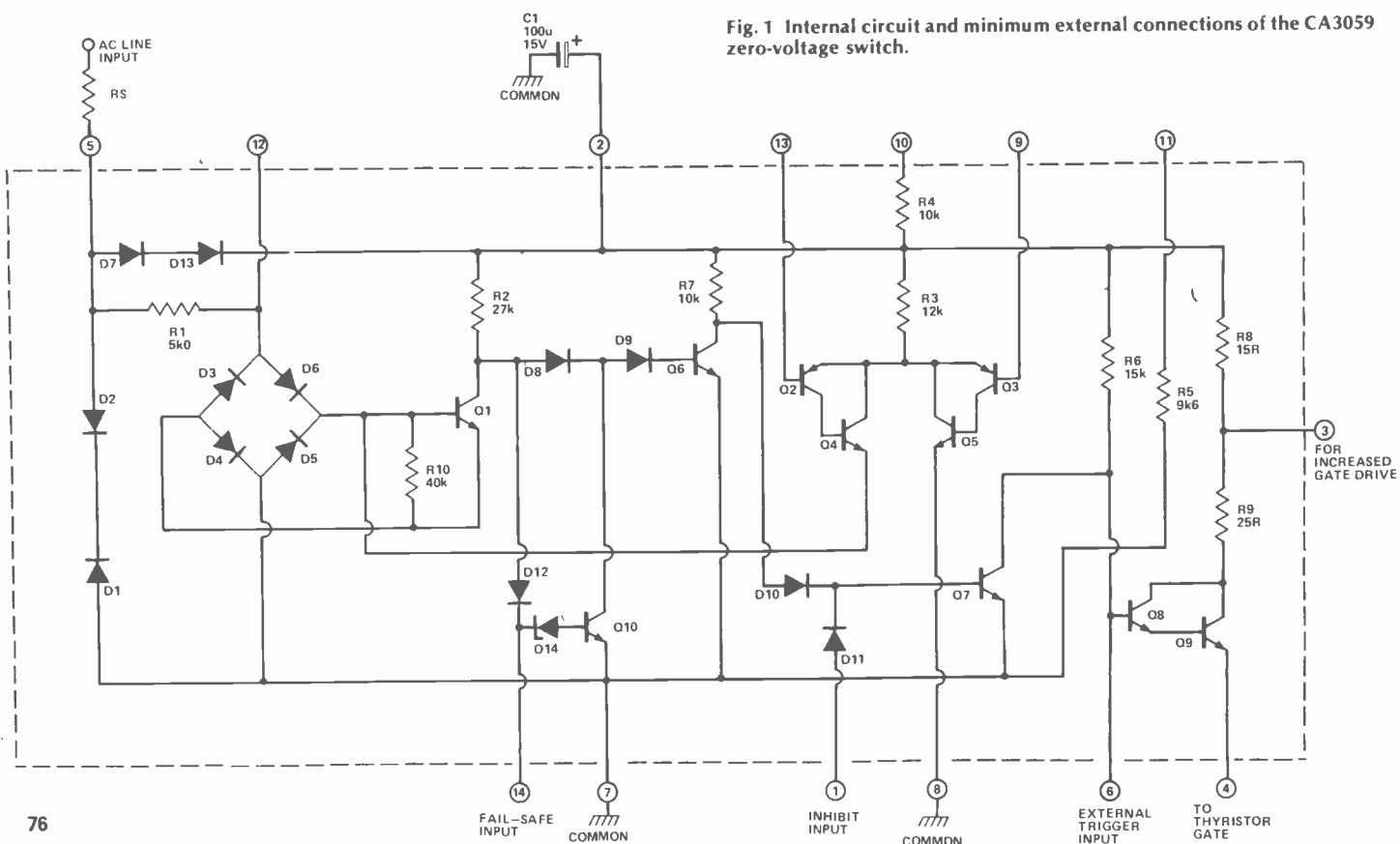

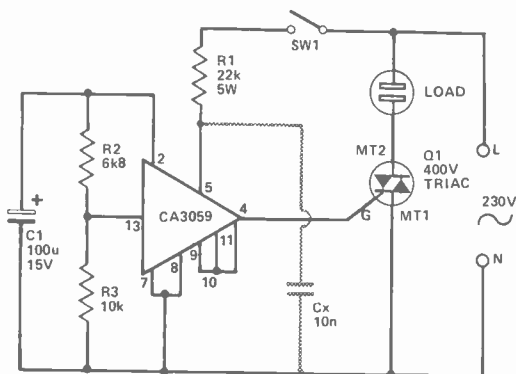

Fig.2 A simple mains-switched zero-voltage switch. Cx may be used to overcome latching deficiencies of some triacs.

of a few milliamps. They automatically turn off at the end of each mains half cycle as their main-terminal currents fall to near-zero. They can be turned on near the start of each half cycle as soon as their main-terminal currents are capable of exceeding the minimum holding value.

Thus, a triac can be persuaded to generate virtually zero switch-on RFI by feeding it with gate current *only* when the instantaneous mains voltage is close to the zero or cross-over value at the start of each half cycle. This technique is known as 'zero-voltage switching'. Special zero-voltage triac-driving ICs are available from a number of manufacturers. One such device is the CA3059, manufactured by RCA.

## The CA3059 Zero-Voltage Switch

The internal circuit and minimal external connections of the CA3059 zero-voltage switching IC are shown in Fig.1. The device is housed in a 14-pin DIL package and incorporated DC power supply circuitry, a zero-crossing detector, triac gate drive circuitry and a high-gain differential amplifier/gating network. Circuit operation is as follows.

Mains power is connected between pins 5 and 7 of the device via limiting resistor Rs (22k, 5 W when 230 V mains is used). D1 and D2 act as back-to-back zeners and limit the pin 5 voltage to  $\pm 8$  V. On positive half cycles D7 and D13 rectify this pin 5 voltage and generate approximately 6V5 across the 100uF capacitor connected to pin 2. This capacitor supplies sufficient energy storage to drive all internal circuitry and provide adequate triac gate drive, with a few milliamps or so spare drive available for powering auxiliary (external) circuits.

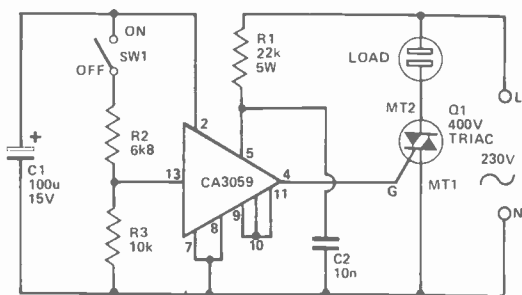

Fig.3 Direct-switched zero-voltage switch.

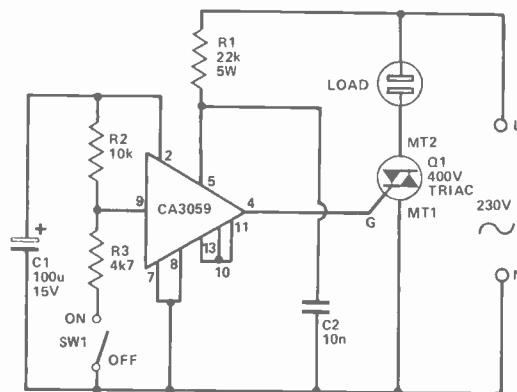

Fig.4 An alternative and very useful method of direct-switching the CA3059 IC.

Bridge rectifier D3-D6 and transistor Q1 act as a zero-voltage detector, their action being such that Q1 is turned on (driven to saturation) whenever the pin 5 voltage exceeds  $\pm 3$  V. Gate drive to an external triac can be made via the emitter (pin 4) of the Q8-Q9 Darlington pair of transistors, but is available only when Q7 is turned off. When Q1 is turned on (pin 5 greater than  $\pm 3$  V) Q6 is turned off through lack of base drive, so Q7 is driven to saturation via R7 and no triac gate drive is available from pin 4. Triac gate drive is thus available only when pin 5 is close to the 'zero-voltage' or cross-over mains value. When gate drive is available, it is delivered in the form of a narrow pulse centred on the cross-over point with pulse power supplied by C1.

## Vive La Differential

The CA3059 incorporates a differential amplifier or voltage comparator, built around Q2 to Q5, for general purpose use. Resistors R4 and R5 are externally available for biasing one side to the amplifier. The emitter current of Q4 flows via the base of Q1 and can be used to disable the thyristor (pin 4) gate drive by turning Q1 on. The configuration is such that the gate drive can be disabled by making pin 9 positive relative to pin 13. The drive can also be disabled by connecting external signals to pin 1 and/or pin 14.

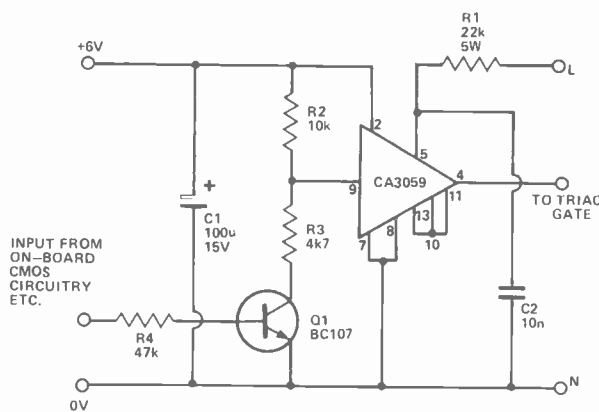

Fig.5 One method of transistor-switching the CA3059 via on-board CMOS circuitry such as one-shots, astables, etc.

## CA3059 Switching circuits

Figure 2 shows the simplest possible way of using the CA3059 as a 'noiseless' switch with the zero-voltage switching provided via the IC and the triac and with on/off switching controlled by SW1. The circuit action is quite simple. The IC is connected to the mains via SW1 and limiting resistor R1. DC energy is stored by C1. The IC is wired in the 'enabled' mode by biasing the pin 9 side of the internal differential amplifier at half-supply (DC) volts via the pin 10 and 11 connections and by biasing the pin 13 side above half-supply via the R2-R3 divider network. Switch SW1 passes only a few milliamps of current and thus generates negligible RFI. The circuit can power mains loads such as lamps and heaters via a suitable rated triac.

The 'zero-voltage' triac-gate-drive pulse of the CA3059 is very narrow. In some applications, the pulse may terminate before the triac main-terminal currents have reached their minimum holding levels and self-latching may fail to occur. This problem can be overcome by wiring Cx as shown in Fig. 2. This capacitor, in conjunction with R1, gives a slight phase shift to the pin 5 signal and extends the 'zero-voltage' pulse further into the start of each mains half-cycle. A value of 10nF is adequate in most applications.

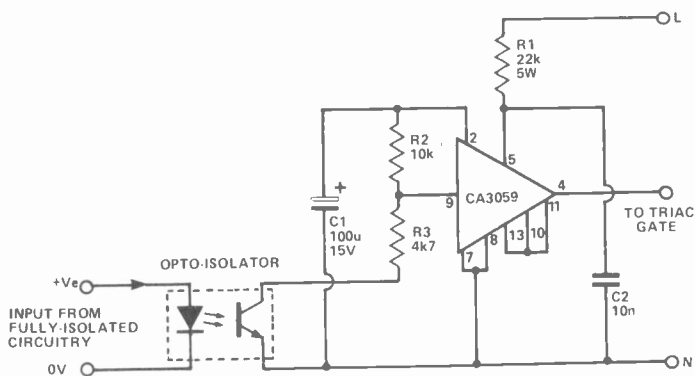

Fig.6 A method of remote-switching the CA3059 via an opto-isolator.

The Fig. 2 circuit consumes virtually zero mains power under the 'off' (SW1 open) condition. The only defect of the circuit is that SW1 operates at full mains voltage. This defect can be overcome by using the switch to directly enable or disable the CA3059 logic circuitry, as shown in Figs. 3 and 4, but in this case the circuit consumes a few watts of power (via R1) when the circuit is in the off mode.

The Figs. 3 and 4 circuits work by using the switch to enable or disable the triac gate drive via the internal differential amplifier of the IC. Remember, the drive is enabled only when pin 13 is biased above pin 9. In the Fig. 3 circuit, pin 9 is biased at half-supply volts and pin 13 is biased via R2-R3 and SW1. In Fig. 4, pin 13 is biased at half-supply and pin 9 is biased via R2-R3 and SW1. In both circuits, SW1 handles maximum potentials of 6 V and maximum currents of 1 mA or so.

Note in Fig. 4 that the circuit can be turned on by pulling R3 low or can be turned off by letting R3 float. Figures 5 and 6 show how this simple fact can be put to use to extend the versatility of the circuit. In Fig. 5, the circuit can be turned on and off by transistor Q1, which

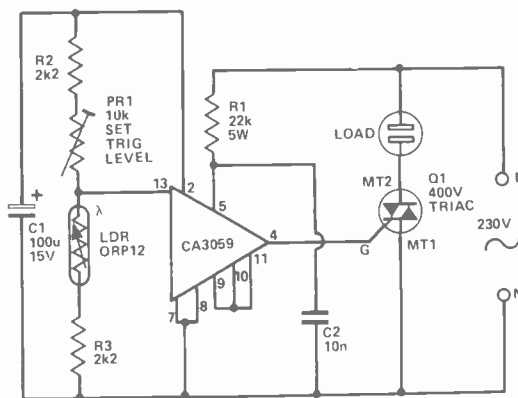

Fig.7 A basic dark-activated zero-voltage switch.

in turn can be activated by on-board CMOS circuitry (such as one-shots, astables, etc) that are powered from the 6 V pin 2 supply.

In Fig. 6, the circuit can be turned on and off by fully-isolated external circuitry via an inexpensive opto-isolator: the isolator needs an input current of only a milliamp or so to give the 'on' action.

## CA3059 Comparator Circuits

The built-in differential amplifier of the CA3059 can readily be used as a precision voltage comparator that turns the triac on or off when one of the comparator input voltages goes above or below the other. If these input voltages are derived from transducers such as LDRs or thermistors, the on/off power control action can be controlled by ambient light levels or temperatures. Figures 7 to 10 show some practical circuits of these types.

Figure 7 shows the circuit of a simple dark-activated zero-voltage power switch. Here, pin 9 is tied to half-supply volts and pin 13 is controlled via the R2-PR1-LDR-R3 potential divider. Under bright conditions the LDR has a low resistance, so pin 13 is above pin 9, the triac is enabled and power is fed to the load. The precise threshold level of the circuit can be preset by PR1.

Figure 8 shows how a degree of hysteresis or 'backlash' can be added to the above circuit, so that the triac does not switch annoyingly in response to small changes (passing shadows, etc) in the ambient light level. The hysteresis level is controlled via R3, which can be selected to suit particular applications.

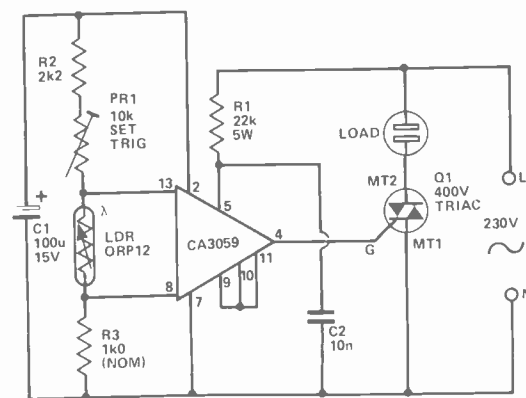

Fig.8 A dark-activated zero-voltage switch with hysteresis provided by R3.

# 'TUSCAN' FROM TRANSAM



## Take a step up to your next Computer!

### THE CONCEPT

How many ways are there to build an S100 system? Not many, and all expensive. TUSCAN changes all that.

Five S100 boards on one single board—just for starters. Plus five extra slots for future expansion.

What a combination! Z80 and S100 with the TRANSAM total package of system and applications software.

How do we do it? Our prices start at £195 and you can build up in easy stages to a fully CP/M compatible disc based system. Something to think about!

### THE HARDWARE

The first Z80 single board computer with integral S100 expansion. British designed to the new IEEE (8 BIT) S100 specification, the TUSCAN offers total system flexibility. A flexibility available now.

The board holds the equivalent of a Z80 cpu card, 8k ram, 8k rom video and I/O cards with 5 spare S100 expansion slots and offers a price/performance ratio which is hard to beat.

Just compare our price with a commercial S100 ten slot motherboard with this specification.

### THE SOFTWARE

TUSCAN offers the user the choice of system monitor, editor, resident 8k basic, resident Pascal compiler or full CP/M disk operating system. All options are upwards

compatible and fully supported with applications software. Both 5¼" and 8" drives are supported in double density.

### THE PACKAGE

TUSCAN is available in kit form or assembled. With several hardware and software options to suit your requirements and budget. Attractive desk top case also available holds 2 x 5¼" Drives.

# TRANSAM

## NOBODY DOES IT BETTER!

Send to Transam Components Ltd., 59/61 Theobald's Road, London WC1.

I am interested in the TUSCAN Z80 based single board computer with S100 expansion and enclose a S.A.E. for further details.

Name \_\_\_\_\_

Address \_\_\_\_\_

Telephone \_\_\_\_\_

- ORDER BY POST OR TELEPHONE WITH BARCLAYCARD/ACCESS
- ELECTRONIC TEST EQUIPMENT SPECIALISTS
- ALL PRICES INCLUDE VAT

# AUDIO ELECTRONICS

- ALL MODELS ON DISPLAY
- RETAIL - MAIL ORDER - EXPORT - INDUSTRIAL
- OPEN SIX DAYS A WEEK
- CALL IN AND SEE FOR YOURSELF

## SCOPES

A range of Scopes in stock from 5mHZ Single Trace to 50mHZ Dualtrace. Mains and Battery/Mains portables. Many on demonstration.

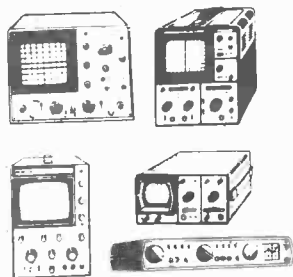

### SINGLE TRACE (UK c/p etc £2.50)

Hm 307-3 10mHZ, 5mV, 6 x 7cm display plus component test	£170.00
CO1303D 5mHZ, 10mHZ, 7 x 7cm display	£109.25
SC110 10mHZ Battery portable, 10mV 3.2 x 2.6cm display (Optional case £8.80, Nicads £7.95, Mains unit £4.00)	£152.50
LB0512A 10mHZ, 10mV, 5" display (plus FREE probe)	£195.50
CS1559A 10mHZ, 10mV, 5" display	£198.50

### OPTIONAL PROBES (ALL MODELS)

X1 £6.50, X10 £8.50, X100 £12.95, X1-X10 £10.95

HAMEG ● TRIO ● LEADER ● SINCLAIR

### DUAL TRACE (UK c/p etc £3.50)

CS1562A 10mHZ, 10mV, 5" display	£244.95
CS1575 5mHZ 5" display	£270.00
Hm312-8 20mHZ, 5mV, 8 x 10cm display	£287.50
CS1566A 20mHZ, 5mV, 5" display	£323.15
CS1352 15mHZ, 2mV, 7.5cm display, battery/mains portable (Nicads pack £29.90)	£346.15
Hm412-4 20mHZ, 5mV, 8 x 10cm display plus Sweep Delay	£399.50
CS1577A 30mHZ, 2mV, 5" display	£455.40
CS1830 30mHZ, 2mV, 5" display plus sweep delay	£507.15
Hm512-8 50mHZ, 5mV, 10 x 8cm display, Delay Sweep	£667.00
LB0514 10mHZ, 1mV (5mV) 5" display (plus 2 FREE probes)	£294.00

## GENERATORS (UK c/p £1.75)

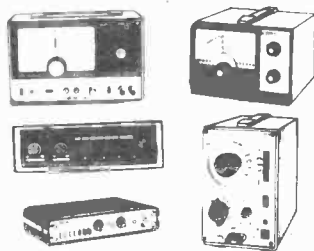

### RF

SG402 100KHZ - 30mHZ with AM modulation	£64.40
LSG16 100kHz-100mHZ (300mHZ on Harmonics)	£56.50
SG2030 250KHZ - 100mHZ low cost range	£46.95
ARF 300 18HZ-200mHZ low cost range audio and RF	£76.95

### PULSE

2001 1HZ-100KHZ	£86.00
TG105 5HZ-5mHZ	£97.75
4001 0.5HZ-5mHZ	£105.00

TRIO ● LEADER ● CSC  
SINCLAIR ● LEVELL

A range of Signal Generators to cover Audio, RF and Pulsing. Mains operated (TG series Battery).

### AUDIO (All sine/square)

AG202A 20HZ-200KHZ	£65.55
LAG26 20HZ-200KHZ	£69.00
AG203 10HZ-1mHZ sine/square	£120.75
LAG120A 10HZ-1mHZ	£137.00

### LEVELL ('M' with Meter)

152 SERIES 3HZ - 300KHZ Sine/Square	£92.00
200 SERIES 1HZ-1mHZ Sine/Square	£113.85
TG152D	£124.20
TG152DM	£149.50
TG200D	£155.25
TG200DM	
TG200DMP	

## SWR/FS AND POWER METERS



Range in stock covering up to 150mHZ and up to 1K watt power. PL259 sockets. Also 250 UHZ Grid Dipmeter  
SWRS SWR/ S 3-150mHZ £3.50  
SWR50 SWR/Power meter 3/2-150mHZ 0-100 watts £13.95  
110 SWR/Power 1/2-144mHZ £11.50  
0/10/100 watts £14.50  
171 As 110 Twin meter plus F/S £14.50  
Plus large range of BNC/PL259/etc leads/plugs/adaptors/connectors always in stock  
176 SWR/Power/FS 1/2-144mHZ, 5-50 watt Plus 25-40mHZ AC match £16.60  
KDM6 Grid Dip 1/2-250mHZ £38.50

## DIGITAL MULTIMETERS

KAISE ● SINCLAIR ● LASCAR

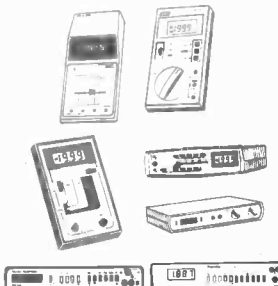

### HAND HELD (UK post etc 85p)

TM352 3 1/2 Digit LCD plus 10 ADC and Hfe checker	£55.95
PDM35 3 1/2 Digit 16 range LED (no AC current)	£32.95
ME502 3 1/2 Digit LED plus 10A DC and Hfe checker	£43.95
LM2001 3 1/2 Digit LCD 2 amp AC/DC 0.1%	£51.70
6200 3 1/2 Digit LCD 0.2A AC/DC, Auto range	£39.95
6220 As 6200 plus 10A AC/DC	£49.95
6100 As 6200 plus Cont. test/range hold	£64.95
6110 As 6100 plus 10A AC/DC	£74.95

A range of LED and LCD Bench and Hand DMM's a battery operated with optional Mains Adaptors - some with optional Nicads. All supplied with batteries and leads.

### BENCH PORTABLES (UK c/p £1.00)

DM235 3 1/2 Digit LED 21 ranges, 0.5% AC/DC 2A	£56.50
DM350 3 1/2 Digit LED 34 ranges AC/DC 10A	£78.50
TM353 3 1/2 Digit LCD AC/DC 2 amp	£86.50
TM351 3 1/2 Digit LCD AC/DC 10 amp	£112.50
LM100 3 1/2 Digit LCD AC/DC 2 amp	£86.50
DM450 4 1/2 Digit LED 34 ranges AC/DC 10 amp (DM series options, Carry case £8.80, Nicads £7.95, Mains adaptor £4.00).	£107.95

## FREQUENCY COUNTERS



Portable and Bench LCD and LED Counters up to 600mHZ. Prices include batteries and leads.

### HAND HELD (UK post etc 85p)

PFM200 20HZ to 200mHZ 8 Digit LED	£54.50
MAX50 100HZ to 50mHZ 6 Digit LED	£61.00
MAX550 30KHZ to 550mHZ 6 Digit LED	£106.00

### BENCH PORTABLES (UK c/p £1.00)

MAX100 8 Digit LED 5HZ to 100mHZ	£89.00
TF200 8 Digit LCD 10HZ to 200mHZ	£166.75
7010A 9 Digit LED 10HZ to 600mHZ	£184.00
TP600 mHZ Pre-Scaler for TF200	£43.00

CSC ● SINCLAIR ● OPTO ELECTRONICS

## LOGIC PROBES MONITORS

Logic probes indicating high/low etc states that scopes can miss. all circuit powered for all IC's.  
LP3 50 mHZ logic probe £55.95  
LP1 10 mHZ logic probe £35.50  
LP2 1 1/2 mHZ logic probe £19.95  
LMI Logic monitor £33.00  
Also in stock range of Protoboard kits and breadboards.

## MINI DRILLS AND KITS

(9-12 Volt 1/8" chucks)	
Small Drill plus 3 collets	£7.25
Medium Drill plus 3 collets	£10.50
Small Drill plus 20 tools	£14.95
Medium Drill plus 20 tools	£17.95
Mains Drill	£13.95
Mains Drill plus 20 tools	£21.50

## MULTIMETERS (UK post etc 75p)

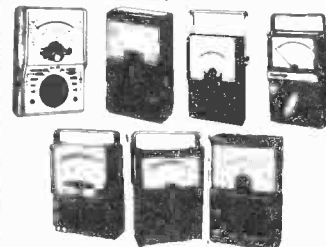

KRT101 1K/Volt 10 range pocket	£4.50
ATM1/LT1 1K/Volt 12 range pocket	£5.95
NH55 2K/Volt 10 range pocket	£6.95
AT1 2K/Volt 12 range pocket de luxe	£7.95
NH56 20K/Volt 22 range pocket	£10.95
YN360TR 20K/Volt 19 range pocket plus hfe test	£13.95
AT1020 20K/Volt 19 range de luxe plus hfe test	£16.95
7081 50K/Volt 36 range plus 10 amp DC	£19.95
TMK500 30K/Volt 23 range plus 12A DC/Cont. test	£21.50
AT20 20K/Volt 21 range de luxe plus 10A DC and 5KV DC	£21.95
AT205 50K/Volt 21 range de luxe plus 10A DC	£24.95
7080 20K/Volt 26 range large scale, 10A DC plus 5KV AC/DC	£26.95
AT2050 50K/Volt 18 range de luxe plus hfe test	£28.50
AT210 100K/Volt 21 range de luxe plus 12A AC/DC	£29.95
360TR 100K/Volt 23 range plus hfe checker and AC/DC 10 amps	£34.95

CHOOSE FROM THE UK'S LARGEST SELECTION

Stockists of electronic equipment, speakers/kits, PA equipment plus huge range of accessories ● UK carriage/packing as indicated ● Export - prices on request ● All prices correct at 1/10/80 E & OE ● All prices include VAT.



FREE CATALOGUE!

Send large SAE (17 1/2p UK) Schools, Companies, etc. free on request.

## AUDIO ELECTRONICS

Cubegate Limited

OPEN SIX DAYS A WEEK

301 EDGWARE ROAD, LONDON, W2 1BN, ENGLAND. TELEPHONE 01-724 3564



# LIGHT SWITCH

A PROJECT  
FOR YOUR  
FREE PCB

An interesting device in itself, our light switch can also form the basis of more ambitious projects — porchlight, burglar alarm . . . the list is endless. Circuit design by Keith Brindley.

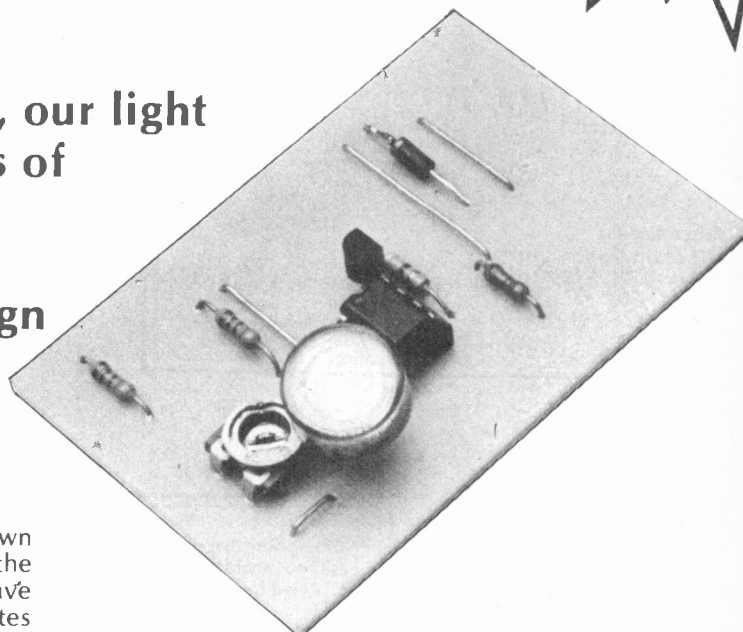

Got a light switch? No, but I've got a dark brown multiplexer. Seriously though, this project using the ETI multi-option board is a must if you have need of a sensitive light operated switch which operates (turning either on or off) when the light exceeds a predetermined level. Such a device can be the heart of an automatic porch light, which turns on at dusk as the ambient light level falls below a certain amount. It could be used as part of a burglar alarm system — the switch operating when light from, say, a burglar's torch activates it.

The circuit diagram of the ETI Light Switch shows the device in its low-light operating mode. When the amount of light on the photocell, LDR1, is lower than the preset amount, the relay is energised. Alternatively, swapping LDR1 and R1 causes the relay to be energised when the light exceeds the preset level.

A single operational amplifier is the active component of the circuit and we have specified this as a type 301. However, don't rush out specially to buy one if you don't have one of these at hand, the only reason we used this particular type was because we had one handy at the design stage. Virtually any 8-pin DIL op amp will function in the circuit eg. 741, 748, 308, 3130, 351, etc can be used as substitutes.

## Construction

Construction, to use a well-worn phrase, is easy if you follow our PCB layout. It is easier still if you have the Multi-Option Board given free with this issue.

There are four links to make and these are best inserted before the components. Next, insert the resistors, the preset pot and the diode. Transistor Q1 is inserted next to IC1, using three of the remaining holes included in the board for a 14 pin DIL IC. Make sure you insert Q1 and the IC the right way round. Finally, make all the off-board connections to the battery, relay and photocell and then switch on and try your completed project. The light level at which the switching action occurs can be adjusted by PR1.

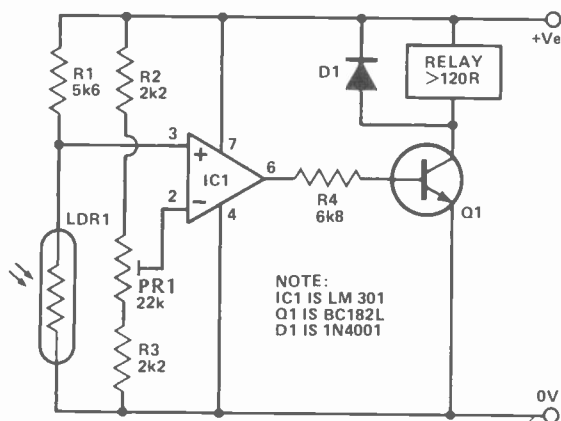

Fig.1. Circuit diagram. The switching threshold is controlled by PR1.

## HOW IT WORKS

LDR1 is a light dependent resistor. The resistance between its terminals varies in inverse proportion to the amount of light which falls on its face — the greater the light intensity the less its resistance. So when it is connected across a power supply with another resistor in series, (R1 in this circuit), the voltage across it decreases with light intensity.

IC1 is a comparator which compares the voltage across the LDR with a predetermined voltage, obtained via resistor chain R2,3 and PR1. As the light level falls, the voltage across the LDR rises until it exceeds the preset level at PR1. At this point the output of IC1 goes high, turning on Q1, which in turn, operates the relay. D1 prevents damage to Q1 from any back EMF when the relay is switched off.

Swapping the positions of LDR1 and R1 means that the voltage at pin 3 of the comparator now rises with increasing light, so circuit operation is reversed.

## PARTS LIST

Resistors All 1/4W 5%	
R1	5k6
R2,3	2k2
R4	6k8
Potentiometer	
PR1	22k miniature horizontal
Semiconductors	
IC1	LM301
Q1	BC182L
D1	1N4001
Miscellaneous	
ETI Multi-Option Board	
Relay (coil 120R)	
LDR1 ORP 12	
9 V battery and connector.	

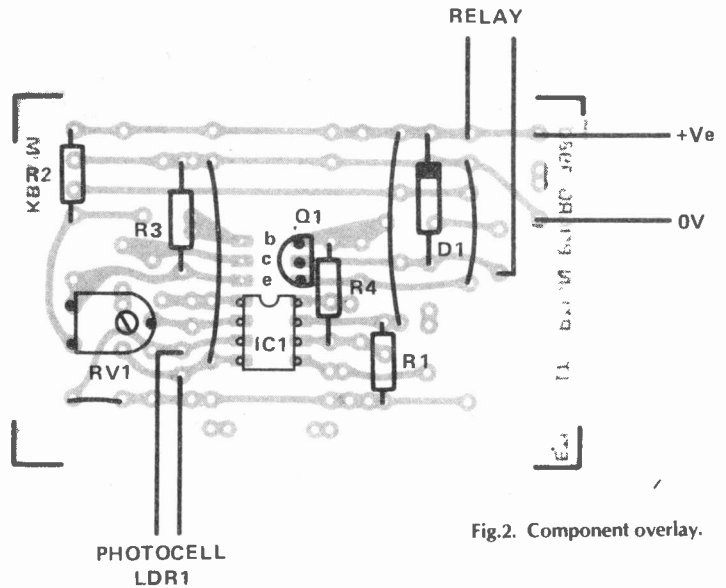

Fig.2. Component overlay.

## BUYLINES

Nothing here that should cause any problems, all of the components are easily obtainable items. Make sure you get a BC182L; the pin-out for the BC182 is different.

ETI

## IT'S A DOGS LIFE!

Mighty mongrel strikes again!



Stop your powerful pooch carving up your carefully collected ETIs with his canine choppers and live in hardback harmony with a profusion of precious project books by armour-plating your archives.

Invest in an ETI binder. You know it makes sense. You can have any colour you like as long as it's black.

Price U.K. £3.95 including postage, packing and V.A.T., overseas orders add 30p. Why not place your order now and send the completed coupon with remittance to:-

EASIBIND LTD., 4 UXBRIDGE STREET, LONDON W8 7SZ. Tel: 01-727 0686

Please allow 3/4 weeks for fulfillment of order.

**it's easy with EASIBIND**

Easibind Ltd., 4 Uxbridge St., London, W8 7SZ.

Nat. Giro No. 5157552.

### Order Form

ELECTRONICS TODAY INTERNATIONAL

I enclose p.o./cheque value .....

for ..... binders

Years required .....

BLOCK LETTERS PLEASE

Name .....

Address .....

.....

.....

Date .....

Registration No. 307469



# WOULD WE LIE TO YOU?

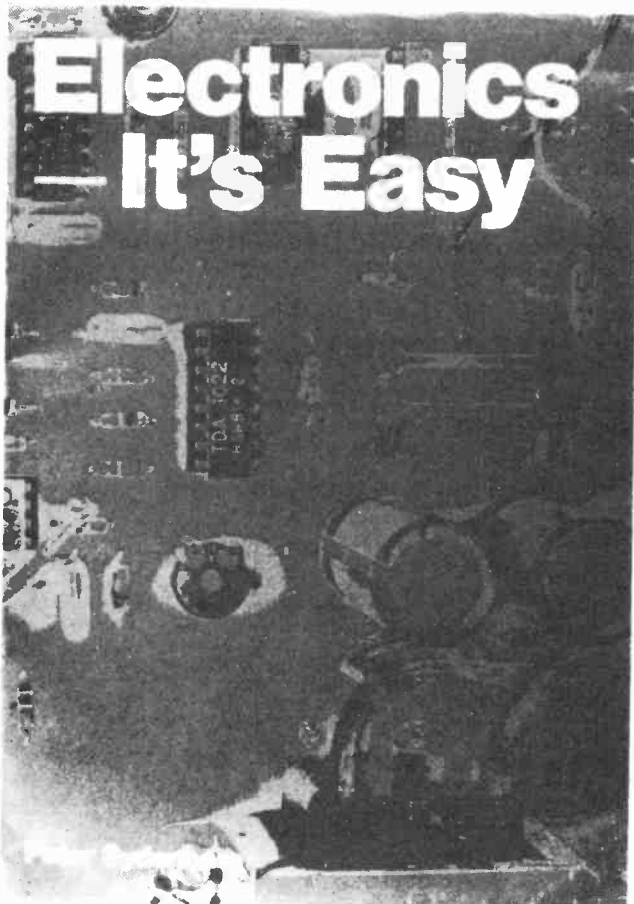

No, we wouldn't. Electronics *is* easy – unless you're trying to learn about it from some dry-as-dust textbook containing page after page of equations. What is needed is a comprehensive and simply-written guide which explains the theory – and the practice – of electronics step by step. So we've provided such a guide, by collecting together our popular series Electronics – It's Easy. Originally published in three parts, the demand was so great that we have reprinted it as a single volume.

Electronics – It's Easy looks clearly and logically at the whole of this far-ranging subject, starting with the basic concepts and working through to the how and why of today's technology. You can obtain your copy by sending a cheque or postal order (payable to Modmags Ltd) for £3.60 plus 80p postage and packing to: Sales Office (Specials), Modmags Ltd., 145 Charing Cross Road, London WC2H 0EE. Please write your name and address on the back of your remittance.

★  
**2**  
**SUPERB NEW KITS!**

Special Offer.  
**£2 OFF!**

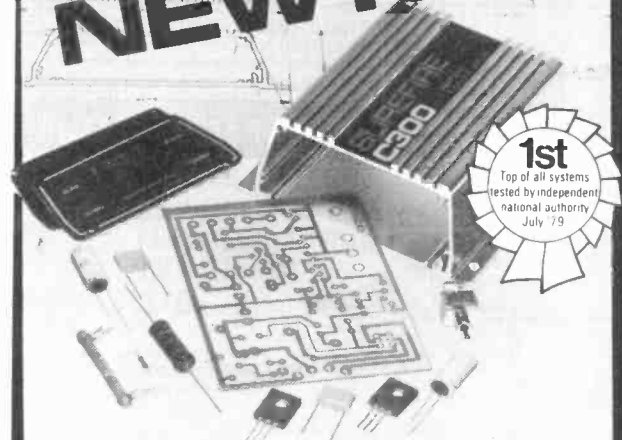

## C300/ES200

high performance electronic ignition to add power, economy, reliability, sustained smooth peak performance, instant all weather starting, to your car.

**Surefire** has sold in its thousands in ready made form from big name accessory firms, but it is now available in quality kit form to fit all vehicles with coil ignition up to 8 cylinders.

**ES200.** A high performance inductive discharge ignition incorporating a power integrated circuit (special selection), electronic variable dwell circuit (maximises spark energy at all speeds), pulse processor (overcomes contact breaker problems), Coil governor (protects coil), Long burn output, Negative earth only, Compatible with all rev. counters.

**C300.** In its ready built form (C3000) it came top of all systems tested by an independent national authority July '79. A high energy capacitive discharge ignition incorporating a high output short circuit proof inverter, top grade Swedish output capacitor, pulse processor circuit, transient overload protection. Fast rise bidirectional output ideal for fuel injection, sports carburation, oily engines. Compatible with most rev. counters. (Low cost adaptors available for rare cases. Application list enclosed with each kit. Note: Vehicles with Smiths/Jaeger rev. counters code RVI on dial will require adaptor type TCI).

**What's in the kits.** Surefire's own precision anodised aluminium extruded case. P.C. mounted security changeover switch, static timing light. Special selection Motorola semi-conductors. Capacitors, resistors etc. selected after 5 years experience. Glass fibre pcb, solder, complete down to last washer. Fully illustrated comprehensive instructions and full technical back up service.

# SUREFIRE

## ELECTRONIC IGNITION

Suretron Systems (UK) Ltd. Dept. ET18  
 Bayer Buildings, Lower Bristol Road, Bath, BA2 3EF. Tel: Bath (0225) 332317

Name

Address

Phone order with Access/Barclaycard  
 VAT and P & P inc

Quantity  
 required

ES200: Neg	£13.95	£11.95	
C300: Pos	£17.95	£15.95	
C300: Neg	£17.95	£15.95	
Tacho Adapt. TCI		£3.90	

Enclose  
 cheq/PO's

£

Chq No

**NEW**

**PRACTICAL ELECTRONICS PROJECT 125 WATT POWER AMP KIT**

**SPECIFICATIONS**

Max. Output power 125 watt RMS  
 Operating voltage (OC) 50-80 Max.  
 Loads 4-16 ohms  
 Frequency response Measured at 100 watts 25Hz-20kHz  
 Sensitivity for 100 watts 400mV @ 47K  
 Typical T.H.D. @ 50 watts 4 ohms load 0.1 %  
 Dimensions 205 x 90 and 190 x 36 mm

The P.E. power amp kit is a module for high power applications—disco units, guitar amplifiers, public address systems and even high power domestic systems. The unit is protected against short circuiting of the load and is safe in an open circuit condition. A large safety margin exists by use of generously rated components, the

output stage uses four 115 watt transistors normally only two would be used, result, a high powered rugged unit. The PC Board is backprinted, etched and ready to drill for ease of construction, and the aluminium chassis is preformed and ready to use, supplied with all parts and circuit diagrams.

**£9.50** plus £1.00 p&p

**ACCESSORIES** £1.00 plus 20p p&p

Suitable L.S. coupling electrolytic  
 Suitable Mains Power Supply Unit £7.50 plus £2.75 p&p  
 sufficient for one power amp

ACCESSORIES available only when purchasing packs.



AS FEATURED IN PRACTICAL ELECTRONICS OCTOBER ISSUE

**DIY STEREO BARGAIN PACKS FEATURING FAMOUS BUILT MULLARD PREAMP MODULES**

**MULLARD STEREO PREAMP MODULES AND TWO 12 WATT POWER AMP KITS.**

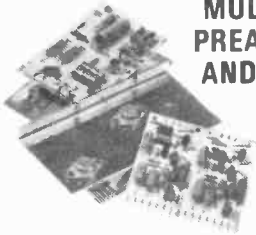

In easy to build form P.C.B.s backprinted, etched and drilled ready to use.

**BUILD A 12 WATTS PER CHANNEL STEREO AMPLIFIER ACCESSORIES AND L.S. KIT EXTRA (not available separately) £6.00**

DIY PACK 1 2 x power amp kits LP1182 / preamp module, suitable for ceramic and auxiliary inputs. **£6.00** plus £1.10 p&p

DIY PACK 2 2 x power amp kits LP1184 preamp module suitable for magnetic ceramic and auxiliary inputs. **£8.50** plus £1.15 p&p

DIY SPEAKER KIT Two 8" x 5" approx. 4 ohm bass. **£3.50** plus £1.70 p&p

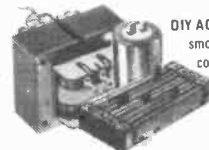

DIY ACCESSORIES Mains transformer smoothing capacitor rectifier 4 x slider controls, for base, treble and volume.

**£3.00** plus £1.60 p&p

ACCESSORIES: Available only at time of purchase of Bargain Packs

**12 + 12 WATT AMPLIFIER KIT** NOTE: for use with 4 to 8 ohms speakers

With up-to-the-minute features. To complete you just supply screws, connecting wire and solder. Features include din input sockets for ceramic cartridge, microphone, tape or tuner. Outputs—tape, speakers and headphones. By the press of a button it transforms into a 24 watt mono disco amplifier with twin deck mixing. The kit incorporates a Mullard LP1183 pre-amp module, plus 2 power amplifier assembly kits and mains power supply. Also featured 4 slider level controls, rotary bass and treble controls and 6 push button switches. Silver finish fascia panel with matching knobs. Easy to assemble teak simulate cabinet and ready made metal work. For further information instructions are available price 50p. Free with kit.

**£13.95** plus £2.55 p&p

NOTE: for use with 4 to 8 ohms speakers.

BSR chassis record player deck with manual set down and return, complete with stereo ceramic cartridge. £8.50 plus £2.75 p&p when purchased with amplifier available separately £10.50 plus £2.75 p&p.

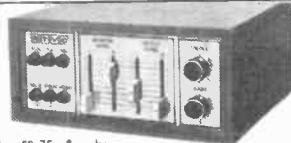

TWO WAY SPEAKER KIT, 2 Phillips 8" approx speakers £4.75 per stereo pair plus £1.50 p&p when purchased with amplifier available separately £6.75 plus £1.50 p&p.

ALSO AVAILABLE Stereo magnetic pre-amp conversion kit all components including P.C.B. to convert your ceramic input on the 12 + 12 amp to magnetic. £2.00 when purchased with kit featured above. £4.00 separately inc. p&p.

BSR Manual single play record deck with auto return and cueing lever. Fitted with stereo ceramic cartridge 2 speeds with 45 rpm spindle adaptor ideally suited for home or disco use.



**£12.25** OUR PRICE plus £2.75 p&p

**PHILLIPS RECORD PLAYER DECK GC037** Size approx 15 1/2" x 12 1/4"



Hi Fi record player deck 2 speed, damped cueing, auto shut-off, belt drive with floating sub chassis to minimise acoustic feedback. Complete with GP401 stereo magnetic cartridge—LIMITED STOCK. UNBEATABLE OFFER AT

**£27.50** complete plus £2.75 p&p

**OFFER!** SAVE MONEY by purchasing 12 + 12 amp kit, BSR record deck and speaker kit together for only **£25.50** p&p £4.50.

**PRACTICAL ELECTRONICS CAR RADIO KIT** (Constructors pack 7) **£10.50** plus £1.75 p&p



2 Wavebands MW and LW

- \* Easy to build \* 5 push button tuning
- \* Modern styling design \* All new unused components
- \* 6 watt output \* Ready etched & punched P.C.B.
- \* Incorporates suppression circuits \* Now with tape input socket

All the electronic components to build the radio, you supply only the wire and solder as featured in the Practical Electronics March issue. Features: Pre-set tuning with five push button options, black illuminated tuning scale, with matching rotary control knobs, one, combining on/off volume and tone-control, the other for manual tuning, each set on wood simulated fascia. The P.E. Traveller has a 6 watts output, neg ground and incorporates an integrated circuit output stage, a Mullard IF module LP1181 ceramic filter type, pre-aligned and assembled and a Bird pre-aligned push button tuning unit. The radio fits easily in or under dashboards. Complete with instructions

**CONSTRUCTORS PACK 7A**

Suitable stainless steel fully retractable locking aerial and speaker (approx. 6" x 4") is available as a kit complete **£1.95** per pack, p&p £1.00

Pack 7A may only be purchased at the same time as Pack 7.

NOTE: Constructor's pack 7A sold complete with radio kit **£15.20** including p&p.

FEATURED PROJECT IN PRACTICAL ELECTRONICS

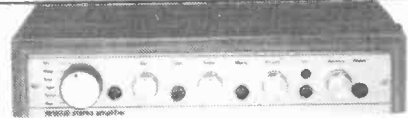

**30 + 30 WATT STEREO AMPLIFIER BUILT AND TESTED**

Viscount IV unit in teak simulate cabinet silver finished rotary controls and pushbuttons with matching fascia, red mains indicator and stereo jack socket. Functions switch for mic magnetic and crystal pickups, tape and auxiliary. Rear panel features fuse holder. DIN speaker and input socket 30 + 30 watts. RMS 60 + 60 watts peak for use with 4 to 8 ohm speakers. Size 14 1/2" x 10" approx.

READY TO PLAY **£32.90** plus £3.30 p&p



323 EDGWARE ROAD, LONDON, W.2  
 21E HIGH STREET, ACTON W3 6NG  
 ACTON. Mail Order only. No callers.

ALL PRICES INCLUDE VAT AT 15 %  
 All items subject to availability. Price correct at 1.9.80 and subject to change without notice

For further information send for instruction booklet 20p plus stamped addressed envelope

NOTE: Persons under 16 years not served without parent's authorisation

**BARGAIN OFFER!!**



**ARISTON PICK UP** £11.95

Ariston pick-up arm manufactured in Japan. Complete with headshell. Listed price over £30.00 OUR PRICE plus £2.50 p&p

**100 WATT MONO DISCO AMPLIFIER**

Brushed aluminium fascia and rotary controls. Size approx 14" x 4" x 10 1/4". Five vertical slide controls, master volume, tape level, mic level, deck level, PLUS INTER DECK FADE for perfect graduated change from record deck No. 1 to No. 2, or vice versa. Pre fade level controls (PRL) lets YOU hear next disc before fading it in. VU meter monitors output level. Output 100 watts RMS 200 watts peak. **£76.00** plus £4.00 p&p

**50 WATT MONO DISCO AMPLIFIER**

Size approx 13 1/2" x 5 1/4" x 6 1/4". 50 watts rms. 100 watts peak output. Big features include two disc inputs, both for ceramic cartridges, tape input and microphone input. Level mixing controls fitted with integral push-pull switches. Independent bass and treble controls and master volume.

**£30.60** plus £3.20 p&p



# Hobby Electronics

Next Month

ON SALE  
OCTOBER 10th

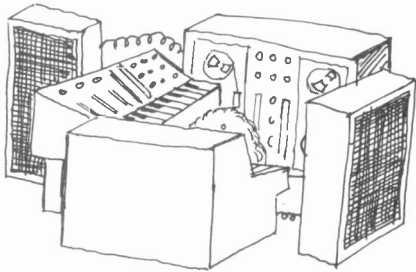

## Thirty Pound Synthesiser

No, not weight, price! That's right, for around thirty quid you can build yourself this high quality, versatile and above all, economical synthesiser. Create outlandish noises, scare your granny, even play a few tunes. This easy-to-build unit features the latest LSI technology to reliably generate the sounds.

We're keeping quiet about the technical details, walls have ears and all that. Suffice it to say that this is the design you've been waiting for. You have four weeks, starting from now to find your £30. It'll be money well spent, we promise you that.

## Electronic Hand Grenade

You'll get a real 'bang' out of this new game. It's the electronic version of that old parlour game 'musical chairs'. The grenade is passed around a circle of players, the longer it is held the greater the chance it will go 'off'. The person that has it then leaves. This ingenious little circuit will provide hours of amusement at parties and can be built by even the most inexperienced constructor in just a couple of hours.

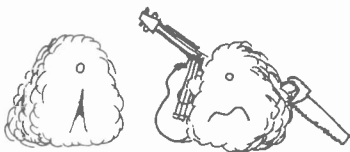

## Guitar Sound Shaper

Gasp, shock, horror, you haven't heard of a Guitar Sound Shaper before. Shame on you. How can you ever hold your head up in decent company? People like you give our hobby a bad name, no wonder dogs cross the street when they see you. There's only one thing you can do, rush out and get next month's copy of HE or forever be a social outcast.

## Battery Eliminator

This 35 kilowatt laser is guaranteed to instantly vapourise any battery from a HP7 to a PP9. Batteries are really becoming a nuisance. Stop their takeover right now. The HE battery Eliminator will forever remove the menace of the dry-cell. Just plug it into your local mains socket and laugh as you count all the money you'll save. Actually it's not really a 35 kilowatt laser but it will save you a few quid. Look out for it in next month's bigger-than-ever issue.

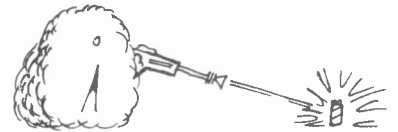

## Transistor Tester

What can we say? Not a lot really, we don't have to tell you that this is the most advanced design ever to measure the collector current of a BC109, you know that already because it comes from Hobby Electronics!

## Stereo

Now for the first time anywhere this century Hobby Electronics has commissioned that Master of the Microcircuit, the Baron of the Breadboard, that well known man of digits, Ian Sinclair (who?) to write the definitive lowdown on Stereo. What is it, how does it do it, what do I do with it? These are just some of the questions that will finally get answered next month in this exciting top-level feature.



The items mentioned here are those planned, but unforeseen circumstances may affect the actual contents.

# RADIOACTIVITY

Spend the last three minutes before the bomb drops reading A.S. Lipson's excursion into that frazzling phenomenon of modern physics — radioactivity

In the last few years of the nineteenth century, a French scientist by the name of Henri Becquerel was fiddling about with some uranium compounds, trying to investigate their fluorescent properties. During the course of his work, however, and almost completely by chance, he discovered something quite different. These compounds could fog photographic plates, even if the plates were wrapped in black paper to keep out light! Henri Becquerel had discovered radioactivity.

## One Into Three

As more and more work was done on the new phenomenon, it was eventually found that there are three main types of radiation. These are known, respectively, as alpha, beta and gamma rays, after the first three letters of the Greek alphabet (scientists and mathematicians long ago ran out of English letters to use as symbols. In fact, they're running short of Greek now, as well. Hebrew letters — Oy Vey! — are beginning to come into use for some things).

What makes the three types of radiation different from each other, though? Suppose we have a lump of some radioactive material. We know it's giving off rays of some sort, but how do we find out which type they are?

## Eeny Meeny . . . .

Well, actually it isn't all that bad. The three radiation types have quite different properties from each other and it's quite easy to tell the difference between them. One of the simplest ways is based on their different penetrating powers. Alpha rays, you see, don't take an awful lot of stopping. Even a moderately thick piece of paper in the way is enough to cut out most of them. Beta and gamma radiation, however, are not stopped so easily. It takes several millimetres of aluminium or lead to block off beta radiation effectively and as for gamma — nothing short of several centimetres of lead will stop that.

## Shields Up, Scotty

Suppose, then, that we have a radioactive source and some means of detecting radiation, such as a Geiger counter (Fig.1). If we find that the radiation from the source is cut off when a piece of card is placed in front of the detector, then it is very likely that the radiation is alpha type. If the radiation is virtually unaffected by card, but is effectively stopped by 5 mm or so of lead, then it is probably beta radiation, whereas if it is only reduced by placing several centimetres of lead in the way, it is most likely to be gamma radiation.

Some radioactive materials give off more than one type of radiation, but, by finding the amount by which the radiation is reduced with different thicknesses of shielding, the amounts of each type present can be discovered. (Easy, Innit?).

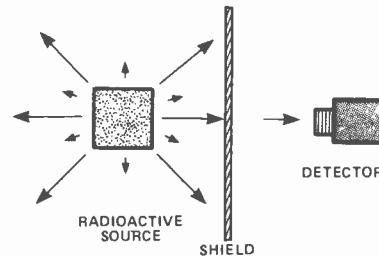

Fig.1. Alpha particles are stopped by thick paper. Beta particles are stopped by several millimetres of aluminium or lead. Gamma rays can only be stopped by several centimetres of lead.

There are other ways of detecting the difference between the three types of radiation. For instance, in an electric or magnetic field, alpha particles will be deflected one way and beta particles the other way, while gamma radiation remains unaffected. This is because alpha radiation carries positive electric charge, beta radiation carries negative charge and gamma radiation is neutral. By finding which way the radiation is bent in an electric or magnetic field, then, it is possible to work out what type of radiation it is (Fig.2). It is this method of detection, in fact, which is used by physicists to detect many other less common types of radiation and subatomic particles encountered in nuclear physics.

## But What Are They?

So far, we have only looked at the different ways in which alpha, beta and gamma radiation behave without really saying much about what they are. What is it that makes a beta ray different from an alpha or a gamma ray? Why should alpha and beta radiation carry electrical charge — alpha positive and beta negative — while gamma radiation is neutral?

## The Gamma Story

Light can be thought of as a wave of electromagnetic radiation travelling through space with a speed of nearly 300,000 kilometres per second with a wavelength of between  $4 \times 10^{-7}$  and  $7 \times 10^{-7}$  metres. In fact, the wavelength determines the colour of the light. There is, however, other electromagnetic radiation, travelling with exactly the same velocity as light and identical to it in every way except that of wavelength. Radio waves, for instance, are this type of radiation, but with much longer wavelengths (up to thousands of metres). Gamma radiation is also this sort of electromagnetic radiation, but with a much shorter wavelength than light (anything under  $10^{-16}$  or  $10^{-17}$  metres).

Gamma radiation, then, is very short wavelength electromagnetic radiation and as such it carries no electric charge, any more than light or radio waves do (Fig.3).

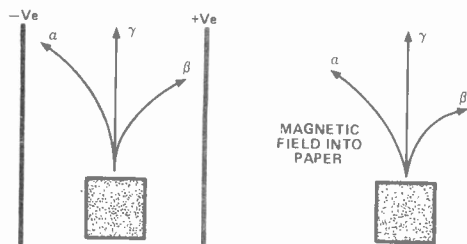

Fig.2. Alpha or beta particles carrying electrical charge can be deflected by electric or magnetic fields. Gamma rays, which are neutral, are not deflected.

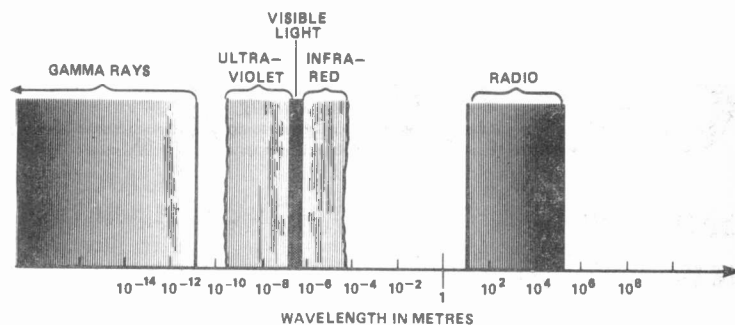

Fig.3. The electromagnetic spectrum.

## A, B, . . .

Alpha and beta radiation are a little harder to explain. The atom consists of a very small, central region — the nucleus — which carries a positive charge. Surrounding the nucleus, and taking up the bulk of the atom, are electrons, which, being negatively charged, counteract the positive charge of the nucleus and make the atom as a whole neutral. The nucleus consists of two types of particles — protons and neutrons. Protons are positively charged and neutrons, as the name indicates, are neutral. The number of protons in the nucleus decides which element the atom belongs to. The number of neutrons present doesn't matter so much, but in most atoms there are at least as many neutrons as protons. (One notable exception is hydrogen, which has a nucleus consisting of just one proton). The protons, you see, being positively charged, all repel one another. The neutrons, by some mechanism still not properly understood, seem to hold the whole kaboodle together in a relatively stable lump. In some atoms, however, — particularly the larger ones, with more than 90 or so protons — the nuclei are not quite stable enough. In fact, they are liable literally to fall apart! This, as you probably guessed, is where the alpha and beta radiation comes in . . .

## Let There Be Helium

It turns out that there are two ways in particular in which atoms 'like' to fall apart. One of them is by giving off two protons and two neutrons together, in a lump. In fact, this 'lump' is exactly the same as a normal helium nucleus, carrying the positive charge of two protons. It is this positively charged helium nucleus, which unstable atoms tend to release, that we call the alpha particle.

And what of the beta particle? Well, it was found by experiment that beta particles are actually free electrons. Because of this, you might be tempted to think that it was one of the electrons from around the atom, which has been released. This is not, however, the case. (It's such an obvious explanation that it can't possibly be right — Murphy's Law). Occasionally, within the nucleus, a neutron will turn into a proton, giving off an electron — and, at the same time, another particle called an anti-neutrino. The anti-neutrino really belongs in an article by itself, so we'll pass it by, except to say that it has no charge, little or no mass, and is virtually impossible to detect, although it is undoubtedly one of the most intriguing particles discovered yet. The electron given off when this happens is (you guessed it!) the beta particle.

We can see, then, that, although we say alpha, beta and gamma 'rays', only the gamma type is a ray. The other two types are really particles. However, when they occur in streams with large numbers of the particles, it is just as convenient to call them rays.

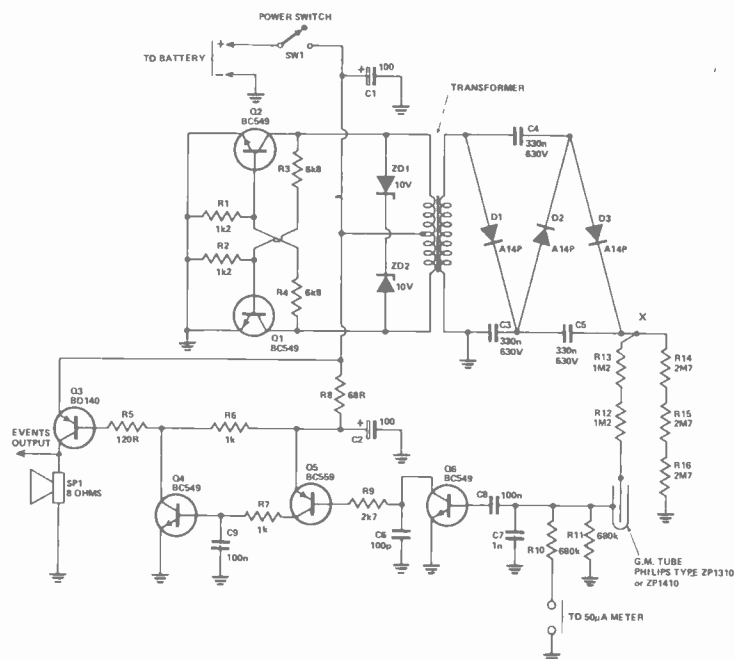

Fig.4. Circuit diagram of a Geiger-Muller tube radiation detector.

## Lead Into Gold

A while back, we stated that the number of protons in the nucleus determined which element the atom belongs to. However, when alpha or beta radiation is given off, the number of protons changes (with alpha radiation, it decreases by two, and with beta radiation, it increases by one). Hence, when atoms 'decay' radioactively, by giving off alpha or beta radiation, they actually turn into other elements! Interestingly enough, the particular elements they turn into, when possessing the numbers of neutrons actually available, are not always themselves stable and so they may decay further. For instance, if you take an atom of astatine with 85 protons and 132 neutrons in the nucleus and allow it to decay radioactively, then it would decay into a bismuth atom by giving off an alpha particle. Now, although a bismuth atom with the right number of neutrons (126) is stable, the bismuth atom produced from astatine has 130 neutrons. Because of this, it is unstable, and will itself decay (usually giving off a beta particle, but occasionally an alpha). It is possible, in fact, to find whole chains of elements, which decay radioactively into one another!

## Age Before Theory

One of the most exciting applications of all this (yes, it isn't just theory; there actually is a use for it) is in radio-carbon dating, in which it is possible to tell the age of an object from measurements of the amount of radioactive carbon in it. That, however, is another story altogether . . . .

ETI

# Metac

## ELECTRONICS & TIME CENTRES

### QUARTZ LCD 11 Function Slim Chronograph

12:30<sup>pm</sup>  
45  
Hours mins secs

8 14<sup>TH</sup>  
Month date day

0:0000  
Min sec 1/10 1/100



Price only  
**£7.95**

Also available:  
SOLAR CHRONOGRAPH  
M9 Price £11.95

6 digit, 11 functions,  
Hours, mins., secs., day,  
date, day of week,  
1/100th, 1/10th, secs.,  
10X secs., mins.  
Split and lap modes.  
Back-light, auto calendar.  
Only 8mm thick.  
Stainless steel bracelet  
and back.  
Adjustable bracelet.

SAME DAY DESPATCH.

**M3** Price includes POST & PACKING

### QUARTZ LCD ALARM with Snooze Alarm

12:30<sup>pm</sup>  
45  
Hours mins secs

8 14<sup>TH</sup>  
Month date day

7:30A  
Alarm



Price only  
**£7.95**

6 functions plus Alarm.  
Conference signal,  
5 minute snooze alarm,  
Conference signal sounds  
4 secs. before main alarm  
to give advance warning  
and an option to cancel.  
Snooze sounds 5 mins.  
after main alarm and is  
always preceded by the  
conference signal.

SAME DAY DESPATCH.

**M4** Price includes POST & PACKING

### QUARTZ LCD ALARM CHRONOGRAPH with 12/24 display

12:30<sup>pm</sup>  
45  
Hours mins secs

8 14<sup>TH</sup>  
Month date day

0:000  
Min sec 1/10th



Price only  
**£11.95**

Also available:  
SOLAR ALARM CHRONO  
M7 Price £17.95

Hours, mins, secs, day  
of week. Month, date,  
day of week, alarm,  
hour, mins., a.m./p.m.  
24 or 12 hour display  
mode. Alarm test.  
Chronograph, lap  
time, stop watch 1/10  
secs.

**M64** Price includes POST & PACKING

### QUARTZ LCD Ladies Day Watch

Hours, mins., secs., day,  
date, back light, auto  
calendar.

12:30  
Hours mins

8 14  
Month date

:45  
Secs



Price only  
**£4.95**

Fully adjustable bracelet.  
Only 25 x 20mm and  
6mm thick.  
Silver or Gold.

**M15** SAME DAY DESPATCH. P.&P. included

### QUARTZ LCD Ladies Cocktail Watch

Beautifully designed with a very thin bracelet.

12:30  
Hours mins

8 14  
Month date

:45  
Secs



Price only  
**£10.95**

Hours., mins., secs., day, date,  
backlight and autocalendar.  
Bracelet fully adjustable to  
suit slim wrists.  
State Gold or Silver finish.  
Only 25 x 20 x 6mm.

**M18** SAME DAY DESPATCH. P.&P. included

### HANIMEX Electronic LED Alarm Clock

Features and Specification:

Hour, minute display. Large LED display with  
p.m. and alarm on indicator. 24 Hours alarm  
with on/off control. Display flashing for power  
loss indication. Repeatable 9-minute snooze.  
Display bright/dim modes control. Size: 5.15"  
x 3.93" x 2.36" (131mm x 11mm x 60mm).  
Weight: 1.43 lbs (0.65 kg).



**M13**

Price only Mains operated.  
**£10.20** Thousands sold!

### QUARTZ LCD 5 Function GENTS/BOYS

Hours, mins., secs.,  
month, date, auto  
calendar, back light,  
quality metal  
bracelet. 6mm thick.

12:30  
Hours mins

8 14  
Month date

:45  
Secs



Price only

**M1** SAME DAY DESPATCH. **£5.95** P.&P. included

### METAC GUARANTEE

All METAC products carry 12 months guarantee and we also refund your money if not satisfied with our goods or service in the first 10 days.

METAC's well equipped service centre minimises service delays. Please note, we do not delay your order to clear cheques.

Telephone your order using  
Barclaycard/Access  
Number on on

**03272 -  
5983**



24 hour answering service  
OR COMPLETE THE  
COUPON

### WHOLESALE MAIL ORDER

Send for our trade price list and order details. Sell our products to your friends and earn yourself

**£££'s**



**NEW 24 HOUR  
DESPATCH SERVICE**

METAC have opened a new even faster Mail Order and Service Centre at DAVENTRY. Orders received before 3.30 p.m. will be despatched same day.

**VISIT OUR ELECTRONIC TIME  
CENTRES AND SEE ONE OF THE MOST  
IMPRESSIVE QUARTZ WATCH RANGES  
IN BRITAIN**

**QUARTZ MELODY  
Alarm Chronograph**

INCREDIBLE WATCH 34 Functions

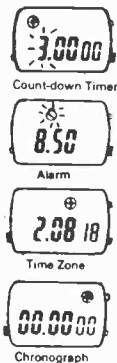

5 independent working modes, day of week in English, French or German. (Just select the one you like). Hours, mins., secs., day, date, countdown alarm, dual time zone, 1/100th sec., stopwatch. Lap/split time, 1st and 2nd place times. Melody test function.

**M30 SAME DAY DESPATCH.**

Price only

**£16.95**

Price includes  
POST &  
PACKING

**SEIKO ALARM  
CHRONOGRAPH**

With WEEKLY Alarm, Hours, mins., secs., month, date, day, am/pm. Weekly alarm — can be set for every day at designated time, e.g. 6.30 am on Monday, Wednesday and Friday. Alarm set time displayed above time of day. Full stopwatch functions, laptime, split etc.



**SAME DAY  
DESPATCH.  
M10**

Price only  
**£49.95**

including POST & PACKING

**METAC IN  
LONDON**  
327 EDGWARE ROAD, LONDON, W2  
01-723 4753

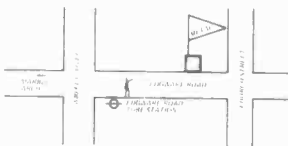

**58 QUEENSWAY, LONDON, W2**  
Opposite Bayswater Tube Station  
Shop open 12 hours/day, 7 days/week

Situated in the heart of London's fast-moving electronics area. A very large selection of watches and consumer electronics products. Also many bargain discount/sale items.

2nd only to Oxford Street, this is London's round-the-clock international tourist area. An excellent selection of expensive famous watches, plus all the popular models.

**METAC IN  
NORTHAMPTON**  
11 ST. GILES SQUARE, NORTHAMPTON  
Tel: (0604) 39550

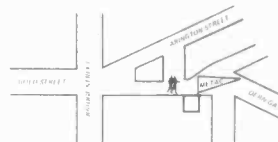

An excellent selection of watches and electronics. This shop also has televisions and video recorders to rent or buy.

**METAC IN  
DAVENTRY**  
67 HIGH STREET, DAVENTRY

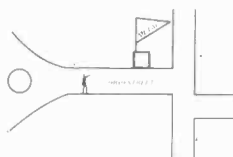

Situated in the middle of Daventry, only a short walk from Metac's Mail Order Centre, the shop stocks a wide range of watches and consumer electronic products. You may also rent or buy televisions and video recorders here.

**METAC IN  
LEICESTER**  
OMNI SHOPPING CENTRE, 27 MARKET STREET  
LEICESTER

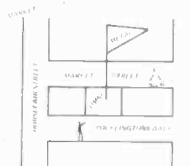

Situated in the Omni walk-round shopping centre. Metac at Omni stocks an excellent range of quality watches at very attractive prices.

**ALSO IN STOCK**

NEW SEIKO	Digital-Analogue Alarm Chrono	<b>£73</b>
SEIKO	James Bond Memory Bank Now only	<b>£39</b>
BEL-TIME	Pico-Quartz 50 Function All Singing, all Dancing Wrist Computer	<b>£29.95</b>
BEL-TIME	Alarm	<b>£12.95</b>
BEL-TIME	Chronograph	<b>£10.95</b>
BULER	Swiss Digital and Quartz-Analogue Collection	
CASIO	Alarm Chrono. Lowest price anywhere. Send for details	
OTRON	Korean Waterproof Ladies' and Gent's Solar Alarm Chronographs, etc.	
TRAFALGAR	Digital-Analogue Alarm Chronograph	<b>£29.95</b>

Also large selection of popular Dual-time, Alarm, Countdown, Musical, Ladies' and Gent's Watches.

**WANT TO KNOW HOW  
THEY WORK?**

Send £1 and we will send you the 40-page Watch Report. A technical survey which describes in detail the function and operation of electronic watches in a completely unbiased and objective way.

**MAIL ORDER**

Mail Order is a safe and simple way to purchase goods. You are well protected by the consumer mail order laws and at Metac we combine a fast service with a genuine 10-day home approval scheme. You may examine any merchandise purchased through our mail order division, in your own home for 10 days at no cost to yourself. All postal charges are pre-paid by Metac. For more information on Metac mail order products send for our free literature, brochure and watch-care leaflets, to: **METAC ELECTRONICS LITERATURE, 47 HIGH STREET, DAVENTRY, NORTHANTS.**

**POST COUPON TO: METAC (24 hour despatch centre), FREEPOST, 47a High Street, Daventry, Northants.**

**PLEASE COMPLETE BOTH COUPONS**

Please send me .....

I enclose P.O./Cheque value .....

Barclaycard/Access No. ....

Name .....

Address .....

**FROM:**

**METAC ELECTRONICS & TIME CENTRE, (HE)  
67 HIGH STREET, DAVENTRY, NORTHANTS.**

Name .....

Address .....

**POST, PACKING AND VAT INCLUDED IN PRICE.**

# ELECTRONICS DIGEST

VOL 1 NO 2  
£1.50

**30** PROJECTS  
TO  
BUILD!

**FULL DETAILS INSIDE:**

- Wheel Of Fortune*
- Telephone Bell Extender*
- Power Bulge*
- Battery Indicator*
- Wine Meter*
- Soil Moisture Indicator*
- Cannibals Game*
- Double Die*
- Rain Alarm*
- Slide Synchroniser*
- Thermal Switch*
- Loudhailer*
- Battery Eliminator*
- Radio Control System*
- Click Eliminator*
- Guitar Effects*
- Microamp*
- Noise Limiter*
- Display*
- Analyser*
- Versa*
- RF Power*
- Car Immobiliser*
- Headlight Delay*
- Digital Tacho*
- Car Security*
- Overspeed Alarm*
- Hammer Throw Game*

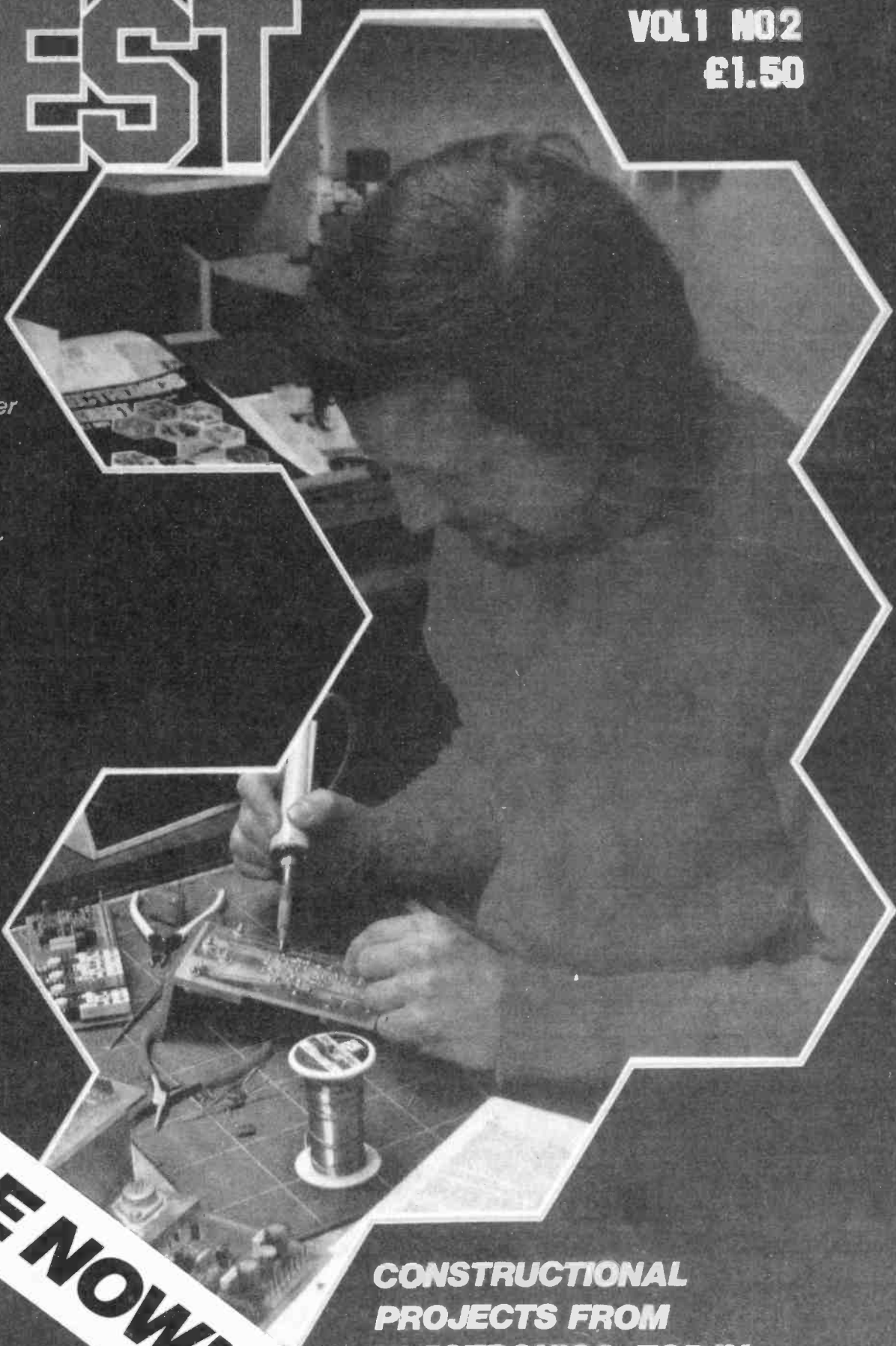

**ON SALE NOW!**

**CONSTRUCTIONAL  
PROJECTS FROM  
ELECTRONICS TODAY**

# DMM SURVEY

The DMM is an invaluable aid to both the handyman and the professional. Tina Boylan explores the low cost end of the digital multimeter market.

The seventies saw the emergence of the digital multimeter onto the test equipment market and since Fluke produced the 800A in 1972 an explosive growth in production and design has been witnessed. A short life-span (three to five years) and the continuing introduction of new models from America and the Far East, as well as from Great Britain, has ensured lower prices and improved performance. The original LED display has been forsaken for the LCD display, despite early teething problems like poor refractory angle, slow response and blackening after two or three years. The LCD display now boasts a life of ten years.

## Analogue to Digital

The analogue meter has been with us for as long as 80 years and, despite its low cost, it contains some unwelcome characteristics which have caused problems in testing and for many of these problems the digital multimeter provides a more reliable service. Primarily the analogue meter contains moving parts which are prone to damage, overload, reverse polarity and wear. On the other hand the digital multimeter contains only electronic components, up to 20% of which may be used solely for protection purposes, and these, as well as being more rugged, mean that the meter itself can be made smaller and lighter than its analogue counterpart — by virtue of the latest integration methods.

As far as hand-held DMMs are concerned, those with standard features, (voltage, current, resistance) are sure to continually drop in price, thus serving the end of the

market traditionally held by the low cost hand-held analogue meter, while it maintains enough room to expand the capabilities of the same size meter for including complicated features.

For the professional, analogue meters can still appear to provide better testing facilities, particularly where bench-top models are concerned, but this is a myth which is fast being disproved by the technical advances being made in the DMM field. Until recently digital versions gave difficulty in reading transients or peaks because of the rapidly changing display, due in part to the fast analogue/digital conversion times of the DMM. The latest models now incorporate a peak reading memory, and these even take the guesswork out of watching a moving needle and making approximate readings.

## Microprocessors

Present trends in DMM development are focusing on the use of microprocessors in their design which will make the instrument easier and faster to use, as well as making it more powerful in terms of computational and mathematical facilities. This coupled with lowering price trends will mean that the man in the street will soon have a sophisticated DMM for his handyman activities while it remains an essential to the engineer and technician.

ETI has compiled a list of some of the low priced DMMs, both of the hand-held and bench varieties, to give some indication of the diverse types which are currently available.

**AVOMETER DA211**  
 PRICE: £45.00 ex. VAT  
 BATTERY: Single 9 V dry cell  
 BATTERY LIFE: 200 hours approx.  
 DIMENSIONS: 90 x 171 x 31 cm  
 WEIGHT: 280 g  
 SELECTION OF RANGE OR FUNCTION: 8 in-line push buttons.  
 FUNCTIONS: Voltage, current, resistance  
 DC VOLTAGE RANGE: 5 ranges, 200 mV to 1000 V  
 AC VOLTAGE RANGE: 5 ranges, 200 V to 1000 V  
 DC AND AC CURRENT: 4 ranges, 200  $\mu$ A to 200 mA plus 5th range measuring up to 10 A DC.  
 RESISTANCE RANGE: 4 ranges, 0 and 2M $\Omega$  plus low voltage diode test facility.  
 DISPLAY: 3½ digit LCD  
 HEIGHT OF DISPLAY CHARACTERS: 13 mm  
 READING RATE: 2.5/S  
 OVERLOAD PROTECTION: 500 mA fuse  
 OTHER FEATURES: Auto-polarity, auto-zero.

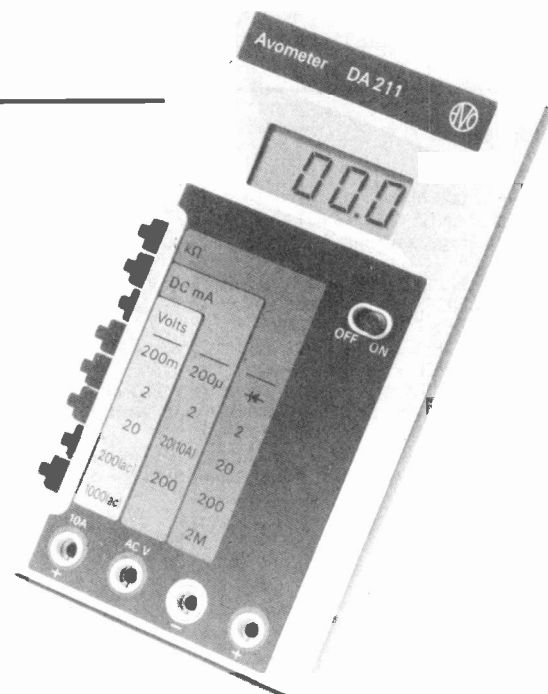

#### AVOMETER DA212

PRICE: £65.00 ex VAT

BATTERY: Two R6 (HP7)

BATTERY LIFE: Approx. 200 hours

DIMENSIONS: 160 x 96 x 47 mm

WEIGHT: 340 g

SELECTION OF RANGE OR FUNCTION: Rotation of two selector switches.

FUNCTIONS: Voltage, current, resistance

DC VOLTAGE RANGE: 5 ranges, 200 mV to 1000 V

AC VOLTAGE RANGE: 5 ranges, 200 mV to 750 V

DC AND AC CURRENT: 200  $\mu$ A to 1000 mA

RESISTANCE RANGE: Two voltage levels, Hi or Lo, by push button.

DISPLAY: 3½ digit LCD

HEIGHT OF DISPLAY CHARACTERS: 13 mm

READING RATE: 2.5/S

OVERLOAD PROTECTION: to 1000 V on voltage ranges and 250 V on all other functions.

OTHER FEATURES: Controlled by on/off switch, auto-polarity, auto-zero, battery low indicator.

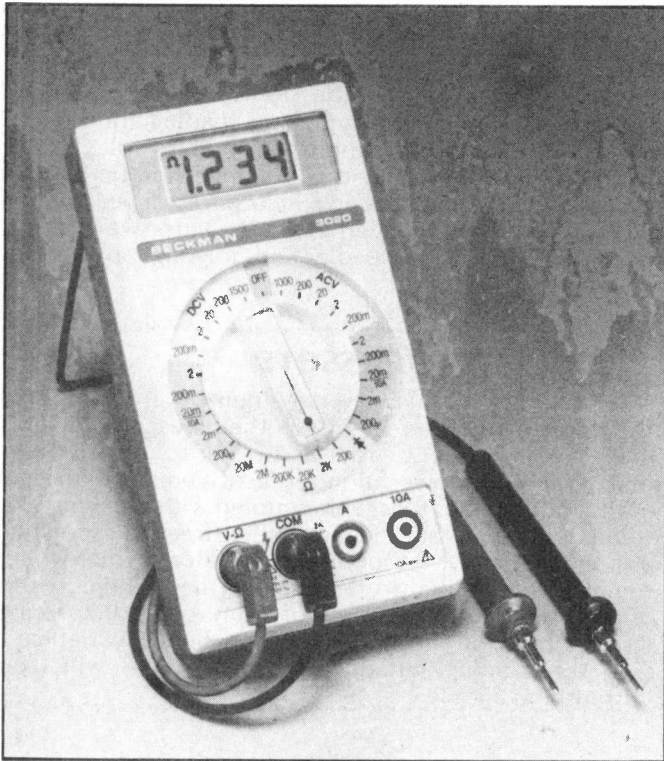

#### BECKMAN 3020

PRICE: £115.00

BATTERY: 9 V transistor type

BATTERY LIFE: 2,000 hours

DIMENSIONS: 17.4 x 9.3 x 4.6 cm

WEIGHT: 453 g

SELECTION OF RANGE OR FUNCTION: Single central dial

FUNCTIONS: Voltage, current, resistance

DC VOLTAGE RANGE: 5 ranges, 200 mV to 1500 V

AC VOLTAGE RANGE: 5 ranges, 200 mV to 1000 V

DC AND AC CURRENT: 5 ranges, 200  $\mu$ A to 2 A. Separate input extends this to 10 A.

RESISTANCE RANGE: 6 ranges from 200R to 2M $\Omega$

DISPLAY: 3½ digit LCD

OVERLOAD PROTECTION: Voltage input protected to 1500 RMS AC. Resistance protected to 300V DC or RMS AC. Current inputs with 2 A fuse.

OTHER FEATURES: Insta-Ohms™ instant continuity test indicator, semiconductor test function provides 5 mA of test current, accuracy within 0.1%  $\pm$  1 digit on all DC voltage ranges, battery low indicator.

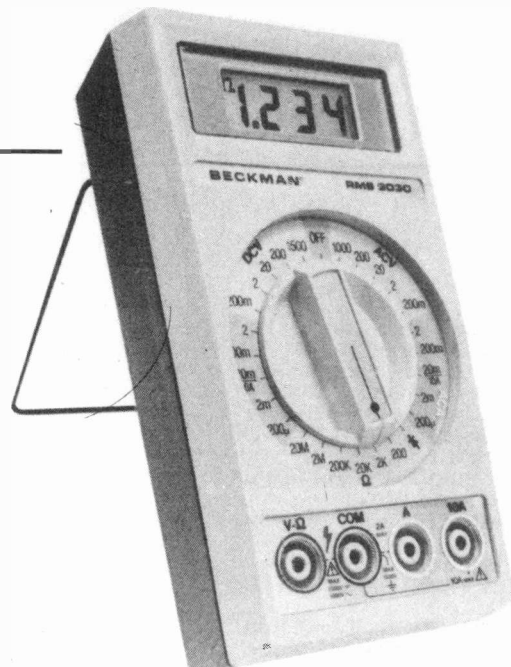

#### BECKMAN RMS 3030

PRICE: £176.00

BATTERY: 9 V transistor type

BATTERY LIFE: 2,000 hours

SELECTION OF RANGE OR FUNCTION: Rotary switch

FUNCTIONS: Voltage, current, resistance, AC voltage and current in true RMS.

DC VOLTAGE RANGE: 5 ranges, 200 mV to 1500 V

AC VOLTAGE RANGE: 200 mV to 1000 V in true RMS

DC AND AC CURRENT: 200  $\mu$ A to 2 A

RESISTANCE RANGE: 6 ranges from 200R to 2M $\Omega$

DISPLAY: 3½ digit LCD

OVERLOAD PROTECTION: Input up to 1500 V DC or 1000 V RMS, resistance up to 300 V DC or RMS. Current inputs with 2 A fuse, 10 A range up to 20 A for 30 S.

OTHER FEATURES: Instant continuity test, RMS input accuracy is 0.5%, battery low indicator, calibration guaranteed for one year.

**FLUKE 8022A**

PRICE: £75.00  
 BATTERY: 9 V  
 BATTERY LIFE: Alkaline 200 hours, zinc-carbon 150 hours.  
 DIMENSIONS: 18.0 x 8.6 x 4.5 cm  
 WEIGHT: 37 g  
 SELECTION OF RANGE OR FUNCTION: 8 in-line push buttons.  
 FUNCTIONS: 6 functions, 24 ranges  
 DC VOLTAGE RANGE: 5 ranges, 200 mV to 1000 V  
 AC VOLTAGE RANGE: 5 ranges, 200 mV to 750 V  
 DC AND AC CURRENT: 4 ranges, 2 mA to 2000 mA  
 RESISTANCE RANGE: 200R to 20M  
 DISPLAY: 3½ digit LCD  
 OVERLOAD PROTECTION: Withstands 500 V on resistance, 1000 V on voltage, 2 A on current and 6 kV voltage transients.  
 OTHER FEATURES: Auto-polarity, auto-zero, battery low indicator, Tilt Stand.

**FLUKE 8024A**

PRICE: £135.00  
 BATTERY: 9 V  
 BATTERY LIFE: Alkaline 200 hours, zinc-carbon 150 hours.  
 DIMENSIONS: 18.0 x 8.6 x 4.5 cm  
 WEIGHT: 480 g  
 SELECTION OF RANGE OR FUNCTION: 8 in-line push buttons.  
 FUNCTIONS: Voltage, current, resistance, conductance, temperature, continuity, level detection.  
 DC VOLTAGE RANGE: 5 ranges, 200 mV to 1000 V  
 AC VOLTAGE RANGE: 5 ranges, 200 mV to 750 V  
 DC AND AC CURRENT: 4 ranges, 2 mA to 2000 mA  
 RESISTANCE RANGE: 200R to 20M  
 DISPLAY: 3½ digit LCD  
 OTHER FEATURES: Audible continuity test, fully compensated direct temperature readings from 0°C for any K-type thermocouple, peak hold feature for transient signals, auto-zero, auto-polarity.

**FLUKE 8010A/8012A (Bench Top)**

PRICE: 8010A: £159.00  
 8012A: £199.00  
 BATTERY: Option of rechargeable NiCad batteries (-01) series)  
 BATTERY LIFE: 40 hours for DC voltage, 10 hours on other measurements.  
 DIMENSIONS: 6 x 22 x 25 cm  
 WEIGHT: 1.08 kg  
 FUNCTIONS: Current, voltage, resistance, conductance, high current  
 DC VOLTAGE RANGE: 5 ranges, 200 mV to 1000 V  
 AC VOLTAGE RANGE: 5 ranges, true RMS, 200 mV to 750 V  
 DC AND AC CURRENT: AC: 5 ranges, 200 uA to 2000 mA  
 DC: 4 ranges, 200 uA to 2 A  
 RESISTANCE RANGE: 6 ranges, 200R to 20M, 8021A low resistance 2R to 20R  
 DISPLAY: 3½ digit LCD  
 OTHER FEATURES: Battery low indicator, one year guarantee, auto-zero, auto-polarity, touch and hold, 8012A has two additional low resistance ranges.

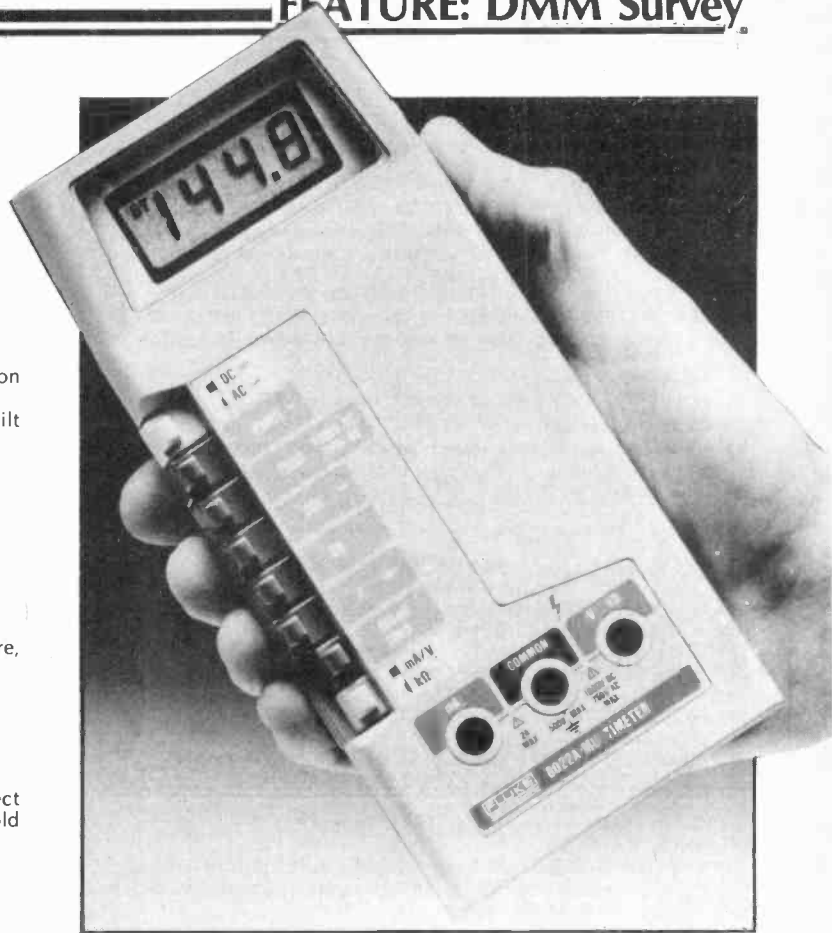

**FLUKE 8050A (Bench Top)**

PRICE: £199.00  
 BATTERY: Rechargeable battery option (-01 series)  
 FUNCTIONS: Voltage (including AC voltage in true RMS, AC coupled) current, resistance, conductance, relative reference, direct readings in decibels. 39 measurement ranges.  
 DC VOLTAGE RANGE: 5 ranges, 200 mV to 1000 V  
 AC VOLTAGE RANGE: 5 ranges, 200 mV to 750 V  
 DC AND AC CURRENT: 5 ranges, 200 uA to 2000 mA  
 RESISTANCE RANGE: 200R to 20M  
 DISPLAY: 4½ digit LCD  
 OVERLOAD PROTECTION: Voltage: 750 V AC or 1000 V DC. Resistance: 300 V DC, short transients to 6 kV. 2 A fuse for current input plus heavy duty fuse.  
 OTHER FEATURES: Microprocessor control, DC accuracy of 0.3% for one year, safety indicator for input above 40 V.

**HEWLETT PACKARD 3476A/3476B (Bench Top)**

PRICE: 3476A: £126.00  
 3476B: £155  
 BATTERY: Rechargeable NiCad batteries with 3476B.  
 BATTERY LIFE: 8 hours with 3476B  
 DIMENSIONS: 5.8 x 16.8 x 20.6 cm  
 WEIGHT: A: 0.77 kg, B: 0.97 kg  
 FUNCTIONS: Voltage, current, resistance  
 DC VOLTAGE RANGE: 100 uV to 1000 V  
 AC VOLTAGE RANGE: 3.3 mV to 700 V (RMS)  
 DC AND AC CURRENT: AC: 3.3 mA to 1.1 A  
 DC: 100 uA to 1.1 A  
 RESISTANCE RANGE: 1R0 to 11M  
 DISPLAY: LED  
 READING RATE: 3/S  
 OTHER FEATURES: Autorange, auto-polarity, auto-zero.

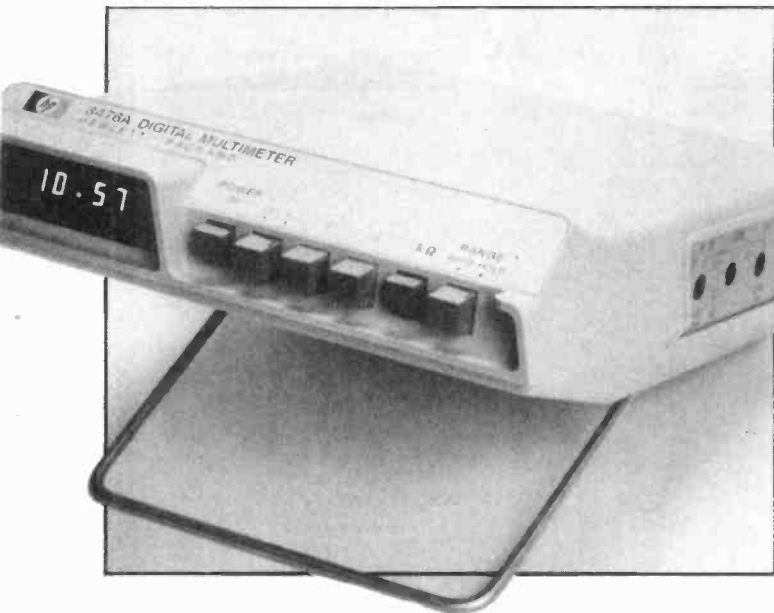

**KAISE MODEL SK-6100, SK-6110**

PRICE: SK-6110: £56.48, SK-6110: £65.17 ex VAT

BATTERY: Two 1.5 V, UM-3 or AA

BATTERY LIFE: 200 hours continuous operation.

DIMENSIONS: 155 x 85 x 28 mm

WEIGHT: 250 g

SELECTION OF RANGE OR FUNCTION: Rotary switch

FUNCTIONS: Voltage, current, resistance, low-power resistance.

DC VOLTAGE RANGE: 5 ranges, 200 mV to 1000 V auto ranging

AC VOLTAGE RANGE: 4 ranges, 2 V to 600 V

DC AND AC CURRENT: 20 mA to 200 mA

RESISTANCE RANGE: 200R to 2M $\Omega$  and low power resistance 2k $\Omega$  to 2M $\Omega$ .

DISPLAY: 3½ digit LCD

HEIGHT OF DISPLAY CHARACTERS: 10 mm

READING RATE: 2/S

OTHER FEATURES: Auto display, auto ranging, range hold function, overrange indication, battery low indicator, 0.5% accuracy, SK-6100 has continuity check with buzzer, SK-6110 has 10 A AC/DC range.

**KAISE SK-6200, SK-6220**

PRICE: SK-6200: £34.74, SK-6220: £43.43 ex VAT

BATTERY: Two 1V5 type UM-3 or AA

BATTERY LIFE: 200 hours continuous operation.

DIMENSIONS: 155 x 85 x 28 mm

WEIGHT: 250 g

SELECTION OF RANGE OR FUNCTION: Rotary switch

FUNCTIONS: Voltage, current, resistance and low power resistance.

DC VOLTAGE RANGE: 200 mV to 1000 V auto ranging

AC VOLTAGE RANGE: 2 V to 600 V auto ranging

DC AND AC CURRENT: 200 mA, SK-6220 only 10 A

RESISTANCE RANGE: 200R to 2M $\Omega$

DISPLAY: 3½ digit LCD

HEIGHT OF DISPLAY CHARACTERS: 10 mm

READING RATE: 2/S

OTHER FEATURES: Full auto ranging, auto display, range hold function, overrange indication, 0.8% accuracy, battery low indicator. SK-6220 has 10 A AC/DC range.

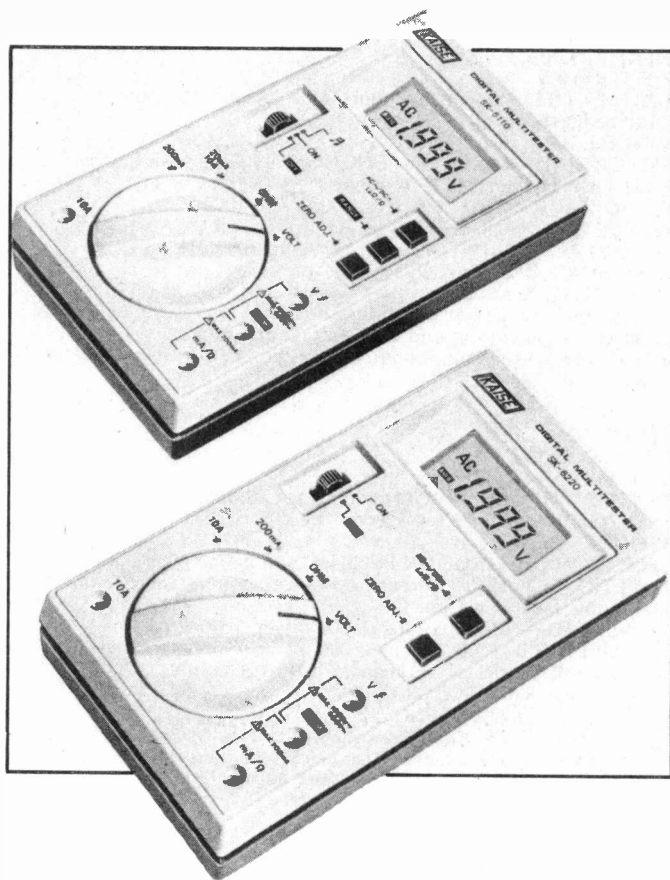

**KEITHLEY 169 (Bench Top)**

PRICE: £110.00 plus VAT

BATTERY: Six 1V5 "C" cells

BATTERY LIFE: 1,000 hours carbon-zinc, 2000 hours alkaline.

DIMENSIONS: 85 x 235 x 275 mm

WEIGHT: 1.4 kg

SELECTION OF RANGE OR FUNCTION: Colour-coded push button switches.

FUNCTIONS: Voltage, current, resistance

DC VOLTAGE RANGE: 5 ranges, 200 mV to 1000 V

AC VOLTAGE RANGE: 5 ranges, 200 mV to 1000 V

DC AND AC CURRENT: 5 ranges, 200  $\mu$ A to 2000 mA

RESISTANCE RANGE: 6 ranges, 200R to 20M

DISPLAY: 3½ digit LCD

HEIGHT OF DISPLAY CHARACTERS: 0.6"

OVERLOAD PROTECTION: Voltage to 1400 V peak, resistance to 300 V RMS, current by 2 A fuse.

OTHER FEATURES: Auto-zero, out of range indication.

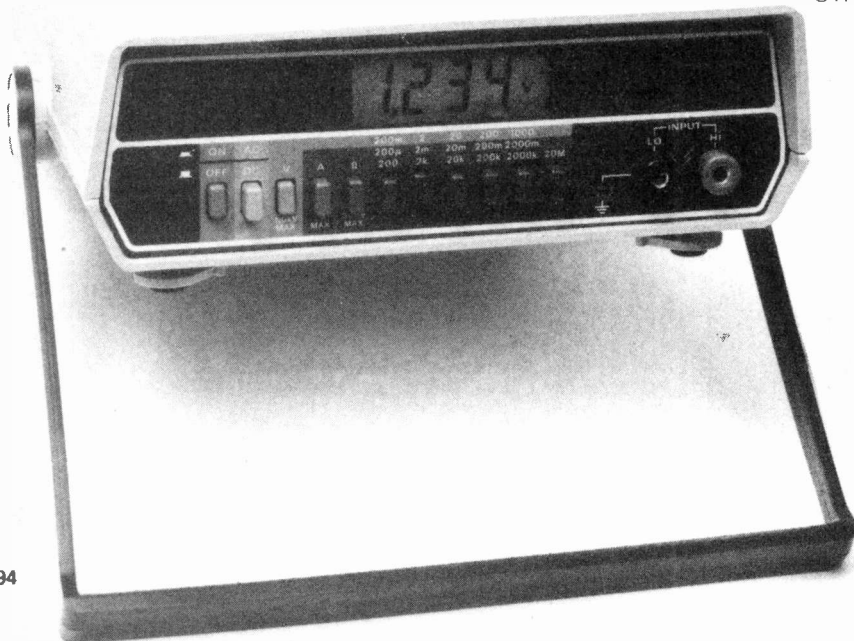

## KEITHLEY MODEL 130

PRICE: £79.00 ex VAT  
 BATTERY: 9 V alkaline or carbon-zinc  
 BATTERY LIFE: Alkaline 200 hours, carbon-zinc 100 hours  
 DIMENSIONS: 178 x 78 x 38 mm  
 WEIGHT: 400 g  
 SELECTION OF RANGE OR FUNCTION: Rotation of two selector switches.  
 FUNCTIONS: Voltage, current, resistance  
 DC VOLTAGE RANGE: 5 ranges, 200 mV to 1000 V  
 AC VOLTAGE RANGE: 5 ranges, 200 mV to 750 V  
 DC AND AC CURRENT: 5 ranges, 2 mA to 10 A  
 RESISTANCE RANGE: 200 $\Omega$  to 20M  
 DISPLAY: LCD  
 HEIGHT OF DISPLAY CHARACTERS: 0.6"  
 OVERLOAD PROTECTION: mA input: 2 A fuse (250 V) externally accessible; 10 A input: 20 A for 15 S unfused.  
 OTHER FEATURES: Auto-zero, auto-polarity, stand mounted, overrange indication.

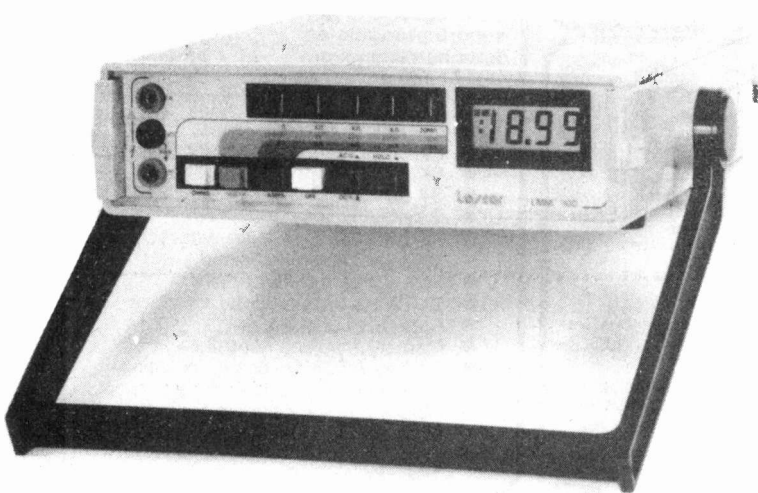

## LASCAR LM100 (Bench Top)

PRICE: £88.61  
 BATTERY: PP7  
 BATTERY LIFE: 2,000 hours  
 DIMENSIONS: 60 x 210 x 255 mm  
 WEIGHT: 1.2 kg  
 FUNCTIONS: 5 functions, 25 ranges  
 DC VOLTAGE RANGE: 6 ranges, 200 mV to 1000 V  
 AC VOLTAGE RANGE: 6 ranges, 200 mV to 1000 V  
 DC AND AC CURRENT: 6 ranges, 200  $\mu$ A to 20 A  
 RESISTANCE RANGE: 200 $\Omega$  to 20M  
 DISPLAY: 3 1/2 digit LCD  
 HEIGHT OF DISPLAY CHARACTERS: 12.5 mm  
 READING RATE: 3/S  
 OTHER FEATURES: Auto-zero, auto-polarity, digital hold facility.

## SOLARTRON 7045 (Bench Top)

PRICE: £360.00  
 BATTERY: 4 type D NiCad rechargeable (Optional)  
 DIMENSIONS: 200 x 70 x 260 mm  
 WEIGHT: 2.1 kg with batteries  
 FUNCTIONS: Voltage, current, resistance, temperature  
 DC VOLTAGE RANGE: 6 ranges, 19.999 V to 1000 V  
 AC VOLTAGE RANGE: 5 ranges, 199.99 V to 750 V  
 DC AND AC CURRENT: AC 6 ranges, 19.99  $\mu$ A to 1999 mA  
 DC 6 ranges, 19.999  $\mu$ A to 1999.9 mA  
 RESISTANCE RANGE: 6 ranges, 199.99 $\Omega$  to 19.999M  
 DISPLAY: 4 1/2 digit LED  
 READING RATE: 4/S  
 OTHER FEATURES: Battery low indicator, freeze display button, automatic ranging.



# NEW THE TUSCAN S100

A Z80 based S100 Computer System.

TUSCAN main board. The heart of the system with Z80, video, Ram, Rom, and I/O plus five S100 slots for expansion.

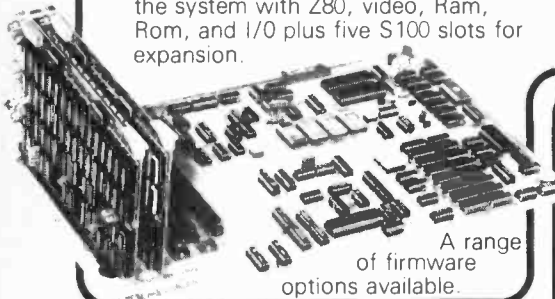

A range of firmware options available.

Available in Kit Form or Assembled.

All components available separately.

Houses two 5 1/4" drives for a compact business system

Professional case will house the complete system

Two keyboard options

Hinged lid for easy access

Stylish finish ideal for office or home

On Demonstration NOW

KITS from £195 + VAT delivery Ex-Stock

## nascom-2

### MICRO-KIT COMPUTER

With improved 16k B RAM Board

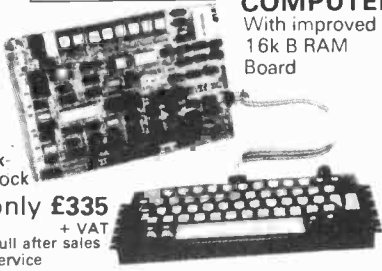

Ex-stock only £335 + VAT

Full after sales service

Power Supply £29.50.

#### Firmware & MOS ICs99 Software

Zeap Assembler (4, 1Kx8 EPROMS) £50  
Nas Pen text editor (2, 1Kx8 EPROMS) £30

#### Expansion boards (in kit form)

16K-RAM £140 ● 32K RAM £175.00  
48K RAM £210

EPROM Card (Nascom compatible) Kit, suitable for 16x2708 or 16x2716 or mixed 1xNascom 8k Basic from £55.00

New Basic Programmers Aid Self-locating Tapes £14.95

### NASCOM PRODUCT LIST + VAT

I/O board kit less I/O chips	45.00
UART + BAUD rate generator + crystal for I/O board	16.00
Ecognographics kit for additional 128 characters (N1 only)	30.00
2708/2716 Programmer suitable for N1 and N2 under NAS-SYS	£20.95 plus VAT
Nascom 19" rack mounting card frame for N1 and N2	32.50
Nas-DA dissembler 3 EPROM from Nas-Sys	37.50
MK36271 8K BASIC in 8K x 8 ROM	40.00
Naspen VS in 2 EPROM	30.00
Nas-sys monitor in 2 EPROM	25.00
4 games tape	6.50
Nasbug T4 2 x EPROM	25.00
Tiny Basic 2 x EPROM	25.00
Super Tiny Basic 3 x EPROM	37.50
Super Tiny Basic upgrade 1 x EPROM	12.50
<b>Tape Software</b>	
ZEAP 2 tape and documentation for Nas-sys	30.00
8K BASIC tape and documentation for N1	15.00

### THE HENELEC DISK SYSTEM

FOR NASCOM and any other Z80 - 8080 Microcomputer with an uncommitted P10



### DISKS

- The Henelec controller card plugs direct into a Z80 P10 and controls up to 3 double-sided mini-floppy drives giving a maximum 480K system.
  - General Purpose FDC control software for simple DOS or for CPM.
  - Simple DOS software for NASCOM 1/2 under NAS-SYS
  - OR ROM CB10S for CPM on NASCOM 1/2 incorporating the major NAS-SYS features. Maximum 60K CPM system.
  - New MD prom supplied for N2/CPM
- TWO SYSTEMS**
- SIM-DOS "Floppy Tape Recorder" with 1 drive PSU firmware, etc. £335 plus VAT
  - CPM System with 1 drive PSU firmware, etc. £395 plus VAT
  - Additional Drives with PSU £255 plus VAT

### COMPUTER KEYBOARDS

#### APPLE COMPUTER KEYBOARD

52 Key 7 bit ASCII coded positive strobe + 5V-12V. Size 13x4 3/4" sturdy construction, sloping keys, black/white print.

Made in USA for Apple Inc.  
**BRAND NEW £35 incl. VAT, Post £2.50**  
Individually packed in anti-static foam

**71 KEY ASCII KEYBOARD INCLUDING NUMERIC KEYPAD. £49.00 plus £7.35 VAT TOTAL £56.35.**  
Uses gold crosspoint keys. Includes keypad and ribbon cable. Only available as fully assembled and tested.

**STAR DEVICES MK III 71 keytouch sensitive keyboard.** With numeric pad. All ASCII characters including control keys. Auto key repeat. Parallel output with strobe. Shift lock with indicator LED. Built in 'beeper' with level control. 5V DC at 300mA 15" x 7" x 1.25". Grey case with white keys on blue. **48.50 plus VAT**

**CARTER 57 key ASCII keyboard.** Conventional key board. 128 ASCII characters including control keys. Parallel output with strobe. Shift lock. + 5 V and -12 V DC. 12" x 5.5" x 1.5". Black keys with white legends. **39.34 + VAT.**

**FERRANTI - "SIZE 14 x 6 x 3" SLOPING FRONT"**  
55 Key ASCII Coded in steel case. Complete with Plug and Cable with circuit to convert to T.T.L. levels.

In good condition at only **£19.95 + VAT P/P £2.50**

# TANGERINE

## COMPUTER SYSTEMS

### "MICRON"

the latest line in superb products on demonstration from your London stockist

**EX-STOCK**  
**£395.00 inc. VAT**  
**BRITISH DESIGN**

- 6502 based microcomputer
- VDU alpha numeric display
- Powerful monitor TANBUG
- 8K RAM
- 32 parallel I/O lines
- 2 serial I/O lines
- RS 232 C/20mA loop, with 16 programmable Baud rates
- Four 16 Bit counter timers
- CUTS cassette recorder interface
- Data bus buffering
- Memory mapping control
- 71 Key ASCII Keyboard, including numeric keypad and with auto repeat
- Including metal cabinets for both keyboard and modules
- Including power supply
- 10K Microsoft BASIC

Ideal for NASCOM - PET - TRS80 - TRITON

## NASCOM IMP



**PLAIN PAPER £325 PRINTER** Fully built and housed in a stylish enclosure for just £325 plus VAT.

INTERFACES WITH ALL MICRO COMPUTERS

The Nascom IMP (Impact Matrix Printer) features are

- 60 lines per minute. 80 characters per line.
  - Bi-directional printing. ● 10 line print buffer.
  - Automatic CR/LF. 96 character ASCII set (including upper/lower case, \$, £). ● Accepts 8 1/2" paper (pressure feed). ● Accepts 9 1/2" paper (tractor feed). ● Tractor/pressure feed. Baud rate from 110 to 9600. ● External signal for optional synchronisation of baud rate.
- IDEAL FOR WORD PROCESSING**

### CENTRONICS QUICK PRINTER

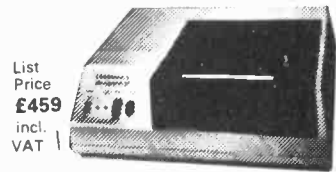

List Price **£459** incl. VAT

**OUR PRICE plus VAT**

**EXCLUSIVE TO HENRY'S 50% OFF MAKER'S PRICE £195**

for: Software selectable 20, 40 and 80 column using 120mm aluminium-ised paper. 1 roll supplied. 150 lines per minute.

**TANDY, PET, NASCOM** Centronics parallel data interface for Nascom, Tandy, etc.

240 volt mains input. ASCII character set Paper feed, and on/off select switches 'BELL' signal Weight 10lbs Size: 13" x 10 1/2" x 4 1/2"  
New, boxed and fully guaranteed  
**POST PAID Price £195.00 + VAT**  
See *COMPUTING TODAY* Recommendations MARCH/MAY ISSUES

### MEMORIES Discounts 10% for 4, 15% for 8, 20% for 16

MK3880 (NZ80)	7.50	2708	5.95
MK3880-N4 (Z80A)	7.95	2716	15.00
MK4116 16K x 1 dy RAM	6.50	IM6402 UART	4.50
MK4027 4K x 1 dy RAM	2.25	2114 1K x 4 Static RAM	3.25
2102 1K x 1 static RAM	1.00	8080A	5.25
4118 1K x 8 static RAM	12.75		

# TANGERINE

## LONDON STOCKISTS

Microtan 65 Kit, incl. VAT **£79.35**  
Microtan 65 Assembled, **£90.85**

Tanex (min. con) Kit, incl. VAT **£49.45**  
Tanex Assembled incl. VAT **£60.95**  
Lower case pack, incl. VAT **£10.90**  
Chunky Graphics Pack, incl. VAT **£7.50**  
20 Way Keypad incl. VAT **£11.50**  
Mini-mother board incl. VAT **£9.95**  
Complete Tangerine range available

SEND FOR COMPLETE COMPUTER BROCHURE FREEPOST TO ADDRESS BELOW

London Tangerine TUSCAN and NASCOM DISTRIBUTOR  
Export Orders deduct VAT, but add 5% carriage  
Official Export & Educational Orders welcome  
Our Telex 262284 Mono Ref. 1400 Transonics

ADD VAT 15% TO YOUR ORDER EXCEPT WHERE STATED



# HENRY'S

Computer Kit Division  
404 Edgware Road, London, W2, England I.E.D.  
01-402 6822





# SUBSCRIPTIONS

ETI 1980 . . . . . available from your newsagent every month.

Forget to buy it this month? Or is your newsagent sold out?

Why worry when ETI gets to the shop? Sit back and wait for it to come to you.

Take out an ETI Subscription. For only £10.00 we'll send you twelve issues of ETI

To claim your years' supply of ETI, send your PO or cheque direct to



ETI Subscriptions  
MAP Publications  
PO Box 35  
Bridge Street  
Hemel Hempstead  
Herts.

## 3½ DIGIT LCD MULTI-METER KIT

# NEW

Build the Practical Electronics handheld DMM. This superb product offers professional precision with extended battery life. Five function operation (AC and DC VOLTS, AC and DC CURRENT, RESISTANCE) with ability to check diodes. 0.5" LCD display with 'Battery Low' warning. Auto-polarity, Auto-zero. Full protection against transients and overloads with ability to withstand mains on any range. 0.5% basic DC accuracy and 15 different ranges. It measures AC/DC voltages from 0.1mV to 500V. AC/DC current from 0.1µA to 2A. Resistance from 0.1Ω to 2MΩ. 200 hour battery life.

The Kit contains all parts needed to construct the multimeter plus assembly instructions, battery and test leads.

We also offer a calibration service (£5.00 + VAT) and a trouble-shooting and calibration service (£7.50 + VAT). Various other component parts are also available as listed.

The multimeter is also available fully assembled and calibrated at a cost of £39.70 + P&P + VAT.

Lascar Electronics Ltd., Unit 1, Thomasin Road, Basildon, Essex. Telephone No: Basildon (0268) 727383.

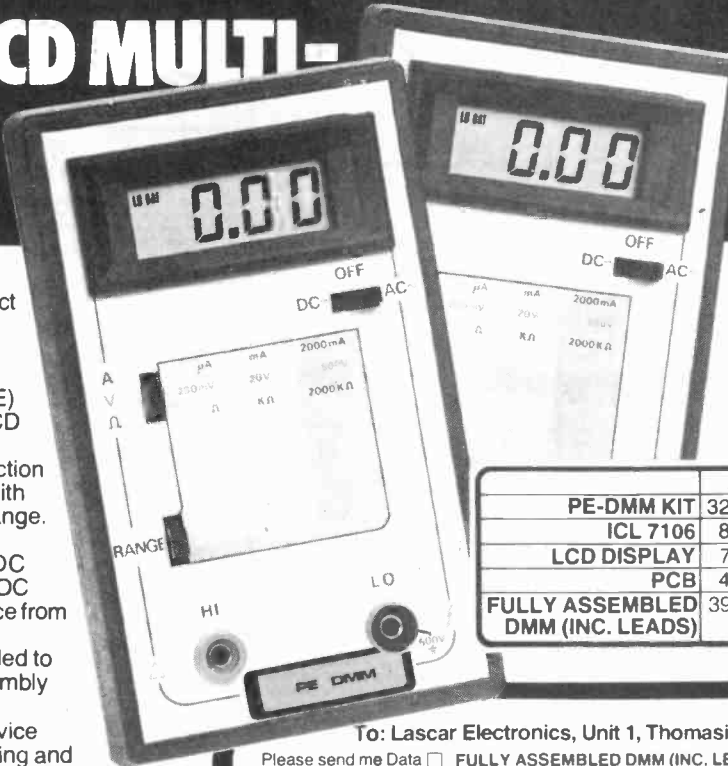

**FEATURED  
ASA  
PROJECT IN  
PRACTICAL  
ELECTRONICS**

	£	P & P	VAT	TOTAL
PE-DMM KIT	32.95	1.00	5.09	39.04
ICL 7106	8.95	0.50	1.42	10.87
LCD DISPLAY	7.95	0.50	1.27	9.72
PCB	4.95	0.50	0.82	6.27
FULLY ASSEMBLED DMM (INC. LEADS)	39.70	1.25	6.14	47.09

To: Lascar Electronics, Unit 1, Thomasin Road, Basildon, Essex.

Please send me Data  FULLY ASSEMBLED DMM (INC. LEADS) £47.09

PE-DMM KIT £39.04  ICL 7106 £10.87  LCD DISPLAY £9.72  PCB £6.27

Name \_\_\_\_\_

Address \_\_\_\_\_

Tel. No. \_\_\_\_\_

I enclose cheque/P.O. value

# PRIME COMPONENTS LOW PRICES

All our micro chips are at micro price. Don't be fooled by low prices. We do not offer for sale, surplus, sub-spec or rebranded devices. All our parts are guaranteed new, first quality, factory prime, full spec devices. It is also our policy to offer you the best of new devices that become available and these are featured regularly. Prices are exclusive of p&p and VAT — please refer to "Ordering Information" before ordering. Official orders from Schools, Colleges, Universities and Gov. Authorities accepted.

DTL	
930	55p
935	65p
937	55p
944	65p
946	55p
957	55p
962	55p
9099	90p

7400	
7400	11p
7401	12p
7402	12p
7403	13p
7404	17p
7409	18p
7410	16p
7412	18p
7417	28p
7513	28p
7420	16p
7430	18p
7432	25p
7440	16p
7442	68p
7448	75p
7493	50p
7496	45p
74121	35p
74123	45p
74154	50p
74157	55p
74172	45p
74175	50p
74195	100p
74196	100p
74283	140p
74290	120p
74365	90p
74366	90p

74LS	
74LS00	18p
74LS01	12p
74LS04	15p
74LS08	20p
74LS10	19p
74LS11	30p
74LS12	30p
74LS14	60p
74LS15	38p
74LS20	19p
74LS30	19p
74LS32	25p
74LS40	26p
74LS42	56p
74LS47	75p
74LS48	85p
74LS49	99p
74LS73	30p
74LS74	30p
74LS75	39p
74LS86	39p
74LS90	40p
74LS107	40p
74LS123	69p
74LS125	60p
74LS132	79p
74LS138	65p
74LS151	75p
74LS153	75p
74LS155	65p
74LS161	78p
74LS163	90p
74LS164	90p
74LS168	190p
74LS174	99p
74LS175	99p
74LS195	87p
74LS221	110p
74LS244	175p
74LS245	325p
74LS251	120p

74C	
74C20	30p
74C46	60p
74C85	145p
74C97	125p
74C98	125p
74C107	100p
74C160	110p
74C161	145p
74C163	145p
74C164	145p
74C192	175p
74C193	175p
74C194	175p
74C195	175p
74C903	45p

74LS	
74LS00	18p
74LS01	12p
74LS04	15p
74LS08	20p
74LS10	19p
74LS11	30p
74LS12	30p
74LS14	60p
74LS15	38p
74LS20	19p
74LS30	19p
74LS32	25p
74LS40	26p
74LS42	56p
74LS47	75p
74LS48	85p
74LS49	99p
74LS73	30p
74LS74	30p
74LS75	39p
74LS86	39p
74LS90	40p
74LS107	40p
74LS123	69p
74LS125	60p
74LS132	79p
74LS138	65p
74LS151	75p
74LS153	75p
74LS155	65p
74LS161	78p
74LS163	90p
74LS164	90p
74LS168	190p
74LS174	99p
74LS175	99p
74LS195	87p
74LS221	110p
74LS244	175p
74LS245	325p
74LS251	120p

74LS	
74LS00	18p
74LS01	12p
74LS04	15p
74LS08	20p
74LS10	19p
74LS11	30p
74LS12	30p
74LS14	60p
74LS15	38p
74LS20	19p
74LS30	19p
74LS32	25p
74LS40	26p
74LS42	56p
74LS47	75p
74LS48	85p
74LS49	99p
74LS73	30p
74LS74	30p
74LS75	39p
74LS86	39p
74LS90	40p
74LS107	40p
74LS123	69p
74LS125	60p
74LS132	79p
74LS138	65p
74LS151	75p
74LS153	75p
74LS155	65p
74LS161	78p
74LS163	90p
74LS164	90p
74LS168	190p
74LS174	99p
74LS175	99p
74LS195	87p
74LS221	110p
74LS244	175p
74LS245	325p
74LS251	120p

74LS	
74LS00	18p
74LS01	12p
74LS04	15p
74LS08	20p
74LS10	19p
74LS11	30p
74LS12	30p
74LS14	60p
74LS15	38p
74LS20	19p
74LS30	19p
74LS32	25p
74LS40	26p
74LS42	56p
74LS47	75p
74LS48	85p
74LS49	99p
74LS73	30p
74LS74	30p
74LS75	39p
74LS86	39p
74LS90	40p
74LS107	40p
74LS123	69p
74LS125	60p
74LS132	79p
74LS138	65p
74LS151	75p
74LS153	75p
74LS155	65p
74LS161	78p
74LS163	90p
74LS164	90p
74LS168	190p
74LS174	99p
74LS175	99p
74LS195	87p
74LS221	110p
74LS244	175p
74LS245	325p
74LS251	120p

74LS	
74LS00	18p
74LS01	12p
74LS04	15p
74LS08	20p
74LS10	19p
74LS11	30p
74LS12	30p
74LS14	60p
74LS15	38p
74LS20	19p
74LS30	19p
74LS32	25p
74LS40	26p
74LS42	56p
74LS47	75p
74LS48	85p
74LS49	99p
74LS73	30p
74LS74	30p
74LS75	39p
74LS86	39p
74LS90	40p
74LS107	40p
74LS123	69p
74LS125	60p
74LS132	79p
74LS138	65p
74LS151	75p
74LS153	75p
74LS155	65p
74LS161	78p
74LS163	90p
74LS164	90p
74LS168	190p
74LS174	99p
74LS175	99p
74LS195	87p
74LS221	110p
74LS244	175p
74LS245	325p
74LS251	120p

74LS	
74LS00	18p
74LS01	12p
74LS04	15p
74LS08	20p
74LS10	19p
74LS11	30p
74LS12	30p
74LS14	60p
74LS15	38p
74LS20	19p
74LS30	19p
74LS32	25p
74LS40	26p
74LS42	56p
74LS47	75p
74LS48	85p
74LS49	99p
74LS73	30p
74LS74	30p
74LS75	39p
74LS86	39p
74LS90	40p
74LS107	40p
74LS123	69p
74LS125	60p
74LS132	79p
74LS138	65p
74LS151	75p
74LS153	75p
74LS155	65p
74LS161	78p
74LS163	90p
74LS164	90p
74LS168	190p
74LS174	99p
74LS175	99p
74LS195	87p
74LS221	110p
74LS244	175p
74LS245	325p
74LS251	120p

74LS	
74LS00	18p
74LS01	12p
74LS04	15p
74LS08	20p
74LS10	19p
74LS11	30p
74LS12	30p
74LS14	60p
74LS15	38p
74LS20	19p
74LS30	19p
74LS32	25p
74LS40	26p
74LS42	56p
74LS47	75p
74LS48	85p
74LS49	99p
74LS73	30p
74LS74	30p
74LS75	39p
74LS86	39p
74LS90	40p
74LS107	40p
74LS123	69p
74LS125	60p
74LS132	79p
74LS138	65p
74LS151	75p
74LS153	75p
74LS155	65p
74LS161	78p
74LS163	90p
74LS164	90p
74LS168	190p
74LS174	99p
74LS175	99p
74LS195	87p
74LS221	110p
74LS244	175p
74LS245	325p
74LS251	120p

74LS	
74LS00	18p
74LS01	12p
74LS04	15p
74LS08	20p
74LS10	19p
74LS11	30p
74LS12	30p
74LS14	60p
74LS15	38p
74LS20	19p
74LS30	19p
74LS32	25p
74LS40	26p
74LS42	56p
74LS47	75p
74LS48	85p
74LS49	99p
74LS73	30p
74LS74	30p
74LS75	39p
74LS86	39p
74LS90	40p
74LS107	40p
74LS123	69p
74LS125	60p
74LS132	79p
74LS138	65p
74LS151	75p
74LS153	75p
74LS155	65p
74LS161	78p
74LS163	90p
74LS164	90p
74LS168	190p
74LS174	99p
74LS175	99p
74LS195	87p
74LS221	110p
74LS244	175p
74LS245	325p
74LS251	120p

74LS	
74LS00	18p
74LS01	12p
74LS04	15p
74LS08	20p
74LS10	19p
74LS11	30p
74LS12	30p
74LS14	60p
74LS15	38p
74LS20	19p
74LS30	19p
74LS32	25p
74LS40	26p
74LS42	56p
74LS47	75p
74LS48	85p
74LS49	99p
74LS73	30p
74LS74	30p
74LS75	39p
74LS86	39p
74LS90	40p
74LS107	40p
74LS123	69p
74LS125	60p
74LS132	79p
74LS138	65p
74LS151	75p
74LS153	75p
74LS155	65p
74LS161	78p
74LS163	90p
74LS164	90p
74LS168	190p
74LS174	99p
74LS175	99p
74LS195	87p
74LS221	110p
74LS244	175p
74LS245	325p
74LS251	120p

74LS	
74LS00	18p
74LS01	12p
74LS04	15p
74LS08	20p
74LS10	19p
74LS11	30p
74LS12	30p
74LS14	60p
74LS15	38p
74LS20	19p
74LS30	19p
74LS32	25p
74LS40	26p
74LS42	56p
74LS47	75p
74LS48	85p
74LS49	99p
74LS73	30p
74LS74	30p
74LS75	39p
74LS86	39p
74LS90	40p
74LS107	40p
74LS123	69p
74LS125	60p
74LS132	79p
74LS138	65p
74LS151	75p
74LS153	75p
74LS155	65p
74LS161	78p
74LS163	90p
74LS164	90p
74LS168	190p
74LS174	99p
74LS175	99p
74LS195	87p
74LS221	110p
74LS244	175p
74LS245	325p
74LS251	120p

74LS	
74LS00	18p
74LS01	12p
74LS04	15p
74LS08	20p
74LS10	19p
74LS11	30p
74LS12	30p
74LS14	60p
74LS15	38p
74LS20	19p
74LS30	19p
74LS32	25p
74LS40	26p
74LS42	56p
74LS47	75p
74LS48	85p
74LS49	99p
74LS73	30p
74LS74	30p
74LS75	39p
74LS86	39p
74LS90	40p
74LS107	40p

# VOLTAGE REGULATOR DESIGN

If you've got the DC DTs, Karl Wright comes to the rescue with this simple design to stabilise your supply

The function of a DC voltage regulator is to supply a constant DC voltage to a load from a specified range of input voltages. The basic circuit of the DC regulator is shown in Fig. 1. This circuit is usable over a wide range of input and output voltages. The actual function of regulation is performed by sampling the DC output of the regulator by a potential divider, formed by R5, R6 and RV1 and comparing it, via Q2, with a reference voltage provided by ZD2 and R3, the potential difference being passed to the DC amplifier, also formed by Q2. The DC signal then passes to the control section, formed by Q3 and Q4, which makes the necessary adjustment to maintain the output voltage at the specified value. The remaining components, R1, R2, ZD1 and Q1, form a constant current source, which supplies the collector of the DC amplifier, Q2, and the base of the control section, Q3. C1 is included to prevent high frequency instability and R4 is included to provide a leakage current path and to allow low load current operation.

## Design Procedure

In order to design the DC regulator to suit the individual requirement of a piece of equipment, the initial specifications must be defined as follows: — the output voltage required,  $V_o = 40$  V DC, the maximum output current required,  $I_o = 1$  A5, the range of input voltages to be used,  $V_{in(min)} = 45$  V DC,  $V_{in(max)} = 60$  V DC, the operating temperature range,  $T_{min} = 50^\circ\text{C}$ ,  $T_{max} = 125^\circ\text{C}$  and the output resistance,  $R_o \leq 0$  R25.

The values shown for each of the parameters will be used in the calculations as an example. The first step is to determine the parameters of the transistors in the control section, Q3 and Q4.

$$\begin{aligned} V_{ce4(min)} &= V_{in(min)} - V_o = 45 - 40 = 5 \text{ V} \\ V_{ce4(max)} &= V_{in(max)} - V_o = 60 - 40 = 20 \text{ V} \\ I_{e4(max)} &= I_o = 1 \text{ A5} \\ P_{tot} &= V_{ce4(max)} \times I_{e4(max)} = 20 \times 1.5 = 30 \text{ W} \end{aligned}$$

By reference to a semiconductor index the TIP29 is found to be adequate for this purpose. It also has a minimum value of  $H_{fe} = 40$ , which is used to determine the base current of Q4.

$$I_{b4} \leq \frac{I_{e4}}{H_{fe4(min)} + 1} = \frac{1.5}{40 + 1} = 36.66 \text{ mA}$$

Q3 is selected by the following parameters;

$$\begin{aligned} V_{ce3(max)} &= V_{ce4(max)} - V_{be4} = 20 - 0.7 = 19.3 \text{ V} \\ I_{e3} &= I_{b4} = 36.66 \text{ mA} \\ P_{tot3} &\leq V_{ce3(max)} \times I_{e3} = 19.3 \times 0.03666 = 0.7075 \text{ W} \end{aligned}$$

By reference to a semiconductor index the BFX50 is found to be suitable for Q3. It also has a minimum value of  $H_{fe} = 30$ .

$$\begin{aligned} \text{So, } I_{b3} &\leq \frac{I_{e4}}{(H_{fe4} + 1)(H_{fe3} + 1)} = \frac{1.5}{(40 + 1)(30 + 1)} \\ &= \frac{1.5}{1271} = 1.18 \text{ mA} \end{aligned}$$

$I_{c1}$  is at least  $= 2 \times I_{b3}$ , thus  $I_{c1} = 3$  mA and  $I_{e2} \geq I_{b3}$ . Using a silicon transistor for Q1 will allow the regulator to operate over the maximum temperature range, i.e.  $-50^\circ\text{C}$  to  $+125^\circ\text{C}$ . As Q1 is a PNP type, a BFX29 is chosen, with an  $H_{fe(min)} = 50$  and  $V_{be} = 1$  V0. Therefore, if  $I_{c1} = 3$  mA,  $I_{e1} = I_{c1} + I_{b1} = 3 + 3/50 = 3.06$  mA.

$V_{ZD1}$  is chosen as 2V7.

$$R2 = \frac{V_{ZD1} - V_{eb1}}{I_{e1}} = \frac{2.7 - 1}{3.06 \times 10^{-3}} = 555.56 \text{ R} \sim 560 \text{ R}$$

$$\begin{aligned} R1 &= \frac{V_{in(min)} - V_{ZD1}}{I_{ZD1} + I_{b1}} = \frac{45 - 2.7}{(148 + 0.06) \times 10^{-3}} \\ &= 285.69 \text{ R} \sim 300 \text{ R} \end{aligned}$$

$V_{ZD2}$  is not critical, so a value of 6V2 is chosen.

Current through ZD2 must be sufficient to maintain breakdown, thus a value of  $I_{ZD2}$  which is larger than  $I_{e2}$  is chosen, in this case 5 mA.

$$R3 = \frac{V_o - V_{ZD2}}{I_{ZD2}} = \frac{40 - 6.2}{5 \times 10^{-3}} = 6760 \text{ R} \sim 6 \text{ k}8$$

The collector current of Q2 will be approximately 3 mA, so a BFX50 is chosen for Q2.

RV1 is chosen as 250R and is a wire wound type.  $I_{R5}$  is chosen as 5 mA.

$$R5 = \frac{V_o - V_{be} - V_{ZD2}}{I_{R5}} = \frac{40 - 0.7 - 6.2}{5 \times 10^{-3}} = 6620 \text{ R} \sim 6 \text{ k}8$$

$$R6 + RV1 = \frac{V_{be} + V_{ZD2}}{I_{R5}} = \frac{0.7 + 6.2}{5 \times 10^{-3}} = 1380 \text{ R}$$

$$\begin{aligned} \text{So, } R6 &= 1380 - RV1 = 1130 \text{ R} \sim 1 \text{ k}2 \\ C1 &= 100 \text{ nF} \\ R4 &= 33 \text{ k} \end{aligned}$$

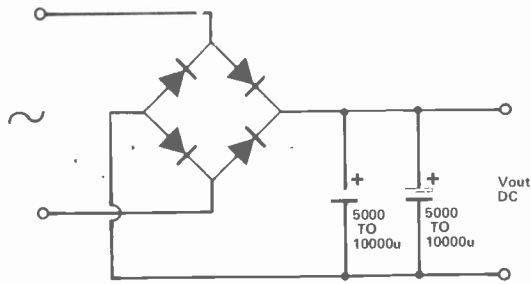
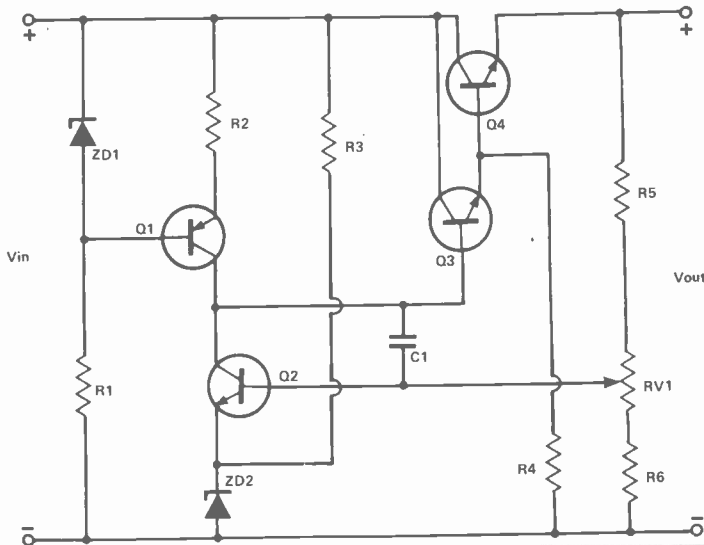

Fig. 1. (top) The basic circuit of the DC regulator.

Fig. 2. (above) This simple circuit will feed the regulator with a smoothed, but unregulated supply.

This is how professionals do it (right). This commercial power supply unit produces a regulated output voltage by the same principles as those on which the above simple design is based.



It should be noted that with the TIP29 operating at 30 W it should be mounted on an adequately sized heatsink. Alternatively a higher power transistor could be used.

The regulator needs a relatively smooth input voltage. This can be supplied by the circuit shown in Fig.2. This is simply a standard full wave bridge rectifier circuit with a large reservoir capacitance.

The DC output from the circuit can be calculated by;  $V_{DC} = 1.414 V_{AC}$ .

The ripple output from the regulator is negligible as long as the ripple from the basic rectifier is relatively small, this being achieved by using a large reservoir capacitance.

If a high output voltage from the regulator is necessitated, then the positions of ZD2 and R3 should be interchanged, this being done to allow the transistor Q2 to operate at low levels irrespective of output voltage.

ETI

## BIBLIOGRAPHY

- Sherr, S., P.M. Levy, and T. Kwap: Design Procedure for Semiconductor regulated Power Supplies, *Electronic Design*, pp.22-25, April 15, 1957.  
 Mamon, M.: High voltage Transistor regulated DC Power Supply, *Elec. Design News*, vol 2, pp.46-47, October 1957.  
 Brenner, E.: Regulated Transistor Power Supplies, *Electronic Design*, vol 7, pp.178-179, March 18, 1959.  
 Towers, T.D.: *Towers' International Transistor Selector*, Foulsham, Revised Edition, Update 1.

## LOW COST AUDIO SIGNAL GENERATORS

(Sine & Square Waves)  
 10Hz-100kHz  
 Very low distortion (< 0.015%)  
 Model 146 **£41.40**  
 (In Kit form **£35.65**) PP £2

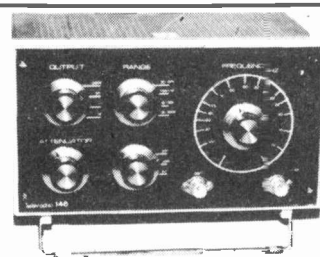

ALSO  
 Model A0127. Sine/Square. 1 volt into 600Ω Dist. .02% **£31.60** {Kit version **£26.50**}. p.p. £1.50



**TELERRADIO ELECTRONICS**  
 325 Fore Street, Edmonton, London N9 0PE  
 S.A.E. for leaflets ... Closed all day Thursdays ... 01-807 3719

# CALCULATORS. SCIENTIFIC

**\* SPECIAL OFFER**  
TEXAS T159 together with PC100C  
(Complete as manufacturer's specifications)  
**£305.00**

TEXAS/HP Accessories available  
 \*TEXAS T159 (Card prog 960 prog steps of 100 mem) **£156.50**  
 \*TEXAS T158 (Key prog 480 steps of 60 mem) **£80.00**  
 \*TEXAS PC100C (Printing Unit for T158/159) **£165.00**  
 \*TEXAS T157 (Key Prog 8 mem. 150 Keystrokes/50 Prog Steps) **£26.00**

For your Texas T158/59 Calculator  
**ELECTRICAL ENG. MODULE**  
**LEISURE (GAMES) MODULE**  
**STRUCTURAL ENG. MODULE**  
**NOW AVAILABLE**

\*TEXAS TI PROGRAMMER (Hexadecimal Oct) **£46.50**  
 \*TEXAS T151 /iii (10 mem 32 Prog Steps Stat/Sci) **£28.50**  
 TEXAS T150 LCD (Sci/Stat. 2 Con Mem) **£23.00**  
 TEXAS T125 LCD (Sci/Stats) **£17.00**  
 TEXAS T53 (Sci. 32 Prog Steps-Coa Mem + 80 Prog List Applications book) **£25.00**

**Make more of your  
Texas T158/59 Calculator  
MATH/UTILITIES MODULE**

If you write your own programs this library is for you! Most programs in this library are designed to be used either on their own or as subroutines of your programs. Applications range from utility programs such as printer formatting and large-scale plotting to advanced mathematical routines.

Module includes:

**Prompter. Alpha Messages. Printer Formatting. Superplotter. Sorting. Data Arrays. Data Packing. Prime Factors. Hyperbolic Functions. Gamma/Factorial. Random Numbers. Normal Distribution. Interpolation. Roots of a Function. Minimax. Romberg Integration. Differential Equations. Discrete Fourier Series. Calculator Status. Variable Arithmetic. Module Check.**

\*TEXAS T158 with Maths/Utilities **£90.00**  
 \*TEXAS T159 with Maths/Utilities **£186.50**  
 \*TEXAS T158 with Applied Statistics **£80.00**  
 \*TEXAS T159 with PC100C & Applied Statistics **£325.00**

### AUTUMN SALE

\*TEXAS T159 Calculator (complete as manufacturer's spec. master module, charger, etc.) PLUS statistics module and extra set of 40 Blank Prog. Cards with wallet, etc.  
**ONLY £180**

### NEW TEXAS T158C\*

\*Continuous program facility on all 480 Program steps/60 mem even when calculator switched off **£79.50**  
 \*TEXAS T158C (complete plus Applied Stats. Module) **£99.00**  
 \*TEXAS T158C + PC100C **£228.00**

**FREE** while stocks last with every purchase of HP 3ZE or HP 33E  
**BATTERY HOLDER WITH RECHARGEABLE BATTERY.** Normally costs £10.38  
 \*HP33E (8 mem. Pro Sci/Stat) **£52.00**  
 \*HP33C (as above but con. mem) **£60.50**  
 \*HP32E (Advanced Sci with Statistics) **£38.50**

\*HP34C (Sci Prog 20 Mem) **£83.00**  
 \*HP67A (K Prog 224 Steps 26 Mem) **£173.00**  
 \*HP97A (Fully prog with Printer) **£384.35**  
 HP41C (the newest calculator from HP) **£167.43**  
 HP41C Card Reader/Printer etc. Modules **Now in stock**  
 CASIO FX501P (Sci. LCD Prog. 128 Steps 11 Mem) **£47.50**  
 CASIO FX502P (Sci. LCD Prog 256 Steps. 22 Mem) **£65.00**

### LEXICON LANGUAGE TRANSLATOR

(With 6 Lang. Module — French/Italian/German/Spanish etc) **£115.00**  
**Ring Translator** **£115.00**

### NOW IT'S YOU AGAINST 'COMPUTERS'

**CHES CHALLENGER '7'** (7 Levels of game) **£74.00**  
**CHES CHALLENGER 'VOICE'** (10 Levels — beginner to Master Plus) The strongest Prog yet in this series — twice as fast as the other challengers. A microprocessor with 128,000 to 160,000 bits of read only Mem. Over 8000 bits of Random Access Mem. Teaches opening & end game solutions. Plays against itself. Solves book problems etc — and in addition IT SPEAKS. Complete with Deluxe playboard, hand carved men with magnetised base plus Deluxe carry case **£170.00**  
**SARGON.** The most advanced chess game yet with add on module availability for other games  
 (Our price inc. FREE rechargeable battery pack) **£234.70**  
 Super System 3 (as recommended by ETI) **£134.75**

**ATARI TV GAMES £98.50 inc. VAT. Philips G7000 P.O.A**

### LEARNING AIDS

TEXAS DATAMAN (Number Games-Table learning etc. 5/10 yrs) **£18.00**  
 TEXAS SPELLING B (Spelling Games ideal 5/10 years) **£22.50**  
 TEXAS SPEAK AND SPELL (for older children 8/13 years) **£39.95**

### IDEAL FOR STUDENTS

ALL WITH LCD DISPLAY

TEXAS T120 (Jun Sci + Con Mem) **£13.00**  
 TEXAS T135 (Sci/Stat C Mem) **£17.00**  
 TEXAS T138 (Sci/Con Mem-Pola Rec Cony Dec Deg conv/Deg Min Sec) **£19.95**

GOODS FULLY GUARANTEED PRICES EXCLUDE VAT (ADD 15%)

Company/Hospital and Government orders accepted by phone

Barclaycard/Visa/Access accepted by phone

Export orders welcome. Air Freight/Air Post Delivery. Quotations on request

**TEL. 01-455 9823**

**SENSORY CHALLENGER 'B'.** The latest Chess Computer from America now in stock. Prices on application

## MOUNTAINDENE

22 Cowper St., London, EC2

# SPECIAL PURCHASE



## OF TOP QUALITY LCD MULTIMETERS

AC/DC  
CURRENT  
22  
RANGES

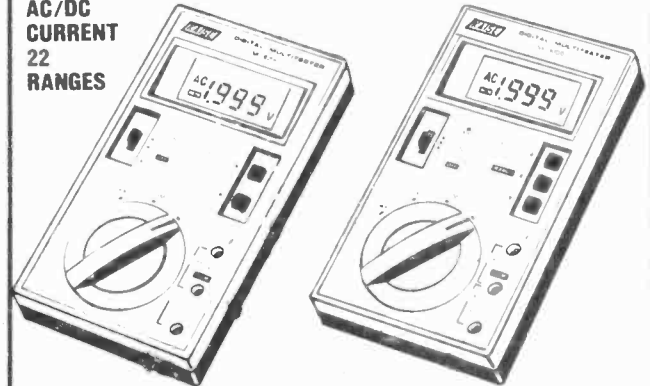

6100

6200

### CHOOSE FROM FOUR MODELS

- \* 3½ digit autoranging (volts/ohms)
- \* 200 hours battery life (2 pencils)
- \* 10 amp AC/DC (6220 & 6110) \* 1000v DC 600v AC
- \* 200mA AC/DC (6200 & 6100)
- \* Range hold facility (6100 & 6110)
- \* Unit and range sign (6110 & 6220)
- \* Continuity buzzer (6100 & 6110)

### RESOLUTION

100 µVDC, 1 mVAC  
 10 µA AC/DC 0.1 ΩHM  
 10 mA on 10A, AC/DC

### ACCURACY

**6100/6110**  
 0.5% DC Volts  
 1% DC Current  
 1.2% AC Current  
 0.5% Resistance

### OTHER FEATURES (ALL MODELS)

Low power OHms Range  
 Zero Adjust key  
 Battery Warning  
 In circuit resistance test  
 Size 155 x 85 x 28mm. 250g.

**6200/6220**  
 0.8% DC Volts  
 1.3% DC Current  
 1.4% AC Current  
 0.8% Resistance

6200 **£39.95**  
 6220 **£49.95**  
 6100 **£64.95**  
 6110 **£74.95**

\* All prices include batteries/leads and UK Vat (UK c/p 65p)  
 \* Order by Post or Telephone with Barclay or Access

### OR CALL IN AND SEE FOR YOURSELF

Prices correct at 1/10/80 E&OE

Cubegate Limited OPEN 9-6 SIX DAYS A WEEK

## AUDIO ELECTRONICS

301 EDGWARE ROAD, LONDON, W2 1BN

TELEPHONE 01 724 3564

**FREE CATALOGUE!**

Send large SAE (175p UK) Schools, Companies, etc. free on request.

From Mr/Mrs/Miss (Block capitals please)

Ref. ETI

Please supply QTY

Models

1/We enclose (incl. 65p post)

Chq/PD value

Or debit Barclay/Access No.

# CHROMASONIC electronics

56 FORTIS GREEN ROAD, MUSWELL HILL, LONDON N10 3HN  
 TELEPHONE 01-883 3705, 01-883 2289

**YOUR SOUNDEST CONNECTION IN THE WORLD OF COMPONENTS**

## PETS

(8K RAM)  
**£399**

16N (16K RAM) **£499**

32N (32K RAM) **£599**

**ALL WITH NEW KEYBOARD  
 AND GREEN SCREEN**

### PERIPHERALS

Service & Assistance available.  
 Interfaces available are:

X-Y Plotters, Analogues to Digital Convertor, 16 channel interfaces, Bi-directional interfaces etc.

EXTERNAL CASSETTE DECK SUITABLE FOR ALL PETS **£55**



## MEMORY

D.RAMS	£	p
4027	2.75	
4050 (350NS)	2.35	
4060 (300NS)	2.39	
4116	4.35	

S. RAMS	
2102A	1.09
2102A2	1.09
2112A	2.25
21L02	.98
2114-4045	2.95
4035	1.07
4044-5257	6.93

BULK PURCHASE	
8x2114	22.50
8x4116	29.95
8x21L02	7.00

BULK PURCHASE	
16x2114	39.95
16x21L02	13.00
32x21L02	25.00
64x21L02	45.00

## UK101

### NEW LOW PRICE

**£179** IN KIT FORM  
**£229** READY BUILT & TESTED  
**£249** COMPLETE IN CASE

- No extras required 8x2114 **£22.50**
- ★ Free sampler tape
  - ★ Full Qwerty keyboard
  - ★ 8K basic
  - ★ Ram expandable to 8K on board (4K inc)
  - ★ Kansas City tape interface

**ASSEMBLER  
 EDITOR  
 TAPE  
 £14.95**

★ NEW MONITOR ALLOWS FULL EDITING & CURSOR CONTROL **£22.00**



## EPROMS

2708	4.95
2716 (5v)	13.95
2532	39.95

## ROMS

2513 (UC)	5.95
2513 (LC)	5.95

## CPUS

6502	9.50
8080	4.75
9900	25.95
6800	5.90
Z80	8.95

## LATEST STOP PRESS AND PRICE LIST

Send sae or phone for up-to-date **PRICES** of all our range of items stocked

### CASES

Available for  
 U.K. 101, Superboard  
 Nascom,  
 Appx. DIM. 17" x 15"  
 435 x 384 mm

**PRICE £24.50**

P. packing £1.50.

### TAPES

Unique stackable tape  
 storage unit. Interlocking  
 drawers.  
 Each drawer containing 2  
 C12 tapes

10 drawers **£9.50**  
 5 drawers **£5.25**  
 Single drawer **£1.10**

### MEMORY EXPANSION KIT

Suitable for UK101, Superboard  
 expansion using 2114's each board  
 has 16K ram capacity kit contains:

- ★ On board power supply
- ★ 4K Eprom expansion
- ★ Fully buffered for easy expansion  
 via 40 pin socket **£99.95**
- ★ 8K kit **£139.90**
- ★ 16K kit

## BUFFERS

81LS95	1.25
81LS96	1.25
81LS97	1.25
81LS98	1.25
SN74365	.52
SN74366	.52
SN74367	.52
SN74368	.52
8T26	1.75
8T28	1.75
8T95	1.57
8T96	1.57
8T97	1.50
8T98	1.57

## BAUD RATE GENS

MC14411	8.75
MM5307	8.75

## PRINTERS

**TX-80 £375**

**EPSON TX-80 £375**  
 Dot-matrix printer with Pet  
 graphics Interface: Cen-  
 tronics parallel, options: PET,  
 Apple and serial.



## UARTS

AY-5-1013	3.45
AY-3-1015	3.98
MM5503	4.75
6011	3.55

**BARCLAYCARD**  
**VISA**

Please add VAT 15% to all prices. Postage on computers, printers and cassette decks charged at cost, all other items P&P 30p. Place your order using your Access or Barclaycard. (Min. tel order £5). Trade and export enquiries welcome, credit facilities arranged.

**Access**  
 We welcome Access

# Greenbank

Greenbank Electronics  
 (Dept. T11E) 92 New Chester Road, New Ferry  
 Wirral, Merseyside L62 5AG  
 (Tel. 051-645 3391)



**TERMS, NAT. CWO.** Cheques etc payable to Greenbank Electronics and crossed. Add VAT at all prices at 15% except where stated otherwise. Post etc: (UK 35p + 5p VAT = 40p) per order. Export: NO VAT but add 35p (Eire), 75p (Europe) and £2.50 elsewhere. Access: Barclaycard, Visa, telephoned orders accepted. (Polys, universities, govt depts, etc can telephone their orders for immediate dispatch on account.)



## UV EPROM ERASERS

### UV 140, UV 141

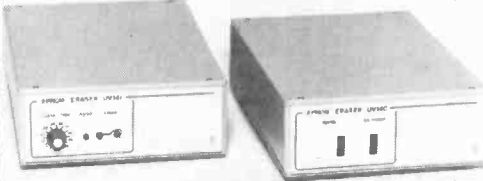

Two easy to use units designed for both the professional and amateur UV-prom user

#### Features

- Can erase up to 14 proms.
- Special short wave ultraviolet tube.
- Erase time variable between 5 and 50 minutes in 5 minute steps (preventing over exposure which may shorten pro life).
- Sliding tray carries proms on conductive foam.
- Safety interlock switch prevents the timing circuit from operating and switching on the tube with the tray open.
- "Mains On" and "Tube On" indicators.
- Smart textured case.
- Complete instructions supplied.

Supplied complete with mains plug and flex

Model UV141. Price £77.70

Also available without timer as

Model UV140: Price £61.20

## Tex Microsystems "EPROMPT" UV ERASER



A low cost alternative to the above erasers (UV 140/141) claimed by the manufacturer to erase up to 32 chips in 15-30 mins. This is the cheapest eraser we have seen. The unit has no timer, power switch or safety interlock switch. The user places up to 32 chips into loose conducting foam in the erasure tray (16 along the base, 8 on each side). The chips are held in place by the UV tube which sits in the tray. (Unlike the UV 140/141, no special precautions have been taken to prevent the seepage of UV light, but the manufacturers state that "incident light from this device is quite safe at distances above 12 inches".)

(Dimensions - 325 x 64 x 38mm)

**EPROMPT ERASER: Price £33.56**

5204/2708 PROGRAMMING SERVICE: £7.50 each prom. (Price does not include prom, we accept handwritten / typed source code - must be hexadecimal).

PROM WASHING SERVICE: 50p each prom

## NEW COMPUTER BOARDS

The following computer boards have been added to the range for use with the Z80 (114x203mm fibreglass with gold plated edge connector).  
 IP2 8 line opto isolated input board **£9.40**  
 OP2 8 line relay output board **£9.40**  
 SIO RS232 serial interface board **£9.40**  
 MXD2 16K dynamic ram board **£9.40**

## SPECIAL OFFER

(Subject to stocks)

No monthly accounts for these prices

	each	per 8
2114 (450ns) - 1K x 4	<b>£2.99</b>	<b>£22.40</b>
2708 (450ns) - 1K x 8	<b>£5.25</b>	<b>£39.60</b>
2516/2716 (450ns) - 2K x 8 single 5v	<b>£12.00</b>	<b>£88.00</b>
4116 (250ns) - 16K x 1 Dynamic	<b>£3.99</b>	<b>£30.40</b>

## CMOS

These cut prices for Amateur Users and Export. Note: industrial users - quantity prices available. Mostly Motorola, RCA

4000 18p	4042 80p	4095 £1.97	4410 £8.55	4531 £1.45
4001 25p	4043 90p	4096 £1.97	4411 £10.72	4532 £1.30
4002 25p	4044 90p	4097 £5.98	4412P £14.93	4534 £5.60
4006 95p	4045 £2.63	4098 £1.92	4415V £5.24	4536 £3.69
4007 18p	4046 £1.10	4099 £2.00	4422 £5.66	4537L £26.10
4008 80p	4047 £1.71	4100 £1.92	4433 £12.30	4538 £1.20
4009 40p	4048 77p	4101 £1.65	4435V £5.40	4539 97p
4010 50p	4049 45p	4102 £3.67	4450 £3.81	4541 £1.19
4011 25p	4050 49p	4103 £3.67	4451 £3.81	4543 £1.80
4012 18p	4051 80p	4104 £1.85	4461 £3.93	4549 £3.38
4013 50p	4052 80p	4105 £1.85	4462 £4.41	4552 £14.85
4014 84p	4053 80p	4106 82p	4469P £4.20	4553 £4.30
4015 84p	4054 £2.18	4107 £1.28	4490P £3.14	4554 £1.38
4016 45p	4055 £2.55	4108 £7.54	4500 £6.95	4555 78p
4017 80p	4056 £2.55	4109 £1.28	4501 29p	4556 72p
4018 85p	4059 £9.23	4110 £3.00	4502 £1.20	4557 £3.26
4019 45p	4060 £2.10	4114 £1.77	4503 70p	4558 £1.85
4020 99p	4062 £10.00	4160 £1.54	4505 £3.71	4559 £4.38
4021 £1.10	4063 £1.90	4161 £1.54	4506 50p	4560 £2.50
4022 £1.00	4066 55p	4162 £1.54	4507 55p	4561 81p
4023 27p	4067 £7.21	4163 £1.54	4508 £2.90	4562 £5.60
4024 78p	4068 27p	4174 £1.54	4510 99p	4566 £1.59
4025 27p	4069 27p	4181 £5.03	4511 £1.50	4568 £2.38
4026 £2.25	4070 30p	4182 £1.90	4512 80p	4569 £2.50
4027 50p	4071 25p	4192 £2.41	4514 £2.65	4572 40p
4028 84p	4072 25p	4193 £2.41	4515 £3.00	4580 £4.77
4029 99p	4073 25p	4194 £3.27	4516 £1.10	4581 £2.62
4030 74p	4075 25p	4200 £7.54	4517 £4.46	4582 £1.14
4031 £4.31	4076 £1.07	4205 £2.31	4518 £1.00	4583 90p
4032 £1.31	4077 29p	4160 98p	4519 80p	4584 90p
4033 £2.63	4078 29p	4161 98p	4520 £1.00	4585 £1.27
4034 £2.00	4081 27p	4162 98p	4521 £2.50	4597 £2.44
4035 £1.10	4082 27p	4163 98p	4522 £1.11	4598 £2.98
4037 £1.99	4085 £1.35	4174 90p	4526 £1.08	4599 £6.95
4038 £1.20	4086 £1.35	4175 £1.15	4527 £1.50	4700 £1.75
4039 £2.78	4089 £2.91	4194 £1.16	4528 £1.20	
4040 £1.00	4093 80p	4408 £9.37	4529 £1.30	
4041 £1.59	4094 £2.50	4409 £9.37	4530 70p	

## 74C

74C00 28p	74C76 57p	74C153 £1.15	74C903 57p	74C975 £5.01
74C02 28p	74C83 £1.34	74C154 £1.08	74C904 57p	74C976 £5.01
74C04 28p	74C85 £1.34	74C165 £1.08	74C905 £7.53	74C977 £5.01
74C08 28p	74C86 67p	74C173 93p	74C906 57p	74C978 £5.01
74C10 28p	74C89 £4.62	74C174 93p	74C907 57p	74C979 £17.90
74C12 28p	74C90 89p	74C175 93p	74C908 £1.00	74C980 £17.90
74C14 28p	74C93 89p	74C192 £1.15	74C909 £1.69	
74C16 28p	74C95 £1.08	74C193 £1.15	74C910 £7.45	80C05 85p
74C18 28p	74C96 £1.27	74C195 £1.08	74C911 £7.39	80C06 92p
74C20 28p	74C98 £3.81	74C196 £7.46	74C912 £7.39	80C07 85p
74C22 28p	74C99 £2.55	74C221 £1.41	74C914 £1.46	80C08 92p
74C24 28p	74C154 £3.81	74C245 £2.98	74C915 £1.15	82C19 £6.20
74C26 28p	74C157 £2.29	74C247 £1.79	74C918 £1.10	86C29 £2.90
74C28 £1.43	74C160 £1.49	74C374 £1.79	74C921 £17.07	88C30 £2.90
74C73 57p	74C161 £1.15	74C901 57p	74C922 £3.78	
74C74 59p	74C162 £1.15	74C902 79p	74C923 £3.86	

## MODULATORS

UM1111 E36 UHF Ch.36 Vision Modulator £2.50	AC 52215 SV/10A £69.90
UM1231 UHF Ch.36 Vision Modulator wide bandwidth (for computers etc) £4.70	AC 92215 SV/5A, 12V/1A, -12V/1A, 5V/0.1A £86.80
UM1263 FM Sound Sub-carrier Modulator £2.50	AC 94215 SV/20A £99.20
	AC 94215 SV/10A, 12V/2A, -12V/2A, 5V/0.1A £126.50

## SWITCH MODE PSUs



## MICROPROCESSORS

COMPUTER BOARDS	8080	8088	8086	8088
114 x 203 mm fibreglass gold plated edge connector. Buffered SC/MF CPU's £4.40	5800 MPU £6.55	5801 (128 x 8 RAM) £9.95	5802 (128 x 8 RAM) £9.95	5803 (128 x 8 RAM) £9.95
SC/MF Protoboard £9.40	6800 MPU £6.55	6801 (128 x 8 RAM) £9.95	6802 (128 x 8 RAM) £9.95	6803 (128 x 8 RAM) £9.95
Z80 CPU card £9.40	6804 ACIA £6.85	6805 ACIA £6.85	6806 ACIA £6.85	6807 ACIA £6.85
VDU A set £8.90	MC6800 £2.64			
VDU B set £8.90				
VDU C 3 theta £9.40				
EPROM Programmer £9.40				
EPROM board (Z708) £9.40				
4k PROM board (Z204) £9.40				
8k PROM board (Z708) £9.40				
2k RAM board (Z102) 1k-2k £9.40				
8k RAM board (Z114) 1k-8k £9.40				
Tape interface £8.90				
Keyboard interface £8.90				
PSU Sw. +12v, -12v board £8.90				
PSU Sw. -12v board £5.50				
ISBUS 1.1 13 slot back-board £11.50				
13" x 14" approx. Epoxy Glue. Unled				
Further details on request				

## UV ERASABLES

Z80 CPU (Z708) £9.90	74LS27 28p	74LS76 40p	74LS125 60p	74LS163 60p	74LS163 60p	74LS240 42.36	74LS283 1.92	74LS375 1.60
Z80-CPU (Z708) £9.95	74LS28 48p	74LS78 40p	74LS126 60p	74LS164 60p	74LS164 60p	74LS241 42.36	74LS290 1.28	74LS377 1.60
Z80-DPU (Z708) £6.60	74LS30 22p	74LS83 40p	74LS127 95p	74LS165 75p	74LS165 75p	74LS242 42.36	74LS292 1.28	74LS378 1.60
(Add £1 for the 4MHz version of any of the above 3 chips.)	74LS32 27p	74LS85 1.18	74LS136 85p	74LS166 85p	74LS166 85p	74LS243 42.36	74LS293 1.28	74LS379 1.60
	74LS33 39p	74LS86 43p	74LS137 85p	74LS170 82.88	74LS170 82.88	74LS244 1.70	74LS294 1.68	74LS384 86p
	74LS37 39p	74LS90 60p	74LS139 85p	74LS171 0.05	74LS171 0.05	74LS245 1.50	74LS295 1.68	74LS384 86p
	74LS38 39p	74LS91 1.04	74LS145 1.08	74LS174 1.06	74LS174 1.06	74LS246 1.90	74LS325 1.20	74LS390 2.30
	74LS39 20p	74LS92 89p	74LS147 1.70	74LS175 1.10	74LS175 1.10	74LS247 1.90	74LS326 2.94	74LS393 2.30
	74LS40 22p	74LS93 89p	74LS148 1.73	74LS181 1.08	74LS181 1.08	74LS248 1.90	74LS327 2.86	74LS393 2.30
	74LS41 22p	74LS94 1.16	74LS151 1.66	74LS182 1.08	74LS182 1.08	74LS249 1.90	74LS328 2.86	74LS393 2.30
	74LS42 22p	74LS95 1.16	74LS152 1.66	74LS183 1.08	74LS183 1.08	74LS250 1.90	74LS329 2.86	74LS393 2.30
	74LS43 22p	74LS96 1.16	74LS153 1.66	74LS184 1.08	74LS184 1.08	74LS251 1.90	74LS330 2.86	74LS393 2.30
	74LS44 22p	74LS97 1.16	74LS154 1.70	74LS185 1.08	74LS185 1.08	74LS252 1.90	74LS331 2.86	74LS393 2.30
	74LS45 22p	74LS98 1.16	74LS155 1.66	74LS186 1.08	74LS186 1.08	74LS253 1.90	74LS332 2.86	74LS393 2.30
	74LS46 22p	74LS99 1.16	74LS156 1.66	74LS187 1.08	74LS187 1.08	74LS254 1.90	74LS333 2.86	74LS393 2.30
	74LS47 22p	74LS100 55p	74LS157 1.66	74LS188 1.08	74LS188 1.08	74LS255 1.90	74LS334 2.86	74LS393 2.30
	74LS48 22p	74LS101 55p	74LS158 1.66	74LS189 1.08	74LS189 1.08	74LS256 1.90	74LS335 2.86	74LS393 2.30
	74LS49 22p	74LS102 55p	74LS159 1.66	74LS190 1.08	74LS190 1.08	74LS257 1.90	74LS336 2.86	74LS393 2.30
	74LS50 22p	74LS103 55p	74LS160 1.66	74LS191 1.08	74LS191 1.08	74LS258 1.90	74LS337 2.86	74LS393 2.30
	74LS51 22p	74LS104 55p	74LS161 1.66	74LS192 1.08	74LS192 1.08	74LS259 1.90	74LS338 2.86	74LS393 2.30
	74LS52 22p	74LS105 55p	74LS162 1.66	74LS193 1.08	74LS193 1.08	74LS260 1.90	74LS339 2.86	74LS393 2.30
	74LS53 22p	74LS106 55p	74LS163 1.66	74LS194 1.08	74LS194 1.08	74LS261 1.90	74LS340 2.86	74LS393 2.30
	74LS54 22p	74LS107 55p	74LS164 1.66	74LS195 1.08	74LS195 1.08	74LS262 1.90	74LS341 2.86	74LS393 2.30
	74LS55 22p	74LS108 55p	74LS165 1.66	74LS196 1.08	74LS196 1.08	74LS263 1.90	74LS342 2.86	74LS393 2.30
	74LS56 22p	74LS109 55p	74LS166 1.66	74LS197 1.08	74LS197 1.08	74LS264 1.90	74LS343 2.86	74LS393 2.30
	74LS57 22p	74LS110 55p	74LS167 1.66	74LS198 1.08	74LS198 1.08	74LS265 1.90	74LS344 2.86	74LS393 2.30
	7							

# HI-FI SYSTEM OFFER

This month we present the biggest and best ETI readers' offer ever — a complete hi-fi system. We've torn up its normal price tag of over £300 and slapped on our own — £279 including VAT and postage. Available only to ETI readers.

The system, imported by Videotone, bears a name unfamiliar to British Audiophiles — Seoum. The loudspeakers bear the familiar Videotone badge.

What do you get for your money? A slimline 30 W per channel stereo amplifier

with moving coil input, an AM/FM stereo tuner and matched cassette deck with Dolby NR (naturally) and selectable bias and equalisation. A pair of the excellent Videotone GB2 loudspeakers completes the system. Just look at the technical specifications.

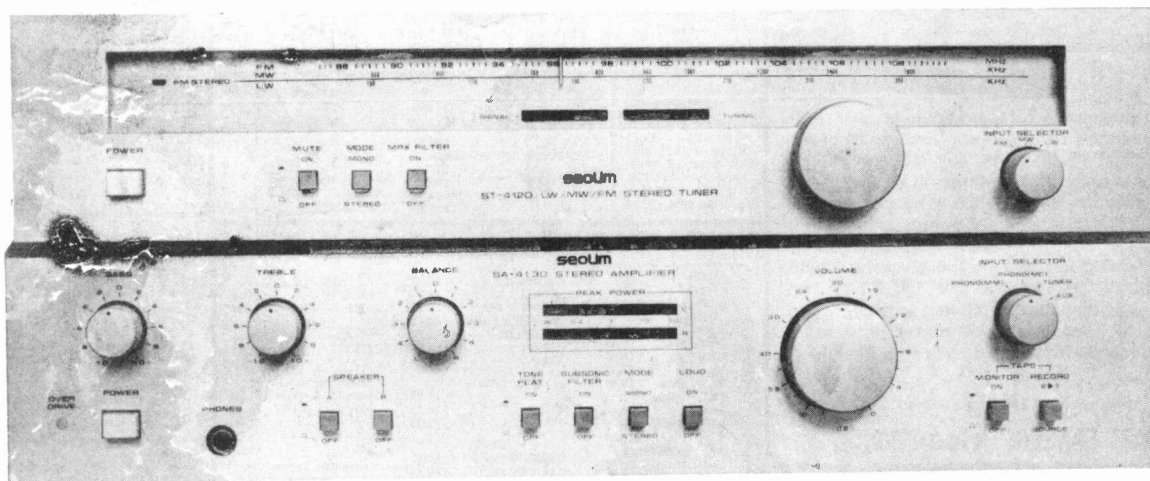

## TUNER SPECIFICATION

**FM Section — Tuning Range** 87.5-109 MHz **Sensitivity** IHF/75R 0.8uV **Selectivity** IHF/200 kHz 95 dB **Capture Ratio** 1.2 dB  
**T.H.D.** Mono 0.08% Stereo 0.15% **S/N Ratio** Mono 85 dB Stereo 80 dB  
**AM Section — Tuning Range** 525-1650 kHz **Sensitivity** IHF/75R 10uV **Selectivity** IHF/75R 45 dB **T.H.D.** 0.8%  
**Dimensions** 430(W) x 285(D) x 184(H) mm  
**FEATURES:** 0.8uV (9.3 dBf) FM sensitivity; New MPX circuit with pilot signal cancelling improves FM frequency response up to 18 kHz within  $\pm 1$ dB; New FM detector quadrates FM S/N

## AMPLIFIER SPECIFICATION

**Audio Section — Output** Continuous RMS driven at 20-20,000 Hz 8R 30 + 30 W **Peak Output** 100 W + 100 W **T.H.D.** at rated output 20-20,000 Hz 0.03% **Frequency Response** 8—60 kHz **S/N Ratio** Phono 1 (MM) 82 dB **IHF "A" Weighted** Phono 2 (MC) 70 dB Aux 102 dB **Input Sensitivity** Phono 1 (MM) 2.2mV/47k Phono 2 (MC) 0.2mV/0.1k Aux 125mV/50k  
**Speaker Impedance** 4, 8, 16 R  
**FEATURES** 30 W + 30 W Output power at 0.03% THD from 20Hz to 20kHz; Quickest electronic overload protection circuit with Green (normal) Red (protected) LED indicator; Super low noise EQ amp for moving coil and moving magnet cartridge; Tape dubbing facility · 12 dB/Oct subsonic filter.



**Under £300!**

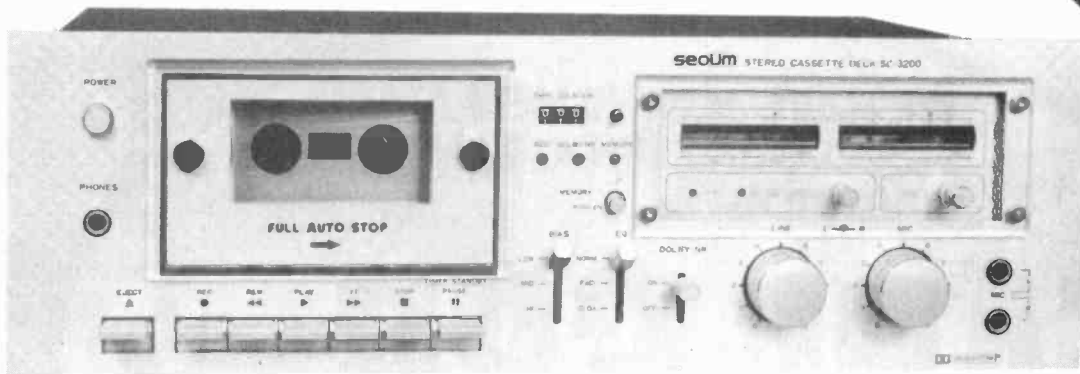

**CASSETTE RECORDER SPECIFICATION**

- 1. **Frequency Response (Dolby NR OFF)** Cr O<sub>2</sub> Tape 30—16,000 Hz FeCr Tape 30—16,000 Hz Normal Tape 30—15,000 Hz
- 2. **S/N Ratio (From Dolby level)** Normal Tape; Flat 52 dB Weighted NR OFF 53 dB Weighted NR ON 62 dB Fe Cr & Cr O<sub>2</sub> Tape; Flat 56 dB Weighted NR OFF 58 dB Weighted NR ON 67 dB
- 3. **Harmonic Distortion (Normal Tape)** 0.5%
- 4. **Cross Talk** 1 kHz 55dB
- 5. **Erase Effect** 75 dB
- 6. **Bias Frequency** 100 kHz
- 7. **Wow & Flutter Weighted** 0.05%
- 8. **Fast Forward time (C-60)** 75 S
- 9. **Rewind time (C-60)** 75 S
- 10. **Input Sensitivity** LINE 60 mV MIC 0.25 mV DIN 8.25 mV
- 11. **Output level** 0-1 V

**EQ & BIAS SELECTOR** Equipped with EQ & Bias 3-position selector switch that can always keep the best recording and playing conditions for any tape used.

**PEAK INDICATOR** Generally a VU meter can't respond to transient sounds, so it can't indicate these sounds accurately. The peak indicator indicates them precisely, so preventing distortion and making an overall better recording.

**FEATURES:** Dolby system front loading stereo cassette deck; New LED VU meter indicating peak level; Selector checking recording & playback level and output level; Full auto-stop and memory function; Output level control volume; FET pre-amplification; 3-position selector of bias and E.Q.; Built-in Dolby NR circuits; Recording mixing facility; Low wow-flutter and distortion; Electronic timer stand by protecting pinch roller.

**GB2 LOUDSPEAKERS SPECIFICATION**

**Type:** Port loaded, two way, floorstanding/bookshelf model. **Recommended Amplifier power:** 15-40 W. In general they need between 10 and 15 W RMS per channel for every 1000 cu ft of room space. **Impedance:** 8 R nominal. **Frequency Response:** 50 Hz to 20 kHz  $\pm$  5 dB. **Efficiency:** 8V8 gives 90 dB. **Distortion:** Less than 1% 60 Hz to 20 kHz for 5 V input. **Finish:** Teak foil with black frets. **Size:** 19" high, 10" wide and 11" deep. **Weight:** 22 lbs each.

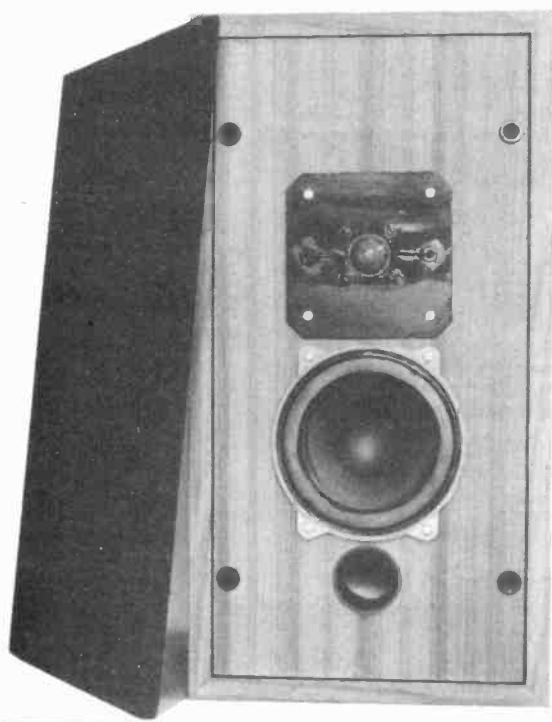

- Amp has moving coil input!
- Peak power delivery of over 75W per channel!
- Tuner has high sensitivity and selectivity
- Cassette deck uses accurate LED indication
- Guaranteed system compatibility for clear sound

Please send me ..... Seoum hi-fi system(s)

I enclose a cheque for £..... (£279 per system)

Name .....

Address .....

.....

Send your order to: Modmags Ltd. (Sales Office),  
145 Charing Cross Road, London WC2H 0EE

**WE HAVE ALL THE NEW ATARI®  
VIDEO GAME PROGRAM™  
CARTRIDGES.**

**ATARI £86 + VAT**  
**SILICA SHOP**

**TELEPHONE FOR FREE COLOUR  
BROCHURE 01-301 1111**

# ELECTRONIC GAMES

## ATARI

SPECIAL  
PRICE



**£86** + VAT

## INTELLIVISION MATTEL

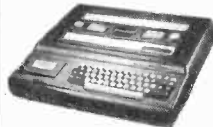

£173.87 + VAT

Available August 1980  
This is the most advanced TV  
game in the world.  
Expandable  
next year into a full  
microcomputer.  
COLOUR CATALOGUE  
AVAILABLE WITH  
DETAILS ON ALL THE  
CARTRIDGES

## CHESS

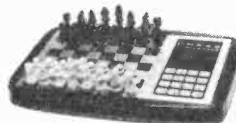

Send for further details.

### COMPUTERS

NEW RANGE  
AVAILABLE  
AUGUST 1980  
We specialise in  
computer chess  
machines & stock  
over 13 different  
models from  
£20 to £300

## TELETEXT



RADOFIN  
TELETEXT  
Add on Adaptor

**£199** + VAT

## BRIDGE

COMPUTER



- \* Plays 1/2/3 or 4 Hands
- \* Problem Mode
- \* Audio Feedback
- \* Instant Response
- \* Auto scorekeeping

## BACKGAMMON

COMPUTERS



OMAR 1  
OMAR 2  
CHALLENGER  
GAMMONMASTER

From £38 to £108. Send for further details.

## SPACE INVADERS



HAND HELDS • CARTRIDGES  
ATARI • ACETRONIC  
PRINZTRONIC  
RADOFIN • DATABASE etc.

We keep a full range!  
Send for cartridge lists stating which  
machine you own.

## DRAUGHTS

COMPUTER

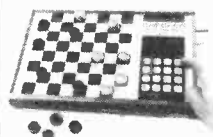

- \* Solves Problems
- \* Rejects illegal moves
- 2 level machine  
£43 + VAT
- 4 level machine  
£77.78 + VAT

## LEISURE

- \* CHEAP TV GAMES
- \* TELEPHONE ANSWERING MACHINES
- \* AUTO DIALERS
- \* CALCULATORS
- \* DIGITAL WATCHES
- \* PRESTEL
- \* HAND HELD GAMES

## 27 TUNE

## DOOR BELL

**£17.13**

+ VAT



**FREE  
CATALOGUE**

For a free copy  
of our 32 page  
catalogue, send  
a 12p stamp to  
Silica Shop Ltd  
or Telephone  
01-301 1111

MAIL ORDER SERVICE — Free postage & Packing

TELEPHONE & MAIL ORDERS — accepted on:  
Access \* Barclaycard \* American Express \* Diners Club

CALLERS WELCOME — at our shop in Welling — Demonstrations daily  
Open from 9am-5pm Mon-Sat (9am-1pm Wed)

GUARANTEE — Full 12 months + After Sales Support!

We have comprehensive brochures on all products. Please let us know what you are interested in and we will send you detailed brochures AND our own 32 page catalogue covering most games on the market.

## SILICA SHOP

SILICA SHOP LTD., Dept. ET111  
102 Bellegrove Road  
Welling, Kent DA16 3OF  
Tel: 01-301 1111

# QUALITY DOES NOT HAVE TO COST VERY MUCH!

## GEC STEREO TUNER/AMPLIFIER

4 wave-band stereo tuner amplifier by GEC

- \* MW/LW/SW/Stereo FM radio
- \* 10+10 watt stereo amplifier
- \* Inputs for PU, tape in/out

Supplied as two assembled units as illustrated — easy to connect. On demonstration for callers.

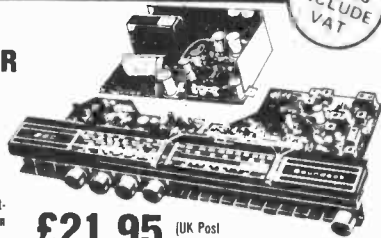

ALL PRICES INCLUDE VAT

£21.95 (UK Post etc. £1.25)

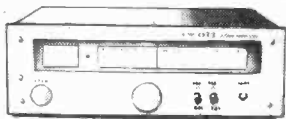

## SCOTT T516 STEREO FM/AM TUNER

HIGH QUALITY STEREO FM/AM TUNER BY SCOTT OF USA.

Overall size 5" x 14 1/4" x 12". Brand new and fully guaranteed at a special low price. On demonstration for callers. (C/P £1.55)

£38.95



## JVC BELT DRIVE TURNTABLE

JVC TURNTABLE WITH FREE AUDIO TECHNICA AT100 STEREO CARTRIDGE.

- \* S' shaped tone arm
- \* Belt drive
- \* 12" Platter \* Calibrated counter-balance weight
- \* Anti-static device
- Size 12 3/4" x 15 1/4"

£29.95 (C/P £1.55)

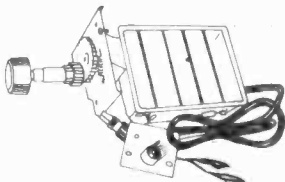

1000's SOLD

## TV SOUND FROM YOUR HI-FI

High quality TV sound converter plugs into aerial socket of your FM tuner. 9 volt battery operated (battery not supplied). Nothing to look at... but just listen!

(UK Post etc. 50p)

On Demonstration for callers. (As reviewed in 'Popular Hi-Fi' July 1979) £8.50



## SEAS SPEAKER KITS

8 ohm



Professional sound hi-fi speaker kits with high sensitivity (89-92dB). Extended frequency response (223-50-20kHz, 253-35-25kHz). Designed and made in Scandinavia to the highest quality. All supplied with complete cabinet plans, tweeters/crossovers/leads etc. \* On Demonstration to callers.

- \* HI-FI 223. 30/45 watt 3 speaker 8" system £43.50 pair
- \* HI-FI 253. 60/100 watt 3 speaker 8" system £34.50 each
- \* HI-FI 403. 60/100 watt 3 speaker 10" system £44.50 each
- \* HI-FI 603. 80/150 watt 3 speaker 8" system £64.50 each

(UK C/P £2.50)

COMPLETE RANGE OF SEAS CHASSIS SPEAKERS ETC ALWAYS IN STOCK ALSO STOCKISTS FOR AUDAX, GOODMANS, KEF, PEERLESS ETC.

## PIEZO TWEETERS

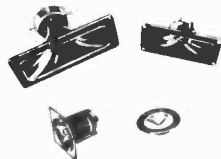

Clean sound, very low distortion tweeters. No crossover required. Suitable up to 100 watts — more in series.

- 1 Mid-range horn for disco/pa/groups ... £9.50
- 2 Tweeter horn for hi-fi/disco/pa ... £6.50
- 3 Popular hi-fi and disco ... £4.95
- 4 Flat type hi-fi ... £3.95

On Demonstration to callers.

## STEREO ACCESSORIES

- \* GE1305 Hi-fi frequency equaliser ... £62.95
- \* 1987 Economy version ... £49.95
- \* APM 200 Peak programme meter (twin scale) £39.95
- \* MS3219 Twin Scale audio output meter £12.95
- \* MC350 Tape echo chamber ... £58.95

## FREE CATALOGUE

Large range of speakers/stereophones/microphones/mixers/PA equipment etc — and much more! Plus huge range of test equipment. ALL PRICES INCLUDE VAT SEND LARGE 17p SAE ALL PRICES CORRECT AT 1/10/80 E&OE

# AUDIO ELECTRONICS

301 EDGWARE ROAD, LONDON, W2 1BN, ENGLAND. TELEPHONE 01-724 3564 OPEN 9-6 Mon-Sat

ORDER BY POST OR TELEPHONE WITH BARCLAYCARD/ACCESS OR CALL IN AND SEE FOR YOURSELF



# Codespeed Electronics

P.O. Box 23, 34 Seaford Road, Copnor, Portsmouth, Hants. PO3 5BJ

**SOUND EFFECTS PCB** brand new, made for spaceman robot toy. Gives 5 spaceman sounds with flashing LED's (speaker not supplied). Entertain the kids for only 85p. **FLUORESCENT REJECT CALCULATORS** modern, ten function calculators with full memory. Most repairable but no guarantees. £2.50 each. **ALARM CLOCK CHIP** MM5316 digital alarm clock I.C. With data. £2.35 each. **GIANT LED CLOCK DISPLAY** non-multiplexed, common cathode display panel. With data £3.95 each. **WRISTWATCH LED DISPLAY** tiny, bright displays for LED watches. Note display is housed in 'legless flatpack' package and required fairly firm soldering. Supplied with data. 95p each or 2 for £1.50. **DIGITAL MULTIMETER CHIP** to build an Auto-polarity, 4 1/2 digit multimeter (requires additional circuitry). With data sheet, £3.55. **8 DIGIT CALCULATOR DISPLAY** common cathode, multiplexed, 0.1" digits. With data, 99p each. **PLASTIC POLARIZING FILTER** 0.006" thick plastic film. Any size cut from 1 square inch up to a maximum size of 19 inches x 250 feet. Only 3p per square inch. **SUPER QUALITY JACK SOCKETS** gold plated contacts for high reliability. Mono 25p, Stereo 30p each. **CALCULATOR KEYBOARDS** excellent value. 2 for 99p. **LM555 TIMER** I.C. suitable for most timer applications, and is supplied with application booklet. 25p each. **CALCULATOR CHIP** NORTEC 4204, four function and constant. With data and diagram. 80p each. **PUSH-BUTTON SWITCHES** with 1 n.o. contact (momentary action). With red button, 15p each. **MINIATURE SLIDER SWITCHES** wit 2 pole change-over contacts, 16p each. **STATIC RAMS** 2102 memories, with data, only 99p each. **REJANG LED CALCULATORS** some repairable but excellent value for spares. Yields lots of parts. £2.50 each. **LIQUID CRYSTAL CLOCK DISPLAY** nice style display gives black digits on grey background, could also be used for freq. meters, dvm's etc. With data £5.25. **PROFESSIONAL QUALITY CONTROL KNOBS** rotary knobs satin finish black nylon knobs to fit standard 1/4" D shaped shafts. Coloured snap-in caps also have position indicator line. Cap colours available, black, white, grey, red, green, blue and yellow. Knob and coloured cap 20p (state cap colour required). **Skirted rotary knobs**. As above but has flared nut cover around base of knob, 27p each. (state cap colour required). **Slider Control Knobs** fits 5mm or 8mm shafts. Available in black, white, grey, red, green, blue and yellow, 14p each (state colour required). **QUALITY REED SWITCHES** tiny but sensitive reed switches, ideal for burglar alarms etc. Only 39p each. **RETANGULAR BAR MAGNETS** small but powerful. Purchased for use with above reed switches, 59p each. **REED RELAYS** 12v d.c. coil, one — n.o. contact. Small enough for PCB mounting, 79p each. **POWER RELAYS** 12v d.c. coil. Two change-over contacts, each rated at 10 amps. Contacts solid silver for high reliability. Only £2.55 each. Relay bases for above relays are 35p each. **TRANSISTOR RADIO I.F. TRANSFORMERS** all brand new. May include several types. Ten transformers for 55p. **NYLON CABLE TIES** 25 for 35p (ties are 4" long). A comprehensive range of resistors and capacitors is now in stock, ranges as shown below. **RESISTORS** 1Q to 10MQ, 1/4W, 5%. **ELECTROLYTIC CAPACITORS** 1µF to 470µF, 25v d.c. **MYLAR CAPACITORS** 0.001µF to 0.1µF, 100v d.c. **MULLARD CERAMIC PLATE CAPACITORS** 1.8pF to 4700pF, 100v d.c. For full range of values and prices see our FREE catalogue. **SATISFACTION GUARANTEED ON ALL ITEMS OR FULL CASH REFUNDED. NEW CATALOGUE (No. 8) NOW AVAILABLE — JUST SEND MEDIUM-SIZED S.A.E. P&P PLEASE ADD 40p (OVERSEAS ADD £1)**

ADD 15% TO THE TOTAL COST OF YOUR ORDER (INCLUDING POST AND PACKING)

V.A.T.

# DON'T HANG ABOUT!

Latch on to binding posts with the new HPA-1 package from CSC. Designed to provide a firm foundation for a variety of electronic interconnections, complete with insulating shoulder washers and mounting nuts. Versatile, too — they accept bare wires, banana plugs, alligator clips, spade connectors, and hook connectors. There are five red, five black posts, 20 insulating shoulder washers and 20 hex mounting nuts. And for large quantity orders, CSC can supply other colours. You won't find it a bind to post off the CSC coupon for more details — do it today!

CSC (UK) Ltd, Unit 1, Shire Hill Industrial Estate, Saffron Walden, Essex CB11 3AQ. Telephone: (0799) 21682. Telex: 817477.

HPA 1	Binding Posts	Nett £ 2.50	Unit price inc P & P 15% VAT £3.73	Div. Price
-------	---------------	-------------	------------------------------------	------------

Please deduct £1 postage from each additional order.

I enclose cheque/PO for £..... or debit my Barclaycard, Access, American Express card

No..... Exp. date..... or Tel: (0799) 21682 with your card number and your order will be in the post immediately.

NAME.....

ADDRESS..... CONTINENTAL SPECIALTIES CORPORATION



FREE catalogue tick box

Continental Specialties Corporation (UK) Limited, Dept. 9SS Unit 1, Shire Hill Industrial Estate, Saffron Walden, Essex CB11 3AQ.

# TOMORROW'S TOOLS TODAY

# ETIPRINTS

ETIPRINTS are a fast new aid for producing high quality printed circuit boards. Each ETIPRINTS sheet contains a set of etch resistant rub down transfers of the printed circuit board designs for several of our projects.

ETIPRINTS are made from our original artwork ensuring a neat and accurate board. We thought ETIPRINTS were such a good idea that we have patented the system (patent numbers 1445171 and 1445172).

Shown below is the listing for the last year's ETIPRINTS.

## PARTS LIST

038	Buffer Moving Coil Preamp Process Controller	Jan 80	040B	ETI 80 - PSU Tuning Fork Filter Coin Toss	Feb 80	042B	Touch Dimmer, Battery Charger RC Guardian (Top, Bottom) 1&2	Apr 80
039A	Hum Filter Logic Probe	Dec 79	041A	ETI Audiophile ETI VCA Signal Trace ETI HC Electromyogram	Mar 80	043	IR60 preamp, Receiver, PSU, Servo Tester, VU - PPM	May 80
039B	Long Period Timer Rain Alarm Touch Switch Flash Trigger Pseudo Random Noise Gen	Dec 79	041B	VCM Heater Controller	Mar 80	044A	IR60 Function Board (Top & underside) Control Circuit, Line Transmitter, Tape Response Meter Ohmmeter	June 80
039C	Function Generator	Dec 79	042A	300W Amp Module	Apr 80	044B	FM receiver PSU & Monitor Amp Drum Synth (function board)	June 80
040A	ETI 80 - VCO and VCLFO	Feb 80	033	Fuel Level Monitor, Alarm, Screen Controller Dynamic Noise Reducer	Sep 79			

## HOW IT WORKS

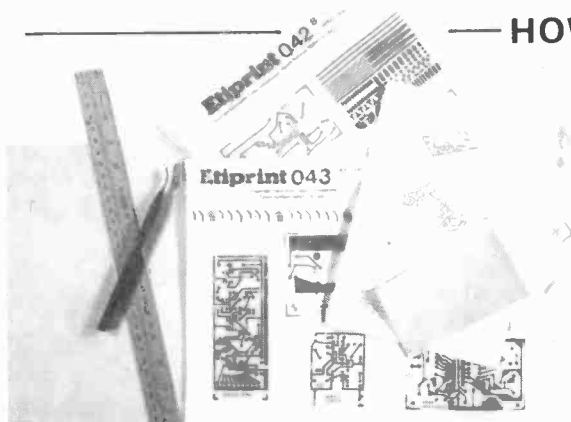

Lay down the ETIPRINT and rub over with a soft pencil until the pattern is transferred to the board. Peel off the backing sheet carefully making sure that the resist has transferred. If you've been a bit careless there's even a 'repair kit' on the sheet to correct any breaks!

## BUY LINES

### ORDER TODAY

Send a cheque or PO (payable to ETI Magazine) to  
ETI PRINT, ETI MAGAZINE 145 Charing Cross Road,  
London WC2H 0EE. Price £1.20p.

# ETIPRINTS

NEW

**SAFGAN** Presents **DT-400** Series from **£150 + VAT**

HIGH QUALITY **DUAL TRACE** OSCILLOSCOPES  
AT PRICES EVERYONE CAN AFFORD

Model DT-410	4" CRT	5mV	10MHz	@ £159 + VAT
Model DT-412	4" CRT	5mV	12MHz	@ £172 + VAT
Model DT-415	4" CRT	5mV	15MHz	@ £185 + VAT

### SPECIFICATION FOR ALL MODELS

- \* CH1, CH2: 5mV/div-20V/div in 9 col. steps
- \* BANDWIDTH: 10MHz (DT-410), 12MHz (DT-412)
- \* BANDWIDTH: 15MHz (DT-415)
- \* TIME BASE: 0.5µs/div-200ms/div in 18 cal steps  
X5 Expansion to 100 ns/div  
X5 Multiplier to 1s/div
- \* XY FACILITY: Matched Inputs X=CH1, Y=CH2
- \* TRIGGER: Level Control, ± Slope  
Bright Line AUTO NORMAL TV Triggering  
CH1, CH2 0.5div, EXT Trig. 100mv
- \* Z Modulation
- \* Graticule blue, ruled 8x10div (6.4x8cm<sup>2</sup>)
- \* Size: H215mm W165mm D280mm. Weight 4.5kg.  
PROBE (X1-REF-X10) £11.50 + VAT

Orders to: **SAFGAN ELECTRONICS LTD.**  
56 BISHOPS WOOD, ST. JOHNS, WOKING, SURREY GU21 3QB. Tel. **WOKING 66836**  
Official Government and Educational orders accepted

(Goods + 15% + £3 P&P)  
or **WOKING 69560**

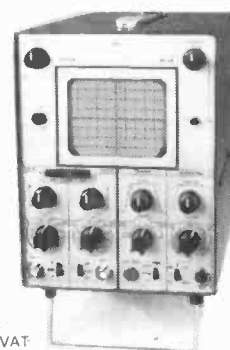

DT-400 Series

---

---

# PCB FOIL PATTERNS

The double sided main board (copyright Tangerine Computers Limited) is not shown. The sound effects board will be shown next month.

A heatsink as described in the Space Invasion article must be used with the project's power supply (foil pattern right) or the unit will overheat and cease operation.

Bottom right: The ETI Multi-Option Board can be used for all five projects.

Below: Audio Test Oscillator.

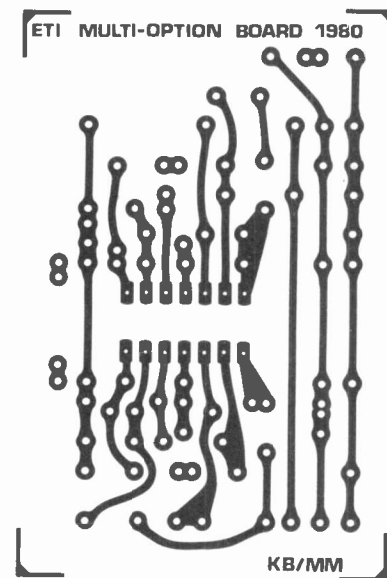
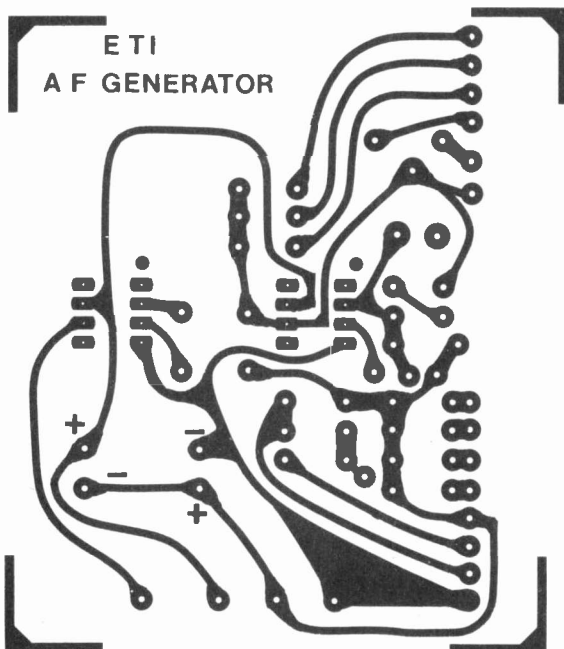
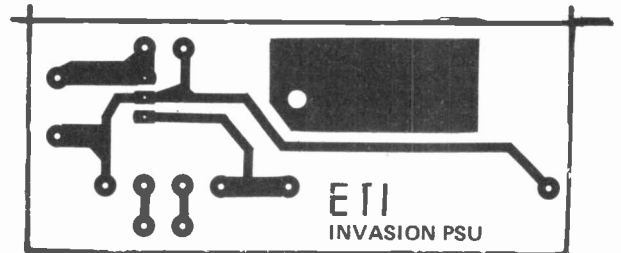

# FANCY A QUICK RUB-DOWN?

With our panel transfers, of course. To look really professional a project needs a neat front panel, which until now has been impossible to do at home. Now Modmags comes to the rescue with panel transfers containing letters, numbers, useful words and control scales for both rotary and slider pots. Simply clean the surface to be used (meths is a good idea) and rub down the appropriate transfer with a soft pencil. (but make sure you've removed the backing paper - some people forget!).

Each sheet measures 180 mm x 240 mm and contains enough symbols for dozens of projects. Send £2.00 (includes VAT and postage) for the two sheet set to : Sales Office (Panel Transfers), Modmags Ltd., 145 Charing Cross Road, London WC2H 0EE. Please use No.1 for black lettering and No.2 for white lettering, and make cheques/postal orders payable to Modmags Ltd.

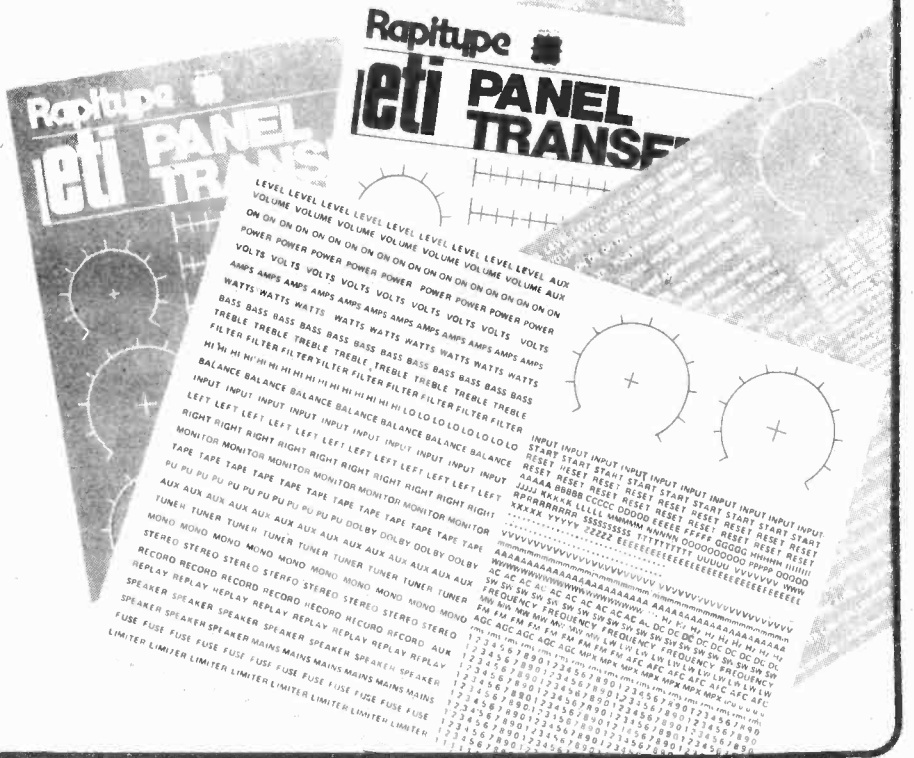

## AVOID DANGER from RADIATION WITH OUR RADIATION DETECTOR

Recommended for: Civil Defence, Fire, Hospital, Medical and general use

### General Information:

Pocket dosimeters provide an accurate, reliable and immediate method of measuring the integrated dose of radiation received by those exposed to ionising radiation. The dose may be read at any time and in any place, providing a source of light is available.

### Principle:

The dosimeter is an ionisation chamber type using a quartz fibre electroscope as the indicating element. A microscope is used to project the image of the moving quartz fibre element on to a graticule scale. The quartz fibre is mounted on a wire electrode, which in turn is supported by a high quality insulator. When the instrument is charged, positive charges distribute themselves over the wire electrode and quartz fibre causing the fibre to bend away from the electrode. The fibre will take up a position depending on the amount of charge on the system.

When the surrounding air in the ionisation chamber is ionised negative ions will be attracted to the positively charged electrode thereby reducing its charge. The resulting fibre movement will be related directly to the quantity of radiation producing the ionisation. The fibre movement can thus be calibrated directly in roentgen units and the rate of movement of the fibre will be proportional to the roentgens received per unit time.

### Construction:

The microscope, electroscope and ionisation chamber are housed in an outer skin which may be of brass or aluminium. At one end of the tubular case is fixed a charging assembly, and at the other an eye-piece window. These two assemblies are soldered into the outer case to ensure a hermetic seal.

Each dosimeter is provided with protective end cap translucent window so that the cap need not be removed for reading.

Dosimeters meet vibration, drop, salt spray, humidity, water immersion and temperature tests.

- BE PREPARED, EVERY HOME SHOULD HAVE ONE ●

YOU CAN'T SEE IT  
HEAR IT  
FEEL IT  
BUT YOU CAN DETECT IT

### Features:

- THESE UNITS WILL READ AUTOMATICALLY THE AMOUNT OF RADIATION IN THE AIR
- THIS INSTRUMENT IS ONLY A LITTLE LARGER THAN A FOUNTAIN PEN
- CLIPS ON TO YOUR TOP POCKET
- WEIGHT LESS THAN 3 OZ.
- CONTAINS THREE LENSES
- FULLY CHARGED, TESTED AND GUARANTEED REBURNISHED BY US
- BRITISH DESIGN AND MANUFACTURE, RUGGED CONSTRUCTION
- MANUFACTURER'S LIST PRICE OF SIMILAR MODEL IS OVER £25
- BUY NOW WHILST STOCKS AVAILABLE. DELIVERY BY RETURN POST

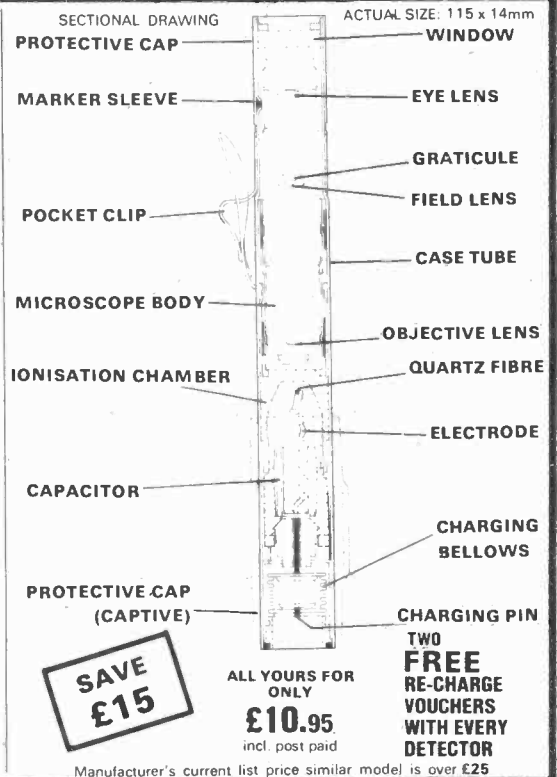

## DONDENE LTD.

Mail Order Division  
404 Edgware Road, London W2, England I.E.D.



Supplied complete with Data and information on radiation and detectors.

All units are checked and tested just prior to despatch by first-class mail in proper protective packing.

VIEW THRU LENS



**LEAR SIEGLER model 310 Ballistic printer.** Save £400. **OUR PRICE ONLY £950** or make us an offer.  
**DEC VT52.** Used but clean **£650.**  
**TERMINET 30 PRINTER WITH TWIN CASSETTE.** 30 cps. Standard 232. **£700 or offer.**  
**NEWBURY VDU** with Keyboard Model 24-80 **£350 or offer.**  
**CIPHER VDU** with separate Keyboard (No case). Printer, port, reverse video / flashing etc **£375 each or offer.**  
**CALCOMP 564 BARREL PRINTER.** MUST GO. **£650.**  
**CIL PLOTTER on STAND.** Ex-Ministry VGC. **£850.**  
**FACIT 4001 READER** with 2 spoolers 4015. **£475** the set. Please make an offer we can accept.  
**FACIT PUNCH** with 5107 CONTROLLER **£250.**  
**DICOM Disk Drive 8"** Ex-Ministry Clean **£120 each.**  
**TELETYPE PUNCH** in Silent Case **£45 each.**  
**ARCTURUS A18D,** 16 bit mini. With Data. Another gift **£425.**  
**COMPUTER AUTOMATION ALPHA 16** with TTL Input Interface. Massive Documentation & quantity of paper tapes. And again a gift at **£390.**  
**HEWLETT PACKARD 2114A COMPUTER.** No interface. No data. HENCE **£475.**  
**TELETYPES ASR 33** with 20ma Loop **£350 each,** 232 available at extra cost. KSR as above **£225 each.**  
**TWIN SHUGART Floppy Drives** a **£450 gift.**  
**A FEW OLIVETTI PRINTERS & KEYBOARD** Type Te300 still available — please enquire.

**709 DIL 14-PIN OPERATIONAL AMPLIFIERS**  
 at 8p each  
 100 off 25% discount.

**CONVERT THIS UNIT TO A SUPER BATTERY CHARGER**

Attractive green ministry quality case with removable top and bottom plates — heavy duty power switches — high powered resistors to control current — good quality centre mounted amp meter — strip of wing nut terminals on front panel which can be used for connecting leads. ALL THIS FOR **£3.50, P&P £2.** Four Units **£12.** Carriage **£5.**

**MINIATURE KEYBOARD**

Push contacts, marked 0-9 and A-F and 3 optional function keys. **£1.75 each.** P&P 65p.

**MAGNETOS**

— Brand New. Boxed  
 Ex-Ministry  
 Originally for Ministry aircraft, therefore finest quality — very reliable  
 Ridiculous **£4.75 each**

**STEPPING MOTORS**

6/12 position with additional where the rotor is coils. Device can be used as a tachometer. Diagram supplied. Will actually work on 5 volts. 12/24 recommended.  
**£1.50 each P&P 75p** or 5 for **£5 P&P £1.50.**

**STEPPING MOTORS**

North American Phillips, 5 volt 3.3 Amp operation. 2 wire PPS 0-200 revs per min 0-250 used. Tested **£16 each.** P&P **£1.50.**

**INFRA RED IMAGE CONVERTER type 9606 (CV 144)**

1 1/4" diameter. Requires single low current 3KV to 6KV supply. Individually boxed. With data.

**£12.50 each P&P 75p**  
 Infra Red Lamps also advertised

**MUST CLEAR POLARAD SPECTRUM ANALYSER**

5" Display. These are supplied with STU 2 plug-in. 1 to 45 GHz  
**£95 each**

**TRANSISTOR INVERTOR**

120V AC 1.7 Amp Input. Switching is at 20KHz. Output windings from Pot Core. Can be rewound to suit own purpose or unit can be broken for host of components. Circuits supplied. **£1.25 each.** P&P **£2.**

**KEYBOARD PAD**

Size 3x2 1/2x2" high with 12 Alma Reed Switches. Blue keys marked in green 0-9 and a star with one blank.  
**£4 each,** P&P **£1** or 5 for **£15 P&P £2.**

**STEPPING MOTORS**

200 Steps — 20-oz/in. torque, 12/24 volt input 4-wire.  
**£12 each.** P&P **£1.50**

**STEPPING MOTORS**

200 Steps. 20 oz/in. torque. 120 volt operating 3-wire.  
**£4 each.** P&P **£1.50**

BC172	5p	BC212B	5p	74C20	25p	2N5449	5p	BC251	5p
BZY884V7	10p	SN76550	5p	74C08	25p	2N3053	15p	BC171A	5p
BZY8813V	10p	IC7451	10p	74C10	20p	TIS92	10p	BFT60	5p
2N3006	5p	MC4001	15p	MC4049	35p	TIS93	10p	4013	30p
1N4305	5p	MC4012	15p	2N3704	8p	BC337	8p		
BZX79C12	10p	MC4020	75p	2N5447	5p	BC327	8p		

**MONSANTO DISPLAY** type MAN 101A 0.3" display. **£1 each.**  
**REGULATORS—all at 45p each.**  
 MC7805; 7812; 7815; 7912.  
 MC1496L 70p. TIS 50 — 10p each. MC4016 — 25p each. 74100N — 75p each.  
 Miniature 4.7K PRESET. 10 for **25p.** 100 for **£2.**  
 16 pin DIL Socket 10p. 14 pin SIL Socket 8p.  
 LED type TIL 209 Red with holder 10p each.  
 SLOTTED OPT SWITCH supplied with data — normally over **£2.** OUR PRICE **75p each.**  
 ROCKER SWITCHES 2 pole c/o — **15p each.**  
 Spring Action TERMINALS — normally over **30p ea.** OUR PRICE **15p each.**  
 TOROIDAL TRANSFORMER 0-115V-230V Input: 13.5V-0-13.5V rated 8VA output **£1.70 each.** P&P 75p.  
 Sub-min TRANSFORMER 0-120-240V Input. 12V-0-12V rated 4VA. Output **75p each.** P&P 50p.  
 L.E.D.s Standard White 12p; Standard Yellow 15p; Small White 8p.

**DIODES**

All new full spec. devices IN3063 BAX 13; 1S44; 1N4148; 1N3470; 1N4151  
 100 off **£1.50** — 1,000 off **£10.**

**BLUE THERMAL PAPER**

430ft roll 8 1/2" wide  
**£2 per roll P&P £1.75**

**MUST CLEAR LARGE QUANTITY OF PHOTO MULTIPLIERS**

all with information. British. Approx. 2" window **£2 each.** British. Approx. 5" window **£3.50 each.** American. Approx. 2" window **£4 each.** Special American version by RCA **£6 each.** P&P all photomultipliers **£1.50 each.**

**EDDYSTONE RXS**

**770R** used tested **£95 each**  
**730/10** used tested **£77.50 each**  
**940 24V** inverter version. Special Government Quality vgc  
**£165 each**

**TANTALUM BEAD CAPACITORS.**

4.7uF 25V. 10 off **£1;** 100 off **£7.50;** 330uF 6.3V 15p ea.  
**TEXAS** Low Profile 40pin IC Sockets **45p ea.**  
**SMALL TRANSFORMER.** 240V Input. Output 2 windings 12V and 24V 1 amp. **£2 each.**  
**SO SIMPLE SO SAFE.**  
 Fit a push button **CIRCUIT BREAKER** Small, compact, 3 ratings 0.8, 1.8 and 10Amp. State which one when ordering. **75p each.**  
**AMP METER 2 1/2"** dia. Scaled 0-60. Basic 75mV FSD. Complete with external 60 Amp Shunt. **£2.50 ea.** P&P **£1.50.**

**MARCONI** Signal Generator type TF144H **£225**  
**R&S UHF** Signal Generator 280-940MHz USVD **£85ea**  
**R&S ATTENUATOR** 0-100db 50 ohm. DPR BN18042/50 **£65ea**  
**R&S** Power Signal Generator 0.1-30MHz SMLR BN41001 **£85**  
**R&S** Direct Capacitance Meter KKH BN5201 **£120**  
**MARCONI** voltmeter TF1041C **£30**  
**MARCONI** Signal Generator TF144H/4 Light front No Case **£175**  
**R&S Z** Graph type ZDD BN3562 **£85**  
**EHT UNIT** 230V 50cs 25VA 7.5KV **£22.50ea**  
**R&S SWOB** BN4244/2/50. POLYSCOPE 1 As New **£375**  
**STODDART** Radio Interference & Field Intensity Meter complete with Power supply 375-1000MHZ. No linking cable **£450**  
**RACAL** Signal Generator type 365A AM/FM 1-320MHZ **£175ea**  
**B&K** Automatic Freq. Response Recorder type 3302 (Beat freq. Osc type 1014 with Recorder type 2304) **£350**  
**MARCONI** Signal Generator TF801D/1/S **£120ea**  
**MARCONI** Signal Generator TF801B **£80**  
**MARCONI UNIVERSAL BRIDGE** TF1313 1/4% **£250ea**  
**MARCONI AM/FM** Signal Generator TF995A/2 **£130**  
**MARCONI** Carrier Deviation Meter TF791C **£20**  
**ADVANCE 1** Meter type T2 **£45**  
**OSCILLOSCOPES** — wide range from **£40ea**  
 The above is a very small fraction of the test gear we have available. The prices we believe are fair — you persuade us they should be less. We will at least have the courtesy to listen. Call and see but please phone to make sure the items are still available.

**LEDEX ROTARY SOLENOIDS** 115V 0C. No switch assembly. 15p ea.  
**DIAMOND H CONTROLS ROTARY SWITCH.** Single pole 12-way. Printed Circuit Mount. New 10p ea. 100 off **£7.**  
**DELAY LINE.** 50 nanoseconds, 3 connections — ground-in-out. Size 2"x7/16"x5/16". New 25p ea.  
**PULSE TRANSFORMER.** Sub min. Size 1/2" x 5/16" x 1/4". Secondary centre tapped. New 20p ea.  
**MOTOR** by Inland Motor Corp DC High Torque. Reversible. Useful torque at 5V. Max voltage 24V **£2.50 ea.** P&P **£2.**  
**REMO TV TYPE MULTIPLIER.** Two high voltage outputs and focus. **£1 each.**  
**DON'T TAKE CHANCES.** Use the proper EHT CABLE. 10p per metre or **£7.50 per 100 metre/4mm.** P&P **£2.**  
**PHOTOGRAPHIC LAMPS.** Pearl 23DV 500 watt Screw cap 75p ea. Box of 12 **£5.50.** P&P **£1.50.**  
**RAYDISCHARGE** capacitors 8mf 4kV **£5 each.** P&P **£2.**  
**MYSTERY IC PACK.** Some 40 pin — good mixture — all new devices. 25 ICs for **£1.** P&P 50p. You find out what they are and we will buy the information from you.  
**VACUUM PUMPS — TRAPS, ETC.** Send for list  
**DECOUPLING CAPACITORS** 0.05mfd. 10V. 0.01mfd. 0.047mfd. 250V 33k. 330pf. All values 100 for **£1.50.**  
**E.H.T. Capacitor 600pF BKV 2Cp each.**  
**10-way MULTI COLOUR RIEBON CABLE.** New 40p per metre. 10 metres for **£3.**  
**GEC UHF 4-button tuner.** **£1.50 each.**  
**CENTAUR 115V FANS** 4 1/2" x 4 1/2" x 1 1/2" **£4.50 ea.**  
**EX-USED equipment, tested, 60p each.**  
**CONTACTORS.** Heavy Duty 24V DC 5 make **£1 each.**  
**GEC UHF/VHF 6-button tuner.** **£2 each.**  
**DIGITAL 24-HOUR CLOCK** with built-in alarm as used in Braun digital clocks. Silent running. Large illuminated numerals. AC mains. Size 8 1/2" x 2 1/2" x 2 1/2". **ONLY £3.75 each.**  
**931A PHOTO MULTIPLIER** in stainless steel container with window and built-in resistor network. **£2 each.** P&P **£1.**  
**RANCO 250V 18A THERMOSTATS** with Control knobs calibrated 50-200 degree **£2.50 each.**  
**SOLID STATE UHF TUNERS.** 30 acs **£1 each.**  
**BRAND REX** blue wire wraps. 30 metres for **£1.** P&P 25p.  
**SLIDER CONTROL 500K Log.** Single track. Complete with knob. Length 3 1/2". **25p each.**  
**TRANSFORMERS**  
**AUTO 240V input** 115V 1.1Amp output **£1.25 each.** P&P **£1.25.**  
**240V input.** Soc. 6V. 1.86A. Size 2 1/2" x 2" x 2". Good quality. **£1.50 each.** P&P **£1.**  
**240V input** Soc 12V 0.92A. Size 2 1/2" x 2" x 2". Good quality. **£1.50 each.** P&P **£1.**  
**240V input** 12V 100MA. Size 6C x 40 x 42mm. **50p each.**  
**240V input.** Soc. 12-0-12V 500mA. Size 53 x 45 x 40mm. **£1.115V input.** Soc. 5V 250MA. Size 1 1/2" x 1 1/2" x 1 1/2". **2 for 50p.**

**SEMICONDUCTORS** 1N4005 — 5p; 1N4002 — 3p.  
**At 5p each:**  
 BC147, BC157, BC158, BC237, BF197, OA90, OA81, BC148B, BA154, BA243  
**At 25p each:**  
 TIP31, TIP41A, 2N296, AF139, 2TK341, BY127 10p; BF181 20p; BD239 49p; BD241 40p; MA343AT 49p; BD228 50p; BD233 & BD234 Comp Pair 25W — 80p per pr. at 50p each.  
**REGULATOR** TBA625. 8 to 20V in — 5V out 100MA TO5 Con. 50p each BF256C 20p.  
**TV AMPLIFIER** TBA 120 20p each.  
**Integrated Circuits**  

74S3	5p	74H74	12p	75325	£1
74S1	5p	74H51	7p	SN15862	4p
7402	12p	74S38	10p	MC4028	69p
7476	20p	74502	12p	7417	14p
7495	35p	74154	70p	7441	40p
74122	12p	74C02	15p	74C86	50p
74C00	17p	74C04	18p	74C161	24p
		74C74	18p		

**MOTOROLA DUAL** in Line 6 pin Opto Coupler **30p each.** Gold plate tester version **50p each.**  
**EPROMS 2708** **£5.50 each.**  
**SMITHS** encapsulated transistorised **AUDIBLE WARNING DEVICES** 4V-12V. Can be driven from TTL. **65p each.**  
**ELECTROSTATIC VOLTMEETERS.** 7.5KV **£8 each.** P&P **£1.50.** Other ranges available. Please enquire.  
**TRIMMERS.** Sub min 0.25 to 1.25 pf. 1 to 4.5pf. 7 to 45pf. All at 6p each.  
**HONEYWELL** humidity controllers **50p each.**  
**TRHYSTOR TIMER.** Solid State. 15 secs adjustable (reset) in plastic relay case. Standard 7 pin base. Series delay **50p each.**  
**MINIATURE PC MOUNT SLIDE SWITCH.** Single pole 3 way 10p each.  
**LARGE EX-MINISTRY SPEAKERS.** OUTSIDE 15 ohm or 500 ohm. Tested. **£25 each** or 5 for **£100**

**VARIACS** Ex-Equipment. Good condition 8 Amps **£25 ea.**  
**20 AMPS**  
 Some 3 phase available. Please enquire.  
**CRYSTALS** 50p each.  
 Flat metal case — 19.2KHZ, 844.8KHZ, 87G — 10MHZ  
**LOAD HAILERS.** Transistorised hand-held. no leads. Standard internal batteries supplied. Howl Switch. **£20 ea.** P&P **£2.**  
**INFRA RED QUARTZ LAMPS.** 230V 620 Watts. Size 1 3/8" x 1/2" dia. **£1.50**  
**BRIDGE RECTIFIER.** 2 Amp 50p ea.  
**PHOTODIODE DETECTOR** 4" fly leads. **25p ea.**  
**AMPHENOL.** 17-way chassis mount edge connectors 0.1 spacing. **15p ea.**  
**I.E.C. Standard MAINS LEAD.** Moulded (3 vertical flat pins centre of lead) **60p ea.**  
**FANS.** 115V 13 Watts. Size 3 1/4" x 3 1/4" x 1 1/4" BRAND NEW. **£4.50 ea.** Secondhand **£2.50 ea.**  
 Miniature **MOTORS** 12V with geared wheel (8 teeth 3/16" dia). Size 1 1/4" x 1/4" dia. New **30p ea.**  
**MOTOR** 12V DC with pulley and integral semiconductor. Speed Control. New **£1 ea.**

**MOTOROLA DUAL** in Line 6 pin Opto Coupler **30p each.** Gold plate tester version **50p each.**  
**EPROMS 2708** **£5.50 each.**  
**SMITHS** encapsulated transistorised **AUDIBLE WARNING DEVICES** 4V-12V. Can be driven from TTL. **65p each.**  
**ELECTROSTATIC VOLTMEETERS.** 7.5KV **£8 each.** P&P **£1.50.** Other ranges available. Please enquire.  
**TRIMMERS.** Sub min 0.25 to 1.25 pf. 1 to 4.5pf. 7 to 45pf. All at 6p each.  
**HONEYWELL** humidity controllers **50p each.**  
**TRHYSTOR TIMER.** Solid State. 15 secs adjustable (reset) in plastic relay case. Standard 7 pin base. Series delay **50p each.**  
**MINIATURE PC MOUNT SLIDE SWITCH.** Single pole 3 way 10p each.  
**LARGE EX-MINISTRY SPEAKERS.** OUTSIDE 15 ohm or 500 ohm. Tested. **£25 each** or 5 for **£100**

Some EHT Transformers and Capacitors available. Please enquire.  
**TELEPHONES** 706 style black grey or blue **£5.50 ea.** 746 style black or grey **£7.50.** Older style black **£2.50 each.** Discoloured grey 706 **£4 ea.** P&P **£1.50** per telephone. INSERT can be used as Microphone / Earpiece (like used as insert in telephone but superior quality) Ex-Min. Brand new wrapped **75p each.** or 10 for **£6.**  
**DC SERVO MOTOR** 120V 2.5Amp continuous. Double shaft. Brand new. 4 wire. 4 brush **£25 ea.** Plus carriage.  
**PC Mount POTS.** Wire wound with knob 200 ohm & 10 ohm. 10p  
**CAPACITORS** at 5p ea — 0.1 of 40V 500V Small rec. block PC Mount German Class 3300pf. 220nf 250V  
 Capacitor 0.1mfd 250V AC — **10p ea.**  
**4 DIGIT 7 SEGMENT** per digit plus a figure one to the left plus a centre minus sign to the left of the figure one with decimal places between digits. Good brilliance at 1.5V. 15 connections **£2.50**

MINIMUM ORDER **£3** VALUE OF GOODS. MINIMUM P&P **£1** — where P&P not stated please use own discretion — excess refunded. **CARRIAGE ALL UNITS.**  
**£5 P&P** or **CARRIAGE** and **VAT** at 15% on total **MUST** BE ADDED TO ALL ORDERS.  
**CALLERS VERY WELCOME STRICTLY BETWEEN 9am-1pm and 2-5pm Monday to Saturday inc.**  
**BARCLAYCARD (VISA) and ACCESS** taken. Official orders welcome.

**CHILMEAD LTD**

**NORWOOD ROAD, READING** **TELEPHONE NO. READING 669656**  
 (2nd turning left past Reading Technical College in King's Roac then first right — look on right for door with "Spoked Wheel")

# GAMES COMPUTERS

**DATABASE GAMES COMPUTER.** Entertaining and Educational, 14 x programmed cartridges available. Database games computer (inc. 1 x cartridge) ..... **£62.50**  
Cartridges ..... **£10.50**

**STARCHESS.** Chess game displayed on your own TV. Absorbing game for two players. Can be used as conventional chess game, or as Intergalactic Space Battle.  
Starchess (Complete) ..... **£50.00**

**DOOR TUNES.** Door bells that play 24 different tunes. (popular/classical)  
DOOR TUNE ..... **£11.50**

**COMPUTE-A-TUNE.** The exciting new musical computer. Features: Tune memory, 10 x musical effects. 4 x built-in tunes. 2 octave keyboard.  
COMPUTE-A-TUNE ..... **£15.50**

**COLOUR CARTRIDGE.** A TV game played on your own TV. Three programmed cartridges available, giving up to 10 x different games per cartridge.  
COLOUR CARTRIDGE (with ten game cartridge) ..... **£27.00**  
CARTRIDGES from ..... **£8.00**

We also have a limited number of Six Function B/W and Colour games, from ..... **£6.00**

We also service Video Game Computers/TV game etc. (Industrial/commercial or hobby).

All prices subject to V.A.T. & P.P.  
For further info. (Brochures, etc.) Please send S.A.E.  
Trade/Bulk enquiries welcome

**BRAINTREE MICRO LEISURE LTD.**  
**92 MANOR STREET, BRAINTREE, ESSEX**  
**Tel: 03763-28196**

# SOUTH WALES

**FOR TTL, CMOS, LINEARS, DISCRETES, PASSIVES, HARDWARE TOOLS, CASES, TRANSFORMERS ETC. LEKTROKIT, BREADBOARDING AND VERO DEALERS**

BOOKS BY NATIONAL, IOR, BABANI

**Come to:**  
**STEVE'S ELECTRONICS**  
**SUPPLY COMPANY**  
**(Formerly Steve's Electronics)**

**15/17 THE BALCONY, CASTLE ARCADE**  
**CARDIFF, CF1 2BU. TEL: (0222) 41905**

**VISIT US AT THE SHOP —**  
**OPEN MONDAY TO SATURDAY 9-5.30**  
**Mail and Official Orders Accepted**

ETI/11/80

# STEVENSON

**REGULATORS**

78L05	33p
78L12	33p
78L15	33p
7805	70p
7812	70p
7815	70p

7905 85p  
7912 85p  
7915 85p

TIC246 16A 400V Triac 115p  
C106D 4A 400V SCR 45p

**SPEAKERS**

64mm 8Ω	110p
64mm 64Ω	110p
70mm 8Ω	140p
70mm 80Ω	170p

56mm 8Ω 100p  
Pair of ultrasonic transducers 380p  
Magnetic earphone + 3.5mm plug 17p  
Crystal earphone + 3.5mm plug 48p

**POTENTIOMETERS**

Preset var. or hor.	8p
Rotary 5K-1M Log or Lin	33p
Rotary 5K-1M stereo	110p
Slide 60mm travel 5K-500K log or Lin, single	65p

Suitable knobs for above with coloured caps in red, blue, green, grey, yellow and black. Rotary 16p. Slide 12p each.

**CONNECTORS**

DIN	Plug	Chassis Socket	Line Socket
2 pin	9p	8p	12p
3 pin	12p	10p	12p
5 pin 180	13p	11p	16p

**JACK**

Plug	Scr. plug	Socket
2.5mm	10p	16p
3.5mm	11p	16p
std.	17p	30p
Stereo	25p	39p

**SPECIAL OFFERS**

2708 EPROM	490p	10 x TL081 op. amps	350p
AY5-1013 UART	290p	100 x 1N4148	180p
TDA1022 Delay line	550p	20 x 1N4001 diodes	70p
MM57160 STAC timer	500p	20 x 0.125 red LED's	150p
SN76477 Sound generator	180p	20 x 0.125 green LED's	260p
NE567 Tone decoder	100p	20 x 0.125 yellow LED's	260p
LM318N Op. amp.	70p	4 x HP7 rechargeable cells	500p
5 x C106D SCR	200p	3 x LM339 Quad comp.	140p
4 x FND500 displays	350p	10 x 2N3707 transistors	50p
3 x 7905 or 7912	150p	10 x BC157 transistors	60p
2 x CA3046 arrays	100p	20 x Miniature slide switches	150p
		20 x 8 pin DIL sockets	160p
		3 x 4P3W rotary switch	100p
		10 x T05 heatsinks	100p

Send 50p for your copy of our catalogue, containing 100 illustrated pages detailing over 3000 line items. You will receive:  
• A mail order form to facilitate rapid despatch  
• A 50p discount voucher.  
All prices include VAT. Please add 50p carriage on all orders below £15. Minimum order £5.

Access & Barclaycard welcome  
Sales office: 01-464 5770.

Mail orders to STEVENSON (Dept ET)

## TRANSISTORS

AC127	25p	BC547	8p	ZTX108	12p
AC128	25p	BCY71	18p	ZTX109	12p
AD161	40p	BD131	35p	ZTX300	14p
AD162	40p	BD132	35p	ZTX500	15p
BC107	10p	BD139	35p	2N3053	25p
BC108	10p	BD140	35p	2N3055	55p
BC109C	12p	BFX29	25p	2N3702	9p
BC147	9p	BFX34	25p	2N3703	9p
BC178	16p	BFY50	23p	2N3704	9p
BC182	10p	BFY51	23p	2N3819	22p
BC182L	10p	MJ2955	98p	2N3905	10p
BC184	10p	TIP29C	60p	2N5777	50p
BC184L	10p				
BC212	10p	1N914	4p	1N4148	3p
BC212L	10p	1N4001	4p	1N4002	5p
BC214	10p	1N4006	7p	1N5401	14p
BC214L	10p	8ZY88 series	8p each.		

## CMOS

4001	25p	4025	25p	4072	25p
4002	25p	4026	150p	4073	30p
4006	95p	4027	50p	4082	30p
4007	25p	4028	90p	4085	85p
4011	30p	4029	110p	4093	80p
4013	50p	4040	110p	4095	110p
4015	85p	4042	85p	4510	90p
4016	48p	4046	110p	4511	100p
4017	90p	4047	95p	4518	90p
4018	90p	4049	50p	4520	110p
4020	110p	4050	50p	4527	165p
4022	100p	4052	80p	4528	100p
4023	25p	4060	120p	4532	125p
4024	80p	4066	63p	4543	170p
		4068	25p	4583	80p
		4069	25p	4585	115p
		4070	25p		
		4071	25p		

## SKTS

Low Profile Texas

8 pin	9p	22pin	20p
14pin	11p	24pin	22p
16pin	12p	28pin	26p
18pin	16p	40pin	38p
20pin	18p		



## OPTO

Red	0.125in.	0.2in.	
Green	TIL209	TIL220	10p
Yellow	TIL211	TIL221	16p
Clips	TIL213	TIL223	16p
			3p
DL704	0.3in	CC	130p
DL707	0.3in	CA	130p
FND500	0.5in	CC	100p

## CAPACITORS

TANTALUM BEAD

0.1	0.15	0.22	0.33	0.47	0.68	1	
and 2.2uF @ 35V							12p
4.7	6.8	10uF @ 25V					20p
22 @ 16V, 47 @ 6V, 100 @ 3V							26p
POLYESTER (Mullard C280 series)							
0.01, 0.015, 0.022, 0.033, 0.047, 0.1							6p
0.15, 0.22							8p
0.33, 0.47							12p

RADIAL LEAD ELECTROLYTICS

63V	0.47	1.0	2.2	4.7	10	7p
						20p
						9p
25V	10	22	33	47	7p	
						9p
100						7p
						20p
						32p

## LINEAR

741	18p	LM324	52p	MM57160	650p
747	70p	LM339	55p	NE531	140p
748	40p	LM348	100p	NE555	23p
7106	850p	LM377	170p	NE566	80p
CA3046	70p	LM378	230p	NE567	120p
CA3080	75p	LM380	85p	RC4136	100p
CA3130	100p	LM381	140p	SN76477	230p
CA3140	60p	LM382	120p	T8A800	80p
LF347	170p	LM386	90p	T8A810	110p
LF351	45p	LM387	120p	TDA1022	630p
LF353	90p	LM1458	40p	TL081	45p
LF356	95p	LM1830	180p	TL082	85p
LM301A	30p	LM3900	60p	TL084	125p
LM316	85p	LM3909	72p	XR2206	390p
		LM3911	120p	ZN414	80p
		LM3914	320p	ZN425E	475p
		LM3915	320p		

## PACKS

Specialty designed packs intended for development work at a considerable saving.  
1/2w resistors, 10 of each value 4.7ohm to 1 Mohm, a total of 650 resistors. 530p each  
1/2w resistors, 10 of each value 4.7ohm to 1 Mohm, a total of 650 resistors. 875p each  
Presets. Pack of 5 of each value from 100ohms to 1 Megohm, a total of 65 presets. 390p each  
LED's. Pack containing 10 of each colour LED 0.2 size. Total of 30 Led's + clips. 450p each  
Zeners. Pack of 5 of each value from 2V7 to 33V a total of 130 zeners 780p each.

**76 College Road, Bromley, Kent BR1 1DE.**



# ETI BOOK SERVICE

How to order: Make cheques payable to ETI Book Service. Payment in sterling only please. Orders should be sent to: ETI Book Service, Modmags Sales Office, 145 Charing Cross Road, London WC2. All prices include P&P. Prices may be subject to change without notice.

## BEGINNERS

Beginners Guide to Electronics Squires £3.75  
Beginners Guide to Transistors Reddihough £3.75  
Beginners Guide to Integrated Circuits Sinclair £3.75  
Understanding Electronic Circuits Sinclair £4.60  
Understanding Electronic Components Sinclair £4.60  
Beginners Guide to Radio King £3.75  
Beginners Guide to Audio Sinclair £3.75

## COOKBOOKS

TV Typewriters Cookbook £7.75  
CMOS Cookbook £8.20  
Active Filters £11.30  
IC Timer Cookbook £7.50  
IC Op-Amp Cookbook £10.00  
Video Cookbook £7.00  
TTL Cookbook £7.55  
The Basic Cook £4.00 inc. p/p  
IC Converter Cookbook £9.50

## APPLICATIONS

Fire and Theft Security Systems B. Weis £2.15  
How to Build Electronic Kits Capel £2.65  
110 Electronic Alarm Projects R. M. Marston £4.45  
110 Semiconductor Projects for the Home Constructor R. M. Marston £4.45  
110 Integrated Circuit Projects for the Home Constructor R. M. Marston £4.45  
110 Thyristor Projects Using SCRs R. M. Marston £4.45  
110 Wave Form Generator Projects R. M. Marston £4.45

## COMPUTING & MICROPROCESSORS

What is a Microprocessor? 2 cassette tapes plus a 72-page book £12.00  
Beginners Guide to Computers and Microprocessors with Projects C. Adams £6.05  
Basic Computer Games Ahl £6.05  
Basic for Home Computers A self-teaching guide. B. Albrecht £6.15  
Illustrating Basic D. Alcock £3.75  
Intro to Microprocessors Aspinall £6.55  
Z-80 Microcomputer Handbook W. Barden £7.75  
How to Program Microcomputers W. Barden £7.25  
Introduction to Microcomputers and Microprocessors A. Barna £8.60  
Microprocessors in Instruments and Control R. J. Bibbero £13.00  
Basic Basic J. S. Coan £7.80  
Advanced Basic J. S. Coan £7.30  
Getting Acquainted with Microprocessors L. Frenzel £7.25  
Beginners Guide to Microprocessors C. M. Gilmore £4.90  
Beginners Guide to Home Computers Grossworth £4.50  
Beginning Basic R. E. Gosling £4.75  
Microprocessor Programming for Computer Hobbyists N. Graham £7.15  
Miniprocessors from Calculators to Computers Heiserman £5.00  
Microcomputers, Microprocessors, Hardware, Software and Applications J. L. Hilburn £17.40  
Basic Programming J. G. Kemeny £7.25  
Microprocessor Systems Design E. Klingman £17.00  
Intro to Microprocessors Leventhal £17.00  
Microprocessors — Technology, Architecture & Applications D. R. McGlynn £10.55  
Interactive Computing with Basic Monro £4.25  
Basic with Style P. Nagin £4.25  
Software Design for Microcomputers Ogdin £7.20  
Microcomputer Design Ogdin £7.25  
Microcomputer Base Design Peatman £5.70  
Hands on Basic with a PET Peckham £9.55  
Basic — A hands on method Peckham £6.95  
6800 Software Gourmet Guide and Cookbook Scelbi £8.90  
8080 Software Gourmet Guide and Cookbook £8.90  
The 8080A Bugbook: Microcomputer Interfacing & Programming P. H. Rony £8.35  
8080/8085 Software Design Titus £7.60  
57 Practical Programs & Games in Basic Tracton £6.65  
Microcomputer Primer M. Waite £6.50  
Your Own Computer Waite £1.60  
Microprocessor/Microprogramming Handbook Ward £6.20

## LOGIC

Logic Design Projects Using Standard ICs J. Wakerly £7.15  
Practical Digital Design Using ICs J. Greenfield £16.00  
Designing With TTL Integrated Circuits Texas Instruments £9.35  
How To Use IC Circuit Logic Elements J. Streater £3.80  
110 COSMOS Digital IC Projects for the Home Constructor R. M. Marston £4.45  
Understanding CMOS Integrated Circuits R. Melen £4.15  
Digital Electronic Circuits and Systems R. M. Morris £4.50  
MOS Digital ICs G. Flynn £5.25

## TEST INSTRUMENTS

The Oscilloscope In Use Sinclair £3.50  
Working with the Oscilloscope A. Saunders £4.25  
Servicing with the Oscilloscope A. King £6.65  
Radio Television and Audio Test Instruments King £7.00

## OP-AMPS

Applications of Operational Amplifiers Graeme (Burr Brown) £8.45  
110 Operational Amplifier Projects for the Home Constructor R. M. Marston £4.45  
Designing With Operational Amplifiers Burr Brown £19.00  
Operational Amplifiers Design and Applications G. Tobery (Burr Brown) £7.55

## COMMUNICATIONS

Communication Systems Intro To Signals & Noise B. Carlson £7.65  
Digital Signal Processing Theory & Applications L. R. Rabiner £24.40  
Electronic Communication Systems G. Kennedy £8.75  
Frequency Synthesis. Theory & Design Manfassewitsch £25.00  
Principles of Communication Systems H. Taub £8.40

## THEORY

Introduction to Digital Filtering Bogner £10.60  
Transistor Circuit Design Texas Instruments £9.75  
Foundations of Wireless Electronics M. G. Scroggie £5.60

## REFERENCE

Electronic Engineers Reference Book (Ed. 4) L. W. Turner £34.50  
Electronic Components M. A. Colwell £2.90  
Electronic Diagrams M. A. Colwell £2.90  
International Transistor Selector T. D. Towers New update £10.20  
International FET Selector T. D. Towers £4.35  
International Op-Amp Linear IC Selector Towers £7.65  
Radio Valve and Semiconductor Data A. M. Bell £4.00  
Radio, TV and Audio Technical Reference Amos £30.40

## MISCELLANEOUS

Electronic Fault Diagnosis Sinclair £3.55  
Integrated Electronics J. Milman £8.20  
Practical Solid State DC Supplies T. D. Towers £6.40  
Practical Triac/SCR Projects for the Experimenter R. Fox £2.35  
Printed Circuit Assembly Hughes & Colwell £2.90

Fallen behind recent advances?  
Just starting out?  
Need a decent reference book?  
ETI Book Service provides an easy way of getting your hands on the right title.

## The finest amplification from Crimson Elekrik

### LATEST DEVELOPMENTS

CRIMSON ELEKTRIK Power amplifiers are the most sophisticated on the market today. Yet now with the latest issue 5 innovations THEY ARE EVEN BETTER! We have included sonic improvements and developed a unique electronic protection circuit which obviates the need for output fuses. In fact, such fuses can seriously degrade the performance of an amplifier. They can blow under heavy drive conditions — even with non faulty loads (due to thermal fatigue), they can be a time consuming nuisance and even dangerous to replace, but more importantly they are responsible for "envelope distortion" i.e. dynamic compression of the signal, even fuses in the feedback loop suffer from the first two disadvantages, and the latter to a lesser extent.

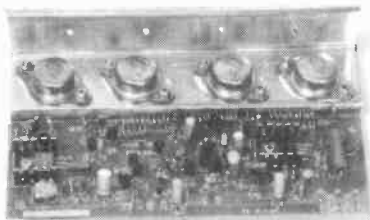

CP3000 POWER AMP MODULE 300 WRMS 4Ω

### BEST VALUE

CRIMSON have an enviable reputation for supplying the best value amplifier kits. You can prove this to yourself by checking out the competition in the following crucial areas: ★ Professional grade phono sockets for ALL signal connections ★ Silver/Gold plated switch contacts ★ Adequate heatsinking for full rated output ★ Available from stock ★ Manufactured by a specialist company with a reputation for friendly and helpful service before and AFTER sale ★ Forms the basis for high quality active loudspeaker systems. Considering the advantages of CRIMSON Kits. Why choose anything else?

### SOUND ADVICE

Crimson Amplifiers are versatile and dependable. The new CP3000 will give up to 300 watts into 4 ohms at 0.03% THD and is the obvious choice for P.A. and Disco's requiring the best performance. For Hi-Fi we produce the ever popular pre- and power amp hardware kits which enable our advanced modules to be housed in attractive metalwork and include everything down to the last nut and bolt.

Our Pre-amplifier can be fitted with the moving coil module allowing it to be used with the latest M.C. cartridge (which can now be bought for as little as £30). Write for details, specifications and full price list or send 50p cheque / p.o. for our comprehensive application / users manual.

Space precludes us from publishing all our products and prices, below are just a few examples.

★ Power Amp Modules (single channel)	
CE 608 (60 WRMS / 8 ohms)	£23.10
CE 1708 — (170 WRMS / 8 ohms)	£38.50
CP 3000 — (300 WRMS / 4 ohms)	£58.00
★ 60 + 60 watt stereo pre and power amplifier complete kit	£208.86
★ Stereo Moving Coil Pre-Pre Amplifier Module MC1	£28.50
★ 3 Way Active Crossover (single channel)	£32.60

Don't forget, Crimson modules are available throughout the country from all branches of Marshalls and Mail order from Badger Sound Services and, of course Crimson Elekrik.

Prices include V.A.T. and post to anywhere in the U.K.



**Crimson  
Elekrik**

1A Stamford Street, Leicester LE16NL

Telephone (0533) 563508

# TELL US ABOUT YOUR LOCAL COMPONENT SUPPLIERS

We want to know who you go to to buy components, equipment, etc.

PLEASE FILL IN THE COUPON BELOW AND SEND IT TO "ETI DEALER LIST", ELECTRONICS TODAY INTERNATIONAL, 145 CHARING CROSS ROAD, LONDON WC2H 0EE.

SUPPLIER ONE: Name .....

Address .....

Supplies: Components / CB / Other .....

SUPPLIER TWO: Name .....

Supplies: Components / CB / Other .....

SUPPLIER THREE: Name: .....

Supplies: Components / CB / Other .....

SENDER: .....

REGION: .....

Tee-shirt size .....

## WIN A FREE TEE-SHIRT!

On December 15th we will sort senders by region and send a free ETI tee-shirt to a randomly-selected winner in each area (provided you've given us three names of dealers in your area). Please use extra sheets if you know lots of local suppliers. Use a photocopy or facsimile if you don't want to cut up your magazine.

### IDENTIFY YOUR REGION BELOW:

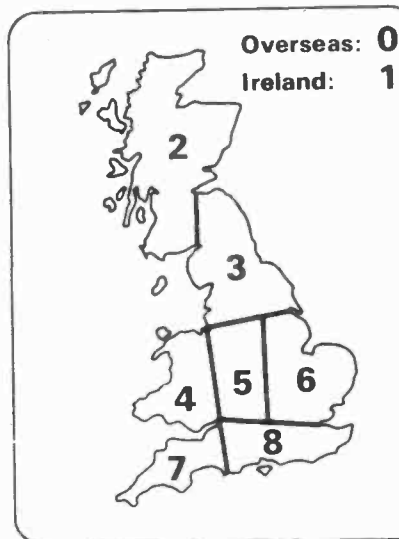

**THIS WAY YOUR  
ELECTROVALUE  
CATALOGUE IS  
IS ALWAYS UP TO DATE**

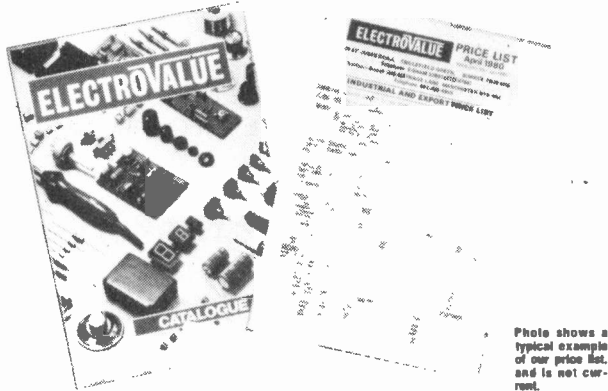

Photo shows a typical example of our price list, and is not current.

It's Electrovalue's quarterly price list published to keep you up-to-date on price and item variations in our 128 page catalogue (FREE ON REQUEST). If you are not yet a customer on our regular mailing list, we will send you our current price list FREE on request and a catalogue (No. 10) with it as well if you wish.

**OUR MINI-SELECTION POINTS THE WAY!**

**EXAMPLE ONE - SOLDERING IRONS**

Oryz 50	£12.08 net	Antex X25	£4.83 net
Isotip	£25.90 net	Desolder tool SR3A	£7.48 net
Antex C	£4.83 net	500 gm reel solder	£7.59 net

**EXAMPLE TWO - PRINTED CIRCUIT MATERIALS**

PCB's 300 x 150 mm		Etch Resist Pen	£1.21
5SHBP S/S	D/S £1.73	Breadboards	
F/Glass S/S	D/S £2.48	Bimboard 12	£9.23
Positive resist 75cc	£1.67	Eurobreadboard	£8.56 net
Ferric Chloride 500g	£3.45	T-DeC	£5.18

**EXAMPLE THREE - SWITCHES**

Chrome toggle		13A time switch adaptors	
Std. SPST 65p	DPDT 89p	Smiths TS 100	£14.43 net
Min. SPDT 66p	DPDT 92p	Wavechange, Lorlin, 1P12W, 2P6W	
		3P4W, 4P3W	46p each

**EXAMPLE FOUR - CAPACITORS BY SIEMENS**

Polyester 7.5mm PCM  
1, 1.5, 2.2, 3.3, 4.7nF, 10, 15, 22, 33, 47nF 8p each, 0.1µ 12p, 0.15µ 15p, 0.22µ 18p, 0.33µ 21p, 0.47µ 27p, 0.68µ 34p, 10mm PCM 1µ 37p.

Electrolytic axial (µF/V)  
1/40 15p, 1/100 12p, 2.2/25 15p, 2.2/63 12p, 4.7/16 15p, 4.7/40 12p, 10/25 12p, 10/40 13p, 22/25 13p, 22/40 16p, 22/63 19p, 47/10 13p, 47/25 16p, 47/40 19p, 47/63 20p, up to 1000/16V 32p, Then 1000/25V 44p, etc.

Also full supporting ranges of other ceramic, plastic and electrolytic caps

**EXAMPLE FIVE-POTENTIOMETERS BY RADIOHM**

Single gang lin or log	34p		
Twin gang lin or log	93p	(Twin types stereo matched)	
Mono slider lin or log	83p	Slider knobs	10p each
Twin slider lin or log	136p	Presets lin, horiz. or vert.	12p

**EXAMPLE SIX - RESISTORS**

1/2, 1/4, 1/8W 2.3p 1W 6p. Wirewound from 23p

**AND AS FOR SEMI CONDUCTORS . . . THIS LIST IS BUT A FRACTION OF WHAT WE CARRY**

1N914	6p	40673	99p	E1110	92p	TIP31A	52p
1N4007	9p	555	34p	E1210	92p	TIP32A	52p
1N4148	6p	556	88p	LM301AN	35p	TIP41A	69p
1N5402	19p	AC128	36p	LM374N	87p	TIP41C	74p
2N1599	£1.01	AC176	87p	LM380N	£1.14	TIP42A	69p
2N2369A	24p	AD136	£4.25	LM390UN	78p	TIP42C	74p
2N3055	81p	AD149	£1.01	MJE2955	£1.13	TIP2955	69p
2N3702 11	11p	AD181	40p	MJE3055	£1.00	TIP3055	69p
2N4443	£1.78	AD162	52p	MPSA12	42p	TIS43	40p
2N4444	£2.28	AF127	43p	MPSA63	44p	W02	35p
2N4991	72p	AL102	£1.84	OA47	14p	ZN425E	£4.49
2N5457 9	45p	BA379	26p	OA90	8p	ZTX107-9	14p
40HF40	£2.25	BB103	43p	OA91	8p	ZTX300	14p
40361	49p	BB104	70p	OA202	16p	ZTX500	16p
40362	49p	BB105	37p	OC29	£1.23		
40636	£1.69	CA106D1	52p	OC36	£1.18		
		CA140F	46p	T2800D			

**INFORMATION:** To show everything we supply would take about seven pages of tightly packed type in this journal, the range is enormous including not only opto devices and very advanced sophisticated items, but all the everyday things you need as well down to nuts and washers! IT'S ALL IN CATALOGUE 10 OUR 120 PAGE CATALOGUE FREE FOR THE ASKING

PRICES AND V.A.T. All prices quoted here include V.A.T. for U.K. orders. Overseas buyers deduct 13% when ordering.

POSTAGE: For orders up to £5.75 value (U.K.) please add 40p for p/p. If over, orders sent post free in U.K. Overseas orders sent at cost (Min. 40p).

DISCOUNTS: 5% allowed on non-net items if order value exceeds £11.50. 10% if order value exceeds £29. Quantity discount prices on most components

**ELECTROVALUE LTD., DEPT. EY111, 28 St. Jude's Road, Englefield Green, Egham, Surrey, TW20; 048. Phone Egham 33603 (STD 0784, London 87). Telex 264475.**

Northern Branch (Personal Shoppers only), 680 Burnage Lane, Burnage, Manchester M19 1NA Phone (061) 432 4945

**MEMORIES FOR**

**ZX80**

1K	2K	3K	4K	16K
----	----	----	----	-----

Not just boards, these are complete units in neat plastic boxes. Built and tested. When necessary, lines are buffered for system expansion. (Only one Fountain memory unit can be fitted.) Larger sizes include all required extra power.

FB01 1K unit	£24.50	FB03 3K unit	£44.50
FB02 2K unit	£34.50	FB04 4K unit	£54.50
FB16 16K unit (with power)	£89.50		

Memory checkout program listing supplied. Inclusive of 15% VAT. UK delivery free. CWO or S.A.E. details.

**FOUNTAIN COMPUTERS LIMITED**

Darvill Road, Ropley, ALRESFORD, Hants. SO24 OBW

**THE ZX80 COMPANION**

**Second Edition—THE MONITOR REVEALED**

This best-selling Sinclair ZX80 manual has now been extended to include a detailed explanation of the monitor, routines and entry points. Send £10 cheque/P.O. to:

**LINSAC**

68 Barker Road, Middlesbrough  
Cleveland TS5 5ES

Send s.a.e. for latest catalogue of ZX80 programs — games, educational and utilities — in lower-priced packages.

**NASCOM OWNERS**

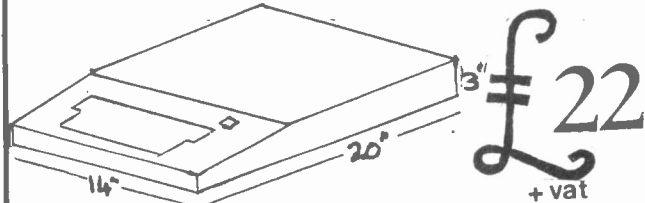

16 Gauge Aluminium Console. Good RFI suppression and heat dissipation characteristics. Enough space inside for 3A PSU, CPU Board and two Expansion Boards. Will support portable T.V. or Monitor. Price includes Keyboard cut-out, rubber feet and carrying handle.

Send cheques or P.O.s for £25.30 to:

**CYBER ELECTRONICS CO. LTD.**

Pavement Square, Addiscombe  
Croydon CR0 6RD. Tel: 01-651 0388

**LCD QUARTZ WATCHES**

Special offer Gent's LCD Alarm	Only £9.75
Slim Gents Chronograph	£7.95
Gents Alarm Chronograph	£12.75
Musical Alarm Chronograph. Plays Yellow Rose of Texas	£13.25
Slim Musical Melody Alarm Chronograph	£13.25
Gents 5 Function LCD	£4.95
Ladies 5 Function LCD	£5.75
Ladies 5 Function Sugar coated oval face or square face. Silver or gold colour	£8.25
Ladies Dress 5 Function, oval or square face, silver or gold colour	£9.50
Christmas Stocking Miller, digital Mickey Mouse watch. Ideal for the kids	£7.95
add 35p P&P to all items	
Gents Quartz Analogue with Calendar	£18.95



**D. K. SUPPLIES 5A  
HALFPENNY LANE  
PONTEFRAC, W.  
YORKS**

All goods carry 12 month guarantee (S.A.E. for fuller list and brochure) Prices include VAT



## MPA 200 100 WATT (rms into 8Ω) MIXER/AMPLIFIER

Featured as a constructional article in ETI, the MPA 200 is an exceptionally low priced — but professionally finished — general purpose high power amplifier. It features an adaptable input mixer which accepts a wide range of sources such as a microphone, guitar, etc. There are wide range tone controls and a master volume control. Mechanically the MPA 200 is simplicity itself with minimal wiring needed making construction very straightforward. The kit includes fully finished metalwork, fibreglass PCBs, controls, wire, etc. — complete down to the last nut and bolt.

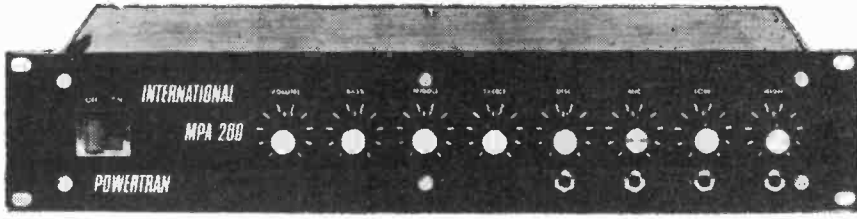

Panel size 19.0" x 3.5". Depth 7.3"

COMPLETE KIT  
ONLY  
**£49.90 + VAT!**

MATCHES THE  
CHROMATHEQUE 5000  
PERFECTLY!

## CHROMATHEQUE 5000

5 CHANNEL LIGHTING  
EFFECTS SYSTEM

This versatile system featured as a constructional article in ELECTRONICS TODAY INTERNATIONAL has 5 frequency channels with individual level controls on each channel. Control of the lights is comprehensive to say the least. You can run the unit as a straightforward sound-to-light or have it strobe all the lights at a speed dependent upon music level or front panel control or use the internal digital circuitry which produces some superb random and sequencing effects. Each channel handles up to 500W and as the kit is a single board design wiring is minimal and construction very straightforward.

Kit includes fully finished metalwork, fibreglass PCB controls, wire, etc. — Complete right down to the last nut and bolt!

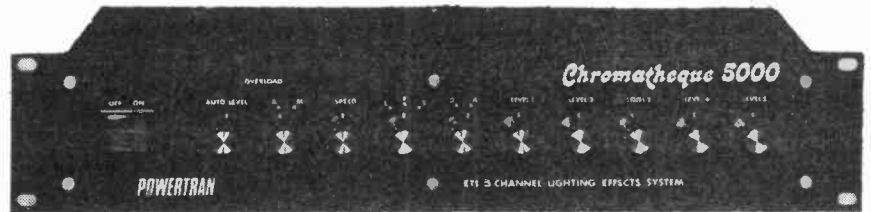

Panel size 19.0" x 3.5". Depth 7.3"

COMPLETE KIT  
ONLY  
**£49.50 + VAT!**

## POWERTRAN

SYNTHESIZER KITS ON PAGE 9. MORE KITS AND ORDERING INFORMATION ON INSIDE FRONT COVER.

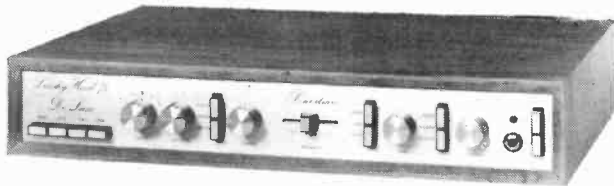

### DE LUXE EASY TO BUILD LINSLEY HOOD 75W STEREO AMPLIFIER £99.30 + VAT

This easy to build version of our world-wide acclaimed 75W amplifier kit based upon circuit boards interconnected with gold plated contacts resulting in minimal wiring and construction delightfully straightforward. The design was published in Hi-Fi News and Record Review and features include rumble filter, variable scratch filter, versatile tone controls and tape monitoring while distortion is less than 0.01%.

Above 2 kits are supplied with fully finished metalwork, ready assembled high quality teak veneer cabinet, cable, nuts, bolts, etc. and full instructions — in fact everything!

All kits also available as separate packs (e.g. PCB, component sets, hardware sets, etc.). Prices in our FREE CATALOGUE.

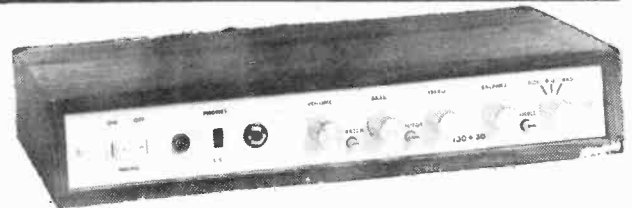

### T20 + 20 20W STEREO AMPLIFIER £33.10 + VAT

This kit, based upon a design published in Practical Wireless, uses a single printed circuit board and offers at very low cost, ease of construction and all the normal facilities found on quality amplifiers. A 30 watt version of this kit (T30+30) is also available for **£38.40 + VAT**.

MATCHING TUNERS — See our FREE CATALOGUE!

## BLACK HOLE

MUSIC EFFECTS DEVICE — AS FEATURED  
IN ELECTRONICS TODAY INTERNATIONAL!

The BLACK HOLE designed by Tim Orr, is a powerful new musical effects device for processing both natural and electronic instruments, offering genuine VIBRATO (pitch modulation) and a CHORUS mode which gives a "spacey" feel to the sound achieved by delaying the input signal and mixing it back with the original. Notches (HOLES), introduced in the frequency response, move up and down as the time delay is modulated by the chorus sweep generator. An optional double chorus mode allows exciting antiphase effects to be added. The device is floor standing with foot switch controls, LED effect selection indicators, has variable sensitivity, has high signal/noise ratio obtained by an audio compander and is mains powered — no batteries to change! Like all our kits everything is provided including a highly superior, rugged steel, beautifully finished enclosure.

COMPLETE KIT ONLY **£49.80 + VAT** (single delay line system)  
De Luxe version (dual delay line system) also available for **£59.80 + VAT**

Cabinet size 10.0" x 8.5" x 2.5" (rear) 1.8" (front)



## DISCO LIGHTING KITS!!!

First class constructional projects. c/w glass fibre P.C.B.'s & full instructions. No extra components needed to make a top rate working unit.

<b>LK1</b> <b>£9.90</b>	3 channel sound-to-light. 300 w/channel 1v - 100w input	<b>LK2</b> <b>£17.90</b>	3 channel 3kW zero voltage firing 200mV - 100 watts input.
<b>LK3</b> <b>£15.50</b>	2kW slider dimmer suitable for clubs/pubs. A professional unit c/w face plate.	<b>LK4</b> <b>£16.50</b>	4 channel 4kW audio - forward/reverse auto - two speed ranges.

ALL KITS C/W  
Facia panel,  
circuit, comprehensive  
instructions & full  
parts guarantee

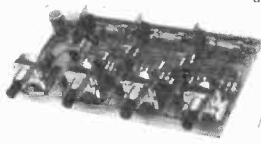

Carriage on above 70p

Suitable case for  
LK 1/2/4 **£3.50**  
100w spots ES or BC  
**£1.50**  
Coloured pigmy lamps  
65p.  
8m rope lights  
**£49**

## UNREPEATABLE HI-FI BARGAIN

### 3 WAY LOUDSPEAKER KIT C/W BAFFLE (pre-cut)

Comprises:  
★ 6 1/2" linen surround bass unit  
★ 5" mid-range unit  
★ 3" tweeter  
★ 3 way crossover, fixing screws & baffle  
★ 20 watts handling capability.  
Full instructions provided  
Must be heard to be believed!!

**£9.95** + £1 carr. or two kits for **£20** carr. free.

## SAXON ENTERTAINMENTS (ETI)

327-333 Whitehorse Rd., Croydon, Surrey CR0 2HS.  
(01) 684 0098.

Order by phone - Access/Barclaycard/C.O.D.  
Open Mon. - Sat. 9am - 5pm.

## CALCULATORS

ALL EQUIPMENT NEW, BOXED AND FULLY GUARANTEED  
Order with confidence and pay no more

### PROGRAMMABLE SCIENTIFIC

Casio FX501P	£46.95
Casio FX502P	£66.95
Casio FA1 Adaptor-Cassette Interface	£19.95
Casio FX501P with FA1	£64.95
Casio FX502P with FA1	£84.95
Texas T157	£28.95
Texas T158	£67.95
Texas T158C	£86.95
Texas T159	£176.95
Texas PC100C	£176.95

### SPECIAL OFFER

Texas T158C with PC100C **£250.00**  
Texas T159 with PC100C **£350.00**

\*Includes mains adaptor/charger

### TEXAS ACCESSORIES in stock e.g. Libraries, etc.

Maths/Utilities, Applied Stats/Electrical Engineering	Each <b>£25.95</b>
Surveying, Structural Engineering	Each <b>£62.95</b>
PL100C Rolls 10 off	<b>£21.95</b>
Battery Packs. State model or BP number	<b>£6.95</b>
Texas T1 Programmer	<b>£51.95</b>

## QUALITY WITH FULL GUARANTEE

See Page 11 September E.T.I.



ML 71	£21.95
ML 81	£21.95
ML 90	£19.95
ML 720	£15.95
ML 831	£12.95
ML 860	£15.95

### CASIO CLOCK CALCULATORS

MQ6	£17.95
Pocket Watch 81	£15.95
AQ 1500	£15.95
AQ 2200	£18.95
MQ 12	£18.95

### CASIO SCIENTIFICS

8 DIGIT		10 DIGIT	
FX68	£18.95	FX100	£14.95
FX81	£13.95	FX510	£18.95
FX330	£15.95	FX3200	£20.85
FX2600	£18.95	National NS108	£17.95

\*ALL PRICES NOW INCLUDE V.A.T., POST AND PACKING \*

Cheque with order or C.O.D. 75p. Extra up to £100

FREEPOST NO STAMP NEEDED. S.A.E. WITH ENQUIRIES PLEASE  
**CALCULATOR SALES & SERVICE FREE POST**  
Redditch, Worcs. **B98 0BR**

## OHIO SCIENTIFIC SUPERBOARD 2

50HZ BLACK AND WHITE VERSION  
**£159.95 + 15% VAT, POST FREE.**  
50HZ COLOUR VERSION **£215**  
+ 15% VAT.

### THIS UNIQUE SPECIAL OFFER

- ★ If bought with superboard or colour board these items are at the reduced prices shown first. Also sold separately at the bracketed prices. Add 15% VAT.
- ★ Modulator and power supply kit **£7.95** (£11).
- ★ 4K extra ram **£20** (£24).
- ★ Display expansion kit approx. 30 lines + 54 characters **£15** (£20). Case **£23** (£26).
- ★ Colour conversion board fully assembled **£55** (£55). Cassette recorder **£13** (£15). Extended monitor **£20** (£20). Assembler/Editor **£25** (£25).
- ★ 610 Expansion Board **£160** (£160). Minifloppy with psu and 2 copies DOS **£275** (£275).

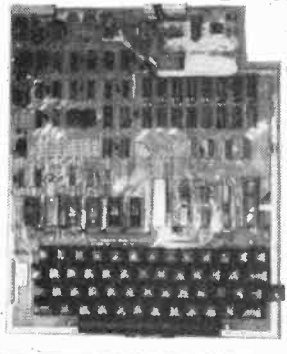

### SHARP MZ-80K

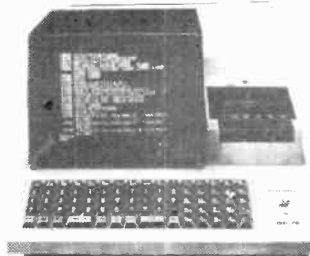

The brilliant new Japanese computer which is beating the hell out of PET. 20K ram expandable to 48K. Built-in VDU screen, music function and cassette. Displays 40 characters x 25 lines and 80 x 50 on graphics. **£465 + 15% VAT.**

### SUPER PRINT 800MST



The ideal impact matrix printer for Superboard. UK 101 pet, apple, trs80, mz-80k. 60 lines/minute. 72, 80, 96, 120 and 132 chr/line. Tractor and friction feed. Graphics and user definable chr. sets. RS232C, 20ma, IEEE488 and centronics I/O. SPECIAL OFFER. Supplied with free word processor program and interface components **£359 + 15% VAT.**

## SWANLEY ELECTRONICS

Dept. ETI, 32 Goldsall Rd., Swanley, Kent BR8 8EZ

Mail order only. Please add 35p postage. Prices include VAT unless stated. Lists 27p post free. Overseas customers deduct 13%. Official credit orders welcome.

### TV GAMES

AY-3-8550 chip **£4**, kit **£5.26**. Stunt cycle AY-3-8765 chip **£11**, kit **£6.95**. 10 game paddle 2 AY-3-8600 chip **£5.95** kit **£7.03**. Modified shoot kit **£5.28**. Colour generator kit **£9.95**.

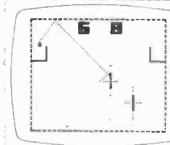

### MAINS TRANSFORMERS

6-0-6v 100ma **96p**, 1 1/2a **£3.12**, 9-0-9v 75ma **96p**, 1a **£2.88**, 2A **£4.73**, 12-0-12v 100ma **£1.20**, 1a **£3.50**, 15-0-15v 1a **£3.78**.

### JC12 AND JC20

Integrated circuit audio amplifier chips with data and printed circuits. JC12 6 watts **£2.50**, JC20 10 watts **£3.54**.

### CONTINENTAL SPECIALITIES PRODUCTS

XP300 **£6.61**, EXP350 **£3.62**, EXP325 **£1.84**, EXP650 **£4.14**, EXP48 **£2.64**.

### STABILIZED POWER KITS

TTL computer supplies 5v 2a **£8.18**, 5v 4a **£13.85**. 8-way types 3/4v/6v/7v/9v/12v/15v/18v 100 ma **£3.12**, 1a **£7.80**, 2a **£11.81**. Variable voltage models 2-18v 100ma **£3.12**, 1-30v 1a **£8.10**, 1-30v 2a **£14.52**.

### PRINTED CIRCUIT MATERIALS

PC etching kits. Economy **£2.72**, standard **£5.06**, 40 sq ins pcb **50p**, 1 lb FeCl **£1.60**. Etch resist pens. Economy **50p**, dialo **90p**, drill bits 1/32" or 1mm **35p**, etching dish **82p**, laminate cutter **£1.30**.

### BI-PAK AUDIO MODULES

AL30A **£4.53**, PA12 **£3.31**, PS12 **£1.75**, T53B **£2.70**, S450 **£27.90**, AL80 **£5.62**, PA100 **£19.24**, SPM80 **£5.26**, BMP80 **£6.06**, Stereo 30 **£23.94**, AL80 **£8.56**.

### COMPUTER GAMES

New Sensory Chess, Challenger 8, Chess Challenger 7, Chess Champion 6 **£49.95**, Checker Challenger 2 **£33**, Star chess **£62**, Atari Video Computer **£129**, Cartridges **£14.95** (except chess **£43.95**), Backgammon **£33.95** and Space Invaders **£27.50**. Special offer. Video Computer plus Space Invaders **£146**.

### S-DECS AND T-DECS

S-Dec **£3.78**, T-Dec **£4.59**, 16 di adaptor **£2.31**.

### COMPONENTS

1N4148 0.9p, 1N4002 3.7p, 2114 memory chips low current 300ns **£3.45**, 723 14 di 36p, NE555 8 di **26p**, 741 8 di **20p**, bc 547 bc 549, bc182, bc184, bc212, bc214 **6.1p**, tip 32 **43p**, tip 41c **48p**, 1c132 **32p**, fuses 20mm x 5mm cartridge 15, 25, 5, 1, 2, 3, 5a quickblow **2p**, Resistors 5% 1/4W E12 10R to 10M **1.5p**, 0.8p for 50+ of age, value. Polyester capacitors 160v 0.015, 0.68mf 2.6p, 0.47, 1mf 4p, 0.1mf 3p, 0.22, 0.33mf 3.3p, 15, 22, 33mf 4.9p, 47mf 6p, Polystyrene capacitors E12 E39 10 to 1000pf 4p, 1n2 to 10n 5p. Ceramic capacitors 50v E6 22pf to 4.7n 2.5p. Electrolytic capacitors 50v 5, 1, 2mf 6p, 25v 5, 10mf 6p, 16v 22, 33mf 6p, 47, 68mf 5p, 100mf 7p, 330, 470mf 9p, 1000 mf 11p, Zeners 400m W E24 2v7 to 33v 7p. Preset pots subminiature 0.1W horizontal or vertical 100 to 2M 2p. Potentiometers 1/4W 4K7 to 2M2 single 29p, dual 71p, "W" rad LEDs 11p, IC sockets 8 di 8.7p, 14 di 10.1p, 16 di 12p.

### BATTERY ELIMINATORS

3-way types with switched output and 4-way multi jack 3/4v/6v 100ma **£2.94**, 6/7v/9v 300ma **£3.45**. 100ma radio types with press-stud connectors 9v **£4.77**, 6v **£4.77**, 4.5v **£4.77**, 9+9v **£5.99**, 6+6v **£5.99**, 4.5+4.5v **£5.99**. Cassette recorder mains unit 7.5v 100ma with 5-pin din plug **£4.77**. Fully stabilised type 3/6/7v/9v 400ma **£6.95**. Car converters 12v d.c. input, output 7.5v 300ma **£1.19**, output 3/4v/6/7v/9v/12v 800ma **£3.04**.

### BATTERY ELIMINATOR KITS

100ma radio types with press-stud connectors 4.5v **£1.64**, 6v **£1.64**, 9v **£1.64**, 4.5+4.5v **£2.30**, 6+6v **£2.30**, 9+9v **£2.30**. Cassette type 7.5v 100ma with din plug **£1.64**, heavy duty 13-way types 4.5v/6/7/8v/11/13/14/17/21/25/28/34/42v 1a **£6.62**, 2a **£10.56**. Car converter input 12v d.c. output 6/7v/9v 1a stabilised **£1.62**.

### SINCLAIR PRODUCTS

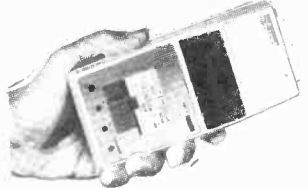

SC110 10MHz oscilloscope **£144.95**, PFM200 **£51.95**, case **£2.07**, adaptor **£4.20**, connector kit **£13.95**. Microvision TV C89 adaptor **£6.88**, PDV35 **£34.23**, adaptor **£4.20**, case **£2.07**, DM350 **£76.70**, DM450 **£102.17**, DM235 **£55.55**. Accessories for all 3 models rechargeable batteries **£7.99**, mains adaptor/charger **£4.20**, case **£8.90**. Enterprise prog calculator **£19.95**, TG105 **£87**, TF200 **£150**.

## PARNDON ELECTRONICS LTD.

44 Paddock Mead, Harlow, Essex, CM18 7RR. Tel: 0279 32700 (Dept. No. 22)

**RESISTORS:** 1/4 Watt Carbon Film E24 range  $\pm 5\%$  tolerance. High quality resistors made under strictly controlled conditions by automatic machines. Banded and colour coded.  
**£1.00** per hundred mixed. (Min 10 per value)  
**£8.50** per thousand mixed. (Min 50 per value)  
 Special stock pack 60 values. 10 off each **£5.50**

**DIODES:** IN4148 3p each. Min order quantity - 15 items.  
**£1.60** per hundred

**DIL SWITCHES:** Gold plated contact in fully sealed base - solve those programming problems.  
 4 Way **86p** each. 6 Way **£1.00** each. 8 Way **£1.20** each

**DIL SOCKETS:** High quality, low profile sockets.  
 8 pin - **10p**. 14 pin - **13p**. 16 pin - **15p**. 18 pin - **19p**. 20 pin - **25p**.  
 22 pin - **29p**. 24 pin - **35p**. 28 pin - **39p**. 40 pin - **57p**.

ALL PRICES INCLUDE V.A.T. & POST & PACKING - NO EXTRAS  
 MIN ORDER - UK £1.00 OVERSEAS £5 CASH WITH ORDER PLEASE

## PROTON ELECTRONICS SAME DAY SERVICE

CMOS	4069	20p	TBA800	80p	BC184	8p	BF180	25p	IN4001	4p	
4000	15p	4085	70p	TBA810	95p	BC212	9p	BFY50	15p	IN4004	5p
4001	16p	4086	70p	TLO81	33p	BC213	8p	BFY51	15p	IN4005	5p
4002	18p			TLO82	60p	BC214	8p	BFY52	15p	IN4007	7p
4006	75p	<b>LINEAR</b>				ZTX214	8p	OC71	15p	IN5401	14p
4007	18p	301A-8	25p	<b>TRANS.</b>		BC327	7p	AD161	15p	OA91	7p
4011	15p	555	21p	BC107	9p	BC328	14p	AD162	40p	W 0 4	1 A
4012	15p	556	58p	BC108	9p	BC337	15p	TIP30	35p	400V	
4014	65p	709-14	29p	BC109	9p	BC338	14p	2N2904	15p	Bridge	30p
4016	42p	710-14	35p	BC109C	10p	BC547	9p	2N2905	15p		
4017	69p	741-8	17p	BC117	18p	BC557	9p	2N2907	19p		
4024	80p	747-14	50p	BC143	20p	BCY70	13p	2N3054	40p		
4030	80p	748-8	36p	BC147	7p	BCY71	13p	2N3055	40p		
4035	95p	723-14	36p	BC148	7p	BCY72	13p	2N3055	40p		
4043	90p	CA3046	85p	BC149	7p	BD131	35p	Ins. Kit	4p		
4044	80p	CA3080	75p	BC157	8p	BD132	35p	(for 3055)			
4047	95p	CA3140	42p	BC158	8p	BD135	38p				
4051	75p	LM3900	48p	BC159	8p	BD136	38p	<b>DIODES</b>			
4056	55p	MC1310P	110p	BC182	8p	BD139	35p	IN914	3p	Red	10p
		MC1458	40p	BC183	8p	BD140	35p	IN4148	2p	Green	13p
										Yellow	13p
										Clips	4p

0.5W Res. Carb. Film 5%. E12 range 100-10MΩ 1p. Polyester Caps. 0.01-0.068μF 3p, 0.1-0.33 μF, 0.47, 0.68 8p, 1.0 13p. Others on free list.

All full spec. guaranteed. C.W.O. P&P 30p. Mail Order only

70 BRIGGS FOLD ROAD, EGERTON, BOLTON BL7 9SQ

## CLEF KITS



### NEW - ELECTRONIC ROTOR

Two-speed organ rotor simulator plus 2 three-phase chorus generator on a single PCB (8" x 5"). Kit includes all components - IC sockets throughout - mains operation and stereo headphone driver PCB. Easily integrated with existing organ. Component kit **£89.00**.

### KEYBOARDS

We believe that we have located the best manufacturer of square front Keyboards, as used in our Kits, and can also supply. Keyswitch hardware including the industry standard soft plated contact springs.

49 NOTE C-C **£23.80**  
 73 NOTE F-F **£37.00**  
 88 NOTE A-C **£45.00**

All Keyboards are easily cut to provide your required length and compass. Quantity enquiries welcome.

### BUILDING SERVICE

We are specialists in Electronic Piano Manufacture and can build your Piano for you - see lists.

### INFORMATION

Please send S.A.E. quoting items of interest. Telephone BARCLAYCARD orders can be accepted, all prices include V.A.T., carriage & Insurance.

### VISITS

Are welcome by appointment, otherwise Mail Order Only.

### EXPORT

Enquiries welcome - in Australia please contact JAYCAR (Sydney).

High Quality Electronic Musical Instruments under the personal supervision of Specialist Designer A. J. BOOTHMAN.

### JOANNA 72 & 88 PIANOS

Six and 7 1/4 Octave Electronic Pianos with unique Touch Sensitive Action as used in the P. E. JOANNA, which electronically simulates piano key inertia - a feature not available in any other design. Build this widely acclaimed professional instrument, for either Domestic or Stage use, from our top quality Component kits.

SIX OCTAVES - **£207**  
 7 1/4 OCTAVES - **£232**

### P.E. STRING ENSEMBLE

The versatile String Synthesizer with a fantastic sound at an economic price. Split Keyboard facility with a range of impressive voices.

COMPONENT KIT - **£169**

Back up TELEPHONE advice is available from the designer to supplement the clear instructions included with the above Kits.

### P.A.'s - SPEAKERS - CABINETS

Units can be supplied to add to the Component Kits, including Domestic or Stage Cabinets and portable tubular legs.

## CLEF PRODUCTS (ELECTRONICS) LIMITED (Dept. E.T.I.)

16 Mayfield Road, Bramhall, Cheshire SK7 1JU. 061 439 3297

## Star Buys ★★★★★ FROM CASIO

### 12 MELODIES CASIO ML-90



### MELODY MAKER

(RRP £21.95)

ONLY **£19.45**

Clock, hourly chimes, calendar to 1999. Alarm 1: 7 different melodies changing daily, a fixed melody or buzzer. Alarm 2: a fixed melody or buzzer. Date memory 1: "Happy Birthday". Date memory 2: "Wedding March" or "Drinking Song". On December 24/25 plays "Jingle Bells". Calculator with 11-note keyboard, full access memory, square roots,  $\%$ ,  $7/32 \times 2\frac{1}{2} \times 4\frac{1}{2}$  inches. Wallet. 1 year batteries.

### OTHER CASIO CALCULATORS

Figures in brackets are R.R.P.

MC34	Ideal for metric conversions	(£13.95)	<b>£11.45</b>
PW81	Clock with alarm card version	(£16.95)	<b>£14.45</b>
AQ1500	Clock with calendar stopwatch	(£16.95)	<b>£14.45</b>
AQ2200	Clock alarm Calendar stopwatch	(£21.95)	<b>£19.45</b>
ML81	Musical Calc. clock alarms calendar	(£25.95)	<b>£22.45</b>
ML71	Card version of 81 only one alarm	(£25.95)	<b>£22.45</b>
M82	Musical calc. clock alarm calendar	(£21.95)	<b>£19.45</b>
MQ12	Card version of AQ2000 without V	(£21.95)	<b>£19.45</b>
FX 100	Scientific 44 functions	(£17.95)	<b>£15.45</b>
FX7100	Scientific clock etc. 39 functions	(£27.95)	<b>£24.45</b>
FX8100	Scientific clock etc. 46 functions	(£27.95)	<b>£24.45</b>
FX3200	Scientific 43 functions	(£24.95)	<b>£21.45</b>
FX330	Scientific 38 functions	(£19.95)	<b>£16.45</b>
FX510	Scientific 50 functions	(£22.95)	<b>£19.45</b>
FX501P	Programmable 51F 11 memories	(£64.95)	<b>£52.45</b>
FX502P	Programmable 51F 256 steps	(£84.95)	<b>£72.45</b>

### Finger-touch keyboard

### CASIO C-801

Watch  
 Calculator  
 Stopwatch  
 Dual time

ONLY **£29.45**

### CALCULATOR WATCH

Hours, minutes, seconds, am/pm and day. Day, date, month, calendar pre-programmed to 2009. Professional 24-hour stopwatch measuring net, lap, 1st & 2nd place times to 1/100 sec. Dual time (24 hour). 8 digit calculator. Backlight. Water resistant chrome plated case with stainless steel bracelet.

C-80 Black resin cased version **£24.45**

### OTHER CASIO WATCHES

Figures in brackets are R.R.P.

F86	Black resin case and strap	(£11.95)	<b>£8.45</b>
F300	Sports chromo latest model	(£14.95)	<b>£12.45</b>
F80C	Sports alarm chronograph	(£24.95)	<b>£19.45</b>
83QS41B	S/S alarm chronograph	(£29.95)	<b>£24.45</b>
83QGS41B	As above gold plated	(£34.95)	<b>£29.45</b>
81QS40B	Alarm chrono 1/100 sec	(£29.95)	<b>£24.45</b>
81QGS35B	Gold plated version as advertised		
59CS33B	Gents dress slim alarm	(£39.95)	<b>£34.45</b>
56QS50B	Digital / Analogue watch	(£39.95)	<b>£34.45</b>
26CGL24M	Ladies gold plated digital	(£79.95)	<b>£46.95</b>
26CL24M	Ladies Palladium digital	(£74.95)	<b>£42.95</b>
26CL20M	Ladies Palladium digital	(£74.95)	<b>£42.95</b>

Most models ex-stock  
**LADIES' CASIO WATCHES from £12.45**

Send 20p for full details of all Casio watches and calculators

### EXECUTIVE ALARM CHRONOGRAPHS



### NEW 79CS-51B

Stainless steel

(RRP £44.95)

ONLY **£39.45**

Hours, minutes, seconds, am/pm and date. Calendar display. Day, date, month and year. Monthly calendar from the year 1901 to 2099. 1/10 sec. stopwatch to 12hrs. Net. lap, 1st & 2nd, 24-hour alarm with 10 step tone control. Hourly chimes, backlight, lithium battery.

8.6mm thick. Mineral glass, water resistant.

### 81QS-35B ALARM CHRONOGRAPH



Stainless steel, mineral glass. Water resistant 5-YEAR BATTERY. Hours, minutes, seconds, day and date, month and year. 12 or 24-hour display. 24-hour alarm, hourly chimes. Stopwatch from 1/100 seconds to 7 hours; net, lap and 1st and 2nd place times.

(£34.95) **£29.45**



**B. BAMBER ELECTRONICS**  
 DEPT: ETI, 5 STATION ROAD LITTLEPORT CAMBS CB6 10E



# CAMBRIDGE LEARNING

# SELF-INSTRUCTION COURSES

*It's faster and more thorough than classroom learning: you pace yourself and answer questions on each new aspect as you go. This gives rare satisfaction - you know that you are really learning and without mindless drudgery. With a good self-instruction course you become your own best teacher.*

## Understand Digital Electronics

In the years ahead digital electronics will play an increasing part in your life. Calculators and digital watches mushroomed in the 1970's - soon we will have digital car instrumentation, cash cards, TV messages from friends and electronic mail.

After completing these books you will have broadened your career prospects and increased your knowledge of the fast-changing world around you.

### DIGITAL COMPUTER LOGIC AND ELECTRONICS £7.00

This course is designed as an introduction to digital electronics and is written at a pace that suits the raw beginner. No mathematical knowledge is assumed other than the use of simple arithmetic and decimals and no electronic knowledge is expected at all. The course moves painstakingly through all the basic concepts of digital electronics in a simple and concise fashion: questions and answers on every page make sure that the points are understood.

Everyone can learn from it - students, engineers, hobbyists, housewives, scientists. Its four A4 volumes consist of:

**Book 1** Binary, octal and decimal number systems; conversion between number systems; conversion of fractions; octal-decimal conversion tables.

**Book 2** AND, OR gates; inverters; NOR and NAND gates; truth tables; introduction to Boolean algebra.

**Book 3** Positive ECL; De Morgans Laws; designing logic circuits using NOR gates; dual-input gates.

**Book 4** Introduction to pulse driven circuits; R-S and J-K flip flops; binary counters; shift registers; half-adders.

### DESIGN OF DIGITAL SYSTEMS £12.50

This course takes the reader to real proficiency. Written in a similar question and answer style to Digital Computer Logic and Electronics, this course moves at a much faster pace and goes into the subject in greater depth. Ideally suited for scientists or engineers wanting to know more about digital electronics, its six A4 volumes lead step by step through number systems and Boolean algebra to memories, counters and arithmetic circuits and finally to an understanding of calculator and computer design.

**Book 1** Octal, hexadecimal and binary number systems; conversion between number systems; representation of negative numbers; complementary systems; binary multiplication and division.

**Book 2** OR and AND functions; logic gates; NOT, exclusive-OR, NAND, NOR and exclusive-NOR functions; multiple input gates; truth tables; De Morgans Laws; canonical forms; logic conventions; karnaugh mapping; three state and wired logic.

**Book 3** Half adders and full adders; subtractors; serial and parallel adders; processors and arithmetic logic units (ALUs); multiplication and division systems.

**Book 4** Flip flops; shift registers; asynchronous and synchronous counters; ring, Johnson and exclusive-OR feedback counters; random access memories (RAMs) and read only memories (ROMs).

**Book 5** Structure of calculators; keyboard encoding; decoding display data; register systems; control unit; program ROM; address decoding; instruction sets; instruction decoding; control programme structure.

**Book 6** Central processing unit (CPU); memory organization; character representation; program storage; address modes; input/output systems; program interrupts; interrupt priorities; programming; assemblers; computers; executive programs; operating systems and time sharing.

## Flow Charts and Algorithms

are the essential logical procedures used in all computer programming and mastering them is the key to success here as well as being a priceless tool in all administrative areas - presenting safety regulations, government legislation, office procedures etc.

### THE ALGORITHM WRITER'S GUIDE £4.00

explains how to define questions, put them in the best order and draw the flow chart, with numerous examples.

### GUARANTEE No risk to you.

If you are not completely satisfied, your money will be refunded upon return of the books in good condition.

**CAMBRIDGE LEARNING LIMITED, UNIT 16**  
RIVERMILL SITE, FREEPOST, ST. IVES, HUNTINGDON,  
CAMBS., PE17 4BR, ENGLAND.  
TELEPHONE: ST. IVES (0480) 67446

All prices include worldwide postage (airmail is extra - please ask for prepayment invoice).

Please allow 28 days for delivery in U.K.

## Microcomputers are coming - ride the wave! Learn to program.

Millions of jobs are threatened but millions more will be created. Learn BASIC - the language of the small computer and the most easy-to-learn computer language in widespread use. Teach yourself with a course which takes you from complete ignorance step-by-step to real proficiency with a unique style of graded hints. In 60 straightforward lessons you will learn the five essentials of programming: problem definition, flowcharting, coding the program, debugging, clear documentation. Harder problems are provided with a series of hints so you never sit glassy-eyed with your mind a blank. You soon learn to tackle really tough tasks such as programs for graphs, cost estimates, compound interest and computer games.

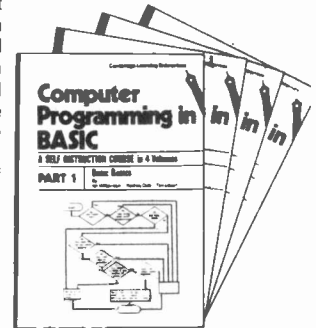

### COMPUTER PROGRAMMING IN BASIC £9.00

**Book 1** Computers and what they do well; READ, DATA, PRINT, powers, brackets, variable names; LET; errors; coding simple programs.

**Book 2** High and low level languages; flowcharting; functions; REM and documentation; INPUT, IF...THEN, GO TO; limitations of computers, problem definition.

**Book 3** Compilers and interpreters; loops, FOR...NEXT, RESTORE; debugging; arrays; bubble sorting; TAB.

**Book 4** Advanced BASIC; subroutines; string variables; files; complex programming; examples; glossary.

### THE BASIC HANDBOOK £11.50

This best-selling American title usefully supplements our BASIC course with an alphabetical guide to the many variations that occur in BASIC terminology. The dozens of BASIC 'dialects' in use today mean programmers often need to translate instructions so that they can be RUN on their system. The BASIC Handbook is clear, easy to use and should save hours of your time and computer time. A must for all users of BASIC throughout the world.

### A.N.S. COBOL £4.40

The indispensable guide to the world's No. 1 business language. After 25 hours with this course, one beginner took a consulting job, documenting oil company programs and did invaluable work from the first day. Need we say more?

## ORDER FORM

Please send me the following books:-

..... Digital Computer Logic & Electronics @ £7.00

..... Design of Digital Systems @ £12.50

..... Algorithm Writer's Guide @ £4.00

..... Computer Programming in BASIC @ £9.00

..... BASIC Handbook @ £11.50

..... ANS COBOL @ £4.40

..... Your Booklist (Free)

I enclose a \*cheque/PO payable to Cambridge Learning Ltd.

for £..... (\*delete where applicable)

Please charge my:

\* Access/American Express/Barclaycard/Diners Club/Eurocard/Visa/  
Mastercharge/Trustcard

Credit Card No.....

Signature .....

Telephone orders from credit card holders accepted on 0480 67446 (Ansafone).

Overseas customers (incl. Eire) should send a bank draft in sterling drawn on a London bank, or quote credit card number.

Name .....

Address .....

Cambridge Learning Limited, Unit 16, Rivermill Site  
FREEPOST, St. Ives, Huntingdon, Cambs PE17 4BR, England.  
(Registered in England, No. 1328762)

## AND NOW A DIMMER THAT MAKES TOUCH DIMMERS OBSOLETE

Two years ago TK Electronics launched a touchdimmer kit, the TD300K, which made knob controlled dimmers obsolete. This was such a great success that many magazines and more retailers soon produced similar reviews. SO THAT OTHERS MAY FOLLOW, TK have designed a touch dimmer kit with an infra red remote control, enabling you to switch and control the brightness of your lights from the comfort of your armchair etc. (as well as manually by touching the frontplate or by using the TDE/K extension kit). As with all our kits, these units come complete with all components including RFI suppression, frontplate, a neon to help you find the switch in the dark and a neat box for the transmitter. The plastic frontplate has no metal pads to touch, assuring complete safety and enabling the plate to be covered with a decorative finish to blend with your room decor.

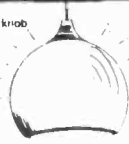

We have designed the light dimmer unit to fit a standard wall box, the transmitter to fit your hand and the price to fit your pocket.

In two years time everyone will be selling remote control dimmers but you can have your TDRK300K kit NOW for only £14.30 for the dimmer unit and £4.20 for the transmitter. For the more athletic of you the TD300K is still available at £6.80 and the TDE/K at £2.00. DON'T FORGET to add 40p P&P and 15% VAT to your total purchase.



### REMOTE CONTROL COMPONENTS

- LD271 IR Emitting Diode **36p**
  - SFH205 Photo-Opto Detector **95p**
  - SL480 IC Pulse Amp **£1.70**
  - SL490 32 command encoder/transmitter **£2.40**
  - ML922 10 channel receiver + 3 analogue outputs **£4.20**
  - ML926 16 channel receiver 4 momentary binary o/p **£1.40**
  - ML928 16 channel receiver 4 latched binary o/p **£1.40**
  - ML929 16 channel receiver 4 latched binary o/p **£1.40**
  - Data Sheets per device **10p**
- These ICs can be used with infra red, ultrasonic or radio links, depending on range, cost and speed of operation.

### RC500K KIT

If you do not require a sophisticated multi-channel remote control, we have developed a simple single-channel on/off infra red transmitter and receiver kit. The transmitter unit comes complete with a hand-held box and requires a PP3 (9V) battery. The receiver includes a triac capable of switching up to 500W at 240V a.c. and comprises a pre-amplifier bistable latch and a mains power supply, making the unit completely self contained. The small size of the receiver enables the unit to be built into all kinds of equipment from lamps to tape recorders. Range approximately 20ft. **£12.50**

ALL COMPONENTS ARE BRAND NEW AND TO SPECIFICATION. ADD VAT AT CURRENT RATE TO ABOVE PRICES. 40p P&P MAIL ORDER - CALLERS WELCOME BY APPOINTMENT

**TK Electronics**  
(ET) 11 BOSTON ROAD  
LONDON W7 3SJ



### TRIACS

400V Plastic Case (Texas)	
3A	49p
8A	58p
12A	85p
6A with trigger	25A 190p
8A isolated tab	80p
Diac	65p
	18p

**TK's SPECIAL OFFERS OF THE MONTH**  
Orders must be received by **30.11.80**

### SPECIAL OFFERS

AY 5 1274 Clock IC	£2.20
LM3915 Bar Dot Driver	£2.10
2 x DL304 0.3" cc Display	£1.35
2 x DL307 D.3" cc Display	£1.35
2 x 2N3442 10 off each 0.2" LEDs	£1.80
Red Green Yellow	£2.90

### MINI KITS

These kits form useful subsystems which may be incorporated into larger designs or used alone. Kits include PCB, short instructions and all components.

- MK1 TEMPERATURE CONTROLLER / THERMOSTAT**  
Uses LM3911 IC to sense temperature (80°C max) and triac to switch heater **1KW £4.00**
- MK2 SOLID STATE RELAY**  
Ideal for switching motors, lights, heaters, etc from logic. Opto-isolated with zero voltage switching. Supplied without triac. Select the required triac from our range **£2.80**
- MK3 BAR/DOT DISPLAY**  
Displays an analogue voltage on a linear 10-element LED display as a bar or single dot. Ideal for thermometers, level indicators, etc. May be stacked to obtain 20 to 100 element displays. Requires 5-20V supply **£4.75**
- MK4 PROPORTIONAL TEMPERATURE CONTROLLER**  
Based on the TDA1024 Zero voltage switch, this kit may be wired to form a 'burst fire' power controller or a proportional temperature controller, enabling the temperature of an enclosure to be maintained to within 0.5°C **3KW £5.55**
- MK5 MAINS TIMER**  
Based on the ZN1034E Timer IC this kit will switch a mains load on (or off) for a preset time from 20 minutes to 35 hours. Longer or shorter periods may be realised by minor component changes. Maximum load 1KW **£4.50**

### DISPLAY LIGHTING KITS

Each unit has 4 channels (rated at 1KW at 240V per channel) which switch lamps to provide sequencing effects, controlled manually or by an optional opto-isolated audio input.

- DL1000K**  
This kit features a bi-directional sequence, speed of sequence and frequency of direction change being variable by means of potentiometers. Incorporates master dimmer control. **£14.80**
- DL21000L**  
A lower cost version of the above, featuring unidirectional channel sequence with speed variable by means of a preset pot. Outputs switched only at mains zero crossing points to reduce radio interference to minimum. **£8.00**
- Optional Opto Input DLA1 **80p**

### MINI TRANSFORMERS



Standard mains primaries 240V a.c. 100mA secondaries

6.0-6V	80p
9.0-9V	85p
12.0-12V	90p

### D.I.L. I.C. SOCKETS

8 pin	8p	18 pin	17p
14 pin	12p	28 pin	24p
16 pin	14p	40 pin	38p

### INTEGRATED CIRCUITS

- 555 Timer **21p**
  - 741 Op. Amp **11p**
  - AY 5 1224 Clock **£2.80**
  - AY 5 1230/2 Clock/Timer **£4.50**
  - AY 3 1270 Thermometer **£8.20**
  - ICL7106 DVM (LCD drive) **£7.00**
  - LM377 Dual 2 W Amp **£1.45**
  - LM3795 Dual 6W Amp **£3.50**
  - LM380 2W Audio Amp **80p**
  - LM382 Dual low noise Preamp **£1.00**
  - LM386 250mW low voltage Amp **75p**
  - LM1830 Fluid Level Detector **£1.50**
  - LM2907 I-V Converter (8 pin) **£1.40**
  - LM2917 I-V Converter (14 pin) **£1.80**
  - LM3309 LED Flasher/Oscillator **80p**
  - LM39 1 Thermometer **£1.20**
  - LM3914 Dot/Bar Driver **£2.10**
  - MM74C911 4 digit display controller **£8.50**
  - MM74C915 7 segment-BCD converter **98p**
  - MM74C926 4 digit counter with 7 seg o/p **£4.50**
  - S556B Touchdimmer **£2.50**
  - S9263 Touchswitch 16-way **£4.85**
  - SN76477 Complex Sound Generator **£2.52**
  - TB800 5W Audio Amp **88p**
  - TBA810AS 7W Audio Amp **£1.00**
  - TDA1024 Zero Voltage Switch **£1.20**
  - TDA2020 20W Audio Amp **£2.85**
  - ZN1034E Timer **£1.80**
- All ICs supplied with data sheets  
Data Sheets only 10p each device.

**MOTORS.** 1.5V Model motors 22P. Sub. min. 'big inch' 115V DC 3 rpm motor 32p. Replacement 8 track 12V DC motor 55p. Gearred mains motors. 2 1/2 rpm. 75p. 115V AC 4 rpm motor 95p. Cassette motors. 5-9V DC. ex. equip. 70p. 9V DC Cassette motors 95p. 6V Cassette motors. new standard jap. type £1.25.

**BUZZERS.** Miniature solid state type. 33x17x15mm. 70db at 3 foot. 15ma drain. operates 4.5V DC 75p each. LD02 12 volt buzzer. 50x30mm 65p. Carriers 12V DC. Miniature alarm sirens £7.65. 12V DC SIREN. all metal rotary type. high pitched wail. £8.50. Rotary alarm siren. 12V DC. red plastic wail with mounting bracket. 68x75mm. £4.50.

**RELAYS.** 2 types both operate on 12V DC. sealed plastic case types. 1-350 ohm with 2 make 5 amp contacts 75p. 2-1,000 ohm with 2 changeover 1 amp contacts 75p.

**SPECIAL OFFER SEMICONDUCTORS.** 2N5062 SCR 10p. 8X504 opto isolator 25p. CA3130 95p. CA3020 45p. TDA1151 25p. 741 22p. 723 35p. NE555 24p. NE536 50p. CD4069 15p. IM4005 10 1/2 35p. 8023B 28p. 8043B 29p. 741S 35p. 2N414 15p. TIL305 alpha numeric display £2.50. MAN3A 3mm LED displays 45p. Min. LDRs 30p. LEDs 0.2" CLEAR 15p. GREEN 12p. RED 10p. infra-red clear LED 30p. MP131 PUTs. 40p. 200ma. 375mA W. 50p. 2N3773 £1.70. Texas TI1038 (T03) Power Trans. 50p. T164443 SCR 45p.

**NEW STOCK ITEM** - We are now stocking Expo mini hand-held drills. These are a precision British-made tool. Ideal for P.C. board drilling, model makers etc. They operate on 12V DC. Drill kit supplied in plastic hinged case, with drill and 21 accessories, drills, sanders, reamers, buffers, etc. complete kit only £14.25. Drill only £7.25. Drill stand to suit vertical drill press £12.95 (postage 65p).

**RECORDING TAPE.** Low noise mylar, supplied unboxed. 7" 1200' £1.00. 7" 1800' £1.75. 10" 3500' £5.00. JACKSONS C804 50 PF variable tuning condensers. Standard 1/4" spindle. 50p each.

**TOOLS.** SOLDER Sucker, good suction. teflon nozzle. £4.99. Side cutters 5" £1.45. Pliers 5" £1.45. MEGN DRIVER 8" LONG 55p. MIYAMA 16 pin IC test clip £1.85. 5 PIECE precision screwdriver sets. individual handles. £1.05. JUMPER TEST LEAD SETS 10 pairs of leads with insulated croos each 50p. CRIMPING TOOL, a combination type for crimping red, blue and yellow terminals also incorporates a wire stripper (6 gauges) and wire cutter. insulated handles. only £2.30.

**MICROPHONES.** Min. Tie pin. Om. uses deaf aid battery (supplied) £4.95. Low cost condenser ECM105 Omni. 600ohms. on/off switch standard jack plug £2.95. EM507 Condenser. uni. 600ohms. 30 kHz. highly polished metal body. £7.95. DYNAMIC-clip microphone dual imp. 600ohms or 20k. 70-15kHz. attractive black metal body. £7.75. EM506 Condenser. cardioid. uni. 600ohms or 50k. heavy chromed copper case. £12.95. DYNAMIC P.A. MEKE. mobile radio etc. thumb switch 506 imp. £3.75. CASSETTE replacement microphone with 2.5/3.5 plugs. £1.35. INSERT crystal replacement 35x10mm 40p. GRUNDIG Electret inserts. with built in FET preamp 3-6V DC. £1.00.

**LED VU METERS.** Utilising sophisticated logic control circuit with adjustable range and decay times via external capacitor. Spec. Response -20Hz to 100kHz. Tolerance within ±0.8. operates on 12-15V DC. 82mm long. 54mm high. MONO VERSION **£6.95**  
STEREO VERSION **£10.95**

**SPECIAL OFFER DEC TYPE BREAD-BOARDS.** Micro DEC "A" with 2 16 pin DIL carriers £3.95. Approximately half original selling price.

**FLOUORESCENT LAMPS.** For caravans, boats, etc. white fitting, paraxip. diffuser. 12V DC. 8 watts. ex/of switch £4.95.

**COPPER LAMINATED PRINTED CIRCUIT BOARD.** Fibreglass Single Sided type (approx. 2mm thick) 150x90mm 40p. 200x90mm 55p. Double-sided Fibreglass 1mm thick. 180x135mm 45p. PAROILIM BASED TYPE: (Came thick). 180x135mm 40p. 280x200mm 50p.

**TAPE HEADS.** Mono cassette. £1.75. Stereo cassette £3.90. Standard 8 track stereo £1.95. BSM MM 1330 1/4 track 50p. BSM SR90 1/4 track £2.10. 1010 dual head assembly 2 heads both 1/4 track R/P with built in erase £1.25.

**SWITCHES.** Sub. min. Toggles. SPST 8x5x7mm. 42p. DPDT (8x7x7) 55p. DPDT Centre off (12x11x36mm) 77p.

**PUSH SWITCHES** (16x6mm). red top. push to make 15p each. push on break version black top 17p each.

**SLIDE SWITCHES** all DPDT 15x8x12mm 13p. 16x11x9mm 13p. 22x13x8mm 13p. 22x13x8 centre off 14p. Multiple slider double action (12 tags) 29x9x11mm 25p.

**ROTARY SWITCHES** (waler) 3P4W. 4P3W. 2P6W and 1P12W all 35p each.

16 pin D.I.L. SWITCHES only 42p each.  
RIBBON CABLE 8-way single core miniature 22p per metre.  
INCAOS. All size 1.2 volts 500ma £1.10 each.

**MOTOROLA PIZZO ELECTRIC TWEETERS**  
3" direct radiating type £3.65

**PIZZO TWEETERS.** require an crossover and can be used with systems up to 100 watts. Frequency response 3.8 to 28kHz.

**MULTI-SOUND HORN SYSTEMS.** Ideal. disc use. 6 controls. will give 81 various sounds. supplied with P.A. horn. speaker. operates on 12V DC £19.50.

**HANK ARENA** stereo cartridge pre-amplifier models. suitable for magnetic cartridges. new, supplied with connection details. £1.95.

**FINNED HEATSINKS.** Supplied undrilled 4mm thick. 27mm high. 75x124mm 60p. 150x124mm 95p. Smaller version 2.7mm thick. 75x108mm 46p. TRANSISTOR SOCKETS 105 or 1018 9p each. T03 type 15p each.

**ALUMINIUM PROJECT BOXES.** 18 S.W. with fitted lid and screws. AB1 3x2x1.52p. AB2 4x3x1.5in 62p. AB3 4x3x2in 66p. AB4 6x4x2in 74p. AB5 6x4x3in 92p. AB6 8x6x2in £1.05. AB7 8x6x3in £1.25.

**ANTEX SOLDERING IRONS.** All 240V AC. Model C 15 watts £3.95. Model ICX 17 watts £3.50. Model X25 25 watts £3.95p. S33 SOLDERING IRON STAND. suits all Antex irons £1.65.

**TRANSUCERS.** REC./SENDER. 40kHz £3.50 pair.

**TRANSFORMERS.** All 240V DC primary (postage per transformer. In shown in brackets after price). MINIATURE RANGE 6.0-6V 100ma. 9.0-9V 75ma. 12.0-12V 50ma at 75p each (15p). 12V 200ma 75p (15p). 0-6:0-5 280ma £1.20 (20p). 6V 500ma £1.10 (22p). 12V 2A £2.35 (45p). 12V 4A £2.85 (45p). 15.0-15V 1A £2.25 (45p). 30-0-30V 1A £2.85 (50p). 20-0-20V 2A £3.85 (54p). 0-12-12-30V 2A £4.75 (54p). 20V 2.5A £2.35 (54p).

**TRIAC XENON PULSE TRANSFORMERS.** 11 (6P0 type) 32p. 11plus 1 sub. min. pcb mounting 65p.

**PROJECT BOXES.** Stereay ABS black plastic boxes with brass inserts and lid. 75x56x35mm 65p. 95x7x35mm 75p. 115x9x37mm 87p.

**VERO HAND HELD BOX.** White ABS. 24in x 3.7in tapered. with screws 68p each.

**VERO POTTING PLASTIC** Boxes with lid and screws 70x50x20mm. black. 43p each.

**CLIFF CLICKTEST.** 13 amp malax connector. ideal for workshop, etc. provides rapid and safe mains connection. moulded in case and lid with neon indicator and fuse. £5.15.

**SPECIAL OFFER DEMAGNETIZER.** Curved probe type. suitable for reel to reel or cassette machines. operates on 240V AC only. £1.95.

**POWER SUPPLIES.** Switched type plugs into a 13 amp socket has 3.4, 5.6, 7.5 and 9 volts D.C. out at either 100 or 400ma. switchable £3.45. HZ24AR stabilised power supply 3.6-7.5V DC at 400ma. has polarity reversing and on/off switch and is fully regulated to give exact voltage from no load to maximum current £5.50.

**KRT101 M/METER.** 1,000. 0ppv. 1KV AC/DC Volts. 150ma DC current. Resistance 0-25k. 0-100k. £4.35.

**NH55 M/METER.** 2,000. 0ppv. 1KV AC/DC Volts. 100ma DC. Resistance 0-10k. 0-1 MEG. £5.50.

**YM360 M/METER.** 20,000. 0ppv. 1KV AC/DC Volts. 250ma DC. 4 resistance ranges to 20 Meg. also has built-in transistor tester with leakage and gain ranges £12.50.

**TMK500 M/METER.** 30,000. 0ppv. 1KV AC/DC Volts. DC current to 12 amps. Resistance to 60 meg in 4 ranges. also has built-in buzzer for continuity testing. £20.95.

Terms. Cash with order (official orders welcomed from colleges etc) 30p postage please unless otherwise shown. VAT inclusive prices. S.A.E. for illustrated lists.

**PROGRESSIVE RADIO**  
31 CHEAPSIDE, LIVERPOOL L2 2JD  
ALL ORDERS DESPATCHED BY RETURN POST



## The 'WINTON' 50+50 WATTS

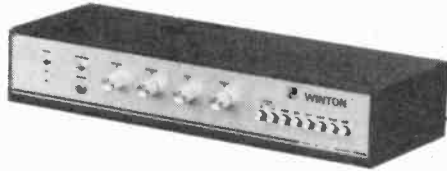

- ★ Power MOS-FET output stage.
- ★ Bi-Fet op-amps.
- ★ Disc, Tuner, Tape and two auxiliary inputs.
- ★ HF & LF Active filters.
- ★ Very low noise disc input stage.
- ★ Easy to build.
- ★ Unconditionally stable.
- ★ Non-magnetic chassis.

During the past eighteen months the WINTON amplifier has set a new standard for Hi-Fi kits and is highly regarded throughout the world. Taking around twenty hours to build and not requiring special equipment for setting up, it represents incredible value for money and is undoubtedly one of the best kits around today. The amplifier with the Ultra Clean Sound, 50+50 watts of its, so clean you'd swear it was sterilised.

A 12p stamp will bring you the full details or better still, send you cheque for the best amplifier kit around. POWER MOS-FETs RULE, O.K.

**COMPLETE KITS** of all parts necessary to build the P.W. WINTON ..... **£133.50**  
Order with complete confidence (C.W.O. only please) from:

**T. & T. ELECTRONICS (Dept. E)**  
Green Hayes, Surlingham Lane, Rockland St. Mary  
Norwich NR14 7HH. Telephone 05088 632

**PRICE INCLUSIVE OF V.A.T. & CARRIAGE**  
Callers by appointment only

**SARGON 2.5 Modular Chess System.**  
Strongest chess program available  
Call us for a price.

**VOICE SENSORY CHESS CHALLENGER.** No keys to press. New sensory playing surface automatically tells the computer your every move. Call us for details and price.

**COMPUTER BACKGAMMON**

- Electronic doubling cube
- Score keeping
- Electronic random roll of dice
- Position verification
- Sound
- LCD display — liquid crystal display for easy visibility in all lighting
- AC/DC operation
- Operates on 4AA batteries (not included)

**£45**

**ATARI Space Invaders.** £27.50.

**ATARI Minis Units.** £98.50.

All Atari cartridges — Never under £10.

**NIGHT DRIVER™. 8 games.** 1 or 2 players. **PADDLES.** The road is winding and dark. And you never know what might jump out in front of you. **£16.20.**

**ATARI CASINO™ Game Program™.** **£16.20.**

The **OSC3C** is a compact 3" oscilloscope suitable for general laboratory and educational use.

Lightweight, portable and modern design, the Chess Traveler offers many special features usually found in much more expensive chess games.

- Battery operated.
- 7 Levels of play, beginner to expert, plus a problem solving mode.
  - 8th Level looks ahead at 5 individual moves.
  - Solves mate in 2 moves.
  - Unique MM (multi-move) key where entered standard openings are automatically checked for legality as keyed in.
  - Position verification.
  - Play levels are changeable during a game, at any time and on any move.
  - Randomized computer responses vary the strategy and play from game to game.
  - Plays white or black: tutorial feature allows you to observe and learn while the computer plays against itself.
  - Does not permit illegal moves, plays according to all international chess rules.
  - Plays opening defenses from world class chess instructors.
  - Plays En Passant capture and pawn promotion.
  - Chess pieces included.
- CHESS TRAVELER 8.25" x 5.5" x 1.75". Wt. 1 lb.**  
Call us for price.

**SHARP PC 1211** Hand held computer — 1K Ram. Basic language. Alpha numeric keyboard — 24 character display. **£89.95 + VAT.**

**ELMAC 4810 CRT 5MHz scope** **£125 + VAT.** As recommended by ETI. The best selling 5MHz 4" CRT scope in the UK. Time-base include sweep range — 100 msec/div to 1µ sec/div in 5 steps. 3" also available. **£99 + VAT.**

Free 10:1 Probe  
**Elax 5810 5" CRT (15MHz)** **£181.71 + VAT.** Vertical axis 1 deflection sensitivity — 10mV/div Bandwidth — DC DC 12.5MHz (between 3dB points). AC 2Hz 12.5MHz (between 3dB points). Rise time 20n sec. Input Attenuator — 12 step — 10mV/div to 50V/div in 1-2-5 sequence calibrated. Time Base — Sweep range 0.5µ sec/div to 0.1 sec/div in 12 steps, calibrated with <5 expansion. Fine control. Variable between steps includes TB calibration position.

**Kramer & Co., Dept. ETI 4, 9 October Place, London NW4. Tel: 01-203 2473. Fax: 888941. Attn K7. Visa, Access. Open Mon.-Fri.**

# Multimeters. what price excellence?

... certainly less than you think. By incorporating a custom made LSI chip, these fully auto-ranging 3½ digit multimeters are available at prices from under £50.00.

SK-6110 (illustrated)  
**£67.17**  
+ VAT

SK-6220  
**£45.43**  
+ VAT



Supplied complete with batteries, test leads, spare fuse and instruction manual.

### SK-6110 and SK-6220

- Full auto-ranging on both voltage and resistance
- Current measurement up to 10A DC and AC
- Unit and range automatically displayed
- Auto polarity and auto zero
- Only 5mW dissipation—200 hours continuous use
- Zero adjust key to correct for test leads on low value measurements
- High impact ABS case
- Low battery indication

### SK-6110

- Audible continuity test function
- Range hold function
- Audible over-range indication

Telephone orders welcome for Access and Barclaycard and all account customers. All prices inc. P.&P.



## WEST HYDE

West Hyde Developments Limited,  
Unit 9, Park Street Industrial Estate, Aylesbury, Bucks. HP20 1ET.  
Telephone: Aylesbury (0926) 20441/5.

# OLSON

## PORTABLE MAINS DISTRIBUTION — NEW WITH CIRCUIT BREAKERS



**New!  
Slim Jim**

Dim. 1 3/4" x 2 1/2" x 18 3/4"  
**£13.50 P&P £1 + VAT**

Fitted with M.K. 10 amp C.B. — 13/A5 SW.CB **£33.00 + post £1 + VAT**

3 1/2" x 19" Rack Mounting Type 13A/4SW/R **£21.50 P&P £1 + VAT**

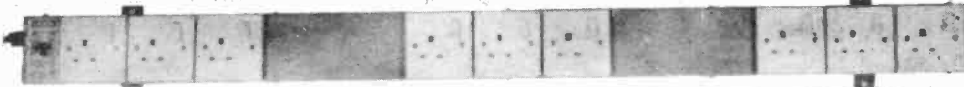

**4 foot LG. 30 amp total load Instant Trunking System for Wall or Bench Mounting**

**NEW!** 10 sockets switched in sloping box

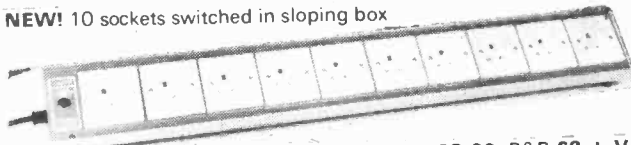

Type 13A/10SW **£33.00. P&P £2 + VAT**

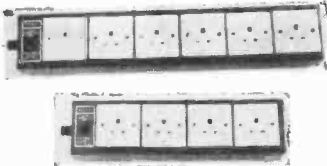

**COMPLETE WITH 6FT. CABLE  
AND 13-AMP FUSED PLUG**

4 sockets 13A	£16.00
6 sockets 13A	£18.75
4 sockets 13A switched	£18.50
6 sockets 13A switched	£21.50
+ Post <b>£1 + VAT</b>	

**ALL DISTRIBUTION PANELS ARE FITTED WITH MK SOCKETS & PLUG**  
Send for details of complete range

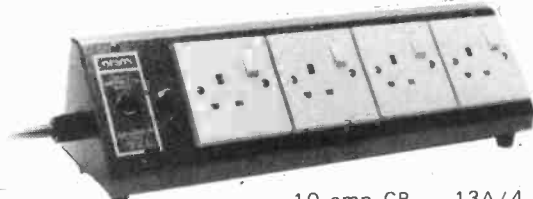

10 amp CB — 13A/4 SW.CB  
**£29.25 + post £1 + VAT**  
**TR6 — 6 sockets switched £27.00**

**TR9 — 9 sockets switched £32**  
Plus P&P **£2 + VAT**

## MAINS ISOLATING UNIT

The Olson mains isolating unit is an essential bench item for safety when testing and repairing mains-operated equipment. The isolating transformer has an earthed screen and is rated 250VA.



**£38 + P&P £2 + VAT**

**OLSON ELECTRONICS LTD., FACTORY NO. 8, 5-7 LONG ST., LONDON E2 8HJ**  
TEL. 01-739 2343

TTL  
CMOS  
74LS  
LEDS

# LB ELECTRONICS

LINEAR  
RAMS  
EPROMS  
SURPLUS

TELEPHONE:  
UXBRIDGE 55399

### PCB OFFERS

(1A) 100 bit shift register PCB. 115mm x 94mm containing 9 x 7491, 6 x 7496 and 1 x 7441. Terrific bargain 85p, p&p 30p.  
(1C) PCB 215mm x 290mm 12 x TMS 3122J (or sim.) Hex 32-bit Shift Reg. + 39 ICs. £2 + 50p p&p (limited stocks).

### MPU CORNER

2112 (200ns). £3. 2114 (450ns) £4.50.  
Texas Instruments 2716 single rail. Brand new. Full spec. £8.95 each p&p 25p. 2708 (400ns) £4.50.  
MK 1002P (dual 128 bit Shift Reg) 35p.  
LM711CH (Voltage Comparator) 30p.

### (All Full Spec)

2526 Character Generator (64 x 9 x 9) £2.95 + data & p&p 25p.  
**International rectifier SOLID STATE RELAY** type A2402. Output 240 VAC 2.5 amps input 90-240 VAC/45-200 VDC **£6.00** p/p 25p.

### D TYPE CONNECTORS

15 Way: wirewrap plugs only **75p**.  
25 Way: sockets (solder) **£1.40**.  
50 Way: skt (wirewrap) **£1.65**.  
50 Way: skt **£1.45**, p&p 25p

### COVERS

25 Way: **75p** (plastic), p&p 25p.  
37 Way: **90p** (plastic), p&p 25p.

### DISPLAYS

HP 5082 4 digit DIL display full spec **£1.50** each, p&p 25p. Large quantities POA.  
MAN 72 7 seg CC **£1.25**, p&p 25p. Burroughs Panaplex 9 Dig. + skt and bezel **£1.00**, p&p 25p.  
LED 3 Digit DIL **55p**, p&p 25p.  
Bowmar 9 digit. 1 in LED with red bezel. (As used in calculators). **£1.00 + 25p** p&p.

### SUPERSAVER

Ribbon Cable Headers 16 DIL Jermyn, gold plated, with cover 45p, p&p 25p.

### SUPERSAVER 2

Tantalum Capacitors 25 volt. 4.7 uF. 14 for **£1.00**, p&p 25p.

### SUPERSAVER 3

**PRICE SMASH FND 500** 5in. LED displays, full spec **50p** each, p&p 25p, large quantities POA.

### SUPERSAVER 4

**HYBRID SYSTEMS DAC 371-8** 8 Bit. DIL packaged, ideal MPU users with data. **£2.95**, p&p 25p.

### SUPERSAVER 5

**Battery eliminator 6VDC 200MA 240V AC** input ideal for calculators, radio, etc., give away price **95p** each. Large quantities P.O.A.

### SUPERSAVER 6

**RS 338-383** Miniature Decade Thumbwheelswitch. **£1.65**, p&p 25p.

### SUPERSAVER 7

SN74116 Dual 4 Bit latch **75p**, p&p 25p.  
SN7418 Arithmetic Logic Unit, **80p**, p&p 25p.  
SN74194 4 Bit Register, **50p** p&p 25p.  
SN74198 8 Bit Shift Register, **75p** p&p 25p.

### SUPERSAVER 8

**ITT 4cx 250b** brand new full spec **£7.50** each p&p 25p.

### SUPERSAVER 9

5 digit 7 segment DIL LED 11" displays 4 for **£1.50** p/p 25p.

### SUPERSAVER 10

9 way male/female connector, ELCO B129, 0.1 inch pitch, gold-plated PCB mounting, ideal for bussing two PCBs together. Superb value. **35p**, p&p 25p.

### SUPERSAVER 11

74LS266 **50p**. 74LS245 **£2.40**. 74LS240 **£1.00**. 74S260 **35p**. P&P on all above 25p.

### SUPERSAVER 12

TMS 3128NC Static shift register. **£1.50**, p&p 25p.

### SUPERSAVER 13

PL259 (UHF) Elbow Connectors. **50p** each, p&p 25p.

### SUPERSAVER 14

Recording Designs Ltd digital cassette deck 50-100 Baud RS232 240V input. A professional superb deck. **£68.00**, p&p £2.00.

### SUPERSAVER 15

5K multitrans trimtops. PCB mounting, per box of 14 **£2.50**, p&p 25p.

### SUPERSAVER 16

Yet another star bargain. Astec UM111E36 modulator 65p each, p&p 25p.

### LEDs (Full spec.)

TIL209, red 10p. 0.2in. red 12p. 0.2in. green 28p. 0.2in. yellow 28p.  
RL54 red Axial lead. 15p. P&P on all above 25p.

**VERNITRON** Ceramic filters type FM4 10yMHz **45p**, p&p 25p.

**TRANSISTORS**, 8D236 **40p**, 8C183L **10p**, 8F195 **10p**, T8A 810S, with data, **85p**, 4-way DIL switches, **75p**. MC1303 Dual Stereo preamp with data. **£1.25**.

7in. Nylon cable ties 100 for **£1.50**. All p&p 25p.

**NEW SN76477** (Yes, back in stock) Sound Generator IC (Train, plane, explosion, laser gun, etc.) with data **£3.25**, p&p 25p.

**PCB KEYBOARD**, 65mm x 82mm, 18 key Clickers less Key tops, ideal Hexadecimal use **35p**, p&p 25p.

**CAPACITOR SCOOP**, 1 600uF at 10v, 160uF at 25v. Axial lead. 2 dozen for **£1 + 25p** p&p.

**MINI FANS** 80mm x 80mm approx. 115v Brand new, **£4.50 + £1.00** p&p.

IEC mains chassis plug 75p suitable socket **35p**, p&p 25p.

**GIVEAWAY**  
22 pin low profile dill socket, gold plated.

**12p EACH**  
**p&p 25p**

### Just arrived. ITT 2082 Data Modem. Brand new and boxed, with manual. 600/1200 Baud. Data Modem to CC ITT. V24/RS232C. Channel centre frequencies 1300 and 1700Hz (600 Baud) or 1300 and 2100Hz (1200 Baud). Synchronous or asynchronous operation over 2 or 4 wire, switch or dedicated lines, built in self and lines test functions. Some of the best equipment we have ever obtained. £115.00 each, p&p £3.00. (Fraction of original cost).

Recordacall telephone answering machines (GPO line matching transformer removed) sold as is from **£2 to £10** depending on condition. Fitted with very nice standard cassette deck. With circuit diagrams. SORRY BUT FOR CALLERS ONLY.

Terms cash with order (official orders welcomed from colleges, etc.). All enquiries s.a.e. please. All prices inclusive of VAT, unless otherwise stated. Postage as shown per item.

**FOR THE PROFESSIONAL USER.** CP Clare Keyboard switches with buttons (blank) 65p each p&p 25p.

**BURROUGHS** keyboard, 96 key station. On-board crystal and TTL. Brand new and boxed. 500mm x 190mm. At the time of advert no data. No keytops at all. Clare pender. Reed switches. Bargain **£12.00** each, p&p **£1.00**.

**PLEASE DO NOT ORDER GOODS FROM OLD ADVERTS. PHONE BEFORE ORDERING.**

**WE STOCK** a vast range of TTL, CMOS, some 74LS, MINIATURE TOGGLES, etc.

**TSUs.** We have a large stock of power supplies at very realistic prices (callers).

**RELAYS**  
ITT 700 ohm Single pole changeover, 45p. 8anor resettable double pole changeover 12V **£1**. 80th p&p 25p.

**CIRCUIT BREAKERS**  
4450v AC 65v DC 0.5A 50p; ditto 7A 80p, p&p 25p.  
**ALLEN KEYS**, 7/16in 5p; 12 for 50p; p&p 25p.

**ASR33** (with tape punch reader), generally overhauled. **£185.00** inc. of VAT.

**CENTRONICS 101A** Dot Matrix printer. Fully overhauled, 165 char/sec. **£450.00** inc. VAT. Carriage at cost. As above dug head. **£300** char/sec **£650** inc. VAT.

**MEMOREX 651** dual disk drives complete with power supplies and format electronics (sorry, no data as yet). **£350** each inc. of VAT.

Recordacall telephone answering machines (GPO line matching transformer removed) sold as is from **£2 to £10** depending on condition. Fitted with very nice standard cassette deck. With circuit diagrams. SORRY BUT FOR CALLERS ONLY.

Terms cash with order (official orders welcomed from colleges, etc.). All enquiries s.a.e. please. All prices inclusive of VAT, unless otherwise stated. Postage as shown per item.

**FOR THE PROFESSIONAL USER.** CP Clare Keyboard switches with buttons (blank) 65p each p&p 25p.

**BURROUGHS** keyboard, 96 key station. On-board crystal and TTL. Brand new and boxed. 500mm x 190mm. At the time of advert no data. No keytops at all. Clare pender. Reed switches. Bargain **£12.00** each, p&p **£1.00**.

**PLEASE DO NOT ORDER GOODS FROM OLD ADVERTS. PHONE BEFORE ORDERING.**

**WE STOCK** a vast range of TTL, CMOS, some 74LS, MINIATURE TOGGLES, etc.

**TSUs.** We have a large stock of power supplies at very realistic prices (callers).

**RELAYS**  
ITT 700 ohm Single pole changeover, 45p. 8anor resettable double pole changeover 12V **£1**. 80th p&p 25p.

**CIRCUIT BREAKERS**  
4450v AC 65v DC 0.5A 50p; ditto 7A 80p, p&p 25p.  
**ALLEN KEYS**, 7/16in 5p; 12 for 50p; p&p 25p.

**ASR33** (with tape punch reader), generally overhauled. **£185.00** inc. of VAT.

**CENTRONICS 101A** Dot Matrix printer. Fully overhauled, 165 char/sec. **£450.00** inc. VAT. Carriage at cost. As above dug head. **£300** char/sec **£650** inc. VAT.

**MEMOREX 651** dual disk drives complete with power supplies and format electronics (sorry, no data as yet). **£350** each inc. of VAT.

**SURPLUS STOCKS PURCHASED FOR CASH**

**LB ELECTRONICS**  
11 HERCULES ROAD  
HILLINGDON, MIDDLESEX  
UB10 9LS, ENGLAND  
All enquiries s.a.e. please

New retail premises, now open Mon., Tues., Thurs., Fri. and Sat. 9.30-6. Lunch 1-2.15 weekdays. Closed all day Wednesday. We are situated just off the A40 opposite Master Brewer.



**UXBRIDGE 55399**

All components full spec.

# GREENWELD

443A Millbrook Road Southampton SO1 0HX

All prices include VAT @ 15% — just add 40p post

## SLIDER POT SCOOP!!!

Made by Pher, types PL40CP & PL60C Silly prices for superb goods!  
 PL40CP — 69x16x9mm, 40mm slide length 220R, 2k2 or 10k lin only. Prices (any mix): 1-24 20p; 25-99 17p; 100+ 14p.  
 PL60C — 84x10x7mm, 60mm slide length 5k, 10k, 22k and 100k log. only Prices (any mix) 1-24 26p; 25-99 22p; 100+ 17p.

## BUZZERS, MOTORS & RELAYS

2401 Powerful 6V DC buzzer, all metal construction 50mm dia x 20mm 70p.  
 2402 Miniature type buzzer, 6, 9 or 12V, only 22x15x16mm Very neat 53p.  
 2450 Miniature 6V DC motor, high quality type 32mm dia x 25mm high, with 12mm spindle Only 11p.  
 A372 Audible Warning device — solid state circuit drives high efficiency transducer to give high output Voltage read 4-18V. Can also be driven direct from TTL or CMOS. Module size 45x21x12mm. Comprehensive data supplied £1.50  
 WB92 Heavy Duty 12V relay, ideal for car use — single 15A make contact. Coil 25R in sealed metal can with mounting bracket 85p.  
 WB90 DIL Reed relay SPCO 2.4-10V. 200R coil Only £2.20.  
 F5RA60 Latching relay, 2 x 10A contacts, 1M, 1B. Coil is 250R, and rated 60V ac, but works on 18-24 DC. Solid Encapsulation with screw terminals makes it ideal for use. £1.20.

## REGULATED PSU PANEL

Exclusive Greenweld design — better spec, than anything on the market being offered at the price. Panel 110x82x33mm high contains all components including bridge rectifier and smoothing capacitor. Ready built and tested — just add a 30V 2A transformer and two pots for a fully variable voltage and current supply  
 SPEC ½ Output voltage 0-28V  
 ½ Source current 20mA-2A  
 ½ Source Impedance 0R1  
 Open circuit ripple 10mV  
 Send SAE for full details of the many ways this useful module can be used, together with price list of parts for various options. Only £8.75

## TRANSISTOR PACK K516

Take advantage of this unbelievable offer!! Small signal NPN/PNP transistors in plastic package at an incredibly low, low price!! Almost all are marked with type number — almost all are full spec devices. Some have bent leads. Over 30 different types have been found by us including BC184/212/238/307/328. BF196/7. ZTX107/8/9/342/450/550, etc. Only available as a mixed pack at £3 per 100. £7 per 250 £25 per 1000.

## P.C. ETCHING KIT Mk IV

The best value in etching kits on the market — contains 100 sq ins copper clad board, 1lb Ferric Chloride, Etch resist pen, abrasive cleaner, two miniature drill bits, etching dish and instructions All for £4.95.

## 1981 CATALOGUE

Now in the process of compilation, available NOV 75p will reserve you a copy, sent as soon as printed.

## BULK SUPPLIES

All new full spec. devices. Prices are for a minimum of 100 of any one device and exclude VAT, which must be added at 15%. Minimum order value from this section is £10+VAT+post. VAT receipt on request.

### RESISTORS

Min ¼W 5% carbon film 1R-10M (10% over 1M), all £8.00/1000  
 The following values only at £3.50/1,000, per value 4R7, 8R2, 18R, 39R 56R, 220R, 1k, 4k7, 18k, 33k, 39k, 47k, 220k, 390k, 560k, 680k, 820k.

### MIN. PRESETS

0.1W miniature type, open construction. All values from 100R to 1M, vertical or horizontal mounting. All at .042.  
 The following values only at .03 470R, 470R, 500R, 1k, 1k5, 2k, 2k2, 2k5, 4k7, 10k. Also some Pher enclosed type at .042 150RV, 200RH, 2kV.

### POTS

5k lin 100k lin, 220k lin, 500k log, 1M lin. All with std. bush and spindle. .14.

### ELECTROLYTIC CAPS

2'2725 R	.028	477'63 R	.045
2'2'63 A	.032	100/6 3 A	.020
4'7'10 R	.022	100/35 R PC	.035
4'7'25 R	.028	220/16 A	.055
4'7'50 R	.034	220/25 R	.065
10/16 R	.030	220/70 A	.075
10/25 R	.032	330/50 A	.075
10/25 R PC	.022	330/100 A	.085
10/25 A	.035	470/16 R	.060
10/50 A	.040	470/100 RC	.150
10/100 R	.042	1000/40 A	.230
15/40 A	.030	1000/63 A	.280
22/10 R	.021	2200/10 A	.080
22/25 A	.025	2200/25 A	.100
22/25 R	.027	2200/40 RC	.350
22/63 A	.040	3300/10 A	.090
33/16 A	.022	3300/25 A	.180
47/6 A	.015	4700/10 A	.100
47/25 A	.032	4700/25 RC	.250
47/35 R	.038	4700/40 RC	.35
47/40 A	.045	10000/15 RC	.250

R = radial leads  
 A = axial leads  
 RC = tag ended can

## BUY A COMPLETE RANGE OF COMPONENTS AND THESE PACKS WILL HELP YOU

ALL PACKS CONTAIN FULL SPEC. BRAND NEW MARKED DEVICES — SENT BY RETURN OF POST. VAT INCLUSIVE PRICES

**K001** 50V ceramic plate capacitors, 5%, 10 of each value 22pF to 1,000pF, total 210. £3.89.  
**K002** Extended range 22pF to 0.1µF, 330 values £5.53.  
**K003** Polyester capacitors, 10 each of these values 0.01, 0.015, 0.022, 0.033, 0.047, 0.068, 0.1, 0.15, 0.22, 0.33, 0.47µ, 110 altogether for £8.07.  
**K004** Mylar capacitors, min 100V type 10 each all values from 1,000pF to 10,000pF. Total 130 for £4.05.  
**K007** Electrolytic capacitors 25V working small physical size, 10 each of these popular values 1, 2, 4, 7, 10, 22, 47, 100µF, total 70 for £3.59.  
**K008** Extended range, as above, also including 220, 470 and 1000µF. Total of 100 for £6.05.  
**K021** Miniature carbon film 5% resistors CR25 or similar 10 of each value from 10R to 1M, E12 series, Total 610 resistors £8.15.  
**K022** Extended range, Total 850 resistors from 1R to 10M £8.50.  
**K041** Zener diodes 400mW 5% BZY88, etc. 10 of each value from 2.7V to 36V, E24 series. Total 280 for £16.37.

## TM4030 RAM

4096 bit dynamic RAM with 300ns access time; 470ns cycle time; single low capacitance high level clock i/p, fully TTL compatible, low power dissipation. Supplied with date £2.75.

## COMPONENT PANELS

2525 Contains 11 800mA 60V 2N5061 SCRs, 11 6V8 zeners, 11 1N4004 diodes plus Rs, Cs, etc. Only £1.  
 2529 74 Series ICs — Gates and complex logic, 20 assd ICs on panels £1; 100 ICs £4.  
 2527 2x6V reed relays 6x25030 or 25230 6x400V reeds, plus Rs. Only 80p.  
 2531 Trimpot Pack — Ex-computer panels with 20 mixed value multi-turn types £1.00.

## TTL, LINEAR, OPTO

All new full spec — Fairchild/SGS  
 TTL: 5400, 5401, 5402, 5403, 5404, 5405, 5410, 5421, 5430, 5450, 5451, 5453, 5460 — All 12p ea. 5470, 5472, 5474, 5475, 5476, 5480, 5486, 5490, 54107, 54121, 54122 — all 20p ea. 5482, 54126 — 40p ea. Others (74S, H) on B/L 12 (SAE please)  
 LINEAR: 9665 or 9666, 7 x 50V Darlingtons in 16 DIL 80p; 75452 or 4 dual perov driver 70p; XK1444 7 CMOS P-channel buffers, 15V 16 DIL 24p.  
 OPTO: Isolators, FCD831 80p; TTL115/118 80p; FPE100/106 Infra red LED £2.50; FND847 7 seg 0.8" CA £2.00; FND850 CC £2.00. (Date on request for linear & opto devices)

## VEROBLOC BREADBOARD

New from Verobloc, this versatile aid for building and testing circuits can accommodate any size of IC. Blocks can be joined together. Bus strips on X & Y axis — total 360 connection points for just £4.15.

## POLYESTER CAPS

01	400V	C296	.025
015	250V	C280	.025
022	400V	C280	.025
068	250V	Advance	.025
120	250V	C280	.035
22	250V	Advance	.035
22	100V	Mini-box	.035
47	250V	C280	.05
47	160V	C296	.04
10	250V	C280	.055
15	83V	Filmcap	.065
22	160V	Filmcap	.085
33	100V	Wima MKS	.15
47	100V	C281	.195
47	100V	Wima MKS	.235
68	100V	Wima MKS	.285

## LED'S TANT BEADS

3mm red	.055	5mm yellow	.09	1 5/35	.06
3mm yellow	.08	5mm green	.09	3 3/25	.08
3mm green	.08	3mm clips	.02	10/25	.15
5mm red	.08	5mm clips	.02		

## MINIATURE CERAMIC CAPS

Thompson/CSF miniature type in the following values  
 3.9pF, 4.7pF, 22pF, 33pF, 47pF, 47pF, 68pF, 82pF, 100pF, 560pF, 2700pF. All 5% except 10%, ±20%  
 Prices, up to 82pF £7/1000  
 100pF £9/1000  
 560pF £5/1000  
 2700pF £9/1000  
 Samples on request (see please)  
 Mullard min. ceramics  
 33pF 5% 100V £7/1000  
 330pF 2% 100V £8/1000  
 3300pF 10% 100V £13/1000  
 Stettner min. ceramics  
 330pF 5% 63V £7/1000  
 022µF 63V £14/1000  
 Lemco 047µF 63V £16/1000

## SEMICONDUCTORS

741, 12, 555, 19, 7401, 08, 7405, 09, 74174, 21, 4001, 17, 4011, 17 S1 signal diodes like IN4148 by TI on banded reels of 10k £80 (1k £10) IN4002 £25/k IN4006 £34/k, IN4007 £36/k. Ge signal diode DK14 £20/k SCRs 2P4M (C106D) 4A 400V .26 2N5060 8A 30V .16 CR201 1A 200V .18.  
 See July's advt for transistors, send sep for latest bulb buyers list

# YOUR COMPLETE RANGE OF BOSS ELECTRONIC HARDWARE

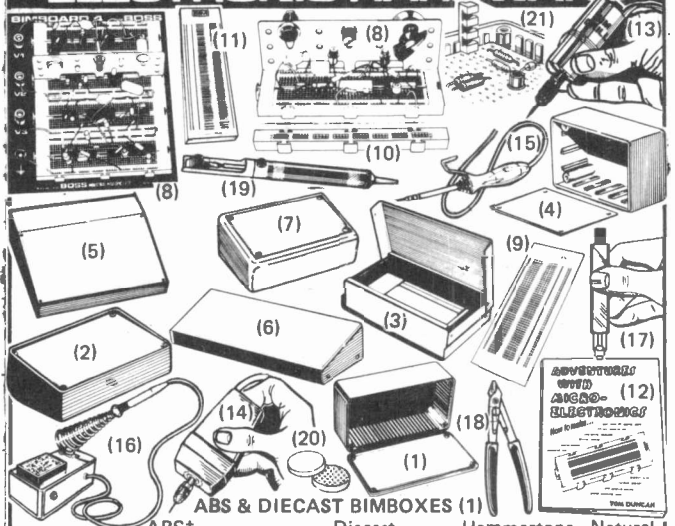

## ABS & DIECAST BIMBOXES (1)

	ABS	Diecast	Hammertone	Natural
(50x50x25)	N/A	BIM5001/11	£1.54	£1.23
(100x50x25)	BIM2002/12	£1.09	BIM5002/12	£1.66
(112x62x31)	BIM2003/13	£1.27	BIM5003/13	£2.24
(120x65x40)	BIM2004/14	£1.51	BIM5004/14	£2.81
(150x80x50)*	BIM2005/15	£1.72	BIM5005/15	£3.19
(190x110x60)	BIM2006/16	£2.69	BIM5006/16	£4.94
(112x61x31)	BIM2007/17	Grey Polystyrene	£1.06	

\*BIM2005 with + 25 deep, clear or ABS lid = BIM2005/25 £2.73)  
**MINI DESK BIMCONSOLES (2)** ALL METAL BIMCASE (3)  
 BIM1005 (161x96x58) £2.48 BIM3000 (250x168x69) £15.52  
 BIM1006 (215x130x75) £3.48 (Red, Orange and Grey, Black Chassis)  
**MULTI-PURPOSE BIMBOXES (4)** KEYBOARD BIMCONSOLES (6)  
 BIM4003 (85x56x29) £1.34 BIM7400 (355x178x102) £19.60  
 BIM4004 (111x71x42) £1.84 BIM7401 (431x178x102) £22.54  
 BIM4005 (161x96x53) £2.48 BIM7402 (508x178x102) £26.25  
**LOW PROFILE BIMCONSOLES (5)** (Black Base—Sand or Grey Top)  
 BIM6005 (143x105x56[32]) £2.76 EUROCARD BIMCONSOLES (7)  
 BIM6006 (143x170x65[32]) £3.58 BIM8005 (169x127x70[45]) £4.71  
 BIM6007 (214x170x82[32]) £4.83 BIM8007 (243x187x103[66]) £6.70  
 (All BIMENCLOSURES Blue, Grey, Orange, Black, †BIM2000 White also)

**DIL COMPATIBLE BIMBOARDS & ACCESSORIES**  
 BIMBOARDS (8) '1' £6.90, '2' £21.17, '3' £28.22, '4' £36.12.  
 PC BIMBOARD (9) £1.72.  
 BIMBUSTRIP (10) £2.50. BIMBOARD LAYOUT PAD (11) £0.65.  
 "Adventures with Microelectronics" [Features BIMBOARD] (12) £2.15  
 12 VOLTS BIMDRILLS (13) MiniDrill £8.10 Major Drill £13.60  
 Mini Kit 1 £15.12 Mini Kit 2 £34.02 Mini Kit 3 £45.36  
 Major Kit 1 £19.44 Major Kit 2 £39.42 Major Kit 3 £50.76  
**MAINS BIMDRILL (14)** £10.53 Mains Kit 1 £2.48 Mains Kit 2 £22.14  
**BIMIRON (15)** Type 30 (27W) £4.05, Type 3M (17W) £4.43  
**BIMSTATION (16)** £11.96 BIMDIP (17) £11.50.  
**BIMSNIPS (18)** £3.15 BIMPUMP (19) Major £7.99, Minor £6.80.  
**BIMFEET (24) (20)** £0.77 BIMDAPTORS (25) (21) £1.08

# BOSS INDUSTRIAL MOULDINGS LTD

2 Herne Hill Road, London SE24 0AU, England  
 Tel: 01-737 2383 Telex: 919693

Type No./Name	Colour	Qty.	Unit Price	Total

All prices are applicable from Sept 1 1980, include VAT & PP but please add 15% for Overseas Orders.

Name .....

Company .....

Telephone Number ..... ETI/11

Please make cheque/P.O. payable to BOSS Industrial Mouldings Ltd and allow 10 days for cheque clearance and order processing.

£395  
incl.VAT& P&P



**micron**

'MICRON' may sound small - but we all know that it's much larger than an atom!

The un-beatable features of Microtan 65 and Tanex have been brought together to give you **Micron**, a ready built and tested computer of outstanding value. Fully supported by comprehensive documentation, **Micron** represents an ideal starting point in personal computing. We've taken a full O.E.M. licence for Microsoft Basic, which means that you'll have the support of the most popular Basic available, (as used on PET, APPLE, TANDY etc.). If you want to expand **Micron** there's no problem, just move into the system rack and choose from the range of Microtan modules. Read the information, study what the magazines have to say about us and compare what we have to offer with other systems, then we feel sure that you'll be convinced that we've produced an excellent product.

- FULLY BUILT, TESTED AND CASED.
- 6502 BASED MICROCOMPUTER.
- VDU ALPHA NUMERIC DISPLAY.
- 8K RAM.
- 32 PARALLEL I/O LINES.
- 2 TTL SERIAL I/O LINES.
- 1 SERIAL I/O PORT WITH RS232/20mA LOOP, AND 16 PROGRAMMABLE BAUD RATES.
- 300 / 2400 BAUD FILENAMED CASS. INTERFACE.
- DATA BUS BUFFERING.
- MEMORY MAPPING CONTROL.
- 71 KEY ASCII KEYBOARD, INCLUDING NUMERIC KEYPAD.
- POWER SUPPLY INCLUDED.

#### SOFTWARE

- 10K EXTENDED MICROSOFT BASIC.
- ALL THE USUAL BASIC COMMANDS.
- INTEGER AND REAL NUMBERS.
- INTEGER AND REAL ARRAYS.
- INTRINSIC FUNCTIONS: ABS, INT, RND, SGN, SIN, SQR, TAB, USR, ATN, COS, EXP, LOG, TAN.
- USER DEFINED FUNCTIONS.
- READ AND DATA STATEMENTS.
- DUMP AND LOAD PROGRAMS.
- PROGRAM EDITING COMMAND.
- STRING FUNCTION FOR TEXT I/O.
- BASIC CAN CALL MACHINE CODE SUB-ROUTINE.
- USER MACHINE CODE INTERRUPT HANDLER INTERFACES WITH BASIC.
- XBUG.
- DATA CASSETTE FILE HANDLING IN BASIC

**TANGERINE**  
COMPUTER SYSTEMS LIMITED

Forehill Works  
Forehill Ely Cambs England Tel: (0353)3633

# microtan 65

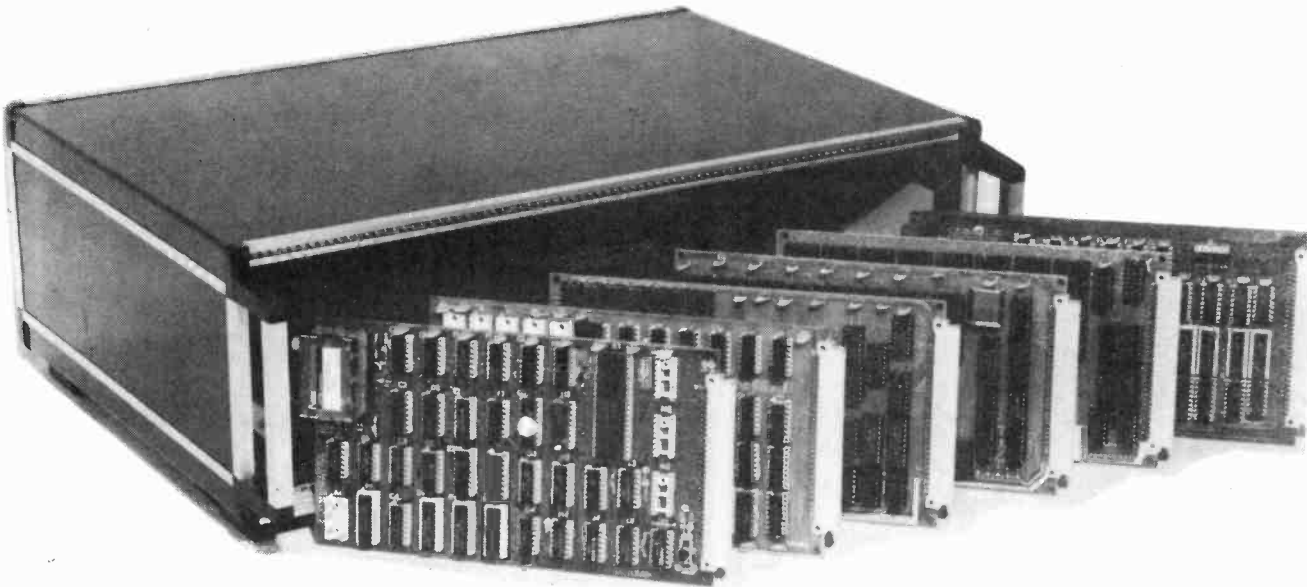

The Microtan system is rapidly becoming accepted as the ultimate approach to personal computing. Start with Microtan 65, a 6502 based single board computer, and expand to a powerful system in simple and in-expensive stages. The Microtan system is a concept and not an afterthought, this means expansion is easy and very efficient! Unlike many other systems, you'll find it difficult to outgrow Microtan, and you won't be wasting your money on a product that will only last you a few months! When you are ready to expand, Tanex is waiting. The features offered by Tanex are tremendous, and you can start into them for just £49.45! Cassette interface, 16 I/O lines, two 16 bit counter timers, data bus buffering, memory mapping and a further 1K of RAM are standard. From thereon expansion is simple, just plug in extra integrated circuits to get yourself 8K of RAM, a further 16 I/O lines and two more counter timers a serial I/O line with RS232/20mA loop and full modem control, XBUG - a firmware package containing cassette file handling routines, plus a line-by-line assembler (translator) and dis-assembler, PLUS 10K EXTENDED MICROSOFT BASIC, a suped-up version of the Basic as used by major manufacturers such as Apple, Tandy and Nascom, NO OTHER LOW COST MICROCOMPUTER OFFERS YOU THIS SUPERB PACKAGE. O.K. so you want more memory, try Tanram for size! Upto 40K bytes on one board starting for as little as £50.60. RAM freaks will be pleased to hear that our system mother board offers page memory logic which will support 277K Bytes, satisfied? To house these beautiful modules you can choose between our mini-rack (as used on Micron), which accepts Microtan and Tanex, or our system rack pictured above. The system rack will support 12 modules. What are these extra modules? Well for starters there's a couple of I/O modules, parallel and serial offering upto 128 I/O lines organised as 16 8 bit ports and 8 serial I/O ports respectively. Shortly we'll be introducing high definition (256x256) colour graphics, A to D and D to A modules, IEEE 488 Bus interface, a PROM programmer, disc controller and TANDOS - a 6502 CPM system. So there's plenty to keep you busy. Send for more details, and find out how you can get started for just £79.35!

ALL PRICES QUOTED INCLUDE V.A.T.

## AIM 65, KIM 1, SIM 1 USERS- READ ON!

We have produced a T.V. interface module which simply connects to the expansion socket of your computer and produces a display of 16 rows by 40 characters! Of even more interest will be our Buffer module, which allows you to expand into our system rack, giving you access to the full range of Microtan modules.

Please underline the information required.

AIM T.V. INTERFACE.      MICROTAN SYSTEM.

NAME: \_\_\_\_\_

ADDRESS: \_\_\_\_\_

PLEASE ENCLOSE 12p STAMP. THANK YOU. \_\_\_\_\_

# HAMEG

OSCILLOSCOPES

TOP PERFORMANCE,  
QUALITY AND VALUE



**HM 307** ..... £149  
Single Trace DC-10MHz  
Plus Built-in Component  
Tester

**HM 312** ..... £250

Dual Trace DC-20MHz  
5mV/cm, Full X-Y, 30MHz  
Trigger, plus TV Trigger

**HM 412** ..... £350

Dual Trace DC-20MHz  
5mV/cm, X-Y, 40MHz Trigger  
plus Sweep Delay

**HM 512** ..... £580

Dual Trace DC-50MHz  
5mV/cm, X-Y, 70MHz  
Trigger Sweep Delay, plus Single  
Shot, Sweep Delay and After  
Delay Trigger



**HM 812** ..... £1,458

Dual Trace as per HM 512 plus  
Storage, Automatic Storage and  
Variable Persistence

Prices U.K.  
List Ex. VAT

For  
FULL DETAILS and  
DISTRIBUTOR LIST  
contact:

**HAMEG LTD.**  
74-78 Collingdon St.  
Luton, Beds LU1 1RX  
Tel: (0582) 413174



# Wilmslow Audio

*THE firm for speakers!*

SEND 50P FOR THE WORLD'S BEST CATALOGUE OF SPEAKERS, DRIVE UNITS, KITS, CROSSOVERS ETC, AND DISCOUNT PRICE LIST.

AUDAX - AUDIOMASTER - BAKER - BOWERS & WILKINS  
CASTLE - CELESTION - CHARTWELL - COLES - DALESFORD  
DECCA - EAGLE - ELAC - EMI - FANE - GAUSS - GOODMAN  
HARBETH - ISOPHON - I.M.F. - JORDON - JORDAN WATTS  
KEF - LOWTHER - MCKENZIE - MISSION - MONITOR AUDIO  
MOTOROLA - PEERLESS - RADFORD - RAM - ROGERS  
RICHARD ALLAN - SEAS - SHACKMAN - STAG - TANNAY  
VIDEOTONE - WHARFEDALE.

## WILMSLOW AUDIO

SWAN WORKS, BANK SQUARE  
WILMSLOW, CHESHIRE SK9 1HF

Tel. 0625-529599 FOR MAIL ORDER AND EXPORT OF  
DRIVE UNITS, KITS, ETC.

Tel. 0625-526213 (SWIFT OF WILMSLOW) FOR HI-FI  
AND COMPLETE SPEAKERS.

# Happy Memories

4116 200ns	£3.75	4116 150ns	£5.50
2114 450ns	£2.95	2114 200ns	£3.95
2708 450ns	£4.95	2716 5 volt	£9.95

**MEMOREX SOFT-SECTORED MINI-DISCS** for  
PET, TRS-80, etc. Supplied in **Free Library Case**  
£19.95 per 10

### Low Profile I.C. Sockets by Texas

Pins	8	14	16	18	20	22	24	28	40
Pence	10	11	12	16	17	20	21	28	37

**Memory Upgrade Kits** for Apple, 2020, TRS-80,  
etc. from £30 please phone

Quantity prices available on request. Government  
and Educational Orders welcome. Trade accounts  
opened.

ALL PRICES INCLUDE V.A.T. POSTAGE FREE ON  
ORDERS OVER £10, OTHERWISE ADD 30p.

*Access and Barclaycard Welcome*

**HAPPY MEMORIES**  
Dept. ETI  
Gladestry, Kington  
Herefordshire HR5 3NY  
Telephone (054422) 618

# CLASSIFIED

## RATES

1-3 insertions £7 per scc  
 4-11 insertions £6.50 per scc  
 12 insertions £6 per scc  
 24p per word (min. 15 words)  
 Box No. of application

All advertisements in this section must be pre-paid  
 Closing Date:- 1st Fri. month preceding publication

Advertisements are accepted subject to the terms and conditions printed on the advertisement rate card (available on request).

SEND TO:- ETI CLASSIFIED, 145, CHARING CROSS ROAD, LONDON WC2H 0EE.

TEL: 01-437 1002

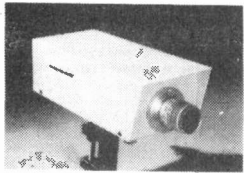

CAMERA  
CCTV

£110.00 + P/P £3.45 (inc. VAT)  
 + VAT (£16.50) Optional extra manual  
 £6 Total £129.95

**BEST OFFER EVER**

**Camera Kit, Lens,  
 Vidicon & Modulator**

**CROFTON**

Tel: 01-891 1923 For full details

**INTERNATIONAL 4600 SYNTHESISER**, fully working, mint condition, professionally constructed and calibrated, housed in a robust cabinet. Must sell, hence only £300. Phone: Hull (0482) 701660 evenings.

**PET 2001-8**. Old ROM manuals, plus £200 worth of programs, only £400 ono. Phone 0442 49762.

**CIRCUIT DESIGN**, Prototype construction, Analogue or Digital, Single Circuits or Complete Instruments/Systems. Write A. J. ATTWOOD, C.Eng., MIERE, Heathercote, Heatherton Park, Taunton, Somerset, TA4 1ET or Phone Bradford-on-Tone (082-346) 536.

**SURPLUS**. Creed 75 Teleprinter £50, Creed 86R, new £50!! Venner time and frequency measuring equipment from £10. 5.5v-16v 2A psu's £20. Digital Voltmeters £15. Overhead projector (viewgraph), new £60. Electronic equipment, machinery and transport. Ex Service Sales, Weymouth 75115.

**NEW WORLD'S FIRST SHARP POCKET COMPUTER PC-1211**  
 Complete with Cassette Interface CE-121 as reviewed in ETI (Aug). Practical Coming (July) Ideal Christmas Gift. Send £115 incl. VAT and P & P to:  
**ELKAN ELECTRONICS**  
 28 Bury New Road  
 Prestwick, Manchester M25 8LD

## SUPERBOARD II

STILL the best value in Home Computers. Just compare the features:

- \* 8K floating point BASIC in ROM
- \* Full ASC11 keyboard
- \* Standard cassette/TV interface
- \* RS232 printer interface
- \* 4K user RAM
- \* Expandable to 32K & dual mini floppy.

AVAILABLE NOW from:

**C.T.S.**  
 31/33 Church Street  
 Littleborough  
 Lancs.

Please ring or write for latest prices

Tel: Littleborough (0706) 74342 any time

**ZX80 ACTIVE DISPLAY**. Now you can write those games or use the ZX80 for 'hands off' continuous data monitoring. This routine allows you to decide how long a display will hold before your program continues (1/50 sec — approx. 10 mins.). Hex loader included, only £5 inclusive for listing and details. K. Macdonald, 26 Spiers Close, Knowle, Solihull B93 9ES.

## BARGAINS FOR THE QUARTZ ELECTRONIC HANDYMAN BRANDED QUARTZ ALARM CLOCKS

ORIENT/PRESIDENT JAPANESE

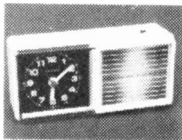

(1)

KIENZLE/PRESIDENT GERMAN



(2)

Returned to Service Department within guarantee period

- (1) Recommended price when perfect £12.95. To facilitate repair 5 offered for £11.95 inclusive of VAT
- (2) Recommended price when perfect £12.95. To facilitate repair 5 offered for £11.95 inclusive of VAT

These will be sold as received from our customers with the existing fault(s) and without guarantee

UK ONLY

Discounts available on large bulk purchases.

**PRESCOTT CLOCK & WATCH CO. LTD.**

Prescott House, Humber Road, London NW2 6ER

## INTENSIVE COURSES IN

### BASIC AND PASCAL

including hands on mini-computer operation

These intensive courses are intended to instruct from minimal knowledge to an operational capability of computer programming.

Courses are fully residential, allowing maximum time for instruction and programming.

**BASIC** — Weekends from Friday Evening to Sunday Afternoon.

**PASCAL** — Weekdays Monday Morning to Friday Afternoon inclusive.

For further details, dates available, fees

Phone (0401) 43139, or write  
**CLEVELAND BUSINESS SERVICES**  
 (Dept. ETI-2), Cleveland House  
 Routh, North Humberside HU17 9SR

**ETI 1972/3**, HE 1978/9, Elektor 1-16, PW 1966-70, PE 1964-70, REC 1969-75, PE/PW/REC 50p. Others 70p. SAE for refund if sold. C. Redwood, 45A Lulworth Avenue, Poole, Dorset.

**ELECTRONIC ENGINEERS**. Research & Development. Quality Assurance, Project and Section Leaders, Test Technicians, Instrument Mechanics (time served) qualified to HNC standard, required for posts within the UK. Relocation expenses paid where applicable. Apply in writing to Mr. R. Somerville, Topstaff Employment Ltd., 5 Dixon Street, Glasgow G1 4AL.

**UK101**. Fully built, tested with 8K RAM. Complete with case and power supply. Assembler and other programs on tape. A bargain at £285. Milton Keynes (0908) 76596.

## ASSEMBLY & WIRING SERVICES

P.c.b. assembly. Panel wiring. Video game/home comp. assembly. Design Development. Q.C. / Insp./Test. Prototype. Pre-Production etc.

LARGE/SMALL BATCH or HOBBY

For these and general services at competitive rates contact.

**BRAINTREE MICRO LEISURE LTD.**  
 92 Manor Street, Braintree, Essex  
 Phone: Three Rivers 28196 (STD 03763)

## LAMP STRINGS

Kit LS-1. Each Kit contains: 200 Lamps (50 each Red, Blue, Yellow, Green). 200 Pre Cut Leads, 400 Sleeves plus Instructions.

Easy to Construct. Ideal for

**DISCOS, SHOPS, DISPLAYS, XMAS DECORATIONS ETC.**

LS-1 c/w Instructions ..... **£10.00**  
SL-1 100 Spare Lamps (25 each colour) ..... **£5.75**

Prices include VAT and P&P

**J & H ASSOCIATES LTD.**

The Maltings  
Station Road

Sawbridgeworth, Herts

Tel: 0279-723156 Telex: 81675

JLamps-G

Trade Enquiries Invited

## stereo light controllers

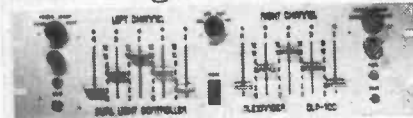

STROBE/RANDOM/CHASER/SOUND/DIMMING  
\*5+5 CHANNELS \*13" RACK MOUNTING  
zero-crossing switching \*opto-isolated drives  
complete unit, panel assembly, 5 channel modules

Kit	132.00	155.00	270.30
Panel assembly	132.25	155.25	270.35
5 channel modules	37.30	40.00	61.30

**alexander systems** 45 SHACKLETON SPRING STEVENAGE HERTS SAE FOR DETAILS

## ETCH RESIST TRANSFER KIT SIZE 1:1

Complete kit 13 sheets 6in x 4 1/2in **£3.00** with all symbols for direct application to P.C. board. Individual sheets 30p each.  
(1) Mixed Symbols (2) Lines 0.05 (3) Pads (4) Fish Plates and Connectors (5) 4 Lead and 3 Lead and Pads (6) DILs (7) BENDS 90° and 130° (8) 8-10-12 T.O.5. Cans (9) Edge Connectors 0.15 (10) Edge Connectors 0.1 (11) Lines 0.02 (12) Bends 0.02 (13) Quad, in Line.

## FRONT AND REAR PANEL TRANSFER SIGNS

All standard symbols and wording. Over 250 symbols, signs and words. Also available in reverse for perspex, etc. Choice of colours, red, blue, black, or white. Size of sheet 12in x 9in. Price **£1.20**.

## GRAPHIC TRANSFERS WITH SPACER ACCESSORIES

Available also in reverse lettering, colours red, blue, black or white. Each sheet 12in. x 9in contains capitals, lower case and numerals 1/2in kit or 1/4in kit. **£1.20** complete. State size.

All orders dispatched promptly.

All post paid

Shop and Trade enquiries welcome  
Special Transfers made to order

**E. R. NICHOLLS  
P.C.B. TRANSFERS**  
DEPT. ET111

46 LOWFIELD ROAD  
STOCKPORT, CHES. 061-480 2179

## FLEXIBLE — EXPANDABLE — BUDGETABLE THE COMMUNITY MIXER KIT

Not just another Mixer — but designed specifically for Hospital Radio, Talking Newspapers and similar users.  
Is there such a word as 'Budgetable'? Consult.

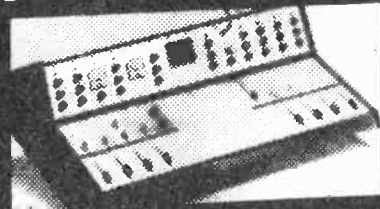

**Partridge Electronics**

56 Fleet Road, Benfleet, Essex SS7 5JN  
or call (03745) 3256 for the answer  
Barclay and Access welcome

## SPEED — VERSATILITY — ECONOMY



Designed originally for logic wiring applications, it is now accepted and used extensively throughout industry, education and research. ROADRUNNER is used by hobbyists, students, technicians, designers and engineers, to carry out work on:—  
\*P.C.B. REPAIRS \*ANALOGUE BREADBOARDING \*SIMPLE LOGIC WIRING \*COMPLEX INTERCONNECTING OF MICROS AND MEMORIES.

EURO INTROKIT **£16.70**. PROJECT KIT **£8.18**.  
MINIKIT (A) **£7**. PENCIL WITH LOADED 'QSE' BOBBIN **£2.81** WITH T.C.W. BOBBIN **£2.76**. STRIPS: GLUE FIX 20/PKT. 6" LONG **£3.20**. HIGH DENSITY GLUEFIX 20/PKT. 6" LONG **£3.20**. PRESS FIX 20/PKT. **£3.20**. SINGLE HIGH DENSITY D-SIDED EUROCARD **£5.18**. SINGLE SIDED **£3.80**. DOUBLE HIGH DENSITY D-SIDED EUROCARD **£8.60**. PROJECT CARD **£2.50**. BOBBINS: BLUE 4/PKT. **£2.12**. GREEN 4/PKT. **£2.12**. GOLD 4/PKT. **£2.12**. PINK 4/PKT. **£2.12**. 1 OF EACH COLOUR **£2.20**. TINNED COPPER 2/PKT. **£0.96**. ADHESIVE **£0.41**. SOLDERING IRON 420°C **£5.52**. REPLACEMENT WELDER TIPS — PTAAB 430°C **£1.40**. PTAAB 480°C **£1.40**.

Please add 40p for P&P + VAT to all orders  
FOR FURTHER INFORMATION ON  
ROADRUNNER PRODUCTS SEND  
LARGE S.A.E. TO:

**T. J. BRINE ASSOCIATES**  
FREEPOST, Haslemere, Surrey GU27 3BL

## ADAM HALL

Cabinet & Flightcase Fittings, fretcloths, coverings, handles, castors etc., Jacks & sockets, Cannons, Bulgins, reverb trays, Emilar compression drivers, AKG mics, Celestion speakers, ASS glassfibre horns.

Send 30p postal order for illustrated catalogues to:  
**ADAM HALL (E T SUPPLIES)**  
Unit B, Charlton Court  
Grainger Road, Southend-on-Sea  
Essex SS2 5BZ

**OSCILLOSCOPE £12**. Easy-build converter plugs into TV aerial socket and converts to large screen oscilloscope. (Components cost under £12). Circuit and plans **£3** — Kerr, 27 Coles Road, Milton, Cambridge, CB4 4BL. (Callers by appointment.)



ONLY  
**£1.85**  
(Incl. P&P)

10-amp Connector Block — in units of two segments. Pack of 100 segments.  
**£3.00** (incl. P&P)



**L.E.M. SERVICES**  
239 RUGBY ROAD  
LEAMINGTON SPA CV32 6DY  
WARWICKSHIRE

## SPECIAL PURCHASE TEMP. GAUGES 0°-120° C

Remote sensor on 38" capillary, snap fitting in 55 mm hole. Adjustment screw on back.

## DIGITAL WATCH BATTERY REPLACEMENT KIT



These watches all require battery (power cell) replacement at regular intervals. This kit provides the means. We supply eyeglass, non-magnetic tweezers, watch screw-driver, case knife and screwback case opener. Also one doz. assort. push-pieces, full instructions and battery identification chart. We then supply replacement batteries — you fit them. Begin now. Send **£9** for complete kit and get into a fast-growing business. Prompt despatch.



**BOLSTER INSTRUMENT CO. (ETI8)**  
11 Percy Avenue, Ashford, Middx. TW15 2PB

**TRANSFORMERS MANUFACTURED** to specification, many popular types ex-stock. Fast turn around on volume production. Send enquiries to Louth Transformers, Queen Street, Louth, Lincs. Tel: (0507) 606436.

**MIXED**. 100 Transistors **£3.50**. 25 ICs **£1.50**. Post paid. Valves. Early radios. Various electronics. Lists 15p. Sole Electronics (ETI), 37 Stanley Street, Ormskirk, Lancs. L39 2DH.

**ZX80 GAMES**. Free Game sent on request. Send SAE. Mastercode, Simon Says, Dr. Who, Alien Invader, The 4 on cassette, **£3** Bobker, 29 Chadderton Drive, Unsworth, Bury, Lancs.

**ETI**  
**PCIB**

Buy it with Access  
BARCLAYCARD

**TRS 80  
SOFTWARE  
NOW  
AVAILABLE**

**CROFTON  
ELECTRONICS  
LIMITED**

35 GROSVENOR ROAD, TWICKENHAM  
MIDDLESEX TW1 4AD • Tel: 01-891 1923



# MICROPROCESSOR TECHNICIAN ENGINEER GRADE 6

required for new Microprocessor Development Unit providing a design and applications service to teaching and research. Experience essential in both hardware and software.

Salary scale (to be reviewed 1st October 1980) £6258-£7323 p.a. inclusive. Generous holidays.

Further particulars and application form from: Mr. M. E. Cane, (MP6), Chelsea College, Pulton Place, London SW6 5PR.

**LOOKING FOR AMPLIFICATION?** Modules/Chassis/Hi-Fi Units. 60+60W from £11.95 inclusive. Leaflets s.a.e. please Klifco Electronics, 1 Regent Road, Ilkley, W. Yorks.



## MICROTYPE STAK-PAK

CASSETTE STORAGE SYSTEM FOR EASY PROGRAM FILING.

- \* Each drawer section takes 2 cassettes
- \* Drawers lock together vertically
- \* Each twin pack comes with 2 C10 digital cassettes
- \* Each 'pak' is complete with index cards, cassette and drawer labels.

FIVE TWIN PAKS (10 CASSETTES) FOR £6.80 INC. VAT & P&P

Send cheques or Postal Orders to:

MICROTYPE, PO Box 104  
HEMEL HEMPSTEAD  
HERTS. HP2 7QZ

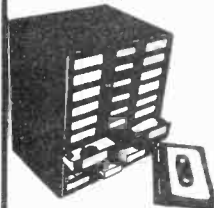

# CENTURION ALARMS

**BURGLAR ALARM EQUIPMENT  
AT UNBEATABLE VALUE  
JUST LOOK!**

- Order No.
- 100 ALARM TRIGGER MODULE. 100% Solid State. Battery operation. Pos. & Neg. Rings. N/C for 4-wire contacts. N/O for Mats. etc. One Amp Switching Capacity. Only £9.95
  - 210 Quality White Flush fitting 4-wire MAGNETIC REED CONTACT + matching magnet £1.10
  - 220 Surface 4-wire MAGNETIC REED CONTACT £1.50
  - 240 PRESSURE MAT. Standard size 4-wire 30"x15" £2.20
  - 250 PRESSURE MAT. Stair size 4-wire 23"x6 1/2" £1.73
  - 260 VIBRATION DETECTOR. Pendulum type in Ivory Case with contacted Lid + self-adhesive backing. Adjustable sensitivity £3.50
  - 360 SIX INCH UNDER DOME BELL £9.95
  - 390 BEST QUALITY BELL HOUSING. PVC coated metal. not to be confused with the cheaper decoy covers. Fully signwritten with our Centurion Insignia £9.50
  - 400 DECOY P.V.C. BELL COVER £6.80

Note: All equipment operates on 12 Volts DC.  
710 SCOOP OFFER SMOKE ALARMS. Self-contained ionisation Type (1.5% obscuration) with low battery warning at the UNREPEATABLE PRICE of only £8.75 While Stocks Last!!!  
Terms: Add 15% VAT to Prices + 40p Postage & Packing.



No Minimum Order.  
Access telephone orders welcome on 0484-35527 or send S.A.E. for Full List to:  
CENTURION ALARMS & ELECTRONIC SALES, Dept. HE, 265 Wakefield Road, Huddersfield, W. Yorks HD5 9BE.

## COMPUTER I.C.'s

Z80 cpu 200Ns £8. MM5290DJ (4116) £3. Eprom 2708 £4, 2716 5V £8. DB251 Uart £8. 2114 £3.  
Transistors, BD 587 £30/100 BFR51 £20/100.  
Capacitors 1000MF/40V 35p each. Rifa interference suppressor caps 250v 10p each pcb mount.  
Transformers 250V input, U clamp brand new, 0-12v @ 1/2 amp, 0-24v - 1 amp £2 each. 0-13 5v @ 1/2 amp £1.50 each. 0-20v @ 0.7 amp £1.80 each. 6-0-6 and 9-0-9 @ 4 amps £5 each shrouded 4 hole fix.  
Terms C.W.O. official orders welcome, please add VAT and postage, phone in when ordering I.C.s. other components available send SAE for lists, components wanted good prices given

"Q" SERVICES ELECTRONIC (CAMBERLEY) LTD., 29 LAWFORD CRESCENT, YATELEY (0252) 871048, CAMBERLEY, SURREY.

## BURGLAR ALARMS

Full range of security equipment. Lowest prices.

Fast delivery.

Technical advice available

S.A.E. for full list

PORTCULLIS

27 Sundown Ave., Dunstable AU5 4AJ  
Tel: 0582 61284

**HALF PRICE MEMORIES.** 4Kx8-bit Static RAM (Pizoz) Boards £70. 4K x 8-bit PROM (1702A) Boards £30. All assembled and tested. B1702A PROMS for above £5.50 each. All chips tested. Phone Clive on (0272) 317626 (evenings).

### PLUG-IN RAM CARDS, SUIT ZX-80

1K-£20; 2K-£30; 3K-£40. send order to Quickstart, 56 Bedford Place, Southampton, Hants. Or S.A.E. for Data.

**BURGLAR ALARM** Component Catalogue out now. Ring: C.W.A.S. 0274 682674.

Z80 Cpu £8. MM5290DJ (NS) (4116) £4. 2708 £4. 2716 5V £8. DB251 Uart £8. BD 587 transistor flat pack 40W 30p.  
Switching transistor BFR51 20p  
Capacitors 1000Mf 25V axial 25p  
Rifa 0.047Mf 250V with internal resistor 10p  
Transformers, brand new, 250V input  
Type 10-12 0.5A. 0-24V at 1A £2 ea  
Type 2-0-13 5V 0.5A £1.50 ea  
Type 3-6-0-6 and 9-0-9V at 4A £5 ea  
Other components for sale, send SAE for lists, please phone when ordering I.C.s. Please add post and packing. VAT is included in the above prices.

"Q" SERVICES ELECTRONIC  
Camberley Ltd., 29 Lawford Crescent, Yateley, Camberley, Surrey. (0252) 871048

## TIME EXACT?

**MSF CLOCK** is ALWAYS CORRECT — never gains or loses, self setting at switch-on, B digits show Date, Hours, Minutes and Seconds, larger digit Hours and Minutes for easy QUICK-GLANCE time, auto GMT/BST and leap year, also parallel BCD output for computer or alarm and audio to record and show time on playback, receives Rugby 60KHz atomic time signals, built-in antenna, 1000KHz range, 12V operation. ABSOLUTE TIME, £54.80.

V.L.F.7 EXPLORE 10-150KHz. Receiver £13.70.  
Each fun-to-build kit includes all parts, printed circuit, case, instructions, postage etc., money back assurance so GET one NOW.

CAMBRIDGE KITS

45 (TL), Old School Lane, Milton, Cambridge

**ELECTRO GUARD SECURITY SYSTEMS.** All alarm equipment at wholesale prices. Car alarms. Linwood £11. Selmar £10. Installation materials. 6" Master Bell in case (steel coated plastic) £15.50. 100 Mtrs. 4 core cable £6.80. 100s more items. S.A.E. lists. 30 Badenharn Grove, Lawrence Weston, Bristol BS11 0LN.

**TELEPHONE ANSWERING MACHINES,** Super Phones, Radio Phones, etc. Ring C.W.A.S. 0274 682674.

## ADVERT INDEX

AITKEN BROS	30	KODE SERVICES	57
AKHTER INSTRUMENTS	40	KRAMER & Co.	121
ALCON INSTRUMENTS	59	LASCAR ELECTRONICS	97
ALTEK INSTRUMENTS	38	LB ELECTRONICS	122
AMBIT INTERNATIONAL	16	LINSAC	115
APEX MICRO-SYSTEMS	58	MACLIN-ZAND	12
AUDIO ELECTRONICS	80, 101 & 107	MAPLIN	132
AURA SOUNDS	63	MARSHALLS	64
BAYDIS	58	METAC	88 & 89
B. BAMBER	118	MICRO-CIRCUITS	98
BI-PAK SEMICONDUCTORS	46 & 47	MIGHTY MICRO	23
BK ELECTRONICS	75	MITRAD	4 & 5
B.N.R.S.	49	MOUNTAINDENE	101
BOSS INDUSTRIAL MOULDINGS	123	NIC MODELS	42
BRAINTREE MICRO-LEISURE	112	E. R. NICHOLLS	128
BUTTERWORTHS	38	N.T.C.	64
CALCULATOR SALES & SERVICE	117	OLSON ELECTRONICS	122
CAMBRIDGE LEARNING ENTERPRISES	119	PARNDON ELECTRONICS	118
CHILTMead	111	POWERTRAN	2, 9 & 116
CHROMASONICS	102	T. POWELL	23
CHROMATRONICS	26	PROGRESSIVE RADIO	120
CLEF PRODUCTS	118	PROTON ELECTRONICS	118
CODESPEED	107	QUANTUM ELECTRONICS	74
COMMODORE SYSTEMS	41	RAPID ELECTRONICS	42
COMP, COMP, COMP	130 & 131	J. W. RIMMER	64
CRIMSON ELEKTRIK	114	RISCOMP LTD.	23
CROFTON ELECTRONICS	38	R.T.V.C.	84
C.S.C.	57, 73 & 107	SAFGAN ELECTRONICS	108
CYBER ELECTRONICS	115	SAXON ENTERTAINMENTS	117
DELTA TECH & CO	42	SCIENCE OF CAMBRIDGE	18 & 19
DISPLAY ELECTRONICS	24	SILICA SHOP	106
DK SUPPLIES	115	STEVE'S ELECTRONICS	112
DONDENE LTD.	110	C. N. STEVENSON	112
DORAM ELECTRONICS	71	SURETON SYSTEMS	83
E.D.A.	7	SWANLEY ELECTRONICS	117
ELECTROVALUE	115	TANGERINE	124 & 125
FOUNTAIN COMPUTERS	115	TECHNOMATIC	10
GMT ELECTRONICS	30	TELERADIO	100
GREENBANK	103	TEMPUS	54 & 55
GREENWELD	123	TK ELECTRONICS	120
HAMEG LTD.	126	TRANSAM COMPONENTS	79
HAPPY MEMORIES	126	T&T ELECTRONICS	121
HENRY'S RADIO	96	VIDEOTONE	14
ILP ELECTRONICS	26, 50 & 51	WATFORD ELECTRONICS	6 & 7
INTERFACE COMPONENTS	74	WILMSLOW AUDIO	126
KEELMOOR LTD.	36 & 37	THE WILSON STEREO LIBRARY	31
		WEST HYDE DEVELOPMENTS	121

NOBODY CAN GET NEAR OUR PRICES EXCEPT OUR CUSTOMERS

**SPECIAL—ONCE IN A LIFETIME OFFER!**

RRP £740

**48K £499**  
+ VAT



**EXIDY SORCERER**

**For Personal or Business Use.**

32K or 48K memory. 8K Microsoft Basic in ROM. Dual Cassette I/O, RS232 I/O. Parallel I/O (Centronics). Expansion available through optional extra \$100 Motherboard. 69 Key keyboard including 16 key numeric pad.

EXTENDED WARRANTY BY COMPUKITE

only **£349** + VAT



**TRS80 LEVEL 2 16K**

Fully converted to UK T.V. Standard. Comes complete with easy to follow manuals. UK Power Supply — Cassette Leads — Sample tapes. Special box to enable you to plug into your own TV. Recommended for first time-buyers. Just plug in and go. Full Range of Software Available

Interface to Centronics Parallel for TRS80 **£75.00** + VAT

only **£295** + VAT

Expand your TRS80 by 32K

32K Memory on board Centronics parallel port. Disk controller card. Real time clock. Requires Level 11 Basic Interface for 2 cassette decks, complete with power supply

**TRS80 EXPANSION INTERFACE**



**BITS & BYTES**

8MHz Super Quality Modulators	<b>£4.90</b>
6MHz Standard Modulators	<b>£2.90</b>
C12 Computer Grade Cassettes	10 for <b>£4.00</b>
Anadex Printer Paper — 2000 sheets	<b>£25.00</b>
Floppy Discs 5 1/4" Hard and Soft Sector	<b>£3.50</b>
Floppy Disc Library Case 5 1/4"	<b>£3.50</b>
Verocases for Nascom 1 & 2 etc.	<b>£24.90</b>
Keyboard Cases	<b>£9.90</b>

EXTENDED WARRANTY BY COMPUKITE

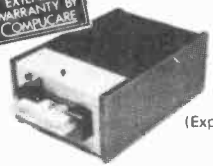

**EXATRON STRINGY FLOPPY FOR TRS80**

(Expansion interface not needed)

only **£169** + VAT

High Speed storage medium that is cheap and reliable. Includes 20 wafers - M/C monitor - BUS EXPN cable. **£169**

EXTENDED WARRANTY BY COMPUKITE



**video 100**

12" BLACK & WHITE LOW COST VIDEO MONITOR

only **£79** + VAT

- Ideal for home, personal and business computer systems
- 12" diagonal video monitor
- Composite video input
- Composite video input
- Compatible with many computer systems
- Solid-state circuitry for a stable & sharp picture
- Video bandwidth - 12MHz + 3dB
- Input impedance - 75 Ohms
- Resolution - 650 lines Minimum In Central 80% of CRT; 550 Lines Minimum beyond central 80%.

**NEW REDUCED PRICES**

8K **£399**

16K **£499**

32K **£599**

RRP £795 for 32K



**The PEDIGREE PETS**

Very popular for home & business use. 8K Microsoft Basic in ROM. 8K Pet 32K & 16K with new improved keyboard. All with green screen. Cassette Deck **£55** extra. Full range of software available. Interface PET IEEE — Centronics Parallel. Not decoded **£49.00** + VAT. Decoded **£77.00** + VAT

**NOW IN STOCK SUPER 80 COLUMN PET**

only **£825** + VAT

**SPECIAL SCOOP GET YOURSELF A PRINTER FOR YOUR PET AND SAVE A FORTUNE**

only **£349** + VAT

Full Pet Graphics including cables. Ready to go.

**EX-STOCK.**



**MEMORY UPGRADES**

16K (8 x 4116) **£29.90** + VAT

4K CompuKit (8 x 2114) **£29.90** + VAT

We now have in stock demonstration models of the Atari 800 and Texas 99/4. Come and see them

**YOU NEED NEVER MISS AN IMPORTANT CALL AGAIN TWO CORDLESS TELEPHONE SYSTEMS — DIRECT FROM USA**

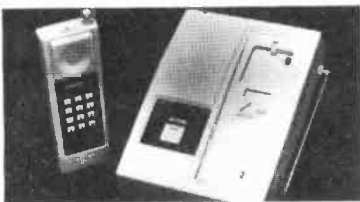

**THE ALCOM**

only **£147** + VAT

Base station connects to your telephone line. Remote handset clips to your belt and gives you push-button dialling — Bleeps when call arriving — Nicad rechargeable batteries. Charger in base unit.

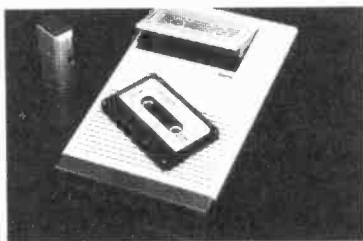

**LOW COST TELEPHONE ANSWERING MACHINE**

only **£99.95** + VAT

Microprocessor controlled answering machine. Plug into your phone line. Records any phone call messages. Remote bleeper enables you to listen to your messages from anywhere in the world. Uses standard cassettes. Comes complete with mains adaptor, microphone, remote bleeper, base unit, cassette with 30 sample pre-recorded messages.

**EUROPE'S FASTEST SELLING ONE BOARD COMPUTER COMPUKIT UK101**



- ★ 6502 based system — best value for money on the market.
- ★ Powerful 8K Basic — Fastest around
- ★ Full Qwerty Keyboard
- ★ 4K RAM Expandable to 8K on board.
- ★ Power supply and RF Modulator on board.
- ★ No Extras needed — Plug-in and go.
- ★ Kansas City Tape Interface on board.
- ★ Free Sampler Tape including powerful Disassembler and Monitor with each Kit.
- ★ If you want to learn about Micros, but didn't know which machine to buy then **this is the machine for you.**

40 pin Expansion Jumper Cable for CompuKit expansion **£8.50** + VAT

Build, Understand and Program your own Computer for only a small outlay

**KIT ONLY £179** + VAT  
**NO EXTRAS NEEDED**

Available ready assembled, tested & ready to go **£229** + VAT

**NEW MONITOR FOR COMPUKIT UK101**

- In 2K Eprom 2716
- Allows screen editing
- Saves data on tape
- Flashing cursor
- Text scrolls down **£22.00** + VAT

**FOR THE COMPUKIT**

Assembler/Editor	<b>£14.90</b>
Screen Editor Tape	<b>£5.90</b>

All Prices exclusive VAT

**Game Packs**

1. Four Games	<b>£5.00</b>
2. Four Games	<b>£5.00</b>
3. Three Games 8K only	<b>£5.00</b>

Super Space Invaders (8K)	<b>£6.50</b>
Space Invaders	<b>£5.00</b>
Chequers	<b>£3.00</b>
Real Time Clock	<b>£3.00</b>
Case for CompuKit	<b>£29.50</b>

EXTENDED WARRANTY BY COMPUKITE



**HITACHI PROFESSIONAL MONITORS**

9" — ~~£129~~ **£99.95**  
12" — ~~£149~~ **£149**

- **Reliability** Solid state circuitry using an IC and silicon transistors ensures high reliability.
- **500 lines horizontal resolution** Horizontal resolution in excess of 500 lines is achieved in picture center.
- **Stable picture** Even played back pictures of VTR can be displayed without jittering.
- **Looping video input** Video input can be looped through with built-in termination switch.
- **External sync operation** (available as option for U and C types)
- **Compact construction** Two monitors are mountable side by side in a standard 19-inch rack.

EXTENDED WARRANTY BY COMPUKITE

**NASCOM 2 DISC DRIVES**

Add a powerful, double density, mini-floppy disc to your Nascom system.

- Disc Controller Card (includes Nasbus 6 S100 interface)
- Will control 4 Drives.
- CPM operating system.
- Extended Disc Basic Compiler.
- Power supply included
- One Disc System — **£499** + VAT
- Additional Disc Unit — **£299** + VAT



**SPECIAL OFFER**

We will part exchange your Sinclair ZX80 for any of our products.

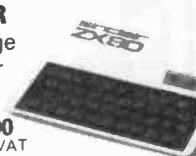

Refurbished ZX80's—fully guaranteed **£69.90** + VAT  
(Supply dependant upon stocks).

We have one of the largest collections of Computer Books under one roof, along with racks of software for the PET and TRS80. Come and see for yourself.

**NEW TV GAME BREAK OUT**

Has got to be one of the world's greatest TV games. You really get hooked. As featured in ETI. Has also 4 other pinball games and lots of options. Good kit for up-grading old amusement games.

**MINI KIT** — PCB, sound & vision modulator, memory chip and de-code chip. Very simple to construct. **£14.90** + VAT  
**OR PCB £2.90 MAIN LSI £8.50** Both plus VAT

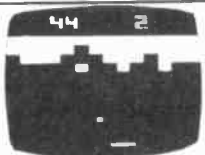

JUST COMPARE OUR CASH AND CARRY PRICES!

### COMP PRO MIXER

Professional audio mixer that you can build yourself and save over £100.

6 into 2 with full equalization and echo, cue and pan controls. All you need for your own recording studio is a stereo tape or cassette recorder.

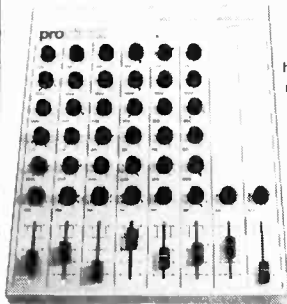

This superb mixer kit has slider faders, level meters and additional auxiliary inputs.

Only **£99.90** plus VAT for complete kit. Plus **FREE** power supply valued at £25.00

Ideal for **DISCOS STAGE MIXING HOME STUDIOS AND MANY OTHER APPLICATIONS**

FULL RANGE OF ACCESSIT AUDIO ADD-ONS

RRP £540

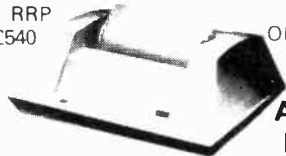

only **£399** + VAT

**ANADEX DP8000**

Super Quality - Low cost printer. Tractor Feed with full 96 ASCII character set. Accepts RS232C at baud rates between 100 and 9600 and Parallel Bit data. Attaches either directly or through interfaces to Pet, Apple, TRS80, Sorcerer, Nascom, CompuKit etc

### NEC SPINWRITER

only **£1490** + VAT



NEC's high quality printer uses a print "thimble" that has less diameter and inertia than a daisy wheel, giving a quieter, faster, more reliable printer that can cope with plotting and printing (128 ASCII characters) with up to five copies, friction or tractor fed. The ribbon and thimble can be changed in seconds. 55 characters per second bidirectional printing — with red/black, bold, subscript, superscript, proportional spacing, tabbing, and much, much more.

### NASCOM 2 GAMES TAPE

featuring Space Invaders and Android Nim, Re-numbering program and other goodies!

**£7.50** + VAT

### THE NEW ANADEX DP9501

A PROFESSIONAL PRINTER

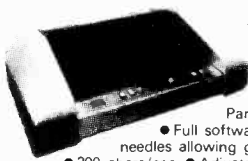

- Bi-directional printing
- Up to 220 chars/line with 4 print densities
- 500 char buffer
- RS232C and Centronics Parallel interface built in
- Full software control of matrix needles allowing graphics capability
- 200 chars/sec • Adjustable width tractor feed.

All this for only **£895** + VAT.

### THE ATARI VIDEO COMPUTER GAMES SYSTEM

Atari's Video Computer System now offers more than 1300 different game variations and options in twenty Game Program™ cartridges!



Most Cartridges only **£13.90** + VAT. Prices may vary with special editions. Basic Maths, Airsea Battle, Black Jack, Breakout, Surround, Spacewar, Video Olympics, Outlaw, Basketball, Hunt & Score™, Space War, Sky Diver, Air Sea Battle, Codebreaker™, Miniature Golf. Extra Paddle Controllers — **£14.90** + VAT. Keyboard Controllers — **£16.90** + VAT. **SPACE INVADERS NOW IN STOCK £25**

**EPROM 2716** £12.50 + VAT

### WE ARE NOW STOCKING THE APPLE II EUROPLUS AT REDUCED PRICES



16K **£599**  
32K **£649**  
48K **£690** + VAT

Getting Started APPLE II is faster, smaller, and more powerful than its predecessors. And it's more fun to use too because of built-in features like:

- BASIC — The Language that Makes Programming Fun.
- High-Resolution Graphics (in a 54,000-Point Array) for Finely-Detailed Displays.
- Sound Capability that Brings Programs to Life.
- Hand Controls for Games and Other Human-Input Applications.
- Internal Memory Capacity of 48K Bytes of RAM, 12K Bytes of ROM; for Big System Performance in a Small Package.
- Eight Accessory Expansion Slots to let the System Grow With Your Needs.

You don't need to be an expert to enjoy APPLE II. It is a complete, ready-to-run computer. Just connect it to a video display and start using programs (or writing your own) the first day. You'll find that its tutorial manuals help you make it your own personal problem solver.

### COMMERCIAL • EXPANDABLE • COMPLETE TRS 80 • MODEL II



EXTENDED WARRANTY BY COMPU CARE

COMING SOON  
26 megabyte  
Hard Disc  
multi-user  
DOS

WE USE THIS MACHINE IN OUR BUSINESS

1 DISK EXPANSION Room for 3



500K per Drive gives total of 1.5M Byte — 1 Drive plus Cabinet **£799** + VAT

This new unit from the world's most successful micro company is now available immediately with software.

The basic unit comes complete with 64 thousand characters (bytes) of Memory. The built-in 8" Floppy disc adds another 1/2 million extra characters including the disc operating system. More disc expansion is now available.

The Model II is a complete unit with a full keyboard including a numeric pad and 12" screen which gives 24 lines of 80 characters. The computer is supplied with both the disc operating system and the Level III Basic.

A full self test routine is written into the power up procedure to eliminate incorrect operation. Both serial and parallel expansion sockets are standard. A printer is a plug-in operation.

Both hardware and software necessary to talk to a mainframe are included. Terminal usage is very possible. With the addition of CPM2 you can operate with COBOL, FORTRAN, MBASIC, CBASIC in which languages are many other applications packages i.e. accounting, payroll stock etc.

64K 1-Disk Model II **£1995.00** + VAT  
RRP £2250.00

CP/M2 **£95.00** C BASIC **£75.00** FORTRAN **£220.00**  
CIS COBOL **£400.00** M BASIC **£155.00** WORDSTAR **£255.00**

**NOW OPEN**

OUR **NEW** SHOWROOM & SALES CENTRE AT 311 Edgware Road, London W2.

Telephone: 01-262 0387

COMPUTER/SALES ENGINEERS REQUIRED

Contact Bill Wood (Chief Engineer)

EXTENDED WARRANTY BY COMPU CARE

We give a full one year's warranty on all our products.

### ENGLISH COLOUR TV/ AMERICAN NTSC COLOUR MONITOR

Suitable for Apple, Atari and Texas 99/4

**£295** + VAT

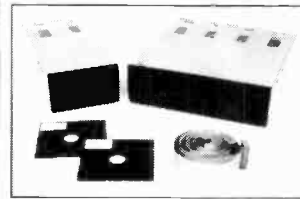

TEAC DISK DRIVES

- TEAC FD-50A has 40 tracks giving 125K Bytes unformatted single density capacity.
- The FD-50A can be used in double density recording mode.
- The FD-50A is Shugart SA400 interface compatible.
- Directly compatible with Tandy TRS80 expansion interface.
- Also interfaces with Video Genie, SWTP, Heathkit, North Star Horizon, Superbrain, Nascom, etc. etc.
- Address selection for Daisy chaining up to 4 Disks.
- Disks plus power supply housed in an attractive grey case.

Single Disk Drive **£225** + VAT Double Disk Drive **£389** + VAT



"Europe's Largest Discount Personal Computer Stores"

Please add VAT to all prices — including delivery. Please make cheques and postal orders payable to **COMP SHOP LTD.**, or phone your order quoting **BARCLAYCARD, ACCESS, DINERS CLUB** or **AMERICAN EXPRESS** number.

CREDIT FACILITIES ARRANGED — send S.A.E. for application form.

#### MAIL ORDER AND SHOP:

14 Station Road, New Barnet, Hertfordshire, EN5 1QW (Close to New Barnet BR Station — Moorgate Line). Telephone: 01-441 2922 (Sales) 01-449 6596 Telex: 298755 TELCOM G

#### NEW WEST END SHOWROOM:

311 Edgware Road, London W2. Telephone: 01-262 0387

OPEN — 10am - 7pm — Monday to Saturday

• IRELAND: 80 Marlborough Street, Dublin 1. Telephone: Dublin 749933

• COMP SHOP USA, 1348 East Edinger, Santa Ana, California, Zip Code 92705. Telephone: 0101 714 5472526



**COMP** COMPUTER COMPONENTS

(Part of the Compshop Ltd. Group)



# MAPLIN

## announce the opening of their new LONDON shop

259-261  
King St.  
Hammersmith  
London W6  
01-748 0926

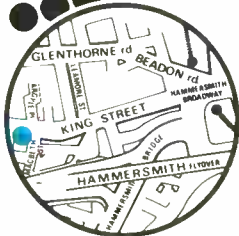

- \* Excellent metered parking
- \* Close to Hammersmith Underground Station for Piccadilly, District & Metropolitan Lines
- \* Bus no's 260·266·704·27·91 267·290 stop outside

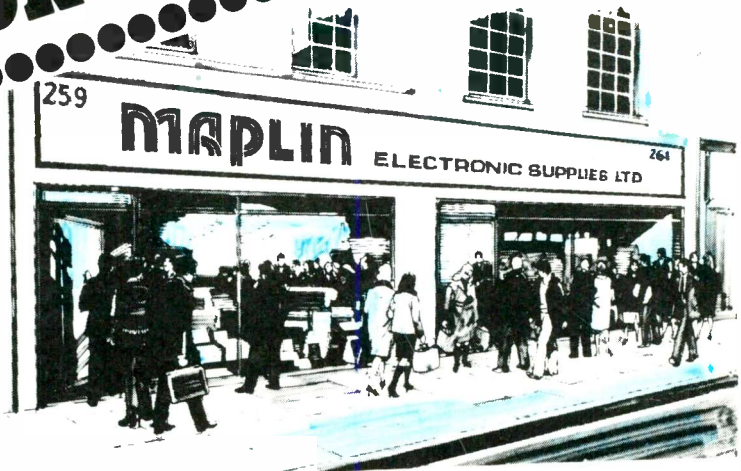

## Opens Tuesday 16th September, 1980

Opening Hours 9.45 am to 5.30 pm Tuesday to Saturday (Closed Monday)

Maplin mail-order –  
Now better than ever!

- \* Up to 8% discount for use with next order
- \* All prices include VAT
- \* Same day service on in-stock lines
- \* Over 95% of our stock lines in stock
- \* Large range of all the most useful components
- \* First class reply paid envelope with every order
- \* Quality components – no rejects – no re-marks
- \* Competitive prices
- \* Your money is safe with a reputable Company

On price, service, stock, quality and security, it makes sense now more than ever to make Maplin – your first choice for components every time!

### Stereo Cassette Tape Deck

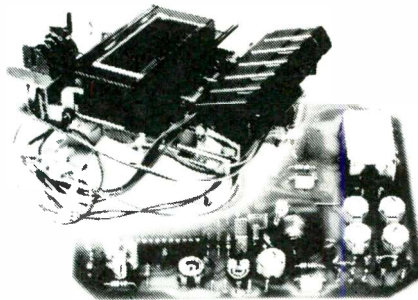

Utilising the superb JVC deck made for Tandberg and a ready-made pre-aligned, tested and guaranteed module, this cassette deck has a superb sound and a high quality specification. We've got everything you need (except cabinet) including full instruction leaflet for only £39.95. Order as XY36P (Cassette Recorder Kit)

### Space Invaders

Fight the space invaders, be a polaris captain or a spaceship commander. Full colour action on your own TV set and over 450 games to play.

Basic console with Combat cartridge (AC00A) £99.50 + £2.50 carriage

All cartridges available including:

Space Invaders (AC26D)	£29.95	Adventure (AC22Y)	£23.95
Indy 500 (AC24B)	£34.50	Skydiver (AC13P)	£16.95
Chess (8levels) (AC28F)	£34.50	Breakout (AC05F)	£16.95
Golf (9holes) (AC18U)	£16.95	Slot Racers (AC19V)	£16.95
Air Sea Battle (AC01B)	£16.95	Programming (AC27E)	£34.50
Space War (AC02C)	£16.95	Olympics (AC04E)	£16.95
Brain Games (AC16S)	£16.95	Street Racer (AC14Q)	£16.95
Outlaw (AC03D)	£16.95	Keyboards per pair (AC29G)	£11.95

All prices include VAT and carriage except where shown.

Post this coupon now for your copy of our 1979-80 Catalogue price 70p

Please send me a copy of your 280 page catalogue. I enclose 70p (plus 46 p&p). If I am not completely satisfied I may return the catalogue to you and have my money refunded. If you live outside the U.K. send £1.35 or ten International Reply Coupons. I enclose £1.16

Name \_\_\_\_\_

Address \_\_\_\_\_

ETI/11/80

# MAPLIN

Maplin Electronic Supplies Ltd

All mail to:- P.O. Box 3, Rayleigh, Essex SS6 8LR.  
Telephone: Southend (0702) 554155.

Shop: 284 London Road, Westcliff-on-Sea,  
Essex. (Closed on Monday)  
Telephone: Southend (0702) 554000.



Catalogue now available in all branches of WHSMITH Price £1.00