

Electronics Today

INTERNATIONAL

MAY 1981

\$1.95

MM70924

Computing Supplement

Review of the
**MULTIFLEX
Z80A**

4017 Circuit
Radiometric Exploration
Typewriter Terminals

**PLUS
10
Projects to Build!**
Including:
Model Train Chuffer
Preamp
Alarm
Switch

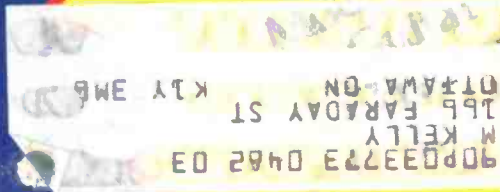

Introducing... arkon's exclusive line!

arkon
electronics ltd

COLOUR MODULATOR Kit #1 \$24.95

This video modulator has been designed to complement the small home computer. It allows the standard colour television to be used as a high quality colour video monitor. Uses state of the art integrated circuit technology. Direct coupling is employed to provide white level compensation in the vestigial sideband output. The gain device of the LM1889's chroma oscillator is used to buffer, level shift, and invert the incoming composite colour input. The signal then passes to the RF modulator where a channel 7 carrier is provided. Requires 12 volt DC for operation.

VIDEO TO RF MODULATOR

Kit #2 \$8.95

Converts a video signal to a RF signal. The RF output terminals connect to the antenna of your TV. Connecting in the video and supplying 5 to 10 volts DC is all that is needed. You turn your channel selector to 4, 5 or 6 (whichever is not used in your area) and tune the adjusting coil for a suitable display.

POWER SUPPLY Kit #3 \$16.95

This kit has been designed to satisfy the need for an economical power supply. Provides 5 volt DC at lamp for TTL projects plus a separate floating power supply that is variable from 5 to 35 volt DC at 1/2 amp for CMOS and other uses.

MAD BLASTER Kit #4 \$4.95

The MB-1 produces a loud "ear shattering" and attention getting siren like sound. This kit can supply to 4 watts of obnoxious audio into an 8 ohms speaker. Requires +5-15 volts DC for operation.

COLOUR ORGAN Kit #5 \$14.95

Good for home colour organ to light up your sound system. Three channel, four level controls. Up to 500 watts per channel (more with heatsinking).

SIREN KIT Kit #6 \$3.95

The siren kit will duplicate the sound of a police siren at a low volume (200 MW) or at a high volume (5 watts) depending upon construction. Closing of the pushbutton will produce the upward wail typical of a police siren, opening will cause the tone to fall downward. Requires 3-12 volts DC.

LM380 AMP-SUPER SNOOP Kit #7 \$6.95

Many applications for this kit, intercom, mini pa system, telephone amplifier, room bug amplifier and more. Uses ceramic or crystal mike for input with 8ohms output. Requires 9 DC volts for operation.

CRYSTAL TIME BASE KIT Kit #8 \$6.95

The crystal time base kit provides a highly accurate source of 60 HZ which is useful for operating digital clocks when there is no source of 60HZ power available.

ELECTRONIC UNIVERSAL TIMER KIT

Kit #9 \$5.95

The universal timer kit provides the basic parts required to provide a source of precision timing and pulse generation. The U.T. makes use of the versatile 555 timer IC which is capable of both astable and monostable operation.

TONE DECODER KIT Kit #10 \$6.95

Can be used as a touch-tone decoder. Its frequency range is 400HZ to over 5KHZ. Bandwidth 2% to greater than 15% of center frequency. Output sink current 100ma. Requires +8-15 volts DC. Audio input level should be 50-100m volts. Useful for touch-tone burst detection, or as a stable tone encoder.

CODE OSCILLATOR/TONE GENERATOR

Kit #11 \$2.95

Can be used as a code oscillator (1KHZ), burglar alarm, light operated oscillator, light operated burglar alarm, variable frequency audio oscillator and much much more. Runs on +3-12 volts.

LED BLINKER Kit #12 \$2.95

Great attention getter with many applications. Alternates flashing of two LED's. Flashing rate is determined by two capacitors which can be changed to increase or decrease the rate of flashing. Runs off voltages up to 20 volts.

BI-POLAR LED BLINKY KIT Kit #13 \$3.95

Another great attention getter. Same as #12, however, it uses 1 LED. The LED changes from red to green. Requires 3-9 volts DC.

FM WIRELESS MIKE KIT Kit #14 \$3.95

The FM-1 is a small circuit used to transmit onto the FM band. Requires crystal or dynamic mike and 3-9 volts DC. Transmits 300 feet.

FM WIRELESS MIKE KIT (WITH PRE-AMP)

Kit #15 \$5.95

Same as #14, however, it has a sensitive mike pre-amp.

DECISION MAKER Kit #16 \$5.95

A random flashing of two LED's. Red for no, green for yes. Requires 9 volts DC.

MAGNETIC PRE-AMP (ASSEMBLED)

Kit #17 \$9.95

This magnetic pre-amp provides the required pre-amplification and RIAA equalization for a magnetic cartridge. Runs on 18 to 24 volts.

ARKON LOGIC PROBE LOGIC 1

Kit #18 \$24.95

Easy to build Logic Probe kit. A full performance logic probe. With it, the logic levels in a digital circuit translates into light from the Hi or Lo LED. Pulses as narrow as 300 nano seconds are stretched into blinks of the pulse LED's. Specs—300 Kohm imp. Power—30ma at 5 volts, 40ma at 15 volts, 15 volts max. Max. Speed—300 nano seconds 1.5 MHZ. Input Protection—+50 volts DC continuous, 117 volts AC for 15 seconds. (case included).

LED POWER METER Kit #19 \$24.95

Uses the popular LM3915 display driver. Features switch selectable peak or average peak power level indication. The front end utilizes precision half wave rectification. LED displays included 30 db (-24 db to +3 db) dynamic range.

LED VU/POWER METER Kit #20 \$29.95

Same as LED power meter but uses NSM series display.

Two types NSM 3915—30 db (-24 db to +3 db power)
NSM 3916 — 23 db (-20 db to +3 db VU)

Send certified cheque, money order, Chargex, Master Charge ... include expiry date, card number and signature. We process C.O.D.'s for Canpar or Post Office. Minimum order \$10.00. Add 5% (minimum \$2.00) for shipping and handling. Any excess refunded. Ontario residents add 7% sales tax. All prices subject to change.

409 Queen Street West, Toronto, Ontario.

M5V 2A5. 868-1315

E.T.I. Printed Circuit Boards

FM Broadcaster	\$3.25
Shortwave Receiver	2.75
Light Chaser	3.75
Dual Electronic Dice	4.75
Audio Compressor	3.25
Differential Temperature Controller	4.25
Wheel of Fortune	4.75
AM Tuner	2.25
Easy Colour Organ	3.75
Two Octave Organ	3.25
Light Activated Tachometer	6.25
Audio Power Meter	6.75
Up/Down Counter	4.25
Road Runner Sound Effects Unit	1.75
Simple Graphic Equalizer	5.25
Cable Tester	2.25
Digital Dial	8.25
Model Train Controller	1.75
Curve Tracer	3.25
60 Watt Amplifier	5.25
Development Timer	1.75
High Performance Stereo Pre-Amp	9.25
Complex Sound Generator	9.25
Click Eliminator	8.25
Dynamic Noise Filter	5.75
Function Generator	10.25
Hebot	18.25
300 Watt Amplifier	11.25
Transistor Gain Tester	2.75
Guitar Effects Unit	3.75
5 Watt Stereo	6.25
General Purpose Pre-Amp	2.75
Balanced Microphone Pre-Amp	2.75
Mixer and Power Supply	4.75
Vu Meter Circuit	3.75
Fuzz Box	1.50
Touch Organ	16.25
Burglar Alarm	1.75
Patch Detector	1.50
Two Tone Door Bell	2.25
Logic Tester	5.25
Stereo Rumble Filter	1.50
Drill Speed Controller	1.75
Metronome	1.50
Electronic Skeet	6.25
Audio Sweep Oscillator	6.25
Digital Tachometer	3.75
Guitar Practice Amplifier	7.00
Alarm, Alarm	1.50
Graphic Equalizer	12.25
Continuity Tester	1.75
Loudhailer	1.75
Three Channel, Tone Controller	1.75
Expander Compressor	6.25
Digital Panel Meter	4.75
Home Burglar Alarm	6.25
Bucket Brigade Audio Delay Line	5.75
Computer Power Supply	5.75
Add on FM Tuner	6.25
Audio Feedback Eliminator	6.25
Ultrasonic Switch	4.25
Proximity Switch	4.25
Sound Level Meter	5.25
Two Chip Siren	1.50
Metal Locator MK II	3.25
Digital Display Audio Oscillator	7.25
Electronic Shutter Speed Timer	4.75
CCD Phaser	6.75
Simple Strobe	3.25
Capacitance Meter	3.50
Eprom Programmer	12.25
Tape Notice Eliminator	1.50
Speaker Protection Unit	5.50

Many Many more available.

Update with recent projects available soon!

319 COLLEGE STREET, TORONTO, ONTARIO, CANADA. M5T 1S2 (416) 921-5295

S. D. SYSTEMS

Low Introductory Prices

VERSAFLOPPY II DISK CONTROLLER



CONTROLS 4 INDEPENDENT DRIVES; 8" SINGLE SIDED/DOUBLE DENSITY, 8" DOUBLE SIDED/SINGLE DENSITY, AND 5 1/4" SINGLE SIDED/SINGLE DENSITY MAY BE USED IN COMBINATION; CONTROL SOFTWARE PROM AVAILABLE.

\$498
VDB 8024
VIDEO BOARD



80 CHARACTERS BY 24 LINES; 7 BY 10 MATRIX; UPPER/LOWER CASE, SPECIAL, AND USER-PROGRAMMABLE CHARACTERS; FULL CURSOR CONTROL; ON-BOARD Z80 CPU AND 2K RAM; KEYBOARD POWER AND INTERFACE; MANY SPECIAL FEATURES.

MPC4 4 CHANNEL SERIAL I/O BOARD



FOUR SERIAL I/O PORTS; TWO Z80-DARTS AND A Z80-CPU; REAL-TIME CLOCK; PROGRAMMABLE BAUD RATES FOR ALL PORTS; 1K RAM ON-BOARD; 2K CONTROL EPROM; FIFO BUFFERS ON ALL PORTS; EXPANDABLE RAM.

SBC200 SINGLE BOARD COMPUTER



Z80A-CPU RUNS AT 4 MHZ; 8K EPROM AND 1K RAM; SERIAL AND PARALLEL I/O PORTS; 4-CHANNEL COUNTER/TIMER USING Z80-CTC; PROGRAMMABLE BAUD RATE GENERATOR; NO FRONT PANEL REQUIRED FOR OPERATION.

\$445
MPB 100
CPU BOARD



S100 COMPATIBLE Z80 MICROPROCESSOR BOARD; 2 OR 4 MHZ OPERATION; AUTOMATIC POWER-ON JUMP TO START OF ANY 4K MEMORY BLOCK; SOCKET FOR 2K EPROM; OPTIONAL WAIT STATES; CAN BE USED WITH MANY S100 COMPUTERS.

EXPANDOPROM EPROM BOARD



16 SOCKETS, DIP SWITCH SELECTABLE, FOR 2708 OR 2716 EPROMS (1 TO 32K) COMPATIBLE WITH SD SYSTEMS, IMSAI, ALTAIR, SOL-20 OR CROMEMCO Z80 CPU CARDS, ALSO COMPATIBLE WITH 8080 AND 8085-BASED SYSTEMS.

EXPANDORAM II MEMORY BOARD

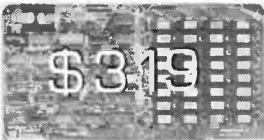

USES 4116 OR 4164 RAM CHIPS FOR UP TO 256K ON ONE S100 BOARD; BANK-SELECT FEATURE ALLOWS 8 BOARDS TO BE USED ON ONE BUS; OPERATES WITH Z80 CPU'S AT UP TO 4 MHZ; HIDDEN REFRESH; ADDRESS-LOCATABLE.

\$319
PROM 100
EPROM PROGRAMMER



PROGRAMS 2708, 2758, 2716, 2732, AND 2516 EPROMS; 25V PROGRAMMING PULSE GENERATED ON-BOARD; AUTOMATIC VERIFICATION OF PROGRAMMING AND ERASURE; ZERO INSERTION FORCE SOCKET; SOFTWARE IN Z80 CODE.

Z80 STARTER KIT

COMPLETE MICROCOMPUTER ON A BOARD; HEX KEYBOARD & DISPLAY; PROM PROGRAMMER; KANSAS CITY STD, CASSETTE INTERFACE; PROVISION FOR TWO S100 SOCKETS; WIRE-WRAP AREA; MONITOR ROM PROVIDES MEMORY/PORT EXAMINE & CHANGE, CPU REGISTER EXAMINE AND CHANGE; BREAKPOINTS; Z80-CTC AND Z80-PIO ALLOW PARALLEL I/O AND VECTORED INTERRUPTS; 1K ON-BOARD RAM EXPANDABLE TO 2K.

\$279
\$485.00

SOLID STATE MUSIC

SBI MUSIC SYNTHESIZER BOARD
USE YOUR MICROCOMPUTER TO MAKE MUSIC UNDER SOFTWARE CONTROL. ATTACK AND SUSTAIN, DURATION, PITCH, TEMPO, VOLUME, WAVEFORM AND ENVELOPE ARE ALL DEFINABLE. SEVERAL BOARDS MAY BE USED AT ONCE FOR HARMONIES.



bare board \$65

PB1 EPROM PROGRAMMER BOARD
2708/2716 PROGRAMMER AND EPROM BOARD (4K OR 8K) IN ONE. ZERO INSERTION FORCE SOCKETS IN THE PROGRAMMING SECTION. UNUSED SOCKETS DO NOT TAKE UP MEMORY SPACE. CONTROL SOFTWARE AVAIL.



bare board \$65

ROCK-BOTTOM PRICES
ON COMPONENTS LIKE
MICROPROCESSORS, LSTTL,
AND MEMORY CHIPS;
ON MULTIFLEX COMPUTER
BOARDS AND SYSTEMS;
AND MORE ON PAGE 34.

OHIO SCIENTIFIC

Ohio Scientific Superboard II Microcomputer



still only

\$389.

custom case
available:

\$73.00

The first complete microcomputer system on a board. Features:

- Many special graphics characters
- Audio cassette interface built-in
- 8K Microsoft BASIC-in-ROM
- 4K RAM on board expandable to 8K
- Full 53 key keyboard with upper/lower case
- Fully assembled and tested
- Requires +5V at 3 Amps and a video monitor or TV set with RF modulator.

RF Modulator Kit **\$8.89**

THE CHALLENGER 1P. The best bargain in personal computer anywhere! 8K BASIC-in-ROM. 4K RAM. Cassette based with 53-key keyboard. B&W video display, 30 rows X 30 columns. Upper and lower case.
C1P with 8K RAM **\$645**
C1P with 4K RAM **\$619**

HAMEG

Spectacular savings this month on German-made Hameg oscilloscopes:

model	reg.	sale price
HM307	\$550.00	\$495.00
HM312	\$855.00	\$769.00
HM412	\$1277.00	\$1149.00
HM512	\$2000.00	\$1795.00

Check our catalog, write, or phone for specifications

RECENTLY, EXCELTRONIX HAS BEEN OVERLOADED WITH SMALL AND TIME-CONSUMING MAIL ORDERS, AND THIS HAS RESULTED IN UNNECESSARY DELAYS FOR OUR CUSTOMERS. WE APOLOGIZE FOR THIS, AND WE ARE INSTITUTING THE FOLLOWING NEW MAIL-ORDER POLICY TO AVOID SUCH PROBLEMS IN THE FUTURE:

- 1: THE MINIMUM MAIL ORDER IS NOW \$10 CANADIAN, PLUS AN ADDITIONAL \$3 TO COVER SHIPPING.
- 2: ALL MAIL ORDERS WILL BE DELIVERED BY THE CANPAR PARCEL SERVICE. CANPAR MAY COST MORE, BUT THEIR SERVICE IS BETTER THAN CANADA POST.
- 3: NO ITEMS WILL BE BACK-ORDERED. IF WE CANNOT SUPPLY A PART WITHIN FIVE DAYS OF AN ORDER, WE WILL IMMEDIATELY ISSUE A CREDIT NOTE WORTH 110% OF THE CUSTOMER'S OVERPAYMENT. THIS MAY BE RETURNED AND REDEEMED FOR CASH IF DESIRED, BUT THE 10% BONUS MUST BE FORFEIT IN SUCH A CASE.

ALL PRICES ARE IN CANADIAN FUNDS, 9% FEDERAL SALES TAX INCLUDED

**Electronics Today International
Editorial and Advertising Offices**
Unit 6, 25 Overlea Boulevard,
Toronto, Ontario, M4H 1B1
Telephone (416) 423-3262

Publisher and Editor
HALVOR W. MOORSHEAD
Assistant Editor
JOHN VAN LIERDE

Editorial Assistant
STEVE RIMMER
Advertising Manager
SENGA HARRISON

Advertising Representative
JIM O'BRIEN
Advertising Services
CAROLYN WYATT

Subscription Department
BEBE LALL
NADIA HIJAZI
Accounts Department
NANCY ALLEN

Production
SARAH-JANE NEWMAN
CINDY BAKER

Contributing Editors
WALLACE PARSONS
DICK CARTWRIGHT

INTERNATIONAL EDITIONS
Electronics Today International,
145 Charing Cross Road,
London WC2H 0EE, UK
Electronics Today International,
Ryrie House, 15 Boundary St.,
Rushcutters Bay, Sydney, Australia

Elrad
Kommanditgesellschaft, Bissendorfer
Strasse 8, 3000 Hannover 61, Germany
Electronica Top International
Postbus 93 Bilthoven, Holland

ETI Magazine is published by:
Electronics Today International (Canada) Ltd
Printed by:
RBW Inc., Owen Sound, Ontario.
Newsstand Distribution:
Master Media, Oakville, Ontario.

SUBSCRIPTIONS
\$16.95 (one year), \$29.95 (two years). For
US add \$3/yr., other countries \$5/yr. Please
specify if subscription is new or renewal.

BACK ISSUES AND PHOTOCOPIES
Previous issues of ETI-Canada are available
direct from our offices for \$3 each; please
specify by month, not by feature you
require. 1977 issues available: Feb, May
Jul, Nov. 1978 issues NOT available: Jan,
Feb, Mar, and Apr. We can supply photo-
copies of any article published in ETI-
Canada for which the charge is \$2 per
article, regardless of length. Please specify
both issue and article.

POSTAL INFORMATION:
Second Class Mail Registration No. 3955.

Mailing address for subscription orders,
undeliverable copies and change of address
notices is:
Electronics Today International,
Unit 6, 25 Overlea Blvd., Toronto, Ontario,
M4H 1B1.

Electronics Today

INTERNATIONAL

MAY 1981 Vol. 5, No. 5.

Features

4017 Applications 66
Once it would have taken 41 relays to do what this little chip can accomplish. Of course, it doesn't click. Ray Marston explains.

Radiometric Exploration 10
Be the first one on your block to find radioactive minerals in your back yard and construct your own nuclear power plant. Great conversation piece, by M. J. Plunkett.

Into Electronics 73
Ian Sinclair talks about logic circuits, often for hours on end. Once he wrote some of it down, which we now present.

Projects

Chuffer 14
Just the thing to add the sound of realism to your model railway unless, of course, all your trains are diesel.

Nobell Doorbell 16
Yes, I suppose a fourteen voice, microprocessor controlled, fully programmable symphonic electronic doorbell could get boring in time. This project reverts to the sound of a simple rap on the door . . . electronically, of course.

Touch Switch 18
The very thing for those moments when you're too weary to operate a manual one. Far cheaper than hiring someone to do it for you.

Guitar Preamplifier 20
There's nothing like an electric guitar, unless it's a much louder electric guitar. Boost yours to the threshold of pain and beyond with this circuit.

Stereo Powermeter 25
Two LED bar graph readouts indicate how close your neighbours are to calling the cops.

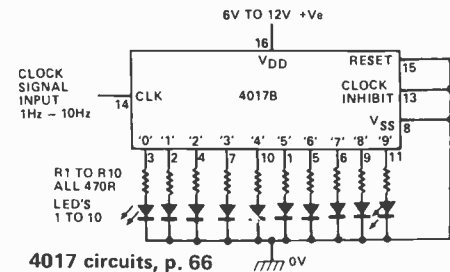

4017 circuits, p. 66

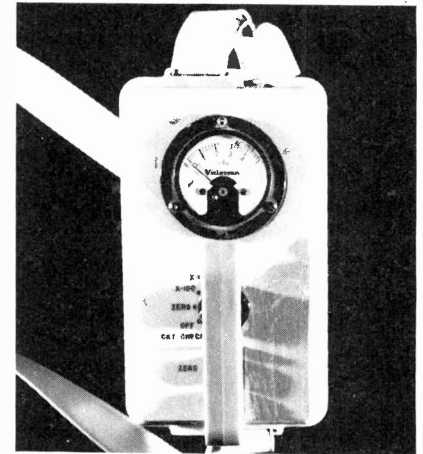

Radiometric Exploration, p. 10

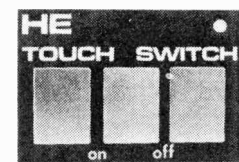

Touch Switch, p. 18



Guitar Preamplifier, p. 20

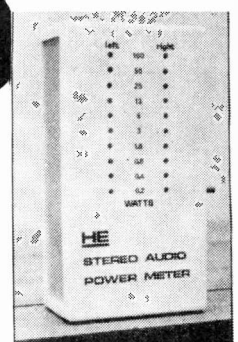

Stereo Audio Power Meter, p. 25

Cover: What has 32 keys, 6 digits two boards and is more fun than a bucket of electric eels at a pool party? Two buckets of eels? No, no, a Multiflex Z-80A. See page 38 (Suppliers for eels are listed in the classifieds).

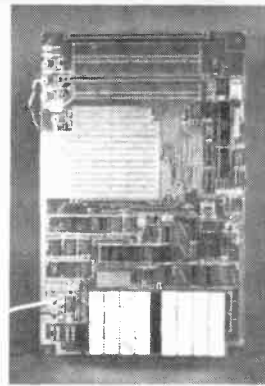

ISSN 0703-8984

Two Tone Train Horn 57
Those miniature plastic cows you've got grazing near your miniature tin tracks could get in the way. Here's a circuit to warn them off.

Flash Trigger 64
Photograph bursting balloons, falling drops of water, political promises and other fleeting phenomena with this sound activated flash trigger.

High Impedance Volt Meter 68
Supplement your universal 3 ohms per volt all purpose test meter and beer opener with this simple instrument.

Jack Tester. 70
The useful life of a patchcord runs from the moment of manufacture until its catastrophic suicidal failure when it is needed most. This little box quickly locates the stiffs.

Freezer Alarm. 71
Similar to the alarm system used at the Canadian mint. However, this one can be used to guard something of value.

= Computer

Multiflex Z-80A 38
Come now . . . you didn't really think that thing on our cover was a Space Invaders game. No, what we've got here is a hot little new microcomputer. Mike Franklin counts the chips.

Computerized DJ 49
Yes, just the thing for AM radio . . . then perhaps we could pull out its plug. Steve Rimmer takes a look at character processing software for small computers.

Columns

- Fun of Electronics. 42**
Paul Geiger
- What's New 61**
Steve Rimmer
- Audio Today 79**
Wally Parsons
- Tech Tips. 82**

News/Info

- News. 7**
- ETI Order Form 31**
- ETI Subscriptions 32**
- ETI Special Publications 45**
- Babani Books 46,47**
- Tab Books 48**
- ETI's Next Month 51**
- Binders 77**
- T-Shirts. 83**

Supplement =

Typewriter Terminals. 43
No, we still haven't come up with a way to make your 1913 Underwood Standard into a printer. However, there are some electronic typewriters available which, with a bit of added circuitry, can become full terminals. Or so says John Van Lierde.



- A-1 Electronics 37**
- Active Component Sales Corp . . . 88**
- Alberta Audio. 85**
- Arkon Electronics 2**
- Atlas Electronics Limited 83,85**
- Audiovision 60**
- Avalon Audio. 81**
- BCS Electronics 32**
- Bryan Electronics 59**
- Cesco Electronics 34**
- Challenge Software 35,55,78**
- Classified. 76**
- Dominion Radio and Electronics. 6,7**
- Dynamic Sound and Components. 84**
- Electronic Packaging Systems . . . 31**
- Electronics 2001. 37**
- Exceltronix 3,36**
- Gladstone Electronics. 56**
- Hammond Manufacturing 59**
- Heath Company 34**
- Len Finkler Limited. 87**
- McGraw-Hill. 28,29**
- Metermaster 33**
- Nu West Video Systems Ltd. 53**
- Omnitronix 30,60,83**
- Orion Electronic Supplies 53**
- RCA. 8,55**
- H. Rogers Electronic Instruments 86**
- Selco Electronics. 83**
- Tuner Service Co. of Calgary 60**
- Videoland 31**

COPYRIGHT
All material is subject to worldwide copyright protection. All PCB patterns are copyright and no company can sell boards to our design without our permission.

LIABILITY
Whilst every effort has been made to ensure that all constructional projects referred to in this magazine will operate as indicated efficiently and properly and that all necessary components to manufacture the same are available, no responsibility whatsoever is accepted in respect of the failure for any reason at all of the project to operate efficiently or at all whether due to any fault in design or otherwise and no responsibility is accepted for the failure to obtain component parts in respect of any such project. Further no responsibility is accepted in respect of any injury or damage caused by any fault in the design of any such project as aforesaid.

EDITORIAL QUERIES
Written queries can only be answered when accompanied by a self-addressed, stamped envelope. These must relate to recent articles and not involve the staff in any research. Mark such letters ETI-Query. We cannot answer telephone queries.

BINDERS
For ETI are available for \$6.75 including postage and handling. Ontario residents add 7% PST.

SELL ETI
ETI is available for resale by component stores. We can offer a good discount and quite a big bonus, the chances are customers buying the magazine will come back to you to buy their components. Readers having trouble in buying ETI could ask their component store manager to stock the magazine.

COMPONENT NOTATION AND UNITS
We normally specify components using an international standard. Many readers will be unfamiliar with this but it's simple, less likely to lead to error and will be widely used everywhere sooner or later. ETI has opted for sooner!
Firstly decimal points are dropped and substituted with the multiplier, thus 4.7uF is written 47. Capacitors also use the multiplier nano (one nanofarad is 100pF). Thus 0.1uF is 100n, 5600pF is 5n6. Other examples are 5.6pF=5p6, 0.5pF=0p5.
Resistors are treated similarly: 1.8M ohms is 1M8, 56k ohms is the same, 4.7k ohms is 4k7, 100 ohms is 100R and 5.6 ohms is 5R6.

PCB SUPPLIERS
This magazine does not supply PCBs or kits but we do issue manufacturing permits for companies to manufacture boards and kits to our designs. Contact the following companies directly when ordering boards. NOTE, we do not keep track of what's available from who, so please don't write to us for information on kits or boards. Similarly, do not ask our PCB suppliers for project help.

K.S.K. Associates, P.O. Box 54, Morrisont, Ontario N0B 2C0.
B&R Electronics, P.O. Box 6326F, Hamilton, Ontario, L9C 6L9
Wentworth Electronics, R.R. No.1, Waterdown, Ontario L0R 2H0
Danocinths Inc. P.O. Box 261, Westland, MI 48185, USA.
Exceltronix Inc., 319 College St., Toronto, Ontario, M5T 1S2
Arkon Electronics Ltd., 409 Queen St. W., Toronto, Ontario, M5V 2A5.
A-1 Electronics, 5062 Dundas St. West, Islington, Ontario M9A 1B9. (416) 231-4331.

535 Yonge Street,
Toronto, Ont. M4Y 1Y5
Phone (416) 922-1818
No collect calls please

DOMINION

PC BOARD SPECIALS

Epoxy Base PC

6''x6 1/2'' 25¢ ea.
13''x4'' 35¢ ea.
13''x6'' 50¢ ea.

ETCHANT

16 oz \$ 2.25
32 oz \$ 4.25
140 oz \$14.95

RESISTORS

Values from 1 ohm to 10 meg. 1/4 or 1/2 watt. Still Only 3 1/4¢ each.

CAPACITORS NISSEI POLYESTER FILM

	Price	uF	Price	uF	Price	uF
.0010	.20	.012	.20	.0027	.20	.027
.0012	.20	.015	.20	.0033	.20	.033
.0015	.20	.047	.30	.0039	.20	.039
.0018	.20	.056	.30	.0047	.20	.12
.0022	.20	.068	.30	.0056	.20	.15
.0068	.20	.082	.30	.018	.25	.18
.0082	.20	.10	.30	.022	.25	.22
.010	.20					

CAPACITORS

AXIAL LEAD

uF	16 (20)	25 (32)	50 (63)
1			.25
2.2			.25
3.3			.25
4.7	.25	.25	.25
10	.25	.25	.30
22	.30	.30	.35
33	.30	.30	.35
47	.35	.35	.35
100	.35	.40	.50
220	.35	.40	.50
330	.40	.50	.65
470	.45	.55	.75
1000	.60	.70	1.00
2200	.75	1.05	
3300	1.05	1.35	
4700	1.65	1.95	

TANTALUMS

DIPPED SOLID TANTALUM
Capacitance Tolerance +/-20%

uF	16 (20)	25 (32)	35 (40)
0.22			.35
0.33			.35
0.47			.35
0.68			.35
1.0			.35
1.5			.35
2.2			.35
3.3			.35
4.7	.35	.35	.35
10	.45	.50	.55
15	.50	.55	.65
22	.55	.65	.75
33	.65	1.20	2.25
47	1.95		
68	2.75		
100	3.50		

RADIAL LEAD

uF	16 (20)	25 (32)	50 (63)
1			.25
2.2			.25
3.3			.25
4.7	.25	.25	.25
10	.25	.25	.25
22	.25	.25	.25
33	.25	.25	.25
47	.25	.30	.35
100	.30	.30	.35
220	.30	.35	.45
330	.35	.40	.50
470	.40	.50	.65
1000	.60	.75	
2200	1.00		

POWER SUPPLY

POWER SUPPLY	16	25	35	50	
1400	.65	6800 Com	25	6.95	
1600	.65	15000 RPE	10	4.30	
2200	.75	12000 COM	40	6.95	
2500	.65	14000 COM	40	7.50	
1000 Can	16	13000 RPE	10	4.30	
4700 R1c	40	15000 Can	16	4.90	
4700 COM	100	13000 COM	25	5.50	
6800 RPE	25	6.95	80000 COM	20	14.95

7400	.45	7423	.55	7472	.55	74123	1.10
7401	.45	7423	.65	7473	.70	74123	.98
7402	.45	7426	.65	7474	.70	74141	1.15
7403	.40	7427	.55	7475	.98	74150	2.50
7405	.75	7430	.45	7476	.70	74151	.98
7406	.85	7440	.45	7483	1.40	74154	2.30
7407	.95	7441	1.35	7486	1.50	74160	1.75
7408	.75	7442	1.35	7490	1.15	74164	1.25
7409	.45	7446	1.45	7491	1.15	74177	1.45
7410	.39	7447	1.15	7492	.85	74190	1.65
7411	.55	7448	1.75	7493	.85	74191	1.60
7412	.55	7454	.65	74121	.65	74192	1.35
7413	.85	7450	.40	74122	.90	74193	2.95
7420	.45						

4000 SERIES

4000	.50	4015	1.50	4026	2.35	4044	1.05
4001	.45	4016	.50	4027	.85	4045	1.78
4002	.45	4017	1.50	4028	1.50	4046	1.09
4006	1.25	4018	.75	4029	1.25	4047	.45
4007	.20	4019	1.65	4030	.40	4050	1.50
4008	1.15	4020	1.25	4033	1.95	4069	.45
4010	.75	4021	1.95	4040	1.29	4510	1.95
4011	.65	4024	1.25	4041	2.05	4511	1.95
4013	.65	4025	.40	4043	1.30	4516	1.35
4014	.90						

MICRO PROCESSOR

LS SERIES	PRICE
74LS00	.85
74LS04	.60
74LS08	.65
74LS10	1.30
74LS11	.75
74LS12	.70
74LS13	.70
74LS15	.70
74LS16	.70
74LS17	.70
74LS18	.70
74LS19	.70
74LS20	.70
74LS21	.70
74LS22	.70
74LS23	.70
74LS24	.70
74LS25	.70
74LS26	.70
74LS27	.70
74LS28	.70
74LS29	.70
74LS30	.70
74LS31	.70
74LS32	.70
74LS33	.70
74LS34	.70
74LS35	.70
74LS36	.70
74LS37	.70
74LS38	.70
74LS39	.70
74LS40	.70
74LS41	.70
74LS42	.70
74LS43	.70
74LS44	.70
74LS45	.70
74LS46	.70
74LS47	.70
74LS48	.70
74LS49	.70
74LS50	.70
74LS51	.70
74LS52	.70
74LS53	.70
74LS54	.70
74LS55	.70
74LS56	.70
74LS57	.70
74LS58	.70
74LS59	.70
74LS60	.70
74LS61	.70
74LS62	.70
74LS63	.70
74LS64	.70
74LS65	.70
74LS66	.70
74LS67	.70
74LS68	.70
74LS69	.70
74LS70	.70
74LS71	.70
74LS72	.70
74LS73	.70
74LS74	.70
74LS75	.70
74LS76	.70
74LS77	.70
74LS78	.70
74LS79	.70
74LS80	.70
74LS81	.70
74LS82	.70
74LS83	.70
74LS84	.70
74LS85	.70
74LS86	.70
74LS87	.70
74LS88	.70
74LS89	.70
74LS90	.70
74LS91	.70
74LS92	.70
74LS93	.70
74LS94	.70
74LS95	.70
74LS96	.70
74LS97	.70
74LS98	.70
74LS99	.70
74LS100	.70

ZENERS

TYPE #	VOLTAGE	WATTAGE			
BZ61-C75	3.3V	1W	IN758A	10	1W
IN4621	4.3	1W	IN759A	12V	1W
IN751A	5.1	1W	IN964B	13	.5
IN4733A	5.1	1W	3Z216D5	14	1W
IN4734	5.6	1W	IN966	16	1W
14-515-04	5.2	1W	BZ61-C18	18	1W
114574	6.2	.5	KZ20C	20	1W
IN753A	6.2	1W	BZ61-C20	20	1W
IN754A	6.8	1W	GE5028	20	1W
IN752A	5.6	1W	14-515-31	22	.5
17-515-35	6.8	1W	IN4751A	30	1W
HZ78	7	1W	BZ61-C30	30	1W
IN755A	7.5	1W	BZ79C36	36	1W
IN74738A	7.5	1W	BZ61-C56	56	1W
IN752A	9.1	1W	IN5045	56	5W
IN4739A	9.1	.5	BZ61-C68	68	1W
BZ61-C9V1	9.1	1W	IN4764A	100	1W
IN757A	9.1	1W	IN5593B	183	1W

PART No	REPLACE	DLR	PRICE					
2N2906	ECC - 159	1.79	2SC1023	ECC - 175	4.95	2SC940	ECC - 283	11.95
BF-245	ECC - 133	1.99	2SC1104	ECC - 124	2.95	2SC939	ECC - 163A	12.95
2N3191	ECC - 199	1.15	2SC1104	ECC - 124	2.59	BF454A	ECC - 133	2.25
BF-199	ECC - 161	1.59	2SD24Y	ECC - 124	2.59	2SC945	ECC - 199	.89
1F5 92	ECC - 128	2.40	AD162	ECC - 131	3.99	2SC1685	ECC - 199	.89
2D136	ECC - 185	2.90	AD139	ECC - 104	1.89	2SC454	ECC - 289	1.59
BD135	ECC - 184	2.79	2SC1160	ECC - 175	3.50	2SC839	ECC - 123A	1.59
2SC1505	ECC - 198	2.95	2N3614	ECC - 121	3.95	2N6558	ECC - 191	4.25
2SC1520	ECC - 198	3.00	2SC1106	ECC - 162	9.95	2SC458	ECC - 289	1.49
2SC1507	ECC - 198	2.95	BD182	ECC - 130	4.39	2N577	ECC - 102A	1.99
2SC1448	ECC - 198	2.95	BU205	ECC - 165	9.95	2N1613	ECC - 128	1.99
NJE2370	ECC - 242	3.59	BU108	ECC - 165	9.95	AC-187	ECC - 103A	2.30

POTENTIOMETERS

A huge selection available. Slider controls from 99¢ to \$2.95; Single pots 49¢ (with switch 59¢) Dual pots 69¢ (with switch 79¢) See out catalogue for full range and other types.

MINIMUM ORDER

\$10.00. All merchandise subject to prior sale. Prices subject to change without notice.

SHIPPING.

Add 5% extra to cover shipping, excess refunded. Orders over \$75 shipped pre-paid. Ontario residents add 7% P.S.T.

EduKit's

LOGIC TRAINER.....\$74.95 MODEL DLT01

A new development package for a BASIC DIGITAL LOGIC COURSE. Four gates and a counter. Circuit is included along with an in-depth manual. Protoboard included.

STEREO PHONO PREAMP KIT.....\$11.25 MODEL EK80SP001

Anyone with a ceramic input receiver can enjoy the quality of a magnetic cartridge with this simple but very effective Stereo Phono Preamp. Specification: Standard RIAA, Frequency Response: 20Hz to 2KHz + 1.5dB. Input Sensitivity: 5mv input for 500mv output. Maximum Output: 700mv rms. Input Overload: 100mv rms. S/N Ratio: Greater than 60dB.

16 CHANNEL MULTI-MODE LED CHASER KIT.....\$32.95 MODEL EK80LCM16

We're proud to add this to our line. It's similar to our 15 channel LED chaser but with many extra features. There are over 60 selectable modes. A few: Up, Down, Skip, Pulse, Scramble, Single Pulse. Multi Pulse and many more. An optional 120 vac board is available. (Extra)

STROBE LITE KIT.....\$21.95 MODEL EK80SL001

Fantastic for special effects. Variable speed Xenon flash gives you a "STILL MOTION" effect. A real attention getter.

CRYSTAL RADIO KIT.....\$8.95 MODEL EK80CR001

A self powered radio which uses a resonant circuit and detector for AM radio reception. An ideal project for the beginners.

1.5 to 24v POWER SUPPLY KIT.....\$24.95 MODEL EK80PS024

A variable Power Supply suitable for many digital and linear applications. Delivers an output current of 100ma. from 1.5v to 15v and 500ma. from 16v to 24v.

0.28 VOLT POWER SUPPLY KIT.....\$39.95 MODEL EK80PS028

A true 0 to 28 volts capable of delivering 1 amp continuous. Full wave rectification, filtering and capacitance multiplication provides a clean dc source for sensitive audio and digital work. An ideal supply for the experimenter.

STEREO AUDIO MIXER KIT.....\$49.95 MODEL EK80AM001

Inputs 2 phono, 1 aux. Master control. Expandable. Frequency response 20Hz-20kHz; 5v output, 0.01% distortion.

16 CHANNEL LED CHASER KIT.....\$22.95 MODEL EK80LC016

A very familiar sight seen at discos, department stores, and on neon signs. 16 LED's flash in sequence up-down or alternate. Adaptable to 120 vac. (Extra)

POWER SUPPORT 120...\$24.95 MODEL EK80PLC120

A 120 volt power board which allows you to connect regular lamps to our LED Chaser Kits. 8 channels are supplied per board with 150 watts per channel. They can be easily interfaced for 16 channels.

5 WATT IC AUDIO AMPLIFIER KIT.....\$19.95 MODEL EK80A005

A general purpose 5 watt amplifier with Thermal Overload and Short Circuit Protection. Because of its low operating voltage and high

RADIO

TRANSFORMERS

8801S \$8.95
 Primary 110V. Secondaries 700V @ 150mA, 250V @ 50mA,
 13.5V @ 1.5A (Specifically designed for the 7984
 transmitting compactron tube.)

2826500 \$3.95
 Primary 110V. Secondaries 28V @ 2A, 6V @ 500mA

24-10182-1 \$14.95
 Primary 110V. Secondaries 56V (CT) @ 8A, 2V @ 2A,
 6.3V @ 4A

24-10182-2 \$14.95
 Primary 110V. Secondaries 58V (CT) @ 10A, 24V @ 2A,
 6.3 @ 4A

321 TK \$3.95
 Primary 1 120V: Secondaries 10V (CT) 500mA, 14V @
 500mA
 Primary 2 120V: Secondaries 20V (CT) 500mA, 28V @
 500mA

PHILIPS



DeForest

Quality
Loudspeakers

Woofers

AD4060W8/4	4" 30W	22.25
AD5060W8/4	5" 10W	20.55
AD70650W8	7"	31.20
AD70652W8/4	7"	28.50
AD08120W8	8"	8.82
AD80100W8/W8W	8" 40W	43.00
AD80601W8	8" 30W	25.95
AD80651W8/4	8" 50W	32.40
AD80652W8/4	8" 50W	30.00
AD80671W8/4	8" 50W	37.50
AD80672W8/4	8" 50W	36.00
AD1065W8*	30 W 10"	56.25
AD10100W8/4*	40 W 10"	75.00
AD10240W8/W8W	70 W 10"	67.50
AD10650W8	30 W 10"	54.00
AD12200W8	80 W 12"	78.00
AD12240W8/W8W	70 W 12"	69.00
AD12250W8	100W 12"	85.50
AD12600W8	40 W 12"	46.80
AD12650W8	60 W 12"	52.00
AD15240W8/W8W	80 W 15"	69.75

Twistors — Dome

AD00400T8/4	18MM	15.40
AD00800T8/4	18MM	14.25
AD00900T8/4	18MM	15.00
AD140T8/4	Polycarbonate	15.40
AD141T8/4	Textile	15.40
AD01600T8/4/15	Exposed Textile	19.28
AD01605T8/4/15	Square Exposed	19.40
AD0162T8/4/15*	Polycarbonate	17.40
AD0163T8/4/15*	Textile	17.30
AD01630T8/4/15	Textile	18.00
AD01631T8	Textile Square	21.20
AD01632T8	Paper	18.00
AD01633T8/4/15	Paper Square	21.00
AD01635T8/15	Diamond Cut Plat.	48.00

Twistors — Dome — Ferro Fluid

AD01404T8/4	Available	17.30
AD01524T8/4	Early	18.00
AD01634T8/4	81	18.00

Twistors — Cone

AD2273T8	2" Cone	5.45
AD2298T8	2" Cone	8.40

Squawkers (Mid Range) Dome

AD0211SQ8/4*	5" Textile	39.90
AD02110SQ8/4		37.75
AD02150SQ8/4		44.25
AD02160SQ8/4		46.50
AD02161SQ8/4	Deluxe Version	52.15

Squawkers — (Mid Range) Cone

AD5060SQ8/4*	5" Cone	28.00
AD5061SQ8/4	5" Cone	20.00
AD5062SQ8/4	5" Cone	28.85

Combi Plates (Squawker & Tweeter on Aluminum Plate)

AD21180ST8	Diamond Cut	85.00
AD21181ST8	Flat Back	85.00

Full Range

AD5081M8	10 W 8"	20.75
AD7082M8	30 W 7"	26.25
9710MC	20 W 8"	48.00
AD12100M8	25 W 12"	80.00

Passive Radiators ("Drone Cones")

AD8000	Rubber Surround	14.25
AD8001	Rubber Surround	12.00
AD8002	Foam Surround	14.25
AD1000	Rubber Surround	34.50
AD10000/W	Foam Surround	15.00
AD12000	Foam Surround	18.75
AD1201	Rubber Surround	35.90

Cross-Over

ADF1500/8/4	2 way	9.75
ADF1600/8/4	2 way	9.15
ADF2000/8	2 way	9.15
ADF2400/8	2 way	7.50
ADF3000/8/4	2 way	8.85
AD3WXSP	3 way hi-Power	37.50
ADF6/3SP	3 way hi-Power	32.00
ADF7/3SP	3 way hi-Power	41.10
ADF500/4500/8	3 way	17.40
ADF700/2600/8/4	3 way	22.50
ADF700/3000/8/4	3 way	22.50
AD1SUBW	Sub Woofer	37.50

NEWS

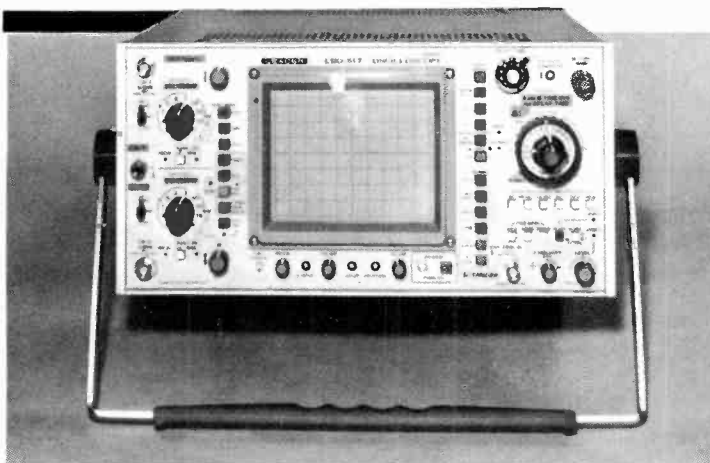

50 MHz Leader

Leader Instruments Corp. announced their entry to the 50 MHz oscilloscope market with the LB0517, a dual trace, dual time base instrument. The time bases may be displayed alternately, allowing the user to view simultaneously the main time base portion intensified and the delayed time bases for both input channels. Further a composite triggering capability allows

triggering on two synchronous signals. Sensitivity of the LB0517 is 1 mV up to 10 MHz and 5mV beyond that up to 50 MHz. The LB0517 comes with two probes and carries a two year warranty. For more information of a catalogue, contact Omnitronix Ltd., 2056 South Service Rd., Trans Canada Hwy, Dorval, Quebec H9P 2N4 or phone (519) 683-6993.

Breadbox

E & L Instruments presents, the LD-1 Pencil Box Logic Designer. A new portable logic design and Breadboarding instrument.

The LD-1 includes major design needs in a handy portable molded plastic case with integral hinged cover. Some of the features are a variable clock, (2) Pulsers, (8) LED readouts, (8) logic level switches and an E & L SK-10 Solderless Breadboarding Socket.

The LD-1 is low priced and a good choice for design work in the lab, home or school. Available in kit or assembled form. Delivery - 30 days. LD-1 kit,



\$75.00, P/N 325-4301. LD-1/ ASSEMBLED, \$99.50, P/N 325-1301.

Write to E & L Instruments Incorporated, 61 First St, Derby, Connecticut 06418.

Little LEDs

Said to be the smallest device of its type yet developed, the GPD 700 package is designed to give substantial reductions in the overall size of multi-character displays assisting in the miniaturisation of a variety of equipment, and allowing space savings which are particularly valuable in aircraft instrumentation applications. It is readable at high levels of ambient lighting and can be readily dimmed without a change in display colour. The seven-segment characters are available in yellow, orange, green and two types of red. The character is 0.26" high and the packages can

be stacked on 0.3" centres.

Contact Plessey Opto-electronics and Microwave, 1641 Kaiser Avenue, Irvine, California 92714 Telephone: (714) 540-9931.

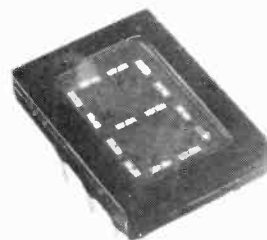

535 Yonge St., Toronto, Ont. M4Y 1Y5

Good news for you and your customers. NESDA/ISCET rates RCA serviceability:

'Excellent'

"The RCA CTC 108 and CTC 109 chassis have earned the highest possible serviceability rating category...

Excellent...by incorporating serviceability features required in the ISCET Serviceability Rating Form.

"RCA's many years of cooperation with ISCET's Serviceability Committee has helped produce excellent results."

—Dean R. Mock, Chairman, NESDA/ISCET Serviceability Committee

ISCET's 92% (CTC 108) and 93% (CTC 109) ratings were good news to us. Because they mean that some of the most demanding critics in the industry agree that we've succeeded in de-

signing chassis that not only give your customers a first rate picture, but are easy to repair too. Here are some reasons why they think so:

All subassemblies plug into chassis. No tools are needed to remove chassis (main circuit board). Just remove the cabinet back, unplug subassemblies and the chassis is ready for removal.

Roadmapping on both sides of the board.

Although the XL-100 chassis use single-sided circuit boards, double road-mapping means you can easily trace circuits from either side.

Circuits and voltages directly identified. Major circuit areas as well as power supply source and key pulse voltages are labeled by name on the board. So you can find them fast.

That all means that when you do have to repair our new XL-100 chassis, in most cases you can fix them quickly and easily.

And you won't have to waste your valuable time trying to find out where to go to fix what you already know is wrong.

Because to us that's what really counts. Making your job easier and your customers happier.

RCA
RCA IS MAKING TELEVISION BETTER AND BETTER.



For your free subscription to RCA COMMUNICATOR, our magazine of news and advice for service technicians, write: RCA, Dept. 1-455, 600 North Sherman Drive, Indianapolis, IN 46201.



Bigger!

Arkon Electronics on Queen street West in Toronto, already one of the biggest electronics parts retailers in the city, are growing yet again.

Two floors above their store are now ready and office and mail order space on the ground floor will be made over to even more retail space: this will now be about 5000 sq feet.

Paul Perrin, the general manager told ETI, "We really need the space to make room for everything we plan to stock. We've got a supert range of S-100 bus computer boards, an enormous stock of both active and passive components and we plan to increase even further our range of Test

Gear. We also have a good stock of professional and hobbyist tools, a large book section and a very wide range of ETI PCB's in stock."

Arkon's first catalogue - an enormous tome planned as 150 pages - is expected to be ready within a month at \$2.50.

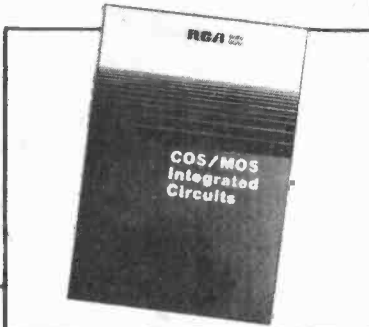

Flat TV Update

Everyone's favourite engineer/entrepreneur, Clive Sinclair is at it again. His long awaited flat tube television which will eventually hang on the wall like a picture is to go into production next year.

Sinclair Research, Ltd. (SRL), of Cambridge in eastern England, has announced the successful completion of a five-year research and development programme on a flat TV tube that is just 19 millimetres deep.

First use of the revolutionary tube will be in a new pocket TV and FM radio that will sell for around \$125 when it is introduced next year. The Microvision set will be produced in a highly automated plant at the Dundee, Scotland, factory of the Timex watch corporation.

The set, with its 76 millimetre screen and total weight of little more than 100 grammes, will be able to operate to the transmission standards of most parts of the world.

The flat tube might also be linked up to the Sinclair personal computer to give it a new visual dimension and together they could be used as a personal mobile teletext unit.

Alas, the British Consulate couldn't come up with any pictures. We're wondering, what's happened to Japan?

The Last Word

Recently, Panasonic sent us a large (24 x 12 x 9 inches) box filled mostly with styrofoam, but also with . . . batteries! It seems that Panasonic is introducing their own line of zinc-carbon and alkaline cells in North America. Additionally they will also be marketing mercury and silver oxide camera batteries and some really nifty looking NiCads.

We're not going to review the

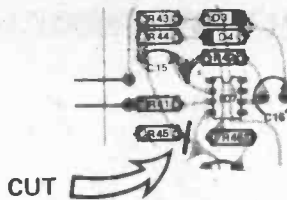

CMOS Picker

A 32-page product guide, COS/MOS Digital Integrated Circuits, COS-278H, describing RCA's extensive CMOS product line, is now available from RCA Solid State Division.

The product guide is intended as an aid to designers in the selection of optimum device types for specific applications. It provides maximum ratings, recommended operating conditions, static electrical characteristics, classifications and selection charts, and functional diagrams for the complete line of 121 B-Series and 70 A-Series CMOS digital integrated circuits.

The material is organized in sections on B-Series ICs, A-Series ICs, packages, ordering information, product classification, function selection, and functional diagrams, with supplemental listings on microprocessor, memory and timekeeping circuits.

Copies of the product guide, COS-278H, may be obtained from RCA Solid State sales offices or by writing to RCA Solid State Division, Box 3200, Somerville, NJ 08876.

samples though. After the January 1981 battery article, we are well and truly sick of watching flashlights go dim, hearing cassette recorders slow down and flashing the flash gun.

The 'C' cells do work in the office slide viewer though.

Interested users and potential dealers would do well to write to Panasonic Canada, 5770 Ambler Drive, Mississauga, Ontario L4W 2T3.

Looking Back Digital Test Meter, Dec. 1980

We have been told that the DVM module is somewhat susceptible to overloading. While nobody has reported any damaged units, we would recommend that a 10M resistor (5%, 1/4W) be inserted in series with the module's in HI pin.

Also, a nasty piece of tape scammed onto board A and effectively shorted the R45,43,44 and C15 node to pin 4 of IC7. Cut the pc track right next to R45 as shown.

Contrary to what some stores are saying, the 9491AM voltage reference is available. You may want to check availability of similar devices such as Teledyne's 9491BM, 9491AJ, 9491BJ; National's LM113, LM313, LM113-1, and LM113-2; or Ferranti's ZN423. 1.2 volt monolithic references are fairly common so hunt around. The differences are largely a matter of accuracy and temperature stability.

Two manufacturer's of precision resistors are Philips and Dale Electronics. A source of both of these is ElectroSonic Inc. (see January '81 Stores Directory for addresses).

Electronic Ignition, January 1981

Two Parts List errors here. First, RV1 is a 100k preset. Also, SCR1 is an RCA S2061M. Any 600V, 4A unit should work.

Some readers have asked if this project will work with eight cylinder engines. We haven't tried it, but no immediate reason comes to mind why not. We would welcome reader feedback on this point.

Auto Probe, April 1981

Several pcb and parts list errors here.

First of all, C1 should be 470n. This will produce a more useable flash rate.

On the component overlay, LED1 and LED2 are reversed. Just change the red and green LEDs around. Also, IC1 is drawn in backwards. Turn it around 180.

And if you're looking for the printed circuit artwork, it's here. Our thanks to the readers who pointed these out.

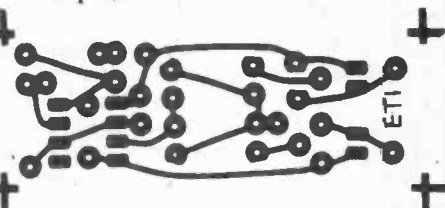

RADIOMETRIC EXPLORATION

All areas of geophysical exploration are becoming increasingly dependent on electronic instruments in the search for minerals and energy sources. Radioactive minerals, in particular, are in great demand. Here's a rundown on the instruments used and how they are employed.

URANIUM EXPLORATION started in earnest after the second world war when "every man and his dog" was selling out and heading for the bush with geiger counter in hand. At that time, the major deposits were discovered purely by surface indications of radioactivity. However, that era is virtually at an end, and future finds are more likely to be below the surface or in inaccessible areas. The Roxby Downs deposits in South Australia for example are over 300 metres below the surface.

It has been necessary therefore to refine existing prospecting techniques, develop new ones, and improve the sensitivity and discrimination of all instruments in radiometric measurement techniques in common use, and to give some insight into the various methods of radiometric surveying.

As mentioned before, Geiger counters were the major instrument in use in early uranium exploration and while other detectors are now available, the Geiger counter still has a place in preliminary exploration and radiation monitoring. A Geiger tube consists of a hollow metallic cylinder with a centrally-located wire inside. The whole system is either sealed in a glass cylinder or the outer metal tube is used as the sealed chamber with appropriate end insulation. The cylinder is evacuated and filled with a gas such as helium, argon or neon, plus a small percentage of an organic or halogen gas as a 'quenching' agent.

A high voltage is applied between the central wire and the outer tube, so that when a gamma ray enters it, the gas filling ionises and causes a discharge. The discharge is quickly quenched or extinguished by the quenching agent, resulting in a relatively large current pulse through the tube that can be easily measured. The gamma rays must be stopped completely for a discharge to occur, which results in a very low conversion efficiency for Geiger tubes

of only 1%, as only one in each hundred rays is completely stopped. This insensitivity can be useful however, as the Geiger counter can be used in areas of very high radioactivity without the count rate becoming excessive.

The Geiger counter circuitry shown in the accompanying block diagram is quite simple using a monostable to give a constant width to the pulses, which are averaged over several seconds so that the count rate is proportional to the average dc level. The range switch can change the monostable width, or the meter resistor, or both, to get the correct division ratios. To maintain accuracy with this system, it is important to keep a constant pulse height and stable pulse width. Although the high voltage supply can be very low powered, it is important to keep the output voltage stabilised within the admissible operating voltage range (known as the counting plateau).

Scintillation counters

Scintillation detectors are the basis for almost all modern radiometric exploration instrument. As with the Geiger tube, the principal of operation is quite simple. However, the method by which the electrical pulses are produced is completely different. The detector assembly consists of a scintillation crystal which is optically coupled to a photomultiplier tube. The crystal is usually made of thallium-activated sodium iodide which has the property of emitting a small flash of light (scintillation), when a gamma ray is stopped in it. The photomultiplier tube is a light amplifier which gives out an accurate, amplified reproduction of the light flash in the crystal, in the form of a short electrical pulse (approx. 2 us).

The great advantage of this rather indirect method of detection is in its efficiency, which approaches one hundred percent. Special protection is needed for, scintillation crystals and

photomultiplier tubes, which results in an instrument which is less rugged, more expensive, but far more sensitive than a Geiger counter. The circuitry of a simple scintillation counter is very similar to a Geiger counter, but usually with extra ranges for the higher count rates.

Radiometric ground surveying

In the search for unknown uranium deposits the ground is traversed on a regular grid, noting the readings at set intervals. The chance of finding an outcrop on the surface is very low, so it is important to note any change in the normal background radiation level, as even a metre or so of soil may have a considerable masking effect. If an area of high radioactivity is located, it would be very premature to stake a claim at this stage. Firstly, the material may be thorium, potassium, or uranium or a combination of them. These can be distinguished from each other because the radiation they produce has characteristic energy levels, resulting in different height pulses from the photomultiplier tube. By counting only three narrow ranges of pulse heights, the ratio of the three radioactive elements can be determined.

This is known as 'pulse height spectrometry' and is beyond the capabilities of a simple scintillation counter and impossible with a Geiger counter. The scintillation crystal used in spectrometers must be large to obtain good results, and the circuitry must be highly stable and temperature compensated. A fourth channel is sometimes used to monitor the pulses from a small quantity of radioactive material which is doped into the crystal, to allow automatic temperature compensation.

A problem encountered with all radiation measuring instruments is that the emissions are random, requiring the circuitry to be ready to accept pulses separated by only a few microseconds

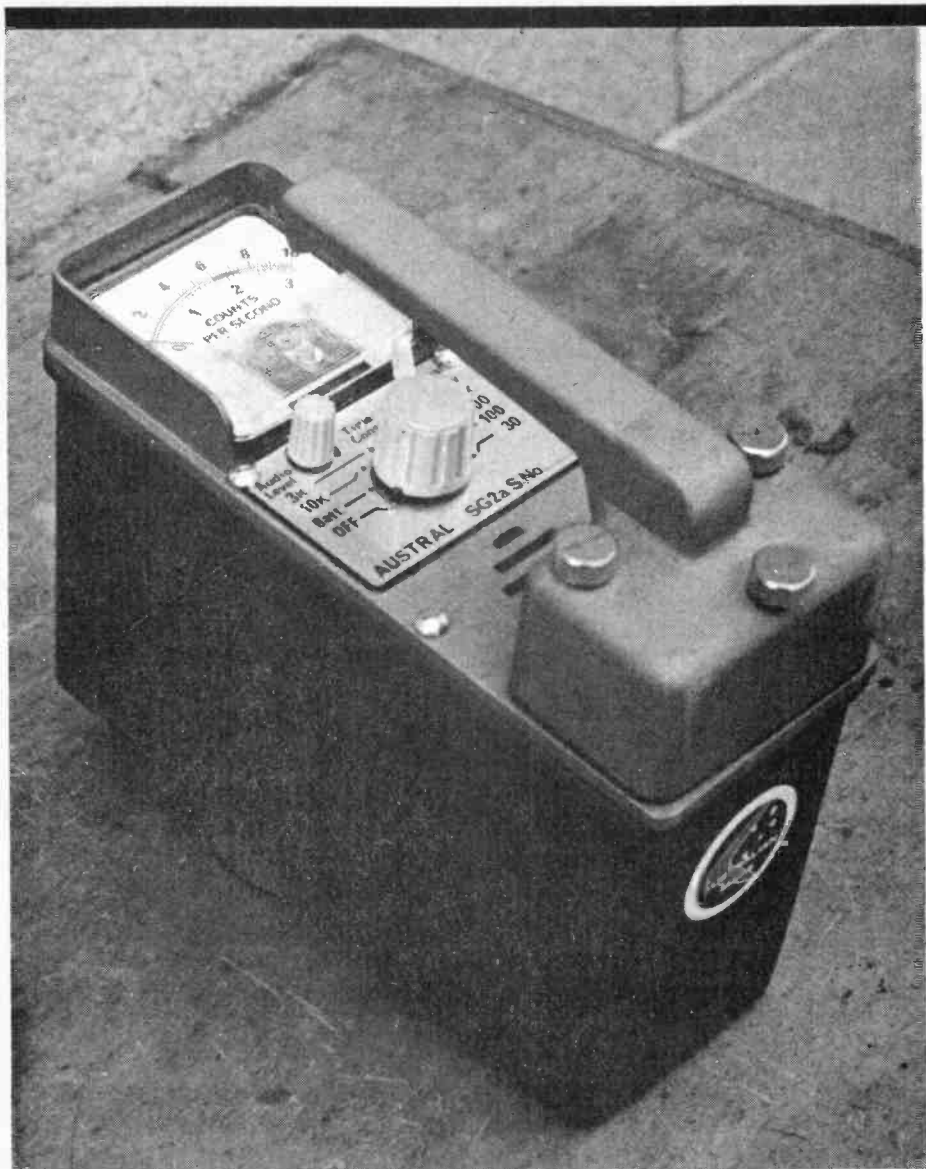

A typical scintillation counter. This model has selectable ranges and an audio output as well as a meter indicating counts per second.

THE BASICS

Uranium exploration is based on the measurement of naturally occurring radioactive elements. All igneous and sedimentary rocks contain variable amounts of the three main naturally occurring radioactive elements, uranium, thorium and potassium. The average concentration of these elements is only 0.1 – 10 parts per million, while uranium ore may have a concentration of several percent.

An element is considered to be radioactive when the atoms of which it is made disintegrate

spontaneously, causing it to decay and form new elements known as daughter products. As it decays it may emit several types of radiation, however the one of interest to us is gamma radiation. Gamma rays have no mass, no charge, and can be regarded as highly penetrating electromagnetic radiation. The measuring device must therefore have a detector for converting these gamma rays into electrical pulses which can be counted for a fixed time period, or averaged as in a car tachometer.

when the average time between pulses may be 100 milliseconds. It is clear then that a simple monostable system would not be suitable, and pulse height spectrometers must employ sophisticated pulse shaping and counting circuits to minimise these problems.

Even spectrometers cannot always determine the usefulness of a deposit, as leaching and weathering can remove the original uranium, leaving only the radioactive daughter products behind.

In conclusion, it can be seen that finding naturally occurring radioactive material is relatively simple, but finding out exactly what you have found is considerably more difficult!

Airborne radiometric surveying

Airborne radiometric surveys have been carried out for many years but even using the latest airborne spectrometers, the results can only be used as a guide. The plane must fly on regular grid lines recording the quantities of uranium, potassium and thorium, as well as the total radiation, on strip chart recorders or magnetic tape. The readings are used to produce radiometric contour maps on which the 'peaks' indicate areas of high radioactivity, known as anomalies. However the size and intensity of the anomaly cannot directly determine the actual extent of the deposit, due mainly to the masking effect of any overlying material. Problems also arise with pockets of airborne natural radon gas, uneven terrain, cosmic radiation and temperature changes.

The results then, are mainly used to eliminate areas which have very few anomalies, and to give a starting point for follow up ground surveys, or borehole drilling.

Radiometric borehole logging

When boreholes are drilled to locate any type of deposit, it is a very costly procedure to recover core samples for laboratory analysis, particularly if the exact depth of the seam is not known. The usual procedure is to lower a probe into the hole and measure the natural radioactivity, which is recorded on a strip chart recorder, relative to the depth of the probe. The probe contains a Geiger tube or more commonly, a scintillation detector, together with its high voltage power supply and a signal buffer. As the cable usually has only one insulated inner conductor and a high tensile steel braid, the pulses must be coupled on to the dc supply to the probe and then picked off across an inductor at the surface. The surface electronics consists of an accurate ratemeter with several selectable averaging time constants, to

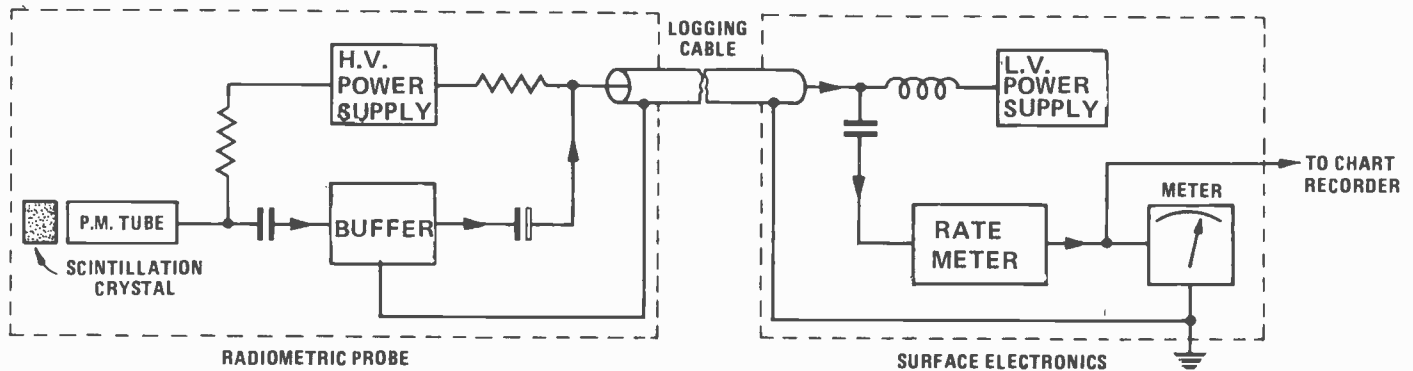
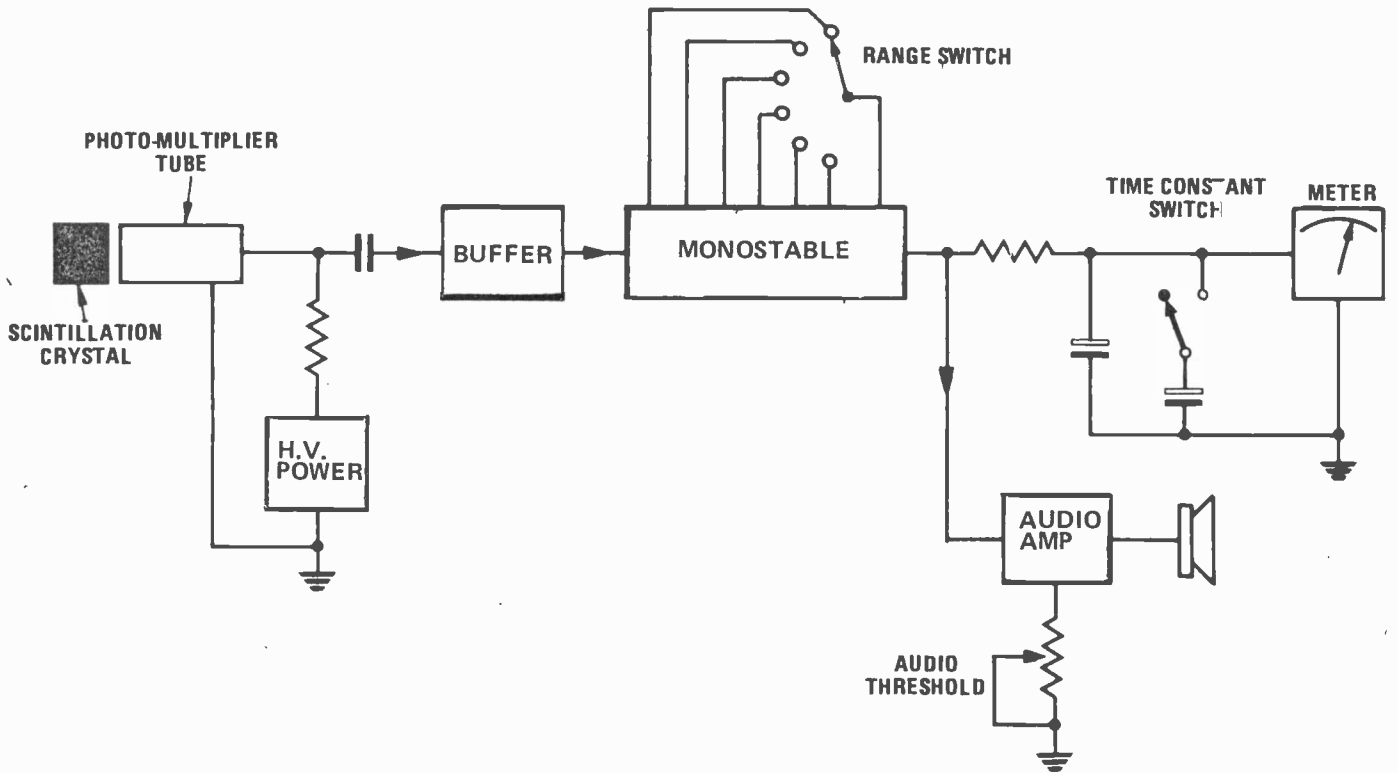
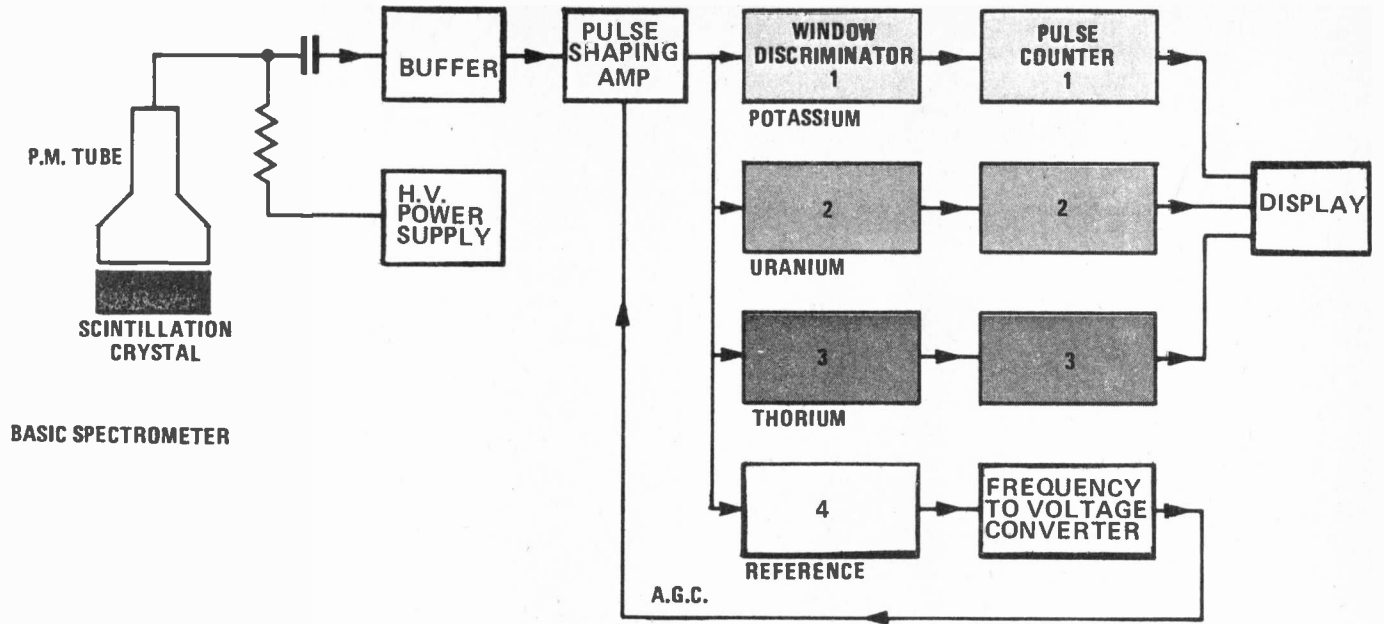

RADIOMETRIC BOREHOLE LOGGER

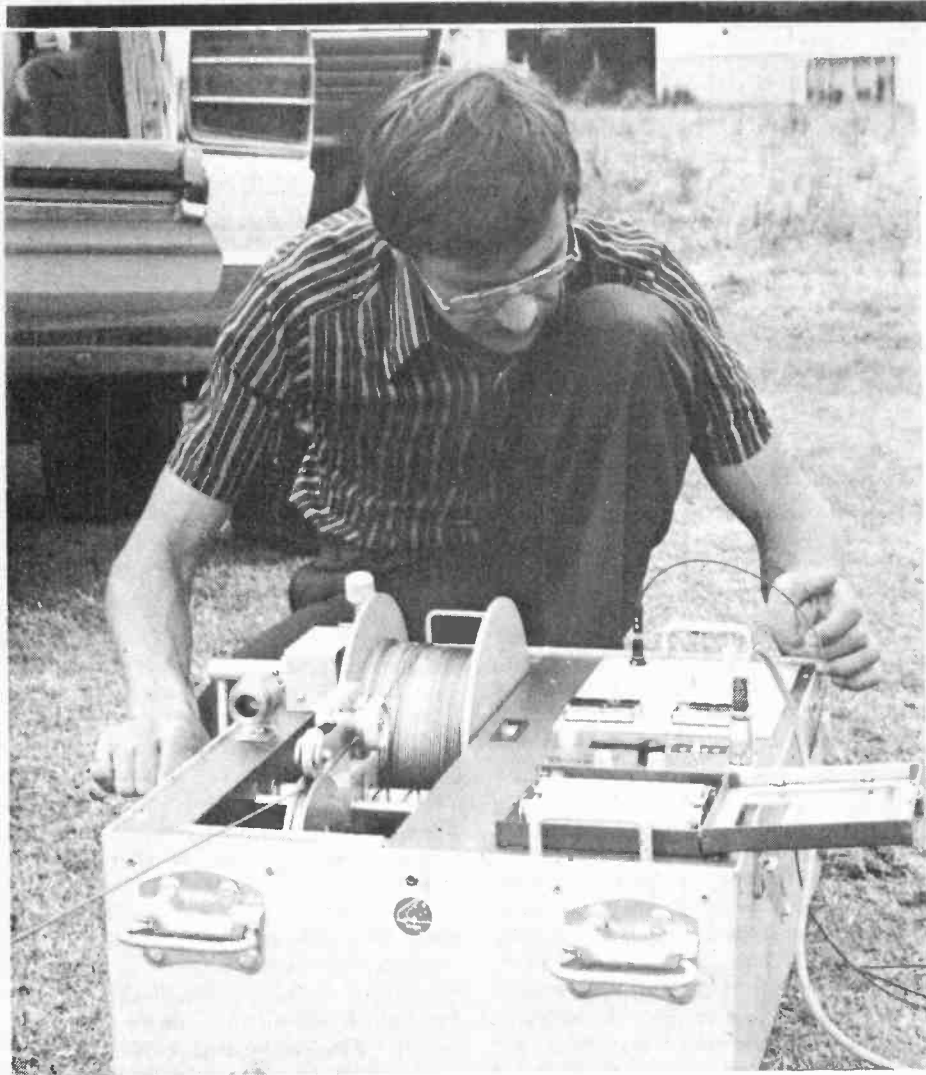

A portable radiometric borehole logger. The logging cable, which conducts power to the head and signals back, is wound off the drum at the rear of the instrument.

Block diagram of a typical commercial Geiger counter. The monostable has provision for selecting preset pulse widths ('RANGE') for differing count rates, depending on the level of radioactivity being measured. The monostable output is differentiated by a CR network and drives a meter calibrated in counts per second.

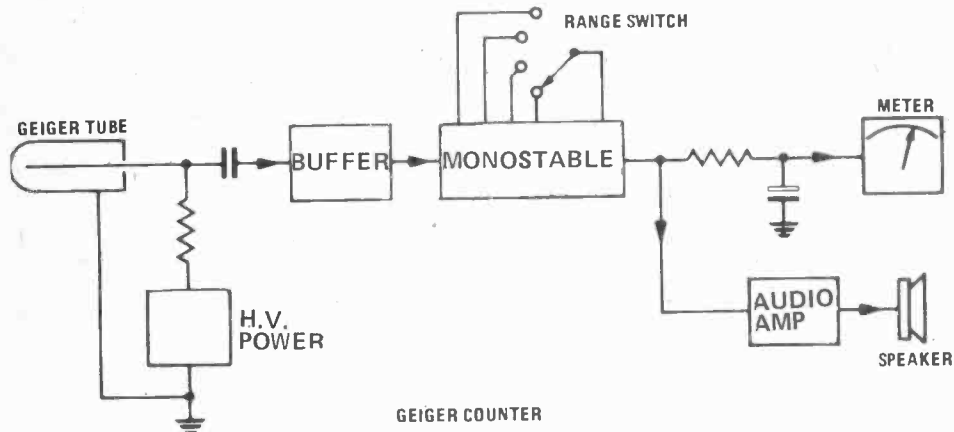

allow low count rates to be resolved accurately.

These probes are extremely important in uranium exploration as they can give the exact depth and thickness of the deposit and also a reasonably accurate figure for the grade of ore. However, radiometric borehole logging is quite often not used to locate uranium.

Because the scintillation detector is so sensitive, it can measure the minute amount of radioactive material present in various rocks, and while the count rate cannot directly identify the rock type, the boundaries between different beds can be sharply defined. This is a very useful measurement because the hole can be air or water filled and steel cased or uncased, without greatly affecting the results.

There are some problems however, as the probe must be watertight to depths of 1000 m or more and able to withstand the pressure at that depth. It must also be rugged and have a wide operating temperature range. This is an extremely harsh environment for sensitive electronic equipment, and careful design is essential.

Summary

Modern electronics and refined measurement techniques have greatly assisted uranium exploration and has led to radiometric borehole logging being accepted as a tool for exploration in general.

Spectrometer-type instruments have eliminated many errors in ground and airborne surveys and allow the field geologist using only a small portable instrument to gain enough information to decide if more detailed investigation is warranted.

In the future, microprocessor controlled spectrometers will undoubtedly become available, allowing automatic correction for the many variables involved in radiometric measurement. However, the measurement techniques will probably remain much the same. *

CHUFFER

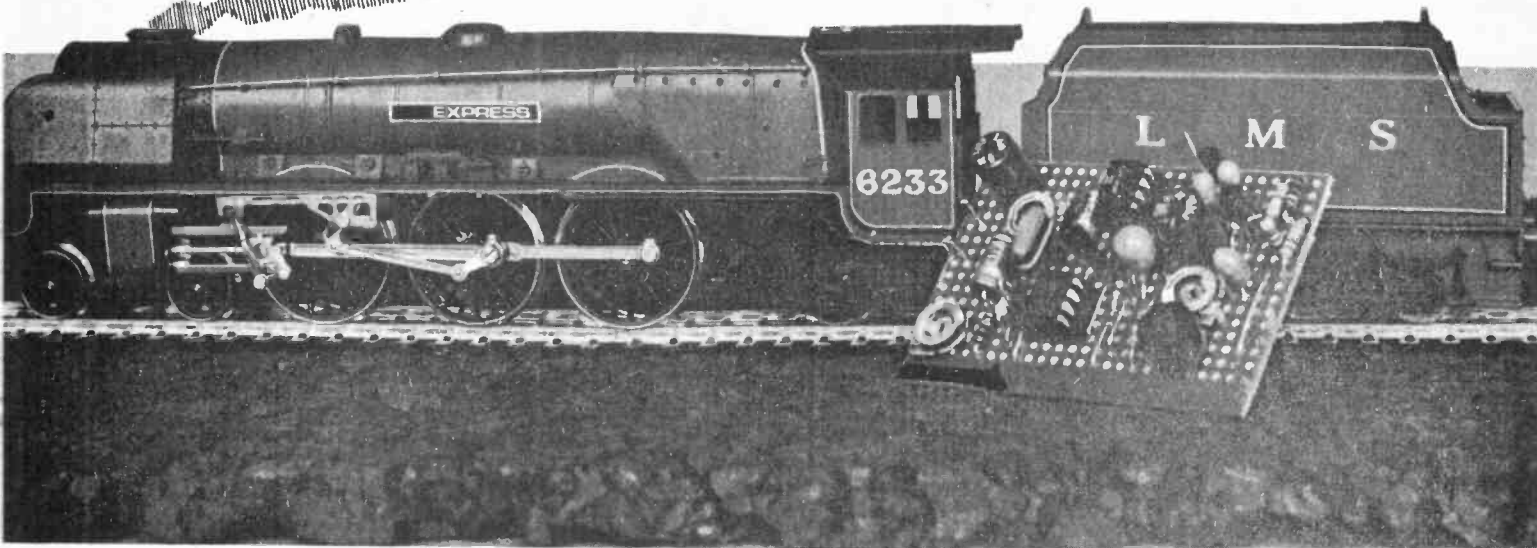

A simple circuit to accurately synthesize the sound railway engineers worked for years to get rid of.

THIS IS FOR model railwayites — that odd breed of beings who choose to sit at home in the attic or spare bedroom, surrounded by miles of track and scaled-down trains, stations and scenery. And what do they hear as they sit there? Certainly nothing resembling *real* train sounds.

Now, this sub-world can be made more complete by building some of our model train sound effects starting with the ETI Chuffer, a device designed to simulate the sound of a steam train. A preamplified output means that the device can be plugged into an external amplifier and preset controls allow it to be used with a wide range of train systems, to give the required sound. The project should perform well with standard (variable resistor type) controllers.

The two IC and three transistor circuit picks up and measures the voltage applied to the track by the controller and converts this into a varied rate of 'chuffs'. The higher the voltage, the faster the chuff rate. When the train is stationary only a faint background or 'parking' hiss is heard, but as soon as the train pulls away, the chuffs commence — slowly at first, until full power is applied, when chuffs are fast and furious as the train hurtles round the track.

Construction

The circuit is built up on a 16-strip by 26-hole piece of Veroboard.

Although this method of construction is very convenient for the hobbyist you

must remember that certain precedures must be followed if the project is to be fault-free. The copper strips or track must be broken in the correct places as shown in the underside diagram of the board in fig. 3. This can be accomplished using a hand-held 1/8" drill bit (if you haven't got the proper tool for the job) but in either case make sure that no loose bits of copper swarf bridge nearby tracks.

Next, insert and solder the wire links into the board as in the overlay diagram. Resistors and capacitors can then be soldered in. Polarised capacitors need to be inserted the right way round — check them carefully before sholdering! IC sockets should be inserted and soldered now.

Finally, all semiconductors should be put in, but like polarised capacitors they should be checked for correct insertion before soldering.

Setting Up

First set the three preset resistors at mid-position. Connect the circuit to an amplifier and a battery or 9 VDC power supply. Switch on. By adjusting RV3, a white noise signal of up to 100mV should be available to the amplifier. The setting of RV3 will be best found by experience and personal choice but as a rough guideline only, adjust it till just a faint hiss is heard from the amp.

Now, connect the input of the circuit to your model train track and set a train running around the track at medium speed. Readjusting RV3 should now give a variable output of white noise

from sharp clonking pulses to a continuous hiss — choose the best overall sound.

Using the train controller, stop the train. Adjustment of RV1 should provide a 'turn-off point' when no modulated noise is available (ie when the train is stationary — no 'chuffs' are heard). Fine readjustment of RV3 will now give a background gentle hiss at this stage, simulating a stationary steam train.

Finally, run the train at maximum speed and adjust RV2 until the required maximum 'chuff rate' is found. It may be necessary to retrim the presets until the best combination of background hiss, stationary turn-off and maximum chuff rate is obtained. ●

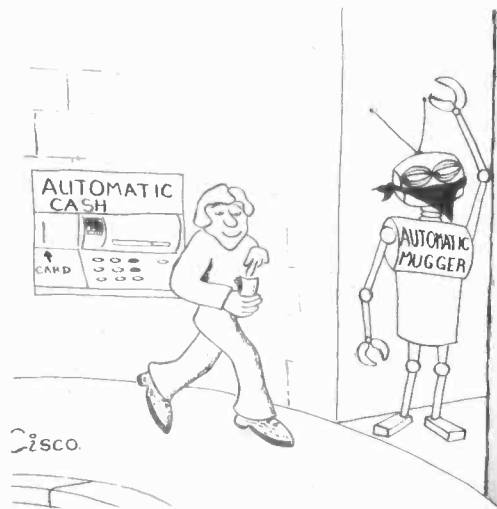

Con't on Page 27

ETI — MAY 1981

Figure 1. Circuit diagram of the Chuffer

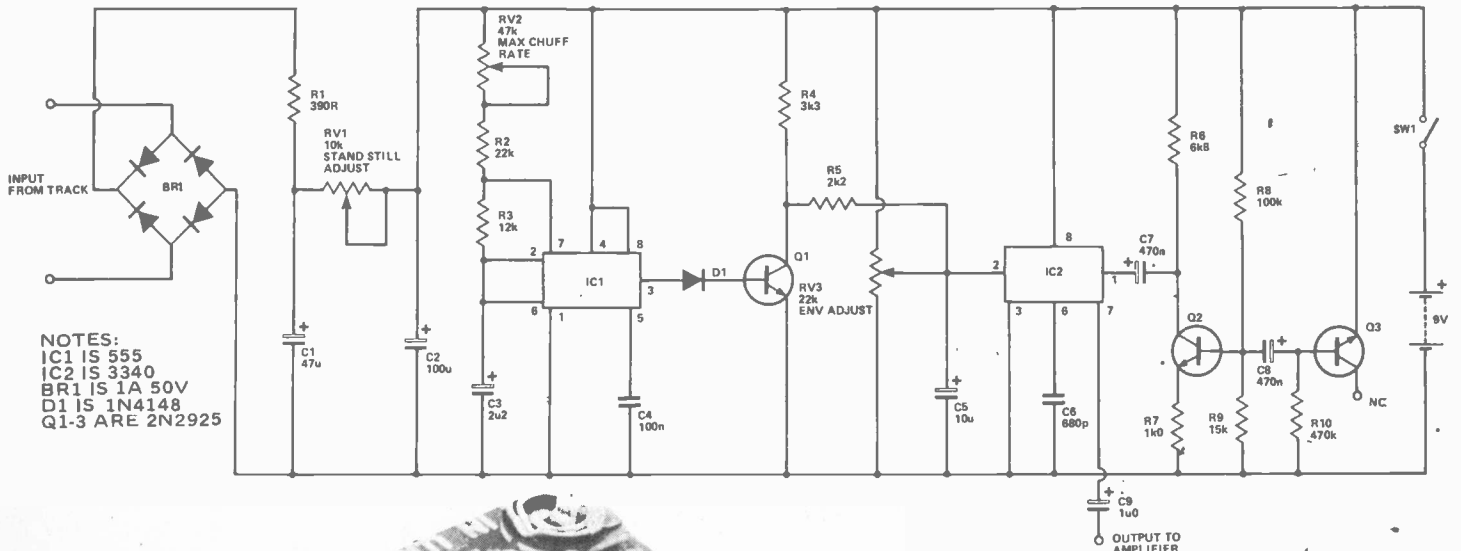

NOTES:
 IC1 IS 555
 IC2 IS 3340
 BR1 IS 1A 50V
 D1 IS 1N4148
 Q1-3 ARE 2N2925

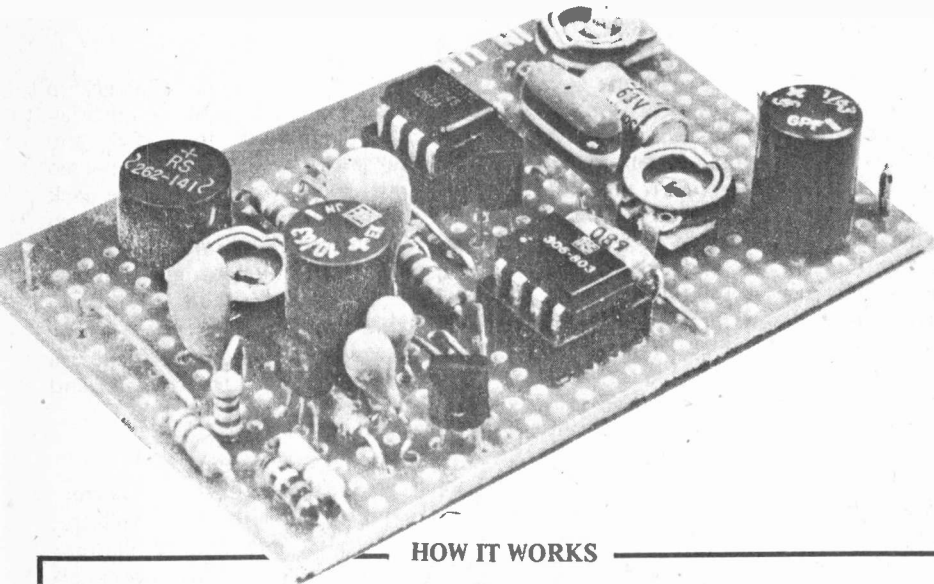

HOW IT WORKS

The main sound generated by a (full-sized) steam train is a more or less equal mixture of all frequencies — in electronics this sort of sound is known as white noise, so called because of this mixture of all audible frequencies (analogous to white light). One way of electronically producing white noise is with a transistor connected as Q3 in the main circuit diagram in Fig. 1. You will see that its collector is open-circuit and its emitter is, unusually, taken positive relative to its base. Connected so, Q3 acts as a zener diode, maintaining a constant voltage across itself. A white noise signal occurs at its base which is amplified by Q3 and fed to IC2.

The 'chuff-chuff' sound required of the circuit is formed by adding an envelope to the white noise. Figure 2 shows this in diagrammatical form. As can be seen, the enveloped white noise means that the noise increases from zero, maintains this maximum level for a while, then decreases

back to zero — forming a resounding 'chuff' sound. By repeating this envelope every so often as the train goes round the track, the required sound is obtained.

The rest of the circuit is designed to trigger the envelope at a rate which corresponds to the speed of the train; ie, at full speed the chuffs are rapid and at standstill, only a background hiss is heard to simulate a stationary steam engine. To do this the voltage present on the railway track is rectified and smoothed by BR1, R1, RV1, C1 and C2, to produce a DC voltage which increases and decreases with the speed of the train. This changing voltage is used to power an astable oscillator (IC1—a 555). As its power supply increases and decreases so does its oscillation rate. Preset RV2 gives overall control of oscillation rate (the chuff rate). Transistor Q1 buffers and inverts this pulse which is then used to trigger the envelope described above.

Figure 2. Combining white noise with an envelope

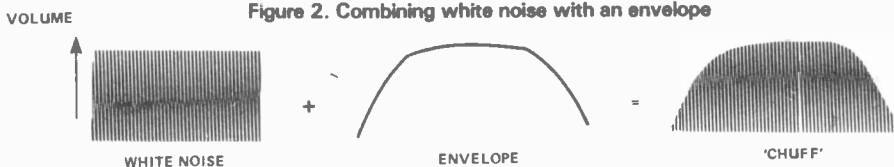

PARTS LIST

RESISTORS (All 1/4W, 5%)

- R1 390R
- R2 22k
- R3 12k
- R4 3k3
- R5 2k2
- R6 6k8
- R7 1k
- R8 100k
- R9 15k
- R10 470k

POTENTIOMETERS

- RV1 10k miniature horizontal preset
- RV2 47k miniature horizontal preset
- RV3 22k miniature horizontal preset

CAPACITORS

- C1 47u 10 V, tantalum
- C2 100u 6V3, tantalum
- C3 2u2 16 V, electrolytic
- C4 100n polyester
- C5 10 u 16 V, printed circuit mounting electrolytic
- C6 680p polystyrene
- C7,8 470n 35 V, tantalum
- C9 1u 16 V, printed circuit mounting electrolytic

SEMICONDUCTORS

- IC1 555 timer
- IC2 MC3340 voltage controlled attenuator
- BR1 1 A, 50 V bridge rectifier
- Q1,2,3 2N2925
- D1 1N4148 diode

MISCELLANEOUS

- SW1 single-pole, single-throw toggle switch
- 16 strip x 26 hole Veroboard battery clip
- IC sockets

NOBELL DOORBELL

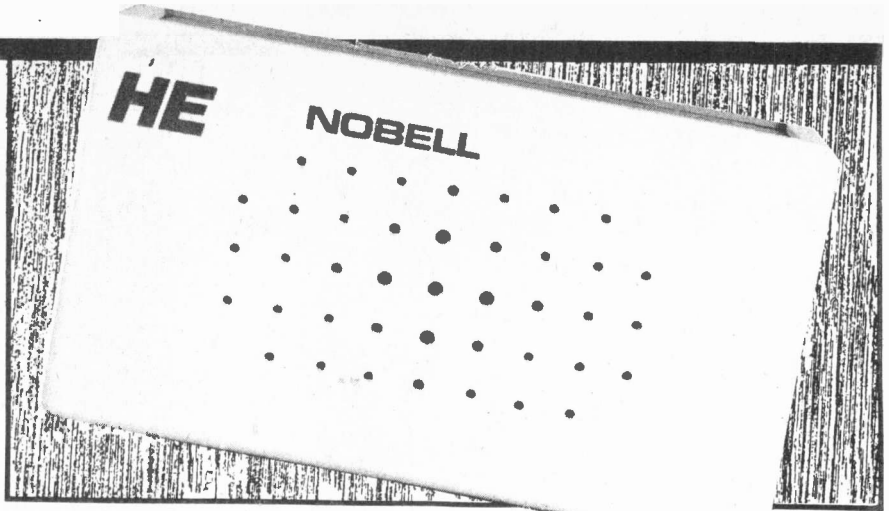

GLANCE THROUGH THE newspapers and it seems that almost every day another field of human activity has been taken over by the relentless march of the microprocessor. It's obvious that there's no limit to man's ingenuity for computerising anything and everything, no matter how trivial. Not even the humble doorbell has escaped, and you can now have the arrival of a visitor brought to your attention with a blast of almost any popular tune you fancy.

Knock Knock ...

Although we at ETI don't exactly disapprove of this electronic takeover bid (it keeps us employed), we feel a bit nostalgic for the good old days when you made your presence known to a householder by banging away on a huge brass knocker. So we've combined the past and the present in the form of the ETI Nobell, an electronic doorknocker. The Nobell's a prizewinning design that won't leave you in peace (OK, don't turn over the page, we promise not to do it again).

The audio generator is built around a single transistor oscillator. When it receives a trigger pulse it produces a 'boing' noise which can be tailored to resemble a knocking sound. Other sounds are possible as detailed in the setting-up procedure below. The sound is amplified by a standard LM380 audio power amp IC, a chip which should be familiar to regular readers of ETI.

The rest of the circuit is there to provide a set of five triggering pulses for the audio generator from the single pulse caused by pressing the push switch

Ring in the changes with this revolutionary design that faithfully reproduces the noise of those old time door knockers.

on the front door. This is done by a tone burst generator, a fairly standard electronic circuit. Two 555-type time/oscillators are connected together, one wired as a monostable (i.e. it produces only one output pulse of fixed length) and the other as an astable (it produces pulses as long as it is turned on). The push switch turns on the monostable which then turns on the astable. This results in a burst of pulses at the output. Normally the frequency of the tone is in the audio range and it is used for testing amplifiers and loudspeakers. In this project we use a very low frequency to generate our set of knocks.

Power can be obtained from any AC or DC supply in the 6 V to 12 V range. If a DC supply is used it may be connected either way round because of the steering action of the bridge rectifier D3 - D6.

Construction

Construction of this project is straightforward, especially if you use our printed circuit board. Make the usual careful checks to ensure that the ICs, electrolytic capacitors and the transistor are soldered in the right way round.

How you case the project is largely up to you. As the photographs and overlay show, we mounted the PCB and loudspeaker in a verobox and connected the input leads to a miniature jack socket. The wires from the push switch were terminated in a matching jack plug. Connect up the power and you're ready to set up the circuit. If you are using this project to replace your existing doorbell then you can make use of the existing bell transformer and push switch.

Setting Up and Customising

RV1 is adjusted to set the correct operating point for the Q1 oscillator, and should be turned until oscillations occur only when a trigger pulse is received. However, the exact position depends on your own personal taste. The sound can be varied from a short, sharp tick, through a sound resembling a knock, to an extremely good impersonation of a bongo drum.

Further alterations can be made by changing component values. As already mentioned, the number of knocks

Fig. 1. Circuit diagram of the ETI NoBell

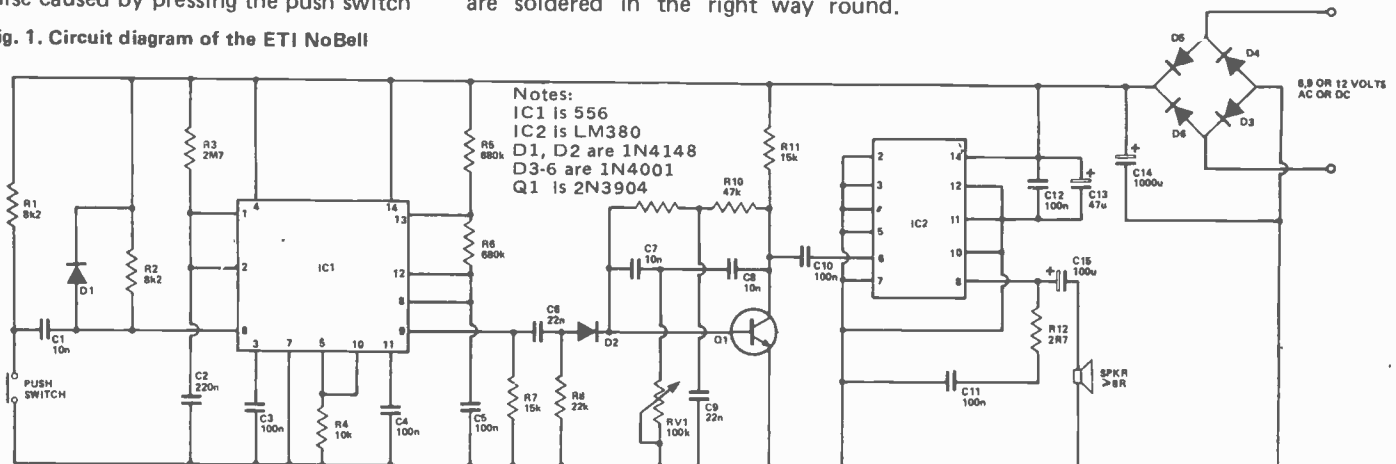

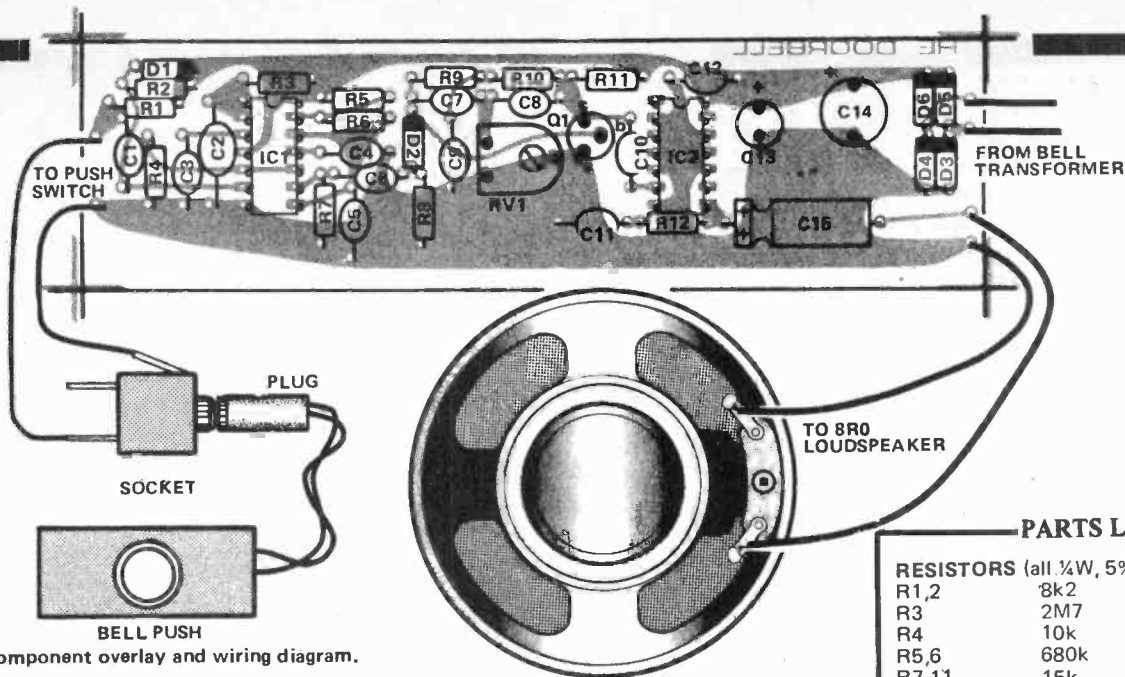

Fig. 2. Component overlay and wiring diagram.

HOW IT WORKS

When the push switch on the door is pressed, the brief pulse that is generated must be stretched out to operate the rest of the circuit. This is done by one half of IC1, a dual 555-type timer/oscillator. This half (pins 1-6) is connected as a monostable multivibrator i.e. a pulse of fixed length appears at the output (pin 5) whenever a trigger pulse from the push switch is received at the input (pin 6). The length of the output pulse is determined by the values of C2 and R3.

The other half of IC1 (pins 8-13) is wired as an astable multivibrator, or oscillator. It produces a square wave at pin 9 whenever the output pulse from the monostable forces pin 10 (enable input) high. The frequency of the square wave is determined by the values of R5, R6 and C5. The square wave passes to the sound generator via C6 and D2.

The sound generator circuitry is a

'twin-T' type sine-wave oscillator. Q1 is an amplifier with a twin-T filter in its feedback loop (R9, R10 and C9 form one 'T' and C7, C8 and RV1 from the other). If the loop gain of this circuit is greater than one, oscillation occurs at the resonant frequency of the filter. RV1 is adjusted so that Q1 is just on the verge of oscillation - a pulse via D2 will force the oscillations to start but they quickly die away. This makes a 'bong' type of sound.

The signal is amplified by audio amplifier IC2, and LM380, and fed to the loudspeaker.

The power supply is not at all critical. An AC supply rectified by diodes D3 - D6 and these same diodes mean that a DC supply can be connected either way round. The supply is smoothed by capacitor C14 and additional decoupling of the supply to IC2 is provided by C12 and C13.

Internal view of the NoBell, note position of the speaker.

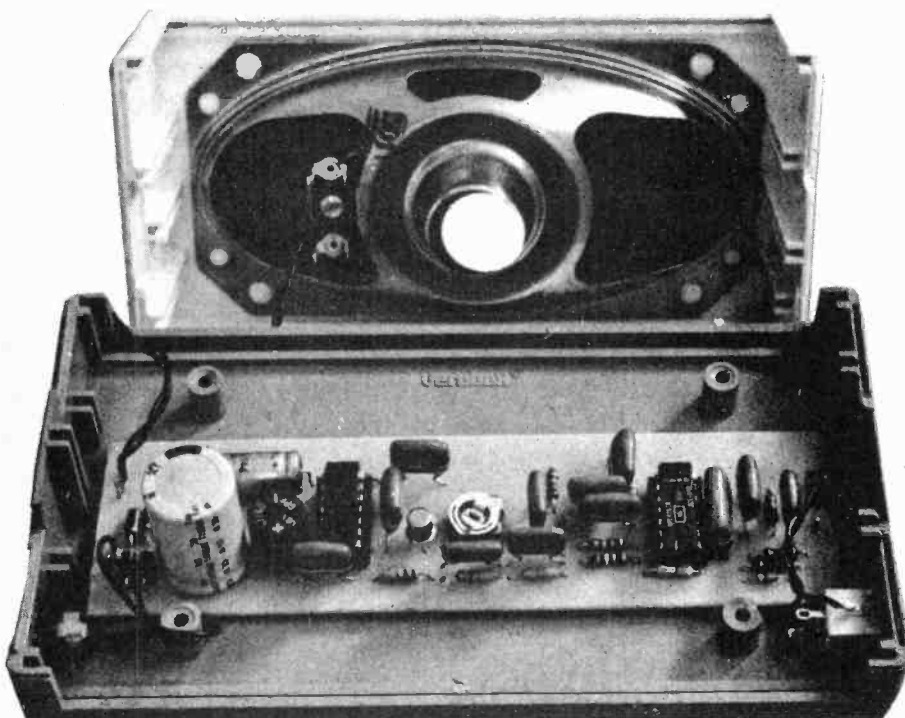

PARTS LIST

RESISTORS (all 1/4W, 5%)

R1,2	8k2
R3	2M7
R4	10k
R5,6	680k
R7,11	15k
R8	22k
R9,10	47k
R12	2R7

POTENTIOMETERS

RV1	100k linear horizontal miniature preset
-----	---

CAPACITORS

C1,7,8	10n polyester
C2	220n polyester
C3,4,5,10	100n polyester
11,12	22n polyester
C6,9	47u 25V PCB-mounting electrolytic
C13	1000u 25V PCB-mounting electrolytic
C14	100u 25V axial electrolytic
C15	100u 25V axial electrolytic

SEMICONDUCTORS

IC1	556
IC2	LM380
D1,2	1N4148
D3-6	1N4001
Q1	2N3904

MISCELLANEOUS

PCB, push switch, loudspeaker (≥ 8 ohms), Verocase.

depends on the time period of the monostable and the frequency of the astable. In our circuit, these are set at half a second and ten Hertz respectively, so there will be five knocks. The monostable period is set by R3 and C2 and increasing either of them lengthens the time of operation. The astable frequency is set by R5, R6 and C5 and if one or more of them is decreased the 'knocks' will come faster.

If you decide to use the bongo sound, then you can vary the pitch by altering the values of C7, C8 and C9 in the twin-T filter. The same approximate ratios between the capacitors should be maintained - for example if you halve their values (to 4n7, 4n7 and 10n) then the pitch of the bongos will be doubled.

TOUCH SWITCH

A unique new design for a popular project. The ETI Touch Switch uses VMOS Field Effect Transistor to turn your offs back on again. A cheap and east to build circuit.

WOULD YOU LIKE to turn your radio, your stereo system or virtually any electrical equipment on and off merely by *touching* it? This simple touch switch can be adapted to do the job.

This unique device uses ordinary skin resistance to trigger a VMOS power transistor into conduction by touching the "ON" metal plates on the front panel. Once it has been touch-triggered, the transistor remains in this state (and so your electrical equipment remains on) until the device is turned off by touching the "OFF" plates.

Obviously the absence of any moving parts to wear out means that a touch switch has the advantage over mechanical switches of an almost unlimited operating life. The ETI VMOS Touch Switch is primarily intended to suit 9 volt battery operated equipment, drawing up to a couple of hundred milliamps or so. However, there is nothing to stop the ambitious reader from connecting a relay at the touch switch output and using the relay contacts to switch line type equipment. The sky's the limit.

Construction

No breaks in the track of the 10 x 24 hole, 0.1" matrix veroboard are required so the components can be soldered in immediately, following the board layout of figure 1.

Although Q2 is a VMOS device, its internal protection diode withstands higher voltages than those which can occur on human skin so special handling precautions are absolutely unnecessary.

Suitable touch contacts can be made from small bits of printed circuit board.

The circuit can be cased if required, or left as ours, on a panel therefore enabling its easy insertion into equipment. It really is up to you and the use to which the Touch Switch is to be put.●

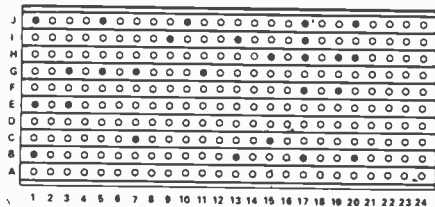

Fig. 1. The veroboard layout and (above) the underside of the board. The three connections from points B1, E1 and J1 go straight to the off, central and on touch plates.

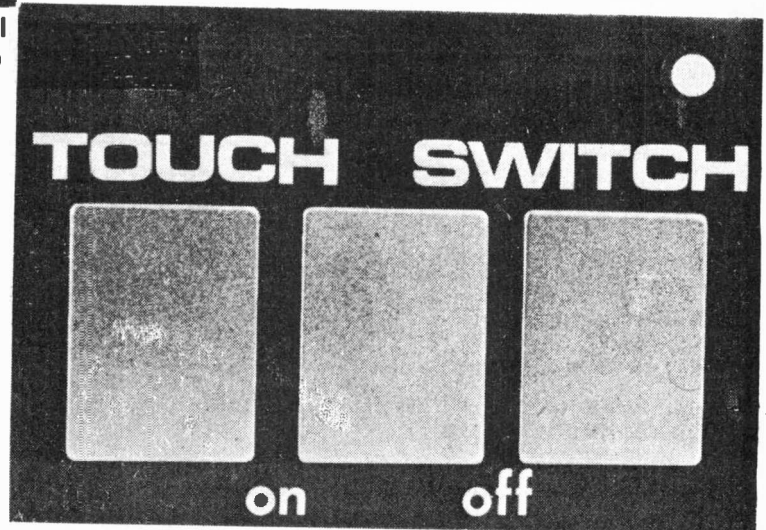
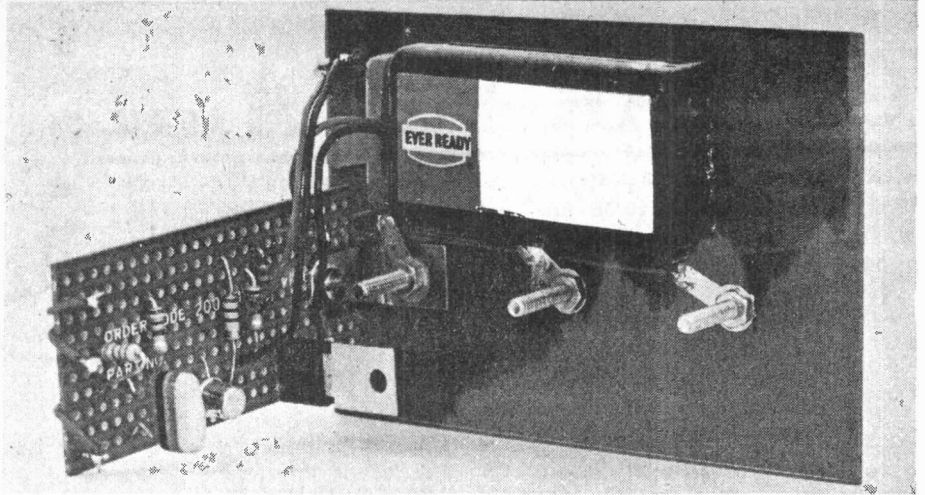

Fig. 2. The ETI Touch Switch circuit diagram. Q2 is a VMOS FET and needs no special handling precautions.



HOW IT WORKS

Fig. 2 shows the circuit diagram of the touch switch, which is a form of bistable multivibrator.

When power is first applied to the circuit it goes into the "ON" state, with Q2 being biased into conduction by R2. The voltage at the drain of Q2 is then at virtually the negative supply potential, and so no base current is supplied via R3 and R4 to Q1, and the latter remains switched off. Many readers may be unfamiliar with VMOS devices, such as the one used in the Q2 position. In practical terms, these differ from ordinary power transistors in that they have an extremely high input impedance, and consume no significant input current. In fact they are voltage rather than current operated devices, requiring a gate potential of about 1 to 2 volts before they start to conduct, and just a very few volts more than this to bias them into saturation. Thus, despite its high value, R2 is quite capable of switching Q2 hard on.

If the two "OFF" touch contacts are operated, a base current for Q1 flows from

the positive supply, through the user's skin and R1 into Q1, causing Q1 to switch on. Q2 then switches off as its gate potential falls to virtually zero, and power is cut off from the load. Q1 then obtains an extremely small base current via the load, R4, and R3, but this current is sufficient to keep the device switched on when the operator's finger is removed from the touch contacts. The circuit therefore latches in the "OFF" state.

The unit can be returned to the "ON" state by touching the "ON" touch contacts. This diverts the base current Q1, causing the device to switch off so that Q2 is biased into conduction once more.

R1 ensures that an excessive base current cannot flow into Q1 if an accidental short circuit across the "OFF" contacts should occur. C1 prevents electrical noise from producing spurious operation of the unit. The current drain of the unit is an insignificant 9 μ A when it is in the "OFF" state, and practically zero when it is in the "ON" state.

PARTS LIST

RESISTORS (All 1/4W, 5%)

R1	3k3
R2	1M0
R3,4	10M
R5	270R

CAPACITORS

C1	47n polyester
----	---------------

SEMICONDUCTORS

Q1	MPS 6515
Q2	VN66AF or VN67AF N-channel power VMOS
LED 1	0.2" Red LED

MISCELLANEOUS

3x	touch contacts
10x	24 holes 0.1" matrix veroboard
1x	battery and clip

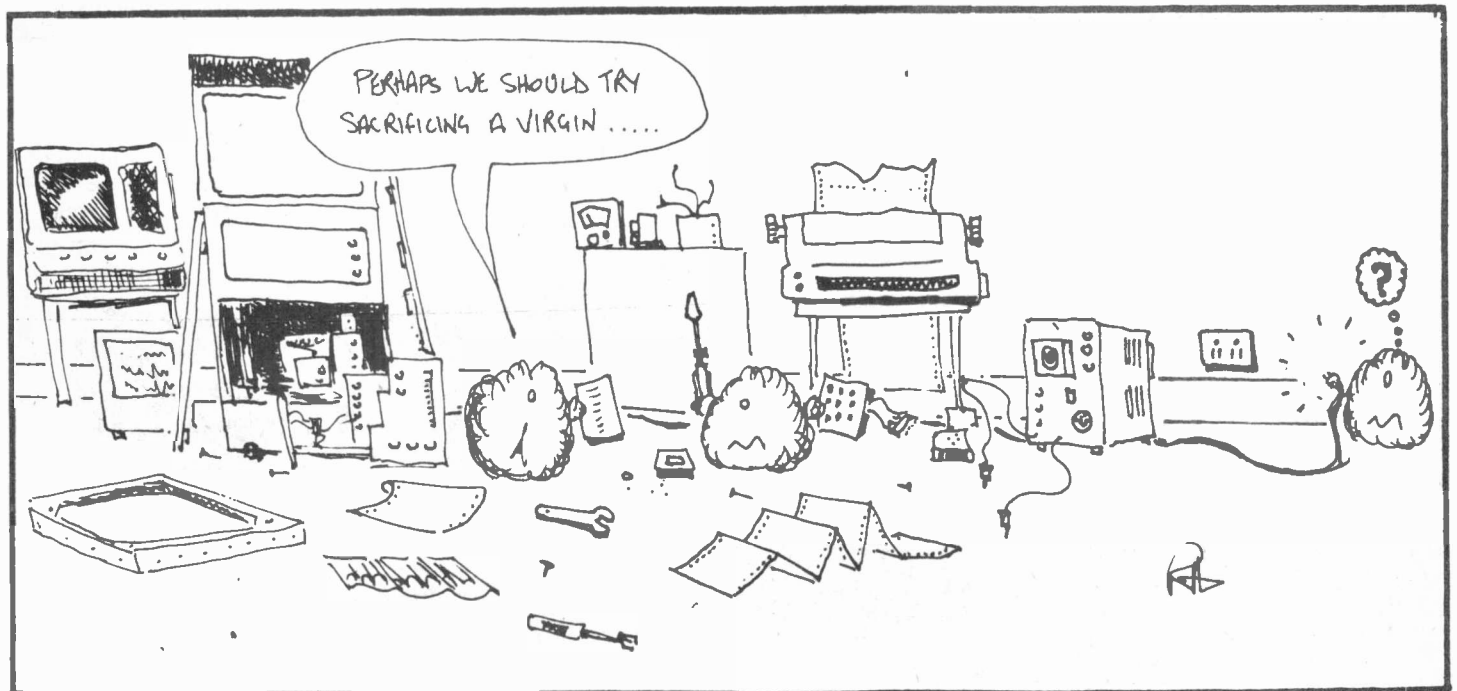

GUITAR PRE AMP

Got a guitar? Here's a way of improving its frequency response and cutting down noise and interference. This may seem too good to be true, but the ETI Guitar Preamp can do all these things and a few more.

WHY SHOULD YOU need to build a circuit like the ETI Guitar Preamp into your guitar? I mean, who wants to take hacksaw, mallet, chisel and Black-and-Decker to their favourite Les Paul, simply to stick in some classy tone controls? Well, (believe it or not) there is a good reason why: you see, the trouble is that guitar pickups produce only a very low-level signal, usually just a few millivolts. And it's amazing just exactly what this signal has to put up with before it comes blasting out of the speaker at 4000 MW audio power.

First this feeble little signal has to fight its way through the passive tone networks and volume control on the guitar. After this, it reaches the outside world through the socket on the guitar body. But here it finds itself confronted with a long tunnel — about 20 feet (6 metres) of screened cable. Exhausted, it arrives at its destination, the amplifier. Up to this point the signal receives no amplification at all. Instead it relies on the high-gain preamplifier in the main amp to do all the work.

This arrangement, although popular for decades, has some serious pitfalls:

- passive tone controls — they do the job but don't allow for a great deal of tonal change in the sound. Active controls are much better

- a low-level signal in a long lead — very susceptible to noise and interference pickup. This can be understood more easily as a ratio of signal-to-noise. For instance, consider a noise or interference pulse, with an amplitude of 10 mV, so the signal-to-noise ratio is 10 to 1. The result will be an audible click. If, however, the guitar signal is amplified at source to say 5 V, then the ratio becomes 500 to 1. Because the noise amplitude remains the same it will be totally masked by the signal. Remember, once the noise or interference has been introduced it becomes extremely difficult to eliminate — amplifying the signal at the end of the lead only amplifies the noise too!

- A high-gain preamp is prone to interference itself — and unfortunately a

power amplifier is a very good producer of interference (because of the high currents roaming around inside it). It is better to keep the preamp and power amplifier as far apart as possible.

Inserting the preamplifier inside the body of the guitar immediately reduces all these effects and gives an improvement in guitar sound. This is the method we have adopted for the ETI Guitar Preamp. The preamp is as close to the signal source as possible and the resultant quality just has to be heard to be believed.

Construction

Although the circuit is rather compact, using Veroboard, its construction is still remarkably easy. Remember to break the copper strips of the board in the correct places before inserting components. Either the correct tool or an 1/8 in. drill bit — carefully hand-held — can be used for this job. Press lightly down on the correct hole and gently twist the tool or drill bit clockwise until the track is broken. Make sure no bridges have been formed between adjacent tracks by loose copper swarf.

The components can now be inserted following the overlay diagram of the circuit. An IC socket is advised for IC1 but not essential. Make sure that all polarised components, C4, C7 and IC1, are the right way round.



After checking that you have no solder bridges across copper tracks, you can commence wiring up the board to pots, battery and jack socket — and final housing.

As you can see in the photographs we housed our circuit inside the body of the guitar, directly underneath the pickup. This is the most advantageous position. However, if you don't want to carve up the inside of your Gibson, Guild or Gretsch, build it in a small box outside the guitar: the improvement in performance will still be worth the effort.

You will find it easier to mount all three pots and the 1/4" socket on the front panel before commencing wiring. Solder longer-than-necessary leads on the pots (screened lead need only be used on the volume pot). Mark them and loosely mount the panel, taking the leads along inside the body of the guitar to wherever the circuit board and

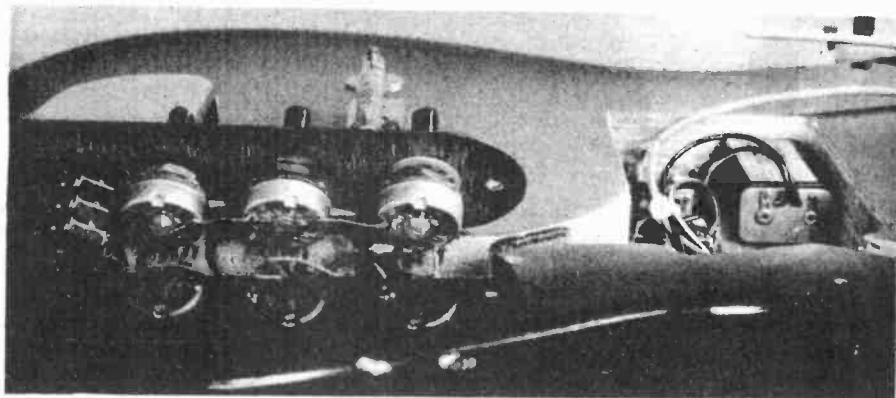

battery are mounted. The connection diagram shows where all connections from the pots to the board go. Remember C10 (we ran out of room on the board!) mounts on the volume pot. Cut the leads to the required length before soldering and when all connections have been made, the group of leads, nine in all, can be held together with cable ties to form a neat cable. Finally, ground all pot bodies with one length of wire. You may have to lightly file the body of each pot to clean up the surface before it will solder.

And that's it! You can check the whole thing before putting the guitar back together by plugging the unit into an amplifier — remember the guitar will now work with an amplifier without a pre-amplifier — and set all controls at about mid-position. Dangle anything metallic, — a bunch of keys will do — close to the pickup. The result will be a raucous noise from the speaker, proving that everything is OK. Check that all controls function correctly and if so you can now replace all guitar panels and play to your heart's content — with hifi sound.

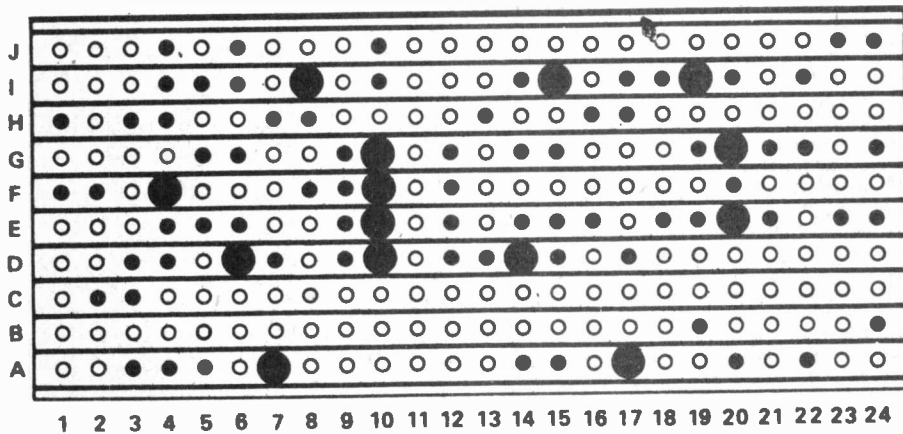
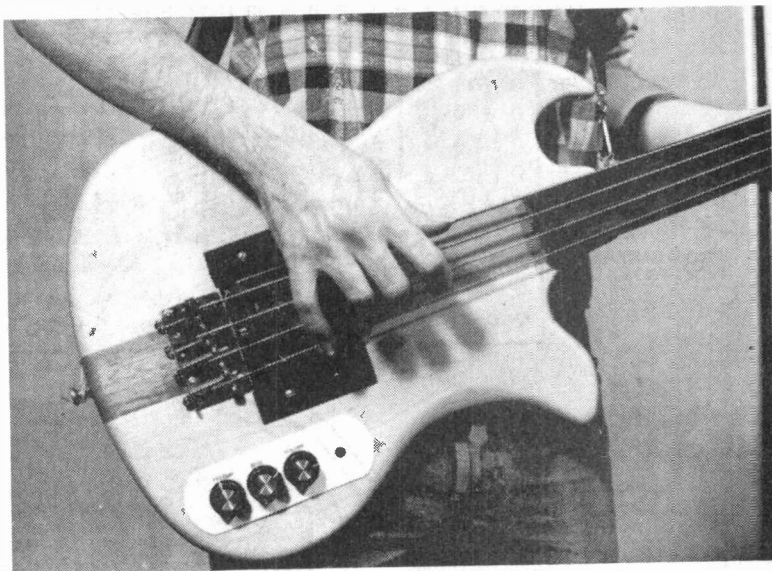

Fig. 2. Veroboard track cutting diagram.

PARTS LIST

RESISTORS (ALL ¼W, 5%)

R1	330k
R2	10k
R3	270k
R4	680k
R5,6,7	12k
R8	47k
R9,10	3k9
R11	18k
R12	680R

POTENTIOMETERS

RV1	100k lin
RV2	500k lin
RV3	10k log

CAPACITORS

C1,3,9	100n polyester or ceramic
C2,8	10n polyester or ceramic
C4,7	22u 10V tantalum
C5	47n polyester or ceramic
C6	4n7 polyester or ceramic
C10	1u 10 V electrolytic

SEMICONDUCTORS

IC1	LM387 dual preamp
-----	-------------------

MISCELLANEOUS

10 strip x 24 hole Veroboard stereo ¼" socket, battery and clip, knobs to suit

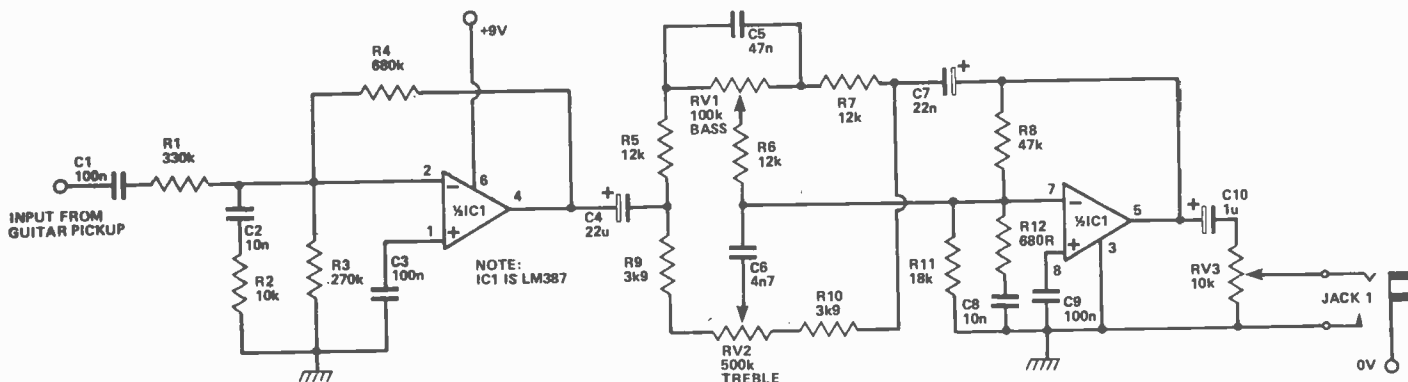

Fig. 1 Circuit diagram of the Guitar Preamp.

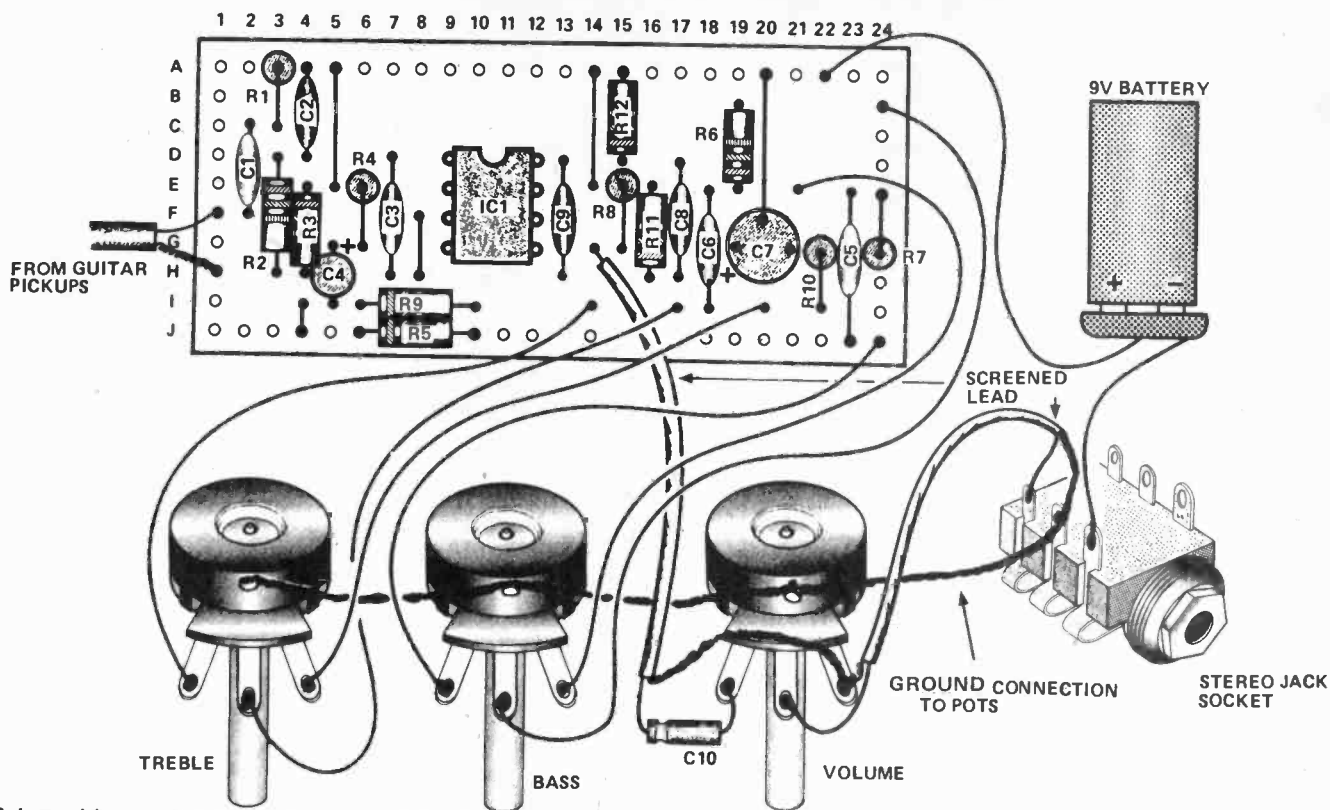

Fig. 3. Interwiring and overlay diagram for the Guitar Preamp.

HOW IT WORKS

The main component, IC1 consists of two separate preamplifiers housed in the same 8-pin DIP body connected only by a common power supply of between 8 and 30 VDC. Both preamps are identical and are ideally suited for single 9 V-battery operation – current consumption is low, meaning that a 9 V sized cell can be used and has a reasonable life.

The first preamplifier (pins 1, 2 and 4) acts as a fixed gain, flat response circuit, meaning that all frequencies within the audio band are amplified equally. The gain factor of this stage is determined by the ratio of R4 to R1. If further gain is required, R1 should be reduced in value. Conversely, if gain has to be reduced, R1's value should be increased. This facility need only be used if the output from your guitar pickup is either less than, or larger than, average. We used a medium-output amplitude pickup and so our value for R1 provides a good starting point.

The input impedance of this preamplifier is such that the guitar pickup

will not be loaded at all.

The second stage is designed around the second half of IC1 (pins 7, 8 and 5) and forms an active two-band tone control block. Bass and treble potentiometers are inserted in the feedback loop of this pre-amplifier, and provide very good control over the desired frequency response.

Potentiometer RV3 can be adjusted for volume. Because the output signal amplitude of the whole circuit is in the region of 2 volts it should be more than adequate for most requirements. A stereo jack socket is used for the output connections – this provides a useful means of on/off switch for power. When a normal mono jack plug is inserted into the stereo socket, the first two connections are shorted by the jack. Thus, if the battery 0 V connection is taken to the circuit via these two connections, power will only be supplied when a plug is in. You must, however, remember to take out the lead, when not using the guitar, to switch off the circuit and save your batteries.

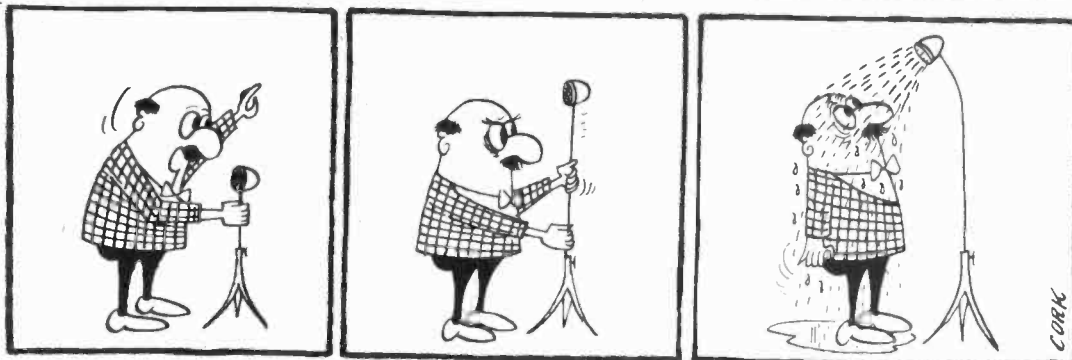

USING VEROBOARD

Methods of circuit construction are always an obstacle to the hobbyist. John Van Lierde describes how Veroboard can ease some of the bother.

REGULAR READERS OF ETI know that after printed circuitry, our favourite method of construction is Veroboard.

Veroboard combines the best features of both printed circuit and perfboard. First of all, the holes are spaced on a 0.1" grid, allowing the board to accommodate virtually any type of IC package. Second, the holes are joined by parallel strips of copper. The net result is a general purpose printed circuit board. The advantages are that much of the rat's nest inherent in perfboard construction is replaced by the copper tracks beneath, and the components are rigidly mounted to the board.

Using It

Essentially, one loads the board with components, solder, apply power and hope for the best. This is, of course, is over-simplifying things. Further versatility is possible by breaking the copper tracks. The easiest way to do this is to use a Vero spot face cutter. These cost approximately \$4.50 and usually last a long time. If you're into saving money, you can get by with an 1/8" drill bit, but the Vero tool can save you time and agony.

As with any endeavour, a little forethought results in a more satisfactory end product. If you're not careful, you may run out of real estate before you finish the circuit. Alternatively, you may finish the job with several square inches of board left over (ie. wasted). Another point to remember is not to build up the circuit and cut the board afterwards, it's not worth the effort.

Generally speaking, the fewer track breaks one makes, the more elegant the layout. This is purely a matter of taste, but it is worth considering — especially because it can save soldering tracks together when you've cut one too many.

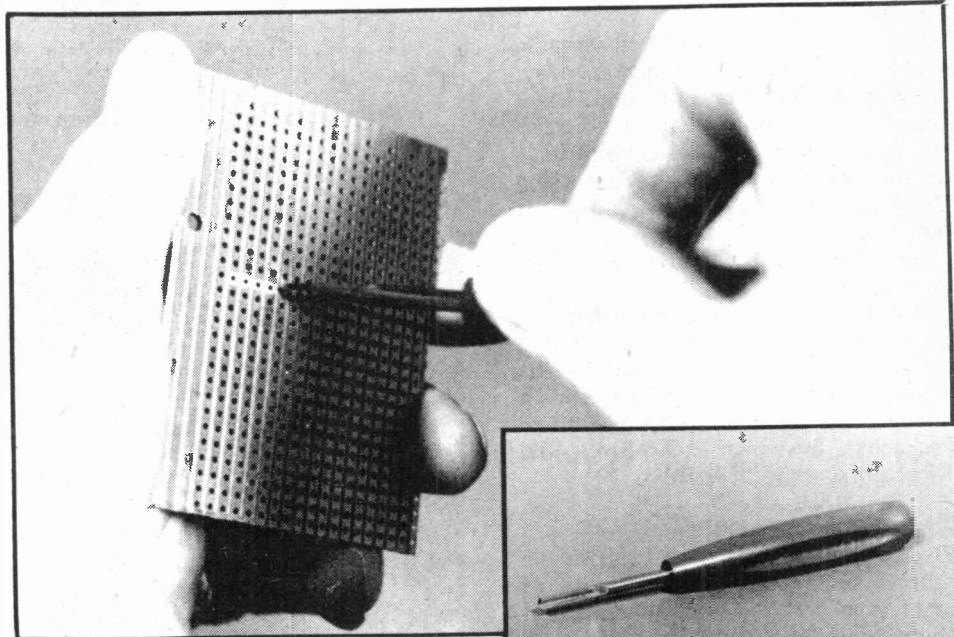

At right, a Vero spot face cutter. The photo above shows it in use.

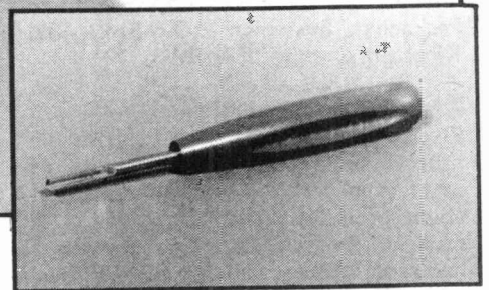

An alternate method of approach is to break the tracks at regular intervals, every 5 or 6 holes, with a hacksaw. You can locate ICs over the breaks and connect other components between the copper 'lands'. In this way, a circuit can be conveniently sectioned. By marking the location of the breaks above board, the builder can follow the circuit from the top without having to constantly refer to the underside.

This technique is similar in concept to regular solderless breadboard sockets. You could in fact transfer a layout from breadboard to Veroboard with very little modification. Incidentally, Vero manufactures a board that suits this method of construction. It's called VQ Board.

Frills

The 0.1" spacing of the copper strips also makes Veroboard a very serviceable edge connector. Veroboard comes precut for this purpose, or you can cut or nibble shoulders into a standard piece of board.

Veroboard is manufactured from phenolic, which, as some readers may know, isn't the best board around.

Phenolic consists of paper pressed and bonded with phenol resin. For the most part it is a satisfactory circuit foundation — strong, rigid and impervious to moisture. What phenolic will not tolerate is repeated stress or heating of joints. This will cause the copper to separate from the board.

For the most part this is only a problem with flying leads. These are frequently flexed, pulled and soldered on & off. The solution to this problem comes in the form of Veropins. These

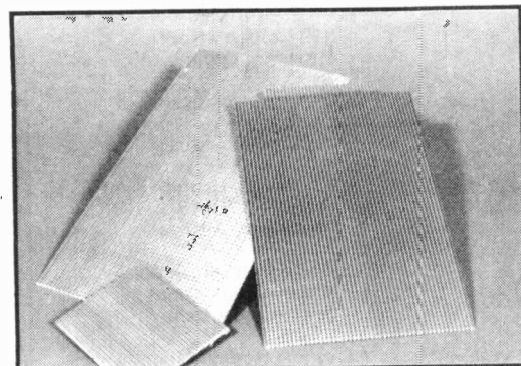

USING VERO BOARDS

are essentially the same idea as flea clips with the exception that they're a heck of a lot easier to stick into the holes.

Needless to say, there's a pin insertion tool available. It costs about \$6.00, but you could get by with a piece of small diameter rigid tubing. However, as with the spot face cutter, having the right tool makes the job easier.

Finally

Veroboard is one of the most versatile circuit perfboards on the market today. A 2.5 x 5" piece retails for about \$2.40 and is fairly competitive with other types of board. We've published a number of projects this month using Veroboard, so buy a piece and try it out.

Buy the spotface cutter later when you're a convert.

Vero products are imported by Electronic Packaging Systems. For a copy of the catalogue 'Products for the Hobbyist', current price list and a retailer near you, write to Electronic Packaging Systems, P.O. Box 481, Kingston, Ontario K7L 4W5.

Where To Buy Vero Products

Electronic Packaging Systems is in the process of establishing a network of retailers for Vero products. To find out about products available, you can get a hold of Product for the Hobbyist, a handy catalogue available from EPS or any of their retailers.

Electronic Packaging Systems
P.O. Box 481
Kingston, Ontario K7L 4W5

Kris Electronics Limited
1070 Morrison Drive
Unit 1B
Ottawa, Ontario

Kingston Electronic Supply
147 Joseph Street
Kingston, Ontario

General Electronics Limited
5511 Yonge St.
Willowdale, Ontario

Exceltronix
319 College Street
Toronto, Ontario

Interior Electronics Limited
Vernon - Kelowna - Kamloops
British Columbia

R.A.E. Industrial Electronics Limited
17680 - 170th St.
Edmonton, Alberta

Waterloo Electronic Supply
219 Hartwood Avenue
Waterloo, Ontario

Cite Electronique Inc.
3185 Rue Hochelaga
Montreal, Quebec

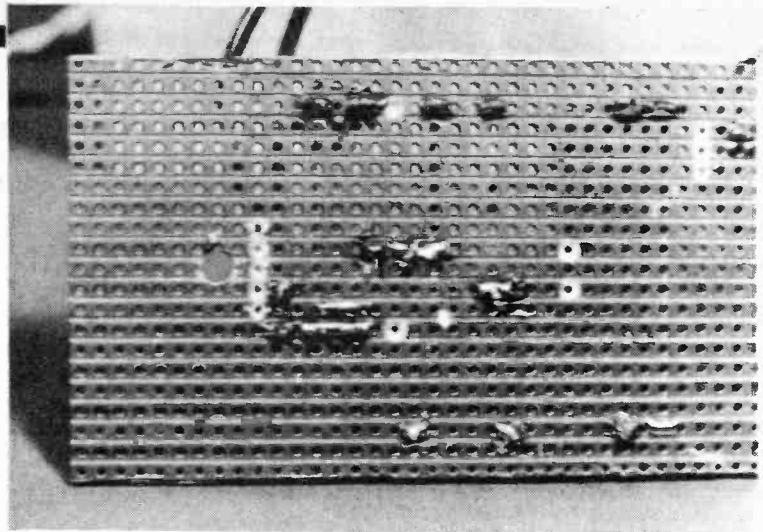

Underside of a small power supply project. Note the use of breaks in copper tracks.

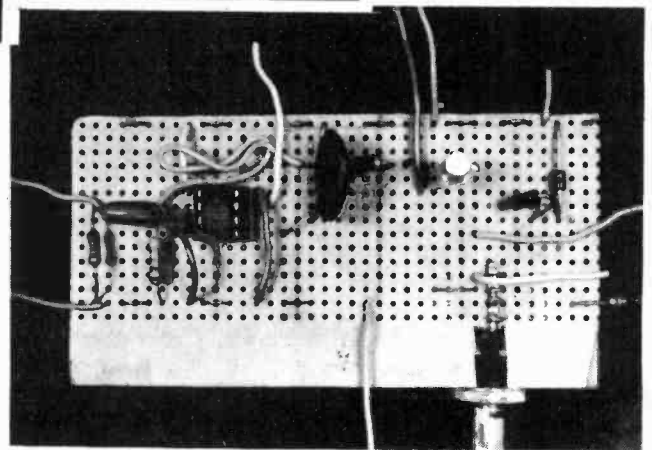
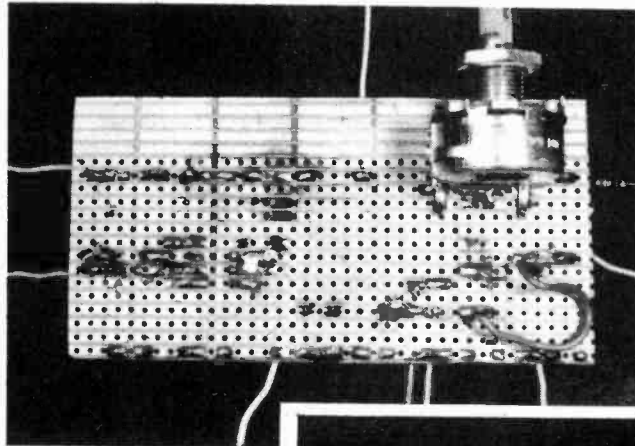

Another method of Veroboard construction is to break the copper into separate lands at regular intervals.

HALF PIN

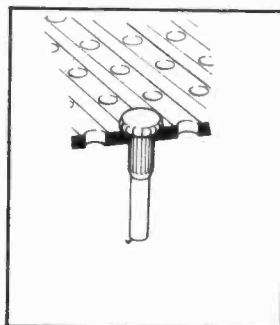

HALF PIN INSERTION

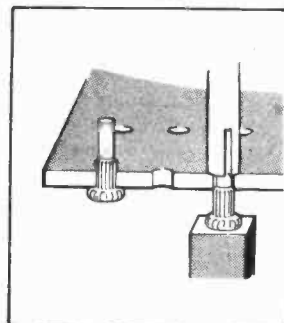

STEREO POWER METER

Find out WATT power your stereo system delivers with this gadget from ETI — simple to make and even simpler to use, this little device can be built as a piece of test gear or as a decorative sound-to-light converter

THERE ARE TWO main problems associated with audio power measurements:

the signal peaks (that is the changes in volume level) are so fast-moving that an ordinary meter — digital or analogue, cannot respond fast enough to give an accurate reading

the changes of levels of volume occur over a very wide range — for example, the difference in signal amplitude between the quietest sound we can hear and the loudest sound we can bear is over 100,000 times. Our Audio Power Meter overcomes both problems by using a 'line of LEDs' display instead of a conventional moving coil meter. The LEDs are scaled in logarithmic steps of 3 dB (each step representing a doubling of power). This display responds exceptionally quickly to the signal peaks and is easily read and also very rugged, whilst the logarithmic scale reduces the apparent scale length to a manageable form.

The circuit is for a stereo version and it fits into a small hand-held case. Two ICs (one per channel) do literally all of the work, measuring the audio power and driving the LED display in the correct logarithmic manner, measuring from 0.2 to 100 W in 3 dB steps. The meter is simply connected to the two speakers. If a continuous display is desired (such as for use as a decorative ornament), then a line operated power supply should be used in preference to the built-in battery. (A fair amount of current is required to drive the LEDs.)

Construction

Start construction with the printed circuit board. Insert the link first, followed by passive components, the resistors, capacitor and the two IC sockets (if used).

Mark and drill the bottom of the case to fit the phone plugs, JK1 and SW1, and insert all four into their places. Next, attach 22 leads, about five inches long, to the board, where connections to the LEDs go, but don't attach the leads to the LEDs yet. Before fastening the PCB into the case connect the phono sockets, jack and switch to the relevant places on the board, following the diagram in Fig. 2.

The top half of the case should now be marked and drilled for the 20 LEDs. If you make the holes just the right diameter for the LEDs to push-fit then no special fixing procedures are necessary. Alternatively, a spot of glue will be OK.

The anodes of each line of LEDs can be wired together using a short length of uninsulated wire and from there to the relevant point on the PCB shown in Fig. 2. Next, wire the remaining 20 connections from the PCB to the correct cathode of each LED and finally cable-form the two groups of leads using a couple of cable ties.

Resistors Rx and Ry can both be calculated from the table in Fig. 3 and need to be the correct value for whatever speaker impedance the audio system uses. Simply check on the table what the speaker impedance is and insert Rx and Ry as the corresponding resistor values.

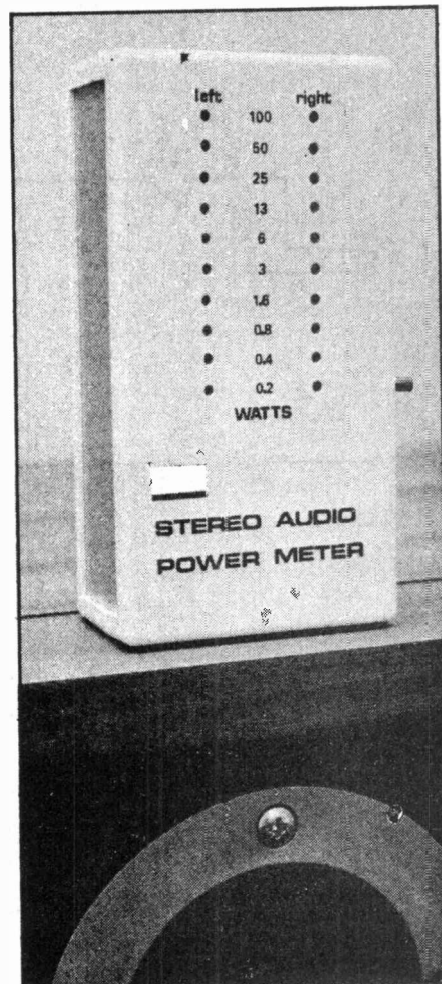

HOW IT WORKS

Figure 1 shows the full circuit diagram of the audio power meter and from this the reader can appreciate that each stereo channel is identical. The following description therefore explains how only one channel (IC1 and associated components) function, the other (IC2 and its components) operates similarly.

Integrated circuit IC1 is an LM3915, which is classified as a dot/bar display driver, suitable for driving a line of 10 LEDs either in dot mode (one LED at a time) or bar mode (a continuous line of LEDs). This application sees the LM3915 in bar mode.

The IC has an internal ten-step voltage divider and as the voltage at pin 5 (owing to the varying audio signal) increases above these steps a corresponding LED is turned on. Thus if the voltage at pin 5 was half way up the voltage divider scale

then five LEDs would be on. The voltage divider is measured in steps of 3 dB. Now, we weren't too sure what this meant so we asked the postman and he told us that when a voltage V_1 increases by 3 dB over a second voltage V_2 it simply means that it is 1.414 times as big. Thus:

$$V_2 = V_1 \sqrt{2} = 1.414 V_1$$

Now, power P is given by:

$$P = \frac{V^2}{R} \quad \text{so}$$

$$P_1 = \frac{V_1^2}{R} \quad \text{and} \quad P_2 = \frac{(V_1 \sqrt{2})^2}{R} = \frac{2V_1^2}{R} = 2P_1$$

Hence for a voltage gain of 3 dB, power is doubled.

Correspondingly, the scale of the power meter can be marked off either in steps of 3 dB or as power (doubling for each LED in the line).

PARTS LIST

RESISTORS (All 1/4W 5%)

R1,2	10k
R3,5	390R
R4,6	2k7
Rx,y	see text

CAPACITORS

C1	2u2 16 V tantalum
----	-------------------

SEMICONDUCTORS

IC1,2	LM3915 dot/bar display driver
LED 1 to 20	miniature LEDs (various colours — see Fig. 1)

MISCELLANEOUS

SW1	single-pole, double-throw toggle
JK1	3.5 mm socket
2 x phono sockets	
9 V battery and clip case to suit	

SPEAKER IMPEDANCE	R _x ,R _y
4R	10k
8R	18k
16R	33k

Fig. 3. The PCB overlay. Above shows how to calculate R_x and R_y.

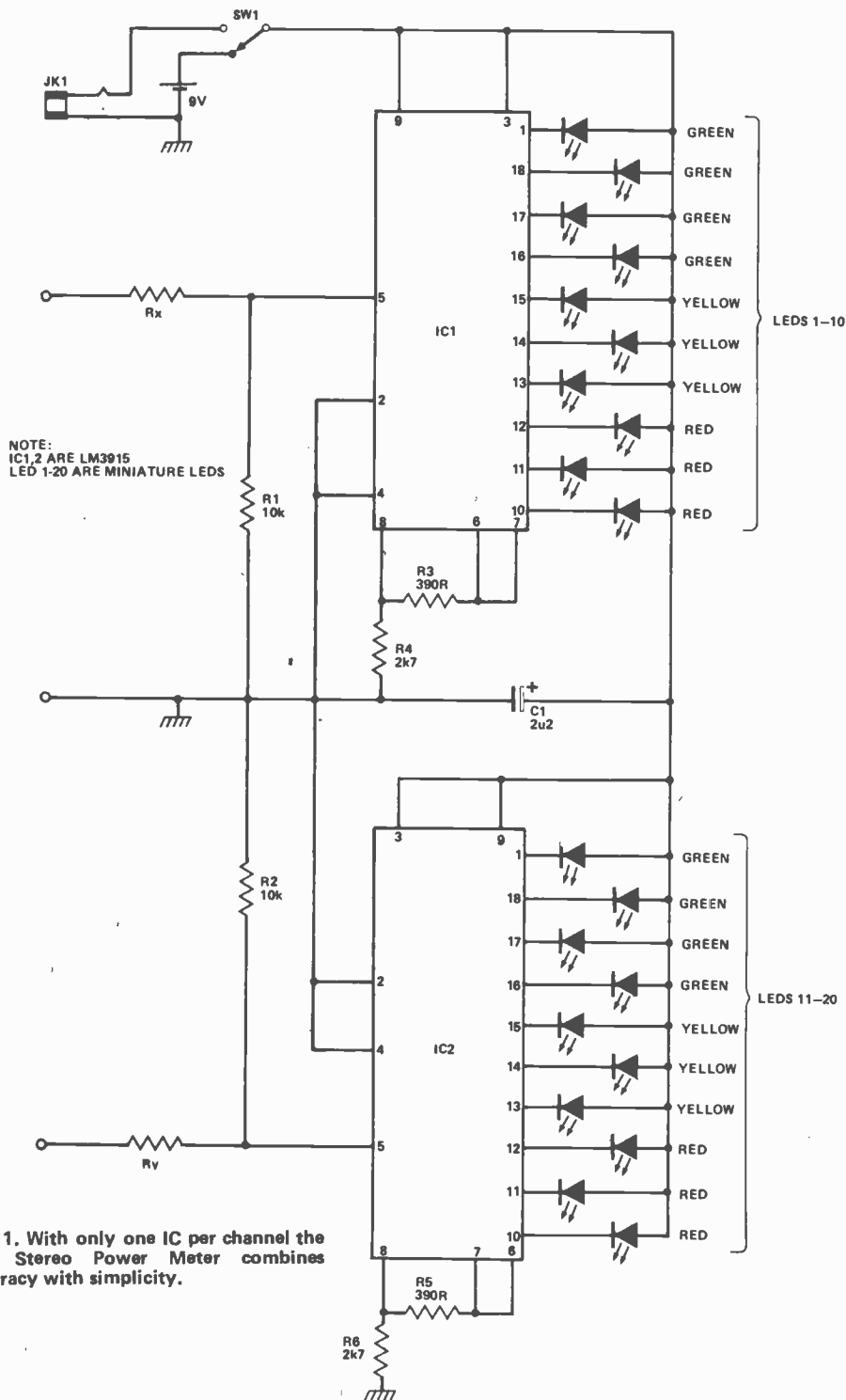
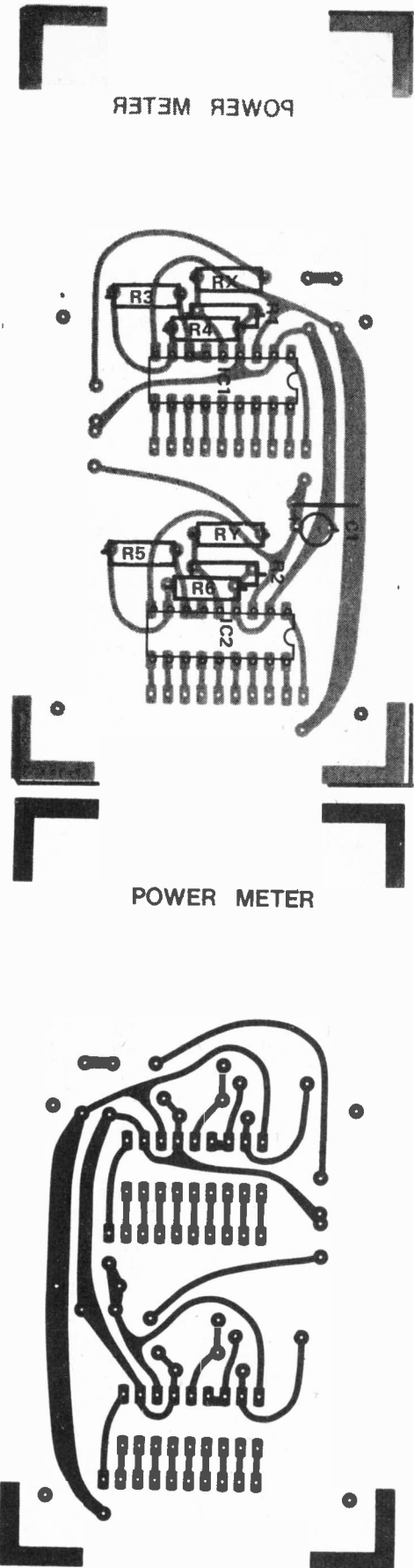

Fig. 1. With only one IC per channel the ETI Stereo Power Meter combines accuracy with simplicity.



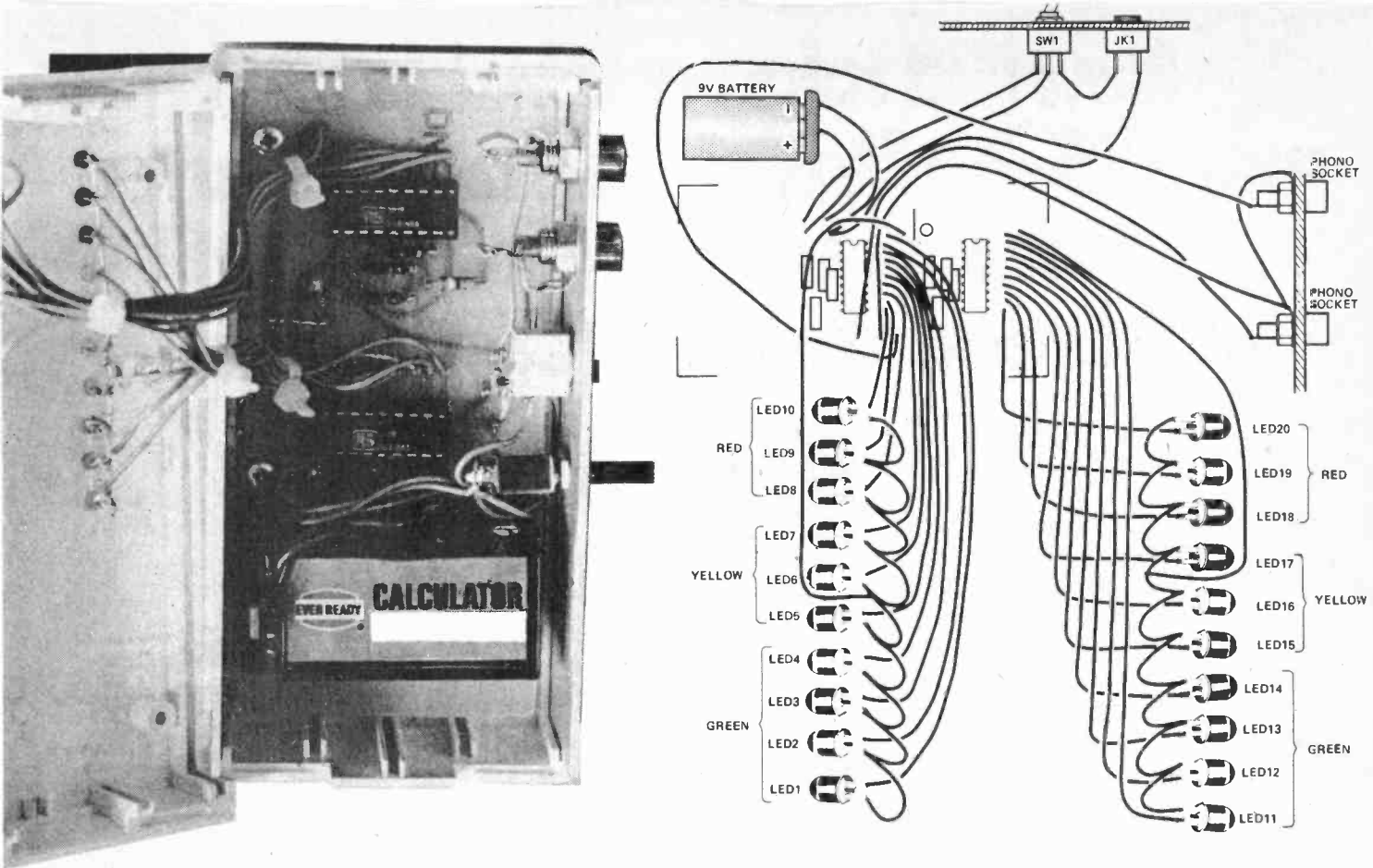

Fig. 2. Connection details of the project with suggestions for LED colours.

CHUFFER
Con't from Page 15

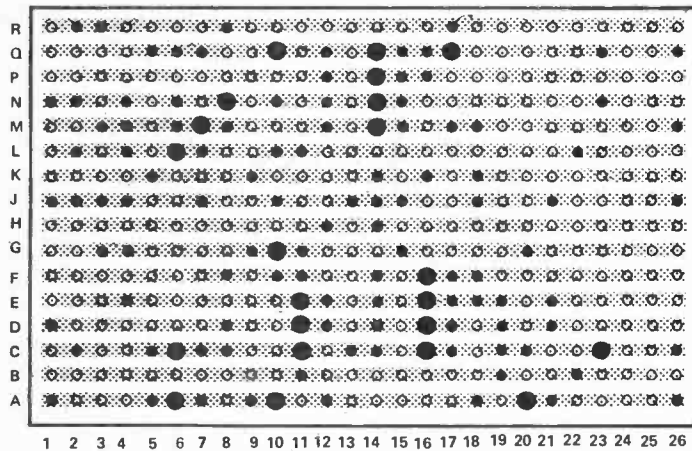
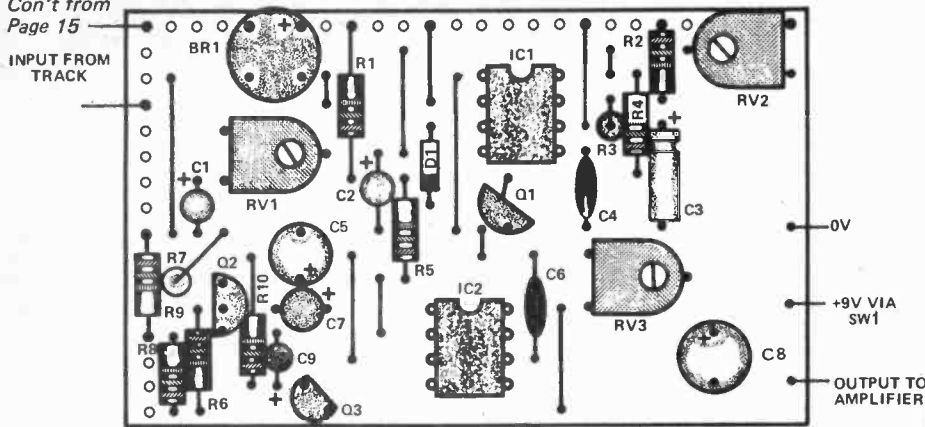
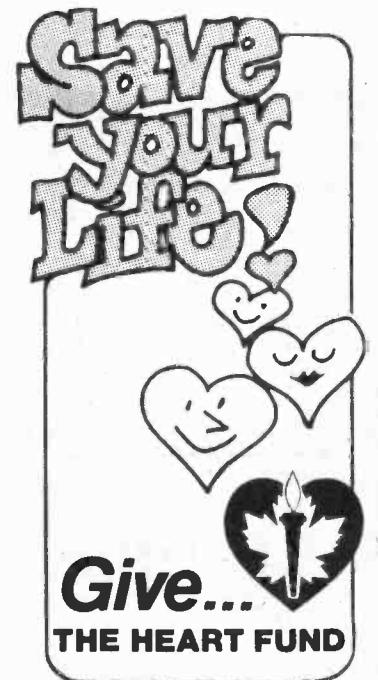

Figure 3. Veroboard layout and underside view, showing track breaks



Now NRI takes you inside the new TRS-80 Model III microcomputer to train you at home as the new breed of computer specialist!

NRI teams up with Radio Shack advanced technology to teach you how to use, program and service state-of-the-art microcomputers...

It's no longer enough to be just a programmer or a technician. With microcomputers moving into the fabric of our lives (over 200,000 of the TRS-80™ alone have been sold), interdisciplinary skills are demanded. And NRI can prepare you with the first course of its kind, covering the complete world of the microcomputer.

Learn At Home in Your Spare Time

With NRI training, the programmer gains practical knowledge of hardware, enabling him to design simpler, more effective programs. And, with advanced programming skills, the techni-

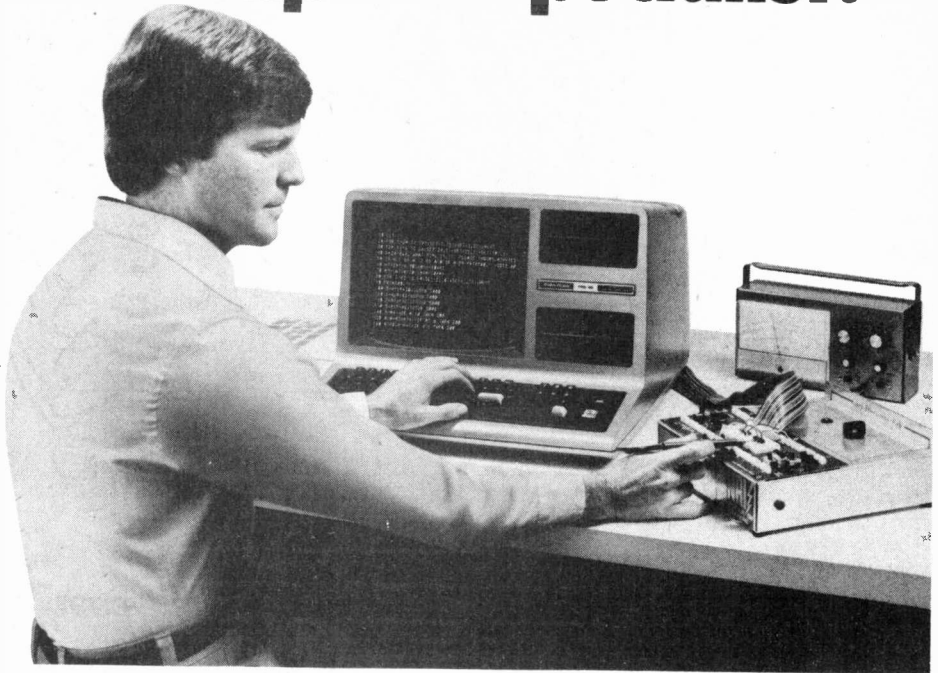

cian can test and debug systems quickly and easily.

Only NRI gives you both kinds of training with the convenience of home study. No classroom pressures, no night school, no gasoline wasted. You learn at your convenience, at your own pace. Yet you're always backed by the NRI staff and your instructor, answering questions, giving you guidance, and available for special help if you need it.

You Get Your Own Computer to Learn On and Keep

NRI training is hands-on training, with practical experiments and demonstrations as the very foundation of your knowledge. You don't just program your computer, you introduce and correct faults... watch how circuits interact... interface with other systems... gain a real insight into its nature.

You also build test instruments and the NRI Discovery Lab, performing over 60 separate experiments in the process. You learn how your trouble-shooting tools work, and gain greater understanding of

the information they give you. Both microcomputer and equipment come as part of your training for you to use and keep.

Send for Free Catalog

Get all the details on this exciting course in NRI's free, 100-page catalog. It shows all equipment, lesson outlines, and facts on other electronics courses such as Complete Communications with CB, TV and Audio, Digital Electronics, and more. Mail the postage-paid card today, and we'll rush your catalog. Keep up with the latest technology as you learn on the latest model of the world's most popular computer. If card has been used, write to:



Training includes new TRS-80 Model III microcomputer, solid state volt-ohm meter, digital frequency counter, and the NRI Discovery Lab with hundreds of tests and experiments.

(TRS-80 is a trademark of the Radio Shack division of Tandy Corp.)



NRI Schools

McGraw-Hill Continuing
Education Center
330 Progress Avenue
Scarborough, Ontario M1P 2Z5
or telephone 416-293-1911

New from NRI! **25"** color TV that DIAGONAL tunes by computer, programs an entire evening's entertainment.

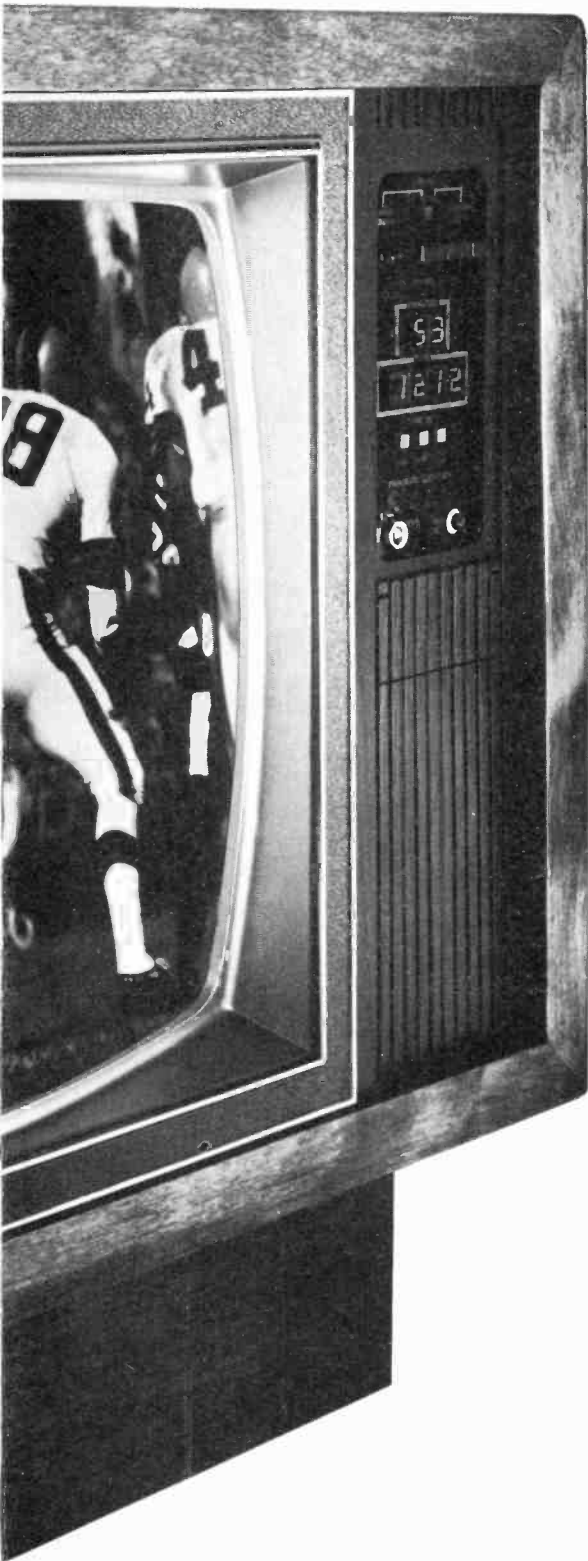

Just part of NRI's training in servicing TV, stereo systems, video tape and disc players, car and portable radios.

Only NRI home training prepares you so thoroughly for the next great leap forward in TV and audio... digital systems. Already, top-of-the-line TVs feature digital tuning, computer programming is appearing, and new digital audio recording equipment is about to go on the market.

NRI is the only home study school to give you the actual "hands-on" training you need to handle servicing problems on tomorrow's electronic equipment. Because only NRI includes this designed-for-learning, 25" diagonal color TV with electronic tuning, built-in digital clock, and computer programmer as part of your training. With this advanced feature, you can pre-program an entire evening's entertainment... even key lock it in to control children's viewing.

Exclusive Designed-for-learning Concept

The color TV you build as part of NRI's Master Course looks, operates, and performs like the very finest commercial sets. But behind that pretty picture is a unique designed-for-learning chassis. As you assemble it, you perform meaningful experiments. You even introduce defects, troubleshoot and correct them as you would in actual practice. And you end up with a magnificent, big-picture TV with advanced features.

Also Build Stereo, Test Instruments

That's just a start. You demonstrate basic principles on the unique NRI Discovery Lab,[®] then apply them as you assemble a fine AM/FM stereo, complete with speakers. You also learn as you build your own test instruments, including a 5" triggered sweep oscilloscope, CMOS digital frequency counter, color bar generator, and transistorized volt-ohm meter. Use them for learning, use them for earning as a full- or part-time TV, audio, and video systems technician.

Complete, Effective Training Includes Video Systems

You need no previous experience of any kind. Starting with the basics, exclusive "bite-size" lessons cover subjects thoroughly, clearly, and concisely. "Hands-on" experiments reinforce theory for better comprehension and retention. And your personal NRI instructor is always available for advice and help. You'll be prepared to work with stereo systems, car radios, record and tape players, transistor



radios, short-wave receivers, PA systems, musical instrument amplifiers, electronic TV games, even video tape recorders and tape or disc video playback.

Send for Free Detailed Catalog

Mail the postage-paid card today for our free 100-page catalog with color photos of all kits and equipment, complete lesson plans, convenient time payment plans, and information on other electronics courses. You'll also find out about NRI's new Computer Technology Course that includes your personal microcomputer. Or Complete Communications with 2-meter transceiver. If card has been removed, write to:



NRI Schools
McGraw-Hill Continuing
Education Center
330 Progress Avenue
Scarborough, Ontario M1P 2Z5
or telephone 416-293-1911

10 to 30 MHz oscilloscopes with more performance and reliability than you ever thought possible.



It's easy to see why LEADER oscilloscopes are now specified more than ever. More performance and quality for less cost... with immediate deliveries from stocking distributors. They come with the best two-year warranty in the industry... backed by efficient factory service.

A full-range of reliable, medium bandwidth oscilloscopes.

LEADER's oscilloscope line includes 11 models, single and dual trace versions, for bench or field use. All models offer comprehensive triggering controls, TTL compatible Z-axis modulation, front panel trace alignment control and convenient, color-keyed front panel layout. Probes are furnished with most oscilloscopes and options include probe pouches, carrying cases, front panel covers and rack mounting adapters.

30 MHz delayed sweep - NEW

LBO-515B is a compact, precision oscilloscope at a moderate price. Using a PDA 4-inch CRT with parallax-free internal graticule, it features 5 mV sensitivity and delayed sweep for viewing and measuring complex waveforms. Also has 120 ns signal delay, trigger hold-off and x-y operation at full sensitivity.

30 MHz with signal delay - \$1585.

LBO-520 combines a 11.7 ns rise time with 5 mV sensitivity and 120 ns signal

The surprising leader.

delay lines. Has single shot triggering, X10 sweep magnifier and bright, sharp PDA CRT. Triggers to 50 MHz.

20 MHz dual and single trace - \$1100., \$865.

LBO-508A and LBO-507A give you versatility at low cost. Rise time is 17.5 ns with 1 M Ω (35 pF) input impedance. Automatic or external triggering, X5 sweep magnifier, 10 mV/cm sensitivity and add/subtract modes.

10 MHz with 1 mV sensitivity - \$895.

LBO-514 has both vertical and horizontal X5 magnifiers. Sensitivity is from 1 mV/cm to 10 V/cm. Sweep speeds from 0.2 s/cm to 0.1 μ s/cm. Auto or normal triggering. Z-axis modulation. (Single trace version, LBO-513, \$775.)

Circle No. 16 on Reader Service Card.

20 MHz battery/ac portable - \$1350.

LBO-308S provides lab performance and high reliability in field service applications. Sensitivity is 2 mV with a complete set of triggering controls and 18 sweep ranges to 0.1 μ s/div. with X5 magnifier. Compact, lightweight with 3-inch rectangular, internal graticule CRT. (Optional 2 hour internal battery pack is recharged during ac operation.)

Two-year warranty. Evaluation units.

A history of high reliability permits LEADER to provide a generous 2-year warranty... backed by factory service. Call or write for:

- an evaluation
- a catalogue
- the name or your nearest franchised distributor
- additional information

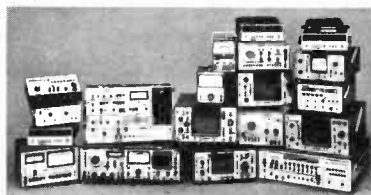

Oscilloscopes, frequency counters, function generators, video and audio instruments... a LEADER instrument for almost every need.

When Quality Counts

LEADER
Instruments Corporation

REPRESENTED IN CANADA BY:

omnitronix Ltd.
2056 Trans Canada Hwy. Unit 7, 6295 Shawson Dr.
Dorval, Quebec. Mississauga, Ontario.
H9P 2N4 L5T 1H4
(514) 683-6993 (416) 678-7170
Telex: 05-822692 Telex: 06-968653

**CAN YOU DO
WITHOUT
IT?**

vero

NEARLY ALL CONSTRUCTION PROJECTS REQUIRE SOME TYPE OF CIRCUIT BOARD.

VEROBOARD is offered to you in 35 sizes, 0.1" x 0.1" and 0.15" x 0.15" matrix. Every square inch of 0.1" Veroboard has 100 accurately placed holes for maximum versatility (imagine drilling those yourself!) Vero also manufacture boards for integrated circuits, strip boards, plain boards, tools, pins and a superb range of plastic and metal cases. All these products are available from your local shop or mail order company.

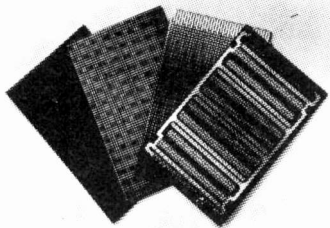

For your free catalogue circle No. 49 on Reader Service Card. Dealers Reply on Letterhead.



ELECTRONIC PACKAGING SYSTEMS LTD.
Retail Department,
P.O. Box 481, Kingston, Ontario
K7L 4W5 Telephone (613) 384-1142

SATELLITE TV

**SUPERB
PERFORMANCE
AT AN
AFFORDABLE
PRICE**

RECEIVE:
* 24 to 60 channels
* Over 500 movies and 400
Sports Programs Monthly.
* R-Rated films plus much more!

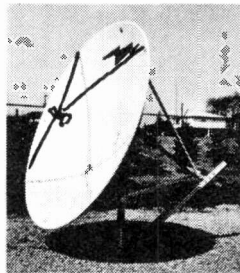

**"24 HOURS
A DAY"**

VIDEOLAND

FREE LIST OF MOVIES + VIDEO EQUIPMENT

LOWEST
PRICES
WE SHIP
ANYWHERE.

**Head Office &
Mail Order
Address:**
*938 Wilson Ave.
(W. of Dufferin)
Downsview, Ont.
M3K 1E2
(416) 638-2974

*1375 Danforth Rd.
(N. of Eglinton)
Scarborough, Ont.
(416) 265-3525

*582 Yonge St.
(N. of Wellesley)
Toronto, Ont.
(416) 921-0264

*1158 Queensway
(W. of Islington)
Etobicoke, Ont.
(416) 255-7543

OTTAWA
*1154 Bank St
(at Glenn)
(613) 236-0475

(FRANCHISES AVAILABLE)

Circle No. 32 on Reader Service Card.

ETI ORDER FORM

BACK ISSUES: Please circle issues desired.

1977	February	May	July	November			
1978	March	May	June	July	August	September	
	October		November	December			
1979	January	February	March	April	May	June	July
	August	September	October	November	December		
1980	January	February	March	April	May	June	July
	August	October	November				
1981	January	February	March	April	May		

QTY.	ITEM	AMOUNT
.....	Back issues @ \$3 (mark choice above)	\$
.....	Canadian Projects Book No. 1 @\$3.45	\$
.....	ETI Circuits Book @ \$5.45	\$
.....	'More Circuits' Book @ \$4.95	\$
.....	ETI T-shirts @ \$5.50	\$
	Small () Medium () Large ()	
.....	ETI Binders @ \$6.75	\$
	Ontario residents add 7% PST on last three only.	\$
.....	Subscriptions @ \$16.95/\$29.95	\$
.....	Hobby Projects @ \$3.95	\$
.....	Electronic Circuit Design @ \$3.95	\$
.....	Canadian Projects Book No. 2 @ \$3.95	\$

QTY.	BABANI	BABANI
..BP1	\$2.80 \$No.223 \$5.50 \$
..BP14	\$4.80 \$No.224 \$4.25 \$
..BP24	\$4.25 \$No.205 \$3.55 \$
..BP33	\$4.25 \$No.213 \$4.50 \$
..BP35	\$5.50 \$No.215 \$3.70 \$
..BP37	\$5.50 \$No.221 \$5.50 \$
..BP39	\$5.50 \$	
..BP42	\$3.55 \$	
..BP44	\$7.55 \$	
..BP46	\$5.90 \$	
..BP47	\$5.90 \$	
..BP48	\$5.90 \$	
..BP49	\$6.25 \$	
..BP50	\$5.90 \$	
..BP51	\$5.50 \$	
..BP62	\$8.95 \$	
..BP63	\$8.95 \$	
..BP64	\$8.95 \$	
..BP65	\$6.55 \$	
..BP66	\$7.55 \$	
..BP67	\$7.55 \$	
..BP68	\$7.25 \$	
..BP69	\$7.55 \$	
..BP70	\$2.40 \$	
..BP71	\$7.70 \$	
..BP72	\$7.70 \$	
..BP73	\$8.58 \$	
..BP74	\$7.70 \$	
..BP75	\$7.30 \$	
..BP76	\$7.30 \$	
..BP77	\$12.30 \$	
..BP78	\$7.30 \$	
..BP79	\$7.30 \$	
..BP80	\$8.25 \$	
..BP81	\$7.30 \$	
..BP83	\$8.20 \$	
BP 84	\$8.11	
BP 85	\$12.25	
	BABANI SUBTOTAL \$	

QTY.	TAB
..No.800	\$18.30 \$
..No.804	\$18.35 \$
..No.805	\$11.75 \$
..No.806	\$11.75 \$
..No.841	\$8.55 \$
..No.1167	\$8.40 \$
..No.1216	\$11.40 \$
..No.1015	\$9.70 \$
..No.1064	\$11.85 \$
..No.1070	\$12.35 \$
..No.1071	\$10.90 \$
..No.1133	\$9.75 \$
..No.1241	\$11.75 \$

QTY.	SYBEX
..C200	\$10.75 \$
..C202	\$18.75 \$
..C280	\$20.75 \$
..C281	\$22.75 \$
..D302	\$18.75 \$
..G402	\$18.75 \$

* BABANI SUBTOTAL _____

**TOTAL
ENCLOSED**

If we cannot complete your order, do you wish the balance refunded? YES NO

PLEASE PUT YOUR NAME AND ADDRESS ON REVERSE SIDE OF THIS FORM.

SUBSCRIBE NOW!

BOOKS, BACK ISSUES BINDERS—SEE OVER

Code _____

Electronics Today Magazine, Unit 6, 25 Overlea Blvd., Toronto, Ontario M4H 1B1.

SUBSCRIPTIONS: NEW SUBSCRIPTION? OR... RENEWAL? Please check one.

One year subscription (12 issues) \$16.95 Two year subscription (24 issues) \$29.95
 Postage and handling to Canada is included, for U.S. please add \$3, other countries add \$5/yr.

NAME _____

ADDRESS _____

TOWN/CITY _____ PROVINCE/STATE _____

CODE _____ DATE _____

PLEASE PRINT CLEARLY

Cheque enclosed DO NOT send cash

Bill Mastercard A/C No _____

Signature _____

Bill Visa A/C No _____

Expiry Date _____

PLEASE ALLOW 6-8 WEEKS FOR YOUR FIRST MAGAZINE TO ARRIVE

0581

Oscilloscope Probes

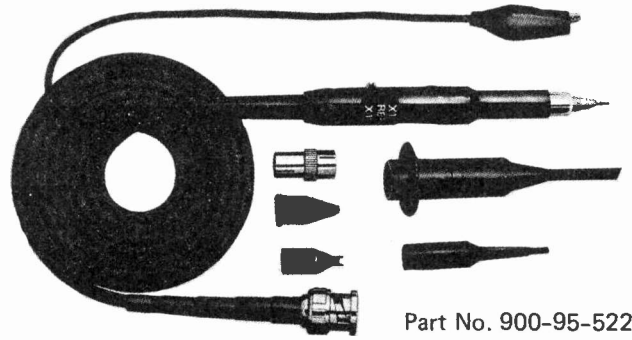

Part No. 900-95-522

SP 100 Oscilloscope Probe Kit

This passive probe incorporates a three-position slide switch in the head and has a cable length of 1.5 metres.

Position x1

Bandwidth: D.C. to 10 MHz
 Input Resistance: 1MΩ (oscilloscope input)
 Input Capacity: 40pF. Plus oscilloscope capacity
 Working Voltage: 600 Volts D.C. (including Peak A.C.)
 Cable Length: 1.5 Metres

Position Ref.

Probe tip grounded via 9MΩ resistor, oscilloscope input grounded

Position x10

Bandwidth: D.C. to 100 MHz
 Risetime: 3-5 nanoseconds

\$51²⁰

ALSO AVAILABLE ARE THE FOLLOWING

MODEL	ATTEN.	FREQUENCY	PRICE
IP20	x1	20 MHz	\$26.60
P100	x10	100 MHz	35.85
2P150	x10	150 MHz	48.10
2P250	x10	250 MHz	63.50
SP100	DUAL	100 MHz	51.20
2LCP100	x100	100 MHz	72.70
DP300	Detector	300 MHz	41.95
DP750	Detector	750 MHz	66.55
TLS2000 TEST LEAD SETS			23.50
Sprung Hook for above probes			6.90
Wire Wrap adapt.above probes			8.15

The above prices include shipping via parcel post. For other means please include additional cost. Ontario residents add 7% sales tax. Send cheque or money order to

Circle No. 9 on Reader Service Card.

BCS

ELECTRONICS LIMITED
 Instruments For Industry and Service

980 Alness Street
 Unit 35
 Downsview, Ontario
 M3J 2S2
 (416) 661-5585

The Best Scope Buys Available!

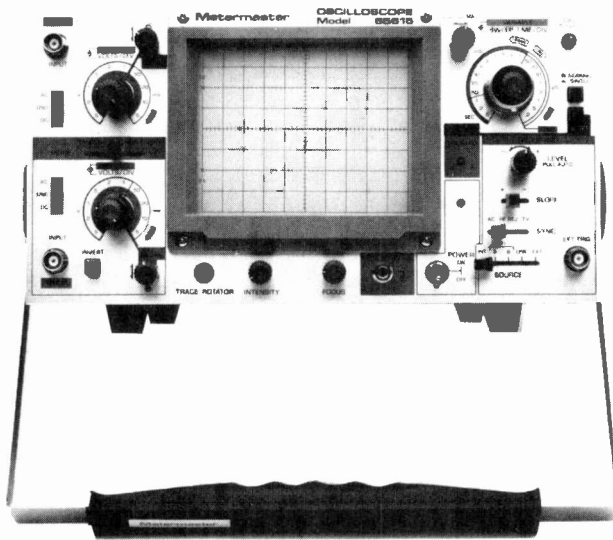

Introducing...

Metermaster's NEW
40MHz Dual Trace
Oscilloscope.

Model 65615

Featuring an Extremely
Bright CRT Display
(15KV acceleration voltage).

only **\$1395.**
F.S.T. INCLUDED

FEATURES INCLUDE:

- Internal Graticuled 5" CRT.
- Full 40MHz Bandwidth at -3dB.
- 5mV Vertical Sensitivity for the full bandwidth, expandable to 1mV/div. utilizing the X5 Gain Multiplier below 10MHz.
- Trace Rotator.

PLUS:

- 50 nsec delay for viewing pre-trigger data.
- X5 Sweep Magnification.
- Supplied with AC Line Cord and an Operations and Maintenance Manual.

Accessories: Probes (extra).

Look...

At the features
of these 15MHz
Oscilloscopes

\$695. each
F.S.T. INCLUDED

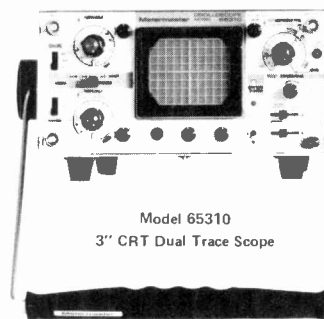

Model 65310
3" CRT Dual Trace Scope

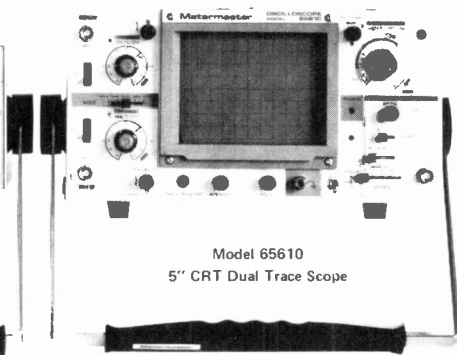

Model 65610
5" CRT Dual Trace Scope

- Model 65310:**
- Operates from 3 Power Sources
 1. Rechargeable Ni Cad Batteries.
 2. 120 VAC Line (also charges batteries).
 3. 11 - 30 VDC.
 - Fully Automatic Triggering.
 - Bandwidth DC - 15MHz (-3dB).
 - Trace Rotator.
 - 2mV Vertical Sensitivity.

Accessories: Vinyl carrying case, probes (extra).

- Model 65610:**
- Operates from 2 Power Sources
 1. 120 VAC Line.
 2. 11.5 - 30 VDC.
 - Fully Automatic Triggering.
 - Bandwidth DC - 15MHz (-3dB).
 - Trace Rotator.
 - HF Rejection.
 - 5mV Vertical Sensitivity.

Accessories: Probes (extra).



Metermaster
R.H. NICHOLS

Head Office: 214 Dolomite Drive, Downsview, Ontario M3J 2P8

TORONTO (416)661-3190 • MONTREAL (514)337-0425 • EDMONTON (403)432-7746 • OTTAWA (613)238-7007

All prices F.O.B.
Downsview, Ontario
subject to change with-
out notice. P.S.T. extra
where applicable.

Circle No. 4 on Reader Service Card.

mail order discount at

CESCO

Now—the Texas Instruments TI-99/4 Home Computer

Designed to be the first true home computer — for skilled computer users or beginners.

16K memory

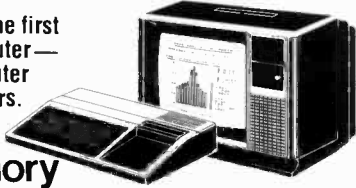

SPECIAL
\$899⁰⁰
Console and modulator

NOW
IN
QUEBEC.

\$499⁰⁰
ASSEMBLED



MULTIFLEX Z80A

- MULTIFLEX Z80A COMPUTER SYSTEM
- Ideal for learning, expandable
 - S-100 bus system, compatible with all S-100 products from many manufacturers
 - High-speed cassette interface, optional RS-232 interface, on-board PIA, built-in EPROM programmer
 - Consists of a 4-slot motherboard and a separate processor board which can be purchased and used alone
 - Powerful 4K monitor-in-ROM makes machine language programming fast and easy

RS 232 extro

The Sinclair ZX80 is an extraordinary personal computer. Compact and briefcase-sized, it weighs just 12 ounces. Yet in performance it matches and surpasses systems many times its size and price.

The ZX80 is an advanced ex-

ample of microelectronics design. Inside, it has one-tenth the number of parts of existing comparable machines. This unique design - packing the system onto fewer, more advanced LSI chips - gives the ZX80 its remarkably low price.

Along with a complete 128-page course in BASIC programming, the ZX80 comes with all the necessary cords for connecting to standard color or B/W televisions and cassette recorders.

PLEASE SEND ME THE ZX80 AT CESCO'S SPECIAL PRICE: \$329

NAME _____
STREET _____
CITY _____ PROV. _____
POSTAL CODE _____
ENCLOSED IS MY CHEQUE MONEY ORDER
CHARGE MC VISA
ACCT. NO. _____
EXP. DATE _____

ZX80



\$329

SPECIAL

SPECIAL!

**UPGRADE (16K)
4116 MEMORY**

\$2.89 each

Large quantities - call for prices!

MINIMUM MAIL ORDER \$10.00
Add \$3.00 to cover postage and handling
PRICES ARE IN CDN. FUNDS. F.O.B. CANADA
Federal Sales Tax Incl.
Provincial Sales Tax Extra

CESCO
electronics Ltd.

DID YOU GET A COPY OF OUR TWO NEW CATALOGUES!

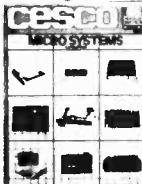

PLEASE SEND ME YOUR FREE MICRO HOBBY CATALOGUES.

NAME _____
STREET _____
CITY _____ PROV. _____
POSTAL CODE _____

Prices subject to change without notice.

4050 Jean Talon Street W.
Montreal, Que. Canada
Tel.: (514) 735-5511

WHAT'S NEW IN HOME COMPUTERS?



Find out in the latest Heathkit Catalogue. It's filled with exciting kits in every price range, all easy to assemble, all at build-it-yourself savings.

Discover the fun you and your family can have building your own home computer, stereo system, color TV. Discover the pride of

saying, "I built it myself!" It's easier than you think.

Send today for your FREE Heathkit Catalogue.



Heathkit®

If coupon is missing, write Heath Company, 1480 Dundas Highway East Mississauga, Ontario L4X 2R7

Send For FREE Catalogue Today!

Send to: Heath Company, 1480 Dundas Highway East Mississauga, Ontario L4X 2R7

Send my free Heathkit Catalogue now. I am not currently receiving your catalogue.

Name _____

Address _____

City _____ Prov. _____

EV 0581 Postal Code _____

Circle No. 28 on Reader Service Card.

Circle No. 21 on Reader Service Card.

COMPUTING NEWS

Bendable Link

When the Australians say a product is flexible, they're not lying. The accompanying picture of a 'bendable' acoustic modem came with an Electro Medical press release.

The acoustical modem is part of Electro Med's new "700 Series" of couplers for Simplex data transmission at 300, 600 or 1,200 BPS. With two modules the transmit/receive speeds can be selected in line with recognized standards.

The low cost "700 Series" derives its power from the terminal via the interface connector though other terminals with non-compatible voltages can be used by incorporating a polarity-independent 9V AC Adapter.

An innovative originate/answer option for the 300 BPS full duplex permits the user to 'originate' a data call to a remote computer or 'answer' a call from another data user with just the flick of a switch. Independent cups allow use with virtually all telephone handsets.



Circle No. 51 on Reader Service Card.

A unique circuit design allows the user to place a "700 Series" acoustic modem at each end of the data connection to provide operational reliability equal to any conventional modem. The units are available in CCITT (V24), RS232 or Bell Standards.

Write to Robert Powell, Electro Medical Pty., Ltd., 69 Sutherland Road, Armadale, Victoria, Australia 3143. Electro Med is also looking for representatives in North America

Expose Yourself

New Digest is a regular feature of ETI Magazine. Manufacturers, dealers and clubs are invited to submit news releases to News Digest, c/o ETI Magazine. Sorry, submissions cannot be returned.



Handy Terminal

A hand-held computer terminal, developed by a British company, can be used to record, store and verify information before transmitting it down a telephone line to a computer for processing.

The full alphanumeric keyboard combined with advanced software enables the standard Microfin keyboard to be used for most applications. Previous systems needed a specific keyboard layout for each application. The terminals retain their value to the company by adapting easily to changing requirements. Programs can be produced to exact specifications quickly and easily. The Microfin User Programming System (MUPS) allows most data capture programs to be written and tested in a matter of hours.

Facilities for sending and receiving personal messages between staff and head office and recording memory joggers are standard options. The company has eliminated the problems of short battery life inherent in some other equipment. A sophisticated power monitoring circuit gives the added protection of a separate memory support battery ensuring that program and data are kept intact for several months.

Write Microfin Systems Limited, Winslade House, Egham Hill, Egham, Surrey TW20 0AZ.

Circle No. 52

Challenge Software...

now takes on other lines.

Leedex Monitor

Video 100

\$194.50

Video 100-80

\$224.50

Color video

\$494.50

Aardvark Technical Services

8K Mem expansion board with 2 I/O ports

\$29.95 No parts

\$52.50 Kit

\$99.95 Assembled

Our own software stuff

Kitchinvent

A two-tape program to keep track of your kitchen goods (foodstuffs) plus their cost. For superboard with 8K \$16.95

Ontario residents add 7% sales tax. No credit cards or COD's, please. Dealer inquiries invited. Shipping charges \$15.00 extra on all monitors and \$2.50 on other products. Please allow 6-8 weeks for delivery. Catalog available — \$1.00.

Challenge Software

1912A Avenue Road
Toronto, Ontario
M5M 4A1

Circle No. 34 on Reader Service Card.

319 COLLEGE STREET, TORONTO, ONTARIO, CANADA. M5T 1S2 (416) 921-5295

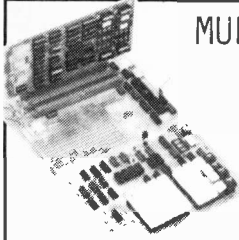

MULTIFLEX Z80A COMPUTER

We've told you all we can. Check out the independent review of this product in this ETI.

PRICE WILL BE INCREASED IN JUNE. GET YOURS NOW!

NEW PRODUCTS OF THE MONTH
EPROM EMULATOR BOARD

This new product is invaluable for development of dedicated microprocessor systems. It works with a host computer to totally simulate a 2716 or 2732 EPROM in real-time.

The board itself plugs into any IEEE compatible S100 computer system and uses a block of its RAM (DIP switch locatable) to simulate a programmed EPROM. A 24 pin connector attached to the board by a ribbon cable, plugs into an EPROM socket

in a separate system and acts just like a real EPROM. The contents of this simulated EPROM can be changed as easily as the host computer can modify a block of RAM.

The size and location of the RAM in the host computer can be determined by DIP switches on the board. All S100 signals, as well as those to the EPROM plug, are fully buffered.

64K MEMORY BOARD

- * BASED ON THE INTEL 8202
 - * ON-BOARD REFRESH: NO WAIT STATES
 - * SOFTWARE BANK-SELECT FEATURE
 - * 16K, 32K, 48K, 64K VERSIONS AVAILABLE
 - * ALL VERSIONS CAN BE EXPANDED TO 64K
- ASSEMBLED & TESTED 64K BOARD \$599
STANDARD S-100 BUS INTERFACE

Kit of all parts except RAM \$419.
10% off any quantity of 4116s with kit.

ALL PRICES ARE IN CANADIAN FUNDS, 9% FEDERAL SALES TAX INCLUDED

319 COLLEGE STREET, TORONTO, ONTARIO, CANADA. M5T 1S2 (416) 921-5295

Z80A-CPU...	\$11.29
6800.....	\$6.49
6802.....	\$11.95
6809.....	\$29.95
8080A.....	\$5.39
8085.....	\$10.95
6502.....	\$8.95
6504.....	\$10.75

MICRO SUPPORT CHIPS

Z80A-CPU	11.29	6810	3.75	8251	7.99
Z80A-P10	9.89	6820	3.50	8253	12.45
Z80A-CTC	9.75	6850	3.75	8255	7.15
Z80A-DMA	27.95	6862	3.85	8257	14.00
Z80A-S10/0	36.95	8080A	5.99	8259	14.00
Z80A-S10/1	36.95	8085	10.95	6902	8.95
Z80A-S10/2	36.95	8212	2.83	6904	10.95
Z80A-S10/9	27.00	8214	4.68	6905	9.95
Z80A-DART	21.75	8216	2.49	6920	10.49
6800	6.49	8224	4.35	6922	11.85
6802	11.95	8226	2.87	6932	14.95
6809	29.95	8228	6.39	6951	14.98

4116 (200ns)	\$3.95 ¹	5101 CMOS	\$5.09
4116 (300ns)		128Kx1 dynamic	
ceramic pkg.	\$2.95 ²	by request	\$159 ³
2114 (200ns)	\$4.95 ¹	2708 EPROM	\$5.89 ³
2114 (450ns)	\$3.49 ¹	2716 EPROM	\$8.39
2114L (200ns)	\$5.29 ¹	2732 EPROM	\$18.95
2102LFPC	\$1.69	all guaranteed!	

10% off over: ¹ 15; ² 31; ³ 4 pieces

74LS00	.19	74LS21	.22	74LS78	.35	74LS133	.65	74LS158	.65	74LS193	.99	74LS251	1.25	74LS296	1.25
74LS01	.19	74LS26	.50	74LS83	.89	74LS133	.95	74LS160	.85	74LS194	1.95	74LS253	.95	74LS299	2.89
74LS02	.25	74LS27	.38	74LS85	.95	74LS136	.95	74LS161	.85	74LS195	.69	74LS257	.92	74LS353	6.25
74LS03	.25	74LS30	.22	74LS86	.49	74LS138	.95	74LS163	.85	74LS196	1.09	74LS258	.75	74LS324	2.90
74LS04	.25	74LS32	.29	74LS90	.48	74LS139	.95	74LS164	.75	74LS197	1.09	74LS259	1.95	74LS365	.99
74LS05	.25	74LS37	.35	74LS91	.95	74LS145	1.38	74LS165	1.35	74LS221	1.05	74LS260	.95	74LS366	.99
74LS06	.15	74LS38	.35	74LS92	.99	74LS147	2.50	74LS166	2.49	74LS240	1.25	74LS266	.55	74LS367	.99
74LS09	.25	74LS42	.54	74LS95	.99	74LS148	1.99	74LS170	2.25	74LS241	1.25	74LS273	1.48	74LS368	.99
74LS10	.22	74LS47	.85	74LS96	.69	74LS151	.95	74LS173	.81	74LS242	1.25	74LS275	4.95	74LS373	1.99
74LS11	.25	74LS48	.89	74LS109	.45	74LS153	.45	74LS174	.99	74LS243	1.25	74LS279	.69	74LS374	1.99
74LS12	.25	74LS51	.25	74LS112	.48	74LS154	2.25	74LS181	2.45	74LS244	1.29	74LS280	2.25	74LS375	1.95
74LS13	.28	74LS73	.39	74LS123	.85	74LS155	.85	74LS190	.99	74LS245	1.48	74LS283	.99	74LS377	1.99
74LS14	.95	74LS74	.54	74LS125	.95	74LS156	1.49	74LS191	.95	74LS246	1.49	74LS290	.95	74LS378	1.45
74LS20	.22	74LS75	.43	74LS126	.99	74LS157	.69	74LS192	.99	74LS249	1.25	74LS293	.48	74LS390	1.99

ALL PRICES ARE IN CANADIAN FUNDS, 9% FEDERAL SALES TAX INCLUDED

319 COLLEGE STREET, TORONTO, ONTARIO, CANADA. M5T 1S2 (416) 921-5295

LOGIC STATE ANALYZER

The ultimate digital test instruments. Described in March 1981 ETI. Regularly \$475...

10% OFF THIS MONTH ONLY

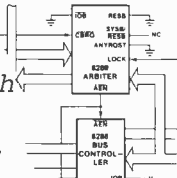

NEW PRODUCTS OF THE MONTH
COLOUR VIDEO BOARD

This month, Multiflex announces a new product: a Colour Video Interface and I/O subsystem for S100 computers. Based on the MC6847 by Motorola, the video section has all the features of that chip. 11 different programmable modes allow 16 line by 32 character text display (with inverse video); 2 semigraphics modes with 8 colours (64x32 or 32x64 pixels); and 8 full-graphics modes with 2 sets of 4 colours and resolutions from 64x64 to 256x192, and 2 sets of one colour in 256x192. The board also contains a 3-channel real-time clock (8251), one channel of which is used as a programmable baud rate generator for an 8251 PCI chip configured as a fully handshaked RS-232 interface. Two 8255 PPI chips are also provided, to allow up to 48-bit parallel I/O functions. All devices on the board may generate interrupts for the host processor for control over memory access, etc. The advanced interrupt circuitry generates vector addresses for all interrupts. The board is compatible with the proposed IEEE standard for S100 computers and is controlled through a block of I/O ports. The displayed data is memory-mapped. A parallel ASCII keyboard interface is provided, as well as up to 6K of static RAM. For the final touch, a complete RF modulator is provided on-board.

DIGITAL SIGNS

In addition to computer systems, Multiflex also produces digital signs similar to those seen along Toronto's Gardiner Expressway. Up until now, these have only been offered to industry, but are now available to the hobbyist market. These products are microprocessor controlled matrix displays using either LEDs or incandescent light bulbs. They may be programmed by the user to display either text messages or graphics, and

the programming may be done remotely by telephone if desired. These are ideal for stores, advertising companies, shopping centres, etc. Multiflex will custom-design signs for particular applications, at prices which start at \$1000. If you or your company would be interested in these, contact Exceltronix at 319 College Street, Toronto M5T 1S2 or phone (416) 921-5295.

ALL PRICES ARE IN CANADIAN FUNDS, 9% FEDERAL SALES TAX INCLUDED

319 COLLEGE STREET, TORONTO, ONTARIO, CANADA. M5T 1S2 (416) 921-5295

10% OFF ALL BOOKS THIS MONTH

We have greatly expanded our selection of books from TAB, Sybex, Sams, etc. as well as many manufacturer's data books. Come in and check out the new titles!

YOU ASKED---WE LISTENED
You, our customers, asked for a better selection of books, small parts, and computer systems. We now have all 3!
PRICES: NEGOTIABLE
Remember that at Exceltronix, all prices are negotiable for quantity purchases. If you cannot afford quantities alone, start a co-op with some friends for great deals

S100 CONNECTORS by Compar	\$5.00	ZERO INSERTION FORCE SOCKETS 24 pin ZIF	
S100 BACKPLANES 6 slots, room for 7	\$55	sockets be Textool, ideal for EPROMs	12, 150
AS ABOVE, WITH METAL FRAME	\$65	TRANSISTORS over 280 types in stock!	
S100 CARD CAGE KITS including pre-drilled steel casing, backplane, AC power filter, fan, card guides, some switches.	\$149	RESISTORS full range of 15K, 3W and 1W.	
DIP SOCKETS high quality low-profile		CAPACITORS good selection of Philips mono-fan, electrolytic types.	
.....A PENNY A PIN!			
TEXAS INSTRUMENTS WIRE-WRAP SOCKETS:			
8 pin	.50	20 pin	1.10
14 pin	.65	24 pin	1.35
16 pin	.75	28 pin	1.45
18 pin	.85	40 pin	1.95

ALL PRICES ARE IN CANADIAN FUNDS, 9% FEDERAL SALES TAX INCLUDED

COMPUTER NEWS

Experimenters Take Note

E & L Instruments announces The Breadbus Designer. The Breadbus Designer, incorporating a unique method, allows the user quick access to plug in cards while the system is in operation. The Breadbus Designer Series incorporates several of the most popular microcomputer buses — STD, Multibus, LSI-11 and S100.

A proprietary mechanical structure allows the user to inspect, wire-wrap and debug cards without the use of extender cards or cables. A high current, multi-voltage, fully protected power supply is self contained in the Breadbus Designer. The Breadbus is encased in an attractive metal cabinet providing a stand alone table-top work-station for the system designer, development engineer or student.

The STD Breadbus Designer will be available May 1, 1981 Contact factory or local rep for pricing.

Write to E & L Instruments Incorporated, 61 First Street, Derby, Connecticut 06418.

Cesco Cat

Cesco Electronics Ltd., has announced the publication of their new Microcomputer Catalogue. This 60 page catalogue is filled with the latest in Microcomputer Products and features the major lines stocked and distributed by Cesco which represent some of the most respected names in the microcomputer industry.

Copies of this catalogue are available by writing to Cesco Electronics Ltd. at 4050 Jean Talon Street West, Montreal, Quebec, H4P 1W1, or by phoning any of the Cesco Locations.

Circle No. 55

Looking Back

Selecting a Floppy Disk

Lots of egg on our very red faces. CP/M is a product of Digital Research, and not DEC.

The Last Byte

ZX80 Clone

Shortly after our ZX80 review in February '81 we were informed that we were incorrect in stating that the ZX80 wasn't available in kit form. The MicroAce (originally reported in News Digest, August 1980) is available as a kit in Canada for \$199.95 from Lorimer Designs. A 2K version is available for \$229.95.

Actually, the original article was correct, the MicroAce is not a ZX80, but only manufactured under licence from Sinclair. While we were aware of the MicroAce's existence, we didn't know if it was available in Canada, largely because *somebody* never bothered to tell us about it (hey guys, News Digest is free publicity). If you're interested, write to Lorimer Designs Ltd., 10436 32 Ave., Edmonton, Alta.

Circle No. 54 on Reader Service Card.

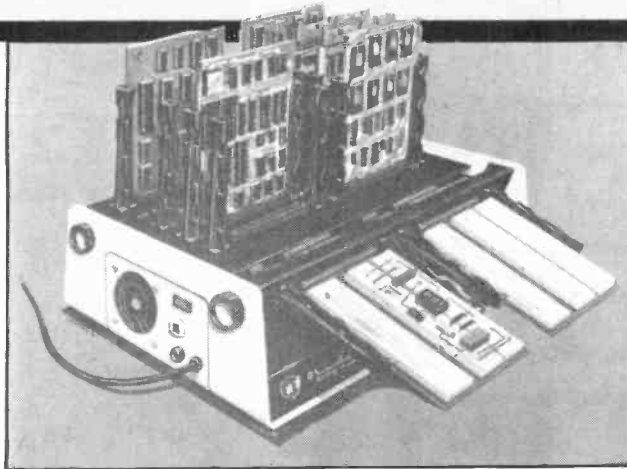

Circle No. 53 on Reader Service Card.

Micro Newsletter

The proliferation of microcomputer systems in the home and small business has ushered in an era of new opportunity for the entrepreneur. For the first time in history, a sophisticated production tool (the home-based computer) has made a cottage business attractive to a great number of people. Micro Moonlighter newsletter is a new publication which caters to those who wish to turn their investment into a business venture which will recover their system cost or even provide full time earnings for an at-home career.

Each issue will also feature reviews of books helpful to the micro-entrepreneur in such areas as business start-up, mail order methods, tax shelters for the small businessman, and personal motivation. Emphasis will always be directed toward getting the greatest return from every hour and dollar invested.

Volume 1 Number 1 will be published in May 1981. Charter subscriptions are available for \$25 per year in the U.S., \$29 per year in Canada, and \$35 per year worldwide. Visa and Mastercharge are accepted. Inquiries should be addressed to the publisher: J. Norman Good, 2115 Bernard Avenue, Nashville TN 37212.

From Vancouver

The Vancouver Amateur Digital Communications Group (VADCG) is devoted to creating a packet switching network via Amateur Radio, and is experimenting with high speed HDLC protocol transmissions. Current efforts include: a smart Terminal Node Controller board, an S100 card to provide the centralized Station Node network control; and a 1200 baud Modem card for VHF transceivers. Some public domain software is available and more will be provided as it is developed. A practical continent-wide network protocol is under development and geosynch satellite experiments will probably begin this year. Newsletter subscription is \$10. Write to VADCG, 818 Rondeau St., Coquitlam, B.C., Canada V3J 5Z3"

Micro Club

Toronto TRS80 owners might be interested in the Toronto Microprocessors Users' Group, or TMUG for short. From the two news letters we've seen, the group seems to be into useful software solutions and some hardware. If you want to know more, write to Ed Philpott, TMUG Microletter, P.O. Box 875, Station A, Toronto, Ontario M5W 1G3.

COMMODORE COMPUTERS

Full keyboard, separate numeric keypad, 25 lines of 40 characters. (8032 has 80 characters by 25 lines).

2001-8k	\$1195.00
2001-16k.	\$1495.00
2001-32k.	\$1795.00
8032	\$2495.00
Cassette Deck	99.00
Memorex 5 1/4" Diskettes . 10 for	\$49.95
Memorex C10 Cassettes	\$1.00 ea.

BOOKS

PET Personal Computer Guide . .	\$19.95
Library of PET Subroutines . . .	\$24.95
The PET Revealed	\$24.95
Hands on BASIC with a PET . . .	\$17.50
PET and the IEEE	\$19.95

We carry a large selection of software for Commodore, Apple and TRS80 computers — write or call for a catalogue or come in and see us.

Send Money Order, Charge, Master Charge. Include expiry date, card number bank name and signature. Add 5% for shipping (excess refunded). Ontario residents add 7% sales tax. All prices subject to change.

ELECTRONICS 2001

5529 Yonge St. (just south of Finch)
Willowdale, Ontario M2N 5S3
(416) 223-8400

Circle No. 23 on Reader Service Card.

Ohio Scientific Superboard II
Microcomputer

★ only ★
\$379.

The first complete microcomputer system on a board. Features:

- Many special graphics characters
- Audio cassette interface built-in
- 8K Microsoft BASIC-in-ROM
- 4K RAM on board expandable to 8K
- Full 53 key keyboard with upper/lower case.
- Fully assembled and tested
- Requires +5V at 3 Amps and a video monitor or TV set with RF modulator.

RF Modulator Kit **\$7.95**

Ontario residents add 7% PST. Orders shipped prepaid or collect. Pay by certified cheque, Charge, Mastercharge (include signature, expiry date, card number and bank name). Shipping cost \$10.00

5062 Dundas St. West,
Islington, Ontario M9A 1B9.
Phone (416) 231-4331

A-ELECTRONICS

Circle No. 10 on Reader Service Card.

REVIEW OF THE MULTIFLEX Z80A

A great complex light flasher or the beginnings of a full blown S100 computer system. The Multiflex Z80A may be the ideal home computer if you like to get your fingers into the strings and wires.

YOU MAY ALREADY have reached the conclusion, whether you are at school, on the job, or waiting to be recycled, 'between positions', that computer technology is an area in which you are interested in becoming familiar, adept or downright mercenary. Whether your interest is in making money, saving your job, or just having fun, the Multiflex Z-80A microcomputer system is worthy of serious consideration for your first or next computer at home, in the lab, or on the job.

I am convinced that this product is one of the best buys on the market today for the computer hobbyist or experimenter. A 'Made in Canada' product, this unique 2-board system has been designed to start as a relatively inexpensive trainer or hardware experimentation device, and grow, along with your capability, interests and pocketbook, into a full S100 based micro-processor system capable of supporting any industrial, business, teaching or entertaining application you may have in mind. Sounds marvelous, doesn't it? - Well, in many regards, it is!

What does \$375 buy?

For many computer systems, \$375 would be the down payment, but at Exceltronixs in Toronto, \$375 plus PST gets you a box full of parts, a couple of manuals, and 2 quality epoxy, solder masked, and silk-screened printed circuit boards, which, when assembled, comprise an entire working microcomputer, less power supply. Board one is a fully buffered Z-80A processor board, com-

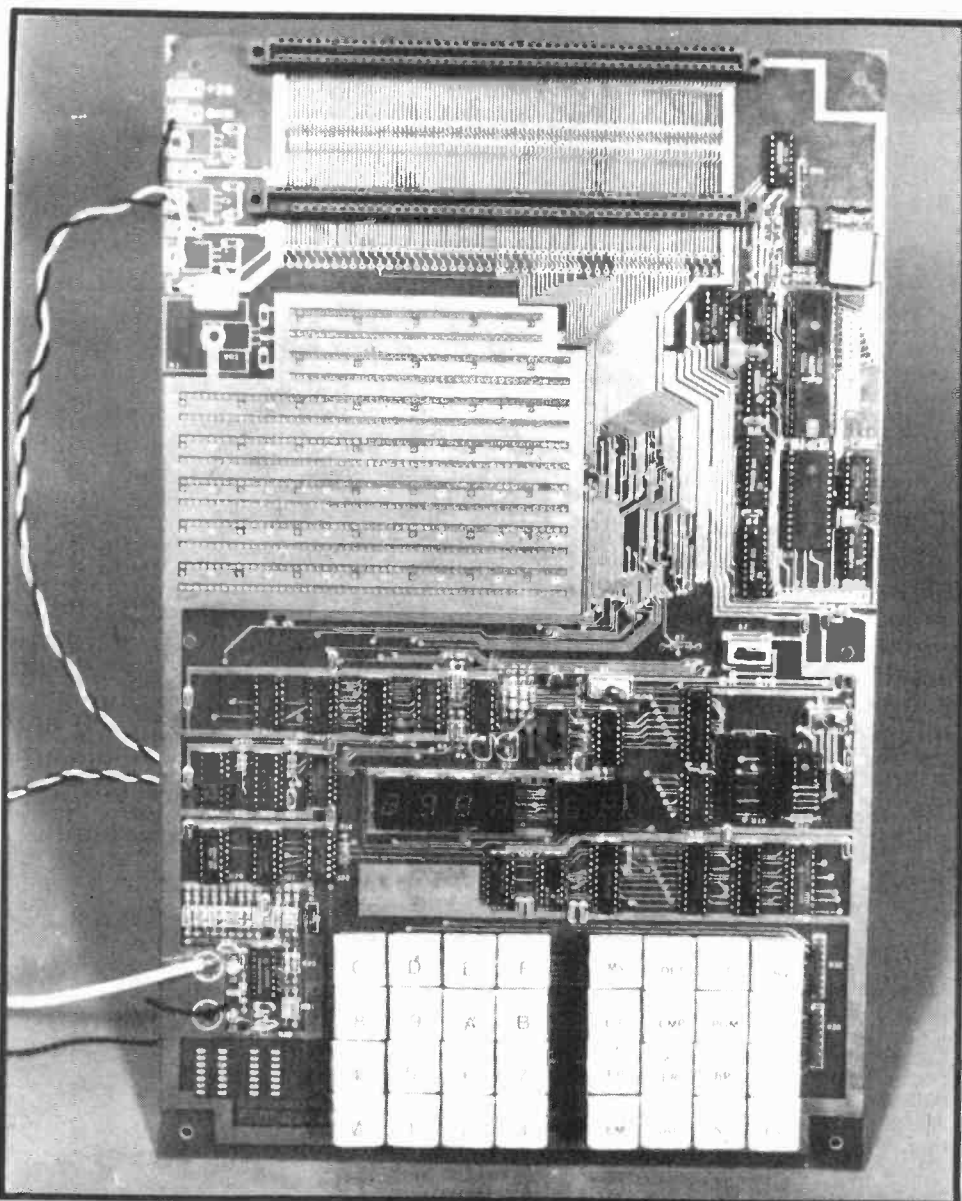

The Multiflex Mother Board in all its glory.

patible with the proposed IEEE S100 buss configuration. Board two is a host mother board for the processor board, and loaded with goodies, such as a parallel I/O port, an EPROM programmer, 3 additional S100 buss slots, a wire wrap area, and 'front panel' items including a data entry hex key pad, a 4-digit address display, a 2-digit data display, and a 14 function monitor command key pad. This board also contains the circuitry for an optional serial I/O port, and for power supply regulation. The parts for both circuits are available from Exceltronixs if you require them.

The Multiflex Z-80A system contains not only a Z-80 CPU board and an S100 backplane, but also the necessary hardware for data entry and display at the machine language level for front panel functions, or for learning machine language programming. Parallel and Serial I/O facilitate expansion to an ASCII key board, a printer or a modem.

The EPROM programmer makes it easy to permanently store programs in the 8 socket EPROM area on the CPU board. The wire wrap area facilitates personal experimentation and customized application of the micro. The kit also comes complete with hex pad oriented monitor, which provides 14 functions to permit data entry, manipulation, and storage.

Multiflex, therefore, has marketed a machine that initially performs the function of a trainer, but permits easy expansion via the standardized S100 buss to virtually any level of sophistication required for your application.

The Specifics - The Hardware

The two circuit boards are made of epoxy glass. The circuitry is 1 oz. copper foil, plated with nickel for corrosion resistance and durability; and then coated with lead-tin reflow for soldering ease. The traces are of sufficient size to accommodate the maximum current draw of the circuits. The entire board, except for the solder connection areas, is covered with a solder mask, a green paint like substance, which minimizes the possibility of shorts from solder splatter, by inhibiting solder adhesion in unwanted places. Component locations are clearly labelled in white lettering, applied by a silk screen process. Please note that the documentation lists 2 polarity errors in the silk screen identification. The board layout is quite dense, but due to good draftsmanship, quality production, and the use of a solder mask, there is minimal risk of creating a short if you

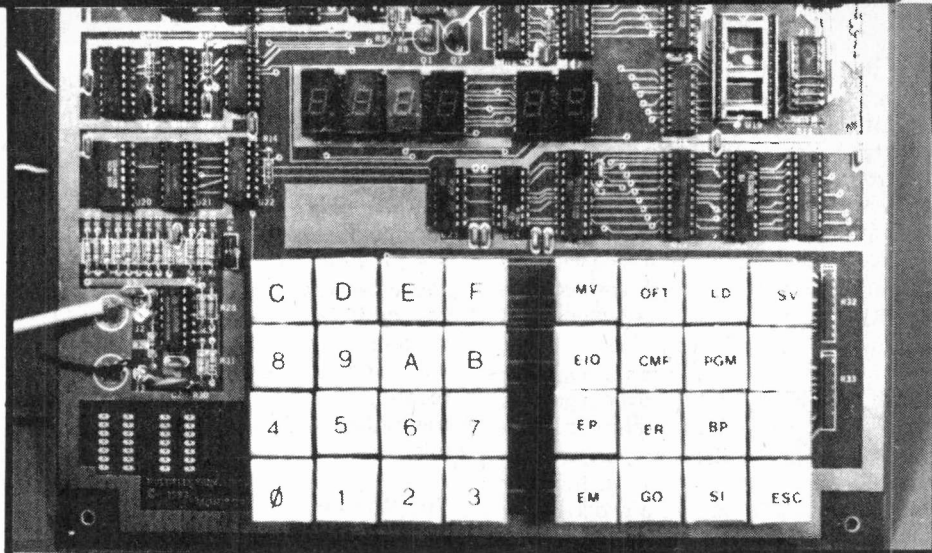

assemble the kit yourself, provided reasonable care is exercised. Sockets are provided for all IC's and quality components are used throughout. If you buy the unassembled version, the components are grouped and bagged in logical categories to facilitate the assembly process.

The Circuitry

The circuit logic on the two boards follows sound principles, with no 'hairy edges' or gimmicky pseudo-logic. While not all the circuits are conventional, those that deviate from accepted norms employ new technology or innovative thinking to produce a superior product. The Multiflex design employs few expensive or esoteric chips, preferring to apply the more common and therefore less expensive IC's available.

The buss signals on the CPU board are heavily buffered to provide protection for the Z-80 chip and for drive capability. Memory addressing for the 4K of RAM is flexible, allowing two blocks of 2 "K" each to be located anywhere in the micro's 65, 536 (64K) address range. The 8 EPROM sockets will accommodate either 1 or 2 K versions, in combination, if desired. The RAM and EPROM located on the CPU card also operate in the shadow mode if additional memory is located on the buss. Shadow mode means it is available to the processor at its correct address space but may be disabled under program control, thus allowing the processor to have access to more than 64K of memory. This circuit is useful for allowing the processor to have access to its monitor, control or interface programs only when required for specific functions, such as receiving or transmitting data, while maintaining the original program in the full 64K of memory, elsewhere.

The EPROM programmer deserves recommendation for two reasons. First, a switch is provided in the circuit to disable all inputs to the EPROM chip, tri-stating the data, address and control signals, and disconnecting the operating and programming voltages. This allows the operator to insert or remove EPROMs while the processor is running, a definite advantage if several EPROMs are to be programmed, since the micro need not be turned off to remove one chip, then turned on and re-programmed for a second.

Second, the circuit operates as a port, with a two output data bytes setting up the address, and controlling the programming pulse, while a subsequent data byte presents the data to be programmed. A second switch selects either the read or the program hardware for the EPROM. Therefore, an EPROM can be used as the data source for copying into other EPROMs, or each EPROM can be verified after programming. It should be pointed out here that the Epromming function of this system, combined with on board RAM, parallel or serial I/O, and the programming routines in the monitor make the Multiflex Z-80A system a very economical, yet powerful, intelligent Eprommer for business applications.

The input and output circuitry offer interesting features too. The two key pads are treated as a single input port, with the low nibble, the first 4 bits of the 8 bit data byte, containing hex data, and the upper nibble containing the monitor function code to be performed. The 4 digit address and 2 digit data display act as an output port under software control, rather than as a hardware function controlled by the buss. In this manner, the data displayed in the 6 display LED's is programmable. Two interesting applications of this control

are the cassette interface signal level meter, and the monitor prompt. The Multiflex monitor contains routines to a constant signal tone from a cassette recorder. The micro-processor outputs a "1" on one of the 6 display LED's, indicating, in a range of 1 to 6, the quality of the signal being received. By varying the cassette tone and volume settings, the quality of the signal may be optimized for data transmission.

The monitor prompt feature applies the same type of control over segments of one of the LED's, indicating that the micro is in the RESET state, or awaiting data or an address, or a monitor command input. Again, a programmer can apply the same programming principles to use the 3 horizontal and 4 vertical segments of each of the 6 LED's to display a specific state during a program's execution. By illuminating a specific segment of a specific LED, 1 of 42 ranked values can be displayed by the processor. The 42 segments could also be used as a very low resolution graphics display.

The serial and parallel I/O circuitry provide access to and from the outside world. Both circuits provide standard features using state-of-the-art technology. The 8255 Programmable Peripheral Interface provides three 8-bit bi-directional ports. Port C may be programmed for data transmission or for control signal input for ports A and B to provide all the normal handshake signals for data transmission control.

The system includes the circuit but not the parts, for a serial I/O port. The 8251 Programmable Communications Interface will operate in either synchronous or asynchronous mode of operation, and generating the serial/parallel conversion for TTL level data transmission. A serial driver and receiver are wired in as an option to provide RS 232C signals. Again, all normal handshake control. The connections for the parallel and serial I/O are brought out to 3 jumper strips for ease of connection.

My final comment on the circuitry of the Multiflex system will be directed toward the cassette interface. Most computer hobbyists utilize the standard cassette recorder for mass storage of programmes. Most cassette interfaces operate at a speed in the range of 300 to 1200 bits per second in order to insure high reliability. The Multiflex cassette I/O hardware has been designed to provide a clean output signal by the use of two shift registers wired as a D to A converter producing a sine wave signal, which is then amplified and filtered

for transmission. The software program serializes the data and generates all control timing, thereby ensuring that the data output is synchronized with the microprocessor's timing. In order to ensure that the tape recorder will reliably record the data signal, routines are provided in the monitor to analyse the cassette's play back characteristics to optimize the cassette recorder's volume and tone settings. The interface will reliably operate at 2000 bits per second, approximately twice as fast as the typical interface available on other micro's.

The Monitor

Multiflex provides the purchaser of one of their kits with a resident 3K monitor stored in two 2716 EPROMs addressed from F000 to FBFF. The Monitor commands are accessed by a key pad rather than by inputting hex data to the micro. The commands may be divided into two groups, those executing directly upon pressing the corresponding key, and those requiring additional data or an address. The lowest horizontal segment of left-most LED display will light, indicating that the micro and monitor are in the reset mode, awaiting input. The lighted segment, or "under bar", is used as a command prompt, indicating that the monitor routine requires more data, that the routine has been completed, or that a problem has arisen. This very useful feature makes the monitor quite easy to use.

The 16 commands provide the programmer with extensive control over the micro. Programs may be entered by direct entry on the hex key pad, by copying from an EPROM by receiving data from a port, or by receiving data from a cassette. These programs may be executed directly, single stopped, or executed partially by use of break

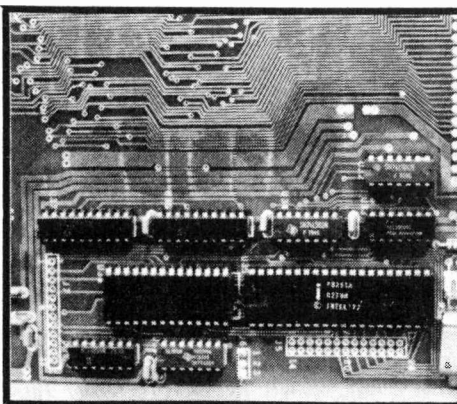

The Mother Board's Programmable Peripheral Interface.

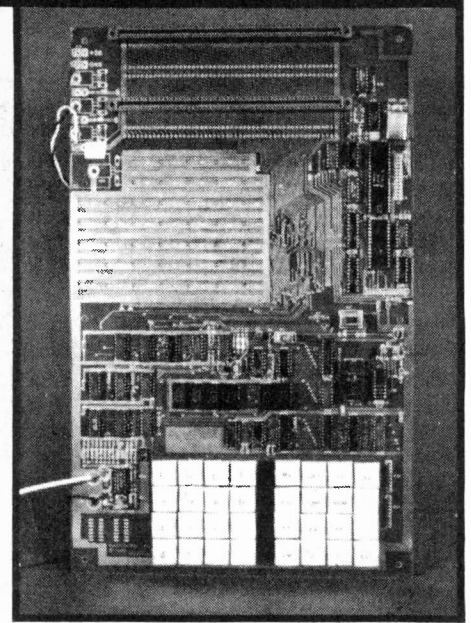

points. Programs may be inspected by stepping through them and observing the address and data on the hex LED display, or by comparing them with an original. Data may be saved on a cassette, moved to another location, stored in a EPROM, or output via a port to another device. A relative branch offset from a specific address can be calculated by another routine. Finally, two utility routines are stored in the monitor but not directly accessed by a command key. The first, entered by a long jump to address FBOO, produces a continuous tone on the cassette interface output, which is then recorded on the cassette recorder. The second routine, located at FB20, is used to analyze the recorded tone produced by the first routine when played back into the micro's input circuit. By adjusting the cassette's volume and tone controls and a trimming potentiometer in the cassette interface circuit on the micro, an optimal cassette playback level can be achieved, thus ensuring the most reliable operation of the cassette recorder and interface. Most of the last 1K of data in the second EPROM of the monitor is unused. The Monitor may be expanded with routines for your particular application, and two command keys are available to provide access these additional routines.

The Manuals

Multiflex has recently revised the operating and assembly manual for this kit in response to suggestions from previous kit purchasers. The new manual is better organized and uses a clearer format to explain the utilization of the monitor commands. Included in the current version is a brief assembly and operating trouble shooting procedure.

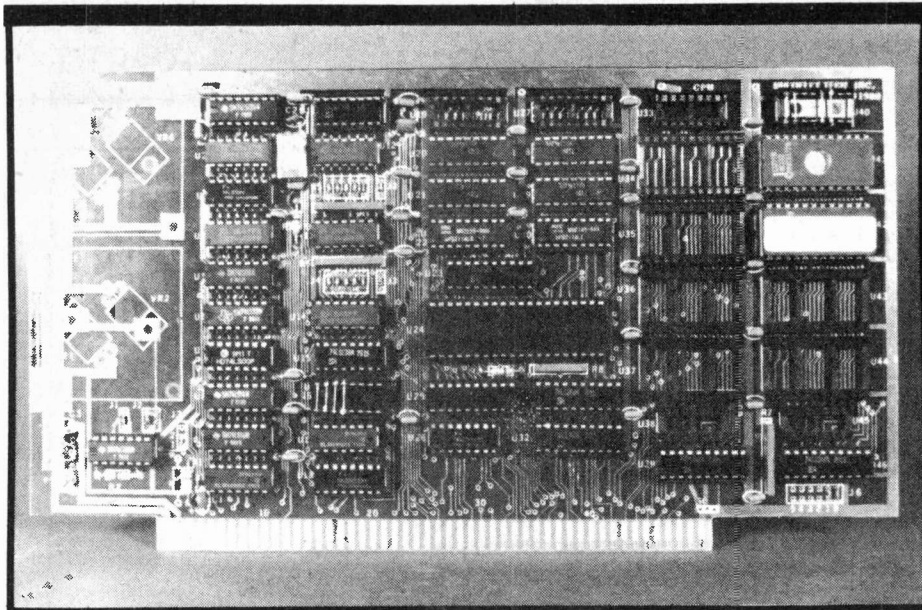

In my opinion, the documentation included with the system is the weakest part of the kit. Don't get me wrong, the documentation is adequate, but not as well designed and thorough as the rest of the package. Certainly the assembly and trouble shooting text and diagrams will provide you with sufficient information to assemble the kit and get it running. But I would like to see more explanation of the operation of the various circuits so that I can utilize them properly, customize them for my own needs, or to troubleshoot them if they give up the ghost. The schematic diagrams should be better labelled, giving purpose and memory map address, definition of the control or address signal input, and the signal level and wave form of critical signals to facilitate signal analysis with an oscilloscope. I would also like a better guide to the signal interconnection to facilitate tracing the circuits, and a continuous schematic of the entire system showing the interconnection of the circuits would be a definite asset.

In my opinion, a few short program listing included in the manual to demonstrate features of the system, and to do some visible activity to impress my better half, would have been a nice thought.

Also, a list of recommended programming books, magazines and other sources of application material would be very useful.

The documentation is better than that provided with most electronic kits, but not on a par with that available from Heathkit or Radio Shack's TRS 80/Technical manual. But then, both of these companies have been developing

kits a lot longer too. Fortunately for the purchaser, the company has been quite willing to accept valid criticism and to upgrade their product and documentation. When I advised Multiflex of my concern with the existing documentation, they produced a draft set of improved schematics within three days. I suspect future kit purchasers will find these changes incorporated into the documentation provided with the kit.

The Company

I found it to be a real pleasure to deal with the people at Multiflex and at their retail store, Exceltronix. For one thing, the people are right there, not an anonymous company in far off California, or a mail order house in Texas. Questions are answered promptly and thoroughly. Skilled technicians are available and willing to troubleshoot a problem or explain a circuit application to you. Two hours of free consultation or troubleshooting are included with the sale agreement. Mailing costs for out-of-town buyers are paid by the company. Another sign of their determination to make it in this very competitive field, is their willingness to customize their product for a "volume" buyer to meet a specific application. Not many companies are willing to design and contract for the production of a dozen or a few hundred special versions of one of their products. So businessmen take note, if the Multiflex Z-80A is close, but not quite what you are looking for, Multiflex could produce the exact product for you.

Multiflex also keeps track of its customers, sending them corrections

and updates on the system, and automatically extending to them a one year subscription to their newsletter. The proposed users club and newsletter will also help hobbyists and professionals alike to get the most out of their purchase.

The Future

Multiflex plans to introduce a number of S100 boards which may be used on the Multiflex Z-80A buss, including a dynamic RAM board, and a colour video display board. Also, an inexpensive black and white display board is nearly ready which is designed to piggy-back onto the wire-wrap area and interconnect to the appropriate signals by direct wiring. Along with the expansion of hardware capability, Multiflex is currently working on a resident full BASIC which is intended to reside in the EPROM area adjacent to the monitor. The BASIC is being written to be compatible with MICROSOFT BASIC, a form of the ever popular language which is available on many micro systems, thus ensuring the ability to utilize most of the BASIC programs available on the market. Once adequate memory, a keyboard, and a video display are available to the programmer, the whole spectrum of Z-80 and 8080 software become available.

Conclusions

While I have tried to restrain my enthusiasm for this product, it is evident that I have not been overly successful. That is because I believe that the Multiflex Z-80A kit is one of the best buys available today for the budding or serious micro processor hobbyist and experimenter. In the previous pages, I have looked at the rationale for purchasing a Z-80A and for using the S100 buss. Once the specific micro chip and buss structure have been selected, choosing the best system, or individual component becomes a matter of acquiring the optimum quality, value, and service for the features you want. I believe that the Multiflex Z-80A will meet all of these criteria, and can be used by a hobbyist, engineer, experimenter, or instructor at any level of programming or hardware competency. With suitable hardware support, and employing off the shelf software, the system can be applied to any application for which a micro processor may be employed. The fact that it is well equipped, relatively inexpensive, and has good company support, are bonuses for you and me to benefit by. Happy Computing!



The reason it doesn't sound very loud is that when we said it was 75 Watts strong, we included the 60 Watt bulb that lights the dial.

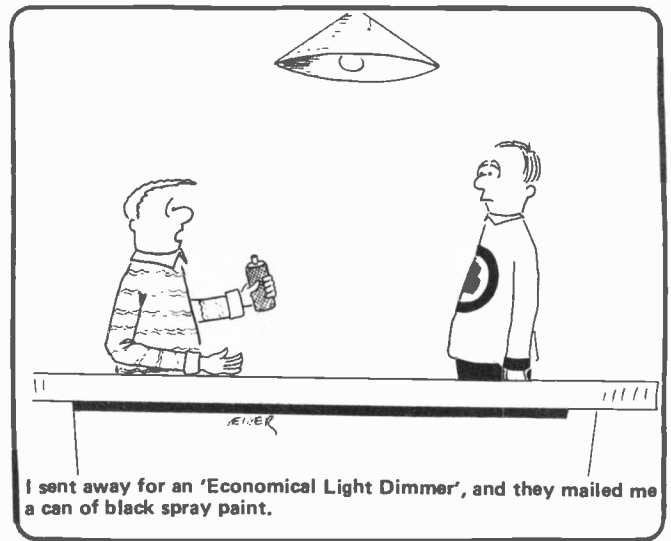

I sent away for an 'Economical Light Dimmer', and they mailed me a can of black spray paint.

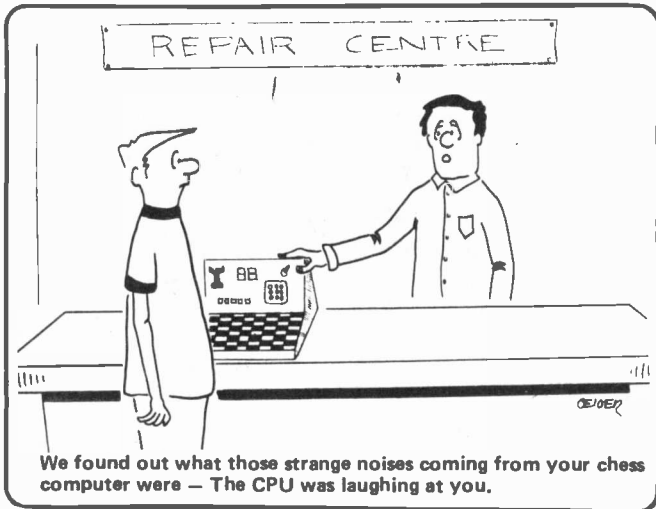

We found out what those strange noises coming from your chess computer were — The CPU was laughing at you.

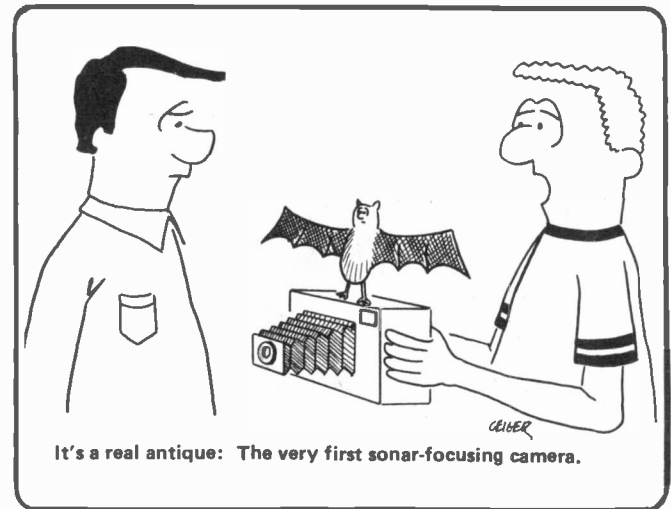

It's a real antique: The very first sonar-focusing camera.

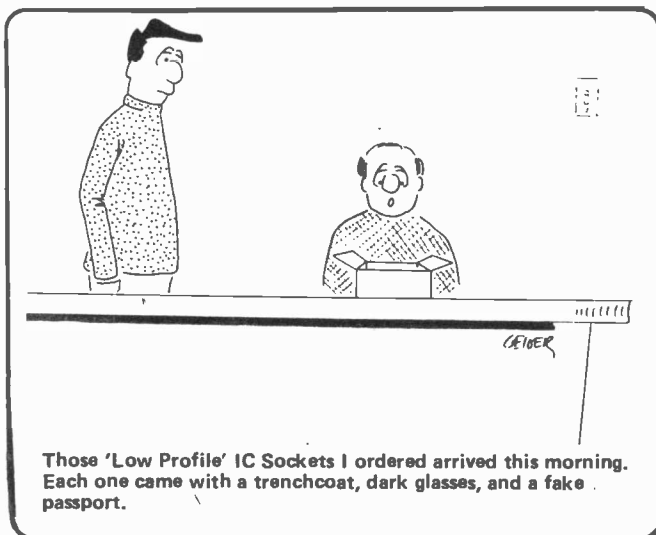

Those 'Low Profile' IC Sockets I ordered arrived this morning. Each one came with a trenchcoat, dark glasses, and a fake passport.

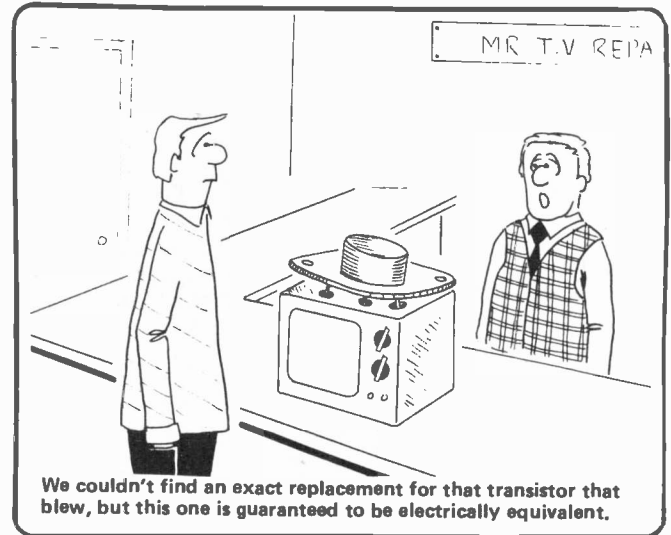

We couldn't find an exact replacement for that transistor that blew, but this one is guaranteed to be electrically equivalent.

TYPEWRITER TERMINAL

High quality printing terminals are pretty expensive. Now a Canadian company has developed an interface that turns a new office tool, the electronic typewriter, into a low cost computer terminal. John Van Lierde reports.

IN A HIGHLY competitive marketplace, the manufacturer who comes out with a better product at a lower price has a definite edge. This is particularly true of the microprocessor industry and the manufacturers of peripherals.

Printers and terminals are a case in point. The cheapest products do not necessarily meet the user's needs. It is possible to buy inexpensive dot matrix terminals, but these are not normally suitable for correspondence purposes. Video terminals are inexpensive, but any serious system must have a source of hard copy.

Now, it seems a Canadian company, Network Data Systems Ltd., has made a major breakthrough in reducing the cost of letter quality terminals. Rather than design a terminal from the ground up, NDS has started with an electronic typewriter and given it an interface that can communicate through an RS 232C port. The end product (Fig. 1, not the Apple II but the thing that looks like TR7) can cost between \$2600 and \$3500 depending on the typewriter model used. Printing terminals of similar quality generally start at \$5000.

While such a device cannot handle the load of more dedicated printers, it does bring the printing terminal closer to small businesses. Its 20 character per second speed is adequate for most purposes and it can accommodate paper widths of up to 17 inches.

Such a terminal is extremely attractive to people who need a low cost link up with micro or minicomputers for such applications as word processing. The low cost will also advance the use of electronic mail in the office. Coupled with a modem, the terminal would allow doctors, lawyers and businessmen to access the data bases available to their professions.

Tronic Typewriters

An electronic typewriter is nothing like a Selectric or that portable you found under the tree at Christmas. Electric



Fig. 1. The NDS 1221 terminal (right) hooked up for use with an Apple II. Even though it's essentially a converted office typewriter, it is nevertheless an effective computer terminal.

typewriters are hideously mechanical contrivances whose innards consist of innumerable wheels, linkages and levers, all capable of breaking or going out of adjustment. That darling of the steno pool, the IBM Selectric, for instance, has over 2500 moving parts!

Electronic typewriters, such as the Olivetti 221 in Fig. 1, use electronics to drive a daisy wheel print head. This offers many advantages, not the least of which is a substantial increase in reliability.

Once a typewriter's insides go digital (well it wouldn't be analogue, would it?), it becomes possible to add other features. The Olivetti 221 (or NDS 1221 when it's a terminal), for instance, has a tow line buffer in which the typist can actually edit a line before it is typed. An electronic typewriter is not by any stretch of the imagination a word processor. The amount of available memory is minimal and editing facilities are limited. They can, however, increase the efficiency of typists and are catching on rapidly.

While some experts contend that the typist's increase in efficiency is marginal, electronic typewriter sales are increasing. Since their introduction to the workplace two years ago, over 200,000 units have been sold. By 1985 that figure is expected to rise to 2.7 million, or approximately one third of the typewriters expected to be in use. *

Some of the more expensive models can be upgraded to terminal or word processor use, but many machines were designed and are sold as smart typewriters.

* Fortune magazine, December 29, 1980.

Making the Change

Figure 2a depicts a crude representation of the internal workings of an electronic typewriter. There are three main parts: the printer; the electronics (an accurate though not terribly descriptive name) which drives the printer; and the keyboard which, with some interpretation, the electronics uses to figure out what to print (a more complete description of the keyboard can be found elsewhere in this article). Figure 2b

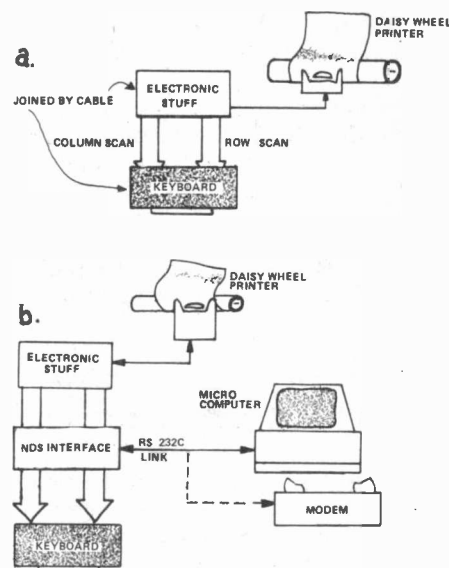

Fig. 2a. The essentials of an electronic typewriter. Fig. 2b. How an electronic typewriter becomes a computer terminal.

shows how 2a becomes a computer terminal. Essentially the keyboard is unplugged from the electronics and the NDS interface is used to remake the connection.

The interface itself (Fig. 3) is a fairly powerful beast. It derives its intelligence from an 8085 processor, 2K of ROM and a 1K RAM. This may seem like using a sledge hammer to crack a nut, but it isn't when you consider that it must appear wholly transparent to the typewriter's electronics.

To the typewriter, the interface has to look just like the keyboard, answering all 'handshaking' signals properly. It must be able to accomplish this in real time. This is to say that it must be answerable to the typewriter's own scanning signals and at the same time, generate a similar set for the keyboard. Additionally, the interface has to monitor its RS 232 port for signals from the outside world.

At present, the interface can only work with Olivetti typewriters. Ultimately, however, NDS hopes to be able to produce similar devices for use in other machines such as IBM, Olympia and others.

Installation of the interface is a relatively simple matter with very little mechanical modification and no changes to the actual typewriter circuitry (the interface could be disconnected at any time and the typewriter would still function normally). Even in service electronic typewriters can be retrofitted with the device. NDS expects this to make up a substantial portion of their sales.

Still More

At present only Olivetti 221, 201, and 121 typewriters can become terminals (the resulting machines are designated NDS 1221, NDS 1201, and NDS 1121). Why did NDS team up with Olivetti? Quite simply because Olivetti was willing to provide technical support. A wise move, since it can only mean another selling point for the product and a considerably expanded market.

NDS benefits from 850 independent Olivetti service centres, all potential retailers of the interface. In effect, the Canadian company has instant access to an established sales network all over North America. This is important since proper marketing is more important to the interface's success than the actual design itself.

While \$2600 is a good price for a computer terminal, it's still a good deal more than a lot of computer hobbyists are going to be willing to spend. But how about \$1500? The 1.5k\$ terminal



Fig. 4. The Olivetti Praxis 35 may become the answer to the hobbyist's need for an inexpensive, high quality printer.

Fig. 3. The interface used to make the conversion. A full computer in its own right, it boasts an 8085 processor, 2K ROM and 1K RAM.

will be a reality if NDS can successfully modify a new Olivetti product.

The Praxis 35 is a new portable electronic typewriter that Olivetti will be introducing early this summer. Tentatively priced at around \$800, it will have a 12 character per second capability. Unlike its big brothers at the office, this is a light duty machine, rated at 20 hours of typing per week.

At the time of this writing there were only two Praxis 35s in Canada and the folks at Olivetti hastened to point out that the Praxis-to-computer-terminal modification was not yet a reality. In fact, NDS hadn't been able to get hold of a unit to modify.

But it is something to look forward to and hope for. While \$1500 is still a substantial sum, it is very competitive with many of the low cost printers on the market today.

And Finally

If you have a sudden urge to rush out and buy yourself an Olivetti 221 *cum* computer terminal then try a call to your local Olivetti dealer. If that doesn't work, write to Network Data Systems Ltd., 245 Yorkland Blvd., Suite 302, Willowdale, Ontario M2J 4W9, telephone (416) 497-0910 or circle number 60 on the reader service card in this issue.

KEY BOARD SCANNING

THE EASIEST (conceptually anyway) method to make a binary, ASCII or whatever keyboard is to use each key-switch to generate each output individually using diodes. This gets very cumbersome when you want to put 64 keys together.

In general, however, it is easier and cheaper to arrange the switches in a matrix. Figure A shows such an arrangement for 16 keys (such as one might find in a calculator). Note that there are only eight external connections, 4 rows and 4 columns. In our example, the black dot indicates a depressed keyswitch (ie closed circuit).

Figure A shows the first cycle of a scan. The microprocessor (or whatever the guiding intelligence is) puts a logic '1' on the first row. Since no keys are activated in that row, the output is zero.

In Fig. B, the '1' is moved down to the second row. Again, it can be seen

that the output would be zero.

In Fig. C the third row gets a logic '1' and a logic '1' is output on the third column.

Figure D is a repeat of A and B, no output occurs.

The result of the above procedure, 0010-0010 or any variation thereof, uniquely defines the activated switch. The piece of data, in conjunction with a suitable look-up table, can be used to generate an ASCII byte, or implement an instruction.

This is keyboard scanning in its most rudimentary form. It cannot cope with such real world problems such as rollover (more than one key pressed at a time), switch bounce, auto-repeat, or the addition of a shift or control key. These, however, can be overcome by a variety of hardware or software solutions or a combination of both.

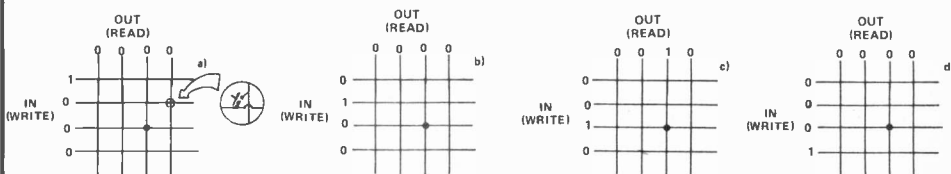

ETI SPECIALS

Special \$3.95

Summer 1980

Electronics Today

ELECTRONIC CIRCUIT DESIGN

CD4019AE
RCA 540

Electronic Circuit Design
92 pages
A collection of major articles on various aspects of circuit design including CMOS, Audio Amplifiers, Power Supplies, SCR's, Op-Amps, Using the 3080 and Temperature Control. A large number of useful circuits are given but the emphasis is on guidance and how to tackle the design for yourself.

\$3.95

More Circuits
108 pages
Over 150 circuits plus articles on Circuit Construction, Test Gear, a project on a Digital Panel Meter, Design notes on Speaker Crossovers, TTL pin-outs, Design notes on Crystal Oscillators.

Electronics Today

Summer 1980

HOBBY PROJECTS

25 Electronic Projects

\$4.50

Hobby Projects
108 pages
First published Summer 1980. Contains 25 straight-forward projects most of which have never appeared in the magazine including: Stereo Amp, Audio Mixer, Scratch and Rumble Filter, Constant Volume Amp, Graphic Equaliser, Envelope Generator, White Noise Effects Unit, Linear Scale Ohmmeter, Intercom, Drill Speed Controller, LED Tacho, Parking Meter Timer, Electronic Organ, Touch Switch, Electronic Dice, Siren, Simple Receivers.

\$3.95

Special Publication \$3.95

JANUARY 1981

Electronics Today

PROJECTS BOOK No. 2

Projects Book No. 2
100 pages
Contains 25 of the best projects from recent issues including the High Performance Series (4000 Amplifier (including Preamps and Power Supply), Rumble Filter, Dynamic Noise Filter, Logic Probe, Cable Tester, Function Generator, Rain Alarm, Digital Tacho, Two Octave Organ, Light Chaser, Shutter Speed Timer, Ni-Cad Charger and more. First published January 1981.

\$3.95

TI Magazine

Electronic Projects

Canadian Projects Book No. 1

100 pages
25 of our most popular projects from our earlier issues including: Audio Limiter, 50W/100W Amp Modules, IB Metal Locator, Touch Organ, Electronic Mastermind, Double Dice, Reaction Tester, Sound Operated Flash, Burglar Alarm, Injector-Tracer, Digital Voltmeter.

Canadian Projects Book No. 1

\$3.00

Available from your local electronic parts store or direct from ETI (please add 45c each to cover postage).
Send money to:
Electronics Today Magazine,
Unit 6, 25 Overlea Blvd.,
Toronto, Ont.,
M4H 1B1

Babani Books from

BP1: First Book of Transistor Equivalents & Substitutes \$2.80

More than 25,000 transistors with alternatives and equivalents make up this most complete guide. Covers transistors made in Great Britain, USA, Japan, Germany, France, Europe, Hong Kong, and includes types produced by more than 120 different manufacturers.



BP14: Second Book of Transistor Equivalents & Substitutes \$4.80

This handbook contains entirely new material, written in the same style as the "First Book of Transistor Equivalents & Substitutes". The two complement each other and make available some of the most complete and extensive information in this field.



BP24: Projects Using IC741 \$4.25

The popularity of this inexpensive integrated circuit has made this book highly successful. Translated from the original German with copious notes, date and circuitry, a "must" for everyone, whatever their interest in electronics.



BP33: Electronic Calculator Users Handbook \$4.25

An invaluable book for all calculator users whatever their age or occupation, or whether they have the simplest or most sophisticated of calculators. Presents formulae, data, methods of calculation, conversion factors, etc., with the calculator user especially in mind, often illustrated with simple examples.



BP35: Handbook of IC Audio Pre-amplifier & Power Amplifier Construction \$5.50

This book is divided into three parts: Part I, Understanding Audio ICs; Part II, Pre-amplifiers, Mixers and Tone Controls; Part III, Power Amplifiers and Supplies. Includes practical constructional details of pure IC and Hybrid IC and Transistor designs from about 250mW to 100W output. An ideal book for both beginner and advanced enthusiasts alike.

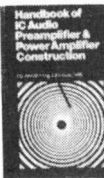

NO.205: First Book of HI-FI Loudspeaker Enclosures \$3.55

The only book giving all data for building every type of loudspeaker enclosure. Includes corner reflex, bass reflex, exponential horn, folded horn, tuned port, klipschorn labyrinth, tuned column, loaded port and multi speaker panoramic. Many clear diagrams are provided showing all dimensions necessary.



BP37: 50 Projects Using Relays, SCR's & Triacs \$5.50

Relays, silicon controlled rectifiers (SCR's) and bi-directional triodes (TRIACs) have a wide range of application in electronics today. These may extend over the whole field of motor control, dimming and heating control; delayed, timing and light sensitive circuits and include warning devices, various novelties, light modulators, priority indicators, excess voltage breakers, etc.

The enthusiast should be able to construct the tried and practical working circuits in this book with a minimum of difficulty. There is a wide latitude in component values and types, allowing easy modification of circuits or ready adaptation of them to individual needs.



BP39: 50 (FET) Field Effect Transistor Projects \$5.50

The projects described in this book include radio frequency amplifiers and converters, test equipment and receiver aids, tuners, receivers, mixers and tone controls, as well as various miscellaneous devices which are useful in the home. This book contains something of particular interest for every class of enthusiast - short wave listener, radio amateur, experimenter or audio devotee.



BP42: 50 Simple L.E.D. Circuits \$3.55

50 interesting and useful circuits and applications, covering many different branches of electronics, using one of the most expensive and freely available components - the Light Emitting Diode (L.E.D.). Also includes circuits for the 707 Common Anode Display. A useful book for the library of both beginner and more advanced enthusiast alike.



BP81: Electronic Synthesiser Projects \$7.30

One of the most fascinating and rewarding applications of electronics is in electronic music and there is hardly a group today without some sort of synthesiser or effects generator.

Although an electronic synthesiser is quite a complex piece of electronic equipment, it can be broken down into much simpler units which may be built individually and these can then be used or assembled together to make a complete instrument.

The book does just that and is divided into the following chapter headings, 1 - Analogue Delay Line, 2 - Single Chip Synthesiser, 3 - Programmable Sequencer, 4 - Voltage-controlled Oscillator, 5 - Envelope Shaper with voltage controlled amplifier, 6 - Putting it all together

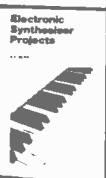

BP84 Digital IC Projects \$8.11

Contained in this book are a number of simple and also more advanced projects, for the home constructor, based on digital integrated circuits.

To assist the newcomer to the hobby, the author has included a number of board layouts and wiring diagrams. Also the more ambitious projects have been designed to be built and tested section by section so as to help avoid or easily correct any faults that might occur.

Highly recommended to both the beginner and more advanced enthusiast alike.



BP44: IC 555 Projects \$7.55

Every so often a device appears that is so useful that one wonders how life went on before without it. The 555 timer is such a device. It is manufactured by almost every semiconductor manufacturer and is inexpensive and very easily obtainable.

Included in this book are Basic and General Circuits, Motor Car and Model Railway Circuits, Alarms and Noise Makers as well as a section on the 556, 558 and 559 timers.



BP46: Radio Circuits Using ICs \$5.90

This book describes integrated circuits and how they can be employed in receivers for the reception of either amplitude or frequency modulated signals. Chapters on amplitude modulated (a.m.) receivers and frequency modulation (f.m.) receivers. Discussion on the subjects of stereo decoder circuits, the devices available at present for quadrophonic circuits and the convenience and versatility of voltage regulator devices. An extremely valuable addition to the library of all electronics enthusiasts.



BP47: Mobile Discotheque Handbook \$5.90

The aim of this book is to give you enough information to enable you to have a better understanding of many aspects of "disco gear". The approach adopted is to assume the reader has no knowledge and starts with the fundamentals. The explanations given are simplified enough for almost anyone to understand.



BP48: Electronic Projects For Beginners \$5.90

The newcomer to electronics, will find a wide range of easily made projects and a considerable number of actual component and wiring layouts. Many projects are constructed so as to eliminate the need for soldering. The book is divided into four sections: "No Soldering" Projects, Miscellaneous Devices, Radio and Audio Frequency Projects and Power Supplies.

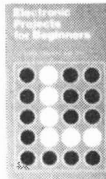

BP49: Popular Electronic Projects \$6.25

A collection of the most popular types of circuits and projects which will provide a number of designs to interest the electronics constructor. The projects selected cover a very wide range. The four basic types covered are: Radio Projects, Audio Projects, Household Projects and Test Equipment.



BP50: IC LM3900 Projects \$5.90

The purpose of this book is to introduce the LM3900; one of the most versatile, freely obtainable and inexpensive devices available to the Technician, Experimenter and the Hobbyist. It provides the groundwork for both simple and more advanced uses.

Simple basic working circuits are used to introduce this IC. The reader should set up each of these for himself. Familiarity with these simple circuits is essential in order to understand many more complicated circuits and advanced uses.



BP51: Electronic Music and Creative Tape Recording \$5.50

This book sets out to show how electronic music can be made at home with the simplest and most inexpensive of equipment. It then describes how the sounds are generated and how these may be recorded to build up the final composition. For the constructor, several ideas are given to enable him to build up a small studio including a mixer and various sound effects units. All the circuits shown in full have been built by the author. Most of the projects can be built by the beginner.

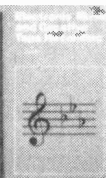

BP62: BOOK 1. The Simple Electronic Circuit & Components \$8.95

BP63: BOOK 2. Alternating Current Theory \$8.95

BP64: BOOK 3. Semiconductor Technology \$8.95

BP77: BOOK 4. Microprocessing Systems & Circuits \$12.30

Simply stated the aim of these books is to provide an inexpensive introduction to modern electronics. The reader will start on the right road by thoroughly understanding the fundamental principles involved.

Although written especially for readers with no more than ordinary mathematical skills, the use of mathematics is not avoided, and all the mathematics required is taught as the reader progresses.

The course concentrates on the understanding of the important concepts central to electronics. Each book is a complete treatise of a particular branch of the subject and, therefore, can be used on its own. However, latter books assume a working knowledge of the subjects covered in earlier books.

BOOK 1: This book contains fundamental theory necessary to develop a full understanding of the simple electronic circuit and its main components.

BOOK 2: This book continues with alternating current theory.

BOOK 3: Follows on semiconductor technology, leading up to transistors and integrated circuits.

BOOK 4: A complete description of the internal workings of microprocessors.



BP85: Single IC Projects \$6.55

All the projects contained in this book are simple to construct and are based on a single IC. A strip board layout is provided for each project, together with any special constructional points and setting up information, making this book suitable for beginners as well as more advanced constructors.



BP85 International Transistor Equivalents Guide \$12.25

This book is designed to help the user find possible substitutes for a popular user-orientated selection of modern transistors and includes devices produced by over 100 manufacturers.

Wherever possible the equivalents are sub-divided into European, American and Japanese types. Also shown are the material type, polarity, manufacturer and an indication of the use or application of the device.



Babani Books are now available from Arkon, CESCO and Dominion Radio, General Electronics.

These books are specially imported from England by us. All prices include handling and postage. To order, use the order form in this publication or write to: ETI Magazine, Unit 6, 25 Overlea Boulevard, Toronto, Ontario, M4H 1B1.

BP66: Beginners Guide To Microprocessors & Computing \$7.55

This book is intended as an introduction to the basic theory and concepts of binary arithmetic, microprocessor operation and machine language programming. The only prior knowledge which has been assumed is very basic arithmetic and an understanding of indices. A helpful Glossary is included. A most useful book for students of electronics, technicians, engineers and hobbyists.

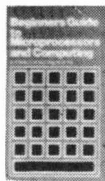

BP67: Counter Driver & Numeral Display Projects \$7.55

The author discusses and features many applications and projects using various types of numeral displays, popular counter and driver IC's, etc.



BP68: Choosing & Using Your HI-FI \$7.25

The reader is provided with the fundamental information necessary to enable him to make a satisfactory choice from the extensive range of stereo equipment currently on the market. This should aid him in understanding the technical specifications of the equipment he is interested in buying. Full of helpful advice on how to use your stereo system properly so as to realise its potential to the fullest and also on buying your equipment. A Glossary of terms is included.



BP69: Electronic Games \$7.55

The author has designed and developed a number of interesting electronic game projects using modern integrated circuits. The book is divided into two sections, one dealing with simple games and the latter dealing with more complex circuits. Ideal for both beginner and enthusiast.



BP70: Transistor Radio Fault-Finding Chart \$2.40

Author Mr. Chas. Miller has drawn on extensive experience in repairing transistor radios to design this book. The reader should be able to trace most of the common faults quickly using the concise chart.



BP71: Electronic Household Projects \$7.70

Some of the most useful and popular electronic construction projects are those that can be used in or around the home. These circuits range from such things as '2 Tone Door Buzzer' and Intercom through Smoke or Gas Detectors to Baby and Freezer Alarms.



BP72: A Microprocessor Primer \$7.70

A newcomer tends to be overwhelmed when first confronted with articles or books on microprocessors. In an attempt to give a painless approach to computing, this small book will start by designing a simple computer that is easy to learn and understand. Such ideas as Relative Addressing, Index Registers, etc. will be developed and will be seen as logical progressions rather than arbitrary things to be accepted but not understood.



BP 73: Remote Control Projects \$8.58

This book is aimed primarily at the electronics enthusiast who wishes to experiment with remote control and many of the designs are suitable for adaptation to the control of other circuits published elsewhere. Full explanations have been given so that the reader can fully understand how the circuits work and see how to modify them. Not only are Radio control systems considered but also Infra-red, Visible light and Ultrasonic systems as are the use of Logic ICs and Pulse position modulation etc.

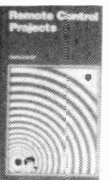

BP74: Electronic Music Projects \$7.70

Although one of the more recent branches of amateur electronics, electronic music has now become extremely popular and there are many projects which fall into this category, ranging in complexity from a simple guitar effects unit to a sophisticated organ or synthesiser.

The purpose of this book is to provide the constructor with a number of practical circuits for the less complex items of electronic music equipment, including such things as Fuzz Box, War-War Pedal, Sustain Unit, Reverberation and Phaser-Units, Tremolo Generator etc.

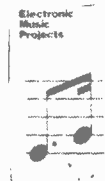

BP75: Electronic Test Equipment Construction \$7.30

This book covers in detail the construction of a wide range of test equipment for both the hobbyist and radio amateurs. Included are projects ranging from a FET Amplified Voltmeter and Resistance Bridge to a Field Strength Meter and Heterodyne Frequency Meter.

Not only can the home constructor enjoy building the equipment but the finished project can also be usefully utilised in the furtherance of his hobby. An ideal book for both beginner and advanced enthusiast alike.



BP76: Power Supply Projects \$7.30

Power supplies are an essential part of any electronic project. The purpose of this book is to give a number of power supply designs, including simple unregulated types, fixed voltage regulated types, and variable voltage stabilised types. The latter being primarily intended for use as bench supplies for the electronic workshop. The designs are all low voltage types for use with semiconductor circuits. There are other types of power supplies and a number are dealt with in the final chapter, including a cassette supply, Nicad battery charger, voltage step up circuit and a simple inverter.

BP78: PRACTICAL COMPUTER EXPERIMENTS \$7.30

This book aims to fill in the background to microprocessors by describing typical computer circuits in discrete logic and it is hoped that this will form a useful introduction to devices such as adders, memories, etc. as well as a general source book of logic circuits. An essential edition to the library of any computer and electronic enthusiast.

BP79: Radio Control For Beginners \$7.30

The aim of this book is to act as an introduction to Radio Control for beginners to the hobby. The book will commence by dealing with the conditions that are allowable for such things as frequency and power of transmission. This is followed by a "block" explanation of how control device and transmitter operate and receiver and actuator(s) produce motion in a model. Details are then given of actual solid state transmitting equipment that the reader can build. Plain and loaded aeriels are then discussed and so is the field-strength meter to help with proper setting up. The radio receiving equipment is then dealt with, this includes a simple receiver and a crystal controlled superhet. The book ends with electro-mechanical means of obtaining movement of the controls of the model.

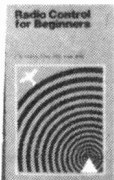

BP80: POPULAR ELECTRONIC CIRCUITS—BOOK 1 \$8.25

Another book by the very popular author, R.A. Penfold, who has designed and developed a large number of circuits which are accompanied by a short text giving a brief introduction, circuit description and any special notes on construction and setting up that may be necessary. The circuits are grouped under the following headings: Audio Circuits, Radio Circuits, Test Gear Circuits, Music Project Circuits, Household Projects, and Miscellaneous Circuits. An extremely useful book for all electronic hobbyists, offering remarkable value for the number of designs it contains.



BP83: V MOS Projects \$8.20

Although modern bipolar power transistors give excellent results in a wide range of applications, they are not without their drawbacks or limitations. With the advent of field effect devices it seemed that it would only be a matter of time before improved power transistors became available, this has happened and a number of different power FETs are now available to the hobbyist. This book will primarily be concerned with V MOS power FETs although power MOSFETs will be dealt with in the chapter on audio circuits. A number of varied and interesting projects are covered under the main heading of Audio Circuits, Sound Generator Circuits, DC Control Circuits and Signal Control Circuits.



NO.213: Electronic Circuits For Model Railways \$4.50

The reader is given constructional details of how to build a simple model train controller; controller with simulated inertia and a high power controller. A signal system and lighting for model trains is discussed as is the suppression of RF interference from model railways. The construction of an electronic steam whistle and a model train chuffer is also covered.



NO.215: Shortwave Circuits & Gear For Experimenters & Radio Hams \$3.70

Covers constructional details of a number of projects for the shortwave enthusiast and radio "Ham". Included are: an add-in crystal filter, adding an "S" meter in your receiver; crystal locked H.F. Receiver; AM tuner using phase locked loop; converter for 2MHz to 6MHz, 40 to 800MHz RF amplifier, Aerials for the 52, 144MHz bands, Solid State Crystal Frequency Calibrator, etc.



NO.221: Tested Transistor Projects \$5.50

Author Mr. Richard Torrens has used his experience as an electronics development engineer to design, develop, build and test the many useful and interesting circuits in this book. Contains new and innovative circuits as well as some which may bear resemblance to familiar designs.



NO. 223: 50 Projects Using IC CA3130 \$5.50

In this book, the author has designed and developed a number of interesting and useful projects using the CA3130, one of the more advanced operational amplifiers that is available to the home constructor. Five general categories are covered: Audio Projects, R.F. Projects, Test Equipment, Household Projects and Miscellaneous Projects.



NO.224: 50 CMOS IC Projects \$4.25

CMOS IC's are suitable for an extraordinary wide range of applications and are now also some of the most inexpensive and easily available types of ICs. The author has designed and developed a number of interesting and useful projects. The four general categories discussed in the book are: Multivibrators, Amplifiers and Oscillators, Trigger Devices and Special Devices.

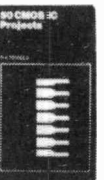

Tab & Sybex books from ETI



Master Handbook of 1001 Practical Circuits
TAB No. 800 **\$18.30**
Master Handbook Of 1001 More Practical Circuits
TAB No. 804 **\$18.35**

Here are IC and transistor circuits for practically anything and everything — with ALL the data needed to put them to work. The ideal schematic sourcebook for all active technicians, engineers, experimenters, amateurs — for anyone who must occasionally or regularly construct or adapt electronic circuits for any purpose whatsoever. You'll find any circuit you're ever likely to need in the pages of this rich volume. The schematics are classified according to general application, and the Sections themselves appear in alphabetical order.

99 Test Equipment Projects You Can Build
TAB No. 805 **\$11.75**

Here's the A to Z guide you need to build all sorts of electronic test equipment — from a simple signal tracer to a sophisticated modularized 50 MHz counter — and virtually everything in between! Here are voltmeters and ammeters, capacitance meters, resistance and impedance measurers, testers for solid-state components, digital voltmeters, calibrators and frequency standards, signal generators, frequency counters, oscilloscopes, and a variety of RF test equipment. The variety is incredible and almost endless — virtually every test instrument you could possibly want to build for yourself.

The Power Supply Handbook
TAB No. 806 **\$11.75**

A complete one-stop reference for the hobbyist and engineer. Contains high and low voltage supplies as well as mobile and fixed units. Everything you need to keep your project peaking with the right volts and amps.

Build Your Own Working Robot
TAB No. 841 **\$8.55**

Here are complete instructions — plans, schematics, logic circuits, and wiring diagrams — for building Buster. Not a project for novices, Buster is a sophisticated experiment in cybernetics. You build him in phases, and watch his personality develop as you add progressively more advanced circuitry to his mainframe. The first of this three-phase robot, Buster I, is "leashed" and dependent on his master for decision-making. You create the "animal" and give him wheels, steering capability, and the capacity to "understand" your basic commands. Phase II makes Buster more independent. Now he has a basic brain he can use to decide when he's in need of a battery charge, or trapped into a physically binding situation he can't get out of.

A Beginner's Guide To Computers & Microprocessors — with projects
TAB No. 1015 **\$9.70**

Here's a plain-English introduction to the fascinating world of the microcomputer — its capabilities, parts, functions, and programming... and how you can have one in your own home. Numerous projects, using actual computer parts, demonstrate the operation of a computer and lead to the assembly of a working microcomputer capable of performing many useful functions around the home and office.

How To Design, Build & Test Complete Speaker Systems
TAB No. 1064 **\$11.85**

If you've always wanted to build your own speaker system, here's a book crammed with everything you need to know to do it right... the first time! It contains a variety of ready-to-build speaker system projects, from simple speaker-in-a-box setups to complex multi-driver systems, plus all the information even a beginner needs to design and build his or her own. This clear guide shows you exactly how a speaker works, how its power and resonance are attained, and how speakers may differ from one another. It's as thorough a book as you'll find on the complete subject of speakers, speaker systems, and enclosures.

Digital Interfacing With An Analog World
TAB No. 1070 **\$12.35**

Are you looking for ways to really put your microcomputer to work? This book tells you how to go about it — how to convert energy produced by pressure, force, position, temperature, etc. into an electrical voltage or current that your microcomputer can deal with. It's for the user who views the microcomputer as a bit of hardware to be applied, and who views software as either a simple set of instructions to make the machine go or, more importantly, as a valid substitute for hardware. It presents information, in handbook style, for users of microcomputers who want to design a device or system with a microcomputer at its heart. Very simply, this book is for the microprocessor/computer user who wants to use the machine to measure certain conditions, or to control external devices.

The Complete Handbook Of Robotics
TAB No. 1071 **\$10.90**

Create your own robot? All the information you need to build a walking, talking friend and companion or a helpful servant appears in this book! Your robot can take on many forms and operate in any way you choose. Every possible option is covered in minute detail — including light, sound, heat, and proximity sensors, microcomputer "brains" and more. Whether you want a robot for an experimenting, for a security application or to perform some task suitable for a "smart" machine, all the ideas you need are packed into this book.

The Active Filter Handbook
TAB No. 1133 **\$9.75**

A designer's and users' guide to the theory and applications of active filter circuits. For anyone interested in electronics, this handy one-stop guide to modern filter technology will prove invaluable. It introduces filters and their purpose, compares different filters, and covers LC passive filter operation, op amps, Butterworth filters, Chebyshev filters, low-pass filters, high-pass filters, etc. This all-inclusive manual offers coverage of electronic math and basic electronic theory also. Cannot be beat for a complete and practical discussion and examination of filter techniques.

Electronic Music Synthesizers
TAB No. 1167 **\$8.40**

If you're fascinated by the musical possibilities of electronic music synthesizers, this book provides all the information you need to choose, use, adapt, or even build a synthesizer. It's filled with data on synthesizers in general... and on individual models, candidly explaining the advantages and disadvantages of each one. Such musical workhorses as the Moog (Minimoog and Polymoog), ARP 2600, Odyssey, PAIA, Oberheim, RMI and EML synkyez synthesizers are presented in full detail. Also included is a Chapter on accessories and on the various components that can, with the help of this book, produce almost any sound you hear... or can imagine!

But that isn't all — once you've learned what makes a synthesizer work and how to produce all kinds of music and sound effects, Horn includes a full section on how to build your own. There's even a list of universal patch diagrams to assist you in your tinkering and experimenting. If you'd like a book that gives you solid, practical help in choosing and using — or building — a synthesizer, this informative manual is your best choice.

Towers International Op Amp Linear IC Selector
TAB No. 1216 **\$11.40**

If you deal with op amps (and linear-ICs with op amp characteristics) in any way, here's a wealth of practical information that will help you solve selection, design, and replacement problems. This international guide includes basic specifications for over 5,000 op amps and linear ICs, and contains data on ratings, characteristics, case details, terminal identifications, applications uses, manufacturers, and substitution equivalents. Here you'll readily find data on a specific op amp when you know only the type number. Plus, you'll be able to locate the manufacturer of the device. And, particularly important with obsolete units, you'll find guidance on a readily available substitute.

A series of Appendices includes a glossary of op amp terms, tabulation codes for manufacturers, manufacturer house numbers, tabulation codes for applications, case outline and leadout diagrams, and codes for leadout connections. If you want the latest, most complete details on op amp-linear-IC's available today, you'll find it in this book.

How To Build Your Own Self-Programming Robot
TAB No. 1241 **\$11.75**

This is a straightforward how-to book about machine intelligence — a practical guide that shows you how to build a robot capable of learning how to adapt to changing circumstances in its environment. The unique little creature described in this book, named Rodney, can pick up signals and stimuli from his environment and develop perceptions just like humans and higher animals do. Yet Rodney is fully trainable, and his "personality" can be altered and molded by human intervention. All in all, Rodney is in a class by himself, and is a most remarkable and fascinating machine — he can program himself to deal with the problems of the moment and devise theories for dealing with similar problems in the future. Yes, Rodney is self-programming, and as a result no two Rodney's behave exactly the same way. In fact, if you wipe out his self-generated memory, he'll develop another one that's somehow different from the first.

An Introduction to Personal & Business Computing
SYBEX C200 **\$10.75**

This is a basic introductory text on microcomputers. Its main goal is to answer the question: "What do I need for...?" in specific detail. No previous technical background is assumed. The author addresses progressively all the essential topics of interest to the microcomputer user (as opposed to the designer). How a system works. Which modules are required for which function. How much memory is needed. Which peripheral should be used. The cost. The software. Differences between existing microcomputers. Is a mini-BASIC sufficient? The real cost of a business system. Its limitations. Can you really manage a mailing list on a floppy disk? Packages and other programs. The traps for the hobbyist. Application techniques. New systems and facilities.

The book is designed to educate the reader in all the aspects of a system, from the selection of the microcomputer to the required peripherals. No computer background is required.

Programming the 6502
SYBEX C202 **\$18.75**

An educational text designed to teach you programming from the ground up. Already one of the most successful programming books ever published, it has been revised and expanded at both the low end and high end of the spectrum. The range of programming concepts and techniques presented is such that it addresses the needs of virtually every programmer interested in using the 6502 microprocessor, from beginner to expert.

Programming the Z80
SYBEX C280 **\$20.75**

This book has been designed both as an educational text and as a self-contained reference book. As such, it can be used as a complete introductory book on programming, ranging from the basic concepts to advanced data structures manipulations. It also contains a comprehensive description of all the Z80 instructions as well as its internal operation, and should provide a comprehensive reference for the reader who is already familiar with the principles of programming, but wishes to learn the Z80. All concepts are explained in simple yet precise terms, building progressively towards more complex techniques.

Programming the Z8000
SYBEX C281 **\$22.75**

This book was designed as both an education text and a self-contained reference manual. This book presents a thorough introduction to machine language programming from basic concepts to advanced programming techniques. Detailed illustrative examples and numerous programs show the reader how to write clear, well-organized programs in the language of the Z8000.

With over 113 illustrations, a thorough index, and 5 appendices, Programming the Z8000 is an indispensable text for engineers, students, POP-11 users and anyone interested in learning machine language programming skills.

6502 Applications Book
SYBEX D302 **\$18.75**

This book presents practical applications techniques for the 6502. You will build a complete home alarm system, including fire detection, as well as an electronic piano, a motor speed regulator, a time-of-day clock, a simulated traffic control system, and a Morse code generator. You will also design an industrial control loop for temperature control, including analog-to-digital conversion, and your own simple peripherals from paper-tape reader to microprinter. Truly the "input/output" book for the 6502, it includes more than 50 exercises designed for testing yourself at every step.

6502 Games Book
SYBEX G402 **\$18.75**

This book is designed as an educational text on advanced programming techniques. It presents a comprehensive set of algorithms and programming techniques for common computer games. All the programs are developed for the 6502 at the assembly language level.

The reader will learn how to devise strategies suitable for the solution of complex problems, typical of those encountered in games. He/she can also use all the resources of the 6502, and sharpen his/her skills at advanced programming techniques. All the games presented in this book can be played on a real board (the SYM), and require a very small amount of additional components.

To get yours, fill in the form in this issue or write to ETI Magazine, Unit 6, 25 Overlea Blvd., Toronto, Ontario M4H 1B1. Please allow six weeks for delivery. Due to sometimes uncertain supplies, some books may not be in stock, please indicate whether you wish your order held or if you wish your money refunded.

THE COMPUTERIZED DJ

Many statements of the BASIC programming language are fully useful only when configured with other commands. Steve Rimmer looks at a nasty long program with a number of examples.

THERE ARE CERTAIN cross cultural traits which are common to the large majority of the people on this orb. Breathing, for example, is a big one. Many people do this frequently, as if their life depended on it. The avoidance of having the feet run over by a semi-trailer while waiting for a bus is another. Ask anybody, regardless of the colour of his or her skin, the number of eyes or who, or what, he or she eats for dinner . . . nobody wants flat feet that have been flattened from the top down. Clever way to avoid military service, though. Then, there are more subtle traits. Most people find pleasure in smashing pink plastic flamingo lawn ornaments with sledge hammers. This also applies to jockies and rubber mushrooms. I was originally going to do this piece on techniques to be used in this pursuit, but, it was suggested after considerable consultation that I consider checking out a slightly different, although related, topic, so as not to become arrested during my research.

It seems that one of those burning global issues is that learning BASIC computer language from a manual can be something of a downer, as, for the most part, the fellows who concoct those things keep forgetting that if their readers knew what they were talking about in the first place, they wouldn't have bought the book. This piece launches itself into this particular fray. "Next time, we'll explain how to build a lasting peace in the Middle East".

```
LOAD ADD, AMMEND OR RETURN? ADD
NAME: ETI 89
TIME: 1138
SPOT: ETI 89
NAME: LEVIS 5
TIME: 1135
SPOT: LEVIS 5
NAME: RECORDS ON WHEELS 75
TIME: 1148
SPOT: RECORDS ON WHEELS
NAME: DONALD'S 18
TIME: 1138
SPOT: DONALD'S 18
NAME: HOLSON'S 9
TIME: 1135
SPOT: HOLSON'S 9
NAME: ETI 89
TIME: 1138
SPOT: ETI 89
NAME: LEVIS 5
TIME: 1135
SPOT: LEVIS 5
NAME: RECORDS ON WHEELS 75
TIME: 1148
SPOT: RECORDS ON WHEELS
NAME:
TIME:
SPOT:
```

This article is intended to be a different approach to the voracious and hoary task of unravelling BASIC programming. Most writings which gallop off to meet this foe do so with a handful of explanations of the various statements used to put programs together, but no clear idea of what they do when assembled. In fact, many of the statements are designed to be used in groups . . . and many functions of the machine are executed by not one, but several lines.

With this trip, we are going to check out a large, complex BASIC program, and understand how its component subprogrammes operate. The software shang-haied here for illustrative purposes, as it stands, will probably not be of monumental use to practically anybody. However, its component parts will, and in seeing what causes them to do their things, it will be possible for any of you bleary eyed trolls to modify and re-concoct them to do other, more relevant tasks.

The program itself is derived from a generic text editing routine. It has been developed to handle the play lists and on-air logs for a small FM radio station. It is, in this presentation, considerably simplified from its original form, as there was much in the working model which would serve little purpose for the sake

of this treatise. There was a fair bit of writing to tape in the program itself, a separate program for loading data produced by the play list routine. All of the tape files have been excluded from this version, as they are fairly pointless without the other two support programs, which are too long to include. In addition, they were both pretty dull.

As mentioned previously, however, this program is not presented to be run in its present form, (although it will, if entered), but, rather, to be messed about with.

The playlist program is used by a DJ to keep track of his on air activities. First of all, it asks him his name, the hours of his shift, the type of stuff he'll be playing, and the name of his show. Then it provides a form to be filled out with the label, artist, and name of each cut played. Whenever a commercial or other air spot is to be played it prints a line to this effect. There is a password by which the file of commercials and spots may be written into or updated. As each commercial is played, it is deleted from the file.

This program is written in PET Basic. The PET is the only common machine having an internal clock function, which is rather necessary

for several aspects of this thing. It will, however, run with a few changes on most of the other BASIC equipped beasts, if the functions which utilize the clock are omitted.

The Software

The program consists of three sections. The first is the initialization flotsam, running from the REM vanity statements of lines 1 and 2 to the flag reset of line 22. These statements just set up a few important variables for the machine, and are pretty well self explanatory. The second is the mainframe proper. This has two sequential, and repeating, functions, these being to inhale characters from the keyboard, and spit them out after processing them. The third section, and by far the largest, is the subroutine library, which actually performs all the functions of the program.

The mainframe's two bits consist of the character getter and the character sorter. The getter is located at line 40, and is of the general form GET A\$: IF A\$ = " " THEN 40. It is a glorified waiting routine. First of all, it skulks over to the keyboard register, and stealthily snatches whatever is there. It stuffs it in a gunny sack, and skulks off. Later, in the 'IF' part of the statement, it looks to see what it's come up with. Chances are it's nothing, so it goes back and tries again. If it has found something, it presumes that it is clutching a character, as opposed to a gnome or something similar, which it tosses down into the rest of the mainframe.

In fact, the program spends almost all its time looping through the character getter, waiting for someone to type something. Thus, anything we want to be done frequently, or before any character processing takes place, must be located within the getter loop. As such, statement 40 has a few things between the GET and the IF. There's many a slip between the Get and the IF, or so it goes.

GOSUB 301 is responsible for putting the digital clock readout up in the right hand corner of the screen. Its actual function will be examined shortly. By putting this in the getter loop, the clock is checked and updated several times a second. If it were anywhere else in the program, it would only be set each time a character was typed. POKE 548,0 is kind of interesting, because it isn't listed in the PET manual. It is a flag to turn the cursor on during intervals in which it would normally be snuffed. POKEing this location with a 1 will



The new computer has just finished drawing up this year's budget — it's allocated five million dollars for comput maintenance.

turn it off again, as we do when the sorter is being used.

Location 245 of memory holds the number of the line to be printed, and 226 is the horizontal position. The variable LYNE is used here to hold the line number, and OMMA is the column. By clamping these two locations, the screen may be written onto by PRINTing instead of POKEing, which is faster. These two variables are held throughout the program.

The processor, or sorter, begins after line 40. 43 to 46 are a routine for straightening out the PET's inverted keyboard, which normally gives upper case characters when unshifted, the reverse of a standard typewriter. This bit gets a decimal ASCII back into a character, loaded into Q\$. This is sent on the GOSUB 200.

GOSUB 200 will be fully explained shortly. What it does for the mainframe, however, is to set a pole full of flags that determine the eventual disposition of the character. Operations within the mainframe that are determined within the GOSUBs cannot be carried out directly, but, rather, must be run by flags, to avoid GOSUB WITHOUT RETURN ERRORS . . . which really mess up the screen. All the flags in this program, except for internal, machine flags, of course, are set at 10 and reset at 0.

The functions of the flags are as follows. LINDA tells the program to go back to its beginning and restart. CAT determines whether the character in Q\$ should be added to the string B (LYNE). This would be filed on tape in the full program. FROG suppresses and unsuppresses printing Q\$ in the next screen location. FLAG allows the LYNE counter to be advanced by one. DOG governs the incrementing of the OMMA counter. Statement 87 insures that all the flags that don't self-reset are returned to zero. After this, the mainframe goes to line 40 and starts groping around for its next

character.

The GOSUBs

GOSUB 100 is a sub-GOSUB, used as a clean-up routine by other GOSUBs. If you can say that ten times in thirty seconds, you deserve to win something. Perhaps a GOSUB of your very own. Statement 102 calculates the location of the cursor minus one and blanks out that screen location by POKEing it with 32. This is necessary because, when using the fairly crude cursor movers herein, the thing will leave behind a white square if it happens to change locations while it's on.

GOSUB 200 is a filter which decides whether a character is a printable character, like an "a", or a control character, like a "RETURN". This is pretty simple, as these routines go. The REMs from 201 to 208 list what are considered to be control characters. The actual filter is from 220 to 240. Note that RETURN can be two characters. The numbers used are derived from the keyboard shifter in the mainframe.

In most cases, if the character hitting the filter turns out to be a control character, the whole mess shifts to yet another GOSUB, which does something with it, and sets the appropriate flags. The exception is the upward arrow character, which just sets the LINDA flag to tell the mainframe to restart. Printable characters pass through the filter unaffected, and RETURN to the mainframe.

Shifted 2, which GOSUB's 400, is used for testing and setting up GOSUB 400 only, and can be deleted once the system is running.

GOSUB 300 is the digital clock routine, as first crept up upon in the GET loop of the mainframe. Anything in the GET loop which requires much time to execute will limit the maximum speed at which characters can be entered. Thus, the alacrity with which the clock routine happens is of considerable concern. As it is, it's just barely fast enough. First of all, its calling statement is GOSUB 301, as opposed to GOSUB 300, so that the REM statement with its name never gets executed. The rest of the routine is crammed onto two consecutive lines, 301 and 302. The DATA statement contains the six screen locations where the time information is to be displayed. The FOR NEXT loop in 302 cycles six times, each trip through getting one of the DATAs and the next consecutive element of TI\$, the string

Electronics Today

INTERNATIONAL

At the time of going to press, the articles mentioned are in an advanced stage of preparation. However, circumstances may result in changes to the final contents of the magazine.

NEXT MONTH

JUNE

Project Galileo

It may be a CIA operation; in a few years the Americans hope to drop a hidden camera probe into the clouds of Jupiter. If you have any Jovian relations, send them a copy of this article so they'll know what to expect.

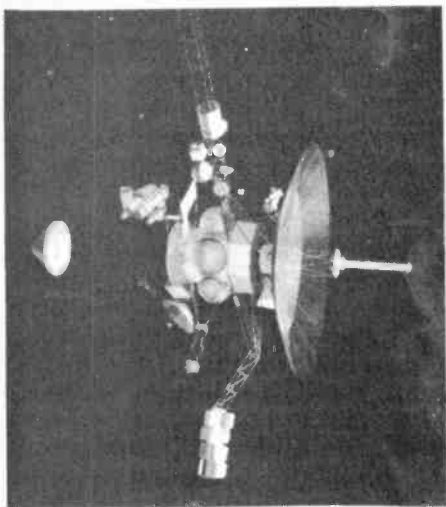

High Speed Cassette Interface

Turn that poor, wretched twelve ninety five Distort-o-tone cassette machine into a lightning fast, unspeakably wonderful 4800 baud data storage device. This project also transmutes lead into gold with suitable modifications.

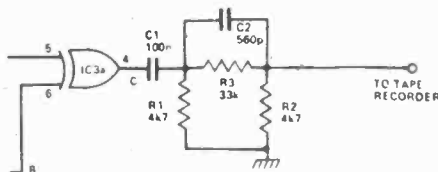

Telidon Magazine

Computerese may be the ultimate computer publication. Not only does it deal with the topic, but it is "published" digitally. Instead of landing in your mail box, it crops up on your TV screen via the Telidon system.

Double Dice

Roll them laughin' bones... electronically. The perfect adjunct to your hand drawn Monopoly set, or a gift for the compulsive craps player. Guaranteed to save wear and tear on the wrists.



Bicycle Speedometer

One so rarely encounters cops who are diligent enough to bust cyclists for speeding, but the possibility looms larger with each commuter who switches to public transit. Here's a project to help you keep your velocity in check.

1537A VCA

Scrupulously clean, linear to a fault, accurate beyond question... yes, the 1537A VCA will probably even outperform those venerable CA3080's. Just the little beast for synthesizers, hi-fi, and a raft of other audio applications.

Save up to 38% by subscribing to ETI. See Page 32.

```

1 REM*****
2 REM** COPYRIGHT 1980 STEVE RIMMER **
3 DIM B$(40)
4 POKE53468,14
6 DIMSA$(20)
7 DIMSB$(20)
13 PRINT"DJ"
20 GOSUB 1100
22 LINDA=0
40 GETA$:GOSUB331 POKE548 B POKE245,LYNE POKE226,OMMA:IFA$=""THEN40
41 POKE548,1
43 A=ASC(A$):IFA>192THENA=A-128 GOTO46
44 IFA<91 AND A>64 THEN A=A+128
46 Q$=CHR$(A)
47 MAX=0 GOSUB200
48 IFLINDA=10THEN13
60 IFCAT<>10THENB$(LYNE)=B$(LYNE)+Q$
70 IFFROG<>10THENPRINTQ$
75 IFFLAG=10THENLYNE=LYNE+1:FLAG=0:GOSUB100:GOTO40
80 IFDOG<>10THENOMMA=OMMA+1
85 IFOMMA=40THENGOSUB800
87 DOG=0:CAT=0:FROG=0
90 GOTO40
100 REM DO ALL CLEAN UP SUBROUTINE
102 V=PEEK(245):H=PEEK(226):ZOT=V+40+H+32808 POKEZOT,32
103 RETURN
200 REM CHARACTER DIFFERENTIATOR
201 REMRETURN=141,13
202 REM177:SHIFTED 1
203 REM20:DELETE
206 REM178:SHIFTED 2
207 REM94:↑
208 REM95:←
220 IFA=141ORA=13THENGOSUB1000
225 IFA=20THENGOSUB700
230 IFA=94THENGOSUB1200
235 IFA=95THENLINDA=10
240 IFA=178THENKITTY=10:GOSUB400
299 RETURN
300 REM CLOCK SUBROUTINE
301 DATA32797,32798,32800,32801,32803,32804
302 FORTX=1T06:READZ0:DO$=MID$(TI$,TX):MO=ASC(DO$):POKEZO,MO:NEXT:RESTORE
303 RETURN
400 REM COMMERCIAL SEARCH ROUTINE
410 GAMMA=VAL(LEFT$(TI$,4))
415 FOR DL=1T020
420 PSLN=VAL(SA$(DL))
425 BBC=GAMMA-PSLN
427 IFBBC<-15ORBBC>15THEN430
428 LYNE=LYNE+1:POKE245,LYNE:PRINT" "
429 PRINT"PLAY SPOT: "SB$(DL)" AT: "SA$(DL):SA$(DL)="XXX":WW=10
430 NEXT DL
440 IFWW=10THENPRINT" "LYNE=LYNE+1:POKE245,LYNE:WW=0
450 RETURN
500 REM RETURN SUBROUTINE
510 OMMA=0
515 FLAG=10
522 GOSUB100
525 DAD=LYNE+1:B$(DAD)=" "
530 IFMRV=10THEN599
575 ALICE=VAL(MID$(TI$,2,3)):HA=INT(ALICE/5):HA=HA*5:IFA=ALICETHENGOSUB400
599 RETURN
700 REM DELETE SUBROUTINE
705 GOSUB100
710 IFOMMA=1THENOMMA=OMMA-2
715 FOCUS=LEN(B$(LYNE))-1:IFFOCUS<=1THENB$(LYNE)=""GOTO790
720 G$=LEFT$(B$(LYNE),FOCUS):B$(LYNE)=G$:G$=""
790 CAT=10
799 RETURN
800 REM LINE RETURN SUBROUTINE
    
```

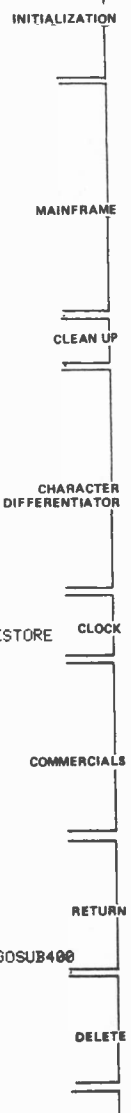

holding the time. After it has got a location and something to put into it, it POKEs the ASCII value of the number onto the screen. After all six digits are up it leaves the FOR-NEXT loop and restores the data for next time. It's all much faster to do than to explain.

In fact, all of the GOSUBs could be compacted to this degree. Originally, GOSUB 300 was ten or fifteen statements. This type of packing reduces the memory used and zaps the execution speed, but it also makes debugging wholly wretched, and complicates modification.

GOSUB 400 is the routine to see if it is time to play a commercial. It gets called from the main return GOSUB. Statement 410 loads GAMMA with a calculable value for the hours and minutes of the clock

string, TI\$. For convenience, we've limited the number of commercials that the machine can file to 20. Using the FOR NEXT loop initiated at 415, it checks through the file. SA\$ holds the time each commercial is to be played, which gets compared to the clock time. If these two values are within fifteen minutes of each other, the routine prints a line instructing the DJ to play the spot at the appropriate moment. The SA\$ string for the commercial is thereupon over-written with "XXX" to keep it from being displayed the next time the routine is called.

If the FOR NEXT loop does encounter a commercial to be played, it sets flag WW, which advances the line counter by printing a space after the loop is completed. The LYNE counter is also incremented.

GOSUB 400 is a loathsome little fellow, and is quite temperamental about getting its stuff printed in the right place without disrupting the rest of the screen.

GOSUB 500 is the main carriage return. It resets OMMA, sets the FLAG flag, which allows the mainframe to increment LYNE' and GOSUBs 100 to clean up behind it. Statement 525 looks ahead and makes sure the string about to be written in is blank . . . essentially by erasing its matrix location. Line 575 decides whether TI\$ is at an integral five minute point, in which case it calls GOSUB 400 to troll for advertising.

GOSUB 700 is the delete, which is just a backup and cleanup. It decrements OMMA by 2. . . once for backing up and once because it will be incremented at the mainframe. It shortens the current B\$ by one, lopping off the last character. It does this by finding out how long B\$ is, and taking the LEFT most characters totalling this number minus one, which it sticks in G\$. G\$ gets put back into B\$, and then cleared out to conserve memory. CAT is set to suppress loading B\$ with the delete character.

GOSUB 800 is a secondary line return, which is called when a line exceeds forty characters. Its operation is essentially identical to GOSUB 500, without a few of the trappings and whizzbangs.

More GOSUBs

The GOSUBs after line 1000 are unique to this application.

GOSUB 1000 is the cursor mover. When the RETURN key is hit, it is, actually, here that the program lands. The four lines that deal with the SPAN variable are a kind of cheap and dirty data statement. A real one can't be used because it interacts with the clock data. The first time return is hit, the cursor moves to the fifth spot on the line, the second to the 20th, and it is only on the third that it actually calls the return GOSUB and executes a carriage return. The DOG and FROG flags deal with keeping the RETURN character from getting printed, and keeping OMMA from incrementing on the new line.

GOSUB 1100 is called before the GET loop to obtain data about the DJ. It is, in essence, just a flock of INPUT statements. The data from these would be written to tape. Once so done, memory space could be conserved if each string, N\$, F\$ and so on, were to be assigned null set value, ("").

The IF statement in 1110 allows

INTERACT COMPUTER 16K LEVEL II



Just
\$595.

Write for our
flyer on Interact
Computer

A powerful microcomputer with a full standard 53 key typewriter style keyboard and built-in cassette recorder for use in entering and storing programs. Utilizing the versatile Intel 8080A micro processor, the Interact computer has 16K of RAM and 2K of ROM at its disposal. Output is in color on your own TV screen. Sound is also generated through your TV set and can consist of exhilarating computer beeps or two full octaves of music. This is truly a powerful computer capable of developing and handling a variety of programs, and with available software provides true educational stimulus (examples: Star Track, Chess, Concentration, etc.). The Interact computer offers the ideal opportunity to learn BASIC, the most popular computer language for small business and hobbyists, and with the use of the 84 page manual, you learn at your own pace.

INSTALLATION: Attach to antenna terminals of your color TV set and plug into 120 VAC wall outlet. Computer includes built-in RF modulator, FCC approved and UL and CSA listed.

PROGRAMING: Most Micro-computers start you off with an abbreviated 4K BASIC, and then later you have to relearn the more powerful language. Since this computer has 16K of RAM, we start you with Level II Microsoft 4.7 BASIC. BASIC is the most popular Micro-computer language using commands that are words we are ordinarily used to: such as, PRINT, NEW, GOTO (For go to), END, COLOR, JOY, INPUT, etc. To help you learn programming we have included an 84 page instruction manual, plus a 20 page book of program examples.

Educational and Entertaining

SATELLITE TV FROM \$4575.

RECEIVE 40 TO 60 CHANNELS
ON HOME TV.

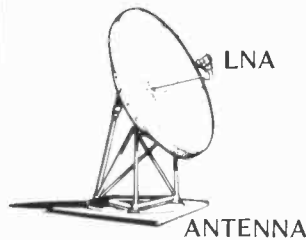

10 FOOT FIBERGLASS
ANTENNA 40DB GAIN
\$1265.00

120° LNA WITH
SPECIFICATION SHEET
FROM* \$995.00



24 CHANNEL RECEIVER
C/W REMOTE
\$1950.00

Satellite Receiver

I enclose
 Cheque Money Order Master Charge Visa
(Allow 2 - 3 weeks clearance time for personal cheques)
Credit Card No. _____ Exp. Date _____
NAME _____

STREET _____

CITY _____ PROV _____ CODE _____

* Quantity discount - 6 or more. All prices are F.O.B. Vancouver.



(604) 324-3343 Nu. West Video Systems Ltd.

6590 VICTORIA DRIVE, VANCOUVER B.C. V5P 3X9

Circle No. 1 on Reader Service Card.

ORION

Electronic Supplies Inc.

ELECTRONIC DISTRIBUTOR

INDUSTRIAL - EDUCATIONAL - COMMERCIAL - HOBBYIST

START WITH ORION FOR
A NEW ERA IN THE WORLD
OF ELECTRONICS

We have the most complete selection
of electronic components.

Full line of TTL, CMOS, Linear,
ICs, Computer Interface, Support Chips
and CPUs.

-Special-
SAVE

\$25.00

WITH THIS AD
ON INTERACT
16K LEVEL II,
OR IN
OR ON THE
SINCLAIR ZX80
COMPUTERS.

RCA

COSMAC

VIP

Authorized distributor for RCA, COSMAC VIP

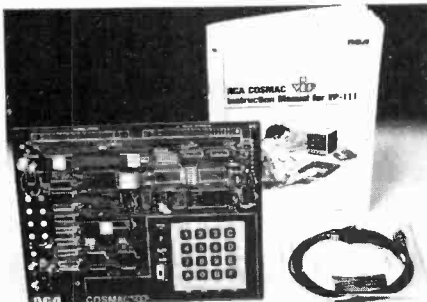

New! VP 111 \$139.50
Microcomputer

- Features:
- RCA 1802 Microprocessor
 - 1K Bytes static RAM
 - Expandable on-board to 4K
 - Expandable to 32K Bytes total
 - 512 Byte ROM operating system
 - CHIP 8 interpretive language or machine language programmable
 - Hexadecimal keypad
 - Audio tone generator
 - Single 5-volt operation

Assembled* and tested.

- Video output to monitor or modulator
 - Cassette interface - 100 Bytes/sec
 - Instruction Manual with 5 video game listings, schematics, CHIP-8, much more
- Ideal for low-cost control applications
- Expandable to full VIP capability with VP-114 Kit

*User need only connect cables (included), a 5-volt power supply, and speaker

The ZX80 Personal Computer

\$329.00

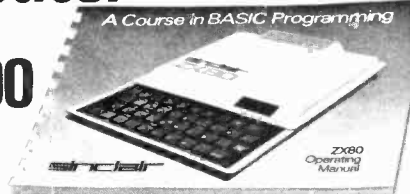

The Sinclair ZX80 is an extraordinary personal computer. Compact and briefcase-sized, it weighs just 12 ounces. Yet in performance it matches and surpasses systems many times its size and price.

The ZX80 is an advanced example of microelectronics design. Inside, it has one-tenth the number of parts of existing comparable ma-

chines. This unique design - packing the system onto fewer, more advanced LSI chips - gives the ZX80 its remarkably low price.

Along with a complete 128-page course in BASIC programming, the ZX80 comes with all the necessary cords for connecting to standard color or B/W televisions and cassette recorders.

SINCLAIR ADVANCED DESIGN FEATURES

- 4K Integer Basic.
- 1 stroke entry for key words.
- Automatic error detection.
- Text editing capability.
- Machine code programming too.
- 26 string variables, any length.
- Random function, built-in.
- 1K RAM matches others 4K.

Price includes TV and cassette connectors, AC Adapter, and 128 page manual.

Please send more information on Sinclair Computers

Microprocessor/Memory

Z80A 3.25MHz clock
ROM: 4K bytes containing BASIC
RAM: 1K bytes internal, externally expandable to 16K bytes.

Keyboard

40 key touch-sensitive membrane with keyword entry gives an equivalent of 62 keys. After entering the statement number, the next key you touch enters the keyword printed above it automatically.

ASCII Keyboard Fully encoded, 128-character ASCII alphanumeric keyboard, 58 light touch keys (2 user defined) Selectable "Upper-Case-Only" **\$109.75**
VP-601
ASCII/Numeric Keyboard ASCII Keyboard identical to VP-601 plus 16 key numeric entry keyboard for easier entry of numbers. VP-611 **\$139.75**
Cable: ASCII Keyboards to VP-711 Flat ribbon cable, 24 in. length for connecting VP-601 or VP-611 and VP-711. Includes matching connector on both ends.
VP-620 **\$27.50**
Cable: ASCII Keyboards Flat ribbon cable, 36 in. length with mating connector for VP-601 or VP-611 Keyboards. Other end is unterminated
VP-623 **\$27.50**

Orion Electronic Supplies Inc.
40 Lancaster Street West
Kitchener, Ontario N2H 4S9
(519) 576-9902

Master Charge & Visa, COD, Cheque, Money Orders accepted. CODs, shipping & insurance extra. Write for our FREE catalogue!

Circle No. 6 on Reader Service Card.

```

805 GOSUB100
810 LYNE=LYNE+1 OMMA=0
815 B$(LYNE)="
830 RETURN
1000 REM CURSOR SPAN SUBROUTINE
1005 CAT=10
1007 B$(LYNE)=B$(LYNE)+""
1010 DATA=20.40
1012 SPAN=SPAN+1
1014 IFSPAN=1THENOMMA=5
1015 IFSPAN=2THENOMMA=20
1016 IFSPAN=3THENOMMA=40
1020 IFOMMA=40THENSPAN=0 GOSUB500 GOT01035
1025 DOG=10
1030 FROG=10
1035 GOSUB100
1039 RETURN
1100 REM INITIAL SUBROUTINE
1105 PRINT"Q"
1110 INPUT"NAME".M# IFM#=""#THEN1150
1115 INPUT"TIME.FROM".F#
1117 INPUT"TO".E#
1120 INPUT"PROGRAM NAME".T#
1125 INPUT"TYPE OF MUSIC".M#
1160 PRINT"Q" POFE245.0
1165 PRINT"LABEL.....ARTIST.....OUT....."
1170 PRINT"Q" POFE245.2 LYNE=2
1199 RETURN
1200 REM COMMERCIAL LOADER SUBROUTINE
1201 INPUT"PASSWORD".PW# IFPW#="BONZO RABBIT" THEN 1295
1204 PRINT"Q"
1205 INPUT"LOAD.ADD.AMEND OF RETURN".AD# IFAD#="ADD"THEN1209
1206 IFAD#="LOAD"THEN1209
1207 IFAD#="AMMEND"THEN1300
1208 IFAD#="RETURN"THEN1295 GOT01205
1209 FORJAC=1TO20 SA$(JAC)=" SB$(JAC)=" NEXT
1210 JAC=0
1215 JAC=JAC+1
1220 INPUT"TIME".TA#
1222 IFTA#="END"THEN1204
1225 INPUT"SPOT".TB#
1226 SA$(JAC)=TA# SB$(JAC)=TB#
1227 PRINTJAC"TIME "SA$(JAC) " SPOT "SB$(JAC)
1230 IF JAC=20 THEN 1215
1235 PRINT"EXCEEDING AVAILABLE NUMBER OF SPOTS"
1240 GOTO 1204
1260 REM ADDER
1265 JAC=0
1270 JAC=JAC+1
1272 PRINTJAC"TIME "SA$(JAC) " SPOT "SB$(JAC)
1275 IFSA$(JAC)<"#""THEN1270
1280 GOT01220
1295 GOSUB1330
1296 PRINT"Q"
1297 LINDA=10
1299 RETURN
1300 REM AMMENDER
1302 PRINT"TO RETURN ENTER ANY LINE NUMBER GREATER THAN 20"
1303 FOR JILL=1TO20 IFSA$(JILL)="""THENJILL=20
1304 PRINTJILL"TIME "SA$(JILL) " SPOT "SB$(JILL) NEXTJILL
1305 INPUT"LINE NUMBER".JAC
1307 IFJAC<20THEN1204
1310 INPUT"TIME" SA$(JAC)
1315 INPUT"SPOT".SB$(JAC)
1320 GOT01305
1330 REM TIMESET
1335 PRINT"THE INTERNAL CLOCK TIME IS ".TI#
1340 INPUT"IS THIS CORRECT".OP# IFOP#="YES"THEN1380
1345 INPUT"WHAT IS THE CORRECT TIME".TI#
1380 RETURN

```



entry number greater than 20 is called for, it goes back to the selector. If RETURN is selected, the routine GOSUBs 1330, clears the screen, and sets the LINDA flag at 10 to tell the mainframe to commit suicide and start over. And lastly, GOSUB 1330 is wonderful and simple, and should need no explanation at all.

Applications
If you are looking at this software in terms of utilizing it is something like its present form, it can be made into one of two basic creatures. The first is a reconversion back into a text editor. Actually, it's only the text part; the editing is a bit tricky. To start on this, bid a fond farewell to all the statements from 1000 on. It will be necessary, as well, to remove any references to them in the rest of the software. The filter will, presumably, want expanding to cover other functions, and a tape file will have to be inserted. The details thereof are a bit more than can be fit into this limited space.

What this thing really is, however, is a forms control program. Small computers have some talents at forms as they stand, using input statements, but these are rather messy, and not very professional looking. However, with this program, any form can be printed and filled out. The initial GOSUB is used to print the blank form on the screen. These look pretty good in reverse field. The CURSOR SPAN GOSUB can then be used to place the cursor at the beginning of each blank as it comes up, by using a data statement containing the appropriate screen locations. This would, of course, require dispensing with the onscreen digital clock, but life is like that. The filled in information would be periodically written to tape.

The beauty of a forms control program such as this one is that it allows un-computerized human beings to provide the machine with data, yet it doesn't require that all the human bits be stored or processed. Once filed and later recovered, the data can be presented for analysis on the same form, but without ever having to store the form itself.

Finally, of course, there is that marvelous clock routine. You might just want to use that. All it takes is a simple program:
10 GOSUB 301: IF TI\$=073000"
THEN 20:GOT010
20 PRINT"*****RISE AND
SHINE! IT'S MORNING*****"

one to by-pass the initial form by typing a "#". This is intended primarily for use with the commercial loader GOSUB.

GOSUB 1200 is the just recently mentioned, and justly renowned, commercial loader GOSUB. It is the nastiest, most complicated of the lot. It can be called whenever the mainframe is running by typing an upward pointing arrow. If this is done, it demands a password. The one I've used is "BONZO RABBIT". . . you can change this if you like. If it doesn't get this, it returns to the beginning of the main frame.

There are four functions of the GOSUB. The commercial file can be LOAded, ADDed to, AMMENDED or gotten out of, by entering RETURN, Upon RETURNing, the machine will ask for verification of the setting of its

internal clock, and permit adjusting it if necessary, by calling GOSUB 1330.

The LOAD function is taken care of from line 1209 to line 1235. 1209 erases all previous data in the file. The TIME and SPOT name are then inputted for each file entry. The routine will print out whatever it got for verification. If the TIME is entered as "END", the thing will bounce back up to the function selector at 1205.

The ADDER, beginning at line 1260 prints out the file as it stands. It then uses the entry insertion part of the LOADER, except that it begins with the number of the next blank file space, instead of the first slot.

The AMMENDER, at 1300, will print the file, and allow the replacement of any entry. If a file

What can you honestly expect from an interactive data terminal that costs only **\$369?***



Well, to begin with, color graphics.

RCA's VP-3301 has unique color-locking circuitry that gives you sharp, jitter-free color graphics and rainbow-free characters.

Plus much more: Microprocessor control. Resident and programmable character set. Reverse video. State-of-the-art LSI video control. 20 and 40 character formats. RS232C and 20 mA current loop. Six baud rates. Eight data formats. ASCII encoding. Light-touch flexible-membrane key switches for reliability and long life. CMOS circuitry and a spill-proof, dust-proof keyboard for hostile environments.

The VP-3301 can be used with a 525-line color or monochrome monitor or a standard TV set through an RF modulator.** It serves a wide variety of industrial, educational, business and individual applications including communication with time sharing and data base networks such as those provided by Dow Jones News/Retrieval Service, CompuServe and Source.

All this—for the low price of \$369. And it's made by RCA. So get the whole story about the surprising VP-3301 today. Write RCA Solid State, 1 Vulcan Street, Rexdale, Ontario M9W1L3, or phone (416) 247-5491.

Circle No. 26 on Reader Service Card.

**Model VP-3303 with built-in RF modulator—\$389. (U.S.)

*Suggested user price. Monitor and modem not included. F.O.B. U.S. in U.S. dollars. OEM pricing available.

SOFTWARE FOR CHALLENGER AND SUPERBOARD SYSTEMS

Copy-mate

Foolproof copier of diskettes with only one drive \$13.50

Disk-vu

Direct disk-to-video display of data. Doesn't disturb memory. \$14.50

Tape-vu

As Disk-vu except for taped program. \$13.50D \$9.95T

Ont. and Fla. residents add sales tax. No credit cards or COD's please. Allow 4-6 weeks for delivery. Catalog available on request. Dealer inquiries welcome.

CHALLENGE SOFTWARE
1912 AVENUE ROAD
TORONTO, ONT. M5M 4A1

Circle No. 11 on Reader Service Card.

Leedex Monitors

Video 100

- Portable
- Plastic case
- 12" b/w
- High resolution
- \$194.50

Video 100-80

- Stationary
- Metal case
- 12" b/w
- High resolution
- Space for 5 1/4" disk drive
- \$224.50

No COD's or credit cards. \$15.00 additional for shipping. Allow 6-8 weeks for delivery. Ontario residents must add 7% sales tax. Catalog \$1.00.

Challenge Software
1912A Avenue Road
Toronto, Ontario
M5M 4A1

Circle No. 31 on Reader Service Card.

The first personal computer for under \$300

The Sinclair ZX80.
A complete computer—
only \$299.95 plus \$5.00 shipping.

Now, for just \$299.95 you can get a complete, powerful, full-function computer, matching or surpassing other personal computers costing several times more.

It's the Sinclair ZX80, the computer that independent tests prove is faster than all previous personal computers. The computer that "Personal Computer World" gave 5 stars for 'excellent value.'

The ZX80 cuts away computer jargon and mystique. It takes you straight into BASIC, the most common, easy-to-use computer language.

You simply take it out of the box, connect it to your TV, and turn it on. And if you want, you can use an ordinary cassette recorder to store programs. With the manual in your hand, you'll be running programs in an hour. Within a week, you'll be writing complex programs with confidence.

Sophisticated design makes the ZX80 easy to learn, easy to use.

We've packed the conventional computer onto fewer, more powerful LSI chips—including the Z80A microprocessor, the faster version of the famous Z80. This makes the ZX80 the world's first truly portable computer (6½" x 8½" x 1½" and a mere 12 oz.). The ZX80 also features a touch sensitive, wipe-clean keyboard and a 32-character by 24-line display.

Yet, with all this power, the ZX80 is easy to use, even for beginners.



Your course in computing.

The ZX80 comes complete with its own 128-page guide to computing. The manual is perfect for both novice and expert. For every chapter of theory, there's a chapter of practice. So you learn by doing—not just by reading. It makes learning easy, exciting and enjoyable.

The ZX80's advanced design features.

Sinclair's 4K integer BASIC has performance features you'd expect only on much larger and more expensive computers. These include:

- Unique 'one touch' entry. Key words (RUN, PRINT, LIST, etc.) have their own single-key entry and are stored as a single character to reduce typing and save memory space.
- Automatic error detection. A cursor identifies errors immediately to prevent



PLUG-IN
16k RAM
EXPANSION MEMORY
\$169.95
Orders now being taken

- entering programs with faults.
- Powerful text editing facilities.
- Also programmable in machine code.
- Excellent string handling capability—up to 26 string variables of any length.
- Graphics, with 22 standard symbols.
- Built-in random number generator for games and simulations.

Sinclair's BASIC places no arbitrary restrictions on you—with many other flexible features, such as variable names of any length.

COMPUTER LEARNING LAB

Interactive laboratory uses the full power of your ZX80 to make computers fun and easy to understand from the very beginning. You will discover how to solve math problems, create video games, and make graphic designs on your TV screen. Each lesson begins with a few short experiments, and ends with a long program that will be part of your permanent reference laboratory. Twelve complete programs on six lesson cassettes, plus two blanks for recording and saving your own programs. Includes workbook and 100 experiments. \$79.95



The ZX80 is a family learning aid. Children 10 and above will quickly understand the principles of computing—and have fun learning.

THE ZX80 COMPANION

A manual for the broad spectrum of ZX80 owners, from the electronics specialist wanting to learn about microcomputers, to the computer professional buying his own system for the first time, and most particularly for the person wanting to use a computer in his own home. 132-pages of practical applications, 30 programs, and the ZX80 monitor revealed. \$29.95

PHONE ORDERS (416) 787-1448
Use your VISA or MASTERCARD.

GLADSTONE ELECTRONICS

1736 Avenue Rd.
Toronto, Ont.
M5M 3Y7

Please send:

() Sinclair ZX80 Computer(s) @ \$299.95
 () 16K RAM Expansion Memory (ies) @ \$169.95
 () Computer Learning Lab(s) @ \$79.95
 () ZX80 Companion(s) 132 pages @ \$29.95
 () SYNC Magazine (current issue) @ \$3.95

Name

Address

City..... Prov..... Code.....

Total Enclosed:

() Check () Money order.
 Charge to
 () Visa () Mastercard.
 Number

TWO-TONE TRAIN HORN

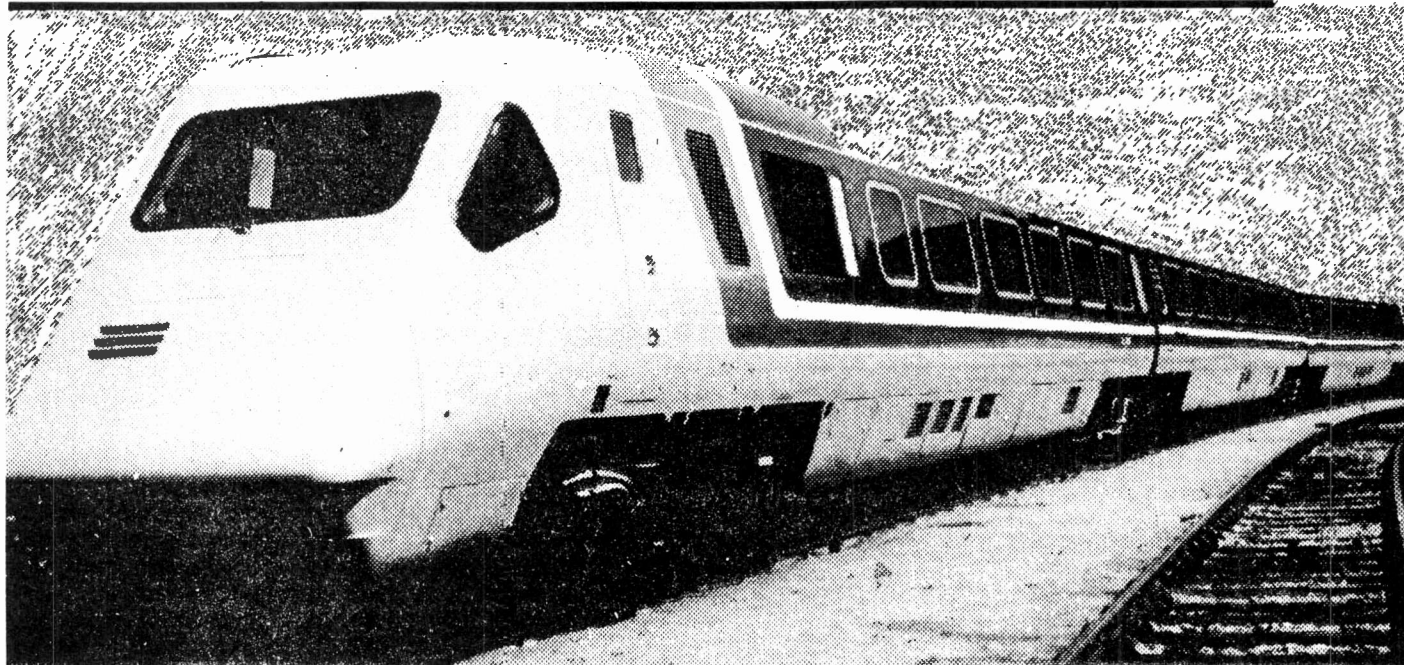

We've had more fun with our train set this month, designing yet another sound.

THIS SECOND project in our series of model train sound effects allows you to electronically simulate, the noise of a diesel-train horn. The sound is triggered automatically as the train reaches a desired place on the track so you can produce the sound as the train approaches stations, level crossings etc.

The two-IC circuit is simple-to-build and uses readily obtainable parts. Both ICs are 555s, one of the most common types of integrated circuits available and this accounts for the circuit's simplicity: with only a couple of component changes the 555 adapts to many different applications.

Output power from the Two-Tone Train Horn is adequate to drive a miniature loudspeaker directly so all that is required is a single 9 V battery to get your circuit up and running.

Construction

Veroboard construction on a standard sized 10 strip by 24 hole board means that this project is quite easy to build. The usual procedures and precautions should be followed but you will find that very few of the components are critical. In fact you may like to experiment with different values to get other sounds.

Make your track breaks first with either the purpose-made tool or simply a hand-held 1/8" drill bit. Next, insert all links and IC sockets, followed by resistors, capacitors and finally semiconductors.

Figure 2 shows connection details of the project along with overlay and underside-board views and you should follow it carefully.

PARTS LIST

RESISTORS (All 1/4W, 5%)

R1	330k
R2	390k
R3,5	68k
R4,6	33k

CAPACITORS

C1	100n ceramic
C2	2u2, 10 V electrolytic
C3	4u7, 10 V electrolytic
C4	47n ceramic
C5	100u, 10 V electrolytic

SEMICONDUCTORS

IC1,2	555 timer
D1,2	1N4001 diode

MISCELLANEOUS

SW1	single-pole, single-throw toggle switch
Reed switches + magnets	
2 x 8-pin IC sockets	
10 strip x 24 hole, 0.1" matrix Veroboard	
Miniature speaker (8to 100 R)	
Battery + clip	

To generate the two-tone sound automatically, mount a reed switch under the track at whatever location you require. A magnet attached to the bottom of the train will operate the reed switch as it passes. You can connect as many reed switches as you wish, in parallel, to trigger the sound at various places around the track. ●

HOW IT WORKS

The sound generating part of this circuit is formed by IC2, a 555 connected as an astable multivibrator. The frequency of the sound varies with the overall charge and discharge times of capacitor C4. So, when the junction of D1 and 2 is high, the frequency of oscillation is set by the current through R4 plus that through R5, charging the capacitor. Similarly, when the junction of D1, 2 is low the frequency is set by the current through R5 (no current can flow through R4). When the charge current is less, therefore, the frequency is lower.

Integrated circuit IC1, another 555, forms a monostable multivibrator with an 'on' time of about 2 s. The multivibrator output (pin 3) is connected directly to the junction of D1, 2 and hence when the monostable is 'on' the frequency is higher than when it is 'off'.

A reed switch under the track is operated by a magnet attached to the train as it passes and this triggers IC1 into its

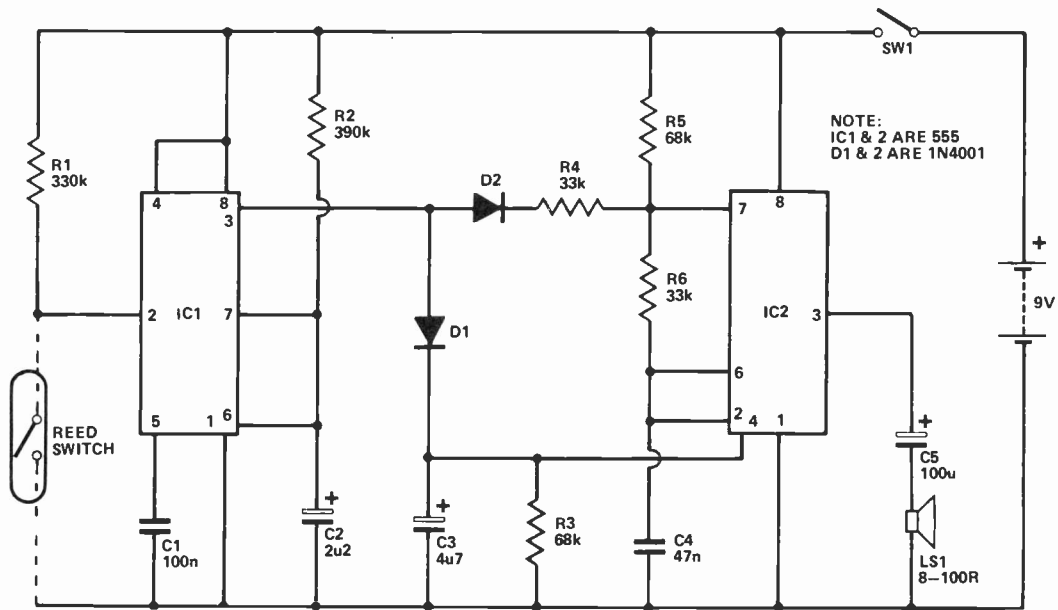
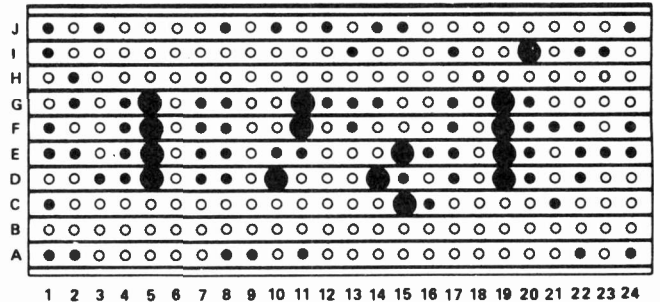
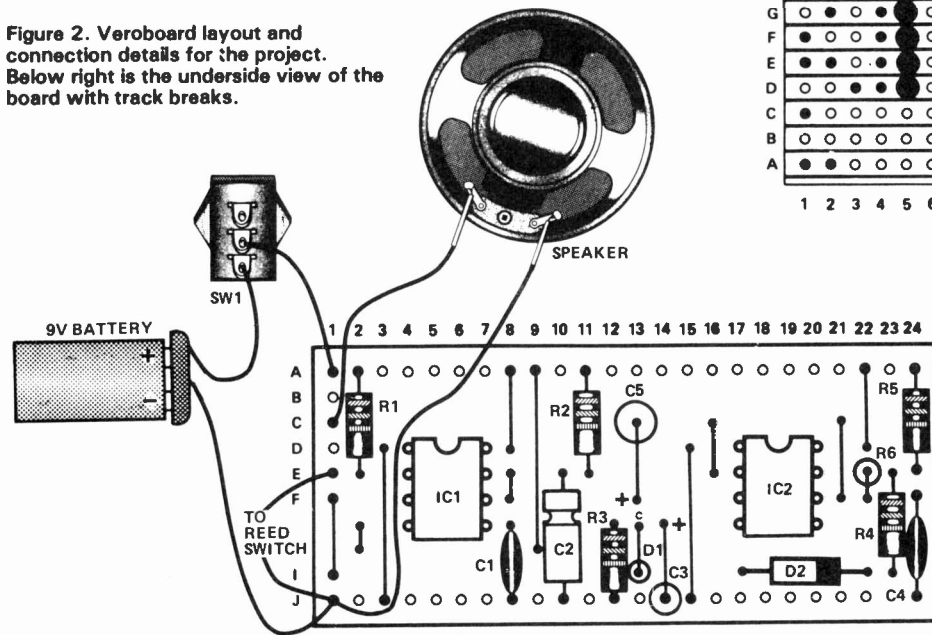

Figure 1. The Two-Tone Train Horn circuit diagram.

Figure 2. Veroboard layout and connection details for the project. Below right is the underside view of the board with track breaks.



Oxfam

Working with People
Who Are Helping Themselves.

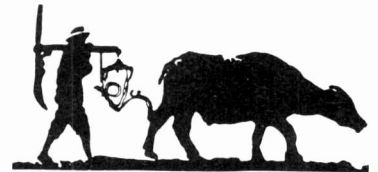

OXFAM supports small, self-help projects in developing communities around the world. OXFAM projects stress self-reliance and seek maximum participation by the local population. OXFAM is more than a charity. It is a movement for social justice.

**YOUR CONTRIBUTION CAN
MAKE THE DIFFERENCE**

OXFAM-CANADA

BOX 18,000 TORONTO, OTTAWA,
HALIFAX, ST. JOHN'S
BOX 12,000 WINNIPEG, REGINA,
CALGARY, VANCOUVER
HERE IS MY DONATION \$ _____
FOR YOUR WORK.

NAME _____

ADDRESS _____

ALL DONATIONS ARE TAX DEDUCTIBLE.

For Parts

BRYAN ELECTRONICS

For Everything

THE R.F. CONNECTION

PL259 Standard - \$1.29 ea 10 lot \$1.20 ea 100 lot \$1.15 ea
 PL259-built in reducer R6/8U - .99 ea 10 lot \$.85 ea 100 lot \$.75 ea
 PL259-built in reducer R6/58 - .99 ea 10 lot \$.85 ea 100 lot \$.75 ea



UG175U (R658U)-reducer - \$.30 ea 10 lot \$.27 ea 100 lot \$.23 ea
 UG176U (R659U)-reducer - \$.28 ea 10 lot \$.25 ea 100 lot \$.21 ea



PL258 double female - \$1.25 ea 10 lot \$1.09 ea 100 lot \$.89 ea
 Bulkhead double female \$1.50 ea 10 lot \$1.30 ea 100 lot \$.99 ea



UG646U double male - \$2.10 ea 10 lot \$1.78 ea 100 lot \$1.55 ea
 SD239 chassis connector - \$.84 ea 10 lot \$.70 ea 100 lot \$.62 ea



N359 right angle - \$2.75 ea 10 lot \$2.40 ea 100 lot \$1.99 ea



N358 T-connector - \$4.49 ea 10 lot \$1.17 ea 100 lot \$3.57 ea

Crimp type PL259-58U-\$1.25 ea 10 lot
 \$1.09 ea 100 lot \$.99 ea



TANTALUMS

DIPPED SOLID TANTALUM
 Capacitance Tolerance +/-20%

WV(SV)	WV(SV)	WV(SV)
18 (20)	25 (32)	35 (46)
0.22		
0.33		
0.47		.35
0.68		.35
1.0		.35
1.5		.35
2.2		.35
3.3		.35
4.7	.35	.35
8.8	.35	.35
10	.45	.50
15	.50	.55
22	.55	1.35
33	.65	1.20
47	1.95	2.75
68		3.50
100		

CHECK & COMPARE OUR PRICE!
 MINI-MINI-SWITCHES 3A-125VAC
 4050-S.P.S.T. - \$1.45 ea 10/\$12.95
 4051-S.P.D.T. - \$1.50 ea 10/\$13.95
 4052-O.P.O.T. - \$1.90 ea 10/\$17.95

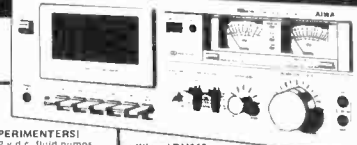

CUT COSTS

T.C.G. REPLACEMENT SEMI-CONDUCTORS - Available from BRYAN ELECTRONICS. Compare the price, set the list, write us today!

YOU'RE ON THE AIR! WITH OUR FM WIRELESS MICROPHONE
 300' max. range, tunable on FM radio band
 1.5V AA battery inc. included
 \$24.95 each

COAXIAL CABLE - (shielded)
 RG59U1 - 75 ohm - \$15 ft., 100' \$12.00
 RG58U1 - 50 ohm - \$10 ft., 100' \$8.00
 RG11 - cable single - \$2 ft., 100' \$9.50
 RG11 - cable double - \$2 ft., 100' \$19.95

SOLDER
 Handy 1 oz. roll - resin core
 \$1.33 ea 10 lot \$1.15 ea

WISH WE HAD INVENTED THEM!
RECTANGULAR BASE, ROUND HOLE
 5 amp 125 vac

S.P.S.T. paddle - \$1.57 ea 10 lot - \$1.41 ea
 S.P.D.T. paddle - \$1.39 ea 10 lot - \$1.69 ea
 P.D.T. paddle - \$2.37 ea 10 lot - \$2.13 ea
 S.P.S.T. rocker - \$1.57 ea 10 lot - \$1.41 ea
 P.D.T. rocker - \$1.81 ea 10 lot - \$1.63 ea
 P.D.T. rocker - \$2.59 ea 10 lot - \$2.33 ea

LEARN JET 6855 10 band graphic equalizer booster
 70W total, fader, LED power meters, eq. defeat, booster by pass, 1 year P & L. \$119.95 each.

ALWAYS NEEDED!
R.C.A. CHASSIS JACK
 \$3.35 ea 10 lot \$3.31 ea 100 lot \$2.27 ea

R.C.A. PHONO PLUG, INSULATED
 Red or Black
 \$2.28 ea 10 lot \$2.25 ea 100 lot \$2.21 ea

POPULAR ITEM
 263 PF tuning capacitor
 GREAT FOR CRYSTAL RADIO PROJECTS
 ETC.
 \$1.69 ea

NEW

POWER FROM THE SUN!
SOLAR PANEL
 Incredible 3 volt, 6 volt and 9 volt output at 50 ma. Combine 2 or more for increased current or voltage - \$29.95 ea.

TRANSISTOR BLITZ!
 2N2222 - 39¢ ea. 2N3906 - 15¢ ea.
 2N3055 - 69¢ ea. TIP29C - 69¢ ea.
 2N3704 - 10¢ ea. TIP30C - 69¢ ea.
 2N3904 - 15¢ ea. MPS6515 - 16¢ ea.

add \$2.50 for shipping & handling
 C.O.D. orders \$2.00 additional
 Ontario residents add 7% sales tax
 MasterCard, Visa, Money orders do not send cash
 Be sure to sign your order.

BRYAN ELECTRONICS
 90 KENNEDY ROAD SOUTH
 BRAMPTON, ONTARIO
 L6W 3E7
 (416) 457-9269

INJECTORAL FAST DELIVERY ON CANPAR ROUTES!

SPACE

HUSES
 3/4" x 1 1/4" 1" AST HLOW
 1/4", 1/2, 3/4, 1, 2, 3, 4, 5, 7.5, 10, 15, 20, 25, or 30 amp
 \$2.00 each
 50 lot - \$1.15 each
 100 lot - \$1.0 each
 1000 lot - \$0.8 each (assorted)
 Digital - \$.25 each

CHEMTRONICS
 AVAILABLE FROM BRYAN ELECTRONICS - COMPETITIVE PRICING -

WE HAVE CONNECTORS AND TERMINALS BY MOLEX, WALDOM, HOLLINGSWORTH, BIVAR

STURDY UTILITY BOX
 8 1/2" x 3 3/8" x 2"
 \$3.89 each
 2/\$3.50 each
 4/\$3.25 each

Ceresist Direct-etch PCB transfers
 \$1.69 pkg.

LOOK! NOT HARD TO FIND ANYMORE! RAIN BOW OR RIBBON CABLE

12 CONDUCTOR
 1' - \$3.00
 10' - \$23.00
 50' - \$20.00
 100' - \$18.00
 20 CONDUCTOR
 1' - \$4.00
 10' - \$36.00
 50' - \$32.00
 100' - \$28.00



No. 1236 - Liberoptic - \$10.95
 No. 1123 - The Laser Experimenters Handbook - \$7.95
 No. 984 - CMOS Databook - \$10.75
 No. 1060 - 303 Dynamic Electronic Circuits - \$7.95

CAPACITORS - POLYESTER FILM

Price	uf	price	uf	price	uf	price	
0010	\$20	012	\$20	0027	\$20	027	\$30
0012	\$20	015	\$20	0033	\$20	033	\$30
0015	\$20	047	\$30	0039	\$20	039	\$30
0018	\$20	056	\$30	0047	\$20	047	\$35
0022	\$20	068	\$30	0056	\$20	056	\$35
0068	\$20	082	\$30	018	\$25	18	\$35
0082	\$20	10	\$30	022	\$25	22	\$45
010	\$20						

PUT YOUR \$ TO WORK AT BRYAN'S

Circle No. 24 on Reader Service Card.

The alternative to custom enclosures

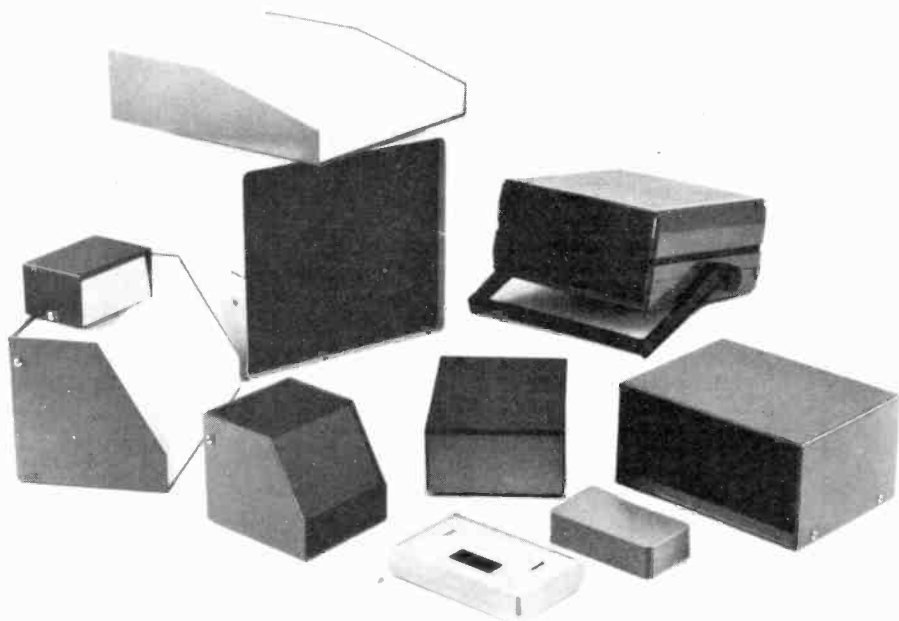

HAMMOND MANUFACTURING
 HAMMOND MANUFACTURING CO. LTD.
 394 Edinburgh Rd. Guelph Ontario N1H 1E5 (519) 822-2960 or (416) 456-3770

The problem with custom fabricated enclosures is the cost of tooling and the cost of making changes.

We offer you an alternative; one of the largest selections of small enclosure designs, shapes, sizes and colours available in Canada today. We have IN STOCK, miniature enclosures, small enclosures, meter housings, desktop component and keyboard consoles; in steel, aluminum and plastic. In all, over 750 models available in many different colours. No stocking, tooling or manufacturing problems for you.

Investigate the alternative, call your local Hammond distributor and have a hard look at cost, availability and design freedom. We think you will like what you find.

Circle our reader card number, and we will send you our catalogues, prices and a list of Hammond distributors in your area.

Circle No. 3 on Reader Service Card.

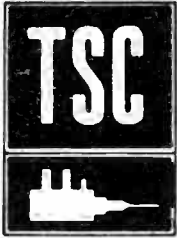

**Serving The
Technician
Since 1971**

**- Tuners are
our only
business.**

Tuners are cleaned ultrasonically, checked on new Wavetek sweep equipment for gain, bandwidth, oscillator tracking and AFC divergence. Shaft repairs a specialty. Affiliated with Tuner Service Corporation, Bloomington, Indiana. Only new parts are used, meeting manufacturer's specifications.

\$16.95 VHF UHF Varactor

Same day service.

One year warranty on workmanship and materials on tuner repairs.

Please do not send mounting brackets.

TUNER SERVICE Co. of CALGARY

P.O. Box 5823
Station "A"

Calgary, Alberta T2H 1Y3
(403) 243-0971

Circle No. 7 on Reader Service Card.

AUDIO KITS

250W Stereo Class "A" Integrated Power Amp \$189.50
140W RMS Stereo Class "A" Integrated Power Amp \$138.50
260W RMS Class "A" Stereo Power Amp \$169.50
100W Class "A" Stereo Power Amp \$ 75.00
120W RMS FET Super Class "A" Power Amp \$ 96.00
DC FET Super Class "A" Stereo Preamp \$112.50
DC Class "A" Stereo Preamp \$ 84.50
Parametric Equalizer with Cabinet \$199.50
10 Band Stereo Graphic Equalizer with Preamp \$ 88.50
Super Colour Power Level Indicator with Cabinet \$ 88.50
15 Step Power Level Indicator \$ 56.00

RACK MOUNT CABINETS:

16" (W) x 4" (H) x 8" (D) \$ 39.00
19" (W) x 4" (H) x 12" (D) \$ 54.00
19" (W) x 7" (H) x 12" (D) \$ 74.00
19" (W) x 5 1/4" (H) x 10" (D) with Heatsinks \$ 99.50

ELECTRONIC KITS from \$5.95

Send cheque or money order plus 5% for postage and handling. Ontario residents add 7% P.S.T. Mastercard and Visa accepted.

Please write for FREE CATALOGUE
AUDIOVISION SERVICE
P.O. BOX 955, Station B,
Willowdale, Ont. M2K 2T6

**NEED MORE
INFORMATION?**

If you would like more information on the products or services mentioned in the advertisements:

1. Fill in the attached card with your name, address, etc
2. Circle the appropriate Reader Service number for further information about advertised products.
3. Mail the card and the advertiser will send you literature free of charge. If the card has been removed, or if you want the information in a hurry, phone or write direct to the advertiser and refer to the ETI issue and page number.

Your Company Classification (if applicable):

- A. Manufacturer
- B. Retailer
- C. Government
- D. R&D
- E. Servicer/Installer
- F. Distributor/Representative
- G. Educational Institution

In the field of:

1. Computer and Related Equipment
2. Communications Equipment & Systems
3. Navigation, Guidance or Control Systems
4. Test & Measurement Equipment
5. Consumer Products
6. Industrial Controls & Equipment
7. Components & Subassemblies
8. Other (Please specify on the card)

Your major job function (if applicable):

- A. Buying
- B. Technologist
- C. Educator
- D. Not employed in an electronics-related field
- E. Engineering
- F. Technician
- G. Management
- H. Sales
- I. Other (Please specify on the card)

What interests you most about ETI? (your favourite five or less):

- A. Audio
- B. Video
- C. Ham Radio
- D. Shortwave Listening
- E. Servicing
- F. Components & Technology
- G. Reports on the Electronic Industry
- H. Microcomputers
- J. Projects
- K. News Digest
- L. Other (Please specify on the card)
- M. Tech Tips

**FAST RELIEF
FOR TV
RECEPTION
HEADACHES**

When TV picture problems give you "headaches", take Winegard Chromstar for fast, effective relief.

Chromstar is an outstanding, complete line of antennas and preamps from Winegard. They are the best performing, best built line of antennas yet.

High quality materials and workmanship combine with Winegard engineering and know-how to produce best possible pictures on all TV channels.

Circle No. 8 on Reader Service Card.

Represented in Canada by

omnitronix ltd.

2056 Trans Canada Hwy. Unit 7, 6295 Shawson Dr.
Dorval, Quebec, Mississauga, Ontario.
H9P 2V4 L5T 1H4
(514) 683-6993 (416) 678-7170
Telex: 05-822692 Telex: 06-968653

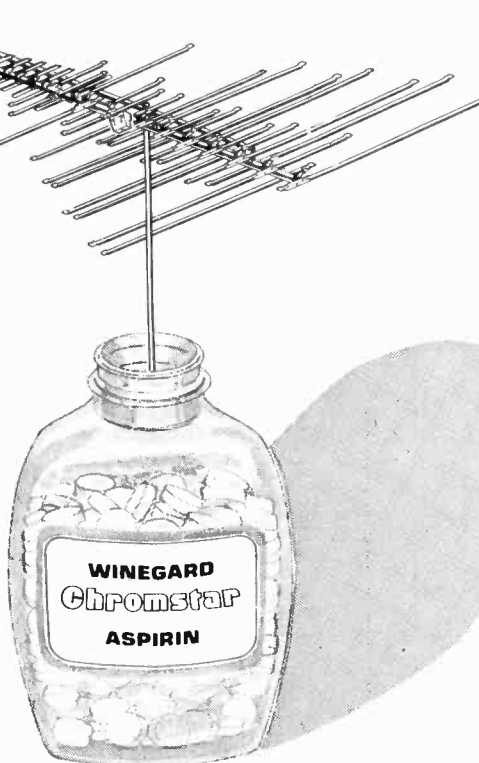

Dealer inquiries invited.



WHAT'S NEW

By Steve Rimmer

This month, Steve looks at a computerized synth that does everything but create.

THERE ONCE was this chick, see . . . with long, blond hair that she wore in pigtails. She had big blue eyes, a bright smile, and wore a little blue dress that her mommy had made for her. She also wore a twenty four karat razor blade on a chain and red leather boots. Everyone called her Goldiefox. She lived in a little cottage just beside the docks down by the river, and every morning, at about two a.m., she'd go outside to troll for sailors.

On this particular morning there were no sailors to be had, and it began to rain. "Oh, son of a ---", said Goldiefox sweetly, as she ducked into a nearby dive to avoid being soaked. The dive was small, dusty, and smelled like a land fill sight in June. The floor was covered in thick pile fungus, and an encrusted twenty five watt bulb dangled in the middle of the room. "Gee", thought Goldiefox to herself. "Just like Grandmama's place." Grandmama was doing five to seven in the Kingston pen for armed robbery.

Over in the corner of the dive, Goldiefox found a table on which there stood several half empty bags of junk food. There were Mister Spuds, stale Cheezies, bits of Fritos, a quarter jar of Planter's mixed nuts with all the cashews picked out, and several fairly soggy Twinkies. "Moma, moma," cried Goldiefox. "Munchies." And she stuffed the food daintily into her face like trash into a truck.

Next she found a comfortable-looking old chair. "Gee" said Goldiefox. "I'll bet the last guy that used this thing was probably pretty slimy, but I'm just so burned out." And with that, she plopped herself down into the chair. One of the back legs gave out, and the chair toppled over. It totally smashed a '54 Martin acoustic guitar that was leaning behind it, and crushed the '63 Tele beside it. It also bumped a mike stand, which toppled over through the

big double bass in the corner. This, in turn, wiped out half a drum kit, and went through a speaker. "Oh my God," Moaned Goldiefox, rubbing her bruised body. She stood up, looking dazed, and collapsed across a string synthesizer and a Rhodes stage piano, both of which buckled under her weight and smashed to the floor.

The noise of all this destruction brought the owners of the dive in from the alley where they'd been blowing a little weed. They were three out of work musicians who's last few bucks were tied up in the instruments that Goldiefox had just reduced to kindling. There was Reg, on lead guitar, who weighed three hundred pounds and was covered with greasy brown hair. There was his woman, Bertha, on keys, who also weighed three hundred pounds and was covered with greasy brown hair. Lastly, there was the drummer, Orville,

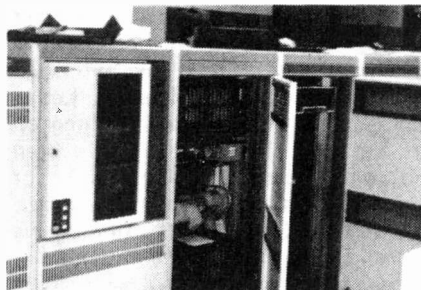

Fig 1. A small chunk of McLey's computing power

who had recently been tarred and feathered during a performance up North. He really looked like he weighed three hundred pounds and was covered with greasy brown hair. "Somebody's been eating my munchies," Bellowed Reg.

"So what. Somebody's totalled my footstool." Whined Bertha.

"Pity that." Said Orville in a phony English accent. "Somebody's mashed all the instruments and is now sleeping in the debris."

"What's that?" Said Reg. He looked over at Goldiefox, passed out peacefully among the carnage. "What say we beat the stuffing out of her."

Which, of course, they did, and Goldiefox didn't regain consciousness for four whole days. Which only goes to show that if you can't think of something to start one of these columns with, you can always fracture a fairy tale and use that. Or at least, I can. This month we're going to have an introductory look at a computer music system.

The Studio

Nimbus 9 studios lurks among the trendies, rancid boutiques, plastic day-glo souvenirs and post-hippies of Toronto's Yorkville district, number thirty nine Hazleton Lane. It lacks that large, oppressive, Muscle Shoals ambience that all the "top" recording outfits seem to try for. Just a folksy little multimillion dollar operation, with a circa 1940's Coke sign hanging in the window. The lobby is done in oak and mahogany, with half an electrician sticking up through a hole in the floor. Presumably there's the other half kicking around somewhere. Or, perhaps they didn't want to pay the contractor union scale.

The secretary seems to be surrounded by typewriters and komputerwerken type monitors, pads, and such. The phone might have been a prop for the third Star Wars movie, except that it seems to be functional. Constantly. In between calls she types my name into the computer terminal, and informs me that I'll probably have to wait a while; the fellow I'd come to have words with is occupied.

"You know, if you borrow some wire cutters from this chap stickin out of the floor, here," I offer, "you could shut that box up for a while." A dry smile for this, and she lances out at another flashing button.

I had arrived at this oasis of technology and antique brass to have speakings with one David McLey, reputed to be the mondo gaucho of computer music in the entire cosmos, or, at the very least, in the country. A goodly head, too; he showed up a few minutes later in scruffed out torn Levis and suitably weird hair, and ushered me into an office the likes of which any corporate executive would have been proud. There was more komputerwerken on a desk, an old tuba; tastfully tarnished, hanging above the fireplace, and a pristine grand piano in its own little alcove.

"Nice office." Sez I. "How'd you come to get a place at Nimbus 9?"

"It wasn't hard" Sez he. "I own the studio."

I don't suppose he won it playing blackjack.

Dave McLey has built what is generally acknowledged, by anyone having heard of him, as being the most elite and well engineered computer-interfaced music system going. Several years ago, when it was smaller than it is now, he trotted the whole thing over to a computer show and blew a lot of people away. Now, filling several rooms, it has taken up residence, more or less permanently, at the studio, where it does things of unparalleled complexity. It can be anything from a single guitarist to a philharmonic orchestra. More important than its capacity, though, is the engineering that has gone into it to make it a musical instrument, rather than a tricky sort of data processor.

The main processors of the system are DEC VAX1170's, with Megabytes of RAM and gigabytes of available disc storage. These are able to control the parameters of up to one hundred and twenty eight separate voices, each one a complete voltage controlled Moog type synthesizer. Each synthesizer consists of three separate voices of its own, plus filters, voltage controlled amps and transient generators, giving them all the capacities of one of those big mothers with all the knobs and wires. The machine is able to control them from moment to moment, all simultaneously, meaning that it can actually run the whole show all by itself.

This is fairly trippy, especially if all you've got is an 8K PET to play with. However, it's not really all that marvellous . . . it's just a product of enough mass storage and interface. The really cool part is actually in the software.

Softy Does It

The first area we get into is in how the

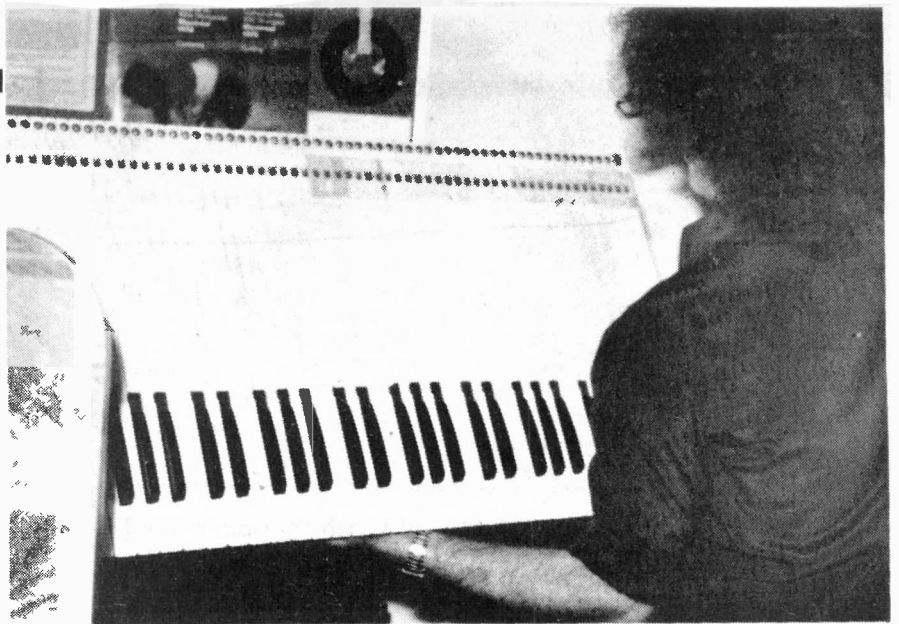

Fig 2. An organ-style synthesizer keyboard

computer deals with the way the musician plays. The obvious thing to use is an organ type keyboard. McLey is polyphonic, and made like a true organ manual, as opposed to a plastic spring loaded affair. The keys are real wood, like, from trees, and as long as those used in an acoustic piano, so they feel more like a real instrument. They are velocity modulated, which means that hitting them harder causes the resulting note to be louder, just as with a real piano. This, in itself, isn't too surprising, except that this keyboard does it without any switching contacts at all. McLey declined to suggest the possible method involved, for reasons of patent and possible for Eastern copies.

Context Patching

The computer deals with the music with something called "context patching". Now, you've got to move your lips when you read this, and listen carefully, or you'll miss this bit. Let us suppose that we are playing along on the keyboard, doing a well bred rendition of some little Mozart thing, or possibly one of the works of the Frigid Pink, and we desire that the first twelve bars be played by a massed ensemble of baritone kazoos, followed by a three bar kangaroo horn solo, thereafter going into a choral arrangement of eight shwams, a sackbutt and a mean lute strung with wombat gut. We would thereupon play through the first bit, and designate that as bit "A", and then go on to the second bit, tell the machine it was bit "B", and so forth. Thereafter, the machine could see what was going on, judging by criteria of timing, key, and suchlike, and know when bit "A" begins, and then when it switches over to bit "B", and so on. This information could be used to change the patches on the synthesizers.

The system isn't perfect just yet, McLey admits. You never play the same piece twice in exactly the same manner. The machine can track variations up to a point, but you can throw it off. This involves another bit of human engineering. The idea is not to create an unbeatable system, one that can pass all kinds of tricky lab tests and such like, but, rather, one which is responsive to the player, just as other musicians are responsive to you when playing live. You can throw the machine off if you try just as you can throw off a drummer who's expecting the song to be played one way and suddenly finds it isn't coming down as planned. There is still some fine tuning of the software to be done in this area, to optimize the balance between having the machine "interested" enough in what's being played to change the patches when its supposed to, but not so nit picking that it cannot cope with minute changes from performance to performance.

The system is designed so that the player can deal with it in purely musical terms, and can, in fact, be quite ignorant of computers and all the hardware and software paraphernalia involved. For example, telling the computer how to arrange the individual patches of its voices is not a question of saying "I want the third harmonic sixteen db down, the fifth harmonic twenty nine db down, a six hertz sweep at eight percent modulation on the amplitude control . . ." and onward and upwards. The system is able to translate more standard musical verbiage into this sort of stuff. It is possible to tell the machine something like the following. "First off, be a piano. Okay, now, keep being a piano, but have the attack of viol. Now, instead of having the timberal disposition of a piano, use that

of a soprano crumhorn with a cracked reed." I don't actually know if it could really deal with the cracked reed bit unless it were given a bit more to go on. The system's disc storage contains the parameters for quite a variety of sounds, and, of course, new ones can be specified as needed. The combined parameters can also be designated as instruments, stored and used.

Thus, if the machine was not aware of what a knargaroo horn might be, it could be told without having to resort to a sonic analysis of the nasty thing. The sound source will be lips and embouchurs, as in a French Horn. Having been rudely constructed by half drunk Kangaroo ranchers, the instrument will have a brassy tone, as a bugle. Being some sixteen feet long, the attack will be long, as it will take a fair bit of time to get up steam in the thing. The decay will be abrupt, with a burst of filtered noise, as in the case of a tongued flute in the upper register, to indicate that the player has been kicked in the stomach by an irritated walabee.

The system is also capable of dealing with musical scores, both coming and going. It can be set up to play from a score entered into it by means of a graphics tablet. It can also produce perfectly drawn score sheets from playing done at the keyboard on a plotter. The system will have its uses in just this area for classical musicians, and other performers who either aren't into synthesized music, or are more interested in strictly live renditions, McLey suggests. Writing scores is a tedious business, especially when it involves scoring a piece for instruments other than those for which a piece was written, or even just simple transposition. It is necessary to be quite intimately familiar with the capabilities of the instruments in question, to be sure that one is writing down notes that will, in fact, be playable. The computer can take care of all these little details, so that, say, an orchestra conductor can deal with the more important aspects of his job . . . keeping his baton waxed, and his hip flasks filled.

McLey's principle use for his computer music system these days is in doing film scores and sound tracks, tasks which actually would have taken an orchestra a few years ago. Because of this, he is beginning to get interested in using his system for another, related area, that of computer animation. "A guy will bring an animated film in to be scored," he explains, "because that's usually the best way to do it. . . . write the music to fit the film. Then there'll be some changes, cuts, and the music will have to be edited to keep it fitting

in. This kind of defeats the whole idea of writing a score to fit the film." Thus, he sees the day when his machine will be able to handle animated drawings with as much resolution as human artist can today. Thus, changes will be done in house, and there'll be an opportunity to re-adjust the music with respect to the finished product.

Stage Fight

Since his first, and only, public performance with his system almost two years ago, McLey has added quite a bit to it, and the fairly herculean task of transporting the thing back then has swelled to near impossibility. He recently moved it across town from a previous studio location, and it's taken several weeks just to get the whole works functional again. Thus, he began considering the possibility of designing a smaller, largely portable clone of the beast, of somewhat lesser capabilities, of course, to serve as a kind of expansion out into the cold and barbaric world of real time. This in turn led to the idea of building an instrument for other musicians to use. Thus it is that one of the back rooms at Nimbus 9 is full of circuit boards and grunting, hunched back gnomes chanting aged incantations over steaming, bubbling cauldrons of chips and fiberglass, building the first model of McLey's marketable computer music system.

The initial model, when it first hits the streets, will be in the then thousand dollar range . . . that beat up combo organ you've got under the old tires out in the garage probably won't make a meaningful trade in on one, but it will be within reach of many performing stage musicians. There will probably be considerable interest from recording studios and university music departments, as well. This basic instrument will have about four complete voices, a polyphonic keyboard, again, a wooden one, so it will feel like a real live acoustic instrument, and a computer to do all the good stuff we've been talking about, but on a smaller scale. MacLey was a bit vague on exactly how one will go about communicating things like tonal characteristics to the machine, but it would almost seem that a typewriter keyboard and screen would be essential.

The portable system will be expandable, probably up to thirty two full voices, and an equivalent component of computing power to deal with it. The full house will probably be going for about fifty thousand dollars, complete with owners manual and a pat on the back from your friendly salesman.

Taking Five

McLey's system wasn't doing all its tricks the last time I saw it . . . we'll probably have another look at it in a few months when it's really cooking. It is, though, a nice example of an artistic approach to utilizing technology. It makes the machine something more than an end unto itself, and renders it useful to the people best able to produce something with it . . . and, of course, least able to understand the means of production. It bespeaks a tremendous amount of effort gone into for the sake of making it humanly workable. When it finally gets scaled down and offered to the scrambling masses, it won't be much more difficult to play than a piano. It is, perhaps, a proper solution to the problem we dealt with last month, of the tradeoff between versatility and play-ability. At the very least, it's impressive as all get out to look at.

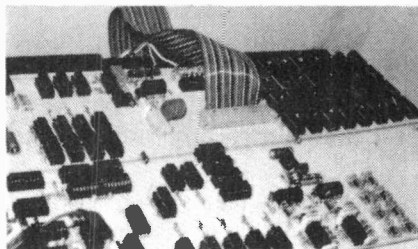
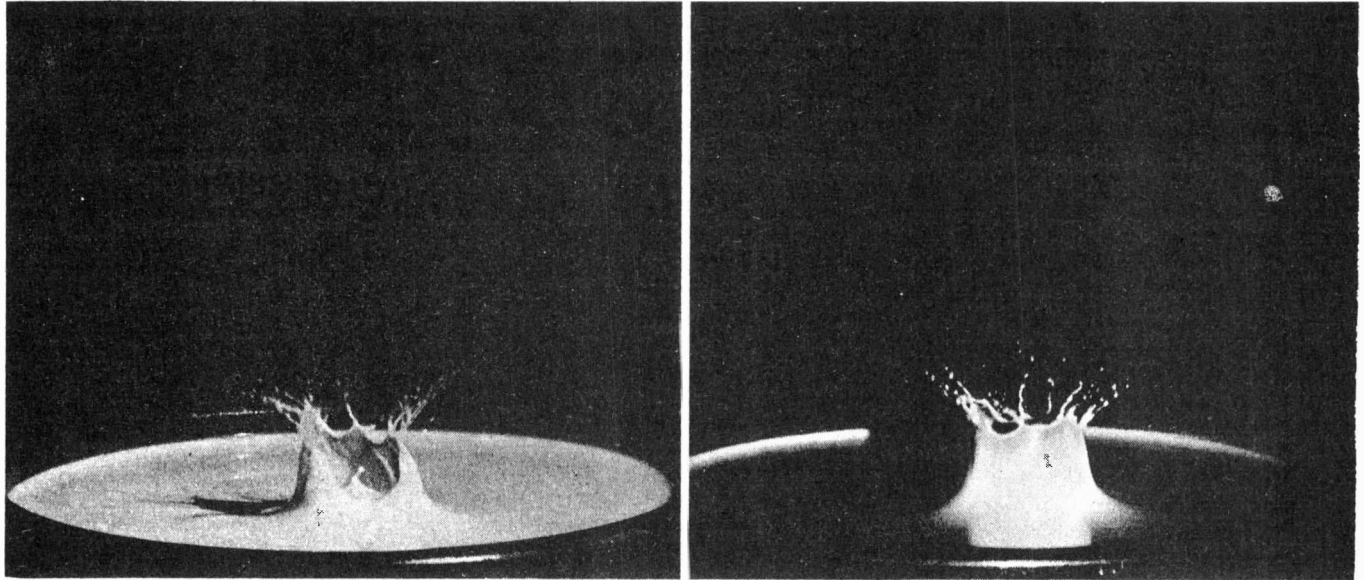

Fig 3. Part of the portable system prototype.

Anyway, I'm gonna take five now. Like, I can get into all these knobs and wizzbangs, all right, but there comes a time for simplicity. An instrument where the fingers are not too far separated from the strings, and you can hold the whole works in your hand. A Telecaster and a loud amp, for example. Ah, yes, technological simplicity. Just a guitar, and an amp . . . maybe a chorus switch to fatten up the sound a bit. And a fuzz wouldn't hurt, maybe a wah wah pedal. A flanger? Okay, a flanger. One of those rack mounted multi-echo pitch transposition boxes. Okay, ya, and maybe a feedback sustainer, coupla squack box amps with a voice tube formant processor. Octave divider, fifth and seventh interval multiplier, and a few Morely envelope fudgers, third octave dual graphic equalizer and a pitch shifter to keep the feedback down to a manageable hugeness. Ya, and get that little Traynor bang box amp outa here, man, like we're gonna need at least eight hundred watts of power here, twelve columns of speakers, a microprocessor controlled switching matrix. But I want an eight bit micro. Just eight, okay. I really hate it when you take a simple instrument and start getting it complicated. ●

Stay tuned.

SOUND OPERATED FLASH TRIGGER



Faster than a speeding bullet (almost), the ETI Flash Trigger will produce those out-of-the-ordinary photos.

DO YOU LIKE pictures of bursting balloons? Then this is the project for you. Though it uses less than twenty components, it offers the photographer an opportunity to instantaneously "freeze" the action and create fascinating photographs using just an ordinary camera and a simple electronic flash gun.

No special optics are required and you should be able to use even the simplest camera with this unit; a "pin-hole" camera would do! It is necessary to set up your camera in a darkened room, or conduct your experiments at night, with the shutter open. Most cameras have a "B" or "T" position on their speed selector dials. You may need to use a locking shutter release cable. Don't open the shutter until you are ready to take the picture. If you have a tripod you will find it helpful — otherwise you'll probably need an assistant to hold the camera or direct the action.

The electronic flash gun is positioned for best lighting and the unit can be switched on and connected. A control on the board enables you to adjust the unit's sensitivity to suit your application. Now, whenever the ambient sound exceeds the threshold level the unit will fire the flash gun. Remember that if the unit is set for high sensitivity, the flash gun is likely to go off when someone slams a door upstairs or when a flea jumps into the microphone! Experiment

with the sensitivity setting, microphone positioning and lighting angle with a few trial-runs before you open the shutter and expose the film.

This unit will work with any electronic flash gun. Most of them have a flash duration of a thousandth of a second or less so you can "stop" slow motion — though you will not be able to "freeze" an insect's wings. (If you don't believe me, try it . . . but remember; bees sting!) For certain shots it is useful to be able to vary the delay between the sound-making event and the triggering of the flash. For bursting balloon shots this delay has to be precisely controlled. The delay is proportional to the distance between the sound source and the microphone (approximately one thousandth of a second per foot).

The circuit as shown has a gain of at least 100. With high output crystal inserts you may find that there is too great a sensitivity. This can be reduced by changing the value of R4 from 100k to 10k or simply by replacing R4 with a piece of wire! When you come to connect the unit to your flash gun remember that thyristors only work "one way round". If it does not work first time, reverse the leads and try again. There may be a high voltage at the trigger terminal of an undischarged flash gun. Try not to discharge it through your finger or you may have a surprise!

Construction

We used veroboard, though any method of construction may be used. A simple circuit like this lends itself to bread-

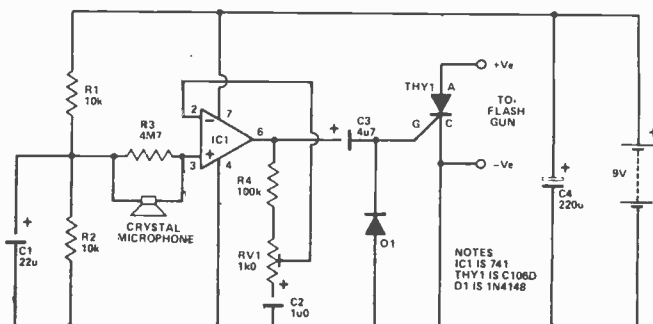

Fig. 1. The circuit diagram of the Flash Trigger.

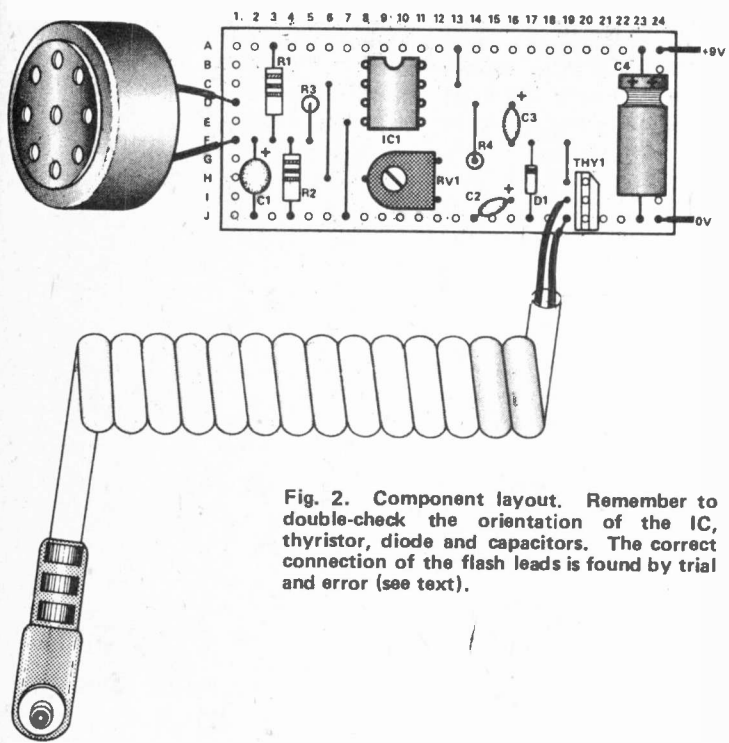

Fig. 2. Component layout. Remember to double-check the orientation of the IC, thyristor, diode and capacitors. The correct connection of the flash leads is found by trial and error (see text).

HOW IT WORKS

Sound waves striking the microphone are transformed into electrical impulses and amplified by IC1. The gain of this stage is variable by adjustment of RV1. When there is no sound, the output of IC1 (pin 6) will be steady, at about four or five volts; roughly half the supply voltage. Capacitor C3 prevents current from flowing into the gate of the thyristor until a sound impulse causes the output of IC1 to swing towards the positive rail. Diode D1 provides a recharge path for C3.

The thyristor is an electronic switch. It will switch on very fast when the current flowing through the gate-cathode junction exceeds a certain value. The 'turn-on' current for the C106D is about 200uA (two ten thousandths of one amp). Once turned on, the thyristor will stay on, even if the gate current is removed, until the current from the anode to cathode falls below a few milliamps. This is a very useful feature in some circuits and causes no problem here as the flash gun discharges in a fraction of a second and the thyristor switches off again. Note that the thyristor will only conduct current in one direction. With the voltage across its terminals reversed, it behaves just like an ordinary diode and no current flows until the breakdown voltage of the device is exceeded.

boarding. If you do use veroboard then just follow our drawings. Any nine volt battery will power the unit – we used a 9V transistor type. Keep the leads to the crystal microphone short or use screened cable (connect the screen to the junction of R1, R2, and C1).

You can try connecting other transducers in place of the crystal microphone. An LDR, any cadmium-sulphide light dependent resistor, should make the unit sensitive to changes in light intensity. We have not tried it but experience has shown that LDRs usually work best at low light levels – so if you do try, mount the LDR at the end of a cardboard tube or make a light shield with some rolled up paper. Once you have the unit working, you can set the sensitivity to the required level and shoot away.

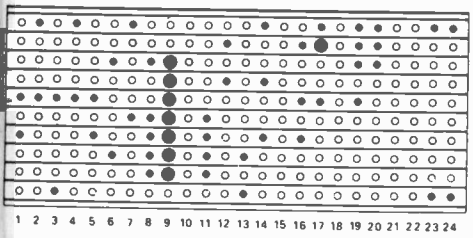
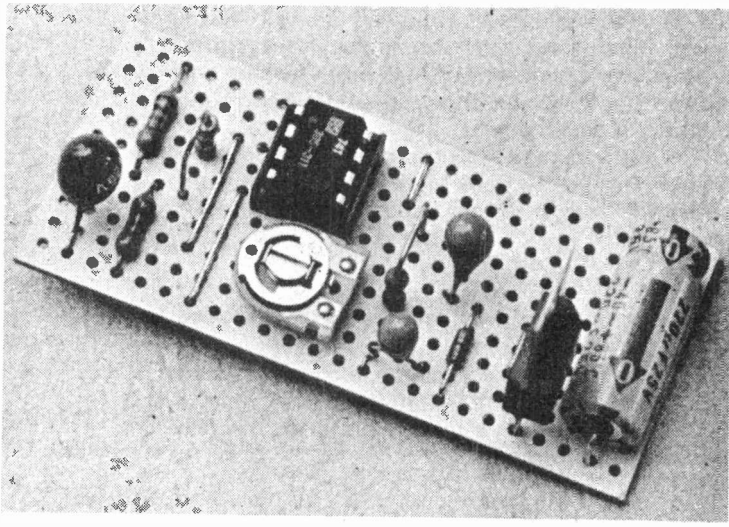

Fig. 3. The underside of the board. The large circles show where to cut the tracks, the dots are soldering points for the component leads.

PARTS LIST

RESISTORS (ALL 1/4W, 5%)		SEMICONDUCTORS	
R1, 2	10k	D1	1N4148
R3	4M7	IC1	741
R4	100k	THY1	C106D
POTENTIOMETER		MISCELLANEOUS	
RV1	1k0 LIN preset	Crystal microphone	
CAPACITORS		9V battery	
C1	22u 25V tantalum	Flash extension lead	
C2	1u0 35V tantalum	1 in x 2 1/2 in Veroboard	
C3	4u7 35V tantalum		
C4	220u 25V electrolytic		

4017 CIRCUITS

A monthly look at the notebook of ETI's chief design engineer, project editor Ray Marston.

THE TEN decoded outputs of the B-series 4017 can be used to directly drive a bank of LED's to make pretty displays, or to switch tone generators to create pretty tunes. Alternatively, outputs can be coupled back to the devices control terminals to make the IC count to, or divide by, 'n' (any number from 2 to 9) and then either stop or recycle. Numbers of 4017 IC's can readily be cascaded to give either multi-decade division, or to make counters with any desired number of decoded outputs. Let's take a closer look at the device.

4017 Basics

Figure 1 shows the outline and pin designations, the functional diagram, and the basic timing diagram of the CD4017, which incorporates a 5-stage Johnson counter. The device has clock, reset, and clock inhibit input terminals.

The counters are advanced one count at each positive transition of the clock signal when the clock inhibit and reset terminals are low. Nine of the ten decoded outputs are low, with the remaining output high, at any given time. The outputs go high sequentially, in phase with the clock signal, with the selected output remaining high for one full clock cycle. An additional carry out signal completes one cycle for every ten clock input cycles, and can be used to ripple-clock additional 4017's in multi-decade counting applications.

The 4017 counting cycle can be inhibited by setting the clock inhibit terminal high. A high signal on the reset terminal clears the counter to zero and sets the '0' output terminal high.

4017 Applications

Figures 2 to 6 show a few ways of employing the decoded outputs of a single B-series 4017.

Note in the figure five and six circuits the counter can be made to divide by any number simply by taking the "free" terminal of the circuit's multi-vibrator to the Nth output terminal of the counter.

Greater than 10

There are times when ten stages of counting/decoding aren't enough for a particular task. Examples that spring to mind are complex remote control coders and decoders

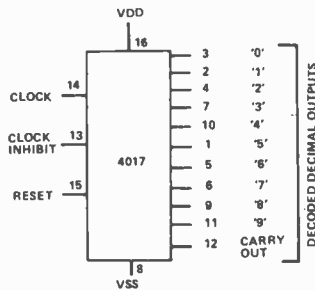

CLOCK IS INHIBITED BY A HIGH SIGNAL ON PIN 13
COUNTER IS RESET BY A HIGH SIGNAL ON PIN 15
COUNTER ADVANCES ON POSITIVE TRANSITION OF CLOCK SIGNAL.

Fig. 1b. Functional diagram and data for the CD4017.

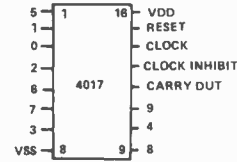

Fig. 1a. Outline and pin designations of the CD4017.

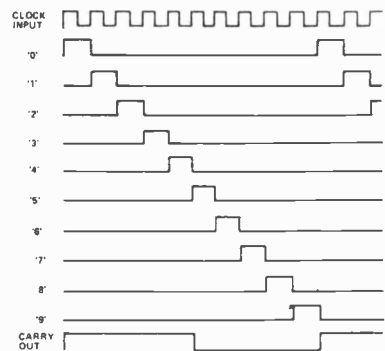

Fig. 1c. Waveform timing diagram of the CD4017, with its RESET and CLOCK INHIBIT terminals grounded.

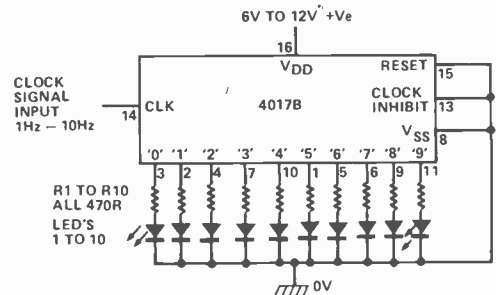

Fig. 2. The circuit of a 10-stage sequential LED flasher or chaser in which one LED is on and the other is off at any given time, and the on LED moves one step up the line each time a clock pulse arrives. An alternative action, in which nine LED's are on and one is off at any given time, can be obtained by reversing the polarity of all LED's and taking their common point to the positive supply line.

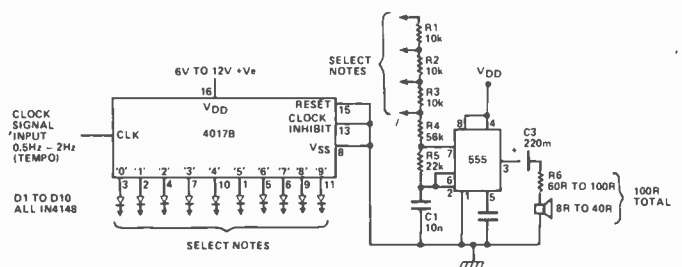

Fig. 3. The circuit of a 10-stage 4-note musical sequencer, that can be used to generate simple tunes or melodies. The number of available notes can be increased by adding more resistors to the R1-R2 component chain.

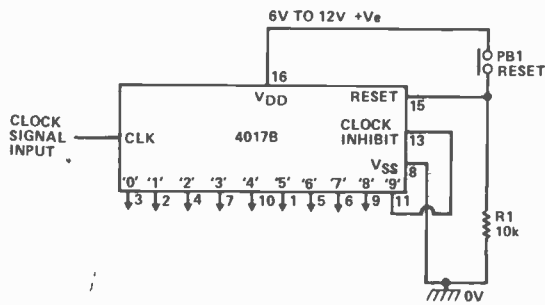

Fig. 4. How to connect the 4017 so that it stops operating after completing a pre-determined counting sequence. Here, the counter is set to stop when its clock inhibit terminal is driven high by the '9' output. The count sequence can be restarted by pressing reset button PB1.

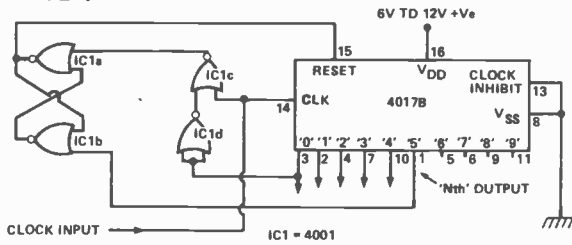

Fig. 5. One way of connecting a 4017 as a divide-by-N ($2 < N < 9$) counter with N decoded outputs. This circuit is set to divide by 5. The circuit operation here is such that the Nth output of the counter momentarily goes high on the positive transition of the Nth clock pulse, and immediately causes the IC1a-IC1b flip-flop to change state and apply a reset command to pin 15 of the 4017, which in turn causes its '0' output to go high and feed a low signal to one terminal of NOR gate IC1c. When the negative transition of the Nth clock pulse arrives, it places a low signal on the remaining terminal of the IC1c NOR gate, which therefore feeds a high signal to IC1a and causes the flip-flop to again change state and remove the reset command from pin 15 of the 4017. The 4017 is then free to count again.

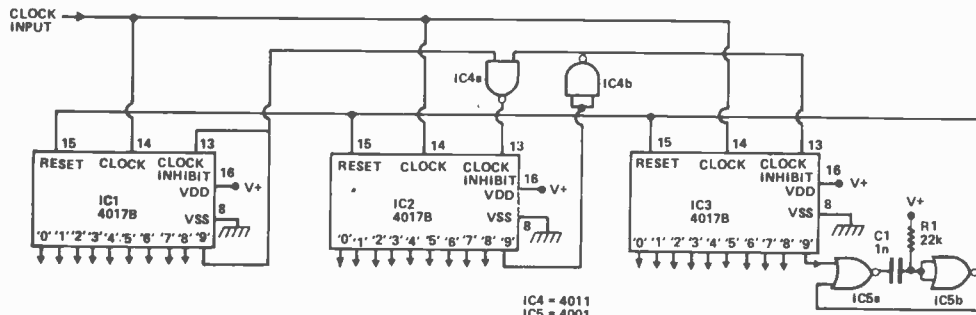

Fig. 8 shows the connections for making an 18 to 25-stage counter/decoder from three 4017's. In this case IC3 is inhibited via IC4b and the low output '9' of IC2, and IC2 is inhibited via IC4a and the low output '9' of IC1, up to the 9th clock pulse. IC1 is inhibited via its high '9' output, and IC3 is inhibited via IC4b and the low output

'9' of IC2, between the 10th and 17th clock pulses. Finally, IC1 is inhibited via its high '9' output, and IC2 is inhibited via the high '9' outputs of IC1 and IC2 via IC4c between the 18th and 25th clock pulses and the entire circuit is reset to the '0' stage via the IC5 and IC5b monostable on the 25th-plus-one clock pulse.

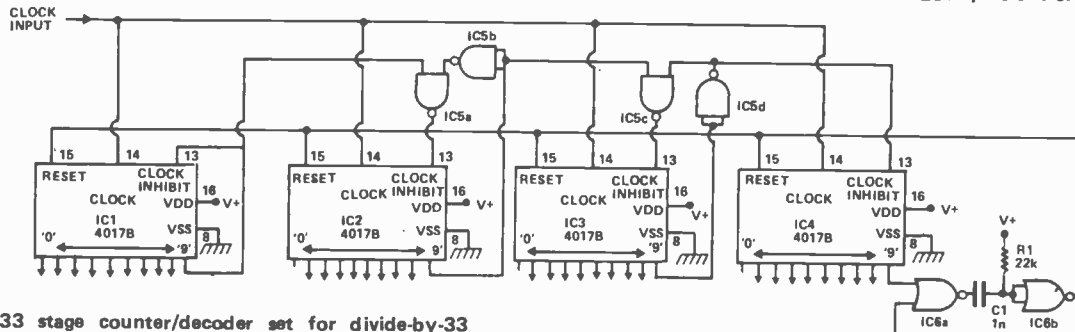

Fig. 9. A 26 to 33 stage counter/decoder set for divide-by-33 operation. This circuit can be expanded to give any number of decoded output stages by interposing additional IC2-IC5a-IC5b

stages between IC2 and IC3. Each additional stage makes an extra eight decoded outputs available.

Con't on page 78

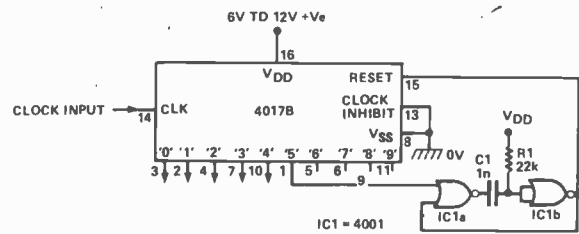

Fig. 6. An alternative way of obtaining divide-by-N operation. Here, the Nth output (the 5th in this diagram) momentarily goes high on the arrival of the positive transition of the Nth clock pulse and causes the IC1a-IC1b monostable to generate a 15 uS pulse that immediately resets the counter to the '0' or empty state, ready for the arrival of the positive transition of the next clock pulse.

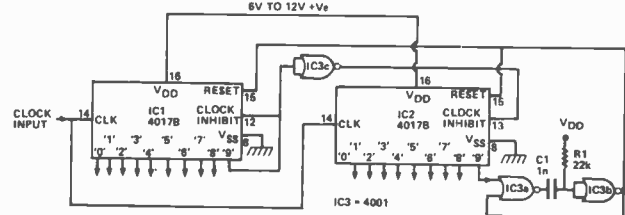

Fig. 7. How to interconnect a pair of 4017's to make a 10 to 17-stage counter decoder. The circuit is shown set for divide-by-17 operation.

The clock input signal is parallel-fed to IC2. When, however, the count is below 9, the '9' output of IC1 is low and causes the clock inhibit terminal of IC2 to be set high via IC3c, so IC2 is not influenced by the clock signals. As soon as the 9th clock pulse arrives the '9' output of IC1 goes high and inhibits IC1 from further clocking action, and simultaneously drives the clock inhibit terminal of IC2 low via IC2c and enables IC2 to respond to subsequent clock signals. Eventually, on the arrival of the 17th clock pulse, the '9' output of IC2 goes momentarily high and triggers the IC3a-IC3b 15 uS monostable, which in turn resets both counters to the empty or '0' states. The counting sequence then repeats.

Note that the '9' output of IC1 and the '0' and '9' outputs of IC2 are 'lost' in the counting action, so that circuit provides a maximum of 17 usable counter/decoder stages. The circuit can be made to count by any number in the range 10 to 17 by connecting the "free" input terminal of IC2a to the appropriate output terminal of IC2.

HIGH IMPEDANCE VOLTMETER

A quick and easy project to supplement your trusty 20K VOM.



ALTHOUGH AN ordinary multimeter can normally be relied upon to tell the whole truth, complete truth, and nothing but the truth, it can sometimes give misleading results when making DC voltage measurements. The problem arises when making measurements on high-impedance circuits where there is a current flow of only a few μA or less. With most multimeters requiring about $50 \mu\text{A}$ to produce full scale deflection (FSD) of the meter, the current in the circuit under test is obviously inadequate to drive the meter. Thus there might be 6 V at the test point until the multimeter is connected, when the voltage could fall to less than a volt because of the loading effect of the meter. The meter would truthfully record this low reading, misleading the user.

This problem can be overcome by using our high-impedance voltmeter. This uses a current amplifier ahead of the meter circuit to reduce the input current requirement to a level that ensures reliable results when testing any normal circuit. It has three measuring ranges of 1, 10, and 100 V FSD and the input impedance is over 11 megohms.

Construction

The circuit is easily accommodated on one of our standard (24 by 10 holes 0.1" matrix) Veroboards using the component layout shown in Fig. 2. Resistors R1 to R3 are not mounted on the board as it is more convenient to mount them directly on SW1, as shown in the

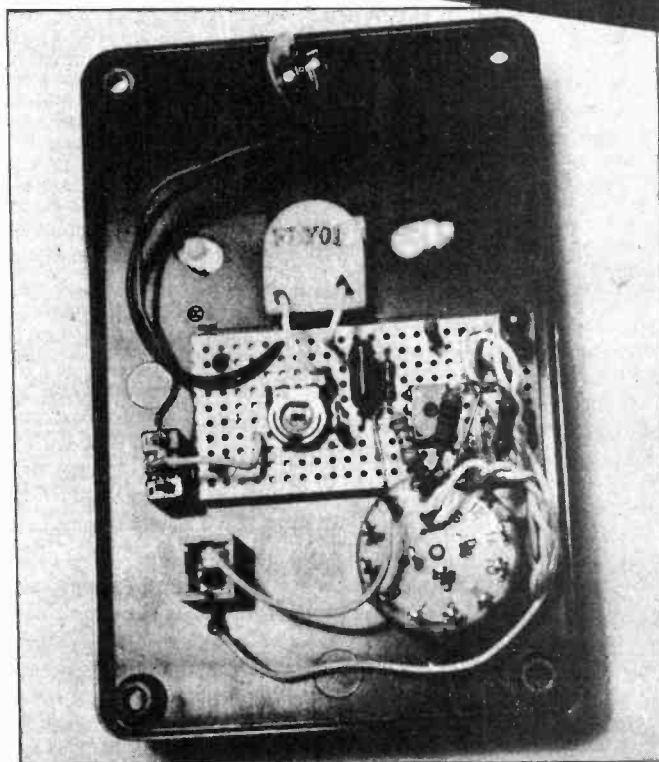

Internal view of the project — everything fits on the inside of the case lid

diagram. The two mounting holes and breaks in the copper strips should be made before fitting the components and link wire to the board. As IC1 has a MOS input stage and is vulnerable to damage by large static charges it should be connected last, and should be left in its protective packaging until then. It should either be fitted in a socket or soldered in place using an iron having a grounded bit.

A large mounting hole in the case is needed for the meter, and plastic or aluminum cases can usually be cut quite easily using a fretsaw, or a coping saw.

Another method is to drill a series of closely-spaced holes with an $1/8"$ drill within a pencilled outline of the hole. The centre piece is then removed with the aid of a small round file, which is also used to provide a smooth rim to the hole.

To calibrate the unit, switch SW1 to the 10 V range, adjust RV1 for maximum resistance (fully clockwise) and connect the positive input to the positive supply rail. Use a multimeter to measure the supply voltage, and then adjust RV1 to give the same reading on ME1. The unit is then ready to use. ●

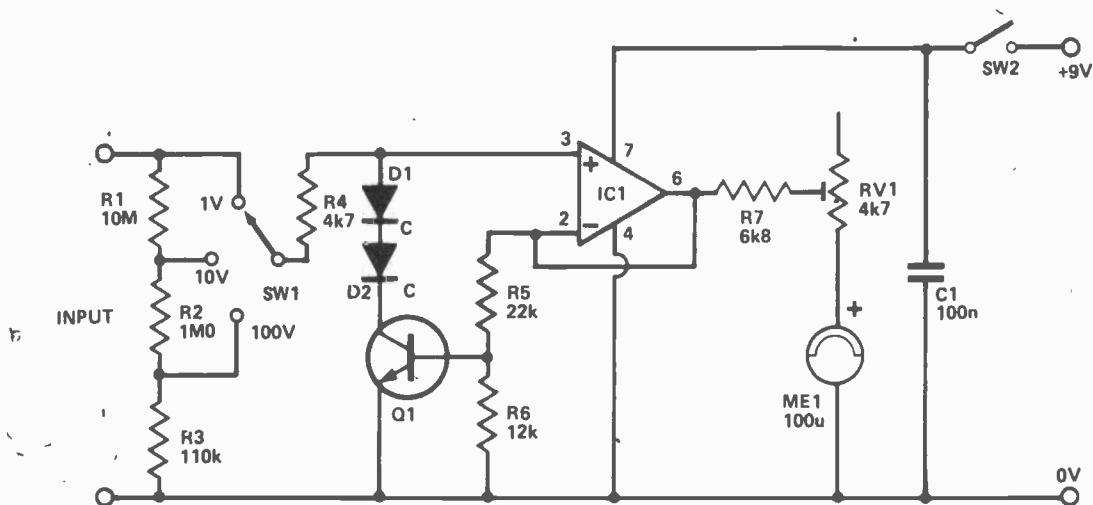

Figure 1. Circuit diagram of the High-Impedance Voltmeter

HOW IT WORKS

The unit is based on an operational amplifier, and has its circuit shown in Fig. 1. Operational amplifier IC1 has 100% feedback from its output to its inverting input, and therefore gives unity voltage gain. Resistor R7, preset RV1 and meter ME1 form a voltmeter at the output of IC1, and RV1 is adjusted for a full scale sensitivity of 1 V. Thus an input of 1 V is needed at the non-inverting input of IC1 to produce an FSD on ME1, but IC1 has a MOS input stage that consumes no significant input current.

Most of the input current drawn by the unit is that which flows through input attenuator R1-R2-R3. By means of SW1 this provides three switched attenuation settings of 1, 10 and 100, giving the unit its three measuring ranges.

Normally Q1 is switched off, but if the circuit is overloaded and much more than about 1 V appears at the output of IC1, the voltage fed to Q1's base is sufficient to switch this device on. Diodes D1 and D2 are then effectively connected as a low-voltage zener across the input to IC1, which limits the input voltage to only about 1.3 V. This method of overload protection does not interfere with the accuracy of the unit in normal use, but prevents the meter from being overloaded by more than about 30% (which is nowhere near enough to do it any harm). The protection circuitry also prevents an excessive input voltage to IC1.

The circuit has a current consumption of only about 1.2 mA.

PARTS LIST

RESISTORS (All 1/4W, 5% unless stated)

R1	10M
R2	1M 2% or better
R3	110k 2% or better
R4	4k7
R5	22k
R6	12k
R7	6k8

POTENTIOMETER

RV1	4k7 miniature horizontal preset
-----	---------------------------------

CAPACITOR

C1	100n polyester
----	----------------

SEMICONDUCTORS

IC1	CA3140E op amp
Q1	MPS6515
D1, D2	1N4148 diode

MISCELLANEOUS

SW1	four-pole, three-way rotary switch
SW2	single-pole, single-throw toggle switch
ME1	100 uA moving-coil panel meter
10 strip by 24 hole, 0.1" Veroboard	
Battery and clip	
2 x 4mm sockets	

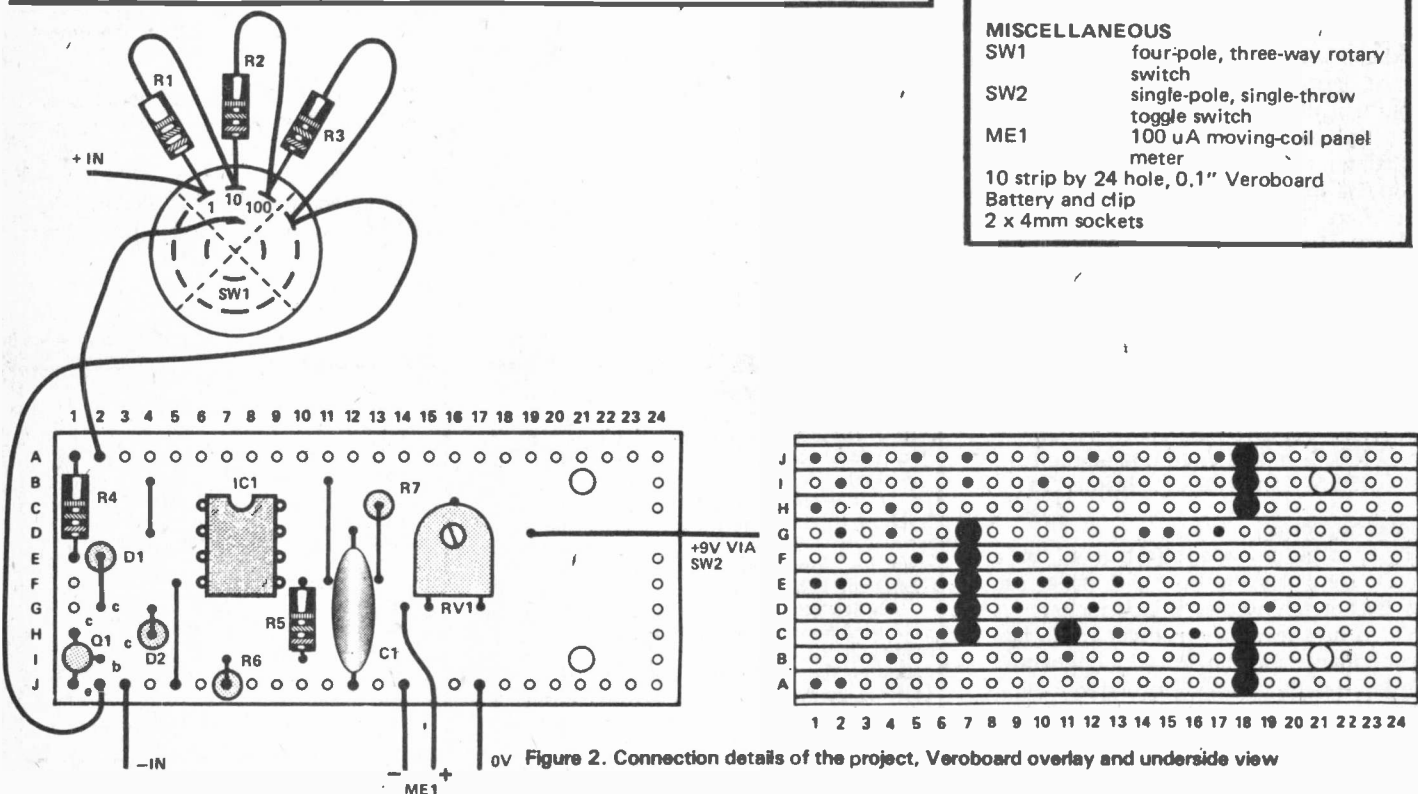

Figure 2. Connection details of the project, Veroboard overlay and underside view

JACK LEAD TESTER

Test your Jack-to-Jack leads in record time with the help of this simple to build circuit. Donncha Butler explains his own designs.

JACK-TO-JACK leads are used by almost every band and disco in the country (the exceptions are those who can afford expensive cannon connectors and those who can't even afford standard jacks!) Now, provided all goes well, these leads perform admirably. But — there is a well known law — Murphy's — which states that: 'any seemingly perfect contribution to the whole entity's function will, at the most inconvenient time, pack in — good and proper.' Put simply, what this means is that half-way through a gig at least one of the jack leads will develop a one-in-a-million fault which leaves the owner, running around like a rabbit lost in a maze, looking for the lead which has gone down and for a good replacement. Having been in this sort of situation myself from time to time, I decided to do some research into the subject and found that any fault in a lead must fall into one of three categories:

- an open-circuit
- a short-circuit
- crossed wires (out-of-phase connections)

With the aid of the Jack-to-Jack Tester, leads can be tested for these three areas of fault in less time than it takes to say xxxx!

At last, no more frantic struggles, holding the jack plug steady between your knees, while you grapple with the multimeter prods in one hand (and to stop the meter falling off the table onto the floor with the other), trying to make good contact with the plug connections. All you need to do is plug both ends of the lead into the unit and visual indication of the lead's state of health is given instantly by three LEDs:

- RED — indicates a short-circuit
- YELLOW — indicates that the plugs are wired out-of-phase
- NONE — indicates an open-circuit
- GREEN — indicates the lead is OK

Construction

The prototype was constructed in a black Vero potting box and makes use of two matching plastic jack-sockets. A PCB is not necessary as there are so few components and they may be connected quite neatly with insulated wire. Follow the connection diagram for details. Two holes are drilled in one end



Fig. 1. Circuit diagram of the ingenious ETI Jack Lead Tester.

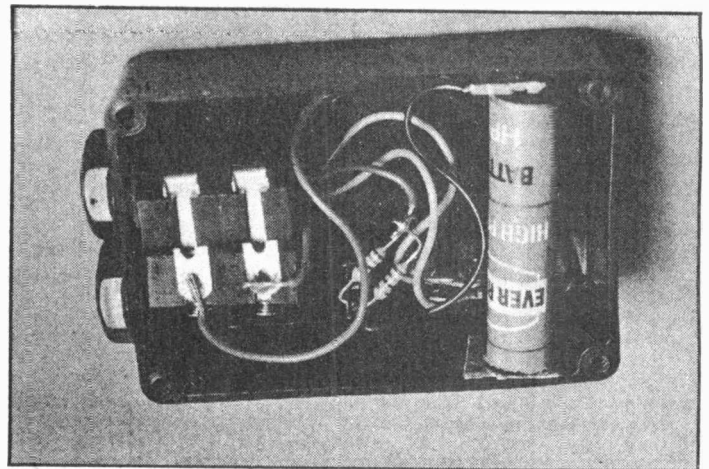
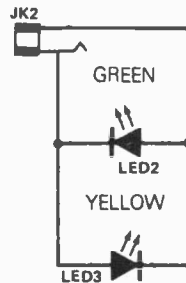
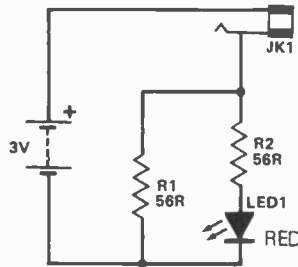

Fig. 3. The innards.



HOW IT WORKS

If a good lead is plugged in, the green LED will be forward-biased and current will flow through via R1 (there will not be sufficient voltage across the red LED to light it).

If the lead is wired out of phase, the yellow LED will be forward-biased and so will light. If there is a short-circuit, 3 V will be dropped across R1 and so the red LED will light.

Note that 50 mA is shunted through R1, so the circuit should not be left in the short-circuit condition or the batteries will soon go flat. No switch is included in the circuit, because the battery is automatically disconnected once the plugs are removed.

of the box for the jack sockets and three holes are drilled in the front of the box for the LEDs. The jack sockets are fixed in place and the LEDs may be glued in place or held in LED clips. The batteries may be soldered in or contacts may be made of Vero-board.

When all the parts are in place, screw on the lid and the tester is ready for use.

Con't on Page 86

PARTS LIST

RESISTORS (All 1/4W, 5%)
R1,2 56R

SEMICONDUCTORS

LED 1 0.2" Red LED
LED 2 0.2" Green LED
LED 3 0.2" Yellow LED

MISCELLANEOUS

JK,1,2 1/4" sockets
batteries (2 x AAA size)
Vero potting box 75-1413E

FREEZER ALARM

When the temperature starts to rise you'll be glad you built the ETI Freezer Alarm to protect your frozen food!

AFTER CENTURIES of complaining about the daily drudgery of their lives, it seems that women are finally getting a better deal. Manufacturers are finding more and more ways of applying technology in the home, from motors in the can-opener to microprocessors in the washing machine. One of the most useful items for a working woman (or bachelor, come to that) is a freezer. Not only does it remove the need for daily shopping trips, but meals can be prepared weeks in advance, in bulk, and simply heated up when required.

Finding Fault

Unfortunately we don't live in a perfect world and the convenience of a freezer can become a great inconvenience should anything go wrong. A failure can be very difficult to detect as the pilot light on the front will only tell you that the power is connected. Any other fault may only become apparent the next time you open the door and find a messy heap of defrosted food. Despite the fact that a freezer is designed to stay cold without power for long periods (in case of power cuts), it is not a very good idea to rely on this and hope you'll spot something wrong next time you use it. It might be too late.

Fault Finding

Prevention is better than cure, even if you are insured, and the obvious answer is to fit a temperature monitor that sounds an alarm if the temperature inside the freezer starts to rise above normal, towards the point of no return. This gives you a chance to get the freezer fixed before the contents are ruined.

The Freezer Alarm uses an LM3911 temperature controller IC as a sensor. This is placed inside the freezer, connection to the rest of the circuit is made by a thin cable. This can pass under the rubber door seal without affecting the insulation. The alarm we used is the now-familiar solid-state buzzer.

You might think it strange that the circuit is powered from the lines but this is OK. It means that you can't forget to replace the battery, and in any case, as mentioned above, freezers are designed to cope with power cuts provided you don't keep opening the door.

Construction And Setting Up

Nothing unusual here apart from the mounting of the sensor. We soldered a length of twin miniature screened cable to the pins of an IC socket and encased the socket in the plastic cover from a DIN speaker plug. The drawing and photograph should make this clear. The LM3911 is then fitted into the socket. We only used a socket to make a tight fit in the plastic cover — if you choose some other method of construction there is no reason why you cannot solder directly to the pins of the IC (provided you do it quickly).

Take the usual precautions when building the rest of the circuit, making sure that transistors and electrolytic capacitor are the right way round. Please be careful with the primary circuitry — we would hate to lose any of you!

To set up the unit, switch the freezer to its highest working temperature and leave the sensor inside to cool down. Adjust RV1 until the buzzer sounds then back it off slightly to turn the buzzer off. The alarm is now ready for use.

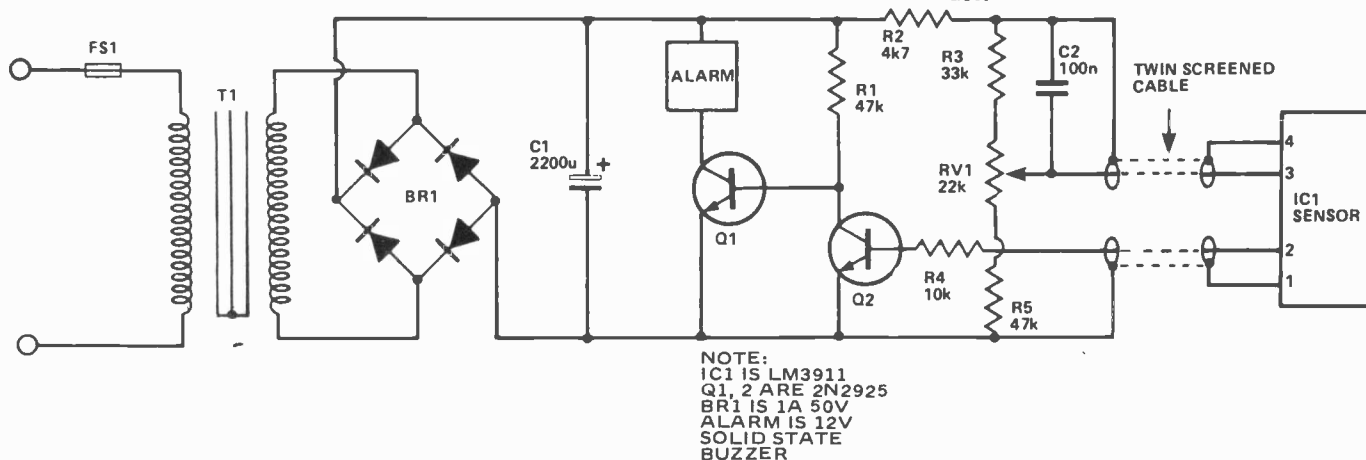
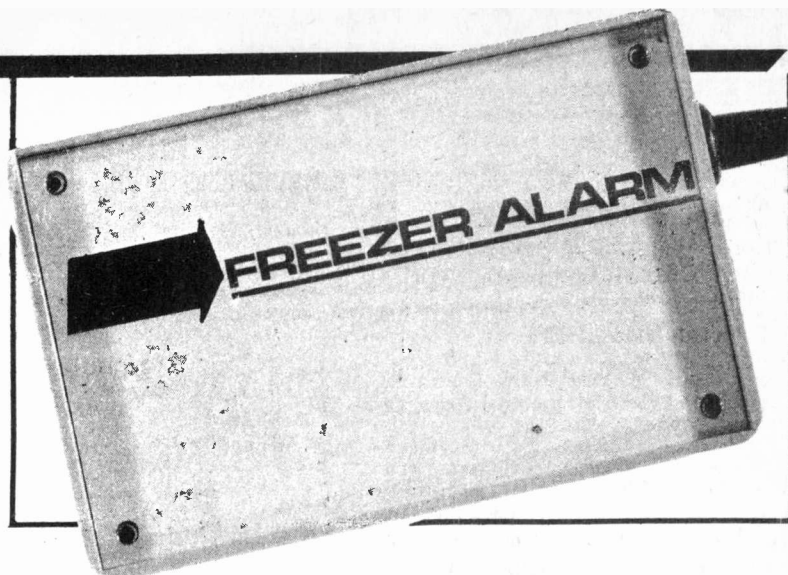

Figure 1. Circuit diagram of the Freezer Alarm

HOW IT WORKS

The heart of the alarm is the LM3911 — an integrated circuit specifically manufactured for use in temperature control equipment, although we have adapted its use slightly for this project. The IC itself has three main sections as seen in Figure 1, a zener diode, a temperature sensor and an operational amplifier.

The zener diode is used with R2 in the circuit diagram to provide a stable reference voltage of 6V8 which supplies the temperature sensor and the internal op amp. The op amp is connected as a voltage comparator — ie. when the voltage at the non-inverting (+) input rises above that at the inverting (-) input, the op amp output goes high. The voltage at the inverting input is set by potential divider chain R3, RV1 and R5. The voltage at the non-inverting input is set by the output of the temperature sensor — and this falls as the temperature increases.

RV1 is adjustable to allow for a temperature setting of approximately — 25°C to 0°C. Different resistors in the potential divider chain will alter the turn-over temperature of the op amp to allow the IC to be used as a room thermostat, say. In fact the LM3911 can be used to measure temperatures of — 25°C to +85°C. Power is provided via transformer T1 to isolate the circuit from line voltage. BR1 is a bridge rectifier which changes the AC from the transformer to DC and C1 filters the voltage to give a smooth DC supply of about 16V.

The output of the internal op amp of the LM3911 drives Q2 via R4. As long as the temperature is below the present level, Q2 is turned on and prevents base current flowing into Q1, which is therefore held off. When the op amp swings low, Q2 is turned off and current can now flow into Q1 base via R1. Q1 turns on and sounds the alarm.

PARTS LIST

RESISTORS (ALL ¼ W. 5%)

- R1,5 47k
- R2 4k7
- R3 33k
- R4 10k

POTENTIOMETER

- RV1 22k linear

CAPACITORS

- C1 2200u 16 V PCB-mounting electrolytic
- C2 100n polyester

SEMICONDUCTORS

- Q1,2 2N2925
- IC1 LM3911
- BR1 1A, 50 V bridge rectifier

MISCELLANEOUS

9V, 100mA transformer, fuse (500mA) and fuse-holder, 10 x 24 hole veroboard, twin screened cable, solid state buzzer, socket for mounting IC (see text).

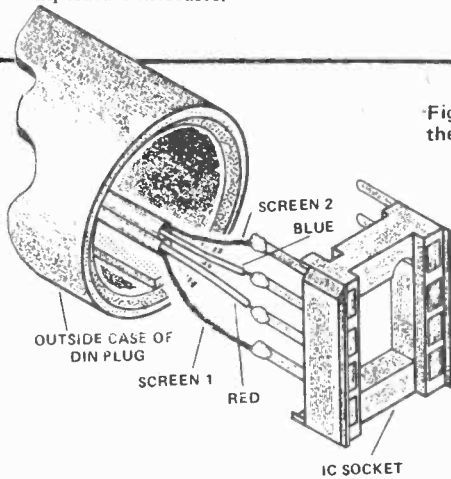

Figure 4. (left) Using an IC holder to mount the LM3911

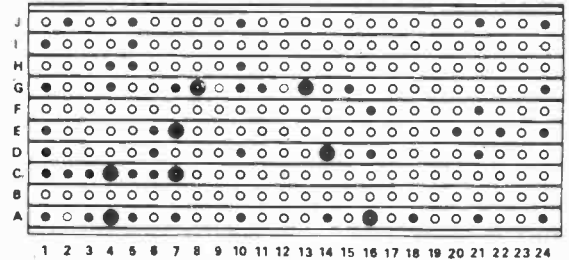

Figure 3. Veroboard layout showing component positions and track cuts.

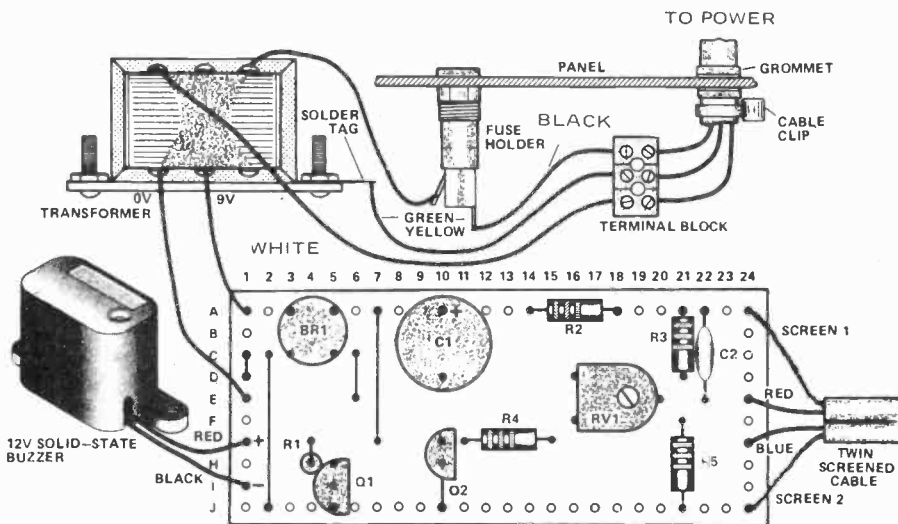
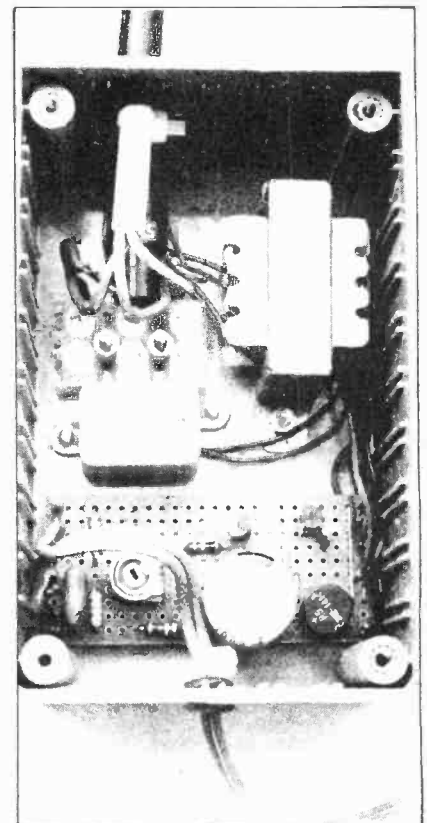

Figure 2. (above) Overlay and interwiring diagram.



INTO ELECTRONICS (Part 8)

Ian Sinclair looks at Logic Circuits.

IN CHAPTER 7 we looked at the wave-generating effects of positive feedback, however, we left out one device, mainly because it doesn't generate any wave by itself. It's the bistable, and it's distinguished from all the others in its family (astables and monostables) by having no capacitors and no time constants. It doesn't sing, it doesn't dance on one leg, what does it do?

Take a look at the bistable circuit in Fig. 1. The circuit looks just like an astable multivibrator, except that there are no coupling capacitors, just the resistors R2 and R3. Suppose that Q1 is conducting, so that its collector voltage is bottomed. That means there is no current flowing through R2 into the base of Q2, which is cut off. With Q2 off, current flows from the supply through R4 and R3 to keep Q1 conducting. It'll stay that way as long as the circuit is switched on, or until it's switched over. How do we switch it over? Easy, just ground input A momentarily. That cuts off Q1, switches on Q2, and the positive feedback makes sure that the changeover will be really fast. Now Q2 is on, and Q1 is off, and it will stay that way until switched off or until input B is grounded.

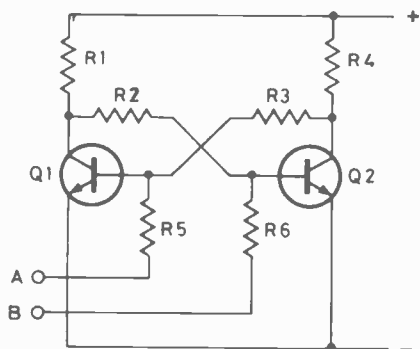

Fig. 1. Bistable multivibrator. To try it out, use values: R1, R4 = 4k7, R2, R3=47k, R5, R6=47k. Q1, Q2 can be any NPN general-purpose transistors such as 2N2209. Supply, 6-9 V battery.

Steering Bistables

Very interesting, but is it useful? Well, we can certainly make some use of the circuit as it stands — it's useful for making square waves out of sinewaves, for example, but the addition of what is called a 'steering system' makes this into one of the most-used types of circuit in modern electronics. Fig. 2 shows the simple bistable with the addition of steering diodes which make it into a scale-of-two or flip-flop. We've added three resistors, two capacitors, and two diodes to the basic circuit; fasten your seatbelts so that we can run through what happens.

Suppose that Q1 is conducting, with its collector voltage bottomed, and Q2 is off, so that its collector voltage is high. The base voltage of Q1 must be at about 0.6 V, and its collector voltage at about 0.2 V; these are

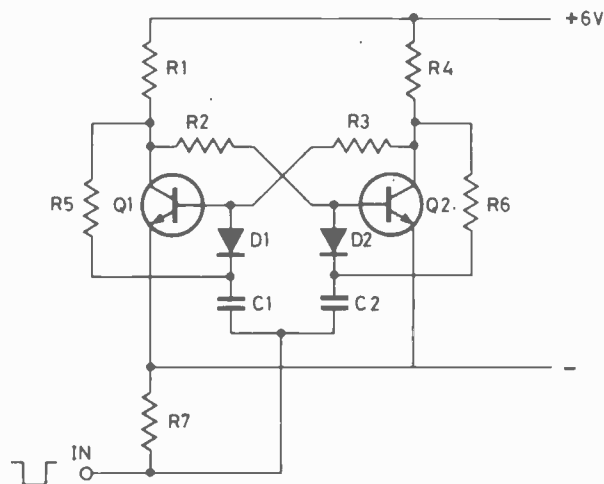

Fig. 2. Bistable counter with steering diodes. Use values R1-R4 as in 6.1, but with R5, R6=100k, C1, C2=0.01uF, R7=10k, D1, D2, silicon diode such as 1N4148. Supply 6-9V battery.

the normal voltages for a bottomed silicon transistor. These voltages are also the bias voltages for the diode D1, so that D1 has about 0.6 V on its anode and 0.2 V on its cathode — almost, but not quite, conducting. How about D2? It's connected to Q2, whose base is cut off, at about 0.2 V (because it's connected to the collector of Q1) and with its collector at a voltage very close to the supply voltage, perhaps 5 V. D2 must, therefore, be reverse biased, then, with 0.2 V on its anode and about 5 V on its cathode.

That sets the scene, then, with D1 almost conducting and D2 thoroughly reverse biased. Now imagine what happens when a negative trigger pulse arrives at the input. The trigger pulse is a brief change of voltage, negative because the voltage drops suddenly from zero to a negative value and then returns to zero. The duration of this pulse can be short, a micro-second or so, but the effect on the circuit is not brief. If we make the size (amplitude) of the negative pulse somewhere between 1 V and 6 V, assuming a 6 V supply, then the pulse can pass current through only one of the diodes, D1, because only D1 is biased so that it can conduct on a pulse of that size. Current flowing through D1, caused by the negative pulse, will cut off Q1 and switch on Q2, so leaving the circuit with the conditions reversed. Q2 is now conducting and Q1 is now off.

Flipping Bias

Of course, the bias on the diodes has also flipped over. D1 is now reverse biased, and D2 is almost conducting. On the next trigger pulse, then, Q2 will cut off and Q1 will switch on again. Two negative pulses at the input have put the conditions back where they were at the

beginning. If we take the output of this bistable circuit as being the voltage at the collector of Q2, then this voltage has gone from high to low to high again for an input of two pulses. This output is itself a single negative pulse, so that the circuit has produced one negative pulse at the output from two negative pulses at the input.

Since the output of this circuit is a negative pulse, we can use it as a trigger pulse for another identical circuit. The same sort of action is going to take place in this second bistable circuit, so that two complete pulses from the first bistable will produce one complete pulse from the output of the second bistable. Of course, we need four trigger pulses into the input of the first bistable to give us two pulses from its output; the complete circuit therefore needs four trigger pulses in for one complete pulse out. Now take a deep breath and think of what will happen if we have three of these bistable circuits connected in a chain (fig. 3.). How many trigger pulses into the first bistable will give one pulse at the output of the third bistable? Yes, eight is the answer, and so it goes on. If we have N bistables connected in a chain like this, we need 2^N pulses in to give one pulse out.

Organic Bistables

This type of bistable circuit acts as a counter, then, counting not in the scale of ten but in the scale of two, and it's the basis for all the remarkable circuits that make calculators and computers possible. More about that in later parts. Before we leave the bistable counter, though, remember that it can have several uses that are not concerned with computing or calculating. The division-by-two is itself a very useful feature for several applications. Just to take one example, dividing the frequency of a note of sound by two means obtaining a



Fig. 3. A chain of bistable counters, with the Q2 collector of bistable 1 connected to the input of bistable 2 and the Q2 collector of bistable 2 connected to the input of bistable 3.

sound which is exactly one octave lower. This makes a bistable an essential part of the circuits of electronic organs and synthesisers, because if we use a set of oscillators to generate a scale of notes of very high sound frequencies, dividers, which are just bistables, can be used to produce all the lower frequencies. That way we have 12 oscillators (because there are 12 notes in an octave) to keep in tune, and the other notes must be of the correct pitch, a lot easier than using a separate oscillator for each note.

This frequency division is also used for timekeeping. Electronic watches use crystal oscillators (remember?) to ensure a very stable frequency. These oscillators work at anything from about 38 kHz upwards, so that to operate a display that flips numbers every second, a large number of bistable stages will be needed. It simply wouldn't be possible if we had to build each bistable from separate transistors, but integrated circuits (ICs) make it possible to build the complete oscillator and divider circuit in one set of operations and on one tiny chip of silicon.

Two's Company

All of this counting in twos affects the design of all the circuits that we use along with bistables. When we count

in the scale of two, there are only two digits, 0 and 1. These are particularly easy to represent electrically, because we can so easily arrange that the voltage of the collector of a transistor is either high, with the transistor completely off, or low, with the transistor bottomed. Practically every system uses what's called positive logic, with high collector voltage representing the digit 1 and low meaning 0. The terms, 'logic 1 and logic 0' therefore mean collector voltage high and collector voltage low respectively.

Certain Flippers Make Things Easy

Now this sort of counting system has lots of advantages, and one of them is that it's pretty certain. If we use circuits like bistables, the outputs are either on or off, they never hang around at any voltage between these two states, so that there's no doubt about which digit is represented by the voltage at any collector. We can forget about linear amplification and bias, and simply design circuits with lots of positive feedback to make sure that they flip over fast and completely. Problems like noise and interference shouldn't cause so much trouble when all of the transistors are either cut-off or bottomed. One slight snag is that 2 is rather a small number to use as a counting base, so that lots of bistable circuits are needed to handle even moderately large numbers; once again the use of ICs helps us out. A more serious problem is that we need at some stage to enter numbers into, and read numbers out of, a set of counting bistables, so that conversion to and from decimal numbers is needed. Once again, the use of ICs has simplified things, so that we can make these encoder and decoder circuits on single silicon chips.

Are You Gating Enough?

All the circuits that we call digital circuits make use of bistable counters but some other types of circuits are needed as well. Counting, for example, has to be

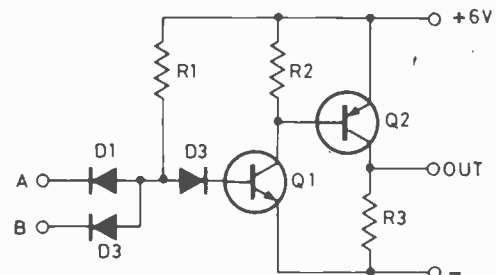

Fig. 4. A gate circuit using diodes and transistors.

stopped and started, and the type of circuits we use for stopping and starting counters are next on our list. They're called gates. Digital gates are like any other sort of gates, to let anything through you have to open them.

Take a look at the circuit in Fig. 4. This is intended as a digital circuit, so that the inputs will be either be zero volts (connected to ground) or supply voltage, and we expect the output to be one of these two voltage levels as well. Suppose both of the inputs, A and B are grounded, low, logic zero. Current will then flow through R1 and through D1 and D2 to ground and the voltage across D1 or D2 will be around 0.55 V, the usual voltage across a conducting diode. That sort of voltage isn't enough to

start current flowing through both D3 and the base-emitter junction of Q1, so that Q1 is off and its collector voltage is high. A high collector voltage means that there's only a small voltage between the base and the emitter of Q2, which is a PNP type. A PNP transistor needs to have its base voltage lower than its emitter voltage to turn it on, so Q2 is off. With Q2 off, the output voltage is LOW, logic 0.

Now if we take one of the inputs, A or B, and connect it to the +6 V supply, then it makes no difference to the circuit action, because all we've done is to reverse-bias one of the diodes, D1 or D2. Current will still flow through R1 and through the other diode, so that the voltage will stay low and Q1 stays off. If, however, we connect both inputs, A and B, to +6 V, then both of the diodes, D1 and D2, are reverse biased, and current now flows through D3 and into the base of Q1, turning on Q1. Some of the collector current of Q1 will flow through the base-emitter junction of Q2 (PNP, remember) so that this transistor is turned fully on. The output now is high, at logic 1.

This sort of gate has been described in detail because if you can understand the working of one sort of gate, you will soon find it easy to understand other types. It's called an AND gate. The name? Well, to make the output high, logic 1, we need to have input A *and* input B high, also at logic 1.

The Truth, The Whole Truth

Circuits like this are never built nowadays, because all of the gate circuits we need are obtainable as ICs. The circuits that *are* used inside the ICs are very complex; very often we don't know what the circuit is, so that we need some method of remembering what each gate does. One such easy way is the use of a truth table. A truth table shows what the output of a gate will be for each possible combination of inputs. Now for the AND gate we've just looked at, the output is 1 only when both inputs are 1, so that the truth table is as shown in Fig. 5. A shorthand way of writing the action is $1 \cdot 1 = 1$, where the dot means AND, and the equals means

A	B	OUT
0	0	0
0	1	0
1	0	0
1	1	1

Fig. 5. The truth table for the circuit of Fig. 4.

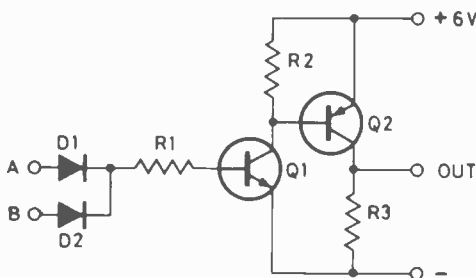

Fig. 6. A simpler gate circuit with a different truth table.

'gives'. The use of these 'equations' forms a branch of mathematics called **Boolean Algebra**.

How about some other gates? Fig. 6 shows another variation of the previous circuit, using fewer diodes this time. Once again there are two inputs, A and B. With both input voltages low, at logic 0, Q1 is unbiased and so Q2 is also unbiased, with no current flowing. The output voltage is low, logic 0. If we now connect A to +6 V, then current flows through D1 and R1 into the

A	B	OUT
0	0	0
1	0	1
0	1	1
1	1	1

Fig. 7. The truth table for the circuit of Fig. 6.

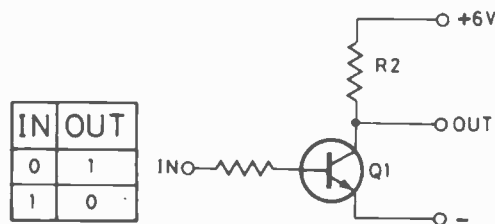

Fig. 8. A simpler inverter (NOT-gate) and its truth table.

base of Q1. D2 is reverse-biased so that it plays no part in the action. With Q1 switched on, Q2 is also on, and the output voltage is high, logic 1. The same result is obtained if input B is high and input A low, except that diode D2 now conducts and D1 is reverse-biased. In fact, the output is at logic 1 when A or B is high (or both), and the circuit is an OR gate. The truth table for this gate is shown in Fig. 7.

Classed among the gates is the simple inverter circuit, sometimes called the NOT gate (Fig. 8.), which is just an unbiased amplifier. When the input voltage is high, the output voltage is low, and vice versa. The truth table isn't too difficult!

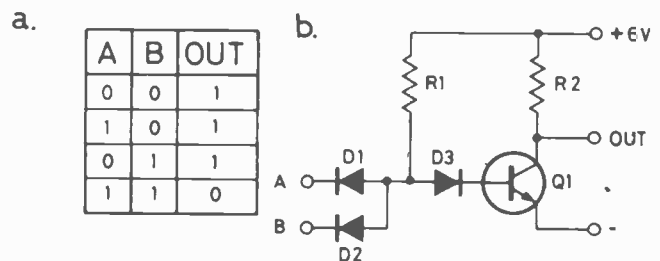

Fig. 9. The NAND gate. (a) Truth table, (b) a circuit using diodes and a transistor.

A	B	OUT
0	0	1
1	0	0
0	1	0
1	1	0

Fig. 10. The truth table for the NOR gate.

CLASSIFIED ADVERTISING

ETI's classified advertising section allows you to reach 30,000 Canadian readers nation-wide for 75¢ per word. For as little as \$15 per insertion (there's a 20 word minimum) you can promote your business from coast-to-coast.

WHAT DO YOU DO?

Send us your typewritten or clearly printed words, your permanent address and telephone number, and your money (no cash please). Make your cheque or money order payable to 'ETI Magazine'. We're

at Unit 6, 25 Overlea Blvd., Toronto, Ontario. M4H 1B1

WHAT DO WE DO?

We typeset your words (and put the first word and your company name in BOLD capital letters). If we get your message by the 14th of the month, it will appear in ETI 1½ months later. For example if we receive it by October 14th you (and thousands more) will see it in the December issue.

WE DO printed circuit boards - single side, double side, through holes and masked. For any information call or write to: **BEYER & MARTIN ELECTRONICS LTD.**, 2 Jody Ave., Downsview, Ontario. M3N 1H1 Tel: (416) 743-3010.

BOOKS: The ELECTRONIC INVASION . . . \$ 9.95 . . . 184 pages of schematics and information . . . also FREE booklet . . . experiments with the Microphone with your postpaid order . . . Complete Money Back Satisfaction guarantee . . . Send to: **COMP-U-TRONIX**, P.O. Box 548, Seattle, Washington 98111.

PRINTED CIRCUIT BOARDS for ETI projects. C.D. Ignition-\$5.75; Digital Freq. Meter-\$7.50; Fuzz-\$3.00; Guitar Practice Amp. \$10.15; Drum Synth-\$6.30; Function board-\$6.50; Monitor Amp. PSU-\$3.70; Shark-\$4.75. We also have boards for Summer '80 Projects and Special Projects Book 2. Full list free. Post and Pack 50¢. Ontario tax 7%. Cheque, Money Order or C.O.D. **B & R ELECTRONICS**, Box 6326F, Hamilton, Ontario. L9C-6L9.

HOW TO tune up and fix your vacuum cleaner. Instructions manual, \$5.00. Specify make, model number. **EMBASSY SERVICES**, Box 189, Station B, Toronto, Ontario. M5T 2W1.

PRINTED CIRCUIT BOARDS* single sided, 1 oz. copper* glass epoxy* holes drilled* conformal coating applied--/solder masks & parts maps screened on large runs, as well as tin/solder plating--/double sided pcbs on approval. Hobbyist orders delivered in approx. 2 weeks; industrial orders dependent on size. Methods of payment: cheque, postal money order, ChargeX/Visa, Mastercharge, C.O.D. (add \$2.00). Cost: 35¢/sq. in. drilled, 20¢ un-drilled. Ontario residents add 7% PST. Cdn orders add \$1.00 P&H, USA add \$2.00 P&H. Free price list and data sheets on request. Over ten years experience and still growing. Give us a try: **SPECTRUM ELECTRONICS**, P.O. Box 4166, Stn. D, Hamilton, Ontario, Canada. L8V 4L5.

MINI-FLOPPY, drive problem expert service, only \$35.00 + Parts. Apple, Pet, . . others. We let you know full cost before repairs. No charge if we don't make your system work. **HOWARD & STEPHEN COMPUTERS LTD.**, 2360 Lucerne, Suite 3, Montreal, P.Q. H3R-2J8. Tel: (514) 585-8801. 739-2251.

USED PDP8M's for sale complete or parts \$500.00 Telephone **REUTERS LTD.**, 416-869-3037, 9-5, Monday through Friday for further information

SEMIS & KITS 1.250W class A power amplifier kit \$239.00/2.160W class A amplifier kit \$149.00/ 3.MJ15003, 15004 \$10.00 per pair/4. MJ802, 4502 \$8.00 per pair. Send \$1.00 for our catalogue. Add 5% for shipping **KITSTRONIC INTERNATIONAL**, Box 577, Station J, Toronto. M4J 4Z2

TELETYPE MODEL 33 R.O. Ideal for computer printer or amateur use. Brand new in original carton only \$350.00. Used excellent condition \$150.00. Used slightly cracked cabinet \$100.00. No cabinet \$55.00 **DEL ELECTRONIQUE**, 83 Alexandre, Valleyfield, Quebec J6S 3J7. (514) 371-5720



Glenwood Trading Company Ltd.
278 East 1st Street
North Vancouver, B.C. V7L 1B3
Telephone (604) 984-0404

Canada's largest mail-order Ham and Communications Equipment Dealer.

FEATURING:

- KENWOOD
- CUSHCRAFT
- HY-GAIN
- CDE
- LARSEN
- HUSTLER
- DATONG
- BEARCAT
- PANASONIC



Write or phone for your FREE catalogue.

LOW-PRICED, high quality, Printed Circuit Boards. Glass epoxy, drilled, tinned, guaranteed. Most ETI boards available. Custom boards from your artwork. 8080/85/Z80 hardware and software design capability. Send 17¢ stamp for flyer. **KSK ASSOCIATES**, P.O. Box 54, Moriston, Ontario N0B 2C0.

ROBERT J. BUCKLAND CO., ELECTRONIC WAREHOUSE. Distributors for Mode Kits, Ceresist, Lenline, Tab Books and plenty of unique electronic surplus items. Write for our free flyer. 123 St. George Street, London, Ontario N6A 3A1 (519) 672-8390 VE3AQE Bob, VE3ICN Dan

J&J ELECTRONICS LTD., P.O. Box 1437E, Winnipeg, Manitoba R3C 2Z4. Surplus Semiconductor Specialists. Do you get our bargain flyer? Send \$1.00 to receive the current literature and specials and to be placed on the mailing list for future publications.

SPECIAL ! Each of the following kits \$10.00 . KR1: Asst'd resistors, ¼-½-1-2W. . Qty: 1000. KR2: Asst'd resistors, 5-7-10-20W. . Qty 100. KR3: Asst'd var. res. mini trimmers. . Qty:100. KC1 Asst'd dipped silver mica cap. . Qty: 200. KC2: Asst'd disc ceramic capacitors. . Qty:500. KC3: Asst'd tantalum capacitors. . Qty:50. KH1: Asst'd transistor heatsink. . Qty:100. KH2: Asst'd terminal lugs. . Qty:1000. KH3: Asst'd nuts, bolts, washers, etc. . Qty:2000. KS1 4"speakers. . Qty:10. SP1: Electronics parts, capacitor - relay - hardware - resistor - switch - etc. . Qty: 1000. All new material, first quality. Money-back guarantee. Free flyer. **SURPLUS ELECTRO QUEBEC**, 2264 Montee Gagnon, Blainville, Quebec, Can. J7E 4H5.

WSI RADIO - SWL Radios - Ham radios 18 Sheldon Avenue North, Kitchener, Ontario N2H 3M2. Tel. (519) 579-0536. Write for giant catalogue, free of course!! (VE3EHC).

CHALLENGER SOFTWARE. Quality software now available for Superboard/Challenger systems. Send \$1.00 for listing (refundable with first order). Dealer enquiries welcome, write on letterhead or phone (416) 789-4458 for information. **CHALLENGE SOFTWARE**, 1912A Avenue Rd., Toronto, Ontario M5M 4A1 or **CHALLENGE SOFTWARE**, P.O. Box 6984, Orlando, Fl. 32803.

POWER (100W) inverter/converter kit - change 12VDC to split ± 20VDC - variable to ± 35VDC. Power amplifier modules from car/van battery. Step by step instructions, PC & parts layout diagrams \$3.95. Above with all parts including wire. . \$29.95: Drilled PC Board. . \$7.95. 4 channel 5 control 1600W colour organ kit: Parts & instructions . . \$29.95 Drilled PC Board. . \$2.95. Strobe light kit, electronic parts, PC Board & instructions only. . \$24.95 **FELINA ELECTROLAB**, 11097 84A Ave., Delta, B.C. V4C 3A9

NEW STORE! Hobbyist. Parts. Speakers. Kits. Equipment. **GENERAL ELECTRONICS**, 5511 Yonge St., Willowdale, Ont. M2N 5S3, 221-6174. Please write for free catalogue. Monday, Friday, Saturday: 10:00 AM - 6:00 PM. Tuesday, Wednesday, Thursday: 10:00 AM - 8:00 PM

COMPLETE Electronic Hobby Services. Custom kits, circuits, technical writing, special parts. original designs. Free information. **TEKNIKIT ASSOCIATES** 301 Flora Street, Carleton Place, Ontario K7C 3M8.

COMPUTER OSI C4P: 16KRAM plus lots of extras asking \$1400.00 cash. **RON KRAMER VE3MX** 416-835-2940 after 6 p.m.

INTEGRATED CIRCUITS, all prime, standard and house numbers - 100/\$9.95; 74L73 - 5/\$1; N8T80A - \$2; 7413 - 5/\$1; 709 or 741 - 10/\$2; Epoxy Caps, unmarked - 500/\$5; 15 Amp Rocker Switch - \$1.89; 200 Resistors - \$3.99; 20 Slide Switches - \$3.99; 1N4148 Diodes - 100/\$7; Terminal Strips - 40/\$3.89; 100 Assorted Capacitors - \$4.95; \$10 Min. + \$1 P & H - Free Flyer **ELECTRONICS**, Box 68, Whitecourt, AB. T0E 2L0



ALAS!

Platonius, Thou hast missed thy chance. I hath purchas-ed the final copy of ETI from yonder squire news-stand. Thee shall miss all the verily fascinating articles, projects, features and most rightios news. 'Tis indeed a pity. Eat-eth out thine heart, turkey.

SUBSCRIBE

And you need never fear being caught running around chasing after a snooty woman in a toga.

\$16.95 for one year, Save 27.5%

\$29.95 for two years, Save 38%

Fill out the coupon and send your cheque or Visa or Mastercharge when and Expiry Date.

**ELECTRONICS TODAY INTERNATIONAL
SUBSCRIPTION DEPT
UNIT 6, 25 OVERLEA BLVD.
TORONTO, ONT, M4H 1B1**

GUD STUF!

BINDERS FROM ETI

You've been getting ETI for a few months and already they're getting tattered and dog eared. Protect your investment with ETI binders. They're made of quality durable plastic and will hold twelve issues. Cost? Just \$6.75 post-paid (Ontario residents add 7% provincial sales tax).

To get yours, use the handy order form in this issue or send cheque or money order to:

Binders Offer
ETI Magazine
Unit 6
25 Overlea Blvd.
Toronto, Ontario M4H 1B1



Really doctor! . . . with a daughter babbling about taking up electronics and these filthy microthings, im damn sure its a glandular disorder!

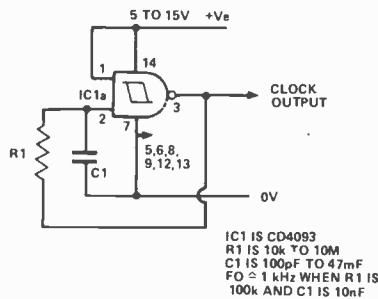

Fig. 10. This simple circuit makes an excellent clock generator for driving 4017 circuits.

that may require as many as nineteen sequential stages, simple music or tone sequencers that may require more than twenty stages, and LED-driving electronic games such as roulette which may require up to thirty-eight sequential stages. In such cases it is a fairly simple matter to interconnect a number of 4017 IC's to obtain any required total of decoded output stages.

INTO ELECTRONICS

Con't from Page 75.

...NOR Any Drop To Drink

Two other common types of gates are just combinations of AND, OR and NOT gates, but are often easier to make. The NAND gate has the truth table shown in Fig. 9a., The output is high unless both inputs are 1, when the output becomes 0. The circuit of Fig. 9b is one form of a NAND gate, and you can see that it's just the circuit of Fig. 6 without the PNP stage. The name of the gate comes from NOT AND, because its truth table is that of an AND gate followed by a NOT. Inevitably, there's a NOR gate, which is the NOT-OR. Its output goes to zero one input or the other goes high, and the truth table is shown in Fig. 10.

To save having to draw circuits of the gates themselves, we use symbols. These aren't universally standardised, but practically everyone working in electronics uses the (American) symbols which are shown in Fig. 11.

Note in the Fig 8 circuit that the 1 counter gives nine useful outputs, and that all succeeding stages give eight useful outputs. The basic circuit can be expanded to incorporate any number of 4017 stages by simply adding slightly modified IC2-IC4a-IC4b stages between IC1 and the final two stages of the system.

Rabbiting on

If you want to play with the 4017 circuits that I've described, you may find the Fig. 10 clock generator circuit useful. It uses only one quarter of a CD4093 Schmitt, but generates beautifully clean and interference-free clock pulses.

You can fiddle with the R1 and C1 values to get any clock frequency that you want. C1 can have any value from 100p to 10u, and R1 can have any value from 10k to 10M. Values of 10n and 100k give a clock frequency of about 1 kHz.

Fig. 11. Gate symbols — three-input gates are shown.

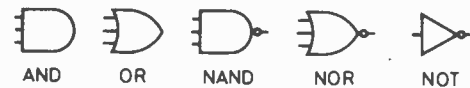

IT TAKES A STRONG WILL TO BEAT CANCER

Imagine for a moment a world where cancer is as obsolete as the dinosaur. It can happen. The research is willing but unfortunately

the funds are weak.

All bequests received by the Canadian Cancer Society are used to support cancer research, unless otherwise stipulated in the will. That's where you come in. Please insert one simple sentence in your will: "I give to the Canadian Cancer Society the sum of _____ dollars."

Our hope is to free the world from cancer. And where there's a will, there's a way.

Canadian Cancer Society ↓

CAN CANCER BE BEATEN? YOU BET YOUR LIFE IT CAN?

COMPU-LINE
IS
COMING



Audio Today

Do you suspect utter and irrevocable deafness in one ear? It may only be poor speaker placement. Wally Parsons addresses the issue.

A GREAT MANY aspects of audio seem to be poorly understood by many people who assume the responsibility of counselling others, people such as dealers, salesmen, writers, and editors, not to mention manufacturers' representatives and their technical consultants.

Perhaps the area in which this situation is most obvious is that of acoustics, in particular loudspeaker/room interface, including optimizing of speaker placement, as well as performance characteristics which relate to placement.

Reality vs. Illusion

The entire process of stereophonic sound reproduction currently in use is based on illusion. Ever since consumer audio equipment was introduced to the public, enthusiasts and advertisers have talked about "realism", "like being in the concert hall" and stuff like that, most of it no more true than a politician's press release.

Nevertheless, the general aim is to achieve realism such as to allow ourselves to be fooled into believing that the reproduction is identical to the real thing, even to the point of believing that we are within the ambience of the hall in which the performance took place.

Oddly enough, we make no such demands of any other reproduction form, including the visual arts. Certainly painters have never attempted to produce this illusion of reality, and no one expects to see a statue of a general astride his steed to go galloping off into the sunset, except in the Twilight Zone.

Even a photograph, when created as a visual record, is judged on its detail, relative spacial relationships, colour quality, and the like; likewise the image on the motion picture screen or a television image.

At most we might describe such creations as resembling windows through which some reality is viewed; we do not talk about feeling as if we were actually within the scene. Even early attempts at duplicating the experience of stereoscopic vision were abandoned, not because they didn't work, but because it wasn't worth the trouble.

Probably this is just as well. It's bad enough watching the good ol' boys of Hazzard County smashing up cars, but who would want to be in the middle.

With audio, the aim has been the reproduction of an experience which served to convey the art. Audio itself is not the art, nor is the experience the art.

To experience any artistic creation it seems necessary to get as close to the creation as possible, with a minimum number of barriers. Thus, a photograph of a picture is not as satisfying as the real thing, no matter how accurate the reproduction.

In the case of music, the reproduction lacks the visual cues which are normally a part of the original experience, at least for the sighted individual, so the need for the most accurate reproduction of as much information as possible becomes apparent if we are to re-create the total experience rather than merely the basic elements.

Our hearing mechanism is possibly the most important of all our senses as a means of survival, not only in the primitive natural environment in which it evolved, but in today's urban environment where aural cues still warn us of danger.

Of all the characteristics of human hearing, probably the most important and most sophisticated is that of directionality, along with the ability to sense environmental size and character. And although these faculties evolved as

aids to survival, they are still used in artificial situations such as listening to music, and can even affect motor activity.

Two immediate examples of this come immediately to mind. Shortly before I began this column my wife gave the dog a bath. Lady is a very small dog with very long hair and is subject to chills when wet. Consequently, my wife then proceeded to dry her using a blow dryer. The sound of the dryer was such as to provide some masking of the sound of the type-bars striking the paper, giving it a muted quality. The effect of this was to impart a feeling that the keyboard was stiff, and I had difficulty typing. This, despite the fact that on an electric typewriter the hardness of the type stroke is not fed back to the keyboard and should have no effect.

Indeed, I even know when I'm near the bottom of the page long before looking at the paper, just by the change in the sound, which gives the keyboard a sloppy feel.

Back to Reality

Anyway, returning to the subject of directionality, this faculty is the result of our having two ears connected usually, to a brain which is capable of analyzing pressure changes at each ear and comparing them.

The two most important characteristics to be compared are amplitude, and phase. In addition, we seem able to distinguish time differences as short as a few milliseconds. How this discrimination occurs within the brain is not fully understood, but we know that the shape of the head, the outer ears, especially the pinna (the pinna is the little lobe at the bottom of the ear to which rings are often attached) and their placement on either side of the head are responsible for the phase and amplitude differences at the ear drum.

These characteristics are not used independent of frequency, but tend to be used either alone or in combination, depending on the frequency involved.

At any frequency, sound originating from a point directly in front of or behind the listener will arrive at each ear with equal intensity. They will also arrive at the same time. Consequently, the sound is perceived as coming from directly in front or behind. (Which of the two directions it is depends on other mechanisms. For the moment we will deal only with intensity and time, and assume a source somewhere within the frontal hemisphere.)

As the sound source moves in either direction from the centre point two

ears as the sound source moves from azimuth, and consequently little directionality sensed using this mechanism. Many simple minded souls have jumped to the conclusion that there is no directional sense at low frequencies. Some have even gone further and claimed that low frequencies are non-directional, despite the fact that

as the source moves further to the side. Differences in time are sufficient to produce substantial phase differences at high frequencies with even small shifts from azimuth.

Thus, at high frequencies we perceive directionality by a combination of intensity *and* phase differences, with the brain apparently even comparing the relative dominance of the two characteristics.

The Critical Middle Ground

It's an axiom in audio that the middle frequencies are the most critical, particularly in the range of about 500 Hz to 3 kHz. Since we've already shown that intensity differences begin to assume significance at the lower end of this range, and that phase differences are also substantial directional cues as long as there are any signals of sufficient intensity to compare, it should come as no surprise to learn that both mechanisms are significant to directional cues as long as there are any signals of sufficient intensity to compare, it should come as no surprise to learn that both mechanisms are significant to directional perception in this range. It also explains the importance of smooth response of a system and of minimal phase anomalies in this range. Not only are we particularly sensitive to these frequencies, at least, those of us whose hearing has not been destroyed by excessive exposure to industrial noise or loud rock music, but our sense of directionality is most acute in this region.

Unfortunately, hearing damage most often causes impairment within this mid-range, and it's not always symmetrical. Consequently, in many people the sense of directionality is seriously impaired and they don't even know it.

The subject of hearing damage will be dealt with in another column, but the implications of the mechanisms discussed here are considerable in setting up a listening environment, including the critical matter of speaker placement and performance requirements: In this respect the audio world abounds in myths, folklore, and plain nonsense.

Next month I intend to tackle some of the nonsense head-on, and debunk some of the myths. I also intend offering a rational approach to speaker selection and placement. ●

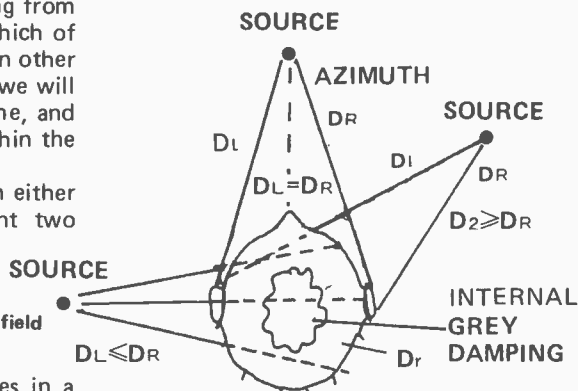

Fig 1. Showing human head in sound field

things happen. Whether it moves in a straight line or describes an arc such that it remains the same distance from the centre of the head, the sound source moves closer to one ear and further from the other. It therefore arrives at the closer ear earlier than it arrives at the other. The time difference is the same at all frequencies, therefore the phase difference increases with frequency. In addition, the head itself is now interposed between the sound source and the ear on the opposite side of the azimuth. Assuming there is anything inside the head, sound trying to pass through will be attenuated, and part of the sound field will attempt to go around the head. At low frequencies there is little attenuation, and as sound will easily go around a small object. The intensity is almost identical at each ear, with the result that there is little sense of directionality due to intensity differences at low frequencies.

As frequency increases wavelength gets shorter and the dimensions of the head become a substantial fraction of the wavelength. At this point, generally above 200 Hz, significant absorption occurs, increasing with frequency, resulting in substantial intensity differences between each ear. The brain analyzes the difference, noting the frequency, and perceives direction.

Thus, at high frequencies we are very sensitive to directionality, using intensity differences. As a matter of fact, the difference can be as much as 20 dB at 6 kHz, even more at higher frequencies.

The Effect Of Phase

Returning to the lower end of the audio spectrum, it was observed that there is little intensity difference between the

there is no logical connection between the two premises, even if true.

Although laboratory experiments have often been cited to show that the ear is insensitive to changes in phase, it can be shown that we *do* perceive relatively small *differences* in phase between sounds of identical frequency and amplitude at each ear. Although a sound of 100 Hz originating on the axis of one ear may reach the other ear at almost equal intensity, the difference in travel distance is around six inches, which allows a phase difference of about 15°, a difference easily detectable by the brain and useable as a directional cue. At lower frequencies the phase difference is less, and not as readily perceived. Thus, directional perception is *reduced* with frequency, but it's still there. Substantially!

Naturally, as frequency increases, phase differences increase. However, above about 2 kHz the difference is about one wave-length, and at higher frequencies the differences are even greater with several multiple wave-lengths.

As we discussed earlier, at these frequencies we also experience substantial intensity differences, as much as 10 dB at 3 kHz. By the time we get to about 10 kHz, the phase difference is substantial, but at extreme angles there is little intensity at the far ear with which to make a comparison, so phase differences become less relevant, and we depend more and more on intensity differences. However, as the sound source moves slightly from azimuth, intensity differences are initially of less importance, becoming increasingly significant



Cramolin®

CURES
TERMINAL
ILLNESSES



Cleans and preserves electrical contacts.
Hobby and Industrial sizes available (as shown)
For further information and your local dealer's name contact
AVALON AUDIO, 500 ADELAIDE ST. WEST, TORONTO M5V 1T2 (416) 861-1031

Circle No. 25 on Reader Service Card.

FALCON

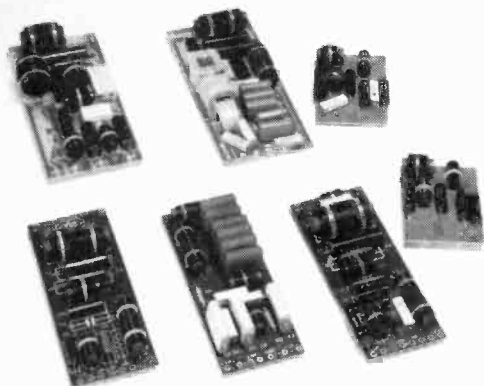

CROSSOVER NETWORKS

WE ARE PLEASED TO OFFER FALCON ELECTRONICS' RANGE OF PRECISION CROSSOVER NETWORKS.

Made with high-tolerance components of large power capacity, each type is tailored & fine-tuned for a specific set of drivers. We supply networks, with project plans, for the popular Audax combinations as well as Kef, Coles, Peerless and others.

A detailed listing is available on request.

WE ALSO STOCK: KITS BY COLES, CRIMSON, KEF; PLUS: ANGSTROM, A&R, CAMBRIDGE, ADC, AKG, AIWA, AUDIO DESIGN, BLAUPUNKT, BRYSTON, DYNAVECTOR, ELESON, HADCOCK, HARMAN, KARDON, LINN, MERIDIAN, MICRO SEIKI, MISSION, NAIM, ORACLE, PSB, REGA, ROGERS, SAC, SENNHEISER, SPENDOR, SUPEX, SYRINX, TANDBERG.

Circle No. 27 on Reader Service Card.

AUDAX

THE COMPLETE RANGE OF BEXTRENE WOOFERS AND SOFT DOME TWEETERS IS NOW AVAILABLE FROM US.

You've seen these drivers used in some top-rated systems from Angstrom, Meridian, Plasmatrix, Spondor and many others, so you probably think they're expensive. You'll be pleasantly surprised!

In addition, we stock Audax' top-rated automotive speakers, and the superb Professional Series for PA and sound reinforcement.

In fact, there's an Audax unit for any requirement — just ask us!

We answer all correspondence individually, and you're welcome to phone or drop in to discuss your needs.



MAIL ORDERS WELCOME —

WE SHIP ANYWHERE IN CANADA.

553 QUEEN ST. W.

TORONTO M5V 2B6 364-5058 364-5738
SALES SERVICE



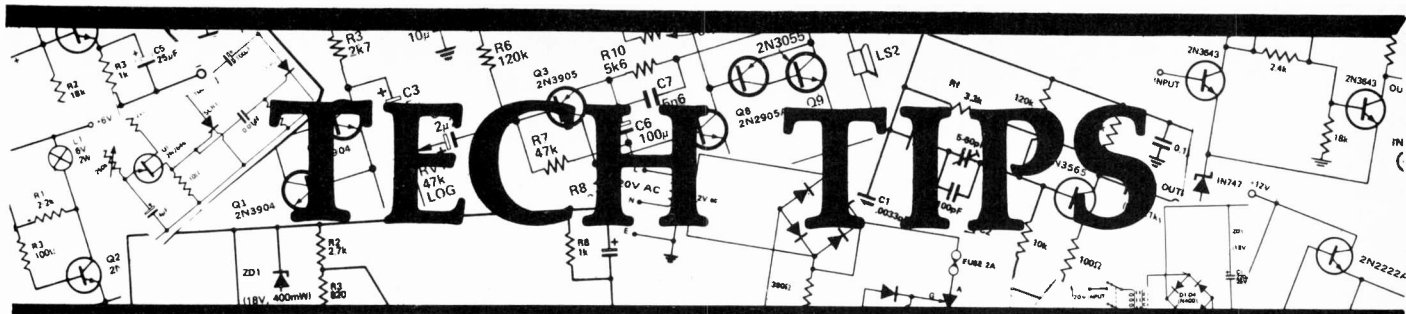

TECH TIPS

Sound To Light Modulator

Modulating a light, or a bank of lights, from a sound source (such as a tape recorder or record player) is an ever-popular topic so we dragged this circuit from the depths of our files.

A high impedance input is provided by a source-follower, Q1, so that the unit may be driven from either a high or low impedance source. An op-amp (a 741) then provides sufficient gain to trigger the SCR which drives the LED. As the input varies, the drive to the LED will vary, modulating the light output. Each 'Section' (1,2,3...) drives a LED, all the LEDs being mounted in a row.

When setting up, RV1 and RV2 are adjusted so that with the maximum input voltage available, 1 V is available at pin 6 of the op-amp. Then VRX is adjusted so that the LED lights. Then Section 2 is tackled; adjust VRX for that section so that its LED lights with 0.9 volts at pin 6 of the 741. Continue

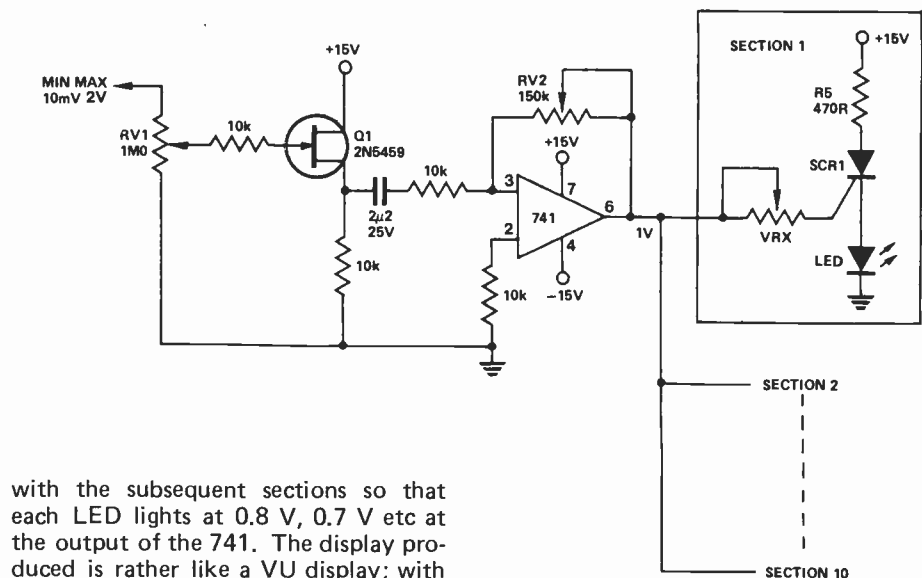

with the subsequent sections so that each LED lights at 0.8 V, 0.7 V etc at the output of the 741. The display produced is rather like a VU display; with the column lighting up as the sound rises and falls.

Current-Sharing For Diodes

G. Bundell

The current handling capacity of a diode can be increased by adding a second diode in parallel. However no two diodes have exactly the same characteristics. This will result in one of the diodes taking more than its share of the current and destroying itself.

If a small value resistor is put in series with each of the diodes the effect of differing junction resistance will be swamped by the external resistor and the current will divide equally between the diodes. The resistors should be selected for a one volt peak drop across them and, at one amp, would require a one ohm one watt resistor.

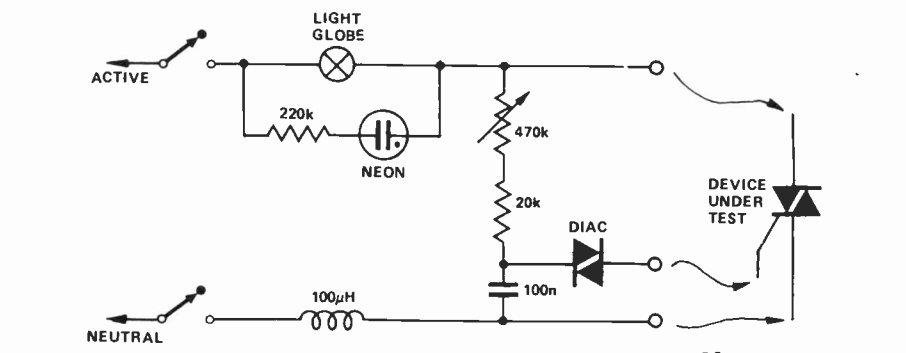
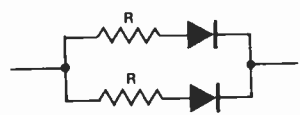

Triac Tester

K. Benson

This circuit was made to fill a need to quickly test triacs under a light load. By observing the neon it is possible to tell whether ac or dc is flowing through the lightbulb. The device to be tested is connected to the circuit with clip leads and the 470k potentiometer advanced until the globe lights. If the neon glows on both stalks the bulb is fed with ac and the triac is working properly. If one stalk only glows, one cycle of the

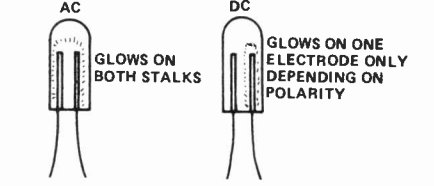

waveform is passing through the globe signifying a fault with one junction of the triac. Of course, if it doesn't glow at all and the light is not lit, the triac is completely faulty.



**WALLPAPER
FOR YOUR
BOD !!!**

ETI T shirts do not require pre-pasting. They are dry strippable, and easily removed when it comes time to slip into that casual aardvark hide trench coat you got for Christmas. They cover a multitude of imperfections, such as peeling paint, graffiti, rust spots, bullet holes, green chest hair, and other little embarrassments.

They can be obtained by sending \$5.50 plus P.S.T. if you live in Ontario, to:

ETI T-Shirts
Unit 6, 25 Overlea Blvd.,
Toronto, Ontario,
M4H 1B1

SAVE FULLY GUARANTEED

74XX	74123	1.17	40XX	
7400	74150	1.83	4000	.51
7401	74193	1.54	4001	.51
7402	74196	1.59	4010	.89
7405			4011	.51
7410	74LSXX		4013	.89
7411	74LS00	.50	4016	.99
7417	74LS02	.50	4017	1.99
7432	74LS04	.57	4023	.51
7437	74LS08	.54	4024	1.51
7440	74LS10	.50	4049	.89
7445	74LS32	.62		
7447	74LS74	.77	LINEAR	
7451	74LS86	.94	LM301	.44
7472	74LS109	.77	741CN	.65
7473	74LS136	.85	LM747	.91
7474	74LS367	1.20	NE555	.65
7486	74LS368	1.20	LM340T-5	2.29
7490			LM340T-12	2.29
7492			LM340T-15	2.29

Solder Tail		Wire-Wrap	
8 pin	.15	8 pin	.39
14 pin	.22	14 pin	.42
16 pin	.23	16 pin	.49
20 pin	.35	20 pin	.99
28 pin	.45	28 pin	1.75
40 pin	.65	40 pin	2.49

Resistor 1/2 watt 5%----- .21/5
NEON LAMP NE-2----- .29

Many more IC's, Resistors, Capacitors, Diodes, Switches, heat sinks and Hardware on STOCK

ASK FOR YOUR FREE CATALOG

PHONE ORDERS: (418) 839-8367
Send your cheque, M.O., VISA or COD.
NO Shipping Charge. Minimum order:
\$5.00. Quebec Resident add 8% PST.

SELCO CASE POSTALE 2036
ELECTRONIQUE ST-ROMUALD
QUEBEC, G6W-5M3

Circle No. 17 on Reader Service Card.

You've heard OAKTRON...



...more than you've heard of OAKTRON

Over the past 25 years, you may have heard more Oaktron speakers than any other single brand — without knowing it.

If you've added a custom sound system to your car, you may be hearing Oaktron every time you drive. Oaktron has made speakers for most of the well-known U.S. manufacturers and installers of audio products. You've heard Oaktron in cars, living rooms, airports and theaters — and you've liked what you heard.

We'd like you to get to know our speakers. Call us for the name of your nearest dealer or drop in and hear them at:

Represented in Canada by:
omnitronix Ltd.
2056 Trans Canada Hwy. Unit 7, 6295 Shawson Dr.
Dorval, Quebec Mississauga, Ontario.
H9P 2N4 L5T 1H4
(514) 683-6993 (416) 678-7170
Telex: 05-822692 Telex: 06-968653



For further information circle No. 2 on Reader Service Card.

Dealer inquires invited.

ETI — MAY 1981

Accurate in RF fields!

B&K-PRECISION portable and lab DMM's

For field or lab applications, your DMM should stay accurate—even in the presence of strong RF fields. Most DMMs can't pass this test, but the B&K-PRECISION 2830 lab DMM and the 2810 portable DMM easily meet the challenge.

In addition, both of these instruments feature 3½ digit readout, 0.5% DC accuracy, auto-zeroing/auto polarity, selectable high-/low power ohms and really complete overload protection. Special features of each include:



Model 2830—\$235

- AC operation; battery pack optional
- 100 μ V, 100nA, .01 Ω resolution
- Reads to 20 amps
- Push button range and function selection
- 0.5" high efficiency LED display

Model 2810—\$130

- Battery operation standard
- 100 μ V, .01 Ω resolution
- AC charger optional
- Bright 3" LED display



BK PRECISION
DYNASCAN
CORPORATION

Represented and stocked in Canada by:
Atlas Electronics Limited
50 Wingold Avenue, Toronto, Ontario
M6B 1P7 Tel: (416) 789-7761
Telex: 065-24140

Electronique Atlas Ltée.
970 Montee De Liesse, Ste 202
St. Laurent, Quebec, H4T 1W7
Tel: (514) 337-5260, Telex: 05-824695

Circle No. 19 on Reader Service Card.

DYNAMIC Sound and Components®

Division of Inouye Enterprises Limited

87 Green Lane, Unit 12, Thornhill Ontario L3T 2A1

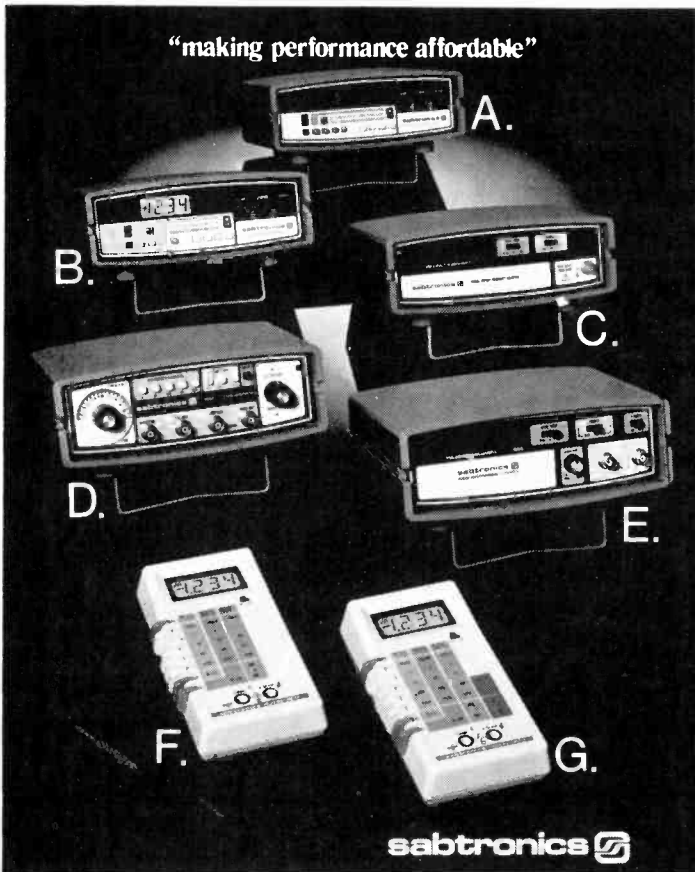

"making performance affordable"

Model	Description	Kit	Assemble
2035A	LCD hand held DMM	\$126.00	\$159.00
2037A	LCD hand held DMM/ Thermometer with probe	\$159.00	\$194.00
2010A	LED bench DMM	\$134.00	\$191.00
2015A	LCD bench DMM	\$159.00	\$239.00
8110A	100 MHz Frequency counter	\$126.00	\$161.00
8610A	600 MHz 8 digit Frequency counter	\$159.00	\$209.00
8610B	600 MHz 9 digit Frequency counter	\$191.00	\$239.00
8000B	1 GHz Frequency counter	N/A	\$339.00
5020A	Function Generator .2 to 200KHz	N/A	\$184.00

Accessories Model	Description	Price
THP-20	Touch and Hold Probe	\$ 34.00
AC-115	AC Adapter	\$ 14.75
HVP-30	30 KV DC High Voltage Probe	\$ 59.75
NiCd	Nickel Cadmium Battery Set	\$ 29.75

Dealers welcome. Please Call Dean Stuart for further information. Please include \$6.75 for shipping and handling charges per instrument.

Prices Subject To Change Without Notice.

A - 2010A	B - 2015A	8110A, 8610B, and Acc.
C - 8610A	D - 5020A	Not Shown.
E - 8000B	F - 2035A	
G - 2037A		

(Above prices are FST inclusive)

TIMEPIECE AND BALL POINT PEN COMBINATION MODEL SP-05 PEN WATCH

- * 3½ digits 5 functions (Hour, Minute, Second, Month, Date)
- * Quartz crystal 32768 Hz
- * 4-year permanent calendar
- * Single silver oxide battery U.C.C. 392 or equivalent
- * 2-section slim stainless steel barrel.
- * parker® refill useable
- * \$29.95 PLUS 7% PST (if applicable)



Polystyrene Capacitors: Excellent for audio use, 2.5% tolerance, axial leads. All @ 63 volts.

100pf, 120pf, 150pf, 180pf, 220pf, 270pf, 330pf, 390pf, 470pf, 560pf, 680pf, 820pf, 1000pf, 1200pf, 1500pf, 1800pf, 2200pf, 2700pf, 3300pf, 3900pf, 4700pf, 5600pf, 6800pf, 8200pf, 10000pf, .01uf, .011uf, .012uf, .013uf, .015uf, .016uf, .018uf, .02uf, .022uf, .024uf, .027uf, .03uf, .033uf, .036uf, .039uf, .043uf, .047uf, .051uf, .056uf, .062uf, .068uf, .075uf, .082uf, .091uf, .1uf.

No Minimum order required on Capacitors

100 - 1000pf \$ 16.43 for 100 or 18¢ each
1200 - 1500pf \$ 17.33 for 100 or 19¢ each
1800 - 2200pf \$ 18.45 for 100 or 21¢ each
2700 - 4700pf \$ 25.20 for 100 or 28¢ each
5600 - 6800pf \$ 26.10 for 100 or 29¢ each
8200pf - .1uf \$ 28.58 for 100 or 32¢ each

Dipped Solid Tantalum Capacitors

- Radial Leads, all @ 35 volt.
.1uf \$ 31.19 for 100 or 36¢ each
33uf \$ 31.19 for 100 or 36¢ each
1uf \$ 33.08 for 100 or 38¢ each
2.2 \$ 44.42 for 100 or 51¢ each
3.3uf \$ 51.98 for 100 or 59¢ each
4.7uf \$ 80.64 for 100 or 92¢ each
6.8uf \$ 102.38 for 100 or \$1.17 each
10uf \$ 160.65 for 100 or \$1.84 each

Electrolytic Capacitors:

1uf @ 50 V. \$ 14.03 for 100 or 20¢ ea.
4.7uf @ 35 V. \$ 14.03 for 100 or 20¢ ea.
2.2uf @ 50 V. \$ 14.03 for 100 or 20¢ ea.
10uf @ 25 V. \$ 14.03 for 100 or 20¢ ea.
10uf @ 50 V. \$ 14.44 for 100 or 21¢ ea.
22uf @ 50 V. \$ 20.21 for 100 or 29¢ ea.
47uf @ 50 V. \$ 21.18 for 100 or 31¢ ea.
100uf @ 50 V. \$ 46.75 for 100 or 68¢ ea.
220uf @ 35 V. \$ 51.01 for 100 or 74¢ ea.
470uf @ 50 V. \$ 72.01 for 100 or \$1.23 ea.
1000uf @ 35 V. \$ 77.53 for 100 or \$1.33 ea.
2200uf @ 50 V. \$247.98 for 100 or \$4.25 ea.

All Electrolytics have radial leads except the 2200uf @ 50 volt which has axial leads.

Potentiometers: Smooth quiet rotary pots, pc terminals with 3/8 standard threaded bushing.

(Audio) Log Taper: 25K, 50K, 100K single \$ 1.56 ea.
25K, 50K, 100K dual \$ 5.32 ea.

Linear Taper: 10K, 25K, 50K, 100K, 250K, 500K, 1M single \$ 1.56 ea.
10K, 50K, 100K, 500K, 1M dual \$ 5.32 ea.

60 mm Slide Potentiometers: Controls glide smoothly and quietly, pc pins. Approx. 2.3/8 inch long.

(Audio) Log Taper: 50K, 100K \$ 2.78 each
Linear Taper: 10K, 25K, 50K, 100K \$ 2.78 each

1/4 watt carbon film resistors: 10, 47, 56, 68, 100, 120, 150, 220, 270, 330, 390, 470, 560, 680, 750, 1K, 1.2K, 1.5K, 1.8K, 2.2K, 2.7K, 3.3K, 3.6K, 3.9K, 4.7K, 5.6K, 6.8K, 8.2K, 10K, 12K, 15K, 18K, 22K, 27K, 33K, 36K, 39K, 47K, 56K, 68K, 100K, 120K, 150K, 180K, 220K, 270K, 330K, 470K, 560K, 680K, 1M.

5% tolerance 10 ohm - 1M minimum quantity of 10 of same value 30¢ for 10
100 of same value \$2.50 for 100.
1000 of same value \$20.00 for 1000

1/4 watt carbon film resistors: 1.2M, 1.8M, 2.2M, 3.3M, 4.7M, 5.6M, 6.8M, 10M.

10% tolerance 1.2M - 10M minimum quantity of 10 of same value 42¢ for 10
100 of same value \$3.50 for 100.
1000 of same value \$28.00 for 1000

1% Precision Metal Film 1/4 Resistors: Low thermal noise, excellent for audio use. All industry standard values available, over 600 different values to choose from.

Special Order Item, allow 1-2 weeks delivery. Minimum order 100 @ \$ 9.80 for 100
1000 @ \$78.40 for 1000

T.N.I.P. (Taxes Not In Price)

All items T.N.I.P. (Taxes not in price) Federal Sales Tax @ 9% if exempt supply type written or stamped P.O.

Provincial Sales Tax, Ontario residents please add P.S.T. @ 7% if exempt supply tax exemption form.

Please add 5% for postage and handling minimum \$2.00 excess will be refunded.

To speed delivery enclose certified cheque, money order, Visa or mastercharge (include signature, expiry date, card number and bank name.) Personal cheques allow 1-2 weeks delivery. Dealers welcome.

Prices subject to change without notice.

DYNAMIC SOUND AND COMPONENTS, division of Inouye Enterprises Limited, 87 Green Lane,

Unit 12, Thornhill, Ontario, L3T 2A1. (416) 886-1070/71

FREE GIFT pack (\$5.00 Value) of assorted prime components and or controls, switches etc. will be mailed to you with your order if it is any one of the first ten mail orders received. Minimum order is \$10.00.

Audio Display

C.S. Histed

This circuit is a novel LED display, which when plugged into your hi-fi will send a dot of light zooming around a ring of LEDs at different speeds, depending on the music. The input signal from your hi-fi is fed into a voltage controlled oscillator (IC1), which then sends its variable length pulses to the clock input of a 4017.

This causes each LED in turn to be briefly lit and, because the clock input changes, the time taken for the dot of light to move along the LEDs varies in time with the music. The best visual output is achieved if the LEDs are arranged in a circle of about 1½" to 2" in diameter.

The input voltage can be adjusted by the 100k preset and the normal speed of the leds can be adjusted as desired using the 2M2 preset. The 4017 is able to drive the LEDs directly and no current limiting resistors are needed.

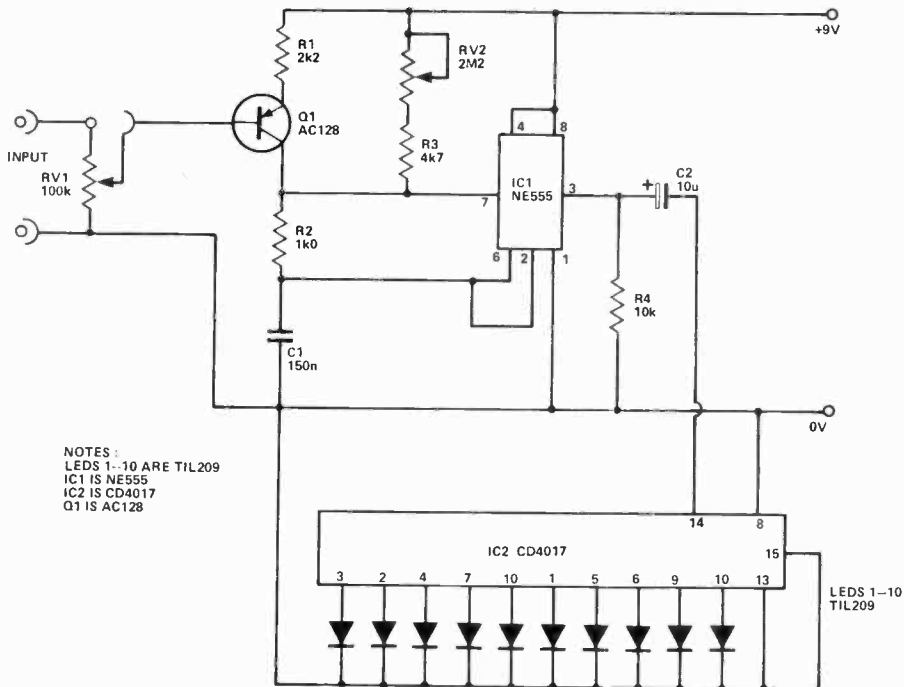

JENSEN

— best prices —
— speakers - decks —

PAY NO SALES TAX.

Alberta Audio

1107 73rd. Ave. S.W., Calgary, Alberta T2V 0R9
(403) 252-1038

Circle No. 30 on Reader Service Card.

A Switch Hit

Compact, High Quality, Switchcraft "DW" Multiple Station Push-button Switches with 1-18 stations available illuminated or non-illuminated. Four locking functions. Multiple-row arrays. Buttons on 5/16" centers. All the facts are in free Product Bulletin S-325.

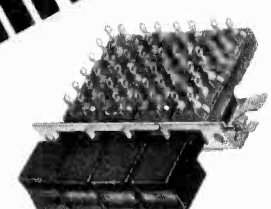

Represented and stocked in Canada by:
Atlas Electronics Limited
50 Wingold Avenue
Toronto, Ontario M6B 1P7
Telephone: (416)-789-7761
Telex: 065-24140
Electronique Atlas Ltée.
970 Montee De Liesse, Ste 202
St. Laurent, Quebec H4T 1W7
Telephone: (514)-337-5260
Telex: 05-824695

SWITCHCRAFT®

Circle No. 29 on Reader Service Card.

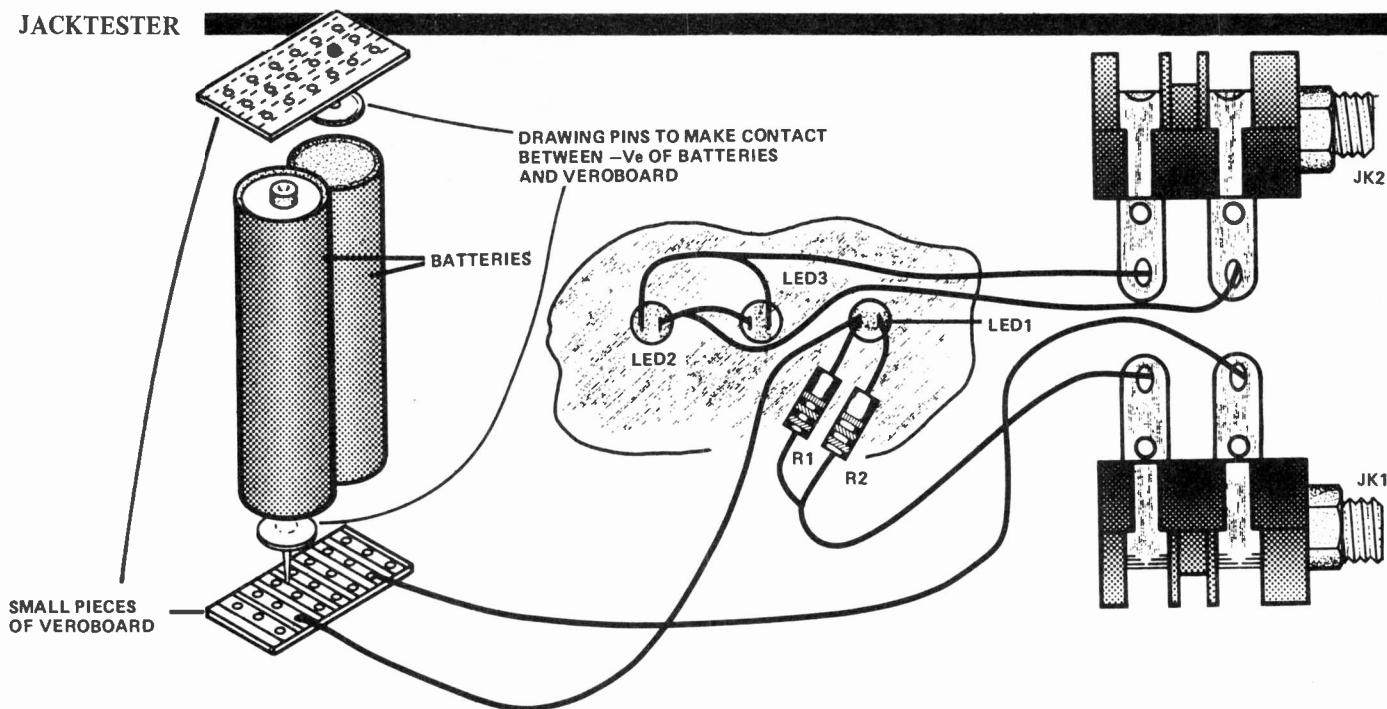

Fig. 2. Connection details — note that we have used neither PCB nor Veroboard to construct the circuit!

HICKOK MX SERIES DMM's

World's Fastest Troubleshooters



MX333 \$ 295.00

MX331 \$ 199.00

Compact size, unique shape and easy-to-read-from-almost-any-angle sloped display facilitates use as a hand held, bench top or belt mounted instrument.

VARI-PITCH, audible signal on MX333 provides instant indication of the resistance, voltage or current measured for quick and easy troubleshooting. The audible response is instantaneous and proportional to the reading.

- 0.1% Basic Accuracy
- LCD Display In Unique Wide Vue Case
- Uses Single 9V Battery
- Compact Size. Rugged Construction
- Superior Overload Protection
- Exclusive VARI-PITCH Audible Output (MX333)
- Fast LOGI-TRAK Logic Function (MX333)
- 20Ω Range (MX333)

LOGI-TRAK function on MX333 combines the features of a high performance logic probe and voltmeter in one convenient function. Use any 10:1 high frequency scope probe to measure all logic signals and DC voltages from 10mV to 20V. Audible tone output identifies logic Hi's, Lo's, pulses as narrow as 5 nsec as well as marginal and faulty logic states and pulse trains.

Duty and FST included. Charge (Visa) accepted. Ont. res. add 7% sales tax. Shipping Extra.

ROGERS electronic instruments Ltd.

P. O. Box 310, 595 Mackenzie Avenue Units 1 & 2
Ajax, Ontario L1S 3C5 Tel. (416) 683-4211

CONDENSED SPECIFICATIONS: MX331 and MX333
DC VOLTS (5 RANGES): 200mV to 1000V full scale, RESOLUTION: 0.1mV, ACCURACY: ± 0.1% + 1 digit, INPUT IMPEDANCE: 10MΩ, OVERLOAD PROTECTION: 1000V DC or peak AC + up to 6kV transients all ranges

AC VOLTS (5 RANGES): 200mV to 1000V full scale, RESOLUTION: 0.1mV, ACCURACY: ± 1% + 2 digits, 45 Hz to 1kHz, ± 5% + 5 digits to 5 kHz, INPUT IMPEDANCE: 10mΩ, OVERLOAD PROTECTION: 1000V DC/750 RMS.

RESISTANCE (7 RANGES): 20Ω to 20MΩ full scale except no 20Ω range on MX331, RESOLUTION: 0.01Ω on MX333, 0.1Ω on MX331, ACCURACY: 0.1% + 1 digit except 0.2% on 200Ω, 1% on 20MΩ, and 3% on 20Ω ranges. OVERLOAD PROTECTION: 500V DC on RMS all ranges plus 2A fuse on 20Ω range. TEST VOLTAGE: Low power, 0.25V max of full scale.

DIODE TEST (1 RANGE): Measures forward voltage drop across diode and transistor junctions at 2mA nominal current.

AC/DC CURRENT (5 RANGES): 2mA to 10A full scale, RESOLUTION 1μA, ACCURACY: ± 1.2% + 1 digit DC, ± 2.5% + 1 digit AC, OVERLOAD PROTECTION: 250V @ 2A all ranges except 10A, max 15A on 10A range.

VARI-PITCH (MX333 ONLY): Variable pitch proportionate to reading, off at open circuit. Increasing frequency as resistance approaches "0" on ohms function. Increasing frequency as input increases on volts and current functions. RESPONSE: Instantaneous (less than 100 msec.)

LOGI-TRAK (MX333 ONLY): 0-20V range using Hickok SP-7 (not incl.) or other 10:1 scope probe. HI/LO INDICATION High or low audible tone. PULSE INDICATION: Audible "chirp" plus lighted colon on display. MIN PULSE WIDTH: 5 nsec typical, MAX FREQUENCY: 80 MHz, ACCURACY ± 0.25% + 1 digit + probe accuracy INPUT IMPEDANCE 10MΩ, INPUT PROTECTION: 300V DC or RMS

GENERAL: Dimensions: 2.2 x 6.7 x 6 in. (5.6 x 17 x 15.2 cm), Weight, 22 oz (7kg); Power, 9V battery (incl) or Hickok AC adapter, Battery Life: 200 Hrs. typical, Temperature, 0-50°C operating, -35 to +60°C storage. INCLUDES Deluxe safety test leads, battery, manual and belt clip.

ACCESSORIES

SP-7 10:1 Divider Probe for Logi-Trak Input	\$54.00
TP-20 (C or F) Temperature Probe	\$72.50
VP-14 RF Probe (0.25V to 40V rms)	\$55.50
VP-40 40KV DC Probe (0 to 40KVDC)	\$63.00
CC-4 Deluxe Vinyl Carrying Case	\$21.75
RC-3 AC Adapter	\$13.50

Circle No. 18 on Reader Service Card.

You can't beat The System!

GLOBAL SPECIALTIES CORPORATION
Smarter tools for testing and design.

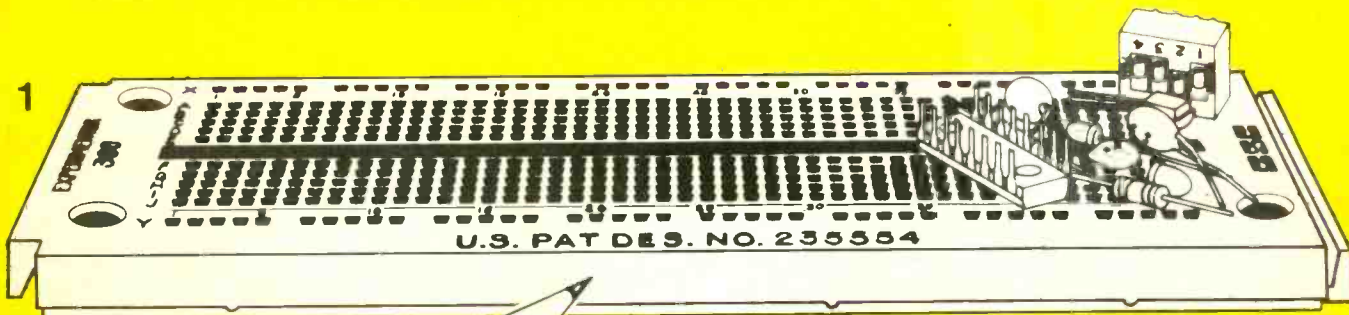

1
Experimenter solderless breadboard

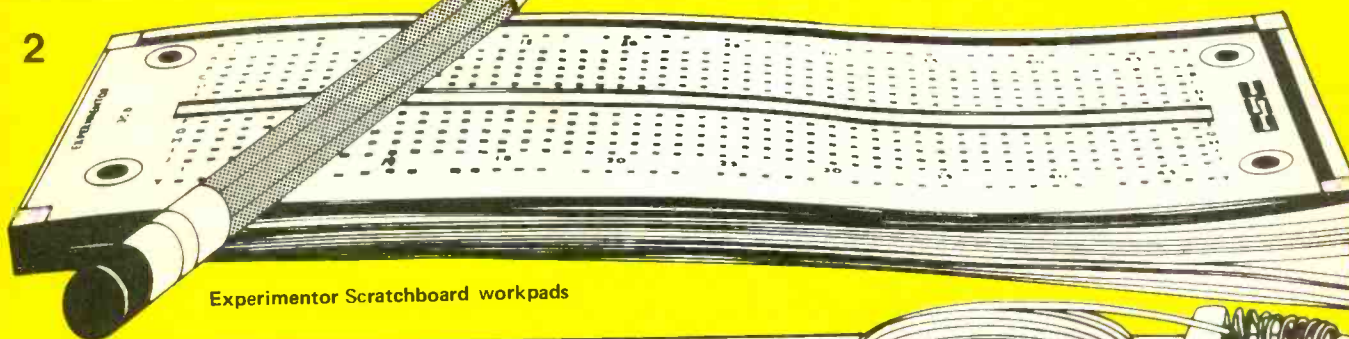

2
Experimenter Scratchboard workpads

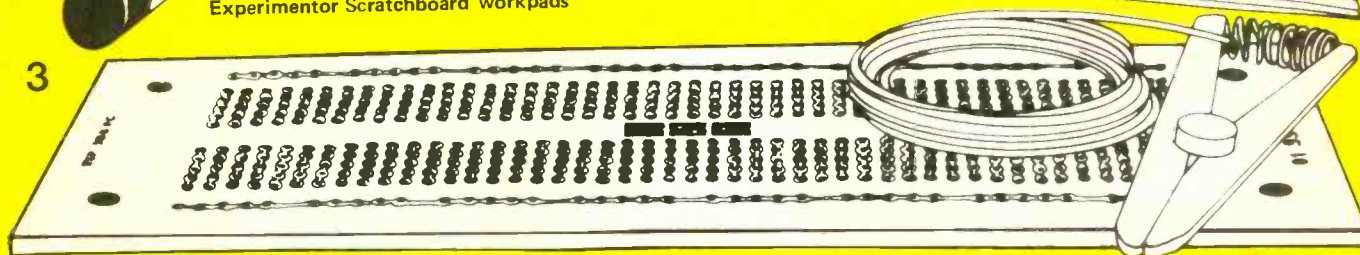

3
Experimenter Matchboard pre-drilled PCBs.

When you have a circuit idea that you want to make happen, we have a system to make it happen quicker and easier than ever before: The Experimenter System.

You already know how big a help our Experimenter solderless breadboards can be. Now we've taken our good idea two steps further.

We've added Experimenter Scratchboard workpads, with our breadboard hole-and-connection pattern printed in light blue ink. To let you sketch up a layout you already have working so you can reproduce it later.

With Experimenter Matchboard you can go from breadboard to the finished product nonstop! We've matched our breadboard pattern again, this time on a printed circuit board, finished and ready to build on. All for about \$4.25.

There's even a letter-and-number index for each hole, so you can move from breadboard (where they're moulded) to Scratchboard (where they're printed) to Matchboard (where they're silkscreened onto the component side) and always know where you are.

When you want to save time and energy, you can't beat the Experimenter System.

THE EXPERIMENTOR SYSTEM

Circle No. 13 on Reader Service Card.

YOU CAN'T BEAT THE SYSTEM!

1	EXP-300PC which includes one item A Matchboard pre-drilled PCB	\$4. ²⁵
2	EXP-302, which includes three items Three 50-sheet Scratchboard workpads	\$5. ²⁰
3	EXP-303 which includes three items Two Matchboards and an EXP-300 solderless breadboard	\$25. ¹⁵
4	EXP-304, which includes four items Two Matchboards, an EXP-300 breadboard and a Scratchboard workpad	\$26. ⁷⁰

For your **FREE** Global Catalogue, mail this coupon to:

len finkler limited

80 Alexdon Rd. Downsview, Ontario, M3J 2B4

Please send catalogue to:

Name _____ Position _____

Company _____ Dept. _____

Address _____

_____ Postal Code _____

Circle No. 13 on Reader Service Card.

Available from leading Electronic Parts Distributors

TTL

Table listing various TTL chips such as 7400N, 7401N, 7402N, etc., with their part numbers and prices.

Zilog

Table listing Zilog microprocessors and related chips like Z80-CPU, Z800A-CPU, etc., with specifications.

MOS Memories table listing MOS Static RAM's with Part No., configuration, and Price.

UART's table listing AY5-1013A and other UART chips with specifications.

Shift Registers table listing 1403A (TO-5) and other shift registers.

CMOS table listing Rockwell AIM 65 and other CMOS microprocessors.

CMOS table listing various CMOS chips like CD4001BE, CD4002BE, etc., with prices.

Super Special Voltage Regulators table listing 7800K series and other regulators.

Plastic Power Transistors table listing TIP29A, TIP141, TIP122, etc., with prices.

COMPUTER SUPPORT CENTER

MICROPROCESSOR CHIP SETS

Table listing microprocessor chip sets like 8035 CPU, 8039 CPU, etc., with prices.

EPROM'S

Table listing EPROM chips like C1702A, 2K 1U5, etc., with prices.

PROM'S

Table listing PROM chips like 74S288, 74S289, etc., with prices.

16K STATIC RAM

Table listing 16K static RAM chips like TMM2016-3, etc., with prices.

ECL RAM

Table listing ECL RAM chips like 10410ADC/HM2106, etc., with prices.

LINEAR I.C.'s

Table listing linear ICs like LM310AN-8, LM307N-8, etc., with prices.

OPTOELECTRONICS

Table listing LED209, LED211, LED212, etc., with prices.

DUAL IN-LINE LOW PROFILE I.C. SOCKETS

Table listing dual in-line low profile IC sockets with prices.

DISPLAYS

Table listing displays like FND357, FND500, etc., with prices.

ANNOUNCING 1981 IC MASTER NOW TWO FULL VOLUMES OF PRODUCT DATA

- List of products including integrated circuit data selector, development systems, and isolation systems.

ALPHANUMERIC

Table listing alphanumeric displays like ILD74, ILCT6, etc., with prices.

SCR'S and TRIAC'S

Table listing SCR and TRIAC chips like C106D, TIC44, etc., with prices.

Bi-Fet OP AMPS

Table listing Bi-Fet OP AMPS like TL062CP, TL064CN, etc., with prices.

METAL CAN TRANSISTORS

Table listing metal can transistors like 2N404A, 2N697, etc., with prices.

SMALL SIGNAL TRANSISTORS

Table listing small signal transistors like 2N2904, 2N3055, etc., with prices.

MINIMUM MAIL ORDER \$10.00. Add \$3.00 to cover postage and handling. PRICES ARE IN CDN. FUNDS. F.O.B. CANADA.

LARGE INVENTORY AT ALL LOCATIONS. STORE HOURS: Monday to Thursday 9:00 am - 6:00 pm.

VISA AND MASTER CHARGE ACCEPTED.



6651 FERRIER ST. MONTREAL, QUEBEC H4P 2K5. Tel: (514) 731-7441

4800 DUFFERIN ST. DOWNSVIEW, ONTARIO M3H 5S9. Tel: (416) 661-1115

5809 MacLEOD TRAIL S. UNIT 109. CALGARY, ALBERTA T2H 0J9. Tel: (403) 259-6437

30 KINGSWAY. VANCOUVER, B.C. V6R 5J7. Tel: (604) 438-3321