

# Student Manual

WIRING  
AND REPAIR

**COYNE**  
ELECTRICAL AND  
RADIO-TELEVISION  
**SCHOOL**  
CHICAGO 12, ILLINOIS

Page  
52  
Chicago  
Illinois

Copyright 1950 by  
COYNE ELECTRICAL SCHOOL  
500 So. Paulina Street  
Chicago 12, Illinois

## F O R E W O R D

This manual contains basic technical and practical information based on the curriculum outline for the Wiring & Repair Department of this school. The subject matter covered in this manual is necessary information that the student must learn in order to master the jobs that will be presented in this department and in following departments.

The purposes of this instructional manual are as follows:

1. To provide a guide for the student in his class and shop work.
2. To supply information in outline form to which the student may add supplemental notes in his own words as the different points are explained by instructors.
3. To service as a reference both to the student in school and to the graduate after he enters the field.

Appreciation is extended to the Testing & Repair personnel and to the entire faculty for developing the material for this manual.

B. W. Cooke,  
President

## ACKNOWLEDGMENTS

We wish to acknowledge and express our appreciation for the assistance and co-operation given by the following companies in supplying data and illustrations for the preparation of this manual.

AEROVOX CORPORATION  
ALLIS CHALMERS CO.  
AMERICAN INSTITUTE ELECTRICAL ENGINEERS  
AMERICAN STANDARDS ASSOCIATION  
BENDIX AVIATION CORP. (Scintilla Magneto Div.)  
BODINE ELECTRIC CO.  
BUSSMAN MANUFACTURING CO.  
DRIVER HARRIS CO.  
FAIRBANKS MORSE CO.  
FISKE BROTHERS REFINING CO.  
GENERAL ELECTRIC CO.  
GENERAL MOTORS CORP.  
HOBART BROTHERS CO.  
ILG ELECTRIC VENTILATING CO.  
JOHNSON BRONZE CO.  
LITTLE FUSE CO.  
MANNING BOWMAN CO.  
MINNEAPOLIS HONEYWELL CO.  
M.R.C. BALL BEARING CO.  
NATIONAL BOARD FIRE UNDERWRITERS  
NATIONAL ELECTRICAL MANUFACTURERS ASSOCIATION  
C. E. NIEHOFF AND CO.  
PEARSAL APPLIANCE CO.  
SEARS ROEBUCK CO.  
SIMPSON ELECTRIC CO.  
SQUARE -D- CO.  
THE ELECTRIC AUTO-LITE CO.  
UNDERWRITERS LABORATORIES INC.  
WESTINGHOUSE ELECTRIC & MFG. CO.  
WESTON ELECTRICAL INSTRUMENT CORP.  
WICO ELECTRIC CO.

T A B L E O F C O N T E N T S

LESSON NO.	PAGE NO.
1. DC-AC Fundamentals - Testing - - - - -	1
2. The Coyne Multimeter - - - - -	19
3. Push-Button Stations - - - - -	30
4. Refrigerator Controls & Electrical Circuits - - - - -	33
5. Motor Starting Capacitor - - - - -	41
6. National Electrical Code - - - - -	51
7. Contracting and Estimating - - - - -	65
8. Old House Wiring - - - - -	73
9. Electricity on the Farm - - - - -	83
10. Electrical Appliances - - - - -	97
11. Single-phase Motors - - - - -	107
12. Vacuum Cleaner Motors - - - - -	124
13. Bearings - - - - -	137
14. Magnetos - - - - -	147
15. Magneto Testing - - - - -	155
16. Automatic Furnace Controls - - - - -	161
17. Fan Motors & Speed Controls - - - - -	178
18. Insulation Resistance Testing - - - - -	187
19. Electrically Heated Appliances - - - - -	208
20. Tools and Micrometers - - - - -	219
Table of Contents - Job Section - - - - -	227

## DC-AC FUNDAMENTALS - TESTING

Objectives

1. To learn the fundamentals of d-c and a-c power.
2. To learn how to use testing instruments.

References:Lesson Content

D-c power is required for telephones, lifting magnets, electro plating work, etc. The characteristics of d-c motors make them especially suitable for loads that are difficult to start, where the speed must be varied over a wide range, and where the load must be started and stopped often; such as, traction work, milling machines, mine work, lathes, pumps, steel mill work, printing presses, elevators, etc.

Any d-c motor, Fig. 1, may be used as a d-c generator or any d-c generator may be used as a motor. The following construction information applies to both machines.

The frame, is made of iron because it is used to complete the magnetic circuit for the field poles. Frames are made in three types; open, semi-enclosed and closed types. The open frame has the end plates or bells open so the air can circulate freely through the machine. The semi-enclosed frame has a wire netting or small holes in the end bells so that air can enter but will prevent any foreign material entering the machine. The enclosed type frame has the end bells completely closed and the machine is air tight. Some machines are water tight which makes it possible to operate them under water. The closed type frame is used in cement plants, flour mills, etc., where the air is filled with dust particles that damage machine insulation.

The field poles are made of iron, either in solid form or built of thin strips called laminations. The iron field poles support the field windings and complete the magnetic circuit, Fig. 2, between the frame and armature core.

The bearings, Fig. 2, are the parts of the machine that fit around the armature shaft and support the weight of the armature. They are made in three general types; sleeve roller, and ball. Bearings will be discussed in detail later in the course.

The oil rings are small rings used with sleeve type bearings. They carry the oil from the oil well to the shaft. The oil ring must turn when the machine is operating otherwise the bearing will burn out.

The rocker arm supports the brush holders. This arm is usually adjustable to make it possible to shift the brushes to obtain best operation. When the brushes are rigidly fastened to the end bell the entire end bell assembly is shifted to obtain best operation.

Fig. 3.

The brush holders, support the brushes and hold them in the proper position on the commutator. The brushes should be spaced equi-distantly on the commutator when more than two sets of brushes are used. When only two sets are used they will be spaced the same distance as a pair of adjacent field poles. The brush tension spring applies enough pressure on the brush to make a good electrical connection between the commutator and brush.

Brushes used on electrical machines are made of copper, graphite, carbon or a mixture of these materials. The purpose of the brushes is to complete the electrical connection between the line circuit and the armature winding.

Commutators, Fig. 4, are constructed by placing copper bars or segments in a cylindrical form around the shaft. The copper bars are insulated from each other and from the shaft by mica insulation. An insulating compound is used instead of mica on small commutators. The commutator bars are soldered to and complete the connection between the armature coils.

The armature core is made of laminated iron (thin sheets) pressed tightly together. The laminated construction is used to prevent induced currents (eddy currents) from circulating in the iron core when the machine is in operation. The iron armature core is also a part of the magnetic circuit for the field, and has a number of slots around its entire surface, in which the armature coils are wound.

The armature winding is a series of coils wound in the armature slots and the ends of the coils connect to the commutator bars. The number of turns and the size of wire is determined by the size speed and operating voltage of the machine. The purpose of the armature winding is to set up magnetic poles on the surface of the armature core.

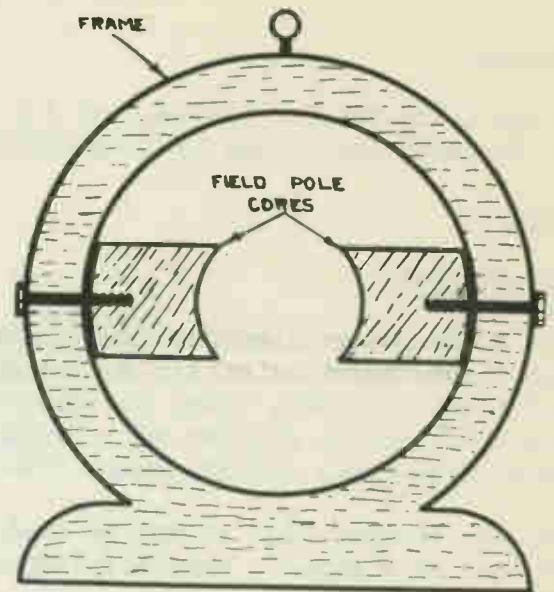

Fig. 1

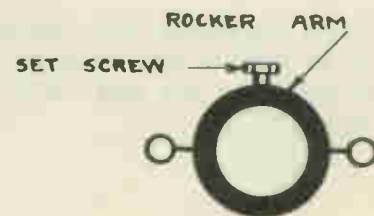
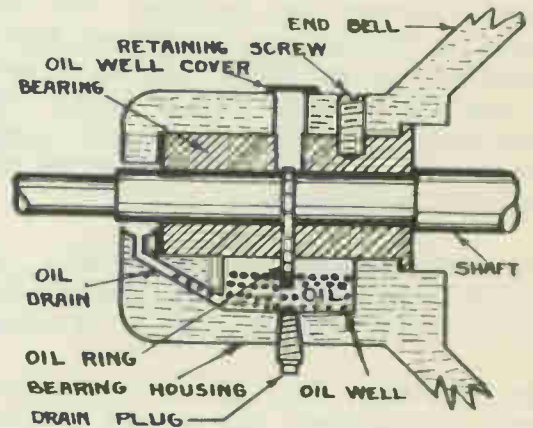

Fig. 2

The field windings are made in three different types; shunt, series and compound wound fields. Shunt fields have many turns of small wire and series fields have a few turns of heavy wire. The compound field is a combination of the two windings. The name of the field winding depends on the connection with respect to the armature winding. The purpose of the field winding is to produce magnetic poles that react with the armature poles to produce rotation.

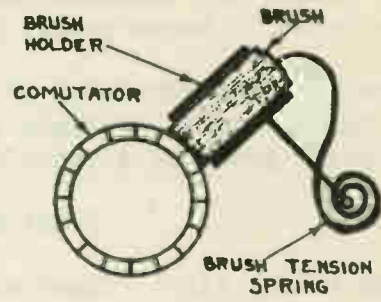

Fig. 3

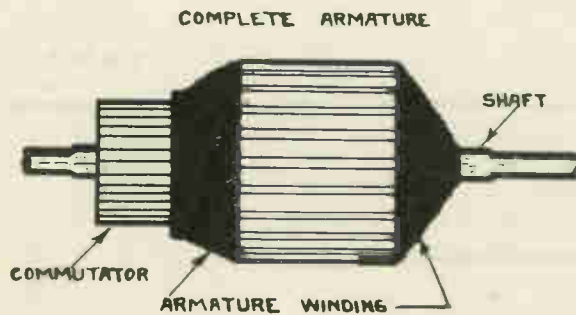
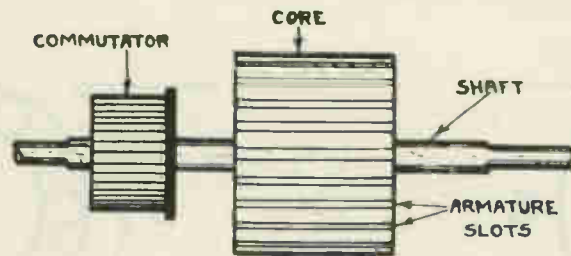
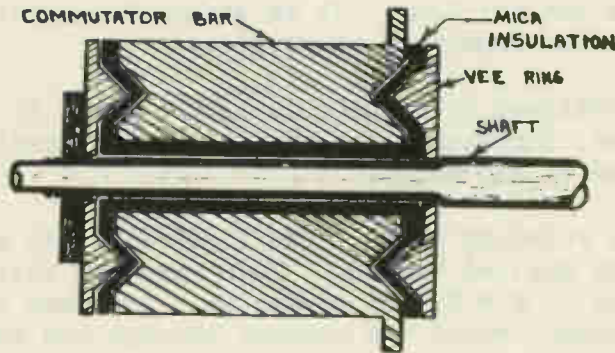

Fig. 4



## B. DC Motor Principles

Electric motors are machines that change electrical energy into mechanical energy. They are rated in horse power, HP.

The attraction and repulsion of the magnetic poles produced by sending current through the armature and field windings causes the armature to rotate. The armature rotating produces a twisting effort called torque.

## Fleming's Left Hand Rule For Motors

Place the thumb, first finger and remaining fingers at right angles to each other. Point the first, finger in the direction of the field flux, remaining fingers in the direction of the armature current and the thumb will indicate the direction of rotation.

The direction of rotation can be reversed on any d-c motor by reversing either the armature or field leads but not both. It is standard practice to reverse the armature leads to reverse the direction of rotation.

The amount of torque developed by a motor is proportional to the strength of the armature and field poles. Increasing the current in the armature or field winding will increase the torque of any motor.

The armature conductors rotating through the field flux has a voltage generated in them that opposes the applied voltage. This opposing voltage is called counter electro motive force, C E M F, It serves as a governor for the d-c motor. After a motor attains normal speed the current through the armature will be governed by the C E M F generated in the armature winding. This value will always be in proportion to the mechanical load on the motor.

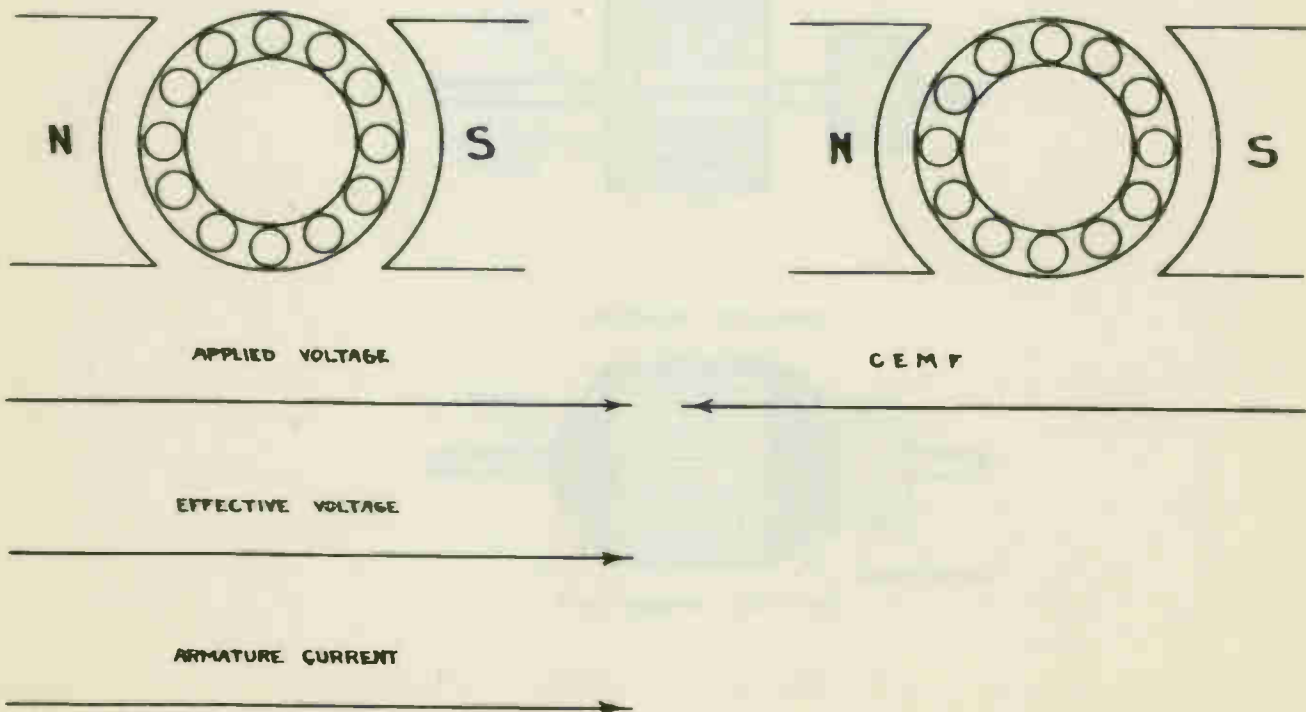

CONNECTIONS OF CIRCUITS

When two or more lamps are connected in a circuit, they may be connected in series or in parallel. In a series circuit, the current flows through each lamp in turn. In a parallel circuit, the current flows through each lamp independently of the others.



DC MOTORS AND GENERATORS

1. OPERATION

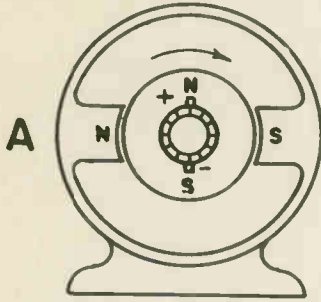

The d-c motor operates on the first law of magnetism which states that like poles repel and unlike poles attract. Current in the field coils produces the field poles, and current in the armature coils develops armature poles midway between the field poles. Attraction and repulsion between these two sets of poles produces rotation. Note that the armature poles remain stationary in space.

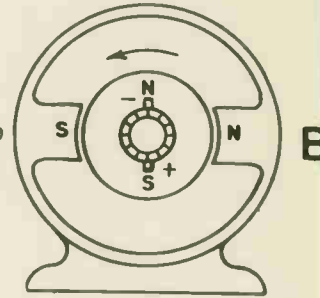

2. ROTATION

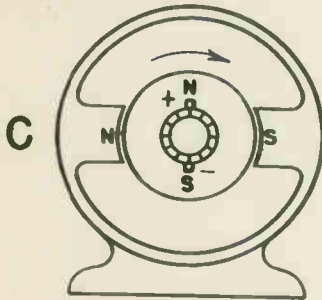

By reversing the direction of current through the fields or through the armature, the field poles or the armature poles will be reversed, and the direction of rotation changed. Compare A with B and C with D.

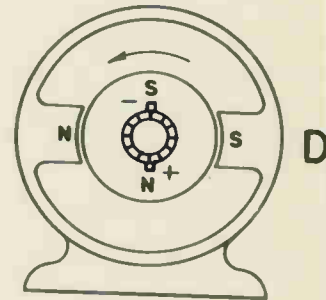

3. ARMATURE POLES

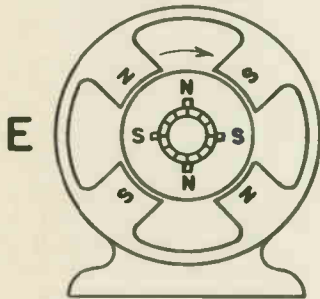

Diagrams E and F show a 4 pole motor. Note that the number of armature poles always equals the number of field poles, and that the armature poles are located midway between the field poles. From the above it is obvious that a 2 pole armature will not work in a 4 pole field. Note also that when the direction of current is reversed all poles are reversed.

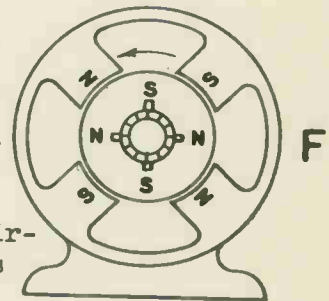

4. GENERATORS

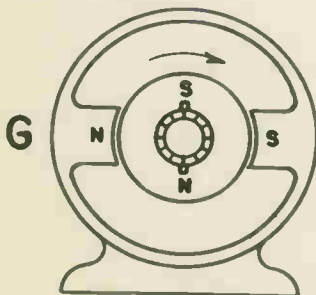

Diagrams G and H show two generators, one arranged for clockwise and the other for counter clockwise rotation. Note that poles are set up on the generator armatures also, but that in this case the poles oppose rotation. As more current is drawn from the armature, these poles increase in strength; this explains why an electric generator is harder to drive as the armature current increases.

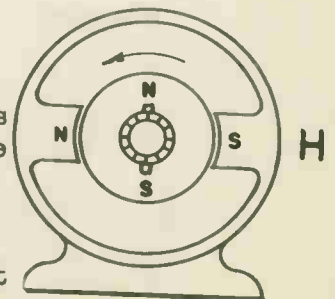

D. Fundamental Principles of AC.

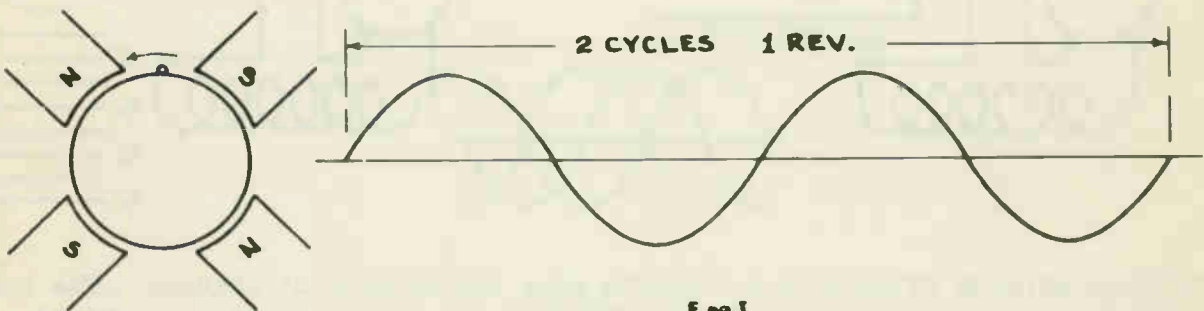
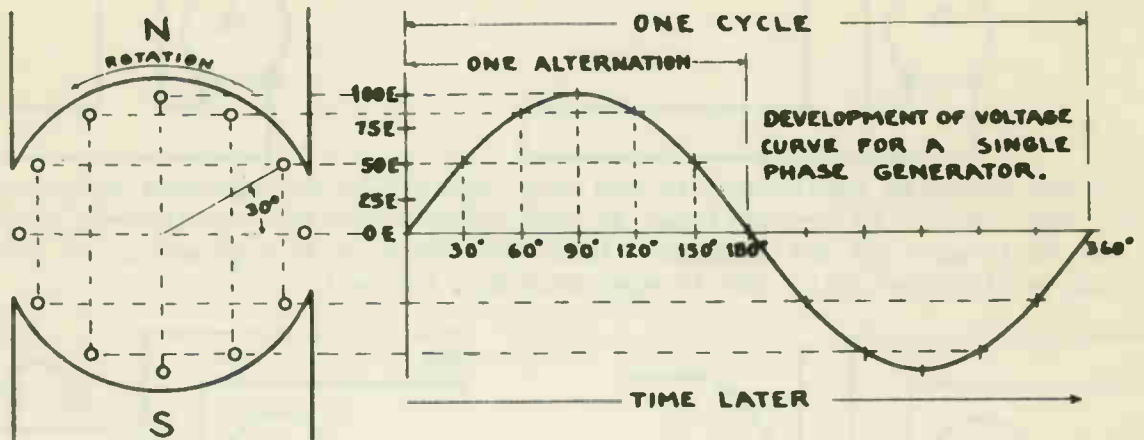

NO. OF POLES	CYCLES PER REV.	REV. PER SEC. FOR 60~	R. P. M. FOR 60~	INDUCTION MOTORS	
				R. P. M. OF MAGNETIC FIELD	R. P. M. OF ROTOR
2	1	60	3600	3600	3450
4	2	30	1800	1800	1740
6	3	20	1200	1200	1160
8	4	15	900	900	860
10	5	12	720	720	690
12	6	10	600	600	580

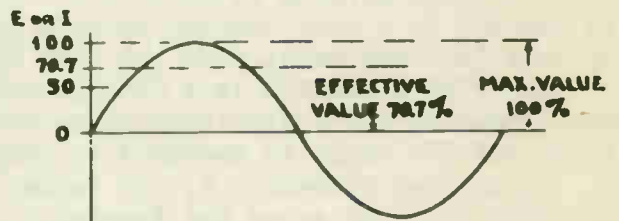

$$\text{POLES} = \frac{120 \times \text{FREQUENCY}}{\text{R. P. M.}}$$

$$\text{R. P. M.} = \frac{120 \times \text{FREQUENCY}}{\text{POLES}}$$

$$\text{FREQUENCY} = \frac{\text{POLES} \times \text{R. P. M.}}{120}$$

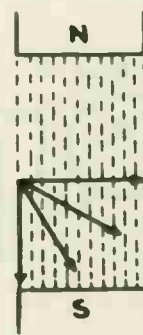

THIS SKETCH SHOWS THAT THE NUMBER OF LINES CUT PER SEC. DEPENDS UPON THE FIELD STRENGTH, CONDUCTOR SPEED AND THE ANGLE WHICH THE CONDUCTOR MOVES WITH RESPECT TO THE LINES OF FORCE.

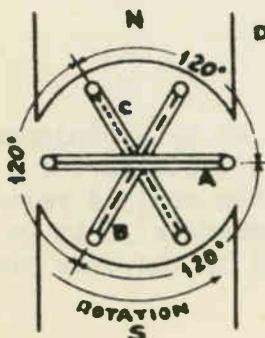

DEVELOPMENT OF VOLTAGE CURVES FOR A 3 PH. GEN.

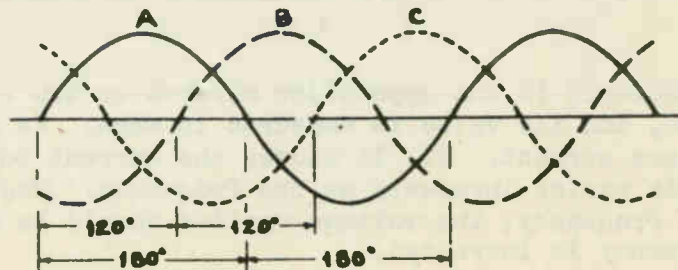

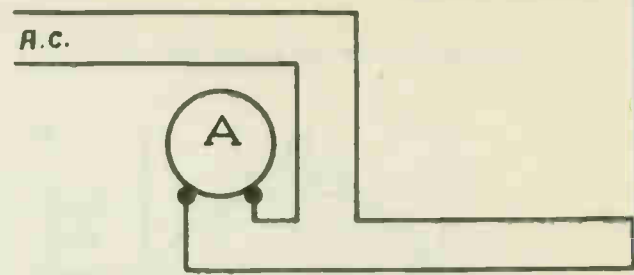
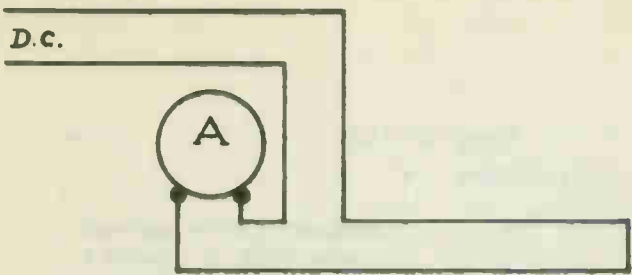

In d-c circuits resistance is the only opposition encountered by current, therefore, the current is proportional to the voltage applied, or inversely proportional to the resistance of the circuit. OHMS LAW for DC also applies to AC circuits containing resistance only, and is approximately correct.

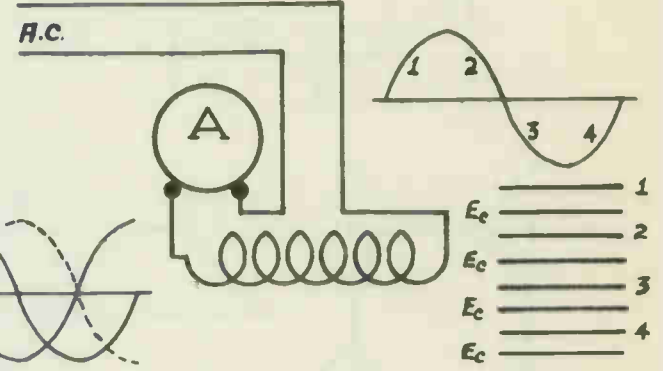
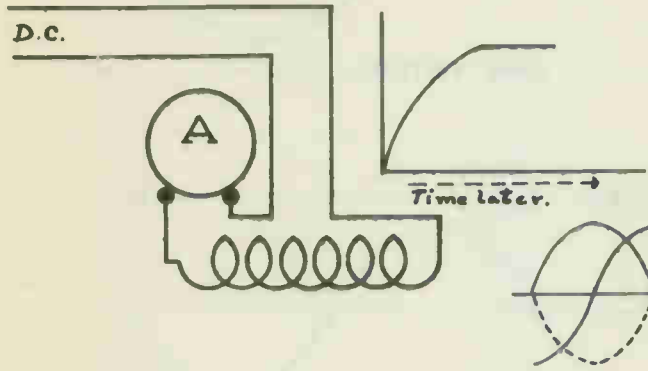

Inductance effects exist in d-c circuits only during current changes. The current is opposed by a self induced voltage generated by the expanding magnetic field. This voltage does not exist when the flux becomes stationary.

INDUCTIVE REACTANCE is a CEMF generated in the a-c circuit of inductive nature by the expanding and contracting magnetic field set up by the varying AC. Its symbol is  $X_L$  and its value is measured in ohms.  $X_L$  has 2 effects in the a-c circuit:  
 1. It opposes current. 2. It causes the current to lag the applied voltage by almost  $90^\circ$ .  $X_L$  varies as the frequency. The voltage applied to apparatus designed for one frequency must be changed in the same proportion when operated on another frequency.

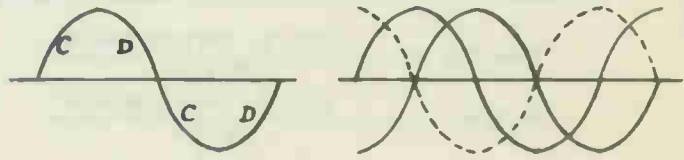
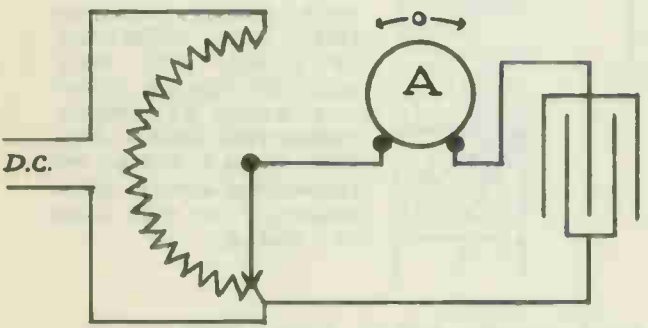

CAPACITY REACTANCE is the opposition offered to the flow of AC by a condenser. Its symbol is  $X_c$ , and its value is measured in ohms.  $X_c$  has 2 effects in the a-c circuit:  
 1. It opposes current. 2. It causes the current to lead the applied voltage by almost  $90^\circ$ .  $X_c$  varies inversely as the frequency. When a condenser is to be operated on a higher frequency, the voltage applied should be reduced in the same proportion as the frequency is increased.

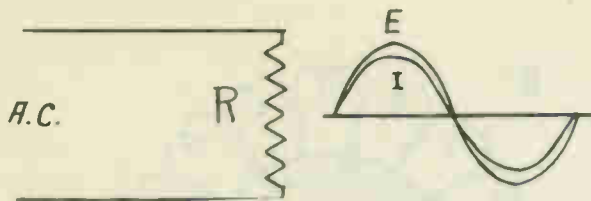

In a circuit of resistance only the current will be in phase with the voltage, since there is no reactance present to cause current to lag or lead the voltage applied.

IMPEDANCE is the total opposition offered to the flow of AC. Its symbol is Z, and its value is measured in OHMS. Z may consist of R only,  $X_L$  only,  $X_C$  only, or any combination of these effects.

OHMS LAW for AC - The current is proportional to the voltage applied, and inversely proportional to the IMPEDANCE of the circuit.

$$Z = \frac{E}{I}, \quad I = \frac{E}{Z}, \quad E = I \times Z$$

$X_L$  is 90° out of phase with R.

$X_C$  is 90° out of phase with R.

$X_L$  is 180° out of phase with  $X_C$

A-c quantities must be added geometrically when out of phase with each other. They may be added by simple arithmetic only when they are in phase with each other.

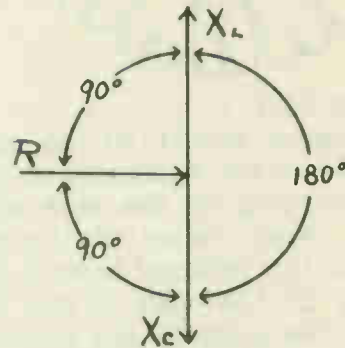

EXAMPLES FOR IMPEDANCE IN A SERIES CIRCUIT

R and  $X_L$  in series.

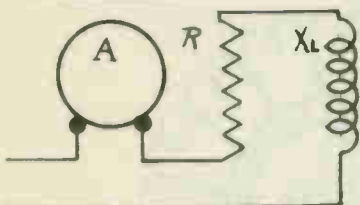

$$Z = \sqrt{R^2 + X_L^2}$$

$$\sqrt{\begin{matrix} 2 & + & 2 \\ 2 & + & 2 \end{matrix}}$$

$$\sqrt{\quad + \quad}$$

$$\sqrt{\quad} = Z$$

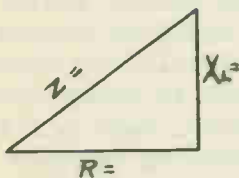

$E_L = \text{Line } E$

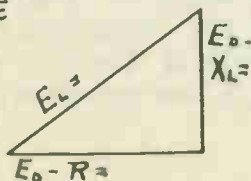

Scale = 1 Unit Per  $\frac{1}{4}$ "

TA-W&R-P35

R and  $X_C$  in series.

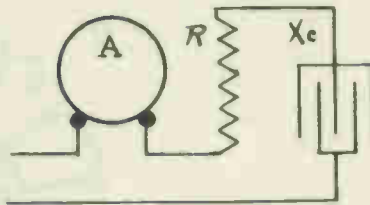

$$Z = \sqrt{R^2 + X_C^2}$$

$$\sqrt{\begin{matrix} 2 & + & 2 \\ 2 & + & 2 \end{matrix}}$$

$$\sqrt{\quad + \quad}$$

$$\sqrt{\quad} = Z$$

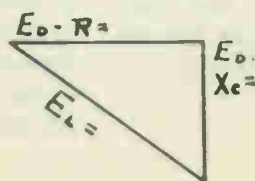
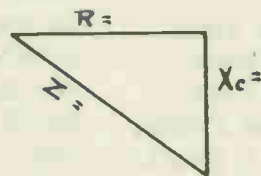

Scale = 1 Unit Per  $\frac{1}{4}$ "

Coyne Electrical School

R,  $X_L$ , and  $X_C$  in series.

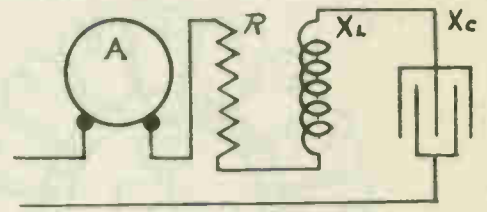

$$Z = \sqrt{R^2 + (X_L - X_C)^2}$$

$$\sqrt{\begin{matrix} 2 & + & 2 \\ 2 & + & 2 \end{matrix}}$$

$$\sqrt{\quad + \quad}$$

$$\sqrt{\quad} = Z$$

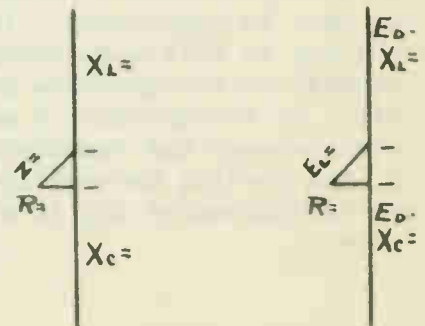

Scale = 10 Units Per  $\frac{1}{16}$ "

## G. Armature Growler Tests

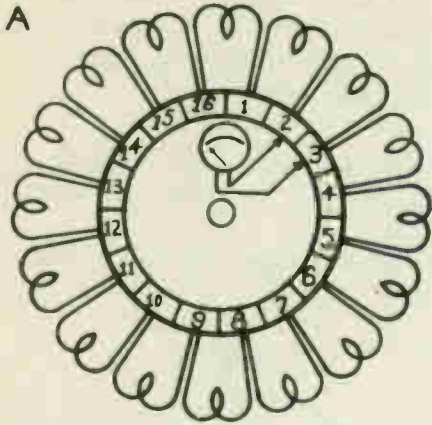
**TROUBLE: OPEN COIL -**

This defect shows itself on the operating machine by excessive sparking at the brushes and burning of the bars attached to the coil. When tested on the growler, the meter reading between bars 2 and 3 will be zero. If the open is due to poor soldering at the commutator, resolder. If caused by an open in the coil itself, disconnect the leads insulated the ends, and connect a jumper from bar 1 to bar 2.

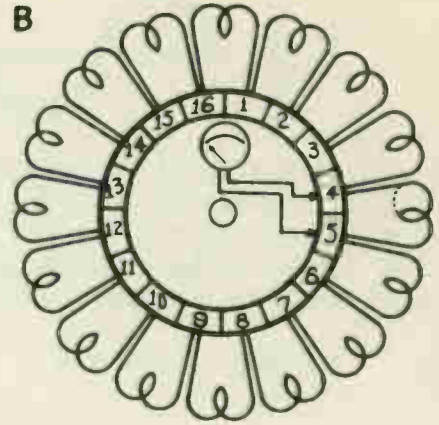
**TROUBLE: SHORTED COIL -**

When the machine is in operation, a shorted coil is indicated by the excessive heat it generates. While other coils on the armature maintain a normal temperature. The shorted coil becomes so hot that it burns the insulation from the winding. On the growler, the meter reading between bars 4 and 5 will be low or zero. A hacksaw blade will vibrate over the slots in which the shorted coil lies.

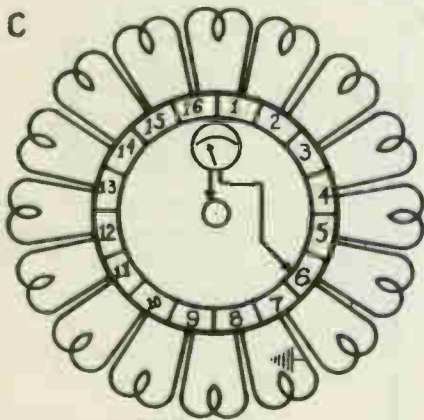
**TROUBLE-GROUNDED COIL -**

A grounded coil will usually give no indication during operation unless the frame of the unit be ungrounded. In this case, a shock may be felt when touching the frame. Two grounds on the armature produce a short-circuit. On the growler, a meter reading is taken between the commutator bars and the shaft, the reading becomes less as the shorted bar is approached and is minimum when contacted.

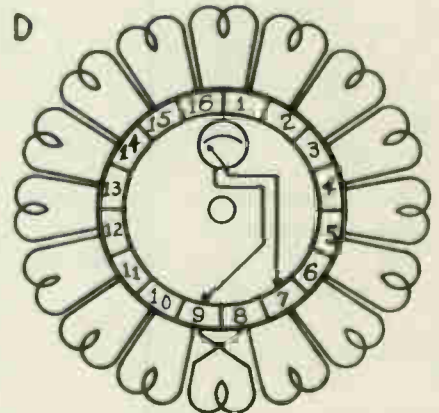
**TROUBLE: REVERSED COIL LEADS -**

In operation, this defect would create unbalance in the armature circuit with the result that circulating currents would flow and tend to cause overheating. On the growler, make a 1 to 3 bar test. When testing between bars 7 and 9, the reading would be zero and the same reading would be obtained between bars 8 and 10. This would indicate that the leads of the coil attached to bars 8 and 9 are reversed.

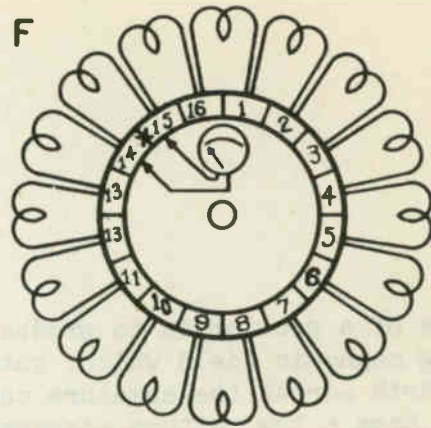
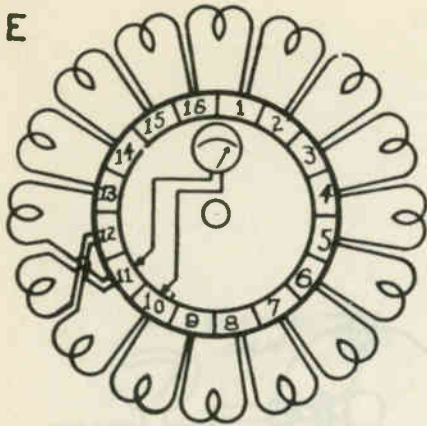

**TROUBLE: REVERSED COIL LOOPS -**  
 This fault, which usually occurs in a re-wound machine, may produce sparking at the brushes during operation. When tested on the growler, the meter will show a double reading between bars 10 and 11, a normal reading on 11 and 12, and a double reading on 12 and 13. To remedy, unsolder loops on 11 and 12 and reverse them. Hacksaw will give no indication of this fault.

**TROUBLE: SHORTED BARS -**  
 Indication during operation is overheating of coil attached to bars 14 and 15 and possible sparking at the brushes. On growler hacksaw blade will vibrate over slots containing coil connected to shorted bars, and meter reading between 14 and 15 will be zero. Remedy: Remove short from bars or disconnect coil and install a jumper from 14 to 15.

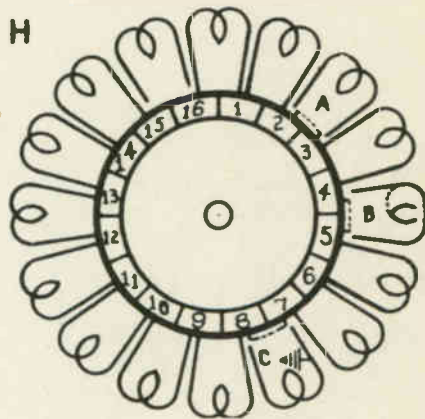
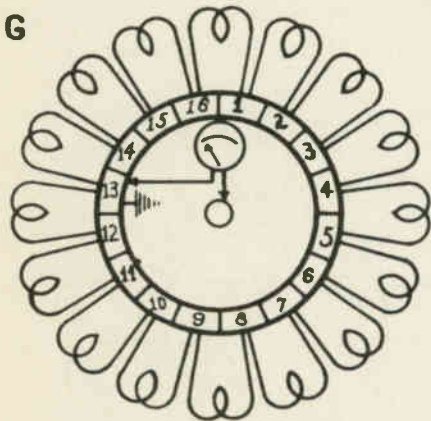

**TROUBLE: GROUNDED BARS**  
 If there are no other grounds on the machine, the fault will not affect the operation of the machine at all. If other grounds are present, severe flashing at the brushes will usually occur. The test procedure is the same as employed in diagram "C". To determine if ground is coil or bar, disconnect wires from bar 13 and then test bar for ground. Remedy: Reinsulate bar.

This sketch shows how the different faults above listed are remedied. The letters on the sketch refer to diagrams above in which the fault is given detailed treatment. "A" shows remedy for open coil, "B" for shorted coil, "C" for grounded coil, dotted lines between bars represent jumpers. Note that with a shorted coil it is essential that the coil itself be cut as shown in "B" to remove the shortcircuit.



The purpose of a growler is to produce an alternating magnetic field which, cutting back and forth across the armature coils, induces in them a low voltage measurable at the commutator bars with an A.C. millivoltmeter. The resistance "R" is used to adjust the reading to approximately mid-scale. When a shorted coil is placed between the growler jaws, the heavy current set up in the coil causes periodic magnetization of the slot in which the coil lies. Resulting in the hacksaw blade held near the slot being alternately attracted and released.

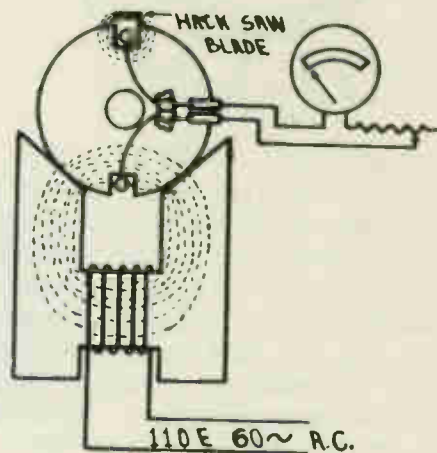

I. Armature Tests  
Using Meter

A

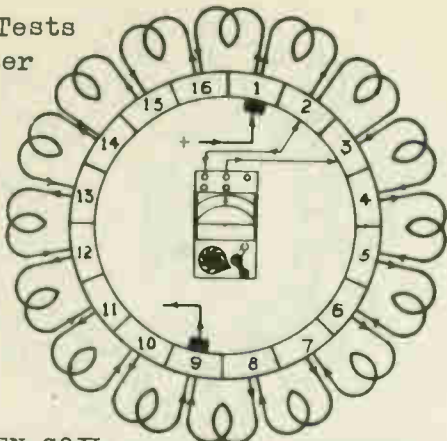

TRUBLE - OPEN COIL

To prevent injury to the meter, this test must precede all others when the millivolt method of testing is used. Set meter on the 15 volt range and, with current flowing through the armature, take readings between bars 1-2, 2-3, 3-4, etc., until all pairs of segments have been covered, a high reading between any pair of bars indicates an open coil. Note that in this method of testing the meter is used to measure the voltage drop in each armature coil, and that this is done by taking readings between commutator segments.

B

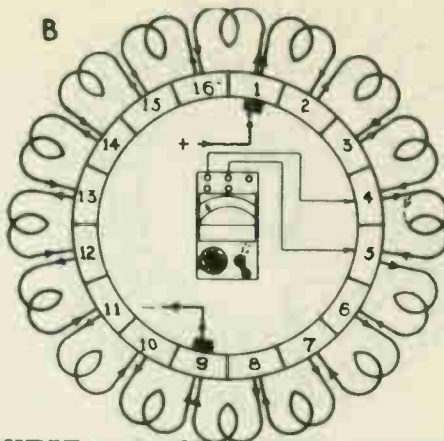

TRUBLE - SHORTED COIL

For this test set meter on the M.V. range that gives the best deflection, starting with the 300 setting and work down to the 50 M.V. range if necessary. Adjust current through armature until approximately midscale deflection is obtained on a normal coil and make a bar-to-bar test on all segments. The defective coil will give a low or zero reading depending upon how many turns are shorted. It should here be understood that this method of testing is merely a comparative one, for it is how the readings compare that is important.

C

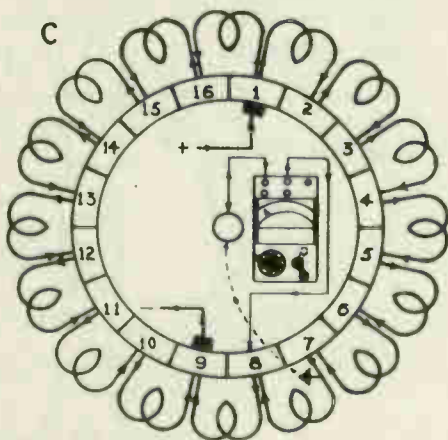

TRUBLE - GROUNDED COIL

To make this test, send a current of suitable value thru the armature and measure the voltage difference between each segment and the armature shaft. If the winding is grounded, a reading will be obtained that becomes gradually less as the bars to which the grounded coil is connected are approached. The reading will be lowest on the bars to which the grounded coil is connected. It should also be noted that as the grounded coil is passed the meter reading will reverse, to determine if the bar is grounded, disconnect the coil leads and repeat.

D

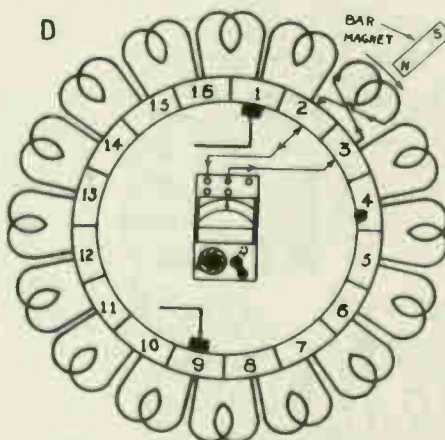

TRUBLE - REVERSED COIL LEADS

Usually encountered on armatures that have just been rewound, this fault requires a different testing method. Set meter on 50 M.V. range, select the first coil to be tested, and find the segments to which the ends of this coil are connected, with the meter leads on these bars draw a magnet swiftly across the slot in which one side of the coil lies and note deflection on the meter. Repeat this test, on all other coils, always moving the magnet in the same direction. When drawn across a reversed coil, the meter will reach backwards.

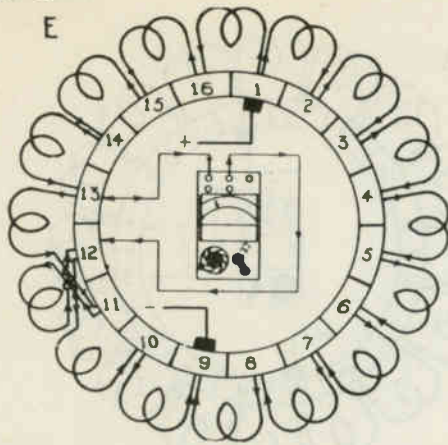
**TROUBLE - REVERSED COIL LOOPS**

Usually found only in rewind machines, this fault is checked by the regular bar-to-bar test. Proceed in exactly the same manner as used for locating shorted coils. Since the current in passing from segment 10 to segment 11 must flow through two coils, it follows that the voltage drop between bars 10 and 11 will be double the value obtained on a normal coil: The same is true for bars 12 and 13. Bars 11 and 12 will give a normal indication; Thus reversed coil loops are indicated by a double reading, a normal reading, and a double reading.

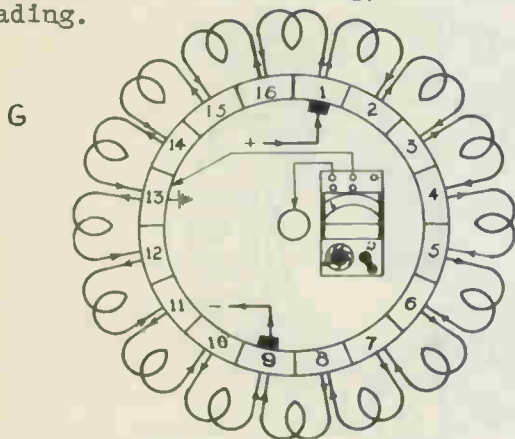
**TROUBLE - GROUNDED BARS**

Test for this defect is the same as for a grounded coil. Meter reading from bar to shaft will be zero when the grounded bar is contacted. To determine whether the bar or the coil is grounded, disconnect the coil from the bar and test again: If bar now tests clear, coil is grounded. When making this test, the meter readings may change so rapidly as the ground is approached, that a satisfactory deflection cannot be obtained without turning to a different range. Therefore, as the reading falls, the meter switch should be moved to a lower range.

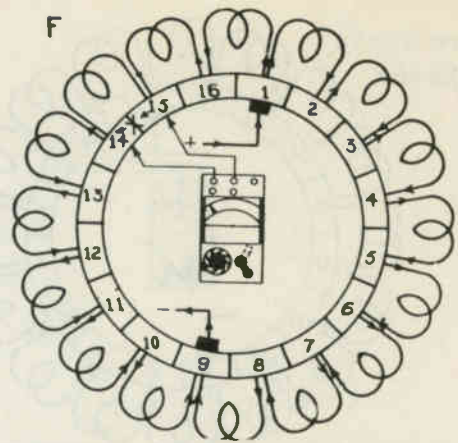
**TROUBLE - SHORTED BARS**

Make same test as for shorted coil. With current flowing through the armature measure the voltage drop between segments. When the shorted bars are encountered, the meter will read zero. Inasmuch as the same indication would be obtained if the coil leads were shorted, it will be necessary to disconnect the leads from the commutator segments before it can be determined whether the low reading was caused by shorted bars or shorted coil leads. If after the coil is disconnected a zero reading is obtained, the bars are shorted.

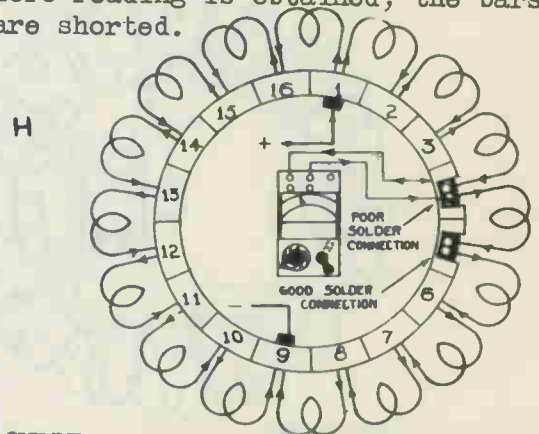
**TROUBLE - BAD CONNECTIONS**

Trouble frequently develops in armatures as the result of poor electrical connections between the coil leads and the commutator segments due either to poor soldering or to overheating of the armature while in service. High resistance connections of this type are indicated by high readings on the millivoltmeter. To positively locate which bar has the poor connection. Make the test indicated above. A poorly soldered joint will produce a readable deflection on the meter, whereas a good joint will give no reading.

**TESTING PROCEDURE**

Connect the armature to a 6 volt, 110 volt or other D.C. supply with a controlling resistance in series. This resistance may consist of a number of parallel-connected lamps arranged to be switched in or out of the circuit at will. Feed current into armature through bars exactly one pole pitch apart, and adjust current until the millivoltmeter gives a midscale reading on a normal coil. The amount of D.C. current required will vary with the size of the armature, fractional H.P. units requiring about 2-4 amps. Machines up to 20 H.P. about 10 amps. and the largest armature currents as high as 20 amps. After the current has been adjusted to a suitable value, take millivolt readings between bars 1-2, 2-3, 3-4 etc. If no faults are present, the readings will be approximately equal. High readings indicate high resistance connections, usually caused by poor soldering, while low readings show shorted coils or commutator segments.

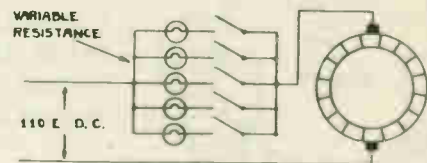
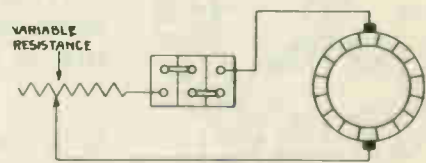

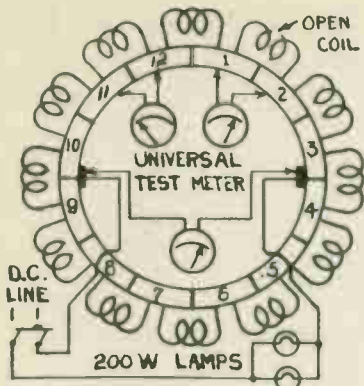

Connect armature across line with current-limiting lamps in series. Place meter selector switch in the 15 volt position and measure voltage across armature. Next make a bar-to-bar test; meter will read zero until open coil is bridged when total armature voltage will be registered. Example: 8E across armature; bars 11, 12 read zero; bars 1, 2 read 8E. To protect the meter, the test for spans should always be made before any other check involving bar-to-bar readings.

**SHORTED ARMATURE COIL TEST**

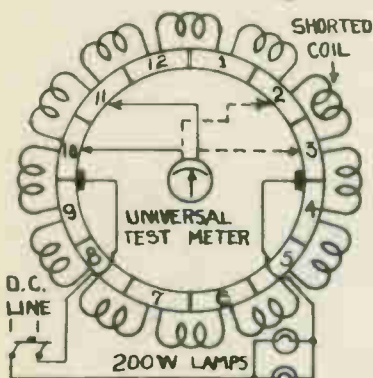

Connect armature to circuit, as directed above. Set meter selector switch to 150 M.V. and make a bar-to-bar test. If necessary, change selector switch to obtain about half-scale reading on a normal coil. A low or zero reading will then indicate a shorted coil; a high reading a poor connection - usually at the commutator riser. Example: Meter reads half scale on bars 11-12, 12-1, 1-2; gives low reading on 2-3, thereby indicating a shorted coil.

**GROUNDING ARMATURE COIL TEST**

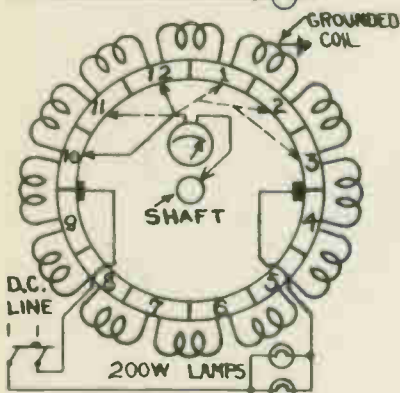

With the test connection remaining the same as before, a meter reading between the commutator segments and the shaft indicates a grounded coil. As the segment to which the grounded coil is connected is approached, the reading will become less and will be minimum when the test prod is in contact with the segments connected to the grounded coil. Example: With meter selector switch set on 15 V., a reading from bar 10 to shaft is full-scale and this value is gradually reduced to a minimum on bars 1 and 2. Beyond this point, the reading reverses and starts to increase again.

**SHORTED FIELD COIL TEST**

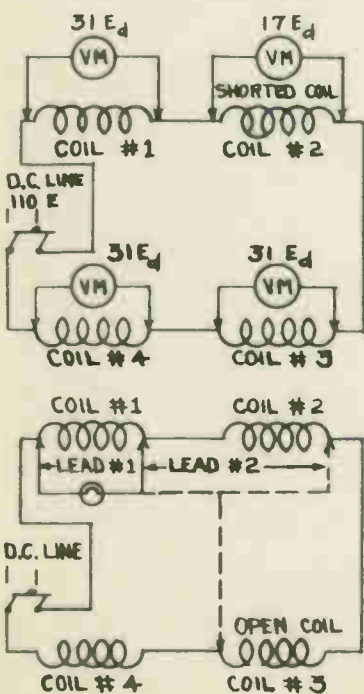

Connect shunt field to line as shown in sketch and take the voltage drop across each field coil with a D.C. voltmeter. If the voltage across all coils is the same, the field is O.K. A reading below normal indicates a shorted or partially shorted coil. The normal voltage across any field coil is equal to the line voltage divided by the number of poles. Example: Coil 1, 31Ed; coil 2, 17E; coil 3, 31Ed; coil 4, 31Ed; coil 2 is shorted.

**OPEN FIELD COIL TEST**

Connect field as indicated in sketch and place voltmeter or test lamp across each field coil. If the field is open, no reading will be obtained until the open in the circuit is bridged. Then the open may be found by testing each coil individually, or by connecting one test lead to one of the circuit wires and moving the other lead around the field toward the other line until a light is obtained. The open will then be in between the point at which the light was obtained and the previous point tested.

**GROUNDING FIELD TEST**

Apply line voltage between the field leads and the frame with a suitable voltmeter or test lamp in series. If the meter indicates or the lamp lights, the field is grounded. To locate the ground, disconnect and test each coil separately.

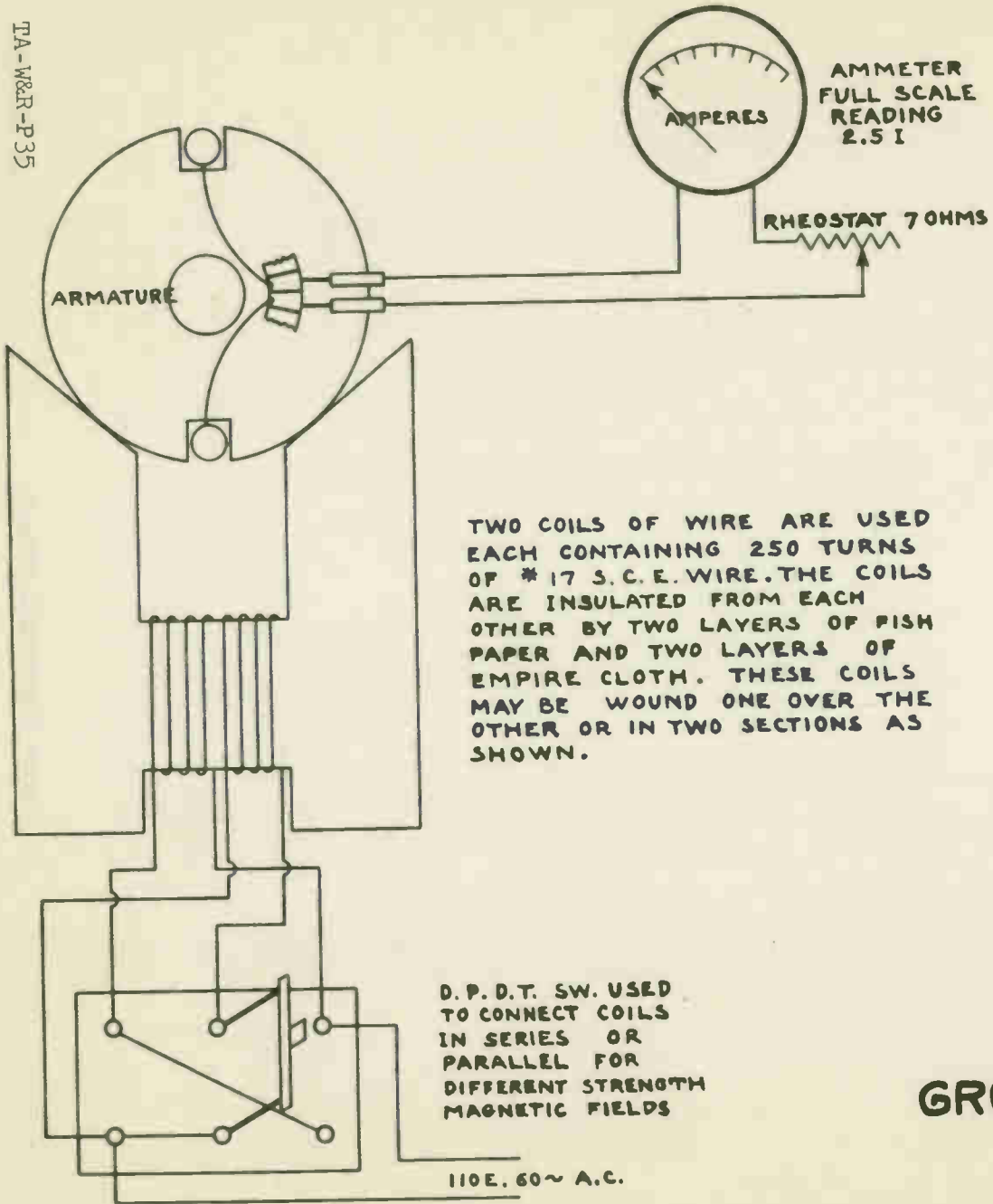

TWO COILS OF WIRE ARE USED EACH CONTAINING 250 TURNS OF # 17 S.C.E. WIRE. THE COILS ARE INSULATED FROM EACH OTHER BY TWO LAYERS OF FISH PAPER AND TWO LAYERS OF EMPIRE CLOTH. THESE COILS MAY BE WOUND ONE OVER THE OTHER OR IN TWO SECTIONS AS SHOWN.

D.P.D.T. SW. USED TO CONNECT COILS IN SERIES OR PARALLEL FOR DIFFERENT STRENGTH MAGNETIC FIELDS

110V. 60~ A.C.

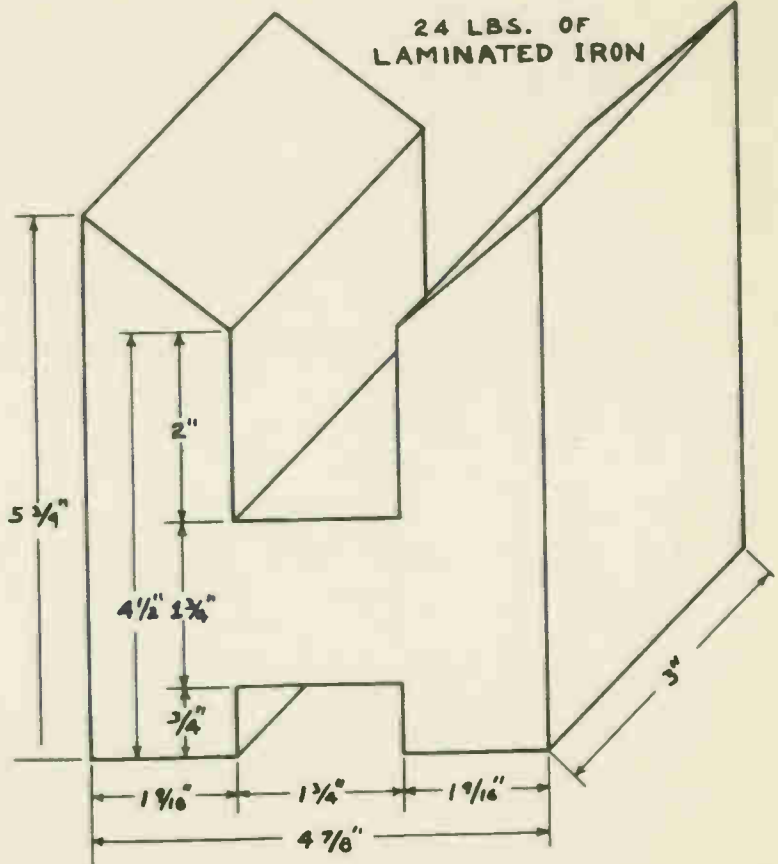

# GROWLER SPECIFICATIONS

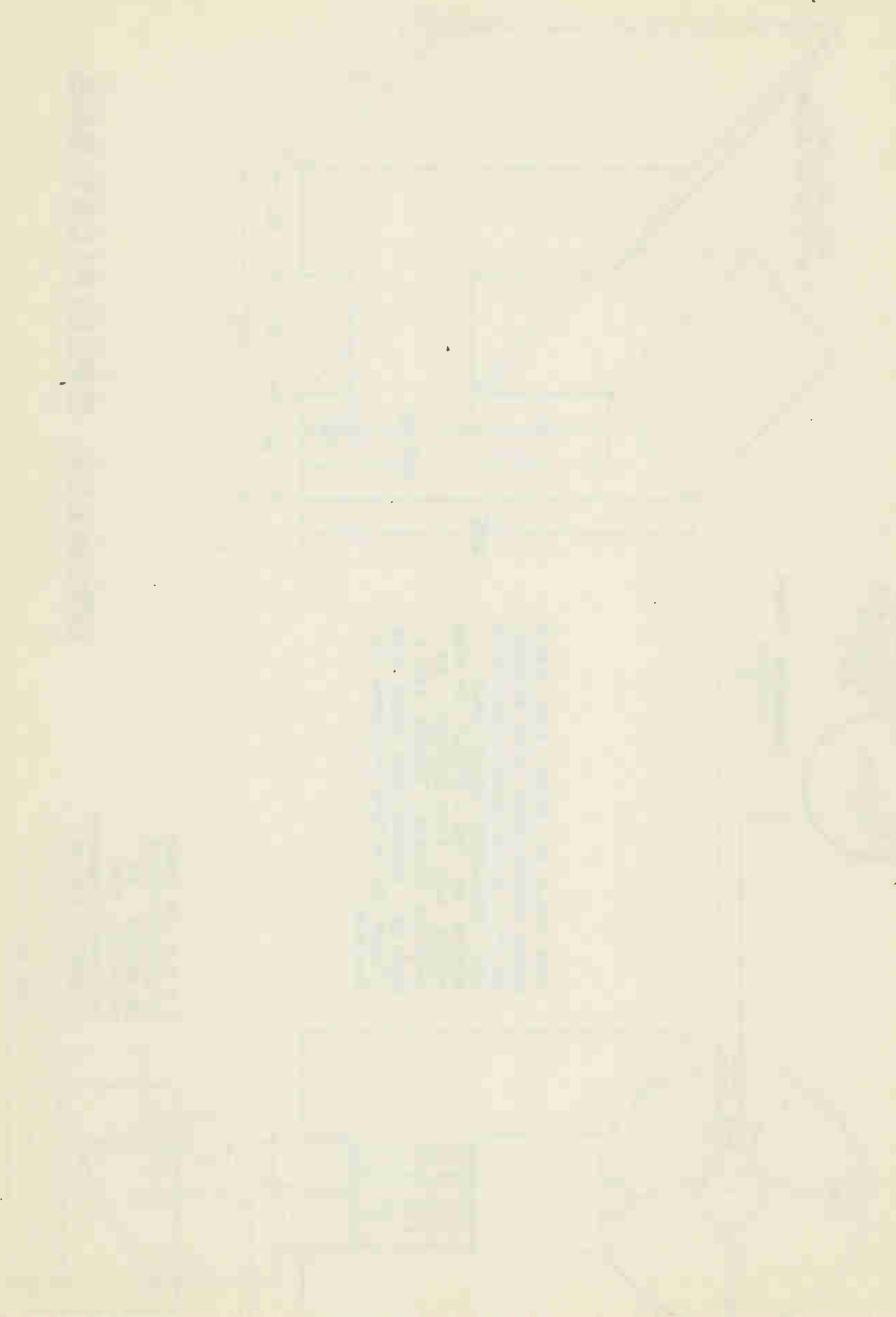







## THE COYNE MULTIMETER

Objective

To learn the construction and use of a Multimeter and the precautions which should be observed and practiced when using a multimeter.

ReferencesLesson Content

## A. Review

An instrument is a device for measuring the present value of the quantity under observation.

An indicating instrument is an instrument in which the present value of the quantities measured is indicated by the position of a pointer, relative to a scale.

A zero adjuster is a device for bringing the pointer of an electrical instrument to zero when the electrical quantity is zero.

The rating of an instrument is a designation assigned by the manufacturer to indicate its operating limitations.

The permanent-magnet moving-coil (d'Arsonval) instrument is an instrument which depends for its operation on the reaction between the current in a movable coil and the field of a fixed permanent magnet.

An instrument multiplier is a series resistor which is used to extend the voltage range of an instrument beyond some particular value for which the instrument is already complete.

An instrument shunt is a resistor connected in parallel with the measuring device to extend the current range beyond some particular value for which the instrument is already complete.

To determine the value of a multiplier when a higher voltage range is desired:

$$R_x = \frac{E_x}{I_x} = \frac{E_t - E_m}{I_m}$$

Where:  $R_x$  equals Resistance in ohms of multiplier

$E_x$  equals Voltage-drop across multiplier

$I_x$  equals Current through multiplier

$E_t$  equals Voltage range desired

$E_m$  equals Voltage rating of meter

$I_m$  equals Current rating of meter

NOTE: The voltage rating of the meter ( $E_m$ ) is the voltage which must be applied to the movement of the meter to obtain full scale deflection.

The current rating of the meter is the current which will move through the movement of the meter, when applying rated voltage to obtain full scale deflection.

EXAMPLE: Given - one instrument mechanism which has a voltage rating of 50 millivolts and a current rating of one millampere.

To find - the resistance of the multiplier necessary to allow the instrument to measure 10 volts.

Solution: - By making use of the equation given above -

$$R_x = \frac{E_t - E_m}{I_m} = \frac{10 - .050}{.001} = \frac{9.950}{.001} = 9950 \text{ ohms}$$

To determine the value of a shunt when a higher current range is necessary:

$$R_{sh} = \frac{E_{sh}}{I_{sh}} = \frac{E_m}{I_t - I_m}$$

Where:  $R_{sh}$  equals Resistance, in ohms of shunt  
 $E_{sh}$  equals Voltage applied to shunt  
 $I_{sh}$  equals Current through shunt  
 $E_m$  equals Voltage rating of the meter  
 $I_m$  equals Current rating of the meter  
 $I_t$  equals Current range desired

NOTE: " $E_m$ " and " $I_m$ " have the same meaning as given in preceding paragraph.

EXAMPLE: Given - one instrument mechanism which has a voltage rating of 50 millivolts and a current rating of 1. milliamperes

To find - the resistance of the shunt necessary to allow the instrument to measure 10 amperes

$$\text{Solution - } R_{sh} = \frac{E_m}{I_t - I_m} = \frac{.050}{10 - .001} = \frac{.050}{9.999} = .005 \text{ ohms}$$

A fuse is an overcurrent device with a circuit-opening fusible member directly heated and destroyed by the passage of current through it.

## B. The Multimeter, Fig. 1

A permanent-magnet moving-coil instrument is used in the Coyne Multimeter. This type of instrument is recognized as the best for all around accuracy and sensitivity. The multimeter will indicate the value of an a-c voltage; a direct current or voltage; or an ohmic resistance.

There are many other types of instruments and meters used for testing and checking electrical equipment. The electrician should analyze the scale and the operating limitations of any instrument he must use in his work, before trying to apply the instrument.

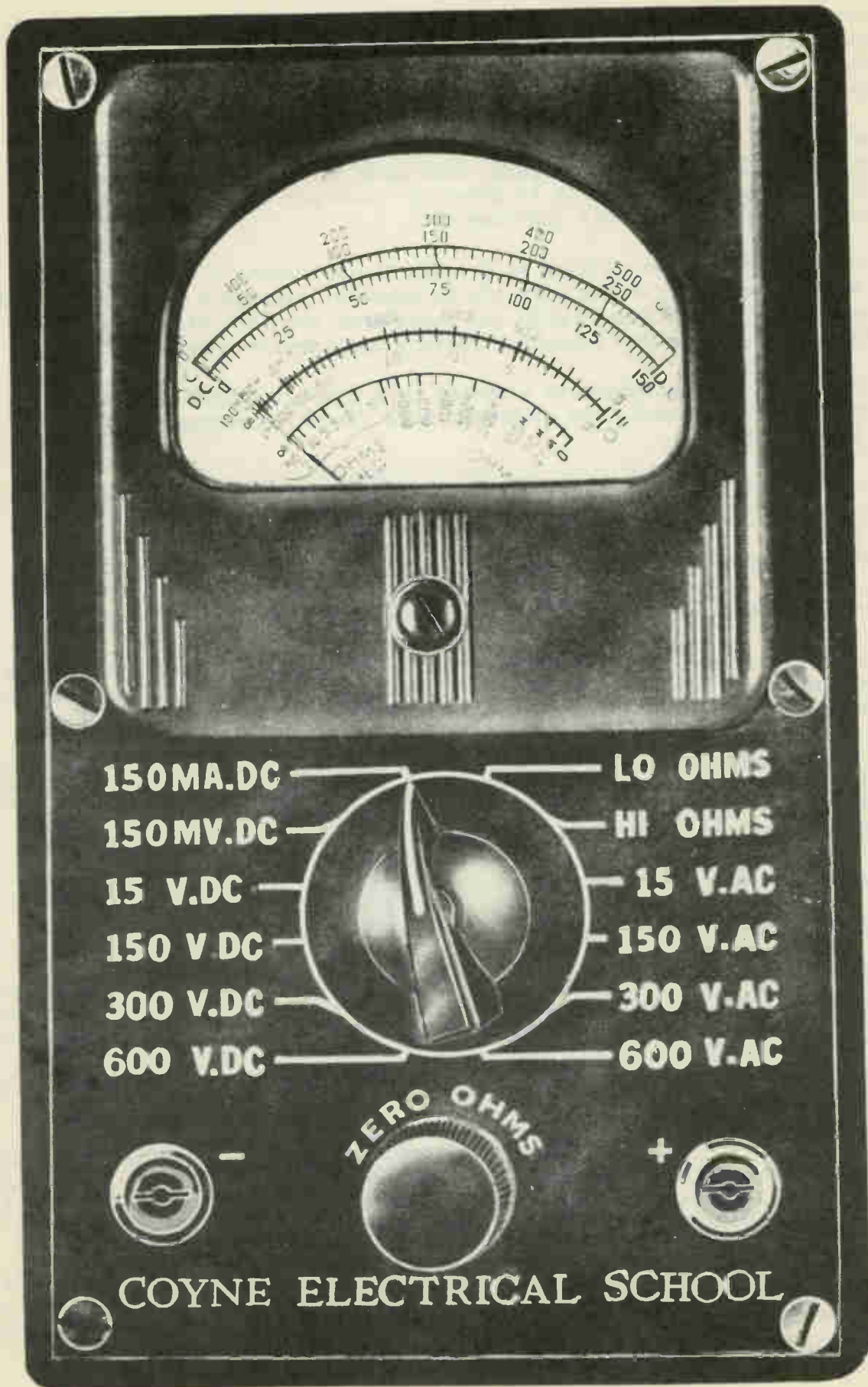

COYNE ELECTRICAL SCHOOL

The rating of the moving element of this instrument -  
Resistance equals 50 ohms  
Current (for full scale deflection) equals 1 milliampere  
and therefore - Voltage equals  $.001 \times 50$  equals .050 volts.

This means that when 50 millivolts (.050 volts) is applied to the element a current of one milliampere (.001 ampere) will move through the element. Since the sensitivity of many instruments is given by "ohms per volt" (R/E), we could say this is a "1000 ohms per volt instrument".

The above relations have nothing to do with an instrument's accuracy. It is important, however, on low current circuits to have an instrument with at least 1000 ohms per volt. An instrument with low resistance per volt will draw too much current to operate the meter, thereby affecting the circuit under test.

The accuracy of an instrument is a number or a quantity which defines its "limit of error." To understand this statement more clearly, perhaps, the following example is presented.

Given - A voltmeter which reads 120 volts when the voltage applied to its terminals is actually only 115 volts.

Then error equals  $120 - 115$  equals 5 volts.

Percentage of error equals  $5/115$  equals .043 or approximately 4 percent.

The accuracy is given, by most manufacturers, at full scale deflection. The life of a Multimeter is dependent on the CARE given it. The two most probable sources of trouble are excessive currents and rough handling.

A fuse may be used to protect the instrument against excessive currents; however, there is nothing mechanical being used to "free our minds" of our responsibility in handling the instrument. Respect for an instrument is usually developed through application.

## 1. Construction and operation

### a. The multimeter, face fig. 1.

The scale of the Coyne Multimeter is used for indicating various factors when testing electrical equipment. The heavy lines on the scale are referred to as "divisions". The light lines are referred to as "subdivisions".

All a-c volt ranges are read direct on the red a-c scale, using the black figures.

When measuring an alternating voltage above 300 volts, the selector switch should be set in the 600 volt a-c position. The red scale is calibrated in six equal divisions. Each division represents 100 volts and is divided into ten sub-divisions. Each subdivision represents ten volts.

When measuring an alternating voltage below 300 volts, set the selector switch in the 300 volt a-c position. This scale is calibrated in six equal divisions also, but each division now represents only 50 volts. Each division is divided into ten subdivisions and each subdivision indicates five volts.

When measuring an alternating voltage below 150 volts, set the selector switch in the 150 volt a-c position. The red colored a-c scale is used with the black 0-150 figures. Each division will then represent 25 volts and each subdivision 2.5 volts. Example: The meter pointer points to four full divisions plus 1 sub-division on the red-colored a-c scale. The actual voltage being measured would be 102.5 volts.

When measuring an alternating voltage below 15 volts, set the selector switch in the 15 volt a-c position. The red a-c scale is used in conjunction with the black 0-150 volt figures divided by 10. Each division will then represent 2.5 volts. Each subdivision will represent 0.25 volts.

- b. All d-c volt ranges are read direct on the black d-c scale using the black figures.

When measuring direct voltages, the black colored scale marked "DC" is used. The same calibration of the division and subdivisions are determined as stated in the above paragraphs for AC.

When measuring direct voltages below 150 millivolts (.15 volts) the selector switch should be set in the 150 millivolt d-c position and the black 0-150 scale used. Each division will represent 25 millivolts. Each subdivision indicates 2.5 millivolts (.0025 volts).

The same scale as stated in above paragraph is used for measuring from 0-150 milliamperes. The scale is calibrated in the same manner and will indicate the electron flow in milliamps.

- c. "HI ohmmeter scale

1. When measuring resistance not exceeding 100,000 ohms, set the selector switch to the "HI OHMS" position. The first division (reading from right to left) represents 500 ohms. Each subdivision is 50 ohms.
2. The second division represents 500 ohms. Each subdivision is 100 ohms.
3. The third division represents 1000 ohms. Each subdivision is 200 ohms.
4. The fourth division represents 3000 ohms. Each subdivision is 500 ohms.
5. The fifth division represents 5000 ohms. Each subdivision is 1000 ohms.
6. The sixth division represents 40,000 ohms. Each subdivision is 10,000 ohms.
7. The seventh division represents 50,000 ohms. Each subdivision is 25,000 ohms.

- d. "LO" ohmmeter scale

When measuring resistance not exceeding 1,000 ohms, set the selector switch to "LO OHMS" position. The division and subdivisions are calibrated accordingly with the zero to 1,000 ohm figures.

- e. Megohm scale

To measure megohms, with this meter it is necessary to use a d-c source of supply of 500 volts.

The selector switch should be SET ON THE 150 millivolts d-c position.

The instrument is then connected in series with the 500 volts d-c supply and the resistance to be measured.

The value of resistance will be indicated on the megohm scale.

A properly constructed power supply, Fig. 3, will work nicely for the 500 volt d-c supply.

When using the "HI-OHM" and "LO-OHM" ranges touch meter leads together and using "ZERO-OHMS" selector, set the needle at zero ohms.

The jacks are marked positive and negative. These polarity markings indicate the polarity of the instrument when using a d-c range.

## 2. Circuit analysis

The schematic diagram shown on job 2 illustrates how this type of meter movement can be made adaptable to different measurements of electricity.

Switch 1, 2, and 3 are ganged. By rotating a single knob all three switches move respectively. Switch pointers 1, 2, 3, 4, and 5 connect proper values of high resistance in series with the moving-coil so as to measure various ranges of d-c voltages. A voltmeter must be designed for connection across the terminals of a circuit. Sufficient resistance therefore must be connected in series with the coil movement to limit the current through the instrument to a small value, or considerable damage will result to the meter movement.

The moving coil, as previously stated, is wound with a very fine wire. It is not advisable to pass more than one milliamperere through the Coyne Multi-meter moving coil. In order to measure 150 MA, switch position 6, this meter is so designed that only a fraction of the current to be measured passes through the moving coil. This is accomplished by means of a shunt "R-5", which consists of a conductor of relatively low resistance and of sufficient carrying capacity to pass the current to be measured without over-heating, connected parallel with the moving coil circuit.

The permanent magnet type of meter movement can also be used to measure resistance of a circuit. Fig. 2 illustrates a simple series ohmmeter circuit.

Since a change in the resistance of a circuit will cause a change in the current through that circuit ( $I$  equals  $E/R$ ) it is possible to calibrate a moving coil type of meter in terms of the resistance required to produce a given change in current indication. It must be understood all other circuit factors such as circuit voltage and resistance must remain constant.

The circuit drawn in Fig. 2 illustrates the general components used to make a series ohmmeter. The total circuit resistance  $R_t$  would be 1500 ohms (a series circuit consisting of 475 plus 1000 plus 25 ohms). With the test prod points "A" and "B" connected together the 1.5 volt battery will force a current of .001 ampere to flow. ( $I$  equals  $E/R$  equals  $1.5/1500$  equals .001 ampere). Since a zero to one milliamperere meter movement is used, the pointer will then deflect clock-wise to full scale.

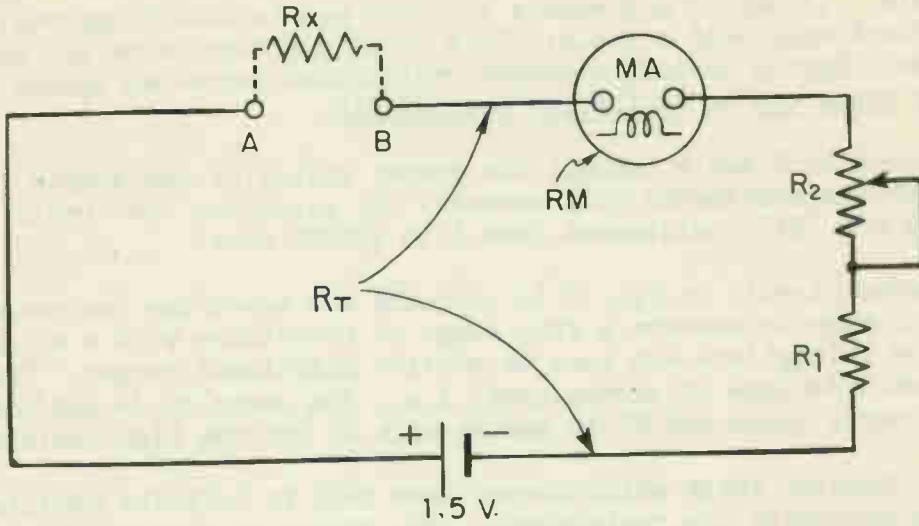

- $R_1 = 1,000 \text{ OHMS}$
- $R_2 = 1,000 \text{ OHMS}$  (Set at 475 ohms)
- $R_x = \text{Known Resistance to be measured (1500 ohms)}$
- $R_T = \text{Total Circuit Resistance}$
- $A-B = \text{TEST PRODS}$
- $R_M = 25 \text{ OHMS}$
- $MA = 0-1 \text{ Milliammeter}$

Fig. 2 Series Ohmmeter Circuit

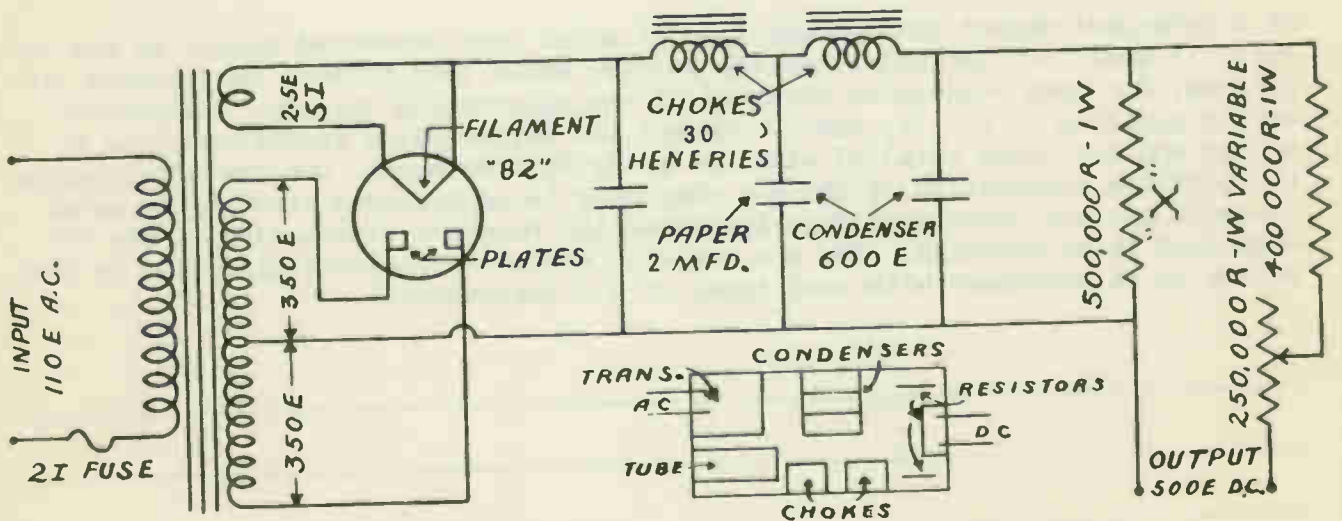

Fig. 3 Power Supply



By connecting the test prod across a known resistance "Rx" (1500 ohms) this resistance will be added to that of the total circuit resistance. Rt then will be increased to 3000 ohms. With the total circuit resistance increased, the current through this circuit will be reduced. Thus the meter pointer will not deflect to full scale. ( $I$  equals  $E/R$  equals  $1.5/3000$  equals 0.0005 amperes). The pointer will deflect only half a scale. This point can then be marked on the scale as 1500 ohms. Having various accurate resistances connected across "A" and "B", an ohmmeter scale can be calibrated accordingly.

Switch position 7 and 8 connect the proper values of resistance in series and in shunt with the multimeter coil movement for measuring "LO" resistance from 1 to 1000 ohms and "HI" resistances from 1 to 100000 ohms.

The ohmmeter circuit in Fig. 2 is suitable for measuring one range of resistance only. In order to measure a wide range of resistance with a single ohmmeter, shunts and multipliers are used to provide additional ranges. The Coyne multimeter uses this type of arrangement, i.e., the shunt R6 is employed for the low resistance range and R7 in series with R6 for the high resistance range.

A single ohmmeter range which covers from zero to infinite resistance, is not practical for measuring low resistances. The reason is that an extremely low resistance to be measured would cause such a very small change in pointer deflection (as compared with the ohmmeter test prods shorted) that no reasonably accurate reading could be obtained.

For very high resistance measurements, the ohmmeter reading would be similarly inaccurate because it would differ so little from that obtained for an open circuit. The Coyne multimeter is most accurate near the center scale indication. The purpose of the shunt and multiplier arrangement employed for the ohmmeter circuit is to bring high and low values of resistance closer to the center scale indications, schematic diagram job number 2.

One of the greatest errors in the proper use of the ohmmeter is the failure to "zero-center" the pointer before making a measurement. This error is especially noted when shifting from "HI" to "LO" scales. When testing circuits with the ohmmeter, use the range which will give nearest to mid-scale deflection.

If a permanent magnet moving-coil type of meter were connected across an a-c circuit, it would not deflect since the pointer would tend to move in opposite directions, for each successive reversal of the alternating voltage. Therefore, switch position 9, 10, 11, and 12 connect two copper oxide rectifiers, one in series and the other parallel with the meter coil movement. One rectifier passes the positive alternation of the a-c component being measured through the meter movement and the other rectifier by-passes the negative alternation of the a-c component being measured. The a-c scale is marked to indicate effective or RMS values as is customary with most types of a-c instruments.

---

---

---

---

## Summarization

Do not use the Coyne multimeter on voltages greater than 600 volts.

The voltage to be measured may be greater than you suspect, when using the multi-meter use the higher voltage range first, test to determine approximate value, and then select the lowest scale that will cover the voltage indicated.

If an external voltage is applied across the meter with the selector switch on the ohm position, the meter may be damaged. CHECK THE SELECTOR SWITCH.

Be careful when using an instrument on circuits which contain capacitors. The capacitors could discharge through the instrument. CHECK THE CIRCUIT UNDER OBSERVATION.

---

---

---

## Summary Questions

1. What is a shunt? A Multiplier? A d'Arsonval instrument?
2. Does the permanent-magnet moving-coil instrument compare favorably with other types in-so-far as the sensitivity is concerned?
3. What is the rating of the moving element used in the Coyne Multi-meter?
4. Is the "sensitivity" of an instrument and the "accuracy" of an instrument the same rating?
5. When should the ZERO ohm selector be used?
6. How is the megohm scale used?
7. How is the zero adjuster used? Why?
8. What type of rectifiers are used? Why?
9. What do you believe to be the three most important precautions to be observed when using the multimeter?
10. Why is a rheostat used in a series ohmmeter circuit?
11. Why is the ohm scale calibrated from right to left?
12. If the meter is set to measure "HI" ohms and the pointer deflects three divisions and three subdivisions what is the value of the resistance being measured?





## PUSH-BUTTON STATIONS

Objective

To review push-button switches and "stick" or "holding" circuits.

References

---

Lesson Content

- A. The principles and procedures on the development of "stick" or "holding" circuits were studied in the Electrical Wiring department. The circuits were used on controllers in both the d-c and a-c departments.

Push-button switches are used as master stations with a-c and d-c magnetic controllers, and as auxiliary control stations with magnetic and manual controllers. Being able to install and check these circuits is an important phase of the maintenance man's work.

Push-button switches may be divided into two classes, momentary and maintained.

1. Momentary

When using the momentary style the circuit is closed or broken only when the operator "presses the button."

2. Maintained

The maintained style holds the circuit open or closed like an ordinary knife switch.

Any electrical circuit which controls any other circuit through a relay or an equivalent device is classed, by the National Electrical Code, as a remote control circuit.

---

---

---

B. Construction and Operation

1. Push-button switches

It has been mentioned that we are using the momentary type. The diagram for this switch is shown in Fig. 1. A photo of the switch appears in Fig. 2.

NOTE: The switch terminals are marked C<sub>1</sub> , C<sub>2</sub> , and C<sub>3</sub> .

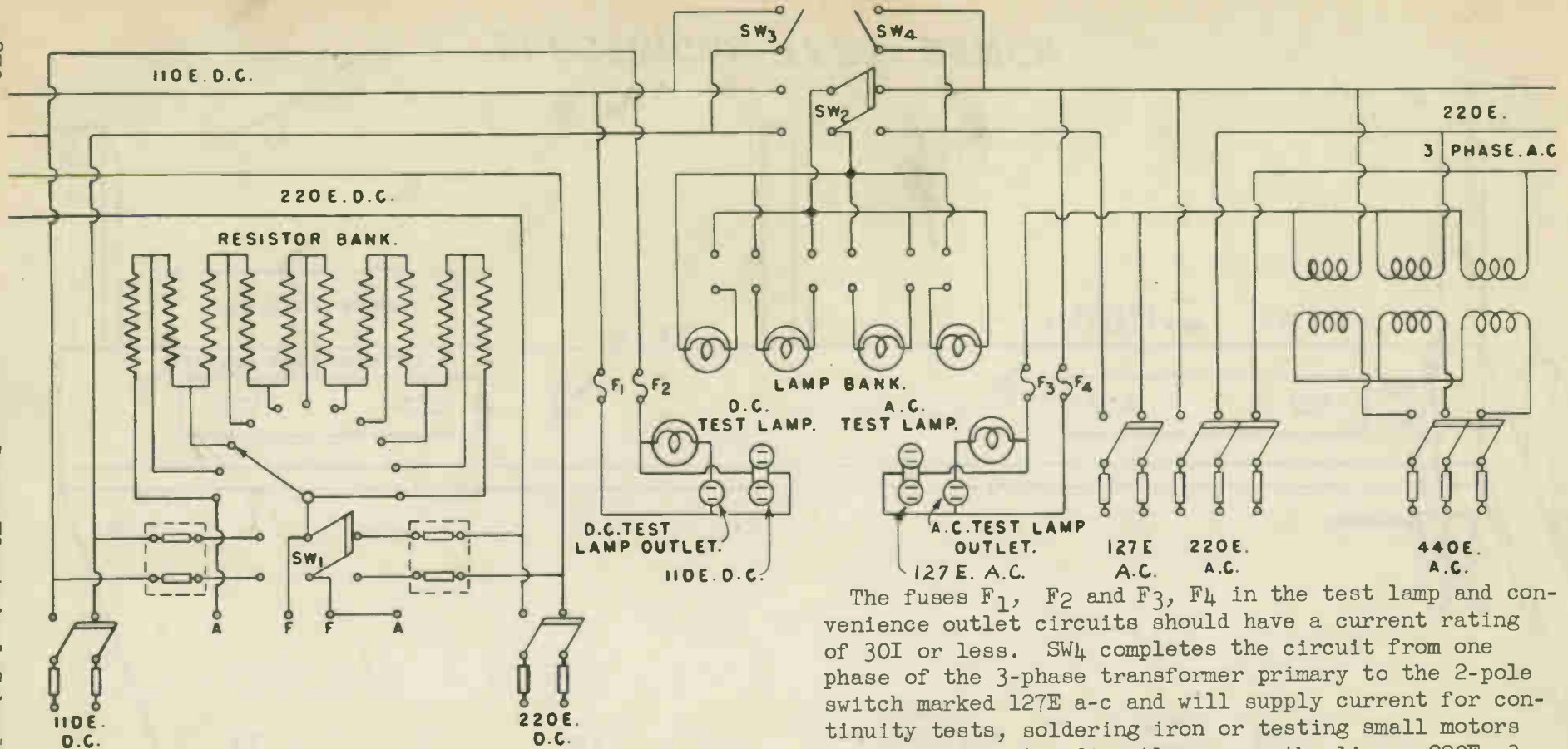

#### HOW TO USE THE TEST BENCH:

Test d-c motors by connecting to 3-point starter terminals, A,F,F,A. SW<sub>1</sub> is arranged to connect the starter to either 110E or 220E, which must be supplied from separate sources, or from a single source provided with proper voltage control, the current rating of the resistor bank, its resistance in ohms, the current rating of fuses, switches and the d-c supply will be dependent upon the size of d-c machines to be tested. Closing SW<sub>3</sub> completes the circuit from 110E d-c supply to the 2-pole switch marked 110E d-c for testing apparatus directly across 110E d-c.

The fuses F<sub>1</sub>, F<sub>2</sub> and F<sub>3</sub>, F<sub>4</sub> in the test lamp and convenience outlet circuits should have a current rating of 30I or less. SW<sub>4</sub> completes the circuit from one phase of the 3-phase transformer primary to the 2-pole switch marked 127E a-c and will supply current for continuity tests, soldering iron or testing small motors or other apparatus directly across the line. 220E, 3-phase is available directly from the 3-phase supply line. A transformer may be used to obtain 440E for testing. The KVA rating of the transformer will be determined by the size of motors or other equipment to be tested at that voltage.

The lamp bank is arranged to parallel 2, 3 or 4 lamps to limit the current through stator windings or d-c armature windings when testing for opens, grounds or reversed connections. SW<sub>2</sub> connects the lamp bank to either d-c or a-c. Apparatus under test is connected to 110E d-c or 127E a-c. SW<sub>3</sub> and SW<sub>4</sub> must be in open position when lamp bank is in use, otherwise lamp bank is shunted.

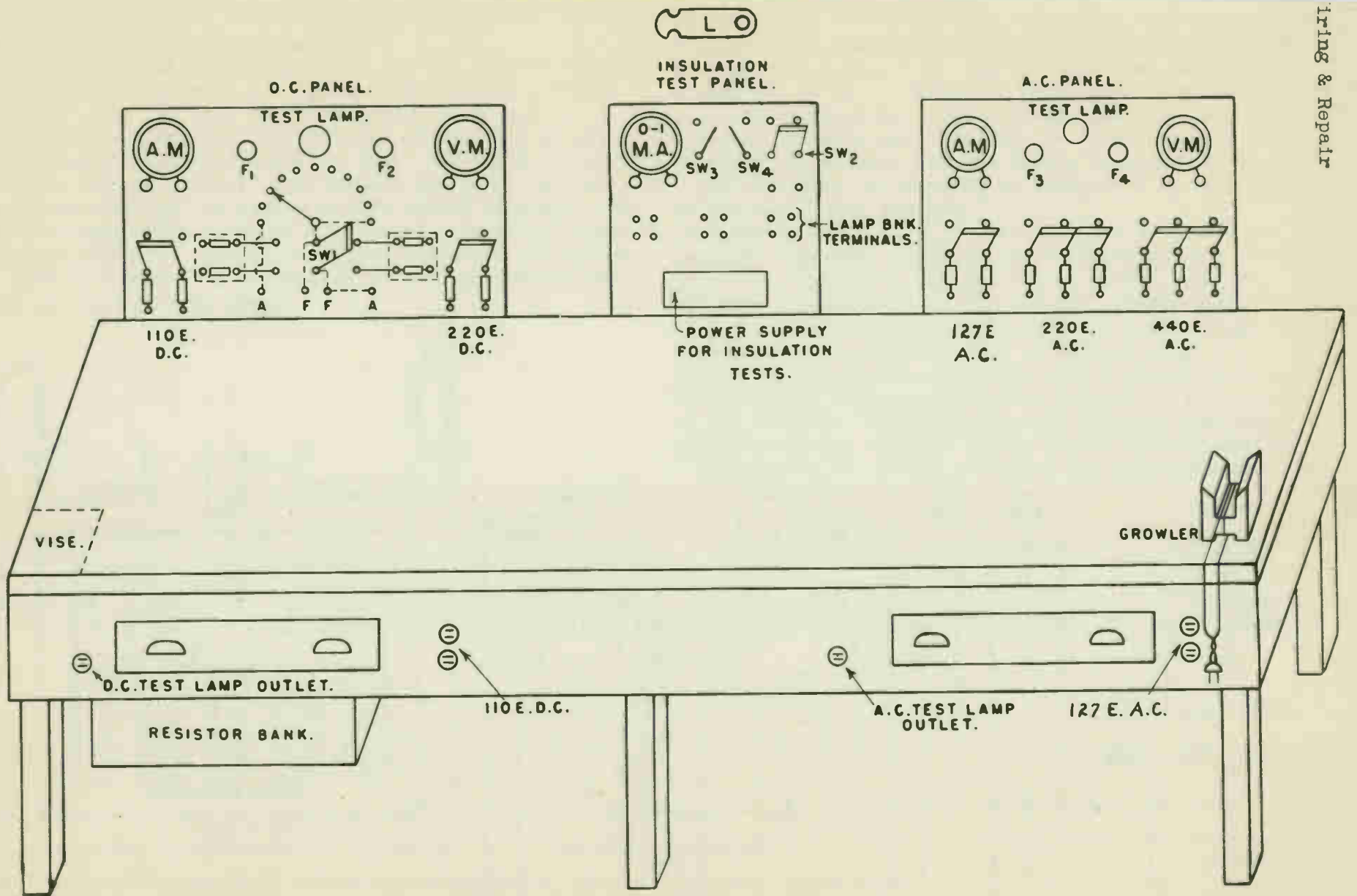

ELECTRICAL TEST BENCH.



# WARM AIR LIMIT OR FAN CONTROL

## INSTRUCTION SHEET FOR INSTALLATION AND OPERATION

This furnace control has been carefully inspected and calibrated before leaving the factory. The following precautions should be taken when installing or adjusting the control:

1. **DO NOT TWIST OR BUMP THE BI-METAL COIL**, as this may permanently distort the coil, destroying the correct calibration and impairing the accurate performance of the instrument. See instructions on differential setting before making adjustments.

2. **DO NOT OVERLOAD**—Check the nameplate for the electrical capacity and make certain that load to be handled is within the rating.

3. **DO NOT OIL ANY PARTS** on this instrument as oil accumulates dirt and may become gummy with age and heat, thereby interfering with the sensitivity of the control.

### MOUNTING THE CONTROL:

1. Hold the Mounting Flange "A" against the sloping portion of the bonnet as indicated.
2. Drill four  $\frac{1}{8}$  inch holes for the sheet metal screws.
3. In the center drill the hole  $1\frac{1}{4}$  inch in diameter.
4. Fasten to the bonnet of the furnace with the four sheet metal screws (furnished). This mounting flange should be mounted vertically with the greater portion of the center slotted hole extending downward.
5. Attach by means of two screws (furnished) as shown in "B"; both screws should be drawn up tight.

*Attention is called to the fact that the control will operate satisfactorily even though it is not mounted vertically.*

Use the wiring diagram designed for your particular installation and connect the furnace control as indicated. If so desired, or if City Ordinance requires it, the rubber grommet may be removed from the hole in the base and BX or conduit fitting may be used in its place.

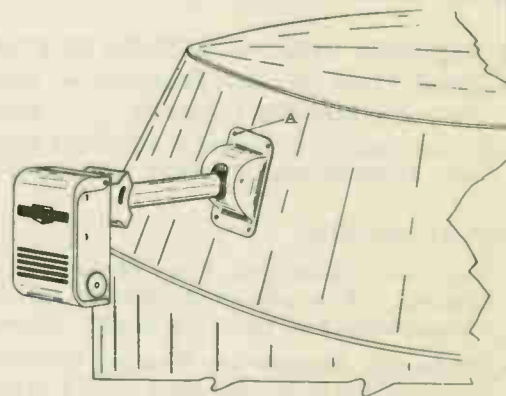
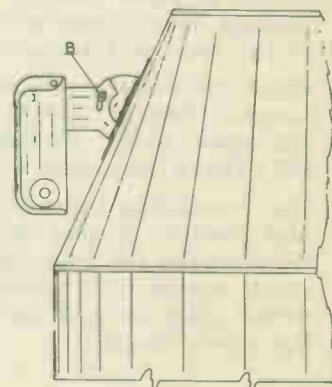

FIG. 1

FIG. 2  
MOUNTING CONTROL

### DIFFERENTIAL SETTING

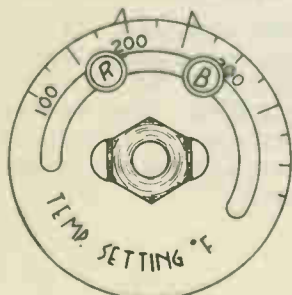

FIG. 3

**DIFFERENTIAL SETTING** refers to the amount of heat necessary to reverse the action of the switch. The instrument as it leaves the factory is satisfactory for most applications. If it is found necessary to change the differential setting, loosen lock screws by turning in a counter-clockwise direction; set Blue pointer to the desired operating temperature on the dial; set Red pointer to operating temperature desired; **WITH THE FINGERS ONLY**, tighten Pointer screws; when loosening or tightening screws, it is a good idea to steady the plate with the other hand so that there is no appreciable load applied to the Bi-Metal Coil. In Diagram Illustration, the circuit will open at 250 degrees and close at 200 degrees, operating on a differential of 50 degrees. The settings shown in Fig. 3 are not recommended settings but are used for illustrative purposes only.

HOMART HEATING EQUIPMENT IS SOLD ONLY BY SEARS, ROEBUCK AND CO.  
U. S. A.





## DAMPER CONTROL INSTALLATION INSTRUCTIONS

### GENERAL OPERATIONAL DATA:

is Damper Control, operated by the Thermostat, is for use on hand fired heating systems to provide automatic control of furnace operation. When the room temperature falls below the thermostat setting, the draft door opens, thereby increasing the combustion in the firebox of the furnace. This causes the room temperature to rise to the degree of heat chosen on the thermostat; the draft door then closes and the check door opens to retard combustion, thus slowing down the fire.

**DAMPER MOTOR** — is automatically set by the Thermostat, and is an automatic safety device which prevents the furnace from overheating under unusual conditions. It closes the draft doors and opens the check door when the heat in the bonnet of the furnace becomes excessive; this retards combustion, slowing down the fire, as well as saves fuel. See Instructions furnished with the Limit Control.

### SUGGESTED LIMIT CONTROL SETTINGS —

on Hand Fired Gravity Furnaces — between 200 and 325 degrees

on Forced Warm Air Furnaces — between 150 and 200 degrees

Each installation presents a different problem — if you'll follow these suggestions, and observe the action of your installation, it won't take long before you find the ideal setting for your comfort and needs.

### INSTALLATION:

Use red, white and blue terminals on Thermostat and Damper Control. The yellow terminals on the Damper Control provide connections for the Day-Night Thermostat.

Connector Jumper on Damper Control between yellow and green terminals is to be removed **ONLY** when Limit Control is to be used.

Mount Damper Control in upright position either on a board extending down from an overhead joist or in a convenient location on the wall of the furnace room.

When switch on motor is turned to closed position, the arms on the Damper Control should be so placed that they will close draft and open check. **ALWAYS ATTACH DRAFT DOOR BY MEANS OF CHAIN** furnished to the left arm of the damper control.

5. The connecting links of Damper Control arms should be set in the best position to give the proper opening of the Damper. On most installations the link can be set at the end of the slot nearest the shaft, which will usually provide the proper opening; a longer throw may be had by sliding the arm link out, and tightening the screw firmly.

TO  
THERMOSTAT

W B R

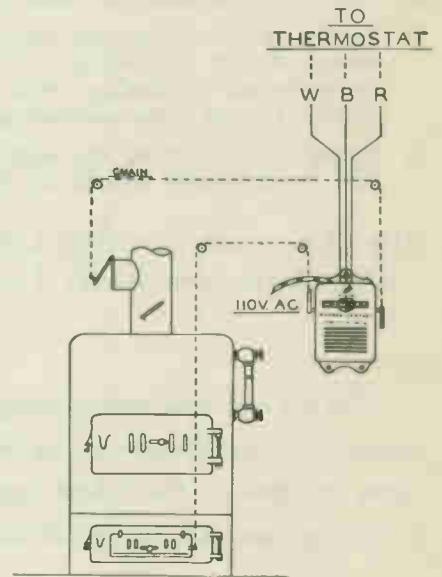

TO  
THERMOSTAT

W B R

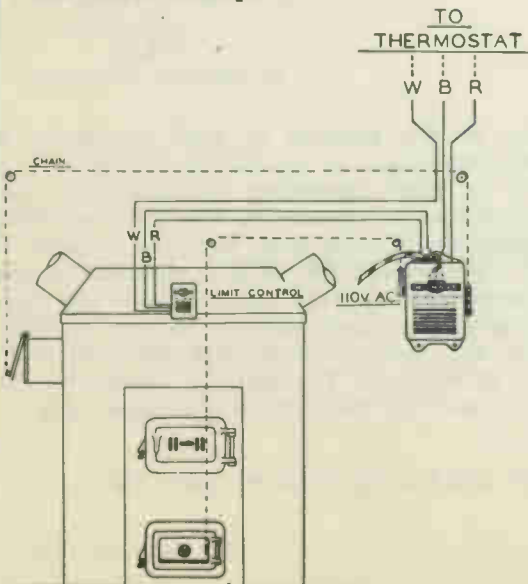

6. Locate chain pulleys directly above damper arms in order to give a straight pull on the chain rolling over the pulley.

7. Eighteen feet of chain is furnished with each unit. If this is not sufficient, use wire for any necessary additional length between pulleys - **CHAIN MUST BE USED AT POINTS WHERE IT PASSES THROUGH PULLEYS**. Two sets of hooks are furnished for chain connections; the two small hooks are for use on the Damper Control, and the two larger hooks are for use on the Draft and Check.



## DAY-NIGHT THERMOSTAT

Patent Pending

For Use With Any Two-Wire Automatic Heating Equipment (Oil, Gas or Stoker)  
and Three-Wire Damper Control

### INSTRUCTION SHEET FOR INSTALLATION AND OPERATION

**THIS DAY-NIGHT THERMOSTAT** is precision built by expert HOMART Engineers; it will give you years of dependable service. The control is calibrated to operate with a variation in temperature of degrees; where a closer differential is required, the thermostat can be adjusted to a temperature variation as  $\frac{1}{2}$  degree, however it is not advisable to start the heating unit too often.

**LOCATION** — Install the Thermostat on an inside wall, approximately 54 inches from the floor, protected doors and drafts and several feet from radiators, registers, chimney or warm air ducts.

**ADJUSTMENT** — The Day Setting Dial, with red numerals, No. 5, is located at the right hand side of the Thermostat; the Night Setting Dial, with black numerals, No. 13, is located on the left hand side of the Thermostat. Set Day dial to the temperature reading you find the most comfortable, then set the Night dial slightly lower for economy of operation, and for sleeping comfort.

The Thermostat is equipped with a lever located at top-center which enables you to prolong the day temperature into the late evening hours by moving the lever, No. 4, to the left as far as it will go; this is done rather than change the Night Dial to a higher temperature. When the need for Day Heat is over, move the lever to its normal position, to the right as far as it will go.

**TO ADJUST DAY AND NIGHT OPERATING PERIODS** — Remove the cover of the Thermostat by turning

the two screws on the bottom of the case. Note the 24 Hour Dial—No. 8. This instrument is set at the factory to drop the room temperature to night level at 10:45 P. M. and to bring the day temperature up at 5:30 A. M. No. 2 Pointer indicates change to Night temperature; No. 11 Pointer indicates change to Day temperature.

The minimum day or night period of operation is one hour; the maximum day or night period of operation is 23 hours. The control can be adjusted to change anywhere between these ranges.

To change the setting of Day and Night periods, loosen knurled nut No. 1, by turning counter-clockwise about one-eighth turn—no more. Move Pointers No. 2 and No. 11 to desired positions, then tighten knurled nut firmly.

**TO SET THE CLOCK** — IMPORTANT — If at 4:00 P. M. the position of the black, or Night space on Dial No. 12, is at the bottom of this 24 Hour Dial, it is 12 hours out of position. You should set the clock 12 hours ahead by turning reset wheel, No. 7, in a clockwise direction — DO NOT TURN THE CLOCK BACKWARDS. Pointer No. 10 indicates the correct time and period of the day — morning, afternoon or night.

**TO SELECT TEMPERATURE VARIATION ON DAY THERMOSTAT**—No. 3 is known as the differential lever. This thermostat is set at the factory to allow a variation of  $1\frac{1}{2}$  degrees in room temperature. If it is desired to reduce the variation in room temperature, push lever toward "MIN.", and if desired to widen the variation, push the same lever toward "MAX.".

**TO ADJUST CALIBRATION OF THERMOSTAT** — Occasionally in the temperature reading on Day Temp Dial, No. 5, and the reading on the Night Temp Dial, No. 13, the thermostat, mounted inside the Thermostat case, may become separated slightly. In order to synchronize the two, turn screw No. 9 in a clockwise direction to raise the reading on the Day Temp Dial, and in a counter-clockwise direction to lower them. Do not turn more than one turn in either direction. The operation should be applied to the Night Temperature Dial by using Screw No. 9. It is our opinion that a slight difference between the Night Dial and Day Dial Thermometer Reading is not objectionable.

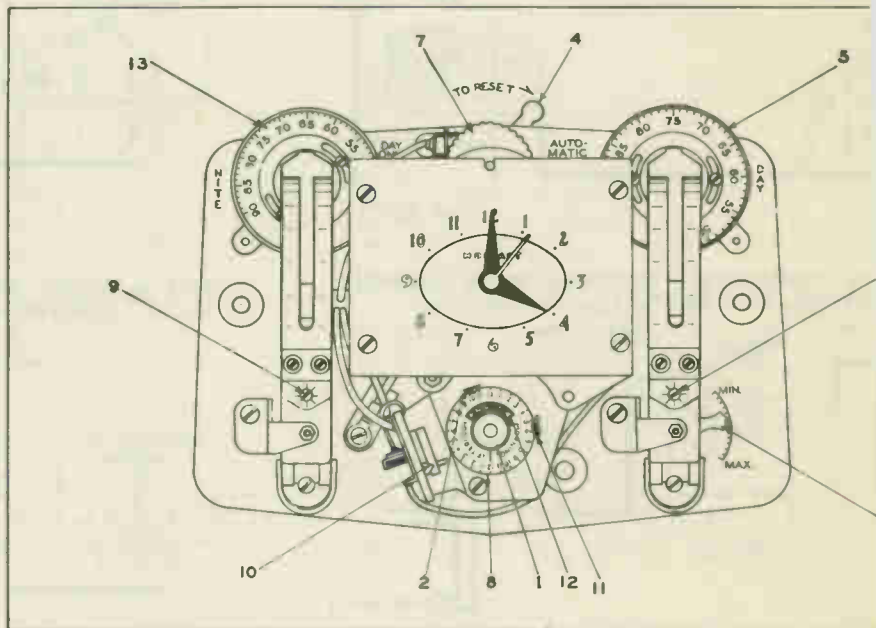



WIRING DIAGRAMS

D THERMOSTAT HOOK-UP WITH DAMPER CONTROL

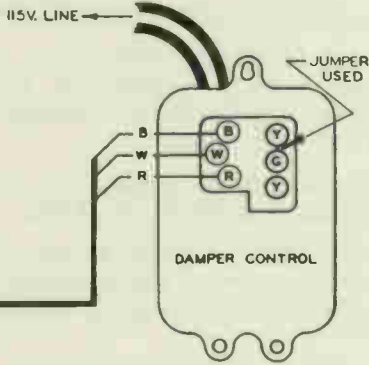

STANDARD THERMOSTAT HOOK-UP WITH DAMPER CONTROL & LIMIT CONTROL

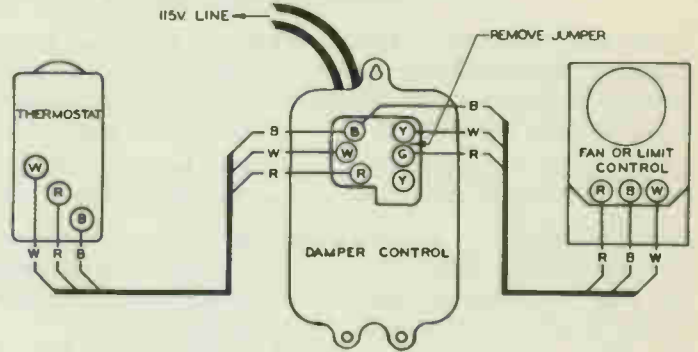

NIGHT THERMOSTAT HOOK-UP WITH DAMPER CONTROL

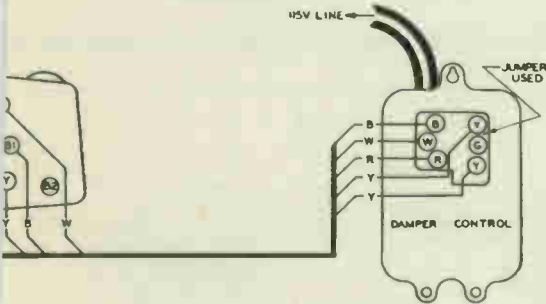

DAY & NIGHT THERMOSTAT HOOK-UP WITH DAMPER CONTROL & LIMIT CONTROL

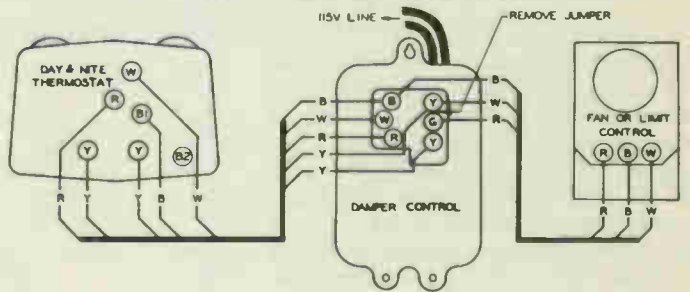

RD THERMOSTAT HOOK-UP WITH DAMPER CONTROL AND FAN & LIMIT CONTROL

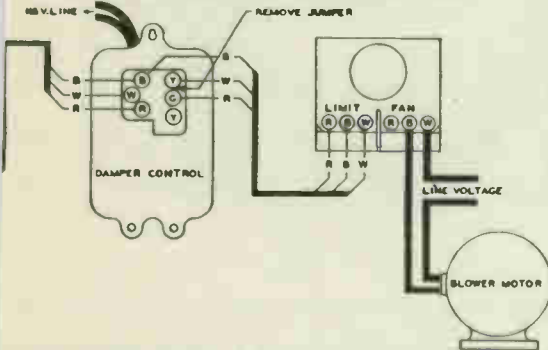

DAY & NIGHT THERMOSTAT HOOK-UP WITH DAMPER CONTROL AND FAN & LIMIT CONTROL

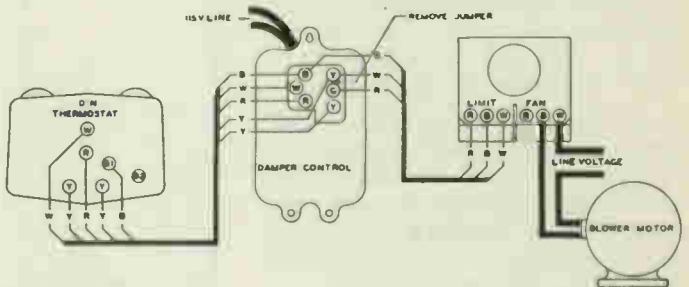

MIT CONTROL HOOK-UP WITH BLOWER UNIT

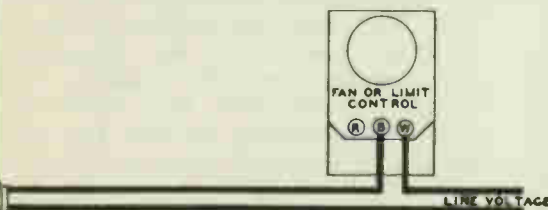

DAY & NIGHT THERMOSTAT HOOK-UP WITH J M I PRIMARY CONTROL WITH LIMIT FOR OIL BURNER APPLICATION

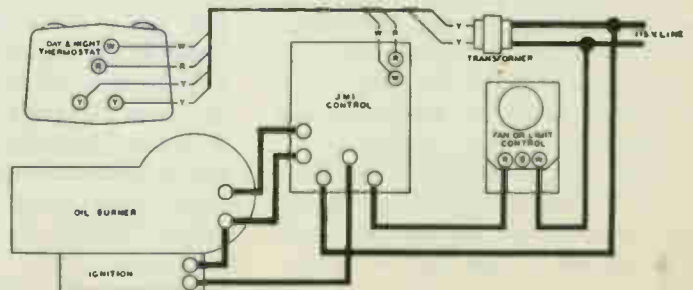

Fig. 2A

1-2-6-7-14-15-23

# MOTOR SELECTION GUIDE

n g n-	REVERSIBILITY		Radio Interference	Approximate Comparative Price	Price List	Descriptive Data	APPLICATION DATA
	At Rest	In Motion					
if-h	Yes Change Connections	No Except with Special Design and Relay	None	85%	2865 2867 2868	DMF-5851 F-8485 F-8486 F-8490 F-8487	For applications up to 1/3 hp where medium starting and breakdown torques are sufficient. Low starting current minimizes light flicker making motor very suitable for frequent starting, such as on oil burners, office appliances, fans and blowers. Thermoguard available for ratings from 1/8 hp up.
rif-lch	Yes Change Connections	No Except with Special Design and Relay	None	60%	2865	DMF-5836 F-8496	Designed for continuous and intermittent duty applications where operation is infrequent and starting current in excess of NEMA values is not objectionable. Ideal for washing machines, ironers, sump pumps, and home workshop machines. May cause light flicker on underwired or overloaded lighting circuits.
rif-lch	Yes Change Connections	No	None	165%	Refer to Works		Recommended for belted furnace blowers, attic ventilating fans and similar belted medium-torque jobs. Simplicity permits operation with any 1-pole, double-throw switch or relay. Starts equally well on either speed thus can be used with thermostatic or other automatic control. Thermoguard recommended as tight belt or incorrect pulley ratio may overload motor.
rif-lch	Yes Change Connections	No Except with Special Design and Relay	None	100%	2865	DMF-5850 F-8490 F-8489	All-purpose motor for high starting torque, low starting current, quietness and economy. Efficiency and power factor among highest. Ideal for all heavy-duty drives, such as compressors, pumps, stokers, refrigerators and air conditioning. Single voltage in 1/6, 1/5 and 1/4 hp, 4-pole sizes—dual voltage in all others. All sizes obtainable with Thermoguard.
trif-lch	Yes Change Connections	No	None	200%	Refer to Works		Supplements line of 2-speed split-phase motors (see above) and is used on identical applications requiring horsepower ratings from 1/3 to 3/4 hp.
one	Yes Change Connections	No	None	125%	2868	F-8485	For direct connected fan drives . . . particularly unit heaters. Not for belt drives. Same motor adaptable for 110 or 220 volts for 1-speed, 2-speed, or multi-speed service by use of 1-pole, single-throw switch, 2-pole, double-throw switch, or speed controller, respectively. Fan load must be accurately matched to motor output for proper speed control. All ratings dual voltage and dual rotation.
ort-uit-r	Yes Shift Rocker Ring	No	Yes During Starting	105%	2865	DMF-5837	Suitable for applications requiring high breakaway torque, such as certain types of industrial compressors, machine tools and farm machinery. All ratings are dual voltage. Resilient mountings not available with this type of motor.
one	No	No	None	. .	2870	F-8485 F-8488	Enclosed for fan duty in sub-fractional hp range—cooled by air flow over motor. Available with sleeve or ball bearings, rigid, resilient or footless frame, and with 2 or 3-speed controller. Driven fan load should be accurately matched with motor output to get proper speed control. No conduit box—conduit connector optional.
trif-lch	See FH	See FH	None	325%	Refer to Works		Definitely constant speed. Principal applications are on instruments, sound recording and reproducing apparatus, teleprinters and facsimile printers. Type selected depends largely on starting torque. Type FBL is recommended where low watts input is desirable and low starting torque is sufficient. Type FBH or FBJ are recommended where higher starting torque is needed. Pull-in torque on all types is affected by inertia of connected load.
trif-lch	See FJ	See FJ					
one	See FL	See FL					
one	See FS	See FB					
one	Yes Change Connections	Yes Change Connections	None	140%	2865	F-8537 F-8485 F-8487	For all applications where polyphase circuits are available. Special designs with extra high starting torque for such applications as hoists, door operators, tool traverse and clamp motors. All ratings available with ball bearings to meet the special needs of industrial applications. All permit starting directly across the line. Overload protection usually provided in control.

# WESTINGHOUSE SM

TYPE OF MOTOR		WIRING DIAGRAM	 TYPE	HP Range	SPEED DATA			Appr		
					Rated Speed	Speed Characteristics	Speed Control	Start		
SINGLE PHASE	SPLIT PHASE	GENERAL PURPOSE		FH	1/20 to 1/3	3450 1725 1140 860	Constant	None	Medium	
		HIGH TORQUE			FH	1/6 to 1/3	1725	Constant	None	High
		TWO-SPEED Two Windings		FH	1/8 to 1/4	1725/1140 1725/860	Two-Speed	1-Pole Double-Throw Switch	Medium	
	CAPACITOR	GENERAL PURPOSE (Capacitor-Start, Induction-Run)			FJ	1/8 to 3/4	3450 1725 1140 860	Constant	None	Extra High
		TWO-SPEED, Capacitor-Start (Two Windings)			FJ	1/3 to 3/4	1725/1140 1725/860	Two-Speed	1-Pole Double-Throw Switch	Medium
		SINGLE VALUE (Permanent Split)			FL	1/20 to 3/4	1620 1080 820	Constant or Adjustable Varying	Two-Speed Switch or Autotransformer	Low
	REPULSION START	GENERAL PURPOSE (Repulsion-Start Induction-Run)			FR	1/4 to 3/4	3450 1725 1140	Constant	None	Extra High
	SHADED POLE	SHADED POLE			FE	1/300 to 1/30	1500 1000	Constant or Adjustable Varying	Choke Coil	Low
	1, 2, 3 PHASE	SYNCHRONOUS	SPLIT-PHASE	Refer to FH	FBH	1/250 to 1/3	3600 1800 1200 900	Absolutely Constant	None	Low
			CAPACITOR-START	Refer to FJ	FBJ					Medium
			SINGLE VALUE CAPACITOR	Refer to FL	FBL					Very Low
			POLYPHASE	Refer to FS	FBS					Medium
POLYPHASE	2 or 3 PHASE	SQUIRREL CAGE			FS	1/6 to 3/4	3450 1725 1140 860	Constant	None	High







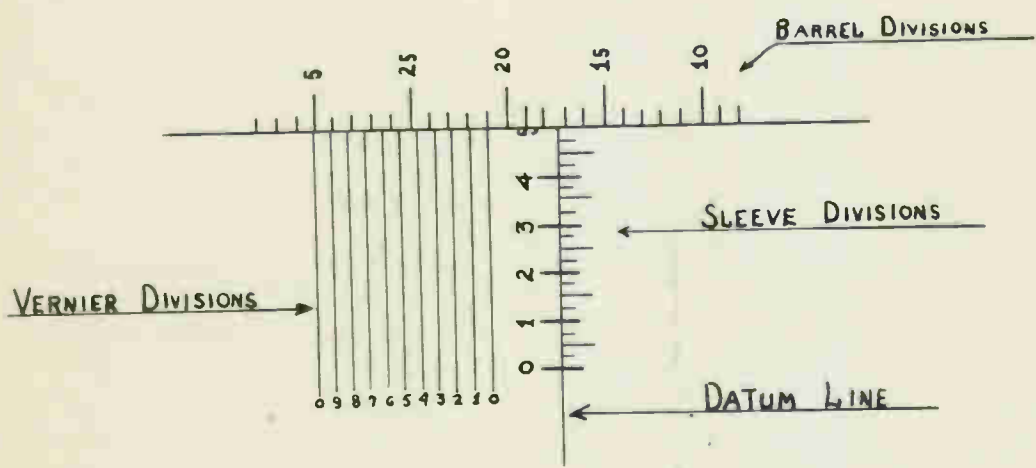
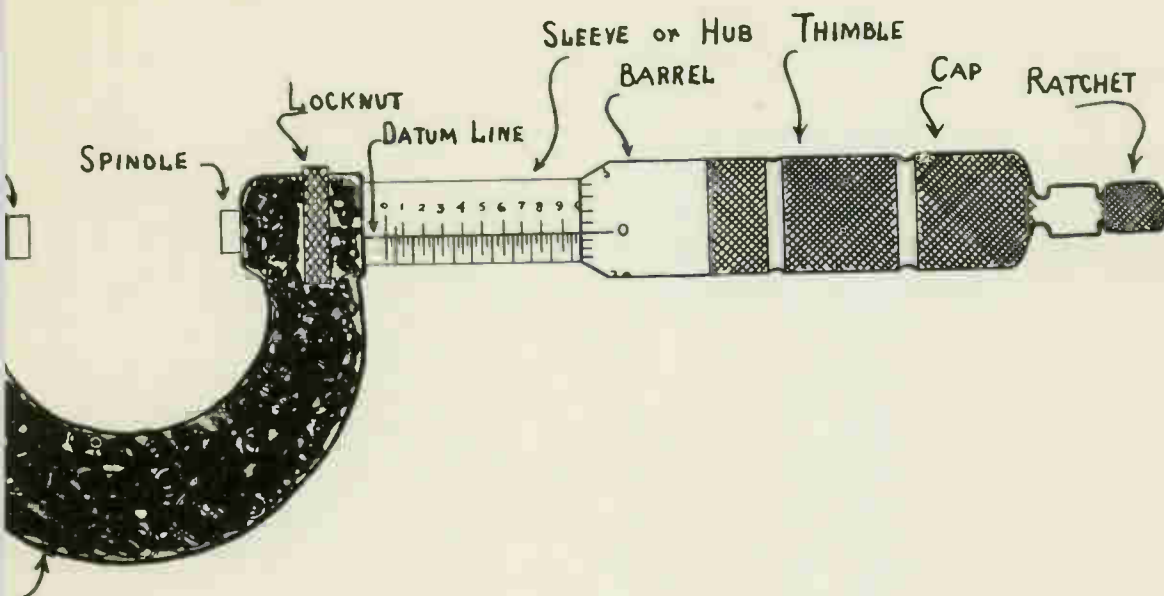

MICROMETER READING

Objective

To learn how to read a Micrometer.

Average Time Required: 2 hours

References:

Tools, Equipment & Materials

Micrometer Kit

Precaution

DO NOT LEAVE MICROMETER SPINDLE AND ANVIL CLOSED TIGHTLY.

Procedure Steps

1. Obtain a Micrometer Kit from stock.
2. Measure with the micrometer, all items in the kit and record the readings.
3. Have an Instructor check the readings and give credit for the job.



The vertically mounted armatures for this experiment are used to demonstrate the fact that magnetic poles are produced on the armatures surface when current flows through the windings. The tests outlined below will be very helpful in understanding the action of the armature and its windings.

Make the Following Tests:

A. Connect d-c supply to brushes and move a compass around the armature.

1. How many poles are there? *Four Poles*
2. Are there as many north poles as south poles? *yes*
3. Are adjacent poles like polarity or are the unlike polarity? *Unlike*
4. Are all the poles the same distance apart? *yes*

B. Reverse the current through armature by reversing the attachment plug, and check the polarity at the same position on the armature.

1. What has happened to the armature polarity? *Reversed the Poles*
2. What caused the polarity to be reversed? *Reversing the Polarity of the*
3. Do all of the poles change? *yes*

C. Rotate the armature.

1. Do the armature poles change position (with reference to space)? *No*
2. Do the armature poles change position (with reference to the armature core)? *yes*
3. Do the armature poles change polarity? *No*

D. Shift the brushes to a different position.

1. Do the armature poles change position (with reference to the armature core)? *yes*
2. Does the position of the poles change (with reference to space)? *yes*
4. Do the poles shift in the same direction as the brushes? *yes*
4. Do the poles move through the same angle as the brushes? *yes*

E. Test the magnetic pull with a small piece of steel.

1. Will a south magnetic pole produce as much pull as a north magnetic pole? *yes*

F. Complete the following diagram according to steps 1 through 4.

1. Show position of brushes.
2. Mark the N and S poles of the armature with reference to the brushes.
3. Assume field pole polarity.
4. Show rotation (for the assumed field pole polarity).

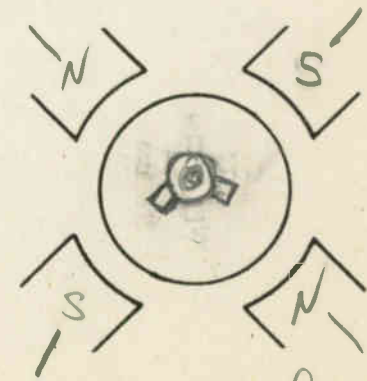
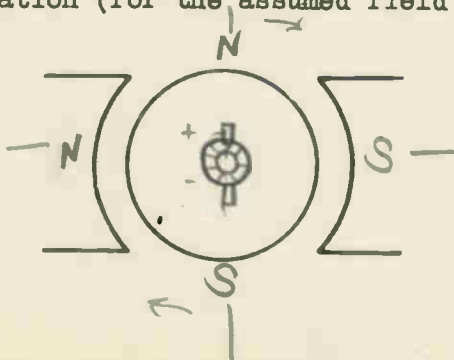

5. Will the rotation be affected by changing the armature leads? How? *It reverses*



FANS

Objective:

To learn a disassembly procedure, construction and testing of an electric fan.

Average Time Required: 1 hour

References:

Tools, Equipment & Materials

- 1. Coyne multi-meter
- 2. Appliance tool set
- 3. W & R tool set

Precaution: Do not "force" screws in plastic or bakelite handles or covers.  
Do not "plug-in" a fan when guard is removed.

Procedure Steps

1. Obtain a set of "appliance tools" at the stockroom.
2. Obtain a fan from an instructor.
3. Check the cord and fan for "opens" and "shorts" by using the volt-ohm-milliammeter. The volt-ohm-milliammeter should be set on the "low" ohm range.
4. Check the fan for opens and shorts by using the volt-ohm-milliammeter.
5. Check the fan for grounds using a 110 volt test lamp or a 2 watt, 110 volt neon test lamp.
6. Does the fan change speed when the control is varied?
7. When disassembling the fan, follow instructors directions carefully.
8. Check construction and connection of the speed control. What type? \_\_\_\_\_
9. What type of motor is used?
10. Fill in the chart:

	OPENS	SHORTS	GROUNDS
STATOR WINDING			
ROTOR			

11. Reassemble motor.
12. Make use of a watt-meter or ammeter and voltmeter and check the power input. Would you change the number of blades on a fan to move a greater volume of air? Explain.
13. Have the job checked by an instructor.

# DAY & NIGHT THERMOSTAT

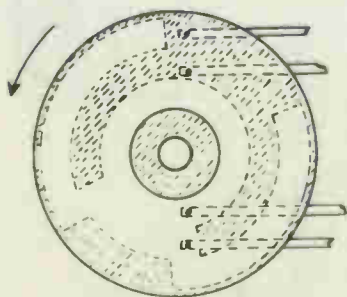
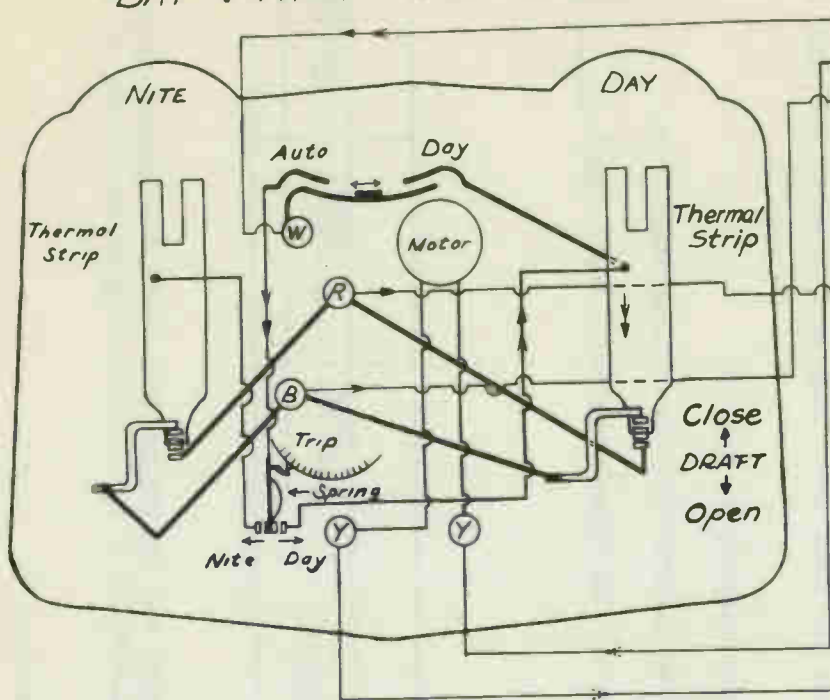

Circuits:  
 → Open Draft  
 → Close Draft  
 → Clock

Position of Wheel to Close Draft

# DAMPER CONTROL

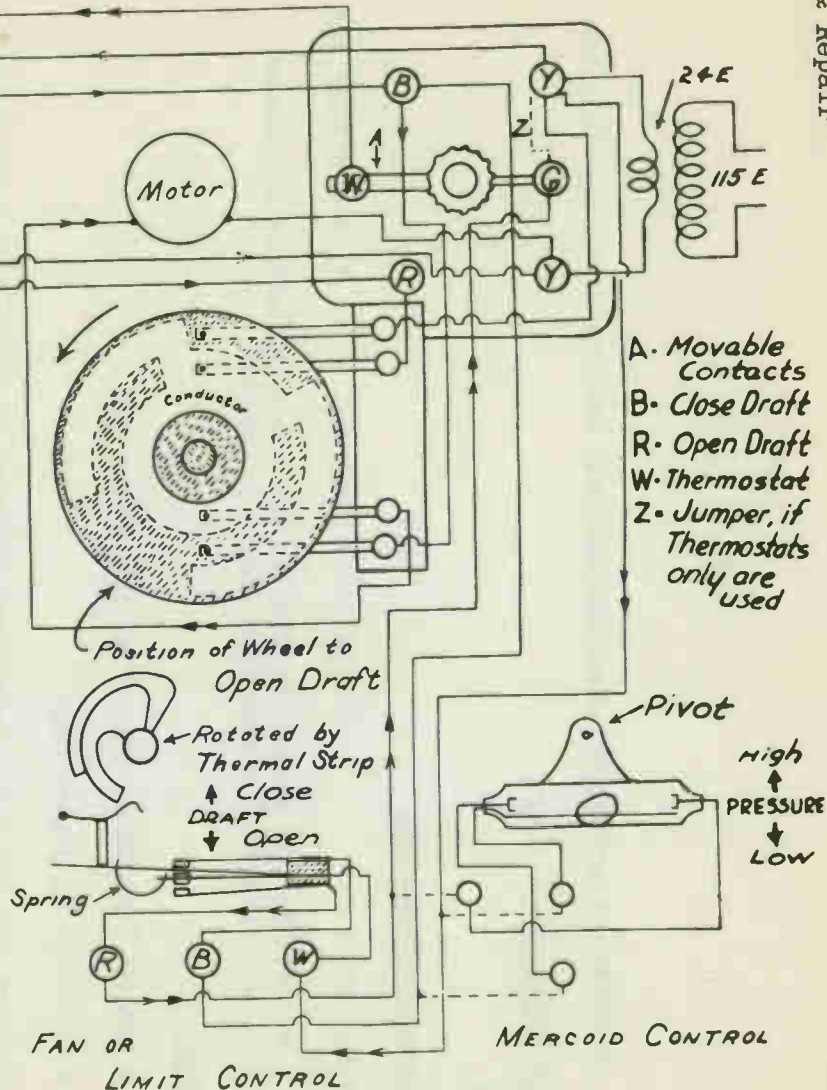

A - Movable Contacts  
 B - Close Draft  
 R - Open Draft  
 W - Thermostat  
 Z - Jumper, if Thermostats only are used

## AUTOMATIC FURNACE CONTROLS

Objective

To analyze an automatic furnace control circuit and connect one for proper operation.

Average Time Required: 2 hours

References:Tools, Equipment & Materials

1. W & R Tool Kit.
2. Scrap Wire #24.

Procedure Steps

1. Trace the circuits on Fig. 1 as follows:
  - a. Trace in RED, that circuit which opens the draft when the control knob is set on "open draft".
  - b. Trace in BLUE, that circuit which closes the draft when the heat in the bonnet has reached the temperature for which the limit control is set.
  - c. Trace in GREEN, that circuit which is completed when the temperature in the bonnet has dropped below "low" setting at night and the room temperature below thermostat setting.
  - d. Trace in BLACK that circuit which continues closing or opening the damper after the switch wheel has turned about 50°.
2. Have the diagram checked by an instructor.
3. Obtain some scrap wire, #24, and connect up a furnace control panel.
4. Have an instructor check the completed job.



# TESTING MAGNETOS

MAKE OF MAGNETO	No. OF CYL.	ROTATION	CHECK CONDITION OF				ARMATURE			MAGNETS LBS. PULL	
			BREAKER	COLLECTOR RING	BEARINGS	INSULATION	CURRENT THRU. PRI.	VOLTAGE DROP ACROSS SEC.			SPARK JUMP
								V. M.	WINDING		

## TEST CIRCUITS

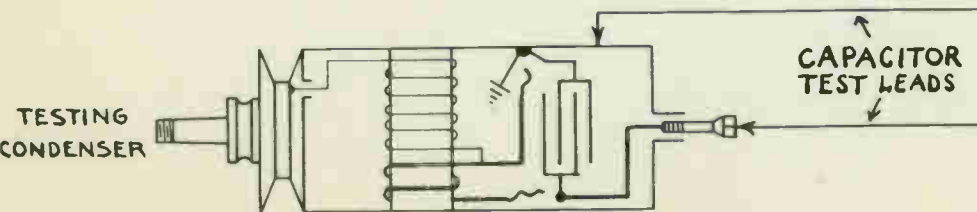
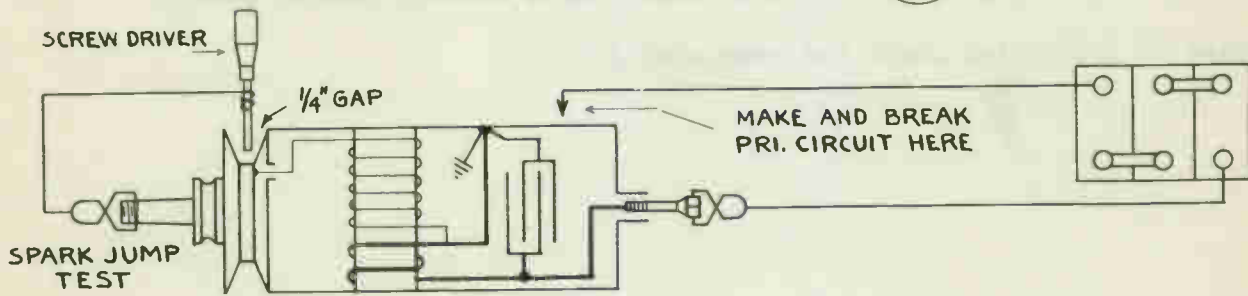
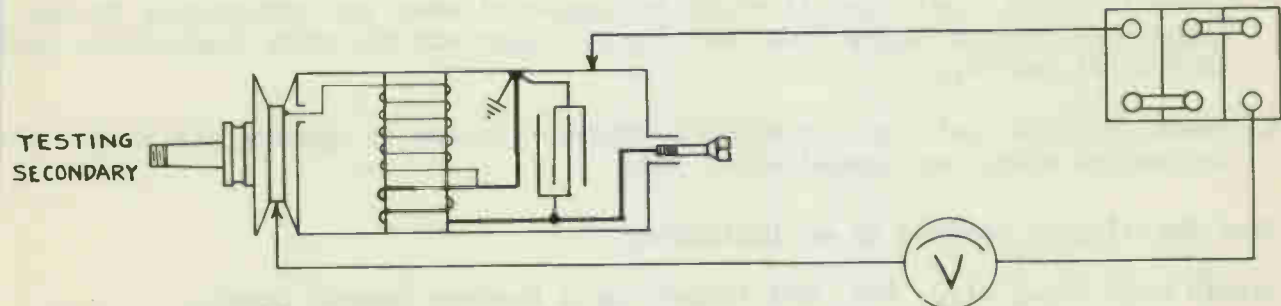
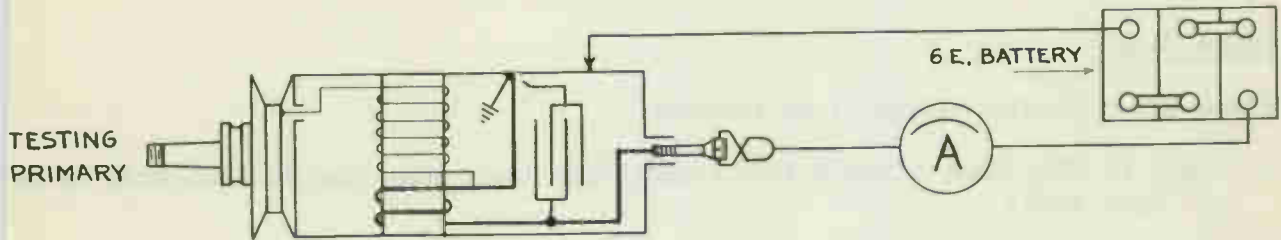

IN ORDER TO TEST CAP. PRI. WINDING MUST BE DISCONNECTED AS SHOWN.

## MAGNETOS

Objective

To learn to disassemble, check, and reassemble a magneto.

Average Time Required: 3 hours

References:Tools, Equipment & Materials

1. Magneto
2. W & R Tool kit.
3. Additional tools may be obtained, as they are needed, at the desk.

Precaution

Follow disassembly procedure carefully, lesson No. 18

Procedure Steps

1. Obtain magneto at the stockroom
2. Disassemble (follow disassembly procedure in lesson 18 carefully).
3. Make tests as indicated on Fig. 1 and also fill out the chart.
4. Reassemble the magneto (Be sure the keepers are used when removing the magnets for charging and be sure the magnets are placed on the magneto frame properly.)
5. Have the data, Fig. 1 and the magneto checked by an instructor.
6. Return the magneto to the stockroom and have it exchanged for another.
7. Apply the above procedure to the second magneto. After completing the second magneto. Take the magneto to the desk for a running test.

NOTE: An instructor will allow credits for the completed job.

8. Return the magneto to the stock room.

## MAGNETO IGNITION SYSTEM

Objective

To learn the fundamental operating and mechanical characteristics of a magneto ignition system.

Average Time Required: 1 hour

References:

Precaution: Do not operate the magneto with the distributor cap removed.

Procedure Steps

1. This test stand is assembled on the table lettered "I".
2. Operate the system and write answers to the following questions:
  - a. Make of magneto? \_\_\_\_\_
  - b. Designed for how many cylinders? \_\_\_\_\_
  - c. At what speed is the magneto on this stand being driven? \_\_\_\_\_
  - d. On an engine, at what speed would it be driven in relation to crank-shaft speed? \_\_\_\_\_
  - e. What is the direction of armature rotation? \_\_\_\_\_
  - f. What is the direction of distributor rotation? \_\_\_\_\_
  - g. What is the firing order according to distributor numbers? \_\_\_\_\_
  - h. How many sparks occur for each revolution of the armature? \_\_\_\_\_
  - i. How many breaker cams in the breaker box? \_\_\_\_\_
  - j. How many sparks per minute at the speed at which it is being driven? \_\_\_\_\_
  - k. What is the purpose of the safety gap? \_\_\_\_\_
  - l. How is the safety-gap connected in relation to the spark plugs? \_\_\_\_\_
  - m. In which circuit is the control switch operated? \_\_\_\_\_
  - n. Why does the engine stop when the control switch is closed? \_\_\_\_\_
  - o. In which direction is the breaker-box moved, in order to advance the spark? \_\_\_\_\_

## BEARING REAMING

Objective

To learn a procedure for installation and reaming of bearings.

Average time required: 2 hours

References:Tools, Equipment and Material

1. Motor and bushings.
2. Bearing tool kit (the bearing puller contains 17 parts)
3. Bearing reamer.

Precaution

Never turn a reamer counter-clockwise. Never expand the reamer while it is in the bearing. Check the bearings to see that they are not too small for bearing housing.

Procedure Steps

1. Obtain at stockroom, a motor, bushings and tools, including bearing reamer.
2. Disassemble the motor and remove the old bearings.

NOTE: To pull the bearings from the housing, pull from the outside toward the inside. To replace bearings pull from inside, out.

3. Replace the bearings with new ones.

NOTE: Be sure the slot in the bearing is lined up properly in the housing.

4. Ream bearings for .510", .515", and .520". Check each demension with the proper plug gauge.

CAUTION: Never expand reamer while in bearing. Never expand the reamer more than one-fourth turn, for one cut.

5. Have an instructor check your job after the bearings have been reamed for .520.
6. Return the motor and tools to the stockroom.

10. Check to determine if the armature is connected progressive or retrogressive? Which did you find? 1. progressive 2. retrogressive

Why is this type connection used on this motor? 1. to prevent a short  
2. to prevent a short

What would be the effect on operation, if changed from progressive to retrogressive or vice-versa? 1. reverse  
2. reverse

What is the proper method of reversing rotation?  
change wiring on brush leads

Why is the iron of armature always laminated?  
to prevent eddy currents

11. Check the voltage drop across each field coil. (apply 6V. d-c). What is the drop across each coil? 1. 3 Volts 2. 3 Volts

Is armature grounded? 1. No 2. No Does armature have an open? 1. No 2. Yes

Does armature have a short? 1. No 2. No Is field grounded? 1. No 2. No

12. Reassemble the motor.

13. Test the motor to see if it will operate.

14. Return the motor to the desk. Obtain another motor and repeat the above procedure. Credits will be allowed upon completion of the second motor.

## VACUUM CLEANER MOTORS

Objective

To disassemble and check a vacuum cleaner motor.

Average Time Required: 3 hours

References:Tools, Equipment & Materials

1. Vacuum cleaner
2. W&R tool kit.

NOTE: If brushes and springs are needed, see an instructor at the desk.

3. Volt-ohmmeter

PRECAUTION: Keep hands away from the fan when operating the motor.

Procedure Steps

1. Obtain a universal motor at the desk.
2. Remove the brushes and springs first and then completely disassemble the motor.
3. Check bearings - what is the condition of the bearings? 1. Roller bearings  
2. Both bearings worn (ball type)
4. Determine the number of poles in motor field winding. How many are there 1. 2  
2. 2 poles
5. Determine the number of poles in the motor armature. How many are there? 1. 2  
2. 2 poles
6. Check to determine if the winding is symmetrical or non-symmetrical. Which is it? 1. Non-symmetrical 2. Non-symmetrical  
Why is this type winding used? Compact & easy to construct
7. Check to determine if the armature is wound lap or wave? Which is it? 1. Lap  
2. \_\_\_\_\_
8. Check to determine the number of elements - how many did you find? 1. 2 elements  
2. 2 elements
9. Check the coil span. What is the coil span? 1. 1-11  
2. 1-6

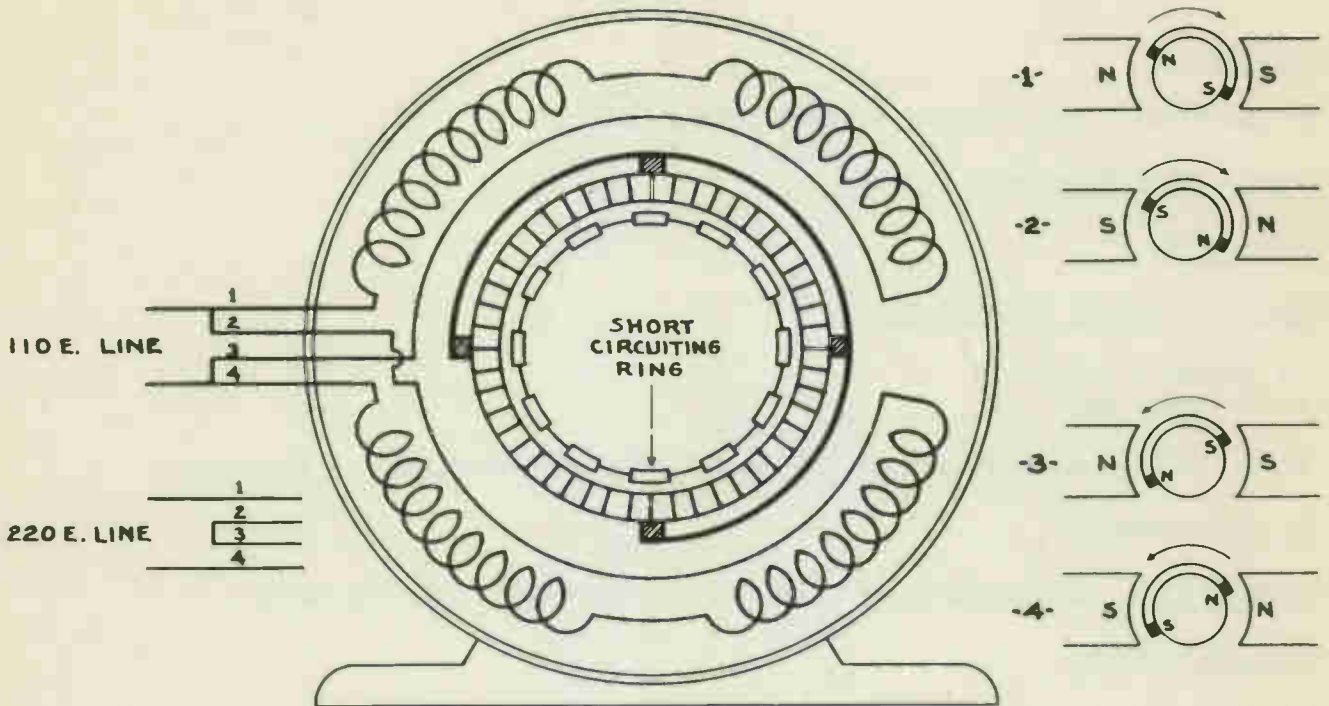

### REPULSION-START-INDUCTION MOTOR

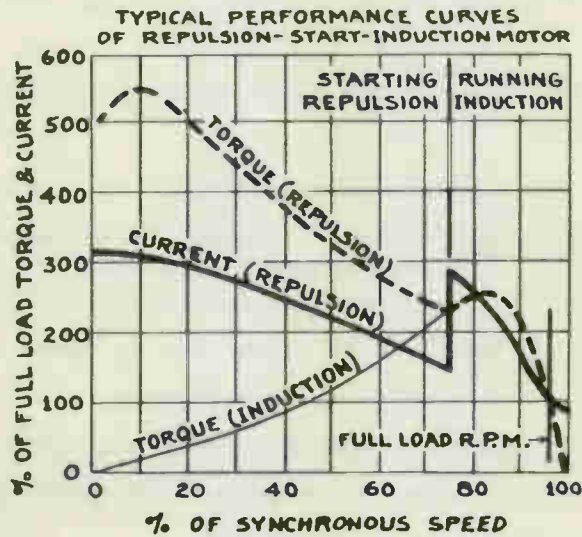

## REPULSION-START-INDUCTION MOTOR

OPERATION - In this motor are combined the high starting torque of the repulsion-type and the good speed regulation of the induction motor. The stator of this machine is provided with a regular single-phase winding, while the rotor winding is similar to that used on a D.C. motor. When starting, the changing single-phase stator flux cuts across the rotor windings inducing currents in them that, when flowing through the commutator and brushes, set up poles on the rotor which remain stationary in space and maintain a continuous repulsive action upon the stator poles. This motor starts as a straight-repulsion-type and accelerates to about 75% of normal full speed when a centrifugally-operated device connects all the commutator bars together and converts the winding to an equivalent squirrel-cage type. The same mechanism usually raises the brushes to reduce noise and wear. Note that, when the machine is operating as a repulsion-type, the rotor and stator poles reverse at the same instant, and that the current in the commutator and brushes is A.C.

CHARACTERISTICS - This motor will develop 4 to 5 times normal full load torque and will draw about 3 times normal full load current when starting with full line voltage applied. The speed variation from no load to full load will not exceed 5% of normal full load speed. For complete data on current, torque, etc., see curves below.

APPLICATION - Air compressors, refrigeration compressors, plunger-type pumps, meat-grinders, small lathes, small conveyors, stokers, etc. In general, this type of motor is suitable for any load that requires a high starting torque and constant speed operation. Most motors of this type are less than 5 H.P.

TROUBLES - Commutator, brushes, centrifugal switch, short-circuiting rig, bearings, oil-soaked insulation, solder thrown out of commutator, too much or too little tension on the throw-out spring; opens, shorts, or grounds in the rotor or stator winding. Rotation is reversed by shifting the brushes.

## REPULSION START, INDUCTION RUN MOTOR

1. T  F ( ) There is only one winding in the stator of this motor.
2. T ( ) F  The armature gets its current from the Stator through the brushes.
3. T ( ) F  D-c always flows in the conductors of an armature.
4. T  F ( ) The advantages of commutating the rotor current is to set-up poles on the armature with relation to the field poles, so that maximum starting torque can be obtained.
5. T ( ) F  This displacement is 90°.
6. T  F ( ) This motor runs as an induction motor after 75% of full speed is reached.
7. T  F ( ) This motor develops 4 to 5 times normal torque and draws 3 to 3.5 normal I at instant of starting.
8. T  F ( ) The stator winding is divided into two sections and four leads are brought for the purpose of adapting the motor to one of two different voltages.



iring & Repair

**SHADED POLE MOTORS** - A shaded pole motor is a single phase induction motor provided with an uninsulated and permanently short-circuited AUXILIARY WINDING displaced in magnetic position.

The AUXILIARY WINDING is known as the SHADING COIL and usually surrounds less than one third. The MAIN WINDING surrounds the entire pole and may consist of one or more coils per pole.

**OPERATION** - In the unshaded section of the pole, the magnetic flux produced by the main winding is in phase with the main winding current, whereas the flux produced by the shading coil is out of phase with the main flux. Thus the shading coil acts as a phase splitting device to produce the rotating field that is essential to the self-starting of all straight induction motors. As the movement of the flux across the pole face is always from the unshaded to the shaded section of the pole, the direction of rotation can be determined on the normally non-reversible motor by noting the position of the shading coil with respect to the pole itself. This type can be reversed by removing the stator from the frame, turning it through 180° and replacing it.

**CHARACTERISTICS** - The starting torque will not exceed 80% of full load torque at the instant of starting, increases to 120% at 90% of full speed, decreasing to normal at normal speed. This type motor operates at low efficiency and is constructed in sizes generally not exceeding one-twentieth H.P.

**APPLICATIONS** - Fans, timing devices, relays, radio dials, or in general any constant speed load not requiring high starting torque.

**SHADED POLE MOTOR - 2 MAIN WINDINGS** - This type is externally reversible by means of a S.P.D.T. switch as shown in the lower diagram. Note that only one set of shading coils is used. Trace the circuits and establish the position of poles for both rotations.

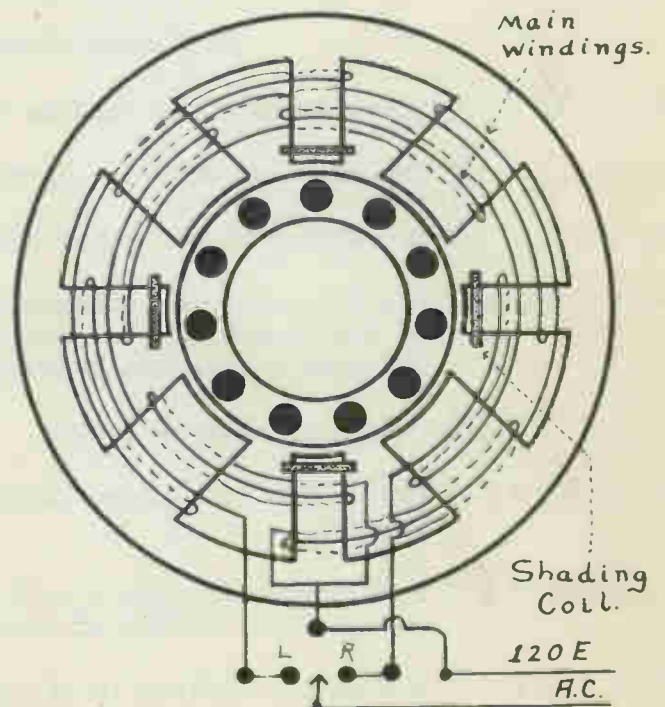
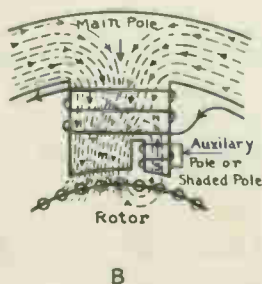
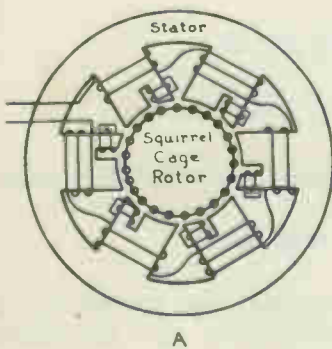

## SINGLE PHASE, SHADED POLE INDUCTION MOTOR

1. T  F ( ) The auxiliary winding is used to obtain a phase splitting effect.
2. T  F ( ) Energy reaches the shading coil by induction.
3. T ( ) F  The flux reaches maximum value first in the shaded pole section?
4. T  F ( ) The movement of flux is toward the shaded pole section?
5. T  F ( ) Rotor rotation is from the unshaded part of the pole toward the shaded section.
6. T  F ( ) Shaded pole motors have a very low efficiency.
7. T ( ) F  This motor has a high starting torque?
8. T  F ( ) In the externally reversible shaded pole motor, only one main winding is in operation at any time.
9. T  F ( ) The principle cause of trouble in this motor is worn bearings.
10. a ( ) b  This motor employs a starting winding called a (a) spiral winding  
c ( ) d ( ) (b) shading coil (c) skein winding (d) lap winding.
11. a  b ( ) The shading coil usually consists of (a) a single turn of heavy, bare  
c ( ) d ( ) copper bar (b) many turns of fine wire (c) a straight bar of bare copper.
12. a  b ( ) The torque developed at the instant of starting is (a) 80% (b) 90%  
c ( ) d ( ) (c) 100% (d) 120% of full load torque.
13. a ( ) b ( ) The normally non-reversible shaded pole motor may be reversed by  
c  d ( ) (a) shifting the brushes (b) reversing the shading coil leads  
(c) removing stator from frame and turning it end for end.
14. a ( ) b ( ) Operating efficiency of shaded pole motors is low because of (a) poor  
c  d ( ) starting torque (b) small motor size (c) interference of shading  
c coils with rotor action.
15. a ( ) b ( ) Shaded pole motors would not be suitable for which of the following  
c ( ) d  applications? (a) fans (b) timing devices (c) phonograph turntables  
(d) air compressors.
16. a ( ) b  The induced E of the rotor, as compared with stator E, is (a) high  
c ( ) d ( ) (b) low (c) the same (d) not related in any way.
17. a  b ( ) The induced I of the rotor, as compared with stator I, is (a) high  
c ( ) d ( ) (b) low (c) the same (d) not related in any way.
18. a ( ) b  The maximum H.P. rating commonly found in this type of motor is (a)  
c ( ) d ( ) 1/100 H.P. (b) 1/20 H.P. (c) 1/4 H.P. (d) 1/2 H.P.

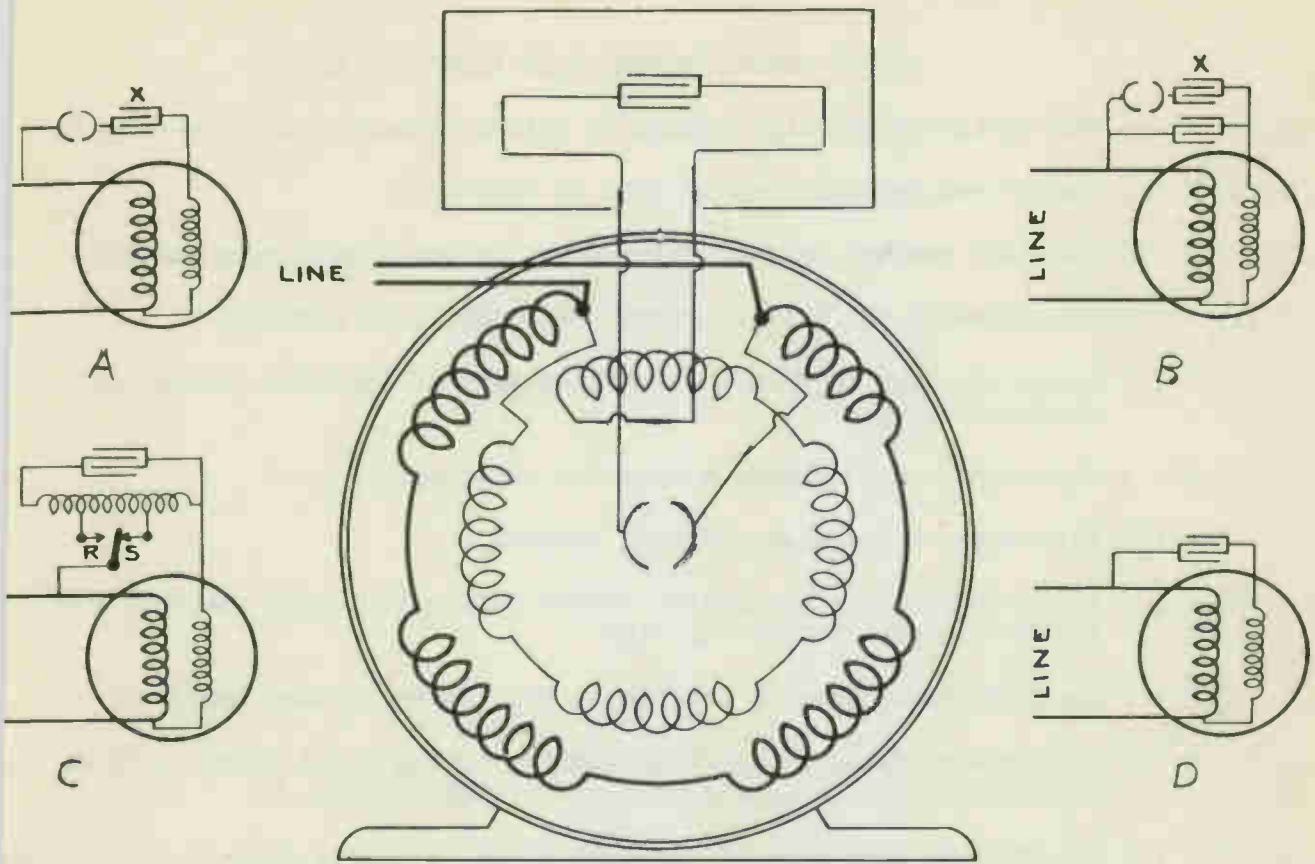

CAPACITOR START MOTORS

1. T ( ) F (X) Inductive reactance ( $X_L$ ) causes I to lead the applied E.
2. T (✓) F ( ) Capacity reactance ( $X_c$ ) causes I to lead the applied E.
3. T ( ) F (✓) The condenser is connected in parallel with the starting winding.
4. T (✓) F ( ) The electrolytic capacitor should not be in the circuit more than three seconds.
5. T (✓) F ( ) The displacement of currents in the two windings will be nearly 90 electrical degrees.
6. T (✓) F ( ) This displacement produces maximum starting torque.
7. T ( ) F (✓) The paperfoil condenser should not be in the circuit more than three seconds.
8. T (✓) F ( )  $X_L$  is 180° out of phase with  $X_c$ .
9. T ( ) F (✓) Each pole is 90 Electrical degrees.
10. T (✓) F ( ) The displacement in Electrical degrees between windings is 90°.
11. T (✓) F ( ) The capacitor start motor is used where a high starting torque is needed.

## CAPACITOR MOTORS

The above capacitor motor Fig. A is classified as a capacitor start motor. So called because it uses a capacitor in series with the starting winding for the purpose of causing the current to lead the applied voltage through that winding. With the leading current in the starting or auxiliary winding and the lagging current in the running winding it is possible to split the current through the two windings nearly 90 electrical degrees - from the same voltage supply. 90° is the theoretical perfect displacement of currents for maximum starting torque, in a single phase motor.

These motors have 3 to 4 times normal running torque at the instant of starting with about 5 to 7 times full load current. This motor should be used where it takes 3 seconds or less to come up to 75% of full speed at which time the centrifugal switch opens and the motor runs with the same characteristics as a single phase split phase motor.

These motors are used in nearly all household refrigerators and for compressors - and small lathes where instant reversing is required.

The ratio of the number of turns and wire sizes that are used in the Single phase split-phase motor does not hold true for the capacitor start motor. Usually the starting winding will have almost as many turns as the Running winding with wire 2 or 3 sizes smaller. This permits a smaller and therefore less expensive capacitor unit than would be needed if only half as many turns were used in the starting winding.

Keep in mind however that there is no hard and fast rule for this. The winding combination is designed for the particular starting characteristics desired.

The capacitor unit used is classified as a dry electrolytic non-polarized motor starting capacitor.

A much higher capacity is obtained with this unit for its size than any other type.

These condensers should not be left in the circuit for more than 3 seconds. Failure to observe this will greatly shorten their life by overheating which causes breakdown and boiling away of the electrolyte. Always replace defective unit with one of same MF and voltage rating or if the same mf is not obtainable one of slightly higher rating is preferred over one of a lower MF rating.

Diagram B shows a 2 value capacitor motor the small paper foil condenser is left in the circuit at all times. The starting winding current when the motor is running is not limited by the design of the winding it is limited by the high reactance of the small condenser. The value of these is usually 2- 16 MF diagram C shows an older method of obtaining the same effect. By using 1 condenser and an auto transformer during starting a High voltage is applied to the condenser which have the same effect as increasing the size of condenser.

At 75% of normal RPM the transfer switch changes to run position which lowers the voltage to the condenser and reduces the effective MF rating - Fig. D is a capacitor start capacitor run motor with the auxiliary winding in at all times. These motors are used where a high starting torque is not needed.

The running characteristics and power factor will be greatly improved with this arrangement - Quite often you will find more turns of wire in the auxiliary winding than the main winding on these motors.

SINGLE-PHASE SPLIT-PHASE INDUCTION MOTOR

**OPERATION** - To be self-starting, the stator winding of a squirrel-cage induction motor must be capable of setting up a rotating magnetic field. Since such a field cannot be produced by a single winding energized by a single-phase current, some method of splitting this current into two currents out of phase with each other must be provided. This is accomplished by having the single-phase current flow through two parallel paths having different electrical characteristics. One path, being highly inductive, causes the current flowing through it to lag behind the current through the other path. By this method, a revolving magnetic field is produced with single-phase current. Starting as a two-phase machine, this motor accelerates to about 75% of normal full load speed when a centrifugally-operated switch disconnects the starting winding and converts the unit to a straight single-phase type.

**CHARACTERISTICS** - This motor will develop from 1 to 1.5 times normal full load torque, and will draw as high as 9 times normal full load current when full line voltage is applied at starting. The speed variation from no load to full load will not exceed 5% of the normal full load speed. For complete data on current, torque, etc., see curves given below.

**APPLICATION** - Washing machines, ventilating fans, sign flashers, bottling machinery, oil burners, dairy machinery, garage equipment, stokers, coffee mills, shoe machinery, exercisers, dish washers, oil pumps, etc. In general, this motor - which is usually built in fractional h.p. sizes only - may be used for any small load that does not require a high starting torque and can be operated at constant speed.

**TROUBLES** - Centrifugal switch, starting winding, bearings, loose connections, oil-soaked insulation, opens, shorts and grounds, improper connections.

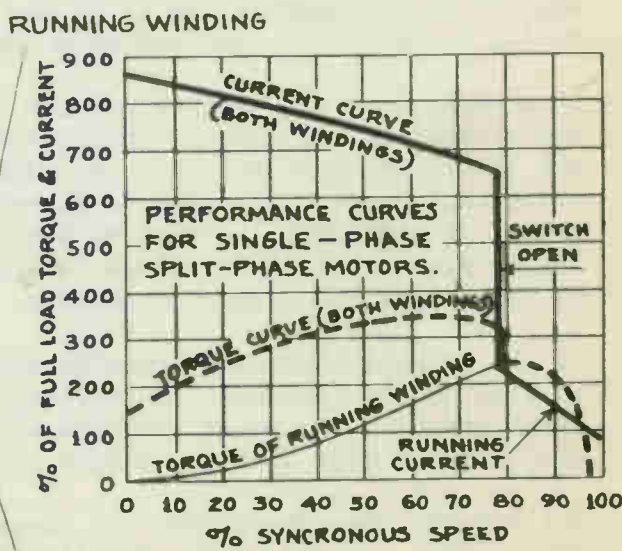
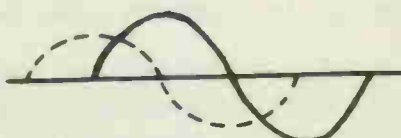
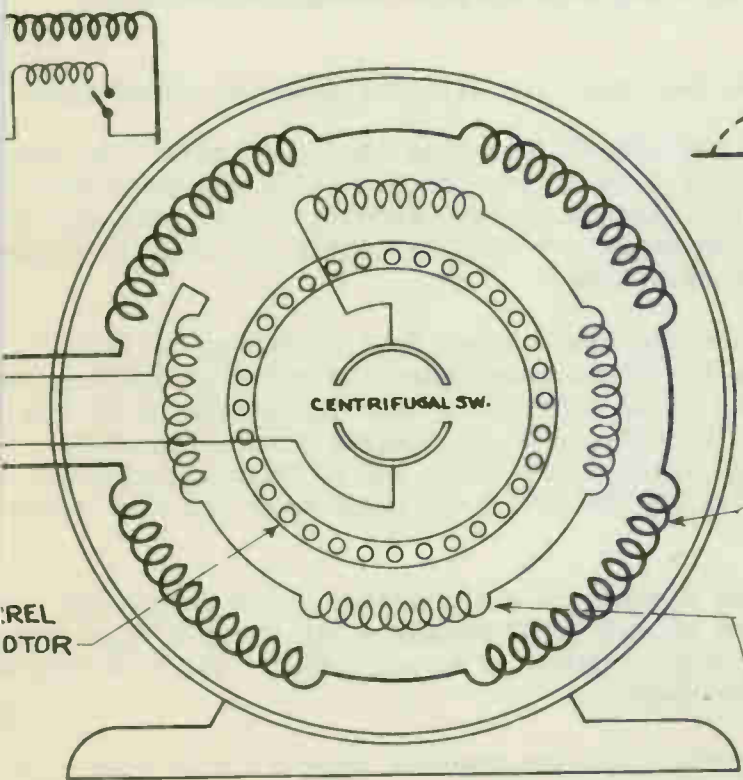

  
QUESTIONS

1. a (✓) b ( ) The windings of the split phase motors are (a) connected parallel  
c ( ) d ( ) with each other, (b) connected in series with each other (c) elec-  
trically independent of each other (d) in phase with each other.
2. a ( ) b ( ) The starting and running windings are placed on the stator (a) 30  
c (✓) d ( ) (b) 60 (c) 90 (d) 120 electrical degrees apart.
3. a ( ) b ( ) Two windings are used in this motor to (a) increase its speed  
c (✓) d ( ) (b) give it a greater running torque (c) set up a revolving field  
at starting (d) improve the efficiency of the motor.
4. a (✓) b ( ) The starting winding is taken out of the circuit by means of a  
c ( ) d ( ) (a) centrifugal device (b) magnetic device (c) timing relay (d) man-  
ual switch device.
5. a ( ) b (✓) The starting circuit is opened when the motor reaches what percent  
c ( ) d ( ) of full speed? (a) 50 (b) 75 (c) 90 (d) 100.
6. a ( ) b ( ) If the starting winding remains in the circuit for too long a time  
c ( ) d (✓) it will be (a) grounded (b) open circuited (c) not damaged (d) burn-  
ed out.
7. a (✓) b ( ) The winding used on the rotor is a (a) squirrel cage (b) lap (c) wave  
c ( ) d ( ) winding (d) box.
8. a ( ) b (✓) What percent of full load torque is developed at the instant of  
c ( ) d ( ) starting? (a) 80 (b) 100 (c) 150 (d) 400 (e) 400 - 500.
9. a (✓) b ( ) A-c stator and rotor cores are laminated to (a) reduce eddy currents,  
c ( ) d ( ) (b) reduce weight (c) make them stronger (d) increase voltage.
10. a ( ) b ( ) The most common source of trouble in this motor is the (a) bearings  
c (✓) d ( ) (b) starting winding (c) centrifugal switch (d) running winding.
11. a ( ) b (✓) The speed regulation of this motor is (a) excellent (b) good (c) fair  
c ( ) d ( ) (d) poor.
12. T (✓) F ( ) "Phase splitting" means obtaining a 2 phase effect by passing single  
phase current through two parallel paths having different electrical  
characteristics.
13. T (✓) F ( ) There are two windings used in the stator of this single-phase split-  
phase motor?
14. T ( ) F (✓) The running winding has a greater R and less  $X_L$  than the starting  
winding.
15. T (✓) F ( ) This motor is started as a two phase machine.
16. T (✓) F ( ) This centrifugal switch is connected in series with the starting  
winding.
17. T (✓) F ( ) Energy reaches the rotor winding by induction.
18. T ( ) F (✓) It is possible for the rotor of an induction motor to revolve at the  
same speed as the stator field?

## INSPECTION OF SINGLE PHASE MOTORS

Objective - To learn the construction and fundamental principles of single phase motors.

References:Tools and Equipment

1. W-R Tool Set
2. Multimeter

Precaution - Do not use force on screws or nuts. The threads on bolts or nuts strip easily.

Procedure Steps

1. Obtain a single phase split phase motor at the bench near the desk.
2. Disassemble the motor and answer questions pertaining to this motor.
3. Instructor will check your answers while the motor is disassembled and give credits.
4. Reassemble the motor and return it to stock at the desk.
5. Obtain a capacitor motor and repeat procedure steps 2 through 4.
6. Obtain a shaded pole motor and repeat procedure steps 2 through 4.
7. Obtain a repulsion induction motor and repeat procedure steps 2 through 4.





9 West High Street New York

St. Louis, Mo. at 10:30 a.m. on 10/10/1910

- 7. Follow instructors directions, carefully, on disassembly.
- 8. Check the construction and the connection of the thermostat. What is the advance of the thermostat adjustment?
- 9. Reassemble the iron
- 10. Check for opens, shorts, and grounds.
- 11. The following procedure should now be applied:

- a. Set the temperature control at the highest heat position.
- b. Connect the iron. Place it on the test stand and allow it to heat for three cycles before taking any readings. Watch the instrument to see that the needle does not attempt to go above the range of the instrument. Highest setting equals 475° to 600°F.
- c. After the thermostat "cuts-off" the third time, take a reading the next time the thermostat closes.
- d. Take a second reading when the thermostat opens.
- e. Compute the average temperature by adding the two above readings and dividing by two.

Example: Cut-on temperature . . . . . 530°  
                   Cut-off temperature . . . . . 580°  
   1110°

- f. To find the differential, subtract the "cut-on" reading from the "cut-off" reading.

Example: 580° - 530° equals 50°

- g. Compare the average temperatures and the differential with the limits given in a chart or table. These tables are developed by the manufacturers.
- h. A check of one position is all that is necessary. To change the knob position to agree with the temperature records, lift the knob on the splined shaft and reset it on the shaft. Rotate the knob clockwise if the reading is high. Rotate the knob counter clockwise if reading is low. One notch on the shaft equals approximately 15°F.

- 12. Check the wattage of the iron and apply a hi-potential test.

- a. W equals plus or minus 5% of the name-plate.
- b. Hi-potential equals 1100 volts or you may use a 2 watt, 110 volt neon lamp.

- 13. A usable temperature chart follows:

Rayon (low)	. . . . .	275°	to	350°	F
Rayon (high)	. . . . .	350°	to	400°	F
Wool	. . . . .	400°	to	450°	F
Cotton	. . . . .	450°	to	500°	F
Linen	. . . . .	500°	to	550°	F

# AUTOMATIC IRON

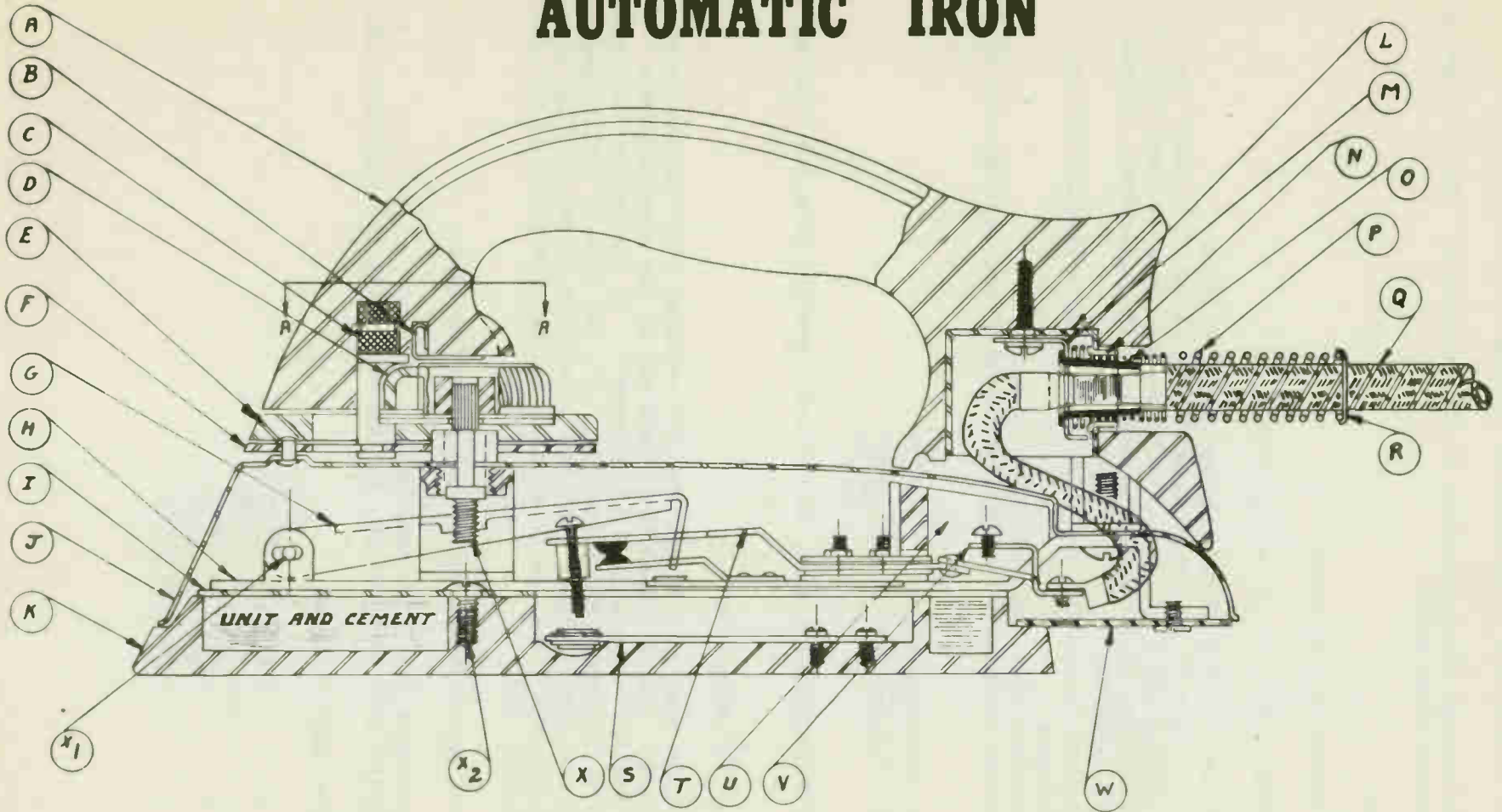

- A Bakelite Handle
- B Indicator Spring
- C Handle Insert
- D Indicator Knob
- E Insulator Fin
- F Bracket Fin
- G Adjustable Arm
- H Pressure Plate
- I Asbestos Pad

- J Top Shell
- K Sole Plate
- L Swivel Cup
- M Strain Relief
- N Brass Eyelet
- O Rubber Gasket
- P Cord Spring
- Q Cord
- R Cord Bushing

- S Thermostat Blade
- T Control Blades
- U Terminal Block
- V Control Lead
- W Cover Plate
- X Adjustable Screw
- X1 Cotter Pin
- X2 Mounting Screw

## ADJUSTING AUTOMATIC IRONS

Objective

To learn how to check for defects and to adjust an electric iron.

Average Time Required: 1 hour

References

---

Tools, Equipment & Materials

1. Set of appliance tools
2. Volt-ohmmeter
3. Test lamp
4. Other material and equipment necessary may be obtained at the desk.

Precautions:

1. A heated iron can give you a serious burn. BE CAREFUL.
2. Do not force any screws - threads in plastics and bakelites can be "stripped" easily.

Procedure Steps

1. Obtain a set of appliance tools and an iron at the stock room.
2. Check the cord and iron for "opens" and "shorts" by using the volt-ohmmeter. The volt-ohmmeter should be "set" on the low-ohm range.
3. Check the iron for opens and shorts by using the volt-ohmmeter.
4. Check the iron for grounds using 110 volt test lamp or a 2 watt, 110 volt neon lamp.
5. Check the iron with the test lamp or volt-ohmmeter to make sure the contacts of the thermostat open when the control knob (temp. control) is set in the "off" position.
6. Check the "stop" position.
  - a. Rotate the knob slowly from "off" position and check to see if contacts close between "off" and "rayon", but near the lower marking for "rayon".
  - b. Continue to rotate clockwise and make sure knob pointer reaches highest marking on "linen" before stopping.





## BUNGALOW WIRING

Procedure Steps

1. Copy the bungalow wiring diagram located on the table near the department gate.
2. Report at the bungalow with your partner. An instructor will check your diagram and assign the job.
3. Obtain a tool requisition from the instructor in the bungalow. Two men are to sign the requisition and have it punched.
4. Get your tools from the stock-room.
5. See instructor for further instructions before you start to pull in wires. Do not cut wires, unless instructed to do so. Use fish tape to pull in wires. After all wires have been pulled in, call the instructor in charge in the bungalow. He will check your wiring and punch your job card for this step. Another requisition for equipment will be issued at this time.
6. Be sure and check all equipment for defects, missing screws, or badly worn screws, broken switches etc., before leaving the stock-room. If all equipment is in usable condition; then connect all equipment and keep your hook-up's polarized. Connect 3-way switches on armored cable by the N.E. Code standard requirement.
7. After all connections are completed; call the instructor to check your job, he will then issue the cartridge fuses.  
  
CAUTION: Do not snap cartridge fuses over the top in the fuse holder pull-out block.  
  
Slide the fuses through the end of the fuse holder. Be careful and do not use force when inserting the fuse holder block into place. It should slide into place easily.
8. All splices should be soldered and taped. Instructor will then make final inspection and ask questions regarding your job.
9. Remove all surplus wire from the job and deposit it in the container by the fence outside of the bungalow.
10. Disconnect all fixtures, pull out all wires and put them in the box. Clean up and return all tools and equipment to stock-room. Return both requisitions to the instructor in the bungalow and receive final credit for the job.





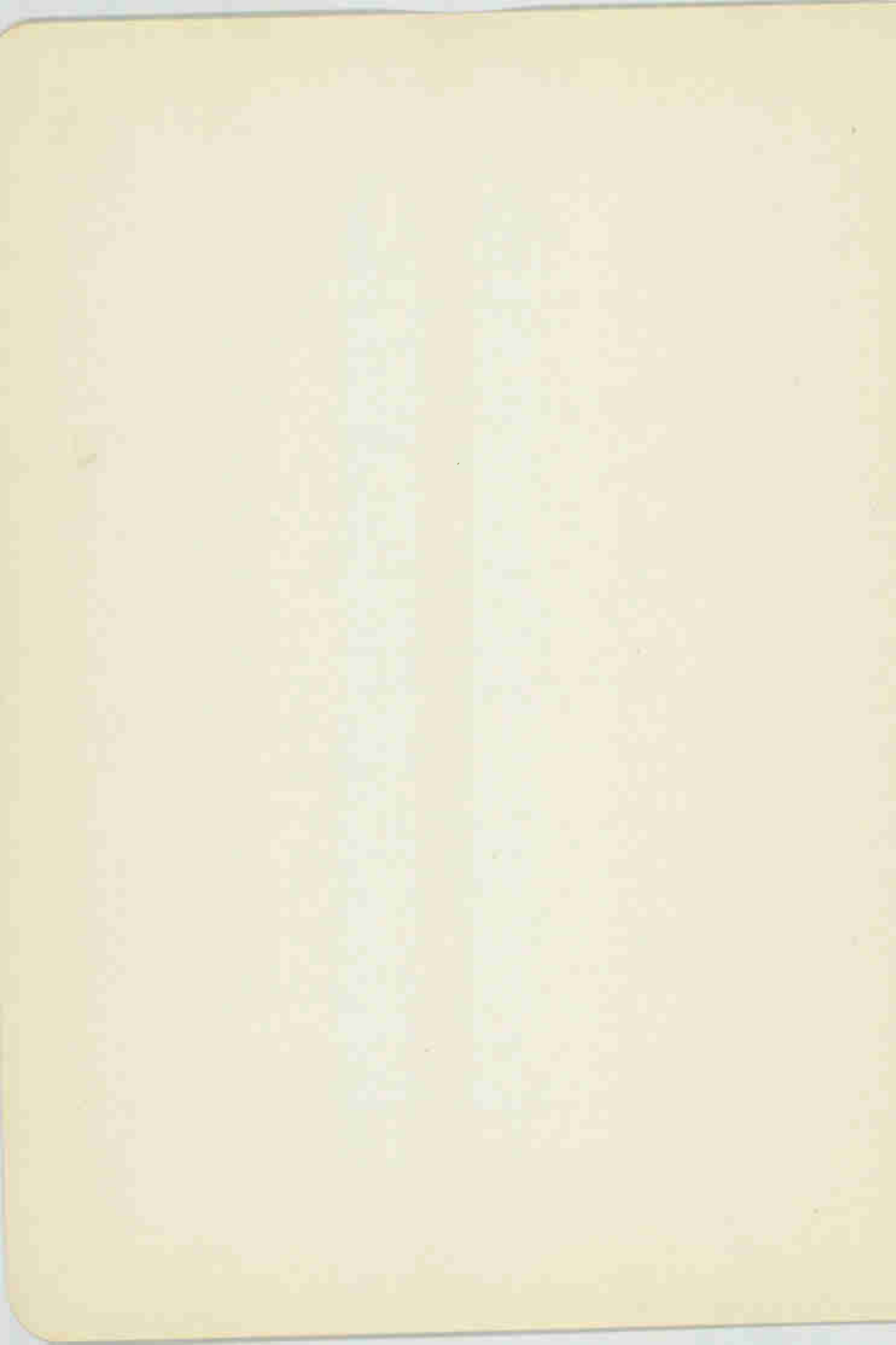

## SPLIT-PHASE TO CAPACITOR-START

Objective

1. To learn the difference in the starting torque of a single-phase split-phase motor and capacitor-start motor.
2. To determine the correct capacity for best possible torque when changing from "split-phase" to "capacitor-start".

Average Time Required: 2 hours

Reference:Tools, Equipment & Materials:

Panel board used on Job No. 7, #24 wire, VOM, W & R tool set, motor, six electrolytic capacitors and one a-c ammeter.

- Precaution: 1. Be sure and connect capacitors in series with the "start" winding - use #24 wire.
2. Make chart to show results

Procedure Steps

1. This test is to be worked with the same motor and panel board used on Job #7.
2. Obtain six capacitors at the stock room.
3. Check the capacitors for opens, shorts and grounds.
4. Using an ammeter, determine the amount of current drawn by the motor when it is connected "split-phase" and also when connected capacitor-start for maximum torque.
5. Make a locked rotor test with motor connected "split-phase" and have the job checked by an instructor.
6. Make a locked rotor test with the motor connected with one capacitor in series with "start winding."
7. Add capacitors #2, #3, #4, #5, #6 - record the amount of capacity and torque developed for each combination.
8. Take readings on ten different parallel combinations.
9. Determine the correct capacity for the best possible torque.
10. Have an instructor check the job for credits.





## FRACTIONAL H.P. MOTOR CONTROLS

Objective

To learn the operating principles of the "magnetic control" and "thermal control" as to construction, connection, and operation.

Average Time Required: 2 hours

Reference:Tools, Equipment & Materials:

Pencil, paper, #24 wire, T & R tool set, VOM, motor, and panel board.

Precaution: IN WIRING UP JOB - FOLLOW DIAGRAMS CAREFULLY - BE SURE TO USE #24 WIRE

Procedure Steps:

1. ~~Obtain a panel board from the stock room.~~
2. ~~Obtain a motor at the desk.~~
3. Test the motor and locate the two terminals of the "run winding" and the two terminals of the "start winding", by using the VOM or a 110 volt test lamp.
4. Determine "start" and "run" terminals by use of the VOM. (Set the meter on the Lo-ohm scale).
5. Draw a diagram of both the magnetic control and the thermal control properly connected to the motor, but do not wire up the system at this time.
6. Have diagrams checked by instructor.
7. Connect and operate both controls.
8. ~~Write an explanation of both controls as to construction, connection and operation.~~ *omit*
9. Have instructor check for credits. (Have one control connected).

*Have diagrams checked when other steps are checked*

## PUSH-BUTTON STATIONS

Objective

To develop a holding circuit on a relay and use two push-button stations.

Average time required: 1 hour

References

Lesson No 3

---

Tools, Equipment & Materials

1. Test lamp from T & R tool kit
2. Obtain requisition at desk for relay panel.
3. #24 scrap wire
4. Volt-ohm-milliammeter

Precaution

Do not overlook step #4 in the following procedure.

Procedure Steps

1. Obtain a "relay panel" from stock room
2. Identify the terminals on the panel. (Set VOM on Lo-Ohm range)
3. Using black pencil "draw-in" the wires from the switch symbols to the terminals below the switch symbols, Fig. 3 lesson No. 6.
4. Using red pencil "draw-in" the connections, which you will make to develop a stick circuit on the relay.
5. Have Fig. 3 checked by an instructor.
6. Using scrap wire, #24, "wire-up" the panel according to the diagram you have developed in Fig. 1.
7. Connect the unit to 110 volts DC, and operate it. Have an instructor check the operation of the panel.

Wiring & Repair

Position # 1  
600 V. DC

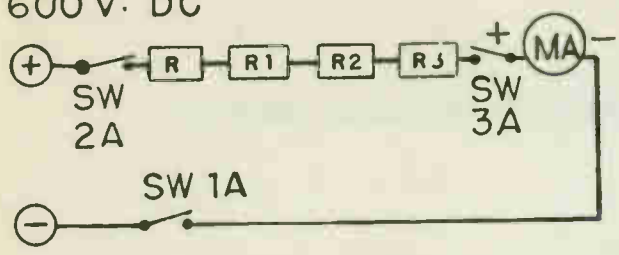

Position # 7  
LO OHMS

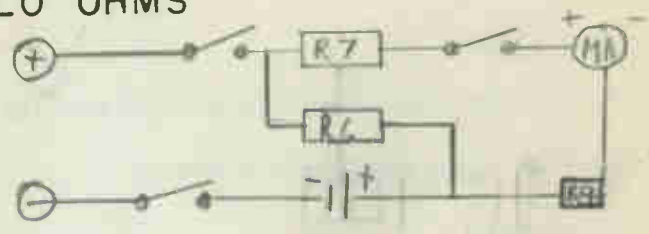

Position # 2  
300 V. DC

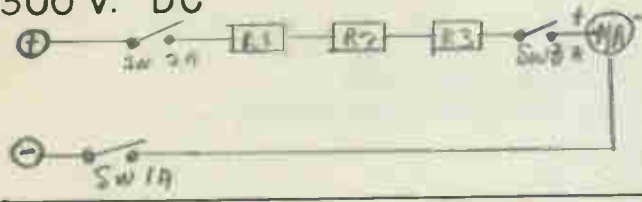

Position # 8  
HI OHMS

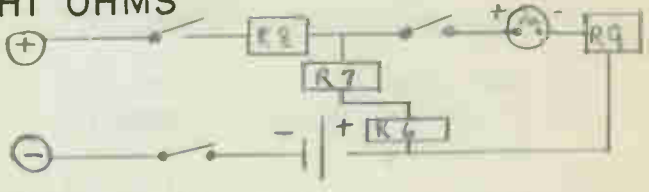

Position # 3  
150 V DC

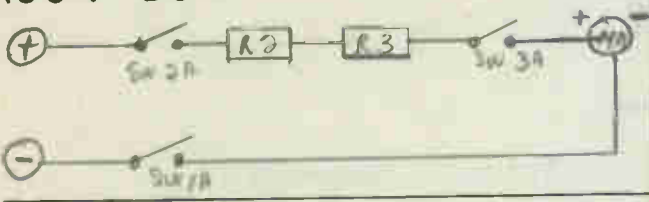

Position # 9  
15 V AC



Position # 4  
15 V DC

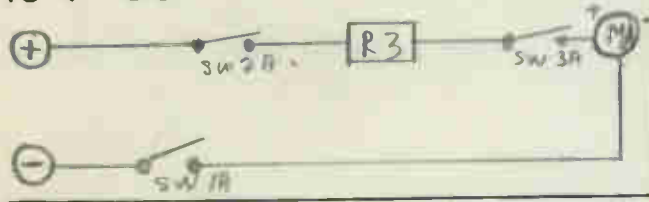

Position # 10  
150V AC

Position # 5  
150 MV DC

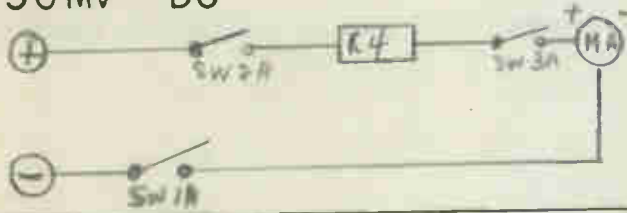

Position # 11  
300 V AC

Position # 6  
150 MA DC

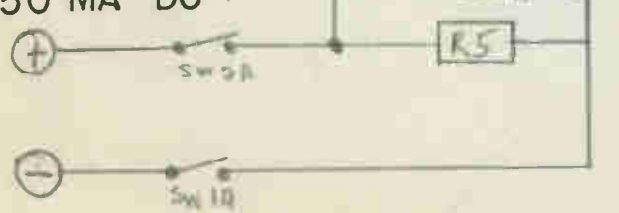

Position # 12  
600 V AC

MULTIMETER CIRCUIT TRACING

Objective: To learn the circuit construction of a multimeter.

Average Time Required: Two hours.

References:

Tools, Equipment, & Materials: Coyne Multimeter

Procedure Steps

1. Trace all circuits on the following schematic, for all switch positions.
2. Identify the twelve individual circuits by using different colored pencils or different arrow markings.
3. Draw the individual equivalent circuits for all meter positions in the spaces provided on page No. 197. (Example: position 1 page 197).

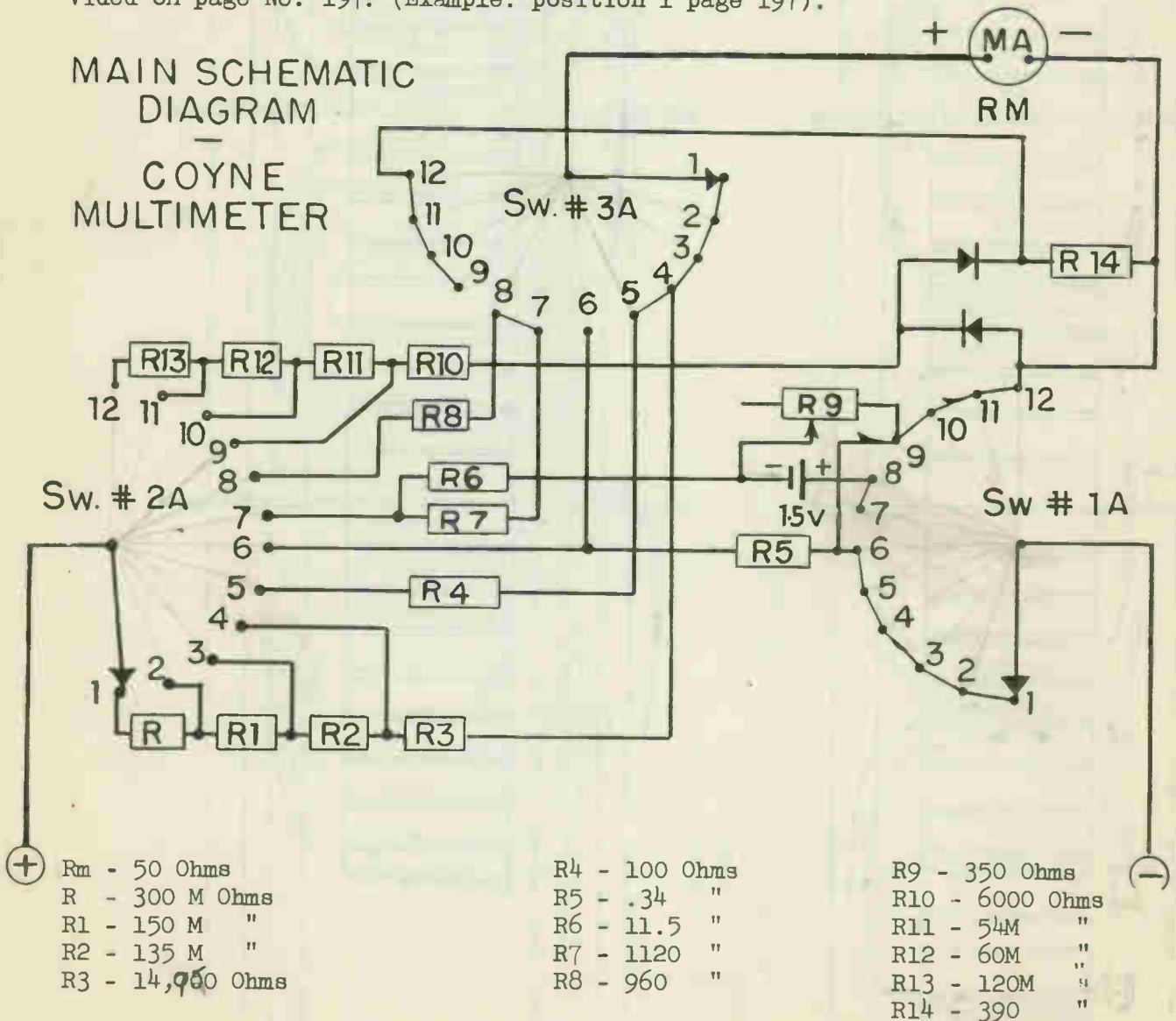



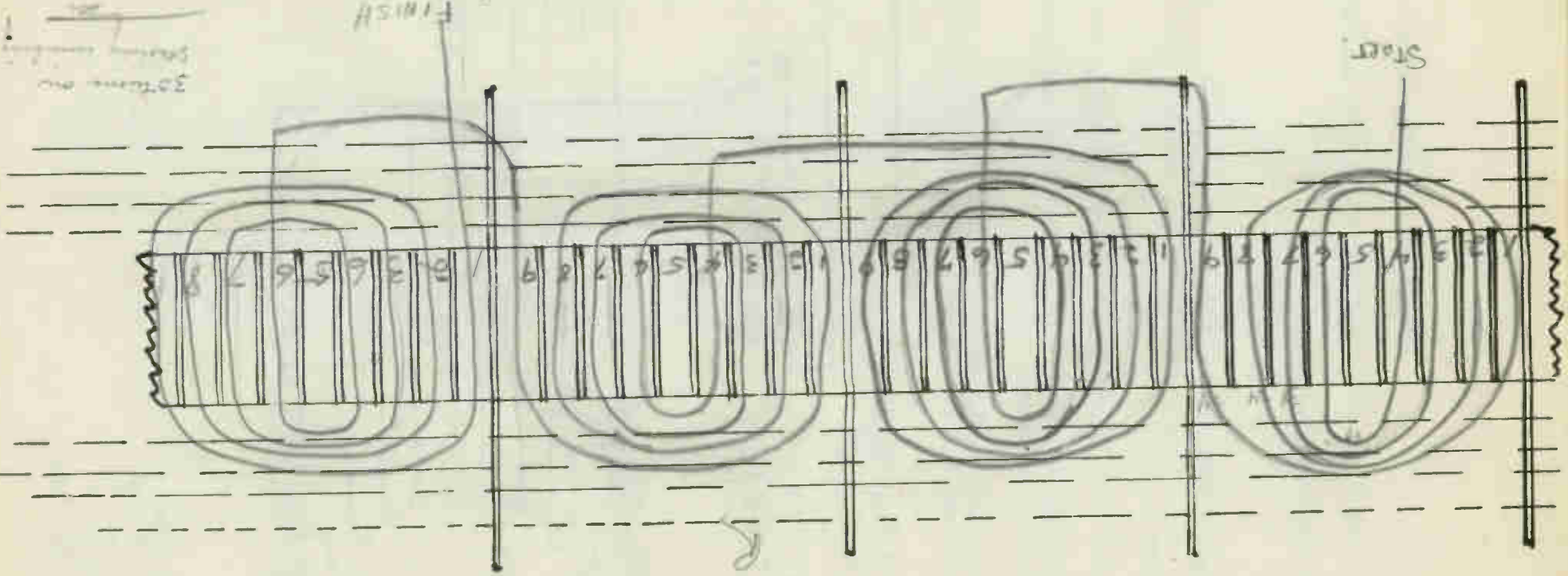
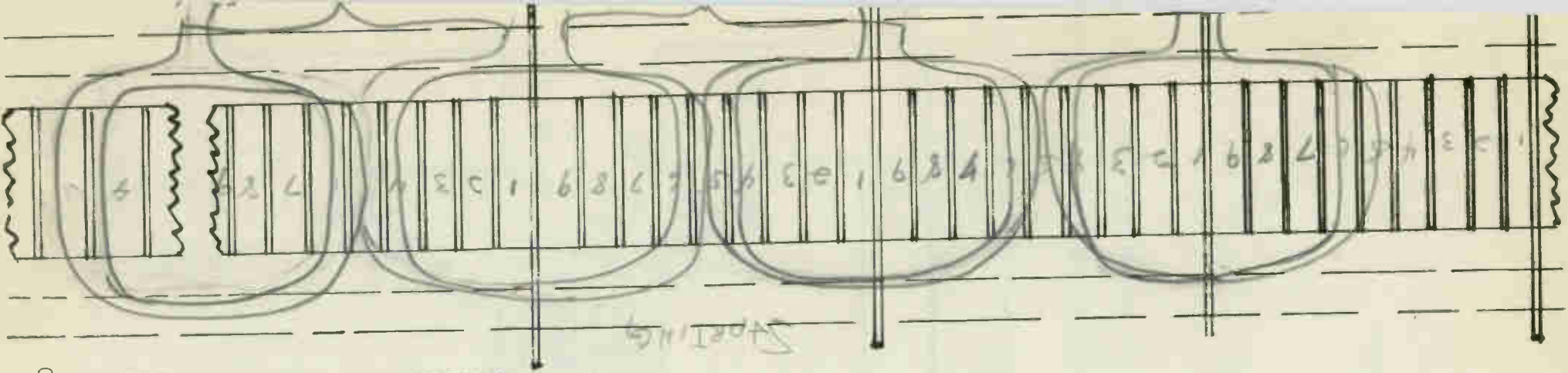

Coyne Electrical School

4-6 = 19  
 3-7 = 34  
 2-8 = 34  
 1-9 = 34

## STRIPPING &amp; REWINDING A ONE-PHASE STATOR

Procedure Steps

1. Remove the slot sticks and put them in the tool box until needed for replacing in stator.
2. Disconnect leads between starting winding skeins. Lift skeins from slots avoiding damage to Formvar insulation. DO NOT UNWIND SKEINS. Straighten out kinks as much as possible by hand, and bring out new leads by unwinding one half turn at each end of skein. Re-use skeins if they have 24 or more turns.
3. Remove running winding, one turn at a time, and wind the wire on spool. Avoid loops or sharp kinks as these may cause wire to break in straightner.
4. Straighten running winding wire on one of the machines. Instructor will show you where they are located.
5. Inspect slot insulation. Remove and replace all defective pieces, make cuffs on replacement slot insulation. New insulation may be obtained at the desk.
6. Have the stator core checked by an instructor after replacing defective insulation. A punch in a space at one end of the card will be given if the insulation is in acceptable condition.
7. Start rewinding running winding, construct the coils as shown in the diagram. If sleeving is used on start and finish leads of winding, it should be anchored by placing the end in the slot.
8. Insert long metal slot sticks on top of coils one and three to act as a form for succeeding coils. Two wooden slot sticks should be placed on top of each metal stick to keep it at proper level in slot. Slot sticks should be put in all slots as soon as coils are completed.
9. Test for grounds each time you complete a coil by touching test lamp leads to start end of wire and stator core.
10. Test for continuity at each splice. Never allow a splice to fall in a slot. All splices must be completely covered by sleeving.
11. Test running winding for proper polarity. Use DC from the outlet on the work bench.
12. Place starting winding skeins in proper slots as shown in diagram. Make temporary connections and check polarity. If polarity is correct, cut leads to proper length and make permanent connections. Insulate splices with sleeving.
13. Place stator in frame on test bench for running test. Operate at least one minute.
14. Have job checked before removing it from the frame.

T A B L E O F C O N T E N T S  
J O B S H E E T S

JOB NO.	PAGE NO.
1. Stripping and Rewinding a One-phase Stator - - - - -	228
2. Multimeter Circuit Tracing - - - - -	230
6. Push-button Stations - - - - -	232
7. Fractional H.P. Motor Controls - - - - -	233
8. Split-phase to Capacitor-Start Motor - - - - -	234
9. Bungalow Wiring - - - - -	235
12. Adjusting Automatic Irons - - - - -	236
14. Inspecting of single phase motors - - - - -	239
15. Vacuum Cleaner Motors - - - - -	248
16. Bearing Reaming - - - - -	250
17. Magneto Ignition System - - - - -	251
18. Magnetos - - - - -	252
19. Automatic Furnace Controls - - - - -	254
22. Fans - - - - -	256
23. Experiment (Armature Characteristics) - - - - -	258
24. Micrometer Readings - - - - -	260

The first part of the document discusses the importance of maintaining accurate records of all transactions. It emphasizes that every entry should be supported by a valid receipt or invoice. This ensures transparency and allows for easy verification of the data.

In the second section, the author details the various methods used to collect and analyze the data. This includes both primary and secondary data collection techniques. The primary data was gathered through direct observation and interviews with key stakeholders. Secondary data was obtained from existing reports and databases.

The analysis phase involved using statistical software to identify trends and correlations within the data. The results show a clear upward trend in the number of transactions over the period studied. This is attributed to several factors, including increased market activity and improved infrastructure.

Finally, the document concludes with a series of recommendations for future research and implementation. It suggests that further studies should focus on the long-term sustainability of the current trends and the impact of external factors. The author also provides practical advice on how to optimize the data collection process for future projects.

CHICAGO, ILLINOIS

**COYNE ELECTRICAL SCHOOL**

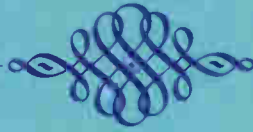

**STUDENT MANUAL**  
**JOB SECTION**

[The main body of the page contains extremely faint, illegible text, likely bleed-through from the reverse side of the paper. The text is too light to transcribe accurately.]

4. Do not leave a mike on a piece of steel for if left this way rust will form on the part of the mike that is in contact with the steel. Do lay your mike down on a piece of cloth.
5. Do not leave your mike so far open that the very accurate threads are exposed. Particles of grit and harmful abrasive dust will stick to the oil on the threads, and when you close it this grit will cause a grinding action between the threads, make the threads rough and eventually cause looseness and sloppy action and consequently an inaccurate instrument. Do keep the threads from being exposed.

#### E. Summary Questions

1. Should you tighten a "mike"? Explain.
2. Why not leave a "mike" with anvil and spindle closed?
3. What is the purpose of the ratchet?
4. State briefly the purpose of the lock-nut.
5. Interpret the following reading: 7 divisions, 2 sub-division on the hub,  
2 sub-divisions on the barrel and 4 sub-divisions on the Vernier scale.
6. Name the parts of a micrometer.
7. Why is the Vernier micrometer more desirable for some applications than the standard micrometer?
8. If you were to check a shaft to .500" plus or minus .0002" which micrometer would you use?
9. For what purpose would you use an outside mike?
10. Where could you use an inside mike?
11. What is common to the inside and outside micrometer?
12. Briefly describe the purpose of the cap.
13. Which one of the instruments mentioned in this lesson would be the best for checking a shaft for trueness?
14. A shaft is mounted between centers in the lathe and checked with a dial gauge. Which is designed to read .001. When the shaft is rotated one revolution the needle swings from 0-6 thousandths of an inch, the shaft is bent (A) .006" (B) 0.12" (C) .003". (D) the shaft is not bent.

Another precision instrument which is closely related to that of the micrometer is the dial gauge. It has a round face which is graduated in .001" or .0001" of an inch and a pointer which can move all around the scale.

This instrument can be, but seldom is, used to check the size of a piece of work directly. It is used extensively in production and inspection work for checking sizes of sheet metal, etc.

In a shop its useful purposes would be to check shafts and commutators, etc., for out of roundness. For this purpose it excels any other instrument. In order to make a check the shaft or object to be checked is mounted in the lathe between centers. The dial gauge is mounted in the tool post and adjusted so the lever touches the shaft. The scale is then turned so the point lines up with the zero mark. The shaft is then rotated slowly by hand, and the pointer will read directly. It will show if the shaft is true or not.

#### D. Life of Micrometer

Micrometers have no limit as to useful service. They will last and give accurate service a lifetime.

Careful handling of any precision instrument can not be over-emphasized. Keep the instrument clean and a thin coat of light oil will keep them from rusting.

It was said that a mike is a precision instrument. It must be treated as such, if it is to give accurate service.

#### Precautions:

1. Do not tighten a micrometer. Tightening can easily bind the frame and render the mike inaccurate for future use. Do adjust it very gently until you feel a very slight drag on the object you are measuring. This operation is very commonly referred to as the "feel" you have to develop in order to use a "mike". It is a "feel" developed individually and by experience only, and your success in using the mike will to a very large extent depend on developing this feel.
2. Do not put your mike down with the anvil and spindle closed. Any severe temperature changes may cause the frame to shrink in size. If the anvil and spindle are closed, this will cause the frame to bend.

The face of the anvil and spindle will rust more readily if left in a closed position.

Do leave the mike open.

3. Do not drop a mike or lay it down roughly. Too much jarring will eventually destroy the accuracy of a mike. Lay it down gently on a soft piece of cloth.



If each .001" of an inch is going to be sub-divided into ten parts, there will be ten parts on the Vernier scale 0-1-2-3-4-5-6-7-8-9-0. These are so etched on the hub that they occupy the same distance as one less or nine division on the barrel.

Each division on the Vernier is then equal to nine-tenths of a barrel division. Another way of stating this would be that each Vernier division is one-tenth shorter than a barrel division. Two Vernier divisions are two-tenths short of two barrel divisions.

In actual practice we look for the line on the Vernier scale which lines up with any of the divisions on the barrel; notice the number of the Vernier and this is then read as the numbers of ten-thousandths. For example; if four on the Vernier lines up with one of the lines on the barrel, it then reads .0004" more than the other reading, you have on the mike. To take a complete example; if we read four divisions, three sub-divisions on the sleeve, twenty-three on the barrel, and six on the Vernier scale, it then becomes .4" plus .075" plus .023 plus .0006" or .4986" or .0014" less than  $\frac{1}{2}$ ". A little additional practice will help you to read quickly the Vernier micrometer.

Several of the micrometers are equipped with "extras" which do not improve the accuracy of the mike, but make it somewhat more convenient and handy to use.

One practice is to etch the different fractions of an inch and its decimal equivalents on the frame, which saves time in figuring or looking it up in hand-books.

A lock ring is another nice thing to have. After the mike has been adjusted, the sleeve can be locked so that it will not turn. This is handy where several pieces of material are going to be machined to the same size, or several pieces are going to be compared to one another for size. A third extra is the ratchet situated in the end of the cap. The ratchet is calibrated at the factory so that when the correct tension has been obtained against the piece you are measuring, the ratchet will slip and prevent the mike from being clamped too tight.

The inside micrometer is used for measuring inside diameters of cylinders and any inside measurements where accuracy is required. It is used and read the same way as any other mike.

Usually only the one inch mike is used and a number of extensions are sold with it which makes it useful for different inside dimensions.

A very common type has a mike that reads from two inches and different shaft extensions, which extends its application up to six inches. (inside mikes usually have sleeve travel of one-half-inch). Another type of inside measuring device not a micrometer, has a hollow shaft in which fits a spring loaded plunger, which when released is expanded against the inside of the object to be measured. Then the spring loaded plunger is locked in place with a set-screw the tool is removed and measured with an outside micrometer.

The depth gauge is a mike, so designed that it will measure accurately the distance from one surface to another. Tool-makers, lay-out men, and machinist have good uses for this tool.

4. To check thicknesses of shims used in motors for adjusting and eliminating end play.
5. To check accurately the diameter of drills and reamers used from time to time.

Micrometers can be classified in three classes, outside, inside, and depth. These again can be classified into different kinds with different specific purposes and uses.

The outside micrometers, Fig. 1, are made in different forms. Some have special anvils and spindles and are designed to measure screw threads, etc.

It is not practical to design a micrometer with a spindle travel of more than one inch, therefore they are designed to measure from 0 to 1". This is designated a 1" mike; from one inch to two inches is designated a 2" mike; from 2" to 3" inches a 3" mike, etc. The one inch mike is the one which finds the most use.

A micrometer works on the same principle as the common screw. The threads, however, must be cut very accurately. The mike has a thread pitch of  $1/40$ " or 40 threads per inch.  $1/40$ " is equal to .025". Therefore one complete turn (counter-clockwise) of the thimble will extend the distance from anvil to spindle exactly .025" and close it by the same amount when turned in a clock-wise direction.

It will be seen from the diagrams, Fig. 1 & 2 that the hub is graduated in ten different parts or divisions 0-1-2-3 etc., making each one of these parts .1" or four complete turns of the thimble for each part or division. Each division is in turn divided into four sub-divisions. Making each sub-division .025" or one turn of the thimble.

The beveled edge of the barrel is graduated into five numbered divisions around its circumference 0-5-10-15-20 and 25 thousandths of an inch and each one of these divisions is sub-divided into five. Each sub-division is .001".

Now we have the hub divided into .1" and .025" and the barrel into .005" and .001". Reading these figures is a matter of a little practice. For example: if we measure a small motor shaft; we adjust the "mike" until we feel a very slight drag as the mike moves over the shaft; then read the mike and find that we can see two divisions and one sub-division on the hub; twenty-four on the barrel lines up with the datum line on the hub. This will give us .2" plus .025" plus .024" which equals .249". This is .001" less than  $\frac{1}{4}$ ". This would indicate that the shaft is .001" undersize because it would be a  $\frac{1}{4}$ " shaft to begin with. If we read seven divisions and two sub-divisions on the hub and the 0 line on the barrel lines up with the datum line this would be .7 plus .050" or .750" which is  $3/4$ ".

A little practice will enable you to read quickly and to develop the feel so necessary to get accurate readings. Since some work requires greater accuracy than .001", an auxiliary scale is incorporated along with the other scales. This is called a vernier scale according to its inventor. The vernier scale divides each .001" into ten parts. It then becomes apparent that the micrometer can measure to .0001". High grade mikes usually have the Vernier scale on them and are then called vernier micrometers.

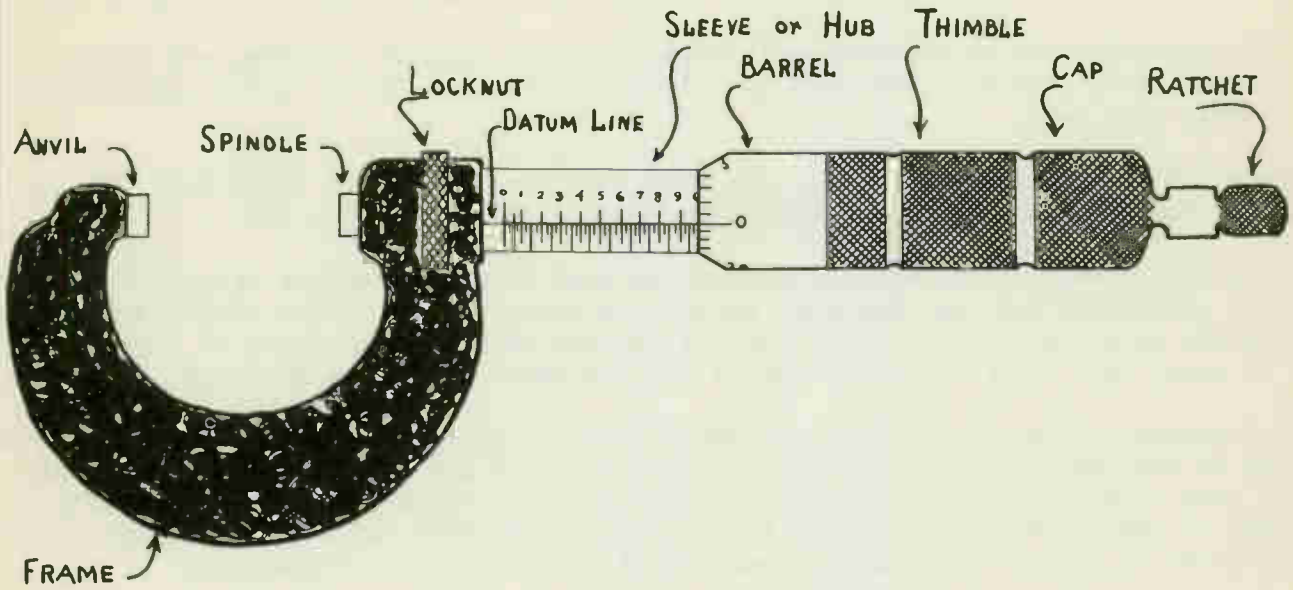

Fig. 1 A one inch micrometer

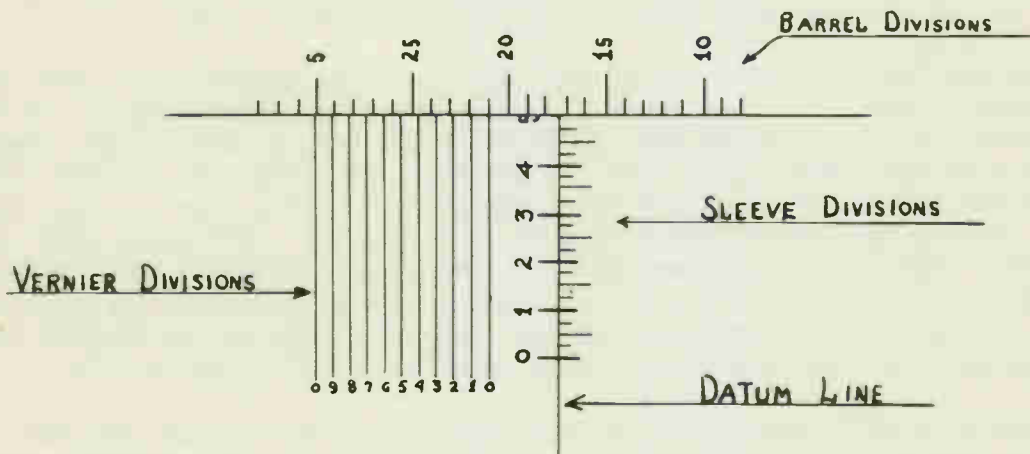

Fig. 2 The scale of a vernier micrometer

T-shaped cell drift  
 Large knife  
 Testing instruments  
 Stator holders & turn-tables  
 Small lathe 4' bed, 12" swing  
 Bearing pullers  
 Gear & Wheel pullers  
 Thermo-grip soldering unit  
 Coil lifter and shaper  
 Extra parts, such as centrifugal switch parts  
 Motor rebuilding materials

Lead scraper  
 Suitable work-benches  
 Variable voltage transformer 1 & 3 ph  
 Armature holders  
 Explosion proof trouble lamp  
 Bearing reamers  
 Wire strippers  
 Set of coil tamping tools  
 Copper magnet wire - assorted sizes  
 Tachometers  
 Blower, electric  
 Appliance repair materials.

3. Additional tools construction

Solder dip with long handle (insulated) \$ .75	$\frac{1}{4}$ " to $2\frac{1}{4}$ " taper reamer.....\$ :	
8" Stilson wrench.....)10.00	$\frac{3}{8}$ " to 2" electricians stock and die..... 40	
12" Stilson wrench.....)	2# ball-peen hammer ..... 2	
18" Stilson wrench.....)	Ratchet brace..... 5	
1-3/4" to 3" expansion bit.. 4.00	Pipe vise..... 5	
Thin-wall steel tubing bender) $\frac{1}{2}$ ", 3/4" and 1"..... 6.00	Rigid conduit bender $\frac{1}{2}$ ", 3/4" and 1"..... 7	
Raceway benders - hydraulic conduit bender.....250.00	100' steel fish tape..... 3	
Torch tip..... 2.50	Electricians prest-o-lite tank (rent)..... 2	
Torch lighter..... .50	Punch set to 1"..... 20	
Electric drill..... 25.00	Electric drill $\frac{1}{4}$ "..... 50	
Vises	Tool grinder	Chains and locks
Ladders	Electric hammers	Ackerman sets
Axe, hand	Benches	Snatch blocks
Blocks and Tackles	Cable marking labels	Clamps
Crow-bars	Conduit cutters	Bolt cutters
Cranes	Extension cords	Crimping tools
Portable generator	Safety goggles	Safety gloves
Hoists	Jacks	Oil
Oilers	Pulling compound	Hemp rope
Wire rope	Scaffolds	Welding equipment

B. The Micrometer

The micrometer, mike, is truly a precision instrument. No machinest or toolmaker would think of working without one. The micrometer uses in an electric shop would be:

1. To check accurately, motor shafts and bearings.
2. Check wire sizes.
3. Check thicknesses of insulation papers.

TOOLS AND MICROMETERS

Objective

To become acquainted with recommended tools

To learn how to use the micrometer

References

Lesson Content

The following list of tools and approximate prices should suggest the necessary equipment.

1. Maintenance tools, one each of the following:

National Electrical Code Handbook by Abbott.....	\$ 3.50		
Tool Case.....	\$ 7.50	3/4" wood bit.....	1.50
Tool Pouch & Belt.....	2.50	1" wood bit.....	1.50
6 foot rule.....	1.50	1 1/4" pipe reamer.....	1.50
Combination square.....	8.00	4" screw-driver.....	1.00
9-inch level.....	3.00	6" screw-driver.....	1.00
Plumb bob.....	3.00	8" screw-driver.....	1.00
Chalk line.....	.50	12" expansion screw-driver.....	2.50
B & S wire gauge.....	3.50	1" wood chisel.....	1.50
50' steel tape.....	3.00	1# ball-peen hammer.....	2.00
Drill & tap gauge.....	2.50	8" line-mans pliers.....	4.00
Hack saw.....	2.00	9" line-mans pliers.....	4.50
1 doz. hack-saw blades	1.25	6" diagonal pliers.....	3.50
8" crescent wrench.....	1.50	6" long-nose pliers.....	3.50
6" crescent wrench.....	1.50	Combination plier.....	2.50
10" pipe wrench.....	2.00	Set of drills	
Breast drill.....	3.50	1/16" to 1/2".....	6.00
1/2" wood bit.....	1.50	Set of taps, 6/32, 8/32	
Flash-light.....	1.50	10/32, 10/24, 12/24.....	5.00
1" cold chisel.....	1.50	Fuse puller.....	1.00
1 center punch.....	.50	I# solder copper.....	1.00
		1 key-hole saw.....	1.50
		Voltmeter.....	10.00

2. Additional tools & equipment for a small shop - motor and appliance repair.

Air compressor 35 cu. ft. capacity	Insulation cutter
Insulation cell former	Insulating varnish tank
Drying oven	Paint sprayer (air pressure)
Mica under-cutter	Growler (inside & outside)
Small balancing ways	Arbor press
Torque testing stands	Assorted files
Soft-faced mallets - 2 sizes	Flat Steel drifts
Assorted fiber slot drifts	Scissors, large and small
Wedge driver	Riveting hammer



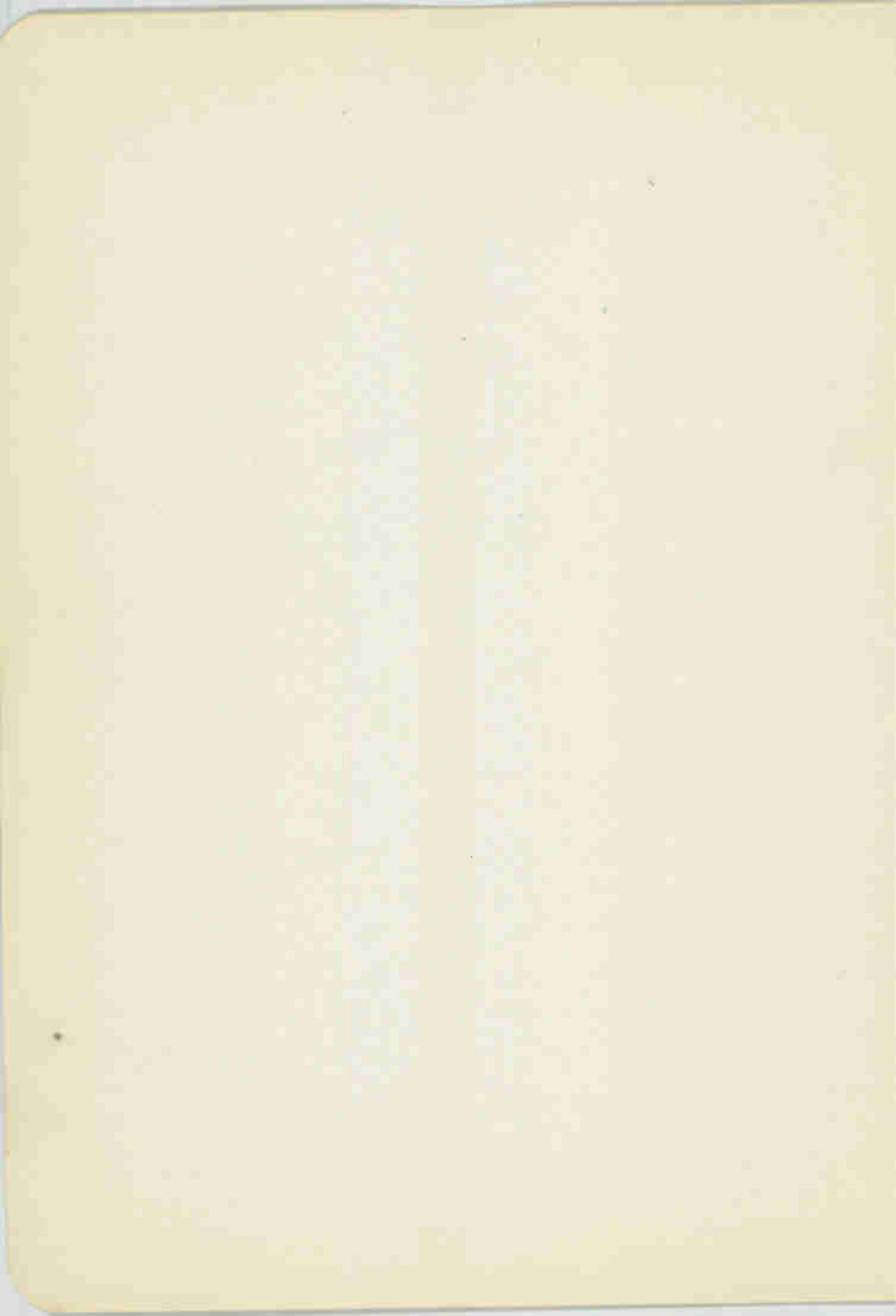

## I. Questions

1. What are the three "installation forms" provided by Domestic Electric Range Standard of Underwriters Laboratories and what do they mean?
2. What is the difference between the bi-metallic and hydraulic types of oven temperature controls?
3. Name the three types of surface units used on the electric range.
4. Is the rotating type switch control used on the modern electric range?
5. What type of unit is usually used for oven heating?
6. What is meant by demand factor? Would a 12 K.W. Range be fused for 12 K.W. ?
7. What troubles usually develop in ranges?
8. Where might you find the diagram of the circuits for any particular range?
9. How would you repair the heating unit of an open type coil?
10. How would you test to determine if a thermostat was operating properly?



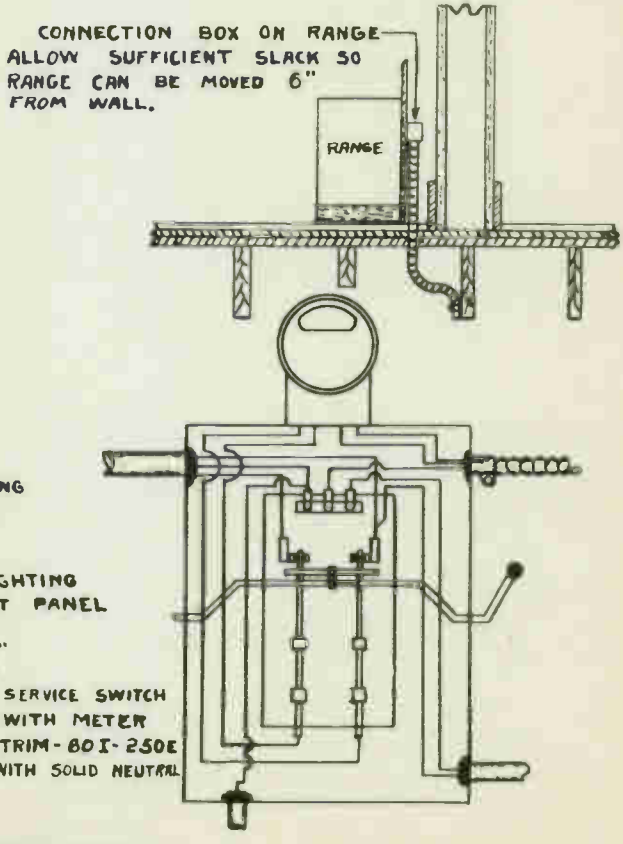
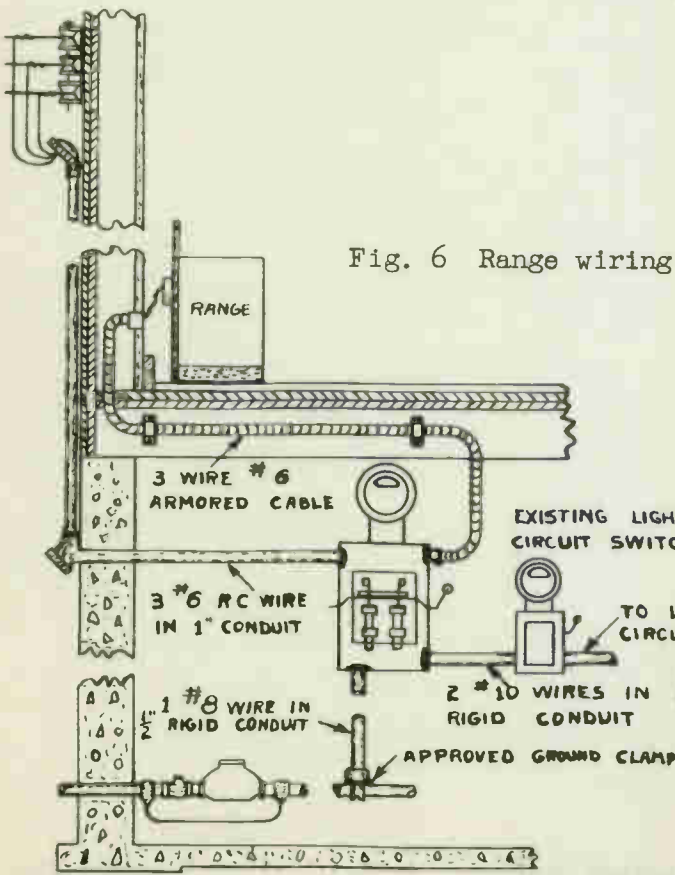
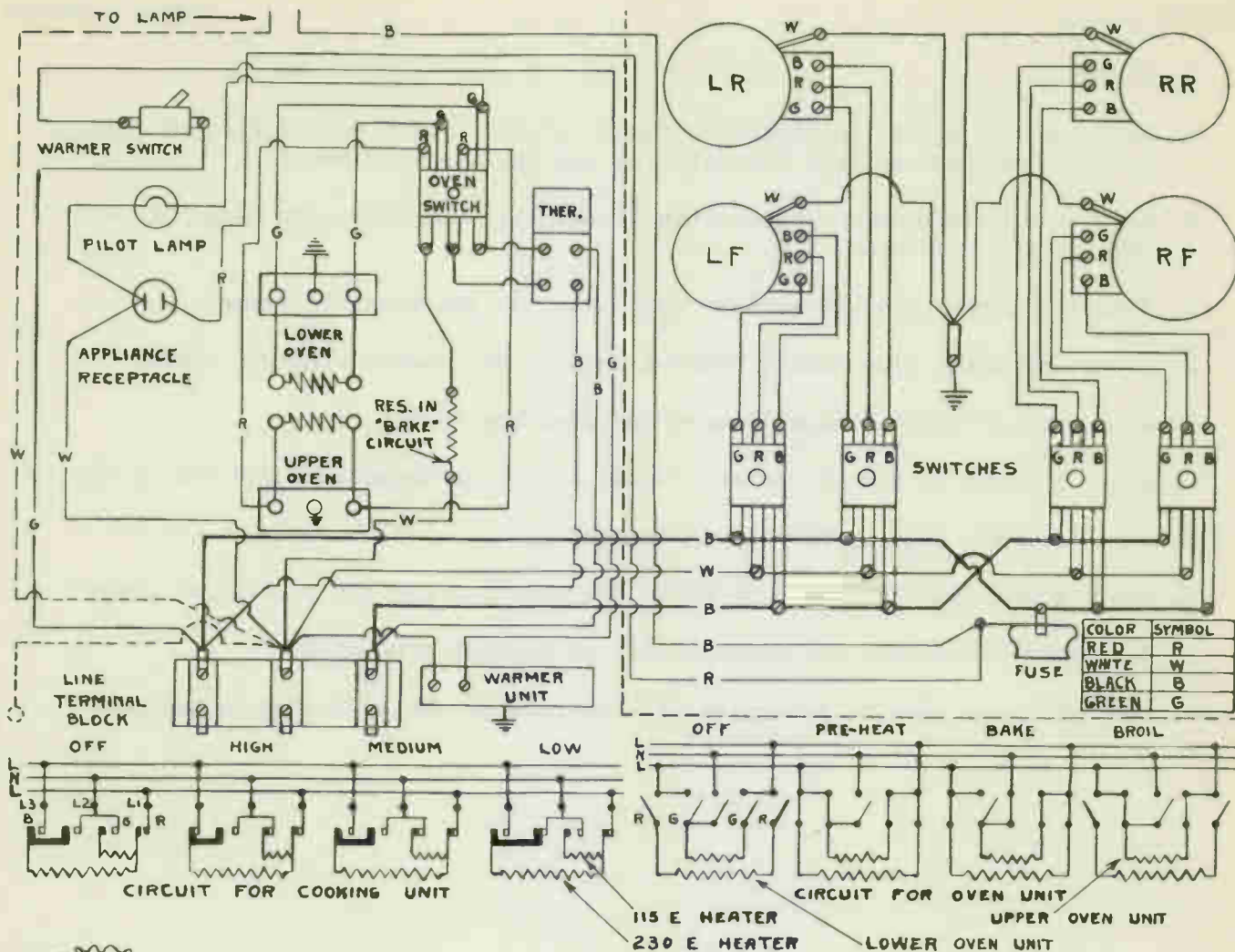

Fig. 6 Range wiring

For calibrating the thermostats, General Electric and Westinghouse have developed "oven testers". They are thermocouple elements connected to a moving coil instrument whose dial is calibrated in degrees rather than volts or amperes. A good high grade thermometer can be used. The testers are preferred. Always attempt to calibrate a thermostat before deciding to replace it. In any thermostat the trouble will usually be found either as an inoperative switch mechanism or as friction in the temperature indicating arm.

In using a tester or a thermometer:-

- a. Check to see that the tester, or the thermometer, is indicating room temperature correctly.
- b. Place the thermocouple of the tester, or the thermometer, near the center of the oven.
- c. If using a tester, the leads from the thermocouple to the indicating instrument will come through the oven door. The instrument can be placed on a chair near the oven.
- d. Set the temperature control at about 400 degrees.
- e. Allow the oven to heat until the thermostat has cut-off two times, possibly three times.
- f. About one minute after the last cut-off read the test thermometer as quickly as possible. It should read between 380 degrees and 420 degrees.
- g. If it does not fall within the above limits, an adjustment should be made on the thermostat. They are designed, as a rule, with an adjusting screw or two, to enable you to adjust the operation. Each notch on the dial of most thermostats represents a change of about ten degrees. It is recommended that the oven temperature run from 10° to 25° above the temperature which is indicated on the control knob.

The oven timer of today is a standard clock and timer combination. A few years ago there were "spring-wound" and "torque clock" timers.

#### H. Summarization

All appliance distributors have service literature available, parts lists, price lists, and service aids to help you.

No matter how simple a problem might appear to you, it is of major importance to the range user. Use diplomacy and salesmanship.

Disconnect the range from the supply circuit before making any adjustments on or near exposed wiring or terminals.

Always record the complete name-plate data of the range when ordering parts.

BE SURE THE RANGE IS GROUNDED. BE SURE THE RANGE IS LEVEL

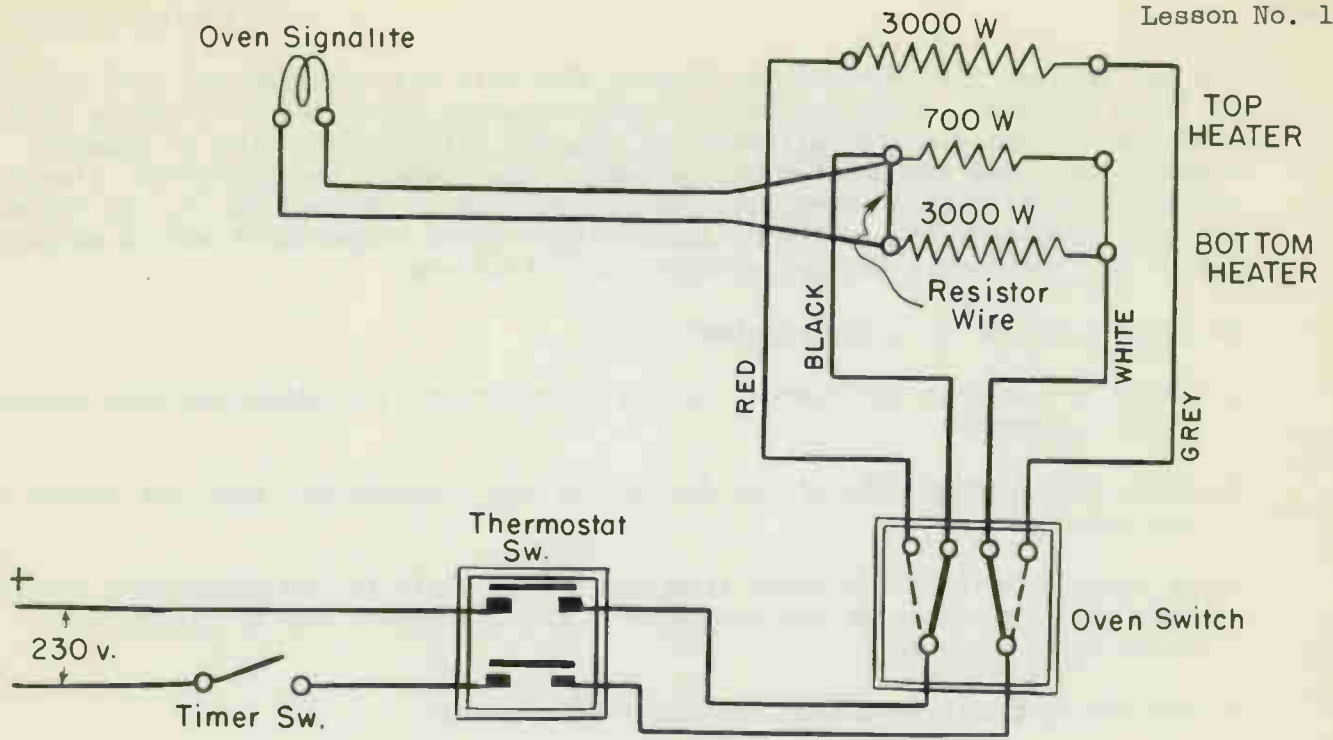
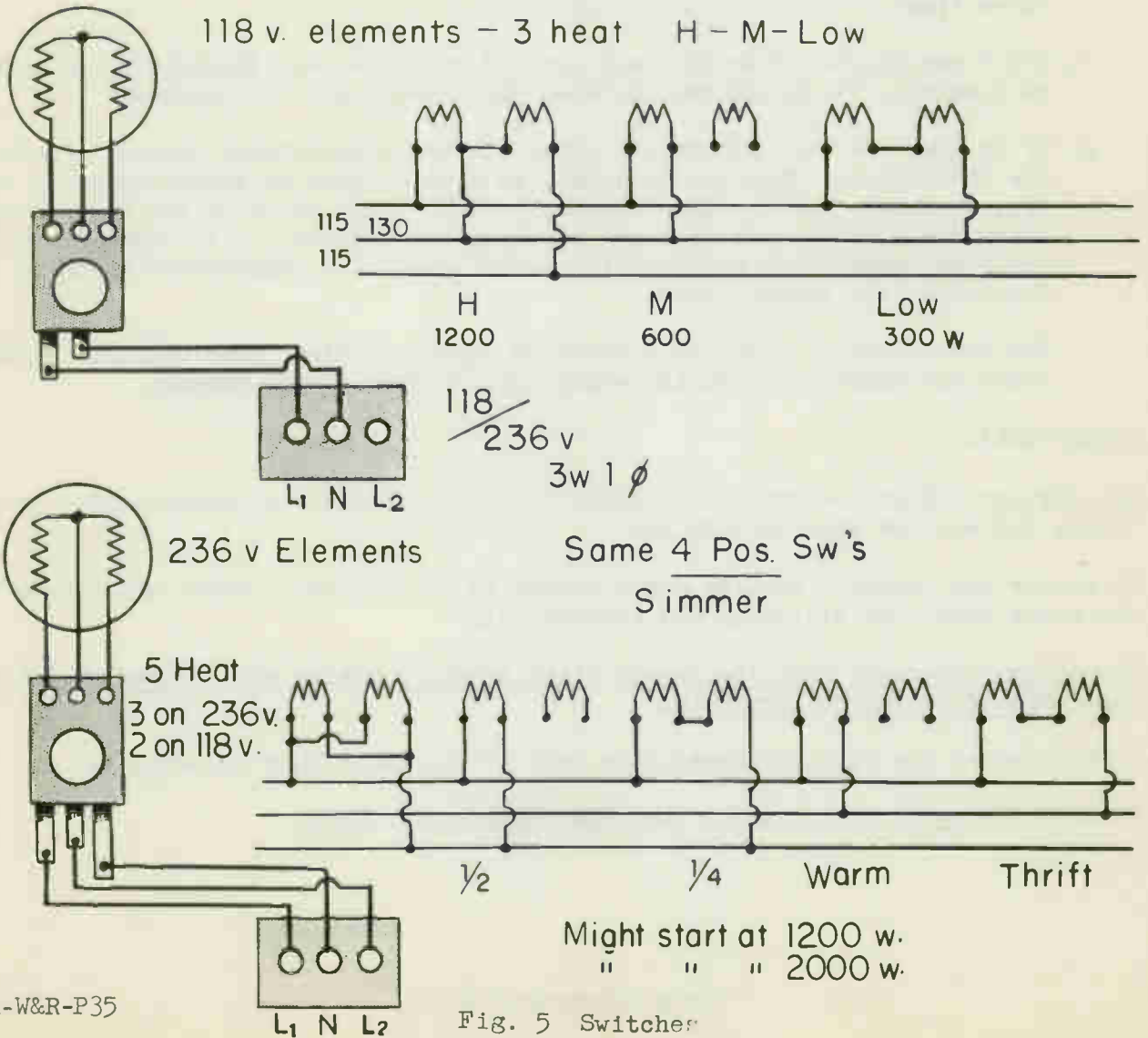

Fig. 4 Fully Automatic oven control



Those ranges which have been installed against a back wall are usually designed with a recess, or opening in the back, so as to leave space for a plug and receptacle. The plug and receptacle can be reached by removing a drawer from the front of the range. TAKE YOUR TIME ON A SERVICE CALL.

## 2. Switches and elements

Most switches should be replaced rather than repaired. If switch trouble is suspected, remove the panels, etc., so you may get at the switches. (The knobs on switches may usually be removed by pulling out and turning counter-clockwise. They may have a set-screw. They may be a friction fit.)

Use a voltmeter and check the voltage at bus wiring system on the service side of the switch. Then check the voltages on the unit side of the switch while operating the switch. When a defective switch is found, disconnect the range from the power source and then remove the switch and replace it with a good switch.

The elements of the surface units, if of the open type, may be repaired. The tubular type will be replaced if found defective.

Both coils do not need to glow. (Check with piece of tissue paper.)

If the resistance wires of the unit are not too badly oxidized, an "open" can be repaired by a "mend-it" sleeve. This sleeve fits over the two ends to be joined and is then crimped. It is advisable to replace the element if it is oxidized. When replacing an element, stretch the new coil to the same length as old coil and then connect it into "brick". BE SURE, ON ANY UNIT, TO MARK THE LEADS PROPERLY. This will help you to properly connect the new unit.

When replacing oven units be sure to push the unit all the way. The connection to the supply is made by plug and receptacle. If the units do not make good contact they will heat and eventually develop an open.

## 3. Oven, timer and thermostat

Graphite is about the best lubricant to use on the hinges of an oven door.

You may receive more complaints on the oven or oven door and the switches than any other part of the range. Since the hinges and servicing of same are mechanical and not electrical and since there are so many different types, the servicing of the door of an oven will be left to your mechanical ingenuity. Service manuals on specific types give you complete information on door hinges and operation.

Fig. 4 shows the oven elements, oven switch, thermostat switch, and timer switch of a fully automatic oven system. The thermostat would be a hydraulic type.

Fig. 3 shows an oven circuit and controls which make use of a "contactor" or "relay".

The above diagrams make up a part of the complete wiring diagram which will be found on the back of the range.

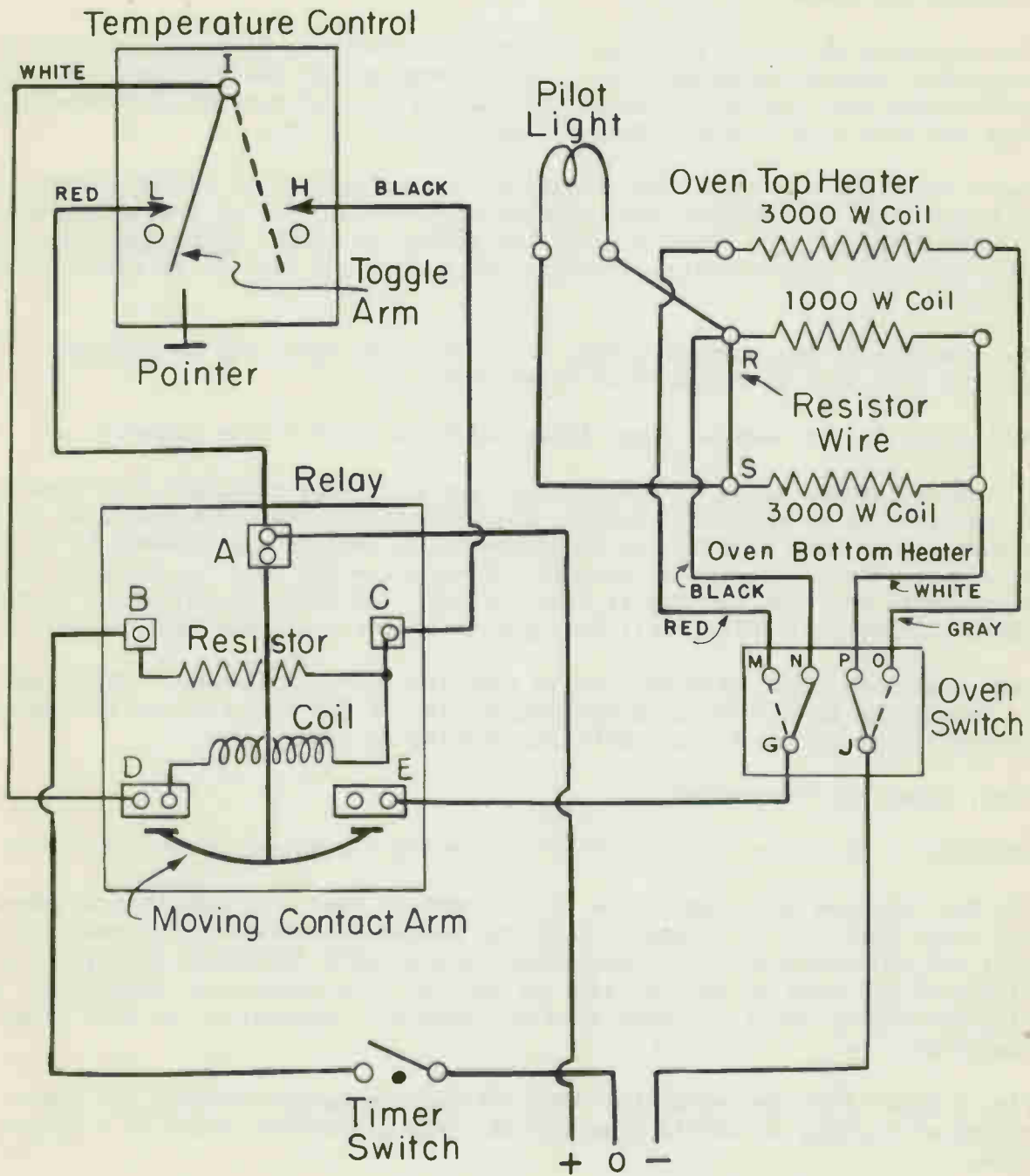

Fig. 3 Oven control circuit using a relay.

Since  $I$  equals  $\frac{W}{E}$  then  $I$  equals  $\frac{8000}{236}$  equals 33.8a.

NOTE: Check table #1 in NEC.

The above circuit would be classed as an "individual" branch circuit.

D. Check Section 4241 (NEC)

E. Check Sections 2560, 2557, 2559 (NEC)

---

---

---

#### F. Troubles

1. Mechanical troubles may develop in the oven doors more than any other section of the range. The construction and assembly of the hinges is so varied that we refer you to a service manual on the type under consideration. If you find it necessary to replace a hinge, be sure to order by part number and give full name-plate data from the range.
  2. Electrical or mechanical troubles may develop in:
    - a. Switches
    - b. Temperature control of oven i.e., thermostat or timer.
    - c. Blown fuse to range
    - d. Blown fuse in appliance circuit
    - e. Burned out surface unit or other heating unit.
    - f. Not enough heat.
- 
- 
- 

#### G. Service-Testing and Repair

1. The user of the range will tell you the circumstances under which the trouble developed. This usually gives you a clue to the trouble.

Every range has a name-plate. Whenever ordering parts, always give complete name-plate data. The name-plate might be found below the cooking top, on the front of the range frame, inside a drawer, on front of range, etc. An electrical diagram will be located on the back of the range. The diagram on the back of the range will assist you very much in trouble-shooting. It is a good idea to check the diagram, especially if the range is of a type or make on which you have not previously had an opportunity to work.

The fully automatic oven is a timer controlled oven, Fig. 4.

Surface units are made in the six inch, eight inch, and ten inch size. Their wattage ratings will range from less than 1000 watts to over 2000 watts.

General Electric tubular units are called "Calrod" while the Westinghouse are named "Corox".

Most ranges are designed and wired for 118 to 236 volts., 3-wire, single phase operation; however, the heating units may be ordered for other voltages.

Most elements which are controlled by a "three position" switch are 118 volt elements. The 236 volt elements are usually used with the five-position switches.

### c. Switches

The switches control the circuits to the various heating units. There have been some toggle and snap switches used, however, they are mostly of the rotary type which may operate to furnish two, three, four, or five different heat values, Fig. 5.

Fig. 5 shows how the switches and heating units might be connected and also the way in which the elements are connected across the line. Many of the latest types of switches are sealed and when one develops defects it is replaced. Switches are made to act slow or fast. Switches which will operate on AC will not necessarily operate on DC.

## 2. Installation and code, Figs 1 and 6.

- a. Be careful when uncrating a range. It is easy to damage the enamel finish.
- b. Most ranges are mounted on a "skid". Leave this skid on until the range is delivered to the customers home.
- c. Before making delivery, remove the switch panel and check the electrical connections to see that they are not loose.
- d. Upon delivery, remove the skid and be careful while in customers home.
- e. Connect the range to supply circuit after carefully checking the "ground" and next install the surface units. Be sure that the surface units, are grounded to the frame. (Green wire)
- f. Level the range. This can be done by making use of a pie tin of water placed in the oven. Shims may be used under the corners of the range for leveling purposes.
- g. Be sure the housewife has an instruction book, sell "good will".

Code - Check section 2121b (NEC) and table 29, NEC.

C. Check Section 2103 (NEC).

Example: Any range whose rating is 12 K.W. or less has a maximum demand of 8 K.W.

## Control &amp; Protection of appliances

- Section 4241 - Disconnecting means
- Section 4242 - Over-current protection
- Section 4243 - Automatic flatirons

## Marking of appliances

- Section 4241 - Name-plate
- Section 4262 - Marking of heating elements

## 1. Construction and operation of the Electric range, Fig. 2.

Fig. 2 is not a drawing of any one type of range. The surface units might be located in any one of several positions on the top of the range. The switches might be located on the back splasher or on the right hand side of the range, etc. All the different sections, shown in the diagram, might be found in some other location on the range.

- a. The Timer, Time clock, allows the oven to be turned "on" and "off" automatically. It looks like a standard clock except that it has extra knobs or dials which are used to "set" the "on" and "off" time.

Some ranges have time reminders, which are not controls. They give a sound as a reminder of the lapse of a set time.

- b. The oven temperature control allows the user to adjust the temperature of the oven. The oven and this temperature control unit are important parts of the range. Over a period of the last thirty years there have been many changes made in the temperature controls. Some of the first ranges did not have a temperature control on the oven. It would be referred to as a non-automatic type of oven.

The semi-automatic type made use of thermostats which regulated the heat in the oven. They respond to changes in temperature. There are two general types, the bimetallic and the hydraulic.

The bimetallic thermostats are of two types, spiral and flat blade.

In the spiral type the helical coil curls up to actuate the switch and interrupt the circuit. The flat blade type is usually inserted through the cooking top.

The hydraulic thermostats are of two types, bellows and diaphragm. In the bellows type, the bellows is actuated by the expansion of a fluid which is contained in a long capillary tube and a bulb. The expansion and contraction of the bellows actuates the switch which closes or opens the circuit to the oven units.

In the diaphragm type the capillary tube and bulb are connected to a diaphragm instead of a bellows.

In the earlier types of ranges, the thermostats did not have the current carrying capacity necessary to directly control the heating units. A contactor was used in the circuit, Fig. 3.



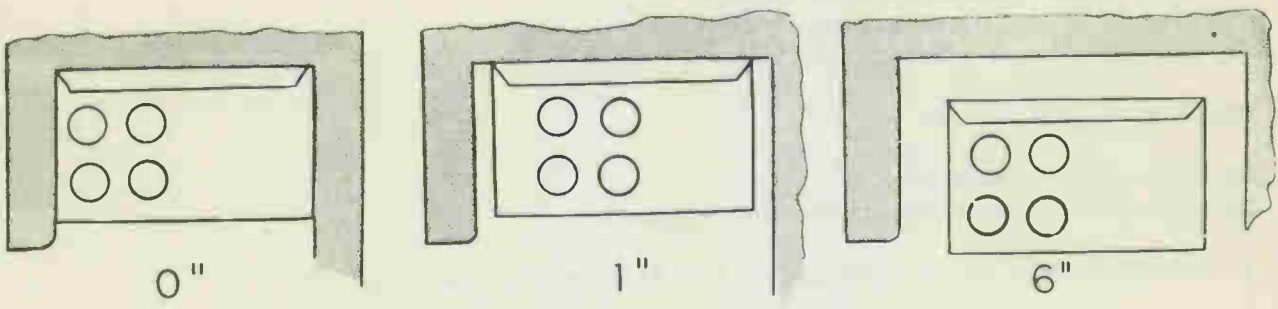

Fig. 1 Installation forms

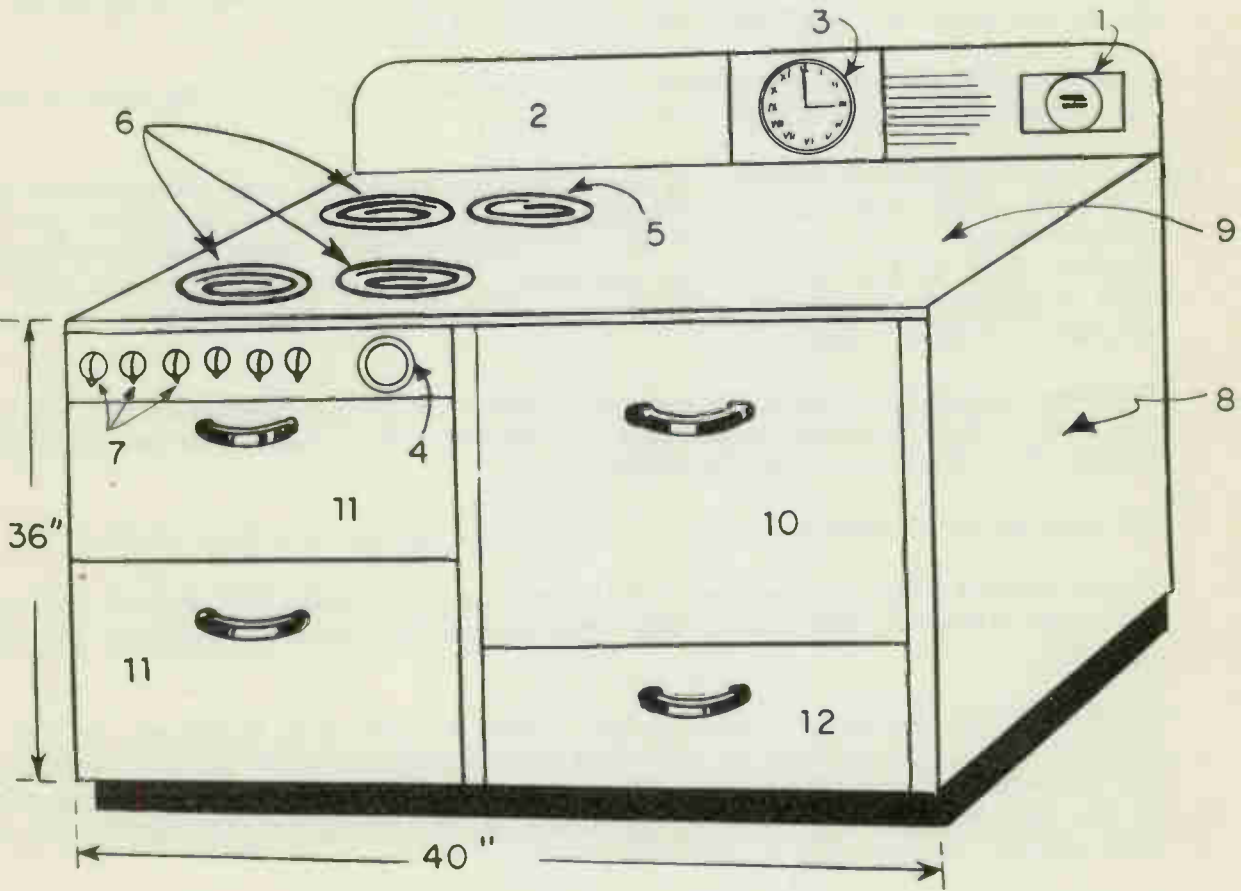

Fig. 2 Electric range

ELECTRICALLY HEATED APPLIANCESObjective

To become familiar with National Electric Code rules and specifications on appliances, and the construction and installation of the electric range.

References: National Electric Code

Lesson Content

## A. Definition of appliance (National Electric Code, article 4221).

Appliances are current consuming equipment, fixed or portable.

For example: heating, cooking and small motor operated equipment.

Section 4221 - This article shall apply to electric appliances used in any occupanc

Section 4222 - Branch circuit requirements

Refer to the following sections of your National Electric Code book at this time:

Section 4231 - Insulation of cords

Section 4232 - Insulation of appliances

Section 4233 - Portable immersion heaters

Section 4234 - Protection of combustible material

---

---

---

## B. Specifications of the Electric Range

All ranges do not have the same design, nor do they have the same insulation. The electric range standards of Underwriter's Laboratories, Inc., provide for three different installation forms. See Fig 1.

The specification for installation should be indicated on the name-plate of the range.

1. "0" - indicates the range may be installed with no space between itself and walls and cabinet bases.
2. "1" - the range may be against the back wall but the sides must have a clearance of one inch.
3. "6" - there must be a clearance on all sides of range of six inches.

Section 4235 - Stands for portable appliances

Section 4236 - Signals for heated appliances

Section 4237 - Infra-red lamp industrial

Section 4238 - Grounding

[illegible text]

[illegible text]

[illegible text]

[illegible text]

[illegible text]

[illegible text]

[illegible text]

[illegible text]

[illegible text]

[illegible text]

[illegible text]

[illegible text]

[illegible text]

[illegible text]

[illegible text]

[illegible text]

[illegible text]

[illegible text]

[illegible text]

[illegible text]

[illegible text]

[illegible text]





## L. Summary Questions

1. What value of resistance do you consider necessary in a good insulator?
2. What physical conditions will cause insulation to deteriorate?
3. What is dielectric strength? Insulation resistance?
4. What is the AIEEE equation for determining minimum insulation resistance?
5. Do you believe it wise to make an insulation resistance test after a dielectric test? Why?
6. What are the specifications on the proper application of a dielectric test?
7. How would you dry out a piece of equipment?
8. What is surface leakage?
9. What is the most common standard voltage used for insulation resistance testing? AC or DC?
10. What is a megohmmeter?
11. What is the current sensitivity of the VOM?
12. What is the maximum current output of a 500 volt d-c source which has an internal resistance of 500,000 ohms?
13. Three megohms equals how many ohms? \_\_\_\_\_  
.014 megohm equals how many ohms? \_\_\_\_\_  
5,0130 ohms equals how many megohms? \_\_\_\_\_
14. What items should be listed on the record form for insulation resistance tests?
15. Do you believe it necessary to list temperature? (Reference to question 15.) Discuss.
16. What minimum value of insulation resistance should be required on most equipment?
17. Referring to question 17, name some exceptions.
18. Should you attempt an insulation test on "live" equipment?
19. What precautions would you take when making tests on equipment which had capacitance?

FILM PROPERTIES										CURE AND AGEING		CHEMICAL PROPERTIES			BAKING CYCLES (MINIMUM IN HOURS)					AIR DRYING TIME		
BUILD RELATIVE	ADHESION	TOUGHNESS	HARDNESS	FLEXIBILITY	PENETRATION	BONDING	BONDING—HIGH TEMP.	THROUGH-CURE (CUP TEST)	AGEING FLEXIBILITY (100° C)	AGEING STATIC TEST (150° F)	WATER	ACID	ALKALI	OIL	SALT WATER	100° C-212° F	110° C-230° F	125° C-257° F	135° C-275° F	150° C-300° F	AIR DRYING TIME IN HOURS	PAGE NUMBER
● ● ● ▲ ● ■ ● ★ ★ ▲ ★ ● ● ▲ ★ ● 8-12 7-10 5-7 3-5 2-3 15																						
● ● ● ● ● ● ● ▲ ▲ ■ ● ● ● ▲ ● ● 10-12 8-10 6-8 4-6 3-5 15																						
● ● ▲ ▲ ● ● ● ▲ ★ ● ● ● ● ● ■ 18-24 15-18 6-10 4-8 3-6 16																						
■ ● ● ● ● ■ ▲ ● ★ ▲ ■ ▲ ■ ■ ★ ■ 12-14 8-10 5-7 4-6 2-4 16																						
■ ● ★ ▲ ▲ ● ★ ★ ★ ★ ● ● ● ★ ● 2-3 1-2 1-1½ ½-1 ½ 3-4 17																						
● ★ ★ ■ ★ ● ● ★ ★ ★ ★ ★ ▲ ★ ● ★ ½-1 17																						
■ ● ★ ★ ▲ ▲ ▲ ★ ● ★ ★ ■ ■ ■ ★ ■ 4-6 3-5 2-4 1-3 1-2 2-2½ 18																						
■ ● ★ ▲ ▲ ● ▲ ★ ★ ★ ■ ■ ■ ★ ■ 2-3 1-2 1-1½ ½-1 ½ 1-1½ 18																						
● ▲ ● ● ● ● ▲ ★ ★ ■ ▲ ● ● ● ▲ ● ● 8-10 6-8 5-6 3-4 2-3 19																						
● ■ ● ● ■ ■ ■ ★ ▲ ■ ■ ● ● ★ ■ ● ● NR 12-15 8-10 6-8 4-6 19																						
▲ ■ ● ● ● ■ ■ ■ ★ ▲ ■ ■ ■ ▲ ■ ■ NR 12-15 7-9 5-7 4-6 20																						
■ ■ ■ ■ ▲ ● ● ■ ● ● ● ■ ■ ■ ■ ■ 15-18 10-12 5-7 3-5 2-4 20																						
■ ● ■ ■ ● ● ● ■ ● ● ● ■ ● ● ■ ● ● 12-15 10-12 6-8 4-6 3-5 21																						
● ● ● ■ ● ▲ ● ▲ ▲ ● ● ● ● ▲ ● ● 10-12 6-8 4-6 2-4 1-3 21																						
● ■ ● ● ● ● ● ▲ ▲ ■ ■ ● ● ▲ ■ ● NR 10-12 8-10 6-8 3-5 22																						
■ ■ ■ ■ ■ ■ ● ■ ■ ■ ■ ■ ■ ■ ■ 10-12 8-10 6-8 5-7 3-5 22																						
■ ■ ● ● ■ ● ● ▲ ● ■ ■ ■ ■ ● ■ ● NR 10-12 8-10 6-8 4-6 23																						
■ ■ ■ ■ ■ ● ■ ● ● ■ ▲ ■ ■ ■ ● ■ ■ 10-12 6-8 5-7 4-6 2-5 23																						
■ ■ ■ ■ ■ ● ■ ● ● ■ ● ● ■ ■ ■ ■ ■ 12-15 8-10 5-7 4-6 2-5 24																						
■ ■ ■ ■ ■ ■ ■ ■ ■ ■ ■ ■ ■ ■ ■ ■ 12-15 8-10 4-6 3-5 2-4 24																						
● ▲ ▲ ■ ★ ■ ■ ■ ■ ★ ★ ■ ■ ■ ■ ■ 4-6* 3-5* 2-4* BLISTERS 2-2½ 25																						
● ■ ● ■ ■ ■ ★ ■ ▲ ▲ ★ ■ ▲ ■ ▲ ■ ● 3-5 2-4 1-3 1-2 1-2 4 25																						
● ● ● ● ● ● ★ ▲ ● ● ■ ■ ● ● ■ 10-12 6-8 4-6 2-4 1-3 4-6 26																						
■ ● ★ ★ ▲ ▲ ▲ ★ ★ ★ ★ ● ● ■ ★ ■ 6-10 5-8 4-6 3-5 2-3 4-6 26																						
● ■ ● ● ■ ■ ● ★ ▲ ■ ● ■ ■ ▲ ● ● 8-12 7-10 5-7 3-5 2-3 18-24 27																						
● ● ● ● ● ★ ● ★ ★ ★ ● ▲ ★ ● ★ 5-7 4-6 3-5 2-4 1-2 12-16 27																						
● ● ▲ ● ● ● ★ ★ ■ ■ ● ● ★ ● ● 4-6 2-4 1-2 18-24 28																						
■ ■ ■ ■ ▲ ★ ★ ★ ▲ ★ ■ ▲ ● ▲ ■ ● 5-8 4-6 2-3 1-2 ½-1½ 2-8 28																						
▲ ▲ ▲ ▲ ★ ★ ★ ▲ ■ ■ ■ ★ ● ▲ 8-10 6-8 3-4 2-3 1-2½ 4-12 29																						
▲ ● ● ● ● ● ★ ★ ★ ● ● ▲ ■ ★ ■ ▲ ½-2 ¼-1 1/3-½ 29																						
▲ ● ● ● ▲ ★ ★ ★ ▲ ■ ■ ● ■ ★ ■ ▲ 3-4 2-3 1-2 1-2 1-2 1-4 30																						

**LEGEND**

- Excellent
- Good
- ▲ Fair
- ★ Poor

## SPECIFICATIONS

	G.E. VARNISH NO.	TYPE OF BASE	PER CENT SOLIDS CONTENT	THINNER	VISCOSITY AT 25° C		GRAVITY AT 21° C		FLASH POINT DEGREES F	DIELECTRIC STRENGTH VOLTS MIL.	DIELECTRIC STRENGTH 24 HOURS WATER IMMERSION	ARC RESISTANCE IN SECONDS	SUP.
					C. P.	AVERAGE	20	875					
BLACK BAKING	150	ASPHALT RESIN AND DRYING OIL	54	VM & P NAPHTHA	225	0.875	50	1280	875				
	1693	SYNTHETIC RESIN ASPHALT AND DRYING OIL	51	PET. SPTS.	225	0.880	50	2060	760				
	9435	SYNTHETIC RESIN ASPHALT AND DRYING OIL	50	PET. SPTS.	225	0.880	95	1860	900	195			
	9450	ASPHALT AND DRYING OIL	50	TOLUOL	300	0.925	20	1500	800	100			
BLACK AIR DRYING	183	ASPHALT AND DRYING OIL	42	TOLUOL	50	0.915	20	800	400				
	271	SPIRIT GUM	41	DENATURED ALCOHOL	0.905		55	400	200				
	457	ASPHALT AND DRYING OIL	45	VM & P NAPHTHA	250	0.830	20	1160	400	40			
	462	ASPHALT AND DRYING OIL	53	TOLUOL	1000	0.925	20	1000	500	60			
CLEAR BAKING	450	NATURAL GUM AND DRYING OIL	48	VM & P NAPHTHA	400	0.867	50	1000	400	242			
	1154	GLYPTAL	50	G-E 1154-T	450	0.950	78	1400	800	220			
	1673	GLYPTAL	50	PET. SPTS.	900	0.910	95	1480	900	226			
	1678	PHENOLIC RESIN AND DRYING OIL	60	G-E 1513	850	0.930	50	1910	1240	240			
	1679	PHENOLIC RESIN AND DRYING OIL	55	G-E 1513	900	0.930	50	1900	1500	210			
	1685	MODIFIED PHENOLIC RESIN AND DRYING OIL	51	PET. SPTS.	350	0.890	77	1380	725				
	1696	GLYPTAL	50	G-E 1500	2500	0.975	77	1577	418				
	7148	PHENOLIC MODIFIED GLYPTAL	50	G-E 9407	1200 1500	0.980	65	1595 730	1612 975				
	7153	GLYPTAL	50	G-E 1500	1100 1600	0.985	78	1595	1610				
	9535	SYNTHETIC RESIN AND DRYING OIL	53	G-E 9407	750	0.965	50	1794	522				
	9574	PHENOLIC DRYING OIL	62	PET. SPTS.	250	0.915	95	1685	940				
CLEAR AIR DRYING	1180-4	PHENOLIC RESIN VARNISH	56	DENATURED ALCOHOL	500	1.035	55	1000	600	15			
	1202	GLYPTAL (OIL MOD. ALKYD)	50	G-E 1500	300	0.980	78	1450	505	227			
	9564	MODIFIED PHENOLIC RESIN AND DRYING OIL	52	PET. SPTS.	250	0.900	95	1540	570	180			
BLACK AIR DRYING AND BAKING	458	ASPHALT AND DRYING OIL	46	VM & P NAPHTHA	250	0.850	50	1230	600	116			
	9438	SYNTHETIC RESIN ASPHALT AND DRYING OIL	52	VM & P NAPHTHA	150	0.895	95	1375	300				
CLEAR AIR DRYING AND BAKING	152	NATURAL GUM AND DRYING OIL	55	VM & P NAPHTHA	25-35	0.850		1600	200				
	1170	MODIFIED PHENOLIC RESIN AND DRYING OIL	48	PET. SPTS.	125	0.887	95	1725	1125				
AIR DRYING AND BAKING ENAMELS	1201	GLYPTAL	65	G-E 1500	400	1.14	78	1400	300	480	7.5 x 10 <sup>7</sup>		
	1224	GLYPTAL	49	G-E 1500	320	0.990	78	820	250	242	4 x 10 <sup>8</sup>		
	2600	GLYPTAL	41	G-E D5819	1800	0.980	15	500	275	480	4.2 x 10 <sup>8</sup>		
	7622	GLYPTAL	44	TOLUOL	1.020		78	1680	688	240	1 x 10 <sup>12</sup>		

\*Preceded by low temperature bake to remove solvent (6-8 hrs. 70-80° C (160-175° F) NR — Not Recommended.



## Wiring &amp; Repair

## K. Varnishing &amp; Baking &amp; Painting

## 1. Varnishes

Varnishes should be kept at normal room temperature.  
Consistency must be kept at value recommended by manufacturer  
(measure viscosity)

Tanks and vats must be kept covered when not in use.  
Check with manufacturer and be sure of characteristics of varnish  
and thinner.

Some windings are dipped in an open vat, drained, dipped, drained and baked.  
Some are preheated before any cycle of dip and bake.  
Preheating should be used on all larger equipment as it improves penetration  
of the varnish.

Vacuum impregnation, pressure impregnation, and vacuum and pressure impregna-  
tion are used in large plants.

Brushing a varnish on equipment should be used on finish coats, however, it  
may be used on some types of smaller machines.

The vapor, of some solvents in varnishes, are inflammable and explosive  
when mixed with air.

Check ventilation

Check toxic effect

Avoid direct contact with varnishes and solvents. Sometimes infections  
of skin occur.

All surfaces to be coated and, or, impregnated must be clean and free from  
oil and dirt.

Masking material can be used on parts of equipment where a film of varnish  
is not desired.

## 2. Baking

Ventilated electric or steam ovens can be used.

Baking removes moisture and solvent and improves most of the mechanical, chem-  
ical and electrical properties of the unit.

If infra-red is used for baking be sure you are using a varnish and solvent  
which can be cured properly when subjected to same. Infra-red is used efficient-  
ly in pre-heating. When pre-heating -- keep in mind you are increasing hazards.  
When properly done it is desirable over cold dip. 165°C is a good preheat,  
temperature, however, dip immediately. When the pre-heat method is used, use  
a small vat of varnish. Many vats make use of cooling coils.

Baking may be accomplished by passing a current through the winding.

The silicon varnishes are the latest developments.

## 3. Testing

Before motor assembly:

- a. Check electrically, insulation resistance, grounds, shorts etc.
- b. Balance

I T E M	C O N S T R U C T I O N	U S E	H O W O R D E R E D and A P P R O X I M A T E D I M E N S I O N S
Wedges	Hard maple, plastics, papers etc.	Holding coils in machines	Number in variety of sizes and shapes
Cements & Adhesives	Numerous		Purchased by gallon i.e., so many gal. per drum
Fiberglas (a tradename of Owens-Corning Fiberglas Corp.)	Fiberglas products are made from glass yarn. Cloths, tapes, cords sleeving, etc.		
Sealing & Filling Compounds	Putty-like compounds and liquids	Different types used for coating arc-chutes, treating cables, building up field coils, sealing transformer terminal bushings, filling in coil ends, etc.	by gallon
Lacquers Enamels		Motor frames, windings controls for sealing gaskets pipe connections, etc.	
Mica	Natural mica is split into thin flakes and then bonded by shellac or varnish into the shape or form desired. (Sheets, tapes, plates.) tubing etc.	Cones, collars, V rings on commutator all high voltage applications. Application is dependent on bonding agent.	

ITEM	CONSTRUCTION	USE	HOW ORDERED and APPROXIMATE DIMENSIONS
Tapes	Varnished tapes Cotton tapes Friction tapes Rubber tapes Webbing		7-25 mils thick from $\frac{1}{4}$ " in width up to about 3"
Tubings	Made from cotton sleeves * and varnish impregnated  Cotton sleeving (+)	Insulating leads and conductors at special points of mechanical strain or dielectric stress. Sometimes used as gasket material.	* Ordered by "number" and inside diameter + Ordered by number and the manufacturer will specify the size of wire the sleeving will cover properly. Ordered in feet.
Cords and Twine	Usually linen.  Cotton, usually	permanent bindings  temporary bindings, insulation and space filler	Ordered by spool and number (each number represents a certain breaking strength in lbs., diameter in inches and the no. of feet per lb)
Varnished Cloth	A cotton cloth, varnish impregnated, cut bias or straight, drill and duck.	Insulating coils, leads iron frames, etc., used mostly for its insulating properties.	5 to 45 mils thick ordered in sq. yds. black or yellow.
Insulating papers and Fibers	Untreated papers and fibers impregnated with varnish	Lining slots, insulating core ends and shafts etc.	Ordered by sq. ft. 10-125 mils thick.
1. Pressboard (fullerboard)	Readily absorbs oil	Used mainly as insulation on transformers	
2. Asbestos paper		Wrappings on cable, separators and linings for controllers and other boxes.	
3. Rawhide fiber (fish paper)		High resistance to mechanical injury and heat	
Many others	Many are a combination i.e., a varnished cloth and paper combined.	Any application necessary	

Some insulating materials are used for the purpose of mechanically bracing and protecting certain parts of electrical apparatus, electrical insulation, withstanding high temperatures; and for withstanding oils, alkali, vapors, etc. An idea of the characteristics of insulating materials may be had by referring to the chart on varnishes on pages 204 and 205 of this lesson.

The chart on page 201 will give you information on many of the different types of insulating materials.

Varnish is necessary to: Hold windings secure, prevent abrasion, allow a rotating unit to retain its balance, retard absorption of moisture, dissipate heat and thereby decrease temperature rise, increase dielectric strength, and resist chemicals.

One of the most recent developments in insulating varnishes has been the commercial production of high temperature silicon resins.

Tests have indicated these resins can withstand temperature of approximately 200°C to 250°C nearly 50° higher than that of other types of varnish.

Wire companies supply magnet wire with insulation which is impregnated with silicon varnish.

Experiments indicate that the life of electrical apparatus will be increased considerably by making use of the silicon varnishes.

The silicon insulating varnishes have an ability to resist heat, moisture, and corrosive fumes far beyond that of older types of insulating varnishes.

They are chemical compounds made from sand, brine, coal, and oil. It is not an inorganic compound but a semi-inorganic.

The organic carbon content of an ordinary insulating varnish is the component which allows appreciable deterioration. In the silicon insulating varnishes this carbon has been replaced by a chemically inert silicon. It may be applied by dipping spraying, or brushing. It requires baking in a temperature of about 250°C (482°F) to set.

## J. Definitions

### 1. "Start" and "Finish"

The coil winder usually refers to the end of a coil as either a "start" lead or a "finish" lead. When developing coils, many times it is necessary to make one lead of a coil longer than the other lead. The above terminology will allow the coil winder to develop a coil whose leads have the proper length.

### 2. "Top" and "Bottom".

The armature, or stator, winder usually refers to the end or lead of a coil as either a "top" lead or a "bottom" lead. The top lead is the lead which comes from that half of the coil which lies, or will lie, in the top half of the slot. The bottom lead is the lead which comes from that half of the coil which lies, or will lie, in the bottom half of the slot.

CIRCULAR OF THE BUREAU OF STANDARDS  
TABLE XIV  
Hard-drawn Aluminum Wire at 20°C (or, 68°F)  
American Wire Gage (B&S) English units

gauge no.	Diameter in Mils	Cross Section		Ohms per 1000 Feet	Pounds per 1000 Feet	Pounds per Ohms	Feet per Ohms
		Circular Mils	Square Inches				
00	460.	212000.	0.166	0.0804	195.	2420.	12400.
00	410.	168000.	.132	.101	154.	1520.	9860.
00	365.	133000	.105	.128	122.	957.	7820.
0	325.	106000.	.0829	.161	97.0	602.	6200.
1	289.	83700.	.0657	.203	76.9	379.	4920.
2	258.	66400.	.0521	.256	61.0	238.	3900.
3	229.	52600.	.0413	.323	48.4	150.	3090.
4	204.	41700.	.0328	.408	38.4	94.2	2450.
5	182.	33100.	.0260	.514	30.4	59.2	1950.
6	162.	26300.	.0206	.648	24.1	37.2	1540.
7	144.	20800.	.0164	.817	19.1	23.4	1220.
8	128.	16500.	.0130	1.03	15.2	14.7	970.
9	114.	13100.	.0103	1.30	12.0	9.26	770.
10	102.	10400.	.00815	1.64	9.55	5.83	610.
11	91.	8230.	.00647	2.07	7.57	3.66	484.
12	81.	6530	.00513	2.61	6.00	2.30	384.
13	72.	5180.	.00407	3.29	4.76	1.45	304.
14	64.	4110.	.00323	4.14	3.78	0.911	241.
15	57.	3260.	.00256	5.22	2.99	.573	191.
16	51.	2580.	.00203	6.59	2.37	.360	152.
17	45.	2050.	.00161	8.31	1.88	.227	120.
18	40.	1620.	.00128	10.5	1.49	.143	95.5
19	36.	1290.	.00101	13.2	1.18	.0897	75.7
20	32.	1020.	.000802	16.7	0.939	.0564	60.0
21	28.5	810.	.000636	21.0	.745	.0355	47.6
22	25.3	642.	.000505	26.5	.591	.0223	37.8
23	22.6	509.	.000400	33.4	.468	.0140	29.9
24	20.1	404.	.000317	42.1	.371	.00882	23.7
25	17.9	320.	.000252	53.1	.295	.00555	18.8
26	15.9	254.	.000200	67.0	.234	.00349	14.9
27	14.2	202.	.000158	84.4	.185	.00219	11.8
28	12.6	160.	.000126	106.	.147	.00138	9.39
29	11.3	127.	.0000995	134.	.117	.000868	7.45
30	10.0	101.	.0000789	169.	.0924	.000546	5.91
31	8.9	79.7	.0000626	213.	.0733	.000343	4.68
32	8.0	63.2	.0000496	269.	.0581	.000216	3.72
33	7.1	50.1	.0000394	339.	.0461	.000136	2.95
34	6.3	39.8	.0000312	428.	.0365	.0000854	2.34
35	5.6	31.5	.0000248	540.	.0290	.0000537	1.85
36	5.0	25.0	.0000196	681.	.0230	.0000338	1.47
37	4.5	19.8	.0000156	858.	.0182	.0000212	1.17
38	4.0	15.7	.0000123	1080.	.0145	.0000134	0.924
39	3.5	12.5	.00000979	1360.	.0115	.00000840	.733
40	3.1	9.9	.00000777	1720.	.0091	.00000528	.581

CIRCULAR OF THE BUREAU OF STANDARDS  
TABLE VIII  
WORKING TABLE, STANDARD ANNEALED COPPER WIRE  
American Wire Gage (B&S), English Units

Gage No.	Diameter In Mils	Cross Section		Ohms per 1000 Feet		Pounds p 1000 feet
		Circular Mils	Square Inches	25°C (=77°F)	65°C (=149°F)	
0000	460.	212000.	0.166	0.0500	0.0577	641.
000	410.	168000.	.132	.0630	.0727	508.
00	365.	133000.	.105	.0795	.0917	403.
0	325.	106000.	.0829	.100	.116	319.
1	289.	83700.	.0657	.126	.146	253.
2	258.	66400.	.0521	.159	.184	201.
3	229.	52600.	.0413	.201	.232	159.
4	204.	41700.	.0328	.253	.292	126.
5	182.	33100.	.0260	.319	.369	100.
6	162.	26300.	.0206	.403	.465	79.5
7	144.	20800.	.0164	.508	.586	63.0
8	128.	16500.	.0130	.641	.739	50.0
9	114.	13100.	.0103	.808	.932	39.6
10	102.	10400.	.00815	1.02	1.18	31.4
11	91.	8230.	.00647	1.28	1.48	24.9
12	81.	6530.	.00513	1.62	1.87	19.8
13	72.	5180.	.00407	2.04	2.36	15.7
14	64.	4110.	.00323	2.58	2.97	12.4
15	57.	3260.	.00256	3.25	3.75	9.86
16	51.	2580.	.00203	4.09	4.73	7.82
17	45.	2050.	.00161	5.16	5.96	6.20
18	40.	1620.	.00128	6.51	7.51	4.92
19	36.	1290.	.00101	8.21	9.48	3.90
20	32.	1020.	.000802	10.4	11.9	3.09
21	28.5	810.	.000636	13.1	15.1	2.45
22	25.3	642.	.000505	16.5	19.0	1.94
23	22.6	509.	.000400	20.8	24.0	1.54
24	20.1	404.	.000317	26.2	30.2	1.22
25	17.9	320.	.000252	33.0	38.1	0.970
26	15.9	254.	.000200	41.6	48.0	.769
27	14.2	202.	.000158	52.5	60.6	.610
28	12.6	160.	.000126	66.2	76.4	.484
29	11.3	127.	.0000995	83.4	96.3	.384
30	10.0	101.	.0000789	105.	121.	.304
31	8.9	79.7	.0000626	133.	153.	.241
32	8.0	63.2	.0000495	167.	193.	.191
33	7.1	50.1	.0000394	211.	243.	.152
34	6.3	39.8	.0000312	266.	307	.120
35	5.6	31.5	.0000248	335.	387.	.0954
36	5.0	25.0	.0000196	423.	488.	.0757
37	4.5	19.8	.0000156	533.	616.	.0600
38	4.0	15.7	.0000123	673	776.	.0476
39	3.5	12.5	.0000098	848.	979	.0377
40	3.1	9.9	.0000078	1070.	1230.	.0299

CIRCULAR OF THE BUREAU OF STANDARDS

TABLE IV

Tabular Comparison of Wire Gages  
Diameters in Mils

ENGLISH

Gage No.	American Wire Gage (B&S) 22	Steel Wire Gage 23	Birmingham Wire Gage (Stubs)	Old English Wire Gage (London)	Stubs' Steel Wire Gage	(British Standard Wire Gage)	Gage No.
-0		490.0				500.	7-0
-0		461.5				464.	6-0
-0		430.5				432.	5-0
-0	460.	393.8	454.	454.		400.	4-0
-0	410.	362.5	425.	425.		372.	3-0
-0	365.	331.0	380.	380.		348.	2-0
0	325.	306.5	340.	340.		324.	0
1	289.	283.0	300.	300.	227.	300.	1
2	258.	262.5	284.	284.	219.	276.	2
3	229.	243.7	259.	259.	212.	252.	3
4	204.	225.3	238.	238.	207.	232.	4
5	182.	207.0	220.	220.	204.	212.	5
6	162.	192.0	203.	203.	201.	192.	6
7	144.	177.0	180.	180.	199.	176.	7
8	128.	162.0	165.	165.	197.	160.	8
9	114.	148.3	148.	148.	194.	144.	9
10	102.	135.0	134.	134.	191.	128.	10
11	91.	120.5	120.	120.	188.	116.	11
12	81.	105.5	109.	109.	185.	102.	12
13	72.	91.5	95.	95.	182.	92.	13
14	64.	80.0	83.	83.	180.	80.	14
15	57.	72.0	72.	72.	178.	72.	15
16	51.	62.5	65.	65.	175.	64.	16
17	45.	54.0	58.	58.	172.	56.	17
18	40.	47.5	49.	49.	168.	48.	18
19	36.	41.0	42.	40.	164.	40.	19
20	32.	34.8	35.	35.	161.	36.	20
21	28.5	31.7	32.	31.5	157.	32.	21
22	25.3	28.6	28.	29.5	155.	28.	22
23	22.6	25.8	25.	27.0	153.	24.	23
24	20.1	23.0	22.	25.0	151.	22.	24
25	17.9	20.4	20.	23.0	148.	20.	25
26	15.9	18.1	18.	20.5	146.	18.	26
27	14.2	17.3	16.	18.75	143.	16.4	27
28	12.6	16.2	14.	16.50	139.	14.8	28
29	11.3	15.0	13.	15.50	134.	13.6	29
30	10.0	14.0	12.	13.75	127.	12.4	30
31	8.9	13.2	10.	12.25	120.	11.6	31
32	8.0	12.8	9.	11.25	115.	10.8	32
33	7.1	11.8	8.	10.25	112.	10.0	33
34	6.3	10.4	7.	9.50	110.	9.2	34
35	5.6	9.5	5.	9.00	108.	8.4	35
36	5.0	9.0	4.	7.50	106.	7.6	36
37	4.5	8.5		6.50	103.	6.8	37
38	4.0	8.0		5.75	101.	6.0	38
39	3.5	7.5		5.00	99.	5.2	39
40	3.1	7.0		4.50	97.	4.8	40
41		6.6			95.	4.4	41
42		6.2			92.	4.0	42
43		6.0			88.	3.6	43

## I. Insulation - Tables

The insulation of Special-purpose motors and generators must withstand moistures, acids, fumes etc., in excess of that encountered in an application involving a general purpose motor.

Classification of Insulating Materials. - Insulating materials when considered in connection with temperature limits shall be classified as follows:

## 1. Class A

- a. Cotton, silk, paper and similar organic materials when either impregnated or immersed in a liquid dielectric.
- b. Molded and laminated materials with cellulose filler, phenolic resins, and other resins of similar properties.
- c. Films and sheets of cellulose acetate and other cellulose derivatives of similar properties; and
- d. Varnishes (enamel) as applied to conductors.

## 2. Class B.

- a. Mica, asbestos, fiber glass, and similar inorganic materials in built-up form with organic binding substances. A small portion of class A materials may be used for structural purposes only.
- q b. The electrical and mechanical properties of the insulated winding must not be impaired by application of the temperature permitted for class B material. (The word "impair" is here used in the sense of causing any change which could disqualify the insulating material for continuous service). The temperature endurance of different class B insulation assemblies varies over a considerable range, in accordance with the percentage of class A materials employed, and the degree of dependence placed on the organic binder for maintaining the structural integrity of the insulation.

## 3. Class C

Entirely of mica, porecelain, glass, quartz, and similar inorganic materials.

## 4. Class O

Cotton, silk, paper and similar organic materials when neither impregnated nor immersed in a liquid dielectric.

An insulation is considered to be "impregnated" when a suitable substance replaces the air between its fibers, even if this substance does not completely fill the spaces between the insulated conductors. The impregnating substances, in order to be considered suitable, must have good insulating properties, must entirely cover the fibers and render them adherent to each other and to the conductor; must not produce interstices within itself as a consequence of evaporation of the solvent or through any other cause; must not flow during the operation of the machine at full working load or at the temperature limit specified; and must not unduly deteriorate under prolonged action of heat.



Other transformers, not oil immersed should indicate somewhere near 600 to 1000 megohms.

#### 6. Power cables.

High values to be expected (1000 megohms and higher) measured between each conductor to all other conductors and sheath or covering. Telephone and telegraph cables a minimum of 500 megohms and will usually obtain readings much higher. The insulation resistance will vary inversely with the length in miles.

#### 7. Switch-boards and panelboards.

The insulation resistance between any pair of bus bars should be 50,000 ohms. For determining the minimum value of insulation resistance, on rotating apparatus, it is usually good practice not to accept any installation which will give a reading lower than "two times the value found, using the AIEEE formula."

When checking rewound motors the resistance should be from 10 to 100 megohms. When checking power wiring, experience seems to indicate an infinity reading to be very desirable. If the system is connected to controls, safety devices, and motors, there should be not less than four megohms.

#### H. Precautions:

Apparatus must not be "live".

Observe all company rules of safety when preparing to make, and when making any insulation resistance tests on high voltage apparatus. If infinity readings are obtained on successive tests, touch leads of test equipment together to determine if test equipment is O.K. If the apparatus, or equipment under test is so designed that there may be capacitance developed, discharge the capacitance before and after tests.

Keep records on tests, handle all instruments at all times, with care, When using: place test equipment on a firm level base. Avoid magnetic fields.

A record should be kept on all insulation resistance tests. See Fig. 6.

## G. Approximate Insulation Resistance Values to be Expected.

### 1. Insulation Resistance

All wiring shall be so installed that when completed the system will be free from short circuits and grounds; and in order that a reasonable factor of safety may be provided the following table of insulation resistances is suggested as a guide where the insulation is subjected to test.

- a. For circuits using #14 or #12 wire, 1,000,000 ohms. For circuits of #10 or larger conductor, a resistance based upon the allowable current carrying capacity of the conductors as fixed in the wire tables as follows:

25 to 50 amperes, inclusive . . . . .	.250,000 ohms
51 to 100 amperes, inclusive . . . . .	.100,000 ohms
101 to 200 amperes, inclusive . . . . .	50,000 ohms
201 to 400 amperes, inclusive . . . . .	25,000 ohms
401 to 800 amperes, inclusive . . . . .	12,000 ohms
Over 800 amperes . . . . .	5,000 ohms

- b. The above values shall be determined with all switchboards, panelboards, fuseholders, switches, and over-current devices in place.
- c. If lampholders, receptacles, fixtures, or appliances are also connected, the minimum resistance permitted for branch circuits supplying same shall be one-half the values specified in paragraph a.
- d. Where climatic conditions are such that the wiring or equipment is exposed to excessive humidity, it may be necessary to modify the foregoing provisions.

It might be a good idea to accept an installation only if an indication of at least one megohm is obtained, when there are no appliances "plugged in".

### 2. Appliances and portable tools.

It is possible to obtain enough of a shock to lead to a major accident when the insulation test shows only one megohm or less.

### 3. Instruments

A reading of not less than 20 megohms should be obtained between all meter circuits and the case. A reading between circuits should not be less than 5 megohms.

4. Rotating machines up to 600 volts, 1-10 megohms; above 600 volts 10-100 megohms.

### 5. Transformers

Test high and low voltage windings separately, and between one another. Instrument transformers not below 100 megohms (this reading quite low).

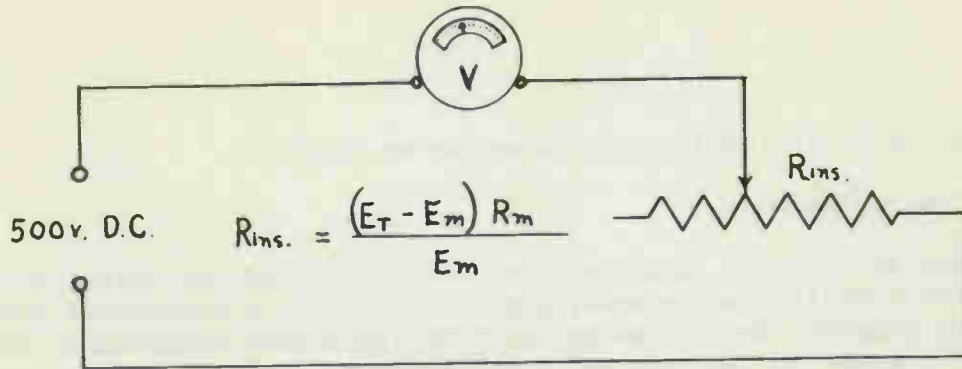

Fig. 5 Equation and circuit when using a voltmeter

LOCATION						
EQUIPMENT						
DATE INSTALLED						
RATING						
DATE	R <sub>in</sub> MEGOHMS	AMBIENT TEMPERATURE	OPERATING TEMPERATURE	TIME IN SERVICE (load)	WEATHER CONDITION	NAME OF INSPECTOR

Fig. 6. Insulation resistance chart.

It has been shown that if the 500 volt d-c source was constant and  $R_1$  equals 500,000 ohms, the resulting current would be one milliamperere. Since the instrument is now inserted in the circuit we now have 500,150 ohms and the current would be slightly less than one milliamperere. Since the resistance of the instrument however, is so small, in respect to  $R_1$  it is not an important factor.

In case the insulation is defective and offers no opposition to the flow of current, the instrument will burn out unless the source voltage is lowered.

Remember the equation presented in the Electrical Wiring department:  $I = \frac{E}{R+r}$

where  $I$  equals current in amperes,  $E$  equals EMF;  $R$  equals external resistance, and  $r$  equals internal resistance of the source. This reminder points out the fact that the internal resistance of the source will determine the current output of the source with any given external resistance used.

The power-pack incorporates a rheostat which may be adjusted to limit the output to one milliamperere when the volt-ohmmeter (150 MV range) is placed across the output terminals. The megohm scale on the volt-ohmmeter was calibrated to be used with the power-pack shown and the volt-ohmmeter set on the 150 millivolt range.

If a 500 volt d-c voltmeter is used as shown in Fig. 5 the following relation could be used:  $R_{ins.} = \frac{(E_t - E_m)R_m}{E_m}$

where:  $R_{ins.}$  equals insulation resistance  
 $E_t$  equals source voltage (d-c)  
 $E_m$  equals voltage reading of voltmeter  
 $R_m$  equals resistance of the meter.

If the voltmeter is a 100 ohm per volt instrument the  $R_m$  will equal 50,000 ohms and the  $I_m$  will equal 10 milliamperes.

The proof of the above equation may be developed from Ohm's Law as follows:

1.  $I_1$  equals  $\frac{E_1}{R_1}$
2.  $I_m$  equals  $\frac{E_m}{R_m}$
3. Since the circuit is a series circuit:
4.  $I_1$  equals  $I_m$
5. Therefore  $\frac{E_1}{R_1}$  equals  $\frac{E_m}{R_m}$  (since values equal to the same quantity are equal)
6. Therefore  $R_1$  equals  $\frac{E_1 R_m}{E_m}$  (transposing #5)
7. Since  $E_1$  equals  $E_t - E_m$  (Kirchoff's Law)
8.  $R_1$  equals  $\frac{(E_t - E_m) R_m}{E_m}$  (Substituting 7 in 6)

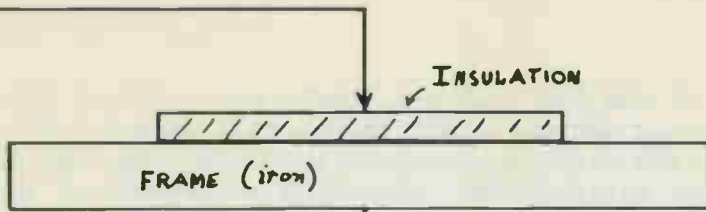

Fig. 1 Basic circuit of an insulation resistance test.

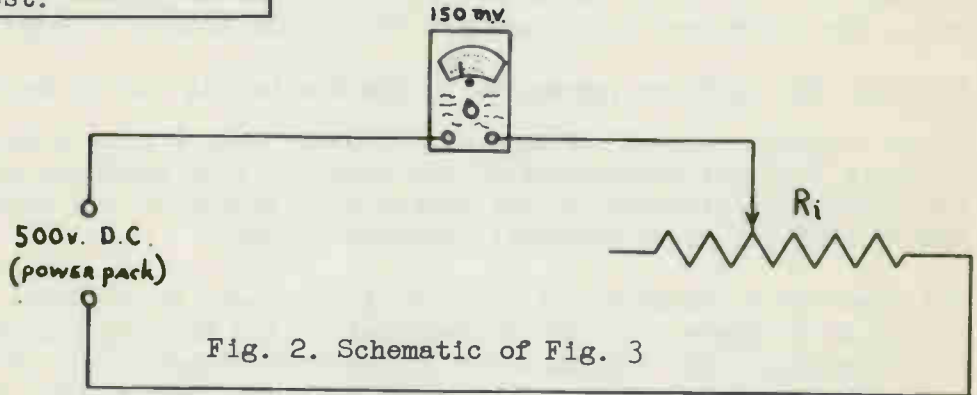

Fig. 2. Schematic of Fig. 3

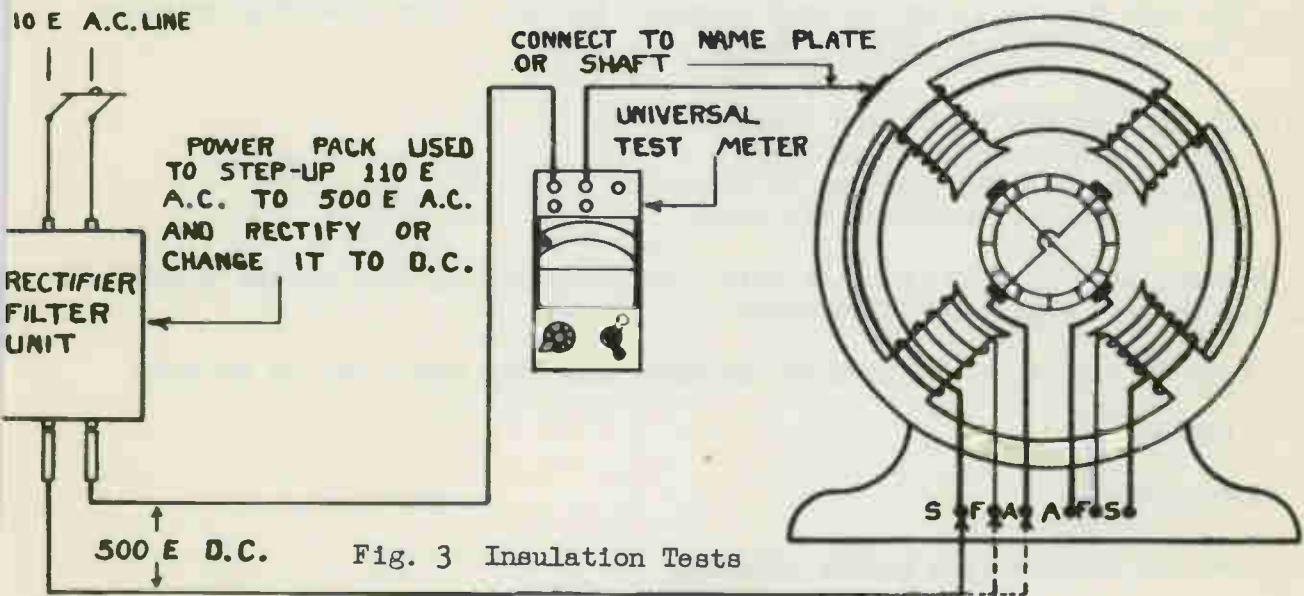

Fig. 3 Insulation Tests

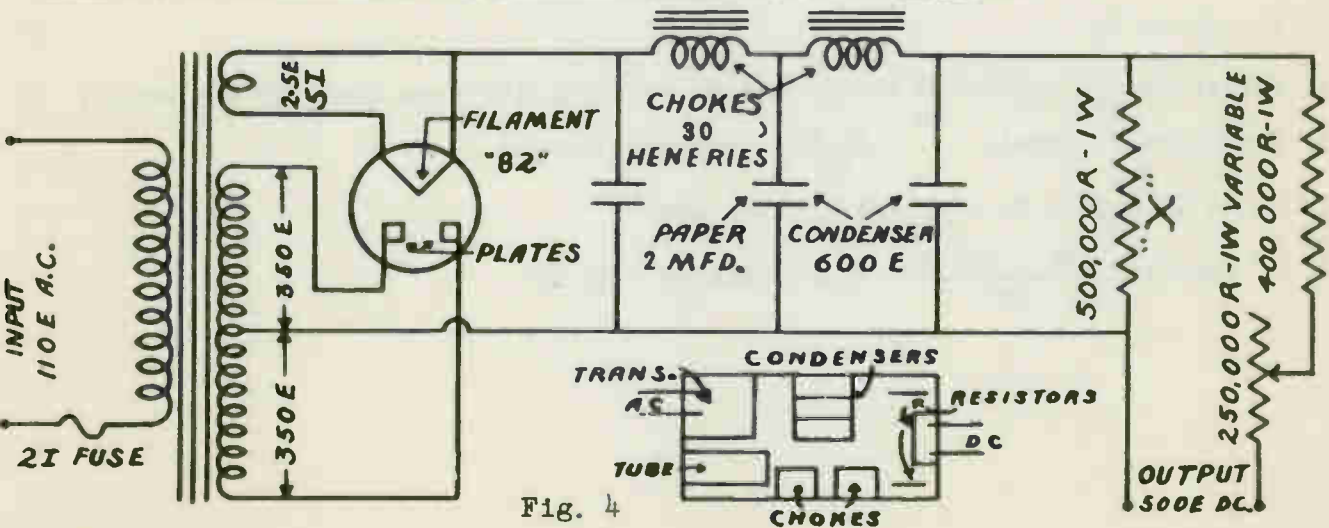

Fig. 4

## E Applying Insulation Resistance Tests

There are no definite formulas for determining a safe value of insulation resistance.

Two identical pieces of equipment may not have the same insulation resistance but they may still be in good operating condition.

When making an insulation resistance test, you are actually measuring the leakage current through an insulator which is due to an impressed voltage, d-c, or 500 volts, Fig. 1.

Let us assume that the resistance of the insulation,  $R_1$  in Fig. 1, is 500,000 ohms. This is a lower value than should be expected in most cases.

Since, according to Ohms Law,  $I = \frac{E}{R}$ ; then  $I = \frac{500}{500,000} = \frac{5 \times 10^2}{5 \times 10^5} = 1 \times 10^{-3}$  ampere of  $I$ , equals 1 milliamperere.

Let us say that  $R_1$  equals 100 megohms, then  $I = \frac{500}{100 \times 10^6} = \frac{5 \times 10^2}{1 \times 10^8} = 5 \times 10^{-6}$  amperes equals .005 milliamperes.

Notice that in the first problem the leakage current is equal to one milliamperere and in the second problem is equal to only .005 milliamperere or 5 micro-amperes.

## F. Instruments

An instrument inserted in the circuit of Fig. 1, would give a reasonable deflection at both limits, but it should be a combination instrument. Consequently you will find instruments designed for certain ranges within which a reasonable indication may be observed. The two types of instruments that are used are the meg-ohmmeter and the voltmeter.

The meg-ohmmeter is made by many different manufacturers. It is many times referred to as a "megger", however, this name "megger" is a trade name for a certain meg-ohmmeter. The meg-ohmmeters are instruments specifically designed for insulation resistance testing.

The voltmeter may be used as shown in Figs. 2, 3, and 5. Fig. 2 shows the equivalent circuit (disregarding capacitance) of Fig. 1, with the addition of a voltmeter in the circuit. The voltmeter is a multi-meter type instrument set on the 150 millivolt range. On this setting there are 150 ohms in series in the instrument, between leads. The resistance of the movement equals 50 ohms, and the multiplier in series with the movement equals 100 ohms, resulting in 150 ohms. Also, the instrument has a sensitivity of 1000 ohms per volt, or in other words, the instrument movement will develop full scale deflection of the pointer whenever one milliamperere flows through the instrument.

## D. Insulation Resistance Tests

An insulation resistance test indicates the condition of the insulation in-so-far as its d-c resistance is concerned. Fig. 1.

An insulation resistance test should be made on equipment at times indicated below:

1. After repair.
2. After installation and before the apparatus is put into service.
3. Periodically while in service.
4. Before and after any dielectric test.

The schedule on the tests while in service will be determined by the type of equipment and the conditions under which the equipment must operate.

The temperature coefficient of resistance for insulating materials is negative. A small increase in temperature will, therefore, allow an increase in leakage current. Consequently, it is necessary to check temperature of apparatus under test when making insulation resistance tests. When testing a piece of equipment at a temperature of 32° F. or below, keep in mind that ice has greater electrical resistance than water. Therefore a check under this temperature would not be a good indication of moisture conditions.

One of the most important uses of insulation resistance testing equipment is the determination of the presence of moisture.

When drying out equipment, two methods are used:

1. Low voltage is applied to the equipment.
2. Heat is applied externally.

The actual value, in ohms or megohms of an insulation resistance test is not too important, as long as it is above a minimum standard for the equipment under test.

All readings should be taken when the equipment is warm, especially on equipment that operates continuously. Cold readings are valuable on the equipment that is used intermittently.

Make a note of such items as time of service, temperature, load, general atmospheric conditions (rain, dry, etc.)

Watch for surface leakage (current over, not through the insulation).

## C. Dielectric Test

Dielectric strength is not affected by area but varies inversely as the thickness of the sample under test. Dielectric strength is affected by heat due to current. Since heat is cumulative, time is an important factor.

To determine the dielectric strength of an insulating material, a hi-potential test is made. A hi-potential test indicates that the insulation is good on one test only.

All hi-potential tests should be preceded by an insulation resistance test. An insulation resistance test will avoid unnecessary breakdown on a hi-potential test. A dielectric test might stress the insulation to a point where it would breakdown quickly in the future. This indicates that it is advisable to make an insulation resistance test after the dielectric test.

The American Standard Association, ASA, specifications are as follows:

The voltage used on high potential tests is usually applied for one minute; 25-60 cycles and a peak value of 1.414 times the test values specified. The standard test voltage is 1000 volts plus twice the rated voltage of the circuit to which the machine is to be connected, i.e., 1000 plus (2 times rated voltage).

If the above calculation results in a test voltage of 2500 volts or less, a test voltage 20% higher may be applied for one second.

Machines smaller than  $\frac{1}{2}$  horsepower having rated voltages not exceeding 250 volts, and all universal motors regardless of output shall be tested by applying 900 volts.

The test voltage for armatures or rotors not connected to the line and rated between  $\frac{1}{2}$  and one horsepower shall be tested by applying 1000 volts. For those below  $\frac{1}{2}$  horsepower, apply 900 volts. ( $\frac{1}{2}$  HP equals 373 W.)

The test voltage shall be successively applied between each electric circuit and the frame. The windings not under test and the core and other metal parts should be connected to the frame.

Other values of voltage are used for other apparatus.



## INSULATION RESISTANCE TESTING

Objective

To learn the procedure for properly making insulation resistance tests.

ReferencesLesson Content

## A. General

All insulating materials are subjected to one or more of the following: Moisture, chemical actions, temperature, vibration, oil, dirt, etc., therefore deterioration will develop over a period of time.

Since insulation is of major importance, wherever electrical machines and equipment are expected to give uninterrupted service, we will devote time to a study of insulation and insulation testing.

We should discover defective insulation before it is exposed to conditions which would break it down.

The two most important properties of insulating materials are:

1. Insulation resistance
2. Dielectric strength

## B. Definitions and Standards

The American Institute of Electrical Engineers, AIEE, defines dielectric tests as tests which consist of the application of a voltage higher than the rated voltage for a specified time for the purpose of determining the adequacy against breakdown of insulating material and spacings under normal conditions.

AIEE defines the insulation resistance of an insulated conductor as the resistance offered by its insulation to an impressed direct voltage tending to produce a leakage of current through the same.

The minimum insulation resistance at operating temperature for rotating machinery as given by the AIEE equals

$$\frac{\text{rated E}}{\text{rating in KW plus 1000}} \quad \text{or} \quad \frac{\text{rated E}}{\text{rating KVA plus 1000}}$$

All circuits of equal voltage, above ground are to be connected together. Voltage used equals 500 volts DC.



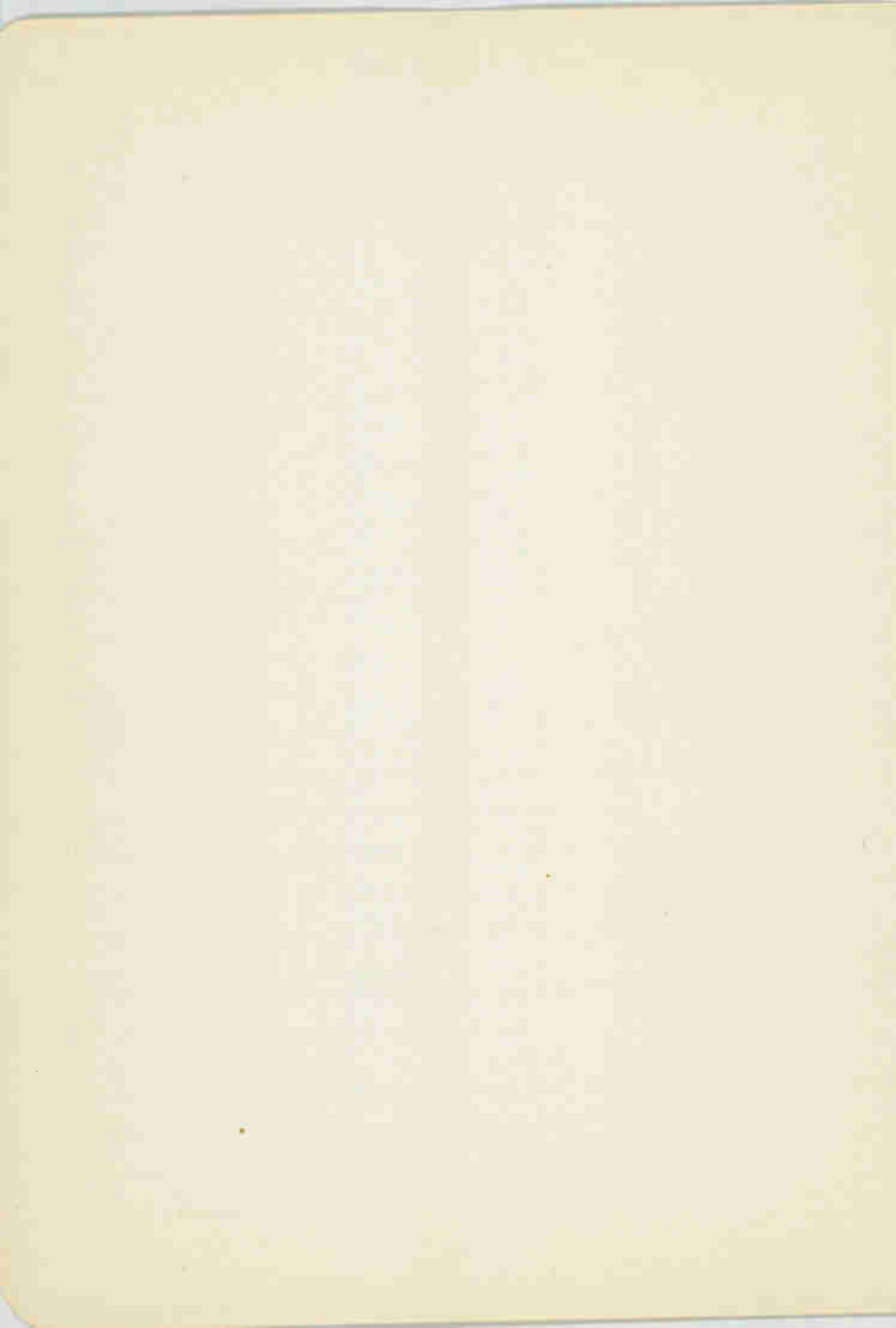

## H. Summary Questions

1. Define concentrated and distributed field windings.
2. How would you test a speed control for a short?
3. If the speed of fan did not change, when lever arm of control was moved, what fault would this indicate?
4. What indication would worn bearings give?
5. What is the difference in construction between a squirrel cage rotor for a fan motor and a large power motor?
6. What are the two types of speed controls used in multi-speed motors?
7. What is the reason for having a speed control on a capacitor motor?
8. Why does changing the voltage change the speed?
9. What is the purpose of the intermediate winding?
10. Does the motor mentioned in question 9 have a centrifugal switch?

used as a covering for the exhaust vent. Do not use window screening unless its area is increased over that of the exhaust vent. Window screening has a net free opening of about 50%. It is best to have several small vents than one large vent. Check prevailing winds.

4. Installation

Check with local inspector for proper wiring procedure.

In most cases automatic means must be provided for disconnecting fan and closing the ceiling grille in case of fire.

Check motor bearings for lubrication. Check fan belt tension.

Before the fan is started be sure a window or door is open.

Check installation while operating before leaving installation. A yearly inspection is recommended.

5. Summarization

Every building which does not have a good ventilating system is a prospect for a fan or blower.

Ventilating fans and blowers are used in all types of industrial plants, offices, homes, stores, apartments, etc.

$$CFM = V/N$$

The following table is presented as an aid in calculating ventilation for other than attic ventilating.

AIR CHANGE TABLE

CLASS OF BUILDING	RECOMMENDED AIR CHANGE FOR SENSIBLE VENTILATION AND COOLING	RECOMMENDED AIR CHANGE FOR GOOD VENTILATION
Offices	2 minutes	5 minutes
Stores	2 minutes	5 minutes
Restaurant and hotel kitchens	1 minute	2 minutes
Factories (General ventilation)	3 minutes	6 minutes
Garages	3 minutes	6 minutes
Halls (Meeting)	2 minutes	5 minutes
Churches	2 minutes	5 minutes
Theatres	2 minutes	5 minutes
Laundries	1 minute	3 minutes
Home Kitchens	1 minute	2 minutes
Attic Cooling and Ventilation	2 minutes on floor below attic space	-----
Farm Barns	-----	60 CFM per cow 30 CFM per horse
Poultry Houses	-----	$\frac{1}{2}$ to 1 CFM per chicken

Definition of Sensible Ventilation and Coil ng: Exhaust ventilation with a rate of air change high enough to provide a combination of good ventilation, refreshing air movement, and effective heat exhaust.

unit it would restrict too much air from passing over the motor therefore, it is usually mounted separately with leads running from the motor to the auto-transformer unit.

The motor has the fan connected directly to the motor shaft. The motor is secured directly to the frame of the unit heater.

#### e. Testing and servicing.

Check for continuity through all leads to the switch.

Apply 110 volts to auto-transformer terminals, using a fuse in series to check for a possible short circuit in the transformer, and turn the switch to each of its positions.

Only a small current will be drawn, hardly large enough to detect on a one ampere ammeter.

Connect a voltmeter to the terminals of transformer with 110 volts applied. The voltage should be high, medium and low depending upon the switch position. The motor can be serviced like a conventional capacitor motor.

Very little trouble can be encountered with the "L" or "T" connection as a transformer unit is not required. The switch or capacitor will possibly be the most likely to give trouble.

#### G. Fan Sizes

The size of the fan will be determined by the frequency of air changes.

In some cases an air change per minute is desired. In other cases a change of air every two minutes might be advisable. Experience indicates that an air change every minute is advisable in the southern states while for locations farther north, an air change once every two minutes is sufficient.

As an example, let us assume an air change is desired once every two minutes.

Let CFM = free air delivery of the fan in cubic feet per minute

V = M volume of home in cubic feet

N = number of minutes per air change.

$$\text{Then CFM} = \frac{V}{N}$$

$$\begin{aligned} \text{If the cubic contents of the home figures 9000 cubic feet; then } \text{CFM} &= \frac{V}{N} \\ &= \frac{9000}{2} \\ &= 4500 \end{aligned}$$

Therefore a fan rated at 4500 cubic feet per minute should be used.

If it was desired to have an air change once every minute, in the above home, a 9000 cubic feet per minute fan would be necessary.

#### 2. The Grille

The grille opening should be about twice the area of the fan discharge opening. The grille may be of wood or metal. Many automatic ceiling shutters are used in conjunction with suction chambers.

#### 3. Attic discharge vents

The total area of the discharge vents should never be less than the grill opening into the attic. A mesh hardware cloth of at least one-half inch should be

The high speed operates on the higher voltage and when a lower speed is required the voltage is lowered, usually, by an auto-transformer. Diagrams 1, 2, and 3, show schematically how these voltages are varied.

The second method of speed control varies the number of effective conductors in the main winding.

Referring to diagrams 4, 5, 6 and 7, it will be noticed that there is an additional winding called an intermediate winding which is used across the line when a speed change is desired. This type of control will only operate at two different speeds while the voltage control will usually give four different speeds.

#### b. Voltage control method

In an induction motor, the torque developed, at any given speed, is proportional to the square of the applied voltage. By reducing the voltage applied to the field the slip of the motor can be increased. In other words, a strong field will cause the rotor to turn at a higher speed, with less slip, than will a weaker field. This is true because a strong field will induce more eddy currents in the rotor for any given slip.

The torque developed by the rotor is proportional to the product of the field strength and the rotor currents. The field strength is varied by changing the voltage.

#### c. Speed control by varying the number of effective conductors.

This tapped-winding capacitor motor speed control is similar in principle of operation to the voltage control method. This motor likewise varies the slip by varying the field strength; but this motor changes the number of effective conductors in the main winding and not by changing the impressed voltage. The field strength of any given induction motor, at a given frequency is proportional to the volts per conductor.

The tapped-winding capacitor motor has three windings, which are called main winding, intermediate winding, and auxiliary winding. Refer to diagrams 4, 5, 6 and 7.

The intermediate winding is usually wound on top of the main winding in the same slots with the same distribution, but not necessarily with the same number of turns or the same size wire. The auxiliary winding is displaced ninety electrical degrees from the main and intermediate winding and does not use a centrifugal switch.

There are two types of connections used with this type of motor. Diagrams 4, 6, and 7 show how the "L" connections are made and diagram 5 shows a "T" connection.

#### d. Installation and auxiliaries.

Switch and auto-transformers are usually in the same unit and mounted separately from the motor. They may, in some cases, be mounted on the front of the motor if the auto-transformer is a small unit. Since it is usually a large

To reduce the speed more turns are placed in the primary of the transformer. This has the effect of adding reactance in series with the main winding to reduce the flux density of the field. Also since the iron in the transformer is worked at high flux density, the added turns in the primary with the decrease of primary current have the effect of keeping the secondary voltage of the transformer approximately constant. This makes a high starting torque at low speed and a wider speed variation.

### 1. Correcting trouble

NOTE: With the induction type fan motor it is general practice to wind the stator of six blade fans for six poles and four blade fans for four poles. The motor windings are single-phase split-phase type and the load must be kept within the pull-out torque of the motor. The synchronous speed of four pole, 60 cycle motors is 1800 RPM and six pole, 1200 RPM. If a six blade fan is put on a four pole motor the speed of the blade will be increased 50%. The power required to turn the fan varies as the cube of the speed and this would cause the motor to be overloaded, resulting in over-heating of the motor.

Use the correct number of fan blades!

### 2. Testing the speed control for trouble

- a. Use meter and make a continuity test or check, with a voltmeter, the voltage on the motor side of the control.
  - b. Connect the voltmeter on the motor side of the control and move the lever arm across the contacts. If the control winding is shorted out, there will be no change in voltage. If the control is found to be defective it should be replaced.
- 
- 
- 

## F Multi-speed Capacitor Motors

### 1. Application

- a. This type of motor is used in a large number of fan and blower applications where speed control is considered essential. Usually it is desirable to operate a unit heater at a high speed to obtain quick initial "warm-up" and then reduce the speed after the room is warm. The capacitor motors seem best adapted to this type of service.

### 2. Construction and operation

#### a. Types of controls

There are, in general, two ways to control the speed of these motors. One is by voltage control on either or both the auxiliary and the main winding.



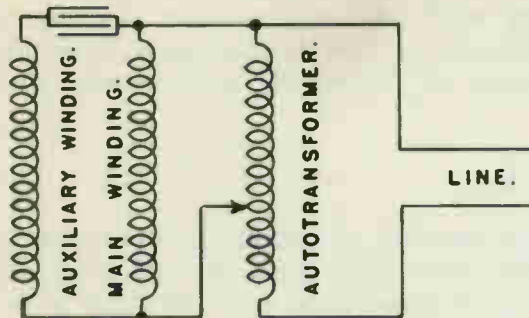

Fig. 1

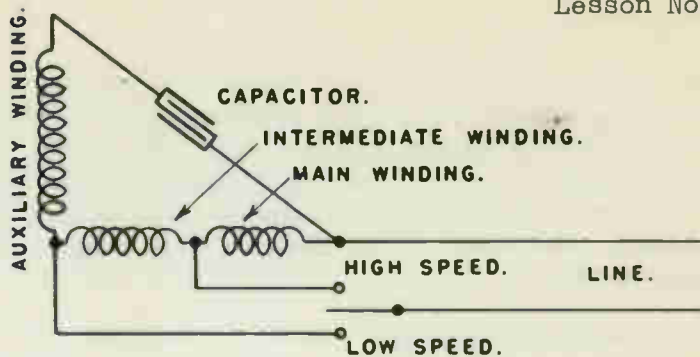

Fig. 4

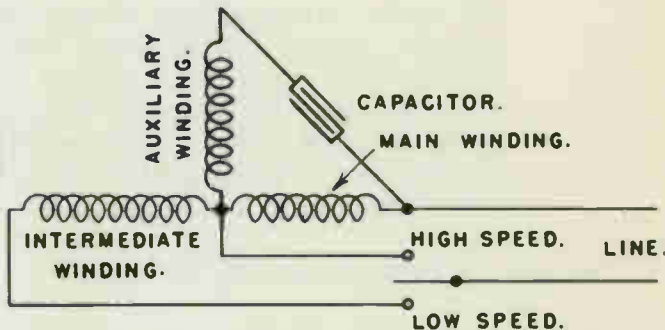

Fig. 5

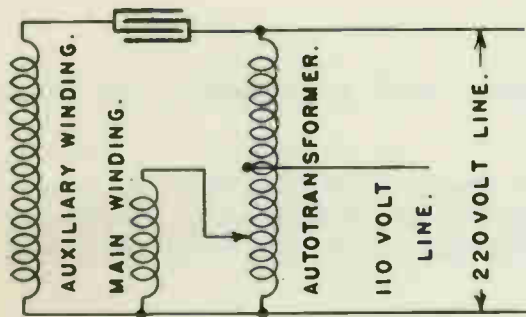

Fig. 2

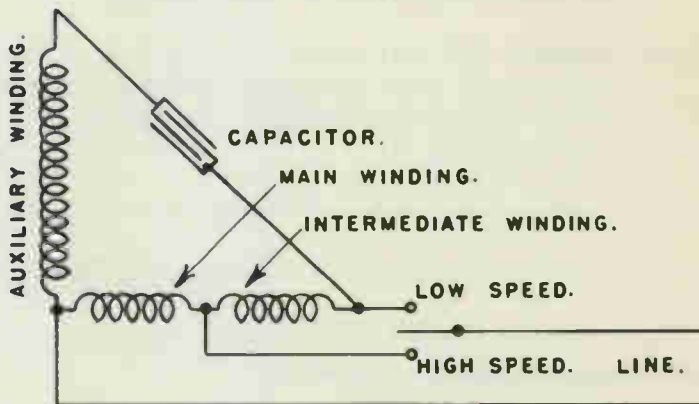

Fig. 6

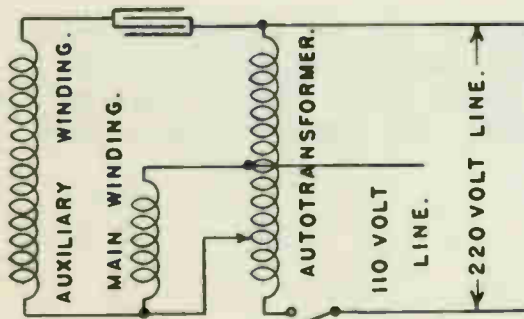

Fig. 3

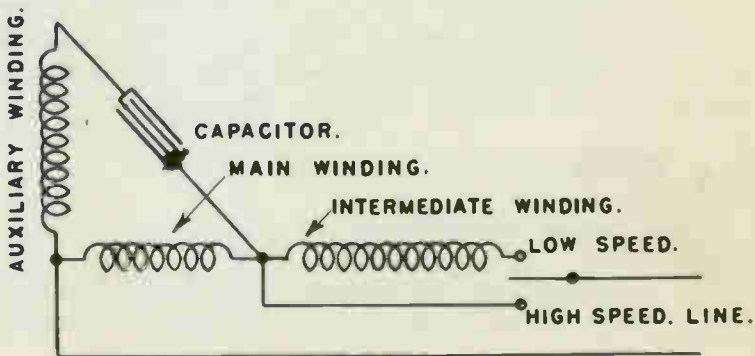

Fig. 7

### C. Distributed Pole Fan Motor Windings

The laminated field pole with several slots per pole, allows for the distribution of the winding across the face of the pole.

There are two types of starting windings used on distributed main field windings:

The permanently connected and the type which is used only during the starting period. Fig. 3.

### D. Motors that have Three Windings and Operate on Single-phase Circuits.

The fan motor diagram in Fig. 4, has three windings in the field. These windings are connected at a common point in the motor. The windings are usually spaced somewhat similar to three phase windings. The resistance and reactance connected in the circuit is proportional so that the current flowing through winding "A" divides between "B" and "C" in such a manner that the field flux has the rotating characteristics of a three-phase motor. The resistance in winding "C" is placed in the motor winding by using a smaller size wire. Since the current in the high resistance circuit leads the current in the reactance circuit and the combined current passes through "A", the flux of winding "C" leads the flux of winding "A", also the flux of winding "A" leads that in winding "B", thus the direction of rotation is from "C" to "A".

Speed regulation with a winding of this type is usually obtained by having more turns in the choke coil, which is in series with winding "B", than are needed for the reactance necessary for high speed. Taps in these added turns are arranged so that they can be placed in series with the total winding of the motor including the resistance and reactance. This reduces the voltage applied to the winding and reduces the speed of the motor.

---

---

---

### E Induction Fan Motors with High Starting Torque.

The latest type of fan motor winding is one that develops a high starting torque, high efficiency at running speed without a cut-out switch and with a large speed reduction. See Figure 5.

This motor employs a transformer with the primary winding connected in series with the main winding and the secondary connected across the starting winding. The characteristics of the transformer are similar to those of a series transformer with reactance in the secondary circuit. When a motor with this hook-up is connected to the line, the current through the main winding flows through the primary of the transformer and the induced secondary voltage is applied to the starting winding of the motor. The voltage lag of the secondary behind the main current in the primary, plus, the lag caused by the inductance of the starting winding, causes a large phase angle between the currents in the main and starting windings. With properly designed transformer the angle between these two currents on starting is approximately ninety electrical degrees. In operation this angle will change slightly but is always great enough to assist the main winding.

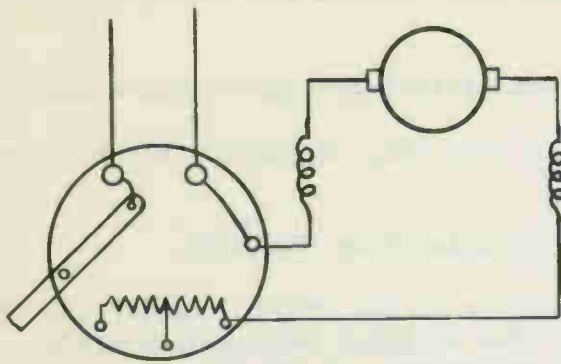

Fig. 1

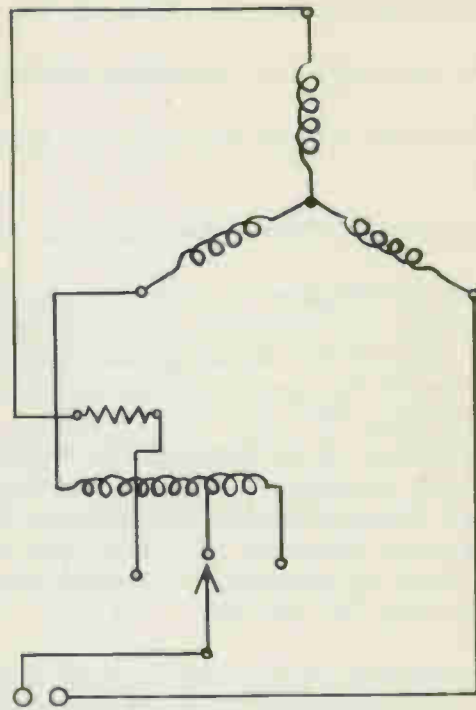

Fig. 4

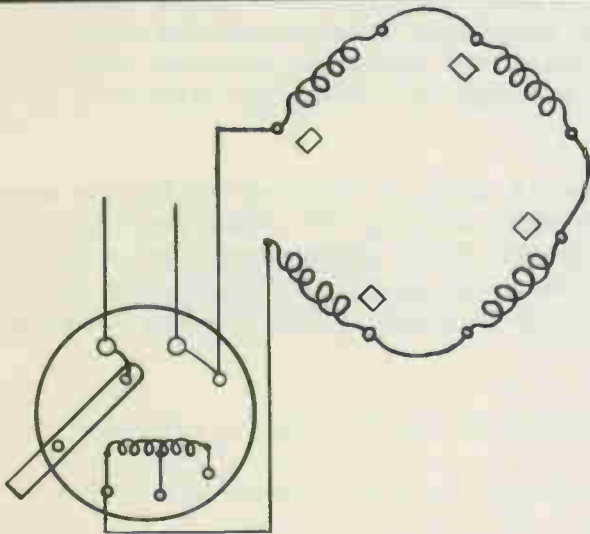

Fig. 2

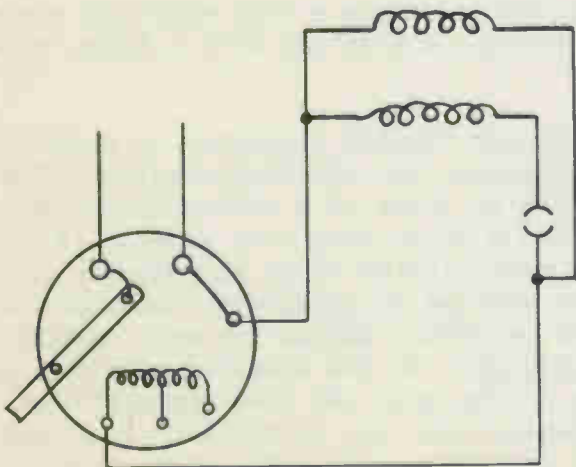

Fig. 3

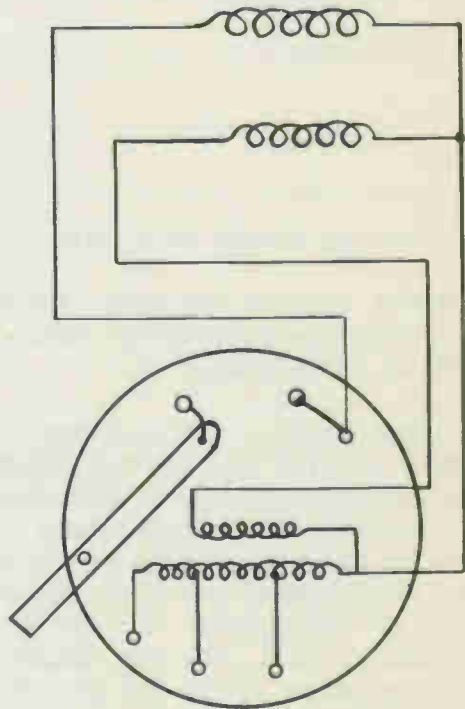

Fig. 5

## FAN MOTORS &amp; SPEED CONTROLS

Objective

To learn how to identify different types of fan motors and types of speed controls used.

References:Lesson Content

## A Series Fan Motors

A series d-c motor may be operated on alternating current of equal voltage by decreasing the reactance of the field. This may be accomplished by decreasing the number of turns in the field coils. To produce good torque with a small amount of current, a large number of armature conductors are used.

Speed control on early designs of fan motors was obtained by shifting the brushes away from the neutral position. The later designs use a resistance in series with the winding to decrease the voltage applied to the motor winding, Fig. 1. This causes a reduction in the speed. Taps at different points on the resistance may be used to give the desired speed change.

The motor core must be laminated for use on alternating current. Laminations are necessary to prevent overheating which would result from eddy current losses.

---

---

---

## B Induction Type Fan Motors

The earliest type of induction motor used for fan duty was the shaded pole type.

Compared to rotors of power motors, fan motor rotors have higher resistance to give a reduction in speed of the fan when the flux density in the field poles is decreased. Speed change on induction fan motors is obtained by reducing the voltage applied to the stator winding. This reduced voltage decreases the current and thus decreases the flux density which allows a greater slip of the rotor.

The voltage applied to the winding is reduced by use of a resistance or choke coil connected in series with the winding, Fig. 2.

---

---

---

---

## K. Summary Questions

1. What is a thermal strip?
2. What is the function of the day-night thermostat?
3. What is the purpose of a "damper control"?
4. What is the purpose of a "limit control"?
5. What is the purpose of a "fan control".
6. Should the damper close when the draft opens? Why?
7. Are any circuits interrupted by the thermostats?
8. In what order would you check a defective installation?
9. How could you improve the system, shown in Fig. 1.?
10. What use is the thermostat put to in an automatic heating system?
11. If the safety pilot burner is out on a gas heating unit will the magnetic shut-off valve be in an open or closed position?
12. What is the purpose of the hold fire control used on a coal stoker heating system?
13. What is the duty performed by the ignition transformer on an oil burner unit?
14. What is the difference between an ordinary thermostat and one with an anticipation feature?
15. In what class of the National Electric Code do furnace controls fall under?
16. What is the approximate voltage of the ignition transformer on an oil heating unit?
17. Is there any protection against breakage of feed screw of a coal stoker unit?
18. Are low water limit controls used on steam systems?
19. Explain purpose of a pressure regulator used with a gas heating unit.



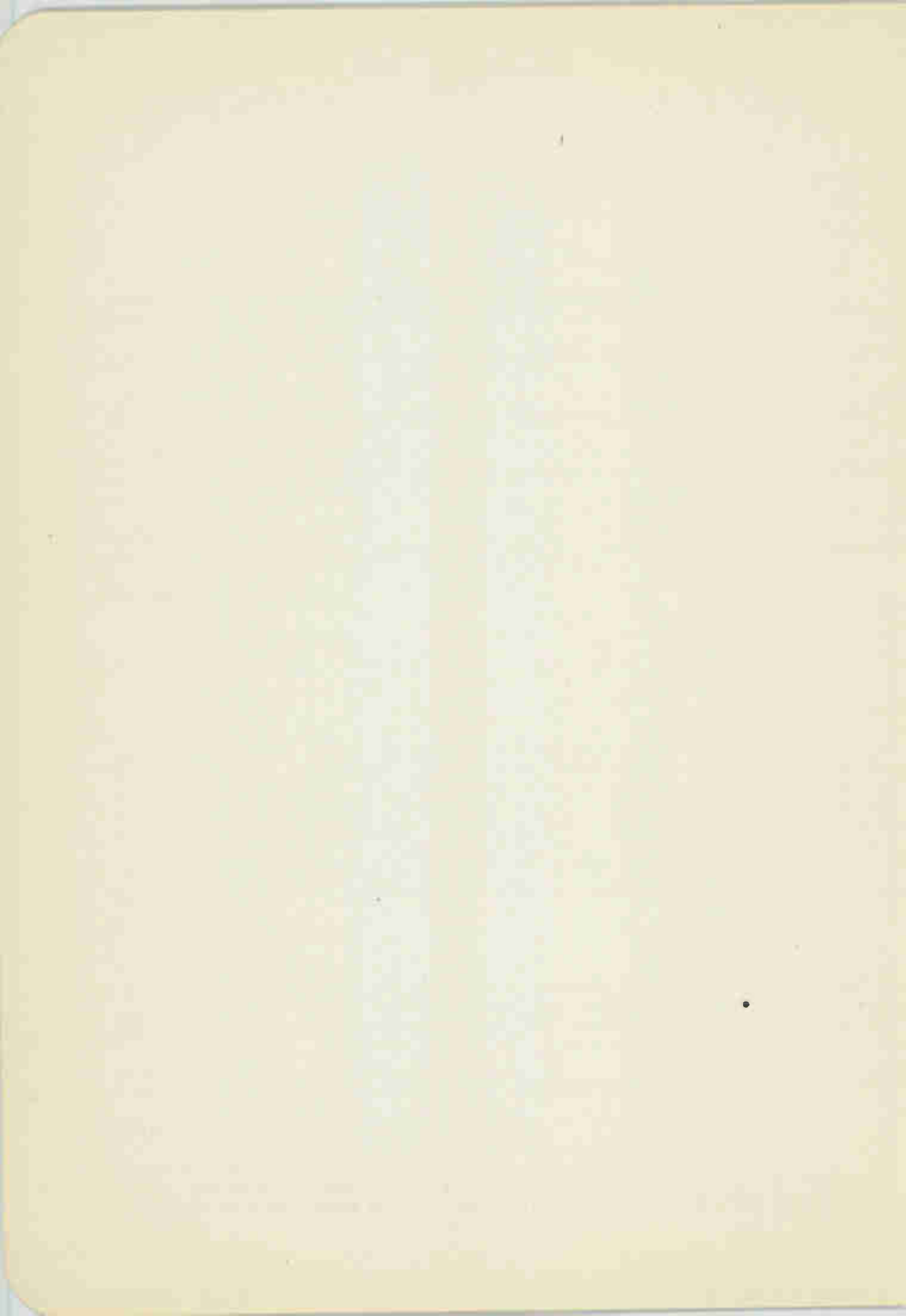

This rise in temperature expands the liquid in the tube, causing the bellows to expand and tilt a mercury switch tube. This breaks the electric circuit and shuts off the burner.

#### 6. Boiler safety automatic limit controls.

For operation the controls depend upon: pressure of steam; temperature of water or stem; and height of water in boiler.

Safety limit controls are special "stand by" or emergency controls to shut off the burner in case of any abnormal action not corrected by the regular control system. They may operate by the bi-metal method, or by pressure, steam, or by a combination of both.

#### 7. Air failure switch

This device is used on oil burners in case of failure of the blower, due to lint on fan blade, blocking of fan outlet, or any other restriction of air. This device stops flow of oil to burner and unit will not start. The switch consists of a bi-metal element, a resistor and a set of contact points. The resistor is connected across the transformer. As long as there is air flowing by the resistor element it does not become hot enough to cause bi-metal unit to open contacts. If air supply fails resistor heats up causing bi-metal element to operate opening up the contacts of the switch so motor will not start.

#### J. Summarization

1. Heating units must always be installed according to the manufacturers instructions.
2. All state and local installation rules must be strictly adhered to when installing gas and oil heating units.
3. Heating unit systems should always have a complete cleaning and check up during the summer months.
4. Limit controls are safety controls, they should always be in working condition.
5. When repairing and adjusting the controls of a heating unit, you should never leave until you are sure the unit is working correctly.



## I. Control Units of Heating Systems

## 1. Thermostats

Sensatherm, chronotherms, and acratherms are all thermostats to control the heating unit cycle of operation. The thermostat is the main control of a heating system. By using variations in the room temperature to close a set of electric switch contacts we can have heating unit cut on and off as needed. The basic principle of the thermostat is that different metals, when heated or cooled expand or contract at a different rate. Therefore, if two different metals are joined together into a bi-metal strip, this strip will bend or warp as the temperature changes and this bending movement may be utilized to open or close a set of contacts connected in an electrical circuit.

Fig. 1, 2, 3, 4, 5, and 6 are thermostat controls that could be used on most any kind of heating unit to control room temperature. Some thermostats have a heat anticipation feature after the heating unit has been in operation a short time, a heating element of the thermostat warms up slightly and has a warming effect on the thermostat mechanism, causing the contacts to open in anticipation of the heat that has been generated in the furnace, but has not reached the room.

## 2. Primary controls

Master control, stack switch, protects relay, saftrol, combustion safety control, and pyrotherm, are what is known as primary controls. A primary control is the control or assembly of electrical devices which actually start the burner and stops it in response to signals from the room thermostat. It consists of several electrical switches connected together in such a way that each part of the heating unit operates at the right moment when needed.

## 3. Limit controls

Pressuretrol, vaporstat, and aquastat are what is known as limit controls. It is their duty to shut down the heating unit when the furnace reaches a high temperature or steam pressure becomes excessive. A bi-metal unit is used on hot air systems and a vapor or pressure type on hot water and steam boilers.

## 4. Low water limit control

This control shuts off heating unit when water in boiler reaches such a low level that it would be dangerous.

## 5. Temperature operated control

The temperature control method is based on the expansion and contraction of a volatile liquid with changes of temperature. The liquid is contained in a metal bulb and bellows, the tube or temperature element is tapped into the boiler a little above the dangerous low water level, as the water resides to the low limit the tube is exposed to the steam which becomes super-heated, due to over-heating of the boiler metal above the water.

### 3. Troubles

There are a number of troubles that could cause a burner to be inoperative. The gas supply may be cutoff at the pressure regulator due to faults in the regulator. Some units have a screen in the line to keep foreign material out, may be clogged with dirt.

Magnetic control valves may stick in the on or off position, if so they must be cleaned. Moisture in the lines sometimes causes this to occur. Burners may be out of adjustment, follow manufacturers directions for re-adjusting.

Pilot burner line may become clogged causing the pilot to go out. Clean lines and re-adjust pilot flame. The electrical control circuit may also get out of order, troubles usually consist of blown fuses burnt or poor contacts on relays loose connections and open circuits.

### 4. Testing and repair

The electrical control system may be checked by the following procedure: The operation of the safety pilot may be noted by turning off the pilot burner, with the thermostat calling for heat. The electrical circuit to the automatic main gas valve should be interrupted and close the main gas valve shutting off the main burner.

Relight the pilot burner and lower the adjustments of the limit control (if used) until the gas valve shuts off the main gas supply. Reset the limit control and turn the main burners "on" and "off" by moving the thermostat dial up and down. Move the temperature adjustment dial on fan switch to the lowest position, fan should start; move dial to highest setting, fan should stop.

If summer switch has been installed, turn to "on" position, fan should start. Turn off summer switch and return fan switch to correct temperature settings. If controls do not operate as stated above they must be replaced or repaired. Contacts of relays become dirty and some times cause a relay to be in-operative, Clean points with fine sand-paper. Always blow all dust and dirt out of controls when opening the covers for testing.

### 5. Maintenance

Gas unit burners should always be cleaned and checked during the summer season. The inside of the furnace should be given a good cleaning. Blower, motors, valves and electrical control circuits should be checked for faults, all dirt should be blown from controls and the entire unit given a complete inspection. Motors and working parts should be given a few drops of oil once every three months while unit is in operation during the heating season.

## H. Gas Heating Units

## 1. Construction and operation

A domestic heating system using natural gas or artificial gas, the complete heating unit would consist of the following parts:

- a. Gas burner - see figure 11
- b. Pressure regulator - see figure 13
- c. Automatic safety pilot light
- d. Thermostat
- e. Gas shut-off valve (electrical)
- f. Blower motor

Fig. 11 shows a complete gas heating unit showing parts and the electrical control system. When the manual shut-off valve is open gas flows into the pressure regulator and on into the magnetic control valve, then to the burners in the furnace.

The pilot is supplied with gas from a separate shut-off valve. The pilot, which burns through out the heating season, has two jets or flames. One flame is directed toward the burner to light the main flame when the magnetic valve opens, and the other flame is directed against the tip of a tube which contains a thermocouple. Current generated by the thermocouple, due to the heat from the flame, holds a sensitive relay in a closed position, contacts for which are in the magnetic control valve circuit, Fig. 13.

Unless the pilot burner is heating the thermocouple, the safety switch opens, and there will not be a circuit to open the magnetic valve even though the thermostat is calling for heat; thus any failure of the gas supply, or blowing out of the pilot light causes the magnetic valve to close, thereby preventing any unburnt gas being in the burner compartment.

The limit switch and motor switch, Fig. 11, are of the mercury bulb type, tilted by a bonnet or duck type of thermostat, both switches tilt together at the same instant. In the cold position the low voltage circuit of the thermostat is completed through the top switch. When the thermostat calls for heat and closes this circuit, the magnetic control valve opens and gas passes on into the burner. When the furnace warms up the switch tilts to the hot position, which closes the lower mercury switch starting the fan. If the heating continues and produces a temperature higher than the upper limit for which the control is adjusted the motor circuit is kept closed through the lower switch; but the circuit to the magnetic valve is opened and shuts off the main burner.

## 2. Installation

All conversion gas burners must be installed in strict conformance with instruction issued by manufacturers. It must be installed to conform to local ordinances; also to all rules and regulations of the company furnishing the fuel gas. Installations must pass that inspection of the gas company before being placed in service. The burners, valves, and gas control device should be of types and models approved by the American Gas Association Testing Laboratories and should carry the AGA label.

is not established within a set time, after the thermostat calls for heat. It is located in the stack or some place where heat of combustion reaches it, Fig. 10. Sometimes other types of controls are used in conjunction with the above controls to accomplish some special job.

#### 4. Troubles

The usual electrical troubles occur in oil burner electric control circuits such as bad contacts, opens, shorts, and failure of the ignition system. The above faults can all be found by a point to point check with a continuity checker of some type.

Mechanical troubles usually consist of a plugged oil line, clogged filters, pressure regulator valve stuck or oil pressure pump inoperative. In checking for troubles, first check the fuel system to see if burner is getting fuel. If fuel is being received at the nozzle and it does not ignite check the ignition system.

Electrodes sometimes become too widely separated and the spark will not jump the gap. The gap between electrodes is usually about  $1/16$  to  $3/16$  of an inch.

#### 5. Testing and repair

Mechanical troubles are usually found by visual inspection and repaired by replacement of parts and by adjustments when adjustment means are found. The electrical control circuit may be checked by the following procedure:

Turn room thermostat to a high temperature setting, burner should start operating at once. If the motor unit starts but the burner does not light check the ignition and fuel-oil supply. Oil lines may be stopped up or the pressure valve or pump not working, or the nozzle may be plugged.

Disassemble the nozzle jet and wash all parts in a grease solvent and reassemble the unit. Never use a metal instrument to clean the nozzle as it would damage the finely machined surfaces. If motor fails to start when the thermostat is turned to high temperature, check for continuity through the thermostat. The contacts may be burned or pitted so that they are not closing the circuit. Check the high limit control. It may be in an open position, thereby breaking the line circuit to the unit. Check all control contacts that might be in the circuit at that time.

#### 6. Maintenance

Oil burner units should undergo a complete check during the summer season. It is a good idea to disassemble the unit, replace any worn parts, and readjust control settings where needed. The unit should be oiled one or two times during the heating season and control contacts cleaned by wiping a paper between the contacts to remove dirt that might be on the contacts.

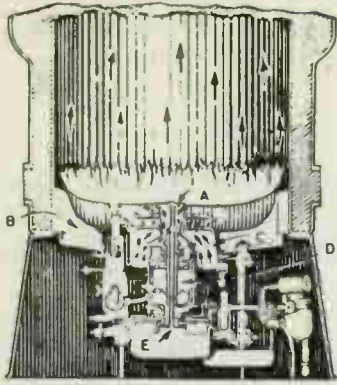

Fig. 8 Rotary cyntrifugal atomizing oil burners

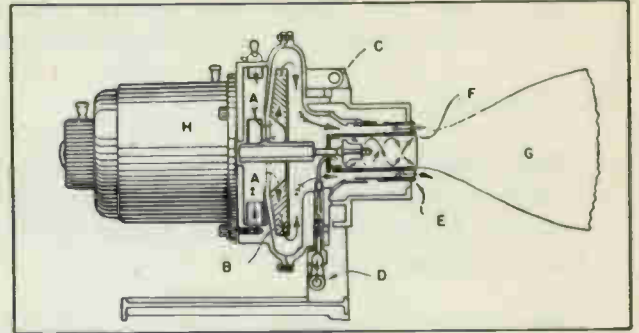

Fig. 9 Horizontal rotary cup type atomizing oil burner.

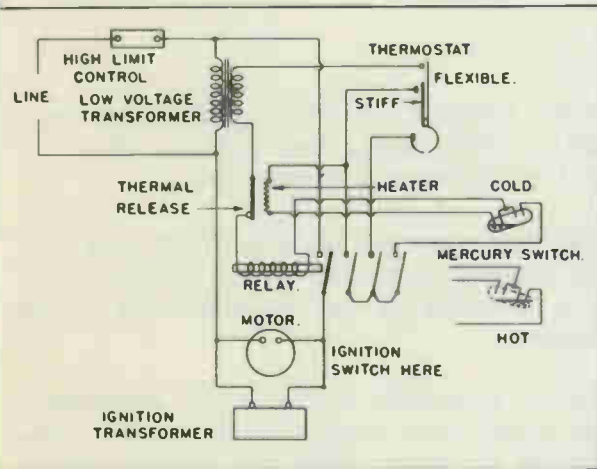

Fig. 10 Control system with safety features

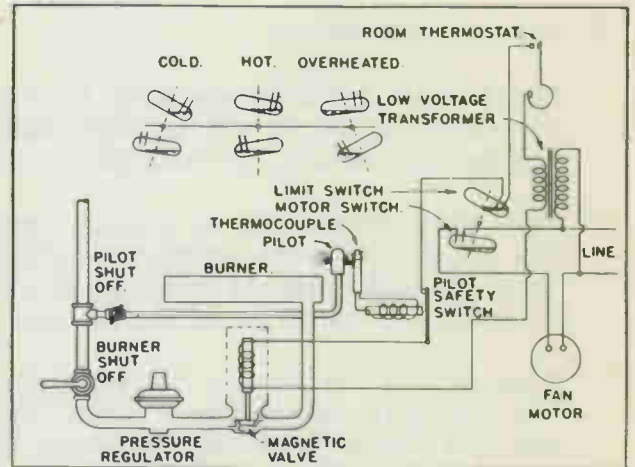

Fig. 11

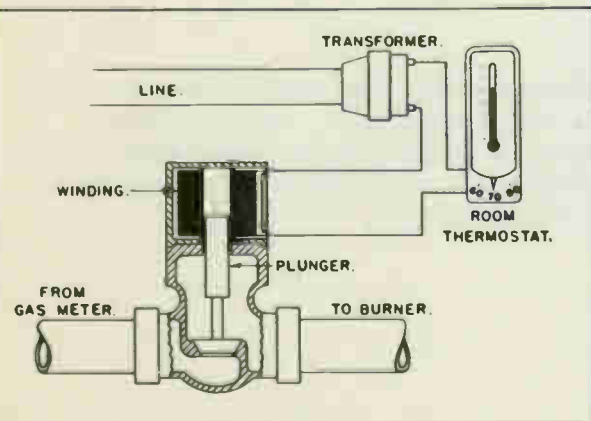

Fig. 12

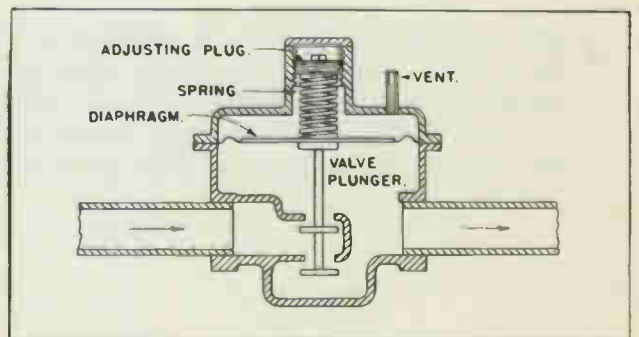

Fig. 13

It is better known in the field as the gun-type burner. See Fig. 7. The principle parts of a gun type burner are motor fan, oil pump, oil filter, pressure regulating valve, ignition transformer, ignition electrodes, and the automatic control system that switches the burner off and on when needed. The oil is passed through a filter or strainer to remove solid impurities, then through a motor driven pump that raises the pressure to around 100 pounds per square inch. The oil then passes through an automatic pressure regulating valve adjusted to maintain an outlet pressure suitable for the burner. The oil then goes to the oil nozzle and is delivered as a fine spray, usually conical in form. The oil nozzle is in the end of a large diameter air tube through which air is forced by a fan or blower directly connected to the motor. The oil and air mixture at the end of the tube is ignited by an arc jumping across between two electrodes just outside the oil spray.

This arc is caused to jump the gap by a high voltage ignition transformer, which changes the line voltage of 10,000 to 15,00 volts to produce the ignition sparks. The flame from the burner is given a whirling by vanes placed inside the air stream of the large air tube. The flame is shot out from the burner into a combustion space lined with fire brick or with some alloy steel, to form a cavity of the same general form as the flame from the burner.

## 2. Installation

For maximum satisfaction, any oil burner must be installed strictly in accordance with instructions furnished by its manufacturer. These instructions cover the dimensions and construction of the combustion chamber, or the hearth. On these items depend much of the responsibility for successful operation. The installation applying to any certain burner show diagrams and give directions for installing tanks and connecting piping, they include diagrams for all necessary electrical wiring and connections, and cover the adjustment and operation of all automatic controls and the controls for oil and air to the burner. Oil supply tanks may be indoors, may be buried outside the building, or may be above ground outside the building. The matters of tank sizes, their settings, the necessary vents and reliefs, the connections, and the running of burner suction lines and pipes for filling and over-flow are regulated quite strictly by local ordinances which should be consulted before such work is started. Information may be obtained from pamphlets issued by the NBFU for the installation of oil burning equipment. A separate electric circuit of proper capacity and voltage should be supplied from the distribution panel to the furnace, entirely free of additional loads other than furnace control equipment. In connecting the fan motor, flexible conduit should be used, preferably connecting to rigid conduit outside of the fan casing. The use of rubber grommet avoids metal to metal contact of conduit and casing. Be sure that the flexible conduit is neither in tension nor under compression, which may cause transmission of motor vibration or interfere with moving the motor to adjust belt tension.

3. Automatic controls for oil burner controls for heating plants using oil burners will include a room thermostat that turns on and off the motor that drives the draft fan and oil pump, a limit control to prevent excessive air temperature in the warm air system, excessive steam pressure in a steam or vapor system, and excessive water temperature in a hot water system. There must be a combustion safety control. This control automatically shuts off oil feed in case flame

coupling to the screw. This can easily be replaced, thereby putting the unit back into operation.

#### b. Electrical troubles

Electrical troubles are found in the drive motor, and its control circuit, or in auxiliary circuits. Motors are covered in other lessons so we will not dwell on them here. Instead we will cover the automatic control system.

1. Room thermostat contacts dirty or rough, temperature or differential settings not suited to requirements.
2. Relay completely in-operative due to loose or broken connections. Some or all of relay circuits remain open due to dirty, rough or pitted contact points.
3. Mercury switches may have cracked glass tubes.
4. Heater or thermal switch in relay unit may be burned out or disconnected.
5. Helix type of thermostat may be loose on rod or its support. If used in stack it may be covered with soot and should be cleaned.
6. High temperature or pressure limit controls may have been adjusted to operate at temperature or pressure, which are so low as to interfere with normal operation.

Careful checking of thermostat contacts, circuits, and switches will locate the most common troubles and indicate the remedy.

---

---

---

#### G. Oil Burners

##### 1. Construction and operation - types of oil burners

###### a. Nozzle atomizing types

- (1) High pressure type; often called a gun type burner. See Fig. 7.
- (2) Low pressure type.

###### b. Rotary atomizing types

- (1) Vertical axis of rotation. See Fig. 8.

- (a) Wall wiping flame
- (b) Central flame

- (2) Horizontal axis of rotation. See Fig. 9

###### c. Pot type vaporizing

Of the many types that have been named above, the high pressure nozzle atomizing burner is the one most often used in domestic heating installations.

## 2. Installation and adjustments

The installation of any stoker must be carried out in strict accordance with the instructions issued by its manufacturer if maximum satisfaction is to be obtained. The top of the fire retort is usually placed about twelve to fourteen inches above the floor line; but the setting must be low enough to leave enough flame clearance above the retort. After checking the combustion space volume and flame clearance, the furnace spaces and flues should be cleaned, and all joints inspected and repaired if necessary. Tight joings are necessary, because with air being forced through the retort, from the fan there might be a positive pressure inside the furnace in case of too little chimney draft.

Stoker adjustments; there are three principle adjustments for stoker operation, other than settings of automatic controls. The three principle adjustments are rate of coal-feed, forced air supply, and chimney draft. These three adjustments are to suit the kind of coal being burned, the characteristics of the furnace or boiler and the general operating conditions. Once the adjustments are made they should not require changing, unless there is a change of coal or of operating conditions.

### a. Rate of coal-feed adjustment

The rate of coal feed is adjustable by means which vary with the type of stoker. Some machines have change gear drives which are set by movement of a hand lever; others provide for removal and exchange of drive gears, or for adjustments of drive belt pulley diameters. Some machines have adjustable speed motors. The feed rate should be such as maintains a coal and coke' bed four to eight inches deep over the top of the retort; the depth will vary with changes of heat demand, or with changed of weather. The stoker ordinarily runs fifteen to thirty minutes each time it is put in operation by the thermostat.

### b. Forced air supply adjustments.

The rate at which air is forced into the retort, by the fan, is adjusted by means of rams, dampers, shutters, or air valves, or by varying the fan speed. The rate is adjusted to the rate of feed, while the stoker is operating, and should be the minimum which will cause good combustion.

### c. Chimney draft

Chimney draft may be regulated by some type of automatic damper installed in the smoke pipe leading to the chimney. It is adjusted for correct draft when the stoker is installed and will automatically hold the draft the same at all times.

## 3. Troubles

### a. Mechanical

Mechanical troubles are due to breakage or ordinary wear, due to use. Mechanical troubles can usually be found by a close inspection of the various parts of the unit. Worn bearings, parts out of alignment, and a stalled feed screw are common. A stalled feed screw is usually caused by slate or some other foreign material catching in the screw. Most units have made provision for taking care of this trouble, by having a small pin shear off in



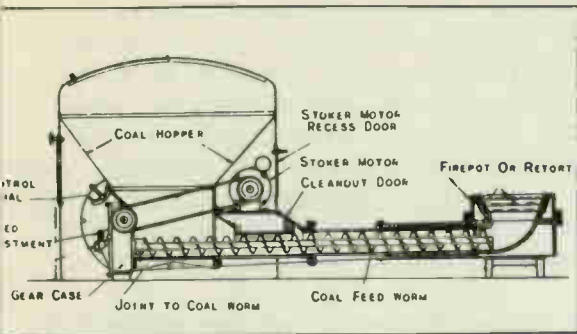

Fig. 1 Operating parts of an automatic coal stoker (Norge).

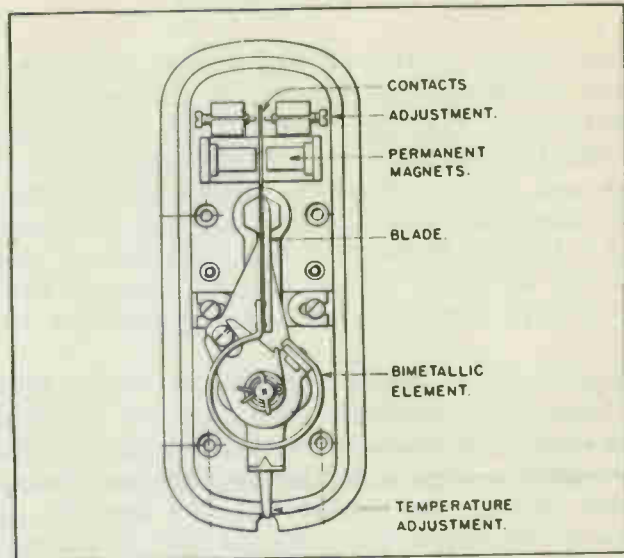

Fig. 2 The working parts of a room thermostat.

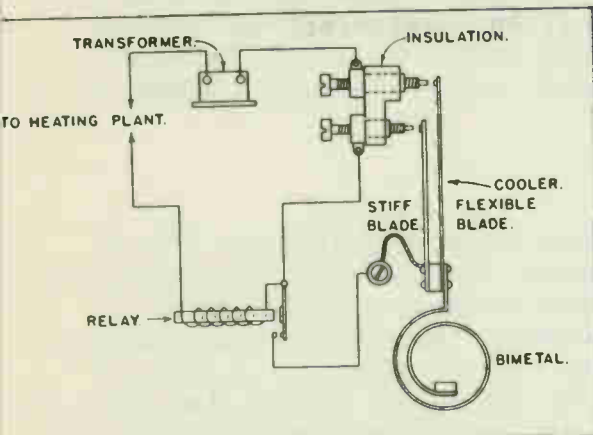

Fig. 3 Molding relay used with double-blade thermostat.

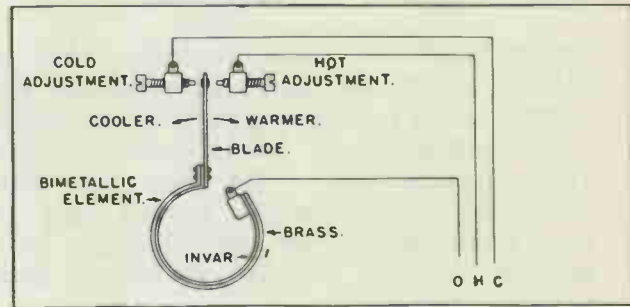

Fig. 4 The bimetallic element and contacts.

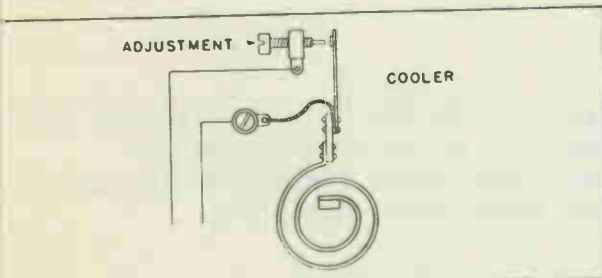

Fig. 5 Insulated spiral bimetallic element.

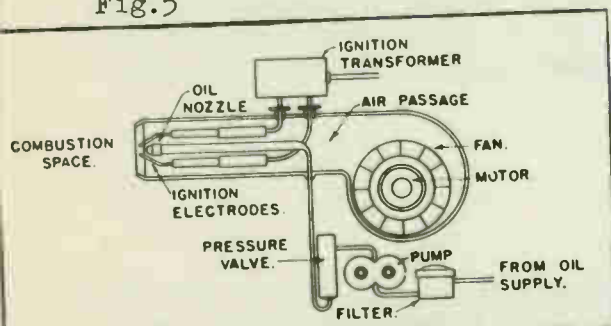

Fig. 7 Principal parts of gun type oil burner.

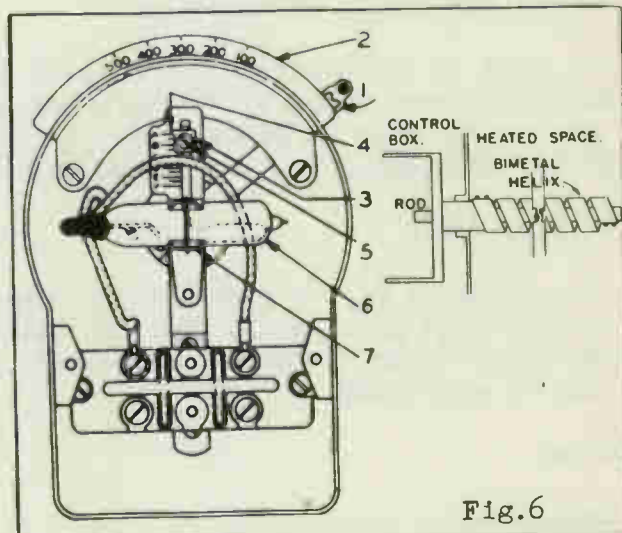

Fig. 6 The bimetallic helix used as a thermostat in bonnets, ducts and stacks: 1. Temperature indicator. 2. Temperature dial. 3. Differential adjustment. 4. Differential pointer. 5. Lock screw. 6. Mercury switch. 7. Clip for mercury tube.

### 3. Conductor size

Special color coated wire of #16 or #18 is used for the control hook-up. If the distance is greater than sixty feet a large size wire is recommended, due to the voltage drop in the smaller size wire.

---

---

---

## F Automatic Coal Stokers

### 1. Construction and Operation

The automatic stoker feeds coal to a boiler or furnace, and usually supplies air at the same time by means of a blower or fan.

There are several types, but the under-feed stoker is the one most usually found in domestic installations. By the "under-feed" it is meant that the coal is fed into the fire retort from the bottom, Fig. 1. This may be accomplished by the use of a large screw or by means of a combination of rams, plungers, or screws. The coal carrying device is driven by an electric motor through gearing or other drive elements which allows adjustments for rate of feed.

To have the unit operate automatic we must have the following controls:

#### a. Thermostat, Figs. 2, 3, 4, 5, and 6.

The thermostat control determines the rate of coal feed. If the room thermostat calls for heat, the stoker starts and runs a certain length of time; also on some installations the thermostat closes a switch to an electric blower motor if the bonnet temperature has reached the setting of the blower control.

#### b. Fire pilot control

The purpose of this control will increase the fire for a short period when furnace temperatures fall below a pre-determined setting even though the thermostat is not active. This control is necessary, for if a coal fire is deprived of draft for a considerable length of time it will smother out regardless of the amount of un-burnt coal in the fire retort.

#### c. Limit control

The limit control permits a stoker to operate only when furnace temperatures are not too high. When the heat of the furnace reaches the temperature for which the limit control is set, the limit control operates, shutting off the stoker and blower until the furnace temperature has dropped to a safe value. This control is the bi-metal type for hot air furnaces, and pressure type for steam and hot-water furnaces.

## D. Testing

When making a service call check to see that there is current up to the transformer. It is possible that a fuse may have blown in the circuit to which the control is attached.

Check to see if there is voltage on the secondary side of the transformer. This will usually be 24 volts. From this point a continuity test will be necessary. Here is where a circuit diagram will be very handy. Always check for loose connections.

Under normal operation the contacts of the thermostats will not open while current is flowing. Thus, the contacts should not become burned or pitted. It is, however, necessary to see that the contacts make good contact. A permanent magnet is often used to hold the thermostat contacts more securely together. If the controls do not make good contact check this magnet.

If the "day" and "night" settings do not function properly, check these contacts, and then observe closely the trip that operates these contacts. The projections on this trip may have come loose.

The electrical contacts that "break" to stop the control, are located on the "fingers" which make contact with the switch wheel. It is possible that these finger contacts may become burned and not make a good electrical contact.

## E. National Electrical Code

The heating unit controls should be wired in accordance with the National Electric Code.

Remote control low energy power and signal circuits have the following classification:

- a. Class "1" control and signal circuits in which power is not limited  
Section 7231 N.E.C.
- b. Class "2"; control and signal circuits in which power is limited.  
Section 7283 N.E.C.

Heating system controls fall under the class "2". Their current is limited usually by the type of transformer used.

## 1. Current limitations

Circuits operating at more than fifteen volts, but not more than thirty volts, shall have current protection of not more than 3 ampere rating. If the current supply is from a transformer or an other device, having inherent current limiting characteristics and approved for the purpose, or from primary batteries, the over current protection may be omitted.

## 2. Transformer rating, Section 7283 N.E.C.

Transformer devices supplying class "2" systems shall be approved for the purpose and be restricted in their rated output to not exceeding one hundred volt amperes. They shall be marked where plainly visible to show the voltage to be applied to the circuit, and whether or not of the circuit limiting type.

around it will flip the contact to the night position as indicated by the arrow. The current will now flow through the night thermostat.

If it is desired to continue the day temperature later into the night than the time for which the trip is set, the manual shift on top of the clock may be shifted from "auto" to "day". This shunts out the "night" thermal strip and the unit will continue to operate on the "day" thermostat.

4. Installation - Install as per manufacturers instruction sheets.
- 
- 
- 

### C. Troubles, maintenance and service calls

As mentioned before, these controls should give very little trouble when installed and operated properly.

In the first place the thermostat will usually have an adjustment to increase or decrease the differential between the temperature at which the control opens the draft and the temperature at which the draft closes. For more economical fuel consumption and to avoid excessive wear from frequent running of the control, the differential should be set for at least one and one-half degrees Fahrenheit.

A mistake that is sometimes made is to hook only the draft to the control and leave the damper off. The control is so made that the load on each end of the shaft should be balanced. When the weights on each end are the same the motor will only have to overcome the friction of the gear train. On the other hand if only the draft is connected to one end of the shaft, the motor will also have to lift the weight of the draft door. This may overload the motor. If it is desired to operate the control without the damper connected, a counter weight should be hung on the "NO Load" end to balance the load. If the damper door is lighter than the draft door enough weight should be added to the damper to balance the load.

The gear train will be usually greased properly when received from the supplier. The bearings will usually come packed so no greasing is necessary. If there are some oil holes they should of course be oiled with two or three drops of light machine oil each season. The motor will often have a felt wick surrounding the bearings. In this case one drop of light machine oil once or twice a season should keep the bearings well lubricated. In making service calls always take care of this oiling.

During the summer or when the control is not in use it should be well covered to keep out the dust. In the event the oil and greases become gummy and the operation is sluggish, it may become necessary to wash out the gear train with carbon tetrachloride and gasoline and then regrease the gears with an adhesive grease.

---

---

---

DAY & NIGHT THERMOSTAT

DAMPER CONTROL

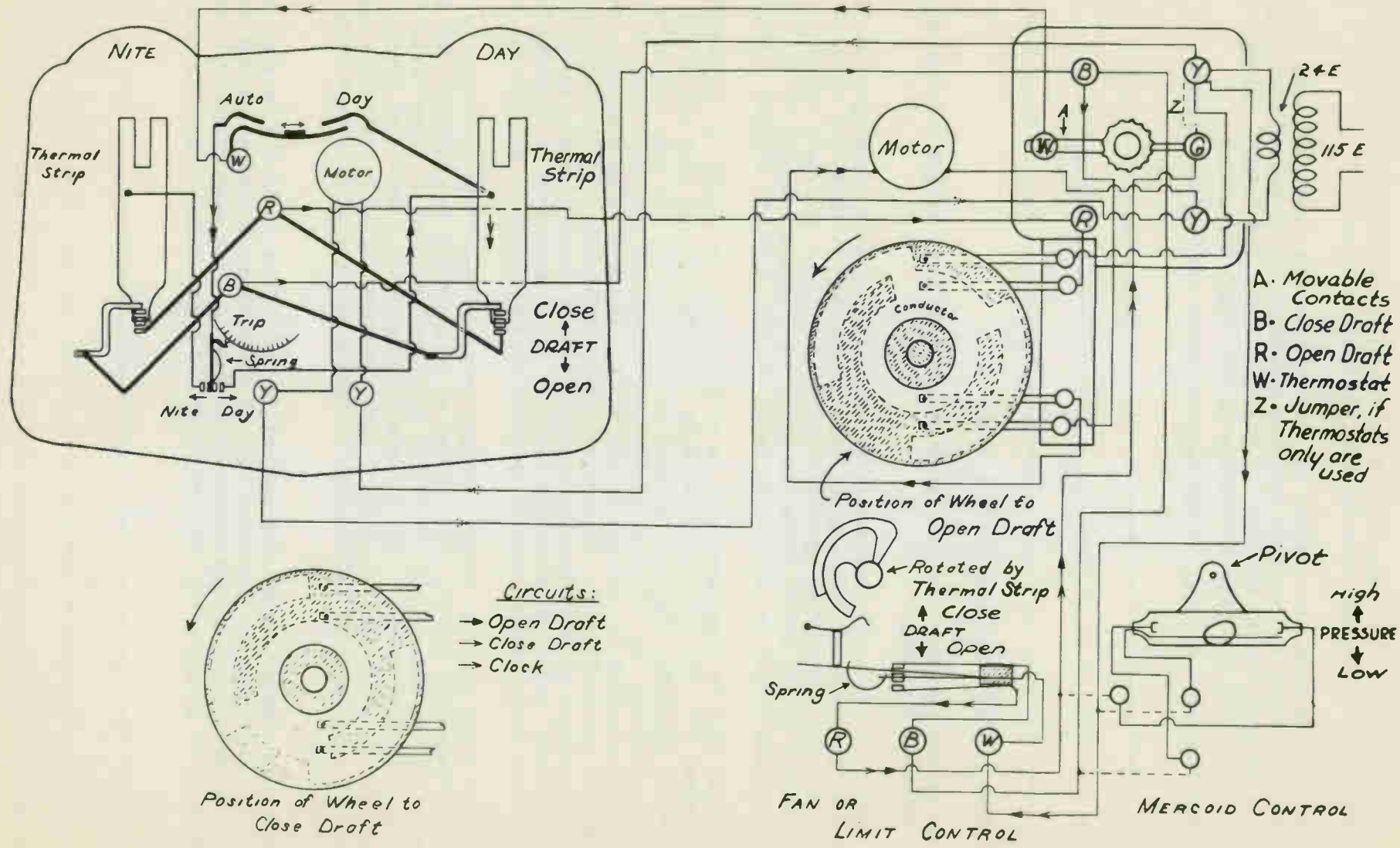

## B. Operation

## 1. Day &amp; Night Thermostat

Turn the selector switch to "Thermostat", turn the day and night thermostat to the desired temperature and close the power switch. "Open draft" and "Close draft" positions are for manual operation. These would be desirable when cleaning out clinkers or when putting in coal.

When the room temperature is below the thermostat setting the thermal strip will bend down making contact with the bottom stationary contact. This closes the circuit and the motor begins to run thereby starting to open the draft and close the damper. The "switch wheel" then begins to turn. After turning a short distance #1 finger makes contact and supplies the current direct rather than through the thermostat control. When the "switch wheel" has made one half revolution the conductor has passed #1 finger, this breaks the circuit and the motor stops with the draft in the open position and damper closed.

When the room temperature has again reached the temperature for which the thermostat is set the thermal strip springs upward and makes contact with the top stationary contact. This again closes the circuit. The motor starts turning thereby closing the draft and opening the damper. The "switch wheel" also turns and, after a short distance, #1 finger again makes contact and supplies the current as before. After one-half turn the conductor again passes #1 finger and the motor stops with the draft closed and damper open.

## 2. Limit or fan control

The limit or fan control is used to protect the furnace from high temperature and warping the fire chamber. This control is located in the bonnet of the furnace.

The limit control has a moveable and two stationary contacts. The bottom and moveable contact are connected in series with the thermostat control when the furnace is not overheated. When furnace becomes overheated the thermal trip will turn the limit control mechanism. This will break the bottom contact and close the top contact. The thermostats are now shunted out and also the circuit to the control motor is closed. As the motor turns it will again close the draft and open the damper as before.

When the temperature in the bonnet has cooled, below the "low" setting, the thermal strip has again rotated the control mechanism far enough in the opposite direction to open the top contact and close the bottom contact. This again puts the thermostats into the circuit.

The mercoid control operates on steam pressure rather than heat. In hot water systems it operates on the heat of the water.

## 3. Day and Night control

The switching from day to night is automatic and operates, by means of the clock through a gear train to the trip wheel. The trips on this wheel may be set for any desired time. For day time control the trip will flip the moveable contact in the direction as indicated by the arrow. When the bottom trip comes

## AUTOMATIC FURNACE CONTROLS

Objective

To learn the fundamental principles of automatic furnace control, to be able to trace a typical control circuit and wire up a control.

References

---

---

Lesson Content

## A Construction

## 1. Day and night thermostat, Fig. 1

The day and night thermostat consists of two thermal strips or thermostats, one for day and one for night operation. The spring tension on the thermal strip may be varied by the dials on top of the control. This will change the temperature at which the contact on the thermal strip makes contact with the bottom stationary contact, closing the circuit to the control motor.

An electric clock is used to operate the trip wheel by means of a gear train. The trip wheel moves the movable contact to close the circuit to either the day or the night thermal strip. If it is desired to keep the day temperature late into the night a little lever on top of the thermostat housing may be moved to the "day" position.

## 2. Damper control.

The damper control consists of the motor which operates a gear train to which the arms are attached which raise and lower the draft and damper of the furnace. On the same shaft as the arms is a "switch wheel: which has a conductor built into it and is insulated from the wheel. Against this "switch wheel, ride four "finger contacts" through which different circuits are completed.

The selector knob operates a movable contact to three stationary contacts. These contacts are to open draft, close draft, and for thermostat operation.

In this control we also have a small transformer to step the voltage down from 115 AC to 24 volts AC

## 3. Limit or fan control for hot air furnaces.

The limit control consists of a movable contact which makes contact with either of two stationary contacts. The movable contact is actuated by a thermal strip located in the bonnet of the furnace. It also has an adjustment so that the heat limits may be varied.







Fig. 2

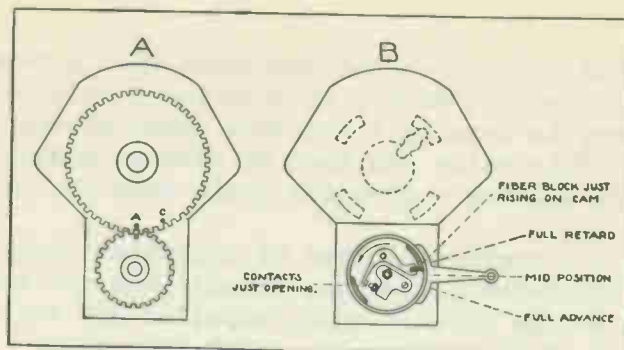

magneto armature in the normal direction of rotation until the fibre block on the breaker arm is just moving up on the cam and opening the contacts. Then rotate the distributor gear to a point where the brush is in the middle of the segment, Fig. 2B. While making sure that the armature gear and the distributor gear maintain these positions, move the gears into mesh with each other.

To check the setting move the breaker housing to the full retard position and, turning the armature in the proper direction of rotation, see if the brush is still on the segment with the breaker contacts open. Make the same test on full advance position. The brush should be on the segment in both positions.

**TIMING THE MAGNETO TO THE ENGINE** set the engine so that #1 piston is at the top dead center on the compression stroke. Fully retard the magneto breaker housing and turn the magneto armature in the normal direction of rotation until the distributor brush is on segment #1 of the distributor cap and the breaker contacts are just beginning to open. Then connect the magneto to the engine by the drive coupling, being very careful not to allow the armature or distributor to change position while making the connection.

#### B. Summary Questions

1. If you were called-out on a job, what would you do first? Explain.
2. What would you check first, at installation?
3. How would you check magneto spark?
4. What tools and equipment might be necessary to service breaker assembly?
5. Should the magneto be lubricated every 1000 miles or should it be lubricated every 100 hours?
6. How would you check the coil of the magneto?
7. How would you check the capacitor?
8. What type of solvent would you use for cleaning parts? Why?
9. What are distributor gear timing marks? Explain.
10. How would you connect a magneto to an engine?

- j. Test coils - this can best be accomplished with a commercial type of coil tester. Possibly the best method of checking a coil is to measure primary current necessary to develop a standard spark discharge across the secondary terminals. This value can then be checked against a chart. Check for leakage spark by holding a grounded plate near the outside insulation of the coil.
- k. Test capacitor - a commercial type of capacitor tester will usually check a capacitor for break-down, leakage, capacitance and resistance. The circuit employs an a-c bridge circuit which supplies 350 volts a-c and about 500 volts d-c by use of rectifiers for break-down test.
- l. Magnets - the horseshoe type of magnet may be easily charged on a magnet-charger made by specifications shown in Fig. 1. To charge the rotating magnet type, special charging blocks would also be necessary. Use keepers. Watch polarity.

#### 5. Disassembly of rotating armature type (Bosch)

- a. Remove the breaker-box cover
- b. Remove the distributor head
- c. Remove the dust shield
- d. Remove the collector plug and safety gap
- e. Remove the magnets
- f. Remove the grounding brush
- g. Remove the breaker plate screw and breaker assembly
- h. Remove the high tension pencil stabilizing ring
- i. Remove the nuts holding the bearing plate in position
- j. Remove the armature, large timing gear with high tension pencil attached and bearing plate, as an assembly, by tapping the drive end of the armature shaft.

The checking of the various parts involved in the above disassembly would follow the procedures previously mentioned in this lesson. Also refer to job 18.

#### 6. Reassembly

The order in which the reassembly should occur would be the reverse of the disassembly procedure. There is, however, one very important item - SETTING DISTRIBUTOR GEAR.

The distributor gear meshes with the armature gear. In order that the rotating contact or segment of the distributor will be at the correct position, when the breaker contacts open, it is necessary that these two gears must be meshed properly. Manufacturers have placed small punch marks on the edges of the gears. Refer to Fig. 2A.

Magnetos are often arranged so that, by making about two changes, they can be driven clock-wise or counter-clock-wise. The direction in which you wish to drive the magneto will determine how you will mesh the gears. If the magneto is for clock-wise rotation, the "C" mark on the distributor gear should "line up" with the mark on the armature gear. If the magneto is to be driven counter-clock-wise, the "A" (Anti clock) mark should be lined up. Remember, the direction of rotation is taken when viewing the magneto from the drive end.

If the marks on the gears have been destroyed, set the breaker housing in mid-position, i.e., half-way between full advance and full retard. Now turn the

- a. Coil tester
- b. Capacitor tester
- c. Some arrangement for driving the magneto at slow, idle and normal speeds.
- d. A standard spark gap
- e. Arbor press or screw type press
- f. Magnet charger
- g. Standard hand tools (screw-driver, pliers, spin tites, wrenches, etc.)
- h. Special hand tools which are developed by the manufacturer; such as gear pullers, slotted wrenches, snap-ring pliers, etc.
- i. Replacement parts, a list of these may be developed by obtaining information as to the magneto types and applications in your territory. Check with local tractor and engine dealers.
- j. A synchroscope or magnescope
- k. Other items, such as rags, lubricating oils and greases, solvents, etc.

#### 4. Shop procedure

- a. Clean the magneto
- b. Mount the magneto on the "test block" and slowly turn rotor by hand. If rubbing or binding is noticeable, other than "magnetic pull" it usually indicates bad bearings, distributor or interrupter assembly. Disassemble the magneto and correct the trouble.
- c. If test "b" does not indicate the trouble then drive the magneto at about 100 RPM, and also at a higher speed to check impulse coupling action.
- d. Connect the high tension cables to individual spark gaps and check spark at starting speed, idling speed and normal speed. At some time you should close the primary ignition switch and observe effect on spark.
- e. Clean breaker points and check the assembly for wear.
- f. Edge-gap, (E gap), lesson 17, is adjustment, - when the rotor is set with the proper E gap the breaker points should just begin to open. This checks for wear on breaker assembly. This check is especially important on older types of magnetos which did not make use of alnico magnets.
- g. Bearings - successful operation of magnetos is very dependent on good bearings. You will find ball, sleeve and needle (small diameter roller) bearings in use. Ball bearings, separable and nonseparable. To clean, use carbon-tetra-chloride. Compressed air is sometimes used after the carbon tetra-chloride.  
To relubricate, immerse and spin the cleaned bearing in a clean light oil until the solvent is removed. If the bearing is grease lubricated it should be repacked about 1/3 to 1/2 full.  
Working with bearings is not difficult if you have the proper tools. The general precautions are the same as those given in lesson 16 of this manual.
- h. Distributor rotors and discs - the surfaces of distributor rotors are finished very carefully at the factory. It is not advisable to make use of sandpaper or emery cloth. You are likely to mar the surface and consequently the carbon paths soon reappear.  
A clean linen cloth and carbon-tetra-chloride might be used to an advantage. A fine polishing paper is available from most manufacturers.
- i. Leakage paths - causes are broken cables, poor connections, too high engine compression, spark plug gap too wide, moisture, dirt, carbon and corrosion in the magneto. A surface leakage path can usually be found because of the burning effect that the high voltage spark has on the insulating material. It is best to replace any of these parts.

**LIST OF MATERIAL.**

- 2 SOFT IRON CORES (ROUND) 4" x 2".
- 2 SOFT IRON TOPS 3 3/4" x 3 3/4" x 1/2".
- 1 SOFT IRON KEEPER 8 3/4" x 3 3/4" x 3/4".
- 4 FIBER OR BAKELITE WASHERS 3 3/4" DIA. 2" HOLE 3/16" THICK.
- 4 FLAT-HEAD MACHINE SCREWS 3/8" DIA. 1 1/4" LONG.
- 4 HEXAGON-HEAD MACHINE SCREWS 3/8" DIA. 1 1/2" LONG.
- 500 TURNS #14. S.C.E. MAGNET WIRE ON EACH CORE LAYER WOUND.
- 9 1/2 LBS. COPPER WIRE ARE REQUIRED FOR THE WINDINGS WHICH ARE CONNECTED IN SERIES.

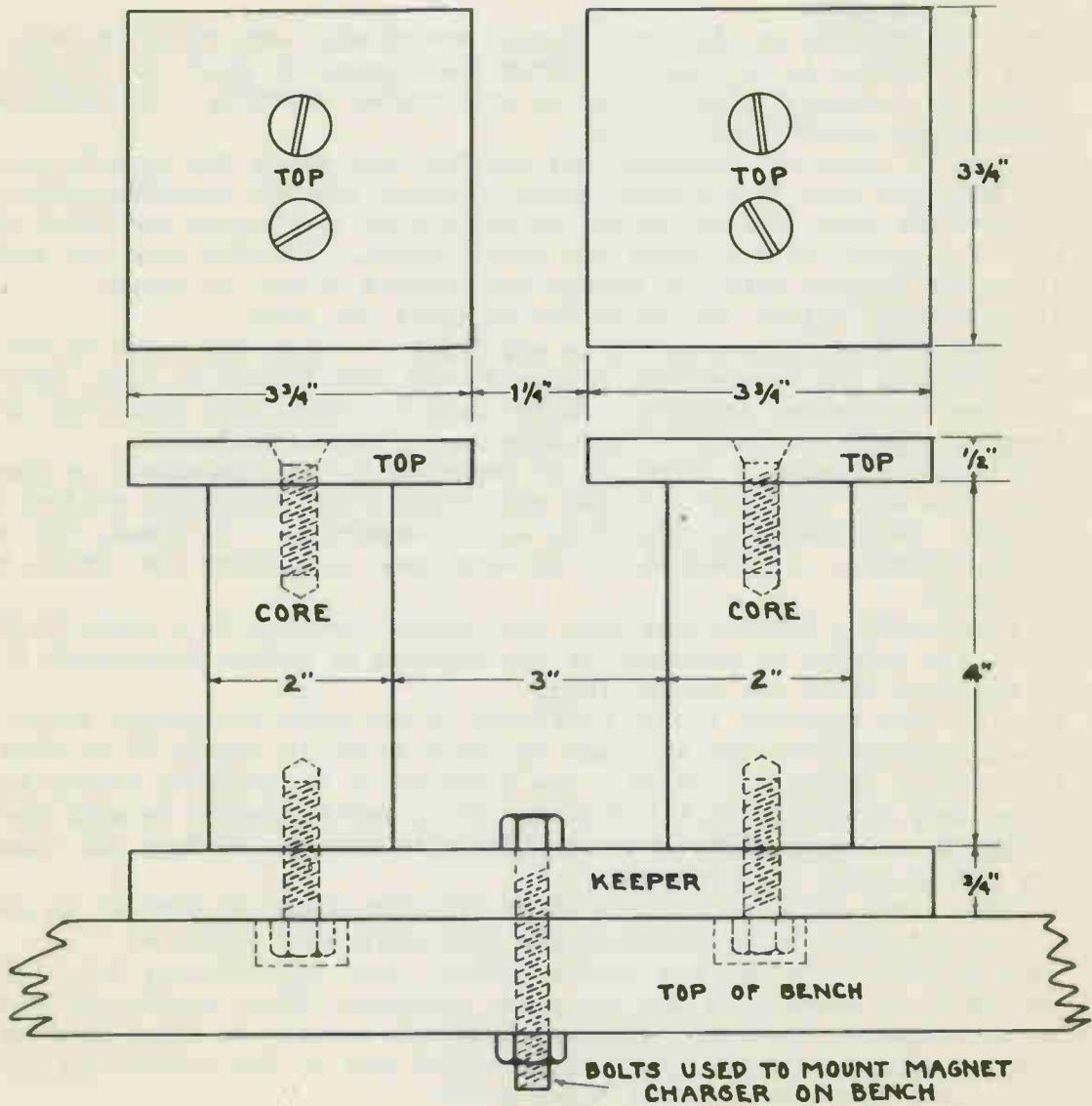
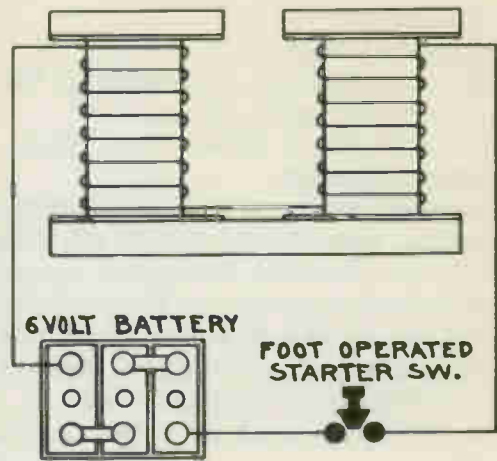

Fig. 1 - Magnet charger

engine for this check. Check all brushes. They should not be chipped, worn, or stuck. They should move freely in the brush holders. Spring tension should be sufficient. If doubtful on the ability of the brushes to function properly, replace them with new brushes.

- e. Breaker points. These should be observed carefully, for pitting, pyramiding, etc. You may use a small tungsten file or fine stone to correct above defects. Use a vise to hold the points while resurfacing.

The points must be kept free from oil and grease. Carbon tetra-chloride is a good solvent to use for cleaning the point. A tooth brush comes in handy. If any doubt about serviceability of the points replace them with new point assembly. The contact gap must be used which is given in the manufacturers specifications, usually about .015 inch. This can be checked with a feeler gauge. You may check the spring tension by using a spring scale.

- f. Lubrication. Many manufacturers have developed bearings and lubrication systems which will function properly for the life of the unit without oiling. There are others that will require a periodic attention, use a light highly-refined oil. Do not over lubricate. The oiling plate, on some magnetos, will give complete information concerning lubrication.
- g. Check the coil and the capacitor. The substitution test should be used whenever possible, i.e., remove old coil or capacitor and substitute one known to be good.
- h. Impulse coupling. Disconnect all ignition cables and slowly crank the engine. Listen carefully for the "snap" of the coupling as each pawl releases. If you cannot hear the above indication, the magneto must be removed and the impulse coupling checked and cleaned and repaired or replaced. This may involve the use of special coupling tools, such as: special wrenches and coupling hub pullers.

## 2. Maintenance

Every 1000 miles on trucks and busses and every 100 hours on tractors and stationary engines. Check for cleanliness and distributor brushes and interrupter contacts.

## 3. Shop service

The shop should be kept clean and well-equipped. Oil, grease, dirt and grime are the most frequent causes of magneto "break-down". A clean and orderly shop is a foundation for "good will", it develops "customer confidence". Many shops make use of work cards which may be used in keeping a record of each magneto. These cards could also be used for billing purposes. Some of the items listed - customers names, manufacturer, type, model, serial number, application, date received, spark test, starting speed, idling speed, and normal speed; and the condition of exterior, interior, breaker points, brushes, capacitor, coil, coupling, distributor, and bearings. A space might be provided for "service work performed" on each of the above mentioned items, a "parts used" list, and "hours of labor" on the unit.

Since the amount and type of work handled in the shop is dependent on the territory served it is difficult to list the equipment necessary to produce satisfactory work; however, a list of tools and equipment, that you may check, follows:

## MAGNETO TESTING

Objective

- a. To learn of the trouble which may develop in magnetos.
- b. To learn how to disassemble and test a magneto.

References:

## A. Magneto Service

Magneto service might be best classified into two divisions, field service and shop service.

Since there are so many different makes and models of magnetos in use it is difficult to develop a procedure of "trouble-shooting", testing and repair which would apply to all. The following procedures must be considered as general. By making use of specific service instructions, which are available from the manufacturer, in addition to the following general procedure, a satisfactory service should result.

## 1. Field service

Field service work should be limited to minor repairs, adjustments and spark tests.

Follow service directions carefully on the magneto under test.

When you are called out on a service job, the following procedure is recommended.

- a. Upon receiving a call, ask for make and model number of the magneto. This will allow you to take a few of the minor replacement parts with you. Many service stations make use of a card file system of the magneto installations in their territory.

This service card could incorporate a magneto service record as well as name of customer, address, application, make of magneto, model and serial number.

- b. Checking the strength of the ignition spark. This test is made while the engine is running by holding the end of each high tension cable, one-at-a-time, about 1/16 inch away from its spark plug terminal. If the spark plug continues to fire the strength of the ignition spark is likely to be satisfactory.
- c. Test the magneto spark. Remove all high tension cables from the magneto. Insert a short piece of heavy wire in one of the cable outlets and move the other end to within about 1/8 inch of the engine block. Slowly crank the engine and watch for spark which should occur on the release of the impulse coupling. Repeat the test for each of the other outlets. If a strong spark occurs at each, then check all high tension cables, terminals, and spark plugs, if no spark is developed, carefully check the switch and the ground cable.
- d. Carbon brushes. It is usually not necessary to remove the magneto from the







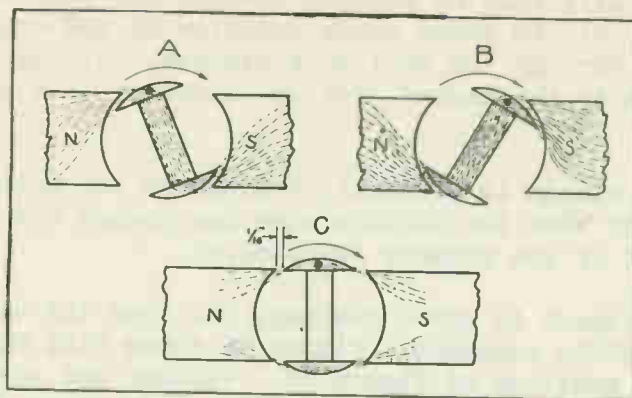

Fig 8

The name rotating magnet type means that the magnet revolves and the coil remains stationary. See Fig. 7 "B". This type simplifies construction because it simplifies many of the parts needed with the rotating armature type. With each  $180^\circ$  of rotation of the magnet, the direction that flux cuts the coil is reversed. When reluctance is maximum and rate of change is maximum through the armature, the points are broken. This magneto has the advantage of a stationary armature and capacitor. The points do not revolve. A simpler arrangement of conducting the high voltage to the external system is possible. The development of better magnet materials such as "alnico" has resulted in the development of this type of magneto.

Figure "C" represents the moving iron type of magneto. A permanent magnet is to furnish flux, when the revolving iron is in the position shown, the reluctance is minimum and flux movement between poles maximum. When the rate of change is maximum the points should be broken opening the primary circuit.

#### F. Summary Questions

1. What is the purpose of a magneto?
2. What are the advantages of magneto ignition?
3. What are the disadvantages of magneto ignition?
4. Name three types of magnetos.
5. What is an interrupter?
6. What is the purpose of the capacitor? What is its capacity in mfd?
7. What is the purpose of the distributor?
8. Approximately what is the air-gap in a magneto?
9. What is the direction of rotation of a magneto?
10. Is a primary and a secondary necessary on all magnetos?

wise direction. Flux will then be passing through the iron core from the unmarked end to the marked end (B). In other words rotation of the armature causes flux to decrease its movement through the coil to a minimum, (C) then to cut the armature from the unmarked side to the marked side and increase to a maximum as shown in 6C.

When the rate of flux change is greatest, voltage in the primary is greatest. Experience has shown that when the shuttle edge has passed the edge of the pole shoe  $1/16"$ , maximum current of the primary is obtained.

6C shows that flux movement is again maximum, but from the unmarked side to the marked side of the shuttle armature. Figure 6D shows flux movement again at minimum but  $180^\circ$  from the position of Figure 6B. Voltage and current are again maximum, but in an opposite direction. When current is maximum in the primary, flux produced by the primary winding will also be maximum. The primary circuit should then be opened by point action. Flux collapsing across the secondary induces a high voltage in the secondary.

Turn ratio between primary and secondary is about 50 to 1. However, the voltage ratio is much greater than fifty times the primary voltage due to the speed of flux collapse. The capacitor aids in flux collapse and its action should be understood.

When the points open, flux collapsing and cutting the secondary, also cuts the primary inducing a voltage in the primary that tends to keep the primary circuit current flowing in the same direction. This self-induced voltage is an instantaneous voltage that may reach as high as 200 volts. Such a voltage causes arcing of the points. As long as an arc is maintained across the points, primary current will flow through at a greatly reduced rate. Since current and flux are in phase, as long as current flows, there will be a certain amount of flux present in the primary. As long as current flows in the primary, there can be no complete flux collapse, necessary for high induced voltage in the secondary.

To prevent arcing of the points a capacitor is shunted across them. The voltage that is induced in the primary can "bounce" into the capacitor easier than it can establish and maintain an arc across the points. The result is that when the primary circuit is opened, current flow stops and flux collapses immediately.

The high induced voltage of the secondary is picked up by the collector ring brushes and distributed to the various plugs by the distributor. It is necessary to time the distributor disc so it will line up with the segment at the proper time. Each time a spark occurs the disc must move the distance between one segment. The disc of the distributor has a "C" or "R" to indicate clockwise or right hand rotation, and an "A" or "L" to indicate left hand rotation. When one of these marks lines up with a timing mark on the armature, the distributor is said to be timed for right or left hand rotation.

The speed ratio between the four cycle engine driving the magneto and the magneto may be found by the formula  $\frac{1}{2} \frac{\text{no. of cylinders}}{\text{no. of cams}}$

Fig. 7 indicates the three types of magnetos. "A" is the rotating armature, "B" the rotating magnet and "C" the moving iron type.

If two cams were used, there would be two times as many teeth on the distributor disc as on the armature gear.

Another device called a grounded brush is used to complete the circuit from the grounded windings of the armature to the magneto frame. The races of the armature shaft bearings are insulated from the magneto to prevent current from crystallizing the lubricants of the bearings. The ground brush is a carbon brush that makes a sliding contact with a machined surface of the armature. It is held in place by a spring.

We may now trace two circuits from the armature. From the primary circuit, current can pass from the insulated side to the insulated point, to the grounded point and back to the grounded side of the primary. Another circuit could be traced from the secondary, collector ring, collector brush, high tension pencil, distributor disc, distributor terminal, external circuit (the spark plug) to the frame, the magneto grounding brush and back to the grounded side of the armature.

The safety gap is another important device. Its purpose is to protect the secondary winding insulation. It is connected parallel with the high voltage distribution system. Although construction differs greatly with different magnetos, the gap consists of two electrodes spaced about  $5/16$ " apart. In case the secondary circuit is not completed externally, the high voltage surge can jump the gap and complete its path to ground. It is designed to pass voltages in excess of 8,000 volts.

---

---

#### D. Operation

Fig. 6 represents a magneto of the rotating armature type, showing magnets, pole shoe and armature. One side of the shuttle has a dot so that the direction of rotation and its position, can easily be followed. In "A" the flux is passing from the north pole across the air gap through the iron part of the armature core, across the other air gap to the south pole and completing its path through the magnet to the north pole. In this position the reluctance of the magnetic circuit is minimum and the flux movement maximum between the poles. Voltage and current in the primary are at minimum. 6 B shows the position of the armature after it has revolved  $90^\circ$ . Flux which was passing through the side of the armature marked by the dot is now passing across the shuttle ends of the armature. Lines of force which formerly were cutting the coil at maximum rate are now cutting at minimum because reluctance is now maximum. Flux which had been cutting from the dotted side to the unmarked side will soon be passing from the unmarked side to dotted side. Or in other words, rate of change is greatest. Therefore the voltage of the primary is maximum.

A glance at Fig. 8 gives a better idea of what takes place in the primary. At "A" the lines of force are taking the path as illustrated, i.e., from the north pole, to the dotted side of the armature, through the armature to a south pole. The number of lines of force have decreased due to the position of the armature. Consider what will happen after the armature has rotated a few degrees in a clock-

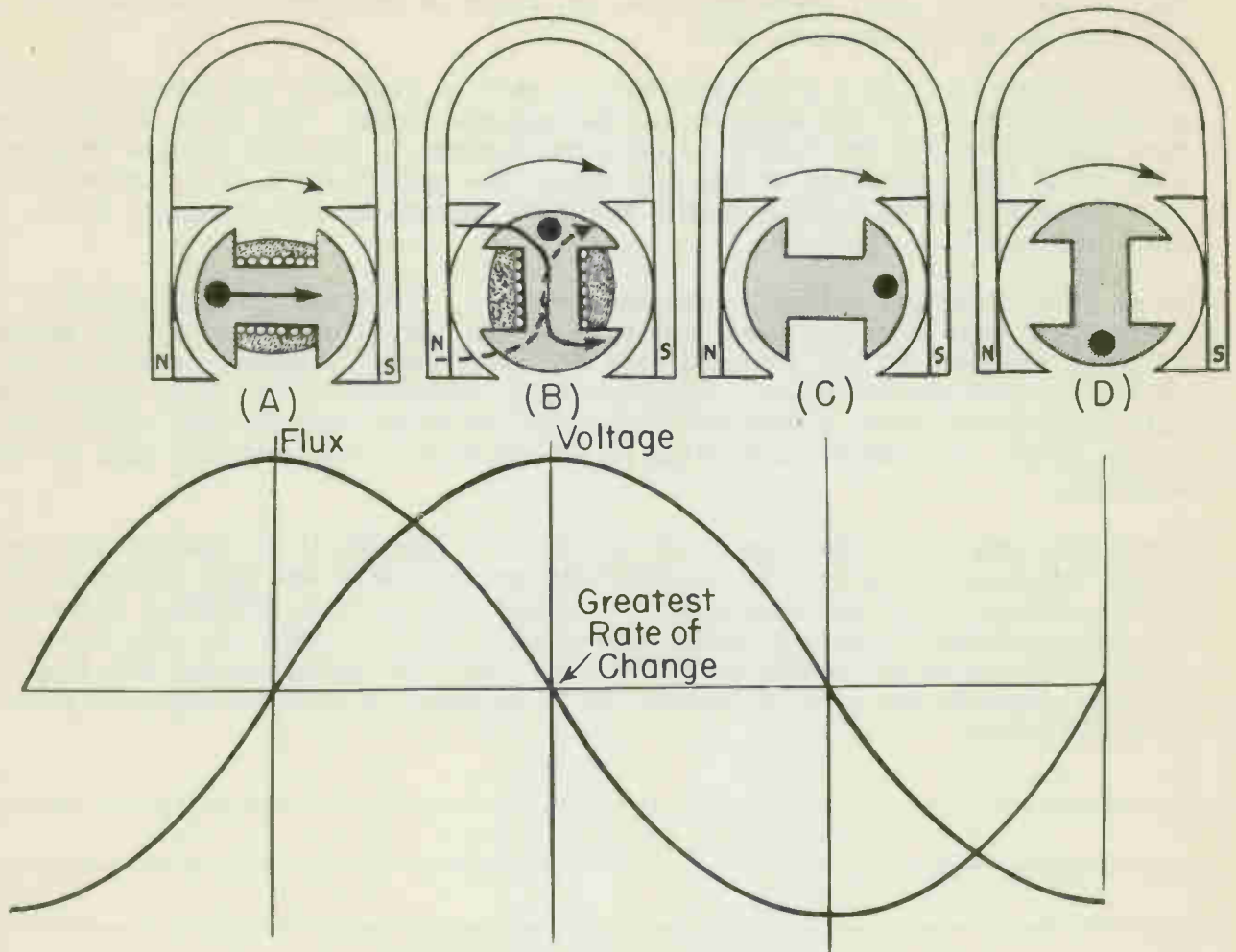

Fig. 6 - Rotating armature type magneto

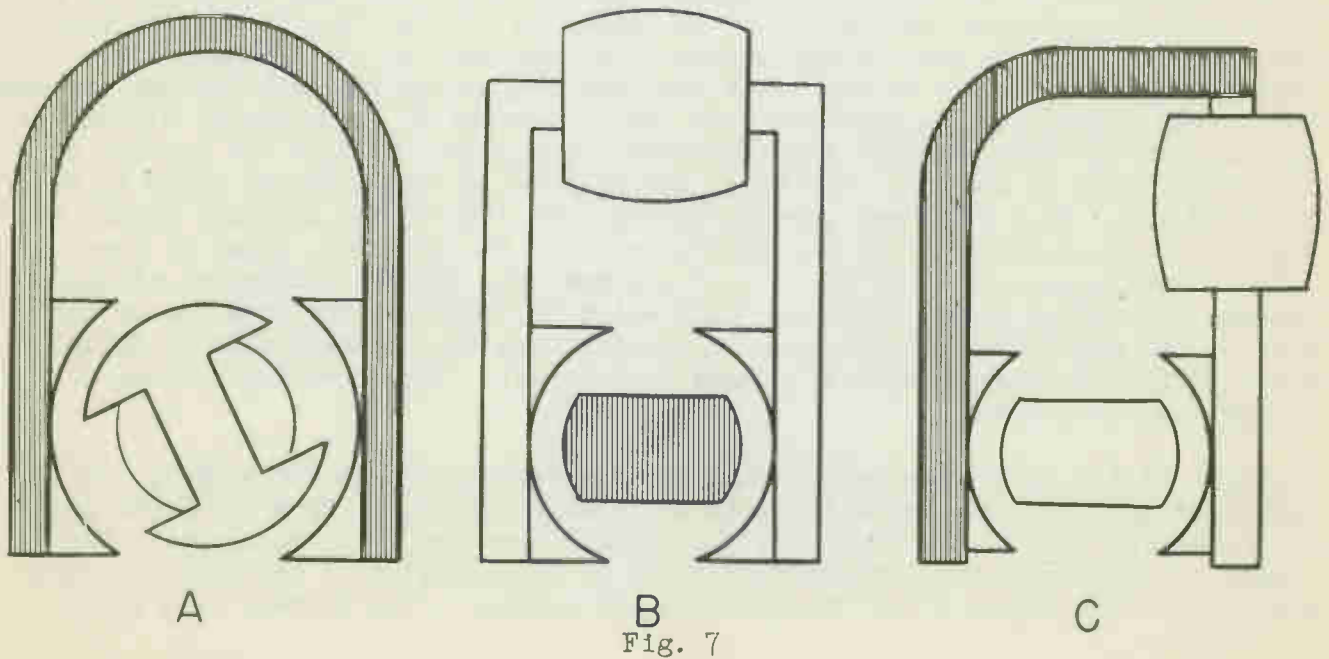

Fig. 7

the primary and many turns on the secondary. Such a circuit is shown in Fig. 3 while #1 represents the primary, #2 the secondary, #3 the interrupter, #4 the condenser, #5 a safety gap and #6 a switch. The primary winding will have an ohmic resistance of between  $3/4$  and 1 ohm. The secondary winding will have an average resistance of around 3,000 ohms. The primary has an average of 100 turns while the secondary has around 10,000 turns.

### 3. Interrupter

Fig 4 shows the interrupter used by the magneto in Fig. 1. The purpose of the interrupter is to make and break the primary circuit. Note the breaker retaining screw. It serves a dual purpose, connecting the insulated side of the primary to the insulated "point" and also holding the breaker plate assembly in its correct position. The opening and closing of the contact points is obtained by the interrupter lever. During rotation of the interrupter, the interrupter lever engages a cam causing the points to open. Points are normally held closed, by spring tension. The point attached to the lever is grounded. When the points open, the primary circuit is broken. Spring tension holding the points closed is approximately sixteen ounces. Maximum clearance between contact points, when the interrupter lever engages the cam, is usually between .012 and .015.

The cams are attached to the breaker housing. This housing is free to rotate approximately 60 degrees. By changing the relative position of the cams, it is possible to cause the points to open earlier or later during the revolution of the armature. This action times the magneto causing the high voltage spark to occur when desired. Experience has shown that when the edge of the shuttle has passed the pole shoe  $1/16$ " maximum current flows in the primary.

### 4. Capacitor

The capacitor is shunted across the points. Its purpose is to increase point life and cause a higher voltage to be induced in the secondary winding. When the primary circuit is broken, a spark results, and the capacitor absorbs this spark. Size of this capacitor is usually between .12 to .17 mfd.

### 5. Distributor

Fig. 5 shows the distributor. Its purpose is to distribute the high voltage surges to the spark plugs. A carbon brush, called the collector brush, carries the voltage of the secondary from the collector ring to the high tension pencil, which makes a sliding contact with the distributor disc. The disc has a geared edge that engages a gear on the armature. A distributor head, consisting of segments of copper imbedded in insulation, fits over the distributor disc. Terminals connect to the segments.

Different methods are employed to connect the high voltage surges from the distributor disc to the distributor head. A sliding contact or a jump contact may be used, depending upon the design of the magneto.

The gear ratio between the armature and distributor is dependent upon the number of segments and the number of cams. Segments necessary will equal the number of cylinders. Also, the number of segments will equal the ratio of "teeth on the distributor gear disc to teeth on the armature gear". Thus a four cylinder engine would require a magneto with four segments.

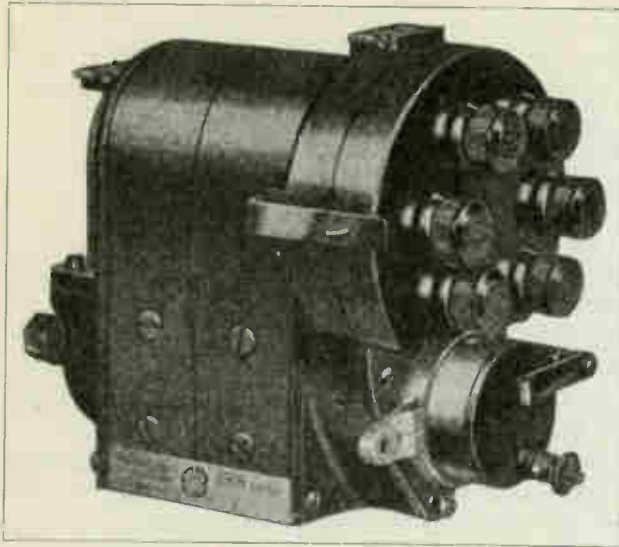

Fig. 1

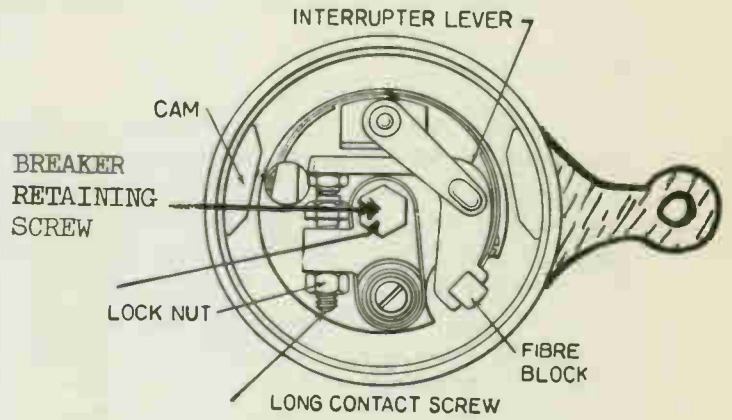

Fig. 4

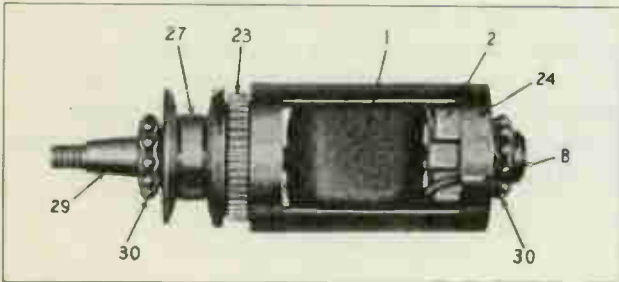

Fig. 2

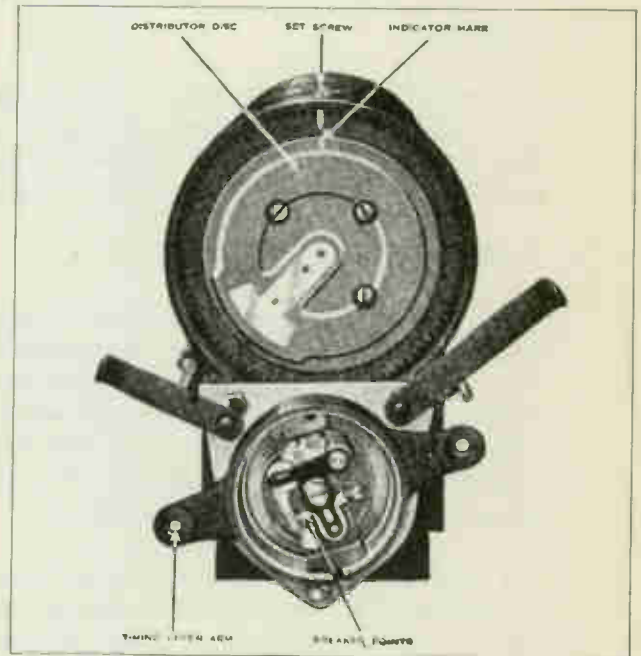

Fig. 5

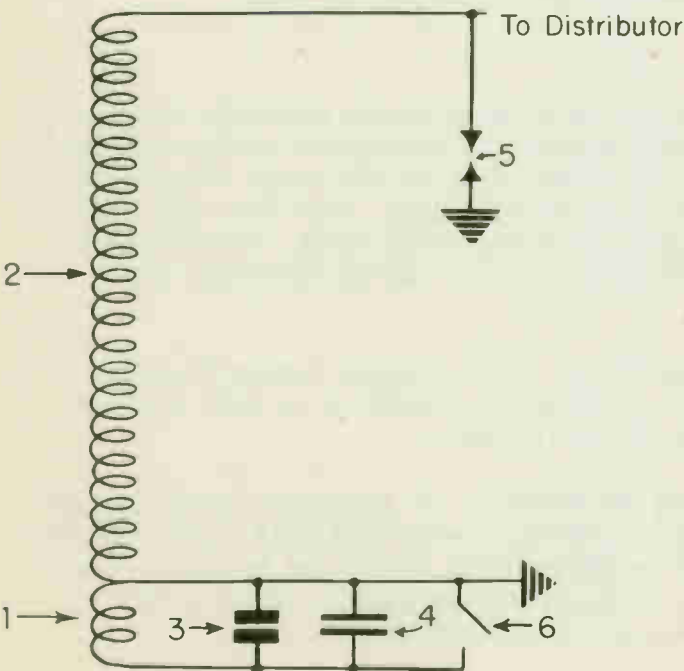

Fig. 4

## C. Construction

All magnetos require the following: magnets, coil consisting of a primary and a secondary winding, interrupter, condenser and a distributor.

## 1. Magnets

Fig. 1 shows a magneto of the rotating armature type. Note the permanent magnets used to produce the flux. They are known as "horseshoe" type magnets. Formerly magnets were made of an alloy of cobalt and iron, but research in magnetic materials has led to the development of more efficient alloys. For example "Alnico", an alloy of aluminum, nickel, iron, and cobalt, has great magnetic retaining properties. Powerful magnets may be made from this material. Size for size, alnico magnets will exert more pull than magnets made of an alloy of cobalt and iron.

The strength of the magnets of any one magneto determine the magnetos voltage output. A strong magnet that will maintain its magnetic properties over a period of years is desirable.

Attached to the poles of the magneto, shown in Fig. 1, are pole shoes that permit the lines of force to pass from pole to pole through the armature. Pole shoes are made of iron to reduce the reluctances of the magnetic circuit. The armature rotates between these shoes. The air gap between the armature and pole shoes is kept as small as possible. A clearance of from between .003" and .005" is an average value. The reluctance of the magnetic circuit through the clearance in the air gap would increase the reluctance of the magnetic circuit and decrease the flux through the armature and would result in a lower output voltage of the magneto.

A magnet should have a pull of around 20 pounds, when attached to a spring scale, to produce a good magnetic field. A horseshoe magnet with a cross-sectional area of  $\frac{1}{2}$ " x  $1\frac{1}{2}$ " may be charged until it will exert a pull of from 20 to 35 pounds. No magneto can be expected to produce a strong spark with weak field magnets. One important point, like poles of the horseshoe type magnets must be placed side-by-side when more than one magnet is used for field flux.

## 2. Coil

Fig. 2 shows the armature used in the magneto of Fig. 1. Due to its shape it is called a "shuttle" type winding. #1 indicates the coil consisting of a primary and secondary winding. One end of the primary is grounded to the iron core while the other end is insulated and goes to the interrupter. #27 points to the collector ring, which ties to the insulated end of the secondary. The other side of the secondary is also grounded to the iron core. Note the bearings (#30) that supports the armature between the pole shoes. #29 indicates the shaft that attaches to the engine driving the magneto. Another important point, DIRECTION OF ROTATION IS CLOCKWISE OR COUNTER-CLOCKWISE, DETERMINED FROM THE DRIVE END OF THE MAGNETO. #23 shows the gear that drives the distributor. #2 indicates the condenser.

The winding may be considered as an autoformer with relatively few turns on



## MAGNETOS

Objective

To learn the fundamental principles of high-tension magneto construction and operation.

References

---

---

Lesson Content

## A. General

The purpose of a magneto is to furnish the ignition for the compressed fuel charge in the cylinder of an engine. The time the ignition spark occurs may be accurately controlled. The voltage must be sufficient to "break-down" the high resistance between the electrodes of the spark plug.

One reason why magnetos are desirable for certain types of engine operation is that no auxiliary apparatus is required. The unit is complete in itself. Magnetos supply higher voltages at higher speeds, while the voltage developed by battery ignition, at higher speeds, will actually decrease due to the inductance of the primary winding of the ignition coil.

Magneto ignition does have its limitations. The voltage output of a magneto, operating at low speed, is much lower than when operating at high speed. To aid in starting, a device called an impulse coupling may be used with the magneto, to help supply the high voltage required. To accomplish this the rotating member is temporarily locked and the shaft, operating the magneto, compresses a spring. When tension is increased to the proper point, the catch holding the armature stationary is released and the spring tension gives the magneto a quick "flip" that is sufficient to cause the magneto to produce a high voltage spark.

---

---

## B. Classification

Magnetos may be divided into three types:

1. The rotating armature type
2. The rotating magnet type
3. The moving iron type.

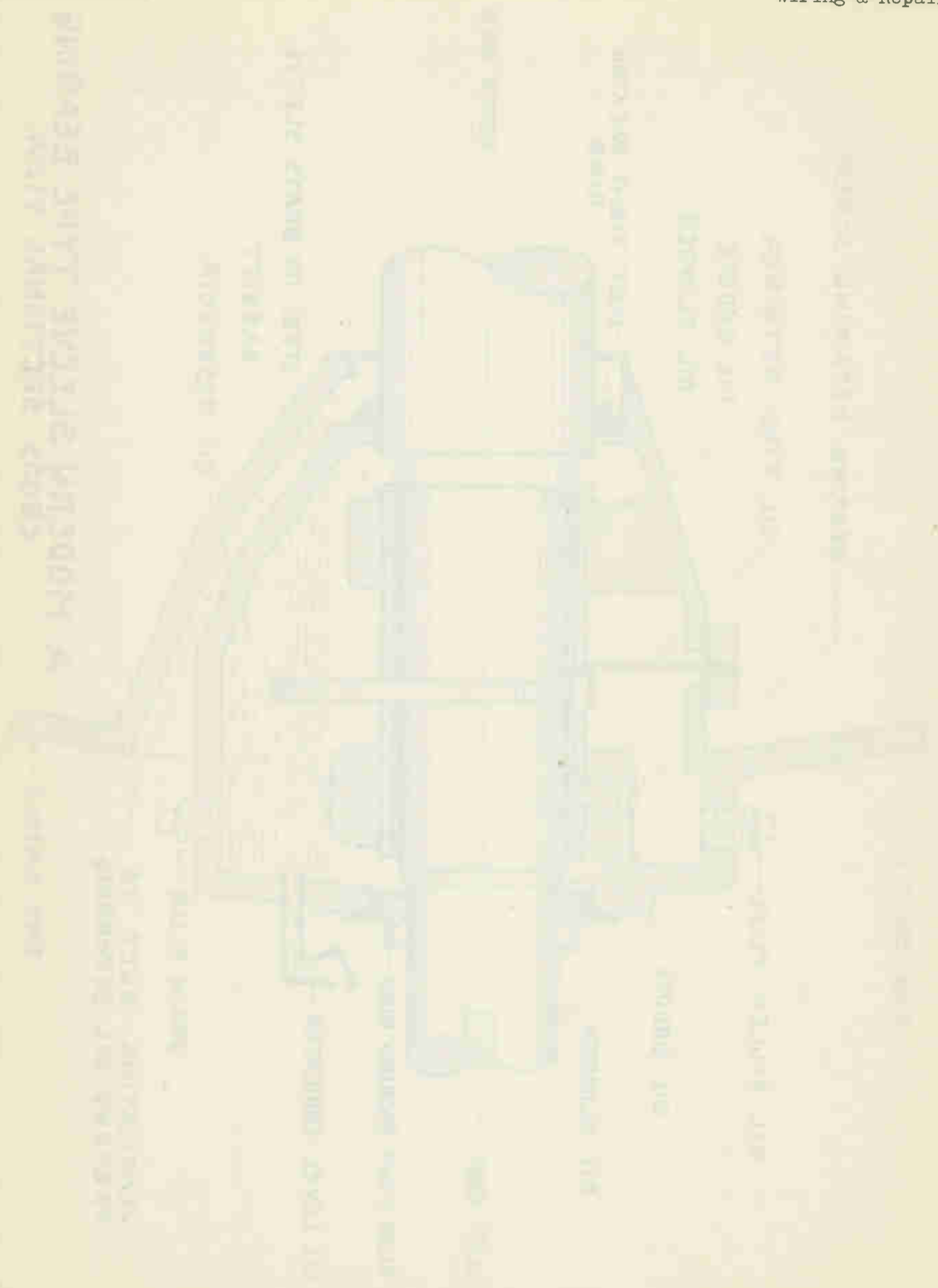

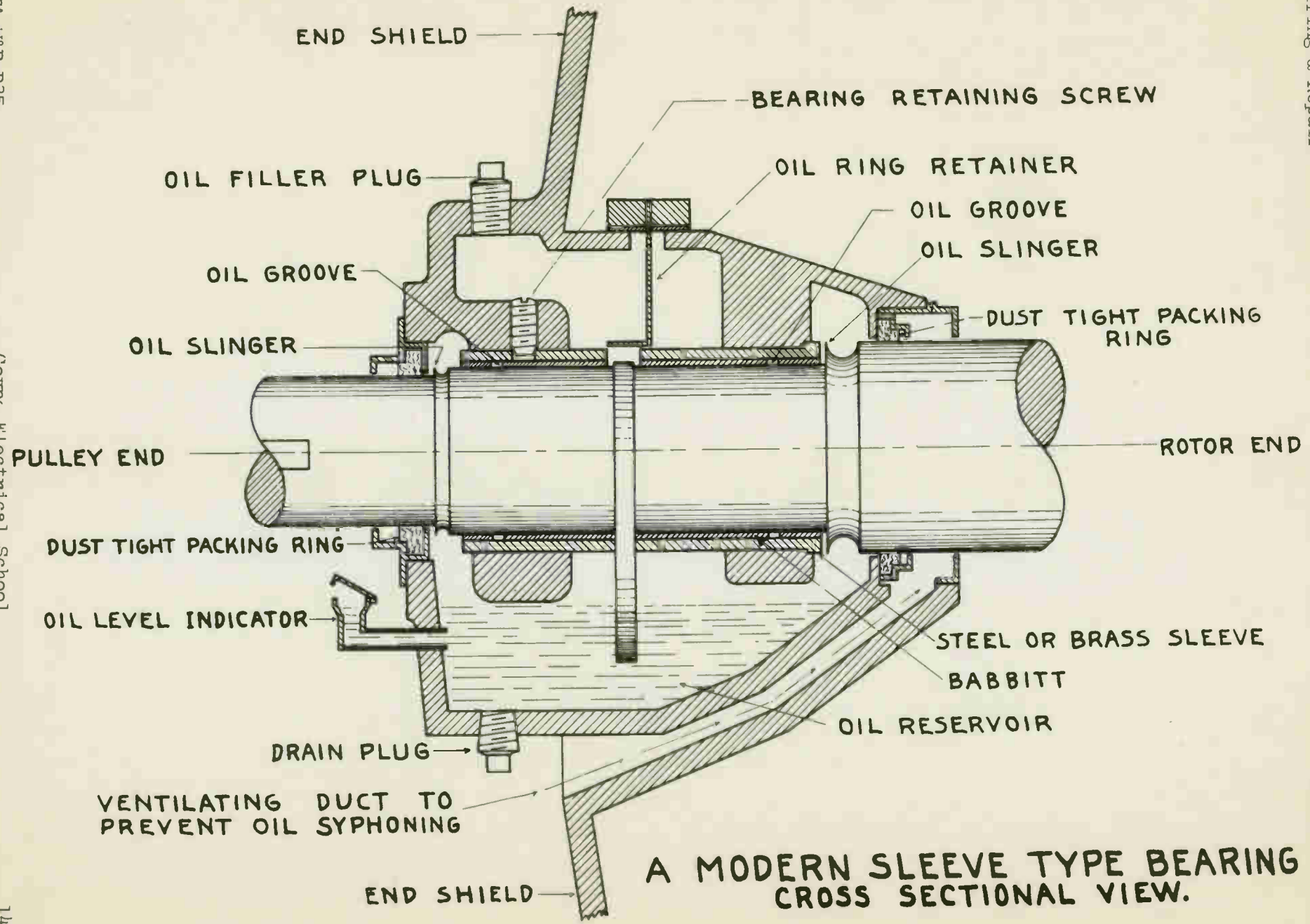

A MODERN SLEEVE TYPE BEARING CROSS SECTIONAL VIEW.

f. Replace plug in bottom and inject solvent until it splashes in filling hole, allow to churn a few minutes, remove plug and drain. On above procedure have ventilating openings in the motor shielded to keep solvent from windings. Repeat until solvent runs clear.

g. Motors should be greased while operating.

h. Have clean greases.

i. Always remove bottom relief plug and be sure hardened grease is removed.

j. Add grease with hand operated pressure gun until it begins to flow out bottom.

k. Allow to run for a while so the rotating parts can expel all excess grease.

1. Replace plug and wipe clean.

Many ball bearing assemblies consist of several parts. When working on these assemblies, be very careful to replace parts properly. It is easy to make a mistake and if you do a bearing will go bad in just a few minutes. These assemblies might consist of felt washers, metal washers, gaskets, springs etc. The outer race sometimes has a wider face on one side than the other. It is a common fault of repairmen to fail to notice this. The wide face always faces out. Usually the manufacturer has his trade mark on the wide side of the outer race.

---

---

---

#### D. Summary Questions

1. The bearings usually used in small motors are of the split-sleeve type. True or False.
2. Will worn bearings effect the power factor and efficiency of a motor?
3. What types of elements are used in the construction of bronze bearings?
4. What is the purpose of a flanged bearing?
5. Name some of the methods of applying the lubricant to the shaft.
6. What is an oil groove?
7. Name six of the defects in a bearing installation which would make the bearing over-heat.
8. When pulling bearings from an end shield or bearing bracket, are they pulled from the outside in, or, from the inside - out.
9. What is a frozen bearing?
10. What procedure would you follow in servicing an excessively hot bearing?
11. What is a "line reamer"?

- a. Where dripping of oil is undesirable.
- b. Wherever there happens to be large amounts of foreign matter in the air.
- c. Where extreme moisture conditions are encountered.

Pressure methods are usually used for the application of greases.

## 2. Troubles (Over-heated bearings)

- a. Dirt - loose protective covers, seals, or dirty grease.
- b. Binding - race must be assembled square with shaft.
- c. Assembly replaced in wrong order.
- d. Bad shaft.
- e. Too much grease
- f. Insufficient grease.
- g. Worn bearings.

## 3. Maintenance, servicing, and greasing.

The inspection periods will vary widely, however in general, the maintenance schedule on ball and roller bearings does not require as many checks per year as the schedule on sleeve bearings. You may use the check list which was given for the maintenance of sleeve bearings. Of course the lubricants will be different.

Never remove ball or roller bearings from a shaft unnecessarily. When assembling or removing these bearings from a shaft, exert pressure on the inner race if at all possible. The pressure must be applied evenly and parallel to the shaft.

A bearing should not be removed from the package it was shipped in, until it is to be installed. Do not remove the grease from new bearings. A soap-base grease of sodium calcium and mineral oil (79%) the flow point being at least 280°F. would be a good grease. A little harder grease could be used on small vertical motors. In double sealed, use only the grease specified by manufacturer.

NOTE: Do not mix greases.

While a motor is disassembled, for over-haul, the bearings can be easily washed with a grease solvent. Carbon tetra-chloride is a good nonflammable solvent which will dissolve the grease quickly. All traces of grease solvent should be removed from insulation and the bearing housing, and it should not be allowed on the winding. Carbon tetra-chloride should be used in a ventilated room.

To grease an assembled motor:

- a. Clean pressure gun and relief fittings.
- b. Free the hardened grease in pressure-fitting hole.
- c. Free the hardened grease in relief-plug hole in bottom of bearing housing.
- d. Fill a syringe with solvent and inject while motor is running.
- e. Continue until solvent runs clear.

tools and equipment which might be used. It covers items necessary for both installation and maintenance.

Line reamer,	Two grades of babbitt	Soldering pot & ladle
Screw driver	Steel and iron stock for	Bar bronze
Spin-tites	mandrels and arbors	Wool waste
Raw hide mallet	Air gap gauges	Oils and greases
Adjustable open end wrench	Inside calipers	Felt washers
Bearing scrapers	Outside calipers	Wool wicking
Bearing pullers (Fig. 8 )	Micrometer	Flux
Gear pullers (Fig. 9)	Arbor press	Solvent
	Syringe	Bearing blue

## 6. Summarization

Watch bearings - use good lubricants - keep lubricants and bearings and bearing housings clean - check for temperature rise before leaving a new installation.

Bushings can be replaced in all small power motors and some large power motors with only the first five items mentioned under Tools and Equipment.

## C. Ball and Roller Bearings, Fig. 10, 11, & 12.

### 1. Construction

Ball and roller bearings have inner and outer rings or bearing races made of hardened steel and between which the balls or rollers run. The inner race is pressed tightly on the shaft and is held in place against the shoulder on the shaft by a clamping or retaining nut. The inner race turns with the shaft at all times. The outer race is held securely in the bearing housing in the motor end-shield. This race should always be stationary and it should not be allowed to rotate in the bearing housing.

The balls and rollers of these two types of bearings are made of very hard steel and, if properly lubricated and kept clean, will last for many years. The balls are spaced and held in their proper positions by light metal cages to prevent them from bunching up and jamming in the race.

Some ball bearings and assemblies, are sealed. Grease is not renewed in some cases, until after a period up to five years. In any case follow the manufacturers specifications.

NOTE: A grease is a medium by which oil is delivered to a bearing.

The greases used are made up of a base of metallic soaps, in combination with a mineral oil. As the grease becomes warm the mineral oil is freed from the soap. Greases are used in most ball and roller bearings. Grease is usually used:-

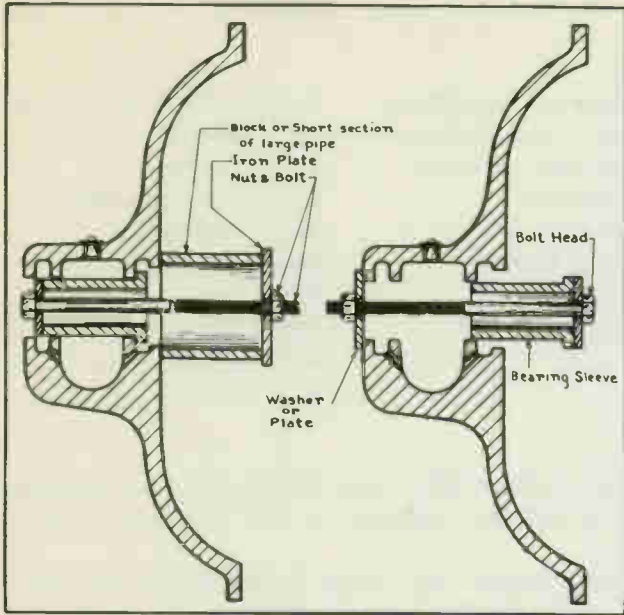

Fig. 8 Sleeve bearing puller

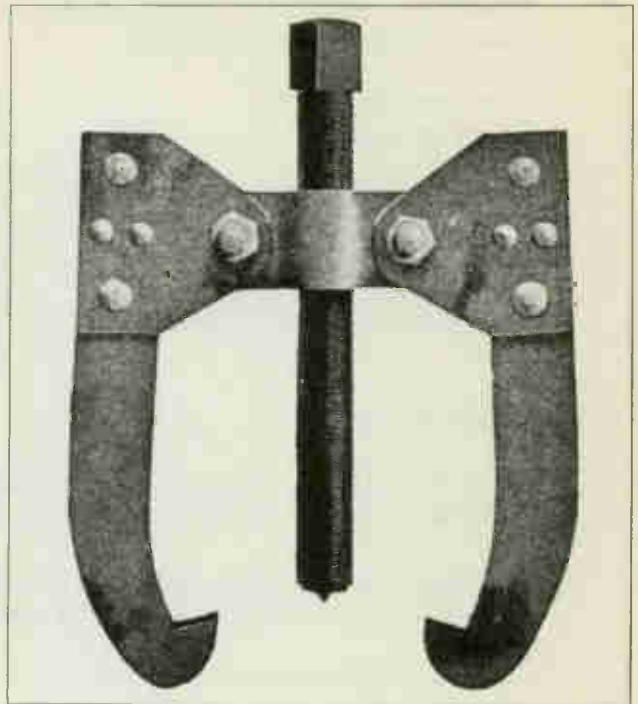

Fig. 9 Gear puller

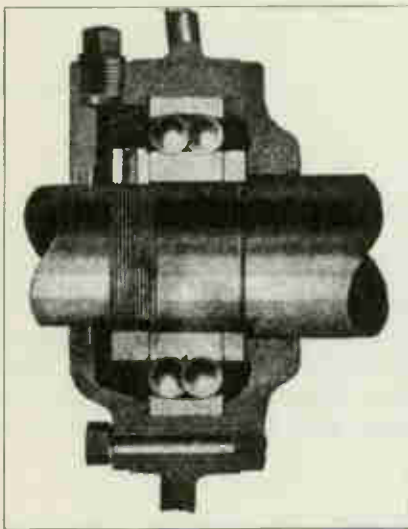

Fig. 10 - A double-row ball bearing unit

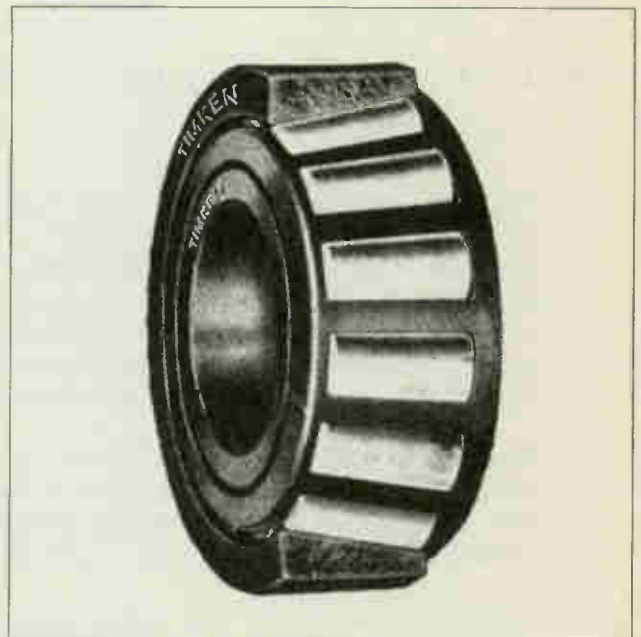

Fig. 11 - Timken tapered roller bearing

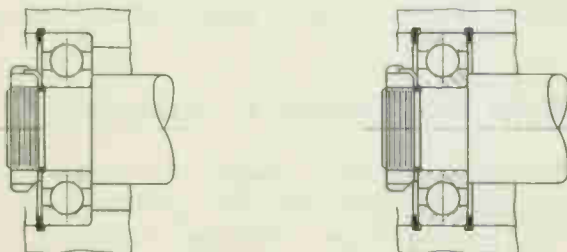

Fig. 12 Snap ring holder.

NEVER ALLOW THE MACHINE TO STOP until the bearing has been cooled. It can be cooled by applying a heavy grade of oil to the bearing while machine is still running.

#### 4. Maintenance

The inspection periods will vary to such an extent it is advisable to follow the manufacturers service specifications. Some bearings need not be drained and cleaned for six months intervals, others bi-weekly and a daily inspection on most important bearings.

Items to check.

- a. Air gap - air gap gages are used. The air gap should be within 10% as measured under like poles. Should be checked weekly on motors operating on excessive belt tension.
- b. Check for oil on windings.
- c. Check for oil splash on the floor below the machine.
- d. Check for excessive shaft play.
- e. Oil filler gages should be at about 1/8 of an inch from top, Fig. 7.
- f. Lubricants and all auxiliaries must be kept clean.
- g. Use good grades of lubricants. For sleeve bearings, oil is usually used, mineral oil. Its viscosity should be approximately 200 sec. SAYbolt @ 100°F. This is a grade about like SAE 10, however, a good grade of turbine oil rather than automotive oil is advised. Wherever high temperatures are encountered or heavy belt pull, use a heavier oil.
- h. Do not over-lubricate bearings.
- i. Check the condition of the oil well covers and drain plugs.

#### 4. Installation

The installation procedure for sleeve bearings is covered on the job procedure sheet at the end of this lesson. The line reamers are used to increase the bore in the bearing after it has been pressed or pulled into the bearing bracket and to keep the bearings "lined up". This is necessary in all small motors because of the very small air gap.

NOTE: Never expand a reamer while it is in the bearing.  
Never turn a reamer counter-clockwise.

#### 5. Tools and equipment

The tools and equipment necessary will naturally be dependent upon the size of motors to be handled and the number of motors handled. You can buy bushings in quantity and stock them, for the small-power machines. If the shop has a lathe it is advisable to purchase bar bronze for larger bearings. Below is a list of



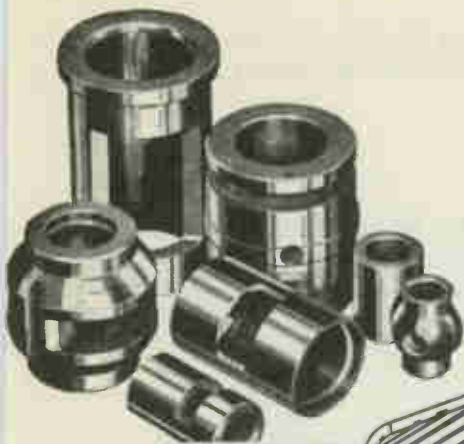

Fig. 1



Fig. 2

GRAPHITE  
BRONZE

Fig. 3

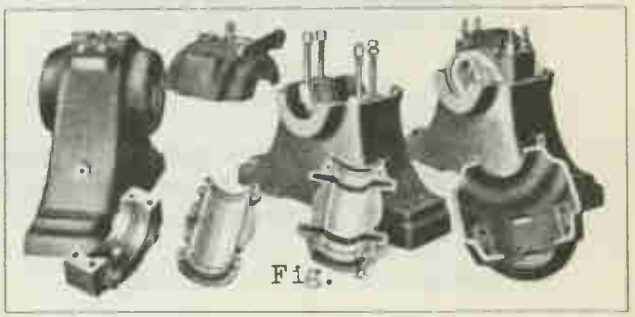
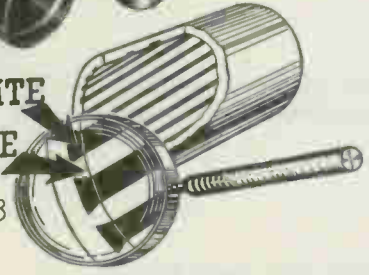

Fig. 4

Graphite Held Permanently in Place

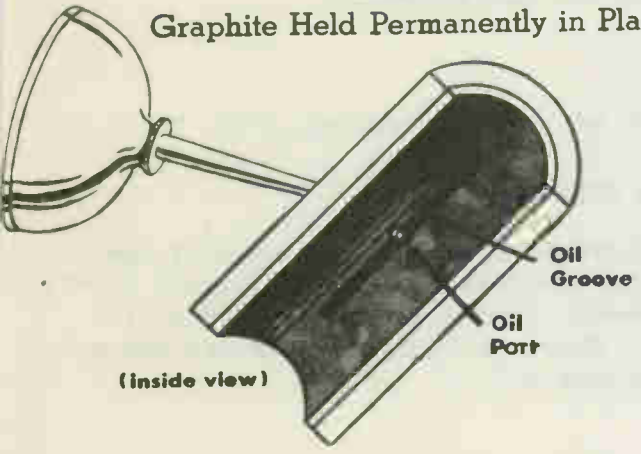

Fig. 5 - Top half sleeve bearing

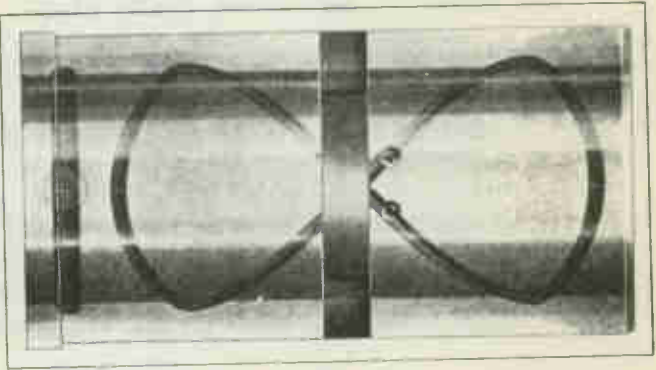

Fig. 6.

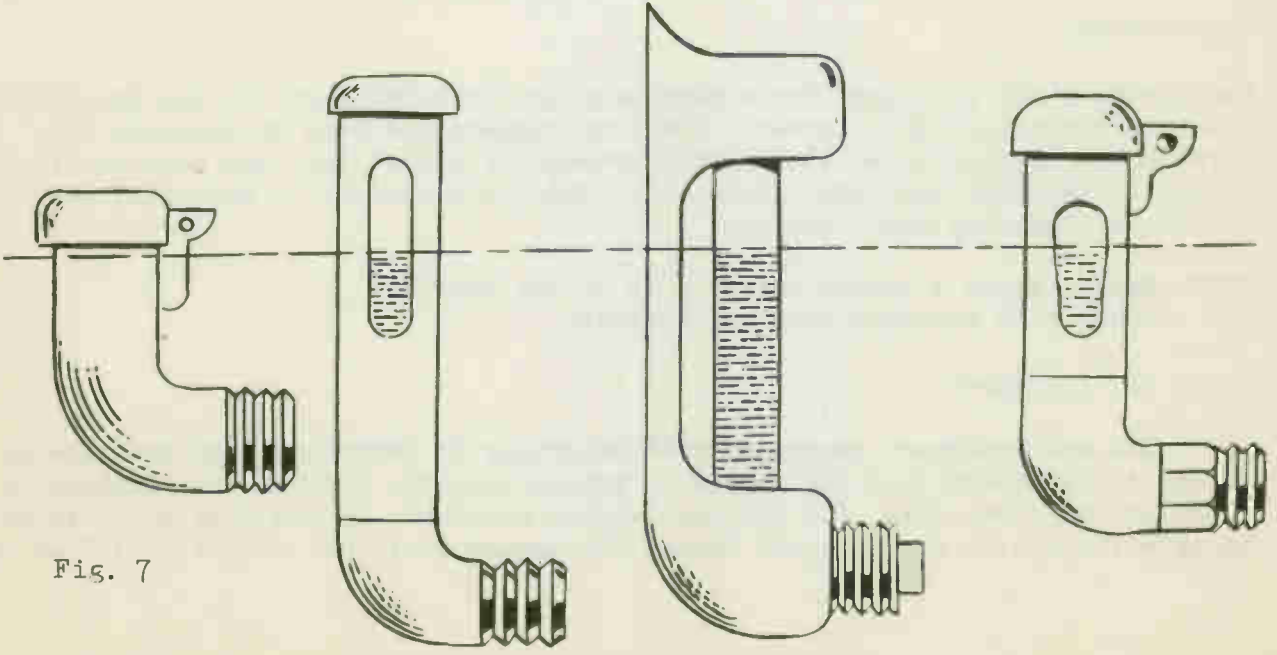

Fig. 7

- b. Lead-base babbitt, used for general industrial applications. The alloy consists of lead, 75%; tin, about 12.5% and antimony, about 12.5%.

## 2. Bronze bearings

Bronze is an alloy which consists of copper, tin and lead, the percentages of each being a little different for the different applications. General purpose bronze bearings consist of approximately - copper 80%; tin 10%; and lead 10%. The cost of bronze bearings for general purpose applications will vary from 13¢ each to \$12.00 each. The price not only depends on size but also on quantity ordered. You can also buy bar bronze to enable you to cut your own bearings. Other types of bearings, other than general purpose bearings are:

- a. Flanged bearings, single or double, Fig. 2, used where end thrust is a factor or where the flange locates or anchors the bearing.
- b. Cast bronze graphited bearings, Fig. 3 are used where lubrication is difficult or where lubricants might damage goods being processed. The graphite is imbedded in grooves cut in the inside of the bearing, however, the bearing is not used in applications where the shaft will exceed a peripheral speed of thirty feet per minute.
- c. Self-lubricating bearings, usually a sintered alloy, are not recommended where there is impact or shock. They are a porous alloy and will hold up to 35% of oil, by volume.

Sleeve bearings are made in both the solid and split sleeve types, Fig. 4. In either case the bearings form a sleeve with a very smooth inside surface in which the shaft rotates on a thin film of oil.

The inner surfaces of sleeve bearings are usually provided with oil grooves to allow the oil to flow more freely to all parts of the bearing sleeves, Fig. 6.

## 3. Troubles (Over heated bearings)

- a. Tight bearings.
- b. End shields out of alignment.
- c. Bent shaft.
- d. Dirt.
- e. Insufficient oil.
- f. Bearing up-side-down.
- g. Excessive belt tension.
- h. Rough shaft.
- i. Mis-aligned gears.
- j. Motor not level.
- k. Too heavy oil.
- l. Bad oil rings, bent, or flat spot.
- m. Hot commutators, heat transfer.

A frozen bearing is a bearing which has become stuck or locked due to overheating. When a bearing becomes overheated, beyond a certain point, a thin layer of bearing metal surface becomes soft and partly molten. If the shaft stops turning when the bearing is in this condition, the bearing will cool and grip the shaft very tightly, usually making it impossible to start the machine again.

## BEARINGS

Objective

Instruction pertaining to types of bearings and their construction. A procedure for reaming bearings of small power motors.

References

---

---

Lesson Contents

## A. General

1. The purpose of any bearing or bushing:
  - a. To center the rotating member properly and allow it to rotate freely.
  - b. To withstand load imposed on it, as long as machine is used properly.
2. To enable the machine to operate quietly, develop adequate torque at desired power factor and efficiency, and not exceed temperature rise, requires a reasonably even air gap. This, of course, is dependent on the quality and type of bearing.
3. Any motor shop must give service on bearings.
4. The maintenance and replacement of bearings is one of the most important phases of motor and generator maintenance.

In the study of bearings we shall classify them into two types.

- a. Sleeve bearings.
  - b. Ball and Roller bearings.
- 
- 

## B. Sleeve Bearings - Babbitt and Bronze, Fig. 1.

## 1. Babbitt bearings.

Babbitt is an alloy, made in two general types:

- a. Tin-base babbitt, used in bearings subject to high speeds, severe vibration heavy shock or impact loads. The alloy is made of tin, 89%, copper, about 4% and antimony, about 7%.





APPLICATIONS - This motor is widely used in fractional H.P. sizes for fans, vacuum cleaners, kitchen mixers, milk shakers, and portable equipment of all types such as electric drills, hammers, sanders, saws, etc. Higher ratings are employed in traction work, and for cranes, hoists, and so on. In general, they are suitable for applications where high starting torque or universal operation is desired.

PRINCIPAL TROUBLES - Commutator, brushes, brush holders, bearings. Opens, shorts, or grounds in the armature, field, or associated apparatus. Loose connections. To reverse the direction of rotation, reverse the armature connections or the field connections but not both.

#### G. Summary Questions

1. How would you describe a universal motor?
2. Why is a universal motor recommended for use on vacuum cleaners?
3. What is a concentrated winding?
4. If you were testing the dielectric strength of the insulation would you apply DC or would you apply AC? Of what value?
5. Name five applications of the universal motor.
6. What is a compensating winding and why is it used?
7. For what speeds are Universal motors usually designed?
8. What do you think would be the most common trouble? Why?
9. What is one outstanding procedure in the assembly of a ball-bearing motor?
10. How would you check the field windings for defects?

UNIVERSAL SERIES MOTOR

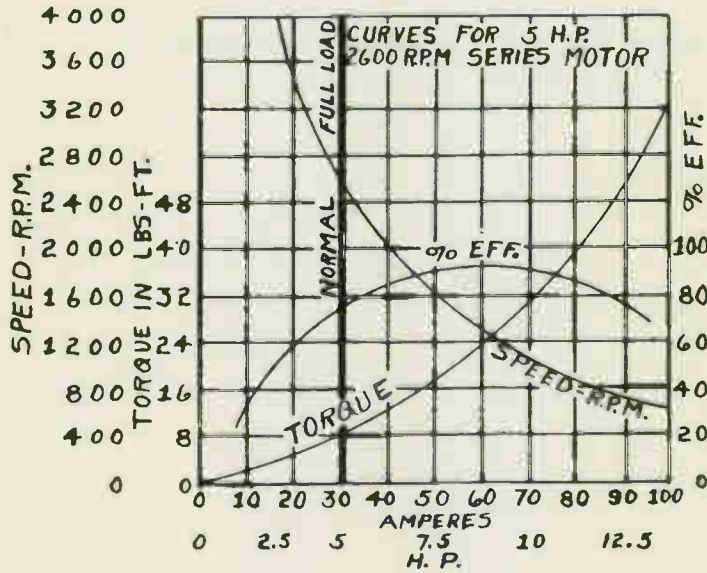
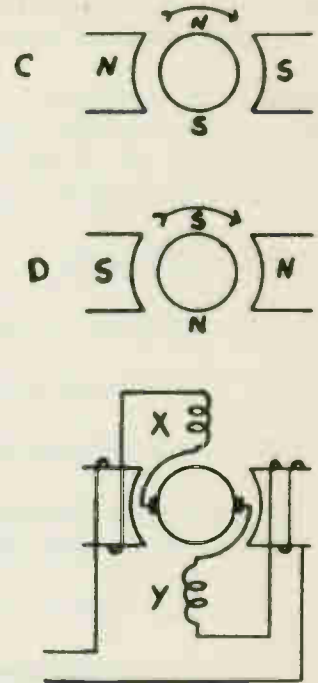
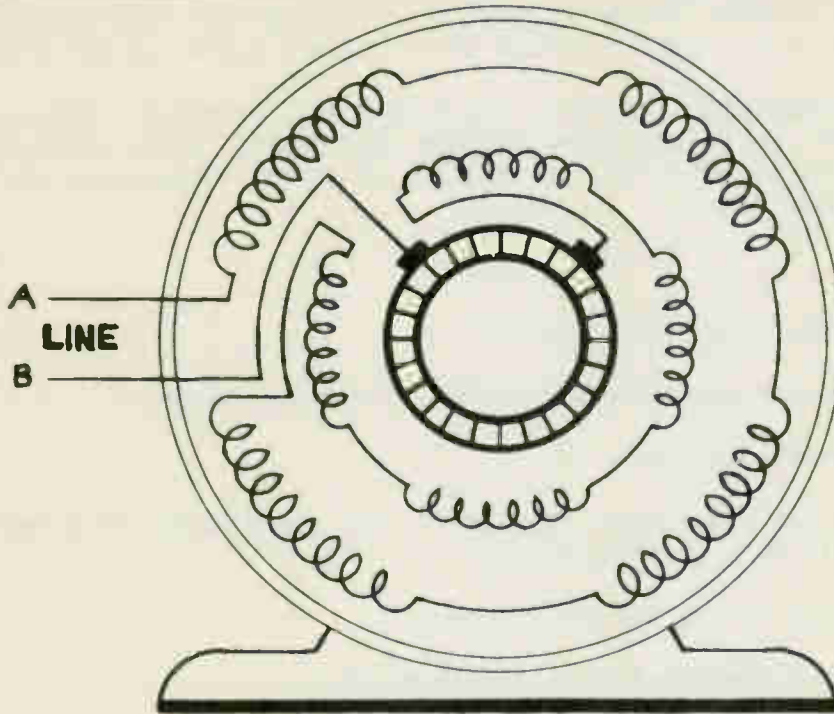

Brush carbon can be purchased in standard blocks 4" x 9" and any desired thickness. The capacity of carbon varies from 40 ampere to 125 amperes per square inch of brush surface on the commutator. Usually a 60 ampere carbon brush will meet the average requirements. Several blocks, varying in thickness from  $\frac{1}{4}$ " for small machines to  $\frac{1}{2}$ " for large machines, should be kept in stock.

To make a brush, take a hack saw and cut a piece of brush material that is slightly larger than the brush being replaced. Use brush stock that is the same thickness as the old brush. Next place a piece of sand paper (000) on a flat surface and sand the brush to the exact dimension of the old brush, except making it the proper length, Fig. 1.

To prepare the brush for the brush shunt, (pig-tail) drill a  $\frac{1}{4}$ " hole in the side of the brush as shown in sketch. The depth of this hole should be equal to three-fourths the thickness of the brush. Another hole as shown by the dotted lines in Fig. 1, should be drilled from the top of the brush, and at an angle until it meets the first hole. This hole should be about the same size as the brush shunt used, so a snug fit will be obtained when the shunt is put in place.

The brush shunt must be cemented in place. For this purpose a cement made of powdered copper and mercury should be used. To make the cement, put the powdered copper in a glass container. The amount of powdered copper to use will be governed by the amount of cement needed. Cover the powdered copper with muriatic acid and stir the mixture thoroughly. To cleanse the copper pour off the acide and cover the remaining copper with warm water and again stir to stop the action of the acid. Next thoroughly dry the copper and mix it with mercury to form a thick paste.

Tamp the cement in place by using a small tamper and light mallet. Be very careful not to crack the carbon when tamping the cement. A good electrical connection will be made, as the cement will adhere to the brush shunt and carbon brush. A spade lug should be soldered on the end of the shunt.

#### F. Universal Series Motor

The universal series motor operates on the magnetic interaction between the armature and field poles, and runs in the same direction whether the current flows in on line A or line B, since reversing the flow of current in the line wires changes the polarity of both armature and field poles at the same instant as shown at C and D. Therefore, if such a motor be supplied with AC the torque developed will always be in the same direction. Since this machine operates on both DC and AC it is called a Universal motor. To operate satisfactorily on AC all parts of the magnetic circuit must be laminated to prevent undue heating from eddy currents, and element windings are usually desirable on the armature to ensure acceptable, commutation. On the larger motors compensating windings are employed to improve operation and reduce sparking.

**CHARACTERISTICS** - This motor will produce about 4 times normal torque with 2 times normal full load current. The torque produced increases very rapidly with an increase in current as the curves below indicate. The variation in speed from no load to full load is so great that complete removal of load is dangerous in all motors of this type except those having fractional H.P. ratings.



In general, the higher the speed; (A) the harder the brush (B) the higher contact drop, (C) the less abrasiveness, (D) the lower the coefficient of friction and (E) specific resistance will vary from medium to low.

Hardness is measured with an instrument called a "sceleroscope".

SCELORSCOPE READING

UP TO	
15	very soft brush
30	soft brush
45	medium brush
60	hard brush
above 60	very hard brush

NOTE: A sceleroscope rating of about 105 equals the hardness of commercial steel and one of about 20 equals the hardness of commercial brass.

Abrasiveness is not the same as hardness. A highly abrasive brush will not cause undue wear on the commutator of any machine under almost all ordinary conditions.

The grade of mica used in the commutator must be carefully checked.

Contact drop is the drop in voltage between the brush face and the surface on which it bears.

Very low .....	less than	.5
Low .....	up to	.7
Medium .....	up to	.9
High .....	up to	1.1
Very high .....	above	1.1

The coefficient of friction will usually be classed as very low, low medium, high, or very high. The brush pressure might be 1.25 pounds per square inch.

Average brush equals about 2 to 2.5 pounds per square inch.

Up to 2.5 pounds per square inch .....stationary motors

From 3 to 5 pounds per square inch .....crane motors

From 4 to 8 pounds per square inch .....railway motors

### 3. Replacing brushes

The manufacturers of motors and generators make many tests on any one type of machine before deciding on the brush which will be used.

Remembering the various characteristics which were listed in section #2 of this lesson and in view of the above statement, it is best to use the brush specified by the manufacturer.

Many times it is necessary to install a brush without the aid of a manufacturer or his data.

If the electrician has brush stock, and understands how to do the work, only a few minutes are required to make a brush that will give satisfactory results.

## E. Brushes

## 1. Standards

Complete standard specifications are given in Nema, Carbon, Graphite, and Metal-Graphite Brush Standards.

This publication may be obtained from the National Electrical Manufacturers Association, 155 East 44th Street, New York City, New York.

## 2. Brush characteristics

Those characteristics of a brush which would affect brush selection are:

- a. Specific resistance
- b. Carrying capacity
- c. Peripheral speed limitations
- d. Hardness
- e. Abrasiveness
- f. Contact Drop
- g. Coefficient of friction
- h. Pressure requirements

The specific resistance varies from about .0020 of an ohm to  $6 \times 10^{-6}$  of an ohm. It is the resistance of an inch cube. This characteristic is important in-so-far as brush voltage drop and watt loss is concerned.

Carrying capacity is the capacity for carrying current, measured in amperes, per square inch of cross-sectional area without the temperature rise exceeding 50° Centigrade. (The brush pressure would affect above rating).

For d-c machines the area of brush necessary, in square inches, equals the total current of the machine, divided by the product of brush width, brush thickness, and one-half the number of brushes.

For slip-rings the area of the brush necessary equals: Total current per ring, divided by the product of brush width, brush thickness and total brushes per ring.

The maximum peripheral speed of the commutator on which a certain grade of brush should be used is usually listed by the manufacturer.

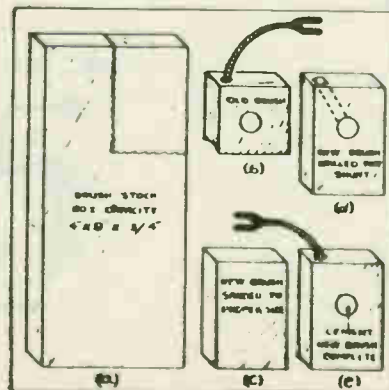

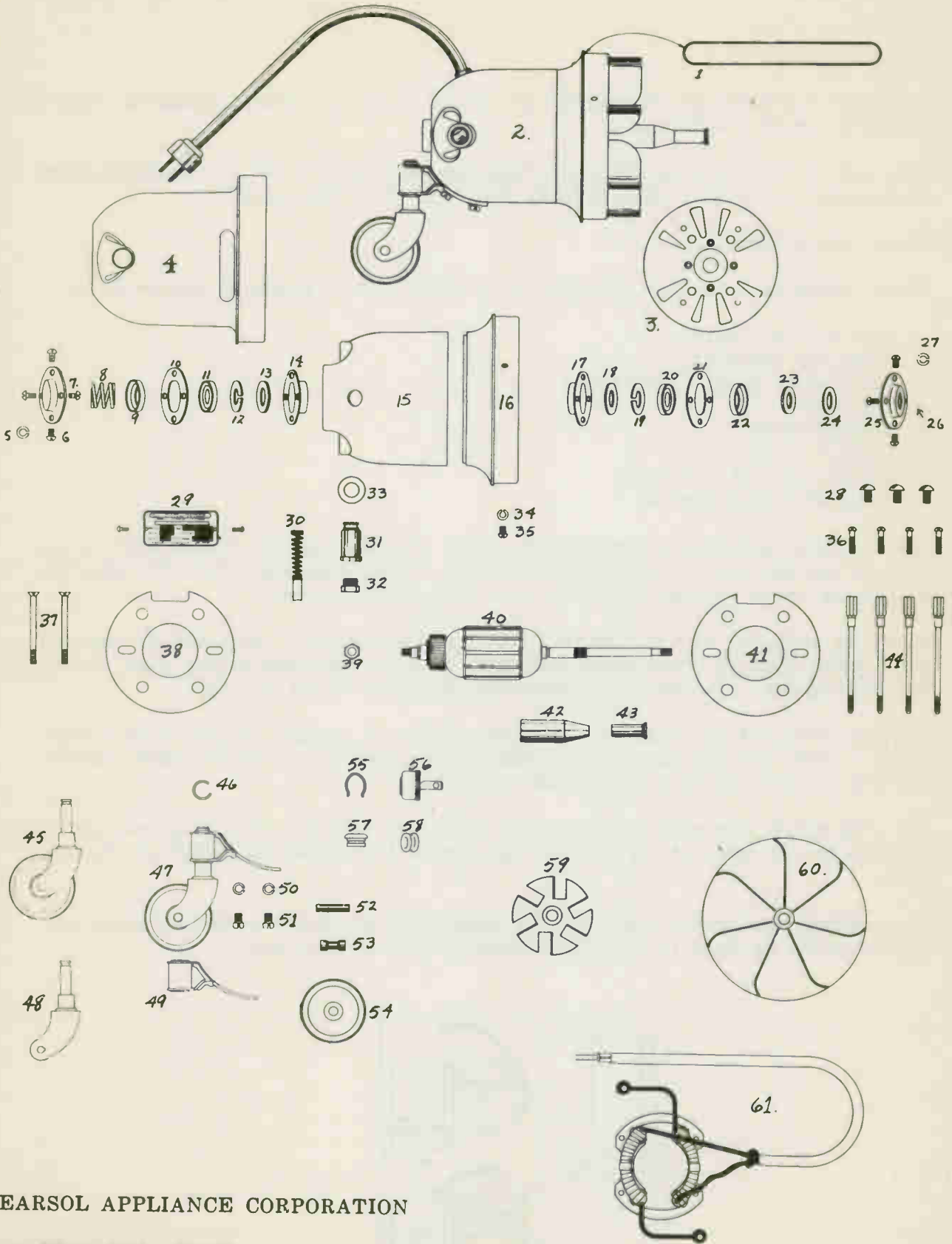

MODEL 99 MOTOR GROUP

PEARSOL APPLIANCE CORPORATION

MODEL 99

Fig. 9

## Disassembly

Unscrew the fan pulley and fan. (These units usually have left-hand threads). Place the fan end of shaft in hole in bench. This will allow bearing on the commutator end to be upright.

Remove the screws holding the cap down.

Remove in order, cap, spring, and cup.

Lift motor and push up armature. This will raise the bearing assembly above the motor housing.

Press the bearing cup down off bearings.

Pull the bearing out by hand. (Do not force - pull straight).

Pull out ball race or cage, it will spring over inner race.

CAUTION: When reassembling the motor do not reverse the facing of the outer race. The wide side must face toward the outside, Fig. 6.

## 5. Brush assembly.

a. New carbon brushes and springs are recommended for every job. Seat the new brushes properly. A small spark, when the motor is operating, is not harmful.

b. Check the carbon-brush "holders" very carefully. Check for grounds by using a 110 volt a-c test lamp.

## D. Vacuum Cleaner Parts List.

- |                             |                                 |
|-----------------------------|---------------------------------|
| 1. Rubber band dust seal    | 31. Carbon brush holder         |
| 2. Assembled motor          | 32. Insulated screw cap         |
| 3. Motor base plate         | 33. Insulating washer           |
| 4. Motor cap                | 34. Lock washers                |
| 5. Lock washers             | 35. Bottom screws               |
| 6. Screws                   | 36. Base screws                 |
| 7. Spring housing           | 37. Baffle plate screws         |
| 8. Spring                   | 38. Baffle plate                |
| 9. Spacing cup              | 39. Hex nut                     |
| 10. Bearing cup gasket      | 40. Armature                    |
| 11. Ball bearing            | 41. Insulator                   |
| 12. Washer                  | 42. Shaft sleeve                |
| 13. Felt washer             | 43. Pulley                      |
| 14. Bearing cup             | 44. Field studs                 |
| 15. Motor housing           | 45. Caster fork assembly        |
| 16. Motor base              | 46. Locking ring                |
| 17. Bearing cup             | 47. Swivel caster               |
| 18. Felt washer             | 48. Caster fork section         |
| 19. Washer                  | 49. Caster bracket              |
| 20. Bearing                 | 50. Lock washers                |
| 21. Bearing cup             | 51. Caster stud                 |
| 22. Spacing cup             | 52. Caster shaft                |
| 23. Filler                  | 53. Rear wheel axle             |
| 24. Felt washer             | 54. Side wheels                 |
| 25. Bearing cover           | 55. Cord bushing spring         |
| 26. Screws                  | 56. Male plug                   |
| 27. Lock washers            | 57. Fibre bushing               |
| 28. Motor base screws       | 58. Rubber bushing              |
| 29. Name plate              | 59. Ventilating fan             |
| 30. Carbon brush and spring | 60. Suction fan.                |
|                             | 61. Field with contact springs. |

---

---

---

### C. Motor Check

1. Disassembly procedure has been given, however, before disassembling, check bearings for:

- a. End play.
- b. Side play.

2. Check armature for:

- a. Grounds; 110 volt a-c test lamp.
- b. Shorts' growler and hack-saw blade.
- c. Open; growler and millivoltmeter
- d. Condition of the commutator and shaft.
- e. Condition of insulation

3. Checking field coils for:

- a. Grounds; 110 volt a-c test lamp.
- b. Open; 110 volt a-c test lamp or d-c source with voltmeter in series.
- c. Shorts, place jumper between two brush holders and apply six volt d-c to motor terminals. Take voltage reading across each coil, Fig. 7.
- d. Check insulation
- e. Always replace field coils in sets.

4. Checking bearings.

a. Sleeve bearings

Babbitt or bronze.

Check for "rattle" when motor is started and stopped.

Side play which can be felt indicates poor bearings.

It is best to "press" bearings.

They may be pounded out. Take care to support housing around bearing.

Use pilot arbors. See Fig. 8

Check oil holes or grooves.

Use line reamers

A motor is in good shape if it will run, or coast, for some time after current is turned off.

After reassembling a motor, allow it to run a while without the fan and while running, tap the housing several times with a soft faced mallet. This gives bearings a better chance to align themselves properly.

Check oil wick carefully.

b. Ball bearings.

NOTE: See Figs. 6 & 9 for ball bearing assembly.

You must watch the order of ball bearing assemblies. The above mentioned diagrams will apply in 90% of the machines. Others may have a single piece grease seal bearing.

light it is an indication of an open circuit.

- a. Check the carbon brushes to determine whether or not they are stuck.
  - b. Shake the cord. If light flickers the cord is defective. It is possible to locate an open in the cord. It is good practice to replace the old cord with a new one.
6. If none of the above indications are present, disconnect the motor from the cord and twist the two ends of the cord together. This will determine if the trouble is in the cord and switch assembly.
7. Plug the test leads into receptacle 2. Clip the alligator clips on the motor terminals and check the carbon brushes to make sure that they are making good contact.
- a. The lamp will light unless there is an open in one of the field coils or from the motor terminal to the field coils.
  - b. Of course a "high-resistance connection" might not allow enough current to light the lamp.
  - c. An open in the armature would not prevent the lamp from lighting
8. If the lamp does light, in above test, you can then check the armature for an "open". Turn fan slowly and watch the lamp. If the flickering is unsteady, rotate armature a little slower. If you find a place where you can stop, and the light stays out there is likely to be an open in the armature.
9. If, after the above points have been checked, you have found no trouble, plug the motor into receptacle 1. If the motor runs indications of trouble are likely to be as follows:
- a. Ring of fire around commutator
  - b. Excessive sparking
  - c. Noise
  - d. Incorrect speed.
10. Check the end play of the motor.
11. Check the side play of shaft.
12. If necessary, disassemble the motor.
- a. On some fans, take off the front nozzle and remove the fan. On others, the motor housing is removed from the fan case without first taking the fan off.
  - b. Remove the carbon brushes and springs.
  - c. In the space behind the fan you will find either nuts or screws which permit the end plate to be taken off and the motor to be completely taken down.
- Exception: Ball bearing motors. The ball bearing screw must be removed and the outer bearing race removed before the end plate can be taken off the motor. WATCH ORDER OF PARTS WHEN WORKING ON BALL BEARING MOTORS. See motor check Fig. 6 & 9.
13. Check fan and fan case assembly, belt and brush.



Fig. 5

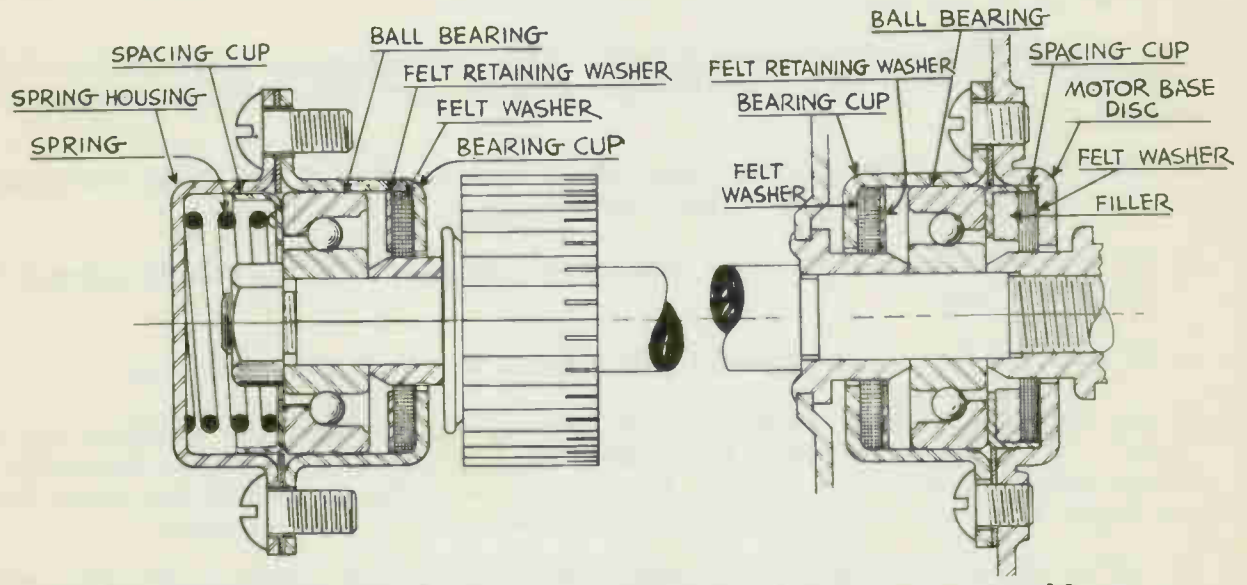

Fig. 6 - Commutator and bearing assembly - Fan end bearing assembly

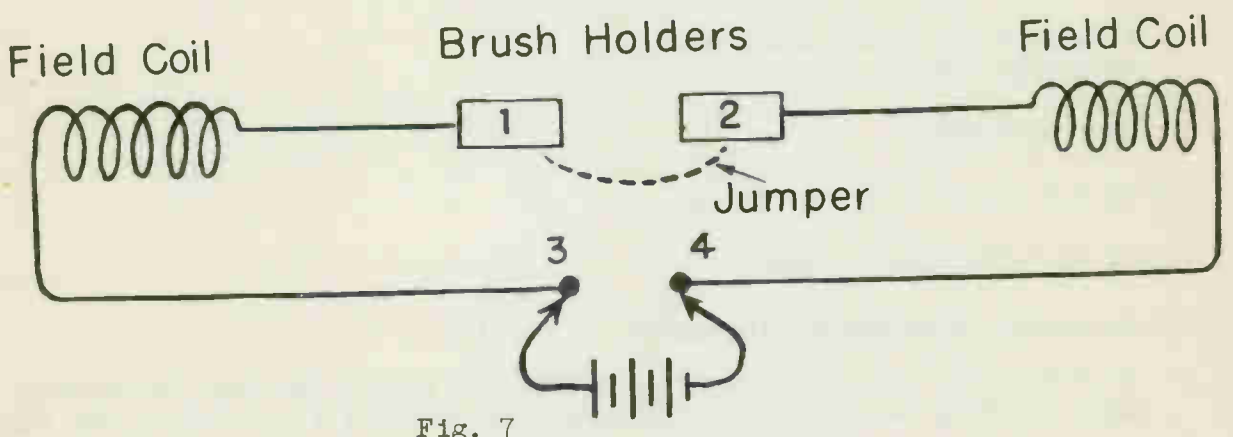

Fig. 7

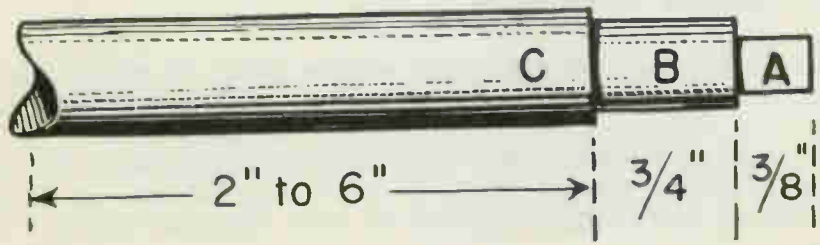

Fig. 8

four times the normal full load torque, at two times the full load current. the variation in speed from full load to no load is so great that complete removal of the load is dangerous except motors having small power ratings. Universal motors are usually designed for speeds above synchronous speed. (5,000 10,000 RPM).

b. Non-compensated Universal motors, Fig. 2.

These motors are used for higher speeds, they are less expensive, and they have greater variation in speed when changing from AC to DC. They are simpler in construction and are usually supplied only in lower horsepower ratings.

The field windings are concentrated on salient poles.

The armature is wound like any other d-c motor.

Commutation is poorer on a-c than d-c due to induced voltage from the a-c field, in the short circuited coil.

c. Compensated, distributed field, Fig. 3.

The compensated winding may consist of two separate windings or only one winding which is the equivalent of the two windings. It is used to improve operation and reduce sparking at brushes.

Field windings are distributed in a stator frame, the same type of punching that is used on induction motors.

The armature is wound the same as any other d-c motor.

Commutation is improved over that of a non-compensated motor.

B. Checking and Disassembling the Cleaner.

1. Have a clear workbench with room for laying out parts as the vacuum cleaner is disassembled.
2. Open the front case coupling outlet for access to the fan. Check to make sure that the fan will turn freely. This check is to determine whether or not the bearings are frozen.
3. Make a test circuit like the one shown in Fig. 4 and a set of test leads as shown in Fig. 5.
4. Assuming the bearings are not frozen, plug the cleaner into receptacle 2. Have vacuum cleaner switch in the "off" position. If the bulb lights there is a short somewhere in the cleaner. The short is likely to be in the cord, switch, or leads to motor.
5. If the bulb does not light, turn on the cleaner switch. Then if bulb does not



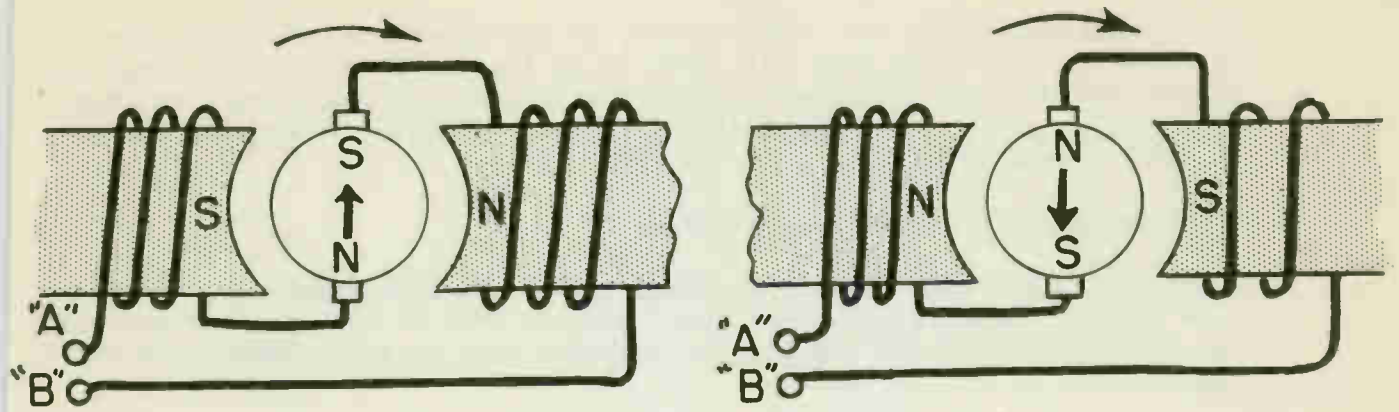

Fig. 1

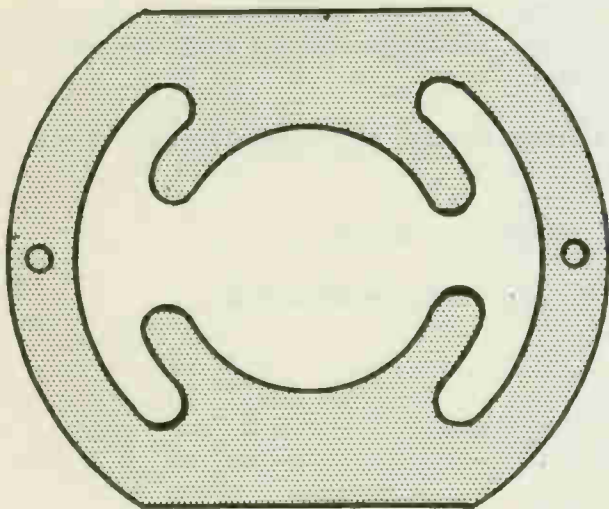

Fig. 2

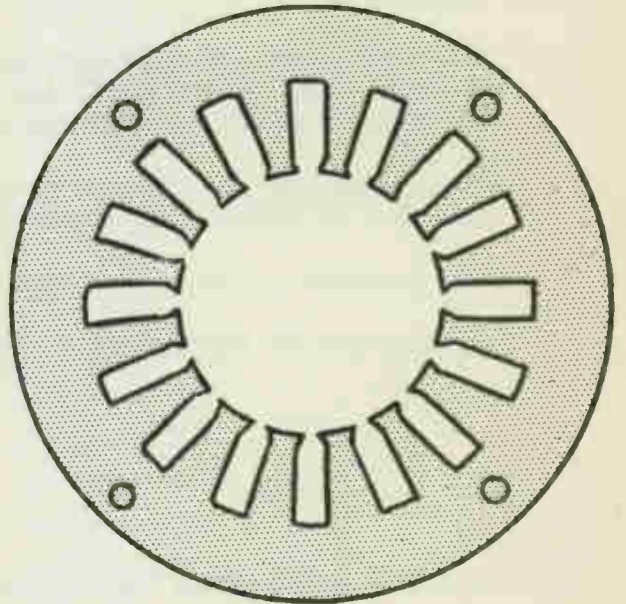

Fig. 3.

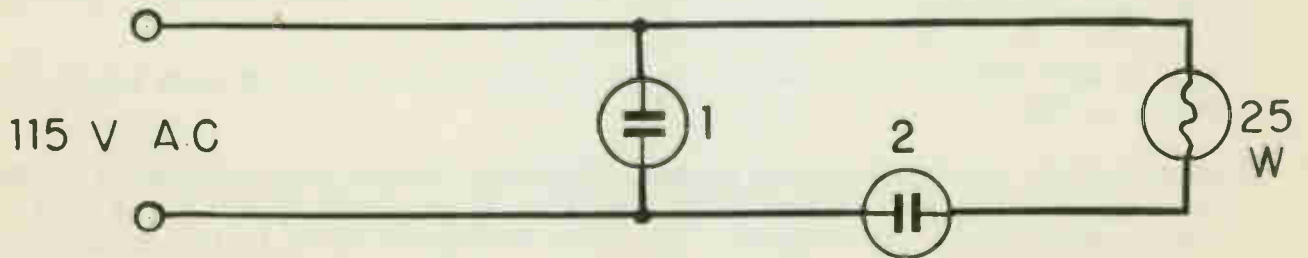

Fig. 4

## VACUUM CLEANER MOTORS

Objective

1. To obtain general service information on vacuum cleaners.
2. To become acquainted with the construction and characteristics of universal motors.

References

---

Lesson Content

## A. Universal Motor

## 1. Definition

A universal motor is either series-wound, or a compensated series-wound. It may be operated at approximately the same speed and output, either on direct current or single-phase alternating current. These conditions will be met when the d-c and a-c voltages are approximately the same and the frequency of the AC is not greater than 60 cycles per second.

## 2. Classification

- a. Plain series - a varying speed motor with concentrated poles.
- b. Compensated series - a varying speed motor with distributed windings.

## 3. Ratings

- a. Voltages are 115 or 230 volts DC or AC
- b. AC frequency up to sixty cycles per second.

## 4. Application

In addition to its use on vacuum cleaners, the universal motor is widely used in food mixers, adding machines, fans, drills, sewing machines etc.

Universal motors are designed for continuous ratings up to one horsepower. Above one horsepower they are usually designed for intermittent service.

## 5. Construction and operation

## a. General

The motor operates on either DC or AC and runs in the same direction in either case. This can be easily understood by referring to Fig. 1. Whether the current flows in on line "A" or line "B" the direction of rotation will be the same. Therefore, such a motor may be supplied with AC. To operate satisfactorily on AC all parts of the magnetic circuit must be laminated to prevent undue heating from eddy currents. These motors when starting will develop about

the poles on the rotor being produced by magnetic induction from the stator. Turning at synchronous speed, the rotor is polarized and is in the position shown when the stator current is maximum. As the current diminishes, momentum carries the rotor to the vertical position just as the main poles reverse and, as the hard steel rotor still retains its poles, it is again attracted to the horizontal position and rotation continues. Shading coils are employed to make the unit self starting. Speed is determined by frequency; if frequency is constant, speed will not vary.

2. **SUBSYNCHRONOUS CLOCK MOTOR** - Consists of a 2 pole stator and an iron rotor with 16 or more salient poles. The motor is not self starting, but when operating at synchronous speed, 2 diametrically opposite poles are attracted to the field poles as the flux of the field is increasing. Because of the inertia of the rotor, it continues to rotate while the flux is decreasing and passing through zero. The next pair of poles is then attracted by the field flux as it increases in the opposite direction. Although the stator has only 2 poles, the speed of the motor is the same as that of a motor having the same number of stator and rotor poles. **EXAMPLE** - At 60 cycles the speed is 450 R.P.M. corresponding to the 16 rotor poles. Because the rotor speed is much less than that corresponding to the 2 stator poles, the motor is said to operate at **SUBSYNCHRONOUS** speed.
3. **SELF-STARTING INDUCTION-REACTION SUBSYNCHRONOUS MOTOR** - This motor is a 2 pole, single phase, combination induction and synchronous motor with a shaded pole field and a squirrel cage rotor. In this particular motor there are 6 rotor slots, so proportioned that they produce 6 salient poles on the rotor which give the synchronous (or reaction) motor effect. **AT STARTING**, the induction motor torque must be sufficient to overcome the tendency of the salient poles of the rotor to lock in with the stator poles. The motor operates as any induction motor, the rotor tending to accelerate to nearly synchronous speed. **EXAMPLE** - At 60 cycles, the induction motor torque tends to accelerate the rotor nearly to the 2 pole synchronous speed of 3600 R.P.M. The motor is so proportioned that at 1200 R.P.M., the 6 pole synchronous speed, the reaction torque due to the pulsating stator pole flux reacting with the 6 rotor poles, predominates over the induction motor torque developed at that speed. The rotor, therefore, locks in with the stator poles and runs synchronously at 1200 R.P.M. At its operating subsynchronous speed, the motor develops simultaneously induction motor and synchronous motor torque. This type is used chiefly with timing devices.





2. It is possible to change the speed on either the L or T types of connections by varying the number of turns in the intermediate winding or changing the capacitor for one of a different rating.

Increasing the micro-farads will increase speed and vice-versa.

Check operation carefully on any of the above changes.

#### M. Repulsion-start Induction Changes.

1. Voltage changes and torque changes.

Same rules as applied to split-phase.

2. Frequency changes.

Check "short circuit switch" if changes from 50-60 or 60-50 cycles are attempted. Performance (torques) will be affected.

No other changes advisable.

3. Pole Changes

Do not attempt pole changes. This would involve changing armature, etc.

#### N. Small Synchronous Motors.

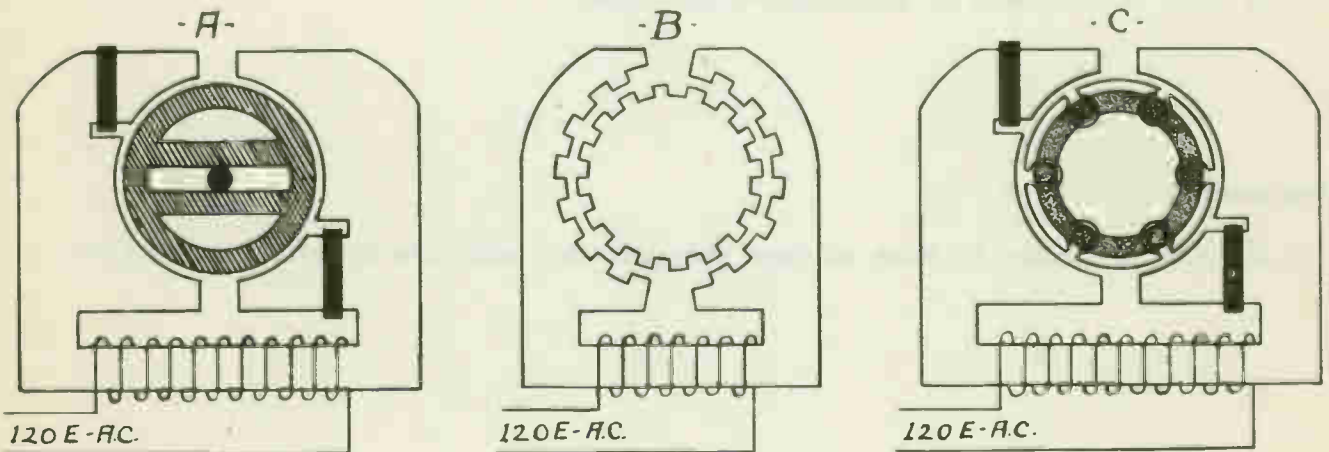

1. Due to their constant speed characteristics, small synchronous motors are widely used in stroboscopes, mechanical rectifiers, electric clocks, recording devices, timing relays, demand meters, etc. These small motors operate similarly to the large power types except that the small units are not separately excited,

In any case the capacitor should have a voltage rating equal to the voltage applied to the start winding and

$$\frac{C_n}{C_o} = \frac{E_o^2}{E_n^2}$$

Where:  $C_n$  equals the new value of capacitance in micro-farads  
 $C_o$  equals original value of capacitance in micro-farads  
 $E_o$  equals original voltage  
 $E_n$  equals new voltage

2. Torque changes - torque changes are not practical
3. Frequency changes - Frequency changes are not practical

A capacitor-start motor may be used as a split-phase motor. The starting torque will not be nearly as great; however, it will be sufficient for starting a load which does not demand a high starting torque.

#### J. Two-value Capacitor Motor

##### 1. Voltage changes

About the only opportunity would be to change the main winding only, and, make use of the swing connection. Remember each section of the main winding must be designed for one-half applied voltage. Watch cross-sectional area of copper. Any other changes on this type of motor are not practical except when changing it to a split-phase or capacitor-start type.

#### K. Permanent-split Type

It is only advisable to make voltage changes. May make use of swing connection.

#### L. Two-speed Winding

##### 1. L-connection, voltage change.

Vary the number of turns in the main and intermediate windings, leave the auxiliary the same and change to T-connection.

Many motors, however, are so designed that there cannot be much torque change. It is advisable to run the motor and gradually increase the voltage until the desired torque is obtained. Do not increase the voltage to a value that will cause the motor temperature to rise above a safe value for the motor.

The motor should be operated for a period of time which will allow the temperature rise to reach a steady value.

The break-down torque will vary inversely with the square of the turns in the main winding.

$$\frac{T_o}{T_n} = \frac{t_{mn}^2}{t_{mo}^2}$$

Where:  $t_{mn}$  equals new number of turns in main winding.  
 $t_{mo}$  equals original turns in main winding.

If the number of turns in the main winding are decreased you should increase the CM area.

If a change to a lower torque is to be attempted the procedures given above should be followed.

For additional information, refer to the procedure developed in Job No. 8.

#### H. Frequency Changes

1. The procedure given on the three-phase motors may be followed.
2. Keep in mind that most motors will withstand a variation in frequency of 10%, consequently it is not necessary to make any changes in the winding when a 50 cycle motor is used on 60 cycles.
3. A change from 60 to 50 cycles, however, may require an increase in the number of turns by about 10%. The increase in the number of turns may be necessary in order to prevent overheating.

Check starting switch.

A 25 to 60 cycle frequency change is about maximum.

#### I. Capacitor-start

##### 1. Voltage changes

Use the relations given for the split-phase motor, lesson No. 9T.

**CAUTION:** If a start winding is changed for double its original voltage, the capacitor must be changed also. Its voltage rating should be doubled and its capacitance in micro-farads should be changed to one-half the original value.

The swing connection, as previously explained, could also be used. With this arrangement the same capacitor could be used.



## F. Voltage Changes

1. Reconnecting for lower voltage. - If the auxiliary winding and the main winding were originally series, they may be reconnected parallel.

If the motor is series connected in both windings, it is impossible to reconnect it for a higher voltage. You would have to rewind the motor.

If both windings of the motor are parallel connected, they may be reconnected series.

If the main winding is connected parallel and the auxiliary winding is series, connect the main winding series and rewind the auxiliary winding.

Check the limitations of starting switch (Centrifugal, etc.).

2. Rewinding for different voltages - The voltage rating will vary directly with the number of turns in series.

$$\frac{E_o}{E_n} = \frac{t_o}{t_n}$$

When this equation is applied it must be remembered that the cross sectional area of the copper must be changed to retain the original performance of the motor.

$$\frac{CM_o}{CM_n} = \frac{E_n}{E_o}$$

It is not necessary to adhere strictly to the above relation, between area and voltage, when this relationship is applied to the main winding of split-phase motors. In many cases it is permissible to use the largest size wire which can be placed in the slots. On the other hand, any deviation from the fundamental equations in-so-far as the auxiliary winding is concerned, any change in the relationship between voltage and turns, would change the performance of the motor.

A variation in the resistance of the auxiliary winding in any motor will effect the torque considerably.

Keep the difference of the "CM in the main" and the "CM in the auxiliary" the same. That is, when the wire size is doubled in the main winding it should also be doubled in the auxiliary winding.

## G. Torque Changes

Since the torque of induction motors varies directly as the square of the applied voltage -

$$\frac{T_o}{T_n} = \frac{E_o^2}{E_n^2}$$

## b. Dual voltage -

The line voltage drop, which is developed whenever small-power motors of about one-third horse power or larger ( $\frac{1}{2}$  &  $\frac{3}{4}$ ) are used on 115v circuits, will cause lights to flicker. They also have high starting currents and therefore many power companies will place restriction on the connection of certain size motors to certain voltages. Most 2, 6, and 8 pole motors are connected for dual voltage to allow a greater range of supply.

Non-reversible - the windings would usually be connected as shown in Figs. 12 and 13. A capacitor would be connected in series with the auxiliary winding.

Only that number of leads would be brought through the frame which would allow for dual voltage connections four leads without thermal protection and 5 with thermal protection.

Reversible, Figs. 12 and 13.

## 3. Two-value capacitor motors.

## a. Single voltage

One type uses a transformer and one capacitor, Fig. 17.

One type uses two capacitors, Fig. 18.

In either case there is one capacitor which is of a design which allows it to remain in the circuit while the motor is running. These are oil filled - paper capacitors. In the type which uses the capacitor and transformer arrangement the voltage rating of the capacitor must be sufficient to withstand the starting voltage (up to 800v). The voltage rating of the oil-filled capacitor is about 330v at about 3 to 16 mf capacity rating, (800v intermittent). A running capacitor increases breakdown torque, full-load efficiency and power factor, reduces noise and increases locked rotor torque.

Non reversible, Figs. 17 and 18.

If a thermal device was used, two leads would come from the thermal device and would be connected in series with the supply. The pole-group connections might be the same as any split-phase winding, Fig. 3a, 3b, 3c.

The capacitor unit might be mounted on motor as shown in Figs. 17, 18, 19 or it might be separately mounted. There may be a terminal board used on a capacitor unit. One of the common types is shown in Fig. 20.

The line is connected to TL and L whenever an external control switch (such as a refrigerator cold control) is to be used. If no external switch is to be used the line would connect to T & L. The external SW would connect between TL & T.

## b. Dual voltage, Fig. 21 and lesson no. 22.

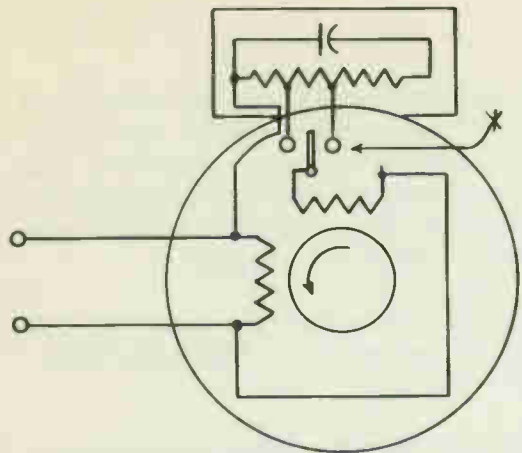

Fig. 17 A two value capacitor motor

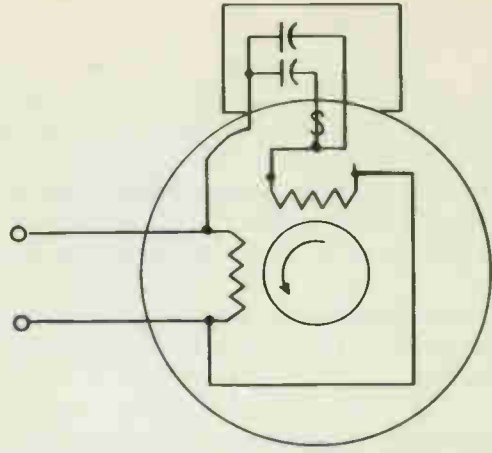

Fig. 18 A two value capacitor motor

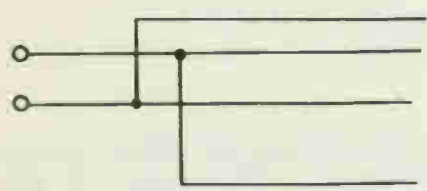

Fig. 19 A reversible motor

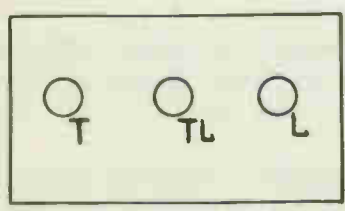
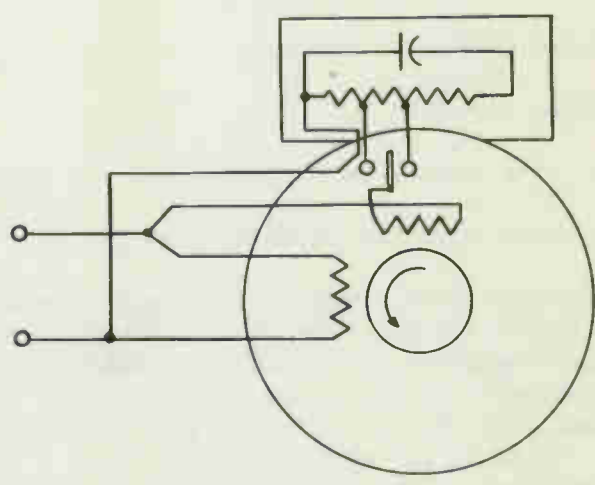

Fig. 20 Terminal board

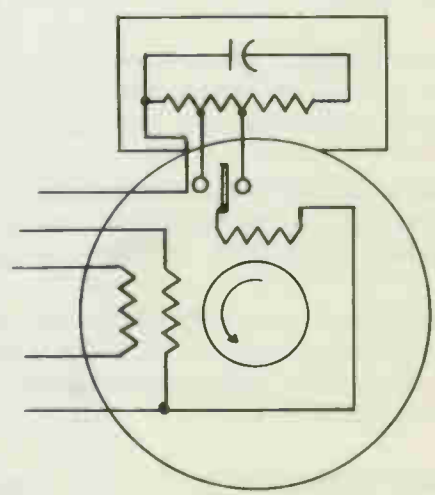

Fig. 21 A dual voltage motor

A revolving primary is used in General Electric washing machine motors.

Instant reversing - the Enoch Company has developed "The Sprague Switch". It allows instant reversing of a split-phase or capacitor-start motor.

Dual Voltage - Non-reversible, Fig. 11.

The starting torque of this motor will change with any change in the supply voltage. Notice; that the low voltage connection follows the "odd to odd and even to even" hook up.

Reversible - the above motor, Fig. 11 may be made reversible by bringing out more leads. Another type is shown in Fig. 12. In this type of motor the torque is approximately the same on both connections. Notice that the auxiliary winding is connected across T3 - T4 section of the main winding. The main winding acts as an auto-transformer in so far as the auxiliary winding is concerned.

The two sections of the main winding have been drawn to indicate they lie in the same slots and have the same distribution. The main windings may be placed in the stator by winding with "two wires in hand" (approximately 115v between turns) or by placing each section in individually and placing insulation between the two.

When thermal devices are used on dual voltage motors they are usually of the three-terminal type, Fig. 6. The contacts would be connected in series with the supply and the heater coil would be connected in series with one half the main winding, Fig. 13.

## 2. 2. Capacitor-start type of single-phase motor.

### a. Single voltage

Non-reversible. The windings would be connected as shown in Figs. 5 & 6 except the capacitor would be connected in series with the auxiliary winding. The capacitor might be found on the motor, in the motor, or external.

Reversible - Connect capacitor in series with auxiliary winding of Fig. 7 or 8.

Also check Fig. 14. This is called the "swing" connection. The auxiliary winding is connected to the middle of the run winding and as the switch is changed the direction of current through the auxiliary winding will change thereby reversing rotation of motor. This hook-up is usually used on 230v motors. Only a 115v capacitor is necessary. If a thermal device is to be used one lead of thermal device would be connected to the main winding and the other lead to line. Notice the pole-group layout in Fig. 15.

Two-speed - refer to Figs. 9 and 10. Sometimes two capacitors might be used in the four-winding arrangement.

Other features - a Current operated relay may be used rather than a centrifugal switch. There is another type which is sometimes used on hermetic units. See Fig. 16. This is called a voltage operated relay.

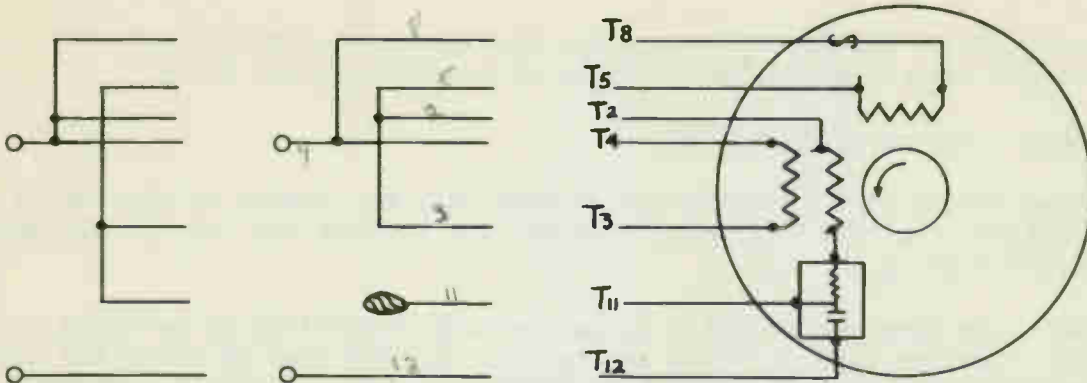

Fig. 13 A dual -voltage, split phase, reversible, thermally protected

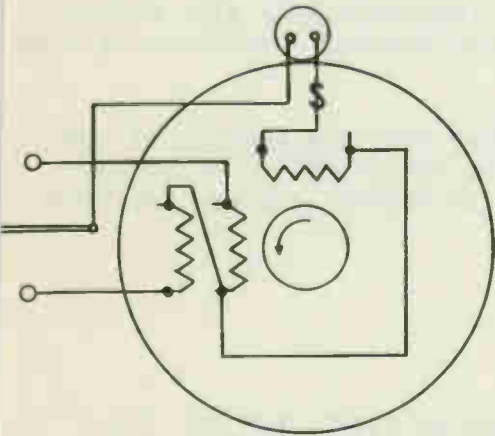

Fig. 14 Swing connection - 230v motor

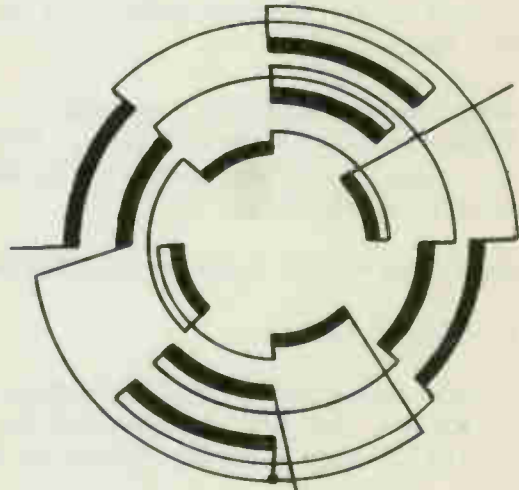

Fig. 15 Pole group connection per Fig. 14

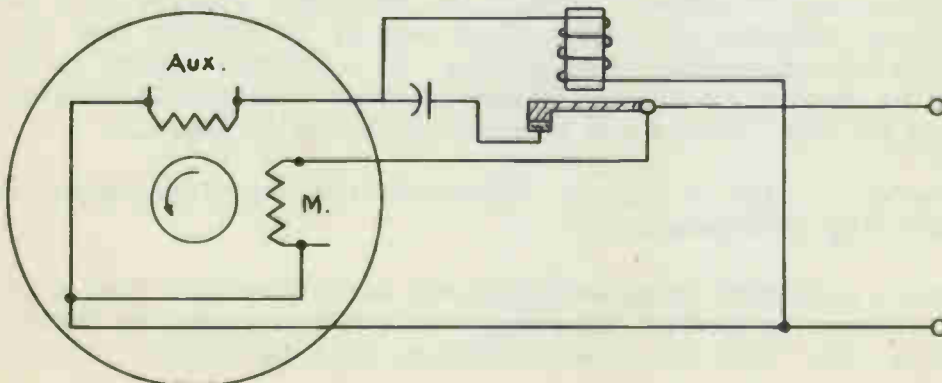

Fig. 16 A relay control operating across the auxiliary winding.

## D. Motor Over-current Protective Devices.

At this time we are interested only in the manner in which the devices are connected in the circuit. They are mounted in or on the motor. (Proper consideration is given to all phases of over-current protection in later lessons).

Thermal devices should be connected to the "hot" side of line on all grounded motors. This keeps windings at ground potential, if a thermal unit is open.

There are many different types of thermal units in use, made by about as many different companies.

The Spencer Thermostat Company has developed a disc type thermal unit which can be had either manual reset or automatic; the "Thermotector" which is a helix type of unit is made by General Electric. The "Thermotron" is made by Delco Products Co. The Thermoguard is made by Westinghouse, and the Fustat and Fusetron are made by Bussman Mfg. Co.

Many overcurrent protective devices operate on current only. Most of the thermal devices that are shown in the diagrams in this lesson will act on high ambient temperatures as well as on the heat developed due to  $I^2R$ .

## E Types of Single-phase Motors.

## 1. Split-phase

A single voltage non-reversible, see Fig. 5 & 6.

If thermal protection is used it would be located, electrically, at the points marked \*. It may be mounted in the motor, connected to the terminal board, or on the motor. Fig. 6 shows a three-terminal type of thermostat which is used on certain motors, such as, oil burner motors.

Reversible, Fig. 7 & 8. The small sketches to the left of the motor indicate the two connections which would be made to reverse the motor.

Fig. 8 shows a reversible motor which makes use of a thermal device. The dotted line indicates a connection of one thermal wire to T8 thereby resulting in a five lead motor.

Two-speed. The connection of the pole - groups of a four-winding machine is shown in Fig. 9.

Fig. 10 shows the electrical connection that might be made of the windings and switches.

If we were to leave out the aux. 2 winding we would have to start the motor on terminal No. 1. This would give us a 3-WINDING TWO-SPEED MOTOR. If the motor is designed in such a way that it may be started on either speed, the centrifugal switch must be designed to operate on the lower speed.

Some split-phase motors, make use of a mechanical clutch. On starting, the centrifugal switch cuts out at about 35% synchronous speed and then the clutch cuts in at about 70% synchronous.

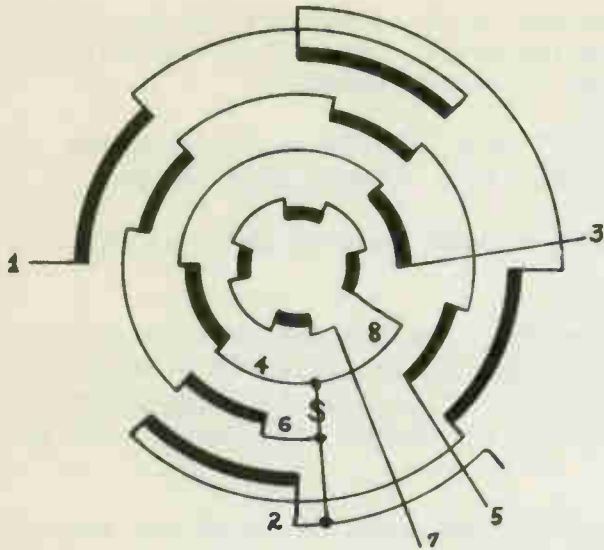

Fig. 9 Two-speed

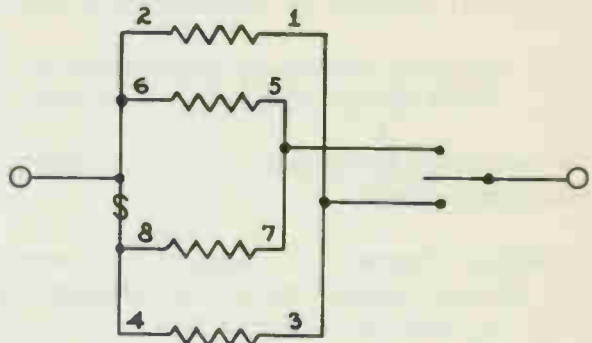

Fig. 10 Two-speed

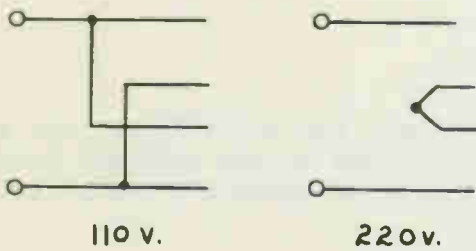

Fig. 11 Dual voltage non-reversible

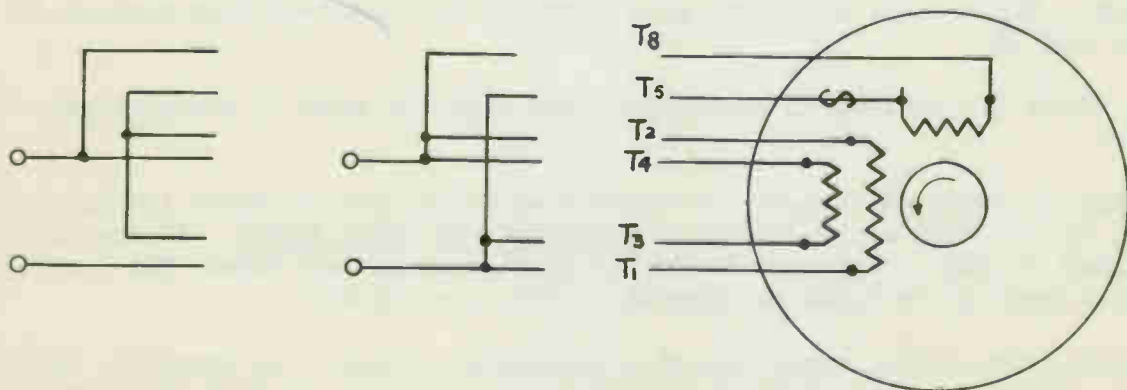
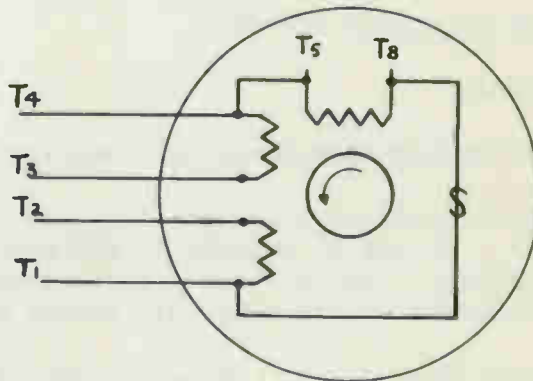

Fig. 12 A dual voltage, reversible split phase motor.

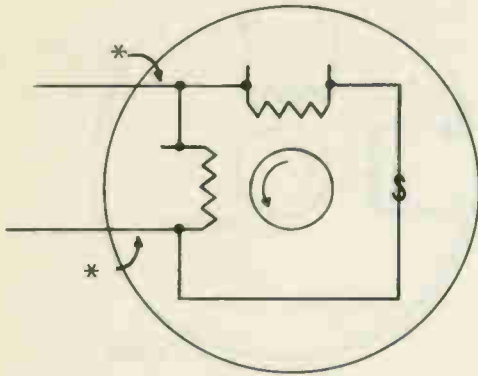

Fig. 5 Single voltage, non-reversible

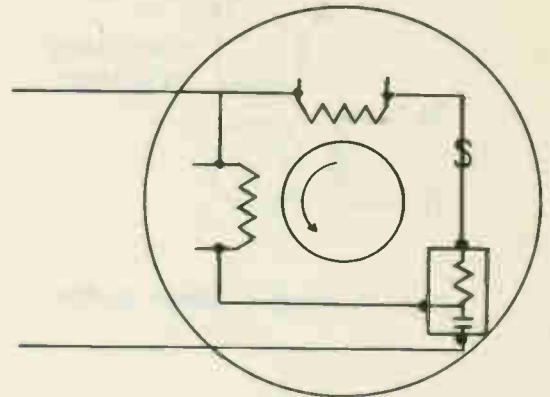

Fig. 6 Three terminal thermal device used.

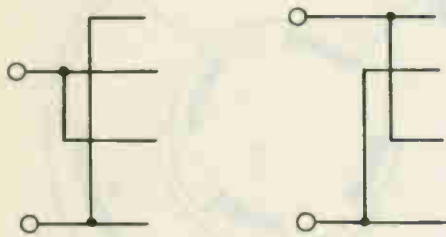

Fig. 7 A reversible split-phase motor.

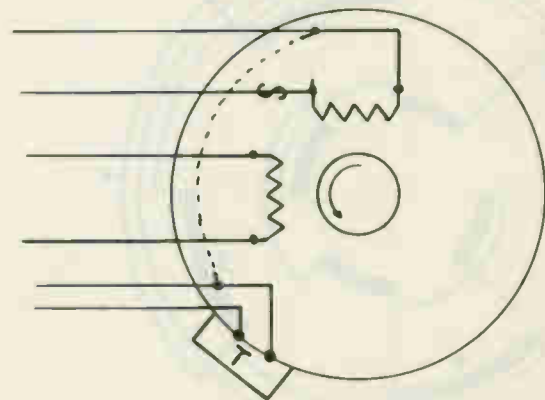
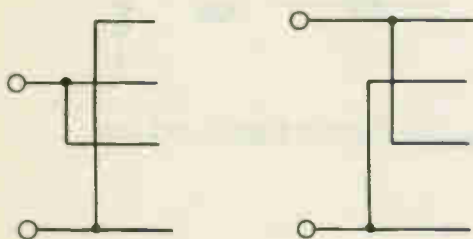
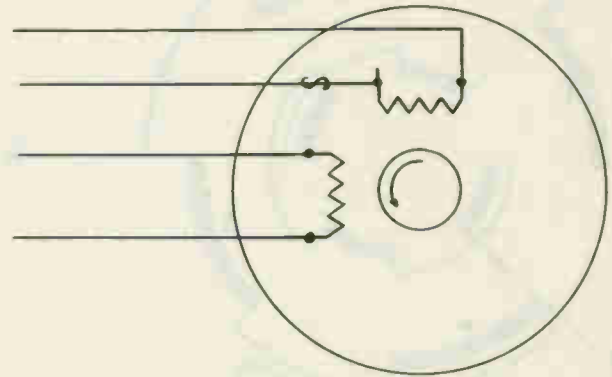

Fig. 8 A reversible and thermally protected motor.



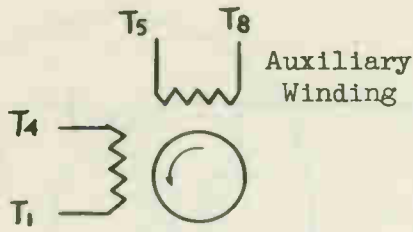

Fig. 1 Single phase motor

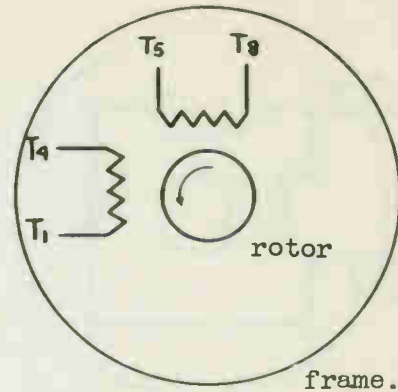

Fig. 2 Single phase motor

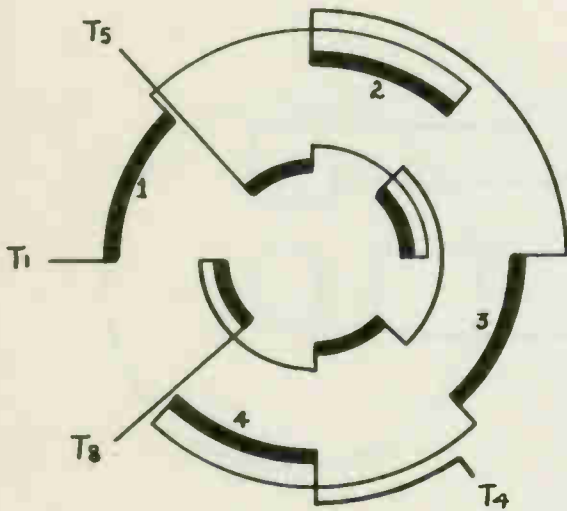

Fig. 3A Series pole group connection

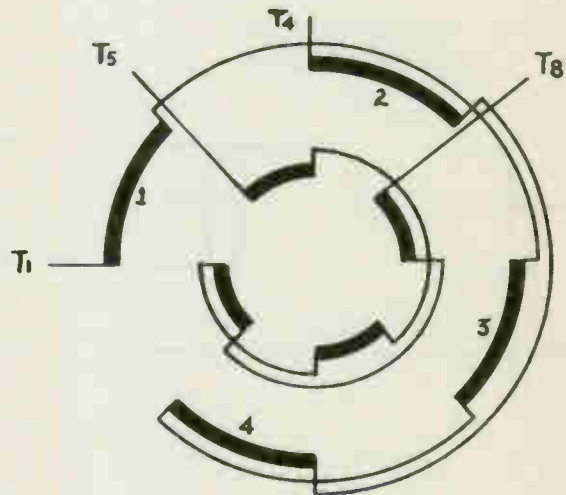

Fig 3B Same as 3A except long jumpers are used.

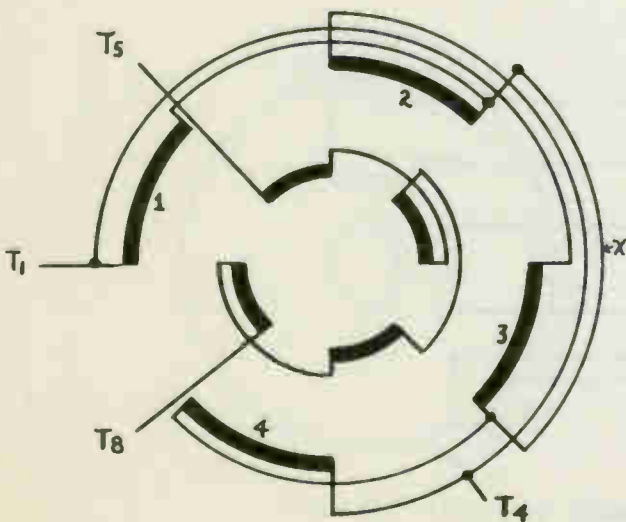

Fig. 3C Parallel connection of main winding

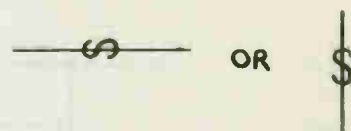

Fig. 4A Centrifugal switch

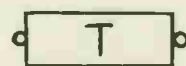
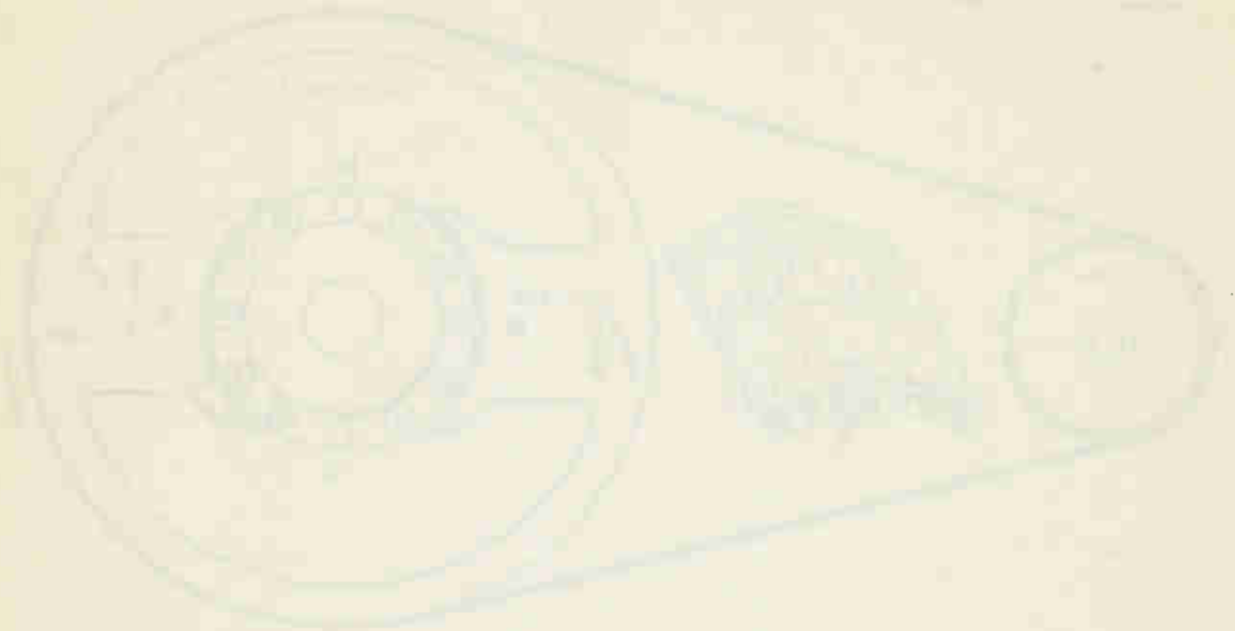

Fig. 4B Thermal device



The first drawing is a side view of the pulley showing the V-groove on the rim and the shaft. The second drawing is a top view of the pulley showing the internal segments and the central hub. The third drawing is a cross-section of the pulley showing the internal structure and the shaft.

The following drawings show the pulley in various positions and views. The first drawing is a side view of the pulley showing the V-groove on the rim and the shaft. The second drawing is a top view of the pulley showing the internal segments and the central hub. The third drawing is a cross-section of the pulley showing the internal structure and the shaft.



The following drawings show the pulley in various positions and views. The first drawing is a side view of the pulley showing the V-groove on the rim and the shaft. The second drawing is a top view of the pulley showing the internal segments and the central hub. The third drawing is a cross-section of the pulley showing the internal structure and the shaft.



The following drawings show the pulley in various positions and views. The first drawing is a side view of the pulley showing the V-groove on the rim and the shaft. The second drawing is a top view of the pulley showing the internal segments and the central hub. The third drawing is a cross-section of the pulley showing the internal structure and the shaft.



The following drawings show the pulley in various positions and views. The first drawing is a side view of the pulley showing the V-groove on the rim and the shaft. The second drawing is a top view of the pulley showing the internal segments and the central hub. The third drawing is a cross-section of the pulley showing the internal structure and the shaft.

FLUX MOVING UP IS EQUIVALENT TO CONDUCTOR MOVING DOWN.

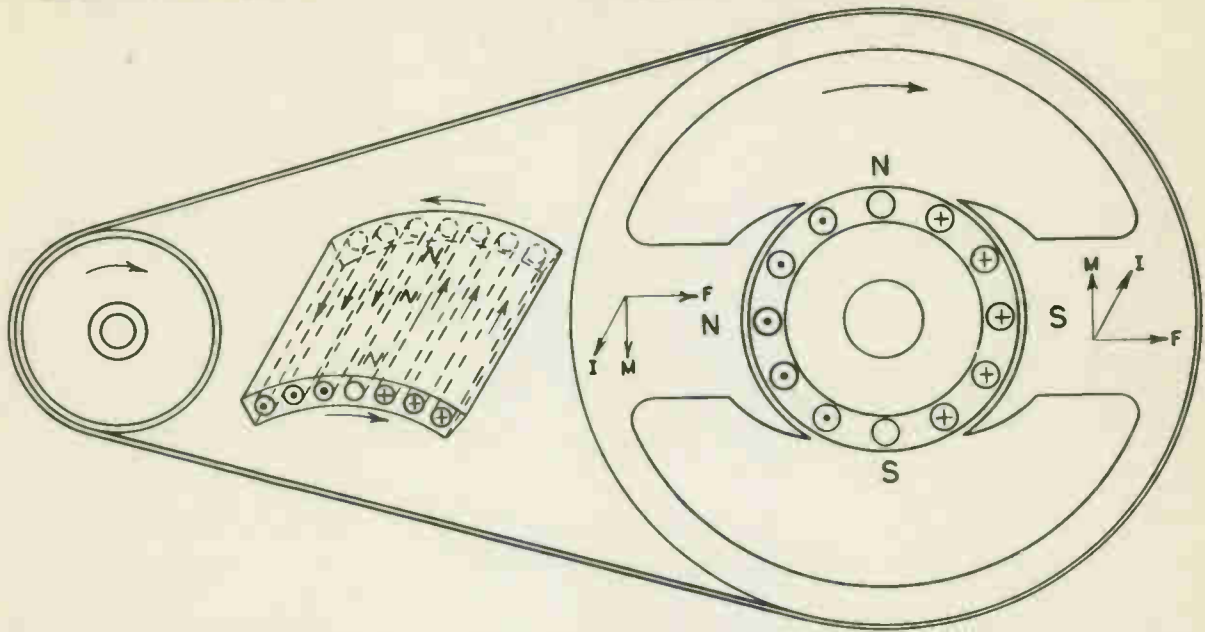

If a permanent magnet of the type shown above be rotated about a squirrel cage rotor, the flux of the magnet will cut across the squirrel rotor bars and induce voltages in them. The direction of these voltages at any instant may be determined by Fleming's Right Hand Rule. Application of this rule to the diagram above shows that currents will be flowing toward the observer under the North pole, and away from the observer under the South pole.

Viewed from above, current is circulating counter-clockwise around the rotor thereby establishing a North pole at the top and a South pole at the bottom. As the magnetic field is rotated, the rotor poles move at the same speed and in the same direction and maintain the same relative position; that is midway between the stator poles.

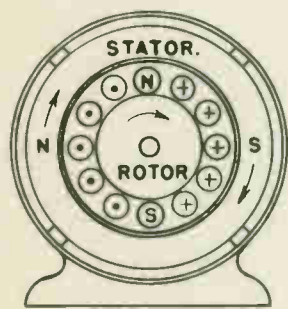

Diagrams A B C D show the relative position of the rotor and stator poles for four different points in one revolution.

In A there exists at the instant shown the same condition described above. In this case however, the rotating magnetic is produced by a different method.

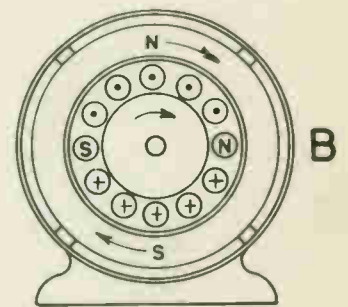

In B the revolving field has moved through one-quarter revolution. Note the change in current distribution in the rotor bars and the movement of the rotor poles. Diagrams C and D show the condition at later points in the revolution. Reversal of current in rotor bars causes rotor poles to revolve.

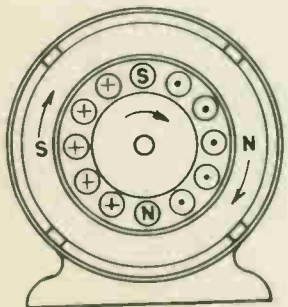

Although the diagrams show the current in the rotor bars changing direction in groups, the rotor bar currents actually reverse one at a time as the stator flux sweeps by. This produces a smooth progression of the poles around the rotor.

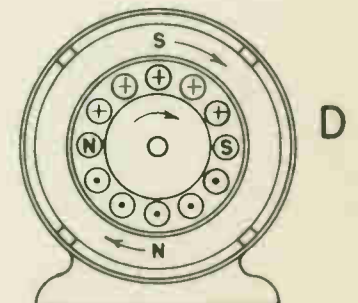

By reviewing the following rules and studying the remainder of this lesson we will simplify our problem considerably.

### C. Rules and Fundamentals.

1. To reverse the direction of rotation of a split-phase, single-phase motor - interchange the leads of the "start" winding OR interchange the leads of the "run" winding.
2. To identify the leads.
  - a. Use an ohmmeter. The "start" or auxiliary winding is usually of higher resistance than the "run" or main winding.
  - b. Take off end bells and check position of winding in core -- main winding in bottom of slot.
  - c. The power factor of the auxiliary winding is higher than the power factor for the running winding, because of less inductance in the auxiliary winding
3. The direction of rotation. (ASA and NEMA)

The direction of rotation is to be counter clockwise as viewed from the front end. The direction of rotation can be predetermined (before operating motor by checking connections. It will be from an auxiliary pole to the next adjacent main pole of the same polarity.

NOTE: Front end is the end opposite the shaft extension. The connections of the windings (stubs and jumpers) are usually made in front end.

4. The ASA diagram for a single-phase motor.

The ASA diagram for a single-phase motor is shown in Fig. 1. The winding marked T5 - T8 is the auxiliary winding. The arrow on the rotor indicates standard rotation. Fig. 2 shows the addition of a circle around the ASA schematic which we will use to represent the frame of the motor.

5. Pole-group connection diagrams are shown in Fig. 3.

Figure 3a shows a four pole layout making use of the short jumper connection. This type of diagram could be used for any number of poles. Fig. 3b shows a layout making use of long jumper connection. Fig. 3c shows a layout which is used on single voltage and dual voltage motors.

In Fig. 3c the main winding is connected two-parallel, it could be four parallel. The auxiliary winding is connected series. This type of diagram could be used for any number of poles. The auxiliary could be connected parallel also. The connections would be made in the same manner as they are made on the main winding. Notice the equalizer at X.

6. A distribution chart is shown in the lesson on motor rewinding.
7. Fig. 4a shows the symbol we will use for the centrifugal switch. A centrifugal switch might be connected at either end or in the middle of the auxiliary winding. Fig. 4b shows the symbol we will use for a thermal device. Usually, thermal devices are connected in series with the supply.

## SINGLE-PHASE MOTORS

Objective

To learn of the different types of stator winding connections, line connections and connections to auxiliaries used with single-phase motors.

ReferencesLesson Content

## A. Definitions and Standards

1. The permanent-split capacitor motor is a capacitor motor having the same value of capacitance for both the starting and running conditions.
2. A two-value capacitor motor is a capacitor motor using different values of effective capacitance for the starting and running connections.
3. Connection diagrams

The American Standards Association has developed standard methods of showing the connections of the windings of a motor to one another, to the line, and to auxiliary devices.

Rotation and terminal marking standards have also been developed.

The purpose of applying markings to the terminals of electric power apparatus, according to a standard, is to aid in making up connections to other parts of the electric power system and to avoid improper connections which may result. There are many manufacturers of small-power motors, however, that use a code other than standard.

## B. Classification of Single-phase Motors.

There are several different types of single phase motors - the ASA lists eleven different types. Each of these types can be connected in several different ways, i.e., "split-phase, single-phase, single-voltage, non-reversible-motor -- with or without thermal protection", or possibly, "capacitor-start, dual-voltage, reversible, thermally protected capacitor motor, etc. The motor may have four windings, three, tapped windings etc.

The leads can be tagged according to the present ASA standards or they may be tagged according to ASA standards which were used previous to latest revision. The leads may not have tags, but instead they are colored.

In view of the above, one should be impressed with the idea of becoming well acquainted with fundamentals and the possibilities of different types of windings and the purpose and function of auxiliaries.



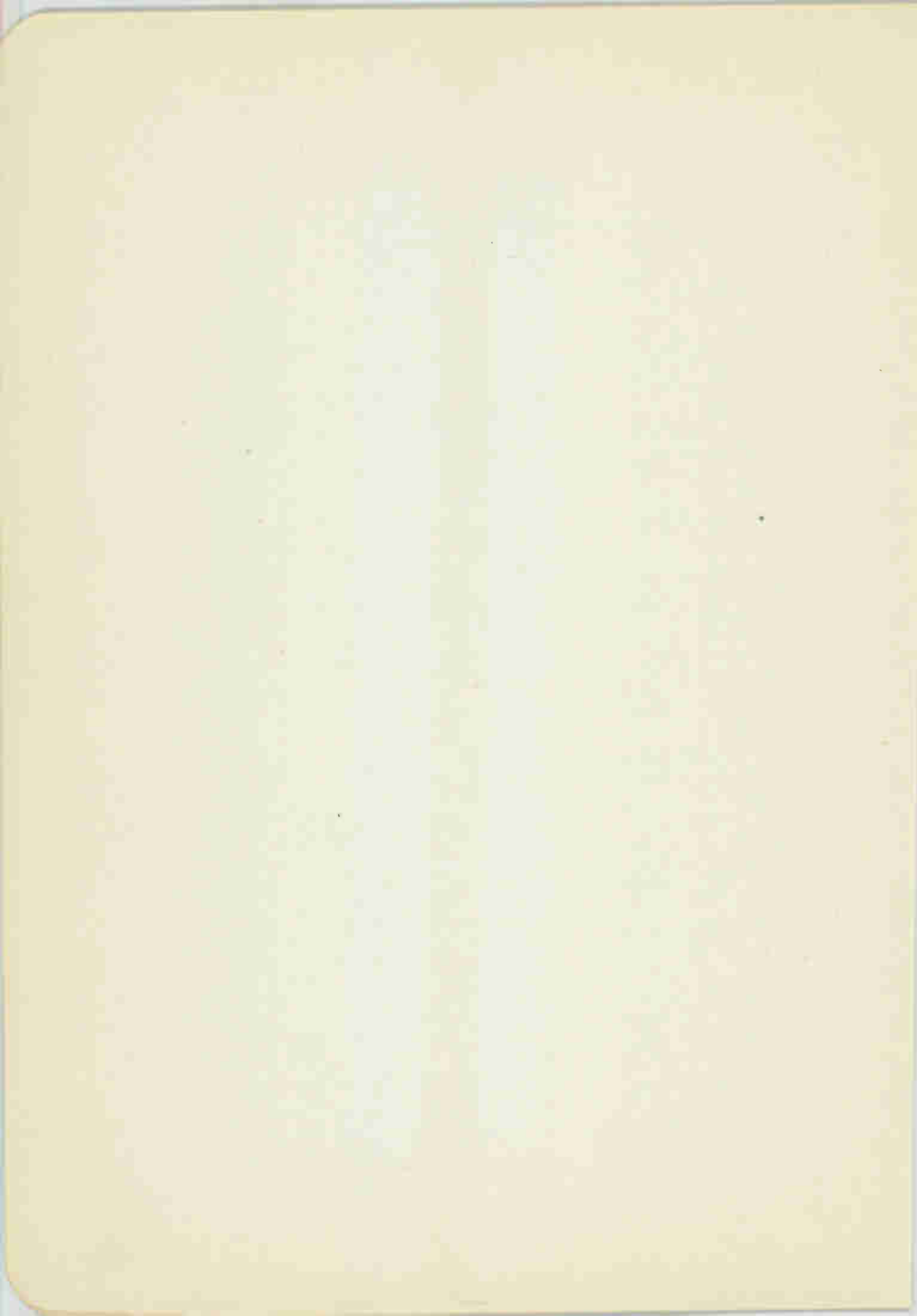

The meter will give the correct temperature reading at any given point. The light in the power circuit indicates whether the thermostat is open or closed. By taking a record of the temperature as the light goes off and on it is easy to check the range, initial overshoot etc., at various temperatures?

b. Roasters

In testing roaster temperature, the iron test stand can be replaced with a shielded thermocouple, which should be placed inside the roaster on the center of the rack.

G. Summary Questions

1. Describe how a heat indicator operates.
2. Does a steam iron usually have a thermostat?
3. What is the value, in mfd's., of the capacitors used on small motor-driven appliances?
4. What type of motor is used in most motor-driven appliances?
5. How is speed control obtained on the motors mentioned in question 4?
6. What are the average horse-power and speed ratings of the motors mentioned in question 4?
7. If you were to order some wire for replacing elements in electrically-heated appliances, what kind would you order?
8. What is a thermostat?
9. How would you test an appliance (electrically-heated) for defects?
10. What is a thermo-couple and how could you make use of it in testing appliances?



- a. Porcelain socket with a two watt neon bulb. (A  $7\frac{1}{2}$  watt bulb can be used).
- b. Shunted porcelain socket and outlet plug.
- c. Porcelain socket with outlet plug.
- d. One test prong identified as ground.

To test for grounds, Fig. 7.

Plug the appliance in the upper socket "B" and touch the shell with the grounded test prong. If the light glows, there is a ground. If the appliance has no cord, short across both terminals of the appliance with the ungrounded test prong and touch the shell with the grounded test prong.

To test for a complete circuit plug the appliances in the lower circuit (C) or use the test prongs. If the light glows the circuit is complete.

#### 8. Test circuit, Fig. 8.

- a. This test circuit enables you to test temperature on irons and roasters. The light in the circuit saves time because it allows the operator to work on other appliances during the temperature test and at the same time to catch high or low readings when the light turns on and off.

- b. The power circuit with an outlet plug and an indicator light can be made up from parts from an iron.

1. Miniature lamp socket with a 5718085 lamp such as used on F113 iron.
2. Two 5718280-1 resistors used on the F113 iron.
3. Toggle switch to short out second resistor.
4. Porcelain socket with an outlet plug.

- c. Testing units, Fig. 9

1. Standard iron temperature test stand, which is available through your appliance Service Center, 9 B.
2. Shielded thermocouple such as used on the TC-300 range oven testing, 9C
3. Type Do41 temperature meter such as supplied for TC-300 tester, 9 D.

- d. In testing appliances having a wattage of 800 to 1320, the toggle switch should be closed. This shorts out the second resistor.

- e. In testing appliances with a wattage of 375-800 the toggle switch should be open allowing both resistors to remain in the circuit.

#### 9. Testing procedure.

All automatic irons require a special fixture for proper calibration. A temperature stand supplied by the company that makes the iron will be satisfactory.

An automatic iron which has bad thermostat trouble or a heat complaint should also be tested, and it is good practice to test all automatic irons for cut-off temperature at the high heat setting.

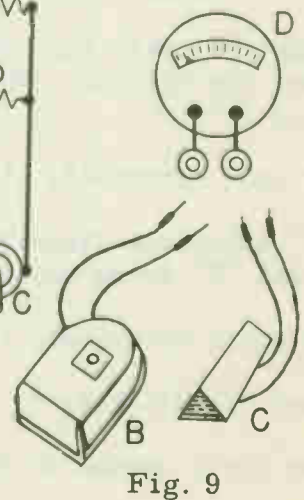
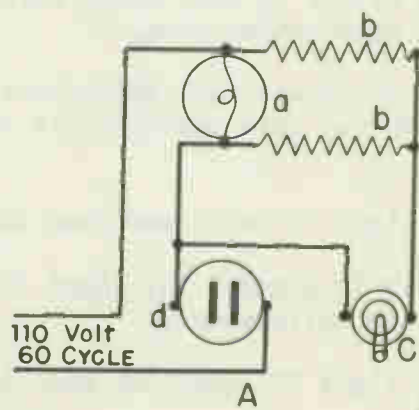
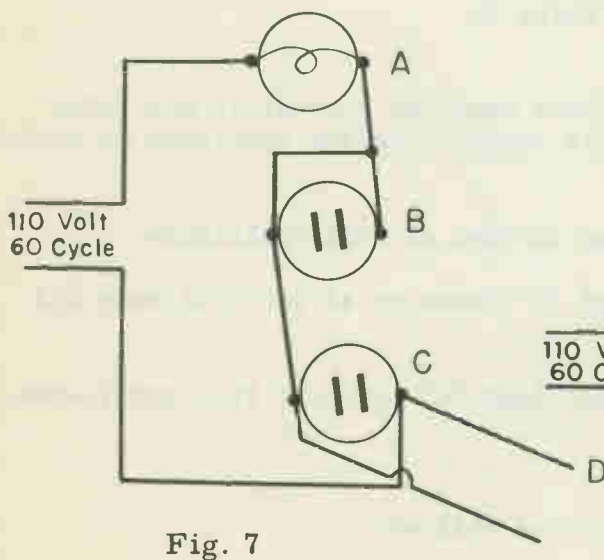
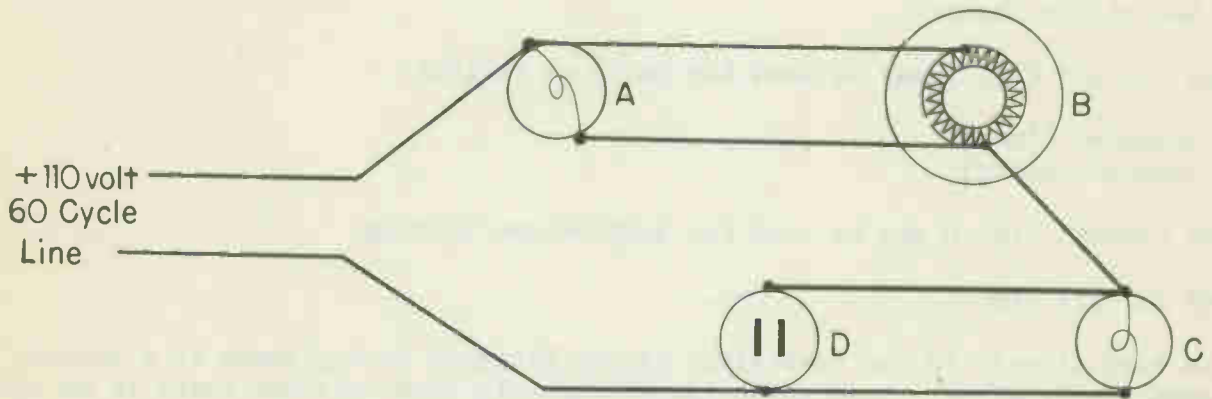
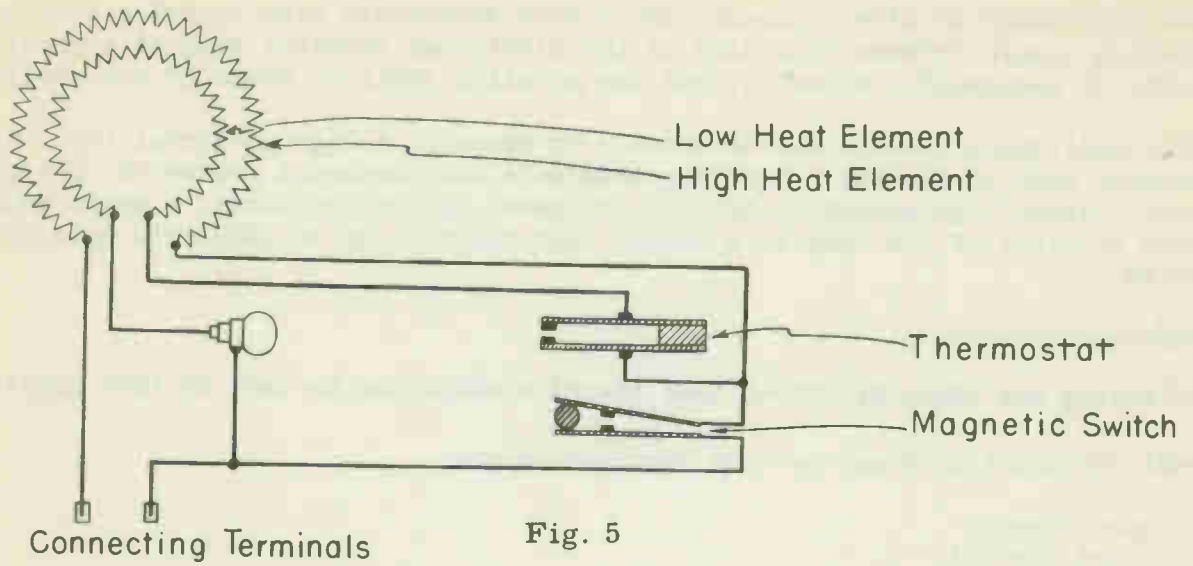

Low resistance or direct grounds are easily detectable with a series test lamp, testing always between each side of the electrical terminal plug or connecting cord, if permanently attached, and the metallic shell or frame of the appliance.

High resistance grounds are detectable by means of a high potential test. Test between each of the two connecting terminals and the metal framework of appliance. Where high potential testing equipment is not available, a small neon bulb in place of the lamp in a series test circuit can be used with good results.

## 5. Testing Circuits

Following are three practical test circuits which can be used to test appliances.

Test Circuit Fig. 6 may be used for testing for:

- a. Open circuit
- b. Short circuit
- c. Resistance circuit

Test circuit Fig. 7 may be used for tests as follows:

- a. Grounded circuit
- b. Complete circuit

Test Circuit Fig. 8 may be used for temperature testing.

## 6. Test circuit Fig. 6.

This test circuit in one operation, simply plugging in appliance in a socket, automatically gives a test which instantaneously shows whether there is an open circuit, a short circuit or a resistance circuit. It consists of the following parts.

- a. Porcelain socket with  $7\frac{1}{2}$  Watt mazda bulb, A.
- b. Porcelain socket with a 660 Watt resistance B.
- c. Porcelain socket with a  $7\frac{1}{2}$  Watt mazda bulb, C.
- d. Procelain socket with outlet plug, D.

Light "C" will burn at almost full brilliance whenever circuit is not being used for testing. To use this test circuit simply plug the appliance in outlet plug "D".

If open circuited, light "C" will continue to burn at full brilliance.

If resistance circuit is plugged in, light "A" comes on at low brilliance and light "C" drops to low brilliance.

If short circuited, light "C" goes out and light "A" burns at full brilliance.

## 7. Test circuit Fig. 7.

The parts needed to build this test set are as follows:

On fused appliances such as perculators, the fuse should be checked for possibility of having opened the circuit.

## 2. Uneven or low heating

Check for broken or partially broken cords or defective contacts or for high resistance connections caused by any of the above. Stressing and flexing of connections and cords are helpful in locating these points.

Partially grounded, shorted, or open portions of heating elements are usual causes of such complaints. Visual examination plus series lamp testing will serve to locate these failures. Wattage may be checked against rating on nameplate. Allow plus or minus five percent limit. ( $E \times I = W$ ).

## 3. Blown fuses

Providing the appliance has been used at its rated voltage and on a line having adequate capacity, the only reasons for "blowing of fuses" can be; grounded circuit (See #5) or a direct short circuit in either the connecting cord set or in the appliance proper. Short circuits can be located by a series test lamp. The brilliancy with which the lamp burns is the indication. A shorted circuit will cause the lamp to burn with much more brilliance than a circuit which is not shorted.

A watt-meter may also be used for checking against the rated wattage.

To determine the exact location of the short circuit the appliance will probably have to be partially disassembled to isolate the trouble.

## 4. Overheats

The only appliances which are subjected to this trouble would be those which are automatically controlled.

These complaints fall into two classes, namely:

- a. Thermostat inoperative or incorrectly wired.
- b. Thermostat out of calibration.

Regardless of the cause, the performance of the appliance should be checked either by a recording temperature indicator or by an indicating temperature meter and the "on" and "off" cycles recorded. A high temperature thermometer can be used on such appliances as heating pads, irons etc.

## 5. Grounds

If an appliance becomes grounded, complaints of blowing of fuses or of electrical shock upon handling will be received.

Electric shocks can result from a high resistance ground, with the appliance resting on an insulated surface, if contact is made simultaneously with the appliance and a water faucet or the range, or if the person is standing on a damp floor.

Most roasters are thermostatically controlled having a range of 150 degrees to 550 degrees Fahrenheit. A pilot light is sometimes put in the circuit to tell when the elements are in the "on" position.

### E. Electric Toasters

There are three general groups of toasters.

1. Non-automatic
2. Semi-automatic
3. Automatic

#### Non-Automatic

1. Two types of heating units are used.

- a. Mica insulated units
- b. Open coil units

#### Semi-automatic

Some of the semi-automatic toasters operate on a thermostatic principle. The thermostatic strip lies against the surface of the bread, making it directly affected by the temperature of the bread. Whether the toast is light or dark depends on how far the end of the thermostatic strip has to move before it presses apart the switch points.

Some toasters may be equipped with a bell to indicate when the toast is finished. Others will have devices to make the toast "pop up" when it is finished.

#### Automatic toasters

These toasters are usually two-slice oven type and equipped with a variable speed clock mechanism which automatically adjusts the toasting time as the toaster heats up.

### F. Testing Procedure for Appliances.

Some of the more common troubles which the repair man will probably come in contact with in an appliance repair shop are listed below.

1. Will not heat

Connect the appliance to the rated power supply and check operation. If there is no current, remove the cord if detachable.

1. Give the cord a continuity test with a series test lamp.
2. If the cord tests satisfactorily, make a continuity test on the circuit in the appliance.

If the cord is not detachable from the appliance, dismantle the appliance so that a continuity test can be made.

On automatic appliances, incorporating a thermostat, further series testing must be done to eliminate a faulty thermostat. In this case the heating element should be isolated and tested with a series lamp.

### 3. Two-heat manual electric

The high heat element is located in grooves of ceramic brick.

The temperature maintaining unit is located on the underside of the brick.

With the mercury switch on the high position, the high-heat element is energized and the low heat temperature maintaining element, being connected on the same side of the line, is not operating.

When the boiling water has been forced to the upper bowl and the stove is ready to be turned off, the switch is manually moved to low position.

By this time, the temperature of the stove has caused the thermostat to open, thus preventing the low heat element from being energized. If the low heat unit were energized at this time the water would not return to the lower bowl soon enough.

Eventually the thermostat re-closes, and since the circuit is open at the mercury switch, the two heating elements are in series across the line and with the increased resistance the combined heat output of the two units is just sufficient to maintain the brew at a proper serving temperature of approximately 185 degrees Fahrenheit. Normally the thermostat does not open again.

The pilot light indicates that the low-heat circuit is energized. (See Diagram #4).

### 4. Automatic electric

This unit is similar in construction to the two-heat unit except that in the automatic the mercury button manual switch is replaced by an automatic magnetic switch.

This unit uses two elements, a magnetic switch and also a thermostatic control to maintain a constant temperature to the coffee after it has been brewed. (See Diagram #5).

When the cord is plugged in, the high heat element and the low heat element are in series since the magnetic switch is open. After the pot is assembled and a small button is depressed, the magnetic switch is closed so that only the high heat element is in the circuit. As the temperature increases, the magnetic switch is caused to open in order to shut off the high heat position. The thermostatic control will probably be open, but will close as soon as the temperature drops. When the thermostat closes, it will maintain the temperature at about 160 degrees to 185 degrees Fahrenheit automatically.

### D. Electric Roasters

Roasters will probably have two heating elements.

One is located around the sides of the roaster and may have a rating of about 660 watts.

The second element is located in the bottom and is usually made up of two coils connected in parallel and having a rating of about 1320 watts.

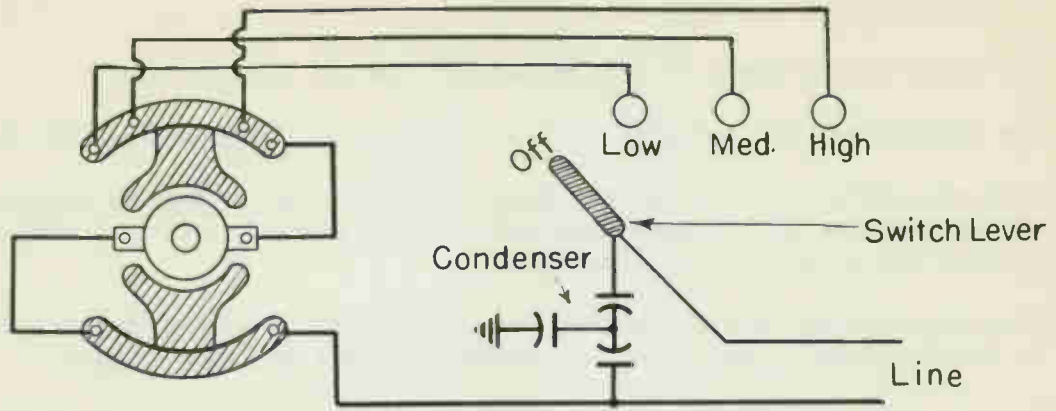

Fig. 1

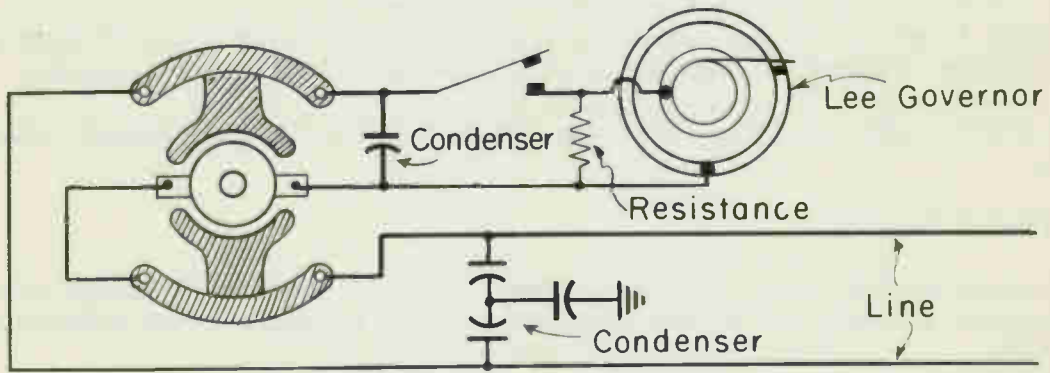

Fig. 2

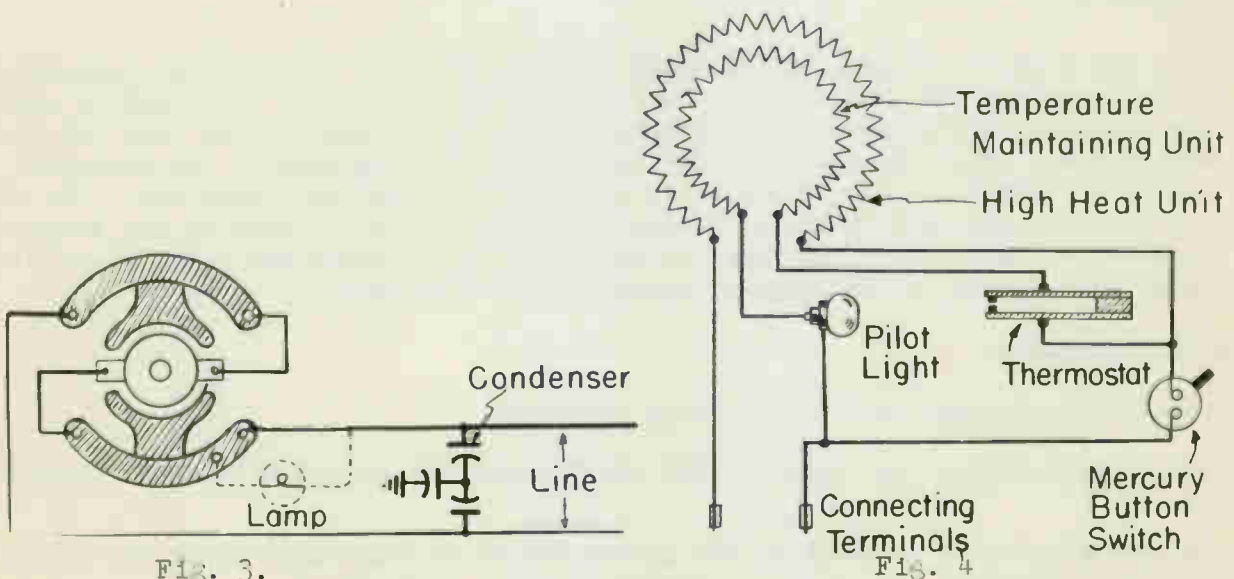

Fig. 3.

Fig. 4

The heat control is with a 3-way switch.

Parts are very similar to irons previously mentioned.

## B. Electric Mixers.

The motors are of the series wound type and operate on either 110 volts AC or DC.

### 1. Parts most likely to need servicing.

- |             |                              |
|-------------|------------------------------|
| a. Brushes  | c. Field coils               |
| b. Armature | d. Speed regulating devices. |

### 2. Types of speed regulating devices

- Tapped field - one field is tapped in several places and is controlled by a switch. (See diagram #1).
- Lee Governor - Centrifugal switch is attached to the armature which makes and breaks the circuit cutting in and out a resistance. (See diagram #2).
- Adjusting the brushes - by changing the position of the brushes on the commutator, the position of the energized armature coils is changed in relation to the field coils. (See diagram #3).

### 3. Sizes and speed

Sizes usually run around 1/12 to 1/20 horsepower.

Speeds are around 8,000 to 10,000 RPM.

Beater blades are geared down to turn about 300 RPM, low speed to <sup>1000</sup>10,000 RPM high speed. (Speed is checked with a tachometer).

### 4. Radio interference

A .15 mfd capacitor is connected directly across the 110 E line to reduce the noise heard in a radio caused by the brushes.

In some models which use the "Lee Governor" there will be a condenser across the points of the Governor to keep the contacts from arcing and burning.

## C. Coffee Makers

### 1. Models

- Non-automatic electric
- Two-heat manual electric
- Automatic electric

### 2. Non-automatic electric

The heating element is retained in grooves cast in a ceramic plate.

The elements are usually of nichrome wire.

Temperature controls are not used.



## ELECTRICAL APPLIANCES

Objective

To give a general understanding of traffic appliances, testing circuits and tools used in an appliance repair shop.

References:Lesson Content

## A. Electric Flat Irons

## 1. Models

- |                                      |            |
|--------------------------------------|------------|
| a. Non-automatic                     | d. Steam   |
| b. Non-automatic with heat indicator | e. Laundry |
| c. Automatic                         | f. Tailor  |

## 2. Non-Automatic

## a. Types

1. Mica insulated units
2. Tubular enclosed units

## 3. Non-automatic with heat indicator

The construction is identical to the non-automatic iron except for a bi-metal blade which moves over a scale indicating the heat at which the iron is operating.

## 4. Automatic irons

Most of these irons are of the tubular enclosed type.

The thermostat is of the bi-metallic type and is fully automatic.

## 5. Steam iron

This iron differs greatly from the other mentioned in that a steam chamber is recessed into the top side.

Stainless steel wool is used to filter the steam generated in the chamber.

In the bottom of the soleplate there are steam outlets provided to allow for the escape of the steam to the material.

Distilled water is used and is regulated automatically by a control valve.

Thermostat operation is the same as on irons previously mentioned.

## 6. Laundry and tailor irons

These irons are built for commercial use and are usually of much heavier construction than other irons.





# FARM MOTORS

## Application and Operating Data

### FRACTIONAL HORSEPOWER MOTORS

Satisfactory performance from a small general purpose motor will be assured by use of a repulsion-induction motor or a "capacitor" motor as described in the following table. These types are slightly higher in price than a split-phase motor, but pro-

vide higher starting power without imposing heavy current demands that may reduce voltage in the line and cause lights to flicker, or cause a fuse to blow because of starting overload. On the other hand the split-phase motor will give satisfactory service for the lighter jobs such as running the washing machine, churn, small tool grinders, etc.

#### 1. REPULSION-START INDUCTION MOTORS

Similar in performance to the larger 3, 5, 7½ horsepower motors. Sizes from ½ to ¾ horsepower, high starting power, low starting current. For use on 110-220 volt, single phase, 60-cycle circuits.

#### 2. CAPACITOR MOTORS

For use on 110 or 220-volt single-phase service. High starting power, low starting current, high efficiency. Highly satisfactory for general purpose use. Sizes range from ⅓ to ¾ horsepower.

#### 3. SPLIT-PHASE MOTORS

Inexpensive type of small motor but requires high starting current. Suitable for washing machine, ventilating fan, small tool grinders or other uses where starting load is not heavy. Sizes, ⅓ to ½ horsepower for 110 or 220-volt service.

Machine	Hp. Most Used	RECOMMENDED MOTOR TYPE			Recommended Control
		Repulsion Induction	Split Phase	Capacitor	
Washing Machine	⅓ or ¼		x		Sentinel Breaker
Cream Separator	⅓ or ¼	x		x	Sentinel Breaker
Churn	¼		x		Sentinel Breaker
Concrete Mixer (small)	¼ or ⅓	x		x	Sentinel Breaker
Farm Shop Equipment	¼	x		x	Sentinel Breaker
Fanning Mill	¼		x		Sentinel Breaker
Corn Sheller (single hole)	¼	x		x	Sentinel Breaker
Fruit Grader	¼	x		x	Sentinel Breaker
Grindstone	¼		x		Sentinel Breaker
Shearing Tool	¼		x		Sentinel Breaker
Sausage Grinder	¼	x		x	Sentinel Breaker
Potato Grader	⅓	x		x	Sentinel Breaker
Pump Jack	½	x		x	Sentinel Breaker
Root Cutter	¼ and 1	x		x	Sentinel Breaker
Small Feed Grinder (Burr)	½ and 1	x		x	Sentinel Breaker

### MINIMUM RECOMMENDED SPEEDS OF CUTTER FANS TO ELEVATE ENSILAGE INTO SILOS OF DIFFERENT HEIGHTS USING 5-HP. MOTOR\*

Diameter of Cutter Fan * Inches (Wing Tip to Wing Tip)	Height of Silo in Feet								
	25'	30'	35'	40'	45'	50'	55'	60'	75'
	Recommended Fan Speed, Revolutions per Minute								
30	500	530	575	610	650	690	720	750	835
32	465	495	540	575	610	645	675	705	735
34	440	465	510	540	570	610	635	660	780
36	415	440	480	510	540	575	600	625	695
38	390	415	450	480	510	545	570	595	660
40	370	395	430	460	485	515	540	565	625
42	355	380	410	435	465	490	515	535	595
44	340	360	390	415	440	470	490	510	570
46	325	345	375	400	425	450	470	490	545
48	310	330	360	380	405	430	450	470	520

For silos higher than 40 feet, the 7½ h.p. motor is recommended.

\*From Wisconsin Rural Electrification Handbook. (Published by University of Wisconsin)

COURTESY WESTINGHOUSE ELECTRIC & MFG. CO.

# MOTORS AND CONTROL

for

Lesson No. 9

## FARM WORK

INFORMATION SHOWING THE TYPE OF MOTOR AND CONTROL FOR VARIOUS TYPES OF MACHINERY USED ON THE FARM

Name	FARM JOB		MOTOR			CONTROL	
	Speed Recommended Rpm.	Pulley Recommended Dia. Inches	Hp. Most Used	PULLEY RECOMMENDED INCHES Dia. Face		PREFERRED Westinghouse Pushbutton Class No.	ALTERNATE Westinghouse Manual Class No.
Milking Machine† (Pipe Line Type)	800	6	1	3	2½	Sentinel Breaker††	WK-18
Refrigerator (Dairy)†	See mfrs. specification	Determine by formula	¾ or 1	3	2½	Sentinel Breaker††	WK-18
Hay Hoist	Rope speed 100-200 ft./min	Determine by formula to give correct rope speed	3 or 5	5½	6¾	WK-16†† or 11-200	10-030
Rain Elevator (Inside or outside)	See mfrs. specification	Determine by formula	3 or 5	5½	6¾	WK-16†† or 11-200	10-030
Stone Grinder	See mfrs. specification	Determine by formula	5	4½	6¾	11-200	10-030
Wheat Mill (large)	See mfrs. specification	Determine by formula	5	4½	6¾	11-200	10-030
Feed Grinder Hammer Type*	3500	4	5	8	6¾	11-200	10-030
Feed Grinder Burr Type	800	12	5	5½	6¾	11-200	10-030
Feed Mixer	See mfrs. specification	Determine by formula	5	5½	6¾	11-200	10-030
Grain Blower Elevator*	3500	4	5	8	6¾	11-200	10-030
Wood Saw	1300	6	5	4½	6¾	11-200	10-030
Ensilage Cutter	SEE PRINT No. 243	Determine by formula	5 or 7½	4½	6¾	11-200	10-030
Hay Baler	600	16	5 or 7½	5½	6¾	11-200	10-030
Spraying Plant (Stationary)	600	13	5 or 7½	4½	6¾	11-200	10-030
Husking and Shredding Corn	See mfrs. specification	Determine by formula	5 or 7½	4½	6¾	11-200	10-030
Irrigation	Depends on conditions and capacity of pump. See manufacturers requirements.						

\* If an individual motor is justified for these machines, it may be desired to use a 3450-Rpm. motor direct connected to eliminate pulleys and belts. † Would generally be permanently installed. †† These are manual starters.

### MOTOR PULLEY DIAMETER

Dia. of Pulley on Driven Machine	3½"	4½"	5½"	7"	8"	9"
3"	2040	2580	3140	4000	....	....
4"	1530	1930	2360	3000	3500	3950
5"	1225	1540	1880	2400	2800	3150
6"	1020	1290	1570	2000	2340	2620
8"	765	965	1175	1500	1750	1970
10"	612	770	940	1200	1400	1575
12"	510	640	785	1000	1170	1310
14"	437	550	670	860	1000	1120
16"	383	480	580	750	880	990
18"	340	430	520	670	780	880
20"	306	385	470	600	700	790
22"	278	350	430	550	640	720
24"	255	320	390	500	580	660

### FORMULA FOR FIGURING PULLEY SIZES AND SPEEDS

For machine speeds and pulley sizes not covered in the tables, the following simple formula may be used.

$$\text{Machine Pulley Diameter} = \frac{\text{Motor Pulley diameter} \times \text{Motor Rpm.}}{\text{Machine Rpm.}}$$

(Pulley diameters should be figured in inches)

For example, the motor pulley is 8 inches in diameter. The motor speed is 1750 revolutions per minute. It is desired to operate a hammer mill at 3500 rpm. What size pulley should be used on the mill?

Using the formula, we get:

$$\text{Hammer Mill Pulley Diameter} = \frac{8 \times 1750}{3500} = 4 \text{ inches}$$

COURTESY WESTINGHOUSE ELECTRIC & MFG. CO.

On the other hand, instances may be cited in which animals, and in a few cases human beings, have been killed by such equipment. Most of these casualties, however, have been traced to home-made or makeshift devices. It should be recognized that there is extreme danger in making and using any electrical device which limits the current supplied to the so-called electric fence. This is true whether the current is supplied by a 6-volt battery, the 32-volt home electric plant or from a 115 volt service line; hazard likelihood increases with supply voltage.

It is worthy of note that it is amperage (flow) and not voltage (pressure) that is so dangerous. However, unless equipment is so designed that the amperage is definitely limited, higher voltages are more dangerous. Home-made transformers or current-limiting devices are not dependable. It is not considered safe to use transformers that will deliver more than about 5 milliamps on dead-short unless some sort of dependable current-interrupting arrangements are incorporated.

#### I. Summary

1. Farm wiring should be planned to meet future as well as present needs.
2. Determine where electricity can be used to advantage and the type of electric outlet required at each location.
3. Provide an adequate number of branch circuits.
4. All wiring on electric systems financed by the R.E.A. must be installed in accordance with the National Electrical Code.
5. Three-wire, 60-ampere service entrances to residences are recommended.
6. Service entrances to barns and outbuildings where power is to be used should not be less than three No. 8 wires.
7. Grounds may be either 3/4 inch galvanized iron pipe or patented copperweld rods and must be at least 8 feet 6 inches long, driven to a depth of 8 feet.
8. It is good practice to inspect the circuits of an electric system frequently and have all damage repaired.
9. Use a trouble lamp to locate circuit trouble.
10. Use only nontamperable fuses so there will be no opportunity to meddle with the old fuse or replace with a larger fuse than the circuit should have.
11. If wires in lamp cords become broken or the insulation wears off, never splice for permanent use. Throw the old cord away and buy a new one.
12. Home-made transformers or current-limiting devices for electric fences are dangerous.

wet appliances and motors, salt film, metal filings, and the like. A short once started will continue until the circuit fuses blow, the circuit switch is opened (it opens automatically in a circuit-breaker type) or until equipment or circuit are destroyed. Before being put back into service the damage should be completely and correctly repaired.

#### J. Fuses.

Fuses are used to protect the wiring from possible overloads and short circuits which may result in fires or damage to wiring and appliances. They are purposely made the weakest link in a system or circuit in order to protect, by their weakness, the equipment and other more expensive parts of the circuit. Each wire in a building was installed to carry a certain load. A larger one may be dangerous. When a fuse blows, eliminate the cause of its blowing before replacing it with a new one of the proper ampere rating, or resetting circuit breaker if protection or panel is of this type. A larger fuse would permit more current to flow in the wires than they can carry safely. The size in amperes is stamped on the small end of plug fuses, near the ends of cartridge fuses.

Only, the nontamperable type of fuses should be used, so there will be no opportunity to meddle with the old fuse or replace with larger fuses than the circuit should have.

No fuse larger than 15 amperes can be put in any lighting circuit, regardless of the size of wire, and meet the safety requirements of the National Electrical Code. Other circuits supplying only heavy-duty electrical appliance, and special motor circuits, must not be fused above the capacity of the size of wire installed in the circuit. Never increase the size of the fuse over the wire capacity, or the efficiency of the "safety valve" will be lessened.

When making repairs to appliance cords, necessitating removal of the socket or plug from the cord, care should be taken when reconnecting the wires. In making such plug connections to cords, be sure to tie an electricians' knot as shown in Fig. 8. The screw connections are further protected against strains from accidental jerks by making a half turn of the wire around the prongs of the plug before it is fastened under the screw connections. (See Fig. 8c).

Only one wire should be placed under each screw, never more. A lamp cord should never be left so that the base of the lamp can wear off the insulation. This wire should run through an insulating bushing in the lamp base. Electrical toys should be carefully watched for any defect which would be hazardous to children.

#### K. The Electric Fence

Along with the increase in electricity available to rural areas, farmers have turned increasingly to use of the electric fence. They have done this despite repeated warnings from many sources that the electric fence, when improperly constructed and under certain other conditions, can be dangerous.

Since farmers have demonstrated that they definitely intend to use both the single- and double-wire fence, because of its low cost and convenience, precautions are here stated. The electric fence materially reduces fencing costs (by 90 percent or more for larger areas), and simplifies the use of temporary fence for pastures and crops that are to be harvested by animals. Likewise, operating requirements are low, usually under 10 kilowatt-hours per month.

The first thing to do in connection with almost any trouble of this nature is to determine whether the house distribution panel is "alive" or not. To do this, take one of the insulated wires of the trouble lamp in each hand, stand on a dry box or dry board, and touch the bare ends of these leads to the bare binding screws on the panel where the leads from the meter terminate. CAUTION: Be sure to keep the hands or fingers well back on the insulated handles and to not allow them to touch metal current-carrying parts. Be sure the board of box and shoe soles are dry. Should the lamp light up, the panel is alive and the trouble is in the branch lighting circuit. Disconnect all portable appliances that are connected to the circuit. The trouble may be "blown" fuses. They may be checked by touching the wires on the trouble lamp to the binding screws on the branch circuit side of the fuses. If the trouble lamp lights, the fuses are good and the branch circuit is "open" somewhere; if it does not light up, the fuse is blown. Blown fuses may be due to a short circuit somewhere on the branch circuit, a defective or burned-out appliance, or an overloaded circuit. If fuses are blown by a defective appliance, new fuses will also be blown when the appliance is again plugged into the convenience outlet. Also, if blown fuses are due to a short on the circuit or to an overloaded circuit, renewing the fuses will do no good. The cause must first be located and remedied.

Going back to our first test at the main distribution panel, suppose the lamp failed to light up. This indicates that the panel is "dead". The power is then off the line or there is a blown service-entrance fuse. In this case open the service entrance safety switch, then open the safety switch cabinet door, and touch the lamp leads to the switch jaws on the line side of the switch. Should the lamp fail to light up, the highline is dead and the utility or electric co-op should be notified at once. If it lights up, one or more of the service-entrances fuses are blown, or there is a loose connection. In this case do not renew the fuses until a check has been made of the circuits and appliances, and the trouble found and repaired.

#### I. Circuit-Breaker Services.

If the service switch is of the circuit-breaker type instead of the fuse type, it is necessary to use the trouble lamp at the service switch. When any lamp fails to burn or appliance fails to operate, look at the breaker controlling the circuit to which the lights or appliances are connected. If the breaker is in trip position it is evident that either the circuit has been overloaded or a short circuit has occurred on the connections to lights or appliances. If the breaker is in operating position, then either the lamp has burned out, wires have become broken or disconnected, the appliance element has failed, or the highline power is off. Attention is called to the fact that certain types of circuit breakers do not indicate when they have been tripped. In such cases they must be thrown out and back into operating position before there can be certainty they are not "out".

First, see if lights on other circuits will burn. If not, remove cover on breaker panel and connect test light to terminals of main service on line side.

If test light will not burn, then the highline power is off, and the utility or electric co-op should be notified. If test light does burn, then examine all lamps and appliances to locate the source of trouble. After the trouble has been corrected, reset the breaker to operating position.

Short Circuits - A "short circuit". or more briefly a "short," occurs when current accidentally flows by a relatively low resistance path from one conductor to the other or to ground. The common causes of short circuits are bare wires touching each other, lack of good insulation, poorly connected service plugs and outlets,



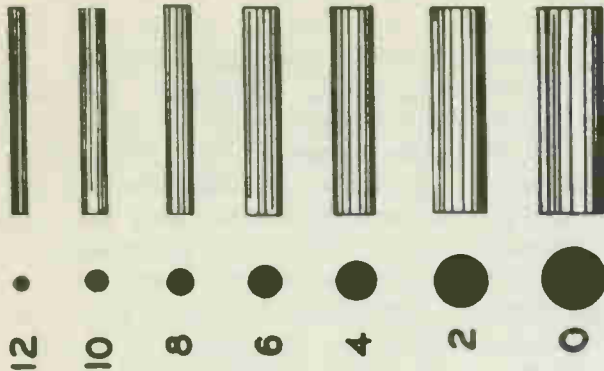

Figure 5.—Actual wire sizes

The wire size to use depends upon the load in amperes and the length of the circuit. Wire sizes for the farm range from No. 0 to 14. The larger the number, the smaller the size of the wire. No. 14 wire is used for light and small-appliance circuits in the home, but the larger sizes are needed for the large-sized motors and heating equipment. No. 12 wire should be used for lighting with 32-volt farm electric plants. For circuits used exclusively for appliances in kitchen, laundry, or dining room, No. 12 wire is required. The greater the distance from the transformer to the equipment, the larger the size of wire required.

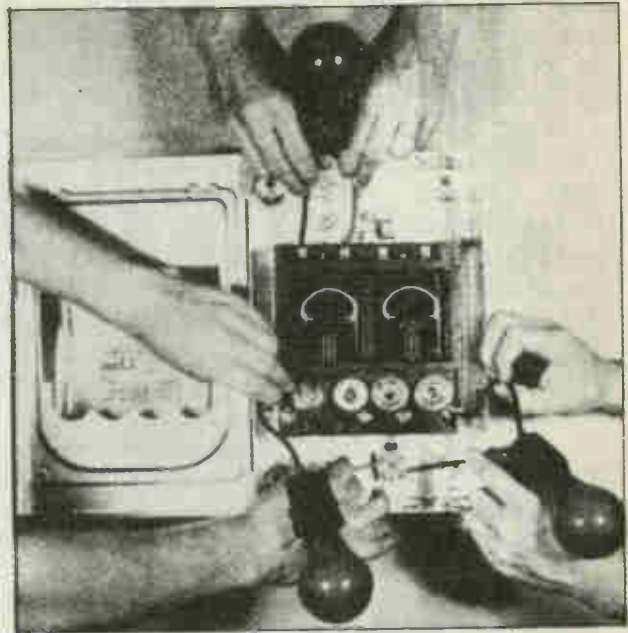

Figure 6.—Use of the trouble lamp.

- Step No. 1—Lower right hand corner. Test to determine whether branch circuit fuse is alive or blown out. One wire on fuse terminal and one on neutral buss.
- Step No. 2—Lower left hand corner. Test to determine if main fuses are alive or dead. Remove fuse. Put one wire on center contact fuse holders and one wire on neutral buss.
- Step No. 3—Upper left hand corner. Test to determine if central station power is on or off. Wires of test lamp connected to 2 left hand main terminals.

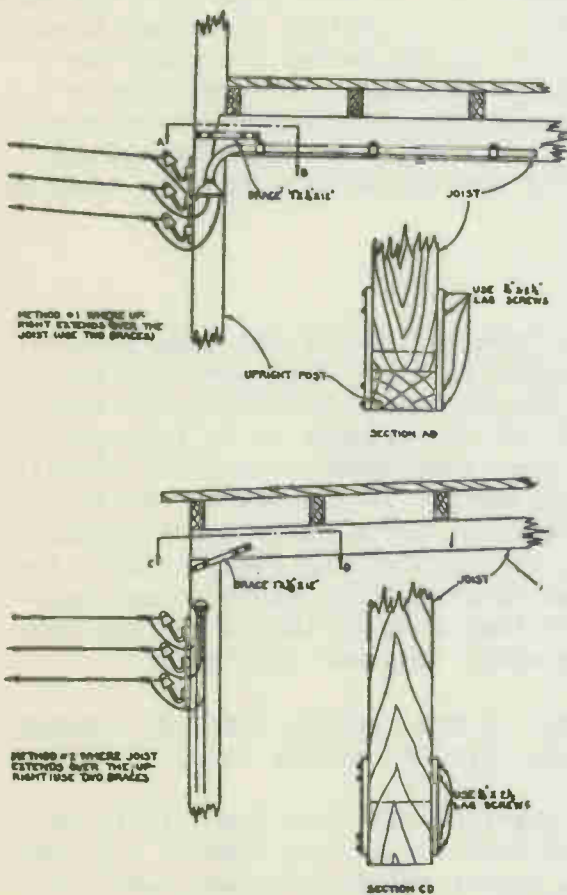

Fig. 7. The above two sketches show the method of arranging the connections of service wires to a building with strain insulators, drip loops, and weather heads. Also note the method of bracing a porch or corner of a building to stand the strain of a long run of service wires.

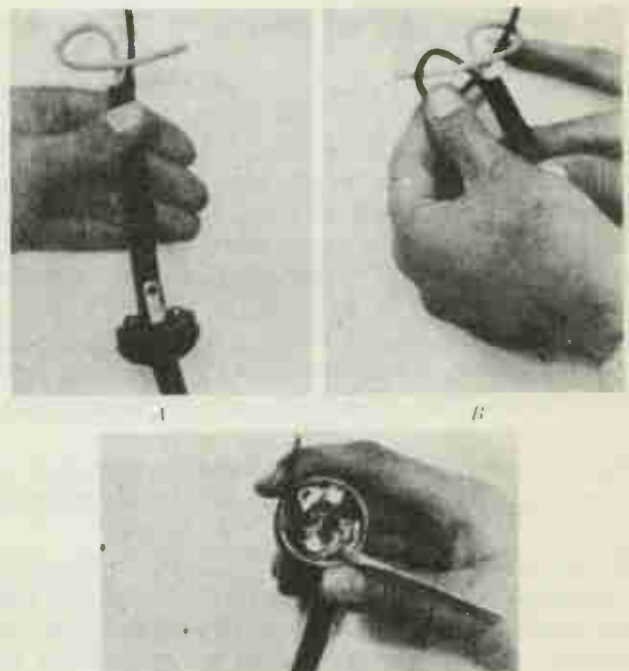

Figure 8.—Attaching a plug to an appliance cord. A and B show how to tie an electrician's knot. C shows knot in place.

ing serviced by highlines should be correctly installed and passed by accredited inspectors, so as to meet every safety requirement of the National Electrical Code.

Most hazards in correctly installed electrical systems develop because the owners do not maintain properly the electric wiring and electrical equipment connected to the system. Many other hazards develop because owners make unsafe extensions to the original wiring installation, or purchase and use electrical lamps and appliances that are not constructed safely. Buying only lamps and appliances which carry underwriters approval will help to assure the purchaser of proper protection.

#### G. Maintenance and Repair of Wiring System

The following instructions on simple repairs may help the users of electricity to keep their wiring installations safe for life and property.

At least during the early years of the installation few, if any, repairs will be required except those due to accident such as a "short circuit" a broken insulator, or similar causes. The copper wire will not deteriorate unless badly overloaded, and the insulation, should last for years. It is good practice to inspect the circuits frequently and have all damage repaired. The load should be checked from time to time as new loads are added to prevent an overload on the circuit. Trees will often grow up and interfere with the wires. These should be topped, or the wires moved. Appliance cords may pull out of the plug or wear through near the appliance. These must be reconnected. The circuit wires themselves may come loose from the binding screws or a wire may become broken. Most of these may be repaired safely and satisfactorily by the householder. The owner should, therefore, know how to locate the common wiring troubles and how to correct them, regardless of whether he does any electrical work himself.

#### H. Trouble Shooting

Fuse Service - Trouble must be located before it can be removed from the electrical circuit. Locating this trouble is called circuit "trouble shooting," and is usually accomplished by the aid of a "trouble lamp". (See Fig. 6.) Every electrified farm should have one. The trouble lamp consists of a weather-proof non-metallic lamp socket into which a 25-watt, 220-volt lamp is screwed and to which short, well insulated wires are attached. The insulation at the end of each wire should be removed for a distance of an inch.

To illustrate how circuit trouble is located by the use of this trouble lamp, assume that neither the light in the kitchen nor dining room come on when the switch is turned. This indicates that the trouble is probably not due to a burned-out bulb. The most probable sources of trouble in this case are: (a) a blown circuit fuse (b) power off (c) an "open" in the lighting circuit.

In the home farm shop good lighting is one of the first essentials. If possible the shop should be of a size to accommodate the larger implements found on the farm and comfortable enough to work in during cold weather. Time, money, and inconvenience can be saved in a shop equipped with a bench, a few well-selected tools, electric lights, and convenience outlets.

A central ceiling light with switch just inside the door, lights with reflectors over benches controlled from individual wall switches conveniently located, and at least two convenience outlets for an extension light and appliances will usually satisfy the lighting and convenience requirements.

One power outlet for heavy motors, drills, or other heavy electric tools should be provided. The farm shop can also be equipped with a direct-current generator for use with a portable motor for battery charging; or small rectifier type chargers may be used.

#### E. Wiring General

The wire for service entrance in each building should be made sufficiently large to take care of both present and future uses. Service entrances to residences must not be smaller than No. 8 wire. It is recommended that 3-wire 60-ampere service entrances be installed in all cases so that 230 volt current will be available for cooking, water heating, and motors operation. Barns and all major out-buildings, in which there is any possibility of using electric power, should not have a service entrance of less than 3 No. 8 wires.

In many instances, meters are located on the yard pole. Where a main disconnect switch is mounted on the yard pole, it should be provided with a lock to prevent tampering. Services to residences should be as near the kitchen as possible because, generally speaking, this is where the greatest amount of current is used. By locating the service entrance as near the load center as possible, voltage drop is lessened and the installation is made less costly through the use of smaller wire.

Proper grounding for protection against hazards from lightning is one of the most important safe-guards to any wiring installation. The ground must be connected to the neutral wire of the service. In farm installations, a separate ground must be installed at the yard pole service and at the service entrance to each major building. If this is not done, the individual building would not have protection in case storms broke the neutral wire between the building and the location of the ground. Since the average farm water system is not a good ground, it is required on all work financed by Rural Electrification Administration that standard grounds of the driven type be used. These grounds may be either 3/4 inch - galvanized iron pipe or patented copperweld rods. All grounds must be a minimum of 8 feet 6 inches long, driven to a depth of 8 feet.

Of course all these suggestions on how to plan farm wiring are variable according to the specific needs of different farms and farmhouses. But the general principle of adequate wiring for adequate use of electricity always holds good.

#### F. Simple Electrical Repairs

Electricity is one of the safest most economical and most convenient sources of light, heat, and power when wiring and equipment are properly installed and properly maintained, providing the cost of current is not excessively high. All wir-

This special circuit is necessary since the amount of current required to operate efficiently the heavy duty appliances used in these locations cannot be supplied with No. 14 wire.

#### D. Yard and Outbuildings.

Careful provisions should be made for the use of electricity in the yard and outbuildings. A typical farm wiring lay-out is shown in Figure 4.

The electrical water pump is usually installed first to provide an ample supply of water for both home and farm use. The yard light can be turned on or off from either the barn or the house and provides illumination for doing chores and other work early in the morning or after dark.

Two different sets of plans of farm buildings are also shown in order to provide examples of farm wiring and lighting under varying conditions. (See Figs. 2 and 3) Every part of each barn is provided with electric lights. These lights have switches to prevent unnecessary fumbling in the dark. Outlets are provided for the operation of small motors, tool grinder, feed grinder, fanning mill, corn sheller, drill press, potato grader, and many other similar pieces of equipment.

In the cow barn a row of ceiling lights is provided over each row of stalls and a row of ceiling lights in the center aisle. In every building ample light is a great convenience but the most suitable number and location of lighting outlets will vary with conditions. (See Fig. 2) Several convenience outlets are provided on the wall behind each row of stalls for the use of such equipment as clippers or a portable milking machine. If a pipe-line milking machine is used, a safety switch is needed at the place where the vacuum pump will be located. Power outlets are sometimes provided in the cow barn for ventilating fans, however, most barn ventilating fans can be pulled into a regular convenience receptacle.

In the milk house convenience outlets are provided for cream separator, bottle washer, water heater, and milk cooler.

Where there is a silo, a conveniently located portable motor power outlet should be provided.

In the poultry house it is common practice to install a light for every 200 square feet of floor space. These lights are controlled by a time switch so that they will be automatically turned on at the proper time in the morning. This automatic switch can be an ordinary alarm clock. There should be convenience outlets for poultry water warmers.

Among the various systems of poultry-house lighting, "all-night light" and "morning lighting" are by far the most popular. In the former a small light is placed over the feed hopper, the convenience outlet for the poultry water warmer also being provided within the better lighted area. One light is provided about 6 feet above the floor for each 200 square feet of floor area, the outlets being located half way between the dropping board, or pit, and the front of the house. With these two systems dimmers are not required.

If 60-watt CX Mazdas are used for all-night lighting, the outlet is generally placed close to the dropping boards and as low as practicable exposing the chickens to a maximum of "irradiation." It is essential that the voltage be close to that for which the lamps are designed; for example, when operating at only 10 percent below the voltage for which they are designed the ultraviolet output is so reduced as to make the lamps of questionable value except as a source of ordinary

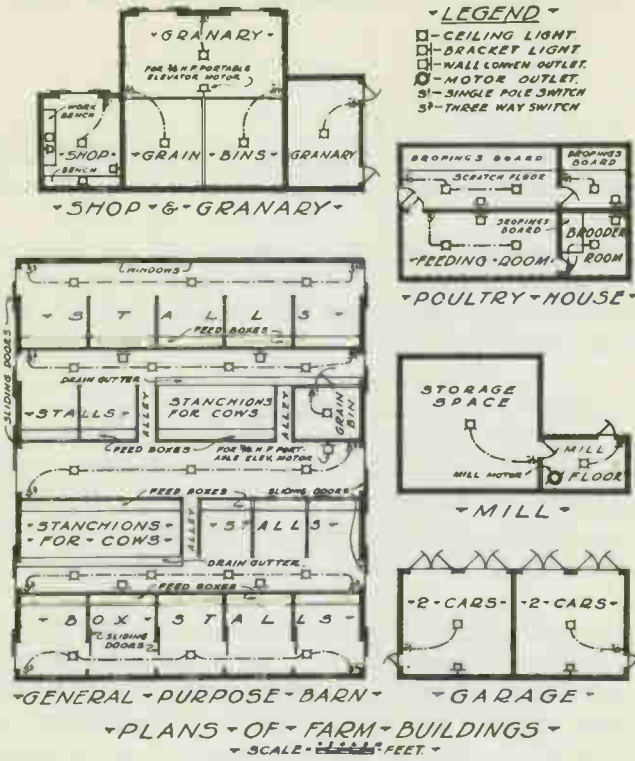

Fig. 3

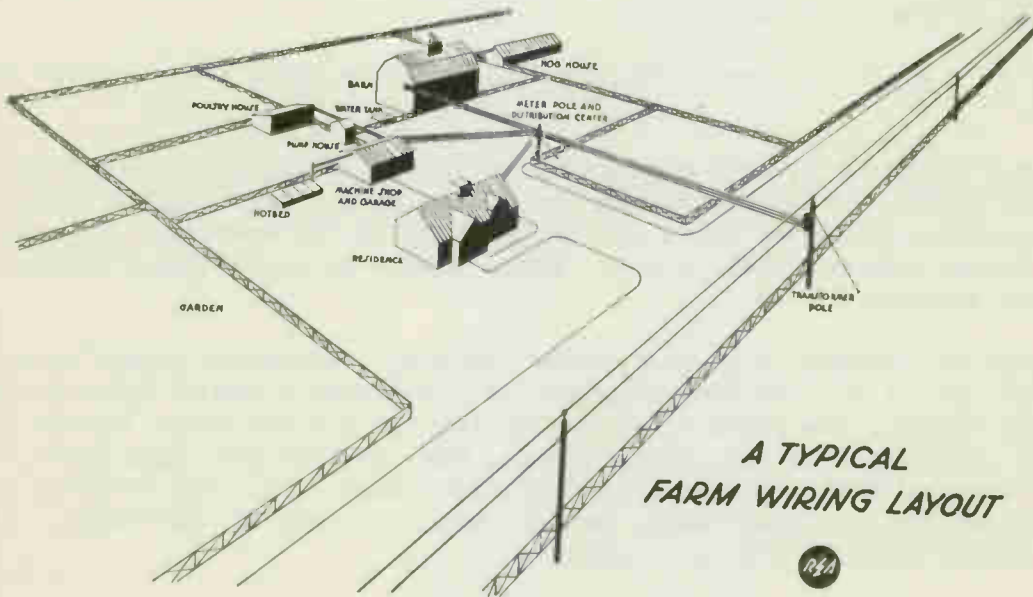

Fig. 4

board or serving table to connect the same equipment when not placed on the dining-room table, or to connect sideboard lights, vacuum cleaner, and the like. The dining room shown in the plan is used as dining room and general living quarters for the family. A receptacle has been placed near the couch, as the farmer desires to rest and read after work. The receptacle mentioned as serving the vacuum cleaner or possible sideboard lights also supplies current for the radio. The receptacle near the serving table takes care of the sewing machine.

In the kitchen, in addition to the ceiling light controlled by a switch at the door, there is a convenience receptacle located so as to care for an electric refrigerator. A convenience receptacle is provided near the kitchen cabinet for the use of a toaster, waffle iron, broiler, or food mixer. A convenience outlet is also provided for the operation of a kitchen ventilating fan on hot, sultry days.

Although it is not always intended to install an electric range at once, it is wise to provide a range outlet so that wiring will not have to be changed later on. Also, the main switch should be large enough to take care of the electric water heater, which is usually permanently installed.

In the parlor or bedroom shown on the accompanying plans a ceiling light with a switch at the inside door has been installed. Two receptacles are sufficient here as there is no possibility of placing furniture near the French doors opening on the outside porch. Note that the receptacles have been placed so that lights could be had for either divan or chair from one receptacle and on the other side of the room lights could be had at the chair or service could be provided for other appliances and devices.

In addition to providing the proper number of light, switch, and convenience outlets, it is also necessary to put in the proper number of branch wiring circuits in the house and out-buildings. The number of circuits installed in the beginning should be sufficient not only for present needs, but should anticipate future uses.

On all electric systems financed by the Rural Electrification Administration, all wiring must be installed in accordance with the REA wiring specifications which are drawn to meet the requirements of the National Electrical Code. The wiring installations must be inspected and approved before electric service can be obtained. Section 2107-08 of the National Electrical Code define the method of providing the proper number of branch circuits, regardless of the number of outlets installed. The method used is as follows:

Multiply the total floor area of the house (using the outside dimensions and including all floors) by 2 watts per square foot. Divide the total obtained by 1,650 (The allowable number of watts per circuit) and the result will be the total required number of branch circuits required for all lighting outlets and all convenience receptacle in the kitchen, dining room, pantry, and laundry; or, if there is no laundry, wherever else laundry equipment will be used).

All of the convenience receptacles in all portions of the house, with the excepted locations mentioned above, and all light outlets would, of course, be evenly distributed over these circuits.

Now add to these circuits, one No. 12 wire, 20-ampere circuit to supply only the convenience receptacles in the kitchen, dining room, pantry, and laundry, or where laundry equipment will be used. No light outlets can be connected to this circuit.

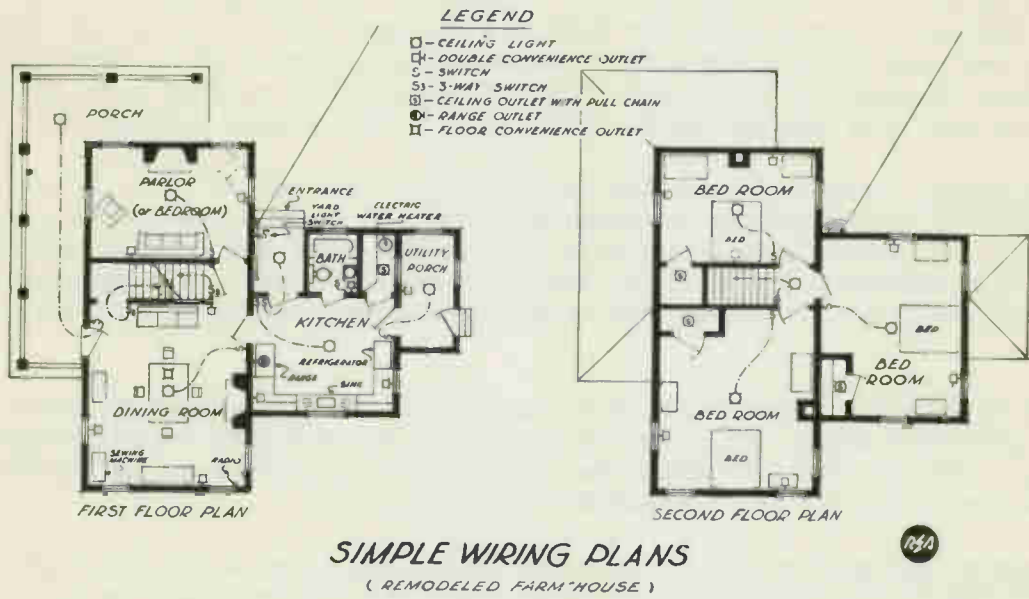

Fig. 1

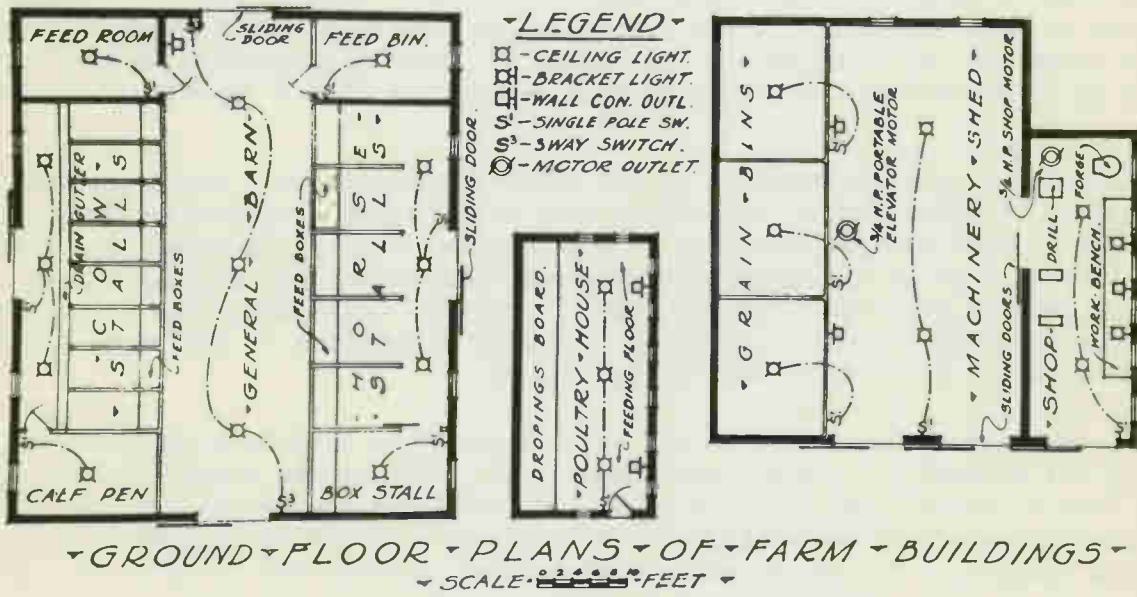

Fig. 2

In planning a farmstead wiring installation, the first thing to do is to determine where electricity can be used to advantage; then determine the type of an electric outlet required at the various locations.

Persons who have never used electricity and are wiring their homes for the first time usually think in terms of installing only a drop-cord in the center of each room. Then, if they want to use a radio, floor lamp, vacuum cleaner, washing machine, electric iron, refrigerator, or any other appliance, they simply screw into the lamp socket a plug-in receptacle containing a light outlet.

The first difficulty encountered by following such a procedure is that of having entangling wires spread all over the room. To overcome this, wires are tacked around the walls and doors. This creates a fire hazard, as in time the tacks are apt to break the insulation on the wires, thus causing sparks and short circuits.

The wire to a drop-cord outlet is only No. 16 or 18. This wire is not heavy enough to supply the required amount of power to operate properly any of the appliances and may decrease the operating efficiency. The large amount of current that necessarily flows over these wires heats the insulation to an unsafe degree, sometimes causing it to break down. Short circuits result and may cause costly fires.

A convenience receptacle should be installed at every point on the premises where there is a future possibility of a motor-operated appliance of  $\frac{1}{4}$  horsepower or less being used, or wherever an appliance rated at 1,650 watts or less is to be used. Appliances with ratings above 1,650 watts require a special type of receptacle, and these receptacles should be connected to circuits larger than No. 12 wire, as is explained later. No. 14 wire is satisfactory for ordinary branch circuits, other than the circuit for convenience outlets in the kitchen, dining room, laundry, and pantry, which should be of No. 12 wire.

### C. The House

In fig. 1 is shown the plans of an average farm home which has been wired for electricity. This home is typical of old houses in which wiring was not installed at the time of building. Part of the remodeling here consisted of placing the bathroom on the side porch, since there was no other place available for it. When remodeling the kitchen, the old coal range was removed and an electric range installed in its place; also, a new kitchen sink and new cupboards. The following description refers to the various rooms shown on these plans and it is suggested that the plans be referred to while reading the following paragraphs:

In each bedroom a ceiling light is provided and controlled from a switch at the door. A convenience receptacle is installed near the bed for a bed light, and one near the dresser for a lamp. Some prefer to use "pin-it-up" lamps in the convenience outlets -- eliminating the ceiling outlet. If possible, receptacles should be located so that electric service could be used in two places from one duplex receptacle. Note that lights with pull-switch control have been provided in the closets.

In hall and stairway, three-way switches are provided for the lights, so they can be turned on or off from either floor.

In dining room, there is a ceiling light over the table. As shown in the drawing, if desired, this light can be controlled by a switch at the door most frequently used to enter the room. There is a convenience receptacle near the table to operate toaster, waffle iron, or percolator; also a convenience outlet near the side-



## ELECTRICITY ON THE FARM

Objective

To learn how to apply basic wiring methods to the various applications on the farm or ranch.

References

---

Lesson Content

## A. Introduction

The growing demand for new ways of using electricity on the farm is directly related to the increase of rural electrification since 1935, the date of the establishment of the Rural Electrification Administration.

The rapid increase in the number of farms using electricity, coupled with the change in rural living standards and production methods, is reflected in the desire of both present and prospective farmers to learn more about new and better ways of doing various farm jobs with electricity.

If a farmer has to purchase all of the electrical equipment desired or is forced to hire others to build it, his use of electricity will either be limited or more costly. There are many pieces of simple equipment that a farmer can make by following the procedures outlined in this section.

This section contains subject matter material supplied by the Rural Electrification Administration. It includes: (1) Hints on farm wiring, maintenance, and repair; (2) analyses of operative training content for special electrical jobs; (3) statement of certain interpretive science and related information of importance in connection with the jobs; (4) illustrations; (5) a list of uses of electricity.

## B. Planning Farm Wiring

The first step toward the efficient and satisfactory use of electric current on a farm is a safe, properly installed, and adequate job of wiring intelligently planned to meet present as well as future needs.

In many instances rural people spend money to wire for lights only, and then find it will cost twice as much later on to extend or revise the entire system, so they can get enough electricity to operate additional home appliances and farm equipment. Often it costs only half as much to install adequate wiring in the beginning for all future electrical needs.

To be able to use electricity effectively, convenience outlets should be provided for plugging-in floor lamps, radio, vacuum cleaner, toaster, coffee percolator, electric room heater, refrigerator, electric iron, washing machine, and the like. Special outlets are necessary for electric range and water heater as well as for the many pieces of equipment used in barns and other farm building.





## A D E Q U A C Y

An adequately wired home is one which has been wired in such fashion as to permit the occupant to secure a maximum of utility from the use of electricity, with a minimum of inconvenience. He must be able to plug in various floor and table lamps and radios without using extension cords, even when the arrangement of the furniture is changed. He must be able to plug in various appliances without unplugging others. He must be able to turn on the lights in any room without having to stumble through darkness to find a switch or pull-chain. He must get the full utility out of appliances by having them heat quickly, without lights dimming when the appliance is turned on.

## FUSES MUST BLOW VERY RARELY

Many homes are being wired with entirely too little thought about adequacy, even though today electricity is expected to provide from 10 to 50 times as much light per room as in the early days of electric lighting and is expected to run radios, vacuum cleaners, toasters and many other devices.

An inadequately wired home is like the automobile of 25 years ago, which furnished transportation but did not have such convenience as spare tire, electric starter, a top, or a lighting system. Today no one considers buying a car without all these things, which 25 years ago were luxuries but which today are considered essential. Plan the wired home to include all these things that are today essentials.

Factors in Adequate Wiring

In order that a home may be adequately wired, careful attention must be paid to the following details:

1. Service entrance of sufficient capacity.
2. Wires of sufficient capacity throughout the home.
3. Sufficient number of circuits.
4. Receptacle (plug-in) outlets in sufficient number.
5. Lighting outlets in sufficient number.
6. Lighting fixtures of scientific design.
7. Wall switches in sufficient number for complete flexibility.
8. Miscellaneous outlets are devices for signaling, radio, and so on, in proportion to the size and pretentiousness of the house.

Lifting Floor Boards.

In few cases the outlet and switch boxes may be so located with regard to wall and ceiling obstructions that it is necessary to lift hardwood floor boards in the floor above. THIS SHOULD BE AVOIDED IF POSSIBLE, but where necessary use extreme care in lifting the boards so that when replaced there will be no visible damage to the floor. Attic flooring is simply lifted, but the usual hardwood floor with the tongue-and-groove construction presents more of a problem.

## WIRING APARTMENT HOUSES

If an apartment house is considered in its entirety as a multi-family dwelling, a number of new wiring problems arise that have not yet been covered.

If an apartment is considered merely as that space within the building which is occupied by a single family, there are no new problems of importance.

Planning Individual Apartment.

To determine the minimum number of circuits required by CODE, proceed as in the case of a single family dwelling. For lighting, ALLOW 2 WATTS PER SQUARE FOOT. To this add the minimum of 1,500 watts required for small appliances. (If the apartment has an area of 1,000 sq. ft., or less, it is still necessary to add 1,500 watts, despite the fact that in single family dwellings under 1,000 sq. ft. only 1,000 watts need be added.)

For example, for an apartment of 700 sq. ft. allow 1,400 watts at 1,725 watts per circuit obviously a minimum of two circuits is required, plus a separate circuit for each appliance rated above 1,650 watts.

Service Entrance Problems.

In practically all cases there is but a single service drop for the entire building. Since in most cases there is a separate meter for each tenant, plus usually another meter to carry hall lights, oil-burner motors and similar loads, this service drop must feed a number of separate meters and disconnecting means. If there is a common space available accessible to all tenants, such equipment should be grouped there. THE CODE in SECTION 2351b, requires that each occupant have access to his disconnecting means.

If there are not over six meters and disconnecting means, it is not necessary to provide a main disconnecting means and over-current protection ahead of them. Instead each meter is, through its over-current device and disconnecting means, connected directly to the service entrance wires, as outlined.

No separate switch or over-current device is required in multiple occupancy installation if not over SIX separate entrance switches are used.

If the box is to be mounted on wall-board or similar material over which there is no plaster, then the mounting ears are reversed, thus bringing the front edge flush with the surface. There are also available special hangers for supporting switch boxes on wallboard and similar materials.

If the cable runs into the bottom of the box, there is no problem involved in cutting the right size opening. If, however, the cable runs into knockouts in the side of the box, it is not so simple. If the cable is rigidly attached to the box with a connector before the box is mounted, then it will no longer be possible to get the box into the opening - the cable is in the way. If the opening is made big enough, a box which has been reassembled with cable and connector will slip through. But it will be a very sloppy fit, that no self-respecting workman will tolerate. To do a good job, cut the opening only big enough for the box, plus about 1/8 in., or the thickness of the wire inside of the cable. Leave a generous length of wire sticking out of the cable. Attach the connector to the cable, let the wire stick out of the opening in the wall, with the connectors inside the wall, push the wires through the knockout into the box and grasp them inside the box. Push the box into the wall; there will be room at the ends of the opening for the wires to slide through into the wall. When the box is in place, pull the cable and connector into place and attach the locknut to the connector.

### Cable Through Attic

In single story houses, or when working on the second floor of two story houses, it is generally entirely practical to run cable through the attic. It is a simple matter to lift a few boards of the usual rough attic flooring and lead the cable around, to avoid all openings in the walls of the living quarters except the openings for boxes. No baseboards need then be lifted. It may require a few feet more of cable, but the saving in labor more than offsets this. Always explore this possibility before proceeding with a more difficult method.

### Wire Sizes:

Remember that the code specifies only minimum sizes. While No. 14 wires may generally speaking be used throughout the average installation, the trend is entirely toward No. 12 as a minimum.



In cutting the opening for the switch box, take into consideration the dimensions of the box compared with the width of lath, the ordinary switch box is 3 in. long, while two laths plus three spaces between laths measures more than 3 in.

If two full laths are cut away, it will be difficult to anchor the switch box by its ears on the next two laths, for the mounting holes on the ears will then come very close to the edges of the laths, which will split when the screws are driven in. Cut one lath completely and remove part of the width of each of the two adjoining laths, this should be clear, as shown in Fig. 6.

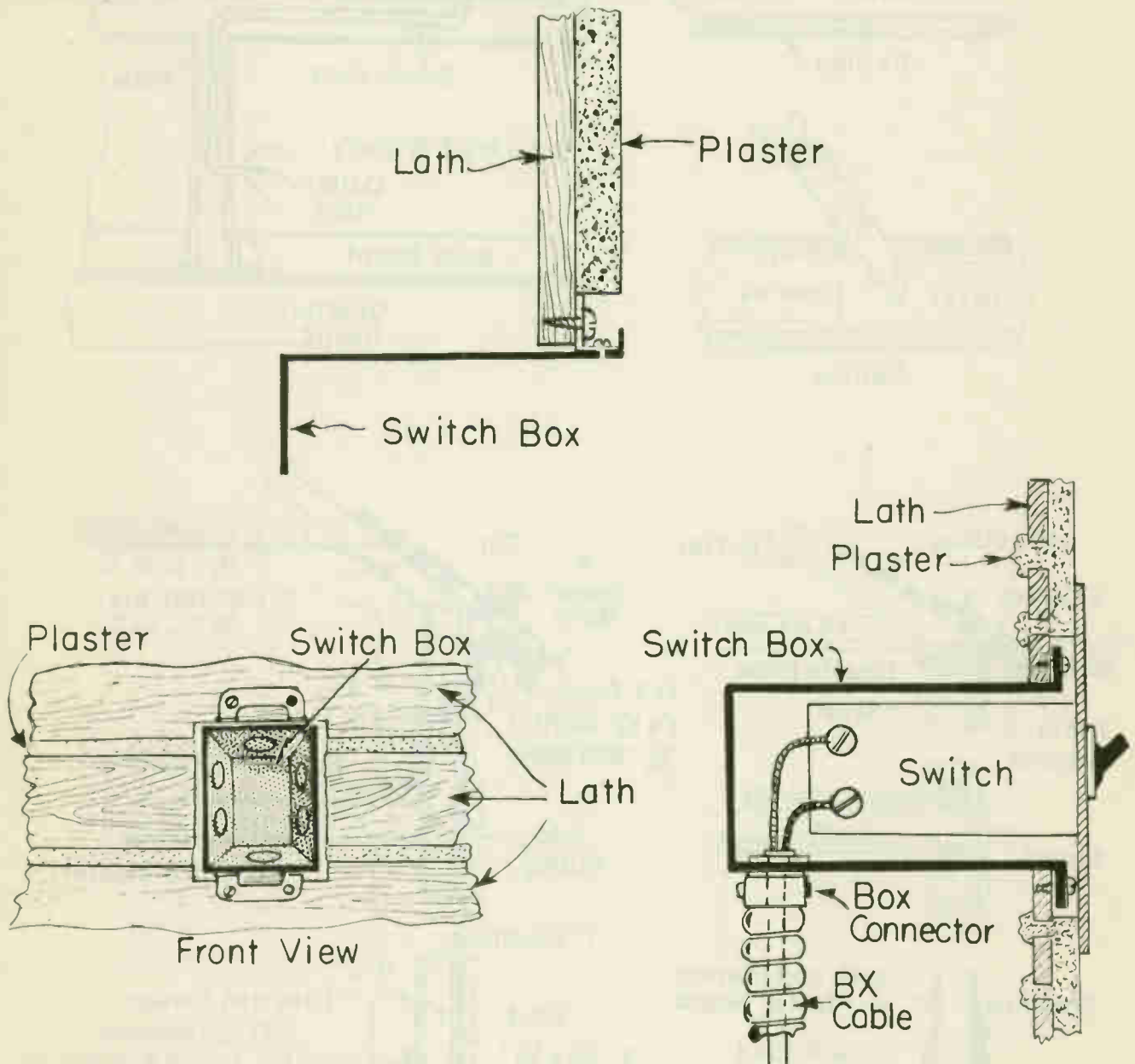

Fig. 6 - in cutting the opening for a switch box, do not cut away two complete laths. Cut away one and a portion of each of two others.



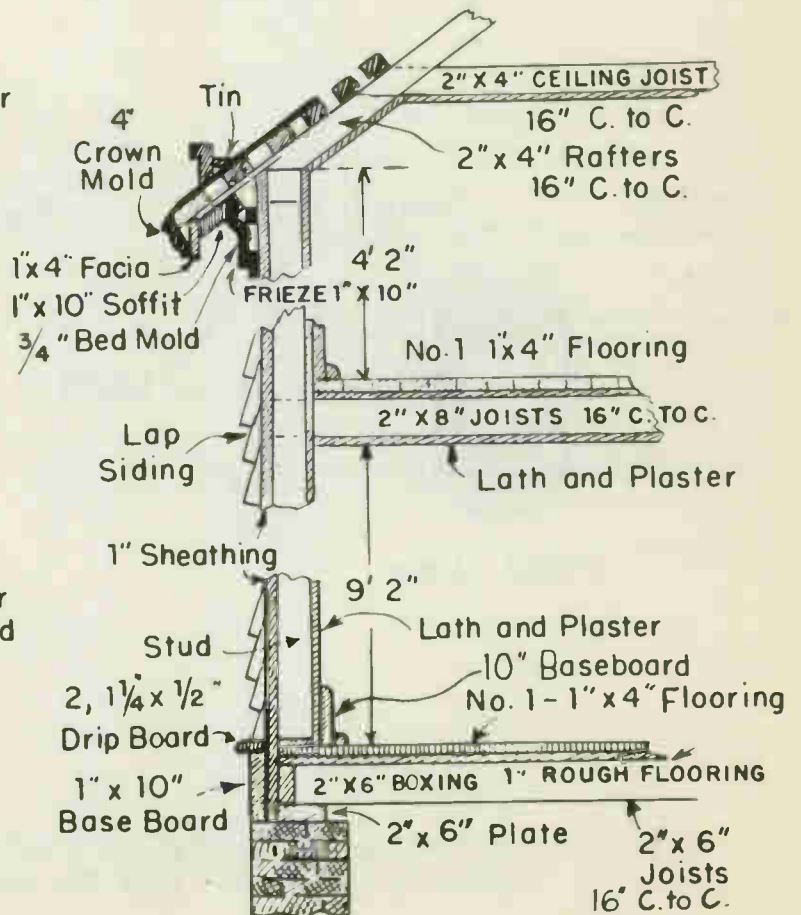
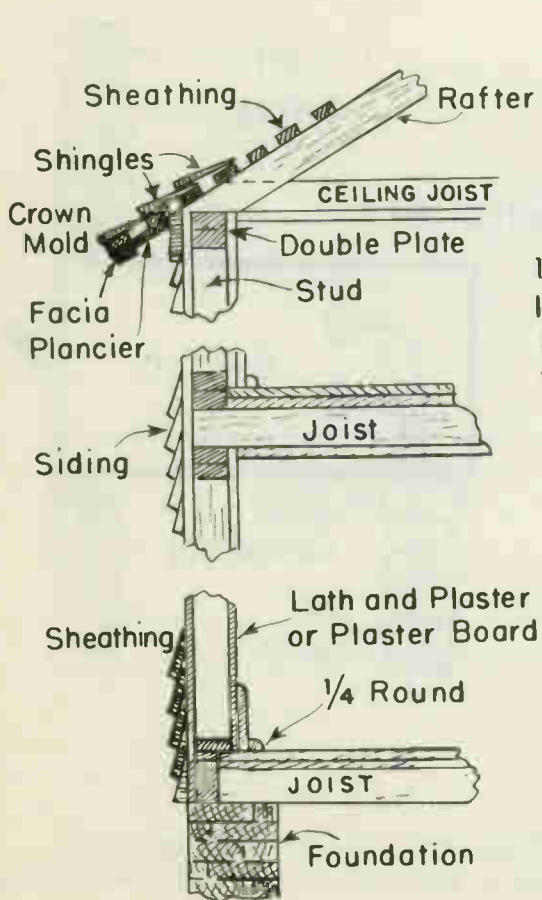
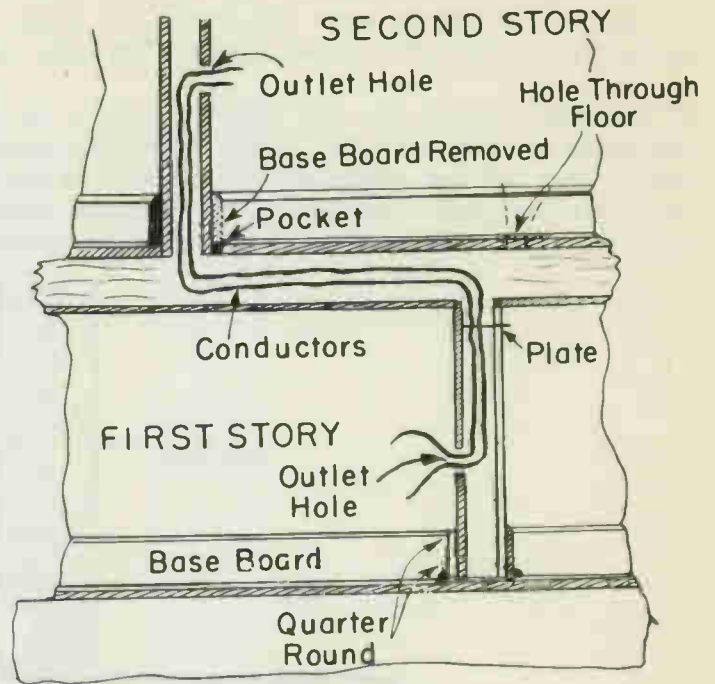
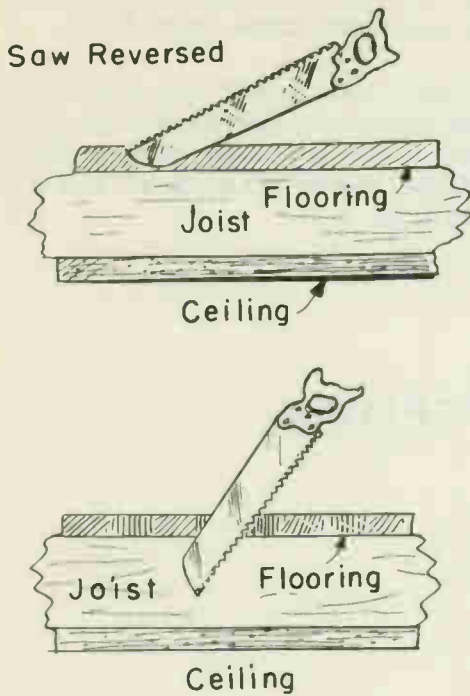

Fig. 5

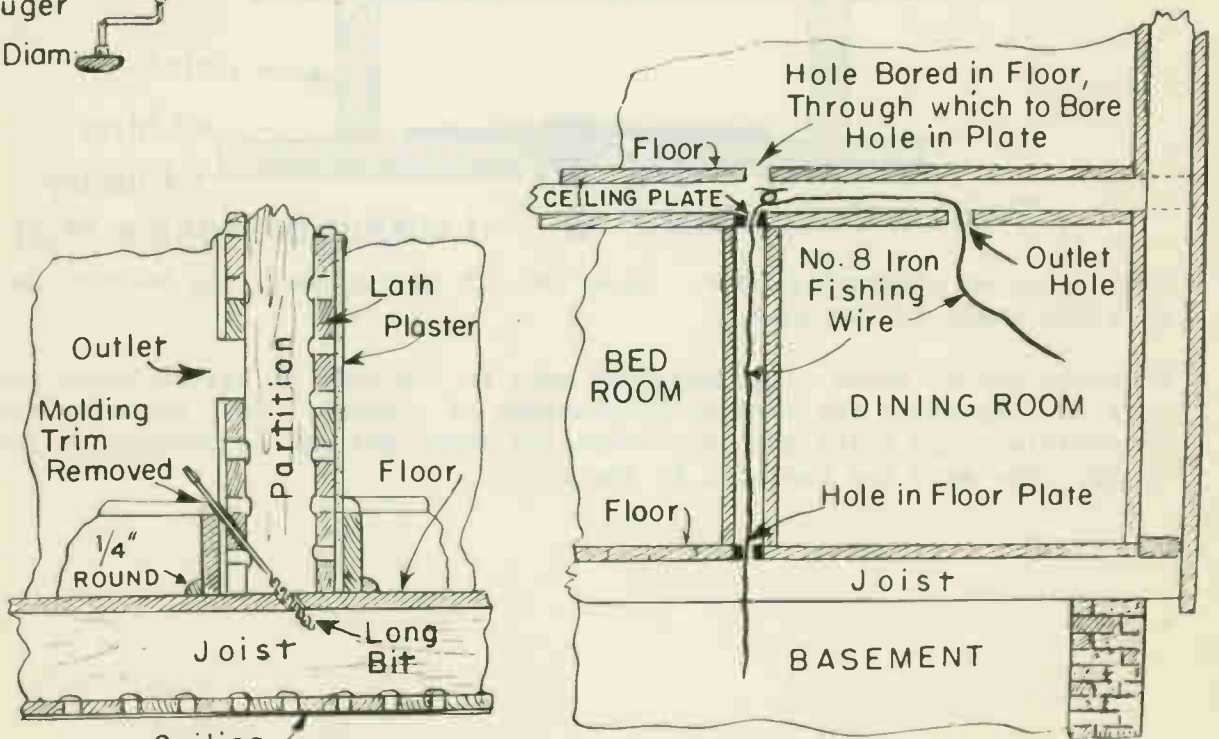
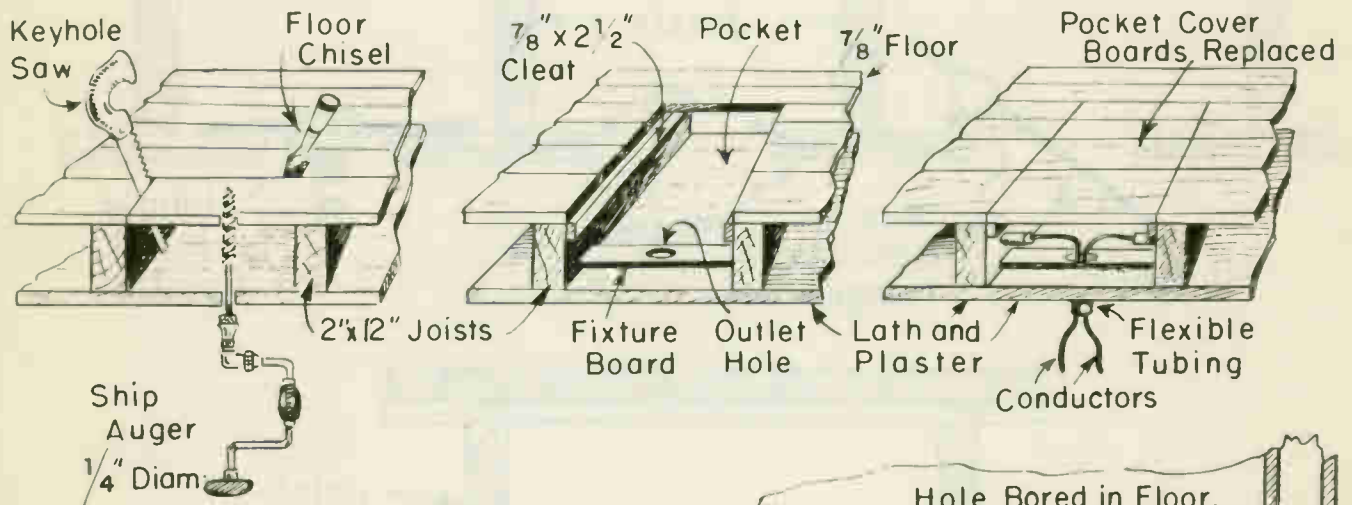
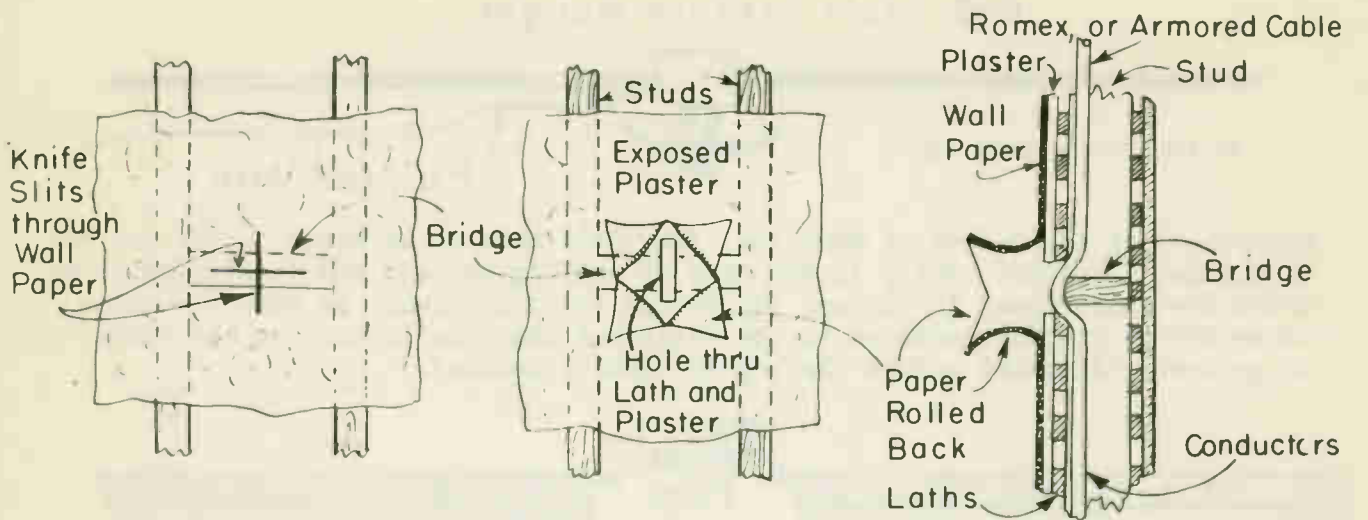
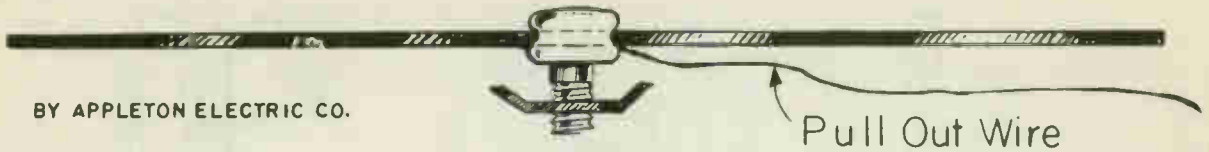
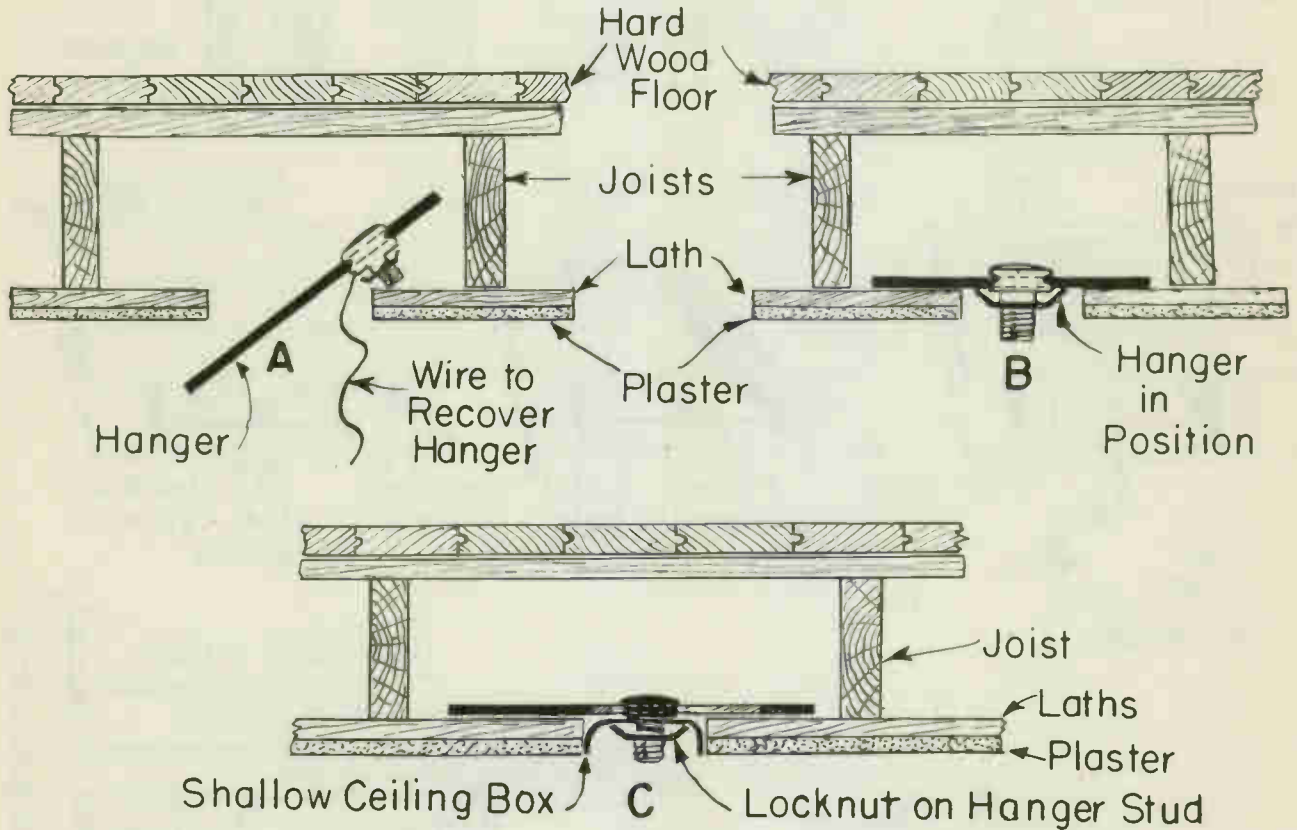

Fig. 4

## Old Style Fixture Hanger



Regardless of the method of mounting, the cable must be attached before the box is mounted in place. This, in the case of ceiling outlets and in similar cases where the cable comes in through the bottom is no problem. Be sure the cable connector is rigidly anchored to the cable and that the locknut on the connector is securely tightened before the box is finally mounted.



Installing an old-work hanger. When the job is finished, the hanger should lie at right angle to the lath.

Mounting Switch Boxes - The mounting ears on the ends of switch boxes are adjustable to compensate for various thicknesses of plaster. They are also completely reversible. The boxes are so constructed that they may be mounted on plastered walls. The ears are fastened to the lath.

The cutting is done as the blade is pulled, not when pushing the blade away as in usual sawing. If an attempt is made to saw in the usual way so that the work is done while pushing the blade into the wall, there is greater danger that the lath will be pulled away from the plaster on either side of the opening, with the result that there may then be a considerable area of plaster unsupported by lath inside. While sawing, hold the hand against the plaster so that it is rigid, otherwise, there is a tendency for the plaster to be pulled off the wall.

If the room is papered, remove a generous square of paper at the point where the temporary opening is to be made. Cut through the paper with a razor blade; apply moisture with a sponge or rag, soak the paper, and the cut portion can usually be removed intact. Save it and later replace it. The opening in the plaster of paris or similar compound that needs only be mixed with water and that sets quickly. The same mixture is used to fill in the openings around switch and outlet boxes, for the CODE does not permit open spaces; the plaster must come up to the box.

**Mounting Outlet Boxes** - For new work, the code requires outlet boxes with a minimum depth of  $1\frac{1}{2}$  inch; for old work this requirement is waived when the use of deeper boxes leads to injury of the building structure. Boxes  $\frac{1}{2}$  in. deep are therefore commonly used. If the outlet box is located so that it can be attached to a joist or similar substantial timber, install as shown in Fig. 1.

In similar fashion a box may be mounted directly on lath even if it is not backed up by a joist, this method is to be DISCOURAGED because, if a fixture of any substantial weight is attached to the box, damage to the ceiling may result.

By far the simplest method is to use one of the old-work hangers. First, a hole is made in the ceiling at the proper place. Then the hanger is slipped into the hole; Note: the hanger has a length of wire attached to the stud so that it is not easily lost inside the ceiling or wall. It is then pulled back by this wire, and the stud only is allowed to project from the opening in the ceiling. Turn the bar crosswise so that it lies at right angles to the lath; this will later distribute the weight of the fixture over a number of laths instead of throwing it all on one or two as is the case when the box is mounted directly on lath. Remove the locknut from the stud, slip the stud through the center knockout to the box, tighten the locknut on the stud inside the box, and the job is finished.

## OLD HOUSE WIRING

In old work, or the wiring of buildings completed before the wiring is started, there are few electrical problems that have not already been covered. Most difficulties can be resolved into problems of carpentry, in other words, how to get wires and cables from one point to another with the least effort and minimum tearing up of the structure of the building.

In new work, it is a simple matter to run wires, and cables from one point to another in the shortest way possible; in old work more material is used because often it is necessary to lead the cable the long way around through channels that are available, rather than to tear up walls, ceilings, or floors in order to run it the shortest distance.

Written material cannot give all the answers as to how to proceed in old work; here the common problems will be covered, but considerable ingenuity must be exercised in solving actual problems in the field. A study of buildings while they are under construction will help in understanding what is behind the plaster in a finished building.

Conduit Method - It is impossible to use conduit in old work without practically wrecking the building. It would be used only where a major rebuilding operation is in process, and installation then is as in new work.

Knob and Tube - Since the Code requires that all wires fished through walls must be enclosed in separate continuous lengths of loom, this method will not be found very practical because the cost of two lengths of rubber-covered wire and two lengths of loom is at least as much and usually more than the cost of an equivalent length of armored or non-metallic cable. The cable is easier to handle and more quickly installed. For these reasons, the knob and tube system is little used in old work.

Cable Wiring - The usual method of wiring in old work is with armored or non-metallic cable. This material is easily fished through the wall and other spaces. It is sufficiently flexible so that it will go around corners without much difficulty.

Cutting Openings - To cut good openings for outlet and switch boxes in walls requires a certain amount of skill and a generous measure of common sense. The openings must not be oversize and must be neatly made. Start by marking the approximate location of the box, and if possible, allow a little leeway so that the opening can be moved a trifle in any direction from the original mark. First make sure there is not a stud or a joist in the way; usually thumping on the wall or ceiling will disclose the presence of timber. Then dig through the plaster at the approximate location and probe until the space between two laths is found, then go through completely. It would be well to reach through this opening and, with a stiff wire or similar instrument, probe to right and left to confirm that there is no stud or similar obstruction. Assuming that every-thing is clear, mark the size of the final opening and proceed with the actual cutting, which is done with a hack-saw blade, with the teeth pointing backward, the opposite of the usual fashion.

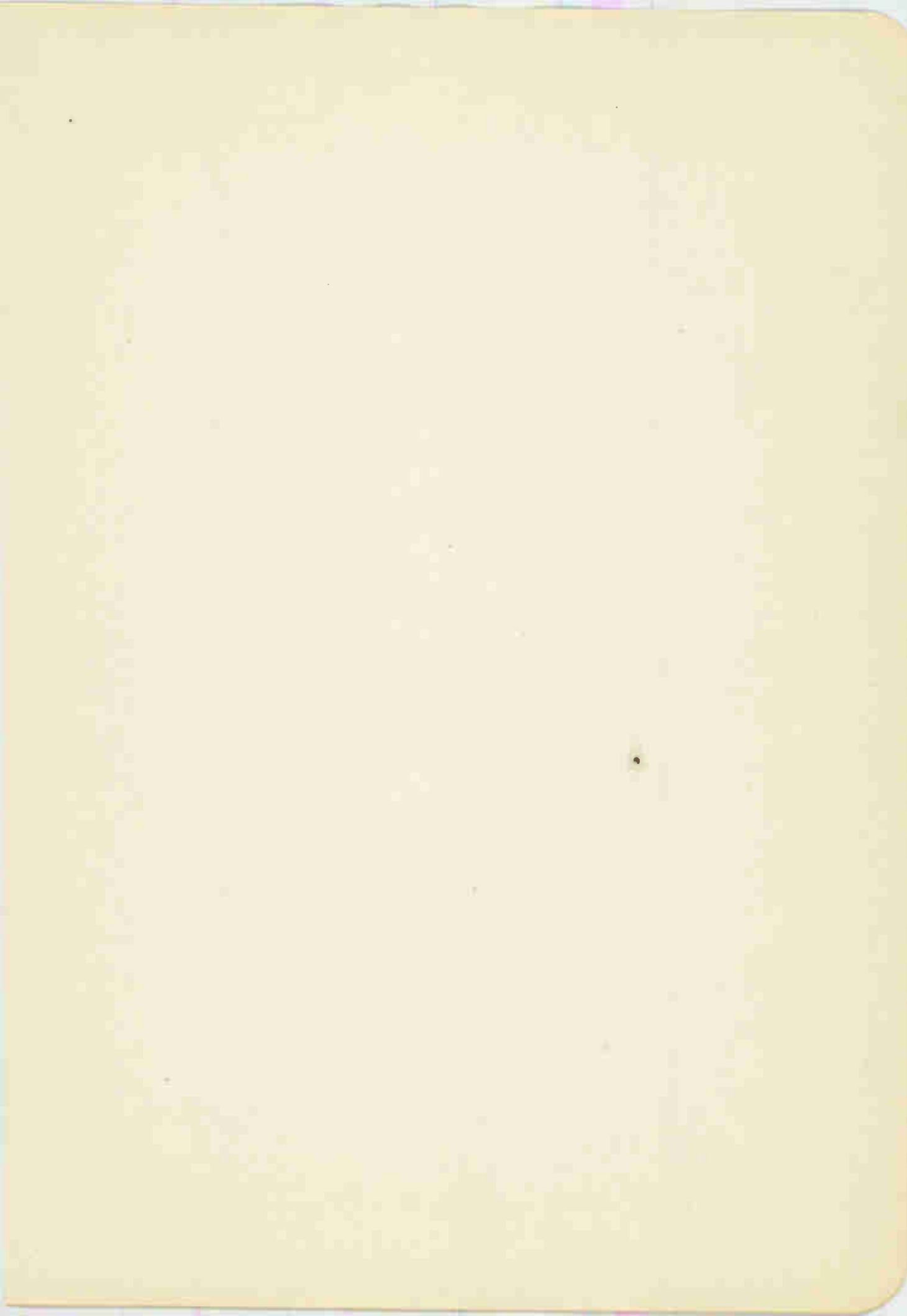

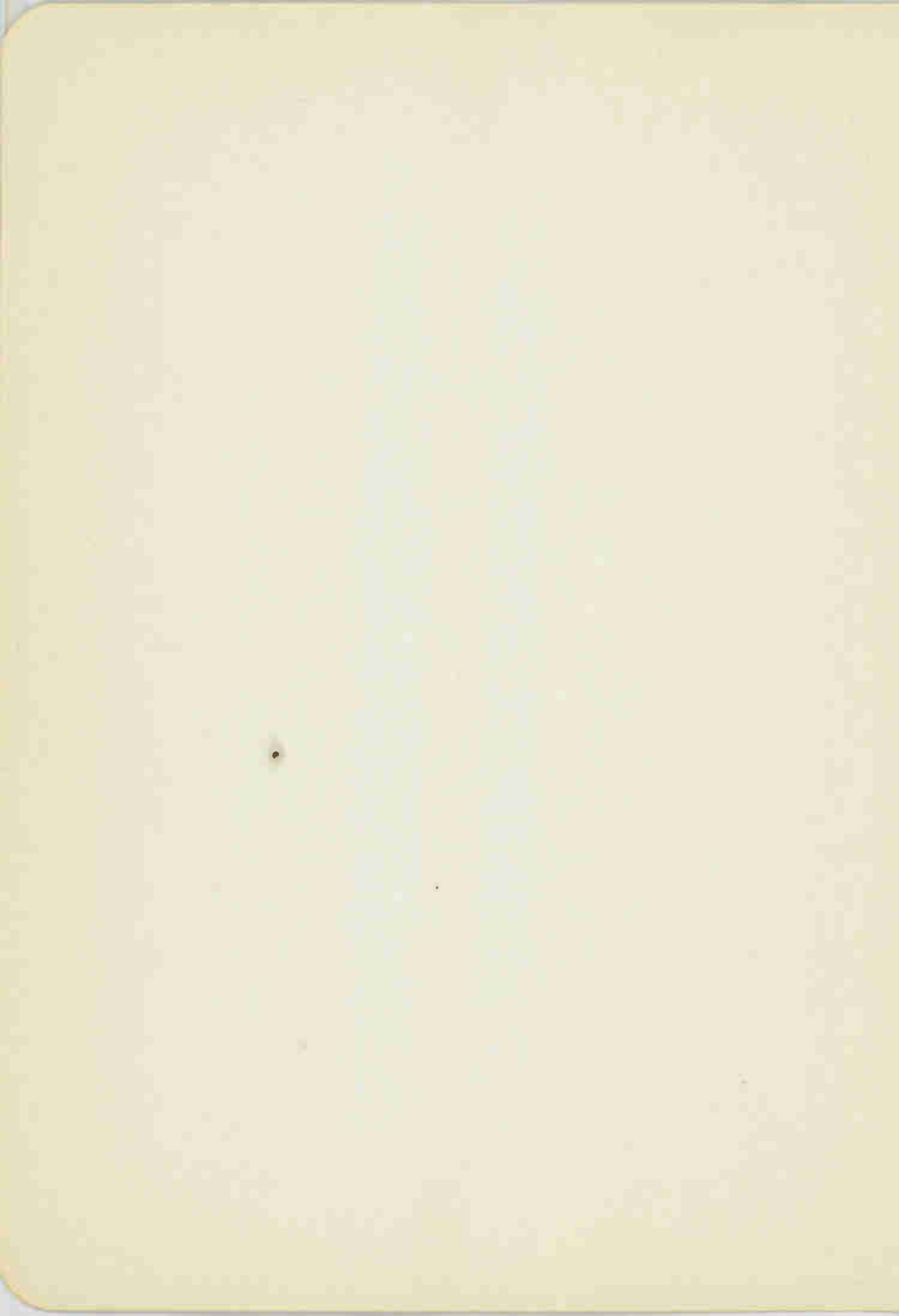

*[The following text is extremely faint and illegible due to low contrast and scan quality. It appears to be a series of paragraphs or sections of text, possibly containing technical instructions or theoretical concepts related to electrical wiring and repair.]*



Solution - Minimum size feeders (or service conductors) required.

For 115 - 230 volt, 3-wire system:

Ampere load; 39 plus 26 - 65 amperes.

Size of each feeder, #3

NOTE: in stores and similar occupancies where practically the entire load is likely to be used for long periods of time, the loading of the circuit shall not exceed 80 percent of the branch circuit rating. Therefore, in such installations the number of branch circuits shall be increased accordingly.

C. Specifications for wiring of Bungalow.

General Conditions.

The standard form of "General Conditions of Contract" of the American Institute of Architects, copies of which are on file with the owner, shall govern and is hereby considered and acknowledged a part of the specifications covering this work.

Progress of Installations.

The electrical contractor shall keep himself informed of the progress of the general construction of the building so that he may begin his work at the earliest opportunity in order to avoid delaying the progress of the work as a whole. He shall provide a working crew of adequate numbers to install the work as rapidly as may be consistent with the class of work required. He shall cooperate with all other contractors on the job to serve the best interests of the owner.

Code Rules

All material and work shall conform in all respects to the latest rules and requirements of the National Electric Code and the Public Service Company requirements.

Bids

This bid shall be based on armored cable (B X) with conduit used only from point of entrance to the service switch.

Service

The electric company shall bring the main wires to the weatherhead and connect them to the service wires which shall be installed by the contractor. The contractor shall furnish an approved type service switch and wire for the meter. The meter to be furnished and installed by the Public Service Company.

Materials

All materials shall be new, and shall bear the Underwriter's label. Outlet boxes for walls and ceiling lights shall be fitted with a fixture stud. Wall switches shall be of the toggle type and shall be either single pole or three-way to suit the plan requirements. Whenever two or three switches are adjacent to one another they shall be arranged for gang or tandem cover plates. Wall or base outlets shall be of the double or duplex flush type.

Fixtures

Fixtures and hanging of same will be done under separate contract.

For 115 volt 2-wire system;  $3,700 \div 115 = 32$  amps. or #8

For 115 volt - 230 volt, 3-wire system:  
 $3,700 \div 230 = 16$  amperes or #8

Solution - Minimum number of receptacles required

Living room:  $16' \times 22' = 76'$  total (gross) distance  
 around the room.  $76' \div 20 = 3.8$  or 4 receptacles.

Each bed-room:  $14' \times 15'$ ;  $58'$  total (gross) distance  
 around the room.  $58' \div 20 = 2.9$  or 3 receptacles.

Dining-room:  $16' \times 16'$ ;  $64'$  total (gross distance around  
 the room.  $64' \div 20 = 3.2$  or 3 receptacles.

Breakfast-room:  $10' \times 12'$ ;  $44'$  total (gross distance  
 around the room.  $44' \div 20 = 2.2$  or 3 receptacles.

Kitchen:  $14' \times 14'$ ;  $56'$  total (gross) distance around the  
 room  $56' \div 20 = 2.8$  or 3 receptacles.

NOTE: a. Receptacles to be placed equal distances apart in-so-far as practicable.

b. Receptacles in these locations, also in the laundry to be supplied by circuit or circuits of not less than #12 wire.

#### D. Store Building

A store building is to be wired for general lighting and show window illumination. The store has a floor area of 50 feet by 60 feet and 30 feet of show window. With a density of illumination requiring 3 watts per square foot for the store and 200 watts per foot for the show window.

Calculate: a. Total load  
 b. Minimum number of branch circuits required.  
 c. Minimum size feeders (or service conductors) required.

Solution - Total load  
 $3,000$  sq. ft. at 3 watts per sq. ft . . . 9,000 watts  
 Show window lighting load:  
 $30$  Feet at 200 watts per foot . . . . . 6,000 watts

Solution - Minimum number of branch circuits required  
 General lighting load;  $9,000 \div 230 = 39$  amperes for 3-wire  
 (115-230 volts) or 78 amperes for 2-wire (115 volts)  
 Two 25 ampere, 2 wire and two 15 ampere, 2-wire circuits or  
 One 25 ampere, 3-wire and two 15 ampere, 2-wire circuits; or  
 Six 15 ampere, 2-wire circuits; or Three 15 ampere, 3-wire circuits.

Special lighting load (show window)  
 $6,000 \div 230 = 26$  amperes for 3-wire, 115-230 volts; or  
 52 amperes for 2-wire, 115 volts.  
 Four 15 ampere, 2-wire circuits; or two 15 ampere, 3-wire circuits.

## DEMAND FACTORS

## A. Code Requirements as to Feeder Wires and Sizes?

Feeder conductors shall not be smaller than that specified in the tables for the computed feeder load. A 2-wire feeder supplying two or more 2-wire branch circuits, or a 3 wire feeder supplying in excess of two 2-wire branch circuits, or two or more 3-wire branch circuits, shall be not smaller than #10. If a feeder carries the total current supplied by the service-entrance conductors, such feeder shall for service of #8 and smaller, be of the same size as the service-entrance conductor.

## B. Code Requirements as to Voltage Drop?

The size of the feeder conductors should be such that the voltage drop up to the final distribution point for the load as computed will not be more than 3% for power load and not more than 1% for lighting load or combined lighting and power loads.

## C. Single Family Dwelling

It is required that a single family dwelling be wired in accordance with the requirements of the National Electrical Code. The dwelling has a floor area of 2,500 square feet, exclusive of unoccupied cellar, unfinished attic, and open porches. The load is assumed as 2 watts per square foot, and the small appliance load consisting of toasters, vacuum cleaners, electric iron, refrigerator, etc., may be taken as 1500 watts. The voltage is assumed as 115 or 230 volts.

- Example: Calculate:
- Total load
  - Minimum number of branch circuits required
  - Minimum size of feeders (or service conductors) required
  - Minimum number of receptacles required

Solution - Total load. General lighting load.

2,500 sq. ft. at 2 watts per sq. ft . . . . .	5,000 watts
Small appliance load . . . . .	<u>1,500</u> watts
Total computed load . . . . .	6,500 watts

Solution - Minimum number of branch circuits required

General light load = 5,000 ÷ 115 = 43 amperes or three
15 - ampere #14 wire circuits
Small appliance load = 1,500 ÷ 115 = 13 amperes, or one 2-wire
15 ampere #12 wire circuit.

Solution - Minimum size feeders (or service conductors) required.

Total computed load 6,500 watts	
2,500 watts at 100% . . . . .	2,500 watts
4,000 watts at 30% . . . . .	<u>1,200</u> watts
Net computed load	<u>3,700</u> watts

ARMORED CABLE WORK

(B.X)

NEW HOUSE

Items	Unit Cost	ceiling/wall		convenience out		s.p. switch		3 w. switch	
		quantity	cost	quantity	cost	quantity	cost	quantity	cost
#14-2 wire B.X.		17'		13'		14'		8'	
#14-3 wire B.X.								12'	
Outlet box		1							
Box support		1							
3/8" fixture stud		1							
Switch box				1		1		1	
Switch box support				1		1		1	
B.X. connector		2		2		2		2	
3/8" pipe straps		9		3		3		5	
Convenience outlet				1					
S.P. Switch						1			
3 way switch								1	
Miscellaneous									
Labor-hours		.55		.66		.66		.88	
Total									

ARMORED CABLE WORK

(B.X.)

Items	Unit cost	ceiling/wall		convenience out		s.p. switch		3 w. switch	
		quantity	cost	quantity	cost	quantity	cost	quantity	cost
#14-2 wire B X.		22'		20'		20'		9'	
#14-3 wire B.X.								12'	
Shallow outlet box		1							
Old work hanger		1							
Switch box				1		1		1	
B.X. connector		2		2		2		2	
3/8" pipe strap		3		3		3		3	
Convenience outlet				1					
S. P. switch						1			
3 way switch								1	
Miscellaneous									
Labor-hours		1.55		1.9		1.9		2	

Coyne Electrical School

TA-W&R-P35

Wiring & Repair

SERVICE

(Conduit)

Items	Unit Cost	2 cir. 2 wire		4 cir. 3 wire	
		quantity	cost	quantity	cost
1/2" conduit		15'		15'	
3/4" conduit		20'			
1" conduit				20'	
#8 wire		45		65'	
Ground wire		20'		20'	
2w. Service sw.		1			
3w. Service sw.				1	
* 3/4" Service Head		1		1	
* 3/4" LB Fitting		1		1	
Ground clamp		1		1	
Fuse Plugs		3			
Fuse Plugs				6	
Miscellaneous					
Labor-hours		7		9	
Total					

\* For a 3 wire service these items should be 1"

SUMMARY

quantity	Items	Unit Cost	TOTAL
	ceil/wall outlet		
	convenience out.		
	S.P. switch		
	3 way switch		
	Service		
	Permit		
	Total		

%	Items	TOTAL
65	Labor and material	
25	Overhead	
10	Profit	
100	Total	

CONTRACT

Estimate number \_\_\_\_\_ Date \_\_\_\_\_

I (We) hereby propose to furnish labor and material necessary to install the wiring system in and about the premises located at \_\_\_\_\_ for the sum of \_\_\_\_\_ Dollars.

Payment shall consist of 80% of the total when the work is roughed in, the balance to be paid after final inspection.

The work done and the material furnished under this proposal shall comply with all local requirements governing this class of work and in accord with the latest rules and requirements of the National Electric Code.

The work done and the materials furnished under this proposal shall comply with the specifications and drawings submitted.

All changes shall be made in writing and signed by both parties hereto, which said writings shall set out and contain in full the character, extent, cost and conditions of said change.

Accepted \_\_\_\_\_ Owner \_\_\_\_\_ Date \_\_\_\_\_ Contractor \_\_\_\_\_

The item of profit is one to which you are justly entitled and it should be included in your estimate.

The cost of any job should be divided into at least four groups:

1. Net cost of material
2. Net cost of labor
3. Over-head expense
4. Profit

#### ALWAYS DO FIRST-CLASS WORK

Never make a practice of trying to get a job by cutting your price so low that you have to install poor materials, or do a poor job of installation. Always do first-class work at a fair price.

After making up an estimate, it is generally a good plan to add 5% to cover small items which cannot be anticipated. For example:

Suppose we consider a house wiring job by the outlet. Assume this to be a RomeX wiring job in a new building under construction, and that there are to be 50 outlets, half of which are lighting outlets and the other half are for flush type switches of flush receptacles. If our records show that on this size job we should get \$2.75 per outlet for lighting, and \$3.25 per switch for convenience outlet, then the estimate should be \$150.00; plus the service price, which the records may show will average \$15.00; we make the total estimated price \$165.00. In such cases as this your records of previous jobs of a similar type will be of great assistance in making an accurate and intelligent bid.

## CONTRACTING &amp; ESTIMATING

Objective: To obtain knowledge of the method of estimating on a time and material basis.

ReferencesLesson Content

## A. General

When it comes to giving a price on any job, there are several ways in which this can be handled. The time and material basis is ideal for the electrician, and can usually be made satisfactory to the customer. When the job is done in this manner, the customer pays you by the hour for the work done, and also pays you for the material, which you may purchase wholesale and sell to the customer at retail prices at a reasonable profit over and above your wages.

If you make fair wages on the first few jobs, this should be quite satisfactory, because you will obtain experience, not only in doing the actual work and gaining confidence in your knowledge and ability, but also in the time it requires for each type of work, and the cost of different items and material.

You should keep a very close record of these things, as they will be of great help in making accurate estimates on future jobs.

## B. Profit &amp; Overhead Expenses

After you get started, and you are doing larger jobs, a certain percentage should be added to the cost of materials and labor for overhead expense and profit. These things sometimes have to be explained to customers, so they do not get the impression that you are over-charging them for certain items.

There will be some overhead expense, whether you have a shop or are operating a business from your home. This over-head consists of certain small items of expense which cannot be charged directly to the customer, but should be added to the job cost.

Some items of overhead are as follows:

Telephone, Electric & Water Bills	Rent (Taxes, if you own the building)
Insurance, both fire and liability	Non-productive labor
Truck and hauling expenses	Depreciation of stock and material
Bad or uncollectible bills	(on hand)
General office and shop expense	Bookkeeping or any office help







The first step in the process of wiring is to determine the load of the circuit. This is done by adding up the wattage of all the devices that will be connected to the circuit. Once the load is determined, the next step is to select the proper size of wire and conduit. The size of wire is determined by the load and the length of the run. The size of conduit is determined by the size of the wire and the number of wires that will be in the conduit. After the wire and conduit are selected, the next step is to install the conduit and wire. This is done by pulling the wire through the conduit and securing it to the conduit with wire nuts. The final step is to connect the wire to the devices that will be connected to the circuit.

The second step in the process of wiring is to determine the type of wiring to be used. There are two main types of wiring: single phase and three phase. Single phase wiring is used for most residential and commercial applications. Three phase wiring is used for industrial and large commercial applications. The type of wiring is determined by the load and the type of equipment that will be connected to the circuit.

The third step in the process of wiring is to determine the voltage of the circuit. This is done by checking the voltage of the power source. The voltage of the power source is determined by the type of power source and the type of equipment that will be connected to the circuit. The voltage of the circuit is determined by the voltage of the power source and the type of equipment that will be connected to the circuit.

The fourth step in the process of wiring is to determine the type of equipment to be connected to the circuit. This is done by checking the specifications of the equipment. The specifications of the equipment are determined by the manufacturer and the type of equipment. The type of equipment is determined by the load and the type of equipment that will be connected to the circuit.

The fifth step in the process of wiring is to determine the type of conduit to be used. There are two main types of conduit: rigid and flexible. Rigid conduit is used for most residential and commercial applications. Flexible conduit is used for industrial and large commercial applications. The type of conduit is determined by the load and the type of equipment that will be connected to the circuit.

The sixth step in the process of wiring is to determine the type of wire to be used. There are two main types of wire: single conductor and multi-conductor. Single conductor wire is used for most residential and commercial applications. Multi-conductor wire is used for industrial and large commercial applications. The type of wire is determined by the load and the type of equipment that will be connected to the circuit.

The seventh step in the process of wiring is to determine the type of wire nuts to be used. There are two main types of wire nuts: standard and heavy duty. Standard wire nuts are used for most residential and commercial applications. Heavy duty wire nuts are used for industrial and large commercial applications. The type of wire nuts is determined by the load and the type of equipment that will be connected to the circuit.

The eighth step in the process of wiring is to determine the type of wire ties to be used. There are two main types of wire ties: standard and heavy duty. Standard wire ties are used for most residential and commercial applications. Heavy duty wire ties are used for industrial and large commercial applications. The type of wire ties is determined by the load and the type of equipment that will be connected to the circuit.

The ninth step in the process of wiring is to determine the type of wire markers to be used. There are two main types of wire markers: standard and heavy duty. Standard wire markers are used for most residential and commercial applications. Heavy duty wire markers are used for industrial and large commercial applications. The type of wire markers is determined by the load and the type of equipment that will be connected to the circuit.

The tenth step in the process of wiring is to determine the type of wire labels to be used. There are two main types of wire labels: standard and heavy duty. Standard wire labels are used for most residential and commercial applications. Heavy duty wire labels are used for industrial and large commercial applications. The type of wire labels is determined by the load and the type of equipment that will be connected to the circuit.

Minimum size, shall be not smaller than No. 8 for ranges of 8-3/4 Kw or more rating, nor smaller than No. 14 for other loads.

Range loads. See Note 4 of Table 29 Chapter 10 National Electric Code.

Where the maximum demand of a range of 8-3/4 Kw or more rating is computed according to column A of Table 29 Chapter 10. The neutral conductor of a three wire branch circuit supplying a household electric range may be smaller than the ungrounded conductors but shall have a current-carrying capacity of the ungrounded conductors and shall not be smaller than No. 10.

Cable assemblies with the neutral conductor smaller than the ungrounded conductor shall be so marked.

The Code also requires that there must be a disconnecting means for every permanently installed appliance rated at more than 1,650 watts. This may be a heavy duty cord and plug arrangement, this is usually used on ranges. A heavy duty receptacle three wire is rated at 50 ampere, this receptacle is usually installed at a point where the range is to be located.

From the receptacle, three wires are run back to the fuse cabinet or circuit breaker. These can be either No. 6 No. 8 depending on the wattage of the range; No. 6 is mostly used.

The wires may be any type used for houses wiring, such as rubbercovered wires in conduit, or armored or Non-Metallic sheathed cable.

Service Entrance Cable can also be used. (Code, Section 3382) in which case the bare conductor must be used as the continuation of the incoming neutral wire. Service entrance cable may be used in interior wiring only in connecting electric ranges, never for other wiring purposes.

Range on the first floor of residence or flat. A new service connection shall be installed, locating the meter and main line switch in the customary place and connecting existing lighting circuits to the new service. The range circuit should then be extended from circuit cabinet to the range by the most direct route.

Range on the second floor of apartment or resident. The existing location of meters should be used where ever possible, installing the new circuit to the building outlet. Where necessary, the old meter loop should be taken out and connections to the existing lighting circuits brought to the new meter location.

Mains feeding more than one range, should be large enough to supply the total load of all the ranges at the same time. Where it is probable that the other tenants in the house will install electric ranges or heating devices, it will prove much cheaper to provide capacity for the total load when making the first installation.

These specifications are not intended to give detailed instructions covering the methods to be used in wiring electric heating devices and ranges, but to furnish an out-line of certain general arrangement and requirements.

Each job presents a different problem to the wire man the details of which must be solved by the man on the ground, and the completed job made to conform with the general requirements of the National Electrical Code and the existing Local Code.

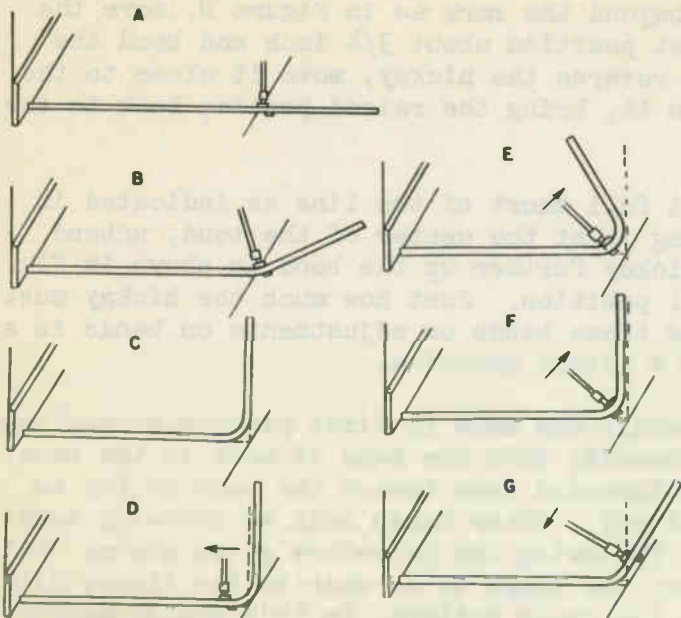

**BENDING THIN WALL CONDUIT  
ACCURATE STUBS**

TO MAKE 11" - 90° BEND WITH 1/2" ELECTRUNITE STEELTUBES, ALLOW 5" FOR TAKE-UP AS SHOWN.

WITH 3/4" STEELTUBES ALLOW - 6"  
WITH 1" STEELTUBES ALLOW - 8"

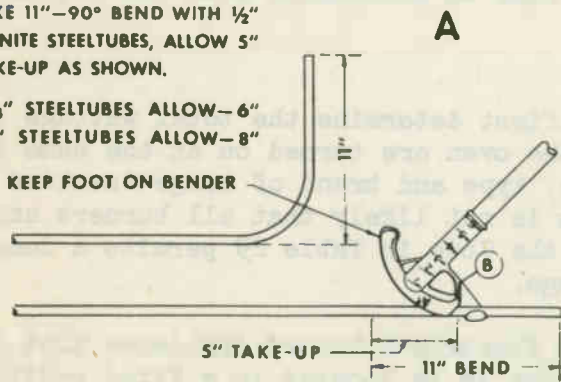

**TO STRAIGHTEN**

PLACE HANDLE OF BENDER OVER STUB AND PUSH DOWN TO FLOOR IN ONE FULL SWEEP.

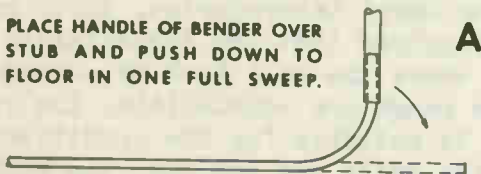

**TO MAKE A SADDLE BEND**

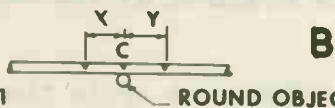

FIG. NO. 1

ROUND OBJECT

"C" - CENTER OF FINISHED SADDLE.

"X" - 2 TIMES DIA. OF ROUND OBJECT FROM - "C"

"Y" - 2 TIMES DIA. OF ROUND OBJECT FROM - "C"

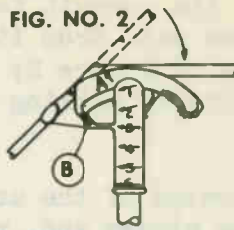

PLACE TUBE IN BENDER SO THAT "C" ON TUBE IS AT "A" ON BENDER AND MAKE 45° BEND

REVERSE TUBE IN BENDER AND PLACE "X" ON TUBE AT "B" ON BENDER AND MAKE RETURN BEND OF 22 1/2°. DUPLICATE SAME PROCEDURE

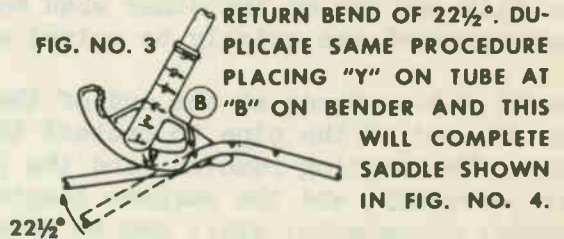

FINISHED SADDLE - NOTE THAT ROUND OBJECT FITS NEATLY UNDER SADDLE.

FIG. NO. 4

**PERFECT BACK TO BACK BENDS**

MAKE STUB BEND AT "X". MEASURE OFF REQUIRED DISTANCE "L" FROM "X" TO "Y" ON TUBE AND PLACE MARK "A" ON BENDER AT POINT "Y". COMPLETE SECOND BEND.

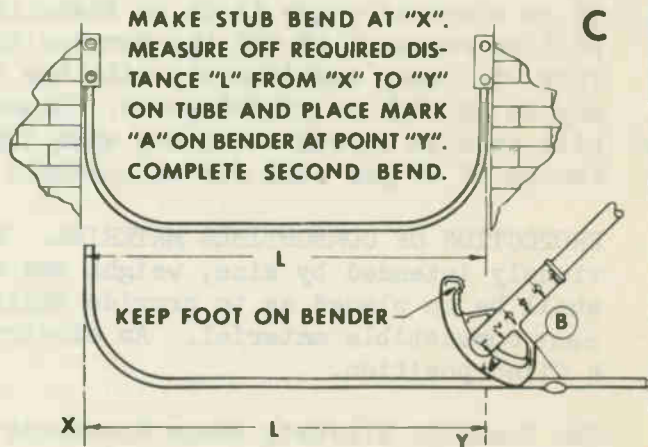

**TRUE OFFSETS**

FIRST MAKE 45° BEND IN TUBE. REVERSE TUBE IN BENDER AND ADJUST SO THAT POINT "X" IS IN ALIGNMENT WITH INCH MARK ON HANDLE CORRESPONDING TO DEPTH OF OFFSET DESIRED. THEN MAKE SECOND BEND 45° AND A TRUE OFFSET WILL RESULT BETWEEN POINTS "X" AND "Y".

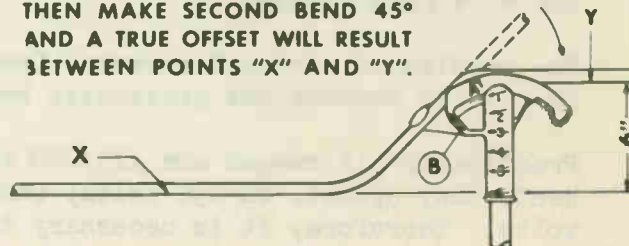

If the outer edge of the conduit falls beyond the mark as in Figure D, move the hickey back toward the wall from its last position about  $3/4$  inch and bend the pipe still further as in Figure E; then reverse the hickey, move it close to the center of the bend, and by pulling up on it, bring the raised portion back to the vertical position.

Should the raised portion of the conduit fall short of the line as indicated in Figure F, reverse the hickey and, placing it at the center of the bend, unbend the conduit slightly. Then slide the hickey further up the bend as shown in Fig. G bring the raised section to a vertical position. Just how much the hickey must be slid one way or the other when making these bends or adjustments on bends is a problem that can quickly be solved with a little practice.

Small radius bends at the end of the conduit are made by first placing a coupling on the end of the pipe to protect the threads; then the bend is made in the usual way, the coupling removed, and the pipe threaded down toward the bend as far as is necessary, and the surplus length cut off. Other bends such as offsets, saddle bends, goosenecks, etc., can be made by following the procedure given above. With these bends, it is a good idea to lay out the shape to be made on the floor, with chalk; and then to bend the pipe to fit the chalk pattern. On this basis, measurements are made where the pipe is to be installed, and the angle required of the various bends determined; these values are then transferred to the chalk drawn pattern, and the bends executed one at a time in accordance with the requirements.

#### J. Electric Ranges,

If an electric range is to be installed, first determine the total wattage that will be consumed if all the burners and the oven are turned on at the same time. This will vary considerably with the size, type and brand of range involved and may be as high as 15,000 watts. Since it is not likely that all burners and oven will ever be turned on at the same time, the Code in Table 29 permits a demand factor of 80 per cent for an electric range.

**PROTECTION OF COMBUSTIBLE MATERIAL.** Each Electrical heated appliance that is obviously intended by size, weight and service to be located in a fixed position shall be so placed as to provide ample protection between the appliance and adjacent combustible material. An electric range is obviously intended to be left in a fixed position.

The Domestic Electric Range Standards of Underwriters' Laboratories, Inc., provides for three different "installation forms". It requires that the installation form designation must be marked on the name plate. Where the wall back of a range and the wall or cabinet adjacent to the ends of the range are combustible, the range should have a form designation showing that it is suitable for the conditions. A Form 0 range may be installed in contact with the walls and cabinet; the back of a Form 1 range may be in contact with the wall but an air space of 1 inch must be provided at each end; an air space of 6 inches is required at the back and at each end of a Form 6 range.

The problem of wiring for ranges from the service entrance up to the fuse cabinet or circuit breaker has previously been covered.

Practically all ranges are 115/230 volt units. When they are turned on at high heat, they operate on 230 volts; when turned on at low heat they operate at 115 volts. Therefore, it is necessary to run three wires to the range.

## RADIUS OF CONDUIT BENDS

Size of Conduit	Conductors without Lead Sheath	Conductors with Lead Sheath
$\frac{1}{2}$ In.	3.7 In.	6.2 In.
$\frac{3}{4}$ "	4.9 "	8.3 "
1 "	6.3 "	10.5 "
$1\frac{1}{4}$ "	8.3 "	13.8 "
$1\frac{1}{2}$ "	9.6 "	16.1 "
2 "	12.4 "	20.6 "
$2\frac{1}{2}$ "	14.8 "	24.6 "
3 "	18.4 "	30.6 "
$3\frac{1}{2}$ "	21.3 "	35.5 "
4 "	24.1 "	40.2 "
$4\frac{1}{2}$ "	27.0 "	45.0 "
5 "	30.3 "	50.4 "
6 "	36.4 "	60.6 "

Bends - Number in one Run - A run of conduit between outlet and outlet, between fitting and fitting or between outlet and fitting shall not contain more than the equivalent of 4 quarter bends or in other words no more than 4-90° bends in one run, including those bends located immediately at the outlet or fitting.

3001 to 3020 inclusive and in addition shall comply with the provision of sections 3462 to 3471 of the National Electrical code.

Rigid metal conduit may be used under all atmospheric conditions and occupancies except that ferrous raceways and fittings protected from corrosion solely by enamel may be used only indoors and in occupancies not subject to severe corrosive influences. In these installations the conduit shall be of corrosion-resistant material suitable for the conditions. If practicable, the use of dissimilar metals throughout the system shall be avoided to eliminate the possibility of galvanic action.

Meat-packing plants, tanneries, hide cellars, casing rooms, glue houses, fertilizer rooms, salt storage, some chemical works, metal refineries, pulp and paper mills, sugar mills, round houses, some stables, and similar locations are judged to be occupancies where severe corrosive conditions are likely to be present.

Wet locations in portions of dairies, laundries, canneries, and other wet locations, and in locations where walls are frequently washed, the entire conduit system, including all boxes and fittings used therewith, shall be made water tight, and the conduit shall be mounted so that there is at least one-quarter inch - air space between the conduit and the wall or other supporting surface.

Minimum size - No conduit smaller than  $\frac{1}{2}$  inch electrical trade size, shall be used except as provided for under-plaster extensions in article 344, and for enclosing the leads of motors as permitted in Sec. 4439, Paragraph b. of the N.E.C.

Number of Conductors in Raceway. One conduit shall not contain more conductors of a given size than are specified in Table 4 to 11 of Chapter 10 of the N.E.C.

Reaming - All ends of conduits shall be reamed to remove rough edges.

Bushings - where a conduit enters a box or other fittings, a bushing shall be provided to protect the wire from abrasion unless the design of the box or fitting is such as to afford equivalent protection. See paragraph (b) of section 3736 of N.E.C. for the protection of conductors at bushings.

Bends - Home Made - Bends of rigid conduit shall be so made that the conduit will not be injured and that the internal diameter of the conduit will not be reduced. The radius of the curve of the inner edge of any field bend shall not be less than shown in accompanying table:

#### I. Conduit Bending -

The use of a bending hickey, and the procedure for making conduit bends is shown in the accompanying diagrams. Assuming a right angle bend to be required, first measure the distance from the point where the conduit is to start to the outside of the bend that is to be made, and then mark this distance off on the floor by a line drawn as shown in figure A. Place the conduit on the floor with one end against the pipe from moving while the bend is being formed. Place the hickey on the conduit about two inches beyond the floor mark, put one foot on the pipe at the point where the bend is to start and bend the conduit up about 30 degrees, as in Figure B, then move the hickey slightly closer to the wall end of the conduit and increase the bend. This procedure is repeated until the outer edge of the raised end of the pipe is vertical. If the bend has been successfully completed, the outer edge of the raised portion will be aligned with the mark on the floor as shown in Figure C.

# WIRING METER BASE FOR SOCKET TYPE METER

## 3-WIRE

## 2-WIRE

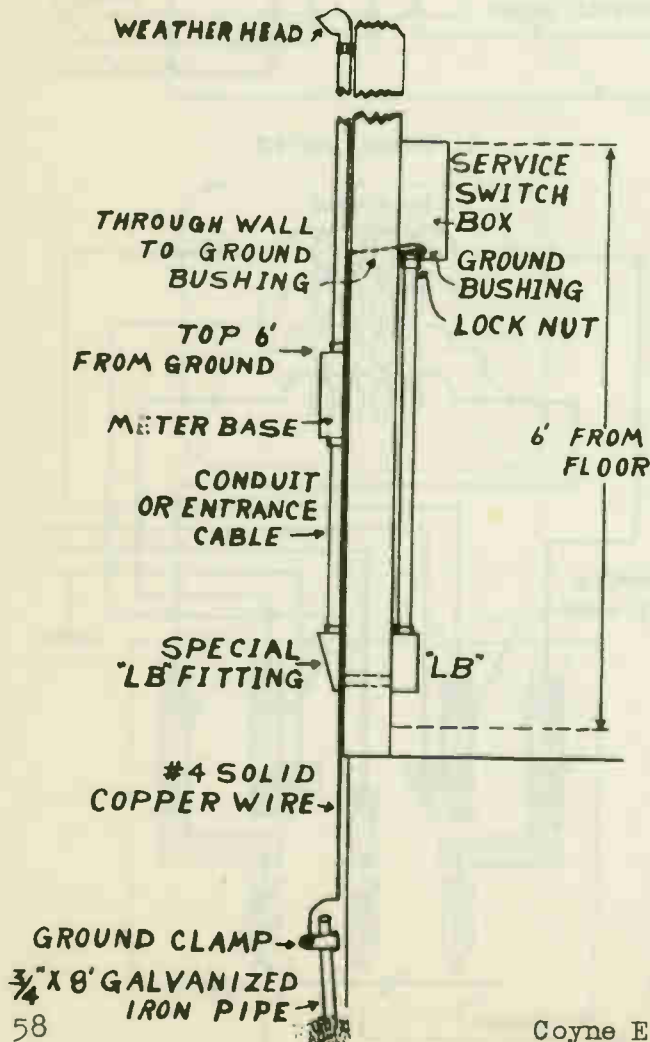
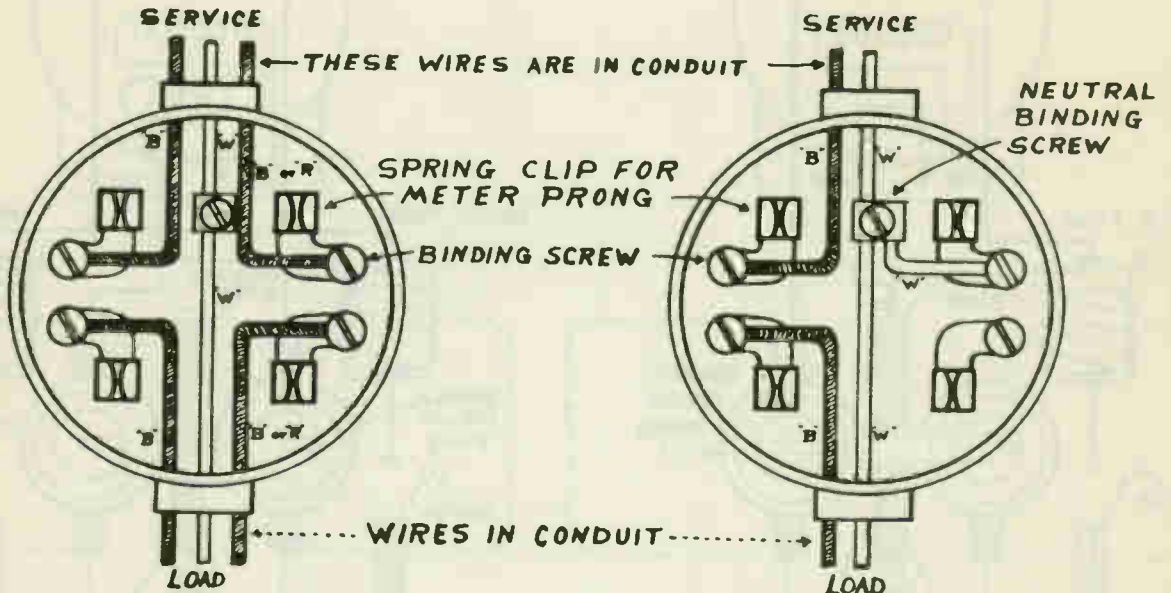

## CONNECTIONS IN SERVICE BOX

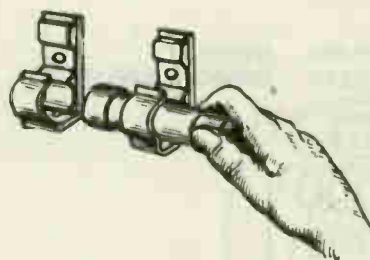

INSERT FUSE FROM END AS SHOWN

OPERATING INSTRUCTIONS

PULL OUT TO "OFF"

PUSH IN TO "ON"

TO INSERT IN "OFF" POSITION REVERSE HEAD TOP TO BOTTOM

PUSH UNTIL FULLY SEATED TO "ON"

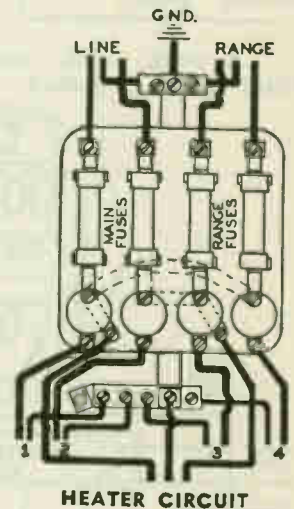

*Federal*

NOARK

SERVICE EQUIPMENT



2-WIRE SINGLE FUSED SWITCH.  
TWO 2-WIRE SINGLE FUSED BRANCH CIRCUITS.

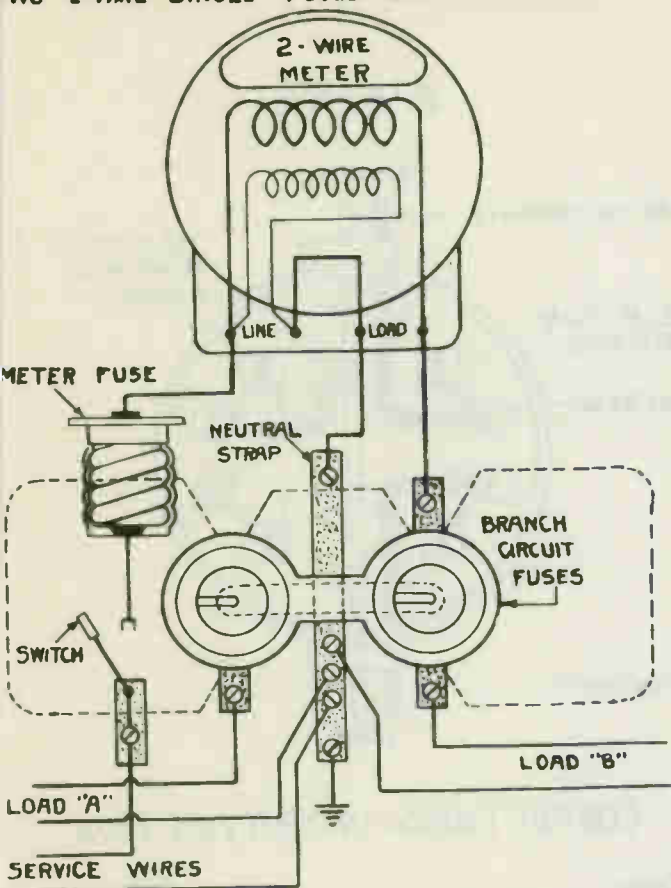

3-WIRE SOLID NEUTRAL SWITCH.  
ONE 3-WIRE 2-FUSED BRANCH CIRCUIT.

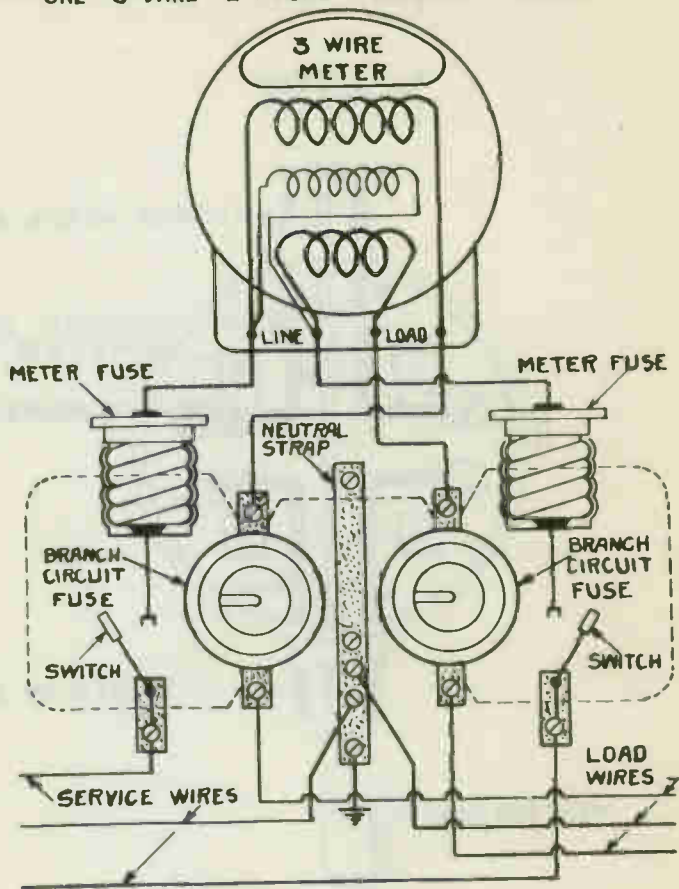

3-WIRE SOLID NEUTRAL SWITCH.  
FOUR 2-WIRE SINGLE FUSED BRANCH CIRCUITS.

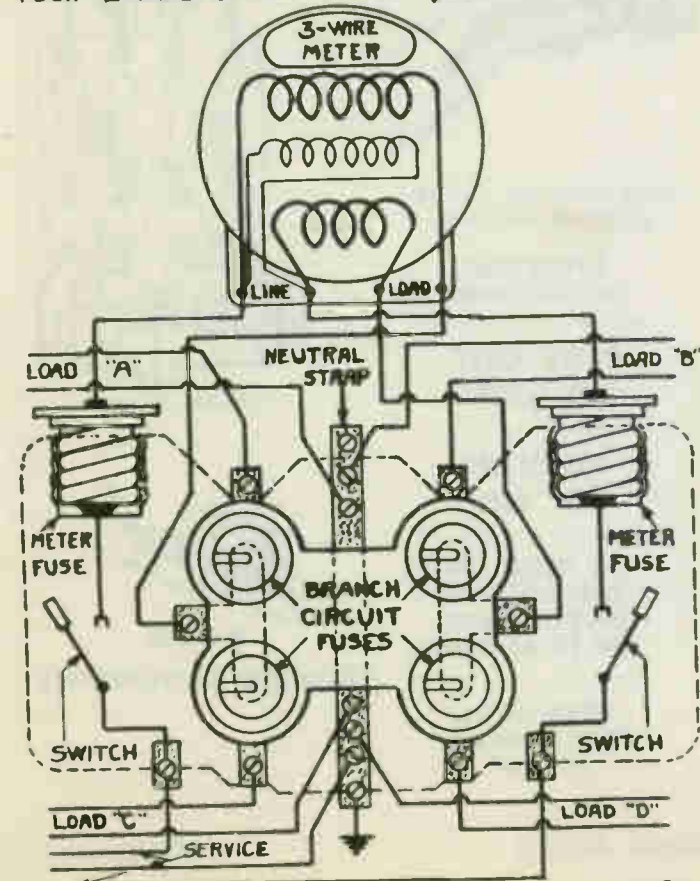

3 PHASE METER

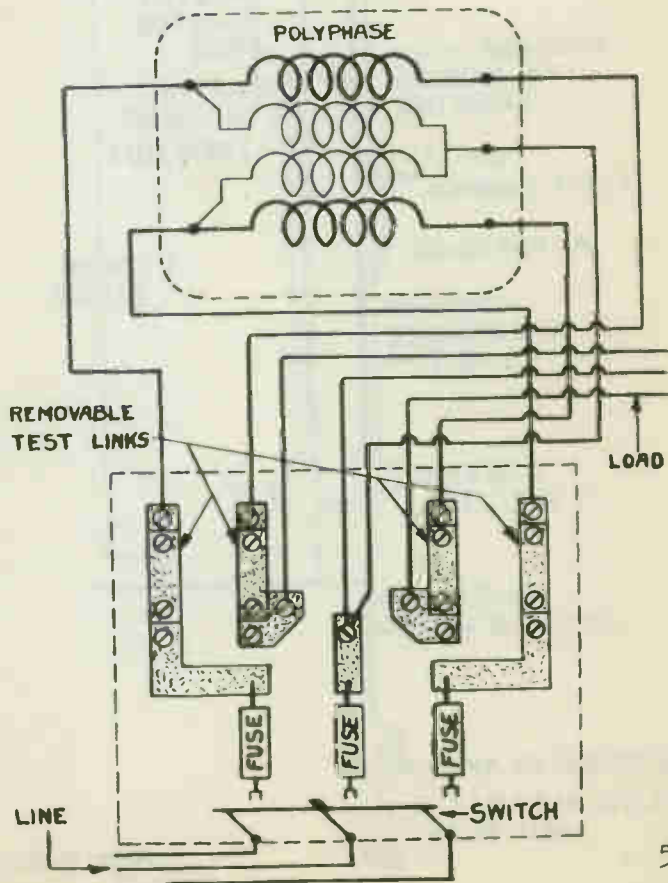

1. - If the load is increased to an extent to require new service wires the neutral shall be grounded.
2. - If the service wires are changed from 2 - wire to 3 - wire the neutral shall be grounded.
3. - If the service switch is moved sufficiently to require the installation of new service wires, the neutral shall be grounded.
4. - If, in the installation of new work, no change is required in the service wires the rules do not require the grounding of the neutral but in such cases it is recommended that the neutral service wires be grounded.

#### G. Service Switch Location.

The service switch shall be located so that the wiring between the service switch and the point of connection of the wires from the pole will be reduced to a minimum. To conform to this requirement the service switch should be located at the part of the building nearest to the pole from which the service is taken.

The service switch shall not be placed in a Coal bin, fruit closet, toilet room, or in any room that is liable to be locked or in a location where the passage to the switch is liable to be obstructed.

Service switches shall be installed inside the main walls of the building. The placing of these devices in storm sheds, storm boxes or rear porch enclosures or any portion of a building attached to the main building will not be approved.

Service switches, cutouts, and meters shall not be installed above or in close proximity to; laundry tubs, sinks, gas meters, radiators, stoves, furnaces, plumbing fixtures; or other grounded surfaces.

Meters are not to be mounted on switchboards or metal frames unless by special permission.

The contractor will furnish and install meter boards, service circuit breakers or switches, branch circuit breakers or fuses and related equipment, together with the necessary wiring at his expense.

Meter Boards: - Of adequate size to provide proper mounting area for the meter equipment and free from all obstruction are required in most installations.

Meter Boards - may be constructed of wood or other approved material and if constructed of wood are to be of new, clear soft, dressed lumber at least 7/8 inch thick, free from knots, cracks and checks, so constructed and mounted that the meter will be supported in rigid and truly vertical position. Scrap lumber will not be acceptable. Meter boards are to be painted on both sides with a good quality paint before the equipment is installed on them.

#### H. Rigid Metal Conduit

Installations of rigid metal conduit shall comply with the provisions of sections

- b. Will the service be for light or power? We use single phase, two or three wire for the light load, and three phase for the power load.

The Demand Factors: - (D.F.) which is the ratio of the maximum demand to the connected load may be applied under certain conditions in determining the size of service and feeder wires.

A diagram of feeders (if required) shall be supplied previous to installation and should show: area in square feet, load (before applying the demand-factors, demand factors selected, computed load (after applying the demand factors, and the size of the conductors).

#### D. Feeders

Any conductors of a wiring system between the service equipment and the branch circuit over-current device are known as feeders. Feeders are frequently used on larger installations to provide, on each floor of the building, a convenient distribution center for branch circuits.

Conductors used in feeder circuits should be of such size that the voltage drop will not be more than 3 per cent for power loads, and not more than 1 per cent for lighting load.

#### E. Grounding.

Grounding consists of an electrical connection from some point in the wiring to the earth. Circuits are grounded for the purpose of limiting the voltage upon the circuit which might otherwise occur through exposure to lightning or other voltages higher than that for which the circuit is designed or to limit the maximum potential to ground due to normal voltage.

On - a-c polarized metallic systems, two grounds are required.

1. The identified, or neutral wire. (commonly called the white wire).
2. The metal system enclosing conductors.

A continuous, metallic underground water piping system shall always be used as the grounding electrode where such piping system is available. Where such system is not available, one of the following may be used:

1. The metal frame of a building, if effectively grounded.
2. A continuous metallic underground gas piping system.
3. A local metallic underground piping system, metal well casing and the like.
4. An artificial ground whose electrode consists of a driven pipe, driven rod, buried plate, or other devices approved for the purpose.

Resistance to Ground - not to exceed 25 ohms and the grounding wire not smaller than No. 8. Grounding conductors smaller than No. 6 shall be in conduit, electrical metallic tubing, or armored cable.

#### F. Grounding Conduit and Neutral.

The question frequently arises as to the grounding of the service neutral on old installations. Where additional work is installed or changes are made in existing wiring, the neutral of a-c service shall be grounded in the following cases.

Where the environment is such that rapid deterioration of conductors of insulation is probable, the inspection department may require the wires to be suitably enclosed, coated or otherwise protected to better withstand the particular conditions of service.

Wires should not be laid in plaster, cement or similar finish, nor fished for any great distance or where the inspector cannot satisfy himself that the rules have been complied with. Wires should not be fastened with staples.

Twin wires should not be used, except in conduit or where flexible conductors are necessary.

Wires of No. 8 or larger supported on solid knobs should be securely tied thereto. If wires are used for tying, they should have an insulation of the same type as that of the wires which they confine.

Wires in dry places should be rigidly supported and for voltages not exceeding 300 volts should be separated  $2\frac{1}{2}$  inches from each other and  $\frac{1}{2}$  inch from the surface wired over.

For voltages from 301 to 600 volts the wires should be separated 4 inches from each other and one inch from the surface wired over.

In damp places a separation of at least 1 inch from the surface wired over should be maintained for all voltages.

### C. Service and Feeders

SERVICE: A service is the conductors and equipment for delivering electric energy from the secondary distribution or street main, or from a distribution feeder, or from the transformer, to the wiring system of the premises served. The service usually consists of:

1. Service Conductors - from the street main to the service equipment.
2. Service drop - between the pole and the first point of attachment to the building.
3. Service entrance conductors - between the terminals of service equipment and a point outside the building where joined to the service drop or other source of supply. Service Wires must be not smaller than No. 8.
4. Service Equipment - usually a switch (or circuit-breaker) and fuses and their accessories located near the entrance point of supply conductors and intended to constitute the main control and means of a cutoff for the supply to the building.

Service Conductors shall have adequate current-carrying capacity and mechanical strength. Service raceways shall be equipped with raintight service-head (or weather-head) and drip loops formed on the individual conductors.

Two factors must be considered in planning a service:

- a. Will it be two or three wire? We change from a two to a three wire system, when the load becomes greater than 3,000 watts.

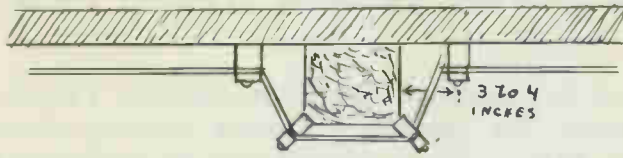

METHOD OF BRACKETING AROUND BEAMS

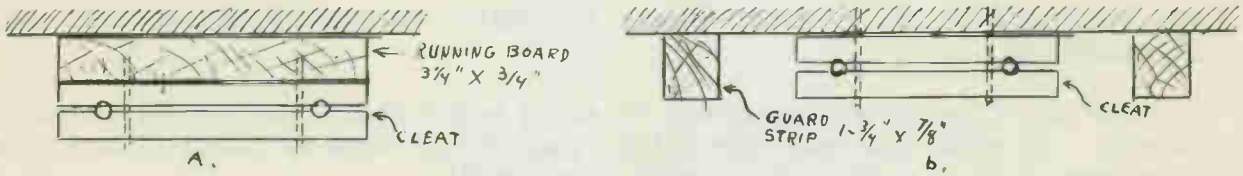

PROTECTING WIRES FROM INJURY.  
A. USING RUNNING BOARD. B. USING GUARD STRIP.

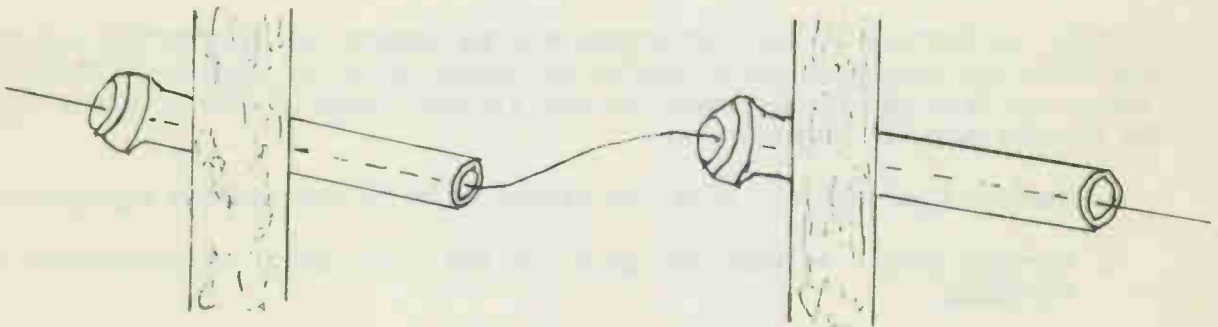

Tubes should be installed as shown above to prevent them from dropping out of place.

used to some extent in small towns and rural homes. If carefully installed it will give very good service and at very low cost of installation.

The principal materials required for a wiring job of this type, are the porcelain knobs, porcelain tubes, and flexible non-metallic tubing known as Loom.

The knobs are used to support the wires along surfaces or joists of the building. The tubes are to protect the wires where they run through holes in joists or wall and the loom to protect the wires where they enter outlet boxes or run close together.

You will note that the knob has grooves on each side, with ridges in them to grip the insulation on the wire. The wire can be run in either groove, but do not run two wires of opposite polarity on one knob.

The nail has a leather washer under its head to prevent splitting the knob caps when driving it tight. Care should be used, however, as it is possible to split the knob cap if it is tightened too much.

Knobs should be placed along the wire not farther than  $4\frac{1}{2}$  feet apart, and in some cases should be more frequent to provide proper support.

Before tightening the knobs, the wires should be drawn up tight so they will not sag and touch the wood, or prevent a bad appearance.

Wires of opposite polarity supported on knobs, must be spaced 3 inches or more apart.

#### 1. Cleat method (exposed wiring)

Wire shall be rigidly supported and for voltages under 300 volts, separated  $2\frac{1}{2}$  inches from each other and  $\frac{1}{2}$  inch from the surface wired over. Cleats not more than  $4\frac{1}{2}$  feet apart.

#### 2. Knob and Tube method

Knob and tube (may be used concealed or exposed) wires shall be separated at least three inches from each other and maintain at least one inch from the surface wired over. At distribution centers, meters, outlets, and other places where space is limited and the three inch separation can not be maintained, each wire shall be incased in a continuous length approved flexible tubing, (LOOM).

Open wires shall be prevented from making contact with floor, timber, joist, or partitions through which they pass by tubes composed of non-combustible, non-absorbent insulating material.

Wires located in dry places should be of approved rubber-covered (R), slow-burning weather-proof (SBW), varnished cloth insulated (VC), or slowburning (SB) type.

Wires located in damp places or in buildings especially subject to moisture should be of rubber covered type, suitable for the condition.

Wires subjected to corrosive vapors should be of the weather-proof varnished cloth or rubber covered type, as may be directed by the Inspection Department.

NATIONAL ELECTRICAL CODE

References: National Electric Code - Basic Electricity, Lesson No. 5.

Objective

Learn the proper use of the code as applied to housewiring.

Lesson Content

## Introduction

The National Electrical Code was originated in 1897. In addition to the NEC, the wireman is concerned with: State Codes, City (local) Codes, and Central Station Codes.

Central Station rules refer to the Public Service Company Requirements, for the installation of the service.

One of the fundamental requirements for any successful electrician, maintenance man or inspector is a thorough knowledge of the definitions, specifications and requirements of the NATIONAL ELECTRICAL CODE.

The purpose of the National Electric Code is: The reduction of fire and hazards from electrical causes through application of sensible and up-to-date installation requirements.

Any installation of electrical wiring and associated equipment throughout the country is governed by the requirements of this code.

In addition to the National Electrical Code requirements, existing Local Codes should also be considered. They may be obtained from the Municipal Authorities. In territories outside the jurisdiction of municipalities, State and Country Authorities should be consulted.

In most license examinations for electricians of the various grades, the knowledge of the National Electrical Code is one of the basic requirements.

It cannot be too strongly emphasized, however, that the National Electrical Code be studied as a unit.

The code is generally enforced by inspections conducted by Fire-Insurance Company representatives. Requirements of the Code, now incorporated in status of many Cities in the country and enforcements are largely in the hand of Municipal and State inspectors.

The National Electric Code usually covers installations only. It covers the electric conductors and equipment installed within or on public buildings and other premises, including yards, carnival and parking lots, etc.

## . Knob and Tube Wiring

The knob and tube system is one of the oldest and simplest forms of wiring, and while not as reliable as conduit, it is allowed by the National Code, and is still







# SYMBOLS FOR WIRING PLANS

## GENERAL OUTLETS

	CEILING	WALL
Outlet .....	○	○
Capped Outlet .....	⊙	⊙
Drop Cord .....	Ⓓ	
Electrical Outlet—for use when confused with columns, plumbing symbols, etc. ....	Ⓔ	⊖
Fan Outlet .....	Ⓕ	⊖
Junction Box .....	Ⓖ	⊖
Lamp Holder .....	Ⓕ	⊖
Lamp Holder with Pull Switch .....	Ⓕ <sub>ps</sub>	⊖ <sub>ps</sub>
Pull Switch .....	Ⓕ	⊖
Outlet for Vapor Discharge Lamp ..	Ⓕ	⊖
Exit Light Outlet .....	Ⓕ	⊖
Clock Outlet (Lighting Voltage) .....	Ⓕ	⊖

## CONVENIENCE OUTLETS

Duplex Convenience Outlet .....	⊕
Convenience Outlet other than Duplex. 1=Single, 3=Triplex, etc. ....	⊕ <sub>1,3</sub>
Weatherproof Convenience Outlet ..	⊕ <sub>WP</sub>
Range Outlet .....	⊕ <sub>R</sub>
Switch and Convenience Outlet .....	⊕ <sub>\$</sub>
Radio and Convenience Outlet .....	⊕ <sub>R</sub>
Special Purpose Outlet (describe in specifications) .....	⊕
Floor Outlet .....	⊕

## SWITCH OUTLETS

Single Pole Switch .....	\$
Double Pole Switch .....	\$ <sup>2</sup>
Three Way Switch .....	\$ <sup>3</sup>
Four Way Switch .....	\$ <sup>4</sup>

Automatic Door Switch .....	\$ <sup>D</sup>
Electrolier Switch .....	\$ <sup>E</sup>
Key Operated Switch .....	\$ <sup>K</sup>
Switch and Pilot Lamp .....	\$ <sup>P</sup>
Circuit Breaker .....	\$ <sup>CB</sup>
Weatherproof Circuit Breaker .....	\$ <sup>WCB</sup>
Momentary Contact Switch .....	\$ <sup>MC</sup>
Remote Control Switch .....	\$ <sup>RC</sup>
Weatherproof Switch .....	\$ <sup>WP</sup>









## SPECIAL OUTLETS

Any standard symbol with the addition of a subscript letter designates some special variation of standard equipment.

List the key of symbols on each drawing and describe in specifications.

○	a, b, c - etc.
⊕	a, b, c - etc.
\$	a, b, c - etc.

## PANELS, CIRCUITS & MISCELLANEOUS

Lighting Panel .....	
Power Panel .....	
Branch 2-Wire Circuit — Ceiling or Wall .....	
Branch 2-Wire Circuit—Floor .....	
Indicate a greater number of wires:  (3 wires),  (4 wires), etc.	
Feeders. Use heavy lines and designate by number from Feeder Schedule .....	
Underfloor Duct & Junction Box — Triple System. For double or single systems eliminate one or two lines .....	
Generator .....	Ⓖ
Motor .....	Ⓜ
Instrument .....	Ⓘ
Transformer .....	Ⓣ

Controller .....	
Isolating Switch .....	

## AUXILIARY SYSTEMS

Push Button .....	
Buzzer .....	
Bell .....	
Annunciator .....	
Telephone .....	
Telephone Switchboard .....	
Clock (Low Voltage) .....	
Electric Door Opener .....	
Fire Alarm Bell .....	
Fire Alarm Station .....	
City Fire Alarm Station .....	
Fire Alarm Central Station .....	
Automatic Fire Alarm Device .....	
Watchman's Station .....	
Watchman's Central Station .....	
Horn .....	
Nurse's Signal Plug .....	
Maid's Signal Plug .....	
Radio Outlet .....	
Signal Central Station .....	
Interconnection Box .....	
Battery .....	
Auxiliary System 2-Wire Circuit .....	

For a greater number of wires designate with numerals — 12-No. 18W-3/4"-C., or by listing in schedule.

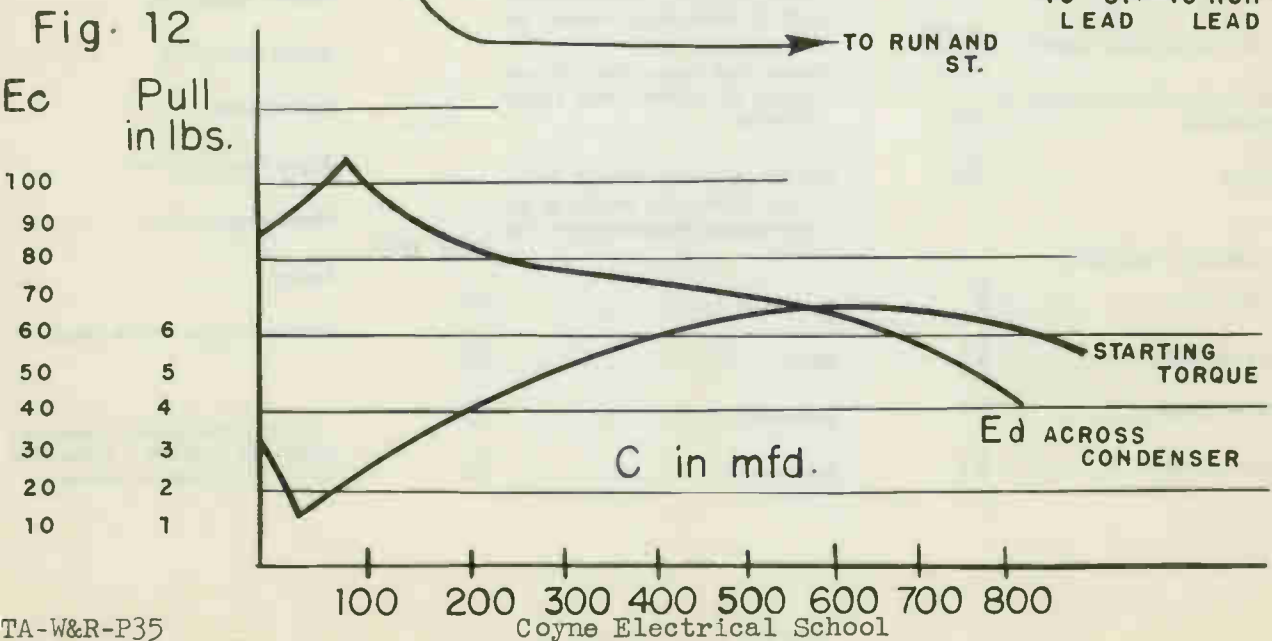
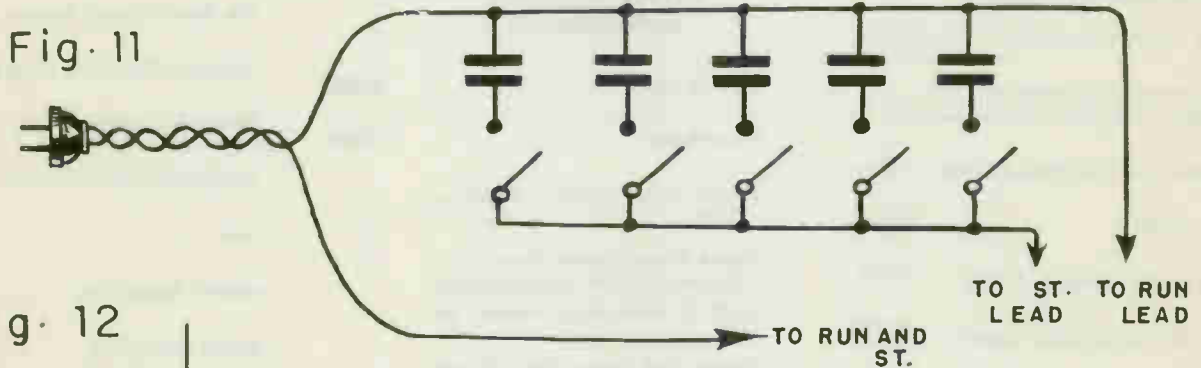
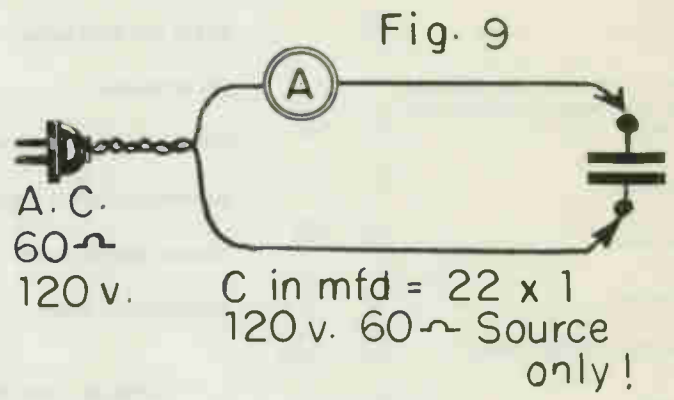
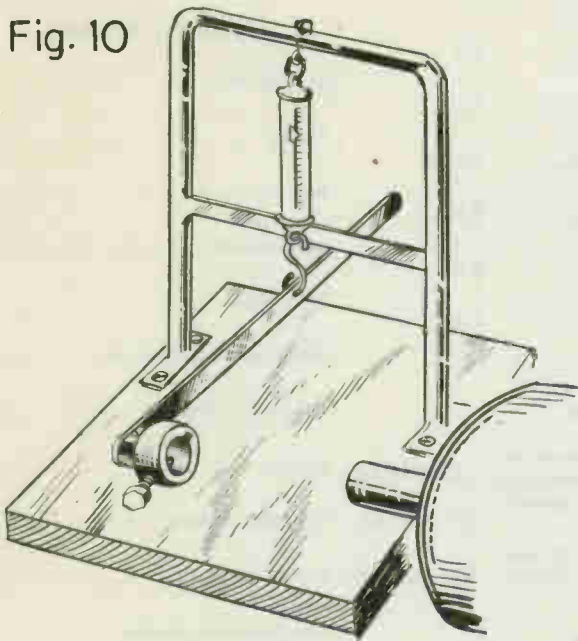
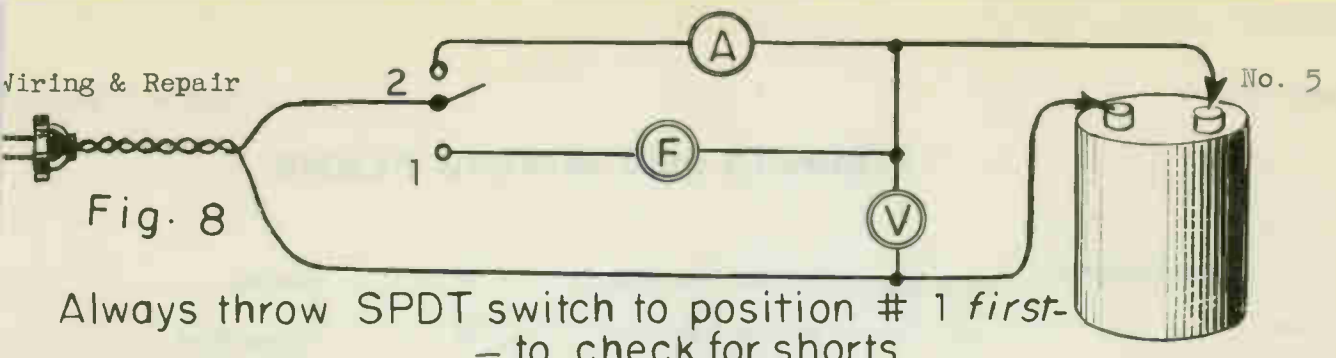

## G. Summarization and Trends

The above job is practical. Although the cost of capacitors for a motor may run as high as five or six dollars, the cost is still below that of a new capacitor-start motor which would have the needed torque.

Electrolytic capacitors have undergone breakdown tests and "held up" for fifteen minutes to two hours, depending upon design. If the designers continue to progress at the present rate it would seem that in the future they will have electrolytic capacitors operating continuously on a-c circuits.

One outstanding field of application would be for power factor correction and since opportunities in this field are great, possibly millions of electrolytic capacitor installations would be the result.

Their application in circuits for the by-passing of voltage surges would be another large field.

CAUTION - Before leaving a capacitor-start motor installation:

1. Check to make sure that  $E_c$  is not above 138 volts for a 110 volt capacitor. On any other voltage rating, not above 110% of voltage rating.
2. Check starting time.
3. Check starts per hours.
4. Measure temperature of capacitor container.
5. Be sure capacitor is not grounded to frame.
6. Always make sure on any installation that the equipment is not subjected to any operating conditions which are detrimental to normal operation.

The opposition offered to the flow of current by a 100 mf. capacitor is approximately 25 ohms @ 60 cycles.

$$\text{Check:- } X_c = \frac{1}{2\pi fC} = \frac{1}{6.28 \times 60 \times .0001} = \frac{1}{.0377} = 26.5$$

Since  $X_c$  is inversely proportional to  $C$ , the opposition offered by any value of  $C$  can be readily approximated. -

EXAMPLE: - 200 mf. = 12.5 ohms  
 400 mf. = 6 ohms  
 50 mf. = 50 Ohms etc.

Knowing values of  $X_c$  we can determine rating of fuse or ammeter for testing circuits.

$$\text{For a 50 mf. capacitor } X_c = 50 \text{ ohms } I_c = \frac{E_c}{X_c} = \frac{110V}{50} = 2.2a.$$

For a 500 mf. capacitor (which is about maximum rating for motor-starting capacitors).

$$X_c = 5 \text{ ohms } I_c = \frac{E_c}{X_c} = \frac{110}{5} = 22 \text{ a.}$$

to first one terminal, then the other, Fig. 5 the lamp SHOULD NOT light.

- e. Test for shorts and opens - remove the lamp from your test circuit and screw in a thirty-ampere fuse. Apply rated voltage to the capacitor, Fig. 6, for about one second. If the fuse "blows", the capacitor is shorted. If the fuse does not "blow", use an insulated conductor to discharge the capacitor. A "snappy" spark will be obtained if capacitor is not open. (Be sure the fuse is screwed tightly into the circuit receptacle.) To some extent, the above test is a test for "capacity" as well as "opens". A check for capacity can be obtained by using the circuit shown in Fig. 7.

CAUTION: The capacity test is never made until it has been determined that the capacitor is not shorted.

Apply the voltage for about three or four seconds, in any case just sufficient time to obtain readings. By use of the following equation the C may be approximately determined.

$$C \text{ in mf.} = \frac{2650 \times I}{E} \text{ for 60 cycles only.}$$

The range of the voltmeter should be up to 150 volts.

The range of the ammeter should be up to 25 amperes.

Both of the above testing circuits could be combined as in Fig. 8.

NOTE: Test circuit, Fig 7, can be simplified. The voltage is usually known and fairly constant in a certain locality, therefore you could use the circuit shown in Fig. 9 and apply the following equation:

$$\text{Assume } E \text{ to be 120 volts. } C \text{ in mf.} = \frac{2650 \times I}{120} = 22I$$

A voltmeter, however, is so easily used, it is advisable to make use of fig. 7. If some fault of supply were to be introduced it would be indicated immediately.

## 2. Motor test

To test the split-phase motor to convert it into a capacitor-start, you must have some method available to "lock the rotor" and measure the motor's starting torque, Fig. 10.

Place the motor on the test stand. Apply rated voltage to the motor and check rotation before fastening torque arm to the shaft of the motor.

Fig. 11 shows how a capacitor can be arranged for converting a split-phase motor.

You will find that the capacity necessary for converting a split-phase type of motor to a capacitor-start type will be much higher than the capacity necessary for "splitting the phase" in a motor that is originally designed to work on a capacitor-start motor.

The required capacity will be from 400 to 600 mf. to convert a one-fourth horse-power split-phase motor, whereas it is only about 110 to 118 or 124 to 137 mf. for a capacitor-start motor of same horse-power rating. See Chart - Fig. 12.

It has been previously shown that the current through both the "start" winding and the "run" winding will lag the applied voltage.

It is possible, by placing capacitance in series in the "start" circuit, to make the current in the "start" circuit lead the applied voltage. This gives a larger angle of phase displacement between the current in the "start" and "run" windings, thereby obtaining greater "starting" torque, Fig. 3.

---

---

---

#### D. Capacitor Installation

A round container can be purchased for about thirty to fifty cents in which the capacitor may be placed. This metal container is mounted on top of the motor.

The capacitor should be insulated from the frame of the motor. This is usually accomplished by a cardboard tube which fits around the capacitor.

NOTE: Before leaving an installation, see that starting period is not too long.

#### E. Troubles and maintenance

The troubles which might develop in the motor have been previously listed and studied.

Troubles pertaining to the capacitor are usually due to too high a voltage across the capacitor or long starting time. Troubles developed due to defective materials in manufacture are rare but are possible.

It is possible to make some repairs on defective capacitors; however, they are not usually checked or tested with that idea in mind. If they are found to be defective they are usually replaced.

#### F. Testing

##### 1. Capacitor unit

- a. The testing of split-phase and capacitor-start motors has been covered in previous lessons.
- b. The tests applied to the capacitor should determine if it is "shorted" "open" or "grounded" and a test to determine its capacitance in mfd.
- c. Leakage - the leakage test requires a d-c source. Practically, this test is not necessary for motor-starting capacitors.
- d. Power factor - since the capacity is much more critical than power factor, we will not consider it necessary for practical purposes, to measure power factor.

By using your test lamp, Fig. 4, you can quickly test the capacitor for GROUNDS. Place one test lead on the can or container. Touch the other lead

Fig. 1

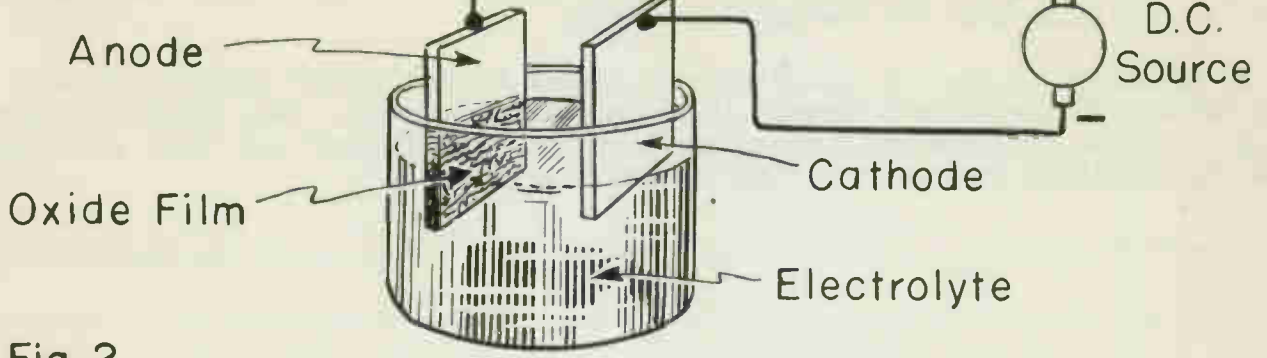

Fig. 2

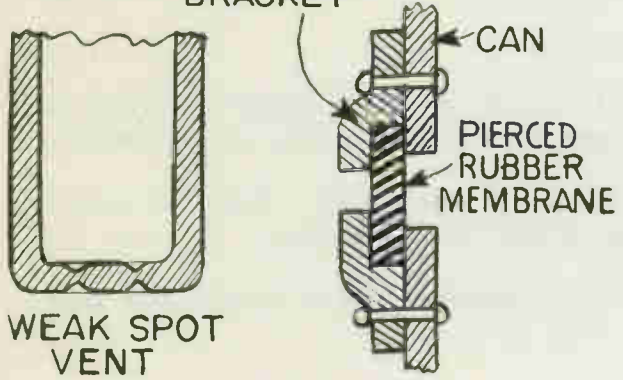

Fig. 3

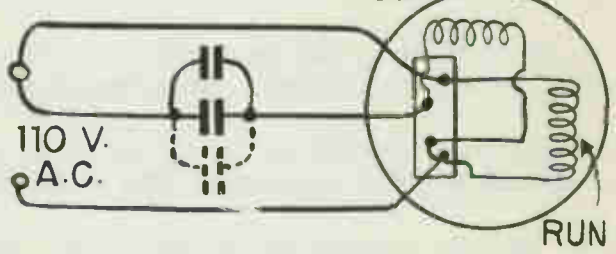

Fig. 4

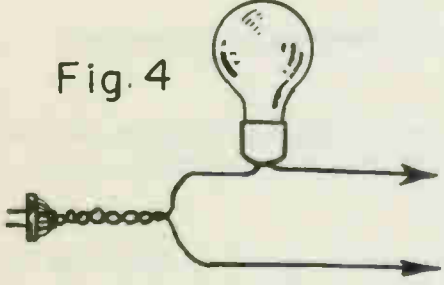

Fig. 5

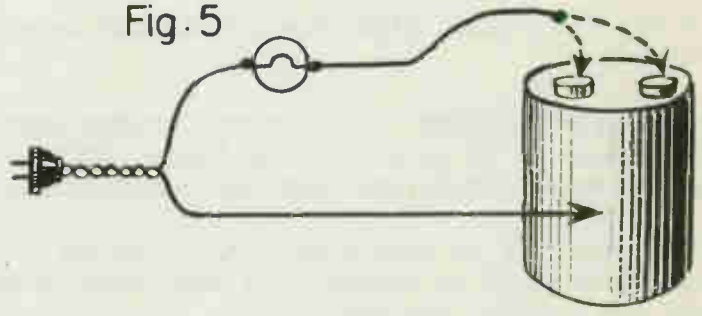

Fig. 6

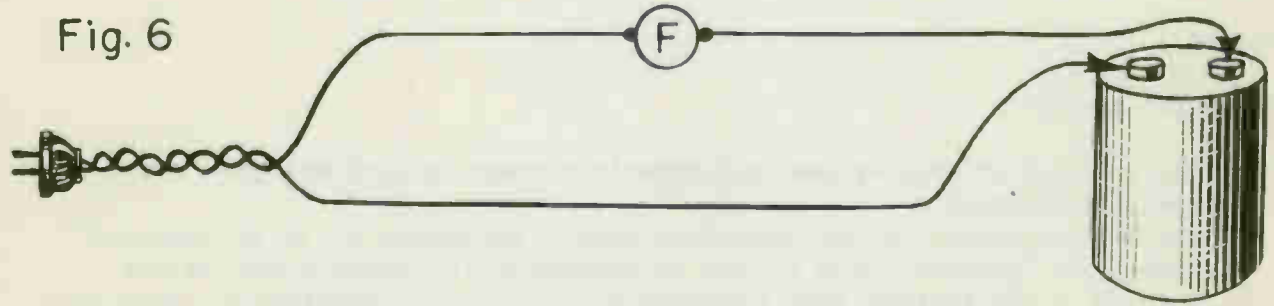
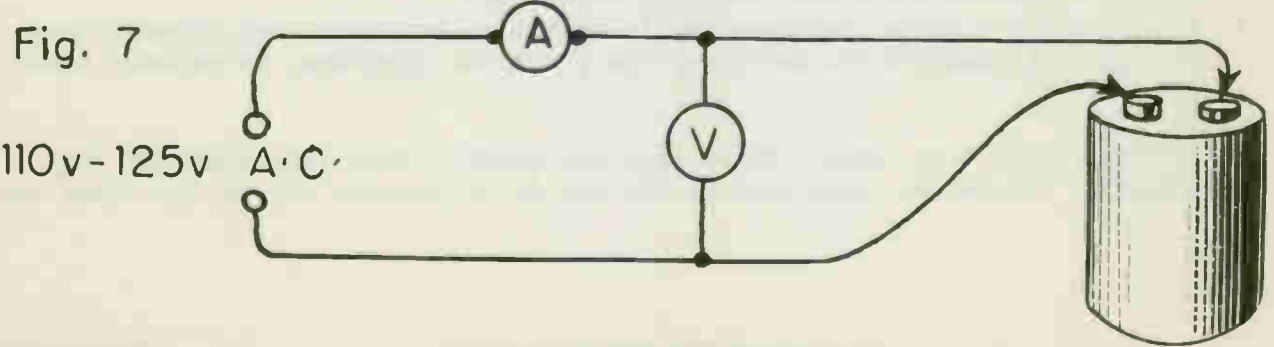

Fig. 7



## C. Capacitor Construction and Operation

### 1. Electrolytic capacitor

When DC is applied to an electrolytic cell (aluminum electrodes and boric acid electrolyte) there will be an oxide film formed on the surface of the anode, Fig. 1.

The voltage of the d-c source is called "forming voltage" and its value determines the thickness of the film.

The oxide film is the dielectric.

One plate of the capacitor is the anode and the other plate is actually the electrolyte, the electrode not formed acts only as a connection between the external circuit and the electrolyte.

The above capacitor is a wet type polarized capacitor. It is used in d-c circuits, which may or may not have an a-c component.

### 2. Motor-starting capacitor (dry electrolytic)

The motor-starting capacitor is a non-polarized type of electrolytic capacitor, that is, both electrodes are "formed". Each film is fully effective only when subjected to a positive potential.

The electrodes are constructed of an aluminum foil, approximately .0005 to .003 of an inch in thickness. The electrodes are spaced about .001 and to .006 of an inch by paper spacers which absorb the electrolyte. The foil and spacers are "rolled" similar to a wax or oil-paper capacitor.

The dielectric (oxide film) may be .0001 of an inch to .000001 of an inch in thickness. Its thickness will vary directly with forming voltage.

The electrolyte is usually boric acid and sodium borate with possibly an anti-freeze added, such as glycerin or ethylene glycol.

The container is usually made of aluminum or zinc and inserted in a cardboard or specially treated box which acts as insulation between the capacitor and frame of motor and thereby prevents grounds. If an electrolytic capacitor is subjected to an excessive voltage it gets hot, develops gas and will tend to explode. For this reason the container is provided with "vents". See Fig. 2. Some of these vents are nothing more than an indentation in the container. Some are pierced rubber membranes.

### 3. Split-phase capacitor motor

In most split-phase type of single-phase induction motors the phase displacement between the current in the "start" winding and the current in the "run" winding will be approximately 20 to 30 electrical degrees.

The starting torque will vary directly as the sine of the angle between current through the start winding and current through the run winding.



## Application, Ratings, Cost and Life

## 1. Electrolytic capacitor

An electrolytic capacitor is a combination of two conductors, at least one of which is a valve metal, separated by an electrolyte, and between which a dielectric film is formed adjacent to the surface of one or both of the conductors.

NOTE: A valve metal is a metal which, when placed in contact with a solution, will allow current to flow more readily in one direction than in the other direction.

It is possible to increase the starting torque or reduce the locked rotor current of a split-phase motor or both by connecting the proper capacitance in series with the "starting" or "auxiliary" winding.

## 2. Electrolytic capacitor ratings and cost (round dry-type Electrolytic)

MFD	SIZE (inches)	APPROXIMATE COST
53-60	1-3/8 by 3-1/4	\$1.05
70-78	1-3/8 by 2-3/4	1.10
75-84	1-3/8 by 3-1/4	1.10
86-96	1-3/8 by 3-1/4	1.15
108-120	1-3/8 by 3-1/4	1.25
124-138	1-3/8 by 3-1/4	1.25
145-162	1-3/8 by 3-1/4	1.50
161-180	2 by 3-1/8	1.70
216-240	2 by 3-1/4	2.25
270-240	2 by 3-1/8	2.95
320-360	2 by 3-1/8	3.35
430-480	2 by 3-1/8	3.50

Life of these capacitors is difficult to predict. However, keep in mind that an excessive voltage or high temperature will cause early break-down.

The life of capacitors can be greatly increased by adhering to the following precautions.

- Voltage should not go above 138 volts for 110 volt capacitor.
- Frequency of starting periods should not be over twenty per hour.
- Duration of starting period not over three seconds.
- Temperature not over 130° Fahrenheit.

Some electrolytic capacitors are made whose capacity rating is 20,000 mfd, about the size of an automobile battery, and above. Voltage ratings are as high as 600 volts in the dry type, and up to approximately 500 volts maximum for wet type. When higher voltages are encountered, two or more units would be connected in series inside one container,

4. Capacitive Reactance ( $X_c$ )

Capacitive reactance is the opposition offered to the flow of current through a capacitor (condenser).

$$X_c = \frac{1}{2 \pi f C} \quad \text{or} \quad X_c = \frac{1}{6.28 f C}$$

## 5. Capacitor (condenser)

A capacitor is a device, the primary purpose of which is to introduce capacitance into an electric circuit.

Capacitors are usually classified according to their dielectrics, as air capacitors, mica capacitors, paper capacitors, etc. An exception - the electrolytic capacitor.

The capacitance of a capacitor varies directly as the area of its plates and inversely as the thickness of its dielectric.

The current through a purely capacitive circuit leads the applied voltage by 90 electrical degrees.

To determine the combined capacity in a series circuit we use the formula.

$$C_T = \frac{1}{\frac{1}{C_1} + \frac{1}{C_2} + \frac{1}{C_3}}$$

To determine the combined capacity in a parallel circuit we use the formula:

$$C_T = C_1 + C_2 + C_3$$

## MOTOR STARTING CAPACITORS

Objectives

1. To change the split-phase type of single-phase motor to a capacitor-start type.
2. Compare the torques of each type and measure the total current drawn by each.
3. To learn construction and testing procedure on motor-starting capacitors. (Non-polarized dry type electrolytic).

References

---

---

Lesson Content

## A. Review

## 1. Split-phase motor

A split-phase motor is a single-phase induction motor equipped with an auxiliary winding. This auxiliary winding is displaced in magnetic position compared to the main winding and it is connected in parallel with the main winding.

Unless otherwise specified, the auxiliary circuit is assumed to open when the motor attains a predetermined speed.

## 2. Capacitor motor

A capacitor motor is a single-phase induction motor with a main winding arranged for direct connection to a source of power, and auxiliary winding connected in series with a capacitor. There are three types of capacitor motors.

- a. Capacitor-start motor
- b. Permanent-split capacitor motor
- c. Two-value capacitor motor

The capacitor-start motor is a capacitor motor in which the capacitor phase is in the circuit only during the starting period.

## 3. Capacitance (Capacity)

Capacitance is that property of a system of conductors and dielectrics which permits the storage of electricity when a potential difference exists between the conductors.

The unit of capacitance is the farad.

When one coulomb of electricity is stored in a capacitor under a pressure of one volt the capacitance of the capacitor is one farad.

1 micro-farad = one millionth of a farad

1 micro-micro-farad = one millionth of a micro-farad







## . Testing. See Fig. 4

1. Unit not operating properly. If the unit is operating, but not operating properly, the trouble would more than likely be traced to a defective refrigeration cycle. The refrigeration cycle will be covered in the Refrigeration Department.

The parts of the electrical system which might be defective but still allow some operation of the unit:

- a. Low voltage
- b. Poor contacts, either in the relay or the thermal control.
- c. Dry bearings in the motor
- d. Intermittent short.

2. Unit will not start.

Determine if the trouble is in the motor or in the auxiliaries and wiring to the motor.

This can be done by plugging the unit service cord into supply receptacle. Listen for a hum in the motor. If you hear a hum, but the motor does not drive the compressor, there are two possibilities (1) A defective winding or (2) A defective relay.

Disconnect the motor from the unit wiring system and apply rated voltage to the motor. If the motor properly drives the compressor the trouble will be found in the relay.

If the motor does not operate - make a check on the motor for opens, shorts, and grounds.

If you hear no hum on the original test, it might be an indication of a defective (open) thermostat. It might be an open most any place in the line, for example, at the motor terminals. Make a motor check and then if necessary, check the wiring system & other controls.

## F. Summary Questions

1. Why has the trend been toward capacitor motors in refrigerators in recent years?
2. Why does the current decrease in a split-phase motor after the motor comes up to speed?
3. Why are magnetic and thermal relays used with split-phase motors instead of a centrifugal switch?
4. Why are fustats used instead of fuses in some cases?
5. What is the purpose of the thermostat?
6. What is the difference between a "sealed unit" and a "regular unit"?
7. Why is a transformer unit used in some applications?

- d. Excessive load
- e. Low voltage
- f. High voltage
- g. Incorrect line connection to motor leads.

## 4. Motor burns out.

- a. Frozen bearings
- b. Some condition of prolonged excessive overload.

## 5. Motor is noisy

- a. Unbalanced rotor
- b. Worn bearings
- c. Switch rattles
- d. Excessive end-play
- e. Motor not firmly fastened down.
- f. Loose accessories on motor
- g. Air-gap not uniform
- h. Amplified motor noises.

## E. Temperature Control

It is difficult to describe control service except in a general way as there are so many different designs of contacts, adjusting points and special arrangements featured by the various manufacturers. Some controls are non-adjustable, some have sealed cases.

The cleaning of burned, scorched or corroded contacts is a delicate operation and should be performed carefully. Never use emery cloth. Use a very fine grade of sandpaper and do not score the contacts.

## F. Starting Relay

A starting relay may fail to operate if the relay coil is defective.

The starting contacts sometimes become pitted and burned. Usually there is very little repair work done on a relay.

NOTE: Experience has shown that the failure of a compressor to start may be caused by any one of the following parts being defective; starting relay, motor, capacitor, thermostat, or the pressure control. Therefore, before a compressor itself can be claimed defective, all of the above auxiliary equipment should be checked.



Alternating Current	Motor	Fusetron or Fustat, ampere rating	Auto-matic Reset	Switch Size	Minimum Wire Size		
Single-phase	H.P.	Amp. Rating	Heavy Ser.	Code Max.	Ampere Rating	Amperes	Rubber Covered
110 volt	1/8	2.8	4	5	5	30	14
	1/6	3.3	4.5	5	5	30	14
	1/4	4.8	6.25	8	6.5	30	14
	1/3	5.0	6.25	8	10.0	30	14
	1/2	7.0	8.0	10	12.0	30	14
	3/4	9.4	12.0	12		30	14
	1	11.0	15.0	15		60	12
220 volt	1/3	2.5	3.2	4.0	5	30	14
	1/2	3.5	4.0	5.0	5	30	14
	3/4	4.7	6.25	6.25	6.5	30	14
	1	5.5	6.25	8.0	10.0	30	14

4) Troubles - - Servicing

The most probable sources of trouble are the motor, temperature control, and relay, if one is used.

A few of the more frequent motor troubles are as follows:

1. Failure to start

- a. Blown fuses on operation of overload device.
- b. No voltage or low voltage.
- c. Open circuit field.
- d. Improper current supply. Incorrect voltage or frequency.
- e. Condenser short circuit or open circuit.
- f. Improper line connection
- g. Excessive load.
- h. Shorted stator.

2. Excessive bearing wear

- a. Belt tension too great, unbalanced or out of line coupling.
- b. Improper, unclean or insufficient oil.
- c. Dirty bearings.

3. Motor runs hot.

- a. Bearing trouble (See 2 "b")
- b. Short circuited coils in stator
- c. Rotor rubbing stators.

## 2. Overload protection.

There are three general types of overload protection.

- a. Ordinary fuse - an ordinary fuse is considered less desirable than other methods of overload protection.
- b. Fusetron - the Fusetron is considered a good method of protection. The fusetron is constructed so that it will stand a momentary overload such as the starting current, but it will blow if the overload is sustained for a period of time.
- c. Automatic reset - The Automatic reset operates after an overload surge has passed. This is an advantage over the other method of overload protection.

There are two general types of automatic reset devices. They are internal and external. The internal type is built into the motor by the manufacturer. The end bell must be removed in most designs, to make the unit accessible. The external type may be mounted on the motor or at a point near the motor.

Both units consist of a bi-metallic type of (warp) switch.

The table on page 52 might be very convenient as a guide to the approximate size of protection unit necessary for refrigeration motors.

The greatly increased use of small motors on ordinary branch circuits, in the household as well as in business, caused the blowing of plug fuses unnecessarily, from the starting current of the motors. Hence, the Fusetron idea was incorporated into plug fuses.



Knife blade type fusetron

Up to 1935 all plug fuses were made with the Edison base. Inspectors found that many people ignorant of the importance of proper fuse protection, would use fuses of too large a size or use pennies or other materials to bridge the fuse, thereby wiping out all protection.



To guard against this, the Fustat was developed. This type of fuse is made to prevent the use of too large a size and is so designed as to prevent the use of pennies or other bridging material, making it virtually impossible to tamper the fuse protection. This type of fuse is made with the Fusetron feature so that unnecessary blows from starting currents of motors are entirely eliminated.



The Fustat is made to fit into regular Edison base fuseholders by means of a simple, inexpensive adapter, which locks in place. The Fustat can then be removed or inserted in the same manner as the ordinary fuse.



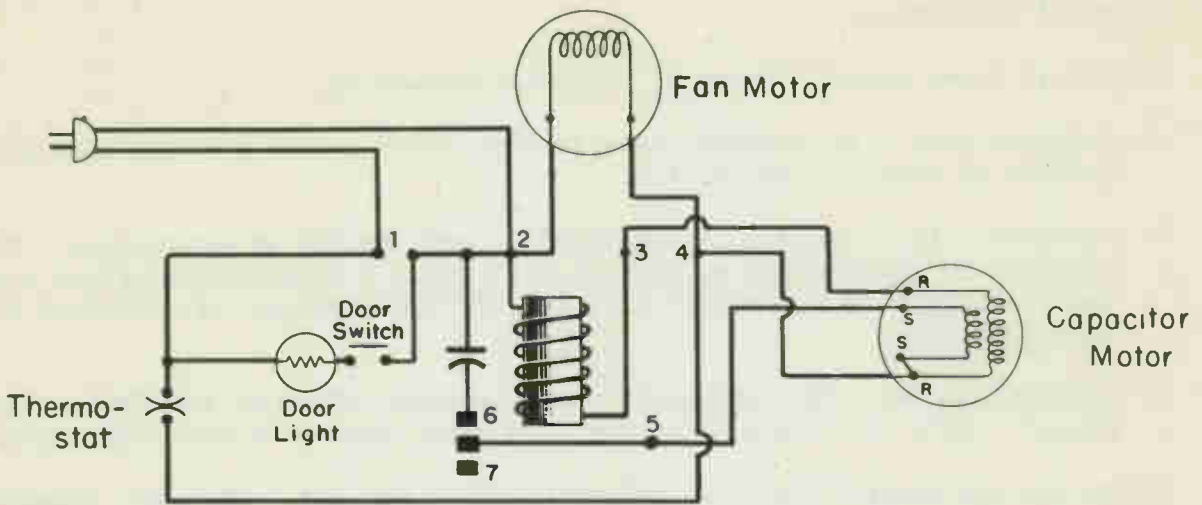

Fig. 1

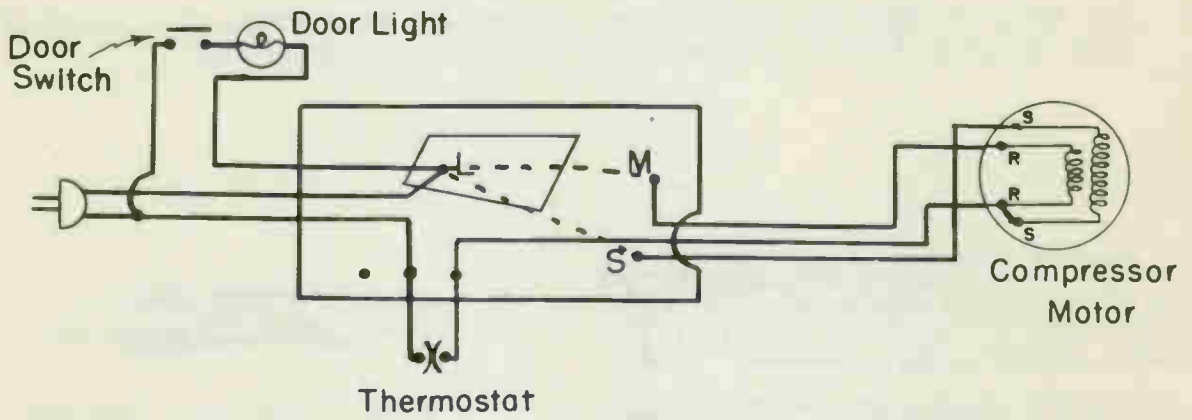

Fig. 2

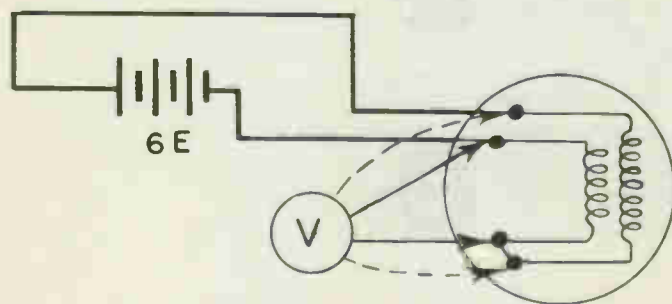

Fig. 3

manner that it has very good thermal contact between the surface of the bulb and the low side surface. As the temperature of the low side increases, the temperature of the bulb increases accordingly, thereby causing a pressure in the bulb and capillary line and then in the bellows operating the switch mechanism, causing the switch to close.

#### 4. Electrical circuits

The electrical circuit is usually a very simple system. A typical example of the simplicity of these systems can be seen from Fig. 1 which shows a Grunow wiring system on the J, K, & M models. This diagram shows a common type magnetic relay in the motor.

The thermal relay is another popular control. It is used, among others, by Coldspot and Norge. For an example of this type relay refer to Fig. 2. This relay is used for the same purpose as the magnetic relay, but the principle of operation is somewhat different. A thermal wire is connected in series with the running winding and the current through this alloy wire causes it to elongate and hold the starting contacts open after the motor has started.

If the motor develops an overload the thermal wire will elongate still more causing the running contacts to open and provide overload protection. When the thermal wire cools both sets of contacts close, thereby completing the circuit to the motor.

### C. Installation -- Auxiliaries - Controls

#### 1. Motor

The motor is necessary to drive the compressor. The open type motors used for this service are special refrigeration duty motors with electrical characteristics and mechanical features that give efficient, quiet, and dependable service.

The sealed type usually consists of a stator, which is wound with a starting and running winding, pressed into a housing which attaches to the compressor body casting. The motor rotor is on the end of the crankshaft and the whole assembly is enclosed in a steel jacket or shell. The motor leads are brought to the outside through the shell and, if a capacitor motor is used, attached onto the relay and capacitor.

## REFRIGERATOR CONTROLS &amp; ELECTRICAL CIRCUITS

Objectives

1. To obtain information concerning the operating principle of controls used in refrigeration.
2. To study the electrical wiring system used on typical refrigeration installations.

References

---

---

Lesson Content

## 1. Introduction

1. Refrigerator controls are used to automatically start and stop the motor which drives the compressor.
  2. At a pre-determined temperature the control will close the circuit to the motor. When the refrigerator has been cooled sufficiently the control will open the circuit which in turn stops the motor. This cycle repeats itself continually and maintains a temperature somewhere between the cutting in point and the cutting out point of the control.
  3. Refrigerator controls are rated in horse-power. Besides having a horse-power rating there is usually a temperature rating which gives the lowest and highest setting which can be obtained with the control.
  4. The price of the controls varies depending on the size and type, but usually the price range will be between \$5.00 and \$10.00.
- 
- 

## 3. Construction and Operation

There are two general types of controls - low pressure and thermostatic

1. The low pressure control operates on, and is directly connected to the low pressure side of the refrigeration system. The connection is a short piece of tubing connected by a tee into the suction line or by a fitting to the compressor. The control is actuated by the pressure in the suction side of the system.
2. Thermostatic control is the one most commonly used in household cabinets. This control has a bulb and capillary tube which furnishes the pressure for operating the bellows. The bulb is usually fastened directly to the low side in such a





When testing these switches to locate C<sub>1</sub>, C<sub>2</sub> and C<sub>3</sub> you may use the following instructions: Using a test lamp or a volt-ohm-milliammeter.

- a. Determine C<sub>2</sub> and C<sub>3</sub>.  
The terminal to which the test leads are not applied is C<sub>1</sub> (open terminal).
  - b. Now place one test lead on C<sub>1</sub> and the other test lead on one of the other terminals.
  - c. Push down on both the "start" and "stop" buttons.
  - d. If you obtain a light you have the test leads on C<sub>1</sub> and C<sub>2</sub>. If you do not obtain continuity you have the test leads on C<sub>1</sub> and C<sub>3</sub>.
2. The relay we are using is designed for 110 volt DC. It will not operate on an a-c circuit of the same voltage. When AC is applied to a coil, the coil develops an opposition in excess of its ohmic resistance. This excess is called inductive reactance (  $X_L$  ). This increased opposition limits the current to such a low value that the ampere-turns (IN) are not sufficient to develop enough flux to attract the armature.

When testing a coil for continuity with a test lamp, it is very possible that the lamp will not "light-up" even though the coil is O.K. This is due to the high reactance of the coil when an a-c source is used. You could use a six volt d-c source in series with a voltmeter. In case a 110 volt d-c source is available, use the test lamp. You may use the volt-ohmmeter to test continuity.

The holding circuit is a series connected circuit.

---



---



---

### C. Summary Questions

1. What are the two general types of push-buttons? *Momentary Squared?*
2. Is a "holding" circuit a series circuit, or is it a parallel circuit? *Series*
3. Do you believe it is possible to operate a d-c relay on a-c? Explain. *No.*
4. How would you test a Push-button station for proper identification of terminals?
5. What is the meaning of the symbol " $X_L$ "? *Inductive reactance*
6. What is inductance?



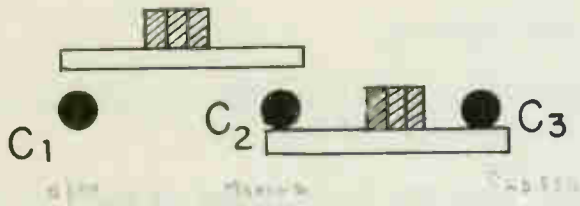

Fig. 1



Fig. 2

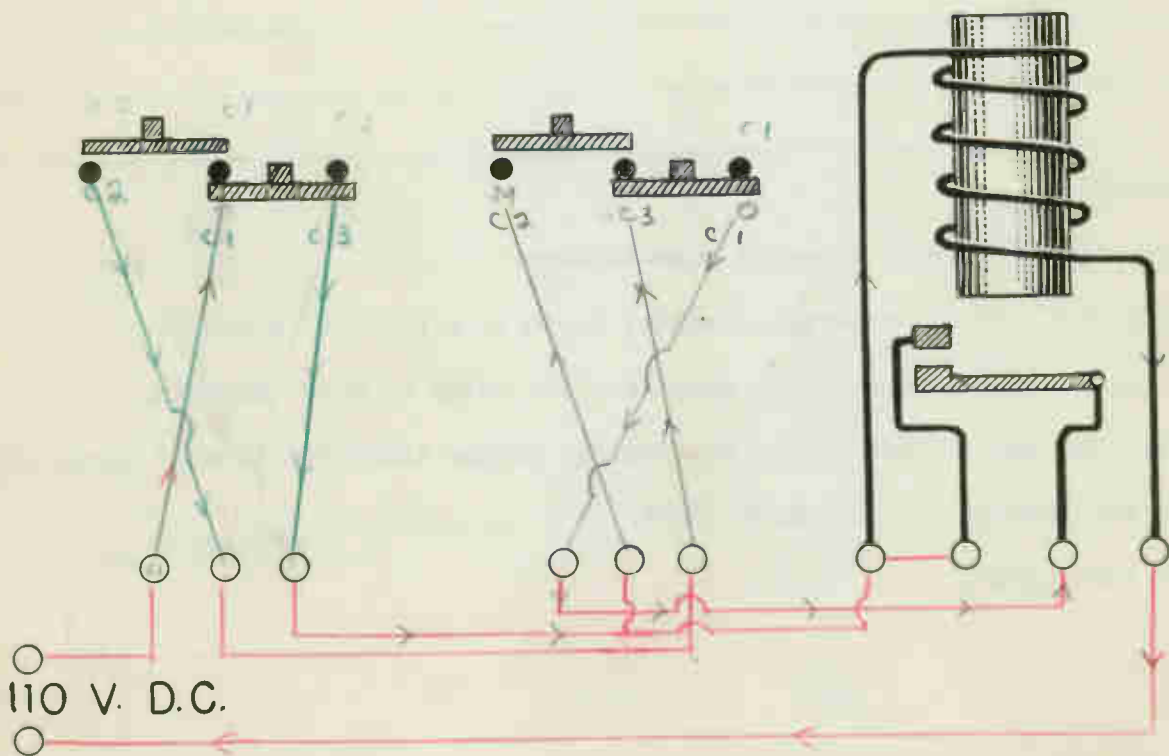

Fig. 3

