

ELECTRONIC INDUSTRIES

THE STATE-OF-THE-ART MAGAZINE

B54
211
B-C
83-

F. W. Preziosi Grp Hd
2921 Soutter Ave SE
Cedar Rapids Iowa

126500 Collins Radio

Exclusive
WIRE & CABLE CHART!



*Silicon Dioxide
Crystal*

PROGRESS IN SOLID STATE DEVICES

Linear Circuits • More Complex Digital
Circuits • Transistors • Diodes

SEPTEMBER 1965  Chilton Company



"SPECIAL" (CUSTOM BUILT) FILTERS

TO YOUR SPECIFICATIONS

ILLUSTRATED ARE
TYPICAL SPECIAL FILTERS

RANGE OF FREQUENCIES ON SPECIAL UNITS
IS FROM 0.1 CYCLE TO 400 MC.

Over thirty years of experience in the design and production of special filters have resulted in UTC being a first source for difficult units. Present designs both military and commercial incorporate a wide variety of core structures, winding methods, and capacitors to provide maximum performance, stability, and reliability. Fully experienced, top engineering talent backed by complete environmental testing and life testing facilities assure the highest standard in the industry. Full analysis and evaluation of materials are conducted in UTC's Material and Chemical Laboratories. Rigid quality control measures coordinated with exhaustive statistical findings and latest production procedures results in the industry's highest degree of reliability.

MILITARY AND COMMERCIAL TYPES FOR
EVERY PHASE OF THE ELECTRONICS ART

POWER TRANSFORMERS • AUDIO TRANSFORMERS • INDUCTORS • PULSE TRANSFORMERS • ELECTRIC WAVE FILTERS • LUMPED CONSTANT DELAY LINES • HIGH Q COILS • MAGNETIC AMPLIFIERS • SATURABLE REACTORS • REFERENCE UNITS

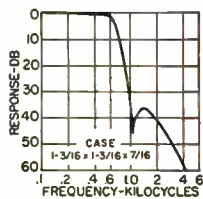

560 \sim Telemetry low pass filter. Available from 400 \sim to 70 KC. \pm 7.5% bandwidth flat to 1 db. Attenuation greater than 35 db beyond the 2nd harmonic of \sim 7.5% frequency. Impedance 47K ohms. MIL-F-18327B. Wt. 0.8 oz.

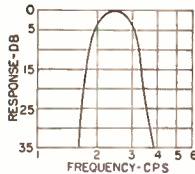

Low frequency band pass filter. Designed for 2.5 cps center frequency. At 2 to 3 cps within 3 db. At 1.5 cps and lower, and 4 cps and higher, greater than 30 db. Source and Load 10K ohms. Size: 4 x 4-11/16 x 6". MA MIL case, MIL-F-18327B.

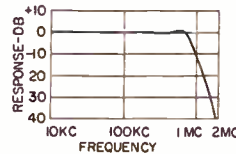
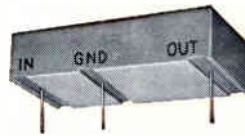

High frequency low pass filter. Zero to 700 KC within 1 db. 1.95 mc to 10 mc 40 db minimum. Source and Load 1000 ohms. Molded flat construction for printed circuit applications. Size: 1 x 2 x 1/2"; Wt: 1 oz. MIL-F-18327B.

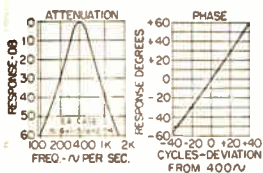

Band pass 400 cycle Gaussian filter. Linear phase response in pass band. Attenuation 380 cps to 420 cps within 0.5 db. 2nd harmonic down 25 db, 3rd harmonic down 45 db. Source and load 5K ohms. MIL-F-18327B Wt., 0.9 lbs.

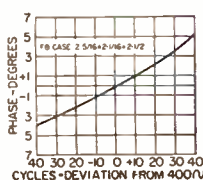

Minimum phase shift 400 cycle band pass filter. Within \pm 1.5 db 370 to 430 cycles, greater than 45 db beyond 1100 cycles. 1K ohms to 100K ohms. MIL-F-18327B; 1 lb.

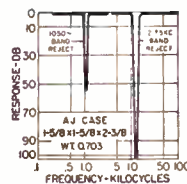

Band reject filters (two shown). The 1050 \sim filter has 50 db attenuation and is only 3 db at 950 and 1150 cycles. The 12.75 KC filter has more than 100 db attenuation and is only 3 db at 10.8 and 15 KC. Source and load 600 ohms, both are MIL-F-18327B.

Write for catalog of over
300 UTC HIGH RELIABILITY
STOCK ITEMS
IMMEDIATELY AVAILABLE
from your local distributor.



UNITED TRANSFORMER CORP.

150 VARICK STREET, NEW YORK 13, N. Y.

PACIFIC MFG. DIVISION: 3630 EASTHAM DRIVE, CULVER CITY, CALIF.
EXPORT DIVISION: 13 EAST 40th STREET, NEW YORK 16, N. Y. CABLE: "ARLAB"

ELECTRONIC INDUSTRIES

The State-of-the-Art Magazine

Please Pass Us Along!

Dear Reader:

"How can I get on your subscriber list?"

We hear this question often from engineers we meet in our editorial travels.

ELECTRONIC INDUSTRIES distributes 66,800 copies every month under a controlled circulation plan. This is the largest circulation of any electronic magazine. Qualified subscribers receive the publication without cost. Advertising revenue pays all the production and distribution costs.

Ideally, we should like to provide every electronic engineer in the industry with a personal copy. However, production costs are about \$12.00 per year for each subscriber.

We estimate there are about 250,000 electronic engineers. Thus you can see how expensive 100% individual coverage would be.

Under controlled circulation the objective is to have the magazine reach all engineering departments in electronic manufacturing plants, industrial plants using electronic products, research and development laboratories, and government agencies. We ask that each subscriber pass along his copy to his associates when he has finished reading. Experience shows that an average of three engineers read each copy. Thus most electronic engineers have an opportunity to see either a personal or a pass-along copy of ELECTRONIC INDUSTRIES.

Our circulation department makes every effort to place ELECTRONIC INDUSTRIES into the hands of all eligible readers. We maintain an active "waiting list" and are constantly updating our subscriber lists to cope with the many engineering changes that our industry generates.

As you receive each issue we suggest that you attach a routing slip to it. It will enable all interested parties in your organization to have the opportunity of staying abreast with the ever changing technical developments each month. We shall be glad to provide reprints of any article appearing in ELECTRONIC INDUSTRIES.

*Sincerely,
The Editors*

1965-1966 EDITORIAL FEATURES

- OCTOBER**
- Potentiometers, part 1, Specification Chart
 - Survey of Microelectronic Devices
 - Dynamic Testing of Integrated Circuits
-

- NOVEMBER**
- Microwave, 13th Annual Issue
 - Potentiometers, part 2, Specification Chart
-

- DECEMBER**
- Switches, part 1, Specification Chart
 - Computers, State-of-the-Art
-

- JANUARY**
- 1966 Review & Forecast for the Electronic Industries
 - Potentiometers, part 3, Specification Chart
-

- MARCH**
- 1966 IEEE Show Coverage
-

The Problem of Keeping Abreast

AS A WORKING ENGINEER, no doubt you feel the need for some form of continuing engineering education. And you are in good company if you don't know how to get it. Some say it's the engineer's fault if he becomes obsolete. But, is it?

Departments of "continuing education" are being established at many colleges. Some schools offer evening or off-hour courses only to those working toward advanced degrees. But engineers out of school ten or more years may not qualify for admission to such studies. Other schools offer non-degree short courses or semester programs in advanced engineering concepts. However, these can be attended only by those who can get company time off during the work week. Some schools, in cooperation with industry, offer evening courses. Such courses are impractical for engineers who travel, even occasionally.

Good instructors are hard to obtain for non-degree programs. Some college professors consider such teaching as subprofessional. Those who do teach, even though top authorities in their fields, frequently do not communicate at the educational level of their students.

The engineer who waits for his employer to "assign" him to take specific courses may well be gambling with his future. He must do all he can to avoid his own obsolescence. It is not enough to keep up only with new developments in the narrow field of one's current work. Such an assignment could terminate because of advances in engineering technology or loss of a government contract.

Industry and educators are learning that interdisciplinary knowledge is needed to solve today's complex engineering problems. Undergraduate students now study fundamentals of materials and their interrelationships. They attack most problems with a systems approach and through synthesis. The old "how to do it" courses are gone. Such training is left to industry. These are new concepts to many engineers of "the old school."

Fortunately, helpful courses are becoming available to those who seek them out and who are willing to pay

a reasonable price for such knowledge. We believe the challenge to the serious engineer has never been so great. Opportunity for the study of new engineering concepts is becoming greater as educators, industry leaders and engineering societies recognize the problem.

No electronic engineer can hope to have a firm grasp on all aspects of this broad field. That doesn't necessarily make him obsolete. Instead, the tremendous amount to be learned should stimulate him to work all the harder to keep abreast of new developments. This quest for more engineering knowledge will result in better products, more corporate profits, job promotion, and a better life for all.

What can you do to help yourself? We suggest the following:

1. Be alert to courses and seminars given within your own company and by educational institutions in your area. Don't overlook adult courses offered in the local high school.
2. Seek courses for their content, not solely because they provide credit toward an advanced degree.
3. Help your company training director set up courses under company sponsorship that meet your needs and those of your fellow engineers.
4. Discuss your needs for technical knowledge with educators in nearby engineering colleges to help them in curriculum planning. Communication between engineers and educators is most important.
5. Encourage your engineering society to take the lead in continuing engineering education.
6. Attend conferences and meetings and participate in the affairs of appropriate professional groups on subjects important to your job or your profession.
7. Read engineering magazines in your field.

Keeping abreast will never be easy. It will be a challenge. It can even be fun.

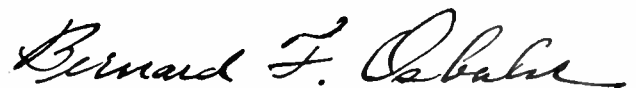

A Staff Study on Continuing Education by the editors of ELECTRONIC INDUSTRIES will appear in the October issue.

**Now from
Sprague!**

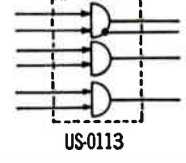
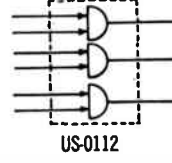
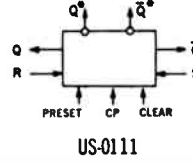
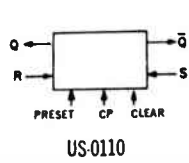
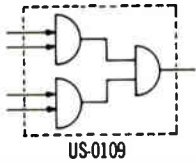
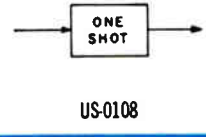
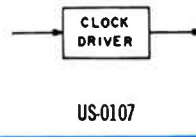
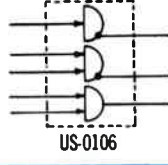
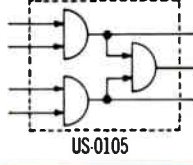
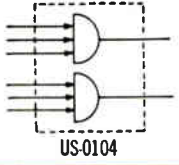
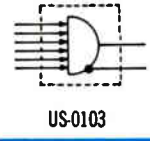
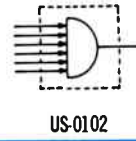
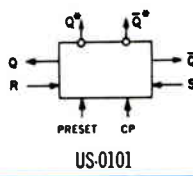
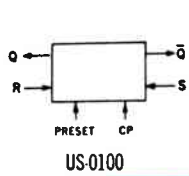

14 low-power RCTL integrated circuits capable of performing up to 95% of the functions of a complete digital system

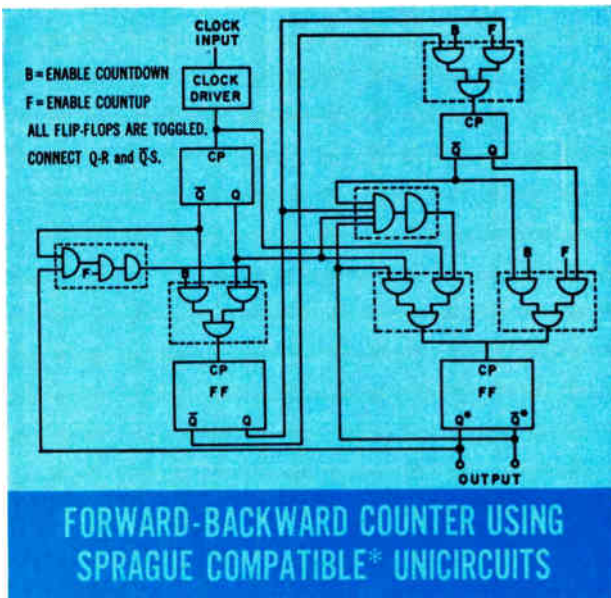

*Series US-0100 Unicircuits now provide the electronic industry with two major sources for low-power RCTL circuits.

**COMPLETELY INTERCHANGEABLE
WITH NETWORKS FROM
THE OTHER RCTL LOGIC SOURCE!**

UNICIRCUIT® Integrated Circuits now include the US-0100 Series of low power (2 mw typ.) RCTL circuits, utilizing reliable master-matrix construction, a proven technique for producing complex silicon monolithic circuits. Sprague US-0100 circuits consume less than one-third the system power required by the next lower power-logic form currently available.

For complete information, write to Technical Literature Service, Sprague Electric Company, 233 Marshall Street, North Adams, Mass. 01248.

SPRAGUE COMPONENTS

INTEGRATED CIRCUITS
THIN-FILM MICROCIRCUITS
TRANSISTORS
CAPACITORS
RESISTORS

PULSE TRANSFORMERS
INTERFERENCE FILTERS
PULSE-FORMING NETWORKS
TOROIDAL INDUCTORS
ELECTRIC WAVE FILTERS

CERAMIC-BASE PRINTED NETWORKS
PACKAGED COMPONENT ASSEMBLIES
BOBBIN and TAPE WOUND MAGNETIC CORES
SILICON RECTIFIER GATE CONTROLS
FUNCTIONAL DIGITAL CIRCUITS



*Sprague and ® are registered trademarks of the Sprague Electric Co.

Editorial: Please Pass Us Along 1

STATE-OF-THE-ART FEATURES

1965 Survey of Commercial Semiconductor Photosensitive Devices
Part 3: Phototransistors & PNP Light Activated Devices R. D. Kaus 82
1965 Survey of Relay Specifications, Part 4: General Purpose Relays 95

PROGRESS IN SOLID STATE DEVICES

- A Look at Linear Integrated Circuits W. L. Fowler 64
- Digital Integrated Circuits and Their Limiting Factors Nevala & deAtley 70
- Report on the Transistor Industry J. Haenichen 75
- Semiconductor Diodes—Past, Present, and Future N. J. Egli 90

DESIGN/DEVELOPMENTS

Wire & Cable Reference Chart 33
A Miniature R-F Switch for Space Applications Ward, Schwanke & Russell 89
Nomograph for the Parabolic Surface Area R. L. Peters 151

MEASUREMENT/TEST

Curve Tracer for Field-Effect Transistors C. D. Todd 130

WHAT'S NEW

Automatic Trace Seeker 32	High Speed IC Tester 138
Computer Sets Type 32	Photos from Mars 140
Low-Power Computer Memory 81	Visual Noise Code Reader 142

PROFESSIONAL GUIDELINES

Electronic Engineering Profile—1965 147

DEPARTMENTS

Highlights 4	New Products 44
Radarscope 8	New Tech Data 116
Coming Events 14	Measurement News 129
Washington Trends 18	Editor's Notebook 136
Electronic Snapshots 22	Books 137
Marketing: Fact & Figure Roundup 26	Professional Guidelines 145
Letters 31	International News 158

COVER: In the course of their "Defects Analysis" program, Fairchild Semiconductor engineers purposely grow some defective silicon dioxide crystals. A few of them are shown in this striking picture. Articles on other aspects of the solid state developments are on pages 64, 70, 75 and 90.

*STATE-OF-THE-ART: up-to-the-moment capability in each area of electronic technology



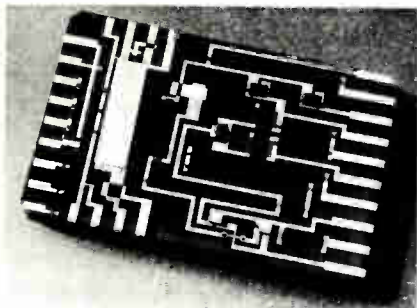

Diode Devices

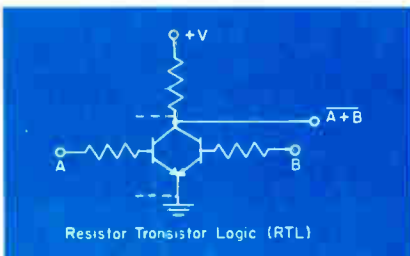

Linear Integrated Circuits



A Transistor Report

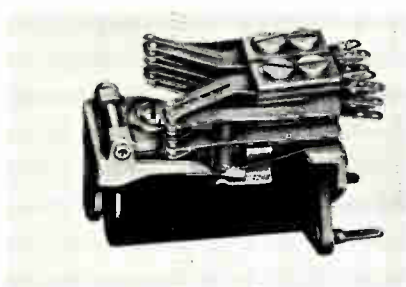

Relays

A Curve Tracer

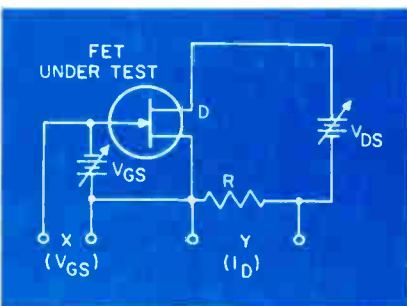

WIRE & CABLE REFERENCE CHART

33

Our exclusive Wire and Cable Reference Chart contains useful information about common wire insulations, selected flexible coaxial cable guide, conductor configurations, common conductor materials, tabulation of cable-shield qualities, bare copper wire data and other data. Remove this 4-page, multi-color chart now, before you forget.

A LOOK AT LINEAR INTEGRATED CIRCUITS

64

A close look at linear integrated circuits is taken by the author. He discusses their development, use and capabilities. He also discusses device improvements coming in the near future and new technologies that may provide the functions normally performed by capacitors, transformers, and inductors.

REPORT ON THE TRANSISTOR INDUSTRY

75

Past, present and future developments in the transistor industry are discussed in this report. Materials, techniques, geometries, and packaging are some of the many areas covered. Here is the reader's chance to be brought up to date on many of the developments in this ever changing industry.

1965 SURVEY OF COMMERCIAL SEMICONDUCTOR PHOTSENSITIVE DEVICES

82

This material is being presented in three parts—Part 1: Photoconductors; Part 2: Photovoltaic Diodes; and Part 3: Phototransistors & PNP Light Activated Devices. Also included here in Part 3 is a complete table of manufacturers, their general categories of devices and complete mailing addresses.

A MINIATURE R-F SWITCH FOR SPACE APPLICATIONS

89

Contemporary spacecraft often require a means of switching r-f circuits. The design described here answers that need.

SEMICONDUCTOR DIODES PAST, PRESENT, AND FUTURE

90

Over the years there have been many changes in materials and structures of diodes. These changes are described here, from the beginning to the present, with a look at the future. Most of the diodes described are still in use.

GENERAL PURPOSE & SPECIAL PURPOSE RELAYS

95

Fourth in the series of special reports describing key commercial and military type relay specifications as compiled by EI editors from information supplied by the manufacturers.

CURVE TRACER FOR FIELD-EFFECT TRANSISTORS

130

A curve tracer adaptor is described which can be used with an X-Y recorder to plot the common characteristics for MOS and junction field-effect transistors. It is also useful for several unusual functions.

ELECTRONIC ENGINEERS PROFILE: PART 2

147

While our Electronic Engineering Profile survey conducted in March and April contained 28 "yes" or "no" questions (tabulated in the August issue) there were five other questions that required essay-type answers. Here is what engineers had to say.

• A REPRINT of ANY ARTICLE in this issue is available from ELECTRONIC INDUSTRIES Reader Service Department, 56th & Chestnut Streets, Philadelphia, Pa. 19139

Now from Sprague!

DIFFERENTIAL AMPLIFIERS IN FLAT PACKS!

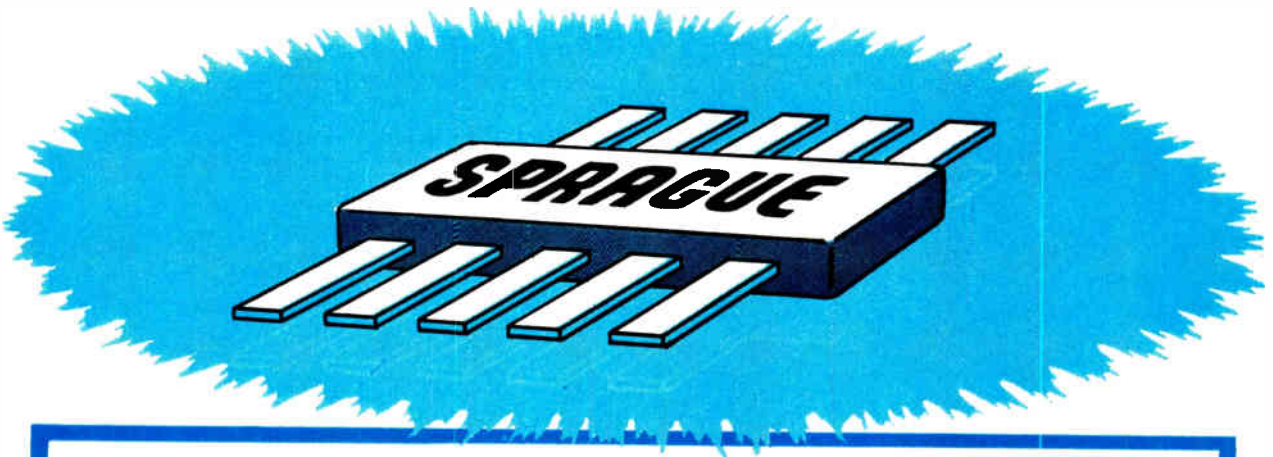

2N3043	2N3044	2N3046	2N3047	2N3049
2N3050	2N3051	2N3052	2N3520	2N3524

PNP or NPN • BETA MATCHING to 10%

V_{BE} MATCHING to 3mV • VOLTAGE CAPABILITY to 60 VOLTS

TEMPERATURE COEFFICIENTS to $5\mu\text{V}/^\circ\text{C}$

ALSO AVAILABLE IN 6-LEAD TO-5 OUTLINE PACKAGES!

For complete information, write to Technical Literature Service, Sprague Electric Company, 233 Marshall Street, North Adams, Mass. 01248

SPRAGUE COMPONENTS

TRANSISTORS
CAPACITORS
RESISTORS
INTEGRATED CIRCUITS
THIN-FILM MICROCIRCUITS

PULSE TRANSFORMERS
INTERFERENCE FILTERS
PULSE-FORMING NETWORKS
TOROIDAL INDUCTORS
ELECTRIC WAVE FILTERS

CERAMIC-BASE PRINTED NETWORKS
PACKAGED COMPONENT ASSEMBLIES
BOBBIN and TAPE WOUND MAGNETIC CORES
SILICON RECTIFIER GATE CONTROLS
FUNCTIONAL DIGITAL CIRCUITS



'Sprague' and '®' are registered trademarks of the Sprague Electric Co.

How many different bushings, collars, contacts, eyelets, fasteners, finials, flanges, grommets, inserts, knobs, pins, rings, rivets, sleeves, spacers, terminals can Fischer make ?



B2589-PS

Thousands! More than four thousand to be exact. Within the limits of our equipment (1 $\frac{3}{16}$ " round or 1 $\frac{1}{16}$ " hex and 1" long) we can make almost any part you can think of. But first of all, send for our "UNCOMMON PARTS" IDEA KIT . . . it shows you how to specify parts to reduce costs, what material to use and suggests ways in which Fischer parts can help you achieve product simplicity and reliability with single or multi-purpose parts. Even has easy-to-use drawing/specification sheets for you to sketch your ideas. Tell us about them!

Fischer
SPECIAL MANUFACTURING CO.
492 Morgan Street
Cincinnati, Ohio 45206
Phone 513-961-1280

Send for your FREE copy of FISCHER'S "UNCOMMON PARTS" IDEA KIT . . . specially developed for creative engineers and buyers.



ELECTRONIC INDUSTRIES



SHELBY A. McMILLION,
Publisher

BERNARD F. OSBAHR,
Editor

CREIGHTON M. MARCOTT
Executive Editor

JOHN E. HICKEY, Jr.
Managing Editor

SMEDLEY B. RUTH
SIDNEY FELDMAN
Associate Editors

JOHN J. HUNTER
ROBERT J. BRAMLETT
Assistant Editors

DR. ALBERT F. MURRAY
Consulting Editor

ELMER KETTERER, Art Director

ANNE AXE, Editorial Assistant

ANN LAVENDER, Research Assistant

MAE MOYER, Reader Service

IDA GOOD, Editorial Secy.

EDITORS-AT-LARGE

Eastern Region

ELMER T. EBERSOL,
100 East 42nd St.
New York 17, N. Y.
(Area Code 212) OXford 7-3400

Western Region

I. PHILIP GEDDES,
1543 W. Olympic Blvd.
Los Angeles, Calif.
(Area Code 213) DUnkirk 7-1271

Defense/Space

CHARLES R. WILHIDE,
4400 Brookside Drive
Alexandria, Va.

WASHINGTON NEWS BUREAU

1093 National Press Bldg.
(Area Code 202) 393-3474
TWX-202 965-0675

GEORGE BAKER, Mgr.
NEIL R. REGEIMBAL

BUSINESS DEPARTMENT

ELMER DALTON
Advertising Promotion
& Circulation Manager

EDWARD G. SHAUD, Jr.
Marketing Manager

ARA H. ELOIAN
Production Manager

See Advertisers Index on page 195 for Regional Sales Managers.

Chilton Company—G. C. BUZBY, Chairman of the Board; R. E. McKENNA, President. Executive Vice President: G. T. Hook. Vice Presidents: P. M. Fahrendorf, L. V. Rowlands, M. E. Cox, E. B. Terhune, Jr., R. W. Case, Jr., J. H. Kofron. Treasurer: Stanley Appleby. Secretary: J. A. Montgomery. Other Directors: C. A. S. Heinle, T. C. Campbell, H. W. Barclay, W. A. Phair; Assistant Treasurer: J. Miades; Assistant Secretary: I. C. Holloway.

JOHN H. KOFRON
Chilton Research Director

ELECTRONIC INDUSTRIES, September, 1965. Vol. 24, No. 9. A monthly publication of Chilton Company. Executive, Editorial & Advertising offices at Chestnut & 56th Sts., Phila., Pa. 19139. (Area Code 215) Sherwood 8-2000. Controlled circulation postage paid at Philadelphia, Pa. \$1 a copy; Reference issue (June), \$5.00 a copy. Subscription rates U. S. and U. S. Possessions: 1 yr. \$10.00; 2 yrs. \$18.00. Canada 1 year \$12.00; 2 yrs. \$20.00. All other countries 1 yr. 18.00; 2 yrs. \$30.00. Copyright 1965 by Chilton Company. Title Reg. U. S. Pat. Off. Reproduction or reprinting prohibited except by written authorization.

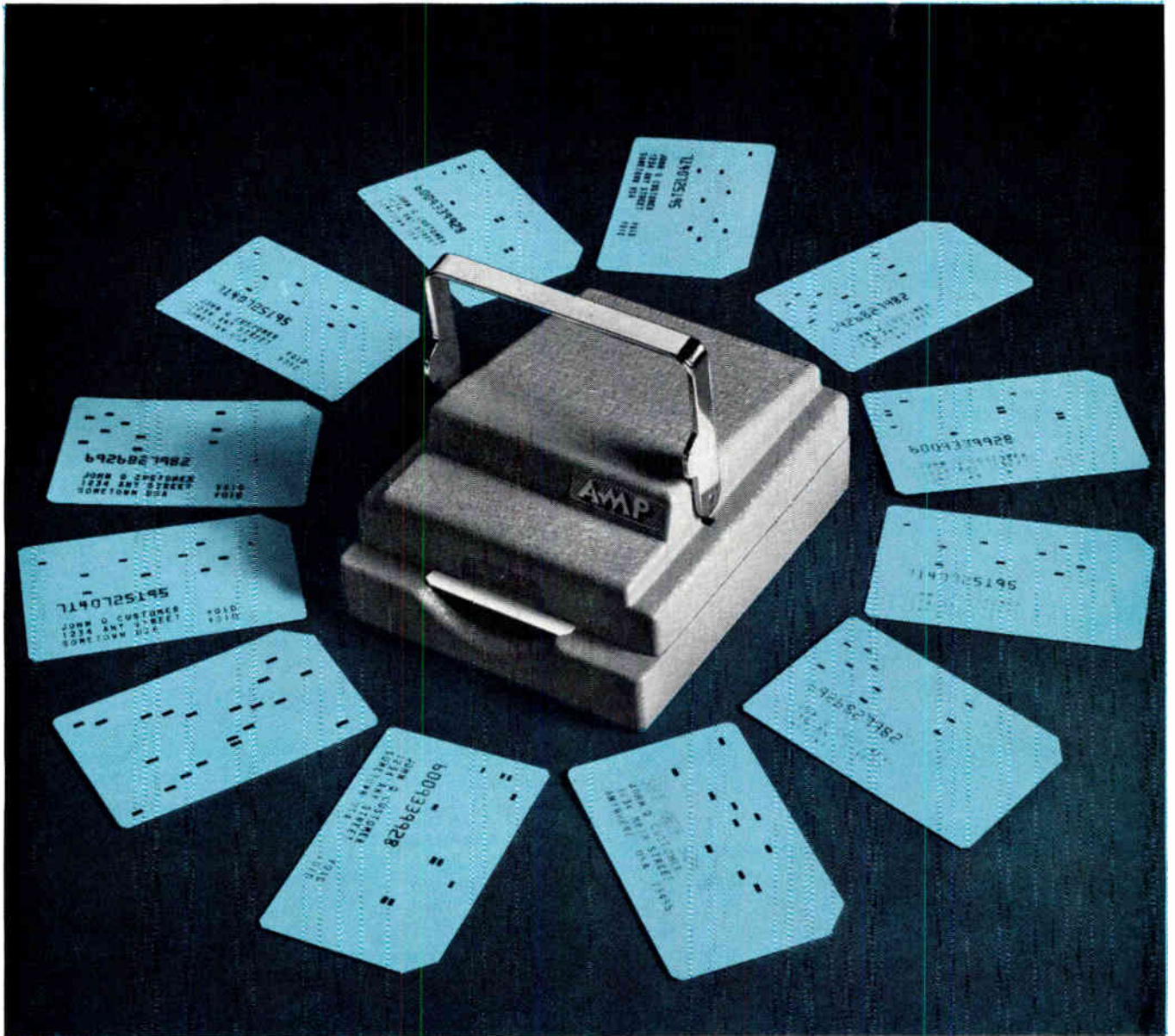

Credit's good here . . . over 1,000,000 times

This new, attractive card reader can register over a 1,000,000 insertions of various credit-type cards and translate the card information to electrical output circuits.

It's fast . . . it's reliable . . . it's foolproof!

Compact and rugged, the A-MP* Credit Card Reader can be used as an input device for credit handling systems, validating systems, security systems or other data collection and control applications. Available in either desk top or rack mount models, this versatile reader is supplied with either manual or automatic operation. Long, trouble-free operation is assured by the quality features built in this rugged unit. Electrical and mechanical interlocks provide foolproof operation. Redundant contacts with exclusive double wiping action insure a clean electrical surface for reliable sensing.

Here's a sample of other quality features which are engineered into this new product.

- Semi-automatic or automatic card ejection
- Reads plastic credit-type cards 2½" x 3¾"
- 250 ma, 500 V operation
- Pre-wired or wired to customer's specifications
- Redundant contacts with double wiping action for reliable sensing
- Long life—over 1,000,000 cycles
- Compact size—5" x 6" x 2¾"

Check the applications this item might find in your system, then write for complete information.

*Trademark of AMP INCORPORATED



A-MP* products and engineering assistance available through subsidiary companies in: Australia • Canada • England • France • Holland • Italy • Japan • Mexico • Spain • West Germany

Developments and trends affecting the State-of-the-Art of technologies throughout the electronic industries



WHERE 14 SECONDS EQUALS 24 HOURS

A 24 hr. day shrinks to only 14 secs. on this analog computer developed in Honeywell's temperature-control laboratories. Computer electronically simulates temperature, humidity, wind, sunshine — even hills and trees — to help engineers like Lorne Nelson (above) design building control systems for the future.

RESEARCHERS at Cornell Aeronautical Laboratory are seeking methods for obtaining 3-D topographical information on lunar and planetary surfaces as an aid to spacecraft landing operations and exploration. Among the methods under initial consideration are optical radars using lasers in combination with fiber optics, single point radiation detectors, and stereo TV systems. Both real-time and non-real-time systems will be studied under a contract with NASA.

LASER SYSTEM which uses the Q-switching technique and has an output capability of 1000 Mw has been announced by Applied Lasers, Inc. The model 1014-Q4 features a split elliptical cavity. It uses four flashlamps for uniform illumination of the ruby rod, and a $9 \times \frac{3}{4}$ in high-quality, brewster-angle fabricated rod for minimization of reflection losses at the rod end faces. It has the ability to use either a high-quality ruby rod or a special Neodymium-doped glass rod as the basic lasing medium. When the glass rod is used, the maximum Q-switched output is 300 Mw.

HIGH-VOLTAGE ELECTRONIC SWITCHES developed by General Electric Co. are a new triggered vacuum gap line. These cold cathode devices work because of a hydrogen plasmoid injection trigger which gives fast, reliable, low-jitter triggering and gas-free, high-purity, zone-refined metal electrodes which will not produce contaminating gases. The tubes feature a very wide dynamic range, and will find use in radar.

DOUBLE-DOPED IR LASER CRYSTAL, guaranteed for continuous, room-temperature operation at 1.06 microns output, is now available from Union Carbide Corp.'s Linde Division. The material, yttrium aluminum garnet (YAG) is doped with neodymium (Nd+3) and chromium (Cr+3). Double-doping increases output and efficiency by broadening the absorption band of the crystal, which also makes it more compatible with existing arc pump sources. Absorption band of the new material is 0.38 to 0.82 microns.

COMPUTER PROGRAMMING for the nation's first two semi-automatic air traffic control systems will be done by IBM for the FAA. The two systems being programmed will be in operation in 1967. Through the programming, the computers will take over many routine, non-control functions for traffic control that is now done manually.

PROPOSALS from ten firms have been received by NASA for a preliminary design study of the Optical Technology Satellite which is being considered as part of the Apollo Extension System. Objective of the proposed OTS program is to advance NASA's capability in space optics technology by performing a number of engineering and scientific experiments in space.

HEAT SHRINKABLE vinyl-based tubing designed for covering capacitors, resistors, and other electronic components, has been announced by 3M Co. The new flame retardant tubing, called "No. 3028 Scotchtite," possesses a 50% shrinkable range with a nominal 0.010-in. wall thickness. It is suitable for automated production lines and is available in either coils or cut to size.

HYBRID COMPUTER SYSTEM recently ordered by Douglas Aircraft Co. will be used in the development of the Saturn moon rocket. The Beckman Instruments, Inc., all solid state computer system will include two Beckman Model 2200 analog computers and a Scientific Data Systems, Inc., Model 930 digital computer linked with a Beckman interface. The equipment will be used in the development of the S-IVB upper stage being built for NASA.

PLANS TO INTRODUCE commercial facilities for the international transmission of TV programs via the Early Bird satellite have been announced by RCA Communications, Inc. The new service will begin immediately following approval of a joint tariff offering expected to be filed shortly by the international communications carriers with the FCC.

"ELECTRONIC MAPS" of the ocean bottom will pinpoint the position of NASA ships used in the Apollo program. A new system built by General Instrument Corp. will be used for precise position-fixing. Called "Bathymetric Navigation Equipment," or BNE, it permits a ship to find its position by taking sonar depth soundings over a previously surveyed area of the ocean bottom. The previously acquired information is processed by computer and stored in the form of an "electronic map," or 3-D profile of the ocean bottom, on punched tape. "Retrieval," or determination of the ship's position is assured by traversing the surveyed area while examining the bottom profile with an acoustic fathometer (depth-sounder).

BETA TANTALUM MATERIAL

A new phase or structure has been found in tantalum films which has electrical properties much different than those of normal tantalum. Mildred Read, of Bell Telephone Labs, and Carl Altman, of Western Electric, examine X-ray diffraction patterns of normal tantalum and new material they discovered, beta tantalum.

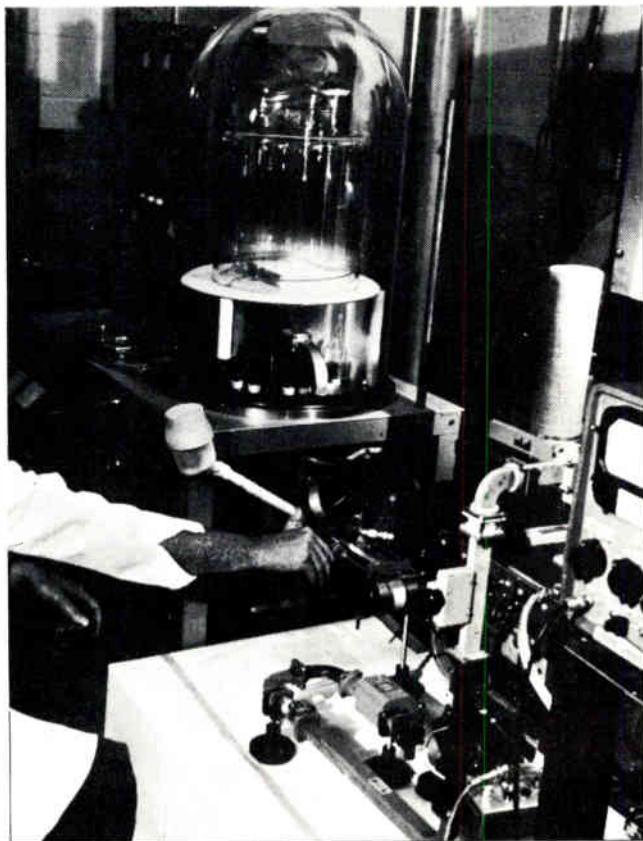

COMMUNICATIONS "BLACK-OUT" STUDY

Communications "black-out" which spacecraft encounter when re-entering the earth's atmosphere is being studied at Sylvania. Here, a field of plasma is formed around a typical space vehicle antenna inside the glass globe to enable company engineers to measure radio activity in various depths of plasma accumulation.

FLATPACK INTEGRATED CIRCUIT that is so sturdy it can withstand a hammer-blow has been announced by ITT Semiconductors. The new flat-pack uses Kovar ribbon leads directly bonded to thin-film aluminum bonding pads on the silicon substrate. After the leads are bonded, the chips and lead tips are hermetically sealed by coating them with silicon dioxide and molding them in glass. After plating, they look like normal 14-lead flat-packs.

N-CHANNEL FET which provides low-noise capability extending from 10 cycles to over 500 mc has been announced by Texas Instruments Incorporated. The new FET is available in a four-lead TO-18 package designated 2N3823, and a dual matched-pair in a TO-5 type configuration, TIS25-27. The 500 mc capability of the new unit opens many h-f communications applications formerly restricted to normal bipolar transistors.

LASER MEASUREMENT SYSTEM will be used to align a hydrophone array relative to radio direction finder antennas on the Navy's 354-ft.-long unmanned research vessel SPAR. SPAR can be shifted from the normal horizontal position to a vertical position to study underwater sound transmission and propagation. When in the vertical position the Perkin-Elmer Corp. polarimeter system will be used to measure twist in the hull of the vessel.



This is where the eagle sits

Look who stepped out of the Great Seal to wear a CMC Crusading Engineers' medal. Think he looks proud? You should see us! **He's on the first and only solid-state counter fully militarized to meet Mil Specs.**

If you want the safety of a counter providing full Mil Specs reliability at a price surprisingly close to a commercial counter, then check these specs: 0 to 100 Mc frequency range; oscillator stability of 1 part in 10^8 ; meets or exceeds MIL-E-16400, including appropriate temperature, humidity, vibration, shock, and RFI

specs; built-in time interval measurement. Three militarized plug-ins available: 500 Mc heterodyne converter, 3 Gc heterodyne, and a 15 Gc transfer oscillator.

It may take some time, but you can probably expect copies of this counter from our creative competition at high-powered H-P and big, bad B. But they'll be copying the instrument



originated and designed by CMC. State-of-the-art development of a fully militarized solid-state counter isn't the first or last technological coup for CMC. Add to it the first all solid-state counter, first all-silicon solid-state counter, first 10-line-per-second low-cost printer, first dual plug-in counter, and numerous others.

Write today for a complete spec sheet on our new Model 880 so you can compare when and if the others arrive on the market. And remember, we won't give you the bird, we'll give you a medal.

12976 Bradley · Sar. Fernando, California · Phone (213) 367-2161 · TWX 213-764-5993

COMPUTER MEASUREMENTS COMPANY IS A LEADING DESIGNER AND MANUFACTURER OF ELECTRONIC INSTRUMENTATION TO COUNT, MEASURE, AND CONTROL.

Astrodata's New Astrolock*^{*}-loop FM Subcarrier Discriminator



Stability

Within $\pm 0.01\%$ of center frequency for 24-hours after a 5-minute warm-up.

Linearity

Better than $\pm 0.02\%$ of full bandwidth, best straight line.

The Astrodata Model 402-201, all solid-state FM subcarrier discriminator utilizes the new Astrolock phase-frequency detector, crystal-referenced, FET chopper-stabilized VCO, and current mode loop filter, which are proprietary developments of Astrodata, Inc.

This completely new and different type of locked-loop discriminator gives performance exceeding that of both conventional phase-locked-loop and pulse-averaging types of discriminators.

The new crystal-referenced, FET chopper-stabilized VCO provides state-of-the-art performance in stability and linearity, without a temperature controlled oven.

The Astrolock detector, with its composite phase-frequency characteristic, assures positive lock-in at any signal

level within the 66 db dynamic range. True locked-loop performance is provided for deviations up to $\pm 40\%$, with specified linearity. A quadrature detector mode of operation, selected by a switch on the front panel, provides correlation detection for extremely low S/N signals.

The Model 402-201 introduces a new method of tape-speed compensation in which the reference frequency is processed in the frequency domain. As a result, tape speed compensation is perfect at any fixed frequency from lower bandedge to upper bandedge, and is better than 30 db for intelligence frequencies up to a modulation index of 4. Deviations of more than $\pm 3\%$ anywhere in the band can be accommodated. No adjustments are necessary.

With this new Astrodata Tape Speed Compensation system, the over-all

stability for a given data channel is that of the data discriminator alone, whereas in a conventional system the over-all stability is the sum of the stabilities of both the data discriminator and the reference discriminator.

A complete line of accessories is available for use with the Model 402-201. Channel Selectors and Low Pass Filters are provided for all standard IRIG and Constant Bandwidth center frequencies up to 300 kc. Six discriminators and one common power supply mount in a rack adapter which occupies a panel space of 7-in. x 19-in.

For complete technical information on Astrodata's unique Astrolock - loop FM Subcarrier discriminator and full line of telemetry components, call your local Astrodata engineering sales representative or write to us directly.



ASTRODATA, INC.
P. O. Box 3003 • 240 E. Palais Road • Anaheim, California 92803

*Trademark TEL. (714) 772-1000 • TWX 714-776-3760 • FAX • TELEX 06-78828 • CABLE ADDRESS • ASTRODATA, Anaheim

This is Siemens

Serving the entire field of electronics and nucleonics, the Siemens Group is one of the world's most diversified electrical engineering organizations.

The particular strength of the Siemens Group is in its all-round capabilities—both in the overall handling of large-scale technical projects, from planning to final delivery, and also in the quantity production of electrical components and electronics devices. Distribution companies and agencies in 80 countries, backed by Siemens factories and hundreds of depots maintained in all parts of the world, guarantee customers a maximum of service. In cooperation with their central offices, they provide or arrange for every conceivable form of service that may be required in connection with electrical installations.

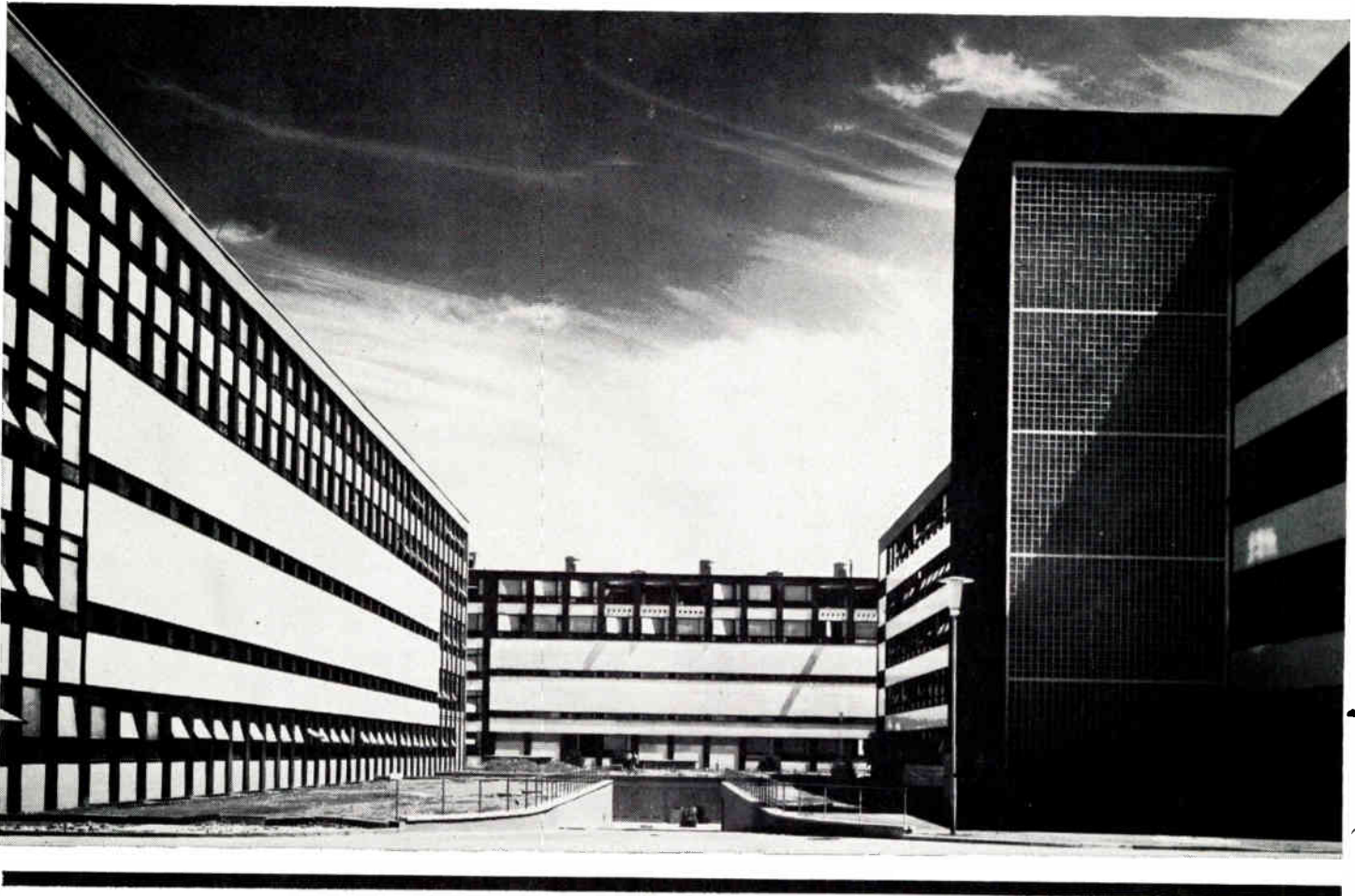

Siemens & Halske AG
Components Division

Siemens Tubes

Microwave Tubes

Velocity Modulated Types

The advanced technology of Siemens Microwave Tubes facilitates the design of new multi-channel communications equipment, radar systems and microwave test instruments.

Type	Frequency Range	Typical Operation		
		Saturation power W	AVG Gain dB	Focussing
Travelling Wave Tubes				
YH 1020	0.47 to .96 Gc/s	350	35	PM
RW 2	1.7 to 2.3 Gc/s	30	40	PPM
RW 21	2.5 to 2.7 Gc/s	30	40	PPM
RW 4	3.3 to 4.3 Gc/s	16	40	PPM
RW 6	5.8 to 7.3 Gc/s	18	39	PPM
RW 80	5.8 to 8.5 Gc/s	30	39	PPM
YH 1040	5.9 to 6.4 Gc/s	3000	29	PPM

Type	Frequency Range	Typical Operation		
		Average power output mW	Modulation sensitivity Mc/V	Resonator voltage V
Reflex Klystrons				
RK 25	3.6 to 4.5 Gc/s	180	1.8	310
RK 6	5.775 to 5.925 Gc/s	175	3.0	400

Type	Frequency Range	Typical Operation		
		Average power output mW	Tuning voltage V	Current mA
Backward Wave Oscillators				
RWO 40	26.5 to 42 Gc/s	60	500 to 2700	15
RWO 60	42 to 65 Gc/s	20	500 to 2400	15
RWO 80	60 to 90 Gc/s	5	500 to 2500	15

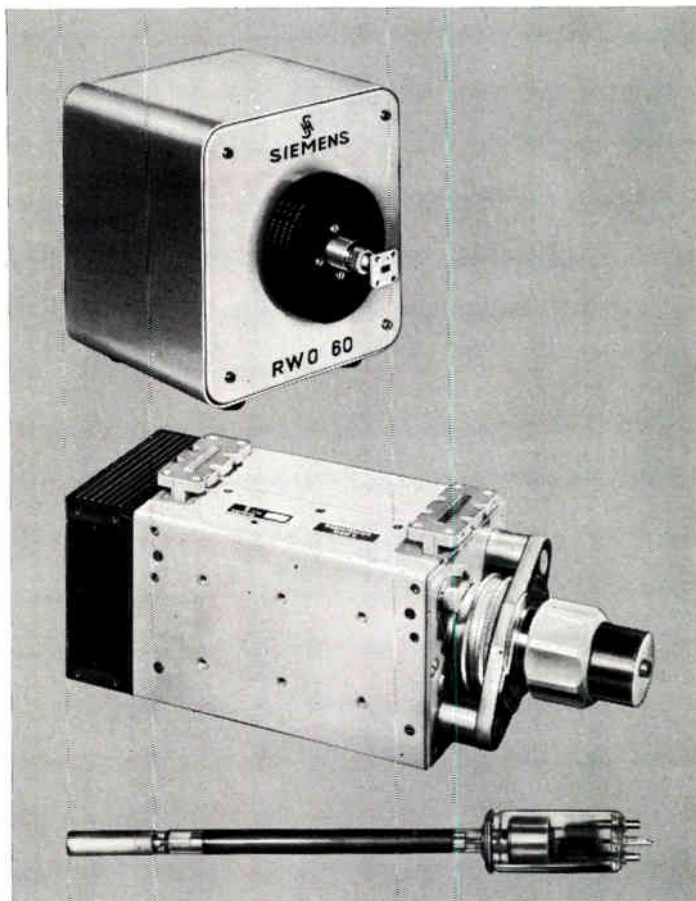

SIEMENS AMERICA INCORPORATED
 Components Division
 230 Ferris Avenue, White Plains, N. Y.

In Canada:
 SIEMENS CANADA LIMITED
 407 McGill Street, Montreal 1, P.Q.



This "AIRFLOW RESEARCH LAB" makes McLEAN blowers better than they have to be!

(to make your system more reliable than you thought it ever could be)

This Airflow Test Chamber is used by McLean for the development of new cooling products and for continuous quality control and testing of production units. Built by McLean to meet NEMA and ASRE standards it is calibrated with critical accuracy to permit simultaneous reading of mechanical, thermal and electrical characteristics. It establishes accurate performance, optimum design of air-moving equipment and sure knowledge of the pressure drop and volume of air required to cool specific packaged electronic loads. This is one more reason why you get guaranteed predictable performance with every McLean blower or fan.

SEND FOR
NEW 1965
44-PAGE
CATALOG



McLEAN ENGINEERING LABORATORIES

P.O. Box 228, Princeton, New Jersey
Phone 609-799-0100 • TWX 609-799-0245
TELEX 083-4345

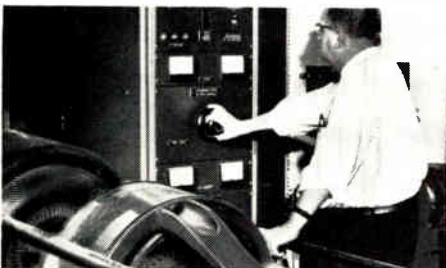

McLean generators cover all military and commercial ranges. This harmonic alternator provides any voltage 0 to 220, 3 phase, 40 to 500 cps. Also generates square waves, sawtooth waves and perfect sine waves.



Each McLean-built motor is fabricated to microscopic tolerances on the world's finest and most expensive machinery. Our investment in equipment pays you dividends in reliability.

COMING EVENTS

September

- Sept. 8-10: 13th Annual Indus. Elect. & Control Inst. Conf., IEEE; Sheraton Hotel, Phila., Pa.
- Sept. 13-14: 13th Annual Joint Eng. Mtg. Conf., IEEE-ASME; New York Hilton, New York, N. Y.
- Sept. 13-15: 12th Annual Petroleum Industry Conf., IEEE; Sheraton-Lincoln Hotel, Houston, Tex.
- Sept. 13-17: 6th Int'l Elec'l Insulation Conf., IEEE; New York Hilton Hotel at Rockefeller Ctr., New York, N. Y.
- Sept. 19-22: Nat'l Power Conf., IEEE, ASME; Schine-Ten Eyck Hotel, Albany, N. Y.
- Sept. 22-24: Int'l Conv. on Military Electronics (Mil-E-Con 9), IEEE; Washington Hilton Hotel, Washington, D. C.
- Sept. 23-25: 15th IEEE Broadcast Symp., IEEE; Williard Hotel, Washington, D. C.
- Sept. 24-25: 13th Annual Comm. Conf., IEEE; Cedar Rapids, Iowa.
- Sept. 28-29: 7th Biennial Heating Conf., IEEE; Hotel Carter, Cleveland, Ohio.
- Sept. 29-30: Fall Nat'l Mtg. Society for Information Display, SID; Commodore Hotel, New York, N. Y.
- Sept. 29-Oct. 1: 12th Nat'l Vacuum Symp., Am. Inst. of Physics; Hotel Statler-Hilton, New York, N. Y.

'65-'66 Highlights

- Nat'l Electronics Conf., Oct. 25-27; McCormick Place, Chicago, Ill.
- NEREM, Northeast Research & Eng. Mtg., Nov. 3-5, IEEE; Boston, Mass.
- IEEE Int'l Conv., Mar. 21-24, 1966; Coliseum, New York Hilton, New York, N. Y.

October

- Oct. 4-6: Fall URSI-IEEE Mtg., IEEE; Dartmouth College, Hanover, N. H.
- Oct. 4-6: 1965 Canadian Electronics Conf., IEEE; Automotive Bldg., Toronto, Canada.
- Oct. 4-7: Instrument Soc. of America Conf. & Exhibit, ISA; Los Angeles Sports Arena, Los Angeles, Calif.
- Oct. 12-13: 3rd Annual Product Maintainability Seminar, ASQC; Sheraton Motor Inn, Phila., Pa.
- Oct. 11-13: 1965 IEEE NATCOM (Communications Symp.), IEEE; Utica, N. Y.
- Oct. 12-14: 1965 Protective Relaying Conf., IEEE, Univ. of Minn.; Univ. of Minn., Minneapolis, Minn.
- Oct. 18-19: Systems Science Conf., IEEE; Case Institute, Cleveland, Ohio.
- Oct. 18-20: 12th Nuclear Science Symp., IEEE; San Francisco Hilton Hotel, San Francisco, Calif.
- Oct. 18-20: Joint Materials Handling Tech. Conf., IEEE, ASME; Pittsburgh Hilton Hotel, Pittsburgh, Pa.

Now! All the Features of Larger Size Potentiometers—Except Larger Size!

- (1) Dimensions: 1/4" x 1/4" x 0.17"
- (2) Multi-turn adjustment
- (3) Damage-proof clutch action
- (4) Indestructible SILVERWELD® termination
- (5) Standard resistances from 10 Ω to 20K
- (6) 20 ppm wire

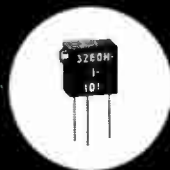

New TRIMPOT® Potentiometer Model 3260
ACTUAL SIZE

Write today for complete technical data

If it's TRIMPOT®, it's BOURNS

TRIMPOT is a registered trademark of Bourns, Inc.

MANUFACTURER: TRIMPOT® & PRECISION POTENTIOMETERS, RELAYS: TRANSDUCERS FOR PRESSURE, POSITION, ACCELERATION. PLANTS: RIVERSIDE, CALIFORNIA; AMES, IOWA; TORONTO, CANADA

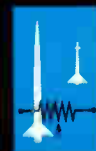

BOURNS

BOURNS, INC., TRIMPOT DIVISION
1200 COLUMBIA AVE., RIVERSIDE, CALIF.
PHONE 684-1700 • TWX: 714-682 9582
CABLE: BOURNSINC.

Permanent Threads Resist Pull Out, Push Out, Torque Out!

National Captive Hardware can improve designs, simplify assembly, and enhance the appearance of your finished product.

Hex-head design resists torque. Recessed cavity accepts cold-flow of parent material. Result: They never push out, pull out, or torque out of the parent material. They can be installed easily without special tools, even in cramped chassis locations. (Just drill hole, insert hardware, and press in . . . even with

an arbor press.) They provide permanent threads for otherwise soft and easily-stripped materials. They are inexpensive.

National Captive Hardware is the answer to your fastening or assembly problems. Shown below are just nine possible applications for National Captive Hardware, but many others exist. Why don't you investigate the many uses available?

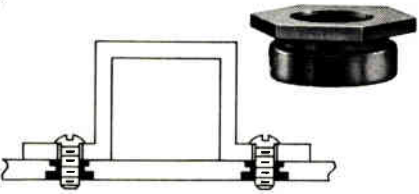
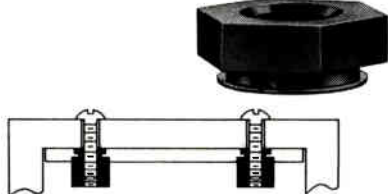
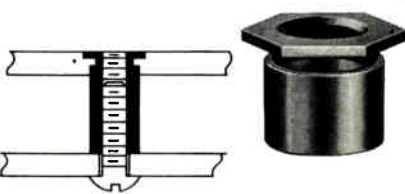
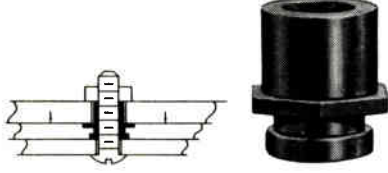
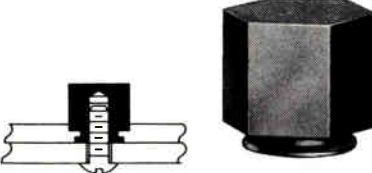
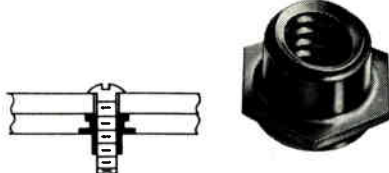
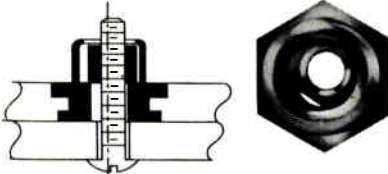
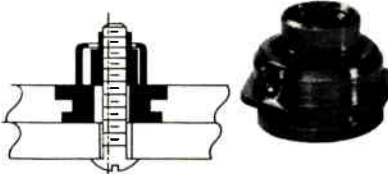
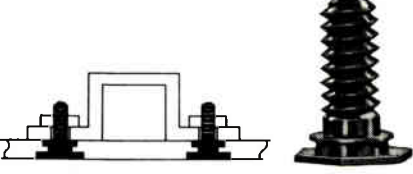
 <p>Back of panel inaccessible, no extensions allowable: Type 1 National captive nut fits flush on both sides. Can be used for mounting bracket or component or in cases when top and bottom are closed.</p>	 <p>Extra threads required, or possibly to stand off compression load: Type 2 National captive nut extends hex-head above parent material, gives extra holding power for thin materials.</p>	 <p>Tensile load spacer needed: National's Type 3 meets several requirements with cylindrical barrel which projects from parent material.</p>
 <p>Compression load stand-off required, need orientation guide for second plate: Type 4 National captive nut meets these requirements while it provides extra threads.</p>	 <p>Need water-tight or short-circuit-proof nut: National's Type 5 do not have through taps, but end in a blind hole, preventing water seepage or shorting of chassis components. Can also stand off compression load.</p>	 <p>Components subject to vibratory or cyclic motion: Type 6 self-locking National captive nut has an oval-shaped extension that holds, yet is easily installed. Meets MIL-N-25027.</p>
 <p>Holes in two materials misaligned: Type 7 National floating captive nut will adjust to correct misalignments of as much as .031". Low profile. Simple installation.</p>	 <p>Holes misaligned, vibration present: Type 8 self-locking version of National's floating captive nuts answer both problems, yet offer strong threads in weaker materials. Type 8 combines the features of 6 and 7. Locking feature meets MIL-N-25027.</p>	 <p>No extensions permitted on panel, but threads required: National's captive stud fits flush with parent material. Wide range of standard sizes and threads, with many others available on special order.</p>

Is your application here?

National Radio Company, Inc.

 37 Washington Street, Melrose, Massachusetts 02176 Telephone: 617-665-4800, TWX: 617-665-5032

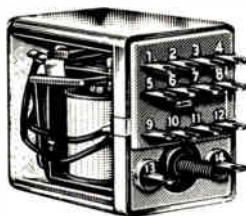

Should YOU specify this small four-pole relay by P&B?

Here is why so many engineers have

An extraordinary combination of features distinguish the KH relay. Small size (only slightly larger than one cubic inch), 4-poles, exceptional electrical stability over a long life, a wide choice of mountings . . . all of these and more are found in the KH.

SWITCH FOUR CIRCUITS FROM LOW LEVEL TO 3 AMPS

This is a four-pole relay normally used in a 4 Form C arrangement. It can be supplied with a 2 Form Z (DPDT-DB) configuration or, by not wiring certain contact terminations, any four-pole combination of Forms A or B may be achieved. Beryllium copper is used for the contact arms for excellent conductivity and long mechanical life.

Both AC and DC relays are available. Minimum power requirement for AC relays is 0.55 volt amperes at 25° C. DC relays will operate on only 0.5 watts at 25° C. KH relays are rated at 3 amperes, as shown below. Under certain favorable conditions, KH relays will switch up to 5 amperes providing extended life is not required.

TERMINAL BLOCK CONSTRUCTION CONTRIBUTES TO RELIABILITY

Glass reinforced alkyd, a material of exceptional dimensional stability and dielectric properties, is used for the terminal block. The terminals are molded into the block. This construction serves to keep the relay in precise adjustment throughout its life. The pierced solder terminals are easily accessible, speeding hook up.



CHOOSE FROM WIDE VARIETY OF MOUNTINGS

The terminal block is uniquely embossed to allow for mounting KH relays on metal strips or angles. This embossing, around the two bottom terminals, keeps the relay from turning when the nut is tightened on the stud. The KH may be mounted in a variety of ways. A tab-and-stud mounting plate on any side or the top of the dust cover is available. Also, a choice of three sockets may be used to make the KH a plug-in relay. One socket has printed circuit tabs, the other two have pierced solder terminals.

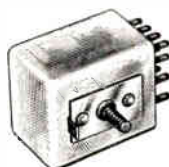

CHOICE OF ENCLOSURES TO MEET ALL REQUIREMENTS

Dust covered KH relays (KHP) can be ordered with translucent nylon or clear Lexan cases. Hermetically sealed relays are designated KHS, and are enclosed in a steel cover. The nylon cases are available on special order in red, blue, green, yellow or black so that relays in various circuits may be color coded.

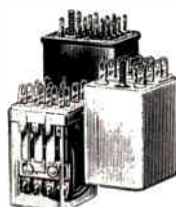

RELIABILITY OF KH SERIES FIELD-PROVED IN MANY APPLICATIONS

The KH has found its way into such diverse gear as citizens band transceivers, dictating machines, walkie-talkies, computers, aircraft communications equipment, scoreboards, alarm systems, and many others.

For full information call your local P&B distributor or Sales Representative, or write: Potter & Brumfield, Princeton, Indiana.

KH SERIES SPECIFICATIONS

CONTACTS:

Arrangements: 4 Form C (4PDT), 2 Form Z (DPDT-DB).

Rating: 3 amps @ 30 volts DC or 115 volts AC resistive for 100,000 operations.

COILS:

Resistance: DC: 11,000 ohms max.
AC: 3,900 ohms max.

Power: AC: 1.20 volt amperes nominal @ +25°C., .550 volt amperes minimum @ +25°C.

DC: 0.9 watt nominal @ +25°C., 0.5 watt minimum operate @ +25°C., 2.0 watts maximum @ +25°C.

TIMING VALUES:

Nominal Voltage @ 25°C.	Max. Values
Pull-in time	13 ms
Drop-out time	10 ms

INSULATION RESISTANCE:

1500 megohms min.

MECH. LIFE:

DC: In excess of 100 million cycles.
AC: In excess of 50 million cycles.

ENCLOSURES:

Dust cover or hermetically sealed.

TERMINALS:

Solder lug and taper tab.

SOCKET:

Solder lug or printed circuit terminals. Available as accessory.

DIMENSIONS:

1-21/64" x 1-7/64" x 55/64"

*Now available at leading
electronic parts distributors*



POTTER & BRUMFIELD

Division of American Machine & Foundry Company, Princeton, Indiana
In Canada: Potter & Brumfield, Division of AMF Canada Ltd., Guelph, Ont.

STUDY FCC ACT CHANGES—Congress is moving to bring the FCC Act up to date with present practice and needs. The Senate Commerce Committee recently heard six measures, including one to permit FCC to restrict radio interference from electronic devices. Another would give authority to require painting and lights on antenna towers after they are no longer used, and in some cases require dismantlement. Another would close a legal gap in filing requirements by some connecting communications carriers. Another measure would ease conflict-of-interest laws governing FCC employees to exempt investments in firms with only casual FCC licenses (executive aircraft radio, for instance).

NEW COMSAT STATIONS — Communications Satellite Corp. (COMSAT) has let contracts for two more earth stations, plus expansion of an existing earth station, soon to be erected. The three stations will be an integral part of COMSAT's global satellite system. Probable locations: Brewster Flat, Wash., and Oahu, Hawaii, for the new stations, Andover, Me., for the expansion. All are scheduled to be in operation by fall of 1966. Meanwhile, common carrier companies and the government continue to juggle the hot question of control over the three first ground stations (and related facilities) servicing the satellites. Outlook is for the FCC decision (government control) to prevail, leaving common carriers with usage rights but no ownership rights.

SPEED, ACCURACY IN SATELLITE TRACKING

Error-free data transmission is essential for NASA scientists to determine exact angle and distance of satellite passes over ground stations so they can aim antennas in advance of satellite pass. Among recent systems acquired is the Digitronics Dial-o-verter system.

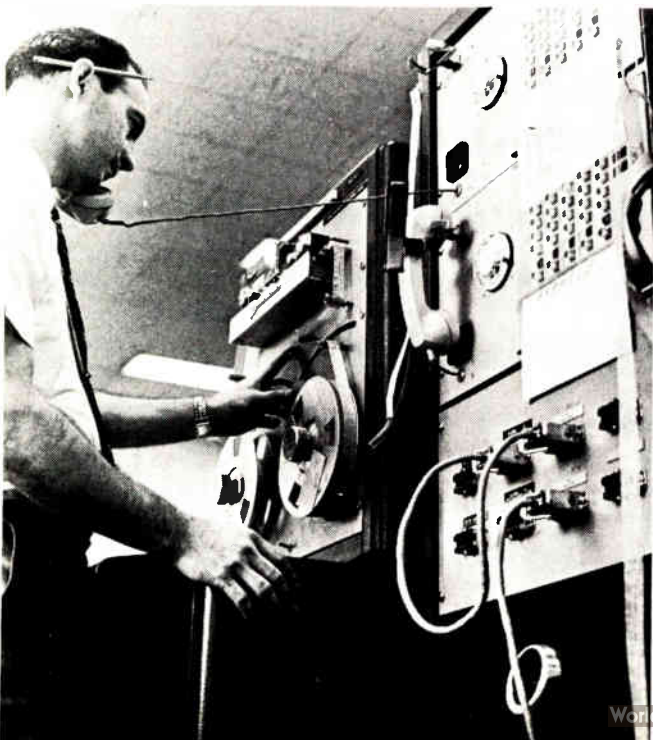

SPACE-TO-EARTH PHONE—One of our astronauts (probably James A. Lovell) is ready to make the first space-to-earth phone call next year. He'll use a laser beam. NASA experts predict laser beams will one day be the major link between earth and satellites, and possibly the moon as well. When Gemini-7 is over White Sands, N. M., Lovell will put on blue-tinted glasses, sight through a 6x telescope, and flash his beam at the White Sands receiver. If he's on beam, he'll lock into the first space-to-earth phone circuit and can start talking.

IMPORTS ARE PROTESTED—Tariff Commission is looking into an "unfair competition" complaint against imported walkie-talkies. Electrosolids Corp., Los Angeles, claims there are illegal acts in the importation and sale of walkie-talkies incorporating super-regenerative detector circuits. The Commission must now decide whether to call a halt to further imports of these items, or to dismiss the complaint.

SET-ASIDE RULE PROTESTED—A congressional subcommittee is protesting the requirement in armed services procurement regulations that limits bidding on never-before-produced items to small manufacturers. Committee members feel that, by thus discriminating against larger manufacturers, the government is denying itself the advantages of obtaining more bids on certain procurements. House Armed Services subcommittee on military operations is making the protest. The rule now is that DOD makes 100% set-aside on new-item procurement, thus shutting out larger firms completely.

WAR CONTROLS CONSIDERED—Stepped-up pace of the Vietnam war raises the strong possibility that several forms of war production controls, including rationing of materials, may be ordered into effect. Government officials are paying closest attention to use of metals by manufacturers. Supply-and-demand situation, already tight in two key metals (copper, nickel) is being watched with great care with a view to possible government usage controls.

COSTLIER PATENTS—To make the Patent Office more self-supporting, sharp increases in fees for receiving and issuing patents will soon be in effect. For years, the U. S. Patent Office has charged \$60 in fees (\$30 for filing; \$30 for issuing). This will be tripled under legislation enacted this year, effective in October. Meanwhile, the Patent Office reports an unusually heavy volume of filings, as inventors and attorneys rush to qualify for the old rate. At present, the Office earns only about one-third of its costs.

RCA VIDICONS "SHOT" THE MOON...and the experience and techniques gained from this space-age achievement can now benefit you in a broad range of RCA Vidicons—including the RCA-7735B, recently introduced and already acclaimed as the world's finest compact TV camera tube. RCA-7735B offers improvements in shading, resolution, sensitivity, and freedom from spurious signal response.

RCA-4478 and 4488, designed especially for industrial and educational applications, are two more examples of the wide line of Vidicons, from 1/2" diameter to 1 1/2" diameter, for superior black-and-white and color pickup. You get these outstanding features: high sensitivity, high resolution, high uniformity of tube-to-tube characteristics, low lag, and uniform photoconductive surface.

For more information on RCA Vidicons, see your RCA Representative. For technical data on specific types, write: RCA Commercial Engineering, Section I50Q, Harrison, N. J.

ALSO AVAILABLE FROM YOUR RCA INDUSTRIAL TUBE DISTRIBUTOR

RCA Electronic Components and Devices



The Most Trusted Name in Electronics



One Low-Cost Series Of Digital Integrated Circuits Is Preferred For New Designs

THESE



(They're the Motorola MC350 series MECL* circuits with 6 nsec propagation delay and simultaneous complementary logic functions — priced as low as \$1.95 per circuit!)

Whether you're looking for fewer parts per system for reasons of economy or to minimize overall space requirements for your equipment, you satisfy both goals with the high-logic capability of the MC351-MC365 series Motorola-designed 6 nsec MECL integrated circuits — with simultaneous complementary functions at each gate (AND/NAND, OR/NOR)! You completely eliminate those extra inverter circuits.

This new current-mode computer complement, with fan-in and fan-out capability up to 25, also features a 0 to +75°C operating temperature range . . . offering new design freedom for most commercial equipment applications!

Best of all, when you look at individual circuit prices, you'll find these high-speed, complementary-logic MECL circuits priced competitively with others offering less than 1/3 the speed and no dual function logic capability . . . with individual circuits priced as low as \$1.95 in 100 quantities!

They're available from your local Motorola franchised semiconductor distributor or in production quantities through your nearest Motorola field office. For complete technical details on the MC350 series MECL circuit, write the Technical Information Center, Box 955, Phoenix, Arizona 85001.

*TM of Motorola Inc.

COMPARE THESE NEW LOW CIRCUIT PRICES

Type† Number	Circuit Function	Speed/Circuit (Typ)	Maximum Operating Frequency	Power Dissipation per Circuit (typ)	Noise Immunity	Operating Temperature Range	100-Up Price
MC351	5-Input Gate	6 nsec	30 mc	35 mW	400 mV	0 to +75°C	\$3.65
MC352	R-S Flip-Flop	6 nsec	30 mc	35 mW	400 mV	0 to +75°C	3.65
MC353	Half Adder	6 nsec	30 mc	60 mW	400 mV	0 to +75°C	4.75
MC354	Bias Driver	6 nsec	30 mc	18 mW	400 mV	0 to +75°C	1.95
MC355	Gate Expander	6 nsec	30 mc	—	400 mV	0 to +75°C	2.25
MC356	3-Input Gate	6 nsec	30 mc	35 mW	400 mV	0 to +75°C	2.85
MC357	3-Input Gate (no output resistors)	6 nsec	30 mc	13 mW	400 mV	0 to +75°C	2.85
MC358	J-K Flip-Flop	6 nsec	30 mc	52 mW	400 mV	0 to +75°C	7.60
MC359	Dual 2-Input Gate	6 nsec	30 mc	49 mW	400 mV	0 to +75°C	2.95
MC360	Dual 2-Input Gate	6 nsec	30 mc	49 mW	400 mV	0 to +75°C	2.95
MC361	Dual 2-Input Gate	6 nsec	30 mc	36 mW	400 mV	0 to +75°C	2.95
MC362	Dual 3-Input Gate	6 nsec	30 mc	49 mW	400 mV	0 to +75°C	4.00
MC363	Quad 2-Input Gate	6 nsec	30 mc	110 mW	400 mV	0 to +75°C	8.55*
MC364	J-K Flip-Flop	6 nsec	40 mc	114 mW	400 mV	0 to +75°C	9.25
MC365	Line Driver	—	—	230 mW	400 mV	0 to +75°C	7.35

†Add suffix letter "G" to type number for TO-5 package, "F" for flat package. (Slightly higher priced). *flat pkg. only.

New J-K Flip-flop — Quad 2-Input Gate — Dual 3-Input Gate — Line Driver

... or Choose From These Other 92 Motorola Digital Integrated Circuits

FAMILY	SINGLE GATES	MULTIPLE GATES	BUFFERS AND DRIVERS	ADDERS	STORAGE ELEMENTS (R-S FLIP-FLOP)	J-K FLIP-FLOPS	EXTRA-ORDINARY FUNCTIONS
MILITARY DTL (MC200 Series) -55 to +125°C	MC201 4-Input NAND/NOR MC202 3-Input NAND/NOR MC203 6-Input AND	MC206 Dual 2-Input NAND/NOR MC207 2-3 Dual Input NAND/NOR MC208 2-3 Dual Input NAND/NOR MC212 Dual 3-Input NAND/NOR MC213 Dual 3-Input NAND/NOR MC215 Dual 3-Input AND	MC204 3-Input Power Gate MC205 Line Driver		MC209 R-S Flip-Flop MC210 R-S Flip-Flop Split Capacitor		MC217 Dual 3 Expander
COMMERCIAL DTL (MC250 Series) 0 to +75°C	MC251 4-Input NAND/NOR MC252 3-Input NAND/NOR MC253 6-Input AND	MC256 Dual 2-Input NAND/NOR MC257 2-3 Dual Input NAND/NOR MC258 2-3 Dual Input NAND/NOR MC262 Dual 3-Input NAND/NOR MC263 Dual 3-Input NAND/NOR MC265 Dual 3-Input AND	MC254 3-Input Power Gate MC255 Line Driver		MC259 R-S Flip-Flop MC260 R-S Flip-Flop Split Capacitor		MC267 Dual 3 Expander
MILITARY MECL (MC300 Series) Current Mode 0 to +125°C	MC301 5-Input AND/OR-NAND/NOR MC306-MC307 3-Input Expandable AND/OR-NAND/NOR	MC309, MC310, MC311 Dual 2-Input NAND/NOR MC312 Dual 3-Input NAND/NOR MC313 Quad 2-Input NAND/NOR	MC315 Line Driver	MC303 Half Adder (Sum-NOR-Carry Outputs)	MC302 R-S Flip-Flop	MC308 J-K Flip-Flop MC314 J-K Flip-Flop	MC304 Bias Driver MC305 5-Input Expander
COMMERCIAL MECL (MC350 Series) Current Mode 0 to +75°C	MC351 5-Input AND/OR-NAND/NOR MC356-MC357 3-Input Expandable AND/OR-NAND/NOR	MC359, MC360, MC361 Dual 2-Input NAND/NOR MC362 Dual 3-Input NAND/NOR MC363 Quad 2-Input NAND/NOR	MC365 Line Driver	MC363 Half Adder (Sum-NOR-Carry Outputs)	MC352 R-S Flip-Flop	MC358 J-K Flip-Flop MC364 J-K Flip-Flop	MC354 Bias Driver MC355 5-Input Expander
MILITARY DCTL (MC900 Series) -55 to +125°C	MC903 3-Input NAND/NOR MC907 4-Input NAND/NOR	MC914 Dual 2-Input NAND/NOR MC915 Dual 3-Input NAND/NOR	MC900 Buffer	MC904 Half Adder	MC902 R-S Flip-Flop MC905 Gated R-S (with inverter) MC906 Gated R-S (without inverter)	MC916 J-K Flip-Flop	MC901 Counter Adapter
COMMERCIAL DCTL (MC800 Series) 0 to +100°C	MC803 3-Input NAND/NOR MC807 4-Input NAND/NOR	MC814 Dual 2-Input NAND/NOR MC815 Dual 3-Input NAND/NOR	MC800 Buffer	MC804 Half Adder	MC802 R-S Flip-Flop MC805 Gated R-S (with inverter) MC806 Gated R-S (without inverter)	MC816 J-K Flip-Flop	MC801 Counter Adapter
INDUSTRIAL DCTL/RTL (MC700 Series) +15 to +55°C	MC703 3-Input NAND/NOR MC707 4-Input NAND/NOR MC711 4-Input NAND/NOR	MC710 Dual 2-Input NAND/NOR MC714 Dual 2-Input NAND/NOR MC715 Dual 3-Input NAND/NOR MC718 Dual 3-Input NAND/NOR	MC700 Buffer MC709 Buffer	MC704 Half Adder MC708 Adder MC712 Half Adder	MC702 R-S Flip-Flop MC705 Gated R-S (with inverter) MC706 Gated R-S (without inverter) MC713 Type D Flip-Flop	MC723 J-K Flip-Flop	MC701 Counter Adapter MC721 Expander
MILITARY MILLIWATT RTL (MC908 Series) -55 to +125°C	MC911 4-Input NAND/NOR	MC910 Dual 2-Input NAND/NOR MC918 Dual 3-Input NAND/NOR	MC909 Buffer	MC908 Adder MC912 Half Adder	MC913 Type D Flip-Flop		MC921 Expander



MOTOROLA Semiconductor Products Inc.

BOX 955 • PHOENIX, ARIZONA 85001 • A SUBSIDIARY OF MOTOROLA INC.

ELECTRONIC SNAPSHOTS

The Changing
STATE-OF-THE-ART
in the electronic industries

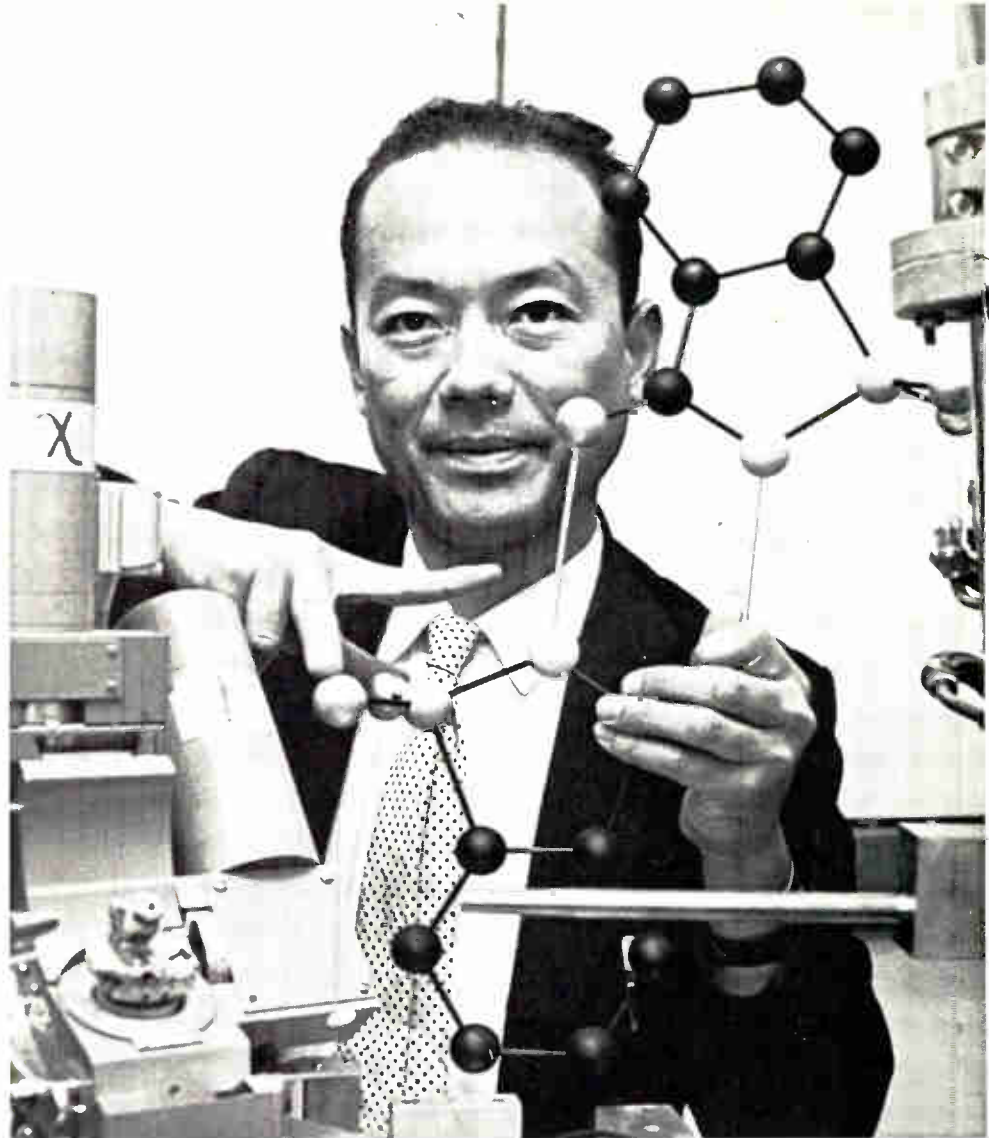

▲ COMPUTER-DERIVED MOLECULE

IBM scientist Dr. Y. Okaya determined exact shape of saccharin molecule 86 years after sweetener's discovery. Controlled by IBM 1620, x-rays reflected off planes of crystal atoms. Measure of reflection intensity provided shape. Experiment took only one month.

▼ FUSION PLASMA SIMULATOR

Thermally-operated plasma system (TOPSY) is employed at Sperry Rand Research Center to simulate in small scale, the hot, dense and large plasma—ionized gas—necessary for the generation of a thermo-nuclear fusion reaction; may be non-radioactive power source.

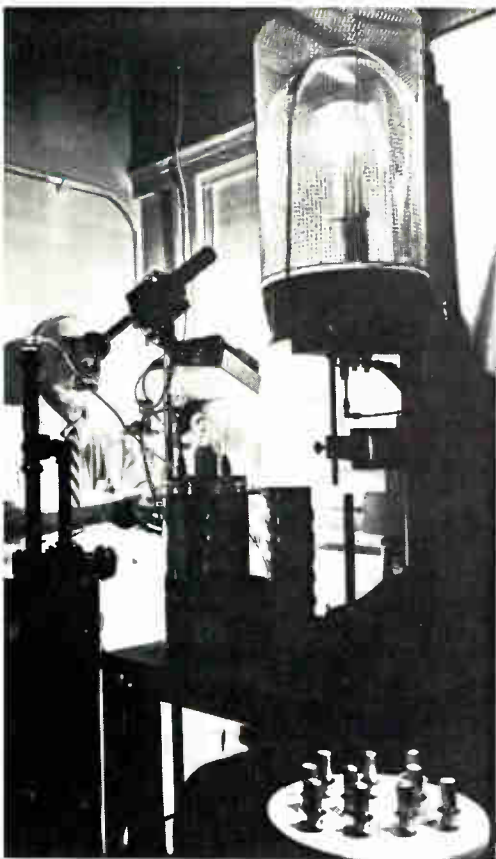
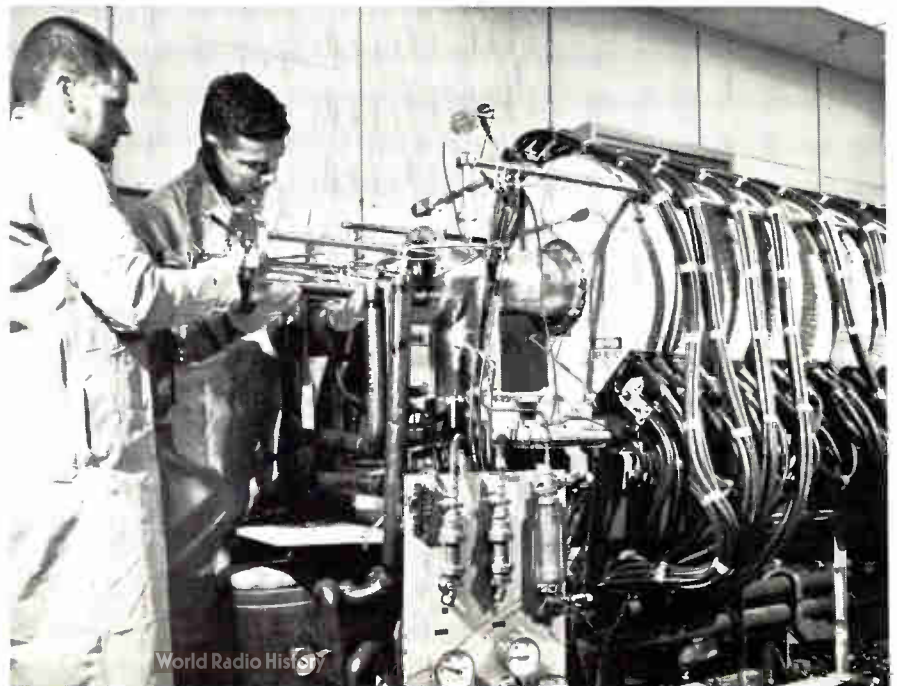

▲ VERY HOT

Engineer Ralph Bondley, General Electric, observes brightness of new high emission cathode. High temperature sintering in hydrogen atmosphere contributes to cathode strength. Emission densities exceed 10a/sq.cm. at 1000°C.



▲ **GETTING THE MESSAGE**

Doctors, salesmen and other businessmen now can feel as close to important messages as the nearest highway telephone. Pagemaster "Car Caddy" (dash), by Bogen Division of Lear Siegler Inc. uses car antenna to receive page signals.



▲ **WORLDLY TOUCH SPANS OCEANS**

International data communication service inaugurated at ITT World Communications headquarters, New York, as operator links data machines in New York and London over voice-coordinated coaxial circuit. The new service permits up to 1,500 teleprinter words per minute.

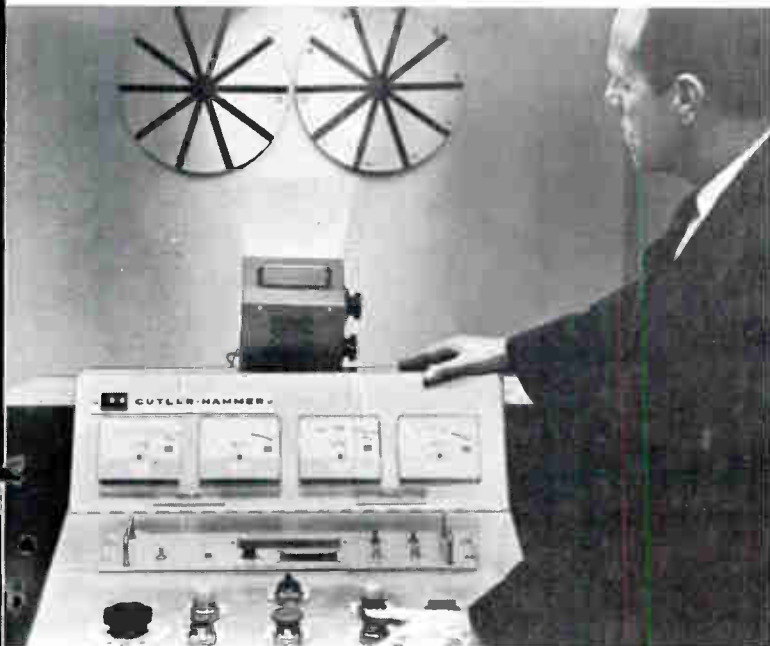

▲ **FREQUENCY BASED SPEED CONTROL**

Stroboscope unit demonstrates "lock in" accuracy of two "shafts"—reference disc (left), speed follow disc (right), rotating at constant 1-10 speed. Alignment of discs, simulating machine shafts, indicates precision of Cutler-Hammer frequency-based speed control.

▼ **AUTOMATED MORSE CODE TRAINING**

Computer-controlled, audio-visual method of teaching Morse Code developed by Sylvania Electric Products Inc. Computer provides audible Morse signals and turns on corresponding light on keyboard. Trainee depresses right key; method is believed fast and reliable.

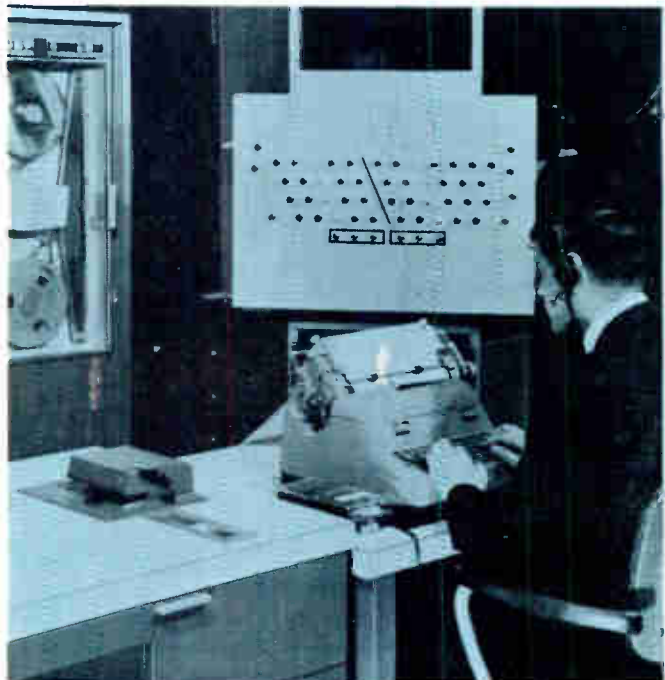

DURANT

instrument counter accuracy with a
 $\pm .00000$ tolerance!



ENCLOSED

Both units shown actual size

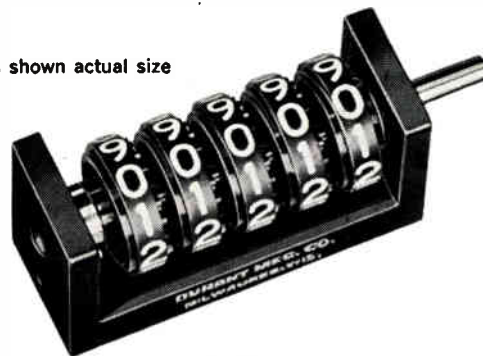

OPEN

Durant "Y" series counters are 100% accurate. No skipped numbers or lost counts. Speeds up to 1500 RPM continuous, 2000 RPM intermittent. Precision manufacture is one of the reasons. Here are others: built-in lifetime lubrication, one-piece die cast frame, stainless steel shafting and Nylatron pinions to mention just a few.

But that's only half of the Durant story. "Y" series instrument counters offer greater visibility than competitive models because of larger figures and open window design. They are also easier to "design in." 263 "standard" models offer the designer every conceivable variation of rotation, mounting, shafting arrangement and counting wheels. Ver-

satility without the expense and time delay inherent with "special" counters. "Y-7" models are resettable.

Durant "Y" series has been proven dependable when used in recorders, metering devices, tool position indicators, servo systems, digital voltmeters, navigation and other scientific instruments. They are as service free as a counter can possibly be.

"Y" series instrument counters are available in either open or the new enclosed models. Right or left hand drive. Clockwise or anti-clockwise rotation. Ability to add *and* subtract. Variety of special unit wheel graduations and drive ratios. Quiet operation. Low torque requirements.

Other "Standard" DURANT Instrument Counters

VERSATILE "D" SERIES

3, 4, 5 or 6-figure instrument counter without case . . .
1800 RPM intermittent duty, high speed models 2500
RPM intermittent duty . . . lubricated for life . . . fungus
proof . . . 44 models . . . $\frac{1}{4}$ " figures . . . special unit
wheels available.

SUB-MINIATURE "S" SERIES

3, 4 or 5-figure sub-miniature instrument counter without
case for use where space and weight requirements are
limited . . . 2500 RPM intermittent duty . . . lubricated
for life . . . 12 models . . . $\frac{1}{8}$ " figures.

Write for Catalog 400; Durant Manufacturing Company,
685 North Cass Street, Milwaukee, Wisconsin 53201



DURANT[®]
M A N U F A C T U R I N G C O M P A N Y
MILWAUKEE, WISCONSIN

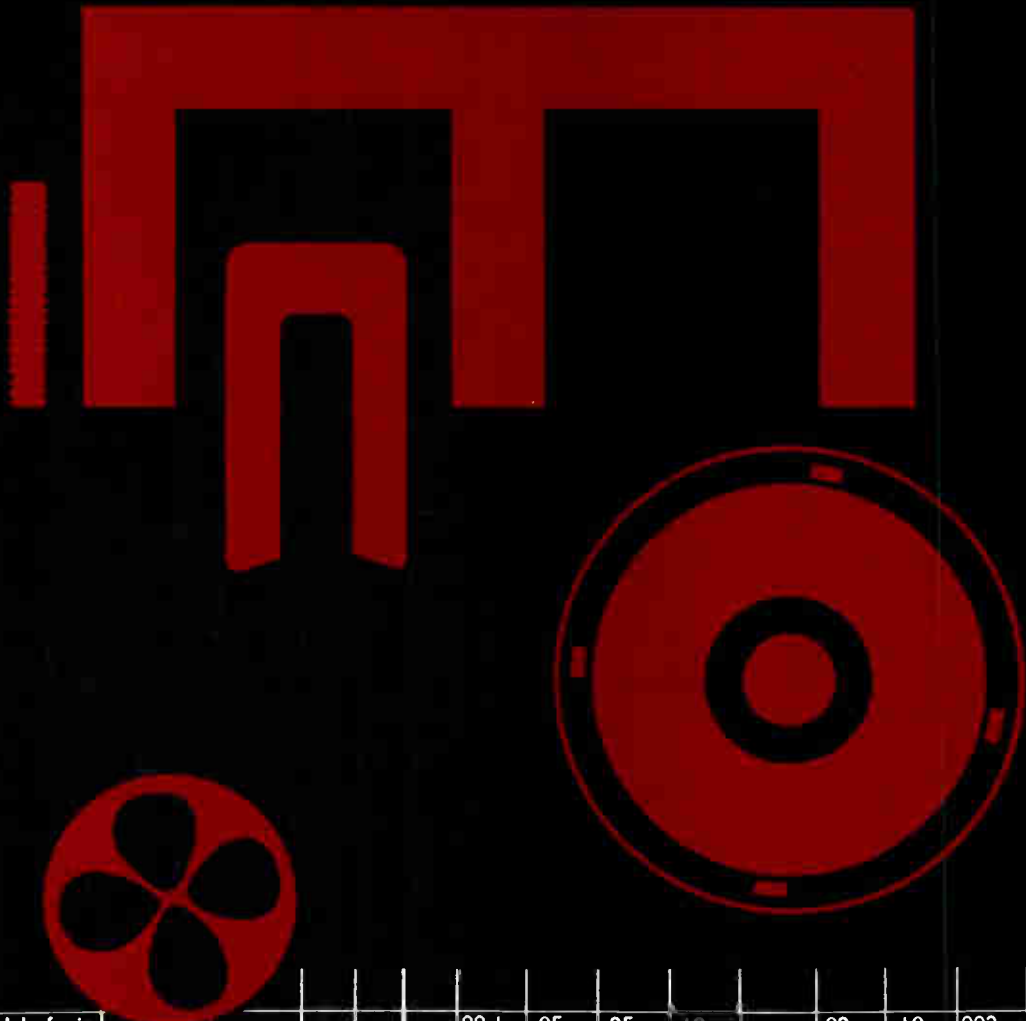

Red 110-2

alpha ferric oxide	cubical	0.3-1.2	5.4	.33	.67	99.1	.05	.25	.10	.15	.03	.02	.10	.002	.002	.08	.15
						99.4	.10	.35				.04	.15	.005	.004		

THIS COLOR REPRESENTS A MASS TONE OF MAPICO RED 110-2.

Columbian Carbon focuses on the reduction of fluctuating characteristics in magnetic tape and ferrite components

It's a safe bet that product uniformity is a critical problem in your plant. Starting with extremely uniform raw materials goes a long way toward making your quality control problems considerably less difficult.

State of the art in ferrites advances at an extremely rapid rate. So do the requirements for iron oxides with pre-selected and controllable characteristics.

Columbian Carbon's Mapico® pure synthetic iron oxides are produced by a variety of carefully controlled methods,

each designed to give a different shape, size and set of electronic characteristics. Uniformity from shipment to shipment is strictly held within pre-set narrow limits. Sixteen basic iron oxides are available in quantity.

Write for detailed specs. Or tell us about your particular application and special requirements. Columbian Carbon Company, Mapico Iron Oxides Unit, 380 Madison Avenue, New York, New York 10017. Branch offices and agents in principal cities.



CENSUS SHOWS SMALL UNITS FASTEST IN COMPUTER SALES

Small computers (monthly rental fee under \$12,000) which were 75% of the total computer market in 1956, now account for 89% of total installations in the U. S., according to The Diebold Group Inc., international management consulting organization.

Reductions in price over the last decade, plus increased capacity and improvements in software, have made smaller data processing systems extremely attractive to more and more users. The review of the computer industry, published semi-annually, indicated that small computers are being used increasingly to support large scale systems.

In an analysis of findings, Diebold states that medium computers (monthly rental fee between \$12-25,000) have gone from 9% of total market to 7%, while large computers (monthly rental fee between \$25,000 to over \$75,000), which accounted for 16% of installations in 1956, represent only 4% today.

Small computers installed, however, have increased almost forty-fold since 1956. The total number of all computers has increased slightly more than thirty times over the same period. In the ten-year period general purpose digital computers installed in the U. S. have grown from 810 to 25,413.

IMPROVED CONTACT WITH FINANCIAL WORLD CITED

Electronic firms are ignoring an important aspect of communications vital to future growth—communications with the financial community, according to Irving L. Straus, vice president of the Energy Fund.

He said that with recent trends toward more thorough securities analysis, demands for detailed data on all parameters of company affairs are just as stringent as those of the most exacting defense or industrial customer.

SOME MARKETS MAY GROW WITH FOOD IRRADIATION

Markets for some electronic equipment and instruments may develop with increasing activity in the Food Irradiation Program sponsored mainly by the Atomic Energy Commission.

Developments were explored at recent hearings by the Joint Committee on Atomic Energy of Congress. Department of the Army witnesses presented information on current progress in research efforts and future plans.

28-OUNCE DICTATING UNIT



Model 224 "Executory" dictation machines being shipped at IBM, Lexington, Ky. The 28-oz., all-purpose unit can be used for dictation and for transcription, is powered by mercury batteries for about three months dictation. An adapter permits the machine to work on regular ac power.

EIA PRESIDENT FORECASTS MORE ELECTRONIC SALES

Electronics manufacturers face prospects of an 800-million-dollar expansion in business this year, reports Dr. Harper Q. North, president of the Electronic Industries Association.

Dr. North, who is vice president R & D, TRW Inc., Redondo Beach, Calif., foresees gains in the consumer and industrial electronics sectors moving total sales at the factory level to \$16.9 billion, up 4.7% from the \$16.1 billion record peak reached in 1964.

The EIA president, in his annual report to association members said statisticians of EIA Marketing Services expect sales of electronic consumer products to increase 13% and sales of industrial electronic equipment to move up by 11%. Consumer products volume last year totaled \$2.95 billion, while industrial electronics sales reached \$3.35 billion.

Sales of electronics to the government are expected to show a decline of 0.4% under the \$9.1 billion recorded for 1964, Dr. North said, adding that while those products "remain an important share of our dollar volume," they declined from 60% of total industry volume to 53% last year.

As government requirements leveled, "civilian demands for color television and an increasing number of new electronic consumer products have grown along with the market for electronic industrial and business

R&D SPENDING GETS LARGER, GOV'T PROVIDES MOST FUNDS

The nation's bill for research and development continues to mount, with industry still spending most of the money and the federal government supplying most of the funds, according to a new report from the National Science Foundation.

Total R & D spending in calendar year 1963 climbed to \$17.4 billion, up \$1.7 billion from the previous year and almost \$7 billion over 1958. Of the total, research accounted for almost \$6 billion.

Industry spent more than half (\$3.2 billion) of the research funds and most (\$9.5 billion) of the development funds. Of the research spending, less than \$2 billion went for basic research, and colleges and universities did about \$1 billion of it, or more than half.

The federal government put up about 65% of the \$17.4 billion for R & D during the year, and industry paid for about 32%.

EIA, NEMA CONSIDERING COORDINATING SERVICES

The Electronic Industries Association and the National Electrical Manufacturers Association jointly announced beginning of a study of respective membership services to determine how they may be improved and reduced in cost through coordination in areas of mutual interest.

The Boards of Directors of the two associations adopted identical resolutions authorizing their respective presidents to appoint representatives to serve on this joint committee as promptly as possible.

equipment," Dr. North said.

With repeal of the excise tax on consumer products, fall and winter sales of color TV receivers "apparently will be limited only by the number of color tubes available." But despite that possibility, more than 2 million sets are expected to be shipped by manufacturers, compared with 1.4 million in 1964, said Dr. North.

In international trade, he said, the electronics picture is "mixed, but government figures do indicate that electronic imports are increasing faster than exports." He set the volume of first-quarter electronic imports at 39% above the comparable period in 1964, with imports of electronic components 70% higher. While exact comparison with exports is not available, he said, it is known that shipments of consumer electronic products were up 16% and components up 22%.

everything
HALL EFFECT
 from
F. W. BELL



HALL EFFECT MULTIPLIERS

These solid state components utilize Bell "Hall-Pak" Hall elements in laminated steel or ferrite magnetic structures. They provide output voltages instantaneously proportional to the product of two independent d-c or a-c input currents.

Ten standard series, with up to 20 models in a series, are offered. A few of the many applications are: FUNCTION GENERATION, POWER MEASUREMENT, MODULATION, PHASE MEASUREMENT, CONVERSION, LEVEL CONTROL.

Model BH-701
 "Hall-Pak"



HALL EFFECT DEVICES

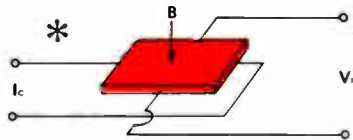

The Model BH-701 "Hall-Pak" represents a state-of-the-art breakthrough and offers a linearity of $\pm 0.25\%$ from -10 to $+10$ kG and $\pm 1\%$ from -30 to $+30$ kG. General purpose and highly specialized "Hall-Paks" are now available because of F. W. Bell's advanced research and development programs. Bell devices of high reliability and accuracy are used today for magnetic field measurement, magnet inspection, and in magnetic circuits, transducers and multipliers. If you have a special application problem, look to Bell for assistance in solving it.



BELL GAUSSMETERS

With the Model 660 comes the ultimate in precision Hall Effect Gaussmeters.

Now an invaluable laboratory instrument! Seven F. W. Bell Gaussmeters now solve knotty testing and production problems in diversified industries! Many are cases where customers once said they "didn't need" Magnetic Field Measurement or Hall effect circuitry. Write for full specs on all seven models! Let us show you, too, how profitable these instruments can be.

*

The Hall phenomenon may be expressed by the equation:

$$V_H = K_{HOC} (I_C \times B)$$

V_H is the Hall voltage,

K_{HOC} is the open circuit sensitivity constant,

I_C is the control current,

B is the component of the magnetic flux density perpendicular to the device.

Send for 24-page booklet,
 "The Hall Effect and its Applications."

Fw



BELL INC.

1356 Norton Avenue
 Columbus, Ohio 43212
 Phone (614) 294-4906
 TWX 614-759-0193

When You Think of Practical Hall Effect Application — Think of Bell

Mac Panel Plugboard Programming Systems

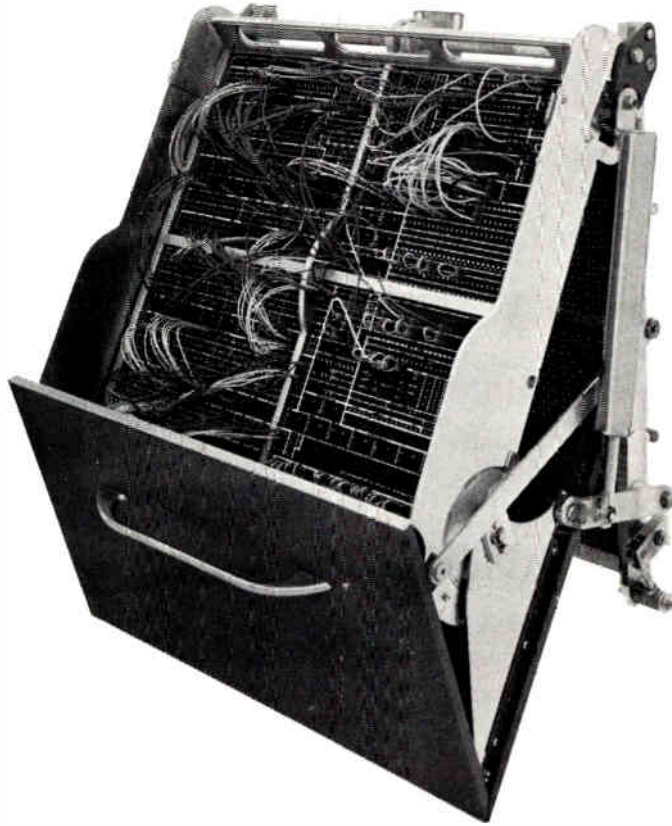

Mac Panel total engineering assures you of precisely made systems that meet the most critical requirements.



System design and engineering



Precise handwork

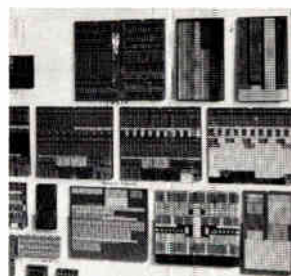

General or special legend silk-screening

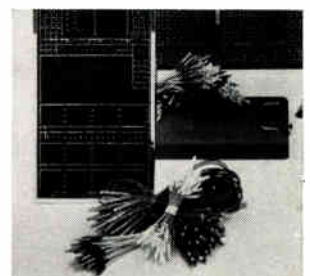

All types of plugwires

Total engineering at MAC Panel means that from initial design through delivery, each Plugboard Programming System receives personal attention by skilled engineers. This attention to detail guarantees that the system specifications meet all of your requirements for circuits, space limitations, environmental conditions, signal levels, frequency range, and reliability. From the precise handwork necessary for contact spring placement to the silk-screening of general

purpose or multi-color special legends, you are assured of receiving only top quality, precision products. □ MAC Panel offers eleven standard sizes of Plugboard Programming Systems and a wide variety of standard Plugwires. We can also provide custom designed systems and wires for special applications. Find out how MAC Panel can give you a reliable, low-cost method of flexible program control in your equipment. See your MAC Panel representative or write today.

O.E.M. Division

MAC PANEL COMPANY **MAC** High Point, North Carolina

Representatives Throughout the World

Bourns Introduces INFINITRON™ Element 10-Turn Precision Potentiometers*

Here at last are multi-turn precision potentiometers that offer long life and essentially infinite resolution without asking you to compromise on your specifications. Noise in Bourns INFINITRON-element units is so low you can test them as if they were wirewounds. You don't have to hook up special filter circuits or contrive "output smoothness" tests. No need, either, to limit these potentiometers to voltage-divider applications or to guess where the resistance element starts and ends. Precise end-points make our linearity specification a reality in your circuits.

Convince yourself of the higher performance that Bourns INFINITRON-element 10-turn potentiometers can bring to your designs. Write today for product information and actual test data.

STANDARD SPECIFICATIONS

3/8" Diameter, 10-Turn, Bushing-Mount Model 3501	
3/8" Diameter, 10-Turn, Servo-Mount Model 3551	
Noise Performance:	100 ohms or 1% of total resistance, whichever is greater
Humidity Performance:	MIL-STD-202, Method 103
Independent Linearity:	±0.5%
Temperature Coefficient, All Resistances:	±300 PPM/°C
Total Resistance Tolerance:	±5%
Rotational Life:	Model 3501: 4,000,000 shaft revolutions Model 3551: 10,000,000 shaft revolutions
End Resistance:	1 ohm or .1% max., whichever is greater
Electrical Rotation:	3600° (+10°/-2°)
Power Rating:	2 watts at 70°C
Operating Temperature Range:	-65°C to +125°C
Environmental Stability:	Resistance shift < 5%
Approximate Weight:	1 oz.
Resistance Range:	1K to 500K
Price, 1-9 pieces:	Model 3501 (Bushing Mount): \$14.00 Model 3551 (Servo Mount): \$30.00

Long-life, ball-bearing shaft supports, standard in the servo-mount model, are also available in the bushing-mount unit.



BOURNS, INC., TRIMPOT DIVISION
1200 COLUMBIA AVE., RIVERSIDE, CALIF.
PHONE 684-1700 · TWX: 714-682 9582
CABLE: BOURNSINC.

*Patent pending

Why does Arco ship connectors sooner than we have to?

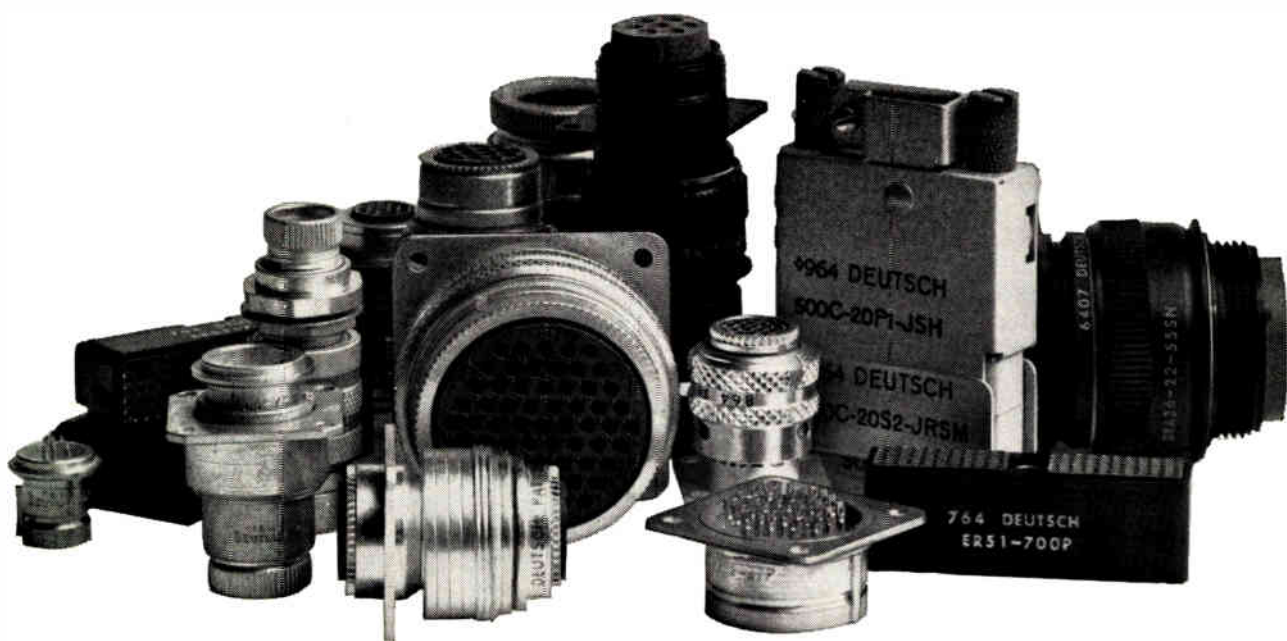

When you're a distributor who's also a manufacturer, that's the way you do things.

Buy connectors from most people and they ship in a few days. Buy them from Arco and we ship within 24 hours — days sooner than we have to, to keep up with the competition.

Because Arco's a distributor, we know how fast you need the connectors you order. So we've set ourselves up to ship them out as fast as if we'd done the ordering.

Because Arco's a manufacturer, we've set ourselves up to ship them out as well built as if Deutsch had done the assembling. We have the components, the blueprints, the

tools and the people to assemble Deutsch connectors with the same care and precision that Deutsch does. We have the test equipment to make sure they're assembled with the same accuracy and reliability. When you order Deutsch connectors from Arco, you get the most reliable connectors you can buy. And you get shipment within 24 hours.

That's why it pays to do business with a distributor who's also a manufacturer. If we don't have what you want already built, we can build it for you in a hurry.



Arco Electronics Community Drive, Great Neck, N. Y. / Dallas, Tex. / Pasadena, Calif. / Write for our free Deutsch catalog.
A DIVISION OF LORAL CORPORATION

LETTERS

to the Editor

More on Graphic Arts

Editor, ELECTRONIC INDUSTRIES:

Your editorial "Electronic Sciences Spur Graphic Arts" is very timely indeed. Of course there are many more areas, where Electronics can help the graphic arts. It is strange however that the potentialities are not recognized by the American Electronic Industry. Some of the most advanced equipment comes from Europe and the Klischograph and Colortron are still not matched by US made equipment.

Progress is, however, being made in numerical control printing and plate-making equipment. Step and Repeat machines are available with tape and more recently with card control, as manufactured by Consolidated International in Chicago. As a consulting engineer serving the graphic arts industries I appreciate your comments and hope that they will be read by the persons in charge in the design department and in purchasing.

Karl Steiner, P.E.
Consulting Engineer

P. O. Box 2134
Hammond, Indiana

You Missed Us . . .

Editor, ELECTRONIC INDUSTRIES:

From time to time you must receive irate letters from subscribers who have been ignored on a special issue devoted to their product line and I am sorry to relate that Torr Laboratories Inc. did not adorn your pages in the article entitled "Specifications of High Voltage Relays" in the May 1965 edition. For your edification Torr Laboratories is the largest independent producer of high voltage relays in America today with excellent research, development and production facilities devoted exclusively to the high voltage switching field.

I realize that this was possibly an error of omission and would like to be considered (at least for honorable mention) in the subsequent issues of your fine magazine on this subject.

Victor E. DeLucia
Director

Torr Laboratories, Inc.
2228 Cotner Avenue
Los Angeles 64, Cal.

We Make Photocomposing Equipment

Editor, ELECTRONIC INDUSTRIES:

During the past week I had received my copy of ELECTRONIC INDUSTRIES magazine. This "State-of-the-Art" magazine has always been of interest to me personally, and you are to be commended on the good work you have been doing.

It came as a somewhat pleasant surprise to see the Graphic Arts industry prominently mentioned in your June editorial. I have stated "somewhat pleasant" because Photon, Inc. had not been mentioned in your fine effort.

Photon, Inc., while a small company in relative size, is a large manufacturer of photocomposing equipment. We are a company that devotes its entire effort to manufacture of photocomposing equipment and accessories; and in this area we feel that we have proven a leader when compared to the "giants" you have mentioned.

Photon has for the past decade delivered to the graphic arts industry electronic equipment (switching circuits and electronics controlling optical mechanical systems) for the placement of images on film at high speed.

Perhaps in some future issue or editorial you might be able to give some credit to Photon and its equipment. Better still, if you are planning to be in the New England area some time in the near future, we would be pleased to show you what we are doing and the equipment in process of manufacture.

H. A. Johnson
Vice President

Photon, Inc.
355 Middlesex Avenue
Wilmington, Mass.

A Bouquet . . .

Editor, ELECTRONIC INDUSTRIES:

Congratulations on your June 1965 issue.

Your use of full color printing in both the technical articles and Electronic Snapshots section was particularly effective.

Wallace A. Weissman
Manager of Marketing Services
PRD Electronics, Inc.
1200 Prospect Ave.
Westbury, L. I., N. Y. 11590

Who needs a slot-range system power supply?

You might—if you need up to 40 amps of precision power in a 5¼" package. It's the most economical power package available today and it's new from the Power-House of Trygon. Consider the advantages.

For \$450-475, the new silicon LR Series offers you three standard models, designed for 5¼" x 19" rack installation in critical systems applications—with the precision regulation and low noise demanded by today's semiconductor circuits.

The LR Series offers models at: 5-7V at 40A (LR6-40), 11-13V at 30A (LR12-30) and 24-32V at 20A (LR28-20). All provide: Automatic overload protection and warning light. .01% line and load regulation. Remote voltage programming. Remote sensing. 1mv rms ripple. .05% stability (with .01% optional). Maximum ambient temperature 60° C.

Who needs it? If you want a low-cost, precision regulated systems supply unmatched in performance and features,

you do!

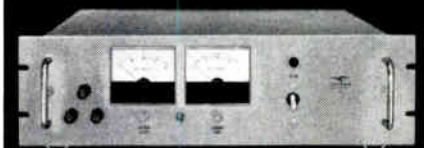

For all the exciting features, write

TRYGON
POWER SUPPLIES
Roosevelt, New York

TEL (516) 378-2800 • TWX (516) 868-7508

Circle 19 on Inquiry Card

Automatic Trace Seeker

A NOVEL OSCILLOSCOPE PLUG-IN, which automatically determines trace amplitude, has been developed by Tektronix, Inc., P.O. Box 500, Beaverton, Ore., for use with its oscilloscopes. The Type 3A5 automatically adjusts vertical amplifier sensitivity to within predetermined limits. Activation of the "seeking" feature is accomplished by a front-panel pushbutton or by a pushbutton on a 10X probe, type P6030, specially designed for the purpose.

The "seeking" feature of the Type 3A5 is useful where it's important that the operator not have to remain within arm's length of the oscilloscope, or for production line checkouts where quick qualitative checks call for continuous readjustment of the sensitivity (v/div.) control.

Upon receipt of a signal, the vertical sensitivity sets itself so neither display peak is more than ± 3 divisions from the graticule center, thus establishing the display size typically between 2 and 6 divisions. The vertical sensitivity factor is read out digitally on a bulb-and-film readout. With the P6030 10X Probe, the scaling factor is automatically changed to read the correct deflection factor. The maximum display size can be changed from ± 1.5 div. to ± 4 div. if desired. Seeking time is about 100msec.

A remote control feature allows the Type 3A5 to be externally preset for a given measurement. Volts/Div., X1, X10, AC-DC and Position can all be remotely controlled. Passband of the Type 3A5 is dc to 15Mc, and sensitivity is 10 mv/div. to 50 v/div. in twelve steps. Signal delay makes possible the display of the leading edge of the transient waveform.

Unit automatically adjusts vertical amplifier sensitivity.

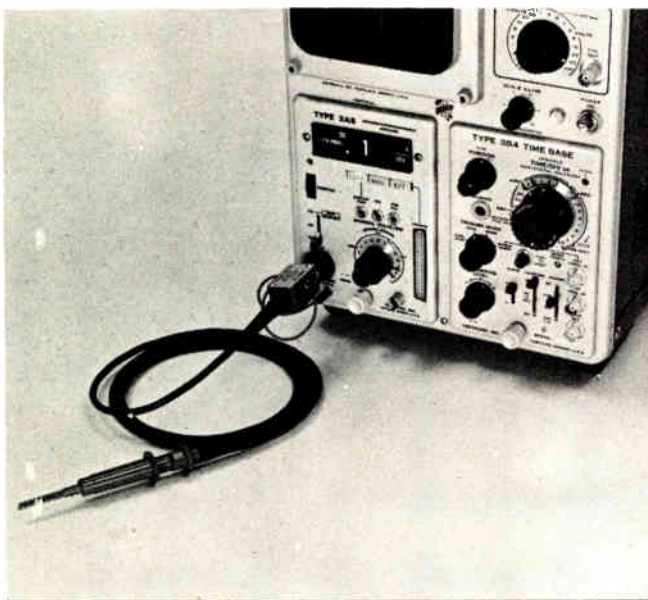

COMPUTER SETS TYPE

A LOW-COST TYPESETTING SYSTEM THAT USES AN INTEGRATED CIRCUIT COMPUTER to produce 12,000 lines/hr. has been developed by Digital Equipment Corp., Maynard, Mass.

The new product, called the PDP-8 typesetting system, accepts unjustified and unhyphenated (idiot) tape punched by perforator operations; justifies according to column width, type size and font; hyphenates according to rules and an exception dictionary stored in the computer memory; and generates a clean operating tape for tape-driven linecasting machines.

The basic system consists of the PDP-8 computer with 4096-word core memory, complete hyphenation and justification program, reading unit for the 6- or 8-level idiot tape, and punching unit for the output operating tape. This system accepts tapes from 12 non-counting perforator operators and generates enough output tape to keep 12 linecasters busy.

Because the computer functions so rapidly, it can make the justification decisions now being made by human operators much sooner and in a more uniform way. The result is a galley of type that is shorter than one set by the counting perforator. A page carries more copy and each story looks exactly like all the others, no rivers of white and no lines set tighter than others.

Hyphenation accuracy runs better than 90% in the basic system, and it can be increased through the addition of more memory. More memory would also provide more than the 16 combinations of font, size, and column width available in the basic system.

Here is Your 1965 WIRE & CABLE Reference Chart



Tear it out, NOW
... and mount it
on your wall.

If the Chart has been removed,
Circle Number 25 on the
Inquiry Card for a copy.

1902 . . . Over a period of 63 years, Belden engineers, cooperating with American industry, have developed hundreds, yes thousands of refinements and innovations in electrical and electronic wire and cable . . . refinements and innovations that have helped Belden earn its present position of leadership.

And Belden has published countless technical papers, manuals, magazine articles, engineering booklets and related materials to help design engineers in the correct application of wire and cable. The Wire and Cable Reference Chart presented on succeeding pages is one example of Belden's continuing effort.

From the finest drawn magnet wire to the most complex multi-conductor cables, Belden's many exclusive values including exact, continuous length spools . . . pricing by the unit . . . easy-to-read trade numbers . . . and distributor rack merchandise pre-priced on package . . . help to make it the number one preferred line. Shown on the page to the right is just part of Belden's complete line of electronic and electrical wire and cable—available from the world's largest wire inventory!

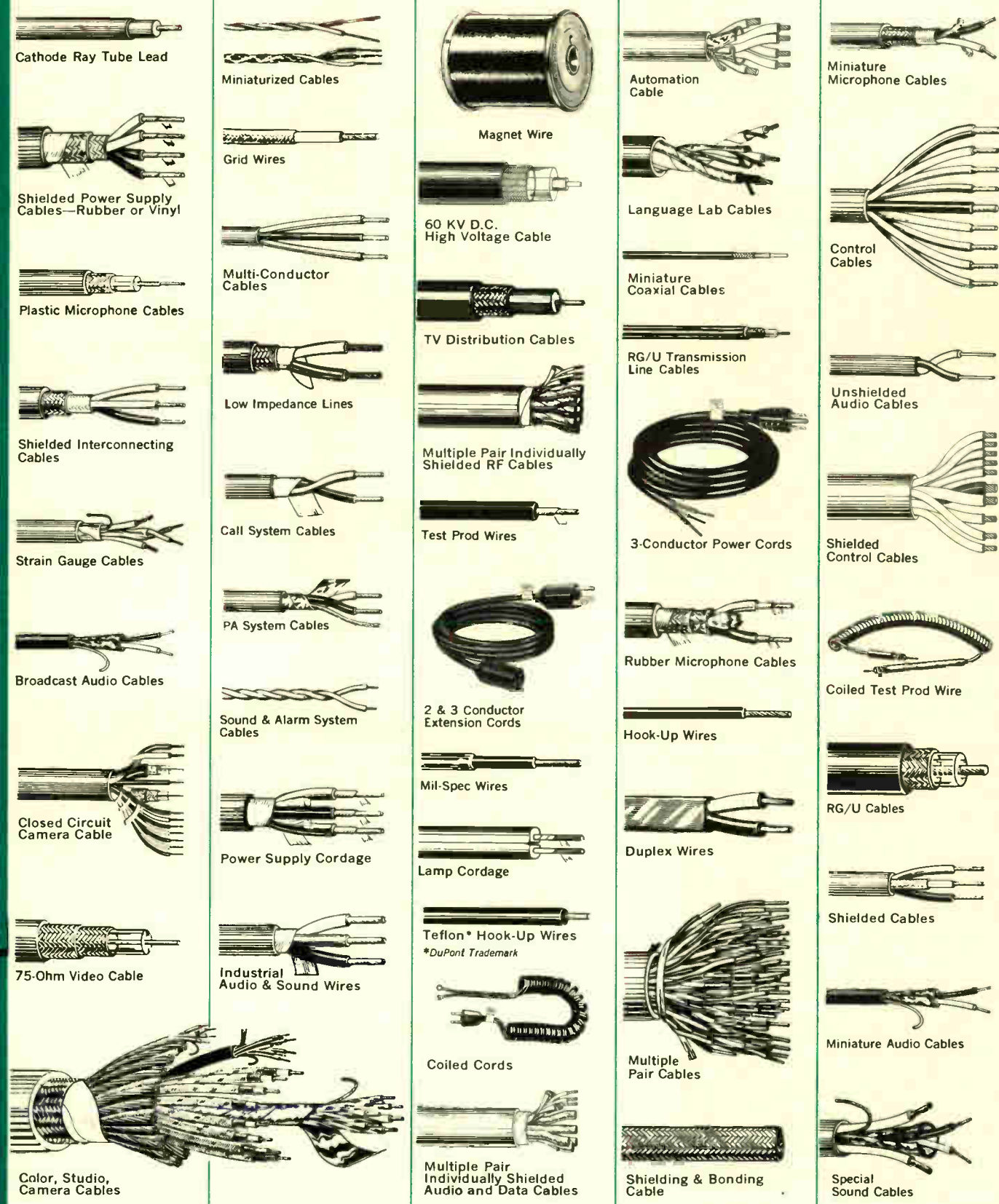

Compiled by the Editors of ELECTRONIC INDUSTRIES with the cooperation of the Engineering Staff of Belden Manufac

SELECTED FLEXIBLE COAXIAL CABLE GUIDE

MAJOR GROUP	IMP. OHMS	RG NO.	PF. FT.	O.D. IN.	MIL JKT TYPE	CENTER COND.	MAX. OPER. VOLTS (RMS)	LBS./100'	APPLICABLE SPECIFICATION
50	50	5A/U	28.5	0.328	II	16S	3000	8.7	JAN-C-17A
	50	5B/U	28.5	0.328	IIa	16S	3000	8.7	MIL-C-17D
	52	8/U	29.5	0.405	I	7/21C	5000	10.6	JAN-C-17A
	52	8A/U	29.5	0.405	IIa	7/21C	5000	10.6	MIL-C-17D
	51	9/U	30	0.420	II	7/21S	5000	15.	JAN-C-17A
	51	9A/U	30	0.420	II	7/21S	5000	15.	JAN-C-17A
	50	9B/U	30	0.420	IIa	7/21S	5000	15.	MIL-C-17D
	52	14A/U	29.5	0.545	IIa	10C	7000	21.6	MIL-C-17D
	52	17/U	29.5	0.870	II	.188C	11000	47.	JAN-C-17A
	52	17A/U	29.5	0.870	IIa	.188C	11000	47.	MIL-C-17D
	52	19A/U	29.5	1.120	IIa	.250C	14000	74.	MIL-C-17D
	53	21A/U	29	0.332	IIa	16N	2700	8.7	MIL-C-17D
	58	54A/U	26.5	0.250 (max.)	III	7/.0152C	3000	4.1	JAN-C-17A
	53.5	55/U	28.5	0.206 (max.)	III	20C	1900	3.6	JAN-C-17A
	53.5	55B/U	28.5	0.206	IIIa	20S	1900	3.6	MIL-C-17D
	53.5	58/U	28.5	0.195	I	20C	1900	2.9	JAN-C-17A
	50	58A/U	28.5	0.195	I	19/.0071TC	1900	2.9	JAN-C-17A
	50	58C/U	28.5	0.195	IIa	19/.0071TC	1900	2.9	MIL-C-17D
	50	122/U	29.3	0.160	IIa	27/36TC	1900	2.	MIL-C-17D
	50	174/U	30.4	0.100	I	7/34CW	1500	0.8	BuShips
	50	178B/U	29.0	0.075 (max.)	IX	7/38SCW	1000	0.6	MIL-C-17D
	50	188A/U	29.0	0.110 (max.)	VII	7/.0067SCW	1200	1.3	MIL-C-17D
	50	196A/U	29.0	0.080 (max.)	VII	7/38SCW	1000	0.7	MIL-C-17D
	50	213/U	29.5	0.405	IIa	7/.0296C	5000	10.6	MIL-C-17D
	50	214/U	30	0.425	IIa	7/.0296S	5000	15.	MIL-C-17D
	50	217/U	29.5	0.545	IIa	.106C	7000	21.6	MIL-C-17D
	50	218/U	29.5	0.870	IIa	.195C	11000	49.1	MIL-C-17D
	50	223/U	29.5	0.216	IIa	.035S	1900	3.6	MIL-C-17D
75	75	6A/U	20	0.332	IIa	21CW	2700	8.2	MIL-C-17D
	75	11/U	20.5	0.405	I	7/26TC	5000	9.6	JAN-C-17A
	75	11A/U	20.5	0.405	IIa	7/26TC	5000	9.6	MIL-C-17D
	74	13/U	20.5	0.420	I	7/26TC	5000	12.6	JAN-C-17A
	75	34B/U	21.5	0.630	IIa	7/.0249C	6500	22.4	MIL-C-17D
	73	59/U	21	0.242	I	22CW	2300	3.2	JAN-C-17A
	75	59B/U	21	0.242	IIa	.023CW	2300	3.2	MIL-C-17D
	78	108A/U	24.5 (max.)	0.235	IIa	2-7/28TC (Twin)	1000	2.9	MIL-C-17D
75	140/U	21	0.233	V	.025SCW	2300	4.5	MIL-C-17D	
93	95	22/U	16	0.405	I	2-7/.0152C (Twin)	1000	15.1	JAN-C-17A
	95	22B/U	16	0.420	IIa	2-7/.0152C (Twin)	1000	15.1	MIL-C-17D
	93	62/U	13.5	0.242	I	22CW	750	3.8	JAN-C-17A
	93	62B/U	13.5	0.242	IIa	7/32CW	750	3.8	MIL-C-17D
	93	71/U	14.5 (max.)	0.250 (max.)	III	22CW	750	4.6	JAN-C-17A
	93	71B/U	14.5 (max.)	0.250 (max.)	IIIa	22CW	750	4.6	MIL-C-17D
95	180B/U	15.5	0.145 (max.)	IX	7/38SCW	1500	2.2	MIL-C-17D	
95	195A/U	15.5	0.155 (max.)	VII	7/38SCW	1500	2.5	MIL-C-17D	
125	125	63/U	10	0.405	I	22CW	1000	8.3	JAN-C-17A
	125	63B/U	10	0.405	IIa	22CW	1000	8.3	MIL-C-17D
185	185	114/U	6.5	0.405	I	33CW	1000	8.7	JAN-C-17A
	185	114A/U	6.8 (max.)	0.405	IIa	.007CW	1000	8.7	MIL-C-17D

RED PANEL INDICATES COAXIAL CABLE FOR HIGH TEMPERATURE OPERATION.

ABBREVIATIONS:

S = Silver coated copper, C = Bare Copper, TC = Tinned Copper
 CW = Copperweld, SCW = Silver coated copperweld, N = Nichrome

JACKETS

JACKET TYPE	DESCRIPTION	TEMP. RANGE	JACKET TYPE	DESCRIPTION	TEMP. RANGE
I	Black Vinyl	-40°C to 80°C	IIIa	Black Polyethylene	-55°C to 80°C
II	Gray Vinyl (non-contaminating)	-55°C to 80°C	V	Fiberglass, silicone-impregnated varnish	-55°C to 250°C
IIa	Black Vinyl (non-contaminating)	-55°C to 80°C	VII	White TFE Teflon	-70°C to 200°C
III	Clear Polyethylene	-55°C to 80°C	IX	Brown FEP Teflon	-70°C to 200°C

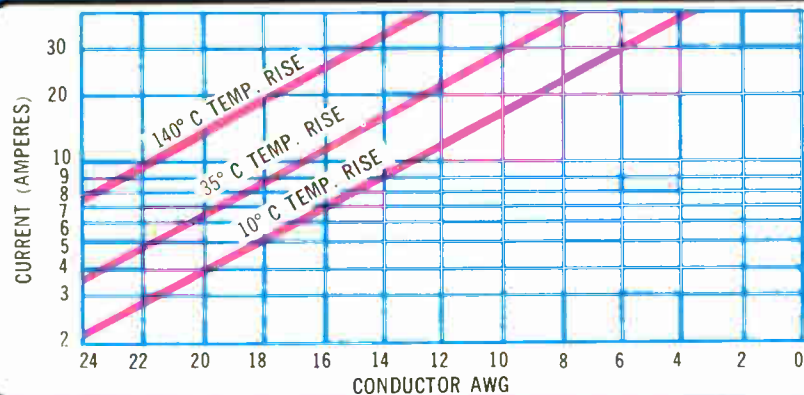

TEMPERATURE RISE OF CONDUCTORS SURROUNDED BY STILL AIR AT 25°C

CORRECTION FACTORS FOR CURRENT CARRYING CAPACITY

NO. OF CONDUCTORS	MULTIPLYING FACTOR
1	1.6
2-3	1.0
4-5	0.8
6-15	0.7
16-30	0.5

COMMON WIRE

MATERIAL	LIMITING		OUTSTANDING		
	INS. RES.	VOLT. BREAK-DOWN (NOMINAL)	RES. TO COLD FLOW	RES. TO ABRASION	CAPACITANCE
RUBBER	Good	Good	Exc.	Exc.	Good
SILICONE RUBBER	Good	Good	Good	Poor	Fair
NEOPRENE	Poor	Fair	Exc.	Exc.	Poor
POLYVINYL CHLORIDE (PVC)—STANDARD	Good	Good	Fair	Good	Fair
POLYVINYL CHLORIDE (PVC)—PREMIUM	Good	Good	Fair	Good	Fair
POLYETHYLENE—SOLID	Exc.	Exc.	Poor	Good	Exc.
POLYETHYLENE—FOAM	Exc.	Poor	Poor	Poor	Exc.
TEFLON (TFE & FEP)	Exc.	Good	Fair	Exc.	Exc.
NYLON	Poor	Poor	Good	Exc.	Poor
POLYPROPYLENE	Exc.	Exc.	Fair	Exc.	Exc.

*When properly pigmented to resist ultraviolet light **FEP Teflon 200°C Max.

BARE COPPER

AWG	DIA. MILS	CROSS-SECT. AREA CIR. MILS	LBS. PER 1000 FT.	BREAKING STRENGTH (LBS.)		RESISTANCE OHMS PER 1000 FT. 20°C	
				SOFT (ANL)	MED. HARD	SOFT (ANL)	MED. HARD
10	101.9	10,380	31.43	314.0	467.5	0.999	1.033
11	90.7	8,230	24.92	249.0	372.9	1.260	1.303
12	80.8	6,530	19.77	197.5	297.5	1.588	1.643
13	72.0	5,180	15.68	156.6	237.2	2.003	2.072
14	64.1	4,110	12.43	124.2	189.2	2.525	2.613
15	57.1	3,260	9.86	98.5	150.9	3.184	3.295
16	50.8	2,580	7.82	78.1	120.3	4.016	4.154
17	45.3	2,050	6.20	61.9	96.0	5.064	5.239
18	40.3	1,620	4.92	49.2	76.5	6.385	6.606
19	35.9	1,290	3.90	39.0	61.0	8.051	8.330
20	32.0	1,020	3.09	30.9	48.7	10.15	10.50
21	28.5	812	2.452	24.5	38.8	12.80	13.24
22	25.3	640	1.945	19.4	30.9	16.14	16.70
23	22.6	511	1.542	15.4	24.7	20.36	21.06
24	20.1	404	1.223	12.7	19.7	25.67	26.56
25	17.9	320	0.970	10.1	15.7	32.37	33.49
26	15.9	253	0.770	7.98	12.5	40.81	42.22
27	14.2	202	0.610	6.33	9.97	51.47	53.24
28	12.6	159	0.484	5.02	7.95	64.9	67.1
29	11.3	128	0.384	3.98	6.34	81.8	84.7
30	10.0	100.0	0.304	3.16	5.05	103.2	106.8
31	8.9	79.2	0.241	2.50	4.03	130.1	134.6
32	8.0	64.0	0.191	1.99	3.21	164.1	169.8
33	7.1	50.4	0.152	1.58	2.56	206.9	214.1

63 years of assistance to design and development engineers

REFERENCE CHART

ELECTRONIC INDUSTRIES

Manufacturing Co. • Copyright 1965 • CHILTON COMPANY • Chestnut and 56th Sts. • Philadelphia, Pa. 19139 • Price \$1.00

INSULATIONS				SOLVENTS—HYDROCARBONS		
FLAME RETARD. PROPERTIES	PLIABILITY	WEATHER-ABILITY	TEMP. RANGE °C (NOMINAL)	ALIPHATIC (ALCOHOL-GLYCOL)	AROMATIC (GASOLINE-BENZINE)	CHLORINATED (TRICHLORO-ETHYLENE)
Poor	Exc.	Poor	-40° to 70°	Poor	Poor	Poor
Poor	Exc.	Exc.	-60° to 200°	Good	Fair	Good
Good	Exc.	Exc.	-30° to 90°	Good	Poor	Poor
Exc.	Good	Exc.	-20° to 80°	Poor	Poor	Fair
Exc.	Good	Exc.	-55° to 105°	Poor	Poor	Fair
Poor	Fair	Exc.*	-60° to 80°	Poor	Poor	Poor
Poor	Good	Exc.*	-60° to 80°	Poor	Poor	Poor
Exc.	Fair	Exc.	** -70° to 250°	Exc.	Exc.	Exc.
Poor	Poor	Exc.	-40° to 120°	Exc.	Good	Exc.
Poor	Poor	Exc.*	-20° to 105°	Good	Poor	Poor

CONDUCTOR CONFIGURATIONS

For a given AWG wire size (based on equal cross-sectional area of conductor), limpness and flex life are increased by use of a large number of fine strands. It follows, costs are also increased with fine stranding.

TYPICAL APPLICATION:	AMERICAN WIRE GAGE							
	12	14	16	18	20	22	24	26
FIXED SERVICE	19 x 25	Solid or 19 x 27	Solid or 19 x 29	Solid or 7 x 26 or 16 x 30	Solid or 7 x 28 or 10 x 30	Solid or 7 x 30	Solid or 7 x 32	Solid or 7 x 34
HOOK-UP WIRE CABLE IN RACEWAY								
MODERATE FLEXING	65 x 30	19 x 27 or 41 x 30	19 x 29 or 26 x 30	16 x 30 or 41 x 34	7 x 28 or 10 x 30 or 19 x 32 or 26 x 34	7 x 30 or 19 x 34	7 x 32 or 10 x 34	7 x 34
FREQUENTLY DISTURBED FOR MAINTENANCE								
SEVERE FLEXING	165 x 34	104 x 45	65 x 34 or 104 x 36	41 x 34 or 65 x 36	26 x 34 or 42 x 36	19 x 34 or 26 x 36	19 x 36 or 45 x 40 *	7 x 34 or 10 x 36 *
MICROPHONES TEST PRODS								
MOST SEVERE DUTY—MERCURY SWITCHES	259 x 36 (7 x 37** Rope Lay)	168 x 36 (7 x 24 Rope Lay)	105 x 36 (7 x 15 Rope Lay)	63 x 36 (7 x 9 Rope Lay)	105 x 40 (3 x 35 Rope Lay)	(Consider braid or tinsel)		

*Composite constructions consisting of 4 strands Copperweld and 3 strands copper are frequently used for severe flexing in small size cables. #25 AWG (4 x 33 Copperweld + 3 x 33 Copper) is popular in microphone cables.

**Rope Lay is several stranded groups cabled together. For example: #12 AWG, 259 x 36 is 7 cords each consisting of 37 strands of #36 AWG.

PER WIRE

AWG	DIA. MILS	CROSS-SECT. AREA CIR. MILS	LBS. PER 1000 FT.	BREAKING STRENGTH (LBS.)		RESISTANCE OHMS PER 1000 FT. 20°C	
				SOFT (ANL)	MED. HARD	SOFT (ANL)	MED. HARD
34	6.3	39.7	0.120	1.25	2.04	260.9	269.9
35	5.6	31.4	0.095	0.990	1.63	329.0	340.4
36	5.0	25.0	0.076	0.785	1.30	414.8	429.2
37	4.5	20.2	0.060	0.623	1.03	523.1	541.2
38	4.0	16.0	0.0476	0.494	0.823	659.6	682.4
39	3.5	12.2	0.0377	0.392	0.656	831.08	860.5
40	3.1	9.61	0.0299	0.311	0.523	1,049	1,085
41	2.8	7.84	0.0237	0.246	0.415	1,323	1,368
42	2.5	6.25	0.0188	0.195	0.329	1,668	1,725
43	2.2	4.84	0.0149	0.155	0.261	2,103	2,176
44	2.0	4.00	0.0118	0.123	0.207	2,652	2,743
45	1.76	3.10	0.00981	0.09		3200	
46	1.57	2.46	0.00775	0.07		4050	
47	1.40	1.96	0.00593	0.054		5290	
48	1.24	1.54	0.00436	0.04		7200	
49	1.11	1.23	0.00366	0.033		8570	
50	0.99	0.980	0.00303	0.027		10,400	
51	0.88	0.774	0.00234	0.023		13,400	
52	0.78	0.608	0.00184	0.017		17,000	
53	0.70	0.490	0.00148	0.013		21,200	
54	0.62	0.384	0.00116	0.011		26,900	
55	0.55	0.302	0.000916	0.006		34,300	
56	0.49	0.240	0.000727	0.0052		43,200	

COMMON CONDUCTOR MATERIALS

MATERIAL	DC RESISTANCE COMPARED TO ANNEALED COP.	R-F RESISTANCE COMPARED TO ANNEALED COP.	TENSILE STRENGTH (PSI)	
			ANNEALED	HARD
COPPER	100%	100%	35,000	66,000
COPPERWELD® 40% LC	250%	100%	50,000	96,000
COPPERWELD® 30% HM	333%	100%	70,000	130,000
CADMIUM BRONZE 99% Cu, 1% Cd	115%	115%	38,000	90,000
ALUMINUM ³	164%	164%	17,000 ⁴	23,000

(1) Flex life will, in general, be improved by use of higher strength material.
 (2) Theoretically, annealed material will have longer fatigue life than hard. However, in practice the stiffness of hard material frequently tends to restrict the sharpness of bend, resulting in improved life.
 (3) Aluminum used in aircraft and power distribution for weight reduction. Not normally used for electronic applications.
 (4) 3/4 hard.

TABULATION OF CABLE-SHIELD QUALITIES

	COPPER BRAID	COPPER SERVED	CONDUCTIVE TEXTILE	ALUM-MYLAR FOIL	CONDUCTIVE PLASTIC
SHIELD EFFECTIVENESS A-F	Good	Good	Fair	Exc.	Fair
SHIELD EFFECTIVENESS R-F	Good	Poor	Poor	Exc.	Poor
NORMAL % OF COVERAGE	60-95%	90-97%	100%	100%	100%
FATIGUE LIFE	Good	Fair	Exc.	Fair*	Good
TENSILE STRENGTH	Exc.	Fair	Poor	Poor	Poor
TERMINATION METHOD	Comb & Pigtail	Pigtail	Drain Wire	Drain Wire	Drain Wire

*Special Techniques can provide excellent fatigue life for use in retractile cords.

CONDUCTOR COATINGS

BARE COPPER (NO COATING) LOW COST OXIDIZES RAPIDLY DIFFICULT SOLDERING HIGH CONTACT RESISTANCE
TINNED COPPER MODERATE COST RESISTS OXIDATION •SOLDERS EASILY
SILVER COATED COPPER HIGH COST LOW R-F LOSS USED WITH TEFLON TO 200°
NICKEL COATED COPPER HIGH COST USED WITH TEFLON TO 260° DISCOURAGES SOLDER WICKING NOT RECOMMENDED WITH CRIMP TERMINALS

Belden

WIREMAKER FOR INDUSTRY
SINCE 1902 - CHICAGO

Belden Manufacturing Company
P.O. Box 5070-A,
Chicago, Illinois 60680

Please unfold this...

It's your copy of a newly published Wire and Cable Reference Chart—presented with the compliments of.....

Belden

WIREMAKER FOR INDUSTRY
SINCE 1902—CHICAGO

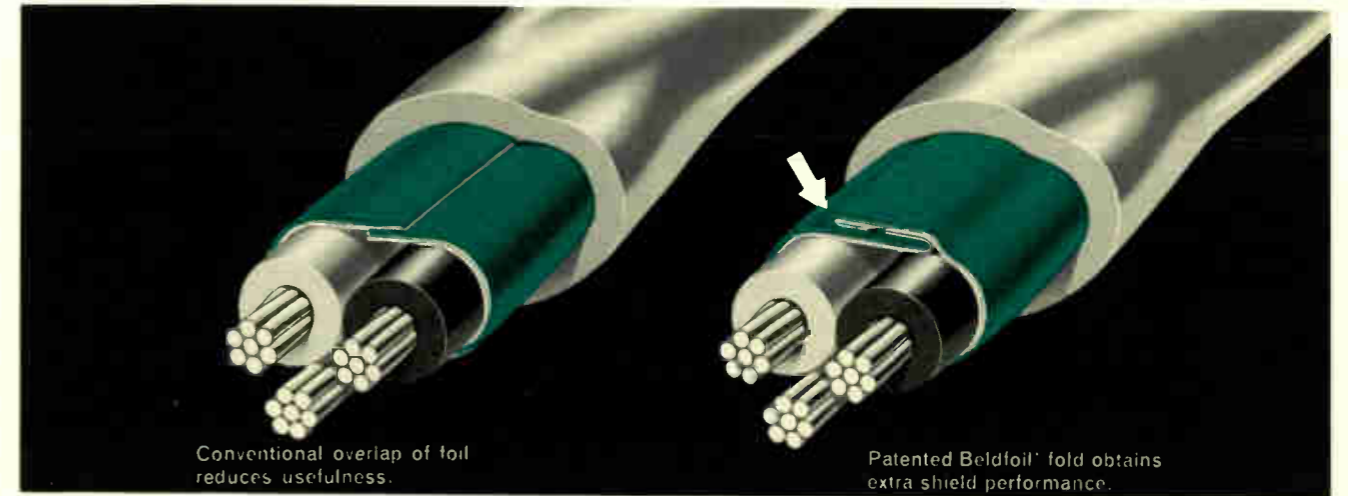

It's in the fold!

By Frank Timmons, Chief Engineer, Electronics Division, Belden Manufacturing Company

There are a number of cables on the market today which utilize Mylar[®] Aluminum Shielding to eliminate noise, hum and cross-talk. These cables have been developed to meet the needs of equipment engineers who have found that standard braided and spiral shields are inadequate in reducing pick-up and transmitted noise.

There is a big difference in the various cables available . . . and the big difference is in the manner by which the Mylar Aluminum Shielding is applied to the cable. The cable which does the most effective job of eliminating noise, hum and cross-talk uses a unique, patented wrapping process that "folds back" one or both edges of the Mylar Aluminum Shielding. It provides "total shielding" and was introduced in 1957 by the Belden Manufacturing Company under the trade name, "Beldfoil."

It is evident that many interested persons do not completely understand the manner in which Mylar Aluminum Shielding is used in the manufacture of Beldfoil cable. Therefore, Frank Timmons, Chief Engineer of the Electronics Division at Belden's Richmond, Indiana plant answers some of the more frequently asked questions, and points up some of the more important benefits offered by Beldfoil.

Q. You talk about a patented process wherein the Mylar Aluminum Shielding is folded back . . . on one or both edges. Just how is this done?

A. First, let us define Mylar Aluminum Shielding . . . it is a lamination of Mylar insulation film from 0.0005" to 0.001" thick and aluminum foil of .00035" to .001" thickness, applied spirally around the shielded conductor or conductors to give 100% shield coverage.

In some instances the wires are wrapped with the metal foil on the outside as shown in the cross-sectional drawing Fig. 1.

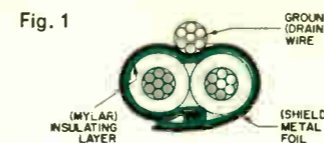

Note the heavy black line showing the foil edge folded back so that a full layer of Mylar "bonus insulation" is provided between the conductors and the foil shield, increasing the reliability of the cable.

Cables to be used at radio frequencies, or sensitive to radio frequency interference, may need the fold shown in Fig. 2. This fold creates a metal-to-metal connection which eliminates any possible inductive effect, and makes the shield the electrical equivalent of a solid aluminum tube.

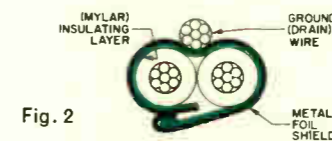

Shields shown in Fig. 1 and 2 are used for cables with one pair of conductors.

For cables carrying multiple pairs of conductors, a different technique is used. On each pair, the aluminum foil is placed on the inside, with the Mylar layer on the outside (See Fig. 3). This is important because if the aluminum surface were on the outside we would have random metallic contact between the shields on the different pairs of wires. This would permit the voltages existing on one shield to generate currents in the adjacent shield, creating a transfer of energy or cross-talk between circuits.

Note that the outer edge of the shield is folded to tuck the edge of foil out of the way where it cannot short to the adjacent shield.

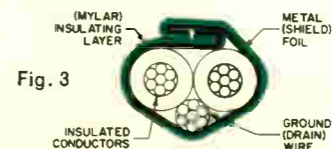

The inner fold again provides the electrical equivalent of a solid aluminum tube. Belden calls this combination of two folds in one shield a "Z" fold because an end view of the unwrapped tape looks like the letter "Z".

Q. How much signal isolation results between pairs, when aluminum foil is on the inside, and Mylar layer outside?

A. This type of construction obtains isolation of more than 100 db between pairs, per thousand feet of cable, at 10 Kc. The short-circuited tape shield makes the cable quite suitable for use at frequencies ranging from audio to RF.

Q. Do any contact-resistance problems arise between the drain wire and the aluminum foil shield on Beldfoil?

A. No. Belden design and field service experience on millions of cable-feet in wide service environment have proved this point of reliability.

Q. Can Beldfoil shields be used over small single conductors as well as over large complex cables?

A. Yes. Belden applies it on groups from .050" to 1.25" OD.

Q. Design engineers are constantly faced with miniaturization problems. What about the size of Beldfoil shielded cables?

A. Beldfoil definitely reduces the diameter of multi-conductor cables . . . in some instances by as much as 66 $\frac{2}{3}$ %. The small diameter provides design engineers with extra conduit space, extra raceway, extra console and rack space.

Q. How can I determine which type of shield I should choose for a given cable?

A. Belden application engineers are available for engineering assistance. Or, you can obtain preliminary printed information by writing to Belden Manufacturing Company, Advertising Department, P.O. Box 5070-A, Chicago, Illinois 60680.

Better Built... Better Buy...

Belden

WIREMAKER FOR INDUSTRY
SINCE 1902—CHICAGO

8-7-5

*Belden Trademark Reg. U.S. Pat. Off. [®]duPont Trademark

Another great idea from Daven...

Electromagnetic Delay Lines

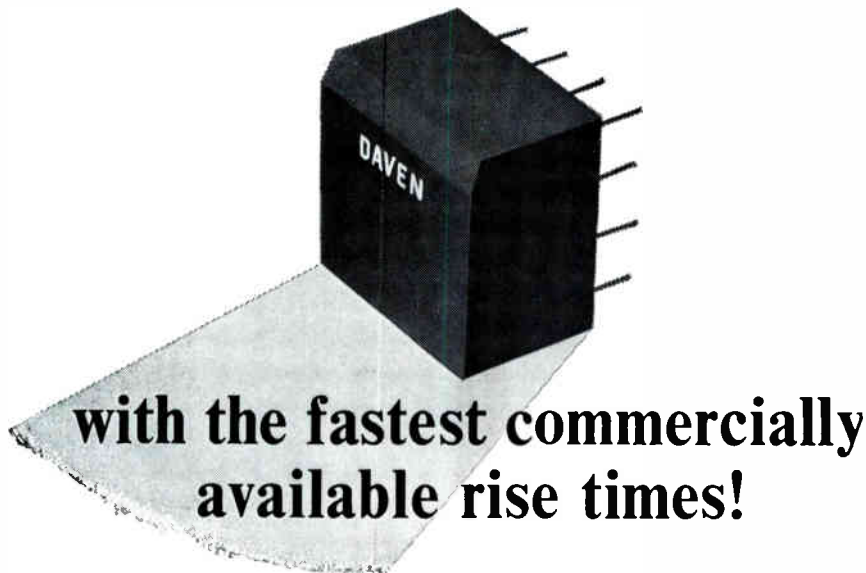

The specs speak for themselves: delay times from 1 to 100 nanoseconds... rise times of less than 1 nanosecond... frequency response of better than 1,000 mc.

These are the fastest rise times commercially available in an electro-

magnetic delay line today, and they are available only in the newest Daven Series M lines. These Daven delay lines feature high reliability in both miniature and subminiature sizes; in your choice of encapsulated or hermetically-sealed units.

For the entire series, delay times range from 1 to 1,000 nanoseconds; and characteristic impedances from 50 to 2,000 ohms. Special delay lines are also available to meet your custom application. We will be happy to quote on your requirements!

DAVEN 
MANCHESTER, NEW HAMPSHIRE
(603) 625-9746 • TWX 603 623-4938 • Cable: Daven Manchester N H

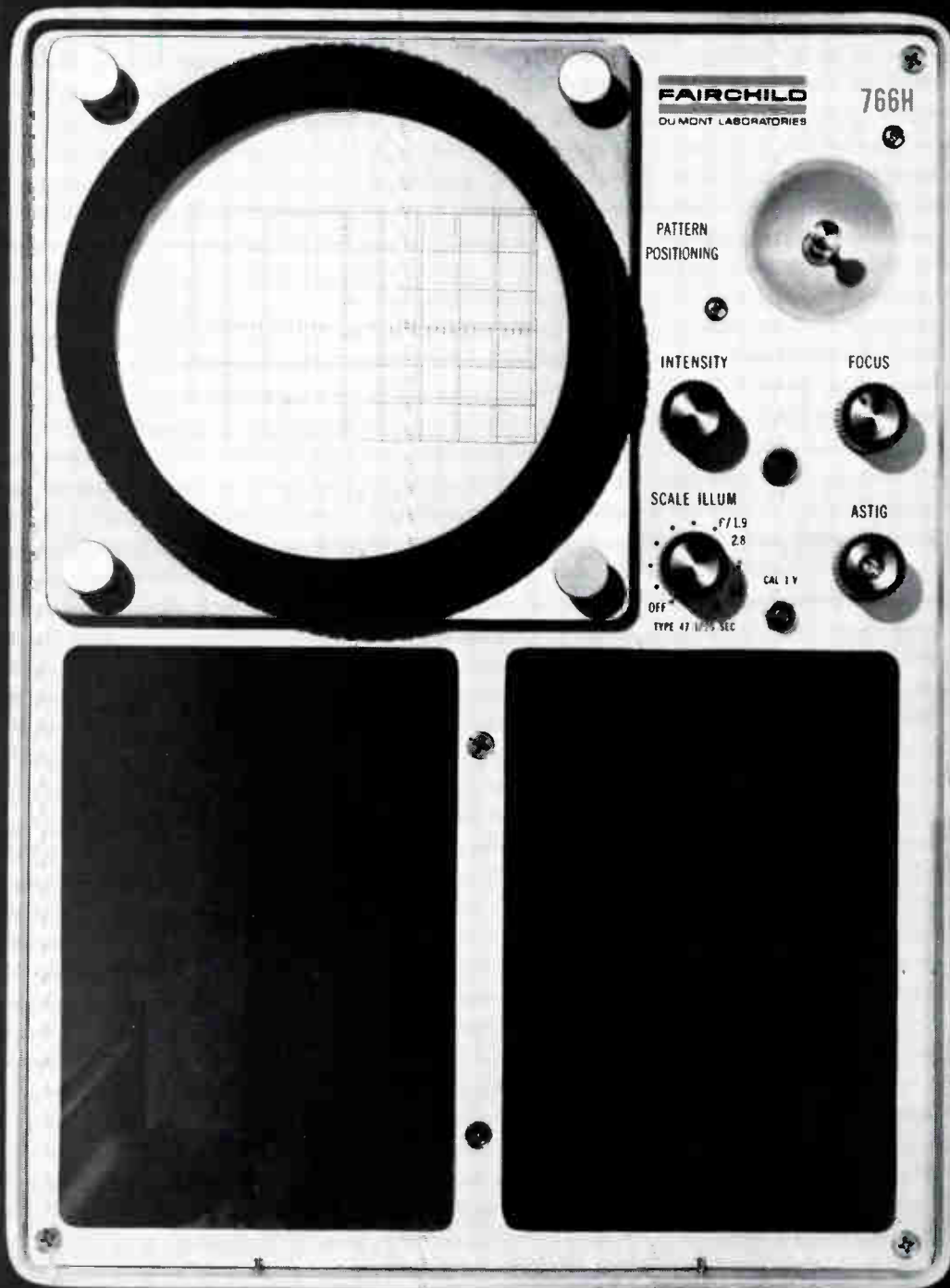

*Technological Obsolescence

WITH THIS SCOPE AND THOSE PLUG-INS...

Your oscilloscope applications change with the work you're doing and the state-of-the-art. Over the years, you could buy a lot of special purpose scopes for that reason. But you don't have to. There are now 20 plug-ins available for the Fairchild Series 765H main frame (and more are on the way). The versatility not only helps you beat the high cost of T.O.—Technological Obsolescence; it lets you add new capabilities at low cost if and when you need them. Other factors that contribute to Fairchild value are . . . all solid-state circuitry for long term reliability . . . all deflection circuitry in the plug-in . . . four main frame configurations (bench, rack, portable, and dual gun).

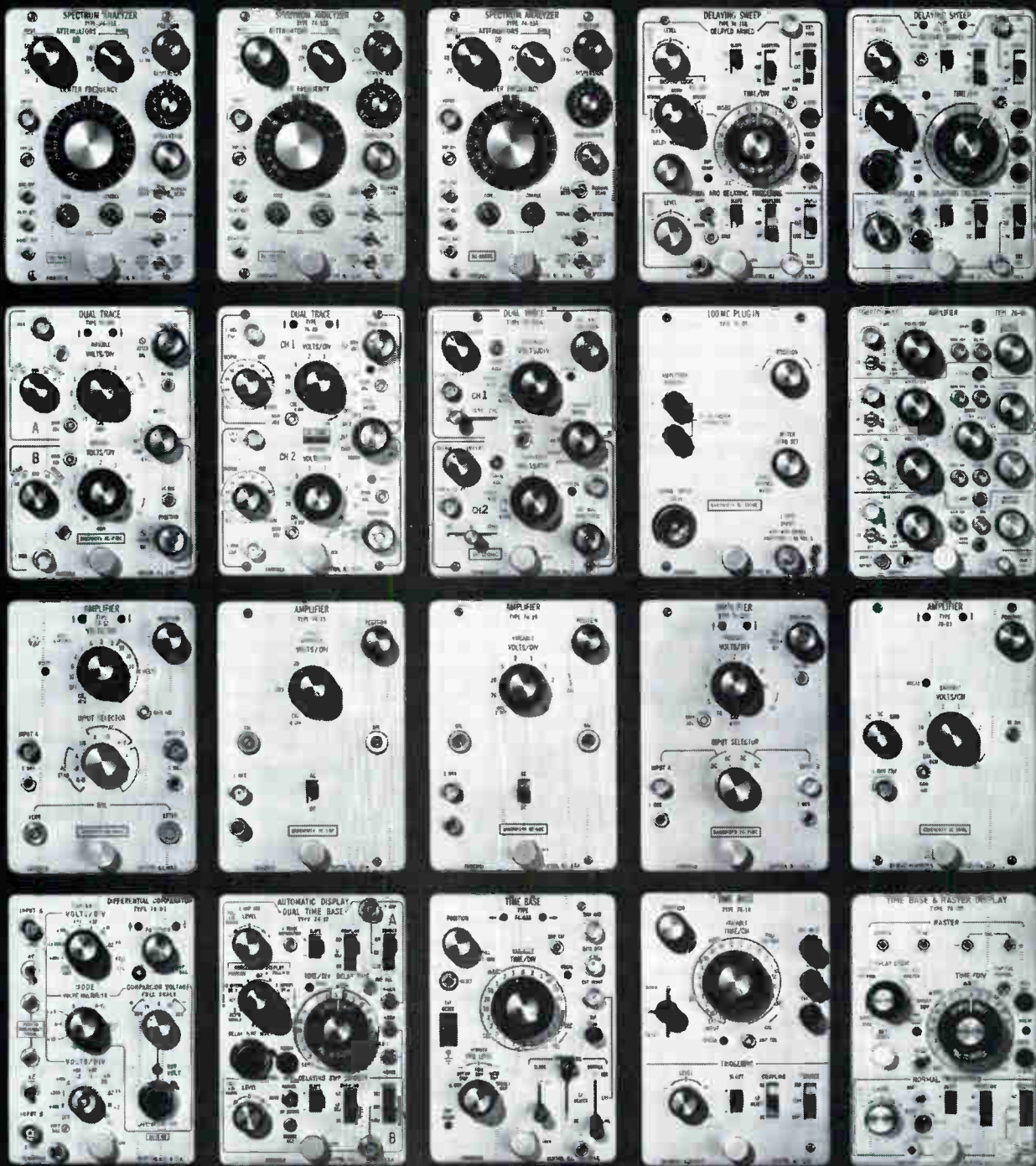

...WHO NEEDS COSTLY SPECIAL PURPOSE SCOPES?

Ask your Fairchild Field Engineer for a demonstration of the Series 765H. Judge it on performance and by your own standards of value analysis. For a new catalog describing the Series 765H and other Fairchild scopes write Fairchild Instrumentation, 750 Bloomfield Ave., Clifton, N.J. For a demonstration in your plant call your nearby Fairchild Field Engineer.

Circle 21 on Inquiry Card

World Radio History

FAIRCHILD
 INSTRUMENTATION
 A DIVISION OF FAIRCHILD CAMERA
 AND INSTRUMENT CORPORATION

PROGRAMMING SWITCH

The 3½ x 2¾ x 3¼ in. switch controls 10 circuits.

The MiniActan device is a complete programmer that provides time-based sequential control for as many as 10 independent circuits. Its precision machined memory drum carries field-adjustable actuators past the circuit control contacts. The drum is driven by a synchronous motor at 1 rpm. The 60 discrete program positions on the drum provide programming increments of 1 sec. each. The switch has adjustable cams with up to 30 on/off segments. Sealectro Corp., 225 Hoyt St., Mamaroneck, N. Y.

Circle 130 on Inquiry Card



DATA DISPLAY SYSTEM

For rapid retrieval, editing, and composing of stored data.

The DIDS-400 table-model digital-data display system eliminates card punching, batch totaling and other intermediate steps in data processing by providing a direct interface between computer and operator. By using an alphanumeric keyboard, data in a random access memory can be recalled almost instantaneously for flicker-free presentation on a 6 x 9 in. display area. It may then be corrected or replaced with new data and returned to the memory. The DIDS-400 is a product of Raytheon Co., Wayland, Mass.

Circle 131 on Inquiry Card

VOLTMETER/RATIOMETER

Max. deviation from true value is 0.01% of reading ±1 digit.

With the Model 511 DVM-ratiometer, a single, combined front panel control selects both the measurement range and functions (volts or ratios). A sensitivity control enables stable operation in the presence of noisy input signals. Power consumption is 15w. It has 100µv sensitivity on all scaled voltage and ratio ranges with negligible zero offset. Cohu Electronics Inc., Kin Tel Div., Box 623, San Diego, Calif.

Circle 132 on Inquiry Card



TELEMETRY ANTENNAS

Tracking antenna consists of two separate antenna subsystems.

These antennas are mounted on a heavy-duty positioner and withstand a load of 120 mph winds with icing conditions. The elevation over azimuth positioner operates at a maximum speed of 40°/second under a windload of 75mph. The upper 130-140MC disc on rod array receives both left and right hand polarized signals either simultaneously or separately with a minimum gain of 8dbic. The lower 225-300MC bifilar helical antennas are circularly polarized (one left hand, one right hand) and provide a minimum gain of 12dbic. Andrew Corporation, P. O. Box 807, Chicago, Illinois.

Circle 133 on Inquiry Card



MAGNETIC TESTING

High-energy magnetic field testing of high-voltage tubes.

High-energy magnetic field testing of high-voltage tubes is being done in a new barrel-shaped magnet assembly. Developed by The Arnold Engineering Company, Marengo, Ill., this powerful magnet is to be used with complex high-voltage electron tubes such as klystrons. Extreme caution has to be taken by its users due to its strong magnetic field.

Circle 134 on Inquiry Card

BWO FOR MC BAND

Voltage-tunable from 500 to 1000 mc.

Type SE-223 is a permanent-magnet-focused backward-wave oscillator. It is said to be the first commercially available PM-focused tube capable of being voltage tuned over the full octave P-band. Warranty is 2500 operating hours. Watkins-Johnson Co., 3333 Hillview Ave., Palo Alto, Calif.

Circle 135 on Inquiry Card

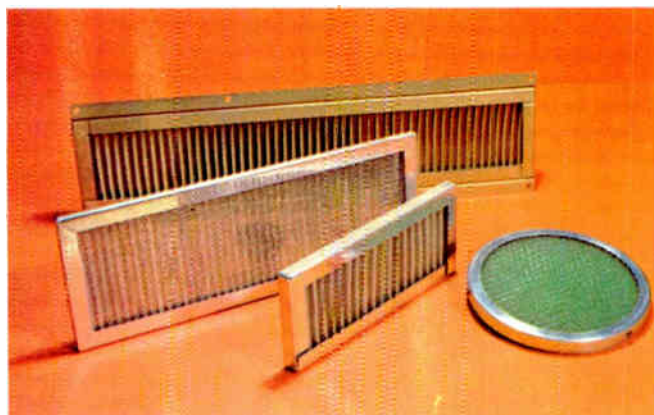
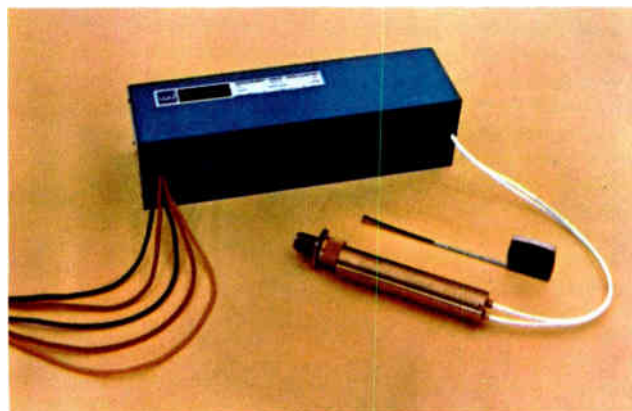

AIR FILTERS

For filtration on cabinets employing forced air cooling.

This line of Air-Maze air filters come in viscous and dry types. Highlighting the group is the P56, a viscous impingement type which conforms to BuShips Spec. 16E4. Average dust arresting efficiency is 60%. It is designed for air cooling systems in cabinets housing electronic equipment.

Rockwell-Standard Corp., 25000 Miles Rd., Cleveland, Ohio.

Circle 136 on Inquiry Card

FOUR-DIGIT VOLTMETER

Constant high impedance; accuracy of $\pm 0.01\%$ of full scale.

Model 4000 is an integrating-type DVM which provides controllable, fast readings from 10 readings/sec. to 15 sec./reading. It operates without stepping switches, high-precision resistors, and few reed relays. Stability results from a unique freq.-to-voltage comparator. By checking the correlation of the output freq. of the VCO with the input voltage, the freq.-to-voltage comparator corrects for any degree of nonlinearity, and for both short- and long-term drift. Hughes Aircraft Co., Vacuum Tube Products Div., 2020 Oceanside Blvd., Oceanside, Calif.

Circle 137 on Inquiry Card

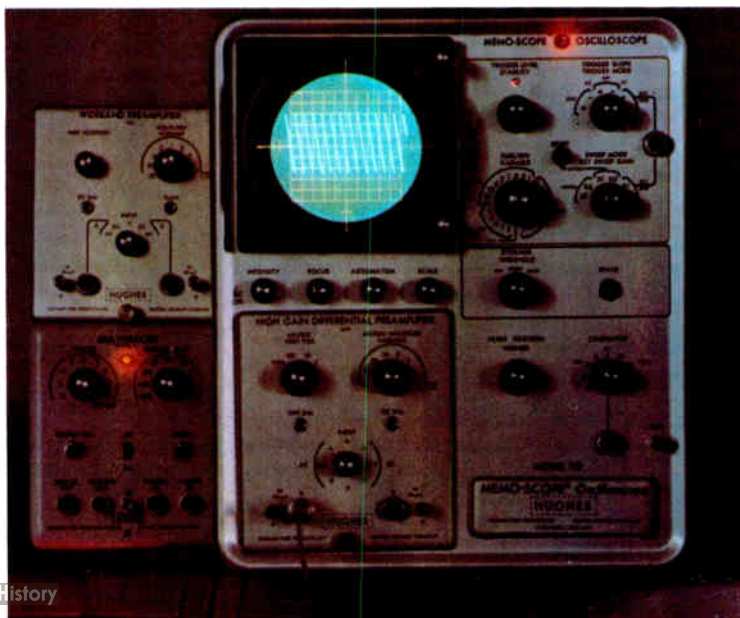

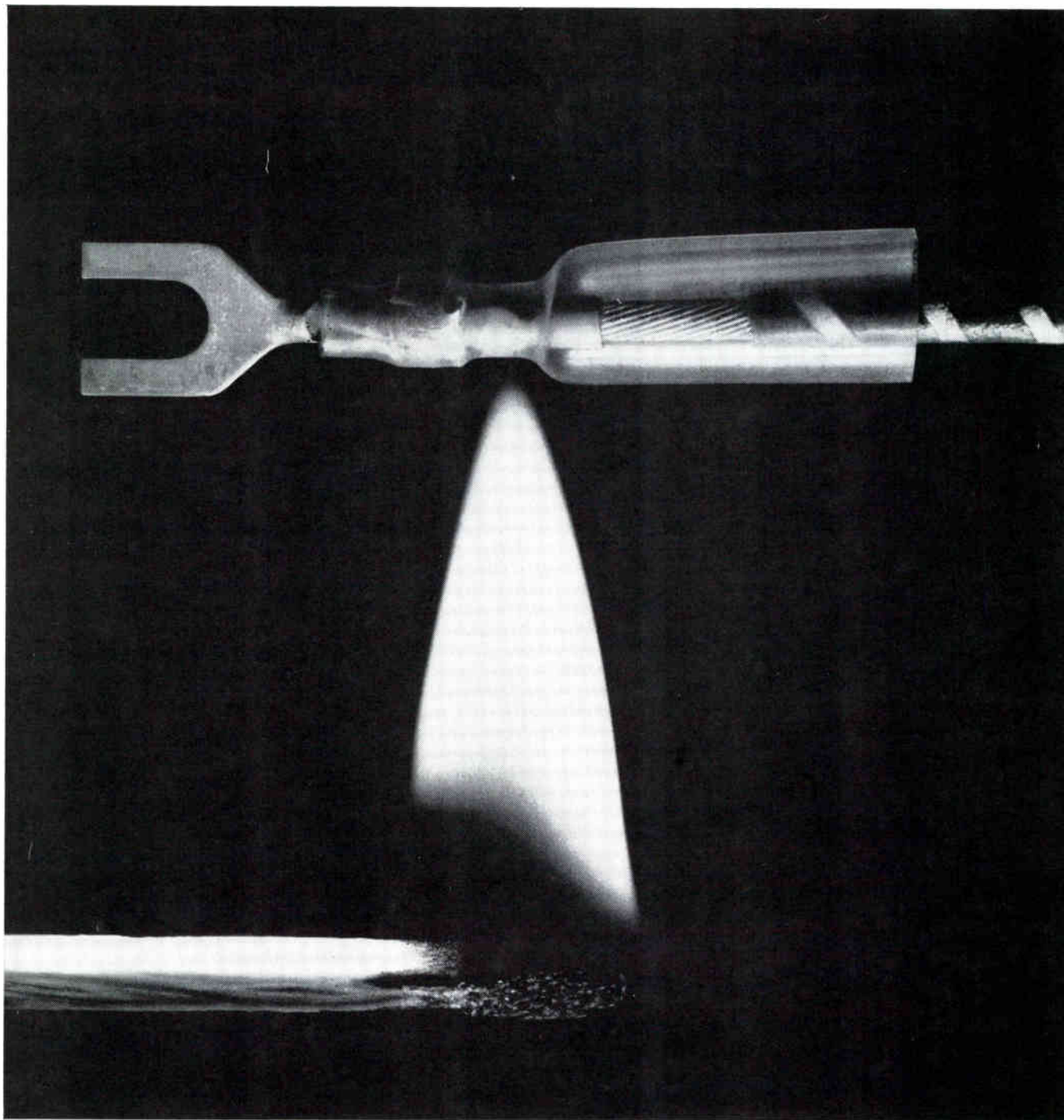

Who's Alpha Wire to take all the fun and guesswork out of heat shrinkable tubing?

In seven seconds, the diameter of this insulation tubing will shrink from .093" to precisely .045" and give you a tight mechanical bond. Without splitting. Without crushing.

You get predictable, controlled shrinkage. Alphlex FIT® irradiated tubing ends all the guesswork.

It won't melt at elevated temperatures (up to 350° C). Or split when shrunk over irregularly shaped objects.

It resists stress and solvents. Even the longitudinal

shrinkage is controlled (usually no more than 5%).

How do you use it? For insulating. Encapsulating. Splicing. Connecting. Jacketing. Capping. We have a type and size for every job.

Why does Alpha Wire get involved with irradiated tubing? Because we believe that making the best wire in the business is only half the story. The other half is being sensitive to your application problems.

Until now, heat shrinkable tubing was one of them.

Alpha Wire Headquarters: Elizabeth, New Jersey 07207. Write for our new 108-page catalog.
A Division of Loral Corporation



portability with Dual-Trace and Sweep Delay



Here's the new portable oscilloscope for DC-to-50 Mc applications. It operates almost anywhere—and under severe environmental conditions. It's small and light—with overall dimensions of 7¼" high x 12½" wide x 22½" deep (including extended carrying handle), and weighs less than 29 pounds.

Performance features include:

Bandwidth (with new P6010 Probe)

20 mv/div through 10 v/div > 50 Mc

10 mv/div > 45 Mc

5 mv/div > 40 Mc

1 mv/div > 25 Mc (Channels cascaded)

Sweep Rates—5 sec/div to 10 nsec/div (with 10X Mag.)

Calibrated Sweep Delay—50 sec to 1 μsec.

CRT—New 4" rectangular, operating at 10 kv.

X-Y Operation—DC to > 5 Mc, 5 mv/div through 10 v/div.

Triggering—To 50 Mc, from Channel 1 or combined signals (both sweeps).

Type 453 Oscilloscope U.S. Sales Price f.o.b. Beaverton, Oregon . . . \$1,950

Circle 23 on Inquiry Card

TO PLANES



new
453
from

tektronix



NEW PRODUCTS

PLANAR ANTENNA

Isolation, or cross-talk, between linear planes is 25db min.

An important feature of this crossed-log planar antenna is its ability to permit linear polarizations or circular polarizations when used in conjunction with a hybrid coupler. It is ideal for use as a parabolic dish feed. Its outstanding isolation capability makes it particularly suited for uses where exact knowledge of field components is necessary. Operating freq. is 400 to 2500mc, and constant gain over entire band is 7db. American Electronic Laboratories, Inc., P. O. Box 552, Lansdale, Pa.

Circle 138 on Inquiry Card

PLUG-IN FLAT PACKS

IC packages feature plug-in pins on 100-mil grid spacing.

This modular family of plug-in flat packs include units with 10, 16, 24, and 40 pins. The larger packages are designed to accommodate complex logic arrays. The 16-pin packages have 2 rows of sturdy pins coming out of the bottom, with rows spaced 200 mils apart. A ceramic-to-metal, hermetically sealed version has dimensions of 390 x 890 mils. A subsequent version using other materials will be 290 x 790 mils, but pin spacings will remain the same. The packages, by Texas Instruments Incorporated, P.O. Box 5012, Dallas, Tex., have a flange tab to provide a means of indexing. The packages are adaptable to low-cost assembly techniques, including high-volume manual or automatic insertion.

Circle 139 on Inquiry Card

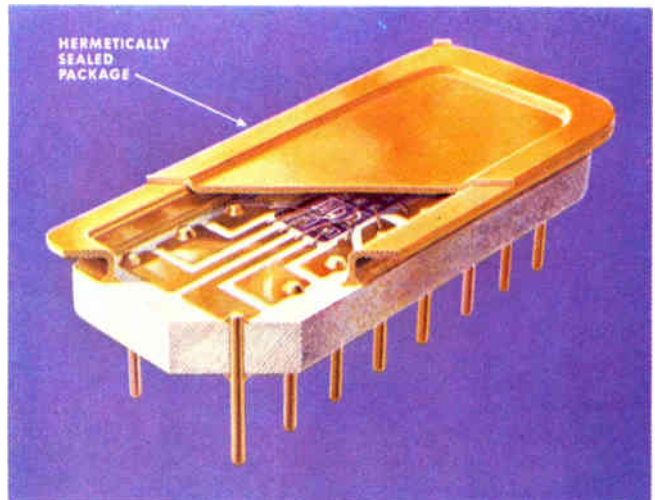

THERMOCOUPLE CONNECTORS

Serviceable throughout an extremely wide temperature range.

The connector shell of this ceramic thermocouple connector is a shock resistant ceramic which withstands temp. to -400°F and as high as 1200°F . The color-coded shell permits immediate identification of the thermocouple alloy combination used in the connector. The connector pins are also marked internally for further identification. A variety of tube and cable clamps are available for use with these connectors so that they can be quickly coupled to thermocouples and lead wires. The connectors have standard polarized pins and are thus interchangeable with other standard connectors. Omega Engineering, Inc., P. O. Box 47, Springdale, Conn.

Circle 140 on Inquiry Card

LOG-LINEAR RECORDER

Has 17 full-scale input ranges linearly & 17 logarithmically.

The V.O.M.-8 Log-Linear Recorder directly measures and/or records dc volts, ohms, and milliamps in the linear or logarithmic mode without external converters. It provides full scale spans of 10 and 100 mv dc, 1, 10, 100, and 500vdc; 0.0, 0.1, 1, 10, and 100ma dc; 1, 10, 100, 1K, 10K, and 100K ohms. Response time is less than $\frac{1}{2}$ sec. full scale on all ranges. Sensitivity is 0.25% of full scale. Bausch & Lomb Inc., Rochester, N. Y.

Circle 141 on Inquiry Card

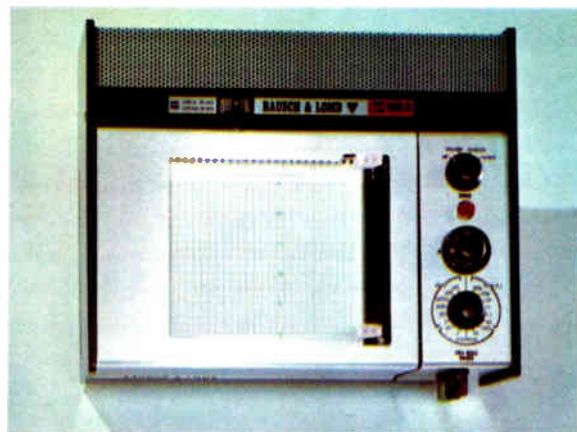

A-D CONVERTERS

Binary, cyclic binary, or binary-coded-decimal encoders.

Size 11 are direct-drive analog-to-digital code converters consisting of coded drums, the number of which depends on the code and total count. They are actuated by an analog (rotary) input by means of a shaft connected directly to another shaft, positioned in a gear train, or rotated by a servo loop input. These encoders use continuously geared coded drums having tracks divided into flush conductive and nonconductive segments (or bits) arranged in the desired coding. The converters can be supplied in a wide selection of ranges, either with or without isolation diodes. General Precision Inc., 1150 McBride Ave., Little Falls, N. J.

Circle 142 on Inquiry Card

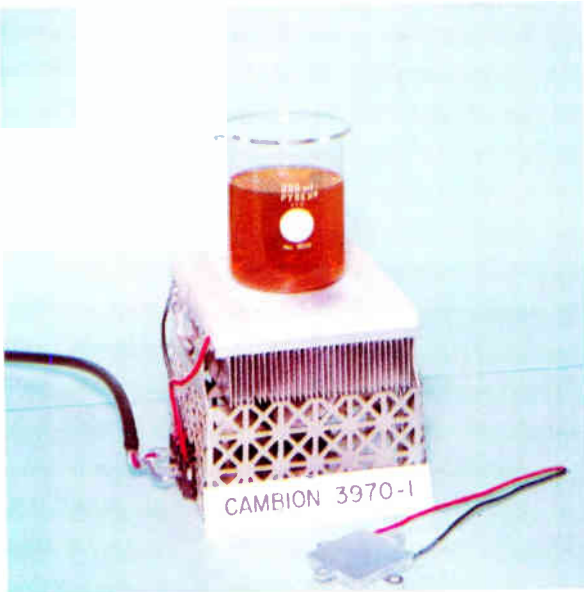
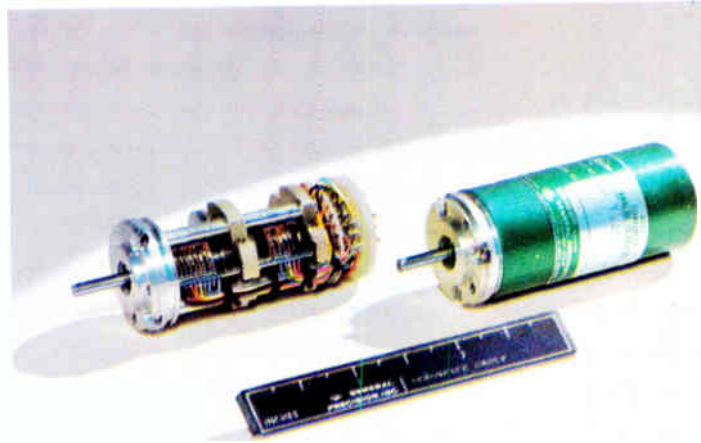

THERMOELECTRIC ASSEMBLY

Provides 12 vdc (+5%) and 7 amps dc. Heat pumping, 40w.

Model 3970-1 Thermoelectric Modular Assembly is ready to plug-in and use when attached to a proper power supply. It produces a min. heat-sink to cold-plate temp. differential of 45°C. System has a thermal resistance of 0.12°C/watt for heat dissipation under normal ambient conditions and maximum thermal load. Cambridge Thermionic Corp., 445 Concord Avenue, Cambridge, Mass.

Circle 143 on Inquiry Card

TELEMETRY RECEIVER

Virtually spurious free and offers strong signal handling.

The TR-711 is modular in construction. It can be supplied with a complete complement of plug-in modules, including r-f tuning units from 100-2300MC; i-f amplifiers with 10KC to 3.3MC bandwidths; AM, FM and phase demodulators; and plug-in spectrum display unit, oscilloscope, predetection up and down converter, or high capture ratio discriminator. Any combination of plug-in modules can be utilized, thus providing unlimited receiving combinations adaptable to any known or proposed telemetry system. Defense Electronics, Inc., Rockville, Maryland.

Circle 144 on Inquiry Card

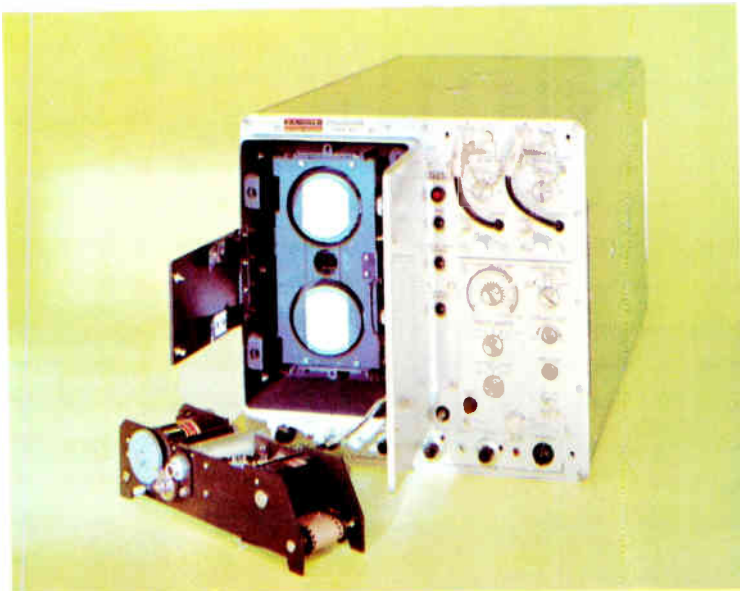
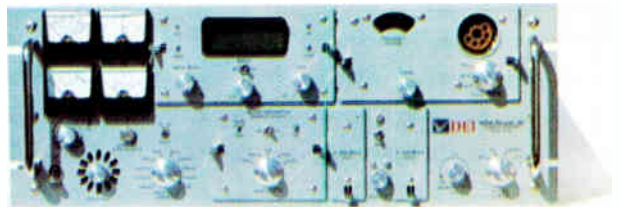

FIBRE OPTICS CRT

Designed for direct contact photography of transients.

Type 977 is a fibre-optic, fully solid-state oscilloscope. Amplifier risetimes exceed 3.5 nsec with a bandwidth of dc to 100MC. The instrument uses 2 fibre optics CRTs, the resolution of which has been optimized for a spot size of nominally 1 1/2 mil. This results in a resolution of better than 350 lines in the signal axis, and 450 lines in the time axis. Recording is possible in excess of 5 x 10¹⁰ trace widths/second and can be extended by special developing techniques to speeds beyond 10¹¹ trace widths/second. Fairchild Instrumentation, 750 Bloomfield Avenue, Clifton, N. J.

Circle 145 on Inquiry Card

This is Siemens

...making motors and transformers in Pakistan, in the modern factory shown below. We also make cables in India, generators in Spain, telephones in Argentina. We manufacture in 28 countries and erect, service and repair our installations in almost every country in the world. Of the 240,000 in the Siemens family, 40,000 are employed abroad. Everywhere, they provide imaginative planning, high-quality equipment, skilled and rapid construction and reliable service.

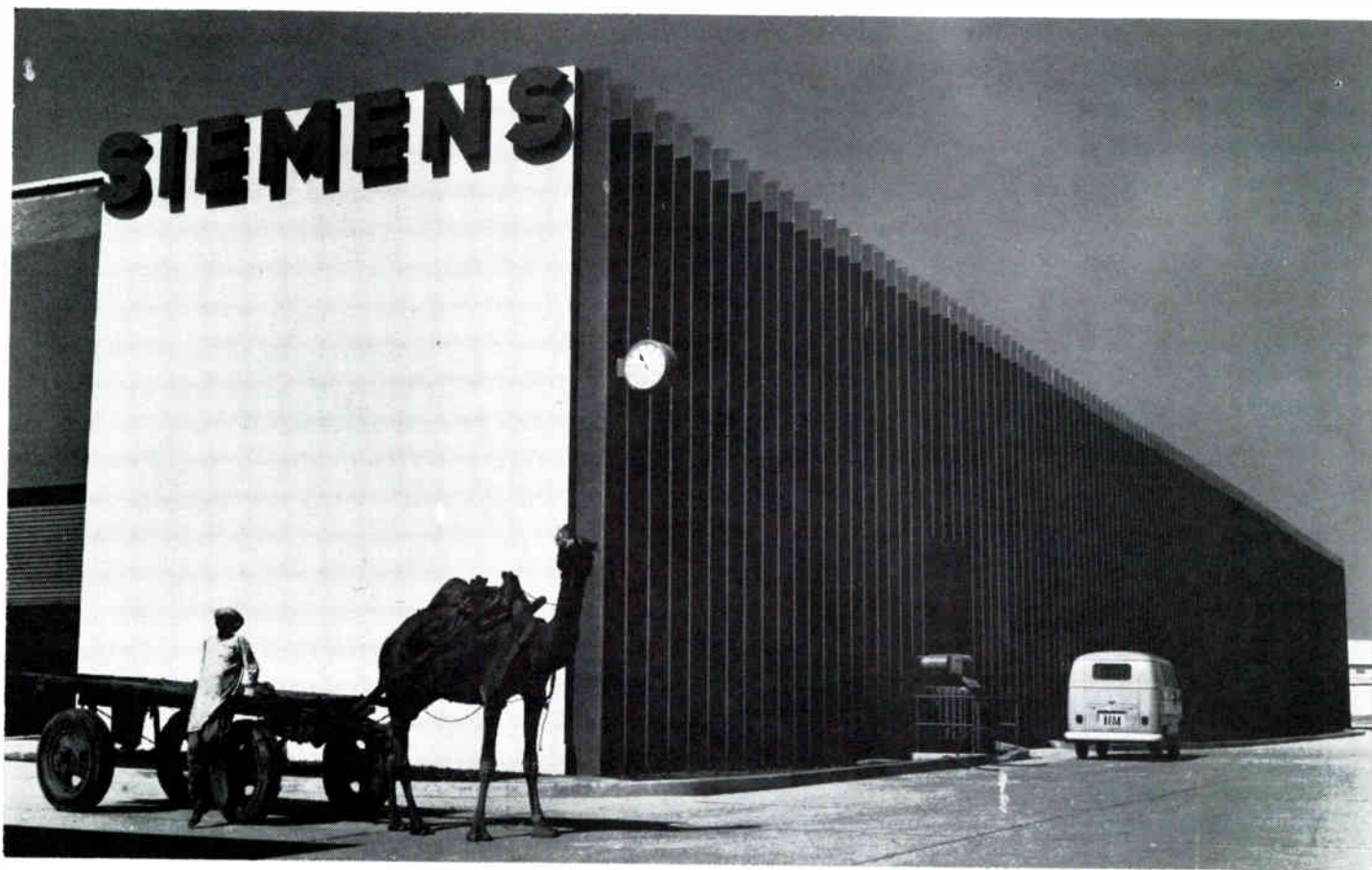

Siemens MKH metallized film capacitors

Small size and high reliability are new standards set by Siemens capacitors. Twenty years' experience in making metallized capacitors has resulted in advanced precision techniques which closely control every capacitor property, making them 100% "foolproof" in service. "Self-healing" is an automatic reaction, eliminating the possibility of any voltage breakdown.

Two-way self-healing gives double protection. Internal voltage breakdown very rarely occurs. If it does, the thin metal coatings at the breakthrough point, act as a fuse and immediately vaporize, eliminating the breakthrough point within microseconds.

Electrochemical self-healing is the second protective process. It starts whenever and wherever insulation resistance decreases in the dielectric material. This process operates at any voltage, even as low as 10 mV, changing the metal coating at the point of lowest insulation resistance to a non-conductive oxide—thus eliminating the point electrically.

Less than one breakdown (self-healing) per year and per mF—that is the consistent average shown by tests at nominal voltage. This value, which is for the first year, is even less for succeeding years.

Highly stable capacitance. Overload tests (at 2.2 nominal voltage and at 85°C) show that decrease in capacitance as a result of self-healing is negligible, even after several years.

Small size—low cost. Intricate manufacturing techniques enable MKH (metallized polyester) capacitors to be produced to unvarying standards. They are available with axial or radial leads, in flat compact form. Leads soldered to metallized ends ensure reliable contact. The dielectric is polyester film, widely used for capacitors.

MKH properties. Operating temperatures: -40° to +125°C. Insulation resistance: minimum 20,000 megohms for normal capacitance up to .022mF at +20°C. For higher capacitance values: 10,000 megohms X mF (typical values). Temperature coefficient: approx. .04%/C° between 0° and 70°C. Dissipation factors: 0.5% at 1 kc; 1.5% at 10 kc (typical values).

Immediate shipment. Substantial stocks are held in White Plains, N. Y.

Write now for full information on Metallized Film Capacitors.

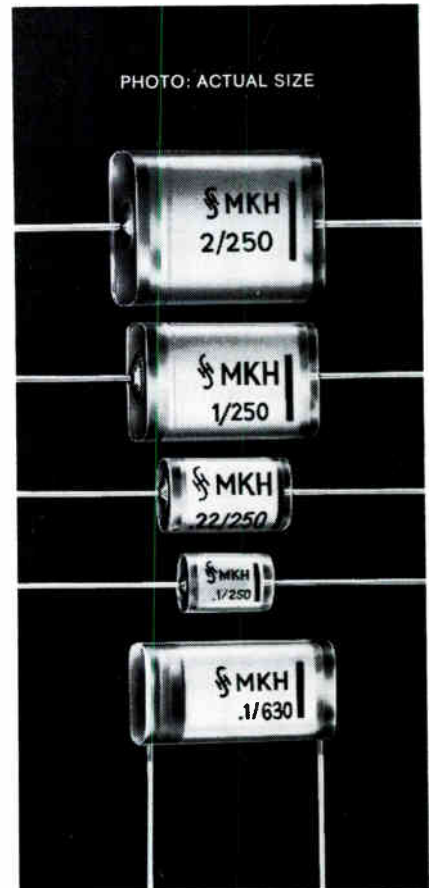

SIEMENS AMERICA INCORPORATED
Components Division
230 Ferris Avenue, White Plains, N. Y.

In Canada:
SIEMENS CANADA LIMITED
407 McGill Street, Montreal 1, P. Q.

DIFFUSION FURNACE

Has solid-state control system plus building block design.

The Diffuzor II is designed for the critical diffusion process essential in the production of integrated circuits and electronic components. Materials placed in the furnace reach the diffusion temp. level within minutes, and maintain the set temp. level precisely along 22 in. of the furnace tube with $\frac{1}{2}^{\circ}\text{C}$. Max. operating temp is 1300°C . Solid-state control system provides easy furnace temperature regulation and simplicity of operation. BTU Engineering Corp., Bear Hill, Waltham, Mass.

Circle 146 on Inquiry Card



GLASS CAPACITORS

True hermetic seal protects against environmental conditions.

The Monobloc glass encased capacitors have capacitance ranges to 0.068 mf. They are available in 2 sizes: 0.100 in. in dia. by 0.260 in. long with a capacitance range to 10K pf.; and 0.130 in. in dia. by 0.390 in. long with a capacitance of 0.68 mf. Insulation resistance after 20 days of moisture cycling is 20K megohms. In manufacture, very thin films of ceramic are bonded into solid structures, yielding high capacitance-to-volume ratio. The resulting construction is said to provide rugged capacitors for critical uses. Erie Technological Products, Inc., Erie, Pa.

Circle 147 on Inquiry Card

SQUARE LENS LAMPHOLDER

The Contempo 300 Series indicator lights are two-terminal devices. They feature removable lenses in 4 colors. Lamps are replaced from front by removing lens. Series 301 features a $\frac{3}{4}$ in. sq. lens and mounts in a $\frac{7}{16}$ in. dia. hole. It is $1\frac{11}{32}$ in. long. Unique feature of this series is its "push-pull" lens. The lens is "pulled" to remove, and "pushed" to insert. The Sloan Co., P. O. Box 367, Sun Valley, Calif.

Circle 148 on Inquiry Card

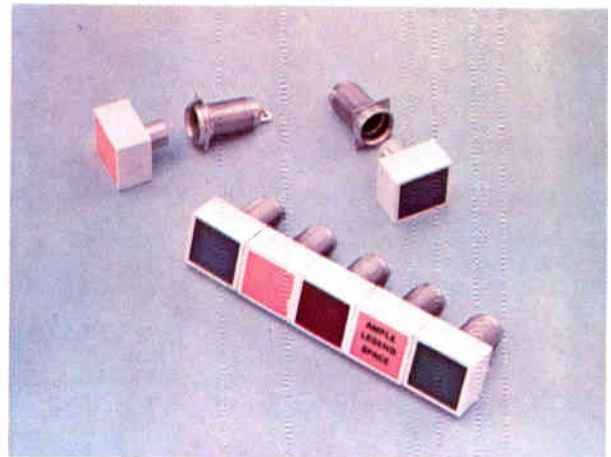

TECHNICAL REFERENCE

Vertical reference provides data with less than 0.5° of error.

The GVR-10 supplies accurate, gyro-stabilized roll and pitch synchro outputs during dynamic conditions. This done by compensating for acceleration errors which affect ordinary gravity-sensing erection systems. In addition, it provides outputs of vertical acceleration, vertical velocity, and flight-path angle. Accuracy of flight-path angle is 3%. Lear Siegler, Inc., 4141 Eastern Ave., S. E., Grand Rapids, Mich.

Circle 149 on Inquiry Card



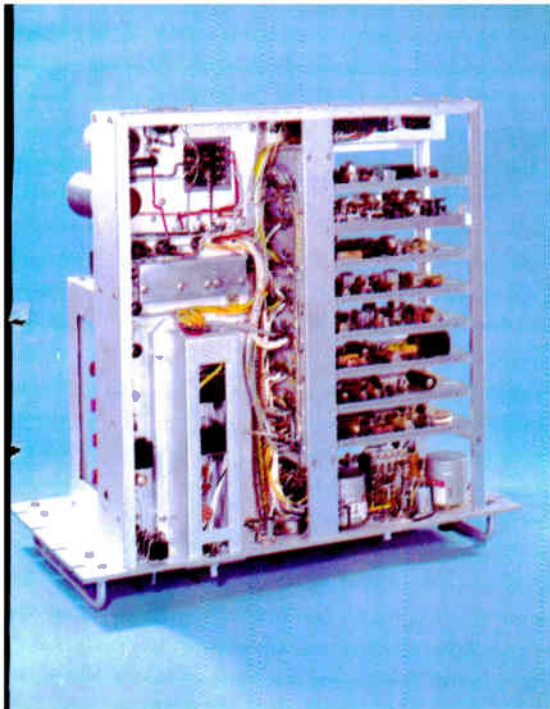

SPECTRUM ANALYZER

Freq. range 85 cps-8 kc. Response, ± 2 db; resolution 45-300 cps.

The 6061A audio spectrum analyzer provides visual records of amplitude vs. freq.; amplitude vs. time; and freq. vs. time vs. amplitude at very fast rates. It records any selected 2.4 sec. interval of an audio signal within the freq. range. The recording medium is magnetic tape. Input impedance is 50 ohms low level, 600 ohms and 10 K high level. Kay Electric Co., Maple Ave., Pine Brook, N. J.

Circle 150 on Inquiry Card

EDGEWISE PANEL METER

Model 111 thin-line edgewise panel meter has a compact flat case which allows stacking of meters. Accuracy is 2%. Front window size is 1.81 in. x 0.5 in., and depth behind panel is approx. 2.5 in. Scale length is 1.3 in. Meters can be horizontally or vertically mounted. Weston Instruments Inc., 614 Frelinghuysen Ave., Newark, N. J.

Circle 151 on Inquiry Card

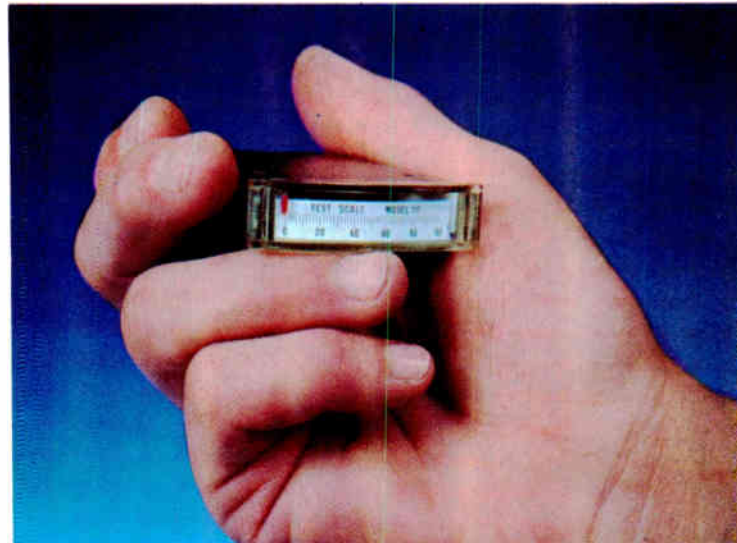

CALCULATOR

Combines computer speed with desk-top calculator simplicity.

Model 132 operates at speeds in the msec. range with answers appearing almost immediately on the screen. The simple 11-key keyboard and clearly marked controls, automatic decimal control from 0 to 13 places, and multiple registers, make it easy to operate. An outstanding feature is the automatic transfer of terms or intermediate answers which permits a logical flow of calculations. Friden, Inc., San Leandro, Calif.

Circle 152 on Inquiry Card

GAGING EQUIPMENT

The MICROtrol® 160-170 is a complete line of electronic dimensional gaging equipment. It performs a wide variety of functions, from the accurate measurement of layout surface plate work to ultra precision laboratory comparators. It also provides a convenient means of applying gaging and automatic control to new or existing machines. The line includes many basic and accessory units that can be combined to meet individual requirements of specific applications. Airtronics Instrument Laboratory, A Div. of Size Control Co., 2500 West Washington Street, Chicago, Ill.

Circle 153 on Inquiry Card



Report from

**BELL
LABORATORIES**

Programmed Measuring Set for High-Quality Communications

In a Long Distance telephone office, hundreds and often thousands of circuits must be maintained at prescribed levels of transmission quality. Test equipment and test procedures therefore must be such that preventive maintenance will ensure high-quality communications channels whenever customers need them.

At Bell Telephone Laboratories there is a continuing program under way to improve such test procedures and equipment by taking advantage of the latest advances in technology. One of the results of this program is a new test set developed by Bell Laboratories for

use in the Bell System. Much of the memory and logic required for the tests has been built into this push-button programmed set. With it, a man can make accurate measurements at speeds ten times faster than possible with earlier test equipment. It also greatly simplifies equipment alignment when necessary.

The tests are performed by measuring transmission "pilots"—special tones interspersed throughout the frequency band containing the channels. Instead of following a complicated series of tuning and measuring steps involving several pieces of equipment, the crafts-

man now rapidly sets up the test to be made by pushing buttons, performs simple balancing steps, and receives a digital readout of any deviation from prescribed values.

The entire test, including connections, takes only a few seconds. The test can be performed—and any required adjustment made—with the telephone equipment in service, without disturbing any conversations under way.



Bell Telephone Laboratories
Research and Development Unit of the Bell System

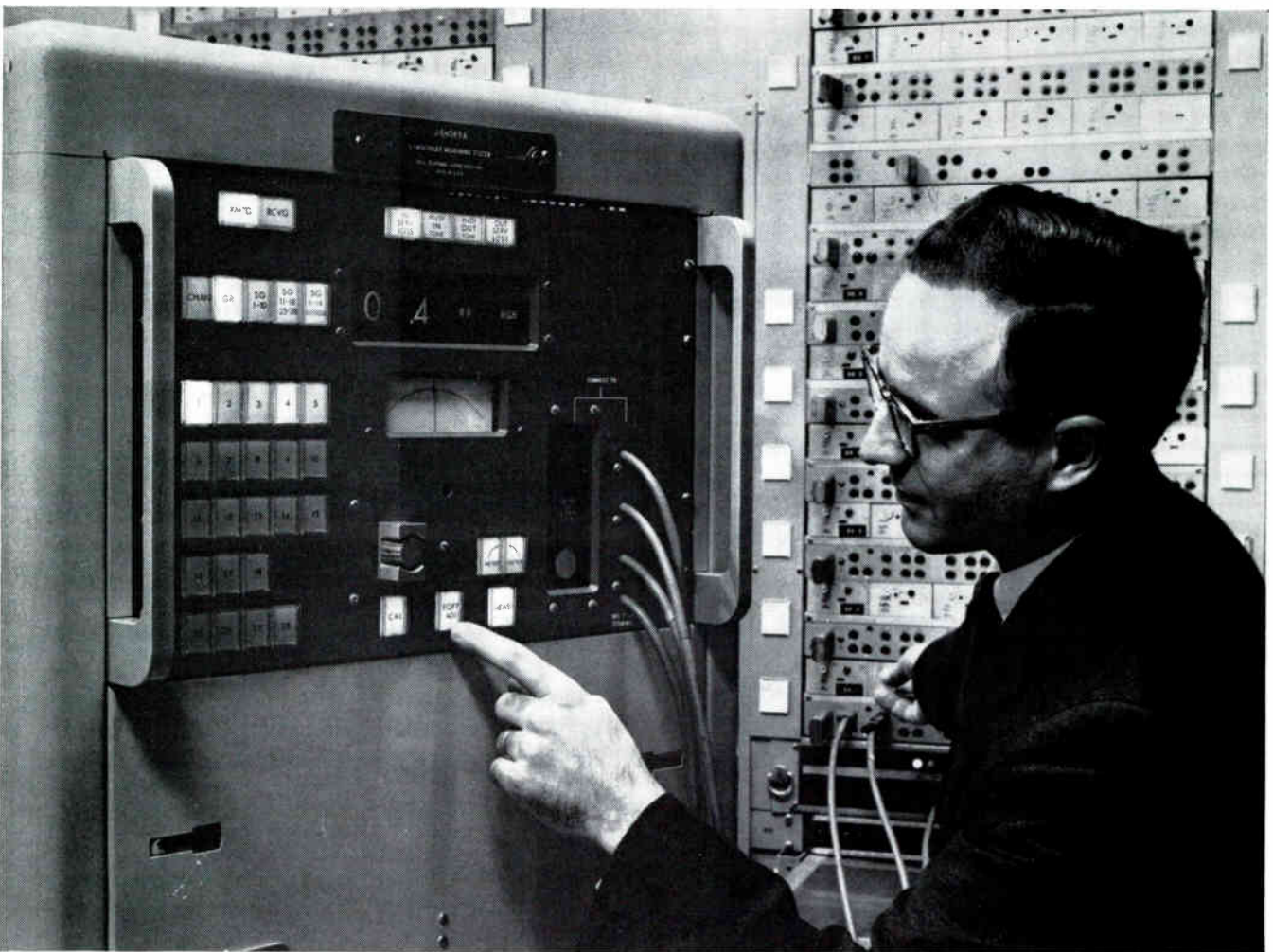

T. L. Maione demonstrating use of new measuring set developed at Bell Laboratories. He is about to adjust the in-service loss of transmitting group No. 1. The message displayed in the digital readout above the meter indicates that the loss of this group is 0.4 db higher than

prescribed value. The testing is programmed so that buttons and lights operate only if the correct procedure is followed. The set permits very narrow bandwidth measurements (.003% at 3 mcps, for example) of pilots as low as -63 dbm (0.5 nanowatt) with 0.1 db (1%) accuracy.



Take the 5894 out of the Amperex line of twin tetrodes and what have you got...

what have you got?

You've got the best developed, best manufactured, best proven line of indirectly-heated push-pull tetrodes in the world!

You've got the kind of tube quality, uniformity and applications assistance that only the oldest and biggest producer of vehicular communications types can offer!

You've even got new tetrodes on the way that'll revolutionize your design thinking as completely as the 5894 already has.

So you've got everything except the

5894. Isn't it lucky you can get that from Amperex, too.

But come to think of it you always could. We developed the 5894 in the first place, you know.

To get the word on Amperex Indirectly-Heated Twin-Tetrodes for your special vehicular communications application, wire or write:

Amperex Electronic Corporation, Tube Division, Hicksville, L. I., N. Y. 11802.

TYPICAL OPERATING CONDITION

Tube Type	Freq. (Mc.)	Approx. Drive Power (Watts)	Approx. Load Power Output (Watts)
5894.....	250.....	6.....	96
	470.....	3.....	33
6252.....	200.....	2.....	67
6360.....	175.....	1.0.....	16
6907.....	470.....	3.0.....	24
6939.....	470.....	1.2.....	6.0
7377.....	470.....	1.4.....	12.5
	960.....	1.5.....	5.0
7854.....	175.....	3.5.....	163
8458.....	175.....	1.2.....	30

Amperex®

IN CANADA: PHILIPS ELECTRON DEVICES, LTD., TORONTO 17, ONTARIO.

Circle 28 on Inquiry Card

World Radio History

CEC Leak Detector proves leak tightness of Apollo Spacecraft

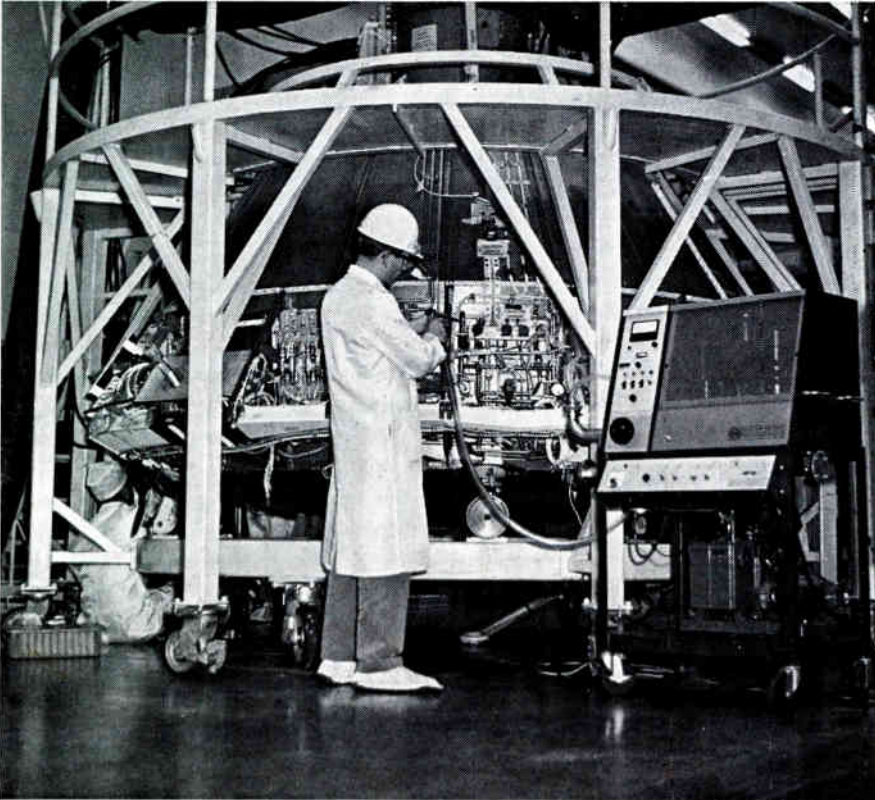

North American Aviation's Space and Information Systems Division is making certain that all systems in the Apollo Command and Service Modules can pass rigid leak inspection by using CEC's 24-120B Leak Detector.

In the Command Module, in which three astronauts will pilot the spacecraft

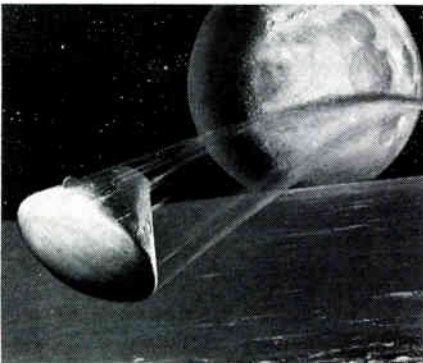

from Earth to Moon orbit and return, cabin hatches and seams plus more than 500 gold-brazed joints are checked and rechecked by using the 24-120B. Leaks as small as 2×10^{-8} atm cc/sec/div of helium must be located and sealed.

Furthermore, each of the joints in the systems used to steer the spacecraft and maintain its "shirtsleeve" environment is required to meet standards that assure leak integrity in the vacuum of space — as well as during the heat of re-entry when external temperatures reach an awesome 5000°F.

Similar tests are applied to all joints and seams in the tanks, lines and engines of the Service Module and the giant Saturn S-II second-stage booster. In the S-II stage, a pressure of 36 psi is required in the liquid hydrogen tank, which makes constant leak tightness an absolute necessity.

In these and other programs, CEC's 24-120B has proved to be efficient, reliable, and versatile. Is it any wonder that the 24-120B Leak Detector has become the ideal answer for virtually every critical leak checking application, from bench-top to mobile testing?

Primary advantages:

- ☐ Detects and locates leaks as small as 5×10^{-11} atm cc/sec/div of helium.
- ☐ Can detect as little as one part of helium in 10 million parts of air.
- ☐ Less than 1 second is required to produce 50% full-scale deflection on x 1 scale of leak rate meter.
- ☐ Built-in automatic protection valve guards leak detector vacuum system against external pressure bursts.
- ☐ Includes high-conductance roughing valve permitting use of 15 cfm pumps for fastest pumpdown yet devised.

A complete line of accessories to meet every conceivable need:

- Audio Alarm
- Semi-Automatic Test Port Stations
- Adjustable & Fixed Sampling Probes
- Multiple Valve Fast-Response Inlet Manifolds
- Calibrated Leaks
- Tracer Gas Spray Probe
- External Cold Trap
- Quick-Disconnect Manifold Adaptors
- Mobile Workstand

For complete information about the 24-120B, call or write for CEC Bulletin 24120B-X24.

CEC

Analytical & Control Division

CONSOLIDATED ELECTRODYNAMICS

A SUBSIDIARY OF BELL & HOWELL/PASADENA, CALIF. 91109
INTERNATIONAL SUBSIDIARIES: WOKING, SURREY, ENGLAND
AND FRIEDBERG (HESSSEN), W. GERMANY

This is ITT Electron Tube Division

ACHIEVING THE BEST is impossible without care and capability. Producing the best electron tubes—whether “standards” by the hundreds or “specials” by two’s—our care and capability becomes evident as in the envelope assembly of this miniaturized BWO (A) . . . in the final visual inspection of this massive hydrogen thyratron prior to packing (B) . . . in the eagle-eyed inspection of the delicate web-like grid of this industrial power triode (C) . . . exhaust and hydrogen fill process required for these thyratrons (D) . . . in the frequent inspection of tubes in stock (E) . . . in cradle-coddling this broadcast triode being readied for shipment (F) . . .

It's evident too in our production of the world's largest liquid cooled power tubes each weighing more than 80 pounds, or lightweight miniaturized, high resolution image dissectors for space exploration. Care and capability are part of the talents of the people of ITT Electron Tube Division who work for you at two new plants in Easton, Pennsylvania, and Roanoke, Virginia. Here they produce power tubes, hydrogen thyratrons, TWT's, BWO's, mm wave klystrons, storage tubes, image converters . . . and the tubes that are just beginning to take shape from ideas. This is a glimpse of what you'd see at these two unique facilities.

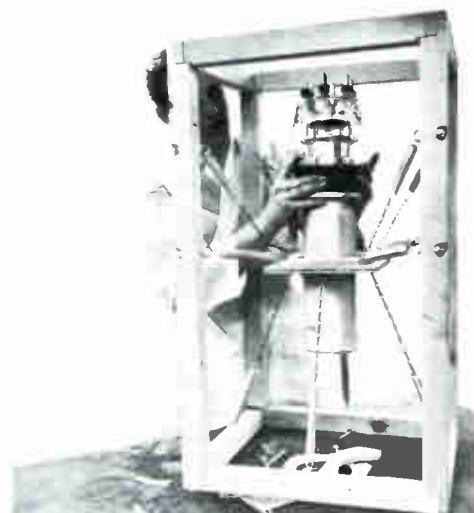



G

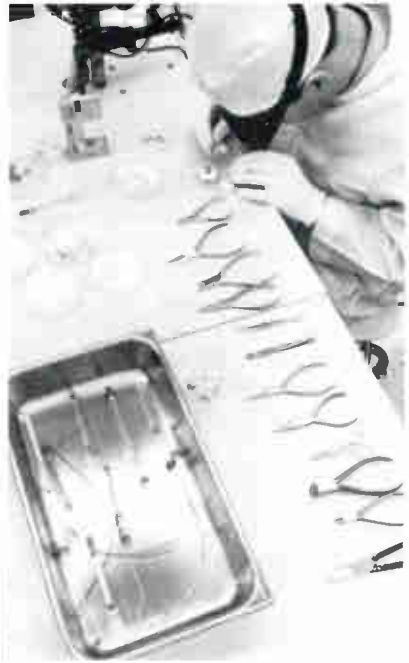

H

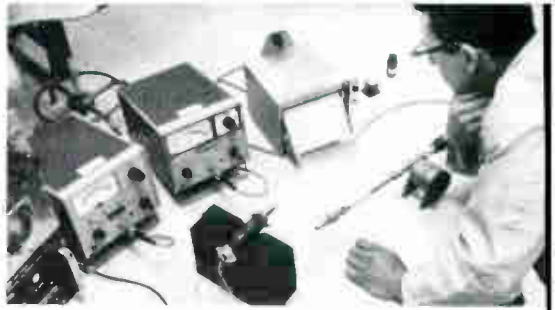

J



M



Q



P



R



N



O



U

This is ITT Electron Tube Division

... engineers checking new needs against past performance, getting the facts that mean a new or improved tube (G) ... while microscopic elements of a new TWT are assembled with a surgeon's skill (H) ... design and craftsmanship are verified by precise recording and metering (I) ... followed by more test and development in this section (J) ...

passing tests means production in this controlled atmosphere assembly room (K)

... where latex finger covers prevent minute quantities of skin oil from contaminating klystron elements during welding (L) ...

storage tubes await transfer to the next stage of manufacture in the clean room air lock (M) ... where a facile technician weaves a web of wires, constructing the cathodes of a broadcast triode (N) ...

wires are welded into a single structure in a hydrogen atmosphere (O) ...

and inspected for possible flaws prior to complete assembly (P) ...

joining and sealing the envelope that gives the tube its shape and substance is the work of

39 experienced glass blowers (Q) ... red hot heat degasses metals and the first shock of power begins a 20-hour seasoning of this triode (R) ...

we test power triodes in this 600 kw test set, one of two such sets in existence (S) ... or carefully check the overall performance of these airborne weather radar thyratrons (T) ...

evaluate broad band TWT's (U) ... test peak power of hydrogen thyratrons up to 288 megawatts in the largest test installation of its kind (V) ...

conduct life tests on hydrogen thyratrons in aisle after aisle of chambers such as these (W) ... and start to ship the ones that pass (X). ■ Ship well cradled, accompanied by a tattle-tale that tells of careless handling. Colored beads at the arrow's base stick to a tacky section in the middle if the crate is tilted off vertical (Y). ■ Care and capability ...

from your requirement to design, development, production, to you ... care and capability, two factors that make ITT Electron Tubes just a bit better than standard number and nomenclature indicates. (Is there a suffix for that spec number that means best?) ■ A partial listing of the hundreds of available tubes is on the next page. For a more complete tabulation or specifications write ITT Electron Tube Division, International Telephone and Telegraph Corporation, Easton, Pennsylvania.

from your requirement to design, development, production, to you ... care and capability, two factors that make ITT Electron Tubes just a bit better than standard number and nomenclature indicates. (Is there a suffix for that spec number that means best?) ■ A partial listing of the hundreds of available tubes is on the next page. For a more complete tabulation or specifications write ITT Electron Tube Division, International Telephone and Telegraph Corporation, Easton, Pennsylvania.

from your requirement to design, development, production, to you ... care and capability, two factors that make ITT Electron Tubes just a bit better than standard number and nomenclature indicates. (Is there a suffix for that spec number that means best?) ■ A partial listing of the hundreds of available tubes is on the next page. For a more complete tabulation or specifications write ITT Electron Tube Division, International Telephone and Telegraph Corporation, Easton, Pennsylvania.



K

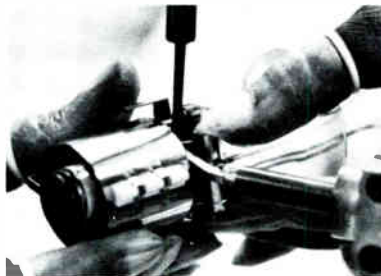

L

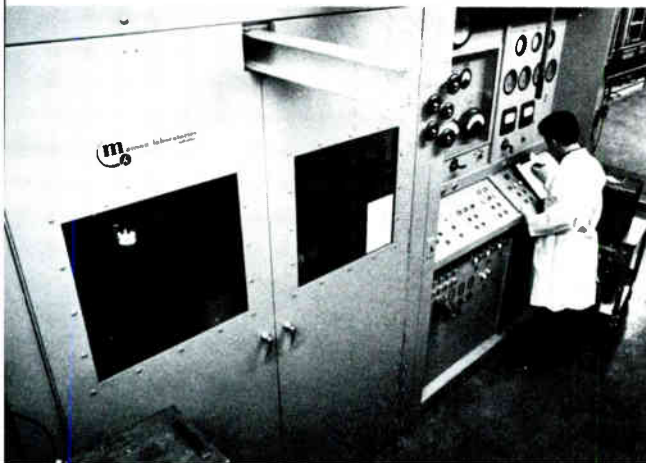

S



T



Y



V



W



X



Here are a few of the hundreds of tubes available. Which ones do you need?

PULSE POWER TRIODES

TYPE	Epx	Pulse Current Rated F11 Ipk
F-7C23	17.5	25
F-5680	17.5	35
F-5918	35.0	140
F-6398	65.0	400
F-6401	17.0	75
F-6920	35.0	140
F-7012	17.5	40
F-7560	46.0	375
F-7839	65.0	160
F-8033	65.0	500
F-8047	22.0	150
F-8145	75.0	300

Epx — max. peak inverse voltage

TRAVELING WAVE TUBES

TYPE	Frequency KMF	Power Output (Watts)	Focus
F-2075	1.1 to 1.8	2	PPM
F-6658	1.7 to 4.0	2	S
F-6868	1.7 to 4.0	10	S
F-2086	2.0 to 16.0	2	PPM
F-2038	2.0 to 4.0	100(P)	S
F-6825	2.0 to 4.0	1000(P)	S
F-2057	2.0 to 4.0	1000(P)	PPM
F-2507	4.0 to 8.0	1000(P)	PPM
X-282	4.0 to 8.0	10	S
F-2019	4.0 to 8.0	10	PPM
F-2032	5.4 to 5.9	4000(P)	S
F-2071	5.0 to 11.0	1	PPM
F-2084	5.4 to 11.0	10	PPM
F-2552	7.0 to 11.0	20	PPM
F-2072	8.0 to 12.0	10	PPM
F-2087	8.2 to 12.4	15	PPM
F-2088	8.5 to 9.6	25	PPM
F-7340	7.0 to 11.0	1000(P)	S
F-2533	7.0 to 11.0	1000(P)	PPM

CW POWER TRIODES

TYPE	Dissipation ² (KW)	Input ² (KW)
F-7C25	2.5	6.5
F-8C25	12	30
F-5604	10	32.5
F-5606A	10	30
F-5666	12.5	20
F-5657	7.5	20
F-5668	20	28
F-5669	10	28
F-5771	22.5	60
F-5874	25	30
F-6009	6	12
F-6366	3	7
F-6367	3	12
F-6374	70	150
F-6398	225	400
F-6399	6	9
F-6400	6	12
F-6696	60	144
F-6697	35	144
F-6800	10	40
F-6803	70	175
F-6804	35	150
F-6925	3	12
F-6926	6	12
F-7206	20	60
F-7207	17	30
F-7532	10	18
F-7560*	175	600
F-7820	4.3	
F-7831*	20	60
F-7832*	30	60
F-7837	90	200
F-7838	25	200
F-8033	90	200
F-8045	90	200
F-8046	35	200
F-8104	8	12
F-8131*	8	18
F-8132*	5	18
F-8133*	10	18
F-8146*	40	80
F-8147*	20	80
F-8148	40	64
F-8333	30	60
F-8387	45	250
F-8386*	100	250
F-8387*	45	250
F-8388	100	250
F-8550	45	120
F-8555*	3	16

*Ceramic Construction

HYDROGEN THYRATRONS

TYPE	Po MW	Epy KV
3645	.05	3.0
6777	.12	8.0
8370	.22	5.0
5957	.33	8.0
4635A	.35	8.0
7621*	.4	8.0
5622	2.0	16.0
6587	2.0	16.0
7782*	2.0	20.0
7665*	3.5	20.0
5949A	6.0	25.0
5948	12.0	25.0
7322*	12.0	25.0
8354*	12.0	25.0
7666*	18.0	25.0
1257	33.0	33.0
7390*	33.0	33.0
7667*	40.0	33.0
7890*	48.0	40.0
7866*	60.0	50.0
F-74B*	66.0	33.0
8479*	100.0	50.0
8301*	100.0	50.0

*Ceramic Construction

POWER DIODES

TYPE	Epx	Ipk
F-7030	25	30
F-7100	30	30
F-7131	40	40
F-7779	25	30
F-7869	56	65
F-7906	50	50
F-7907	50	50
F-8034	25	25
F-8109	60	60
F-8110	60	60
F-8207	30	20
F-8208	45	10

BACKWARD WAVE OSCILLATORS

TYPE	Frequency KMC	Power Output (Watts) (mw)	Focus
F-2508	1.0 to 2.0	100	PM
F-2513	1.3 to 4.0	25	PM
F-2507	1.8 to 2.8	100	PM
F-2509	2.0 to 4.0	100	PM
F-2514	2.0 to 8.0	20	PM
F-2556	2.0 to 4.0(1)	10	PM
F-2512	3.6 to 7.2	20	PM
F-2517	3.7 to 5.5	50	PM
F-2544	4.0 to 8.0(2)	10	PM
F-2555	4.0 to 8.0(1)	10	PM
F-2510	4.0 to 8.0	25	PM
F-2521	5.4 to 5.9	250	PM
F-2516	5.3 to 11.0	25	PM
F-2518	6.6 to 8.7	50	PM
F-2547	7.0 to 11.0(1)	10	PM
F-2520	7.0 to 12.4	20	PM
F-2554	8.0 to 12.0(1)	10	PM
F-2511	8.0 to 12.4	25	PM
F-2557	12.0 to 18.0(1)	10	PM

(1) sub-miniature size—1.5 lb., 13 in.³
(2) miniature size 3.5 lb., 36 in.³

HYDROGEN DIODES

TYPE	Epx KV	ib a
F-51	15	
7178	16	500
F-52	18	325
F-91	15	150
8274	20	300
8275	30	500
8376	33	750
8276	40	2000

IATRON STORAGE TUBES

TYPE	Diameter (Inches)	Focus Mode	Deflection
F-229	2.5	ES	ES
F-235	4.0	ES	ES
F-7173	4.0	EM	EM
F-212	5.0	ES	ES
F-241	5.0	ES	ES
F-243	5.0	ES	ES
F-267	5.0	EM	EM
F-3001	5.0	ES	ES
F-3006	5.0	ES	EM
F-3007	5.0	ES	EM
F-3010	5.0	ES	ES
F-3013	5.0	ES	EM
F-3014	5.0	ES	EM
F-7423	5.0	ES	ES
F-3018	5.0	ES	EM
F-201	6.0	EM	EM
F-245	7.0	EM	EM
F-247	7.0	ES	ES
F-3501	7.0	ES	ES
F-271	10.0	ES	ES
F-272	10.0	EM	EM

TRIGGERED SPARK GAPS

TYPE	Maximum Holdoff Voltage KV	Energy Discharge Joules
F-810	14.0	200
F-811	7.5	200
F-820	30.0	2500
F-821	19.0	2500
F-822	42.0	2500
F-823	7.5	2500
F-830	86.0	4500
F-831	70.0	4000

NOISE SOURCES

TYPE	Frequency Gc
F-2813A	1.0 to 2.0
F-2824A	2.9 to 3.1
F-2837A	5.4 to 5.9
F-2854A	8.5 to 9.6
F-2864A	15.0 to 17.0
F-2887A	26.0 to 40.0
F-2897A	50.0 to 75.0
F-2898A	60.0 to 90.0
F-2899A	90.0 to 140.0

KLYSTRON TUBES

TYPE	Frequency GC	Power Output MW
F-2904	28.0 to 33.0	1100
F-2906	28.0 to 33.0	600
F-2900	33.0 to 40.0	1100
F-2905	33.0 to 40.0	600
F-2907	44.0 to 49.0	1100
F-2908	44.0 to 49.0	600
F-2902	69.0 to 76.0	250



electron tube division

ITT Electron Tube Division, International Telephone and Telegraph Corporation, Easton, Pa.

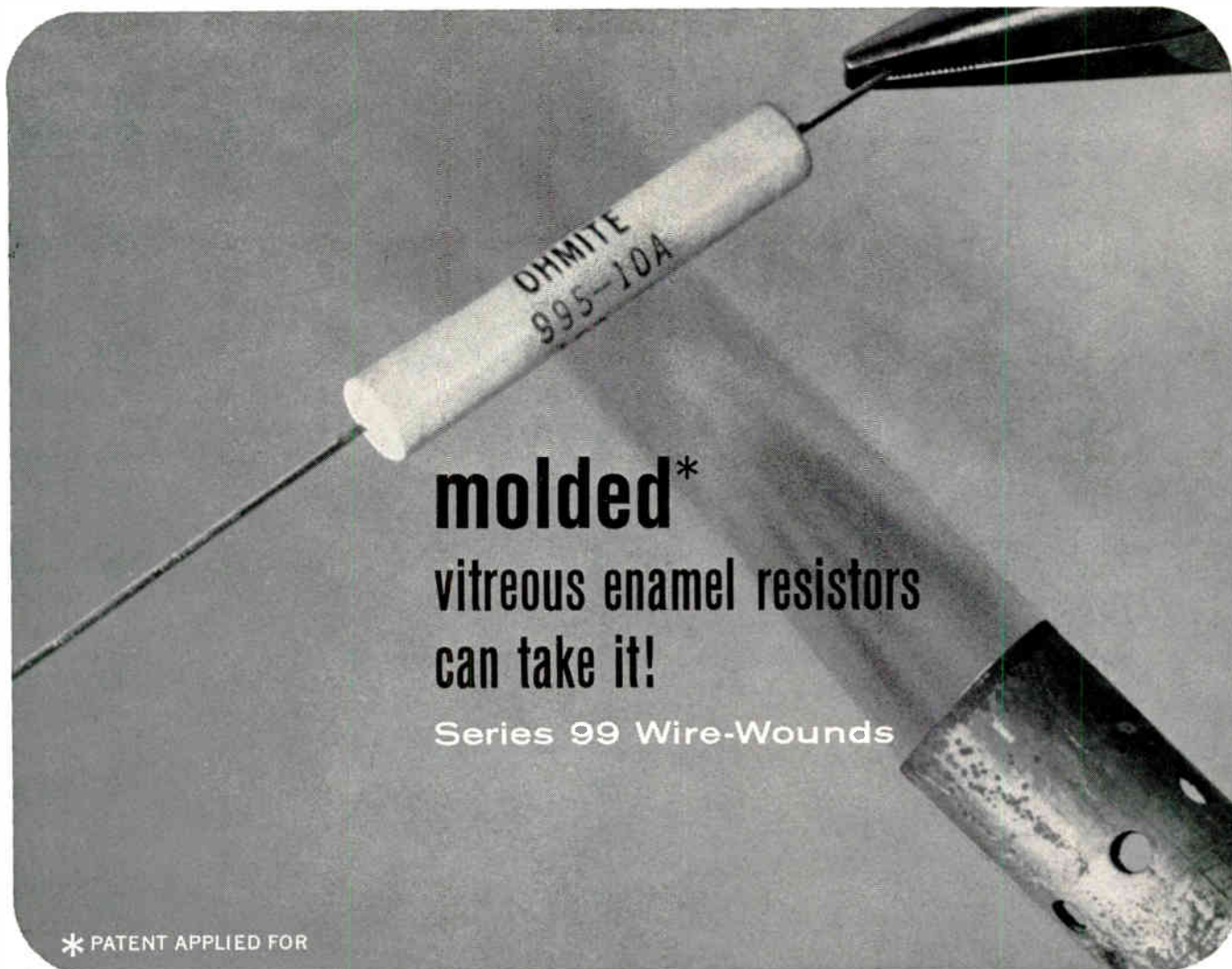

molded* vitreous enamel resistors can take it!

Series 99 Wire-Wounds

* PATENT APPLIED FOR

■ Prove it to yourself. Get some samples and try these tests. You'll find that Series 99 resistors will not deform at a red hot 1500°F . . . that the markings will not dissolve or rub off . . . that lead bending doesn't chip the jacket. Then note the uniform shape which won't jam automatic assembly equipment, and gives snug fits in fuse-type clips with up to 100% wattage increase on a metal surface. Specify them on your next project for an extra edge in reliability.

Stocked for immediate delivery in 5% tolerance in five wattage sizes and 146 resistance values.

Nominal Wattage Ratings—1.5, 2.25, 3.25, 5, 6.5, 9, 11 watts at a maximum hot spot temp. of 350°C, 25°C ambient.

Resistance Values—0.1 to 187K ohms.

Tolerances—0.25% to 5%.

Temperature Coefficient— 0 ± 30 ppm/°C at +25°C to +350°C for 10 ohms and above.

Cyclic Loadlife Test—24,542,000 unit-hours.

Insulation—1000 VAC minimum breakdown rating.

Stability—Less than $\pm 2\%$ ΔR after 2000 hours of cyclic testing for Type 994.

MIL Requirements—Meets MIL-R-26C and proposed MIL-R-26D specifications.

Moisture Resistance—Withstands the 10-day MIL-R-26 test after 2000 hours of cyclic loadlife at full-rated wattage.

Write for Bulletin 103

RHEOSTATS • POWER RESISTORS • PRECISION RESISTORS •
VARIABLE TRANSFORMERS • TANTALUM CAPACITORS • TAP
SWITCHES • RELAYS • R.F. CHOKES • SEMICONDUCTOR DIODES

ELECTRONIC INDUSTRIES • September 1965

TORTURE IT!



ABRADE IT!

**SOAK IT
IN SOLVENT!**



OHMITE
MANUFACTURING COMPANY
3662 Howard Street, Skokie, Illinois 60076
Phone: (312) ORchard 5-2600



Circle 31 on Inquiry Card

61

From Sola, the CV leader...

...now, the "Little Tiger"

...the only
constant
voltage regulator
in captivity
that is frequency
insensitive

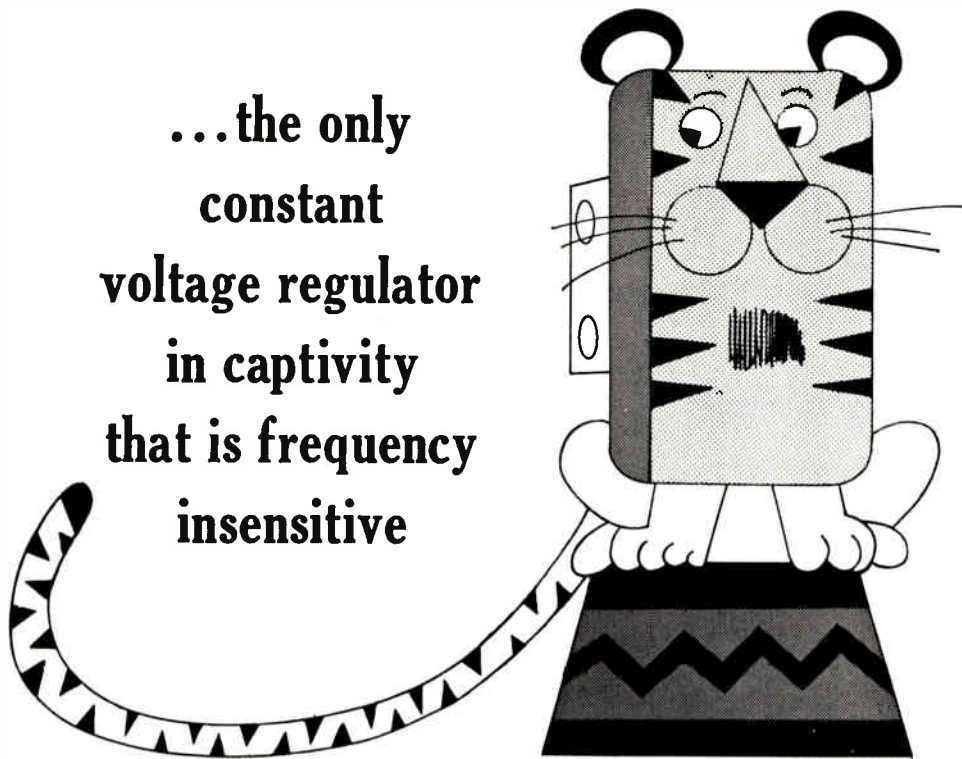

Get a "Little Tiger" of your own ...

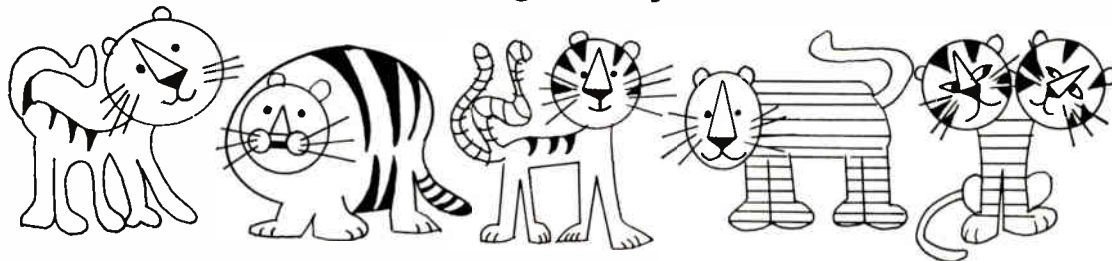

custom designed any way you want it.

It will put an end to one of your most sensitive problems . . . a problem no other constant voltage regulator has been able to master.

Our new frequency insensitive "Little Tiger" is available for 50/60 cycles (47 to 63 cycles). Also adaptable to military applications including 400 cycles. And it regulates to within $\pm 1\%$ rms, from an input voltage range of 108 to 132 volts for total line, load, and frequency changes. Present ratings range from 40 to 250 VA. Typical sizes: 60 VA — 4" x 4" x 3"; 120 VA — 4" x 4" x 4"; 240 VA — 4" x 4" x 6".

We can tailor the "Little Tiger" in every way to your specific application. Such features as power factor loading, overload characteristics, harmonic content, and speed of response will be determined

after carefully analyzing your requirements. Write for complete information or contact your local Sola representative . . . listed in the Yellow Pages of most major markets. (Or have a talk with Jim Kimball at Sola. Telephone: 312-439-2800.)



Division of Basic
Products Corporation
SOLA ELECTRIC CO.,
1717 Busse Rd., Elk Grove, Ill., HEmpstead 9-2800
IN CANADA: SDLA BASIC PRODUCTS, LTD.,
377 Evans Avenue, Toronto 18, Ontario

Industry's voltage regulation headquarters

SHORT CUTS

TO SUCCESSFUL DATA PROCESSING SYSTEMS

MAGNETIC
SYSTEMS

MAGNETIC SYSTEMS CORPORATION
2000 Calumet Street
Clearwater, Florida

Gentlemen:

Please send me my free copy of "Short Cuts to Successful Data Processing Systems."

Name _____

Title _____

Company _____

Address _____

City _____

State _____ Zip _____

This NEW design aid can cut logic hardware as much as 50%

Send for your free copy today!

The information in "Short Cuts," a just-published design aid from Magnetic Systems Corporation, will speed and simplify the design and specification of digital logic systems. And it can reduce the number of components required by as much as 50%.

Among other things, "Short Cuts" contains:

- Six rules for foolproof implementation of compatible 1Mc NAND-NOR logic. With these rules — and Magnetic Systems' exclusive new compatible logic modules — you can mix NAND and NOR elements in the same logic system, whether it's positive or negative.
- Specific examples that show you how Magnetic Systems 1Mc NAND-NOR compatibility cuts component requirements by 10 to 50%.
- Detailed specifications for a new, complete line of compatible welded encapsulated modules.
- An easy-to-use selector chart for fastest selection and specification of modules for your system.

The cost? Nothing. The coupon above or the reader service card in this magazine will get you a free copy immediately.

**MAGNETIC
SYSTEMS
CORPORATION**

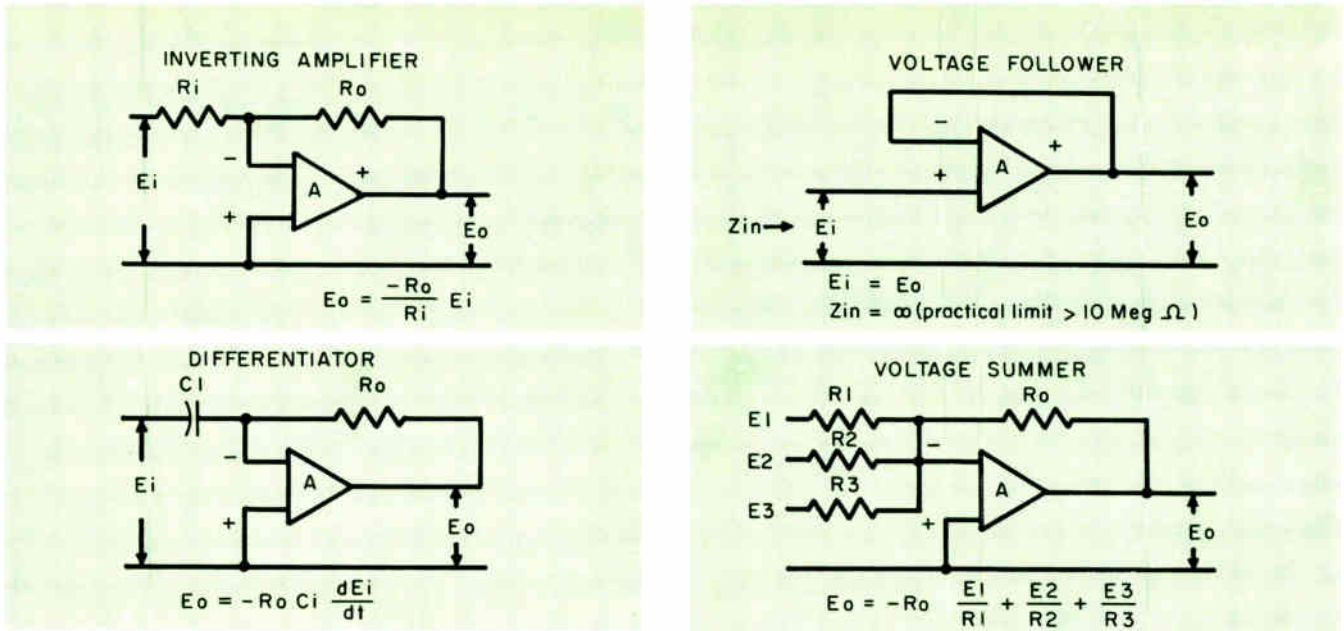

Fig. 1: Examples of a few of the various circuit functions obtainable by using feedback around a standard amplifier.

A Look at Linear Integrated Circuits

A close look at linear integrated circuits is taken by the author. He discusses their development, use and capabilities. He also discusses device improvements coming in the near future and new technologies that may provide the functions normally performed by capacitors, transformers, and inductors.

ELECTRONIC INDUSTRIES
STATE-OF-THE-ART
FEATURE

ANY LOW LEVEL LINEAR SYSTEM with a frequency response requirement of less than 200 MC can be designed using available monolithic integrated circuits (IC's). Of course, there are many advanced systems being designed today

without linear IC's. This is because present IC's cannot necessarily do a better job, or sometimes even as good a job as discrete components. Although the capability, reliability, and small size are there, compromises which may have to be made may not warrant conversion of the discrete component circuit to IC's.

This article will examine the causes of the relatively slow development and use of monolithic IC's, and the capability of the devices available to the circuit designer today. Also discussed will be device improvements likely to be on the market in the next 12 months and new technologies that may provide the functions normally performed by capacitors, transformers, and inductors.

The term "microelectronics" and the often synonymously used "integrated circuits" refer to a whole spectrum of circuit assembly technologies. These technologies span a wide range. They include: cord-wood modules assembled from unusually small discrete components, passive components simultaneously built on a common substrate that has the active components attached, active and passive components made by similar

process separately and then assembled by wire bonding (often referred to as "chip and wire"). Also included are circuits in which active and passive components are built in a single monolithic structure and all interconnections are made simultaneously by forming a metal interconnection on the surface of the monolithic bar of active and passive components. This article will consider only monolithic IC's, because this process offers maximum potentialities in regard to cost, reliability, performance, and size.

Linear Circuit Development

Industry literature reveals that there are at least 10 times as many standard digital IC's offered for sale as there are linear circuits. Observation of manufacturers' linear "standards" discloses that many of these circuits were designed for very specific system needs; that other than the unique application for which they were designed they have limited use.

There are many reasons for there being more digital IC's available than linear circuits. The same digital circuit function may be used hundreds of times in a

By **WILLIAM L. FOWLER**,
Manager,
Linear Integrated Circuits Marketing,
Texas Instruments, Incorporated,
Dallas, Texas

single computer. Thus, the IC manufacturer chose this type of circuit to build first, since only a few different designs were needed to gain access to a large potential market. There is no similar large repetitive market for linear circuits except, possibly, in the i-f amplifier area. This circuit function as it is now accomplished is a difficult one in which to realize the major advantages of monolithic IC's.

Another reason that the logic circuits are so abundant is that discrete component logic circuit designs have been easy to translate directly into monolithic form. Direct translation of linear circuit designs into integrated circuitry is usually impossible or impractical. Early digital IC's were simply monolithic versions of discrete component circuits that had been in production almost unchanged for years. In fact, only recently with the introduction of transistor transistor logic (TTL) have logic circuits been designed specifically to use the advantages of monolithic construction.

A further deterrent to the growth of the number of standard linear IC's has been one of component tolerances. The linear circuit designer is accustomed to requiring resistor tolerances of 10% or better, narrow H_{FE} spreads and other tight component specs. The logic designer on the other hand, to reduce the cost and insure the working of his large numbers of identical circuits, has grown accustomed to doing worst-case analysis and statistical analysis so that individual component tolerance needs are minimized. This design approach has also made conversion of digital circuit requirements to black box specs relatively easy. Because the economical approach in linear circuit design in the past was usually to use a few tightly specified components rather than many loosely specified devices, the linear circuit designer must change his concept of efficient design.

Part of the burden of the slow development of linear IC's must rest on the linear systems designer. The conversion from discrete components and semiconductor devices to integrated circuitry in many ways is a similar problem to the conversion of tube linear amplifiers to semiconductors. The linear systems designer finds that it is usually necessary to change the whole system design and is reluctant to do it. Signal levels must be reduced, power supply voltages probably have to be altered, and often the whole manner of accomplishing the desired circuit function must be changed. Systems design under these conditions is enough more difficult that designers have been slow to learn and use effectively the advantages of linear IC's.

Operational Amplifiers

The nearest thing to a standard linear IC is the differential or operational amplifier. Operational amplifiers are usually thought of as having a single output and an inverting and a non-inverting input so that either positive or negative feedback can easily be applied. The differential amplifier is a special form of operational amplifier. In the differential type, both inputs have

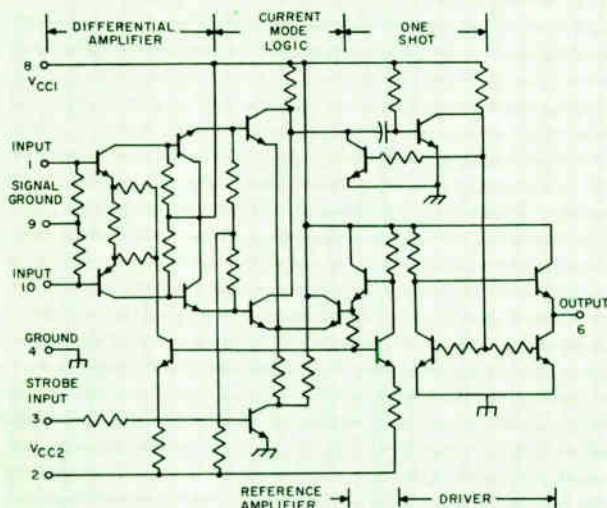
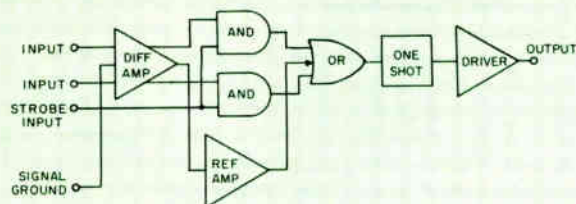
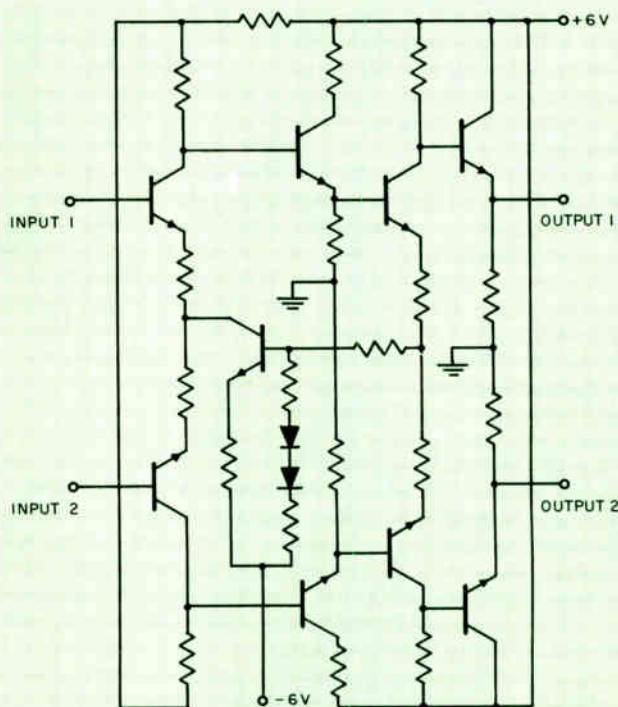

Fig. 2: Circuit and logic diagram of the SN5500, a complete monolithic sense amplifier including differential preamplifier, reference amplifier, strobe gate and pulse shaping output circuit.

Fig. 3: Circuit diagram of SN5510 video differential amplifier shows differential output and common-mode feedback amplifier.



LINEAR IC's (Continued)

separate outputs so that the difference in the input signal is amplified and is available as a difference signal at the output. The differential type may be used as a normal operational amplifier by ignoring one of the outputs. Many different circuit functions can be performed with an operational amplifier by using different feedback networks around the amplifier, Fig. 1. In this manner, entire linear systems can be built using the same standard amplifier, and the advantages of IC's can be fully achieved. The equations in Fig. 1 indicate that performance of the configuration is independent of the operational amplifier. This is true only in the case of an ideal operational amplifier, but using available integrated operational amplifiers, the simple equations in Fig. 1 will be accurate within 10%. The ideal operational amplifier would have an infinite gain, infinite input impedance, and a zero output impedance.

current capability. But, looking at the SN525A and SN526A which were introduced by Texas Instruments in March, 1965, it is obvious that presently available monolithic integrated operational amplifiers meet or in many cases exceed the performance of the typical discrete component amplifier. Only on open loop gain do they not meet or exceed the discrete component amplifier specs. And, for nearly all circuit designs, a gain of 88 db is entirely accurate. In some respects, not indicated on the chart, the integrated operational amplifier exceeds the performance of the discrete components amplifier. Because the transistors are manufactured simultaneously, and close together, the V_{be} and H_{FE} matching of input pairs and their temperature drift characteristic are much better than is normally available. This is true even in special dual input transistors made especially for use in differential amplifiers.

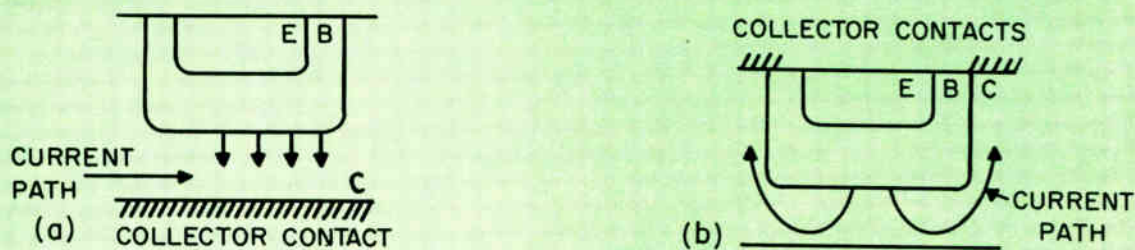

Fig. 4: Drawings a, b, c and d (above and opposite page) illustrate integrated and conventional transistor construction.

Unfortunately, except for manufacturers of instrumentation equipment and analog computers, this feedback concept with a standard amplifier is not generally used by linear circuit designers. Although the fundamentals for this approach are generally well covered in all EE courses, the concept has been largely ignored by most designers of linear systems. The main function of the linear circuit designer in recent years has been to obtain maximum gain using the fewest possible number of components. In doing this, designers have lost the art of using a standard amplifier to obtain many different circuit functions. This feedback concept is also particularly suited to IC's. This is because the complete circuit specification is dependent on the tolerance of one or two feedback components rather than any variation in the components of the integrated operational amplifier. There have been many companies making operational amplifiers from discrete transistors and components for several years. Typical characteristics of one of their amplifiers and some of the amplifiers that are available in monolithic form are shown in Table 1.

When the SN521A was introduced in Dec., 1962, it fell somewhat short of the then available discrete component amplifier on gain, input impedance, and output

The same design approach of balance amplifiers has also been used for the design of wider bandwidth amplifiers such as the SN5500 and SN5510. Both the logic diagram and the circuit of the SN5500 are shown in Fig. 2. The SN5500 is the best example to date of optimum use of the full capabilities of a monolithic circuit. The SN5500 is a complete sense amplifier for magnetic core memories; it requires no external components except for connections to input and output circuits and power supplies. The large number of components available on this bar and a circuit design that makes use of the balance of the components and the ratio rather than the absolute value of resistors permit this device to provide all the needed functions of a magnetic core sense amplifier in a single package whose volume is 0.001 in.³

The differential amplifier raises the bipolar magnetic core output to the proper level to operate the current-mode logic AND circuits. These circuits, along with the strobe input, prevent any signal other than one present at "read" time from triggering the one-shot output. If the strobe and a memory output signal are present simultaneously, they are compared at the OR logic stage to the internally generated reference voltage to determine whether or not the sensed signal is of

enough magnitude to represent a logic one. If logic one is present, the one-shot activates and a signal compatible with integrated digital circuits is present at the driver. This circuit also features high common-mode signal rejection, fast recovery time, and a sensitivity characteristic that varies in a manner analogous to that of a magnetic core over the full military temperature range.

The SN5510 is a dc to 40 mc amplifier with a minimum gain of 40 db over this frequency range. It can be used as a constant gain video amplifier, and by selection of proper feedback networks can also be used as an i-f amplifier, a zero-cross-level detector, a pre-amplifier for low level sensing, and for many other h-f uses. The SN5510 circuit, Fig. 3, again illustrates the use of balanced amplifiers in a differential amplifier setup.

small solid state frequency selective device is much more critical. The major advantage of IC's is achieved when many stages of amplification can be cascaded in a single package. The normal i-f amplifier design with its single stage amplifier followed by a tuned coil fails to use either this advantage or the even size advantage of monolithic fabrication. The other i-f design methods of using mechanical or crystal filters followed by a high gain, wide bandwidth amplifier or the use of resistor-capacitor filters to provide frequency selectivity are more amenable to use with IC's. High gain, wide bandwidth amplifiers such as the SN5510 are certainly useful in receiver designs using mechanical filters, but the difficulties of applying AGC to such an amplifier limits its usefulness to FM receivers. But, a similar gain-controllable amplifier could be developed for AM receiver use. Some work has been done using T-notch

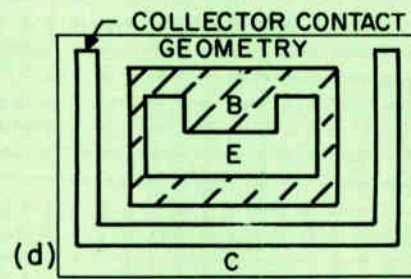
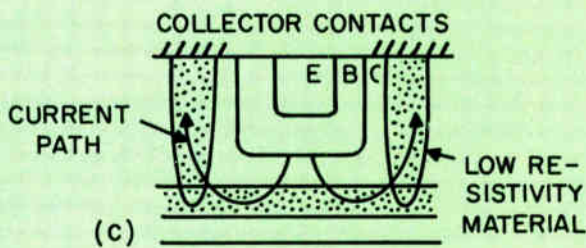

Special Problems

IC's encounter several special problems in the linear applications of r-f, i-f and power amplifiers. Most of these problems are a deterrent to the digital IC designer also. The major problems in r-f and i-f IC amplifier design are the parasitic capacitances between elements in the monolithic substrate, the capacitances between the element and the substrate, often ground, and the lack of a compatible solid state frequency selective scheme.

Better photographic methods in the past few months have greatly improved the frequency response of monolithic circuits by helping reduce the device geometries and, therefore, their associated capacities. Transistors with 0.05 pf collector-base capacitances and 2 pf collector-to-substrate capacitance are available in standard devices. The cutoff frequency of transistors available in monolithic form now exceeds 1 GC. Circuit problems associated with the Miller capacitance effect, however, still keep the full frequency capability of the integrated transistor from being realized in other than very simple circuit configurations. The oxide isolation method promises to eliminate the inter-component capacity problem.

The problems of i-f amplifiers are similar to those of r-f, but in i-f design, the need for an economical

filters built on the monolithic substrate to provide selectivity. This method will probably be useful later for i-f frequencies below 500 kc where lumped constant filters are useful and above 30 mc where distributed component filters can be used.

There are few integrated power amplifiers on the market. This is due to problems that can be classified as those relating to the package, the chip size, and the collector saturation resistance of a planar transistor. Because the power output devices generate such a large portion of the heat in a power amplifier, they determine the thermal characteristics of the package. There seems to be little logic, at least from a cost standpoint, in subjecting the preamplifier and driver stages to the heat within the package of the output devices. About the only advantage to having them all within the same package would be reliability and slightly smaller size. Monolithic power amplifiers also have a severe problem caused by the collector saturation resistance of large geometry planar devices. Fig. 4 shows the long collector current path of a planar device compared to that of regular back-contact transistors.

Fig. 4a shows the short direct current flow from the base-collector junction to the collector contact for a normal transistor. Fig. 4b shows the long current path of the standard triple diffused IC transistor. The satura-

tion resistance of a planar IC transistor will often be as much as 100 times greater than that of a similar geometry standard transistor. By using double epitaxial methods by which a heavily doped region of collector material is placed under a lightly doped section, one can reduce the resistance of the collector path from that of a normal construction by a factor of 10.

Fig. 4c shows a cross section of a double epitaxial IC transistor that has had the resistance of its collector path further reduced by a deep diffusion of collector impurity which contacts the heavily doped epitaxial layer. Although the collector current path in this unit is as long as the standard construction, Fig. 4b, the saturation resistance of such a unit can be 10 times lower than that of a non-epitaxial device because of the much lower resistance of the current path. By increasing the size of the transistor and using the C shaped collector and emitter shown in Fig. 4d, the saturation resistance can be further reduced by a factor of 2 to 4. The C geometry reduces the collector resistance because there is a relatively short radial path to the collector contact. But, this reduction is accomplished at a cost of greater chip size and, therefore, lower frequency response. Undoubtedly, even better methods of reducing the collector saturation resistance of planar devices will be developed. But, it is doubtful if they can ever be made to approach the characteristics of two sided units. With this high saturation resistance, a monolithic or planar power device will always be less efficient or require an even heavier heat sink than an equivalent discrete component circuit. This will severely limit the economics and development of monolithic integrated power amplifiers.

New Techniques

The linear circuit designer often confronts the IC industry with the formidable problem of how to integrate large capacitors and transformers to provide circuit coupling and dc isolation. Fortunately, the industry has recognized the need for these circuit functions and has worked on new methods of providing the essential characteristics of transformers and capacitors.

The thermal properties of the silicon bar itself can be used to substitute for the electronic functions usually accomplished by capacitors. Fig. 5 shows how the time interval required for a heat generated in one portion of the bar and detected in another has the electrical analog of a delay line. In the SNX1303, which uses two of these thermally operated chips in the feedback loop around a video amplifier, this method gives a suppression of dc signals of up to 32 db. Thus, the video amplifier appears to be coupled to the input circuit by the equivalent of a 2 μ f capacitor. Normally, the volume of a 2 μ f capacitor is measured in cubic inches and not the size of a flat pack. In the case of the SNX1303, a single flat pack contains the equivalent of two of these capacitors. This method can be used to build phase shift oscillators with very stable frequency characteristics.

Circuit and dc isolation can be obtained by using the optical properties of semiconductors. When a gallium arsenide (GaAs) diode is forward biased, it emits infrared energy of a wavelength ideally suited for detection by silicon photo diodes and transistors. GaAs diodes can be modulated at very high frequencies, and in some ways they may be better than normal wire-wound transformers in providing the circuit isolation function.

The SNX1304 made by Texas Instruments uses a planar GaAs diode mounted on top of a monolithic light detector and pulse amplifier. The pulse amplifier is designed to drive standard integrated logic circuits. This unit can be used to provide dc isolation between the logic circuitry and the drive circuits of up to 100 v. This device is particularly well suited for isolating long data information lines from the logic circuits where large voltage transients are generated in the information lines which might damage the logic circuits.

Special Designs

The list of standard linear devices is growing every month and those devices which are available become more and more flexible in their application. Even so, the linear system IC designer often finds that his application could best be accomplished if he had a special linear IC.

The industry offers several ways to build these special circuits. If the circuit is simple, quite often the special circuits can be made most economically by mounting multiple chips in a simple header and inter-connecting the device by wire bonding methods. But, these units have little advantage over discrete components except in regard to size. They often suffer in performance compared to the original circuit. This is because of the inability to measure accurately the chip characteristics before they are mounted in the header.

If the system designer desires the reliability and potentially low cost of monolithic structures, this may be done by two methods. After he has defined his circuit and its functional requirements, he may ask a manufacturer to design a special bar for this circuit, or he may take the more expedient approach of asking that the interconnection pattern on a standard bar be changed

Table 1

Performance comparisons of Discrete-Component and IC Operational/Differential Amplifiers.

Characteristic	Typical Discrete-Component Amplifier	1965		
		1962 SN521A	SN525A	SN526A
Gain, Open-loop, db	94	62	88	60
Input-voltage Offset, mv	1	2	1	3
Temp, Coefficient	5	8	5	10
Input-voltage Offset, μ v/ $^{\circ}$ C				
Input-current Offset, μ a	0.2	0.5	0.3	0.03
Common-mode Rejection, db	92	60	100	80
Output-voltage Swing, v	\pm 11	\pm 4.5	\pm 8	\pm 5
Output-voltage Swing, v	2	1	1	10
Input Impedance, megohm	0.3	0.01	0.07	2

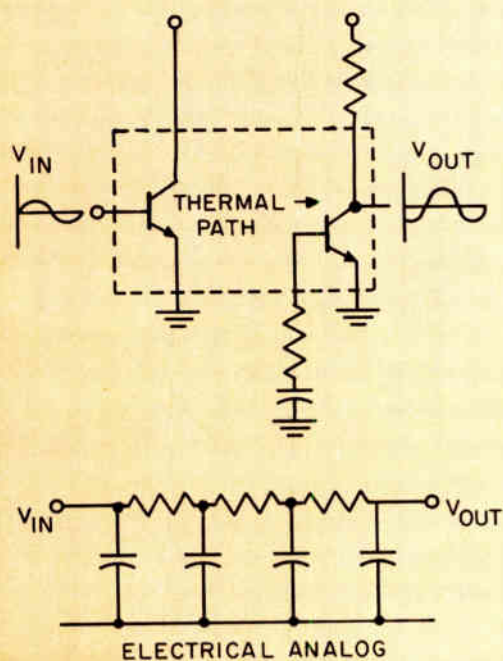

Fig. 5: Above illustrations show how the time interval required for a heat generated in one portion of a silicon bar and detected in another has the electrical analog of a delay line.

in order to fabricate his circuit. Special bar designs normally require several months of design effort and can cost several thousand dollars. Many manufacturers are reluctant to develop special bars for small quantity requirements. A pattern change on a master bar can often be effected in a few weeks at a nominal cost. This master slice method can be taken into consideration by the manufacturer when he designs the bar for his standard devices.

Series 52 manufactured by Texas Instruments has two bars which are ideally suited for this master slice method. One of these bars contains 10 NPN transistors and four PNP transistors and over 300,000 ohms of resistance. This large number of components places very few limitations on the design of most special linear circuits. After the design has been proven on the master slice method, if the volume warrants, it is relatively easy to design a special bar for the device. The special bars are used to eliminate unnecessary components and reduce the cost of the final device.

Reliability

Reliability information on linear circuits is as sparse as the number of standard circuits themselves. This is a result of the general emphasis on logic circuits and the early use of digital circuits in military and space equipment. The difficulty of measuring and defining a failure of linear circuits also has contributed to the problem of acquiring reliability data. But, by examination of the wealth of reliability data available on digital circuits, it's easy to acquire a high degree of confidence that the proven reliability of digital IC's can be expected by the linear circuit designer. The logic data substantiates the integrity of the monolithic IC

processes of diffusion, interconnection technique, and device geometry. The various packages that are available have also been thoroughly tested. Because linear devices use the same packages and physical processes, there is no reason to believe that their reliability should not be as good as that of the digital circuit. The over 1½ million hours of life test data which has been taken on Series 52 operational and differential amplifiers without a single failure indicates a 0.07%/1000 hr. failure rate at the upper 60% confidence level for operation at 55°C. The failure criteria for all the tests used in compiling this data was that any deviation of a data sheet parameter of over 20% constituted a failure. Although this is about a five times poorer failure rate than is now quoted for digital IC's, it must be remembered that this is based on no failures to date and that, therefore, the lower percentage confidence level would be zero. Moreover, this series has been manufactured a much shorter time than the digital series to which it is compared. A look at history will reveal that when the digital processes had been in production no longer than Series 52, this actual observed failure rate was much higher. The inherent lack of dependence on individual component parameters of the typical linear IC design, the greatly reduced number of interconnections, and the simultaneous processing and subsequent identical environmental conditions of all the devices within the single monolithic structure should manifest themselves in greatly improved linear IC reliability when compared to that of similar circuit functions using discrete components. Most systems designers have reported a reliability improvement of from 6 to 30 times on actual systems that have been converted from discrete components to IC's.

Future Developments

The linear area is undoubtedly the fastest changing area of the IC market today. The digital devices are fairly well established as far as design techniques and performance characteristics are concerned. However, in the linear area, the increased engineering emphasis being placed on this area by all manufacturers is just beginning to be shown as an increase in the linear devices available. In the next one to two years, operational amplifiers will be offered with even higher output voltage and current capabilities. Also, performance will be improved to the point where they will begin to displace chopper stabilized amplifiers by offering input voltage temperature drift coefficients of 0.2 $\mu\text{V}/^\circ\text{C}$ or less. Process controls will also improve to the point that high beta devices will be economically available for the input stage so that the input currents can be greatly reduced. In the high frequency area, video amplifiers of higher gain and wider bandwidth will be available; and, it will be possible to build log i-f amplifiers and matched amplifiers to a degree of precision not now obtainable with discrete components. The techniques of using thin film resistors and capacitors de-

(Continued on Page 176)

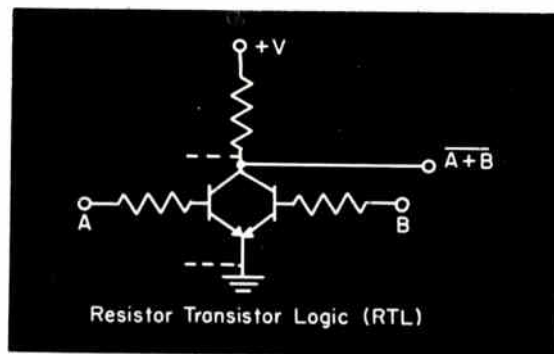
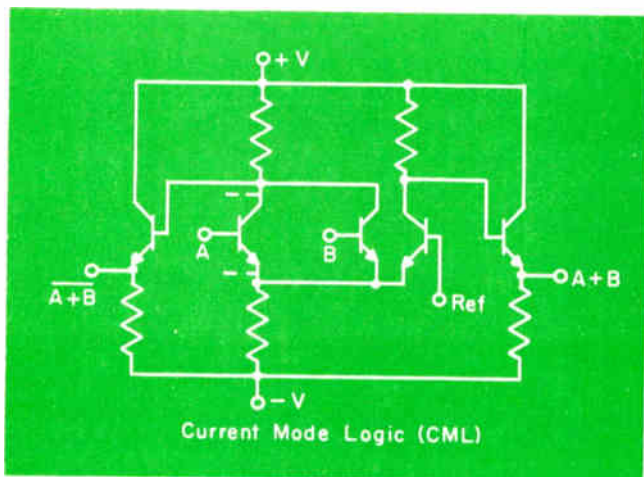

Steady improvements in masking and processing have increased component densities and yields. The lack of a suitable crossover scheme, power dissipation, standardization of elements, testing, and more pins per package are the areas requiring attention now.

Digital Integrated Circuits and Their

**ELECTRONIC
INDUSTRIES**
STATE-OF-THE-ART
FEATURE

SINCE THE FIRST MICROCIRCUITS evolved from transistor technology, the trend has been to integrate more and more circuit functions into one chip. The reason is mainly economic. When the planar process made it possible to

batch fabricate transistors, it was wasteful, in many uses, to dice and reassemble them before use when one could, at little extra cost, make circuits by the same process. Also, as designers learned how to use the advantages of integrated circuits, better system performance and design flexibility were achieved.

Continuous improvements in masking and processing have increased component densities and yields. At the moment the problem of obtaining a large enough chip area with all good circuits is not the main limitation. Instead, the limiting factors seem to be the lack of a suitable crossover scheme to permit more interconnections between components on one chip, the problems of power dissipation per package, standardization of elements, testing, and the need for more pins per package. Once these problems have been resolved, yield may again present an upper limit, but not before at least an order of magnitude increase in complexity (above that of a J-K flip-flop, for example) has been done.

(1) Here we will give quantitative examples of the advantages to be derived in improved system performance by integration of more complex functions;

(2) Consider some of the problems facing us as we advance from the present 4- to 6-gate levels to higher complexity arrays;

(3) Discuss the need for a new approach to system

designing to realize the full potential offered by increasing complexity. We will confine the discussion to digital circuits using transistors.

Advantages of Increased Complexity

Although *circuits* will have the same performance level whether individually packaged or in monolithic arrays, *systems* using large functional blocks will show greatly improved performance over systems using individually packaged circuits. Noise immunity, for example, will be far less of a problem in systems of higher complexity arrays for two reasons: (1) the elements within the array can be well isolated from external noise; and (2) mutual capacitance — and therefore crosstalk—between signal lines will be reduced.

In this section we will deal with the improvement in system speed offered in most logic families by increased monolithic functional complexity. We will give examples of the amount of speed improvement to be expected in specific families and the reduction in the product of average gate propagation delay and power dissipation (delay-power product) for gates in systems.

Saturating logic families. Because of the relatively limited current available, the common saturating logic families, such as Diode Transistor Logic (DTL), and Resistor Transistor Logic (RTL), stand to gain

By R. D. NEVALA
and E. R. deATLEY,

Fairchild Semiconductor
313 Fairchild Drive
Mountain View, Calif. 94041

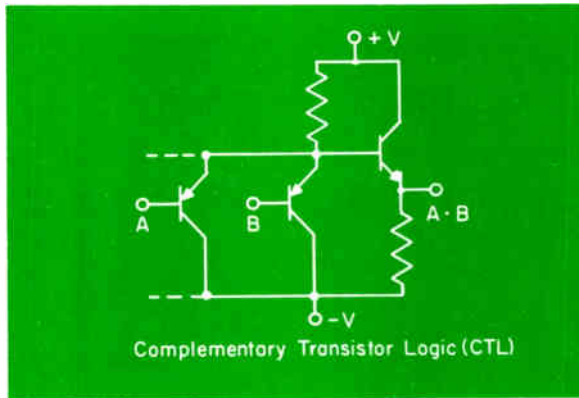
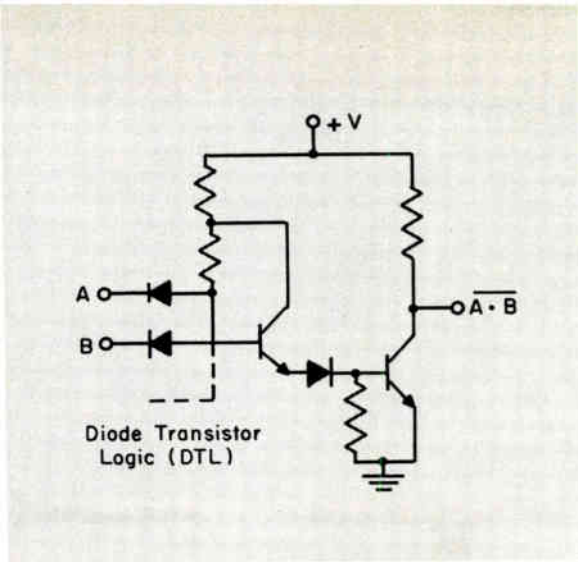

These four drawings illustrate common logic circuits that are available today in integrated circuit packages.

Limiting Factors

much speed for any given fan-out and power level by the integration of larger functional groups. The main reason is the great reduction in inter-gate capacitance. Fig. 1 shows the effect of capacitive loading on propagation delay for the 5 mw DTL gate shown in Fig. 2, with a fan-out of 5—4 inactive loads and 1 active load, assuming a 4 inch line to each gate being driven. The coarseness of the plots in Fig. 1 and subsequent figures allows for normal component variations. Line capacitance may vary from 0.5 to 1 pf/in. In this case we will assume 1 pf/in. Each package pin presents an additional 0.7 pf, and the input diodes 1 pf each. Thus the total capacitance for the circuit of Fig. 2 is about 30 pf.

From Fig. 1, we see that the average propagation delay of a gate at this level of capacitive loading will be about 41 nsec. If all six gates are integrated into one chip, the only load capacitance would be that from the input diodes, or about 5 pf total. For this amount of capacitive loading the propagation delay would be about 20 nsec—an improvement of about 50%.

The corresponding delay-power products for the two systems—individually packaged and monolithic—with 5 mw DTL are about 210×10^{-12} watt-secs and 100×10^{-12} watt-secs, respectively.

Low-power saturating RTL logic types show comparable improvements with reduced capacitance. The typical propagation delay versus capacitive loading curve for 2.5 mw RTL, for example (see Fig. 3), shows that the propagation delay for separately packaged units in a configuration similar to that discussed above would be about 36 nsec for separate gates, and 22 nsec for a monolithic system—an improvement of about 40%. The corresponding delay-power products for the

separate gates and complex arrays, therefore, are 90 and 55×10^{-12} watt-secs, respectively.

Common DTL logic families in individual packages range in delay-power product from 100 to 200×10^{-12} watt-secs, or an average of 150. Assuming a 50% improvement in this average figure by going toward higher functional complexity, the average for all these DTL families in complex arrays would be about 75×10^{-12} watt-secs.

The delay-power products of common RTL families, with their lower noise immunity, range from 40 to 80, or an average of 60×10^{-12} watt-secs. Assuming an improvement of 40% by going toward higher functional complexity, systems using complex arrays of the various families of RTL gates should show an average delay-power product of under 40×10^{-12} watt-secs.

The delay-power product of a saturating-type family can be considered a constant only in the range above 9 to 15 nsec. Below this range the transistor storage delay becomes a large portion of the total delay, and power tends to increase rapidly with further attempts to reduce delay.

High-speed logic families. In the case of high-speed families, such as Complementary Transistor Logic (CTL) and Current Mode Logic (CML), which have large amounts of current available, the increase in speed due to reduced capacitive loading in complex functional blocks will be much less than in the case of the saturating logic types—about 10% instead of 40%.

Both CTL and CML offer propagation delays of 3 to 5 nsec in individual packages, and both can get into the 1 to 2 nsec range with state-of-the-art devices. Neither family, however, can hope to attain its full speed potential in systems using individually packaged gates. The terminated transmission lines required for stable operation at such high speeds have delays of about 1.5 to 2 nsec per foot (as opposed to 1 nsec per foot delays for open lines).

With 4 in. terminated lines between gates in a configuration similar to that discussed above for the saturating logic families, delays of 0.5 to 0.7 nsec would occur in the lines alone, increasing a potential 1.5 nsec

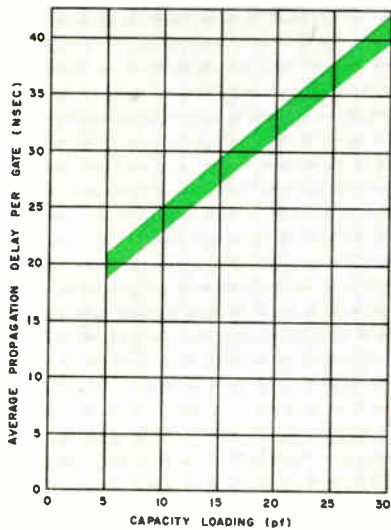

Fig. 1 (left): Propagation delay vs. capacitive loading per gate for 5mw DTL in Fig. 2.

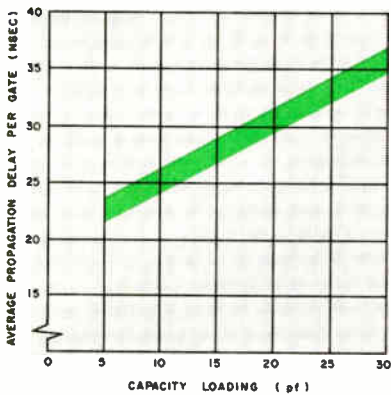

Fig. 2 (right): 5mw DTL gates have a fan-out of 5-4 inactive and 1 active load.

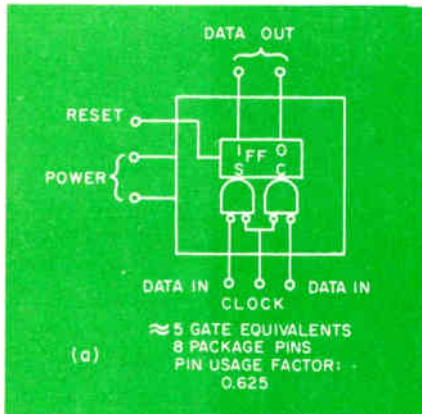
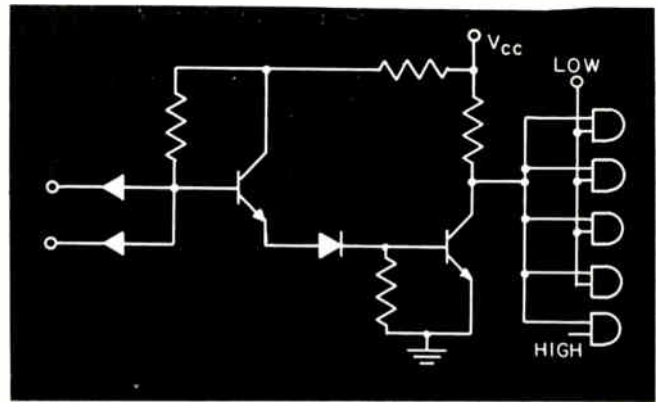

Fig. 3 (left): Graph for 2.5mw RTL gate with fan-out of 5-4 inactive loads and 1 active.

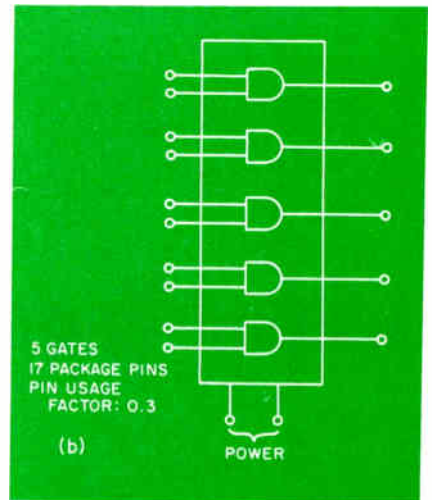

Fig. 4a (above): J-K flip-flop has about the same number of components as the five 2-

input gate array in Fig. 4b, but requires only 8 package pins because of complexity.

DIGITAL I/Cs (Continued)

speed, for example, to 2-2.2 nsec. Since the small line lengths in a monolithic system contribute almost no propagation delays, the circuit speed of 1.5 nsec is possible on a system basis. This improvement, coupled with that to be expected from reduced capacitance, would provide at least a 40% increase in system speed by integrating complex functional blocks. The delay-power product could be reduced even further, since the relaxed capacitive loading would allow designs with less internal power dissipation for a given speed.

Available CTL and CML circuits have delay-power products in about the same range as the DTL circuits described—i.e., 100 to 200 $\times 10^{-12}$ watt-secs. They can be expected to show similar improvements with higher complexity, i.e., from an average of 150 to 75 $\times 10^{-12}$ watt-secs or less.

Problems of Increased Complexity

Crossovers. One of the principal limitations on higher functional complexity is the lack of a suitable crossover method for making the required number of interconnections on the chip. Two possible solutions are (1) the use of a highly doped diffused tunnel for each

crossover point, and (2) a second layer of metalization separated from the first by insulation, analogous to the printed circuit board with signal lines on each surface. The second seems more promising than the first, which is very wasteful of silicon area.

Pin limitation. It seems at first glance that, to increase the components in an array without multiplying the interconnections between them, we should integrate larger independent logic arrays, such as separate gates, instead of more interdependent functions, such as flip-flops. But, arrays of separate gates would not only lose the performance advantages which high complexity provides; in addition, they would soon exhaust the available pins on the package, since each added gate would require several outlets. To increase the pin usage factor, i.e., the number of gate equivalents* per package pin, we must increase the interdependence of elements in an array. And, therefore the number of interconnections. Fig. 4 provides a simple example of this fact. The J-K flip-flop in Fig. 4a has about the same number of components as the five 2-input gate array shown in Fig. 4b. Yet, because of its greater complexity, the J-K flip-flop requires only eight package pins, instead of a total of 17 as in the independent

*A gate equivalent is a grouping of elements containing approximately the same number and type of components (transistors, resistors, etc.) as a single gate.

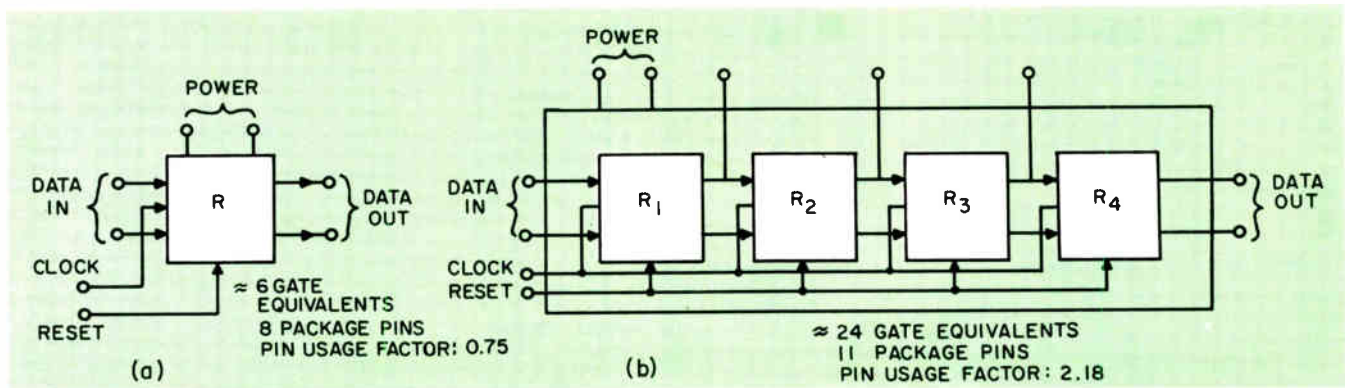

Fig. 5 (a&b): A single and 4-stage register are shown with their associated gate equivalents, number of pins required and pin usage factor.

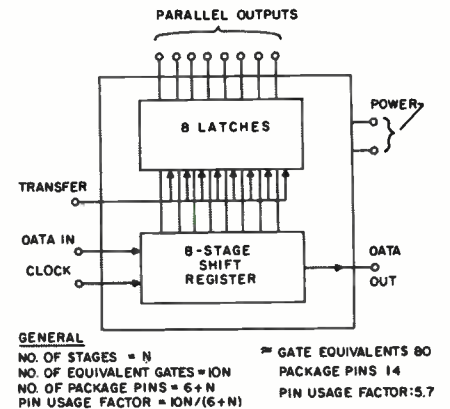
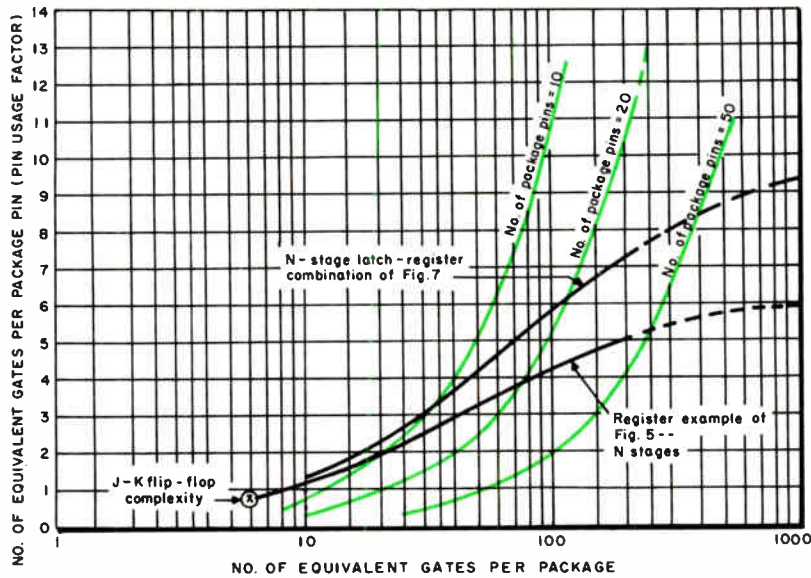

Fig. 7: 8-shift register with latch buffering shows pin usage factor.

Fig. 6: Trend of pin usage plotted against number of equivalent gates per package.

array. Thus the pin usage factors of the J-K and the separate gates are 0.625 and 0.3, respectively.

As larger logic functions are integrated monolithically, the pin usage factor, and therefore the number of interconnections, will have to increase still further to avoid pin limitation. Of course packages with more pins will be made as the need arises. But, in view of the yield and reliability problems when adding lead bonds, as well as the higher package price and assembly cost, manufacturers will use each pin level fully before proceeding to the next. They will tend to choose functional units with maximum pin usage factor, and hence, maximum internal complexity.

What blocks of higher complexity logic could be put into present-day packages with 12 to 14 pins? Serial shift registers and forward-backward counter elements needing few input-output pins would be suitable. Also other types of multiple-stage controlled counters and registers, and even register-to-register transfer with the associated control logic.

Fig. 5 shows the increase in pin usage with added stages in an expandable shift register. Figs. 5a and b show a single register stage and a 4-stage register, with their associated gate equivalents, number of pins required, and pin usage factor. In general, the pin usage factor of a shift register, connected as shown, would increase with the number of stages. In this case it

approaches a constant value of 6 as the number of stages becomes very large. A 7-stage shift register of this type could be encapsulated in a 14-pin package. Its pin usage factor would be 3.

Another example of a complex function requiring no more pins than are provided by available packages is shown in Fig. 7. This 8-stage shift register with internal transfer to latches has a still larger pin usage factor than would a 7-stage shift register of the type shown in Fig. 5. The register in Fig. 7 is assumed to have 6 gate equivalents in each register stage and 4 in each latch stage, or a total gate equivalent of 80. Since it requires only 14 pins, its pin usage factor is 5.7.

Testing. As the numbers of interrelated inputs and outputs, as well as internal states, increase—and they must increase with increasing complexity—the number of tests required to verify all possible conditions will multiply at an even faster rate. For example, to test all possible conditions of 24 interrelated inputs to a combinatorial array containing no internal states would take about 4.5 hours at an input rate of 1,000 patterns per second. Hence, 100% testing of large arrays will not be economically feasible. Programs for performing limited-sequence testing will need to be considered. Perhaps further simplification can be obtained by bringing intermediate key test points outside the array. Fig. 8 shows a simple testing arrangement.

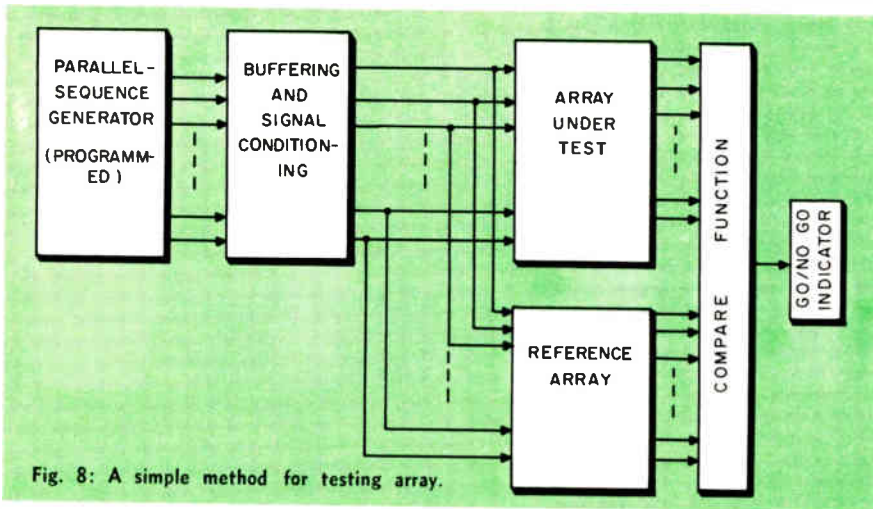

DIGITAL I/Cs (Concluded)

In this case the parallel-sequence generator can be programmed to provide all or a fraction of the desired patterns with which the array under test can be exercised.

Delay-power product. The average delay-power product for the various logic families can be expected to decrease from 40 to 50% in systems using more complex functional blocks. Even further reductions can be expected with improvements in device cutoff frequency and storage time.

Despite these improvements the delay-power product will always impose a limit on the number of logic gates in a complex array for a given gate speed and package power. Fig. 9 shows the power per gate plotted against propagation delay per gate for individually packaged gates of the DTL, CTL, or CML families and for gates of the same families in systems using large arrays. Since, in general, the delay-power products for the various types of available logic families having about the same fan-out capabilities will not vary

Fig. 9: Graphs of delay power product for systems of individually packaged gates (black) and complex monolithic blocks (color).

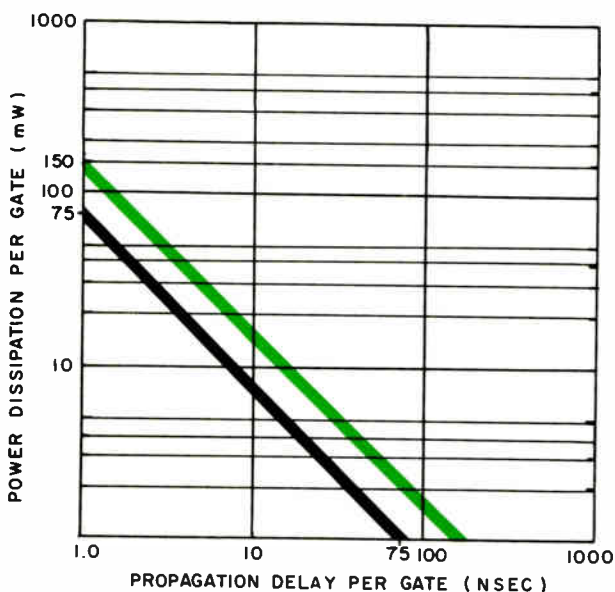

by much more than two to one, these and subsequent curves for DTL, CTL, and CML families are reasonably useful in predicting the performance of other logic families as well.

Based on an average delay-power product of 75×10^{-12} watt-secs for systems of complex arrays, the curve of Fig. 10 shows the maximum number of gates per array versus the propagation delay per gate for various values of package power using DTL, CTL, or CML families. For example, a package with a maximum power-handling capability of 250 mw could hold no more than about 83 gates with a propagation delay of 25 nsec each. Obviously packages

with higher power-handling will be required to gain full advantage of high complexity.

Note the dividing line shown on the curve in the 9 to 15 nsec range. Below this range a nonsaturating logic type would be required with present-day circuits because of the built-in storage delay of the saturating types.

Need for a New Approach

Complex arrays will undoubtedly be done on a custom basis. What forms an array should take is not likely to be well enough defined to enable manufacturers to provide a great variety of standard units.

In working with large functional blocks, the system designer may tend to design his system first and then attempt to group circuits to be integrated monolithically. To derive all the advantages offered by high-complexity, the form of the arrays to be used should be considered in the early stages of a design. Problems such as pin usage factor, feasibility of testing, and power dissipation will require early attention.

Fig. 10: Maximum number of gates per array vs. the propagation delay per gate for various values of power for DTL, CTL or CML.

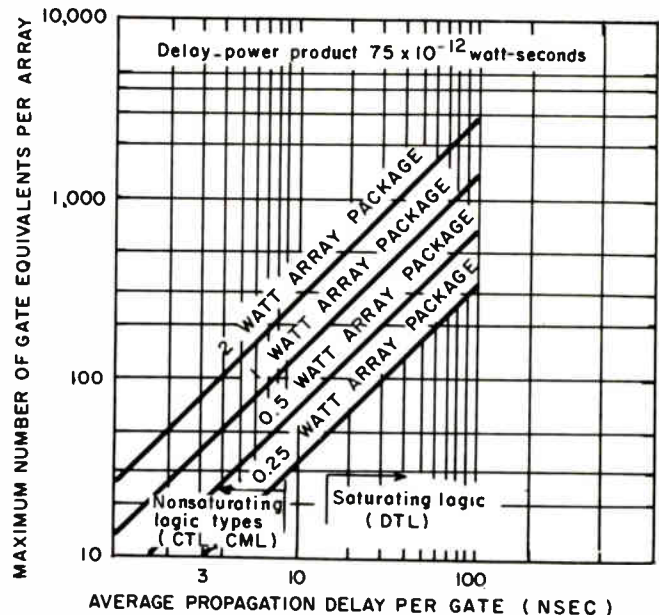



REPORT ON THE TRANSISTOR INDUSTRY

- Manufacturing Techniques
- Geometries
- Materials
- Marketing Forecasts
- Future Applications

**ELECTRONIC
INDUSTRIES**

**STATE-OF-THE-ART
FEATURE**

THE ORIGINAL TRANSISTORS fabricated at Bell Telephone Laboratories were made from germanium (Ge). This probably accounts in large measure for the industry's initial effort which was applied to Ge as a transistor material.

It was known that silicon (Si) had potential as a transistor material, but it was not actively pursued as such until a sizable business had developed in Ge transistor production. However, by 1953, the industry had found that Si was as workable a material as Ge, and extensive work with it led to the development of today's Si transistor. During the course of these events, it became evident that other materials would be suitable, at least on a theoretical basis, for the fabrication of transistors. These include other Group IV elements such as carbon, and the III-V compounds. While a number of materials from this group are potential candidates for transistor use, little success has been enjoyed to this end with any except gallium arsenide (GaAs). Even with this material, however, despite extensive effort by the industry, the results have been discouraging. More will be said about this later.

We can conclude that only Ge and Si will persist as materials suitable for large-scale transistor production. It is true that some specialized devices of GaAs and other materials have been made and sold; but, their total contribution as a business is negligible.

Fig. 1 is a plot depicting total industry transistor and receiving tube sales from 1954 to the present. At about the beginning of 1964, total dollar sales for Si transistors exceeded that of Ge for the first time, despite higher unit volume in Ge. This trend has continued, and some time in 1965 the Si unit-volume will surpass Ge. Before 1970, we may see annual Si transistor sales

in excess of one billion units. The current price attrition will continue and the ASP curves for Si and Ge will cross and finally flatten out with the price level for Si devices being much lower than that for Ge.

Receiving tubes still fill the bulk of sockets in TV and home radio equipment. But, it is felt that by 1969 no further vacuum tube TV receivers will be made. During the period 1965 to 1969, the unit-volume of transistor sales will enjoy an increase beyond its normal growth rate equal to the total TV volume, about 200 million devices per year. The sale of receiving tubes will, of course, drop by a like amount. It is felt that almost all of the transistors which will find their way into TV receiver designs will be of Si.

Introduction of the integrated circuit (IC) a few years ago is already having an impact upon the transistor industry. Just as a large portion of present transistor sales is displacement business, so will much of tomorrow's IC business be displacement, with the transistor itself being displaced. Thus, it is not unreasonable to expect a volume versus time curve for transistors which is similar to that of the vacuum tube. The tailing off of transistor volume is not expected to begin until 1972.

Silicon Versus Germanium

As indicated above, most of the original development in production engineering work was done on Ge. Considering this, and the fact that carrier mobilities are higher in Ge than Si, why then are we predicting dominance of Si, at least in terms of total unit-volume? The answer lies in one fact: Si possesses a stable oxide which can be thermally grown upon its surface, while Ge does not. This is important for two reasons: first, by growing thin oxide films on the surface of Si wafers and then selectively interrupting such films with a masked etching procedure, it is possible to introduce impurities locally into the crystal at such interruptions by a solid state diffusion operation. This means that contiguous regions of opposite conductivity type can be formed in the crystal with very fine control over

By **JACK HAENICHEN**

Motorola Semiconductor Products Inc.,
5005 East McDowell Rd.,
Phoenix, Ariz. 85008

TRANSISTORS (Continued)

Fig. 1: The growth of transistors as compared with tubes over the past decade. (A.S.P. designates the average selling price).

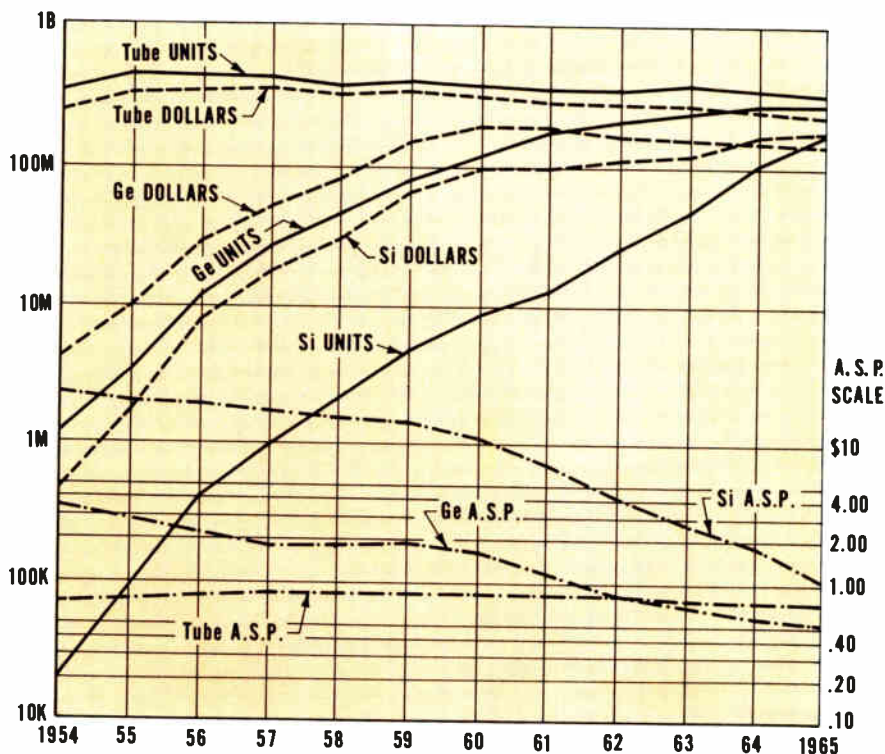

the lateral dimensions of such regions. Control of masked selective etching within ± 2 microns is feasible today in production. The second reason is that such an oxide film, when grown upon a Si substrate by introducing oxygen at high temperature, serves another function as well. This function is passivation. Because the film was produced in the manner described, it represents a modified continuation of the molecular structure of the crystal. And, as such, it tends to protect from external contaminants any junctions or other critical regions which come to or near the surface.

Annular

Early success with such passivated structures was followed by disappointment when an attempt was made to apply these methods to building high-voltage breakdown devices. Fabrication of a high-voltage breakdown junction requires the use of high-resistivity material on at least one side of the junction. In high-resistivity material the majority-carrier concentration is much lower than in low-resistivity material. The product of majority and minority concentrations in a semiconductor crystal is a constant at a given temperature. Thus, it follows that, if the majority-carrier concentration is suppressed to provide high resistivity, the minority-carrier concentration must be correspondingly increased so that the product of the two remains constant.

In a typical low-resistivity crystal, the majority-carrier concentration might exceed the minority-carrier concentration by 12 orders of magnitude. In a typical high-resistivity crystal, the ratio might be only six orders of magnitude. Since such crystals are essentially dielectric materials possessing two charge distributions

(positive and negative) which are completely mobile, it should be clear that, under the influence of external electric fields, these charge distributions can be substantially redistributed.

The presence of a passivating coating on the surface of a Si device usually has associated with it a permanent electric field which, of course, penetrates into the crystal. This field is probably associated with certain fixed charge distribution in the oxide layer. Quite simply then, this permanent electric field will effect a redistribution of holes and electrons in the crystal near the surface, where the field is strongest. In a semiconductor region which has a relatively modest majority-carrier concentration (high resistivity), this field can, under the appropriate set of conditions, cause such drastic local charge redistributions at the surface, that the conductivity type of the surface can actually invert.

The answer to this dilemma was found in the annular process whereby the undesirable effects of surface channeling were circumvented. Fig. 3 shows briefly how these results were achieved. The original starting resistivity of the crystal is kept high to provide HV breakdown. Intense channeling is deliberately induced during processing of the crystal. The final device winds up with a "worst-case" channel already built-in. In addition to the normal processing steps, however, a diffused band is placed completely around the junction, on the high-resistivity side. The conductivity type of the band is the same as that of the high resistivity side, but its impurity concentration is much higher (it is of very low resistivity). Because of this, no channeling is possible in the region of the band. The existing channel in the high-resistivity region is effectively terminated

and turned upwards toward the surface under the passivated coating. As long as the annular band is placed far enough from the original junction to prevent any punch-through limitation, the breakdown voltage of the composite structure so formed will be limited only by the original starting resistivity.

Using this method, both PNP and NPN silicon transistors with breakdown voltages specified at 300 v. minimum are now in large-scale production. This limit will probably soon be pushed beyond 500 v.

Most recently, the deposition of silicon monoxide and silicon dioxide films upon Ge surfaces has provided some of the advantages mentioned for Si, to Ge. The masking and introduction of selectivity diffused regions has now been done in Ge as well. But, such films do not serve as passivants in the same sense as they do in Si devices because they are not a molecular extension, but merely a deposition in the Ge case. Nevertheless, because of the sizable mobility advantage in Ge over Si, the introduction of the well-developed method for masking and geometry control to Ge is providing some devices with very high performance characteristics. Devices are in production now which have noise figures of 2 db and 4 db at 200 mc and 1,000 mc, respectively. Other developmental Ge devices have been made with a common emitter current band width product, f_t , in excess of 6,000 mc. It is not likely that performance such as this will ever be duplicated with Si.

Because of the wider band-gap in Si its performance at high temperature exceeds that of Ge. Practical limits of junction temperature for Ge and Si transistors are about 100°C and 175°C respectively. Also, cost of basic materials becomes important in large-volume production. Availability and cost for Si are both more favorable than for Ge. Because of increased usage of Si, especially in devices which use a large amount of semiconductor material per unit, far more capability for Si refining and crystal production is being built by the industry. Such increased capability and experience with this material will lead to still lower costs in the future.

Besides these two the other semiconductor materials should be briefly considered. Most of these are not practical in the industry, despite theoretically better suitability. The reason for this lies in the difficulty in making useful devices from such materials. The III-V compounds, for example, suffer from the fact that they are heterogeneous materials. This not only causes them to possess anisotropies in their electrical properties with direction, but, more important, these materials have unequal evaporation rates for their two constituents. As a piece of such material is heated to a high temperature one or the other of the elements can evaporate selectively from the surface of the material, reducing the surface to a metallic.

Thus, to successfully carry out high temperature operations such as solid-state diffusion, this evaporation must be inhibited by providing a high vapor pressure of the evaporating species. Such operations are often carried out in sealed ampules. These procedures are awkward and difficult to carry out and even more

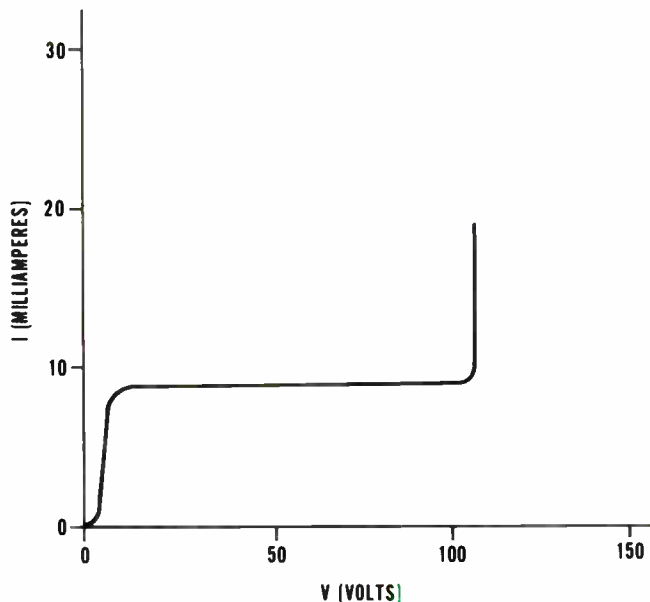

Fig. 2: Typical voltage-current relationship of a passivated, reverse-biased transistor junction exhibiting current limiting characteristics as a result of channeling is illustrated here.

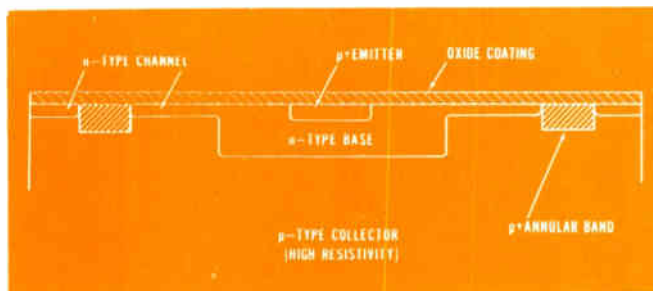

Fig. 3: Annular transistor structure.

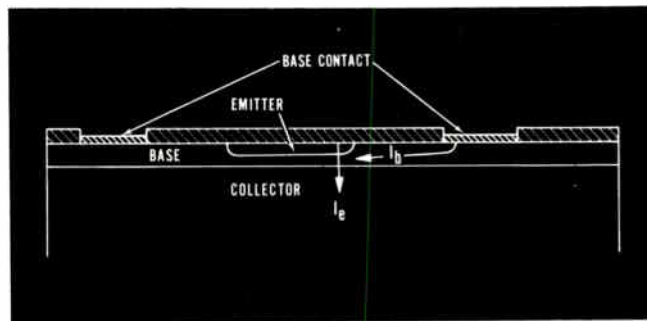

Fig. 4: Thin-base transistor structure.

difficult to control. As a result, finished devices possess such an inept set of physical characteristics that their electrical performance turns out far below the optimum. Thus, except in the case of certain special devices such as varactor diodes, it is almost always possible to build a device from Si or Ge which will outperform the III-V device and be much easier to make.

• A REPRINT of ANY ARTICLE in this issue is available from ELECTRONIC INDUSTRIES Reader Service Department.

TRANSISTORS (Continued)

Geometries

Base thickness of a transistor can be very important in setting its electrical characteristics. From the early days of grown junction and alloy transistors the industry has been devising ways of producing transistors with ever thinner base widths. A thin base offers two advantages; first, it provides a necessary ingredient for h-f performance; second, it enables the use of material in which the carrier lifetime is very low. This could be the case, for example, if material was used in which the amount of lifetime killing impurities had not been carefully controlled.

Use of such material might be desirable for cost reasons. Or, more important, it might be desirable to

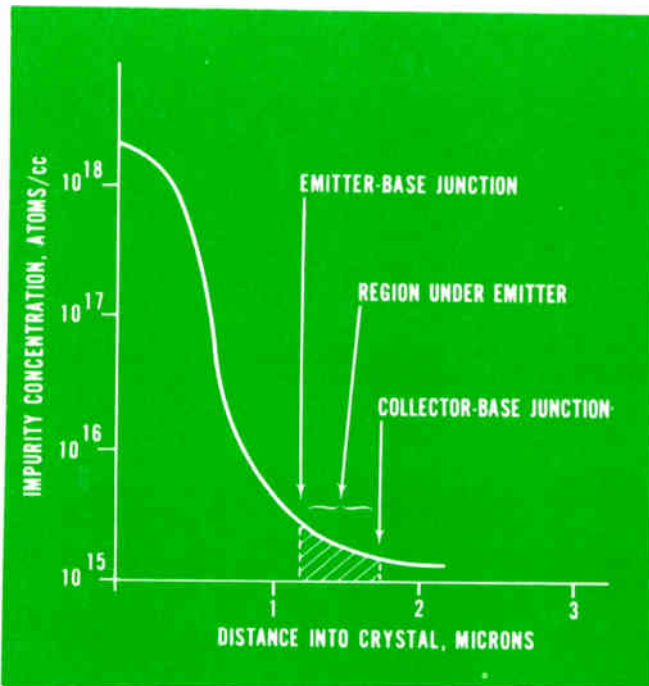
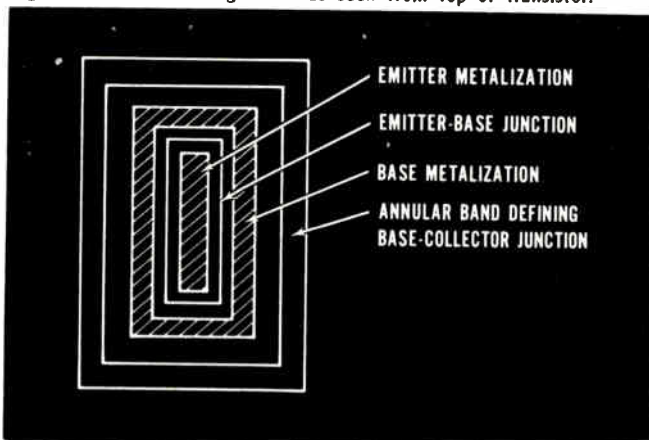

Fig. 5: Typical impurity profile of thin-base transistor structure.

Fig. 6: Geometric configuration as seen from top of transistor.



deliberately introduce a lifetime killing impurity (such as gold) to provide control over some other property, such as charge storage. Presence of a very thin base then enables the device designer to have both low storage time and high current gain in the same device.

Today the industry has learned to control base thickness to less than 0.5 micron. But, base regions which are this thin suffer from new problems. One of these is seen in Fig. 4. Here is shown a transistor in which the base thickness W is much smaller than the lateral dimensions of the device. In such a case the flow of base current in the active region is essentially orthogonal to the flow of emitter current. Also, because both base and emitter regions are usually diffused in such structures, the effective resistivity of the base region under the emitter is very high, even if the overall base sheet resistance is low. This is true because this region under the emitter represents only the "tail" of the base impurity profile, Fig. 5. Thus, the flow of base current transversely in such a high-resistivity region sets up a voltage drop along its flow. This drop is of the correct algebraic sign to inhibit injection of the emitter at points remote from its edge. In other words, injection by the emitter becomes non-uniform and tends to "crowd" toward the edges of the emitter. This effect is more pronounced at high current densities and for very thin base regions.

Very thin base units tend to be quite sensitive to burn-out in high current uses. This is the familiar "safe-area" problem wherein a small region of the device overheats and actually melts. This is usually followed by complete transistor destruction. For very thin base devices many effects combine to aggravate this situation. The crowding effect is coupled with local imperfections in the emitter region and high power density in the base. Hence, power transistors are usually made with thicker base regions. But, because of cost, especially in Si, it is desirable to use some of the newer methods of selective impurity distribution (as opposed to alloy methods, for example) even for power transistors. Thus, ironically, the industry has had to relearn how to make thick-base transistors, with this method. Early attempts produced devices with good safe areas, but low current gain.

Recently, however, Si power transistors with high safe-area and good current gain out to high current have reached the production stage. For example, transistors with usable current gains out to a collector current of 30 a., with a safe operating area in hundreds of watts, are available.

Considering then devices of "modern" construction, wherein lateral dimensions of the semiconductor element are large compared with the thickness, we can confine our interpretation of the word geometry to mean the lateral form of the important regions as seen from the surface of the device, Fig. 6. Largely because of crowding, it is advantageous to provide an emitter region or regions possessing a high perimeter to area ratio.

Recalling our discussion on crowding, we indicated that for reasonably thin base regions and high current densities, the bulk of the charge injected by the emitter is found at its edges. Designs have evolved in which the emitter is largely composed of "edge" region. The simplest form of such an emitter, conceptually, would be a long thin line region with surrounding base contacts.

The difficulty with such a structure, aside from the fact that it would require an unusually shaped semiconductor element (i. e., a thin filamentary structure) is that it suffers from a second biasing effect. This effect is associated with the fact that any contact metal placed along its length is other than superconducting. A contact deposited along the length of the line emitter is a metal having some finite cross-sectional area and finite conductivity. If current is introduced to such a contact at a point or points, then regions of the emitter remote from such points will sustain a bias which is tending to cut them off. The only difference between this effect and the one alluded to earlier is that now it is emitter current which is responsible for the cutoff instead of base current.

A host of intricate geometries has evolved; typical of these shapes are the "Star" and "Snowflake" geometries, Fig. 7. In these a number of emitter "fingers" radiate from a central contact area to which a lead is attached. Tapering of these fingers is consistent with the fact that current is continually leaving them along their lengths. Thus, the end portion of the fingers must carry less total current than the inner portion. Length to width ratios of the fingers and the thickness of the contact metallization are designed to provide nearly uniform injection along the fingers. The injection is dropped by a factor of about three for each 25 mv of bias. Normally, contact metals with high conductivity such as aluminum, gold, and silver are used.

R-f power transistors will be the ultimate in the geometry game because usually a large emitter perimeter is needed (high power) but, at the same time, a high perimeter to area ratio must be maintained (high frequency).

The geometrical control afforded by the masking methods permit much higher use of a semiconductor element of given size. This comes about because the plasma of current in the device can be easily distributed at will over the entire semiconductor element by distributing the emitter in various forms.

Methods have been devised for making tiny geometries and such devices can be operated at low current but, because of their small size, current density in the device is reasonably large. Design of such devices has been spurred by the quest for computer circuits which will operate at ever lower currents yet retain high operating speed. These circuits are important from the standpoint of physical size and power consumption.

If an ordinary transistor which has high speed at some nominal operating current, say 10 ma, is operated at a low current, say one μ a, operating speed of the cir-

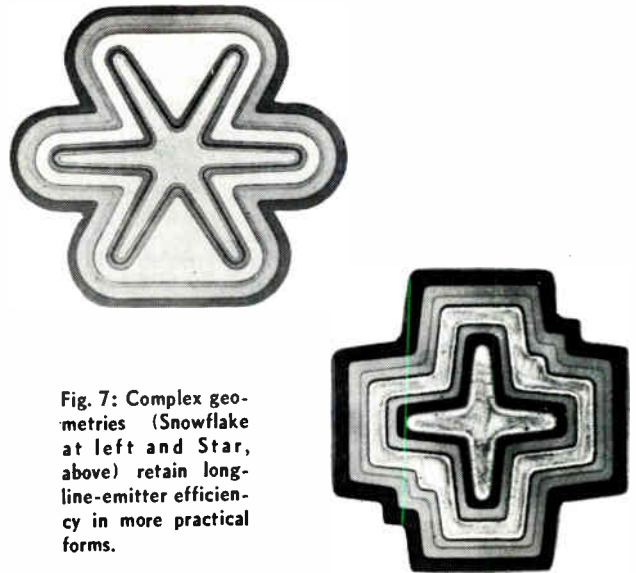

Fig. 7: Complex geometries (Snowflake at left and Star, above) retain long-line-emitter efficiency in more practical forms.

cuit is greatly reduced. The reason for this is that certain parameters, such as common emitter current gain-bandwidth-product, fall off rapidly with current on the low end. In fact, at low enough current density, f_T is roughly linear with emitter current. The proportionality constant between f_T and I_e includes the factor of $1/C_{Te}$. In other words, the smaller the emitter capacitance, the higher will be f_T at a given current.

By using normal masking methods the spacing between regions formed in successive processing steps is limited to about 0.5 mil. Using these tolerances, a device about the size of the 2N918 is the smallest that can be made at low cost. It is possible to make a small number of devices with much tighter tolerances by merely cutting the size of the wafer down so as to include only a few devices on the wafer. But, this raises the costs.

The most significant of the errors or tolerances is found in the masks themselves. A new procedure has been devised which eliminates this major source of error. In this procedure *all* of the patterns needed to

Fig. 8: Comparison between old and new type power transistor structures. Both elements are rated at same current of 3-5 a.

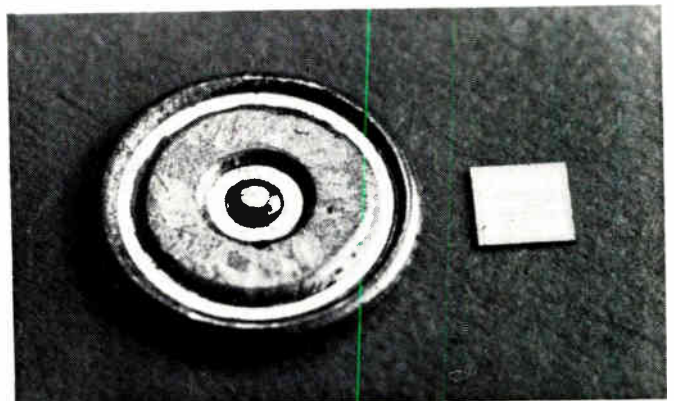

TRANSISTORS (Continued)

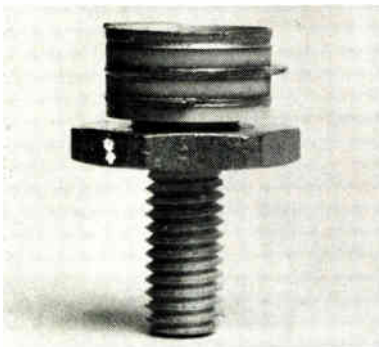
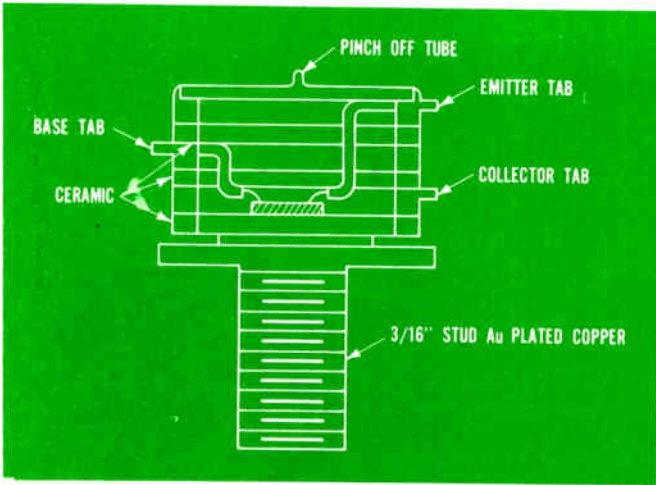

Fig. 9: Above and left, newly developed high-frequency power transistor package.

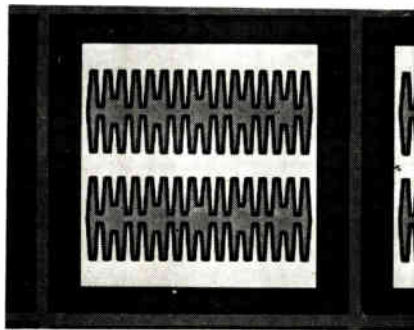
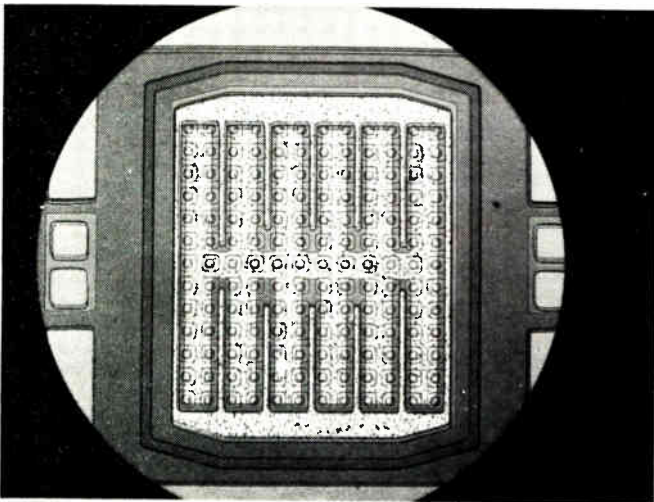

Fig. 10: Fifty-watt, 50 MC power transistor.

Fig. 11: Fifteen-watt, 200 MC power transistor.



make the device (5 or more) are placed on a single mask.

Using this process, it has been possible to build devices approximately an order of magnitude smaller than the 2N918. The 2N3493 is such a transistor; this device has an f_T of over 50 mc at $I_C = 10 \mu a$.

R-F Power Transistors

A transistor designed to operate at high power levels, high power gain, and high frequency represents a combination of all the difficult problems which have had to be solved in the semiconductor industry. The semiconductor element itself must have a thin base region and tightly spaced geometry, and it must possess these uniformly over a large area. Essentially, the problem boils down to producing two regions with an interface which has a spacing of only a tenth of a thousandth of an inch and a length of perimeter of up to 2 in. Nowhere along this perimeter can one region touch the other.

Packaging for such devices is challenging. The package must possess a means for removing heat from the semiconductor element with a minimum of thermal resistance. It must also have minimum electrical parasitics. Because transistors are usually low voltage, high current devices, it is generally parasitic inductance that is important rather than parasitic capacitance. The need for the package being hermetically sealed often interferes with the shape and materials used for the "leads." For instance, glass-to-metal seals require oxidized ferrous metals whose skin-effect performance is poor. Fig. 9 is a drawing of an improved r-f package. The leads are broad area flanges and can be made of non-ferrous material because they are brazed to a metallized ceramic instead of sealed to a glass dielectric.

Figs. 10 and 11 show two r-f transistor chips which use a high perimeter to area ratio emitter. In one case, the emitter is broken up into a number of slender fingers which connect to bonding areas. This device produces 50 w of r-f power at 50 mc and 10 db of gain. In the other device, the emitter consists of a number of small "dots," which are interconnected by a metallizing method. Devices such as this can produce 15 w of power at 200 mc with about 7 db of gain.

Other geometries and packages have been used to provide combinations of power and frequency. Fig. 12 is a plot of what the author feels is state-of-the-art in r-f power transistors, and where the art will advance within the next two years.

Field Effect Devices

In the field effect transistors (FET), majority-carrier current is allowed to flow through a thin channel in the semiconductor crystal. Compressing or opening this channel with a "grid" or gate diminishes or increases, respectively, the flow of this current. Manipulation of channel width by the gate is done by forming a depletion region there. This region in turn is set up by means of the field associated with applied gate voltage. Thus, the name field effect. This mechanism

accounts for the high input impedance of such devices.

The depletion region can be set up by means of either a reverse-biased junction as a gate or by an isolated gate electrode which is separated from the crystal by a thin dielectric region. Because of the finer geometrical control possible with the latter device and also because of certain other desirable properties from an applications point of view, the insulated gate field effect transistor (IGFET) seems to be gaining more in popularity. But, because in a field effect device the flow of active current is transverse to the "geometry" portion of the device rather than orthogonal to it, the charge associated with this current flow must cross several registration boundaries with their associated tolerances. This means that the path length for carrier flow is much larger than it is, for instance, across the base region of a modern bi-polar transistor. For a given degree of perfection in the tolerances of the device, it is generally possible to build a bi-polar device with higher frequency performance than its unipolar counterpart.

Even so, IGFETs with respectable h-f performance have been made in the lab. Power gain of 10 db at 450 MC has been observed. Such devices do not represent a production situation at present.

Past, Present, and Future

The main factor in any discussion of an important industrial entity is cost. If transistors could never have been sold for less than \$10.00 apiece, they still would have replaced vacuum tubes in some limited uses. This is because their use would have allowed either extended performance or reduced circuit cost. But, this usage would have been very limited and no such industry as exists today would have ever been born. The fact is that transistors are cheaper to build than vacuum tubes on a function for function basis. Also, they are more reliable. But, it is strictly for reasons of cost that the transistor will dominate for the next five years. Herein lies the reason for the big growth in the Si transistor business. Elimination of the hermetic seal in the package

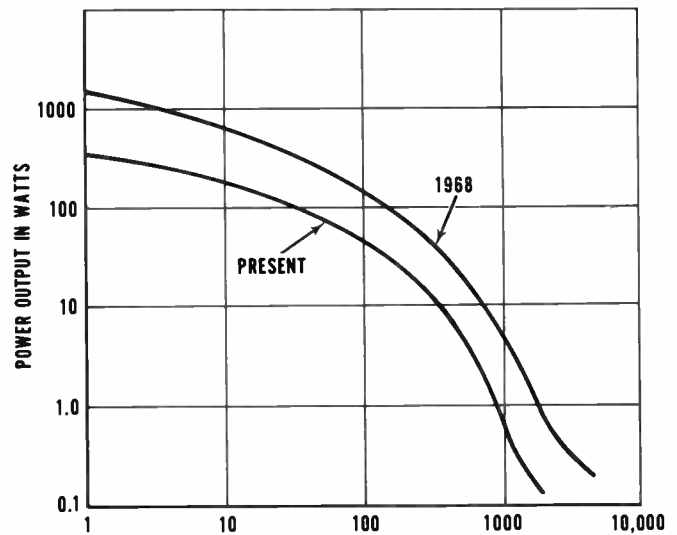

Fig. 12: R-F power transistors, present and future.

has greatly reduced the cost. Furthermore, Si devices which are built in large numbers on a single wafer assume their final electrical form before they are separated from each other and assembled in packages. This means that their electrical properties can be interrogated at this point by means of probe contacts and they can be separated into two or more categories before dicing. Flexibility with this procedure reduces cost. Hence the Si transistor will emerge as the leader in unit-volume sales for many years to come.

The silicon IC represents an extension of these procedures. Because it contains many components connected together in a definite way, it reduces some of the freedom of the circuit designer. Systems using more elaborate IC's tend to have less flexibility in their design. It is probably true that a compromise will be reached among all of these factors. An IC of some modest complexity will emerge as the active device being produced in largest volume.

LOW-POWER COMPUTER MEMORY

A NEW ELECTRONIC MEMORY under development is expected to fill a technological gap which currently exists in the field of airborne computers. The gap exists because the new generation of small, low-power aerospace computers are unable to use integrated circuits to drive their memory sub-systems due to the power needed.

The new memory, a product of LFE Electronics, Boston, Mass., achieves the drastic power reduction required by using tiny magnetic toroids as memory elements, photoetched *en masse* from Permalloy sheet. It will use integrated circuits for drive and sense circuits. LFE is fabricating and assembling a 1000-word, 30-bits-per-word, 2 μ sec.-cycle-time feasibility model complete with electronics.

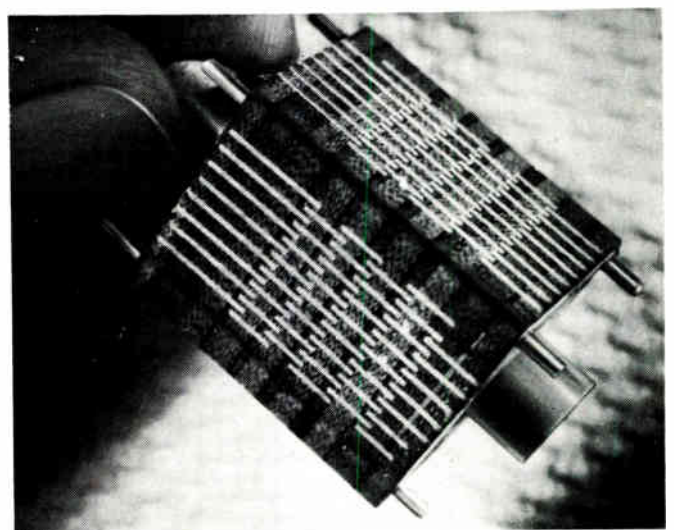

1965 Survey of Commercial Semiconductor Photosensitive Devices

By R. D. KAUS

Assoc. Engineer
GPD Development Lab.
IBM Corp.
Rochester, Minn. 55901

Part 3: Phototransistors, PNP Light-Activated Devices, and Manufacturers

PHOTOTRANSISTORS ARE ACTIVE NPN OR PNP junction devices normally operated with the collector junction reverse biased. As in the photovoltaic diode, the photon-excited minority carriers (in the base and collector regions) generated within a diffusion length of the collector junction, diffuse to the junction and are swept by the field in opposite directions. The only difference between the photocurrent and that due to thermal agitation (the dark current) is in the mechanism by which

the minority carriers are generated. Under equivalent conditions, the phototransistor is more sensitive than the photovoltaic diode since the photon-generated majority carriers (electrons in the N conduction base and holes in the P conduction base) produce emission of minority carriers (referred to the base) from the emitter region.

Phototransistors have slower response times since the time required for secondary charge carriers to travel

TABLE 3: CHARACTERISTICS OF PHOTOTRANSISTORS

Manufacturer	Type Number	Material	Spectral Response		Physical Dimensions					Package Description	Transistor Type	Number of Terminals	Dark Characteristics				Ambient Test Temp. °C	Light Characteristics (Base Open)		
			Spectral Limits (10% Points)	Sensitivity Peak	Diameter	Depth	Length	Width	Dimensional Coding				Sensitive Area	Collector-Emitter Voltage (Base Open)	Maximum Dark Current (Base Open)	Collector-Base Voltage (Emitter-Open)		Maximum Dark Current (Emitter-Open)	Collector-Emitter Voltage	Photo Current
			micron	micron	in.	in.	in.	in.	sq. in.				V _{CEO} v	I _{CEO} μa	V _{CB0} v	I _{CB0} μa		V _{CE} v	I _c ma	
Amarc Corp.	ES3511	Ge			0.1575	0.276			P											
Amperex Electronic Corp.	QCP70	Ge	1.43	<0.236	<0.59				P	0.01	A	PNP	3	-4.5	-325			25	-2	>0.75
	QCP71	Ge	1.55	<0.236	<0.59				P	-0.01	A	PNP	3	-4.5	-300			25	-2	1.5-4
Electro-Nuclear Laboratories, Inc.	904	Si	0.4-1.08	0.84	0.219	0.19			P		G'	NPN	2					25	4	>2
	904-2	Si	0.4-1.08	0.84	0.219	0.19			P		G'	NPN	2					25	4	>20
Fairchild Semiconductor	2N986	Si	0.5-1.07	0.8	<0.23	<0.23			P		G	NPN	3			80	0.01	25	25	>0.1
	2N2452	Si	0.5-1.07	0.8	<0.23	<0.23			P		G	NPN	3			80	0.01	25	25	>0.26
General Instrument Corp.	2N469A	Ge	0.38-1.7	1.55	0.219	0.312			P	0.0011	C'	PNP	3			-10	-8	25		
	2N1392	Ge	0.38-1.7	1.55	0.219	0.312			P	0.0011	C'	PNP	3			-10	-8	25		
	2N1393	Ge	0.38-1.7	1.55	0.219	0.312			P	0.0011	C'	PNP	3			-10	-8	25		
	2N1394	Ge	0.38-1.7	1.55	0.219	0.312			P	0.0011	C'	PNP	3			-10	-25	25		
General Sensors, Inc.	GS-100	Si			0.06	0.08			P		E	NPN	2	30	0.025			25	5	>0.8
	GS-120	Si			0.06	0.067			P		C	NPN	2	15	0.025			25	5	>0.3
	GS-135	Si			0.082	0.55			P		A'	NPN	2	30	0.01			25	5	>0.5
	GS-150	Si			0.082	0.55			P		A'	NPN	2	30	0.01			25	5	>1
	GS-160	Si			0.082	0.45			P		A'	NPN	2	30	0.025			25	10	>0.1, <0.2
	GS-161	Si			0.082	0.45			P		A'	NPN	2	30	0.025			25	10	>0.1, <0.3
	GS-162	Si			0.082	0.45			P		A'	NPN	2	30	0.025			25	10	>0.1, <0.4
	GS-163	Si			0.082	0.45			P		A'	NPN	2	30	0.025			25	10	>0.2, <0.3
	GS-164	Si			0.082	0.45			P		A'	NPN	2	30	0.025			25	10	>0.2, <0.4
	GS-165	Si			0.082	0.45			P		A'	NPN	2	30	0.025			25	10	>0.4, <1
GS-600	Si			0.214	0.198			P		G'	NPN	3	5	0.05			25	5	>20	
HP Associates	4202	Si			0.22	0.61			P		G	NPN	3	10	1			25	10	6
International Electronics Corp. (Mullard)	QCP71	Ge	1.55	0.232	0.591				P		A	PNP	3	-10	-300			25	-2	3.23
Nucleonic Products Co., Inc.	TP-30	Si			<0.078	<0.375			P		A'	NPN	2	24	0.05			25	24	0.03
	TP-31	Si			<0.078	<0.375			P		A'	NPN	2	24	0.05			25	24	0.005
	TP-32	Si			<0.078	<0.375			P		A'	NPN	2	24	0.05			25	24	0.01
	TP-33	Si			<0.078	<0.375			P		A'	NPN	2	24	0.05			25	24	0.02
	TP-34	Si			<0.078	<0.375			P		A'	NPN	2	24	0.05			25	24	0.04
	TP-35	Si			<0.078	<0.375			P		A'	NPN	2	24	0.05			25	24	0.0015
Raytheon Company	RM3002P	Si	0.8	<0.23	<0.21				P		G	NPN	3	20	0.1	30	0.01	25	6	>0.25
Texas Instruments, Incorporated	LS-400	Si			0.082	<0.6			P		A'	NPN	2	30	0.025			25	5	>1
	LX-600	Si			<0.062	<0.093			P		E	NPN	2	30	0.025			25	5	>0.8

from the emitter to the collector must be added to the transit time of the primary photon-generated charge carriers. From a design viewpoint, the present state-of-the-art phototransistors are response-time limited because of non-epitaxial construction, large base junction areas, and higher bulk resistivities. Phototransistors exhibit response times of the order of microseconds and sensitivities about 100 times that achieved with photo-voltaic diodes.

Phototransistors can be divided into two broad categories, those with an electrical connection to the base, and those without. It is argued that the apparent sensitivity of a three-terminal phototransistor is reduced by the metal contact to the base obstructing incident light. To the contrary, an increase in sensitivity can be achieved by biasing the device to a more favorable point (higher gain) on the I_C-V_{CE} characteristic. In addition, the collector-to-emitter breakdown characteristics are improved with base-to-emitter biasing.

Since germanium phototransistors are unstable in the open base configuration, these devices have an electrical connection to the base. The use of a base-to-emitter bias resistor increases the light-to-dark current ratio by causing a much greater proportional decrease in dark current. In general, germanium phototransistors exhibit maximum sensitivity under open circuit base conditions. Thus, proper operation is a compromise between sensitivity and stability.

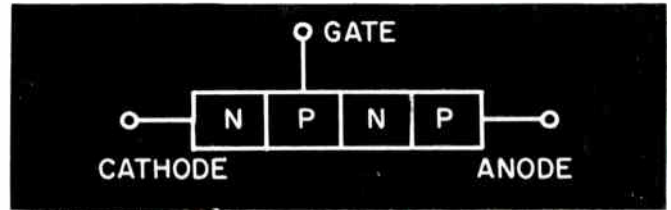

Fig. 1: PNP silicon light-activated device.

PNPN Light-Activated Devices

The two-terminal light-activated switch and the three-terminal light-activated SCR (Silicon Controlled Rectifier) are bistable silicon PNPN junction devices characterized by a high impedance "OFF" state (of about 100 megohms) and a low impedance "ON" state (of about 10 ohms). Under dc conditions, with the anode (Fig. 1) biased positive with respect to the cathode, these devices latch into conduction with very short light pulses. With ac bias conditions and short light pulse excitation, turn-off is achieved at the end of each positive half cycle.

In the "OFF" state, the center junction is reverse biased and the forward current increases with light intensity. Because of the high gain of the PNPN structure, the light and gate triggering levels are highly dependent on temperature and anode-to-cathode voltage. In the "ON" state, the center junction is forward biased and the forward current is limited only by the external series resistance.

Radiation Source					Sensitivity		Maximum Ratings				Saturation Characteristics			Response Time		Response Time Test Parameters			3 db Cutoff Frequency	Notes		
Illumination	Irradiation	Type	Wavelength	Color Temperature	Illumination Sensitivity	Irradiation Sensitivity	Collector Dissipation at 25°C	Ambient Operating Temperature	Collector-Emitter Voltage (Base Open)	Emitter-Collector Voltage (Base Open)	Maximum Saturation Voltage	Collector Current	Irradiation	Rise Time (10-90%)	Fall Time (90-10%)	Series Resistance	Supply Voltage	Load Current Switched				
ft-c	mw/cm ²		micron	°K	μa/ft-c	(μa/cm ²)	mw	°C	LV _{CEO}	BV _{ECO}	v	ma	mw/cm ²	μsec	μsec	K	v	ma	cps			
					>10.76j		50	55														
75		T		2700	>10		100		-7.5												3Kc	a
75		T		2700	20-53.3		50m		-25												3Kc	a
	5.6	MC	0.91			>357	500		30												>100Kc	b
	5.6	MC	0.91			>3570	500		30												>100Kc	b
100	5	T		3000	>1	>20	500		60					<1	<10			1				b
100	5	T		3000	>2.6	>50	500		60					<1	<10			1				b
		T		2770	7-14.9k		50														-20Kc	c
		T		2770	3-6.9k		50														-20Kc	c
		T		2770	>15k		50														-20Kc	c
		T		2770	7k		50														-20Kc	c
	20	T		2870		>40	50	125	50	7				1.5	15	1	35	0.8				n
	20	T		2870		>15	50	125	15	5	0.25	0.25	20	1.5	15	1	15	0.4				o
	20	T		2870		>25	50	125	35	4				1.5	15	1	5	0.4				d
	20	T		2870		>50	50	125	50	10				1.5	15	1	5	0.4				e
	20	T		2870		>5, <10	50	125	50	4				1.5	15	1	5	0.4				i
	20	T		2870		>5, <15	50	125	50	4												i
	20	T		2870		>5, <20	50	125	50	4												i
	20	T		2870		>10, <15	50	125	50	4												i
	20	T		2870		>10, <20	50	125	50	4												i
	20	T		2870		>20, <50	50	125	50	4												i
	20	T		2870		>1000	250	150	10	5				4	60	1	3	1				i
	22.1	MC	0.9			271			25		0.4	2										g
75					43.1		50m		-25													a
1000					0.03		50	125	40					-1								h
250					0.02		50	125	40					-1								h
250					0.04		50	125	40					-1								h
250					0.08		50	125	40					-1								h
250					0.16		50	125	40					-1								h
250					0.03		50	125	30					-1								h
10		T		2700	>25		500		30													l
	9	TF		2870		>111	50	125	30					1.5	15	1						b
	20	T		2870		>40	50	125	50	7				1.5	15	1	35	0.8				b

TABLE 5: 1965 SEMICONDUCTOR PHOTOSENSITIVE DEVICE MANUFACTURERS

Manufacturer	Visible Photoconductors			Infrared Photoconductors ^a				Photovoltaic Diodes								Phototransistors		PNPN Light Activated Devices		
	CdS	CdSe	CdSSe	PbS	InSb	PbSe	Ge	PN Photovoltaic Diodes						Solar Cells or Modules	Photo-Duo-Diodes	Si	Ge	Si	Si	
								InSb	Si	Se	Ge	InAs	GaAs							Si
Amarc Corp. 129-11 18th Ave. College Point, N.Y. 11356	X		X							X							X			
American Elite, Inc. 48-50 34th St. Long Island City, N.Y. 11101	X																			
American Semiconductor Corp. 3940 North Kilpatrick Ave. Chicago 41, Ill.														X						
Amperex Electronic Corp. 230 Duffy Ave. Hicksville, Long Island, N.Y. 11802	X			X						X							X			
Angstrom Electronics Corp. Sagamore Hill Dr. Box 712 Port Washington, N.Y.	X	X	X ^b																	
Avco Corp., Electronics Div. 2630 Glendale-Milford Rd. Cincinnati 41, Ohio																				
Block Engineering, Inc. 19 Blackstone St. Cambridge, Mass. 02139					*	X						X								
Cetron Electronic Corp. 715 Hamilton St. Geneva, Ill.				X																
Clairrex Corp. 8 West 30th St. New York, N.Y. 10001	X	X							X											
Crystalonics, Inc. 147 Sherman St. Cambridge, Mass. 02140																	X ^e			
Datasensors, Inc. 318 Interstate Rd. Addison, Ill.										X				X						
Davers Corp. Horsham Valley Industrial Center Horsham, Pa. 19044									*					*	X					
Delco Radio Div. General Motors Corp. Kokomo, Ind. 46901	X																			
Eastman Kodak Co. Apparatus & Optical Div. Rochester, N.Y. 14650				*	X	*	X													
Edgerton, Germeshausen & Grier, Inc. 160 Brookline Ave. Boston 15, Mass.									X											
Electro-Nuclear Labs, Inc. 2433 Leghorn St. Mountain View, Calif.									X					*	X		X			
Fairchild Semiconductor 313 Fairchild Dr. Mountain View, Calif.									X								X			
Ferranti Electric, Inc. Plainview, Long Island, N.Y.									X							X				
Ferroxcube Corp. of America Saugerties, N.Y.	X																			
General Electric Co. Rectifier Components Dept. West Genesee St. Auburn, N.Y.																		X		
General Electric Co. Tube Dept. Owensboro, Ky.	X	X																		
General Instrument Corp. Semiconductor Div. 65 Gouverneur St. Newark 4, N.J.																	X			
General Sensors, Inc. P.O. Box 231 Athens, Tex.																X				
The Harshaw Chemical Co. 1945 East 97th St. Cleveland, Ohio 44106									(CdS only)											
Heliotek Div. of Tectron Electronics, Inc. 12500 Gladstone Ave. Sylmar, Calif.									X						X					
Hoffman Electronics Corp. Semiconductor Div. Hoffman Electronic Park									X						X	X		X	X	

PIN — PIN reverse biased photovoltaic diode.
 X — Uncooled detectors designed for feasible operation at room temperature.
 * — Cooled detectors, not tabulated in Tables 1-4.
 a — Not tabulated in Table 1 since many of these devices require cooling to achieve desirable noise and dark characteristics.
 b — Not tabulated in Table 1 due to lack of sufficient information.
 c — Not tabulated in Table 4, P-channel silicon photosensitive field-effect transistor.
 d — Photo-sensitive Darlington amplifier.
 e — Not tabulated in phototransistors and PNPN light activated devices; N-channel silicon photosensitive field-effect transistor.

TABLE 5: 1965 SEMICONDUCTOR PHOTOSENSITIVE DEVICE MANUFACTURERS (CONT.)

Manufacturer	Visible Photoconductors			Infrared Photoconductors ^a				Photovoltaic Diodes								Phototransistors		PNPN Light Activated Devices		
				PbS	InSb	PbSe	Ge	PN Photovoltaic Diodes						Solar Cells or Modules	Photo-Duo-Diodes	Si	Ge	LASCR	LAS	
	CdS	CdSe	CdSSe					InSb	Si	Se	Ge	InAs	GaAs	Si	Si	Si	Ge	Si	Si	
HP Associates 620 Page Mill Rd. Palo Alto, Calif. 94304									PIN								X			
Infrared Industries, Inc. Photoconductor Div., P.O. Box 42 Waltham, Mass. 02154				*	X	*														
International Electronics Corp. (Mullard) 81 Spring St. New York 12, N.Y.	X			X	X			X	X								X			
International Rectifier Corp. 233 Kansas St. El Segundo, Calif.								X	X					X						
National Semiconductors Ltd. 2150 Ward St. Montreal 9, Canada	X	X						X												
Nucleonic Products Co., Inc. Nucleonic Components & Devices Div. 3133 East 12th St. Los Angeles, Calif. 90023										X							X			
Opto-Electronic Devices, Inc. Braintree, Mass. 02185	X	X	X																	
Philco Corp., Lansdale Div. Lansdale, Pa.				*		*	*	X				X	X							
Pioneer Electric & Research Corp. 743 Circle Ave. Forest Park, Ill.	X																			
Radio Corp. of America Electronic Components & Devices Harrison, N.J.	X							X	X											
Raytheon Company Semiconductor Div. 350 Ellis St. Mountain View, Calif.																	X ^d			
Sarkes Tarzian, Inc. Semiconductor Div. 415 North College Ave. Bloomington, Ind.																				X
Siemens America, Inc. 230 Ferris Ave. White Plains, N.Y. 10603								X	X											
Siliconix, Inc. 1140 West Evelyn Ave. Sunnyvale, Calif.																	X ^c			
Solar Systems, Inc. 8241 Kimball Ave. Skokie, Ill.								X						X						
Solid State Products, Inc. One Pingree St. Salem, Mass.																		X		
Standard Telephones & Cables Ltd. Rectifier Div. Harlow, Essex, England										X										
Sylvania Electric Products, Inc. Electronic Tube Div. Seneca Falls, N.Y.	X																			
Texas Instruments, Incorporated Semiconductor-Components Div. P.O. Box 5012 Dallas 22, Tex.								X							X	X				X
Transitron Electronic Sales Corp. 168-182 Albion St. Wakefield, Mass.																		X		
Tupper Trent Co., Inc. 207 Carter St. Chelsea 50, Mass.				*	X															
United Detector Technology P.O. Box 2251 Santa Monica, Calif.								X												
Vactec, Inc. 1209-1215 Olive Way St. Louis, Mo. 63130	X	X							X											
Western Semiconductors, Inc. 2200 So. Fairview St. Santa Ana, Calif. 92704																				X
Weston Instruments, Inc. 614 Frelinghysen Ave. Newark, N.J. 07114									X											

PIN — PIN reverse biased photovoltaic diode.
 X — Uncooled detectors designed for feasible operation at room temperature.
 * — Cooled detectors, not tabulated in Tables 1-4.
 a — Not tabulated in Table 1 since many of these devices require cooling to achieve desirable noise and dark characteristics.
 b — Not tabulated in Table 1 due to lack of sufficient information.
 c — Not tabulated in Table 4, P-channel silicon photosensitive field-effect transistor.
 d — Photo-Sensitive Darlington amplifier.

PHOTOSENSITIVE DEVICES

Abbreviations
Used in Tables 3, 4 and 5.

Material

Si—Silicon.
Ge—Germanium.

Device Description

LAS—Two-terminal PNP light-activated switch.
LASC—Three-terminal PNP light-activated SCR.

Dimensional Coding

P—Specified dimensions refer to the package and/or mount. For devices in transistor type cans, the package diameter includes the flange. Device depths excludes flexible leads.

Package Description

Primed quantities designate the device is hermetically sealed in the specified package.
A—Glass encapsulated.
C—Metal case.
CC—Kovar case.
D—TO-5 case.
DT—TO-5 case, mounted on a diamond base heatsink.
E—Microminiature metal ceramic case.
G—TO-18 case.
S—TO-9 case.

Radiation Source Type

E—Effective irradiation, integral of the product of the spectral response curve of the cell and the spectral distribution of the radiant power density at the cell surface.
MC—Monochromatic.
T—Heated tungsten filament (incandescent lamp).
TF—Tungsten filament source filtered through a Corning¶ CS7-69 filter (9 mw/cm² equivalent to 20 mw/cm² unfiltered).

Notes for Table 3 (Characteristics of Phototransistors)

- Side illuminated. Alloy junction.
- Glass lens. Planar geometry.
- Glass window. Alloy junction.
- Flat window.
- Flame formed lens.
- Glass window. No connection to the base lead.
- Device uses a fiber optic light guide.
- Surface-passivated planar geometry.
- Flame formed lens. Planar geometry.
- Bias conditions: $I_B=1$ ma, $V_{CE}=-5$ v.
- Measured with the sensitive area illuminated with incandescent light, chopped using a chopping disc at 400 CPS. Bias conditions: $I_B=1$ ma, $V_{CE}=-5$ v and base open circuit to ac.
- Convex lens.

¶Corning Glass Works, Corning, N.Y.

- Specified at 45°C ambient temperature.
- Planar geometry.
- Flat window. Planar geometry.
- Planar photo-Darlington amplifier (two transistors, common collectors and emitter one connected to base two).

Notes for Table 4 (Silicon PNP Light-Activated Devices)

- Glass window.
- Flat lens. Gate current trigger values include the current supplied to the bias resistor.
- Passivated planar geometry. Gate trigger current and voltage specified at 5 v anode-to-cathode bias. Gate trigger voltage specified with 100 ohm gate-to-source resistor. Gate current trigger values include the current supplied to the bias resistor.
- Side illuminated.
- Glass lens. Diffused geometry. Gate current trigger values include the current supplied to the bias resistor.
- Glass lens. Planar geometry.
- Planar geometry.
- Gate terminal returned to the cathode terminal through the specified gate-to-cathode resistance.
- Half sine wave, $f=60$ CPS.
- Specified at 75°C lead temperature.
- Specified at 50°C ambient temperature.
- Specified at 75°C ambient temperature.

CIRCUIT-WISE

VARIABLE VOLTAGE SUPPLY

A SIMPLE TRANSISTORIZED CIRCUIT, using a zener diode as the reference element, to provide a stable variable reference voltage is described.

As shown on the diagram, zener diode D_1 is used as the reference element for the supply. Voltage control is provided by a two-stage amplifier, consisting of Q_1 and Q_2 . The output voltage can be varied by adjusting R_2 , and is equal to—

$$V_{out} = V_2 \left(1 + \frac{R_1}{R_2} \right)$$

where V_2 is the breakdown voltage of the zener diode.

A positive starting signal applied to the base of Q_1 activates the supply. Since a positive feedback loop between the transistor is used in the circuit, the starting signal can be removed when the zener diode starts to conduct.

Current flow through Q_1 and Q_2 is controlled by the setting of R_1 . Increasing the resistance of R_1 increases the current flow through the transistors which, in turn, cause an increased current flow through D_1 and R_3 . The output voltage appears across the series

connection of D_1 and R_3 . As the characteristics of the zener diode are fixed, an increased output voltage can be obtained by increasing the voltage (IR drop) across R_3 . The voltage rise at the emitter of Q_1 limits the feedback in the circuit and prevents unlimited increase of the output voltage.

D_2 is included in the circuit to eliminate output voltage dependence upon the emitter-base voltage of Q_1 . It may be omitted from the circuit, if desired. The output voltage may be applied to an emitter follower circuit to obtain higher operating currents.

For further information contact: Technology Utilization Officer, Goddard Space Flight Center, Greenbelt, Md. 20771, Ref. B65-10097.

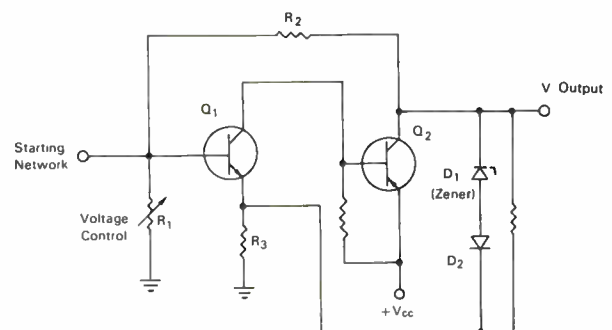

By **H. T. WARD** and **V. SCHWANKE**,
Fairchild Hiller Corp., Space Systems Division, Rockville, Md.,
and **S. RUSSELL**, Grumman Aircraft Corp., Houston, Texas

A Miniature R-F Switch for Space Applications

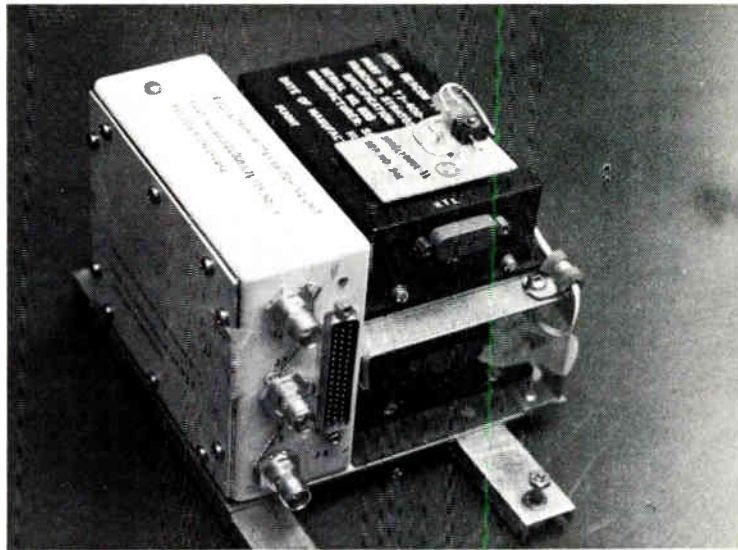

A FREQUENT NEED IN TODAY'S SPACECRAFT is a means of switching r-f circuits. A common example is the need for selection by ground command, of redundant transmitters and/or receivers. Existing coaxial r-f switch designs use continuous duty coils. Thus, they consume large amounts of power. The design described here is switched by a pulse (typically of 20 msec. duration and 20 v. amplitude). Thus, it can be driven directly from a command decoder, resulting in a reliable, simple configuration, which consumes negligible power.

To achieve the stated need, a standard Potter and Brumfield micro-miniature magnetic latching relay was used. The relays, of the double-throw type, have the ability to remain firmly latched in either

armature position without applied coil power. No changes were made internal to the relay; an electro-mechanical design for attaching coaxial cables was evolved experimentally. Size of the switch is $2\frac{1}{2} \times 1\frac{3}{4} \times \frac{3}{4}$ ins. and the weight is $\frac{1}{2}$ oz. (exclusive of mounting bracket).

Measured performance of the switch is shown in the graph. Insertion loss of the switch seldom exceeds 0.2 db for frequencies up to 300 mc. Insertion loss is about 0.5 db at 700 mc and increases rapidly for higher frequencies. VSWR of the switch, when terminated in a 50 ohm load, is generally less than 1.2 for frequencies up to 300 mc. The isolation, or coupling to the open port, exceeds 30 db for frequencies less than 300 mc.

Electrical characteristics of the switch may be summarized by stating that insertion loss, vswr, and isolation are all acceptable for most space uses at frequencies up to about 500 mc. Above 700 mc, the insertion loss, vswr, and isolation all degrade rapidly.

Symmetry of the switch is good, with both channels of the switch having about the same behavior. The slight differences may be seen on the graphs where measured data for both channels are plotted.

Power handling ability of the switch is over 5 w. cw. This value is for "cold" switching, since, for the present application, switching does not take place with r-f power flowing through the switch.

First application of the switch is on the spacecraft "Pegasus," which has been developed by Fairchild Hiller, under contract to NASA's Marshall Space Flight Center. The photograph shows the switching unit and two identical vhf beacon transmitters. Selection of transmitters, one of which is a spare, is effected by the r-f switch discussed here. The switching of primary power, and modulation, as well as r-f output, is accomplished by identical relays. Two relays are used, with one acting as an interlock to prevent accidental switching while a transmitter is operating. The complete package, consisting of a transmitter and its back-up, and the switch, is shown in the photo.

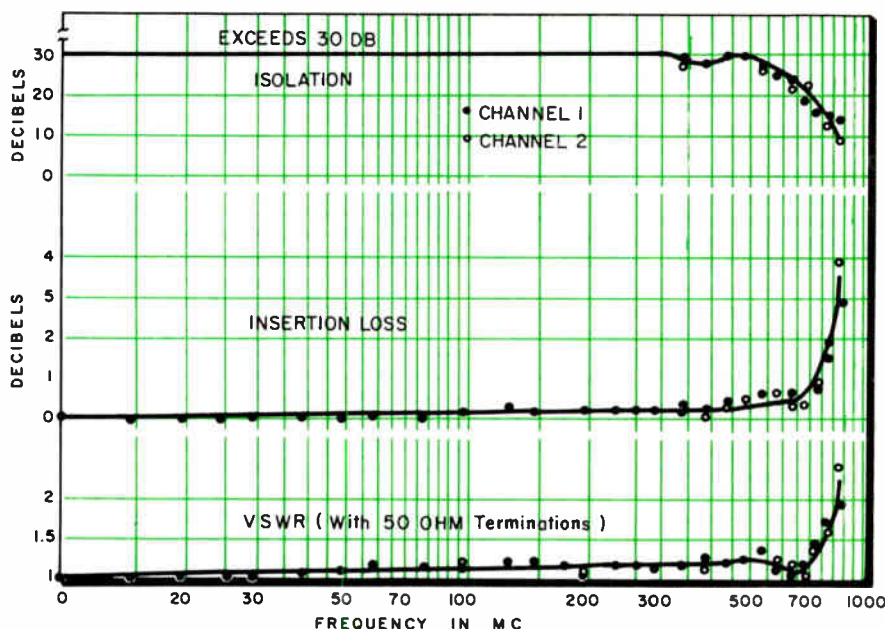

Mr. D. M. Bowie of Keltec Corp. contributed to the original design and measurements of the switch.

SEMICONDUCTOR DIODES

Past, Present, and Future

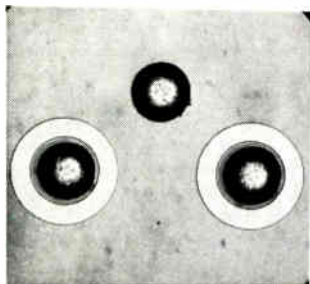

Dual diode showing one cathode and two anode contacts.

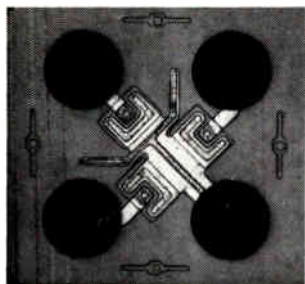

Triple diode with one cathode and three anode contacts.

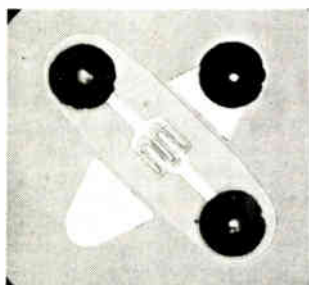

Transistor showing the emitter, base and collector contact.

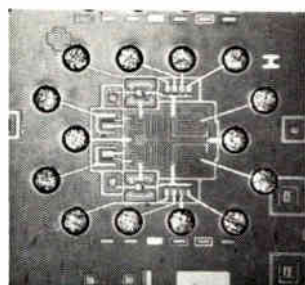

Glass ambient fourteen bump dual DTL chip is shown.

ELECTRONIC INDUSTRIES STATE-OF-THE-ART FEATURE

TO FULLY APPRECIATE the advances of the diode device during the last ten years, a step-by-step review of device structures is necessary. In this manner, we can follow the evolution of the low power PN junction diode and better understand the value of the drastic changes which have, and are, taking place.

Germanium Diode Junction Structures

Point Contact: The typical PN junction germanium diode, as made for the past 15 years, begins with antimony (N) doped germanium; while the P material comes from the whisker contact. Similar to silicon, germanium is doped and grown into a monocrystalline ingot. From this, dollar-sized wafers are sawed into dice. These are solder mounted onto a metallic post in a glass package.

The sealing of the diode package takes place with a pointed molybdenum whisker making, essentially, a point under pressure against the germanium die. The tip of the whisker is plated with indium (P-type material). By pulsing the device with a surge of current, the indium melts and flows, bonding the whisker to the die to form a PN junction. The amount and duration of the pulse determine, to a large extent, the properties of the diode.

While only four manufacturers still produce germanium general purpose diodes with point contact junction structures, each is enjoying a ready market. The profit margin, however, is low.

The first point contact diodes were registered in 1946 by Sylvania³ (the 1N34). The first subminiature glass packaged germanium diode was announced by Hughes in 1950 and registered in 1952³ (the 1N67A, 1N81A, 1N89 and 1N90). Non-pulsed point contact germanium diodes were used in 1953-1955 as UHF mixer diodes but were replaced by silicon point contact diodes.

Gold Bonded: The molybdenum whisker point contact diode has largely given way to the gold-bonded diode.

A typical gold-bonded diode differs from the point contact diode in that the whisker is made of gold gallium rather than "point" indium plated molybdenum. Pulsing again forms a PN junction. But the pulsing must occur at the time the glass package is fused closed. Unlike the molybdenum point contact whisker, the gold gallium whisker anneals during the glass fusion, losing some of its contact pressure.

Gold bonded diodes are designed for higher forward conductance and lower back currents than obtainable with molybdenum point contact diodes. Inherent in this diode is a sharp voltage-current reverse characteristic, much like that which silicon gives. That is, the reverse current has less change with applied back voltage and exhibits a sharp breakdown. In both cases, small junctions are formed. Such characteristics help reduce both the capacitance and recovery parameter values.

While only a few companies still produce this device, there are certain uses and circuits into which it has been designed. This is true of many current production computers, where the germanium device was

Over the years there have been many changes in materials and structures of diodes. These changes are described here, from the beginning to the present, with a look at the future. Most of the diodes described are still in use.

By **NORMAN J. EGLI**

Manager,
Microelectronic Devices and Circuits
Microelectronics Div.
Hughes Aircraft Co.
Newport Beach, Calif.

chosen prior to silicon selling at a competitive price. However, germanium diodes still offer many attractive characteristics.

Gold bonded germanium diodes, first manufactured at Western Electric, were introduced commercially in 1954 by Transitron[®] with their 1N139 thru 1N145 general purpose series.

Slice Diffused: The diffused junction has not found major usage for low power germanium diodes. Planar germanium diodes, however, could offer certain advantages over their silicon counterparts for commercial use, if available.

Silicon Diode Junction Structures

Point Contact: The point contact silicon diode, primarily, has found use as a microwave mixer or detector. This unit first made its appearance during World War II. These devices, made by three companies, appear to have changed little during the past decade. The other major silicon point contact use is in UHF TV tuners. The original standard microwave mixers using point contact junctions were the 1N25 and 1N27 registered by Sylvania in 1946 and the 1N22 registered by BTL in 1946. The first UHF mixer was registered in 1953 by Sylvania.

The junction for these devices is made by selectively locating a point whisker contact on a single crystal silicon die.

Alloy: A more widely used silicon diode contains an alloy junction, which was marketed eleven years ago. A typical silicon alloy diode junction is made from an arsenic (N) doped silicon die into which an aluminum

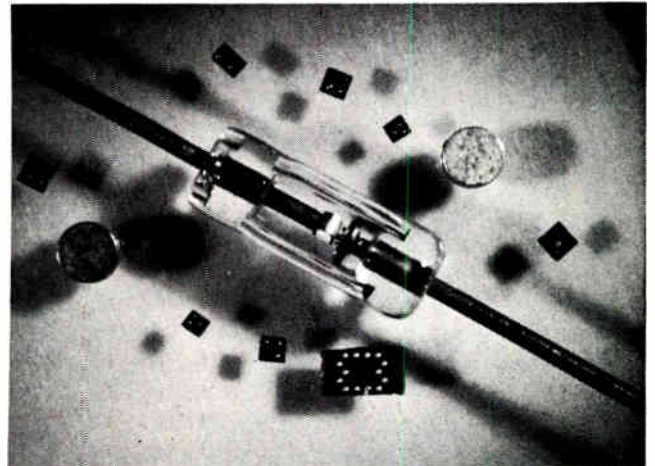

Standard DO-7 subminiature glass diode with new glass ambient diode, transistor and circuit chips compared.

Devices ultrasonically bonded on thin film pattern on glass.

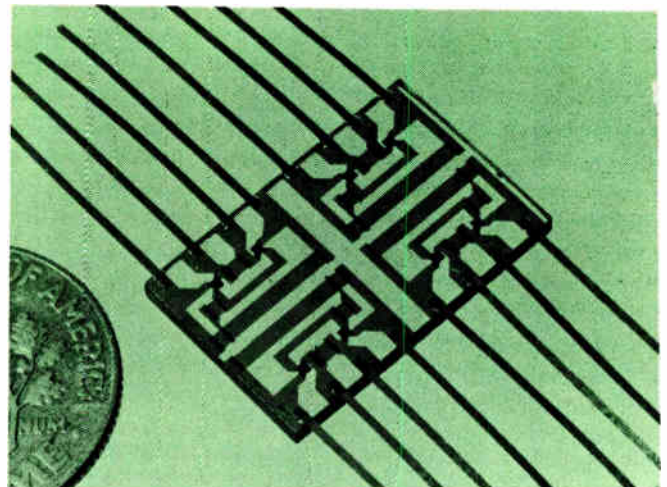

Devices ultrasonically bonded on thin film pattern on alumina.

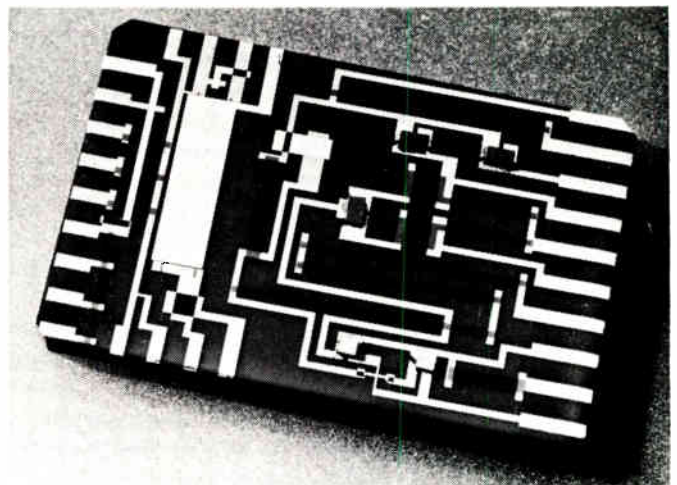

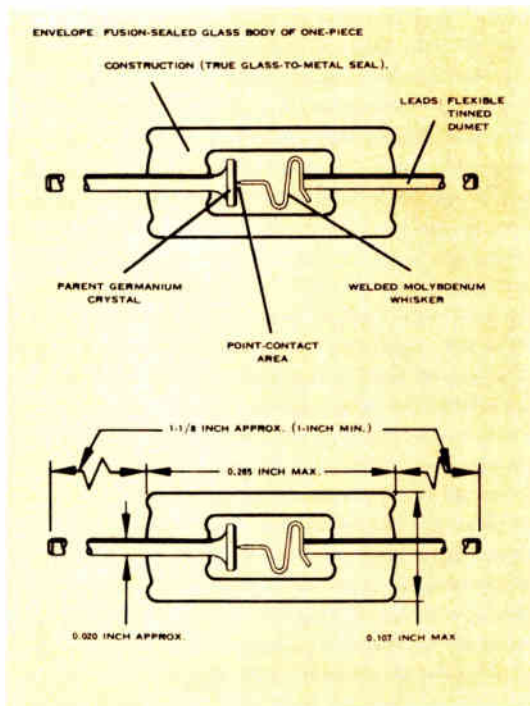

Section view of a point contact diode (DO-7 package).

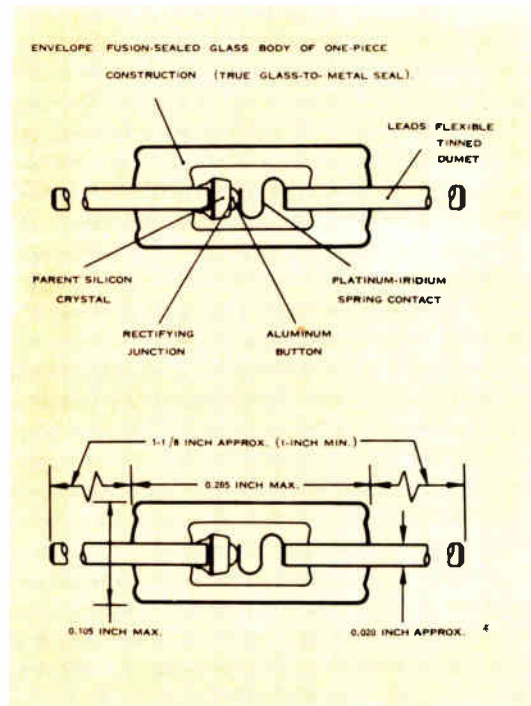

Section view of an alloy junction diode (DO-7 package).

DIODE DEVICES (Continued)

(P) wire or pellet has been fused to form an area-type PN junction. The fusion is normally done in a continuous belt furnace. The temperature, belt speed, gas and time of fusion are very important in determining the PN junction depth and area.

Unlike germanium, silicon alloy junction diodes have the junction formed prior to packaging. The back leakage current in the finished diode is highly dependent upon the etch and handling in final packaging.

After fusion, a thin layer of the silicon is then etched from around the aluminum-formed bump exposing the junction and forming a small "mesa." The junction area is then carefully cleaned and a protective coating of silicon dioxide or a silicone varnish was used to seal the junction from further contamination.

Desired characteristics in this type of device are achieved by such process variations as: heat treatment or doping of the slices (to decrease recovery time), reduced aluminum button size (for lower capacitance), reduced die thickness (to improve conductance), and larger button and lower resistivity (for greater capacitance in capacitors).

The first alloy junction zener diodes were registered by NSP³ (now Hoffman) 1N200-239 in 1954. The first general purpose alloy diodes were registered by Hughes³ and Raytheon³ in 1956.

Slice Diffused: The much used silicon diffused junction process opened up new vistas for semiconductor diodes. Slice or sheet diffused junctions first appeared in production diodes in the high voltage rectifier series, the 1N645 through 1N649, registered by Texas Instruments Incorporated (TI) in 1957, and in the 1N643 computer diode registered by PSI in the same year.

The then-new diffusion method made possible the control of both the concentrations and the concentration gradients to very precise limits. The fine tolerances achieved through this dimensional control led to superior design and, in turn, improved yields over alloy structures.

In the case of logic diodes, the diffused junction offers the advantage of lower capacitance for a given area. This increased the conductivity for devices in the lower capacitance range.

The older point contact and alloy junction processes required the making of the PN junction either after dicing and/or packaging of the silicon (or germanium) die. However, with the diffusion process a complete slice was diffused, making a large area PN junction. Then the slice was diced either by diamond sawing (or scribing) or ultrasonics. The diffusion process decreased the dice handling costs for the manufacturer. He now was able to produce thousands of diodes at once in a batch, rather than a single unit by unit process.

A typical diffused junction diode is made by placing polished or etched slices of monocrystalline silicon in a high temperature atmosphere which contains the desired type diffusant. Either static or dynamic atmospheres can be used successfully. After diffusion the slice is diced, etched, and ready for packaging, as with alloy junction structures.

Mesa Diffused: Soon after the appearance of diffused junction diodes on the market, a variation was developed called the diffused mesa. A "mesa-type" junction was described under "alloy."

Today, however, the majority of the mesa-type diodes are made with the diffused process. This process is similar to the sheet diffusion described. A selective masking method is used to define the desired mesa area and the surface is then etched until the desired junction is

exposed and cleaned to eliminate any possible shorts. The mask is then removed and all exposed surfaces are glass passivated, mainly to protect the junction. The glass coating is then removed from the top or "mesa" surface only, exposing a contact area. (Some mesa diffused use oxide instead of glass.) The slices are then diced in the normal way.

With the diffused methods, manufacturers are able to achieve a graded junction rather than an abrupt junction of the earlier alloy type structures. Even with the danger of contaminating the junctions during this process, it afforded manufacturers the voltage characteristics desired. With proper prior junction cleaning the glass or oxide gave excellent protection to the junction area during further packaging steps and is better than varnish protection normally used on alloy junctions.

Planar Oxide Passivated: This method was developed in an effort to find a way of eliminating the exposure of the PN junction during the manufacturing process. A silicon dioxide layer is used as the passivating coat. Photolithographic and chemical etching methods are then used to open a window in the oxide coating.

Subsequent diffusion processes form the PN junction using the silicon dioxide coating as a mask. During the diffusion temperature cycle, the impurities forming the PN junction diffuse laterally under the silicon dioxide mask.

In most processes, a second oxide layer is then grown in the window. A subsequent photo operation opens a smaller window (for contacting) further removing the junction from the window oxide edge. This optimizes most of the device characteristics which previously degraded because of junction contamination.

The first planar diodes were introduced commercially by Fairchild.

Glass Ambient: Introduced in 1964 by Hughes, the glass ambient junction is similar to an epitaxial planar diffused junction, except that the process had two basic improvements. First, the normal oxide passivation is supplemented with a glass coating which provides a hermetic seal. This coating eliminates the need for further packaging of the die. Second, the front or anode contact to the die is a continuous metallurgically bonded bump.

Glass coatings are usually made by one of the following methods: glass frit deposition with subsequent fusion, sputtering or pyrolytic.

These devices are available in "chip" form, as well as in a variety of packages.

Ion Implantation⁶: An even newer diffusion process now in the experimental stage is referred to as ion implantation. This new process could ultimately supplant all of the current classic diffusion processes.

This method implants the junction through the passivated oxide surface without resorting to photo

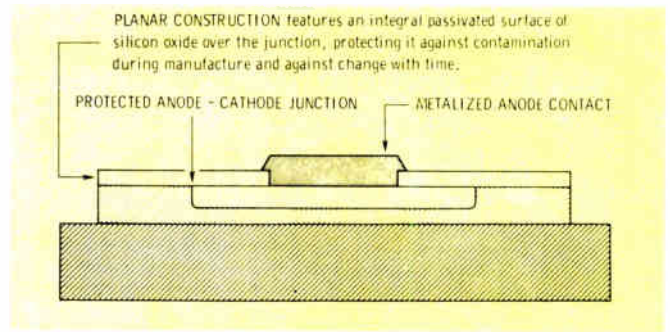

Section view of a planar diffused junction by Fairchild.

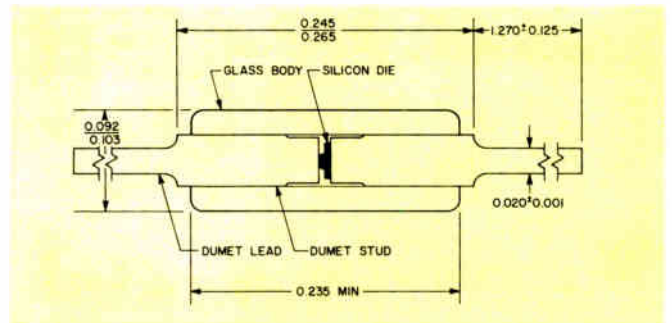

A planar epitaxial junction diode (DO-7 package) by Raytheon.

lithographic and chemical etching methods. The process requires a linear accelerator and may be digitally programmed.

Ultrasonic Chip Bonding

Hughes has developed and has been delivering to customers since July, 1965, ultrasonic mounting and bonding equipment. This equipment is used for mounting glass ambient bump contact type diodes, transistors and integrated circuits to substrates. (Either thin or thick-filmed deposited pads and interconnects.)

Mounting speed is 250 chips or circuits per hour. (Equivalent to 1000 or more T.C. Bonds/hour.) Speeds up to 1000 chips per hour are predicted for machines under design.

With the development of the high-speed ultrasonic bonding equipment, the full use of the glass ambient bump contact structure may be obtained.

This bonding process using glass ambient flip chips will eliminate the need for the present day packaged discrete devices.

Only silicon chips are available today to take advantage of this mounting method.

Epitaxial Materials Effect on Structures⁴

Available since 1960, epitaxial silicon slices have afforded specific improvements in diode processing and diode design.

The epitaxial process consists of growing a very thin (about 10 microns) layer of high resistivity single crystal silicon upon a slice (several mils thick) of degenerate (low resistivity) single crystal silicon.

Epitaxial material allowed the manufacturer to minimize series resistance, improve forward conductance and reduce recovery time in their diffused junction

• A REPRINT of ANY ARTICLE in this issue is available from ELECTRONIC INDUSTRIES Reader Service Department.

DIODE DEVICES (Concluded)

structures. These improvements could be obtained even with increased overall wafer thickness, which in turn reduced wafer breakage. Epitaxial germanium has been used for volume production of diffused transistors; it has not found large usage in germanium diode structures.

New Types Replace Need for Packaging

Microwave packages have remained relatively unchanged during the past ten years. The industry package for most other diode types has been the standard subminiature glass diode envelope. Various microsized packages are available, but none have found as wide acceptance since they have all lacked multiple source availability. They also could not be high-speed-assembled onto printed circuit boards as was the case with the standard DO-7 type subminiature glass diode.

Microsized whiskerless diodes were made possible by the various diffused processes. They became available in the late fifties.

View shows a glass ambient junction structure by Hughes.

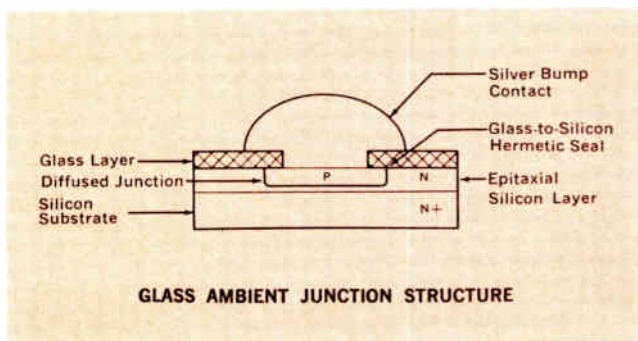

Section view of a leadless pellet diode from Hughes.

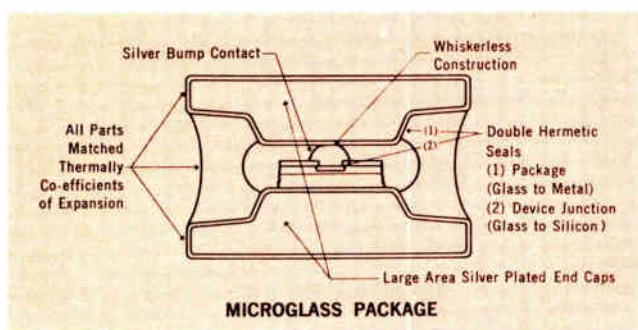

Microsized diodes with leads made by Texas Instruments.

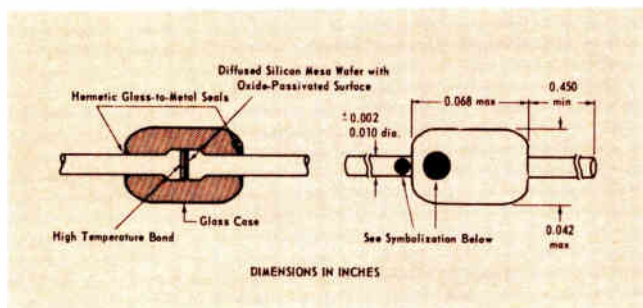

To overcome the lack of high speed assembly capability with microsized devices. Texas Instruments micro diode is offered with universal automatic insertion equipment.

Another approach to high-speed automatic insertion was announced this summer by Hughes for their micro-glass diode. This equipment is made by Technical Devices and is available in two versions: One equipment will insert leaded microglass diodes on 0.250 in. centers and the other equipment will insert the leadless pellet version of their microglass diode.

There is an increasing demand for the newer type unpackaged, glass protected, hermetically sealed diode for low power uses. These units or "chips" can be tab-mounted or solder-mounted to a substrate. Such substrates already contain deposited interconnects. This "flip-chip" method receives its name from the mounting process whereby the chip is "flipped" to make direct contact with the interconnect pattern. No interconnection wires are required.

The glassed bumped diode most nearly approaches that device which could obsolete the familiar diode package. The elimination of the additional hermetic sealing process also makes multiple construction possible. Instead of having a one-to-one situation, where each diode must be sealed into a package, several devices can be on a single chip. This combines the best circuit design features of discrete devices and integrated circuits.

Future Trends

After reviewing the various junction structures and their associated materials and packaging developments, the following conclusions may be drawn:

All the "obsolete" discrete junction types will continue to be produced for specific uses for which they are still clearly best suited.

Large portions of the discrete computer diode market will evolve into micro modules.

Assembly costs for the systems manufacturer will further be decreased with the increased use of glass coated chips with bump contacts.

The ultrasonic high speed chip bonding method will find increased use throughout industry.

Passive substrate assemblies using chips (from simple diodes to integrated circuits) will allow the engineer to maintain complete design flexibility.

References

1. H. O. North, (Hughes Aircraft Company), "A New Germanium Diode of Improved Design," Paper presented at WESCON, IRE Convention, September 14, 1950.
2. S. H. Barnes, (Hughes Aircraft Company), "Silicon Junction Diodes Sealed in Glass," *AIEE*, 1954.
3. JEDEC Semiconductor Devices Council *JEDEC Publication No. 3E*.
4. Christensen, H., and H. C. Theurer: Unpublished Work, Bell Telephone Laboratory.
5. Published Sales Literature from: Clevite Transistor Products, Inc. Fairchild Semiconductor Corp. General Electric Company Hughes Aircraft Company International Telephone and Telegraph Micro Semiconductors, Inc. Microwave Associates Motorola, Inc. North American Raytheon Manufacturing Company Sylvania Electric Products Texas Instruments, Incorporated Transiron Electronics Corp. Uni'rode Transistor Products, Inc.
6. *Electronic News*, Dated June 28, 1965.

1965 Survey of Relay Specifications

Part 4: Special and General Purpose Relays

ELECTRONIC INDUSTRIES
STATE-OF-THE-ART
FEATURE

THIS PART 4 of the relay survey presents a broad line of relays that have been classified by EI editors as either "special purpose" or "general purpose" types. This is an arbitrary grouping intended to include relays not covered in Parts 1, 2 and 3 of the survey. Therefore, it also excludes types that have been presented previously such as sensitive relays, reeds, steppers and power relays, types that may be considered by some as belonging in the special purpose or general purpose categories.

General Purpose Types

One standout in the broad general purpose category is a low cost, small size and weight class relay particularly suitable for light industrial and commercial use in TV remote control, photocell control, model aircraft, warning systems, tape recorders, games, light dimming controls and similar applications. A line of relays in this class features sensitivity ranges down to 10 milliwatts, sizes one to 1½ cubic inches and weights of one to two ounces (Cornell-Dubilier) (Eagle Signal).

Another class of general purpose relays enclosed in plastic cases and with plug-in or solder terminals is used for general automation work and other light industrial or heavy communications applications. One of these relays features 4PDT contacts with 5-amp or 10-amp capacity,

and all terminals on one panel (Ohmite).

A double-break, 4PDT design employs unique construction. The case, rather than merely a shock-proof enclosure, is an integral part of the relay, acting as a support for the relay mechanism and a means for eliminating parts. Circuits can be added or revised by replacing the existing relay with a new one. Terminals are quick connect types (Dormeyer).

A crystal can relay with bifurcated contacts employs a hinged suspension of the armature, a design feature that eliminates bearings and pins (Hart).

A sealed 2PDT subminiature employs the principle of a plunger-type solenoid to actuate the moving contacts, wherein the actuator movement in either the energizing or deenergizing direction is translated into a wedging action of the moving contact against the fixed contact ramp, resulting in large wiping action and high contact pressure (Electro-Tec).

New Miniatures

High density packaging is getting a boost from several new miniature and subminiature relay designs. One

Series 220—Price Electric
Model SSR-1285-5050—Solid State Electronics
Type 1000—Electro-Tec
Series 18—General Automatic
Type S6H3—Allied Control
Type GPR—Ohmite
Series 30—F. A. Scherma
Series T—Hi-G

General Purpose Relays

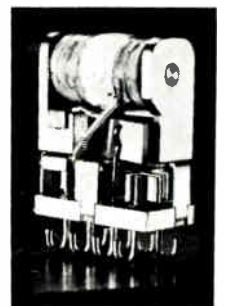
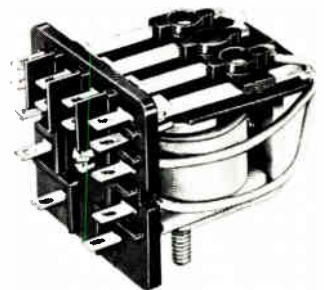
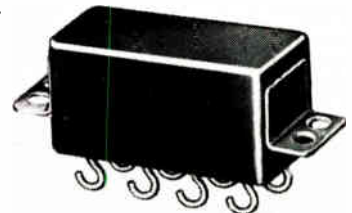
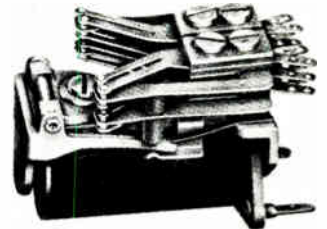

Special Purpose Relays

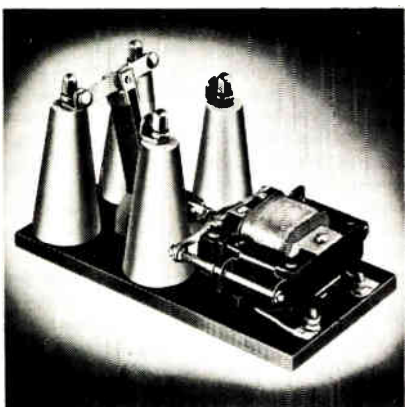
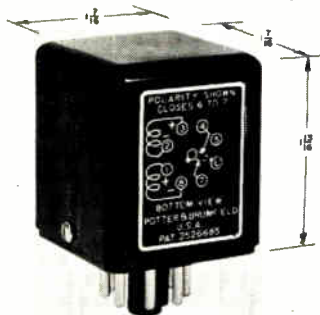
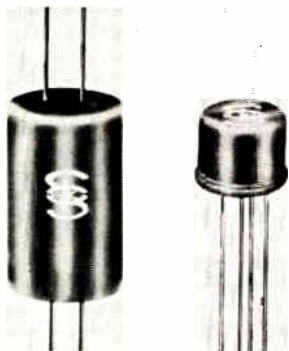
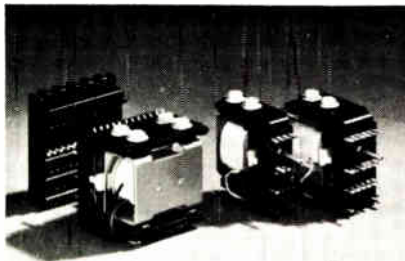

example is an all welded DPDT .5 amp unit enclosed in a TO-5 case. It has a volume less than .025 cubic inches and weighs .09 ounce (Tele-dyne Precision). A sealed DPDT .040 cubic inch 3-amp p-c board relay weight .1 ounce (Hi-Spec). Another hermetically sealed, rotary balanced armature DPDT high environmental type with one-amp contacts weighs 4 grams and is .048 cubic inch size (Bourns). Other types highlighted: 1/7th and 1/6th size crystal cans, each with .1-inch grid terminals (Couch Ordnance) (Union Switch and Signal); a 1/4th crystal can sealed aerospace relay .32-inch high (General Electric); a .128 cubic inch sealed DPDT 2-amp unit weighing .3 ounce (Allied Control); a half crystal can, 2-amp DPDT unit weighing 9 grams (Struthers-Dun); and a crystal can, balanced armature DPDT unit with 10 amp, 28 volt capacity in .46 cubic inch size (Price Electric).

Also, for printed circuit board users, a new permanent magnet, plug-in latching relay is available. Employing ceramic magnets instead of mechanical linkage, the 6-24 volt DC relay requires only a 7 millisecond DC pulse to switch and no hold-in power is needed in either latched position (Executone Printac).

Telephone Types

Telephone type relays are found among the relay products of a large number of manufacturers. These relays offer high contact density and pressure, low power requirements, fast action and long term reliability.

Wire Contact—IBM
 Type HF—Adams & Westlake
 Models 651 & 661—Solid State Electronics
 Series MDP—Potter and Brumfield
 Style 6225—Price Electric
 Series 100—Stearns-Lyman

Their performance has been proven over many years of reliable operation not only in the telephone industry but in other switching applications as well.

Basically, telephone type relays of different manufacture are similar. Springs which support the contacts are usually flat cantilever types interleaved with phenolic or other insulators to form stacks or "pile-ups" held together by high tensile screws. Slow operate and slow release types utilize a copper slug either at the armature end or the heel end of the coil to delay either the build-up or decay of magnetic flux, thus providing a time delay period which varies with the size of the slug. Delays up to one second or so are possible.

Special High Speed Relays

The "permissive-make" relay is an IBM development resulting from efforts to improve upon the Company's own wire contact type used in punch card accounting machines. The wire contact type is rated for 200 million operations and speeds of 4.5 ms. The new Permissive-Make relay nearly doubles this performance. A comparison of the characteristics of the two relays can be seen by reference to these relays in the General Purpose charts.

In the Permissive-Make relay, high speed operation is facilitated by a contact spring formed in the shape of U to reduce the natural frequency. The contact wire is permitted to make because of its own spring pressure, thus the name permissive-make contact.

Another hard contact relay of entirely different construction useful in data sampling and multiplexing is a 1-3 pole double throw type with gold alloy contacts rated at 10 volts, one milliamperere. In this, the speed

Relay Survey Parts 1, 2, and 3 appeared in these issues:

Part 1: Reed Relays and Sensitive Relays
 (EI March, 1965)

Part 2: Stepping Relays and High Voltage Relays
 (EI May, 1965)

Part 3: Power Relays
 (EI August, 1965)

for a form K contact set driven by a square wave with a 10 microsecond rise time is 650 microseconds (James).

Mercury Wetted Relays

What is generally considered a very significant contribution to industrial relay design in the last decade is the mercury wetted contact relay. Basically it comprises a sealed switching capsule containing fixed contacts, armature contacts and a pool of mercury. When placed in a magnetic field, the armature within the capsule moves to close the normally open contacts. As it does so, capillary action between the arms of the contact draws from the pool a filament of mercury which joins the contacts.

Mercury wetted relays feature mechanical simplicity, little or no wear or contact damage in fast operations, dissipated heat and no bounce or chatter. In one test of reliability, a mercury wetted relay carrying 250 va at 60 cps continue to perform within specifications after more than 13 billion operations (C. P. Clare).

Mercury wetted relays also provide relatively high speed. One single switch (Form D) type has an operate time as little as 3 milliseconds, and multipole versions average 5 milliseconds or less (Adams & Westlake).

Special Purpose Relays

The special purpose relays covered in this part of the survey include the light-duty delay relays, coaxial types, electrically operated temperature sensitive, photo sensitive and frequency sensitive relays, voltage and current change sensitive relays, polarized relays and other types of relays for specialized applications.

Electrically operated time delay relays may provide a delay between energization and contact make, between de-energization and contact break, or a make and break plus a proportional delay. Proportional delay relays, commonly used in transmitter circuits, provide in addition

to the delay on make, a proportionately shorter time delay period following brief power interruptions to allow sufficient time for load circuit warm-up before power reapplication.

Delay relays utilize various devices, principally resistance heater elements, R-C networks, semiconductor networks, oscillators, pneumatic, mechanical and hydraulic escapements, motors and still other means to provide time delays over any range from microseconds to years.

Solid state time delay relays may or may not use mechanical switching in the output depending upon the switching requirement. The timing circuit usually consists of a resistor in series with a capacitor. When voltage is applied to this circuit, voltage across the capacitor slowly increases. When the firing level is reached, a solid state trigger circuit turns on a solid state switch or relay in the output. Several manufacturers offer relays using this basic design. A series of these relays with and without hard contacts in the output circuits are available in various package configurations, offering fixed and adjustable delays from .1 to 180 seconds (Potter & Brumfield).

One R-C type employing silicon semiconductors provides fixed delays of .01 to 20 seconds, 350 ma output and is packaged in a .2 cubic inch diallyl pthalate cube including capacitors and resistors (Jay-EI). An adjustable subminiature silicon device with .5 cubic inch volume provides 2 microsecond switch-on time and a delay range of 50 microseconds to ten minutes (Solid State Electronics). Another .5 cubic inch solid state unit provides an adjustable delay of .1 to 200 seconds (Bourns).

Series 2400—Electric Stop Nut
 Type 3907—Bourns
 Type CD-45—Potter & Brumfield
 Series LT—GV Controls
 MEK-45—Machinery Electrification
 Series 3000—Master Specialties

Time Delay Relays

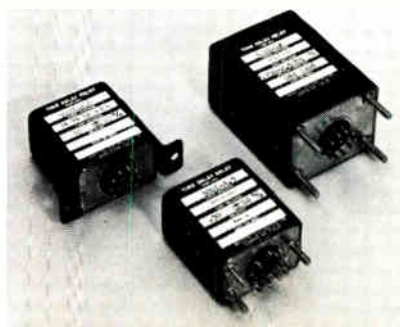
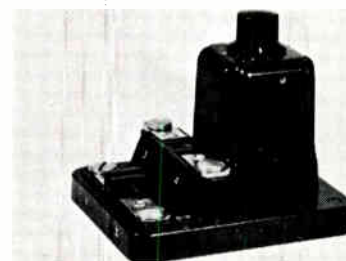
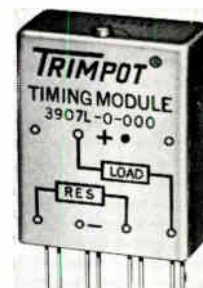

Miniature Relays

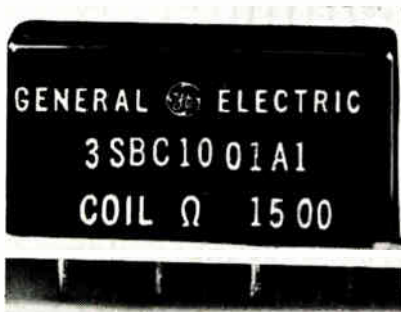
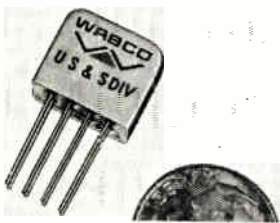
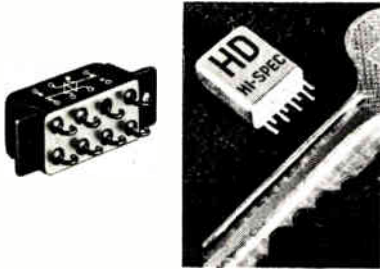
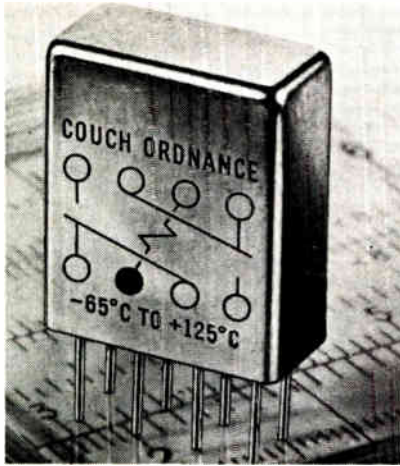

Thermal Delay Relays

Thermal time delay relays operate as the result of the heating effect of an electrical current passing through the sensing or actuating element, the heat changing the length or position of the element so that it opens or closes contacts.

Actuating elements are used in various forms according to sensitivity, delay periods, energizing voltage and other factors. For example, a series of hermetically sealed relays in miniature and octal sizes is made with a hot wire for delays up to 3 seconds, a tension ribbon for delays from 3 seconds to 12 seconds and an internal heater for delays from 12 to 180 seconds. A fourth, high precision type uses a heater filament embedded in a stainless steel element (GV Controls).

Thermal time delay relays are available featuring "snap action" double throw contacts. In this type, a toggle assembly is mechanically activated by movement of the bi-metal element (Electronic Fittings Corp.).

Magnetic Time Delay Relay

An electronic timing technique using a magnetic core counter is being employed in a series of timing modules providing delays with 100:1 adjustability in six ranges from .05 to 500,000 seconds. These magnetic units substitute a differential amplifier section for the semiconductor used in solid state R-C timers. The magnetic core counter acts like a period multiplier. Upon receiving a predetermined number of pulses from an oscillator, which may be an extremely stable RF type, it triggers the output through a logic circuit. Longer time ranges are achieved by cascading magnetic counting stages (Elastic Stop Nut).

Type 2X—Couch Ordnance
 Type FC1—Struthers-Dunn
 Series HD—Hi Spec
 Series 412—Teledyne Precision
 Model 901—Union Switch & Signal
 Model 150—General Electric
 Type 952—Cook Electric

Magnetically Amplified Relays

Magnetically amplified relays are being used to provide switching of AC or DC loads as the result of a signal received from low level transducers such as thermocouples or resistance bridges. Signals as low as one milliwatt or 10 microamps are sufficient to operate 3PDT, 5-amp load relay with no intermediate amplification (Development Associates Controls).

Motor and Solenoid Driven Delays

Both motor driven and solenoid wound, spring driven delay relays are commonly used in industry for adjustable time lag in the operation of process controls, shakers, automatic doors, heat treatment equipment and similar applications. Both economy and precision types are available in the motor driven dial indicator types offering time periods from a few seconds to several hours (Giannini Controls) (Cutler-Hammer). One make of solenoid wound, spring driven types offer delay periods ranging from .025 seconds to 15 minutes (Rhodes).

Photosensitive Relays

Extensively used for inspection and control in business and industry, photosensitive relays employ a light source playing upon a photocell which in turn generates a current that is amplified sufficiently to drive an electromagnetic load relay. The load relay then operates when a change in light intensity takes place on the photocell. This change may be an increase or decrease in light caused by an obstruction, the removal of an obstruction or the variation of reflected light. Equipments are available that will detect light changes of 1/1000 of a second in duration (Photomation).

Another photo-electric device, which is actually a light controlled resistor combines a light source (either tungsten or neon) plus a photocell within an opaque subminiature enclosure. Varying the drive to the light source from zero to full excitation decreases the resistance of the electrically isolated output circuit by a factor of 10^6 (Solid State Electronics).

(Continued on page 114)

RELAY LISTINGS (Cont'd)

GENERAL PURPOSE RELAYS		TYPE NO. OR SERIES	AC OPERATED	AC OR DC OPERATED	DC OPERATED	CRYSTAL CAN	MERCURY WETTED	HIGH CURRENT	INDUSTRIAL CONTROL	TELEPHONE TYPE	LATCHING	PLATE CIRCUIT	SOLID STATE	HIGH ENVIRONMENTAL	NO. OF POLES	CONTACT FORM	NOM. CONTACT VOLTAGE (V)	NOM. CONTACT CURRENT (A)	NOM. OPER. VOLTAGE (V)	NOM. OPER. CURRENT (A)	NOM. OPER. SPEED (MS)	MINIATURE	SUBMINIATURE	ENCASED	PLUG-IN	PRINTED CIRCUIT MFG.	SIZE (CU. IN.)	WEIGHT (OZ.)	HERMETIC SEAL	MIL SPEC																		
Elec-Trol, Inc. 18828 Bryant St. Northridge, Calif.		300C			X										1-5	A-C			6-24			X																										
Electronic Controls, Inc. Danbury Rd. Wilton, Conn. 06897		801/831/808 801/831/808 801/831/808 801/831/808 801/831/808 801/831/808 801/831/808			X						X				12 24 36 12 24 36 48	A-C A-C A-C A-C A-C A-C	3 3 3 3 3 3 3	6-110 6-110 6-110 110 110 110 110		30 30 30 30 30 30 30			X		X	X				4.5 5 5.5 4.5 5 5.5 6.0	X X X X X X X	X X X X X X X																
Electronic Specialty Co. 4561 Colorado Blvd. Los Angeles, Calif. 90039		60 65, 68 79R 93 94 103 104			X										2 2 2 2 2 4 4	DT DT DT DT DT DT DT	115 115 115 115 115 115 115	2 2 2 10 10 10 10	to 96 to 110 to 110 to 110 to 56 to 110 to 72	.2w .3w .25w .35w .15w .65w .3w	5 5 5 8 12 8 9		X	X	X	X	X				.8 .6 .7 1.7 1.7 2.4 2.4	X X X X X X X	X X X X X X X															
Electro-Tec Corp. P. O. Box 667 Ormond Beach, Fla.		400 1000 2000		X	X										2 6 6	DT DT DT	115 26 30	2 2 2	26 26 26		10 13 13			X	X	X				1.5 4.3 4.5	X X X	X X X																
Executone, Inc. Printac Relay Div. 47-37 Austell Pl. Long Island City, N. Y.		LS LD			X						X				5 5	A-C A-C	24/110 24/110	3 3	6-24 6-24	.5w 1w	7 7		X	X	X	X	X	7/8 ³	.8																			
Filters, Inc. 65 Daly Rd. E. Northport, L. I., N. Y.		H LL V VL P J A PL G BRJ DJW BRF	X	X	X						X				2-6 2-6 4-6 4-6 1,2 1,2 1,2 1,2 2 1,2 2 2	DT DT DT DT DT DT DT DT DT DT DT DT			to 100 to 127 to 234 to 127 to 117 to 98 to 98 to 74		10 10 10 5 5 6 5 5 5 4 10		X	X	X	X	X						X	X	X	X												
General Automatic Corp. 7 Sherman Ave. Jersey City, N. J. 07307		18 200 31 32 20	X	X	X				X						1-6 1 1-3 1-3 1-6	C A C C C	29/115 200 29/115 29/115 29/115	4 .25 10 10 10	220 24 110/115 110/115 110	4w				X	X	X				2.5 1.5 3 3 2.5	X X X X X																	
General Electric Co. Specialty Control Dept. P. O. Box 812 Waynesboro, Va.		35 AV 35 AC 35 AE 35 AF 35 AH 35 AK 35 AA 35 AM 35 AB 35 AN 35 BC 35 BD 35 BF 35 AT			X	1/2									2 2 2 4 1 2 2 2 2 2 2 2 2	C C C C C C NO/NC C C C C A/B C C	to 115 to 115 to 115 to 115 to 115 to 115 to 115 to 115 to 115 to 115 to 115 to 115 to 115 to 115	to 2 to 2 to 2 to 2 to 2 to 2 to 25 to 2 to 2 to 2 to 2 to 0.5 to 2 to 2	28 28 28 28 28 28 28 28 28 28 28 28 28 28	.040 .025 .05 .047 .056 .039 .066 .019 .058 pulse .020 .008 .009 .006	3 4 3 5 1 15 2 8 p.2 1 6 8		X	X	X	X	X	X	X	X	X	X	X	X	X	X	X	X	X	X	X	X	X	X	X	X		
Globe Electrical Mfg. Co. 1729 W. 134th St. Gardena, Calif. 90247		P W WL WP J L	X	X	X										1-4 1-3 to 6 1-3 2,4 1-4	ST/DT DT DT DT DT ST/DT	115 115 115 115 125 125	3 10 10 5 5 3	to 230 to 230 to 250 to 250 to 120 to 230	2w			X	X																								
Guardian Electric Mfg. Co. 1550 W. Carroll Chicago, Ill. 60607		995 395 490/5 590/5 695 795 895 405/415 600/605 1200/1205 640/645 240/245 900/905 1220/1225 1210/1215 625 220/225			X										4 4 2 4 6 2 4 8 4 3 4 4 2 2 3 4 1	DT DT DT DT DT DT DT DT DT DT DP DP DP DP DP NO	30 30 30 30 30 30 30 30 115AC 115AC 115AC 115AC 115AC 115AC 115AC 115AC 230AC	3 3 3 3 3 3 3 3 10 10 10 15 10 10 10 8 8 20	to 110 to 110 to 110 to 110 to 110 to 110 to 110 to 110 to 230 to 230 to 230 to 230 to 230 to 230 to 230 to 230 to 110 to 230	3w 3w 3w 3.5w 4.5w 2w 2w 7w 3w 3w 3w 3w 3w 2w 2w 1.5w 3w	5 5 5 5 8 5 5 15 15 15 15 15 15 15 15 8 8 10		X	X	X	X	X	X	X	X	X	X	X	X	X	X	X	X	X	X	X	X	X	X	X	X	X	X

RELAY LISTINGS (Cont'd)

SPECIAL PURPOSE RELAYS	TYPE NO. OR SERIES	FEATURES													NOM. CONTACT VOLTAGE (V)	NOM. CONTACT CURRENT (A)	NOM. OPER. VOLTAGE (V)	NOM. OPER. CURRENT (A)	NOM. OPER. SPEED (MS)	MINIATURE	SUBMINIATURE	ENCASED	SIZE (CU. IN.)	WEIGHT (OZ.)	HERMETIC SEAL	MIL SPEC				
		AC OPERATED	DC OPERATED	ALARM	COAXIAL RELAY	DIFFERENTIAL	INTERLOCKING	FREQUENCY SENSITIVE	LIGHT SENSITIVE	TEMPERATURE SENSITIVE	VOLT/AMP CHANGE SENSITIVE	KEYING RELAY	TIME DELAY	MERCURY WETTED													SOLID STATE	CONTACT FORM		
Adams & Westlake Co. Elkhart, Ind.	HF 1040 1200	X	X										X	D SP ST SP ST	50-500 max 230 max 230	.5-5 5 5	— to 440 to 440	— .025 .009	7		X									
Airborne Accessories Corp. 1414 Chestnut Ave. Hillside 5, N. J.	B1C A1C A1A A1B		X	X	X	X	X	X	X	X	X	X	X	X	X	X	110 115 115	250w 250w												
Allen-Bradley Co. 136 W. Greenfield Ave. Milwaukee 4, Wisc.	BA CL NT	X										X		2-6P 2-4P DP ST			to 240													
Allied Control Co. 2 E. End Ave. New York, N. Y. 10021	RA RB TD	X	X	X								X		1P DT 1-6P DT	29 115	150w to 10	6-110 6-115 (p-c plug-in)	2.5w			X		3		X	X				
American Instrument, Inc. 8030 Georgia Ave. Silver Spring, Md.	4-427 4-425 4-5303 4-5300	X	X									X	X	SP ST SP ST SP DT SP ST	115 115 115 115	30 30 2 30	115 6 12 30	.08 .5 .08 .08			X X X X	9 9 5 350	8 8 4 64	X X X X						
Amphenol RF Div. 33 E. Franklin St. Danbury, Conn. 06813	R10 R17 320 315/321 316 317 318 319 335 346 323 325 326 351 327 328 R28	X	X	X	X	X	X	X	X	X	X	X	X	X	1P 2-6T 1P 2-6T SP DT 1-2P DT SP DT SP DT SP DT SP DT SP DT SP DT 1P 4T 1P 6T 1P 12T 1P 2-4T	3 kw 8 kw 1 kw 100 w 500 w 100 w 100 w 100 w 100 w 50 w 100 w 100 w 100 w 1 w 100 w 100 w 1.2 kw	26 6-115 20 20 20 20 26 26 26 20 20 20 20	.07 sec .2 sec		X X		20 4			1.1		X			
Artisan Electronics Corp. 171 Ridgedale Ave. Morristown, N. J.	BT 900 221 100 300 500 600	X	X	X	X	X	X	X	X	X	X	X	X	DPDT SPDT DPDT	30 29 28 28 28	2 2 2 2 25	12-32 30 28 28 28	1 .015 .015			X X X X		8 3.2 2.8 1							
Automatic Electric Co. Northlake, Ill. 60164	AVR PTW TQA LEL DDC	X	X	X	X	X	X	X	X	X	X	X	X	1	C A, B, C A-E	to 3	6-115 to 320 to 350 to 250 to 230	.13	2 1 (plug-in)	25	X	X	8							
Automatic Metal Prods. 315 Berry St. Brooklyn, N. Y. 11211	101 102 103 104 105 107 108-110 111-113 114 115 116-117 118-121	X	X	X	X	X	X	X	X	X	X	X	X	SPDT DPDT SPDT SPDT DPDT DPDT DPDT DPDT DPDT SP /3T SP /6T			to 230 to 230 to 230 to 230 to 230 to 230 to 230 to 230 to 230 to 230 to 230	15			X X X X X X X X X X X	3 5 2.5 7/14 9	X X X X X X X X X X X							
Bay-Roy Electronics, Inc. 16608 Madison Ave. Cleveland, O. 44107	CU	X	X	X												1 kw	6-220	2 VA	12											
James G. Biddle Co. Township Line & Jolly Rds. Plymouth Meeting, Pa. 19462	RR 1 RR 10 RR 5				X	X	X	X						1P 1P 1P			.215 .035 .215	150 500 150			X X X	.911 .33 2.63	2.25 1.25 3.25	X						
Bowns, Inc. Trimpot Div. 1200 Columbia Ave. Riverside, Calif. 92507	3900 3907 3908	X	X	X									DPDT 1P /ND DPDT	26 26	1 1	30 30 30	.06 .03 .05			X X X	.8 .6 .8	X X X								
Branson Corp. Vanderhoof Ave. Denville, N. J.	QR MTRH 4 MTRH 8	X	X	X	X	X	X	X	X	X	X	X	X	1P* 2C 1A	28 28 28		28 (p-c plug-in) 26.5 (plug-in) 26.5 (plug-in)			X X X	.13 2.2 2.2	1/3 3 3	X X X	X X X						
C. P. Clare & Co. 3101 Pratt Blvd. Chicago, Ill. 60645	CW JV HGS 2 HG 2 MT HGS 2 MT	X	X	X	X	X	X	X	X	X	X	X	X	T 2PDT 2d, 2C		5 0-500 0-500	to 300 to 300 6-48 6-48 6-48	2 secs 5		X X X X X	7 15 9 2.7 1.7 6.0									
Coch Ordnance, Inc. 3 Arlington St. N. Quincy, Mass. 02171	709 T1007	X	X	X								X	X	C	28 28	3 0.5	28 28			X X X	2 4 1	8 1	X X X	X X X						

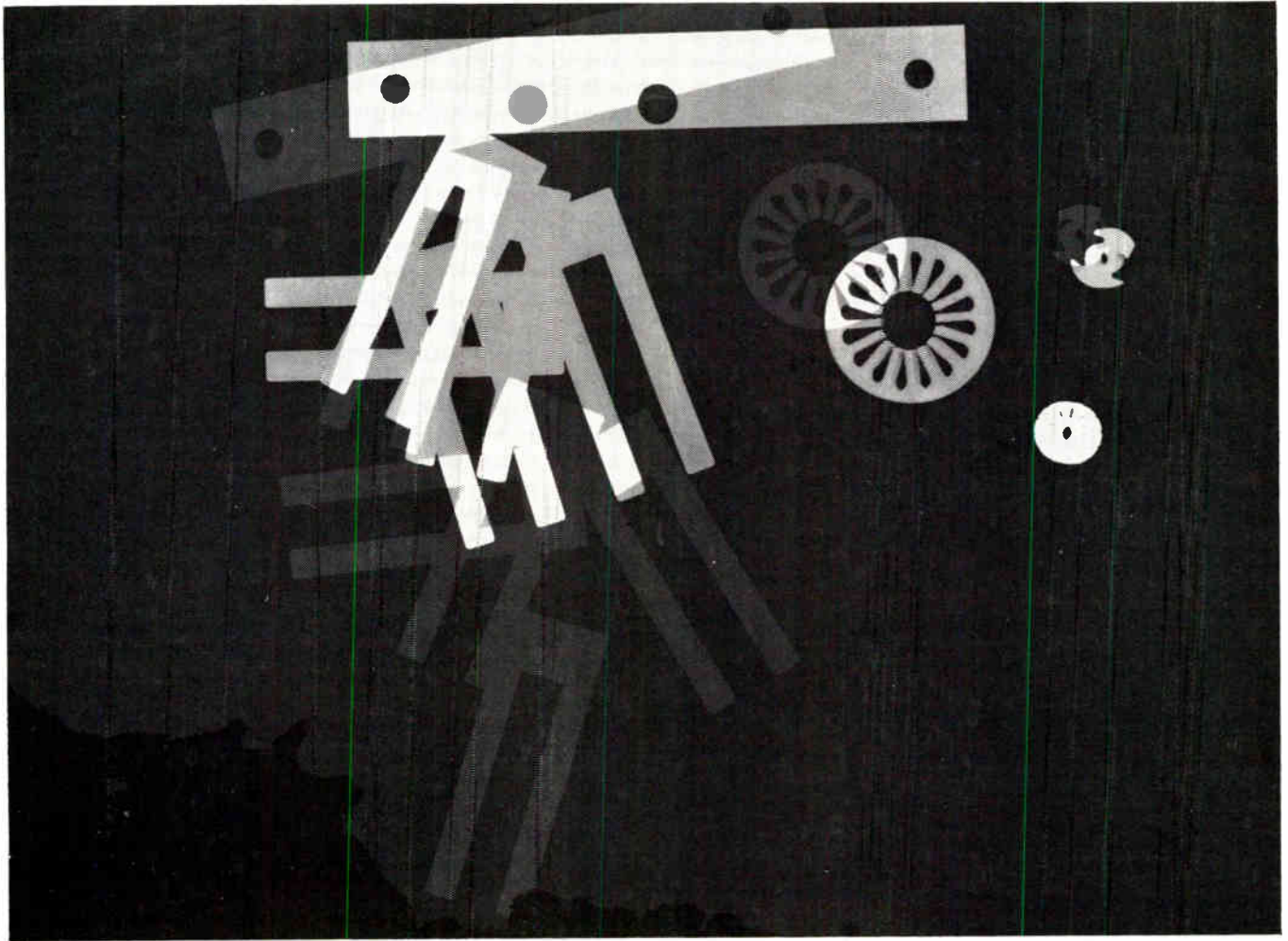

Cut energy loss, core size, and weight with Armco 48 Ni and 48 Ni-R Nickel-Iron Magnetic Alloys



Armco 48 Ni and 48 Ni-R magnetic alloys offer you a wide range of magnetic properties, thicknesses, and costs. They enable you to select core material to achieve the most effective design for high quality audio and instrument transformers, specialty motors and generators, communications, computer, and other high frequency equipment.

Armco 48 Ni is produced in thicknesses of 14, 10, 6, 4 and 2 mils. Precise control of processing assures low hysteresis loss. Armco 48 Ni has

exceptionally high permeability at low and moderate inductions. Its initial permeability is approximately twice that of the oriented silicon steels. Extremely low coercive force enables you to minimize core losses for a wide range of frequencies. In the low and moderate range, H_c for 48 Ni is only 10 to 30% of that for silicon steel.

Armco 48 Ni-R is produced in thicknesses of 14, 10, and 6 mils. Processed to produce small grain size and uniform magnetic properties in all directions, it develops higher per-

meability with a lower temperature anneal than 48 Ni. These special characteristics make it ideal for rotor applications in communications equipment, guidance systems, and sensing devices. Many satisfied customers have reported that Armco 48 Ni-R is superior to any other rotor grade offered in the industry.

For full information on Armco 48 Ni and 48 Ni-R magnetic alloys, call your local Armco Sales Office. Or write Armco Steel Corporation, Dept. E-3395, P. O. Box 600, Middletown, Ohio 45042.

ARMCO STEEL



RELAY LISTINGS (Cont'd)	SPECIAL PURPOSE RELAYS	TYPE NO. OR SERIES	AC OPERATED	DC OPERATED	ALARM	COAXIAL RELAY	DIFFERENTIAL	INTERLOCKING	FREQUENCY SENSITIVE	LIGHT SENSITIVE	TEMPERATURE SENSITIVE	VOLT/AMP CHANGE SENSITIVE	KEYING RELAY	TIME DELAY	MERCURY WETTED	SOLID STATE	CONTACT FORM	NOM. CONTACT VOLTAGE (V)	NOM. CONTACT CURRENT (A)	NOM. OPER. VOLTAGE (V)	NOM. OPER. CURRENT (A)	NOM. OPER. SPEED (MS)	MINIATURE	SUBMINIATURE	ENCASED	SIZE (CU. IN.)	WEIGHT (OZ.)	HERMETIC SEAL	MIL SPEC				
																														SPDT	DPDT	SPDT	
Jordan Electronics (Continued)	AUO 252 AUO 0255 AUO 254 AUO 346 AUO 295	X X X X X	X X X X X										X X X X X	X X X X X	X X X X X	X X X X X	SPDT DPDT SPDT	18-30 18-30 18-30 28	.05 .15 .1				X X X X			2.7 4.5 3.2	X X X X X	X X X X X					
Klann, Inc. P. O. Box 2398 Waynesboro, Va. 22981	RM 638 RM 1238 RM 2438 SR 3227 SR 6127 SR 7327 RL 10 RL 18 RL 30	X X X X X X X X X	X X X X X X X X X										X X X X X X X X X	X X X X X X X X X	X X X X X X X X X	X X X X X X X X X	6 12 24 32 61 73 10 18 30																
Lake Shore Electric Corp. 205 Willis Ave. Bedford, O.	— —	X X	X X								X (55-65 cy)	X (3-phase sensor)			X			28/120 28/120	2 2	120 120-440				X X									
Leach Corp., Relay Div. 5915 Avalon Blvd. Los Angeles, Calif.	"S" "R"	X X	X X										X X	X X	X X		2NO 2ZD	.5 2-10	30 30	.12				X X			1.5 2						
Ledex, Inc. 123 Webster St. Dayton 2, Ohio	— — *	X X X	X X X										X X X	X X X	X X X	X X X	A or B C A	115VAC 1 12	2 10 .1	28DC 117AC 24	1 2 2	15 2	X X X	6 1200 2	8 5	X X X							
* Bramco Div., Ledex, Inc., Piqua, O. ** Also available electromechanical																																	
Line Electric Co., Div. Industrial Timer Corp. 200 River St., Orange, N. J.	TRP	X	X										X	X	X		SPDT	115	5	115			X										
Liquidometer Corp. Rockingham Rd. Bellows Falls, Vt.	B 250	X	X														2C	2	26	.015			X			5	X						
Livingston Electronic Corp. Livingston, N. J.	—	X	X										X	X	X		SPST (to 300 secs)	250	3	6-120	5w			T9				X					
Machinery Electrification, Inc. Northboro, Mass. 01532	MEK-5520 MEK-5530 MEK-1803 MEK-2060 MEK-03-AA MEK-03-AC MEK-45-AA MEK-45-TP MEK-55 MEK-2100	X X X X X X X X X X	X X X X X X X X X X								X X		X X	X X	X X	X X		115 115 300 300 115 115 to 600	5 5 15 15 10 15/5	110 110 115 115 115 115-600	8VA 8VA 8VA 8VA			X X (Plug-in) (Plug-in)									
* Rate of Change Sensitive																																	
Magnecraft Electric Co. 5575 N. Lynch Ave. Chicago 30, Ill.	22 S 110 126 128 122 120 875	X X X X X X X	X X X X X X X										X X X X X X	X X X X X X	X X X X X X		1-4 DT 2 DT 3 DT SPDT 3P/DT SPDT 3P/DT	115 500w 150w 115	to 50	to 115													
Master Specialties Co. 15020 S. Figueroa St.	3000 P/N399-100	X X	X X										X	X	X		(Flasher)			18/115 18-32	.5		X X			7							
Mosman-Elliott Corp. 202 S. Larkin Ave., Joliet, Ill.	ADT	X	X										X	X	X		(Motor Driven)	A,B,C	250	.25	120			X			to 150						
E. V. Naybor Labs, Inc. 26 Manorhaven Blvd. Port Washington, N. Y.	TD TD 310 TD 5 TLC	X X X X	X X X X										X X X X	X X X X	X X X X		1-3 P/DT 1-2 P/DT 1-2 P/DT 1-3 P/DT	250 250 250 250	5 10 5 5/10	26 26 26 26						4.5 4.2 5 8.2	X X X X						
Networks Electronic Corp. 9750 De Soto Ave. Chatsworth, Calif.	M 779 M 999 M 811 M 449 M 339 2015 2075 2100 7505 7503	X X X X X X X X X X	X X X X X X X X X X								X X X X X X X X X		X X X X X X X X X	X X X X X X X X X	X X X X X X X X X		SPST SPST SPST SPST SPST SPST SPST SPST SPST SPST	2.5 2.5 1.0 1.0 1.0 10.0 1.5 7.5 10.0 5.0 15.0			1.2 1.2 .3 .3 .3 1.3	100 100 20 20 20 100							.8 .8 .8 .8 1.0 .7 .7 1.0 .7 1.0 .7 1.0	1.6* 1.6* 1.6* 1.6* 1.6* 7.5* 2* 3* 6* 6* 3* 7*	X X X X X X X X X X X X X X	X X X X X X X X X X X X X X	
* Grams																																	
Ohmite Mfg. Co. 3601 Howard Ave., Skokie, Ill.	GPR																(Thyratron Relays)																
Ortronix, Inc. Box 8217, Orlando, Fla.	4503 4505												X X	X X	X X	A C	260 260	70 ma 70 ma	3 3	15-60 ma 15-60 ma	3 3			X X	10 10	2 2							

RELAY LISTINGS (Cont'd)

SPECIAL PURPOSE RELAYS		TYPE NO. OR SERIES	AC OPERATED	DC OPERATED	ALARM	COAXIAL RELAY	DIFFERENTIAL	INTERLOCKING	FREQUENCY SENSITIVE	LIGHT SENSITIVE	TEMPERATURE SENSITIVE	VOLT/AMP CHANGE SENSITIVE	KEYING RELAY	TIME DELAY	MERCURY WETTED	SOLID STATE	CONTACT FORM	NOM. CONTACT VOLTAGE (V)	NOM. CONTACT CURRENT (A)	NOM. OPER. VOLTAGE (V)	NOM. OPER. CURRENT (A)	NOM. OPER. SPEED (MS)	MINIATURE	SUBMINIATURE	ENCASED	SIZE (CU. IN.)	WEIGHT (OZ.)	HERMETIC SEAL	MIL SPEC
Struthers-Dunn, Inc. (Continued)	P Series	X	X										X				DPDT	115	10	115	.08	to 3 min.		X	15	16			
	49	X	X														SPDT	230	3	115	.08	30			12	10			
	192																DPDT	230	30	-	125	30			10	40			
	91																DPDT	.001	.010	115	.04	30			8	10			
	149	X	X														SPDT	115	3	115	.08	30			12	10			
	RSX 1440	X	X	X													DPST	115	5	6-115	.36 to .017	15		X	9.5	8			
275	X	X														TPST	600	15	6-230	1.1/.04	15			16	12				
TDR Electronics 5500 E. Pacific Pl. Denver, Colo. 80222	2	X	X										X		X		1-4P/DT		5	24/115	1.5w			X					
Techrand Corp. 4031 Grand Haven Rd. Muskegon, Mich.	CDS MSD	X									X		X	X	X			110 5	500w	110				X X					
Teledyne Precision, Inc. 3155 W. El Segundo Hawthorne, Calif.	570 590 CS11	X	X		X												SPST SPST SPST	.1w 10w	28 to 115 to 115		6 7 10				2 3 2.5		X		
Telex-Aemco Div. Telex, Inc. 10 State St. Mankato, Mich.	153 95 ED/FD 83	X	X		X									X			2P/DT 1P/DT 4P/DT	100w 100w 117 115	12-26 26 to 130 6-230	1w	6		X X		.8 8		X		
Thermal Controls, Inc. 75 Rutgers St. Belleville, N. J.	200 700 900 900G	X	X	X			(Thermal)			X	X	X	X	X			SPST SPST	250 115	3 3	6-120 6-115	5w 4w		X	X X	1.9 1.5	1.5 1.5	X X	X X	
Trepac Corp. 30 W. Hamilton Ave. Englewood, N. J.	553-T/C 537-2 530-D	X	X		X					X	X	X	X	X	X				10	115				X X					
Trompeter Electronics, Inc. 8936 Comanche Ave. Chatsworth, Calif. 91311	CSV	X			X													.5	.012-.048		1.0			X					
George Ulanet Co. 413 Market St. Newark 5, N. J.	212	X	X				(Thermal)						X				NO/NC	230	1.5 kw	to 250				X					
	GT	X	X				(Thermal)						X				NO/NC	230	1 kw	to 230									
	PB-1	X	X				(Thermal)						X				NO/NC	230	100 w	to 230			X						
	TK	X	X				(Thermal)						X				NO/NC	230	1.5 kw	to 230									
	TA	X	X				(Thermal)						X				NO/NC	230	1.5 kw	to 230									
	261	X	X				(Thermal)						X				NO/NC	230	100 w	to 230				X					
	TRM	X	X				(Thermal)						X				NC	230	1 kw	to 230									
	TD	X	X				(Thermal)						X				SPDT	230	1.5 kw	to 230									
	208	X	X				(Thermal)						X				NO/NC	115	5	to 230				X					X
213	X	X				(Thermal)						X				NO/NC	115	5	to 230					X (Plug-in)					
Voltron Products 1020 S. Arroyo Pkwy. Pasadena, Calif.	85.001	X	X				(Signal Inputs;			X		X								28/115									
Welex Electronics 2431 Linden Lane Silver Spring, Md. 20910	1-SSR6						(250 Band)			X		X	A					120 V	.020/ .060		.020/ .060			X	7	6	X		
	2-SSR-9						(200 Band)			X		X	A					120 V	.020		.020/ .050			X	12	16	X		

1 - RFI: Narrow Band conducted less than 5 uv.
Broad band conducted 1uv/KC 80KC to 1 gc
Radiated narrow band & broad band meet MIL-1-16910

2 - RFI: MIL-1-11748B (SIG-C) Broad band & narrow band



What's our line? Electronic Chemicals. Only Mallinckrodt makes such a complete line . . . just for the electronics industry. Look what's in it: Czochralski crystals **1** up to 1¼ inches in diameter. TransistAR® Etchants **2** including the first Ammonium Fluoride offered in convenient solution form. Dip, paint-on and diffusion dopants **3** . . . quality found nowhere else. Solvents with unusually low particulate levels . . . such as Trichloroethylene TransistAR **4**, the industry's standard cleaning solvent. For higher device yields, be sure of the purity and compatibility of your chemicals. Rely on the technical competence of Mallinckrodt . . . a company that knows electronics, as well as electronic chemicals. It'll pay off. **5** You can check it.

Mallinckrodt Chemical Works  Electronic Chemicals

St. Louis • New York • Los Angeles

Circle 37 on Inquiry Card
WorldRadioHistory

RMC

HIGH STABILITY, TYPE JE

DISCAPS

are Practically Immune to Severe Temperature Change

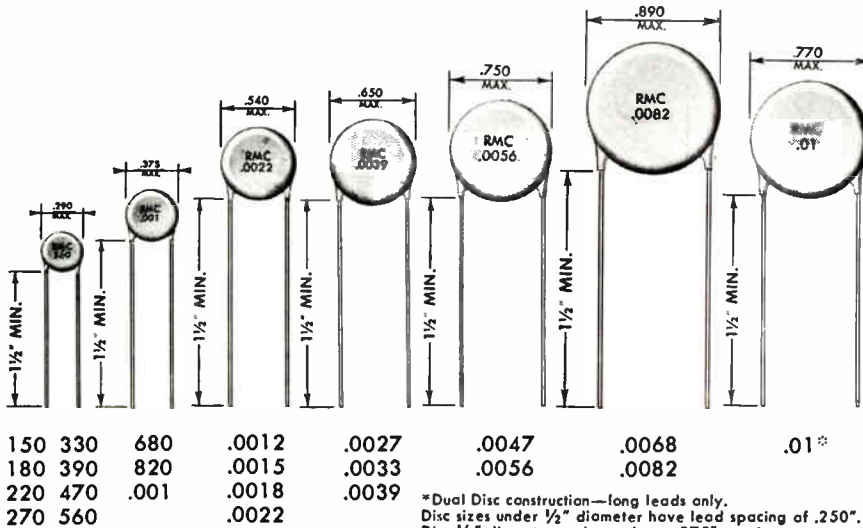

*Dual Disc construction—long leads only.
Disc sizes under 1/2" diameter have lead spacing of .250".
Disc 1/2" diameter and over have .375" spacing.

Specifications

CAPACITANCE: Within tolerance @ 1KC and 25°C.

CAPACITANCE TOLERANCES: +10%, +20% or +80 - 20%

WORKING VOLTAGE: 500 VDC

POWER FACTOR: 2.0% @ 1KC

INSULATION RESISTANCE: Greater than 7500 Megohms @ 500 VDC

TEMPERATURE COEFFICIENT: Z5E, Y5E

FLASH TEST: 1250 VDC for one second

LIFE TEST: Per EIA RS-198 Class II

POWER FACTOR AFTER HUMIDITY: 3.0% @ 1KC

INSULATION RESISTANCE AFTER HUMIDITY: Greater than 1000 Megohms @ 500 VDC

BODY INSULATION: Durez phenolic -- vacuum wax impregnated

LEAD STYLES AVAILABLE: Long lead - #22 tinned copper -, fin-lock, kinked lead plug-in and pin type plug-in

RMC Type JE Discaps exhibit only $\pm 4.7\%$ capacitance change over the extended -30° to $+85^{\circ}\text{C}$ temperature range. These capacitors are especially suited for use in mobile communication and like equipment. Typical usage in R-C response shaping networks and feedback loops, in addition to conventional applications, is indicated.

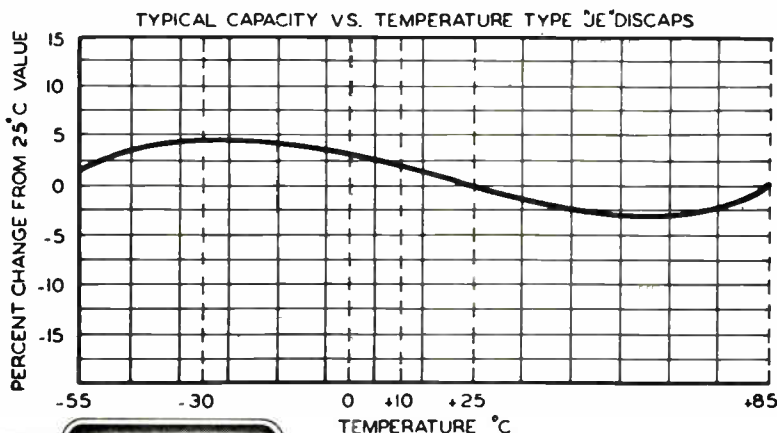

DISCAP CERAMIC CAPACITORS

RADIO MATERIALS COMPANY
A DIVISION OF P. B. MALLORY & CO., INC.
GENERAL OFFICE: 4242 W. Bryn Mawr Ave., Chicago 46, Ill.
Two RMC Plants Devoted Exclusively to Ceramic Capacitors
FACTORIES AT CHICAGO, ILL. AND ATTICA, IND.

RELAYS (continued)

(Continued from page 96)

Optical Relay

A light controlled solid state device capable of switching extremely weak signals for space craft multiplexing operations uses light energy as the signal carrier rather than electrical or magnetic fields. Called an optical relay, the developmental unit is integrated into a package occupying a volume of .003 cubic inch (IBM).

Safety Discharge Relay

A double break, double throw contactor used in isolation switching and safety discharge circuits with peak currents above 100 amperes, is now employed in a 155,000-joule (155 kilowatt-second) laser power supply designed by Westinghouse. Actually, fifteen of the contactors are used in this system, the energy storage of which consists of three modules each employing two 1400-mf banks of capacitors. The capacitors are charged from a silicon rectifier unit to any preset voltage up to 6 kilovolts. When the bank is charged (in 60 seconds or less), the charging unit is automatically isolated from the storage bank by opening of the relay contactors. A safety discharge circuit for emergency use actuates the contactor to connect the storage bank to a discharge resistor (Price Electric).

ADVANCED STUDY BROCHURE LISTS ENGINEER COURSES

A 24-page brochure on scientific and engineering courses to be offered during the fall and winter of 1965-66 is available from The Program for Advanced Study, Bolt Beranek and Newman Inc., 50 Moulton Street, Cambridge, Mass.

Information on courses in Random Processes, Modern Optics, Oceanography, Underwater Acoustics, Design of Experiments, and Systems Engineering is included, as well as schedules for Cambridge, Mass.; New York City; Los Angeles; San Francisco; Washington, D. C.; and Houston.

18 OCTAVE RESISTANCE RANGE WITH HELIPOT'S NEW THIN-LINE CERMET TRIMMER



It's a Mil-spec trimmer completely in tune with MIL-R-22097B (type RJ12). Available in pin or lead versions, Helipot's brand new Model 56 Helitrim[®] potentiometer is less than 0.200 inch thick. And it sells for \$5.50 and down.

One-watt power rating (at 85°C) throughout its entire scale of resistances (10 ohms to 2 megohms) is made possible by the Cermet resistance element ... which, incidentally, provides essentially infinite resolution and freedom from sudden failure. For the complete score on the new Model 56 trimmer, just sing out for your local Helipot[®] rep.

Beckman[®] INSTRUMENTS, INC.
HELIPOT DIVISION
FULLERTON, CALIFORNIA • 92634

INTERNATIONAL SUBSIDIARIES: GENEVA, SWITZERLAND;
MUNICH, GERMANY; GLENROTHES, SCOTLAND; PARIS, FRANCE;
TOKYO, JAPAN; CAPETOWN, SOUTH AFRICA.

BLOCKS FOR BUSS FUSES

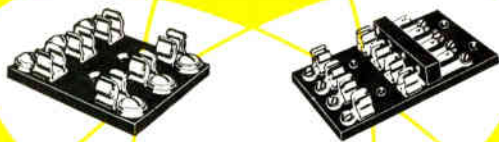

TYPES AVAILABLE FOR ALL APPLICATIONS

Single pole, multiple pole, small base, full base, molded base, laminated base, porcelain base for fuses from 1/4 x 3/8 inches up. Also signal type fuse blocks and special blocks of all types.

Tell us what you need or...

Insist On
BUSS

QUALITY
Fuse Blocks

BUSSMANN MFG. DIVISION, McGraw-Edison Co., St. Louis, Mo. 63107

Write for
BUSS
Bulletin SFB

Made to
Military
Specifications

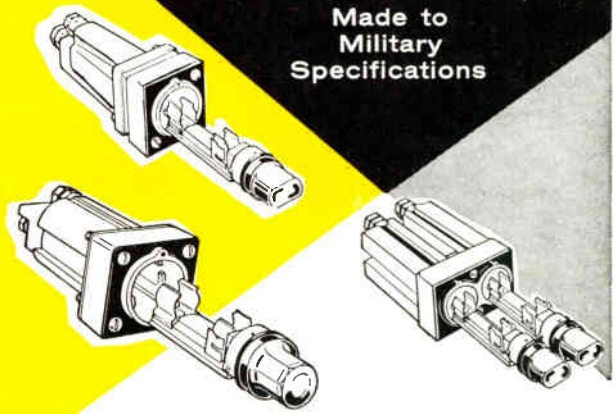

BUSS FUSEHOLDERS

LAMP INDICATING SERIES HG

Made to MIL Specs.—FHL10U, FHL11U, FHL12U

Quick, positive, visual identification of faulted circuit. Transparent knob permits indicating light to be readily seen.

Fuses held in clips on fuse carrier which slides into holder and locks in place with bayonet type knob.

Holder designed for panels up to 1/8 inch thick.

Insist On
BUSS

QUALITY
Fuseholders

BUSSMANN MFG. DIVISION, McGraw-Edison Co., St. Louis, Mo. 63107

Write for
BUSS
Bulletin SFB

BUSS: The Complete Line of Fuses and . . .

NEW TECH DATA

Connector Handbook

A 1965 handbook giving complete details of all standard connectors is available. The 176-page handbook contains detailed application data and physical and electrical specifications. Winchester Electronics Division of Litton Industries, Main Street and Hillside Avenue, Oakville, Conn.

Circle 230 on Inquiry Card

Power Supply Catalog

Catalog B-657, 48 pages, contains application notes which are particularly useful for constant-current operation, and an updated glossary of power supply terms. In addition, company capabilities are outlined. Kepco Inc., 131-38 Sanford Ave., Flushing, N. Y.

Circle 231 on Inquiry Card

Design Monograph

"Fallacy and Fact on Vibration Control" is a new design monograph. This two-color presentation states a number of erroneous ideas about vibration control that are commonly held in design engineering circles. In each case, the monograph counters the fallacy with the engineering fact of the matter. Curves and block diagrams are included. Lord Manufacturing Co., Erie, Pa.

Circle 232 on Inquiry Card

Tape Recorder

This data sheet pictures and describes the Model D/C-1 cartridge tape recorder. It uses a tape cartridge containing magnetic tape loops of any length up to 1700 ft. The machine is 4-speed with 4 data channels. The unit is capable of direct or FM recording. Data/Cartridge, Inc., 161 Constitution Dr., Menlo Park, Calif.

Circle 233 on Inquiry Card

PC Connector Catalog

Catalog DPZ-2C describes and illustrates the DPZ printed circuit connectors. Receptacles in the rack/panel series incorporate right angle contacts, and are designed to accommodate boards with thicknesses of 1/16, 1/8, or 1/4 in. The connectors have floating eyelets to provide a float of 0.031 in. when mounted. They conform to the specifications of NAS 713, 714, and 715. ITT Cannon Electric, 3208 Humboldt Street, Los Angeles, Calif.

Circle 234 on Inquiry Card

Plugs/Connectors Catalog

Catalog CC-1, 68 pages, covers a wide variety of tube sockets, plugs and connectors for commercial and industrial use. The section on tube sockets features a discussion on advantages and disadvantages of various contact and dielectric materials along with a table of dielectric mechanical and electric characteristics. Connectors featured in the catalog include U/L-recognized units. Amphenol Connector Division, Amphenol Corporation, 1830 S. 54th Ave., Chicago, Ill.

Circle 235 on Inquiry Card

Pilot Lights Catalog

The miniature Glo-Dot pilot lights are tiny, yet complete neon units. They are available in seven lens shapes and four body sizes. These lights are mounted in a 5/16 in. hole. The catalog fully describes all models and details all possible combinations of lens shapes, body sizes, lamps and resistors. Industrial Devices, Inc., Edgewater, N. J.

Circle 236 on Inquiry Card

Low-Noise Zeners

Data is available on low noise, temperature compensated zener reference diodes. Two new series feature low noise and low operation test currents with types for 500µa on up to 7.5ma. Both series offer temperature coefficients of 0.01%/°C to 0.001%/°C, and maximum noise specified from 0.2 to 1.0µv square-root cycle. Dickson Electronics Corp., 310 Wells Fargo Ave., Scottsdale, Ariz.

Circle 237 on Inquiry Card

Terminal Blocks

Data is available on a new series of miniature size, 300 volt terminal blocks. The SE Series blocks have 1/4 in. center-to-center terminal spacing. This allows a much higher density of terminals in a given area, yet carries a rating of 5 amps and 300 volts. Molded of black thermosetting phenolic, these new blocks are available in 1-18 pole lengths with #2-56 terminal screws on all types, which take up No. 16 AWG wire. Curtis Development & Mfg. Co., 3266 North 33rd St., Milwaukee, Wis.

Circle 238 on Inquiry Card

Training Course

"Strategies for Using Programmed Instruction" describes how off-the-shelf courses in plant maintenance and operation, electronics, and management information can be used to reduce training costs and improve on-the-job performance. Copies available from Basic Systems Inc., 880 Third Avenue, New York, N. Y. Circle 239 on Inquiry Card

Capacitors

Data is available on a wide selection of molded ceramic capacitors in "cordwood" size with capacity range of 10pf to 20,000pf. These units, types MC70 and MC705, also fully meet environmental requirements of MIL-C-11015, MIL-C-38100, and MIL-C-39014. Manufactured in a uniform molded case, the units are supplied with gold plated dumet leads. Aerovox Corporation, Distributor Division, New Bedford, Mass. Circle 240 on Inquiry Card

Silicone Rubber Guide

CDS-592 is a 40-page guide on silicone rubber for wire and cable uses. This guide brings together data from many sources. The guide contains up-to-date information on silicone insulation compounds, typical construction details plus specification data for both commercial and military silicone insulated wire and cable. General Electric, Silicone Products Department, Waterford, New York. Circle 241 on Inquiry Card

Drafting Catalog

This comprehensive, full color, 100 page catalog gives data on pressure-sensitive drafting, art and visual communication materials. It contains thousands of stock items as well as a "how to" section that describes the preparing of many types of graphic presentations. Chart-Pak, Inc., One River Road, Leeds, Mass. Circle 242 on Inquiry Card

Panel Meter Selection

This 20-page catalog is for quick reference of panel meters and accessories. The catalog, called "Stock Panel Meter Selector," covers all the various models and series of panel meters in 2½, 3½, 4½, 5½ and 7½ in. A glossary of terms, conversion factors, and ordering information are covered as well. Weston Instruments, Inc., 614 Frelinghuysen Ave., Newark, N. J. Circle 243 on Inquiry Card

Potentiometer Handbook

A 64-page "Handbook of High Precision Potentiometers" is planned to help the designer solve difficult circuit problems. It shows many applications of basic designs to special requirements. Subjects covered include potentiometer computing circuits; trig, log and exponential functions; loading effects and tracking; and mil specs for shock and vibration. Also discussed are quadrature, noise measurement, and potentiometer definitions. Potentiometer Division, Litton Industries, 226 E. Third Street, Mount Vernon, N. Y. Circle 244 on Inquiry Card

Time Delay Relay

Bulletin ESF 312 describes electronic time delay modules featuring factory preset or externally adjustable delays from 0.10 sec. to 400 seconds. Output is 10 amps resistive, 5 amps inductive @ 28vdc or 115vac, 400cps. Accuracy: ± 5% for short delays, ± 10% for longer delays. The A. W. Haydon Co., 232 North Elm Street, Waterbury, Conn. Circle 245 on Inquiry Card

Integrated Modules

Data is available on a series of plug-in modules featuring monolithic integrated circuits. Called Logitals™ they provide entire subassemblies such as scalars, registers, and decoders on a single circuit board. Units are offered individually and also in custom designed systems. Linear Alpha, Inc., 823 Emerson Street, Evanston, Illinois. Circle 246 on Inquiry Card

Event Recorder Catalog

This event recorder catalog includes data about recently perfected high-impedance dc voltage sensing recorders which can be bridged onto power circuits without upsetting their operation in any way. Input impedance is 200kΩ. Application data and specs. for broad line of inkless and ink event recorders are covered. Esterline Angus Instrument Co., Inc., P. O. Box 24000, Indianapolis, Indiana. Circle 247 on Inquiry Card

.. Fuseholders of Unquestioned High Quality

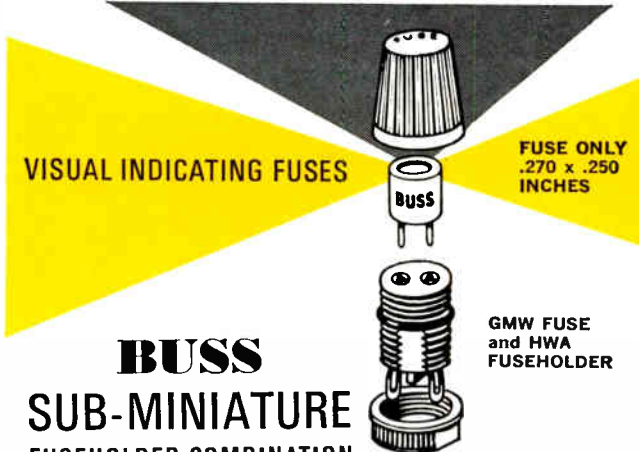

VISUAL INDICATING FUSES

BUSS

SUB-MINIATURE FUSEHOLDER COMBINATION

FUSE ONLY .270 x .250 INCHES

GMW FUSE and HWA FUSEHOLDER

For space-tight applications. Fuse has window for inspection of element. Fuse may be used with or without holder.

Fuse held tight in holder by beryllium copper contacts assuring low resistance.

Holder can be used with or without knob. Knob makes holder water-proof from front of panel.

Military type fuse FM01 meets all requirements of MIL-F-23419. Military type holder FHN42W meets all military requirements of MIL-F-19207A.

Insist On
BUSS

QUALITY
Fuses and Fuseholders

BUSSMANN MFG. DIVISION, McGraw-Edison Co., St. Louis, Mo. 63107
Circle 40 on Inquiry Card

Write for
BUSS
Bulletin SFB

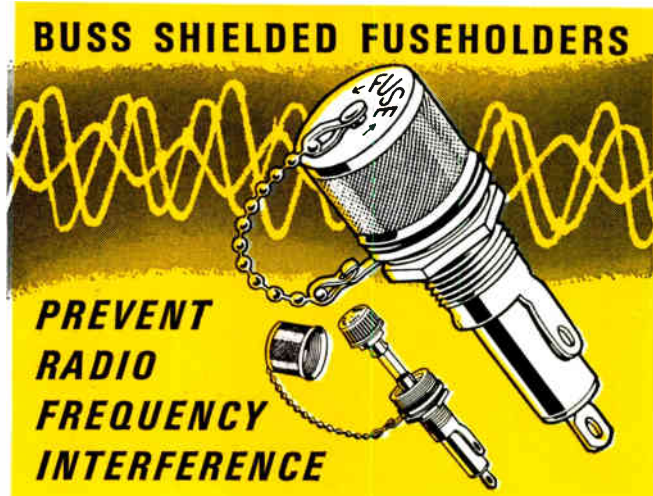

BUSS SHIELDED FUSEHOLDERS

PREVENT RADIO FREQUENCY INTERFERENCE

For use where fuse and fuseholder could pick up radio frequency radiation which interferes with circuit containing fuseholder—or other nearby circuits.

Fuseholder accomplishes both shielding and grounding.

Available to take two sizes of fuses—¼ x 1¼" and ¼ x 1" fuses.

Meet all requirements of both MIL-I-6181D and MIL-F-19207A.

Insist On
BUSS

QUALITY
Fuseholders

BUSSMANN MFG. DIVISION, McGraw-Edison Co., St. Louis, Mo. 63107
Circle 40 on Inquiry Card

For complete information
write for
BUSS Bulletin SFH-12

NEW TECH DATA

Note & Slide Rule

A new 15-page application note details effective new techniques by which coaxial cable may be speedily and precisely evaluated. It describes the Model 1415A time domain Reflectometer, which reveals some previously undetectable flaws. Included is a slide rule which makes calculations useful with the technique in arriving at dielectric constant, propagation velocity, characteristic impedance and distance between discontinuities. Hewlett - Packard, 1501 Page Mill Road, Palo Alto, Calif.

Circle 248 on Inquiry Card

Card Cooler

Heat removal from groups of solid-state circuit cards closely confined in compact enclosures is made easy and economical with this new blower which delivers 290CFM of filtered air. These blowers take up a minimum space and are available with four choices of air discharge. Each unit contains a motor guaranteed for thousands of hours of uninterrupted duty. More data available from McLean Engineering Laboratories, P. O. Box 228, Princeton, New Jersey.

Circle 249 on Inquiry Card

Laboratory Refrigerator

The Cryo-Tip refrigerator operates at temperatures down to 3.6°K. The cryogenic device makes it possible to obtain regulated temperatures down to liquid helium temperatures without using a liquid helium supply. It uses a three-stage Joule-Thomson refrigerator which operates at 3.6°K and above on cylinders of compressed hydrogen and helium plus a liquid nitrogen supply. Details available from Air Products and Chemicals, Inc., Allentown, Pa.

Circle 250 on Inquiry Card

Switch Catalog

Catalog S-323, 10 pages, covers the series 35000, 36000, 37000 and 38000 multi-switches. Complete engineering specifications are provided about such items as illumination, styles and shapes of push-buttons, stack module design and many other design requirements. Switchcraft, Inc., 5555 N. Elston Ave., Chicago 30, Ill.

Circle 251 on Inquiry Card

Telemetry Module

Technical data describing an all solid state Astrolock-loop FM subcarrier discriminator, voltage controlled oscillators, and other data modules for all FM telemetry data reduction and data processing applications are available. Equipment described includes an FM subcarrier discriminator using the Astrolock phase frequency detector, crystal referenced FET chopper stabilized VCO and current mode loop filters, plug-ins/optional equipment and associated modules. Linearity is less than $\pm 0.2\%$, and stability is within $\pm 0.01\%$ center frequency long term. Astrodata, Inc., 240 East Palais Road, Anaheim, Calif.

Circle 252 on Inquiry Card

IBR[®]

SILICON AVALANCHE
INTEGRATED BRIDGE RECTIFIERS

FULL WAVE BRIDGES

FULL WAVE CENTER
TAP RECTIFIERS

HALF WAVE THREE
PHASE RECTIFIERS

Each in one
small package

You can reduce rectifier cost, size requirements, and installation time with the Varo IBR[®] series of silicon avalanche integrated rectifiers. All IBR[®] devices feature 2000 V min. circuit-to-case insulation and SAR[®] (silicon avalanche rectifier) characteristics to control transient overvoltages and permit decreased PRV safety factors in design consideration.

For full-wave bridge applications: the 1N4436 (250 V min. BV_R), 1N4437 (450 V min. BV_R), and 1N4438 (650 V min. BV_R). Output current is 10 amps at 100° C (T_C).

The full-wave center tap and 3-phase half and full wave rectifiers are designed for 140 V and 280 V RMS operation with 250 V and 450 V min. avalanche voltages. They have 5 amp/leg DC I_O at 100° C (T_C) and 100 amp, one-cycle current surge. IBR[®] voltage doublers for 70 V and 140 V RMS operation are also available.

IBR[®] devices are available in three mounting configurations: press-fit, TO-3, and single stud. Flag terminals also available.

Write today for complete information and new low prices.

45524 - 3 ϕ FULL WAVE

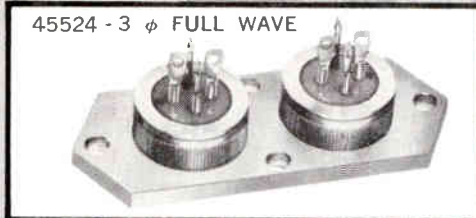

SPECIAL PRODUCTS DIVISION

2201 WALNUT ST., GARLAND, TEXAS 75041 (AREA CODE 214) 276-6141 TWX 214-276-8577

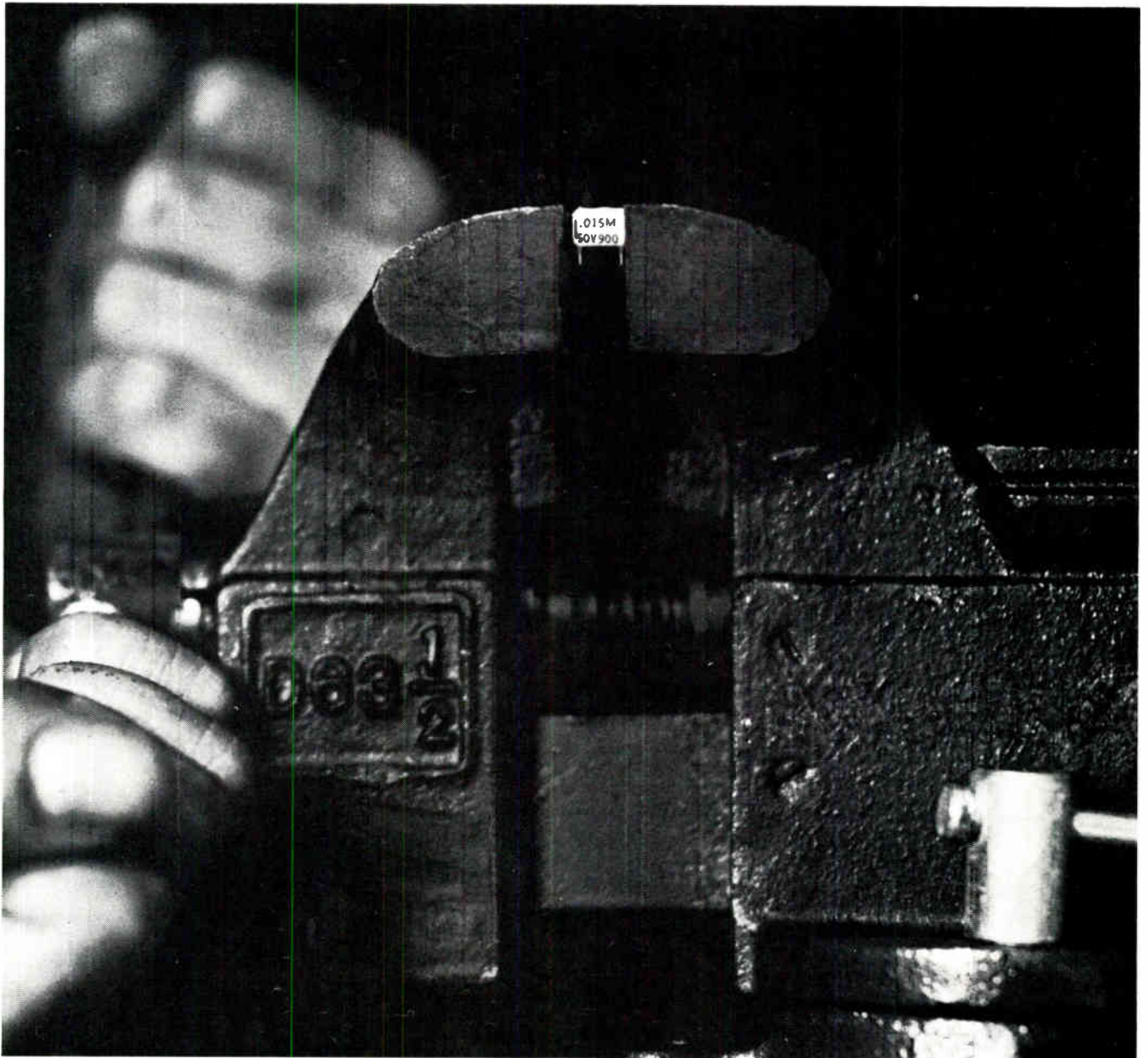

PAKTRON *hi-white-50*TM CAPACITORS FIT IN TIGHT SPOTS

When you need really small capacitors for quality transistorized circuits, PAKTRON® *hi-white-50*TM capacitors are the logical answer. They meet subminiature requirements in a wide range of industrial and commercial applications, and back up your circuitry with quality performance and rugged durability. PAKTRON *hi-white-50* capacitors are modestly priced making them the perfect economy capacitor for circuits requiring up to 50 WVDC. PAKTRON's special way of constructing extended foil capacitors makes for top capacitance, while its special epoxy impregnant provides superior moisture resistance. Why not try samples . . . on us?



PAKTRON *hi-white-50*TM epoxy coated polyester film capacitors

- Working Voltage: 50 WVDC
- Tolerances: ±5%, ±10%, ±20%
- Operating Temperature Range: -55°C to +125°C

MW-600

Subminiature size, 0.6 inches long, maximum. Capacitance values to 0.10 mfd.

MW-400

Ultra miniature size, 0.4 inches long, maximum. Capacitance values to 0.015 mfd.

it **PAKTRON**
W DIVISION ILLINOIS TOOL WORKS INC.
 1321 LESLIE AVENUE • ALEXANDRIA, VIRGINIA 22301

"Remember, you're never more than a few feet away from a product of ITW"

IT'S NEW RJ2A



High Current Ceramic Vacuum Relay

The era of ceramic vacuum relays was first ushered in by Jennings with the introduction of the fabulous 50 kw interruptive RF10. Now comes the equally great RJ2A with outstanding design features of its own.

In the RJ2A Jennings has combined field-proven patented design with two important additions not usually found in lesser relays.

1. A thorough knowledge of the problems involved in designing relays for high voltage airborne, mobile or marine communications systems.
2. The best combination of elements; vacuum for unchanging, low, contact resistance and high voltage withstand, copper to carry high current, and ceramic to withstand shock and high temperature.

In such applications as airborne electronic systems these advantages are invaluable. Especially for antenna switching, switching between antenna couplers, tap changing on RF coils, switching between transmitter and receiver, or pulse forming networks. The proof of superiority is evident in the following ratings which reflect only the minimum capabilities of the relay.

Contact Arrangement	SPDT
Operating Voltage (60 cycles)	12 KV peak
16 mc	8 KV peak
Test Voltage (60 cycles)	18 KV peak
Continuous Current	
60 cycle	25 Amps RMS
16 mc	15 Amps RMS
Contact Resistance	.012 Ohm
Net Weight	3 oz. Nom.

We will be pleased to send you more detailed information about the RJ2A and the rest of our complete line of vacuum transfer relays.

RELIABILITY MEANS VACUUM
VACUUM MEANS

ITT Jennings

JENNINGS RADIO MFG. CORPORATION • Subsidiary
of International Telephone and Telegraph Corporation
970 McLAUGHLIN AVE., SAN JOSE, CALIF. 95108 • PHONE 292-4025

Circle 43 on Inquiry Card

NEW TECH DATA

Transistor Selector Guide

This uniquely designed silicon transistor selection guide permits the user to easily choose the h-f amplifier or switching device which most closely fits his exact requirements. The guide, called the Selection Guide for Motorola Silicon Annular Transistors, categorizes devices for high-speed saturated logic, small-signal amplifiers, current-mode switches, core drivers, pulse amplifier, micro-power device, choppers, field effect transistor (FET) applications, and high-voltage and general-purpose amplifiers. Motorola Semiconductor Products Inc., P. O. Box 955, Phoenix 1, Arizona.

Circle 253 on Inquiry Card

Circuit Modules

Data sheet BCPD 126-5-65 describes and illustrates a complete family of Series 8000 electronic circuit modules. The modules make up a 1 mc product line and are compatible with the electro-magnetic characteristics of fixed or flying head magnetic drums and disc files. Bryant Computer Products, 850 Ladd Road, Walled Lake, Mich.

Circle 254 on Inquiry Card

Capacitors

Engineering Bulletin 3521.5 describes a complete series of high-reliability, non-polarized solid-electrolyte capacitors. The Type 351D Hyrel ST capacitors are available in working voltages from 6 thru 50 volts with corresponding maximum capacitance values ranging from 160 μ f to 11 μ f. The bulletin lists all standard capacitance ratings and gives typical performance curves. Sprague Electric Co., Marshall Street, North Adams, Mass.

Circle 255 on Inquiry Card

Clock Indicator

Data is available on a remote digital clock indicator assembly which accommodates any of the following IEE rear-projection read-out devices: Series 10, Series 120, Series 220, which have a front plug-in capability for front panel accessibility, and Series 360. Using these various readouts, units are available with display characters ranging in size from $\frac{3}{8}$ in. to a full 2 in. Units are available in packages with up to eleven rear-projection readouts for indicating seconds, minutes, hours, days, etc. Industrial Electronic Engineers, Inc., 7720 Lemona Avenue, Van Nuys, Calif.

Circle 256 on Inquiry Card

Telemetry Brochures

Two brochures (bulletin 50303A and 50304A) are available which introduce the Model 600 PAM/PDM signal simulator-calibrator and Model 603 PAM/PDM Telemetry Decommulator systems equipment. The decommutator features a completely automatic set-up which adjusts gain and level of the input amplifier. The calibrator has versatile channel programming. Operating description and complete specifications are given. Astrodata, Inc., P.O. Box 3003, 240 E. Palais Rd., Anaheim, Calif.

Circle 257 on Inquiry Card

ELECTRONIC INDUSTRIES • September 1965

Circle 44 on Inquiry Card →



Population Explosion

Our Innovators in Switch Design have produced more than 200,000 different types. That's a lot of switches.

200,000 different speciality switches are offered by Arrow-Hart. All quality. All types from electro-mechanical switches to solid state controls. Switches for use on tools, appliances, electronic gear, aerospace devices, ground support equipment, and all electrically-operated equipment.

What does this mean? Simply, that whatever kind of switch you need, Arrow-Hart is the place to get it. Because if it's not on hand, it can be created for you—and produced quickly, efficiently, and economically.

This broad line of quality speciality switches and the specialists who can innovate creatively for you and your products . . . are two of many reasons why you **buy better electrically** at Arrow-Hart. Write today for data. The Arrow-Hart & Hegeman Electric Co., 103 Hawthorn Street, Hartford, Conn.

MOTOR CONTROLS
WIRING DEVICES
ENCLOSED SWITCHES
SPECIALTY SWITCHES



QUALITY SINCE 1890

ARROW-HART

The Arrow Hart & Hegeman Electric Company, Hartford Connecticut 06106

*Our 75th
Anniversary Year*

BUY BETTER ELECTRICALLY • BUY BETTER ELECTRICALLY • BUY BETTER ELECTRICALLY • BUY BETTER ELECTRICALLY

World Radio History

Subminiature ILLUMINATED PUSH BUTTON SWITCHES and matching Indicator Lights

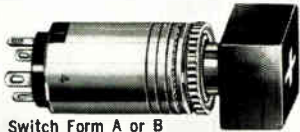

Switch Form A or B
with 3/4" sq. cap

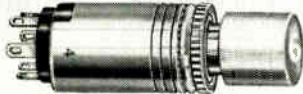

Switch Form C
with 1/2" rnd. cap



Matching Indicator
with 3/4" rnd. cap



Matching Indicator
with 1/2" sq. cap



For complete
data, request
current Catalog.

Illust. approx. 75% actual size

DIALCO Switches and Indicator Lights provide almost limitless applications—are flexible in arrangement—economical in price—and feature high reliability.

Switches are the silent, momentary type—requiring 24 oz. (approx.) operating force. Contact arrangements are: S.P.S.T., normally open or normally closed; S.P.D.T. two circuit (one normally open, one normally closed). Ratings: 3 amps, 125V A.C.; 3 amps, 30V D.C. (non-inductive). The switch is completely enclosed and independent of the lamp circuit. The light source is the T-1 3/4 incandescent lamp, available in voltages from 1.35 to 28V. Units are made for single hole (keyed) mounting in panels up to 3/16" thick and mount from back of panel in 1/2" clearance hole. Switch forms for dry circuits are also available.

Other features include: 1/2" or 3/4" interchangeable caps, round or square, rotatable or non-rotatable, in a choice of 7 color combinations.

DIALCO®

FOREMOST MANUFACTURER OF PILOT LIGHTS

DIALIGHT CORPORATION

60 STEWART AVENUE, BROOKLYN, N.Y. 11237 212 HYACINTH 7-7600

Circle 45 on Inquiry Card

SMALLEST HIGH VOLTAGE POWER PACKS

Announcing Additions to the Widely-Used PC 1 HV-M Series Power Packs
New Ratings . . . Most Items Available From Stock
Rated Output Voltages from 1000 to 75,000 Volts

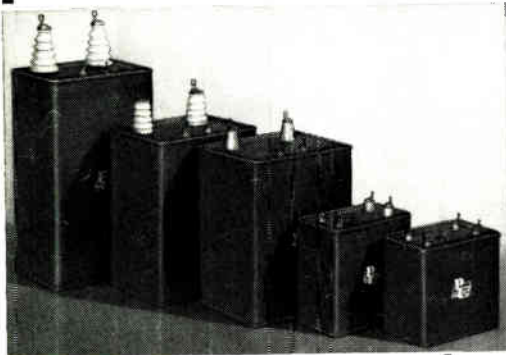

Write today for complete information, including technical data, on these amazing new compact power packs.

A welcome development in power packs — highest quality materials, smaller packaging, long life and high reliability — features commonly found only in power packs of much larger size and much higher cost.

Compact "M" Series Power Packs Give You:

- Choice of rated output voltages from 1000 to 75,000 DC
- Choice of rated output currents of 1.5, 5 and 10 milliamperes
- Choice of input voltages of 118, 220, 230 and 240 volts AC
- Input frequency range 50 to 500 CPS
Output ripple 190 RMS at rated load and voltage with 60 CPS input
- Wide ambient temperature range
- Variable output from 0 to rated voltage
- Hermetically sealed

Plastic Capacitors, Inc.
2620 N. Clybourn • Chicago 14, Ill.
DI 8-3735

Custom Engineering at
Production Prices

High Power Tubes

A technical brochure describing a line of high power tubes for use in radar and microwave modulators is available. Included are both ceramic and glass hydrogen filled diodes and thyratrons, along with several high voltage vacuum switch tubes. Ratings on the hydrogen filled tubes extend to 50kv and 4,000 amperes. The maximum plate voltage rating on the vacuum switch tubes is 125kv. Tung-Sol Electric, Inc., 1 Summer Ave., Newark 4, N. J.

Circle 258 on Inquiry Card

Signal Generator

TM-103 is a two-color data sheet describing the Model 351A solid-state tracking signal generator. The publication provides specs. on frequency accuracy, output level, distortion and other performance parameters of a crystal-controlled signal generator covering 10kc to 15mc, with automatic level-control circuits. Included is a block diagram of the signal generator circuits. Sierra Operations/Communications, Philco Corp., 3885 Bohannon Drive, Menlo Park, Calif.

Circle 259 on Inquiry Card

VTVM

Model 312 has an input resistance of 16 megohms, not the usual eleven. It offers 40% less circuit loading than most conventional VTVMs. The unit features 1/2 volt range and improved dc and ac accuracies of ±3% of full scale on all ranges. More data is available in Bulletin ET 510 from Simpson Electric Company, 5200 West Kinzie Street, Chicago 44, Illinois.

Circle 260 on Inquiry Card

Modulator Packages

A bulletin is available which describes pulse modulator packages tailored to match characteristics of specific microwave tubes. With the package approach, the pulse transformer, pulse forming network, and charging choke are designed as a module. Current-pulse shapes and rise times match non-linear loads of microwave oscillators, assuring optimum tube performance. The bulletin also describes typical pulse package designs having outputs ranging from 4800 watts to 234kw. Raytheon Company, Magnetics Operation, Waltham, Mass.

Circle 261 on Inquiry Card

Molded Knobs

Bulletin 168 describes a line of molded plastic knobs. They are specially designed for oscilloscopes, computers, control systems and other applications where panel space is a factor. The new knobs are available with nickel-plated brass bushings, one or two socket set screws, and with choice of regular or overall decorative, radially spun aluminum inserts. Indicator line is also available on inserts and skirts. Rogan Brothers, Inc., 8025 N. Monticello Ave., Skokie, Ill.

Circle 262 on Inquiry Card

NEW TECH DATA

Hardware Catalog

This 46-page catalog describes binding posts, binding post boards, contact and terminal strips, interlocks, fuse and diode holders, lugs and terminals, etc. It contains a number of tables that give data on the characteristics of various insulating materials and laminated sheets. National Tel-Tronics, Inc., 52 St. Casimir Street, Yonkers, New York.

Circle 263 on Inquiry Card

Ultrasonic Bonder

This data describes the ultrasonic Stitchbonder for internal semiconductor connections. It is capable of attaching a 0.005 to 0.002 in. aluminum or gold wire from semiconductor chip to package lead within 2 seconds. Wire feeding is fully automatic and leaves no pigtailed. Machine available with rotating chuck for all popular integrated circuit packages. E. M. B. Corp., 4151 Middlefield Road, Palo Alto, Calif.

Circle 264 on Inquiry Card

Wire Markers Catalog

Thousands of self-adhering stock wire markers in many materials and sizes can be instantly selected from this 16-page wire-marker catalog. Printed marker legends include numbers, letters, electrical symbols, NEMA colors, machine tool codes, cycles, voltages, etc. Westline E-Z Code Division, 600 East 2nd Street, P. O. Box 2980 Terminal Annex, Los Angeles 54, Calif.

Circle 265 on Inquiry Card

Magnetic Modulators

An application data sheet is available which describes the magnetic modulator, a solid-state device capable of performing analog functions of addition, subtraction, and multiplication. It needs no diodes to perform the functions. Applications and block diagrams are included. General Magnetics, Inc., 135 Bloomfield Ave., Bloomfield, N. J.

Circle 266 on Inquiry Card

Antennas & Reflectors

Descriptive and technical data is available concerning microwave devices based on the use of a specially-developed artificial dielectric medium. The medium consists of a foamed plastic and tiny metallic silver occlusions. Armstrong Cork Co., Lancaster, Pa.

Circle 267 on Inquiry Card

Bandpass Filters

Model 1700 EN series of bandpass filters are available in five ranges between 1700mc and 2300mc fixed tuned or individually tunable to any frequency within the range of each unit. Maximum vswr at center frequency ± 1 mc is 1.15 and load vswr is 1.03 max. The 3db bandwidth is 15.5 (± 1.5 mc) and insertion loss at mid-band is 1.1db. Complete specs available from Frequency Engineering Laboratories, P. O. Box 527, Farmingdale, N. J.

Circle 268 on Inquiry Card

Who ever heard of a kilovolt Zener?

Here is something better (actual size).

30kV
High Voltage
350V
MICRO amps
Corotron Diode

300V
Low Voltage
10
Milliamps
Zener

**Other Zener-equivalent Victoreen diodes
range from 350 to 30,000 volts**

In low voltage power supply circuits, transistors and Zeners are OK. But what about high voltage supplies? Wish you could eliminate voltage dividers and dc amplifiers used with low voltage references?

You can. You're wishing for a *Victoreen diode, the gaseous equivalent of an ideal high-voltage Zener.*

A single Victoreen Corotron diode can be used as a reference, shunt regulator, dc coupling element, or portion of a divider. Corotrons are microminiature... free from relaxation oscillation... free from catastrophic failure caused by surges or transients... immune to radiation or ambient light effects... have excellent stability and temperature characteristics.

Sound ideal? That's only half the story. Get the rest by addressing Applications Engineering Department today.

3377-A

VICTOREEN



**THE VICTOREEN INSTRUMENT COMPANY
10101 Woodland Ave. • Cleveland, Ohio 44104**

**Ever need plug-in power supplies in a hurry?
Send for our 1965 catalog.
It lists 62,000 different types.
The one you need will be shipped in 3 days.
(We've never failed to make good on this promise)**

Acopian
TRANSFORMER REGULATED PLUG-IN POWER SUPPLIES

Acopian
TRANSFORMER REGULATED PLUG-IN POWER SUPPLIES

Acopian

Acopian Corporation, Easton, Pennsylvania, (215) 258-6149

Circle 48 on Inquiry Card

Measures 300 μ V to 300 V at frequencies 10 Hz to 11 MHz

Ballantine VTVM Model 317

The Model 317 is an exceptionally wide-band sensitive voltmeter embodying the most advanced features of electrical and mechanical design. The heart of the instrument is a stable multi-loop feedback amplifier which feeds an average-responding rectifier circuit. The instrument is designed for accurate voltage measurements down to 300 μ V, or as a null detector to 100 μ V.

The Model 2317 Cathode Follower Probe uses a rugged Nuvistor tube. Its high input impedance makes accurate voltage measurements possible from 300 mV down to 300 μ V with a minimum of loading of the circuit under test.

Price: \$495. with probe

SPECIFICATIONS

- Voltage Range..... 300 μ V to 300 V
- Frequency Range..... 10 Hz to 11 MHz
(Useful as a null detector 5 Hz to 30 MHz)
- Accuracy AT ANY POINT ON THE SCALE
 - 2%, 20 Hz to 2 MHz
 - 4%, 10 Hz to 6 MHz
 - 6%, 10 Hz to 11 MHz
- 19 inch Rack Version Available..... Yes

Write for full details



— Since 1932 —
BALLANTINE LABORATORIES INC.
Boonton, New Jersey



Circle 49 on Inquiry Card

NEW TECH DATA

Split-Field Microscope

Data is available on a microscope for split-field viewing, rapid alignment, and exposure of sequential semiconductor patterns. Model 352 has resolution comparable to high-quality metallurgical microscopes. Alignments of $\frac{1}{4}$ micron are possible. Electroglas, Inc., 150 Constitution Dr., Menlo Park, Calif.

Circle 269 on Inquiry Card

Proximity Systems

Two new proximity switch systems offering AND and OR logic outputs are described in Data Sheet 239. The sheet describes how each system uses two proximity sensors which are sensitive to all metals. An AND system operates only when an electroconductive metal object is within range of both sensors. The OR system reacts to a metal object within range of either sensor and releases only when both sensors have no metal within their sensing range. Micro Switch, Freeport, Ill.

Circle 270 on Inquiry Card

Potentiometer Catalog

Catalog 11 describes a complete line of military, industrial and commercial units with wirewound, carbon, and Palirium® elements. It also lists brief specs. on precision potentiometers, relays, time delays, microcomponents, and exponential resistors. Performance and dimensional specifications are given. Bourns, Inc., Trimpot Division, 1200 Columbia Avenue, Riverside, Calif.

Circle 271 on Inquiry Card

Mounting Boards

The ADC 13-8 series microcircuit mounting boards are designed to simplify breadboarding and small production run problems. The literature describes the overall line, its applications and data on individual boards and patterns. Applied Development Corp., 1131 Monterey Pass Road, Monterey Park, Calif.

Circle 272 on Inquiry Card

Five-Digit DVM

Data Sheet No. 464 describes the Model 5603 DVM, a remote programmed five-digit unit with 22-msec reading time, 0.005%-of-reading accuracy, split-second filtering of superimposed noise, and 130-db CMR. The data sheet gives full description and specification data. Dana Laboratories, Inc., Irvine, Calif.

Circle 273 on Inquiry Card

Test Equipment

Data on over 1200 standard waveguide and coaxial instruments and components, which cover the frequency range of 2 to 40cc are contained in this microwave test equipment catalog. This catalog contains complete information on waveguide and coaxial devices. Complete technical data, descriptive text illustrations, and price lists are included. Waveline, Inc., Caldwell, New Jersey.

Circle 274 on Inquiry Card



PROGRESS REPORT

ALSiPAK

**CERAMIC
PACKAGES**

ALSiPak CERAMIC packages for electronic circuits are used because of their greater strength, much higher thermal dissipation, their dimensional accuracy with little or no deformation of sides . . . and because of their RELIABILITY. As these advantages have become more widely recognized, both the preferred style and custom made ALSiPak CERAMIC packages have grown in quantity and in available variety.

Recently, production facilities for both alumina and beryllia ALSiPak CERAMIC packages have been expanded. Volume of production is

growing steadily. The selection of ceramic depends primarily on the heat sink requirements.

Custom ALSiPak CERAMIC packages offer you the widest possible design freedom. Some applications can be served well, quickly, and economically with one of the growing line of preferred style ALSiPak packages. For information on these items, current inquiry is suggested. These ALSiPak packages have two big advantages over the usual ceramic packages. First, the inside depth can be varied within reasonable limits at no additional cost. Second, in most instances

the number of leads can be varied with no additional cost except the tooling for the leads.

Custom made ALSiPak CERAMIC packages are currently produced in sizes ranging from .100" square to 1" square. Packages as large as 1" square can be supplied with any number of leads up to 64. At present ALSiPak preferred style packages range in size up to .750" x .875" exterior. If you need a custom package, please send complete details including outside size, interior height, device area, number of leads, and any electroplating requirements.

American Lava Corporation

3M
COMPANY

PHONE 615 265-3411, CHATTANOOGA, TENNESSEE 37405

A SUBSIDIARY OF

For service, contact American Lava representatives in Offices of Minnesota Mining and Manufacturing Co. in these cities (see your local telephone directory): Birmingham, Michigan • Boston: Needham Heights, Mass. • Chicago: Bedford Park, Illinois • Cleveland, Ohio • Laurens, S. C. • Los Angeles, Calif. • Minneapolis, Minn. • Metropolitan New York: Ridgefield, N. J. • Up-State New York: Phelps, N. Y. • Philadelphia, Penn. • Richardson, Texas • Roanoke, Va. • South San Francisco, Calif. All export except Canada: Minnesota Mining and Manufacturing Co., International Division, 700 Grand Ave., Ridgefield, N. J.

64th
YEAR
OF
CERAMIC
LEADERSHIP

Circle 50 on Inquiry Card

World Radio History

“... STATE-OF-THE-ART information on Components and Equipment.”

Recording Papers

Three oscillograph recording papers which cover virtually all modes of recording that utilize direct print or printout techniques are described in bulletin 1639-6. Dataflash 54 is a high-writing speed paper for ultra-violet light source instruments; Dataflash 55 has writing speed in excess of 75,000 ips and an extremely high latentification rate; and Dataflash 56 is formulated with a wide spectral response and is used in instruments having Zenon light sources. Consolidated Electrodynamics Corp., 360 Sierra Madre Villa, Pasadena, Calif.

Circle 154 on Inquiry Card

Capabilities Brochure

Bulletin 5B128 describes capabilities for manufacturing digital data systems. The brochure includes examples of typical systems designed for nuclear radiation monitoring, missile battery check-out, communications status monitoring, high-speed projectile timing, steel coil classifying, and telemetry frequency monitoring. Descriptions of standard building blocks for systems are also included. Beckman Instruments, Inc., Berkeley Division, 2200 Wright Avenue, Richmond, Calif.

Circle 155 on Inquiry Card

Computer and IC Terms

The Schweber Glossary of Computer & Integrated Circuit Terms defines widely used words and phrases in a rapidly developing industry. Copies are available from Schweber Electronics, Westbury, New York.

Circle 156 on Inquiry Card

Film-Foil Capacitors

Flat-Kap plastic film-foil capacitors are described in this bulletin. Curves present data on high-Q and its temperature stability, high insulation resistance, uniform capacitance vs. temperature, and superior capacitance stability. Data includes dissipation factor, insulation resistance, temperature range, dielectric strength, and life and humidity test results. A table lists the range of capacitance values available, and a dimensioned sketch shows case sizes. Union Carbide Corp., Kemet Department, 11901 Madison Avenue, Cleveland, Ohio.

Circle 157 on Inquiry Card

DTL Nand Gates

Data is available on a new quadruple DTL NAND gate for high-reliability military uses. Designated WM-246G, the device uses four separate two-input gates packaged in a single 1/8-inch-by-1/4-inch flat pack. It provides increased logic density since it has four gate functions/device, and each gate function has the output capability to drive at least eleven other gates. Noise margin is 1v and average switching time is 23nsec. Westinghouse Molecular Electronics Division, Box 7377, Elkridge, Md.

Circle 158 on Inquiry Card

Ferrite Design

Bulletin #28A gives complete data on temperature compensated cup core assemblies for filter uses requiring tuneable inductors having low loss characteristics over a wide temperature range. Four design nomographs are included to provide the engineer with an easy and quick method for determining inductance, number of turns, copper resistance and wire gauge. Indiana General Corp., Electronics Div./Ferrites, Keasbey, New Jersey.

Circle 159 on Inquiry Card

Display Selection Chart

This fold-out chart outlines in detail the specifications and functional characteristics of Transindicator continuous and latching numerical display. It provides a clear decimal display of binary data. The compact unit features extremely wide operating tolerances on supply voltage, temperature range and input signal level. Transitron Electronic Corp., 168 Albion Street, Wakefield, Mass.

Circle 160 on Inquiry Card

Curve Tracer

Technical bulletin 100-6 describes the AEL Model 438 diode capacitance curve tracer. It is used for a number of voltage variable capacitance devices including varactors, tuning diodes, computer diodes, PIN diodes, transistors and related semiconductors. Test adapters are available to accept various diode packages. The new bulletin gives details of operation of the curve tracer, and lists dimensions, weight and materials of construction. American Electronic Laboratories, Inc., P. O. Box 552, Lansdale, Pa.

Circle 161 on Inquiry Card

Laser Bulletin

Bulletin #4 discusses the noise properties of both the laser amplifier and the conventional laser oscillator, and describes laser noise in terms of the classical electromagnetic theory of light. Material is based primarily on applications of the helium-neon laser, oscillating at 6328 Å, but most of the formulations are quite general, applying equally well to other types of gas discharge lasers. Spectra-Physics, Inc., Mountain View, Calif.

Circle 162 on Inquiry Card

Micrologic Modules

Typical applications of SEL 8500 series micrologic modules are described in this comprehensive, 40-page booklet. Presented are specification tables and diagrams showing circuit configurations, logic symbols and signal connections for typical NOR, flip-flop, buffer, inverter, half-adder, expander and counter modules. Circuit loading, grounding and power distribution rules are explained. Systems Engineering Laboratories, Inc., P. O. Box 9148, Ft. Lauderdale, Fla.

Circle 163 on Inquiry Card

Reference Guide

This "Quick Reference Guide" lists 144 different resistors and trimmer potentiometers. Listed in the guide are a wide variety of wirewound resistors, including categories for high reliability, precision power wirewound, housed power wirewound and special purpose wirewound. Film resistor categories include: precision metal film, precision power metal film, and precision carbon film. Also included are vital statistics covering a complete line of wirewound trimmer potentiometers in military, commercial and general purpose grades. Dale Electronics, Box 609, Columbus, Nebraska.

Circle 164 on Inquiry Card

Computer Storage Brochure

Bulletin 5350 describes ultrasonic computer storage systems. The publication contains general data on ultrasonic delay lines and a detailed discussion of delay time, frequency response, and pulse response. A discussion of delay line storage system capabilities is given, including high bit rates, large storage capacity, multiple channels, and versatile storage. Microsonics, Inc., 60 Winter Street, Weymouth, Mass.

Circle 165 on Inquiry Card

Plastics Charts

In this 16-page brochure, thermoplastics and thermosets are treated in the conveniently organized two-way charts. A final portion treats high pressure laminates, listing mechanical properties, electrical properties, and physical and thermal properties of phenolic, silicone, melamine and epoxy binders with various fillers. The first six pages are devoted to the thermoplastics, and thermosets are dealt with in six pages and in the same format. Commercial Plastics & Supply Corp., 630 Broadway, New York, N. Y.

Circle 166 on Inquiry Card

Transistors

Four data sheets are available covering a line of molded GEM transistors. The SL 100 is designed for VHF oscillator and amplifier uses. The SL 200 series are PNP and the SL 300 series are NPN transistors for small signal general purpose applications where the low leakage currents and inherent stability of silicon devices are essential. The 2N3793 and 2N3794 are silicon NPN medium power transistors. National Semiconductor Corporation, Danbury, Conn.

Circle 167 on Inquiry Card

Cable Catalog

A comprehensive 20-page catalog is available which covers semiflexible coaxial cable and connectors. The catalog pages are devoted to specifications for delay lines, miniature, and phase-compensated coaxial cable product lines. Times Wire and Cable, Hall Avenue, Wallingford, Conn.

Circle 168 on Inquiry Card

“Allen-Bradley hot molded resistors have always proved **absolutely reliable and superior to any others . . . foreign or domestic**”

*H. H. Scott, Inc.
Maynard, Mass.*

In the Scott 344 transistor FM stereo tuner/amplifier, Allen-Bradley hot molded resistors provide excellent gain stability, low noise, at top operating voltages.

“Based on our use of more than 30,000,000 Allen-Bradley hot molded resistors over the past 18 years, under a continuous re-evaluation program for all component parts.”

The known reputation of Scott hi-fi equipment is based on their unquestioned engineering excellence and their rigid quality standards. And Allen-Bradley hot molded resistors have played an important role in this achievement.

The consistently high quality of Allen-Bradley resistors — year after year, and million after million — is the result of an *exclusive* hot molding process developed and used only by Allen-Bradley. It produces such uniformity that the long term performance of Allen-Bradley resistors can be accurately predicted . . . and catastrophic failures never occur.

You can be certain of this same “built-in” resistor reliability and superlative performance *only* when standardizing on Allen-Bradley hot molded resistors. For more

complete specifications, please send for Technical Bulletin 5050: Allen-Bradley Co., 222 W. Greenfield Ave., Milwaukee, Wis. 53204. In Canada: Allen-Bradley Canada Ltd., Galt, Ont. Export Office: 630 Third Ave., New York, N.Y., U.S.A. 10017.

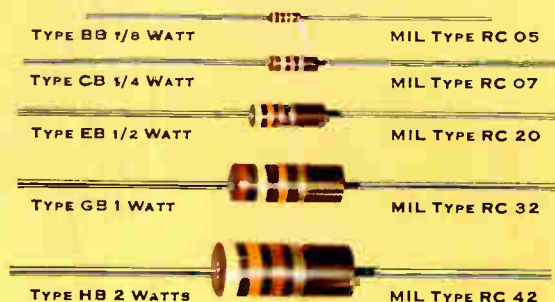

HOT MOLDED FIXED RESISTORS are available in all standard EIA and MIL-R-11 resistance values and tolerances, plus values above and below standard limits. Shown actual size.



ALLEN-BRADLEY
QUALITY ELECTRONIC COMPONENTS

Chart showing the consistency of resistance change in Allen-Bradley Type HB 2-watt resistors in all resistance values from 10 ohms to 100 megohms during humidity test at 95%, 55°C for 113 hours.

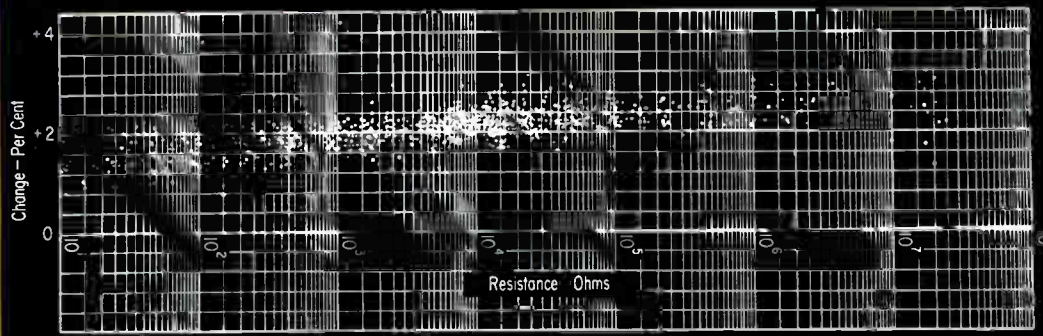

HOT MOLDED FIXED RESISTORS are available in all standard EIA and MIL-R-11 resistance values and tolerances, plus values above and below standard limits. Shown actual size.

TYPE BB 1/8 WATT		MIL TYPE RC 05
TYPE CB 1/4 WATT		MIL TYPE RC 07
TYPE EB 1/2 WATT		MIL TYPE RC 20
TYPE GB 1 WATT		MIL TYPE RC 32
TYPE HB 2 WATTS		MIL TYPE RC 42

fantastically

uniform

...billion after billion!

Chart at right shows actual per cent resistance change after temperature cycling tests (5 cycles from -55°C to 85°C) on samples regularly taken from production of over 2½ billion Allen-Bradley Type EB ½ watt hot molded resistors.

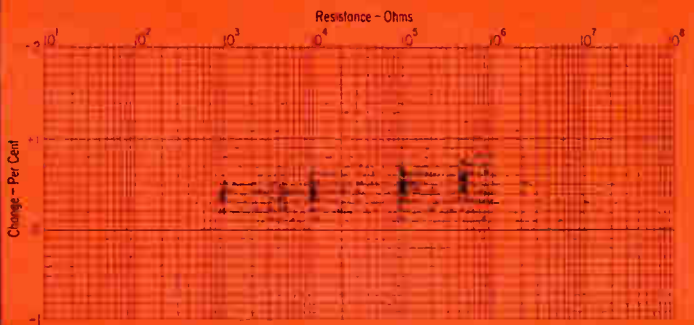

■ To maintain absolute uniformity, Allen-Bradley quality control engineers continuously take samples of resistors from production and test them. The results of these tests, as shown by the charts on this page, are truly amazing. One chart, covering the results of tests on 1248 samples representing production of more than 2½ billion resistors, shows a typical resistance change of only ½ of 1% after five cycles from -55°C to 85°C !

The other chart, plotting production sampling from more than 175 million resistors in a humidity test at 95%, 55°C for 113 hours, shows only a slight deviation in resistance—and complete freedom from any wide deviations.

So far as uniformity of electrical characteristics and physical properties are concerned, Allen-Bradley hot molded resistors have no equal. That's why they are so decidedly preferred by electronic engineers throughout the world. For complete specifications, please write for Technical Bulletin 5050: Allen-Bradley Co., 222 W. Greenfield Avenue, Milwaukee, Wisconsin 53204. In Canada: Allen-Bradley Canada Ltd., Galt, Ont. Export Office: 630 Third Ave., New York, N.Y., U.S.A. 10017.



ALLEN-BRADLEY
QUALITY ELECTRONIC COMPONENTS

PORTABLE 70KV TESTER

More than 70kv can be generated by this dielectric strength tester for on-site testing of high-voltage capacitors, switches, transformers, etc. The JHP70 Portable AC Hipot, a product of Jennings Radio, Box 1278, San Jose, Calif., also checks capacitive current leaks.



Direct reading of transistor latch-up and secondary breakdown voltages for all transistors is accomplished by the Model 70 semiconductor test set. A product of Birtcher Corp., Monterey Park, Calif., it measures high peak currents without destruction of the transistor. This is accomplished by using a pulsed power supply having a low duty cycle.

A laser will soon be used as an illumination source for high-speed photography of ballistics range models. The laser system, which will be used in photographing ballistic studies with model velocities of 10,000 to 25,000 ft./sec., is being developed for the Navy by Lear Siegler, Inc., Grand Rapids, Mich. The laser device is part of shadowgraph instrumentation for detecting and recording boundary layer and air stream flow.

A sequential tester, that both detects a fault and points out the inoperative component, has been developed to automatically check aircraft, missile and ground power systems. The "GO/NO GO" equipment, by General Electric, Schenectady, N. Y., tests each programmed function in a system to determine if it is operative within prescribed limits. The new tester moves sequentially throughout the entire system stopping only if it locates a faulty component. The portable tester weighs between 35 and 75 lbs., depending on testing functions built into the unit.

A new concept in environmental shock testing has been introduced by Ling Electronics, Anaheim, Calif. The shock testing system determines the shock spectrum of any shock pulse. Analysis of this signal allows the operator to program an equalized signal with same energy content as the original pulse. This signal is applied to the test package with an electro-dynamic shaker system.

An oscilloscope display device, which simultaneously shows 5 displays, is available from Telonic Industries, Beech Grove, Ind. The Skan-A-Skope provides the simultaneous display of three amplitude vs. freq. characteristics, plus seven reference lines. The displays are presented on a 17 in. CRT.

A voltage calibrator has been developed by Electro-Mechanical Research, Inc., Sarasota, Fla., for use in telemetry systems. Model 278A calibrates both airborne and ground voltage-controlled oscillators to IRIG or AIA standards.

Missile nose cone designers will have their tasks substantially reduced thanks to a computer program developed by Electronic Associates, West Long Branch, N. J. Given an initial body shape and aerodynamic heating equations, it will obtain a time history of the ablating body profile. This will enable the safest, most economical nose cone design to be selected.

An ultrahigh vacuum chamber system that produces vacuum levels approaching those in deep space has been supplied to the Air Force by Union Carbide Corp.'s Linde Div. The system, which uses no conventional ultrahigh vacuum pump, has attained pressures to 10^{-12} .

Those designing silicon controlled rectifiers will welcome this new selector and calculator. It features JEDEC and IR house numbers; output voltage as a function of firing pulse angle of phase retard, single through 12 phase rectifiers; design constants for single through 12 phase rectifier circuits; and other scales. Send \$1.00 to International Rectifier Corp., 233 Kansas St., El Segundo, Calif.

High tunnel-emission current densities of over 242 amp/cm² have been achieved in thin layers of aluminum oxide by Air Force researchers. This implies the attainment of substantial levels of hot electron current production. The results can be attributed to methods of specimen preparation and measurement techniques. Testing methods and results are contained in Thin Film Measurement Techniques (order AD 614 891N) from Clearinghouse, U.S. Dept. of Commerce, Springfield, Va. Price is \$3.00.

RAPID DRUM-HEAD CHECKING

Flying head clearance of magnetic memory drums can now be inspected ultrasonically with an 85% reduction in check-out time. The system pinpoints which head among as many as 193 on a 160-channel drum is not maintaining required clearance at operating rpm. Called the Ultrasonic Translator detector, it is a product of the Delcon Div. of Hewlett Packard, 943 Industrial Ave., Palo Alto, Calif.

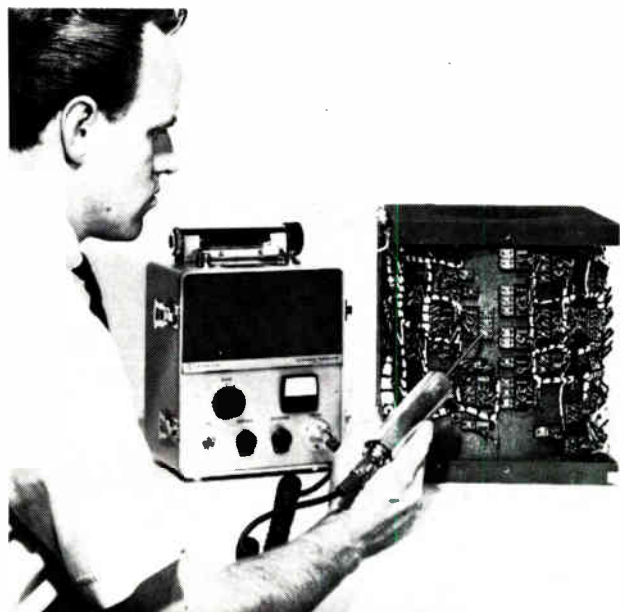

A curve tracer adaptor is described which can be used with an X-Y recorder to plot the common characteristics for MOS and junction field-effect transistors. It is also useful for several unusual functions.

A Curve Tracer For Field-Effect Transistors

**ELECTRONIC
INDUSTRIES**

STATE-OF-THE-ART

FEATURE

GRAPHICAL ANALYSIS IS OFTEN USEFUL in helping to understand the operation and design of various circuits. This is especially true when working with new devices like the field-effect transistor (FET).

There are two main characteristic curves used with FET's: The *transfer characteristic curve*, which relates the drain current as a function of gate-to-source voltage with the drain-to-source voltage held constant; and the *drain curve*, which relates the drain current as a function of the drain-source voltage with the gate voltage serving as a variable parameter.

The transfer characteristic curve is helpful in determining self-bias conditions, and the drain (or output) characteristic curve aids in determining the proper load line for adequate signal swing, stability, and for meeting distortion requirements. An output characteristic covering only the very low drain voltage level is also useful when working with FET chopper circuits or when using the FET as a voltage variable resistor.

Any of the FET characteristic curves may be plotted on the normal transistor curve tracer with slight modification and may be observed directly on the CRO tube or may be photographed for permanent record and for detailed graphical analysis. It is often more desirable to have the characteristic curves plotted on a more expanded and more accurate scale than can be obtained on the normal CRO-type curve tracer.

An adaptor for use with the X-Y recorder, to trace out the various characteristics of FET's, will be described. With it, not only is the resulting trace larger and more accurate, but finer details are observed. Also, the tracing speed can be adjusted to achieve various degrees of thermal stability for making the plot.

*Formerly with Hughes Aircraft Co., Mr. Todd is now an engineering consultant, 2270 Meyer Place, Costa Mesa, Calif.

Basic Circuit

Consider the fundamental circuit approach which may be used with the X-Y recorder to provide various types of characteristic curves:

Drain or Output Characteristic Curves. The simplest form of circuit arrangement which might be used with the X-Y recorder for plotting the FET output or drain characteristic curves is shown in Fig. 1. One power supply provides the gate-to-source bias, V_{GS} , while another provides the drain-to-source voltage, V_{DS} . To trace out the characteristic curve, V_{DS} is varied from zero to the maximum drain voltage to be displayed for each value of gate bias.

A small resistor, R , is inserted between the drain power supply and the FET to develop a voltage proportional to the drain current. If this voltage is kept small enough, using a relatively low value of R , the true value of the drain-to-source voltage will be nearly equal to that of the power supply, V_{DS} .

While the circuit of Fig. 1 is very simple, it is somewhat difficult to vary power supply V_{DS} by hand and achieve uniform and smooth results. Since the variation in voltage must be slow enough to be followed by the X-Y recorder, it would be more desirable that the V_{DS} power supply be swept automatically at a predetermined speed.

The greatest variation in drain current occurs for the lower value of drain voltage. Thus, it would be desirable to provide a sweep rate essentially constant for the higher voltage, while very little variation in drain current occurs, and then a reduced sweep rate for the lower drain-source voltages.

Transfer Characteristic Curves. The simple circuit of Fig. 2 is an arrangement which may be used with an X-Y recorder to plot the transfer characteristic. It is similar to that used for the output characteristic, except that the drive voltage for the X input of the recorder is

taken from the gate voltage supply rather than from the drain voltage supply.

To plot the transfer characteristics, the drain voltage supply is set to some prescribed or desired value while the gate voltage supply is varied from zero to an amount adequate to completely turn the field-effect transistor off. Here, again, a resistor is inserted in series with the drain voltage supply to provide an output voltage proportional to the drain current, for driving the Y input of the X-Y recorder. As before, if this voltage is small, the drain-to-source voltage is close to the supply voltage (V_{DS} in Fig. 2).

In plotting the transfer characteristic curve, the greatest variation in the drain current occurs for the low gate voltage. Thus, it might be desirable to reduce

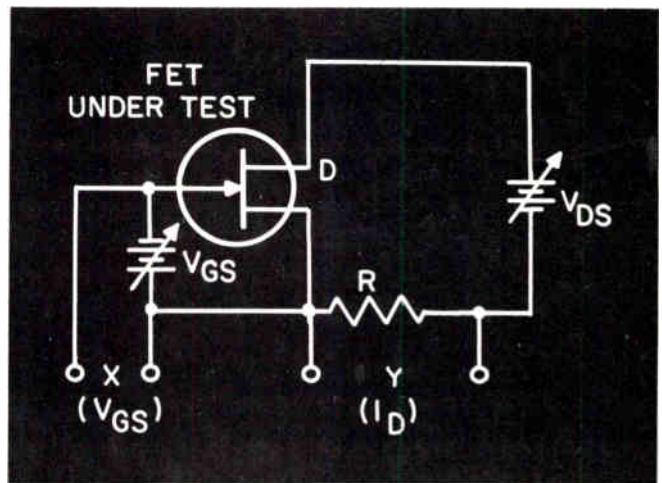

Fig. 1 (left): Simplest arrangement for plotting FET output characteristics in conjunction with an X-Y recorder.

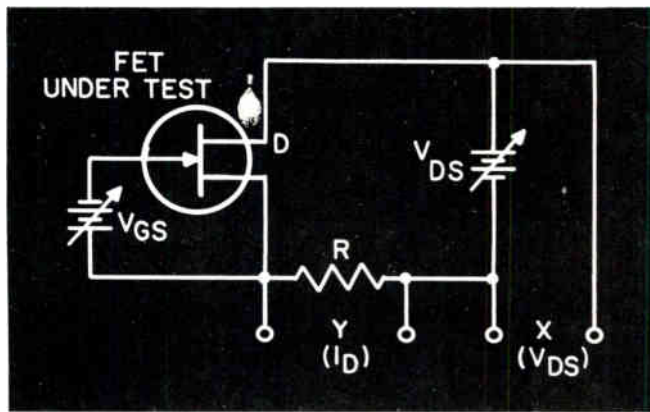

Fig. 2 (above): Simple form of test circuit for plotting transfer curves for FET's.

zero as is normal for RC discharge circuits. This gives the desired variation in sweep rate described above. For larger drain voltages, sweep rate is highest, which is acceptable, since there is little variation in drain current, and hence the X-Y recorder has little difficulty following it.

As the lower levels of V_{DS} are reached, where there is substantial variation in V_{DS} , the sweep rate is automatically decreased so that the recorder can follow the large changes of the drain current. A 10 to 1 variation in overall sweep rate is provided by control R5.

Resistor R3 protects Q1 and Q2 if the output is shorted or overloaded.

Gate Voltage Generator. The gate voltage generator is like the drain voltage supply except that it supplies lower voltage and less current. Since the curve tracer is to be used for FET's with a wide range of pinchoff voltages (from a few tenths of a volt to 10 or 11v), the control for V_{GS} must be at least a 10-turn pot for adequate resolution at the lower voltages.

Current Sampling Resistors. Five values of current sampling resistors are selected by switch S5. Because of the relatively low voltage level, current and voltage switching is used to prevent errors due to contact resistance. Sampling resistors from 1 to 100 ohms are provided to yield current ranges of 10 ma down to 100 μ a full-scale, respectively, for 10 mv input for the X-Y recorder.

Function Switching. Switch S9 changes the X input of the X-Y recorder from the drain voltage supply for the output characteristics to the gate voltage supply for the transfer characteristics. It is necessary to switch both leads of the X-input; and for the transfer characteristic, the entire X input must be isolated from the Y input on the recorder.

Metering Circuits. For precise measurements, it is advisable to use external metering for setting the fixed drain and gate voltages. But, it is convenient, for rough

the sweep rate for the lower voltage as suggested for the output characteristics.

Characteristic Curve Tracer Circuit

The complete circuit, for a characteristic curve tracer adaptor capable of plotting both output and transfer characteristics of p- and n-channel depletion and enhancement FET's, is shown in Fig. 3. A discussion of this circuit follows:

Drain Voltage Supply. With S2 in its normally closed position, capacitor C4 charges to a voltage determined by setting $V_{DS(max)}$ control, R2. When S2 is depressed, C4 begins to discharge at a rate determined by the setting of the V_{DS} rate control, R5. Three values of storage capacitance are possible by setting S3 to give three sweep rate ranges.

To provide careful control and resolution in setting the maximum V_{DS} , and in plotting areas which are near the breakdown region of FET's, it will be convenient to have the control $V_{DS(max)}$ a multiturn potentiometer.

Transistors Q1 and Q2 are connected in a compound emitter follower to drive the FET under test without appreciably loading the sweep capacitor.

When the sweep (which begins at maximum V_{DS}) first starts, the rate is at its maximum as is normal with RC discharge circuits. This rate slows down appreciably, though, as the drain voltage approaches

CURVE TRACER (Continued)

checking, to have a built-in meter that will indicate the magnitude of either of these voltages.

FET Type Switching. Switch S4 allows the polarities of the drain and gate voltage supplies to be changed to provide the proper biasing polarities for either of the four different types of FET's in accordance with Table 1.

Test Sockets. Unfortunately, the basing arrangement for FET's has not been standardized as with the majority of bipolar transistors. Thus, different socket arrangements must be provided.

In addition to the test sockets, it is advisable to bring out the three test leads to banana jacks for adaptability to other configurations and to allow measurements in oven, etc. Other banana jacks are provided to allow external measurement of the drain and gate voltage supplies without interference with the terminals going to the recorder.

Using the Curve Tracer

Using the FET curve tracer adapter is simple and straight-forward. The X-Y recorder inputs are con-

Table 1: BIAS POLARITIES

FET TYPE	V _{DS} POLARITY	V _{GS} POLARITY
n-DEPLETION	+	-
n-ENHANCEMENT	+	+
p-DEPLETION	-	+
p-ENHANCEMENT	-	-

nected to the adapter, and voltage ranges for the X-Y recorder are adjusted to give the proper drain or gate voltages and drain current in conjunction with the sampling resistor chosen by selecting the position of S5. The FET type switch, S4, is placed in position to provide correct bias polarities.

For precise measurements, it is advisable to apply an external precision resistor between the drain and source terminals and to use external metering to set the drain voltage to about full scale. The precision resistor is then chosen to give roughly full-scale current. The calibration adjustment on the recorder may be adjusted to give the precise setting. This eliminates any inaccuracies due to contact potential and possible loading of the current sampling resistor by the input of the X-Y recorder.

Fig. 3: Schematic of FET curve tracer adapter for use with X-Y recorder.

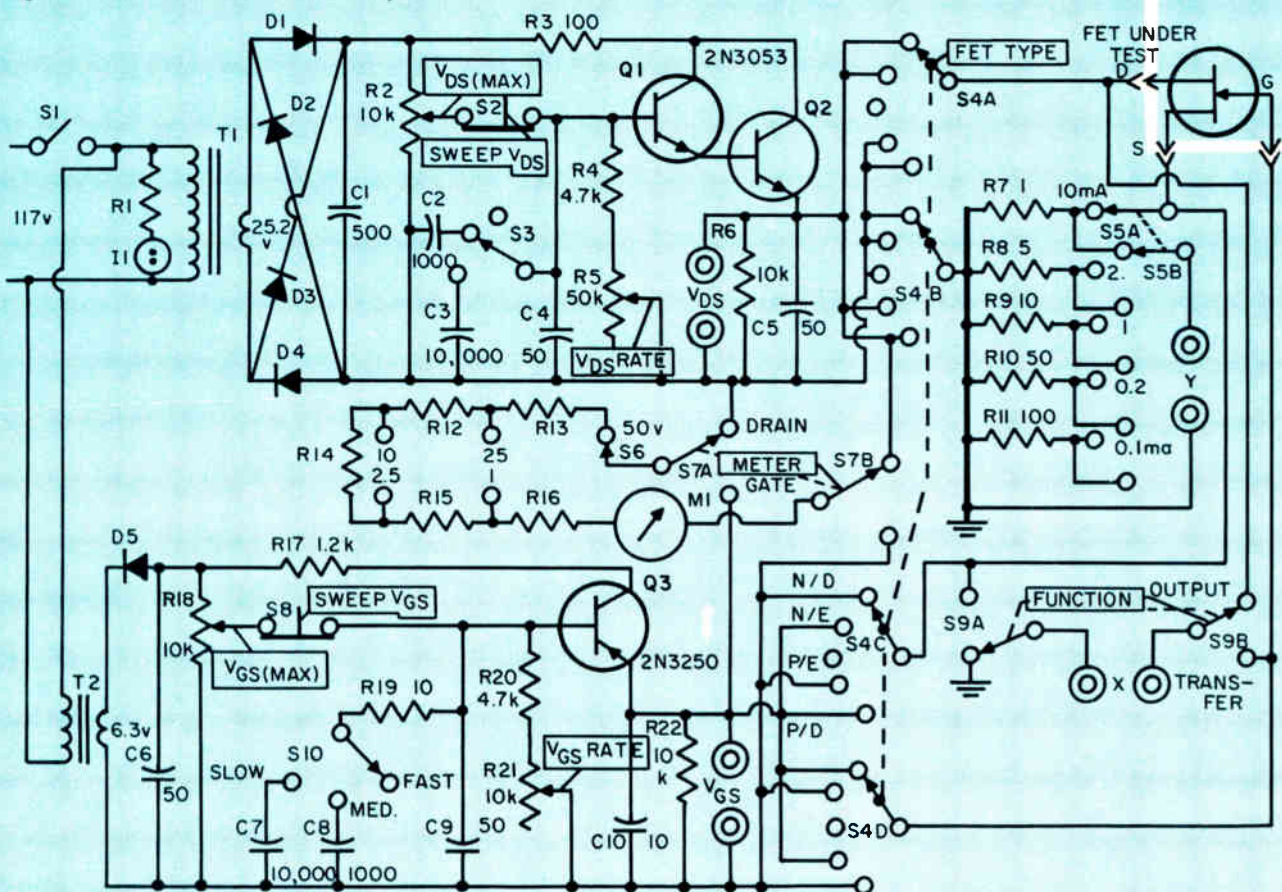

With the precision resistor removed, the transistor to be tested is placed in the test socket, the function switching is thrown to the proper position, and the bias voltage is set.

Transfer Characteristics.

For plotting the transfer characteristic curve, first set the drain source voltage V_{DS} . This is done by adjusting the $V_{DS(max)}$ control, R2. Then set the V_{GS} control to give maximum desired voltage to the gate. For the depletion-mode FET, this normally is a little more than needed to turn the transistor off.

The V_{GS} rate control is set to either a low, medium, or high speed depending on the response time of the X-Y recorder, and depending upon the heating effects on the FET under test.

In the curve tracer shown in Fig. 3, S2 and S8 are combined into a three-position switch. The center position has both switches normally closed. As such, either side position will open the sweep switch for the drain or the gate generator as desired. Non-momentary switching is used to permit long-time sweeping without requiring the switch to be held down.

To activate the sweeping of the transfer characteristic, S8 is opened to allow the gate voltage to discharge at a pre-determined rate and thus trace out the transfer characteristic curve.

A typical FET transfer curve plotted for a type 2N3067 is shown in Fig. 4. Transfer characteristics may also be used to determine the optimum bias point where the temperature coefficient is zero. It is only necessary to plot several transfer curves for different temperatures and note where they intersect as at "A" in Fig. 5.

Output or Drain Characteristics.

To plot the output characteristics of the FET, set the gate voltage to the fixed value needed and then set the $V_{DS(max)}$ control to the maximum value of the drain voltage for which the display is to extend. The voltage sweeping action is initiated by opening S2 which allows the drain-to-source voltage to decrease from $V_{DS(max)}$ to zero.

To plot the entire family of output characteristics, change the V_{GS} to the next bias step and repeat the above procedure as many times as needed. A typical drain characteristic family is shown in Fig. 7.

Thermal Equilibrium Characteristics.

Since the FET parameters and hence both the transfer and output characteristics are a function of temperature, it is sometimes desirable that the characteristic curves represent the drain current for the state of thermal equilibrium; that is, with each point allowed to reach its stable temperature before proceeding to the next. This requires a very long sweep time which is provided in the FET curve tracer adapter by means of the larger capacitors, C3 and C7, for the drain voltage and gate voltage respectively. The slow sweep rate is adjustable from minutes to a couple of hours whereas the normal sweep rate is a matter of seconds.

(Continued on following page)

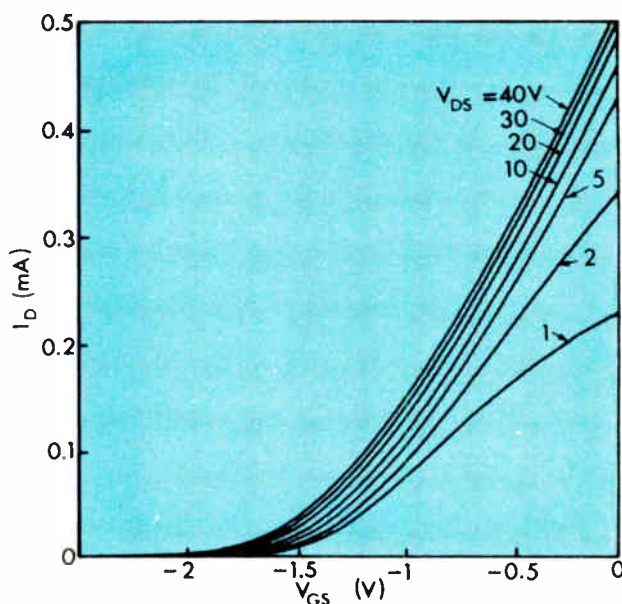

Fig. 4: Typical transfer curve for the Dickson 2N3067 FET.

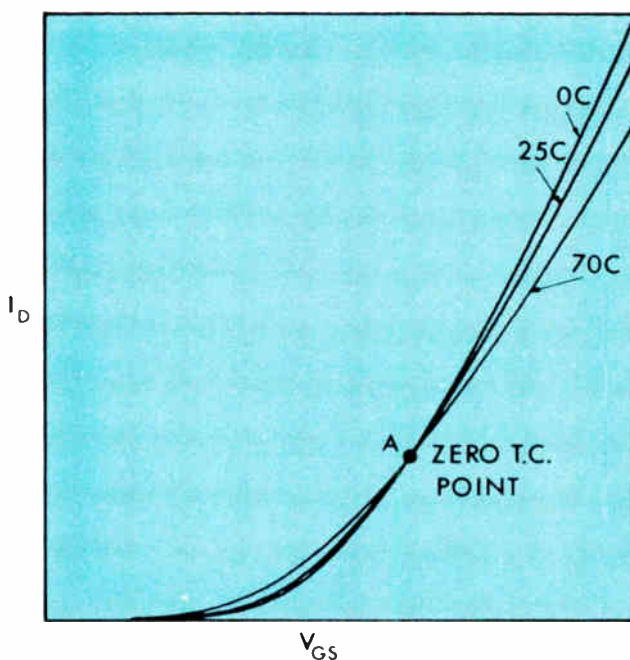

Fig. 5: Effect of temperature on transfer characteristic. Illustrates zero temperature coefficient point for I_D .

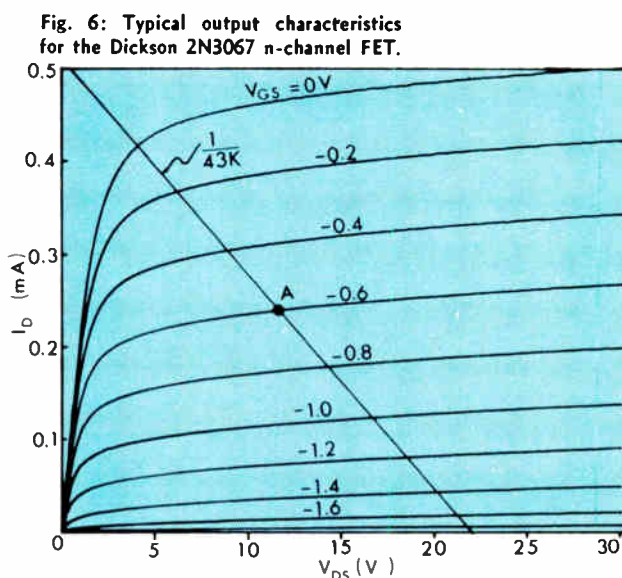

Fig. 6: Typical output characteristics for the Dickson 2N3067 n-channel FET.

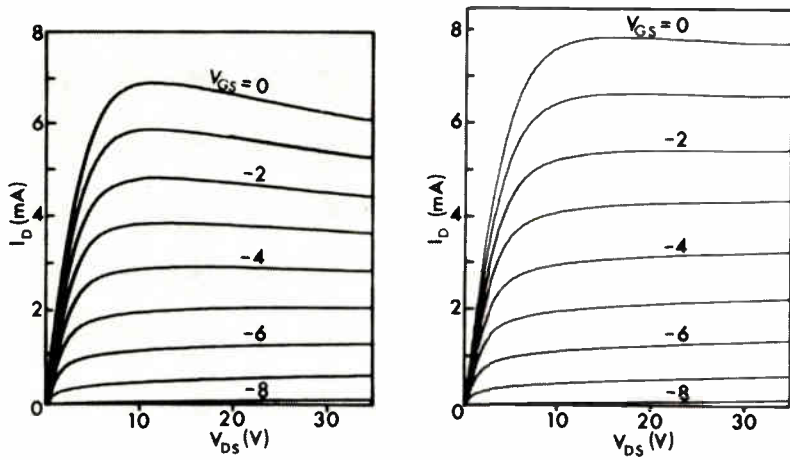

Fig. 7: Output characteristics for a typical 2N3368 FET showing the differences between the thermal equilibrium plot (a) and the normal trace (b) for the same unit.

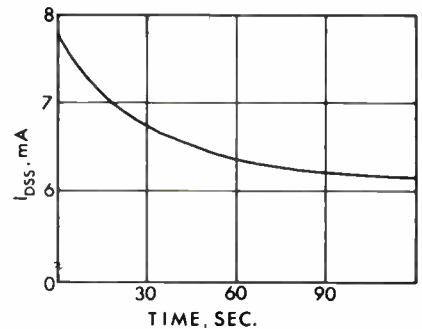

Fig. 8: Thermal heating plot for I_{DSS} with V_{DS} of 40 v. Typical 2N3368 FET curve.

CURVE TRACER (Concluded)

A typical plot of slow-swept drain characteristics for an FET exhibiting negative resistance is shown in Fig. 7a. The V_{DS} variation is slow enough to allow thermal equilibrium to take place at each point. A faster sweep would yield the characteristic of Fig. 7b. This same FET, plotted on a CRO-type curve tracer, would ex-

hibit no negative resistance but would appear much like the curve of Fig. 6 with the current level increased.

Should it be desirable to obtain a characteristic curve where the junction temperature is to remain close to ambient, then a heat sink will help to decrease the possible temperature rise which occurs even with fast sweep.

Other Characteristics.

With minor adaptations, the FET curve tracer adapter may also be used for plotting other types of characteristics. For example, one input of the X-Y recorder might be used to record the drain current for the voltage bias supplied by the FET curve tracer adapter as a function of temperature, with the other input of the X-Y recorder driven by a thermocouple. Thus, an I_{DSS} vs temperature graph may be obtained if the thermocouple is attached to the FET and the ambient temperature is caused to vary.

The curve tracer adapter may also serve as a varying supply for driving other test sets. Plots may then be made, for example, of g_{fs} as a function of drain current, g_{fs} as a function of gate voltage, and g_{fs} as a function of drain voltage, where the second input of the X-Y recorder is taken from the meter indicating g_{fs} .

Of course, the FET curve tracer can be used to plot the characteristics of normal and VR diodes, although it is not particularly designed for that function. It may also be used to plot such functions as the hysteresis curve for Schmitt triggers.

The thermal equilibrium plot for I_{DSS} as a function of time is shown in Fig. 8. Here, one input of the X-Y recorder is taken off the adapter to read I_{DSS} , and the other input is taken from a linear time ramp. Or, the trace may be plotted on a strip-chart recorder. This curve gives an indication of the thermal time-constant of the FET and may be very useful in the study of the effects of various types of heat sinks.

UNLIMITED DESIGNS IN TERMINAL STRIPS AND BOARDS

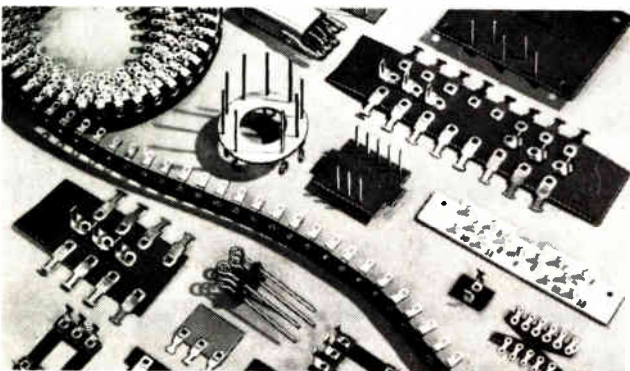

FOR PILOT AND LIMITED RUNS

Here is the versatility you have been looking for in terminal strip and board selection. It's the long needed answer for creating new circuit designs, developing pilot circuitry or for limited production runs.

You have complete freedom in specifying size, length, shape and number of terminals in any configuration. All types of terminals are available. Electrical and insulating materials can be furnished to your requirements.

Our extremely flexible tooling facilities and engineering know-how are at your service for recommendations and/or assistance. Give details and application data or send b.p.'s and specs. Request literature for general information.

Rush service on standard terminals and materials!



PRECISION PAPER TUBE CO.

Automation Devices and Engineering Division
Dept. EI, 85 Lancaster Road, Shirley, Mass.
TELEPHONE: 617 . . . HA 5-4453

• A REPRINT of ANY ARTICLE in this issue is available from ELECTRONIC INDUSTRIES Reader Service Department.

MICROELECTRONIC DEVELOPMENTS . . .

The DDP-124, a new 24-bit word computer made with monolithic integrated circuits, has been announced by Computer Control Co. Inc. The microcircuit computer employs 3C's new module line of μ -PACS. The DDP-124 is capable of 285,000 computations/sec., has a basic memory cycle of $1.75\mu\text{sec.}$ with $0.8\mu\text{sec.}$ access time, and multiplies in $14\mu\text{sec.}$

Uncased Ceralam chip capacitors in voltages of 25, 50 and 100 are now available from the Hi-Q Division of Aerovox Corp. The Ceralam capacitor is a rugged, nearly monolithic block of ceramic dielectric and metallic plate laminated into an extremely dense unit. The high ratio of capacity-to-volume in Ceralam capacitors allows unusually small sizes suited to hybrid circuitry.

Advanced Scientific Instruments, of Minneapolis, has ordered Si monolithic integrated circuits worth about \$500,000 from Fairchild Semiconductor. The circuits, Fairchild complimentary-transistor-logic (CTL) will be used in ASI's new Advance Series line of digital computers.

An integrated 8-watt, Class A, linear differential servo amplifier is available from Norden division of United Aircraft Corp. The circuit, highest powered device available in its field, according to Norden, can drive a center-tapped tuned servo motor, or a tuned transformer load. It can operate with +28-volt power supply and a differential input signal DC to 10 KC.

A family of "low cost," miniaturized (integrated microcircuitry) precision digital magnetic tape systems for computers, data systems, or automated typewriters, has been announced by Dartex Inc., Anaheim, Calif. Basic element is the Dartex-100 Digital Magnetic Tape Transport. The unit can store 2.4 million bits on a $3\frac{1}{4}$ -inch reel of quarter-inch, one-mil computer grade tape. It will search at 22,240 bits/sec.

A new company, Microtek Electronics Inc., Cambridge, Mass., is designing and producing custom ceramic-metal resistor capacitor networks, linear and digital microcircuits in the 20-500MC range. Standard linear circuits will include wideband amplifiers, i-f amplifiers, crystal oscillators and wideband detectors. Microtek says it is developing new ceramic-metal combinations.

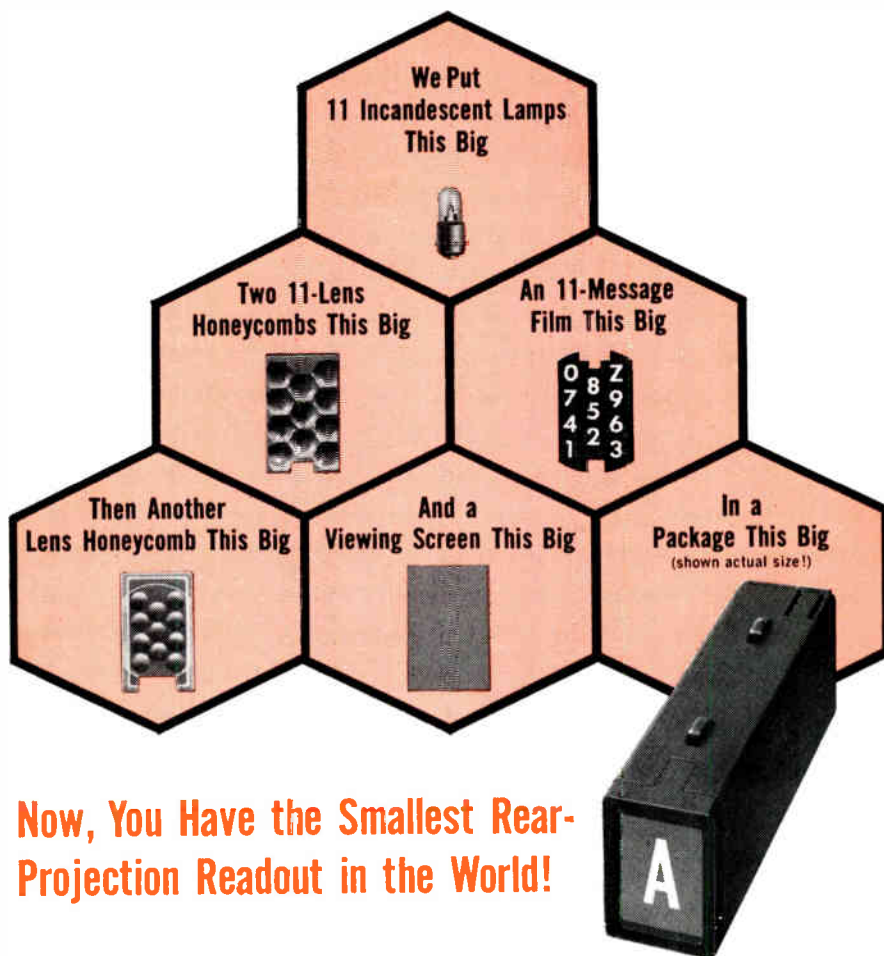

Now, You Have the Smallest Rear-Projection Readout in the World!

It Displays Characters This Big.

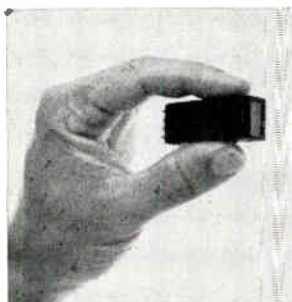

All the versatility, readability, and reliability of our patented rear-projection readouts are now available in the world's tiniest theatre: the $\frac{3}{4}$ " H x $\frac{1}{2}$ " W IEE Series 340. We've managed to fit everything but a projectionist in there to give you a choice and clarity of message that no other type of readout can match—regardless of size!

The tiny 340 uses film to project any message: numbers, letters, words, symbols, colors. *Anything* you can put on film! You're not limited to crudely formed characters that look strange to the eye. Choose type styles that human-factors tests prove to be most readable!

Your message appears clearly and sharply on a single-plane screen. There's no visual hash or camouflage-netting effect from unlit filaments. The 340 may be tiny, but your message appears *big*, up to an easily read $\frac{3}{8}$ " in height!



HERE'S HOW IT WORKS:

All IEE readouts are passive, nonmechanical devices built for long life. An input signal through the proper contact illuminates the desired lamp, projecting only the selected message through the lenses onto a non-glare viewing screen. This one-lamp-per-message concept eliminates character misreadings caused by partial failures.

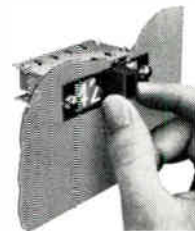

**CLICK, IT'S IN
CLICK, IT'S OUT!**

For quick, easy lamp replacement or change of message, just press the front of the 340, pull the whole unit out! Permanently wired base remains in assembly!



SEND TODAY FOR COMPLETE INFORMATION

INDUSTRIAL ELECTRONICS ENGINEERS, INC.

7720 LEMONA AVE. • VAN NUYS, CALIFORNIA • PHONE: (213) 787-0311 • TWX (213) 781-8115
REPRESENTATIVES IN PRINCIPAL CITIES

EDITOR'S NOTEBOOK

CLOSED-CIRCUIT TV experiments by Liverpool City Police have proved so successful in crime detection and prevention that officials have ordered more systems and extra channels. A Police Commando Force will use the equipment supplied by EMI Electronics Ltd. to stake out places where crime is likely to occur, such as car parks, storage areas and warehouses. Cameras have zoom lenses.

EARLY BIRD was in commercial application by United Air Lines recently when the firm relayed engineering data to Rolls Royce Co., in Derby, England, via the "switchboard in the sky" with teletypewriter hook-up between United's maintenance in San Francisco and Rolls. United obtains engines for its Caravelle jets and the Viscount jet-prop fleet from Rolls Royce.

TRANSPONDER in a World War II Spitfire will help the craft to survive for future air rallies and Battle of Britain Days. Cossor has an unexpected order for its 1600 Airborne Transponder for fitting in one of the few surviving Spitfire Mk.9 aircraft. The plane is often flown where transponders are needed, and "indeed will have to be fitted if the airplanes are to be used."

DATA PROCESSING moves deeper into milk land as two large dairies expand EDP facilities for all operations except—you guessed it—milking and mooing, (but then who knows). One firm, Lake-to-Lake Dairy Cooperative, Sheboygan, Wis., has taken on a Honeywell 120 to handle routes, pickups, deliveries and inventory. The other firm, or rather, the other firm, Sealtest Foods' Northeastern Division, Schenectady, N. Y., has installed an H-200 for similar jobs.

COMPUTERIZED police and fire department work will prevail in Costa Mesa, Calif., when that city of 68,000 takes on automation in government next January. The system scheduled is a National Cash Register 315 CRAM (Card Random Access Memory). First job: processing police and fire records, then municipal accounting—and then—"criminal investigation." Somewhat the same rig will be used in San Juan, Puerto Rico, for keeping tab on criminals, and in Manila, Philippines, by the Philippine National Bank.

X-RAY INSPECTION is helping Minute Maid Co. give customers their money's worth by guarding against underfills in canning frozen fruit juice concentrates. At Leesburg, Fla., Minute Maid has installed a General Electric HYTAFILL^{RM} 1000 X-ray gage on one processing line for inspection-rejection at speeds up to 1000 cans/min.

TRANSISTORIZED flasher light reportedly operates in any extreme weather and fits any barricade. Lenses offer high candle power concentration and focusing pattern which allow penetrating flashes to be seen more

than a mile—so you can see more clearly the barricade you are going to run into. Light visibility is omnidirectional. Developer Hazard Controls Inc. reports transistorized circuitry provides highest efficiency.

COMPUTER is helping Humble Oil & Refining Co. select new brand names. As a not-so-humble partner of Humble's Brands Committee, the system is almost too helpful. Asked for five-letter combinations, it churned out more than 500,000 like fast. A simpler request for four-letter combinations produced a list about 40,000 long.



BOOKS

Space Probes and Planetary Exploration

By William Corliss. Published 1965 by D. Van Nostrand Co., Inc., 120 Alexander St., Princeton, N.J. Price \$7.75. 542 pages.

This book, which was published in cooperation with NASA, explains the objectives of and equipment needed on unmanned spacecraft that are sent toward the Moon, Sun, the other planets, and more remote parts of the solar system. Particular attention is given to all of the instruments used to report information back to the Earth.

Switching Theory, Vol. 1: Combinational Circuits

By Raymond E. Miller. Published 1965 by John Wiley & Sons, Inc., 605 Third Ave., New York, N.Y. 10016. Price \$12.95. 351 pages.

The technique and theory for the design and analysis of switching circuits is presented in this book. Particular emphasis is placed on circuits involving gate-type elements such as those used in modern digital computers. There are sections on functional decomposition, the application of techniques developed for relay-contact networks to the design of cryogenic switching networks; and a full section on the connection of Boolean Algebra to group and lattice theory.

Biomedical Electronics Equipment

By S. Zimmerman. Published 1965 by Economic Index & Surveys, Inc., Colonnade Bldg., University Circle, Cleveland, Ohio 44106. Price \$100.00. 28 pages.

This study covers the market potential for equipment (and systems) which use electronics in their functioning and are for therapeutic, diagnostic, or research work in medicine. The technical, demographic, economic and political forces at work changing the nature and scope of this industry are analyzed. Historical and projected data are presented for the total industry, five major segments, and sixteen product groupings. The industry structure is detailed and an appendix contains a description of 56 medium-size firms active in the field.

Semantic Mathematics: An Introduction to the Concept of Calculating Notations

By Morris Lewis Groder, 220 Berkeley Place, Brooklyn 17, N. Y. 117 pages.

This volume was written as an introduction to a semantic symbol technique and is based on the author's researches. The book is neither a text nor an analytical discussion. Its purpose is to introduce a new concept, describe some techniques, suggest possibilities, and stimulate further research in the subject. The book is not yet being sold, but interested parties should contact the author.

A History of the General Radio Company

By Arthur E. Thiessen. Published 1965 by General Radio Co., West Concord, Mass. 01781. 116 pages.

This story is principally about the company itself and the men who made it. It is a limited edition. The company is willing to send a copy to anyone with a serious interest in the subject, but they cannot handle large-volume requests.

Books Received

Theory of Indirect Speed Control

By M. Nechleba. Published 1964 by John Wiley & Sons, Inc., Publishers, 605 Third Ave., New York, N. Y. 10016. Price \$10.00. 273 pages.

Fundamentals of Radio

By Murray P. Rosenthal. Published 1965 by John F. Rider Publisher, Inc., 116 W. 14th St., New York, N. Y. 10022. Price \$8.95. 327 pages.

Electronics Systems for Convenience, Safety, and Enjoyment

By Edward A. Altshuler. Published 1965 by Howard W. Sams & Co., Inc., 4300 West 62nd St., Indianapolis 6, Ind. Price \$4.95. 255 pages, paperback.

Microwave Scanning Antennas: Vol. 1, Apertures

Edited by R. C. Hansen. Published 1964 by Academic Press Inc., Publishers, 111 Fifth Ave., New York, N. Y. 10003. Price \$16.00. 442 pages.

Discharge Detection in High Voltage Equipment

By Dr. F. H. Kreuger. Published 1965 by American Elsevier Publishing Co., Inc., 52 Vanderbilt Ave., N. Y. 17, N. Y. Price \$12.00. 223 pages.

Commercial Profits from Defense—Space Technology—An Action Guide

Edited by W. R. Purcell, Jr. Published 1964 by The Schur Co., One Emerson Place, Boston, Mass. Price \$18.50. 138 pages.

Compatible insulations that fit together for highest reliability

You can be confident of complete system dependability when you choose compatible 3M insulating products. For these products were developed from identical or related chemistry to work with and complement each other when combined in a single system. They help you realize the full potential from your electrical equipment by reducing the risk of failure due to use of incompatible materials. Whatever your need—tape, tubings, slot-linings, or resins—3M's compatible insulations assure maximum dependability. For more information, see your 3M "IQ" Man*.



"IQ" means Insulation Qualified. Your 3M Man is trained and qualified to advise and assist with insulation problems. Call him or write: 3M Co., St. Paul, Minn. 55119

Electrical Products Division  COMPANY

TAPES • RESINS • TUBINGS • VARNISHES • COATED FABRICS • LAMINATES • MICA PRODUCTS

Circle 53 on Inquiry Card

ELECTRONIC INDUSTRIES • September 1965

WHAT'S NEW

HIGH SPEED IC TESTER

HIGH SPEED, FULLY AUTOMATIC TESTING of integrated circuits is accomplished by a tester produced by Aircraft Armaments Inc., Cockeysville, Md. It uses stored programs on a disc memory to allow essentially instantaneous change-over from testing one type of device to another. The tester can store test sequences for as many as 15 integrated circuit devices, with the capability of expansion to 64. Each sequence may consist of any number of go-no-go tests to completely check-out a device. Tests are performed at 200/second.

Programs are written into the memory from either a Flexowriter keyboard or a paper-tape reader. With one input instruction, the operator may write an entire sequence of tests into memory, or he may rewrite only one or more tests anywhere in a sequence which is already stored. To allow verification of a program stored in memory, the operator may command a non-destruct readout of either an entire sequence of tests, or one or more tests in any sequence.

The analog section consists of a number of automatically programmable forcing functions and a comparator for making go-no-go measurements. One of the forcing functions is a constant-current generator, capable of being programmed for any of three ranges of current; three forcing functions are voltage generators programmable to either of two voltage ranges. The fifth forcing function generates voltage on either of two ranges, and senses the current drawn by the load at the programmed voltage. The current sensing may be done on any of four ranges, with the lowest range having a resolution of 10na. A program instruction is available to extend the test time on the low current-sensing range to allow additional settling time of the amplifiers on very low current measurements.

In addition to the internal forcing functions, four lines are furnished which allow external forcing function to be used, as well as the programmable capability of adding external loads in shunt or series with any of the forcing functions.

The tester is used in conjunction with an automatically indexing probe whose points are applied to appropriate points on the circuit chip. In automatic operation, the probe signals the tester when it is in place on the chip and tells it which test sequence to perform. Since the disc memory contains programs for a number of different integrated circuit devices, the tester will select the desired sequence and perform all the tests. Upon completion of the sequence, the tester sends the results to the probe to allow the device to be marked appropriately; at this point, the probe automatically indexes to the next device and the testing operation is repeated. (*More What's New on page 140*)

alpha number one source for VACULOY* BAR SOLDER

users report
less rejects
up to **90%**
plus 10% savings
on solder

Exceeding Govt. Spec. QQ-S-571 and ASTM Standards, Vaculoy processed bars and ingots are available in all tin-lead, silver bearing, indium and other low-melting alloys for dependable, economical dip soldering of printed circuit boards and electronic components.

**FREE
FROM
NON-
METALLIC
INCLUSIONS,
VACULOY
USE MEANS:**

- Longer bath life
- Improved wetting
- Shallower fillets
- Brighter joints

GET THE PROOF!

Degassing tests show Vaculoy Solder has less surface dross and degassing pockmarks.

Photomicrographs show Vaculoy Solder freezes in fewer and larger grains — indicating greater uniformity and a consistently low level of non-metallic impurities.

Ask for Vaculoy Technical Bulletin 37 and Solder Bulletin A-103A

alpha® **alpha metals, inc.**

56 WATER ST., JERSEY CITY, N. J. (201) 434-6778
Los Angeles, Calif. - Alphasoy Corp., (Div.) Chicago, Ill.
Alpha Metals, Inc. (U.K.) Ltd., London, England



*Registered — a special process of alpha metals, inc.

J-9396

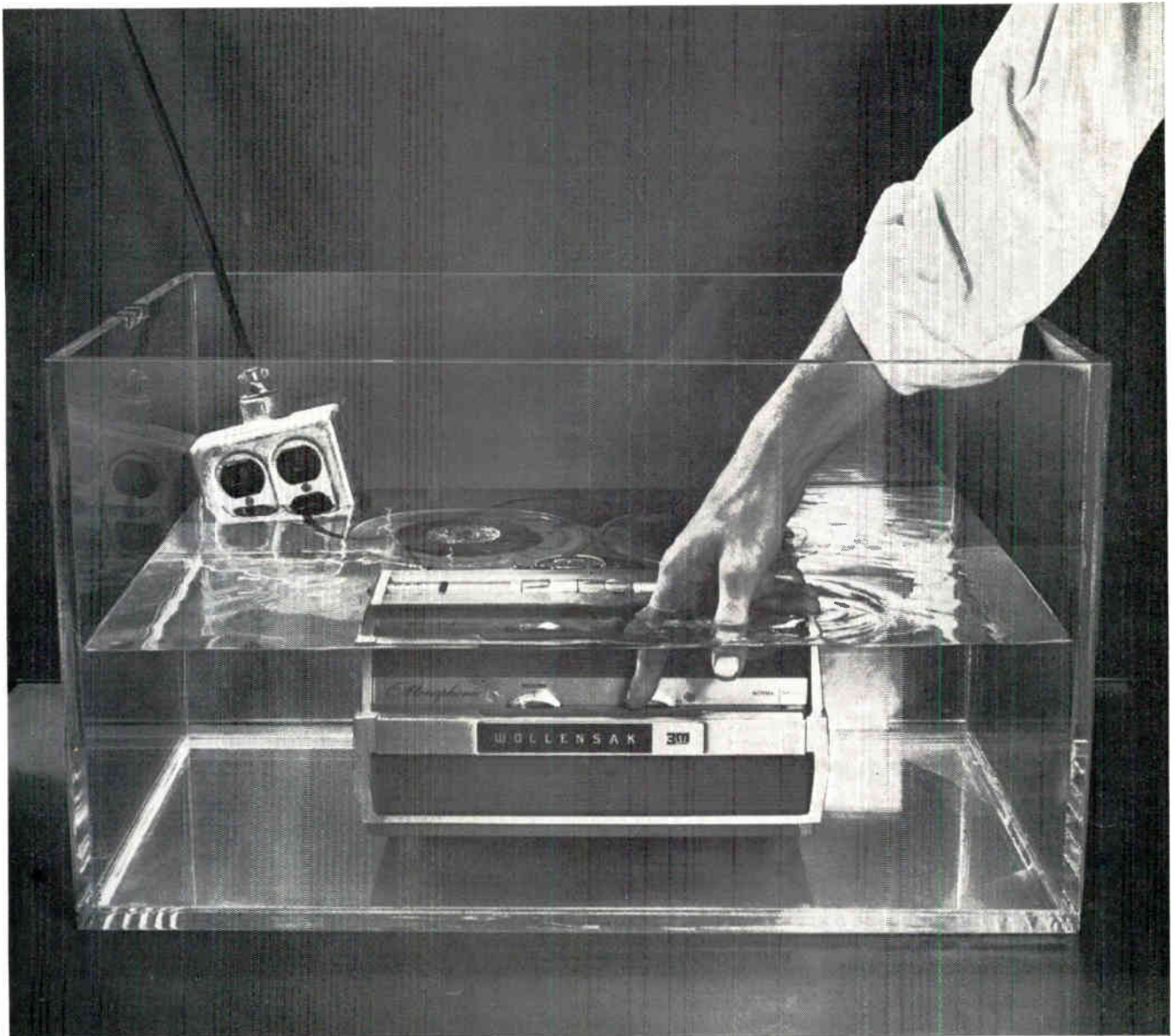

WHAT IS A TAPE RECORDER DOING IN FC-77 COOLANT?

Playing!

This traffic-stopping demonstration of the completely inert dependability of FC-77 coolant has been featured at several national electronic trade shows. An ordinary "right-out-of-stock" tape recorder is lowered into a tankful of FC-77, plugged into an electrical outlet and a hand reaches in and pushes the button to start a practically continuous concert that plays during the show.

All this time, recorder parts of steel, copper, chrome, plastic, rubber, elastomers, glass, nylon, adhesives, as well as recording tapes are directly immersed in FC-77 coolant. Nevertheless the recorder plays on. When at the end of a show, the player is removed from the tank none

of its components are affected. How's that for "inertness"!

All members of 3M's fluorochemical coolant family have this exceptional compatibility with most materials (even at temperatures above the maximum permissible with other dielectric coolants). This "easy-to-get-along-with" coolant, incorporated into your system can bring about better reliability. *Want more?* These coolants have wide liquid ranges, excellent electrical properties, thermal and chemical stability, are non-flammable, non-corrosive, non-toxic. Write and ask about them, particularly our new, economical FC-77. 3M Company, Chemical Division, Dept. KCQ-95, St. Paul, Minn. 55119.

Chemical Division **3M**
COMPANY

NEW

4

Grayhill®

Adjustable Stop Rotary Switches

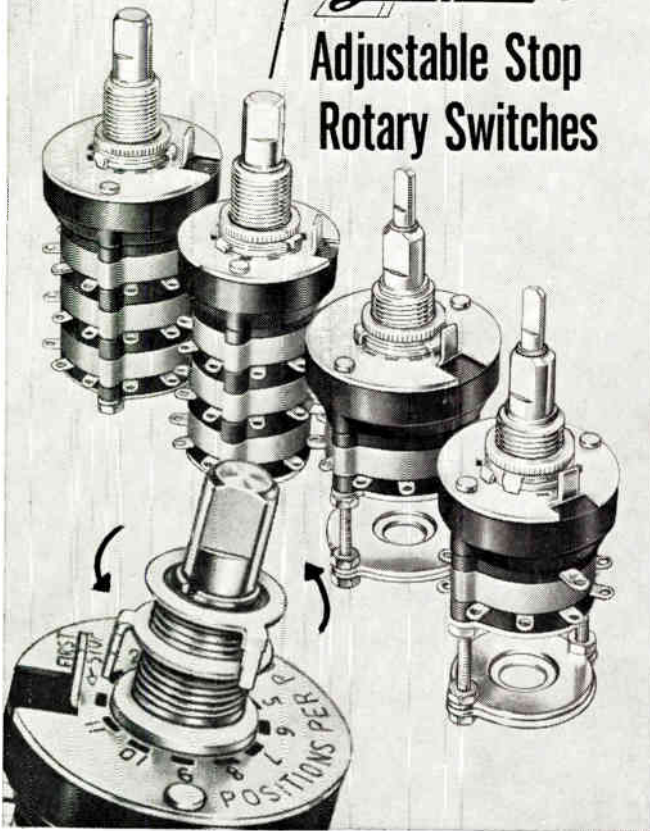

**offering quick circuit selection
for Prototypes
or Small Production Runs.**

Selection of stops is easily and quickly accomplished by the positioning of two stop washers on top. These new Grayhill Switches provide a choice of 30° and 36° angles of throw, one to 12 decks, 2 to 12 positions per deck, 1 to 4 poles per deck — and Add-a-Pot versions as illustrated.

**Write for complete specifications
or see your local distributor.**



543 Hillgrove Avenue
LaGrange, Illinois 60526
Area Code 312, Phone 354-1040

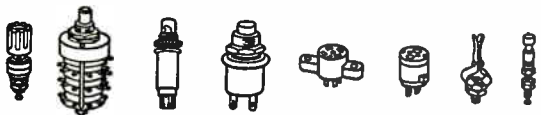

"PIONEERS IN MINIATURIZATION"

WHAT'S NEW

PHOTOS FROM MARS

THE VIDEO TAPE RECORDER ABOARD THE MARINER was required to perform a vital and unusual function. It had to record digital data at an input rate of 10,700 bits/sec., and play back the data at an output rate of 8½ bits/sec. Here's how the recorder, built by Raymond Engineering Laboratory, Middletown, Conn., did it.

The storage capacity of the recorder was 5.2×10^6 bits. The ratio between record and playback rates was 10,700:8.33 or 1284:1. In other words, just 1 second worth of data at record speed took 21.4 minutes to play back.

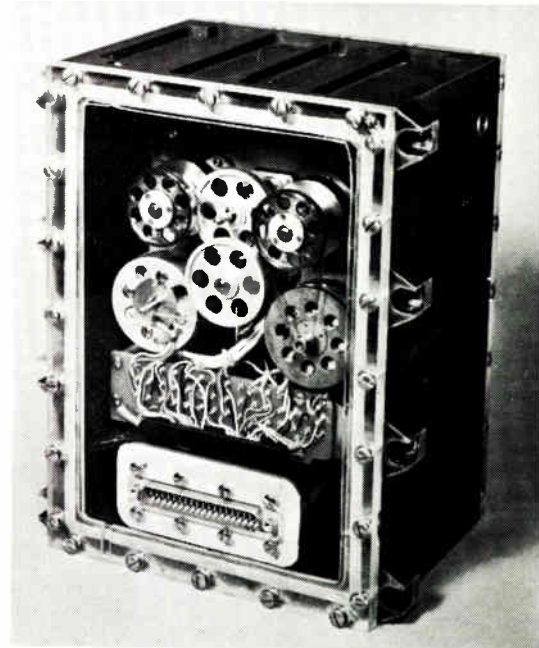

The Mariner video-tape recorder recorded data at 10,700 bits/sec. and played back at 8½ bits/sec.

To achieve this large ratio between record and playback, the tape speed had to be changed in the same ratio. Transport speeds were 12.84 and 0.01 in./sec. Transport geometry, type of tape and other materials in contact with the tape, surface finishes, and the like were chosen to assure jitter-free operation at the low speed of 0.01 ips. In addition, the extremely low repetition rate (8pps) and low amplitude of the signal output from the playback head (less than 100 microvolts p-p) imposed very severe requirements on the playback signal amplifiers. A unique feedback provided the required gain and low frequency passband while avoiding the drift problems associated with dc amplification.

To permit a simple control system and obviate the need for rewinding, the transport used two tracks on an endless tape loop of ¼ inch lubricated instrument tape. The length of the tape loop was held to 330 feet by the recorder's ability to operate at 0.01 ips. At higher tape speeds, the video storage system would have to settle for either a greater playback rate and attendant loss of data during transmission; or reduced storage

(Continued on page 142)

i/c's and modules tested...

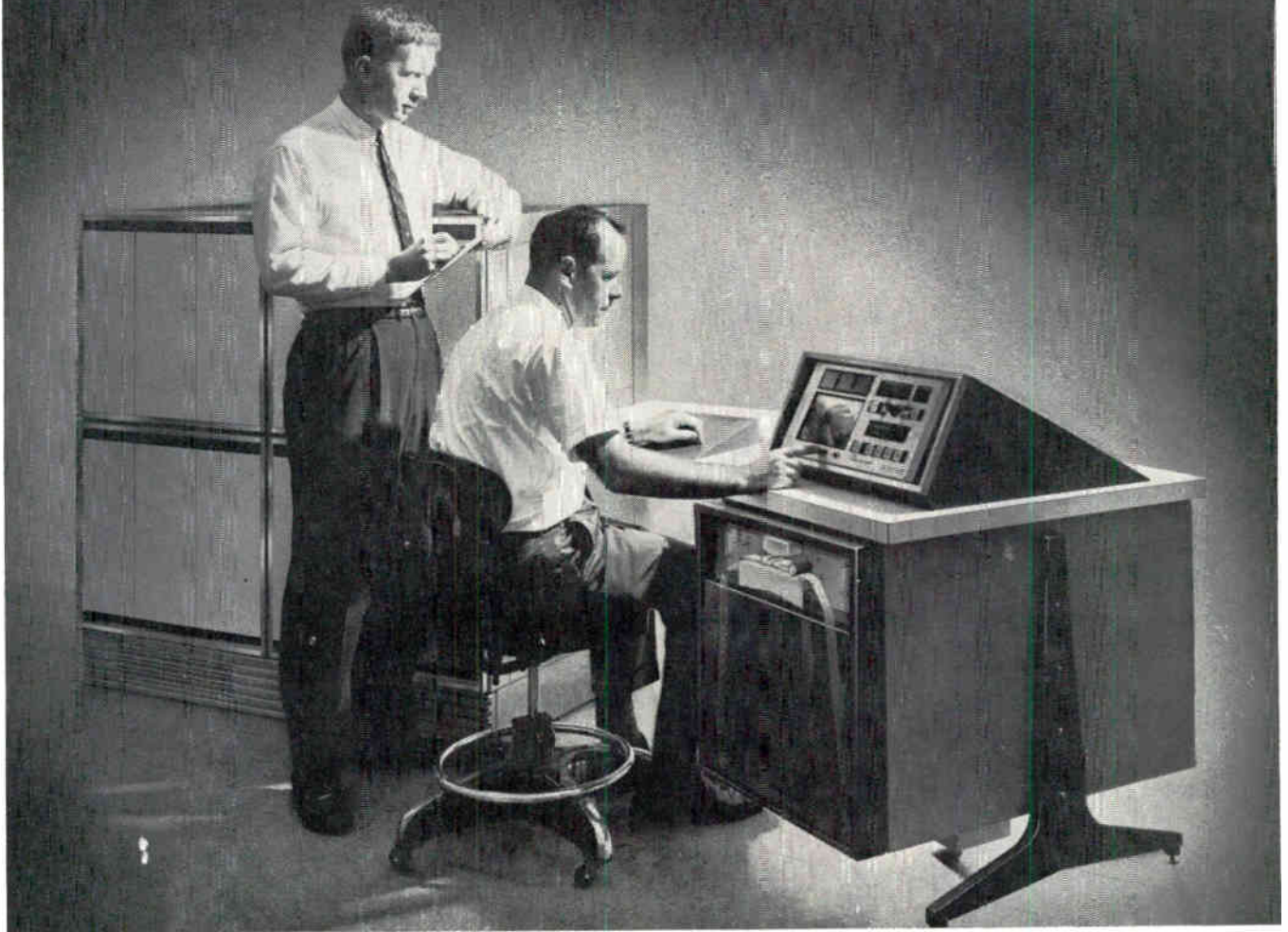

DYNAMICALLY!

Now you can perform important *dynamic* tests in addition to ordinary static (dc) tests with TI's Model 553 *Dynamic Test System*. Measure propagation delay and noise feed-through; *dynamically* determine "fan-in"/"fan-out" ratios, and noise immunity; assess the effects of transients. Now, measure switching times in terms of percentage or absolute values. You save money by performing more tests at high speed with handling reduced by single-socket testing.

The 553 *Dynamic Test System* is designed for intergrated circuits, transistors, diodes, thin films, logic cards, other circuit elements with 10, 20, 50, or more active leads. Testing can be done from dc to 50 mc, thereby simu-

lating actual operating speeds. Time or voltage is measured anywhere *on* or *between* pulses (widths from 10 ns to 1 ms) with a resolution of .000001%. Jitter is less than 50 ps; accuracies better than 2%.

Modular design and variable word-length program logic provide for infinite system expansion. Simplified programming language allows operators to learn to program in 45 minutes. Data as well as double-ended hi-lo limits can be produced at test rates faster than go/no-go systems with a wide variety of output recording techniques available.

For detailed information about the 553, contact your TI Field Office or the Test Equipment department, Houston.

INDUSTRIAL
PRODUCTS
GROUP



TEXAS INSTRUMENTS
INCORPORATED
P. O. BOX 66027 HOUSTON, TEXAS 77006
118 RUE du RHONE GENEVA, SWITZERLAND

WHAT'S NEW

PHOTOS FROM MARS

(Continued from page 140)

capacity meaning fewer pictures; or more tape meaning a bigger, heavier transport.

Because the video data are recorded intermittently, sections of the 330 feet of tape between pictures remained unrecorded. The length of these sections was controlled so that during playback, when the tape is running continuously, each section yields two hours during which data other than video can be transmitted to earth.

A unique requirement of this system was that during playback, the data output from the recorder must be bit-synchronous with a spacecraft bit sync clock signal.

The data was recorded using a frequency doubling code rather than simple NRZ so that the data always contained a frequency component at the bit rate. This technique avoids the need for a separate track for recording of synchronizing signals. During playback a bit sync signal was extracted from the raw data. This sync signal was compared in phase with the spacecraft bit sync clock, and the resultant phase-error signal was used to actuate a phase-locked loop tape speed control.

VISUAL MORSE CODE READER

A TINY DEVICE THAT PLUGS INTO ANY ARMY RADIO and makes Morse code as easy to read as an electric signboard has been developed for the Army.

The new code translator, about the size of a pack of cigarettes, transforms the dots and dashes of Morse code into English letters. This enables soldiers untrained in code operation to read messages sent to them by radio when voice communications are erratic or unintelligible. Low, continuous-wave (CW) freqs., on which Morse is carried, are better able to penetrate jungle and cover longer distances than most voice radios.

The translator measures $1\frac{1}{4} \times 2\frac{7}{8} \times 2\frac{7}{8}$ in. and weighs less than a lb. It contains 350 diodes and 75 transistor circuits, a display panel that frames letters with 17 tiny incandescent lamps, and a power pack of four small re-chargeable nickel cadmium penlight batteries.

The translator plugs into an Army radio through a tiny jack, and a smaller jack is attached to an ear-piece headphone used for tuning. The operator tunes his radio through the translator until he hears the most intelligible code signal, and he is ready for operation. All the receiving operator has to do is copy down the sequence of letters as they appear on a viewing screen.

The translator was designed and built by Regency Electronics, Inc. of Indianapolis, under the technical direction of the U. S. Army Electronics Command's Laboratories, Ft. Monmouth, N.J.



ACHIEVE

AND
RELIABILITY

with **SAGE'S** new ultra-miniature resistors developed for Autonetics improved Minuteman program

257SM		1 WATT
1007SM		2.25 WATT
1247SM		4 WATT
1507SM		7 WATT

Resistors shown actual size

SM SERIES

WIREWOUND UNITS PROVIDE SUPERIOR HEAT CONDUCTIVITY FROM CENTER HOT SPOT TO CAPS AND LEADS

- Fully welded construction with multilayer IMPERVOHM* encapsulation.
- Solid nickel leads for weldability. Solder coated if so specified.
- Fine wire sizes to .0007", TC to ± 20 ppm/ $^{\circ}$ C.
- Far exceed design and environmental features of MIL-R-26C.
- Every 1% part is individually power aged and subjected to screening acceptance test.



SEE OUR SPECIFICATIONS IN
VSMF
THE MICROFILM CATALOG FILE

SAGE

SAGE ELECTRONICS CORP.
BOX 3926 • ROCHESTER, N. Y. 14610

Our only problem

is to reach every engineer who would like to enjoy the blessings of truly quantitative and precise spectrum analysis at VLF (10 cps—30 KC) with the news that now there's a low-cost, state-of-the-art, modular **Polarad** Low Frequency Spectrum Analyzer with 7 cps resolution. The Model 2736 sells itself.

HERE'S WHY: ■ **Modular Expandability** (to SSB, and through microwave) ■ **Automatically-Optimized Resolution** (down to 7 cps!)

- **Accurately Calibrated Dispersions** (150 cps to 30 KC)
- **Calibrated Log/Lin/Power Display** (on 5 1/2" x 4 1/2" rectangular CRT)
- **Built-in Mixer** (extends range to over 100 MC with external L.O.)
- **Implements Ultra-High Resolution Microwave Spectrum Analysis** (just add PEI modular phase-locked local oscillator source for one-part-in-10⁸ resolution up to 21 GC operation!)

model 2736				
				
Model	Freq. Range	Resolution	Dispersion	Sensitivity (S+N=2N)
2736	10 cps to 30 KC	Automatic optimized 7 cps min.	150 cps to 30 KC	1 μ Volt

NOW there are PEI Spectrum Analyzers from 10 cps to 100,000,000,000 cps—All with **Polarad Years-Ahead Engineering Distinction** . . . All in Full Production. Call your Local Polarad Sales Engineer or call us directly at (212) EX 2-4500 for a demo or a quote.



World Leader in
Microwave
Instrumentation

POLARAD
ELECTRONIC INSTRUMENTS
A Division of Polarad Electronics Corporation
34-02 QUEENS BOULEVARD
LONG ISLAND CITY, NEW YORK 11101

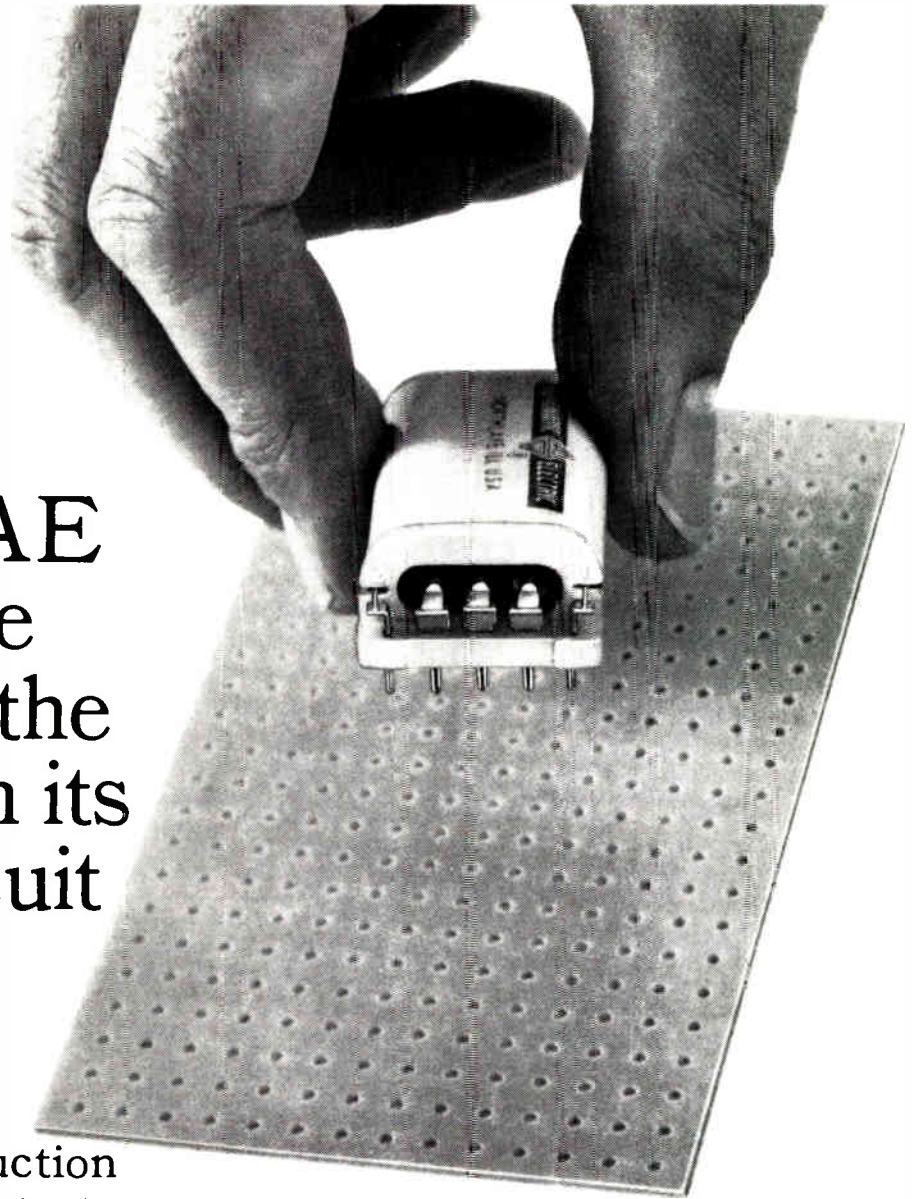

Why does AE separate the leads from the terminals in its printed circuit dry reed switches?

Because this construction provides better electrical characteristics.

Should a capsule lead have to “double” as a terminal? *Separate* terminals give you superior electrical contact—and eliminate strain on the glass capsules. That’s the AE approach on dry reed switches for PC boards.

AE also uses *welded connections* in these new PC Correeds*. The contact terminals are welded, not soldered, to the capsule leads. This reduces stress—makes more reliable connections, with greater mechanical strength.

These switches are easy to insert.

*U.S. Patent Pending

The terminals are longitudinally ribbed for extra strength and rigidity.

Bobbins are stronger too, because they’re made of glass-filled plastic. Besides adding strength, this construction is moistureproof — to prevent electrical failure.

AE Printed Circuit Correeds are made to “standard” measurements: multiples of 0.200 inches between terminals, the industry standard for circuit boards. Standardized terminal size and spacing also allow for greater pack-

age density.

Get helpful, detailed information. Find out how new PC Correeds meet the requirements of modern electronic circuitry. Just write to the Director, Electronic Control Equipment Sales, Automatic Electric Company, Northlake, Ill. 60164.

2-capsule
(Forms 2A, 1B, or
1A Mag. Latch)

3-capsule
(Forms 3A,
2B, or 1A-1B)

5-capsule
(Forms 5A
or 2A-2B)



AUTOMATIC ELECTRIC
SUBSIDIARY OF
GENERAL TELEPHONE & ELECTRONICS **GTE**

Reporting late developments affecting the employment picture in the Electronic Industries

TECHNICIAN GROUPS PUSH FOR INTERNATIONAL SOCIETY

An organization of representatives of engineering technician societies of Canada, Latin America and the United States has been formed. Plans are to establish relations and initiate procedures toward a future international society of engineering technicians.

Joseph M. Garcia, E.T., Vice President—North Central Region, American Society of Certified Engineering Technicians, is coordinator of the new organization as well as chairman of the ASCET delegation.

Objectives of this organization briefly are: (A) to maintain, improve and increase the professional knowledge, ability and competency of engineering technicians by facilitating and encouraging their studies. (B) to define the qualities and qualifications required to become an engineering technician, as well as obligations and responsibilities.

STUDY REVEALS PICTURE OF U.S. ENGINEER MANPOWER

What is today's engineer like? National Science Foundation did some research, and found that he is 41, is most likely employed either in electronics or in methods and work simplification, probably works in New York or California.

He is a joiner, maintaining one or more memberships in any of about 50 professional societies. By "employment function," he is most likely to be concerned either with development or design" or with "management or administration (21% in each of these two categories).

Nearly three out of four work for a company or are self-employed; 15% work for the U. S. government. Write to National Science Foundation, Washington, D. C. 20550 for a copy of "Engineering Manpower in Profile."

FOR MORE INFORMATION . . . on opportunities described in this section fill out the convenient resume form, page 152.

LOGIC LABORATORY GOES TO CLASSROOM

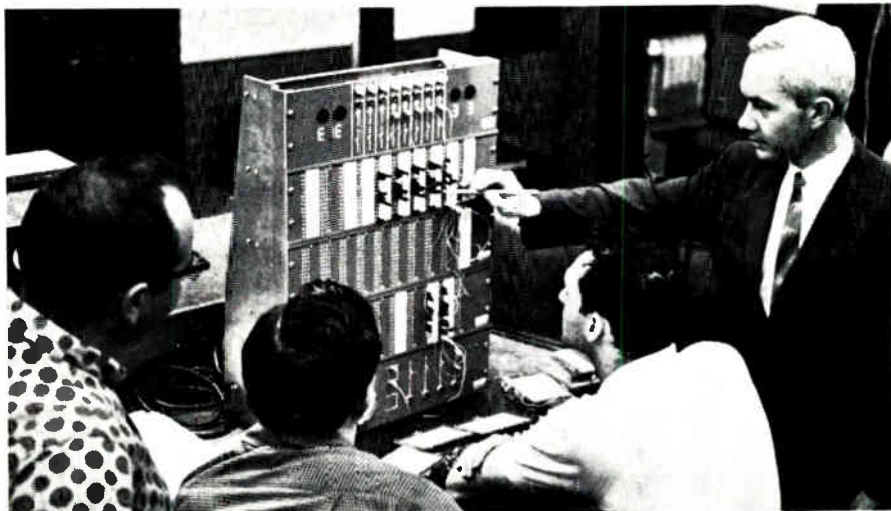

Instructor Robert Coughlin at Boston's Wentworth Institute explains computer circuits visible in plastic diagrams on face of Digital Logic Laboratory designed by Digital Equipment Corp. Wentworth is the first school to acquire the machine and to use it to teach two-valued logic. It permits students to work experiments in computer fundamentals.

COMPUTER USAGE GROWING IN MANPOWER PLANNING

The main role of engineering and scientific manpower in industry has been recognized by the widespread use of technical manpower planning programs, according to a new study by Deutsch & Shea, Inc., "Technical Manpower Recruitment Practices, 1964-65."

There is a growing trend to use computers and other types of electronic data processing equipment to cope with complexities of such planning.

Of 112 organizations polled, 81 have established technical manpower planning programs. The average company now projects its technical manpower needs some 16 months ahead, but the many variables involved make accurate forecasting difficult. Hence the interest in using computing technology—hitherto concerned chiefly with engineering, scientific and financial problems—to develop better predictions and improve recruitment planning. Seventeen of the participating organizations already use EDP, and 21 more expect to employ it in the very near future.

Included in the study are estimates of the number of technical people participants plan to hire in 1965, broken down by company, field and geographic area.

The report also includes an extensive analysis of the 1964 recruitment picture, characterized by Deutsch & Shea as an "abnormal year" in which ". . . there was the apparently paradoxical situation of technical people earnestly seeking work and not finding it while many companies continued and even increased their recruiting activities to fill professional openings. . . ."

SALARIES RISE 2% SINCE 1962, EJC REPORT SHOWS

Median salaries of U. S. engineers rose by 2% between mid-1962 and mid-1964, reports the Engineers Joint Council of the National Society of Professional Engineers.

A report of the latest EJC survey reveals \$11,325 per year as the median salary, compared to a figure of \$10,375 two years ago—an apparent increase of 4.5%. Because of the median years of experience increased from 11.2 to 12.8, a corresponding adjustment in the 1964 figure reduces the increase to 2%.

Disregarding median years of experience, median salaries have risen more than 74% since 1953, when the median was \$6,500.



Gold-plated components
 conduct better,
 solder easier,
 reflect heat,
 and resist wear,
 corrosion,
 oxidation,
 galling.

Now let us give you the details.

The details are in our comprehensive reference guide—a voluminous encyclopedia of precious metal electroplating processes. Here you'll find charts, graphs, technical papers, magazine articles. A compendium of today's most advanced knowledge of gold-plating—the facts that have put gold into computers, communications equipment, jet aircraft, missiles, space probes. Write for your copy of "Gold Electroplating Processes."



Sel-Rex Corporation, Dept. Q-9, 75 River Road, Nutley, N. J. 07110.

IN ITS AUGUST EDITION, ELECTRONIC INDUSTRIES presented tabulated results for 28 questions from "our Electronic Engineering Profile" questionnaires published in March and April of this year. In addition to the 28 "yes" or "no" and "check-one" questions, there were five others that required essay-type answers of at least a sentence or two to indicate current opinions.

Many of the answers were lengthy, strongly opinionated, controversial, often overlapping, and sometimes seemingly contradictory to other questions on the same form.

Here, for better or for worse, is our evaluation of the written answers, and in some way, a sort of evaluation of the current state of electronic engineering.

The first open ended question read simply "If applicable: What would you do differently? Give an example if possible."

Would Begin Differently

Nearly half of the respondents (about 45%) indicated that they would have done things differently. Professional study such as law, medicine, dentistry, pharmacy and optometry would have been the choice of some 15%, while another 19% indicate they would prefer to have studied business management and gone into the business fields such as investments, banking, insurance, retailing, marketing and advertising. About half of these feel that as long as they are in electrical engineering, they should have taken, or should take, additional study in business and industrial management. Nearly 9% more specified various other fields that they thought would have given a more satisfying life, such as politics, music, college, teaching, self employment, psychology, and even cabinet making, not to mention missionary work.

Some 10% felt that they should have taken more education and obtained advanced degrees, especially while they were still in college. A few (3%) wish they had gone to "better schools," feeling that a large university has higher status than a little obscure college. Other fields of engineering such as mechanical, chemical, civil, electric power, would have been the preferred choice of another 5%, while 6.5% feel that things would have been much better had they concentrated in physics and mathematics instead of engineering.

About 1/2% feel they should have gone into basic research or into commercial electronics instead of defense work.

'Advice' for Students

"Why would you not recommend electrical engineering to an inquiring student?" was another question, to which 37% (overlapped) gave such answers

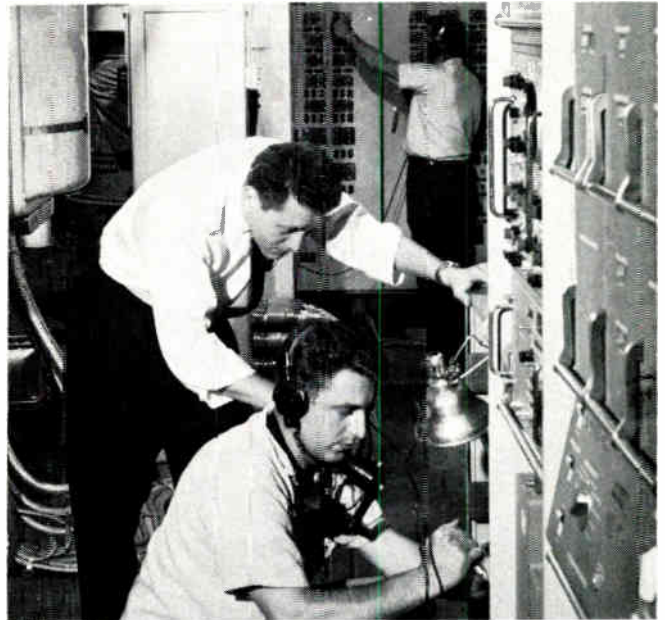

Courtesy Sperry Gyroscope Co.

About 52% of the electronic engineers polled recently by Electronic Industries indicated they are satisfied with their jobs. Some 66% said they would recommend an engineering career to young students.

as: no future, no security, unstable field, small rewards, no recognition, frustration, rapid "obsolescence," distorted image and highly over-rated. More than 3% said they would advise students to concentrate heavily in physics and mathematics.

On the other hand, some 14% said it all depends on the student's desires and aptitude, but that they would present the "truth" and all of the "facts" about electrical engineering and then let the student decide for himself. The upshot is that about two-thirds (66.5%) of total respondents evidently felt no qualms about recommending the field to students, some even strongly so. Some even went so far as to praise the field highly pointing out that "the sky is the limit for advancement."

Future Prospects

A somewhat revealing picture came to light in answers to "What future prospects do you see in your present job?" Although some 40% replied that prospects were good, or excellent for advancement into supervisory or managerial positions with higher income (some of these did not answer, possibly indicating satisfaction) the rest indicate varying degrees of apprehension about their jobs. "Possibly some prospects" was the answer offered by 18.5%, while 15% felt there was little hope. Uncertainty was expressed by 5.5%, but 22% said there were no prospects at all. Reasons for the latter varied with "bad" management, no business, defense contract shifts, diminishing fields, and "company-evaluated obsolescence." A number indicated that their prospects for staying where they were are secure as long as their projects are secure.

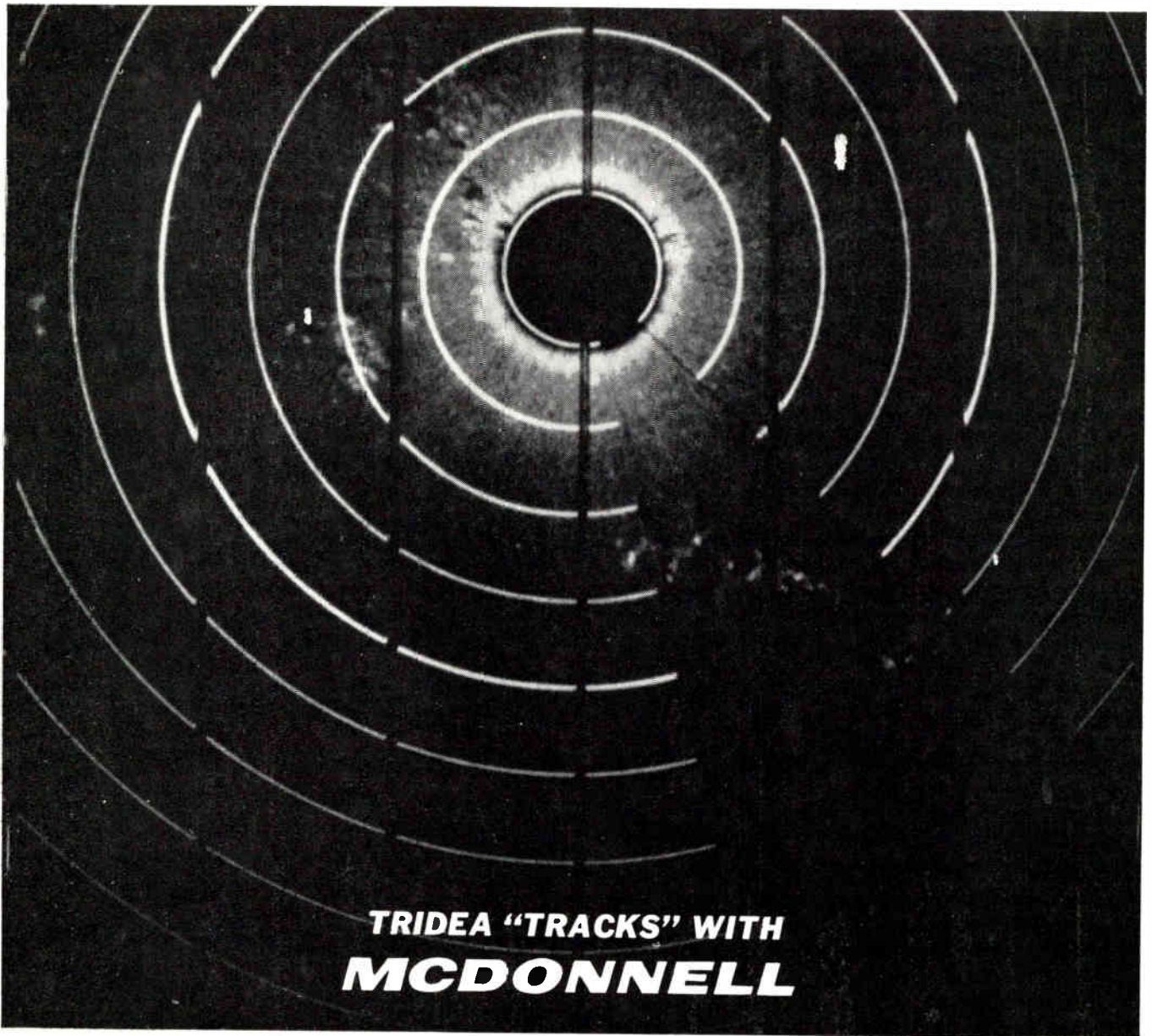

TRIDEA "TRACKS" WITH MCDONNELL

In joining the McDonnell organization, Tridea has extended its production capabilities and developed an *end-mission* association that includes contract assignments for fighter aircraft, manned spacecraft, winged glide vehicles and other lifting reentry spacecraft. As a subsidiary of McDonnell, its allied electronics goals and dynamic scientific and engineering talents provide increased opportunity for transmission of ideas and experience.

The combined talents of Tridea and McDonnell Electronics Division make it plain that Tridea is going to make large and lasting "tracks" in the electronics industry, in radar systems, ECM, GSE, telemetry and air navigation and traffic control.



TRIDEA ELECTRONICS

Subsidiary of
MCDONNELL

For information write Dept. 946 • Box 516 • St. Louis, Missouri 63166

Applying Electronics as an Interdisciplinary Science

"PROFILE OF TODAY'S ELECTRONIC ENGINEER—1965"

Job-Seeking Reasons

The next obvious question is "What are your reasons for either thinking about looking, or for actually looking for a new job?" More than 52% indicated in some measure that they were not looking, or that they were satisfied. The rest of the answers, by the nature of the question and the possible individual answers, are necessarily overlapped in percentage.

Some 26% feel their talents and schooling are being wasted. They want varying degrees of recognition, challenge, more creative work, new fields and varied experience. Another 25% are considering relocating because of "unstable field, poor management and supervision, dislike for management and its policy, job fails to hold interest, frustration, too-close supervision or not enough to do, menial tasks, doing technician's work, dislike for defense work and government policies, no work in sight and expected reductions."

For the usual reasons such as advancement, salary and other benefits, security and better location, some 30% are thinking about pulling up stakes. An outstanding complaint among many respondents is having to follow jobs around the nation like "fruit-pickers." Some indicate that they are being forced by boredom and apathy to relocate. One asserts that he is too young at 34 to be stuck in a rut.

Job Help for Engineers

What does an engineer do when he needs professional or vocational help? The question was "In time of professional and vocational need, to what groups or organizations do you believe the engineer may turn?" These answers also are overlapped.

To begin with, some 32% apparently had no opinion, or they declined to answer. Professional and technical societies were suggested by 25% as sources of help, while 22% declared that there is no real source of such help. College and university placement was chosen by 11%; friends, colleagues, senior engineers by 5%; and employment and professional placement agencies by 8%.

Some 4% would also turn to unions for help, while 3.5% decided they would help themselves. About 5.5% are somewhat divided between seeking help from their future erstwhile employer's personnel office, and magazines, journals and newspaper ads.

A few tongue-in-cheekers suggest talking to the chaplain, corresponding with the National Geographic Society, or seeking solace from the family. One enterpriser says that in times of such peril he calls the local weather bureau to see which way the wind is blowing.

Favors Electronic Career

All in all, the weight seems to be slightly, though definitely, on the positive side in favor of going into and continuing with a career in electronic engineering.

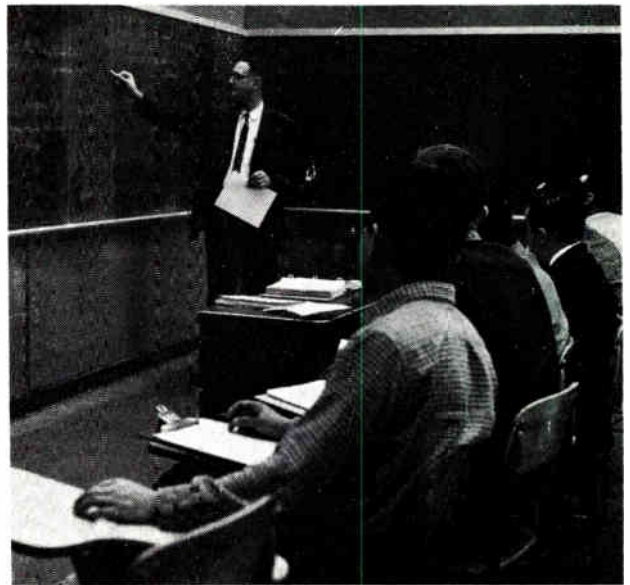

Courtesy University of Pennsylvania
In the recent Electronic Industries engineer survey, some 55% say they would study engineering if they had it to do again. Many said they would take advanced degrees and perhaps some business courses.

Various opinions, some isolated, others not so isolated, came out during the compilation. Engineers, by and large, feel that they need a very strong professional quality national representative organization to fight their battles, lobby, establish means of security and professional standards. The example most often exhibited is the American Medical Association, which engineers feel their organization should emulate.

Many are also tired of having to move around the nation wherever the heaviest business, the most contracts, or the most hiring happens to be. They are also tired of having to go to school constantly in order to advance, or even to keep jobs in some cases; they insist that so-called "engineering obsolescence" is purely company-made, and in most cases is not really valid.

As one respondent put it so succinctly—engineers appear to be getting frustrated with the feast and famine atmosphere of the defense electronic business.

A number of sources have suggested recently that very often new activities begin in U. S. areas where there are not enough engineers, and because of adverse job climate and atmosphere firms have trouble finding and holding engineers. Yet, the bulk of out-of-work engineers, or those about to be so, seems to be concentrated in industrial complex areas where such technical help is in great surplus. It is really a state of job imbalance.

This news, nevertheless, fails to prevent engineers from looking askance at reports of engineer shortages and taking a "show me" attitude. A questionnaire respondent, apparently quite satisfied with everything as it is, had this to say: "I believe that any person with enough desire to do a job correctly will always be able to find a job that is satisfying in every respect."

VALUE ENGINEERED FOR LOWER COST THRU SIMPLIFIED DESIGN

4 New 1/2" x 13/32"

High Performance Trimmers with Solder or Pin Terminals

Infinite resolution. Excellent high frequency performance characteristics. No catastrophic failures.

These four new additions to the extensive CTS trimmer line have many applications in High Performance Industrial and Military fields: computers, instruments, medical electronics, communications equipment, electronic machine controls, aerospace electronics, microwave transmission, etc.

Series 330



80¢

in production quantities
Priced lower than comparable wirewound trimmers.

Series 330P



85¢

- Proven Reliable CTS Carbon-Ceramic Resistance Element
- Far Exceeds Environmental Performance Spec of MIL-R-94B, Char. Y
- ± 8% Humidity Stability
- 100 Ohms to 2.5 Megohms
- 3/8 Watt @ 70°C Derated to Zero Load @ 150°C
- Grounded Construction Available on Model 330

Series 330 Has Solder Terminals. Series 330P Has Pin Terminals on .100" Grid Configuration and Standoffs to Insulate Metal Cover From P. C. Board.

Write for Data Sheet 2330A

Series 630



\$1.50

in production quantities
Priced lower than comparable wirewound trimmers.

Series 630P



\$1.60

- Famous CTS CERMET™ Resistance Element
- Extreme Stability Under Severe Environmental Conditions
- ± 4% Humidity Stability
- 20 Ohms to 2.5 Megohms
- 1/2 Watt @ 85°C Derated to Zero Load @ 150°C
- Low Noise—Long Life
- Extreme Overload Capacity
- Grounded Construction Available on Model 630

Series 630 Has Solder Terminals. Series 630P Has Pin Terminals on .100" Grid Configuration and Standoffs to Insulate Metal Cover From P. C. Board.

Write for Data Sheet 3630A



Founded 1896

CTS CORPORATION
Elkhart, Indiana

Sales Offices and Representatives conveniently located throughout the world.

Principal Products

Variable Resistors
Selector Switches
Loudspeakers
Trimming Potentiometers
Microminiature Components
& Circuit Packages
Crystals, Filters,
Oscillators & Ovens

Subsidiaries

CTS of Asheville, Inc., Skyland, N. C.
CTS of Berne, Inc., Berne, Indiana
CTS of Paducah, Inc., Paducah, Ky.
Chicago Telephone of California, Inc.,
South Pasadena, Calif.
CTS of Canada, Ltd., Streetsville, Ontario
CTS Microelectronics, Inc., Ridgefield, Conn.
CTS Research, Inc., Lafayette, Ind.
CTS Knights, Inc., Sandwich, Ill.

#80 Nomograph for the Parabolic Surface Area

By ROBERT L. PETERS, Ph.D.

Consultant, 789 West End Ave., New York, N. Y. 10025

THE ELECTRONICS ENGINEER often faces problems involving parabolic surface areas in both optical relationships and energy reception. This nomograph provides a simple means of finding the surface area from a knowledge of the depth and focal length.

To Determine Area

1. Enter the depth to focal length ratio on the left line. Note on which side of this line the ratio is found. Values below unity are on the left side, values above unity are on the right side.

2. Enter the focal length on the right line extracting the decimal notation.

3. Align these values to intersect the surface area on the centerline. Read value from the same side as the ratio entered. Restore the decimal notation. (As indicated by 10^{2n} .)

Example

What would be the surface area if the depth were 135 cm and the focal length 27 cm?

1. Dividing 135/27 to obtain 5, this value is entered on the left line. (The entry is on the right side of the line.)

2. 27 cm is entered on the right line as 2.7.

3. Connecting these, the centerline is intersected at 100. Restoring the decimal, the answer is 10,000 sq. cm.

PARABOLIC SURFACE AREA

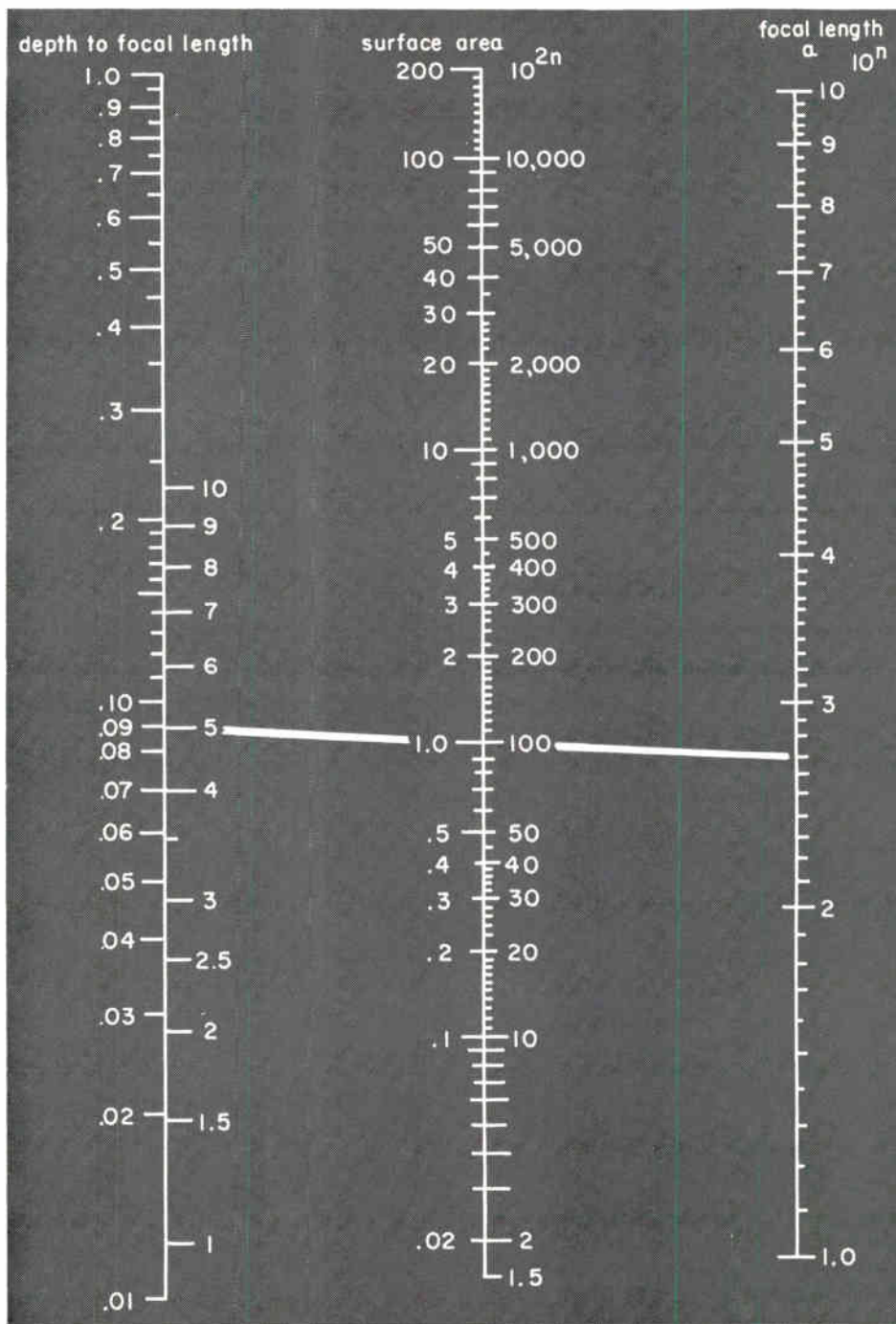

ELECTRONIC INDUSTRIES Professional Profile

Please type or print

The ELECTRONIC INDUSTRIES Job Resume Form for Electronic Engineers

Name _____ Tel. No. _____
 Street Address _____ Zone _____
 City _____ State _____

Single Married Citizen Non-Citizen Date of Birth _____
 Will Relocate Yes No. If Yes Another City Another State
 Salary Desired to Change Jobs in present area _____
 Salary Desired to Change Jobs and relocate in another area _____
 Professional Memberships _____

College or University	Major	Degree	Dates

RECENT WORK EXPERIENCE

Company	Div. or Dept.	Title	Dates

SIGNIFICANT EXPERIENCE AND OBJECTIVES

STATE ANY FACTS ABOUT YOURSELF THAT WILL HELP A PROSPECTIVE EMPLOYER EVALUATE YOUR EXPERIENCE AND JOB INTERESTS. INCLUDE SIGNIFICANT ACHIEVEMENTS, PUBLISHED PAPERS, AND CAREER GOALS.

Mail to: ELECTRONIC INDUSTRIES—Professional Profile—56th & Chestnut Sts.—Philadelphia, Pa. 19139. This resume is confidential. A copy will be sent only to those Companies advertising for engineering personnel in this issue, whose number you circle below.

800 801 802 803 804 805 806 807 808 809 810

newest Esterline Angus design

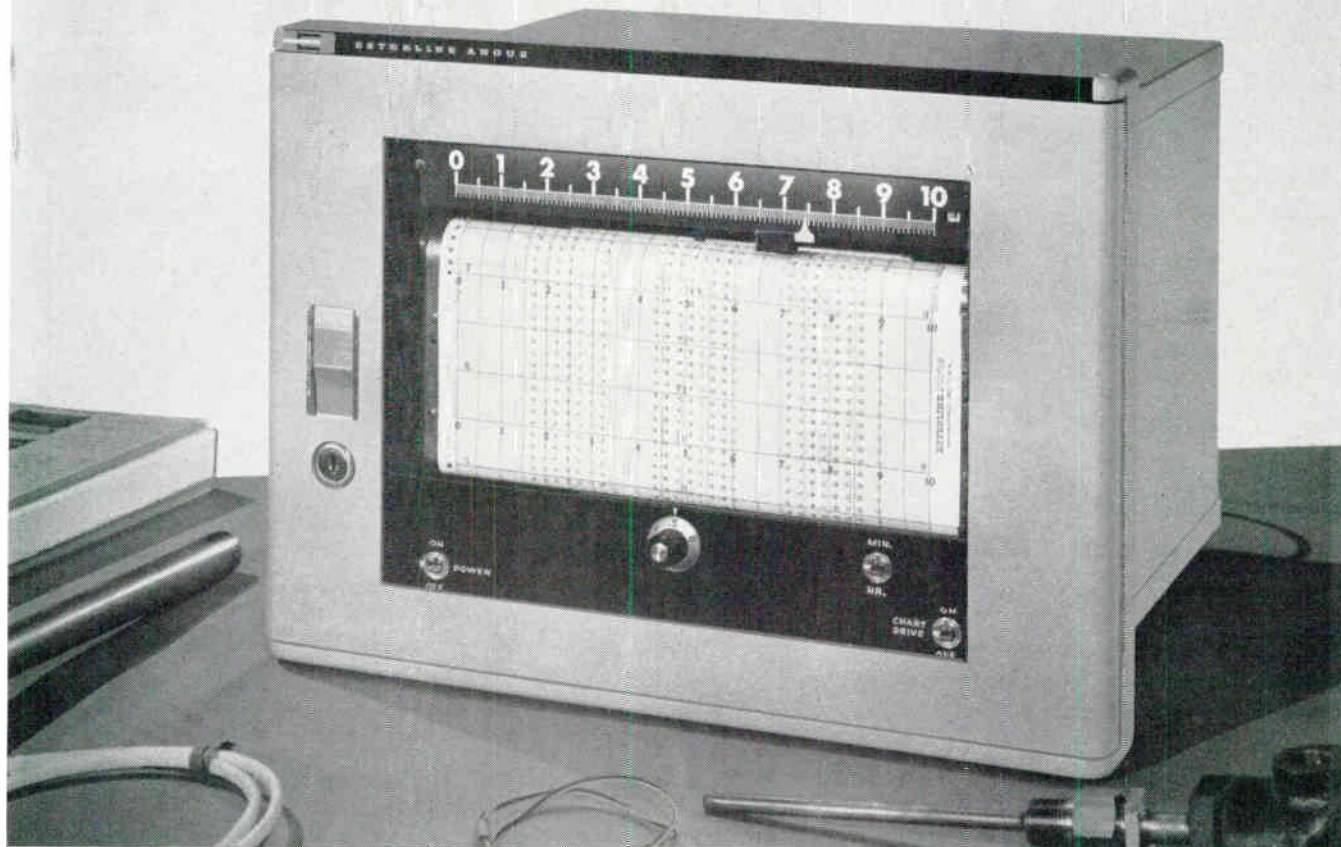

Illustrated is the E1124E Multipoint, one of five new Series "E" recorders

solid state amplifier
+
automatic chart drive* } = 2 reasons to buy our
24 point recorder

A few other reasons you should buy the new Esterline Angus Multipoint:

handles up to 24 points. can be programmed to skip points as fast as $\frac{1}{4}$ second. stray rejection (longitudinal 60 cycle) 1000x span. new print head. dial in any point without disturbing synchronization. 50,000 ohm off balance input impedance. meets or exceeds A.S.A. C39.4.

With unique remote programmed printing, you electrically select the points to be scanned using foolproof toggle switches. There is no restriction on point grouping, and programming can be done by computer or by almost any electrical switching device.

Learn more about our Multipoint. Write for Series "E" catalog.

ESTERLINE ANGUS INSTRUMENT COMPANY, INC.
Box 24000EI • Indianapolis, Indiana 46224

*Open door shows simple controls, including automatic chart drive . . . select chart drive to meet your needs . . . single speed, two speed, 10 speed or 15 speed . . . from $\frac{1}{2}$ " per hour to 8" per second without gear change, motor change or screw driver adjustment . . . sloped writing surface and chart tear off standard features.

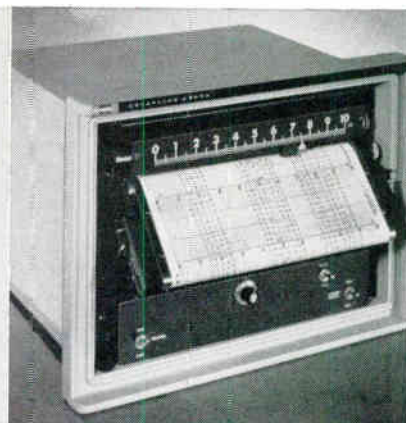

ESTERLINE ANGUS

Excellence in instrumentation for over 60 years



Test Yourself.

PERT

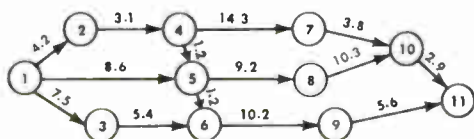

Examine the network you have just constructed.

- Identify the critical path by giving the sequence of events along the path: _____
- Give the T_E which you calculated for the ending event of the network _____ weeks
- It is now reported that activity 6-9 cannot be completed in less than 11.8 weeks. Will it still be possible to meet T_L ? yes no
- If the changes mentioned in (c) above would make it impossible to plan completion of the project by the time the allotted span has run out, what can he do to replan so that he does meet the schedule?

BASIC TRANSISTOR CIRCUITS

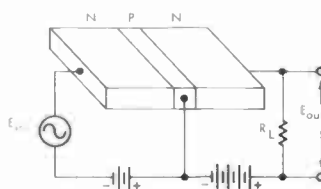

- The NPN transistor circuit illustrated above operates as a(n) _____
- With reference to the circuit shown above, MATCH the items below on the left with those on the right by placing one letter in each blank:

A. base-collector junction	1. _____ high impedance
B. emitter-base junction	2. _____ input impedance
	3. _____ low impedance
	4. _____ output impedance

INTRODUCTION TO TRANSISTORS

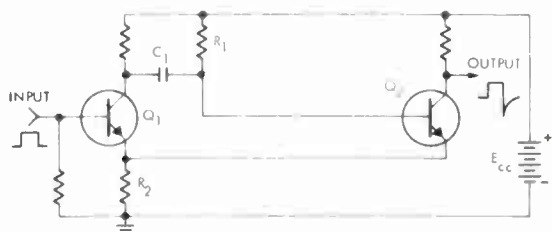

- The schematic diagram above shows an emitter-coupled one-shot _____
- In the stable state Q_1 is on off and Q_2 is on off.
- The positive pulse turns on Q_1 , which in turn: cuts off Q_2 turns on Q_2 .
- When C_1 discharges, Q_2 is: cut off turned on.
- When Q_2 conducts, drawing current through R_2 , Q_1 becomes _____ biased.

COUNTING SYSTEMS & BINARY ARITHMETIC

PERFORM THE FOLLOWING ARITHMETIC CONVERSIONS.

- CONVERT the decimal numbers 85 and 35 into binary equivalents and
- ADD their binary equivalents, then
- CONVERT the sum back to decimal
- CONVERT the decimal number 26 into its binary equivalent and
- SUBTRACT it from the binary sum you found in (b)
- CONVERT the result back to decimal
- CONVERT the decimal number 20 into the form it would have been in number systems with a base of 2____5____8____.

If any of these questions are over your head, keep reading.

O.K. You can't spend half your time keeping up with new developments.

The fact is you don't have to.

Now, there is a fantastic new system of speed learning that makes it possible for you to master complex subjects in a matter of hours.

These are not correspondence courses.

We flatly claim that a Ph.D. with 40 years experience and a young man just starting out in the field will both score about 90% on any of our final examinations.

This chart shows the actual results of Members of the American Material Handling Society who taught themselves PERT using this method. Take particular notice of the scores before and after training.

Job Title	Fore-man	Ops. Mgr.	Proj. Eng.	Supervisor			Pers. Mgr.	Chief Eng.	Traffic Mgr.	Avg.
Education	H.S.	B.S.	M.S.	H.S.	H.S.	B.A.	B.A.	B.S.	B.S.	
Time (hrs.)	11.3	10.5	9.4	13.3	19.0	8.0	13.8	11.3	9.5	11.8
Age (yrs.)	36	22	44	48	52	34	47	47	50	34
Before Training Score (%)										29
After Training Score (%)	94	97	97	94	92	90	87	80	79	90

Persons with many years of experience and advanced education were able to finish the course faster than persons with less experience and training. But compare the scores. Compare the percentage of improvement. Every individual mastered PERT. And that's where our system differs from all others. We can virtually guarantee results.

The teaching method we used is based on the principles of learning developed primarily by Dr. B. F. Skinner of Harvard University.

What is this new learning technique and how does it work?

This new learning technique is called "Programmed Instruction." It's totally different from any textbook you've ever read.

Programmed Instruction teaches you the same way a good tutor would. It starts you off with the most basic information, and tests you to make sure you understand before going on to the next step.

The entire subject is broken down into a series of small easy steps. Step-by-step, you go from the most basic information to the most complex in a matter of hours.

Compare this method with ordinary textbooks.

Even the best textbooks don't teach. They merely present information. You have to sift the important from the unimportant. You have to get a firm grasp of the *necessary* material so you will be able to understand what follows.

You mentally sift and organize the material to the best of your ability. The better you are at organizing material, the better you can remember what you are studying.

However, very few people have a mind that follows this process in a fluent manner from one end of a textbook to the other.

Instead, most people get bogged down because of the format of the text.

With Programmed Instruction, you never get stuck. You review, are presented with new information, and are tested every step of the way.

Before you know it, you will be able to answer highly technical questions instantly. You will have an ever-expanding foundation of knowledge which will make even the most complicated parts of the program clear as a bell. In less than two days, you will have completely mastered the

subject. And you'll be able to score 90% or better on the comprehensive exam.

Where else can you get action like this?

XEROX Basic Systems, Inc.
AN EDUCATION SUBSIDIARY OF XEROX CORPORATION

Clip Coupon For Free 10-Day Trial.

Look these courses over for 10 days. We'll promptly return your money if not satisfied.

- PERT \$12.50
- Introduction to Transistors 9.50
- Basic Transistor Circuits 9.50
- Counting Systems and Binary Arithmetic 7.50
- Applied Electricity 12.50
- Reading and Evaluating Financial Reports 6.75
- Introduction to Electronic Data Processing 9.50

My check is enclosed. Bill me.

NAME _____

TITLE _____

ADDRESS _____

CITY _____ STATE _____

COMPANY _____

Send this coupon to:
Basic Systems Incorporated, 880 Third Ave., N.Y.

A JOINT SERVICE OF
ELECTRONIC INDUSTRIES MAGAZINE
AND
BASIC SYSTEMS INCORPORATED
880 THIRD AVENUE, NEW YORK, N.Y.



THE JANUS APPROACH TO RADAR MAPPING

Like the mythological Roman guardian of portals, the U.S. Army's new AN/UPD-2 airborne electronic sensor has the ability to look in opposite directions simultaneously. Produced by Motorola's Western Center, this sidelooking radar system (SLAR) transmits a high-energy pulse at a 90° angle to the line of flight — from horizon-to-horizon. A narrow fan-shaped beam, less than 1° in thickness, penetrates fog and darkness and the intensity of the return echo from outlying terrain is recorded as a synchronous "range vs. time" video signal. This signal is displayed on a cathode ray tube as intensity modulation, and photographed synchronously with the illumination of successive strips of terrain by the radar antenna. The AN/UPD-2 compensates for drift angle distortion by rotating the intensity-modulated line scan on the cathode ray tube a proportionate amount. This SLAR has **outstanding stability and field-proven reliability.**

Motorola's leadership offers challenging opportunities to engineers and scientists. Specific program areas are:

Antennas & Propagation
Solid State R.F.
Microwave Techniques
Missile & Space Instrumentation
Operational Support
Integrated Circuitry

Equipment Reliability Analysis
Parts Reliability
Data Acquisition, Processing
& Display
CW Transponders
Radar & Radar Transponders
Fuzes

Guidance & Navigation
Command & Control
Space Communications
Signal Processing
ECM, CCM & Surveillance
Tracking & Telemetry

Contact Phil Nienstedt, Manager of Recruitment, Department 699

MOTOROLA



in PHOENIX

Military Electronics Division • Western Center • P.O. Box 1417, Scottsdale, Arizona
MOTOROLA ALSO OFFERS OPPORTUNITIES AT CHICAGO, ILLINOIS — AN EQUAL OPPORTUNITY EMPLOYER

VERY THIN GOLD PLATE RESISTS HIGH TEMPERATURE

To new gold plating processes have been developed for the electronics industry by a British firm, Precious Metal Depositors Ltd., Coventry.

One process, designed for transistor and semi-conductor manufacture, produces a pure 24-carat gold deposit of low porosity with high temperature resistance. Deposits of 0.0001" directly on to Kovar will resist temperatures up to 500° C.

The second process is designed for printed circuits. The alkaline solution contains no free cyanide and will therefore not attack printed circuit adhesives. Bright, low porosity deposits of not less than 23.5 carat can be obtained with hardnesses of 120 VPN to 140 VPN, the firm indicates.

EXPAND MANAGEMENT SKILLS, ENGINEERS ARE TOLD

Engineers must add understanding of market, economic and financial factors to technical skills to contribute fully to their companies' growth and profit, said John M. Crockett, administrative assistant to the president of Speer Carbon Co., at South Dakota School of Mines and Technology.

Mr. Crockett claims that need for engineers is expanding, but they must be prepared for areas of management other than purely technical. Some engineers, unfortunately, consider manufacturing, sales and related departments as being somewhat inferior, in intellectually. Also, the heavy concentration on technical problems sometimes results in narrowing of interest.

To overcome these problems, said Mr. Crockett, a further degree of communications and understanding between engineers and their firms must be implemented, after technical careers are started.

WOMEN NAME OFFICERS

The Society of Women Engineers installed the following National officers during its Fifteenth Annual Convention in Detroit, Mich. President, Isabelle French, Bell Telephone Laboratories, Allentown, Pa.; Vice President, Alice Morgan, Douglas Aircraft Space Systems Center, Huntington Beach, Calif.; Secretary, Mary Louise Wolf, Westinghouse Electric Corporation, Friendship, Md.; Treasurer, Beatrice Williams, Lockheed Aircraft Co., Burbank, Calif.

NAVY ORDERS INSTRUMENTS FOR OCEAN RESEARCH

The U. S. Naval Oceanographic Office has ordered 12 highly advanced instrument systems for oceanographic research from The Bissett-Berman Corp.

The systems will measure and produce continuous graphic profiles of basic ocean properties—salinity, temperature and depth—in a given column of sea water. Continuous data profiles enable ocean researchers to note small changes in ocean conditions which might otherwise be missed with traditional sampling methods.

Accuracy of data compares with that achieved under controlled laboratory conditions, even though measurements are made in the ocean under rugged conditions.

STANFORD USES DEC SYSTEM TO ANALYZE MEDICAL DATA

The School of Medicine of Stanford University is using a LINC (Laboratory INstrument Computer) supplied by Digital Equipment Corp. in the analysis of experimental data.

Stanford's Department of Pharmacology is using the system on and off line. The data comes from evoked and spontaneous electrical activity in the nervous systems of mammals subjected to learning situations and to a variety of drugs used in treatment of the mentally ill. The computer is being used with low-level, low-frequency biological amplifiers, analog tape systems, and operant conditioning equipment. It has a random access core memory of 2,048 12-bit words with an 8- μ sec. cycle time.

Planned analytical techniques include conventional forms of time series analysis and averaging, as well as less conventional techniques adapted to problems of pattern recognition.

COMPUTER COURSE

Sessions of a one-week course on digital computer programming concepts and techniques will be held by Electronic Associates Inc. The sessions are oriented primarily to engineers and scientists. One will be at the Los Angeles Computation Center during the week of October 4-8, another at EAI's Princeton Computation Center November 29-December 3. Information available by writing to the company's Research and Computation Division, P. O. Box 582, Princeton, N. J.

TELEPHONE INTERCEPT SYSTEM COMPUTER CONTROLLED

A computer-controlled automatic telephone intercept system—which gives the telephone user an individually composed voice message whenever he dials a non-working number—has been announced by International Business Machines Corp. and Southwestern Bell Telephone Co. engineers.

The intercept system, which has been operating in Metropolitan St. Louis since February, was developed as the result of a joint IBM-Southwestern Bell study at Boulder, Colo. It is de-

signed to provide fast, accurate information to telephone subscribers who attempt to reach changed, disconnected or unassigned numbers, and to reduce telephone company costs of handling such non-revenue producing calls.

IBM 7770 audio response units are used in the automatic system. Changes in telephone number assignments are entered into an IBM 1440 system via punched cards and stored in its memory, which includes peripheral IBM 1311 disk storage units.



**NOW! FROM CAPCO... QUALITY...
AVAILABILITY... VERSATILITY!**

Capco offers complete standard lines of Metallized Mylar®, Metallized Polycarbonate, Mylar and Foil, and Teflon® and Foil capacitors in epoxy impregnated kraft paper wrap, Mylar thermosetting tape wrap, and hermetically sealed metal case styles. Standard working voltage ranges are 100 VDC, 200 VDC, 400 VDC, and 600 VDC.

Capco also specializes in units custom designed to your specifications using the same dielectrics with voltage ranges up to 3000 VDC or 1500 VAC.

Let Capco supply the right capacitor to fill your particular need. Capco's reputation for reliability and fast delivery is unsurpassed in the capacitor industry.

For complete data and prices for our entire capacitor line, contact:

CAPCO CAPACITORS
A DIVISION OF TEXTTOOL PRODUCTS, INC.
1410 Pioneer Drive, Irving, Texas

Dallas:
ME 1-5585

Irving:
BL 3-9296



®MYLAR AND TEFLON ARE REGISTERED TRADEMARKS OF DUPONT.

Look
to the
Leader

PERMACOR®

For Every
Electronic
Powdered
**IRON
CORE
Need!**...

As the world's largest
producer of iron cores,
Permacor has the capa-
bility and facilities to
supply any requirement
or meet any specifica-
tion you may have.

Write for Complete Information

PERMACOR®
A Division of Radio Cores, Inc.

9540 Tully Ave., Oak Lawn, Ill.
Phone: 312-GARDEN 2-3353

Circle 69 on Inquiry Card

**Alpha Wire
makes it easier
for you to
specify**

Refer to
their 30-page catalog
in the 1965

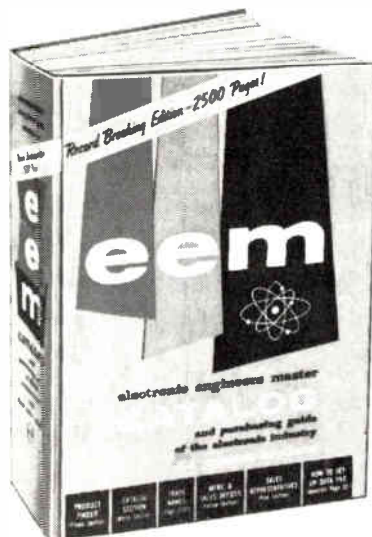

eem — Electronic Engineers Master
645 Stewart Ave. • Garden City, N. Y. 11533

INTERNATIONAL NEWS

London—First production models of new flight data recorder (Type PV710) have been delivered to British European Airways, reports Plessey-UK, Ltd. Similar gear has been supplied to British Aircraft Corp.

London—Dr. Vladimir K. Zworykin, Honorary Vice President of RCA Research Laboratories, and inventor of the ionoscope, received the 1965 Faraday Medal of the Institute of Electrical Engineers.

London—Associated British Picture Corp. discloses installation of a National Cash Register 315 system for accounting and research analysis, checking daily returns on admissions and candy sales from some 300 theaters.

London—Phenomenal growth of the Radio and Electronic Component Show, "valuable technical shop window in Britain," was stressed recently. Attendance at the 1965 show in May was more than 20% higher than the 1963 show.

Billerica, Essex—Specialized Components Division of Marconi Company have moved to new quarters at Billerica to accommodate rapidly growing orders, for its nearly 300 components, reports the company.

Hayes, Middlesex—A new all-transistor closed-circuit TV camera, only 4½ inches long and less than two pounds, has been developed by EMI Electronics Ltd. The camera "produces very high resolution pictures on 405, 525, 625-line standards."

Farnborough, Hants—Solartron Electronic Group Ltd. announced that it and Physical Sciences Corp., of Pasadena, Calif., have agreed to exchange licensing and patents on their respective products.

Witham, Essex—A new secondary radar system, SECAR, developed jointly by Compagnie Francaise Thomson Houston (CFTH) and the Marconi Co., can interrogate on all civil and military modes using two or three pulse interrogation with full side lobe suppression.

Harlow, Essex—Ministry of Aviation has ordered RBDE-5 16-inch Radar Bright Display with 945-line raster from Cossor Electronics Ltd. Radar data is displayed in P.P.I form.

Farnborough, Hants—Solartron has developed a new quality control monitor that can use 15 modules to monitor up to 30 production lines. The monitor, type TY .1710, can monitor any product resulting from an extrusion process.

Sidcup, Kent—Marsh and Marine underwater connectors for undersea power and control uses, capable of up to 200a and 100v, were exhibited by STC at a recent exhibition in London. Visitors represented television, petroleum and mining industries.

Glasgow—Clydesdale Bank Ltd. is using a 315 computer system (National Cash Register International Div.) to serve branches in Aberdeen, Edinburgh, Aye and Dundee, and will eventually apply the system to some 200 other branches on the Isles.

The Hague—Royal Netherlands Air Force has awarded ITT Corp. a \$280,000 contract for two complete Ground Control Approach Radar systems. The system, Quadradar, can be operated by one man.

Heidelberg—Teldix has developed a pocket-size transistor unit called Teldicord for monitoring heart beat in emergencies. The unit permits unambiguous detection of the weakest heart action through short 3KCS audio pulses.

Stuttgart—After a slow start in autumn 1963, stereophonic broadcasting is now making inroads in West Germany. "Sender Freies Berlin" was first to broadcast stereo in 1963. Most other German systems have followed suit.

Vienna—Austrian Telephone and Telegraph Ministry has ordered \$1,960,000 worth of the latest long distance telephone transmission equipment from ITT's Standard Telephones and Cables Ltd.

Madrid—Hidroelectrical Espanola, S.A., (HE) has ordered a General Electric process computer (GE/PAC 4000) for the Escobreras Thermal Power Plant—largest privately-owned plant in Spain (290,000 kw).

Rome—Two Italian subsidiaries of GT&E International Inc. have merged. Marelli Lenkurt S.p.A. and Automatic Electric S.p.A. have joined to form Societa' Generale di Telefonia ed Elettronica S.p.A.

Berne—Radio-Suisse has ordered from Whittaker Corporation two video defruiter systems which eliminate stray images from radar screens of surveillance radar beacon systems now in use at Swiss airports.

Nice—The French Government disclosed a contract to Airborne Instruments Laboratory (AIL) Division of Cutler-Hammer, for a new type of Waveguide Glide Slope antenna system for France's Nice airport.

Lusaka (Zambia)—A subsidiary of General Telephone & Electronics International Inc. has become the first U.S. company to open an office in the new African nation of Zambia, once Northern Rhodesia.

Beirut—Telephone service has begun over the first microwave link installed in Lebanon, it was disclosed by GT&E International Inc. The system, with an ultimate of 300 channels, extends north 50 miles to Tripoli.

Sante Fe, Argentina—A new TV station will begin serving Sante Fe and Parana toward the end of 1965. Operated by Televisora Santafecina S.A., the station will be equipped with Marconi equipment costing about \$300,000.

Mexico City—Philco Corp.'s International Division (Philco S.A. de C.V.) is investing \$1.1 million to triple manufacturing capacity in Mexico for radios, TV sets and phonographs.

Baghdad—Installation for the fourth power line carrier plan, as part of the Euprates Development for the Iraq Government, will be done by Nippon Electric Co. Ltd., of Tokyo, as in the previous three plans.

Tokyo—A new company, National Mallory Denchi Kabushiki Kaisha, is a joint venture of Matsushita Electric Industrial Co. Ltd., and P. R. Mallory & Co. Inc. It will manufacture batteries developed by Mallory.

Zama, Japan—An SDS 910 real-time computer system is now controlling production and monitoring quality control at a Nissan Motor Company truck assembly near Zama, it was disclosed by Scientific Data Systems.

Ceylon—The island's local constabulary has started a program to equip policemen with personal radiotelephone equipment. First on the line is a series of Cossor CC/8 Pocket radiotelephones installed in a motorcycle fleet for crowd control.

Seoul—Ten new Korean deep-sea fishing vessels now under construction in France will be outfitted with Raytheon Model 358 automatic radio direction finders that cover marine and aviation beacon bands, consolan band, marine communications frequencies and standard broadcast band.

THE KEY TO YOUR MAGNETIC SHIELDING

Problems...

*Seamless tubing
construction*



Hydrogen annealing for maximum permeability



Customized fabrication to your exact engineering specifications



Fabrication in all types of MU metal materials including . . .

- Magnaloy
- Westinghouse Hypernik
- Hypernom
- Carpenter 49
- HY-MU 80
- Mu Metal



Ultimate in attenuation—60/-80 db

We have perfected the art of seamless-tube construction in magnetic shielding components at a price comparable to or lower than the "old-fashioned" overlapped welded seam designs

QUOTATIONS submitted on request per your blue print specifications for . . .

- ENGINEERING SAMPLES
- PROTOTYPES
- PRODUCTION RUNS

SEND FOR ILLUSTRATED BROCHURE

Magnetic RADIATION LABORATORIES, INC.
7325 W. North Ave. — River Forest, Ill.
PHONE (Area Code 312) 771-7172

new Allen type screwdrivers

work faster, easier . . . reach where wrenches won't go



fixed handle SCREWDRIVERS

11 hex sizes: .050" to 1/4"
Precision formed, alloy steel blades
Shockproof, breakproof, amber plastic (UL) handles

detachable BLADES

8 hex sizes: 1/16" to 3/8"
Fit all "99" Series handles
Available singly — as a set of six in free plastic pouch — or in roll kit with handle



WRITE FOR BULLETIN N763

XCELITE®

XCELITE, INC., 28 BANK ST., ORCHARD PARK, N. Y.
Canada: Charles W. Pointon, Ltd., Toronto, Ont.

Circle 72 on Inquiry Card

2.0 MC RECORDER

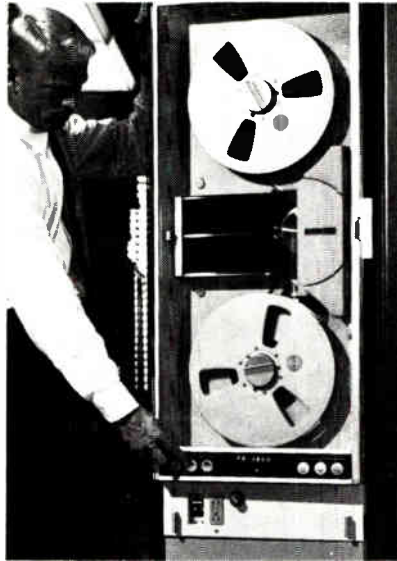

Ampex FR-1600 offers 2.0 mc bandwidth and more than 100 times the time-base accuracy of previous instrumentation tape recorders. PR-1600 (portable) and AR-1600 (airborne) are also available. All models of the family have 14-track record/reproduce capability, and six-speed (120 to 2 3/4 ips) electrically switchable transport.

FLORIDA FACILITIES AID ENGINEER GRADUATE STUDY

More than 300 engineers in both private industry and government are now enrolled in graduate level courses at a system of campuses throughout Florida, linked by closed-circuit TV to the University of Florida's College of Engineering, Gainesville.

Under a program, called the Graduate Engineering Education System, authorized by special Act of the Florida Legislature in 1963, the engineers are receiving graduate instruction in classrooms equipped with TV at Orlando, Daytona Beach, Cape Kennedy and Melbourne. In addition to those state-owned facilities, classes are being held at Patrick Air Force Base and at NASA's Merritt Island Launch Area.

INSTRUMENT INSTITUTE

The Second Annual Measurement and Instrumentation Institute is being sponsored by TRAINING SERVICES, INC., Rutherford, N. J. October 29 & 30, 1965 at the City Squire Inn, New York. Theme of the Institute will be "Conversion of Phenomenon to be Measured into a Usable Signal." The two-day program is directed toward users of instruments, engineers specifying instruments, manufacturers and sellers of instruments and associated equipment.

SCHAUER Heavy Duty 1/2 Watt ZENERS

— are the highest quality, lowest priced in the industry!

Check the data below and compare Schauer Zeners with the units you are now using for quality and price. These 10-watt silicon junctions in a 1/2-watt package feature very low dynamic impedance and very high surge capacity — 25-watt-ms surge from 1.0 to 10 ms.

TYPICAL CHARACTERISTICS

Vz @ 25°C.	Iz @ 20 ma	Iz @ 100 ma	TC %/°C.	1-99 price 10% Tol.
2.4 V.	14 ohms	3.2 ohms	—0.54	81c
2.7	16	3.7	—0.055	81c
3.0	17	3.9	—0.055	64c
3.3	17	3.9	—0.054	64c
3.6	18	4.1	—0.050	64c
3.9	17	3.9	—0.045	64c
4.3	17	3.9	—0.037	64c
4.7	12	2.8	—0.029	64c
5.1	10	2.3	—0.019	64c
5.6	6.0	1.4	—0.009	64c
6.2	2.0	0.5	+0.018	64c
6.8	1.5	0.4	+0.035	64c
7.5	1.5	0.4	+0.044	64c
8.2	2.0	0.5	+0.049	64c
9.1	4.0	0.9	+0.053	81c
10.0	6.0	1.4	+0.055	81c

In addition to the communications industry, a wide range of products incorporate Schauer semiconductors in their circuitry. Shown below is the circuit for an inexpensive automobile tachometer.

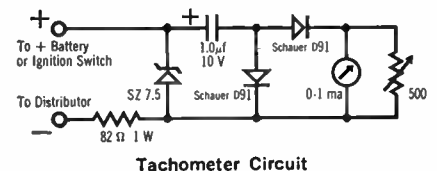

Contact your local distributor or write direct for prices and Catalog No. 621.

Semiconductor Division
SCHAUER MANUFACTURING CORP.
4518 Alpine Avenue
Cincinnati, Ohio 45242

Circle 73 on Inquiry Card

**FIRST CLASS
PERMIT NO. 36
PHILA., PA.**

BUSINESS REPLY MAIL
No Postage Stamp Necessary If Mailed in U.S.A.

POSTAGE WILL BE PAID BY

ELECTRONIC INDUSTRIES

P. O. Box 9801

Philadelphia, Pa. 19140

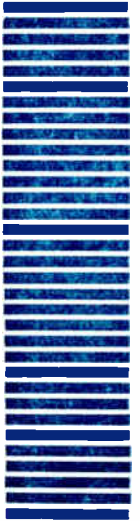

**FIRST CLASS
PERMIT NO. 36
PHILA., PA.**

BUSINESS REPLY MAIL
NO POSTAGE STAMP NECESSARY IF MAILED IN UNITED STATES

POSTAGE WILL BE PAID BY

ELECTRONIC INDUSTRIES

Chilton Company

Chestnut & 56th Sts.

Philadelphia, Pa. 19139



Att: Circulation Dept.

FREE!

Catalogs, Literature
New Products and
New Tech Data
Another Reader Service of the

ELECTRONIC INDUSTRIES

STATE
OF THE
ART
MAGAZINE

NAME

COMPANY

ADDRESS

CITY, STATE

TITLE

DEPT.

MAIL STOP

Zip Code

Please send me the items I have circled.

1-B	12	13	14	15	16	17	18	19	20
1	12	13	14	15	16	17	18	19	20
21	32	33	34	35	36	37	38	39	40
41	52	53	54	55	56	57	58	59	60
61	72	73	74	75	76	77	78	79	80
81	92	93	94	95	96	97	98	99	100
101	112	113	114	115	116	117	118	119	120
121	132	133	134	135	136	137	138	139	140
141	152	153	154	155	156	157	158	159	160
161	172	173	174	175	176	177	178	179	180
181	192	193	194	195	196	197	198	199	200
201	212	213	214	215	216	217	218	219	220
221	232	233	234	235	236	237	238	239	240
241	252	253	254	255	256	257	258	259	260
261	272	273	274	275	276	277	278	279	280
281	292	293	294	295	296	297	298	299	300
301	312	313	314	315	316	317	318	319	320
321	332	333	334	335	336	337	338	339	340
341	352	353	354	355	356	357	358	359	360
361	372	373	374	375	376	377	378	379	380
381	392	393	394	395	396	397	398	399	400

1-B EI-229 SEPTEMBER 1965

For immediate need or a call by a sales representative, write number (s) in box (do not circle above)

SPECIAL PRIORITY REQUEST

Postcard valid 8 weeks only

Item No. Item No. Item No. Item No. Item No. Item No.

NEW

Change of Address

Company _____
Mail Stop/or
Dept., Div. _____

Street _____

City _____ State _____ Zip _____

OLD

PASTE WRAPPER IMPRINT OR WRITE COMPLETE OLD ADDRESS



Source
Date

Co. Code

File No.

Function
Industry

Title
Unit

1. Do you wish to continue receiving ELECTRONIC INDUSTRIES? Yes _____ No _____

Signature _____ Title _____

2. Check—ONE—box for your PRIME FUNCTION

A	B	C	DESIGN ENGINEERING				H	J	K	M	N	P	R	S	T	V	W	X	Y	Z
			D	E	F	G														

3. Check—ONE—box for your plant's PRIME nature of business

MANUFACTURING INDUSTRIES

- (01) Computers, Data Processing & Peripheral Equipment Mfr.
- (02) Communication Systems & Equipment Mfr.
- (03) Consumer Electronic Equipment Mfr.
- (04) Industrial Control Systems & Equipment Mfr.
- (05) Navigation & Guidance System Mfr.
- (06) Test Measurement & Instrumentation Mfr.
- (07) Aircraft, Ground Support, Missile, Space Vehicle & Undersea Access & Equipment Mfr. not covered in other product classifications
- (08) Component Mfr.
- (09) Sub-System Assembly Mfr. (Modules, Assembled Circuits)

(10) Materials & Hardware Mfr.

(11) Industrial Co. Using or Incorporating Any Electronic Equipment In Their Manufacturing, Research or Development Activities. (Other than Electronic Co.)

NON MANUFACTURING INDUSTRIES

- (12) Commercial Users of Electronic Equipment
- (13) Independent Research, Test & Design Laboratories & Consultant (Not Part of a Manufacturing Company)
- (14) Government Agencies & Military Agencies
- (15) Distributors, Mfr. Representatives
- (16) Education & Libraries
- Other (explain) _____

4. This Address is (check most applicable)

Mfg. Plant (*) Mfr's R&D Lab. (&) Other (explain) _____

If address shown is your home, where is your company located? City _____ State _____

NEW Subscription Order

Company _____

Mail Stop/or _____

Dept., Div. _____

Name _____

Company _____

Address _____

City _____ State _____ Zip _____



Source Date	
Co. Code	
File No.	
Function Industry	-
Title Unit	-

1. I wish to receive ELECTRONIC INDUSTRIES

Signature _____ Title _____

2. Check—ONE—box for your PRIME FUNCTION

Pres., V.P.'s, Chiefs, Directors, Dept. Heads, Mgrs. & Asst.	DESIGN ENGINEERING												Research & Development Engineering	Application	Evaluation	Mechanical	Quality Control	Production	Reliability	Standard	Test	Value	Purchasing	Sales	Co. Copies & Libraries	All Others	
Corporate Management	Engineering Management	Manufacturing Management	Circuits	Components	Equipment	Systems																					
A	B	C	D	E	F	G	H	J	K	M	N	P	R	S	T	V	W	X	Y	Z							

3. Check—ONE—box for your plant's PRIME nature of business

- MANUFACTURING INDUSTRIES**
- (01) Computers, Data Processing & Peripheral Equipment Mfr.
 - (02) Communication Systems & Equipment Mfr.
 - (03) Consumer Electronic Equipment Mfr.
 - (04) Industrial Control Systems & Equipment Mfr.
 - (05) Navigation & Guidance System Mfr.
 - (06) Test Measurement & Instrumentation Mfr.
 - (07) Aircraft, Ground Support, Missile, Space Vehicle & Undersea Access & Equipment Mfr, not covered in other product classifications
 - (08) Component Mfr.
 - (09) Sub-System Assembly Mfr. (Modules, Assembled Circuits)
- (10) Materials & Hardware Mfr.
- (11) Industrial Co. Using or Incorporating Any Electronic Equipment in Their Manufacturing, Research or Development Activities. (Other than Electronic Co.)
- NON MANUFACTURING INDUSTRIES**
- (12) Commercial Users of Electronic Equipment
 - (13) Independent Research, Test & Design Laboratories & Consultants (Not Part of a Manufacturing Company)
 - (14) Government Agencies & Military Agencies
 - (15) Distributors, Mfr. Representatives
 - (16) Education & Libraries
 - Other (explain) _____

4. This Address is (check most applicable)
 Mfg. Plant (*) Mfr's R&D Lab. (&) Other (explain) _____
 If address shown is your home, where is your company located? City _____ State _____ Zip _____

SPECIAL PRIORITY REQUEST

Postcard valid 8 weeks only

For immediate need or a call by a sales representative, write number (s) in box (do not circle above) →

1	2	3	4	5	6	7	8	9	10	11	12	13	14	15	16	17	18	19	20	1-B	EI-229	SEPTEMBER 1965
21	22	23	24	25	26	27	28	29	30	31	32	33	34	35	36	37	38	39	40			
41	42	43	44	45	46	47	48	49	50	51	52	53	54	55	56	57	58	59	60			
61	62	63	64	65	66	67	68	69	70	71	72	73	74	75	76	77	78	79	80			
81	82	83	84	85	86	87	88	89	90	91	92	93	94	95	96	97	98	99	100			
101	102	103	104	105	106	107	108	109	110	111	112	113	114	115	116	117	118	119	120			
121	122	123	124	125	126	127	128	129	130	131	132	133	134	135	136	137	138	139	140			
141	142	143	144	145	146	147	148	149	150	151	152	153	154	155	156	157	158	159	160			
161	162	163	164	165	166	167	168	169	170	171	172	173	174	175	176	177	178	179	180			
181	182	183	184	185	186	187	188	189	190	191	192	193	194	195	196	197	198	199	200			
201	202	203	204	205	206	207	208	209	210	211	212	213	214	215	216	217	218	219	220			
221	222	223	224	225	226	227	228	229	230	231	232	233	234	235	236	237	238	239	240			
241	242	243	244	245	246	247	248	249	250	251	252	253	254	255	256	257	258	259	260			
261	262	263	264	265	266	267	268	269	270	271	272	273	274	275	276	277	278	279	280			
281	282	283	284	285	286	287	288	289	290	291	292	293	294	295	296	297	298	299	300			
301	302	303	304	305	306	307	308	309	310	311	312	313	314	315	316	317	318	319	320			
321	322	323	324	325	326	327	328	329	330	331	332	333	334	335	336	337	338	339	340			
341	342	343	344	345	346	347	348	349	350	351	352	353	354	355	356	357	358	359	360			
361	362	363	364	365	366	367	368	369	370	371	372	373	374	375	376	377	378	379	380			
381	382	383	384	385	386	387	388	389	390	391	392	393	394	395	396	397	398	399	400			

FREE!
 Another Reader Service of the
ELECTRONIC INDUSTRIES
 STATE OF THE ART MAGAZINE

Catalogs, Literature
 New Products and
 New Tech Data

NAME _____ TITLE _____

COMPANY _____ DEPT. _____

ADDRESS _____ MAIL STOP _____

CITY, STATE _____ Zip Code _____

**FIRST CLASS
PERMIT NO. 36
PHILA., PA.**

BUSINESS REPLY MAIL
No Postage Stamp Necessary If Mailed in U.S.A.

POSTAGE WILL BE PAID BY

ELECTRONIC INDUSTRIES

P. O. Box 9801

Philadelphia, Pa. 19140



**FIRST CLASS
PERMIT NO. 36
PHILA., PA.**

BUSINESS REPLY MAIL
NO POSTAGE STAMP NECESSARY IF MAILED IN UNITED STATES

POSTAGE WILL BE PAID BY

ELECTRONIC INDUSTRIES

Chilton Company

Chestnut & 56th Sts.

Philadelphia, Pa. 19139



Att: Circulation Dept.

ONLY SPERRY Makes ALL of these PNP – NPN Differential Amplifier Transistors



AND IN
ANY OF THESE
FOUR
PACKAGES TOO!

T0-77
(TO-5 Type)

T0-78
(Low Profile To-5)

T0-71
(TO-18 Type)

FLAT PACK

ONE HUNDRED SIXTY-FOUR COMBINATIONS NOW AVAILABLE.
Chances are which ever differential amplifier transistor you need, you can get it from Sperry and in the package you want. Get complete information today— Contact SPERRY— SPERRY SEMICONDUCTOR, Norwalk, Connecticut 06852.



Sperry Europe Continental, 7 Avenue de l'Opera, Paris 1, France

SPRINT MICROWAVE UNIT



Microwave signal source for Army SPRINT missile, radar-guided weapon designed to destroy nuclear missiles, designed by Sylvania Electric Products Inc. Disc-shaped unit, lower right, undergoing final tests, was designed to withstand extreme pressures in SPRINT, NIKE-X system.

ONE/SIX MERGERS A LEMON NATIONAL STUDY SHOWS

One of every six mergers involving manufacturing firms has turned out to be "a lemon" in the past ten years, a recent national study disclosed.

Conducted for Bjorksten Research Laboratories, Inc., a scientific consulting firm, Madison, Wis., the study covered about 6,300 acquisitions and mergers. There were 705 in the electronic and electrical industries. Of these, 113 (16%) proved a costly mistake for the acquiring firms.

Mergers are classed as lemons if any of the following conditions occurred: (1) acquired firm did not make a profit within three years, (2) acquired products or processes had to be radically changed in materials and/or engineering, (3) acquired company was later sold or liquidated.

Major reason for mistakes is failure to evaluate correctly the scientific and technological aspects of the products, patents, or processes, according to president Dr. Johan Bjorksten.

Another 12% of electronic/electrical mergers (85 in all) proved to be a waste of time and money, though not with significant losses. In such situations, the acquired firm either declined in profit or needed heavy investment to prevent losses. Thus almost 30% of all mergers in the past decade have

NEW WET WAFER PROCESSOR COMPLETELY AUTOMATIC

A newly developed wafer wet processing machine (Model 692) offers advanced speed and fully automatic operation, according to Kulicke & Soffa Manufacturing Co.

K&S engineers say that all that is necessary to operate the machine is (1) load the carrier containing ten wafers onto the machine, and (2) press actuating buttons. The carrier loading system eliminates use of tweezers, greatly reducing wafer damage. Operations are completely contained in the self-sealing machine chamber.

It is possible, reports Kulicke & Soffa, to sequence up to seven different wet operations through separate heads, each with its own pre-set timing. The machine completely controls this timing, requiring no action from the operator, after he actuates the first wet operation.

TUNGSTEN-RHENIUM WIRE

A new tungsten 1.5% rhenium wire to provide the electron tube industry with a more economical alloy than the current 3% wire has been disclosed by Sylvania Electronic Products, Inc.

John S. Kratz, Metallurgical Product Sales Manager, said the new wire is primarily for receiving tube heaters. It is, he said, especially useful in improving heater performance on tube types currently using unalloyed tungsten heater wire.

not been worthwhile.

Major areas that required scientific evaluation before merger include: (1) materials used, (2) manufacturing technology and equipment, (3) effect that current research would have on products and/or processes, and (4) evaluation of potential competition from new materials "on the horizon."

The study shows that mistaken judgments were made just as much by large firms as by smaller ones, despite larger scientific staffs with major firms. Prime reason is that many products, processes and patents fall in "no man's land"—an undefined area that lies between chemistry and physics, between biology and plastics, between metallurgy and pharmacology—between any two established fields.

Scientists on large company staffs are often too specialized to know the pitfalls in "no man's land," Dr. Bjorksten finds.



DELCO RADIO SEMICONDUCTORS AVAILABLE AT THESE DISTRIBUTORS

EAST

BINGHAMTON, N. Y.—Federal Electronics

P. O. Box 1208/PI 8-8211

PHILADELPHIA 23, PENN.

Almo Industrial Electronics, Inc.

412 North 6th Street/WA 2-5918

PITTSBURGH 6, PENN.—Radio Parts Company, Inc.

6401 Penn Ave./361-4600

NEWTON 58, MASS.—Greene-Shaw Company

341 Watertown Street/WO 9-8900

CLIFTON, N. J.—Eastern Radio Corporation

312 Clifton Avenue/471-6600

NEW YORK 36, N. Y.—Harvey Radio Company, Inc.

103 West 43rd Street/JU 2-1500

BALTIMORE 1, MD.—Radio Electric Service Company

5 North Howard Street/LE 9-3835

SOUTH

BIRMINGHAM 5, ALA.

Forbes Distributing Company, Inc.

2610 Third Avenue, South/AL 1-4104

WEST PALM BEACH, FLA.—Goddard, Inc.

1309 North Dixie/TE 3-5701

RICHMOND 20, VA.—Meridian Electronics, Inc.

1001 West Broad Street/353-6648

MIDWEST

BATTLE CREEK, MICH.—Electronic Supply Corporation

94 Hamblin Ave./P. O. Box 430/965-1241

INDIANAPOLIS 25, IND.

Graham Electronics Supply, Inc.

122 South Senate Avenue/ME 4-8486

CLEVELAND 1, OHIO—The W. M. Pattison Supply Co.

Industrial Electronics Division

777 Rockwell Avenue/621-7320

CHICAGO 30, ILL.—Merquip Electronics, Inc.

4939 North Elston Avenue/AV 2-5400

CINCINNATI 10, OHIO—United Radio, Inc.

7713 Reinhold Drive/241-6530

KANSAS CITY 11, MO.—Walters Radio Supply, Inc.

3635 Main Street/JE 1-7015

ST. LOUIS 17, MO.

Electronic Components for Industry Co.

2605 South Hanley Road/MI 7-5505

WEST

DALLAS 1, TEXAS—Adleta Company

1907 McKinney Ave./RI 2-8257

HOUSTON 1, TEXAS—Harrison Equipment Company, Inc.

1422 San Jacinto Street/CA 4-9131

SAN DIEGO 1, CAL.

Electronic Components of San Diego

2060 India Street, Box 2710/232-8951

LOS ANGELES 15, CAL.—Radio Products Sales, Inc.

1501 South Hill Street/RI 8-1271

LOS ANGELES, CAL. 90022—Kieruff Electronics

2585 Commerce Way/OV 5-5511

MOUNTAIN VIEW, CAL.—Kieruff Electronics

2484 Middlefield Road/968-6292

DENVER, COLO.—L. B. Walker Radio Company

300 Bryant Street/WE 5-2401

SEATTLE 1, WASH.—C & G Electronics Company

2600 2nd Ave./Main 4-4354

PHOENIX, ARIZ.—Midland Specialty Co., Inc.

1930 North 22nd Ave./258-4531

ALBUQUERQUE, N.M.—Midland Specialty Co., Inc.

1712 Lomas Blvd., N.E./247-2486

TUCSON, ARIZ.—Midland Specialty Co., Inc.

951 South Park Ave./MA 4-2315

Ask for a complete catalog

DELCO RADIO

DIVISION OF GENERAL MOTORS • KOKOMO, INDIANA

Get ready
to change your thinking about
high energy circuits.



Now you can operate directly from rectified line voltage, reduce current, use fewer components, improve efficiency. All with Delco Radio's new 400V silicon power transistors—DTS 413 and DTS 423. And they're priced low—less than 3¢ a volt even in sample quantities.

A wealth of applications are possible. Vertical and horizontal TV outputs, for instance. High voltage high effi-

RATINGS	DTS 413	DTS 423
VOLTAGE		
V _{CEO}	400 V	400 V
V _{CEO (Sus)}	325 V (Min)	325 V (Min)
V _{CE (Sat)}	0.8 (Max)	0.8 (Max)
	0.3 (Typ)	0.3 (Typ)
CURRENT		
I _{C (Cont)}	2.0A (Max)	3.5A (Max)
I _{C (Peak)}	5.0A (Max)	10.0A (Max)
I _{B (Cont)}	1.0A (Max)	2.0A (Max)
POWER		
	75 W (Max)	100 W (Max)
FREQUENCY RESPONSE		
f _t	6 MC (Typ)	5 MC (Typ)

ciency regulators and converters, single stage audio outputs, to name a few more.

And our standard TO-3 package dissipates more heat (junction to heat sink 1.0°C per watt).

Your Delco Radio Semiconductor distributor has these two new 400V silicon power transistors on his shelf. Call him today for data sheets, prices and delivery.

FIELD
SALES
OFFICES

UNION, NEW JERSEY*
Box 1018 Chestnut Station
(201) 637-3770
SYRACUSE, NEW YORK
1054 James Street
(315) 472-2668

DETROIT, MICHIGAN
57 Harper Avenue
(313) 873-6560
CHICAGO, ILLINOIS*
5151 N. Harlem Avenue
(312) 775-5411

SANTA MONICA, CALIFORNIA
726 Santa Monica Blvd.
(213) 870-8807
General Sales Office:
700 E. Firmin, Kokomo, Ind.
(317) 452-8211—Ext. 500

*Office includes field lab and resident engineer for applications assistance.

DELCO RADIO

Division of General Motors
Kokomo, Indiana

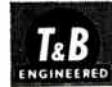

CABLE TYING AND CLAMPING PRODUCTS

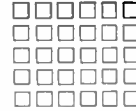

Samples available on letterhead request

NEW TY-RAPTM. METHOD SIMPLIFIES HARNESS MAKING AND CABLE TYING



Fabrication costs are reduced, reliability factors improved

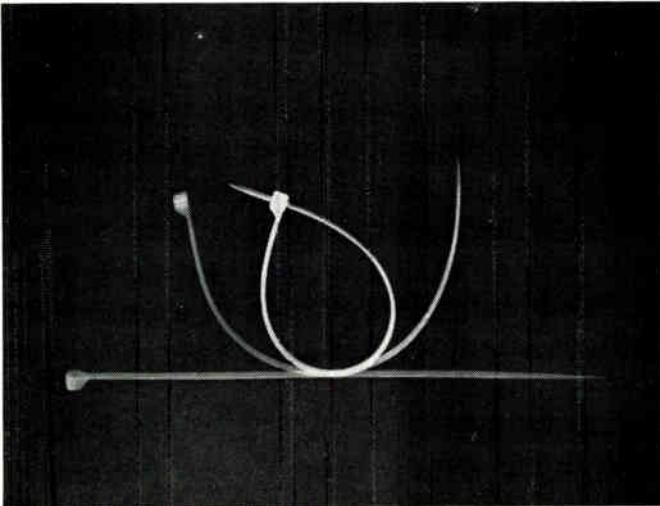

If you have a volume of harnesses or many ties to install you can immediately reduce costs by incorporating the TY-RAP METHOD. It simplifies all the steps in harness making and cable bundling. A step by step time and materials evaluation including the planning, fabrication, inspection and installation, will show you that the TY-RAP METHOD is easier and less costly than any other way. In fact, users of this method have saved over \$8,000,000 in cost reductions of harnessing and point-to-point wire bundling. You will not only record cost savings but the packaging job gains in reliability which is evident with the high degree of inspectability.

To help you evaluate the TY-RAP METHOD, a fully illustrated 40 page brochure is now available. It describes tying, clamping and identifying techniques.



NEW ADJUSTABLE CLAMP FOR MOUNTING COMPONENTS OR WIRE BUNDLES

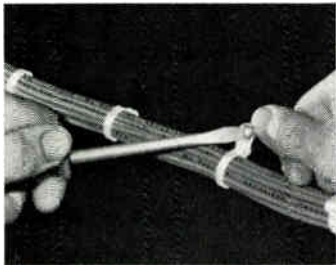

You can eliminate over 60 various sizes of plastic and metal clamps with only one size TY-RAP strap. It is infinitely adjustable over a range from 1/16" to 3-3/4" diameter. The TY-RAP clamp is a TY-RAP tie with the addition of a mounting hole. It is molded of DuPont Zytel 101 (nylon). Since it is a tie as well as a clamp, it can be used as one of your ties during harness fabrication. Harnesses which include TY-RAP

clamps install quickly in equipment and cabinets because they are prepositioned on the harness and eliminate extra components. Over 20 different catalog numbers are contained in the clamping section of the new 40-page brochure.

†Reg. TM of Dupont

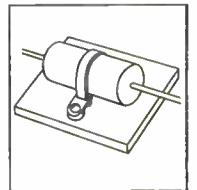

TOOLS FOR HIGH SPEED TYING

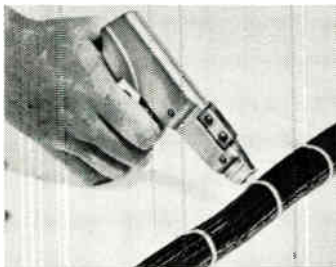

Greatest savings and efficiencies can be obtained with the TY-RAP Method by using the manual or semi-automatic tools. Speed in tying wire bundles ranging from 1/16" to 4" is accomplished in only two operations. One operation positions the ties. Speed tying with the aid of a tool completes the job. Because the tool has a tension control for tying and semi-automatically completes the other functions necessary for

a neat tie, an operator with only a few minutes training can achieve complete tying uniformity.

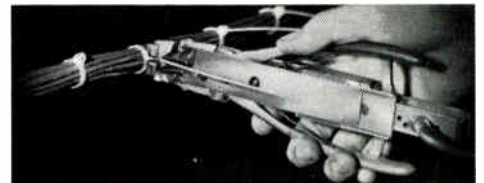

SOLD COAST-TO-COAST THROUGH AUTHORIZED T&B DISTRIBUTORS
The Thomas & Betts Co., Incorporated • Elizabeth, New Jersey
In Canada, Thomas & Betts Ltd. • Montreal



THOMAS & BETTS





PRE-MOUNTABLE MINIATURE CLAMP PRACTICALLY HIDDEN FROM VIEW

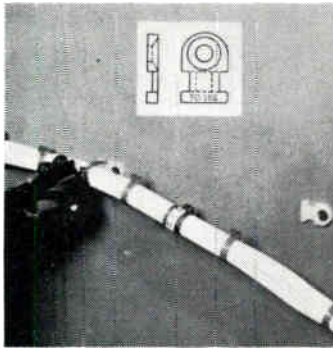

High density electronic packaging and appearance problems are solved with the TY-RAP miniature mount. Harnesses and cables can be tied to these pre-mountable bases with standard TY-RAP ties. The mounts are available in various sizes and accommodate different cable bundle diameters, holding strength up to 50 lbs. Available with screw holes, the mount is easily fastened to chassis. Clamping Section of T&B catalog T66 illustrates over 30 catalog numbers with complete details.



NEW STRAPS IDENTIFY AND TIE

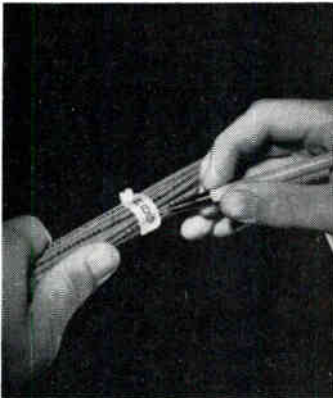

Harnesses, breakouts, cabling, tubes and lab set-ups are easily and quickly tied and identified with TY-RAP Identification Straps. The identification surface is easily marked with pencil, ball point pen, marking pens or heat stamped. Identified wire bundles and harnesses aid trouble-shooting and wire reworking. Since the identifying strap is also a tie, it will not loosen under vibration or stress as can conventional identifying plates. Single and continuous length identification plates are also described in the TY-RAP Identification Section of the 40-page brochure.



NEW SNAP-IN RETAINING CLAMP

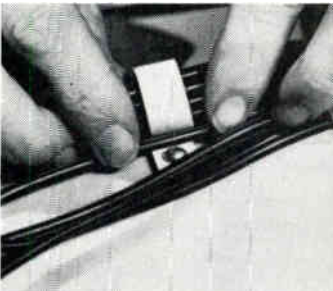

Ideal for supporting long runs of cable in point-to-point wiring. This clamp, TC70 series is available in 5 sizes to accommodate bundles from 1/4" to 1 1/2" in diameter. Wire bundles are quickly snapped into place after the clamps have been mounted in position. These clamps are not only recommended for permanent wiring, but also as a handy device for temporary wiring and bread boarding.



NEW KNOCK-IN MINIATURE MOUNT

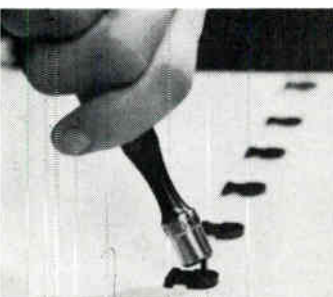

Speed and flexibility are the major benefits of these new knock-in mounting bases. Quick installations are completed simply by knocking in the projecting pin which locks the mount in position. Production flexibility can be achieved by pre-mounting these bases while the harnesses or cable bundles are being fabricated. The clamping section of the new catalog illustrates several types of pre-mountable devices.

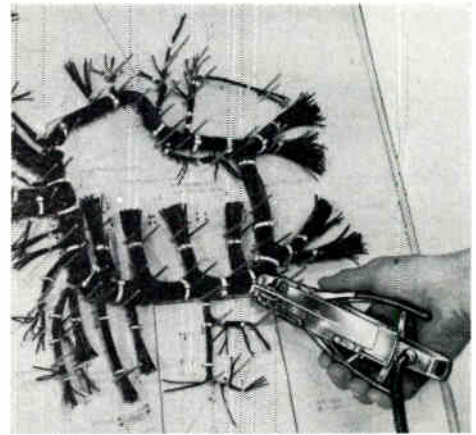

TY-RAP™ METHOD SPEEDS INSPECTION

The fact that each tie is isolated and not dependent on other ties, speeds and eases inspection. A glance at the head of the TY-RAP tie will disclose the tying reliability. In the case of harnesses requiring conductor repositioning or circuit changes, only those ties in the re-work section need be removed. When the wiring is corrected, tie or ties can be quickly replaced.

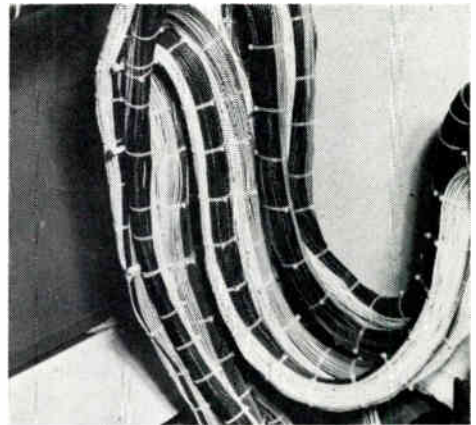

POINT-TO-POINT WIRE BUNDLING SIMPLIFIED

New self-locking TY-RAP ties and manual tools are recommended for field tying and wherever you run wires from one point to another. The photo above is a communications installation which utilizes self-locking ties as well as self-locking clamps and identifying straps.

TY-RAP is a registered trademark of The Thomas & Betts Co. assigned to the line of cable ties, clamps, straps and accessories.

SOLO COAST-TO-COAST THROUGH AUTHORIZED T&B DISTRIBUTORS
The Thomas & Betts Co., Incorporated • Elizabeth, New Jersey
In Canada, Thomas & Betts Ltd. • Montreal



THOMAS & BETTS

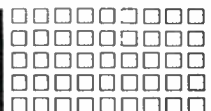

MANDEX

OFFERS YOU THE MOST COMPLETE LINE OF TERMINAL STRIPS

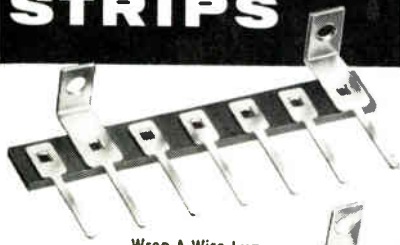

Wrap-A-Wire Lug



Tear-Drop Lug



External "T" Lug



Subminiatures (1/4" Spacing)



Universal Lug



Wire-Grip Lug

High Speed Automated Assemblies Bring You:

- Consistent Quality
- Quick Delivery
- Low Cost

Send prints-specs for prompt quotation... For complete information request

NEW MANDEX GUIDE BOOK TO TERMINAL STRIPS



MANDEX MANUFACTURING COMPANY, INC.
Specialists In Electronic Parts

2618 West 48th St., Chicago 32, Illinois
Circle 75 on Inquiry Card

COMPACT DATA MODEM

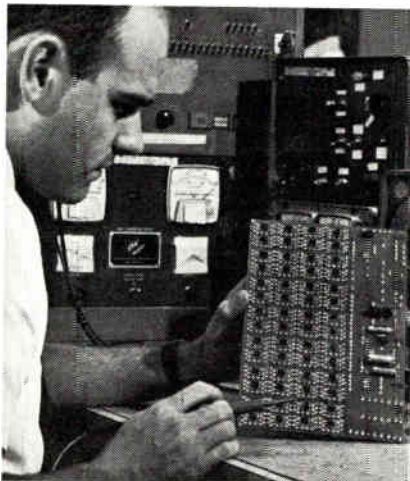

Microminiature data modem (modulator-demodulator), designed by Electronic Communications Inc. to utilize monolithic integrated circuits, accepts digital data and modulates it for transmission over voice channel. Process is reversed as data is demodulated at receiving end. Modem can work at 1300 bits/sec. 2-phase, 2600 bits/sec. 4-phase, is for military or non-military, according to Project Engineer Martin C. Poppe.

KITS PERMIT IN-FIELD WAVEGUIDE FABRICATION

A series of microwave communication rectangular waveguide fabrication kits has been introduced by Gabriel Electronics, division of Maremont Corp. The kits, according to Gabriel, allow on-site adjustments for length or configuration, or last minute line approach changes.

The firm points out that the kits can eliminate factory re-order time element as well as provide the equipment engineer with considerably greater latitude in microwave line layout design. In many cases, the kits can be used for total on-site custom installation.

PHILCO PLANT TO REOPEN

Philco Corp. will reopen its Spring City, Pa., plant in the near future, M. W. Newell, vice president and general manager of the Lansdale, Pa., Division, announced. The present Solid-State Products Operation, and the people associated with it, will be transferred to the Spring City plant.

1,000 COMPANIES HELPED

More than one thousand industrial contractors supplied equipment for NASA's Mariner IV, and scientific experiments aboard the craft were provided by scientists from eight universities.

DEPTH SOUNDER 'SPEAKS,' GIVES DANGER ALARM

A new dimension has been added to electronic depth sounders that already can read and write depth of water. In addition to listening for the ultrasonic pings bounced off the bottom, they're now able to "speak."

Raytheon Company's new depth alarm attaches to a regular Fathometer® depth sounder and animates it by sounding-off should the depth of water shoal become dangerously shallow. The Fathometer will react to any pre-set depth between five feet and 360 feet.

The Raytheon "Sound-Off Sounder" can be used as a navigation aid to alert the boatman to a ridge or other underwater landmark. Setting the alarm to go off at the charted depth of the ridge, he will be "buzzed" when the boat crosses the ridge giving him an opportunity to note the time for position fixing.

NEW MICROWAVE/POWER DEPT. AT RCA COMPONENTS/DEVICES

A new Microwave and Power Devices Operations Department has been established at RCA Electronic Components and Devices in Lancaster, Pa.

RCA officials say the new department combines the activities of the Microwave Tube Operations Department and the Power Tube Operations Department.

In addition, the current Microwave Market Planning function will be consolidated with the Industrial Tube and Semiconductor Marketing Department.

PATENT-LICENSE PACT

Texas Instruments, Inc., has been granted a license to manufacture solid-electrolyte capacitors (condensers) under Sprague Electric Co. patents, it was revealed by a Sprague spokesman. The patent license was described as a "non-exclusive license with royalties." Texas Instruments has agreed to pay Sprague royalties for its past production and sale of solid-electrolyte capacitors.

SOLAR CELL POWER

Electrical power for NASA's Mariner IV was provided by 28,224 solar cells mounted on four panels. The vital directional antenna on Mariner which beamed information back to Earth over millions of miles weighs only 4.5 pounds.

**THERE'S A SMILE
BEHIND THIS MASK.
WHY?**



Comfortable, this 3M Brand Filter Mask. Weighs least of any mask of its kind. So light, it takes seven to make an ounce. Only edges contact face, so the breathing's easy. So is communication. Lint-free! Developed from the 3M Surgical Masks, used extensively in hospital operating rooms. Reusable, yet inexpensive enough to throw away after a day's use. Send for free samples. 3M Company, Dept. COQ-95, St. Paul, Minn. 55119.

3M
BRAND
Filter Mask

3M MINNESOTA MINING & MANUFACTURING CO.
Circle 76 on Inquiry Card

ELECTRONIC INDUSTRIES • September 1965

LOW-CURRENT CAR RADIO



Compact two-way radio for cars uses less than half the current needed for a tail light. Developed by Raytheon for Automobile Manufacturers Association Highway Emergency Locating Plan, the five-channel unit draws so little current that it will operate when a car battery is so far down it will not start the engine, light the headlights, or blow the horn.

**SDS COMPUTERS TO BE MADE
IN ENGLAND AND FRANCE**

Scientific Data Systems will soon become the first computer manufacturer to have its complete line of equipment produced and marketed overseas, it was announced by SDS President Max Palevsky.

Mr. Palevsky said that long-term agreements have been signed granting manufacturing and marketing rights for all SDS computers and related equipment to Compagnie Pour L'Informatique et Les Techniques Electroniques de Controle (CITEC), Paris, France, and The General Electric Co., Ltd., (GEC), Wembley, England.

Both companies, ranked as two of the largest electronic firms in Western Europe, will begin production of the SDS 92, 930 and 9300 computers. The SDS 910, 920 and 925 computers will also be available to customers of GEC and CITEC.

ANTENNA PROCEEDINGS

The Proceedings of the Applications Forum on Antenna Research have been published. The Forum, held in January 1964, brought together top men in antenna research from all over the U. S. Lectures included frequency-independent antennas, data-processing antennas, antennas in anisotropic and moving media, and aperiodic arrays. The Proceedings, 611 pages of text, include 300 figures, and cost \$5.00. Contact Engineering Publications Office, 112 Civil Engineering Hall, University of Illinois, Urbana, Ill.

FREE! NEW!

**NEWARK
1966 INDUSTRIAL
ELECTRONICS
CATALOG**

LISTING

**P & B SOLID
STATE
TIME DELAY RELAYS**

■ Among the many advantages of these new P & B solid state time relays are: time repeatability of $\pm 2\%$, nearly instantaneous (milliseconds) reset, no waiting for thermal elements to cool and no heating problems.

■ Time delays range from 0.1 to 180 seconds. Three modes of timing are available—knob adjustable, resistor adjustable, and fixed.

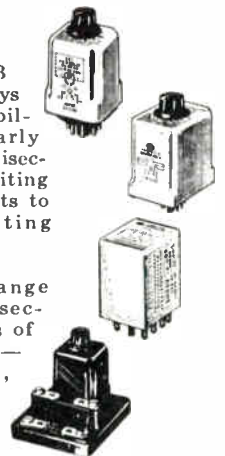

• Immediate Delivery from Stock
Factory OEM Prices

NEWARK CATALOG 85

- Industry's Most Complete Catalog
- 660 Pages • Over 70,000 items
- Over 600 Standard Brand Lines
- Seven Stocking Warehouses
- Over \$6,000,000 Industrial Electronics Inventory

NEWARK ELECTRONICS CORPORATION

Main office and warehouse • Dept. EI
223 West Madison • Chicago, Ill. 60606

Authorized P & B Warehouses in:

CHICAGO, ILL.

(312) ST 2-2944

CINCINNATI, OHIO

(513) 421-5282

DENVER, COLORADO

(303) 757-3351

DETROIT, MICHIGAN

(313) 548-0250

GRAND RAPIDS, MICHIGAN

(616) 452-1411

LOS ANGELES AREA

(213) OR 8-0441

Other Newark Warehouses in:

NEW YORK CITY

(212) 255-4600

Circle // on Inquiry Card

ENCLOSURE
DESIGN
TIME

TOOLING



ELIMINATE FIVE

RAW
MATERIALS
INVENTORY

PRODUCTION

*manufacturing and
sales barriers to
marketing your product or
system and convert your work
force to more profitable pursuits*

HIGH COST PER UNIT

Specify EMCOR[®] I MODULAR ENCLOSURE SYSTEMS

Benefit from EMCOR Modular Enclosure Systems mass production prices. Then by reducing cost per unit, apply savings to sharpen your competitive market price. Eliminate costly custom enclosure design time, tooling, raw materials inventory and production. EMCOR Modular Enclosures and associated components provide virtually limitless enclosure assembly combinations. Request full details. Call EMCOR Sales Engineering Representative nearest you or write direct—no obligation!

Albany: 436-9649; Albuquerque: 265-7766; Binghamton: 723-9661; Boston: 944-3930; Bridgeport: 368-4582; Buffalo: 632-2727; Chicago: 676-1100; Cleveland: 422-8080; Dallas: 631-7450; Dayton: 298-7573; Del Mar, Calif.: 454-2191; Denver: 934-5505; Detroit: 357-3700; Ft. Lauderdale: 564-8000; Houston: 526-2959; Huntsville: 536-8393; Indianapolis: 356-4249; Kansas City: 444-9494; Los Angeles: 938-2073; Minneapolis: 545-4481; New Orleans: 242-5575; New York City: 695-0082; Orlando: 425-5505; Palo-Alto: 968-8304; Philadelphia: 242-0150; Phoenix: 273-1673; Pittsburgh: 884-5515; Seattle: 722-7800; St. Louis: 647-4350; Syracuse-Utica: 732-3775; Tulsa: 742-4657; Fort Lee, N. J.: 944-1600; Valley Forge, Pa.: 265-5800; Washington, D. C.: 836-1800; Winston-Salem: 725-5384.

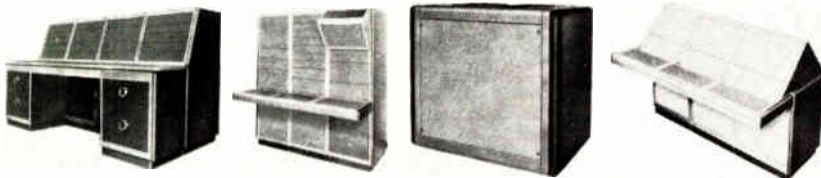

Ingersoll Products 1000 W. 120th St., Dept. 1245, Chicago, Ill. 60643

DIVISION OF BORG-WARNER CORPORATION

electronic
equipment



VISIT US IN BOOTH 1102 AT PRODUCTION ENGINEERING SHOW, CHICAGO

READER SPOOLER

Reader is either unidirectional or bidirectional. Operates at 700 characters/second.

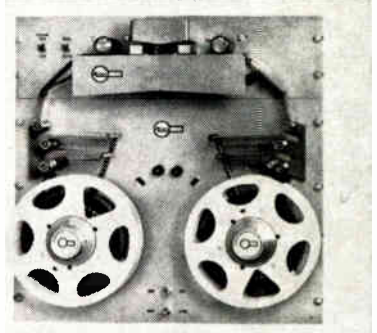

The RR-702 photocell punched-tape reader and the RS-702 tape spooler operate as input devices for numerical control systems, digital computers, automatic drafting machines, automatic circuit evaluators, or other systems requiring reliable high speed punched tape reading. The spooler features bidirectional rewind from pushbutton or remote control at 200 inches second. Rheem Electronics, 5250 West El Segundo Boulevard, Hawthorne, Calif.

Circle 169 on Inquiry Card

SWEEP MEASURING SET

Makes possible rapid and exact sweep measurements up to 15mc.

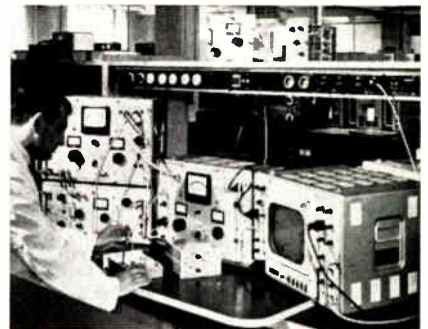

Carrier-frequency sweep measuring set Type Rel 32 M 701 measures the entire carrier systems or parts thereof. Power levels and attenuation (including cross-talk, signal-to-distortion, and signal-to-reflection ratios) are traced as a function of frequency. Measurements are made on specimens with bandwidths from 100cps to 15mc. It has highly accurate, internally calibrated spectrum analysis on carrier and radio systems and voice channel bandwidth for noise evaluation. Frequency can be measured with crystal accuracy anywhere in the frequency range. Siemens America Inc., 230 Ferris Avenue, White Plains, N. Y.

Circle 170 on Inquiry Card

NEW PRODUCTS

FIBRE OPTICS WINDOW

New construction and sealing allows vacuum operations to 10^{-10} Torr.

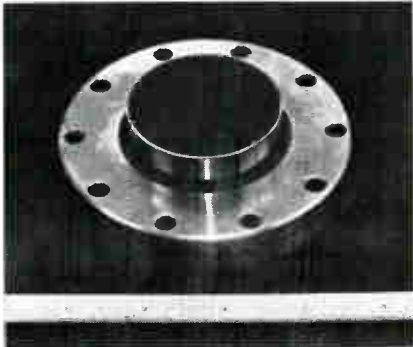

The V4-159 window can be used in conjunction with image intensifiers for low-light level work, and with contact Polaroid camera backs for photographic work. Mounted on a copper gasketed vacuum flange, it is backed by a phosphor screen on a removable pyrex disk. The entire assembly is bakeable to 400°C . Transmission of parallel light is 76%. Resolution is 90 line pairs/mm. Materials Research Corp., Orangeburg, N. Y.

Circle 171 on Inquiry Card

CAVITY AMPLIFIERS

Lightweight high-performance cavity amplifiers for L- and S-bands.

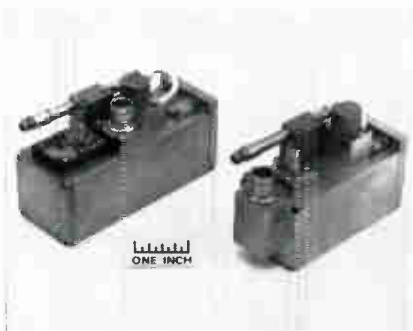

The EM-4539 (1.42-1.6 cc) and EM-4596 (2.2-2.3 cc) cavity amplifiers provide 20 watts CW output each, with 10db minimum gain. Only three field tuning adjustments are required to tune across the bands. Hermetic sealing eliminates altitude and humidity problems, with the amplifiers rated to operate at any altitude. A low-pass filter is included to attenuate all harmonics to at least 60db below the carrier. For maximum flexibility of mounting, all tuning controls, connectors, and the output filter are located on a common slide. Aerospace Products Div., Eitel-McCullough, Inc., 301 Industrial Way, San Carlos, Calif.

Circle 172 on Inquiry Card

POTTING RESIN

For lightweight potting and encapsulation of electronic modules.



Scotchcast brand resin XR-5068 is a one-part, homogeneous, glass bubble filled material. Its porous structure provides lightweight structural integrity, and may also serve as a low density matrix for impregnation with liquid resins. It is ideally suited for corona suppression in the rarefied atmosphere of extreme high altitude or outer space. 3M Company, Dept. D5-389, 2501 Hudson Road, St. Paul, Minn.

Circle 173 on Inquiry Card

SIGNAL GENERATOR

FM signal generator covering 470 mc to 960 mc in one continuous band.



Model 1060/3 has a drift of less than 50 ppm/ten minutes and delivers an output of 0dbm into 50 ohms with accurate attenuation to -130 dbm. The tuned line oscillator operates on fundamentals with no subharmonics. Carrier harmonics are below 2% distortion factor. Three ranges of FM deviation are provided with full scale values of $\pm 30\text{kc}$, $\pm 100\text{kc}$ and $\pm 300\text{kc}$. Internal modulation is at 1kc and the external modulation bandwidth extends from 30cps to 100kc; 5 volts provides 300kc deviation. A 1kc AM tone of 30% mod depth can also be selected. Marconi Instruments, 111 Cedar Lane, Englewood, N. J.

Circle 174 on Inquiry Card

GLASS ENCLOSED AMPERITE

Thermostatic DELAY RELAYS

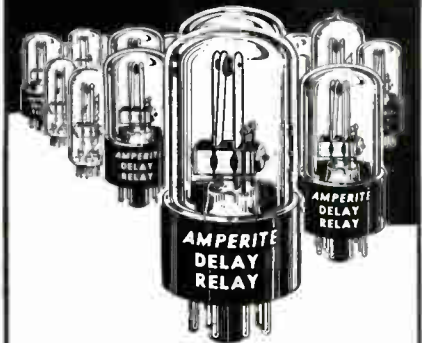

Offer true hermetic sealing
-assure maximum stability and life!

Delays: 2 to 180 seconds . . . Actuated by a heater, they operate on A.C., D.C., or Pulsating Current . . . Being hermetically sealed, they are not affected by altitude, moisture, or climate changes . . . SPST only—normally open or normally closed . . . Compensated for ambient temperature changes from -55° to $+80^{\circ}\text{C}$. . . Heaters consume approximately 2 W. and may be operated continuously . . . The units are rugged, explosion-proof, long-lived, and—inexpensive!

TYPES: Standard Radio Octal, and 9-Pin Miniature.
List Price, \$4.00

PROBLEM? Send for Bulletin No. TR-81

AMPERITE

BALLAST REGULATORS

Hermetically sealed, they are not affected by changes in altitude, ambient temperature (-50° to $+70^{\circ}\text{C}$), or humidity . . . Rugged, light, compact, most inexpensive.

List Price, \$3.00

Write for 4-page Technical
Bulletin No. AB-51

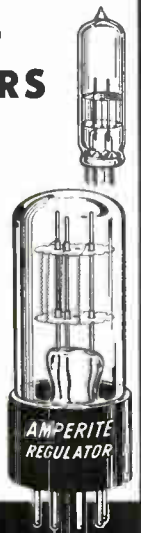
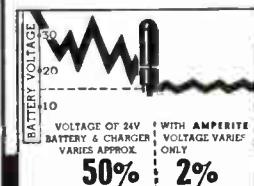

AMPERITE

600 PALISADE AVE., UNION CITY, N.J.
Telephone: 201 UNION 4-9503
In Canada: Atlas Radio Corp., Ltd.,
50 Wingold Ave., Toronto 10

Circle 78 on Inquiry Card

Profit By America's Broadest Stock of Standard Magnetic Lamination Dies

LET **HOWCOR**
TOOLING SAVE YOU
TIME AND MONEY

Whatever the application, the chances are you will find in HOWCOR-owned dies a size and type exactly suited to your needs. Reduces your lamination costs, speeds delivery of quality-controlled HOWCOR laminations. For proof, consult our new catalog, mailed on receipt of the coupon below.

Please send us the catalogs checked:

HOWCOR Motor Lamination Catalog

HOWCOR Transformer Lamination Catalog



NAME _____

ADDRESS _____

CITY _____ STATE _____ ZIP _____

HOWCOR
LAMINATIONS
A Division of Howard Industries, Inc.
3912 McLean Ave., Chicago, Illinois 60647

Circle 79 on Inquiry Card

NEW PRODUCTS

CRYSTAL-CAN RELAY

Half-size latching relay has 90mw standard transfer power.

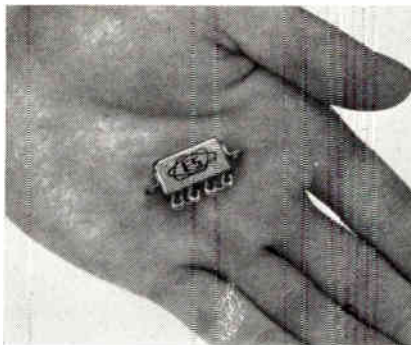

Model 55R meets all requirements of Mil-R-5757D. A main feature is the use of all-welded sealing. It has 10 μ a dry circuit and 2 amp high-level contact ratings; contact operate time is 5.0 msec max. The relay is 0.800 x 0.400 x 0.400 in. without flanges and weighs 0.35 ounces. Min. dry circuit life is 5 million operations at 10cps. Electronic Specialty Co., 4561 Colorado Boulevard, Los Angeles, Calif.

Circle 177 on Inquiry Card

MAGNETIC TIMER

Eliminates first cycle error. Time ranges from milliseconds to years.

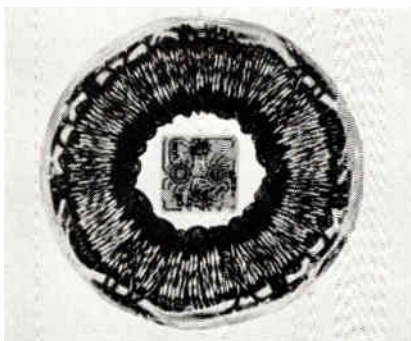

The first cycle effect error is often as much as 25% of the total delay setting. It is inherent in all circuits employing tantalum timing capacitors and unijunction transistors. These magnetic timer units substitute a differential amplifier section for the unijunction transistor used for measuring time in typical R-C timers. The accuracy of the oscillator periods, combined with the inherent stability of the magnetic core which multiplies these periods, produces delays of outstanding repeatability. Neither off-time, prolonged storage or aging have any measurable effect. Elastic Stop Nut Corporation of America, Elizabeth Division, Elizabeth, N. J.

Circle 178 on Inquiry Card

DUAL OUTPUT AMPLIFIER

Suitable for driving wideband and narrowband devices simultaneously.



The Model 3630 is a 3-wire, dual-output direct-coupled differential amplifier. Wideband output has a full-scale load current of 100ma at ± 10 volts; variband output has a passband that is switch selectable from 10cps to full bandwidth and a full-scale load current of 10ma. Shorting or grounding the variband output does not affect the wideband output. Dana Laboratories, Inc., Irvine, Calif.

Circle 179 on Inquiry Card

AUTOMATED WELDING

Welds flat packs to printed circuit board assemblies automatically.

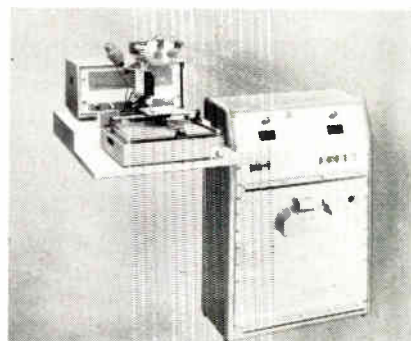

This numerically controlled unit incorporates a parallel gap micro-welder and positioner in an integrated system. The control unit houses the manual positioning controls, the block tape reader, a tape punch programmer and associated power supplies. The welding system prepares programming tapes by visually positioning the work to be welded using the manual controls. At each set of coordinates a button is pushed which punches out the complete block of information onto the tape. Welding speeds of up to three connections/second are possible. Arvin Systems, Inc., Department DMP, 506 South High Street, Yellow Springs, Ohio.

Circle 180 on Inquiry Card

BARNSTEAD AUTOMATIC REGENERATION CUTS COSTS

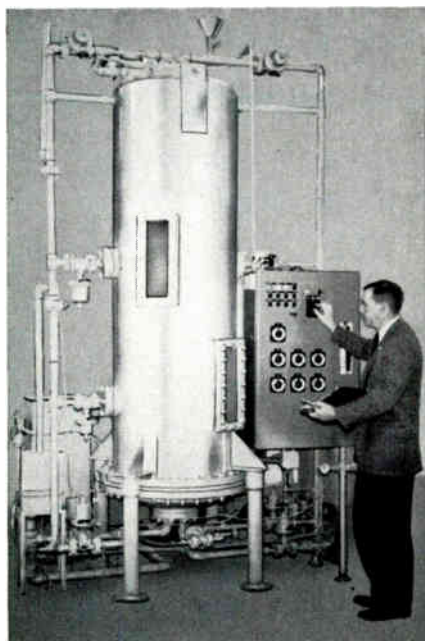

Users of demineralized water can save many man-hours in regeneration time with a Barnstead fully automatic demineralizer that regenerates itself. Operating costs are lowered — labor costs are reduced — and consistent quality of demineralized water is insured. Many other exclusive features such as individual adjustable timers for each step. Any step can be repeated or bypassed. Either resin can be regenerated separately if desired.

WRITE

For Catalog 160 and Bulletin 202. They describe the complete line of Barnstead "Automatic Regeneration" Demineralizers. Add this free literature to your "Pure Water" file.

Barnstead
STILL AND STERILIZER CO.

48 Lanesville Terrace, Boston 31, Mass.
New York, Philadelphia, Washington,
Atlanta, Cleveland, Detroit, Chicago,
St. Louis, San Francisco, Los Angeles

Circle 80 on Inquiry Card

ELECTRONIC INDUSTRIES • September 1965

NEW PRODUCTS

GLASS FLAT PACK

Two-transistor glass flat pack has inner dimension of 0.140-in. sq.

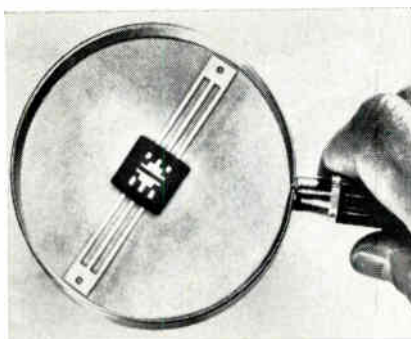

This six-lead package is supplied with gold-plated Kovar leads hermetically sealed into the dual-pad case, along with a Kovar lid glazed with low expansion sealing glass. The customer makes a hermetic seal between the glazed lid and the glass case after inserting devices. The glass is black so that it blocks out infrared and visible radiation. Besides transistors, the package can be used for hermetic protection of other miniature devices. Corning Glass Works, Corning, New York.

Circle 181 on Inquiry Card

TIME-PULSE GENERATOR

Measures electrical length of coaxial cable with sub-nsec. accuracy.

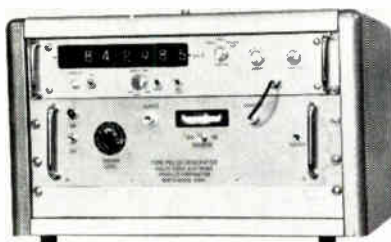

This unit consists of an avalanche pulse generator and 6 digit frequency counter. It is designed for high-precision measurement of the relative electrical lengths of similar cable assemblies. It may also be used to determine the absolute electrical length of cable. In the area of relative measurements, cable assemblies may be matched with the time pulse generator to 1 part in 10^4 or 0.1 nsec., whichever is greater. Absolute measurements, with calibration curve, can be achieved to 2 parts in 10^4 or 0.2 nsec., whichever is greater. A separate curve is required for each cable type. Phelps Dodge Electronic Products Corp., 60 Dodge Avenue, P. O. Box 187, North Haven, Conn.

Circle 182 on Inquiry Card

You'll forget to worry
about component
heat,

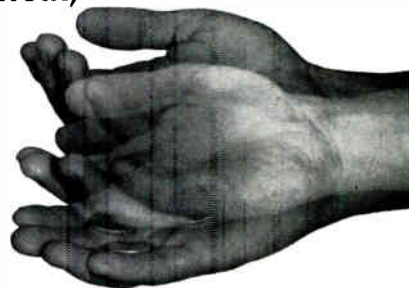

and just gloat
over your savings...

...with IERC tube shields
and semiconductor
heat dissipators



Longer component life, higher operational efficiency, and greater reliability. They add up to quite a savings. And, increase your competitive advantage. IERC saves you even more. New IERC Thermo-Rel shields, for example, are the lowest-priced heat-dissipating tube shields ever! And, typical IERC semiconductor heat dissipators cut size by $\frac{1}{3}$ and weight by $\frac{2}{3}$ over competitive models, yet cool components faster! Circle our number on the inquiry card to get more data on heat dissipators and tube shields with extra savings from IERC.

 more problem solvers from IERC

 Heat Transfer Meter, Model 5900
Provides fast, convenient means of measuring heat transfer characteristics, thermal resistance, thermal mass, and serves as constant temperature source. One instrument does all.

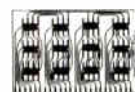

WELDED
MICRO-CIRCUIT
PACKAGING



MILLRICH
SPACE-AGE
MACHINING

TELEMETRY
AND ELIN
POWER SUPPLIES



HENCO
PROTECTIVE
COATINGS

Dept. EI-965

IERC

INTERNATIONAL ELECTRONIC
RESEARCH CORPORATION
135 W. Magnolia, Burbank, California 91502

A  DCA SUBSIDIARY

Circle 81 on Inquiry Card

NEW PRODUCTS

WAVE METERS

Absorption-type meter is tunable over full octave ranges from 50mc to 4gc.

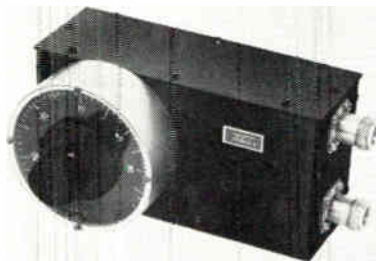

Series TWM are ideal for determining unknown frequencies, for frequency marking in swept frequency applications, and as a means of identifying spurious signals. Accuracy is $\pm 0.2\%$ with 0.5db maximum insertion loss. They are essentially broadband devices, consisting of high Q, capacitively-tuned cavities. Incoming signals are passed through a matched transmission line while the sample is absorbed by the cavity at resonant frequency only. Telonic Engineering Co., 480 Mermaid Street, Laguna Beach, Calif.

Circle 183 on Inquiry Card

MICROCIRCUIT CARDS

Prepatterned cards can be supplied for either TO-5 cans or flat packs.

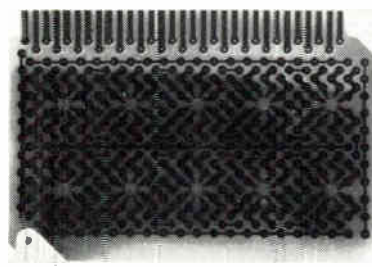

The ADC 13-8 series microcircuit mounting cards meets every microcircuit breadboarding problem and provide a convenient and economical means of circuit support for small production runs. The new cards are available in a number of configurations, including blank, general pattern, terminal, extender, grid and general purpose. They are supplied for connectors with 31 or 62 pins as required. The wide range of cards includes those designed for complete freedom of interconnection, as well as types which are prepatterned and interconnected for rapid assembly. Applied Development Corp., 1131 Monterey Pass Road, Monterey Park, Calif.

Circle 184 on Inquiry Card



DESTRUCT BUTTON NEEDED

WITH KELVIN HIGH RELIABILITY PRECISION WIRE-WOUND RESISTORS

Assured reliability—the reason why Kelvin is the prime or sole source for precision wire-wound resistors on many of the nation's most important high reliability missile and space programs. Kelvin resistor superiority in high reliability specifications is indicated in the following typical test data:

TEST	38101/12A	"HRL" SERIES	
	Maximum	Average	Maximum
Short Time Overload	$\pm .05\%$.0012%	.0080%
Temperature Cycling	$\pm .1\%$.0014	.0100
Moisture Resistance	$\pm .1\%$.0072	.0192
Dielectric Strength	$\pm .05\%$.0010	.0013
Terminal Strength	$\pm .05\%$.0001	.0004
Failure Rate	$\pm .2\%$.0150	.0240
Shock	$\pm .05\%$.0008	.0010
Vibration	$\pm .05\%$.0007	.0020

"HRL" SPECIFICATIONS

Kelvin Type	Watt- age	Resistance Maximum	Dia. $\pm .015$	Length $\pm .015$	Max. Volts	Lead Dia.
HRL-20	.08	25K	.187	.375	150 V	#22
HRL-1009	.125	50K	.250	.295	150 V	#22
HRL-1097	.125	90K	.193	.500	150 V	#22
HRL-417	.125	125K	.250	.343	150 V	#20
HRL-467	.150	225K	.250	.500	150 V	#20
HRL-334	.200	350K	.375	.500	300 V	#20
HRL-812	.250	500K	.250	.750	300 V	#20
HRL-815	.333	750K	.375	.750	300 V	#20
HRL-1100	.500	600K	.312	.812	300 V	#20
HRL-254	.500	1.5meg	.375	1.000	600 V	#20
HRL-27	.750	2.0meg	.500	1.000	600 V	#20

Kelvin's "HRL" Series Resistors were designed to achieve a failure rate of .005%/1000 hours at a 90% confidence level. All data is based on life tests conducted at full rated power at 125°C for a minimum of 1500 hours. No "acceleration factors" are used. Present failure rates are .008%/1000 hours at a 60% confidence level.

Write for Bulletin "HR-04" for complete data on Kelvin's "HRL" Series High Reliability Resistors.

SEE OUR SPECIFICATIONS IN
VSMF
THE MICROFILM CATALOG FILE



Circle 83 on Inquiry Card

ELECTRONIC INDUSTRIES • September 1965



Adlake

makes
more kinds of
mercury relays
than anybody



Send
for a
free
catalog.

A recent addition to the Adlake line: the polarized bi-stable mercury wetted contact relay, pictured above, which delivers speeds up to 100 operations per second. Others include: time delay; load (contacts open or closed); wetted contact (including epoxy encapsulated and sensitive non-bridging).



**THE ADAMS &
WESTLAKE COMPANY**

Elkhart, Indiana

Dept. R-2809 Relay Division
Dial Area 219 Congress 4-1141
Circle 82 on Inquiry Card

SWITCHCRAFT QUALITY ELECTRONIC COMPONENTS

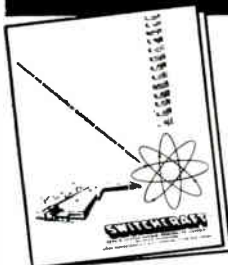

Select the
Jack, Plug
or Switch
Needed for
Your
Application

Switchcraft manufactures Jacks, Plugs, Connectors, Manual Switches, Ganged Switch Assemblies and Stack Switches. Special Purpose Patch Cords and Molded Cable Assemblies.

JACKS AND PLUGS

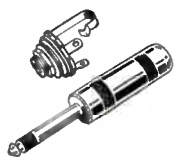

Dependability, low cost with consistent quality. One piece Plug tip rod is mechanically locked and centered to provide dependable connection with Jack. Jacks hold mating plug firmly—no shifting of parts. Special nickel silver provides maximum spring life.

LEVER-SWITCHES

The largest selection of Lever-Switches in the industry offering the first illuminated lever switch, the "Lever-Lite". Available in various circuits, locking and non-locking types and permanent lock type, such as the "Lever-Lock". There is a Switchcraft Lever-Switch in single or multiple stations ("MLK") to meet every application.



BUTTON AND PUSH BUTTON SWITCHES

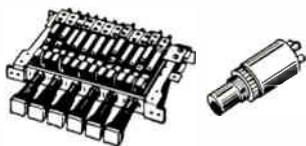

Developed by Switchcraft in single and multiple station types for industrial, commercial, communication and audio equipment. Illuminated or non-illuminated in a wide variety of contacts, switching circuits, stations, mounting centers, lamp voltages and switching functions. For all applications where dependable leaf-type switching is needed.

JACK PANELS — PATCH CORDS



Aluminum and black phenolic type Jack Panels support Switchcraft "T-Jax" and "MT-Jax". Single and double row panels accommodate up to 52 Jacks. Quality Patch Cords for connection to broadcast, telephone and communication panels. Utilizes superior nylon cord. Available with 2-conductor and 3-conductor plugs or "Twin-Plugs". Shield connected to both ends or only one end.

PHONO JACKS, PLUGS, CONNECTORS

Microphone and Miniature Connectors, "Y" Connectors, "RF" Jacks and Plugs, Phono Jacks and Plugs. Used extensively in record players, sound equipment, tuners, tape recorders and microphones.

MOLDED CABLE ASSEMBLIES

An extensive line of Phone and Phono Plugs, Extension Jacks, Mic Connectors and "Y" Junctions molded directly to various types and lengths of Cable. Flexible manufacturing methods make possible a virtually unlimited variety of Molded Cable Assemblies.

Write for Catalog.

SWITCHCRAFT®

5599 N. ELSTON AVE., CHICAGO 30, ILL.

Circle 116 on Inquiry Card

ELECTRONIC INDUSTRIES • September 1965

NEW PRODUCTS

GALVANOMETER

Sensitivity of $2\mu\text{a}/\text{scale division}$;
take a million-to-one overload.

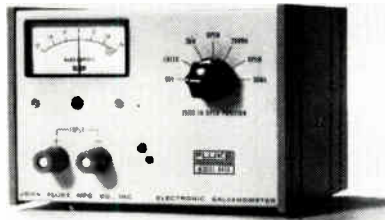

This solid state electronic galvanometer eliminates external damping requirements. The unit may be operated in any position. Recorder output is provided. The galvanometers are available in Models 841 A & B for laboratory use, or 840 A & B for OEM applications. The "A" models have an input resistance of 180 ohms on three ranges of $\pm 30\text{na}$, $\pm 300\text{na}$, and $\pm 3\text{na}$. "B" models have an input resistance of 18 ohms; $\pm 100\text{na}$, $\pm 1\mu\text{a}$, and $\pm 10\mu\text{a}$ current ranges. Fluke Mfg. Co., Box 7428, Seattle, Washington.

Circle 185 on Inquiry Card

VHF/UHF POWER SOURCE

Joins semiconductor and
electron tube technologies.

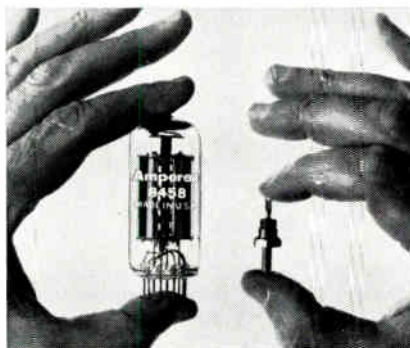

Using the Amperex 8458 twin tetrode as a driver and the Amperex IN4885/H4A silicon-planar epitaxial varactor as a frequency tripler, 22 watts at 450mc is obtained at a much greater efficiency and lower cost. The basic specifications of the IN4885/H4A are: efficiency 70%; breakdown voltage 150 volts; series resistance 0.7 ohms; and a capacitance range of 29 to 39 pf. The basic specifications of the 8458 are: plate voltage 600 volts; plate current 120 ma; screen voltage 180 volts; and a drive power of approximately 3 watts. Amperex Electronic Corporation, Hicksville, Long Island, New York.

Circle 186 on Inquiry Card

Induction Heating's Most Trusted
and Creative Craftsmen Since 1926

Lepel

INDUCTION HEATING FOR EPITAXIAL GROWTH

- Minimum contamination since induction coil is outside the decomposition chamber.
- Uniform and controlled growth of the epitaxial layer.
- Design flexibility of gas chamber.
- High production—large number of wafers processed simultaneously.

Arrangement for induction
heating within bell jar...



another arrangement
using quartz tube...



Many solid state devices used in the Electronic, Computer and Aerospace industries depend upon material produced by Epitaxial Growth. Several methods have been developed for decomposition of the carrier gas to form an epitaxial layer on the substrate. Induction heating has been found most effective, particularly when high temperatures are required.

The silicon wafers are heated to decomposition temperature of the silicon tetrachloride by conduction and radiation from the graphite susceptor which is heated by the induction coil, producing the epitaxial layer on the wafers.

WRITE FOR NEW LEPEL CATALOG

Lepel HIGH FREQUENCY LABORATORIES, INC.

Manufacturers of INDUCTION HEATING EQUIPMENT
55th ST. & 37th AVE., WOODSIDE 77, N. Y. C.

Circle 84 on Inquiry Card

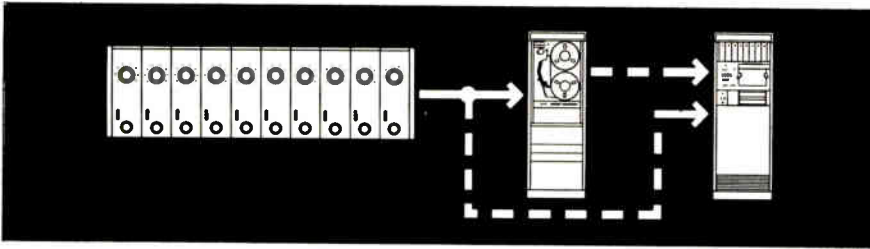

Flexible Way to Amplify, Store and Display Low Level DC-75KC data

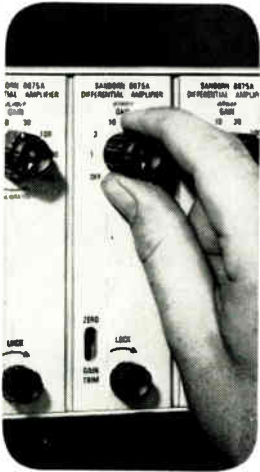

1000X Amplification, high common mode rejection

new wideband, chopper-less, all-solid-state, differential DC amplifier precisely measures thermocouple, strain gage and similar DC outputs. Unmatched in 0.01% non-linearity, $\pm 0.1\%$ gain accuracy, $\pm 0.01\%$ gain stability and 120 db c.m. rejection (dc — 60 cps, up to 1K source imped. in either side of input) — for \$495. including the power supply. Ten of these compact units rack- or case-mount in only 5" x 19" of panel space, deliver 10v across 100 ohms with up to 1000' of cable, to drive magnetic tape recorder, oscillograph, etc. as described at right.

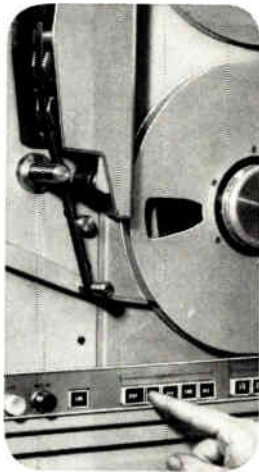

IRIG-compatible tape recording at lower cost

with 7- or 14-channel 3900A Series systems following 8875A Data Amplifiers. Record at 1 $\frac{1}{2}$ to 60 ips, push-button-selected tape speeds, from 100-100,000 cps in direct mode; 3 db response, better than 40 db signal/noise ratio rms at 60 ips. Integral footage counter accurate to 99.95%, plug-in solid state amplifiers, snap-on reels, no maintenance except occasional tape path cleaning. Fully-compatible with other IRIG-standards instrumentation, at basic system prices from \$6,185 (7 channels), or \$8,415 (14 channels), plus desired electronics. Store all your low level data signals on 3900A-recorded tape, then see . . .

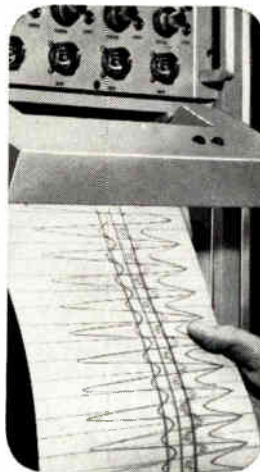

High resolution graphic recordings immediately

made by slow-speed playback of taped signals into the new 8- to 24-channel 4500 Series dc-5kc optical (ultraviolet) oscillograph. Improved optical writing system and charts produce high contrast traces which may occupy entire 8" chart width, overlap, be positioned along a common baseline or anywhere on the chart. Traces clearly readable in room light immediately following recording, may be permanently preserved by chemical fixing. Entire dc-5 kc frequency range covered by one set of galvanometers, eliminating separate galvanometer inventories and tedious changes. Trace resolution aided by choice of 9 pushbutton chart speeds, 0.25 to 100 inches/sec.; full width time lines, amplitude lines partially or wholly removable, sequential trace interruption for trace identification. Complete 8-channel systems from \$6,950.

For complete specifications and application help, call your local HP/Sanborn field engineering office, or write: Sanborn Division, Hewlett-Packard Company, 175 Wyman Street, Waltham, Mass. 02154.

**HEWLETT
PACKARD**  **SANBORN
DIVISION**

NEW PRODUCTS

TRUE RMS DIGITAL METER

Precise and easily readable measurements from 1000vac to 0.1vac to within 1%.

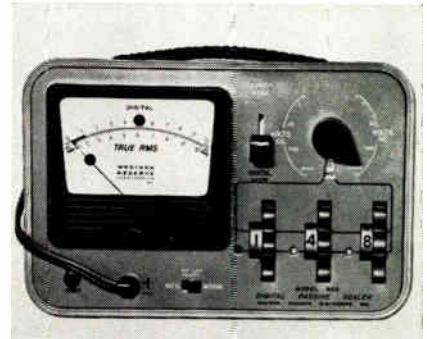

Model 320 provides true RMS measurements of complex waveforms. It uses a digital passive scaler system for direct true RMS measurements; thus it does not require the care usually associated with delicate thermocouple devices. Basic frequency response is 10cps to 100kc, through 10v, within 1%. The extended frequency response is 1mc, within 5%, to provide for broad crest factor utilization and excellent pulse characteristics. Western Reserve Electronics, Inc., 12430 Euclid Avenue, Cleveland, Ohio.

Circle 187 on Inquiry Card

ELECTROMETER AMPLIFIER

Provides an output of ± 100 volts at current up to 10ma.

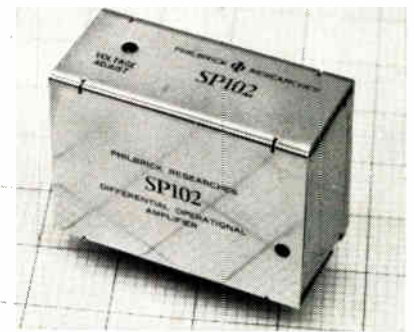

Model SP 102 differential operational amplifier has fully-floating guarded inputs with effective input impedance greater than 10^{12} amperes. It accepts input signals having common-mode range greater than ± 200 volts. It combines the properties of an "almost-electrometer" input with the dynamic range of 100-volt level computing circuitry, and the low noise, small voltage offset, miniscule common-mode error and insignificant power consumption usually available only in low-voltage solid-state systems. Philbrick Researches, Inc., Allied Drive at Route 128, Dedham, Mass.

Circle 188 on Inquiry Card

NEW PRODUCTS

COAXIAL SWITCHES

For ECM receiver switching and low-power antenna switching in phased arrays.



The 3503, 3504, and 3505 are single-pole single-throw microwave switches. They operate over the range 500mc to 12.4gc with isolation minima ranging from 25db at 500mc to 45db at 12.4gc. Insertion loss of all units at 500mc is 0.4db maximum and at 12.4gc is 1.5db maximum. The availability of alternate r-f connectors and bias polarities provides the circuit designer significant flexibility of choice in switching, attenuation, and modulation uses. HP Associates, 620 Page Mill Road, Palo Alto, Calif.

Circle 189 on Inquiry Card

PROGRAM SIMULATOR

Capable of simulating any known format, regardless of complexity.

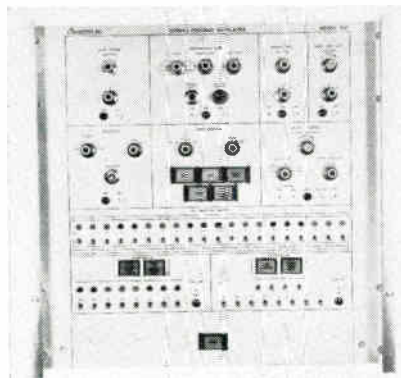

The Model 513 is designed to evaluate, check out, and calibrate PCM, PAM, and PDM decommutation systems, digital or video tape systems, digital and analog computers, quick-lock devices, XY plotters, and telemetry data processing routines. It consists of a 20 x 256 core memory, an 8-bit address register, a 20-bit input/output register, and various generating circuits. Word and frame length is limited only by the ultimate capacity of the memory, and multiple formats may be stored simultaneously. Telemetrics, Inc., 2830 S. Fairview, Santa Ana, Calif.

Circle 190 on Inquiry Card

ONE SOURCE FOR ALL YOUR RECORDING NEEDS

Rustrak

MINIATURE
STRIP CHART
RECORDERS

Rustrak analog recorders are specially designed to record information accurately and dependably. In spite of their low cost, they are precision instruments housed in a rugged aluminum case. The motor drive mechanism, galvanometer, and writing system will give many years of service under extremely rough usage. The Rustrak line includes AC or DC voltage and current recorders; event recorders; temperature recorders; controlling systems; AC and DC amplifiers; multirangers. Rustrak features include:

- Inkless, pressure sensitive writing system.
- Records 1" per hour for 31 days.
- Chart speeds from 1/4" per hour to 1800" per hour.
- Reroll, write-in and tear-off models.
- AC synchronous motors for any standard voltage or frequency; DC motors which consume only milliwatts of power.
- Miniaturized: 3 3/8" wide, 5 5/8" high, 4 1/8" deep; only 3 1/2 lbs.
- Portable or panel mount.
- Engineering facilities to meet your specific needs.



MODEL 88
0-1MA
\$79.50

Rustrak
INSTRUMENT COMPANY, INC.
A SUBSIDIARY OF GILTON INDUSTRIES
Municipal Airport, Manchester, N. H.
Tel 603 623-3596 TWX 603 623-3343

Circle 86 on Inquiry Card

Distinctively Styled

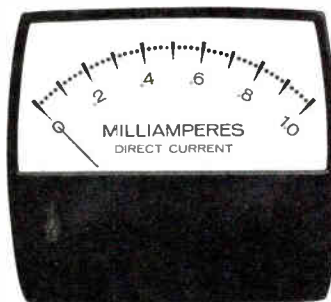

1 1/2 in. AM-1 (actual size)

high torque, self-shielded panel meters

Clean, modern styling... easy scale readability... sizes 1 1/2 to 4 1/2". High torque mechanism gives 1% linearity, 2% accuracy and sensitivity to 20 ua. Magnetic system completely shields external field influences, permitting bezel-to-bezel mounting on any material without interaction or effect on calibration. Choice of colors or finishes, custom dials—ASA/MIL 4-stud mtg.

AMMON

AMMON INSTRUMENTS, INC.
345 Kelley Street, Manchester, N. H. 03105
Circle 87 on Inquiry Card

CHRISTIE
SINCE 1929

"TRANSIENT FREE"

D-C POWER SUPPLIES
100-200-250-400-600 AMP

Military & RFI Specs
Also Mobile & Rack

15 to 36 volt d-c
50 microsec
Response

F. L. Regulation:
Static: .01%
Dynamic: .5v



Also 200 other Models of Power Supplies
and Battery Chargers. Write for Catalog.
CHRISTIE ELECTRIC CORP.
3408 W. 67th St., Los Angeles 43, Calif.

Phone (Code 213) 750-1151

Circle 88 on Inquiry Card

For Design Latitude... Specify T & S Engineered Laminations

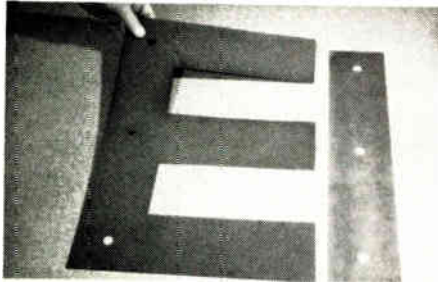

T&S Giant Lamination, 3.60 three phase type.

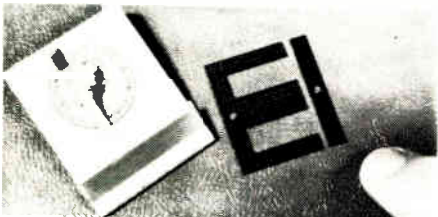

This $\frac{3}{8}$ " single phase lamination is the smallest standard manufactured by Thomas and Skinner.

When it comes to transformer laminations, T&S offers the widest range of standard sizes in the industry today. Designed within scrapless dimensions, T&S Laminations provide most efficient use of core material... avoid special die costs... permit use of standard mounting hardware. Write for descriptive literature on the T&S Laminations that suit your need...

THIN LAMINATIONS... 4 & 6 mil Orthosil® (grain oriented Silicon Iron). Bulletin L502

WIDE WINDOW LAMINATIONS... For high frequency applications. Bulletin L513

CENTRA-GAP LAMINATIONS... Specially engineered for Reactor Transformers. Bulletin L514

GIANT LAMINATIONS... Largest standard sizes in the industry. Bulletin L-501

3 () LAMINATIONS... A T&S development. Bulletin L514

Mr. Magnetician, symbol of over 60 years T&S experience in the field of magnetics.



CERTIFICATION OF MAGNETIC QUALITY

Thomas and Skinner is the first manufacturer to provide certification of magnetic quality with each lamination shipment. All T&S laminations are tested and certified under ASTM A-346-58 specification. The T&S material certifications provide volt amperes per pound, core loss and material lot number. The material lot number identifies and serves as a control on each lot. The material certification is forwarded with the invoice and a duplicate copy is forwarded with the packing slip covering the shipment. Our quality control system conforms to MIL-T9858.

Thomas & Skinner, Inc.



Box 103
1120 EAST 23RD STREET
INDIANAPOLIS, INDIANA 46207
PHONE 317-WA 3-2501

Circle 89 on Inquiry Card

NEW PRODUCTS

RF TESTER

R-F semiconductor tester measures wide range hfe and power gain.

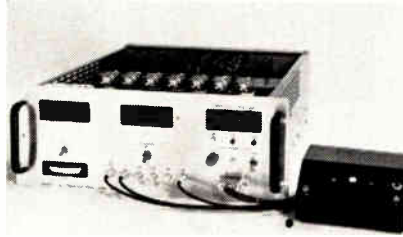

Model 7515S is a bench or rack mounted instrument that tests transistors and other semiconductor devices over a range of 30 to 150mc. Accuracy is ± 0.5 db. The tester is a basic self-balancing digital bridge built using silicon planar devices and high-performance frequency attenuators. It features easy digit switch programming, direct readout, GO/NO-GO programming and data logger adaptability. Fairchild Instrumentation, 750 Bloomfield Avenue, Clifton, N. J.

Circle 191 on Inquiry Card

WAFER SCRIBER

Completely automates and motorizes the indexing and scribing operations.

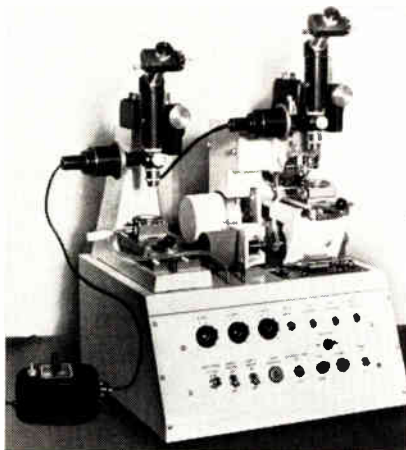

The Model 752 wafer scriber travels at a maximum of 3 ips and virtually eliminates indexing time, producing a typical 40 scribe line per minute. The machine, when adjusted to the diameter of the wafer, uses a built-in pre-set limit switch to stop the scribing operation at the end of the wafer. The operator then rotates the chuck 90°, reverses the direction of the index, realigns the wafer and completes the scribing. The indexing accuracy is ± 0.00020 in. over a $1\frac{1}{8}$ in. traverse. The unit will accept wafers up to a $1\frac{1}{8}$ in. diameter. Kulick & Soffa Mfg. Co., Fort Washington, Pa.

Circle 192 on Inquiry Card

Columbia Wire

The Source That's Geared for

"Specials"

Columbia Wire is specifically geared for producing special wire orders. These include custom molding (plastic and rubber) • braiding and shielding • harnesses • marked or numbered leads • extension cords • cut leads with terminals • assemblies • automatic terminal attaching • wire stripping • power cord sets.

Columbia also warehouses millions of feet of cord and cable... U/L and C.S.A. listed. Included is air conditioner cable ■ automotive cable ■ coaxial cable ■ hi-temp wire ■ hook-up wire ■ hi-voltage wire ■ general purpose wire ■ inter-com wire ■ juke box speaker cable ■ microphone cable ■ shielded cable ■ shielding braided copper ■ shielded multi-conductor cable ■ speaker cable ■ test lead wire ■ tinned copper-solid ■ U/L service cord ■ Teflon ■ mil-spec hook-up wire ■ mil-spec cable ■ heater cord ■ breaker tube cord sets ■ foreign cord sets.

No matter what your next wire need is, Columbia can fill it... promptly, with careful attention.

Write for Catalog 111



Columbia

WIRE & SUPPLY CO.
2850 IRVING PARK RD.
CHICAGO 18, ILL.

Circle 90 on Inquiry Card

NEW PRODUCTS

TWO-POLE RELAY

Contacts rated for 100 K operations at 1/2a. In TO-5 case.

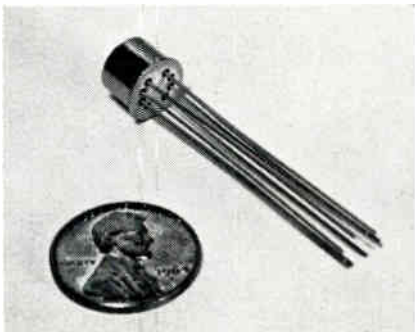

Series 412 relay is a DPDT non-latching unit employing all welded construction within a standard TO-5 type enclosure. It has a volume less than 0.025 cubic inches and weighs 0.09 ounces. Designed for continuous operation in ambients from -65 to $+125^{\circ}\text{C}$, it withstands 80 Gs shock and vibration of 30 Gs to 3kc. This hermetically sealed relay requires 130mw of operate power. Operate time is 2msec with bounce less than 1.5msec. Teledyne Precision Inc., 3155 W. El Segundo Blvd., Hawthorne, Calif.

Circle 193 on Inquiry Card

PORTABLE INSTRUMENTS

Units meet rigid requirements of laboratory accuracies.



Model 825 dc portables feature Bar-Ring suspension movement (no pivots, bearings, hairsprings, thus no rolling friction) providing rugged instruments with greater sensitivity and repeatability. They have a 6.84 in. mirror scale, knife edge pointer, and fully open meter front with top and side natural lighting for easy and accurate reading. Accuracy is $\pm 1/2$ of 1% in horizontal position. Three distinct multi-range units are available: dc voltmeter, dc milliammeter, and dc micro/milliammeter. The Triplett Electrical Instrument Co., Bluffton, Ohio.

Circle 194 on Inquiry Card

DIRECT-WRITING RECORDER

Has a variety of writing and pre-amplifier input combinations.

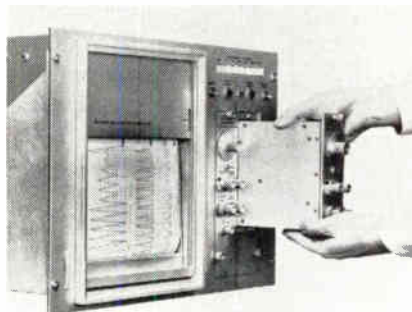

With the Mark 240, each versatile, high-accuracy direct-writing recording combination is a complete, self-contained system. It may be fitted with any two of three direct-writing penmotor systems. These include a dual-channel system containing two pens for recording analog traces on adjacent 40mm channels; a single-channel system containing a single pen for recording analog traces on an 80mm channel; and a module containing eight event Multimarkers. Brush Instruments, Div. of Clevite Corp., 37th & Perkins, Cleveland 14, Ohio.

Circle 195 on Inquiry Card

MINIATURE REED RELAYS

Performs better than 125 million operations at std. operating conditions.

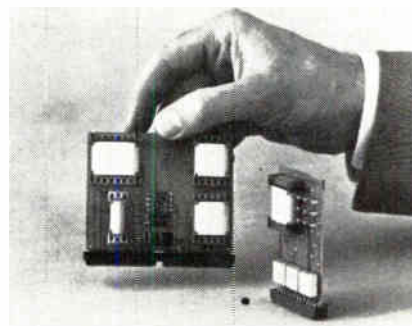

These relays provide a reliable interface between electronic and electromechanical circuit elements and can perform a wide range of logic functions. They can switch an extensive range of currents and voltages with switch times within 1msec. Release time is within 100msec. with no suppression network. Reed switches in the relay are rated to handle dc switch signals from 10mv at 100 μ a to 50 volts at 500ma. They are 0.35 in. high. IBM, Industrial Products Division, 1000 Westchester Avenue, White Plains, New York.

Circle 196 on Inquiry Card

NORTRONICS DOES IT AGAIN!



8 TRACKS ON 1/4" TAPE!

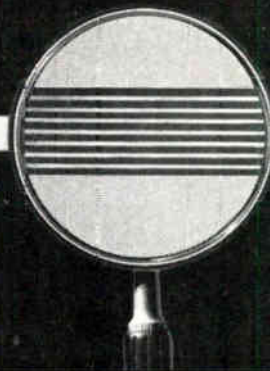

Now... twice the playing time... with Nortronics B2L heads

Nortronics has pioneered the development of a new track system to double the storage on 1/4-inch tape. When maximum storage capacity is required—on tape-cartridge or reel-to-reel players—check the new 2-channel, 8-track Nortronics heads! Widely used in automotive and home background music players.

These new B2L heads can be mechanically indexed to provide eight monophonic channels or four sets of stereo pairs—thus doubling the capacity of existing 4-track systems for a given tape speed.

The B2L is a 2-channel head with 20-mil tracks spaced 127-mils on centers—available in either solid or laminated core versions.

- Special close fitting mu-metal cases provide outstanding shielding against external magnetic fields.
- Precision deposited 100 micro-inch quartz gaps result in exceptionally clean, sharp gap edges for optimum high frequency resolution.
- Hyperbolic face contours give intimate tape-to-gap contact.
- Highly polished all-metal faces, greatly reduce oxide build up.

These new advanced-design heads, available now, are another result of the "engineering-in-depth" policy that has made Nortronics the world's largest manufacturer of laminated tape heads.

Cut specification time... check Nortronics FIRST!

Nortronics 

8149-H 10th Ave. N., Minneapolis, Minn. 55427

Circle 91 on Inquiry Card

STANPAT

REPETITIVE SYMBOLS
& DRAWING DETAILS

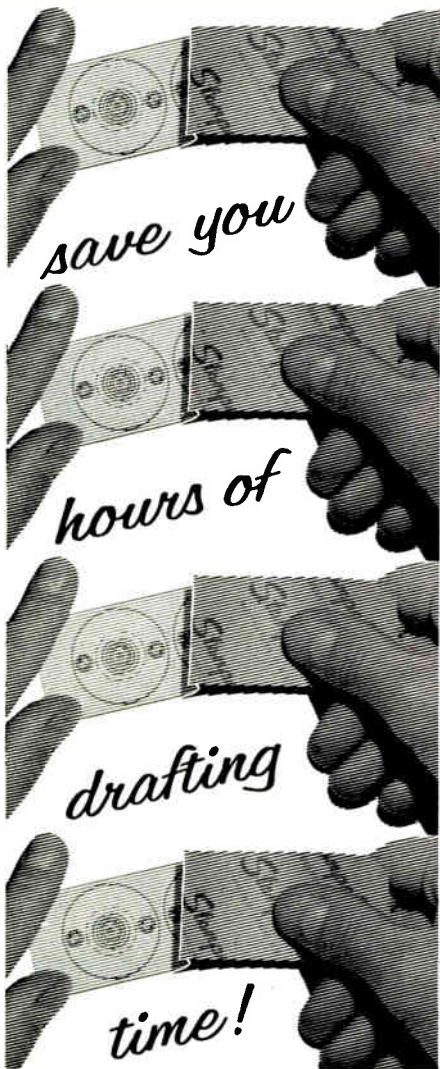

If your engineering designs require four or more repetitive drawings, STANPAT triacetate sheets, preprinted with your own symbols, can be applied in seconds rather than hours.

The STANPAT formula gives permanent adhesion without ghosting. Your own drawing details reproduce crisp and clean everytime on all types of tracing media. Excellent for microfilm reproduction . . . non-reflective surface receptive to both pencil and ink.

Write today and find out how STANPAT can save you hours of routine drafting time. Literature and samples on request, or enclose your symbols for quote.

*faithfully serving the engineer
for over two decades*



STANPAT
PRODUCTS INC.

Whitestone 57, N.Y., Dept. E9
telephone: 212-359-1693

Circle 92 on Inquiry Card

NEW PRODUCTS

PC CONNECTOR

Provides the high density potential necessary for microelectronic circuits.

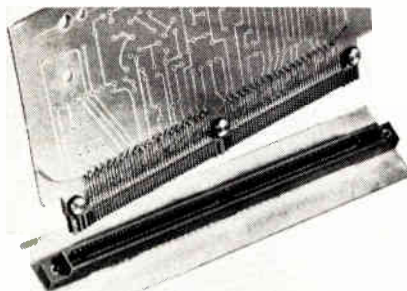

The AMP-MECA™ is a subminiature board-to-board connector utilizing contacts on true 0.050 in. centers. The plug half of two-piece connector contains spring-type contacts and is fastened to the module card by three special mounting ears. The receptacle half is fastened to the mother board by tines which protrude through the board. Either half is then soldered or welded in place on the board paths. The connector can be supplied in 160 to-the-row contact standard or 156-contact "split" versions, which can be used to mate with two mother boards.

AMP Inc., Harrisburg, Pa.

Circle 197 on Inquiry Card

TELEMETERING INDICATOR

Band scans and analyzes the entire 25-200,000 cps subcarrier band.

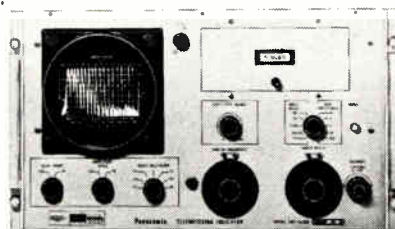

Panoramic Telemetry Indicator Model TMI-4/200 scans and analyzes spectrum contents of the entire IRIG FM/FM telemetry subcarrier band spectrum from 25cps to 200kc in one second. It monitors and checks all telemetry subcarrier channels, including the proposed, higher IRIG channels 19, 20, and 21, F, G, and H, as well as the new AIA constant bandwidth channels. Its rapid graphic display facilitates monitoring and troubleshooting during operations and reduces system downtime. A calibrated level vs. frequency spectrographic display is presented on a 5-inch CRT. The Singer Co., Metrics Div., 915 Pembroke St., Bridgeport, Conn.

Circle 198 on Inquiry Card

REED RELAYS

Offers adjustable operating voltage selection; optional 3-mode operation.

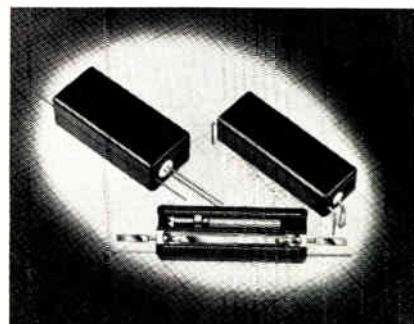

Micro-flux relays are magnetically-biased, dry reed switching devices. They feature vernier adjustment for variable operation in normally closed contact modes. The assembly consists of a hermetically sealed dry reed switch, a coil, and a movable permanent magnet. Position of the permanent magnet is adjustable by means of a fine thread adjustment screw. This permits adjustment of operating values to exact circuit requirements in manufacture or in the field. Contact ratings range from 1 to 3 amps, 15 to 50 watts. Aero-Mec Electronics, 14116 South Towne Avenue, Los Angeles, Calif.

Circle 199 on Inquiry Card

N-CHANNEL FET

Provides low-noise capability extending from 10 cycles to more than 500mc.

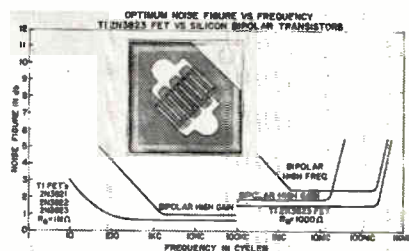

The 2N3823 is an N-channel FET available in a four-lead TO-18 package. Its 500mc capability opens many high frequency communications uses formerly restricted to conventional bipolar transistors. Typical applications are in UHF and VHF mixers, FM tuners, i-f - r-f amplifiers, and low-noise wide-band amplifiers. The device features symmetrical geometry, which means that the drain and source leads are interchangeable. Low-noise capability from 10cps to beyond 500mc are possible. Spot noise figure is typically 1.5db at 100mc, 2db at 200mc and 3.5db (4.5db maximum) at 500mc. Texas Instruments, Incorporated, P. O. Box 5012, Dallas, Tex.

Circle 200 on Inquiry Card

NEW PRODUCTS

FREQUENCY CHANGERS

Supplies 3 phase 0 to 3.2 kva continuous output at 400 cps.



The 3.2 kva frequency changer supplies three-phase 0-to-3.2 kva continuous output at 400 (± 1) cycle, from a three-phase, 60 cps, 208v input. Harmonic distortion does not exceed 5% under any combination of load changes and line voltage variations. The unit is capable of withstanding short circuits on the output for 5 minutes without damage. Efficiency is rated at 75% full load, 51% at 10% full load. Operating temperature is from 0°C to 55°C. Microdot Magnetics, Inc., 5960 Bowcroft Street, Los Angeles, Calif.

Circle 201 on Inquiry Card

DC AMPLIFIER

Features a true differential, isolated input with high common mode rejection.



Model A 414-14 differential dc amplifier has a drift of under 2mv with a temperature coefficient of less than 1mv/°F. Common-mode rejection exceeds 120db at 60cps and the input can be floated to ± 120 volts dc or peak ac. Gain is variable from 20 to 500 in four steps plus vernier. The isolated output provides ± 5 volts at up to 1ma and can be grounded or floated as required. Output impedance is under 30 ohms over the full bandwidth. Ectron Corp., 8070 Engineer Road, San Diego, Calif.

Circle 202 on Inquiry Card

CV TRANSFORMER

Regulates over a band of 47 to 63 cps for line, load, and freq. changes.



The Little Tiger is manufactured on a custom basis. The unit is frequency insensitive and only one type is needed in both 50 and 60 cycle apparatus. Input voltage is 120 volts ($\pm 10\%$) and output voltage is regulated to $\pm 1\%$ RMS, for line change, 0 to 100% load change, and frequency changes from 47 to 63 cycles. Its insensitivity to freq. makes it ideal for regulating motor-generators and other stand-by power sources, inverters, etc. Sola Electric Co., 1717 Busse Road, Elk Grove Village, Illinois.

Circle 203 on Inquiry Card

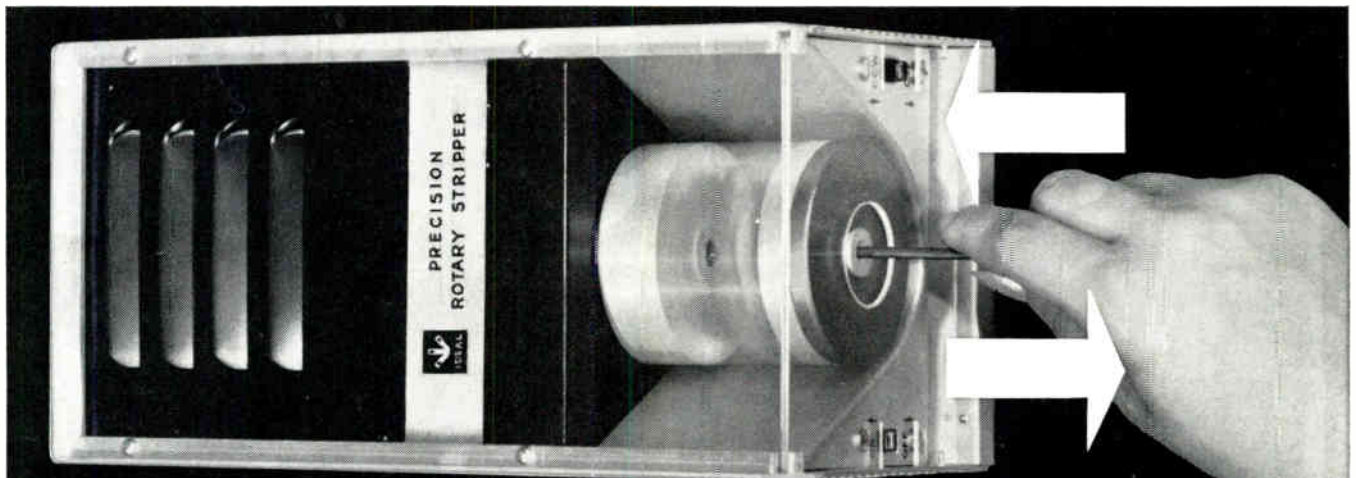

That's all the operator does with the new Ideal Precision Wire Stripper. Insert the wire, pull it out, and it's automatically precision stripped without nicking, or scraping.

The secret is a unique stripping blade design, a carbide blade mounted on a leaf spring and installed on a rotating head. The blade partially cuts insulation, then rotational force twists the slug, severing the remaining web of insulation. Since the blade never touches the conductor, stripping is nick-free. Blade adjusts in increments of .0004".

For single-conductor wire, either solid or stranded, in sizes AWG #16 to #26 with single-layer insulation including Teflon and PVC. Write for specifications.

IDEAL MAKES NICK-FREE STRIPPING AT PRODUCTION RATES AS EASY AS PUSH-PULL



IDEAL INDUSTRIES, INC.
5127-I Becker Place, Sycamore, Illinois
IN CANADA: IDI (Canada) Ltd., Ajax, Ontario

NEW PRODUCTS

PORTABLE WELDER

Spot welder has energy output adjustable to 100 watt-seconds.



The Porta-Weld uses capacitor-discharge stored energy principles for high-resistance welding techniques. It welds wire as fine as 2 mil stainless steel or as large as No. 20 gauge tinned copper, and even larger sizes in higher resistance metals. The unique self-regulating welding time compensates for adjustments necessary in welding dissimilar and exotic metals. Electro-Magnetics Company, 50 Baiting Place Road, Farmingdale, N. Y.

Circle 204 on Inquiry Card

THERMOELECTRIC COOLER

For stabilizing the temperature of integrated circuits, transistors, or crystals.

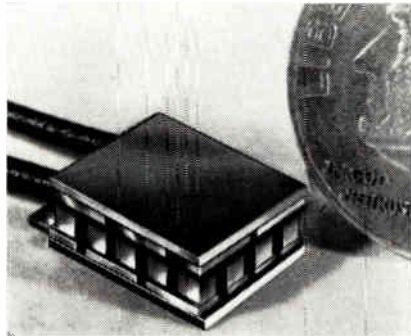

Model 4 KA requires 5 amps input current at approximately 1v. Heat sink capacity is 9 watts. Cold and hot surfaces both measure 0.415 x 0.320 and the unit's height is 0.15 in. It has metalized ceramic plates which can be soldered to the heat sink or soldered to the components to be cooled. It has greater than 3500 volts breakdown voltage. International Energy Conversion, Inc., 430 Kirby St., Garland, Texas.

Circle 205 on Inquiry Card

ZENER DIODES

Has a 1w rating at 50°C and is capable of cw with heat sinking.

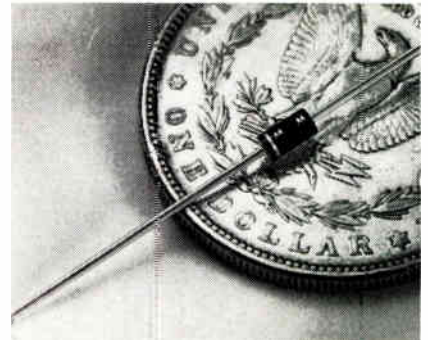

The IN4728-64 are available in voltages from 3.3 to 100-volts in standard tolerances of $\pm 5\%$ and $\pm 10\%$. The units feature silicon oxide-passivated dice and silver leads for cooler, more reliable operation. In addition, "nail head" lead construction allows them to withstand high shock and acceleration levels as well as high current surges during overload conditions. Motorola Semiconductor Products, Inc., Box 955, Phoenix, Arizona.

Circle 206 on Inquiry Card



actual size

ULTRA MINIATURE MOTOR

Globes Type VT permanent magnet d.c. motor is the smallest standardized power motor we know about. Fourteen standard armature windings are available for 3 to 50 v.d.c., with no-load speeds from 5,000 to 22,000 rpm. You can apply this miniaturized unit for continuous duty ratings up to 1-1/2 watts, and for starting torques up to 1.0 oz. in. Unit is 5/8" in diameter by 1-5/8" long; weight is 1.5 ounces. Brakes, governors, gear heads, and radio noise filters can be supplied.

Type VT is only one of many d.c. and a.c. motors built to high standards of quality by the largest manufacturer of precision miniature motors. Request Bulletin VT-2.

Globe Industries, Inc., 2275 Stanley Avenue, Dayton, Ohio 45404



Circle 94 on Inquiry Card

WEBBER Environmental Chambers

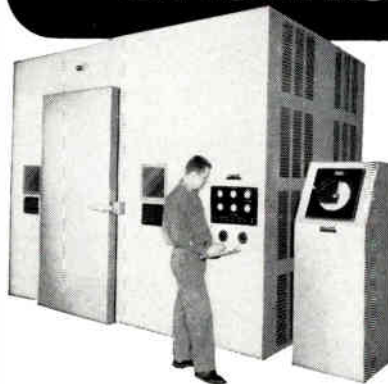

- **TEMPERATURE**
Any temperature from -225° F. to +1000° F.
- **ALTITUDE**
Any altitude simulated from 0 to 500,000 ft.
- **HUMIDITY**
Relative humidity range standard and special

Thanks to six exclusive patented features, Webber offers more BTU's per hp, better performance, and greater reliability. Ask for a quotation . . . or for a representative to help with your problem.

Ask for This New Webber Brochure!
It's one of the most helpful ever published for buyers of environmental chambers.



WEBBER MANUFACTURING CO., INC.

P. O. Box 217 • Indianapolis, Ind. 46206 • Phone Area 317: 632-1378

Circle 95 on Inquiry Card

ELECTRONIC INDUSTRIES • September 1965

NEW PRODUCTS

MOUNTING WAFERS

Wafer electrically insulates the semiconductor from the chassis.

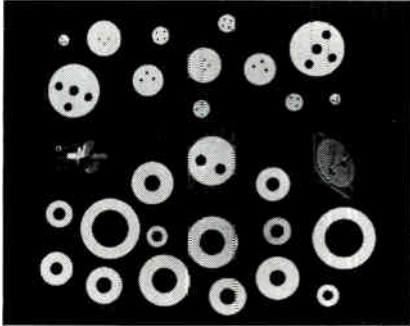

These semiconductor mounting wafers use boron nitride. This makes it possible to insulate the semiconductor while at the same time conducting heat generated in the semiconductor into the chassis. Because dry boron nitride has a thermal resistance of less than 0.1°C/watt, conductive greases are often not required. Available in 1/16- and 1/32-inch thicknesses. Union Carbide Corporation, Carbon Products Division, 270 Park Avenue, New York, N. Y.

Circle 207 on Inquiry Card

CARD CONNECTORS

Hermaphroditic contact PC card connectors with crimp-on, snap-in contacts.

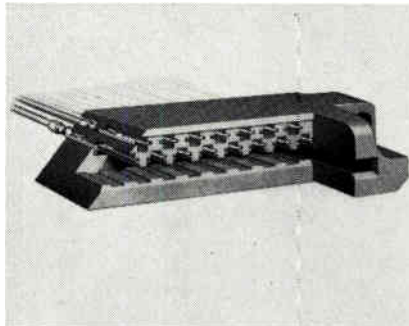

The 7015 series connectors are designed for exacting requirements where printed circuit techniques are applied. They are currently produced in 35 and 47 position sizes, with or without integrally molded card guides. The contact termination is crimped directly to the conductor and the insulation is also firmly gripped for strain relief. Once inserted the contact will not twist, turn or bend out of alignment. Cinch Manufacturing Co., 1026 South Homan Avenue, Chicago, Illinois.

Circle 208 on Inquiry Card

WELDER POWER SUPPLY

Puts out more than 1000 amperes with an unlimited duty cycle.



The AC-10 is capable of welding through the insulation on small wires or soldering all the leads of a flat pack in one operation. Discharge times range from 0.1 to 3 seconds. The output transformer is provided with a tap switch to allow for a wide range of output impedances. The power supply is useable with practically any welding, bonding, or soldering head on an adequately rated 110v, 60 cycle line. Wells Electronics, Inc., 1701 S. Main St., South Bend, Ind.

Circle 209 on Inquiry Card

Now you can have greater system versatility at less cost

CEC brings its modular concept to signal conditioning

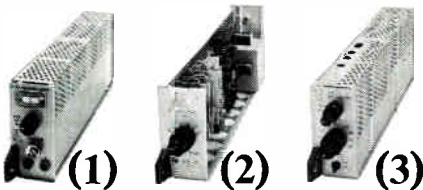

(1) 3-140 Constant Voltage Supply for strain gage excitation
 (2) 1-163 D-C Amplifier single-ended, low-gain, wideband
 (3) 1-165 D-C Amplifier differential, high-gain, wideband

Specifically designed for compatibility with all CEC Series 7-300 Recording Galvanometers, the 1-163 and 1-165 Amplifiers have the output capability (± 10 volts, 100 ma) and a plug-in damping assembly to properly damp and drive all other currently available recording galvanometers.

The 3-140 Voltage Supply is an excellent d-c excitation source for all CEC 4-200 Strain Gage Accelerometers and 4-300 Pressure Transducers—or any other input signal device requiring d-c excitation within the range of 1–24 volts.

From 1 to 8 plug-in modules may be mounted in either the 1-028 or 1-046 Fixed Rackmount Case; or a single module may be mounted in the 1-029 Portable Case. The 1-028 Universal Case and the 1-046 are completely wired to provide a-c operating power through a common line cord to each of 8 channels and also to accept (without plug-in or mounting case wiring changes) any mixed combination of the 1-163, 1-165 and/or 3-140 Plug-in Modules. Individual channel input and output connectors and a hinged flip-down front panel with power on/off indicating switch are also provided with the 1-028 Universal Case. In addition to fixed rack mounting, accessories for the 1-028 permit slide rack mounting or bench mounting.

SPECIFICATION TABLE

(1) 3-140	(2) 1-163	(3) 1-165
<input type="checkbox"/> Strain gage excitation, 1 to 24 volts, 200 ma (1)		

- Remote sensing (1)
- Excitation monitor meter (1)
- Current limiting (1)
- Single-ended operation (2)
- Differential operation (3)
- Calibrated/vernier gain, 1 to 20 (2)
- Calibrated/vernier gain, 10 to 1000 (3)
- Frequency response, $\pm 3\%$ to 20 kc (2) (3)
- Zero/offset adjustment (2) (3)
- Output capability, ± 10 volts, 100 ma (2) (3)
- Input impedance, megohms (2) (3)
- Simultaneous low and high impedance output (2) (3)
- Plug-in galvanometer damping (2) (3)
- Intermix modules in common mounting case (1) (2) (3)
- Fixed rackmount or slide rackmount/benchmark (1) (2) (3)

For complete information, call or write CEC for Bulletins in Kit #7016-X2.

CEC

Data Recorders Division

CONSOLIDATED ELECTRODYNAMICS

A SUBSIDIARY OF BELL & HOWELL/PASADENA, CALIF. 91109
 INTERNATIONAL SUBSIDIARIES: WOKING, SURREY, ENGLAND
 AND FRIEDBERG (HESSSEN), W. GERMANY

NEW PRODUCTS

DIGITAL VOLTMETER

Accurate to 0.008% over a wide range of environmental conditions.



Model 3460A has both an input filter and the integrating feature, plus guarding. It rejects the effects of both superimposed and common-mode ac noise to 155db or more, and has a common-mode noise-rejection at all frequencies (160db at dc). Fixed gate length is 200 msec. Its features include autoranging, reversible decade counters for integration around zero, and a sixth digit to display its 20% overrange capability. Hewlett Packard, 1501 Page Mill Road, Palo Alto, Calif.

Circle 210 on Inquiry Card

MINIATURE TRIMMER

Miniature ¼ watt trimmer available to mil-R-27208A style RT10 spec.

Series L160 measures 1 x 0.320 x 0.180 in. The unit has all welded connections for electrical reliability and a sealed diallyl phthalate housing. Resistance range is 100 ohms to 20K ohms. Environmental specs. include 1% maximum resistance change due to moisture and 3% maximum change on life. CTS of Berne, Inc., Berne, Ind.

Circle 211 on Inquiry Card

ILLUMINATED SWITCH

Lighted push-on/push-off switch is rated at 5a, 125vac or 28vdc.

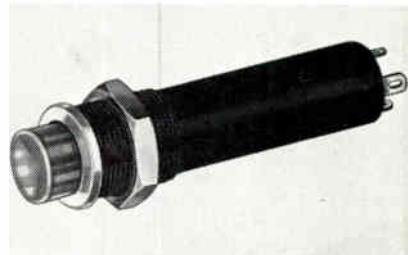

Type LA1 combines a pushbutton switch and indicating lamp mounts in a ½ in. diameter hole. Its housing extends less than 2 in. behind the panel. The ⅜ in. diameter lighted pushbutton projects 0.291 inch from the panel. It has SPDT contacts which permit single pushbutton to control two circuits alternately. The lamp circuit is independent of the switching circuit and can be wired to indicate either ON or OFF. Unimax Switch, Div. of Maxson Electronics Corp., Ives Road, Wallingford, Conn.

Circle 213 on Inquiry Card

ILLUMINATED PUSHBUTTON

Switch designed for simple snap-in mounting from front of panel.

The 01-800 requires no special tools or mounting aids. Back of panel protrusion is 1.81 in. for momentary style; 2.25 in. for maintained style. Designed for panels 1/16 to ⅛ in. thick, as standard. Available in a wide choice of circuitry with T 1¼ flange base lamp socket as standard. Licon, Division Illinois Tool Works, Inc., 6615 West Irving Park Road, Chicago, Ill.

Circle 212 on Inquiry Card

ONE PART PER MILLION O₂ and H₂O

Model HE-533 VAC-OVEN with HE-43 DRI-LAB and HE-93B DRI-TRAIN

- Especially suited for degassing and drying electronic components in vacuum oven
- Components sealed in DRI-LAB under ultra-dry inert atmosphere conditions produced by DRI-TRAIN recirculating gas purification system
- Many other curing, pre-heating and aging applications
- Temperature range of oven to 600°C controlled to ±1°
- Provisions for 6" diffusion pumping system for high-vacuum operations
- Front panel can be adapted with sealed microscope for microsoldering, microwelding, etc.

For full information write or call: (Area code 213) 983-0763

VAC

VACUUM / ATMOSPHERES CORPORATION

7356 GREENBUSH AVENUE, NORTH HOLLYWOOD, CALIFORNIA
Circle 97 on Inquiry Card

HART SERIES T CRYSTAL CAN RELAY

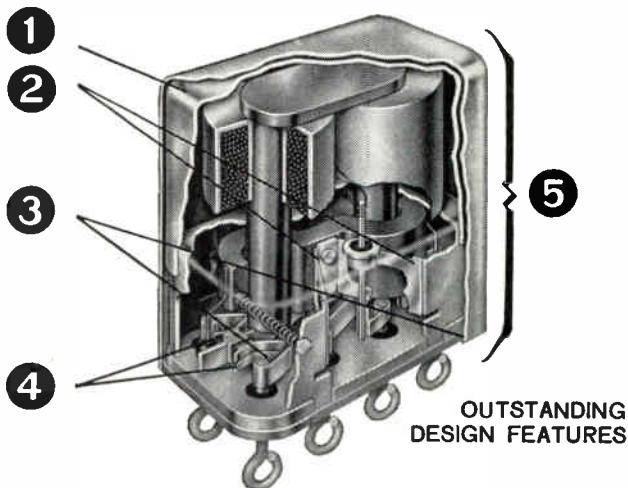

OUTSTANDING DESIGN FEATURES

- 1 Hermetically Sealed Coil prevents contact contamination; seals organic coil material from switch section.
- 2 Unique Hinge Design—no pivot or bearing problems; free from wear particles.
- 3 Welded Construction increases reliability of joints; further reduces contamination.
- 4 Bifurcated Contacts increase low level switching reliability.
- 5 Improved Sensitivity—100 MW or less at pull-in.

Specify Hart Series T for sensitive, highly reliable dry circuit switching. Write for literature.



HART MANUFACTURING CO.
306 BARTHOLOMEW AVE., HARTFORD 1, CONNECTICUT
Tel. 203-525-3491
a subsidiary of OAK ELECTRO/NETICS CORP.
Circle 99 on Inquiry Card

ELECTRONIC INDUSTRIES • September 1965

NEW PRODUCTS

CRYSTAL OSCILLATORS

Solid-state voltage-controlled units feature wide frequency control.



Designed for use in FM generators, pulse doppler radar, and frequency control and synthesis in communications systems, these vacuum-controlled units can be provided with center frequency from 10kc to 75mc. Freq. control range is $\pm 0.3\%$ of center frequency. High frequency stability is achieved through packaging in a proportionally controlled oven. Frequency deviation is up to ± 65 kc. Linearity is $\pm 5\%$ or less, and long-term stability is $\pm 0.0007\%$. Hughes Electronic Products Division, P. O. Box H, Newport Beach, Calif.

Circle 214 on Inquiry Card

COAXIAL CONNECTOR

Improves VSWR characteristics and reduces assembly and inspection time.

TNC, BNC, C and type N connectors are available with a new 3 piece construction. Termination to RG coaxial cables have extremely high mechanical strength. Pin contact is captivated, no special tools are required and connectors are completely reuseable. Trompeter Electronics, 8936 Comanche Avenue, Chatsworth, Calif.

Circle 215 on Inquiry Card

AC TO DC CONVERTER

For making ac voltage measurements on any dc digital voltmeter.

Model 710A linearly converts an ac voltage from 1mv to 1kv in decade steps at freq. from 30cps to 250kc. Conversion is better than $\frac{1}{4}\%$ from 1mv to 250v at midband frequencies of 50cps to 10kc. The dc output for each decade of ac input is 1 to 10 volts, thus making full use of a four digit dc voltmeter. Maximum sensitivity is 10mv full scale ac for 10vdc output. Ballantine Laboratories, Boon-ton, N. J.

Circle 216 on Inquiry Card

SELECTOR SWITCH

Designed for use behind control panels, where space is at a premium.

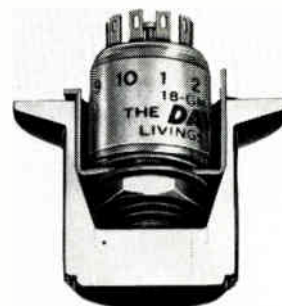

With the Switch-In-Knob configuration, the switch is built right into the knob outside the instrument and uses only $\frac{3}{16}$ in. behind the panel. It is built in a clean room environment to meet applicable Mil specs. on temperature, humidity, corrosion, vibration, acceleration, shock and immersion. The component is both explosion-proof and waterproof. The switch comes in single deck, shorting and non-shorting, in various combinations up to 4 poles and 10 positions. Daven Division of Thomas A. Edison Industries, Livingston, N. J.

Circle 217 on Inquiry Card



Z82R10
82 Volts $\pm 1V$

VOLTAGE REFERENCE AND REGULATOR TUBES

Tolerance ± 1 Volt



Z100R12
100 Volts $\pm 1V$

GENERAL SPECIFICATIONS		
TUBE NUMBER	Z82R10	Z100R12
Maximum DC Breakdown Voltage (in dark or light)	115	150
Average	105	140
Reference Voltage (DC)	82 ± 1	100 ± 1
Measured at	2.0 ma.	3.0 ma.
Voltage Regulation - limits for less than 1 volt variation	0.3 to 10.0 ma.	0.6 to 12.0 ma.
Temperature Coefficient (typical)	-2 mv/ $^{\circ}C$	-9 mv/ $^{\circ}C$
Maximum Operating Current	14.0 ma.	14.0 ma.
Minimum Operating Current as shunt regulator	0.3 ma.	0.7 ma.
in parallel with capacitor	0.7 ma.	1.8 ma.
Life Expectancy (Hours)	30,000	30,000
Typical Variation at 250 Hours	Less than 0.3%	Less than 0.6%

Used in oscilloscope calibrators, digital voltmeters, regulated power supplies, and dc amplifiers. Provide the advantages of close regulating voltage control, low temperature coefficient, miniature size, low price and high reliability.

The Single Source for All Glow Lamps **Signalite** INCORPORATED

NEPTUNE, NEW JERSEY AREA CODE 201-775-2490 • TWX 201-775-2255

Circle 100 on Inquiry Card

NEW

HIGH QUALITY- LOW COST Tuning Fork Oscillator Model Y.....

CRYSTAL ACCURACY
AT AUDIO FREQUENCIES



1/2" x 1 1/2" x 2-9/16" High

STOCK DELIVERY

FEATURES	PRICES
Frequency Range: 50 to 8000 CPS	60CPS—square wave output... \$69.00
Operating Temperatures: -25°C to +85°C	60CPS—sine wave output... 84.00
Hermetically Sealed With Octal Plug	400CPS..... 45.00
12 VDC Supply	1000CPS..... 35.00
One Year Guarantee	5000CPS..... 35.00

Full Line of other Oscillators Available. Phone or send for complete information:

FORK STANDARDS, INC.

219 Main Street • West Chicago, Illinois
Telephone (312) 231-3511

Circle 101 on Inquiry Card

NEW PRODUCTS

BAND-PASS FILTERS

Variable filters offer adjustable transmission characteristics.



Models 330B and 330N are variable band-pass filters covering the freq. ranges 0.02cps to 2kc and 0.2cps to 20kc. Separate controls for each cutoff frequency permit a choice of optimum response for transient waveform studies as well as continuous-frequency filtering. Upper and lower cutoff freq. are independently adjustable over the entire frequency range of each instrument, with an attenuation rate of 24db/octave outside the passband. Krohn-Hite Corp., 580 Massachusetts Ave., Cambridge, Mass.

Circle 218 on Inquiry Card

HIGH POWER RESISTORS

Minimizes the reactance encountered in high-current pulse applications.

The HL-225-1 is rated at 1 kw at 25°C, derating to 0 at 350°C. Low reactance properties are achieved through the use of a non-inductive winding which is protected by a multi-layer silicone coating. Tolerances of 0.01% can be supplied, depending on resistance value specified. Dale Electronics, Inc., P. O. Box 488, Columbus, Nebraska.

Circle 219 on Inquiry Card

HIGH-VOLTAGE DIODES

For h-f, fast-recovery uses. Delivers up to 6kv in a single package.

This line of silicon glass diodes combines a low junction capacitance of 0.2pf and low inverse leakage characteristics of 5na at 6kv. Reverse recovery time is 0.2µsec. Maximum forward current rating is 25ma. for 6kv series to 50ma. for 1kv series. Applications include: laser power supplies, pulse detectors, and infra-red power supplies. Semicon Inc., Sweetwater Avenue, Box 328, Bedford, Mass.

Circle 220 on Inquiry Card

ADJUSTABLE POWER SUPPLY

Accepts 50/60 cycle input and furnishes output freq. at 50 to 500cps.

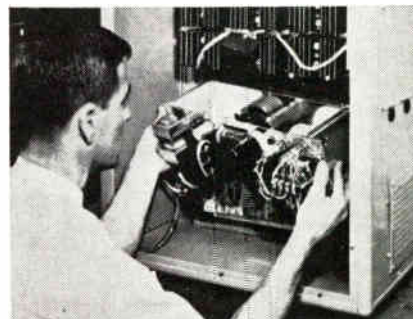

These adjustable frequency power supply units are available for either single-phase or three-phase input with the same phase output, or single-phase input, three-phase output. Standard capacities are available through 10kva. The standard 10kva enclosure measures 23 x 14 x 34 in. The total unit weighs 120 lbs, and is suitable for wall mounting. In addition, it features removable, plug-in modular construction for easy maintenance. EMD Components, Inc., 1400 E. 289th Street, Wickliffe, Ohio.

Circle 221 on Inquiry Card

COOLING SEMICONDUCTORS?



STANDARD HEAT SINKS . . .

milliwatt to high power . . . are available from distributor stock in your area. All types and sizes described in 1965 DISTRIBUTOR CATALOG, including extrusions, thermal joint compound and accessories.

CUSTOMIZED COOLING PACKAGES . . .

for groups of semiconductors up to 64 . . . available from the factory thru local sales representatives.

Write today . . . for latest literature plus list of authorized distributors and representatives.

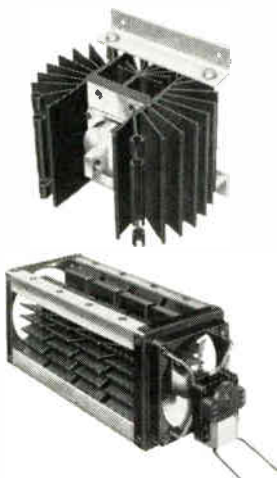

SEE THE FULL RANGE OF COOLERS AT WESCON BOOTH No. 614

WAKEFIELD
ENGINEERING, INC.



139 FOUNDRY ST. / WAKEFIELD, MASS. (617) 245-5900 • TWX 617-245-9213

Circle 102 on Inquiry Card

Here's the Ratchet that professional mechanics choose

S-K Wayne tools are the No. 1 choice of professional mechanics, the toughest tool buyers in the world. ■ Mechanics insist on quality. But they also demand price. They get both in S-K Wayne . . . and now you can, too. ■ Typified by the famous S-K ratchet (owned by 7 out of 10 mechanics), S-K Wayne tools offer you premium quality . . . at prices below those of comparable industrial lines. ■ Get details now on S-K Wayne value in sockets and ratchets, industrial and utility pliers and wrenches of all types. Check your industrial distributor. Or write for Free catalog.

The quality you want . . .
at the price you want to pay.



S-K Wayne Tools • Chicago, Ill. 60632 • Defiance, Ohio
Subsidiary of Symington Wayne Corporation

Circle 103 on Inquiry Card

ELECTRONIC INDUSTRIES • September 1965

NEW PRODUCTS

FREQUENCY SYNTHESIZER

For testing and calibrating VLF receivers. Output frequency of 1kc to 100kc.

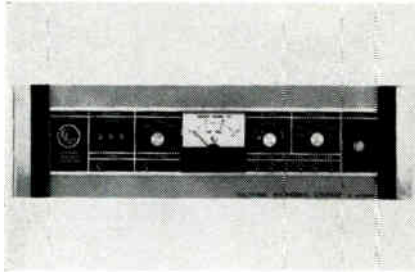

Model 883 produces a synthesized output in either sinewave, triangular, or squarewave, from an input reference of 100kc (or 1mc). The output frequency is locked to the input reference with less than 0.1 μ sec phase jitter. Thumbwheel switches provide selection of the output frequency from 1kc to 100kc in steps of 100cps. Output level is adjustable by calibrated attenuators which permit selection of output levels from a fraction of a microvolt to 3 volts RMS sinewave or 15 volts P-P triangular or squarewave. Electronic Engineering Co. of Calif., 1601 East Chestnut Avenue, Santa Ana, Calif.

Circle 222 on Inquiry Card

CERAMIC SUBSTRATES

Flat beryllium oxide substrates with thickness of 0.010-0.030 in.

AlSiMag 754 has an as-fired surface of 15 RMS (CLA) or better on one side and 20 RMS (CLA) or better on the other side. Since substrates may now be formed in thicknesses up to 0.030 in., the economy in material is apparent. The substrates have remarkable thermal conductivity. American Lava Corp., Chattanooga, Tennessee.

Circle 223 on Inquiry Card

MICROMODULE PACKAGING

Carrier boards used as building blocks for integrated circuit assemblies.

Each board in this group is 1 1/4 in. square and carries and connects up to 12 integrated circuit flat-packs. The board functions as both a means for mechanical support and also as a connector. Contacts are attached to the bottom edge of each board to mate with contacts in a module base. This enables a board to be removed from a module without desoldering. ITT Cannon Electric, 3208 Humboldt Street, Los Angeles, Calif.

Circle 224 on Inquiry Card

TRANSMITTER

Designed for spacecraft telemetry, tracking and guidance applications.

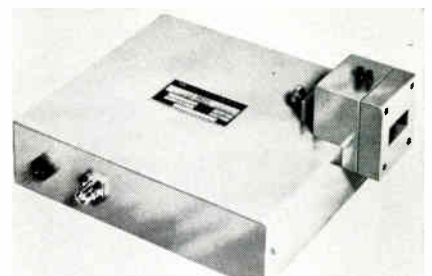

This X-Band transmitter is adaptable to a wide range of transmit frequencies. Power output, as a function of the operating frequency, varies from 17.5 watts at 325mc to 1 watt at X-band. Theoretical reliability in excess of 60,000 hours MTBF. The dc power requirement is 67 watts; r-f driving power is a few mw at 108mc. It uses high-power transistors, varactors, waveguide and coaxial transmission line, and no TWTs. By removing doublers, the output frequency is lowered and the power increased. TRW Systems, Inc., One Space Park, Redondo Beach, Calif.

Circle 225 on Inquiry Card

NOW! MAGNETS TAKE THE HEADACHES OUT OF LATCHING RELAYS!

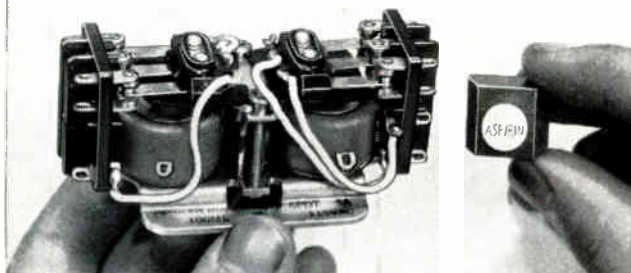

NO Mechanical Interlock Relay Can Match the 10 Million + Mechanical Operations of These Magnetic Relays!!

New Milwaukee general purpose latching relays use trouble-free magnets instead of troublesome interlocking metal levers. Results: Longer life; greater reliability and sensitivity in AC and DC versions; better shock and vibration characteristics — won't trip when jarred; securely mounted — far less chance of misalignment during installation and servicing.

AVAILABLE IN ALL THESE VARIATIONS

- Electrical or mechanical operation — or both
- Polarized — at less than half the cost of competitive relays
- Center off — up to 6 PDT 10 amps contacts
- Push-to-reset — can replace circuit breaker
- Dust cover, plug-in — easy to install and maintain

NEW 120 magnetic power latcher — up to DPDT 15 amp or DPST NO DM 35 amps. Write us or wire for details.



Milwaukee Relays

606 Pioneer Road, Cedarburg, Wis. 53012
Telephone (414) 377-4010

Circle 104 on Inquiry Card

ELECTRONIC INDUSTRIES • September 1965

NEW and STRONGER

Printed Circuit Molded Coil Forms



For Inductances .1 μ H to 1.0 MH

New CAMBION® molded coil forms 3623 and 3624 are .340" and .495" high respectively. Both offer superior physical strength and a high dielectric material immune to moisture and most common acids and solvents.

These two new forms from CAMBION operate effectively over a range of -55°C to +105°C, and from 50 to 2000 cycles at temperature extremes without damage or movement of the core. Both coil forms mount with .025" pins on .200" centers and are available in all popular core types. Both feature antimisture steps to prevent flush board mounting. Their low silhouette is ideal for card stacked designs.

Made by mating pliable polypropylene with durable Diallyl, CAMBION'S new 3623 and 3624 provide precise tuning over restricted ranges.

For instant availability of our 1500 types of CAMBION coil forms, call DIAL-A-PART, (617) 876-2800, Cambridge Thermionic Corporation, 403 Concord Avenue, Cambridge, Massachusetts 02138.

CAMBION®
"DIAL-A-PART" SERVICE

Standardize on CAMBION... the guaranteed electronic components

Circle 105 on Inquiry Card

NEW PRODUCTS

POWER MODULE

Converts 115vac to any required output voltage from 5v to 10kv dc at 60w.



The V6/HA6 series uses a modular design approach and provides a compact unit 4½ x 6 x 4 in. These converters feature isolation of outputs and inputs, and an adjustment range of 12% from the nominal output voltage. Design characteristics insure close regulation (0.2%) for line variations of 105 to 125vac and a low ripple of less than 0.2% RMS. Abbott Transistor Laboratories, Inc., 3055 Buckingham Road, Los Angeles, Calif.

Circle 226 on Inquiry Card

VARIABLE SPEED DRIVE

Allows present machinery to operate at all speeds 0 to 275 RPM.

This hydraulic transmission replaces conventional motors. It operates at forward and reverse speeds. Drives heavy-duty machinery at 0 to 275 RPM in either direction . . . changing speeds continuously; stopping; starting and reversing instantly. Powerful 6-to-1 torque multiplier produces an output torque of 660 in.-lbs. Roberts Electric Co., 849 W. Grand Avenue, Chicago, Ill.

Circle 227 on Inquiry Card

TWO-WAY RELAY

Can be used as either plug-in or directly-wired units.

The series G basic relay is a stud-mounted unit with solder tab terminals. With the addition of a companion socket, the same relay—with no alteration—becomes a plug-in unit. The tab terminals fit directly into the socket. Relays provide DPDT or 4PDT contacts rated 2 amps resistive at 29vdc or 115vac. Struthers-Dunn, Inc., Pitman, N. J.

Circle 228 on Inquiry Card

LEAD STRAIGHTENER

Rapid, routine lead straightening with rugged, convenient device.

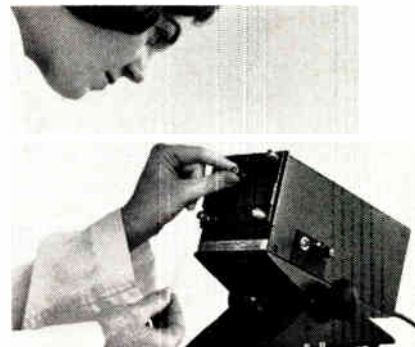

Model No. 1100 has insert configurations to accept up to four TO-18 leads or up to ten TO-5 leads. In addition, blank inserts are available for preparation of special lead configurations. Actuating plates are dry-lubricated to combine cleanliness with long life. Size of the unit is 5¼ in. high by 4¼ in. wide by 10 in. long and operating voltage is 115v, 60 cycle. Macronetics, Inc., 220 California Avenue, Palo Alto, Calif.

Circle 229 on Inquiry Card

KIT OR ASSEMBLED!

World's Best Values In Electronic Instruments... **HEATHKIT®**



5" Lab Oscilloscope
Kit IO-12, 24 lbs. . . \$ 76.95
Assembled IOW-12 \$126.95

Laboratory AC VTVM
Kit IM-21, 5 lbs. . . \$33.95
Assembled IMW-21 \$52.95

RF Signal Generator
Kit IG-102, 6 lbs. . . \$27.95
Assembled IGW-102 \$54.95

Condenser Checker
Kit IT-11, 7 lbs. . . \$29.95
Assembled ITW-11 \$49.95

VTVM
Kit IM-11, 5 lbs. . . \$24.95
Assembled IMW-11 \$39.95

"Service Bench" VTVM
Kit IM-13, 7 lbs. . . \$32.95
Assembled IMW-13 \$49.95

Variable-Voltage Regulated Power Supply
Kit IP-32, 17 lbs. . . \$56.95
Assembled IPW-32 \$84.95

Audio Generator
Kit IG-72, 8 lbs. . . \$41.95
Assembled IGW-72 \$64.95

"Solid-State" Regulated OC Power Supply
Kit IP-20, 13 lbs. . . \$ 72.95
Assembled IPW-20 \$114.95

Battery Eliminator
Kit IP-12, 18 lbs. . . \$47.50
Assembled IPW-12 \$59.95



HEATH COMPANY, Dept. 53-9 Benton Harbor, Michigan 49023
In Canada: Daystrom Ltd., Cooksville, Ontario
 Please send my FREE Heathkit Catalog.

Enclosed is \$ _____ plus shipping. Please send model(s) _____

Name _____

Address _____

City _____ State _____ Zip _____

Prices & specifications subject to change without notice. TE-138

Circle 106 on Inquiry Card

NEW
FOR 1966

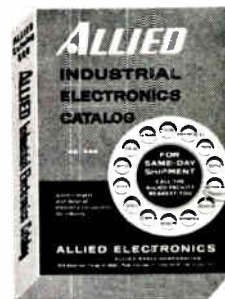

FREE INDUSTRIAL ELECTRONICS CATALOG

Here's the standard of the industry from Allied, the world's largest stocking distributor of electronic components and equipment. 552 pages. 64,000 items, 6,000 new products. Factory OEM prices. Same-day shipment. Get your personal copy now.

P&B See your Allied Catalog for Potter & Brumfield Relays: General Purpose, Special Purpose, Power, High Performance, Mercury Wetted Contact, Telephone types — available from stock.

For FREE catalog, check reader service card or write direct to:
ALLIED ELECTRONICS
subsidiary of ALLIED RADIO CORPORATION
100 N. Western Ave., Dept. 216, Chicago, Illinois 60680

Circle 107 on Inquiry Card
ELECTRONIC INDUSTRIES • September 1965

SENATE ASKED TO POSTPONE RADIATION-CONTROL BILL

The Electronic Industries Association has asked the Senate Communications Subcommittee to delay action on legislation proposed by the Federal Communications Commission to empower FCC to regulate production of electronic or electrical devices which might cause radio interference.

Forwarding recommendations formulated by the EIA board of directors, Executive Vice President James D. Secrest asked Subcommittee Chairman John O. Pastore (D., R.I.) to postpone action on the measure (S 1015) until industry representatives, together with the FCC, can study radiation-interference problems and alternative methods of solving them.

CENTRAL COMPUTER LINK

One of the country's larger agricultural cooperatives plans to centralize its data processing operations by linking 125 retail outlets and its manufacturing and wholesale divisions to a central computer. Heart of the system will be a National Cash Register 315 computer, scheduled for delivery to the Missouri Farmer's Association.

SERVOCONTROLLER



DC servocontroller Series 82-137 that delivers ten times the power (2.5w) of previous models has been developed for industrial control systems by Moog Servocontrols. Drift (input) stands at plus/minus 0.025 mvdc per day. Thermal drift is 2.5mvdc (10 to 50°C). Controls include system balance, gain, bias, auxiliary input.

NEW LEAR DIVISION

A new organization called Information Systems Company, and entry into the field of computer-based information systems for use by military and civilian customers organizations, has been announced by Lear Siegler Inc. The new division will be independent of LSI's present 12 divisions.

RESEARCH MAY PRODUCE BLOOD CELL AUTO-SCANNER

Perkin-Elmer Corp. is conducting research on automatic instruments capable of detecting varied types of blood cells at extremely high speeds through computer analysis.

The research is part of a continuing program, under Dr. Marylou Ingram of University of Rochester, to develop a high speed "cellscan" system which could be applied to clinical and hematological laboratory use for a variety of blood cell discriminations.

The program is intended to show feasibility of machine methods in blood cell identification; this would allow gathering of blood cell data at a much faster rate than is now possible.

FAA BUYS COMPUTER

The Federal Aviation Agency has purchased an ASI 210 solid-state digital computing system from Advanced Scientific Instruments, Minneapolis, a division of Electro-Mechanical Research Inc. (EMR). The desk-type system will be used for terminal air traffic control experimentation at FAA National Aviation Facilities Center, Atlantic City, N. J.

HIGH POWER

FROM 20W
UP TO ...

4 KW

DC SERVO AMP

For driving DC motors & torquers

Features:

- ★ Small Size 2 $\frac{3}{8}$ x 8 x 3 $\frac{1}{2}$
- ★ SCR Control
- ★ Adjustable Current Limiting
- ★ AC or DC Signal Inputs
- ★ 50, 60, or 400 CPS Power Supply
- ★ Full Wave, Bi-directional Output

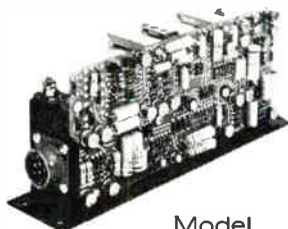

Model
A570

Servo Amplifiers / Static Inverters / Power Supplies

WESTAMP

SANTA MONICA, CALIFORNIA • 213+393-0401

COMMUNICATIONS and COMMUNICATIONS SYSTEMS ENGINEERS — R & D

Major division of nationally prominent company offers these exceptional growth opportunities in Research & Development in field of Communications and Communications System.

CARRIER SYSTEMS ENGINEER

For subscriber, extended area service, and toll carrier system. Requires Electrical Engineering degree, knowledge of Western Electric N and ON, TI, Lenkurt 45 and Lynch B410 types of cable carrier systems and familiarity with subscriber carrier. Assignment will involve design activities in supervision of application & installation engineering of new carrier systems.

JR. SYSTEMS ENGINEER

Electrical Engineering degree with communication or electronics option. Requires training or experience in Fortran and symbolic programming systems.

PROCESS DEVELOPMENT ENGINEER

Mechanical Engineering degree and experience in machine design & development and tool design.

Location in Chicago area.
Relocation expenses paid.

Please send resume stating salary history to:
Box 839, 1501 Broadway, N.Y.C.

An Equal Opportunity Employer



New N-channel FET by low-noise amplification

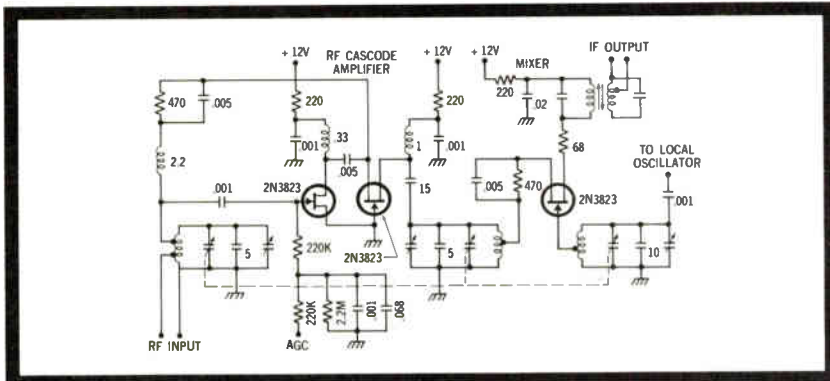

Figure 1. FM front end employs TI 2N3823 FET's. Circuit developed by H. H. Scott, Inc.

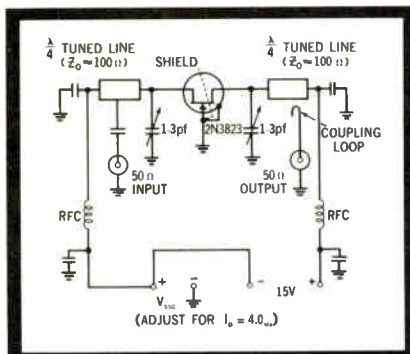

Figure 2. 500 mc amplifier using TI 2N3823 FET gives power gain of 11 db (5 mc bandwidth). Maximum spot noise figure is 4.5 db.

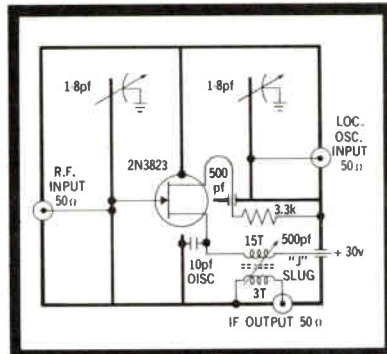

Figure 3. 555 mc mixer employs TI 2N3823 FET. Conversion gain is greater than 7 db for 10 mc bandwidth. Noise figure is less than 6.5 db.

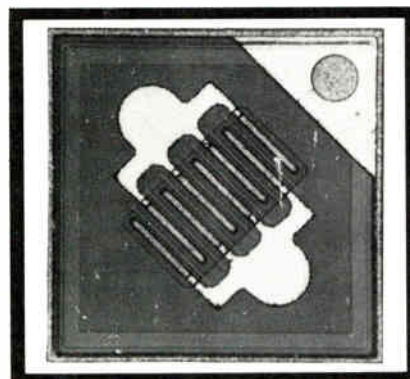

Figure 4. Photograph of active element of TI 2N3823 FET. Notice symmetrical, interdigitated geometry.

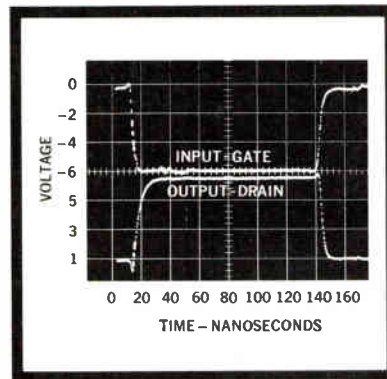

Figure 5. Unretouched sampling scope photograph illustrates zero storage time and fast response of TI 2N3823 FET.

Texas Instruments has made a "significant contribution" in field-effect transistor technology — an N-channel FET capable of low-noise performance from 10 cycles to more than 500 megacycles. The new FET is priced for consumer and industrial applications while offering the high reliability required for military and space use.

The new FET, designated 2N3823, is available in production quantities in a four-lead TO-18 package. A dual matched pair, typed TIS 25-27, is in a low profile TO-5 type package.

Circuit designers can now take advantage of the unique characteristics of FET's in high frequency circuits and a wide range of other applications when cost is critical. Characteristics of FET's include reduced cross-modulation, low noise and high input impedance.

Reduced Cross-modulation

Since they follow "square law" behavior, 2N3823's give very little cross-modulation when used as RF amplifiers or mixers. The H. H. Scott FM tuner front end shown in Figure 1, for example, exhibited IHF sensitivities of 1.6 to 2 microvolts with cross-modulation rejection of from 96 db to more than 100 db. Two strong signals, equivalent to more than 50 mv per meter and separated by 800 kc, can be fed into the input without having any measurable intermodulation products generated. This performance is at least equivalent to the very best tube front ends and is more than 20 db better than the best bipolar transistorized front ends.

A 200 mc cascode amplifier, using 2N3823's, generated less than one percent cross-modulation when a 1000 μ v, 200 mc signal and a 200,000 μ v, 150 mc signal were combined.

VHF and UHF Performance

The 2N3823 is the first FET that provides useful amplification at vhf and uhf. Figure 2 shows a 500 mc amplifier that gives 11 db gain and a bandwidth of 5 mc. Typical spot noise figure is only 4.5 db (with an equivalent source conductance of approximately 13 millimhos.) No other FET's can approach this performance. Circle 109 on the Reader Service card for an application note describing this circuit.

FET's also make excellent vhf and uhf mixers. Figure 3 shows a 555 mc mixer that gives conversion gain of more than 7 db and a bandwidth of 10 mc. Local oscillator frequency is 600 mc and output to IF is 45 mc. Noise figure is 6.5 db (measured with 12 db image rejection and an IF amplifier with 3.5 db noise figure).

Low Noise

Figure 6 shows optimum noise figures for the 2N3823 at various frequencies. Notice that the FET is better than two of industry's most

Texas Instruments gives from 10 cps to beyond 500 mc

widely used bipolar transistors at all frequencies up to more than 500 mc. The amplifier shown in Figure 3 has a maximum spot noise figure of only 4.5 db at 500 mc.

High Input Impedance

Input impedance of the 2N3823 is high. This high impedance, plus the low leakage of 10 picoamps typical at 25°C, with V_{GS} of 10 volts, gives circuit designers many benefits.

In switching applications the high input impedance of FET's permits a virtually infinite fan-in — leading to important reductions in component requirements.

FET's also simplify design and reduce component requirements in both linear and switching applications. In choppers, untuned amplifiers and similar applications, interstage transformers can be eliminated, reducing weight and cost as well as permitting improved performance. Coupling capacitors can be greatly reduced in size or eliminated altogether, particularly in low-frequency applications.

Symmetrical Geometry

Symmetrical geometry (Figure 4) means that drain and source leads are interchangeable. This allows both electrical and mechanical replacement of older devices with non-standard lead configurations.

Zero Storage Time

In Figure 5 a sampling scope photograph shows the zero storage time of FET's. This characteristic is important in switching applications such as digital logic gates.

Other electrical characteristics of this device include high transconductance (3500 to 6000 micromhos) and low input capacitance (4.8 picofarads typical). Extremely small, interdigitated geometry and an epitaxially deposited junction area make possible the exceptional performance. Circle 114 on the Reader Service card for 2N3823 data sheet.

TI Offers Complete FET Line

TI, a pioneer in field-effect transistors, offers 16 families of P-channel and eight families of N-channel FET's. You can select a device from this broad line to meet any requirements.

New Book on FET's

Here is the first definitive work devoted exclusively to the theory, application and behavior of field-effect transistors — the latest addition to the TI Microlibrary of electronic books. It is cloth bound; 130 pages with 140 illustrations. The title: **Field-effect Transistors**. Author is Leonce J. Sevin, Jr. Publisher is McGraw-Hill and price is ten dollars. Send orders to: Texas Instruments Incorporated, TI Microlibrary, Mail Station 7, P. O. Box 5012, Dallas, Texas 75222.

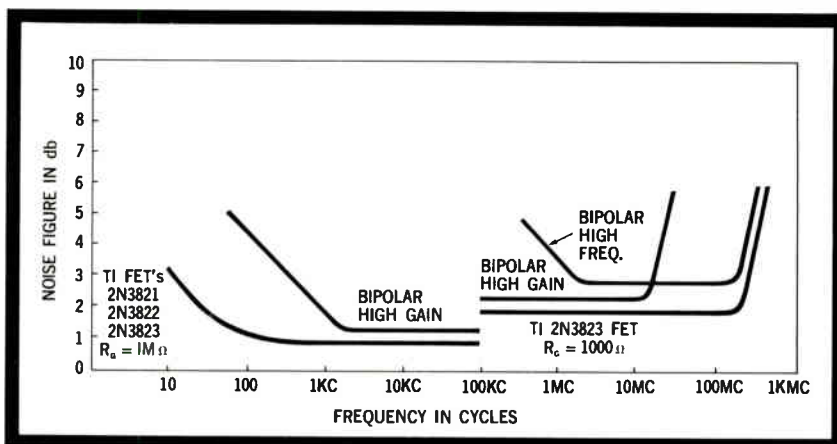

Figure 6. Optimum noise figure vs frequency TI 2N3823 FET vs widely used bipolar transistors.

LINEAR			
APPLICATION	ADVANTAGES OF FET's	APPLICATION	ADVANTAGES OF FET's
D-C amplifiers	Zero TC Low drift Low noise	Choppers	Zero offset Low leakage currents Simplified circuitry Eliminates input transformers
Low frequency amplifiers	Small coupling capacitors Low device noise High input impedance	A-D converters multiplex switching (arrays) and sample hold	Improved isolation of input and output Zero offset Symmetrical Simplified circuitry
Operational amplifiers	Summing point essentially zero Low device noise Less loading of transducers	Relay contact replacement	Solid-state reliability Zero offset Symmetrical No inductive spiking No contact bounce High repetition rate
Medium and high frequency amplifiers	Low cross-modulation Low device noise Simplified circuitry	Voltage variable resistor	Symmetrical Solid-state reliability Functions as variable resistor Low noise Improved resolution
Mixers - 100 mc and up	Low mixing noise Low cross-modulation		
SWITCHING			
Logic gates	Virtually infinite fan-in Simplified circuitry Zero storage time Symmetrical		

Figure 7. Advantages of using FET's in various applications.



TEXAS INSTRUMENTS
INCORPORATED
13500 N. CENTRAL EXPRESSWAY
P. O. BOX 5012 • DALLAS 22, TEXAS

LINEAR IC's (Concluded)

(Continued from page 69)

posited on top of the silicon substrate will greatly improve the tolerances available in these components. But, primary emphasis will always be placed on diffused components because of the lower cost resulting from the fewer processing steps needed to make these devices. Oxide isolation or other methods for reducing the capacitance between the individual components and the monolithic substrate will greatly reduce the problems of converting breadboard circuits to IC's. But, there will still be much emphasis placed on improving present methods so that the performance of isolated elements can be approached without the additional cost associated with oxide isolation methods. Sense amplifiers will be further improved and will be available for biax, thin film, and solid state memory devices. Their complexity will be increased by the addition of logic functions to their output.

The full advantage of IC's is realized when the circuits are very complex or when a standard circuit is used repeatedly. This has led almost all manufacturers of digital IC's to go to multifunction or single packages containing many identical circuits. The first multi-function circuits have begun to appear in the linear IC designs. The SN526A manufactured by Texas Instruments has a differential amplifier that can be used separately from the single-ended output power amplifier which is on the same bar. Already several systems have been

designed in which the differential amplifier and power amplifiers are used separately. We will soon see single packages containing two or more operational amplifiers and possibly multi-pin packages which contain an entire linear system on a single chip of silicon.

Conclusion

The development of linear circuits has been much less rapid than that of digital or logic circuits for several reasons. The logic circuits offered a large market of repetitive usage and the principles of worst-case design, and the circuit configurations were already well established using discrete components. The linear market, on the other hand, has required new circuit approaches to accomplish the same circuit function that was being done by discrete components. The concentration in the design of digital devices will probably persist for several years because of the large use of logic devices in commercial computer and industrial control systems. In Dec., 1964, Mr. P. E. Haggerty, President, Texas Instruments, Inc., indicated that the dollar value of the IC's market in 1973 would be between \$500,000,000 and \$1 billion. He further indicated that the \$1 billion level could not be obtained unless the industry made significant progress in the development of linear circuits. Such progress is beginning to appear within the industry; indeed, it seems entirely possible that any advanced linear system designed after 1967 which does not contain a large percent of IC's will be as dated as the triode receiving tube or spark-gap transmitter.

NEW BRADY WIRE MARKING KIT FREE!

Big, 16-page, illustrated catalog lists over 7000 stock Brady Wire Markers . . . Tech Data, Industrial and Mil specs, types, sizes, prices . . . plus time-saving automatic application methods. Over 200 individual self-sticking markers included for testing. Get acquainted with Brady's efficient, low-cost wire marking system. Order your free kit now.

Big, 16-page, illustrated catalog lists over 7000 stock Brady Wire Markers . . . Tech Data, Industrial and Mil specs, types, sizes, prices . . . plus time-saving automatic application methods. Over 200 individual self-sticking markers included for testing. Get acquainted with Brady's efficient, low-cost wire marking system. Order your free kit now.

146-B

W. H. **BRADY** CO., 751 W. Glendale Ave., Milwaukee, Wis. 53209

Manufacturers of Quality Pressure-Sensitive Industrial Tape Products, Self-Banding Nameplates, Automatic Machines for Dispensing Labels, Nameplates, Masks and Tape

Circle 110 on Inquiry Card

PORTABLE TRANSISTOR & DIODE TESTER

IN-CIRCUIT

Measures the true small-signal AC current gain (ac beta) at a frequency of 1 kc with shunting impedance as low as 20 ohms. The dc operating current is continuously variable to 1000 ma.

Also measures saturation voltage of transistors and forward voltage drop of diodes and rectifiers in-circuit and supplies gate signal current of 100 ma for testing controlled rectifiers in-circuit.

OUT-OF-CIRCUIT

PRICE: \$425
ACCESSORIES EXTRA

Send for complete brochure
TEST EQUIPMENT CORPORATION
3009 S. Post Oak Road
P. O. Box 22042
Houston, Texas 77027
(713) NA 2-4570

TEQUIPCO

Circle 111 on Inquiry Card

This index is published as a convenience.

No liability is assumed for errors or omissions.

A	
Acopian Corp.	124
Adams & Westlake Co.	176
Allen-Bradley Co.	Insert Fol. p. 126
Allied Electronics	190
Alpha Metals, Inc.	138
Alpha Wire Corp.	46
American Machine & Foundry Co. Potter & Brumfield Div.	17
Ammon Instruments, Inc.	179
AMP Incorporated	7
Amperex Electronic Corp.	55
Amperite	173
Arco Electronics	30
Armo Steel Corp.	109
Arrow-Hart & Hegeman Electric Co., The	121
Astrodata, Inc.	11
Automatic Electric Co.	144
B	
Ballantine Laboratories, Inc.	124
Barnstead Still and Sterilizer Co.	175
Beckman Instruments, Inc., Helipot Division	115
Belden Manufacturing Co.	Insert Fol. p. 32
Bell, Inc., F. W.	27
Bell Telephone Laboratories	54
Borg-Warner Corporation	172
Bourns, Inc.	15, 29
Brady Co., W. H.	194
Bussmann Mfg. Division McGraw-Edison Co.	116, 117
C	
Cambridge Thermionic Corporation	189
Christie Electric Corp.	179
Columbian Carbon Company	25
Columbia Wire & Supply Co.	180
CMC-Computer Measurements Company	10
Consolidated Electrodynamic	56, 185
CTS Corporation	150
D	
Dale Electronics, Inc.	Inside Back Cover
Daven	41
Delco Radio	166, 167
Dialight Corporation	122
Durant Mfg. Company	24
E	
EEM-Electronic Engineers Master	158
Esterline Angus Instrument Co., Inc.	153
F	
Fairchild Instrumentation Div. of Fairchild Camera and Instrument Corp.	42, 43
Fischer Special Mfg. Co.	6
Fork Standards, Inc.	187
G	
Globe Industries, Inc.	184
Grayhill, Inc.	140
H	
Hart Manufacturing Co.	186
Heath Company	190
Howard Industries, Inc. Howcor Laminations Division	174
I	
Ideal Industries, Inc.	183
Industrial Electronics Engineers, Inc.	135
International Electronic Research Corp.	175
ITT Electron Tube Division	Insert Fol. p. 56
Jennings Radio Mfg. Corp.	120
K	
Kelvin	176

L	
Lepel High Frequency Laboratories, Inc.	177
M	
Mac Panel Company	28
Magnetic Radiation Laboratories, Inc.	159
Magnetic Systems Corporation	63
Mallinckrodt Chemical Works	113
Mandex Manufacturing Company, Inc.	170
McDonnell	148
McLean Engineering Laboratories	14
Milwaukee Relays	189
Minnesota Mining & Mfg. Co. American Lava Corporation	125
Chemical Division	139
Electrical Products Division	136, 137
Retail Tape & Gift Wrap Division	171
Motorola, Inc. Military Electronics Division	156
Semiconductor Division	20, 21
N	
National Radio	16
Newark Electronics Corp.	171
Nortronics	181
O	
Ohmite Manufacturing Co.	61
P	
Paktron Div. Illinois Tool Works	119
Plastic Capacitors, Inc.	122
Polarad Electronic Instruments	143
Potter & Brumfield Division American Machine & Foundry	17
Precision Paper Tube Co.	134
Q	
Q-Max Corporation	196
R	
Radio Cores, Inc.	158
Radio Corporation of America Electronic Components & Devices	Back Cover
Designers' Industrial Conversion	19
Radio Materials Company	114
Rustrak Instrument Company, Inc.	179
S	
Sage Electronics Corporation	142
Sanborn Division Hewlett-Packard Company	178
Schauer Manufacturing Corp.	160
Sel-Rex Corporation	146
Siemens America Incorporated	12, 13, 50, 51
Signalite Incorporated	187
S-K Wayne Tools	188
Sola Electric Co.	62
Sperry Rand Corporation Sperry Semiconductor Division	165
Sprague Electric Company	2, 5
Stanpat Products, Inc.	182
Switchcraft, Inc.	177
Syntronic Instruments, Inc.	196
T	
Tektronix, Incorporated	47
Test Equipment Corporation	194
Texas Instruments Incorporated Industrial Products Group	141
Semiconductor-Components Division	192, 193
Textool Products, Inc.	157
Thomas & Betts Company, Inc., The	168, 169
Thomas & Skinner, Inc.	180
Trygon Power Supplies	31

U	
United Transformer Corp.	Inside Front Cover
V	
Vacuum Atmospheres Corporation	186
Varo, Inc.	118
Victoreen Instrument Co., The	123
W	
Wakefield Engineering, Inc.	188
Webber Manufacturing Co., Inc.	184
Westamp	191
X	
Xcelite, Inc.	160
Xerox Basic Systems, Inc.	154, 155

ELECTRONIC INDUSTRIES

REGIONAL SALES MANAGERS

Philadelphia 19139—56th & Chestnut Sts.
(Area Code 215) Sherwood 8-2000
JOSEPH DRUCKER

New York 10017—100 East 42nd St.
(Area Code 212) OXford 7-3400
GERRY PELISSIER

Boston, Mass. 02110—10 High St.
(Area Code 617) LIBerty 2-4460
ROBERT G. SMITH

Chicago 60621—540 N. Michigan Ave.
(Area Code 312) 467-9660
JOHN W. BERNHART
PHILIP T. CLARK

Cleveland 44114—601 Rockwell Ave.
(Area Code 216) SUperior 1-2860
GREG JOHNSON

Hollywood, Fla. 33021
4831 Tyler St., Hollywood Hills
FRANK A. SMITH

Los Angeles 90057—
1543 W. Olympic Blvd.
(Area Code 213) DUmkirk 7-1271
GEORGE F. KELLEY
BURT UNDERWOOD

San Francisco 94103—1355 Market St.
(Area Code 415) 861-7107
DON MAY

Atlanta 30309—1776 Peachtree St. N.W.
(Area Code 404) 875-1255
JOHN W. SANGSTON

Dallas 75206—Meadows Bldg.
Expressway at Milton
(Area Code 214) EMerson 3-6426
HAROLD E. MOTT

EUROPEAN SALES OFFICES

London, S. W. (1)—67/68 Jermyn St.
St. James
MAX F. HOLSINGER

United International Industrial Press
Eitelstrasse 32
4 Dusseldorf—Rath, Germany
MAX F. HOLSINGER

FAR EAST SALES OFFICE

Tokio Marunouchi, Japan
C. P. O. Box #1572, Room 814
Tel.: 211—3506-3509
Togin Bldg.
CLARENCE T. SAKAGUCHI

Specifically
Engineered
for RF
Components!

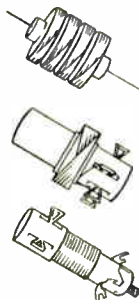
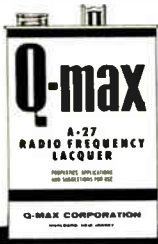

Q-MAX impregnating and coating composition penetrates deeply, seals out moisture, provides a surface finish. Q-MAX imparts rigidity and promotes stability of the electrical constants of high frequency circuits. Effect on the "Q" of RF windings is negligible.

Write for catalog today.

Q-max Corporation

MARLBORO, NEW JERSEY

Telephone: 462-3636 (Area Code 201)

Circle 112 on Inquiry Card

EMPLOYMENT

TECHNICAL, RESEARCH AND SALES ENGINEER

Man knowledgeable in the field of inorganic pigments with emphasis on ferrites for electronic uses. Should have record of successful accomplishment and should possess initiative and ingenuity. Salary commensurate with education and experience. Write in confidence to

Personnel Department
Columbian Carbon Company
380 Madison Avenue
New York 17, New York

CHEMICAL SPECIALTIES WANTED

Small going business or individual products being sold to electronic and related industries. Details to POST OFFICE BOX 178, RIDGEFIELD PARK, N.J.

SYLVANIA PRESENTS NEW SECOND GENERATION ICs

What has been described as the second generation of integrated circuits has been introduced by Sylvania under the name SUHL II. The family consists of 7 gates with 6 nsec. speeds, and 2 J-K flip-flops which operate at 30mc from a single 5v. supply.

Every SUHL II circuit, including a single-logic level NAND/NOR gate, a 2 logic level expandable OR (AND-NOR) gate, and complex J-K flip-flops, has a noise immunity of -1.5 to 1.0v. @ 25°C. Logic swing is: "0" = 0.25v. and "1" = 3.5v. No extra buffered packages are required to restore logic levels or noise margin at the system level. A fan-out of 12 (min.) is available. Made on a silicon base, the circuits use the monolithic epitaxial technique to enhance the noise protection, high switching speeds, and high fan-out. Temperature ranges are -55° to +125°C or 0° to 75°C.

SUHL II is available in a flat-pack or plug-in package which is 7/16 x 1/4 in. Its 14 Kovar leads are formed on 0.020 in. diameter, and spaced on 100 mil centers.

METEOR COMMUNICATIONS 'STABLE, CONTROLLABLE'

A data processing and transmission system which hitches a ride from falling stars has been successfully demonstrated by The Boeing Company from an underwater mountain in the Pacific Ocean.

Termed meteor-burst communication, the system transmits data by bouncing radio signals off trails left by meteors entering the earth's atmosphere. The system was designed by the Boeing antisubmarine warfare systems organization as a communications link for an oceanographic research program conducted by the University of Washington.

In tests from Cobb Seamount, 440 miles from Seattle, meteor-burst signals were received at Inglewood Research Site, near Issaquah, Washington, a total line-of-sight distance of 450 miles. Range of the system, based on other company conducted tests, is about 1,000 miles, according to Paul Pflueger, Boeing Aero-Space Division ASW systems manager.

Use of meteor trails to transmit data offers the advantages of greater stability and control of the radio signal, according to Mr. Pflueger.

YOKE SPECIALISTS

FOR INFORMATION DISPLAYS

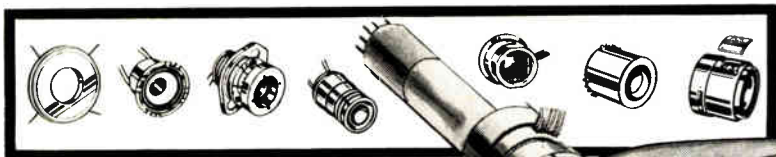

Syntronic's devotion to precision and attention to detail assure skillfully engineered deflection yokes in prototype or full production quantities. A complete line of value engineered yokes offer cost saving solutions to your CRT projects. Consult scientifically oriented Syntronic Yoke Specialists for the right yoke for your display.

Syntronic

INSTRUMENTS, INC.

100 Industrial Road, Addison, Ill.
Phone: Area 312, 543-6444

AN OPEN LETTER TO T-POT BUYERS:



There are 3 elements to any T-Pot purchase – let's look at them.

- 1 PRICE:** Through an extensive value analysis program Dale has reduced individual trimmer prices by as much as 25%.
- 2 QUALITY:** This same value analysis program has achieved an overall quality level which meets all recognized military and commercial standards.
- 3 DELIVERY:** An expanded stocking program enables us to ship many orders from finished goods stock within hours after receipt. On new orders with urgent delivery requirements we can produce up to 1,000 pieces within one week ARO.

In Price, Quality and Delivery, Dale can be more than competitive in meeting your wirewound T-Pot requirements.

BUYERS TELL US...

"We've been more than satisfied with Dale T-Pots, particularly the way they keep us out of hot water when a delivery date is critical."

*Tom E. Holtz, Buyer
General Dynamics – Pomona*



CHOOSE FROM 52 MODELS...



MILITARY (HUMIDITY PROOF, PRECISION)

600/900 SERIES Eight different configurations, standard, panel or printed circuit mounting; 10 to 50K ohms; 5% tolerance; 1 watt up to 70 C, derating to 0 at 175 C. SERIES 600, meets RT-10, MIL-R-27208. SERIES 900 has stainless steel screwhead.

1200 SERIES Three different terminal configurations, standard or printed circuit mounting; 10 to 100K ohms; 5% tolerance; 1 watt up to 70 C, derating to 0 at 175 C. Models 1287, 1288, 1289 meet RT-11, MIL-R-27208.

1600 SERIES Three terminal configurations, standard, panel and printed circuit mounting; 10 to 100K ohms; 5% tolerance; 1 watt up to 70 C, derating to 0 at 175 C. Models 1697, 1680, 1690 meet RT-12, MIL-R-27208.

5000 SERIES Three space saving square configurations; 10 to 50K ohms; 5% tolerance; 1 watt up to 70 C, derating to 0 at 150 C. Mil. equivalent RT-22.

COMMERCIAL

200 SERIES Five terminal configurations; 10 to 50K ohms; 10% tolerance; .5 watt to 70 C, derating to 0 at 105 C.

300 SERIES Two terminal configurations; 100 to 20K ohms; 15% tolerance; .25 watt to 70 C, derating to 0 at 85 C.

2100 SERIES Four different terminal configurations, flexible, printed circuit, solid leads or solder lug; 10 to 100K ohms; 10% tolerance; 1 watt up to 70 C, derating to 0 at 125 C; commercial counterpart of RT-11.

2200 SERIES Three terminal configurations; 10 ohms to 50K ohms; 10% tolerance; 1 watt up to 70 C, derating to 0 at 125 C; commercial counterpart of RT-10.

WRITE FOR CATALOG B

GENERAL PURPOSE

100 SERIES Five terminal configurations; 10 to 50K ohms; 5% tolerance; .8 watt to 70 C, derating to 0 at 135 C.

1100 SERIES High temperature. Three terminal configurations; standard or printed circuit mounting; 10 to 100K ohms; 10% tolerance; 1 watt to 70 C, derating to 0 at 175 C.

1500 SERIES Nine configurations, standard, panel and printed circuit mounting; 10 to 100K ohms; 5% tolerance; 1 watt up to 70 C, derating to 0 at 175 C.



DALE ELECTRONICS, INC.

1304 28th Avenue, Columbus, Nebraska
Also Sold by Dale Electronics Canada, Ltd., Toronto, Ontario, Canada

Circle 98 on Inquiry Card

WorldRadioHistory

ASSIGNMENT: BUILD A 16,384-BIT MEMORY STACK FIT FOR OUTER SPACE, TO WITHSTAND: -

50 G SHOCK

10 G VIBRATION

ΔT of -55° to $+105^{\circ}C$

Result: This RCA ferrite memory stack, designed to withstand the rigors of space flight, meets the toughest kind of environmental specs:



Vibration—10 g (0 to peak) 5 to 2000 to 5 cps at 1 minute/octave logarithmic sweeps, once along each of 3 mutually perpendicular axes.

Mechanical Shock—50 g, 11 ± 1 msec, half-sine wave, 2 shocks in both directions in each of 3 mutually perpendicular axes, a total of 12 shocks.

ΔT —5 cycles per MIL-STD-202, Method 102A, within limits of $-55^{\circ}C$ to $+105^{\circ}C$. Unit to operate at specs at $0^{\circ}C$, $25^{\circ}C$ and $70^{\circ}C$ (without use of heaters or other means of internal temperature control).

See the newest in RCA
High-Reliability Ferrite Memories
at INTERDATA 65—Booths 136 and 137.

How did RCA meet these demanding requirements?

- **By double-testing** each RCA wide-temperature-range ferrite memory core for 100% quality assurance.
- **Precision stringing** an array of 16 planes, each 32 x 32 cores, with continuous wiring through all 16,384 cores; no splices or internal solder joints are permitted. Then 100% testing the entire array.
- **Folding** the 16 planes over to form a continuously wired memory stack—and 100% testing it again.
- **Encapsulating** the stack in silicone rubber and securing it to its support case—and 100% testing it again.
- **Shaking, shocking and temperature cycling** the stack and 100% testing it at three different temperature levels.
- **AND DELIVERING ON SCHEDULE!**

Here's one more example of what RCA can do to build memory-system components to meet *your* requirements, regardless of how difficult they may be. Whatever you need in ferrite memory components, call your local RCA Field Office or write, wire or phone: RCA Electronic Components & Devices, Memory Products Operation, Section FJ9, 64 "A" Street, Needham Heights, 94, Mass. Phone: (617) HI 4-7200.



The Most Trusted Name In Electronics