

# ELECTRONIC INDUSTRIES

& TELE-TECH

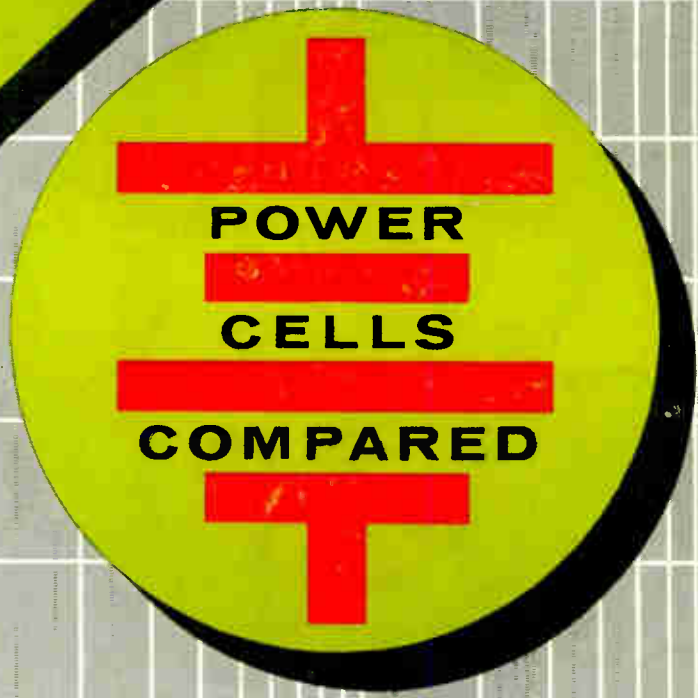

HOURS DISCHARGE

July • 1957

A Chilton Publication



RMC  
100

## RMC DISCAPS



RMC  
005



RMC  
.0022



RMC  
JF  
.0039

### Specify For Highest Quality and Fastest Service

Specification of RMC DISCAPS, where design requires ceramic capacitors, has built a volume operation where quality and service are paramount. Quality control is absolute as every DISCAP is checked on the production line for power factor, capacity, leakage resistance, and breakdown. Prompt shipment of orders is assured as RMC controls production from basic powders to completed capacitor.

RMC is prepared to service your requirements for standard or special ceramic capacitors. Write for complete information.

DISCAP  
CERAMIC  
CAPACITORS



**RMC**

**RADIO MATERIALS CORPORATION**  
GENERAL OFFICE: 3325 N. California Ave., Chicago 18, Ill.  
Two RMC Plants Devoted Exclusively to Ceramic Capacitors  
FACTORIES AT CHICAGO, ILL. AND ATTICA, IND.

# ELECTRONIC INDUSTRIES & TELE-TECH

Vol. 16, No. 7

July 1957

## MONTHLY NEWS ROUND-UP

<b>RadarScope:</b> <i>What's Ahead for the Electronic Industries</i> .....	2
<b>As We Go To Press</b> .....	5
<b>TOTALS:</b> <i>Late Marketing Statistics</i> .....	7
<b>Electronic Industries' News Briefs</b> .....	16
<b>Coming Events</b> .....	44
<b>Washington News Letter</b> .....	64
<b>New Tech Data for Engineers</b> .....	66

<b>Editorial: WESCON 1957; Standardize Wired-TV</b> .....	33
<b>New Horizons for Battery Power</b> .....	A. E. Look 34
<b>New Grids Improve Lead-Acid Cells</b> .....	Dr. H. J. Strauss 39
<b>Telemetered Data Checks Vanguard Flight</b> .....	F. W. Phalen 40
<b>What's New</b> .....	42
<b>1957 Coming Events Calendar (July to Dec.)</b> .....	44
<b>Cooling Robot Brains</b> .....	N. E. Sheldon, C. A. Nolph & G. A. Fleischer 46
<b>Design for an Improved HF Transistor</b> .....	G. Thornton, J. Roschen & T. Miles 47
<b>Improving the Glow Transfer Tube</b> .....	T. M. Jackson 50
<b>Metallurgical Aspects of Resistance</b> ..	Dr. T. P. Wang & E. T. Kubilins 52
<b>Hot Junctions and Collector Cut-Off Current</b> .....	B. Reich 56
<b>High Amplitude Pulse Gate</b> .....	G. A. Sample 57
<b>International Electronic Sources</b> .....	81

## NEW ELECTRONIC EQUIPMENT

<b>New Products . . . for the Design Engineer</b> .....	58
<b>New Products . . . for the Electronic Industries</b> .....	60
<b>New Products . . . for Communications</b> .....	62

## DEPARTMENTS

<b>Tele-Tips</b> .....	18	<b>Industry News</b> .....	114
<b>Books</b> .....	26	<b>Personals</b> .....	112
<b>News of Reps</b> .....	78		



## New Batteries!

34



Solid electrolyte, indium and nuclear cells are adding a new dimension to the battery field, in terms of increased shelf and service life. The familiar secondary cells, too, are much improved.

## A Look At "Vanguard" 40



Instrumentation in the Vanguard test vehicles faced the problems of corrosive atmospheres, high acceleration and heat ranges from -300° to 900°F. Unique transducers supplied the answer.

## Alloy Transistor 47

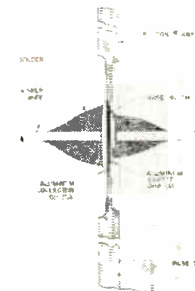

Manufacturing refinements make possible highly stable parameters for the silicon surface alloy transistor when operated at high temperatures.

## Computer Pulse Gate 57

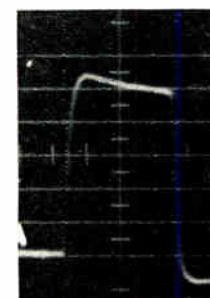

A unique circuit has been designed which is capable of blocking or passing positive pulses of 100 usec. minimum width. Insertion loss is 15%, with switching time of 0.25 usec.

ELECTRONIC INDUSTRIES & Tele-Tech, July 1957, Vol. 16, No. 7. A monthly publication of Chilton Co., Executive, Editorial & Advertising offices at Chestnut & 56th Sts., Phila., Pa. Accepted as controlled circulation publication at Phila., Pa. 75¢ per copy, except June (Directory issue, \$3.00). Subscription rates U. S. and U. S. Possessions: 1 yr. \$5.00; 2 yrs. \$8.00; 3 yrs. \$10.00. Canada 1 yr. \$7.00; 2 yrs. \$11.00; 3 yrs. \$14.00. All other countries 1 yr. \$10.00; 2 yrs. \$16.00. Copyright 1957 by Chilton Company. Title Reg. U. S. Pat. Off. Reproduction or reprinting prohibited except by written authorization.

# RADARSCOPE

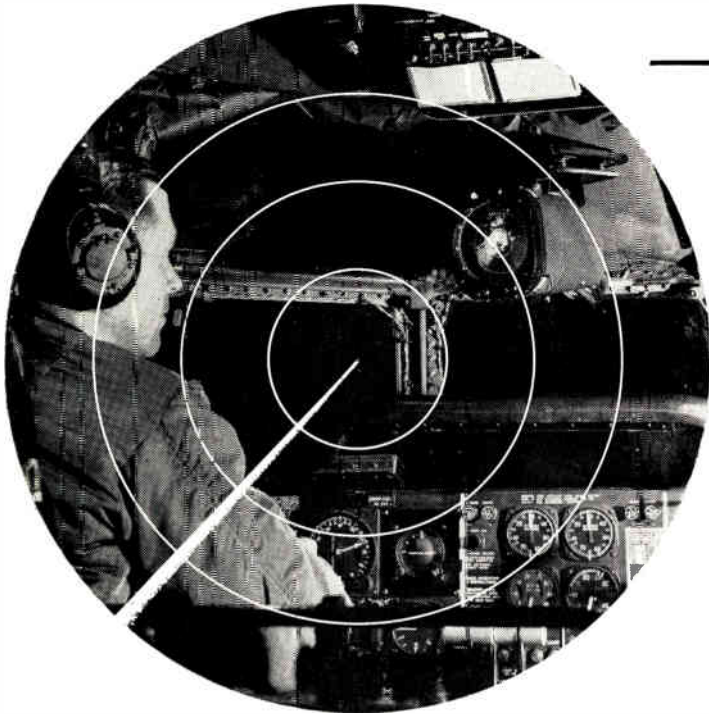

## RADAR INDICATOR

Latest feature of Sperry Gyroscope Co's APN-59 radar system is the pilot's auxiliary indicator shown in this Air Force C-97. A unique feature of the 5-in. indicator is the relative bearing presentation.

**VANGUARD FLIGHT TEST** on May 1 was made with a two-stage rocket combination which was launched to check out third stage separation techniques. The first stage, a modified Viking rocket, was attached to a medium size, solid propellant rocket simulating the third stage. The Viking attained 3500 mph by burn out and inclined into a horizontal trajectory while coasting up to 120 miles altitude. At that point the third stage was separated and fired. Both the vehicle and its instrumentation performed satisfactorily in all respects.

**SELF-CHARGING ELECTRIC WATCH** has been patented. Random motions of the wearer wind a small impulse spring which generates current to charge a small storage cell. The storage cell reportedly is able to operate the watch for as much as several weeks in a bureau drawer. No plans to manufacture the watch have been announced.

**OPERATION AT 1000° F** will be demanded of electrical wiring, magnetics, and semi-conductors by 1962 — airframe temperatures will be as high as 2000° F in the next five years, according to latest industry predictions. Engineers will be required to provide instrumentation for high-temperature tests of specimens, structures, and equipment at these elevated temperatures. Aviation experts foresee needs for new and improved sources of electrical energy for future aircraft systems operating at these temperatures.

**COLOR TV** takes a decidedly optimistic turn with the announcement by RCA that within three months five major manufacturers will join them in promoting color and that the remaining manufacturers will join the color push before the end of the year. No mention of how many will be producing sets, but even having their moral support will be a great improvement over the negative effect on the public of having the industry apparently split on whether color TV was practical. RCA's Robert A. Seidel complains that it is the dealer, not the public, that is holding back color sales. He says RCA's findings around the country are that the public is ready and willing to pay for color but that the apathy of dealers is creating doubts in the public's mind.

**ENGINEER UNIONIZATION** got a severe setback in Milwaukee where some 1,400 salaried engineers at Minneapolis-Honeywell voted overwhelmingly against both the UAW Federation of Honeywell Engineers and the Engineers and Scientists of America (ESA). The vote was 896 for "neither union," 314 for UAW and 197 for ESA. The vote was called for after union membership voted to terminate their decade-long affiliation with the ESA in favor of the more powerful UAW. Honeywell, supported by a group of non-union engineers, then challenged the federation's right to act as bargaining agent. While the engineers now will be without a collective bargaining agent there is a movement to organize a "sounding board" organization which would give professional employees a voice in their working conditions.

## ATLAS TEST SITE

Secluded Sycamore Canyon, northeast of San Diego, Calif., is the site of this Atlas Test tower. Here, systems tests and short periodic engine runups are conducted on the Convair-built missiles.

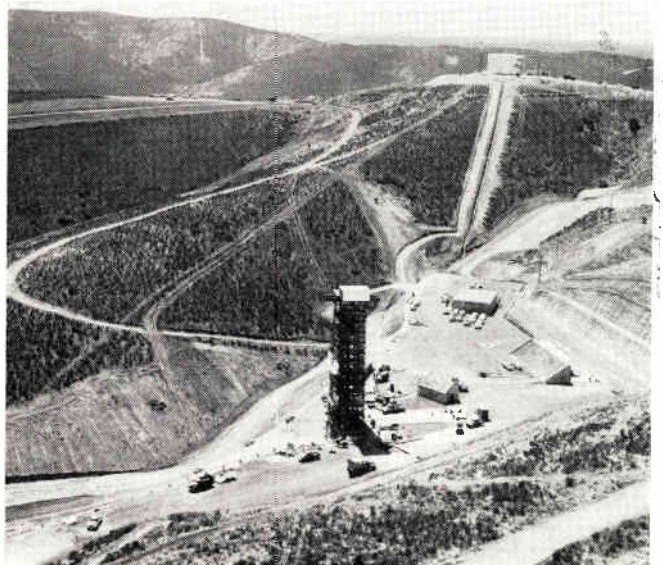

*Analyzing current developments and trends throughout the electronic industries that will shape tomorrow's research, manufacturing and operation*

**CANADIAN RADIO CROWDING** has reached serious proportions. Canada, already one of the four greatest users of radio, is seeking closer liaison between spectrum assigning officials and equipment manufacturers in order to cut interference.

**RADIATION RESISTANCE OF TUBES** made of ceramic materials is far greater than similar glass tubes. This, coupled with higher temperature tolerance of the ceramic tubes, will bring a weight bonus to nuclear powered aircraft—the ceramic tube requires less radiation shielding, and no refrigeration equipment. Additional advantages of ceramic tubes come from the "stacked tube" technique which gives smaller size and unusually stable performance under physical and thermal shock.

**BROADCASTING, 1994 STYLE**, will probably include automatic TV receivers which will turn on and off, and switch channels according to a pre-marked program card—and probably also program lights and other household electric devices. Remote switching for radio receivers, and camouflaged baffles to give room-filling acoustics to tiny sets are also among predictions made by NARTB president, Harold E. Fellows.

**BDSA DIVISION CUTS**, will probably lead to assumption of industry division functions by another department or bureau, according to RETMA testimony before the Senate Subcommittee on Appropriations for the Commerce Department. RETMA urges restoration of funds for BDSA industry divisions to prevent less efficient performance of these necessary functions by another Governmental department less familiar with the Electronic Industry's problems. Importance of services performed by BDSA Electronics Division for the \$6 billion electronics industry in 1956 is stressed in the testimony.

### **AIR FORCE PROCUREMENT**

**AIR MATERIEL COMMAND PROCUREMENT CHIEF**, Maj. Gen. David H. Baker, warned editors attending the meeting of the Society of Business Magazine Editors in Washington last month that the shift in emphasis from manned aircraft to guided missiles will mean reduced business for firms acting as airframe sub-contractors to the prime industry.

The Air Force is planning a sharp decrease in the number of aircraft to be delivered over the next few years, and simultaneously a sharp rise in the complexity—and cost—of individual aircraft. For this reason, the Air Force will be unable to consider new systems that do not add significantly to the country's striking or defensive power.

The smaller number of systems to be procured will mean fewer prime contractors, and in turn, less opportunity for sub-contractors.

While the missiles involve a much higher proportion of electronic equipment than manned aircraft, Gen. Baker saw little likelihood that electronic firms will assume a more leading role in missile development. The management responsibility, he said, will remain with the aircraft firms because of the very valuable past experience which they have acquired.

In describing the Air Force plans, Gen. Baker cited these figures: the present aircraft and missile production is 5,000,000 lbs./month. Production will peak, early in 1958, at about 6,500,000 lbs./month, and then will tail off in the following three years to 2,500,000 lbs./month. For comparison, at the peak of the Korean War, production was 11,000,000 lbs./month.

**FISCAL '58 MISSILE PROCUREMENT** by USAF will amount to about \$1,950,500,000. The Air Force will carry Thor development in fiscal 1958, and the Department of Defense hopes to continue the Jupiter program through calendar 1957, at which time a decision between the two, or a combination, will be possible. A similar decision may soon have to be made between Atlas and Titan ICBM's. The Air Force expects to have its long-range ballistic missiles in operational squadrons of the Strategic Air Command sometime after fiscal year 1960.

### **SUPER-RADAR ANTENNAS**

This shot of the Navy's missile ship **CANBERRA** shows the turret-like super-radar antennas which guide the Terrier missiles. The antennas are part of the two highly flexible SPQ-5 radar systems aboard the ship.

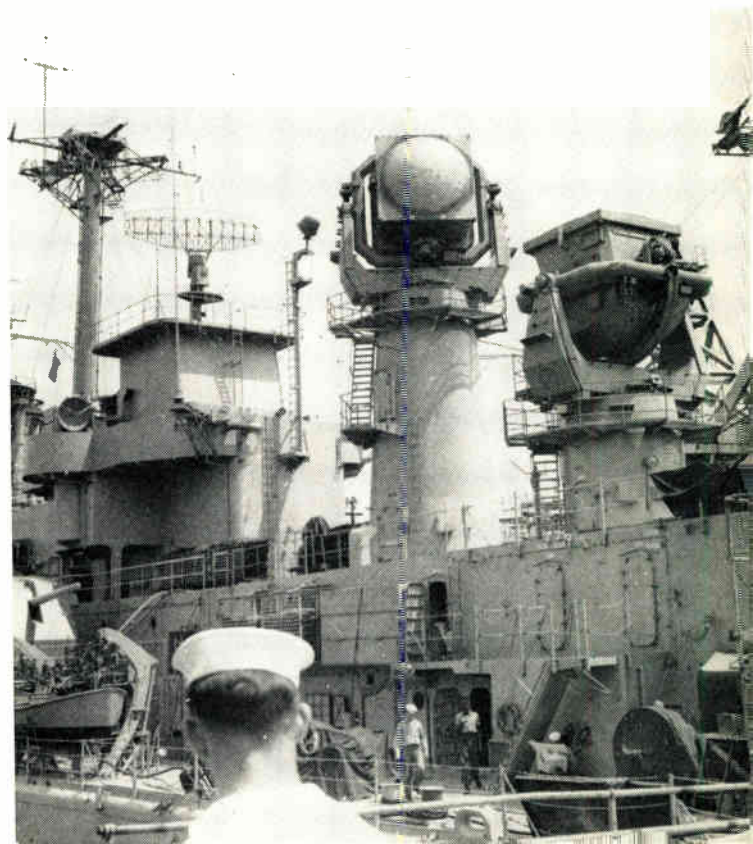



# MILITARY DESIGNERS

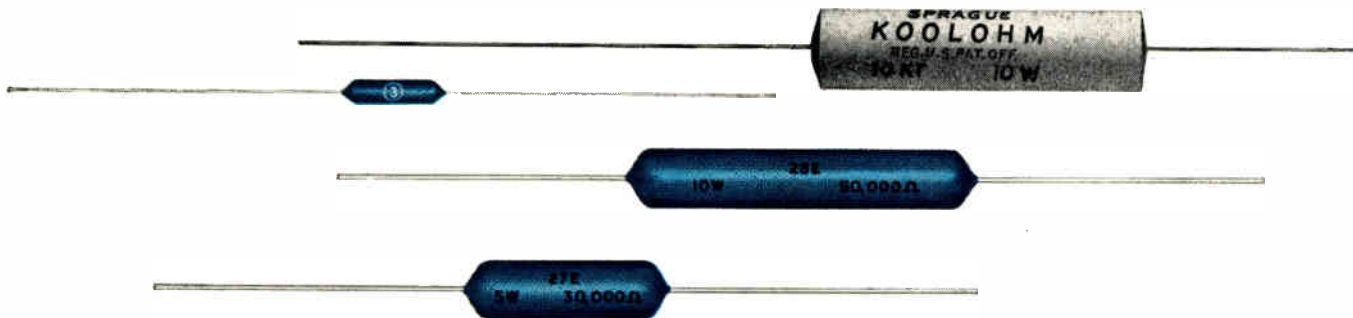

## SPRAGUE

### AXIAL-LEAD POWER RESISTORS ARE NOW AVAILABLE TO MEET ALL CHARACTERISTICS OF MIL-R-26C

When you want a lot of power in the smallest possible package—you'll be greatly interested in the Sprague Blue Jacket Resistor Type 151E—one of the smallest 3-watt resistors ever made. In Mil-R-26C it is designated as RW59.

Military designers find Sprague vitreous enamel Blue Jackets Type RW57 (5-watt) and RW58 (10-watt) Characteristic G and V resistors, extremely useful for point-to-point wiring on terminal boards.

When vibration is a factor in equipment, Sprague's Koolohm Resistors are designed to solve your mounting problem. They mount directly to chassis with a

wrap-around clamp and still withstand a ground test voltage of 10,000 volts.

Sprague Koolohm Resistors have compiled an outstanding service record in military equipment for more than 15 years. Axial-lead Koolohms, encased in a ceramic shell are designated RW55 (5-watt) and RW56 (10-watt) Characteristic G resistors.

The Sprague family of axial-lead resistors offers a complete range of sizes, ratings and characteristics to meet your requirements. They're designed to give you the stability and the physical and atmospheric protection you want. Write for Engineering Bulletins. ★ ★



ELECTRIC COMPANY • 233 MARSHALL ST. • NORTH ADAMS, MASS.

# As We Go To Press...

## New Basic Material For High Temperatures

Pyroceram, a new family of basic materials, harder than high carbon steel, lighter than aluminum and up to 9 times stronger than plate glass, has been announced by Corning Glass Works. The first commercial use of these new materials will be for a guided missile radome.

The new material can be made with a wide range of properties. Possible thermal expansions range from slightly negative to high enough to match those of heavy metals. It can have electrical insulating properties superior to those of the best commercial dielectric ceramics. It can be

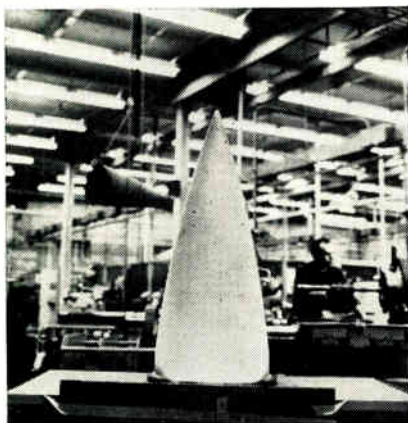

This machined missile radome is made of Pyroceram, a new high-temp material

made opaque or it can be transparent, the first polycrystalline material ever to exhibit this optical property.

Experimental Pyroceram compositions have flexural strengths as high as 60,000 pounds per square inch. The strength-to-weight ratio of one Pyroceram is identical to that of annealed aluminum, greater than that of titanium and stainless steel. Certain types of Pyroceram keep their strength at temperatures as high as 1300°F.

The Pyroceram developed for missile radomes is lighter than aluminum and has a flexural strength of 40,000 pounds per square inch. The softening point of this Pyroceram is 2460°F, which is above the melting point of some stainless steels.

## SOLAR RADIO HELMET

Strips of solar cells on crown of GI helmet provide power for tiny helmet radio designed by Signal Corps. Storage batteries retain energy for night time operation.



## SHF Radio Relay For Marine Corps

A new lightweight radio relay set, transportable on a man's back, is being produced for the Marines by Raytheon Mfg. Co. Previous sets had to be carried by truck or other vehicle.

Eight voice messages can be sent or received simultaneously with these new sets, adding flexibility to troop operation.

Super high frequency use makes it possible to reduce the diameter of the antenna reflector to 2½ ft. Power is supplied by a man-carried generator.

The new radios have a point-to-point range up to 10 mi., or, linked in chain fashion, up to 40 mi.

## Bell Labs Develop Power Transistor

A silicon power transistor, providing an output of 5 watts at 10 MC as an oscillator or an amplifier, is a most recent development at Bell Telephone laboratories. Unilateral gain in excess of 20 db, and collector efficiency better than 40 per cent has been achieved.

A p-n-i-p diffused emitter and base transistor, it has a near-intrinsic or "neutral" layer of silicon separating the collector from the other elements.

Alpha cutoff is about 100 MC—some samples have provided 1 watt output as an oscillator at 100 MC. Input and output impedances: 20Ω & 300Ω, respectively.

## New Forward Scatter Network for NATO

Supreme Headquarters Allied Powers Europe has issued a Letter of Intent to the International Standard Electric Corporation, foreign overseas management subsidiary of the International Telephone and Telegraph Corporation, including a directed subcontract to Hycon Eastern, Inc., Cambridge, Mass., for the engineering and installation of one of the most modern and extensive military communications systems in the world. This new network will combine over-the-horizon tropospheric forward scatter and line-of-sight radio relay links to further integrate, from a communications viewpoint, certain international and national military agencies and installations.

## SPACE SAVER



Designed to take "desk clutter" out of mobile radio base station installations, the "Minitrol" is the first combination talk-hear-control unit of its kind. Measuring 6 x 2½ x 2 in., it can be pre-set for hands-free operation.

MORE NEWS ON PAGE 9

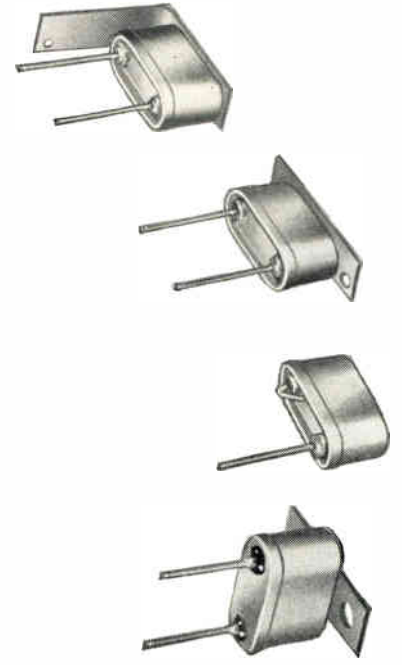
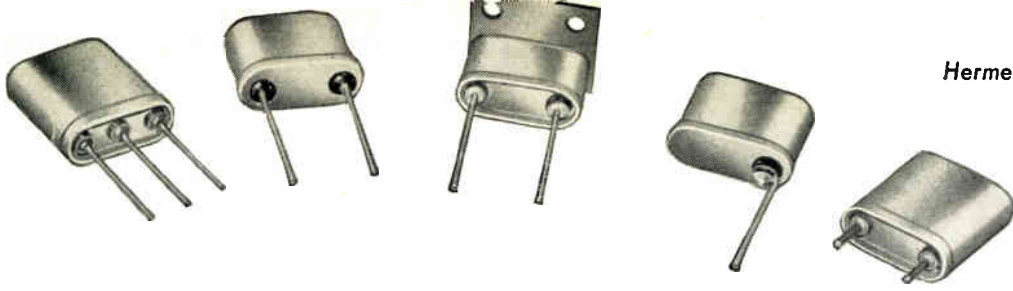

*Question*

**How to get fast response and close temperature control**

*Answer*

**Specify STEMCO Type C Thermostats for electronic devices**

*Semi-Enclosed Type C Thermostats*

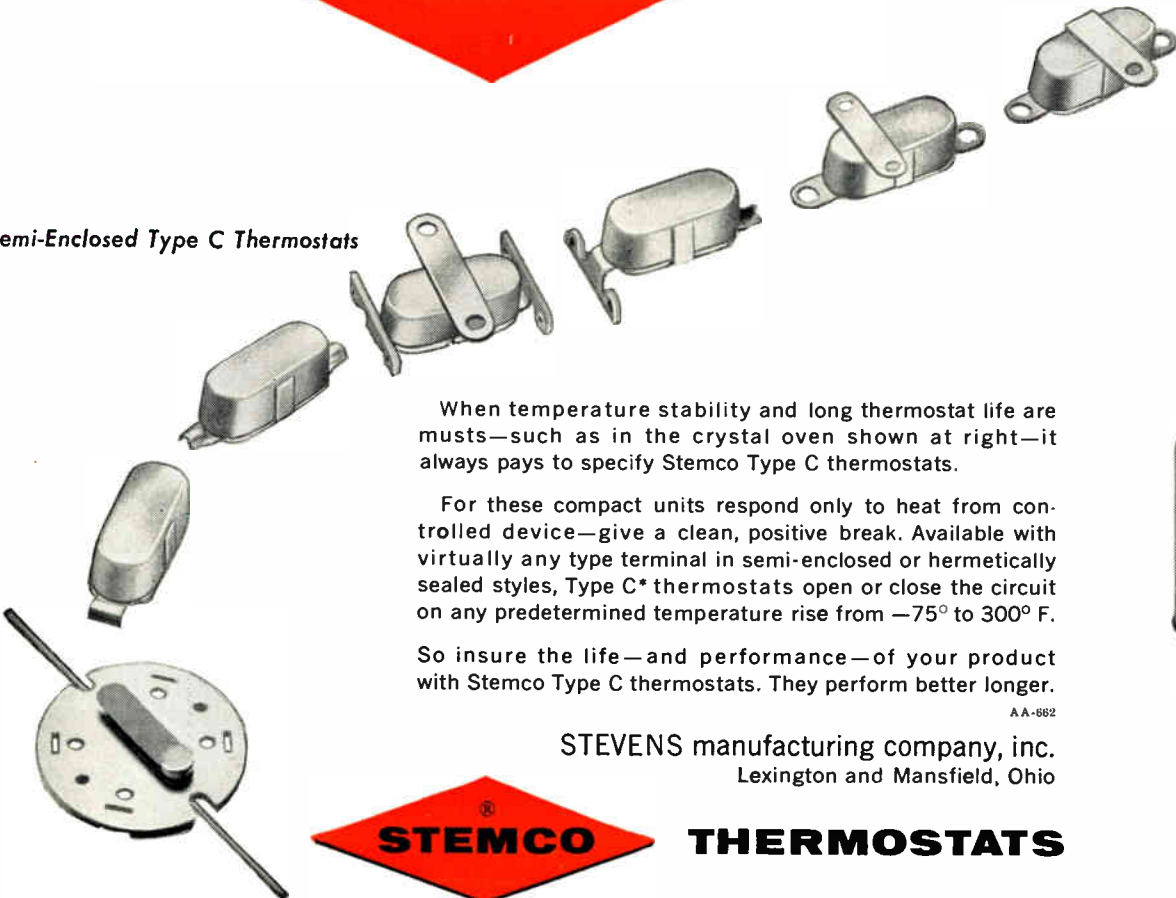

When temperature stability and long thermostat life are musts—such as in the crystal oven shown at right—it always pays to specify Stemco Type C thermostats.

For these compact units respond only to heat from controlled device—give a clean, positive break. Available with virtually any type terminal in semi-enclosed or hermetically sealed styles, Type C\* thermostats open or close the circuit on any predetermined temperature rise from  $-75^{\circ}$  to  $300^{\circ}$  F.

So insure the life—and performance—of your product with Stemco Type C thermostats. They perform better longer.

AA-682



STEVENS manufacturing company, inc.  
Lexington and Mansfield, Ohio



Potented

Stemco thermostats are used in leading Electronic and Avionic Devices • Computers • Radar • Appliances • Apparatus

Crystal oven courtesy James Knights Co.



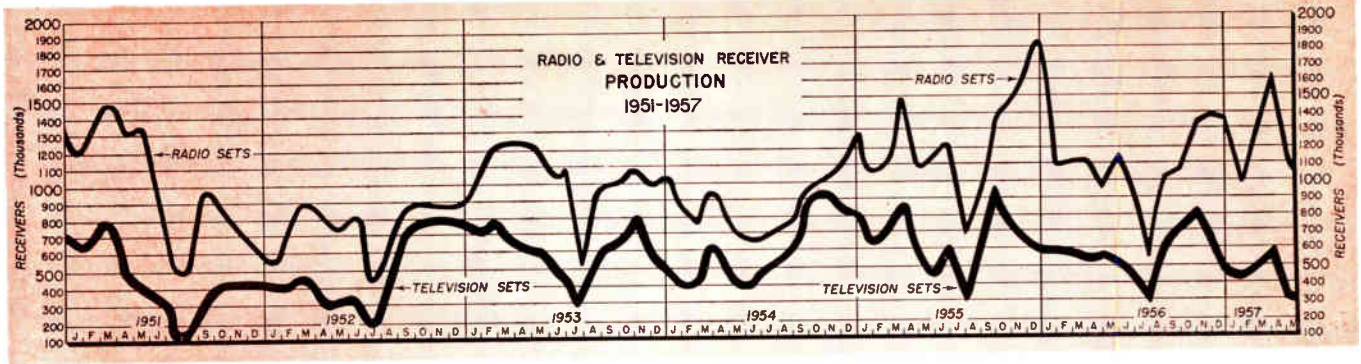

PICTURE TUBE SALES (B & W)

	Average No. B & W TV Sets in Use (000,000)	Rate of Tube Failure Per Set	Renewal Tube Sales (000,000)
1940	.....	.....	.....
1950	6.7	.09	.6
1952	18.1	.10	1.9
1954	29.0	.13	3.8
1956 E	39.5	.14	5.6
1957 J	43.5	.15	6.5
1960 J	50.2	.17	8.3
1963 J	49.5	.17	8.4
1966 J	41.3	.17	7.1

Sylvania Electric Co.

E—Estimate J—Projection

MILITARY EXPENDITURES

Budget Category	FY 1957		Total
	1st Quarter	2nd Quarter	
Aircraft	\$213.0	\$353.0	\$ 566.0
Ships and Harbor Craft	17.0	19.0	36.0
Combat Vehicles	1.0	2.0	3.0
Support Vehicles	.2	1.0	1.2
Guided Missiles	205.0	216.0	421.0
Electronics & Communications	130.0	236.0	366.0
Research & Development	66.0	76.0	142.0
Miscellaneous	.4	.7	1.1
	<b>\$632.6</b>	<b>\$903.7</b>	<b>\$1,536.3</b>

Millions of Dollars

—RETMA

PROJECTED TRANSISTOR SALES

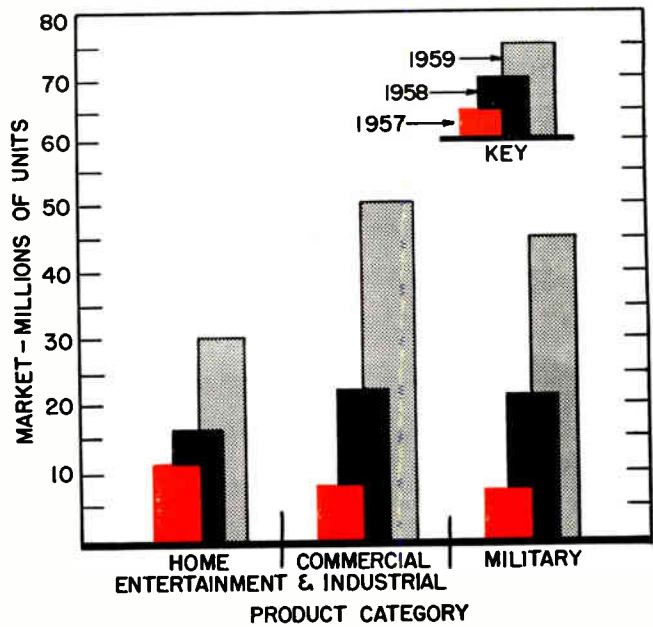

"The Transistor Market in the United States" prepared for Philco Corp., Lansdale Tube Co. Div., by Stanford Research Inst.

GOVERNMENT ELECTRONIC CONTRACT AWARDS

This list classifies and gives the value of electronic equipment selected from contracts awarded by government procurement agencies in May, 1957.

Amplifiers	2,607,611	Insulators	107,514	Radio Sets	5,299,049
Amplifiers, Audio	936,457	Inverters	356,647	Radio Transmitters	2,173,637
Antennas & Accessories	635,505	Kits, Modification	522,052	Radiosonde Equip.	1,368,454
Batteries, Dry	673,573	Kits, Radar Modification	240,597	Recorders & Accessories	998,725
Batteries, Storage	1,204,884	Meters, Frequency	520,010	Relays	240,679
Beacon Sets, Radio	216,962	Meters, Noise & Field	292,650	Switches	171,803
Cable Assemblies	194,826	Modulators	255,940	Syncros	138,257
Cable Sets, Interconnecting	262,075	Multimeters	464,747	Tape, Recording	292,608
Capacitors	146,649	Oscillators	255,000	Teletype Equip.	4,348,464
Computers & Accessories	605,172	Oscillographs	227,652	Testers	1,547,035
Connectors	153,540	Oscilloscopes	421,784	Test Sets	1,069,111
Echo Boxes	203,889	Power Supplies	755,995	Test Sets, Insulation	143,518
Facsimile Equip.	294,524	Power Units, Auxiliary	1,115,999	Test Sets, Radio	622,922
Generators, Signal	2,357,281	Radar Equip.	2,283,575	Transformers	173,890
Headsets	787,627	Radio Receivers	894,417	Tubes, Electron	2,842,650
Indicators	2,998,265	Radio Receivers-Transmitters	531,509	Wire & Cable	4,877,967

# THERMAL DESIGN PROBLEMS?

(Here's big news about thermally stable Hymu "80" laminations)

Magnetic Metals Company is processing Hymu "80" transformer laminations which will remain stable at temperatures from  $-55^{\circ}\text{C}$  to  $+85^{\circ}\text{C}$ . Core designers will find of great value the combination of thermal stability and reliable high permeability at low density. Laminations for a variety of applications are available in this material.

## MAGNETIC METALS COMPANY



ELECTROMAGNETIC CORES and SHIELDS

HAYES AVENUE AT 21st STREET • CAMDEN 1, N. J.

## ELECTRONIC INDUSTRIES

& Tele-Tech

One of the Publications  
Owned and Published by  
CHILTON COMPANY

Address all mail to  
Chestnut & 56th Sts., Phila. 39, Pa.  
SHerwood 8-2000

ROBERT E. McKENNA, Publisher  
BERNARD F. OSBAHR, Editor  
MAURICE CLEMENTS  
ORESTES H. CALDWELL  
Consultants

CREIGHTON M. MARCOTT  
Managing Editor

ARNOLD LOOK  
RICHARD G. STRANIX  
JOHN E. HICKEY, Jr.  
Assistant Editors

DR. A. F. MURRAY  
STANLEY GERSTIN  
Contributing Editor  
ROLAND C. DAVIES  
Washington News  
B. V. SPINETTA  
Directory Editor  
ELMER KETTERER  
Art Editor

### BUSINESS STAFF

Philadelphia Office—

ELMER DALTON  
Circulation Manager  
GORDON HERNDON  
Production Manager  
WILLIAM D. MCCARNEY  
Sales Promotion Manager

New York Office—100 East 42nd St.  
Phone OXford 7-3400  
JOSEPH DRUCKER  
GERALD B. PELISSIER  
MENARD DOSWELL III  
Regional Managers

Chicago Office—360 N. Michigan Ave.  
RAndolph 6-2166  
GEORGE FELT  
Regional Manager

Cleveland Office—930 Keith Bldg.  
SUperior 1-2860  
SHELBY A. McMILLION  
Regional Manager

Los Angeles Office—  
198 S. Alvarado St.  
DUnkirk 7-4337  
B. WESLEY OLSON  
Regional Manager

San Francisco Office—1355 Market St.  
UUnderhill 1-9737  
DON MAY  
Regional Manager

Tulsa—Petroleum Building  
420 S. Boulder St.  
LUTher 4-1769  
HAROLD J. MOTT  
JOHN W. SANGSTON  
Regional Managers

### OFFICERS and DIRECTORS

JOS. S. HILDRETH, Board Chairman  
G. C. BUZBY, President

Vice Presidents: P. M. Fahrendorf,  
Harry V. Duffy, Treasurer, William H.  
Vallar; Secretary, John Blair Moffett;  
George T. Hook, Maurice E. Cox,  
Frank P. Tighe, Leonard V. Rowlands,  
Robert E. McKenna, Irving E. Hand,  
Everit B. Terhune, Jr., Russell W. Case,  
Jr., John C. Hildreth, Jr.,  
Stanley Appleby, Comptroller



### GROUND SUPPORT MISSILE

Lacrosse all-weather missile for use against enemy troop concentrations, is launched from standard Army truck. Federal Telecommunication labs supplied the guidance system.

### DuMont Now Markets All Receiving Tubes

A complete line of receiving tubes for television, radio, communications, and industrial electronics is now being marketed by the Television Tube Division of Allen B. DuMont Laboratories, Inc., through their cathode-ray tube dealers.

### USAF Hits Buying Rule

A high Air Force source discloses that it will have to delay or cancel up to \$3.5 billion of long-range "installment" buying if it complies with a new procurement regulation.

This "initial off-the-cuff estimate" was supplied by the Air Force to Defense Secretary Wilson in response to a directive that bans defense purchases not fully covered by Congressional spending authorities.

### New Semiconductor, Gallium Arsenide

Gallium arsenide microwave capable of operation at radar frequencies, and at temperatures well above the maximum for silicon units, have been made in substantial sample quantities at RCA's David Sarnoff Research Center at Princeton, N. J. Efficient operation is possible at temperatures as high as 850°F, nearly 300 degrees hotter than the maximum for present types.

Although many compounds are being tested in a search for improved semiconductors, Gallium arsenide shows notable promise for devices operating at the high temperatures required by ultra-high-speed aircraft and miniaturized computers.

Gallium arsenide solar cells have already been made, and laboratory tests show promising performance.

## WESCON 1957

We are now putting the finishing touches on our sixth annual West Coast issue which is published in conjunction with the WESCON show and convention. A few of the highlights about this year's event are of interest.

There will be more than 750 exhibitors occupying 175,000 square feet of display space. More than 30,000 registrants are expected, which is more than before. The San Francisco visitors bureau has reserved more hotel rooms for WESCON 1957 than for any single convention in the city's history! The technical papers this year have been carefully screened. There will be 225 papers at 48 Technical sessions. In addition to the regular exhibits the Army and the Air Force are planning extensive military electronic displays. There will be at least eight field trips to points of electronic interest in the San Francisco Bay area. A "Future Engineers" show has been arranged for the younger set accompanying WESCON registrants. It features "Science in Action" and offers a \$500 scholarship to the youngster with the most ingenious scientific exhibit.

Full details in your August WESCON issue. Watch for it!

## Inertial Guidance

Sperry Corp last month gave industry a brief look at the problems encountered in the manufacture of gyroscopically controlled inertial guidance systems at their Lake Success, N. Y. plant. Dimensional tolerances to 25 millionths of an inch, and assembly under completely dust-proof conditions are highlights of the manufacturing process. Units are being delivered to the military for airborne use.



(Left) Assemblers wash, scrub shoes and don nylon uniforms before entering assembly area.

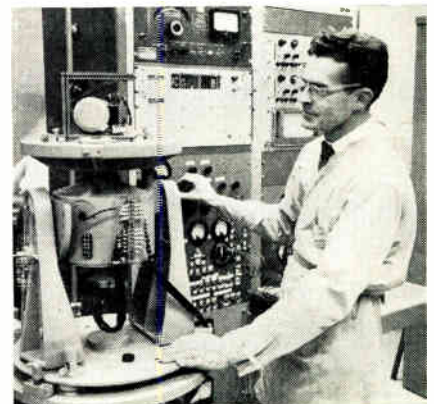

(Right) Super-accurate gyro is oriented on a true line to Polaris (North-South) within  $\pm 2$  secs of arc.

# F-I-a-s-h!...from Transistor Center, U.S.A.

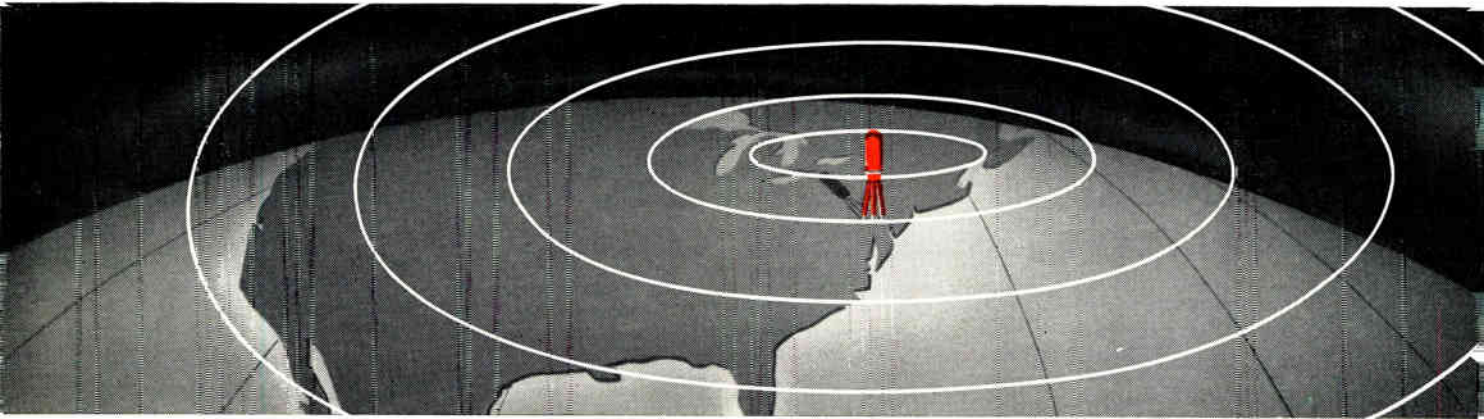

## Announcing a new transistor class . . . The PHILCO Micro-Alloy Transistor (MAT)\*

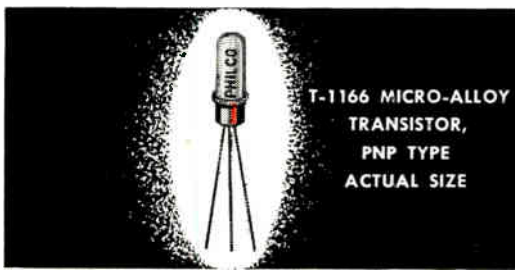

### CHECK THESE UNEQUALLED FEATURES

- Excellent High Speed Switching characteristics.
- Low Saturation Voltage (low impedance)
- Excellent high frequency amplification.
- Excellent low-level amplifier over entire frequency range from D.C. to Megacycles.
- Exceptionally Long Life (hermetically sealed)
- Permits high speed computer design with Fewer Stages.

... world's first production transistor with exceptionally high frequency and high gain . . . plus low saturation resistance!

This newest development from Philco Transistor Center features the characteristic high frequency response obtainable with extremely precise base width control. Designed for low voltage operation, the new MAT transistor is especially well suited for high speed applications where low saturation resistance (reduced power consumption) is necessary.

To combine high gain at high currents with high frequency response, the new MAT transistor employs a gallium doped alloy junction for the emitter electrode.

A special short-alloying cycle, combined with precise electro-chemical production techniques (pioneered and developed at Philco Transistor Center for production of SBT), results in the micro-alloy contact for exceptionally high injection efficiency. This new process assures higher gain, and permits operation at higher current. Beta linearity is excellent over the entire range of operating currents . . . up to 50 milliamperes.

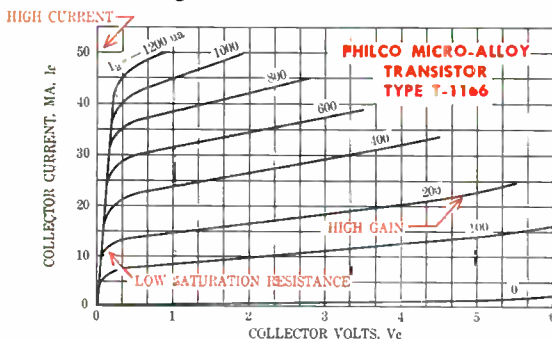

● Write for complete information and specifications. Make Philco your prime source of information for high frequency transistor applications.

\*Patent Applied For

Visit The Unique Philco Transistor Display at WESCON Show, San Francisco Cow Palace, August 20-23, Booth # 2217-2218.

# PHILCO CORPORATION

## LANSDALE TUBE COMPANY DIVISION

LANSDALE, PENNSYLVANIA

## IGY PLANS



The arrangements committee of the International Union of Geodesy and Geophysics XI Assembly in Toronto, September 3-14, display equipment to be used this summer by University of Toronto and Canadian Research Board expeditions in British Columbia and the Canadian Arctic to study glaciers as part of the International Geophysical Year.

## New RETMA Committee

RETMA is now forming a new commercial committee to be known as the Closed-Circuit TV and Television Distribution System Committee in order to better serve the rapidly expanding closed-circuit TV and television distribution system industry, including master antenna systems and community antenna systems, according to an announcement today.

The new committee will be a part of the Broadcast and Closed-Circuit TV Equipment Section of the Technical Products Division and will be under the chairmanship of Max H. Kraus, of Jerrold Electronics Corp. of Philadelphia.

## WEATHER RADAR

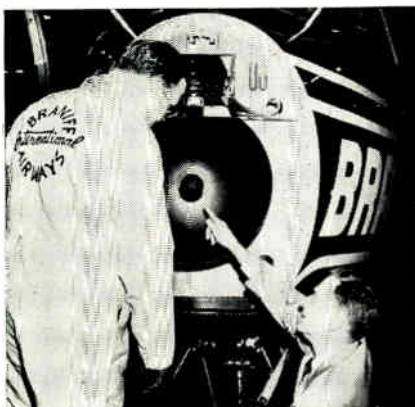

Braniff International Airways, Dallas, Texas, is installing RCA weather radar systems which enable pilots to "see" storm formations up to 150 miles ahead. They are the sixth major American commercial airline company to purchase the RCA AVQ-10 weather radar system.

# ELECTRONIC SHORTS

▶ The Electronic Messenger, a facsimile transceiver, manufactured by Electronic Communications, Inc., has shrunk the 85 mi. between New York and Philadelphia, communication wise, to a matter of minutes. The equipment rapidly converts information contained on paper, be it handwritten, typed or pictorial, into electrical impulses which can be transmitted over a telephone circuit. A companion transceiver reconverts the impulses into an exact reproduction of the original on electro-chemical sensitive paper.

▶ USAF crews flew Lockheed-built C-130 airplanes, propjet troop-and-cargo transports, at altitudes of 25,000 and 26,000 ft. and at a speed of over 350 mph across oceans and mountain peaks. The craft's ability to fly at high altitudes enabled them to avoid unfavorable weather and heavy air traffic and speed directly to bases in Europe and Panama on test missions. The plane, powered by 4 Allison P-56 propjet engines, sailed above the Alps—rather than around them—and flew directly from Athens, Greece, to Evreux, France.

▶ In keeping with the increased costs of material and the continued upward spiral in manufacturing costs, Dage Television Div., manufacturers of industrial television equipment, have announced an overall increase in the list price of closed-circuit TV equipment ranging from 10% to 20%. Dage recently installed the world's largest closed-circuit TV system—105 TV cameras and 103 monitors—in New York's Pennsylvania RR Station. The system has speeded up ticket sales, reservations, and information as much as 90%.

▶ A square wave drive test recently developed by Sylvania, has been termed the "most promising" for testing horizontal deflection tubes. The development of 110" wide angle TV picture tubes and "off the line" B+ power supplies have made obsolete the former static methods. G. M. Lankard, an advanced application engineer at Sylvania, also traced attempts to test dynamically the horizontal deflection tubes through the use of 60 cps sine wave grid drive voltage in his paper delivered at the 11th Annual Technical Conference on Television.

▶ The Educational Television and Radio Center has moved into its modern new building in Ann Arbor, Mich., a move which gives National Educational Television its first permanent home. N.E.T. is the youngest TV network, linking together 23 non-commercial stations.

▶ Recognizing the need for a constant source of that vital raw material—the graduate engineer—the National Science Foundation has made a \$10,000 grant to support the first phase of a comprehensive study of how American engineering colleges may attract and keep top flight engineering teachers for their growing numbers of students.

▶ The U. S. A., Britain's best customer for high-fidelity equipment, sent 26 buyers to the Radio and Electronic Component Show in London. Nearly 24,000 people, including representatives from 28 countries abroad, visited the exhibition during its 4-day run.

▶ The U. S. S. Skate will be powered by the third full-scale operating nuclear reactor designed and developed for the U. S. Navy by Westinghouse Electric Corp. The Skate is the first of 4 fleet-type submarines with nuclear power plants to join the Navy's new "atomic fleet."

▶ Production models of the IM-99 Bomarc pilotless interceptor have been ordered by the USAF from the Boeing Airplane Co. The contract is for more than \$7-million. In a series of successful firings at Patrick AFB, Florida, the IM-99 has proved itself an excellent interceptor weapon. Its range is such that it can shoot down enemy bombers at a far greater distance than any other missile presently in use in air defense.

▶ Now, in addition to the TV picture tubes which it has provided to electronic parts distributors since 1938, Dumont Television Tube Div. will market a complete line of receiving tubes for television, radio, communications and industrial electronics. The complete tube requirements of parts jobbers can now be filled with Dumont products.

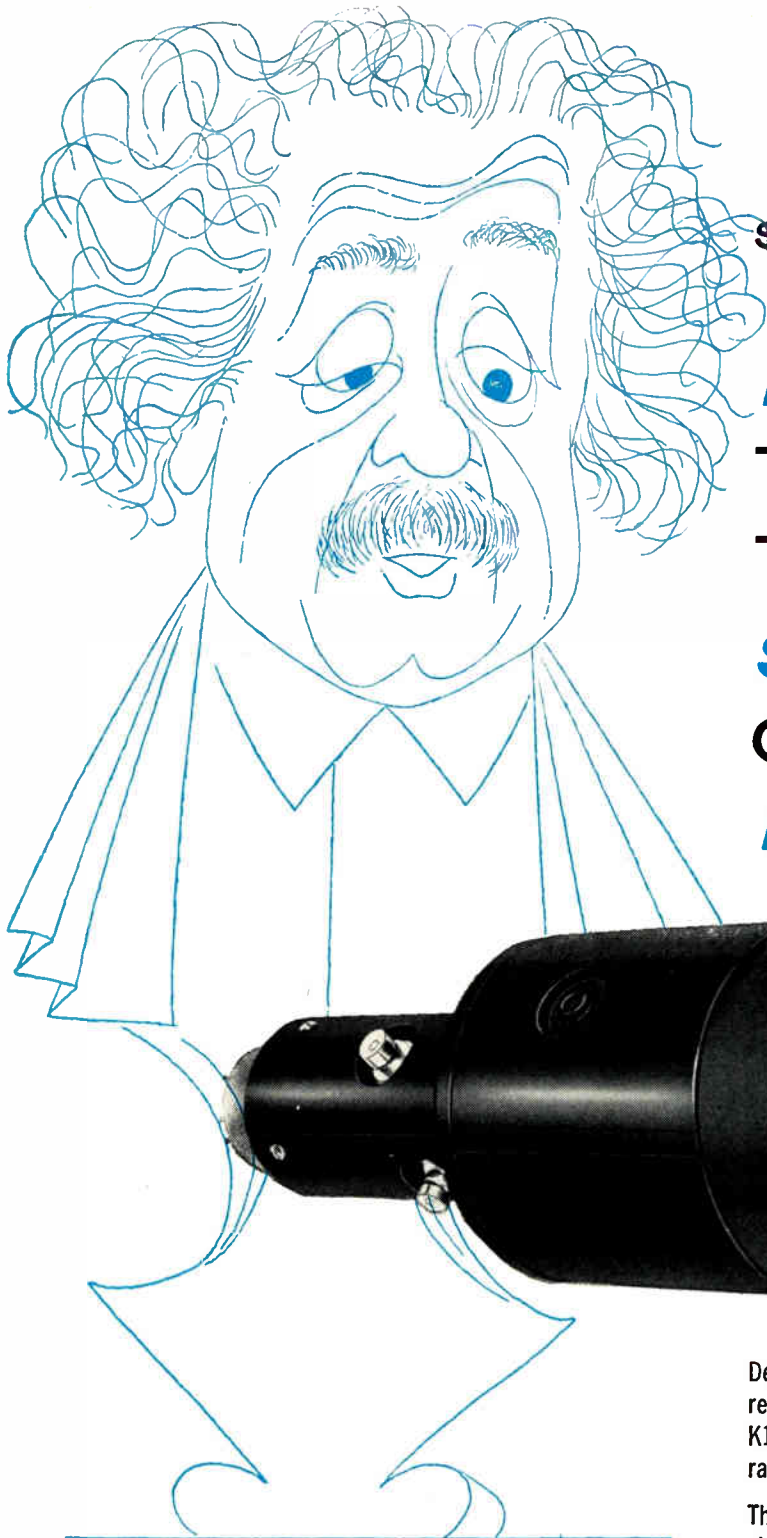

SPOT WRITING RATE:

**FASTER**  
THAN  
THE  
**SPEED**  
OF  
**LIGHT**



Developed to meet the precise needs of nuclear research and investigation, the Du Mont Type K1409 cathode-ray tube develops a spot writing rate exceeding the speed of light.

This is another example of the "can do" spirit and ability of the Du Mont Tube Research Laboratory.

For cathode-ray tubes, or multiplier phototubes of unusual abilities, call on Du Mont's "can do" . . .

**DU MONT**

INDUSTRIAL TUBE SALES,  
ALLEN B. DU MONT LABORATORIES, INC.

2 Main Ave., Passaic, N. J.

ELECTRONIC INDUSTRIES & Tele-Tech • July 1957

$$E=MC^2$$

PD-9 provides instant adjustment and soundless mobility for dolly shots, with Power Driven up and down camera movement. This new concept, Model PD-9, allows the cameraman to devote maximum attention to his subject without removing his hands from the camera controls. Available in two models — PD-9C for color and PD-9M for monochrome.



**ALL NEW  
MOTOR  
DRIVEN  
TV  
PEDESTAL**

The Houston Fearless Line of TV and Motion Picture Studio Equipment Also Includes This Variety of Products:

**Standard Television Pedestals**—Used in most of the leading television stations throughout the country. Three different versions available.

**Panoram Dolly**—For complete camera mobility, smooth pan effects, angle shots, running shots, tilts, dolly shots and countless special effects.

**All-Metal Adjustable Tripod**—Ideal for use with 35mm cameras in the studio or field.

**Tripod Dolly**—Designed to provide convenient mobility for tripod-mounted television and motion picture cameras.

**Cradle Heads**—Perfect balance and remarkable ease of horizontal and vertical panning for monochrome and color television cameras.

**Remote Control Units**—For Mounting TV cameras in inaccessible places and operating them completely from a small portable camera control.

**Remote Control Microwave Parabola**—Easy control of the direction or degree of azimuth and tilt from the television transmitter room at distances of over 1500 feet.

For complete information regarding model PD-9 and any or all of the Houston Fearless TV and Motion Picture Equipment, send in the attached coupon.



**HOUSTON FEARLESS** Dept. E1 7  
11801 W. Olympic Blvd. Los Angeles 64, Calif.

Please send me complete information on:

- |   |  |
|---|--|
| <input type="checkbox"/> PD-9 TV Pedestal   | <input type="checkbox"/> Cradle Heads                      |
| <input type="checkbox"/> Standard Pedestals | <input type="checkbox"/> Remote Control Units              |
| <input type="checkbox"/> Panoram Dolly      | <input type="checkbox"/> Remote Control Microwave Parabola |
| <input type="checkbox"/> All-Metal Tripod   | <input type="checkbox"/> Tripod Dolly                      |

Name \_\_\_\_\_

Company \_\_\_\_\_

Position \_\_\_\_\_

Address \_\_\_\_\_

City \_\_\_\_\_ Zone \_\_\_\_\_ State \_\_\_\_\_

# smallest connector



## CEC's NEW LIGHTWEIGHT MINIATURE CONNECTOR FOR HIGH-ALTITUDE, HIGH-TEMPERATURE OPERATION

Consolidated's new series of miniature electrical connectors open new horizons for design engineers. Designed especially for the electronics, avionic, and instrumentation industries, these extremely reliable, multi-contact connectors meet or exceed MIL-E-5272A specifications. Recommended for all applications that require high-temperature characteristics, high break-down voltage between pins and ground, low noise, and positive sealing against moisture and pressure leakage.

The unique cold-flow properties of the Teflon\* inserts under compression provide a positive dielectric and mechanical seal against leakage and eliminate air voids between individual contacts and between contacts and ground. With CEC Connectors, no supplementary pressure-tight sealing is ever needed for missile applications.

*\*DuPont registered trademark. See drawing for exclusive CEC design features.*



SQUARE-FLANGE RECEPTACLE  
*Series 100*



PANEL-MOUNT RECEPTACLE  
*Series 200*



CORD RECEPTACLE  
*Series 300*



STANDARD PLUG  
*Series 400*

## cec's new miniature connector



# with the biggest story

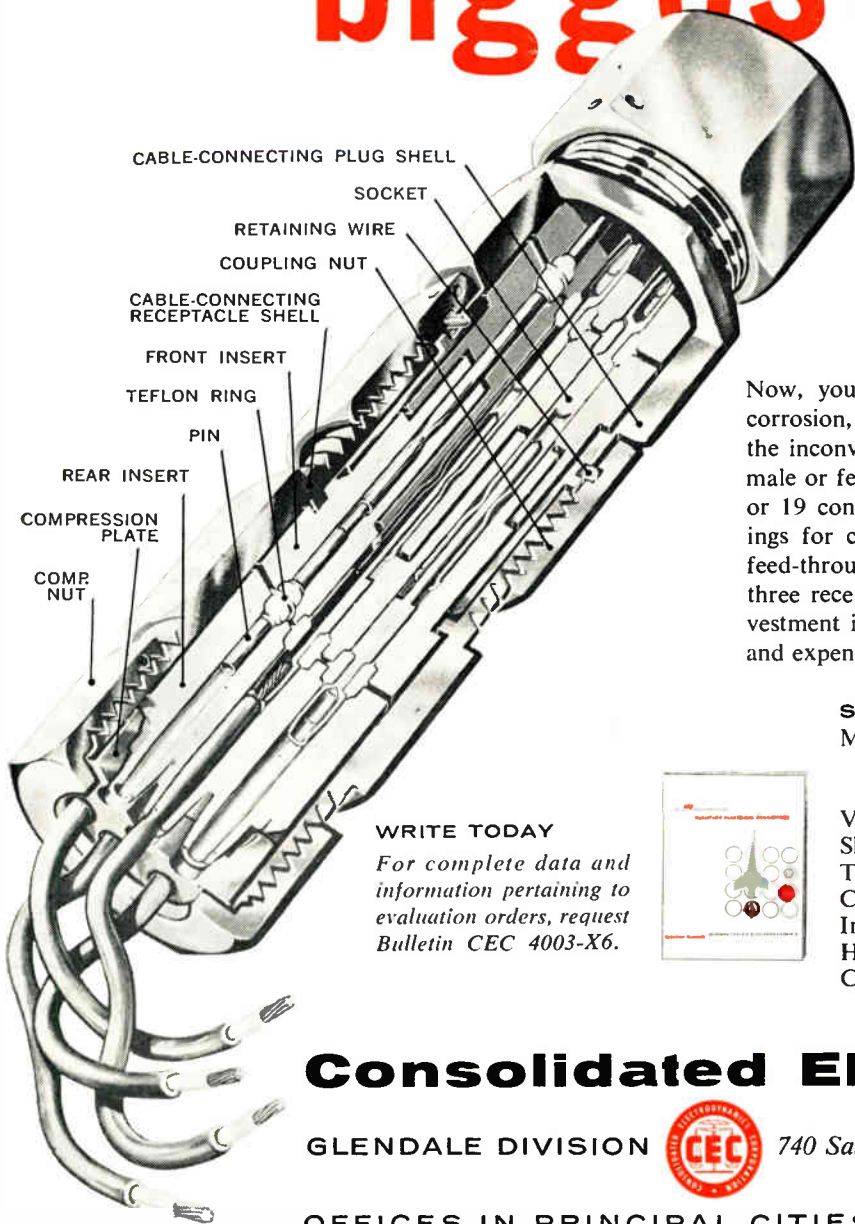

CABLE-CONNECTING PLUG SHELL

SOCKET

RETAINING WIRE

COUPLING NUT

CABLE-CONNECTING  
RECEPTACLE SHELL

FRONT INSERT

TEFLON RING

PIN

REAR INSERT

COMPRESSION  
PLATE

COMP  
NUT

## WRITE TODAY

For complete data and information pertaining to evaluation orders, request Bulletin CEC 4003-X6.



## SUPERIOR ELECTRICAL CHARACTERISTICS

Now, you can achieve positive sealing against moisture, corrosion, explosive vapors, and pressure leakage without the inconvenience and expense of potting. Interchangeably male or female, CEC Connectors are available with 1, 3, 7, or 19 contacts in three differently shaped receptacle housings for cable-to-cable, cable-to-equipment, and bulkhead feed-through. A standard plug connector mates with all three receptacles. Compare these specifications—a small investment in some evaluation units now may save you time and expense in the future.

### SPECIFICATIONS

Max. Operating Voltage

1. Sea Level.....1800-v, a-c
2. 70,000 feet.....800-v, a-c

Vibration.....No resonances to 2000 cps

Shock.....> 200 g's

Temperature.....-67° to + 400° F

Contact Voltage Drop...< 25 mv at 5 amps

Insulation Resistance.....> 10<sup>10</sup> megohms

Humidity.....160° F, 14 days, 95% RH

Corrosion.....Salt spray per QQ-M-151a

## Consolidated ElectroDynamics

GLENDALE DIVISION



740 Salem Street, Glendale 3, California

OFFICES IN PRINCIPAL CITIES THROUGHOUT THE WORLD

# Electronic Industries' News Briefs

Capsule summaries of important happenings in affairs of equipment and component manufacturers

## EAST

**FEDERAL TELEPHONE & RADIO CO.** has received a contract for \$19-million to manufacture AN/ARN-21 Receiver-Transmitters for the Bureau of Aeronautics, U. S. Navy.

**DIGITRONICS CORP.**, consultants and manufacturers of digital systems and components has recently been formed. Their offices will be at 35-10 36th Ave., Long Island City 6, N. Y.

**GLASS-TITE INDUSTRIES, INC.**, 1391 Atwood Ave., Johnston 9, R. I., has been formed to manufacture hermetic seals for the electronic industry.

**H. K. PORTER CO., INC.**, has acquired Federal Wire & Cable Co., Ltd., Guelph, Ontario.

**GULTON INDUSTRIES, INC.**, now makes ultrasonic systems and equipment available on a rental basis. There will be no exploitation of the company's patent position as the purchaser has the option of renting or buying the equipment outright.

**RADIO CORPORATION OF AMERICA** has been awarded a USAF product improvement contract under which it will develop industry wide design and reliability standards for various types of airborne electronic equipment.

**GE'S MISSILE AND ORDNANCE SYSTEMS DEPT.** has added guided missile production facilities. The production capability was added to supplement existing research and development capabilities.

**WESTINGHOUSE ELECTRIC CORP.** is working on multi-million dollar contracts to supply control equipment for the USAF's Project SAGE, the automatic early warning radar and air defense system.

**ELECTRONIC SYSTEMS DIV., SYLVANIA ELECTRIC PRODUCTS, INC.**, has begun construction on a new multi-million dollar research and development center at Amherst, N. Y. Completion of the 100,000 sq ft building is scheduled for Feb., 1958.

**SPERRY GYROSCOPE CO.** has been awarded a \$3.5-million contract for continued production of MA-2 automatic flight control systems for B-52 Stratofortress super bombers.

**REMINGTON RAND UNIVAC DIV., SPERRY RAND CORP.** is conducting free summer courses in electronic computers for college and university faculty members through its newly formed Univac Educational Department.

**ORRADIO INDUSTRIES, INC.**, and **AMPEX CORP.** have "pooled resources" and joined forces toward the development of the highest possible quality instrumentation type magnetic recording tape.

**MINNEAPOLIS - HONEYWELL REGULATOR CO.** has received a USAF contract totaling more than \$1-million to supply its toss-bombing system for the B-47 stratojet bomber. Known as LABS (low-altitude bombing system), it is already in general use on a number of USAF, Navy and Royal Air Force fighters.

**INTERNATIONAL BUSINESS MACHINES CORP.** has announced that it will move the headquarters of its Data Processing Div., the company's largest, from New York City to Westchester County. The move will be made in two stages and will be completed in 1959.

**GATES RADIO CO.** has recently delivered two of its 30 kw transmitters and six 10 kw transmitters to Press Wireless, Inc., a radio communications company with connections in the important news centers of the world.

**GENERAL TRANSISTOR CORP.** has authorized Arrow Electronics, Inc., 525 Jericho Turnpike, Mineola, N. Y., to be the first electronic wholesaler to become an authorized distributor.

## MID-WEST

**INSULATION MANUFACTURERS CORP.** has moved its Milwaukee office to the Bockl Bldg., 2040 West Wisconsin Ave. Cyrus H. Lyle continues as office manager. The firm's Detroit office is now in the New Center Bldg., 7430 Second Blvd. Carl A. Brandelle will serve as branch manager.

**SENTINEL RADIO CO.** has moved its general sales offices to 2131 Bueter Rd., Fort Wayne, Ind.

**GENERAL ATOMIC DIV., GENERAL DYNAMICS CORP.** has signed a contract with the Texas Atomic Energy Research Foundation for a four year, \$10-million jointly sponsored research program in the field of controlled thermonuclear reactions.

**ELECTRONIC ENGINEERING CO. OF CALIFORNIA** has occupied its new \$550,000 40,000 sq. ft. bldg. at 1601 East Chestnut Ave. Santa Ana, Calif.

**GE's DISTRIBUTION ASSEMBLIES DEPT.** is nearing completion of its \$500,000 expansion and modernization program at its Houston, Texas, Plant.

**SEMICONDUCTOR - COMPONENTS DIV., TEXAS INSTRUMENTS INCORPORATED.** has opened marketing department offices at its new quarters at 2929 Cedar Springs Rd., Dallas, Texas.

**RADIATION INSTRUMENT DEVELOPMENT LABORATORY** has begun construction on expanded facilities that will enable it to triple its present production.

## FOREIGN

**REFLECTONE CORP.**, manufacturers of precision devices, simulators, and training systems, has appointed Nissho Co., Ltd., of Osaka, Japan, as its representative in Japan, the Philippine Islands, Formosa, Thailand, Indonesia, and India.

**WESTINGHOUSE ELECTRIC INTERNATIONAL CO.** has signed a formal contract with Societe Cooperative Electro Nucleaire for 11.5-thousand kw atomic power plant which will provide Belgium with electrical energy by the end of 1959.

**RCA COMMUNICATIONS, INC.** has opened a direct radio-teletype exchange service (TEX) between the United States and Portugal.

**PHILCO (OVERSEAS) LTD.** will furnish technical "know-how" along with The Plessey Co. Ltd. for Semiconductors Ltd., a new company to manufacture transistors and other semiconductors in England.

**MANSOL CERAMICS CO.** has opened its first overseas manufacturing plant at Thornton Heath, Surrey, England. The new plant will manufacture glass preforms for hermetic sealing.

## WEST

**PERMOFLUX PRODUCTS CO.**, with offices and plant formerly in Chicago, has concentrated all manufacturing, engineering, and sales offices in their new modern, and enlarged plant at 4101 San Fernando Rd., Glendale 4, Calif.

**AERO ELECTRONICS CORP.**, Gardena, Calif., has been licensed to manufacture rectilinear potentiometers utilizing designs originally developed by Hubbard Scientific Laboratories, Inc., Pomona, Calif.

**REMINGTON RAND** has delivered a large scale Univac electronic data processing system to the Arizona Public Service Co.

**SEABOARD PACIFIC DIV.** is the new name of Seaboard Coil Spring Div., Associated Spring Corp., Gardena, Calif. The new designation reflects more accurately the much broader range of types of precision mechanical springs which the division is now supplying.

**HOFFMAN SOLAR DIV., HOFFMAN ELECTRONICS CORP.**, has been established in recognition of the growing importance in the field of solar energy. The new division will be headquartered in Evanston, Ill.

**PROCESS INSTRUMENTS DIV., BECKMAN INSTRUMENTS INC.**, has been established with headquarters in Fullerton, Calif. Mark H. Howlett will head the new division which will maintain an eastern manufacturing and engineering facility in Ronceverte, W. Va., as well as at Fullerton.

**GOVERNMENT & INDUSTRIAL DIV., PHILCO CORP.** has established new Western Development Laboratories at Redwood City, Calif.

**HUGHES AIRCRAFT CO.** has been awarded a USAF contract for almost \$3-million for modification of armanent control system components.

**HALLAMORE ELECTRONICS CO., SIEGLER CORP.** has announced that it has received a substantial increase in its contract for missile test equipment from Convair Div. of General Dynamics Corp., bringing the total contract up to more than \$4-million.

**SYSTEMS DIV., DAYSTROM, INC.** has been awarded a contract by North American Aviation, Inc., for automatic check-out systems for guided missiles.

**SIERRA ELECTRONIC CORP.** has moved into its new and larger facilities at 3885 Bohannon Drive, Menlo Park, Calif.

**BARLOWE ELECTRONICS** is the new company name for Barlowe Television. The name change was made to cover more adequately the firm's diversified activities in the electronic field.

**CIRTRONICS CORP. OF AMERICA** has been formed and will have headquarters at 13736 Saticov St., Van Nuys, Calif.

**SHEPARD INSTRUMENT DIV., SAVAGE INDUSTRIES, INC.**, has begun operations in Phoenix, Ariz., manufacturing telemetric data systems. The plant is located at 3131 North 29th Avenue.

**AERONUTRONIC SYSTEMS, INC.**, recently activated the newest facility in its series of leasehold expansions at 1234 Air Way in Glendale, Calif.



**HIDDEN TREASURE!**

... the engineering skill in every component by Burnell. Burnell files contain thousands of special designs in regular and subminiature filters.



**TOP OF THE LADDER ...**

Burnell products incorporate the highest standards of engineering know-how and precision manufacturing in toroids, filters and related networks.

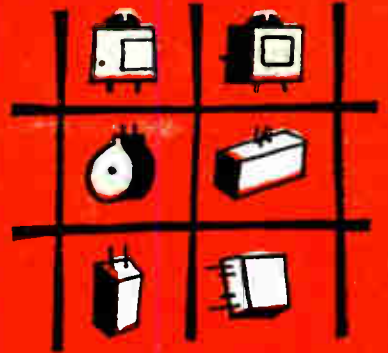

**CROSS-SECTION OF A HUGE SELECTION!**

Burnell has over 8,000 filter designs in stock, including subminiature filters for aircraft and guided missiles, communications filters for receivers, and side-band filters for carriers... in addition to an array of other new, specialized components.

**WHICH AD DO YOU LIKE BEST?**

*they all tell the same basic story*

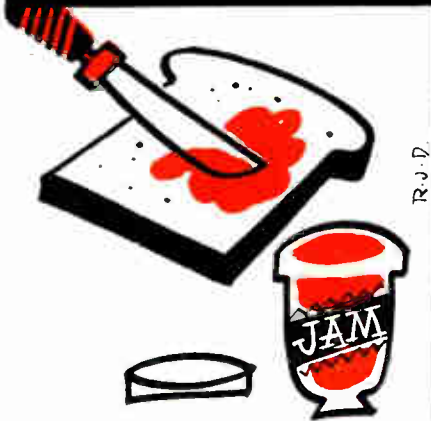

**WANT JAM ON IT?**

Burnell supplies the **extras** in service, courtesy and sheer engineering value. Your inquiries on toroids, filters and related networks will be handled promptly.



**HOW ABOUT SOME ICING?**

Burnell provides the "top layer" that makes all the difference. Your toroid and filter problems are solved by the most advanced engineering in the field—by Burnell.



**LIKE THE GRAVY TOO?**

Burnell success depends on meeting your exact needs. If the toroidal component you require is not already on our files, we will make it to your exact specifications.



**BEFORE YOUR WIRES GET CROSSED ...**

... consult Burnell about your network problems. Or write for technical information and catalog, without cost or obligation, with details on our toroidal components in regular down to subminiature sizes.



**CREAM COSTS NO EXTRA**

Depend on Burnell for toroids, filters and related networks whether you require standard components, or special, custom-designed equipment.

*Burnell & Co., Inc.*



PELHAM MARION, NEW YORK, Dept. 1-87  
TELEPHONE: PELHAM 6-6002

PACIFIC DIVISION  
722 MISSION STREET SOUTH PASADENA, CALIF  
TELEPHONE: PASADENA 7578  
TELEPHONE: RYAN 1-2841

*Used in toroids, filters and related networks*

You are cordially invited to visit our booth, #3101, at the WESCON Show.

## Tele-Tips

**ENGINEERING DAFFINESS** is summarized in this waggish collection of definitions from "Berkeley Engineering," journal of Berkeley Division of Beckman Instruments:

**Servomechanism:** A system, usually of great complexity, in which the output of a device is sampled and fed back into the input in order to produce uncontrollable oscillations.

**Feedback Loop:** That portion of a servomechanism circuit which makes possible its instability.

**Follow-Up:** A device in a servomechanism which is used to follow, as faithfully as possible, its oscillations.

**Rate Generator:** A small but costly electrical device affixed to the output end of a servo system for ornamental purposes.

**Stability:** The desired optimum of servo performance, as manifested by violent threshing of an output member.

**Amplifier:** An electronic device for superimposing electrical instabilities on mechanical.

**Specification:** A form of heroic or epic poetry favored by engineers; a collection of impossible conditions; a collection of loopholes loosely held together by wistful verbiage.

**Zero Back-Lash:** A whimsical concept much professed by authors of specifications.

**Nyquist Diagram:** An ornamental figure derived from mathematics which demonstrates the stability of an obviously unstable system.

**Wiring Diagram:** A form of the graphic arts which has the characteristic of changing form constantly in the manner of cloud formations.

**Production** (With respect to servo electronics): The process of painfully assembling, dismantling and reassembling electrical components in accordance with wiring diagrams (q. v.); a vicious circle.

*(Continued on page 22)*

**99.07%**

**ENGINEERS  
AND  
DESIGNERS**

**STAY WITH**

**AC**

**THE ELECTRONICS DIVISION  
GENERAL MOTORS**

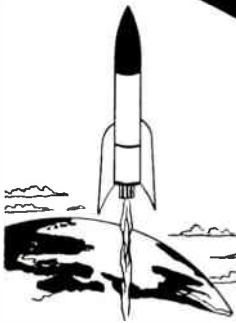

### Pioneering Opportunities in the Following Fields!

- Missile Guidance
- Avionics
- Automotive-Aviation Electronic Products
- Computers
- Jet Engine Fuel Controls

AC turn-over figures are amazing. Less than 1%! Speaks highly for the advancement opportunities, working conditions and wages we pay our Engineers and Designers. It's been that way for years at AC. That's why we are so proud of and why you should investigate your Better Future at AC by writing

G. M.'s long-standing policy of decentralization creates unlimited opportunities for qualified Electrical, Mechanical Engineers and Designers. Masters Degree Program available at University of Wisconsin, Milwaukee to all eligible AC Engineers. Arrange a personal confidential interview in your locality by writing

For Employment Application  
Mr. Cecil E. Sundeen, Supervisor of Technical Employment

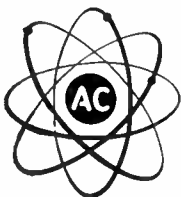

**AC the ELECTRONICS DIVISION  
GENERAL MOTORS CORPORATION**

Flint 2, Michigan

Milwaukee 2, Wisconsin

# ALL VIDEO TRANSMISSION TEST

## STANDARDS in a suitcase



The Original Fall Back and the Portable Unit Produce the same Test Signals.



**TELECHROME**  
INCORPORATED

### Model 1003-B

Video Transmission Test Signal Generator

- ★ Completely self contained ★ Portable
- ★ Multi-frequency burst ★ Stairstep ★ Modulated stairstep
- ★ White window ★ Composite sync ★ Regulated power supply.

Now, Telechrome Video Transmission Test Equipment is available as a completely portable 17 1/2" standard rack mounting unit.

Features these Test Signals generated by Telechrome equipment are transmitted (and received) by NBC, CBS, ABC, the Bell System, Canadian Bell and leading independent TV stations throughout the U.S. and Canada. Hundreds of network affiliated TV stations and Telechrome TV centers that check incoming video signals.

The compact, inexpensive, portable Model 1003-B is all that is required to generate signals for local and remote performance checking of your entire video, cable, or wire-wire facilities.

#### DELIVERY 30 DAYS

Literature on the above and more than 100 additional instruments for monochrome and color TV by TELECHROME are available on request.

The Nation's Leading Supplier of Color TV Equipment

28 Renick Drive     Amityville, N. Y.  
Lincoln 1-3600

**TELECHROME**  
INCORPORATED



**MULTI-FREQUENCY BURST AMPLITUDE vs FREQUENCY.** Check wide band coaxial cables, microwave links, individual units and complete TV systems for frequency response characteristics without point to point checking or sweep generator.

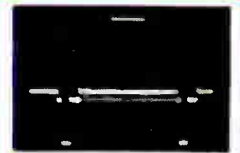

**WHITE WINDOW**  
**LOW & HIGH FREQUENCY CHARACTERISTICS.** Determine ringing, smears, steps, low frequency tilt, phase shift, mismatched terminations, etc. in TV signals or systems.



**STAIRSTEP SIGNAL** modulated by crystal controlled 3.579 mc for differential amplitude and differential phase measurement. Checks amplitude linearity, differential amplitude linearity and differential phase of any unit or system.  
Model 1003-C includes variable duty cycle stairstep (10-90% average picture level).

Model 608-A HI-LO CROSS FILTER for Signal analysis.



**MODULATED STAIRSTEP** signal thru high pass filter. Checks differential amplitude.



**MODULATED STAIRSTEP** signal thru low pass filter. Checks linearity.

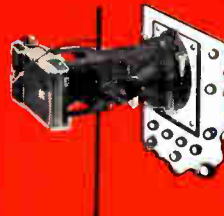

**1527-B OSCILLOSCOPE CAMERA**—Polaroid type for instantaneous 1 to 1 ratio photo-recording from any 2" oscilloscope.



**1008-A VIDEO TRANSMISSION TEST SIGNAL RECEIVER** for precise differential phase and gain measurements. Companion for use with 1003-B.



FROM "GIANT" 10-INCHERS TO "SUPER-COLOSSAL" 27's . . . early black-and-white to the latest rainbow colors . . .

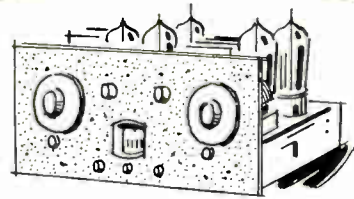
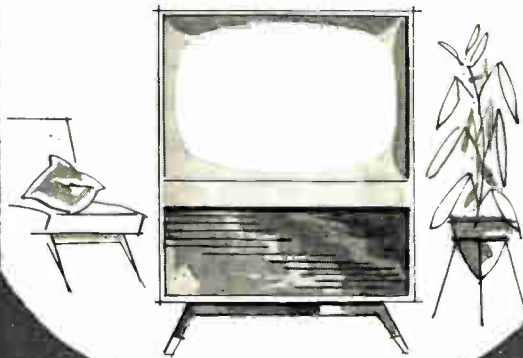

FROM PRIMITIVE "TRF'S" TO THE HIGHEST OF THE "FI" . . . the earphone era to the most modern of radios.



# KESTER SOLDER

COMPANY • 4210 WRIGHTWOOD AVENUE • CHICAGO 39, ILLINOIS  
NEWARK 5, NEW JERSEY • BRANTFORD, CANADA

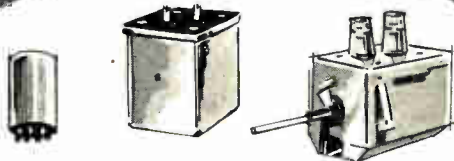

FOR MORE THAN HALF A CENTURY, one of the "constants" of the ever-expanding electronics industry has been Kester Solder. Equipment and components originally soldered with Kester continue to give excellent service; regardless of their age, the soldered joints stay in perfect condition for the life of the unit. That's why Kester Flux-Core Solder has the greatest acceptance in the industry . . . why you should always insist on Kester.

WRITE TODAY for the KESTER 78 page text-book "Solder . . . Its Fundamentals and Usage." Free!



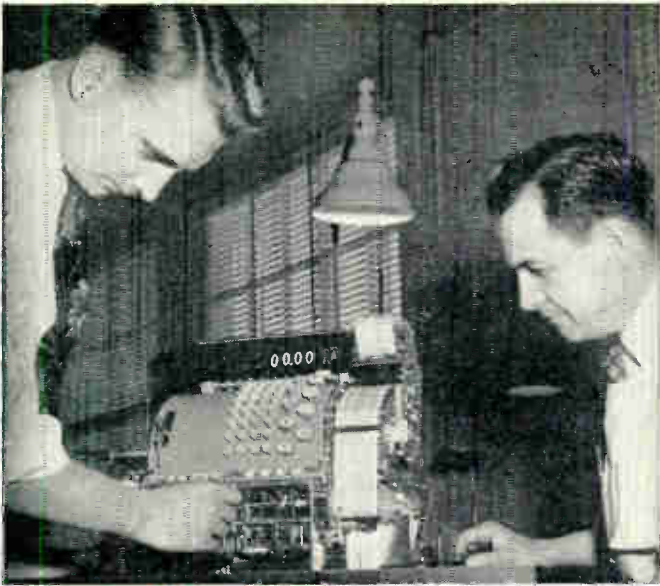

**MECHANICAL ENGINEERS** are using their skills in the design and development of new mechanisms required for business machines and for those mechanical products which are associated with electronic data processing equipment.

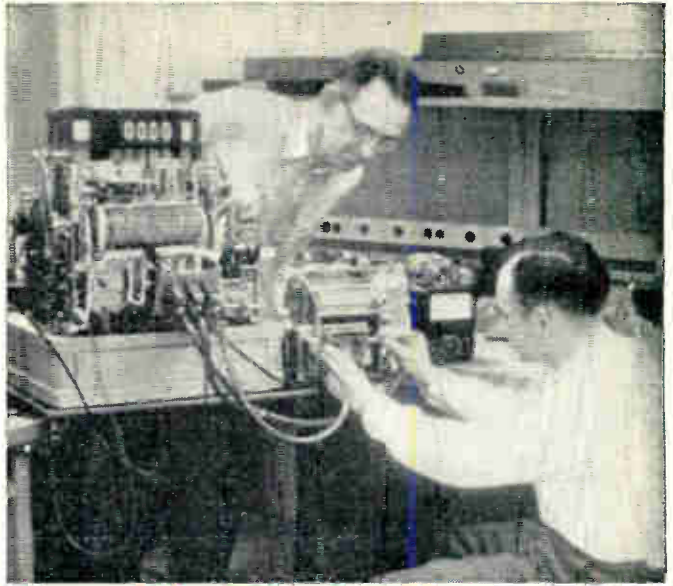

**ELECTRO-MECHANICAL ENGINEERS** are constantly faced with the problems of capturing information from the various input devices and converting this information into a usable form for subsequent use in data-handling equipment.

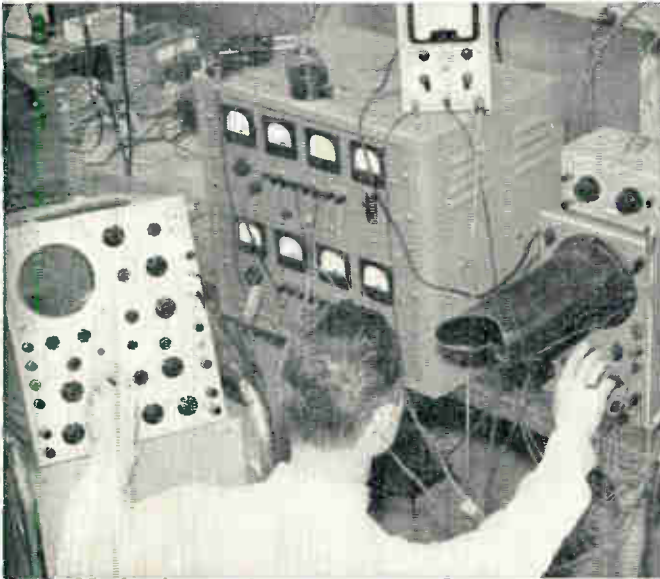

**ELECTRONIC ENGINEERS** enjoy an unparalleled freedom in the development of new types of circuitry and components which are necessary to maintain leadership in the competitive field of record-keeping automation.

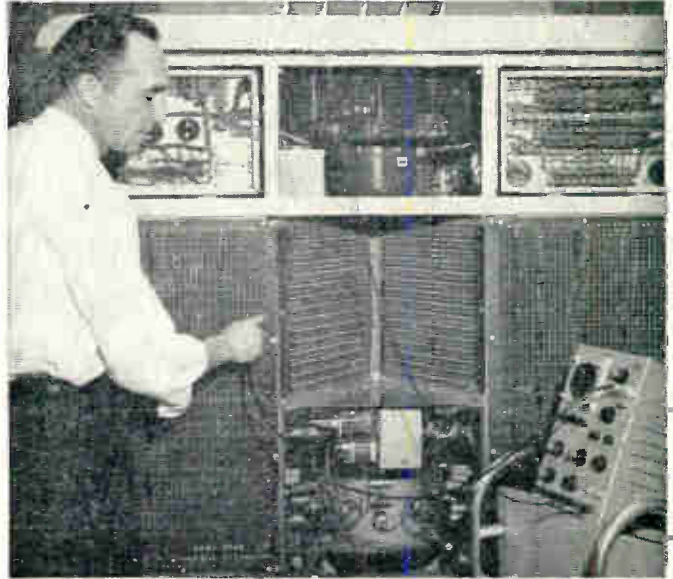

**COMPUTER ENGINEERS** backed by the company's computer research since 1938 are developing an economical, flexible digital computer to meet the requirements of all record-keeping applications.

# **ENGINEERING UNLIMITED**

**AT ONE OF THE WORLD'S MOST SUCCESSFUL CORPORATIONS**

If you are looking for a challenging opportunity with an established company which has tripled its sales in ten years—one that offers excellent starting salaries as well as permanent positions . . .

Act at once! Send resumé of your education and experience to Employment Department, Technical Procurement Sec. L, The National Cash Register Company, Dayton 9, Ohio.

# **NCR**

THE NATIONAL CASH REGISTER COMPANY

# IERC's FREE TUBE SHIELD GUIDE helps you improve electron tube reliability —



— provides information you need to properly match over 1,400 sizes and types of electron tubes and heat-dissipating tube shields for best cooling, retention and protection against shock and vibration!

New 20 page IERC Heat-dissipating Tube Shield Guide has been carefully and accurately compiled in answer to many hundreds of Electronic Engineer suggestions and requests for just such a practical Guide. New design applications and retrofitting of electronic equipments with IERC Heat-dissipating Tube Shields (for the excellent cooling, extended tube life and reliability they provide) created the need for this type of professional information — plus another "first" for IERC — the first reference manual of this type to the electronic industry!

For a free copy, please send request on your company letterhead to: Dept. TSG.

**International**  
electronic research corporation  
145 West Magnolia Boulevard, Burbank, California

Heat-dissipating tube shields for miniature, subminiature, octal/power electron tubes  
Circle 14 on Inquiry Card, page 89

## Tele-Tips

(Continued from page 18)

**Servomechanisms Engineer:** A soothsayer of mystical powers skilled in mathematical rubrics and incantations; a prophet without honor in California or anywhere else, a dreamer or wool-gatherer.

**Performance Evaluation:** A grateful appreciation of whatever results from a servo system.

**RELIABILITY** of a transistor portable radio was proved the hard way when Arvin Industries salesman James R. Rohm fell, with an Arvin portable, to the foot of a long flight of concrete stairs. Final score: one unconscious salesman; one working portable.

**LONGER LIFE EXPECTANCY** is found at the managerial, technical, and administrative level, contrary to the current belief that promotion can kill you. Further improvement can result from executive health examination plans. Health exams are given by the larger companies more often than the smaller concerns. Good health of the management team is a valuable company asset, worthy of the same "preventative maintenance" given more tangible assets.

**COMPUTER COURTSHIP** recently featured on a TV show has gone on the rocks. UNIVAC picked Barbara Smith and John Caran as having most similar likes and dislikes among a number of unmarried folk. High expenses, the 70-mile distance between John's and Barbara's homes, and the prospect of a live-in mother-in-law have killed the romance. We don't need a computer to predict that computer experts will plead "Insufficient data"!

**THE TV ERA** has brought another change in our way of life. Westport Connecticut is giving each fireman a small radio receiver to bring fire warnings inside the home where they can compete with TV, Radio and Hi-Fi!



# GENERAL TRANSISTOR

**MEETS NARROW PARAMETER SPECS  
FOR COMPUTER CONTROL COMPANY'S  
ONE SHOT MULTIVIBRATOR**

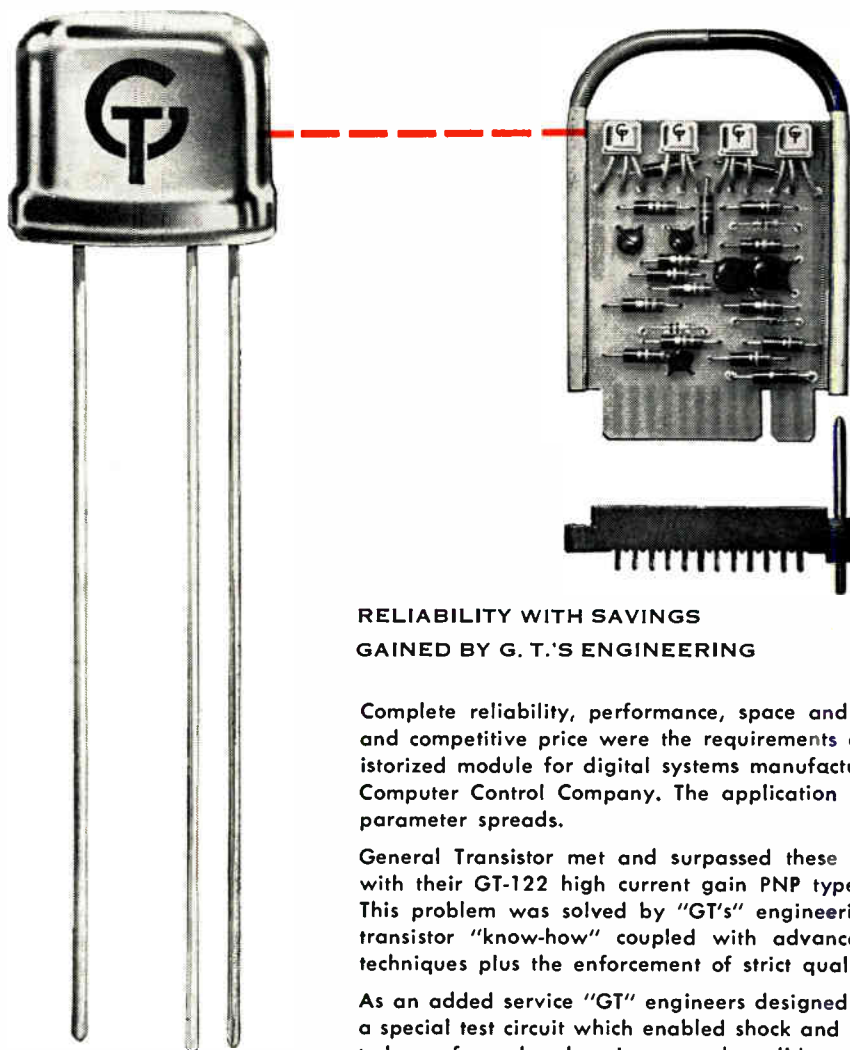

## RELIABILITY WITH SAVINGS GAINED BY G. T.'S ENGINEERING

Complete reliability, performance, space and weight limits and competitive price were the requirements of this transistorized module for digital systems manufactured by the Computer Control Company. The application required narrow parameter spreads.

General Transistor met and surpassed these very tight specs with their GT-122 high current gain PNP type transistor. This problem was solved by "GT's" engineering skill and transistor "know-how" coupled with advanced production techniques plus the enforcement of strict quality controls.

As an added service "GT" engineers designed and constructed a special test circuit which enabled shock and vibration tests to be performed and environmental conditions created to assure the customer complete reliability under extreme conditions.

This is just one more example of why General Transistor is the fastest growing name in transistors.

Send today for complete technical data and specifications.



## GENERAL TRANSISTOR

C O R P O R A T I O N

91-27 138TH PLACE  
JAMAICA 35, NEW YORK





**Exclusive  
with ARNOLD**

## ... SENDUST POWDER CORES

They use NON-STRATEGIC MATERIALS  
... you can avoid alloy shortages

Try  
**SENDUST CORES**  
in these typical  
applications

- Cores for loading coils
- Cores for filter coils
- Transformer cores for voice and carrier frequencies

Write for a copy of the Sendust Core Bulletin SDC-110, containing data on standard core sizes, electrical and magnetic properties, standard permeabilities, etc.

**ADDRESS DEPT. T-77**

Arnold sells SENDUST Powder Cores in this country under exclusive license from The Tohoku Metal Industries Co., Ltd., of Japan. They are available in a wide selection of sizes, ranging from .800" O.D. to 3.346" O.D.—and in permeabilities of 10, 13, 25, 30, 50 and 80, although not all sizes are available in all permeabilities.

SENDUST cores possess magnetic properties that are generally superior to iron powder cores, but inferior to Mo-Permalloy powder cores in the audio and carrier frequency range. The eddy current loss for SENDUST

cores is lower than that of Mo-Permalloy powder cores, but the hysteresis loss of SENDUST cores is substantially higher, and they also have higher values of electrical resistivity. In other characteristics of powder cores, the two types are somewhat similar, but SENDUST cores contain *no scarce or strategic materials and can offer a core source in times of alloy shortage.*

Sample SENDUST cores as well as production quantities are available from stock. *For more detailed information, send for technical data sheet SDC-110.*

WSW 6320

### **THE ARNOLD ENGINEERING COMPANY**



**Main Office & Plant: Marengo, Illinois**

**Repa: Pacific Division Plant: 641 East 61st Street, Los Angeles, Calif.**

**District Sales Offices:**

**Boston: 200 Berkeley St.**

**Los Angeles: 3450 Wilshire Blvd.**

**New York: 350 Fifth Ave. Washington, D.C.: 1001-15th St., N.W.**

Having your ups  
and downs?



... if they involve WIRE WOUND RESISTORS

# DALOHM has the answer!

All Dalohm components are carefully designed and skillfully made to assure you of supreme quality and dependability, plus the widest versatility of application.

Outstanding examples of the Dalohm line are the following miniature, silicone coated, wire wound resistors.



You can depend on Dalohm

FOR CRITICAL ELECTRONIC DESIGN WHERE SPACE IS A PROBLEM



## TYPE RS



Smallest in size, Dalohm Type RS resistors are silicone sealed, offer high dielectric strength, maximum heat dissipation, and resistance to abrasion, plus every other desirable characteristic:

- 100% impervious to moisture and salt spray
- Complete welded construction from terminal to terminal
- Temperature coefficient 0.00002/Deg. C
- Resistance ranges from 0.05 ohm to 175K ohm, depending on type
- Tolerances 0.05% to 3%, depending on type
- Five wattages—2, 3, 5, 7, and 10; six physical sizes

Write for Bulletin R-23D

## DALE PRODUCTS, Inc.

1304 28th Avenue  
Columbus, Nebraska, U.S.A.

## TYPE RLS

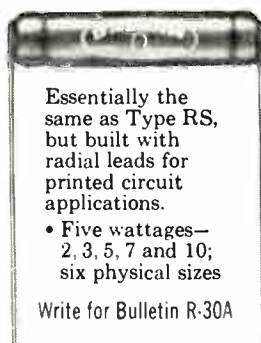

Essentially the same as Type RS, but built with radial leads for printed circuit applications.

- Five wattages—2, 3, 5, 7 and 10; six physical sizes

Write for Bulletin R-30A

## TYPE RSE

“RUGGEDIZED”

A modified RS Type, with tremendous shock resistance obtained by encasing them in a metal housing, yet maintaining miniature size.

- Five wattages—2, 3, 5, 7, and 10; seven physical sizes.

Write for Bulletin R-25B

## JUST ASK US!

You are invited to write for the complete catalog of Dalohm precision resistors, potentiometers and collet-fitting knobs.

If none of our standard line fills your need, our able engineers and skilled craftsmen, equipped with the most modern equipment, are ready to help solve your problem in the realm of development, engineering, design and production. Just outline your specific situation.

### • Export Dept:

Pan-Mar Corp.,  
1270 Broadway, New York 1, N.Y.

### • In Canada:

Charles W. Pointon, Ltd.  
6 Alcina Ave., Toronto, Ont.

# HIGH VOLTAGE

## BREAKDOWN TEST

... proves Johnson tube sockets are built to take it!



### 3 grades for every tube socket means greater reliability...lower cost!

Pick the tube socket that meets your specifications from Johnson's 3 basic grades for every socket type! Check Johnson's standardization program... you'll find that selection is simplified, delivery cycles are shorter—and many times you'll find that you will get superior quality sockets at lower cost due to the elimination of special set-up and tooling charges. Johnson's tube socket standardization program provides you with complete specifications for standard, industrial and military socket requirements. For complete information, write for your copy of Standardization Booklet 536, today!

**STANDARD**—These are commercial grade sockets for general requirements. Bayonet Sockets equipped with porcelain bases, glazed top and sides. Phosphor bronze contacts .0002 cadmium plated. Nickel-plated hardware. Bayonet shells are etched aluminum. Wafer Sockets equipped with glazed steatite base—DC200 treated.

Contacts are plated brass with steel springs. Shielded types equipped with etched aluminum shields.

**INDUSTRIAL**—Superior in quality to "Standard" types, equipped with glazed steatite bases, DC200 treated. Phosphor bronze or beryllium copper contacts and springs, .0005 silver-plated. Fungus resistant cushion washers under contacts.

Aluminum bayonet shells and shields for wafer types, iridite No. 14 treated.

**MILITARY**—Top quality for military requirements. Glazed L4 steatite bases, DC200 treated. Bayonet Sockets equipped with beryllium copper contacts .0005 silver-plated. Hot tin-dipped solder terminals—brass bayonet shells, .0003 nickel-plated. Threaded hardware .0002 nickel plated—unthreaded hardware .0003. With fungus resistant cushion washers under contacts. Wafer Sockets equipped with phosphor bronze contacts and beryllium copper springs, silver-plated .001. Hot tin-dipped solder terminals. Fungus resistant, glass base melamine cushion washers under contacts. Aluminum shields on shielded types, No. 14 iridite treated. Entire socket protected for 200 hour salt spray test.

Complete specifications... Write for your copy of Socket Standardization Booklet 536, today!



**E. F. Johnson Company**

2215 SECOND AVENUE S.W. • WASECA, MINNESOTA

CAPACITORS • INDUCTORS • SOCKETS • INSULATORS • PLUGS • JACKS • KNOBS • DIALS • PILOT LIGHTS

## Books

### Transmission Circuits

By Everard M. Williams, Ph. D. and James B. Woodford, Jr., D. Sc. Published 1957 by the Macmillan Co., 60 Fifth Ave., New York 11. 156 pages, ix pages. Price \$4.25.

The text comprises material used for some years in a one-semester course for senior students majoring in electrical engineering at Carnegie Institute of Technology. Except for Chapter 1 and parts of Chapter 2, the text is organized so that any desired portions of chapters can be omitted to suit the particular requirements. The portion of Chapter 2 dealing with the detailed derivation of skin-effect formulas can be omitted without destroying the continuity of the subsequent sections and chapters.

This work is assembled primarily for use in teaching rather than as a reference work. The wealth of detail which characterizes a reference work would jeopardize the educational objectives of the courses in which this text has been used.

### Guidance

By Arthur S. Locke. Published 1956 by D. Van Nostrand Co., Inc., 120 Alexander St., Princeton, N. J. 729 pages, xvii pages. Price \$12.50.

Every basic problem encountered in directing a controlled missile reliably to its target is considered. From a discussion of fundamental problems, the book proceeds to different methods in obtaining intelligence on a target by employment of infrared, radio, and acoustic waves, and fixing its location by terrestrial and celestial references. It covers the mathematical groundwork geared for solving guidance problems and gives an unusually lucid exposition of related servo system theory.

Tactical considerations limiting the employment of guided missiles, an analysis of the several flight trajectories, the use of radar in tracking targets, and bandwidth studies are given in detail. Among the other topics covered are guidance problems arising during the prelaunching and launching phases, economic considerations, the influence of airframe design upon choice of guidance systems, and methods of simulation, computation, and telemetry.

An invaluable survey of guidance devices and techniques, this book is an essential background for work with missile guidance systems, even for those already in the field.

### Books Received

#### Proceedings of the National Electronics Conference, Vol. XII

Published 1957 by the National Electronics Conference, Inc., 84 E. Randolph St., Chicago 1, Ill., 1095 pages, xlvii pages. Price, \$5.00.

These proceedings cover the 1956 Conference held at the Hotel Sherman, Chicago, Illinois, on October 1-3, 1956.

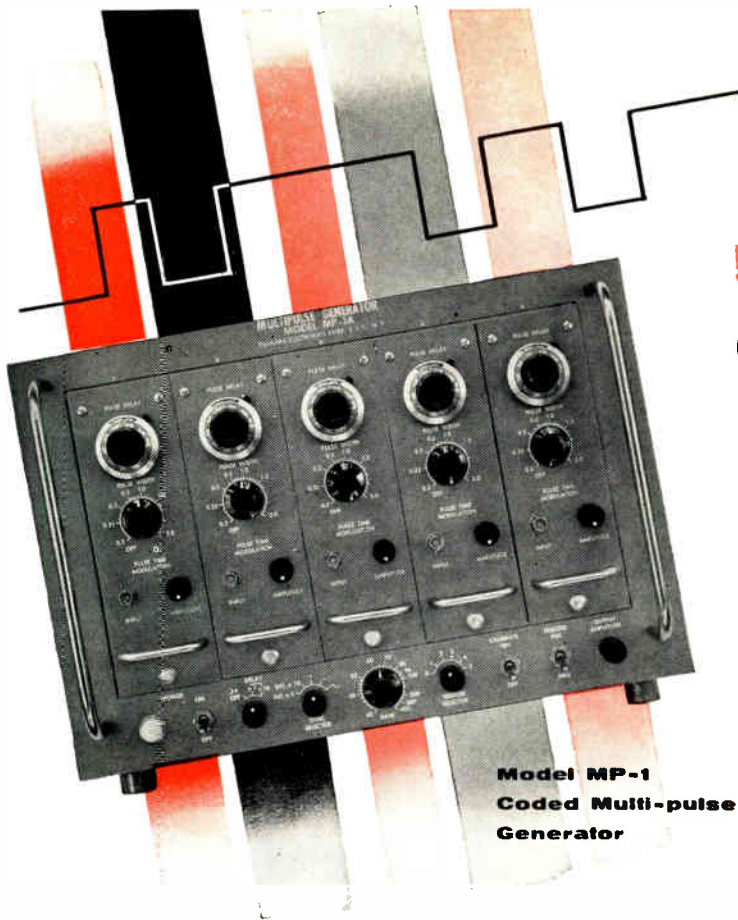

# 5 PULSE CODED MULTI-PULSE GENERATOR

Generates 5 separate pulses each with independently variable width and delay for missiles, beacons, and other systems

**Model MP-1  
Coded Multi-pulse  
Generator**

A self-contained unit. Provides any code—one to five pulses—with completely independent adjustment for each pulse.

Any or all pulses can be time modulated. And, the Model MP-1 can be used to synchronize other equipment because of its trigger output.

The instrument is provided with internal calibration circuits — 1 microsecond markers to check code settings.

In addition, it supplies a square wave pulse, at a separate output jack, operating at 40 to 4,000 pps. This is extremely useful for modulation and general testing.

Write to Polarad for a detailed data sheet on the Model MP-1.

## SPECIFICATIONS:

### Internal Pulse Characteristics:

**No. of Channels**  
1 to 5 independently on or off

**Repetition Rate**.....40 to 4,000 pps

**Pulse Width**.....0.2 to 2.0 microseconds

**Pulse Delay**.....0 to 30 microseconds

**Minimum Pulse Separation**  
2 to 300 microseconds

**Initial Channel Delay**  
0.1 microsecond

**Initial Channel Delay**  
2 microseconds from sync. pulse

**Output Pulse Characteristics:**

**Rise Time** .....0.1 microsecond

**Delay Time** .....0.1 microsecond

**Overshoot** .....less than 10%

**Amplitude**.....20 v. minimum into 100 ohms

### Trigger Pulse Output:

- (a) At zero time or simultaneous with any one of the output pulses.
- (b) 10 volts positive and negative into 75-ohms.

### External Sync Pulse:

Positive or negative pulse or sine wave

### Pulse Time Modulation:

**Frequency**.....40-400 cps any or all channels

**Required Ext. Mod.**.....1 volt rms min.

**Maximum deviation** .....±0.5 microsecond

## FEATURES:

- Provision for external pulse time modulation.
- Trigger selection at any of the code pulses.
- High level, low impedance output.
- Short rise and fall time of pulses.
- Square wave output.
- Internal calibration time marker.
- Accurately calibrated delay dial.

*Reliable maintenance  
service throughout  
the country is  
an important  
part of the  
Polarad instrument.*

*For private demonstration  
without obligation  
ask for the*



**ELECTRONICS CORPORATION**  
43-20 34th Street • Long Island City 1, New York

REPRESENTATIVES: Albany, Albuquerque, Atlanta, Baltimore, Boston, Chicago, Cleveland, Dayton, Denver, Englewood, Fort Worth, Kansas City, Los Angeles, New York, Philadelphia, Portland, Rochester, St. Louis, San Francisco, Schenectady, Stamford, Syracuse, Washington, D. C., Winston-Salem, Canada: Arnprior, Ontario.  
Resident Representatives in Principal Foreign Cities



# Who submits the most complete laboratory reports with all custom-built delay line prototypes?



It is a known fact that ESC Corporation is unequalled for the most complete and definitive laboratory reports submitted with delay line prototypes. Every ESC lab report includes submitted electrical requirements, photo-oscillograms (which indicate input and output pulse shape and output rise-time), the test equipment used, and evaluation of the electrical characteristics of the prototype. This is unmatched in the industry.



**1st** *in sales!*



**1st** *company devoted exclusively to the manufacture of delay lines!*



**1st** *in research, design and development of custom-built delay lines!*

Exceptional employment opportunities for engineers experienced in pulse techniques.



ESC CORPORATION  562 BERGEN BOULEVARD • PALISADES PARK • NEW JERSEY

# An Engineer "Doodled" and Solved an Explosive Problem with

## FUSITE TERMINALS

The problem was literally explosive. It was a pump and motor to operate safely submerged in gasoline. The electrical connections had to be made through a vapor-proof seal. Two simple and inexpensive Fusite glass-to-metal terminals did the job like this "doodle" shows.

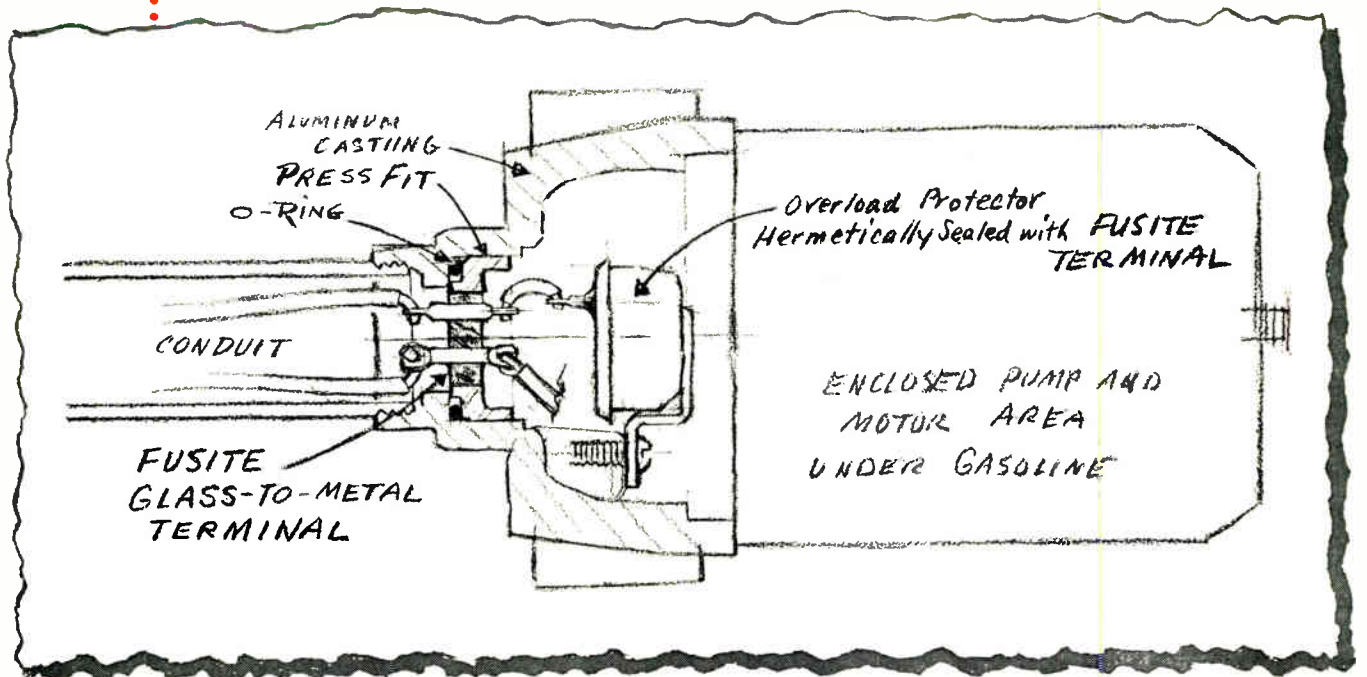
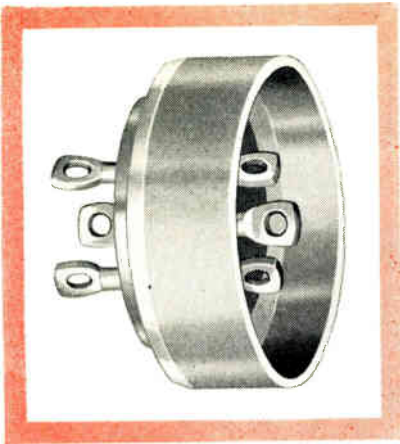

This can't be called a "typical" Fusite case history. In our long list of successful new applications, we have helped engineer, there are none we could call "typical".

So just keep Fusite Terminals in your

"noodle" the next time you "doodle" and pass your problems on to us.

We make hundreds of stock terminals of both multiple bead and solid glass types. We're prepared to design and make special terminals to your needs.

Write today for catalog — Dep't. U-4



THE

FUSITE CORPORATION

6026 FERNVIEW AVE., CINCINNATI 13, OHIO

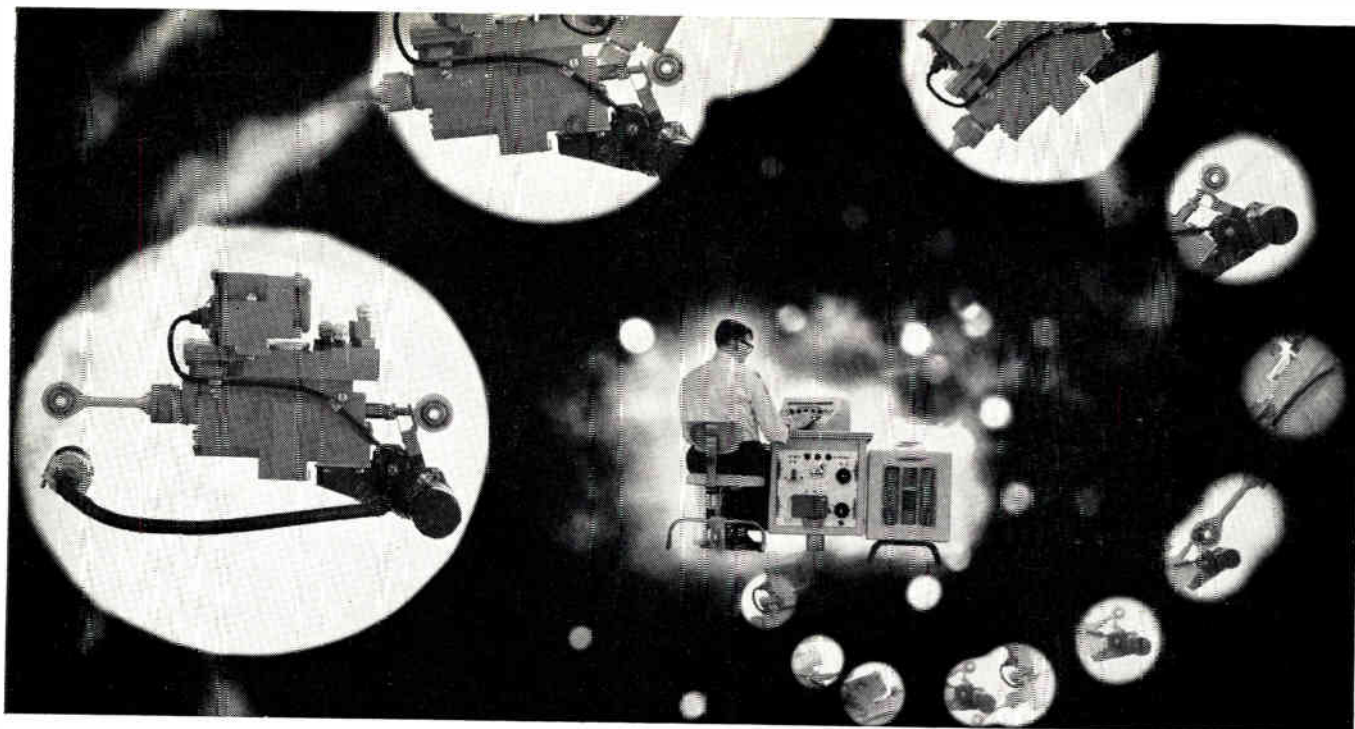

*Let the engineers who are doing it tell you*  
**What it's like to work in a nerve center of the new industrial era**

Dr. John L. Bower, Chief of our Automatic Industrial Controls Section, put it this way:

"Automatic electro-mechanical control systems are the eyes, ears, and brains of the second industrial revolution. At Autonetics, we've been in the relatively young field of electro-mechanics for 11 years... making breakthroughs on many major fronts. The time was never riper for creative engineers to get in on this work?"

Today you can build your career on this solid base of accomplishment, and grow forward with us as we tackle new and ever more challenging assignments.

For instance, if you are strong on servo, transistor, or digital techniques—you may qualify for a special position in the development of automatic machine tool controls, computers, automatic checkout equipment, bombing navigation systems,

or advanced inertial navigation systems.

Two of our new developments in these fields are: *Numill*—a completely transistorized, numerical tape-directed control system for machine tools... and *Recomp*—a 200 pound portable computer that has giant-computer capacity.

Whatever field of engineering you enter at AUTONETICS, you'll work in an engineering-management atmosphere that is conducive to your professional advancement. You'll enjoy research, development, and test facilities as advanced as the project on which you're working.

Our engineering brochure tells the story in more detail. It's easy to get one; just send the coupon below.



Dr. John Bower, former associate professor of electrical engineering at Yale, has been with Autonetics 7 years... 5 years in charge of automatic machine tool controls development. Last April he was promoted to automatic industrial controls section chief.



Leo Noe, MSEE-Yale, joined Autonetics in 1951 as research engineer in autopilots. In '53 he was promoted to supervisor. Leo's responsibilities included development of aircraft yaw and pitch dampers. In '56 he made group leader in automatic checkout.

**Autonetics**



A Division of North American Aviation, Inc.

**AUTOMATIC CONTROLS MAN HAS NEVER BUILT BEFORE**

Mr. A. N. Benning, AUTONETICS, Dept. 353, EI-7, 9150 E. Imperial Hwy., Downey, California

Dear Mr. Benning: Please send me AUTONETICS' engineering brochure. I am interested in the following fields. (check one or more)

Guidance  Fire Control  Computers  Flight Control  Automated Machine Control  Systems Analysis  Test Equipment

Name \_\_\_\_\_ Home Address \_\_\_\_\_

Degree(s) \_\_\_\_\_ Home Phone \_\_\_\_\_

Experience \_\_\_\_\_



# now

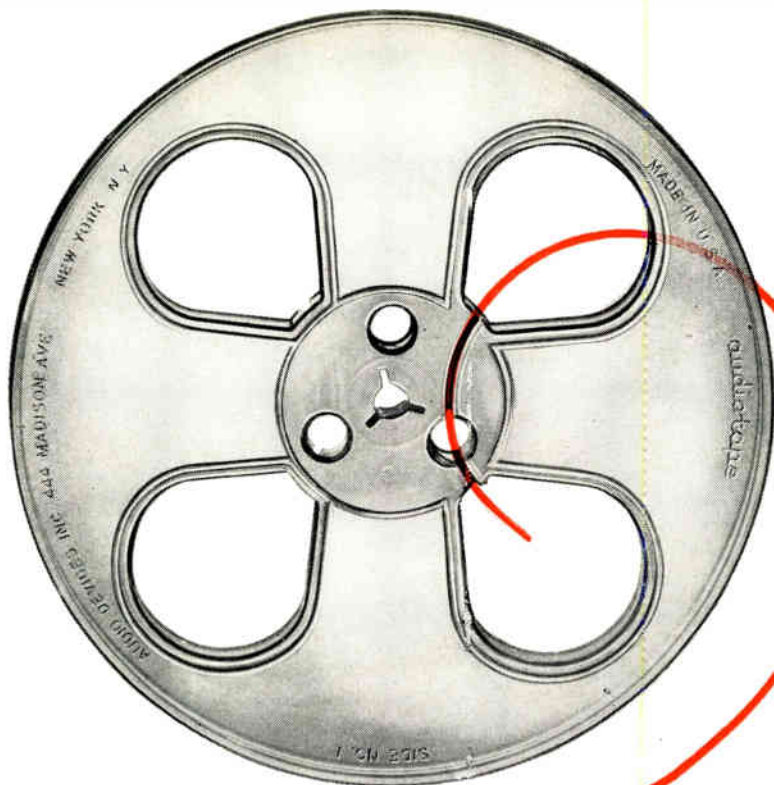

## audiotape TRADE MARK gives you **C-SLOT THREADING**

*... the fastest, easiest-threading reel ever developed!*

This revolutionary new improvement in tape reel design is now standard for all 7" reels of Audiotape — an extra-value feature at no extra cost!

With the C-slot reel, threading becomes virtually automatic. No more fumbling with tiny loops or sticking your finger in little holes. What's more, the new reel is actually heavier and stronger than ever before. All five types of Audiotape now come on this great new reel.

### Only C-SLOT threading gives you these advantages:

- No kinks or loops in tape*
- No "pigtails" to stick up and break off or cause reel to wobble when turned over*
- No need to turn reel by hand to anchor tape*

### PLUS these improved construction features:

- Smooth, unbroken rim — no slit to warp or bind*
- Perfectly smooth inner surface — no sharp edges to catch or roughen tape*
- Strong, non-warping construction — the ultimate in reel ruggedness*

Ask your dealer for a demonstration  
of the Audiotape C-slot reel.

### HERE'S ALL YOU HAVE TO DO:

1. Insert tape through flange opening at top of C-slot.

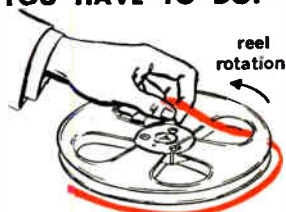

2. Drop tape into slot, leaving about 1 inch projecting beyond the hub with tape slack on both sides of recording head.



### THEN PRESS THE "START" BUTTON!

Tape will grip and hold firmly . . .  
no need to turn reel by hand to anchor free end.

**audiotape** *it speaks for itself*

AUDIO DEVICES, INC., 444 Madison Ave., New York 22, N.Y.

In Hollywood: 840 N. Fairfax Ave.  
In Chicago: 5428 Milwaukee Ave.  
Export Dept.: 13 East 40th St., N.Y. 16, N.Y.  
Cables "ARLAB"

surface barrier transistors from SPRAGUE

**2N344/SB101**  
for Medium Gain  
Amplifiers

	Min.	Typ.	Max.
$h_{fe}$	11	23	83
$f_{max}$	30	45	—

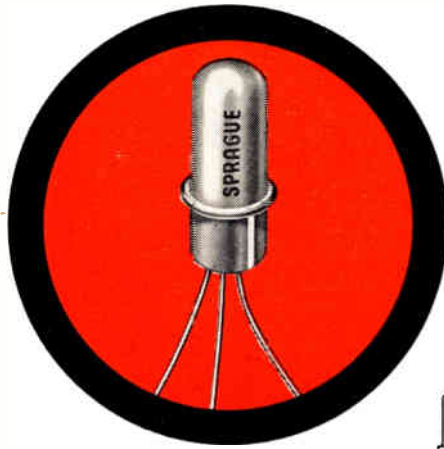

**2N345/SB102**  
for High Gain  
Amplifiers

	Min.	Typ.	Max.
$h_{fe}$	25	40	110
$f_{max}$	30	45	—

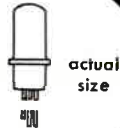

**2N346/SB103**  
for High Frequency  
Oscillators

	Min.	Typ.	Max.
$h_{fe}$	10	—	—
$f_{max}$	60	90	—



**2N240/SB5122**  
for Computer  
Switching

	Min.	Max.
$h_{fe}$	16	—
$f_{max}$	30	—
$T_s$	—	80



IN VOLUME PRODUCTION

*Now!*

For general high frequency applications, and for high speed computer switching circuits, design around Sprague surface barrier transistors. They are available now in production quantities from a completely new, scrupulously clean plant, built from the ground up especially to make high quality semi-conductor products.

The four transistor types shown are the most popular. Orders for these units are shipped promptly. What's more, surface barrier transistors are reasonably priced. High quality and excellent electrical characteristics make them an economical solution to many difficult circuit requirements.



WRITE FOR COMPLETE ENGINEERING DATA SHEETS ON THE TYPES IN WHICH YOU ARE INTERESTED. ADDRESS REQUEST TO THE TECHNICAL LITERATURE SECTION, SPRAGUE ELECTRIC CO., 233 MARSHALL ST., NORTH ADAMS, MASS.

TRANSISTORS • RESISTORS • MAGNETIC COMPONENTS  
CAPACITORS • INTERFERENCE FILTERS • PULSE NETWORKS  
HIGH TEMPERATURE MAGNET WIRE • PRINTED CIRCUITS



# ELECTRONIC INDUSTRIES

## & TELE-TECH

ROBERT E. McKENNA, Publisher

• BERNARD F. OSBAHR, Editor

### Standardize Wired-TV

Like other things surrounding the rapidly-expanding field of wired TV, the present name—"Closed circuit TV" (CC-TV), just grew. At present the uses include: industrial, scientific, entertainment, sports, educational, business, community and other broadcasting services, exhibition of Motion Pictures in the home etc. Some day every modern home will boast of its own CC-TV system, with a camera at the front door so that the visitor can be "scanned" before he is admitted.

A quick glance over the field shows that TV transmission over wires can be at rf or at vf frequencies. Distances covered can be from a few feet to 3,000 miles or more across our nation.

There are less than a dozen well-known CC-TV manufacturers. Each has designed along different but orthodox lines. The majority have only one item in common, a "Vidicon" tube in the camera. The employment of a single system, which is a must for TV broadcasting, is not necessary in CC-TV. Some use the FCC 525-line standard; other supply 245-line, non-interlaced systems which usually cost less.

There has been some standardization but much more is needed before a great deal of equipment is in the hands of users. The usual good reasons for standardization apply. In particular we need it to retard obsolescence, lower manufacturing costs, improve interchangeability, aid installation and servicing, and protect the customer by offering more uniform specifications.

What could be standardized? First, take Community Systems. Here characteristics such as transmission line impedance, voltage levels, etc. should be discussed. Second, for commercial, scientific and educational installations, where the user is the owner, the matter of system, number of lines, interchangeability and the like is important. Third,

in the case of business and sales conferences, where the customer goes to the firm who owns equipment (which usually includes large screen projectors), leases the common-carrier network and often provides programming and director's services (very important), a different kind of standardization is needed. It is standardization of business practices and to a certain degree standardization of proposals outlining definitely just what services will be furnished.

Why do we think wired television is in an expansion era? The number of business conferences have increased 300% in 1956 over 1955. Large companies are finding out that their scattered, key personnel can be thus linked together at a fraction of the travel cost required to assemble at a resort convention site. Community TV systems are growing steadily in numbers. As yet we do not know what to expect from the newly-proposed home movie service over wires. For certain types of education which require the eye of the student to be close to the demonstration, such as dentistry or surgery, we had the pleasure of seeing, at the world's most elaborate installation at the Walter Reed Army Medical Center, Washington, with its color equipment, the proof that such systems provide large-class viewing not possible by other means. On every hand we see industrial and scientific wired TV being used for more and more purposes. When the "packaged" installation of a small camera and a receiver, which may replace one or more watchmen now patrolling guarded property, costs around \$1,000, what manager would not be interested? With most of our TV broadcasting stations now licensed and operating, it is natural for the manufacturers of such TV equipment to look toward this expanding field.

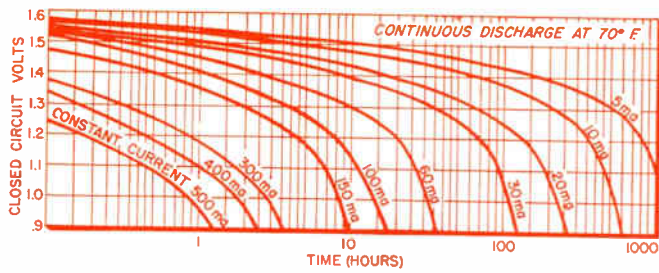

Fig. 1: Modern Size "D" cells have improved characteristics.

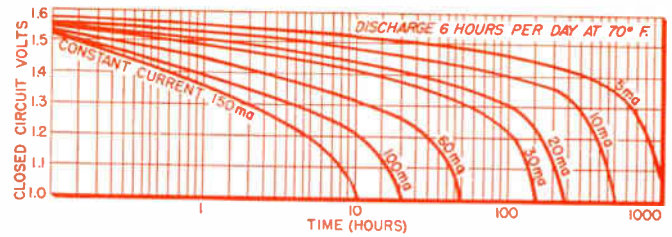

Fig. 2: Intermittent constant-current life of "D" dry cell.

*Transistorized and miniaturized equipment have such low power requirements that batteries have become competitive with other power sources. The special requirements of air-borne and underwater missiles have spurred the development of many different battery types, each with unique advantages. Shelf life and service life have extended far beyond the capabilities of pre-war models.*

By **ARNOLD E. LOOK, JR.**  
 Assistant Editor,  
 ELECTRONIC INDUSTRIES & Tele-Tech

# New Horizons For Battery Power

THE steady development of primary cells has, in recent years, been surmounted by a rapid spurt in research and development of batteries to meet the needs of miniature and transistorized equipment. Great improvements in shelf life and capacity have been made, as well as improvements in power-to-weight characteristics. New shapes and manufacturing techniques, combined with improved active ingredients and packaging materials give us better performance and greater economy. The large volume of battery sales makes possible the production of an ever increasing variety of shapes, voltages and capacities for specialized applications. The electronic engineer of today can choose from a wide variety of batteries for his new electronic equipment.

The modern dry cell was born in 1888, when Gassner modified the LeClanche cell to produce the first practical dry cell. Those first cells, while embodying all the basic principles of present cells, had limited life and capacity. Our "flashlight" was originally just exactly that, because the first small dry cells could produce the necessary power only in short flashes.

### Steady Improvement

Today's descendant of the original carbon-zinc dry cell is vastly improved. Back in 1901 the Government

tested early No. 6 dry cells and they showed an average 35% deterioration during 6 months on the shelf. By 1916, this had dropped to 25%, still a severe limitation. In 1934, the average No. 6 cell was deteriorating only 7% in six months. A series of tests in 1951 showed that the industry had improved the cell to such a degree it would deteriorate only a low 2% in half a year.

The same sort of improvement over the years can be traced for that work horse of the dry cells, the standard Size D flashlight cell. National Bureau of Standards ran a standardized 4-ohm intermittent test on a large batch of D cells in 1910. In those days the D cell gave 260 minutes of service. By 1935 this had been nearly tripled to 750 minutes, and a later test series, in 1951, showed average service of 800 minutes—and some types went over 1,000 minutes.

### Flat Cells

Automated manufacture, and decreased weight and volume have resulted from the development of flat cells. These new cells consist of a sandwich of manganese dioxide mix between flat zinc and carbon electrodes. In one form, these flat cells are assembled by machine and wrapped in an airtight pliofilm envelope which is then heat sealed. In another version, a

plastic case is shrunk onto the machine-assembled cell. Advantages of these types of cell include automated manufacture and elimination of inter-cell leakage. Extensive use of plastics has reduced weight and volume. The active ingredients are essentially unchanged, but more refined materials have increased shelf life and capacity of the cells.

### Electric Watch

A striking example of convergent design efforts by equipment and cell engineers is the Hamilton electric wrist watch. The watch itself is a tribute to Hamilton engineering; its motor uses micro-coils wound of nearly invisible .0006-in. wire. More than ten years



Fig. 3: New design concept of Elgin Indium cell permits variety in shape and size.

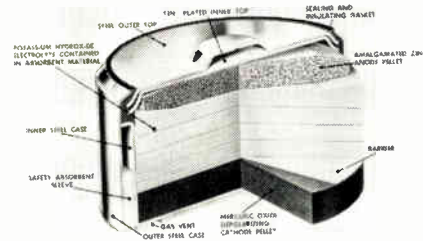

Fig. 4: Mallory's mercury cell design includes a filtered relief vent space between cases.

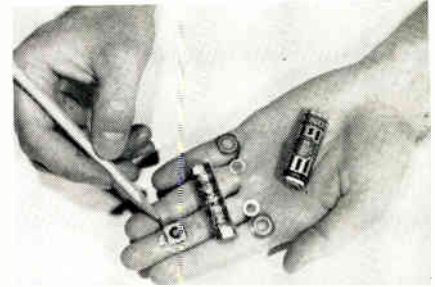

Fig. 5: Plastic-cased "wafer cells" give design freedom for Burgess Batteries.

of design and development effort went into the new watch. It was made possible, however, only with the aid of concurrent development of a miniature cell which could power the watch for more than a year—about 125 million cycles of the motor.

Such a cell is National Carbon Company's new Eveready W-307. This tiny cell, weighing only 1/20 ounce is capable of providing 32 watt-hours per pound. Nominal rating of the cell is 1.5 volts, and it is rated at a total of 60 milliampere-hours to a 1.3-volt cutoff. Recommended average current is 60 ma or less. It employs highly refined standard dry-battery ingredients, and measures only .440-inch diameter by 1/8-inch thick. It is made completely of non-magnetic materials.

Fig. 6 This Eveready W-307 cell is capable of driving a wrist watch for a year.

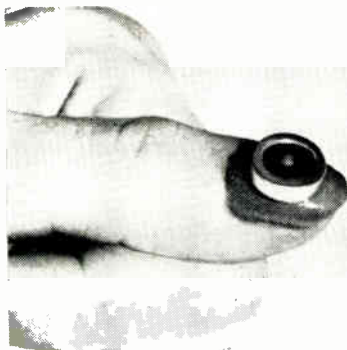
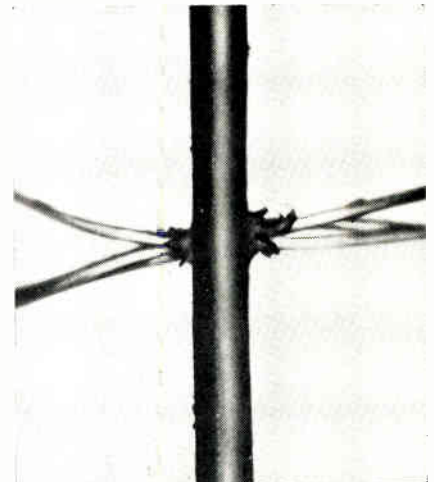

Fig. 7: The new Hamilton electric wrist watch has fewer parts than a wound watch.



Fig. 8: Three strands of .0006-inch watch-motor wire can be passed through a pierced hair.



### Mercury Cell

The mercuric oxide zinc potassium hydroxide primary cell, commonly called the "mercury cell" was developed during the early part of World War II. Since that time it has come into increasing use for both military and civilian applications.

As in other electrochemical cell systems the electrical energy of the mercury cell is produced by a reaction between the anode and the depolarizing cathode aided by the cell electrolyte. An anode pellet of pure amalgamated zinc is used, with a depolarizing cathode consisting of high purity mercuric oxide to which small amounts of other materials are added to improve physical and electrical characteristics. The potassium

hydroxide electrolyte, with added zincate, provides a high degree of stability and limits the evolution of hydrogen during shelf storage and during normal discharge.

During abnormal conditions, such as reverse currents or short circuits, excessive gas can be generated within the cell. This need be no serious problem, however, due to the use of double-jacketed cells in which venting can occur in the space between the internal cell container and the outer steel jacket. A safety absorbent ring is provided so that any cell electrolyte carried into the space will be retained. Corrosive materials are thus prevented from escaping with gas through the vent hole at the bottom of the outer steel jacket.

## Primary Cells (Continued)

### Life

Mercury cells display a variety of advantageous characteristics. One of the more important is long shelf life. A typical cell stored at room temperature will retain over 93% of its capacity after a twelve-month storage time. Low internal resistance gives good regulation under load.

### Stability

Voltage stability is such that the cells are widely used as secondary voltage standards. The cells can withstand momentary short circuits with no permanent damage, and almost complete recovery of full open circuit emf within minutes. Small reverse cur-

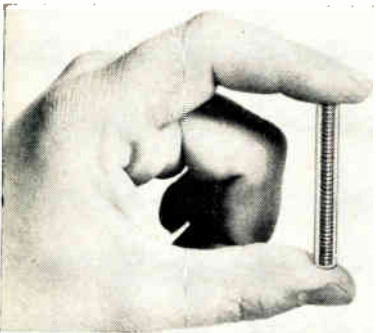

Fig. 9: Mallory's Solidion solid-electrolyte cells are rated at 200v/cu in.

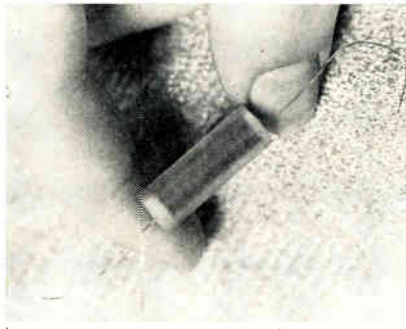

Fig. 10: GE's solid - electrolyte cell can deliver 8 microamperes flash current.

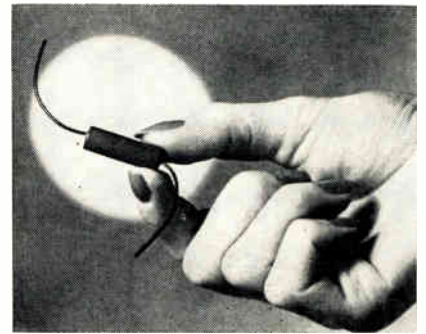

Fig. 11: Life of the Eveready solid-electrolyte cell is estimated at "decades."

rents can be tolerated without adverse effects. Temperature stability is high, emf varies only slightly over a wide range of temperatures. The cells are used successfully in sub-surface geological survey instruments where operation is required at temperatures which may briefly exceed 250°F. Many different shapes and sizes of mercury cell are manufactured, providing a wide variety of batteries and power packs.

### Indium Cell

Among the new cells recently announced is the Elgin indium cell. This cell was developed specifically for use in electronic watches being developed by Elgin National Watch Co. Electrical characteristics of the

indium cell are similar to those of the mercury cell, but important advances are claimed for the new cell.

The most common commercial disadvantage of primary cells—parasitic reaction during storage and discharge—has been further minimized in the indium cell, giving a shelf life of at least one year and up to 2 years of service life. Other important advantages are: dimensional stability during storage or discharge, a sealed plastic case which eliminates leakage, high insensitivity to a wide range of ambient temperatures, essentially constant discharge voltage during service life, low weight and volume, and adaptability to unusual shapes.

Present cells deliver an open circuit voltage of about 1.15 volts, but recent studies show a change can be

made in the cathode material to produce an open circuit voltage of 1.37 volts. A half-penny-sized cell is now being produced by Elgin. Success of this first cell has led Elgin to consider opening production of the cells to any desired size or shape, a development of extreme interest to designers of micro-miniature electronic equipment.

### Acknowledgments

1. Technical information on the carbon-zinc dry cell was provided by Burgess Battery Co., Freeport, Ill.; P. R. Mallory & Co., North Tarrytown, N. Y.; National Carbon Co., New York 17, N. Y.; Radio Corp. of America, Harrison, N. J.; and Ray-O-Vac Co., Madison 10, Wisc.
2. Characteristics of the mercury cell were provided by P. R. Mallory & Co., North Tarrytown, N. Y., and National Carbon Co., New York 17, N. Y.

## Nuclear Cells

**B**ETA-RAYS emitted by some radioactive isotopes consist of a stream of high-energy electrons. An extremely simple, rugged cell can be constructed by coating the radioisotope on a central emitter electrode, and collecting the electrons by an outer conducting member. This technique has been developed and cells using this principle are available. These cells are capable of producing a very high voltage if enough time elapses for the charge of electrons to build up. With a sufficiently large capacitor in parallel with the nuclear cell, sufficient charge can be stored to operate low powered or one-shot devices. Such cells and cell-capacitor combinations are used for biasing elements, reference sources, radiation measurement,

timing circuits, and a number of classified military applications.

### Beta-Current

Among the more attractive features of the Beta-current cell are rugged construction, elimination of corrosive elements, light weight, high reliability, im-

Fig. 12: Nuclear energy gives current in the Elgin-Kidde Cell.

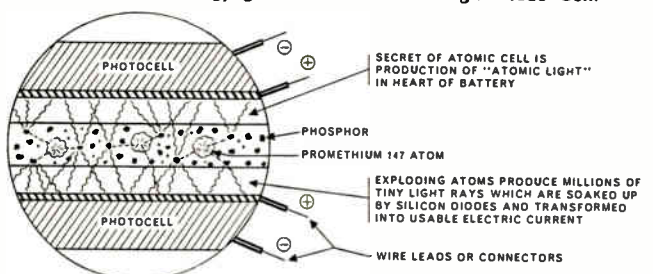

munity to short-circuit damage, linear self-charging rate, and a combined operational and shelf life of as much as 25 years. Pressure, temperature, and acceleration extremes can be tolerated by the cells.

### C-P-D Cell

Several other effects of radioactivity can be utilized to produce useful voltages and currents. One of these, the contact-potential-difference cell, has received considerable attention in government-sponsored research. In this cell, maximum output voltage is the contact potential difference. These cells have dissimilar electrodes separated by a heavy gas diffused with a radioactive gas such as tritium. Radiated Beta-particles ionize the gas, and the oppositely charged ions migrate to opposite electrodes, where the ions are neutralized.

### Secondary Emission

Other possible configurations include cells in which primary emissions bombard a secondary material from which a larger number of lower energy electrons would emit, a thermopile using a radioactive heat source, and direct irradiation of a semiconductor junction. This latter is among the more attractive, but early experimenters soon found out that radiation gradually destroyed the junction by altering the crystalline structure of the semiconductor.

### Nuclear-Light-Cell

Recently, however, a novel configuration has been devised which eliminates this problem. The new cell mixes a radioactive substance with a phosphor which both absorbs the destructive radiation and at the same time converts the radioactive energy to light. A photo-diode bordering the radioactive light source then converts the light to useful electric energy. As presently conceived, the light source consists of a mixture of finely divided phosphor and an oxide containing about  $4\frac{1}{2}$  curies of Promethium 147, one of the more abundant nuclear fission products. This amount of radioactive substance creates a cell with a nominal power output of 20 microwatts when new, decreasing to 10 mw after  $2\frac{1}{2}$  years, and reaching a level of 5 mw after about five years.

### Phosphors

The phosphor used contains cadmium sulphide or mixtures of cadmium and zinc sulphides. These phosphors emit in the red and infra-red region, which is efficiently converted by the modified silicon solar cells. An interesting design feature of some of the present developmental cells is the use of four semicircular silicon photo-diodes so that output voltage can be varied from about  $\frac{1}{4}$  volt to 1 volt with no change in total power. Economic feasibility of the cell is enhanced by the fact that in large quantities, Promethium 147 is expected to cost approximately 50¢/curie.

### Solid Electrolyte

One of the most recent newcomers to the battery field is the "solid electrolyte" battery. Production techniques have been devised to form the basic cell—electrodes and solid electrolyte—in extremely thin  
(Continued on page 119)

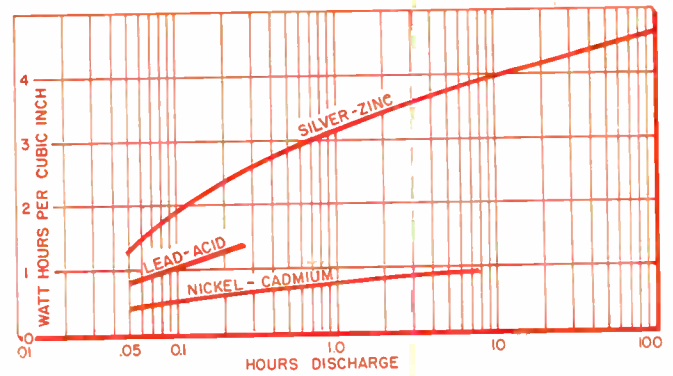

Fig. 1: Typical power/pound curves for light-weight power cells.

## Power Cells Compared

**O**FTEN, the demands made on a battery are such that rechargeable secondary cells are an economic necessity. Three types are used most frequently for mobile and portable equipment: lead-acid, nickel-cadmium, and silver-zinc cells.<sup>1</sup> These cells all have the ability to provide large amounts of power at high discharge rates. In addition to this, each cell has unique properties which lead to its use in certain applications. Even the oldest of these, the lead-acid cell, is the subject of research aimed at further improvement of its characteristics. New alloying materials for the lead grid for this cell have been introduced. An analysis of recent developments in the lead-acid cell is presented by Dr. Howard J. Strauss on Page 39.

### Nickel-Cadmium

The nickel-cadmium alkaline battery has been on the market for nearly fifty years.<sup>2</sup> Among the important features of this cell is the alkaline electrolyte, which permits the use of sturdy steel grids and cases. In the original construction, still used extensively, the active nickel and cadmium oxides are enclosed in finely perforated steel pockets in the grid structure.

### Low Gas Rate

The potassium hydroxide electrolyte solution serves, in effect, only as a conductor, and maintains constant specific gravity and conductivity at all conditions of charge. Because of this, there is no variation of resistance in the electrolyte during charge and discharge of the cell. The electrolyte serves only to transfer oxygen between negative and positive plates during charge and discharge. Gas is evolved almost exclusively as a result of electrolysis during extremely high charge rates or during overcharge periods.

### Temperature

Typically, the cells will take a charge at temperatures from  $-65^{\circ}$  to  $+165^{\circ}$ F. They can be stored without damage in any state of charge, including complete discharge. Long life and good voltage regulation during discharge are other important features. These cells find large use for standby power and control, signal and alarm systems, laboratory dc supply, and emergency lighting. Transistor engineers now use tiny nickel-cadmium cells as filters for smoothing ac-operated dc power supplies and as power sources in conjunction with solar cells.<sup>5</sup>

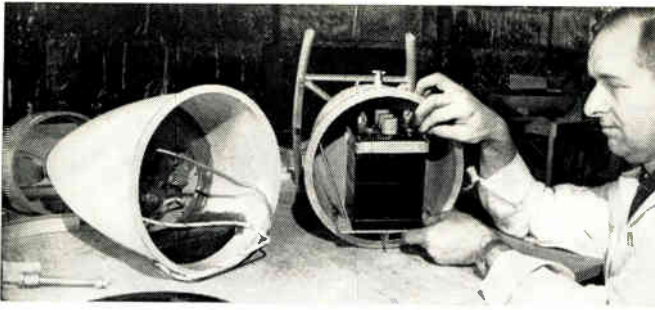

Fig. 2: A nickel-cadmium cell powers this underwater "Power Diver" made by the Link Aeronautical Corp., Endicott, N. Y.

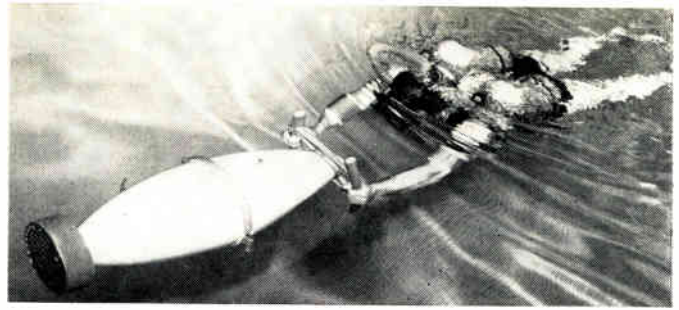

Fig. 3: Even skin-divers use power cells, in this electric underwater propulsion unit. Shielded propeller is in bow.

## Power Cells (Continued)

### Sintered Plate

During the past ten years, extensive research and development work has led to a new type of plate for the nickel-cadmium cell. This is the "sintered plate" now used in many commercial cells. These plates are formed by sintering nickel powder to a fine-mesh nickel screen. This produces a highly porous plate within which the active materials can be electrochemically deposited, giving improved characteristics. The thin plates, separated by synthetic fabric, can be closely packed to produce a cell with small volume and great resistance to shock and vibration. Nickel-cadmium cells can be used with constant voltage, constant current, stepped constant current, or float charging systems. Optimum charging occurs when the cell is given a charge equal to 140% of rated capacity within a maximum of three hours.

The inherent capabilities of the sintered-plate nickel-cadmium cell are revealed in recent tests made at the Naval Research Laboratory.<sup>3</sup> The study shows that the sintered-plate construction makes possible a cell which will give satisfactory performance at low temperatures, is capable of being fully charged in less than one hour, and can be discharged in a few minutes without excessive capacity loss. Capacity loss during a 90-day stand was on the order of 20 to 25 per cent at room temperature and considerably less at 0°F. NRL reports that as cycling continued beyond 700 cycles, there was still no indication of the approach of the end of cycle life. The electrolyte remained clear, there was no evidence that the plates had shed any active material after this series of tests including severe cycling under adverse conditions.

Fig. 4: Triggered gas generator injects electrolyte to energize Cook battery.

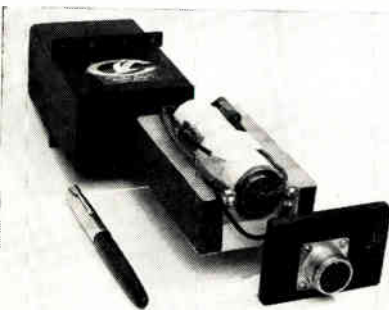

Fig. 5: Tiny Yardney silver-zinc, less than 4/5 oz., cell can deliver 45 amperes.

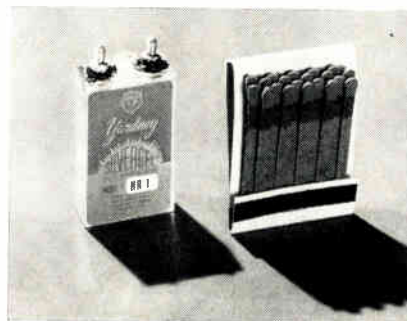
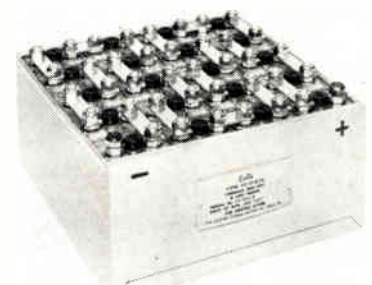

Fig. 6: This Exide silver-zinc battery can be stored dry-charged until needed.



### Silver-Zinc

A vigorous contender among the power cells is the silver-zinc cell. Much of the demand for this cell is based on two factors: the high capacity in watt-hours per unit weight, and the high current density at which this power can be produced. Research is being actively pressed to bring still further improvement of these characteristics.<sup>4</sup>

### High Rates

The cell uses silver and zinc as active materials, and potassium hydroxide for electrolyte. During cell discharge, silver oxide is reduced at the positive plate and zinc is oxidized at the negative plate. The cells are capable of extremely high discharge rates without serious voltage drop; continuous high rate discharges are limited primarily by the heat evolved.

### Light Weight

Low weight, low resistance, and high resistance to shock and vibration make the silver zinc cell particularly suitable to aircraft and missiles. In addition to these advantages, the cell evolves little or no gas during discharge, and is thus operable in any position. Cells now being manufactured include postage-stamp-sized cells rated at 0.1 ampere-hour, and cells rated at 300 ampere-hours. Experimental cells capable of several thousand ampere-hours have been designed.

### "One Shot" Use

In addition to use as a secondary, or rechargeable cell, the silver-zinc cell can also be used as a primary, or "one shot" power supply. In one refinement, these cells are assembled with a built-in activating mechanism which forces electrolyte into the charged cell

(Continued on page 118)



# New Grids Improve Lead-Acid Cells

*A familiar standby power source for communications centers, the lead-acid cell, has undergone steady improvement over the years. Now, alloyed grids provide a choice of properties for different applications.*

By **DR. HOWARD J. STRAUSS**

*Chief Product Engineer  
Exide Industrial Div.  
Electric Storage Battery Co.  
42 S. 15 St., Phila. 2, Pa.*



**I**N the Electronic Industries, the lead acid battery continues to be the standard for stand-by power in alarm, signal, and all types of communication. In these areas, the lead acid battery finds its greatest use as a stationary installation. For stand-by power, the lead acid battery can economically provide large reserve capacities with an absolute maximum of reliability and a minimum of maintenance. In addition to this, the lead acid battery can serve as an excellent voltage stabilizer, frequently forming an actual functioning component of the electronic system. It also can be used to provide switching power and relay stability. In this regard, the fact that the state of

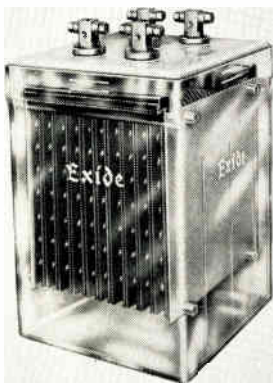

Fig. 1: New grids, plastic cases, and new manufacturing techniques result in improved performance from tiny storage batteries such as this.

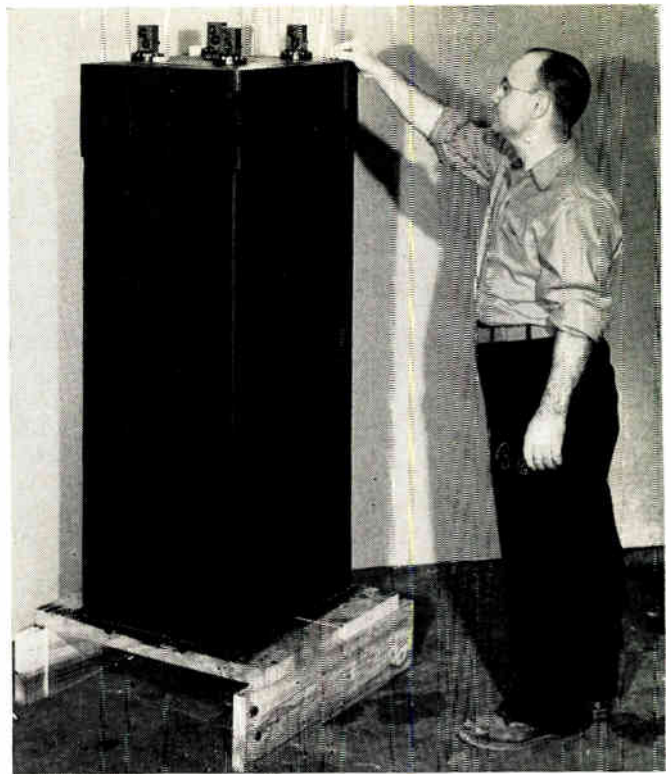

Fig. 2: This giant cell powers phone exchanges and submarines.

charge and general condition of the battery can be readily checked by specific gravity measurements of the electrolyte is of particular value.

## **Calcium Alloy**

The fundamental lead acid system has undergone a steady, continuous development and improvement, until today, such batteries have a high degree of efficiency, both from the electrochemical and physical design viewpoints. Notable among some of the more recent advances is the introduction of calcium alloy grids. This alloy, which is essentially a pure lead stiffened by a very small addition of calcium, eliminates certain impurities, which contribute to high charge maintaining currents. In this way, grid corrosion is minimized, as is water consumption, and the ultimate life of the battery is increased while the maintenance requirements are minimized. Calcium alloy batteries are now fully in production in a wide variety of sizes, but all are designed principally for emergency stand-by power and voltage stability, since this system is not at its best under repetitive deep cycling.

## **Lead-Antimony**

Where some cycling is a routine requirement, and battery systems are frequently called upon to supply a variety of minor DC requirements in communication and signal installations of all types, the antimonial-alloy grid battery, or the Planté type, are recommended. Particularly where long life is required, the Planté, or Manchester, battery has been improved even over its former performance by the use of special grid alloys particularly those containing arsenic and silver. Through continuous research, suit-

*(Continued on page 118)*

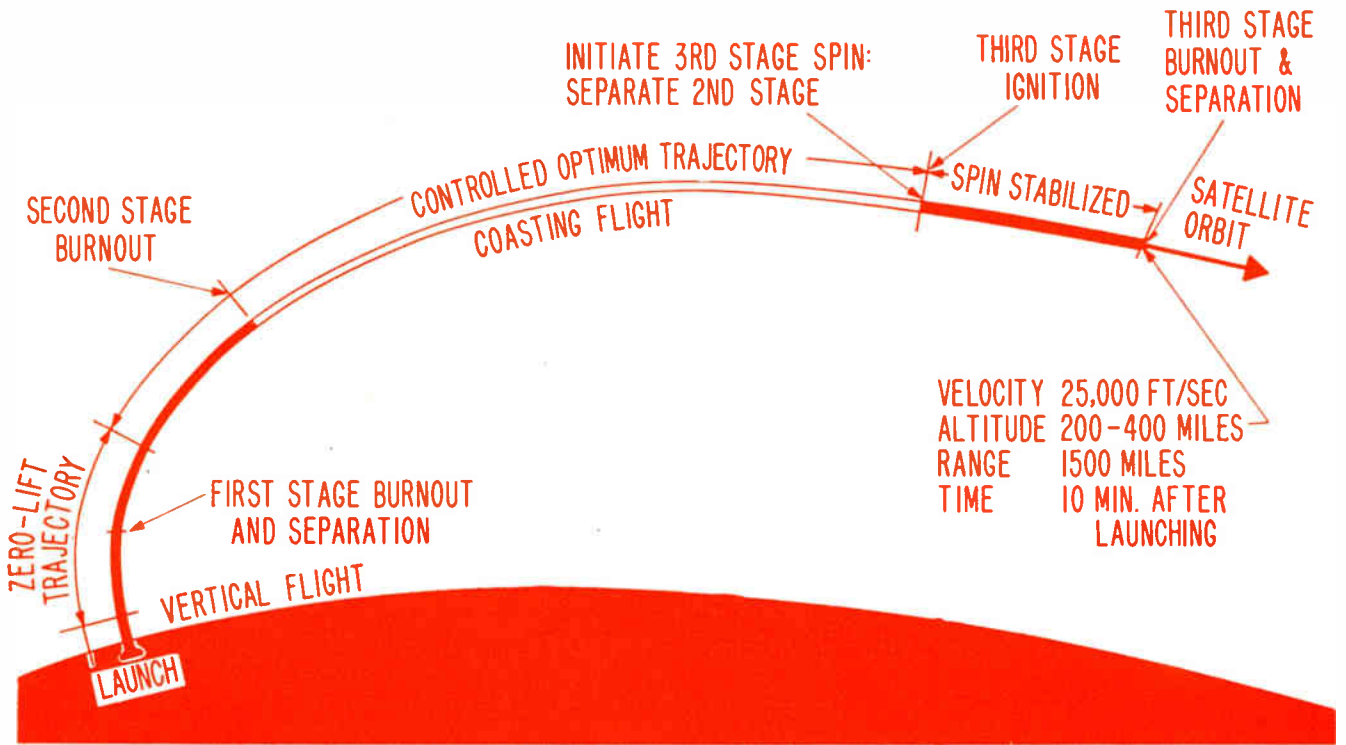

# Telemetered Data Checks Vanguard Flight

*A Vanguard Viking test needs up to 200 measurements, including data from highly corrosive fuels. Engineers are meeting the challenge with new components and techniques.*

**By F. W. PHALEN**  
 Director, Instrumentation Staff  
 Glenn L. Martin Co.  
 Baltimore 3, Md.



FLIGHT testing for the earth satellite program began on December 8, 1956, when a Navy-Martin Viking rocket arched 123 miles into the upper atmosphere from the Air Force Missile Test Center at Patrick Air Force Base, Florida. Additional test vehicles of increasing refinement will be fired in the months to come, paving the way for man's first full-dress attempt to place a satellite in orbit around the earth.

## Problem

Vanguard mission requirements are novel and tough, and the instrumentation task reflects them. We are shooting for very high altitude—the satellite launch point is 300 miles up. Velocity is another challenge. The 22-pound spherical payload must be accelerated to about 17,500 miles per hour if it is to stay in its prescribed orbit. The most exacting demand, however, is for precise control. At the time it is injected into orbit, the satellite must be traveling a course that roughly parallels the curve of the earth with angular deviation of no more than 2.5 degrees.

## Vehicle

These orbiting conditions of altitude, velocity, and control are brought about by the successive impulses of a three-stage rocket, designed and built by Martin under management of the Naval Research Laboratory. Joined in tandem at launch, the combined stages measure some 72 feet in length and 45 inches at the widest diameter. With fuel, the vehicle weighs about 22,000 pounds. As they complete the various trajectory phases, the stages drop off in numerical order to decrease weight.

Stage one is an improved Martin Viking rocket powered by a General Electric rocket engine operating on kerosene and liquid oxygen. An Aerojet General en-

gine burning unsymmetrical dimethyl hydrazine (UDMH) and white fuming nitric acid (WFNA) drives the second stage of Vanguard, which houses the inertial reference guidance system and the magnetic amplifier control equipment. The third stage is a solid propellant ballistic rocket.

The satellite vehicles will carry a minimum of instrumentation. But the test vehicles which precede them are heavily instrumented for 150 to 200 measurements.

#### Test Instrumentation

With this array of internal instrumentation we are evaluating the design criteria of the vehicle and the performance of all components and systems. The vital control system comes in for special attention.

Fig. 1: Preparing the Vanguard test vehicle for a night launching

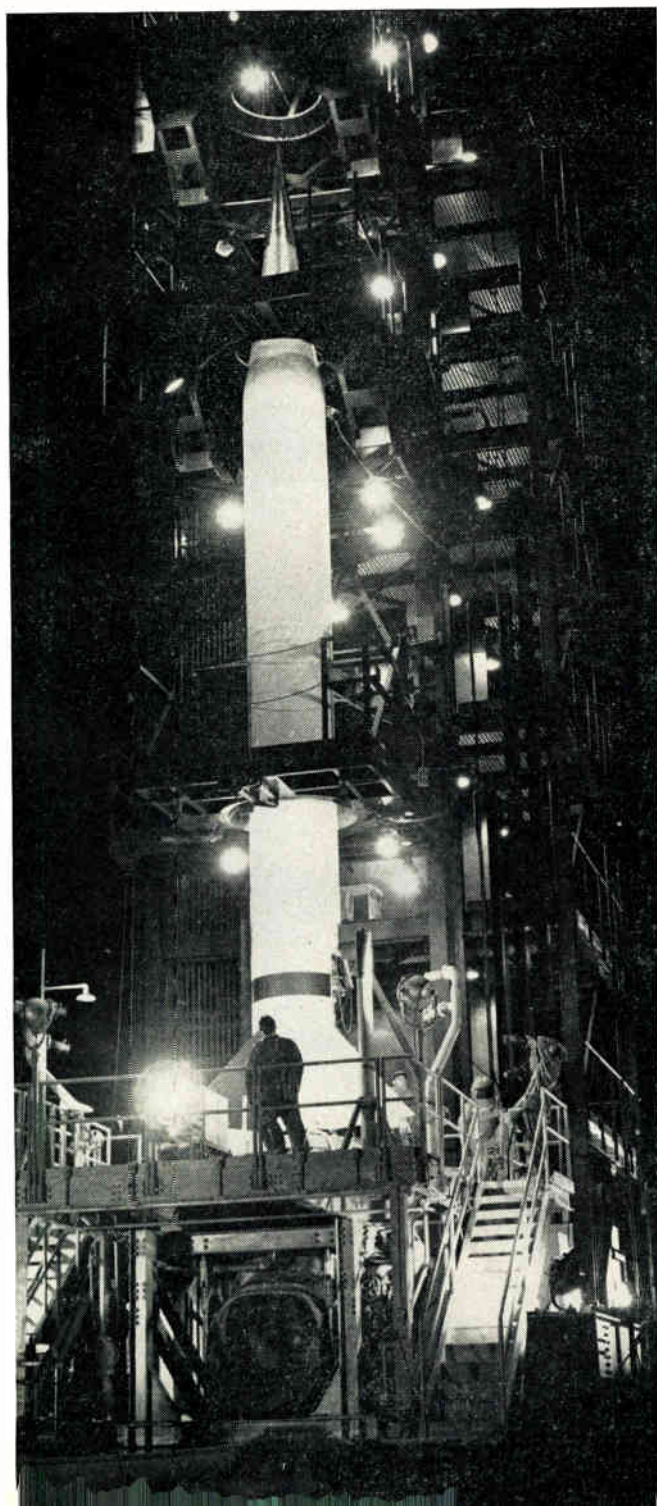

First- and second-stage engine performance is being analyzed, and checks are being made of separation techniques of the various stages and methods of starting the second and third stages at extreme altitudes.

The kinds of information sought with internal instrumentation are indicated in Fig. 3, while Fig. 4 is a breakdown of the various engineering activities requiring measurements. External instrumentation, also used extensively, includes radar and doppler tracking for trajectory and velocity measurements, which must be highly accurate. Good optical coverage is provided as well.

#### Data Channels

Data obtained by rocket-borne instruments are sent back to recording stations by up to four telemetering transmitters of these types: PWM/FM, providing 43 channels at 20 samples per second; PPM/AM with 15 channels, at 312.5 samples per second, subcommutated according to demand at lower rates; and FM/FM with 12 continuous data channels. (See Fig. 2 for details.)

#### Transducers

Potentiometric - type sensing elements are used wherever possible because the telemetering input requirements generally fall between 0 and 5 v. dc. Thermocouples, strain gauges and inductance pickups are avoided. They involve black boxes and associated circuitry. The job of converting to a usable 0 to 5 v. can be a headache, not to mention the severe weight penalty for signal converters.

Guided by our Viking rocket experience, we set out to find new measuring techniques for the temperature and pressure of liquid oxygen and hydrogen peroxide in the first stage. Both are dangerously explosive when mishandled. Second-stage propellants, however, posed the knottiest problems. White fuming nitric acid used as oxidizer, is highly corrosive and will attack most metals vigorously. Among those showing the greatest corrosion resistance are titanium, aluminum and stainless steel. Both WFNA and second-stage fuel (UDMH) are highly toxic, and present an explosion and fire hazard.

Understandably, we found no commercially available transducer that would measure these media satisfactorily. The need was filled by Rahm Instrument Company in an instrument development program.

(Continued on page 77)

Fig. 2: Vanguard utilizes three methods of telemetering information

DESIGNATION	NO. OF DATA CHANNELS	SAMPLING RATE PER CHANNEL
PWM/FM (PULSE-WIDTH MODULATION)	43	20 SAMPLES PER SECOND
PPM/AM (PULSE POSITION MODULATION)	15	312.5 SAMPLES PER SECOND
FM/FM (FREQUENCY MODULATION)	12	CONTINUOUS

# What's New . . .

## "Molded" Circuits

A NEW method of producing printed wiring board, said to eliminate one of the most important bottlenecks to the mass production of printed circuits, has been developed by Rogers Corporation, Rogers, Conn., producers of non-metallic specialty materials.

### *Uncured Stock*

The basis of the new process is a phenolic impregnated cellulose sheet material. The material can be cured and formed into three dimensional shapes, providing far greater design flexibility than has been possible by the use of standard phenolic laminates and methods of producing printed circuits.

### *No Etching*

The new manufacturing process eliminates the etching or plating processes required with standard methods, thus removing one of the most serious obstacles to the economic mass production of printed circuits. In addition, the new method permits the molding-in of three-dimensional effects at the same time the circuit itself is molded.

Hole concentration can be twice that of punched XXXP parts and can be molded at lower costs and with less difficulty. Molding also allows holes to be tapered or stepped in depth, adding to freedom of creative designing. In addition, the Rogers technique forms a resin skin seal over all edges and hole walls, significantly reducing moisture absorption.

### *3-D Shapes*

Supplied uncured, the materials can be molded into three-dimen-

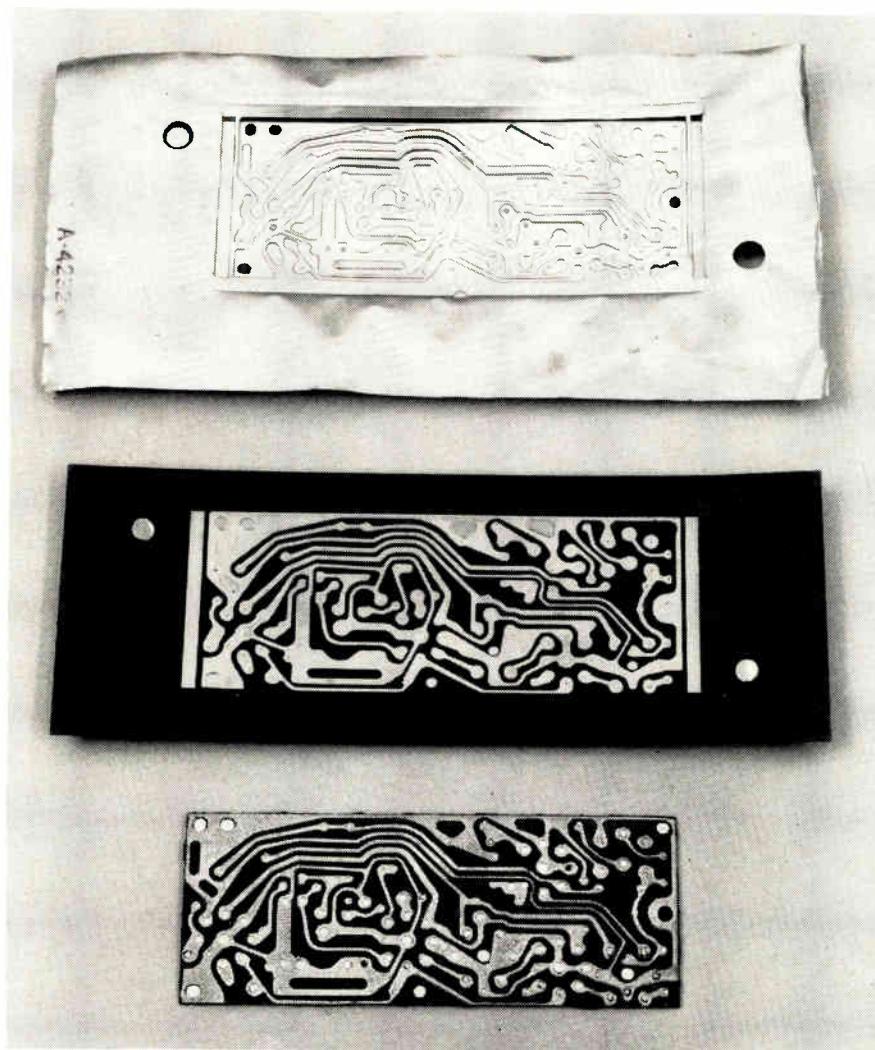

Method of mass producing printed circuits by the molding method developed by Rogers Corporation, Rogers, Conn., is shown in this picture. Top, copper punched into the molding board; center, pattern on molding board with excess copper stripped away; bottom, the molded circuit. This circuit is designed for an automotive radio part.

sional shapes, with holes for component lead insertion. Difficult fabrication, common to standard laminates, is thereby eliminated.

Several processes have been adapted by Rogers for producing circuits to meet various requirements, including a die stamping process in which an adhesive-backed continuous copper strip is stamped into the molding board. Since the board serves as the cutting edge and female die, significant economy in tooling is achieved.

The punch impresses the copper below the surface of the board, adhering those parts which will form the circuit. Excess copper is strip-

ped away prior to molding and salvaged as scrap. Standard compression molding techniques are used to complete the circuit. Low-cost tooling methods for making the molds have been devised.

### *Low Cost*

Other advantages claimed for the new method are low initial investment in equipment, economy of operation, adaptability to various molding techniques to meet user need, close control of product quality, and consistency of product quality.

(Continued on page 100)

# Precision Cutter for Short Iron Wire

By J. A. Price and P. L. Kerles\*

TO produce short lengths of soft wire with a  $\pm 1/16$ -inch tolerance, a unique and simple wire cutter has been developed at Sandia Corporation in Albuquerque. The new device improves on the tolerance permitted by using jigs and reduces the handcutting time for each operation from six hours to 20 minutes.

While developing a special purpose HV transformer, Sandia found a need for a more compact, lower-loss core material. No. 22 annealed soft iron wire in short lengths was considered best. When suppliers were unable to provide  $1\frac{1}{2}$ -inch and 2-inch lengths to  $\pm 1/16$ -inch tolerance, with no bend of angle exceeding 10 percent, Sandia built its own wire cutter, which actually operates within  $1/32$ -inch length tolerance.

The cutter operates as follows: wire is pushed through the guide tubing until it actuates a micro-switch lever and simultaneously comes to rest at the length-determining bumper. The microswitch

energizes a solenoid which pulls the cutter blade upward, cutting the wire against the hardened shear sleeve.

Normally, because of upward momentum of the wire on being sheared, it would bend. However, bumpers counteract this tendency. As the solenoid releases the cutting blade the straight pieces of wire, as pictured, fall downward. The microswitch lever then springs back to the open position against a bumper until the sequence is repeated.

\* Sandia Corp., Sandia Base, Albuquerque, N. M.

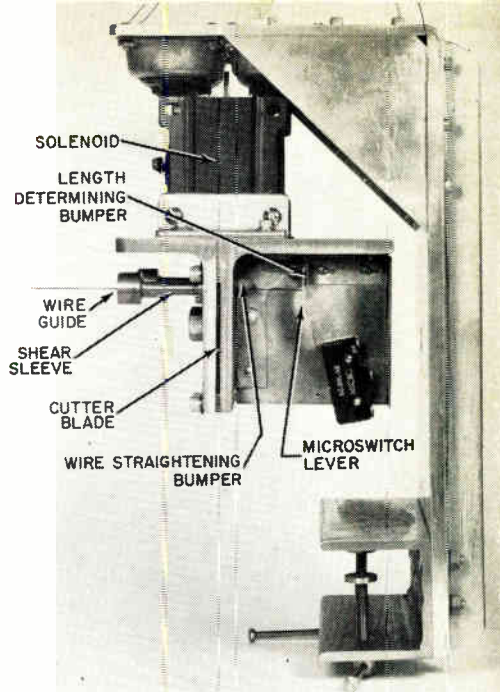
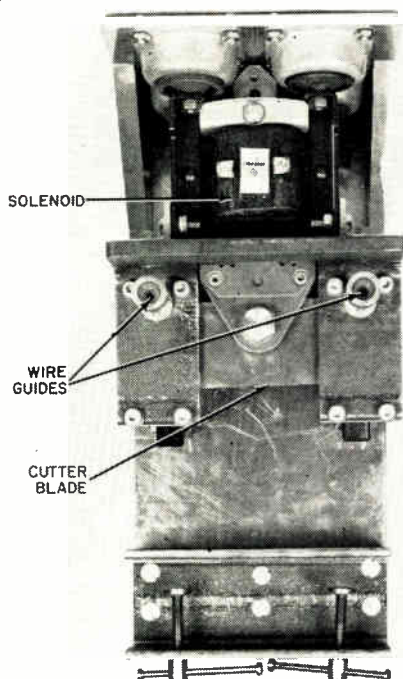

Fig. 2: In this side view of the precision cutter, we see the wire-straightening bumper which prevents bending of the wire when cut.

Fig. 1: When wires are fed into this solenoid-operated cutter, it shears short pieces to within  $1/32$  inch.



## Relay Test Set

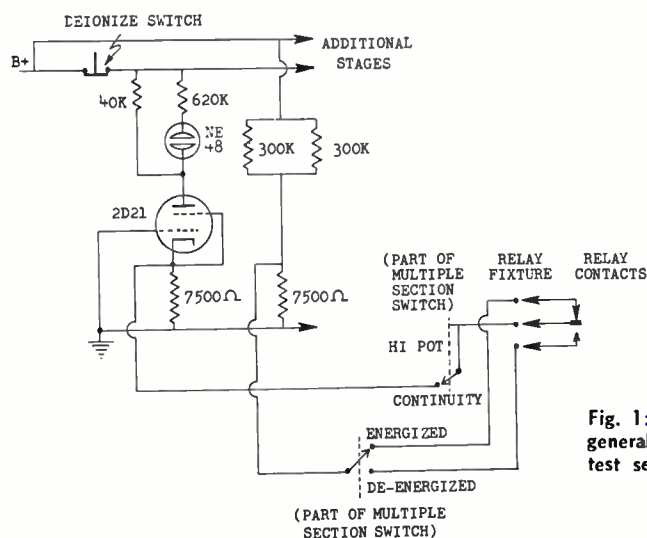

Fig. 1: Continuity circuit of the general purpose relay acceptance test set (one of four sections).

SEVERAL years ago the military electronics division of the Magnavox Company began an informal program to minimize construction of specialized test equipment. This is a familiar pattern, of course. Government contracts these days are for smaller quantities and competition is far keener. A piece of equipment which is good for only one part is an expensive luxury. For general purpose relays there had been two approaches—either a specialized black box, or a lash-up of meters, power supplies, continuity indicators, and hipot test sets. Testing with a specialized test set can be run faster and with less skilled labor than the lab bench

approach. But temporary hookup of standard supplies, meters and so forth provides equipment with a long useful life.

To provide the advantages of each of these systems they built a general purpose or universal relay tester. It incorporates coil voltage controls and metering for DC, 60 cps and 400 cps. DC coil current is metered and a meter jack is provided for AC coil current. Opening and closing of up to four pairs of contacts are indicated independently on the front panel. Metered breakdown voltages up to 2500 volts AC or 5000 volts DC are applied separately to all the possible break-

(Continued on page 110)

# 1957 Coming Events Calendar

Portraying important electronic events ahead from July to December

Engineering Events    
  Trade Events    
  Avionic Events    
  Electronic Meetings and Shows

	1	2	3	4	5	6	7	8	9	10	11	12	13	14	15	16	17	18	19	20	21	22	23	24	25	26	27	28	29	30	31
<b>JULY</b>	International Symposium on Color TV Paris, France																National Audio-Visual Convention National Audio-Visual Association Marrison Hotel, Chicago														
											Music Industry Trade Show & Convention National Association of Music Merchants, Inc. Palmer House, Chicago															11th Annual Convention Air Force Association Sheraton Park & Shoreham Hotels Washington, D. C.					
<b>AUGUST</b>	The Avionic Convention 37 Years of Progress Sheraton Park & Shoreham Hotels Washington, D. C.																	12th General Assembly of the International Scientific Radio Union Boulder, Colorado													
														Regional Aviation Meeting AS U. S. Sheraton Hotel San Diego, California																	
											Analog-Digital Conversion Techniques Massachusetts Institute of Technology M. I. T., Cambridge 39, Mass.												Management Science and Computer Technology Courses University of Michigan Ann Arbor, Michigan								
<b>SEPTEMBER</b>											Western Electronic Show & Convention (WESCON) West Coast Electronic Manufacturers Association Cow Palace, San Francisco, California																AIEE Pacific General Meeting AIEE Pasco, Washington				
	ARRL National Convention American Radio Relay League Palmer House, Chicago																	Annual Convention & Seminar National Alliance of TV & Service Associations Sheraton Hotel, Chicago										ARRL National Convention American Radio Relay League Palmer House, Chicago			
											National Television Week NARTB, NARDA, RETMA & TVB				62nd Annual Meeting & Convention International Municipal Signal Association Hotel Fountainbleau, Miami Beach, Fla.												6th Annual Meeting Standards Engineers Society Hotel Commodore, New York				
	ARRL National Convention American Radio Relay League Palmer House, Chicago				12th Annual Instrument-Automation Conference & Exhibit Instrument Society of America Cleveland, Ohio				3rd Annual Titanium Conference New York University New York City				NARTB Regional Conference NARTB Hotel Van Curler, Schenectady, New York				ASME Fall Meeting ASME Statler Hotel, Hartford, Conn.				NARTB Regional Conference NARTB Hotel Grove Park, Asheville, N. C.				7th Annual Symposium IRE Group on Broadcast Transmission Systems (PGTBS) Washington, D. C.						
Technical Conference on Magnetic Amplifiers IRE & AIEE Fenn Sheraton Hotel, Pittsburgh, Pa.																	Electronic Control & Data Processing Symp. PETMA Ambassador Hotel, Los Angeles, California										X-Ray Diffraction School Phillips Electronics, Inc. Sir Francis Drake Hotel, San Francisco, California				
										NARTB Regional Conference NARTB Hotel Statler, Cleveland, Ohio												Conference on Industrial Electronics IRE & AIEE Marrison Hotel, Chicago									

	1	2	3	4	5	6	7	8	9	10	11	12	13	14	15	16	17	18	19	20	21	22	23	24	25	26	27	28	29	30	31							
<b>OCTOBER</b>				82nd Semi Annual Convention Society of Motion Pictures & TV Engineers Sheraton Hotel, Philadelphia																		IRE Australian Convention Australian IRE Hotel Australia, Sidney, Australia																
				Semi-Annual Meeting The Electrochemical Society Buffalo, New York																			International Conference on Ultra High Frequency Circuit & Antennas Societe des Radioelectriciens 10 Ave. Piere-Larousse, Malakoff (Seine), France															
				National Electronics Conference IRE, AIEE, RETMA & SMPTE Hotel Sherman, Chicago																			Computer Applications Symposium Armour Research Foundation Sherman Hotel, Chicago															
<b>NOVEMBER</b>																																						
<b>DECEMBER</b>																																						

- Abbreviations:**
- ACM: Assn for Computing Machinery
  - AICE: American Inst. of Chemical Engrs
  - AIEE: American Inst. of Electrical Engrs
  - AIMME: American Institute of Mining and Metallurgical Engineers
  - APS: American Physical Society
  - ASCE: American Society of Civil Engineers
  - ASME: American Soc. of Mechanical Engrs
  - ASQC: American Society for Quality Control
  - ASTM: American Society for Testing Materials
  - IAS: Inst. of Aeronautical Sciences
  - ICA: Industrial Communication Association
  - IRE: Institute of Radio Engineers
  - ISA: Instrument Society of America
  - NARTE: National Assn. of Radio & TV Broadcasters
  - NEMA: National Electrical Manufacturers Association
  - NICB: National Industrial Conference Board
  - RETMA: Radio-Electronic TV Mfrs. Assn.
  - SIAM: Society of Industrial and Applied Mathematics
  - SMPTE: Society of Motion Picture & Television Engineers

Two interesting approaches to the air conditioning of electronic equipment have been pursued by Carrier Corporation engineers at Sylvania Electric Products Company's Data Processing Center in suburban Syracuse, N. Y., and in RCA's Bizmac at headquarters of the Army's Ordnance Tank-Automotive Command in Detroit.

Bizmac is used in controlling inventory levels of automotive parts — some 150,000 different parts—at 12 U. S. and overseas supply depots. The system consists of 361 components, and contains 96,000 tubes and diodes. An air conditioning system, employing electrostatic filtering for keeping dust off magnetic tape, had to be designed to relieve an internal heat load of about 1.8 million Btu per hour. It is possibly the only data processing system yet built in which air conditioning has been incorporated directly into the design of electronic equipment. Air conditioning equipment here supplies conditioned fresh air via ducts connected directly to the electronic machines. A 15-second lapse in controlled air-supply results in shutting down of the system.

At Sylvania, on the other hand, chilled water is furnished to components of a Univac System, to relieve an internal heat load of about 527,000 Btu per hour. The system operates on air recirculated through equipment cabinets. Temperature of the air is maintained at 85° or less by passing it over chilled water coils in a plenum within each cabinet. Blowers recirculate the air. If temper-

Fig 2 (below): Extensive use of paper tape requires control of humidity and temperature.

Fig. 3 (right): Sylvania's Data Processing Center uses 200-ton Carrier conditioner.

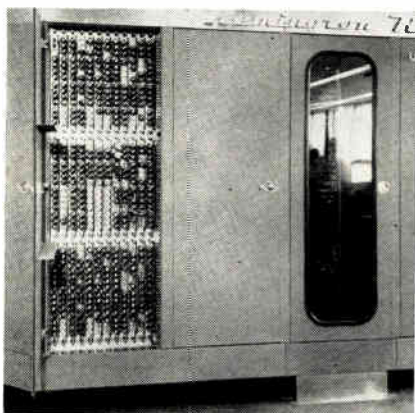

FFig. 1: Univac, with its 5,400 heat-generating tubes, requires extensive cooling equipment.

## Cooling Robot Brains

By NELSON E. SHELDON

CLARENCE A. NOLPH

GORDON A. FLEISCHER

*Carrier Corp., Syracuse, N. Y.*

ature reaches a danger level—88°—the Univac System is automatically shut down. The Sylvania Data Processing Center is the focal point of an inter-company communications network that ties in 71 plants and offices.

Virtually all electronic computer installations require some form of cooling in order to function properly. By means of filters, dust or other damaging airborne

particles must be kept off circuits and working surfaces. And where paper is used in the form of tape or punch cards, its stability must be insured through close control of humidity. Thus, as electronic installations have grown in size and scope of function, the techniques of air conditioning—of providing cooling, filtering and humidity control—have become of

*(Continued on page 102)*

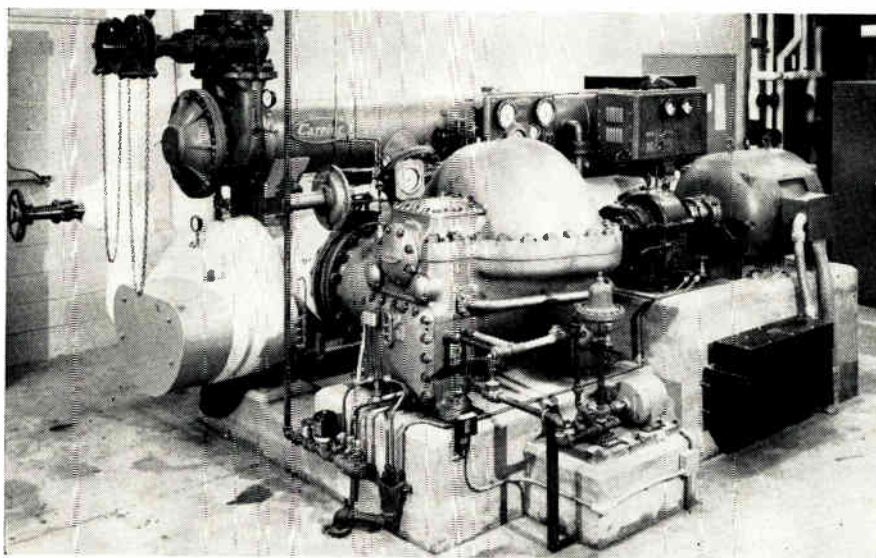



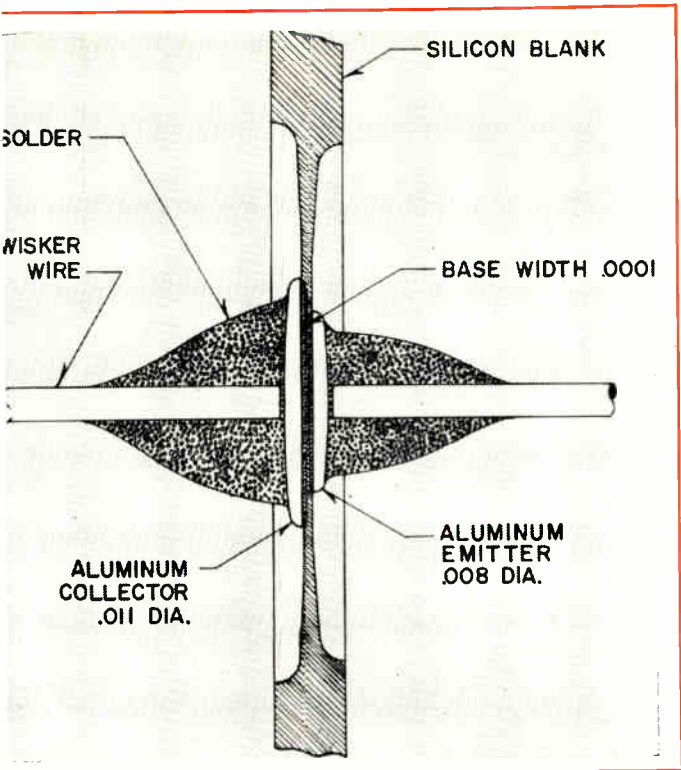
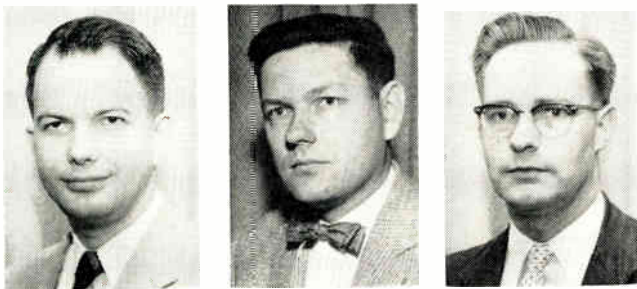

Fig. 1: Geometry of a silicon alloy transistor.

# Design For An Improved High-Frequency Transistor

By **C. THORNTON, J. ROSCHEN, and T. MILES**  
*Lansdale Tube Division, Philco Corp.*



C. Thornton

J. Roschen

T. Miles

*Silicon surface alloy transistor designed to meet military high temperature h-f applications utilizes a thinner base width and smaller diameter electrodes.*

MUCH has been learned during the past year about making silicon surface alloy transistors.<sup>1, 2</sup> Many have now been made to a specified geometry, and operating parameters have been fully characterized as a function of temperature.

The geometry of the L-6100 surface alloy transistor is shown in Fig. 1. The design was chosen to meet objective specifications for a number of high temperature military applications by the Signal Corps. These include high frequency switching, oscillator, and amplifier circuits.

The changes over previous units include a thinner base width and smaller diameter electrodes—to improve the high frequency performance. The flat base region is produced by an electrochemical machining operation followed by a very carefully controlled alloying process. The width of the machined blank in the base region is now automatically regulated by monitoring the transmission of a portion of the visible light spectrum through the thin silicon.

Fig. 2: Photomicrograph of a cross-sectioned transistor.

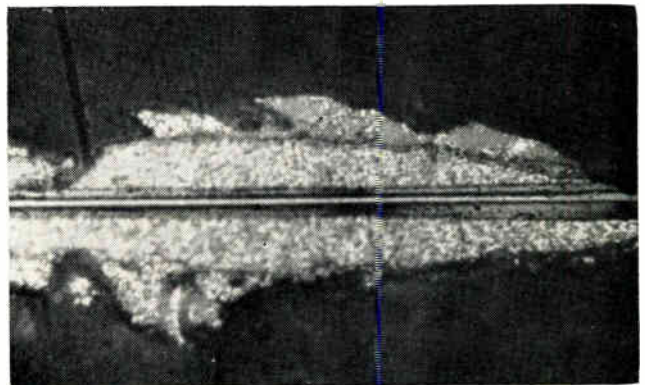

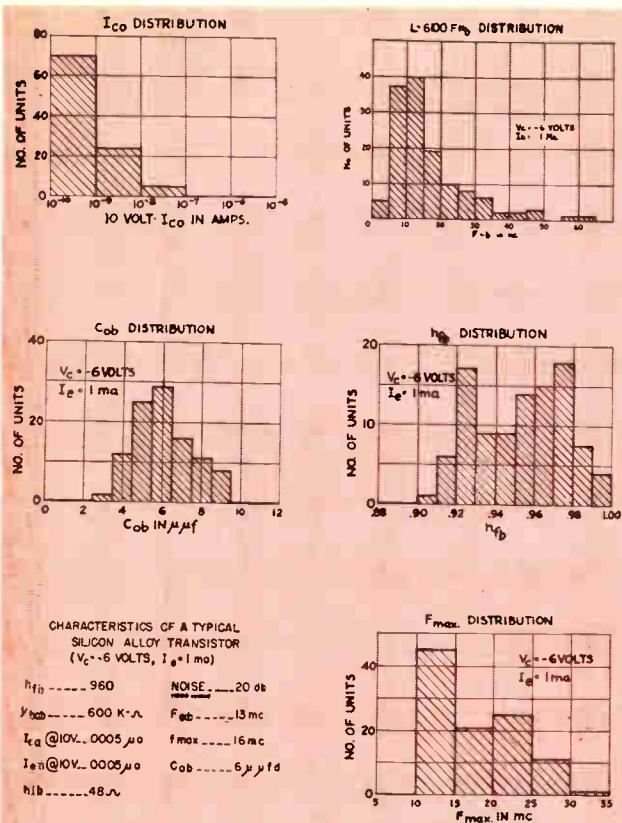

Fig. 3: Distribution of characteristics in 100 L-6100 transistors

## Transistor (Cont.)

Extreme cleanliness is necessary during the evaporation and alloying process so that unwetted or improperly penetrated areas during alloying are kept to a minimum. An example of the excellent results which can be obtained is seen in the cross section of a typical silicon surface alloy transistor of Fig. 2. The PN junction boundaries remain continuous and flat across the entire junction area with a measured base width of .00007".

Careful clean-up etching and appropriate stabilization lead to very low values of surface recombination velocity, giving higher values of  $\beta$  at low currents. Improved emitter injection efficiencies now permit operation up to emitter current densities of 100-200 amp. per  $\text{cm}^2$  before a 50% loss in current gain results. A significant feature of silicon transistors is their ability to operate over a wide range of temperatures. Recent changes in materials used in the assembly of the units permit operation up to 200°C.

Distribution of the more important electrical characteristics on a

Fig. 4: (top right) Variation of  $I_{co}$  with temp.

Fig. 5: Variation of parameters with temp.

Fig. 6: Characteristics as function of collector volts (right)

Fig. 7: (bottom) Typical  $V_C$ - $I_C$  characteristics near saturation

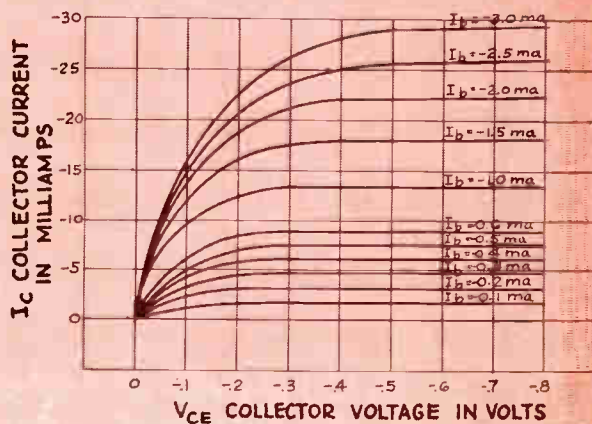
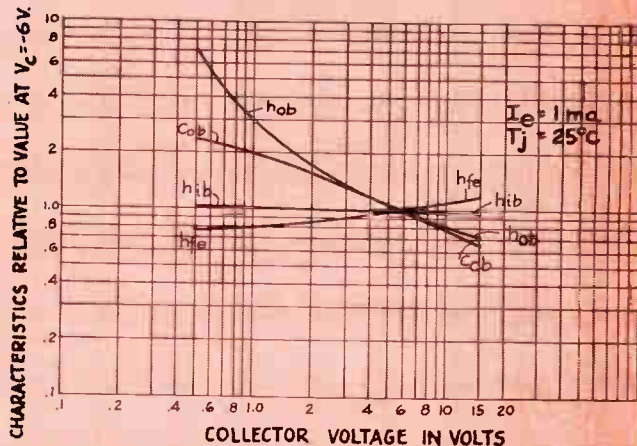
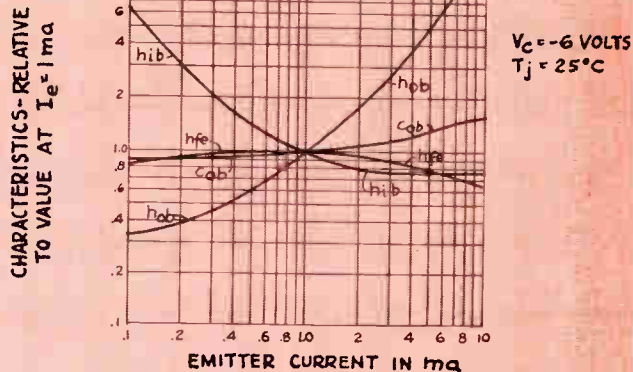
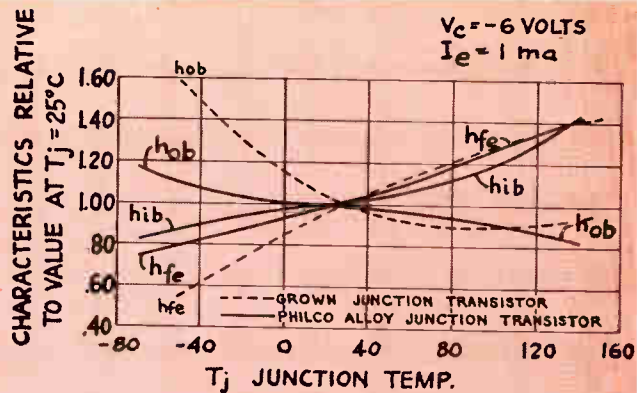

lot of 100 L-6100 transistors, together with the median values of measured parameters, is given in Fig. 3. In fabricating these units, the alloying schedule was chosen to produce a maximum of transistors capable of operation at collector voltages greater than 25 volts. Punch-through thus limited the minimum base thickness. Units with thinner base width, designed to operate at lower collector voltages, have correspondingly higher current gains and alpha cut-off frequency. The common base output impedance is centered at about 600 kilohms and is limited almost entirely by the space charge widening effect of the collector depletion layer on alpha. Input impedance has been reduced with greatly improved solder contacts to the aluminum-silicon eutectic electrodes.

The maximum frequency of oscillation averages about 16 MC. Since the power gain of an alloy transistor falls off at approximately 6 db per octave, the present units deliver a power gain of about 24 db at 1 MC. At 455 KC, measured stage power gains above 32 db are obtained on typical units. Collector capacitance is lower than earlier units by a factor of about two. The 10 v.  $I_{co}$  is maintained below .1  $\mu$  amp. as a quality control. Most of the units, however, have collector currents of tenths of millimicroamperes even at 10 v.

A more difficult parameter to measure is the intrinsic alpha cut-off frequency of the transistor. It has recently been shown, however, that this parameter can be obtained by measuring the common emitter current gain at a suitable frequency where the current gain is decreasing with frequency at a

constant slope. The alpha cut-off is obtained as the product of the current gain and the frequency of measurement. This parameter is particularly useful in predicting performance in switching applications.

The variation in  $I_{co}$  with temperature for the L-6100 is shown in Fig. 4. The observed increase according to an exponential law is commonly observed on germanium and silicon transistors at low voltages (1 v.) where the saturation component of the collector current predominates. It is seldom realized at higher voltages, however, due to the presence of leakage components which lead to values of  $I_{co}$  that may be either

### PULSE RESPONSE

Unit No.	$fc_{\alpha}$ mc	Rise Time $\mu$ sec.	Fall Time $\mu$ sec.	Hold Storage $\mu$ sec.
3875	4.9	.02	.11	.15
3894	6.8	.02	.08	.18
3534	9.9	.07	.09	.10
3910	15.1	.05	.10	.08
3825	15.4	.03	.07	.12
3774	16.0	.02	.04	.05
3474	35.7	.02	.04	.03
1764	48.0	.05	.05	.04
3252	48.5	.01	.02	.02

higher or lower than exponential extrapolation predicts at high temperatures. The nearly straight line dependence of this parameter, measured at 10 v. on the L-6100, indicates minimum effect of surface leakage components.

The behavior of  $h_{ob}$ ,  $h_{ib}$ , and  $h_{fe}$  with temperature is seen in Fig 5. The continuous increase in alpha and decrease in  $h_{ob}$  with elevated temperatures is typical of silicon transistors with a low resistivity base region. The dashed lines indicate the  $h_{fe}$  and  $h_{ob}$  characteristics for a typical NPN grown junction transistor having similar room

temperature characteristics. It is worthwhile to note the relatively smaller changes in these parameters for the PNP alloy unit where an extensive fall-off in gain at low temperatures would not be expected. The continuous decrease in  $h_{ob}$  with temperature is in sharp contrast to the variation of this parameter in a germanium transistor where the output admittance increases by several hundred per cent as the temperature is raised, with a resultant loss in power gain. The output and feedback characteristics over a wide range of temperatures for a particular unit are shown in Fig. 6. The unit can be seen to be operable over the entire temperature range from  $-50^{\circ}\text{C}$  to  $+200^{\circ}\text{C}$ . The variation in parameters with current and voltage can be seen in Figs. 7 and 8. These variations are similar to those in other transistors of conventional design. It is significant that this  $h_{fe}$  value peaks at the relatively low value of 1 ma. indicating a small effect of surface recombination velocity on current gain.

The silicon alloy transistor is expected to be very useful in switching and computer applications because of its very low saturation resistance, high impedance in the cut-off region, and rapid switching times. The saturation resistance, defined as the DC collector-emitter resistance where  $I_c/I_b = 1$  at  $I_c = -10$  ma, is equal to about 7 ohms. This is to be compared with values of 40-200 ohms reported for silicon grown junction or melt-back transistors. The low voltage characteristics for a typical unit at  $125^{\circ}\text{C}$  are shown on an expanded scale in Fig. 9. It is seen that the collector is readily driven into saturation

(Continued on page 124)

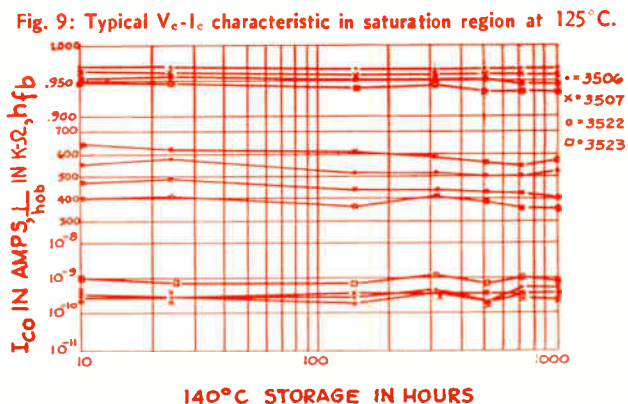
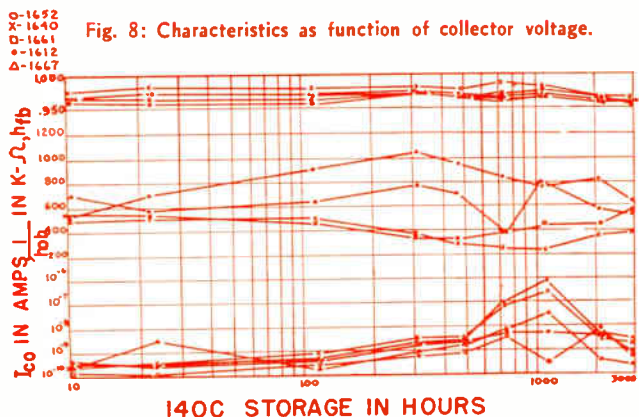

# Improving the Glow Transfer Tube

*Glow counter tubes may misfire after long stationary periods. This is caused by cataphoresis, a migration of impurities toward the cathode. Careful design, however, has created tubes and circuits which will step reliably after the glow has remained on one cathode for over 1000 hours.*

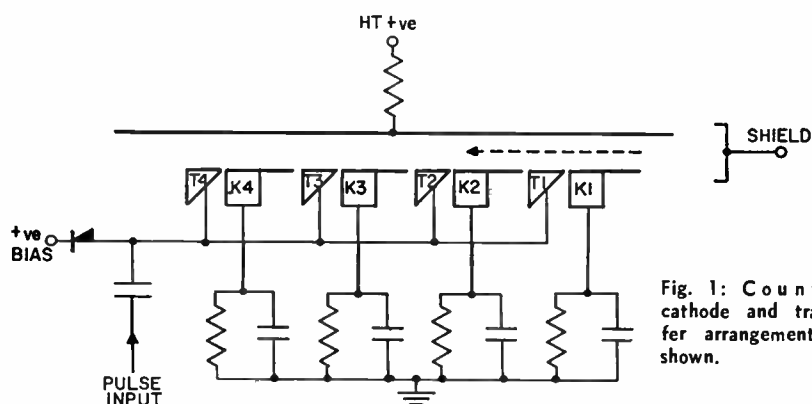

Fig. 1: Counter cathode and transfer arrangement is shown.

By T. M. JACKSON

Enfield Laboratories  
Standard Telephones and Cables, Ltd.  
Associate of IT&T Corp.  
London, England

THE Nomotron is a ten point counter or distributor tube having one set only of commoned transfer electrodes and providing ten output cathodes operating at a nominal current of 3.6 ma into a 15 k ohm load. The tube is unidirectional, the cathode directivity being obtained by cathode geometry and the transfer directivity by means of residual bias level on controlled cathode time constant circuits. The tube operates on a rectangular input pulse and is capable of operating at input recurrence frequencies up to 20 kilocycles. The diagram of Fig. 1 shows the cathode and transfer cathode arrangement. Assuming a glow discharge to be established on K<sub>2</sub>, the glow will be located on the plate portion in distinct preference to the edge, or so called tail portion. The common transfer electrodes are biased positively with respect to cathode and are "held off." In this condition the forward transfer electrode to the conducting cathode is primed to a much greater extent than any other transfer electrode due to its close proximity to the cathode glow. Lowering of transfer potential by application of a negative pulse transfers the glow from

K<sub>2</sub> to T<sub>2</sub> and provided the transfer voltage is sufficiently reduced, the cathode glow will be extinguished and the cathode output signal will decay according to the time constant of the cathode circuit. When this time constant is large compared with the applied pulse width, a positive bias voltage will remain on K<sub>2</sub> at the end of the pulse, when the anode voltage becomes sufficient to cause breakdown of an adjacent gap. The choice is between K<sub>2</sub> and K<sub>3</sub> but the residual bias on K<sub>2</sub> makes K<sub>3</sub> preferential, glow is established on the tail portion of K<sub>3</sub> and rapidly spreads on to the plate section when the glow on the tail is extinguished.

## Abnormal Behavior

Having described the normal glow transfer mechanism, we now consider the effect of a non-uniform transfer surface. Supposing the surface state of a transfer electrode to be modified to the extent that an area of low work function exists at the tip such as marked on T<sub>3</sub> in Fig. 1. A glow discharge at this electrode would show a preference for the low work function region and though it may, at high current,

spread to cover the entire surface, it would recede to the shaded area when the current was again reduced. Considering the case where glow transfer is to be effected from  $K_3$  to  $K_4$ , the process would be identical to that described above, until the termination of the stepping pulse when, as before, a choice would have to be made, in this case, between  $K_3$  and  $K_4$ . The ionization coupled breakdown of any gap is a function of the spacing; the effective change in spacing brought about by the localized glow position can be sufficient to overcome the differential produced by the residual bias on  $K_3$ . Consequently,  $K_3$  may re-fire, constituting a failure to step.

This behavior has been observed in tubes after long resting periods on individual cathodes and is attributed to cataphoresis—a phenomenon in gas discharges, by which impurities are carried towards the cathode and concentrated in this region, the accumulation of impurities being a function of current and time. The design of the Nomotron is based on a relatively high cathode current density and, consequently, close interelectrode spacing is necessary to obtain the degree of ionization coupling required for fast operation. Under nominal operation conditions the cathode is in the abnormal glow region and the outer edge of the negative glow envelopes the extreme tip of the adjacent transfer electrode—the actual portion in which surface changes have been observed. The nature of the effect, being a surface change, caused some difficulty in studying the condition because very short periods of conduction restored the homogeneous surface and the effect disappeared. Testing was therefore carried out on a single pulse basis, applied after a period of continuous cathode conduction and, in this way, the effect of various processing and aging techniques was investigated, with the aim of removing contaminants and depositing the remainder on parts of the tube remote from the glow areas. Substantial improvement in stability of characteristics was obtained by these methods, but a low incidence of the effect was still apparent.

### Stabilization

Conduction tests carried out with various transfer bias settings indicated two settings which appeared

Fig. 2: Stable transfer characteristics are at "A" and "B".

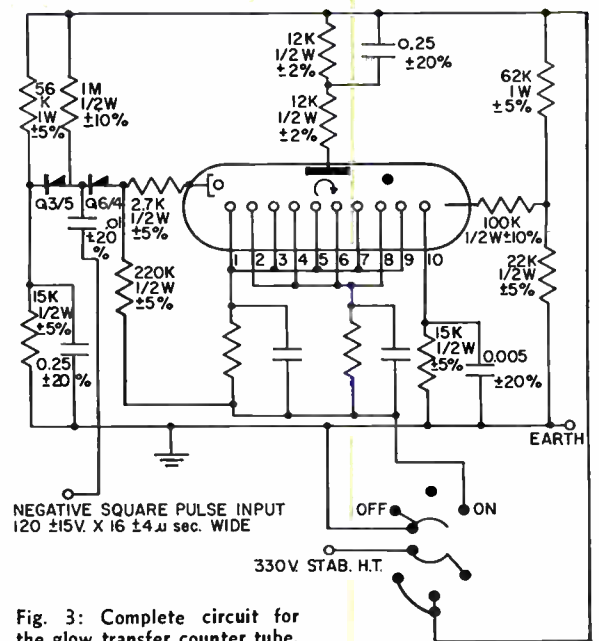
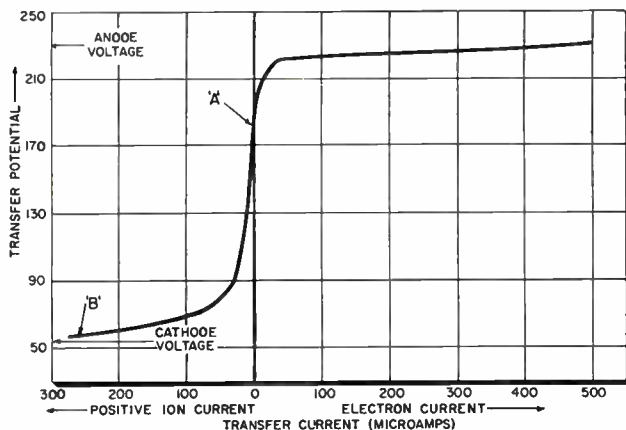
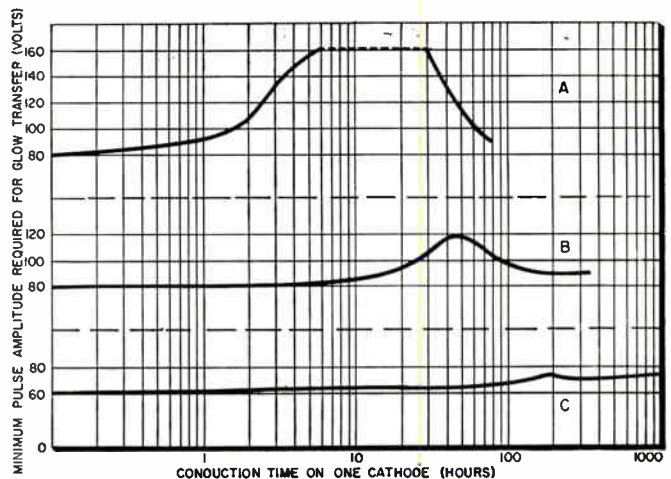

Fig. 3: Complete circuit for the glow transfer counter tube.

to produce stable transfer characteristics, i.e., free from the changes mentioned above. These are shown in Fig. 2, on a typical transfer I V characteristic adjacent to a conducting cathode.

Point A, corresponding to zero transfer electrode current, at a bias setting of approximately 180 v. positive, and point B, where the transfer conducts appreciable positive ion current. The former was unattractive due to the high pulse voltage required; operation at point B, however, was examined further and was later shown by large scale tests to be a satisfactory solution. By this means, the part of the transfer electrode liable to contamination due to the relatively high current density of the adjacent cathode discharge, is continuously cleaned by the transfer conduction current. This is in itself of such low current density that the effect on the forward part of the transfer electrode is negligible. The requirement therefore, was to maintain sufficient transfer current to stabilize the transfer characteristic but insufficient to reduce the break— (Continued on page 106)

Fig. 4: Variations in processing cause changes in characteristics.



# The Metallurgical Aspects of "Resistance"

*The resistance of a wire is determined by the alloys and heat treatment used in its manufacture, as well as subsequent deformation and elastic strains. An understanding of these metallurgical factors is essential to the systematic design of resistive components.*

By **DR. T. P. WANG**  
Research Metallurgist

and **E. T. KUBILINS**  
Sales Engineer  
Wilbur B. Driver Co.  
1875 McCarter Highway  
Newark 4, N. J.



Dr. T. P. Wang



E. T. Kubilins

**P**ROGRESS in electronics creates a great demand for precision resistors and potentiometers. This progress, in turn, creates a similarly great demand for more perfection in the resistance element, the "heart" of resistors and potentiometers.

The primary requirements of resistance elements are:

- (1) Low temperature coefficient of resistance.
- (2) Moderately high resistivity.
- (3) Stability of resistance at operating temperature.
- (4) Good corrosion resistance.
- (5) Good mechanical properties.

Cupron\* is one alloy which possesses all these properties. This alloy has a basic composition of 45 per cent nickel, 55 per cent copper, with minor amounts of iron, manganese, cobalt, etc. In the fully annealed state, it has a temperature coefficient of resistance between  $-60$  to  $+100^{\circ}\text{C}$  of less than  $\pm 20 \times 10^{-6}$  ohm/ohm/ $^{\circ}\text{C}$  and a resistivity of about 294 ohms/cir. mil ft. or 48.8 microhm-cm. The stability of resistance of Cupron is excellent within the above temperature range. On account of its high nickel content, it has a high corrosion resistance at ambient temperatures. The mechanical properties of Cupron are a combination of good strength (T.S. 70,000 to 100,000 p.s.i.)

Fig. 1: Conductivity vs. temperature coefficient.

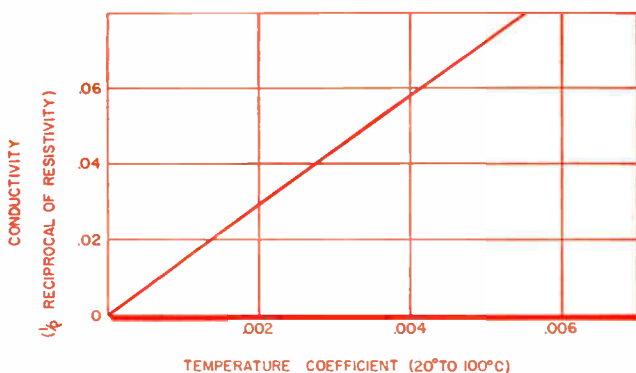
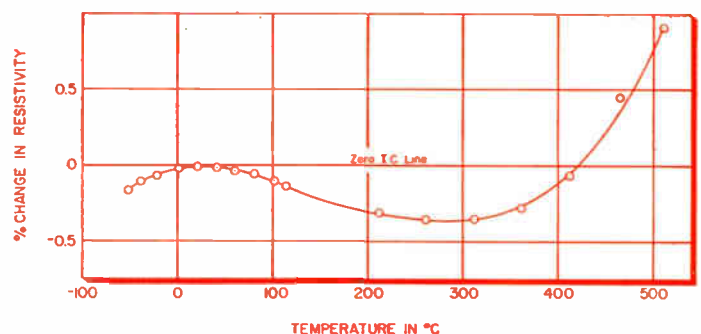

Fig. 2: Percent change in resistivity vs. temperature.



and ductility (up to 30 per cent elongation). It can be drawn to wire of .001 in. diameter while maintaining sufficient ductility and strength. Because of these properties, Cupron is widely used as resistance wire.

### Resistance

By definition, as shown in Eq. (1), the resistance of a material at a certain temperature is a function of its dimension while resistivity is independent of dimension.

$$R = \rho l/A \quad (1)$$

where  $R$  = resistance of the material in ohms

$l$  = length in inch or cm.

$A$  = cross sectional area in circular mils or sq. cm.

$\rho$  = resistivity of the material in ohms/circular mil ft. or microhm - cm.

The temperature coefficient of resistance (T.C.) of a metal or an alloy between temperatures  $T_1$  and  $T_2$  is usually defined as:

$$T.C. = \frac{R_2 - R_1}{R_0 (T_2 - T_1)} \quad (2)$$

where  $R_1$  and  $R_2$  = resistance of a material at temperatures  $T_1$  and  $T_2$  respectively.

$R_0$  = resistance of the alloy at a reference temperature  $20^\circ\text{C}$  is generally used as the reference temperature.

Since in the above expression  $R_0$ ,  $R_1$ , and  $R_2$  are taken from the same material, Eq. (2) is actually

$$T.C. = \frac{\rho_2 - \rho_1}{\rho_0 (T_2 - T_1)} \quad (3)$$

where  $\rho_0$ ,  $\rho_1$  and  $\rho_2$  are the resistivities of the material at  $T_0$ ,  $T_1$ , and  $T_2$  respectively. Therefore T.C. is a function of resistivity and is independent of the dimension of the material.

The Metallurgical Engineer therefore strives to produce an alloy with a constant resistivity over a wide temperature range, in order to insure an alloy with a constant temperature coefficient. This also gives a wire with a constant resistivity. It does not, however, give an alloy whose resistance is independent of any dimensional change. The responsibility for a constant resistance in the finished product rests with the Electronics Engineer who must design and fabricate an assembly such that dimensional changes are avoided during manufacture and functioning of the precision resistors and potentiometers.

At a given temperature, the resistivity of a metal or an alloy is a function of its constituents and previous treatment. Published data show that there is a linear relationship between the conductivity of a metal or a binary solid solution alloy and its temperature coefficient of resistance. This relationship is schematically shown in Fig. 1. It can be observed that: (1) Temperature Coefficient increases as conductivity increases, or as resistivity decreases. (2) For every value of resistivity, there is one and only one corresponding T.C. (The reverse of this statement is not always true. In some alloys, it is possible to obtain two different resistivities and the same T.C. by heat treatment.)

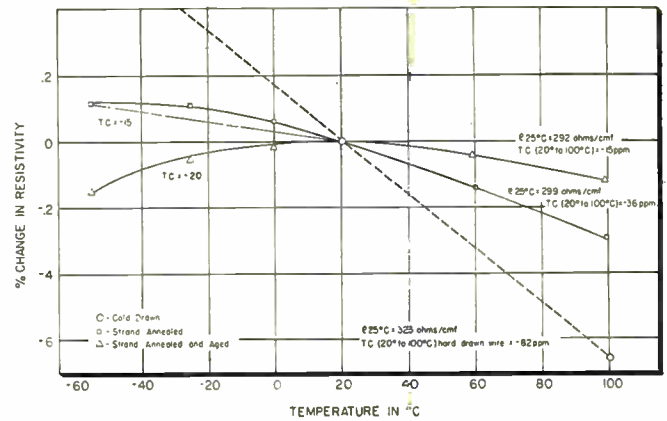

Fig. 3: Percent change in resistivity vs. temp. ( $-60^\circ$  to  $100^\circ\text{C}$ ).

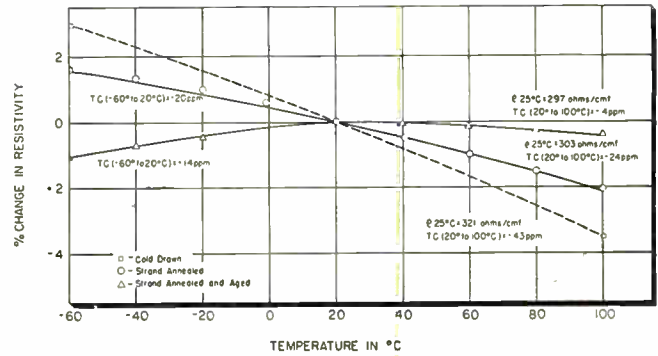

Fig. 4: Experimental Cupron resistivity vs. temperature curve.

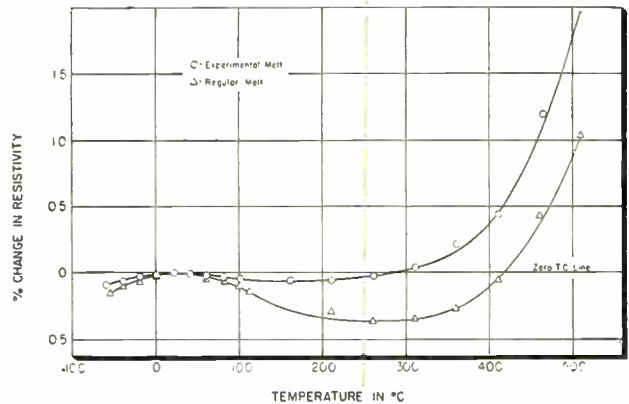

Fig. 5: Resistivity vs. temperature of two different melts.

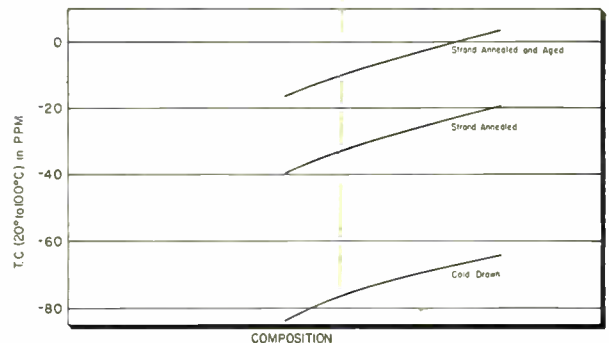

Fig. 6: Variation of temperature coefficient with processing.

# Resistance (Continued)

## Resistivity vs. Temperature

It has been well recognized that one of the primary conditions of an ideal resistance alloy is that the resistivity of the alloy remains unchanged throughout a wide temperature range. Resistivity is inversely proportional to the mean free path of the electrons, and the mean free path decreases as temperature increases. As a result, the resistivity of an alloy is always higher near its melting point than at a temperature close to absolute zero. But this does not necessarily mean that the resistivity increase of an alloy is a linear function of temperature. Some alloys, when properly heat treated, have a temperature range within which the resistance is relatively constant. It is within this temperature range that an alloy is useful as a precision resistance element. Cupron is one of the alloys which possess this characteristic.

The resistivity change versus temperature curve of a fully annealed typical Cupron wire is shown in Fig. 2. The resistivity change is very small, throughout the range from  $-60^{\circ}$  to  $+100^{\circ}\text{C}$ . Within this range, there is a resistivity maximum around room temperature. Above room temperature, resistivity decreases until around  $250^{\circ}\text{C}$  and then increases very sharply. For most applications, Cupron is used within  $-60^{\circ}$  to  $+100^{\circ}\text{C}$  range. Because of the presence of a resistance peak within this range, the T.C. of Cupron is usually taken between  $-60^{\circ}$  to  $+20^{\circ}\text{C}$  and from  $20^{\circ}$  to  $+100^{\circ}\text{C}$  instead of from  $-60^{\circ}$  to  $+100^{\circ}\text{C}$  directly.

Fig. 7: Calculated vs. measured temperature coefficient of strand annealed and aged Cupron.

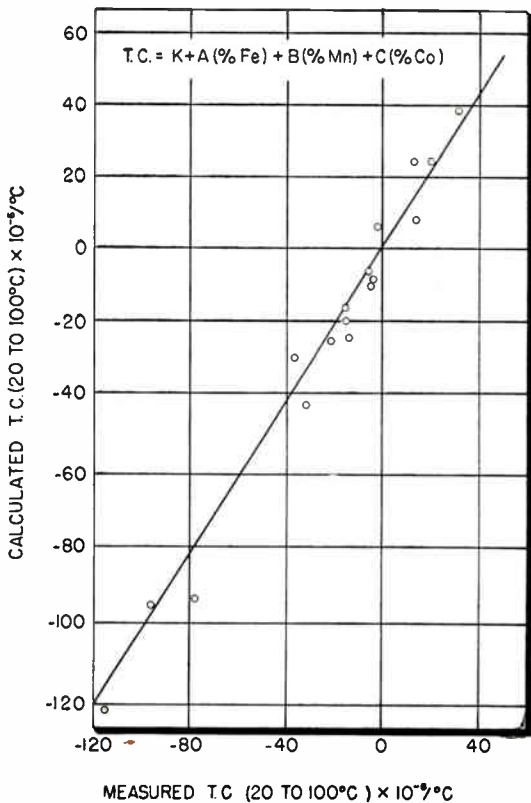

## Effect of Heat Treatment

The heat treatment during the processing of Cupron consists of strand annealing and aging. Whether this aging treatment is given or not depends on the ultimate properties desired. Strand annealing consists of heating the cold drawn wire in strand form to above the recrystallization temperature for a short period of time, followed by rapid cooling. The subsequent aging treatment is done in batch form at temperatures below the recrystallization range for a longer period of time and followed by slow cooling. Both strand annealing and aging treatments are conducted in a protective atmosphere.

Table 1

Resistivity and T.C. Changes of a .0025" Cupron of Nominal Composition

	Cold Drawn Reduction of Area = 99%	Strand Annealed	Strand Annealed and Aged
Resistivity, Ohms/cm <sup>2</sup>	300	323	292
T.C. (20 - 100°C) in p.p.m.*	-82	-36	-15

\* p.p.m. = parts per million per  $^{\circ}\text{C}$ .

The resistivity versus temperature changes upon heat treatment within the range of  $-60^{\circ}$  to  $+100^{\circ}\text{C}$  are shown in Fig. 3. Both the strand annealing and aging treatment cause a decrease in T.C. towards the positive direction. The T.C. change is analogous to pivoting the Resistivity versus Temperature curve in a counter clockwise direction around  $20^{\circ}\text{C}$  as reference.

(Continued on page 120)

Fig. 8: Effects of permanent uniform strain.

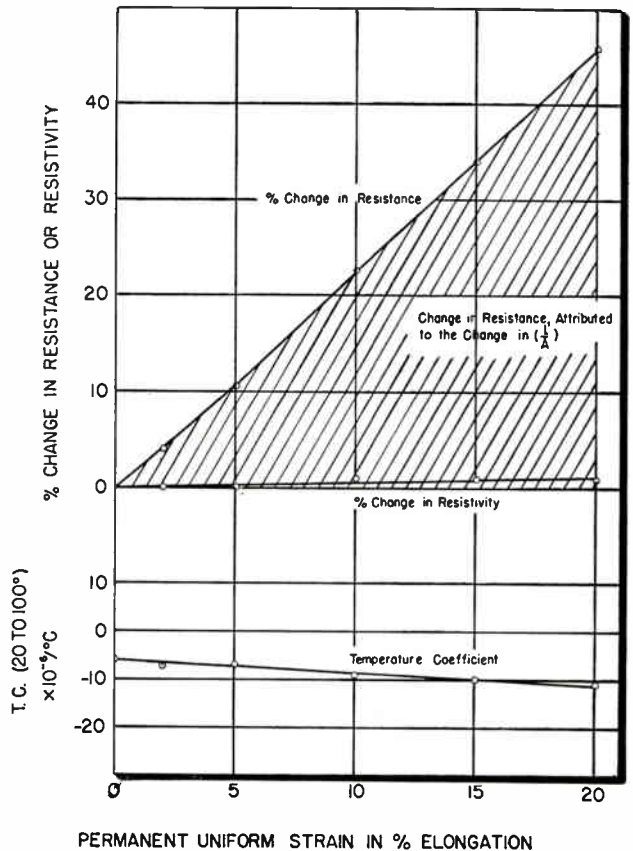



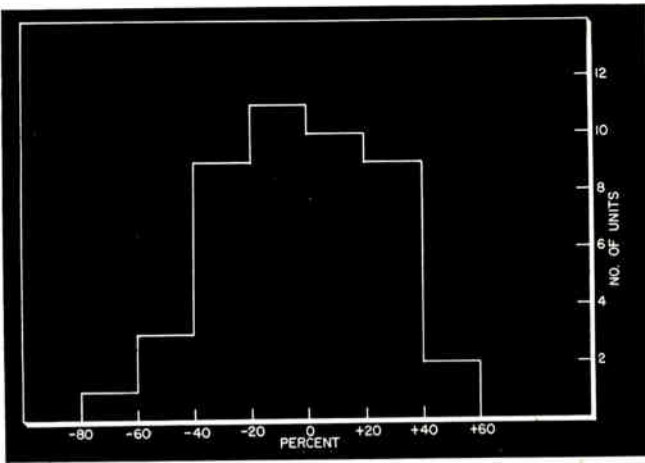

Fig. 1: Distribution of errors encountered in the prediction of  $I_{co}$

WHEN power transistors are applied in circuits, it is very common for the junctions to be operated at temperatures above ambient. It is quite reasonable for a power transistor to be operated at an ambient temperature of  $25^{\circ}\text{C}$  and at a junction temperature of  $85^{\circ}\text{C}$ . The value of collector cut-off current,  $I_{co}$ , is often necessary from the design viewpoint. It is possible to measure this value, but in practice this is laborious and time consuming.

#### Reverse Current

The current in a p-n junction can be expressed as follows:

$$I = I_s \left( e^{\frac{qV}{kT}} - 1 \right) \quad (1)$$

Considering the collector junction only, and assuming a reverse bias applied to this junction with the emitter floating, the saturation component of  $I_{co}$  is now defined as follows:

$$I = I_s = \frac{K\sigma_i 2}{\sigma_p L_e} + \frac{K\sigma_i 2}{\sigma_n L_h} \quad (2)$$

Assuming  $V_c \gg 0.1$  v.

where  $\sigma_i$  is the intrinsic conductivity.

$L_e$  is the diffusion distances for electrons in p region

$L_h$  is the diffusion distances for holes in n region.

$\sigma_p$  conductivity of the p-type region

$\sigma_n$  conductivity of the n-type region.

$K$  is proportionality factor.

It is seen that, theoretically, the reverse current in a p-n junction is relatively independent of voltage above a few tenths of a volt. In practice, however, it is found that  $I_{co}$  in power transistors is dependent on back voltage which probably occurs because of surface leakage effects. Due to this surface leakage effect, it is now assumed that  $I_{co}$  can be expressed as follows:

$$I_{co} = I_s + I_L \quad (3)$$

where  $I_s$  is the saturation component of  $I_{co}$  and  $I_L$  is the leakage component of  $I_{co}$ .

It is further assumed that the leakage component of Eq. 3 does not vary with temperature and that the saturation component increases  $9\%/^{\circ}\text{C}$ . This increase is an approximate figure, quoted by Bell Telephone Laboratories and others based on experimental data.  $I_{co}$  at elevated temperatures can now be expressed as follows:

With junctions operating far above ambient, the designer must have some idea of the magnitude of  $I_{co}$ . The data show the only temperature sensitive parameter is the saturation component.

# Hot Junctions and Collector Cut-Off Current

By BERNARD REICH,

U. S. Army Signal Engineering Laboratory,  
Fort Monmouth, N. J.

Table 1

Unit No.	Measured and Calculated Value of $I_{co}$ '					% Deviation
	$I_s$ 25°C ma	$I_{co}$ at 40 v. 25°C ma	$I_{co}$ ' at 40 v. Calculated 55°C ma	$I_{co}$ ' at 40 v. Measured 55°C ma		
56	0.25	2.55	4.3	4.9	-12	
58	0.23	1.5	3.1	2.2	+50	
59	0.41	4.4	7.3	6.7	+9	
60	0.175	1.1	2.4	3.4	-29	
62	0.47	3.0	6.26	5.0	+25	
19	0.195	0.30	1.7	1.4	+21	
20	0.177	0.21	1.3	1.47	-11	
20-3	0.18	0.29	1.55	1.3	+19	
20-6	0.16	0.32	1.44	1.3	+9	
20-7	0.22	0.375	1.82	1.4	+30	
21	0.26	0.51	2.33	1.9	+23	
Average % Deviation					22	

# Collector Cut-Off Current (Cont.)

$$I_{co}' = I_s' + I_L \quad (4)$$

where  $I_{co}'$  is the  $I_{co}$  at elevated temperatures and  $I_s'$  is the temperature sensitive component of saturation current.

On the basis of these assumptions, measurements were made on various types of power transistors. The results of these measurements are presented in the following section. The values of  $I_{co}$  were measured below the rated voltage maxima of the transistors.

## Experimental Results

On the basis of assumptions made in the above section, measurements were made on 5 types of germanium alloyed power transistors, 4 being of the pnp variety and 1 of the npn variety. One measurement was made at a reverse collector voltage of 2 v. to indicate a value of the saturation component, and the other measurement made at an elevated reverse voltage as specified in the data tables; both voltage measurements at room ambient temperature. On the basis of this information, an attempt was made to calculate the value of  $I_{co}'$  at 55°C. This value was chosen since it is a common temperature listed on some military specifications for germanium transistors.

Tables 1 through 5 list the data taken on 57 random samples of transistors representing 4 different manufacturers. The data sheets reflect a low voltage reading and higher voltage reading at about 25°C, representing  $I_s$  and  $I_{co}$ , respectively. The 3d column represents  $I_{co}'$  calculated on the basis of low temperature measurements. The 4th column represents the actual high temperature reading, and the final column indicates the percentage deviation of the calculated value from the measured value.

Considering the overall results of the measurements and calculations of the pnp units, it is found that on the basis of the 45 samples, the average percentage deviation is about 23%. Fig. 1 is a graph showing the frequency distribution of errors encountered in the prediction of  $I_{co}$  at elevated temperatures. It should be pointed out that the errors shown could be attributed to experimental error in the measurement of  $I_s$  at room temperature.

The data points out that for the purposes of the design engineer it can be assumed that the leakage component of  $I_{co}$  does not vary with temperature and that the only temperature sensitive parameter is the saturation component.

Acknowledgment is made of the efforts of Mr. Theodore Redgate, Solid State Devices Branch, Electron Devices Div., who made the measurements presented in this report.

**Table 2**

Measured and Calculated Value of  $I_{co}'$   
 Manufacturer: B Type: pnp Alloy

Unit No.	$I_s$ 25°C ma	$I_{co}$ at 25 v. 25°C ma	$I_{co}'$ at 25 v. Calculated 55°C ma	$I_{co}'$ at 25 v. Measured 55°C ma	% Deviation
1	0.022	0.51	0.664	0.68	-3
2	0.0078	0.066	0.122	0.125	0
3	0.059	1.3	1.7	1.4	+21
4	0.046	0.28	0.6	0.85	-29
5	0.078	1.1	1.65	1.4	+18
6	0.0078	0.055	0.11	0.15	-24
7	0.043	0.27	0.57	0.70	-19
8	0.56	0.275	0.667	0.51	+31
9	0.185	1.2	2.5	3.5	-28
10	0.014	0.105	0.2	0.18	+11
11	0.011	1.1	1.18	2.0	-42
12	0.041	0.27	0.55	1.6	-66
Average % Deviation					24

**Table 3**

Measured and Calculated Value of  $I_{co}'$   
 Manufacturer: B Type: npn Alloy

Unit No.	$I_s$ 25°C ma	$I_{co}$ at 25 v. 25°C ma	$I_{co}'$ at 25 v. Calculated 55°C ma	$I_{co}'$ at 25 v. Measured 55°C ma	% Deviation
13	0.024	1.4	1.54	1.5	0
14	0.026	0.65	0.86	0.8	+8
15	0.025	0.044	0.25	0.2	+20
16	0.03	0.09	0.30	0.346	-15
17	0.026	0.58	0.79	0.75	+5
18	0.015	1.4	1.62	1.5	+8
19	0.102	2.4	2.57	3.7	-44
20	0.016	0.2	0.34	0.38	-12
21	0.035	1.06	1.34	1.36	-2
22	0.034	1.56	1.77	1.85	-5
23	0.025	1.35	1.56	1.53	+2
24	0.0115	0.475	0.545	0.54	0
Average % Deviation					11

**Table 4**

Measured and Calculated Value of  $I_{co}'$   
 Manufacturer: C Type: pnp Alloy

Unit No.	$I_s$ 23°C ma	$I_{co}$ at 40 v. 23°C ma	$I_{co}'$ at 40 v. Calculated 55°C ma	$I_{co}'$ at 40 v. Measured 55°C ma	% Deviation
69	0.01	0.46	0.53	0.58	-5
70	0.021	0.086	0.263	0.285	-8
71	0.031	0.12	0.234	0.212	+10
72	0.033	0.17	0.45	0.375	+25
73	0.012	1.08	1.18	1.7	-30
74	0.032	0.4	0.674	0.71	-5
76	0.012	0.35	0.454	0.95	-52
22	0.0096	0.084	0.154	0.32	-52
23	0.011	0.034	0.129	0.134	-4
28	0.02	0.73	0.9	1.4	-36
Average % Deviation					23

**Table 5**

Measured and Calculated Value of  $I_{co}'$   
 Manufacturer: D Type: pnp Alloy

Unit No.	$I_s$ 25°C ma	$I_{co}$ at 40 v. 25°C ma	$I_{co}'$ at 40 v. Calculated 55°C ma	$I_{co}'$ at 40 v. Measured 55°C ma	% Deviation
1	0.043	0.12	0.421	0.55	-24
15	0.060	3.0	3.42	4.5	-24
33	0.063	0.70	1.14	1.2	-5
74	0.034	0.30	0.54	0.56	-4
83	0.028	0.072	0.268	0.23	+16
89	0.075	0.13	0.655	0.45	+45
105	0.026	0.19	0.374	0.36	+4
125	0.070	0.16	0.64	0.55	+16
159	0.061	0.25	0.67	0.54	+24
174	0.135	1.5	2.4	1.8	+33
183	0.065	0.074	0.53	0.45	+18
185	0.038	1.6	1.88	2.8	-33
Average % Deviation					21

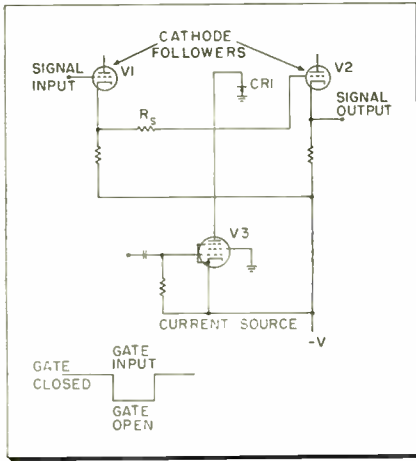

Fig. 1: Simplified gate circuit

Of particular interest to the computer designer, the pulse gate described here is capable of passing or blocking positive pulses of 100 v. maximum amplitude and 0.25  $\mu$ sec. minimum width. Additional features of the pulse gate are an insertion loss of approximately 15% (voltage attenuation), switching time of 0.25  $\mu$ sec. and pedestal and read-through of 1.2 v. or less.

### Operation

General operation of the gate may be described by means of Fig. 1. The input stage (cathode follower, V1) drives the output stage (cathode follower, V2) through the series resistor,  $R_s$ . The gate is closed when the current tube V3 is conducting. The plate current of V3 flowing through the crystal diode, CR1, causes the grid of V2 to be clamped at approximately ground potential. If the resistance of  $R_s$  is large compared to the forward resistance of the diode, nearly all of any signal appearing at the input to V1 is dissipated across  $R_s$  and very little signal appears at the output of V2. The gate is open when V3 is not conducting. The grid of V2 is now at a high impedance with respect to ground for positive signals. If the parallel combination of the back resistance of the crystal diode and the cut-off plate impedance of V3 is large compared to  $R_s$ , signals appearing at the grid of V1 will appear at the cathode of V2 with little attenuation.

# A High Amplitude Pulse Gate

*Important characteristics of this computer circuit are: large signal capacity with low read-through; low pedestal output; rapid switching capacity (0.25  $\mu$ sec)*



By GEORGE A. SAMPLE

A practical circuit utilizing the device is given in Fig. 2. This switch is capable of accommodating positive pulses of 100-v. max. amplitude and 0.25  $\mu$ sec. minimum width. The characteristics of this circuit are summarized in Table 1 and Fig. 3 for a pulse width of 0.5  $\mu$ sec.

### Design Considerations

The design of the circuits associated with V1 influences the amount of pedestal obtained, while the design of those of both V1 and

V2 determine the pulse-handling capabilities of the switch.

The amount of pedestal, i.e., the signal appearing at the output of V2 caused by turning the switch on, is determined by the change of potential at the grid of V2. When the switch is off the potential at this point is negative by an amount determined by the product of the current drawn by V3 and the forward resistance of the crystal diode. When the switch is on, this potential is equal to the potential

(Continued on page 94)

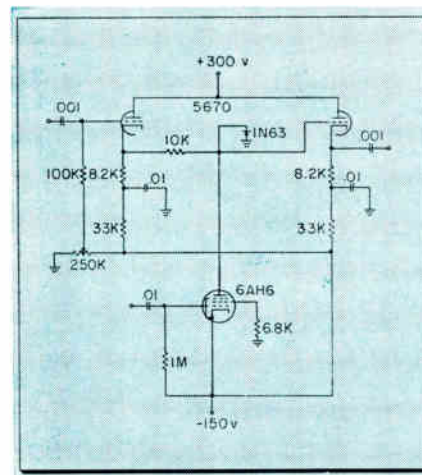
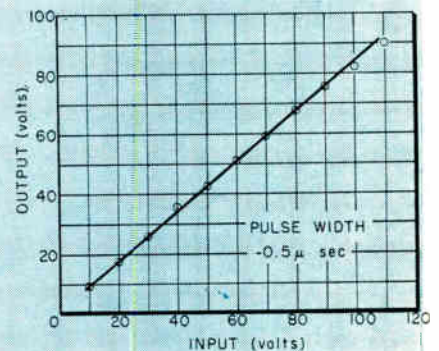

Fig. 2 (left): A practical gate circuit

Fig. 3: Pulse gate parameters



General Electric Company  
Advanced Electronics Center  
Ithaca, N. Y.

## New Products

# ... for the Design Engineer

### THERMAL DELAY

A new thermal time delay resets instantly when its energizing circuit is interrupted, either during the timing cycle or after its completion. Type BR time delay unit contains thermal

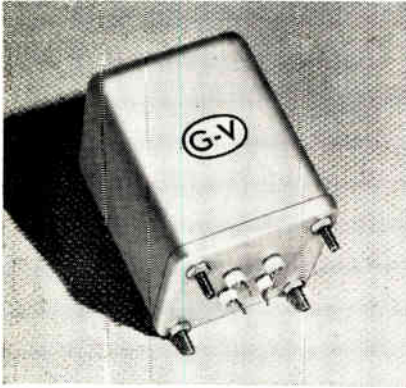

and magnetic elements mounted in a single case. Available for standard delay intervals of 2, 5, 15, 20, 30, 60, 120, 180, and 300 seconds. Other delay intervals on special order. Energizing voltage is 28 vdc. Output contacts are either normally open or normally closed, spst. Contacts are rated at 2 a. up to 230 vac. and 1 a. up to 32 v. dc. G-V Controls, Inc., Hollywood Plaza, East Orange, N. J.

Circle 15 on Inquiry Card, page 89

### VARIABLE RESISTOR

A new hot molded composition variable resistor, especially designed to withstand ambient temperatures up to 150°C, is available. Variable resistors are available in standard U, A, B, S, and DB resistance rotation characteristic tapers in nominal values up to a maximum of 5.0 megohms total resistance. Also available with integrally molded terminals at stand-



ard 35%, 50%, and 65% of effective shaft rotation. Type K controls can be furnished in single, dual, and triple units, with plain or lock bushings. Allen-Bradley Co., 136 W. Greenfield Ave., Milwaukee 4, Wisc.

Circle 16 on Inquiry Card, page 89

### SILICON RECTIFIERS

A line of 170°C. stud-mount silicon rectifiers for use in military and commercial equipment power supplies, the 4 new rectifiers are RETMA designated 1N1115, 1N1116, 1N1117, and

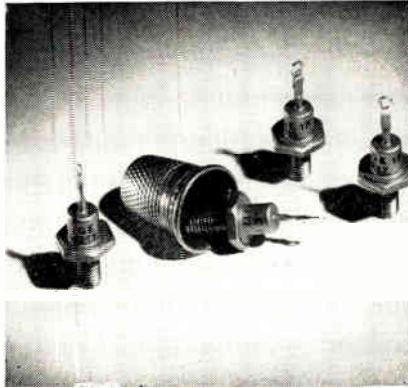

1N1118. They have peak inverse voltage ratings of 100, 200, 300 and 400 v. with max. RMS voltage ratings of 70, 140, 210 and 280 v. respectively. Designed for a max. output of 600 ma. at a case temperature of 150°C. Maximum operating frequency for the new silicon rectifiers is specified as 100 kc. They will meet military mechanical specifications for rectifiers. General Electric Co., Syracuse, N. Y.

Circle 17 on Inquiry Card, page 89

### FERRITE MEMORY CORE

A new low-drive ferrite core for use as an information storage device in electronic computers is available. Designed to operate in the 300-500 ma. range, it features a high output signal and fast switching speed for a low-drive core. HCA-222M1 core is made of a special ferromagnetic spinel. Functioning in a coincident current memory, it will produce an



undisturbed "1" output signal of 64 mv. peak, a disturbed "0" output signal of 8 mv. peak and a switching time of 2.1 sec. when subjected to a typical driving current of 400 ma. RCA, Camden 2, N. J.

Circle 18 on Inquiry Card, page 89

### PARALLELING REACTORS

Type PR580 paralleling reactors are designed to insure equal distribution of current loads to germanium rectifier junctions operating in parallel. They provide dependable operation

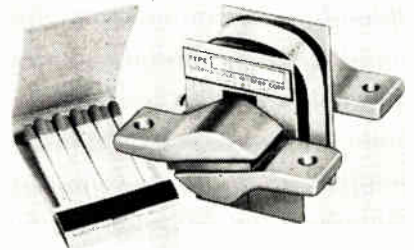

and junction protection that more than pays for the cost of their incorporation in the circuit. No derating of junction is required. Heat failure of junctions and life-shortening overload due to unbalanced forward conduction is greatly reduced. The paralleling reactors are rated at 580 amps. rms for 50°C rise with normal convection cooling. International Rectifier Corp., El Segundo, Calif.

Circle 19 on Inquiry Card, page 89

### AIRBORNE SUPPLIES

A new line of "Glennite" low voltage AC, DC power supplies are available. Engineered to deliver precise plate voltages to aircraft electronic systems, the telemeter and strain gauge power supplies, designed for 400 cycle operation are also available for 60 cycle circuits. Hermetically sealed, the tubeless power supplies have no moving parts. Char-

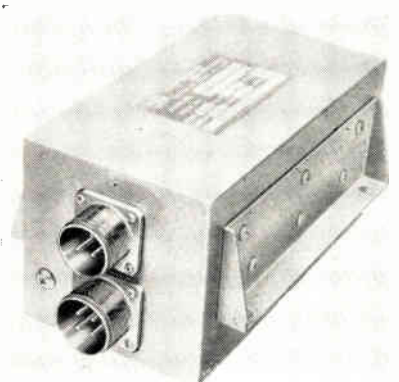

acteristics include a regulation of  $\pm 0.2\%$ , ripple of 1% rms, recovery time of 0.5 sec., and a variety of outputs. They will retain accuracy under extreme airborne conditions. Gulton Industries, Inc., Metuchen, N. J.

Circle 20 on Inquiry Card, page 89

**RATE GYROSCOPE**

The Golden Gnat Rate Gyro, type GN is well suited for autopilot damping, radar antenna stabilization and fire control applications. Some features are: 1 in. dia., 2¼ in. lg.; 3.8 oz.;



wide range of full scale rates up to 600 degrees/sec.; fluid damping is temperature compensated; variable reluctance pickoff; linearity 0.1% of full scale to ½ range, within 2% to full range; ambient temp. range (out-rating) -55°C. to +85°C., Linear Vibration 10 G Peak, 0 to 2000 cps. Shock Up to 100 G depending upon range. Minneapolis-Honeywell, 1400 Soldiers Field Rd., Boston 35, Mass.

Circle 21 on Inquiry Card, page 89

**AIRCRAFT TRANSFORMER**

A new lighter molded aircraft current transformer is available. Used for metering and relaying on aircraft electrical systems, the unit has a 250/2 a. current ratio and operates



on 115 v., 3 phase, 4 wire, 400 cycle systems. It is molded from a high-temperature insulating resin and will operate in ambient temp. from -55°C to +170°C. Conforms to specification MIL-T-7210 for type D-2 current transformers. Max. height and width of 3.25 in., hole dia. of 1.12 in. min., and weighs less than 13 oz. Westinghouse Electric Corp., P. O. Box 2099, Pittsburgh 30, Pa.

Circle 23 on Inquiry Card, page 89

**JUNCTION TRANSISTOR**

This new gaseous diffused-junction silicon transistor, with a rated power dissipation of 37.5 w. at 25°C and 15 w. at 100°C, now makes possible high power transistorized servo and



audio output systems suitable for use in high temperatures. With a 2 a. collector current, the 2N389 also features a maximum saturation resistance of only 6 ohms. When used in aircraft applications, a 60 v. collector-to-emitter rating allows power to be taken directly from the 28 v. power supplies used by military aircraft. Texas Instruments Inc., 6000 Lemmon Ave., Dallas, Texas.

Circle 25 on Inquiry Card, page 89

**INDICATOR TUBE**

Type 6977 filamentary subminiature indicator triode with fluorescent anode is designed specifically for visual monitoring of transistorized computers and other transistor circuits. It is approximately 1½ in. lg. and less than ¼ in. dia. and gives a bright blue-green indication. It is designed for 20,000 hours life. The

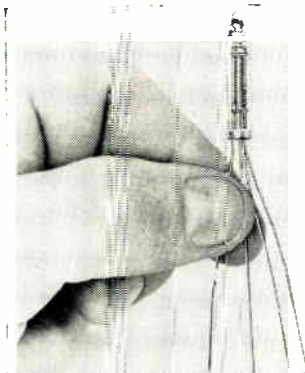

heater voltage is 1 v., 30 ma ac or dc. The anode draws 0.6 ma from a 50 v. supply during the zero-bias "on" condition. 3.5 vdc is sufficient to cut off plate current and light. Ampere Electronic Corp., 230 Duffy Ave., Hicksville, L. I., N. Y.

Circle 22 on Inquiry Card, page 89

**MULTI-PURPOSE OVEN**

The AM-100 oven is designed to yield exacting temperature control of more than just crystals. Entire circuits, components and/or complete sub-assemblies can be housed in one, low cost unit. It features: weight less than 7½ oz.; long life expectancy due to triple insulation on heater windings; high stability ±0.1°C.; Stand-

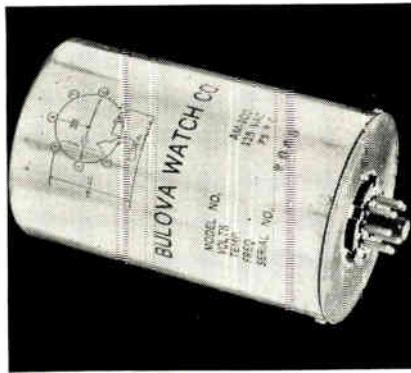

ard octal plug-in (stud mounting available); draws 20w. on initial warm-up, average dissipation less than 5 w. after warm-up; Meets vibration tests MIL-E-5272; 3 in. dia. X 5 in. Bulova Watch Co., Electronic Div. P-765, Woodside 77, N. Y.

Circle 24 on Inquiry Card, page 89

**WAVE MODULATED CRT**

A new short, lightweight version of the "Wamoscope," wave-modulated oscilloscope, a different type of CRT for radar, TV, and other electronic display applications is available. The new one is 17 in. lg., 13 in. shorter than the previous model behind it. The new tube weighs 2½ lbs., or 75% less, and has a rectangular face.

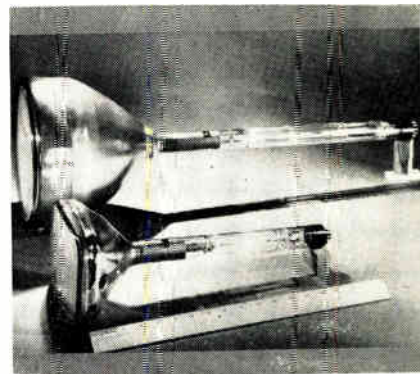

Both have equivalent usable viewing areas in most applications. Advances in the reduction of size and weight are extending its use into airborne equipment. Sylvania Electric Products, Inc., 1740 Broadway, New York 19, N. Y.

Circle 26 on Inquiry Card, page 89

**ULTRASONIC GENERATOR**

An ultrasonic amplifier-generator capable of producing 1500 w., has been developed for production and laboratory testing. Good results are possible even though the transducer

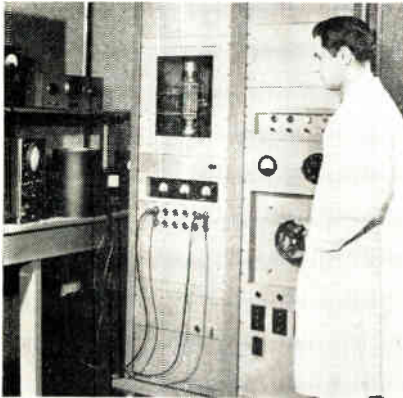

and the power supply are not matched perfectly. The equipment has been designed to protect itself and the transducer from damage. The Vari-Sonic principle also permits relatively efficient transfer of energy in any process in which the load imposed on the transducer is variable. Can be operated by non-technical personnel. Designers for Industry, Inc., 4241 Fulton Pkwy., Cleveland 9, O.

Circle 27 on Inquiry Card, page 89

**GOLD BONDED DIODE**

A unique, gold bonded germanium diode, type DR385, with controlled voltage drop, is being marketed. It features extremely high forward conductance, and at 10 ma., the voltage drop is controlled between .34 and .37 v. It is offered in the hermetically sealed, glass encased subminiature package. The reverse characteristics of the DR385 at 10 v. is 1 Meg. with a



piv of 60 v. It exhibits fast transient response. Similar diodes can be offered fully tested to individual recovery conditions. Radio Receptor Co., Inc., 240 Wythe Ave., Brooklyn 11, N. Y.

Circle 28 on Inquiry Card, page 89

**COLLECTING DEVICE**

A new wire collecting device can be attached to the Artos CS-6 automatic wire measuring, cutting, and stripping machine designated as AE-478, the upper trough collects wire

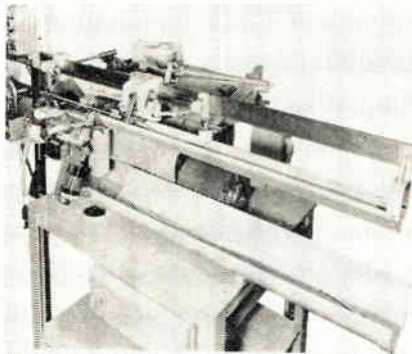

lengths up to 60 inches, then automatically empties them into the lower trough after the wire has been cut. This eliminates the need of an operator for collecting multiple stroke wire lengths. The new collecting device is easily attached to the CS-6 machine without drilling a hole. It is recommended that a wire straightener be mounted ahead. Artos Eng. Co., 2757 S. 28th St., Milwaukee 46, Wis.

Circle 29 on Inquiry Card, page 89

**AUTO TRANSFORMER**

The type W5L has been designed for those 115 v. 60 cycle applications where the usual Variac over-voltage feature is not needed. It can control loads drawing up to 11 amps. at line voltage, thus giving the output power rating of over 1 1/4 kva. Up to 8.5 amps can be drawn from the unit at any voltage. The W5L uses the Dura-trak brush track. Cased models and

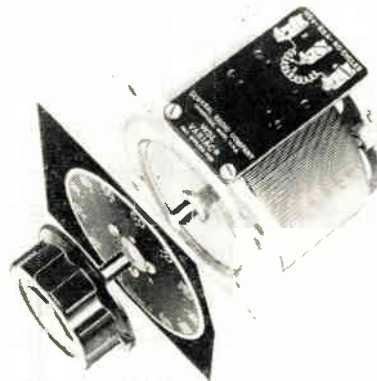

two- and three-gang assemblies are also available. All models can be had with ball bearings at extra cost. General Radio Co., 275 Massachusetts Avenue, Cambridge 39, Mass.

Circle 30 on Inquiry Card, page 89

**INTEGRAL MEASUREMENTS**

The model 270 integrating system is an all-electronic instrument for obtaining the time integral of rapidly varying analog signals. Supplied as a portable or rack-mounted in-

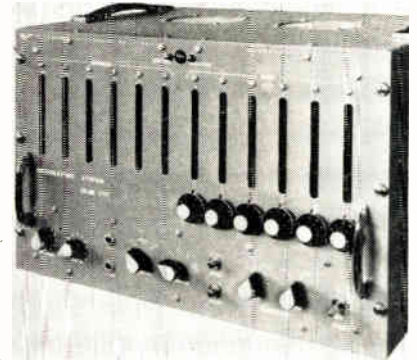

strument, it gives accurate digital display of the integral and action time of phenomenon being measured. Output connectors are provided so information can be automatically printed by a typewriter or fed onto tape. A counting rate of 10,000 counts/sec. permits measured values over time intervals as short as 10 msec. Allegany Instrument Co., Inc., 1091 Wills Mountain, Cumberland, Md.

Circle 31 on Inquiry Card, page 89

**ENGRAVING COOLANT**

Engravolube is a specially designed coolant developed for cutting on hard metals such as stainless steel, nickel-chrome, bronze, brass, copper, high carbon, monel, and cast iron. It assures a cleaner, smoother cut, without burr, and also prolongs the life of your cutting tools. Engravolube is also ideal for tapping, milling, drilling, broaching, counter-broaching, etc.



The new plastic squeeze-type bottle makes it easy to keep handy and use as needed. New Hermes Engraving Machine Corporation, 13-19 University Place, New York 3, N. Y.

Circle 32 on Inquiry Card, page 89

**SPEED REDUCERS**

A new in-line series of speed reducers to be marketed under the trade name StraitLine. StraitLine reducers are available in double and triple reduction. Double reduction units are

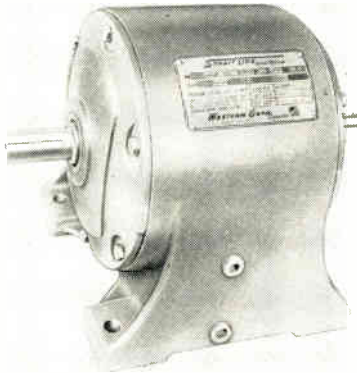

offered in 15 standard ratios from 3.39:1 to 57.3:1 with ratings up to 100 HP. Triple reduction units are available in 9 ratios from 82.1:1 to 190.7:1 with ratings up to 50 HP. StraitLine reducers feature complete interchangeability of individual parts throughout frame sizes as well as packaged sub-assemblies. Western Gear Corp. Box 182, Lynwood, Calif.  
Circle 33 on Inquiry Card, page 89

**DELAY LINE**

Delay line with built-in oven provides high stability performance in memory channel units. This temperature controlled delay line is supplied to specifications in delay time



range from 100 to 1000 microseconds with a stability  $\pm 0.01\%$  from 0°C. to +60°C. Known as the type SDL-25T, it is designed for use in commercial memory channel units. Carrier frequency is 10MC to 40MC. Oven heater voltage is 110 v; power consumption is 30 watts. Bliley Electric Company, Union Station Building, Erie, Pa.  
Circle 35 on Inquiry Card, page 89

**PORTABLE OSCILLOSCOPE**

Portable 3 in. CRO is designed for field use or rack mounting, and combines features found in lab instruments. The unit weighs 27 lbs. and measures 5 x 19 x 11 $\frac{1}{8}$  in. The type



402 oscilloscope offers a sensitivity of 22 dc mv./in., identical direct coupled X and Y amplifiers and amplitude calibration on both channels; calibrated sweeps, both driven and "automatic"; and high sensitivity. 2.5 kv accelerating potential on the type 3WP CRT permits exceptionally bright trace. Allen B. Du Mont Labs., Inc., 750 Bloomfield Ave., Clifton, N. J.  
Circle 37 on Inquiry Card, page 89

**SIGNAL GENERATOR**

A new ultra broadband microwave signal generator covering a frequency range equal to 2 or more present day units, the MSG-34 covers C and X band frequencies 4,200 to 11,000 MC with an output of 1 mw. Direct reading dials indicate frequency and attenuation. Other features are: provision for external modulation; automatically tracked power monitor; and

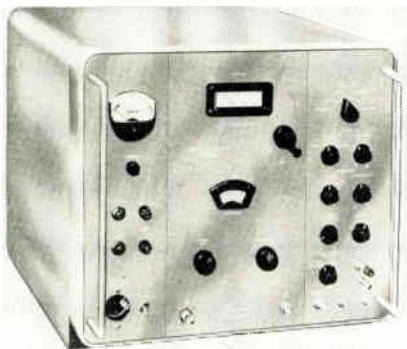

non-contracting oscillator choke. The printed circuit modulator permits internal pulse and square wave modulation from 10 to 10,000 pps at pulse widths of 0.2-10  $\mu$ sec. Polarad Electronics Corp., 43-20 34th St., Long Island City 1, N. Y.  
Circle 34 on Inquiry Card, page 89

**PARABOLIC ANTENNA**

These parabolic antennas utilize one of the following feeds: Button Hook, a rectangular horn preferred for its inherent broadband width, is fed by an accurately formed section of waveguide; Coaxial Horn, applied for broadband use in 1700-2100 MC and 2400-2700 MC range; Dipole, a coaxial fed dipole-reflector that is best suited for operations in the lower

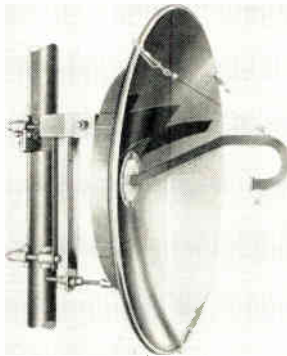

frequencies of 890-950 MC. New mounting and adjustment features have been incorporated. They have elevation and azimuth adjustments which allow for  $\pm 5^\circ$  in each plane. 36 models in stock. Andrew Corp., 363 E. 75th St., Chicago 19.  
Circle 36 on Inquiry Card, page 89

**ALUMINIZING EQUIPMENT**

A high-production unit for aluminizing color-TV plates or the screens of black & white picture tubes. Aluminizing equipment is a self-contained unit, with its own vacuum pumping system. It can handle 2 color plates or 2 black-and-white tubes at the same time. For color plates, a removable metal cone supports them. Dual-tube units will aluminize 20



color plates or black & white tubes per hour. Units can be used singly or mounted on dollies that travel around a circular or oval track for a continuous aluminizing system. F. J. Stokes Corp., 5500 Tabor Rd., Phila. 20, Pa.  
Circle 38 on Inquiry Card, page 89

## TONE-ARM

The Studio Dynetic cartridge employs a magnet moving within a stationary coil. Its counter-weighting applies a tracking force of 1 gm. The straight, tapered tone-arm is 15 in.



lg, 11 in. from pivot to stylus. Both horizontal and vertical suspensions have jeweled bearings. Pushing a control button set in the tone-arm, allows the needle to be moved. It may be used with any conventional turntable. Damping is achieved by floating the arm counter-weight on a leaf-spring embedded in a viscous elastomer. Shure Brothers, Inc., 222 Hartrey Ave., Evanston, Ill.

Circle 39 on Inquiry Card, page 89

## MODULAR INSTRUMENTS

Modular Instruments engineered to provide self sufficient test equipment which can be rack mounted, stacked on a bench, or carried without sacrifice of space, performance, convenience or appearance. These advantages insure wide application in production test, inspection and quality control, as well as laboratory location. The following instruments are

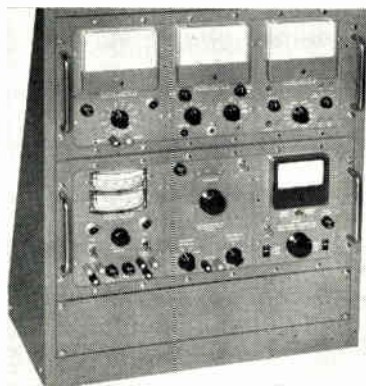

presently available: Audio VTVM, AC-DC VTVM, Multimeter, Audio Oscillator, Regulated DC Power Supply, AC Power Supply, Frequency Meter and Step Attenuator. Teletronics Laboratory, Inc., Westbury, N. Y.

Circle 40 on Inquiry Card, page 89

## INVERTERS

A series of lightweight DC to AC power inverters for enabling portable, aircraft, and vehicular electronic equipment to be battery powered is now available. Standard units that

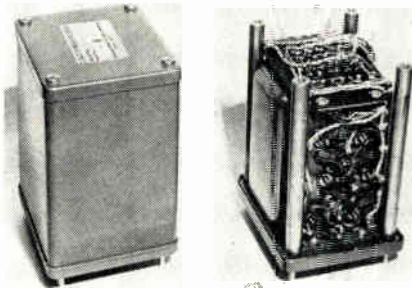

produce up to 250 va. from 28 vdc. input; custom units to 2 kva. Units can be made to meet MIL Spec. Typical of this series is model UAC 100 va/115-1000 which delivers 100 va (100 vac. 1000 cps at 1 A.) weighs 3 1/2 lbs. and comes in a 3 29/32 x 3 11/32 x 5 7/32 in. package. DC to 3 ø AC units are available. Universal Transistor Products Corp., 143 E. 49th St., New York 17.

Circle 41 on Inquiry Card, page 89

## SPRAY PROCESSOR

The 16/35mm spray processor makes possible high speed processing and drying of film in small equipment at rapid speeds. 16mm or 35mm positive film processing is achieved at a rate up to 150 fpm. Negative 16mm and 35mm film can be turned out at a speed of 100 fpm, the dry to dry cycle taking less than 5 min. Machine contains five water and vapor-tight

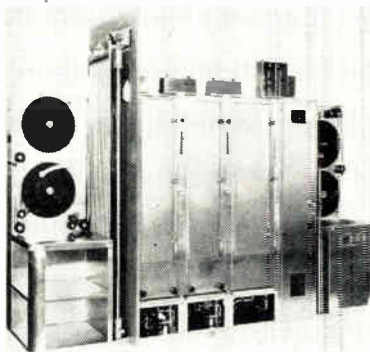

compartments, each containing an independent spray system. The entire processing and drying section is designed for daylight operation. Houston Fearless, 11801 W. Olympic, Los Angeles 64.

Circle 42 on Inquiry Card, page 89

## POWER UNIT

A completely transistorized unit with no moving parts and weighing 1.6 lbs. is available. Known as the DVIOA Dynaverter, it will replace dynamotors in nearly all ARC air-

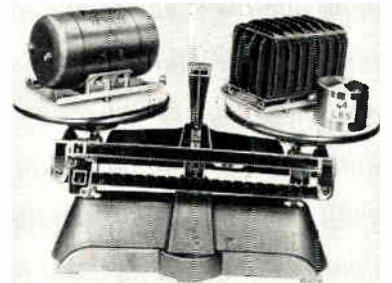

craft radio and navigation receivers. Variations of the DVIOA, with special mountings, have been and will continue to be designed for users who wish to replace the rotating (dynamotor) equipment. It is designed for input of 24 to 28 vdc. with a nominal of 27 v. Input current is 2.3 a. Output voltage is 270 vdc at 150 ma. AC ripple component is .03%. Aircraft Radio Corp. of Boonton, N. J.

Circle 43 on Inquiry Card, page 89

## SQUARE WAVE GENERATOR

The model 72 square wave generator producing square waves with a rise time of 20 millimicrosec. with step selection of 18 frequencies over the range of 5 cycles to 5 Mc. It is a convenient source of ideal square waves for checking the performance of audio and video and components, as well as cathode-ray oscilloscopes. Some of the features are: fast rise

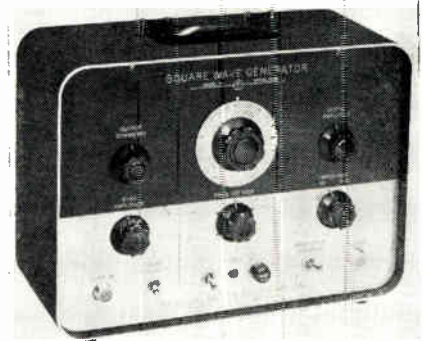

time, wide frequency range, control of square wave symmetry, two output impedances and accommodates synchronizing signals (step selection of 18 frequencies is provided). Measurements Corp., Boonton, N. J.

Circle 44 on Inquiry Card, page 89



## TAPE REEL

A new reel for magnetic recording tape, called the C-Slot Reel, features a curved groove in the hub for threading. Tape is simply slipped into this groove in the opposite direction of

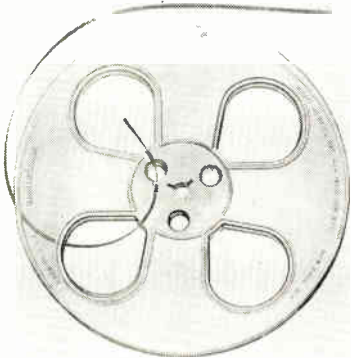

reel rotation and the recorder is ready for operation. No kinks or twists are made in the tape and no tape-ends are left sticking up. It is self-locking, there is no need to turn the reel by hand. All sharp edges have been eliminated. The new type hub construction has been so engineered that the reel is strong and well-balanced. Audio Devices, Inc., 444 Madison Ave., New York 22, N. Y.

Circle 45 on Inquiry Card, page 89

## STOP MOTION MOTOR

The small two speed stop motion motor was designed for the Arriflex 16mm camera. The motor provides for either a 1/2 or 1/4 sec. exposure. The pull of a knob quickly makes the interchange. A built-in Veeder Counter is supplied to indicate the number of frames exposed. Designed to provide the cameraman with the optimum in operating efficiency, it operates

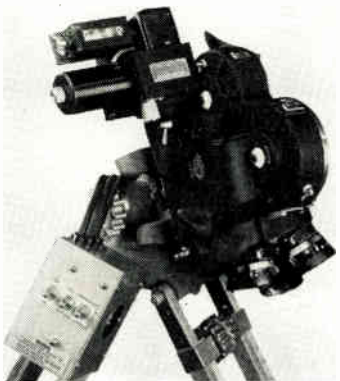

both forward and reverse in either a constant run or stop motion position. If the cameraman wants to use a foot actuator, a receptacle has been installed on the control box. Camera Equip., Co. Inc., New York, N. Y.

Circle 46 on Inquiry Card, page 89

## TV OUTLET BOXES

A new series of single and double TV outlet boxes. All models feature 17 db isolation plus effective strain relief for RG 11/U or RG 59/U "through cable." The new 75 ohm out-

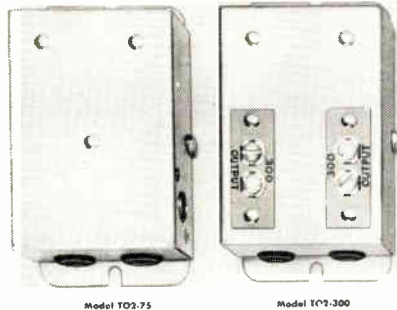

lets are designated T01-75 for one receiver and T02-75 for two receivers. The 300 ohm outlet boxes are matched internally to RG 59/U or RG 11/U distribution cables. These isolating TV outlets are easily installed to make up any signal distribution system. They offer ghost-free reception on color TV as well as black and white. Blonder-Tongue Labs. Inc., 9-25 Alling St., Newark 2, N. J.

Circle 47 on Inquiry Card, page 89

## PULSE GENERATOR

The Dual Pultractor is a new piece of test equipment providing two pulse trains with variable spacing and duration times. Each train has 10 pulses with variable spacing and pulse duration times. Any of the pulses may be omitted or added to the pulse trains by means of selector switches. Pulses may be interlaced or positioned consecutively, with a pulse width range

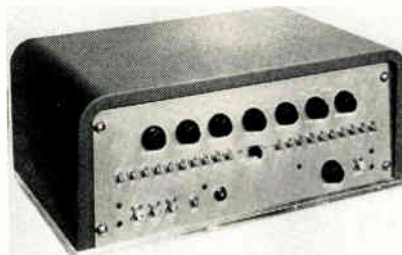

of 0.3 to 0.6  $\mu$ sec and spacing between pulses from 2 to 4  $\mu$ sec. Equipment weighs 38 lbs, is 21 x 9 9/16 x 13 7/8 inches. Packard-Bell Electronics Corp., 12333 W. Olympic Blvd., Los Angeles 64, Calif.

Circle 48 on Inquiry Card, page 89

## GROUNDING SWITCH

A new addition is a rugged yet simple three-position rotary grounding switch. It has been especially designed for TV, radio and other electronic equipment. In such circuit

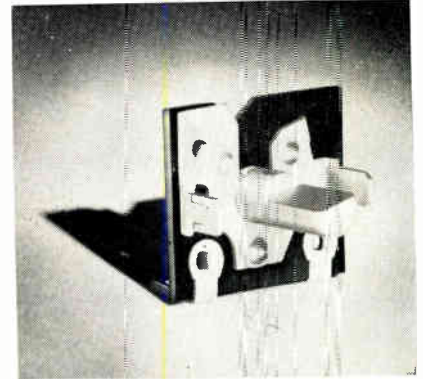

applications as sensitivity controls, the switch permits easy adjustment of signal strength for local, intermediate and fringe reception. The simplified construction permits quick, low-cost assembly thanks to twist-tab mounting of switch to chassis. Complete mechanical and electrical data, as well as suggested circuit applications are available. P. R. Mallory & Co., Inc., Indianapolis, Ind.

Circle 49 on Inquiry Card, page 89

## CO-AXIAL CONNECTOR

TNC connectors are a screw type coupling version of the improved BNC connector series. The performance requirements of the TNC are identical to the improved BNC with the following advantages: a screw lock coupling, safety wire provisions, and better performance under vibration and temperature cycling. Two types are available in the series, high voltage

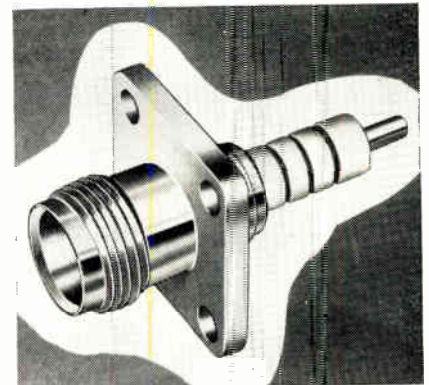

and low voltage. High voltage connectors are rated at 5,000 volts; low voltage rated at 500 volts. They may be safety wired. Cannon Electric Co., 3208 Humboldt St., Los Angeles 31, Calif.

Circle 50 on Inquiry Card, page 89

# WASHINGTON

## News Letter

**\$4 BILLION DEFENSE NEEDS**—For the 1958 fiscal year of the Federal Government which started July 1, nearly \$4 billion has been allotted in the Department of Defense appropriations, just approved by Congress, for communications and electronics equipment requirements, together with electronics components of guided missiles. In the hearings before the Congressional committees, top-ranking officers of the three armed services could not spell out the specific requirements for guided missiles and research and development of new electronic weapons systems because of national defense security. The bulk of the spending for communications-electronics equipment procurement during the current fiscal year will be by the Air Force. This accounted for more than half of the nearly \$4 billion program.

**BASIC INGREDIENT**—In less than a quarter-century electronics has become a “basic ingredient” in military operations, J. M. Bridges, Director of Electronics Activities in the office of the Assistant Secretary of Defense, emphasized to a Washington military-industry communications-electronics group recently. More money, he noted, will be required to establish and maintain adequate research and development programs in military electronics—and these funds must be made available even if they must be obtained from the appropriations for production of weapons and weapon systems development. It is essential, he stated, that research and development efforts in this field be “substantially increased if the demands of new system developments are to be met on a timely and economical basis.” He stressed that “significant advances” are needed in many areas of electronic components and technology.

**VALUE ENGINEERING**—The importance of value engineering in cutting costs for the armed services was emphasized by Rear Admiral Rawson Bennett, Chief of Naval Research, in a recent address. The goal is to produce efficient and reliable electronics equipment that is less complex and less costly, he stated. This can be accomplished, he pointed out, through manufacturers working with the armed services in the development of designs of equipment which meet this criterion. The Navy, the Admiral cited, is following the lead of General Electric in this concept and also received the full support of Motorola through its communications-electronics executive, Vice President Daniel E. Noble.

**AIR FORCE REQUIREMENTS**—Specific equipment procurements by the Air Force in the 1958 fiscal year appropriations total over \$1,390,500,000. Maj. Gen. A. L. Pachynski, Director of USAF Com-

munications-Electronics, informed the Congressional committees. This comprised \$600,000,000 for airborne communications, \$514,471,000 for ground equipment and \$148,867,000 for operation and maintenance of the SAGE system, Dew line and White Alice network, backbone of the nation's air defense warning system.

**MICROWAVE SURVEY**—The pattern for future frequency allocation and usage policies for microwave radio services in the spectrum above 890 mc was blueprinted before the FCC in hearings staged by the Commissioners the latter part of May and during the entire month of June. A most important session in the survey of microwave operation was on June 3 when James B. Williams, Chief Engineer of the Philco Corp.'s Government and Industrial Division, discussed the expected future adequacy of the microwave portion of the spectrum in his role as chairman of the Radio-Electronics-Television Manufacturers Association ad hoc committee on microwave matters. He described microwave equipment and operation to the FCC and outlined a RETMA spectrum utilization analysis.

**PARTICIPANTS IN HEARINGS**—Present and potential users of microwave radio service, the Bell System, Western Union Telegraph Co. and leading microwave equipment manufacturers—General Electric, Lenkurt Electric, Motorola, Raytheon Manufacturing Co. and Westinghouse—were witnesses in the three-day hearings each week before the FCC on microwave allocations and policies which ran during all of last month. The major user representation comprised the electric and gas utilities, petroleum industry, aviation, railroads, police, independent mobile radio systems, trucking industry, the National Association of Manufacturers, special industrial, plastics industry, and television including Dage Television.

**CAUTIOUS APPROACH**—The FCC has decided to move with care and exactitude on the troublesome question of subscription television, and as a result is not slated even to determine whether test operations of the proposed service would be authorized until the fall—if not later. This was delineated by the Commission with unanimous action in its direction to the pay-tv proponents to submit answers to 11 questions on a pay-tv trial plan by July 8. The FCC emphasized that an adequate trial demonstration of subscription tv “is indispensable to a soundly based evaluation of its acceptability to the public.”

*National Press Building  
Washington 4*

*ROLAND C. DAVIES  
Washington Editor*



DPA 32-34P



DPA 32-33S

**DPA CONNECTORS:**

Shell with retaining plate. Pin and Socket Inserts.

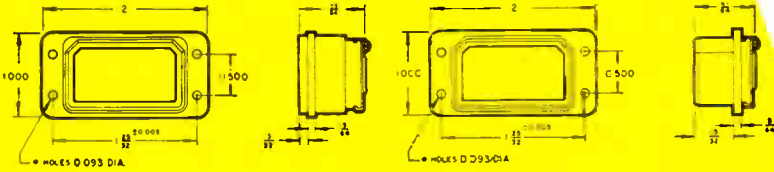

**MORE THAN THIRTY YEARS EXPERIENCE** in the design and manufacture of standard electronic components insure

**D SUB-MINIATURE DPA AND DPX SERIES**

# ★ CANNON CONNECTORS



DPX 23-34P

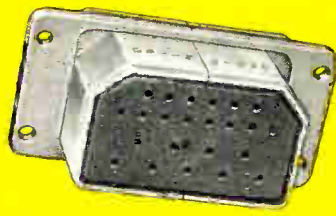

DPX 23-33S

**DPX CONNECTORS:**

Split shell. Pin and Socket Inserts.

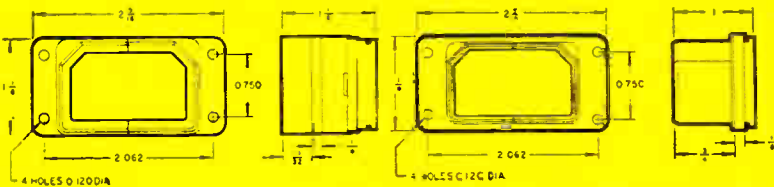

by **CINCH** to be of the highest quality materials, fabricated to specifications to maintain consistent quality of product; highest standards throughout all operations.



DB 25P

DB 25S

Send for illustrated Catalog No. 157 with details of "D" Sub-Miniature, "DPA" and "DPX" Series.

**D SUB-MINIATURES: STANDARD PIN AND SOCKET INSERTS:**

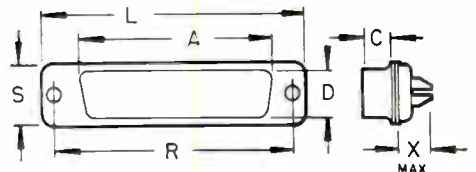

For your connector requirements — you can depend on CINCH.

Centrally located plants at Chicago, Illinois; Shelbyville, Indiana; LaPuente, California; St. Louis, Missouri.



**CINCH MANUFACTURING CORPORATION**

1026 South Homan Ave., Chicago 24, Illinois  
Subsidiary of United-Carr Fastener Corporation, Cambridge, Mass.

**D SUB-MINIATURE SPECIFICATIONS:**

Shell, including flange — steel or brass; Finish — Cadmium plate or Iridite. Contacts — No. 20, 5 ampere rating—Copper base alloy, gold plate finish. Insert arrangements — 5 plus coaxials in 9, 15, 25, 37 and 50 contacts. Insulation material — Zytel 101 or DIALL. Polarization — Keystone cornered shell. Operating temperature — 67° to +310°F.

size	A	C	D	L	R	S	X	weight
DA-15P	1 1/4	1 3/4	2 3/4	1 1/2	1.312	3/4	3/16	.013
DA-15S	1 3/4	1 3/4	3/16	1 1/2	1.312	3/4	3/16	.014
DB-25P	1 9/16	1 3/4	2 3/4	2 3/4	1.852	3/4	3/16	.023
DB-25S	1 3/4	1 3/4	3/16	2 3/4	1.852	3/4	3/16	.031
DC-37P	2 13/16	1 3/4	2 3/4	2 23/32	2.500	3/4	3/16	.035
DC-37S	2 11/16	1 3/4	3/16	2 23/32	2.500	3/4	3/16	.035
DD-50P	2 7/8	1 3/4	1 5/8	2 3/8	2.406	3/4	3/16	.035
DD-50S	2 3/4	1 3/4	2 3/4	2 3/8	2.406	3/4	3/16	.040
DE-9P	4 3/4	1 3/4	2 3/4	1 13/16	.984	3/4	3/16	.011
DE-9S	4 1/4	1 3/4	3/16	1 13/16	.984	3/4	3/16	.012

★ Manufactured by Agreement with Cannon Electric Company

FRACTIONS ± 1/64 Tolerance

DECIMALS ± 0.005 Tolerance

# New Tech Data

## for Engineers

### Connectors

A new 32-page 2-color catalog, GB6, contains complete information on battery connectors, power connectors, and heavy duty connectors for industrial and allied applications. Cannon Electric Co., 3208 Humboldt St., Los Angeles 31, Calif.

Circle 52 on Inquiry Card, page 89

### TV Products

Blonder-Tongue Laboratories, now located at 9-25 Alling St., Newark 2, N. J. has issued a new catalogue of its complete line of TV products. Among the new items are crystal controlled VHF and UHF converters and a series of all-channel indoor cable tapoffs. Illustrations, descriptions and trade prices are included for each B-T model.

Circle 53 on Inquiry Card, page 89

### Control Theory

A new bulletin on pneumatic control instruments, featuring more than 10 pages of general automatic control theory has recently been published by The Bristol Co., 20 Waterbury, Conn. The 44-page, 2-color bulletin describes in simplified terms and illustrations the basic concepts of narrow band, proportional, reset, derivative, and reset plus derivative control actions. Also covered are selective, cascade, and ratio controls.

Circle 54 on Inquiry Card, page 89

### Company Bulletin

Burnell & Co., Yonkers, N. Y. have recently established a regular monthly periodical entitled the Burnell Bulletin. The Bulletin will contain, in addition to information about Burnell's progress, background material on the development and application of their products.

Circle 55 on Inquiry Card, page 89

### High Power Termination

A bulletin has been issued by The Narda Corp., 160 Herricks Rd., Mineola, N. Y. describing their Model 369 high power coaxial termination. Complete specifications and prices are included.

Circle 56 on Inquiry Card, page 89

### IGY Antenna

The Technical Appliance Corp., Sherburne, N. Y., has issued a 6-page booklet describing a satellite tracking antenna for use by individuals wishing to track the Vanguard satellites. Complete information is given.

Circle 57 on Inquiry Card, page 89

### Transistor Wall Chart

A wall chart showing, at a glance, applications and maximum ratings and typical characteristics at 25 degrees Centigrade of 56 types of germanium junction alloyed transistors. It also contains a handy interchangeability table, outlines of 5 different transistor cases, diagrams of various circuits and standard IRE symbols and definitions. General Transistor Corp., 91-27 138th Place, Jamaica 35, N. Y.

Circle 58 on Inquiry Card, page 89

### Resistance Wire

A new 12-page bulletin by Driver-Harris Co., Harrison, N. J. gives complete data on the electrical and physical properties of their principal resistance alloys. Complete with charts and tables, the new bulletin makes it easy for the user to determine exactly which alloy will prove most economical and effective for his specific purpose.

Circle 59 on Inquiry Card, page 89

### Electronic Equipment

Nems-Clarke, Inc., 916 Jesop Blair Dr., Silver Spring, Md., has issued a 60-page, multi-colored booklet describing some of their equipment for broadcasting, telemetering and communications. Booklet is complete with photographs, specifications and prices.

Circle 60 on Inquiry Card, page 89

### Precision Resistors

Four-page bulletin contains data on construction, types, winding technique, winding forms, impregnation, terminals and characteristics of precision wire wound resistors. Detailed charts and graphs are included. International Resistance Co., 401 N. Broad St., Philadelphia 8, Pa.

Circle 61 on Inquiry Card, page 89

### Bearings

A series of 2-color bulletins have been issued by Halax Corp., 17470 Shelbourne Way, Los Gatos, Calif. describing their line of bearings for electronic use. Complete with photographs and specifications along with information on ordering custom bearings.

Circle 62 on Inquiry Card, page 89

### Dry Lubricant

A bulletin on "Henderlube," a new dry lubricant finish for heat-dissipating tube shields is available from International Electronic Research Corp., 145 W. Magnolia Blvd., Burbank, Calif.

Circle 63 on Inquiry Card, page 89

### Socket Screws

A 6-page, 2-color bulletin describes The Bristol Co., Waterbury 20, Conn., complete line of socket screw products. Also included is a postcard for ordering samples.

Circle 64 on Inquiry Card, page 89

### Capacitor Chart

Erie Resistor Corp. of Erie, Pa. has produced a convenient reference chart giving data on capacitors in quickly available form. The plastic card is 7 $\frac{1}{2}$  x 4 $\frac{1}{4}$  in. It shows dielectric qualities and temperature coefficients of Erie tubular and Disc-Ceramicons as well as maximum available nominal capacities in mmf.

Circle 65 on Inquiry Card, page 89

### Rectifiers & Capacitors

The Rectifier-Capacitor Div. of Fansteel Metallurgical Corp., North Chicago, Ill. are giving subscriptions to their bi-monthly technical publication "ReCap" which contains information on rectifiers and capacitors.

Circle 66 on Inquiry Card, page 89

### Power Supplies

The 4-page folder describes and illustrates filament power supplies, telemetering and strain gauge power supplies, computer power supplies, and miniature magnetic amplifier power supplies. Also discussed is the EM transistorized line including dc voltage regulators and dc inverters. Engineered Magnetics Div., Gulton Industries, 212 Durham Ave., Metuchen, N. J.

Circle 67 on Inquiry Card, page 89

### Computing Amplifiers

A 2-color bulletin describes plug-in ferromagnetic computing amplifiers manufactured by Airpox Products Co., Middle River, Baltimore 20, Md. Bulletin is complete with photographs and specifications.

Circle 68 on Inquiry Card, page 89

### Data Processing

A new series of illustrated brochures, detailing individual business applications of the Datatron electronic data processing system is available. The brochures document specific solutions to computational problems in payroll processing, invoice billing, parts inventory controlling, accounts payable processing, utility billing, and life insurance recording. ElectroData, 460 Sierra Madre Villa, Pasadena, Calif.

Circle 69 on Inquiry Card, page 89

# FREE

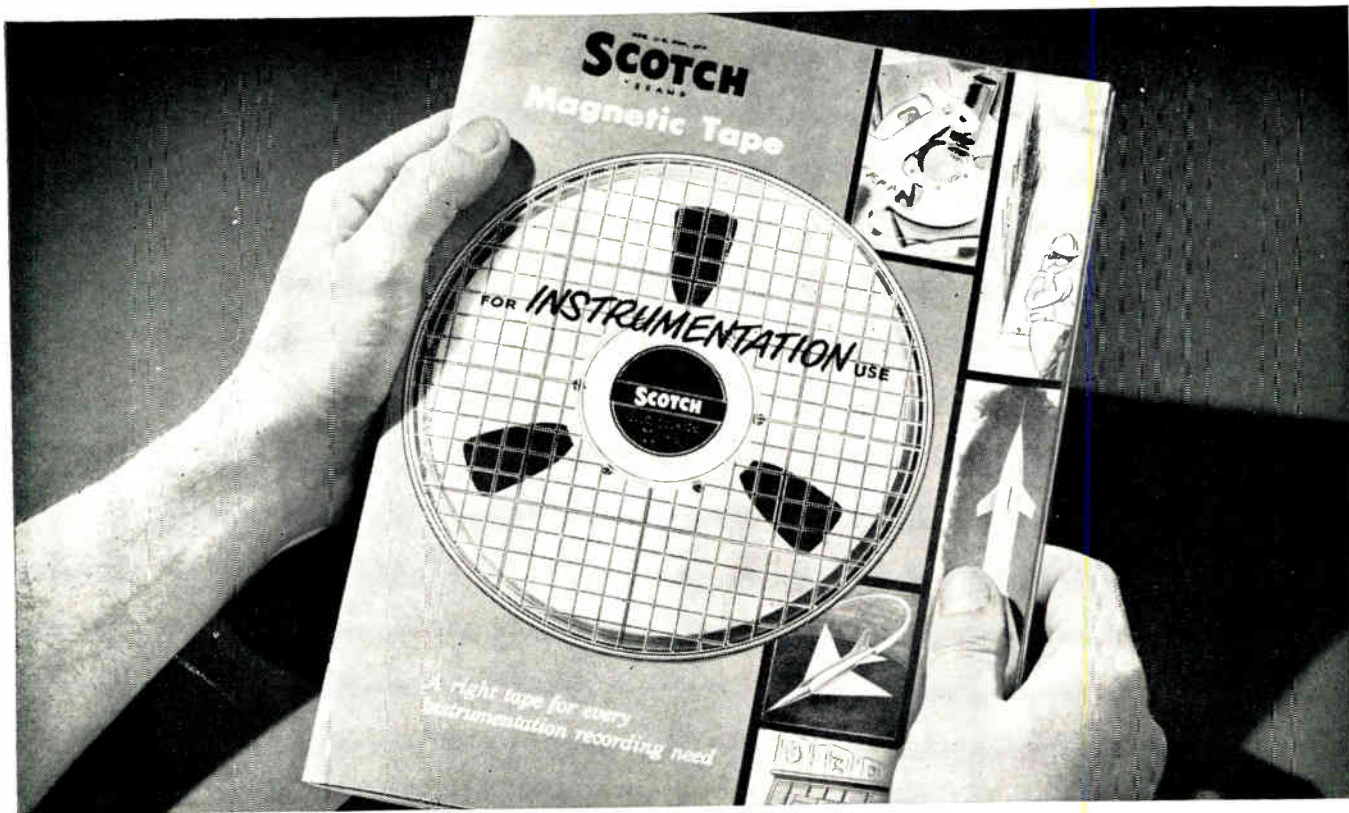

## FREE BOOKLET answers your basic questions about instrumentation tape!

Get all the latest information about America's most dependable, most complete line of instrumentation tapes! Error-free tapes! Minnesota Mining and Manufacturing Company wants to mail you its new, illustrated instrumentation tape brochure. In this reference book you'll find technical specs and analyses on tapes for industry and defense . . . answers to questions, suggestions on instrumentation applications. Mail the coupon for your free copy now.



### INSTRUMENTATION DIVISION

The term "SCOTCH" and the plaid design are registered trademarks for Magnetic Tape made in U.S.A. by MINNESOTA MINING AND MFG. CO., St. Paul 6, Minn. Export Sales Office: 99 Park Avenue, New York 16, N.Y. © 3M Co., 1957

- How to solve rub-off problems
- What tape to use for high, medium, low speeds, pressures and temperatures
- What tape to use for long or short wave length recording

#### FILL OUT AND MAIL

Minnesota Mining & Mfg. Co.  
Dept. GO-77, St. Paul 6, Minnesota

Send me the 3M Instrumentation booklet at once.

NAME \_\_\_\_\_

POSITION \_\_\_\_\_

COMPANY \_\_\_\_\_

ADDRESS \_\_\_\_\_

CITY \_\_\_\_\_ ZONE \_\_\_\_\_ STATE \_\_\_\_\_

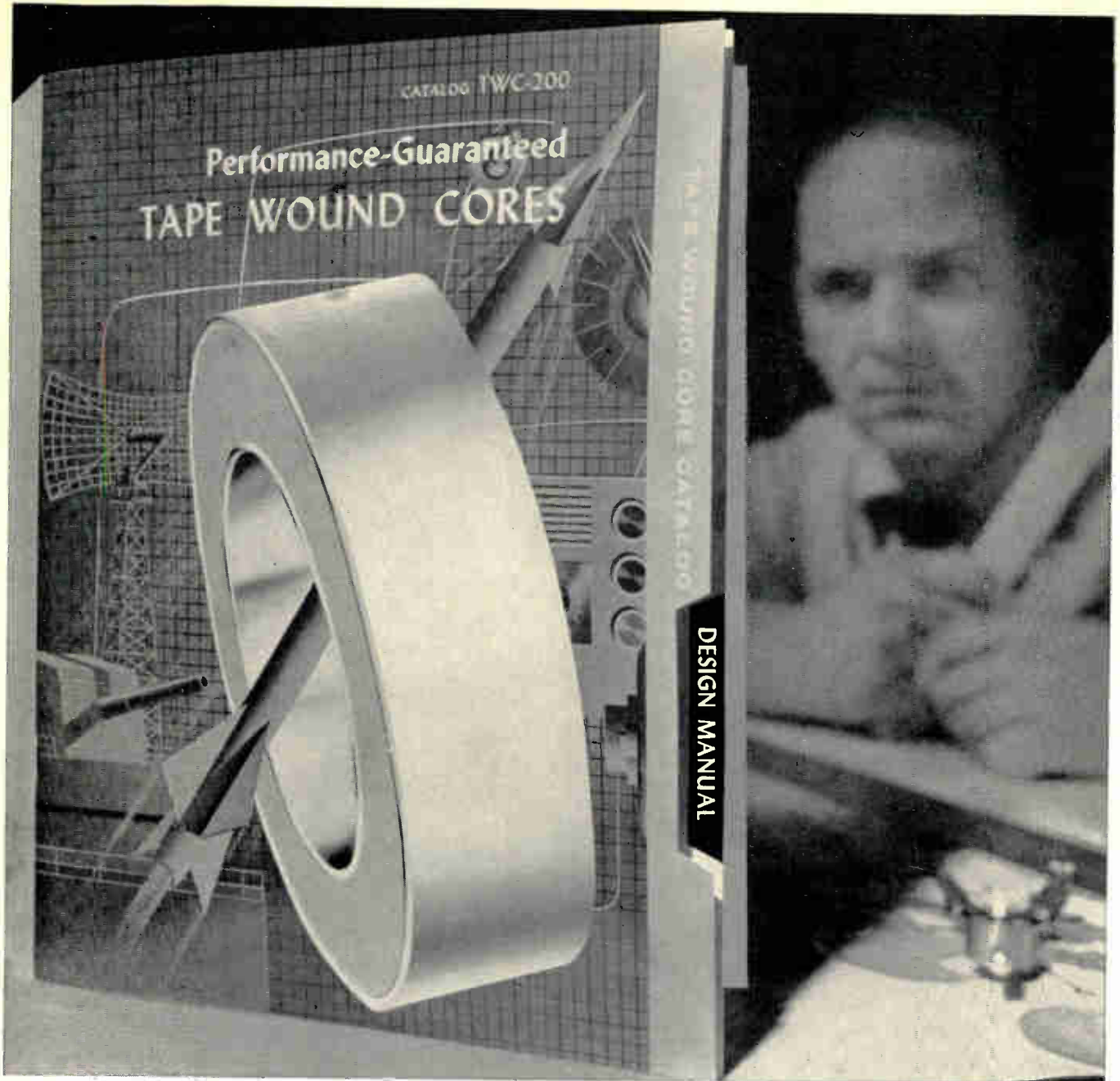

## Here's the first design manual for your work with tape wound cores

Because engineers have expanded high permeability magnetics into a host of new uses, Magnetics, Inc. has combined its new tape wound core catalog with the industry's first design manual. If you and your staff need a working familiarity with magnetic equations, characteristics and terminology, this 28-page book will be of unusual value.

This design manual has been compiled under the direction of our Laboratories. It contains basic units and conversion factors, methods of testing (dynamic, EI loop and d-c), properties and magnetic values of nickel-iron alloys, and many pages of curves showing the variation of magnetic properties with temperature and of core loss with frequency.

This fact-packed catalog and design manual also describes in detail the tape wound cores and bobbin cores which we manufacture. It will enable you to design around and specify the industry's only Performance-Guaranteed Tape Wound Cores. Should your engineering departments feel that more than one copy would be of value, please write for TWC-200 on company letterhead, giving full names and titles. *Magnetics, Inc., Dept. TT-40, Butler, Pa.*

**MAGNETICS inc.**

# New Tech Data

## for Engineers

(Continued from page 66)

### Electron Tube Catalog

A new 16-page, 3-color Quick Reference Catalog has been published by Eitel-McCullough, Inc., San Bruno, Calif. Summarized electrical and physical data is given in handy tabulated form for each of the company's line of triodes, tetrodes, pentodes, klystrons, high vacuum and mercury vapor rectifiers, vacuum capacitors, vacuum switches, ionization gauge, contact finger stock, heat dissipating connectors, air system sockets and chimneys.

Circle 72 on Inquiry Card, page 89

### Bobbins

A new 12-page catalog covering a complete line of bobbins for use in the electrical manufacturing and metal-working industries is available from the Lestershire Spool Div. of National Vulcanized Fibre Co., 1057 Beech St., Wilmington, Del.

Circle 73 on Inquiry Card, page 89

### Custom Molded Plastics

Featuring the theme "What Makes a Good Custom Molder?" the 12-page booklet includes illustrated sections on molding facilities, finishing and assembly of components, research and development, and quality control. Chapters on injection molding, compression molding, and transfer molding list examples of automatic equipment used in the molding of thermoplastic and thermosetting materials at Sylvania Electric Products Inc., Warren, Pa.

Circle 74 on Inquiry Card, page 89

### Numerical Positioning

Functional Description of Numerical Positioning Control, bulletin GET-2675, 14 pages, describes functions of numerical positioning control, gives a detailed breakdown of the 3 major elements, data input, director, and servo drive, lists features, and graphically illustrates each operation. General Electric Co., Schenectady 5, N. Y.

Circle 75 on Inquiry Card, page 89

### Commercial Glasses

A 16-page bulletin, "Properties of Selected Commercial Glasses" (B-83), has been completely revised and is now available. Several new glasses have been added to the property data chart, including aluminosilicate glass, low loss iron sealing glass, fused silica, and radiotron tube and capacitor glass. Corning Glass Works, Corning, N. Y.

Circle 76 on Inquiry Card, page 89

### Antennas & Accessories

Catalog Supplement 21-S describes antennas, feeds, semi-flexible cable and fittings, waveguide and accessories. Booklet is complete with photographs, specifications, and price list. Andrew Corp., 363 East 75th St., Chicago 19, Ill.

Circle 77 on Inquiry Card, page 89

### Precision Optics

Precision optics produced by Texas Instruments Inc., 6000 Lemmon Ave., E. Dallas 9, Tex. at its Optics Division, including infrared systems components fabricated from TI-grown silicon crystals, are described in two new bulletins now available.

Circle 78 on Inquiry Card, page 89

### Power Rectifiers

Sarkes-Tarzan, Inc., 415 N. College Ave., Bloomington, Ind., has issued a series of 3-colored bulletins called "Design Notes" which give complete engineering information on their silicon rectifiers.

Circle 79 on Inquiry Card, page 89

### Microwave Products

A new 4-page short form catalog (57-BG) describing all of the products manufactured by Microwave Associates, Burlington, Mass. is now available. Listed are: pulsed and CW magnetrons, TR and ATR duplexing tubes, microwave silicon diodes, silicon power rectifiers, flange-mounted and solderable waveguide pressure windows, waveguide components, and test equipment.

Circle 80 on Inquiry Card, page 89

### Panel Instruments

Trio Laboratories, Inc., 4025 Merrick Rd., Seaford, N. Y., has issued a new 36-page catalog and designers guide with photos, outline drawings, description, theory of operation, mounting details and complete specifications on their entire line of miniature, panel-mounting electronic instruments.

Circle 81 on Inquiry Card, page 89

### Precision Potentiometers

A 12-page, 2-color booklet has been issued by Beckman/Helipot Corp., Newport Beach, Calif. Booklet describes their line of Helipot, turn-counting digital dials, and turn-counting dials. Booklet contains photographs and complete specifications.

Circle 82 on Inquiry Card, page 89

### Instrumentation Tape

"For Instrumentation Use" is the title of a booklet issued by Minnesota Mining & Mfg. Co., Dept. GO-77, St. Paul 6, Minn. It is a handy reference book for industry and defense that contains technical specifications, information and analysis on tapes.

Circle 83 on Inquiry Card, page 89

### Servo Information

"Around the Servo Circuit" is a quarterly issue available to engineers interested in keeping up-to-date on latest developments in the controls field. Free subscriptions are available. Servo Corp. of America, 20-20 Jericho Turnpike, New Hyde Park, N. Y.

Circle 84 on Inquiry Card, page 89

### Semiconductors

A note book type folder containing complete engineering data on germanium transistors has been issued by Tung-Sol Electric Inc., 95 8th Ave., Newark 4, N. J. The data sheets in this folder contain physical and electrical specifications along with graphs.

Circle 85 on Inquiry Card, page 89

### Recording Equipment

A new 6-page folder, illustrating and describing their direct writing recording systems, has just been released by the Brush Electronics Company, Cleveland 14, Ohio. Covered is the company's line of oscillographs, amplifiers, its penmotor, plus accessories and supplies used with the basic instrumentation equipment.

Circle 86 on Inquiry Card, page 89

### Test Equipment

A new 8-page composite test equipment catalog lists 25 pieces of new test gear, 2 new color generators and the new Cardamatic "automatic" tube testing machine. Hickok Electrical Instrument Co., 10606 Dupont Ave., Cleveland 8, Ohio.

Circle 87 on Inquiry Card, page 89

### Wire & Cable

Catalog No. 857, 20 pages, 2-color, describes the full line of wire and cable manufactured by Belden Mfg. Co., Chicago, Ill. Includes a number of new additions to the Belden line, audio and mike cables, and new hook-up wire conforming to MIL spec 16878-B and others.

Circle 88 on Inquiry Card, page 89

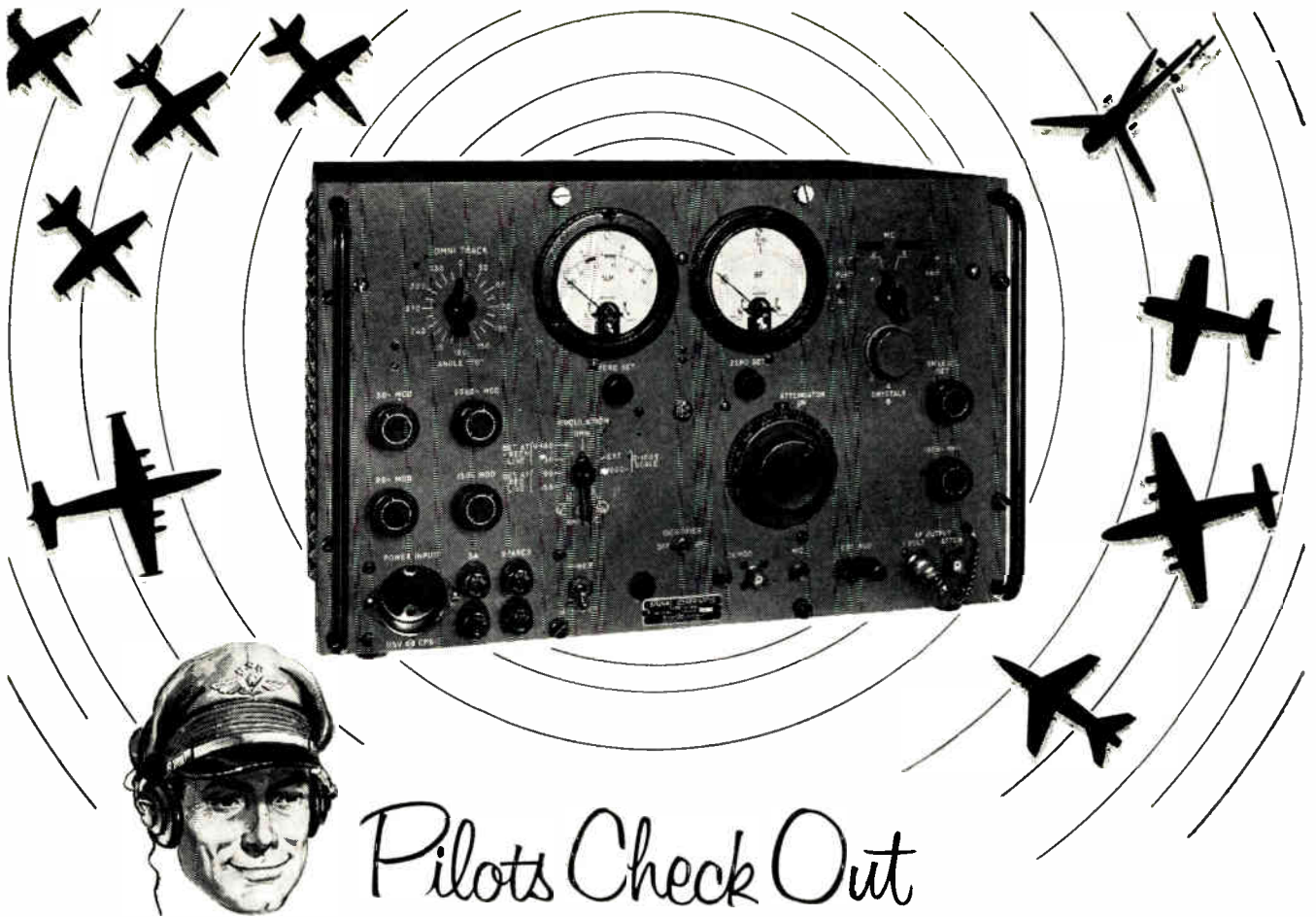

## Pilots Check Out NAVIGATION RECEIVER ACCURACY

### ARC Type H-14A Signal Generator Checks Omni/Localizer Equipment

ARC's H-14A Signal Generator provides a simple and dependable means of checking *omnirange* and *localizer receivers* in aircraft on the field, by sending out on the hangar antenna a continuous test identifying signal that blankets the field. Tuned to this signal, individual pilots or whole squadrons can quickly test their own equipment. Voice can be transmitted simultaneously with signal. The instrument will check 24 omni courses, omni course sensitivity, operation of TO-FROM meter and flag-alarms, left-center-right on 90/150 cps localizer, receiver frequency calibration, reciprocal course accuracy, and receiver output. The H-14A is also widely used for

making quantitative measurements on the bench during receiver maintenance. Input power is 160 watts, 115 volts 60 cps.

The H-16A Standard Course Checker measures the accuracy of the indicated omni course in ARC's H-14A or other omni signal generator to better than 1/2 degree. It features a built-in method of checking its own precision.

ARC's Type H-12 Signal Generator (900-2100 mc) is equal to military TS-419 U, and provides a reliable source of CW or pulsed rf. Internal circuits provide control of width, rate and delay of internally-generated pulses. Complete specifications on request.

Dependable Airborne Electronic Equipment Since 1928

## Aircraft Radio Corporation BOONTON, NEW JERSEY

Miniaturized Automatic Direction Finders • Omni/Loc Receivers • Course Directors • UHF and VHF Receivers and Transmitters  
LF Receivers and Loop Direction Finders • 10-Channel Isolation Amplifiers • 8-Watt Audio Amplifiers  
Interphone Amplifiers • Omirange Signal Generators and Standard Course Checkers • 900-2100 Mc Signal Generators

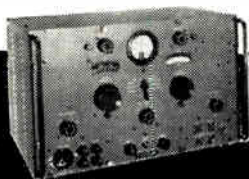

Type H-12  
UHF Signal Generator



Type H-16  
Standard Course Checker







To engineers interested in entering the field of

## **INERTIAL GUIDANCE**

Here is a field whose potential is equalled by the magnitude of its problems. The development of components with extraordinary precision alone offers unmatched scope for achievement.

Engineers and scientists on Lockheed's Sunnyvale and Palo Alto Staffs are working on a number of different inertial guidance systems. They are involved in all phases of inertial guidance and navigation.

Their expanding activities have created new positions for those possessing backgrounds in:

- **Mathematics**
- **Physics**
- **Electronics (such as magnetic amplifiers)**
- **Servomechanisms**
- **Flight Controls**
- **Precision mechanical and instrumentation development**
- **Special purpose computer design**

Engineers and scientists possessing experience or keen interest in advanced applications of inertial guidance are invited to write. Please address the Research and Development Staff, Palo Alto 5, California.

E. V. Stearns (left), head of the Inertial Guidance Department, discusses navigation systems mechanization with Inertial Guidance Scientist R. L. McKenzie (center) and Senior Electronics Scientist D. G. Peterson.

*Lockheed*

**MISSILE SYSTEMS DIVISION**

LOCKHEED AIRCRAFT CORPORATION

PALO ALTO • SUNNYVALE • VAN NUYS

CALIFORNIA

# News of Reps

C. H. Newson and Associates with headquarters in Philadelphia have been appointed to represent Potter & Brumfield, Inc. in the Baltimore area.

Douglas T. Shaw is now a rep in Ontario, Quebec and the Maritime Provinces of Canada for the Heine-mann Electric Co.

William K. Cochrane Associates, 518 Dwight Building, Jackson, Mich. are reps in Michigan, Indiana, Western Ohio and Kentucky for the Gibson Electric Co.

R. B. Barnhill and Associates, P. O. Box 6892, Towson 4, Md. will represent Aladdin Electronics, a div. of Aladdin Industries, in the Middle Atlantic States and Florida, and Rene Bluzat Co. will represent them in Chicago, Northern Illinois and Wisconsin.

Ringer-Mezger Co., Inc. are now reps for The Electronics Div. of the Curtiss-Wright Corp. in Northern New Jersey, Metropolitan New York and Long Island.

Robert J. Marcy and Fred J. Neidig, formerly of Langevin Mfg. Corp., announce the opening of their new office at 1776 Broadway, New York 19, N. Y. The new firm is known as M & N Associates.

R. Edward Stemm has added Dudley A. Hansen to the staff of field engineers for the industrial components, instruments and production equipment which he represents.

The Goory Sales Co., 19555 Henry Rd., Cleveland 26, Ohio, was appointed rep in Ohio for the Hudson Wire Co.

A. L. Livera & Associates, Inc., 4 Green Village Road, Madison, N. J. have been appointed reps for Cleviste Transistor Products, a div. of Cleviste Corp., in New York City, Long Island and Upper New Jersey areas.

O. F. Masin Co., Pelham, N. Y. are representing Tru-Ohm Products, div. of Model Engineering Mfg. Inc. They have the Metropolitan New York area.

Bertram D. Aaron of Los Angeles is now sales rep in Southern California and Arizona for the Budd-Stanley Co., Inc.

J-F Sales Co. a new rep organization, has been established in Los Angeles by Jack W. Falck and John R. Foster. The firm covers the Southern California, Arizona and Southern Nevada markets.

(Continued on Page 78)



## UPB... the capacitor...with immortality

Well, not quite. *But* for the critical applications where extended long capacitor life and highest dependability are imperative, the C-D UPB Electrolytic takes over where the normally long-life electrolytic succumbs.

Many intricate communication systems, telephone networks, laboratory test and control instruments, computing equipment, military and aircraft devices, and the like, require capacitors having this extra high degree of dependability and long service life.

Such a capacitor is the C-D TYPE UPB ELECTROLYTIC.

Materials ordinarily quite acceptable for commercial capacitors are discarded—only super-pure materials are used in the UPB. Every processing step is meticulously supervised under controlled atmospheric humidity and temperature conditions. All of the engineering and manufacturing skill of C-D's 46 years of experience is built into this UPB.

The result is an electrolytic capacitor with "Immortality"—service life far beyond that of the conventional high-grade commercial electrolytic capacitor.

Engineering data and ratings gladly furnished. Address Manufacturer's Division, Cornell-Dubilier Electric Corporation, South Plainfield, New Jersey.

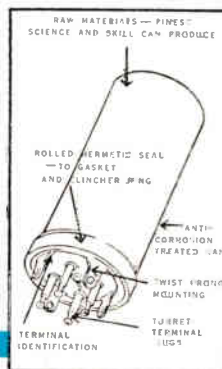

## CONSISTENT HIGH DEPENDABILITY CORNELL-DUBILIER CAPACITORS

SOUTH PLAINFIELD, N. J.; NEW BEDFORD, WORCESTER & CAMBRIDGE, MASS.; PROVIDENCE & HOPE VALLEY, R. I.; INDIANAPOLIS, IND.; SANFORD, FLOQUAY SPRINGS & VARINA, N. C.; VENICE, CALIF.; & SUBSIDIARIES, THE RADIART CORPORATION, CLEVELAND, OHIO; CORNELL-DUBILIER ELECTRIC INTERNATIONAL, N. Y.

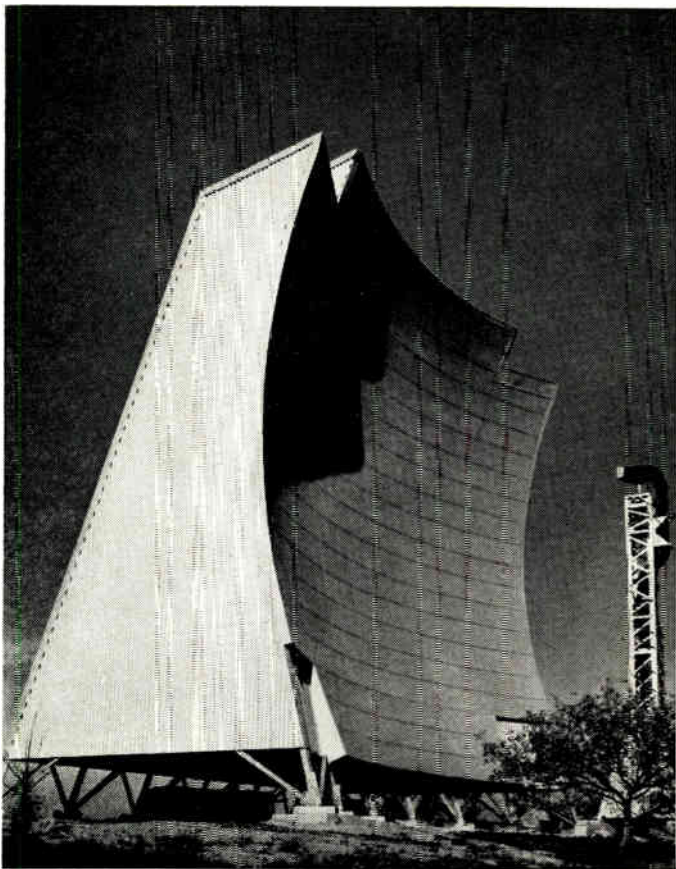

Giant over-the-horizon antenna designed by Bell Telephone Laboratories for "White Alice," Air Force Alaskan defense communications network.

# *How UHF radio got seven-league boots*

THE huge antenna systems which project ultra-high frequency radio communications beyond the horizon began when a Bell Telephone Laboratories engineer became intrigued with a strange phenomenon. Although these radio waves were supposed to be useful only over line-of-sight distances, the waves displayed a mysterious tendency to take off in a giant stride to antennas beyond the horizon.

This phenomenon had been studied both here and abroad, but no practical use was seen until the engineer became interested and thoroughly sifted the experimental data. He came up with the stimulating conclusion that over-the-horizon transmission is far stronger and much more dependable than was generally supposed. Further he predicted that it could be utilized to supply dependable broadband communications. He and his associates at Bell Laboratories confirmed the prediction experimentally, then drew up requirements for the first over-the-horizon UHF transmission system.

This pioneer work at Bell Telephone Laboratories has greatly increased the usefulness of UHF communications. For example, over-the-horizon transmission now provides critically important communications between remote military outposts in the Arctic and in the far north.

For the Bell System it can provide important new links for telephone conversations and television.



contributions in the field of over-the-horizon ultra-high frequency radio transmission.

Kenneth Bullington, B.S.E.E., University of New Mexico; M.S., Massachusetts Institute of Technology; recipient of the 1956 Morris Liebmann Memorial Prize and the 1956 Stuart Ballantine Medal for his

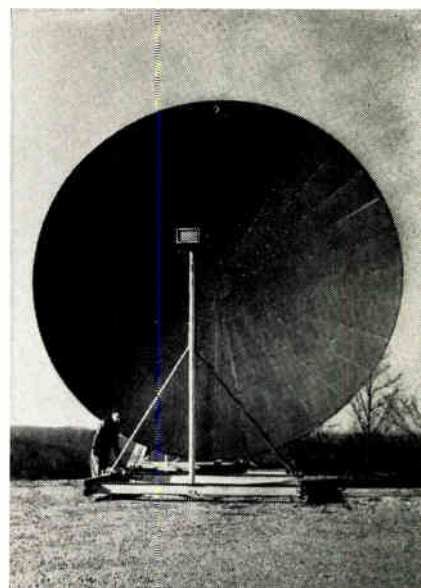

Experimental antenna used in early over-the-horizon UHF radio transmission research. Research extended transmission from 30 mile line-of-sight to 200 miles.

BELL TELEPHONE LABORATORIES



WORLD CENTER OF COMMUNICATIONS RESEARCH AND DEVELOPMENT



## *You can save time and trouble by standardizing on BUSS fuses.*

### **The BUSS fuse line is most complete**

You'll find the right fuse every time, when you turn to BUSS. There are BUSS fuses of all types and sizes for the protection of television, radio, instruments, controls, avionics and other electronic and electrical equipment. A companion line of fuse blocks, clips and holders is most complete.

Buying fuses from one source saves you time, trouble and simplifies your stock handling records.

### **Safeguard the reputation of your equipment for quality and service**

BUSS fuses are tested in a sensitive electronic device that automatically rejects any faulty fuse. As a result, there are never any 'kicks' or complaints from users about BUSS fuses failing to protect or faulty fuses causing needless shutdowns of your equipment.

Why take a chance on anything less than BUSS quality in fuses? Specify BUSS fuses and be sure of dependable electrical protection for your equipment.

### **If your protection problem is unusual . . .**

. . . . let the BUSS fuse engineers work with you and save you engineering time. If possible, they will suggest a fuse or fuse mounting already available in local wholesalers' stocks, so that your device can be serviced easily.

For more information on BUSS and FUSETRON Small Dimension fuses and fuseholders . . . Write for bulletin TT. Bussmann Mfg. Division (McGraw-Edison Co.) University at Jefferson, St. Louis 7, Mo.

***BUSS fuses are made to protect—not to blow, needlessly***

757



Makers of a complete line of fuses for home, farm, commercial, electronic, automotive and industrial use.

# Reliable, Efficient DC Conversion

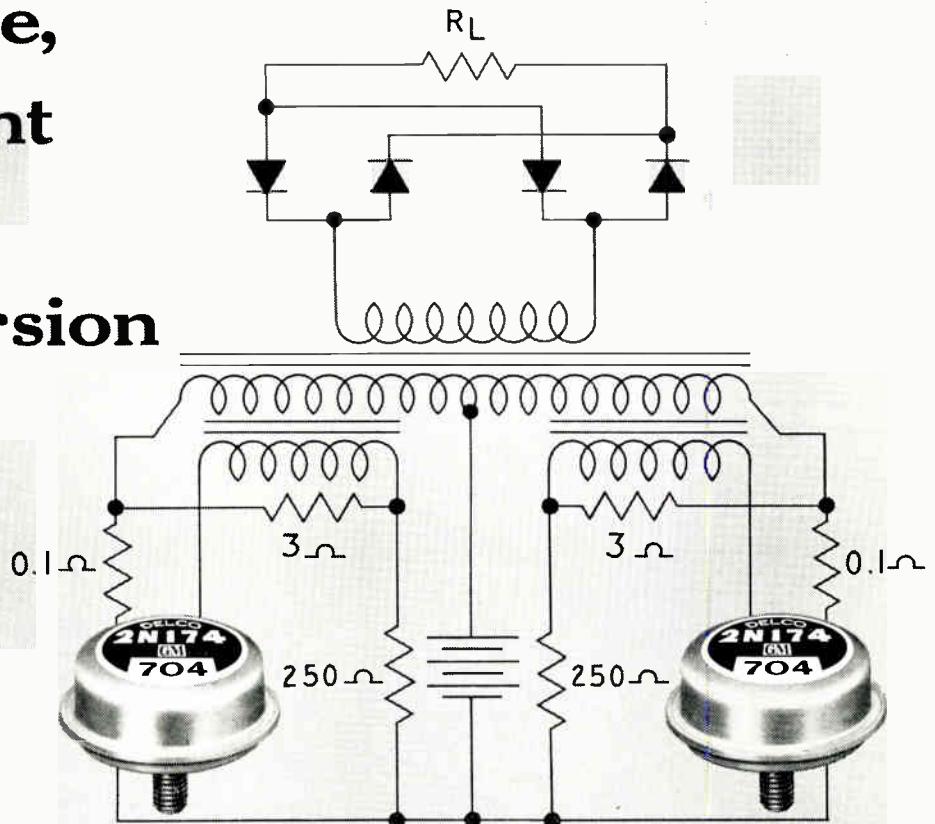

## Industry's Highest Power Transistors

*Low saturation voltage of Delco Radio 2N173 and 2N174 opens new opportunities for converter economy, efficiency and reliability*

The excellent electrical characteristics of Delco High Power transistors permit the conversion of *low* DC voltage to *higher* DC voltage—with a high degree of efficiency—in a wide range of applications. This proved performance offers greater reliability than will be found in corresponding vibrator circuits.

The low saturation voltage of Delco 2N173 and 2N174 transistors also reduces their internal power dissipation in conversion applications to an insignificant degree so that little self-heating is apparent. The result is an overall economy which permits converters of smaller size . . . important in many applications.

TYPICAL CHARACTERISTICS		
	2N173	2N174
Properties (25°C)	12 Volts	28 Volts
Maximum current	12	12
Maximum collector voltage	60	80
Saturation voltage (12 amp.)	0.7	0.7
Power gain (Class A, 10 watts)	38	38
Alpha cutoff frequency	0.4	0.4
Power dissipation	55	55
Thermal gradient from junction to mounting base	1.2°	1.2°
Distortion (Class A, 10 watts)	5%	5%

**DELCO RADIO**

**DIVISION OF GENERAL MOTORS  
KOKOMO, INDIANA**



**OUT OF THIS WORLD**

in the **SATELLITE**

Hundreds of miles out in space a rocket burns out . . . and back on earth, optic and electronic instruments begin tracking the first unmanned satellite as it is launched into its orbit.

Speeding into outer space is perhaps the most rigorous test of components that man has ever devised.

Martin, Baltimore, prime contractor on Project Vanguard, has specified A-MP Terminals and Connectors for the Project because of their proven dependability and enduring quality. Aircraft-Marine products have always been designed to be ahead of the present and abreast of the future.



**A-MP INCORPORATED**

General Office: Harrisburg, Pa.

A-MP of Canada, Ltd., Toronto, Canada  
A-MP Holland N.V., 's-Hertogenbosch, Holland  
Aircraft-Marine Products (G.B.) Ltd., London, England  
Societe A-MP de France, Courbevoie, Seine, France

# Telemetered Data Checks Vanguard Flight

(Continued from page 41)

## Fuel Pressures

Rahm came up with a 316 stainless steel bourdon tube. Hydrogen peroxide, YFNA or UDMH may be introduced directly into the instrument, which is protected by a fail-safe stainless steel case. It tests satisfactorily in all respects.

We overcame the problem of liquid oxygen pressure measurement by eliminating from the transducer organic materials having contact with the liquid oxygen. A Rahm-developed instrument handles hydrogen peroxide pressure measurement in temperatures as high as 500°F. Here the medium is introduced into a capsule of welded stainless steel construction with ceramic interior components.

## Fuel Temperatures

Measuring the temperature of liquids and gases used in the Vanguard vehicle calls for instruments that can withstand the effects of liquid oxygen, white fuming nitric acid, kerosene, hydrazine and hydrogen peroxide. At the same time the instruments must cover a temperature zone ranging from plus 300°F all the way down to -300°F, the approximate boiling point of liquid oxygen.

Thermistors, which have a resistance variable with temperature, receive major consideration. Thermocouples, on the other hand, are avoided to do away with the additional equipment needed to amplify their low-level voltages. Previous experiments revealed that thermistor instruments, particularly in liquid oxygen systems, develop leakage when subjected to pressure.

What is needed is a sealed thermistor temperature probe, similar to the standard thermocouple probes, for assembly into a threaded boss. This has been furnished by Bendix-Friez who enclose the thermistor in an aluminum capsule to make it adaptable for all media in the required temperature ranges. It features series voltage dividing resistors and linearizing resistors in a potted plug and connecting cable assembly.

## Skin Temperatures

Another Vanguard instrumentation challenge is the measurement of skin temperature during the ascent through the atmosphere when extreme aerodynamic heating takes place. With other rockets, similar measurements have been made—probably at lower skin temperatures—by a wire grid cemented to the inside surface of the skin. The electrical resistance of the grid is a function of its temperature.

Such a technique is ruled out in Vanguard. For one thing, the previously used cements have a maximum usable temperature on the order of 600° to 900°F, which is too low for Vanguard. All known

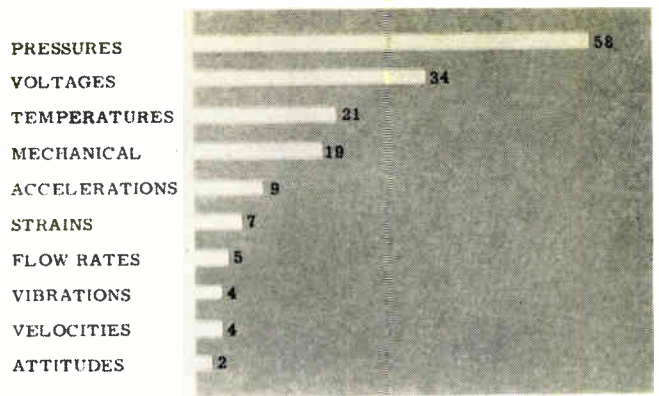

Fig. 3: A measure of the relative importance of telemetered test data is given by this chart of measurements by categories.

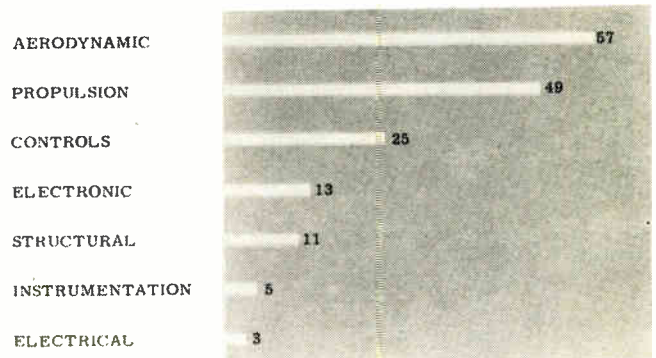

Fig. 4: Relative complexity of different phases of Vanguard project are revealed by this chart of engineering activities.

cementing processes, moreover, require curing at an elevated temperature in an atmosphere of inert gas, usually nitrogen, which prevents the deposit of oxide coatings on the rocket skin. However, it is felt that Vanguard skin materials might warp if held at curing temperature for the required length of time.

The answer to skin temperature measurement has been found in gauges with platinum wire grids cemented to squares of metal foil the size of postage stamps and approximately one mil thick. The foil squares are spot-welded to the Vanguard skin surface, eliminating the need for exposing the skin to high curing temperatures. This fused ceramic process was developed by Aero Research Instrument Company for use in the measurement of jet engine turbine-blade temperatures.

## Philosophy

These are some of the unusual Vanguard instrumentation jobs. For the most part, however, Vanguard instrumentation follows the pattern adopted for other missile and rocket test programs. Our aim has been to step up the quality of proved methods wherever possible instead of jumping into radical techniques that have not been thoroughly verified elsewhere.

It is this system of instrumentation for Vanguard test flights that gives us confidence that a successful satellite launch will take place during the forthcoming International Geophysical Year. Instrumentation, the indispensable bearer of inside information, thus measurably advances the science of rocketry.

\* \* \*

(Continued from Page 72)

Burt U. Levy has been added to the sales staff of Ed Nemeth Associates, industrial electronic reps covering Metropolitan New York and New Jersey.

MEL Sales of Arnprior, Ontario, is now Canadian rep for the Reflectone Corporation.

Components, Inc., 5451 Broadview Rd., Cleveland, will represent the Rotron Manufacturing Co. in Northern Ohio and the western half of Pennsylvania.

Forshay Sales Corp., 27 Park Pl., N. Y. 7, are representing Welwyn International Inc. in Metropolitan New York, Northern New Jersey and Long Island.

J. Y. Schoonmaker Co., 2011 Cedar Springs, Dallas, Tex. has been appointed reps for Clevite semi-conductor products in the Texas, Arkansas, Louisiana, and Oklahoma areas.

Herbert G. Krumich has been appointed rep for the electronic tube division of the Westinghouse Electric Corp.

Yarbrough Sales Co., Los Angeles rep firm, has announced an expansion into new, larger quarters at 2636 Mission St., Marino, Calif.

Loren F. Green & Associates, 5218 W. Diversey Ave., Chicago 39, Ill. has been appointed reps by the Electronic Tube Corp. of Philadelphia, for the states of Illinois, Indiana, Wisconsin, Minnesota and Iowa.

Herman H. Sticht Co., Inc., New York will distribute to the trade in Southern California via Frank A. Emmet Co., Los Angeles electronic rep firm.

East Coast Engineering Sales & Service Co., 1405 Northern Blvd., Roslyn, N. Y. have been appointed reps for the General Hermetic Sealing Corp. in the area east of the Rocky Mountains.

M. J. Howard & Co., 132 Crocus Ave., Ottawa, Ont., Canada are now reps in the Provinces of Ontario and Quebec for the Waters Manufacturing, Inc.

Precision Radio, Ltd., Honolulu electronic components distributor, has been appointed Hawaiian outlet for WYCO Metal Products line.

Bernard L. Cahn Co. has been formed with offices at 247 Lake St. in San Francisco. They will cover the Northern California and Northern Nevada areas.

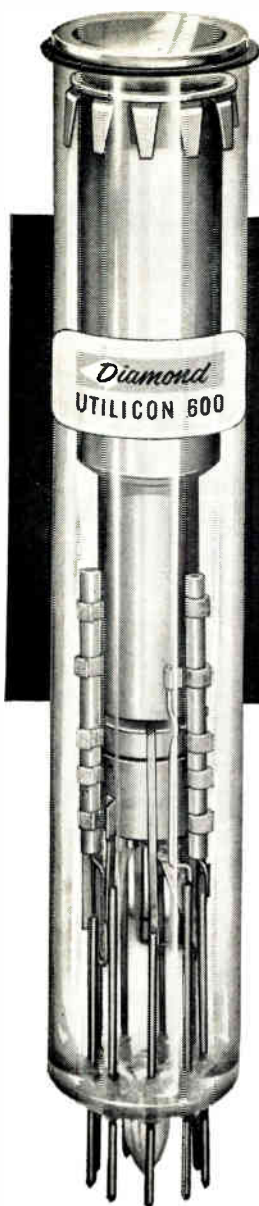

## UTILICON 600

AN *Improved*

### TELEVISION CAMERA TUBE

This new high-sensitivity photo conductive television pickup tube is for use in studio, telecine and ITV cameras. Following are its important advantages: (1) High signal output permitting greater depth of focus and requiring less video amplification. (2) Rugged surface for industrial use—cannot be burned by scan failure. (3) High light current output and low dark current output. (4) Operation at high ambient temperatures—dark current essentially constant with temperature change. (5) Surface uniformity. (6) Low target voltage required—significant in transistor circuits. (7) Tube can be oriented for maximum resolution in any desired direction because there is no side tubulation.

Actual Size

Write for Form 2109 giving specifications and performance data.

7789

*Diamond*

ELECTRONICS DEPARTMENT  
**DIAMOND POWER  
SPECIALTY CORPORATION**  
LANCASTER, OHIO



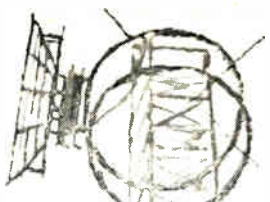

**NEW!**

# BLAW-KNOX TOWERS FOR MICROWAVE SYSTEMS

Here is a new 10 page Bulletin prepared especially to provide answers to your specific questions on—

“What type tower do I need?”

“How much will it cost?”

Describes design features you should look for in selecting a tower.

Contains pictorial description of best tower fabrication methods and procedures leading to simplified erection.

Gives you time saving, step-by-step procedure for obtaining the tower designed to best suit your specific requirements.

Call or write today for Bulletin 2538.



**BLAW-KNOX COMPANY**  
*Blaw-Knox Equipment Division*  
*Pittsburgh 38, Pennsylvania*

## MICROWAVE TOWERS

Blaw-Knox designs, engineers and fabricates guyed and self-supporting type Microwave Towers and ... Transmission Towers... Guyed and self-supporting Antenna Towers for AM, FM, TV, Radar... Parabolic Antennas for tropospheric scatter propagation... Structures custom built to support special equipment

# Reliability



Isolated microwave relay installations must be reliable and require the extra performance factors of mechanical and electrical design found only in ANDREW Parabolic Antennas. Thousands of installations serving over a million channel miles of microwave have proven their superiority.

ANDREW offers a complete range of sizes and frequencies. Specify ANDREW Antennas for your microwave system. Here is a representative selection of stock antennas.

#### TYPE NUMBERS OF STOCK PARABOLIC ANTENNAS

Frequency Range (MC)	ANDREW Type Number			
	4 ft. dia.	6 ft. dia.	8 ft. dia.	10 ft. dia.
890 - 920	1004A-1	1006A-1		1010A-1
920 - 960	1004A-2	1006A-2		1010A-2
1700 - 1850	2004A-1	2006A-1	2008A-1	2010A-1
1850 - 1990	2004A-2	2006A-2	2008A-3	2010A-3
1990 - 2110	2004A-3	2006A-3	2008A-3	2010A-3
2450 - 2700		P6-24		P10-24
3750 - 4200			PS8-37	
5925 - 6425	P4-59	P6-59	P8-59	P10-59
6575 - 7125	P4-65	P6-65	P8-65	P10-65
7125 - 7425	P4-71	P6-71	P8-71	P10-71

#### TYPE P4-71

Freq. Range	7125-7425 MC
Max. VSWR	1.10
Min. Gain Over Isotropic	36.8 db
Side Lobe Level	-24.0 db
Input Connection	UG-343A/U Pressurized (Max. 15 PSI)

Specifications of these and other stock antennas and special design antennas are available by consulting the ANDREW Sales Engineer in your area or by writing to:

**Andrew**  
CORPORATION  
363 EAST 75th STREET • CHICAGO 19

Offices: New York • Boston • Los Angeles • Toronto

Circle 100  
on Inquiry Card

ANTENNAS • ANTENNA SYSTEMS • TRANSMISSION LINES

# ELECTRONIC SOURCES

ELECTRONIC INDUSTRIES' exclusive monthly digest of the world's top electronic engineering articles



## ANTENNAS, PROPAGATION

Adjacent Channels and the Fourier Curse, J. S. Smith. "IRE Trans. PGVC-9." June 1957. 9 pp. The author discusses adjacent channel interference due to wide and narrow band FM, AM, and SSBAM transmitters. Results of measurements are given, together with a brief analytic discussion to illustrate why the expected results are obtained. Improvements resulting from audio cutoff filters are demonstrated.

Directional Antennas with Apertures of Special Shapes, G. F. Koch. "Nach. Z." April 1957. 12 pp. A description is given of rhombic reflectors as examples of homogeneously illuminated aperture radiators with specially shaped apertures. Part II outlines the theory of inhomogeneously illuminated aperture radiators. The appendix contains an explanation of the theory for the calculation of reflections back into the feed caused by a homogeneously illuminated substitute aperture and of the horizontal radiation pattern for paraboloid reflectors with an offset feed.

The Mode Theory of VLF Ionospheric Propagation for Finite Ground Conductivity, by J. R. Wait. "Proc. IRE." June 1957. 8 pp. The space between the earth and the ionosphere is considered as a waveguide with sharply bounded walls. It is shown that the effect of the finite conductivity of the ground is quite important for propagation to great distances. Good agreement is obtained with the experimental results of J. Heritage.

Antenna System Problems with High-Speed Aircraft, by F. W. Bushman. "Aero. Eng. Rev." May 1957. 4 pp.

Reflection at a Sharply-Bounded Ionosphere, by I. W. Yabroff. "Proc. IRE." June 1957. 4 pp. A quantitative description of the waves transmitted into and reflected from a sharply-bounded, anisotropic ionosphere with losses is given. Curves show the effects of the earth's field and losses for a particular model of the night time E layer at VLF.

The Present State of Knowledge Concerning the Lower Ionosphere, by A. H. Waynick. "Proc. IRE." June 1957. 9 pp. A survey of present VLF knowledge.

The Effect of Fading on Communication Circuits Subject to Interference, by F. E. Bond and H. F. Meyer. "Proc. IRE." May 1957. 7 pp.



## AUDIO

Hybrid Hi-Fi Amplifier, by L. Feldman and S. A. Lipsky. "El. Des." May 1, 1957. 1 p. A transistorized preamplifier operating from a high voltage source is described. Circuits described are part of a commercial hybrid amplifier.



## CIRCUITS

On the Approximation of Particular Dependencies on Frequency by Means of Frequency Function Tables, H. Dobsch. "Hochfreq." March 1957. 6 pp. An approximation method applicable to two-terminal networks is described which facilitates the circuit design with the aid of tables. Reactive impedance curves, and phase and group velocity curves can be obtained.

On the Chain Properties of Amplifier-Four-Terminal Networks and Their Equivalent Circuits as Applied to Transistors, C. Kurth. "Freq." April 1957. 8 pp. The theory of determinants as applied to four terminal vacuum-tube amplifier circuits is developed and modified to be applicable to the different properties of transistor networks. A filter, modulator, filter sequence is discussed as example.

Transitron Negative Resistance, A. G. Bogle. "E & R Eng." May 1957. 5 pp. Investigation is reported which leads to the conclusion the negative resistance of the screen of a transitron-connected pentode is approximately inversely proportional to the cathode current.

A Transistor Demodulator, H. Sutcliffe. "El. Eng." March 1957. 2 pp. Economical design is achieved by using transistors both as linear signal amplifiers and as non-linear rectifying elements.

Designing for Reliability, N. H. Taylor. "Proc. IRE." June 1957. 12 pp. The thorough design method developed by Lincoln Laboratory is described in detail; the method provides reasonable component tolerances and adequate safety margins. A detailed example of a high-speed, vacuum-tube flip-flop is used for illustration.

A Low-Voltage D.C. Stabilizer Using a Saturated-Diode Controller, F. A. Benson and M. S. Seaman. "El. Eng." March 1957. 5 pp. An experimental dc stabilizer with an output voltage of 6.3 v and capable of supplying currents up to 30 amp. is described. It uses a saturated diode as the controlling element and is particularly suitable for supplying tube heaters. The circuit can be adapted to operate at other output voltages.

A Feedback Modulator, by J. L. Douce and M. Flinders. "El. Eng." May 1957. 2 pp. The unit modulates the mark-to-space ratio of a 10 kc pulse train in accordance with an input voltage. Feedback is used to obtain high accuracy and long term stability.

Circuit Analysis by Normalization, by J. J. Hupert. "El. Eng." May 1957. 5 pp. The author draws attention to a method of network analysis based on a procedure of normalization similar to that used in the concept of the normalized resonance curve. The concept of frequency as a complex number opens a number of interesting possibilities in application of lucid mathematical techniques to the examination of network functions.

## REGULARLY REVIEWED

- AEG Prog. AEG Progress
- Aero. Eng. Rev. Aeronautical Engineering Review
- Ann. de Radio. Annales de Radioelectricite
- Arc. El. Uber. Archiv der elektrischen Uebertragung
- ASTM Bul. ASTM Bulletin
- Auto. Con. Automatic Control
- Auto. El. The Automatic Electric Technical Journal
- Avto. i Tel. Avtomatika i Telemekhanika
- AWA Tech. Rev. AWA Technical Review
- BBC Mono. BBC Engineering Monographs
- Bell Rec. Bell Laboratories Record
- Bell J. Bell System Technical Journal
- Bul. Fr. El. Bulletin de la Societe Francaise des Electriciens
- Cab. & Trans. Cables & Transmission
- Comp. Rend. Comptes Rendus Hebdomadaires des Seances
- Comp. Computers and Automation
- Con. Eng. Control Engineering
- E. & R. Eng. Electronic & Radio Engineer
- Elek. Elektrichestvo
- El. Electronics
- El. & Comm. Electronics and Communications
- El. Des. Electronic Design
- El. Energy. Electrical Energy
- El. Eng. Electronic Engineering
- El. Eq. Electronic Equipment
- El. Ind. ELECTRONIC INDUSTRIES & Tele-Tech
- El. Mfg. Electrical Manufacturing
- El. Rund. Elektronische Rundschau
- Eric. Rev. Ericsson Review
- Freq. Frequenz
- GE Rev. General Electric Review
- Hochfreq. Hochfrequenz-technik und Elektroakustik
- IBM J. IBM Journal
- Insul. Insulation
- IRE Trans. IRE Transactions of Prof. Groups
- Iz. Akad. Izvestia Akademii Nauk SSSR
- J. BIRE. Journal of the British Institution of Radio Engineers
- J. ITE. Journal of The Institution of Telecommunication Engineers
- J. IT&T. Electrical Communication.
- J. UIT. Journal of the International Telecommunication Union
- Nach. Z. Nachrichtentechnische Zeitschrift
- NBS Bull. NBS Technical News Bulletin
- NBS J. Journal of Research of the NBS.
- NRL. Report of NRL Progress
- Onde. L'Onde Electrique
- Phil. Tech. Philips Technical Review
- Proc. AIRE. Proceedings of the Institution of Radio Engineers
- Proc. BIEE. Proceedings of the Institution of Electrical Engineers
- Proc. IRE. Proceedings of the Institute of Radio Engineers
- Radiotek. Radiotekhnika
- Radio Rev. La Radio Revue
- RCA. RCA Review
- Rev. Sci. Review of Scientific Instruments
- Rev. Tech. Revue Technique
- Syl. Tech. The Sylvania Technologist
- Tech. Haus. Technische Hausmittellungen
- Tech. Rev. Western Union Technical Review
- Telonde. Telonde
- Toute R. Toute la Radio
- Vak. Tech. Vakuum-Technik
- Vide. Le Vide
- Vestnik. Vestnik Svyazy
- Wire. Wld. Wireless World

For more information, contact the respective publishers directly. Names and addresses of publishers may be obtained upon request by writing to "Electronic Sources" Editors, ELECTRONIC INDUSTRIES & Tele-Tech, Chestnut & 56th Sts., Philadelphia 38.

# International ELECTRONIC SOURCES

**Bandwidth Limitations in Equalizers and Transistor Output Circuits**, by J. L. Stewart. "IRE Trans. PGCT." March 1957. 5 pp.

**Degenerate Solutions and an Algebraic Approach to the Multiple-Input Linear Filter Design Problem**, by R. M. Stewart and R. J. Parks. "IRE Trans. PGCT." March 1957. 5 pp.

**Optimum Filters for Independent Measurements of Two Related Perturbed Messages**, by J. S. Bendat. "IRE Trans. PGCT." March 1957. 6 pp.

**A Crystal-Controlled Signal Generator**, by M. T. Stockford. "El. Eng." May 1957. 4 pp. The generator gives 5 watt output at 937.5 mc to drive a VX8175 klystron.

**Design of Three-Resonator Dissipative Band-Pass Filters Having Minimum Insertion Loss**, by J. J. Taub and B. F. Bogner. "Proc. IRE." May 1957. 7 pp.

**Preset Gating Unit for Aeroballistic Testing**, by S. E. Dorsey. "El." May 1, 1957. 3 pp. Circuits were devised for control of flash units to photograph missile models during free flight.

**Electronic Organ Uses Shared Oscillators**, by T. J. George and S. Cutler. "El." May 1, 1957. 3 pp. The design of the tone generator and controls is described. Only 16 oscillators are required in this system.

**Missile Telemeter Uses Transistor Amplifier**, by J. H. Porter. "El." May 1, 1957. 2 pp.

**A Two-Phase Low-Frequency Oscillator (part two)**, by E. F. Good. "El. Eng." May 1957. 4 pp.

**Power Amplifier For Servo Testing**, by J. M. Diamond. "El." May 1, 1957. 2 pp. A 90-watt system provides 400 to 2,600 cps power for servo tests. Circuits and description are included.

**Tristable Gate Moves CRO Line Drawings**, by P. A. Ryan. "El." May 1, 1957. 3 pp. A novel simulator of facial outlines is described. A line drawing of a face appears on the oscilloscope and can be animated by suitable potentiometer controls.

**A Millimicrosecond Time-Base**, by M. W. Jervis and R. T. Taylor. "El. Eng." May 1957. 2 pp. A circuit suitable for sweeping typical single stroke cathode-ray tubes in a few millimicroseconds is described.

**High-Temperature Subassembly Design**, by R. Bruce Kiebertz. "El." May 1, 1957. 4 pp. Work toward 500°C operation is summarized.

**Forming Musical Tone Colours From Complex Waveforms**, by A. Douglas. "El. Eng." May 1957. 5 pp. A survey is made of the principal methods used to derive musical waveforms.

**VLF Oscillator Keys VHF Generator**, by L. H. Dulberger. "El." May 1, 1957. 2 pp. A transistorized keyer for signal generator output is described.



## COMMUNICATIONS

**Very Low-Frequency Radiation from Lightning Strokes**, E. L. Hill. "Proc. IRE." June 1957. 3 pp. A theory of the generation of low-frequency electro-magnetic radiation by cloud-ground lightning strokes is presented. Some qualitative considerations on the emission of radiation at extremely low frequencies are given.

**The Correction of Synchronism in Radio Operated Start-Stop Teleprinter Systems**, W. Kronjäger, B. Lenhart, and K. Vogt. "Nach. Z." April 1957. 8 pp. This article tells of the difficulties encountered with start-stop synchronized teletype radio circuits produced by interference effects on the synchronization pulses. An improvement of transmission quality is effected for uni-directional links when the text is not ciphered.

**Out-of-Channel Radiation from Mobile FM VHF Transmitters**, A. L. Rowles. "El. Eng." March 1957. 6 pp. The peak-clipper method of restricting frequency deviation in mobile fm transmitters produces harmonic distortion of the modulating waveform; this can result in adjacent channel interference. Some theoretical consideration is given to the problem of eliminating the effects of clipped-wave-form sidebands by the use of a post-limiter filter in the transmitter.

**Data Link Rides on Tacan Signals**, J. Holahan. "Aviation Age." May 1957. 4 pp. This is a review of the data link developed by Federal Telecommunication Laboratories. The data link utilizes Tacan signals for transmission of data and acknowledgement signals.

**A Basic Modulation Unit for Military Carrier Systems**, A. E. Peterson. "Bell Rec." May 1957. 4 pp. A modulator and demodulator for the basic group of four channels used by two new carrier telephone systems for the military services is described.

**Where Do We Stand on Data Link?** J. Holahan. "Aviation Age." May 1957. 4 pp. The author reviews the general status of data links. Multiplexing and modulation techniques are compared.

**Experience with Single-Sideband Mobile Equipment**, R. Richardson, O. Eness, and R. Dronuth. "Proc. IRE." June 1957. 7 pp. Experimental vhf single-sideband equipment used for performance comparison with narrow-band fm equipment is described. A lab comparison and a field comparison of the SSB equipment and the fm equipment indicates that for comparable size equipment using the same final amplifier tube, an equal service range can be obtained.

**A Review of Proposed Carrier Systems for Data Transmission**, F. B. Bramhall. "Tech. Rev." April 1957. 9 pp. This is a review of requirements for high-speed transmission and some work done in this field by IBM, Bell, MIT, Sperry Rand, and Western Union.

**Noise Investigation at VLF by the National Bureau of Standards**, W. Q. Crichlow. "Proc. IRE." June 1957. 5 pp. A review of present work.

**Auxiliary Facsimile Developments**, A. S. Hill. "Tech. Rev." April 1957. 4 pp. Some little publicized features of facsimile machines are described, including a synchronous power supply for Desk-Fax machines in d-c powered areas, and an automatic stylus adjustment.

**Some Recent Measurements of Atmospheric Noise in Canada**, by C. A. McKerrow. "Proc. IRE." June 1957. 5 pp.

**Radio Relay Carrier Improvements**, R. R. Gose. "Tech. Rev." April 1957. 8 pp. New microwave components and improved FM carrier terminal apparatus provide for 640 teleprinter circuits on 640 different channel frequencies over 32 three-kilocycle bands.

**The Installations for Wire-Bound Communication in the Air Traffic Control Within the Federal Republic of Germany**, K. Heidelauf. "Nach. Z." April 1957. 8 pp. A review is given of the development and application of the wire communication installations since civil air traffic control was taken over by the German administration in 1953. The installations designed especially for the Air Traffic Control Services are described.

**Investigations into the Possibilities of Coverage with Offset Operation on VHF/FM**, E. Belger, E. Paulsen, and I. Dahrendorf. "Rundfunk." April 1957. 7 pp. According to available data, the offset principle, using two or more geographically adjacent transmitters, is only in exceptional cases suitable for regional coverage. The main reason for this lies in the greatly increased susceptibility to interference with a third transmitter. However, the method offers advantages where transmitters working in other channels are located between the transmitters offset in frequency, as this avoids whistling interference such as occurs between transmitters of nearly the same frequency in the same group. Moreover, it offers advantages for small auxiliary transmitters serving small concentrations of population and in very broken country.

**Phase-Lock A.F.C. Loop**, R. Leek. "E & R Eng." April & May 1957. 13 pp. The application discussed here is concerned with tracking a high-order property of the input signal, namely, its rate of change of frequency. The rate of change discussed is of the order of 10 kc.

**Characteristics of Atmospheric Noise from 1 to 100 KC**, A. D. Watt and E. L. Maxwell. "Proc. IRE." June 1957. 8 pp. Results of preliminary statistical measurements of the envelope of narrow band atmospheric noise are presented for a range of center frequencies from 1 to 100 kc.

**Improvements in Western Union's First Microwave Telegraph System**, T. M. Grybowski. "Tech. Rev." April 1957. 7 pp. Recent changes and improvements in the system installed in 1947 are detailed.



## COMPONENTS

**Improving the Glow Transfer Tube**, T. M. Jackson. "El. Ind." July 1957. 3 pp. Glow counter tubes may misfire after long stationary periods. This is caused by cataphoresis, a migration of impurities toward the cathode. Careful design can eliminate this.

**New Horizons for Battery Power**, A. E. Look, Jr. "El. Ind." July 1957. 6 pp. A survey of new developments in the field of battery power.

**New Grids Improve Lead-Acid Cells**, Dr. H. J. Strauss. "El. Ind." July 1957. 2 pp.

**Reliability in Electrical Connections**, R. George Roesch. "El. Des." May 1, 1957. 4 pp. Electrical connection reliability in printed circuits, mechanical assemblies, and soldered joints is discussed.

**Component Developments Influencing Aviation Electronics**, L. Davis, Jr., and L. G. Rubin. "Aero. Eng. Rev." May 1957. 6 pp. The impact of transistors, infrared devices, ferrites, and MASER devices on aviation electronics is conjectured.

**Transformer Design with Modern Materials**, R. Lee. "El. Eq." May 1957. 4 pp.

**The Magnetic Disc Memory**, O. Schroter. "El. Rund." April 1957. 6 pp. Design, recording process, and address selection of the IBM system are considered. Reference is made to RAMAC and DPM applications of the magnetic disc memory.

**Transformer Design Nomograph**—I. M. Berger. "El. Des." May 1, 1957. 2 pp. An Iron Core Inductance nomograph is described. It is intended for use in designing small audio transformers and filter inductances.

**Flattening response of Crystal Pickups**, by A. L. Cleland. "El." May 1, 1957. 3 pp.

**The Design of Iron-Cored Chokes Carrying Direct Current**, P. K. McElroy. "Experimenter." March 1957. 8 pp. Design considerations are systematically explored, and practical design curves presented.

**Solid-State Research Brews Upheaval**, P. J. Klass. "Av. Wk." April 8, 1957. 4 pp. Micro-miniaturization development and future possibilities as a result of recent solid-state research are discussed.

**Tolerance Limit of Resistors in Binary Scaling Units**, by B. M. Banerjee and S. Choudhury. "El. Eng." May 1957. 5 pp.

**On the General Solution of Boundary Value Problems in the Transmission of Heat or Electrical Energy**, L. v. Szalay and K. H. Loecherer. "Freq." April 1957. 10 pp. The method of Picone and Amerio is applied to the solution of the differential equation for the transmission of heat or electrical energy for various initial and boundary conditions. The solutions for the prism, the cylinder with circular symmetry, and the sphere with radial symmetry are derived.

**Magnetic Amplifiers**. "E & R Eng." April 1957. 6 pp. Basic principles, advantages, and limitations are discussed—and areas of competition from other devices are studied.

**Emission Current Regulator for Rocket-Borne Radio-Frequency Mass Spectrometer**, J. C. Holmes. "Rev. Sci." April 1957. 1 p. A transistorized series-type regulator meeting weight, size, and power requirements of rockets is described.

**Simplified Design of Small Extension Springs**, P. F. Recca and F. W. Smith. "Tech. Rev." April 1957. 12 pp. Theory, practical considerations, and extensive engineering design data are presented.

**Protection of Communication Cables in Regions with Strong Inductive Disturbances**, P. Simon. "Freq." March 1957. 5 pp. The dangers to communication cables and personnel due to the proximity of power stations are outlined. The effects of increased insulation, increased distance, insertion of repeaters, voltage-reducing leakage paths, repeaters or chokes grounded at their center, compensating circuits, and relays circuits are studied.

**Damp-Proofing Electronic Equipment**, A. M. Foote. "El. & Comm." April 1957. 1 p. A large-area heat source is placed in electronic equipment to prevent condensation.

**A New Approach to Conservative Design**, K. A. Pullen. "El. Eq." May 1957. 4 pp. The author describes minor improvements in design information needed to improve the reliability of many common circuits.

**Electronic Equipment Cooling by Simultaneous Heat and Mass Transfer**, A. R. Saltzman, B. T. Plizak, and L. F. Tomko. "Aero. Eng. Rev." May 1957. 8 pp. In the system described here, air is assigned the subordinate role of carrier of vapor heat, thus allowing its usage at relatively high temperature levels.

**Designing for Vibration and Shock Resistance**, T. M. Billings. "Environmental Quarterly." Vol. 3, No. 2. 1957. 4 pp.

**What You Should Know About Shielded Enclosures**, E. S. Kesney. "El. Eq." May 1957. 4 pp. Several common types of shielded enclosure are described, and the relative advantages of each discussed.

**Piezoelectric Crystal Engineering**, H. O. Koch. "Freq." March 1957. 11 pp. This second installment of an extensive article deals with the etching method in an electric field and the results obtained with a light microscope. The observations made during a large number of experiments are reported and illustrations show the various surface configurations found.

**Quality is no Accident**, E. N. Lent. "El. & Comm." April 1957. 3 pp. A general description of quality control functions and facilities for an electronic equipment manufacturer.

**How to Pick Cooling Systems for Electronics at Mach 1-3**, C. F. Johnson. "Aviation Age." May 1957. 3 pp. A review of the present state of the art of cooling airborne electronic equipment.

**Incidents Due to Lightning on the Telephone Cable at Abidjan-Agboville**, R. Beraud. "Cab. & Trans." April 1957. 9 pp. When laying the 84 km long, loaded multiple telephone cable in French West Africa, serious incidents were caused by thunderstorms during the splicing of the conductors. Various precautionary measures to prevent the occurrence of such incidents are suggested and their effectiveness is reported.

**Cryostats and Mechanical Stage for Nuclear Magnetic Resonance Studies**, L. N. Muly. "Rev. Sci." April 1957. 4 pp. Cryostats for use with liquid helium and other coolants providing temperatures in the range 77° to 600°K constant to within  $\pm 1^\circ$  are described.

**Flush Discharger Cuts Corona Static**, P. J. Klass. "Av. Wk." April 29, 1957. 2 pp. A flush-mounted replacement for troublesome wick static dischargers is described.



## COMPUTERS

**High Amplitude Pulse Gate**, G. A. Sample. "El. Ind." July 1957. 2 pp. A pulse gate is described which is capable of passing or blocking positive pulses of 100 volts maximum amplitude and 0.25 microsecond minimum width. Insertion loss is about 15%.

**Cooling Robot Brains**, N. E. Sheldon, C. A. Nolph & G. A. Fleischer. "El. Ind." July 1957. 2 pp. Carefully engineered cooling systems must be provided for modern electronic computers. Filtered and cooled air must be supplied to give reliability.

**Characteristic Function-Groups of Data Processing Systems**, H. Zscheke. "El. Rund." April 1957. 2 pp. The construction of data processing systems comprise a number of functional groups. By way of example, an electric coordinator effecting input and output magnitude coordination by plug connections is described, its essential properties are considered. A multiplication unit is described.

**How to Use Magnetic Shift Registers**. "El. Eq." May 1957. 3 pp. Basic theory is discussed and a typical equipment described.

**A 32,000-Word Magnetic-Core Memory**, by E. Foss and R. S. Partridge. "IBM J." April 1957. 7 pp. Development and engineering aspects are described for a memory unit containing over one million magnetic cores and their circuits. Electrical and mechanical arrangements and packaging are discussed, and a description is given of the driver circuits and the sense amplifier used.

**Binary Data Transmission Techniques for Linear Systems**, by M. L. Doelz, E. T. Heald, and D. L. Martin. "Proc. IRE." May 1957. 6 pp. Advantages of SSB equipment for binary data transmission are discussed.

**Addressing for Random-Access Storage**, by W. W. Peterson. "IBM J." April 1957. 17 pp. Estimates are made of the amount of searching required for the exact location of a record in several types of storage systems, including the index-table method of addressing and the sorted-file method. Detailed data and formulas for access time are given for an

"open" system which offers high exibility and speed of access.

**A Symmetrical-Transistor Steering Circuit**, J. L. Walsh. "IBM J." April 1957. 4 pp. A bilateral transistor phase-inverter having application in digital computer switching circuits is discussed.

**A Self-Clocking System for Information Transfer**, L. D. Seader. "IBM J." April 1957. 4 pp. The author describes a circuit which generates a continuous train of clock pulses bearing a fixed phase relationship to information pulses. By switching two gated oscillators, the information pulses continuously correct the phase of the clock pulses.

**On Matrices of Residues of the Impedance or Admittance Matrices of "n" Ports**, by I. Cederbaum. "IRE Trans. PGCT." March 1957. 2 pp.

**The Multipurpose Bias Device, Part I—The Commutator Transistor**, by B. Dunham. "IBM J." April 1957. 15 pp. A study is made of the Rutz commutator transistor largely in application to three-input, one-output logical situations.

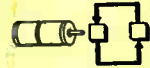

## CONTROLS

**Automatic Punched Card-Controlled Fill-up Weighing Machine**, A. Sessler. "El. Rund." April 1957. 1 p. The machine described here contains photo-electric control elements and electronic counters which are set according to a punched card containing the mixture composition. Operation and application possibilities of such automatic recording multi-ingredient fill-up weighing machines are considered.

**Control and Instrumentation in a Nuclear Power Station**, R. J. Smith. "El. Energy." May 1957. 5 pp. A survey of the systems used in the first Scottish nuclear power station.



## INDUSTRIAL ELECTRONICS

**Printing System for Digital Measuring Instruments**, J. Hacks and M. Klose. "El. Rund." April 1957. 3 pp. By electronic supplementing of an ordinary electric balancing unit, a control device for the printing of digits taken from linear rising voltage steps can be made. The system is applied for the recording of measurement results of electronic counters, digital frequency, time, and voltage meters and similar instruments. The balancing unit remains unaltered, thus facilitating optional conventional hand actuation. Circuits are described for the linear rising voltage step origination.

**An Electronic Measuring System for a Jig Borer**, C. R. Borley. "El. Eng." March 1957. 4 pp.



## MATERIALS

**The Metallurgical Aspects of "Resistance"**, Dr. T. P. Wang and E. T. Kubilins. "El. Ind." July 1957. 3 pp. The resistance of a wire is determined by the alloys and heat treatment used in its manufacture, as well as subsequent deformation and elastic strains.

# International ELECTRONIC SOURCES

**Microwave Frequency Doubling from 9 to 18 KMC in Ferrites**, by J. L. Melchor, W. P. Ayres, and P. H. Vartanian. "Proc. IRE." May 1957. 4 pp. Improved conversion efficiency is reported—marked dependency on geometry of the ferrite is found.

**Effects of Zero Ferrite Permeability on Circularly Polarized Waves**, by B. J. Duncan and L. Swern. "Proc. IRE." May 1957. 9 pp. Experimental data on propagation characteristics of ferrites in the vicinity of zero permeability is presented. Work in the 9 KMC region is cited.

**Selection of Non-Metallic Materials**, J. H. Du Bois. "El. & Comm." April 1957. 4 pp. A general discussion of ceramics, ceramoplastics, glass-bonded mica, and commonly used plastics.



## MEASURING & TESTING

**Telemetered Data Checks Vanguard Flight**, F. W. Phalen. "El. Ind." July 1957. 3 pp. A Vanguard Viking test needs up to 200 measurements, including data from highly corrosive fuels. Engineers are meeting the challenge with new components and techniques.

**New Test Signals Monitor TV Transmission**, J. R. Popkin-Clurman and F. Davidoff. "El. Ind." July 1957. 3 pp. Signals inserted during the vertical blanking interval provide a constant indication of picture quality, yet do not interfere with home reception. Signals check relays simply.

**Localization of Dielectric Faults in Coaxial and Balanced Lines**, I. Eyraud. "Cab. & Trans." April 1957. 11 pp. The apparatus for the localization of the dielectric fault comprises a bridge. Two arms of the bridge are formed by a potentiometer, the two other arms are two line sections on either side of the fault. The bridge is balanced by means of a sensitive galvanometer. The circuit, the measurement technique, subsequent calculations, and results obtained are discussed in detail.

**A Selective Tube Voltage Indicator for the VHF Range**, H. Mack. "El. Rund." April 1957. 4 pp. For echo attenuation measurements, for the recording of attenuation curves of filters, for the measurement of antenna radiation patterns, and many other purposes selective voltage indicators are required with a measuring range up to 80 db. A selective tube voltage indicator for the 30-300 mc frequency range is described. The discussion of its individual stages is combined with an investigation into the sensitivity of the unit, the stability of its gain, and its measuring precision.

**Attenuation and Transients of Electrical Measuring Instruments According to the Regulations for Measuring Instruments VDE 0410/1.53**, G. Jentsch. "Freq." March 1957. 7 pp. The regulations prescribed by the VDE for the behaviour of electrical measuring instruments are set forth. A first excess amplitude of 20% is permissible and a smoothing time of 4 sec. is considered a maximum. The performance of a measuring instrument as based on these two characteristics is discussed and curves to determine the optimum reproduction of a value to be measured are included.

**Speed Indicator Has Expanded Scale**, by P. J. Pollard. "El." May 1, 1957. 3 pp. An accurate electronic speed indicator circuit for operation from an a-c tachometer is described.

**A Continuous Amplitude/Time Analyser for a Band of Low Frequencies**, by W. A. P. Young. "El. Eng." May 1957. 3 pp. A two channel bandpass amplifier and integrator for 16 to 30 cps is used to analyse the faster waves in electroencephalograms.

**Transistor Beta Tester**, by G. F. Montgomery. "El." May 1, 1957. 1 p. Circuit and operating technique are described for a transistor beta test instrument.

**Measuring Aircraft Engine Speed**, J. J. Fraizer. "GE Rev." May 1957. 3 pp. A review of modern requirements for measurement of aircraft engine speeds.

**Sand and Dust Testing**, B. Friedman. "Environmental Quarterly." Vol. 3, No. 2. 1957. 3 pp. The author describes extensive tests, the result of which show testing in strict accordance with MIL-E-5272A is feasible.

**Simultaneous Color-TV Test Signal**, by R. C. Kennedy. "El." May 1, 1957. 4 pp. Principles and operating characteristics of the NBC-developed color test signal system are discussed.

**The Shortest Radio Waves**, W. Gordy. "Scientific American." May 1957. 8 pp. The gap between infrared and microwave has been closed. One result is a microwave spectroscopy offering extraordinarily high resolution and high precision compared with infrared spectroscopes in the same frequency range. Techniques and some early results of work at Duke University are presented.

**An Absolute Microwave Wattmeter**, by A. MacPherson. "Proc. IRE." May 1957. 1 p. Simple, accurate measurements are claimed for a calorimetric highpower microwave wattmeter.

**Counter Circuits Analyze Ignition**, by E. F. Weller, Jr., N. W. Schubring, and M. E. Fitch. "El." May 1, 1957. 5 pp. An ignition analyzer is described; circuits are given.

**A Technique for the Rapid Analysis of Whistlers**, J. K. Grierson. "Proc. IRE" June 1957. 5 pp. A new type of sound spectrograph, intended for analyzing whistlers, is described. The instrument is a single-channel scanning type, scanning the frequency-time plane in frequency at a fixed time rather than in time at a fixed frequency. This type of audio frequency spectrograph appears to combine speed of operation with fine resolution in frequency.

**Role of the Earth Satellite in Four Important IGY Experiments**, R. W. Porter. "Aero. Eng. Rev." May 1957. 5 pp.

**Intercontinental Frequency Comparison by Very Low-Frequency Radio Transmission**, J. A. Pierce. "Proc. IRE" June 1957. 10 pp. Evidence is given that a single source of standard frequency can be made available at vlf on a world-wide basis. At 16 kc, and at a distance of 5200 km, the Doppler effects in transmission seldom exceed  $\pm 3$  parts in  $10^9$ , and a measurement can be made to 1 part in  $10^9$  in a few minutes.

**A Simple Apparatus for Measuring Circuit Capacitances**, J. C. S. Richards. "El. Eng." March 1957. 3 pp. Capacitance to ground can be measured with an accuracy better than 2% with the simple instrument described.

**Relation Between the Character of Atmospherics and Their Place of Origin**, J. Chapman and E. T. Pierce. "Proc. IRE" June 1957. 3 pp.

**A Transistor Cardiotachometer**, L. Molyneux. "El. Eng." March 1957. 3 pp. Transistors may be used to construct a small portable cardiotachometer which is suitable for use in the presence of inflammable vapors such as those found in the operating rooms of a hospital.

**Microwave Model Crystallography**, J. F. Ramsay and S. C. Snook. "E & R Eng." May 1957. 5 pp. Simulation of X-ray diffraction at millimeter wavelengths.

**A Survey of Shock Test Procedures—One Phase of Laboratory Simulation**, C. A. Mills. "El. & Comm." April 1957. 6 pp.

**A Foetal Pulse Rate Recorder**, D. H. Smith. "El. Eng." March 1957. 4 pp.

**Replacing an Environmental Chamber**, T. F. Foti. "Environmental Quarterly" Vol. 3 No. 2. 1957. 4 pp. Design and operational problems of an environmental test chamber for avionic equipment are discussed, and reasons for specific design specifications in the replacement chamber presented.

**The Measurement of Cable Characteristics**, W. R. Thurston. "Experimenter" May 1957. 4 pp. In this first of several parts, the author discusses basic characteristics of coaxial cables. Included are such subjects as current distribution in coaxial transmission lines, variation of inductance with frequency, and variation of velocity of propagation with frequency.

**Magnetography**, F. G. Foster. "Bell Rec." May 1957. 4 pp. This art, "the microscopy of magnetism," includes a technique for "seeing" the actual orientation of poles and domains on the surface of a magnetic material. Thus, the optical microscope is an increasingly important research tool in studies of magnetism.

**Compensation of the Earth's Magnetic Field**, G. G. Scott. "Rev. Sci." April 1957. 4 pp. Horizontal fields in the working space for geomagnetic ratio experiments are held to less than 0.01% of the earth's horizontal component.

**Strain Gauge Measurements**, J. T. Broch and W. E. Green. "Technical Review" No. 2, 1957. 21 pp. The authors describe resistance strain gauges and comment on the different types of measuring instruments—stressing the advantage of an electronic system.

**A Phase-Sensitive Valve Voltmeter**, R. Kitai. "E & R Eng." April 1957. 5 pp. Design and characteristics of a phase-sensitive vacuum-tube voltmeter are discussed. A schematic of such an instrument is included.

**Electronic Monitor Checks Jet Temperatures**, I. Samuels. "El. Eq." May 1957. 2 pp. Jet overtemperature monitor and recorder system is described.



## RADAR, NAVIGATION

**The Probability of Occurrence of Radar Echoes Over Areas of Arbitrary Size**, I. Katz. "Aero. Eng. Rev." May 1957. 5 pp.

**Radar Propagation Diagram**, E. Glaser. "El. Eq." May 1957. 2 pp. A chart is presented for plotting the coverage patterns of radars—correction for the effects of "standard refraction" is included.

**Common System Standards**, H. K. Morgan. "Aero. Eng. Rev." May 1957. 3 pp. The author discusses the need for preliminary standards before development proceeds on integrated reporting, signaling, and surveillance systems for the airways.

**Jamming Figure of Merit for Radar Designers**, A. Mandell and W. G. Madison. "El. Des." May 1, 1957. 2 pp. A copyrighted hand computer for calculating the range at which a radar target signal will appear through the target's jamming noise is described.

**Curtis Team Shows Way to Up-To-Date Aviation Facilities, and Blueprint for Jet Age ATC System**, W. G. Osmun. "Aviation Age" May 1957. 5 pp. The report of the President's special assistant for aviation facilities planning for the next twenty years has been submitted. The author of these two articles examines this report and outlines its major features.

Radio Tracking, Orbit and Communication for the Earth Satellite, J. P. Hagen. "Aero. Eng. Rev." May 1957. 5 pp. The system is described by which satellite orbit and geophysical information will be derived.

Air-Borne Computers Will Reduce Cockpit Workload, V. I. Weihe. "Aero. Eng. Rev." May 1957. 4 pp.



## SEMICONDUCTORS

Design for an Improved High-Frequency Transistor, C. Thornton, J. Roschen, and T. Miles. "El. Ind." July 1957. 3 pp. Recent advances in manufacturing techniques have led to improved silicon surface transistors for high temperature operation.

Hot Junctions and Collector Cut-Off Current, B. Reich. "El. Ind. Op. Sect." July 1957. With junctions operating far above ambient, the designer must have some idea of the magnitude of the collector cut-off current. It is shown that the only temperature sensitive parameter is the saturation component.

Tandem Transistors with Electron-Tube Properties, H. E. Hollmann. "Hochfreq." March 1957. 11 pp. A scale for the measurement of the duality in active four-terminal networks is introduced. The grid-controlled space-charge tube is at the bottom of the scale, the grid-output tube with voltage amplification at the top. In this scale, the transistor assumes an intermediate place. Several tandem transistor circuits are discussed in detail.

Temperature Dependence of Junction Transistor Parameters, by W. W. Gartner. "Proc. IRE." May 1957. 19 pp. Calculated results are given which may serve as a guide line in transistor design and temperature compensation of transistor circuits.

The High Current Limit for Semiconductor Junction Devices, N. H. Fletcher. "Proc. IRE" June 1957. 11 pp. At very high operating levels, the density of carriers injected into the body of a semiconductor junction device is comparable with the carrier density in the emitter regions of the device. The effect of these high densities on the lifetime and mobility of carriers is considered, and new equations derived relating the carrier densities on either side of a forward biased junction. These equations are applied to derive the forward characteristics of two diode types, and to consider the dependence of emitter efficiency on current density for alloy junction transistors.

Designing Transistor Circuits—Video Amplifiers, R. B. Hurley. "El. Eq." May 1957. 4 pp. The author summarizes pertinent information on the design of broadband transistor amplifiers whose response extends down to audio frequencies.

Theory and Experiments on Shot Noise in Semiconductor Junction Diodes and Transistors, W. Guggenbuehl and M. J. O. Strutt. "Proc. IRE" June 1957. According to the general theory of junction diode and transistor shot noise in the region of low-level injection currents presented in this article, general theory presented in this article, junction diode and transistor shot noise in the region of low-level injection currents is dependent on frequency including lf and hf regions. Equations for noise figures in the three basic transistor connections are derived. Experimental curves at high-level injection are presented, and coordination with previous theoretical and experimental data is shown to be satisfactory in the lf region.

Use Transistors as Protective Devices, R. H. White. "El. Eq." May 1957. 2 pp. Transistors can be used to protect meters or power supplies. Typical circuits are discussed.

Transistor Bias Stabilization, J. S. Murray. "E & R Eng." May 1957. 5 pp. Feedback circuitry for low-voltage operation is discussed. Low noise operation can be augmented by these techniques.



## TELEVISION

On the Visibility of Sinusoidal Interference in Television Pictures, H. Grosskopf and R. Suhrmann. "Rundfunk." April 1957. 8 pp. After reviewing the interference patterns which sinusoidal interference produces on the screen of a TV receiver, the authors examine more closely the effect of interference having frequencies corresponding to a multiple of the line frequency or differing from the picture frequency by an even multiple thereof. They also consider the effect of various parameters on the visibility of these frequencies. Evaluation curves are given from some groups of frequencies which are of interest, particularly in the planning of TV transmitter networks. The protection ratios for adjacent transmitters resulting therefrom are compared with the recommendations of the CCIR.

Frequency Transposers (Satellites) as Very-Low-Power Transmitters, A. Kolarz. "Rundfunk." April 1957. 5 pp. In order to provide a TV service for the smaller localities, very low power satellites with an output of 50 mw have been developed. By means of aerials with the appropriate gain, or by the insertion of suitable attenuators, it is possible to adjust the radiated power between 10 and 300 mw, according to requirements. The units do not use an intermediate frequency. Sudwestfunk intends shortly to take into service an increasing number of very low power satellites.

The Myriatron, G. H. Lunn. "E & R Eng." May 1957. 5 pp. An image dissector is used in combination with an image-converter for high-speed cinematography.

Television Terminals for the L3 System, J. J. Jansen. "Bell Rec." May 1957. 5 pp. Special terminals have been developed for television transmission over the L3 coaxial cable system. Design considerations and equipment details are discussed.

Operation Point and Range of Video Stages, W. Spärber. "El. Rund." April 1957. 4 pp. The author discusses input voltage, gain, linearity of characteristic, contrast control, and counter coupling. It is pointed out that the coupling mode between video detector and video tube influences operation point definition and range, also tube losses and disturbance disposition.

The Limits of Optical Compensation with Polygon Prisms in Relation to Freedom from Flicker, Registration and Relative Aperture, H. Grabke. "Rundfunk." April 1957. 8 pp. It is shown that the manufacture of a polygon-ring scanner with 40 to 60 faces is quite practicable, and that it produces satisfactory pictures and is able to compete with other types of flying-spot scanners.

Apparatus for Representing Oscillographically the Phase and Amplitude Displacements of Video and Intermediate-Frequency Networks, W. Kroebe and L. A. Wegner. "Rundfunk." April 1957. 8 pp. Because the calculation of the transient time of amplifiers and of the formation of harmonics of the modulation takes up a considerable amount of time when complicated systems are in question, a measuring device has been developed which directly indicates the phase displacement and amplitude distortion which the modulation of a carrier-frequency undergoes when passing through a network. Provision is made for indicating the

second harmonic produced in the measured network (indicative of linearity). As a typical application, measurements in delay circuits in the video-frequency range are reproduced.

Interesting Details of This Year's TV Receivers, W. Taeger. "Freq." April 1957. 8 pp. Diagrams of several recently developed German TV receiver circuits are presented and discussed. In particular, a block diagram by "Graetz," intermediate amplifiers by "Grundig," circuits designed to prefer the high video amplitudes without other effects, and sound amplifiers are included.

Electronic Shutter for TV Kinescope Recorder, by D. C. Crocker. "El." May 1, 1957. 2 pp. Electronic circuits including multivibrators and gates blank the video-recording kinescope during film pull-down, then allow 525 scanning lines to appear for exposure of the next frame. Thus one complete TV frame is recorded on each film frame despite frame-rate difference.

High-Speed TV Office Duplicator. "Research for Industry," Jan. 1957. 2 pp. This is a progress report on a high-speed office duplicating device which employs a closed-circuit TV network for multiple reproduction. The system, which can be a TV link counterpart of teletype which employs phone circuits, is capable of exceeding the reproduction rate of standard facsimile transmission. It is being developed for the A. B. Dick Co. by Stanford Research Institute.

$$\Delta G = \Delta G / \epsilon_0 \eta \mu_p \delta$$

## THEORY

Remark on Signals of Finite Duration with Maximum Filtered Energy, J. A. Ville and J. Bauzitat. "Cab. & Trans." April 1957. 27 pp. This is an extensive mathematical investigation of the maximum power efficiency obtainable in transmitting a signal of finite duration through an ideal low-pass filter with a sharp cut-off. Further, the wave shape desirable for such a signal to suffer a minimum energy loss when the high-frequency components are suppressed is established.

The Electrical and Mechanical Impedance of Electroacoustic Transducers, R. Bierl. "Nach. Z." April 1957. 8 pp. Equivalent electro-mechanical circuits, which take impedance variations during oscillation into account, can be given for all electro-acoustic transducers and the radiators coupled with these when the electro-mechanical coupling factor is fully known. The acoustic impedance of resonators with distributed mass and elasticity can be approximately represented by combinations of resonators for single frequencies. The theoretical conclusions are confirmed by measurements with transducers coupled to tubes and cones.

Space Charge Waves Along Magnetically Focused Electron Beams, J. Labus. "Proc. IRE." June 1957. 8 pp. The propagation of perturbations along electron beams of finite diameter is determined by boundary conditions. Two different procedures are compared: one assuming a surface current, the other introducing additional but continuous ac space charges and currents over the beam cross section.

Principles of Magnetic Amplifier Engineering, F. Kummel. "Nach. Z." April 1957. 7 pp. The operation of circuits for magnetic amplifiers with and without feedback is explained on the basis of the non-linear magnetization curve for chokes with ferrous cores. Various types of choke designs are compared with one another. A quality factor, which can be obtained from measured characteristic curves, is used for the qualitative critique of amplifiers.

# International ELECTRONIC SOURCES

**Distortion Introduced by RC-Sections in Frequency-Modulated Oscillations.** E. G. Woschni. "Hochfreq." March 1957. 5 pp. The noise due to RC coupling and differentiating networks is evaluated, as well as the noise due to filters with unsymmetrical phase distortion and an amplitude curve that has mirror symmetry for slight mistuning. An example involving stray tube capacities is presented.

**The Lorenz Number.** P. J. Price. "IBM J." April 1957. 11 pp. The theory of the Lorenz number of a conducting crystal is developed for the common models of the electron assembly. For the one-electron model it is shown that, provided scattering is elastic to an approximation which is examined, the Lorenz number is equal to the square fluctuation of the thermo-electric power.

**Frequency Conversion with Nonlinear Reactance.** by C. H. Page. "NBS J." May 1957. 10 pp. A lossless nonlinear impedance subject to an almost periodic voltage (sum of sinusoids) will absorb power at some frequencies and supply power at other frequencies. Necessary and sufficient relations among these powers are found. It is shown that simple cubic capacitors are sufficient for producing any possible conservative modulation or distortion process.

**Breakdown of Air at Microwave Frequencies.** by W. Roberts. "Vide." Sept.-Oct. 1956. 7 pp. A simple theory for the breakdown mechanism is developed which can be applied with success over a wide range of experimental conditions.

**Designing Electronics to Resist Nuclear Energy.** by H. L. Morgan. "El." May 1, 1957. 3 pp. A general discussion of the problem arising out of nuclear power for aircraft and ships.

**Transistor Relaxation Oscillations.** by F. J. Hyde and R. W. Smith. "El. Eng." May 1957. 3 pp. Relaxation oscillations in a point-contact transistor circuit including a parallel CR combination in shunt with the emitter input are studied as functions of emitter bias and ambient temperature. Applications of the circuit to FM telemetry are discussed.

**Topological Analysis of Linear Nonreciprocal Networks.** S. J. Mason. "Proc. IRE." June 1957. 10 pp. The concept of the unistor, a branch-like element whose current is proportional to one of its two terminal potentials and independent of the other terminal potential, or gyrator, whose current is proportional to the sum of its two terminal potentials can be used to model any linear network, in general nonreciprocal. Kirchhoff-Maxwell methods are applicable with a relatively simple modification of the transmission expression.

**Light-Waves and Photons.** "E. & R. Eng." April 1957. 4 pp. The article presents a review and summary of particle and wave theories of light, written in popular style.

**Triode Amplification Factor.** P. Hammond. "E. & R. Eng." April 1957. 3 pp. The author reviews recent work establishing theoretical triode relationships in conflict with traditional concepts—"On the Amplification Factor of the Triode," by E. B. Moulin, I.E.E. Monograph #211 R, November 1956.

**Transistor Impedance Matching.** H. P. Williams. "E. & R. Eng." April 1957. 2 pp. The author presents as a simplifying concept, the fact that the product of the input and output impedances is, for practical purposes, the same for all three transistor configurations.

**Saving Labour in Numerical Computations.** "E. & R. Eng." May 1957. 2 pp. Mathematical tools for speeding up computations are discussed.

**Frequency Transformations and Dissipative Effects in Electric Wave Filters.** D. J. H. Maclean. "El. Eng." March 1957. 7 pp.

**Anti-Gravity. Fact or Fantasy.** I. Stambler. "Aviation Age." May 1957. 3 pp. Editor Stambler surveys scientific opinion on the subject. The Gluhareff gravitational theory is discussed.



## TRANSMISSION LINES

**The Attenuation vs Frequency Characteristics of VLF Radio Waves.** J. R. Wait. "Proc. IRE." June 1957. 4 pp. Theoretical dependence on frequency of the attenuation of the wave guide modes in VLF propagation is discussed in some detail. It is indicated that most of the published experimental data between 1 and 30 KC was compatible with the sharply bounded model of the ionosphere with a reflecting height of about 70 km during the day and 90 km during the night.

**The Application of Negative Impedance Elements to Telephone Transmission Lines.** H. P. Lawther, Jr. "Carrier." March 1957. 7 pp.

**Q Factors of a Transmission Line Cavity.** by L. Young. "IRE Trans. PGCT." March 1957. 3 pp.

**Printed-Circuit Directional Coupler.** "E & R Eng." April 1957. 2 pp. An r-f strip line is coupled by proximity to two auxiliary lines—the coupling exhibits directional properties. The three transmission lines are printed on one side of a printed-circuit board, the other side of which is coated to form an earth-plane.

**A Directional Brancher For A  $H_{01}$ -Wave In A Waveguide With A Circular Cross-Section.** by M. V. Persikov. "Radiotekhnika i Elektronika," Jan. 1957. 10 pp.

The paper examines the system used for coupling a circular waveguide to a metering channel. As a result of the analysis the conditions are found which govern the segregation of the  $H_{01}$ -wave from waves of other types: the formulas for computing the coupling coefficients, the directivity coefficients, and the suppression coefficients for undesirable waves are derived. The theoretical computations are verified experimentally.



## TUBES

**New Cathode Ray Tubes of High Luminance and Deflection System Sensitivity.** E. Gundert and W. Schaffernicht. "El. Rund." April 1957. 2 pp. In order to retain higher deflection system sensitivity while increasing anode voltages, cathode ray tubes have been provided with various kinds of post-acceleration systems. A particularly favorable solution is offered by a resistor coil mounted on the inside bulb wall of the tube. Through this resistor coil a post-acceleration voltage is applied, and a homogeneous post acceleration field is generated. Two crt models of this type are described, a wide-band oscillography tube and a pulse reflex measuring tube.

**The Klystron.** W. Knippschild. "TechRep." March-April 1957. 12 pp. This article reviews the theory of operation, the type of modulation, the tuning methods, and the construction of the reflex klystron, as well as the recent developments in high-power klystron amplifiers.

**Space-Charge Effects in Klystrons.** by W. E. Waters, Jr. "IRE Trans. PGED." Jan. 1957. 10 pp. The results of a digital computer calculation of the effects due to the dc field of

the space charge in a reflex klystron are presented. It is shown that theoretical determination of the large space charge conditions do not correlate closely with the conditions found in actual practice. Improvements on the theory are suggested.

**Low-Voltage Color Tube Gun Assembly with Periodic Focusing.** by P. H. Gleichauf and H. Su. "IRE Trans. PGED." Jan. 1957. 7 pp.

**Electron Bunching and Energy Exchange in a Traveling-Wave Tube.** by S. E. Webber "IRE Trans. PGED." Jan. 1957. 5 pp.

**Voltage-Tuned Magnetron For F-M Applications.** by T. R. Bristol and G. J. Griffin, Jr. "El." May 1, 1957. 2 pp. A stacked metal-ceramic magnetron for the 2 to 4 kmc range is described. Average power capability is up to 10 watts.

**Noise Gating Tube for AGC and Sync.** by J. G. Spracklen, W. J. Stroh, and G. C. Wood. "El." May 1, 1957. 4 pp. A single miniature tube, the 6BU8 performs agc, sync clipping, and noise pulse discrimination functions in a TV circuit.



## U. S. GOVERNMENT

Research reports designated (LC) after the price are available from the Library of Congress. They are photostat (pho) or microfilm (mic), as indicated by the notation preceding the price. Prepayment is required. Use complete title and PB number of each report ordered. Make check or money order payable to "Chief, Photoduplication Service, Library of Congress," and address to Library of Congress, Photoduplication Service, Publications Board Service, Washington 25, D. C.

Orders for reports designated (OTS) should be addressed to Office of Technical Services, U. S. Department of Commerce, Washington 25, D. C. Make check or money order payable to "OTS, Department of Commerce," OTS reports may also be ordered through Department of Commerce field offices.

When an agency other than LC or OTS is the source, use the full address included in the abstract of the report. Make check or money order payable to that agency.

Complete copies of the selected patents described below may be obtained for \$.25 each from the Commissioner of Patents, Washington 25, D. C.

**Test Apparatus for Ferroelectric Memory Condensers.** C. F. Pulvari, The Catholic University of America. Dec. 1955. 29 pages. 75 cents. (PB 121204, OTS) Design and construction data are described for a test apparatus for ferroelectric memory condensers which enables quick determination of optimum operating conditions and selection of condensers with identical properties for a particular application. The apparatus was designed for use in development of improved bistable storage condensers. The test reflects the practical applicability of the developed ferroelectric dielectric in a condenser structure through determination of switching characteristics, optimum switching pulse amplitude, and selection index.

**Transistor Feedback Amplifier Design.** G. L. Benning, University of California. Oct. 1955. 29 pages. 75 cents. (PB 121556, OTS) A method was devised for design of a multistage wideband transistor incorporating constant resistance ladder networks in the external feedback path. The method allows synthesis of the feedback amplifier without use of equivalent circuits for the transistors. This is accomplished by approximating the measured amplifier gain function without feedback with a



rational function of frequency, then applying unilateral feedback theory in design of the feedback path. Interaction effects are eliminated by use of constant resistance ladder networks in the feedback path. Among other advantages, the method is said to considerably reduce design time through use of equipment such as a complex plane analyzer or Spirule, and applying root locus techniques.

**Lovotron — A Low Voltage Triggered Gap Switch.** E. H. Cullington, W. G. Chace, and R. L. Morgan, Air Force Cambridge Research Center. Sept. 1955. 19 pages. 50 cents. (PB 121061, OTS) A triggered gap switch called Lovotron was developed which allows switching of currents in the  $10^6$  ampere region. The switch operates successfully at considerably below the corona voltages. It is described as especially adaptable to "one shot" operation. Time interval between the initiating trigger and firing of the gap is reproducible to 0.1 microseconds. The Lovotron may be used for any operation requiring accurate control of large currents, such as surge current generators, magnetron testing, and light pulse generation. It is said to be simple and inexpensive to construct, and not critical in adjustment.

**Factors Affecting the Frequency of Various Final Digits.** J. Cohen and V. L. Senders, Antioch College. Nov. 1954. 18 pages. 50 cents. (PB 121396, OTS) Visual testing in the past has shown that where subjects report or make responses in terms of numerals, the frequencies with which the various digits are used are not equal and do not always correspond to the distribution of such digits in the stimuli. These departures are called "number preferences," and data on their relationships to scale design have application in the design of instruments and of experiments on instrument reading. In this research, 50,000 numerical responses to scale reading were analyzed to determine the effects on patterns of number preferences of such variables as exposure time, exposure number, scale graduation, and the final digit of the pointer setting. The last two variables proved most influential. It was concluded that the factors which determined the pattern of final digits used in reading skills were rounding, gradients of overestimation and underestimation, and a "liking" for certain numbers.

**Optimum Knob Diameter.** J. V. Bradley and J. Argenteanu, Wright Air Development Center. Nov. 1956. 23 pages. 75 cents. (PB 121852, OTS) Instrument control knobs must be of a minimum size in order to conserve panel space, but not so small as to impair efficient operation. Research into the relationship between knob diameter and operation time concluded that a diameter of two inches for single-rotation, cylindrical knobs is most effective, regardless of frictional resistance. Where frictional resistance is moderate, a diameter as small as one inch can be used without greatly increasing operation time. But with heavy frictional resistance, diameter cannot be reduced below  $1\frac{1}{2}$  inches without considerable increase in operation time.

**Effect of Knob Arrangement on Consumption of Panel Space.** J. V. Bradley, Wright Air Development Center. June 1956. 13 pages. 50 cents. (PB 121518, OTS) This report integrates and compares data from two previous experiments on the arrangement of instrument control knobs so as to minimize the likelihood of accidental operation and, at the same time, use the least amount of panel space. The best arrangement was found to be a line of knobs  $\frac{1}{2}$ -inch in diameter mounted side-by-side with  $\frac{3}{4}$  to  $1\frac{1}{4}$  inches between edges. This grouping was preferred over side-by-side mounting of one-inch diameter knobs or mounting of shielded knobs on concentric shafts.

**Phosphorescent and Fluorescent Material.** L. H. Dawson, NRL. Dec. 1956. 50 pages. \$1.25. (PB 121541, OTS) Increasing interest has been shown in luminous properties and uses of phosphorescent and fluorescent material. In-

dustrial applications may be suggested by this survey report of the properties and military uses of phosphorescent and fluorescent materials. Vision at low values of illumination is discussed, along with methods of photometry and colorimetry as applied to measurement of luminosity and color of luminous material. Characteristics of commercially-obtainable material are shown, and some possible uses are suggested.

**A Study of Environmental Temperature and Pressure Effects on the Plate Dissipation Rating of Receiving Tubes: Part 2.** B. M. Schmidt, University of Dayton. Dec. 1955. 40 pages. \$1. (PB 121780, OTS) This report supplements Part 1 with information on plate dissipation rating extrapolation curves for certain miniature tube types; general curves showing constant plate temperature contours; evidence showing that internal tube temperatures are not directly affected by environmental conditions; an empirical method for determination of the maximum bulb temperature; and confidence limits on maximum bulb temperature and plate temperature showing variation by manufacturer.

**The Effect of Variations in Control-Display Ratio During Training on Transfer to a "High" Ratio.** M. R. Rockway, Wright Air Development Center. Oct. 1955. 18 pages. 50 cents. (PB 121316, OTS) An important consideration in the design of synthetic training devices is the extent of simulation necessary to achieve adequate transfer of learning from training to actual operation. This research considers the relevance of control-display (C/D) ratio, or the magnitude of display change by a given control input, to operational systems utilizing manual tracking. The relationship was studied between amount of transfer of a two-dimensional compensatory tracking skill and the degree, in terms of C/D ratio, between training and final tasks. Subjects received training using either a low, medium, or high ratio, and then were tested at the high (least sensitive) ratio. During training it was shown that tracking performance was a function of the C/D ratio employed. All training ratios produced significant positive transfer to the test ratio. The amount of transfer to the initial test trial was a function of the training ratio employed.

**The Effect of Target Velocity and the Area of Error-Tolerance Circles Upon Performance in a Two-Dimensional Compensatory Tracking Task.** J. C. McGuire, Washington University. Aug. 1954. 38 pages. \$1. (PB 121380, OTS) Increasing demands of highly complex machines on the human operator create a need for new data on his response system. One source of such information is human tracking behavior. This report presents results of a study of tracking performance on a two-dimensional task in which target velocity and size of target were varied. Ten male subjects tracked a spot on a cathode ray oscilloscope by joystick manipulation. The instantaneous value of the error was recorded as a function of time and was integrated with equipment developed for the investigations. Among the results, it was found that the displayed size of target had virtually no effect on the error integrated around the center of the target. However, target velocity produced significant variation in performance.

**Efficiency of Verbal Versus Motor Responses in Handling Information Encoded by Means of Colors and Light Patterns.** P. F. Muller, Jr., The Ohio State University. Dec. 1955. 21 pages. 75 cents. (PB 121520, OTS) This two-phase project, part of research into human engineering aspects of air traffic control, was undertaken to compare the relative compatibility of verbal versus motor responses to different visual stimuli, and to determine the effect of verbalization as a factor affecting the ability to transfer from one type of response to the other. Data on information handling rates were obtained from eight groups of subjects working with spatial and color symbols and

making verbal and motor responses. Performance with lights was far superior to that with color symbols. Verbal and motor responses were comparable to color symbols, and motor responses were superior to verbal with spatial symbols. Transfer from verbal to motor responses was easier than transfer from motor to verbal. Hypotheses were drawn in terms of the general concept of stimulus-response compatibility.

**Stimulation Study of Control of an Aircraft at or Near the Absolute Ceiling.** A. C. Robinson, J. W. Early, and B. J. Doody, Wright Air Development Center. Mar. 1956. 57 pages. \$1.50. (PB 121450, OTS) From the standpoint of accuracy, controls using airspeed information were found considerably more effective than those using information on altitude, pitch angle, and angle of attack in this simulation study of controlling and maintaining a B-45C aircraft at its absolute ceiling. Object was to determine with simulated automatic pilots whether a human pilot can meet the accuracy requirements of the problem. Airspeed control was the only one which apparently could be used with ordinary cockpit instruments. It was controlled to a consistent value which corresponded to the ceiling value. Besides being quite accurate, airspeed control had good dynamic characteristics and should be easily controllable, even by a human pilot, according to the report.

**Development of a Lightweight Distance-Measuring Interrogator. Part 1: The Model DIB Interrogator.** C. C. Trout and W. E. Haworth. CAA. Dec. 1956. 34 pages. 1. (PB 121789, OTS) Tests showed this simple (23 tubes), lightweight (25 pounds), compact interrogator to be particularly adaptable to small commercial and private aircraft. Satisfactory operation was achieved with the 100-channel distance-measuring equipment system to minimum accuracy requirements without the use of crystal-controlled rf oscillators, multistage intermediate-frequency amplifiers, magnetostrictive coders and decoders, mechanically driven ranging and indicating systems, and remote controls.

**Development of Lightweight Distance-Measuring Interrogator. Part 2: The Model DIC Interrogator.** C. C. Trout, CAA. Jan. 1957. 88 pages. \$1. (PB 121787, OTS) This new interrogator incorporates a number of design features not used in the Model DIB unit, yet was developed under the same specification. It contains 35 tubes and weighs 32.8 pounds. The power requirement was reduced from that of earlier designs to a practical value, enabling its use in single-engine executive and personal aircraft. The unit may be connected for either 13.5-volt or 27-volt dc supplies; no additional inverter is required. An important advance in design is the introduction of direct crystal control to the interrogator. The unit exceeded specifications for accuracy of distance measurement and maximum range performance.

**The Silver Oxide-Zinc Alkaline Primary Cell: Part 4, Anodic Characteristics of Zinc Alloys.** C. M. Shepherd, NRL. Feb. 1957. 25 pages. 75 cents. (PB 121744, OTS) Preliminary work toward the improvement of the silver oxide-zinc alkaline battery through a possible increase in cell capacities of zinc alloy electrodes is described. Although the investigation was not completed, and the data is recommended only as a basis for further study, it was reported that most alloying elements decrease cell capacity, particularly if they are present in appreciable amounts. Mercury, however, improved capacity, and a few other elements such as cobalt and calcium indicated promise. The grain structure of electrodes made of zinc and its alloys was shown to have a large effect on cell capacity.

**Design of Minimum Weight Magnetic Cores.** J. W. Kallander, NRL. Jan. 1957. 8 pages. 50 cents. (PB 121776, OTS) A method of calculation useful wherever weight is a factor in the design of magnetic amplifier components

has been devised. The method enables calculation of the configuration of the magnetic core, case and coil yielding minimum weight for a given volt-second capacity of a magnetic core and coil. The analysis is very general and takes into account limiting quantities such as winding resistances and magnetizing currents. It can be extended to include weights of other related components such as the associated batteries merely by the addition of the appropriate terms to the total weight equation.

**Accelerated Modernization of the U. S. Air Traffic Control and Navigation System, President's Air Coordinating Committee.** 111 pages. \$1.75 (Order PB 121932 from Office of Technical Services, U. S. Department of Commerce, Washington 25, D.C.) Recommendations are contained in the report concerning the use of new flight procedures, research and development toward systems automation, newly available electronic facilities such as long-range radar, and highly accurate navigation devices, as well as expanded use of existing facilities. The report is the result of an operational review of the nation's airways begun early in 1954 by the Special Working Group 13 of the ACC's Air Traffic Control and Navigation Panel. The Group is comprised of specialists from government, industry and research-development establishments.

**Human Engineering Aspects of Radar Air Traffic Control, Part I: Performance in Sequencing Aircraft for Landings as a Function of Control Time Availability.** Feb. 1956. 19 pages. 50 cents. (PB 121524, OTS) Results of tests on problems in simulated radar control of air traffic showed specifically that four inexperienced controllers were as efficient in guiding aircraft in sequence to a hypothetical Ground Controlled Approach gate within the critical four minutes available to them as when eight minutes were available. An electronic simulator was used to vector groups of aircraft blips in the GCA control zone to the GCA gate. Each group of planes had fixed airspeeds, was equidistant from the gate and headed directly toward it. Contact was effected exclusively with turns. Conflicts (near misses) occurred relatively often due to the inexperience of the controllers, but performance and safety improved with practice. Investigators felt that with highly skilled controllers the percentage of conflicts would probably be close to zero percent instead of almost nine percent obtained in these experiments. It was thought that the sequencing technique might result in improved control procedures and markedly reduce the number of commands to pilots.

**Human Engineering Aspects of Radar Air Traffic Control, Part IV: A Comparison of Sector and In-Line Control Procedures.** L. M. Schipper et al. Ohio State University. Sept. 1956. 34 pages. \$1 (PB 121773, OTS) The effects of three variables on the relative efficiency and safety of two-man air traffic control procedures in simulating landing problems of numerous jet aircraft returning from a mission are evaluated. The object was to guide the jets safely and efficiently to the 3-mile-wide GCA gate from the moment each one entered the GCA control area. Aircraft entered the GCA gate zone at two different rates, one every minute and one every minute and a half. Efficiency data show that there were no differences between the In-Line and Sector two-man control procedures, the rates at which aircraft entered the system, and the two controllers. While there were no significant differences between the systems with the entrance rates used, the sector system was found slightly superior in efficiency when planes entered at the rate of one every minute. This was a definite indication that at rates still higher than one per minute, the sector system of control might prove to be significantly superior to the in-line system used in present-day military air traffic control centers. Extensive operational tests of the sector system are recommended. Results suggest that different controllers may be able to use the two types of control procedures with different degrees of effectiveness.

## PATENTS

Complete copies of the selected patents described below may be obtained for \$.25 each from the Commissioner of Patents, Washington 25, D. C.

**Cathode-Ray Tube Apparatus, #2,789,156.** Inv. B. E. Arneson. Issued April 16, 1957. A target grid electrode having a plurality of electrically connected conductors is arranged in the path of the electron beam. The beam will intercept one of the conductors each time it has intercepted all three color phosphors, generating a signal for each color cycle. A phase splitting circuit provides three out-of-phase signals derived from this signal, each to be added to one of the color signals.

**Cascade Amplifier-Mixer with Trap to Prevent Local Oscillator in Driven Stage from Affecting Driving Stage, #2,789,213.** Inv. M. Marks and R. Adler. Assigned Zenith Radio Corp. Issued April 16, 1957. An r-f amplifier is coupled to the cathode of a subsequent tube over a circuit presenting zero shunt impedance at a heterodyne frequency to prevent feedback thereof to the r-f amplifier. The grid of the second tube is connected to a circuit of high impedance at the heterodyne frequency and low impedance at the r-f frequency, and the transconductance of this tube is varied at the heterodyne frequency.

**Rotatable Shutter and Transmit-Receive Device, #2,789,272.** Inv. H. C. Alexander and J. E. Burr. Assigned Bomac Laboratories, Inc. Issued April 16, 1957. A transmit-receive hermetically sealed gaseous-discharge device comprises suitably spaced resonant discharge capacitive electrodes and inductive iris members and a rotatable shutter comprising a metallic cylinder with a passageway perpendicular to its axis and containing suitably positioned plural capacitive electrodes and inductive iris members.

**Directional Radio Systems, #2,789,285.** Inv. J. Ortusi and A. Robert. Assigned Co. Generale de Telegraphie Sans Fil. Issued April 16, 1957. Two overlapping polar radiation diagrams are produced. Their line of intersection defines the direction. The amplitudes of the polar diagrams are oppositely varied according to a predetermined periodic law having a period substantially greater than the duration of the polar diagrams.

**Pick-Up Tube with Induced Conductivity Target, #2,776,387.** Inv. L. Pensak. Assigned Radio Corporation of America. Issued Jan. 1,

**Transistor Amplifier Circuit, #2,790,033.** Inv. F. P. Keiper. Assigned Philco Corp. Issued April 23, 1957. A parallel resistor-capacitor network is connected to the collector electrode of a transistor and with its other terminal to a resistor which is connected to the base electrode of the transistor. The ratio of the absolute impedances of the resistance-capacitance network and the resistor is the same as that of the equivalent collector impedance to the equivalent base impedance of the transistor. The input signal is applied between the emitter electrode and the junction between the resistor-capacitor network and the resistor.

**Multiple Band-Pass Amplifier, #2,790,035.** Inv. A. E. Hylas and W. V. Tyminsky. Assigned Allen B. DuMont Laboratories, Inc. Issued April 23, 1957. The single-ended amplifier passes two frequency-separated pass bands. The input is connected between the cathode of the first stage and the grounded grid, the cathode being grounded over the series combination of an inductance and a parallel capacitor-inductance circuit. A double band-pass network couples to the cathodes of a second stage which is grounded over an inductance; the second grid is positively biased. The output is derived from a second double band-pass network.

**Semiconductor Signal Translating Devices, #2-790,037.** Inv. W. Shockley. Assigned Bell Telephone Laboratories, Inc. Issued April 23, 1957. First and second zones of low specific resistivity semiconductive material of one type and a third and fourth zone of the opposite conductivity type are spacedly arranged in a semiconductive body having high specific resistivity. The input is applied between the first zone and the third and fourth zone, the output derived between the first and second zone. Suitable bias potentials are applied, and a space-charge limited flow of the carriers predominant in the first zone flows from that zone to the second zone.

**Vehicle Reporting System, #2,790,071.** Inv. D. L. Gunn. Assigned Westinghouse Air Brake Co. Issued April 23, 1957. A coil on the vehicle can be resonated at a plurality of frequencies. A plurality of coils selectively responsive to different frequencies is arranged in a wayside apparatus; it contains at least one coil responsive to one of the vehicle coil frequencies for detecting the identity of the vehicle. Another wayside apparatus is provided with a single coil selectively responsive to another vehicle coil frequency serves to cancel the identification.

**Tunable Transceiver, #2,790,072.** Inv. E. H. Hugenholz and M. R. Mantz. Assigned North American Philips Co., Inc. Issued April 23, 1957. The transmitter oscillator and the superheterodyne oscillator of a transceiver can be alternately frequency controlled by a control voltage generator, the frequency difference of the two oscillators to be controlled is an integral multiple of the pulse recurrence frequency of the control voltage. The control voltage comprises a coarse component derived from a frequency discriminator and a fine component derived from a phase discriminator.

**Gated Cathode Followers, #2,790,077.** Inv. R. H. Hinkley and P. W. Borgeson. Assigned Raytheon Manufacturing Co. Issued April 23, 1957. The third and first grid of a pentode are maintained at cut-off when no signal is applied; the second grid and plate are connected to the positive terminal of a battery, the negative terminal of which is connected to the cathode over a resistor. A capacitor between the cathode and the second grid prevents any voltage from appearing at the cathode output terminal unless signals are applied to both, the first and the third grids.

**Semiconductor Measuring System, #2,790,141.** Inv. D. V. Geppert. Assigned Motorola, Inc. Issued April 23, 1957. The lifetime of excess minority carriers in a semiconductor is measured by measuring the electrical conductance between points spaced apart a distance several times the diffusion length of the minority carriers. A signal is impressed to inject excess carriers, thereby varying the electrical conductance of the sample. The phase difference between the variation of the sample conductance and the impressed signal is indicative of the lifetime of excess minority carriers.

**Reactance Tube Circuitry, #2,790,147.** Inv. A. C. Armstrong and J. W. Kee. Assigned Vitro Corporation of America. Issued April 23, 1957. An inductance and a series resistance-reactance branch are connected in shunt to the plate-cathode path of a tube. The grid and cathode path of the tube are connected between a tap on the inductance and the junction point of the resistor-reactor-branch parallel thereto.

**Phase Inversion Circuit, #2,791,642.** Inv. J. R. Kobbe. Assigned Tektronix, Inc. Issued May 7, 1957. The cathodes of a pair of substantially identical tubes are connected to the point on the cathode resistor of a cathode-follower tube at which the signal voltage is equal to half its input value. The full signal voltage is applied to the grid of one tube of the pair, while the grid of the other tube of the pair is grounded. Hence the two voltages taken off the plate of the tube pair will be of equal amplitude and opposite polarity.

**GET THE**

# FACTS!

**USE THIS FREE READER SERVICE CARD**

Keep up to date—get the facts about the new products and equipment as they hit the market. ELECTRONIC INDUSTRIES' advertisers will be glad to send you complete literature giving specifications and data relating to those products advertised in this issue. To help you, the new product items, new literature and advertisements in this issue are numbered consecutively, from the front to the back of the book. The extra cards are for the use of your associates with whom you share your copy of ELECTRONIC INDUSTRIES.

Mail Card Below Today For Quick Information On New Products Described in This Issue. No Postage Needed.

FIRST CLASS  
PERMIT NO. 36  
(Sec. 34.9, P.L.&R.)  
NEW YORK, N. Y.

**BUSINESS REPLY CARD**

NO POSTAGE STAMP NECESSARY IF MAILED IN UNITED STATES



POSTAGE WILL BE PAID BY

**ELECTRONIC INDUSTRIES**  
& Tele-Tech

P. O. BOX 73, VILLAGE STATION

NEW YORK 14, N. Y.

Postcard valid 8 weeks only. After that use own letterhead fully describing item wanted **JULY 1957**  
Please send me further information on the items I have circled below.

- |     |     |     |     |     |     |     |     |     |     |     |     |     |     |     |     |     |     |     |     |
|-----|-----|-----|-----|-----|-----|-----|-----|-----|-----|-----|-----|-----|-----|-----|-----|-----|-----|-----|-----|
| 1   | 2   | 3   | 4   | 5   | 6   | 7   | 8   | 9   | 10  | 11  | 12  | 13  | 14  | 15  | 16  | 17  | 18  | 19  | 20  |
| 21  | 22  | 23  | 24  | 25  | 26  | 27  | 28  | 29  | 30  | 31  | 32  | 33  | 34  | 35  | 36  | 37  | 38  | 39  | 40  |
| 41  | 42  | 43  | 44  | 45  | 46  | 47  | 48  | 49  | 50  | 51  | 52  | 53  | 54  | 55  | 56  | 57  | 58  | 59  | 60  |
| 61  | 62  | 63  | 64  | 65  | 66  | 67  | 68  | 69  | 70  | 71  | 72  | 73  | 74  | 75  | 76  | 77  | 78  | 79  | 80  |
| 81  | 82  | 83  | 84  | 85  | 86  | 87  | 88  | 89  | 90  | 91  | 92  | 93  | 94  | 95  | 96  | 97  | 98  | 99  | 100 |
| 101 | 102 | 103 | 104 | 105 | 106 | 107 | 108 | 109 | 110 | 111 | 112 | 113 | 114 | 115 | 116 | 117 | 118 | 119 | 120 |
| 121 | 122 | 123 | 124 | 125 | 126 | 127 | 128 | 129 | 130 | 131 | 132 | 133 | 134 | 135 | 136 | 137 | 138 | 139 | 140 |
| 141 | 142 | 143 | 144 | 145 | 146 | 147 | 148 | 149 | 150 | 151 | 152 | 153 | 154 | 155 | 156 | 157 | 158 | 159 | 160 |
| 161 | 162 | 163 | 164 | 165 | 166 | 167 | 168 | 169 | 170 | 171 | 172 | 173 | 174 | 175 | 176 | 177 | 178 | 179 | 180 |
| 181 | 182 | 183 | 184 | 185 | 186 | 187 | 188 | 189 | 190 | 191 | 192 | 193 | 194 | 195 | 196 | 197 | 198 | 199 | 200 |
| 201 | 202 | 203 | 204 | 205 | 206 | 207 | 208 | 209 | 210 | 211 | 212 | 213 | 214 | 215 | 216 | 217 | 218 | 219 | 220 |
| 221 | 222 | 223 | 224 | 225 | 226 | 227 | 228 | 229 | 230 | 231 | 232 | 233 | 234 | 235 | 236 | 237 | 238 | 239 | 240 |
| 241 | 242 | 243 | 244 | 245 | 246 | 247 | 248 | 249 | 250 | 251 | 252 | 253 | 254 | 255 | 256 | 257 | 258 | 259 | 260 |

YOUR NAME .....TITLE .....

FIRM .....

FIRM ADDRESS .....JULY

CITY OR TOWN.....ZONE.....STATE.....

Circle the item number, fill in your name, title, company; detach and mail.

# ALPHABETICAL LISTING OF

CIRCLE THE NUMBERS OPPOSITE THE NAMES OF THE ADVERTISERS

- |  |   |   |
|--|---|---|
| 10 AC Electronics Div., General Motors Corp.—Engineering personnel | 151 Autonetics Div., North American Aviation Inc.—Engineering personnel | 95 Diamond Power Specialty Corp.—Photo conductive TV tube                               |
| 89 Aircraft Radio Corporation—Navigation signal generator          | 96 Blaw-Knox Company—Microwave towers                                   | 105 Donner Scientific Company—Wave analyzer   |
| 103 Alford Manufacturing Co., Inc.—TV transmitting antennas        | 116 Boehme, Inc., H. O.—Precision gears                                 | 117 Dow Corning Corp.—Silicone-glass laminates  |
| 128 Alpha Wire Corporation—Teflon wire kits                        | 114 Bourne Laboratories—Sub-miniature potentiometers                    | 6 DuMont Labs., Inc., Allen B.—Cathode-ray tube   |
| 115 American Lava Corporation—High temperature alumina ceramics    | 9 Burrell & Co.—Toroids, filters and networks                           | 149 ESC Corporation—Delay lines   |
| 94 AMP Incorporated—Terminals and connectors                       | 92 Bussmann Manufacturing Co.—Fuses and holders                         | 145 Ford Instrument Co., Div. Sperry Rand Corp.—Engineering personnel                   |
| 100 Andrew Corporation—Parabolic antennas                          | 51 Cinch Manufacturing Co.—Sub-miniature connectors                     | 142 Freed Transformer Company—MIL-T-27A Power, filament, pulse & audio transformers     |
| 137 Applegate & Co., C. J.—Filament & transistor power supplies    | 97 Collins Radio Company—Broadcast console                              | 150 Fosite Corporation—Multiple bead and solid glass terminals                          |
| 257 Arnold Engineering Company—Powder cores                        | 8 Consolidated Electrodynamics—Miniature connector                      | 111 General Electrodynamics Corp.—Vidicon television pickup tube                        |
| 152 Audio Devices, Inc.—Magnetic tape                              | 91 Cornell-Dubilier—Electrolytic capacitor                              | 140 General Electric Corp., Light Military Electronic Equipment — Engineering personnel |
| 127 Augat Brothers, Inc.—Transistor clips                          | 258 Dale Products, Inc.—Wire wound resistors                            | 129 General Radio Company—VHF-UHF admittance meter                                      |
| 143 Automatic Coil Company—Coils                                   | 93 Delco Radio Div., General Motors Corp.—High power transistors        | 256 General Transistor Corp.—Transistor   |

Postcard valid 8 weeks only. After that use own letterhead fully describing item wanted **JULY 1957**  
Please send me further information on the items I have circled below.

1	2	3	4	5	6	7	8	9	10	11	12	13	14	15	16	17	18	19	20
21	22	23	24	25	26	27	28	29	30	31	32	33	34	35	36	37	38	39	40
41	42	43	44	45	46	47	48	49	50	51	52	53	54	55	56	57	58	59	60
61	62	63	64	65	66	67	68	69	70	71	72	73	74	75	76	77	78	79	80
81	82	83	84	85	86	87	88	89	90	91	92	93	94	95	96	97	98	99	100
101	102	103	104	105	106	107	108	109	110	111	112	113	114	115	116	117	118	119	120
121	122	123	124	125	126	127	128	129	130	131	132	133	134	135	136	137	138	139	140
141	142	143	144	145	146	147	148	149	150	151	152	153	154	155	156	157	158	159	160
161	162	163	164	165	166	167	168	169	170	171	172	173	174	175	176	177	178	179	180
181	182	183	184	185	186	187	188	189	190	191	192	193	194	195	196	197	198	199	200
201	202	203	204	205	206	207	208	209	210	211	212	213	214	215	216	217	218	219	220
221	222	223	224	225	226	227	228	229	230	231	232	233	234	235	236	237	238	239	240
241	242	243	244	245	246	247	248	249	250	251	252	253	254	255	256	257	258	259	260

YOUR NAME ..... TITLE .....

FIRM ..... JULY

FIRM ADDRESS ..... JULY

CITY OR TOWN ..... ZONE ..... STATE .....

FIRST CLASS  
PERMIT NO. 36  
(Sec. 34.9, P.L.&R.)  
NEW YORK, N. Y.

**BUSINESS REPLY CARD**  
NO POSTAGE STAMP NECESSARY IF MAILED IN UNITED STATES

POSTAGE WILL BE PAID BY  
**ELECTRONIC INDUSTRIES**  
& Tele-Tech

P. O. BOX 73, VILLAGE STATION  
NEW YORK 14, N. Y.



- |  |
|--|
| 112 Heath Company — Electronic Analog Computer Kit                           |
| 131 Hoffman Radio Corp.—Engineering personnel                                |
| 7 Houston Fearless Corp.—Motor driven TV pedestal                            |
| 118 Hughes Aircraft Company—Engineering personnel                            |
| 130 Illumitronic Engineering—Spiral wrap cabling                             |
| 122 Indiana Steel Products Co.—Permanent magnets                             |
| 133 Intex Systems Inc.—Cold cathode decade counter                           |
| 14 International Electronic Research Corp.—Heat-dissipating tube shields     |
| 259 Johnson Co., E. F.—Tube sockets  |
| 138 Jones Div., H. B., Cinch Mfg Co.—Plugs and sockets                       |
| 12 Kester Solder Company—Flux-core solder                                    |
| 90 Lockheed Aircraft Corp — Engineering personnel                            |
| 132 Magnecord Div., Midwestern Instruments, Inc.—Tape recorders              |
| 4 Magnetic Metals Co.—Transformer laminations                                |
| 71 Magnetics, Inc.—Core design manual  |
| 126 Mallory & Co., Inc., P. R.—Low-end-taper control                         |
| 108 Melpar, Inc.—Engineering personnel                                       |
| 70 Minnesota Mining & Mfg. Co.—Magnetic tape for instrumentation use booklet |

# ADVERTISERS IN THIS ISSUE

FROM WHOM YOU DESIRE FURTHER INFORMATION

- 3 National Cash Register Co.—Engineering personnel
- 5 New Hermes Engravers, Inc.—Plastic legend plates
- 3 Ohmite Mfg. Co.—Rheostats, resistors, relays
- 6 Onan & Sons, Inc., D. W.—Electric power plants
- 4 Permag Corp.—Magnets
- 9 Phelps Dodge Copper Products Corp.—Coaxial cable
- 5 Phelps Dodge Copper Products Corp., Wire Products Div.—Solderable film wire
- 5 Philco Corporation, Lansdale Tube Company Div.—Micro-alloy transistor
- 60 Polarad Electronics Corp.—5 pulse coded multi-pulse generator
- 07 Polytechnic Research & Development Corp.—Rotary standing wave detector
- 98 Radio Corporation of America—Traveling wave antenna
- 62 Radio Corporation of America—Phototubes
- 64 Radio Corporation of America—Industrial electron tubes
- 47 Radio Corporation of America—"Premium" and computer tubes
- 1 Radio Materials Corporation—Ceramic capacitors
- 48 Raytheon, Inc.—Wideband television microwave relay
- 54 Reeves Saundcraft Corp.—Magnetic instrumentation tape
- 09 Resistance Products Co.—Resistors for all uses
- 139 Rehn Manufacturing Co.—Communications towers
- 2 Sprague Electric Company—Axial-lead power resistors
- 153 Sprague Electric Company—Surface barrier transistors
- 136 Sta-Warm Electric Company—Compound melting equipment
- 3 Stevens Manufacturing Company—Sealed thermostats
- 141 Stromberg-Carlson Company Div of General Dynamics Corp.—Special purpose telephone handset
- 11 Telechrome, Inc.—Video transmission test standards
- 110 Tower Construction Company—Towers, reflectors and buildings
- 134 Trio Labs—Panel-mounting electronic instruments
- 101 Truscon Steel Div., Republic Steel Corp.—Steel towers
- 119 United Transformer Company—Transformers
- 113 Westinghouse Electric Corp.—Normalized transformer coils

121 Weston Electrical Instrument Corp., Subsidiary of Daystrom, Inc.—Test equip.

144 Williams & Co., Inc., C. K.—Ferric oxides for ferrites

## NEW Subscription Order

Please enter a new complimentary subscription to **ELECTRONIC INDUSTRIES & Tele-Tech**

Name: ..... Position .....

Company Name: .....

Company Address: .....

City: ..... Zone ..... State .....

Products Manufactured .....

**FIRST CLASS  
PERMIT NO. 36  
(Sec. 34.9, P.L.&R.)  
NEW YORK, N. Y.**

**BUSINESS REPLY CARD**  
NO POSTAGE STAMP NECESSARY IF MAILED IN UNITED STATES

**POSTAGE WILL BE PAID BY  
ELECTRONIC INDUSTRIES  
& Tele-Tech**

**P. O. BOX 73, VILLAGE STATION**

**NEW YORK 14, N. Y.**

Postcard valid 8 weeks only. After that use own letterhead fully describing item wanted **JULY 1957**  
Please send me further information on the items I have circled below.

1	2	3	4	5	6	7	8	9	10	11	12	13	14	15	16	17	18	19	20
21	22	23	24	25	26	27	28	29	30	31	32	33	34	35	36	37	38	39	40
41	42	43	44	45	46	47	48	49	50	51	52	53	54	55	56	57	58	59	60
61	62	63	64	65	66	67	68	69	70	71	72	73	74	75	76	77	78	79	80
81	82	83	84	85	86	87	88	89	90	91	92	93	94	95	96	97	98	99	100
101	102	103	104	105	106	107	108	109	110	111	112	113	114	115	116	117	118	119	120
121	122	123	124	125	126	127	128	129	130	131	132	133	134	135	136	137	138	139	140
141	142	143	144	145	146	147	148	149	150	151	152	153	154	155	156	157	158	159	160
161	162	163	164	165	166	167	168	169	170	171	172	173	174	175	176	177	178	179	180
181	182	183	184	185	186	187	188	189	190	191	192	193	194	195	196	197	198	199	200
201	202	203	204	205	206	207	208	209	210	211	212	213	214	215	216	217	218	219	220
221	222	223	224	225	226	227	228	229	230	231	232	233	234	235	236	237	238	239	240
241	242	243	244	245	246	247	248	249	250	251	252	253	254	255	256	257	258	259	260

**YOUR NAME** ..... **TITLE** .....

**FIRM** .....

**FIRM ADDRESS** ..... **JULY**

**CITY OR TOWN** ..... **ZONE** ..... **STATE** .....

# New Products & Tech Data

- |     |   |     |   |
|-----|---|-----|---|
| 33  | Aluminizing equipment—F. J. Stokes Corp.              | 156 | Crystal & oven—Bliley Electric Co.                |
| 37  | Antenna, parabolic—Andrew Corp.                       | 36  | Delay line—Bliley Electric Co.                    |
| 155 | Camera, TV—DuMont Laboratories, Inc.                  | 15  | Delay, thermal—G-V Controls, Inc.                 |
| 26  | CRT, wave modulated—Sylvania Electric Products, Inc.  | 28  | Diode, gold bonded—Radio Receptor Co.             |
| 50  | Connector, co-axial—Cannon Electric Co.               | 42  | Film Processor—Houston Fearless                   |
| 32  | Coolant, engraving—New Hermes Engraving Machine Corp. | 48  | Generator, pulse — Packard-Bell Electronics Corp. |
|     |   | 35  | Generator, signal — Polarad Electronics Corp.     |

FIRST CLASS  
PERMIT NO. 36  
(Sec. 34.9, P.L.&R.)  
PHILA., PA.

**BUSINESS REPLY CARD**  
NO POSTAGE STAMP NECESSARY IF MAILED IN UNITED STATES

POSTAGE WILL BE PAID BY  
**ELECTRONIC INDUSTRIES**  
& Tele-Tech

CHESTNUT & 56th STS.,  
PHILADELPHIA 39, PA.

Chilton Company

- 44 Generator, square wave—Measurements Corp.
- 27 Generator, ultrasonic—Designers for Industry, Inc.
- 21 Gyroscope, rate—Minneapolis-Honeywell.
- 31 Integral measuring equipment — Alleghany Instrument Co.
- 41 Inverters—Universal Transistor Products Corp.
- 18 Memory core, ferrite—Radio Corporation of America
- 46 Motor, stop motion—Camera Equipment Co.
- 38 Oscilloscope, portable—Allen B. DuMont Labs, Inc.
- 47 Outlet boxes, TV—Blonder-Tongue Labs, Inc.
- 24 Oven, multi-purpose—Bulova Watch Co.
- 20 Power supplies, airborne—Gulton Industries, Inc.
- 43 Power unit—Aircraft Radio Corp.
- 19 Reactors, paralleling—International Rectifier Corp.
- 34 Reducers, speed—Western Gear Corp.
- 17 Rectifiers, silicon—General Electric Co.
- 45 Reel, tape—Audio Devices, Inc.
- 16 Resistor, variable—Allen-Bradley Co.
- 49 Switch, grounding—P. R. Mallory & Co.
- 40 Test instruments, modular—Teletronics Laboratory, Inc.
- 39 Tone-arm—Shure Brothers, Inc.
- 23 Transformer, aircraft — Westinghouse Electric Corp.
- 30 Transformer, auto—General Radio Co.
- 25 Transistor, junction—Texas Instruments Inc.
- 22 Tube, indicator — Amperex Electronic Corp.
- 29 Wire collecting device—Artos Engineering Co.

## NEW TECHNICAL DATA

- 68 Amplifiers, computing—Airpax Products Co.
- 57 Antenna, IGY—The Technical Appliance Corp.
- 77 Antennas & accessories—Andrew Corp.
- 62 Bearings—Halax Corp.
- 73 Bobbins—National Vulcanized Fibre Co.
- 65 Capacitor chart—Erie Resistor Corp.
- 55 Company bulletin—Burnell & Co.
- 52 Connectors—Cannon Electric Co.
- 54 Control theory—The Bristol Co.
- 69 Data processing—ElectroData
- 60 Electronic equipment—Nems-Clarke, Inc.
- 76 Glass, commercial types—Corning Glass Works
- 63 Lubricant, dry — Electronic Research Corp.
- 80 Microwave products—Microwave Associates
- 75 Numerical positioning—General Electric Co.
- 78 Optics, precision — Texas Instruments Inc.
- 81 Panel instruments — Trio Laboratories, Inc.
- 74 Plastics, custom moulded—Sylvania Electric Products Inc.
- 82 Potentiometers, precision — Beckman/Heliplot Corp.
- 67 Power supplies—Gulton Industries
- 86 Recording equipment—Brush Electronics Co.
- 66 Rectifiers & capacitors—Fansteel Metallurgical Corp.
- 79 Rectifiers, power—Sarkes-Tarzian, Inc.
- 59 Resistance wire—Driver-Harris Co.
- 61 Resistors, precision — International Resistance Co.
- 64 Screws, socket—The Bristol Co.
- 85 Semiconductors—Tung-Sol Electric Inc.
- 84 Servo information — Servo Corp. of America
- 83 Tape, instrumentation—Minnesota Mining & Mfg. Co.
- 53 TV products — Blonder-Tongue Laboratories
- 56 Terminations, high-power — The Narda Corp.
- 87 Test equipment—Hickok Electrical Instrument Co.
- 58 Transistor wall chart—General Transistor Corp.
- 72 Tube catalog, electronic — Eitel-McCullough Inc.
- 83 Wire & cable—Belden Mfg. Co.

Postcard valid 8 weeks only. After that use own letterhead fully describing item wanted **JULY 1957**  
Please send me further information on the items I have circled below.

1	2	3	4	5	6	7	8	9	10	11	12	13	14	15	16	17	18	19	20
21	22	23	24	25	26	27	28	29	30	31	32	33	34	35	36	37	38	39	40
41	42	43	44	45	46	47	48	49	50	51	52	53	54	55	56	57	58	59	60
61	62	63	64	65	66	67	68	69	70	71	72	73	74	75	76	77	78	79	80
81	82	83	84	85	86	87	88	89	90	91	92	93	94	95	96	97	98	99	100
101	102	103	104	105	106	107	108	109	110	111	112	113	114	115	116	117	118	119	120
121	122	123	124	125	126	127	128	129	130	131	132	133	134	135	136	137	138	139	140
141	142	143	144	145	146	147	148	149	150	151	152	153	154	155	156	157	158	159	160
161	162	163	164	165	166	167	168	169	170	171	172	173	174	175	176	177	178	179	180
181	182	183	184	185	186	187	188	189	190	191	192	193	194	195	196	197	198	199	200
201	202	203	204	205	206	207	208	209	210	211	212	213	214	215	216	217	218	219	220
221	222	223	224	225	226	227	228	229	230	231	232	233	234	235	236	237	238	239	240
241	242	243	244	245	246	247	248	249	250	251	252	253	254	255	256	257	258	259	260

YOUR NAME .....TITLE .....  
FIRM .....  
FIRM ADDRESS .....JULY  
CITY OR TOWN.....ZONE.....STATE.....

FIRST CLASS  
PERMIT NO. 36  
(Sec. 34.9, P.L.&R.)  
NEW YORK, N. Y.

**BUSINESS REPLY CARD**  
NO POSTAGE STAMP NECESSARY IF MAILED IN UNITED STATES

POSTAGE WILL BE PAID BY  
**ELECTRONIC INDUSTRIES**  
& Tele-Tech

P. O. BOX 73, VILLAGE STATION

NEW YORK 14, N. Y.

**ELECTRONIC INDUSTRIES**  
A TELE-TECH

## MICROWAVE PROGRESS

### Impedance Measurements in the 100—1000 mc/s Range

Trying to understand the workings of a woman's mind is like measuring impedance in the 100—1000 mc/s range... both are fraught with difficulties.

While we haven't, as yet, made any progress on the first problem, we have solved the impedance measurement difficulties with our Type 219 Rotary Standing Wave Detector.

Basically, the 219 consists of a coaxial Tee junction. One arm is fed by the generator. The other two arms are terminated, respectively, by a variable capacitor and by the unknown impedance. Vertically above the Tee junction, is a concentrically mounted round cutoff tube which contains the pickup structure.

It can be shown mathematically that an elliptically polarized field exists in the cutoff tube; and if the variable capacitor is adjusted such that at any frequency its normalized susceptance, as seen at the junction, is equal to unity, then the ratio of the major and minor axes of the ellipse is equal to the VSWR of the load. Further, the geometrical orientation of the major and minor axes of the ellipse with respect to the Tee junction is determined by the angle of the reflection coefficient. A rotating probe samples the elliptical field, and with suitable detection, indicates values of  $E_r$  max (electric field vector corresponding to the major axis of the ellipse), and  $E_r$  min (minor axis vector), and  $\theta$  (angle of reflection coefficient). The ratio of  $E_r$  max to  $E_r$  min is the VSWR of the unknown impedance. The dominant mode in the cutoff tube is the  $TE_{11}$  and other modes are eliminated by a mode filter consisting of a series of thin parallel blades mounted in the cutoff tube.

You can obtain additional discussions on the 219, including Theory of Operation, Instrument Accuracy, and Applications, by requesting our PRD Report Vol. 3, No. 2E



## Polytechnic Research and Development Co., Inc.

202 Tillary Street • Brooklyn 1, N. Y. • Tel: UL 2-6800

Cable Address: MICROWAVE, NEW YORK

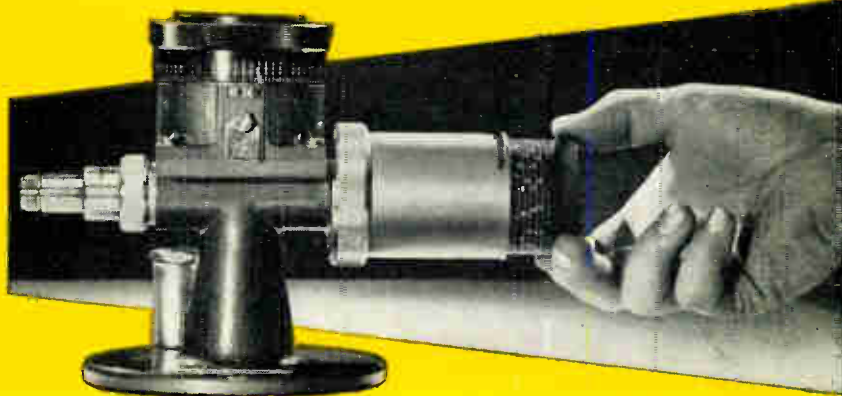

### PRD Rotary Standing Wave Detector for the 100 to 1000 mc/s Range

- Small, Compact, Lightweight\*
- Direct Reading of Reflection Coefficient Angle
- Direct Measurement of VSWR
- Non-Ambiguous Display of Inductive or Capacitive Components

Now, a simple-to-use, easy-to-handle standing wave detector for impedance measurements in the 100 to 1000 mc/s range! A turn of the calibrated top drum dial to minimum indication enables you to read the VSWR; and the angle of the voltage reflection coefficient directly in electrical degrees, and, with the 219, you can immediately determine the character of the reactive component as inductance or capacitance (+ or -).

#### SPECIFICATIONS

Frequency Range: 100 to 1000 mc/s  
Residual VSWR: Less than 1.03  
Minimum Input Signal: Approx. 1V at 100 mc/s; 0.1V at 1000 mc/s for measuring a matched load.  
Characteristic Impedance: 50 ohms  
Detector: G.E. G-7 crystal included  
RF Input Connector: BNC jack  
RF Output Connector: Type N jack. Other interchangeable connectors available.  
Audio Output Connector: BNC jack  
\*Dimensions: 8" long x 5" wide x 5 3/4" high  
\*Weight: 3 1/2 pounds  
Price: \$525. FOB Brooklyn, N. Y.

For additional details on PRD 219 Rotary Standing Wave Detector, contact your local PRD Engineering Representative or write to Technical Information Group, Dept. 9.

## ENGINEERS: *Electronic & Mechanical, PHYSICISTS*

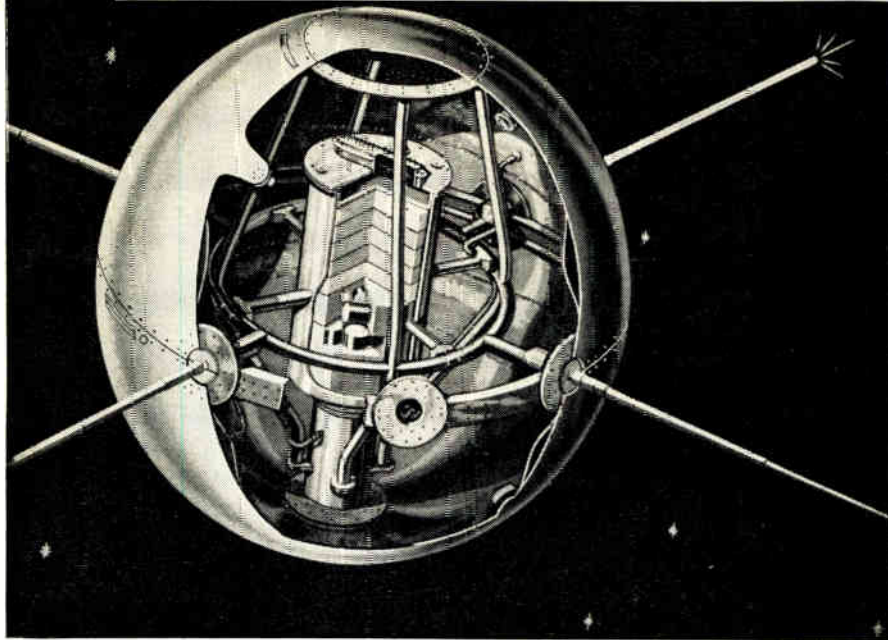

Melpar's work on the earth satellite is one of many diversified projects.

## Melpar's more than 90 projects give wider scope to men of talent

At Melpar the problems posed by our more than 90 current projects allow you to work in the area of your choice and make contributions on advanced levels.

Our dynamic growth (we've doubled in size every 24 months for the past 11 years) constantly creates new middle and top level openings; our policy of *individual recognition* allows you to compete for them *strictly* on merit, and to receive financial compensation limited only by your ability.

As a member of a Melpar project group you'll enjoy freedom and a team spirit found only in a young organization of our size. Each project group is charged with responsibility for solving problems from conception to prototype. This means that you gain invaluable experience in inter-related spheres, essential to eventual directorship responsibility.

Living is relaxed and good in the Washington, D. C. area with its mellow climate and spacious suburbs. Our new air-conditioned laboratory is well-instrumented with an eye to future needs and is situated on a wooded 44-acre tract.

### DUE TO OUR DIVERSIFICATION, OPENINGS EXIST IN PRACTICALLY EVERY PHASE OF ELECTRONIC RESEARCH & DEVELOPMENT

Qualified engineers will be invited to visit Melpar at company expense.

- For detailed information on openings, the laboratory, and the industry-free area in which we're located, write:



Technical Personnel Representative

# MELPAR Incorporated

A Subsidiary of Westinghouse Air Brake Company

3201 Arlington Boulevard

Falls Church, Virginia

## Pulse Gate

(Continued from page 57)

at the cathode of V1. To make this change small the potential at the cathode of V1 should be only slightly positive with respect to ground. It must be equal to or greater than zero, however, to prevent condition of current by CR1 when the switch is on. To obtain this condition the cathode resistor of V1 is returned to a negative voltage, and the cathode potential is then adjusted to approximately +1v. by means of the 250 K grid-bias potentiometer.

It is well-known that difficulty is often encountered in the design of cathode followers for fast waveforms of high amplitude, particularly for the negative swings<sup>1, 2</sup>. Using the design methods of the two referenced papers, a quiescent plate current of approximately three ma and a cathode resistor of 8.2 K ohms was selected for V1 and V2. These values give approximately equal rise and fall times for input pulses of 100-v. amplitude

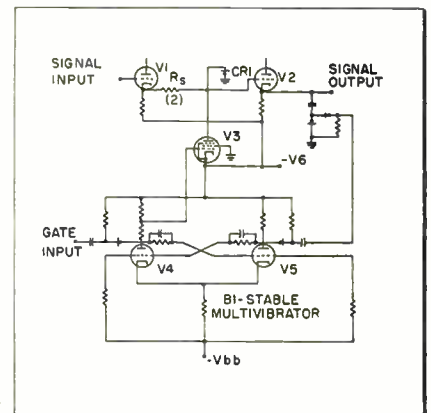

Fig. 4: Pulse selector gate

which have rise and fall times of 0.1  $\mu$ sec. or more. The 33 K resistors, bypassed by 0.01- $\mu$ fd capacitors, are necessary only because the use of a standard 150-v. negative supply appeared desirable. It should be noted that, when the gate is off, the effective cathode load resistance of V1 is the parallel combination of the 8.2 K cathode resistor and the 10 K resistor used for  $R_s$ .

The cathode followers as designed here should be used only for low duty cycle pulses since the load lines obtained extend well

(Continued from page 96)



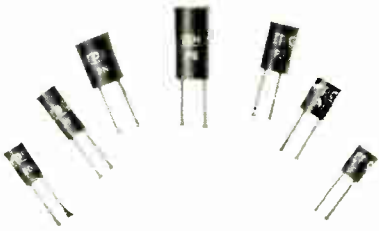

### Printed Circuit Precision Resistors

To meet the requirements for printed circuitry, RPC has developed Type P Encapsulated Wire Wound Precision Resistors. Miniature, single ended units designed for easy rapid mounting on printed circuit panels with no support other than the wire leads. Many newly developed techniques are employed in the manufacture of Type P Resistors. These units can be operated in ambient temperatures up to 125°C. and will withstand all applicable tests of MIL-R-93A, Amdt. 3. Available in 6 sizes, rated from 1/10 watt to .4 watt.  $\frac{1}{4}$ " diameter by  $\frac{3}{16}$ " long to  $\frac{3}{8}$ " diameter by  $\frac{3}{4}$ " long. Resistance values to 3 megohms. Tolerances from 1% to 0.05%.

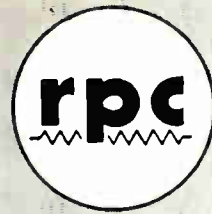

# HIGH QUALITY RESISTORS FOR ELECTRONICS

RPC is a widely recognized supplier of high quality resistors to industry, Government Agencies and the Armed Forces. Advanced production methods, modern equipment and scientific skill enables RPC to manufacture resistors of *highest quality in large quantities at reasonable cost.* Modern manufacturing plant is completely air conditioned and equipped with electronic dust precipitators to insure highest production accuracy. RPC resistors are specified for use in instruments, electronic computers, radiation equipment, aircraft equipment and scientific instruments.

Test equipment and standards for checking and calibrating are equalled by only a few of this country's outstanding laboratories. Our ability to produce resistors of highest quality coupled with prompt delivery have established RPC as a leading manufacturer of resistors. Small or large orders are promptly filled.

Representatives in principal cities. For full information send for latest catalog.



### High Frequency Resistors

Used where requirements call for very low inductance, capacitance and skin effect in circuits involving pulses and steep wave fronts. Depending on size and resistance value, these resistors are usable at frequencies to over 400 mc. Resistance values range from 20 ohms to 100 megohms with tolerance of 20% to 5%. 2 types available.

TYPE G resistors (shown) are tubular, in 6 sizes from  $4\frac{1}{2}$ " long x  $\frac{3}{4}$ " diameter to  $18\frac{1}{2}$ " long x 2" diameter. With band terminals or ferrules. Power rating 10 to 100 watts. TYPE F resistors (not shown) in 8 sizes from  $9\frac{1}{16}$ " long x 0.10" diameter to  $6\frac{1}{2}$ " long x  $9\frac{1}{16}$ " diameter. Lugs or wire leads. Power rating  $\frac{1}{4}$  to 10 watts.

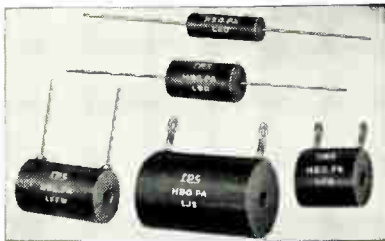

### Encapsulated Precision Wire Wound Resistors

RPC Type L Encapsulated Resistors will withstand temperature and humidity cycling, salt water immersion and extremes of altitude, humidity, corrosion and shock without electrical or mechanical deterioration. Type L resistors are available in many sizes and styles ranging from sub-miniature to standard with lug terminals, axial or radial wire leads. Available for operation at 105° C. or 125° C. ambient temperatures. These resistors will meet all applicable requirements of MIL-R-93A, Amdt. 3. Type L can be furnished with all resistance alloys and resistance tolerances from 1% to .02%.

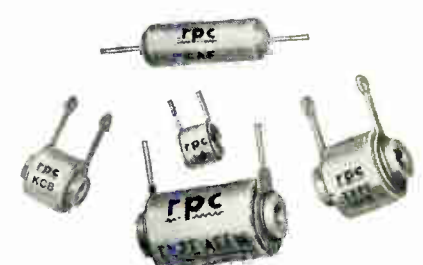

### Unsealed Precision Wire Wound Resistors

Unsealed precision resistors are wound on steatite forms and are used for all general requirements. They can be furnished with all resistance alloys in tolerances from 1% to .02%. These resistors will meet the requirements of MIL-R-93A, Amdt. 2, characteristic B. Special winding techniques, impregnation and thermal aging result in resistors of exceptional stability. They are available in a wide variety of sizes, styles and terminal types. Matched resistors, networks and special assemblies can be supplied.



### High Voltage Resistors

Type B Resistors are stable compact units for use up to 40 KV. These resistors are used for VT voltmeter multipliers, high resistance voltage dividers, bleeders, high resistance standards and in radiation equipment. They can be furnished in resistance to 100,000 megohms. Available as tapped resistors and matched pairs. Sizes range from a 1 watt resistor 1 inch long x  $\frac{3}{8}$  inch diameter rated at 3500 volts, to a 10 watt resistor  $6\frac{1}{2}$  inches long x  $\frac{3}{8}$  inch diameter rated at 40 KV. Low temperature and voltage coefficients. Standard resistance tolerance 15%. Tolerances of 10%, 5% and 3% available. Tolerance of 2% available in matched pairs.



### High Megohm Resistors

Type H Resistors are used in electrometer circuits, radiation equipment and as high resistance standards. Resistance available to 100 million megohms. (10<sup>14</sup> ohms). For utmost stability under adverse conditions Type HSD and HSK Hermetically Sealed are recommended. Eight sizes from  $\frac{3}{8}$  inch to 3 inches long are available. Voltage rating to 15,000 volts. Low temperature and voltage coefficients. Standard resistance tolerance 10%. Tolerance of 5% and 3% available. Also matched pairs 2% tolerance.

# RESISTANCE PRODUCTS CO. 914 S. 13th Street HARRISBURG, PA.

# In 1956, TOWER supplied over one hundred major Microwave Installations

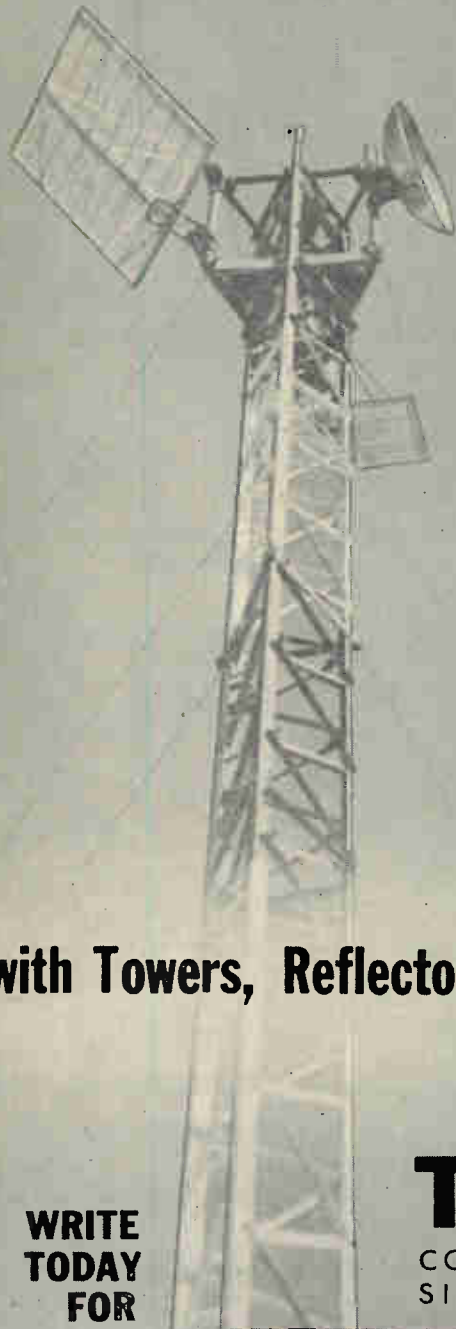

Mid-Continent Broadcasting Co.  
Television Station KSAZ  
Radio Station KFVR  
Radio Station WWTV  
Amalgamated Wireless Ltd., Australia  
Collins Radio Co.  
General Electric  
Lenkurt Electric Co.  
Motorola, Inc.  
Page Communications Engineers, Inc.  
Philco Corp.  
Radio Corporation of America  
Raytheon  
Western Electric  
American Telephone & Telegraph Co.  
Bell Telephone Laboratories  
Colorado Interstate Gas Co.  
Michigan Bell (SAGE project)  
Mid Valley Pipe Line  
Ohio Power Co.  
Southwestern Bell Telephone Co.  
U.S. Air Force

## with Towers, Reflectors and Buildings

tower fabricators  
and erectors  
the world over

# TOWER

CONSTRUCTION CO.  
SIOUX CITY, IOWA

**WRITE  
TODAY  
FOR  
FREE  
BOOKLET**



TOWER CONSTRUCTION CO

2700 Hawkeye Dr., Sioux City, Iowa

Please send me FREE copy of "Aluminum Reflectors"

Name

Firm

Address

City  State

(Continued from page 94)

above the maximum permissible plate dissipation curve.

### Series Resistance

The value of the series resistor,  $R_s$ , affects both the minimum pulse width which the gate can pass and the maximum pulse amplitude which can be blocked. In order for the gate to pass a pulse, the total stray capacity appearing at the grid of V2 must be charged, through  $R_s$ , to the amplitude of the pulse appearing at the cathode of V1 (V3 not conducting). Then for narrow pulses widths  $R_s$  should be small.

When the gate is off (V3 conducting) the current flowing through  $R_s$ , during the time the pulse appearing at the cathode of V1 is at maximum amplitude, must be less than the current drawn by V3; otherwise, the potential at the

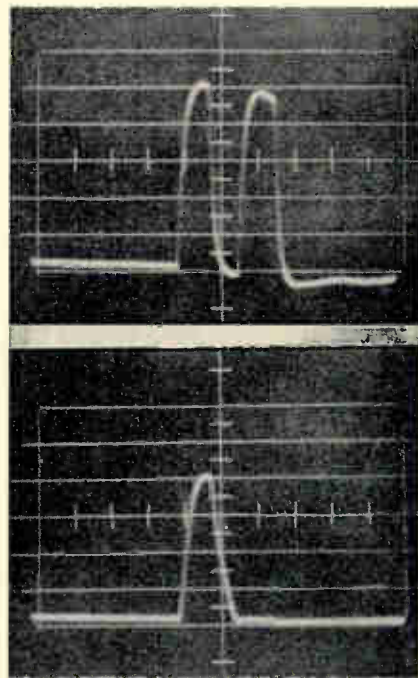

Fig. 5: Pulse selector curves—the gate circuit selects the first of two impulses (scale: 20v/div. and 0.5  $\mu$ sec/div.)

grid of V2 will rise and the gate will exhibit undesirable read-through.

For a given maximum pulse amplitude then,  $R_s$  should be large in order to make the current requirements of V3 small.

In practice a compromise in the size of  $R_s$  is made, based on pulse-amplitude handling capability, pulse width capability, and the current requirements for V3.

(Continued on page 98)

announcing

# GEC VIDICON

a superior television pickup tube



*this tube  
may be operated  
or carried in  
any position*



*Your GEC Vidicons will reach you in factory condition because of GEC-built shockproof packaging.*

Now you can get sturdy GEC Vidicons built for hard handling and usage. Also, you are assured exceptionally long service life by precision manufacture under controlled conditions in GEC's ultra-modern new plant. Both the Industrial 6198A and Broadcasting 6326A types (improved design with side tips eliminated) are available for immediate delivery. See your parts distributor or write directly to GEC.

*Write for new data sheet . . .*



**GENERAL ELECTRODYNAMICS CORPORATION**

4430 FOREST LANE | GARLAND, TEXAS

# solve problems\* electronically

## HEATH *Electronic Analog Computer Kit*

\*In the college classroom, or "on the job" in industry, the Heathkit Analog Computer solves physical or mechanical problems by electronic simulation of conditions. Full kit \$945<sup>00</sup>

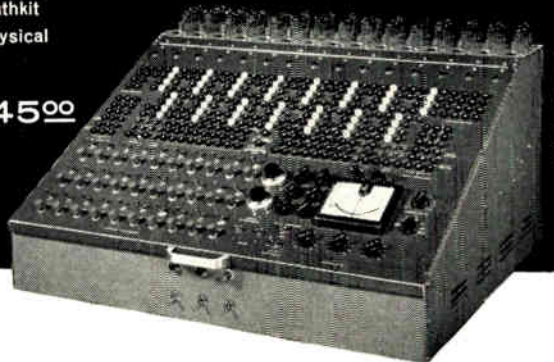

This advanced "slide-rule" is a highly accurate device that permits engineering or research personnel to simulate equations or physical problems electronically, and save many hours of involved calculation.

Ideal for industry, research, or instructional demonstrations. Incorporates such features as:

- 30 coefficient potentiometers, each capable of being set with extreme accuracy.
- 15 amplifiers using etched-metal circuit boards for quick assembly and stable operation.
- A nulling meter for accurate setting of computer voltages.
- A unique patch-board panel which enables the operator to "see" his computer block layout.

Because it is a kit, and you, yourself, supply the labor, you can now afford this instrument, which ordinarily might be out of reach economically. Write for full details today!

## save money with HEATHKITS

Now for the first time, the cost of this highly accurate, time and work-saving computer need not rule out its use—You assemble it yourself and save hundreds of dollars.

FREE CATALOG also available describing test equipment, ham gear, and hi-fi equipment in kit form. Write for your copy today!



**HEATH COMPANY**  
A Subsidiary of Daystrom Inc.  
BENTON HARBOR 37, MICH.

name \_\_\_\_\_

address \_\_\_\_\_

city & zone \_\_\_\_\_

state \_\_\_\_\_



Get the complete computer story from this four-page folder, available free!

(Continued on page 96)

### Crystal Diode

The crystal diode must have a maximum allowable back-voltage characteristic greater than the maximum pulse appearing at the grid of V2. In addition the forward current handling capability must be consistent with the current drawn by V3. In view of the discussion above in regard to the shunt capacity at the grid of V2, a low value of shunt capacity for the crystal diode is desirable.

For this type crystal in the above circuits, hole storage in the crystal appears to be at most a second-order effect.

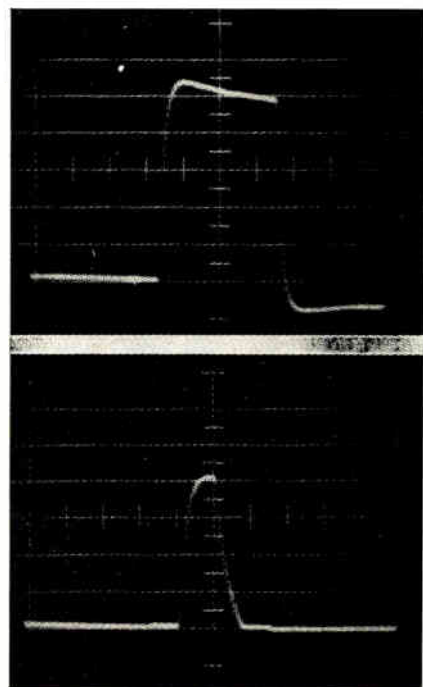

Fig. 6: Here, the gate functions as a sampling switch (scale: 20v/div. and 0.5  $\mu$ sec/div.)

### Current Tube, V3

The current requirement for V3 is based upon the considerations discussed in the section on the series resistor,  $R_s$ . A pentode is desirable in this application in order to secure a constant current source and to minimize gate signal feed-through via the grid-plate capacity of V3.

### Pulse Selection

If the gate is driven by a bistable multivibrator whose output is connected to the gate input terminal of the current source, the gate may be opened by application of a

(Continued on page 100)

“Normalizing” relieves internal stresses, prevents core movement and physical damage such as spreading at the butt joint when subjected to high-temperature operation or encapsulation.

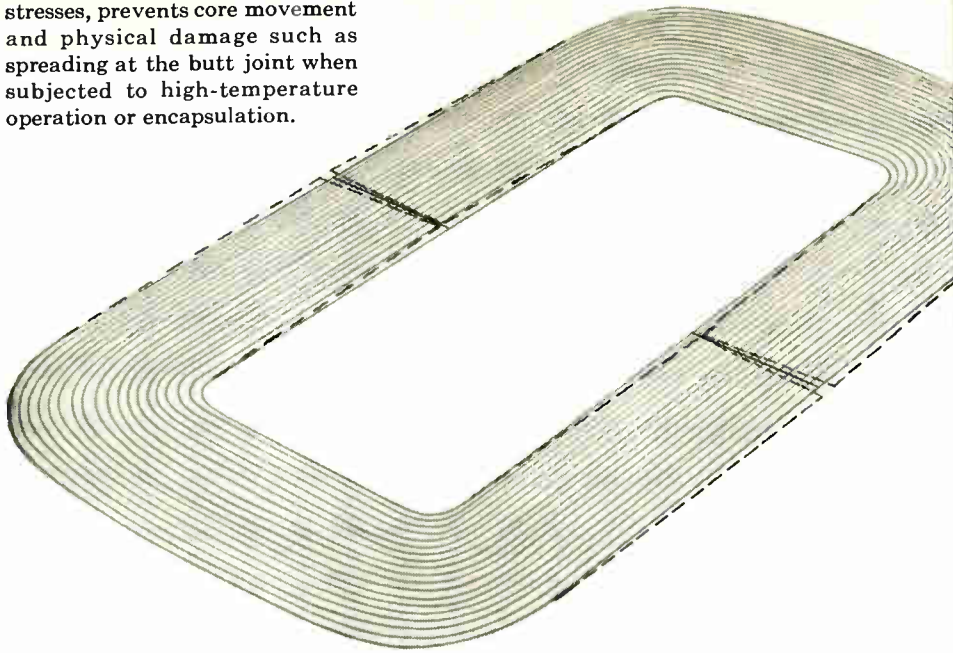

## “Normalizing” Hipersil® Cores holds magnetic values constant

Westinghouse has licked the bugaboo of heat in transformer treatment and operation. “Normalizing,” a process exclusive with Hipersil cores, relieves internal stresses in the core structure.

Both exciting current and inductance “stay put” when a transformer is built around a “normalized” Hipersil core. Thus, magnetic values remain constant (within practical limits) even when the transformer is cast or encapsulated in high-temperature resin, or operated at high temperatures.

Electronics industry demands are ideally met with Hipersil cores. Smaller, lighter transformers result from such revolutionary core properties as oriented grain direction, with 100% coincidental flux; lowest possible core volume for high-temperature transformers; highest permeability, lowest loss; and 100% flux-carrying activity. These values, plus the extra magnetic stability added by “normalizing” make Hipersil the preferred core for more efficient, compact transformers . . . at lower cost.

Also available from Westinghouse: a complete line of both Hipermag\* and Hiperthin\* cores for every electronic application.

For extra profits from your production, send for the *Type “C” Hipersil Core Design and Application Manual*. Write to Westinghouse Electric Corporation, P. O. Box 868, Pittsburgh 30, Pennsylvania.

\*Trade-Mark  
J-70799

YOU CAN BE SURE...IF IT'S

# Westinghouse

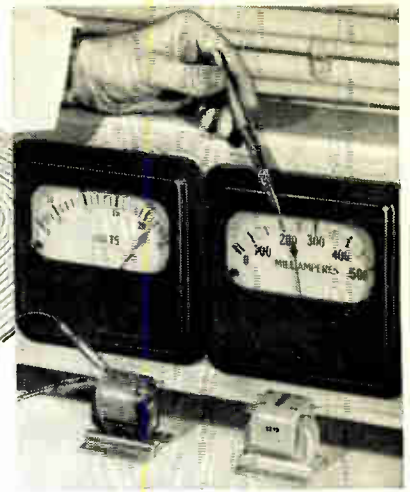

Both “normalized” and un-“normalized” cores record the same exciting current before encapsulation in high-temperature resin.

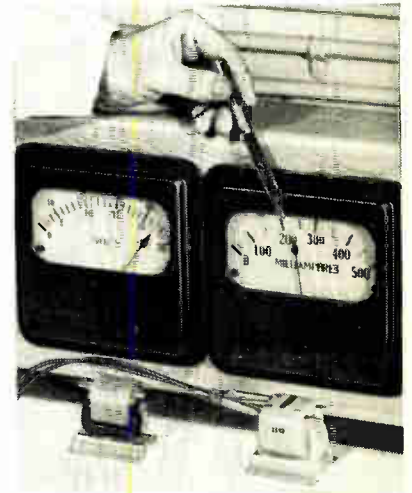

“Normalized” Hipersil core shows exciting current unchanged after encapsulation.

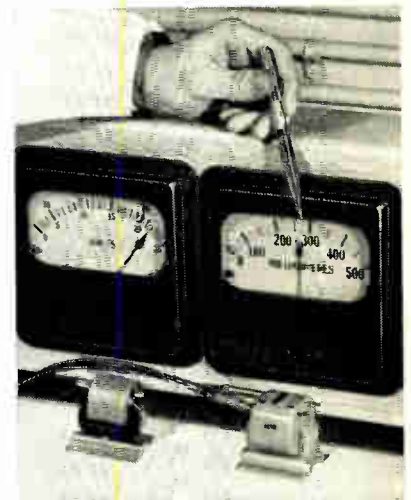

Un-“normalized” core, with the same applied voltage, records considerably higher exciting current after encapsulation.

# BOURNS

## TRIMPOT®

and related sub-miniature potentiometers  
-thousands of variations  
available from stock

SELECT from the many combinations shown below. Any choice is available in a wide selection of standard resistance values... for military or commercial applications.

these TERMINALS:

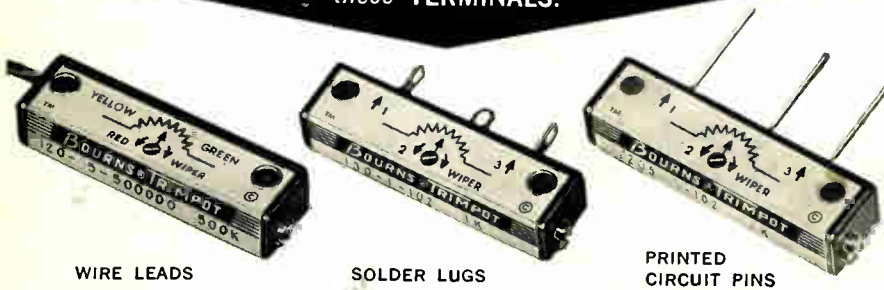

WIRE LEADS

SOLDER LUGS

PRINTED  
CIRCUIT PINS

in these TYPES:

(select one or any combination)

HIGH OR MEDIUM TEMPERATURE	HUMIDITY PROOF	HIGH RESISTANCE	DUAL OUTPUT	VARIABLE RESISTOR
----------------------------------	-------------------	--------------------	----------------	----------------------

with these RESISTANCE ELEMENTS:

WIREWOUND



CARBON



ALL UNITS FEATURE sub-miniature size... space-saving configuration... self-locking shaft with 25-turn screwdriver adjustment... excellent acceleration, vibration and shock characteristics... mounting individually or in stacked assemblies, with standard 2-56 screws.

Over 50,000 units in stock. Send for complete catalog on the TRIMPOT and related potentiometers.

PLUS THE NEW TRIMPOT JR.



Micro-miniature size  $\frac{3}{16} \times \frac{1}{16} \times 1$ "  
2.0-watt power rating. Humidity proof.  
175°C. max. operating temperature.



**BOURNS LABORATORIES, INC.**

General Offices: 6135 Magnolia Ave., Riverside, Calif.  
Plants: Riverside, California—Ames, Iowa

PATENTS ISSUED AND PENDING COPR. 5L

TRIMPOT • LINEAR MOTION POTENTIOMETERS • PRESSURE TRANSDUCERS AND ACCELEROMETERS

(Continued from page 98)

negative pulse to one input of the multivibrator. The gate will then pass the first pulse appearing and automatically shut itself off by means of the circuitry of Fig. 4.

### Sampling Switch

The circuit of Fig. 1 may also be used as a sampling switch. For this type of operation the cathode follower V1 must be redesigned (to prevent excessive plate dissipation) if high voltage signals appear at the input for a high percentage of the total time.

Both negative and positive signals can be passed by the gate if the diode CR1 is returned to a negative voltage slightly greater than any expected negative signal. In this case there would be a signal at the output for no signal at the input. This would present no problem, however, if the gate were being used to sample a continuous signal.

TABLE 1

Input (v.)	Output (v.)	Read-through (v.)	Pedestal (v.)
110	90	1.2	1.2
100	82	1.0	1.2
90	76		
80	68	0.8	1.2
70	59		
60	51	0.6	1.2
50	42.5		
40	35	0.4	1.2
30	26		
20	17	0.2	1.2
10	9		

Pulse width is 0.5  $\mu$ sec.

### References

1. Mills, B. V., "Transient Response of Cathode Followers in Video Circuits," *Proc. I.R.E.*, June 1949.
2. Baer, Ralph A., "Cathode Follower Response," *Electronics*, October 1950.

## Moulded Circuits

(Continued from page 42)

Present marketing plans call for the licensing of companies producing printed circuits for their own use and the licensing of a limited number of firms producing circuits on a contract basis. Rogers Corporation's Killingly division, which specializes in the fabrication of specialty materials, will produce circuits for outside customers.

### Other Uses

In addition to molded circuits and printed wiring devices, this process lends itself also to the production of terminal boards and sliding contact switches.

# The Design Engineer's

## STRONG RIGHT ARM!

# ALSiMAG<sup>®</sup>

HIGH TEMPERATURE  
ALUMINA CERAMICS

No. 576 and No. 614

**Industry endorsed.** For demanding mechanical and electrical applications: AlSiMag 576 is strong, versatile, economical; AlSiMag 614 offers even greater strength plus valuable low loss factors. Many more special purpose AlSiMag Aluminas available.

**Important physical advantages:** Sapphire hard (9 on Mohs' scale). Permanently rigid. Abrasion resistant. Chemically inert. Vacuum tight. High compressive, flexural, tensile strengths. Uniform. Resist chipping and spalling. Held to precision tolerances.

**Important performance values:** Superior dielectric properties. Great hot-cold and mechanical shock resistance. Stable, withstand radiation bombardment without producing contaminants.

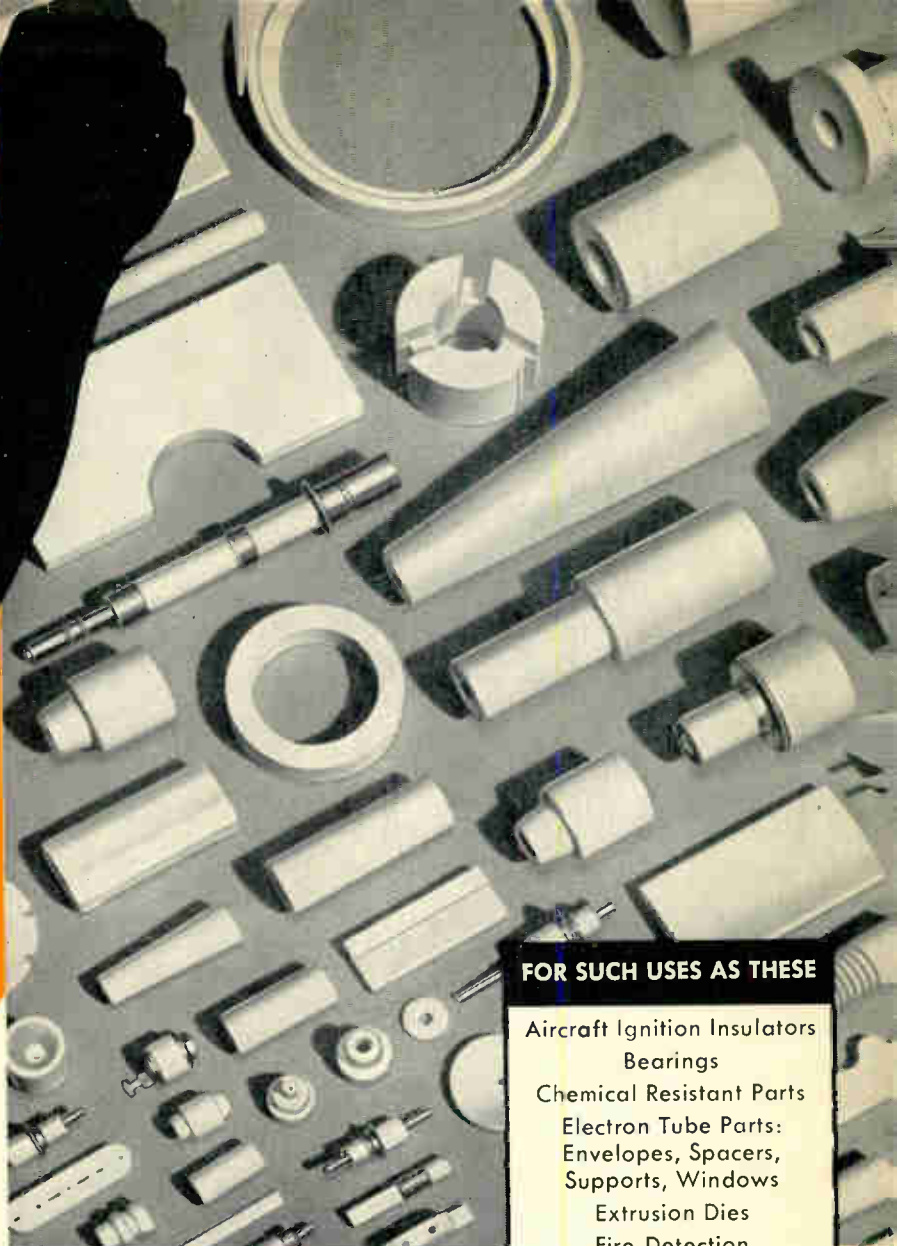

Parts shown approximately 1/2 size.

**Metal-ceramic combinations:** Large-scale metalizing facilities . . . high or low temperature. Custom and standard designs in any volume. Advanced techniques. Permanent bonding.

**Prototype Service available:** Test your designs under actual operating conditions . . . without investing in production tooling!

**Prompt shipment in any quantity!** For complete information on AlSiMag parts in the Alumina material best suited for your application, send blueprint or sketch with details of operation.

### FOR SUCH USES AS THESE

Aircraft Ignition Insulators  
Bearings  
Chemical Resistant Parts  
Electron Tube Parts:  
Envelopes, Spacers,  
Supports, Windows  
Extrusion Dies  
Fire Detection  
Apparatus Parts  
Hermetic Terminals  
Instrument Parts  
High Heat Resistant Parts  
for Jet Engines,  
Rockets, etc.  
Mounting Plates  
Pump Liners  
Pump Plungers  
Refractory Plates  
and Supports  
Thermocouple Tubes  
Wear Plates and Guides  
Work Holding Devices

A Subsidiary of  
Minnesota Mining and  
Manufacturing Company



# AMERICAN LAVA CORPORATION

CHATTANOOGA 5, TENN.  
56TH YEAR OF CERAMIC LEADERSHIP

For service, contact Minnesota Mining & Manufacturing Co. Offices in these cities (see your local telephone directory): Atlanta, Ga. • Boston: Newton Center, Mass. • Buffalo, N. Y. • Chicago, Ill. • Cincinnati, O. • Cleveland, O. • Dallas, Texas • Detroit, Mich. • High Point, N. C. • Los Angeles, Calif. • New York: Ridgefield, N. J. • Philadelphia, Pa. • Pittsburgh, Pa. • St. Louis, Mo. • St. Paul, Minn. • So. San Francisco, Calif. • Seattle, Wash. Canada: Minnesota Mining & Manufacturing of Canada, Ltd., P. O. Box 757, London, Ont. All other export: Minnesota Mining & Manufacturing Co. International Division, 99 Park Ave., New York, N. Y.

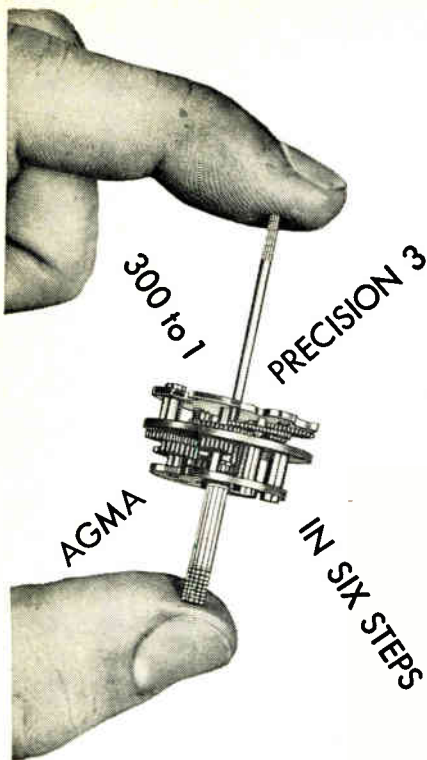

## FINE PRECISION TOP QUALITY GEARS

... Is routine production at Boehme. A glance at this High Precision Reducing Gear Train (300-1 in 6 steps) exemplifies the skill and abilities of BOEHME Instrument Craftsmen

Fine Precision  
Top Quality Gears  
are not hard to get at  
BOEHME

If your requirements include  
up to AGMA Precision #3  
1/8" to 5" O.D.  
180 - 16 D.P.

There is no obligation...  
just send us your  
requirements. They will  
receive prompt attention.

## H. O. Boehme, Inc.

*Designers and Manufacturers*

*Communication Equipment*

*Precision Electro-Mechanical*

*Apparatus Since 1917*

915 Broadway

New York 10, N. Y.



Circle 116 on Inquiry Card, page 89

## Computer Cooling

*(Continued from page 46)*

increasing interest to equipment designers.

The working area that surrounds Univac, containing such auxiliary equipment as 11 magnetic tape stations and a variety of data input and output devices, requires air conditioning. So does the adjacent communication's room, or message center, where original information for Univac, as well as communications to be channeled to personnel throughout the Company, are received via what might be termed a "closed circuit" teletype network. In other words, through central teletype facilities in the Data Processing Center and two remotely-located switching centers, all Sylvania plants, offices and laboratories can communicate directly with one another.

Reason for air conditioning these two areas, in addition to the comfort of personnel, is this: in the message center, incoming messages are punched out on paper tape which tends to grow limp and unmanageable under conditions of excessive humidity. The same is true for punch cards used in the Univac area. Here, messages are first transferred from paper tape to punch cards, then to magnetic tape which makes a permanently useful record of the information. Since the information is put on magnetic tape in the form of digital symbols, dust or other airborne particles, settling on the tape, could distort the message and cause errors.

RCA's Bizmac, built and installed for Army Ordnance in Detroit for use in stock control, is the largest data processing installation to incorporate air conditioning directly into the design of electronic equipment. Occupying 20,000 square feet, it consists of 361 recording, transcribing, sorting and computing units, and maintains complete stock and inventory control over more than 155,000 types of automotive and equipment parts at 12 U. S. and overseas supply depots. Bizmac contains 96,000 tubes and diodes, and the internal heat load relieved by air conditioning is nearly 1,800,000 Btu per hour. Since

Bizmac employs magnetic tape extensively, it is also necessary to eliminate dust and other airborne particles from the atmosphere.

As evidence of the importance of air conditioning to Bizmac, RCA engineers have estimated that even a 15-second lapse in controlled air supply would adversely affect the 70,000 crystal diodes that compose many of the logical elements, requiring the shutdown of machine units.

To prevent such a lapse, Bizmac has its own refrigeration plant, consisting of two 135-ton, multi-stage Carrier centrifugal machines. As a precautionary measure, Bizmac's cooling load is balanced between the two refrigerating machines, either of which can provide all the chilled water needed to cool the electronic units.

The Carrier refrigerating machines furnish 45°F. chilled water, each at a rate of 325 gpm, to six central-system air conditioners serving computer components.

The fan-coil type air conditioners are suspended around the periphery of the Bizmac area. Electrostatic filters remove airborne particles down to 0.1 micron. As incoming outdoor air passes over spiral-fin chilled water coils, its temperature is raised or lowered to a thermostatically-controlled temperature of 55°F. to 65°F. Ductwork carries the conditioned air directly to Bizmac units, through which it is distributed by lateral ducts in the base of the equipment.

Each of the six air conditioning units is equipped with its individual duct distribution system. Each supplies conditioned air to one section of the Bizmac equipment. But, as a further precaution against a possible failure of the air system, the air conditioners are paired by means of interconnecting ductwork. In the event of failure of one unit, a blast gate in the interconnecting duct can be opened, enabling the partner air conditioning unit to supply all the needed air until the other unit is back on the line.

Bizmac's designers expect that air conditioning will account for 50 per cent longer life of the system's 25,000 tubes, an important factor in operating costs.



## Blind Workers Build Silicone Insulated Canned Motor-Pumps

While many manufacturers are making imaginative use of Dow Corning Silicones to improve product performance, other progressive companies are also using these versatile materials to simplify design and assembly. A striking example of this trend is provided by Nuclear Pump, Inc.

Nuclear has licensed the Philadelphia branch of the Pennsylvania Institute for the Blind to build silicone insulated canned motor-pumps ranging in capacity from 40 to 310 gpm. In addition to assembling the pumps, the blind workers also build the 1/2 to 10 hp silicone insulated motors which power the units.

The motor production and assembly operations performed by these workers include uncrating, weighing, stacking, riveting and grinding laminations, cutting and inserting slot insulation, winding and inserting coils, insulating top sticks, wrapping, connecting, dipping and baking.

The finished units, used primarily in the chemical and food industries, have only

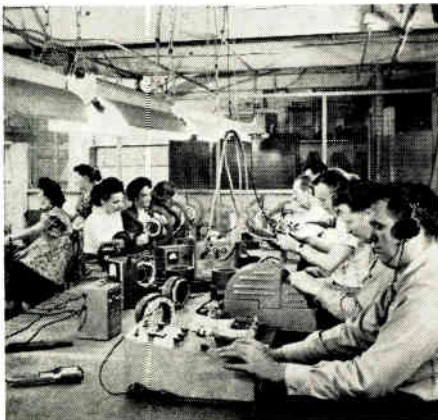

one moving part and can be disassembled in two minutes with a screw driver. An exceptionally low rejection rate highlights the fact that handicapped people are very capable workers, and proves again that electrical insulating components made with Dow Corning Silicones are easy to handle.

The reliability of the motors proves that silicone insulation is the most dependable motor protection money can buy. **No. 49**

## SILICONE-GLASS LAMINATES—NEW SOLUTION TO HIGH TEMPERATURE INSULATING PROBLEMS

Faced with a need for electrical or electronic insulating parts that retain high physical and dielectric properties at elevated temperatures, more and more designers are specifying laminated glass parts bonded with Dow Corning silicone resins. Typical is Stromberg-Carlson's use of silicone-glass laminates for coil spacers and insulators in military field-type telephone switches.

While the cellulose acetate spacers previously employed proved durable enough under normal conditions, they didn't stand up in high temperature use. They failed quickly, for example, when continuing operation with faulty circuits sometimes raised coil temperatures to 320 C (680 F).

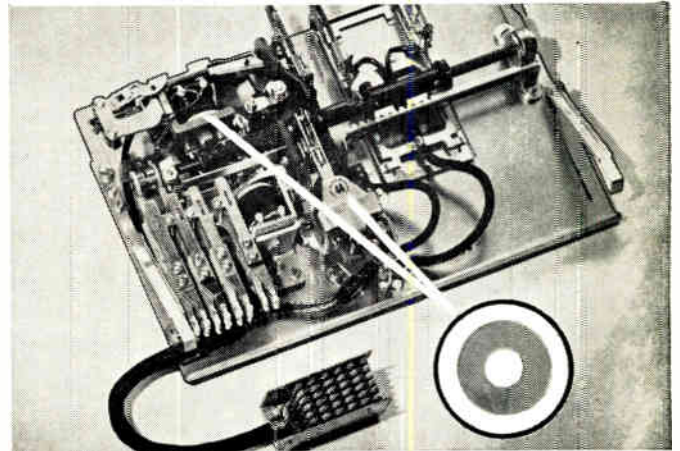

Stromberg-Carlson solved the problem once and for all by replacing the acetate spacers with single-ply silicone-glass laminates supplied by Mica Insulator Company. According to Stromberg-Carlson engineers, the use of silicone bonded glass laminates has "increased the service life and dependability of the telephone switch." **No. 47**

## Boost Insulation Resistance With Silicone Fluids

Because Dow Corning 200 Fluid has better electrical resistance than wax at elevated temperatures, many designers use this high temperature liquid dielectric to increase the life and reliability of capacitors, small transformers and other electronic assemblies.

Gudeman Company of Chicago, for example, impregnate their special line of miniature tubular paper capacitors for filter, by-pass and blocking service with Dow Corning 200 Fluid.

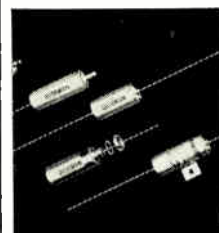

Only about half as big as comparable conventional units, these silicone-impregnated capacitors are designed to meet all the electrical and environmental requirements for Characteristic "K", MIL-C-25A.

While the insulation resistance of com-

parable wax-impregnated capacitors at 85 C (185 F) is only about 15 megohm-microfarads, the new silicone fluid impregnated units register 150 megohm-microfarads at the same temperature. That's approximately ten times the insulating efficiency of conventional units. **No. 48**

**Send Coupon for More Information**

**DOW CORNING CORPORATION - Dept. 1619**  
Midland, Michigan

Please send me **47** **48** **49**

NAME \_\_\_\_\_

TITLE \_\_\_\_\_

COMPANY \_\_\_\_\_

STREET \_\_\_\_\_

CITY \_\_\_\_\_ ZONE \_\_\_\_\_ STATE \_\_\_\_\_

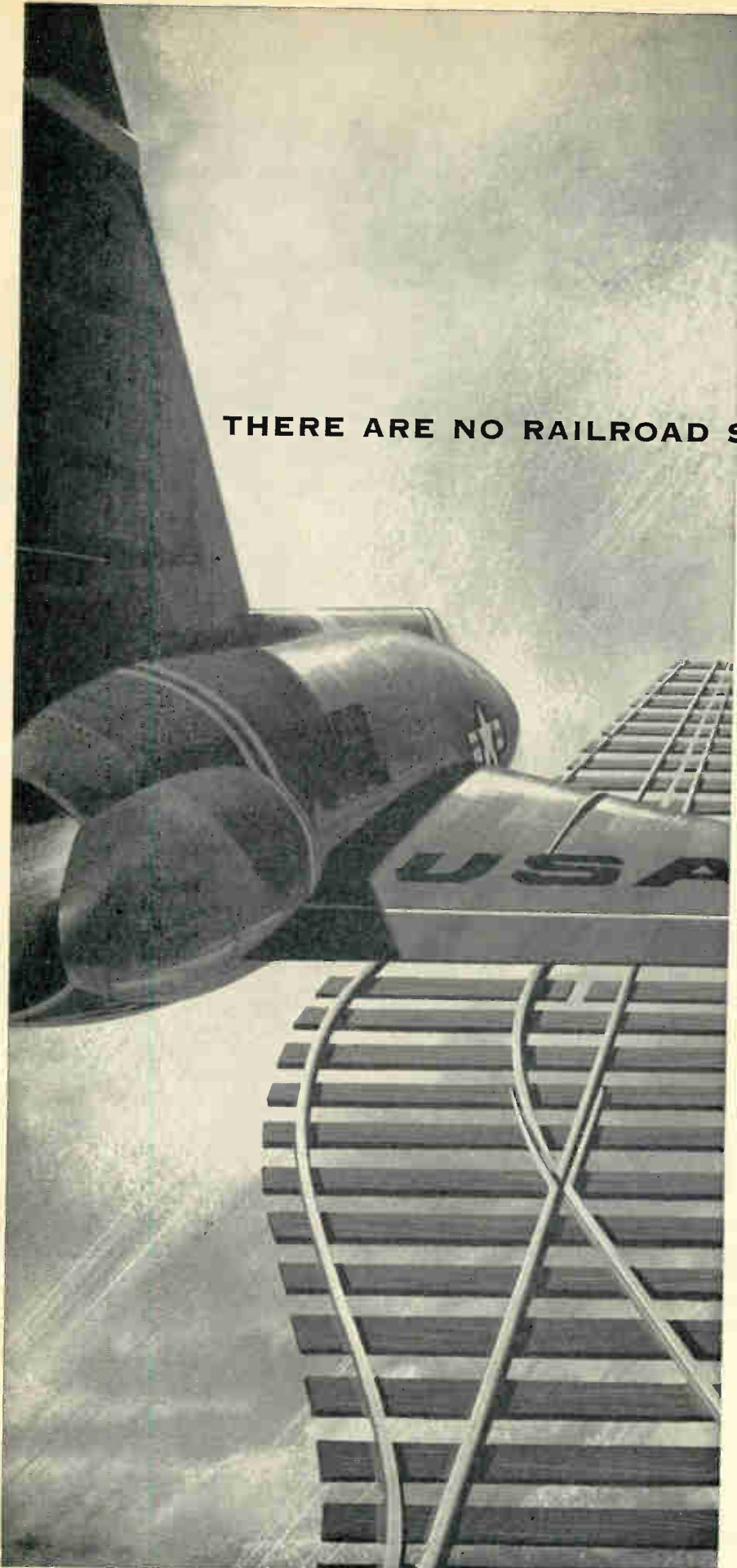

## THERE ARE NO RAILROAD SIDINGS IN THE SKY

When railroad traffic gets too heavy or complex, a train will be switched onto a siding until the tracks are clear. However, high-speed aircraft in busy traffic patterns over metropolitan areas cannot wait . . .

Hughes, a leader in the development of highly advanced data processing techniques, is doing research on air traffic control systems which can continuously monitor a high volume of air traffic and precisely control each individual airplane. With this system the time delays, inefficiency and inaccuracies present in manual control are practically eliminated.

Air traffic control represents only one of many projects underway. Confidential new projects . . . many infinitely more complex . . . promise an unlimited future to scientists and engineers in the Hughes Ground Systems Division.

If your experience is in electronic circuit design, logical design, electronic packaging, and radar systems, we invite you to investigate these outstanding opportunities.

*the West's leader in advanced electronics*

# HUGHES

SCIENTIFIC STAFF RELATIONS

RESEARCH AND  
DEVELOPMENT LABORATORIES

*Hughes Aircraft Co., Culver City, California*

VACATIONING IN  
SOUTHERN CALIFORNIA?  
YOU ARE INVITED  
TO VISIT HUGHES.



# HERMETIC POWER COMPONENTS...

... From Stock

## HIGHEST RELIABILITY FOR MILITARY AND INDUSTRIAL USE

Listed below are just a few of fifty stock UTC hermetic power components. All proved to MIL-T-27A, eliminating costs and delays of initial MIL-T-27A testing.

Exceptional reliability makes these units ideal for industrial, broadcast, and test service (55°C. ambient) use, as well as military (40°C. ambient) applications.

For complete listing of these stock items and 650 others, write for UTC catalog.



### MIL-T-27A RATINGS IN REGULAR TYPE

### INDUSTRIAL RATINGS IN BOLD TYPE

TYPICAL POWER TRANSFORMERS, PRI: 115V., 50-60 Cycles... suited to 400 cycles.

Type No.	HV Sec. C.T.	Approx* DC volts	DC MA	Fil. Wdg.	Approx* DC volts	MA OC	Fil. Wdg.	MIL Case
H-81	500	L 180	65	6.3VCT-3A 5V-2A	L 170	75	6.3VCT-3A 5V-2A	HA
		C 265	55		C 240	65		
	550	L 200	60		L 190	70		
H-84	700	L 255	170	6.3V-5A 6.3V-1A 5V-3A	L 240	210	6.3V-6A 6.3V-1.5A 5V-4A	KA
		C 400	110		C 360	150		
	750	L 275	160		L 260	200		
H-86	720	L 240	260	6.3V-6A 6.3V-2A 5V-3A	L 220	310	6.3V-7.5A 6.3V-2A 5V-4A	MB
		C 425	170		C 410	210		
	790	L 270	250		L 250	300		
H-92	900	L 330	230	6.3V-6A 6.3V-2A 5V-4A	L 320	290	6.3V-8A 6.3V-2A 5V-4A	MB
	1050	L 385	220		L 370	270		

\*After appropriate H series choke. L ratings are choke input filter, C ratings are condenser input.

United "H" series power transformers are available in types suited to every electronic application. Proven ratings are listed for both high voltage outputs... condenser and choke input filter circuits... military and industrial applications.



### A FEW TYPICAL LISTINGS OF FILTER REACTORS.

Type No.	Ind. @ Hys.	MA DC	Ind. @ Hys.	MA DC	Ind. @ Hys.	MA DC	Ind. @ Hys.	MA DC	Res. Ohms	Max. DCV* Ch. Input	Test V RMS	MIL Case
H-71	20	40	18.5	50	15.5	60	10	70	350	500	2500	FB
H-73	11	100	9.5	125	7.5	150	5.5	175	150	700	2500	HB
H-75	11	200	10	230	8.5	250	6.5	300	90	700	2500	KB
H-77	10	300	9	350	8	390	6.5	435	60	2000	5500	MB
H-79	7	800	6.5	900	6	1000	5.5	1250	20	3000	9000	9x7x8

\*Based on maximum ripple voltage across choke in choke input filter circuit, in terms of DC output voltage.

United "H" series filter reactors are extremely flexible in design and rating. Listings show actual inductance at four different values of DC. Bold type listings are industrial application maximums.



### TYPICAL FILAMENT TRANSFORMERS, PRI: 105/115/210/220V., 50-60 cycles... suited to 400 cycles.

Type No.	Sec. Volts	Amps. (MIL)	Amps. (Ind)	Test Volts RMS	MIL Case
H-121	2.5	10	12	10000	JB
H-126	5	20	25	18000	LA
H-127	5	20	30	21000	NA
H-131	6.3CT	2	2.5	2500	FB
H-134	6.3CT	10	12	2500	HA
H-136	14, 12, 11CT	10	14	2500	LA

United "H" series filament transformers have multi-tapped primaries, good regulation, and are rated for industrial as well as military service.



United "H" series plate transformers incorporate dual high voltage ratings and tapped primaries to provide versatile units for a wide range of military and industrial electronic applications. Large units have terminals opposite mounting for typical transmitter use.



### TYPICAL PLATE TRANSFORMERS, PRI: 105/115/210/220V., 50-60 cycles.

Type No.	Sec. V. C.T.	Approx.* DC Volts	MA DC	Choke No.	MA DC	Choke No.	Case
H-111	1050	415	440	H-77	550	H-77	NA
	1200	480	400	H-77	500	H-77	
H-112	1500	615	290	H-77	350	H-77	NA
	1900	790	250	H-76	300	H-76	
H-114	2500	1050	450	H-79	500	H-78	6 3/4 x 6 1/2 x 8
	3000	1265	400	H-78	450	H-78	
H-116	5000	2125	450	H-79	500	H-79	8 1/2 x 9 3/4 x 10 1/4
	6000	2550	400	H-78	500	H-78	

\*After filter choke. All ratings are for choke input filter

# UNITED TRANSFORMER CORPORATION

150 Vorick Street, New York 13, N. Y. EXPORT DIVISION: 13 E. 40th St., New York 16, N. Y. CABLES: "ARLAB"  
PACIFIC MFG. DIVISION: 4008 W. Jefferson Blvd., Los Angeles 16, Calif.

# Glow Counter

(Continued from page 51)

down of the next forward cathode. Automatic biasing by a high resistance leak to earth is preferred to direct biasing, because of the current sensitivity at this point of the characteristic. The value of the transfer leak resistance is important and is selected to give the maximum permissible leak current below the minimum self-maintaining current of an independent discharge. The  $I_a$ - $V_a$  characteristic of an independent transfer discharge shows a negative slope below about 350  $\mu$ a and is self extinguishing at a slightly lower current value, whereas, adjacent to a conducting cathode discharge current is maintained to very low values. A leak resistance value of 220 kohms passes a clean-up current of approximately 250  $\mu$ a and due to the factors described above, it follows that conduction only takes place on the transfer electrode in front of a conducting cathode.

## Modified Circuit

A complete circuit is shown in Fig. 3.

In the static condition the Q6/4 selenium rectifier isolates the input circuit from the transfer electrode, the automatic bias level being approximately 50 v. The negative pulse is applied to the input condenser and is restored to a bias level of  $\pm 75$  v. During the pulse the Q6/4 diode conducts and glow stepping is effected in the normal manner. The anode resistor is replaced by a network as shown and assists in two functions, the cathode current is adjusted to compensate for transfer conduction and during the pulse, the by-pass condenser provides a lower impedance to pulse current. The input impedance of the tube in the circuit is approximately 16 kohms and in order to maintain the correct operating conditions it is necessary to match the driving tube to the Nomotron, so that the 120 volt pulse appears at the input condenser with the tube operating.

With the circuit as described above, test circuits were set up, using tubes in scales of three. The first tube of a scale was supplied with input pulses arriving in

bursts of nine pulses, occurring at approximately one per second, each pulse spacing during a burst being 200  $\mu$ secs. The pulses were gated by one output on to the second tube of the scale, the glow stepping on single pulses at approximately one step per second. By gating again from the second tube, the third tube received one stepping pulse every 10 sec. Twelve such scales of three were operated in parallel. The pulse system was controlled by a mechanical switch and was set so that pulses were applied for about two minutes at fifteen-minute intervals. A detector system was arranged so that any mis-step was immediately detected and the pulses disconnected, the tube involved was then identified by visual examination of the glow positions. Other tests were carried out using functional equipments, several operating in tandem and involving over 100 tubes. A similar start stop duty cycle of approximately 5:1 was maintained in this case but with somewhat different sequence, tubes remained with stationary glow for periods of several hours followed by a glow stepping period. All tubes were examined before and after running tests by means of an automatic routine tester which varied all parameters individually while the tube is operating on a start-stop basis, 18 test conditions appear for each cathode position, i.e. 180 tests carried out in a period of about 1 minute.

Tests were also carried out involving long periods of continuous cathode conduction which represents the worst operating conditions corresponding to zero duty cycle. In this case a number of sockets was provided with connection made to one cathode only, together with the appropriate transfer input circuit. The tubes were removed periodically and tested by measuring the minimum pulse amplitude required to step the glow from the cathode under test. This was done on a single pulse basis, care being taken to apply the minimum number of pulses to avoid further changes in transfer characteristics. Fig. 4C shows a typical result obtained with improved processing and modified input circuit. Fig. 4A shows the behavior

of an unprocessed tube under the original circuit conditions and Fig. 4B indicates the degree of improvement obtained by processing only. The points at which the pulse amplitude required for transfer becomes greater than the specified limits are marked and represent the useful life of the tube under these conditions. The exact mechanism of the subsequent restoration of transfer sensitivity as illustrated in Figs. 4A and B is not perfectly understood though it is clearly associated with the quantity of current conducted in the transfer electrode i.e. at some stage during the deterioration of the transfer sensitivity the current value becomes sufficient to clean up the transfer tip, and so tends to restore the normal characteristic. The stage at which the actual reversal takes place and the transfer sensitivity begins to improve was found to vary between tubes which suggests control by an aging process at the cathode.

Good performance has been obtained at all times under continuously operating conditions at frequencies above a few cycles per second. Under start-stop conditions, changes in characteristics had been observed in some cases after periods as short as 5 minutes of glow resting on one cathode. Under the new conditions, tubes survive periods of 1000 hours' continuous conduction on one cathode without change in characteristics. Operational tests on several batches under the stop-start conditions described above have indicated an overall performance of between 12,000 and 30,000 tube hours per tube failure. Tests which have been extended to 4000 hours under these conditions show no deterioration in reliability and performance with time.

In order to eliminate the occasional breakdown of two cathodes when switching on, which prevents glow stepping, it is recommended that switching on be accomplished in two stages, by arranging initially to disconnect the common transfer leak resistance and all cathodes, except that required for initial discharge. This may be achieved by the use of a double pole, three-way switch, with make-before-break contacts.



*the core magnet  
makes them  
so different!*

# WESTON

## CORMAG®

### PANEL INSTRUMENTS

Weston's core-magnet instrument mechanism *has* made a big difference in panel meters . . . a big difference in instrument *reliability, mounting facility, and instrument costs*. The core-magnet construction is extremely simple, yet it provides measurement reliability meeting Weston's exacting standards. It is self-shielding, thus permitting the instruments to be used interchangeably on magnetic or non-magnetic panels; as well as mounting close together without intereffect. The final difference is their cost. Due to design simplification, they are yours for *less* than you pay for conventional panel instruments. For complete specifications and prices, consult your nearest Weston representative or write Weston Electrical Instrument Corp., Newark 12, N. J.

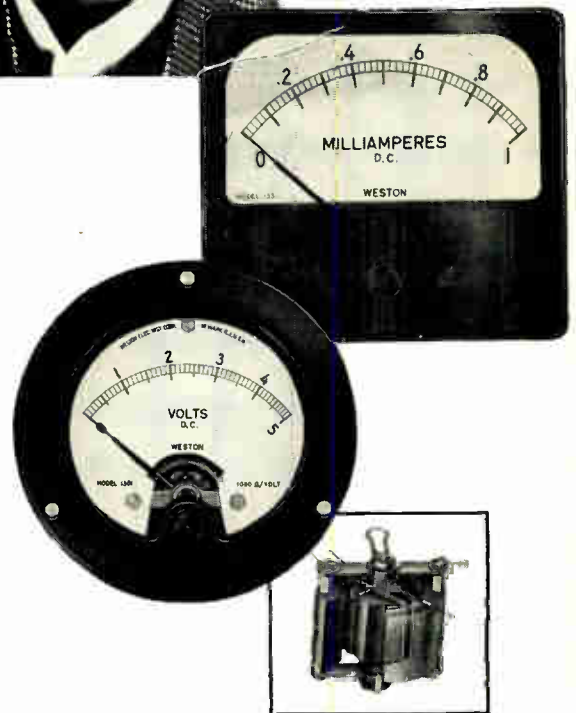

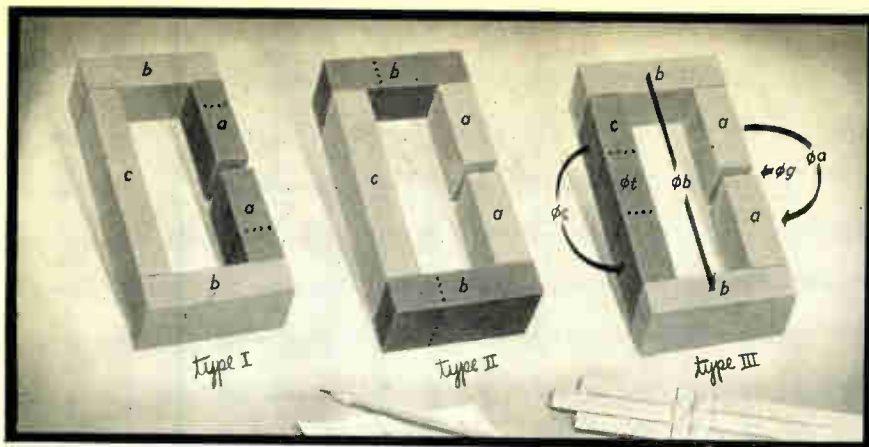

## How You Can Save Time Estimating Leakage Factors for Magnetic Circuits

Computing even approximate values for leakage flux in magnetic circuits is a time consuming job. The research department of Indiana Steel recently undertook a series of studies, supported by the U.S. Air Force, to simplify these computations. Dr. R. K. Tenzer reported the results of this work, which reduce the time in computing leakage flux up to 90% by diminishing the number of mathematical operations necessary.

The investigations were done on circuits with permanent magnets; the results were also found applicable to unsaturated electromagnetic circuits when the coil-covered parts were treated as permanent magnet parts.

After checking values obtained by this method with actual measured values for many Type I, II, and III magnetic circuits, deviations were found to be less than  $\pm 10\%$ .

### Leakage Flux, Leakage Factor

Because of magnetic leakage, only a part of the total flux through the neutral zone of the permanent magnet is found in the air gap. The difference between these two values is known as leakage flux. Mathematically this is:

$$\phi_L = \phi_t - \phi_g \quad (1)$$

In practical design, leakage is best considered as a factor stated thus:

$$\sigma = \frac{\phi_L}{\phi_g} = 1 + \frac{\phi_L}{\phi_g} \quad (2)$$

For simplification, the flux can be assumed to follow three basic, probable paths:  $\phi_a$  between parts *a*,  $\phi_b$  between parts *b*, and  $\phi_c$  along part *c*. The equation above then becomes:

$$\sigma = 1 + \frac{\phi_a + \phi_b + \phi_c}{\phi_g} \quad (3)$$

With  $\phi = mmf \times P$ , this formula can be written:

$$\sigma = 1 + \frac{1}{P_g} \left( \frac{mmf_a}{mmf_g} P_a + \frac{mmf_b}{mmf_g} P_b + \frac{mmf_c}{mmf_g} P_c \right) \quad (4)$$

Letting the *mmf* ratios be denoted by *K*,

$$\sigma = 1 + \frac{1}{P_g} (K_a P_a + K_b P_b + K_c P_c) \quad (5)$$

This becomes the basic equation for numerical calculations of leakage factors after introducing simple expressions for leakage permeances and *mmf* ratios.

### Simplified Leakage Permeances

The following formulas have been found satisfactory for leakage permeances between soft steel parts:

$$P_a = 1.7 \times U_a \times \frac{a}{a + L_g} \quad \text{where } U \text{ is} \quad (6)$$

cross-section perimeter;

$$P_b = 1.4 \times b \times \sqrt{\frac{U_b}{c} + .25} \quad (7)$$

where  $U_b/c$  is greater than .25 and less than 4. The total length of part *b* is used.

Since permanent magnets have a neutral zone which does not contribute to leakage, the value of 2/3 of the magnet's total length is used when computing leakage permeances—this is the effective length *a'* and *b'* to compute *P'*; thus the two equations above become:

$$P'_a = 1.7 U_a \frac{.67a}{.67a + L_g} \quad (6a)$$

and

$$P'_b = 1.4 \times .67b \sqrt{\frac{U_b}{c} + .25} = .67 P_b \quad (7a)$$

When part *c* consists of a permanent magnet (Type III) its permeance can be calculated as:

$$P_c = .5 U_c \quad (8)$$

The permeance of the air gap itself is

$$P_g = A_g/L_g \quad (9)$$

### Simplified MMF Ratios

Simplifying the *mmf* ratios is done by neglecting the reluctance in soft steel parts; so

$$mmf_a = mmf_b = mmf_g \text{ or } K_a = K_b = 1 \quad (10)$$

( $mmf_c = 0$  so  $K_c = 0$ ). Since the *mmf* along permanent magnet parts is not constant, integral values ( $\overline{mmf}$ ) are used. Experiments showed that 2/3 of the  $mmf_g$  was the effective *mmf* for leakage flux between permanent magnet parts; thus

$$\overline{mmf}_a = \overline{mmf}_b = \overline{mmf}_c = 2/3 mmf_g$$

or

$$K_a = K_b = K_c = 2/3 \quad (11)$$

### Basic Formulas

By inserting the permeances for soft steel into equation (5), the general formula becomes:

$$\sigma = 1 + \frac{L_g}{A_g} \left( K_a \times 1.7 U_a \frac{a}{a + L_g} + K_b \times 1.4 b \sqrt{\frac{U_b}{c} + .25} + K_c \times .5 U_c \right) \quad (12)$$

This formula contains only constants and dimensions; and by the two following rules this can be modified into the three basic equations for the Type I, Type II, and Type III circuits.

**Rules:** (1) For leakage flux paths between soft steel parts, use total lengths and constant *K* of 1. (2) For leakage flux paths between permanent magnet parts, use 2/3 of lengths and *K* of .67.

The following provide the leakage factors for the three types of circuits:

#### Type I:

$$\sigma = 1 + \frac{L_g}{A_g} \times .67 \times 1.7 U_a \frac{.67a}{.67a + L_g}$$

#### Type II:

$$\sigma = 1 + \frac{L_g}{A_g} \left( 1.7 U_a \frac{a}{a + L_g} + .67 \times 1.4 b \sqrt{\frac{U_b}{c} + .25} \right)$$

#### Type III:

$$\sigma = 1 + \frac{L_g}{A_g} \left( 1.7 U_a \frac{a}{a + L_g} + 1.4 b \sqrt{\frac{U_b}{c} + .25} + .67 \times .5 U_c \right)$$

For variations on these basic formulas, write today for the April-June issue of *Applied Magnetism* which also shows examples of the formulas in use.

### NEW DESIGN MANUAL READY

Write today for your copy of the newest edition of the Indiana Permanent Magnet Design Manual No. 6. Write to Dept. N-7.



THE INDIANA STEEL PRODUCTS COMPANY  
VALPARAISO, INDIANA

THE WORLD'S LARGEST MANUFACTURER  
OF PERMANENT MAGNETS

INDIANA  
PERMANENT  
MAGNETS

In Canada... The Indiana Steel Products Company of Canada Limited, Kitchener, Ontario

# OHMITE®

the complete

line of

industry-preferred

# COMPONENTS

Long life and dependability are synonymous with the name Ohmite. When you specify Ohmite components . . . you build reliability into your product. This reliability is backed by Ohmite's continuing research programs which explore new product ideas, improve present products, and develop more efficient manufacturing processes. All this plus the fact that Ohmite is the world's leading specialist in the manufacture of power-type resistance components —high quality rheostats and wire-wound resistors in the most complete range of sizes and types available to industry. Reliability is also characteristic of Ohmite tap switches, precision wire-wound resistors, molded composition resistors and potentiometers, general-purpose relays, subminiature tantalum capacitors, and R. F. chokes. Write on company letterhead for the complete Ohmite Catalog and Engineering Manual.

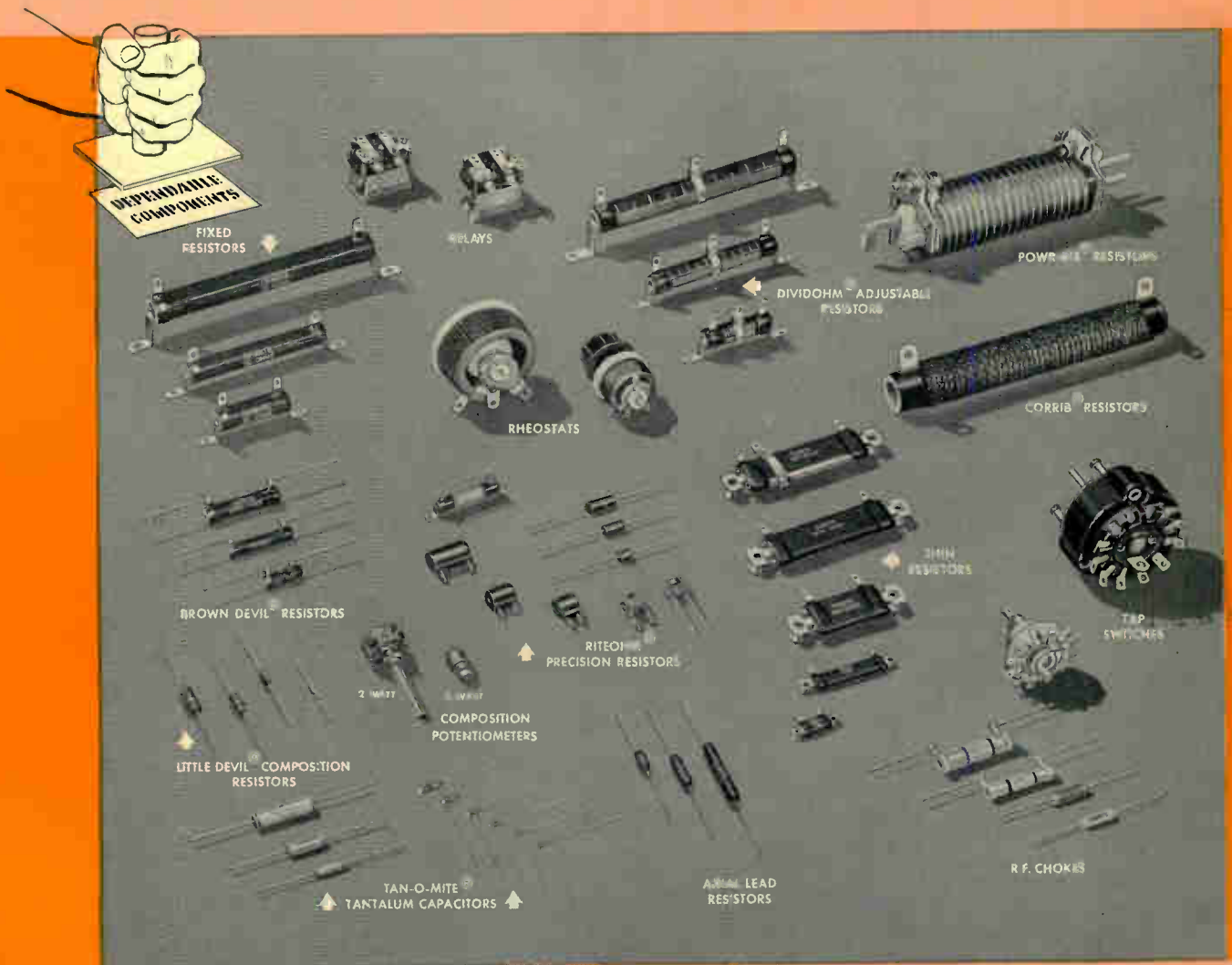

# OHMITE®

BE RIGHT WITH

RHEOSTATS • RESISTORS • RELAYS • TAP SWITCHES • TANTALUM CAPACITORS

OHMITE MANUFACTURING COMPANY • 3662 Howard Street, Skokie, Illinois

## Relay Tester

(Continued from page 43)

down paths by a front panel selector switch. These include coil to frame, contacts to coil, contacts to frame, and across open contacts in both the energized and de-energized conditions. Make-before-break or break-before-make can be indicated on the front panel. An operating time jack is brought out for connection to a timer or time interval meter when desired.

The relay to be tested is plugged

into a holding fixture which is in turn coupled to the relay test panel by a standard connector. This holding fixture is the only equipment required which is peculiar to a particular relay. In operation the first step is to select the coil voltage—switching to DC or AC, and to 60 or 400 cps. With the relay de-energized, the hipot voltage selector is then set to the proper range, and breakdown checks are made on the various positions of the hipot circuit selector switch. The panel layout is such that the

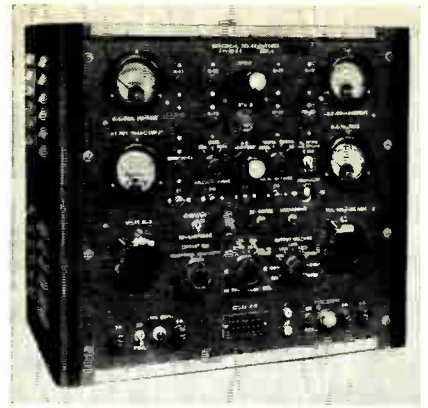

Fig. 2: The Universal Relay Tester.

MAGNETS

HIGH ENERGY  
PRECISION  
ALNICO  
PERMANENT  
MAGNETS

WE CARRY  
IN STOCK  
ALL SIZES,  
ALL SHAPES,  
ALL ALNICO  
GRADES . . .

When you need them — as you need them. Experimental or production quantities.

**PERMAG**  
services include:

- ENGINEERING
- PRECISION CUTTING
- PRECISION GRINDING
- MAGNETIZING

**24 HOUR DELIVERY**

Send for Catalog

**PERMAG CORP.**  
210 TAAFFE PLACE, BROOKLYN 5, N. Y.  
Phone: MAin 2-0114

Circle 124 on Inquiry Card, page 89



## Chip-proof PLASTIC LEGEND PLATES

make them yourself

Tough **GRAVOFLEX** blanks are laminated in sharp contrast colors. No need to keep large inventory—all sizes, varied colors available on short notice. Low-cost **GRAVOFLEX** legend plates stand *up* better, stand *out* better!

Use the portable **ENGRAVOGRAPH** to mark legend plates to your specifications, on the spot, when you need them—with unskilled labor, because it's tracer-guided. Big savings on short runs and "one-shot" jobs. Eliminates costly delays. 17,000 Engravographs in use.

Send for Booklet KL-1 and sample plate.

**new hermes ENGRAVING MACHINE CORP.**  
13-19 UNIVERSITY PLACE, NEW YORK 3, N. Y.

hipot voltage can be brought up to rated value before or after closing the circuit, whichever is desired. The hipot voltage is metered, and breakdown is shown by a neon indicator. The indicator is across the secondary of a transformer sensing current changes in the primary of the high voltage transformer.

After running three possible breakdown circuits in this de-energized condition, the relay is energized and rechecked for breakdown across the open contacts and from the contacts to the frame. For the shortest over-all cycle time, armature pull-in and contact operation can also be checked at this stage. For straightforward acceptance tests the approach is to set the coil voltage at the maximum allowed pull-in value, close the coil circuit, and check the contact operation. (For each pair of contacts, the indicator light comes on when a normally closed contact is open).

Thyratron circuits indicate contact continuity, with the contacts under test in series with the cathode control circuit. The normal condition of the circuit is to have supposedly closed contacts in the circuit which provides cutoff bias to the cathode of a 2D21. This condition is true for both the energized and de-energized conditions of the relay.

These tests can be performed in less than one-half minute base time per relay. The test set is an approach to the most commonly encountered tests of general purpose relays. This does not include "dry circuit" relays or polarized telegraphic types. The universal relay tester is primarily a packaging of the circuits common to operational tests, with switching provided to make these tests fast.



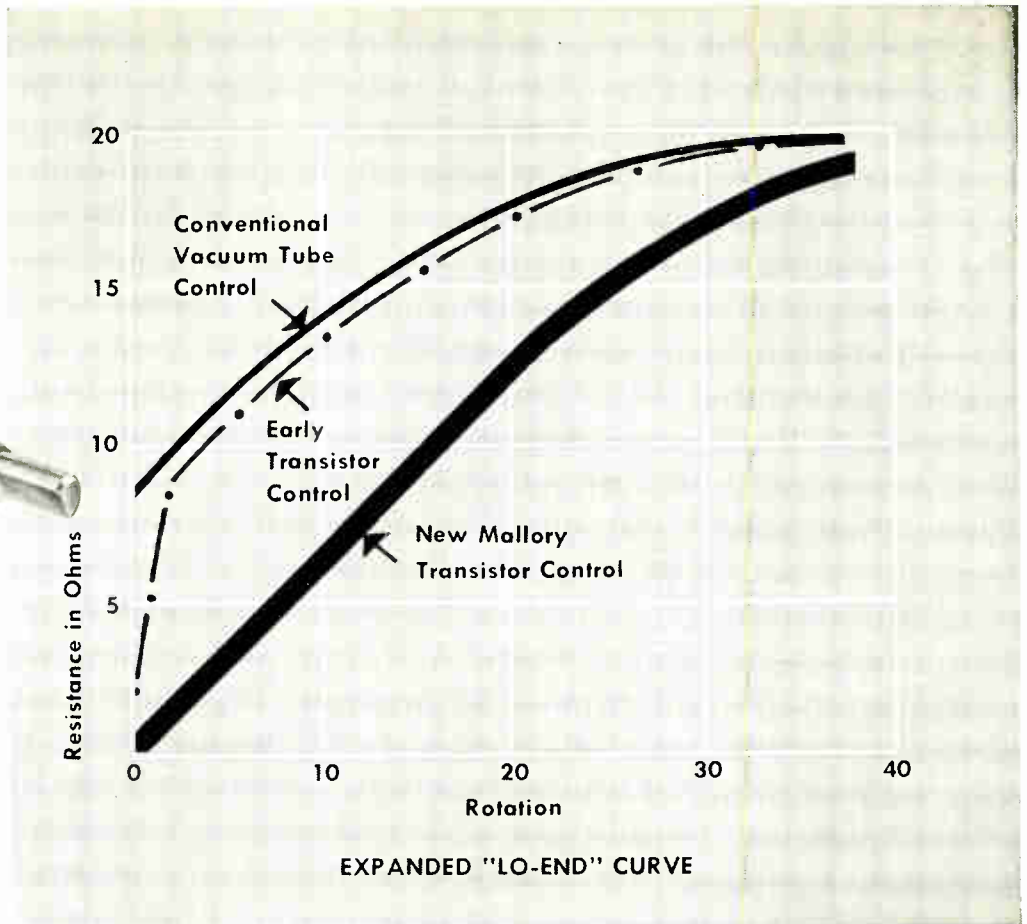
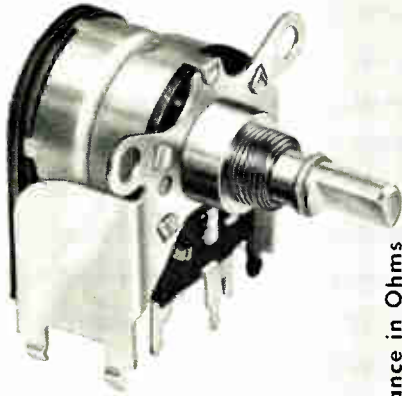

*Now...*

## A Control with Low-end Taper Especially Designed for Transistor Circuits

A new Mallory volume control, created specifically for use with transistors, provides characteristics not previously available to designers.

### Low "hop-off" or zero rotation resistance

gives exceptionally low minimum volume level in low impedance circuits... permits full turn-down of volume level.

### Special "low-end" taper

Starting from the "hop-off" value, resistance rises gradually through the first 20 to 30 degrees of rotation... thus providing smooth control of transistor circuit volume throughout the entire volume range.

### Printed circuit design

Several models of the new control are available for use

in printed circuits, for mounting vertical to or horizontal to the printed circuit panel.

### Push-pull switch\*

Available on all models... new Mallory push-pull line switch. Conventional rotary action switches can also be supplied with these new "low-end" taper controls.

Each sample control is supplied with a tag on which are given its overall resistance-rotation curve, plus a new "low-end" curve showing detailed resistance characteristics in the minimum volume range. Write to Mallory today for a sample in the resistance value, taper and mounting arrangement that you are considering for new designs... and for a consultation by Mallory control specialists on your particular requirements.

Serving Industry with These Products:

Electromechanical — Resistors • Switches • Tuning Devices • Vibrators  
 Electrochemical — Capacitors • Mercury and Zinc-Carbon Batteries  
 Metallurgical — Contacts • Special Metals • Welding Materials

Parts distributors in all major cities stock Mallory standard components for your convenience.

\*Patent applied for

**Expect more... get more from**



# AUGAT'S NEW TRANSISTOR CLIPS

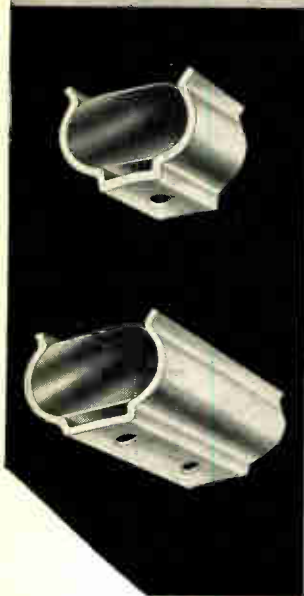

Augat Brothers have developed a new line of clips for the retention of transistors, crystals, diodes, etc.

Now available in all standard sizes, they are the answer to the engineers' layout problems in regards to shock and vibration. Made of either 1065 spring steel or 25 alloy beryllium copper to retain shape, a minimum of clamping action is lost in use.

If your requirements are not listed in our catalog, write us for information on clips made to your specifications.

## AUGAT BROS. INC.

31 PERRY AVENUE • ATTLEBORO, MASS.

Circle 127 on Inquiry Card, page 89

now available from stock  
the  
**WIDEST VARIETY**  
of  
**TEFLON\***  
wire  
**KITS**

Specifically designed for **ALL** your laboratory, prototype, research and development needs . . .

- 36 individual assortments
- 8 stranded sizes (16 thru 30)
- 10 Mil-approved solid colors
- 100', 50', 25', 10' spools

\*extruded hook-up wire per MIL spec 16878 — Type E

Buy it from the leading electronic parts distributors coast to coast. Write for Bulletin T-2 and name of nearest distributor.

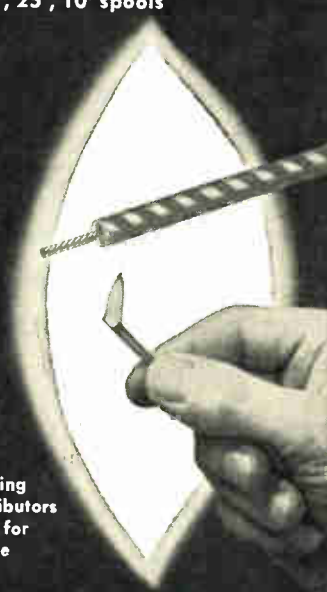

**ALPHA WIRE**



. . . from prototype to mass production

ALPHA WIRE CORP., 200 Varick St., New York 14, N. Y.

In Canada: ALPHA ARACON RADIO, 29 Adelaide St. W., Toronto 1, Ontario.

## Personals

J. M. Miller and E. F. Lapham have been appointed to key engineering positions in the missile section of the Products Division of Bendix Aviation Corp.

Albert E. Schwerin, manager of Flight Test Engineering for the Missile and Ordnance Systems Dept. of the General Electric Co., has been assigned to Patrick Air Force Base to head up the department's test activity in the testing of the Air Force's strategic ballistic missiles.

Bill Waddell, formerly technical assistant to the general manager of G. M. Giannini & Co., has joined the Systems Division of Daystrom, Inc. as Chief Engineer, New Products.



W. Waddell



A. Del Duca

Anthony Del Duca is now Chief Electronics Engineer for the Process Instruments Division of Beckman Instruments, Inc. He will direct the design of electronic circuitry for a variety of instrumentation developed for the monitoring and control of Industrial processes.

Dr. Russell R. Law, formerly director of research and development for CBS-Hytron, division of Columbia Broadcasting System, Inc., has joined Hughes Aircraft Co. as director of new product development.

Robert P. Adams, electrical engineer, has joined the technical staff of the Guided Missile Research Div. The Ramo-Wooldridge Corp., Los Angeles.

Louis G. Karagianis has been appointed military relations engineer for the Semiconductor-Components Div. of Texas Instruments Inc. He will function in a liaison capacity between Defense Dept. engineers and Texas Instruments management and engineering.

William G. Alexander is now chief engineer at the San Diego plant of Stromberg-Carlson, a div. of General Dynamics Corp. He will direct all engineering activities of the company in San Diego.

# Has No Equal for VHF-UHF measurements

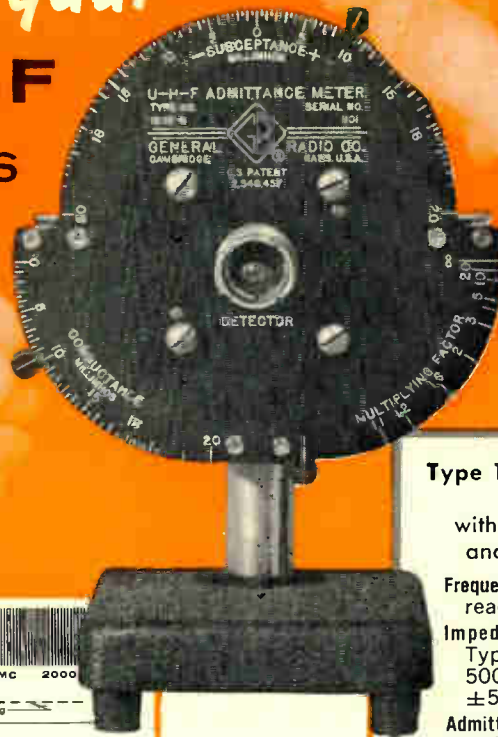

## Type 1602-B Admittance Meter \$295

with complete set of standards  
and interconnecting elements

**Frequency Range:** 20-1500 Mc: direct  
reading between 41 and 1500 Mc.

**Impedance Range:** with accessory  
Type 874-LK Line Stretcher, 1 to  
5000 ohms resistive, and 1 to  
 $\pm 5000$  ohms reactive.

**Admittance Range:** conductance, 0.2  
to 1000 millimhos; susceptance,  
 $\pm 0.2$  to  $\pm 1000$  millimhos.

**VSWR Range:** 1 to 10.

**Basic Accuracy:**  $\pm 3\%$ .



### Small Size, Light Weight

An Asset In Matching and Aligning  
UHF-TV Transmitting Antenna

Admittance Meter is connected directly to  
 $3\frac{1}{8}$ " transmission line through G-R  
adaptor. . . . is supported only at the point  
of connection. Driving oscillator and DNT  
Detector are shown in the background.  
This system finds use at all stages:

. . . at manufacturer's plant, to insure the  
quality of the finished product . . . at TV  
station, for testing upon first delivery and  
during preliminary transmitter setting-up  
. . . after station is "on the air," to make  
certain of impedance uniformity and max-  
imum transmission of power.

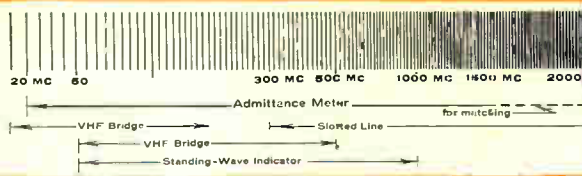

- ✓ **Versatile** the only instrument that can measure Impedance, Admittance, VSWR, and many other characteristics directly.
- ✓ **Easy to Use** unmatched speed of measurement — move two levers to obtain detector null; answer appears directly on dial.
- ✓ **Inexpensive** simplicity of operating principle makes for low cost; accuracy, wide impedance and frequency range inherent in the design.

The Admittance Meter permits measurements on antennas, lines, networks, and components with Rapidity, Ease, and Accuracy not found in other equipment. Resistive and reactive components of impedance or admittance are read directly on scales which are independent of both frequency and detector calibration.

This instrument can just as easily be used to match a load to a line or to compare directly the impedance of one circuit or component with that of another. When used with a Constant-Impedance Adjustable Line, measurements are simplified further, as the correction for the length of line between the unknown and the instrument can be eliminated. A component mount, precision variable attenuator, filters, rectifiers, modulators, adaptors to a wide variety of coaxial connectors, and a full complement of other accessories adapt the Admittance Meter for practically any work. G-R Unit Oscillators and the Type DNT series of detectors are available for measurements over the Admittance Meter's entire range.

This complete and well-integrated line is the simplest and most convenient system available for measurements at very-high and ultra-high frequencies. Over one thousand Admittance Meters are now in use for design, production, and maintenance of apparatus and systems for radar, mobile- and aircraft-communications, navigation, radio-astronomy and television.

Write for VHF-UHF Measurements Bulletin for Complete Information and Specifications.

## GENERAL RADIO Company

275 Massachusetts Avenue, Cambridge 39, Mass., U.S.A.

Broad Avenue at Linden, Ridgefield, N. J. NEW YORK AREA

920 S. Michigan Ave. CHICAGO 5

8055 13th St., Silver Spring, Md. WASHINGTON, D. C.

1150 York Road, Abington, Pa. PHILADELPHIA

1030 N. Seward St. LOS ANGELES 38

1182 Los Altos Ave., Los Altos, Calif. SAN FRANCISCO



All G-R Products  
are now covered by a

## 2-Year Warranty

WE SELL DIRECT  
Prices are net, FOB Cambridge  
or West Concord, Mass.

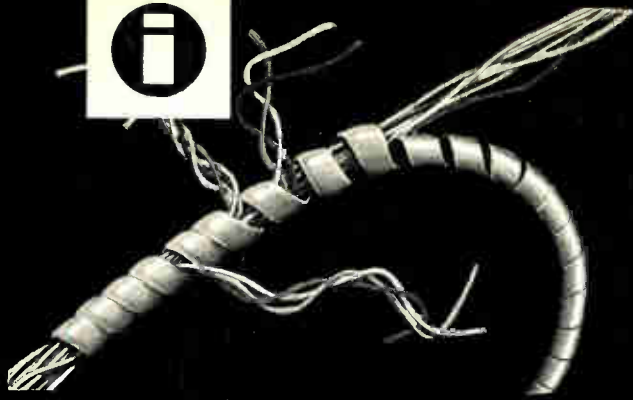
**i**

## SAVE with SPIRAL WRAP

Spirally cut polyethylene tubing with time saving advantages for cabling loose wires into neat cables. For mass production or laboratory prototypes. Spiral Wrap is available from stock in  $\frac{1}{4}$  inch and  $\frac{3}{8}$  inch O.D., both expandable to 2 inches. Available in four colors: white, black, red, and blue. Stocked by leading electronic jobbers. Send for illustrated color brochure for more details. Illumitronic Engineering, 680 East Taylor, Sunnyvale, California.

Circle 130 on Inquiry Card, page 89

### COMMUNICATIONS SYSTEMS ENGINEERS

The expanding scope of advanced communications projects has created several unique positions in fields related to VHF, UHF, microwave transmission and reception, forward scatter and single sideband applications at Hoffman. Electronics engineers with appropriate backgrounds will find these new assignments professionally stimulating and financially rewarding. Please address Vice President of Engineering:

#### **Hoffman** LABORATORIES, INC.

A SUBSIDIARY OF HOFFMAN ELECTRONICS CORP.  
3761 South Hill St., Los Angeles 7, Calif.  
Telephone: RIchmond 9-4831.

## Industry News

L. M. Heineman, President of Permoflux Products Co., is now also head of Linlar, Inc., a Glendale, Calif., advanced electronic products corporation, of which Permoflux is a division.

John R. Campbell has assumed the duties of Regional Sales Manager for Philco's G & I Div. for the Western Regional area with headquarters at Redwood City, Calif.

Walter H. Smith has been appointed Supervisor of Technical Publications for Packard-Bell Electronics.

Raymond E. Ward has become Sales Manager for Distributor accounts at Shure Bros., Inc.

Robert L. Trent has joined Texas Instruments Incorporated to direct a newly-formed engineering branch for applications and test equipment in the Semiconductor-Components Div.



R. L. Trent



H. R. Lowry

Hugh R. Lowry has been named Manager of Application Engineering for the Semiconductor Products Dept., General Electric Co.

James Ford is now Manager of the Detroit district office of ElectroData Div. of Burroughs Corp.

Henry Kogel has joined the staff of Century Lighting, Inc., in the capacity of Sales Engineer.

William J. Voss has been named Director of Purchasing for the Industrial and Television Tube Div. of A. B. Dumont Labs, Inc.

M. R. Johnson is now serving as Manager of the newly established Armament & Control Section of the Light Military Electronic Equipment Dept. of General Electric.

Walton Ayer has joined the Gates Radio Co. as a Sales Engineer. Mr. Ayer will cover a new territory consisting of the states of Pennsylvania, Maryland and Delaware.

(Continued on page 116)

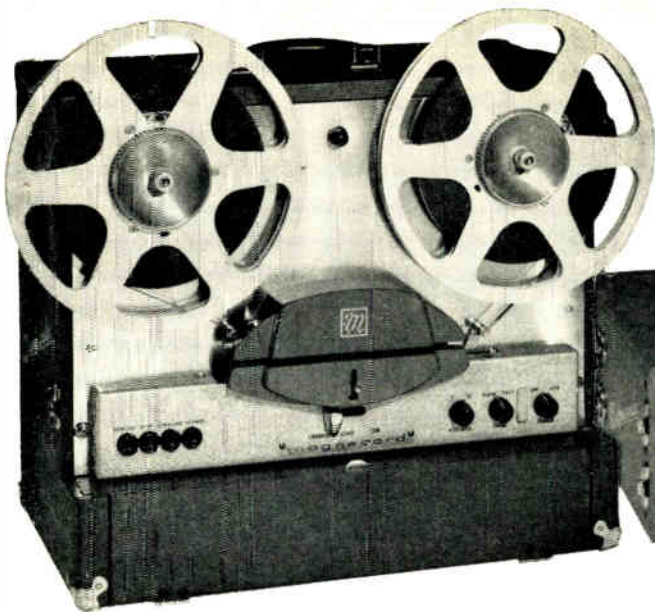

Consider the  
Magnecord  
**M90**

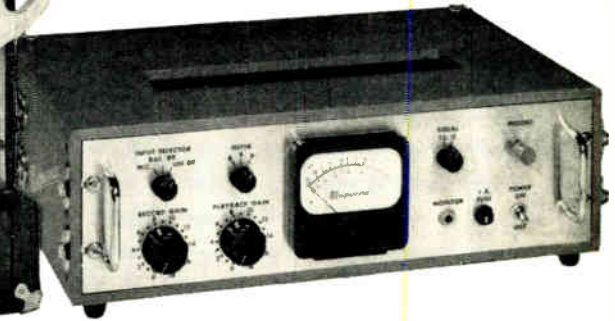

*Top quality delivers the greatest economy!*

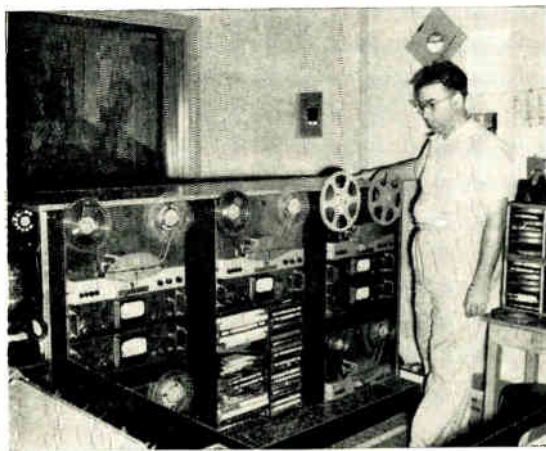

*Used where demands are the greatest*

Gerry Van Caster, studio engineer at Station WBAY, Green Bay, Wisconsin, operating a panel of five Magnecord M-90 tape recorders, which are in operation 8 hours daily. Two other Magnecords give the station equally dependable performance—one being used for pre-taping to save time, and the other as part of the station's mobile unit.

From coast to coast, in every state in the union Magnecord has been and is the choice of professionals. In a recent survey (copy available if you'd care to see it) four out of every five radio and TV stations in the greater Chicago area said in effect, "we depend on our Magnecord M90's. They're the workhorses in our daily operations. Don't know what we'd do without them."

Now we're happy to tell you that the M90 is better than ever and will deliver top performance with a positive minimum of service. You bet—the top quality you get in the Magnecord M90 is not cheap but you'll enjoy the greatest long run economy from this equipment.

**FEATURES:**

- Interlocking push-button controls.
- Precision-made heads for extended-range reproduction.
- Separate record and playback amplifiers permit simultaneous monitoring from tape.
- 15" and 7½" tape speeds with switch selection.
- Automatic tape lifter.
- Instantaneous start and stop less than 1/10 sec.
- High speed cueing control.
- Record interlock.
- Full remote control.

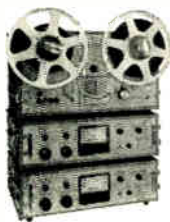

P-63 (above) NEW compatible tape transport instantly converts your present Magnecord equipment to the industry's best standards.



PT-6-6 The workhorse in tape recording — new — better than ever! Ideal for both studio and field work.

P-60 Stereo (at left) The answer to the professional's request.



**FREE! Write Dept. TT7 for beautiful 16-page illustrated catalog!**

**MAGNECORD DIVISION, MIDWESTERN INSTRUMENTS, INC., 1101 S. KILBOURN, CHICAGO, ILL.**

# SPEEDS...up to 20Kc

## WITH THE "NOMOTRON"

### COLD CATHODE DECADE COUNTER

For reliable, high-speed  
Counting · Stepping · Distributing

- High cathode power output
- Instantaneous positive transfer
- Immune to photoelectric effects



Type  
G10/241E

The "Nomotron" operates at speeds hitherto unattainable with tubes of this type. It contains 10 separate cathodes—providing ample output power to control external circuits *without* additional amplification.

Complete immunity to photoelectric effects assures dependable operation in brilliant sunlight or total darkness.

For information in technical brochure CVX2223, write to Dept. Y-166

### INTELEX SYSTEMS INCORPORATED

22 Thomes St. • New York 6, N. Y.  
An Associate of  
International Telephone and Telegraph Corporation

Circle 133 on Inquiry Card, page 89

#### Applications include :

- MISSILE GUIDANCE SYSTEMS
- TELEMETERING CIRCUITRY
- MULTIPLEXING CIRCUITRY
- AUTOMATIC MACHINE CONTROL
- DATA PROCESSING
- BUSINESS OPERATIONS AUTOMATION
- HIGH-SPEED COUNTING

## Intelex



## Industry News

(Continued on page 114)

W. E. Lyons has assumed the duties of General Manager of the Capacitor Div., Good-All Electric Mfg. Co., Ogallala, Neb.

Dr. John P. Nash, noted mathematician, has been appointed Manager of the Information Processing Div. of Lockheed Missile Systems Div., Research and Development branch.

Allan A. Segal is now Vice-President of Hermetic Seal Corp. responsible for Sales and Administration.



A. A. Segal



S. Pfannstiehl

Stewart Pfannstiehl is now Vice-President in Charge of Sales at Cinch Mfg. Corp. Other appointments were Leonard Hvale, Vice-President, Controller and Asst. Treasurer, and John Todd, Vice-President, Attorney.

James S. Locke has been named Manager of Operations for Minneapolis-Honeywell Regulator Co.'s commercial division activities in Minneapolis.

Richard H. Hall will now serve as Manager of the Mycalex Corp. of America, Pacific Div.

Herbert R. Tragesser is now Regional Sales Manager for Non-Linear Systems, Inc. He will establish a sales and engineering office in Cleveland, Ohio.

Richard I. Wilson has been appointed Philadelphia District Manager of Phelps Dodge Copper Products Corp.

W. E. Boss will now serve as Director, Color Television Coordination, Radio Corporation of America. Mr. Boss will be responsible for guiding, coordinating, and integrating all television activities throughout the Corp.

Dr. Herbert C. Corben has been appointed Associate Director of the Electronic Research Laboratory, Ramo-Wooldridge Corp.

William R. Huddleston is now Telephone Sales Representative for the Telecommunications Div. of Stromberg-Carlson.

# free engineering guide tells you how to design-in panel-mounting miniature electronic instruments



HOW TO build-in such miniature instruments as:

- DC VTVMs and AC VTVMs
- Ruggedized Versions
- Phase-sensitive AC devices
- Low-Level DC Millivoltmeters
- Standard and Special designs
- ... with high sensitivity, broad frequency response, high input Z

TRIO laboratories inc., SEAFORD, N. Y.

Please send me your FREE EI-7 engineering guide.

Name ..... Title .....

Firm .....

Address .....

City ..... Zone ..... State .....

... when ordinary instruments  
are too big or inadequate

# trio

... the leader in panel-mounting electronic instruments.

*If you have this problem, investigate*

# GRIP-EZE®

—an example of Phelps Dodge's  
realistic approach  
to Magnet Wire research

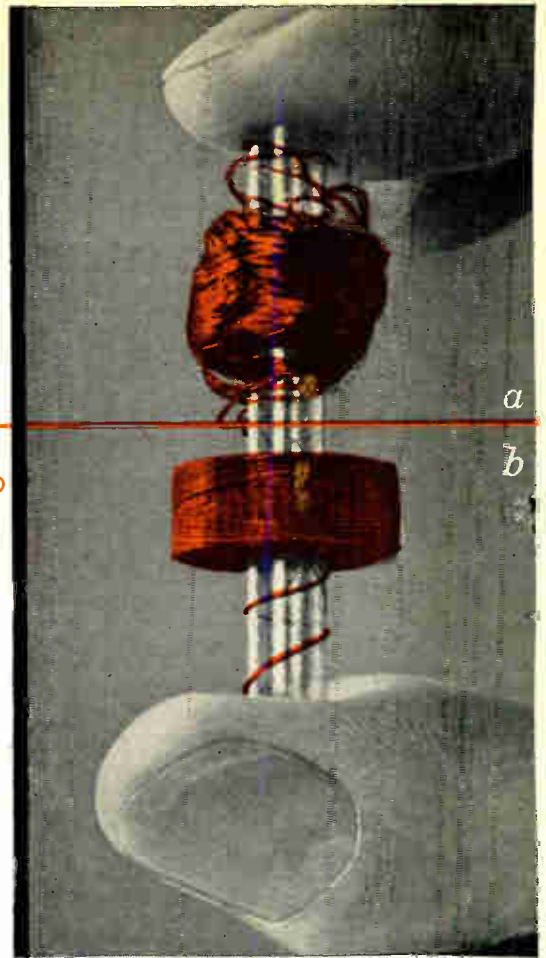

**THE PROBLEM:** To develop a solderable film-coated wire without fabric for winding universal lattice-wound coils without adhesive application.

**THE SOLUTION:** Phelps Dodge Grip-eze—a solderable film wire with controlled surface friction for lattice-wound coils that provides mechanical gripping between turns and keeps wire in place.

**EXAMPLE:** Coils wound with (a) conventional film wire; (b) Grip-eze. Note clean pattern of Grip-eze as compared to fall-down of conventional film wire.

*Any time magnet wire is your problem, consult Phelps Dodge for the quickest, easiest answer!*

Visit our Booth 1111 at Wescon Show, August 20-23, 1957

FIRST FOR  
LASTING QUALITY  
—FROM MINE  
TO MARKET!



**PHELPS DODGE COPPER PRODUCTS  
CORPORATION**

**INCA MANUFACTURING DIVISION**  
FORT WAYNE, INDIANA

# Power Cells

(Continued from page 38)

and develops full power within a fraction of a second. The alkaline electrolyte presents no severe corrosion problem, and such cells can be stored in an inert state for an almost unlimited shelf life.

Further developments are expected to include hermetically sealed cells, large batteries having outputs of several kilowatts per cell, and cells in odd configurations to fit into tightly packed electronic gear. In primary battery design cell designers predict more refined activating systems, improved performance and reliability.

### Acknowledgments

1. Technical information concerning power cells was provided by: C&D Batteries, Inc., Conshohocken, Pa. (L-A); Frank R. Cook Co., Denver 23, Colo. (S-Z); Exide Industrial Div., Electric Storage Battery Co., Philadelphia 2, Pa. (L-A, N-C, S-Z); Gould National Battery Co., Depew, N. Y. (N-C); Nickel Cadmium Battery Corp., Easthampton, Mass. (N-C); Sonotone Corp., Elmsford, N. Y. (N-C); Willard Storage Battery Div., Cleveland 1, Ohio (L-A); Yardney Electric Corp., New York 13, N. Y. (S-Z).
2. Nickel Cadmium Batteries, by Dr. A. Fleischer, Proceedings of Tenth Annual Battery Research and Development Conference, May 23, 1956.
3. A Sintered-Plate Nickel-Cadmium Cell, by G. W. Work, Naval Research Laboratory (Report #4852—OTS PB121533).
4. The Silver Oxide-Zinc Alkaline Primary Cell, Part IV, by C. M. Shepherd, Naval Research Laboratory (Report #4885—OTS PB121744).
5. Designing "Free Power" AM & FM Transistorized Receivers, by Dr. H. E. Hollmann, ELECTRONIC INDUSTRIES & Tele-Tech, September, 1956.

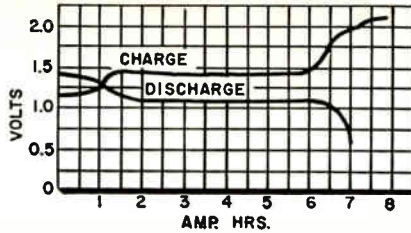

Fig. 7 (above): Typical silver-zinc charge-discharge curves show good voltage regulation.

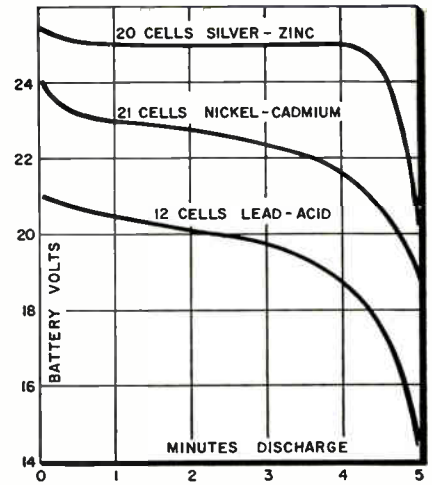

Fig. 8 (right): Relative voltage stability at fast discharge rates can be seen from these curves.

# Lead-Acid Cell (Continued from page 39)

able combinations of these metal additives to the fundamental lead structure have resulted in alloys which have a resistance to corrosion as much as four times that of formerly used alloys.

The rapidly increasing use of plastic components, both internally and externally, is another feature appearing in stationary battery designs. The plastic industry has introduced new materials which have good thermal stability and are completely impervious to the environment within the battery. With these plastics, new separation systems have been developed to insulate the positive and negative plates, materially improving the performance characteristics and life of the battery. In addition, the cell containers have largely been converted to clear plastic so as to readily permit visual examination of the contents of the cell, particularly the water level, which is the principal maintenance requirement of such batteries.

The use of containers made of modern, high-strength plastics has also permitted the elements of long-life batteries to be suspended from the side of the container or from the cover (as contrasted to the former practice of having the element ribs at the bottom of the cell). This permits the element a degree of freedom which heretofore it could not enjoy, thereby minimizing distortion of the parts of the battery, as the cell components modify their dimensions in accordance with the service conditions.

Developments in the lead acid field have generally not been of the spectacular variety, but rather of the slow, but continuous improvement of the product. Future developments, which battery laboratories are currently working on, promise significant improvements even over the present state of development. Principal among these is the work being done, with good indications of success, on a hermetically-sealed cell. Such cells give indications of even longer life than current types, with practically all physical maintenance being eliminated. Further improvements in efficient use of the active materials are also within the foreseeable future. These improvements will appear as greater capacity in present cell configurations, so as to meet the ever increasing demands which the long-term stand-by power system must satisfy.

## DISPENSE MELTED COMPOUNDS ACCURATELY and FAST

To dispense many kinds of heated compounds, soft metals, resins, etc., a drop at a time or for continuous small flow, use the Sta-Warm "CVN" electrically heated compound dispenser. Fast acting, easily controlled.

Speed production. For special applications, variations of the "CNV" employ power agitators, overhead sling installation, bottom operated valves and similar modifications to meet your needs. All have thermostat controlled heat.

Write for catalog literature today



5 gal. model CNV melter with needle valve dispenser is one of 7 sizes in 2 qt. to 25 gal. cap.



"If You Can Wrap a String Around It, Sta-Warm Can Heat It for You."

**Sta-Warm**  
**ELECTRIC CO.**  
222 N. CHESTNUT ST., RAVENNA, OHIO  
Subsidiary of ABRASIVE & METAL PRODUCTS CO.



# Nuclear Cells

(Continued from page 37)

wafers. These cells then are assembled into high voltage stacks. Typically, 200 of the paper-thin cells are packaged to form a 95-volt battery only one-third of an inch in diameter and one inch long. The first truly "dry" chemical primary cells, the new cells are immune to freezing, cannot leak, have virtually unlimited shelf life. Voltage is appreciably unchanged at temperatures from  $-70^{\circ}$  to  $+170^{\circ}$ F. Suggested uses include reference, bias, and polarization voltages; and capacitor charging for missile and other one-shot applications.

### Water-Activated

A war-developed cell, now available for civilian equipment, is the water-activated cell. This cell is constructed with either silver chloride or cuprous chloride and magnesium electrodes. Separated single electrodes can be wound condenser-style to form a compact cell of high capacity per pound, or many electrodes can be interwound to form a compact multi-cellular battery of higher voltage.

### Dry Storage

The cells are built into emergency electronic circuits in a dry state. If kept dry, they can be stored for many years with no noticeable loss of capacity.

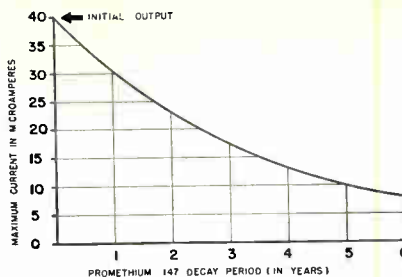

Fig. 13: Age, alone, determines the discharge capacity of the Elgin-Kidde promethium-powered nuclear battery.

They can be energized very simply by immersion in water, fresh, brackish, or salt.

In general, the silver chloride-magnesium types are more stable, have higher output ratings per unit volume, and are somewhat smaller and lighter than cuprous chloride-magnesium types having equivalent electrical characteristics. Generally, the cuprous chloride-magnesium batteries can be used if they are not subjected to prolonged high humidity conditions prior to use, are used shortly after activation, and are not required to expend their full energy within a very short period of time.

### Acknowledgments

1. Data on nuclear powered cells was provided by Elgin National Watch Co., Elgin, Ill.; Walter Kidde Nuclear Laboratories, Inc., 975 Stewart Ave., Garden City, L.I., N.Y.; Patterson Moos Div., Universal Winding Co., Inc., 90-28 Van Wyck Expressway, Jamaica 18, N.Y.; and Tracerlab, Inc., 130 High St., Boston 10, Mass.
2. Solid Electrolyte cells have been announced by General Electric Co., West Genesee St., Auburn, N.Y.; P. R. Mallory & Co., Inc., North Tarrytown, N.Y.; and National Carbon Co., 30 E. 42nd St., New York 17, N.Y.
3. Description of water-activated cells is based on information supplied by Burgess Battery Co., Freeport, Ill.; and General Electric Co., Pittsfield, Massachusetts.

**UNIPLUG  
DC  
FILAMENT  
&  
TRANSISTOR  
Power  
Supplies**



Model	Output	Ripple	Input	Price
119	12.6 v @ 0.9 a	200 mv	115 vac	\$36.00
125A	6.3 v @ 1.2 a	200 mv	115 vac	39.50
*125B	6.3 v @ 1.5 a	175 mv	115 vac	44.00
*225	6.3 v @ 2.0 a	200 mv	115 vac	69.00
*226	6.3 v @ 0.6 a	600 mv	6.3 vac	29.00

\* Silicon Rectifiers. Special "Uniplugs" to your specifications on short delivery. Quantity prices.

*C. J. Applegate & Co.*

Phone Hillcrest 2-8750 1840 24th St. Boulder, Colo.

Circle 137 on Inquiry Card, page 89

**INSURE  
Proven Quality**

with **JONES  
PLUGS  
AND  
SOCKETS**

P-306-CCT Plug, Cable Clamp in Cap. Jones Series 300 Illustrated. Small Plugs & Sockets for 1001 Uses. Cap or panel mounting.

S-306-AB Socket with Angle Brackets.

- Knife-switch socket contacts phosphor bronze, cadmium plated.
- Bar type Plug contacts brass, cadmium plated, with cross section of  $5/32''$  by  $3/64''$ .
- Installation molded bakelite.

- All Plugs and Sockets polished.
- Metal Caps, with formed fibre linings.
- Made in 2 to 33 contacts.
- For 45 volts, 5 amperes. Efficient at much higher ratings where circuit characteristics permit.

Ask for Jones Catalog No. 21 showing complete line of Electrical Connecting Devices, Plugs, Sockets, Terminal Strips. Write or wire today.

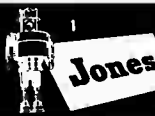

**HOWARD B. JONES DIVISION**  
CINCH MANUFACTURING CORPORATION  
CHICAGO 24, ILLINOIS  
SUBSIDIARY OF UNITED-CARR FASTENER CORP.

Circle 138 on Inquiry Card, page 89

# Communications

## Engineers

...to exploit recent technological breakthrough

Synchronous Detection Techniques have been transformed from a promising theory to a concrete reality by the research staff at General Electric. So impressive was the recent demonstration of the prototype equipment that the Light Military Electronic Equipment Department has given the go-ahead signal for a projected three-year program to develop Synchronous Detection to the product stage.

There are opportunities now at Light Military Department for results-oriented electronic engineers to work on circuitry and systems for the project.

This is a special group with exceptional potential, for this new communications system holds definite promise of becoming a large-scale business, with commercial and military applications.

**FILL IN THE COUPON BELOW FOR FURTHER DETAILS AND MAIL TO US TODAY:**

Mr. John Sternberg  
Light Military Electronic Equipment Dept.  
General Electric Company  
French Road, Utica, New York

Please send me further details on opportunities at Light Military Dept.

Name \_\_\_\_\_ Degree \_\_\_\_\_

Address \_\_\_\_\_

871

**LMEE**

Light Military Electronic Equipment Dept.

**GENERAL ELECTRIC**

## Metallurgy

(Continued from page 54)

The aging treatment results in an observable shifting of the resistivity peak to a higher temperature within this range.

Although heat treatment (strand annealing or aging) changes resistivity and temperature coefficient as described above, these changes are characteristic and independent of the temperature of treatment above a certain minimum temperature.

### Effect of Alloying

Small variations in minor constituents have a relatively insignificant effect on resistivity but a very marked effect on temperature coefficient. The change in resistivity versus temperature of an experimental melt with various processing heat treatments is shown in Fig. 4. Its response to heat treatment was similar to material of nominal composition. However, it showed a flatter resistivity peak between the range of  $-60^{\circ}$  to  $+100^{\circ}\text{C}$  and a lower temperature coefficient between  $20^{\circ}$  to  $300^{\circ}\text{C}$  as shown in Fig. 5.

Small variations in alloying constituents have no significant effect on the characteristic temperature coefficient changes from one processing stage of heat treatment to another as shown in Fig. 6. However, it is the alloying constituents which determine the value of T.C. after heat treatment. The temperature coefficient of Cupron in any processing stage can be expressed as a function of the alloying constituents as shown in Eq. (4).

$$\text{T.C. (between } T_1 \text{ and } T_2) = f(\% \text{ Ni, } \% \text{ Cu, } \% \text{ Fe, } \% \text{ Mn, } \% \text{ Co, etc.)} \quad (4)$$

From a series of experimental and production melts, it was found that for a definite ratio of Ni and Cu the effect of each individual element on T.C. of the alloys is linear up to a certain composition and additive to one another. Therefore, Eq. (4) becomes

$$\text{T.C.} = K + A(\% \text{ Fe}) + B(\% \text{ Mn}) + C(\% \text{ Co}) + \dots \quad (5)$$

where K = a constant which depends on the Ni to Cu ratio and the processing stage of the alloy.

A, B, C - - - are constants.

# BEST ANSWER for Tower Jobs—ROHN

AMERICA'S FINEST  
COMMUNICATIONS  
TOWER OF ITS KIND  
... WITH EXCLUSIVE  
BUILT-IN ECONOMY

• **REDUCE COSTS** by getting the right tower for the right job. When a job calls for a medium weight tower from 200-300 ft. guyed, or self-supporting from 50-66 ft., a Rohn tower can do the job at far less cost. Check your particular tower needs against the "job-rating" a Rohn tower has and you'll save money.

• **HOT DIPPED GALVANIZED** finishes are available. The erection is quick and easy as all towers are in 10 ft. sections. Rohn towers are designed for economy in erection as no specially trained help is required.

• **PROVEN DESIGN** that has been tested with thousands of installations. Workmanship is unexcelled. Mass production machinery is used for precision fabrication yet a big reduction in labor cost.

Picture illustrates 300 ft. Rohn No. 40 Tower installation as being used for community television by Caspian Community T. V. Corp., Caspian, Michigan.

Write, wire or phone for data and prices and nearest source of supply. ROHN representatives are coast-to-coast to serve you.

**ROHN Manufacturing Co.**

116 Limestone, Bellevue  
Peoria, Illinois

"Pioneer Manufacturers of TV and Communication Towers of All Kinds."

Circle 130 on Inquiry Card, page 89

Circle 131 on Inquiry Card, page 89

The temperature coefficient of Cupron can be calculated from Eq. (5) after the determination of the above constants. The calculated temperature coefficients were plotted versus the measured values in Fig. 7 and found to be within  $\pm 10 \times 10^{-6}/^{\circ}\text{C}$  of the measured values.

#### Permanent Strain

The effects of permanent strain on resistance, resistivity and T.C. of Cupron are shown in Table 2. These results were obtained by straining .0056 in Cupron wire from 2 to 20 per cent on an Instron Tensile Machine. The resistivity after deformation was calculated by Eq. (6) which was derived from Eq. (1) by assuming the constancy of volume before and after deformation. Temperature coefficients between 20 and 100°C were also obtained from resistance measurements of the deformed specimens at the above mentioned temperatures.

$$\rho = R d_0^2 / (1 + \epsilon) \quad (6)$$

where  $\rho$  = resistivity of the strained wire, ohms/cm<sup>2</sup>

R = resistance of the strained wire, ohms/ft.

$d_0$  = diameter of wire before straining, in mils (this is found by weight measurement)

$\epsilon$  = percent elongation

The results in Table 2 are plotted in Fig. 8. It can be readily observed that, after permanent deformation, the resistance increases significantly while the increase in resistivity and decrease in T.C. are very slight.

The majority of the resistance increase is caused by dimensional changes. For example, the resistance increase is 46 per cent after a sample is strained to 20 per cent elongation. The percent change in the dimensional factor ( $l/A$ ) can be found as follows:

$$\begin{aligned} \% \text{ change in } (l/A) &= \frac{l_1/A_1 - l_0/A_0}{l_0/A_0} \\ &= \frac{l_0(1 + \epsilon)}{A_0/(1 + \epsilon)} - l_0/A_0 \\ &= \frac{l_0(1 + \epsilon)^2}{l_0 A_0} - l_0/A_0 = 44\% \end{aligned}$$

The corresponding increase in resistivity can also be calculated as follows:

$$\begin{aligned} R_0(1 + 0.46) &= \rho_0(1 + x) \frac{l_0}{A_0}(1 + 0.44) \\ x &= 1\% \end{aligned}$$

Thus, the change in resistance of a strained sample is caused primarily by the dimensional changes attending deformation.

#### Elastic Strain

In T.C. measurements, the resistance wire which has been wound on the mandrel at room temperature tends to contract when the resistor is submerged in a  $-60^{\circ}\text{C}$  bath. Generally, the coefficient of linear expansion of most metals and alloys are much greater than that of ceramics. As a result, the wire is prevented from contracting by the ceramic mandrel, thereby the  $l/A$  ratio of the wire is larger

**Table 2**

Effect Of Uniform Strain On The Electrical Properties Of Cupron

Resistance After Deformation

Strain in % Elong.	Measured Value in $\Omega/\text{ft.}$	R* R/ft. $\times (1 + \epsilon)$	% Change in Resistance	Resistivity ohm/cm <sup>2</sup>	% Change in Resistivity	T.C. (20-100°C) $10^{-6}/^{\circ}\text{C}$
original	9.17	9.17	.....	294	....	-6
2	9.37	9.56	+4.2	294	0	-7
5	9.63	10.11	+10.3	294	0	-7
10	10.21	11.23	+22.5	298	+1	-9
15	10.68	12.34	+34	298	+1	-10
20	11.17	13.40	+46	298	+1	-11

\* Calculated total resistance of strained sample in ohms.

**Table 3**

Resistance And T.C. Change Of .0025" Cupron After Being Wound On Small Enameled Metallic Mandrels

Dia. of Mandrel Inches	Resistance of Wire, Ohms		$\Delta R/R$ %	Change in T.C. 20 to 100°C p.p.m.	Equivalent Strain, % (Interpolated Results)	% $\Delta\rho/\rho$
	Before Winding	After Winding				
.015	75.56	78.16	+3.4	0	1.6	<1
.188	79.96	81.40	+1.7	0	0.9	<1
.5	104.3	104.6	+ .3	0	<.2	<1

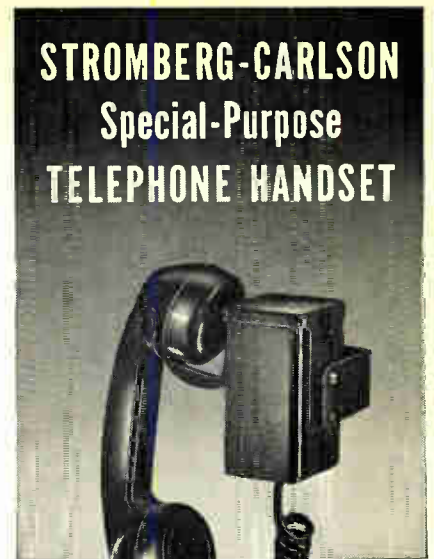

You can mount this special-purpose hang-up telephone almost anywhere: on desk, wall or piece of equipment. The handset shown is only one of many standard and special-application types you may order. The right-angle bracket provides 6 different mounting positions.

#### HOOKSWITCH

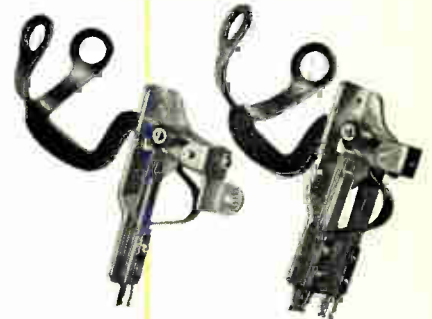

You can get hookswitches with any spring combination you need. Illustrated are two of many possible arrangements.

#### BRACKET



This special bracket gives you a choice of 12 different mounting positions. You may order it separately or with any combination of components you need. You'll find complete details in Booklet T-5005. To get your free copy, write to



**STROMBERG-CARLSON**

A DIVISION OF GENERAL DYNAMICS CORPORATION

Telecommunication Industrial Sales

126 Carlson Road, Rochester 3, New York

# FREED

**MIL-T-27A POWER, FILAMENT, PULSE & AUDIO TRANSFORMERS FOR IMMEDIATE DELIVERY FROM STOCK**

### POWER TRANSFORMERS-STANDARD

All primaries 105/115/125 v., 60 c.p.s.

Cat. No.	Hi Volt Sec.	ct	DC Volts	DC Amps	Filament #1		Filament #2		MIL Case Size
					Volt	Amp.	Volt	Amp.	
MGP1	400/200	✓	185	.070	6.3/5	2	6.3	3	HA
MGP2	650	✓	260	.070	6.3/5	2	6.3	4	JB
MGP3	650	✓	245	.150	6.3	5	5.0	3	KB
MGP4	800	✓	318	.175	5.0	3	6.3	8	LB
MGP5	900	✓	345	.250	5.0	3	6.3	8	MB
MGP6	700	✓	255	.250					KB
MGP7	1100	✓	419	.250					LB
MGP8	1600	✓	640	.250					NB

### FILAMENT TRANSFORMERS-STANDARD

All primaries 105/115/125 v., 60 c.p.s.

Cat. No.	Secondary		Test VRMS	MIL Case
	Volt	Amp		
MGF1	2.5	3.0	2,500	EB
MGF2	2.5	10.0	2,500	GB
MGF3	5.0	3.0	2,500	FB
MGF4	5.0	10.0	2,500	HB
MGF5	6.3	2.0	2,500	FB
MGF6	6.3	5.0	2,500	GB
MGF7	6.3	10.0	2,500	JB
MGF8	6.3	20.0	2,500	KB
MGF9	2.5	10.0	10,000	JB
MGF10	5.0	10.0	10,000	KB

### PULSE TRANSFORMERS

Cat. No.	Block E. Osc. Int. Coupling	Pulse Voltage Kilovolts	Pulse Duration Microseconds	Duty Rate	No. of Wdgs.	Test Volt. KV/VRMS	Char. Imp. Ohms
MPT1	✓	0.25/0.25	0.25	0.2-1.0	.004	3	0.7 250
MPT2	✓	0.25/0.25	0.2-1.0	.004	2	0.7 250	
MPT3	✓	0.5/0.5/0.5	0.2-1.5	.002	3	1.0 250	
MPT4	✓	0.5/0.5	0.2-1.5	.002	2	1.0 250	
MPT5	✓	0.5/0.5/0.5	0.5-2.0	.002	3	1.0 500	
MPT6	✓	0.5/0.5	0.5-2.0	.002	2	1.0 500	
MPT7	✓	0.7/0.7/0.7	0.5-1.5	.002	3	1.5 200	
MPT8	✓	0.7/0.7	0.5-1.5	.002	2	1.5 200	
MPT9	✓	1.0/1.0/1.0	0.7-3.5	.002	3	2.0 200	
MPT10	✓	1.0/1.0	0.7-3.5	.002	2	2.0 200	
MPT11	✓	1.0/1.0/1.0	1.0-5.0	.002	3	2.0 500	
MPT12	✓	0.15/0.15/0.3/0.3	0.2-1.0	.004	4	0.7 700	

### AUDIO TRANSFORMERS

Freq. resp. 300 to 10000 cps ± 2 DB. All Case Sizes AJ

Catalog No.	Application	Impedance		DC Current	
		Prim. Ohms	Cl.	Sec. Ohms	Cl.
MGA1	Single or P.P. Plates — to Single or P.P. Grids	10K	✓	90K Split	10 10 15
MGA2	Line to Voice Coil	600 Split	4, 8, 14	0 0	33
MGA3	Line to Single or P.P. Grids	400 Split	135K	✓	0 0 15
MGA4	Line to Line	600 Split	600 Split	0 0	15
MGA5	Single Plate to Line	7.6K 4.8T	600 Split	40 40	33
MGA6	Single Plate to Voice Coil	7.6K 4.8T	4, 8, 14	40 40	33
MGA7	Single or P.P. Plates to Line	15K	600 Split	10 10	33
MGA8	P.P. Plates to Line	24K	600 Split	10 1	30
MGA9	P.P. Plates to Line	60K	600 Split	10 1	27

Write for further information on these units, or special designs. Send for NEW 48 page catalog. Also ask for complete Laboratory Test Instrument Catalog

# FREED TRANSFORMER CO., INC.

1726 Weirfield Street  
Brooklyn (Ridgewood) 27, New York

Circle 142 on Inquiry Card, page 89

(Continued from page 121)  
than it would normally be at -60°C, or R-60°C of the wire wound mandrel is greater than R-60°C of the wire if there were no elastic strain. Therefore, the temperature coefficient of resistance of the wire wound mandrel will be more negative. An example is shown as follows:

Condition	T.C. in p.p.m.
Strain free wire	+13
Wire wound on ceramic mandrel	+3
Wire wound on enameled metallic mandrel	+11

(Material used was a Cr:Ni:Al resistance alloy wire, Mandrel size and winding tension were identical.)

### Non-Uniform Strain

The effect of non-uniform permanent strain on the electrical properties of Cupron were investigated by winding .0025 in. wire on small enameled metallic mandrels with a constant winding tension of 30 gm. (14,000 p.s.i.). The enameled metallic mandrels were used to avoid T.C. changes caused by elastic strain. The results are shown in Table 3. It can be observed that after the wire is wound on small mandrels of different sizes, its resistance increases ranged from 0.3 to 3.4 per cent, while the respective T.C. and resistivity are unaffected.

A term "equivalent strain" is introduced. It is the permanent strain which would produce an equivalent increase in resistance if the wire were plastically deformed in tension instead of being wound on mandrels. The equivalent strain can be obtained by interpolation from Fig. 8 with the resistance change before and after winding. And, the corresponding change in resistivity and T.C. can be estimated from Fig. 8 with the equivalent strain.

For example, the equivalent strains corresponding to Δ R/R of +.3, +1.7, and +3.4 per cent are .2, .9 and 1.6 per cent respectively. From Fig. 8 the T.C. changes should be zero which is in agreement with the measured values shown in Table 3. Therefore, the equivalent strain is useful in estimating the T.C. and resistivity change after the wire is wound on a mandrel.

The winding tension is an im-  
(Continued on page 124)

# AUTOMATIC Coil Company

An excellent source for all your coil needs. Coils and electronic assemblies of any design and requirement are manufactured to meet your specific demands. Quality materials and precision workmanship assure you of maximum performance and reliability.

**MEETS AND EXCEEDS MIL/JAN SPECS**

**THE ANSWER TO YOUR COIL PROBLEMS.**

- Made to withstand rigid temperature and humidity specs.
- Coils molded in plastic.
- Close tolerances held.

Our facilities are at your service **WRITE, WIRE, or PHONE**

**AUTOMATIC COIL COMPANY INC.**  
415 BEDFORD AVE., BKLYN., 11, N. Y.

Circle 143 on Inquiry Card, page 89

## SEPTEMBER . . .

an important month!

**ELECTRONIC INDUSTRIES**  
& Tele-Tech

will feature guided missiles and military procurement.

- \* Electronic production and procurement directory.
- \* Who's who in guided missiles; types being made and who makes them.
- \* Government posts, camps and stations employing electronic scientists with their grades.

Ad deadline: August 1

# ELECTRONIC INDUSTRIES & Tele Tech Advertisers—July 1957

AC ELECTRONICS DIV., GENERAL MOTORS CORP. .... 18 Agency—E. H. Brown Advertising	FORD INSTRUMENT CO., DIV. SPERRY RAND CORP. .... 124 Agency—G. M. Basford Company	OHMITE MFG. CO. .... 109 Agency—Fensholt Advertising
AIRCRAFT RADIO CORPORATION ..... 70 Agency—Burke Dowling Adams Inc.	FREED TRANSFORMER COMPANY ..... 122 Agency—Franklin Advertising Service	ONAN & SONS, INC., D. W. .... 016* Agency—Groves & Associates
ALFORD MANUFACTURING CO., INC. ... 015* Agency—Engineered Advertising	FUSITE CORPORATION ..... 29 Agency—Perry-Brown, Inc.	PERMAG CORP. .... 110 Agency—Joseph P. Schneider, Inc.
ALPHA WIRE CORPORATION ..... 112 Agency—Krate-Basch Associates	GENERAL ELECTRODYNAMICS CORP. ... 97 Agency—Don L. Baxter, Inc.	PHELPS DODGE COPPER PRODUCTS CORP. 010* Agency—Compton Advertising Inc.
AMERICAN LAYA CORPORATION ..... 101 Agency—Power & Condon	GENERAL ELECTRIC CORP., LIGHT MILITARY ELECTRONIC EQUIPMENT ..... 120 Agency—Deutsch & Shea	PHELPS DODGE COPPER PRODUCTS CORP., WIRE PRODUCTS DIV. .... 117 Agency—Compton Advertising, Inc.
AMP INCORPORATED ..... 76 Agency—M. Russell Berger	GENERAL RADIO COMPANY ..... 113 Agency—K. E. Morang Co.	PHILCO CORPORATION, LANSDALE TUBE COMPANY DIV. .... 10 Agency—Maxwell Associates, Inc.
ANDREW CORPORATION ..... 80 Agency—Frank C. Nahser, Inc.	GENERAL TRANSISTOR CORP. .... 23 Agency—Conti Advertising	POLARAD ELECTRONICS CORP. .... 27 Agency—Howard A. Harkavy, Inc.
APLEGATE & CO., C. J. .... 119	G-V CONTROLS ..... Cover 3 Agency—Keyes-Martin Advertising	POLYTECHNIC RESEARCH & DEVELOPMENT CORP. .... 93 Agency—Smith, Winters, Mabuchi, Inc.
ARNOLD ENGINEERING COMPANY ..... 24 Agency—W. S. Walker Advertising	HEATH COMPANY ..... 98 Agency—Advance Advertising Service	RADIO CORPORATION OF AMERICA ..... 08*, 09*, 014*, 015*, Cover 4 Agency—Al Paul Lefton
AUDIO DEVICES, INC. .... 31 Agency—Marsteller, Rickard, Gebhardt & Reed Inc.	HOFFMAN RADIO CORP. .... 114 Agency—Dan B. Miner	RADIO MATERIALS CORPORATION ... Cover 2 Agency—Turner Advertising
AUGAT BROTHERS, INC. .... 112 Agency—Knight & Gilbert Inc.	HOUSTON FEARLESS CORP. .... 13 Agency—Anderson-McConnell Adv. Inc.	RAYTHEON, INC. .... 07* Agency—Donahue & Coe
AUTOMATIC COIL COMPANY ..... 122 Agency—Spertus Advertising	HUGHES AIRCRAFT COMPANY ..... 104 Agency—Foote, Cone & Belding	REEVES SOUNDRAFT CORP. .... 011* Agency—The Wexton Co.
AUTONETICS DIV., NORTH AMERICAN AVIATION INC. .... 30 Agency—Batten, Barton, Durstine & Osborn	ILLUMITRONIC ENGINEERING ..... 114 Agency—James Logan Associates	RESISTANCE PRODUCTS CO. .... 95 Agency—Arthur Olian, Inc.
BELL TELEPHONE LABS, INC. .... 73 Agency—N. W. Ayer & Son	INDIANA STEEL PRODUCTS CO. .... 108 Agency—Fensholt Advertising	ROHN MANUFACTURING CO. .... 120 Agency—Jackson, Haerr, Peterson & Hall, Inc.
BLAW-KNOX COMPANY ..... 79 Agency—Ketchum, MacLeod & Grove Inc.	INTELEX SYSTEMS INC., ASSOCIATE OF I T & T ..... 116	SPRAGUE ELECTRIC COMPANY ..... 32 Agency—The Harry P. Bridge Company
BOEHME, H. O., INC. .... 102 Agency—William A. Battista	INTERNATIONAL ELECTRONIC RESEARCH CORP. .... 22 Agency—Jaycraft Company	SPRAGUE ELECTRIC COMPANY ..... 4 Agency—Stuart Sande Advertising
BOURNS LABORATORIES ..... 100 Agency—Allen, Dorsey & Hatfield, Inc.	JOHNSON CO., E. F. .... 26 Agency—Firestone-Goodman Advertising	STA-WARM ELECTRIC COMPANY ..... 118 Agency—E. T. Geddes
BURNELL & CO. .... 17 Agency—Mohr Associates, Inc.	JONES DIV., H. B., CINCH MFG. CO. ... 119 Agency—Symonds, MacKenzie & Co.	STEVENS MANUFACTURING COMPANY ... 6 Agency—Palm & Patterson, Inc.
BUSSMANN MANUFACTURING CO. .... 74	KESTER SOLDER COMPANY ..... 20 Agency—Paul J. Steffen Co.	STROMBERG-CARLSON COMPANY DIV. OF GENERAL DYNAMICS CORP. .... 121 Agency—The Rumrill Company
CHILTON CO., INC. .... 122	LOCKHEED AIRCRAFT CORP. .... 71 Agency—Hal Stebbins, Inc.	TELECHROME, INC. .... 19 Agency—Powerad Company
CINCH MANUFACTURING CO. .... 65 Agency—D. T. Campbell, Inc.	MAGNECORD DIV., MIDWESTERN INSTRUMENTS, INC. .... 115 Agency—Gourfain-Cobb Assoc.	TOWER CONSTRUCTION COMPANY ..... 96 Agency—Amundson-Bolstein, Inc.
COLLINS RADIO COMPANY ..... 04* Agency—W. D. Lyon Co.	MAGNETIC METALS CO. .... 8 Agency—Milt Dubins	TRIO LABS ..... 116 Agency—Krate-Basch Associates
CONSOLIDATED ELECTRODYNAMICS ... 14, 15 Agency—Hixson & Jorgensen	MAGNETICS, INC. .... 68 Agency—Lando Advertising	TRUSCON STEEL DIV., REPUBLIC STEEL CORP. .... 013* Agency—Meldrum & Fewsmith Inc.
CORNELL-DUBILIER ..... 72 Agency—Friend-Reiss Advertising	MALLORY & CO., INC., P. R. .... 111 Agency—Aitkin-Kynett Company	UNITED TRANSFORMER COMPANY ..... 105 Agency—Shappe-Wilkes, Inc.
DALE PRODUCTS, INC. .... 25 Agency—Ayles, Swanson & Associates	MELPAR, INC. .... 94 Agency—M. Belmont Ver Standig Inc.	WESTINGHOUSE ELECTRIC CORP. .... 99 Agency—Fuller & Smith & Ross, Inc.
DELCO RADIO DIV., GENERAL MOTORS... 75 Agency—Campbell-Ewald Company	MINNESOTA MINING & MFG. CO. .... 67 Agency—Batten, Barton, Durstine & Osborn	WESTON ELECTRICAL INSTRUMENT CORP., SUBSIDIARY OF DAYSTROM INC. .... 107 Agency—G. M. Basford Company
DIAMOND POWER SPECIALTY CORP. .... 78 Agency—Wirtz & Burden	NATIONAL CASH REGISTER CO. .... 21 Agency—McCann-Erickson Inc.	WILLIAMS & CO., INC., C. K. .... 124 Agency—William A. Hatch Advertising
DONNER SCIENTIFIC COMPANY ..... 016* Agency—Wank & Court & Lee	NEW HERMES ENGRAVERS, INC. .... 110 Agency—Mann-Ellis	
DOW CORNING CORP. .... 103 Agency—Church & Guisewite Advertising		
DuMONT LABS., INC., ALLEN B. .... 12 Agency—C. Lescarboursa & Staff		
ESC CORPORATION ..... 28 Agency—Keyes-Martin Advertising		

\*In Operations Section only

Let Williams  
help you apply

**FERRIC  
OXIDES**

to the manufacture  
of your

**FERRITES**

You'll be well repaid by getting the facts on a special group of Pure Ferric Oxides, developed by Williams especially for use in the manufacture of ferrites.

Williams Ferric Oxides analyze better than 99%  $Fe_2O_3$ . They contain a minimum of impurities. They are available in a broad range of particle sizes and shapes. Among them, we're certain you'll find one that's "just right" for your requirements. The proper application of Ferric Oxides to the manufacture of Ferrites is our specialty.

Tell us your requirements . . . we'll gladly send samples for test. Chances are good that our Ferric Oxide "Know How" can save you considerable time and money. Address Dept. 30, C. K. Williams & Co., Easton, Pa.

**WILLIAMS**  
COLORS & PIGMENTS

C. K. WILLIAMS & CO.  
Easton, Pa. • East St. Louis, Ill.  
Emeryville, Cal.

**P.S.** We also produce IRN Magnetic Iron powders for the Electronic Core Industry, the Magnetic Tape Recording Industry and others. Write for complete technical information.

Circle 144 on Inquiry Card, page 89

(Continued from page 122)

portant factor in the resulting electrical properties of resistance wire. Unnecessarily high winding tensions would alter these properties, particularly the resistance change. The winding tension employed in the above case was 14,000 p.s.i., or about one-quarter of the yield strength of Cupron. Therefore, the uniform strain thus introduced could be taken as zero. As a result, the resistance increase was attributed to non-uniform strain.

## Transistor

(Continued from page 49)

with a voltage drop of the order of a tenth of a volt, leading to a low power dissipation in the unit in the "on" condition and the choice of a low voltage and a minimum load impedance.

Values of pulse response times for units covering a range of alpha cut-off frequencies are given in Fig. 10. Rise, fall, and storage times in the range of tens of millimicroseconds are typical. Response and storage times were measured in a grounded emitter configuration with the transistor in saturation. Test conditions were achieved by adjusting the base input pulse until the transistor was just in saturation with  $V_{cc} = -6$  volts and then lowering  $V_{cc}$  to  $-1.5$  volts for a saturated pulse curve.

Fig 11 shows a phenomenon that appears on earlier lots of silicon transistors when operated or stored at elevated temperatures. Although there are no catastrophic failures to 3000 hours at  $140^\circ C$ , there is considerable variation in alpha,  $1/h_{ob}$ , and  $I_{co}$  during the indicated periods. The tendency for alpha and  $1/h_{ob}$  to increase steadily with time was characteristic of these earlier units. Data on a group of specially processed units at  $140^\circ C$  storage is seen in Fig. 12. At this writing, surface alloy silicon transistors have been on storage life at  $145^\circ C$  for ten thousand hours without any serious degradation in parameters.

## REFERENCES

- (1) The work for this paper was supported in part by the Signal Corps.
- (2) A. D. Rittman and T. J. Miles, *IRE Transactions on Electron Devices*, Vol. Ed.-3, #2, 1956.

# ENGINEERS — CAN YOU QUALIFY?

## ELECTRICAL and ELECTRONIC ENGINEERS

with at least 2 years experience in:  
Microwaves and Radar

Antennas  
Beacons  
Receivers  
Transmitters  
Pulse Circuits

Gyro Development

Digital Computers and Data Processing

Servo-mechanisms and Feedback Systems

Fire Control Systems

Analog Computers

Military Specifications

Electronic Circuitry

## NUCLEAR ENGINEERS and PHYSICISTS

with experience in the  
Control  
Metallurgy  
Physics  
Instrumentation  
of NUCLEAR REACTORS

## MECHANICAL ENGINEERS

with at least 2 years experience in:  
Gyro Development  
Fire Control Systems  
Military Specifications  
Product Design and Packaging of  
Electro-mechanical Devices

For details write Philip F. McCaffrey at:



**FORD  
INSTRUMENT  
CO.** DIVISION OF  
SPERRY RAND CORP.

31-10 Thomson Ave.,  
Long Island City 1, N. Y.  
DIVISION OF SPERRY RAND CORP.

Circle 145 on Inquiry Card, page 89

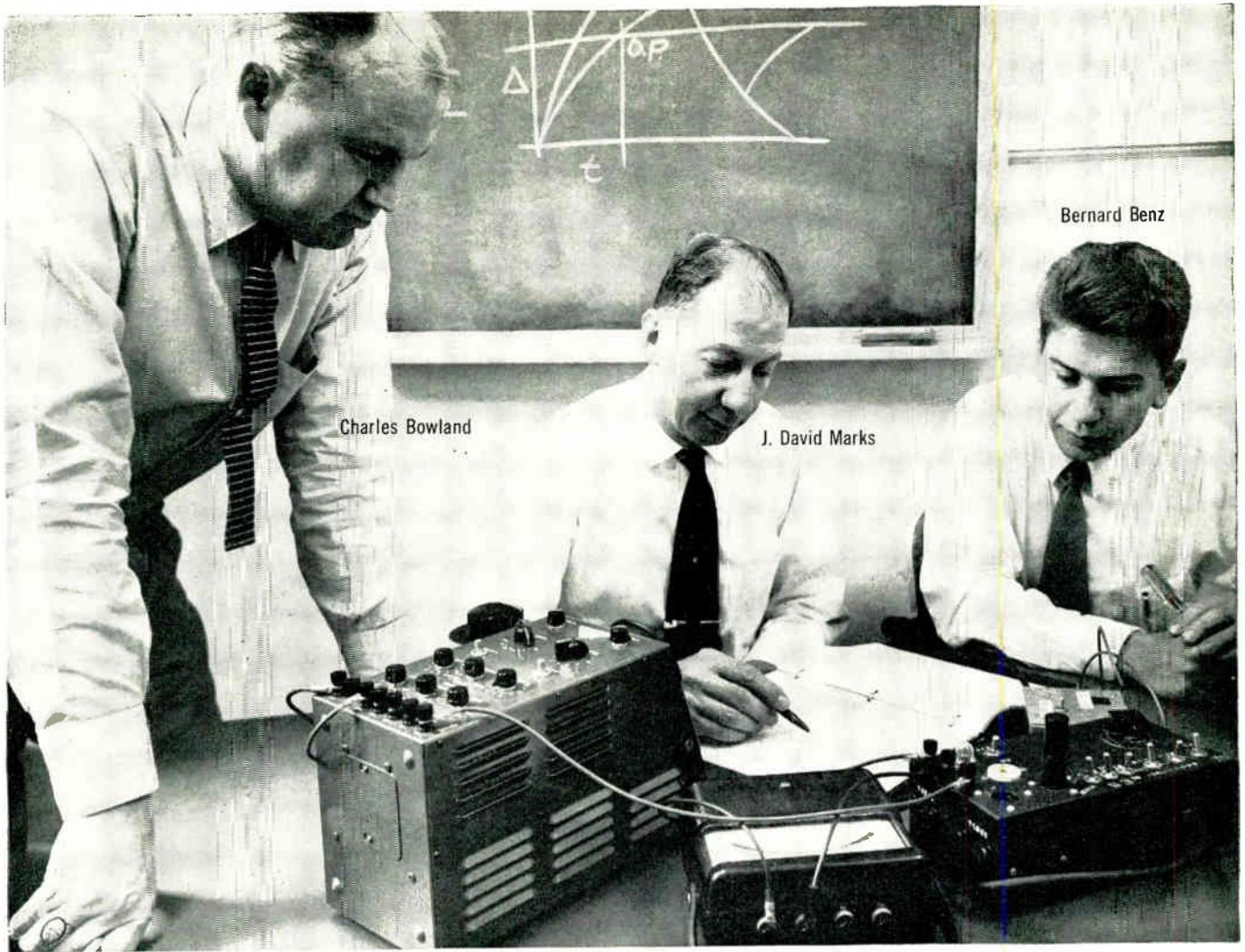

Charles Bowland

J. David Marks

Bernard Benz

an important G-V specialty . . .

## **SOLVING THERMAL RELAY PROBLEMS**

These Application Engineers study each proposed new use of thermal relays, select the relay best suited for the job, and test the relay under your conditions to tell you exactly what it will do. They can choose from more than 1,000 variations of the G-V thermal relay line which are available as standard items, at no additional cost and on dependable delivery schedules. With these standard relays, they solve over 98% of all thermal relay problems submitted to us.

The occasional user who needs a special design finds the separate G-V Research and Development Staff ready to apply their experience and ingenuity to the design of a new unit.

Complete reliability in all G-V prod-

ucts is assured by certified qualification testing in the G-V Environmental Test Laboratory under the most severe conditions found in field use.

These are just some of the reasons why the country's leading manufacturers of aircraft and electronic equipment have used more than a half million G-V Thermal Time Delay Relays...Hot Wire Time Delay Relays...Voltage and Current Sensing Relays...finding them more reliable and more economical than any other.

Well-qualified G-V representatives, backed up by Regional Field Engineers, are ready to serve you anywhere in the U. S. or Canada. Complete catalog data on G-V Relays and Thermostats is available.



# **G-V CONTROLS INC.**

50 Hollywood Plaza, East Orange, New Jersey





# RCA "PREMIUM" TUBES AND COMPUTER TUBES

## Operating Reliability

...extended to new levels of performance

To pace the demands for higher quality tubes in critical applications, RCA "Premium" Tubes and Computer Tubes have opened new possibilities for sustained reliability that exceeds previous levels of tube performance. Here are two important ways in which RCA insures that it *builds* QUALITY into these tubes:

- 1 **RCA** has developed a precision-type quality-control system that provides never-ending vigilance over the quality of "Premium" Tubes and Computer Tubes—*throughout every phase of tube manufacture.*
- 2 **RCA** backs up this quality-control system with 100% microscopic monitoring of 24 different categories of tube workmanship. By this method, each manufacturing point is constantly under surveillance, and prompt corrective action can be taken if needed.

Precision Quality-Control—coupled closely with microscopic monitoring—is another big step ahead in the manufacture of RCA "Premium" Tubes and Computer Tubes to assure excellent uniformity of characteristics and long-term reliability.

Your RCA Field Representative will welcome an opportunity to discuss the unusual advantages of RCA "Premium" Tubes and Computer Tubes for your specific applications. Contact him at the RCA Field Office nearest you:

**East** . . . . . 744 Broad Street  
Newark 2, N. J.  
HUboldt 5-3900

**Midwest** . . . Suite 1181  
Merchandise Mart Plaza  
Chicago 54, Illinois  
WHitehall 4-2900

**West** . . . . . 6355 E. Washington Blvd.  
Los Angeles 22, Calif.  
RAYmond 3-8361



**RADIO CORPORATION OF AMERICA**

Tube Division • Harrison, N. J.