

DECEMBER, 1927

25 CENTS

RADIO



**IN THIS ISSUE — SHIELDED GRID TUBE RECEIVER
A. C. FILAMENT TUBE SETS AND NEW KITS**

Cunningham RADIO TUBES

are designed and built to combine all the qualities which modern broadcast reception demands

E. T. CUNNINGHAM, INC.
NEW YORK CHICAGO SAN FRANCISCO

Since 1915 —
Standard for all sets

Twenty different types—all in the orange and blue carton.

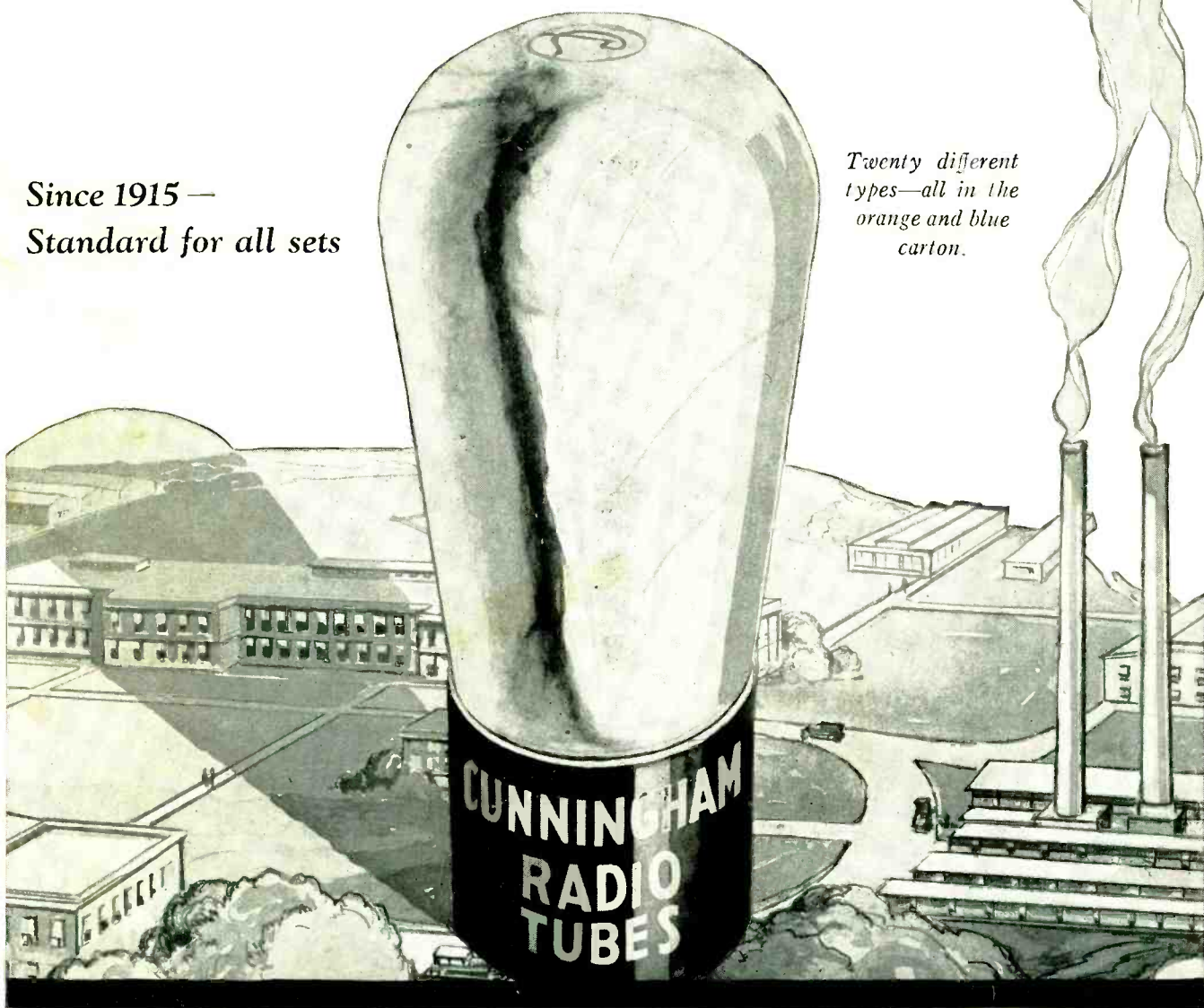

Dec 27

Better... than it looks

Some radio sets are all Queen Ann in front and plain Mary Ann when you lift the lid. A beautiful finish—to please the wife—is more important than quality in the actual working parts. And some circuits are sweet performers when it comes to radio reception but they certainly look like a junk-shop product when you have a party of critical friends in for the evening. But here is a set . . . well, just look at it. And then remember that its performance is even better than its appearance. Yes, of course, it's the

1928 Infradyne

This is a circuit which is never sold as a factory product. It can't be. But that does not mean that you have to work for weeks in building it up from small unmatched parts. Just buy four Remler units, a few extra parts, and in a few hours your Infradyne will give you the finest reception you—or anyone else—ever enjoyed.

Use the coupon below.

REMLER

Division of

Gray & Danielson Mfg. Co.

260 First Street, SAN FRANCISCO

CHICAGO

NEW YORK

Eastern Warehouse, Elkhart, Indiana



REMLER DIVISION, GRAY & DANIELSON MANUFACTURING CO.
260 First Street, San Francisco, Calif.

Please send me complete information about the Infradyne and folder describing all Remler Parts.

Name..... Street..... City.....

Do you build and sell sets?.....

Tell them that you saw it in RADIO

RADIO

With Which Is Incorporated "Radio Journal"
Established 1917

Published Monthly by the Pacific Radio Publishing Co.

ARTHUR H. HALLORAN,
Editor
GERALD M. BEST,
Technical Editor

H. W. DICKOW,
Business Manager
A. I. RIVETT,
Draughtsman

Branch Offices:

New York City, 20 East 42nd St.
Chicago, 307 N. Michigan Ave.
Boston, 86 St. Botolph St.
Kansas City, Mo., Davies & Dil-
lon, 707 Land Bank Bldg.

Rates:

Issued Monthly, 25c a copy.
Subscription price, \$2.50 per year
in the U. S., \$3.00 per year else-
where.

Correct Addresses:

Instructions for change of address
should be sent to the publisher
two weeks before the date they
are to go into effect. Each old
and new address must always be
given.

Advertising:

Advertising Forms Close on the
First of the Month Preceding
Date of Issue.

Member Radio Magazine Publishers' Association
Entered as second-class matter at Post Office at San Francisco, Calif.
Copyright 1927 by the Pacific Radio Publishing Co.

Address all communications to

Pacific Radio Publishing Company

Pacific Building, San Francisco, California

VOLUME IX

DECEMBER, 1927

NUMBER 12

CONTENTS

	PAGE
RADIO	17
<i>By Earle Ennis</i>	
NAVY RADIO HIGH FREQUENCY COMMUNICATIONS.....	18
<i>By Commander C. N. Ingraham</i>	
THE TRIO	20
<i>By Francis Churchill</i>	
DATA ON THE SCREEN GRID TUBE.....	21
CHANGING TO A. C. TUBES.....	22
<i>By D. B. McGown</i>	
VACUUM TUBE TESTING.....	24
<i>By B. F. McNamee</i>	
"... THE KID WAS STEADY".....	25
<i>By Earle Ennis</i>	
FISHING FOR RADIO WAVES.....	26
<i>By Everett W. Thatcher</i>	
WAVE TRAPS	28
<i>By G. F. Lampkin</i>	
AN IMPROVED PHASATROL RECEIVER.....	29
<i>By Alan Donaldson</i>	
COMMERCIAL SHORT WAVE TRANSMISSION.....	30
REACTANCE AND SUSCEPTANCE CURVES.....	31
<i>By Gilbert W. Cattell</i>	
SOCKET POWER OPERATION OF THE TYRMAN TEN.....	35
<i>By Clinton Osborne</i>	
REVAMPING AN OLD INFRADYNE.....	36
<i>By E. M. Sargent</i>	
RADIO KIT REVIEWS.....	38
The Two-Control Karas Equamatic, The Nine-in-Line, Hammarlund-Roberts HiQ Six.	
QUERIES AND REPLIES.....	41
TRANSMISSION AND RECEPTION ON $\frac{3}{4}$ AND 5 METERS.....	42
<i>By A. Binneweg, Jr.</i>	
AN INTERESTING SHORT-WAVE RECEIVER.....	44
<i>By Francis Churchill</i>	
THE COMMERCIAL BRASS-POUNDER.....	45
<i>By P. S. Lucas</i>	
SHAVE AND A HAIRCUT PLUS.....	45
<i>By Will Breniman</i>	
MARINE RADIO NOTES.....	46
<i>By L. O. Doran</i>	
SHORT WAVE STATIONS.....	70
HOW TO IMPROVE SHORT WAVE RECEPTION.....	72
<i>By Thos. A. Marshall</i>	
NOTES ON RADIO PROSPECTING.....	76
<i>By J. E. Smith</i>	

Forecast of Contents for January Issue

Forecasting the contents of next month's issue is as difficult as predicting the weather six weeks ahead. Certain good stories on hand are scheduled to appear, and along comes an unexpected development which crowds them out. So they must be held over until the following month.

This time the unexpected was the liberation of information about the shielded grid tube. Francis Churchill had been experimenting with these tubes for some time and so was prepared to describe and illustrate his article on the Trio, which appears elsewhere in these columns.

But this crowded out his story on the capacity coupled r.f. receiver. This seven-tube set operates from a loop-aerial and is so good that the author is using it in preference to any other for broadcast reception in his home. His description of its construction, illustrated by pictures and diagrams, is definitely scheduled for the January issue.

The shielded grid tube is expected to make some revolutionary changes with regard to reducing the number of intermediate frequency stages in a superheterodyne. Experiments are being made with them in our laboratory and the results thereof will be published as soon as possible. This is one of a number of improvements that probably will be incorporated in a new model of Best's superheterodyne.

Another upsetting influence on prognostications has been the a.c. filament tube. D. B. McGown's practical article on their use in various circuits occupies the space intended for Harry R. Lubcke's story on automatic radio control.

Other articles held over are James Millen's "Cartridge Rectifier," Samuel G. McMeen's account of the construction of a Thomson galvanometer, and the conclusion of J. E. Smith's notes on radio prospecting.

Among the new articles is one describing the construction of a five tube receiver using two shielded grid tubes as r.f. amplifiers.

Alan Donaldson presents the results of some interesting recent tests of loudspeakers and compares the magnetic and electro-dynamic types. He also tells how to improve the tone quality from the average loudspeaker by means of equalizers.

"The Perfam AC-4" is a set devised by Perry S. Graffam to use four a.c. filament tubes, thus doing away with the necessity for a storage battery. His text and drawings give complete details for the constructor.

Donald K. Lippincott discusses the cause and cure of "feed-through" interference from a nearby broadcaster.

For the amateur and commercial operator Arthur Martini tells how to build and operate a flexible low power transmitter. R. Wm. Tanner describes the construction of a good short wave phone transmitter.

B. F. McNamee describes the method to be used in calibrating a short-wave receiver with the harmonics from a broadcast-band oscillator.

The fiction feature is "SOS," by Armstrong Perry. This story delightfully combines humor and amateur radio in a most readable tale.

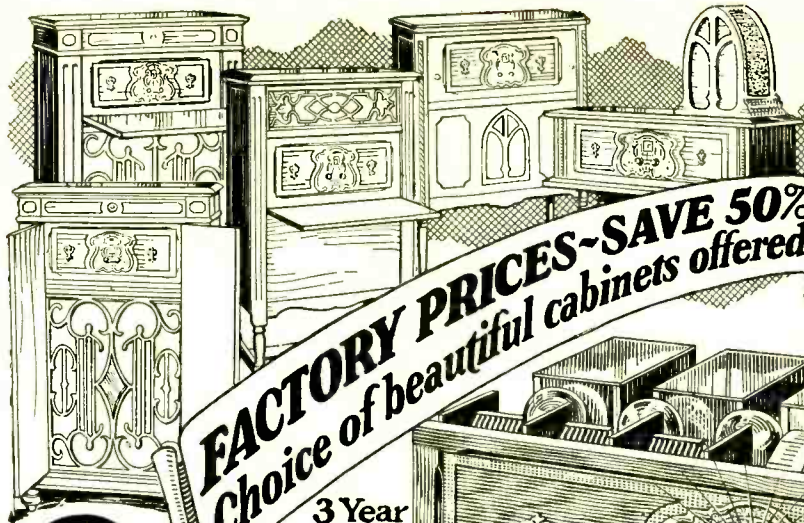

FACTORY PRICES - SAVE 50%
Choice of beautiful cabinets offered

3 Year
Guarantee

8 tube - one dial MIRACO

TRADE MARK REGISTERED

**TRY IT 30
DAYS FREE**
BEFORE YOU BUY

**ALL
METAL
SHIELDED
CHASSIS**

only
69⁷⁵
Retail List
Completely
Assembled

MAGNIFICENT TONE - SUPER SELECTIVE - POWERFUL DISTANCE GETTER

All Electric or Battery Set!

**Big Discounts to
User-Agents**

**MIRACO
Users Say:**

Reports from users everywhere leave little for us to add. These are only a few of the many in our files and which we receive daily. Send coupon for plenty of additional proof and testimony of nearby users.

HEARS CANADA, MEXICO AND AUSTRALIA

Words cannot express the praise that I would like to give the Miraco. Here are some of the stations I have received with this set. KFWO, WBBM, KDAC, WJL, WJAZ, WOK, WENR, WSNR, KYW, WOI, WEBH, WMAQ, WQJ, KOIL, KMJ, CFAC, WSAI, WLW, KFAU, KFRU, KDA, KIL, KFWH, COK, KFJH, KF-WB, KFKX, KFGV, WSUL, KMIZ, WOS, WDAF, KNX, KFI, KIH, KTH, KMTR, KFEX, WMBR, KFO, KFM, KTA, KX, KX, KGW, WCCO, WOL, KF, NF, WGY, KWA, CNRY, CFCT, CFDO, KGW, KJR, KYDA, KOMO, WHQ, KF, AB, KFVD, KMOY, KOB, GJOR, CFQY, KKY, WJAI, WGRD. There are 135 of them in all and they represent all parts of the U. S. and Canada, and here are some special ones: A. M. B. T. Juana, Mexico; CJY, CZE, Mexico City, Mexico; and here's the best of all: ZBL, Sidney, Australia, and furthermore I have a letter of verification and also an authentic reception stamp for ZBL for all to see. I also have letters, cards and stamps from most of the American stations. Enclosed find newspaper clipping boosting Miraco.

—D. C. PARKER, Palermo, Calif.
CALIFORNIA HEARS CINCINNATI TO JAPAN

I have received WLW and WSAI of your city, also JOAK, Tokyo, Japan.—L. W. BLUHTON, Davis Creek, Calif.

CALIFORNIA HEARS JAPAN

It might be interesting to you to know that yesterday morning at 3:30 I tuned my Miraco in and heard Japanese music and singing, then an announcement in Japanese and then "J-O-A-K" in English. This station is located at Tokyo, Japan. This was received over the loud speaker. My radio log consists of about 112 stations to date.—ERLE MARTIN, Hobart Mills, Calif.

STATE OF WASHINGTON HEARS CHICAGO FIRST NIGHT

I have had my set in operation just one week and got WENR, Chicago, the first night. Stations I received the first week: KSL, Salt Lake City; KOA, Denver; WOK, Homewood, Ill.; KIO, Tacoma; K O M O, Seattle; K G W, K O L N, K H J, Portland, KOAC, Corvallis, CNIC, CNRY, Vancouver, B. C.; KFSD, San Diego, Cal.; KFWB, Hollywood; KGO, Oakland; KGW, San Jose; KFWH, Chico; KFWI, San Francisco; KFL, Los Angeles.—EARL F. HOLBROOK, Couer, Washington.

America's big, old, reliable Radio Corporation* (8th successful year) guarantees in its big, powerful, latest 6, 7 and 8 tube Miraco sets "the finest, most enjoyable performance obtainable in high grade radios." Unless 30 days' use in your home fully satisfies you a Miraco is unbeatable at any price for beautiful, clear cathedral tone, razor-edge selectivity, powerful distance reception, easy operation, etc.—**don't buy it! Your verdict final.** Save or make lots of money on sets and equipment—write for testimony of nearby users and **Amazing Special Factory Offer.**

Miraco's work equally fine on "AC" electric house current or with batteries. Take your choice. Many thousands of Miraco users—who bought after thorough comparisons—enjoy programs Coast

to Coast, Canada to Mexico, loud and clear—with the magnificent cathedral tone quality of costliest sets. Don't confuse Miraco's with cheap, "squawky" radios. Miraco's have finest parts, latest approved shielding, metal chassis, etc.—as used in many \$200 sets.

Deal Direct with Big Factory

Your Miraco reaches you completely assembled, rigidly tested, fully guaranteed. Easy to connect and operate. **30 days' trial free.** 3 year guarantee if you buy. You take no risk, you insure satisfaction, you enjoy **rock-bottom money-saving prices** by dealing direct with one of radio's oldest, most successful builders of fine sets. 8th successful year in the radio manufacturing business.

7 tube one dial METAL SHIELDED CHASSIS \$49⁷⁵ RETAIL LIST

MIRACO "Powerplus" sets—both in 8 and 7 tube models—have magnificently beautiful, clear cathedral tone quality. Turn one dial for stations everywhere. Ultra-selective. Miraco multi-stage distance amplification gives "power-plus" on far-off stations. Latest all-metal shielded chassis. Illuminated dial. Fully guaranteed. Try one free for 30 days! Choice of beautiful cabinets.

Dealers Write!

USERS' REPORTS PROVE THAT

MIRACO Radio get 'em Coast to Coast

Free!

Wholesale Price Offer to User-Agents, Bank References, testimony of nearby Miraco users—**all the proof you want**—sent with catalog.

mail coupon right now!

Electrify Any Radio with MIDWEST NO-BATTERY "A-C" Light Socket Power Units

BIG DISCOUNT TO User-Agent

"A", "B" and "C" power, direct from light socket, without batteries! Write for Midwest prices and discounts. Midwest Units are highest grade—lastingly dependable, quiet in operation, fully guaranteed.

6 tube Super \$36⁷⁵ RETAIL LIST

Another Big Bargain! Famous powerful big Miraco Super 6, 1928 model—ultra selective! Thousands find it outperforms sets of much higher price. 30 Days' Trial Free. Fully Guaranteed.

MIDWEST RADIO CORPORATION
Pioneer Builders of Sets
414-E Miraco Building, Cincinnati, Ohio.

Without obligation, send free catalog, AMAZING SPECIAL OFFER, testimony of nearby Miraco users. User Agent Dealer

NAME
ADDRESS

THIS COUPON IS NOT AN ORDER

Tell them that you saw it in RADIO

Sargent *and* Rayment STATION ISOLA

A GAIN the inventors of the Infradyne, Sargent and Rayment, give the radio public an opportunity to greatly increase the selectivity, DX range and volume of any circuit using tuned radio frequency or neutrodyne hook-ups. A year of laboratory research with dozens of selectivity-increasing devices enables us to offer the new Sargent-Rayment Station Isolator to any radio fan who desires to enormously increase the efficiency of his receiver. It is unlike any other device on the market. It is not a wavetrap but a genuine Isolator, incorporating the additional feature of doubling the volume of DX reception and allowing you to get distant stations through the locals. This device has met with instant approval.

Adds One Stage of Powerful R. F.

A specially designed, constructed and balanced stage of radio frequency amplification ahead of your receiving set with an on-off switch to throw the Isolator in or out of the circuit makes it possible to prove for yourself just how marvelously this Isolator improves your set. It is a genuine laboratory product, built of precision instruments—the finest the market affords. Completely wired. Connection Posts, plainly marked, on bakelite strip in rear.

Use it with these Sets

Atwater Kent, Apex, All-American, Aero, Amrad, Bosch, Bremer Tully, Browning-Drake, Crosley, Freshman, Freed Eismann, Erla, Federal, Fada, Garod, Magnavox, Howard, Kolster, Stewart Warner, Splitdorff, Spartan, Infradyne, Stromberg, Mohawk, Hammarlund Roberts, and dozens of other sets using tuned radio frequency or neutrodyne circuits.

Bottom View of Isolator

The picture shows the Isolator from below. Felt padding is secured to the baseboard to prevent scratching of furniture. A CX 301-A vacuum tube is required when the Isolator is used in connection with any sets excepting the Atwater Kent models 30, 32 and 35 or Crosley Band-Box and Freshman Equaphase sets. When used with these models the Isolator operates without vacuum tube. The tube is inserted from the bottom and it is not necessary to remove the case to insert a tube. A pure copper case shields the entire Isolator. The case is finished in baked brown crystalline lacquer which gives the instrument a most pleasing appearance. Ruggedly constructed and securely packed in strong cartons for safe shipment by mail or express anywhere.

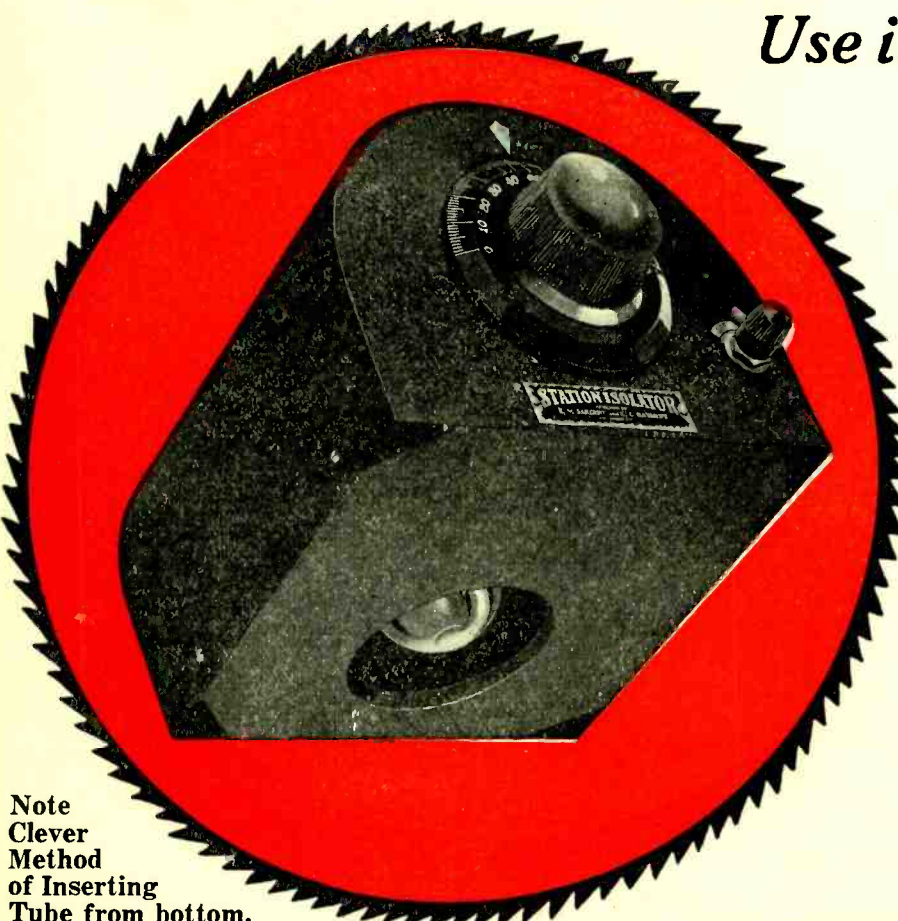

Note
Clever
Method
of Inserting
Tube from bottom.

Announce The New TOR

A New Device That Doubles the Selectivity and Distance Range of any Tuned Radio Frequency or Neutrodyne Set.

Brings in stations you never heard before. Cuts right through locals and gets distance.

Entirely Fool-Proof. Install it in five minutes. Give your set the punch of a super! Has on-off switch to allow use of set either with or without Isolator.

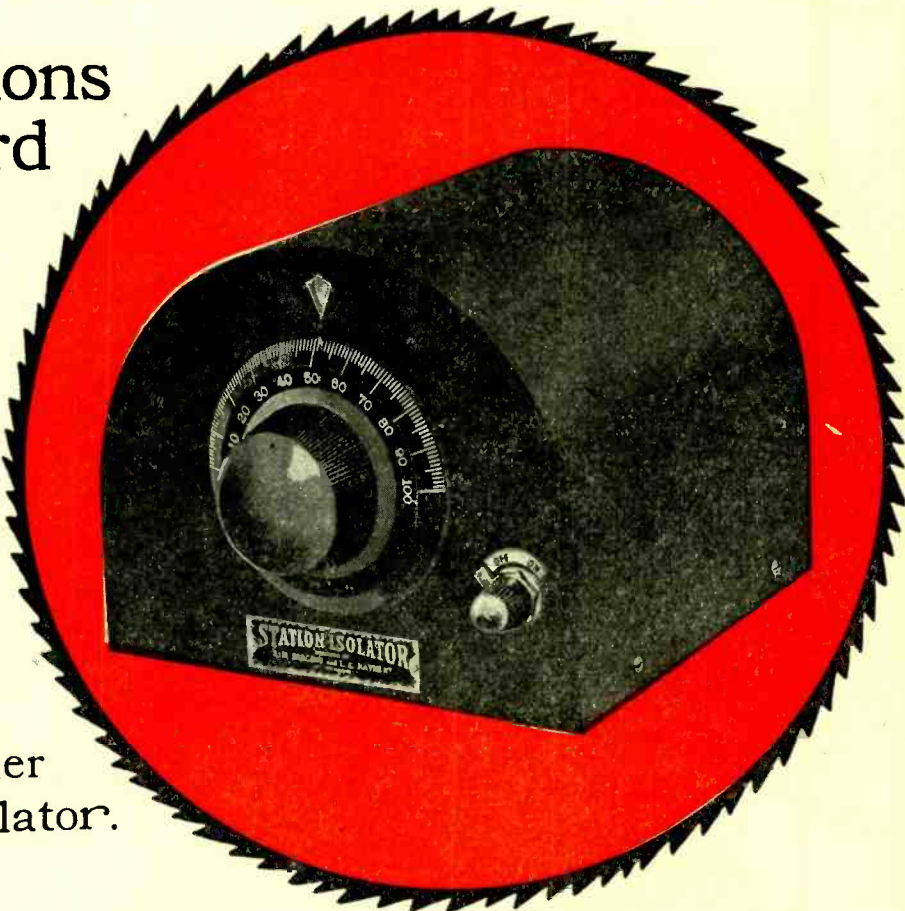

Price

Model A—For Apex, Atwater Kents—Nos. 30, 32 and 35 and for Crosley Band-Box and Freshman sets. **\$10.00**
(No tube required)

Model T—For all other A-K, Neutrodyne and Tuned Radio Frequency sets. **\$17.50**
(Requires one CX-301-A tube. If tube is wanted, add \$1.75 to price.)

**Order Direct by Mail.
USE THE COUPON.**

Specifications

Wavelength range from 200-550 meters, covering entire broadcast band. Amsco Allocating variable condenser used. Contains radio frequency choke, inductance coil, necessary resistances, socket and switch. Bakelite tuning dial. On-Off switch. Bakelite binding posts for connections. Low loss tuning coil. Complete laboratory test made of each Isolator before shipment.

Manufactured by

Radio Constructors Corporation
357 Twelfth St., Oakland, Calif.

DEALERS, WRITE FOR PRICES

Radio Constructors Corporation,
357 12th Street,
Oakland, California

Send one to a friend for Xmas

Bring Xmas radio joy to a radio friend by sending him one of these new Station Isolators. Send us a check, money order or draft. We will send a Christmas card to your friend, advising him of your gift and we will schedule shipment to assure arrival of the Isolator on Xmas Eve. Then treat yourself, also, to real Xmas radio thrills by getting one of these Isolators for yourself. We promise to make immediate shipment upon receipt of remittance from you. CX301-A tested and selected vacuum tube \$1.75 additional, postpaid.

Mail the Coupon Now!

Here is \$..... for which you will ship, postpaid, one of your STATION ISOLATORS for use in connection with..... receiving set. (Be sure to state type of set you are using).

Name.....

Address.....

City and State.....

Tell them that you saw it in RADIO

Now Use This Shielded Grid Tube

Radios' Greatest Last-Minute Achievement

[FOR RADIO FREQUENCY AMPLIFICATION]

Never before have so many outstanding features been incorporated into one tube. Radio Engineers throughout the country marvel at this newest and greatest discovery. Technical Editors proclaim it Radio's Greatest Achievement. (See article in this issue.)

NOTE The 6 Points of Superiority

1. Amplification constant is 175 compared with constant of 8 in general purpose tubes.
2. Oscillation is entirely eliminated.
3. It is self-neutralized.
4. "A" Battery drain is only .131 amperes.
5. Operates on 3 volts.
6. Brings in DX stations like locals.

GUARANTEED

The Shieldplate Tube Corporation guarantee these tubes to be just as represented, or your money cheerfully refunded.

Don't Delay- All Orders Filled
in Rotation



Type SP 122

Price \$7.50

If your Jobber cannot supply you, order direct from the factory. Include money order with your request.

JOBBERS—DEALERS

Technical Editors are devoting many pages of publicity to circuits designed to employ the use of the Shielded Grid Tube, type SP 122.

Be prepared to supply your customers with these tubes. Send in your order immediately to assure an early shipment.

SHIELDPLATE TUBE CORP.
208 South LaSalle Street, Dept. 14
Chicago, Illinois

**Mail-
Your
Order
To-day**

TEAR COUPON OFF HERE

Shieldplate Tube Corporation
208 South LaSalle Street, Dept. 14
Chicago, Illinois

Gentlemen:

Enclosed find \$.....for which kindly send me.....Shielded Grid Tubes, type SP 122.

Name.....

Address.....

City..... State.....

Jobber.....

Build Your Own Power Amplifier

Transform your Receiver into a Real Musical Instrument!

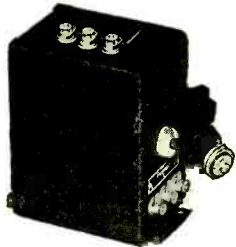
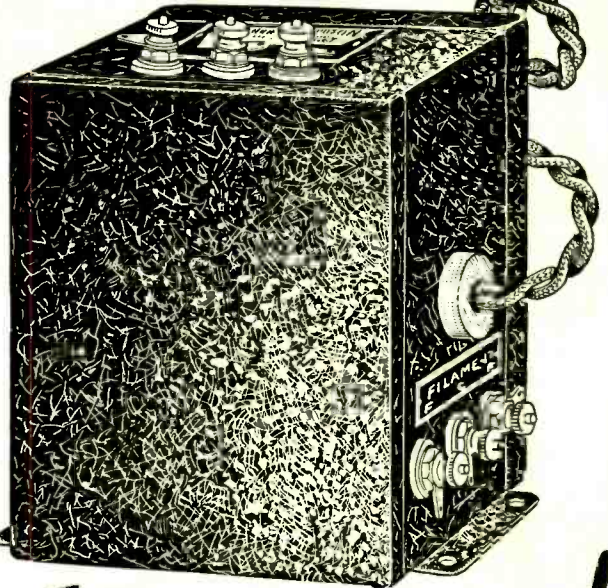

R-210 Power Compact . \$20

With a screw driver, a pair of pliers, and a soldering iron you can build a Thordarson Power Amplifier and B-supply in your own home that will equal the finest commercial amplifier on the market. Complete constructional booklet and simple diagram accompany every transformer.

Thordarson R-210 Power Compact

The Thordarson R-210 Power Compact is scientifically designed to give maximum electrical efficiency and to make home assembly of power amplifiers as simple as possible. The R-210 Power Compact is the foundation unit and contains the following apparatus: (1) A power supply transformer designed for UX-216-B rectifier; (2) Two filter chokes of 30 henries inductance and 65 M. A. current carrying capacity; (3) A 7½ volt supply center tapped for the filament of one UX-210 power tube. Wiring of the complete amplifier is simple—20 leads complete the assembly.

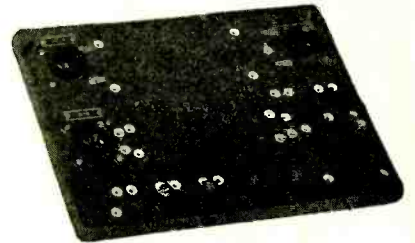

R-211 Metal Baseboard, including sockets, binding posts, mounting screws, and hook-up wire . . . \$5

New Metal Baseboard for R-210 Compact Amplifier

To further simplify home construction of the R-210 type amplifier, you can now buy this new cracked finished metal baseboard. All spring sockets and binding posts are mounted and included in the list price. All mounting holes are drilled. All holes for sub-panel wiring are carefully insulated. Location of all sub-panel wiring is marked under baseboard.

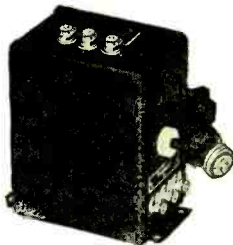

R-171 Power Compact . \$15

R-171 Power Compact

This power compact is similar to the R-210 type, but is adapted for home construction of power amplifiers using the Raytheon BH rectifier and UX-171 power tube. Designed to meet the popular demand for a low priced yet highly efficient power amplifier. Delivers 320 volts either side of center to the Raytheon BH rectifier. The two choke coils are rated at 85 M. A. 30 henries. The filament winding of 5 volts center tapped is suited to one UX-171 power tube. Two 0.1 Buffer Condensers are also included in the case. Wiring the complete amplifier and B-supply is merely matter of connecting 18 leads.



No. 2098 Power Supply Transformer . . \$20

T-2098 Power Supply Transformer—T-2099 Double Choke Unit

Here is an extra heavy duty power amplifier supply that will satisfy the most exacting demands for excess power. An amplifier using this transformer and choke unit will deliver 425 volts at 130 M. A. drain, sufficient for the heaviest receiver using two UX-210 tubes in power push-pull. Transformer T-2098 delivers 550 volts each side of center tap and is designed to supply two UX-216-B rectifiers (full wave). The 7½ volt filament supply will easily handle two UX-210 power tubes. The double choke unit T-2099 consists of two 30 henries 130 M. A. choke coils mounted in a compound-filled case.



No. 2099 Double Choke Unit . . . \$14



THORDARSON ELECTRIC MFG. CO.
500 West Huron St., Chicago, Ill.

Gentlemen:

Please send me a copy of your free booklet "Power Amplification Simplified."

Name

Address

City..... State.....

(9571)

← Get this FREE Book!

THORDARSON POWER COMPACT

THORDARSON ELECTRIC MANUFACTURING CO.
Transformer Specialists Since 1895
WORLD'S OLDEST AND LARGEST EXCLUSIVE TRANSFORMER MAKERS
Huron and Kingsbury Streets — Chicago, Ill. U.S.A.

Tell them that you saw it in RADIO



Both
for
\$2.50
RADIO
and

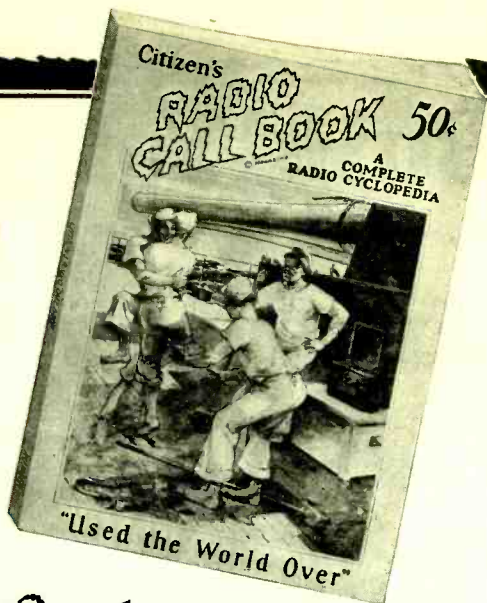

**The BIGGEST Offer
 EVER MADE**

ARRANGEMENTS have been completed between the publishers of "RADIO" and the publishers of "Citizens Radio Call Book" whereby you can now get both of these magazines for exactly the price of one.

EVERY phase of radio is covered in these two leading radio publications—reading material on everything known in radio—"Citizens Radio Call Book" contains a wealth of live radio information, with the most complete up-to-date list of all broadcasting stations, showing schedules, wave lengths, etc., 150 pictures of radio celebrities, and helpful hints for operation and maintenance of receivers. Complete construction articles on all popular circuits and on receivers of unusual merit.

"CITIZENS RADIO CALL BOOK" is entering its seventh successful year.

"RADIO" is one of the oldest radio magazines published and is noted for its well edited, practical and authentic articles devoted to the interests of the radio fan, radio constructor, experimenter and amateur. "RADIO" has been published for eleven years.

**Citizen's
 RADIO
 CALL BOOK**

**16 copies a year
 less than 16¢ a copy -
 Effective Immediately**

THE new November copy of the "Citizens Radio Call Book" and the December issue of "RADIO" will be mailed to you November 21st, provided you fill out and send in the coupon with \$2.50 before this date. Don't fail to send your subscription early so that it can start with the next issue.

"RADIO" is published monthly and will be sent to you for twelve months. "Citizens Radio Call Book" is published four times a year—September, November, January and March. All four issues are included in this joint money-saving subscription offer.

IF you are a present subscriber to "RADIO" or "Citizens Radio Call Book" you can still take advantage of this cut rate price. We will extend your subscription for one year.

IF you bought both of these magazines from a news dealer, you would pay \$5.00 a year. Save \$2.50—exactly half—by subscribing now to BOTH magazines for the price of one. The regular yearly subscription price on "RADIO" is \$2.50 and "Citizens Radio Call Book" \$2.00. You even save \$2.00 on the regular subscription price.

WE advise you to fill in the coupon now and send immediately.

"RADIO"
 PACIFIC BUILDING
 SAN FRANCISCO, CAL.

Here is my \$2.50 for the combination subscription to "RADIO" and "Citizens Radio Call Book" for one full year as advertised in your November issue.

Name.....

Address.....

**SAVE
 \$2.50 by using
 this coupon**

AGAIN! TYRMAN SCORES —

Radios Newest Sensation

Tyrman A.C. Ten!

ONE SPOT

*Selectivity
Distance
Tone Quality
Elegance*

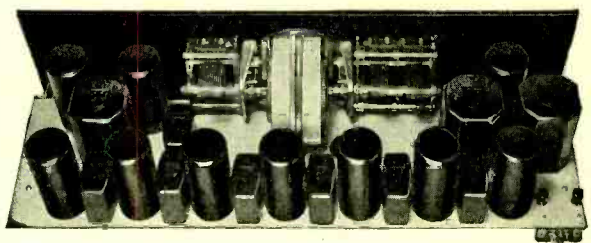



Described in this issue

Now duplicate the famous A-C Operated Tyrman Ten—the most powerful coast to coast receiver. Unequaled for its ultra fine tone quality—sensitivity—selectivity and DX reception. Far superior in appearance to any manufactured set. Convince yourself by comparing the Tyrman Ten with any existing receiver.

FOR ALL POPULAR CONDENSERS

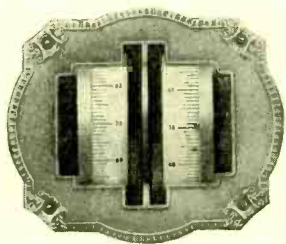
Front view of Tyrman Vernier Drum



Praised — Endorsed

Radio Engineers and Technical Editors highly praise and endorse Tyrman products, now used in the better receivers of 1928.

ASK YOUR JOBBER

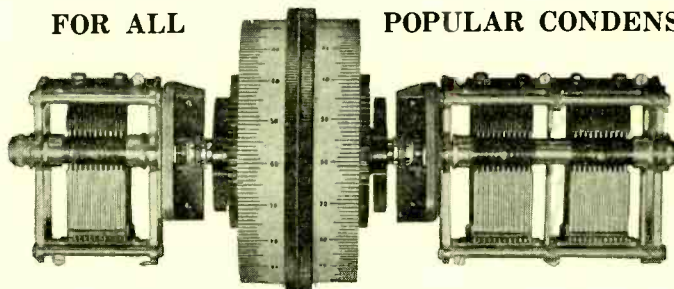

TYRMAN VERNIER DRUM

The Tyrman Vernier Drum is a precision tuning device assuring efficiency—accuracy and simplicity for all double and single control receivers.



AUDIO TRANSFORMER



TYRMAN SHIELDED SOCKET

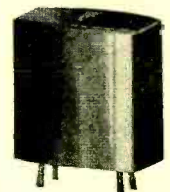

T R F TRANSFORMER

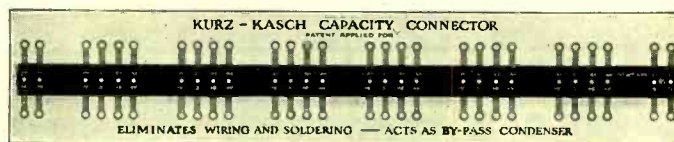

The Kurz-Kasch Capacity Connector is an exclusive Tyrman feature.

2 Ounces of Interesting Radio Literature **FREE TO SET BUILDERS**

TYRMAN ELECTRIC CORP.
141-143 W. Austin Avenue Chicago, Ill.

Mail This Coupon To-day

Tyrman Electric Corporation
141-143 W. Austin Avenue
Chicago, Illinois

Gentlemen:
Kindly send, gratis, your 2 ounces of radio literature.

Signed.....

Tell them that you saw it in RADIO

Tyrman Ten specifies Camfield Equaltune Condensers

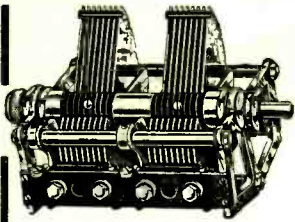

Type 352 (Two Gang)
Capacity .00035—Price \$10.50



The following features of the Camfield Equaltune Condensers are not to be found in any other one Condenser on the market:

1. To facilitate sharp tuning and perfect balancing in sets of the unit control type, the Camfield Equaltune Condensers are provided with a special adjustment feature which makes possible the perfect equalization of all circuits after the receiver has been completely wired. This eliminates the necessity for using Vernier or trimmer condensers of any kind. Complete instructions and a special tool for making this adjustment are packed with each double and three-gang condenser.
2. The shaft may be shortened or lengthened or entirely removed without affecting the adjustment of the rotor plates. This provides a simple means for connecting several units together with a single shaft and anywhere from one to six condenser units may be operated with one dial.
3. The Condenser is so designed that it may be mounted from either end. This is accomplished by reversing the shaft cap nut and the panel mounting nut. After the shaft cap nut has been removed the shaft may be extended from the opposite end of the condenser by loosening the set screws on the rotor hub.
4. A variable spring tension is provided and the rotor is mounted on ball bearings which insure extremely smooth running over a long period of operation.
5. Camfield Equaltune Condensers are beautifully finished. The rotor and stator plates are of bright dipped brass. All other parts are hand buffed and nickel plated.
6. A pair of special brackets for mounting the condensers on a baseboard or sub-panel can be obtained at a slight additional cost. With the use of these brackets several single condensers may be mounted in a row on a baseboard or sub-panel and all operated with a single shaft. Send for free booklet, "Whenever You Require Quality"

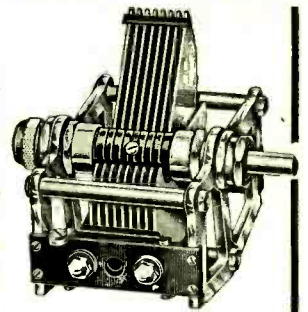

Type 351 (Single)
Capacity .00035—Price \$5.75

{35 E. Wacker Drive} **Camfield Radio Manufacturing Co.** {Dept. RI, Chicago, U.S.A.}

Laboratory Matched Kits

THE many wonderful new kits of the 1927-1928 radio season can be secured from the laboratory of "RADIO." Under the personal supervision of honest-to-goodness expert radio men we can assure you of properly matched kits when your parts are purchased from the laboratory. The new Karas, Infradyne, Tyrman, Hammarlund-Roberts, Nine-in-Line, and the many other kits can be shipped to you within several days after we get your order. A thorough laboratory check-up is made of all the parts. The prices charged for this work are the usual retail prices as advertised in this and other magazines. No extra charge is made for matching and testing. Many thousands of dollars have been invested by the publishers of "RADIO" for the purchase of precision testing equipment. We are here to serve you.

THE LABORATORY OF THE MAGAZINE "RADIO"
435 Pacific Building San Francisco, California

specified!

TYRMAN Products

EXCLUSIVELY SPECIFIED IN

"THE TRIO"

Shielded Grid Tube Receiver

Double Vernier Drum

The Tyrman Vernier Drum is exclusively specified for use in "The Trio"—Shielded Grid Tube Receiver.
SEE ARTICLE IN THIS ISSUE

TYRMAN ELECTRIC CORP.
(Dept. 16) 141-143 W. Austin Ave., Chicago



Total Price Only
\$14.95 *On Easy Payments*

Radio Cabinet and Bench

\$1.00
down

Free Trial!

Just the thing you need to give your radio the appearance of a costly set and to beautify the room with a touch of elegance. Ample space inside of cabinet for all batteries, chargers and eliminators. Keep all unsightly accessories out of sight in this splendid piece of furniture. Made of well seasoned, selected hardwood in **Handsome Walnut Finish**. Two large, French style swinging doors at front with ornamental brass knobs. Front panels of doors in carved panel effects and legs of both cabinet and bench are neatly turned. Edge of top neatly bevelled. Cabinet has lower cross brace to insure rigidity. Top is 33 3/4 x 18 inches, height inside 11 1/2 inches. Full height 33 inches. Bench is 18 inches high.

\$1.50 a Month After 30 days trial if not satisfied, send bench back at our expense and we'll refund your \$1.00 plus all transportation charges you paid. Or keep them and pay only \$1.50 a month till you've paid our smashed cut price for this sale - only \$14.95. Our credit price beats cash prices anywhere. Order by No. B182A. Shpg. wgt. about 70 lbs.

Send Coupon NOW!

Straus & Schram Dept. R3489 Chicago

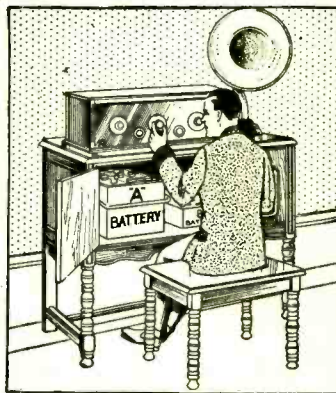

FREE Catalog
of home furnishings sent with or without order. See coupon.

Straus & Schram, Dept. R3489 Chicago

Enclosed find \$1. Ship Walnut Finish Radio Cabinet and Bench. I am to have 30 days free trial. If I keep the cabinet and bench I will pay you \$1.50 monthly. If not satisfied, I am to return them at your expense and you are to refund my money and any freight or express charges I paid.

Radio Cabinet and Bench No. B182A, \$14.95

Name

Street, R.F.D. or Box No.

Shipping Point

Post Office State

Married or Single Nationality or Color

If you want only our free catalog of home furnishings, mark X here

MAGNAVOX

Speaker quality plus

for the electric set and electric phonograph builder

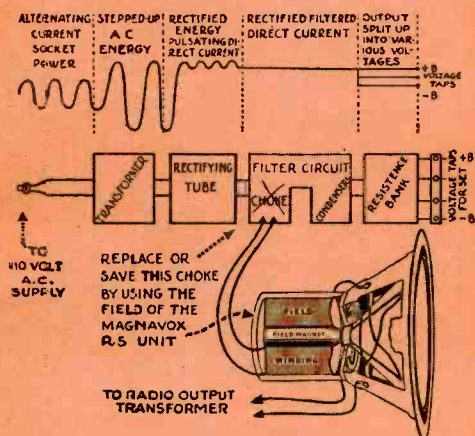

THE field of the Magnavox type R-5 electro-dynamic speaker unit provides the highest class high resistance choke for A.C. rectifier and filter units. The current passed energizes the field for its function as a speaker. Only the electro-dynamic speaker can give the wonderful quality of radio reception possible with modern sets and broadcasting.



R-5 Unit

Type R-5, list \$55 for A. C. radio or phonograph circuits using field as the choke in filter pack. Type R-4 has 6 volt 1/2 ampere field, list \$50. Unit designed for easy installation in radio and phonograph cabinets.



R-500 Unit

Type R-500 unit is R-5 with built-in power amplifier and rectifier using one 216 and one 210 tube. List \$120. Easily installed in your radio or phonograph cabinet.



M-7 Unit

The M-7 passes low frequencies down to about 100 cycles with substantial volume. It also reproduces unusually high frequencies without distortion, provided tubes are not being overloaded. The unit is 8 3/4 in. in diameter—fits into any cabinet, only 4 screws to turn. Unit list price \$15.00.



Aristocrat Model

Two tone mahogany legs and corners. Beautiful butt burl walnut panels. Complete with cords and plugs. No tubes required. With R-4 unit \$85. With R-5 unit \$90.



Beverly Cabinet

Beverly cabinet speaker complete with R-4 unit, cords, switch, \$75. Requires 6 volt A battery for power supply. With R-5 unit, \$80.



Loby Cabinet

Loby cabinet speaker, finished in rich old English brown mahogany, complete with R-500 unit, cords, etc., without tubes, 110 volt 60 cycle A.C. type, \$165. 220 volt 60 cycle A.C. type, price on application.



Warwick Model

Warwick Model has standard M-7 unit mounted on beautiful burl walnut circle on enameled metal base. Extremely sensitive, responds easily to weak signals and low notes. Takes volume from biggest sets and power tubes. List \$27.50.

Send for Speaker Bulletins

They give full information on Magnavox magnetic and dynamic type speakers. We will also give name of your nearest dealer.

The MAGNAVOX Company, OAKLAND, CALIF.
Chicago Sales Office, 1315 South Michigan Ave.

—More Distance—More Selectivity

On the 1928 Model DX INFRADYNE

and Quietest Possible Reception.

READ THIS—FROM AN INFRADYNE OWNER IN MORSE, SASK, CANADA

... The weather up here has been poor for DX so far this fall and lots of static at night and stations from east of Chicago not coming in on any kind of a radio set yet, but the Infradyne surely shows up its fine points in mid day. We have had stations from Chicago to San Francisco, Seattle, Denver, etc., at noon with good volume on loudspeaker. Chicago and Frisco both are about 800 miles air line from here. Have never seen a set that would anywhere near equal this for daylight reception and the tone quality is the very best . . .

AND THIS—FROM McKEES ROCK, PENNSYLVANIA

... It is the best job I ever saw, inside and out. The looks alone should sell the set. The tone quality is fine. The Infradyne is a "wow." The distance stations come in like locals as you listen and enjoy them. This Pittsburg district is a hard district for any radio but believe the Infradyne will overcome everything . . .

YOU CAN DO AS WELL. YOU DON'T KNOW WHAT REAL RADIO RECEPTION IS UNTIL YOU HEAR THE INFRADYNE.

**8 hour
deliveries —**

SEND us your order right now—before you turn this page—and insure yourself against delay in deliveries of the sensational 1928 Infradyne. Telegraphic orders receive especial attention. A shipping clerk is detailed to the telegraph order department and deliveries are made on the same day your order reaches us. Send a telegraphic money order now and your Infradyne will reach you by express a few days later.

The success of our national mail order department is the direct result of keeping our promise to make deliveries within 8 hours. Don't wait until next month. Your orders will be lost in the Christmas rush. **WIRE YOUR ORDER TODAY.**

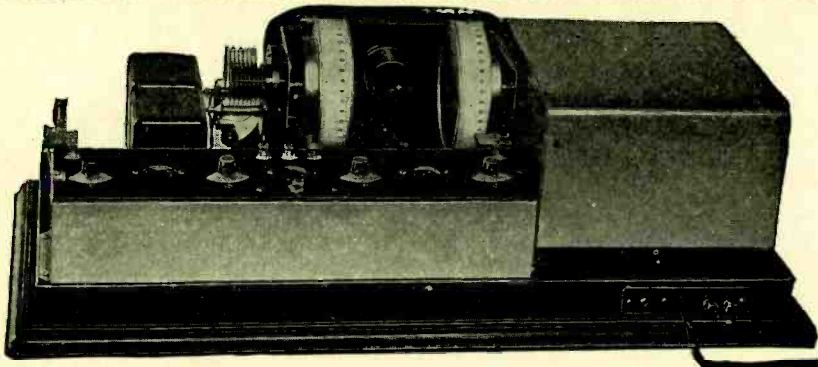

Massive — Professional Construction

The Infradyne for 1928 is built like a battleship. You will see from the illustration that it combines unusual beauty of construction with extreme simplicity. There are no unsightly wires visible. The loud speaker plugs into the rear. The headphone plug is on the front of the set. A beautifully embossed bronze control panel on which is mounted the voltmeter, dial windows and control knobs is also of pleasing design. The 5-10 tube switch is also on the control panel. We ship the

1928 Infradyne to you in completely assembled form—just as illustrated above. All of the battery wires are in place. All connections are soldered. The audio amplifier, radio frequency unit and Infradyne circuit are completely wired. After you receive the complete assembly from us you simply connect a few short leads and your set is ready to operate. You don't know radio until you own an Infradyne. Ask any owner to give you his candid opinion of this wonder receiver.

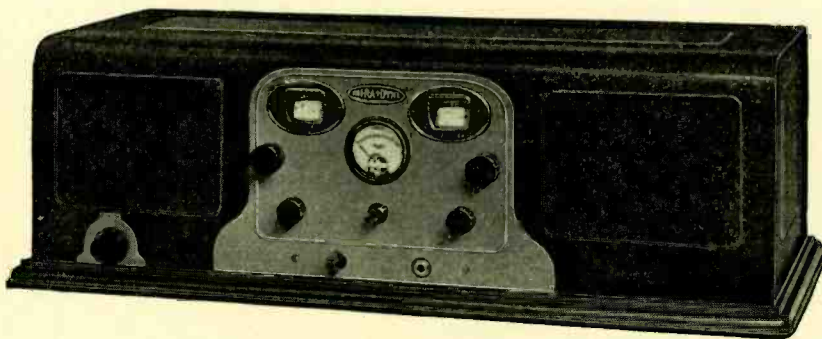

Copper Cabinet of Beauty

The wonderful selectivity of the 1928 Infradyne is the result of carefully spaced and shielded units. Pure copper is used for all shielding. Even the cabinet is of die punched copper with embossed panels on sides and

top. The cabinet is finished in baked crystalline of a dark brown shade. Cabinet is included with assembly at \$179.50. Nothing else to buy—excepting the usual tubes and accessories.

Most Powerful • Most Selective

The 1928 Infradyne combines ALL the good features a radio set should have. Drum dials with illumination; Steel chassis with concealed wiring; totally shielded r.f. units; Battery cable; copper shielded cabinet and an unusually fine audio amplifier. It combines ease of operation with tone quality and selectivity. It is a universal receiver with a switch for 5 tube single dial control operation for local stations and, by the snap of a switch, 10 tube Infradyne operation for hearing stations on the loud speaker you never heard before. The Infradyne circuit gives you long distance reception with very little background noise. Single spot tuning—no critical adjustments. The novice can operate it as well as the expert.

A beautifully illustrated catalog, "RADIO PAR EXCELLENCE," is now ready for distribution. Send for your copy today.

Order by Mail or Telegraph

Directly from Infradyne Headquarters!

Send coupon and remittance now. Avoid the usual holiday delays

Radio Constructors Corporation
357 12TH STREET
OAKLAND, CALIF.

Here is my check for \$179.50. Send me, by express today, one completely assembled and 90% wired 1928 MODEL DX INFRADYNE as advertised in "RADIO" for December. It is understood that delivery is to be made on the same day this order reaches you.

Name.....

Street and No.....

City and State.....

Tell them that you saw it in RADIO

NATIONAL

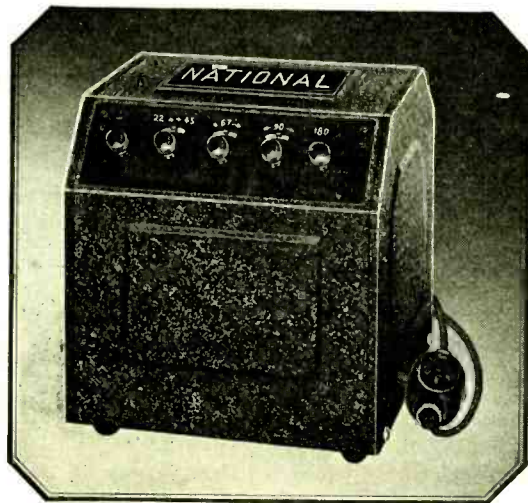

NATIONAL · B

Type 7180---A "B" That's Built for Service

A Strictly Heavy-Duty Power-Unit Supplying

Detector Voltages 22 to 45 adjustable
R. F. Voltages - 50 to 75 adjustable
A. F. Voltages - 90 to 135 adjustable
Power Tube Voltage - 180 fixed

Protects Tubes, Condensers

against excessive and harmful voltages.
Designed for lasting service with liberal factors of safety.

Rating

Output rating is 70 mills at 180 volts.
Uses R. C. A. UX 280 or Cunningham CX 380 Rectifying Tube.

Licensed Under Patents of Radio Corporation of America and Associated Companies. For 110-120 volts, 50-60 cycles A. C. only.

List Price with Cord, Switch and Plug \$40.00. Rectifier Tube \$5.00

Write National Co. Inc., W. A. Ready, Pres., Malden, Mass., for new Bulletin 124

NATIONAL POWER TRANSFORMERS and FILTER CHOKES for AMPLIFIERS.

Specified generally. Transformer Type R, center tapped 600 v. secondary. Price \$12.50. Transformer Type U, both 600 and 460 v. secondary \$14.50.

NATIONAL FILTER CHOKES - per pair in heavy case - TYPE 80, \$10.00.



STONE FILTER
FOR BETTER TONE AND
SPEAKER PROTECTION



FILAMENT TRANSFORMER
NO. 122 FOR THE
NEW A.C. TUBES



THE ORIGINAL
VELVET VERNIER DIAL
TYPE A



POWER TRANSFORMER
FOR PLATE
SUPPLY UNITS

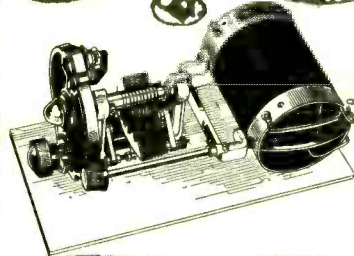
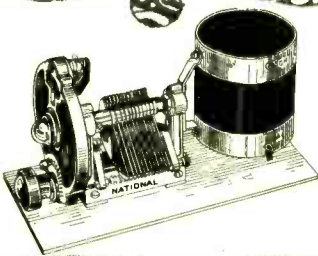

FILTER CHOKES
TYPE 80

NATIONAL TUNING UNITS — THE HEAVENLY TWINS

More National Tuning Units have been used by set builders than all other similar components combined.

Standard since 1923

Approved By

The OFFICIAL Design

BROWNING & DRAKE

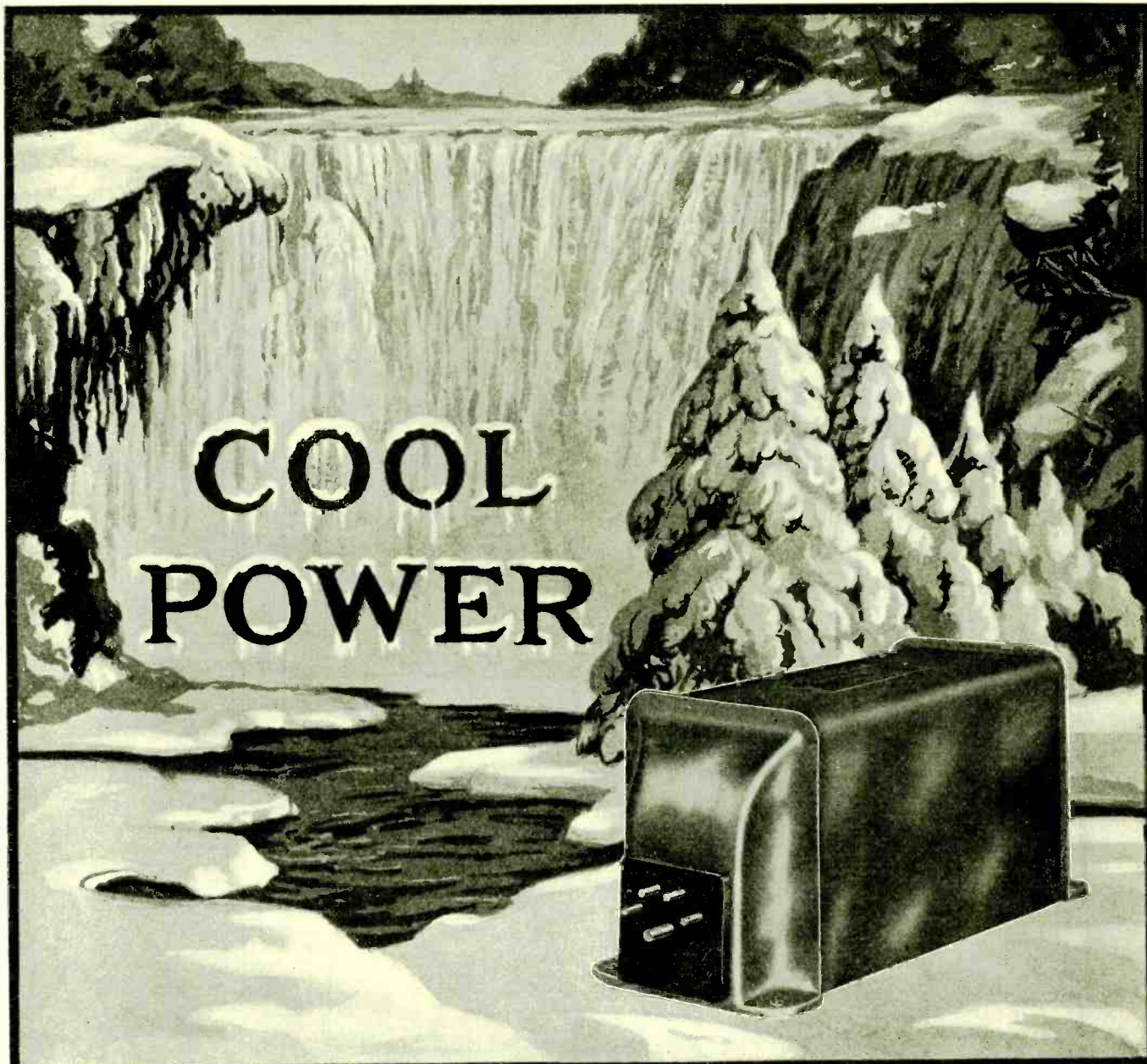

Samson Power Block No. 210

The only block which will supply 500 volts at 80 mils to two 210 tubes

Powerize with Samson Units for Better Results

For new SAMSON Power Units insure the best there is in radio current supply by—

1. Doing away with hum, motor-boating and poor voltage regulation.
2. Remaining so cool after 24 hours continuous operation under full load that they will be well within the 20° rise of temperature specified by the A. I. E. E.
3. Being designed to more than meet the specifications adopted by the National Board of Fire Underwriters.
4. Insuring safety against shock because of protected input and output terminals.
5. Insuring for all tubes the correct filament voltages specified by their manufacturers.
6. Compensating for lighting circuit voltage variation by the use of a special input plug and terminal block to which is attached a 6 ft. flexible rubber-covered connecting cord and plug.
7. Being more economical in operation than other units of same power rating.
8. Living up to the same plate rating.

Limited space prevents us from listing the fourteen types that we make. Our Power Units bulletin descriptive of these is free for the asking. In addition, our construction bulletin on many different "B" Eliminators and Power Amplifiers will be sent upon receipt of 10c in stamps to cover the mailing cost.

Sales Offices in
Thirty Leading Cities

Samson Electric Co.

MANUFACTURERS SINCE 1892

Main Offices at Canton, Mass.
Factories:
Canton and Watertown

Tell them that you saw it in RADIO

Enjoy this Beautiful Natural TONE!

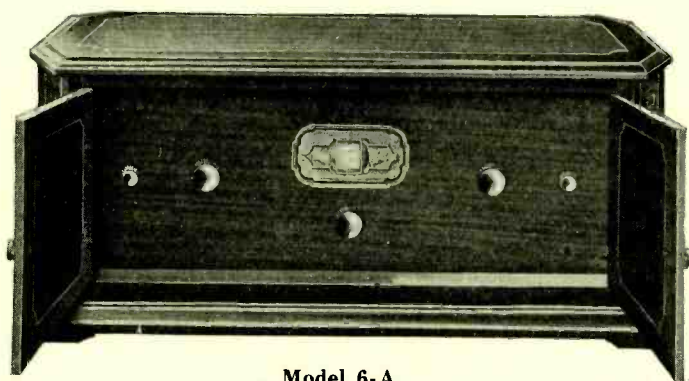

Model 6-A

GO to your nearest radio dealer and ask him to let you hear the new factory-built Browning-Drakes. Note how natural is the reproduction. Every note in the scale, from the lowest to the highest, is reproduced with absolute fidelity. The new Browning-Drakes reproduce every sound sent into the microphone so faithfully, that the broadcasting artists themselves are literally brought into your home. Just listen to the new Browning-Drakes. That is all we ask. You will then know why folks are amazed when they hear a Browning-Drake Receiver for the first time.

Model 6-A has six tubes. Four tubes in the audio amplifier give a natural tone quality and furnish ample volume when needed for dancing, concerts, etc. Single dial illuminated drum control simplifies tuning. Exceptional selectivity makes it easy to tune out interfering stations. Small auxiliary condenser brings signals of distant stations to maximum intensity. Cabinet is beautiful two tone Duco walnut. Length, 27 inches; depth, 15 inches; height, 11 inches. Price without tubes and batteries \$105.

DEALERS:—There is profit and satisfaction in handling popular products. Write or wire TODAY about the Browning-Drake line of factory-built receivers and the Browning-Drake line of parts.

BROWNING-DRAKE CORPORATION
CAMBRIDGE MASS.

MODEL 7-A

Seven tubes; single dial; illuminated drum control. Four audio tubes give fine tone and great volume when desired. Excellent selectivity. Cabinet can be had in either two tone Duco mahogany or walnut. Length, 30 inches; depth, 15 inches; height, 11 inches. Beautiful console is available for this model. List without tubes and batteries \$145; with console \$185.

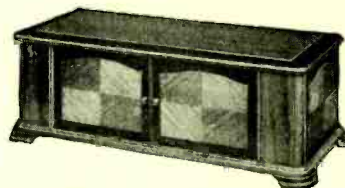

BROWNING
CABINETS PARTS **DRAKE** RECEIVERS KITS

RADIO

WITH WHICH IS INCORPORATED "RADIO JOURNAL"

VOLUME IX

DECEMBER, 1927

No. 12

RADIO

By EARLE ENNIS

Decoration by Sarkis Beulan

Know then, O, Tara, that this Thing called RADIO, that lights the trodden Paths of Men, is the Child of Silence and Slow Time! RADIO is a Song, sent winging by the Sun-God as he strums his gleaming copper Harp with unseen Fingers. RADIO is the Lightning-Bolt trapped within a Cage of Glass, held Prisoner by the gossamer Thread of Man's directed Will. RADIO is a Seed out of the interstellar Void from which, as from a Dragon's Tooth, springs Miracles full-fledged in the Panoply of Divine Array. RADIO is a Presence . . .

Look Thou, O, Tara, RADIO is a Clown, wearing the Mask of Science. A Buffoon. A Mimic, pantomining Gods we know not. A Maker of Quip and deadly Jest, whirling, spinning, gyrating upon Time's boundless Stage. We laugh. We cry. And it gibbers at Us and with Us. We applaud, and it falls to praying in mad Measure. In Its hollow Eyes sit the Dream and the Fear of Ages. And that which We witness is but the Shadow of That which lies behind the Curtain. Ho! RADIO, the Harlequin . . . God help Us!

O, Tara, hearest Thou not? RADIO is a Whisper through the Night. A Sigh of Hope breathed out of Nothingness, pulsing through Wind and Storm down the spiral Stairways of anxious Ears. It swirls with the Blast. It beats with the Rain. It drifts with the Clouds. It crests with the Spray. From Ice-packs to Equatorial Drifts. It haunts tense Mast-tips with sibilant Echoes. A Muted Voice out of Space, It talks to our Souls. Aye, e'en though They be hidden in the Four Corners, far from the Paths of Men! RADIO is the Mysterious One. The Omnipresent. The Inevitable . . .

Ponder Thou this, O, Tara, This RADIO, This God of Shadows, which yet has no Shadow, He is a Footstep in the Dark. A candle in dim Attics where Sickness, Poverty and Misery lurk like Spiders in the Gloom. There He comes, with Face alight, in shining Robe, unafraid throwing wide dull Windows to Life's Light and Air. RADIO is the Giver, the Renewer, the Great Physician. RADIO is a Star gleaming through the Dusk. God's blessing.

RADIO is Knowledge, O, Tara, Wisdom. Energy. Power. It is a Symbol of the All, written in Letters of Fire, built in Walls of Stone, swinging in the Ocean's vast Clypsedra. It is the Moving Finger smudging out Man-made Boundaries of Race and Creed. The Cosmic Metronome marking the Rhythms of Centuries in flicking Light-Seconds that are but as Teeth on the Wheel of Time. RADIO is the Master Builder of ageless Temples dedicated to Truth, all-hidden, all-revealed.

See, Thou, O, Tara, He is the Spirit of Christmas, coming incognito through the Days, weighing each and all, True and False. Kindly. Immutable. Friendly. Inscrutable. Great in His gentleness, mighty in His humility, is This Thing, O, Tara, This Presence that lights the trodden Paths of Men. This Child of Silence and Slow Time. This Father of Twilight Messages. This Comforter of Deep Pain and Far Hungers. This Weaver of Dreams Incredible. See ye, O, Tara, that ye guard and regard It well!

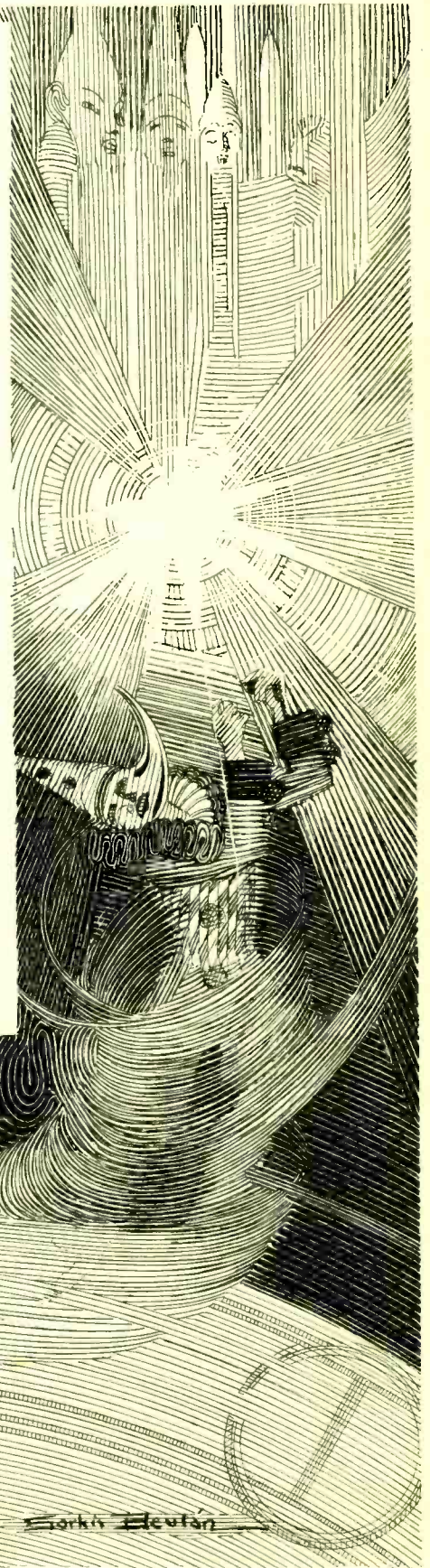

Sarkis Beulan

Navy Radio High Frequency Communications

By Commander C. N. Ingraham

IN THE early days of radio in the Navy and elsewhere, communications were on wave frequencies of from 1000 kilocycles (300 meters) to 500 kilocycles (600 meters). With the increase in power of the transmitters, larger and larger antennas of greater and greater capacity were employed and consequently the frequency of the waves employed for long distance radio communication continually decreased until, in the case of the Naval radio service, the frequency of the Navy's high power station at Annapolis, Md., became 17.5 kilocycles, corresponding to a wave length of 17,143 meters.

Low frequency, or long waves, were considered to be most effective for long distance communication and such waves were universally employed throughout the world for this purpose. Antenna supports from 500 to 800 feet in height were constructed to support huge overhead antenna systems and as much as 100 kilowatts of radio frequency energy was delivered to such antenna systems to effect communications over long distances.

With the advent, however, of the electron tube transmitter and its employment in the amateur wave band of 1500 kilocycles and above, corresponding to wave lengths of 200 meters and below, the amateurs found that they could cover very great distances on their short waves with their low power sets, and it was not long before their remarkable results attracted the attention of the large commercial radio concerns and the Navy.

The Navy conducted experiments with the amateurs on their short waves as early as 1922. The Naval radio laboratory at Pearl Harbor in the Hawaiian Islands assembled electron tube equipment for operation in the amateurs' frequency band of 1500 kilocycles and exchanged signals with amateur radio stations in various parts of the United States. High frequency investigations, experiments, and tests were also taken up by the Naval Research Laboratory in which radio amateurs in the United States and foreign countries collaborated.

By 1925, the Bellevue laboratory's experiments and investigations had progressed to such an extent and the results obtained were so favorable, that it was decided to equip the flagship of the United States fleet with a high frequency transmitter and high frequency receiving equipment for experiments and tests during the fleet maneuvers in Hawaiian waters and the fleet's cruise to Australia

in that year. The high frequency transmitter employed was of only 300 watts power and capable of operating within a frequency band of from 7500 kilocycles (40 meters) to 5000 kilocycles (60 meters). The equipment was installed on the U. S. S. *Seattle*, flagship of the fleet.

With this low power temporary equipment, the *Seattle* experienced no great difficulty in exchanging signals with amateur stations in virtually every state in the United States when the *Seattle* was in Hawaiian waters, and communications were also exchanged with amateurs in Australia, New Zealand, Mexico, South Africa and Japan.

On the cruise of the fleet from Honolulu to Australia via American Samoa, the *Seattle's* high frequency transmitter maintained communications with the Bellevue laboratory, handing traffic when it could not be handled by the medium frequency equipment. This was done while the fleet was lying in the harbor of Melbourne, a remarkable performance that had not previously been

duplicated by any other type of equipment of any power.

With the results thus obtained there remained no doubt of the value of high frequency communications to the Navy and following the return of the fleet to the United States a definite plan of research and development in high frequency equipment for Naval use was mapped out for accomplishment by the Bellevue laboratory.

The results obtained with the *Seattle's* experimental high frequency equipment became common knowledge to all the radio personnel of the fleet, and it was not long after the fleet's return to the United States before they were busily engaged in assembling experimental high frequency equipment for use on their ships with a view to improving the service. As the radio personnel were transferred from vessels of the fleet to radio stations on shore they also undertook to build experimental high frequency equipment for use at their shore stations. It finally became necessary for the Bureau of Engineering to prohibit

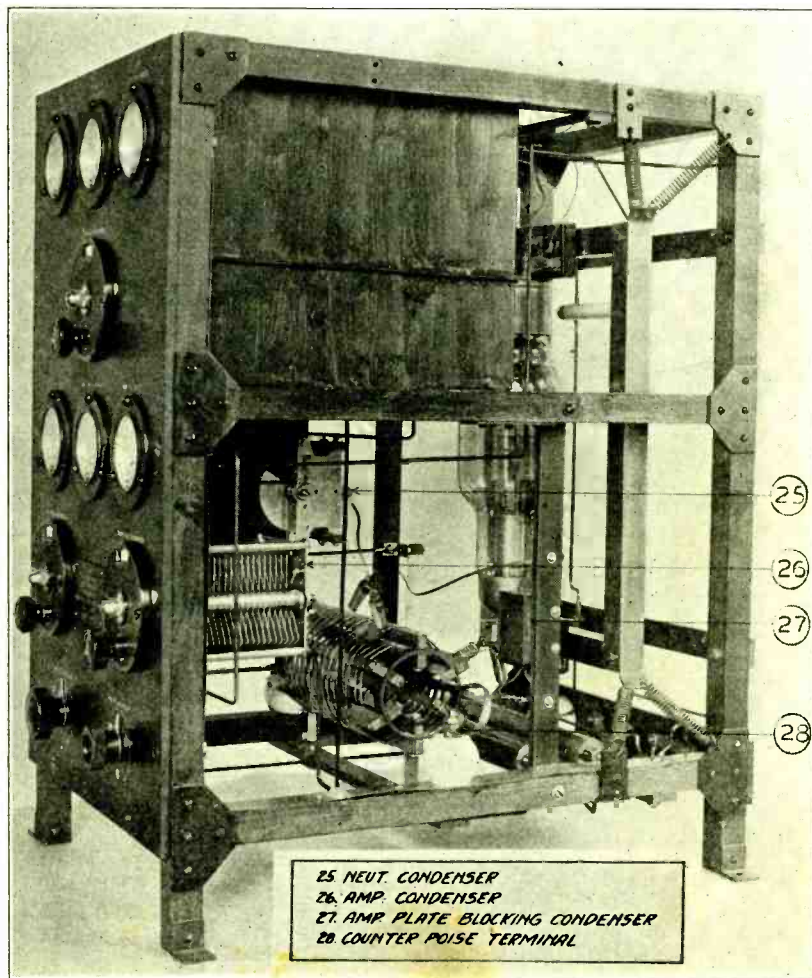

1/4 K.W. High Frequency Transmitter Used in Naval Radio Service.

the practice of assembling "home made" high frequency transmitters for use both afloat and ashore as considerable public funds were being expended for equipment which would later have to be replaced by standard Naval equipment as designed by the Bellevue laboratory.

The "home made" equipment thus brought into use on ships and on shore however has rendered valuable service not only in collaborating with the Bellevue laboratory in further experiments and tests but also in handling large volumes of official traffic which could not be gotten through with the standard Navy equipment.

High frequency transmitters of temporary construction have been installed and placed in operation in the Navy's high power stations at Peking China, Cavite P. I., Guam, Pearl Harbor, Tutuila, Samoa, St. Paul and Cordova Alaska, Puget Sound Washington, San Francisco, San Diego, Great Lakes, San Juan Porto Rico, Brownsville, Texas, New Orleans, Key West Fla., Charleston S. C., and Arlington.

From 50 to 75 per cent of all the Navy's point-to-point traffic ashore is now handled by high frequency with transmitters of antenna power ranging from 250 watts to 5 kilowatts, whereas, formerly, medium and low frequency high power transmitters of antenna power ranging from 5 kilowatts to 100 kilowatts were employed to handle this traffic.

Continuous two-way communications are now maintained over the 4800 mile distance circuit between the Pearl Harbor (Hawaii) and Cavite (Philippine Islands) stations of the Navy throughout the 24 hours of the day and even during the heaviest static season by the use of high frequency radio in conjunction with low frequency radio. Each of these stations now handle approximately 2,500,000 words annually by high frequency and approximately 850,000 words annually by low frequency.

Obviously, a great saving in electric power costs results from the use of high frequency equipment employing not more than 5 kilowatt of radio frequency energy in the antenna to render service that was formerly rendered by low fre-

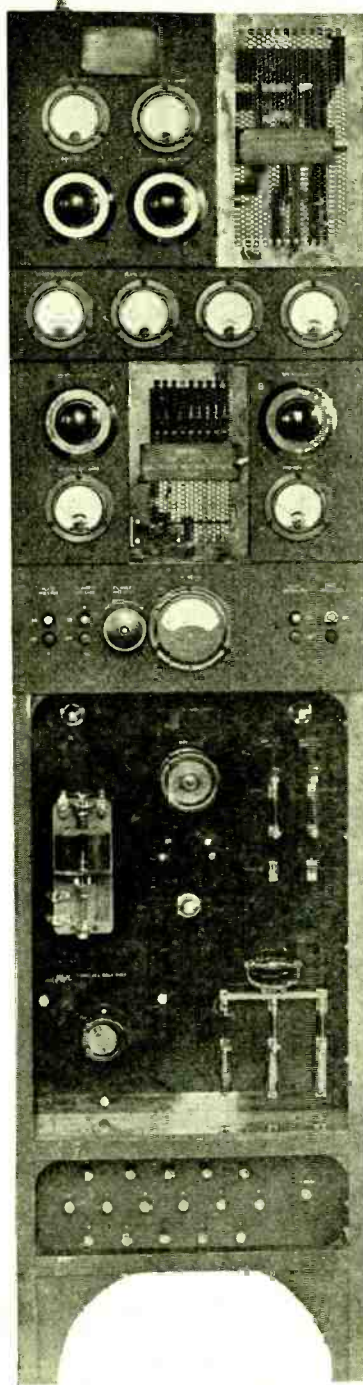

1/2 K.W. High Frequency Transmitter Which Replaces 20 K.W. Unit.

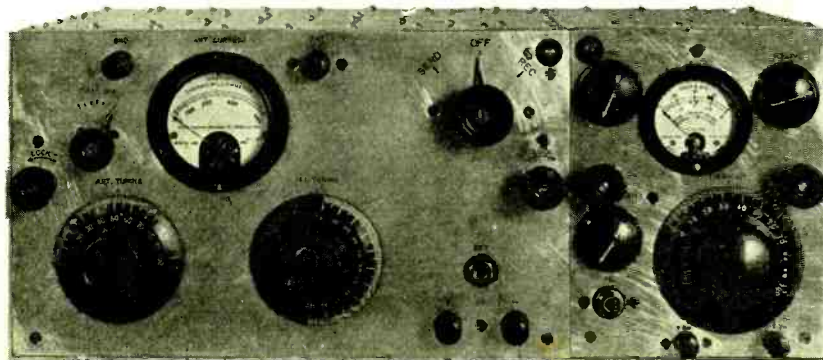

Naval Aircraft Transmitter-Receiver 7,000 to 10,000 K.C.

quency equipment employing 100 kilowatts. Moreover, for high frequency, a single wire antenna approximately 75 feet long suspended from antenna supports 100 ft. high supplant the enormous antenna systems weighing from one to two tons suspended from 600 ft. steel towers, required for low frequency communications.

Another advantage to be derived from the use of high frequency is the comparative freedom of interfering atmospherics or "static" on the very short waves. Prevailing static may be so intense as to completely paralyze radio communications on 500 kilocycles (600 meters) or on 17.5 kilocycles (17,143 meters) while communications may be carried on with comparative ease on 7,500 kilocycles (40 meters).

High frequency radio has certain inherent disadvantages, however, which prevent its adoption for general exclusive use in the Naval radio service. Otherwise, the Navy would lose no time in decommissioning its high power low frequency transmitters with their enormous antenna systems. Although the very short waves are relatively free from static, they are subject to interference from electric fans, elevators, the electric ignition systems of automobiles in the vicinity, and similar electric disturbances in the ether corresponding to the very short waves. Also the action of the very short waves is very much more erratic than the medium or long waves. The short waves appear to be more sensitive to seasonal changes, weather variations, and especially the hours of daylight and darkness regardless of the seasons and weather conditions.

Between two points separated by 2000 miles in Alaska for example, a wave frequency of 4000 kilocycles (75 meters) might provide excellent service during the daylight hours but no service at all during the hours of darkness, whereas a frequency of 12,000 kilocycles (25 meters) might give excellent service during the hours of darkness and no service at all during the daylight hours. On the other hand these frequencies might be entirely unsuitable for corresponding services in the tropics and during the same season of the year it might be necessary to employ 8000 kilocycles (37.5 meters) for satisfactory communications during the hours of darkness and 16,000 kilocycles (18.8 meters) during the daylight hours.

With the fleet moving about in the Atlantic and Pacific Oceans, in the Caribbean Sea and elsewhere, these variations in high frequency radio present a problem which must be satisfactorily solved before high frequency radio can be adopted for exclusive use in the Navy, regardless of its recognized advantages for exchanging communications between two fixed points separated by great distance.

The Trio

A Receiver That Gives Loudspeaker Reception of Distant Stations by Means of Three Tubes, Including One With Shielded Grid

By Francis Churchill

THIS receiver is called the Trio because it uses but three tubes for loudspeaker reception on both local and distant stations. There is one stage of radio frequency amplification utilizing the new shielded grid type of tube, a special detector, and one stage of audio amplification, using a CX-371 power tube. The audio amplifier is a special circuit which has a good frequency characteristic and at the same time gives nearly as much amplification as the ordinary two stage audio amplifier using an A tube and a power tube.

The detector utilizes a 300-A tube, as it is an extremely efficient detector and as it feeds into a resistance coupled amplifier, it will handle considerable more power without overloading, than the usual detector tubes.

The radio frequency amplifier uses one of the new shielded-grid tubes so that an enormous amount of amplification takes place. This tube has an extremely small control-grid-to-plate capacity, thus not allowing much feedback, and so, with its very high amplification constant, gives good voltage amplification. It gives maximum gain when the plate impedance load is extremely high, as may be obtained with a tuned circuit which has very high impedance at resonance. This means that a 1 to 1 ratio, or nearly that, should be used for coupling from the plate of the r.f. amplifier to the grid of the next tube. The circuit shown in Fig. 1 uses a tuned coil

as an auto-transformer so the only voltage gain is that due to the tube itself. However this arrangement gives a greater gain since the impedance facing the r.f. tube is higher than if a r.f. transformer was used. The transformer "primary" in this circuit is used for a detector tickler coil in order to obtain regeneration, as in a Browning-Drake receiver.

eliminate electromagnetic and capacitive feedback. As only one stage is used, a minute amount of feedback may be desirable in order to get some regenerative gain also. Any possibility of trouble may be eliminated by using a shielded tube socket such as the Tyrman.

In this experimental set, the regeneration control in the detector circuit was made automatic by means of a cam on

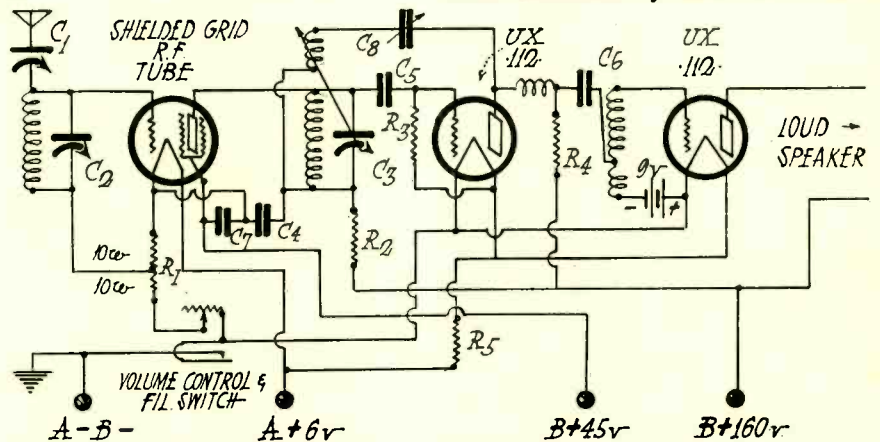
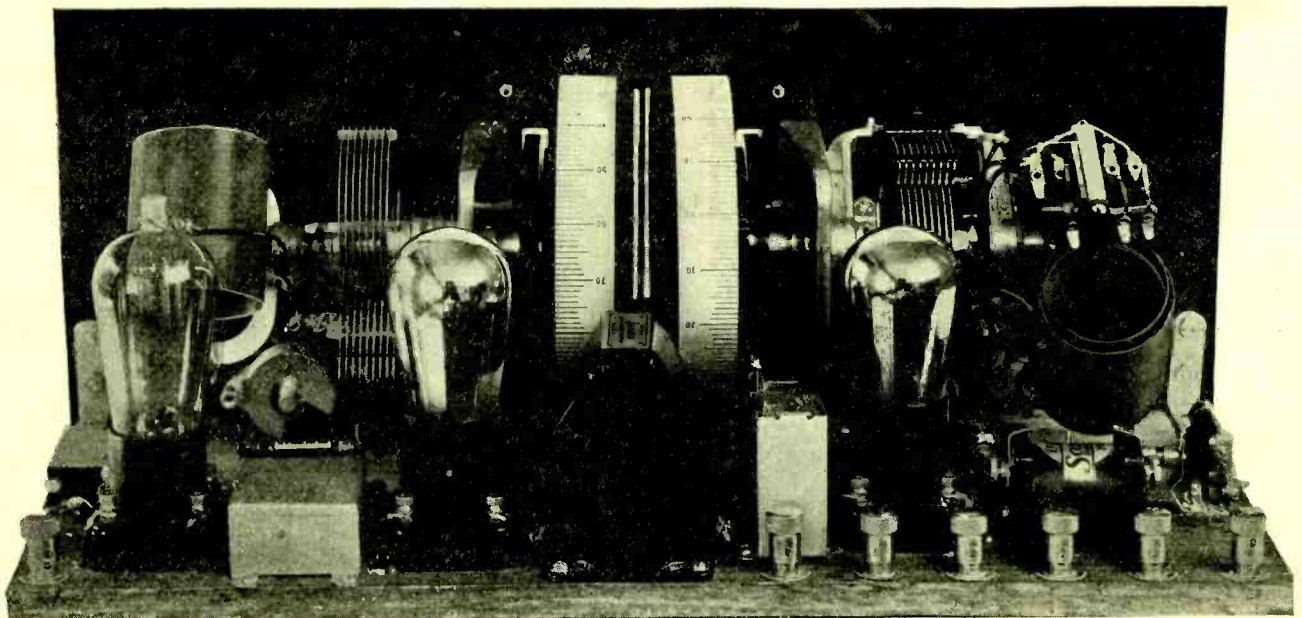

Fig. 1. Circuit Diagram of Shielded Grid Tube Set.

- | | | | |
|--------------------------------|---------------------------------|-------------------------------------|---------------------------|
| R_1 —Center-tapped
20 ohm | R_3 —3 megohm grid
leak | R_5 — $\frac{1}{2}$ amp. Amperite | C_1, C_7 —1 mf. by-pass |
| R_2 —25,000 ohm grid
leak | R_4 —250,000 ohm grid
leak | C_2 —50 mmf. | C_3 —.00025 grid cond. |
| | | C_3, C_8 —.00035 mf. | C_6 —.006 mf. |
| | | | C_8 —.0001 mf. |

The arrangement of the apparatus is pretty well shown in the picture, from which it can be seen that no shielding is used. It was found that with only a single stage of r.f. amplification, placing the coils at least a foot apart and at right angles, was sufficient to practically

the tickler coil which varies the coupling with the tuning condenser. This arrangement gives practically constant regeneration over the whole broadcast band with the amount set by adjustment of the X-L variometer C_8 . The cam arrangement is part of the Hammarlund



Rear View of Set Using Shielded Grid Tube.

auto-couple r.f. transformer such as has been used in various circuits during the past year. A fixed tickler coil may be used and a variable condenser used as C_s for controlling the regeneration.

In mounting the drum dial, it will be found necessary to have the two tuning condensers of clockwise and counter-clockwise rotation if one desires to have the two drums rotate in the same direction. The two coils should be mounted at right angles or preferably shielded from each other. Both the coils have about 85 turns on a 2 in. diameter with spaced turns. The tickler winding should be about 15 turns coupled to the r.f. low potential end of the secondary, that is, the one farthest away from the grid or plate.

The r.f. tube has a 20 ohm fixed resistance in the negative filament lead which is center tapped to obtain about 1.5 volts negative bias. This center tap is used as the grid return from the r.f. tube control grid. This 20 ohm resistance was made from an old Frost 20 ohm rheostat by stripping the resistance wire strip off of its frame and fastening it up flat against the lower side of the baseboard. In series with this resistance is a 30 ohm variable resistance used as a volume control. This rheostat can be turned on full without harming the tube, since with a 6 volt *A* battery, the 20 ohm fixed resistance alone will drop the voltage to the recommended value. The volume control rheostat also has a filament switch for controlling all of the tubes. The two other tubes are maintained at their proper filament voltage by means of an automatic filament ballast or rheostat.

Bypass condensers are necessary, such as the one from the shielding grid to negative filament and the other one from the rotor of the tuning condenser C_3 to filament. A 25,000 or 50,000 ohm fixed resistance should be used as shown in order to reduce the plate voltage from 160 to 135 or thereabouts for the r.f. tube. The detector voltage is dropped to the proper value by means of .1 or .25 megohm resistance as shown also in the wiring diagram.

The audio amplifier is rather novel in that a 6:1 ratio transformer is used as an autotransformer of 7:1 ratio by connecting the transformer terminals marked *P* and $-F$ together, and having the *C-* battery connect to the *B* terminal instead of the usual $-F$ terminal. The plate of the detector tube then connects through a radio frequency choke to a stopping condenser then to the usual terminal marked *P* on the transformer. This stopping condenser is of such a value as to resonate the primary winding at a low frequency with the result that this 7 to 1 ratio autotransformer has nearly as good a gain-frequency curve as a high priced transformer with a 2 to 1 or 3 to 1 ratio.

- LIST OF PARTS FOR TRIO**
- 2—.00035 mfd. Hammarlund midline tuning condensers
 - 1—Hammarlund autotransformer
 - 1—Hammarlund r.f. transformer
 - 1—Hammarlund 50 mmf. midget variable condenser
 - 1—Samson 6:1 audio transformer
 - 1—Samson No. 85 r.f. choke
 - 1—Tobe ½ mfd. by-pass condenser
 - 2—Tobe 1 mfd. by-pass condensers
 - 3—Electrad grid leaks—2 meg., .1 meg., and .025 meg. and mountings
 - 1—18x7x3/16 inch panel
 - 1—Double Tyrman drum dial
 - 3—Frost sockets
 - 1—Frost 30 ohm De Luxe rheostat with filament switch
 - 1—Frost 20 ohm rheostat
 - 1—.00025 Sangamo grid condenser
 - 1—X-L variocoupler type G-1
 - 1—Set X-L push binding posts
 - 1—17½x9x½ inch spruce baseboard
 - 1—4A Amperite
 - 1—S. P. 122 shielded grid tube
 - 1—CX-300 A detector
 - 1—CX-371 or 112 power tube

This high ratio, together with the high amplification constant of the 371 tube, gives an audio amplifier of one stage which is nearly equal to some two stage amplifiers.

The information given in this article is more for the experimenter rather than for the usual set constructor who follows every detail to the letter. This new r.f. amplifier tube has wonderful possibilities for use on all wavelengths and so a great deal of experimenting should be done with it.

DATA ON THE SCREEN GRID TUBE

The new screen grid type or four element vacuum tube will be available for experimental use before the end of this year as the UX-222, CX-322. It is intended primarily for r.f. amplification in special circuits not requiring neutralization or stabilization. The tube has a voltage amplification factor of over 250 and has negligible feedback capacity between plate and control grid.

This tube has a filament, a plate and two grids in place of the usual three elements. The second grid is responsible for its high voltage amplification and freedom from oscillation. The two filament connections, the plate, and the second grid come out to base prongs which fit a large standard UX socket. A fifth connection to the control grid is made through the metal cap at the top of the tube. The tube should be shield-

ed in a metal jacket fitting closely over the bulb.

Its normal conditions of operation are 90-135 volts for the plate, +45 volts for the screen grid, -1 to -1.5 volts for the control grid, and 3.3 volts for the filament. Filament current is .132 amperes.

The chief precaution to be observed in its use is to shield the control grid circuit from all other circuits. This may be accomplished by placing grounded metallic shields around the grid coils and condensers, by making the control grid lead as short as possible, and by keeping it well spaced from other circuit elements. In some cases it may be necessary to surround the grid lead with a grounded metal sheath.

Fig. 1. shows its application in a typical two-stage r.f. amplifier circuit. Here the grid bias is obtained by using the voltage drop in a 15-ohm tapped filament resistor in series with the negative filament lead. With this circuit it is possible to get an actual voltage amplification of from 20 to 30 per stage (depending on circuit losses) as compared with the 4 to 6 per stage obtained with tubes of the general purpose type.

This tube is announced with the statement that "it will not bring about any revolutionary developments in the radio industry, nor will it render obsolete the types of sets now in use or being sold. It must be remembered that although these tubes give greater radio-frequency amplification per tube than former types, nevertheless, a certain number of tuned circuits must be used under present-day broadcasting conditions to obtain adequate selectivity; therefore, all things considered, the new tube will not necessarily reduce the number of tubes required in a given broadcast receiver."

This tube may also be used as an audio frequency amplifier in resistance, reactance or transformer coupled circuits. For this connection the screen grid is used as a space charge grid at a positive potential with respect to the filament. Normally this positive potential is 45 volts with 135 to 180 volts applied to the plate through a coupling resistance of 100,000 to 250,000 ohms, and 0 to -1.5 volts on the control grid.

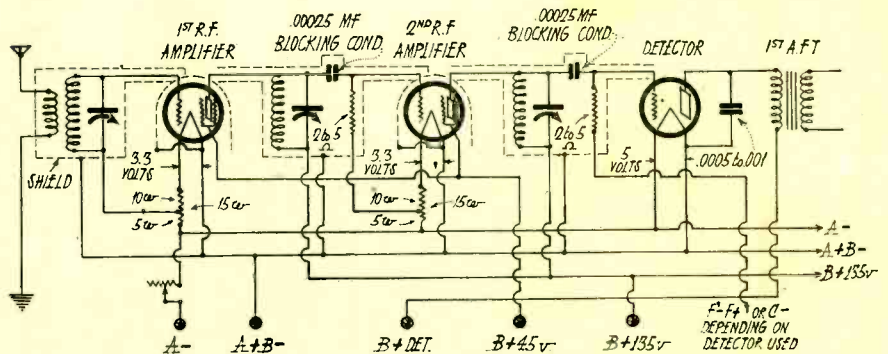

Fig. 1. Two Stage R.F. Amplifier with Screen Grid Tube.

Changing To A. C. Tubes

Detailed Directions for Converting A Receiver from Battery to Socket Power Operation

By D. B. McGown

SUBSTITUTION of tubes whose filaments are heated by a.c. for those which use d.c. from a storage battery can readily be accomplished by a few changes in the wiring of almost any receiver. The advantage in so doing is that it eliminates the necessity for a battery and the care thereof.

These tubes are of two types, the -26 which fits a standard four-prong socket, and the -27 which requires a five prong socket. Filament emission from the former is caused by the passage of a $1\frac{1}{2}$ volt alternating current directly through the filament. In the latter the heating is accomplished by a separate element supplied with $2\frac{1}{2}$ volts a.c. so as to heat the cathode; it is usually used as a detector because it is free from a.c. ripple at low plate current.

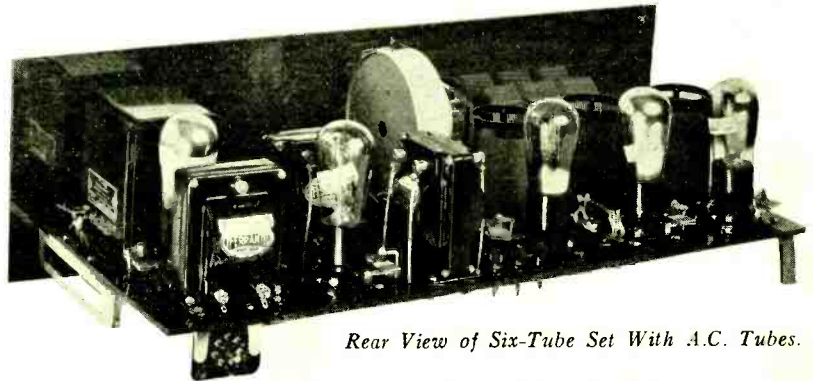

Rear View of Six-Tube Set With A.C. Tubes.

Fig. 1 shows the filament circuits for a five-tube set using two -26 tubes as r.f. amplifiers, one -27 as detector, one -26 as first audio and one -12 or -71 tube as second audio with 5 volt a.c. on its filament. Socket power current at 110 volts is stepped down through a

suitable transformer to $1\frac{1}{2}$, $2\frac{1}{2}$ and 5 volts for connection to the filament terminals of the sockets through resistors whose mid-taps are grounded to a common point.

Fig. 2 shows the complete circuit diagram for a typical six-tube set, such as that shown in the accompanying picture. This set has one stage of untuned r.f. to couple the set to the antenna. A variable input to the grid of the first tube is provided through a 1000 ohm potentiometer in the aerial-ground circuit. The r.f. stages are biased and oscillation is prevented by 200-ohm resistances in their grid circuits. A three-gang Remler condenser with single control drum dial tunes the Aero coils used as r.f. transformers.

The detector is operated with a 5 megohm grid leak and .00025 mfd. condenser. The audio stages are transformer coupled. This set can be constructed by a competent builder using the suggested parts, or their equivalents, and following the arrangement indicated by the circuit diagram and pictures. Lab-

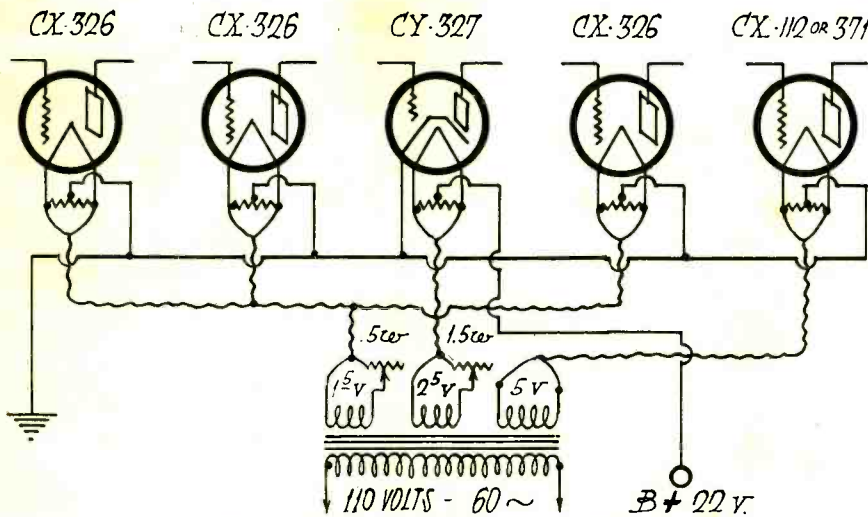

Fig. 1. A.C. Filament Circuit for Five-Tube Set.

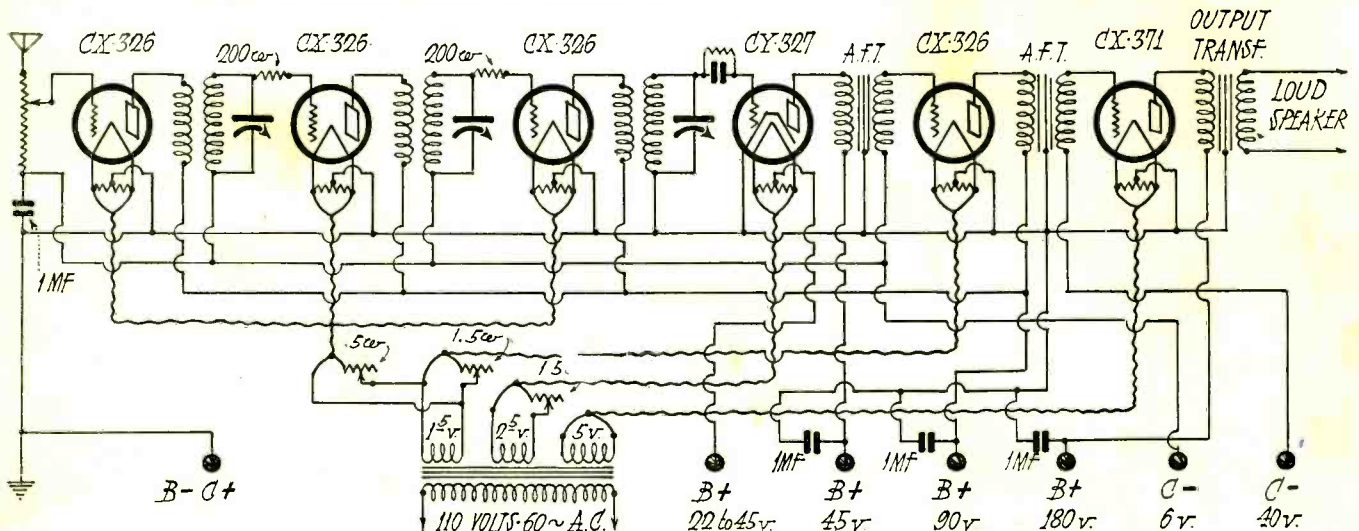

Fig. 2. Circuit Diagram for Six-Tube A.C. Filament Set Shown in Pictures.

ratory tests show it to be a thoroughly satisfactory receiver.

This circuit can also be used as a guide in rewiring any tuned r.f. receiver. As the r.f. tubes should be always given a negative bias, some sets may require a change in the method of volume control, especially if this is accomplished by a variation in grid voltage through a potentiometer or by a variation in r.f. filament voltage. The system can usually be used in a set whose volume is controlled by a high resistance in series with the plate supply.

The same arrangement may be used for a.c. operation of the Browning-Drake and other sets having circuit diagrams similar to Fig. 3. This calls for a -26 r.f. tube, -27 detector, -26 first audio, and power tube in second audio with output transformer. As the r.f. tube has only 45 volts plate, no C battery is provided, but a grid bias resistor is placed in the filament return.

Fig. 4 is the circuit diagram for a conventional superheterodyne adapted for a.c. filament operation. Intermediate frequency transformers which are tuned and matched for A tubes will require no change, but those which are intended for use with -99 tubes should be adjusted and matched to meet the change in inter-electrode tube capacity. The oscillator, first and second detector require type -27 tubes. The others use type -26 tubes.

The intermediate frequency tubes are operated with 135 volts plate potential. The grid potential may vary from 9 to 12 volts negative. This is because the -26 type tubes perform much better with a high plate current, which requires a high plate voltage, and a resultant high grid voltage. These tubes may function satisfactorily with 45 volts plate po-

tential, and in this case, they only require 1.5 volts grid bias. But sometimes it is impossible to get rid of all a.c. noise unless high voltage is used. Another scheme, is to use the -27 type tubes for the intermediate frequency amplifier stages. Volume control of a super-heterodyne on a.c. filament tubes can most readily be accomplished by the use of a shunt resistance of 50,000 ohms across the primary of the second intermediate frequency transformer, as shown in Fig. 4.

Satisfactory results with a.c. tubes depend upon either shunting the filaments with a resistor whose mid-tap is grounded or using a filament transformer with grounded mid-tap. In either case the tap must be at the exact center, a

capacity. Not more than three -26 or two -27 tubes should be operated from one rheostat.

With the -27 type (heater) tubes, the cathode, which corresponds to the filament in the usual tube, is connected directly to the common grounded negative return. The heater element is biased through the center tap on the heater element resistance, to a value of from 10 to 45 volts, depending on the constants of the circuit, and to some extent, on the individual tube used. The purpose of this positive bias is to reduce the a.c. hum, especially when the plate current is low, by biasing it to such an extent that it will not disturb the functioning of the tube.

To convert the set to entire a.c. opera-

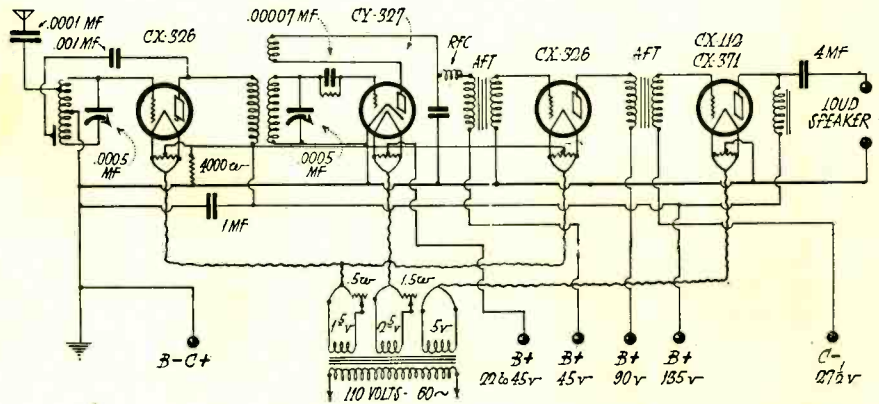

Fig. 3. Circuit Diagram for Browning-Drake with A.C. Tubes.

condition which is easier to attain with resistors than with a transformer. All filament wiring should be done with twisted pair of large wire, preferably of not less than No. 16 gauge. The filaments may be connected to either wire without regard to the other tubes. Filament rheostats, if used, should be of low resistance and high current carrying

tion, there must, of course, be equipment to provide plate and grid bias voltage. The usual types of B battery eliminators, such as have been described in detail numerous times, can be used to provide the B battery power. The C battery potentials can be supplied from a dry cell battery, if the older type of

(Continued on page 52)

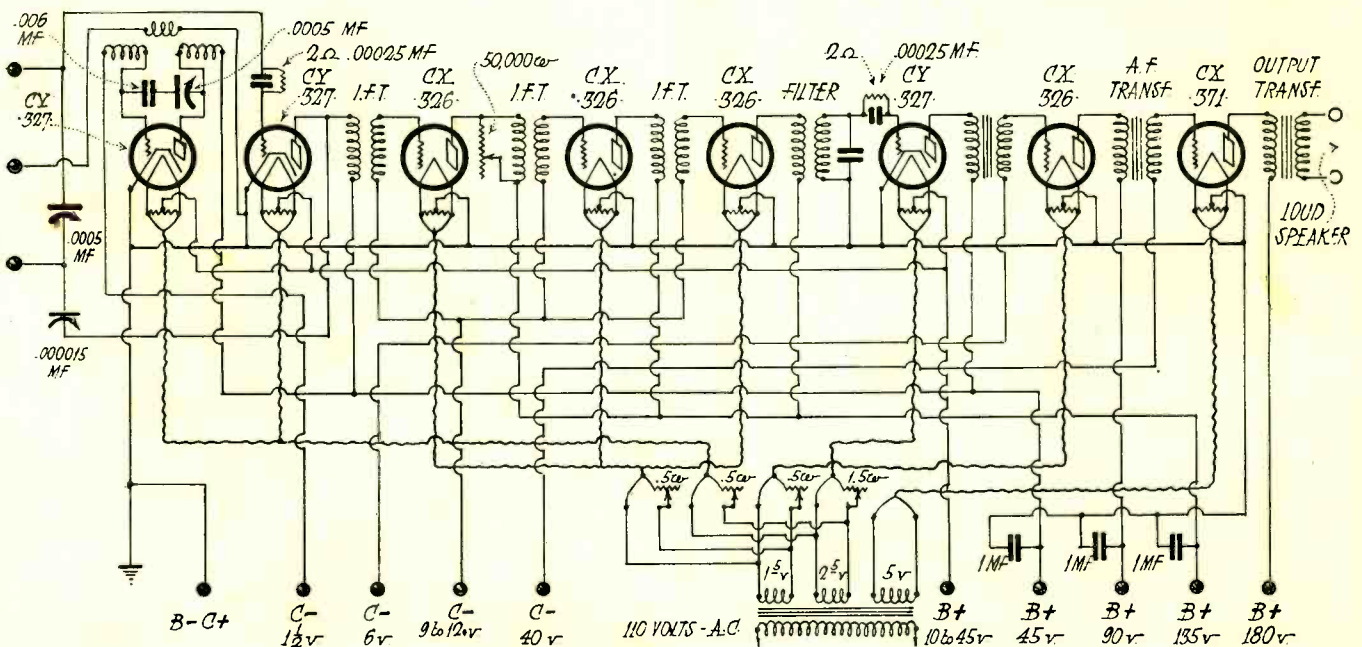

Fig. 4. Circuit Diagram for Superheterodyne with A.C. Tubes.

Vacuum Tube Testing

Practical Methods For Determining Efficiencies of Amplifier, Detector and Rectifier Tubes

By B. F. McNamee

The service man or user is interested in three things about a vacuum tube used as an amplifier: has it sufficient emission, are the elements disconnected or shorted, is the vacuum high enough. These facts can be learned either by the swing test or the oscillation test. Other characteristics such as amplification constant, plate impedance, etc., are of more interest to the manufacturer and can be determined by oft-described methods.

The swing test determines the tube's plate current for specified grid voltage. The equipment required is a milliammeter, voltmeter, tube socket, switch and A, B, and C batteries, connected as in

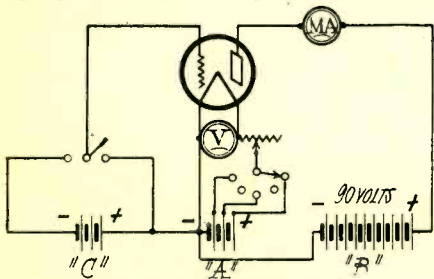

Fig. 1. Circuit Diagram for Swing Test.

Fig. 1. It is used in connection with Table I which gives the minimum allowable difference in milliamperes for various tubes at specified plate and grid voltages and rated filament voltage.

TABLE I. READINGS FOR VACUUM TUBE TESTER

Type	Plate Volts	Grid Volts	Minimum Difference in Milliamps	Minimum Plate Current at Zero Grid (Milliamps)
201-A	90	0 and $-4\frac{1}{2}$	3.0	5
109	90	0 and $-4\frac{1}{2}$	1.6	4
11 and 12	90	0 and $-4\frac{1}{2}$	1.5	4
120	90	0 and $-16\frac{1}{2}$	6.0	9
	135	0 and $-22\frac{1}{2}$	9.0	15
112	90	0 and $-4\frac{1}{2}$	3.5	7
	135	0 and -9	11.0	16
171	90	0 and $-16\frac{1}{2}$	17.0	27
	180	0 and -40	45.0	60
210	90	0 and $-4\frac{1}{2}$	3.5	7
	350	0 and -27	36.0	52
226	90	0 and $-4\frac{1}{2}$	3.5	
227	90	0 and $-4\frac{1}{2}$	3.0	

Note—When testing tubes with a plate voltage higher than 90, it is important that the grid be kept at zero voltage no longer than necessary for reading the plate current. Otherwise

the high plate current may overheat or otherwise damage the tube.

The indication for low filament emission is a plate current below the minimum requirement for zero grid (switch at $-C$). The difference in plate current for zero and $-4\frac{1}{2}$ volts grid indicates the control exercised by the grid over the plate current, or roughly the mutual conductance. For the latter is approximately equal to 1000 times the difference in milliamperes divided by the difference in grid voltage.

Low vacuum is indicated by abnormally high or unsteady plate current. Another indication in some types of tubes is a bluish glow. It is for this reason that a power tube should be tested at its rated plate voltage for the bluish glow may not be evident in a 90 volt test whereas this indication of gas would appear at higher voltages. The B batteries should be measured frequently to insure that the rated voltage is maintained.

As a power tube has a large plate current at zero grid, the switch should be held in this point only long enough to take the reading. This precaution prevents overheating and gasification of the tube.

The oscillation test is based upon the fact that a tube must amplify in order to oscillate. Fig. 2 shows the circuit for an a.c. oscillation tester which will be found more convenient than one using batteries.

Tap-switch A is used to select the proper filament voltage for the tube to be tested, and B the proper plate voltage. P is used to compensate for variations in line voltage, and is adjusted until the filament voltmeter reads the correct voltage for the filament tap be-

ing used. F is adjusted for maximum oscillating current, and its best point will depend on the amplification constant of the tube being tested. Three points will suffice (to be found by trial); one is labeled "low mu," for 171 and 120 type tubes; one is labeled "high mu," for the 240 type; and the third one is for all other tubes. In general the latter point will be found about the center of the coil. The "high mu" point is located near the grid and the "low mu" near the plate end. It is important to connect the wire from switch F, as shown, to that end of the filament supply which is negative during the half of the cycle in which the plate is positive. Otherwise the grid would have a positive bias during the time the tube is supposed to oscillate.

The coil in the oscillating circuit of Fig. 2 may be made with 100 turns of No. 24 d.c.c. on a 3 in. tube. The condenser is a 400 mmf. fixed mica. The meter is a thermocouple milliammeter, and indicates the strength of the oscillating current. A shunting resistance and switch are shown for use with power tubes. Minimum readings for each type of tube must be decided on by trial in each tester after it is built, as it will depend on the particular amounts of resistance, capacity and inductance used. Sockets for tubes having other than X bases may be connected with plates, grids and filaments in parallel to the X socket shown.

Testing A.C. Tubes of the CX-326 type may be done in the standard X socket if a 1.5 volt tap is provided. C-327 tubes require a 5-prong socket, the plate and grid being connected in parallel with those of the X socket, and the heater terminals connected in parallel

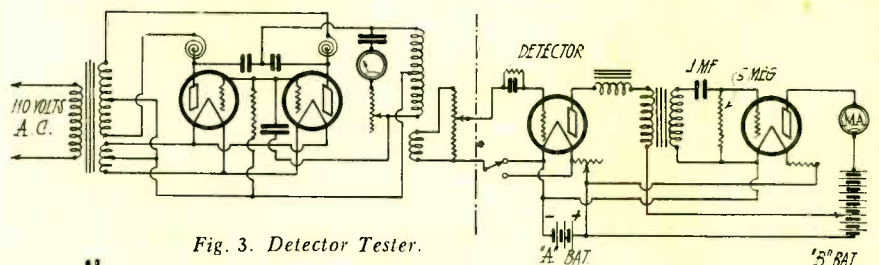

Fig. 3. Detector Tester.

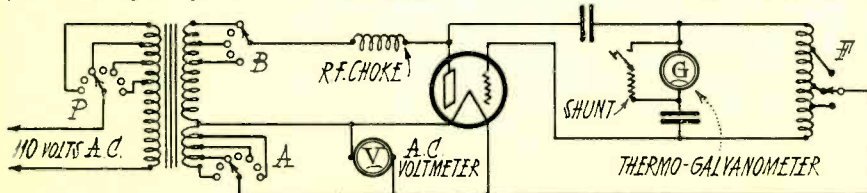

Fig. 2. Circuit Diagram for A.C. Oscillator Tester.

with the filament terminals of the X socket. The cathode terminal is connected to the side of the filament opposite to the connection from switch F. The voltage across the heater element, while the plate is positive, acts as a negative grid bias.

(Continued on page 48)

"... The Kid Was Steady!"

By Earle Ennis

THE night operator at KXX slid down in his chair and spiked a stack of night traffic for the north. Outside, a storm howled and screamed through the rigging of the towers above his head. Against the windows, the rain beat steadily, a roof gutter "tink-tonking" rhythmically in accompaniment. Now and then the operating room jarred with the impact of an invisible fist as the wind gusted viciously against it.

Kinsey was grateful for the little cast-iron stove at his back that cast a friendly glow into the room. It was going to be a bad night—bad for ships, busy for him. The mercury in the barometer was dropping, and the wind bit down with the snap of Bering sea in its breath. He thought of some of the wallowing coffins with which he would have to work during the night, and shivered. There were phases to the marine game nothing short of ghastly. He knew. He'd pounded brass on some of them.

Abruptly he kicked open the front door of the stove and let the ruddy light flicker on the white walls of the operating room. The green shaded lamp over his instruments cast a brilliant glare on his table. He pulled the station log toward him, to make his opening entry. Suddenly he stopped, his pencil poised in mid-air . . .

Christmas Eve!

Kinsey's mind reached across space, over days, hours . . . the Kid! Good Lord! The Kid was going out tonight on his first trip. He remembered now. The date had walked up on him. Some boy, that younger brother—clean-cut, laughing-eyed, steady, full of the hope of life and none of its cynicisms. Time enough for that. Kinsey smiled whimsically at the picture.

There were just three of them—Kinsey, the Kid and—Ma! Ma was the most important unit of the triad, although she always insisted Kinsey was the anchor. She would push up her glasses and look them over, her eyes twinkling.

"A couple of scalawags," she would call them lovingly. They would thump her on the back with bruin-like pats, and call her Ma and "Annie," her given name. She had many a chuckle over "Annie" this and "Annie" that. It kept her young—that disrespectful but beloved salutation.



Ma sent Kinsey away to war with a smile, like many another mother. And like all the others, she failed to fool anybody with her tight-lipped gallantry. It made Kinsey a bit prouder when she said "go 'long with you" and shoved him out of the gate, very spic in his new uniform. The Kid had enough of Ma in him to take it tight-lipped too, but there was a glitter in his eyes. He and Kinsey shook hands. No baby stuff there. Hit each other on the chest and grinned. But—Kinsey felt the Kid's grip almost as long as he felt Ma's hug . . .

Fate was kind to Kinsey. He came home. He found Ma the same—a bit older, that was all. The Kid was astonishingly bigger. Kinsey had a chunk of shrapnel in his leg and his engineering days were over. But he was a good radio man and he found a ship presently. He hadn't stayed at sea long. He was too good on detail. The company gave him the night trick at KXX. Fellow operators were glad. They liked his stuff on the key—sending like print, like an automatic, clear, steady, readable anywhere on the Pacific. And Kinsey liked his work . . .

"He wanted to dash the door open and scream at the night."

Well, the Kid followed him. Hero worship, or love of the new mystery, radio, it was hard to say which. Studied nights, key and buzzer, typewriter and head caps—copying, working, learning, studying code symbols, abbreviations—slaving. Going to be as good a man as Kinsey, he told Ma. Ma nodded briefly, careful not to enthuse too much. Fine pair those two, upstanding monuments to long effort. One tested and proved
(Continued on page 54)

“Fishing” For Radio Waves

Records and Interpretation of Some Radio Fading Experiments on Long and Short Waves

By *Everett W. Thatcher*

Concluded from November issue

TWO phenomena immediately become evident when radio operation is carried on below 100 meters: First, the introduction of a “skip” distance or zone of silence surrounding the station, the size of which is dependent upon the frequency, the time of day and the season, and perhaps certain weather conditions; and second, a rotation of the plane of polarization of the electromagnetic wave, dependent upon much the same factors as the skip distance.

The probability suggests itself that these two facts may be simply different manifestations of one effect governing the propagation of the wave through space. This suggestion is borne out by experiment.

Regarding the magnitudes of the skipped distances and the rotation of the plane of polarization of the wave, little need be included here. A description of some earlier experiments along this line appeared in an article by the writer in *RADIO* for April, 1926. We are primarily concerned now with the evidence presented by the fading records secured at Oberlin. Only a few sections of the great number of records that have been taken can be reproduced here, and some have been chosen as representative of various types of transmission and reception on which the work was done.

Fig. 1 is a representative record, characteristic of the reception from station WTAM at a distance of 40 miles, and on a wavelength of 395 meters. The radio-energy was received on loop antennas which were provided with double gimbal mountings so that they could be revolved through about two perpendicular axes. In this record, the two loops

were at right angles in the directions indicated (NE-SW) and (NW-SE). The variations in signal intensity as shown by these records were very slight and occurred simultaneously, indicating that such fading as occurs is not due to a change in *direction* or *polarization* of the received wave. Changes in position of the loop were accompanied by changes in *intensity* of the received signal, but the type and period of the variations remained the same.

Additional light is thrown on the sit-

zero shows that the *magnetic component* on which the loop operates was *still horizontal* as it was when it left the transmitting antenna. In this plane the turns of the loop are not cut by the advancing magnetic lines of force, and hence no electromotive force is set up between its terminals.

This quite normal behavior is just what we would expect a well-mannered radio wave to do—one which has not been cavorting through the upper atmosphere, but has remained comparatively

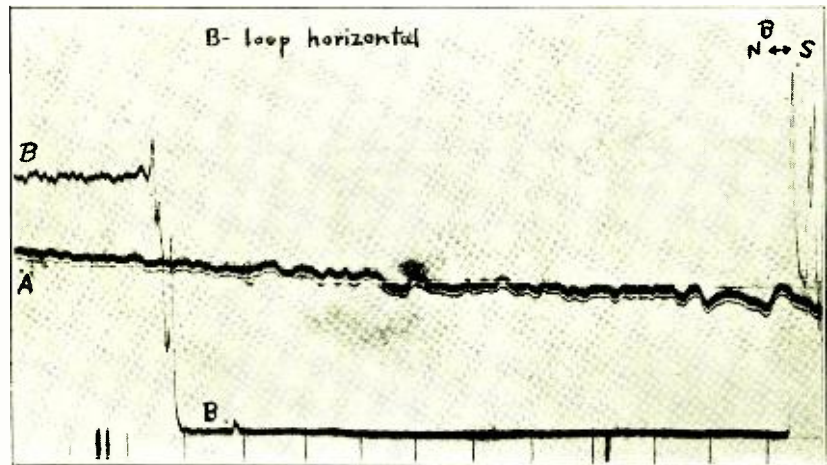

Fig. 2. Effect of Placing One Loop Horizontally.

uation by Fig. 2. Curve A was produced by adjusting the position of the loop until maximum signal strength was obtained. The plane of the loop winding was then in a line connecting the receiving and transmitting points. The abrupt drop in curve B was caused by placing the loop (which had also previously been vertical) in a *horizontal* position. The fact that the received energy dropped to

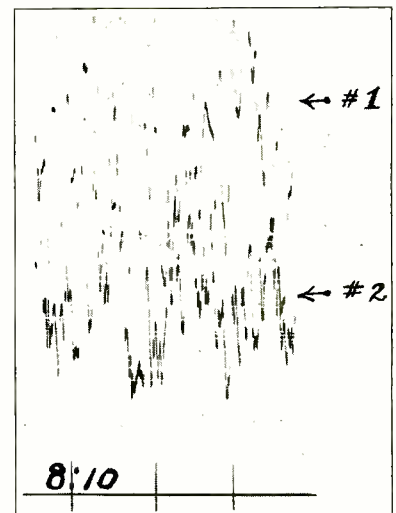

Fig. 3. Rotation of Magnetic Field from Distant Station.

close to the surface of the earth, and has suffered little distortion in propagation.

In contrast to Fig. 1 and 2 is Fig. 3. This was made of the signals of KDKA on 309 meters, the distance being about 160 miles. The lower curve (from set No. 2) is the product of a loop in a

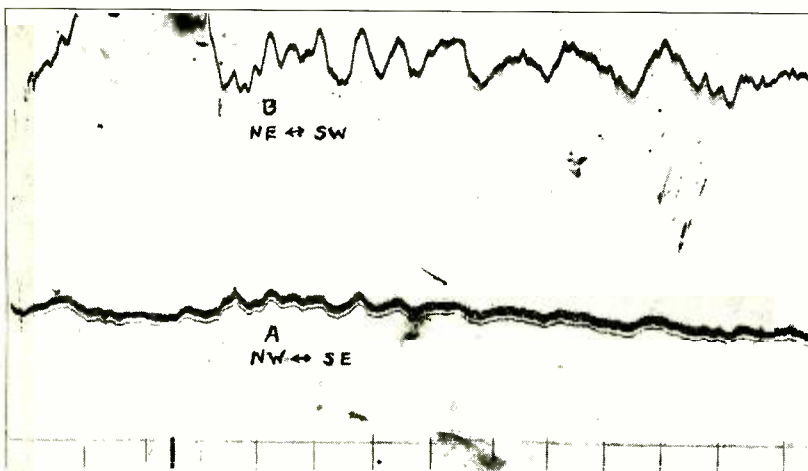

Fig. 1. Variation in Signal Intensity Received from Nearby Station on Two Vertical Loops.

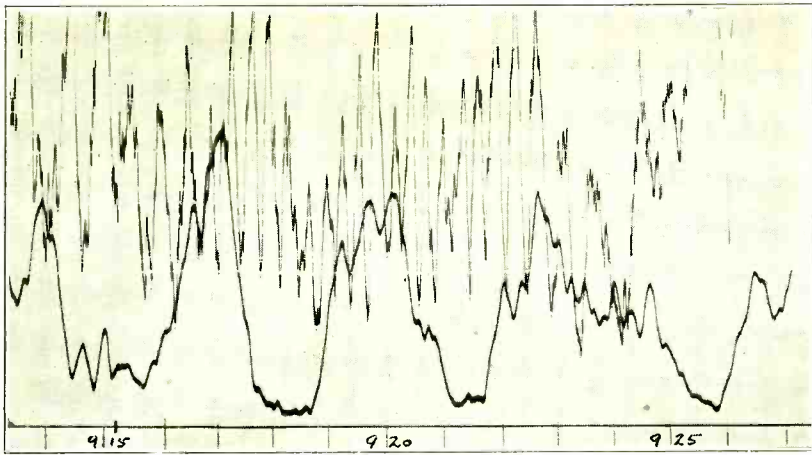

Fig. 4. Comparison of Fading on 63 and 309 Meters.

horizontal position. It shows that in this case, there is present a *magnetic component* of the received wave which has been *rotated* toward the vertical. Another characteristic which is evident from this record is the more rapid and violent fluctuation of signal strength. This is much more pronounced than when a non-directional antenna is used. At this distance, then, we are led to believe that the fading is due, in part at least, to the change in the magnitude of this rotation or change in the direction from which the received wave apparently comes. The effect would be the same in either case.

Fig. 4 is an example of the records of simultaneous transmission from the same station (KDKA) on 309 meters and 63 meters. Non-directional antennas were used in the reception. It is reasonable to suspect that this had the effect of reducing minor variations in signal strength to a minimum, since the effect of variations in any one component of the wave might be counteracted by those of another. In other words, it is a "total" effect that we are measuring. There is evident immediately the difference in the fundamental characteristics of the fading.

The upper curve shows the rapid and periodically violent fading, characteristic of the 63 meter transmission from this station. The lower curve follows the variation in the strength of the 309 meter signal, which consists mainly of a slow fading, the period of which extends

over several minutes. There is a long time variation present in the 63 meter record also. This might be connected in some way with the 309 meter fading, particularly since numerous points were found of coincidence between the two. There were other cases, however, of diametric opposition—that is a maximum in one occurred simultaneously with a minimum value of the other.

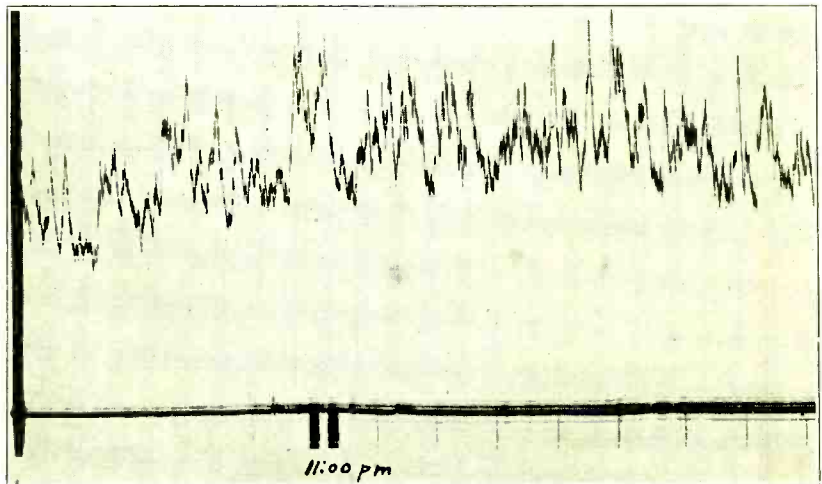
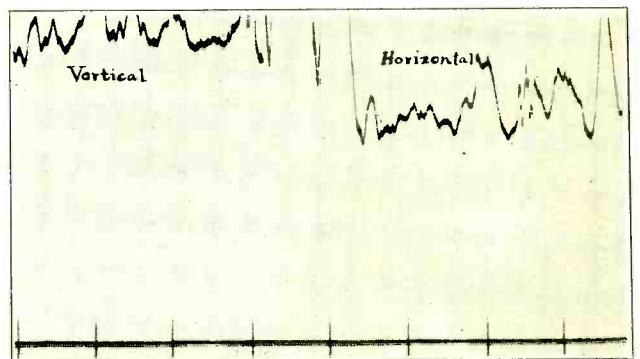
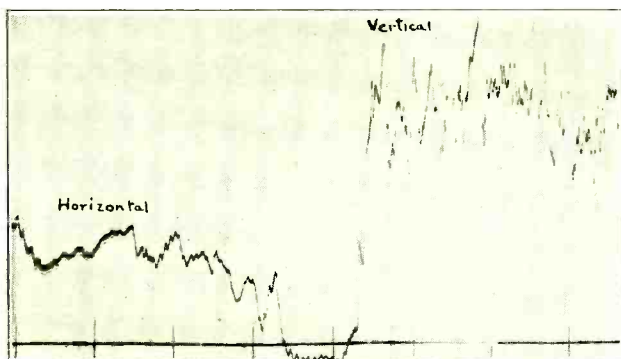

Fig. 5. Record of 41-Meter Signal Intensity.

This curve suggests a number of possibilities. The very fact that the signals were received from the same distance, and especially since the station was the same, means that the conditions accompanying the propagation of one wave were different from those accompanying the other.

KDKA, the fluctuation is seen to be still more rapid, but of smaller amplitude. Only the major changes are detectable in the audible reception of the signal. This record was also made on a non-directional antenna, and therefore represents the total variation in intensity. (Continued on page 65)



Figs. 6 and 7. Effect of Changing Planes of Polarization at Transmitting Station.

Wave Traps

Why and How the Rejector and Acceptor Types Work to Minimize Interference

By G. F. Lampkin

WAVE traps are as old as broadcasting itself, but time and again a listener complains that he cannot receive a thing other than a certain local station, when it is on. The fault may lie with the broadcaster; more often it is in the receiving apparatus of the listener; and sometimes, neither is to blame, but the two are in such proximity that even an excellent receiver will not give reasonable discrimination. Whichever of these ways the difficulty may arise, a wave trap can be used to obviate it to a great degree—usually completely. Such interference from a local broadcaster is perhaps the most common that is suffered by the listener, but there are other kinds that may just as effectively ruin an evening's enjoyment. A wave trap can be used to mitigate the spark interference that is had from shipping along the coasts and lakes. A wave trap will even discriminate against interference from electrical power wiring and devices. The use of such traps, however, is not nearly so prevalent as their simplicity and effectiveness would seem to warrant.

The trap is simple, because the only parts required are a coil and a condenser. These two units may be hooked up in a variety of ways, depending on the type of interference that it is desired to do away with, and on the results that are obtained with the various forms.

One interpretation of the name, wave trap, would indicate that the currents of one particular frequency are to be trapped out, and prevented from flowing into the receiver. The circuit "a" in Fig. 1 is designed to do just this. The condenser is set so that it and the coil are in resonance with the interfering wave, and comparatively heavy currents are set flowing around this resonant circuit. But, when the current in the coil is flowing toward the receiver, that in

the condenser is flowing away from it, as indicated by the arrows in the figure; and, vice versa. The result is that very little, or no, current of the resonant frequency can flow in the outside circuit, and so the interfering wave is prevented from reaching the set.

This action is known in electrical parlance as parallel resonance, for the coil and condenser are connected in parallel; and they offer a high impedance to the flow of currents of resonant frequency. If a graph of the impedance be plotted for different frequencies, it would look like that shown in "c" of Fig. 1. At the resonant frequency it rises to a high value, and falls off at other frequencies. The lower the resistance of the coil and condenser—i.e., the lower their losses—the higher will rise this impedance peak. And as the impedance is in series with the antenna, it will let very little of the resonant frequency get through.

So far as the receiver is concerned, the frequency band may be represented graphically as in Fig. 1d, where the shaded portions represent the response of the set to the various frequencies. The sharp dip in the response curve is of course due to the wave trap. Tuning the condenser moves this dip along the frequency axis, so that it may be placed on top of the interfering station.

The trap, as drawn in Fig. 1a, is connected directly in the antenna circuit. Its utility can be greatly enhanced by coupling it to the antenna circuit, through a coil of 5 or 6 turns. The connections are given in 1b. Using such, the selectivity of the trap is immensely increased, and control can be had over the intensity of the trapping action. The improvement can be likened to that of the multi-circuit tuners over the old single-circuit affair. The impedance and response curves remain the same.

The same kind of response curve can be obtained by using a series-tuned circuit, Fig. 2a, and connecting it across the terminals of the set. When the inductance and capacity elements were connected in parallel, the currents through them tended to cancel. When they are connected in series, the voltage drops across them tend to cancel, at the resonant frequency. Or, in other words, the impedance becomes vanishingly small at this frequency. The impedance curve is as in Fig. 2b; again, the lower the losses in the coil and condenser, the sharper will be the dip in the curve. Because this low impedance is connected across the receiver, it will bypass currents of the resonant frequency, so that they will not flow through the receiver. The receiver-response curve

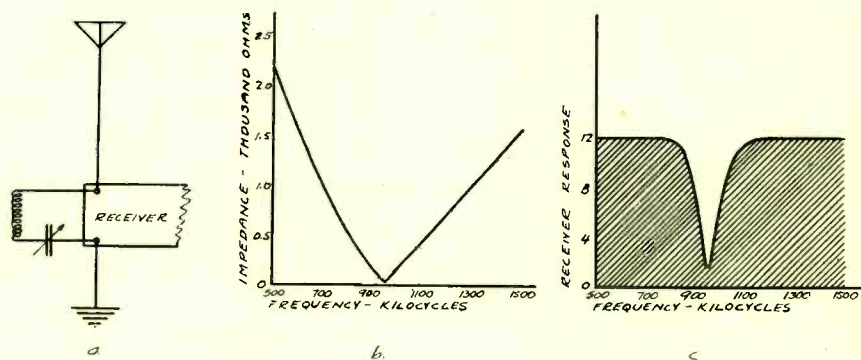

Fig. 2. Conditions of Series Resonance for a Rejector Trap.

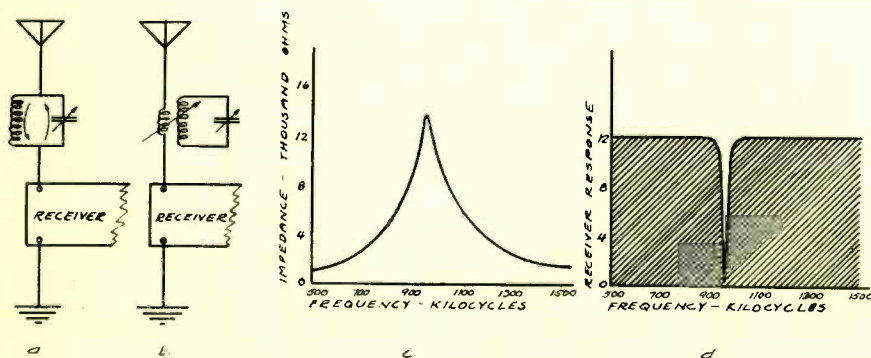

Fig. 1. Conditions of Parallel Resonance for a Rejector Trap.

takes the same general form of that of Fig. 1d. In some cases, this type of filter will give better results than that of Fig. 1. Generally, however, the reverse is true, for the series-tuned bypass circuit cannot be coupled to the receiver, and the resulting advantages cannot be realized.

If the coil and condenser be connected in parallel, and across the receiver, just the opposite of the response curves shown above will be had. The impedance of the parallel combination will of

(Continued on page 67)

An Improved Phasatrol Receiver

By Alan Donaldson

THE Phasatrol was introduced several months ago for the purpose of preventing oscillation in tuned r.f. amplifiers. It is extremely easy to adjust, but the gain is not constant over the whole broadcast band. This is not a fault of the Phasatrol since the same thing happens when any of the usual neutralizing schemes are employed. The r.f. gain is much greater at the lower wavelengths where more regeneration is present, than on the upper wavelengths. This accounts for the greater ease of getting distant stations on the shorter waves with most tuned r.f. receivers.

This receiver employs an automatic means of increasing the amplification on the upper wavelengths by means of resonant circuits in the plate circuits of each r.f. amplifier. These are used to bring up the sensitivity of the r.f. amplifier by having the two tuned circuits, L_1C_1 and L_2C_2 , staggered, that is, one at about 525 and the other at about 550 or 575 meters.

A tuned circuit in the plate load of a tube causes regeneration or oscillation due to the interelectrode capacity of the tube. On account of the tube capacities, there is an effective impedance between grid and filament of the tube which is a function of the output or plate circuit load. If this load is pure resistance or is capacitive, no regeneration is present, since the aforementioned impedance is positive. Here we are concerned particularly with the resistance component of the impedance, since if it is negative it may be enough to overcome the grid circuit resistance with oscillation as a result. This is the phenomena known as negative resistance of a vacuum tube. If this input resistance is only slightly negative, the total resistance of the grid circuit will be reduced and more amplification will result. This is known as regeneration and practically all r.f.

amplifiers use this principle to obtain satisfactory gain or amplification. A few receivers using four or more stages of r.f. amplification, minimize this effect as much as possible. But all single and even two stage r.f. receivers make use of regeneration to a large extent.

Referring to Fig. 1 it will be seen that we have a tuned grid, tuned plate circuit in each r.f. amplifier, though the two tuned plate circuits L_1C_1 and L_2C_2 are tuned to one wavelength only, that is 525 and 575 meters or thereabouts. These circuits would cause oscillations except for the fact that they are shunted by the variable resistances in the phasatrols, and also by the primaries of the r.f. transformers. The two little chokes L_1 and L_2 are wound with very small wire so that the total effect on the grid circuits is to make the input resistance slightly negative and so increase the amplification. The condensers C_1 and C_2 are fixed condensers inside of the phasatrols.

The action of the phasatrols in preventing oscillation is not hindered by the chokes L_1 and L_2 since these modifications were made to make up for the deficiencies of r.f. transformers. The phasatrol acts to change the phase of the voltage feeding back through the tube capacity so that the impressed grid voltage is somewhat out of phase with

the feed-back voltage. This reduces regeneration and prevents oscillation if the condensers C_1 and C_2 are small enough for the particular make of r.f. transformer. As stated earlier, if the plate load is resistive or capacitive, the input resistance is positive so no regeneration takes place. However, in the phasatrol the effective load is still slightly inductive in spite of the shunt resistance and series condenser, so that regeneration is still present, the amount depending largely on the setting of the shunt resistance slider in the phasatrol itself.

In Fig. 1, the condenser C_3 , a semi-variable type, is used as a path for the r.f. component in the detector plate circuit. It is coupled back to the plate of the last r.f. tube so a small amount of regeneration is introduced, enough to make the grid bias detector as sensitive as the grid leak type of detector. The grid bias type of detector will give a little better quality than the grid leak type providing the feedback condenser C_3 is not set at too high a capacity.

A three stage audio frequency amplifier is used in order to have plenty of amplification. Nothing is worse than using a low gain two-stage amplifier and then forcing the r.f. and detector tubes in order to obtain enough volume from the loudspeaker for the average living room. The detector has a high plate

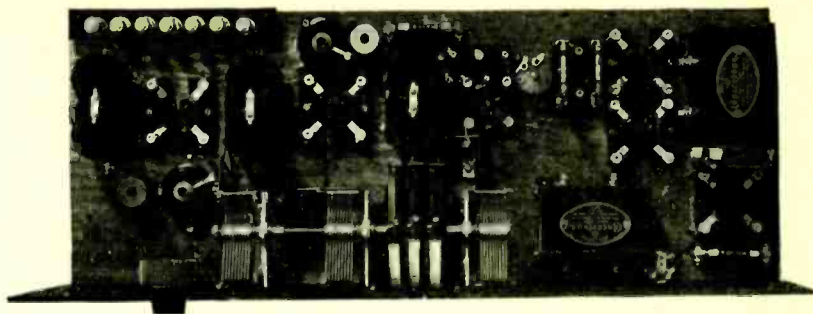

Top View of Improved Phasatrol Receiver.

To conform with pictorial diagram, insert volume control rheostat in negative "A" lead above ".006 M.F."

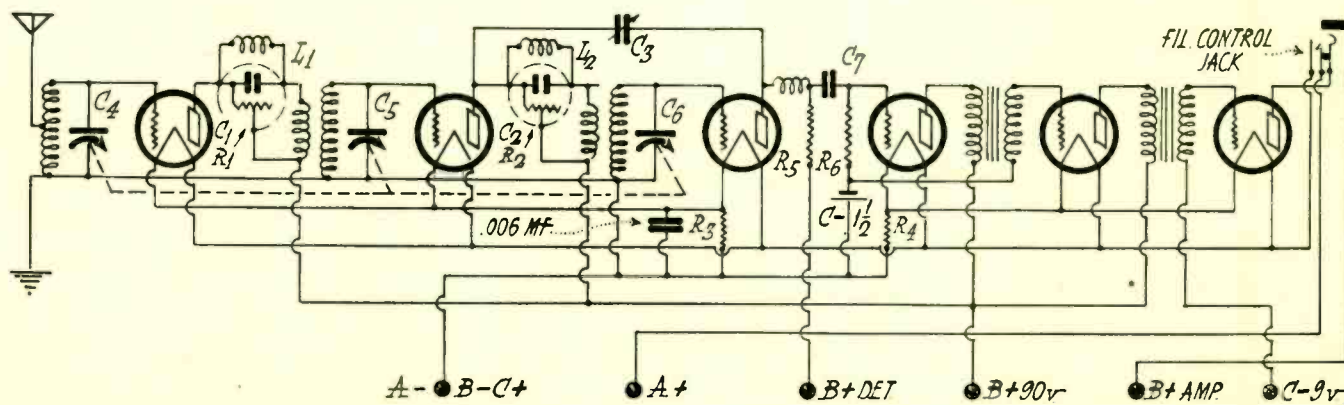

Fig. 1. Circuit Diagram for Improved Phasatrol Receiver.

impedance since it is the grid bias type, so it uses resistance coupling into the first audio tube. Following this tube are two stages of audio amplification using high quality, low ratio transformers. An output choke and condenser or output transformer should be used if more than 135 volts is used on the plate of the last audio tube.

The picture and Fig. 2 show the layout of the apparatus in the receiver as built up by the author. By using a triple condenser having separate drum controls on each section, any one or all can be moved at a time. Practically all the wiring was done underneath the baseboard, running the wire through holes in the baseboard. Ordinary bell wire was used throughout for the wiring since this is well insulated and is easy to work with. The layout of apparatus on the baseboard should be made to suit the builder, making an orderly procedure from the first r.f. transformer through to the last audio tube. The set shown in the picture was an experimental one used in developing the circuit and so the chokes or coils L_1 and L_2 were designed for the particular type of r.f. transformer used in the receiver. These coils will vary somewhat with different types of transformers.

The two coils L_1 and L_2 were made by winding about 40 and 30 turns of wire on ordinary thread spools. L_1 was wound with 30 turns of insulated No. 34 gauge, or thereabouts, German silver resistance wire and L_2 wound with 40 turns of No. 34 DSC copper wire. Either very small wire or resistance wire should be used in order to broaden out the resonant humps of the tuned circuits L_1C_1 and L_2C_2 so as to cover the upper broadcast band efficiently. For this reason L_2 or the one with the most turns, should be wound with the largest wire so as to have a lower effective resistance and

- PARTS USED IN IMPROVED PHASATROL RECEIVER**
- 2—Jefferson Concertone audio transformers
 - 1—Pilot resistance coupler
 - 6—Sockets, 1 cushioned
 - 3—Camfield r.f. duoformers
 - 1—Frost 10 ohm rheostat
 - 1—Frost single jack with filament switch
 - 1—18x9½-in. baseboard
 - 1—Naald triple localized control condenser
 - 2—Amperites 4A and 3A types
 - 2—Type K CeCo r.f. tubes
 - 1—Type H CeCo detector tube
 - 2—Type A CeCo audio tubes
 - 1—Type J71 CeCo power tube
 - 7—X-L push binding posts
 - 2—Electrad Phasatrols
 - 2—Electrad leaks, .1 and 2. megohms
 - 1—Muter .006 by-pass condenser
 - 1—R.F. choke

higher resonant hump. This means more regeneration.

The volume control is a rheostat in the first r.f. tube and the filament switch for all of the tubes is incorporated in the loudspeaker jack. When the loudspeaker plug is inserted into the jack the filaments of all tubes are lighted. Two automatic filament rheostats or ballasts are used, one of 1 ampere capacity for the power tube and two audio tubes, and the other of ¾ amperes for the two r.f. tubes and detector. Type K CeCo special r.f. tubes can be used to good advantage in this receiver since they are about twice as efficient as an ordinary 201A tube for this purpose.

COMMERCIAL SHORT WAVE TRANSMISSION

The use of short wave transmission from the R.C.A.'s Radio Central at Rocky Point, L. I. is most significant in that this site was originally selected as the location for twelve Alexanderson long-wave systems. Two of the latter, with their lofty steel towers, were installed and are the backbone of the transatlantic traffic service for 24 hours a day.

But the development of short wave transmission with vacuum tube gener-

ators has substituted 60 ft. wooden poles for the 410 ft. steel towers, and relatively small vacuum tube equipment for the great Alexanderson generators. A 30 ft. vertical span of copper rod suffices as an aerial.

There are two Alexanderson alternators at Rocky Point, one serving as the WSS channel, and the other the WQK channel. Both are employed for European and South American traffic, on wave lengths above 16,000 meters.

Surrounding the two giant Alexanderson alternators are the short-wave transmitters, taking care of a steadily increasing flow of traffic. The short-wave transmitters already installed may be catalogued as follows:

WTT, 40 k.w., 16.1 meters—Operating to South America, daytime only.

2XT, 40 k.w., 16.18 meters—Operating to Europe, daytime only.

WBU, 20 k.w., 14.1 meters—Operating to South America.

WIK, 20 k.w., 21.75 meters—Operating to Central America, Porto Rico and Europe, 24 hours.

WQQ, 20 k.w., 14.8 meters—Operating to South and Central Americas, from 5 a.m. till 11 p.m.

WLL, 20 k.w., 16.01 meters—Operating to South America and Central America, from 5 a.m. till 11 p.m.

It will be noted that transmitters, operating below 17 meters, are used for daylight transmission only, due to the peculiarities of short waves, in some instances the transmitter working with Europe in daylight, becomes highly efficient for communication with South America at night, and vice versa. All these peculiarities, once considered freaks, have been reduced to definite engineering, with the result that short-wave communication is becoming better established every day.

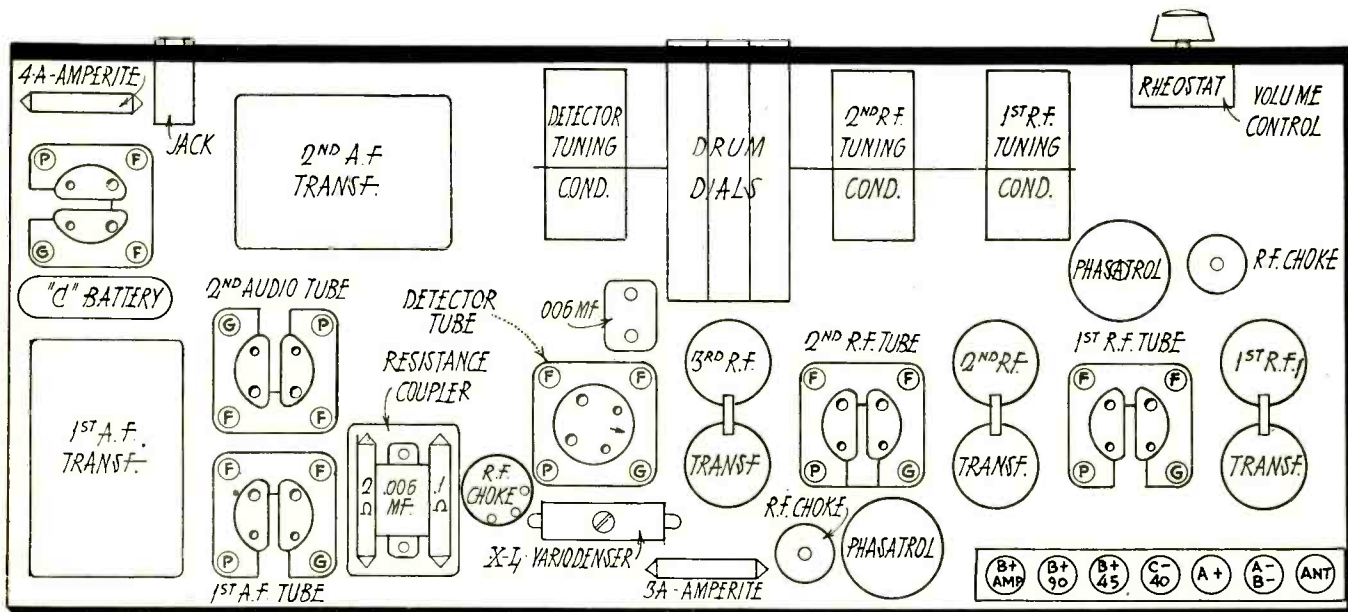

Fig. 2. Pictorial Diagram of Parts Arrangement for Improved Phasatrol Receiver.

Reactance and Susceptance Curves

An Explanation of Their Theory and Practical Application

By Gilbert W. Cattell

IT IS often desirable to know for what frequencies a certain combination of inductances and capacities will be resonant. This can be calculated, but as the combination becomes more complicated the calculations become more and more difficult and soon get beyond the ability of the ordinary reader.

There is a graphic method available for which the calculations are very simple. It is the use of reactance and susceptance curves. To understand them, it is best to learn step by step just how they are constructed.

In any electrical circuit, the impedance is the factor which limits the amount of current which will flow through the circuit when a given voltage is applied. Impedance is made up of two factors, resistance and reactance. The relation of these factors is expressed by the equation $Z = \sqrt{R^2 + X^2}$ where Z is the impedance, R the resistance and X the reactance, all expressed in ohms.

In general, the resistance of a circuit does not vary greatly with the frequency of the current flowing through it. On the other hand frequency is one of the two principal factors which determines the magnitude of reactance.

Reactance may be said to be of two types, commonly referred to as positive or inductive reactance (that due to an inductor or coil), and negative or capacitive reactance (that due to a condenser or other capacity). The equation for capacitive reactance is $X_C = 1/(2\pi fC)$. The equation for inductive reactance is $X_L = 2\pi fL$. X is the reactance in ohms, f is the frequency in cycles per second, L is the inductance in henrys and C is the capacity in farads.

With direct current (zero frequency) the reactance of an inductor is zero and that of a capacity is infinity. It will be seen therefore that reactance does not enter into direct current problems.

When alternating currents are considered, the reactance is important and as the frequency increases it often becomes the controlling factor. This is especially true when the frequency is high as in radio, the resistance being negligible in comparison.

In alternating current circuits when both inductance and capacity are found in series, it can be shown that the resultant reactance is the algebraic sum (or arithmetic difference) of the inductive and capacitive reactances. If the inductance and capacity are in parallel,

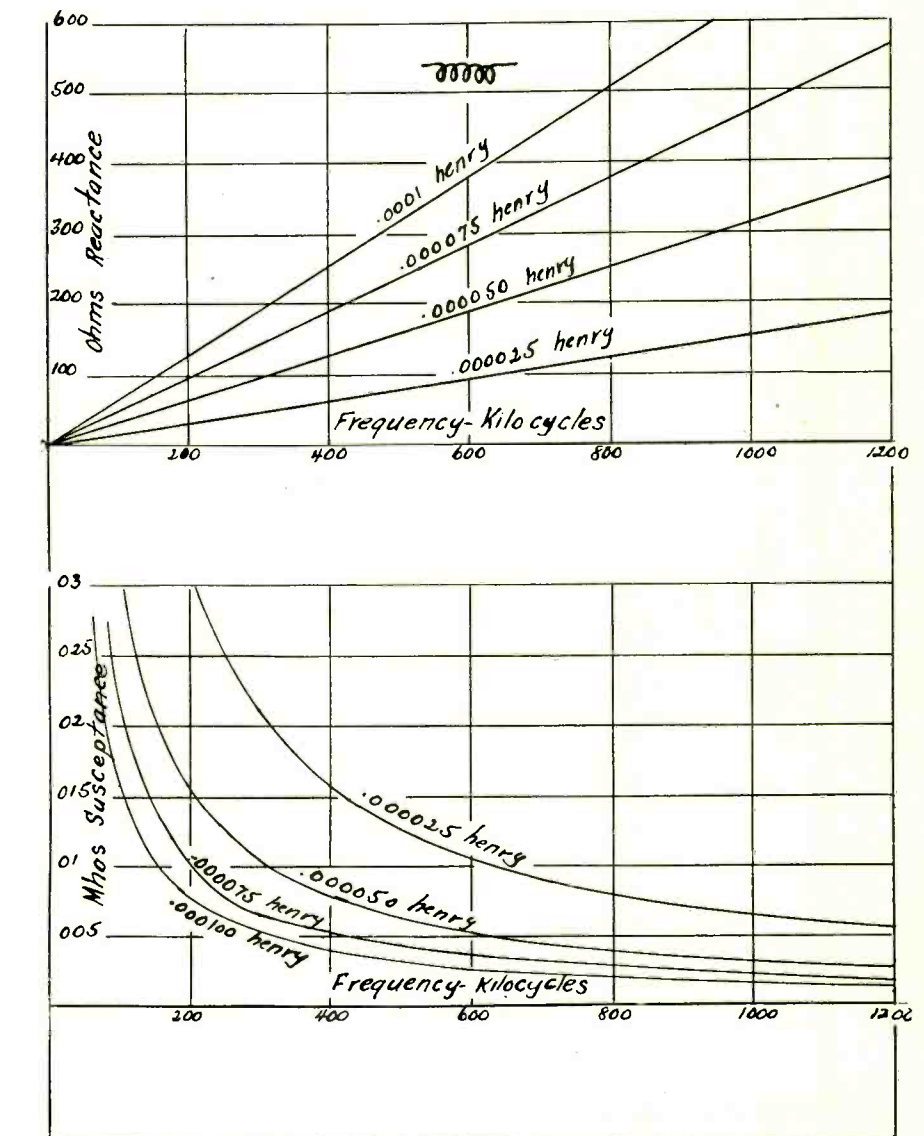

Fig. 1. Reactance and Susceptance Curves for Various Inductances at Different Frequencies.

the reactances are not directly additive but must be treated in a manner similar to that used to determine the resultant resistance of two or more resistances in parallel. In other words the resultant reactance of reactances in parallel is the reciprocal of the algebraic sum of the individual reactances. The reciprocal of reactance is called susceptance and is measured in mhos (ohm spelled backwards). It will be seen therefore that susceptances in parallel are additive.

Repeating this important fact, reactances in series and susceptances in parallel are directly additive. Reactances in parallel and susceptances in series are not directly additive.

If a plot is made using frequency as abscissa and reactance as ordinate a

graphic representation of the variation of reactance is obtained. Such plots are commonly called reactance curves. Similarly, if a plot is made using frequency as abscissa and susceptance as ordinate a graphic representation of the variation of susceptance with frequency is obtained. Such plots are commonly called susceptance curves.

Fig. 1 gives a set of reactance and susceptance curves for a number of different values of inductance. The equation used to compute the reactance was $X_L = 2\pi fL$. The corresponding susceptances were obtained by taking the reciprocals of the reactances. Table A gives the data from which the curves of Fig. 1 were plotted.

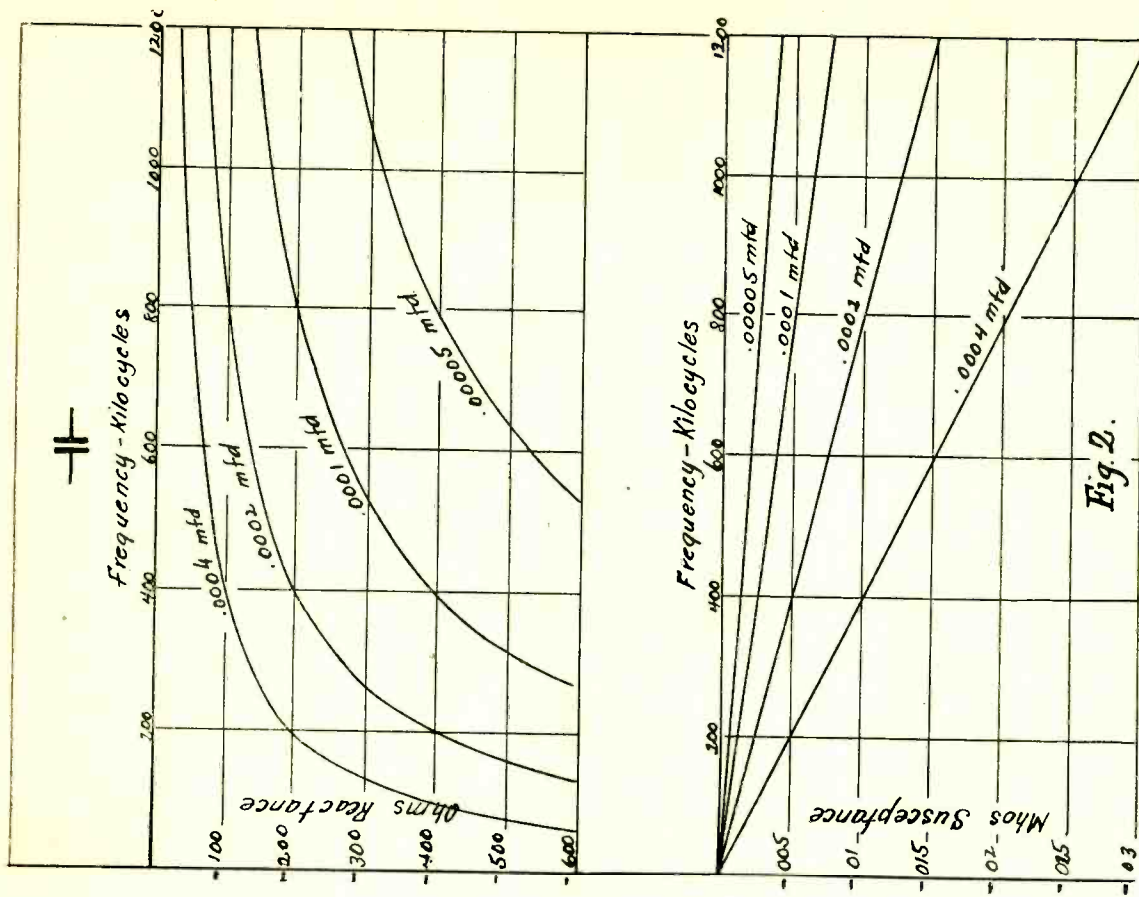

Fig. 2. Reactance and Susceptance Curves for Various Capacities at Different Frequencies.

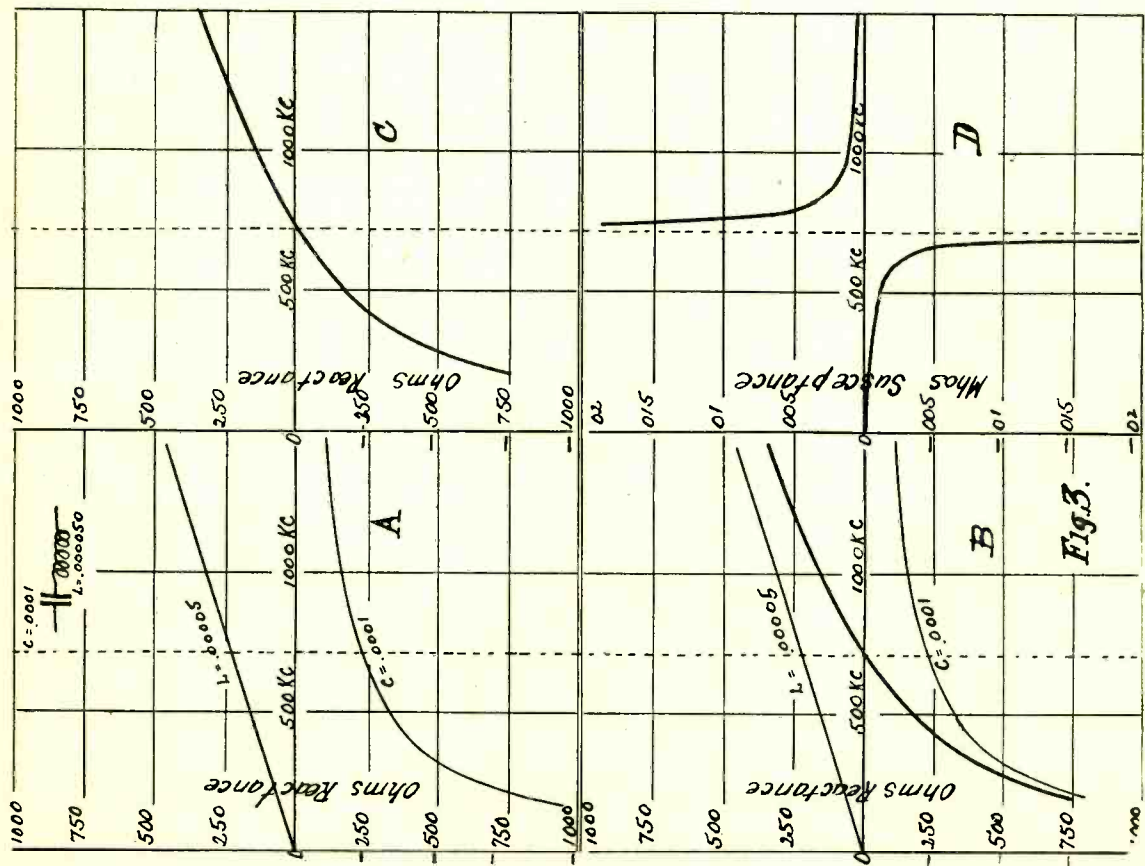

Fig. 3. Method of Deriving Reactance and Susceptance Curves for Series Connection.

TABLE A

Frequency Kilocycles	.000025 H.		.000050 H.		.000075 H.		.000100 H.	
	Reac.	Sus.	Reac.	Sus.	Reac.	Sus.	Reac.	Sus.
100	15.7	.0636	31.4	.0318	47.1	.0212	62.8	.0159
200	31.4	.0318	62.8	.0159	94.2	.01062	125.8	.00795
300	47.1	.0212	94.2	.01062	141.1	.00636	188.5	.00530
400	62.8	.0159	125.8	.00795	188.5	.00530	255.5	.00391
500	78.5	.0129	157.0	.00636	235.5	.00425	314.0	.00318
600	94.2	.01062	188.5	.00530	282.5	.00376	376.5	.00264
800	125.5	.00795	255.0	.00392	376.5	.00265	502.0	.00199
1000	157.0	.00636	314.0	.00318	471.0	.00212	628.0	.00159
1200	188.5	.0053	376.5	.00265	565.0	.00177	753.0	.00133
1500	235.5	.00425	471.0	.00212	706.0	.00141	942.0	.00106

Fig. 2 gives a set of reactance and susceptance curves for various values of capacity. The equation for the reactance is $X_c = 1/(2\pi fC)$ and the corresponding susceptances were obtained by taking the reciprocals of the reactances. Table B gives the data from which the curves of Fig. 2 were plotted.

Consider a more complicated case, that of an inductance of .00005 henry (50 microhenrys) in series with a capacity of .0001 mfd. (100 micro-microfarads). Fig. 3 shows the various steps necessary to obtain the reactance curve of the combination. Fig. 3A shows the reactance curve of the inductance above and that of the condenser below. As was mentioned in a former paragraph reactances in series are directly additive. The addition may be done either mathematically or graphically. Fig. 3B shows the same curves as in Fig. 3A with a third which is the result of a graphic addition of the other two. Fig. 3C shows the resultant curve along with the now useless construction curves omitted. This is the completed reactance curve for a capacity of .0001 mfd. in series with an inductance of .00005 henry. Fig. 3D shows the corresponding susceptance curve which was obtained by plotting the reciprocals of the reactances shown in Fig. 3C.

Similarly Fig. 4 shows the steps necessary to obtain the reactance and susceptance curves for an inductance of .00005 henry in parallel with a capacity of .0001 mfd. Fig. 4A gives the susceptance curves of the two elements, Fig. 4B the same with the resultant susceptance curve added, Fig. 4C the resultant curve alone and Fig. 4D the corresponding reactance curve which was obtained by plotting the reciprocals of the susceptances. It will be noted that the susceptances in Fig. 4B were added in a manner similar to that used in adding the reactances of Fig. 3B.

It will be noted that the resonant frequency is the same for either the series or parallel combination. For the series combination the reactance at resonance was zero, while for the parallel combination the reactance was a maximum (would be infinity if the resistance of the circuit was zero).

Figs. 5 and 6 (page 34) are similar to Figs. 3 and 4 except that different values of inductance and capacity were used. It will be observed that the res-

onant frequency is the same, namely a little over 710 kilocycles. It will be noticed too, that the product of the inductance and capacity (frequently called the LC constant) is the same. So long as the LC constant is the same

it makes no difference how the inductance and capacity are proportioned, the resonant frequency will be the same. The characteristics of the circuit at frequencies other than at the resonant frequency may be quite different. A study of Figs. 3 and 5 will show that the reactance curves are steeper the greater the ratio of the inductance to the capacity (frequently called the L/C ratio). This is another way of saying

TABLE B

Frequency Kilocycles	.00005 mfd.		.0001 mfd.		.0002 mfd.		.0004 mfd.	
	Reac.	Sus.	Reac.	Sus.	Reac.	Sus.	Reac.	Sus.
100	3180.0	.000314	1590.0	.000628	795.0	.001256	397.5	.002512
200	1590.0	.000628	795.0	.001255	397.5	.00251	198.7	.00501
300	1060.0	.000942	530.0	.001885	265.0	.00376	132.5	.00754
400	798.0	.001201	399.0	.00251	199.5	.00502	99.7	.01002
500	636.0	.00157	318.0	.00314	156.0	.00628	78.0	.01256
600	531.0	.001885	265.5	.00376	132.7	.00754	66.3	.01501
800	398.0	.002505	199.0	.00501	99.5	.01002	49.8	.02004
1000	318.0	.00314	159.0	.00628	78.5	.01256	39.8	.0255
1200	265.0	.00377	132.5	.00754	66.2	.01508	33.1	.0306
1500	212.0	.00471	196.2	.00942	52.3	.01885	26.5	.0381

onant frequency is the same, namely a little over 710 kilocycles. It will be noticed too, that the product of the inductance and capacity (frequently called the LC constant) is the same. So long as the LC constant is the same

that in a series circuit the higher the L/C ratio the sharper the tuning. From a corresponding study of Figs. 4 and 6 it will be seen that the higher the L/C ratio the less steep are the reactance

(Continued on page 74)

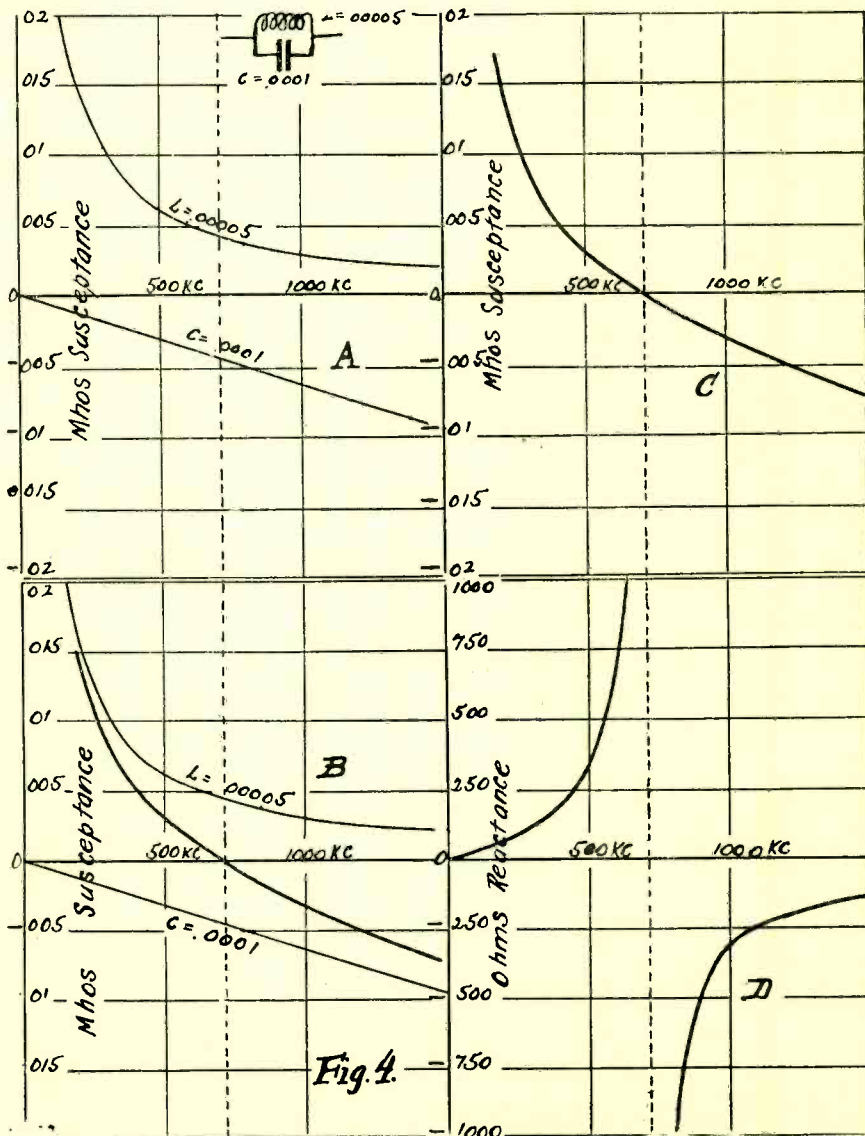

Fig. 4. Method of Deriving Reactance and Susceptance Curves for Parallel Connection.

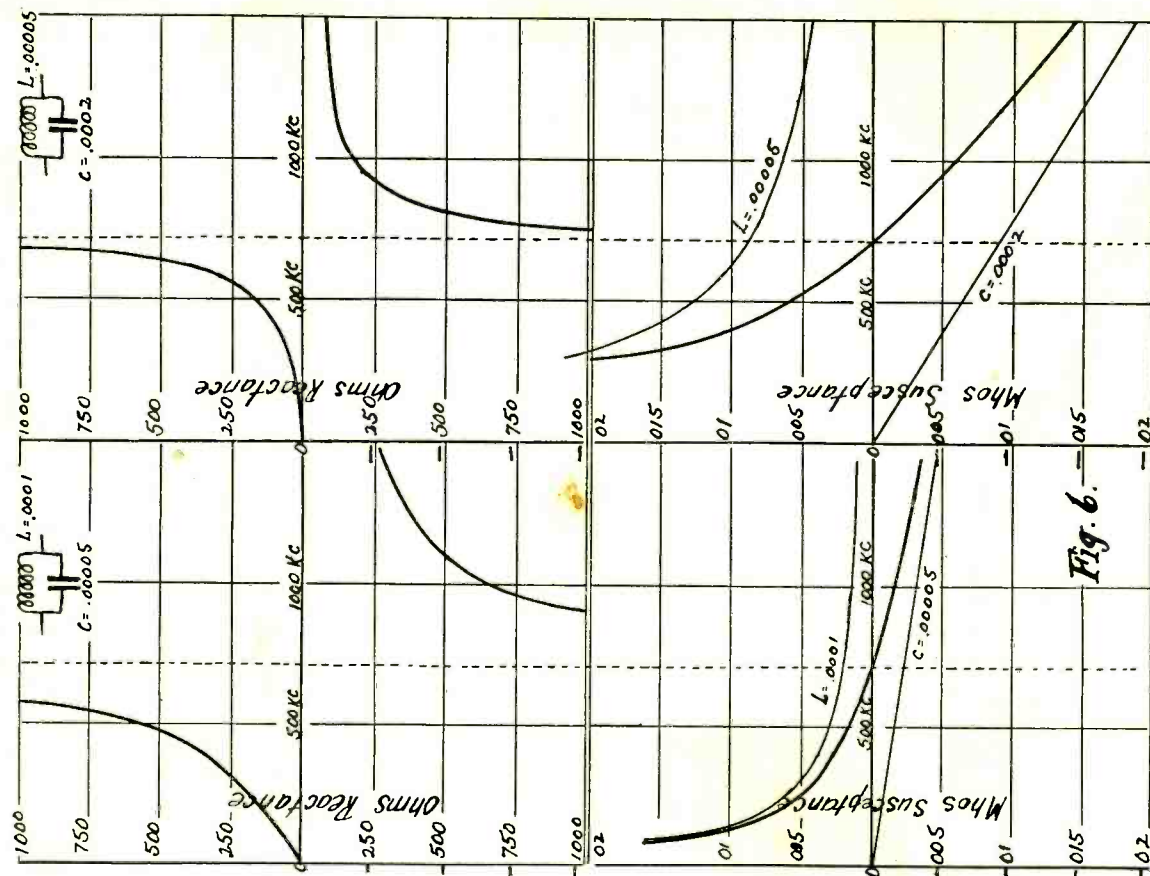

Fig. 6. Reactance and Susceptance Curves for Parallel Connections.

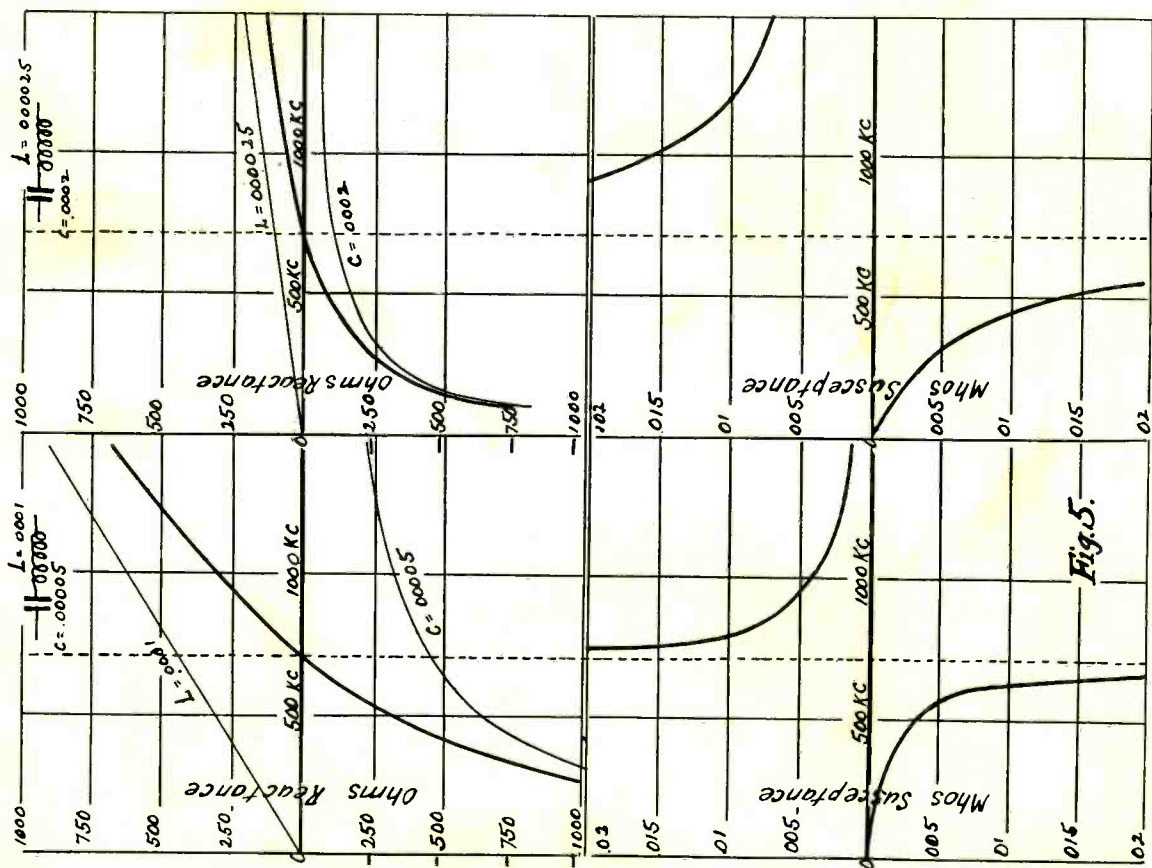

Fig. 5. Reactance and Susceptance Curves for Series Connection.

Socket Power Operation of The Tyrman Ten

By Clinton Osborne

THE Tyrman Ten receiver, whose construction was completely described in October, 1927, RADIO, can readily be adapted for operation from socket power instead of batteries. While these slight changes are being made it is also advantageous from the standpoint of volume to substitute two 210 tubes for the 171 tubes in the last stage of push-pull audio-frequency amplification. This incorporates as an integral part of the receiver a power amplifier giving uniform amplification of all tones at great volume.

The simplest method of filament supply is an A battery eliminator, furnishing 2 amperes at 6 volts for the first eight tubes and 7.5 volt raw a.c. for the two 210 tubes, this being furnished by the power unit which supplies plate current for the entire set. Eventually the new a.c. filament tubes can be substituted for the A tubes used in the present model, but this entails a number of complications which yet have to be worked out and the development of a supply transformer able to meet the high current drain.

Ample plate supply, 120 milliamperes, may be secured from a Thordarson 210 unit using two UX-216B, CX-316B tubes, the circuit diagram for which is shown in Fig. 1. As this unit is not equipped with binding posts for the 210 tube filaments, terminal leads should be attached directly to the 6-volt terminals of the power supply transformer. The grid return of the push-pull stage (-C of the push-pull input transformer in the set) is connected to -B of the power unit through a 750 ohm resistance to the center tap of the 210 filament winding.

The color code for the Yaxley cable connections is black for -A, red for +A, yellow for -B, blue for +45 v.

B, gray for +90 v. B, and brown and green for 7.5 volt filament lead of 210 tubes to B eliminator. A special lead is provided for the +450 v. B for the power tubes and two short leads for the -C (with knot) and -C.

A great increase in the set's sensitivity and consequent range of distance and

ohm grid resistance should also be placed between the grid of the second detector tube and the positive filament, as is done with the first detector. This change is shown together with the modifications in the circuit diagram for the use of 210 tubes in Fig. 2.

It is of interest to note that tests

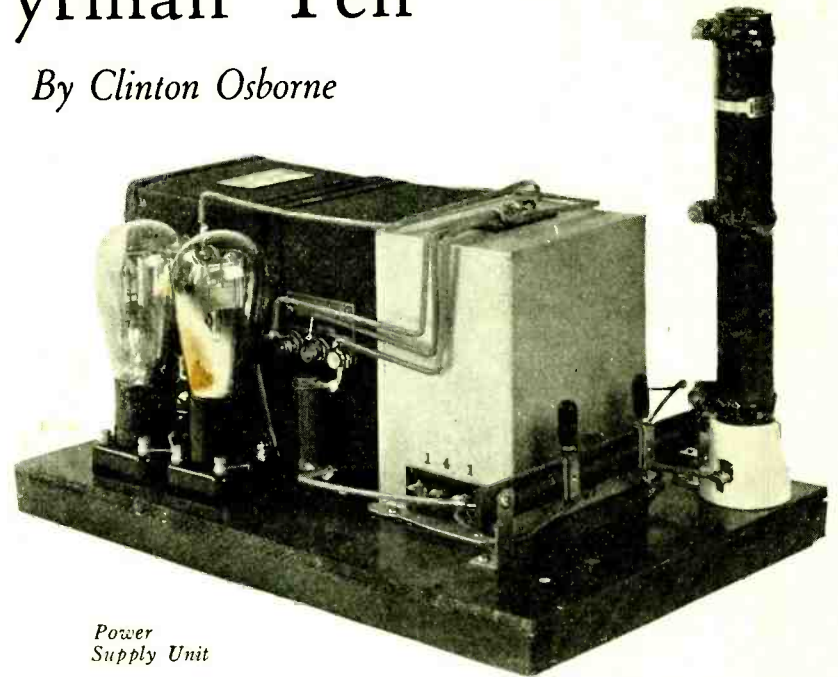

Power Supply Unit

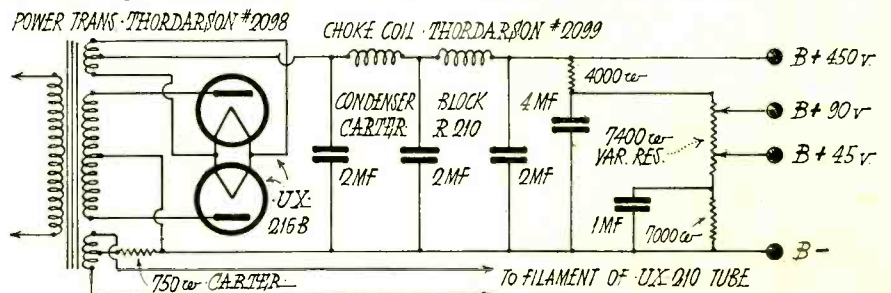

Fig. 1. Circuit Diagram of Power Supply Unit.

volume can be accomplished by inserting a .00025 mfd. condenser in series between the grid of the second detector tube and the grid return of the last intermediate frequency stage. A 3 meg-

ohm grid resistance should also be placed between the grid of the second detector tube and the positive filament, as is done with the first detector. This change is shown together with the modifications in the circuit diagram for the use of 210 tubes in Fig. 2.

(Continued on page 66)

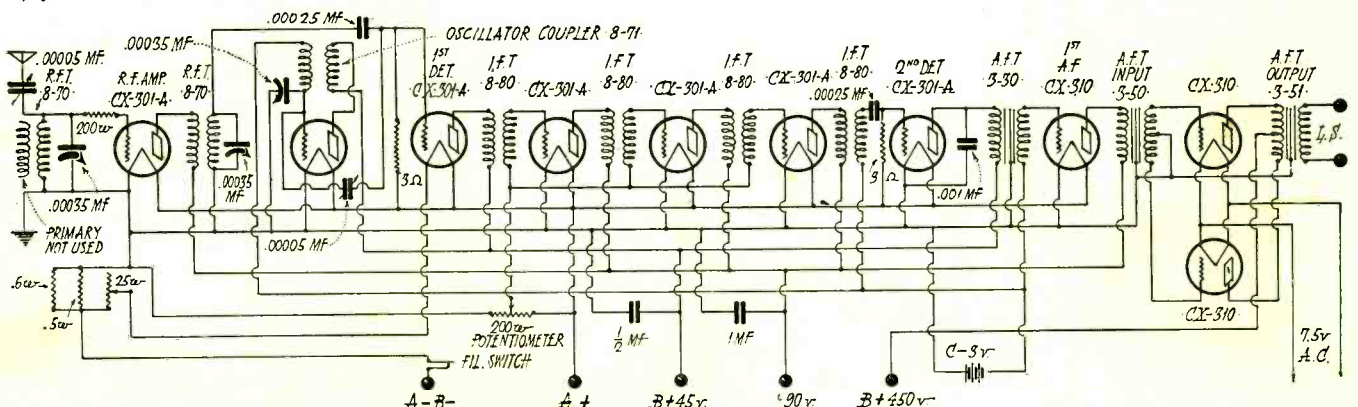

Fig. 2. Circuit Diagram of Tyrman Ten Adapted for Operation With 210 Tubes.

Revamping An Old Infradyne

By E. M. Sargent

THE original 1926 model and the subsequent 1927 model of the Infradyne can be changed to conform to the 1928 model, as described in August RADIO, with but slight trouble and expense. This gives an up-to-date instrument equipped with illuminated drum dials, switch for 5 or 10 tube operation, and a radio frequency amplifier unit especially designed to operate in conjunction with the infradyne amplifier unit.

The r.f. amplifier unit is intended to obviate any trouble from oscillation that may be introduced by a self-constructed "front end" as well as to give maximum amplification and selectivity. It consists

of the grid and filament terminals are brought out from the center.

The antenna compensator includes a three-point switch which varies the number of turns in the antenna primary, and consequently the selectivity. It also includes a miniature variometer which is connected to the grid return from the secondary of the antenna coupler and is used as a final vernier adjustment to bring up a weak signal. When a proper balance has been obtained between the adjustment of the variometer and that of the antenna section balancing condenser the first tuned circuit will stay in line with the others without adjustment.

By means of these various refinements

sary, a new panel, drilled as shown in Fig. 2, is called for.

Two No. 110 drum dials are specified. These dials with their 360 degree rotation, removable logging charts and illumination secured through small pilot lamps mounted directly on their supporting brackets, afford smooth and certain adjustment for both the three gang condenser of the No. 710 Amplifier, and the twin rotor .00035 mfd. condenser, which is retained from the previous models. The dials are so constructed as to provide automatically for the reverse action of the oscillator condenser as compared with the gang condenser in the infradyne.

The 50,000 ohm variable resistance of the 1926 model and the 200,000 ohm variable resistance of the 1926-27 models are done away with. Volume is controlled solely through the 10 ohm rheostat which controls the filaments of the first two tubes of the r.f. amplifier, and through the interstage audio jacks, which are retained as in past models. The inherent stability of the new r.f. unit makes other forms of adjustment unnecessary. The 1 mfd. fixed condenser used as a by-pass for the radio frequency amplifier is no longer needed as a condenser performing the function is built into the 710 amplifier.

The two 30 ohm rheostats, one of which controlled the mixer tube and the other of which controlled the 99 type tubes in the oscillator and infradyne amplifier sockets, are replaced with the 10 ohm rheostat mentioned above and another 10 ohm rheostat, which in conjunction with a fixed resistance of 6

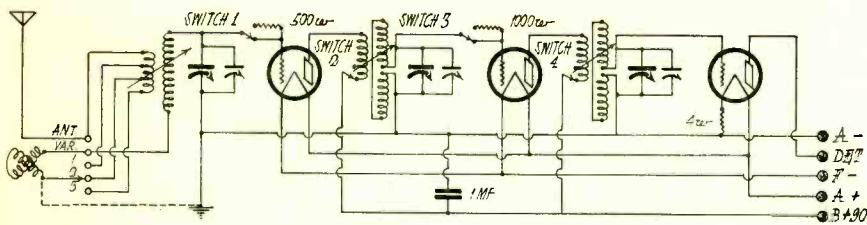

Fig. 1. Circuit Diagram of No. 710 Amplifier.

of a Remler 710 amplifier and antenna compensator. The former consists of a three-in-line condenser equipped with semi-fixed balancing condensers together with three r.f. transformers and sockets, all housed in a shielded cabinet. The primary coils of the transformers are mounted inside of the solenoid secondaries so that the coupling can be varied by means of a common shaft which is driven by a lever and cam from the main condenser shaft. Inter-coil coupling is minimized by winding the second and third secondaries in two halves so that

the amplifier can be adjusted to give maximum selectivity in congested areas or greater sensitivity in remote districts.

The principal substitution and replacement of parts is found first in the removal of the original coils, three-gang condenser and trimmer condensers making up the radio frequency unit, and its replacement with the 710 amplifier. As it is desirable that the original cabinet be retained, the baseboard remains the same, but in order to provide for the drum dial arrangement, which the location of the amplifier unit renders neces-

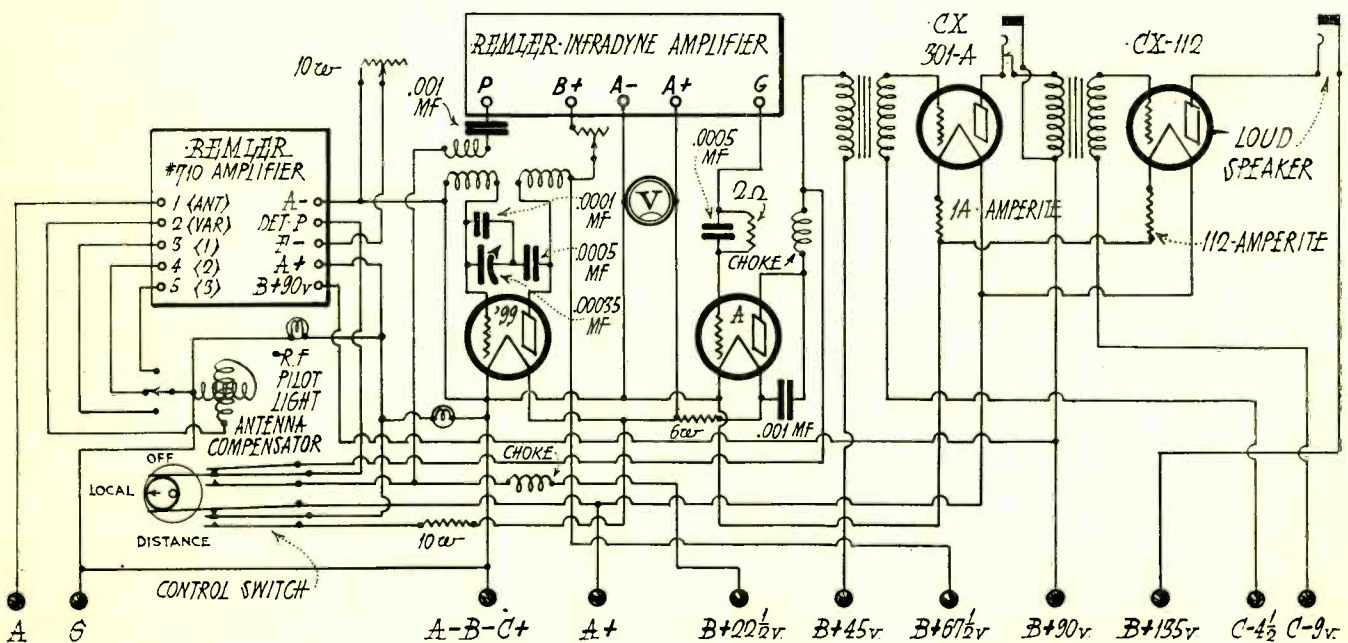

Fig. 4. Infradyne Circuit Diagram.

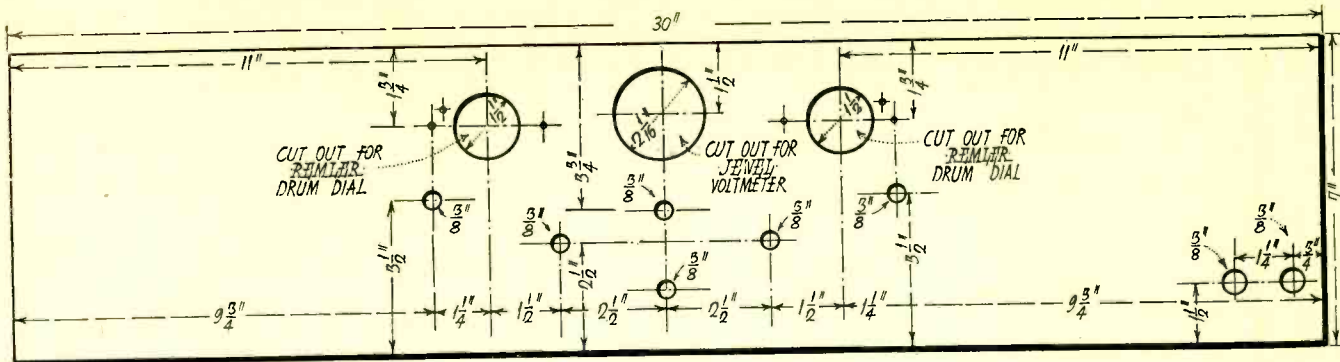

Fig. 2. Panel Drilling Layout.

ohms, gives control of the oscillator and infradyne amplifier tubes, and the second detector tube, as shown in the circuit diagram. The grid condenser and leak used in the mixer tube grid circuit are removed, as bias detection is employed, the mixer tube being biased by a 1 volt drop obtained through a 4 ohm filament resistance which is a part of the r.f. amplifier. As the mixer tube socket is now a part of the r.f. amplifier, the mixer tube socket of the two previous models is dispensed with. The Yaxley No. 10 filament switch is replaced by the Yaxley No. 69 switch, which provides an off position and positions for the five and ten tube operation.

In some cases the more experienced wireman will be able to leave the audio side much as it was before reconstruction of the layout. However, as in most cases it will be necessary to move the first audio transformer toward the right, in order to make room for the remounted oscillator condenser with its drum dial, and to move the first audio jack toward the right also, some wires, depending on the method of arrangement, will have to be cut and resoldered. In some cases it will be advisable to make a clean sweep of the old wiring and rewire. As to the form of wiring used, the constructor may wire as called for in previous models, or may adopt the switch-board or cable harness wiring as is used in the 1928 model infradyne assembly described in August RADIO.

If cable wiring is used filament and negative *B* leads can be included in the cable as can the audio plate leads. All

- NEW PARTS REQUIRED FOR REVAMPED INFRA DYNE**
- 1—Engraved panel, 3/16x7x30
 - 1—Remler No. 710 amplifier and antenna compensator
 - 2—10 ohm Frost rheostats
 - 1—2 to 10 ohm Frost rheostat (used as sensitivity control)
 - 2—Remler No. 110 drum dials
 - 1—Yaxley No. 69 switch
 - 1—Sangamo .0001 mfd. fixed condenser

grid leads and the radio frequency plate leads must be kept free from the cable. The grid leads should be kept as short and direct as possible.

While exact dimensions are necessary in laying out the panel preparatory to drilling, an exact mounting layout for the baseboard is not required, and therefore in the baseboard layout arrangement here given, exact dimensions to scale are not given. Working from this pictorial layout, the constructor will have no difficulty in placing the r.f. amplifier and the audio transformer so as to work in with the arrangement of the other units.

In the remodelled instrument, the original oscillator coupler is retained. This may be either the 14, 14 and 8 turn coupler for which dimensions were given in previous issues of RADIO dealing with the infradyne, or it may be the Silver Marshall No. 110 B coupler wound with enameled wire.

It will be noted that in the circuit diagram presented herewith, a .0001 mfd. condenser is shown shunted around the variable .00035 mfd. twin rotor condenser. In the previous models of the Infradyne, in order to utilize the sum frequency principle involved in the infradyne circuit, the dial of this conden-

ser was so set as to read at 100 with the plates out of mesh, thereby utilizing but one-half the dial surface. The purpose of the .0001 mfd. fixed condenser in shunt around the oscillator condenser is to make it possible to use the entire 360 degree surface of the drum dial instead of but one-half. In order to use the original coil with this arrangement, two turns must be removed from the filament end of the grid coil. The oscillator coupler will then consist of a pick up coil of 8 turns, a grid coil of 12 turns and a plate coil of 14 turns.

Testing the Finished Job

After completion of wiring and setting up of the completed job, the usual methods of testing out connections, tubes and batteries, familiar to the average radio constructor and to those who have already built previous models of the infradyne, should be resorted to. Especial care should be used, in wiring up the Yaxley change-over switch, to see that no soldering flux gets in between the leaves of same, and into the insulation, as leakage across the various connections involved will result in a very marked decrease in the performance of the set. The switch is set on the five tube arrangement first. Properly wired, the three tubes of the 710 r.f. amplifier and the two audio tubes will light. After checking performance on five tubes, the switch is moved to the ten tube position, which will light the oscillator and three infradyne tubes of the 99 type, and the A tube in the second detector socket.

Full directions for adjusting the 710 amplifier are supplied with it.

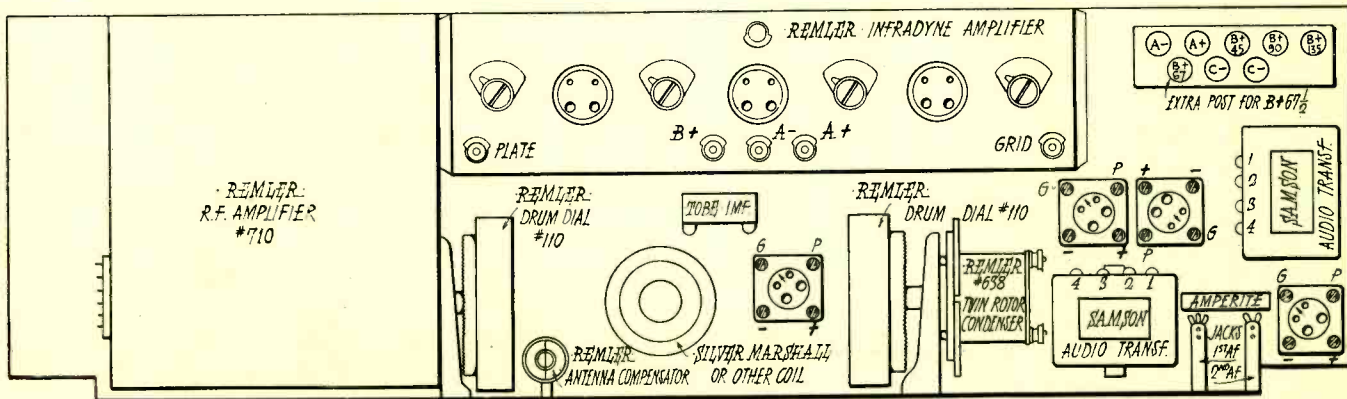

Fig. 3. Baseboard Layout.

Radio Kit Reviews

A Summary of The Salient Features of New Kits which are Sold with Full Directions for Home Assembly

The Two Control Equamatic

THE Equamatic receiver, as originally described in October, 1926 RADIO, has been improved as to simplicity of operation by two-dial instead of three-dial tuning. This has been accomplished without sacrifice of the excellent features of the first model by joining the two radio frequency controls with a link coupling so that they may be tuned as a unit.

The improved receiver retains the King Equamatic system of oscillation control whereby the sensitivity of the set is automatically the same for all frequencies, whether at the upper or lower end of the tuning dial. The primary coil of each r.f. transformer is mounted on the end of the shaft of the variable condenser with which each secondary is tuned. As the condenser is varied, the primary is twisted so as to vary the coupling.

In this way the coupling is increased so as to maintain an equal transfer of energy as the wavelength is increased. Consequently, assuming that the coupling for 545 meters is sufficient to just prevent oscillation at that wavelength, the coupling is automatically reduced so as to likewise prevent oscillation at shorter wavelengths.

These tuned r.f. transformers consist of a 15 turn primary wound on a 2 in. grooved tube and a 60 turn secondary of No. 20 d.c.c. wire wound on a 2½ in. tube. The primary is fastened to the condenser shaft by means of a set screw and its axis can be shifted to give any desired degree of coupling.

As may be noted in the schematic wiring diagram, the first r.f. transformer, with its associated .00037 mfd.

condenser, provides variable coupling between the antenna and the r.f. amplifier. By this means the antenna may be of any length and the coupling varied so as to give the necessary selectivity. The looser the coupling the sharper the signal. This tuning condenser and variable coupler is controlled by the left hand dial.

The two .00037 mfd. variable condensers and associated "variocouplers" in the r.f. amplifiers are controlled with the second dial by means of a connecting link motion which may be seen in the picture of the completed receiver. All of these variable condensers are of the straight line frequency type and are designed to co-ordinate with the variocouplers.

The set has five tubes, comprising two stages of tuned radio frequency amplification, detector, and two stages of transformer-coupled audio frequency amplification. By doubling back the audio amplifier instead of continuing it in line, the panel for this model is made shorter than in last year's model. This

has been made possible by using a shielded audio transformer so as to minimize stray fields. The kit also includes an output filter to keep high voltage direct current out of the loudspeaker.

Any residual tendency toward oscillation in the r.f. amplifiers is minimized by proper choke coils connected as shown in the circuit diagram. Differences in internal capacities of tubes may be neutralized by the small variable condenser between the plate and negative filament of the r.f. tubes.

Volume is controlled by varying the filament current to the r.f. tubes through a 10-ohm rheostat. Detector filament current is controlled through a 20-ohm rheostat and that to the audio tubes by Amperites.

Binding posts are eliminated by means of a multiplug whose leads are marked in code colors. Most of the wiring is concealed under the bakelite baseboard. Most of the essential parts are of Karas make. The total cost of parts is less than \$100, including batteries.

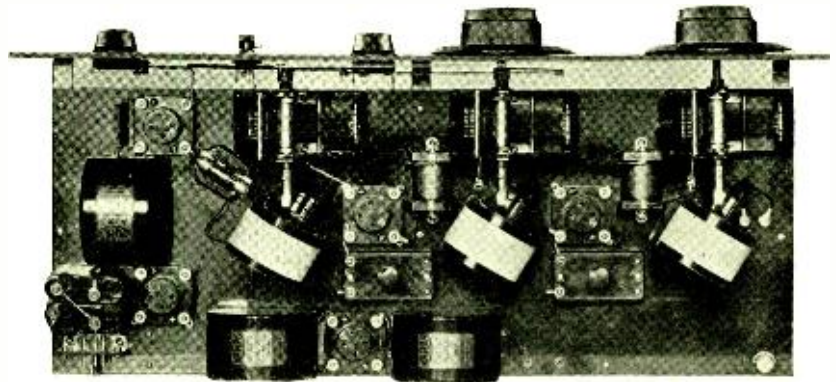

Rear View of Two Control Karas Equamatic.

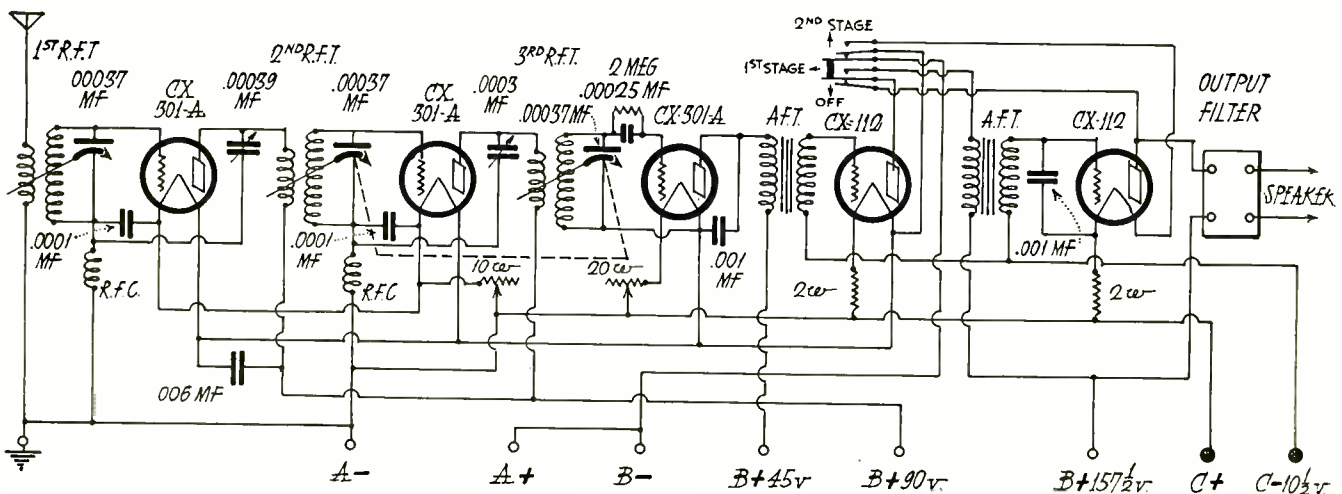

Schematic Circuit Diagram of Karas Equamatic.

THE NINE IN LINE

THE 1928 Nine In Line receiver uses the conventional loop aerial circuit, with a local oscillator and four stages of matched and tuned intermediate frequency amplification (35 k.c.) and a dual detector and two stages of audio frequency amplification. Its outstanding features are in the nature of constructional, rather than electrical developments. The set is supplied in kit form, including blueprint diagrams, full size layout of all parts, and actual wiring diagram.

The set is an admirable arrangement for the novice to lay out, assemble and connect, as it is almost impossible to go wrong in the building when the directions are followed. All parts fit accurately in the places provided for them. The only tools required are a screwdriver, pair of pliers and soldering iron.

Electrically the set is well designed, and operates very efficiently over the entire broadcast wave band. Of the four intermediate frequency transformers provided, two are iron core, and two are air core type, provided with tuning condensers. As the two filter transformers are matched at the factory before they are sealed in their cases, there is no danger of difficulty in attempting to match or tune the transformers. The transformers, as well as the oscillator coil are sealed into a molded bakelite case, which prevents tampering, or alteration.

The audio frequency transformers are also enclosed in molded bakelite cases, and while larger in size, are iden-

tical in type and general appearance with the cases of the other transformers, coils, etc., in the set. Two audio frequency transformers of good characteristics are provided for the audio stages, with an audio frequency output transformer to couple the power tube in the last stage to the speaker. All connection terminals are plainly marked, and are brought out on the bottom of the transformer cases, by screws which project through the sub-panel. This permits all connections to be made on the bottom of the sub-panel and conceals all wiring, and when completed, there is not a wire visible on the top of the sub-panel.

The set uses 301-A tubes in all stages, except the last, or power tube stage, which may be either a 112 or the larger 171 type tube, it being necessary to change the C battery to suit the tube used. A total of nine tubes are used in the set. These are all mounted in a row on the sub-panel, and are controlled by a rheostat mounted on the panel front, and an "off-on" switch, in the A battery lead.

The schematic circuit diagram shows that a mid-tap, regenerative loop is used, which feeds the first tube. This, in turn, supplies the first amplifier tube, which is coupled with the first by an iron core high frequency transformer. An oscillator tube is also provided, which feeds its current to the grid of the first tube, and the frequency of the oscillator is varied at will by the air-condenser mounted on the front panel. The second and third tubes are coupled by air-

core, and iron core high frequency transformers, respectively, and the third tube is then coupled to the detector through another tuned air-core transformer. After detection, the incoming signal is amplified to the desired volume by the audio frequency amplifier tubes. Variation of the volume is accomplished by the variation of the filaments of the tubes, through the series resistance mounted conveniently on the front of the panel.

In building this set, the builder should be careful to see that all parts are assembled and mounted in exactly the order laid down in the builder's design, as the change in order, for example, of one of the intermediate transformers will make a big difference in the operating efficiency. As the transformers are identical in appearance, this error might be very easily made. The set is simple to assemble and wire, but if the maker is not careful, and if he does not exactly follow the instructions, he may not gain the results that he wishes. If the set is built, and arranged exactly as laid out in the design drawings, there can be but little doubt but that the builder will have a very fine set with a minimum of time and energy expended, and without the tedious planning and drilling necessary in many sets provided for the set builder.

The Nine in Line receiver is very sensitive and extremely selective, as well. It will cut through the locals and bring in distant stations nicely. The tone quality is fine and the battery consumption is low. As the set is equipped with the large tubes in all stages, it will also adapt itself very well to operation with the new alternating current filament tubes, with but simple changes in the wiring, and without any changes in the mechanical assembly. The essential parts are made by the Radio Frequency Laboratories.

Improvements over former models include lower resistance secondaries in the i.f. transformers, drum dial controls, new audio transformers, and an output transformer.

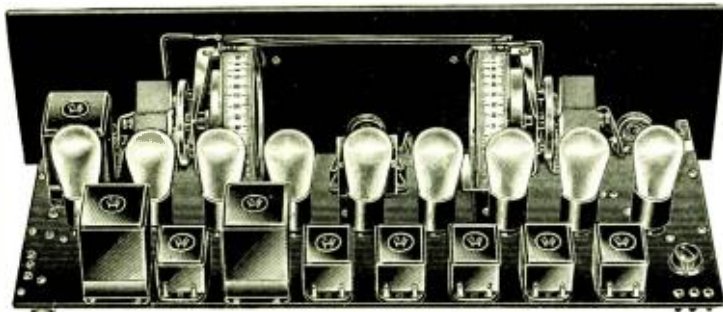

The Completed Nine-In-Line Receiver.

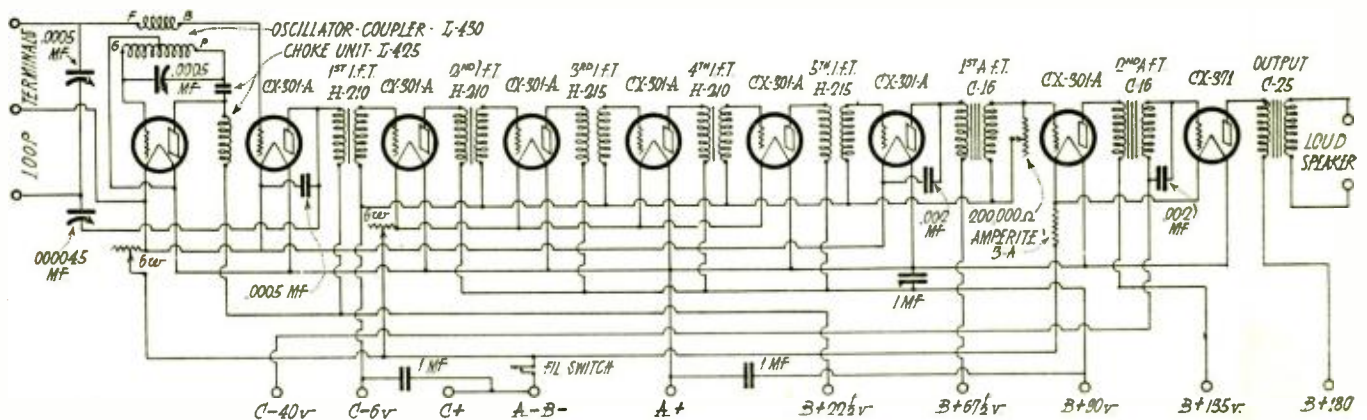

Circuit Diagram of Nine-In-Line Receiver.

HAMMARLUND-ROBERTS "HI-Q SIX"

This receiver has been designed to give distortionless amplification, and consequent fidelity of tone reproduction for distant as well as for local stations. Simplicity of operation is provided by two illuminated drum-dial tuning controls which are centralized in one escutcheon plate. These, with the filament switch and the volume control, are all that appear on the panel.

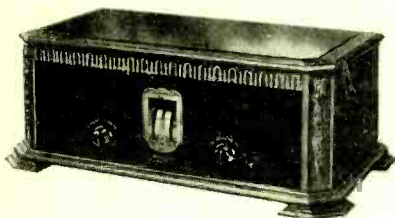

Panel View of Hi Q Six.

Extreme selectivity without distortion from regeneration is secured by four shielded tuned circuits, an antenna tuner and three tuned r.f. transformers. The radio frequency currents are confined to three respective stages by r.f. chokes and bypass condensers.

Uniform amplification for all wavelengths between 200 and 500 meters is secured by variable coupling between the r.f. transformer primary and secondary. Each secondary is moved by means of a cam on the condenser shaft. Any feedback through the internal capacity of the tubes is cancelled by resistance units in the grid circuits of these tubes. Every precaution has been taken to prevent regeneration and to give stability to the circuits. Volume is

controlled by a filament rheostat in the r.f. amplifier circuit.

Two stages of transformer-coupled audio frequency amplification are employed, with provision for a power tube in the last stage.

The material for the assembly of the Hi Q Six is available in the form of a complete kit containing the parts listed herewith. The kit includes a foundation unit consisting of a drilled and engraved panel, steel chassis, aluminum shields and all wire, screws, etc., required to complete the panel. The cost is less than \$100, exclusive of tubes and batteries.

Full directions and diagrams for assembly and operation accompany the kit. These are calculated to make the job of assembling and wiring as easy as possible, especially as regards the pro-

cedure to insure maximum accessibility during construction.

- PARTS LIST FOR "HI-Q SIX"**
- 1—Samson Symphonic transformer
 - 1—Samson type HW-A3 transformer (3-1 ratio)
 - 4—Hammarlund .0005 mfd. Midline condensers
 - 4—Hammarlund "Hi-Q Six" Auto Couple Coils
 - 4—Hammarlund Type RFC-85 radio frequency chokes
 - 1—Hammarlund illuminated drum dial
 - 1—Sangamo .00025 mfd. mica fixed condenser
 - 1—Sangamo .001 mfd. mica fixed condenser
 - 1—Pr. of Sangamo grid leak clips
 - 1—Carter IR-6 "Imp" rheostat, 6 ohms
 - 1—No. 2-A Carter "Imp" battery switch
 - 1—Durham metallized resistor, 2 megohms
 - 3—Acme Parvovolt ½ mfd. series A by-pass condensers
 - 6—Benjamin No. 9040 sockets
 - 3—Ehy engraved binding posts
 - 2—Amperites, No. 1-A
 - 1—Amperite No. 112
 - 1—Yaxley No. 660 cable connector and cable
 - 1—Hammarlund-Roberts "Hi-Q Six" foundation unit

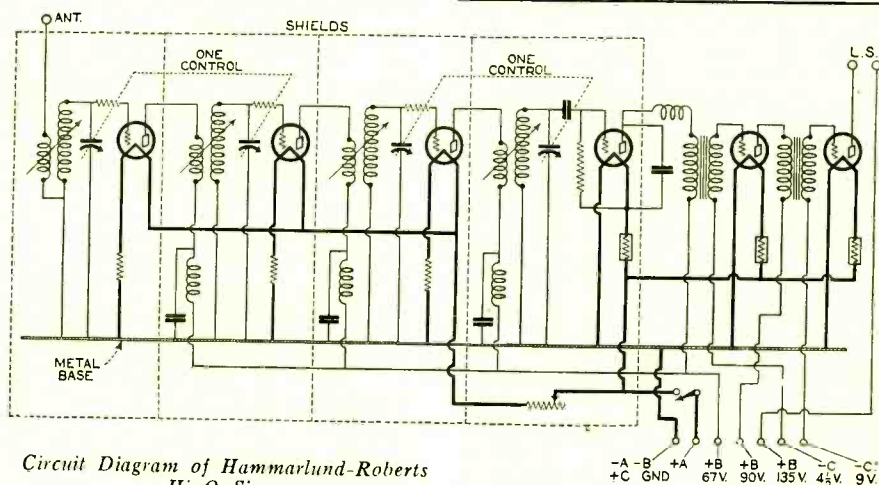

Circuit Diagram of Hammarlund-Roberts
Hi Q Six.

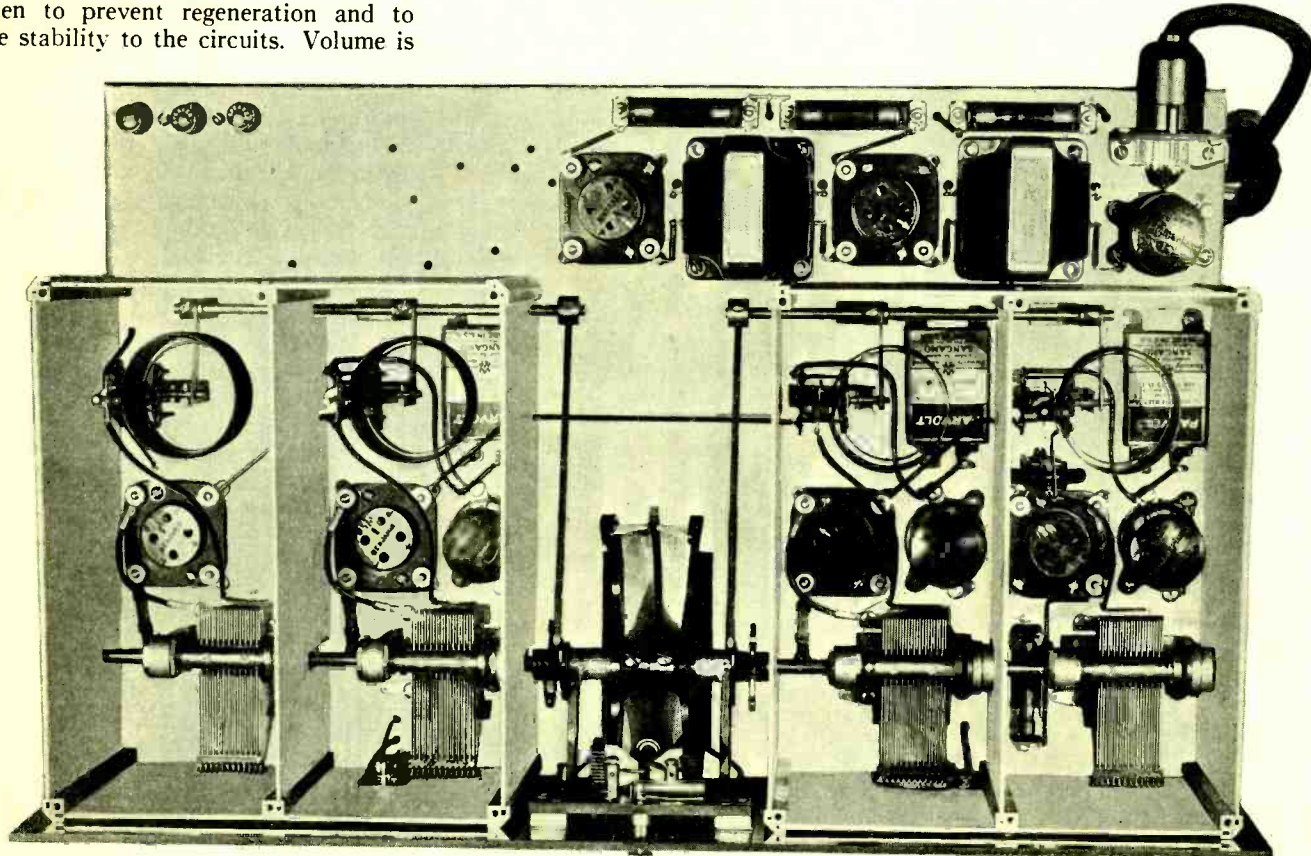

Top View of Hammarlund-Roberts HiQ Six Receiver



QUERIES and REPLIES



Questions of general interest are published in this department. Questions should be brief, typewritten, or in ink, written on one side of the paper, and should state whether the answer is to be published or personally acknowledged. Where personal answer is desired, a fee of 25c per question, including diagrams, should be sent. If questions require special work, or diagrams, particularly those of factory-built receivers, an extra charge will be made, and correspondents will be notified of the amount of this charge before answer is made.

Will the "ABC" eliminator described in July RADIO supply plate current enough for two type 371 power tubes in a push-pull amplifier? What sort of a primary rheostat can I buy, to control the input to the eliminator?—A. B. S., Los Angeles, Calif.

Any of the models shown will give adequate plate current supply for two 371 power tubes in a push-pull amplifier, as well as all of the other tubes in the circuit. The Ward-Leonard Co. have a new 20 ohm power rheostat with 2 ampere current carrying capacity, designed especially for this circuit. The rheostat is placed in the primary of the power transformer, and the eliminator should never be turned on without making sure that at least 4 ohms resistance is cut in the circuit.

Would like to have the circuit of the shielded superheterodyne described in October 1926 RADIO, with any improvements which have been made since that time.—C. H. F., Seattle, Wash.

Since copies of October 1926 RADIO are no longer available, the schematic wiring diagram of this receiver is being reprinted in Fig. 1, with slight modifications to bring the circuit up to date. Some trouble has been had with several sets due to the use of too large r.f. chokes in the oscillator circuit, and as these chokes are not absolutely essential, they have been omitted from the diagram. The filament circuit is arranged for six volt storage battery or A eliminator operation, with a 6 ohm rheostat in series with a 4 ohm fixed resistance for controlling the filaments of the type 99 tubes.

Would like to have a circuit diagram for a Browning-Drake receiver, using the new a.c. tubes in as many sockets as possible. The set now has one type 99 tube, two type A, and a 112 power tube.—R. F. W., Dunmore, Pa.

A diagram showing three of the new type C-327 a.c. tubes, having a heater element for 2½ volt a.c. is shown in Fig. 2. A power transformer having two secondary windings, one for 2½ volts and the other for 5 volts, will be required. The a.c. tubes are connected to the 2½ volt winding as is shown in the diagram, and the power tube has its filament lighted from raw a.c. from the 5 volt winding. A potentiometer, which may be as low as 6 ohms resistance, or higher if the low value is not available, is shunted across the 2½ volt

an output transformer instead of a filter? Could two type 210 tubes be placed in parallel to increase the power output of the circuit?—G. R. D., Los Angeles, Calif.

If the grid leaks are of the heavy duty type, such as are used in the plate circuit of resistance coupled amplifiers, they may be used instead of the 100,000 ohm units. An output transformer may be used instead of a filter, with equally good results. The rectifier will supply suffi-

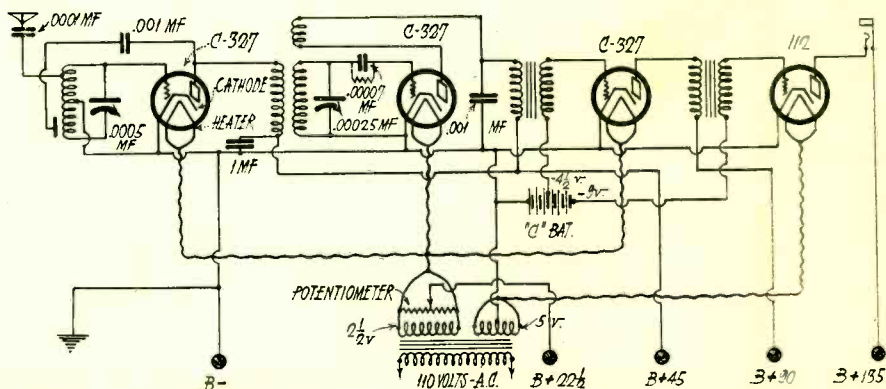

Fig. 2. Browning-Drake Receiver Designed for A. C. Tubes.

winding, and the slider is connected to the 22½ or 45 volt B battery, so as to make the heater coil positive with respect to the cathode of the tube. This potentiometer is very essential when no center tap is provided in the 2½ volt winding.

In the power amplifier circuit described in August RADIO, can the 300,000 ohm resistor in the plate circuit of the high-mu tube be a grid leak, or must it be separate 100,000 ohm units? Can I use

efficient current for another 210 tube, and the output transformer will carry the plate current of two tubes in parallel, so that there is no objection to such a procedure.

Have a set of Silver-Marshall "B" eliminator parts and audio transformers. Want to use two CX-112 tubes as audio amplifiers, and light the filaments from the filament winding of the power trans-
(Continued on page 75)

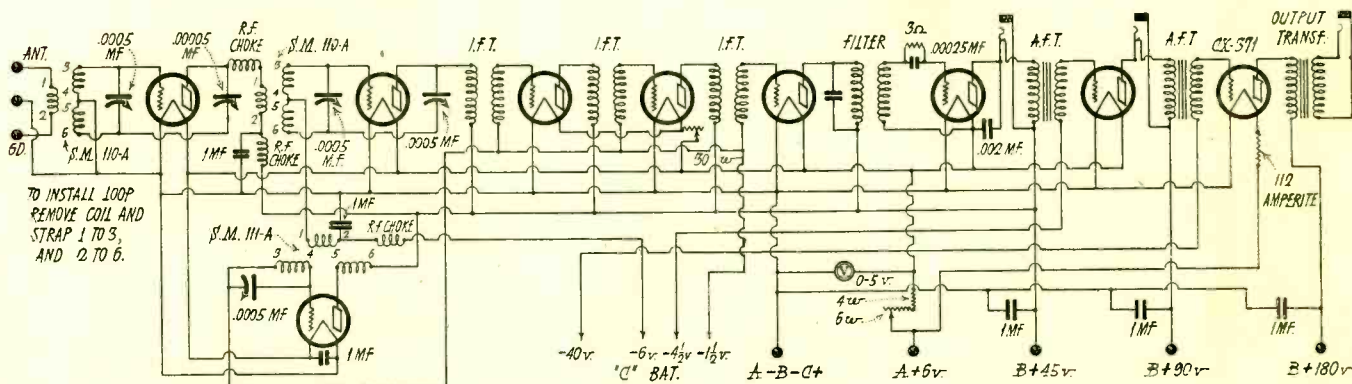

Fig. 1. Diagram of 9 Tube Shielded Superheterodyne.

With the Amateur Operators

PRACTICAL SUGGESTIONS FOR CONSTRUCTION AND OPERATION ON $\frac{3}{4}$ AND 5 METERS

By A. BINNEWEG, JR., NU6BX

The wavelengths below 5 meters are of considerable interest to the experimenter because of the relative simplicity of circuit design and moderate size of radiating systems. Ordinary equipment can be operated at these frequencies with but little modification.

The Hartley circuit oscillates quite easily and the details of a 5 meter arrangement are shown in Fig. 1. It is usually impossible to

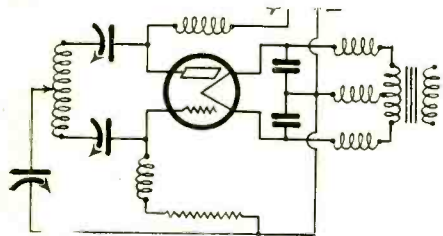

Fig. 1. Hartley 5-Meter Oscillator.

secure steady oscillation when by-pass condensers are used across the filament leads. The only way out is to use a choke in the filament-clip lead or use a variable feed-condenser as shown in the diagram. At 5 meters, this condenser may be an ordinary 3 or 5-plate size, the value being not critical. Results are usually better when the filament clip is employed. The grid and plate-blocking condensers should have about this same capacity but the plate condenser should be double-spaced.

All the r. f. chokes can be made the same size and 15 turns in a 1 in. Lorenz winding will do. Small spacewound chokes are somewhat better. These are wound over celluloid strips spaced around the circumference of a $\frac{1}{4}$ in. rod and can be made of very small wire. Heavier wire is used at the ends to support the winding and furnishes the leads. The coils are removed by twisting the winding. The filament chokes and by-pass con-

densers may be omitted if the distributed capacity is sufficient. It would be best to start with these and omit them if found unnecessary.

With this circuit, one can secure very steady output without the usual difficulties, the arrangement being very flexible. Steady oscillations may be produced even with the W. E. 211-D which is ordinarily very poor for 5 meter work, due to its high internal capacitance and coiled grid and plate leads. There is little advantage in removing the bases of tubes having high internal inductance and capacitance, neither is it necessary at 5 meters, use them the way they are and in the standard sockets. Then properly adjusted, one may couple a wavemeter fairly close without stopping the oscillations. If the condenser dials are slotted, the condensers can be operated by means of an extension handle fitted with a small piece of metal, eliminating the usual permanent extension handles.

To operate, set all three condensers at full-setting. Greater stability is then obtained by decreasing the capacity in the filament-tap feed condenser. The circuit is adjusted for correct wavelength by using the proper inductance and series-condenser settings. The shorter the wavelength, the smaller may be the capacity required in all of them. A little experimentation with different values will steady the oscillations. Although the inductance necessary will depend largely upon the tube employed, 2 or 3 spaced turns of 3 in. diameter 12 or 14 wire will be the average value. The better the d. c. used on the plate, the steadier the oscillations.

The tuned plate and grid circuit works well at 5 meters but small differences in condensers, coils, etc., often throw off the range of one tuned circuit. If the same sort of condensers are used and care is taken to have both circuits the same, adjustment can be made by bending one of the coils slightly. The circuit is shown in Fig. 2.

With a UX-852, a 10,000 ohm leak will allow as much as 4000 volts on the plate, although voltages around 2000 give more stability. The inductances are each 1 turn, 3 in.

in diameter and "three plate" condensers with "triple" space will give a tuning range of about $\frac{1}{2}$ meter at 5 meters. The grid and plate-blocking condensers may be small midgets having a 35 mmfd. maximum. The plate condenser may be spaced or two small pieces of copper foil separated by a piece of mica will serve. Half-scale setting for the grid midget is about right. Adjust the tuning condensers so that the plate current drops to a minimum.

The output from a 5-meter oscillator may be conveniently measured by connecting a small coil and condenser in series with the

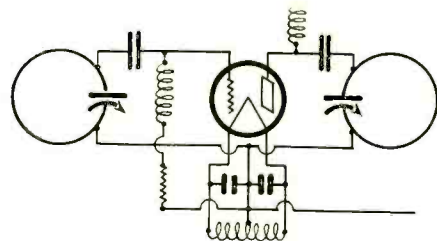

Fig. 2. Tuned Grid and Plate 5-Meter Oscillator.

antenna ammeter. This circuit will also serve as the wavemeter. Since power is given by I^2R and the resistance may be assumed constant, the power output will vary as the square of the current. It is necessary to use a very small capacity so tuning will not be too sharp.

5-meter receivers require more care in construction than the oscillators, as they must work well over a good band. That illustrated is the outcome of several experimental sets. With short r. f. leads, one always arrives at the same arrangement; the tube socket is between the two condensers. The size of inductance is influenced by the size of grid condenser, internal capacitance of the tube, and length of leads. One receiver employed the following constants:

- 50 pfd. grid condenser
- 5 plate Chelton Midget tuning capacity
- 4 in. diameter No. 12 wire inductance
- 99 type tube with "isolantite" socket
- 3 1/2 in. tickler coil, same wire
- 5 megohm grid leak
- 90 volts detector.

The receiver shown in the illustrations employs the following constants:

- 40 pfd. grid condenser
- 5 plate Chelton Midget tuning condenser
- 2 1/2 in. diameter No. 14 wire inductance
- UX-112 with Remler socket
- Same size tickler, No. 18 wire
- 5 megohm grid leak
- 67 1/2 volts on detector.

The throttling condensers in most of the receivers were 45 pfd. Chelton midget condensers are used and they are sufficiently large for the purpose. It is usually difficult to secure proper regeneration at these frequencies with low plate voltages so that the values given should be used at first.

The arrangement of parts and adjustment for proper regeneration must receive special attention. The regeneration-control must be carefully adjusted if one is to avoid the use of extra apparatus in the form of tube resistance controls. Adjust the regeneration-control circuit so that it is not near resonance with the tuning circuit. Near resonance, as with the tuned plate and grid circuit, the wave-change may be as much as that caused by the tuning condenser. The smallest effect on the wavelength was given when using a 99-type tube and operating the regeneration-control near a maximum setting. When covering almost the entire 5-meter band, the throt-

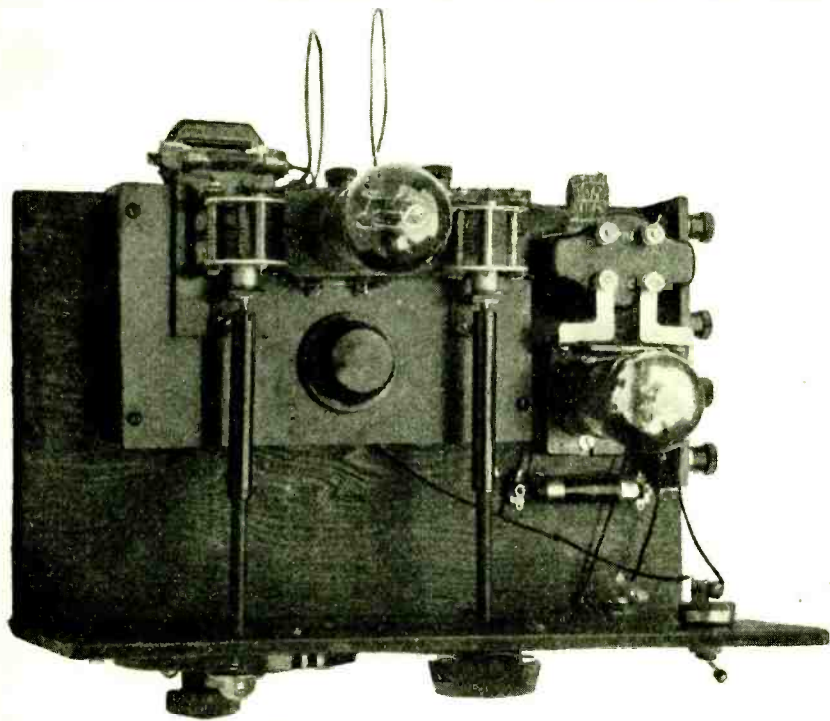

Plan View of 5-Meter Receiver.

ting condenser had only to be moved through 10 dial degrees and the wave-change was negligible.

Small differences in receiving tubes are of considerable consequence at these frequencies so that one has practically to build a receiver around the tube used. Several new 99's were tried in the same receiver and only two would oscillate over the same range. Regeneration is often easier with small chokes in the battery leads. A filament switch should be used which makes operation much simpler. It is a good idea to have the receiver cover a good band, which necessitates a good vernier dial. Body effects are troublesome so that extension handles must be used. To change the tuning range one has only to move the tickler closer, or bend the tuning inductance slightly.

Most capacities are well shielded so that hand capacity effects are not so troublesome from these. It is more important to keep the inductances away from the body. If these are placed at the front of the set, every movement of the body will influence regeneration. In some sets it will be possible to use 2 turns very small in diameter instead of one large turn, and thus limit the field of the inductance. In the receiver shown, there is no trouble experienced from this effect, the coils being at the rear of the set and also as much in the open as possible.

An ordinary antenna is too small at 5 meters so that it is best to use a zeppelin type. In the ordinary shack, the height of the roof is just about correct for convenient fastening of the feeder wires and the antenna is well in the open. No antenna coupling-coil is necessary, just short the ends of the wires as in the lecher wires for calibrating a wavemeter. Small midgets in each wire will allow proper tuning. Often an antenna-ammeter, due to its inductance, throws the antenna out of balance. It is easier to adjust the series condensers for maximum plate current, anyway.

For receiving, an ordinary long, outdoor antenna with a midget cut down to 5 plates as a series condenser is all right. The antenna coupling coil should in this case consist of but a single 2 in. diameter turn. Proper regeneration can only be secured if loose coupling is used.

The zeppelin feed wires are conveniently spaced by means of the ordinary porcelain antenna insulators. A piece of strong cord, secured at the roof, parallels the wires between and loops around each insulator. The other end of the cord is fastened to the floor.

If a vertical transmitting antenna having a full wave on it is used, most of the radiation will be at a high angle and the waves will return to earth better. In a vertical antenna having but one-half wave on it, the radiation is mostly at a low angle. The rays transmitted at a high angle return to earth nearer and it is possible that only through the use of a high-angle radiating antennas that the waves will return to earth with good intensity at respectable distances. The zeppelin antenna with feeder wires of $\frac{1}{4}$ or $\frac{3}{4}$ wave is probably the most convenient antenna for these waves. Feeder wires, $\frac{3}{4}$ wave long, are best as they allow the radiating part to be well in the clear. The exact dimensions of the antenna will be less than the theoretical lengths (as shown in Fig. 3) depending upon the proximity of grounded objects.

At wavelengths in the vicinity of 5 meters, parabolic reflectors become small enough to handle conveniently so that these will be used to quite an extent by experimenters. The distance from the vertex to the focus must be one-fourth wavelength for practical operation and so that the wave traveling along the axis toward the vertex will be reflected and return to the focus so as to reinforce the radiated wave; the antenna, of course, being at the focus of the parabolic cylinder. The properties of the parabola are such that any ray coming into contact with the parabolic surface tends to become reflected in the direction of transmission parallel to the axis of the parabola. The wires comprising the parabolic cylinder must each be tuned to the operating frequency and are each made $\frac{1}{2}$ wavelength; due to the proximity of nearby wires and the capacity to ground, each must be made somewhat shorter. Each wire being resonant at the transmitter frequency, is thus excited and also radiates. The waves in direction of transmission will all be in phase since the distance from the focus to any part of the parabolic surface and to a line at right angles to the axis is the same, no matter which part of the parabola is considered. The waves radiated behind the reflector will interfere, there being different relations. Perfect interference behind the reflector will not occur so that there is always some leakage. Good results are obtained if the reflector wires are spaced half wavelength apart in the parabola and each wire should be carefully tuned to cut down leakage and give good reflection. Tuning can be accomplished by cutting the wires or tuning the oscillator for the best operating wavelength. The antenna cannot be operated at the second harmonic when using a reflector, since the outgoing waves will be out of phase and very poor directional results will be obtained.

One can measure the wave of the transmitter with the aid of the receiver by employing a small d. c. milliammeter in the detector plate circuit. With the transmitter in operation, the detector current will be at a minimum when tuned to the transmitter wave. The wavemeter can then be a simple tuned circuit for use with the receiver. The "field" of the transmitter in the immediate vicinity seems to be somewhat more powerful than at longer waves.

The amateur band at $\frac{3}{4}$ meters should be of considerable interest to experimenters because of the relatively small equipment necessary. Ordinary receiving tubes will operate in this vicinity. With a 5 meter receiver and wavemeter one can work the oscillator lower and lower; at a wavelength of $\frac{1}{2}$ meter there will be harmonics on the 5-meter receiver $\frac{1}{2}$ wavelength apart and the wavelength can also be checked with lecher wires. For $\frac{3}{4}$ meters, the wavemeter should be a small midget cut down to about 10 picofarads; the coil will consist of 1 in. or so of wire. The transmitting antenna should consist of a length of telescoped tubing having an overall length of somewhat less than $\frac{1}{2}$ wavelength. Resonance is secured by sliding one piece of tubing inside the other, changing the length of the antenna. The oscillating circuit consists of the tube capacity, the leads, and a small external air condenser shunted across plate and grid. To reduce the wavelength of the oscillator, shorten

the plate and grid leads; since the two condensers are in series, beyond a certain capacity the external condenser has relatively little effect on the frequency so that the leads must be shortened to lower the wave.

The antenna, as used separately or in a reflector, is easily coupled to the oscillator with a r. f. transmission line or connecting a length of the telescoped tubing directly to the plate of the tube. The antenna can be tuned with an insulated handle while the oscillator is in operation by noting maximum plate current. The r. f. chokes at $\frac{3}{4}$ meters require but 6 or 8 spaced turns about $\frac{1}{2}$ in. in diameter. The effect of the body in the vicinity of a $\frac{3}{4}$ -meter set often seems to be less than at somewhat higher wavelengths, possibly due to the increased effect of other surrounding objects.

Near the lower limit of oscillation of which the tube is capable, and when using a small variable external shunt condenser, there will be ordinarily one definite setting at which oscillation will be best for a given length of plate and grid leads. It is important to maintain filament and plate voltages constant. Best results seem to be obtained with tubes employing tungsten filaments.

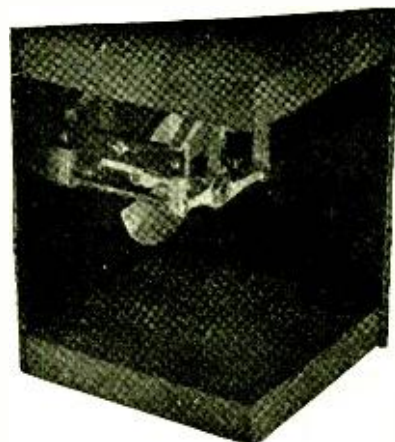

1 Meter Wavemeter.

The wavemeter shown in the illustration tunes from 1.3 to 2.6 meters and consists of a three-plate condenser, triple-spaced, with about 2 in. of wire serving as an inductance. The protruding sides of the case protect the coil and when coupling it to the oscillator the coupling is varied by rotating the wavemeter-case on its corners. The condenser capacity should be small, allowing more inductance which allows the coils to be more easily coupled to the oscillator.

CALLS HEARD

Amateurs worked from SS-2BN on voyage from Montreal to New Zealand and return, period between June 3 to Sept. 13, 1927, on 40 m. band. Cards will be QS L'd from nc2BN, who was operator at time.

NU. lavj, latv, lazd, 1bhs, 1bjk, 1cjc, 1dl, 1mv, 1vc, 1xv, 2aeh, 2aes, 2ag, 2amj, 2and, 2asf, 2bo, 2bs, 2cty, 2czr, 2fg, 2gx, 2ty, 3afu, 3aih, 3bms, 3chg, 3ekj, 3gi, 3hw, 3sh, 3tf, 4ac, 4af, 4gp, 4hl, 4hx, 4js, 4km, 4kz, 4pi, 4ut, 4mw (?), 5ae, 5aj, 5ao, 5av, 5atf, 5ce, 5fs, 5fs, 5hz, 5ie, 5kg, 5ok, 5qj, 5qq, 5uk, 5vx, 5wz, 6aaf, 6aak, 6adk, 6agr, 6ahn, 6aiv, 6aiw, 6ala, 6alz, 6amn, 6ato, 6aqx, 6awy, 6bam, 6bap, 6bax, 6bdn, 6bgb, 6bgo, 6bhv, 6bik, 6bis, 6bjd, 6bjv, 6blw, 6bmw, 6bob, 6bq, 6bts, 6bvh, 6bvm, 6bwk, 6bws, 6bxc, 6bxd, 6bxi, 6byz, 6bxc, 6bxd, 6bxi, 6byz, 6bzc, 6cae, 6abz, 6cdy, 6cej, 6chl, 6chs, 6enx, 6eqh, 6eqm, 6csj, 6csw, 6eua, 6eur, 6ezk, 6ezu, 6dbb, 6dca, 6dfr, 6dh, 6dhr, 6dht, 6dhw, 6dkd, 6dkj, 6dlj, 6dqh, 6etw, 6fh, 6jn, 6js, 6ju, 6kn, 6ks, 6pv, 6rn, 6ta, 6vc, 7abh, 7add, 7adr, 7alk, 7bb, 7fn, 7jv, 7mf, 7mh, 7ok, 7pv, 7tl, 7ti, 7vq, 8ajn, 8akv, 8aly, 8auc, 8auq, 8bbw, 8bja, 8bki, 8brf, 8bsu, 8ben, 8bip, 8bh, 8bxi, 8ced, 8cgv, 8cpq, 8ced, 8erp, 8cwf, 8dbm.

(Continued on page 67)

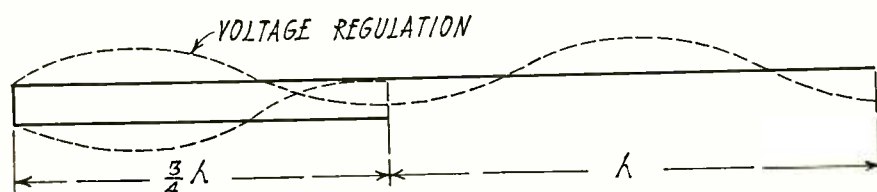

Fig. 3. Zeppelin Antenna for 5 Meters.

AN INTERESTING SHORT-WAVE RECEIVER

By FRANCIS CHURCHILL

This short-wave receiver was designed for getting a better DX on the amateur bands from 40 meter up to 200 meters. However, due to the peculiar r. f. amplifier it also seems to work fine on 20 meters, on which band I've been using it mostly. It only has two coils so it is a simple matter to swap coils for another band.

In Fig. 1 the upper tube is the r. f. amplifier with the coil L_1 and condenser C_1 across the grid and filament. The antenna is coupled to the grid through the midget variable condenser C_8 . From the plate circuit of this r. f. amplifier, the energy is fed through another midget variable condenser C_4 to the grid of the detector tube. Condenser C_2 and the inductance L_2 tune the grid circuit of the detector to the desired wavelength so that it appears to be a simple capacity coupled r. f. amplifier and detector. This eliminates a plate coil for coupling the r. f. tube to the detector and also allows easy control of oscillation by setting C_4 correctly.

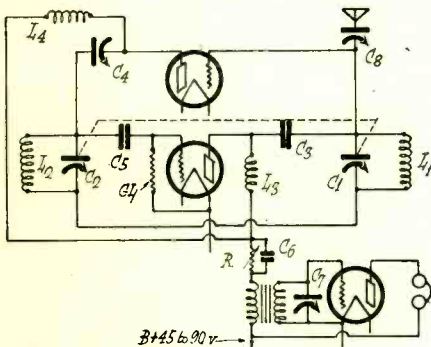

Fig. 1. Circuit Diagram of Short-Wave Receiver.

- L_1, L_2 —Plug-in tuning inductances.
- L_3, L_4 —Samson No. 85 r. f. chokes.
- C_1, C_2 —.0001 mfd. variables coupled together.
- C_3, C_4, C_5 —35 mmf. midget variables.
- C_6 —.0001 mfd. max. X-L variodenser.
- C_7 —1. mfd.
- C_8 —.0005 mfd. max. X-L variodenser.
- R —0-50,000 ohm Centralab.
- Grid Leak—8 to 10 megohms.

In order to get away from a tickler coil in the detector plate circuit, with its attendant difficult construction of a decent plug-in coil system, it was decided to feed back energy through a third midget condenser C_3 to the tuned circuit L_1C_1 . Then if C_4 is fairly large and C_3 small, the r. f. amplifier will oscillate hard and the detector will not, in the usual sense, which would be undesirable. However if C_4 is small and C_3 is large in comparison to C_4 , and regular tuned grid-tuned plate circuit results in the detector circuit as is brought out clearly in Fig. 1. The wiring diagram was drawn in that fashion because it is in that way that the circuit should operate for best results. By having the detector oscillate, the usual sensitivity results, and while the r. f. amplifier may oscillate weakly in one sense, still it gives some good r. f. amplification even on the short waves.

The circuit is certainly a good oscillator and will never fail to function on 20 meters as do so many short-wave sets. By having the antenna coupling C_8 fairly large, the tendency for the r. f. tube to oscillate is further reduced. Type 199 tubes were used throughout due to their low grid to plate capacity. Airgap sockets, especially for the r. f. tube, are recommended.

L_3 and L_4 in Fig. 1 are Samson r. f. chokes which work quite nicely down even below 20 meters. Other chokes were tried but failed to function over the whole short-wave range of the receiver and a good choke is necessary here because it is shunted across the plate to

filament, through the B battery. A couple of Hammarlund short-wave condensers C_1 and C_2 were used because they could be coupled together readily on one shaft which reduces the tuning controls to one dial, which should be a good vernier dial. The regeneration control is a heavy duty Centralab variable resistance of 0-50,000 ohms in the plate circuit of the r. f. and detector tubes. This variable resistance should be shunted by 1 mfd. by-pass condenser in order to by-pass the audio frequency in the detector plate circuit and also to reduce any tendency for noise due to that varying resistance.

The audio frequency component in plate circuit of the detector goes through the primary of the audio transformer and is amplified by one step of audio frequency amplification. It will be noticed in Fig. 1 that the secondary of this audio transformer is shunted by a X-L Variodenser of .0005 mfd. maximum which tunes the audio transformer to some particular frequency. The condenser should be made semi-variable in order to adjust the peak to whatever frequency is most pleasing to the ear. By having an audio amplifier which amplifies one particular audio frequency more than the others, the receiver as a whole tunes sharper and there is less trouble from local interference and power noises. Some audio transformers will not resonate at a desirable audio frequency by this method.

A semi-variable grid condenser was also used in order to get the most desirable value, which seems to be about 50 mmf. for the 40 and 20 meter bands. A slightly larger value is somewhat desirable for the 80 and especially for the 200 meter bands. A grid leak value of 8 to 10 megohms seems to work best for weak signals.

The two coils are mounted at right angles and are several inches apart so as to avoid electromagnetic coupling as much as possible. These coils are plugged into a pair of Push binding posts mounted on a strip of hard rubber $\frac{1}{2} \times 3 \times \frac{1}{4}$ in. These strips are screwed down to the baseboard, clearing the latter by about $\frac{1}{4}$ in. For the 20 meter band 4 turns are used in each of the two coils, these covering the range from about 18 meters up to 30 meters. For 30 meters up to about 50 or 55 meters, two coils of 7 turns each are plugged in. For the 80 meter band 15 turns are used in each coil, all of these coils being cut from Hammarlund short-wave coil forms. These coil forms are space wound with No. 16 DSC wire, I believe, so that there are 10 turns per inch. Home-made space wound or basket-weave coils could be substituted for these coils if such were desirable.

Some ringing noise is present when type 199 tubes are used and the set or tubes are suddenly jarred. This can be cured, if a person especially objects to this ringing sound, by mounting the sockets on sponge rubber cushions and using flexible leads to the sockets.

No dimensions were given as nearly every amateur uses his own parts and practically redesigns a set when building it. The baseboard in this case was $12 \times 14 \times \frac{1}{2}$ in. in size and was made of dry spruce. The panel was a hard rubber affair 7×14 in. and fastened to the baseboard with a couple of brass angles. The variable condensers were fastened down to the baseboard and not to the panel.

This set is excellent for short-wave broadcast stations since a good r. f. amplifier and regenerative detector are used. For this type of reception a peaked audio transformer should not be used but a good two or three stage amplifier with a cone speaker is advisable.

A CHRISTMAS RADIOGRAM

I'm listening, Laddie—listening
Thro' the weary miles between
Your northland and my southland,
Where the Christmas Day is green,
And, the love-song of your spark-gap,
In the old code, reaches me
Thro' the thin receivers, throbbing
To your calling oil-break key.

For, as the tuned condenser
Quickens, to its keynote true,
While you send, my pulses quicken
And my heart is tuned to you!

Across its wireless roadway
To my answering aerial's reach,
The trackless wave train brings me
All the wonder of your speech;

And, the hot wire meter's finger
Marks the giant voltage strength
Of the current crying to me
Thro' the audion's wire-grid length.

I'm answering, Laddie—answering
"Merry Christmas," in the code—
All the love that's in me flaming
Thro' the flaring electrode!

But, as the charged clouds flutter
With the static's low recoil,
When my fingers seek to find you
On the restless tuning-coil,

My heart has ever fluttered
At the mem'ry of your face,
When my arms would reach to draw you
From the loneliness of space!

—KATHERINE D. M. SIMONS, JR.

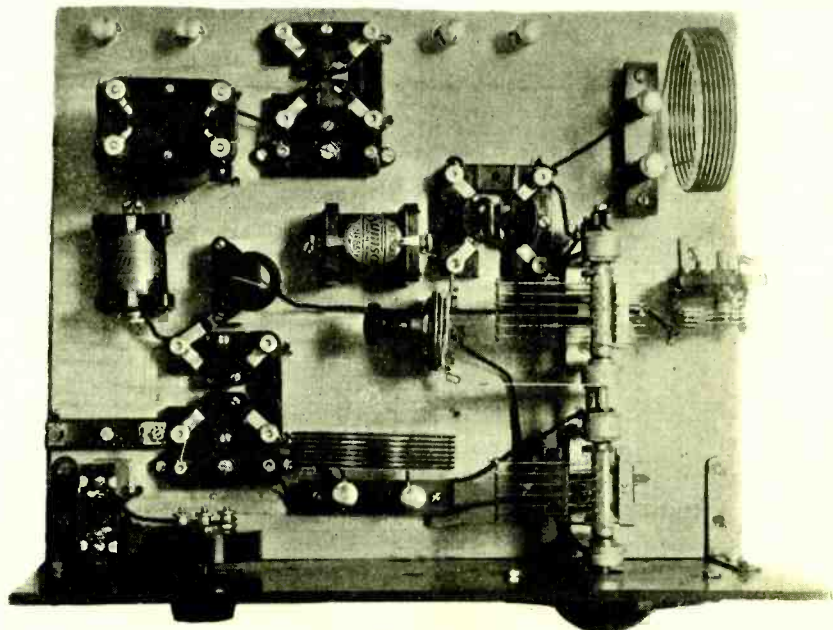

Short-Wave Receiver.

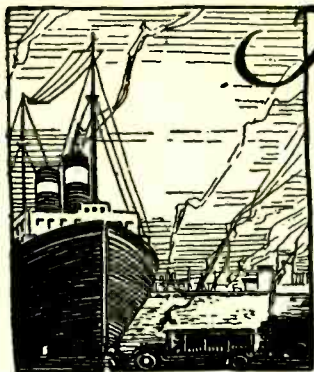

The COMMERCIAL BRASSPOUNDER

A Department
for the Operator
at Sea and Ashore



Edited by P. S. LUCAS

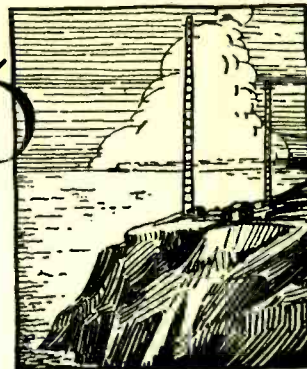

* * * * *

THE HONOR ROLL

KOK	c
KSE	c
KOZC	b
SDT	b
WFK	c
WMW	c

Upon going through our files, hoping to find an idea for this editorial, we checked up and found that the above six stations were the only ones of which a description had appeared in this department. And it will be noticed that four of the above six appeared in the first four issues. We remembered that when we started up, twenty months ago, we intended to run a station write-up every month. That type of article was pretty well received, according to our mail, and we hoped to continue with it, but have been unable to stir you fellows up to the point of sending in the dope.

We have had several letters asking for write-ups on various stations, among them being WCC, WSA, WSC, WNU and KPH. These stations are undoubtedly full of interesting and useful information. How many operators are there who have never "seen the works" of any of these big land stations? Plenty. The smaller coast stations and ship stations also have their interesting features. Location, construction, installation, operation, history—no two stations in the world are alike in all of these points. When there is a point of difference it is a point of interest and many a fine story has been written around one lone point of interest. Why, a Ford spark coil and a Leyden jar shooting in TRs from an oil barge offers an opportunity for a story. It is different.

The trouble with most of us is that we don't recognize story material unless we see a big display of expensive apparatus. We get so accustomed to what befalls our paths that we overlook the fact that the great majority of the readers of this department have never had and never will have the opportunity of seeing what is commonplace in our own lives. For example, we hear vague rumors that some of the river boats on the Mississippi carry wireless. Check? 'Twould make a wonderful story, with a description of the apparatus, a picture of the boat or the cook, description of the service rendered, difficulties encountered and life aboard. Articles of the various Alaska stations would be interesting. And as for foreign stations—the shock would be too great!

Now please don't stall off with that old plea: "My mother didn't raise me to be a writer." All the talent you need is a good sized dose of curiosity. Walk in and ask the operator a lot of questions. When was the station built? What's its best DX record? Does the Aurora Borealis affect the position of

the catwhisker? Jot 'em down as a list of facts, if you wish, and we'll try to cook up the story. But if you do that be sure you get all the facts, because they would be all we should have to go on. Get a picture if possible; and remember that one little point of difference will be the making of the story.

After urging you to do this for us we invite you to write in and ask for stories you may be interested in. We'll run the requests and hope that some one of the gang who knows will shoot us the dope. TU.

Well, here's a sample of co-operation to be proud of. This letter, in answer to Mickey Doran's, shows a spirit which would, if universal, eliminate all our QRM troubles. We are proud to print this letter, and we thank Mickey for taking the trouble to write. It is also interesting to note that the Commercial Brasspounder is read in Apia. That's good DX.

Radio Apia,

Apia, Samoa, April 28, 1927.

Mr. L. O. Doran,
S. S. Stockton.

Dear Sir:

Your plea duly received. Am sorry to hear we make such a disturbance up your way. We have practically gone off the air at nights now except for 20-40 meter work, but unfortunately at the time you complain of qrm we have to broadcast weathers for the Southern Pacific, the arrangements for which are on an elaborate scale. It is really an advantage for ships within 2000 miles to have us making such a noise, as these weathers are probably very useful to them. The system is that we collect weathers from Suva, Nukualofa, Rarotonga, Tahiti, Niue, Awanui, N. Z., Norfolk Island, Vila and broadcast them at 0830 GMT on 2000 meters. Suva listens and copies them and immediately we finish them he rebroadcasts them on 600. You will understand that this has taken a lot of arranging and it would be difficult to alter it, in fact the observatory and navy will not hear of it. It has been usual for us to work VSB, VPD at 0810 but since receipt of your letter I have asked them to take our 40 meter wave to eliminate what qrm I can. The qrm should therefore only be for 3 or 4 minutes while we send the whrs.

Remember seeing your name to articles in "Radio" and which were interesting. Say you can get some first class press on 52 meters from VIS (Sydney) at 1000 GMT and 1230 GMT. Sorry I cannot oblige further at present, 73.

Yours faithfully,
E. E. DUNWOODIE, Supt.

NOTES FROM THE MAILBOX

E. S. Denham writes to correct an error we made a few months ago. It was reported that the Standard Fruit Company's ships, being operated under the Honduran flag, do not require their operators to have licenses. This, Mr. Denham states, is a mistake, as he operated VK for awhile, and knows that it is necessary to be licensed. VK, by the way, is the *Morason* instead of the *Amazon*.

SHAVE AND A HAIRCUT—PLUS

By Will Breniman

For the past two weeks we had steamed steadily southward. Over a week past we had very gladly discarded our woolen shirts and now were on the verge of wearing none at all—so warm had the weather become. We were nearing the torrid zone and the equator, known to us seagoing men as the home of "Father Neptune," who with his wife and loyal band of adherents, exercises complete, unrestricted, despotic control over his realm. He guards it from intrusion by "rubber boots," or more commonly speaking "green sailors," and with the aid of his trusty assistants he formally initiates those who visit, for the first time, the countries of the Southern Cross and the Albatross, into "The Ancient and Royal Order of the Deep."

One would think that the old boy would grow weary of his job, yet it seems that he has the same vigor and perpetual energy as St. Nicholas, who visits the many millions of homes at Yuletide, for he is ever on the alert



Father Neptune and His Assistants.

for any ship that may steam, sail or drift into his domains. Occasionally a passenger ship slips by while "Father Neptune" is busy elsewhere, but a slow moving cargo vessel—crossing the line on Sunday, with an idle crew aboard—never! And thus it was that our "wagon," as we are wont to call our home afloat, entered bravely (?) into his imperial sovereignty.

A strange premonitory unrest gripped those members of our crew who had never faced his royal dignity before. Other members were busy forward at unusual Sunday tasks, working in secrecy. Lunch time came and went. Nothing happened. The tense feeling somewhat abated. At four bells on the afternoon watch, the second mate sent the lookout aft to read the log, then left the flying bridge momentarily to read the log, the glass, the thermometer and wet bulb. Regaining the bridge he was highly surprised to see six strange, uncanny figures clambering down from the bow and ioc's'l deck of the ship to the foredeck. So he called the skipper, or the Old Man, as we are wont to call the captain, and hastened back to sound the general alarm.

As the strange aggregation came down the deck they were challenged by the skipper.

"Sir, I am Father Neptune, the imperial ruler of these domains," answered the leader of the queer band, who wore a crown of gold with the insignia of a cross and anchor thereon. "Allow me to present my wife and my four able lieutenants." And holding out his hand to a comely lady whose dress, while evidently not a direct importation from Paris was very becoming designed from odds and ends of marlin and rope yarn, such as would become the wife of the mighty ruler of the deep.

After introducing the solemn faced parson or sea minister, the doctor, with his bag of pills, the barber with his long razor and the policeman with his gold star and long queer cloak, he again addressed the Old Man:

"I have been informed that there are among you members of your crew who are eligible for the initiation into our fraternal order, known as 'The Ancient and Royal Order of the Deep.' I respectfully ask you, as master of this vessel, for your consent for a few brief minutes to seek these members out and to take them bodily before my court and put them through the rites according to the ancient traditions and customs."

Permission was granted, for we dared not offend the mysterious company. That they meant business was evidenced in short order when we heard one of the members of the crew uttering shrieks of terror as the dutiful policeman brought him blindfolded from aft and stood him before the tribunal. Onto the swaying plank over a specially prepared tank of water he was led to the stand. Father Neptune in his heavy deep bass voice asked him if he wished to join the order, and motioned to the minister, who read from his sea bible the duties and penalties of the order. (We dare not repeat them here under fear of dire results).

While the minister slowly read passage after passage of the sea scriptures in his low, solemn voice, the barber, who appeared to be rather an imp of a fellow, mixed up a solution of shaving compound, which appeared to the uninitiated as a combination of oil and tar, and proceeded to apply it generously upon the entire upper portion of the applicant's body, paying particular attention to the arm pits, neck and ears. With a good lather rubbed in well, he took his razor and proceeded to scrape the neck and ears, but evidently the razor was not very sharp and being of queer construction it jabbed the applicant and caused him to mutter and gurgle incoherently. The doctor gave him five aromatic Cochou pills which without a doubt would cure all past ills and probably many in the future.

About this time the barber seemed to grow a little tired of working on his customer, so with a twinkle in his eye, he gave him a gentle shove which sent him backwards on his downward journey into the tank. Splash! A mad scramble followed to relieve his eyes of the blindfold and then to get up and out of the tank. He was congratulated and declared to be a member in good standing and ordered out of the way for the next aspirant.

In less time than it takes to tell, seven members of the crew were rounded up by the policeman. The latter seemed to have a peculiar sense of direction when it came to finding those who sought to hide in the bilges and other out of the way places in order to escape the ordeal of the trial and initiation.

To each new member a document was presented, showing to all concerned, where and when, he had been accepted into the order.

Suddenly, when they had all finished, there was a cry from aft. We all turned to look and when we turned back—Father Neptune and his entire band were gone. We ran quickly to the ship's sides and looked over but all was quiet, only the swish of the water against the hull as we sped onward into the Southern hemisphere.

MARINE RADIO NOTES

By L. O. DORAN

(Continued from November RADIO)

Japanese Radio-Telegraphic Code

A knowledge of the Japanese language is necessary to a complete understanding of this code. Some of the names used in position reports, greetings, etc., are easy to learn.

In transmitting the code, most Japanese operators have a definite "swing" or "fist" and make the characters as if they were composed of Continental Code letters somewhat run together. Some letters are "spaced"; for instance EI, which is transmitted like R in the American Morse landline code.

The Japanese operators use very little spacing between words.

The word ASHI (sent as XK or DQ in Continental) is used as a sort of break in all messages just before the text. In the code weather messages it comes just before the figure code.

Here's how some of the words sound in Continental Code letters. The double letters are run together.

Yokohama.....M OT B X (abbreviated B X)
 Kobe.....OT U EI
 Osaka.....AS KA L
 Hong Kong.....D AR OT AR
 Manila.....X C S
 Q R F.....M G
 Q R D.....XT KI
 Here (hr).....OT F S
 Thanks.....MW G LI UI U
 Good Morning.....AS B M

* * *

Japanese Code

Accuracy not guaranteed

In the left hand column are shown the Continental Code character or the characters run together to form the Japanese character. The right hand column shows the approximate spelling of the character in Japanese.

Some groups are shown in two places; for instance . . . — may be made as UA or as IK.

* * *

Radio Compass Stations Orient

HONG KONG
 Cape D'Aguilar, VPS. Receiver—22-12-37 N.
 114-15-30 E.

Transmitter—22-13-00 N. 114-16-00 E.
 Call on 600 meters indicating whether 450
 or 800 meters will be used. VPS answers on

600 meters only. This station is frequently out of commission.

INDO CHINA

Cac-Ba, HVC. Receiver—20-44-00 N. 107-02-05 E.

The station works in conjunction with HVB-KIEN-AN. 600 meter wave. A charge of 5 Francs (\$1.00) is made for each bearing.

Kien-An, HVB. Receiver—20-47-00 N. 106-37-00 E.

(To Be Continued)

LETTER TO THE EDITOR

Don't confuse this with the list of write-up requests we mentioned in our editorial. Hl. We were serious. Of course Mr. Dicule might have been, also, but—
 Sir:

As an ardent reader of the Commercial Brasspounder department of your magazine I urgently request that you publish the following items which would be of great interest to a lot of long-suffering-but-hopeful oprs.

Article and photos of the automatic ? transmitting machine used by NAA in sending press and by NPM in weather reports. Also printed copy of code used. Am unable to find some of it in either the Japanese, Siamese, American or International codes.

Statement from NAX as to why they keep their clock ten minutes ahead of Standard Canal Zone Time. Very confusing in getting radio bearings.

Group photo of NPO operators wearing the medals they receive for letting the "hash" machine run backwards when transmitting press.

Explanation as to why VPS picked the 2800 meter wave for weather broadcasts when KPC 10 k.w. spark is going almost continuously on or near that wave and knocks the weather reports deaderenell south of VPS.

Death bed photo of the editor ? or office boy who compiles the press sent out by WNU. Ask any TRT operator. Also enlarged photo of the farmer who furnishes NPL press.

Formula for a high power poison to be given to ship oprs who go on the air every five minutes with offers to QSR, QSQ, TR?, etc. These men are good and should be given help on the road to heaven.

Photo of the fiendish expression worn by Japanese oprs who gum up the air for a thousand miles around.

(Continued on page 68)

CONT.	JAP.	CONT.	JAP.	CONT.	JAP.	CONT.	JAP.
A	I	H	Nu	MU-I	Bi	U	U
AA	Ro			MU-UT	Pi	UA	Mi
AD	Ye	IK	Mi			UI	To
AR	N			N	Ta	UI-I	Do
AS	O	J	Wo	N-I	Da	UT	No
AU	Wi	JE	Se				
AW	Te	JE-I	Ze	O	Re	V	Ku
AW-I	De			OE	So	VI	Gu
		K	Wa	OE-I	Zo		
B	Ha	KA	Sa	OT	Ko	W	Ya
B I	Ba	KI	Ki	OTI	Go	WI	Ye
		KI-I	Gi	OD	Go		
C	Ni	KL	Za			X	Ma
		KAI	Za	P	Tsu	XI	Aru
D	Ho			P I	Dzu	XK	Ashi
D-I	Bo	L	Ka			XT	Yu
DN	Mo	LI	Ga	Q	Ne		
D UN	Po			R	Na	Y	Ke
DQ	Ashi	M	Yo	S	Ra	YI	Ge
E	He	MK	Su			YE	Ru
E-I	Be	MR	Shi				
E-UN	Pe	MU	Hi			Z	Fu
		MW	A	T	Mu	Z I	Bu
F	Che	MU-F	Pa	TJ	E	Z-UN	Pu
		MK-I	Zu	TV	Me		
G	Ri	MR-I	Zi	TP	Ru		

Perfecting *the gift of radio*



Eveready's greatest provider of Battery Power — the Eveready Layerbilt "B" Battery No. 486.



Radio is better

WHEN you give the great gift of a radio set, remember that you are giving not merely a handsome, intricate and sensitive instrument, but you are also giving radio reception, radio enjoyment, radio itself.

So give a receiver that can use the best source of radio power — batteries, for batteries perfect the performance of a radio receiver. The power they provide is pure D. C., Direct Current, which is entirely silent. Battery Power will insure the enjoyment of the listener, for battery-run sets produce exactly the tone their designers built into them.

All Eveready "B" Batteries will give you the vital qualities of Battery Power. Behind Eveready Radio Batteries are 33 years of dry battery

with Battery Power

manufacture, of pioneering, invention, discovery, continual leadership. Buy Eveready Radio Batteries and ahead of you are hours, days, weeks and months of daily use, of solid enjoyment of radio at its best. For modern receivers, choose the Eveready Layerbilt "B" Battery No. 486, built according to a radically new design that gives it ample and even excess capacity to meet the demands of powerful sets. This battery is the longest lasting of all Evereadys. Its unique, patented construction packs the

maximum possible quantity of active materials within a given space, and also makes those materials more efficient producers of current.

NATIONAL CARBON CO., INC.
New York  San Francisco

Unit of Union Carbide and Carbon Corporation

Tuesday night is Eveready Hour Night
Pacific Coast Stations—
9 P. M., Pacific Standard Time

KPO-KGO—San Francisco
KFOA-KOMO—Seattle
KFI—Los Angeles
KCW—Portland

EVEREADY

Radio Batteries

—they last longer

The air is full of things you shouldn't miss

Tell them that you saw it in RADIO

VACUUM TUBE TESTING

(Continued from page 24)

Kellogg a.c. tubes and others which have heater element connections on the top of the tube may be tested, if proper heater voltage is provided on tap switch A, by inserting them in the standard socket, and connecting the heater element to the filament terminals of the socket.

Testing Detector Tubes. Both the swing and oscillation tests depend on the amplifying properties of the tube, and while tubes which pass these tests will also detect, such tests are not a measure of detection properties. A detector tester is shown in Fig. 3. On the left is a special oscillator using two type 201-A tubes and run entirely on 110-volts for convenience. A rheostat in the tuned circuit makes it possible to keep the oscillating current, as indicated by the thermogalvanometer, close to some predetermined amount, so that the voltage induced in the fixed pickup coil is always, within reasonable limits, the same. The oscillator should be entirely shielded.

The tube to be tested is put in the socket marked detector. On its grid is impressed the r.f. voltage selected by the arm of the potentiometer. A switch is provided to return the grid current to either positive or negative A, as required for any particular tube. The last tube is a 201-A and its plate current is indicated by a milliammeter. Normally its plate current is, say, 5 milliamperes, but any a.c. voltage impressed on its grid will reduce the plate current. This arrangement serves as an indicator of the output of the detector tube.

As detector efficiency is important only on weak signals, the test should be operated on as low an input as will give a readable indication. A definite small reduction of the reading of the milliammeter should be decided on, and the potentiometer adjusted, for each detector tested, until this reading is obtained. A dial on the potentiometer will serve to read its setting. The lower the input voltage (as indicated by the potentiometer dial) required to obtain the reading decided on, the more efficient is the detector.

If an ordinary a.f. transformer is used in the plate circuit of the detector tube in this test, the output readings will be a measure of the plate conductance rather than of the detector efficiency of the tube. The primary of the transformer has relatively low impedance at 120 cycles, and a tube having equally low plate impedance may show a high output even if it is a poor detector. To overcome this, the test may be operated at a higher a.f., but where this is not convenient, the impedance of the detector plate circuit may be raised by con-

(Continued on page 50)

TOBE

UNIFORM! They Stand Up

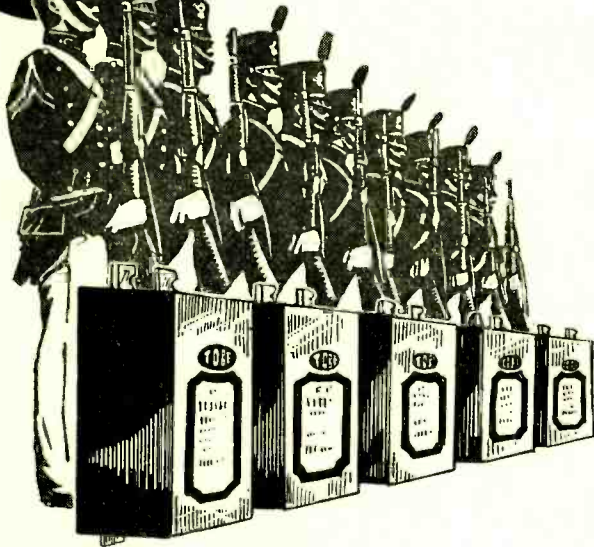

No matter whether you buy a TOBE Condenser in California or New York,—whether you buy it this year or next year,—the quality will be the same. ALL TOBE Condensers are made of materials selected for their serviceable and LASTING qualities, by methods perfected over years of experience. ALL TOBE Condensers are made to work continuously at their rated voltages—AND DO. The trademark "TOBE" takes all the doubt out of condenser performance. For sale wherever Radio is Sold.

Tobe Deutschmann Company

Cambridge

Massachusetts

Write us for Pamphlet

CORWICO

New!

BRAIDITE Hook-Up Wire

"The Braid Snaps Back"



To make a soldered connection, it is not necessary with Braidite, to strip back the insulation. The braid is simply pushed back while the soldering is done and then replaced thus forming the neatest possible connection.

Braidite is made from either solid or stranded tinned copper wire covered first with a cotton wrap and then with a cotton braid. It is then impregnated with a damp proof compound making it impervious to moisture and adding to its insulating qualities. Made in red, green, yellow, brown and black.

25 Ft. Solid Copper Core..... 30c.

25 Ft. Stranded Copper Core..... 35c.

"Corwico" Radio Wires are sold by all leading dealers. Write for free booklet on radio wires and their uses.

"Corwico" Radio Wires

Antenna Wire
(Solid, Stranded
and Braided)
Complete Aerial Kits
Magnet Wire
Battery Cable
Bus Bar Wire
Hook-up Wire
Lead-in Wire
Annunciator Wire
Loop Aerial Wire
Litz Wire
Flexible Wire

CORNISH WIRE COMPANY

30 CHURCH STREET

NEW YORK CITY

Tell them that you saw it in RADIO

"RADIO'S" Outstanding Announcement for 1928

A revolutionary new
SUPER-HETERODYNE
by GERALD M. BEST



IN the January issue of "RADIO" which will be on sale at most news stands in the United States and Canada on December twenty-third, Gerald M. Best, Technical Editor of "RADIO," will describe the construction of his 1928 Superheterodyne. The long awaited masterpiece of Best has arrived. In his new Superheterodyne Best makes use of the new shielded grid tubes; intermediate transformers peaked at 115 kilocycles; two stages of radio frequency ahead of the detector; "99" tube operation—for practical elimination of the "A" battery; dual control; antenna operation with antenna compensation, and radical departures in construction too numerous to mention here. It is unquestionably the most selective and powerful receiver yet described in the columns of "RADIO." Long distance stations sound like locals. Ten kilocycle separation of stations even in congested areas—and no sacrifice of tone quality. The intermediate stages—only two of them—are especially designed for shielded grid tube operation. And two more shield grid tubes are used in the radio frequency amplifier ahead of the detector. Standard factory parts for the new receiver will be available when the spectacular receiver is announced on December 23rd. The instructions for building the set will be so complete that any radio fan can build the set with ease. The quarter million users of Best's Superheterodyne circuit will welcome the news of this new receiver. It will make radio history. The wise radio man knows that Best's instructions must be followed to the letter if complete success is to be expected. Therefore we urge you to subscribe to "RADIO" for the next six months at the special rate of one dollar. We will mail the January issue to you on the day it comes off the press. Better subscribe now. News stand copies will be scarce.

No Advance Information Issued

Simultaneous release nationally on Dec. 23rd

EDITION LIMITED to ONE HUNDRED THOUSAND COPIES

High-Lights on Best's New Super

Most Spectacular Development of the Engineering Staff of "RADIO", San Francisco

115 Kilocycle Transformers

MOST stations can be found at but one point on the oscillator dial, this being made possible by the use of an entirely new intermediate transformer design of the "plug-in" type. Peaked at 115 kilocycles. The transformers will be available shortly after the time the publicity on the new super is released.

4 Shielded Grid Tubes

TWO shielded grid tubes in the radio frequency amplifier and two in the intermediate stages give the new Best Super extraordinary volume on long distance reception with an almost utter lack of background noise. Tube noises, also, are eliminated. The death-like silence of the set when in operation has amazed those who have been fortunate enough to hear it. Long distance stations come in like locals. The circuit is especially designed for shield grid tube operation and has been engineered from this standpoint. The balance of the tubes are of the CX-299 type, with the exception of the power tube. Series filament operation from the alternating current mains is now perfected to such a marked degree in this new super that the AC line noise is inaudible. The receiver described in the January issue of "RADIO" will be of the battery-operated type. Later issues will show how to convert it for series filament AC operation.

10 Kilocycle Separation

ACLEAN cutting super—ten kilocycles—enables you to break through locals and bring in the distance. Tone quality is not sacrificed in accomplishing this feature. There is no cutting of sidebands.

Antenna Compensator

AVARIOMETER coupling device with taps for broad, medium or sharp tuning is a part of the radio frequency amplifier. By this means you automatically compensate for the length of the antenna and the receiver is allowed, at all times, to operate at its most efficient peak.

2 Stages of Tuned R.F. Ahead of Detector

TO TALLY shielded radio frequency amplifier units designed for screen grid tube operation are specified by Gerald Best for constructing his new Super. Two stages of radio frequency and a detector in copper cases—beautiful in appearance and efficient in operation.

New Socket Shields

THE new shield grid tubes are somewhat microphonic but they may be weighted and shielded. A new combination tube weight and shield, fitting snugly over the shield grid tube, has an insulating bushing through which the screen cap protrudes. This weight and shield is a standard factory product and will be available when the new Super is announced next month.

Knock-Down Stage Units

ONE of the largest radio manufacturers is offering a newly designed screen grid amplifier unit for Best's new super. It comes to you in knock-down form and can be assembled and wired with ease. Burnished copper case. Plug-in coils. Resistances, sockets and miscellaneous parts are enclosed in the case. Four of these units are required in addition to the radio frequency screen grid amplifier unit.

Illuminated Drum Controls

TWO dial control by means of illuminated drum dials with marking strips for logging stations by kilocycles, call letters or wavelengths is another feature of the new receiver. The dials have vernier gear drive and are smooth and positive in action.

Cross Country Reception

QUITE naturally, such a receiver must be capable of bringing in stations from Coast to Coast with loud speaker volume. In San Francisco it is possible to receive the Eastern stations nightly with astounding volume. WTAM at Cleveland; stations in Detroit, Tennessee and the Mid-West are received with the volume of stations only a few hundred miles away.

Filament Drain 1 Ampere, Total Current Drain 20 Milliampères

THE filament consumption is low. The shielded grid and "99" tubes draw little current. With the new $\frac{1}{4}$ ampere power tube the entire set draws just one ampere. With the 210 or 310 power tube, which will be recommended, the drain of the set is $\frac{3}{4}$ ampere, excluding the power tube. AC current will be used to light the power tube filament.

Price of Parts, excluding tubes, a little over a hundred dollars

A Word
to the Wise
is Sufficient

We have given you the high-lights on the new Best Superheterodyne for 1928. You who know radio realize what the above statements mean to the radio world. The hundreds of thousands of followers of Gerald M. Best will welcome the news of such a great improvement in radio engineering, design and performance. And you will probably want to subscribe to "RADIO" for 6 months at the special rate of one dollar in order to insure yourself against missing a single issue. Best will tell you about this new receiver for six consecutive months. Better get your check in the mail today and on December 20th we will send you a copy of the January issue, carrying the complete constructional details.

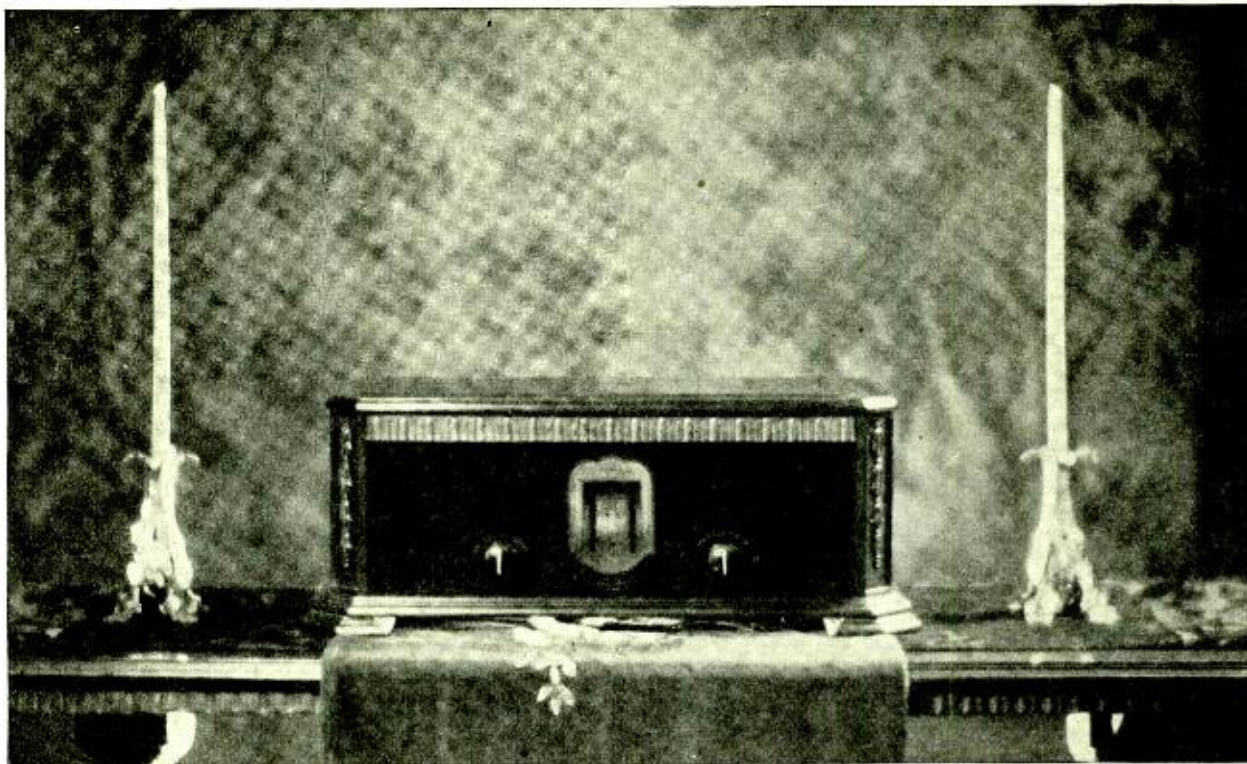

The New Improved Hi-Q Six—the creation of ten foremost American Radio Engineers—a receiving instrument that is far in advance of its time.

Exclusively **CUSTOM-BUILT** By Yourself at Home from our Simple Instructions and at Great Savings!

NO ordinary standards can be applied to this latest improved Hammarlund-Roberts Receiver, for it is the result of a determination to produce America's very finest instrument—absolutely regardless of cost!

Every modern constructional feature has been incorporated. Each part is the most efficient known to radio science, and the entire group has been purposely selected for perfect synchronization.

Complete isolation of four tuned circuits plus Automatic Variable Coupling effects maximum and uniform amplification over the entire wave band. Distortion is totally eliminated. Oscillation is utterly absent. Symphonic transform-

Associate Manufacturers

*Acme Wire Company (Parvot)
Benjamin Electric Mfg. Company
Carter Radio Company
H. H. Eby Mfg. Company
Hammarlund Mfg. Company
International Resistance Company
(Durham Resistors)
Radiall Company (Amperite)
Samson Electric Company
Sangamo Electric Company
Yaxley Mfg. Company
Westinghouse Micarta*

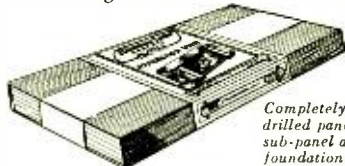

Completely drilled panel and sub-panel are foundation for easy building.

ers and a power tube faithfully reproduce the full musical scale. Selectivity, even in crowded areas is something marvelous. And tonal quality simply **MUST** be heard to be appreciated!

Such a set, factory made, and sold through usual channels, would possibly cost around \$300.00, but through following our simple instructions you can purchase all parts for only \$95.80 and build this supreme receiver yourself—a **CUSTOM BUILT** set which gives you **CUSTOM BUILT** results at a saving of \$100 to \$150.

Get the complete Hi-Q Instruction Book from your dealer—or write us direct. Price 25 cents.



HAMMARLUND-ROBERTS, INC.

1182 Broadway, Dept. F

New York City

The TEMPLE air column-speaker

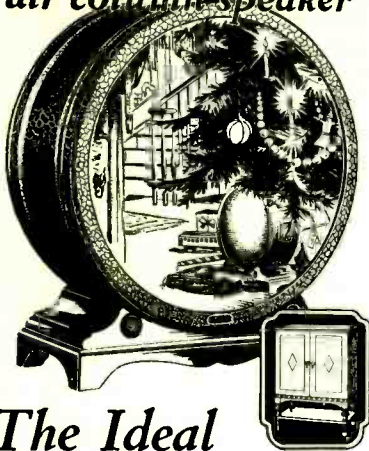

The Ideal Christmas Gift

Nothing will give greater pleasure in radio than a TEMPLE—the speaker that has been the sensation of every radio show, the joy of thousands of fans all over the country. Do your Christmas shopping early—buy a TEMPLE, Console or Drum Type Model. Either will bring you a richness and purity of tone reproduction that is far beyond what you ever thought was possible.

Heard Clearly Six Miles from Shore

Think of it—you fans who sometimes have difficulty in even hearing your own radio from the far end of the living room—the TEMPLE SPEAKER was heard six miles from shore—just as clearly as you hear a man speaking not six inches away! A wonderful test, yet on land or sea, in a living room or an auditorium, the TEMPLE never fails to give a richness and purity of tone that today is the talk of the radio world. Ask your dealer for a demonstration on the TEMPLE COMPARATOR.

Temple Models Priced at
\$29., \$37.50, \$48.50,
\$65, \$85

TEMPLE, INC.
213 S. Peoria St., Chicago

(Continued from page 48)

necting a choke coil as shown. The secondary of an a.f. transformer (leaving the primary disconnected and open) makes a good coil for this purpose.

When a sensitive detector is used on local stations tuned in loudly, distortion usually occurs. Where fidelity of reproduction on local stations is desired rather than distance, a low "mu," low impedance, tube may give better results than a very sensitive detector. A type 171 tube, designed for the last audio stage, can be used for this purpose. If the detector filament current flows through a fixed resistance instead of a rheostat, the use of a 171 tube with a .5-ampere filament will necessitate cutting the resistance in half.

Rejuvenation. A tube loses its emission (low plate current or none at all) if the filament has been subjected to an excessive voltage, or after long use at rated voltage. Frequently the emission can be restored where the filament is of thoriated tungsten, but not in the case of oxide coated filaments, used in such tubes as the WD-12.

Different manufacturers prescribe different rejuvenation procedures, and their recommendations should be closely followed. Usually it is required to light the filament for so many seconds at about double its rated voltage, followed immediately by ten or more minutes at about 25% over rated voltage. With some filaments it is necessary to have no plate voltage. A.C. can always be used on the filament. If the transformer has sufficient capacity, sockets may be connected in multiple in any desired number, and tubes having similar filaments rejuvenated simultaneously.

A typical rectifier tube tester is shown

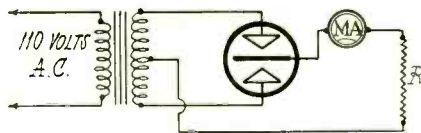

Fig. 4. Rectifier Tube Tester

in Fig. 4. A full-wave gas-filled rectifier tube is indicated, but the changes in the diagram necessary for testing other rectifiers are obvious. Transformers supplying correct input voltages for the various rectifier tubes have been placed on the market by several manufacturers. The resistance *R* takes the place of the radio set. If the output of the tube is rated at 60 milliamperes at 135 volts, the resistance is $135 \div .06 = 2250$ ohms. Since tubes are seldom run at full capacity, a standard resistance unit size of 2500 ohms may be chosen. This would draw 54 milliamperes at 135 volts.

The meter is the usual type of d.c. milliammeter (permanent magnet). The current readings are the same as the rectified current would be if a filter were

(Continued on page 52)

Old INFRADYNES Converted Into 1928 Models

Bring last year's Infradyne up to date by having us install the new Remler radio frequency amplifier, steel chassis, control panel and wiring system. Write us for estimate on this work, telling us what changes you wish to make. Complete re-build job of last year's Infradyne to make it an exact duplicate of the 1928 model—\$122.50.

Radio Constructors Corp.
357 12th Street Oakland, Calif.

KITS

For all known circuits. Get our Special Prices. 36-inch cone kits and cone units in stock. Also kits made up specially for all "RADIO" circuits.
Send for FREE RADIO CATALOG
B. C. L. RADIO SERVICE CO., INC.
218 Fulton Street New York City

Set Builders! Dealers!

FREE
—big catalogue

Standard parts and equipment at money-saving prices, with discounts that show you a real profit. Electrical phonograph pick-ups—latest kits! Complete stock of Tyrnan 10 parts. New AC tubes and transformers—parts for any circuit—power audio equipment—short-wave supplies—they are all in our big new 1928 catalog. Write for it today, 12-hour shipment guaranteed. with discount sheet.

Dan-Ashe Radio Co.

212 North 10th St. ST. LOUIS, MO

KNICKERBOCKER 4

THE WONDER SET

2-Dial Karas Equamatic 5-Tube Receiver

These two famous receivers as well as scores of other well known sets owe no small part of their marvelous performance to the use of Karas parts: Karas Condensers, Transformers, Filters, Coils and Dials

KARAS ELECTRIC CO., 4031-K N. Rockwell St., Chicago

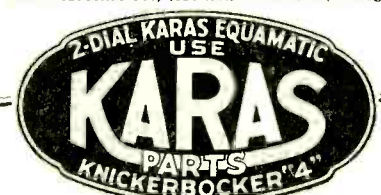

Abox

"A" BATTERY ELIMINATOR

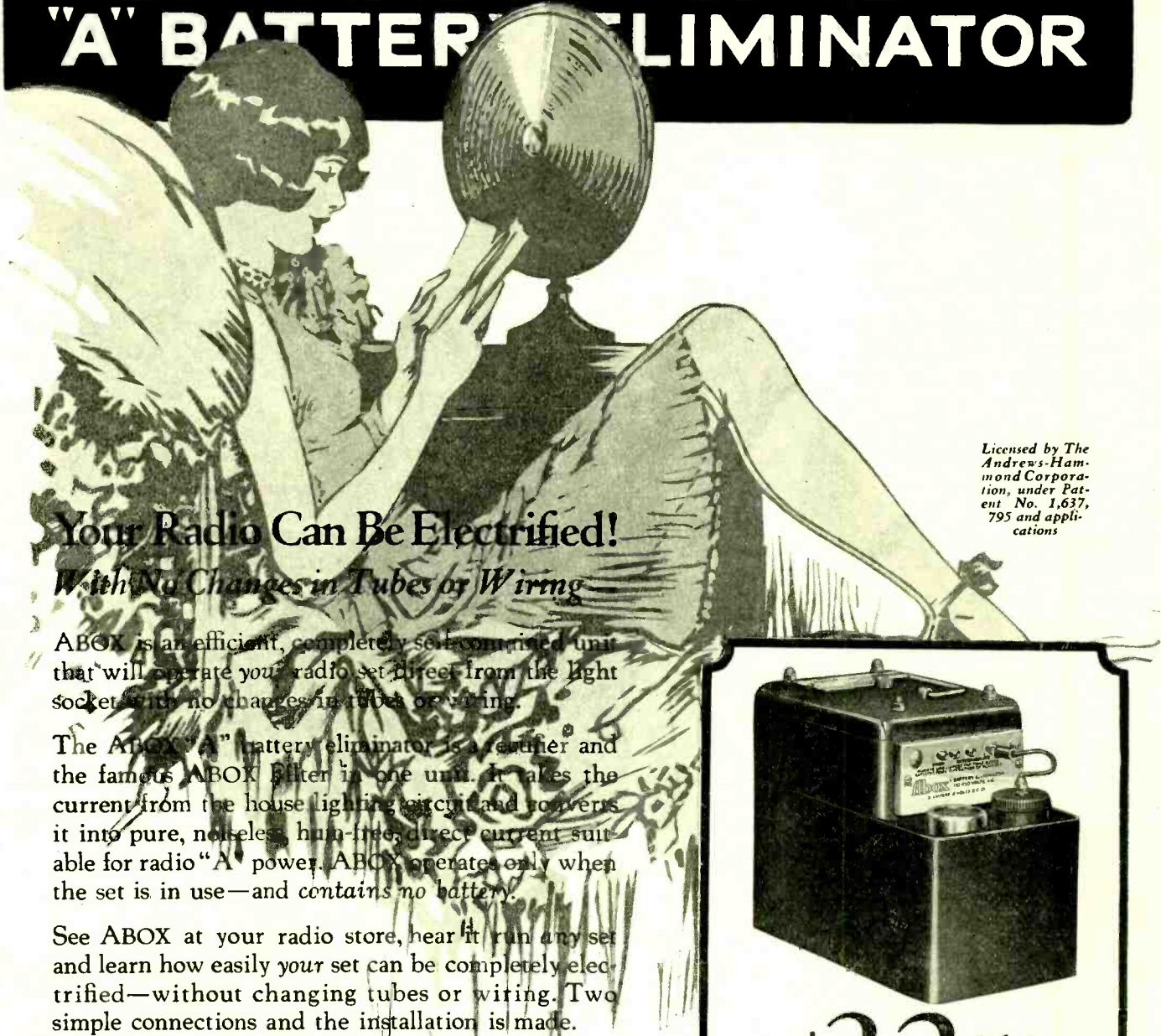

Licensed by The
Andrews-Ham-
mond Corpora-
tion, under Pat-
ent No. 1,637,
795 and appli-
cations

Your Radio Can Be Electrified! With No Changes in Tubes or Wiring

ABOX is an efficient, completely self-contained unit that will operate your radio set direct from the light socket with no changes in tubes or wiring.

The ABOX "A" battery eliminator is a rectifier and the famous ABOX filter in one unit. It takes the current from the house lighting circuit and converts it into pure, noiseless, hum-free, direct current suitable for radio "A" power. ABOX operates only when the set is in use—and contains no battery.

See ABOX at your radio store, hear it run any set and learn how easily your set can be completely electrified—without changing tubes or wiring. Two simple connections and the installation is made.

The six-volt model operates all sets using eight or less 1/4-ampere tubes. The four-volt model operates any set using type 199 tubes and will fit into the battery compartment of Radiola receivers.

[[Send for interesting booklet,
"ABOX and The Light Socket"]]



\$3-2-50

Slightly higher west of the Rockies
Input—110 volts, 50-60 cycles A. C. Output—6 volt direct current,
2 amperes. Shipping weight, 25 lbs. Unlimited shelf life.

4-volt model for Radiola sets or
any receiver using small tubes \$2750

The ABOX FILTER can be used to filter the output of your charger
if you have one. Ask for special circular. Price, \$19.50.
Slightly higher west of the Rockies.

The Abox Company

215 North Michigan Avenue

Chicago, Illinois



Raytheon Type R Voltage Regulator

For improvement in both the construction and performance of light-socket power units here is the tube to use! When incorporated in the proper circuit, Type R maintains constant voltage on the 90 and lower volt taps and greatly improves regulation on the 180 and 135 volt taps regardless of changes in line voltage or load current.

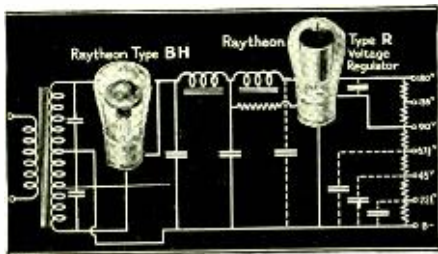

Send for this Diagram

The Raytheon Research Laboratories will gladly furnish you with power unit plans which use Raytheon Type BH 125 m. a. rectifying tube and Type R Voltage Regulator tube to their best advantage. The latest technical bulletin, explaining Type R in detail will be included upon request. Amateurs and experimenters who pride themselves on the proficiency of their apparatus will want to build and own this perfect power unit. Write today.

RAYTHEON MANUFACTURING CO.
305 Kendall Square Bldg. Cambridge, Mass.

TYPE R
90 Volts, 60 m.a.
Price \$4.00

TYPE BH
125 m.a. at 300 Volts.
Price \$4.50



(Continued from page 50)

introduced between the tube and the meter, if the d.c. voltage drop in the filter is taken into account. When the filter is not used, as in the tester of Fig. 4, the number of watts dissipated in the resistance unit will be greater than I^2R , where I is the current shown by the d.c. meter. To use this formula it would be necessary to use a hot-wire or dynamometer type of instrument. The following formulas for wattage apply where I is the unfiltered current read on a d.c. meter: Full wave, watts= $1.22 I^2R$; Half wave, watts= $2.47 I^2R$. These formulas are useful in selecting the correct resistor for testing any particular tube.

Grid-Plate Capacity. It may happen that the inferior of two tubes, as indicated by the usual tests, is the better r.f. amplifier in some particular receiver. This is because of the part played by the grid-plate capacity in r.f. amplifiers, especially in neutralized sets.

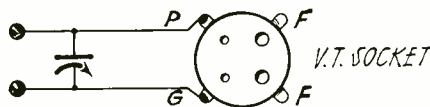

Fig. 5. Comparison of Tube Capacity.

Fig. 5 shows a method of comparing capacities of tubes sufficiently accurate for service work and for matching tubes. The variable condenser is connected to the oscillator-wavemeter previously described with a r.f. transformer, so as to measure the capacity of the condenser. The tube socket is connected to the condenser by short leads. A dial is used on the condenser and set at, let us say, 70, and then the oscillator dial is turned until in tune. A tube is inserted and the condenser dial reset until it is again in tune with the oscillator. It is obvious that the capacity of the condenser will have to be reduced by an amount equal to the tube capacity added. In this way the capacity of various tubes can be compared.

Loose Bases on Tubes can be repaired by applying, between the glass and the base, a little shellac, Dupont's household cement or collodion.

CHANGING TO A. C. TUBES

(Continued from page 23)

eliminator is used, or from the eliminator if provision is made for C voltages.

Bias resistances can also be used between the filament resistor mid-taps and the negative return, as shown in the r.f. amplifier tube in the Browning-Drake diagram. By arranging these resistors to suit the plate currents, the use of C batteries may be done away with entirely. The exact value of these resistors cannot be given, as this will depend on the plate current drawn by the tubes, but this can be readily calculated, if the plate current, potential, and desired grid potential are known.

List of parts on page 64



While your neighbors are cussin' the static

Your set, with its Dubilier Light-Socket Aerial, is bringing the programs in smooth as silk. It's a fact! This little aerial, which you simply attach to the set and plug into the nearest light socket, reduces both static and interference to a marked degree. It uses no current whatever and absolutely eliminates the lightning hazard. Costs you nothing to prove it, for the Dubilier Aerial is sold by all good dealers on a 5-day, money-back basis. If your dealer can't supply you, write direct to us. Price, \$1.50.



Dubilier LIGHT SOCKET AERIAL

If you're replanning to build a power-unit make sure that the condenser blocks you intend to use are built to withstand long hours of heavy-duty service. Dubilier Blocks have an excessive high factor of safety and a "life" that makes them by far the most economical to buy. Full instructions enclosed with each block unit.

DUBILIER CONDENSER CORP.
4377 Bronx Blvd., New York, N.Y.

Dubilier CONDENSERS

VITROHM RESISTORS *and* RHEOSTATS

Vitrohm Radio Resistors

WARD LEONARD
Resistors and Rheostats are now available to the experimenter and home constructor in 93 types and styles covering the resistance demand of every current supply circuit.

A few of these products are listed on this page. A full description is contained in Radio Bulletin 507 which will be sent you without charge.

"Vitrohm News", a monthly Bulletin covering circuits and items of interest to the radio fan, was first published in September. This copy and subsequent issues will be sent you upon request.

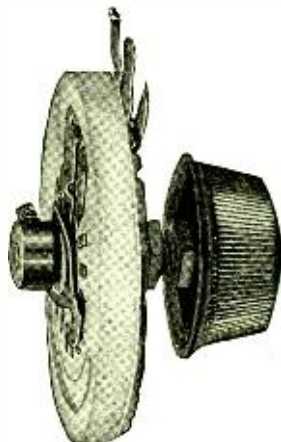

THE ADJUSTAT

The Adjustat

The Vitrohm Adjustat is a 15-step potentiometer connected rheostat adapted for use in all current supply circuits. Like all Vitrohm Products, the resistive element, wire, is embedded in and protected by fused-on vitreous enamel.

The Adjustat is priced at \$3.00.

TYPES

507-79	1 ohm	4000 m. a.	507-81	600 ohms	180 m. a.
507-71	2 ohms	3200 m. a.	507-75	1000 ohms	125 m. a.
507-72	6 ohms	1500 m. a.	507-76	2250 ohms	90 m. a.
507-73	20 ohms	1000 m. a.	507-84	7500 ohms	50 m. a.
507-74	30 ohms	800 m. a.	507-77	10,000 ohms	40 m. a.
507-80	50 ohms	650 m. a.	507-78	25,000 ohms	20 m. a.

Resistor 507-66

Vitrohm Resistor 507-66 is a transmitting grid leak for circuits up to and including 1000 watts inputs. It is particularly recommended for circuits employing the R. C. A. UX852 Tube.

Total resistance 15,000 ohms, tapped at 5000 and 10,000 ohms. \$6.00



RESISTOR 507-66



RESISTOR 507-9

Resistor 507-9

This resistor is for use in B & C Supply Circuits having an output under load of 180 volts. At this voltage, intermediate voltages of 22, 45, 67, 90 and 135 are available. Priced at \$6.75.

Vitrohm HEAVY DUTY Rheostat

The Vitrohm *heavy duty* Rheostat has 11 steps of adjustable resistance. It is particularly adaptable for use in series with transformer primaries to compensate for line voltage changes. These Rheostats are 4 inches in diameter and are arranged for either base or panel mounting. \$5.50.

TYPES

507-83	12.5 ohms	2200 m. a.
507-59	20 ohms	2,000 m. a.
507-63	50 ohms	1000 m. a.

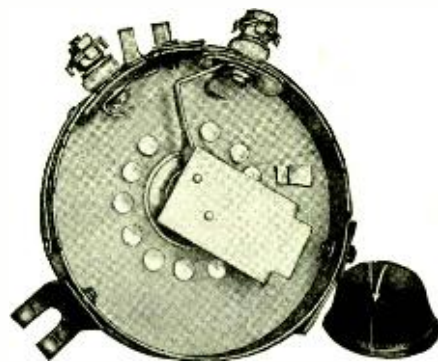

VITROHM HEAVY DUTY RHEOSTAT

Ward Leonard Electric Company

31-41 South Street

Mount Vernon, N. Y.

resistor specialists for more than 35 years

Tell them that you saw it in RADIO

POWERIZER

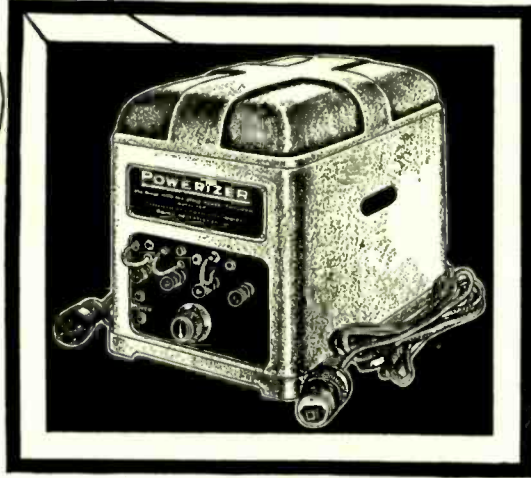
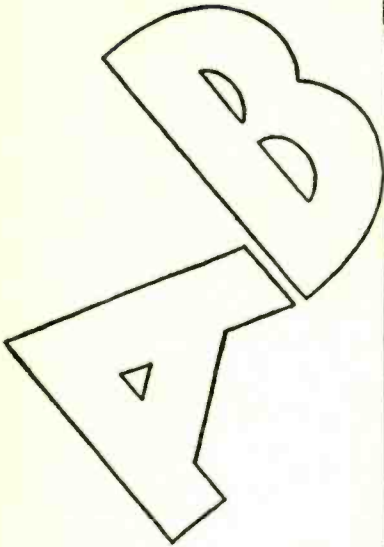

Model for Atwater Kent and other
standard sets \$60.
Radiola "20" Model \$59.

**makes every set a real A.C.
Electric using the newest
A.C. Radiotrons which re-
quire no batteries or "trickle
charger and B Eliminator
units" - -**

No rewiring required!

**Complete with harness and adaptors. Write
for details "How to make your set a 1928
A.C. Electric Receiver without Rewiring."**

RADIO RECEPTOR COMPANY, Inc.
106 SEVENTH AVENUE ~ ~ ~ NEW YORK

LICENSED BY RADIO CORPORATION OF AMERICA and Associated Companies

"... THE KID WAS STEADY"

(Continued from page 25)

true. The other, new steel, waiting for the torque. God bless 'em both! In her own room, she wiped the corner of her eye with her apron.

The night the Kid took the best Kinsey had and copied letter perfect, Kinsey leaned back with a grin. He had been trilling the key like a machine and the Kid was right behind him all the way.

"Shake Kid," he said. "You'll do—on a tanker, maybe!"

Something flickered in the Kid's eyes. That was a big compliment. What Kinsey meant was that he'd do anywhere that Continental code was used from Sprogo to Balikappan. But he wouldn't have him swell-chested because of it. Seven seas to sail, a perfect fist on a key, and seventeen years of life behind What a vista! But something flickered in the Kid's eyes

"I'll speak to the Old Man tomorrow and have him put you on the waiting list." Kinsey was speaking.

Again the flicker. It puzzled Kinsey afterward. Shyness? Gratitude? Exuberation? He wondered. Outside, the Kid shivered and looked up at the stars.

"Oh God . . ." he groaned. "I can't quit now . . ."

As Kinsey had done before him, the Kid fell heir to a rusty switchboard, a battered receiver with cigarette burns on its rim, and the stuttering generator which made up the power unit of the tanker *Monsura's* radio equipment. He was to sleep in Kinsey's old bunk! Kinsey's old commander, McLeran, a hard-bitten Scot, still pounded the bridge. The Kid was glad—in a way. So was Kinsey. It would be living for the first time for the Kid. It was life all over again for Kinsey, just hearing about it.

As for Ma—well, Ma just smiled her tight-lipped smile and listened. One never knew what Ma was thinking, but one always knew where to find her, and that was what counted for Kinsey and the Kid.

The *Monsura* was a slatternly old seacow that meandered from Puget Sound to the Isthmus, down Pago way and back to Hongkong and the Islands, one of the National Oil fleet, distinguished not for the quality of its cargo but for the scale in its engine boilers. The *Monsura* belonged in the boneyard but a marine superintendent who believed anything was possible, provided the hull rivets held, booked her out of Richmond with a hog-load for Vancouver. Go she had to—engines, rivets and God willing! She and the Kid . . .

THIS is all but background. Tonight, Christmas Eve, the *Monsura*, wallowing up the coast, had her nose buried in a stiff norther. Kin-

(Continued on page 56)

Electrify your radio set with

Majestic

“A” and “B” Electric Power Units



No Acids — No Liquids
No Hum — DRY

Gives any radio set full strength, permanent Electrical “A” and “B” power all the time. Both “A” and “B” power **and** your radio set, **all** controlled by one switch. Only one light socket connection necessary.

See your dealer — NOW!

GRIGSBY-GRUNOW-HINDS COMPANY
4540 ARMITAGE AVE. CHICAGO, ILL.

W. J. SEROY
Pacific Coast Sales Manager
122 BROADWAY, OAKLAND, CALIF.

Tell them that you saw it in RADIO

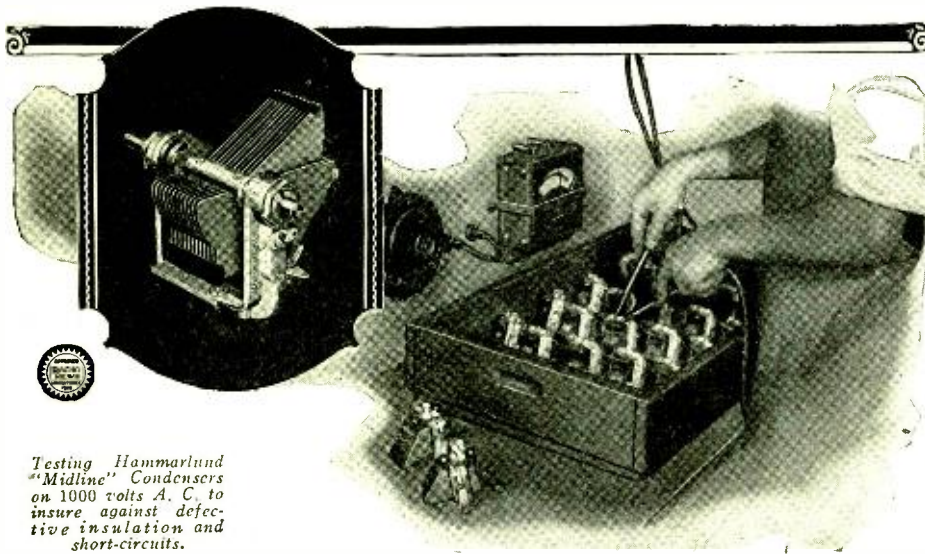

Testing Hammarlund "Midline" Condensers on 1000 volts A. C. to insure against defective insulation and short-circuits.

Hammarlund Precision Means Your Protection

THE word "Precision" as applied to Hammarlund Condensers, Coils, Chokes and Shields means precisely what it says.

It means soundness of design, accuracy of manufacture, fineness of finish and scientific testing. Precision has given Hammarlund Products undisputed leadership in their respective fields.

From the very first, Hammarlund has stood for quality and Hammarlund has never deviated from that principle.

But you pay no premium for Hammarlund reputation. Hammarlund Products are standard-priced. You can pay far more and get far less than Hammarlund Products give you.

Write for the Hammarlund descriptive folder before planning your new receiver.

HAMMARLUND MANUFACTURING COMPANY

424-438 W. 33rd Street, New York
Pacific Coast Representatives HENGER - SELTZER CO.
711 E. 14th St., Los Angeles—377 Brannan St., San Francisco

More than a score of radio designers officially specify Hammarlund Precision Products for their latest circuits.

For Better Radio
Hammarlund
PRECISION
PRODUCTS

Dealer inquiries invited concerning several new and appealing Hammarlund developments having a wide sales demand.

You can quickly learn
**MORSE OR CONTINENTAL
CODE** at home with the NEW
TELEPLEX

The TELEPLEX is the only instrument that REPRODUCES actual sending of expert operators. It sends messages, radiograms, etc., at any speed from 5 to 80 words per minute. Always ready. Easy and fascinating. Saves months of tiresome practice. Sends FIVE TIMES as many words with one tape as any other instrument, and SIX are furnished. Nothing else to buy. Fully guaranteed. Used by U. S. Navy. Write NOW for particulars of this amazing instrument.

Dealers Wanted
TELEPLEX CO.
76 Cortlandt St. New York City



(Continued from page 54)

sey could visualize her rooting along, head downward. There was nothing graceful about the *Monstura*, especially under load, with the bilge sloshing below deck, and the oil booming in the tanks like off-shore surf. Kinsey wondered if the Kid was sea-sick . . .

The barometer dropped steadily. A low-pressure area, central over the Aleutian Islands, was crawling down the coast, shoving gusty gales and a touch of sleet ahead of it. By morning rigging would be slippery and the steel decks oiled glass. McLeran would be at the wheel, all night, rigid against the blast. A sou'wester would be buttoned tight under his scraggly beard, and the stem of a short pipe clamped in his teeth.

Kinsey pulled up the log page—turned back. The *Monstura* had checked out at 4 p. m., passing the Heads. She ought to be off Point Reyes now, getting it right in the face. He took his head with a tight-lipped smile. That was some initiation for a cub operator. He caught himself wishing that it was not the Kid and this troubled him. He'd give him a call presently when he'd cleared up the night traffic . . .

An alarm clock whirred off in the sleeping quarters of the station. That was Watts, getting up. Watts doubled with him on the night trick. He'd be in presently when he had had his coffee. Good man, Watts. A comfort on a night like this. The storm clawed at the windows . . . The land-line telephone jingled. Yes, the *Maui* was due at 8 a. m. Another call presently. No, there was no report from the *Cassie Dollar* yet. She'd probably give her position around midnight. Watts came in presently, yawning.

"Better get that land-wire open," Kinsey said. "It's a bad night . . . we'll have a bunch of stuff."

Watts chuckled and clicked a call. Kinsey was right. The traffic came tumbling at him. Watts' typewriter and the sounder clicked along together, steadily . . .

The blast beat with vicious wings against the frail barrier of wood and glass, built to keep it out. Watts stoked the fire, and peered through the window. A flash of blue flicked high up, as Kinsey worked a boat off-shore.

"That number four guy is leaking again," Watts remarked.

"That's where our power goes," growled Kinsey. "I'm not getting out the way I should tonight . . ."

Watts stoked his pipe. A match rasped. Kinsey's finger kept his key chattering. A thousand feet away, sped from the transmitting unit, a vast voltage went hurtling into the dark, from the giant antennas, to pluck a copper harp on a distant ship, with unseen fingers. Presently Kinsey got an answer, and the traffic of the night began to move.

"The Kid's out on the *Monsura*," Kinsey said after a bit, during a lull. "Hell of a night . . ."

"I'll say." Watt's tone was sympathetic. "First trip, eh?" Kinsey nodded. "Sea cow, too." "Worse."

Watts walked over and studied the log, his finger halting beside the 4 p. m. entry. The same thought was uppermost in the minds of both men.

"Heard her since?"

Watts put the question casually.

"No. All right, I guess, though. Her set gets out—even in this kind of a racket."

The night's routine swung steadily along, with the storm outside growing worse. Kinsey's hand was steady on the key but out of the night the code talk rocked and teetered up to him in broken snatches. Even an expert operator cannot send copper-plate Continental standing on his head one minute, and the next, his feet against the wall. One line, rolling heavily, ceased transmitting.

"Too rough . . . c u later," said the "op," and gave it up.

What of the *Monsura*? Kinsey knew the old tub well and she was no bed of roses. A bucking broncho rather. Some initiation. If the Kid came through that—there was little would phase him. Kinsey's hand went out to give him a call, but he stiffened up and shook his head.

The night traffic was dying off the land wires now. Watts had his feet on the table reading. Kinsey turned around.

"Listen to her blow," he commented. "Some of the boys off the Sound are into it now. Just heard VAE paging a Canuck freighter. Seems worried. Said she was leaking when she went out . . . Yoko bound too."

Watts laid down his magazine.

"Blow is right," he said. "Christmas Eve! Wow!"

Both dropped into a long silence. Into the quiet of the room came the steady drone of a ship on 800 meters, taking compass bearings, and the tat-tat of an automatic beacon signal far up the coast.

"I hope we get through the night without an SOS," said Watts suddenly. Kinsey glanced at him curiously as though the other had spoken his own thoughts.

"Hunch," he asked.

"Not specially," said Watts. "That was just a Christmas wish, that's all."

Ten o'clock Pacific Standard time! The evenly spaced signals from the master clock at Mare Island went out through the storm from the naval station with rhythmic certainty. There is a comfort to time signals on a lonely ship watch, when a storm rips the heavens into nameless terrors. It is a hand reached out from the land—a sudden grip of the fingers, reflecting the orderly phases ashore. In a world of turmoil



Transformers

Two Additions to Last Year's Radio Sensation. The Amazing Achievement in Audio Amplifications

Designed for set builders who demand efficiency, sensitivity, precision and high quality

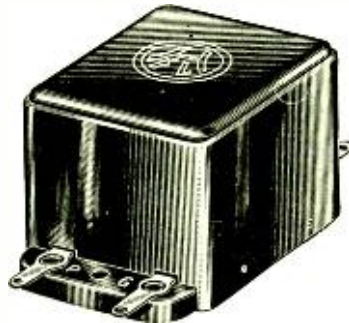

H. F. L. Units Give Wonderful Clear Reception

Engineers acclaim H. F. L. C-16 a marvellously efficient Audio Transformer. It carries signals at highest volume and lowest amplitude without blasting or developing harmonies. Operates with all power tubes as well as standard tubes.

H. F. L. C-25 Output Transformer handles the voltage output of power amplifying tubes, at the same time matches the impedance of the average speaker to tubes. Protects loud speaker unit without reducing plate voltage.

Mechanical features of these two transformers are: A coil designed and treated to exclude moisture and withstand heavy electrical surges without breaking down—complete magnetic shielding to avoid interstage coupling—terminals brought out so as to insure short leads.

PRICES

No. H-210 Transformers	\$8.00
No. H-215 Transformer	8.00
No. C-25 Output Transformer.....	8.00
No. L-425 R. F. Choke.....	5.50
No. L-430 R. F. Transformer.....	5.50
No. C-16 Transformer	8.00

Set Builders—Dealers

If your jobber cannot supply you with H. F. L. Transformers, wire us for name of nearest jobber.

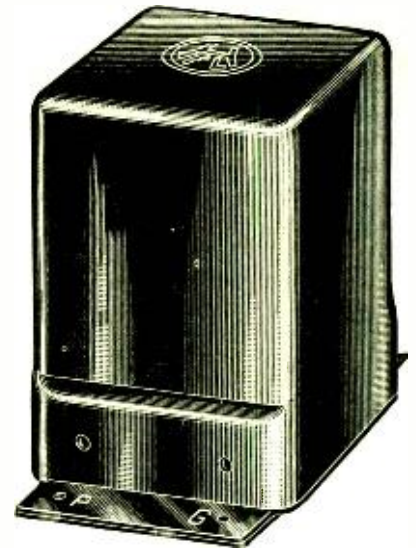

H. F. L. C-16 Audio Transformers and C25 output Transformer—New companions of a Great Unit, will work in any circuit and improve any radio set.

H. F. L. Facts

H. F. L. Units have been used, approved and most highly endorsed by *Radio News*, *Citizens' Call Book*, *Radio Review*, *Radio Age*, *Radio Engineering*, *Radio Mechanics*, *Chicago Evening Post*, the *Daily News* and others. Thousands of engineers and fans, who have turned to H. F. L. Units for better reception, hail them as the finest transformers known to Radio—unexcelled for Power, Selectivity and Purity of Tone.

Perfectly matched, skilfully designed, carefully made, rigidly tested—in a word, H. F. L. transformers are technically correct to the minutest detail.

All H. F. L. transformers are designed for baseboard mounting or invisible sub-panel wiring—each unit is enclosed and sealed in a genuine bakelite moulding.

H. F. L. Units are easily connected into the assembly, simplify set construction, and make a beautifully finished job.

Endorsed by America's Leading Engineers—Guaranteed by the Manufacturers

HIGH FREQUENCY LABORATORIES

133-H NORTH WELLS STREET

CHICAGO, ILL.

BIG DEALERS DISCOUNTS
thousands of
NATIONALLY ADVERTISED
RADIO SETS PARTS KITS

Just Out
Lowest Wholesale Prices
Radio Electrical Supplies
Write for FREE BOOK

Midland Wholesale Co.
5116 Ravenswood Ave.
Dept. R Chicago, Ill.

RADIO AGENTS
Make Big Money

EASY to sell American Radios and Supplies. Nationally advertised, high quality merchandise at wholesale. Big profit on every sale. No capital to invest. No stock to carry. Order direct from my huge warehouse as you sell.
Get My Liberal Offer and also Big New 132-page Catalog and Guide—"How to Sell Radios"—Free. Full of Bargains—all latest in Radio. Write today.
AMERICAN AUTO & RADIO MFG. CO.
HARRY SCHWARTZBERG, PRES.
Dept. 101, American Radio Bldg., Kansas City, Mo.

BIG BARGAIN CATALOG

METERS

WE REPAIR THEM REGARDLESS OF MAKE

**VOLTMETERS
AMMETERS
WATTMETERS**

Send Them To Our Laboratory

HEINTZ AND KAUFMAN
SCIENTIFIC INC. APPARATUS

219-221-223 NATOMA STREET
SAN FRANCISCO

Tell them that you saw it in RADIO

Finally—the Perfect “A” Eliminator

For Your Present Set or the Set
you eventually buy



Our 4-volt “A” Eliminator
Fits Into All Radiola Consoles

Silver Beauty POWER

Replaces “A” storage battery and charger; has full wave “dry” rectification; maintains required voltage in unform, constant flow; operates automatically by moving a switch; economical—uses minimum amount of current (about 1-10 cost of using electric iron); has rheostat control for additional refinement in voltage and reception; gives maximum power to radio tubes and lengthens their life; no acids to test or spill. Satisfactory results guaranteed.

Its principle is simple and correct!

The 110 volts Alternating Current is scientifically reduced with the famous “Silver Beauty” transformer coil to deliver the proper voltage to an especially developed dry, noiseless rectifier, which transforms the electricity to direct current. This current of exact voltage, is then transmitted through a patented special filter which clarifies the current, eliminating all foreign noises caused by rectifier or generator.

The Silver Beauty “A” Eliminator is endorsed by prominent radio engineers—adopted by leading distributors and dealers—approved by thousands of users. These are sufficient reasons for making Silver Beauty your choice.

\$39⁵⁰ \$43⁵⁰ \$39⁵⁰

6-volt; 2 amp. 6-volt; 3 amp. 4-volt; ½ amp.
\$2 Higher West of Rockies

Silver Beauty “B-C” UNIT

Does away with “B”
and “C” batteries

Embodies every up-to-date refinement and principle, insuring smooth, unflinching reception. As beautiful as it is efficient.

No. 450
180 Volts—40
Milliamperes
\$45

No. 460
135 Volts
\$35

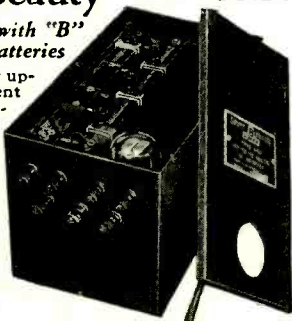

Individual adjustment
adapted to all sets.

Silver Beauty CHARGERS

Employing an entirely new method of rectification. Two models—with or without bulbs.

See Your Dealer or Jobber

Triple-A-Specialty Company

Manufacturers of the famous Silver Beauty Chargers
312-316 South Hamilton Ave., Chicago, Ill.



Model
“N”
Vario-Denser

VARIO DENSER

Tune quickly—adjust accurately—eliminate distracting noises—get correct tube oscillation—with X-L VARIO DENSERS in our circuit. Designers of all latest and best circuits specify and endorse them.

MODEL “N”—Micrometer adjustment easily made, assures exact oscillation control in all tuned radio frequency circuits. Neutrodyne, Roberts two tube, Browning-Drake, Silver’s Knock-out. Capacity range 1.8 to 20 micro-microfarads.
Price \$1.00

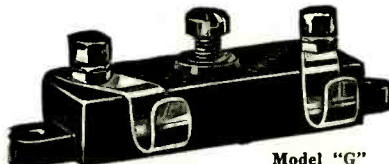

Model “G”

MODEL “G”—Obtains the proper grid capacity on Cockaday circuits, filter and intermediate frequency tuning in superheterodyne and positive grid bias in all sets.

Capacity range:

Model G-1 .0002 to .0001 M. F. D.
Model G-5 .0001 to .0005 M. F. D.
Model G-10 .0003 to .001 M. F. D.

Price, each with grid clips \$1.50

X-L PUSH POST—NEW!

Bakelite Insulated. Push it down with your thumb, insert wire, remove pressure and wire is firmly held. Vibrations will not loosen. Releases instantly. A push post that excels in appearance, action, service and convenience.

Price each 15c

X-L PUSH POST PANEL—

Seven push posts mounted on black insulating panel with permanent white markings. Soldering lugs, raising bushings and screws for mounting, etc., in box complete.

Price \$1.50



X-L Push
Post



X-L Push Post Panel

FREE—New, up-to-date book of wiring diagrams showing use of X-L units in the new LOFTIN-WHITE constant coupled radio frequency circuit, and in other popular hook-ups, also the Goodwin Aperiodic Detector Circuit which adds a stage without added tuning controls. Applicable to any set. WRITE TODAY!

XL Radio Laboratories

2428 Lincoln Ave. Chicago, Ill.

New LOG BOOK Now Ready

A clever log book giving spaces for logging dial setting for any U. S. or Canadian station. Also a complete list of all stations by call letters. A separate list of stations by states. Another list of stations by meters, starting at low wavelengths in numerical order. A directory of stations. Calls, waves, kilocycles and meters in alphabetical order. Printed on bond. Handy size. The best 25 cent investment you can make. Limited edition. Order your copy NOW.

25c PER COPY
POSTPAID

PACIFIC RADIO PUB. CO.
Pacific Building San Francisco

and upset, of roaring wind and smashing waves, that faint tap-tap of the distant clock has steadied many an operator. It is a life-line carried aboard . . .

“Look out for two logs, three feet in diameter . . .” The hydrographic report now—to all ships at sea—carrying warnings of the various menaces to navigation, trees, derelict hulks and the like. Kinsey copied, for relay to other boats later, his hand working automatically

“WYA—QST QST QST de WYA wo nr us?”

Kinsey stiffened in his chair. Watts dropped his magazine on the floor where it lay unheeded. The *Monsura* calling! A general query addressed anyone listening with the question “who is near us?” added. Kinsey’s hand shot to his key. This time there was no hesitation. He was Kinsey, night operator at KXX

“WYA—KXX ga me wts rong?” (Go ahead to me—what’s wrong?)

Back came the *Monsura’s* hoarse moose bellow, the Kid on the key.

“Wo sd nyting rong?”

Kinsey swore.

“Wt u ask fr thn?” he demanded.

“Jst wntd to wv my hnd at thm as we go by,” came the reply. Then, ignoring Kinsey, the Kid repeated his QST and question, “wo nr us?” He got three answers—JJY, a Japanese liner, GHB, a British “juicer,” and WOH, a Kuppen-Crow tramp. All gave positions. The Kid answered each punctiliously, the swing of the *Monsura* breaking up his usually clear sending and forcing him to repeat. Kinsey counted the breaks.

“The Kid’s in trouble . . . calling for stand-by positions,” he said to Watts. “But he wouldn’t tell me. She’s rolling nose in right now. The waves are coming too fast for her to lift over . . . that’s bad medicine . . .”

“How do you know?” asked Watts, surprised.

“By the breaks. She rolls her antenna in and out of her smoke stream and that blanks her out. The radiation follows the smoke down the stack. See? That lags the key. Count the breaks and you’ve got a picture of what she’s doing . . .”

It was a clever deduction but quite accurate.

“Ask the Kid direct?” Watts suggested.

“He’d never tell. He’d sink before he yeeped—on his first trip.”

That explained a lot to Watts, because he knew Kinsey. He went back to his magazine. There was nothing else to do.

Half an hour later a tug, staggering southward with a raft of logs in tow, lost its cargo and shot a query to the owners. The telephone jangled in the station as the latter reported back. When Kinsey finished the relay, a fortune in

logs was adrift in the ship lane, and the tug was racing for Eureka with her pumps wide open.

Westward a Nippon boat tried frantically to unscramble a code from Honolulu, with the static making a hash of the message, and the harbor set growling in his ears for a "check." Before he had solved his puzzle, a Swedish motor-ship, coughing along on distillate, prodded Triangle Island for port instructions out of Vancouver. There were a number of "aloahas" to Hawaiian-bound tourists, the usual "love and regards," and the "will meet you at dock" salutations that congest the message lanes.

Kinsey was in the act of rolling himself a cigarette, when the silence of the operating room was suddenly shattered by a hoarse bellow, carrying the call that both men had sub-consciously been expecting all evening

"CQ CQ CQ de WYA SOS SOS SOS 62 miles north Point Reyes leaking badly send assistance WYA"
"My God!"

Kinsey's cry brought Watts up standing. He joined him at the operating table. Kinsey snapped on his power and the network of antenna wires fairly rocked under the impact of his sending.

"GA ga ga WYA ga to KXX ga sos ga ga KXX K."

And this time the Kid answered

It was a short story. The Kid tried to hold his hand steady as he sent, conscious that Kinsey was copying. But the *Monsura* was rocking frightfully—wallowing was the word—and the Kid was scared beyond anything that anybody but himself could know. He tried to cover that up as he sent, but Kinsey filled in the gaps, copying with leaping fingers, the message from the *Monsura*'s grim commander to Kilray and Company, owners of the sea-cow. The message read:

"*Monsura* sinking condition result your niggardly policy pump gaskets stop send wages due to my widow—McLeran."

Watts gave an exclamation.

"Migosh," he said. "Hear that key wobble it's mighty rough out there, Kinsey"

Kinsey looked up at him, and Watts stared in amazement, for the other had gone haggard so suddenly it startled him.

"It's not that . . ." Kinsey spoke with difficulty. "I wish it was that. It's the Kid . . . he's in a blue funk!"

"Good Lord . . . !"

The memory of that telltale flicker in the Kid's eyes came back now to Kinsey, sitting there and piecing little bits and fragments together. When was that? Oh, yes, the night he had promised the Kid he would get the Old Man to give him a place on the waiting list. That was it. That queer flicker had come

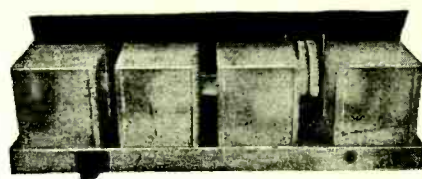

Aluminum Company of America manufacture the L. C. 28 Chassis Sub-panel and the "Junior" Aluminum Box Shields specified for Cockaday's L. C. 28.

ALUMINUM SHIELDING in the newest sets

RECENT radio developments demonstrate that Aluminum has been more widely adopted for shielding by the leading manufacturers than ever before.

This metal is especially effective as a shield at radio frequencies and has been accepted as standard by many of the foremost radio engineers.

Aluminum has countless applications in radio receiving sets. It is rapidly becoming a mark of quality quickly recognized by the layman.

"Aluminum for Radio"—a booklet explaining these manifold uses—will be mailed to you upon request.



Aluminum Company of America

2463 Oliver Building, Pittsburgh, Pa.

Offices in 18 Principal American Cities

"ALUMINUM IN EVERY COMMERCIAL FORM"

\$1.00 WILL SAVE YOUR SPEAKER



The Craftsman Dollar Speaker Filter is Guaranteed to relieve your speaker of the D. C. plate current (up to 250 volts). It gives speaker a chance to operate at its best. Attached in a second. Send dollar bill NOW!

CRAFTSMAN RADIO PRODUCTS
9 Orchard St. Newark, N. J.

SELL YOUR EXCESS PARTS
Through a Classified Ad in
"RADIO" See Page 79

RADIO WHOLESALE



Write for my Big 1928 Radio Catalog—just off the press. Thousands of marvelous bargains in nationally advertised goods. All the LATEST IN RADIOS and equipment. Lowest wholesale prices.

FREE Agents Wanted.

It's a regular encyclopedia on Radio. All about trouble finding. **FREE Log and Call Book and Catalog.** Get your copy today. Send postcard now!

American Auto & Radio Mfg. Co.
HARRY SCHWARTZBERG, PRES.
Dept. 143 American Radio Bldg., Kansas City, Mo. 3

DEALERS NEW 1928 CATALOG

Subscribe Now To
"RADIO"
\$1.00 for six months

Tell them that you saw it in RADIO

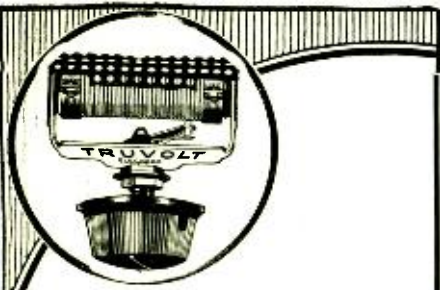

Constant Accuracy!

TRUVOLT

An All-Wire Variable Voltage Control

Install Truvolt in the B - Eliminator you are constructing and vary your voltage exactly. A new type wire variable high resistance kept cool by its greater radiation surface—like an air-cooled motor.

Develops but 1/2 the temperature of other resistances of like size; hence is permanently accurate and lasts indefinitely. Positive metallic contact always and 30 exact readings of resistances.

Type	Resistance (Ohms)	Current (Milliamperes)
T - 5	0 to 500	224
T - 10	0 to 1,000	158
T - 20	0 to 2,000	112
T - 50	0 to 5,000	71
T-100	0 to 10,000	50
T-200	0 to 20,000	35
T-250	0 to 25,000	32
T-500	0 to 50,000	22.5

Price \$3.50 each

All rated at 25 watts.

AT YOUR DEALERS

Also a full line of Wire Fixed Resistances

Write for free hook-up circular

Dept. 16B, 175 Varick St., New York

"This is an Eliminator Year"

ELECTRAD

then . . . it had puzzled him at the time. Now he knew. It hit him all at once with suffocating horror. The Kid was yellow!

KINSEY had seen that flicker before—in the eyes of men other than the Kid. He had seen it grow, like a suddenly recalled dream, coming from the inside out, when a sea upended suddenly like a flat dish, hung poised, and raced down, lathering avidly . . . He had seen men cling to a tilting deck, with staring eyes, and watch the ocean's backwash with the same expression. It was corroding, abysmal fear, older than any racial inheritance, and when it came the spine melted away and left a hideous, hollow gargoyle . . .

Behind Kinsey and the Kid was a long line of sea-farers—men and women who had lived on or by the sea. It had never occurred to Kinsey that anyone could be afraid of the sea. Yet he had, on occasion, been conscious that the sea represented a distinct terror for many people. That the Kid could be one of these struck him with sudden and garish incongruity. It was as though the Kid had become an outcast to family tradition. Somewhat the same idea involved the Kid, had Kinsey but known it.

Just when the Kid developed his first aversion to the ocean he never knew. It may have started with a dislike that magnified into a hate. Or—it might have gone farther into the realms of psychology and become an active fear through instinctive repression. Whatever its origin, when the Kid realized that the great, swirling, restless, flat world of spray-tipped green water was an enemy, he buried the knowledge deep within himself.

He could have faced out Kinsey's quiet amazement because he was essentially an individualist and not afraid to declare himself. But there was Ma. Somehow he felt that it would hurt Ma to find out that the sea on which his father and his grandfather had thrived, after a manner of speaking, represented only a vast terror to him. Had he only known that the corroding thing within him was but a reflection of a fear which Ma carried before he was born—which every woman of the sea carries when she sees one certain ship hull down on the horizon . . . But he didn't know, and so he kept it to himself.

It took all the Kid's self-control to walk up the gangplank of the *Monstura*, with his bag over his shoulder, and report to McLeran. The Scotch skipper gave him a keen glance. He saw Kinsey's laugh, Kinsey's eyes, Kinsey's debonair indifference of manner. He nodded approvingly. Even a ship's commander cannot see a man's soul, cannot know what lies overlaid there . . . ochre or mother-of-pearl . . . He jerked a thumb

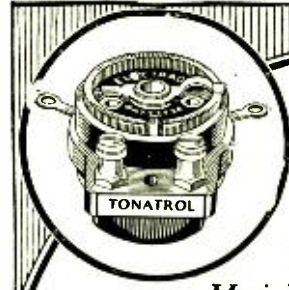

Exclusively Licensed by Technidyne Corporation under U. S. Patent No. 1593658, July 27, 1926

Volume to Fit the Music You Love

TONATROL

A True Tone and Volume Control

"TONATROL" permits reception at its most effective volume. Concert music with the intensity of the artists, sentimental music soft and low, dance music powerful and thrilling. Not until you try "TONATROL" will you know how much you can enjoy your radio.

Tonatrol—Standard Volume Control\$1.50

Tonatrol—Type W. S. (with filament switch attached) \$2.00

Write for free installation booklet for the proper way to control volume.

Dept. 54B, 175 Varick St., New York

ELECTRAD



Check Your Condensers

Compactness, simplicity and dependability are the new quality standards for better set construction. Sprague Midgets, small, compact and dependable meet every set building requirement.

Order the new .1 M.F.D. from your dealer or send one dollar for sample complete with mounting bushings. It is the outstanding condenser revelation of the season.

SPRAGUE SPECIALTIES CO.

Dept. R

Quincy, Mass.



5 TUBE RADIO ONLY \$19.98

It's a wonder for power and selectivity. Famous ART circuit. Coast to coast reception! Finely built of selected, tested parts. Thousands now in use. FREE Log and Call Book and New 132-p. Catalog with thousands of nationally advertised bargains. Latest in radio at big savings. Write for Free Copy.

AMERICAN AUTO & RADIO MFG. CO. HARRY SCHWARTZBERG, PRES. Dept. 141, American Radio Bldg., Kansas City, Mo.



YAXLEY

APPROVED RADIO PRODUCTS



Automatic Power Control FOR CHRISTMAS

The gift of gifts for the set owner. Makes radio more convenient because it handles the switching of the trickle charger and B eliminator automatically. Controls charger or eliminator separately or both in combination.

When the set is turned on the trickle charger is cut out and the B eliminator is switched on. When the set is turned off the trickle charger is cut in and the B eliminator is switched off.

Better reception and greater satisfaction are assured. The A battery is charging when the set is not in use. It is always ready with plenty of kick when the set is turned on. The B eliminator is on only when the set is in use; the tubes last longer and give better service, and there is no waste of power. No. 444—Series Type. \$5.00

Direct Representatives:

HENGER-SELTZER CO.

711 E. 14th Street Los Angeles
377 Brannan Street San Francisco

DON H. BURCHAM

1553 E. Everett Street Portland

SARGENT'S INFRADYNE MANUAL

Describing Last Season's MODEL

Is now ready for
Immediate Delivery

Order your copy now
by sending 25c in coin or
stamps to

"RADIO"

433 Pacific Bldg., San Francisco

Free Wholesale Radio Catalog Send today for it

1928 Catalog Dealers, set builders—make this your biggest radio season. Shure's great wholesale catalog insures the best in quality at lowest prices.

This wonderful book is jammed full of the newest offerings of Nationally known radio parts, kits, sets, accessories, table and console cabinets, etc. Also contains short wave sections showing the finest electrical apparatus for short wave receiving and transmitting. Your request brings our book of a thousand bargains, price list and discount sheet. Write for a copy today.

2000 Items **Big Values**

Shure Radio Company
339V West Madison St. Chicago, Ill.

toward the radio cabin and accepted the Kid on his face value.

The *Monsura* staggered into trouble as soon as she cleared the Golden Gate. She was not quite in cargo, due to a hurried departure, and the oil thudded ominously in the tanks, causing the old craft to squeak in protest. The Kid tucked himself in Kinsey's old quarters comforted somewhat by the big brother's nearness. But the pit of his stomach was fifty fathoms down. It failed to come back even at meal time. The Kid gulped a little coffee and let it go at that, and the *Monsura* pig-walked into the night with an operator, cool-green with terror.

The noises of a tanker are terrifying to an inexperienced boy. Nobody had told the Kid that a steel steamer feels every punch of the waves, and inside the radio cabin the storm sounded even worse than it was. He sat huddled over his instruments, in a cold perspiration, listening to the swash and suck of water over the deck and through the scuppers with one ear, and the chatter of the night's wireless business with the other. He glanced up at the calendar over the table . . .

Christmas Eve!

McLeran came in later. He gave the Kid a quick look and nodded toward a cubby hole above his head.

"There's brandy yon," he said in gruff kindness. "It'll steady your stomach . . ."

He thought the Kid was seasick. The Kid nodded dumbly, and licked a tongue over dry lips.

"I'm all right," he said carelessly.

It was a nightmare after that. Feet running on the deck below, shouts . . . The clank of pumps that refused to work. The thunderous boom of giant combers. The shiver of the *Monsura* as she heeled over with each fresh impact. It all meant nothing to the Kid except a terrible experience until McLeran came in, dripping with water, and sent the message to the owners. Then he knew . . .

When the skipper left him to himself, he half rose to his feet, his hands gripping the table. He wanted to dash the door open and scream at the night . . . After a bit he sank back, trembling! He couldn't act that way on Kinsey's ship . . .

Christmas Eve!

The Kid laughed—a cracked, thin-lipped cackle. Ma was decorating the tree—about now. She did that, each year, no matter whether or not there was anyone home but herself. They always tried to be there with her on that night—he and Kinsey. Sometimes they had been away. Ma decorated the tree just the same. Little candles, balls of gleaming silver, loops of tinsel, all care-

Nathaniel BALDWIN
LOUD SPEAKERS

A Famous Speaker

Benj. Franklin once said: "My performance devotes itself entirely to thy service & will serve thee faithfully and if it has the good fortune to please its master, tis gratification enough for the labor of—"Poor Richard!"

The New "Baldwin 99"

is without comparison. To-day, as 15 years ago, Baldwin performance is the standard by which others are judged. The workmanship of this speaker is comparable to the sensitive mechanism of a fine watch. Can be used on any set.

At all good dealers \$28.50
Ask your dealer to demonstrate it.

BALDWIN UNITS
Loudspeaker units, Phono adapters, and head sets are standard the world over.

J. W. & W. L. WOOLF
Distributors & Exporters
227-229 Fulton St., N.Y.

Write for booklet.

To keep posted on
INFRADYNE
suggestions and
improvements

Why not subscribe now to
"RADIO" for 12 months at
the price of \$2.50.

6 TUBE RADIO
ONE DIAL Latest advanced circuit. All steel chassis totally shielded. Balanced parts of best quality. Marvellous power and selectivity. Gets the long range stations as clear as a bell. One dial single control. An unsurpassed value—just one of our many mighty bargains.

Only \$32.50

FREE Log and Call Book and Big New Catalog—just off the press. Full of Radio Bargains. Send for your free copy now!

American Auto & Radio Mfg. Co.
HARRY SCHWARTZBERG, Pres.
Dep. 142 American Radio Bldg., Kansas City, Mo.

The next
issues of **6**
"RADIO"
for **1** dollar
if you subscribe Now

Tell them that you saw it in RADIO

AMERTRAN

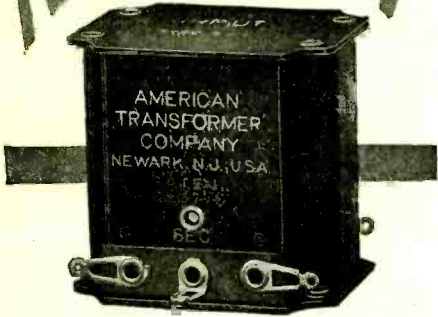

AmerTran Push-Pull For Your Present Set

With your present socket power supply a stage of AmerTran Push-Pull, using the new 171-A tubes, can be operated at no increased cost over the single power tube. It brings the advantages of greater tone reality and added volume. Tube distortion and harmonics are suppressed—the hum caused by raw A.C. on the filaments of the power tubes is eliminated.

For those wishing to utilize their present high voltage power packs we recommend the 210 combination of Push-Pull. Volume will be greater and only a slight change required in the plate supply.

AmerTran Push-Pull Input and Output transformers use high permeability alloy cores with multiple windings to give high inductive coupling and low capacity coupling. The Input transformer, has approximately the same primary impedance as the second state AmerTran DeLuxe. It is suitable for use ahead of any pair of standard power tubes.

The plate impedance of two tubes connected push-pull is double the impedance of a single tube. Since various types of power tubes have different values of plate impedance, this company provides output transformers to correspond with the power tubes and the speakers. The impedance ratios provide for the greatest transfer of energy from 60 to 100 cycles, because at these low frequencies more energy is required to drive the loud speaker mechanism.

AmerTran Push-Pull Transformers are now available in these types:
 Push-Pull Input Type 151—\$15 each
 Push-Pull Output Type 152 (Impedance ratio 4:1), for two UX-210's or similar power tubes—\$15 each
 Push-Pull Output Type 271 (Impedance ratio 2:1), for two UX-171 tubes connected push-pull—\$15 ea.

AMERICAN TRANSFORMER CO.
 178 Emmet Street Newark, N. J.

We also make Audio and Power Transformers, Chokes and Resistors
 Pacific Coast Office, Chronicle Building,
 San Francisco

**Transformer Builders for
Over Twenty-Six Years**

fully packed away in boxes afterward. She had been using the same decorations since he was a kid.

There were packages, all tied up mysteriously, placed at the foot of the tree . . . He and Kinsey had seen to that. Ma would go around and pat each one gently, as she patted the ornaments, her glasses lifted high on her forehead, standing with one hand on her hip wondering if she had forgotten anything. It would be a lonely dinner tomorrow with he and Kinsey away . . . with . . . my God!

The *Monsura* listed heavily. The Kid waited for the shuddering lift that had always followed those plunges. This time, however, the old tanker did not lift. He felt, rather than heard, the sea cascade over her. Landsmen though he was, he knew that she could not stand many of those . . . KXX was calling him, over and over. He reached for the switch that would start his generator and then drew back, shaking his head stubbornly. He dare not answer. Kinsey would know . . . Kinsey was clever. He'd read the terror that was in his soul, in his faltering key-script. No . . . better not!

The tanker heeled still farther over. The Kid braced his feet against the wall, as the operating table stood on edge. He'd heard Kinsey tell of seas like that, and had thrilled to the telling. But there was no thrill, facing the actuality of it. Slowly, feebly the *Monsura* levelled back, tipped and wallowed over the other way. The Kid spun around and crashed against the wall. Pencils, paper, and a bottle of ink crashed to the floor . . .

. . . a pounding on his door. He released the catch, McLeran, his face gray in the dim light, staggered in.

"Tell 'em we're taking to . . . the boats . . ."

He was gone again into the black hell that crushed in upon the Kid's soul. The Kid felt his blood freeze. The boats . . . small boats, in that sea . . . doomed!

Automatically, like a man in a trance, he cut in his generator. With a strange, growing steadiness he called KXX—Kinsey, the stuttering, choking tubes answering him. He was oddly calm now—as though, with an absym wide open, nothing mattered. Kinsey acknowledged instantly, his own pulses hammering . . .

" . . . taking to boats . . ." There was a break. Kinsey called. He got no answer. The Kid was swaying at the table. His generator was still purring . . . there was water in the engine-room but it had not yet reached the turbines. Pretty soon, however . . . The tanker listed with each thud of the waves, a little lower, a little farther over. The Kid braced himself, his eyes on the green-shaded lamp. The flame was bent

**The NEW
3 foot Cone
LOUD**

**"ENSCO"
WALL TYPE
SPEAKER**

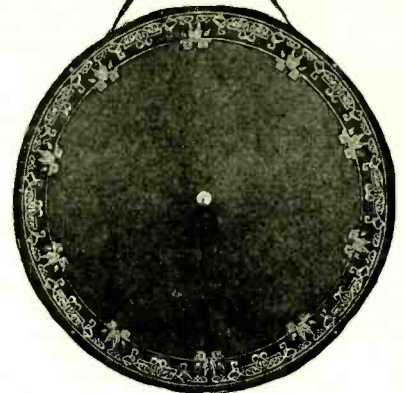

**STANDARD "ENSCO" KIT - \$10.00
With Hardwood Wall Frame - \$11.00**

Anyone can assemble the "World's Finest Loud Speaker" in less than an hour, from the complete "Enesco" Kit. Ask any engineer why the single cone is far superior to the double cone. *At your dealer's* or direct from any of the offices listed below. Send check, money order or C. O. D. (Shipping charges paid) In Canada \$11.50 and \$12.50. Absolute money back guarantee.

ENGINEERS' SERVICE COMPANY
 25 Church Street, New York 73 Cornhill, Boston
 28 E. Jackson Blvd., Chicago 331 Bay St., Toronto, Can.
 Pacific Coast Reps., Phelan & Gardner, Oakland, Cal.
 Pacific Coast Reps., BELDEN S. GARDNER
 144 Second Street, San Francisco

NEW Socket

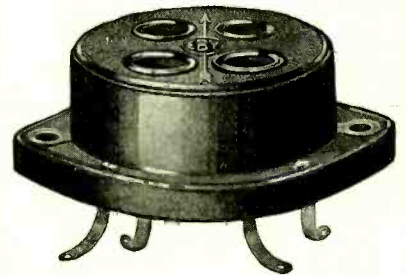

With An Old Name

The name Eby stands for the utmost in quality and performance in the radio industry.

The new Eby socket is a worthy member of a famous family. It has won unqualified approval because of—

1. Contact—3 point wiping spring contact the full length of the prongs—most perfect known. Prongs cannot spread.
2. Appearance—beautifully moulded of phenolic material—top same size as tube base. Small, beautiful and completely self-contained.
3. Easy Mounting—Above or below metal, bakelite or wood. List 40c.

The H. H. EBY MFG. CO., Inc.
 4710 Stenton Ave., Philadelphia, Pa.

MAKERS OF EBY BINDING POSTS

NEW RADIO LOG-25c

All the New Listings
 right up to date
"RADIO"
 Pacific Building - San Francisco

NEW A. C. TUBES & Filament Transformers

Immediate Delivery

THE new A. C. tubes by Cunningham or R. C. A. solve your battery problem forever. We can make delivery now on the new Cunningham CX-326 tubes at \$3.00 each. Cunningham C-327 sell for \$6.00. General Radio Filament transformers for these new tubes, \$10.00. Tube Sockets, General Radio, for new A. C. Tubes 60c each.

You can use the 112 or 171 power tube in the last stage, lighting the filament from A. C. A resistance with center tap is necessary. We sell these resistances for 60c each. We rewire sets for A. C. tube operation. Ship your set to us by express or bring it to our laboratory if you live in San Francisco. Estimates cheerfully furnished. The labor cost for converting your present set for A. C. tube operation is only \$10.00. This does not include tubes, sockets or transformers. A perfect wiring job is guaranteed.



Send check, money order or draft to—

D. B. McGOWN

435 Pacific Building, San Francisco

Master-Craft TUBE REJUVENATOR

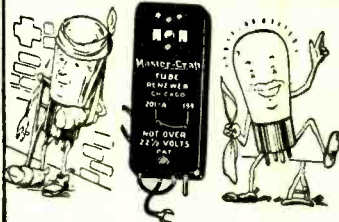

POSITIVELY will rejuvenate any **type tube** on the batteries of your set in 45 seconds. Simple to operate. No other parts necessary. Good for any number of tubes. Made of genuine red Bakelite.

Tested and Approved by Popular Science Institute of Standards, Popular Radio Laboratory, Radio Engineering and twelve other leading radio laboratories.

We guarantee that it will equal the results obtained with any rejuvenator regardless of price. Get yours today. All old radio tubes can be made good as new in 45 seconds. Save the difference.

If your dealer cannot supply you we will send postpaid upon receipt of \$1.00.

Satisfaction Guaranteed

\$1.00 ONLY
POSTPAID

Master-Craft Products Co.
ENGINEERS-DESIGNERS-MANUFACTURERS

1323 N. CLARK ST. CHICAGO, ILLINOIS
BRANCH OFFICES IN ALL PRINCIPAL CITIES

at an angle, the smoke streaking out. God! Would it never cease?

Christmas Eve! . . . Out in the dark came sharp commands . . . men running, the creak of davits, the crash of a boat swung inboard. A number of things raced past the Kid's vision . . . Ma's tight lips as she hugged Kinsey that morning in his uniform . . . Ma had been scared then too. He knew, did the Kid. Yet she had smiled. The Kid suddenly drew a long shuddering breath . . . God—he couldn't be a rotter!

" . . . KXX KXX KXX de WYA . . . "

Up in the little wind-swept operating room on the hill Kinsey smiled softly. The Kid's hand was steady now, clean, rolling in like print . . .

"OK ga get u KXX . . . "

"Dh to U . . . " The Kid was laughing hysterically, but his hand was steel on the button. "Hr dh to U . . . so long Kin . . . she's going . . . boats haven't a chance but it's okay . . . 30 . . . and a Merry Xmas to Ma dear . . . "

He never signed off. The *Monsura* swung over, her deck almost on edge, hung poised, waited for the punch—and got it . . . a huge comber racing out of the dark, and with a shuddering sigh, slipped down to her last sleep . . .

The Kid jerked back the operating door, and plunged against a companionway rail—out into a hell of black spume, and a thunderous roar. He went out and down in a mad blackness, his fingers tearing at slippery planking, his eyes shut, a prayer on his lips . . .

But inside, his heart was singing . . . !

It was Watts, under the green shaded lamp at KXX, who thrust Kinsey out of the chair, took his head caps, and grabbed the key for the swift, clamorous summons of the night which brings every marine agency into quick co-ordination, as the staccato story of a sea tragedy is broadcast. Ship after ship answered Watts' call and started to the aid of the stricken crew of the sunken *Monsura*, somewhere off Point Reyes, in the dark . . .

A coast guard cutter snapped back a response, swung broadside to the gale and started back down the coast. A freighter, a city block in length, changed bearings and went plunging through the night. A passenger liner, gambling with death, nosed into the combers, toward the last known position of the *Monsura*, a lookout lashed to his post, watching for flares. Through it all, Kinsey sat with his head in his hands, trying to blot out two pictures . . . the Kid's smile, and Ma's eyes . . .

It was hours later that he voiced what was really in his mind . . . as the wastrel dawn crept in shamefaced out of the night . . .

"The Kid was steady at the end,



How do you know that your set is operating at its best?

Spend a few minutes with your radio—and a *Weston Voltmeter*—before broadcasting time arrives.

Check up the voltages of your set and note the difference in the power and quality of reception, simply by making the quick little adjustments that your *Weston* tells you are required.

With this Model 489 Portable Weston Voltmeter

correct radio operation is made simple and also *less costly*. You merely test the tubes and batteries once a week—like winding a clock. You do not make a habit of guessing the time—then why guess at the faithfulness of radio set reproduction?

Just ask your dealer for Model 489, having 1000 ohms per volt. Suitable for B-Eliminator or battery operated sets.

Write for Circular J

WESTON ELECTRICAL
INSTRUMENT CORPORATION
156 Weston Ave., Newark, N.J.

Pacific Coast Representatives
Graybar Electric Company, Inc.
84 Marion St., Seattle, Wash.
J. H. Southard, San Francisco
A. A. Barbera, Los Angeles
Repair Service Laboratory
682 Mission St., San Francisco



WESTON RADIO INSTRUMENTS

Tell them that you saw it in RADIO



Instant Response

Snapping the filament switch on your radio set brings an instant response—that is, if you have a Jewell A-B Relay. The trickle charger is automatically disconnected and the B-eliminator connected to the house circuit. Your set is ready to tune in without the trouble of changing the several connections by hand.

When the filament switch is turned off, a complete reverse of the above action occurs.

The Jewell A-B Relay is very convenient and reliable. Write for special Circular No. 1023.

Jewell Electrical Instrument Company

1650 WALNUT STREET, CHICAGO

"27 Years Making Good Instruments"

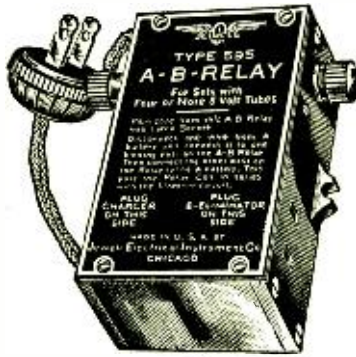

The A-B Relay is very compact and will not interfere with the normal operation of any set. It consists of a low resistance magnet placed in series with the filament and A-battery, and actuating special contact.



The Newest A B C Power Supply Unit

—used with R C A 226 and 227 A C tubes
—and the Raytheon BH tube



No. 5552
List
\$20.00

This latest development of the Dongan laboratories combines in one small, compact case the essential transformers and chokes designed for use with R C A 226 and 227 A C Filament Tubes (also UX 171 power amplifier tube) and the Raytheon BH Rectifier Tube. Complete power supply is secured, eliminating the need of batteries and charger. R C A 226 and 227 A C tubes also take the place of standard 201 A tubes.

For complete information write to Dongan laboratories. If your dealer cannot supply you send check or money order direct.

Dongan Electric Manufacturing Company
2981-3001 Franklin St. Detroit

TRANSFORMERS OF MERIT FOR FIFTEEN YEARS



Things Don't Just Happen

That nothing to equal the patented Chaslyn Balls for accuracy, unbreakability and simplicity of reading has been discovered is why the big manufacturers of Batteries use them as Charge Indicators in Glass-Cased Batteries and Power Units.

Easiest to Read
Nothing to Break

Swim all three—
charged fully
Sinks the white—
charge still right

Sinks the green—charge is lean

Sinks the red—charge is dead

Ask your dealer. If he can't supply, send 75c to us.

Chaslyn Corrosion Cure for Battery Terminals protects contacts. A large tube is 30c.

THE CHASLYN COMPANY

4629 Ravenswood Ave. Chicago, Ill.



FAST CONDENSERS FOR ABC PACKS

Fast Hi-Test, extra capacity condensers are built to withstand every requirement of usage. Millions now in use and since 1919, one of the oldest established and reliable manufacturers.

An exclusive feature—by-pass condensers enclosed in one-piece die-press steel housing, makes them positively impervious to climatic conditions or abuse. Before being encased condensers receive special laboratory treatment, moisture content is effectually removed and the housing seals them permanently—Fast condensers thus give better service. Illustration shows condenser pack used in Q. R. S. or Raytheon A-B-C unit. Fast condensers fit all units, whether specified or not. Write for free condenser booklet. Dealers and jobbers, send for prices.

JOHN E. FAST & CO.

3982 Barry Avenue, Dept. C, Chicago, U. S. A.

Watts . . . *the Kid was steady . . .!*" He spoke shakily.

"Sure he was—Your brother, wasn't he . . .?"

Kinsey nodded slowly.

"Well, I know but . . ." He broke off.

Watts gave him a shake.

"Go on . . . home," he said. "We've done all we can . . ."

Christmas . . .!

. . . . Ma insisted on lighting the candles. It seemed foolish to Kinsey—a grim satire, those points of light gleaming among the loops of silver tinsel. Her face was strangely calm, as she went about the task. Kinsey watched her with his own eyes burning, wondering . . . He was hard hit. For once in his life he failed to understand Ma, and it left him very much alone . . . with his grief. He couldn't get the roar of the sea out of the noises of the storm, out of the wind gusts. They haunted him, like mocking voices . . . The Kid . . .

Stamping feet . . . a door flung wide, a glad cry . . . Ma held the Kid close in her arms, dripping water . . .

"I knew, I knew . . .!" she murmured.

He had run all the way from the life saving station. The cutter had picked them up just before dawn, swimming, clinging to wreckage . . . some of them. Four had gone . . . McLeran . . . lost in the icy water. Kinsey had to touch him, to feel him first . . . hands gripped!

Their eyes met . . . Kinsey's and the Kid's. Kinsey's had a searching scrutiny in them, reading through to the Kid's soul. As he looked, the valse triste of the surf washed out the miserable ghosts of the sea, like foam . . . out of their lives forever.

"Pretty stiff experience," Kinsey said casually.

The Kid grinned with a new found buoyance.

"Part of the game . . .!" he said softly.

. . . . Ma was right, after all. It was the candles that counted . . . not the loops of silver tinsel . . .

Christmas!

LIST OF PARTS FOR A.C. OPERATED AERO 6 RECEIVER

Described on page 22

- 1—Remler 3 gang .00035 condenser
- 1—Remler drum dial
- 1—Set Aero coils No. 123
- 1—Aero No. 60 choke
- 5—X type sockets, G. R.
- 1—5 prong socket, G. R.
- 6—G. R. fil. resistors, center tap
- 5—Binding posts, antenna, Grid, C, —, C
- 1—Yaxley cable and plug
- 1—G. R. No. 440 filament transformer
- 2—G. R. .5 ohm No. 410 rheostats
- 1—G. R. 15 ohm No. 410 Rheostat
- 2—Ferranti audio transformers, AF-3 or AF-4
- 1—Ferranti output transformer
- 1—Pr. Benjamin brackets
- 1—Electrad 1000 ohm potentiometer
- 1—Filament switch, Yaxley
- 2—Yaxley 2000 fixed resistors
- 1—Panel and subpanel
- 4—1 mfd. Tobe condensers
- 1—.00025 grid condenser and leak, Sangamo

FISHING FOR RADIO WAVES

(Continued from page 27)

Fig. 6 and 7 show interesting results obtained in the reception of two waves from the same station. The plane of polarization was periodically changed at the transmitter through 90 degrees. The transitions shown in the figure afford a comparison in the variation in signal strength of the two waves from station 2XI, initially plane polarized horizontally and vertically.

For reception, the analyzer was used, and so adjusted that the strength of the received signal was a maximum. This was found to be in a *horizontal* position, perpendicular to the line of propagation. The rather surprising result is indicated by the records that the received signal intensity is greater when the initial plane of polarization of the electric component is vertical. A marked difference in the type of fluctuations was sometimes evident.

These records seem to give conclusive evidence of a rotation of the plane of the maximum electric component to a horizontal plane when the initial plane is vertical, and fail to indicate such rotation when the initial plane is horizontal. As the distance from 2XI is so great as to preclude all possibility of the reception of the ground wave, the rotation must have occurred in the passage of the electromagnetic wave by the sky route.

This study of radio fading indicates, so far as the records and observations are concerned, several things. Before these could be definitely established, correlative experiments would have to be performed at numerous points throughout the world, and under all possible conditions of propagation.

There seem to be two main factors which bring about this fading, interference between waves which have traveled over different paths to the receiver, and rotation of the plane of polarization which changes the magnitude of the component of the wave received by the antenna.

Confirmation is apparently given to the hypothesis of the existence of a highly ionized layer of atmosphere surrounding the globe, and refraction must occur to bend the waves around the curve of the earth. The rotation of the maximum electric component of the wave, predicted by theory under these conditions has been experimentally shown to exist.

The possibility of expressing with mathematical exactness, the actual conditions is slight. There appear to be several causes of variations among which are:

- Shifting of the ionized layers.
- Seasonal changes in the degree of ionization.
- Long time variations such as those brought about by the sun-spot cycle.

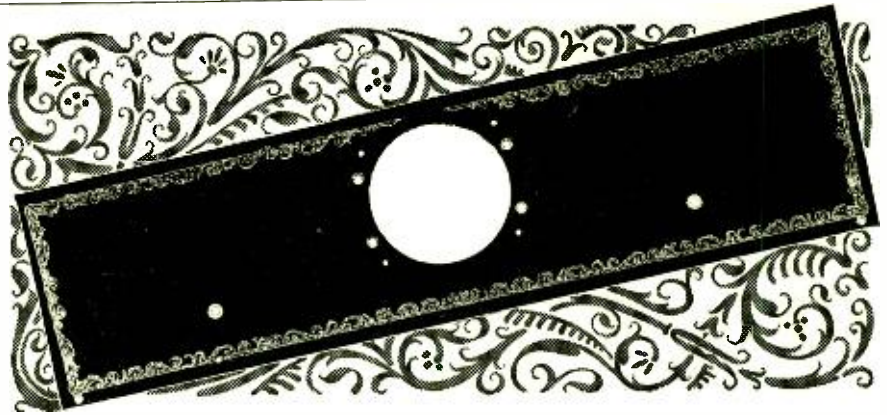

Handsome Panels For These Kit Sets!

FORMICA has prepared handsomely decorated panels for the leading kits of the year, so that home builders can make sets of better appearance. Many of these panels are fully drilled and ready for assembly.

Among the panels offered are Magnaformer, front and sub; World's Record Super Ten, front and sub; Camfield Nine, front and sub; Tyrman, front and sub; Madison-Moore International One Spot for A. C. operation and many others.

Plain Formica panels of any size are also available.

THE FORMICA INSULATION COMPANY

4616 Spring Grove Avenue
CINCINNATI, OHIO

Leading jobbers everywhere can provide you with FORMICA products.

FORMICA
Made from Anhydrous Bakelite Resins
SHEETS TUBES RODS

FORMICA has a complete insulating service for manufacturers.



The New POWERTONE 36" GIANT Cone Speaker Kit (Double Edge)

A speaker of beauty, tone quality and has the characteristics of the higher priced speakers. Can be assembled in less than an hour.

The POWERTONE kit consists of:

- | | |
|------------------------|--------------------|
| 1 POWERTONE UNIT | 1 Apex |
| 1 Designed Front Sheet | 1 Tube Cement |
| Fonotex Paper | 1 Set Screws, Nuts |
| 1 Back Sheet Paper | 1 Stand |
| 2 Metal Rings | Full Instructions |
| 1 Metal Bracket | |

\$12.00

Incl. Stand FREE

Powertone Cone Unit **\$5.50**

Dealers and Jobbers Write for Proposition

POWERTONE ELECTRIC CO.

218 FULTON ST., N. Y. C.

Tell them that you saw it in RADIO

Acme ANTENNA

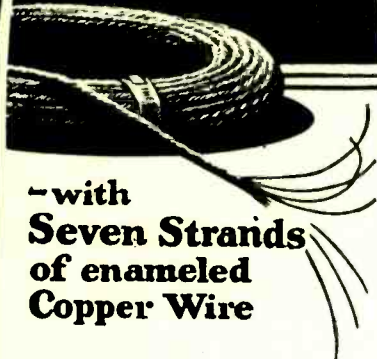

— with
**Seven Strands
of enameled
Copper Wire**

Best outdoor antenna you can buy. Seven strands of enameled copper wire. Presents maximum surface for reception, resists corrosion; this greatly improves the signal. Outside diameters equal to sizes 14 and 16. (We also offer solid and stranded bare, and stranded tinned antenna.)

Loop Antenna Wire

Sixty strands of No. 38 bare copper wire for flexibility, 5 strands of No. 36 phosphor bronze to prevent stretching. Green or brown silk covering; best loop wire possible to make.

Battery Cable

A rayon-covered cable of 5, 6, 7, 8 or 9 vari-colored Flexible Celatsite wires for connecting batteries or eliminator to set. Plainly tabbed; easy to connect. Gives set an orderly appearance.



Acme Celatsite Wire



Tinned copper bus bar hook-up wire with non-flammable Celatsite insulation, in 9 beautiful colors. Strips easily, solders readily, won't crack at bends. Sizes 14, 16, 18, 19; 30 inch lengths.

Flexible Celatsite for sub-panel wiring

A cable of fine, tinned copper wires with non-flammable Celatsite insulation. Ideal for sub-panel or point-to-point wiring. Strips easily, solders readily. Nine beautiful colors; sold only in 25 ft. coils, in cartons colored to match contents.

Spaghetti Tubing

Oil, moisture, acid proof; highly dielectric — used by leading engineers. Nine colors, for wire sizes 12 to 18; 30 inch lengths. (We also make tinned bus bar, round and square, in 2 and 2½ ft. lengths.)

Send for folder

THE ACME WIRE CO., Dept. R
New Haven, Conn.

ACME WIRE
MAKES BETTER RADIO

d. The effect of the so-called "cosmic" rays on the upper strata of atmosphere.

e. The effect of the earth's magnetic field.

The type of fading experienced on the short waves is of an entirely different nature than that recorded on the 200 to 600 meter waves. In general, it is more rapid and more violent, the frequency increasing as the wave is lowered. Further than that, examination must be made of each particular case. As the conditions approach full daylight or full night, in every case greater stability of the signal is noted, the greatest fading occurring at the transition stages. At long distances from the transmitter, the effects of the variation become integrated, the net result being a comparatively steady signal.

In general, horizontal reception at right angles to the line of propagation will give better signal strength and stability on the short waves than reception at other angles. This appeared to be especially marked in the neighborhood of 150 miles.

SOCKET POWER OPERATION OF TYRMAN TEN

(Continued from page 35)

number of reports confirm "Coast to Coast" reception without the slightest local interference. The tuned r.f. amplifier ahead of the intermediate frequency amplifier allows the use of an outside aerial, with its better pick-up, with a selectivity equal to that of the sharpest loop receiver.

LIST OF PARTS FOR POWER SUPPLY

- 1—Thordarson No. 2098 transformer
- 1—Thordarson No. 2099 choke
- 1—Carter R-210 condenser block
- 1—Carter 7400 ohm resistance with 2 sliders
- 1—Carter 4000 ohm resistance
- 1—Carter 750 ohm resistance
- 1—Ward Leonard 700 resistance
- 1—Binding post strip
- 4—X-L bakelite binding posts
- 2—Frost sockets
- 2—216-B tubes

As the intermediate frequency transformers are peaked at about 350 k.c. and separate the two beat notes at 700 k.c., only one setting of the oscillator dial is possible on stations above 275 meters. As the preliminary stage of tuned r.f. will tune out stations below 275 meters if it is followed in resonance with the oscillator setting, their upper side band need not heterodyne with other stations.

The work of assembly and wiring is minimized by the use of subpanel connections on all units and by the Kurz-Kasch capacity connector. The Tyrman r.f. transformers are designed for maximum efficiency and in connection with the adjustable capacity Camfield condensers are readily matched. The drum dials and minimum of panel controls enhance its appearance and the audio system gives as near perfect fidelity of tone reproduction as is possible to attain.

IN **R.F.** by-pass circuits

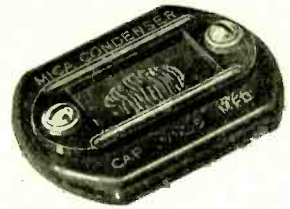

SANGAMO
MICA CONDENSERS

A HIGH self inductance in condensers used in R. F. by-pass circuits means a *loss in capacity* at the lower wave lengths.

In many by-pass condensers the inductive reactance below 300 meters is appreciable. They become choke coils!

Use the larger capacities of Sangamo Mica Condensers in all R. F. circuits. Self inductance is negligible and direct current resistance more than 35,000 megohms! Sangamo Mica Condensers are *all capacity*.



SANGAMO ELECTRIC CO.
6336-2 SPRINGFIELD, ILLINOIS

NEXT MONTH

Best's New Super
Don't Miss January "RADIO"

RADIO Agents Wanted

Make Big Money in Spare Time

Demonstrating the Famous Trego Radios and Phonographs to your friends. Made in both Five and Six-tube Tuned Radio Frequency Sets, at prices ranging from \$49.50 to \$173.80; also the last word in Portable Phonographs; ideal for home, motor trips, camps, etc. \$15 and \$25. As well as hundreds of other fast selling articles for agents

TREGO RADIO MFG. CO.
1427 Chestnut, Kansas City, Mo.

DEPT. NO. 1

WAVE TRAPS

(Continued from page 28)

course duplicate that of Fig. 1c. But in this case it is paralleled with the receiver; and as currents of the resonant frequency cannot go through it, they must flow through the receiver. Currents of other frequencies, however, will

cover the broadcast band. The exception is when a continuous-wave station outside of the broadcast band is to be eliminated by means of the trap of Fig. 1. The coil and condenser, in this case, must be able to tune to the outlying wave. Such is a rather uncommon occurrence, however. The coil and con-

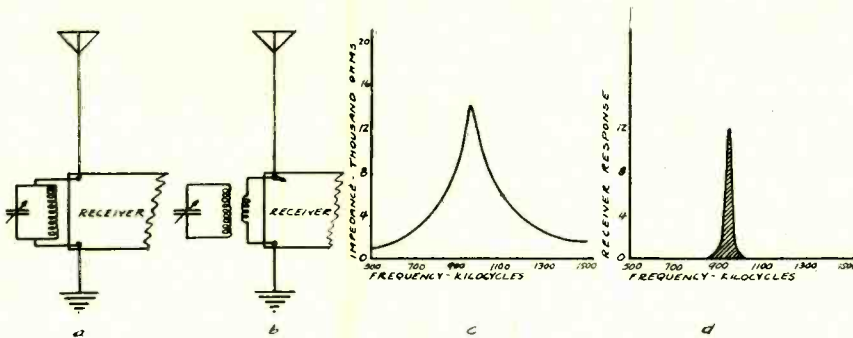

Fig. 3. Conditions of Parallel Resonance for an Acceptor Trap.

be bypassed around the set by the trap. The response curve under these conditions takes the form of Fig. 3d. Only a very narrow frequency band gets into the receiver. It may be seen why this type of trap is sometimes called an "acceptor"; and, similarly, why that of Fig. 1 is designated as a "rejector." The acceptor type can, and had best be, coupled to the set. Its action, also, is tremendously improved thereby.

A study of the response curves will show which type of trap is best suited to eliminate any given kind of interference. The rejector of Fig. 1 cuts out a narrow frequency band. It should be used, therefore, where it is desired to eliminate a local broadcasting station, or other continuous-wave transmitter. The tuning of the coupled type can be made extremely sharp, so that weak signals that are only 10 or 20 kilocycles removed from strong interference can be received. Because it works only over a narrow band, this type of trap cannot be used with much success on spark interference, for such is inherently broad. Neither will it lessen interference of the power-leak variety.

The coupled "acceptor" of Fig. 3b is the type that should be used where these kinds of noise are bothersome. The response of the receiver to a.c. induction hums, line noises, sparking contacts, etc., is low, for they lie way to the left on the frequency scale of the curve. The spark interference for the most part is on the 600 and 720-meter channels, and also lies outside the band to which the receiver responds. The two types of parallel traps, then, will pretty well cover the gamut of interference elimination. The series-tuned trap in some cases may work well. Sometimes it is a help in getting rid of a spark station on a materially different wavelength.

The size of the coil and condenser should, in most cases, be such as to

denser, for general usage of the rejector type, and in all cases of the acceptor type, should be regulation broadcast size. An antenna-coupler unit, having a primary of 5 to 15, or so, turns, and a secondary to be used with a .00025, .00035, or .0005-mfd. condenser, would do nicely for the coupled traps. Or a three-circuit tuner could be used, and the tickler left idle. Even a radio-frequency transformer unit could be used, though usually the coupling between the primary and the secondary is not variable, and flexibility would be lost in this way. Lacking even the above, it is a simple matter to wind a coil or two, and usually to find an idle condenser. The results will more than justify the simple effort necessary to put the device together.

There are two kinds of interference that the trap cannot lesson. One is the heterodyning between stations. Any device that would destroy the heterodyne note would also destroy the sidebands—the music and speech—of the desired station. And the trap will not eliminate static, though it will help, perhaps, to a degree.

CALLS HEARD

(Continued from page 43)

8dem, 8djf, 8djp, 8ey, 8gl, 8jq, 8pl, 8vx, 9adm, 9adn, 9aeb, 9arr, 9ajv, 9apa, 9avz, 9axo, 9baz, 9bcn, 9beq, 9bmm, 9bpm, 8bqe, 9bth, 9bwj, 9ccv, 9cei, 9cks, 9cmq, 9crj, 9cvn, 9cxg, 9cxq, 9czh, 9dah, 9deb, 9des, 9dfz, 9dma, 9dud, 9dpw, 9dr, 9dxg, 9ecs, 9ehn, 9efk, 9ek, 9ekf, 9ekw, 9fi, 9fs, 9nk, 9pc, 9pu, 9wj, 9wr, 9xn, 9wk, 9a-2yj, 9a-2hh, 9a-2rc, 9a-3jk, 9a-3jw, 9a-3vp, 9a-3xo, 9a-2ss, 9a-2uk, 9a-5bg, 9a-5bx, 9a-5dx, 9a-5dy, 9a-5lf, 9z-2bg, 9z-2bp, 9z-2br, 9z-2ga, 9z-2rx, 9z-3ap, 9z-3ar, 9z-4aa, 9z-4ac, 9h-6dcu, 9h-6diu, 9h-6dv, 9a-7kn, 9c-2be, 9c-2bg, 9c-2al, 9c-3hp, 9c-4bt, 9c-4fy, 9c-4gt, 9c-5ad, 9c-5aj, 9c-5go, 9n-1j, 9n-1fmh, 9n-cto, 9e-8aro, 9wnp, 9wbny.

ss-2BN would appreciate cards from the above stations, and also from stations who heard his sigs. All cards will be faithfully qs'd. nc-2BN was operator on this vessel and was on his vacation. From now on, nc-2BN will be active. nc-2BN is J. L. Miller, 136 Vendome Ave., N. D. G., Montreal, Que., Canada.

NEW AERO KITS

USED IN

IMPORTANT CIRCUITS

The Improved Aero-Dyne 6, the Aero 7 and Aero 4—all popular new circuits—are built around these marvelous coils

You Should Learn About Them NOW!



AERO UNIVERSAL TUNED RADIO FREQUENCY KIT

Especially designed for the Improved Aero-Dyne 6. Kit consists of 4 twice-matched units, adaptable to 201-A, 199, 112, and the new 240 and A. C. tubes. Tuning range below 200 to above 550 meters.

This kit will make any circuit better in selectivity, tone and range. Will eliminate losses and give the greatest receiving efficiency.

Code No. U-16 (for .0005 Cond.)...\$15.00
Code No. U-163 (for .00035 Cond.)... 15.00



AERO SEVEN TUNED RADIO FREQUENCY KIT

Especially designed for the Aero 7. Kit consists of 3 twice-matched units. Coils are wound on Bakelite skeleton forms, assuring a 95% air dielectric. Tuning range from below 200 to above 550 meters. Adaptable to 201-A, 199, 112, and the new 240 and A. C. tubes.

Code No. U-12 (for .0005 Cond.)...\$12.00
Code No. U-123 (for .00035 Cond.)... 12.00

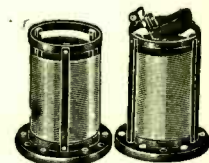

AERO FOUR KIT

An exceptionally efficient kit for use in the Aero 4 and other similar circuits. Consists of one Aero Universal Radio Frequency Transformer and one Aero Universal 3-Circuit Tuner. Uses 201-A, 112, 199 and new A. C. tubes.

Code No. U-95 (for .0005 Cond.)...\$8.00
Code No. U-953 (for .00035 Cond.)... 8.00

NOTE: All AERO Universal Kits for use in tuned radio frequency circuits have packed in each coil with a fixed primary a twice matched calibration slip showing reading of each fixed primary coil at 250 meters and at 500 meters; all having an accurate and similar calibration.

A NEW SERVICE

We have arranged to furnish the home set builder with complete Foundation Units for the above named Circuits and for the Chicago Daily News 4-Tube Receiver, drilled and engraved on Westinghouse Micarta. Detailed blueprints and wiring diagram for each circuit included in foundation units free. Write for information and prices.

You should be able to get any of the above Aero Coils and parts from your dealer. If he should be out of stock order direct from the factory.

AERO PRODUCTS, Inc.

Dept. 103

1772 Wilson Ave. Chicago, Ill.

Tell them that you saw it in RADIO

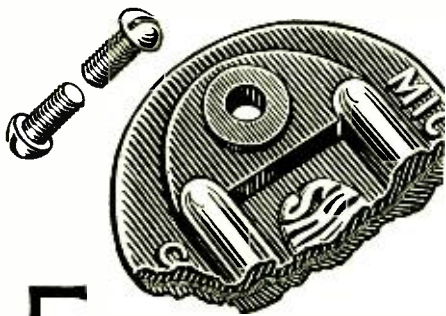

EASY to use

Accurate rating, permanent capacity value, high D. C. resistance — low self inductance are characteristics of Sangamo Mica Condensers.

In addition, they are easy to use!

One may solder directly to the terminals, or pass bus-bar through them, use lugs, or mount the condenser with machine screws — all with the knowledge that the condenser will not be injured and that connections are permanent!

6336-5

Sangamo Electric Company
Springfield, Illinois

SANGAMO

MICA CONDENSERS

Keep a Record of Your Magnaformer Log

The publishers of "RADIO" have a complete station Log Book ready for you. It gives all station listings — spaces for logging all stations received — kilocycle and wave bands, locations of stations and 32 pages of valuable data. It's yours for only 25 cents, postpaid. Stamps accepted.

RADIO, Pacific Bldg., San Francisco

THE COMMERCIAL BRASS POUNDER

(Continued from page 46)

Testimonial to be presented to any ship opr who copies NAM weather reports more than 50 miles, also affidavit from NAM as to why they send weather reports on a punk 600 meter wave right in the midst of QRM from WSC and a hundred ships, when, according to Weather Bureau and Hydrographic publications NAM should send these reports on long wave.

Circuit of buzzer set to be published for the benefit of ship oprs who are obliged to use the ship's transmitter when learning to use a bug.

Photo of a street car, big heavy car, running over the opr who waits two minutes for Lightship Weather Reports and then opens up and asks who got it just as the lightship starts sending.

Article and circuit diagrams on the receivers used for 60 meter reception ? by NPG and NPM. Range 100 miles, maybe.

In closing I would like to offer this information for the department. When a Japanese opr tells you "QSC UL," he does not mean that your spacing is rotten as L. He means TKS CUL. They all do it.

Tnx in advance, 73's, R. I. DICULE.

Here's an interesting letter from a friend in New York. Although he has never pounded brass he is an ardent enthusiast of the game. His observations are well worth noting so I am passing them on to you.

Sir—I have been interested in wireless telegraphy for the past four years and hold a commercial first-class certificate. Although I have never been to sea as an operator, I have a set of my own and listen in nightly, keeping a log, etc. I have made quite an extensive study of the methods of traffic handling used by different nationalities and therefore think I am qualified to speak thereof.

Being an American resident, I have to be content with American wireless together with what foreign shipping comes to New York and vicinity. Recently I made a trip to England and had a chance there to briefly study methods used by European coast stations. I find that the average coast station on the English channel is operated just the same way it was when the Laws of 1912 came into effect. These regulations are very rigidly upheld by the coast stations, particularly the GPO stations in England. The progressive operator hasn't a chance for speedy and efficient work in that congested locality. If he dares to send in any other manner than that stated in the Laws of 1912 he is liable to be severely reprimanded if not reported. This isn't progress, is it? I heard a Yankee ship call G— in the following way: "G—K—p." He was bawled out by the coast station and then referred to paragraph so-and-so of regulation so-and-so of 1912. I hope the International Convention makes a big change in things next month, so the operator who wants to operate efficiently will not be stopped. The man with the 40 w.p.m. bug is, of course, a nuisance wherever he sails. Thank goodness there aren't many of 'em.

Another thing I would like to say and that is, when are the European governments going to erect modern stations to replace the junk-boxes now in operation? One cannot handle traffic, I believe, with any coast station he chooses there. The msg must go to the nearest station even if the LL bill reaches two figures for a fifteen word message. I will quote a paragraph from a letter written by an English operator and which appeared in an English magazine. It reads as follows:

"For service, speed and efficiency give me the American coast station. Listen to KPH or WSC and then try GLD with his 'da-dit-da dit-da' and XYZ three times business."

I am glad to know that there are some British operators who are kicking about their own country's stations.

Yours also for progress on the other side,
HARRY F. WASHBURN JR.
New York City.

KFZH

By the Operators

KFZH was installed eighteen miles from Fairbanks Alaska for the purpose of handling press, weather, etc., with KFZG, Pt. Barrow, for the Detroit News Wilkins expedition in 1927. The equipment at Barrow was a 7.5 watter using Burgess B batteries and crystal control.

The crystal controlled apparatus at KFZH consisted of a 7.5 watt oscillator with a 50 watt amplifier. Two 200 volt B batteries were used as plate supply for the oscillator, but could be replaced by a high voltage B eliminator capable of delivering 250 volts. The amplifier was energized by an Esco 32-750 volt 200 watt dynamotor.

Referring to the diagram, all r.f. chokes are 1 in. in diameter and are of 100 turns each, except the amplifier plate choke, which has 30 turns. The wavetrap between the oscillator and the amplifier is tuned to twice the crystal frequency for frequency doubling. Its effect is to strengthen the second harmonic.

The neutralizing condenser in the amplifier circuit is about ten times oversize, so that that circuit may be made self-oscillatory by cutting off the filament and plate of the oscillator. The plate coil of the oscillator then acts as a wavetrap in the grid circuit, allowing fine variation of feedback, thereby enhancing the note. It also allows much more stable operation and better efficiency.

The oscillator plate coil is 2½ in. in diameter while the other high-frequency carrying coils are 3 in. in diameter. The neutralization coil consists of three turns wound over the amplifier plate coil, in the same direction. The antenna is a Hertz type r.f. feedline consisting of No. 14 rc wire threaded through holes of porcelain cleats. The "hot" ends are insulated with Pyrex. Waves used are 45 and 35 meters.

Shielded Grid Tubes and the Infradyne

By substituting the new shielded grid tubes in the r.f. amplifier of the Infradyne in place of the conventional 301-A tubes the efficiency and distance getting ability of the Infradyne are enormously increased. Those who have purchased 1928 Infradynes can adapt the set for shielded grid tube operation by making only a slight change in the coupling arm adjustment in the r.f. amplifier and adding another small fixed condenser, grid leak and two 10 ohm fixed resistances to cut the filament voltage supply to 3 volts. Complete circulars showing how to make these changes will be sent to our customers without cost. Write now for your copy. Your 1928 Infradyne with the new shielded grid tubes again becomes the greatest of all DX receivers. The Infradyne automatically keeps itself abreast of the times.

RADIO CONSTRUCTORS
CORPORATION

357 12th Street Oakland, Calif.

Amazing New A C radio tubes eliminate batteries by use of electric house current

NEW RADIO TUBES TO USE ORDINARY HOUSE CURRENT FOR POWER

NEW YORK, Jan. 3rd.—Much interest was aroused in radio circles today by the announcement that a radio tube had at last been perfected which used ordinary electric house current in the operation of its plate circuit.

ELECTRICAL WIZARD RUNS RADIO WITH ORDINARY HOUSE LIGHTING CURRENT

—A radio receiver—

NEW RADIO TUBE WILL OBSOLETE BATTERY POWER

WASHINGTON, March 15th.—Persons who from the earliest days of the radio have waited for a tube that would

in the CROSLLEY VAC BANDBOX 6 tubes Genuine Neutrodyne



STORIES in regard to the coming of AC tubes which would operate from house lighting circuits have appeared in various newspapers, arousing a climax of anticipation in the public mind last spring.

With the acquisition of a license by the Crosley Radio Corporation under a large group of patents controlled by the Radio Corporation of America, American Telephone and Telegraph Company, General Electric Company, Westinghouse Electric and Manufacturing Company, etc., the Crosley AC Bandbox is possible through the use of the new R.C.A. alternating current tubes, UX226 and UY227. These tubes utilize for their filaments and heating regular alternating current from the house lighting circuit.

The current is stepped down by means of a transformer without need of rectifiers to supply the heat necessary for the functioning of the tubes. The converter box, which is included with the Crosley AC Bandbox can be tucked

Now \$110 without tubes

away out of sight. It is connected to the Bandbox by a cable and also supplies the current for the plate voltages on the tubes replacing B batteries.

Thus the Crosley AC Bandbox functions entirely from the regular house lighting current without need of batteries, battery chargers, or any of the other usual paraphernalia which requires attention, care and early replacement. The Crosley AC Bandbox with the new alternating current tubes is truly revolutionary, and brings to the radio user an entirely new conception of care-free radio. This AC model together with the battery type BANDBOX which works with standard power sup-

ply units and storage batteries is the country's most talked of radio! The popularity centers around two major factors:

1. The imposing array of patents under which it is built.
2. The number and quality of the features Powel Crosley, Jr., has built in it for the price!

—And what value Crosley has added in:

1. Complete shielding of all elements.
2. Absolute balance (genuine Neutrodyne).
3. Volume control.
4. Accumulators for sharpest tuning.
5. Single cable connections.
6. Single station selector.
7. Illuminated dial.
8. Adaptability to ANY type installation.

Today's radio must be adaptable to the home. It must fit into all kinds of conditions. Perhaps you have a bookcase corner—a desk compartment—a chest—or even a bureau drawer where it could be tucked away. Maybe you want it to be part of the furnishings, as an impressive console or credenza cabinet. The Bandbox fits in everywhere.

The metal outside case is easily and quickly removed. The set is solidly mounted on a stout steel chassis. As all controls are assembled together in the front, cabinet panels are easily cut to allow their protrusion. The metal escutcheon is screwed on over the shafts and the installation has all the appearance of being built to order.

Two large furniture manufacturers have designed console cabinets in which the Bandbox can be superbly installed.

(Shower Bros. Mfg. Co. of Bloomington, Ind., and the Wolf Mfg. Co. of Kokomo, Ind.) Powel Crosley, Jr., has approved them mechanically and acoustically and has seen to it that the famous Crosley Musicones are built in them, so that the best type of loud speaker reproduction may be insured.

This is the kind of a radio you have been waiting for—the real direct electric set that requires absolutely no attention. Let it run all night! Who cares? No run down batteries greet you in the morning.

You owe it to yourself to see the Bandbox and listen to its remarkable performance. If you cannot easily locate the nearest Crosley dealer, his name and address will be supplied on request. Write Dept. 19.

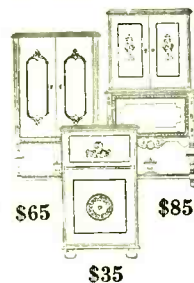

Montana, Wyoming, Colorado, New Mexico and West, prices slightly higher.

CROSLLEY RADIO

THE CROSLLEY RADIO CORP.
Powel Crosley, Jr., Pres.,
Cincinnati, Ohio

"You're there with a Crosley"

Crosley is licensed only for
Radio Amateur, Experimental and
Broadcast Reception.

Tell them that you saw it in RADIO

Sovereign



Tubes and Kits

Don't be a "back number." Throw away all "A" Batteries, "A" Eliminators and Chargers. Slip Sovereign A-C Tubes into your circuit, plug into the light socket for "A" power, and enjoy clear, clean, crackless, truthful reproduction. Sovereign A-C Tubes give astounding satisfaction—unequaled performance—transmit no hum—no disturbance—require no new sockets.

Sovereign A-C Tubes.....Price \$5.00
Sovereign A-C Power Tube for last Audio Stage.....Price \$6.00
Sovereign A-C Kit 110 or 220 Volts, 60 Cycles.....Price \$8.75
Sovereign A-C Kit 110 or 220 Volts, 25 Cycles.....Price \$9.75

If your dealer cannot supply you, we will send C.O.D. Specify line voltage and number of cycles. Get free booklet on A-C Tubes and Circuits.

SOVEREIGN ELECTRIC & MFG. CO.
121 N. Sangamon Street Chicago, Ill.

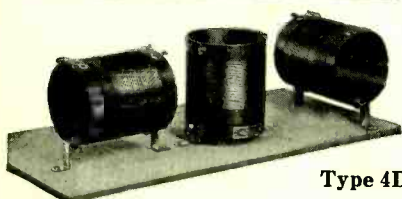

Type 4D

The New Diamond Cut PRECISION COILS

are now the "Standard of Comparison"

They are accurate to within 1% of the rated inductance and most of them are better. Only with diamonds can this extreme accuracy be obtained. The diamond cut bakelite assures accurate spacing of the turns and uniform diameter of the tubing. Our new catalogue gives more details. Send for it.



Coils shown are our Type 4D and R. F. Choke No. 420. Type 4D—\$5 No. 420—\$1

PRECISION COIL CO., Inc.
209 Center Street, New York City

At \$6.00 this famous **Cabinet** has no equal!

The Blue Ridge 7" x 18" x 10" Mahogany or Walnut Finish

Send us your order or write for catalog and full information. 12 hour service, factory to you.

Southern Toy Co. Inc.
MANUFACTURERS HICKORY, N.C.

Short Wave Stations

Wave-length (Meters)	Call	Location
12.25	AGA	Nauen, Germany
13.5	AGA	Nauen, Germany
14.09	U-2XBC	Rocky Point, N. Y.
14.28	F-FW	Ste. Assise
14.93	U-2XS	Rocky Point, N. Y.
15.0	GLS	Ongar
	U-2XAW	Schenectady, N. Y.
16.0	AGA	Nauen, Germany
	WSS	Rocky Point, N. Y.
16.02	U-2XT	Rocky Point, N. Y.
16.57	WLL	Rocky Point, N. Y.
17.0	SPI	Rio de Janeiro
	NKF	Bellevue, Anacostia, D. C.
18.0	POF	Nauen, Germany
20.0	AGK	Nauen, Germany
	NAL	Navy Yard, Washington, D. C.
	OCTN	Mourillon, Toulon
	POX	Nauen, Germany
	GFR	Flowerdown, Hants, R. F. A.
	GLSQ	S.S. "Olympic"
	J-IPP	Tokyo
20.8	NKF	Bellevue, Anacostia, D. C.
21.0	PCTT	Kootwijk, Holland
21.4	WDJ	Harrison, Ohio
21.48	WIK	New Brunswick, N. J.
21.8	KEB	Los Angeles, Calif.
22.0	VIS	Sydney, N. S. W.
	VIT	Townsville, Queensld.
22.02	U-2XAD	Schenectady, N. Y.
23.0	PKH	Soerabaja, Java
23.25	FFW	Sainte Assise
23.3	WBO	Schenectady, N. Y.
24.0	GBL	Leafield
	GBM	Leafield
24.3	KFD	Denver, Colo.
24.5	GLQ	Ongar
24.7	NKF	Bellevue, D. C.
25.0	PCMM	The Hague
	POY	Nauen, Germany
	HZA	Saigon
25.5	AGB	Nauen, Germany
25.6	NKF	Bellevue, D. C.
25.728	VIZ	Melbourne (Beam Stn)
25.906	GBH	Grimsby (Beam Stn)
26.0	AGA	Nauen, Germany
	VIS	Sydney, N. S. W.
	WNU	New Orleans, La.
26.086	GBK	Bodmin (Beam Stn)
26.269	CG	Montreal (Beam Stn)
26.6	AGB	Nauen, Germany
27.0	PCPP	Kootwijk, Holland
	RCRL	Cent. Lab., Leningrad
27.5	PCMM	Kootwijk, Holland
29.3	KEL	Bolinas, Calif.
30.0	GBL	Leafield
	GBM	Leafield
	U-2XI	Schenectady, N. Y.
30.2	PCJJ	Eindhoven, Holland
30.6	NAL	Navy Yard, Washington, D. C.
32.0	FL	Eiffel Tower
	ANE	Malabar, Java
	IDO	Rome
	HVA	Hanoi, Fr. Indo China
	VIS	Sydney, N. S. W.

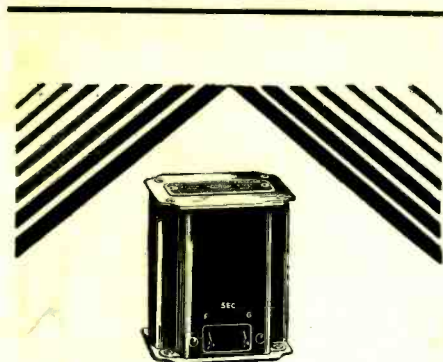

SANGAMO

AUDIO TRANSFORMERS

Uniform Amplification Over Entire Musical Scale

Every note and every delicate variation in tone is reproduced with flawless realism when the new Sangamo Audio Transformer is used in an appropriate circuit. Even the ear of a highly trained musician cannot distinguish between the reproduction and the original.

Best results are obtained by using two Sangamo Audio Transformers (one in each stage) but one will improve any good amplifier. A power tube should be used in the last stage.

Completely shielded. Tested at equivalent of 1,000 volts d.c. between windings and between each winding and case.

3 to 1 ratio. Price \$10

Sangamo Mica Condensers are accurate and stay accurate

Sangamo Electric Company
Springfield, Ill.

Schedule of Short Wave Stations (Wm. A. Breniman)

G.M.T.	P.S.T.	E.S.T.	STA.	WAVE	LOCATION	REMARKS
01:00	5:00PM	8:00PM	NKF	33.8	Anacostia	Navy Press
05:00	9:00PM	Midnite	XDA	34	Mexico City	Spanish Press
06:00	10:00PM	1:00AM	2UO	41	N. Y. City	English Press
07:56	11:56PM	2:56AM	FL	32	Paris	Time Signals
08:00	Midnite	3:00AM	NPM	36.5	Honolulu	File Px NPN-NPO & Tfk
12:00	4:00AM	7:00AM	WUAJ	64	Manila	Pd Press, Tfk & Px
12:30	4:30AM	7:30AM	VIS	51	Sydney, N.S.W.	Australian Pd Px
12:30	4:30AM	7:30AM	VAS	52	Louisburg, N.S.	Pd Px
19:00	11:00AM	2:00PM	HZA	25	Saigon	Time Signals
19:56	11:56AM	2:56PM	FL	32	Paris	Time Signals

(Most of the above can be heard any place in the world, not affected by skip waves.)

Tell them that you saw it in RADIO



Selectivity and Stability

The "bypass" condenser plays an important role in every tuned radio frequency amplifier—because it governs the selectivity and stability.—An individual "bypass" condenser should be employed for each radio frequency amplifying tube.

AEROVOX "bypass" condensers, sealed in Bakelite, are particularly effective in radio frequency amplifiers because of their construction.

They are non-inductive—impervious to moisture and are available in all capacities up to 1 mfd. and rated at 200 volts D. C.



Jensen Dynamic Speaker

WE RECOMMEND the new Jensen Dynamic Speaker to those who desire the last word in glorious tonal quality and maximum volume without distortion. A highly sensitive speaker, reproducing faithfully the entire musical scale. It has no rival at any price. Words fail to describe its superb tone. Works with sets using ordinary power tubes and will also carry the full undistorted output of a power amplifier without any tendency to blast or overload. Requires no output transformer as the speaker has a specially built-in filter protective device. If you want to hear music as you never heard it before get a Jensen Speaker. Price, \$65.00 in beautiful cabinet. The unit without cabinet sells for \$47.50.

Use our mail order service and let us show you what we mean by prompt deliveries. Your order is shipped within eight hours. All merchandise fully guaranteed.

SEND FOR OUR NEW 1928
INFRADYNE CATALOG

Order by Mail

Radio Constructors Corp.
357-12th St., Oakland, Calif.

32.77	U-2XAF	Schenectady, N. Y.
33.0	OCDJ	Issy les Moulins
	OCTN	Mourillon, Toulon
33.5	AQE	S.S. "Sir James Clark Ross"
34.0	NAJ	Great Lakes, Ill.
	XDA	Mexico City, Mex.
35.0	BWW	Gibraltar, N. Front
	BXW	Seletar, Singapore
	BXY	Stonecutters Island, Hong Kong
	BYB	Whitehall, R. C.
	BYC	Horsea
	BYZ	Rinella, Malta
	BZE	Matara, Ceylon
	BZF	Aden
	VKQ	Garden Isld., Sydney, N. S. W.
	NPM	Honolulu
	J-IPP	Tokyo
35.03	WQO	Rocky Point, N. Y.
36.0	PCMM	Kootwijk, Holland
	LPZ	Buenos Aires
	OCRB	Rabat, Morocco
36.8	NPM	Honolulu
37.0	PCRR	Kootwijk, Holland
38.0	PCUU	The Hague, Holland
	U-2XI	Schenectady, N. Y.
39.0	OCMV	Mont Valerien
40.0	NAJ	Great Lakes, Ill.
	NAS	Pensacola, Florida
	NOSN	Coco Solo, Panama
	WNU	New Orleans, La.
40.2	AGC	Nauen, Germany
40.5	J-1AA	Iwatsuki, Japan
41.5	OCBA	Bamako, Sudan
41.6	NKF	Bellevue, Anacostia
41.95	FFW	Ste. Assise
42.0	VIS	Sydney, N. S. W.
	VIT	Townsville, Queensland.
42.5	TFA	Reykjavik, Iceland
42.98	WIZ	New Brunswick, N. J.
43.0	NPG	San Francisco, Calif.
	JOC	Otchishi, Japan
44.03	WAQ	Newark, N. J.
44.5	SPI	Rio de Janeiro
45.0	NPG	San Francisco, Calif.
46.0	OCMY	Mont Valerien
	PCLL	Kootwijk, Holland
46.5	TSB	Norwegian S.S. "Helder"
47.0	POZ	Nauen, Germany
	ICX	Massawa
	SPI	Rio de Janeiro
	SUC2	Abu Zabal, Cairo
49.5	KRP	Salt Lake City, Utah
	TFA	Reykjavik, Iceland
50.0	OCTU	Tunis, La Casbah
	WBZ	Springfield, Mass.
	SAJ	Karlsborg, Sweden
51.0	AIN	Ain Bordja, C'ablanca
	TSB	Norwegian S.S. "Helder"
51.5	WQN	Rocky Point, N. Y.
	VIS	Sydney, N. S. W.
52.0	VAS	Louisburg, N. Scotia
	WKK	Ceiba, Porto Rico
	WGW	Vieques, Porto Rico
52.02	ZLW	Cincinnati, Ohio
53.0	WWT	Bremerhaven
	NPU	Tutuila, Samoa
54.0	NBA	Balboa, Canal Zone
54.4	NKF	Bellevue, Anacostia, D. C.
54.5	WQN	Rocky Point, N. Y.
56.0	GBL	Leafield
	GBM	Leafield
	ANF	Malabar, Java
	U-1XAO	Belfast, Maine
57.0	OCTN	Mourillon, Toulon
	WQN	Rocky Point, N. Y.
58.0	OCBV	Beyrouth
58.79	KDKA	East Pittsburgh, Pa.
60.0	U-1XAO	Belfast, Maine
61.0	NKF	Bellevue, Anacostia, D. C.

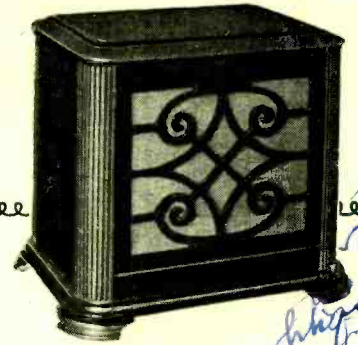

Jensen Dynamic Speaker

TREMENDOUS volume without a trace of distortion—volume as you hear it only on the most expensive phonograph—is now within the reach of all through the remarkable invention of Peter L. Jensen, pioneer in sound producing devices.

The new Jensen Dynamic Speaker employs the movable coil principle, used extensively in reproducers selling for several hundred dollars. The frequency range of this new speaker is from zero to 8000 cycles. The highest and lowest audible notes are reproduced with absolute fidelity. The Jensen Dynamic Speaker uses a specially designed cone, a field coil drawing but 0.4 amperes and a 25-1 ratio step down transformer, all included in the assembly. No output transformer or filter is required even when the speaker operates on 400 volts in conjunction with a power amplifier. This new speaker will give you an entirely new conception of reproduction at its best—reproduction that cannot be surpassed in any instrument at any price.

PRICES

\$65.00

for the beautiful cabinet model as illustrated. Grilled front and rear. Hand polished Mahogany.

\$47.50

for the speaker without cabinet but including step-down transformer.

Jobber and Dealer representation now being made. Manufacturers' orders solicited.

Licensed under Magnavox Patents

JENSEN RADIO MFG. COMPANY

212 Ninth Street, Oakland, Calif.

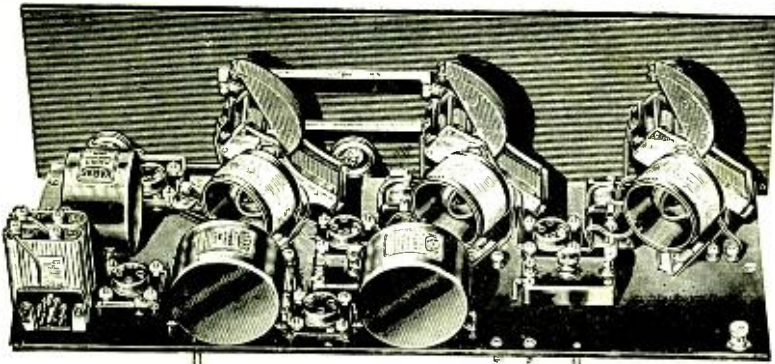

The New 2-Dial Karas Equamatic brings 'em in with amazing ease



Karas Type 28 Audio Transformer, price each, \$8.00

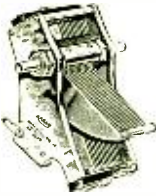

Karas S. F. L. Variable Condensers, Type 17. price each, \$5.25



Karas Output Filter, insuring pure, sweet tone. Price each, \$8.00

THE amazing results secured by those who have built the new 2-Dial Karas Equamatic have amply demonstrated this set's distance-getting ability. Under normal conditions Coast listeners tune in on Eastern stations with regularity and precision, and Eastern listeners do the same with Coast stations. The simplified control of the 2-Dial Karas Equamatic makes DX hunting a pleasure. There is not a particle of doubt about the ability of the 2-Dial Equamatic in this respect. It actually delivers more than most 6 and 7 tube sets.

Completely Balanced and Perfectly Neutralized.

The Karas 2-Dial Equamatic is the perfected product of the Karas engineering department, who have brought to a high degree of development the Equamatic principle, which gives great selectivity, wonderful tone, tremendous volume and simplicity of tuning. This circuit is completely balanced and perfectly neutralized.

Uses the New Karas Parts.

The Karas 2-Dial Equamatic uses the new Karas Type 28 Impregnated Audio Transformers, new Karas S. F. L. Removable Shaft Variable Condensers and the new Karas Output Filter. It also utilizes Karas Equamatic Inductance Coils, Karas Micrometric Vernier Dials, Sub-Panel Brackets and 2-Dial Control System. These parts are revolutionary in their design, give finer results than any others you could possibly use, and insure a receiver of superb appearance. You can secure these Karas Parts and other standard parts needed to build this receiver from your dealer. Meanwhile, mail the coupon below for complete data on this receiver—and on the NEW KNICKERBOCKER 4, the Wonder Set. Be sure to mail the coupon today.



Karas Equamatic Inductance Coil. Price, per set of 3, \$12.00



Karas Micrometric Vernier Dial. Price each, \$3.50

KARAS ELECTRIC CO.
4031-L North Rockwell Street, Chicago



KARAS ELECTRIC CO.
4031-L No. Rockwell St., Chicago

Send me all necessary data on the 2-Dial Karas Equamatic, and also on the Knickerbocker 4, as advertised in RADIO.

Name.....

Address.....

City..... State.....

65.5	U-2XK	South Schenectady, N. Y.
67.0	U-8XS	East Pittsburgh, Pa.
68.0	NPO	Cavite, Philippine Islands
70.5	NQG	San Diego, Calif.
70.54	WRP	Pinecrest, Florida
	WFV	Ponciana, Florida
70.74	WRB	Miami, Florida
71.25	NKF	Bellevue, Anacostia
74.0	WIR	New Brunswick, N. J.
75.0	F-8GB	Ste. Assise
	WGN	Rocky Point, N. Y.
	FL	Eiffel Tower
80.0	NEL	Lakehurst, N. J.
83.0	RDW	Moscow
84.0	NKF	Bellevue, Anacostia
90.0	KIO	Kahuhu, Hawaii
100.0	U-2X1	Schenectady, N. Y.

HOW TO IMPROVE SHORT WAVE RECEPTION

By THOS. A. MARSHALL

Experiments have shown that the best short-wave reception is obtained with a single wire antenna stretched 6 to 10 ft. above the ground. Its total length, including lead-in and ground connections, should be about three times that of the wave to be received. Its free end should be grounded through a non-inductive resistance of from 150 to 400 ohms, depending upon the antenna's surge impedance, $\sqrt{L/C}$, to which it should theoretically be equal.

Maximum signal strength, or greatest energy transfer from the antenna to the receiver is secured when the receiver is tuned to a wavelength equivalent to that of the antenna system and at a voltage loop point. The circuits are then in resonance. The antenna should be tuned with a series condenser to bring the operating wavelength to that of the desired signal.



Fig. 1. Directional Antenna for Short-Wave Reception.

Fig. 1 shows an antenna constructed in accordance with these principles. It is designed to reduce losses to a minimum and to minimize static. It receives best in the direction of its own plane, as illustrated in Fig. 2.

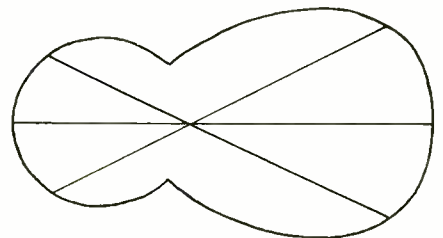

Fig. 2. Graph of Directional Properties.

Because of this directional effect the antenna is strongly influenced by static coming only from its own direction, other atmospherics from other directions having less effect. Consequently the signal-static ratio is high for a signal in the antenna plane.

The strongest signals will be received from stations located opposite the free end. Maximum signals are received when the voltage loops fall as shown in

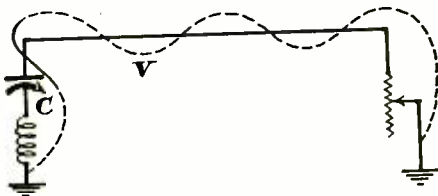

Fig. 3. Condition of Maximum Signal Strength.

Fig. 3. This condition may be obtained by first adjusting condenser *C* to a point where the receiver stops oscillating and then increasing the regeneration control until the signal is at its maximum, slightly readjusting *C* if necessary. If this cannot be done, use fewer turns in

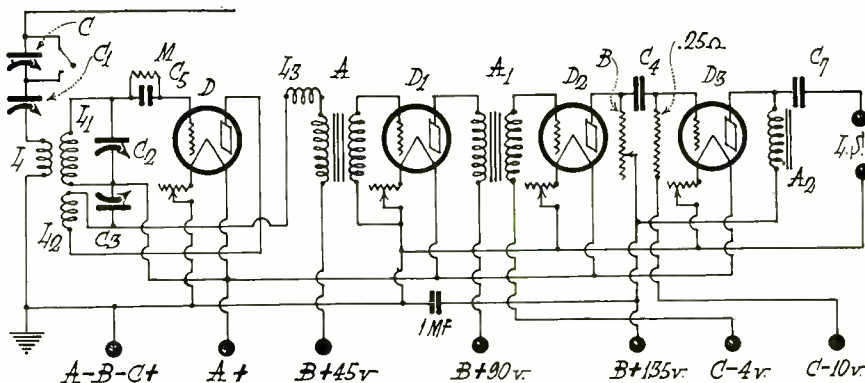

Fig. 4. Circuit Diagram for Short-Wave Receiver.

- | | | | |
|---|--|---|---|
| <i>C</i> , <i>C</i> ₁ —Hammarlund midget | <i>C</i> ₄ —.05 mfd. | <i>L</i> ₅ —r.f. choke, 100 turns 1/8 in. on 1/2 in. diam. | <i>A</i> ₁ —5-1 audio transformer |
| <i>C</i> ₂ —B. T. .00015 mfd. variable | <i>C</i> ₅ —.00025 mfd. | | <i>A</i> ₂ —Output filter or transformer |
| <i>C</i> ₃ —B. T. .00025 mfd. variable | <i>C</i> ₆ —1 mfd. | | <i>M</i> —5 megohms |
| | <i>C</i> ₇ —2 mfd. | <i>A</i> —3 1/2-1 audio transformer | <i>B</i> —1-5 megohms |
| | <i>L</i> , <i>L</i> ₁ , <i>L</i> ₂ —Aero S. W. Coils | | |

the coil or put a small condenser in series with *C* to reduce its capacity.

Fig. 4 is the circuit diagram of a receiver that has given good results with

this type of antenna. It gives remarkable clarity to broadcasts from WGY on 22 and 33 meters and KDKA on 66 meters.



No. 25 Consolette
List Price, \$70.00

Velvet

Reg. U. S. Pat. Off.

Radio Speakers

Manf. by Borkman Radio Corp., Salt Lake City, Utah

The Year's Greatest Loud Speaker Values

Among the many new developments exhibited at the radio shows this fall, none created wider enthusiasm than these Velvet Speakers. Everyone agreed that here was truthful reproduction of broadcast sound, together with unobtrusive beauty of design.

The Velvet Consolette Speaker, with its nine foot air column horn, produces a tone of unbelievable richness. It is equipped with a double-stylus, balanced diaphragm Borkman Velvet Unit.

The Jewel Case model, already an established favorite, continues to gain in popularity every day. It has a 65 in. air column horn, which pours forth a surprising volume of perfectly pitched tone.

Progressive dealers in all parts of the country now have these and other Velvet Speakers in stock. If you are unable to locate the dealer in your community, write to our General Sales Office for information. Address—Borkman Radio Corp., 230 East Ohio Street, Chicago.



No. 21 Jewel Case
List Price, \$40.00

Tell them that you saw it in RADIO

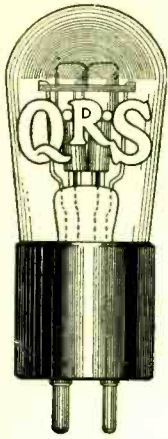

For Your "B" Battery Eliminator,
Ask Your Dealer for Guaranteed

Q · R · S
Trade Mark
Registered

**GASEOUS
Rectifier Tubes
ARE BETTER**

60 Milliamperes

\$4.50

85 Milliamperes

\$4.50

400 Milliamperes
With Ionizer 300 Volts
for A, B and C Eliminators
with Charts and Diagrams
\$7.00

Manufactured by The **Q · R · S** Company CHICAGO
MUSIC

Established 1900. References: Dun, Bradstreet or any bank anywhere

Just a Few Left

Blue Prints of Best's 1927 Shielded Superheterodyne
ONE DOLLAR PER SET "RADIO" San Francisco

FIXED and VARIABLE RESISTANCE IN ONE

You use fixed resistance when you want DEPENDABILITY. You use variable resistance when you seek PRECISE RESISTANCE. But why not use resistance that combines both functions? And that spells

CLAROSTAT

In several turns of its knob, the Clarostat provides the widest range of resistance—a truly universal range—with micrometric adjustment for precision. Any resistance setting is dependably maintained. There is no fluctuation to introduce noises.

The Clarostat is available in three models—Clarostat Volume Control for receiving set circuits; Standard Clarostat for voltage control of radio B-power units; and the big Power Clarostat for series filaments, line-voltage regulation, and transmission applications. The necessary resistance ranges are provided.

The Clarostat will cover the resistance ranges of several other devices combined—and more accurately and dependably. Ideal for your experimental work.

Your radio dealer stocks Clarostats. Improve your present set with Clarostats, or build a better one with Clarostats. Watch radio columns for dope, or write us direct.

AMERICAN MECHANICAL LABORATORIES, Inc.

Specialists in Variable Resistors



285 N. Sixth St.

Brooklyn, N. Y.



As with all standard, the Clarostat is being widely imitated in appearance, but hardly in performance. Watch for the Green Box and for the name stamped on the Clarostat itself. Don't be fooled and disappointed.

REACTANCE AND SUSCEPTANCE CURVES

(Continued from page 33)

curves. In other words for parallel combinations the higher the L/C ratio the broader tuning. Therefore if sharp tuning is desired use a high L/C ratio for series circuits and a low L/C ratio for parallel circuits.

Consider a still more complicated problem. Assume that a radio broadcast receiver with tuned antenna circuit is in use. Assume that the antenna capacity is .00005 mfd. and the circuit is tuned to resonance for 1,000 kilocycles (300 meters) by means of an inductance of .000056 henry. The reactance curves for this combination are shown in Fig. 7A. Suppose also that there is a source of severe interference on approximately 710 kilocycles which breaks up reception on 1,000 kilocycles. One way of eliminating this difficulty is to insert a parallel resonant circuit tuned to 710 kilocycles. Consider .0001 mfd. in parallel with an inductance of .00005 henry, (see Fig. 4). Fig. 7B shows the reactance curves for the antenna circuit and the trap circuit superimposed for addition, the heavy lines representing the result of this addition. It will be noted that the circuit is no longer resonant for 1,000 kilocycles, the frequency we desire to receive; but that it now has a reactance of approximately —325 ohms, and for resonance it should be zero. One way to overcome this difficulty is to insert an additional inductance in the circuit which will have 325 ohms reactance at 1,000 kilocycles. Fig. 7C shows curves for the antenna circuit, trap circuit, and additional inductance. The resultant reactance curve is drawn in heavy lines and has been replotted alone as Fig. 7D. From this it will be seen that the combination is resonant for 1,000 kilocycles as desired and also the interference on 710 kilocycles is effectively choked out by the trap circuit. The curves show that the combination is resonant to 500 kilocycles as well. This we care nothing about as it is reasonable to assume that there is no interference on 500 kilocycles and even if there were the set would probably be able to tune it out since the frequency separation is so great.

To analyze any complicated circuit, work it out step by step, unit by unit. If the units are in series add the reactances, if in parallel add the susceptances and then determine the resultant reactance by taking the reciprocal. If a parallel unit is in series with another unit first add the susceptances, find the corresponding reactance and add that to the reactance of the other unit.

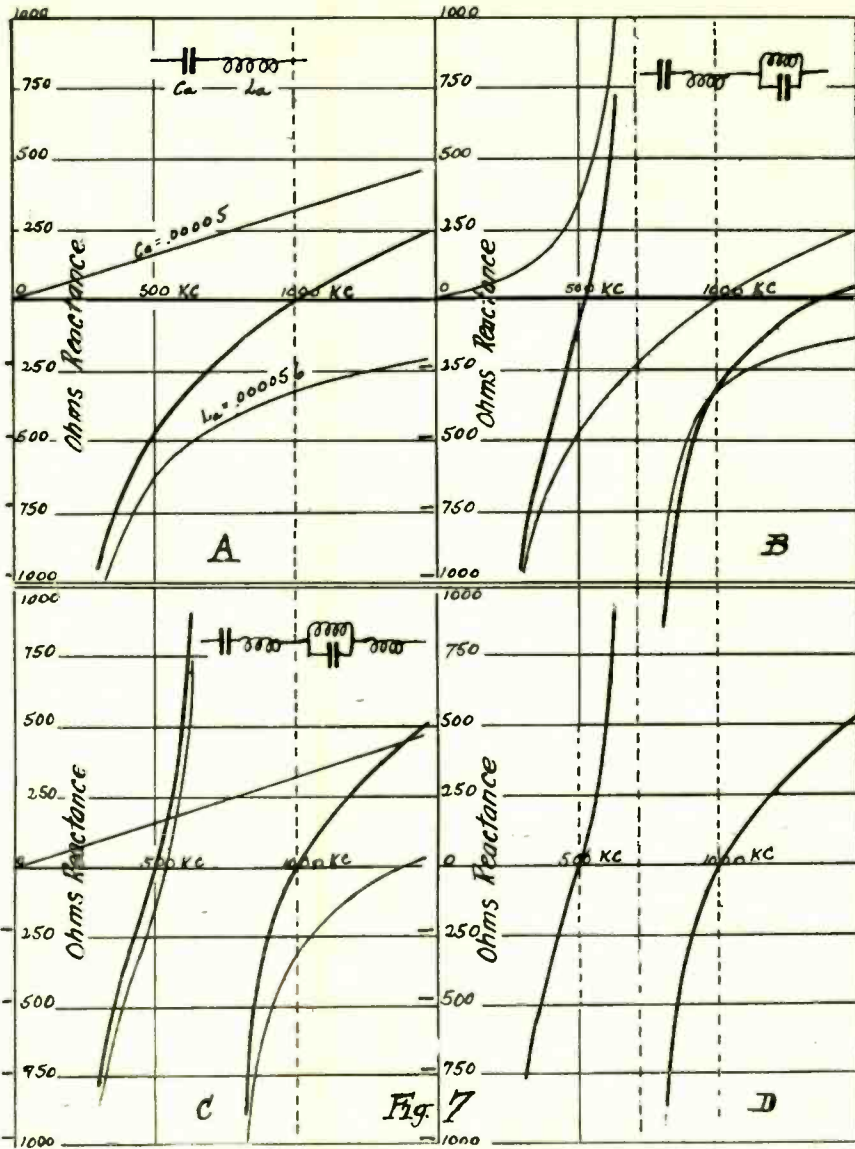

Fig. 7. Method of Deriving Curves for Trap Circuit.

The examples given here are merely illustrative of the many possibilities of the use of reactance and susceptance curves. They do not have to be accurately drawn unless accurate results are required. Very crudely drawn curves will reveal many interesting characteristics of circuits which might otherwise be entirely unknown unless a laborious mathematical analysis is made. It is believed that any one who will take the time to become familiar with the use of this novel method of analysis will be repaid many times in the pleasure he will derive from it.

QUERIES AND REPLIES

(Continued from page 41)

former, as well as the filaments of the CX-313 rectifier tube. How may this be done?—J. H., Healdsburg, Calif.

You cannot use the filament winding of the power transformer which is intended to light the CX-313 rectifier tube filaments, for lighting the power tube filament, as separate windings must be used. If you wish to obtain greater power output from your amplifiers, use a type CX-371 tube, with 40 volts C and 180 volts B. Your B eliminator is cap-

able of supplying this voltage without difficulty. The use of a type 112 tube in the first audio stage will not increase your power output, but will only increase the total amplification obtainable in the audio stages.

How many stages of intermediate frequency amplification can I use in my Best 45,000 cycle superheterodyne, in order to get the maximum possible distance out of the set. In my location, a set must have extreme sensitivity to reach the nearest stations.—D. N. S., Fairbanks, Alaska.

Using iron core intermediate transformers, the only practical arrangement is three intermediates and one filter. If you use three intermediates and two filters, even when the latter are perfectly matched, the amplifier is bound to oscillate, if the transformers give any sort of gain. Of course, if the intermediate transformers give low amplification per stage, with a voltage step up of 2 to 1 or less, you can use a total of four stages, but if the transformers give a gain of 3 to 1, or more, the limit of three intermediates is the only sensible one to follow. If you require more amplification than the above combinations will give, use stages of tuned r. f. ahead of the first detector, as has been described in many past issues of RADIO, the latest of which is the Tyrman receiver described in October RADIO.



AMPERITE is the only automatic filament control that keeps the temperature or voltage of the tube filament constant despite variations in the "A" Battery voltage. It guarantees improved tube performance and increased tube life through always operating tubes at their proper filament temperature. Simplifies wiring, panel design, tube control, tuning. Eliminates hand rheostats. Do not confuse with fixed filament resistors which attempt to imitate AMPERITE but are entirely different in principle and operation. Insist upon AMPERITE. Price \$1.10 mounted (in U. S. A.) For sale by all dealers.

Write for FREE "Amperite Book" of season's best circuits and latest construction data.

Address Dept. -12

Radiall Company
50 FRANKLIN ST., NEW YORK

AMPERITE
The "SELF-ADJUSTING" Rheostat

Intermediate Transformers MATCHED

Let Gerald Best and D. B. McGown match and "peak" the intermediate transformers for your super. Proper fixed condensers will be attached. This entire service for \$2.50. Condensers extra. Laboratory of "RADIO," San Francisco

REMOTE CONTROL

Mechanical Model \$18
Electrical Model 60
(Add 10% west of Rocky Mts.)
Write for illustrated descriptive circular

Imagine the pleasure of tuning your radio without having to get up once all evening! Turn set "on" or "off," tune, regulate volume—from your easy chair! Easily attached to any single removable dial receiver in a few minutes.

ALGONQUIN ELECTRIC COMPANY, Inc.
245 Fifth Avenue, New York City

The NEW **Algonquin**
Trade Mark Reg. U. S. Pat. Off.
Remote Control Radio Tuning Unit

SEND FOR FREE CATALOG

From Chicago's Oldest Radio Jobbers. The Most Valuable Radio Catalog.

Write for your copy today—IT'S FREE!
Telephone Maintenance Company
123-5 S. Wells St., Dept. 51, Chicago, Ill.

Tell them that you saw it in RADIO

Why **CC** Tubes Last Longer

CeCo Tubes are evacuated by an exclusive process developed by our engineers and the exceedingly high vacuum thus obtained is one important reason for the longer life of CeCo Tubes.

Thorough inspection of materials and parts, critical testing to highest standards assures uniform quality, steady performance, longer life.

There's a CeCo Tube for every radio need.

Ask your Radio Dealer for Complete CeCo Data Sheet

C. E. MFG. CO., Inc. PROVIDENCE, R. I., U. S. A.

CC RADIO TUBES

*Exclusive Method of
Evacuating Ce Co Tubes*



Ward Leonard Vitrohm Resistors

Rated to carry 60 watts continuous duty

1100 ohms with taps of 400, 400 and 300 ohms
2600 ohms 7000 ohms

Your choice of any of these three sizes at

**EXTRA SPECIAL PRICE OF
85 CENTS EACH**

All of these Ward Leonard Heavy Duty, Vitrohm (vitreous enamel) Resistors are brand new, Size 4x1 in. They are absolutely permanent and accurate in value and are for use in your Eliminator, Transmitter and all kinds of electrical control work.

AMERICAN SALES CO., 21 WARREN STREET, NEW YORK CITY

**A HOMEY HOTEL IN THE HEART
OF NEW YORK**

THE *New Flanders*

47th to 48th STREET EAST OF BROADWAY

One of the finest Hotels in **TIMES SQUARE**

Single Rooms with Running Water, \$2.00

Double Rooms with Running Water, \$3.00

Single Rooms with Bath \$2.50

Double Rooms with Bath . . . \$3.50

Special Weekly Rates

F. W. BIZEL, Resident Manager



NOTES ON RADIO PROSPECTING

By J. E. Smith

President National Radio Institute

The idea of electrically locating ore bodies was first conceived by D. G. Chilson, a mining engineer, in 1904. These early experiments were made to determine the conductivity of various elements—earth, water, and other substances, and it was found that sulphides are the best conductors.

In 1909, Mr. Chilson turned to radio, experimenting with some of the short waves, using the method now in use for directional telegraphic communication. In 1911, experiments were made with the induction balance. During the following two years, considerable time was spent in determining the audibility of signals from radio stations, through readings taken in so-called "dead" spots in Alaska. Comparative conductivity tests on sulphides and soils proved the electrical continuity of sulphide ore bodies. By introducing currents of different frequencies into sulphide ore bodies, it was found that by using a critical frequency, sulphide ore bodies could be followed regardless of other conductors, such as earth, water, or other materials. The results obtained at that time proved accurate and established the practicability of the process. During the following five years, tests were made in California and in Arizona with good results. From 1920 to 1922, further experiments were carried on at the University of Arizona, and refinements and improvements were made which brought the process to its present state of perfection. It has proved possible with this method to locate sulphide ore bodies to a depth of 2000 ft. or more.

The range of frequencies between 40,000 and 20,000 is the one generally used in this work. However, a higher frequency within the radio band can be used to good advantage as a means to check the results obtained with the lower frequency.

The apparatus consists of a transmitter designed to radiate the proper current at the desired frequency, and the receiver which is to record the audibility of the signal. The transmitter is generally installed underground and contacts made upon the sulphide. The receiver employs several stages of amplification. Its cabinet is suspended from a tripod, and the receiving coil is secured to the tripod in a swivel frame, so that it may be either swung in an arc, or horizontally.

In taking readings, the receiver is set up so that the coil is in a vertical position, and swung in an arc until maximum signal audibility is reached. This gives the strike of the ore. Without changing the angle of the coil, it is dipped horizontally until maximum audibility is again reached. This gives the

In the Heart of Cleveland

AUDITORIUM HOTEL

EAST 6TH AND ST. CLAIR AVE.

TO THE PUBLIC

Are you wondering why you have built "Auditorium Hotel in Cleveland? One must have a good reason for spending nearly two million dollars. We have a reason worth far more than that.

Every hotel operator gives "His best efforts for your comfort." We have centered our efforts around one ideal alone, "To make you happy."

There must be something back of that desire. You can easily prove it by coming here just once.

James L. Smith
Manager

LATEST LOG BOOK 25c

ALL THE NEW LISTINGS
HANDY POCKET SIZE

"RADIO," Pacific Bldg., S. F., Cal.

RAJAH SOLDERLESS SNAP TERMINALS
Instantaneous in Operation — Positive Contact. For Panel, Ground and Battery Connections.



Patented—Sept. 23rd, 1924.

The Base Stud is tapped and furnished with 8-32 screw and washer. This fits all "B" Batteries with screw posts.

Used on
TUNGAR - RECTIGON - PHILCO - EXIDE
Terminal, complete, ...15c Extra Base Studs. ...5c

Furnished with
BAKELITE FERRULES
In Three Colors
BLACK — RED — GREEN

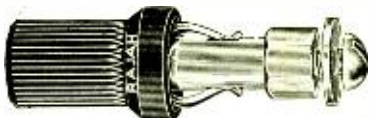

LIST PRICE - 25 Cents Each
Distributors

MARTIN WOODARD CO.
438 Phelan Building, San Francisco, Cal.
28 E. Sprague Avenue, Spokane, Wash.
Terminal Building, Seattle, Wash.
229 Pine Street, Portland, Oregon

THE RAJAH CO.
BLOOMFIELD NEW JERSEY

dip angle. After several set-ups taken in line, these dip angles are projected and the apex of the resultant triangle is the center of the magnetic field caused by the ore body acting as a part of the transmitter. When directly over an ore body, the dip angle is, of course, zero. It is plain that it is possible to cover as large an area as 30 or 40 square miles without moving the transmitter. This depends, of course, upon the characteristics of the particular field being surveyed. In mineralized ground, it is possible to make as many as 80 or more set-ups a day.

The Chilson system uses surface methods depending upon the conductivity or resistance of the ground and the out-cropping of the mineral, instead of using Hertzian waves to penetrate the surface and indicate the presence of ore.

The Hertzian system of locating mines by radio is based on the well-known phenomena of the penetrating resistance offered by good conductors to electric lines of force. As illustrated in

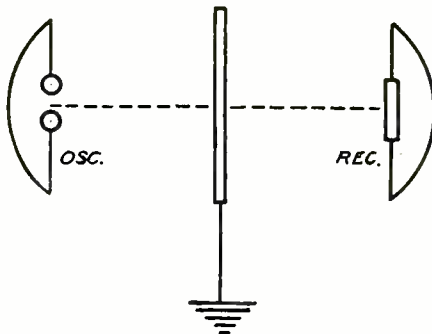

Fig. 1. Hertzian Oscillator with Interposed Grating.

Fig. 1, a Hertzian oscillator produces no phenomena of resonance because of the interposed and grounded grating. Assuming that it is desirable to locate ore deposits in the side of a hill in whose side out-crops of mineral have been found, and desiring to determine how important these deposits might be, it is necessary to make some preliminary drifts to determine the extent of the out-crop and some shafts for determining its depth.

Both of these operations could be avoided by using the apparatus in Fig.

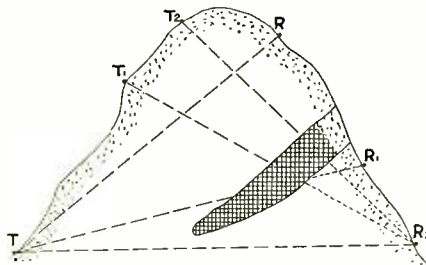

Fig. 2. Radio Survey Method.

2 when the transmitter is located at T, and the receiver is at R. It is found that along the dash line TR, as indicated, no impediment exists to cut off the waves; but if the detector is moved from R to

(Continued on page 79)

What Kind of Voice Has Your Loud Speaker?



Does it S-s-r-rr-rr?
Does it Whine?

or Does it register clear, natural Human Tones?
The New Muter Clarifier
(Output Transformer)

on your set will astonish and delight you by immediate, almost unbelievable improvement in reception. In nine cases out of ten that weak, distorted voice issuing from the speaker unit is suffering paralysis from high "B" Voltage. The Clarifier protects Speaker coils from this shattering current, assuring longer life as well as strong, full tone, clarity and volume.

If your speaker is one of the great majority that fail to respond properly to the output of the set—you need a Muter Clarifier. It's the only thing that will remedy the cause. Easily attached in a few seconds without disturbing set. Try it out to your own satisfaction on our liberal guarantee—you won't recognize your set!

See Your Dealer—or Send Direct

Dealers can easily secure Muter Products for you from leading Jobbers. If, however, you have any difficulty in obtaining from your dealer, mail coupon direct to us. Prompt shipment complete, with phone cards attached, will be made upon receipt of price or C.O.D. if preferred. Give your speaker a chance to produce its utmost. Mail coupon today.

Leslie F. Muter Company
76th and Greenwood

Dept. 819-P CHICAGO, ILL.

MUTER
Dependable Products

The Complete Quality Popular Priced Line
Send for comprehensive catalog



Use This Coupon!

LESLIE F. MUTER CO.

76th and Greenwood Ave.
Dept. 819-P Chicago, Ill.

- Send Muter Clarifier at once, postage prepaid. \$5.00 is enclosed.
- Send C.O.D.
- Send complete Muter Catalog.

Name.....

Address.....

City.....

State.....

Tell them that you saw it in RADIO

The biggest edition --

The biggest edition ever published. Brimsful of newest information, latest circuits and hook-ups, new revised list of world's broadcasting stations with schedules and new wave lengths in meters and kilocycles. 264 pages of news, ideas, and valuable information for fans, set builders, radio dealers and everyone interested in radio's advancement.

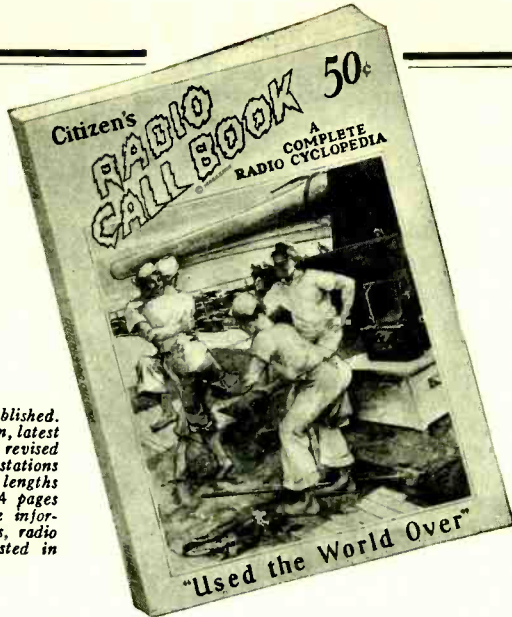

Citizens Radio Call Book

NEW SEPTEMBER 1927 EDITION

On Sale Now At Newsstands and Radio Stores

Wonderful Rotogravure Section

One of the big features of the new Call Book is the 16-page rotogravure section. It is replete with photographs and views. Your favorite radio artists, pictures of studio life, prominent announcers and other features are shown in actual photographic views.

Complete Details on Newest Circuits

Every Receiver Designed and Thoroughly Tested in Our Laboratories. Complete constructional details on the newest modern radio circuits are given, including the Aero-7, Camfield Super-Selective-9, Remler 45 KC., Nine-in-Line, Melohead 14, Magna-former 9-8, Eight-in-Line, Tyrman Super 10, Infradyne, World's Record Super 10, Equamatic, Browning-Drake, St. James Upright-8 and others.

A Complete Radio Cyclopedea

Be sure that you get the CITIZENS RADIO CALL BOOK, the original and most widely circulated publication of its kind. Accept no substitutes. Published four times yearly, September, November, January and March. On sale now at newsstands and radio stores the world over, or subscribe now and be sure of receiving each issue as published. Use the handy coupon below and mail in now.

Mail
This →
Coupon
Today!

CITIZENS RADIO SERVICE BUREAU, Inc., Publishers
508 So. Dearborn St., Chicago, Ill., Dept. R, U. S. A.

Date.....192.....

Please enter my subscription for the CITIZENS RADIO CALL BOOK for one year, \$1.75; two years, \$3.25; three years, \$4.50. Enclosed please find.....in payment for same, mailed postpaid four times yearly, January, March, September and November. Canada and Foreign \$2.00 yearly.

Name.....

Address.....

City.....

State.....

STATEMENT OF OWNERSHIP, MANAGEMENT, CIRCULATION, ETC., REQUIRED BY THE ACT OF CONGRESS OF AUGUST 24, 1912.

"RADIO," published monthly at San Francisco, Calif., for October 1st, 1927.

State of California, County of San Francisco, ss. Before me, a Notary Public in and for the State and county aforesaid, personally appeared H. W. Dickow, who, having been duly sworn according to law, deposes and says that he is the Business Manager of "RADIO," and that the following is, to the best of his knowledge and belief, a true statement of the ownership, management, etc., of the aforesaid publication for the date shown in the above caption, required by the Act of August 24, 1912, embodied in section 443, Postal Laws and Regulations, printed on the reverse of this form, to-wit:

1. That the names and addresses of the publisher, editor, managing editor, and business managers are:

Publisher, Pacific Radio Publishing Co., Pacific Bldg., San Francisco; Editor, Arthur H. Halloran, Berkeley, Calif.; Managing Editor, None; Business Manager, H. W. Dickow, Pacific Bldg., San Francisco.

2. That the owner is:

Pacific Radio Publishing Co., Pacific Bldg., San Francisco; Arthur H. Halloran, Berkeley, Calif.; H. W. Dickow, Pacific Bldg., San Francisco; H. L. Halloran, Berkeley, Calif.

3. That the known bondholders, mortgagees, and other security holders owning or holding 1 per cent or more of total amount of bonds, mortgages, or other securities are: None.

4. That the two paragraphs next above, giving the names of the owners, stockholders, and security holders, if any, contain not only the list of stockholders and security holders as they appear upon the books of the company but also, in cases where the stockholder or security holder appears upon the books of the company as trustee or in any other fiduciary relation, the name of the person or corporation for whom such trustee is acting, is given; also that the said two paragraphs contain statements embracing affiant's full knowledge and belief as to the circumstances and conditions under which stockholders and security holders who do not appear upon the books of the company as trustees, hold stock and securities in a capacity other than that of a bona fide owner and this affiant has no reason to believe that any other person, association, or corporation has any interest direct or indirect in the said stock, bonds or other securities than as so stated by him.

H. W. DICKOW,
Business Manager.

Sworn to and subscribed before me this 22nd day of September, 1927.
(SEAL)

JOHN L. MURPHY,

Notary Public in and for the City and County of San Francisco, State of California. My commission expires August 19th, 1931.

Tested and Matched Tubes

OF COURSE, your set will work 25% better, as a general rule, if all the tubes are precisely matched and hand-picked for best characteristics as to radio frequency amplification, detection, oscillation and audio stages. In the laboratory of "RADIO" magazine we have a complete tube testing device for accurately doing this work. We make no extra charge for hand-picking and matching tubes. Any type of tube can be supplied. Several days' time must be allowed for testing, packing and shipping. Standard retail prices are charged for tubes. Let us show you the way to better reception.

Laboratory of "Radio"

435 Pacific Building
San Francisco California

The
Ritz-Carlton
of
PHILADELPHIA
at Broad and Walnut Sts.
CONTINENTAL ATMOSPHERE.
ROOMS, CUISINE & SERVICE
OF EXTREME EXCELLENCE.
DAVID B. PROVAN MANAGING DIRECTOR

Tell them that you saw it in RADIO



Live

Where uptown and downtown meet

That's what everyone would like to do—combine country quiet with Broadway activities.

And that's exactly what this hotel offers you.

The serenity of Central Park; where two of New York's most desirable thoroughfares meet. Central Park West and 72nd Street, —and yet just 10 minutes from leading shops and theatres.

Appointments, service, cuisine unexcelled, in keeping with its international reputation.

Booklet sent free on request on New York and Hotel Majestic

Opeland Townsend
Proprietor

Majestic Hotel
and
RESTAURANTS

Two W. 72nd St., New York

Entire Block Fronting Central Park

General Headquarters:
New York Automobile Club

The Majestic Hotel, Central Park West at 72nd Street, New York City.
Without obligating me, please send me free Booklet on New York and Hotel Majestic.

Name.....

Address.....

Radio 11-27

CROSS COUNTRY RECEPTION

Stations from Coast to Coast are received with loud speaker volume on the new Best superheterodyne which will be featured in "RADIO" for January. Complete full page constructional diagrams and many illustrations will be shown. This receiver is the newest in radio. Prepare yourself for a real surprise. Better send 25 cents now for your January "RADIO." We will mail a copy to you on December 20th.

"RADIO"
Pacific Bldg. San Francisco

(Continued from page 77)

R_1 , the telephone of the receiver is silent because the waves emitted from T meet the mineralized mass, which acts as a shield. If the receiver is placed in the next position, R_2 , so that the line TR_2 passes below the mass, the telephones will produce a sound. This process is carried on by shifting the transmitter along from T to T_2 while the detector remains at R_2 ; again, the waves are intercepted and the telephone becomes silent. The experiment is repeated, carrying the transmitter to T_2 , and again, the telephone is silent. It is easy to see how, by placing the transmitter and receiver successively in all directions, sufficient exactness may be established, with the aid of plans and calculation, regarding the existence and position of the mineral mass.

It can readily be understood that this work ought to be preceded and accompanied by a complete study of the geological formation of the hill, and in this case, the Hertzian method will give a preliminary indication of the existence and location of the mineral mass. The study should be continued and completed by the means described above. For instance, between the out-crop and the side of the hill to which the lower extremity of the vein seems nearest, the electrical resistance method may be applied. Then, between R and R_2 , assuming that there is a covering of earth over the deposit, the silent zone system can be applied. When this well-organized series of experiments are completed, sections and plans more than sufficient to give an adequate judgment on how to attack the problem of exploiting the deposits, are then available.

(To be continued)

HI-Q and Shielded Grid TUBES

Complete details for converting the latest Hammarlund-Roberts Hi-Q receiver for shielded grid tube operation will be one of the features of the January issue of "RADIO," out just a few days before the holidays. Laboratory tests have convinced us that this new receiver with the new tubes is remarkably efficient. A simple set to operate and construct. See complete story and diagrams in "RADIO" for January. This will be one of our greatest numbers. Watch for it on the news stands or send us 25 cents in stamps or coin and a copy will be mailed to your home from San Francisco on December 20.

"RADIO" for January
"RADIO"
Pacific Building
San Francisco California

Tell them that you saw it in RADIO

RADIO ADS

o o o

A Classified Advertising Section Read by Better Buyers.

o o o

The rate per word is eight cents net. Remittance must accompany all advertisements. Include name and address when counting words.

o o o

Ads for the January Issue Must Reach Us by December Fifth

SALESMAN—Calling on the radio trade to sell **ORTHOCONE Speakers**—nationally famed for their wonderful tonal qualities. Low price, liberal discounts to dealers. Big commissions. An unusual money-making opportunity for you. Sample furnished. References required. Write immediately to Orthocone Speaker Co., 2728 St. George Court, Chicago, Ill.

LATEST three tube circuit and construction data, 25c. Good quality, performance. Radioman, 4528 Adams Street, Chicago.

LOG-CHART YOUR RADIO—By the newest, and simplest way. Absolutely no writing of call letters, wavelength or dial numbers—A **MERE DOT** locates that station as received on your radio. Stations from all parts of the world. Includes outline map of the United States. Priced at 25c. Dearie Radio Laboratory, 505 Madison Square Bldg., Chicago; or 229 Whittemore, Pontiac, Michigan.

DO YOU GET TIRED of buying "B" batteries? A lifetime Edison will solve your troubles. Good. Live, large size element connected with pure nickel wire, electrically welded, 7c pair. All parts for sale. Sample cell and dope sheet, 10c. Paul Mills, Woodburn, Oregon.

BACK ISSUES of "RADIO," perfect condition. Early or late issues. 65c postpaid (no checks). Speedy service. R. M. Harris, Grimes, Calif.

AMERTRAN POWER KIT—These parts have been used but are perfect. PF52 Transformer, 3-854 Chokes, 4-4MFD 1000 Volt Sangamo Condensers, DeLuxe second stage Audio, 316B Tube, 400 Resistor. For quick sale \$30 for lot. Madison-Moore One Spot Transformers, set \$20. J. W. Howlett, Santa Paula, Cal.

CRYSTAL SETS—With crystal complete, 50c; Rheostats, Sockets and Jacks 15c each, stamps or money order. Nathan Bros., 2036 Polk St., San Francisco, Calif.

AVERAGE INTELLIGENCE plus our home training places you in a big paying radio job. Information upon request. McKay Instrument Corp., 631 Railway Exchange Bldg., Portland, Oregon.

MODERNIZE YOUR RADIO. Working drawings for AC operation; or specifications for "B" eliminator and power supply; or Phonograph-Radio console cabinet; each Fifty cents. Special prices on standard sets, kits and parts. Associated Service Bureau, Hillsdale, New Jersey.

SUPERHETERODYNE TRANSFORMERS—Used experimentally but in best condition. Remler 3 iron 1 pair matched and tuned \$12; 3 General Radio No. 271 \$5; 1 Remler Infradyne Amplifier \$12; 1 set Madison-Moore One-Spot, bid. J. W. Howlett, Santa Paula, Cal.

REMLER INFRADYNE AMPLIFIER, Number 700 \$18.00. Cardwell 317 C L Triple Condenser. .00035 mfd. \$9.00. New in original boxes. Young Radio, 329 Connecticut Avenue, New London, Connecticut.

STRANGE BATTERY COMPOUND charges discharged batteries instantly. Eliminates rentals. Gives new life and pep. Big profits. Gallon free. Mickman Co., St. Paul, Minn.

SEND name, address on postcard. Free introductory copy Salesology Magazine. Contains 1000 money making opportunities offered by big reliable firms; no obligation. Salesology Magazine, Desk B278, 500 No. Dearborn, Chicago.

FOR SALE—Ship type Antenna transfer switch, lightning switch, 2 K.W. relay key, and 5 electrose 22-in. insulators. 4 D.C. switchboard meters 150 volts, 250 amp. Goodell-Pratt polishing head No. 23, and lathe No. 29. Make best offer. Thomas G. Waldie, 18 Glenwood Way, Quincy, Mass.

MAJESTIC Super "B" Eliminator, \$23.35 postage paid. Chas. Loseby, Rutland, Vermont.

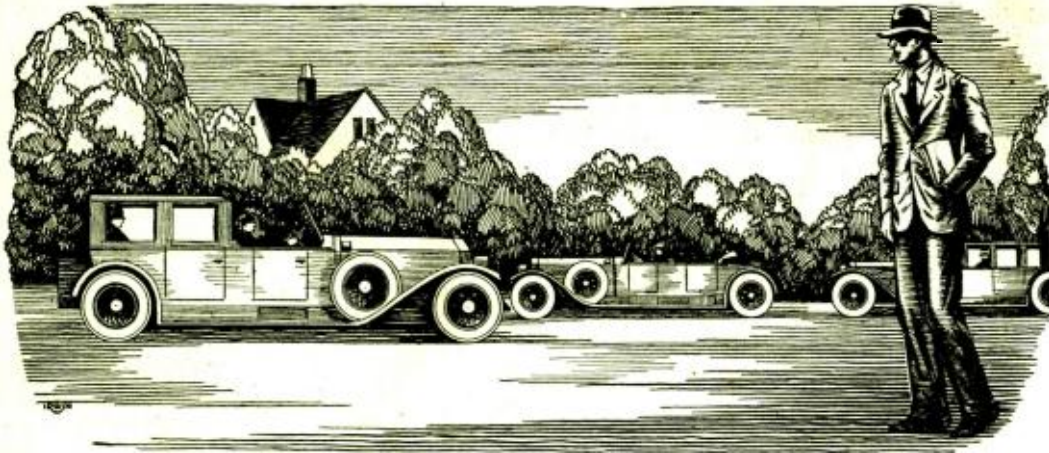

Many times in the old days, while I trudged home after work to save car-fare, I used to gaze enviously at the shining cars gliding by me, the prosperous men and women within. Little did I think that *INSIDE OF A YEAR*, I, too, should have my own car, a decent bank account, the good things of life that make it worth living.

I Thought Success Was For Others

*Believe It Or Not, Just Twelve Months Ago
I Was Next Thing To "Down-and-Out"*

TODAY I'm sole owner of the fastest-growing Radio store in town. And I'm on good terms with my banker, too—not like the old days only a year ago, when often I didn't have one dollar to knock against another in my pocket. My wife and I live in the snug-gest little home you ever saw, right in one of the best neighborhoods. And to think that a year ago I used to dodge the landlady when she came to collect the rent for the little bedroom I called "home"!

It seems like a dream now, as I look back over the past twelve short months, and think how discouraged I was then, at the "end of a blind alley." I thought I never had had a good chance in my life, and I thought I never would have one. But it was waking up that I needed, and here's the story of how I got it.

I WAS a clerk, working at the usual miserable salary such jobs pay. Somehow I'd never found any way to get into a line where I could make good money.

Other fellows seemed to find opportunities. But—much as I wanted the good things that go with success and a decent income—all the really well-paid vacancies I ever heard of seemed to be out of my line, to call for some kind of knowledge I didn't have.

And I wanted to get married. A fine situation, wasn't it? Mary would have agreed to try it—but it wouldn't have been fair to her.

Mary had told me, "You can't get ahead where you are. Why don't you get into another line of work, somewhere that you can advance?"

"That's fine, Mary," I replied, "but *what* line? I've always got my eyes open for a better job, but I never seem to hear of a really good job that I can handle." Mary didn't seem to be satisfied with the answer but I didn't know what else to tell her.

It was on the way home that night that I stopped off in the neighborhood drug store, where I overheard a scrap of conversation about myself—a few burning words that were the cause of the turning point in my life!

With a hot flush of shame I turned and left the store, and walked rapidly home. So that was what my neighbors—the people who knew me best—really thought of me!

"Bargain counter sheik—look how that suit fits," one fellow had said in a low voice. "Bet

he hasn't got a dollar in those pockets." "Oh, it's just 'Useless' Anderson," said another. "He's got a wish-bone where his back-bone ought to be."

As I thought over the words in deep humiliation, a sudden thought made me catch my breath. Why had Mary been so dissatisfied with my answer that "I hadn't had a chance"? *Did Mary secretly think that too?* And after all, wasn't it true that I had a "wish-bone" where my back-bone ought to be? Was that why I never had a "chance" to get ahead? It was true, only too true—and it had taken this cruel blow to my self-esteem to make me see it.

With a new determination I thumbed the pages of a magazine on the table, searching for an advertisement that I'd seen many times but passed up without thinking, an advertisement telling of big opportunities for trained men to succeed in the great new Radio field. With the advertisement was a coupon offering a big free book full of information. I sent the coupon in, and in a few days received a handsome 64-page book, printed in two colors, telling all about the opportunities in the radio field and how a man can prepare quickly and easily at home to take advantage of these opportunities. I read the book carefully, and when I finished it I made my decision.

WHAT'S happened in the twelve months since that day, as I've already told you, seems almost like a dream to me now. For ten of those twelve months, *I've had a Radio business of my own!* At first, of course, I started it as a little proposition on the side, under the guidance of the National Radio Institute, the outfit that gave me my Radio training. It wasn't long before I was getting so much to do in the Radio line that I quit my measly little clerical job, and devoted my full time to my Radio business.

Since that time I've gone right on up, always under the watchful guidance of my friends at the National Radio Institute. They would have given me just as much help, too, if I had wanted to follow some other line of Radio besides building my own retail business—such as broadcasting, manufacturing, experimenting, sea operating, or any one of the score of lines they prepare you for. And to think that until that day I sent for their eye-opening book, I'd been wailing "I never had a chance!"

NOW I'm making real money. I drive a good-looking car of my own. Mary and I don't own the house in full yet, but I've made a substantial down payment, and I'm not straining myself any to meet the installments.

Here's a real tip. You may not be as bad-off as I was. But, think it over—are you satisfied? Are you making enough money, at work that you like? Would you sign a contract to stay where you are now for the next ten years, making the same money? If not, you'd better be *doing* something about it instead of drifting.

This new Radio game is a live-wire field of golden rewards. The work, in any of the 20 different lines of Radio, is fascinating, absorbing, well-paid. The National Radio Institute—oldest and largest Radio home-study school in the world—will train you inexpensively in your own home to know Radio from A to Z and to increase your earnings in the Radio field.

Take another tip—No matter what your plans are, no matter how much or how little you know about Radio—clip the coupon below and look their free book over. It is filled with interesting facts, figures, and photos, and the information it will give you is worth a few minutes of anybody's time. You will place yourself under no obligation—the book is free, and is gladly sent to anyone who wants to know about Radio. Just address J. E. Smith, President, National Radio Institute, Dept. P-B5, Washington, D. C.

**J. E. Smith, President,
National Radio Institute,
Dept. P-B5, Washington, D. C.**

Dear Mr. Smith:
Please send me your 64-page free book, printed in two colors, giving all information about the opportunities in Radio and how I can learn quickly and easily at home to take advantage of them. I understand this request places me under no obligation, and that no salesmen will call on me.

Name.....
Address.....
Town..... State.....