

## Radiatorial Comment

THAT the great increase in interest in radiocasting during the past four years has not been accompanied by a corresponding increase in amateur radio transmission is a matter of regret to many who have the welfare of American boys at heart. No other kind of play combines fascination and useful instruction to such a degree. No boy could be better engaged, not only from his own standpoint but also from that of the nation, than in perfecting himself as a radio operator.

These facts have been recently recognized by the Navy and by the Army, both of whom are endeavoring to build a trained reserve personnel and who are offering attractive propositions to amateur operators. But they find that only a fraction of the licensed operators are on the air with their own sets and that the number of transmitters is actually tending to decrease.

There are many good reasons for this. The simplicity of constructing and the joy of operating the old-time spark set is no longer possible, now that the spark has been abolished because of its interference proclivities. The ban on operation during the evening concert hours deters many a young man who should be in bed by the time that he is allowed to transmit. Both of these restrictions are necessary for the protection of the more numerous concert listeners and yet would not prove insurmountable were it not for the fact that far greater technical knowledge is necessary for the successful operation of a vacuum tube transmitter on the shorter wavelengths now available for amateur use.

This last is probably the real reason why many licensed operators who have passed the examination on code and theory are not on the air. The construction and adjustment of a non-interfering tube transmitter to operate on a specified wavelength requires technical knowledge and skill that can be acquired only by intensive study. It is greatly to the credit of many young men that they have worked out the problems as explained in such magazines as this and it is to be hoped that many more will do likewise.

Such home study should be supplemented by class study either at a commercial radio school or at the classes that have been established by the Navy. Similar classes will probably be established by the Army as this plan of organization gets under way. There is only one road to success in radio—hard study.

To justify the past consideration that has been shown the amateur in the reservation of several bands of frequencies for his use it is necessary that he use them. Other interests want these wavelengths and may eventually get them unless the amateur demonstrates his willingness and ability to use them.

Radio transmission offers a most interesting and profitable field for experimentation. With even moderate-sized and low-cost equipment many American amateurs are com-

municating with amateurs in other countries. The familiarity gained from handling vacuum tube circuits will be of great use in understanding and applying them to their forthcoming industrial uses in power work. We can not too strongly urge the benefits that will accrue to any young man who will study the subject.

ONE of the factors contributing to the stabilization of the radio industry has been the proportionately greater number of factory-built receivers that are being sold as compared to the sale of parts for home-built sets. This tendency on the part of the radio public, desirable as it is, is frequently cited as an indication of the ultimate extinction of the amateur experimenter and builder of sets. With this view we cannot agree.

Although a good home-built set is no longer enough cheaper than a factory-built radio to make its construction worth while for pecuniary reasons, it offers a pleasure and satisfaction that amply compensates for the time and trouble taken. There is a certain pride in personal accomplishment to which all men are susceptible.

All the reading that may be done does not teach us as much about radio as does the actual assembly of a receiver. Even the man who has bought a fine set solely in order to hear good programs likes to understand the general principles governing its operation, if for no other reason than that he may take an intelligent part in the prevalent conversation about radio. This he can readily do by buying a few parts for a bread-board assembly which allows an opportunity for substitution and addition.

To assist the man who has no desire to compete with the manufacturer as a maker of sets for concert reception and yet who wants to know how the thing works, it is proposed to publish in these columns each month a complete description of several factory-built sets. These will not be the manufacturers' statements but will set forth the results of tests in our calibration laboratory. These tests will include a determination of the actual wavelength range, a curve of audio frequencies transmitted, a comparison as to selectivity, and a measurement of sensitivity.

This information will be in addition to the usual constructional and theoretical articles. While primarily for the benefit of the B. C. L., the information will also be of interest and value to the well-informed, whose advice is so frequently sought when purchase of a radio is contemplated.

Time spent in studying any phase of radio is time well spent. While everybody cannot expect to become a radio expert, we are sure that a large number of people will continue to be as much interested in the how and why of what they hear as in the mere matter heard. Thus there is little probability of the radio experimenter becoming as extinct as the dodo.

# The Eiffel Tower Short-Wave Transmitter

A New and Novel Short Transmitter Developed by the French Signal Corps  
By Lloyd Jacquet, U-2 OZ

THE radio station of the Eiffel Tower, the veteran amongst the stations of the world, was not the last to take up the use of short waves, a comparatively modern development of the radio art. For fully a year there has been in operation a 115 meter transmitting plant about which there has been much mystery.

Developed in the thorough way of the engineers of the "Tower," and with new circuits of unknown possibilities, the short wave transmitter has already a fine record. It has been heard in New Zealand, to the West; in Indo-China to the East; and it has perhaps a unique North and South range, since it was picked up in Capetown, South Africa, and by Don Mix, on the Bowdoin in the Arctic. It has practically circled the globe, and many amateurs in every country know its quick, clear signals.

In searching for a stable and reliable type of transmitting circuit for the exacting service of the Signal Corps, Commandant Mesny developed the "balanced" circuit, which is similar in principle to the push-pull transmitter described by D. B. McGown in September RADIO. The method of connection is as simple as it is original.

Two coils, or inductances, wound in opposite directions, the one *G* connecting the grids together; and the other, *P* the plates of two three-electrode vacuum tubes, form the grid and plate coils respectively, of the system, as shown in

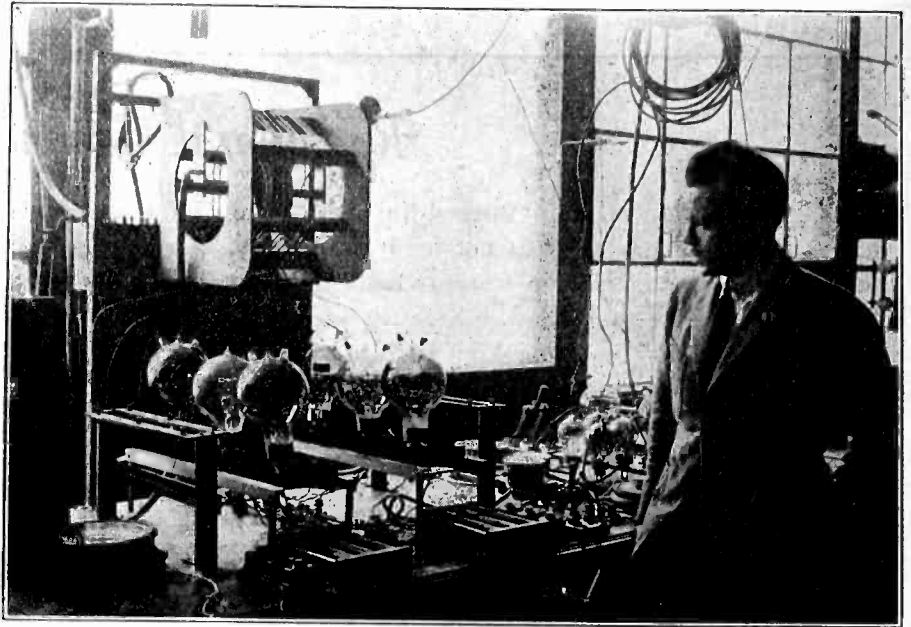

View of Transmitter, Showing Method of Mounting the Inductance Coils.

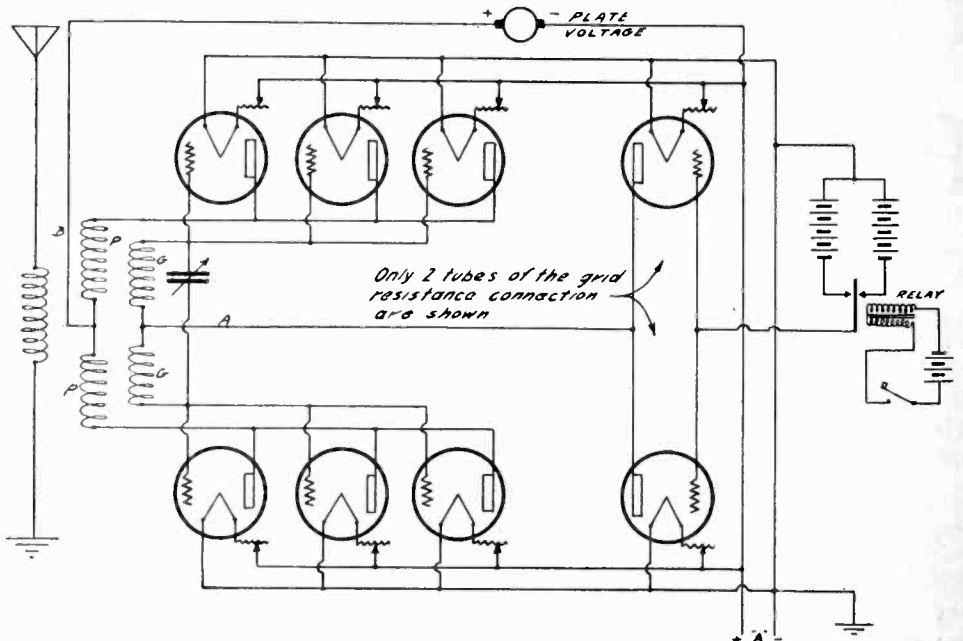
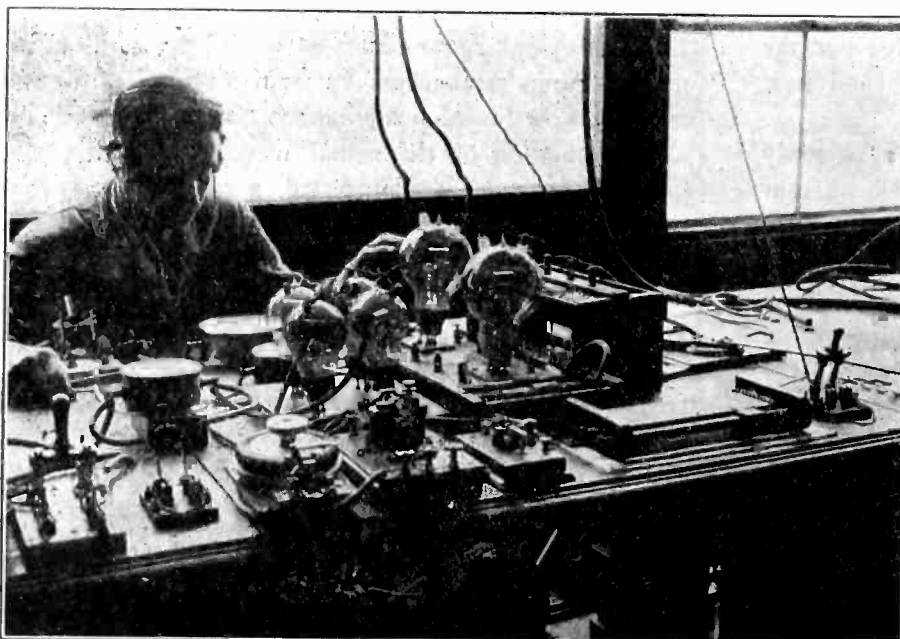

Fig. 1. Schematic Diagram of Eiffel Tower Transmitter.



Grid Resistance Control Unit for Keying Transmitter.

Fig. 1. A small condenser, which may be removed for work on very short waves, may be connected in parallel with each inductance.

The central point of each winding, from the grid and plate coils, are connected to either side of the filament poles, by means of the wires *A* and *B*. In the grid circuit, a resistance of a few thousand ohms is located so as to control the d. c. filament-grid current.

These are the elements, then, of the "balanced" circuit. It can be readily understood that the parts of the circuits connected to the valves will have, at a given moment, potentials of equal value, but of opposite signs. Thus, the oscillations will be localized in the grid and plate windings, and in the wiring connecting the filaments of the triodes. The filament circuits are, of course, connected in parallel.

(Continued on Page 46)

# Broadcasting in The British Isles

By H. de A. Donisthorpe

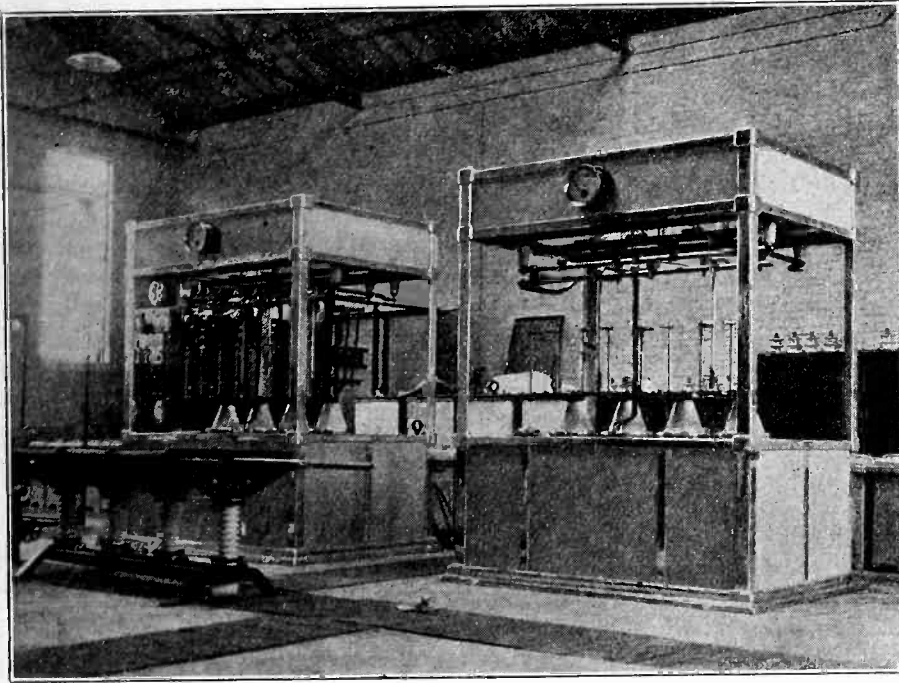

Rectifier Panels at Daventry.

Fig. 1 shows the location of these stations and from this it will be seen that each relay station is situated close to a main station with which it is connected by landline and from where it is

(Continued on Page 50)

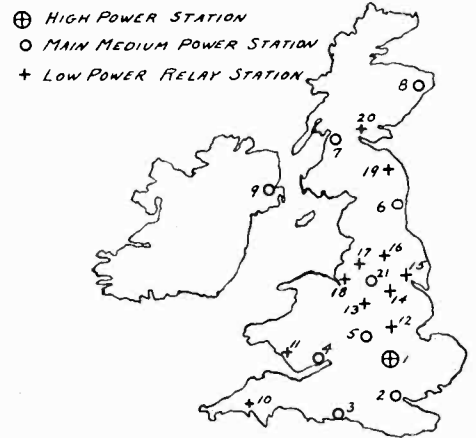
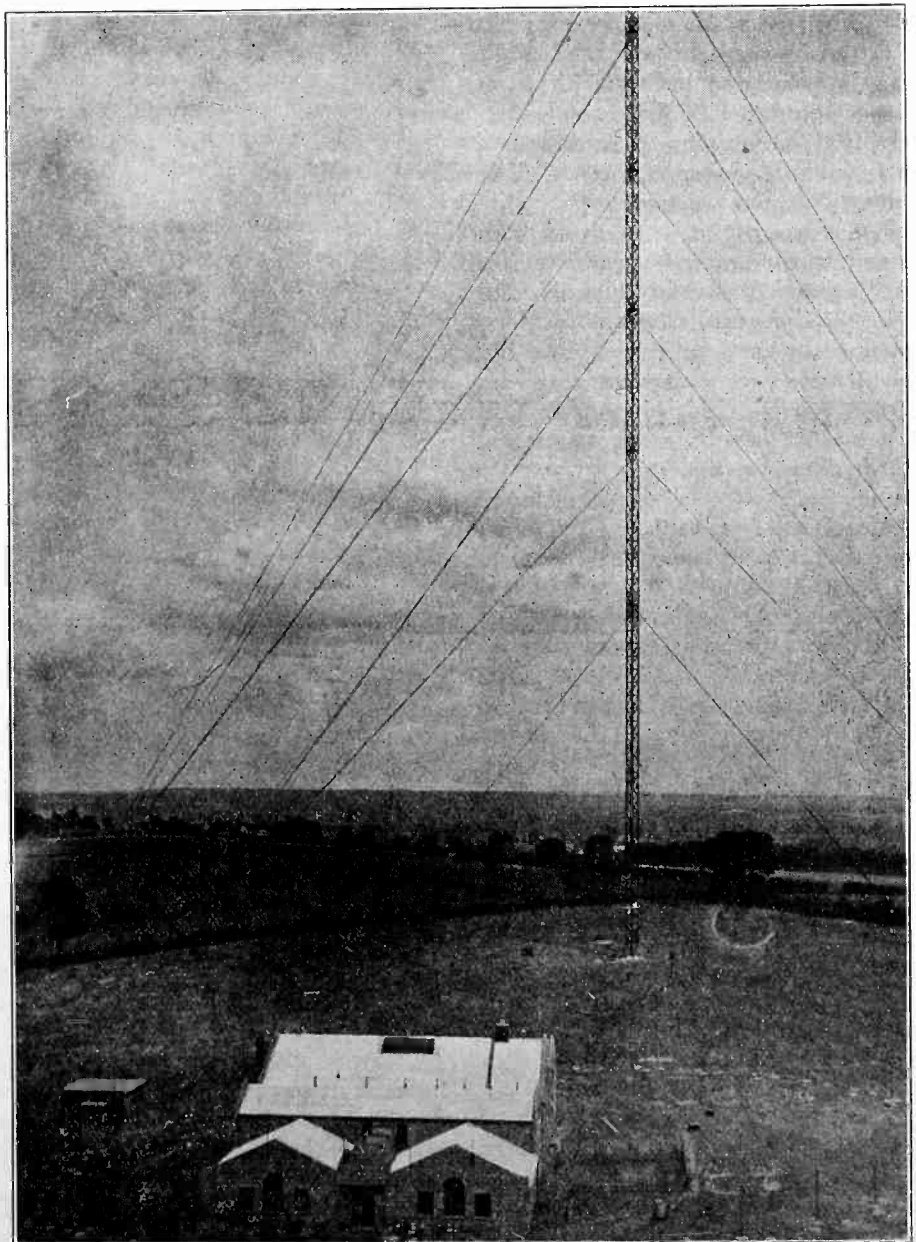

Fig 1. Map Showing Distribution of Broadcast Stations in British Isles.

**B**ROADCASTING made its appearance in the British Isles about a year after its debut in America. All the stations are under the control of the British Broadcasting Company, or the B. B. C. as it is familiarly known, which is a composite company formed by six wireless and electrical corporations under the control of the government through the Post Office department, to whom any deviation from the regular policy has to be referred.

There are twenty-one stations in the B. B. C.'s system. Of these, nine are main stations of medium power, eleven are low power relay stations, and one high power station capable of reaching out all over the islands. A list of these stations is herewith given together with their wavelengths and call letters:

LOCALITY	CALL LETTERS	WAVE-LENGTH	REF. NO. ON MAP
<b>HIGH POWER STATION</b>			
Daventry	5XX	1600	1
<b>MAIN LOW POWER STATIONS</b>			
Aberdeen	2ZD	495	8
Belfast	2BE	435	9
Birmingham	5IT	475	5
Bournemouth	6BM	385	3
Cardiff	5WA	351	4
Glasgow	5SC	420	7
London	2LO	365	2
Manchester	2ZX	375	21
Newcastle	5NO	400	6
<b>LOW POWER RELAY STATIONS</b>			
Bradford	2LS	346	17
Dundee	2DE	331	20
Edinburgh	2EH	328	19
Hull	6KH	335	15
Leeds	2LS	301	16
Liverpool	6LV	375	18
Nottingham	5NG	326	12
Plymouth	5PY	338	10
Sheffield	6FL	301	14
Stoke-on-Trent	6ST	306	13
Swansea	5SX	485	11



Daventry High Power Station.



# Financial Returns on Radio

By Geo. S. Turner

**W**HAT will be the returns as a result of the time and energy you are devoting to radio? Will your compensation be in dollars and cents or, always as now, in the diversion? Are you satisfied to rest on your laurels and sit back with an air of satisfaction now that you have mastered the fundamentals of radio or are you one who has been severely bitten by the "radio bug" and now in the radio game for all you can get out of it? If you are and unless your life's work has previously been chosen elsewhere, you may be interested in making radio your vocation.

First let us consider the advisability of commercializing a hobby. May your avocation be broadened so as to include your vocation? It has been said by a very well known radio engineer, "One disadvantage of radio as a vocation is that you are thus denied it as an avocation." This is as you make it; viz, radio is now so specialized that anyone may easily commercialize one phase of radio, providing it is sufficiently far removed from the particular side-line which is your diversion so there will be no conflict between the two.

You may readily call to mind men prominent in the amateur field who are regularly occupied as radio salesmen, operators of radiocasting stations, dealers, and manufacturers. They are not only prominent in their amateur activities but are successful in their business as well, because they take such an intense interest in their work.

The individual who is devoting much of his time to this fascinating art as an amateur operator or experimenter is preparing himself for the future. These two groups have contained the names of men who are now internationally famous. Review the history of DeForest or Armstrong—experimenters and amateurs of the highest order. However, we can't all be like these men nor expect to become famous. On the other hand, we may take advantage of the opportunities presented by our environment and improve our present status.

For instance, if it so happens that you are an amateur, see to it that your transmitter and receiver are of the best; but do not stop there. Strive for individuality of design or improvement of circuits. Join every worth while organization and strive to become more than just an amateur. Join the local club or if there is none, see that the necessary interest is aroused to instigate such an association. Take an active part therein; be one of the officers if possible. It will mean work on your part but it will

train your mind and give you confidence in yourself that you never before possessed. Do not be afraid to advertise yourself in this manner. It is really necessary in this age of strong competition.

As an amateur radio operator do not be content to copy your ten words per minute—improve your ability by copying just a little faster than your normal speed. When you have become proficient in the Continental code, learn Morse. It may be of use to you at some future date—if not, your mind has been improved by the effort and you will be the better operator for the learning. You may wonder how it is possible for you to measure your ability along these lines. I know of no better way than to take the U. S. Government radio examinations. The different classes of operators' licenses now issued by the Department of Commerce, in the order of their importance, are as follows: Commercial extra-first class, Commercial first class (three grades), Commercial second class, Commercial second class—broadcast grade, Commercial grade four, Amateur extra-first grade, Amateur first grade, Amateur second grade. Information regarding each of these licenses and the regular days when these examinations are held will be furnished upon request, by your nearest Radio Supervisor.

A large number of men now proficient in the radio field obtained their experience either in the Army or Navy during the recent world war. Either branch of the service has well conducted and organized radio schools in theory and code. Both are anxious to co-operate with radio amateurs. Complete details may be had by addressing Army or Navy headquarters in your district.

Of late years another way to become proficient in radio is offered at the vocational and manual training high schools. An investigation of the course of study available in some of these schools has convinced the most skeptical of their great value. Or, if a student desires a more complete course of study he may enter one of the many colleges or universities where radio is taught. In such a course, however, the radio subjects are supplementary to the regular engineering curriculum and for this reason no university is offering a degree in radio. However, when one considers the large number of so-called radio engineers who, at the present, are infesting the game, one is perhaps the better off without such a title.

For the ambitious student, lack of funds necessary to attend a university is no longer a hindrance. Practically

every school has a radio station which is operated by one or more of the students. The money obtained from this source goes a long way toward paying the room and board bill. In addition, a large number of fellows operate ship stations during their vacation months and are thus able to obtain a higher education and to see the world where otherwise it would be almost impossible.

It would hardly be fair not to mention the few radio trade schools situated throughout the country where one may go and obtain valuable instruction. These schools appeal to the fellow who either does not have the money or the inclination to learn radio at a university. Surely they fill a pressing need as proven by the large number of radio men who got their start at just such a school.

Before a student enters the radio field he wishes to know what particular phase of the game he should follow. Naturally that is for the individual to determine. However, it might be well to mention the different branches now available that he may take his choice. Radio was once grouped into a very few lines which, with the passing of the years, have increased in number until it is now difficult to accurately classify the subject. Nevertheless, such a classification must be briefly attempted.

First we have commercial radio subdivided into marine radio with its ship to ship and ship to shore communication; land stations which carry on general and point to point communication such as the high power trans-oceanic and trans-continental stations; the smaller stations such as are used by the Post Office Department in connection with the air mail service; also, the small private point to point stations used by individual concerns such as the oil companies for reporting pressure and flow of oil.

We probably should classify the radiocast stations as next in importance and truly this branch of radio has grown so rapidly as to place it near the top. It is a field where the largest salaries are to be had, considering the effort and ability required. Let us hope they never fall to the level with the average commercial operators pay.

Next we have the manufacturing and retail radio trade, both on a par. Opportunities are without number here and anyone with varying degrees of ability and knowledge of radio may proportionately partake of the rewards. It is unnecessary to go into detail regarding such lines of endeavor for we may investigate numerous factories and stores at any time we see fit. For those interested in

(Continued on Page 53)



# An Efficient Two-Tube Set

The Third in the Series Started in December RADIO

By E. M. Sargent

As previously stated, all of the sets in this series have been designed with selectivity as the first consideration, tone quality next, and ability to get distance a third but still an important factor. It is the belief of the writer that these three items should be considered in this order in any radio set, it being obvious that the first thing to do is to be able to get the station that you want, that after getting the station it is next important to have it sound well, and third, the ability to get distance gives a greater choice of stations from which to pick a good program. Following out this order, Circuit No. 2 is merely Circuit No. 1 with one good stage of audio frequency added. This is a set that will bring in all locals, clear and loud on the speaker, without any interference. The real long distance fans will have to wait until next month when Circuit No. 3 comes out before they will be able to log a great number of DX stations.

We are now fortunate in having at our disposal a large number of extremely fine audio transformers. These transformers not only have from two to three times the power of the transformers formerly available but they also have flat frequency characteristics, which means that they amplify equally well over practically the entire musical scale. It is, therefore, not an easy matter to select the best. The writer has chosen the General Radio No. 285, 6 to 1 transformer as being well suited for the requirements of the series of circuits. This transformer delivers about the same power in a one stage amplifier that former transformers delivered with two

stages. Other transformers that may be substituted are the Rauland Lyric, the Thordarson 2 to 1, the Karas Harmonic or the Amertran De Luxe. Any one of these five, when used with the circuit diagram shown in Fig. 1 will successfully operate a cone type loudspeaker.

The parts needed, in addition to those used in Circuit No. 1 as described in January 1926 RADIO, are one high grade audio transformer, one vacuum tube socket, one rheostat and two Eby C binding posts. The panel layout is the same as for Circuit No. 1 except the holes for the rheostat to be placed in the lower left hand corner, corresponding to those in the lower right hand corner. This makes a well-balanced panel which remains practically the same for the subsequent three and four tube sets.

The placement of parts is shown in the rear view of the completed set, which leaves room for the addition of a third and fourth tube. To facilitate wiring, the transformer should be placed with

the primary toward the panel. The set should be wired up with No. 14 round tinned wire, spaghetti being used in any places where the wires are likely to short-circuit. Otherwise, insulation is unnecessary.

The operation of Circuit No. 2 is exactly the same as that of Circuit No. 1. The first adjustment is the battery clip on the input coil. This clip should be set on the tap which gives the best selectivity and all-around results. The coupler at the bottom of the panel in the center should be set in a position so that the coils are about  $\frac{3}{4}$  of the way uncoupled. These two are selectivity controls and in no case should be used as tuning controls to vary the wavelength. Although the variocoupler may look like a tickler coil, it is not one, regeneration being accomplished with the three plate condenser at the top of the panel. This condenser should be brought into the regenerative position, which will be about half way in, and then the two large dials turned in unison to locate the stations that are on the air. The best voltage to use on the detector is  $22\frac{1}{2}$ , and the transformer should be provided with a C battery of  $4\frac{1}{2}$  volts.

Circuit No. 2 will operate fairly well with dry cell tubes if the builder has not had storage battery tube experience. The recommendation of the writer in a previous article,—to hock everything including the family silverware in order to get a storage battery—still stands if the builder expects to get the very best that is in the set.

The selectivity of Circuit No. 2 is something to be marvelled at and compares very favorably with the best neotrynes. A recent test made at a distance of one mile from KTAB, 1,000 watts, 240 meters, proved that with a

(Continued on Page 52)

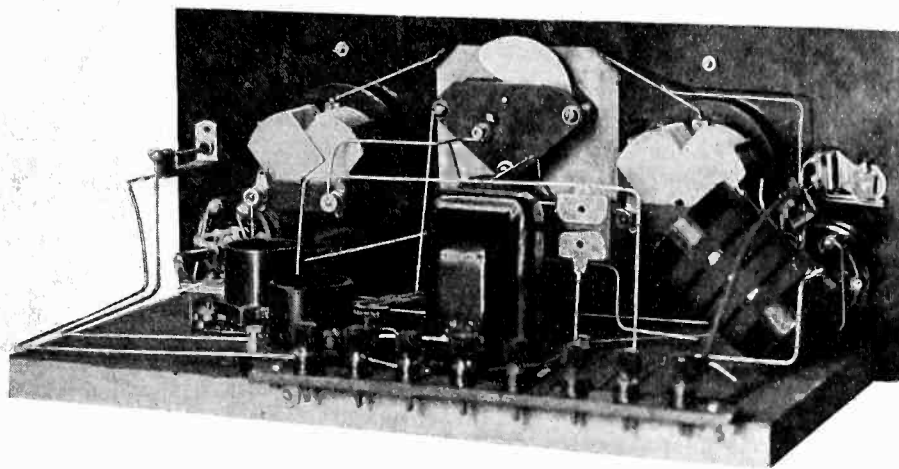

Rear View of Completed Receiver.

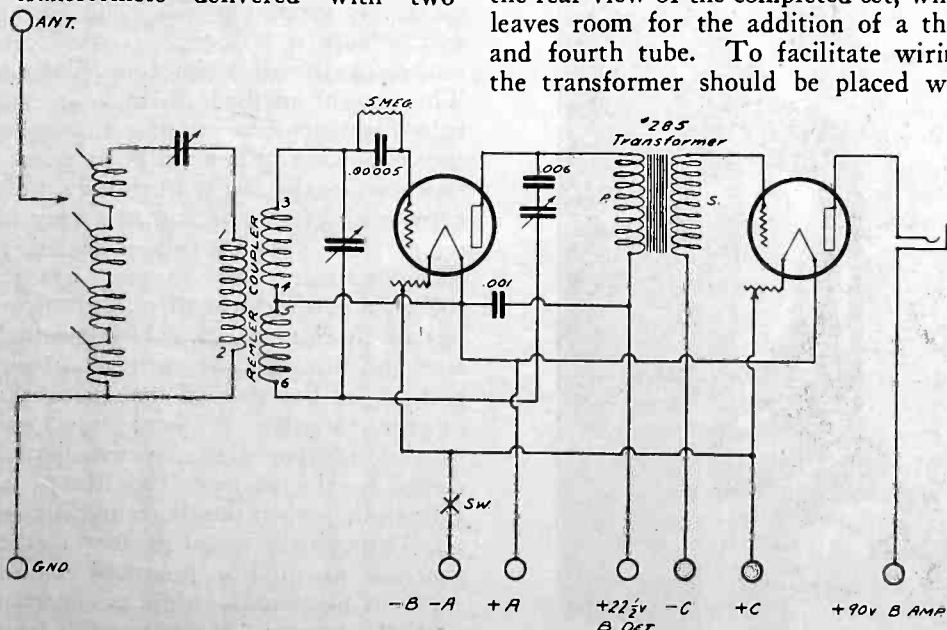

Fig. 1. Diagram of Circuit No. 2 for the Efficient Two-Tube Set.

# Financial Returns on Radio

By Geo. S. Turner

WHAT will be the returns as a result of the time and energy you are devoting to radio? Will your compensation be in dollars and cents or, always as now, in the diversion? Are you satisfied to rest on your laurels and sit back with an air of satisfaction now that you have mastered the fundamentals of radio or are you one who has been severely bitten by the "radio bug" and now in the radio game for all you can get out of it? If you are and unless your life's work has previously been chosen elsewhere, you may be interested in making radio your vocation.

First let us consider the advisability of commercializing a hobby. May your avocation be broadened so as to include your vocation? It has been said by a very well known radio engineer, "One disadvantage of radio as a vocation is that you are thus denied it as an avocation." This is as you make it; viz, radio is now so specialized that anyone may easily commercialize one phase of radio, providing it is sufficiently far removed from the particular side-line which is your diversion so there will be no conflict between the two.

You may readily call to mind men prominent in the amateur field who are regularly occupied as radio salesmen, operators of radiocasting stations, dealers, and manufacturers. They are not only prominent in their amateur activities but are successful in their business as well, because they take such an intense interest in their work.

The individual who is devoting much of his time to this fascinating art as an amateur operator or experimenter is preparing himself for the future. These two groups have contained the names of men who are now internationally famous. Review the history of DeForest or Armstrong—experimenters and amateurs of the highest order. However, we can't all be like these men nor expect to become famous. On the other hand, we may take advantage of the opportunities presented by our environment and improve our present status.

For instance, if it so happens that you are an amateur, see to it that your transmitter and receiver are of the best; but do not stop there. Strive for individuality of design or improvement of circuits. Join every worth while organization and strive to become more than just an amateur. Join the local club or if there is none, see that the necessary interest is aroused to instigate such an association. Take an active part therein; be one of the officers if possible. It will mean work on your part but it will

train your mind and give you confidence in yourself that you never before possessed. Do not be afraid to advertise yourself in this manner. It is really necessary in this age of strong competition.

As an amateur radio operator do not be content to copy your ten words per minute—improve your ability by copying just a little faster than your normal speed. When you have become proficient in the Continental code, learn Morse. It may be of use to you at some future date—if not, your mind has been improved by the effort and you will be the better operator for the learning. You may wonder how it is possible for you to measure your ability along these lines. I know of no better way than to take the U. S. Government radio examinations. The different classes of operators' licenses now issued by the Department of Commerce, in the order of their importance, are as follows: Commercial extra-first class, Commercial first class (three grades), Commercial second class, Commercial second class—broadcast grade, Commercial grade four, Amateur extra-first grade, Amateur first grade, Amateur second grade. Information regarding each of these licenses and the regular days when these examinations are held will be furnished upon request, by your nearest Radio Supervisor.

A large number of men now proficient in the radio field obtained their experience either in the Army or Navy during the recent world war. Either branch of the service has well conducted and organized radio schools in theory and code. Both are anxious to co-operate with radio amateurs. Complete details may be had by addressing Army or Navy headquarters in your district.

Of late years another way to become proficient in radio is offered at the vocational and manual training high schools. An investigation of the course of study available in some of these schools has convinced the most skeptical of their great value. Or, if a student desires a more complete course of study he may enter one of the many colleges or universities where radio is taught. In such a course, however, the radio subjects are supplementary to the regular engineering curriculum and for this reason no university is offering a degree in radio. However, when one considers the large number of so-called radio engineers who, at the present, are infesting the game, one is perhaps the better off without such a title.

For the ambitious student, lack of funds necessary to attend a university is no longer a hindrance. Practically

every school has a radio station which is operated by one or more of the students. The money obtained from this source goes a long way toward paying the room and board bill. In addition, a large number of fellows operate ship stations during their vacation months and are thus able to obtain a higher education and to see the world where otherwise it would be almost impossible.

It would hardly be fair not to mention the few radio trade schools situated throughout the country where one may go and obtain valuable instruction. These schools appeal to the fellow who either does not have the money or the inclination to learn radio at a university. Surely they fill a pressing need as proven by the large number of radio men who got their start at just such a school.

Before a student enters the radio field he wishes to know what particular phase of the game he should follow. Naturally that is for the individual to determine. However, it might be well to mention the different branches now available that he may take his choice. Radio was once grouped into a very few lines which, with the passing of the years, have increased in number until it is now difficult to accurately classify the subject. Nevertheless, such a classification must be briefly attempted.

First we have commercial radio subdivided into marine radio with its ship to ship and ship to shore communication; land stations which carry on general and point to point communication such as the high power trans-oceanic and trans-continental stations; the smaller stations such as are used by the Post Office Department in connection with the air mail service; also, the small private point to point stations used by individual concerns such as the oil companies for reporting pressure and flow of oil.

We probably should classify the radiocast stations as next in importance and truly this branch of radio has grown so rapidly as to place it near the top. It is a field where the largest salaries are to be had, considering the effort and ability required. Let us hope they never fall to the level with the average commercial operators pay.

Next we have the manufacturing and retail radio trade, both on a par. Opportunities are without number here and anyone with varying degrees of ability and knowledge of radio may proportionately partake of the rewards. It is unnecessary to go into detail regarding such lines of endeavor for we may investigate numerous factories and stores at any time we see fit. For those interested in

(Continued on Page 53)

# An Efficient Two-Tube Set

The Third in the Series Started in December RADIO

By E. M. Sargent

As previously stated, all of the sets in this series have been designed with selectivity as the first consideration, tone quality next, and ability to get distance a third but still an important factor. It is the belief of the writer that these three items should be considered in this order in any radio set, it being obvious that the first thing to do is to be able to get the station that you want, that after getting the station it is next important to have it sound well, and third, the ability to get distance gives a greater choice of stations from which to pick a good program. Following out this order, Circuit No. 2 is merely Circuit No. 1 with one good stage of audio frequency added. This is a set that will bring in all locals, clear and loud on the speaker, without any interference. The real long distance fans will have to wait until next month when Circuit No. 3 comes out before they will be able to log a great number of DX stations.

We are now fortunate in having at our disposal a large number of extremely fine audio transformers. These transformers not only have from two to three times the power of the transformers formerly available but they also have flat frequency characteristics, which means that they amplify equally well over practically the entire musical scale. It is, therefore, not an easy matter to select the best. The writer has chosen the General Radio No. 285, 6 to 1 transformer as being well suited for the requirements of the series of circuits. This transformer delivers about the same power in a one stage amplifier that former transformers delivered with two

stages. Other transformers that may be substituted are the Rauland Lyric, the Thordarson 2 to 1, the Karas Harmonic or the Amertran De Luxe. Any one of these five, when used with the circuit diagram shown in Fig. 1 will successfully operate a cone type loudspeaker.

The parts needed, in addition to those used in Circuit No. 1 as described in January 1926 RADIO, are one high grade audio transformer, one vacuum tube socket, one rheostat and two Eby C binding posts. The panel layout is the same as for Circuit No. 1 except the holes for the rheostat to be placed in the lower left hand corner, corresponding to those in the lower right hand corner. This makes a well-balanced panel which remains practically the same for the subsequent three and four tube sets.

The placement of parts is shown in the rear view of the completed set, which leaves room for the addition of a third and fourth tube. To facilitate wiring, the transformer should be placed with

the primary toward the panel. The set should be wired up with No. 14 round tinned wire, spaghetti being used in any places where the wires are likely to short-circuit. Otherwise, insulation is unnecessary.

The operation of Circuit No. 2 is exactly the same as that of Circuit No. 1. The first adjustment is the battery clip on the input coil. This clip should be set on the tap which gives the best selectivity and all-around results. The coupler at the bottom of the panel in the center should be set in a position so that the coils are about  $\frac{3}{4}$  of the way uncoupled. These two are selectivity controls and in no case should be used as tuning controls to vary the wavelength. Although the variocoupler may look like a tickler coil, it is not one, regeneration being accomplished with the three plate condenser at the top of the panel. This condenser should be brought into the regenerative position, which will be about half way in, and then the two large dials turned in unison to locate the stations that are on the air. The best voltage to use on the detector is  $22\frac{1}{2}$ , and the transformer should be provided with a C battery of  $4\frac{1}{2}$  volts.

Circuit No. 2 will operate fairly well with dry cell tubes if the builder has not had storage battery tube experience. The recommendation of the writer in a previous article,—to hock everything including the family silverware in order to get a storage battery—still stands if the builder expects to get the very best that is in the set.

The selectivity of Circuit No. 2 is something to be marvelled at and compares very favorably with the best neodynes. A recent test made at a distance of one mile from KTAB, 1,000 watts, 240 meters, proved that with a

(Continued on Page 52)

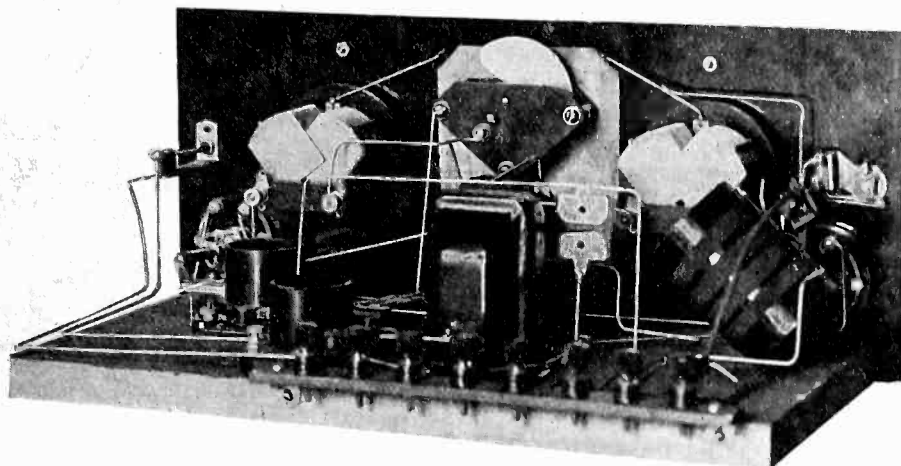

Rear View of Completed Receiver.

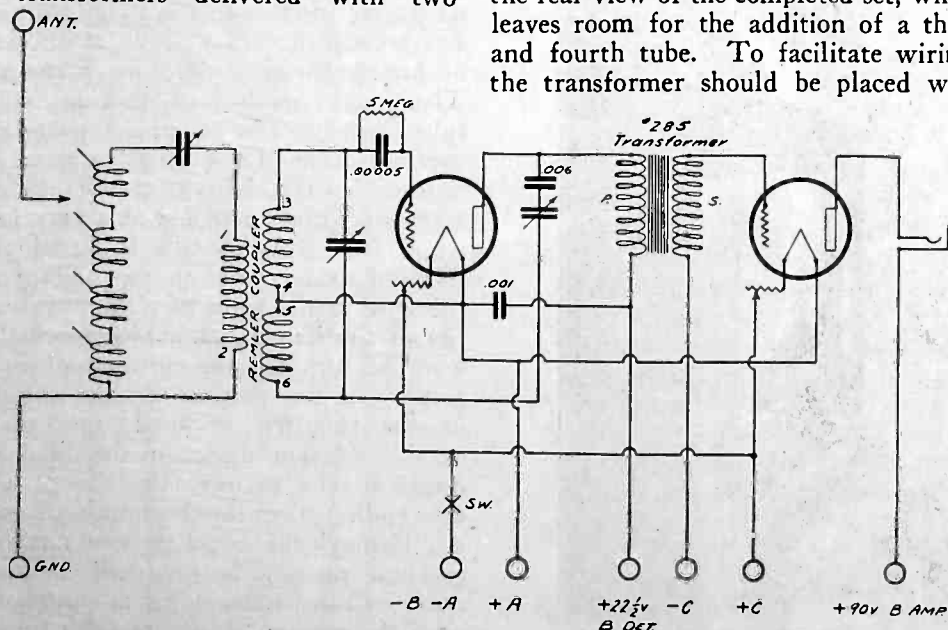

Fig. 1. Diagram of Circuit No. 2 for the Efficient Two-Tube Set.



## PORTABLE RADIO STATION 6XBR

6XBR is a 250-watt portable radio-cast station operated on 108 meters in connection with KFWB at Hollywood, Calif., by Warner Bros. Moving Picture Studio. The apparatus is mounted on a motor coach 22 ft. long behind the dash, giving ample room.

The antenna system consists of a 45-ft. and a 25-ft. collapsible tower which fold down on top of the truck, along which the counterpoise is also run. The transmitter is a coupled Hartley circuit with Heising modulation.

The input panel uses two stages of impedance-coupled power amplification with a third stage when needed. This panel delivers about ten watts to the 50-watt speech amplifier. A 500,000 ohm potentiometer controls the volume of the input panel. A jack and plug arrangement is used in all circuits to test the plate current. Two microphones may be used and a switch is provided for changing from one to the other.

A separate panel controls the power for the generators. On this is mounted switches for changing from one generator to the other or throwing the two in parallel. On this panel are two voltmeters, one for each generator. This enables the operator to read both generators separately which is necessary when running them in parallel.

A fourth panel controls the entire power supply. On this are the switches for the six-volt tubes used on the input panel, and the plate supply for same. The filament voltage for the 250 watters and the current for the generators are also controlled on this panel. When all switches are in the up position the batteries are on discharge, when down all are on charge. Provision is made for charging the batteries at their different voltages.

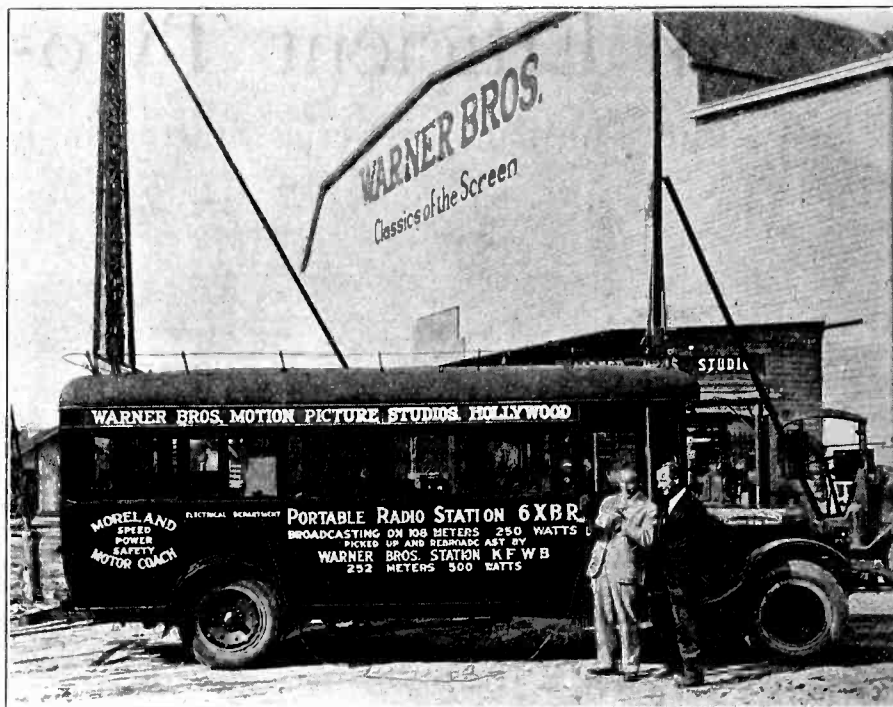

Chas. Wellman, KFWB Announcer, and F. N. Murphy, Electrical Engineer Ready to Radiocast from 6XBR.

The two generators are supplied with 24 volts direct current and deliver 1500 volts D.C. running at 6000 r.p.m. Four hours of steady service is had from one charging of the batteries. Jelly batteries are used throughout, both for the generators and filament. Particular care was taken to run all wires in the truck whether from batteries to tubes, or from one panel to the other in lead covered grounded cable.

Radio 6XBR was built for experimental purposes and to tie up with KFWB on 252 meters. In testing this station out it was found that it reached a class of listeners-in that had been overlooked, that of the radio amateur and the BCL who make it a business to listen-in on the low waves.

In the future 6XBR will reverse operations and rebroadcast KFWB on 108

meters. On the first test, letters were received from as far east as Denver and north to Portland, from those who had heard it on 108 meters.

All equipment and mounting was built at the Warner Brothers' Studios, under the supervision of Frank N. Murphy, their electrical engineer. This portable truck will be used to broadcast sport events, musical entertainment and programs from theatres using Warner Brothers' pictures. These will be put on the air on 108 meters and will be picked up by Warner Brothers' station KFWB, where it will be rebroadcast on 252 meters.

Pure metallic ductile thorium has been prepared for the first time by the Research Laboratories of the Westinghouse Lamp Company, according to a statement by Dr. H. C. Rentschler, head of the Research Department, and Dr. J. W. Marden. Thorium is of particular interest to the radio enthusiasts because it is the active constituent of practically all radio tube filaments. The present method of making radio tube filaments consists of compounding thorium oxide in the tungsten wire, as thorium has the ability to throw off electrons with great ease and at a very low temperature. As the tube is heated, the thorium oxide comes to the surface of the wire in the form of minute quantities of thorium metal, which gradually work off through the emission of electrons. As the thorium on the surface of the tungsten is used up, more of the thorium oxide in the filament comes to the surface, the life of the tube ending when the thorium is all used up. Through the use of the new method, thorium can now be produced commercially in filamentary form as contrasted with the minute admixture with tungsten used at present.

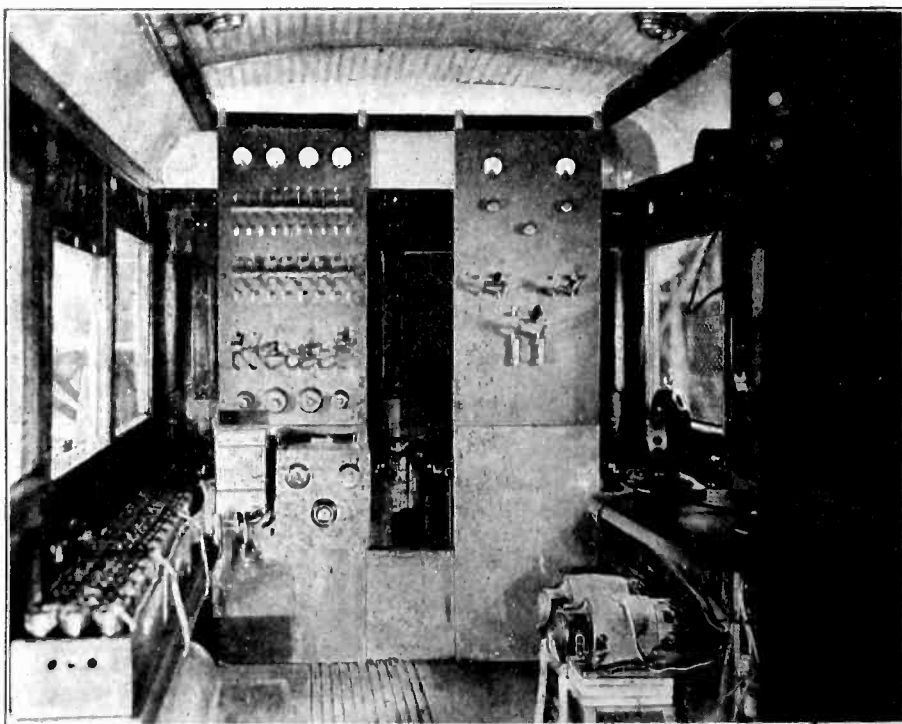

Interior View of 6XBR.

# A Non-Oscillating R. F. Circuit

Wherein A High Resistance Primary Takes The Place of Neutralizing Condensers, Stabilizers or Other Control Methods

By Charles H. Smith

A FIVE-TUBE tuned radio frequency receiver, combining sensitivity and selectivity with extreme simplicity of construction and operation can be made by employing tuned radio frequency transformers having a high resistance primary, and a minimum external magnetic field. The purpose of such a transformer is to reduce the inductive coupling between windings and the capacity coupling of the grid and plate of the vacuum tube. Its use, together with proper arrangement of parts and wires and proper by-pass condensers, practically obviates all causes of oscillation.

Inductive coupling between transformers may be minimized by using split winding coils whose slight external field is still further reduced by placing them so that there is little interaction between them.

The energy ordinarily fed back from the plate circuit to the grid circuit through the capacity of these elements can be counteracted by feeding back en-

- LIST OF PARTS**
- 3 .0003 variable condensers.
  - 3 R. F. Transformers (Camfield Duoformers).
  - 5 tube sockets.
  - 2 audio frequency transformers.
  - 1 6 ohm rheostat.
  - 1 15 ohm rheostat.
  - 1 1 mfd. by-pass condenser.
  - 2 .002 mfd. fixed condensers.
  - 1 .00025 mfd. fixed condenser.
  - 1 .00025 mfd. fixed condenser with grid leak mounting.
  - 1 double circuit 4-prong jack.
  - 1 single pole double throw antenna switch.
  - 1 2 Megohm grid leak.
  - 14 binding posts.
  - 1 panel 7x21x3/16 in.
  - 1 binding post strip 9/16x1 1/2x5/16 in.
  - 1 baseboard, 9 1/2x20x1/2 in.

ergy that is out of phase with the energy fed back through the tube, thus preventing oscillation. The usual methods of oscillation prevention introduce losses which either cut down the efficiency of amplification or require critical adjustments. But by introducing the right resistance in the primary it is possible to reverse the phase of the energy intentionally fed back so that it just neutralizes that fed back by the tube capacity, thus maintaining the efficiency of amplification and not requiring change in adjustments once made.

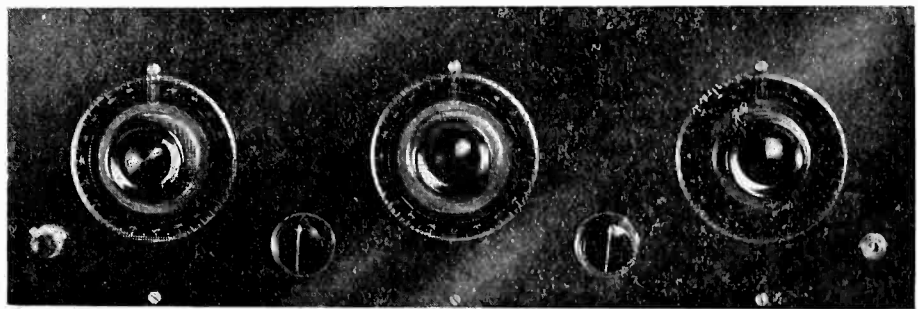

Panel View of Completed Set.

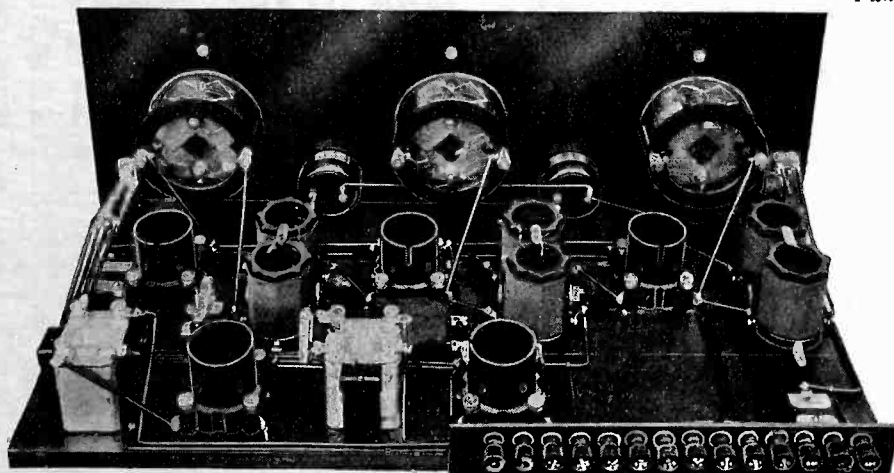

End View Showing Antenna Connections.

Such radio frequency transformers can be obtained ready made as described in the list of parts, or they can be made according to the following dimensions. Each transformer consists of two complete primary and secondary sections, each section consisting of 4 turns primary and 68 turns secondary, wound on a 1 5/8 in. moulded bakelite form or fiber tubing. The primary is wound first, and the secondary placed over it. The primary wire is No. 40 Advance resistance wire. As this may be difficult to obtain in some localities, the availability of the wire should be investi-

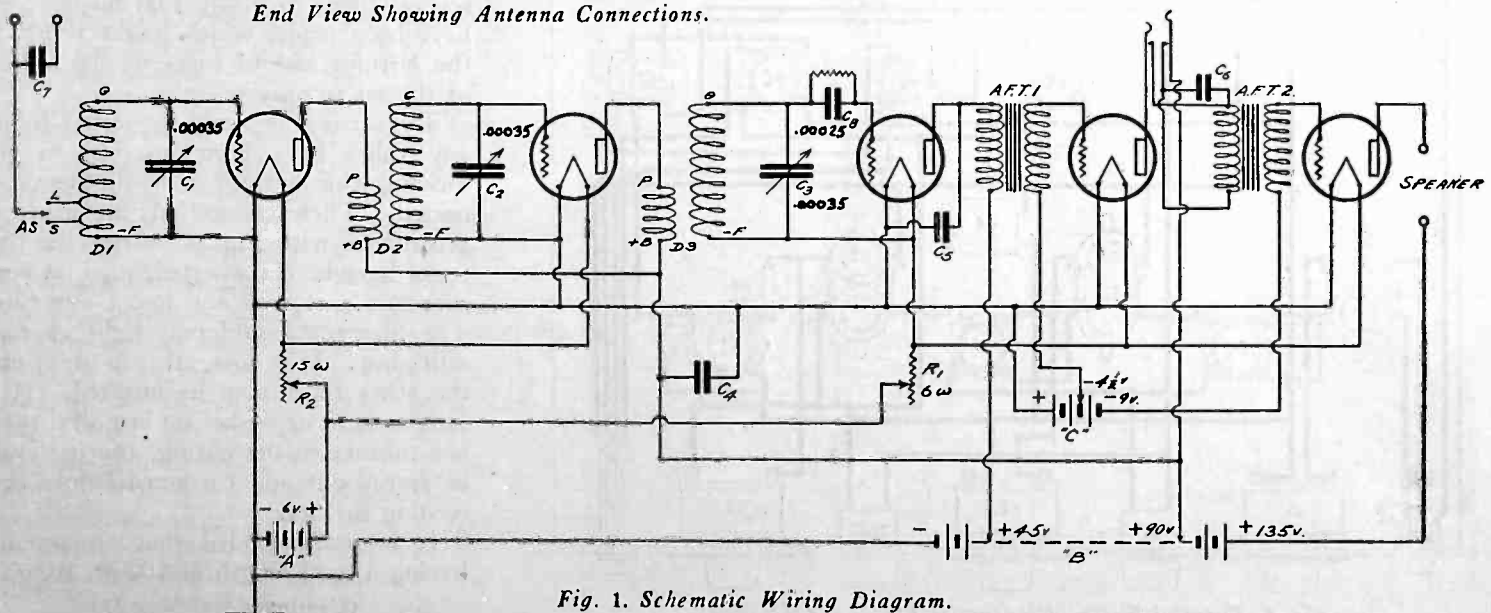

Fig. 1. Schematic Wiring Diagram.

gated before trying to wind the coils. The secondary wire is No. 24 double silk-covered copper wire. Each bakelite form is  $2\frac{1}{4}$  in. long, and the coils are fastened together with small brass strips as can readily be seen in the pictures. The coils are fastened together so that the windings are all in the same direc-

this manner, whenever the use of a six-volt storage battery is practical.

The set will operate satisfactorily, but with slightly less efficiency, when dry battery tubes are used. In either case the set has been designed to use a power tube in the last audio stage. The circuit has been so arranged that no changes

in accordance with Fig. 3, and screw all of the apparatus in place on it. Next mount all of the apparatus on the panel, except the three variable condensers, and secure the panel to the baseboard. The condensers should be mounted and connected in the circuit after all of the other wiring is finished. This is recommended because they might otherwise be in the way when running some of the wires.

The set is now ready for wiring. Before proceeding with this, the schematic wiring diagram of Fig. 1, the actual wiring diagram of Fig. 4 and the pictures should be studied carefully. To those already experienced in wiring sets, the schematic wiring diagram will probably be a sufficient guide. For those who are

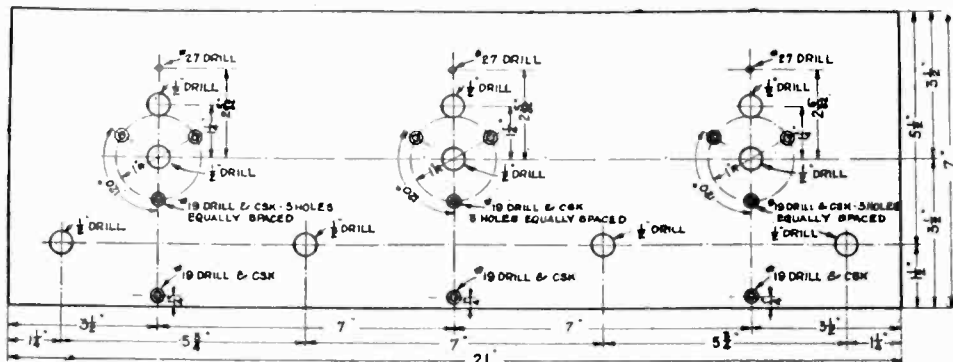

Fig. 2. Panel Template.

tion, the filament connection being at the bottom end of one coil, and the grid connection at the bottom of the opposite coil, the two coils being fastened together at the top, and forming a continuous inductance. Care must be taken not to have the two sets of windings opposing or the set will not operate.

If resistance wire cannot be obtained for the primary, fine copper wire may be substituted, and in this case, some sort of variable loss resistor must be placed in the primary circuit of each transformer between the coil and the B battery. A variable 1500 ohm resistance will serve the purpose ordinarily. The antenna coil is wound with the same size wire and number of turns as for the secondaries of the r.f. transformers but is tapped at the 12th and 25th turns for the antenna connections.

Fig. 1 is the schematic wiring diagram of the circuit using storage battery tubes. The transformers are primarily designed for use with storage battery tubes and it is recommended that they be used in

in the wiring are necessary to change from one type of tube to the other.

In building the set, drill the bakelite



Fig. 5. Details of Binding Post Strip.

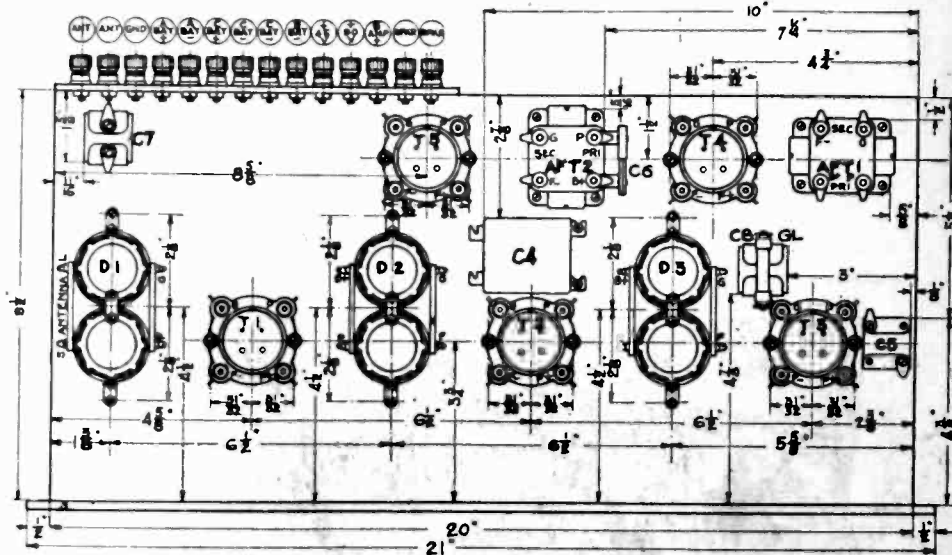

Fig. 3. Baseboard Layout of Apparatus.

panel and binding post strip in accordance with the dimensions shown in Fig. 2. Next, lay out the base board

not generally familiar with such diagrams, the actual wiring diagram of Fig. 4 should be closely followed. The binding post strip dimensions are shown in Fig. 5. After the wiring has been completed, it should be carefully checked several times to insure that no mistakes have been made, which might result in the burning out of tubes or the failure of the set to operate.

The set is now ready for test. Before any tubes have been inserted in the sockets, the batteries should be connected. These connections are made in accordance with Fig. 6. After the batteries have been connected, turn on both rheostats part way and insert one tube. The filament should now light up to a dull glow. If it does, all is in order and the other tubes may be inserted. If it fails to light or flashes up brightly, there is a mistake in the wiring, and it should be traced out and corrected before proceeding further.

It is recommended that an antenna having a total length of 100 ft. from its  
(Continued on Page 58)

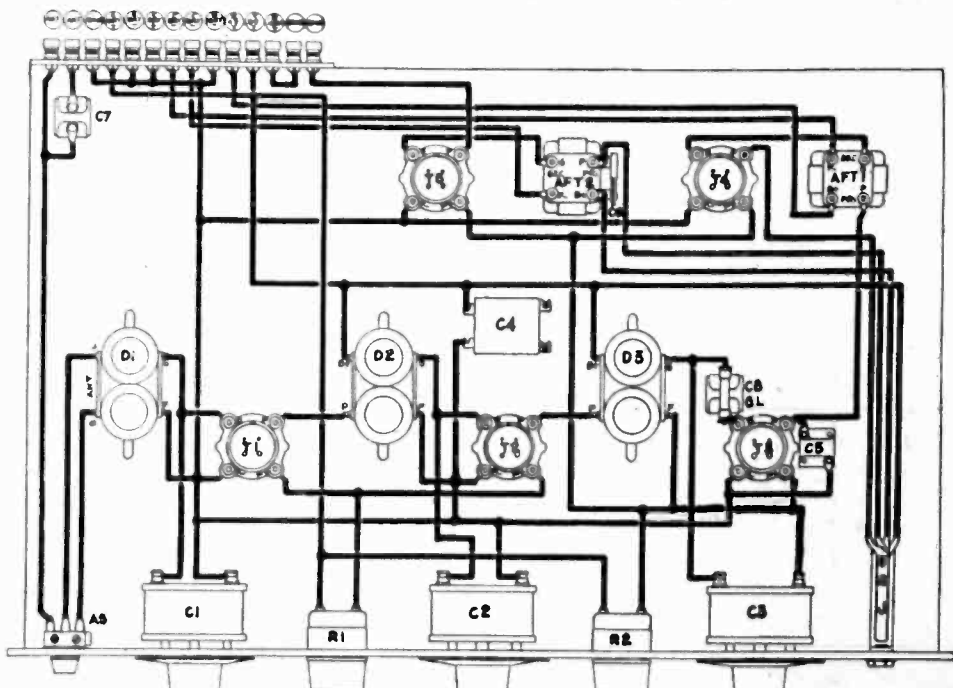

Fig. 4. Pictorial Wiring Diagram of Five-Tube Receiver.



# A High Quality Power Amplifier

Specific Directions for Building a Two-Stage Distortionless Audio Amplifier Giving Great Volume and Using A. C. Supply

By H. W. Armstrong

CONSIDERABLE attention has been given within the past two years to the development of the radio frequency amplifier, with the result that great improvements have been made in the sensitivity and selectivity of the average radio receiver, in that part of the set which is ahead of the detector tube. Presumably the audio frequency amplifier, on which depends to a large extent the quality of the output of the receiver, has been considered good enough.

The new power amplifiers manufactured by the Western Electric and General Electric Companies have shown that the best quality is not obtainable with the ordinary type of receiving tube, such as is used in the r. f. or detector part of the circuit, as this tube is not capable of handling the power required for proper operation of cone type loud speakers. It behooves us, if we wish to obtain maximum enjoyment from our radio sets, to improve our audio frequency amplifiers so that distortion is eliminated.

Distortion in an audio amplifier is caused by any one or all of three things: failure to keep the grid negative with respect to its filament at all times; imperfect transfer of energy from tube to tube at all frequencies; failure to use a tube of sufficient size in the last stage, to handle the necessary power output. The remedies for these defects are readily discernible.

The three usual methods of inter-tube coupling employed in audio amplifiers are resistance, impedance and transformer coupling. These methods have been set forth in the order of their ability to transfer faithfully all frequencies. Each method has its good points as well as its objectionable qualities. So in the amplifier to be described, use is made of all three methods, in such a manner that only the good points of each method are utilized.

Fig. 1 shows the circuit diagram of a two stage amplifier, consisting essentially of an input circuit, a voltage amplifier consisting of a "high mu" tube and associated apparatus, a power amplifier, and an output circuit. In designing the input circuit, it is remembered that most

receiving sets operate the detector tube at a plate voltage of about 45 volts, so the coupling medium to the first stage of the amplifier should have a comparatively low d. c. resistance in order that the voltage drop through this medium be small. This advantage is secured by an inductance of high value, so that the detector tube is coupled to the first audio stage by means of impedance coupling. Since the inductance of the coil used is approximately 400 henrys, and the coupling condenser is 1 mfd., the difference in energy transferred to the grid of the first amplifier tube at 50 and at 7000 cycles is less than 5 per cent.

The tube used in the first stage should have an amplification constant of 20 or more, the Daven High Mu tube being used in the experimental layout, although the Western Electric 102-D High-Mu tube is equally good, but unfortunately not easily obtainable. By its use, one of the objections to resistance coupling, that of low amplification per stage, is removed. The amplification obtainable is at least equivalent to that had with a 3 to 1 transformer and tube having a "mu" of 7. While this tube normally operates on a 6 volt battery without rheostat, it will still function properly at 4 volts, so that a rheostat is provided for voltage control and conservation of filament current. A C battery of 1½ volts, obtained from a small flashlight cell, provides the necessary grid voltage, for 150 volts plate. A 1 megohm grid leak furnishes a termination for the grid circuit and requires no adjustment.

To secure maximum amplification and quality of output from a tube using resistance coupling, the external or coupling resistance must be large compared

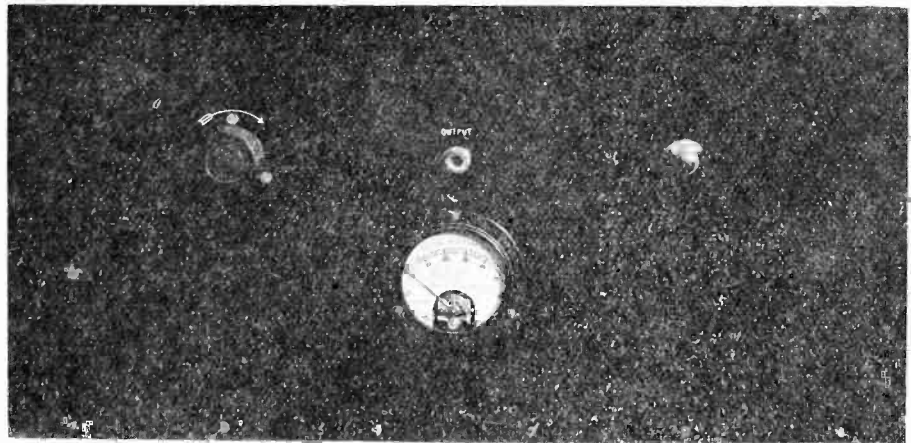

Fig. 2. Panel View of High Quality Amplifier.

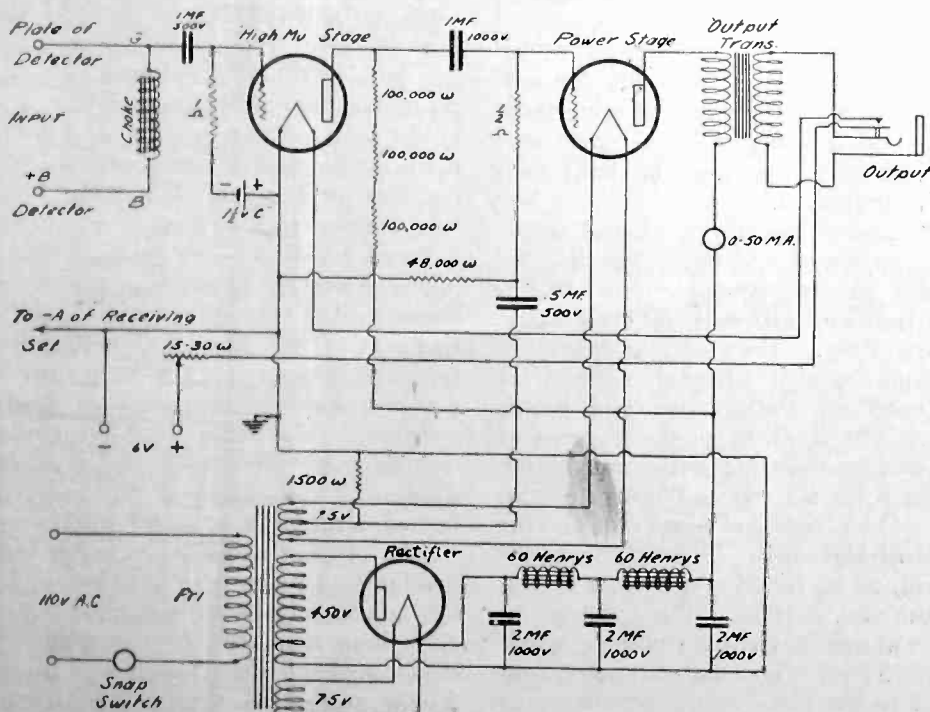

Fig. 1. Schematic Wiring Diagram.

with the plate-filament resistance of the tube. In a high mu tube this resistance is about 50,000 ohms, so the plate resistor must be considerably higher for good results. At 150 volts plate, the plate current of the Daven tube is .9 milliamperes, and as the plate voltage available from the power source is 425 volts, the plate resistor must reduce this to 150 volts while also acting as a coupling resistance. This situation, it will be seen, removes the remaining objection to resistance coupling, the necessity of employing extra batteries to take care of the voltage drop through the coupling resistance, and is ideal in that for maximum quality and gain the coupling resistance should be high, and in the case at hand it must be high in order to reduce the plate potential to the proper value. The coupling resistance is made up of three 100,000 ohm Crescent Lavite resistance units connected in series, which gives coupling resistance six times the plate-filament resistance of the tube. The coupling condenser has a capacity of 1 mfd., but should be capable of withstanding 1000 volts, so a filter condenser is preferable.

We now come to the power stage of the amplifier, which is, to a large extent, responsible for the volume secured. An audio frequency amplifier should be so designed that all stages except the last are operated as voltage amplifiers, that last stage being designed to operate as a power amplifier. To fulfil this function and secure a maximum transfer of energy, this tube should have a large plate current and should work into a circuit whose impedance is equal to the output impedance of the tube. These conditions are fulfilled by the use of the new type CX310-UX210 power tube, together with the General Radio Type 364 output transformer. This tube operates with a plate potential of from 350 to 425 volts and a negative grid potential of from 27 to 35 volts. It has a 1.25 ampere filament current at 7½ volts.

The coupling transformer to the loud speaker separates the a. c. and d. c. components of the plate current of the power tube and the transfer of the a. c. energy to the loud speaker. This is most efficiently done by the use of a transformer whose primary impedance matches the output impedance of the tube and whose secondary impedance matches the impedance of the loud speaker. This method also obviates the necessity of passing the high d. c. potential through the windings of the speaker.

The last section of the circuit comprises the current supply set which operates to furnish filament current for the power tube and the rectifier tube, as well as the high plate potential for the entire amplifier. By its use the necessity for a 7½ volt filament battery is eliminated, as well as a bank of high voltage B batteries. In the amplifier

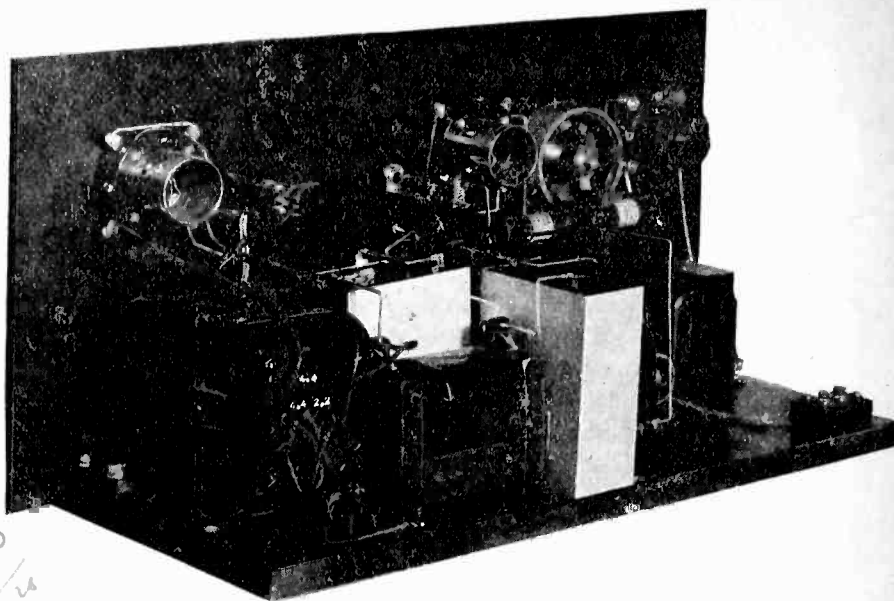

Fig. 3. Rear View, Showing Closeup of Apparatus.

#### LIST OF PARTS USED

- 1 Amertran Power Transformer—110-450-7.5v.
- 2 60 henry choke coils—Amertran, General Radio.
- 3 2 mfd. 1000 v. filter condensers—Tobe Deutschmann.
- 1 1 mfd. 1000 v. filter condenser—Tobe Deutschmann.
- 2 1 mfd. by-pass condensers—Dublier.
- 1 1 megohm gridleak with mounting.
- 1 ½ megohm grid leak with mounting.
- 3 100,000 ohm Lavite Resistances—Crescent or Western Electric 38-W.
- 1 48,000 ohm Lavite Resistance—Crescent or W. E. 38-A.
- 1 Output Transformer, General Radio No. 364.
- 1 Thordarson Autoformer.
- 1 Filament control jack.
- 1 switch for 110 v. a. c.
- 1 15 to 30 ohm rheostat.
- 4 binding posts.
- 3 vacuum tube sockets (2-UX and 1 Navy).
- 1 Eveready No. 950 flashlight battery.
- 1 Federal No. 25 potentiometer, (1500 ohm resistance).
- 1 Panel 10x20x3/16 in.
- 1 Baseboard 8x18x5/8 in.
- 1 Daven MU-20 tube.
- 1 CX-316-B or UX-216-B Rectifier tube.
- 1 CX-310 or UX-210 power tube.
- 1 0-50 m. a. milliammeter (optional)—Weston, Jewell.

base board of the amplifier, which is also connected to a good water pipe ground.

The filament of the rectifier tube is the positive tap for the high plate potential and the choke coils and their associated condensers comprise the filter system for smoothing out the rectified a. c. Due to the fact that the rectifier is of the half wave type, the filter is in two sections, each filter coil having an inductance of 60 henrys with 30 milliamperes flowing through the windings. A total of 6 mfd. is required for the filter, the condensers each having a capacity of 2 mfd. and capable of withstanding 1000 volts. It will be remembered that the peak voltage of an alternating current is 1.4 times the voltage as indicated by an a. c. voltmeter, so that in the case at hand, where the secondary voltage of the power transformer as measured with a voltmeter is 450 volts, the actual peak voltage is 630 volts. Hence, condensers tested to 500 volts d. c. will not do.

The 1500 ohm resistance which is connected between the center tap of the power tube filament winding and ground is for the purpose of providing the proper negative grid potential for the power tube, and eliminates the necessity of a dry cell C battery. A Federal No. 25 potentiometer, which has an average resistance of 1500 ohms, can be used in this part of the circuit. The plate current of the power amplifier, in order to return to ground must flow through this resistance. As the plate current is 18 milliamperes, the resistance causes a drop of 27 volts in the plate supply, and furnishes the necessary grid voltage.

The purpose of the 48000 ohm lavite resistance in series with the grid leak of the power tube is to eliminate any 60 cycle hum which might enter the grid circuit through the C biasing resistance. As the grid of the tube is always main-

(Continued on Page 54)

constructed by the writer, both the amplifier and current supply set were built as one unit and housed in the same cabinet, although they may be built separately if desired.

The power transformer has 4 windings, 1 primary and 3 secondaries, the primary winding being designed to operate from the 110 volt, 60 cycle house lighting lines. Two of the secondary windings furnish filament current at 7½ volts for the rectifier and power tubes. The winding for the filament of the power tube has a center tap at the neutral point for the grid return of this tube. The rectifier tube used is the CX316B-UX216B. This tube contains no grid, as its function is merely to rectify the a. c. current. The third secondary winding is the high voltage winding of 450 volts, one end of it being connected to the plate of the rectifier tube and the other end to the shielding on the

# Transmitting Tubes

Specific Data and Characteristics of Various Types

By Lieut. Jennings B. Dow, U. S. N.

**D**UE to the lack of standardization of vacuum tubes to be used for radio transmission it is still necessary to have knowledge of individual types of tubes in order to get the best results. Both the electrical and physical dimensions of different types vary greatly and only a limited standardization has been attained in plate voltages and base construction.

In all of the types manufactured by the General Electric Company, as shown in Fig. 1, tungsten or thoriated filaments are used. These tubes are designed to withstand abnormal voltages between elements as well as excessive plate dissipation for short periods of time. Plate dissipation means the energy which is liberated from the plate by heating it. If some means, such as water-cooling, is used to carry away the heat energy lost on the plate, the output of a given tube may be materially increased. Since a large

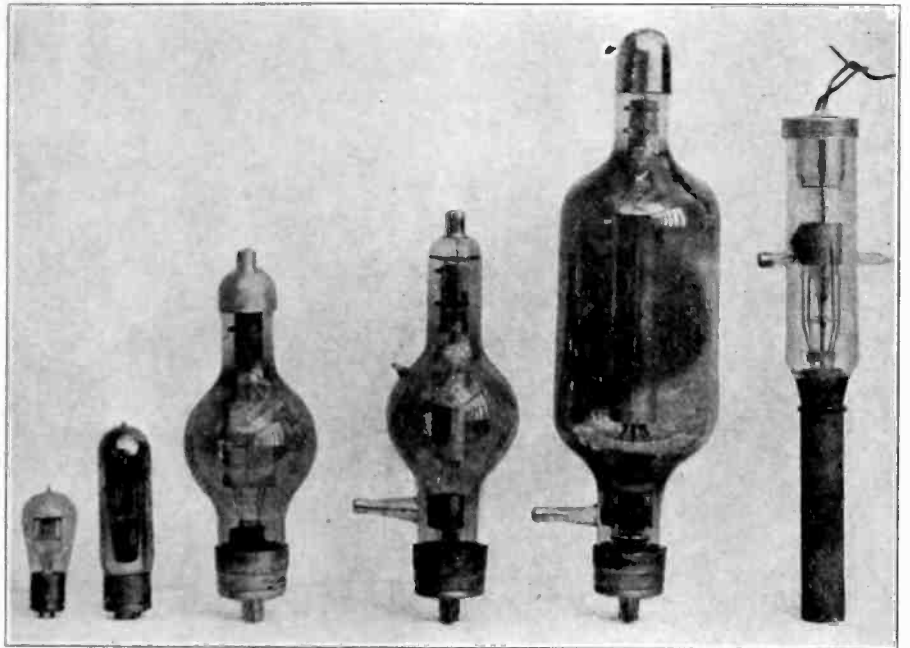

Fig. 1. G. E. Power Tubes. (Left to Right: 5 watt UV-202, 50 watt UV-203 or 203-A, 250 watt 204 or 204A, 1 h. w. UV206, 5 k. w. UV208, 20 k. w. UV207.)

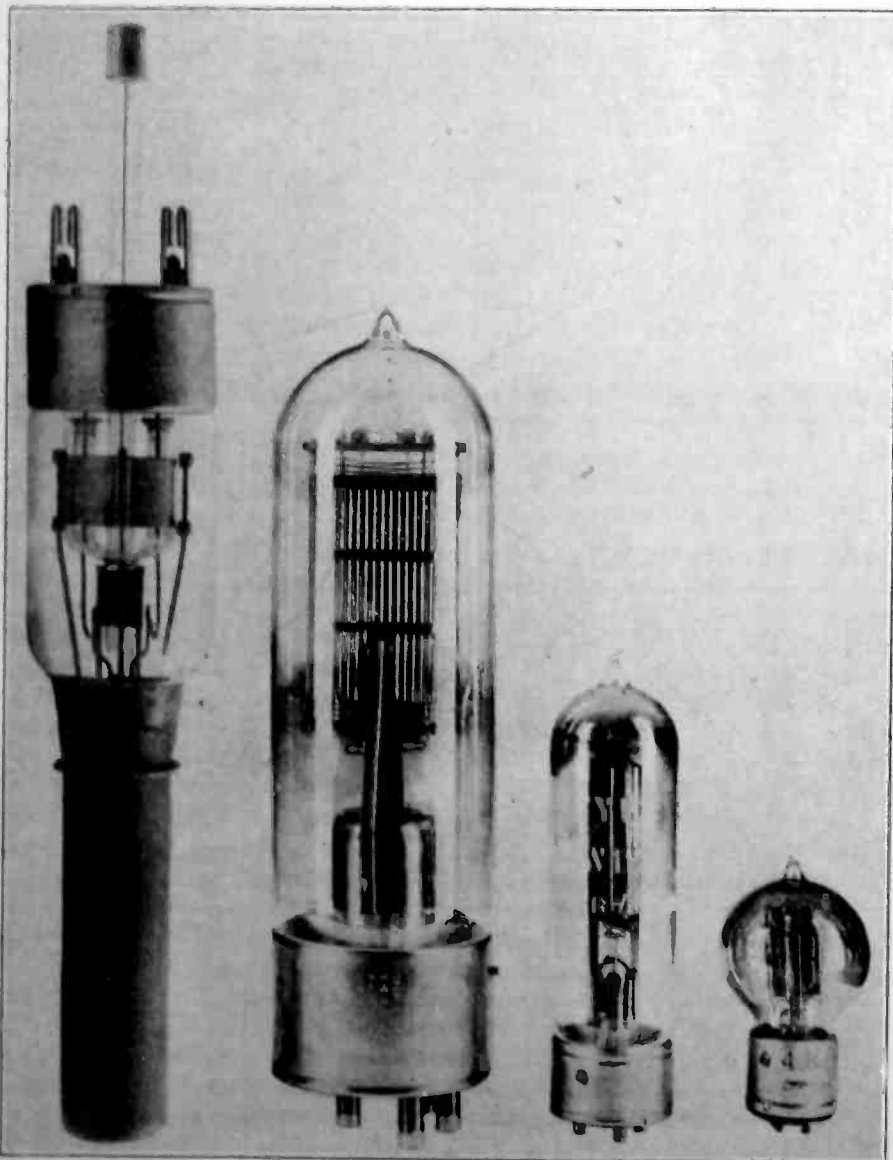

Fig. 2. W. E. Power Tubes. (Left to Right: 5 k. w. 220B, 250-watt 212D, 50-watt 211D, 5-watt 205D.)

percentage (40 to 60) of the total energy supplied to a tube is lost within the tube, and since this loss manifests itself in heat, the larger sizes of tubes are restricted to artificially cooled types. It is interesting to compare the overall sizes of air and water-cooled types.

In Fig. 2 will be seen four commonly used types of tubes manufactured by the Western Electric Company. The one on the left is a water-cooled type, and has a tungsten filament. The others, normally rated at 250, 50 and 5 watts respectively, employ oxide-coated platinum filaments. The use of the latter type of filament permits of adequate filament emission at cherry red temperatures, which is contributory to longer filament life.

A disadvantage found in the use of the oxide filament lies in the effects of excessive filament temperatures and plate dissipation. The effect of high temperatures originating in either the filament or other elements of this type of tube, is to release gases resulting from decomposition of the filament or occluded gases from the element structures. The amount of gas which may be released by overheating is considerably greater than that which would result from overheating other types, and since such gases may not be cleared, as in the case of tungsten filament tubes, by burning the filament at a high temperature for a continued period of time, safety in the use of oxide-coated filament types is not so great as in others of identical rating. For normal operation, however, a longer



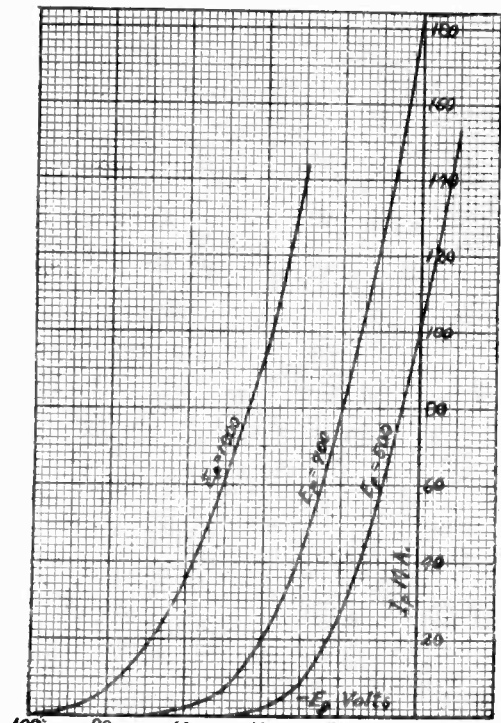

Grid-Plate Characteristics of W.E. 211-A 50-watt Tube with +10 Volts, 3.4 Amperes on Filament.

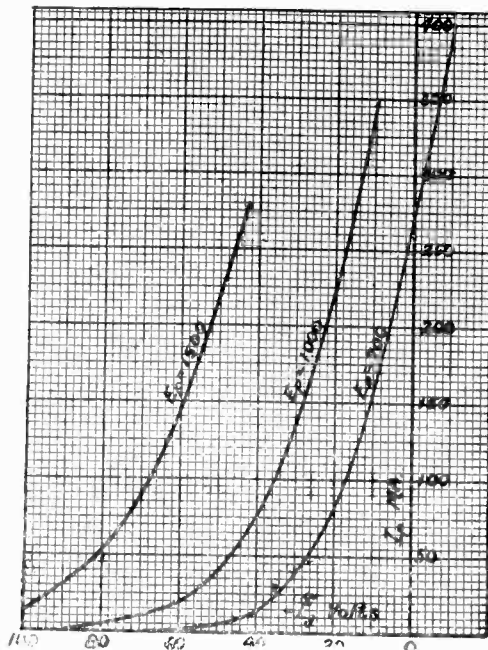

Grid-Plate Characteristics of W.E. 212-A 250-watt Tube with +14 Volts, 6.25 Amperes, on Filament.

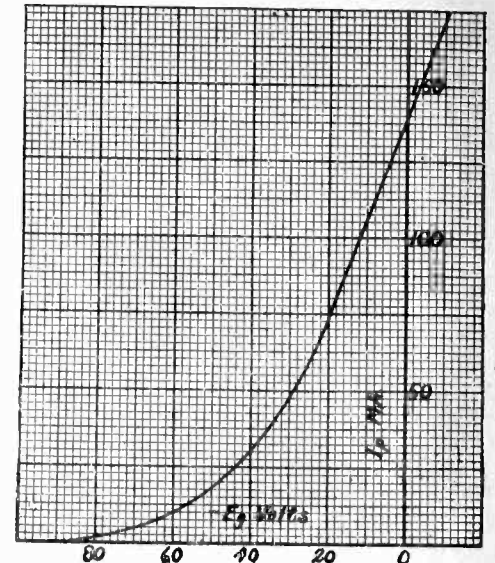

Grid-Plate Characteristics of UV203 50-watt Piotron with 1000 Volts on Plate and 10 Volts on Filament.

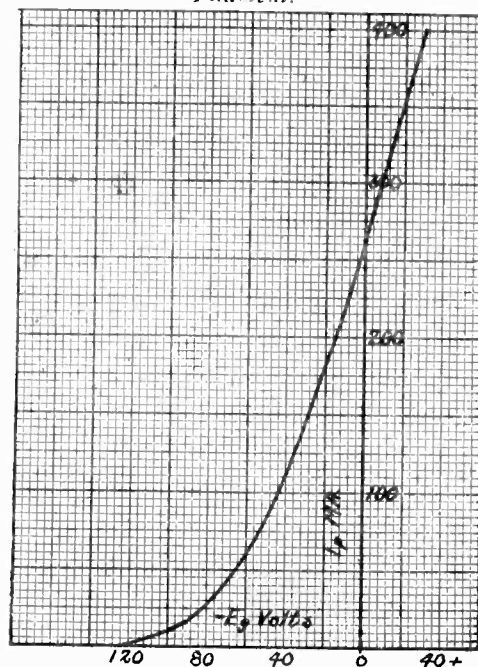

Grid-Plate Characteristics of CW931 or W.E. 205D Five-Watt Tube with 350 Volts on Plate and +7 Volts on Filament.

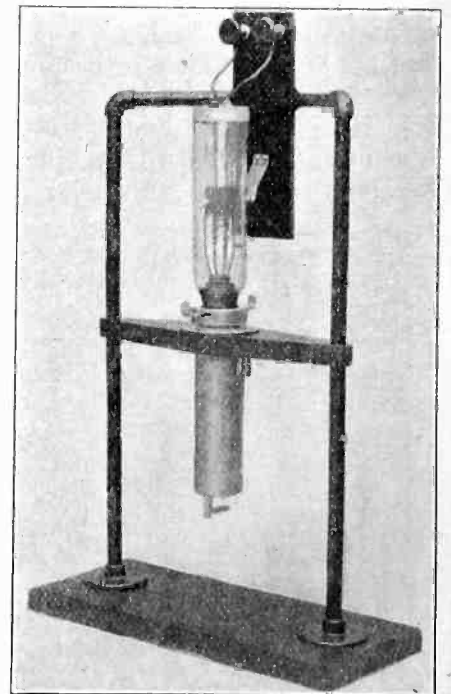

Fig. 3. G. E. 20 k. w. Tube (UV207) in Water Jacket Mounting.

filament life is generally obtained than for tubes having tungsten filaments.

Fig. 3 shows the conventional method of water-cooling a high-power tube. The cylindrical copper plate of the tube is clamped in position in the water jacket and by means of a small motor-driven pump, water is circulated around the plate. Water obviously enters through the lower fitting and leaves through the upper one. Since the jacket of such an arrangement is always at plate potential, it is necessary, in case water or another conducting solution is used for cooling, to provide appropriate insulation in the solution path between the jacket and low potential parts of the circuit. When water is used and it is not desired to isolate the entire water system as in Fig. 4, a sufficient length of hose is usually inserted in the water path to and from

### TRANSMITTING TUBE DATA

Manufacturer	Mfg's Type Number	Navy Number	Signal Corps Number	Mfg's Rating (watts)	Safe Continuous Plate Dissipation (watts)	Filament Volts	Filament Amperes	Type of Filament	Plate to Filament Impedance	Amplification Constant	Plate Volts	Plate Milliamperes	Length (inches)	Diameter (inches)
General Electric Co. (R. C. A.)	UV202			5	12.5	7.5	2.35	Tungsten	4500	7.5	350	50	5.25	2.13
	UV203			50	100	10	6.5	Tungsten	4000	15	1000	150	7.5	2
	UV203A			50	100	10	3.25	XL Tung.	5000	25	1000	140	7.8	2
	UV204	CG1860	VT-8	250	250	11	14.75	Tungsten	5000	25	2000	225	14.4	5
	UV204A		VT-22	250	250	11	3.85	XL Tung.	5000	25	2000	225	14.4	4
	UV206			1000	350	11	14.75	Tungsten	225000	300	10000	40	15.5	5
	(1) UV207	CG1971		20KW	10KW	22	52	Tungsten	3400	40	15000	1.7A	18.6	2.75
	UV208	CG1353		5KW	1.5KW	22	24.5	Tungsten	30000	250	15000	225	22.7	6
	(2) UV210				7.5		7.5	XL Tung.			350		5.25	2.13
	T	CG1162	VT-14		5	5	7.5	1.75	Tungsten	5000	7	350	40	4.3
V	CG1144A	VT-18		50	50	10	6.5	Tungsten	5000		1000	150	7.5	2
P	CG916	VT-10		250	200	18	3.6	Tungsten	20000	25	1500	110	14.25	5
Western Electric Co.	205D	CW931	VT-2	5	8	7	1.35	Oxide	4000	7	350	40	4.25	2.3
	211A	CW1818	VT-4	50	65	9	3.4	Oxide	3500	12	750	65	7.5	2
	212A	CW1819		250	200	13	6.25	Oxide	2000	16	1500	175	13.25	3.5
	(1) 220B	CW1887		3KW	3KW	24.5	41.5	Tungsten			8000	350	18.5	3.5

(1) Water Cooled Type.

(2) Thoriated Filament to Replace UV202.

# The Meaning of the New Tube Nomenclature

By KIRK B. MORCROSS

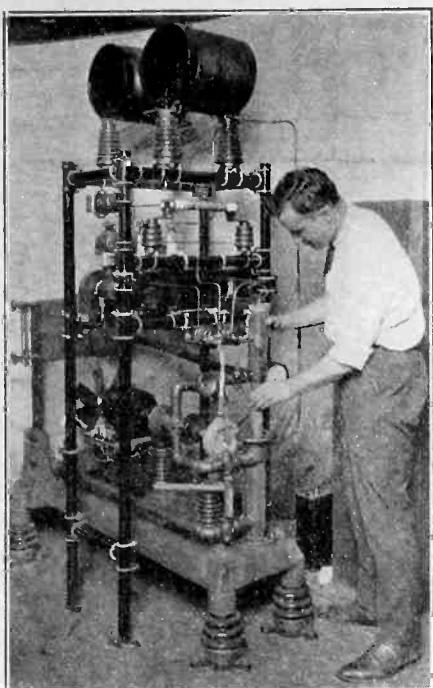

Fig. 4. 20 k.w. Water-Cooled Tube Transmitter.

the jacket to adequately insulate the system.

Fig. 5 shows three commonly used low-power types of rectifier tubes. Their use as rectifiers is covered in a later chapter. The physical dimensions of the three tubes illustrated are similar to the 5, 50 and 250-watt plotrons of Fig. 1.

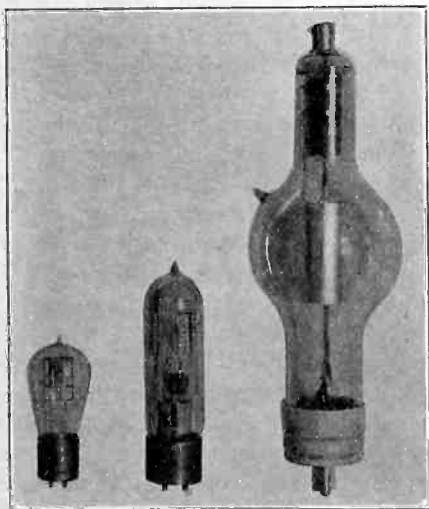

Fig. 5. Kenotron Rectifier Tubes. (Left to Right: 20-watt UV216, 150-watt UV217, 2.5 k.w. UV218).

Because the efficiency of rectifier tubes of these types is considerably higher than the corresponding sizes of plotrons, and because the requirements of a two-element arrangement permit of better construction, these rectifier tubes are rated as outputs of 20, 150 and 2500 watts respectively.

## G. E. RECTIFIER TUBE DATA

Mfg's. Type Number	Rating (watts)	Safe Plate Dissipation (Watts)	Plate Volts	Filament Volts	Filament Amperes	Type of Filament	Length (inches)	Diameter (inches)
UV214	45KW	10KW	16000	22.	52	Tungsten	18.6	2.75
UV216	20	12.5	550	7.5	2.35	Tungsten	5.25	2.13
UV217	150	100	1500	10.	6.5	Tungsten	7.5	2.
UV218	2500	350	15000	11.	14.75	Tungsten	15.5	5.
UV219	12.5KW	1500	16000	22.	24.5	Tungsten	22.7	6.

The confusion caused by the new designations of the new types of tubes can be obviated by remembering the simple rules that underlie the letter and number trade names that distinguish the different trade names. Some of the new tubes have new characteristics that make them better adapted for certain purposes; some of them merely have new bases to fit new types of sockets; all of the new so-called standard tubes are designated by the letter *X* in the trade name.

The first letter and number in the trade name generally indicates the manufacturer: *U* and the 200 series for the Radio Corporation of America, *C* and the 300 series for E. T. Cunningham, Inc., *W* for Westinghouse, *D* for DeForest, etc. An exception to this rule is the 199 for R.C.A. and 299 for Cunningham, although these also are close to their respective numerical series.

The second letter, if any, differentiates between the new and old bases: *V* meaning the old base of RCA tube, *D* the old base of Westinghouse tube, and *X* the new base tubes. The new bases differ from the old in that they fit the new types of sockets, which give firmer contacts. They come in two sizes, depending upon the size of tube. But the pins in either size are spaced alike so that the difference is merely in the size of the moulded insulation in which the pins are imbedded. The new tube with the large base fits either the old or the new standard socket, but the old tube with the large base does not fit the new socket. The new tube with the small base fits the new socket and may be used with an adapter to fit the old socket.

When *X* is the only change, the new tube is identical in all respects to the old type except in size of base. Thus the new UX-201A is the same as the UV-201A except that it has the new base, similarly with the UV-199 and UX-199, the WD-11, WD-12 and the WX-12 the UV-200, UX-200 and the corresponding C-designations.

The confusion between these "base" types will probably be short-lived as the manufacture of the older types will be gradually discontinued as users realize the improved results obtainable with the better contacts given by the new sockets.

Of the new tubes with new characteristics two are of especial interest to owners of receiving sets. These are the UX-120, CX-220, which is intended to replace the UV-199, C-299, in the last stage of audio frequency amplification, and the UX-210, CX-310 which likewise replace the UV-201A, C-301A. Both of these are power amplifier tubes for delivering more energy to the loudspeaker giving greater volume without distortion.

They both require more filament current and greater *B* and *C* battery voltage to give maximum results. The UX-120 takes .125 ampere filament current at 3 volts, which may be supplied by dry batteries, 135 volts *B* battery and 22.5 volts *C* battery. The UX-210 takes 1.25 amperes filament current at 7½ volts, which may be supplied by a transformer, from 90 to 250 volts *B* battery, and from 4.5 to 10.5 volts *C* battery, depending upon the *B* battery voltage. The higher voltages give greater power amplification.

The UX-112, CX-112 is a new 6-volt wet battery tube drawing ½ ampere giving a voltage amplification of 8 with 135 volts *B* and 10½ volts *C* battery. It has about double the mutual conductance of the "A" tube and gives better results as an amplifier. Most of the other new tubes are rectifiers for use in battery eliminators.

## HANDY HINTS

By D. B. MCGOWN

Brass "escutcheon pins" may often be used for handy terminals by driving them directly into a wooden block, or by drilling suitable holes in bakelite, or rubber, and then forcing the pins into them. Being strong and durable, they make substantial terminals.

If your set is noisy, a good thing is to replace all the fixed condensers as these units sometimes leak.

Steel phonograph needles make good contact points for a hard durable crystal, like carborundum.

In many receiving sets care must be taken in "logging" the dial settings to see that the coupling between antenna and tuned circuits is set at the same point, as the detuning effect of the antenna may throw you out quite a few degrees.

In any set, the filament power lost in heating the rheostat is just so much good money wasted, as the heat does no good. Remember, then, when connecting batteries, not to connect so many cells in circuit that you have to use the whole, or almost the whole of the filament rheostat to control the current.

# How To Test Radio Receivers

Instructions for Making and Using Equipment for Testing  
The Relative Performance of Sets

By Harry Diamond

AS THE performance of a radio set is usually judged by its volume of sound output, degree of sound distortion, and selectivity, some sort of simple equipment is desirable in determining these factors in any set or in comparing with other sets. Such equipment should also show the effect of changes in parts or connections. Before describing the construction and operation of a circuit for measuring these several factors, a brief explanation of why they are chosen as the basis of comparison is necessary.

The volume of sound is a function of the set's sensitivity, which may be different for different wavelengths, and of the amount of audio frequency amplification. Considerable volume is necessary for loud speaker operation on distant stations.

The degree of distortion is dependent upon its ability to transmit all audio frequencies from 200 to 3000 cycles with approximately the same efficiency. If the middle frequency notes are more pronounced than either the upper or lower notes the resultant sound is apt to be unintelligible or considerably distorted.

The need for selectivity or sharp tuning is obvious whenever a desired station wavelength differs but little from those of undesired stations.

The test circuit equipment, as shown in Fig. 1, consists of a radio frequency oscillator and modulator, an audio-frequency oscillator, and a device for determining the magnitude of the received signal in the set under test. The complete circuit diagram, with constants, is shown in Fig 2.

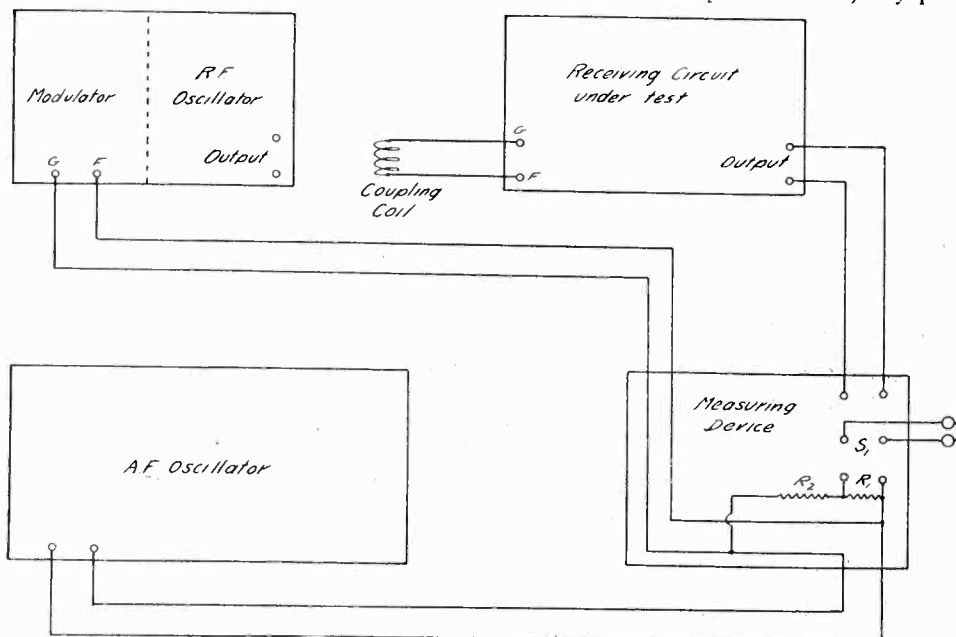

Fig. 1. Test Equipment Layout.

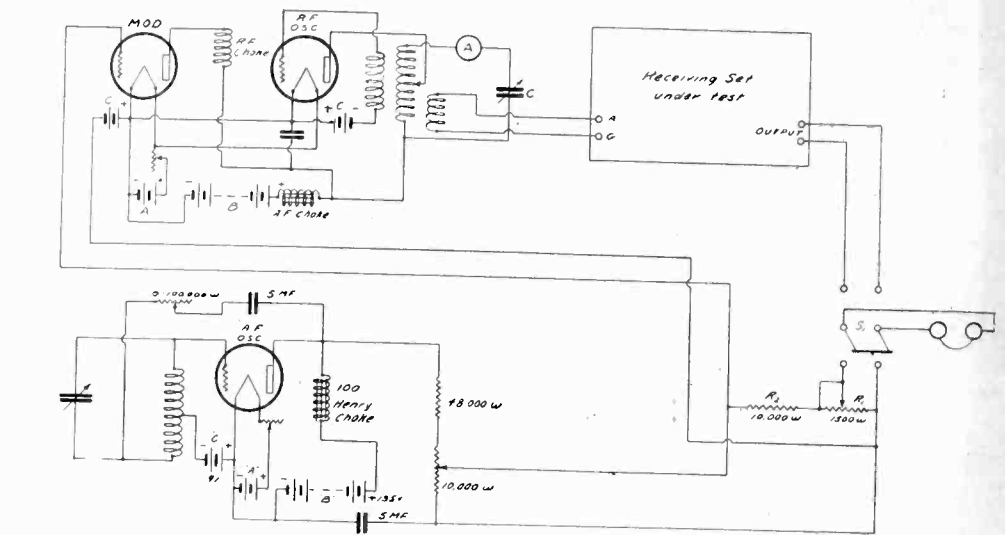

Fig. 2. Schematic Wiring Diagram of Apparatus.

To measure volume, the wavelength of the r.f. oscillator is adjusted, say to 300 meters, and the carrier wave thus set up modulated by a note of, say, 1500 cycles. This is done by adjusting the a.f. oscillator to 1500 cycles, and impressing its output e.m.f. upon the grid circuit of the modulating tube. The modulated wave is then applied to the receiving set under test by means of the coupling coil shown, and is demodulated through the detector action of the receiving circuit.

In addition to impressing a pure audio-frequency e.m.f. upon the grid circuit of the modulating tube, the low frequency oscillator also applies this same e.m.f. across the terminals of the resistances  $R_1$  and  $R_2$  in series.  $R_2$  is equal to 10,000 ohms and  $R_1$  is variable; any portion

of the e.m.f. (V) as measured by a sensitive milli-voltmeter may therefore be impressed across the phones by throwing the double-pole, double-throw switch  $S_1$  downward.

To measure the signal strength received,  $S_1$  is first thrown upward, the phones being thus connected in the output circuit of the receiving set so that the received signal may be heard.  $S_1$  is then thrown downward and  $R_1$  adjusted for the same intensity of sound in the phones as before. This condition signifies that the voltage drop across the phones (and also across  $R_1$ ) is now such as to send a current through the phones of the same magnitude as the signal current. Note that this current is also of the same frequency as the signal current. The value of the voltage drop across  $R_1$  is then a measure of the signal strength received.

Since either the wavelength of the modulated wave, or the frequency of the pure note to which the wave is modulated, can be varied (the former by adjusting the r.f. oscillator and the latter the a.f. oscillator) the signal strength corresponding to any other wavelength modulated by any audio-frequency note can be obtained in an exactly similar fashion. Likewise, for comparison, the volume received with any other receiver at corresponding wavelengths and audio frequencies can be determined. Care must be taken, however, that the energy level of the modulated wave impressed upon the input circuit of each receiving set is the same, otherwise the comparison is worthless. This also applies for all the tests to be described below:

(Continued on Page 56)



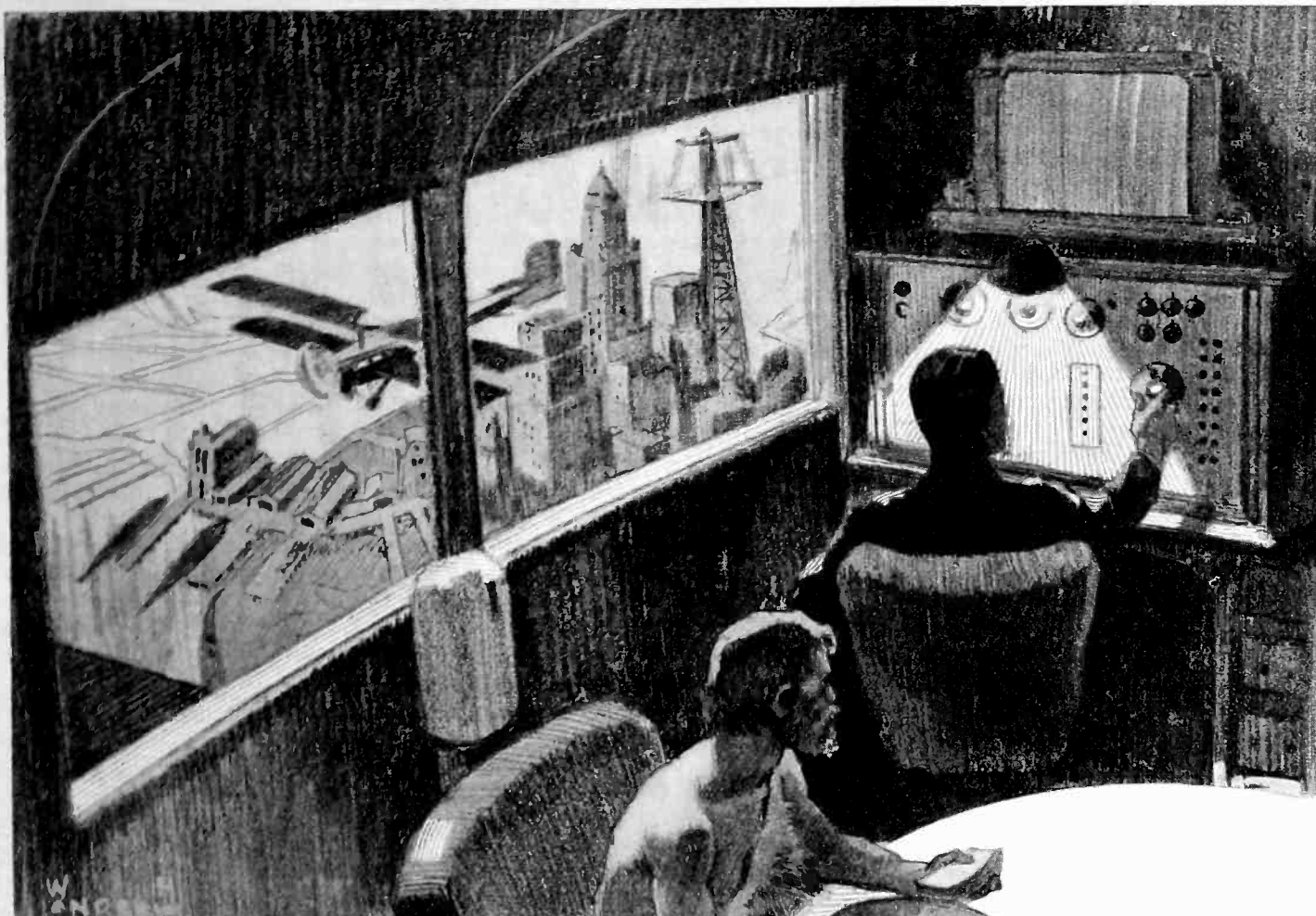

"The Stranger's Intent Gaze Followed Every Movement Made by Dwyer."

## From Ariel

## To Ground

By David P. Gibbons

THE alarm clock gave a preliminary warning click as if clearing its metal throat for the morning greeting to a new day. The sleeper moved uneasily and thrust a groping hand in the direction of the disturber of his dreams. He wondered sleepily how any sane person could regard an alarm clock in friendly fashion. Of course the clock-makers' ads tell about the cheerful, jolly voice of "Big Bill" or "Little Joe," but he doubted very much if a normally sleepy human being could listen with any degree of pleasure to the nerve-jangling clatter that breaks up the most enjoyable portion of one's nightly repose.

"I'll fool you this time," he muttered, "you darn super-efficient nuisance!" and then, marvelling at the ease and lightness which he felt, he slipped quickly to the floor, and dressing with remarkable rapidity he left the room be-

fore the shrill clamor punctured the morning calm.

With the glow of virtuous self-approval which makes the early riser such a pest to his less ambitious fellowmen, he strode along a wide, richly carpeted corridor and entering an automatic elevator at the far end was whisked silently to the roof of the immense hotel forty-five stories above Market Street.

It was still dark and the lights on Twin Peaks were barely visible, the rest of the city being shrouded in the heavy blanket of mist which ignorant visitors from the effete east sometimes refer to as "the blamed fog." He hurried along the smooth expanse of roof, past rows of shining flying machines of every description and nationality, until he reached a slim two-passenger affair parked beside a huge six-hundred passenger trans-Pacific liner. He glanced at the name

*Ariel*—San Francisco stencilled in luminous paint on the sharp pointed bow of the little machine and at his own "Dennis Dwyer" with the national license plate underneath. Opening a door in the fuselage just behind the lower wing he entered the richly upholstered compartment and switched on the lights. For a few minutes he tested the controls of the various radio apparatus and then tuned the telemodyne to receive the power wave from the government station on Mount Tamalpais.

When the meter on the dashboard indicated that the thousand horsepower motor in the rear compartment was ready to deliver its tremendous energy he gradually inserted the clutch that connected it to the large horizontal propeller that replaced the upper wing of the old style airplanes. At once the *Ariel* soared directly upwards smoothly and

silently. Reaching the five thousand foot level—being the height allotted to two-passenger flyers by international regulation—the motor switched itself automatically from the elevating propeller to the forward-driving air screw and the *Ariel* shot forward towards the southwest at a three hundred mile clip while Dwyer adjusted the direction finding and the automatic steering and balancing equipment.

A slight hum penetrated the sound proof, electrically heated cabin and combined with the enormous speed produced a soporific effect on the single passenger. He switched off the lights and sinking into the depths of the cushioned armchair dropped into a sound and refreshing sleep while the *Ariel* sped through the upper air as safely and steadily as if endowed with superhuman intelligence.

For four hours the little flyer raced along and then as the speed began to diminish slightly a buzzer broke the stillness within the car and roused the sleeping passenger. He noted the decrease of speed as shown by the speedometer and glancing at the position indicator realized that he had slept longer than he intended to and that he was passing beyond the fifteen hundred-mile zone served by the Tamalpais station. He again tuned the telemodyne, this time adjusting it to the power wave from the great dynamitter at Honolulu. At once the *Ariel* surged forward to its previous speed and Dwyer picked up the combined hand transmitter and receiver and operating the numbered dial on the telephone stand he was quickly connected with the Hawaiian Central Customs station. He announced his expected arrival four hours later and giving the other necessary details added that he would leave later that evening for the South Seas.

For the next few hours he kept in touch with his San Francisco office, dictating some letters and hearing the more important mail that had been received there that morning. He tuned in on the newscasting station at Telegraph Hill and after hearing the latest murder and bandit reports he listened to the midday musical melange in the tea-room of the Hotel Gorgeous sent out by the jazzcasting station of Kale Sisters Department Store at San Francisco.

Far below he saw a fleet of marine freight carriers speeding eastward through the water with their control flying machine directly ahead on the thousand foot level, and calling up the latter he gave him the weather and atmospheric conditions as traced on his recording chart. From his height the freighters looked like the old time submarines but their speed of around eighty miles an hour allowed no further comparison.

At three o'clock in the afternoon

Honolulu was clearly visible and switching the motor from the driving screw to the lifting propeller he slowed down the powerful radimotor and dropped gently to the spacious roof of the Grand Oriental Hotel on Fort street. He was greeted by the Central Customs agent who entered the cabin and inspected the meters. Dwyer handed him his international scrip book and the agent detached sufficient to cover the cost of the power used since entering the Pacific Central Zone.

A few minutes later he joined the crowd disporting themselves on the beach at Waikiki and for another hour he rode the long slow breakers that rolled in from the deep blue waters of the bay with the regularity of clockwork. After a leisurely dinner in a beautiful dining room overlooking the harbor he again entered the *Ariel* and mounted to the five thousand foot level. He set the controls for the two thousand mile run to Samoa and then getting in touch with his Hongkong office attended to the morning's mail and reports from his agents in the Orient. For a while he listened to several vocal artists of world-wide fame who were singing at the operacasting station at Schenectady and then tuned in the logamitting station at Davenport, which specialized in lectures exclusively, but switched that off when he found it nothing more important than a self-styled master detective telling the world what a wonder he was.

Darkness was falling as he turned on the V-ray signal equipment and connected the veerayscope to the receiving set. He fitted the hooded opening to his eyes and swung the funnel shaped instrument in a slow arc while he gazed intently into the black interior. The wider end was closed by a metal plate so that no light could penetrate, but when pointed in certain directions the internal surface of the plate glowed with a greenish phosphorescence, and sharply outlined on this luminous background were various figures and markings.

"Fanning Island," Dwyer remarked to himself, as he aimed the scope directly abeam and on the glowing plate were visible a triangle surrounded by a circle and the figures 658. He moved it slightly to the right and elevated the angle. "The circle with the cross inside is Tahiti," he murmured as those markings took shape within the darkened hood.

He turned the instrument upwards and swept the air ahead and above him. On the fifteen thousand foot level he saw the signals of an Australian liner speeding far to his left on her way to Vancouver and straight ahead on the ten thousand foot level he picked out the markings of several of the fast expresses plying between New Zealand and Australia.

He then turned the veerayscope directly downwards, but no glow illuminated

the sensitive plate as he ranged across the hundreds of tiny islands which lay beneath the racing *Ariel*. He switched off the instrument and glancing down through the plate glass window in the floor was surprised to note a bright red spot of light on one of the outermost islands of the group. These islands were known at the "Little Fijis" and were supposed to be uninhabited, so swinging the *Ariel* around in a long curve he descended to investigate.

The spot of light continued to increase in size and brilliancy and when within a few hundred feet he saw that it was a huge fire built on the highest point of the island. He hovered for a moment and was about to continue his journey when he saw close to the fire a dark figure dancing excitedly and waving its arms in his direction. Dropping the *Ariel* to a level spot close by, he stepped from the cabin and awaited with interest the figure which came running and shouting from the direction of the blazing pile.

Almost naked, with matted hair and beard, the castaway laughed and cried incoherently as he approached. Dwyer was amazed to perceive that in spite of the brown skin this was no native. He was a white man and the few intelligible words he repeated were in English. Coming closer he ceased his hysterical shouting and gazed with open-mouthed astonishment at the graceful, shining little flying machine, and when Dwyer spoke to him he started violently.

"Who are you and how long have you been here?" Dwyer asked.

"Years and years," the other replied haltingly. "Don't know how long. Been living here like an animal. Have you any civilized food?"

Dwyer reached into the brilliantly lighted cabin and brought forth a container full of steaming coffee and some sandwiches. With exclamations of profound satisfaction the strange figure gulped down the fragrant liquid and ravenously devoured the food in silence. When his hunger was partly satisfied he spoke again.

"You will take me away from here?" he demanded.

"Certainly," Dwyer answered. "Where do you want to go?"

"Anywhere, anywhere," replied the other. "Just get me away from this," he begged, indicating the island shrouded in darkness with the fire blazing on the hilltop.

"Step inside," said Dwyer, and rather timidly the other entered and seated himself on one of the cushioned chairs.

Dwyer followed, closed the door and adjusting the telemodyne to the power wave from the South Pacific dynamitter at Samoa he switched the radimotor to the lifting propeller and they rose swiftly and silently into the night.

The stranger's intent gaze followed  
(Continued on Page 60)

# The Million-Dollar Bend

A Thrilling Story About the Battles Over the Evasion of Radio Tube Patents

By Volney G. Mathison

THREE men, an American, an Englishman, and a Hungarian Jew sat about a plain oak table. Wind-driven rain beat against the small glass panes of the fabricated steel windows of the cold, bare big room in which they sat; and through these windows was presented a cheerless, drizzling view of a section of the great grimy city of Newark.

The faces of the American and of the Englishman were troubled. Indeed, they looked sick. One might have thought they had indigestion, or toothache.

"There are so many millions of dollars imperiled by this injunction that I don't like to estimate them," the American was saying. "My vacuum-tube factory and business conservatively is worth five hundred thousand dollars to me; and that of Archie here is worth quite as much as that to him. And we are only the spokesmen of an association of thirty-five tube manufacturers. Taken collectively, we are the makers of half the tubes that are being produced today. Yes, we're all in the same cage; and the big one-eyed ogre who is going to eat us is the Wide-World Electric Corporation. That fellow, the emperor of all the tube makers, has secured exclusive control of the patents on the machines we all use in making tube-stems. He has served court injunctions on us, all and severally, not only in America, but in Great Britain, France, and Germany, that restrain us from using these stem-making machines."

"And," put in the Englishman, "if we cawn't use our machines, we really cawn't make the infernal things, don't you know—"

"Half the tube production of the world is jeopardized through these injunctions," continued the American. "If our powerful competitor can put us out of business, it not only means a loss of millions to us tube men, but it means, in the course of time, possibly many more millions to the users of radio tubes."

"Really," again put in the Englishman, earnestly, "if we cawn't use our machines, we cawn't well make the infernal things, don't you know."

As the two tube men told their tale of trouble, the Hungarian Jew listened, in thoughtful silence. An extraordinary-looking man he was, broad-faced and thin-lipped, with coal-black hair richly sprinkled with silver.

He was the owner of the plain oak table at which the three men were gath-

ered, of the high bare plastered room with the steel-latticed windows, and of the twenty-million dollar factory, devoted exclusively to the manufacture of tube-making machinery, which adjoined the plain council-room. Scarcely twenty years ago, this Hungarian had come to America with few more worldly goods than a tee-square and a set of draughting instruments—but possessed of a past master's knowledge in the art of mechanical glass-working. Since then, tool by tool, machine by machine, he had acquired this great plant; and his marvellous mechanical genius had expressed itself in the design of hardly fewer than three hundred elaborate machines for use in tungsten-lamp and radio vacuum-tube manufacture. This was the man whom the tube makers, imperiled by injunctions involving a mechanical glass-working process, had come to for rescue from threatened extermination.

"Gentlemen," said the Hungarian Jew, slowly, "there are, as you know, a hundred details to the machine for making the stem of a radio tube. On what exact point are you attacked for infringement of your competitor's patents?"

"It is on the method of putting a small glass pipe or exhausting-tube into the 'crush' or flat part of the glass stem, among the seven sealed-in wires that support the plate, grid and filament. It is a patent on the devices whereby the ex-

hausting-tube, the flare (see Fig. 1-a) and the mounting-wires for the elements are all molded into the flat stem shape in one operation in the gas flame; while at the same time a jet of air is shot into the little exhausting-tube to blow a hole

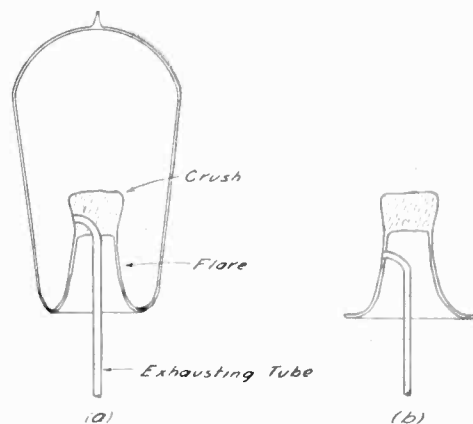
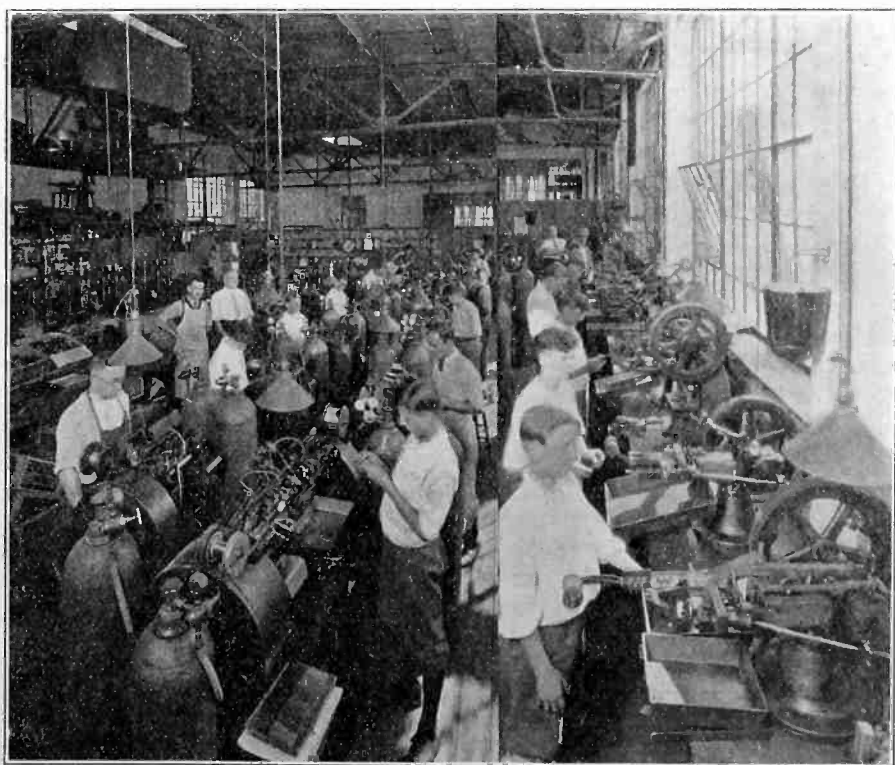

Fig. 1. Sketch of the Welded Glass Parts of a Radio Tube. (a) Stem as Made on Patented Machine. (b) Stem as Made on Non-Infringing Machine.

out through the side of the stem, thus connecting the exhausting-tube with the interior of the bulb that will later go over the stem. If we could get the exhausting-tube out of the 'crush' or flat part of the stem, we'd be all right."

"Why, then," said the Hungarian, "there you have the key to the solution of the problem. Take the exhausting-tube out of the place where it now is, and put it somewhere else."



Wire Working Laboratory and Automatic Stamping Machines for Forming Metal Parts.



The American and the Englishman both laughed, mirthlessly.

"Yes," returned the former. "Columbus made an egg stand on end, but he broke the egg! You are the maker of this equipment for us; and you know what the mechanical difficulties would be in building a high-speed and an economical machine to weld the exhausting-tube in any other position than that which we now use—"

The Hungarian Jew raised his satiny-skinned hand.

"When it is air and it is glass—and when—"

"Yes, we know you can do anything with those two."

"Air and glass, yes," continued the Hungarian. "It is more; it is I that am the top-notch in the cage of the big feller you say is the one-eyed okra, who is starving to eat you. If there is no tube-makers, there is no tube-machine business, no!"

This was true. The foreign Jew, with his great plant and his force of skilled employes, was a bigger factor than any dozen tube makers. The patent-holding corporation had challenged his ingenuity and resourcefulness. They had cast a menacing shadow over his very business existence.

He picked up a sketch-pad from the table.

"Gentlemen, I am going to leave you here, awhile," he said. "Please remain seated."

With his pad and a pencil, he walked out into his factory, an immense establishment of a thousand marvelous whirling machines—machines that pump vacuums too high to be read on the most delicate of scientific gauges; and machines that automatically perform supremely skillful and difficult tiny wire-and-glass welding operations, with the employment of four gases, electricity, and the utmost of mechanical intricacy.

The two tube manufacturers remained in the bare office slumped in their chairs, one glumly chewing on a big black unlighted cigar, the other contemplating the section of the dripping grimy city revealed outside the steel-sashed windows, and looking as if he would like to kick it.

The Hungarian glass wizard went to that part of his factory where radio tube stem-machines were being constructed, a hundred of them at a time. Standing before a completed machine, which was set up on a proving-block, he ordered an attendant of the testing-room to put it into operation. Then, as it went round and round, carrying its rotating batteries of hot hissing gas-jets that looked like turning reddish purple flowers, he stood and gazed at it. For a long while he stood there, thoughtfully, sketching a little, but not much.

At length, the machine before him ceased to engage his attention. He no

longer saw it, even though he looked at it. Instead, he was watching an imaginary delicate glass-welding process, and studying the mechanical action that accomplished it—for it is the power to visualize, to see in the mind a thing complete that does not yet really exist in fact, that constitutes the genius of the inventor.

After he had been absent hardly thirty minutes, the Hungarian returned to the two troubled tube men in his office.

"Gentlemen," he said "I am going to take your order for a non-infringing stem-machine. The price for a machine producing not less than a thousand radio tube-stems an hour will be three thousand dollars; and you must guarantee me an order from yourselves and your associate manufacturers of not fewer than one hundred machines."

The two tube-makers sat up in their chairs and stared at the glass wizard.

"Are you kidding us?" the American demanded.

The Hungarian smiled. "Does three hundred thousand dollars sound like kidding?" he returned. "That is the size of the order I am taking today. Place it subject to the provision that the machines will produce non-infringing tube-stems as rapidly and cheaply as the present type in use—or no pay."

The American pulled out a fountain pen. "All right," he said promptly. "Give us something to sign—" Abruptly, he drew back. "But the injunctions have already been dropped on us;

and this is the middle of the rush season—when do we get delivery?"

"Not this afternoon," replied the Hungarian, with a slight twinkle in his eye. "We'll say in thirty days, counting from today. If sooner, I'll make an extra charge of two hundred dollars for every day less than thirty, for every machine we deliver."

So the two tube-makers placed the three-hundred-thousand-dollar order with the Hungarian glass wizard for a hundred machines they had never seen; and which in fact did not yet exist, except in his fertile brain.

"It's just a matter," said the Hungarian, "of putting a little bend in a glass tube."

"By Jove, it may be only a little bend, or a bow-knot, or a banana," responded the Englishman. "If it pulls us out of the muck, it's jolly well worth a million. Really you know, if we cawn't—"

"Yes," smiled the Hungarian Jew. "Then we will call it the million-dollar bend."

THE problem was to put a bend near the end of a glass tube 8 in. long and about  $\frac{1}{8}$  in. in diameter; to weld this bent end into the inside wall of another glass tube 2 in. long by  $\frac{1}{2}$  in. in diameter; and to pierce or blow a connecting hole through the wall of the larger tube. This larger tube would form the stem of a radio vacuum bulb; and the small bent glass tube welded into it would comprise the exhaust connection (See Fig. 1-b).

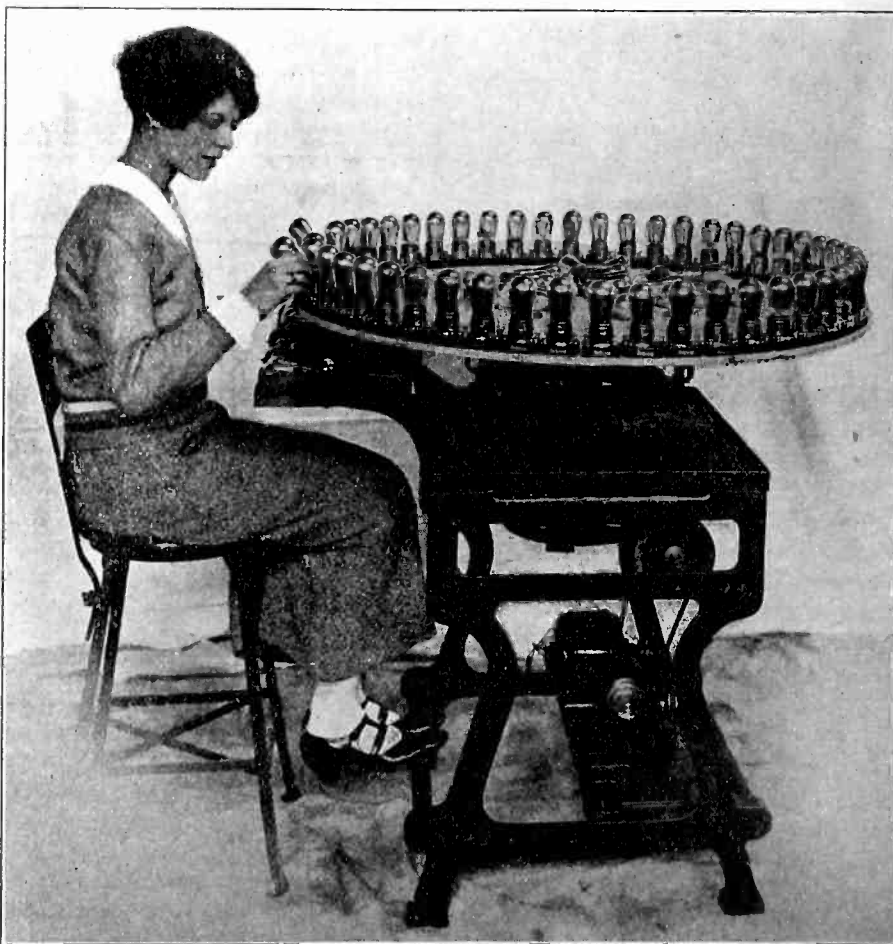

"Aging" Tubes by Means of a Tapered Filament Current Applied as Machine Revolves.

Now, it would not be much of a feat for an expert glassblower to do such a job as this by hand; but the joker in the problem was that this job, which would ordinarily require the close attention for several minutes of a glass-working expert, must be done automatically by machine, at a speed of a thousand or more welds per hour, and at a cost of a fraction of a cent for each operation.

Without going further into detail about the mechanical and glass-working problems involved, or the method of their solution, it will suffice to say that within ten days the Hungarian had designed and built the machine shown in Fig. 2; which has made possible the manufacture of a non-infringing radio tube-stem on a cheap, big production basis. So, briefly, was brought to an early death one of the most powerful patents that ever threatened the radio tube manufacturers of this country with extinction.

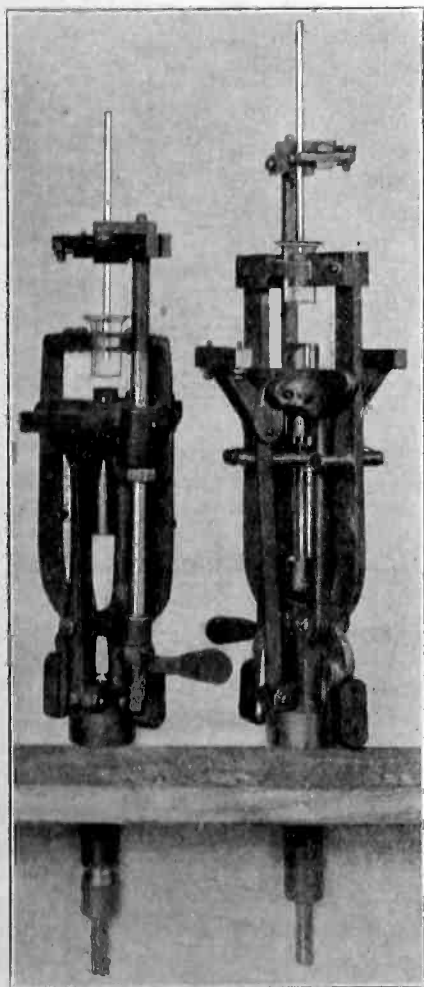
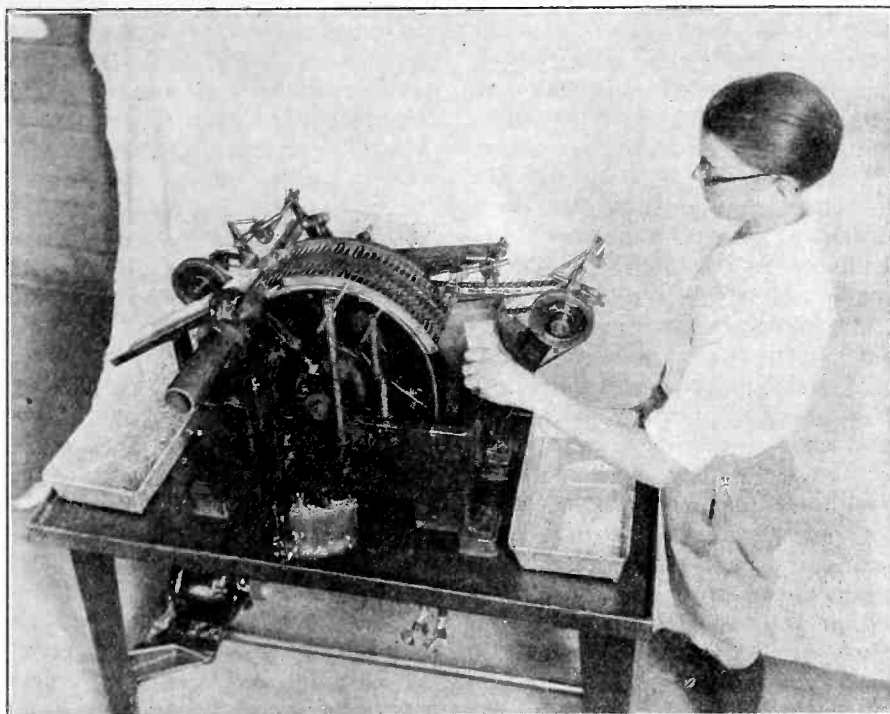

Fig. 2. Essential Part of Non-Infringing Machine.

THE mind of the radio public is muddled on the vacuum-tube patent situation. At one time, you read in the newspapers seemingly well-founded announcements to the effect that "all patents" on radio tubes have expired; and that any one is now at liberty to manufacture them. Then you turn around a week later and read in the same paper where "Honkatron and Blunkenham sue Supertink for ten million dollars for alleged infringement of



Crusher to Flatten Glass Stems and Seal in Seven Mounting Wires.

radio tube patents," "Radio Gobblers sues Little Boy Blue Tube Co. for ten million dollars for alleged infringement of radio tube patents," "Blinkalink sues Vampavox for ten million dollars for alleged infringement of radio tube patents." "Pink Bulbs sues Purple Prong for ten million dollars for alleged infringement of radio tube patents," —and then, as if to top it all, along comes a mystical gesticulating Toodle-de-la-Toot from Toulon or Graustark, or somewhere, who declares he is the first man in the world who ever lured

an electron into captivity and made it jump through a hoop; who owns a wonderful radio patent underlying all the other radio patents in creation; and who is going to sue Honkatron and Blunkenham and Radio Gobblers and Little Boy Blue and Supertink and Blinkalink and Vampavox and Pink Bulb and Purple Prong, and forty-three dozen other tube manufacturers, for six-hundred and seventy-five million billion petetas for "alleged infrnging of radio tube patents." However, he is soon appeased with a good cigar; and then goes

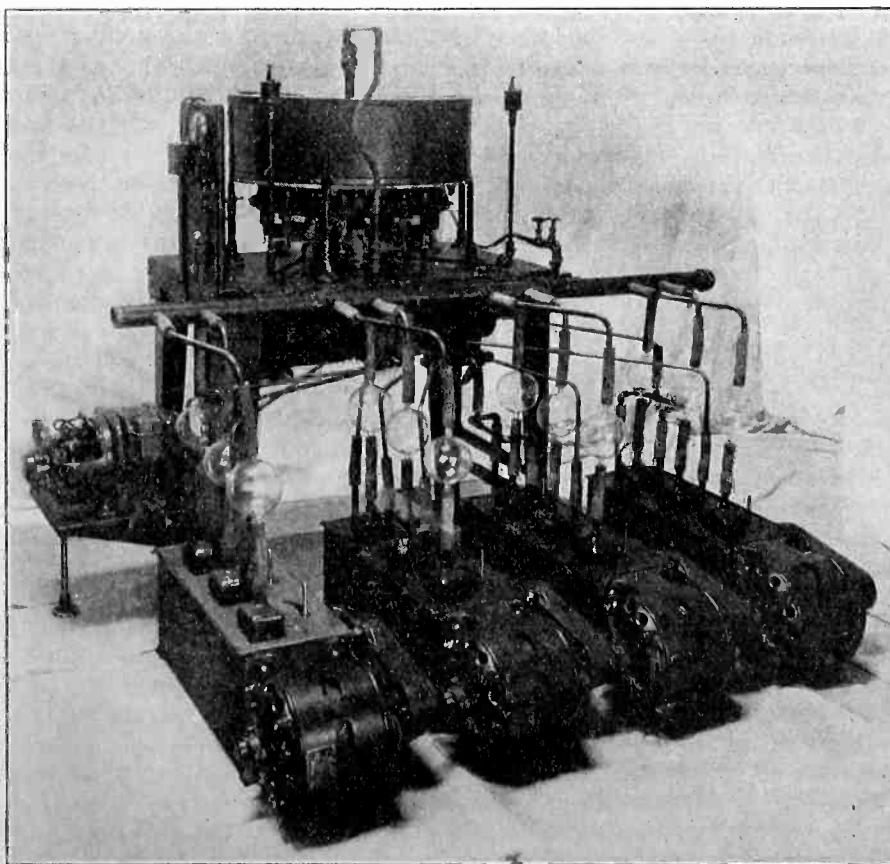

Latest Model of Automatic Radio-Tube Exhausting Machine, Showing Twelve Vacuum Pumps in Foreground. It exhausts a tube every six seconds, seals it off, and rings an alarm bell if tubes are soft.

gaily back to Graustark without his six hundred and seventy-five million billion pesetas for alleged infringing of radio tube patents—to the further mystification of the puzzled and paying public, who wonder what in blazes it's all about, anyway.

It is a fact that there is not, and probably never has been, a business or industry on the face of the earth, wherein has been carried on such unscrupulous, such mean, such ruthless pirating and stealing of patents, of trade-secrets, and of ideas, as has occurred in the radio business. Not a coil, not a condenser, not a battery, in fact not even a mere binding post in your set, but has been, or still is, the object of a million dollars or so worth of fierce patent litigation. Even the phone-plugs have been yanked from hand to hand for years; and hardly a loudspeaker on the market today but has been squawked over vociferously in a dozen patent suits.

But of all the battles over the patents covering the units in the modern radio receiver, none have been so terrific, so costly, and so prolonged, none have been more confusing, various, and conflicting, and none have involved such enormous sums of money, as have those which have raged about the radio tube.

There are several reasons for this. The principal one is, however, that the vacuum-tube is the most wonderful, the most widely used, and the most profitably manufactured single thing in all radio. Then, too, some of the patent-suit massacres and stories of patent-suit massacres dealing with radio tubes seem to have been started that were deliberately intended only for the purpose of throwing a scare into somebody and muddling everybody.

Notwithstanding the often-quoted statement that all tube patents have expired, there are today about forty unexpired patents covering the modern radio tube. About thirty of these patents are in the hands of one corporation. They involve almost everything about a tube, from the frosting of the trade-mark on the bulb to the color of the hair of the girl who packs it in its box.

Some of the later patents are clever attempts to renew or reinforce other older ones; some are of no use whatever in the making of a tube, and therefore mean nothing. A number of them—and among these are the most highly valuable and important ones today—deal not so much with the tubes themselves as they do with the machinery for making tubes—such as the stem-making machine patent partly described in the first part of this story.

The biggest and most fundamental tube patent of all times—and one which unfortunately has netted its inventor the least return—was Dr. DeForest's patent dated February 26, 1908, wherein he distinctly specified the interposition of the grid between the filament and the

plate of the old two-element Fleming valve; thereby creating the first real vacuum-tube, as we know it today. This was a truly basic patent; and it absolutely prevented any open-and-above-board independent manufacturing of radio tubes until it expired on February 26, 1925. An efficient radio tube is an impossibility without a grid. Even the placing of an unusually-shaped grid beside the filament, instead of between the filament and plate, as was essayed by one company, was adjudged an infringement by radio-tube engineers and legal experts, with the result that the infringers virtually had to desist until the expiration of the grid patent.

Then there was a company, as long ago as 1915, which in an absurd effort to beat the grid patent, advertised a tube with a grid mounted *outside* the plate element; in fact, it was clamped around the outside of the glass bulb. When I saw it, I was puzzled as to how that tube could work; and it cost me five dollars (I bought one) to find out that it didn't work.

The most bitter and interminably prolonged battles over radio tubes have thundered around this now dead but once almost priceless grid patent. Because of it, an immense New York factory was torn up by the roots and moved bodily over to the Jersey shore. The New Jersey laws, incidentally, seem more favorable to the operation of corporations of murky legal status than those of any other state in the union. If it is true, as has been alleged, that these flexible laws were framed for the benefit of the larger corporations, then it has proved a disastrous boomerang to some of them; for the smaller concerns, particularly including tube-making companies, acting cheerfully in accordance with the old saw that what is sauce for the goose is pie for the gander, have taken advantage of these New Jersey laws to the fullest possible extent.

The dead grid patent is not even allowed to rest at peace in its grave; it is still a bone of mighty contention, inasmuch as its original owner demands an accounting of past profits on radio tubes manufactured without his legal consent before it died. In a court-famous document signed by him at San Francisco in 1915, he granted a company what he considered to be a limited right to the use of his grid patent; but somehow it turned out to be an unlimited right, and not only were immense quantities of tubes manufactured under it, but the inventor was almost stopped from making any tubes in his own factory. This Arab let the camel merely put his nose to the tent-flap; whereupon the camel promptly ate up the tent, blankets, Arab, and all. But this is a squabble over a thing that is past; it is of no significance in the tube business today.

There is, however, at least one unexpired basic patent affecting radio tubes.

It is not strictly a tube patent; it deals with processes and equipment for drawing and thoriating tungsten wire—the base of the radio tube filament.

The only successful method, so far, of drawing tungsten metal into a fine wire suitable for use as tube filament was accidentally invented by an Austrian named Hahnemann, in 1912. He sold his patent rights to an international corporation for about half a million dollars. It is of interest to note here that for some time it was completely unknown that the activity of a radio tube filament was due entirely to the electronic emission of a thorium content in the tungsten metal. If the thorium had not accidentally been there as a rare adulterant of the tungsten, the tubes never would have worked; and quite possibly would not yet have been discovered or invented.

The moment it was found that the thorium content was what emitted the electrons from the filament, and not the tungsten, steps were taken to enrich the thorium element by artificial means. In connection with this, the patented cold-drawing of the tungsten wire is an essential factor. This tungsten patent, which has four more years to run, would, if it could be strictly enforced, almost inevitably put every unlicensed tube manufacturer in the country immediately and completely out of business.

But the tube manufacturers, wisely, do not make their own filament wire. They buy it. If, as is the case in one or two instances, a tube-maker has anything to do with a tungsten-thoriating laboratory, then it is operated secretly and separately; it is not in the tube factory. The company previously referred to as making a tube with a peculiarly-shaped grid is trying to beat the tungsten patent by using a filament of thoriated molybdenum instead of tungsten—but with poor success. Their tubes are short-lived.

Undoubtedly, the tube manufacturers could be attacked for using infringing tungsten filament wire, even though they do not make it themselves. But there are several reasons why an attack upon the tube makers by the owners of the tungsten-wire patents would be extremely difficult.

For one thing, it is doubtful whether it could be satisfactorily proved in court that a piece of alleged infringing filament wire really was made by the patented process or by some other process. The cold-drawn wire is so confoundedly small that it might seem hard to prove whether it was really a piece of the defendant's tungsten or a couple of hairs from the head of the plaintiff's blonde stenographer. Nobody in a court-room would believe that such fine, hair-like stuff could contain all the infringing quarts and gallons of electronic brickbats that the engineers testifying for the prosecution would try to prove it con-

(Continued on Page 69)



# Superheterodyne Suggestions

Some Practical Ideas for Improving the Reception Obtainable With This Popular Circuit

By L. W. Hatry

THE superheterodyne circuit is much misunderstood and consequently leads to too great expectations. The amplification produced by an eight-tube set can be but little greater than that given by three stages of tuned radio frequency and two stages of audio, such as might be secured from a six-tube neutrodyne, the sixth tube being the detector.

The first two tubes of a super, the oscillator and first detector, act merely as frequency converters, changing the incoming frequency to that to which the intermediate frequency amplifier is tuned, only a limited amount of amplification being supplied by the 1st detector. The superheterodyne differs from other radio frequency circuits in that it tunes the incoming wave to the r. f. stages, whereas the others tune each r. f. stage to the incoming wave.

Therefore, "why the superhet?" The answer is found in the fact that the lower the frequency (the higher the wavelength) at which a radio-frequency amplifier is used, the greater its amplification. By amplifying wavelengths between 1000 and 10,000 meters the super gives greater amplification than another circuit amplifying between 200 and 600 meters. It is also more selective, more stable, and easier to operate. It makes better use of the small amount of energy supplied by a loop than other sets can do with the larger amount of energy supplied by an outside aerial.

Several improvements can be made in the superheterodyne sets as ordinarily constructed. The first is the use of a larger loop to collect more energy. A loop having 3 to 5 ft. to a side is none too large. It should never be less than 2 ft. to a side if good results are to be secured.

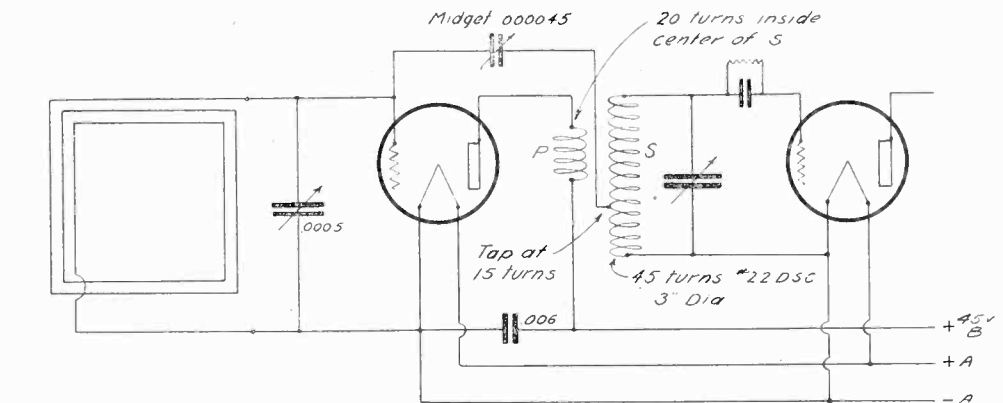

Fig. 1. Adding Stage of Tuned R. F.

Another practical improvement is the reduction of the B battery voltage to the r. f. amplifiers. The heavy current that these tubes take, if the set is operated with a potentiometer giving a positive bias to the grids, can be greatly reduced by cutting the B potential to 45 or even 22 volts.

An expensive but useful addendum is a shield that completely encloses the set. This prevents, if properly installed, any pick-up by the wiring of the set itself and in that way often provides a worthwhile gain in selectivity. The shield is equivalent to a metal box that completely includes the apparatus and should be installed when the set is built, if at all.

The use of an outdoor antenna is a good idea. If the set is shielded it is possible to get a degree of selectivity entirely unexpected. Loose coupling should be used with the coils that tune the antenna and secondary adjusted permanently in one angular relation that does not give maximum signal strength but good signal strength with satisfying selectivity. The secondary coil, which replaces the loop, is outside the metal shield and, although it will pick up di-

rectly, its main pickup from the antenna coupling coil will result in soul-satisfying distance.

The addition of a stage of tuned r. f. amplification ahead of the set itself is also practicable. It is particularly useful in the event of a bad location where a loop must be used or where the size of the loop is limited and a definitely better pickup than now possible would be of great value. The details of such a unit are shown in Fig. 1. This adds a third tuning control to the set, but it prevents the set from radiating, which too many super-heterodynes do—very effectively.

Despite what has been said from time to time, the addition of a stage of intermediate amplification, making four instead of three as in Fig. 2, is useful if done properly. Two of the r. f. stages are controlled by one potentiometer and two by another. This is apparently adding one control, but in actual operation the one potentiometer is set for a position close to oscillation and the other will be found to control all four stages. Only one of the potentiometers is put on the panel while the other is mounted with the other parts and adjusted by test to the proper point. Thereafter the

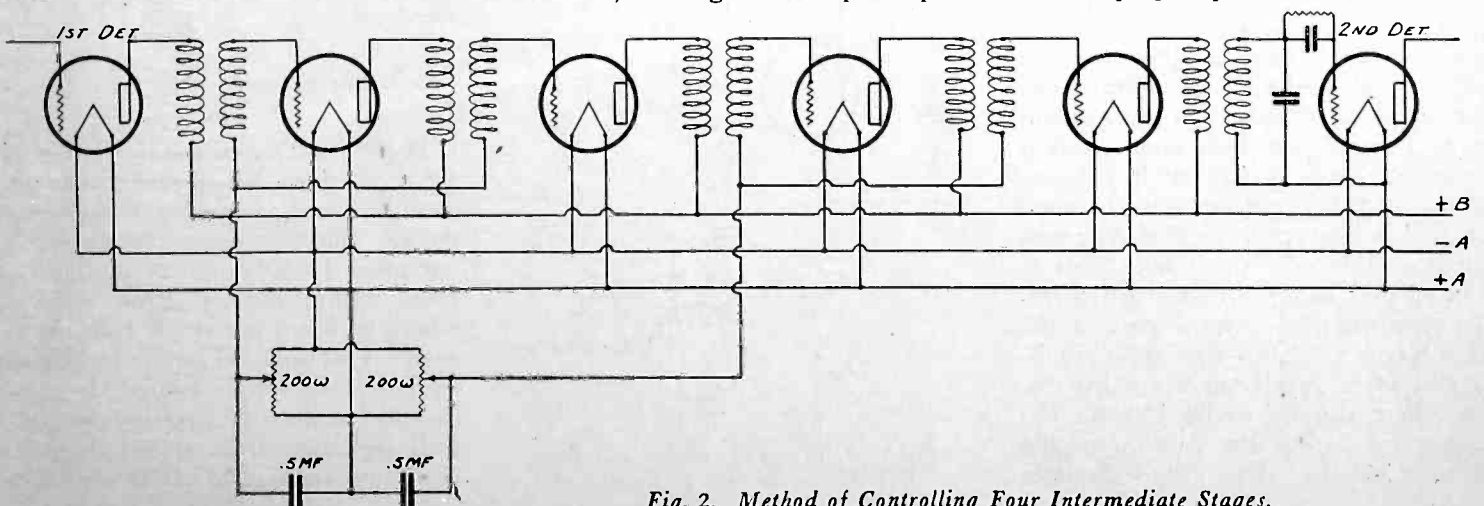

Fig. 2. Method of Controlling Four Intermediate Stages.

panel potentiometer will be found very effective for controlling the intermediate frequency oscillating point to a nicety.

The addition of regeneration to the set is an easily accomplished thing that is included in a number of super diagrams. The circuit of the Best super-heterodyne provides a certain amount of feedback from the loop circuit in the first detector by the use of a .00005 mfd. variable condenser which serves as a feedback control while tapping the loop, which provides the necessary inductive coupling to the grid circuit. This is already familiar to Best fans.

A word here about one thing may save someone some trouble. Using the Best circuit, you know that the first I. F. T. is an untuned one. With the exact connection scheme published in RADIO this first IFT cannot be tuned if regeneration through the loop tap is desired. If a tuned transformer becomes the first one, the capacity used to tune the primary of this acts as a by-pass of that energy that should be fed back and no regeneration results. One fan, who preferred his tuned I. F. T. to come first, tried this and discovered that he had lost the sensitivity due to regeneration. The only remedy of this condition is an r. f. choke in the lead from the plate of the first detector to the grid of the first amplifier. This should consist of 350 turns lumped on a small spool.

The most frequent fault in super construction is the use of incorrect by-pass condensers. A super handles two kinds of radio-frequency current: that having the frequency of the incoming signal and the oscillator, and that having the much lower frequency of the intermediate radio frequency amplifier. The first requires relatively low capacity r. f. by-pass condensers and the second relatively large. It is not unusual to see an .005 mfd. fixed condenser across the potentiometer of a 30 k. c. super. This capacity is supposed to by-pass the r. f. around a 400 ohm potentiometer when its own reactance at 30 k. c. is 2250 ohms! A .5 mfd. condenser having a reactance of about 23 ohms at 30 k. c. would be far more effective. Remember that reactance varies inversely as the frequency and directly as the capacity.

A peculiar by-pass condition is met in the second detector. To use a capacity much greater than .002 mfd. would result in rather bad distortion. This is particularly true where high primary impedance audio transformers are used. Yet .002 is inadequate because its reactance is on the order of 16,000 ohms at 30 k. c., that being our illustrative frequency, which puts a large part of the intermediate r. f. into the audio amplifier and often results in instability because there can be feedback from the loud-speaker to the first detector or the antenna circuit. Also, it sometimes

happens that this r. f. causes howling in the audio amplifier. The remedy is a choke inserted as in Fig. 3. This r. f. choke can well consist of the secondary of one of the intermediate r. f. transformers with the primary left free. By purchasing an odd I. F. T. whose resonant point is at a lower frequency than

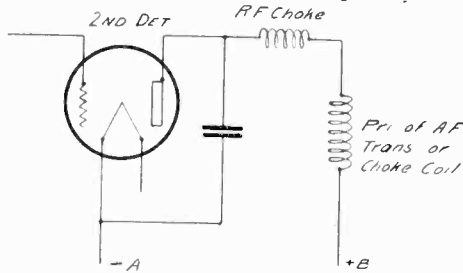

Fig. 3. Use of R. F. Choke in Second Detector.

that of your intermediate r. f. you will be safe. Actually every manufacturer should include an r. f. choke for this purpose in his super kit. The choke should be closed iron-core and it could be made quite small. A choke in the position of the r. f. c. of Fig. 3 must not be too large or it will cause distortion by reducing the amount of the higher audio frequencies that reach that audio amplifier. Too low an intermediate r. f. would require too large a choke, so the only remedy is to choose the I. R. F. at a fair compromise. Between 3000 and 6000 meters is excellent for the purpose. On an unshielded superheterodyne the use of a choke as in Fig. 3 is an absolute necessity for perfect performance.

The proper use and isolation of the energy of the oscillator of a super-heterodyne is important. The detector tube, upon which is impressed the oscillator and signal energy, operates best when the signal energy and oscillator energy inputs are the same. This points to the need of an adjustment that should be made for each signal, but this is not practically necessary. The man searching for supreme DX should have such an adjustment, but the man after a good and sensitive all around receiver does not want a multiplicity of adjustments. However such an adjustment, if provided, can be left fixed for the more normal receptions while always ready for

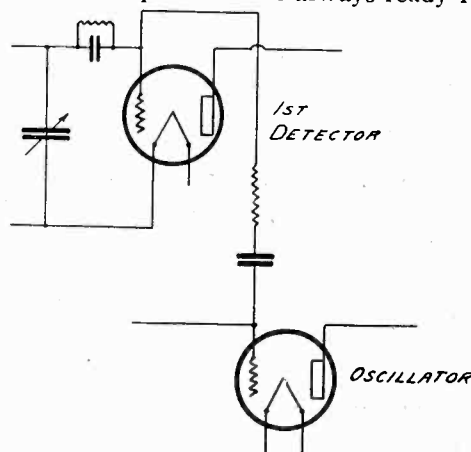

Fig. 4. Coupling Oscillator and First Detector By Means of Resistance.

the sympathetic touch of the searcher for the optimum.

Before going into the arrangement of the oscillator, the more ordinary and familiar methods of limiting the detector's pickup from the oscillator will be of interest. There is the method of coupling the grid of the oscillator to the grid of the detector through a resistance and a capacity. This is shown in Fig. 4 and was used by Best in his most recent super sets described in RADIO. There is the usual idea of a two to five turn pickup coil run from the detector to the oscillator or vice versa. In some sets there is an oscillator-coupler with a rotating coil for pickup containing anywhere from 10 to 40 turns. Although an adjustment of the coupling of the pickup to the oscillator coils is possible, it is often true, due to jamming of parts or else the size of the pickup coil, that anywhere between the limits of rotation of the coil pickup is much the same and the adjustment proves useless. This has led many to the false conclusion that an adjustable pickup is of no value although a correct trial would convince them otherwise.

Then there is the arrangement of Pressley's used by McMurdo Silver in the Super-Autodyne in which the detector and oscillator become one tube. This is an arrangement that can be made every bit as good as the separate tube frequency-converter arrangement if the tickler is arranged to be controllable from the panel so that the degree of oscillation can be adjusted to an exactness. It has seemed odd to me that such an arrangement were not suggested before, for in practice, to the man that likes to push his set to its limit, it works out very well. The Super-Autodyne converter circuit is shown in Fig. 5.

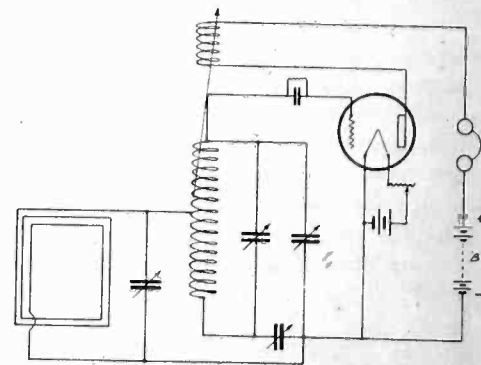

Fig. 5. Super-Autodyne Detector Oscillator.

If the isolation of the oscillation energy is provided for it is not difficult to arrange the proper use of it for beat purposes. The trouble in most cases is in not properly isolating the oscillator currents within the oscillator or circuits where no harm can result from its presence. This isolation can be accomplished fairly well by simple means. It is necessary to see that the detector circuits are well separated from the oscillator and associated apparatus. It is a good idea

to build the oscillator coil in some form that has a limited field. This can be done by making the oscillator coil very small in diameter, 2 in. or less, wound with fine wire, or by using a special form of coil such as the Toroid, the Binocular or the D coil.

For instance, the ordinary oscillator circuit using a two section coil would, on a 2 in. diameter, require a coil of 70 turns of No. 30 d. s. c. wire, 35 turns in each section, wound in the same direction, and to be tuned with a .0005 mfd. variable condenser.

The losses that occur in an oscillator are unimportant since it always has many times the power needed. To further keep the oscillator energy within reason no more than 22½ volts should be used as B battery. I have known a super in which the loop picked up directly from the oscillator the field of the loop and oscillator coils were so large, and no other means of pickup was necessary, even this being too much. J. L. MacLaughlin in the one-control super keeps energy from the oscillator circuit from getting into the B battery by means of a choke coil as illustrated in Fig. 6. This

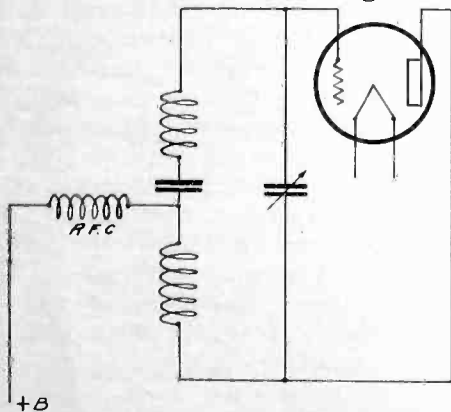

Fig. 6. Method of Localizing Oscillator Current.

should not be necessary where a sufficiently large B battery by-pass condenser is used, .1 mfd. or more.

Probably as good an arrangement as possible is to remove the oscillator tube and components to the end of the set farthest from the first detector and try out the set without any pickup direct and intentional. If the set works well without an apparent pickup, then the pickup is from the wiring and other parasitic feeders. If the pickup is nil unless a special coil is used for the purpose, congratulate yourself on a good job. Arrange the pickup coil with a variable shunt resistance according to Fig. 7, the pickup coil being from 3 to

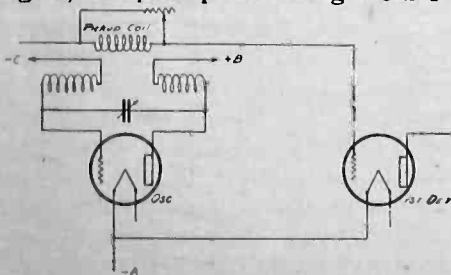

Fig. 7. Variable Resistance Pickup Control.

6 turns, 3 generally being enough. If the variable resistance has a good range, the adjustment of pickup provided will take care of any condition of incoming signal-strength. The pickup coil should have about 6 to 9 turns when the variable shunt resistance is used since the pick-up can be tamed to any desired strength. A variable grid-leak with a range of ½ to 5 or 6 megohms would be excellent for use in place of the resistance R in the coupling method as used in the latest Best super as it would allow a very nice control of the pickup energy. In this latter case some capacity effect would likely result but it can be partly eliminated by carefully mounting the variable resistance with a fairly long control shaft.

The best method of protecting the set from any pickup from the oscillator, other than that intended, is to shield the oscillator circuit completely. As was said before, losses in the oscillator are of not much importance, so it can be crowded to get compactness.

Air-core intermediate r. f. transformers are not always desirable for superheterodyne use. They are too sharply tuned, in the main, and when they prove to be not so sharply tuned they often prove also to be ineffective. Tubes whose capacity vary, differences in wiring capacity from stage to stage, and small similarities can affect the amplification of a sharply tuned transformer. The iron-core transformer is not sharply tuned and is justly the favorite at present. In any case the transformer should be inclosed within a shield unless it has an open iron magnetic circuit. The transformer with a good shield will not interact with its teammates, an important virtue. A closed iron core often makes in effect as good a shield as an inclosing can.

Sometimes exceptional pickup results with a super that is credited to the circuit rather than to outside influences. Particularly is this true where unusual results are secured with a very small loop and a normal circuit. In one case, the pickup of the wiring in a house was the entire foundation of his (the owner's) success with a super. He could hear anything worth hearing until the place was remodeled and the wiring run in grounded conduit. A similar case will be found with smaller set owners who are unable to surpass a light-socket antenna plug with a good outdoor antenna.

Another peculiar situation due to house-wiring occurred with one super owner who was getting excessive interference from a local station. It was another case of open wiring. The house-wiring was practically on the wavelength of the local station and was thus full of quite a bit of energy from it. A strong signal field existed about this set so that in spite of everything that could be easily done it was impossible to get away from interference from the local jazz genera-

tor. The owner was disgusted because he had built what was supposed to be a highly selective set and it had proved otherwise. The problem was solved by the use of three or four high capacity fixed condensers connected across the a.c. wiring in several widely spaced positions. Then the local station's strength dropped, insofar as excess was concerned, to a reasonable point and the set was able to tune it out.

Since the above case points to how easy it is to misjudge a set or circuit there is one other thing to be said in relation. That is, comparisons between circuits and sets are seldom made fairly. A particular instance was a man who built a conventional "super" set that performed very nicely in a good location and of which he was very proud. Later he built another arrangement with a little different kind of oscillator circuit and a new "dyne" name. This he praised very highly as being much better than his original set. I disagreed with him that a tremendous difference was impossible with the same parts and but a rearrangement of the oscillator connections. Then we looked things over. The whole reason for the better performance lay in a loop whose dimensions were nearly 6x6 ft. in place of the 3½x3½ ft. previously used.

## EUROPEAN RADIO NOTES

From H. DEA. DONISTHORPE  
Radio for French Hospitals

France is the next country to follow in the footsteps of America and some of their hospitals are now being equipped with radio receivers for the benefit of their patients. Undoubtedly a patient who can keep his mind off his ailment through the aid of radio will recover more quickly than one who has nothing to occupy his mind.

## Radio Licenses in the British Isles

The army of radio listeners still increases in the British Isles as is shown by the official list of the numbers of licenses issued to radio listeners for the month of September. During this month the number of British licenses issued showed an increase of 41,500 over the preceding month. The total number of licenses issued upto date in Britain is 1,464,500.

## British High Power Station Heard in Australia

Australia seems to be in the happy position of being able to receive the radio programs from any part of the globe. In addition to the frequent reports about American stations being heard in the Antipodes, one now comes to hand which states that the Daventry high-power station of Britain has been heard so well in Australia that it was possible to rebroadcast the signals received.



# How to Read Schematic Circuit Diagrams

By G. M. Best

CIRCUIT diagrams showing the arrangement of apparatus in a radio receiver, in schematic form, are often a mystery to the layman. Even when the identity of the various symbols representing the individual pieces of apparatus are recognized, the purpose of the connecting wire, as well as the function of each part, is not always clear.

This article is not a glossary of radio symbols, but rather an explanation of what sort of electrical currents are circulating in each wire of the radio set, and to show the primary purpose of the coils, condensers and resistances with relation to these currents. Three kinds of electrical current are flowing in any vacuum tube radio set: the incoming radio frequency, the audio frequencies to which it is connected, and the direct current whereby the tube functions.

To facilitate an understanding of their several paths, a series of color diagrams have been prepared, differing from the conventional in that radio frequency paths are shown in red, audio frequency in heavy black and direct current in light black lines. These diagrams show the elementary circuits used in radio reception, and their combination into several complete diagrams representing standard receiving sets with which the radio public is generally familiar.

Referring to the color page opposite, Fig. 1 is a diagram of a simple crystal detector circuit, with loose coupled tuner, primary and secondary air condenser, crystal detector and phones. For the sake of clearness, inductance coils which have both radio and audio frequency currents flowing through the windings will be shown in dotted lines. Where only one current is flowing, the coil is drawn with solid lines, as in Figs. 1 and 3.

Following the path of the radio frequency currents induced in the antenna circuit of Fig. 1, the red lines show that they pass through the antenna series condenser and primary inductance to the ground, causing induced currents to flow in the secondary inductance, around through the crystal detector, through the by-pass condenser, and back to the secondary again. The crystal detector has the property of passing current efficiently in one direction only. Hence it produces a pulsating current which conforms faithfully to the modulations of the high frequency carrier wave from the transmitting station. This audio frequency current is shown in the heavy black line which connects the crystal to the telephone receivers and around through the secondary inductance, forming a complete closed circuit. The radio

frequency current in the secondary circuit must also have a closed path, and as the telephone receivers represent a high resistance to radio frequencies, due to the high inductance and resistance of the receiver windings, a low resistance path consisting of a mica by-pass condenser is provided across the phones and the red lines show how the radio frequencies return to the secondary inductance and back to the crystal detector. As the crystal requires no direct current for its operation, none is shown.

The use of a vacuum tube in place of the crystal for the detector requires a filament and plate current, which are of different voltages, but are both direct current. In Fig. 2 is shown the same tuned circuit as employed in Fig. 1, with a non-regenerative vacuum tube detector.

In this case, the principal radio frequency paths are the antenna tuned circuit and the secondary circuit, including the grid condenser and grid of the detector tube. The vacuum tube, acting as a detector, causes pulsating direct current to be superimposed upon the direct current in the plate circuit, producing an audible signal in the telephone receivers. This pulsating current, for the sake of simplicity, is shown as audio frequency, and in parallel with the audio frequency path is shown the plate current of the tube, the latter being the thin black line. A certain amount of the radio frequency current actuating the grid of the detector tube is amplified by the tube and appears in the plate circuit, where it passes through the by-pass condenser directly back to the filament, so that it does not reach either the telephone receivers or the *B* battery. If it were not for the by-pass condenser, some of the high frequency would pass through the condenser formed by the capacity between wires in the telephone receiver extension cord, and would reach the *B* battery, where it is not desired, especially when connected to an amplifier circuit.

The filament current of the tube is also shown as a thin black set of lines, and it will be noted that for a short distance all three types of current are flowing through one of the filament leads. Actually, radio and audio frequency currents circulate around in the filament circuit, in small quantities, but the principal path is direct to the nearest point of the filament, and so the parasitic or stray currents are not shown.

In Fig. 3 the vacuum tube circuit of Fig. 2 is made regenerative, by adding the feedback coil, which is shown in dotted lines. Here we have three types of current flowing in the coil, for the

radio frequencies are first received from the tuner, which is shown in the red lines, then amplified by the detector tube, and fed back from the plate to the grid circuit again through the tickler and secondary coil, the pulsating d.c. flowing through the tickler coil at the same time, forming an audio frequency component which is heard in the telephone receivers. Theoretically, the pulsating d.c. and the plate current are one and the same but are shown separately in the diagram to clearly illustrate what happens. The by-pass condenser is as necessary as it was in the non-regenerative tube, as it completes the high frequency circuit and isolates the *B* battery and phones.

Fig. 4 illustrates the currents to be found in a one stage audio frequency amplifier, connected either to a detector or preliminary amplifier delivering audio frequency current. In the secondary winding of the audio frequency transformer there is a flow of audio frequency current whenever voltage is applied to the primary winding, and this current causes a corresponding flow of pulsating d.c. in the plate circuit, as represented by the heavy black line. The plate current flow is through the telephone receivers and *B* battery, but the audio frequency component, after passing through the telephones, follows the path through the by-pass condenser, which has a low resistance to alternating current but is infinite to direct current.

In Fig. 5 a four-tube tuned radio frequency set of the Browning-Drake type is shown, incorporating the simpler circuits of the previous diagrams, and enabling the reader to differentiate between the various parts of the circuit. The modulated high frequency passes from the antenna circuit through the tuner to the radio frequency amplifier tube, where it is amplified and passed into the radio frequency transformer, and to the grid of the detector tube. Some of the energy is fed back through the tickler coil, around through the by-pass condenser and back to the filament, while the audio frequency component in the detector plate circuit is shown in a manner similar to Fig. 3. Note that the high frequency path in the primary of the radio frequency transformer is around through the *B* battery by-pass condenser, to the filament of the r.f. amplifier. The audio frequency component in the detector plate circuit passes through the primary of the 1st audio transformer and through the detector *B* battery by-pass back to the filament. The direct current path from the plate

(Continued on Page 42)

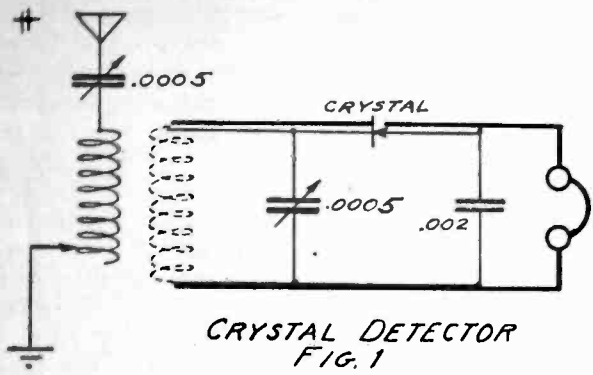

CRYSTAL DETECTOR  
FIG. 1

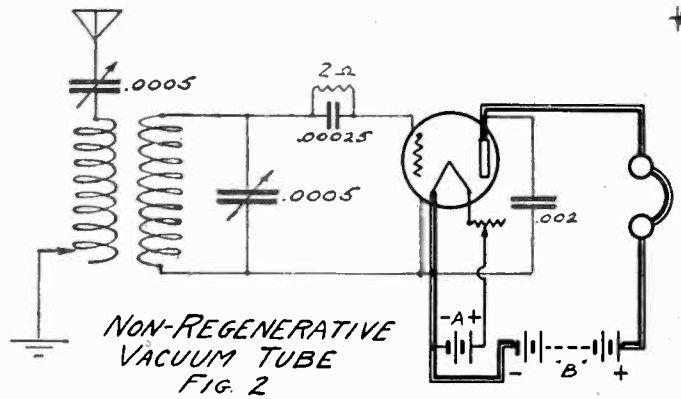

NON-REGENERATIVE  
VACUUM TUBE  
FIG. 2

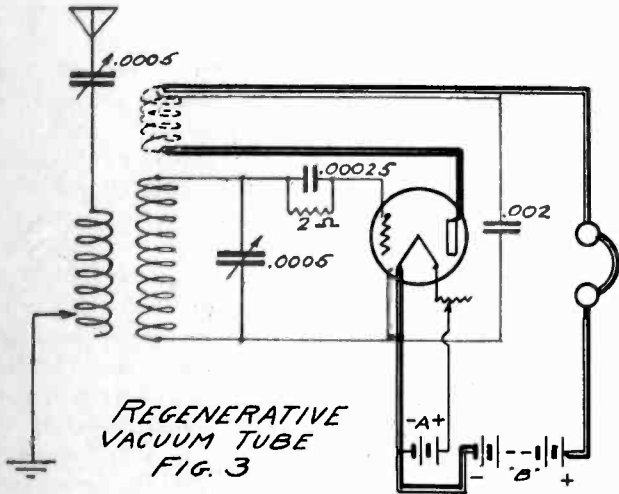

REGENERATIVE  
VACUUM TUBE  
FIG. 3

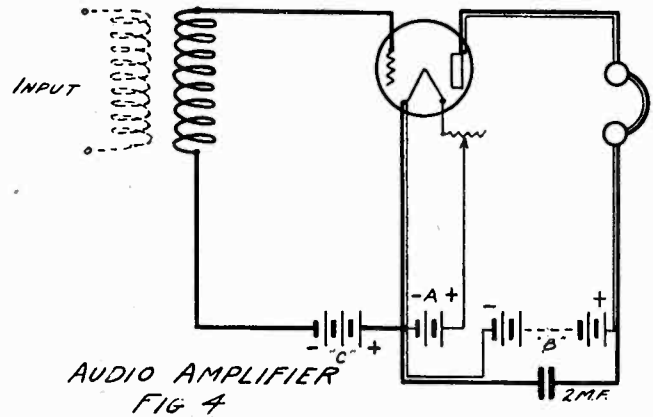

AUDIO AMPLIFIER  
FIG. 4

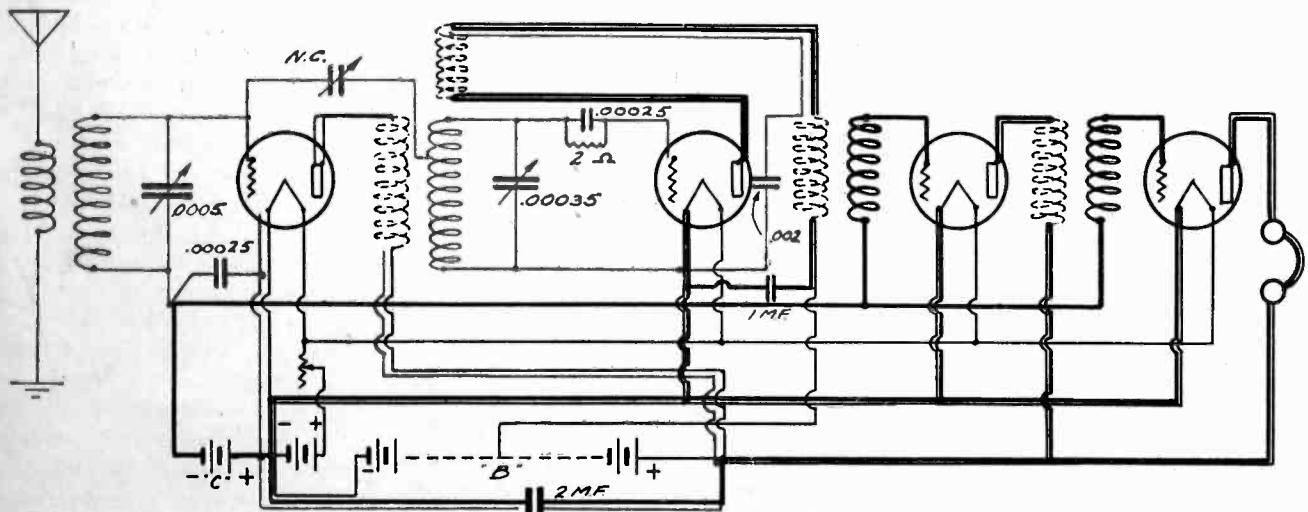

FOUR TUBE TUNED RADIO FREQUENCY  
FIG. 5

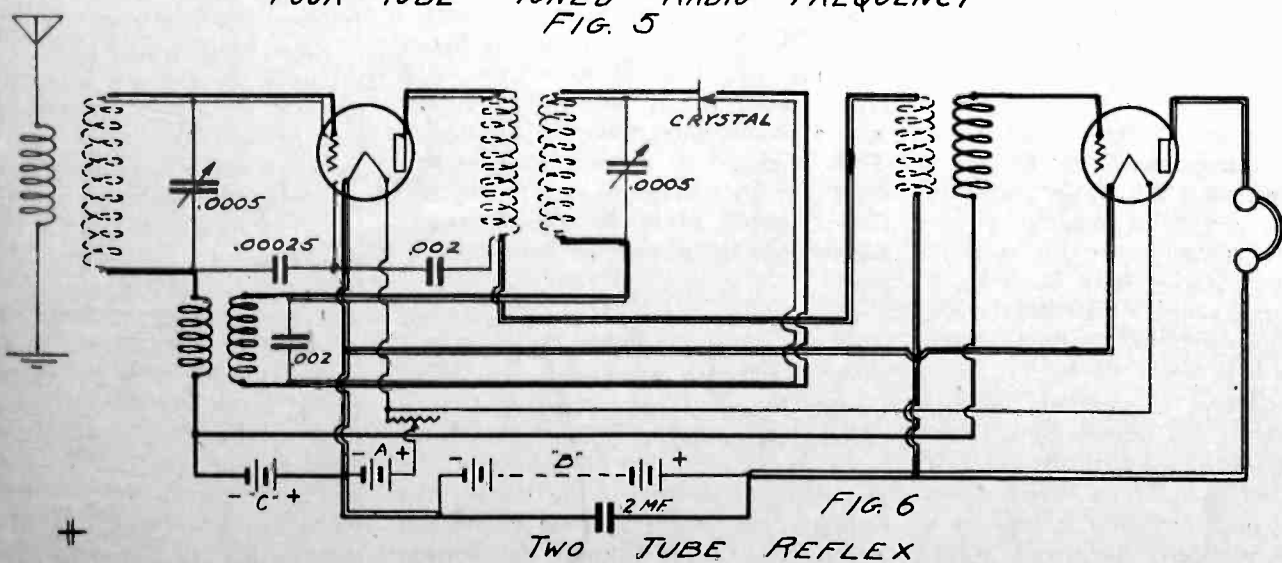

TWO TUBE REFLEX  
FIG. 6

How to Read Schematic Circuit Diagrams.

## POLARIZATION OF RADIO WAVES

By E. F. W. ALEXANDERSON

Two tangible contributions to radio transmission have been made as the result of organized research in wave propagation through space as conducted by the Radio Corporation and its associated companies. One is that the best all-around service is now given by stations operating at a wavelength of about 40 meters and as a result a chain of short wave stations is being installed to cover the Pacific Ocean, including the Philippine Islands. The other is the discovery of horizontally polarized radiation.

The experimental station built by the General Electric Company at Schenectady to explore these possibilities is now capable of operating with seven transmitters simultaneously with different wavelengths and different types of radiators, and observations from these transmission tests are being made all over the world. The object of these tests is partly to explore the propagation characteristics of different wavelengths and partly to make final tests of comparison between various types of radiators.

The three types of radiators used in these comparisons are the result of tests with a great many other antenna systems which have been at least temporarily discarded. The radiators which are now being compared are:

1. The straight vertical antenna oscillating at a harmonic frequency.
2. The horizontal antenna with an over-all dimension of one-half wave fed in the middle through a transmission line.
3. The series tuned horizontal loop.

All these three radiators have one feature in common, that the radiation is projected at a high angle upwards. They may therefore all be classified as high angle radiators. It has been found that only the high angle radiation is useful in reaching great distances. The high angle radiator has therefore the double advantage of economy of energy and the absence of objectionable signal strength in the neighborhood of the station.

The first type of antenna radiates a vertically polarized wave of the same general character as the waves that have been used heretofore in long and intermediate wave stations. It differs from old type of radiation only by being a pure high angle radiator whereas the old type of stations radiated a ground wave as well as a high angle wave.

The second type of antenna, the half wave doublet, is an intermediate form. At right angles to its length direction, it radiates a horizontally polarized wave, and in its length direction it radiates a high angle vertically polarized wave. Thus in its length direction it has a radiation of the same character as that

emitted from the vertical high angle radiator, whereas, in the broadside directions, it emits a wave of different type.

The third antenna system, the horizontal series tuned loop, emits a horizontally polarized radiation in all directions.

For the analysis of the characteristics of high angle radiation, we are particularly indebted to Commander A. Hoyt Taylor of the Navy Department, who has made extensive tests and furnished valuable data on the so-called "skip" distance of the wave. He has found that the distance skipped by the wave, which means the length of the trajectory required for the high angle radiation to come down again to earth, depends upon the wavelength, day and night conditions, and summer and winter conditions, the general rule being that the shorter the wave, the greater is the skip distance.

The horizontally polarized short wave, as investigated by G. W. Pickard, is found usually to be twice as strong and sometimes ten times as strong as the vertical wave. It does not maintain its original plane of polarization, because the reception appears to be of the same nature regardless of whether the wave is radiated with a horizontal or a vertical polarization. It is found at a distance of about ten miles from the horizontal loop radiator, that the wave comes down with an almost vertical direction of propagation. For those who believe in a reflecting Kennelly-Heavyside layer, this would appear to be good evidence because it might be assumed that the wave has been radiated straight up from the station and is reflected directly downwards. A loop receiver under those conditions gave no orientation of the station whatever, because the signals came in apparently equally strong from all directions when the loop was rotated around its vertical axis. This would indicate that the wave besides being vertically propagated was circularly polarized.

Similar observations at a point only a few wavelengths distant from a horizontally radiating loop show that the wave comes down nearly vertically but yet with a definite slant towards the station. Tests with a loop receiver gave in this case a distinct orientation but the station appeared to be located at right angles from the direction where it really was.

One of the loop radiators used in these tests is round, another is about one-sixth wavelength wide and two wavelengths long. These horizontal loop radiators also differ from the ordinary types of antenna by radiating on the magnetic component of the wave. An ordinary long wave antenna creates an electrostatic field around the station whereas the magnetic counterpart of the magnetic energy is confined to a tuning

coil. In the series tuned loop radiator this process is reversed. A magnetic field is created around the antenna, whereas, the electrostatic counterpart of the oscillations is confined to artificial condensers inserted at regular intervals in series with the antenna conductor. One advantage of confining the electrostatic field to artificial condensers has been found to be the fact that the antenna is much less subject to fluctuations in its natural period due to swaying of the wires in the wind. The radiation produced by these loops has a pure horizontal polarization. The oblong loop projects its principal radiation 45 degrees upwards broadside to its own length direction. Reception tests have proven that it is superior to the vertical radiator. From the elementary theory of directive radiation it would be possible to calculate a quite sharp directivity diagram for this antenna. Such a result was, however, not expected in reception tests at long distances because experience with a variety of types of directive antenna systems had proven that whereas the theoretical directivity diagram can be easily confirmed in the neighborhood of the station, the distant measurements do not bear out the elementary theory. The reason for this seems to be that while the antenna sends out a radiation as calculated, there is an additional radiation which is projected almost vertically upwards and then scattered in all directions by the upper layer of the atmosphere. Signals may, therefore be received at distant points in directions where the elementary theory shows that it should be zero. A good deal more evidence must be collected before any definite conclusions can be drawn regarding these secondary phenomena because each case of evidence is usually subject to several interpretations. We have, however, good reason to hope that in a not distant future such a mass of evidence will be available that valuable conclusions may be drawn which will have important bearings not only on the development of radio but on fundamental questions in allied sciences.

From the point of view of the practical radio engineer, it is a satisfaction to be able to state that enough has been learned to create a new and promising field of radio communication as evidenced by the decision of the Radio Corporation to proceed with its chain of short wave stations in the Pacific ocean. The stations which will thus be built will have antenna systems of the type classified as short wave high angle radiators. Which one of the three types discussed above will be adopted will depend upon further results from the comparative tests that are now in progress and also upon final tests in the stations when installed. So far these tests have shown that the horizontally polarized radiation is superior to vertical radiation.

(Continued on Page 70)



## NOTES ON THE ABC ELIMINATOR

By G. M. BEST

THE description of the ABC eliminator in December, 1925, RADIO dealt principally with the theory of the device, and its application to several standard receiving circuits. Numerous questions about the various parts of the circuit have been asked, and it is hoped that the following notes will be of assistance in a better understanding of how the eliminator works.

When the eliminator is used in connection with a UX-213—CX-313 rectifier tube, which furnishes at least 225 volts at the output of the filter, with 60 milliamperes current drain, voltages greater than those required for the UX-112 power tube are available, and it has been asked whether it would be possible to use a 7½ watt power tube such as the CX-310 in this circuit. The normal plate voltage of the Type 310 tube is 350, but it will work well on 250 volts if the proper C voltage is used in the grid circuit. Assuming that 15 volts negative grid potential is proper for the 310 tube, with 225 to 250 volts, it is not possible with the ordinary five tube set, in which the first four tubes are series, to obtain more than 12 volts C potential due to voltage drop across the tube filaments, so the extra three volts to make a total of 15 volts negative grid is obtained from the 50 ohm resistance R shown in Fig. 1. If the

with the filament circuit. The rectifier tubes would have to be of the 50-watt type, and operated at plate voltages in excess of 500, in order to obtain sufficient current in the output circuit. It is easier to use the 60 milliampere tubes in the r. f. and preliminary audio stages, and employ a single power tube with the filament lighted with ordinary a. c. as was described in the previous article. Using two UX-216-B, 7½ watt rectifier tubes, and a power transformer wound to 1200 volts, with center tapped secondary, it is possible to obtain 120 milliamperes to light the filament of the UX-120 power tube, and thus avoid the separate a. c. step-down transformer for the power tube filament.

This arrangement is shown in Fig. 2, from which it can be seen that the path

in the receiving set, when used with the eliminator, it can usually be traced to r. f. oscillation in either the detector or r. f. stages, and is more apparent than when d. c. from storage or dry batteries is available. This will be particularly true with regenerative sets, and the old familiar whistle which is so annoying to the neighbors will be replaced with a raucous growl, both in the loud speaker, and from your neighbor's. Often it will be found that the ground in the receiving set should be placed in a different part of the circuit than shown in the circuit diagrams, and when testing out the completed set, it is a good idea to attach the ground wire to various parts of the filament circuit in order to locate the point where the a. c. hum in the loud speaker disappears.

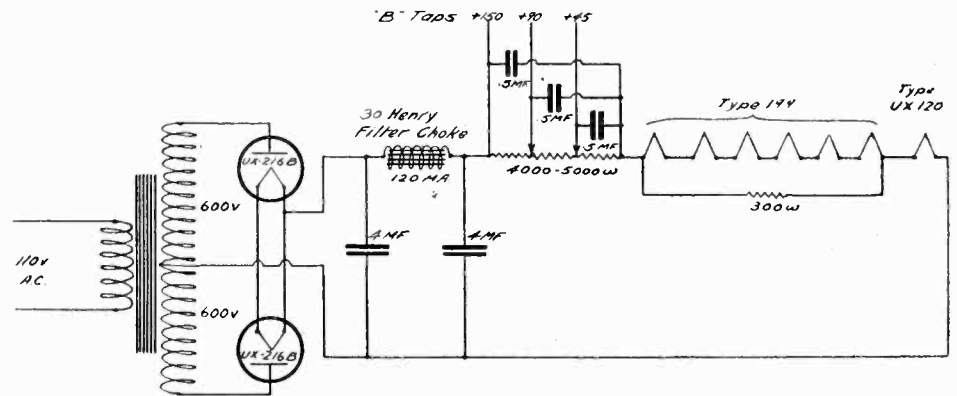

Fig. 2. Circuit of 120 Milliampere Rectifier.

for the current is divided, in the filament circuit, so that the 60 milliampere tubes receive their proper filament current, and the remaining 60 milliamperes

## REBUILDING CONDENSERS

By PHILIP N. EMIGH

There are several thousand radio sets using the old style condensers which "bunched" the stations below 300 meters and tuned broad on those above 400. If the condensers in your set are built up with spacing washers and bolts, they can be easily changed to fair straight line frequency condensers which will separate the stations below 300 meters.

First, your condenser must be about twice the capacity of what you really need, as altering the rotor plates as shown, cuts the total capacity to about half its former value. The rotor plates will look somewhat like Fig. 1 with the

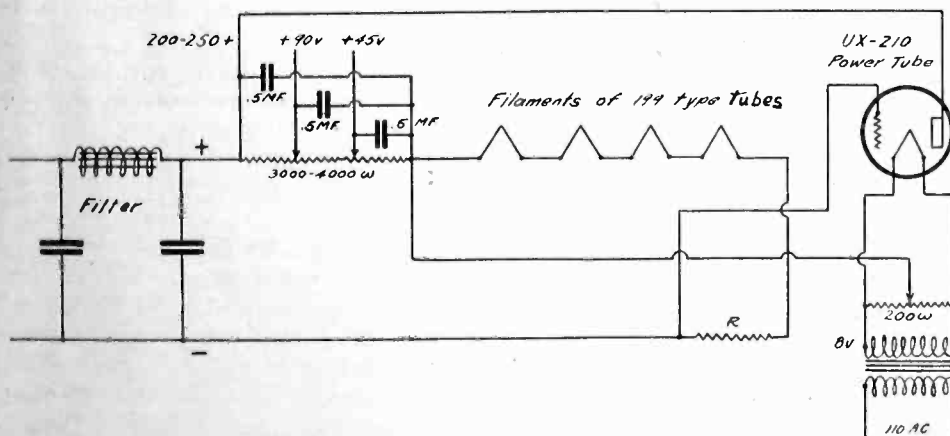

Fig. 1. Method of Obtaining C Voltage.

set has only three 60 milliampere tubes, instead of the four shown in the diagram, then R is 100 ohms, and with two 60 mil tubes, R is 150 ohms. In this manner any desired negative grid voltage can be obtained for any of the tubes, and no critical adjustments will be needed.

Questions have been asked about the possibilities of the scheme for furnishing the filament current of a number of .25 ampere tubes of the UV-201-A, C-301-A type, in series. This can be easily accomplished with the proper rectifier system, but is uneconomical due to the tremendous amount of power which would be dissipated in the form of heat, in the resistances which would be associated

is by-passed through a resistance equal to the resistance of all the 60 mil tube filaments in series. The UX-120 power tube receives the entire 120 milliamperes of current, and requires no shunt resistance. In this circuit, an Acme 30 heny transmitting type choke will be required, as the current would be too great for any of the conventional filter chokes supplied for the Raytheon or low voltage rectifiers. The filter condensers should be tested to 1000 volts instead of 500, and the resistances must be wound with heavier wire than is used for the 60 milliampere rectifier, as the potentiometers used in the latter circuits would soon burn out under the heavy load.

If modulation effects are experienced

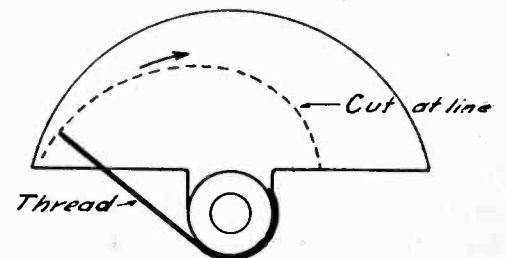

Fig. 1. Rebuilt Rotor Plate.

spacer washer about ½ to ⅝ in. diameter.

Take a short section of string or heavy thread, making a small loop to hold a scriber or point at one end. Wrap this thread once or twice around the spacer washer as shown so that the loop and the scriber touch the outer diameter of the rotor plate.

Carefully move the scriber so as to

(Continued on Page 57)



# QUERIES *and* REPLIES



Questions submitted for answer in this department should be typewritten or in ink, written on one side of the paper. All answers of general interest will be published. Readers are invited to use this service without charge, except that 25c per question should be forwarded when personal answer by mail is wanted.

With reference to the superheterodyne article by G. M. Best in September RADIO, I have been unable to find a variable condenser of .00005 mfd. on the market. What condensers are suitable for this part of the circuit? Is the resistance type of coupling as used in this set as efficient as the inductive coupling ordinarily used? Would it be possible to place the antenna coil and the oscillator coil inside the set on a sub-panel? Are the General Radio coils Type 277 suitable for use in this set without re-winding? Would it be satisfactory to use Amperites on the intermediate frequency amplifier tubes?—K. G. A., Carthage, Ill.

The XL Model G, small size, has a minimum capacity setting which is just about right for the circuit. Many readers have complained that the set is not sufficiently sensitive, and in many cases the trouble was found in this condenser, which was of too small capacity. It varies with the tube used, and may be as high as .00015 mfd in some sets. For any particular wavelength, with the correct number of turns on the grid coupling coil, the inductive method appears to give more signal strength, but unfortunately it is impractical to have a grid coil which has a variable inductance. Hence, for short waves below 200 meters, the grid coil must have a different value of inductance than is required for the wavelength range from 200 to 600 meters, and a rather complicated oscillator coil would be required, or a system of plug-in coils with six contacts.

For this reason the resistance method of oscillator control is preferable, as the plug-in coils require only four contacts, and no grid coil. If the wavelength range for the set is not to be below 200 meters or above 550 meters, the inductive system is the best to use.

The antenna coil and oscillator may be mounted on a sub-panel, but should be separated as much as possible, or the set will radiate energy into the antenna and will interfere with the neighbors. It is a good idea to place a metal shield around the oscillator, grounding the shield to the negative *A* battery. The General Radio coils are specified for this circuit and do not need re-winding. Amperites of the 4V-199 type may be used in the filaments of the intermediate frequency amplifier tubes if desired.

I have a Tuska Superdyne receiver which is not sufficiently selective to cut out the local stations. Please suggest how the selectivity may be improved.—G. M., San Francisco, Calif.

The addition of a loading coil and series air condenser in the antenna circuit, as shown in Fig. 1, will aid in improving the selectivity. The load coil may be a 75-turn unmounted type honeycomb coil, or it may be 75 turns of No. 24 wire wound on a 2½ in. tube. This adds another control to the set, but will not make the set critical in tuning.

I have a McLaughlin one control superheterodyne. How can I sharpen the tuning? Is it possible to eliminate second

harmonics of some stations which interfere with other stations? Would mounting the two condensers help?—A. V. S., Soquel, Calif.

A wavetrap in the antenna circuit will enable you to cut out undesired local stations. Practically all the large radiocasting stations are free from harmonics, as they are equipped with harmonic eliminators, but you are actually hearing the stations by means of harmonics from your own oscillator. See the question on Page 40 of January RADIO, which explains in detail why you hear the stations at more than one place on the dial. Tuning the two condensers separately will often help, if the adjustments are not properly made, and the set cannot be made to function as a single control outfit.

My absorption type tuner is sketched on the enclosed diagram. How may I add another tube to the set?—A. E., St. Paul, Minn.

As you did not state whether the tube was to be a radio or audio frequency amplifier, I am indicating in Fig. 2 how to add an audio frequency stage, as this is most easily accomplished.

Please publish a diagram of the R. C. A. ship receiver No. I. P. 501, also a photograph and other particulars.—J. P., Portland, Ore.

Please do not ask us to publish diagrams of commercial receivers designed for special use, as such diagrams are very difficult to obtain and are of such limited interest that we cannot publish them.

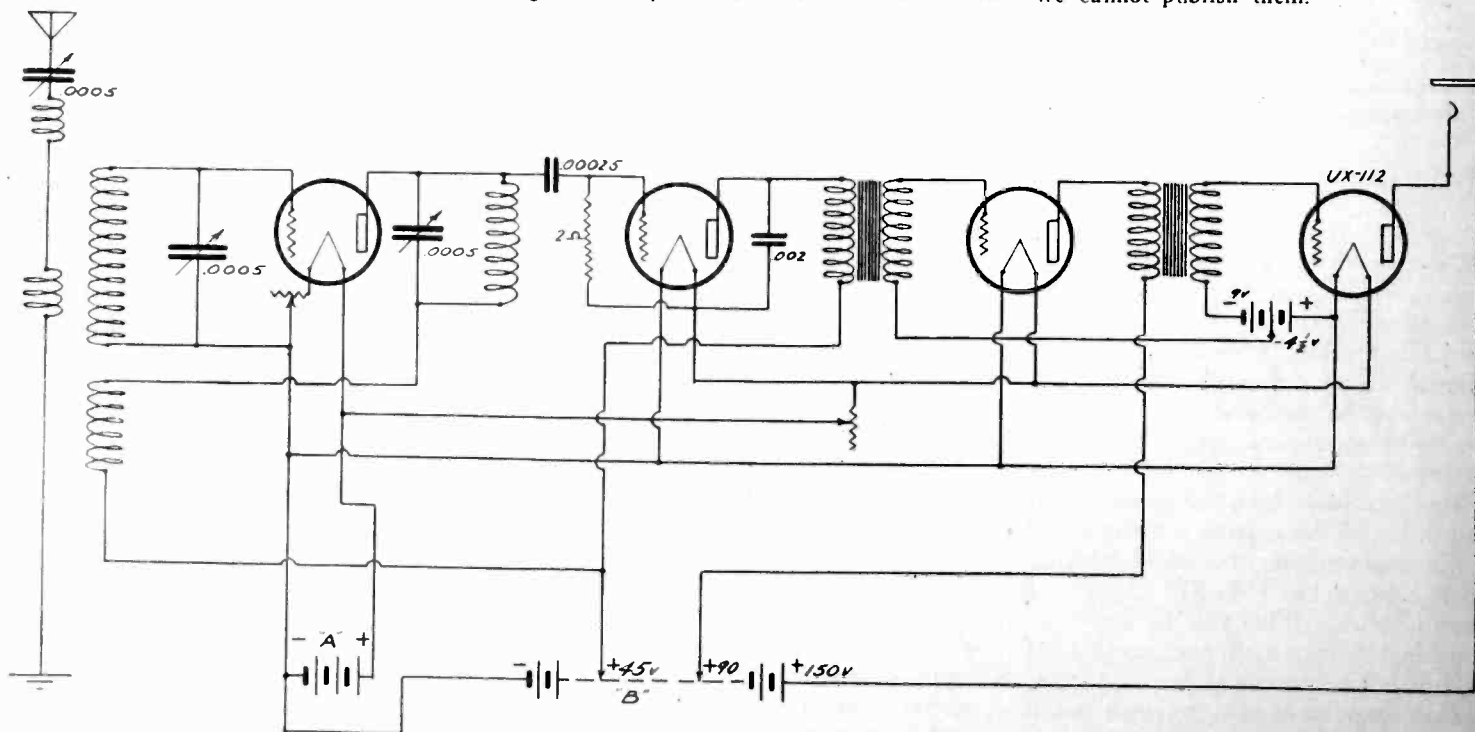

Fig. 1. Circuit for Increasing Selectivity of Superdyne.

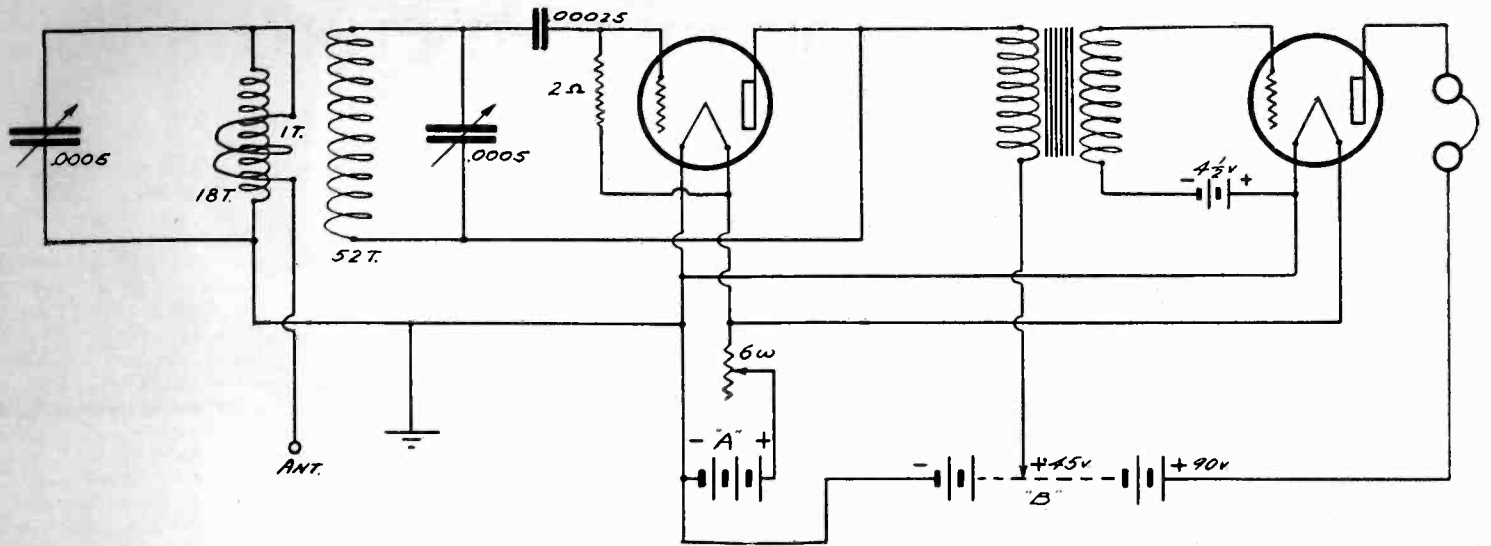

Fig. 2. Adding Audio Stage to Absorption Tuner.

Kindly print a circuit diagram showing a single stage r. f. amplifier to be used with a two tube standard regenerative receiver.—W. E. F., San Francisco, Calif.

In the November issue of Radio, detailed description was given by A. J. Haynes for the construction of a r. f. amplifier such as you describe. The circuit diagram of the amplifier is shown in Fig. 3. It can be con-

so it can be rotated with respect to the secondary. The antenna is connected to the grid end of the tuning inductance through a very small condenser, which may consist of two copper or brass plates, 1 in. square and placed  $\frac{1}{8}$  in. apart. It would be necessary to know the exact type, and winding data on your present tuner in order to give details of modifying the inductance coils.

### BOOK REVIEW

"How Radio Receivers Work" by Walter Van B. Roberts, 53 pp. 7x10 in., clothbound, published by Doubleday, Page & Co., Garden City, N. Y. Price \$1.00.

This book covers the subject given in its title more clearly, concisely and exactly than any other that we have read. Starting with a simple explanation of electricity in terms of the electron theory, it next discusses the factors governing antenna reception of radio waves. Nearly half the book is taken up with vacuum tube circuits, including regeneration. The theory and practice of the several standard forms of receiving circuits, including neutrodyne, reflex and superheterodyne, are briefly set forth. The concluding chapter deals with loudspeakers, parts and accessories. The text is not intended for hurried reading but amply repays the careful student for the time spent. A knowledge of trigonometry will be helpful, though not essential in its study. Its treatment is midway between that of the usual elementary books and the more technical treatises, forming an excellent introduction to the latter.

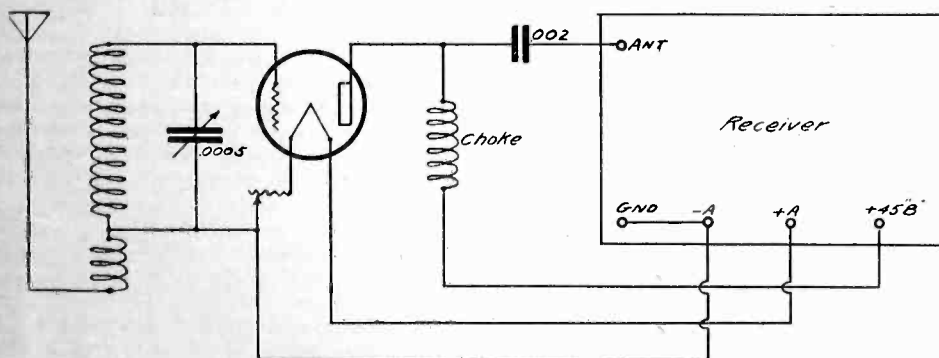

Fig. 3. Circuit of Haynes R. F. Amplifier.

nected to the radio set antenna binding post with out internal changes in the set, and will serve the double purpose of amplifying the signals and preventing radiation into the antenna when the detector tube is oscillating.

Please tell me how I may convert my present single circuit tuner into a short wave receiver.—F. B. S., Atwater, Calif.

A very simple short wave receiver circuit is shown in Fig. 4. The secondary coil,

What is the usual value of the inductance coil used as a choke in the Heising system of modulation? My present radio-telephone has a 1 henry choke, and I don't seem to be modulating any low tones, the output sounding like it was resonant in the middle of the voice range. What can I do to clear up the quality of voice?  
V. M. R., Oltoona, Pa.

The coil may be as high as 30 henrys if the d. c. resistance is low and the wire of sufficient current carrying capacity to pass the plate current of the oscillator and modulator tubes, without heating. With only a 1 henry choke in the plate circuit, frequencies below 500 cycles will not modulate the output satisfactorily. Perhaps your speech amplifier and input equipment between the microphone and the modulator does not amplify the low notes, as would be the case with equipment manufactured several years ago. The speech amplifier should be impedance coupled, with high inductance chokes such as the Thordarson Autoformer, which has an inductance of 350 henrys or more. Ordinary single button microphones of the hand type, such as are used by most amateurs, do not produce good quality, as they are efficient only over a narrow band of audio frequencies. If you wish to obtain quality comparable to that of a good radio-casting station, you will need a two button microphone and associated input transformer, both of which are rather expensive.

### OLE'S HOUR

By MURIEL LILLIAN TIMS

Ay bane a man who vorks an' vorks  
An' never vonce his business shirks,  
Until the night she settles down  
An' all is quiet in our town—  
Den my vife he up an' goes,  
All spangled out in flossy clothes.—  
For all who bane a family man  
Is bound to clearly understan'  
That vifes are rising up to gad,  
Out playing bridge or some such fad,  
An' leaving boobs who used to boss  
At home alone, quite at a loss  
To know what skall be done, and so  
Ve turn to dis hare radio.

Ve get the voice of Hollywood—  
KNX—Ay vish ay could  
See those flapping female stars  
An' Hawaiian Hula czars—  
Ay haf to laf an yump on toe  
Ven ay hear an Eskimo;  
Ay yust shake ven some yazz dame  
Plays "Hot Mama"—till ay bane lame.  
Ve care not for the "howls and squeals;"  
Ve never mind to eat our meals—  
Our vives may spend our vages nights,  
An' den go out for vimmen's rights—  
The kids may have the "croup" or "rickets"—  
VERE "LISTENIN' IN" BY YIMMINY CRICKETS."

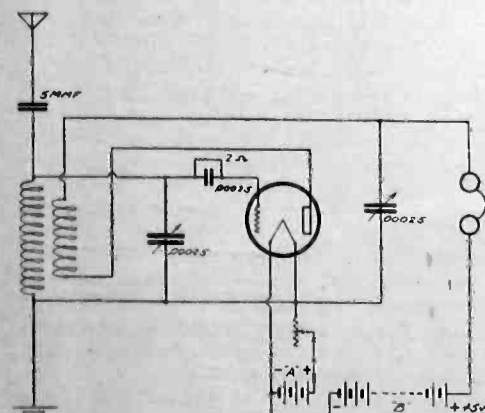

Fig. 4. Short-Wave Receiver.

for use with a 9 or 11 plate condenser, should consist of 12 turns of No. 14 D. C. C. wire on a 3 in. diameter form. The tickler coil should consist of 8 turns of No. 18 or 20 wire wound on a 2 in. form, and arranged



# With the Amateur Operators

## AN EFFECTIVE RADIATION SYSTEM

By T. C. GOODNER, 9DKV and 9AKT

In this day of radio, we are all ready to seize anything that seems to make for better transmission and reception. Especially is this true in short wave work where interference and static are at a minimum and where watts mean "countries rather than just states."

It happened to be the writer's luck, through the aid of a fellow ham, namely 9DFH, to hit upon the idea of the Barrows antenna as described in QST for June, 1925, and to adapt it to a "ham" layout.

The common failing of most short wave antennas is the impossibility of attaining a place free from trees, surrounding buildings, and wires. If the system is short all the wires are down so low as to make those

r. f. line is measured (by inches) from the coupling coil terminals to the out end and should be made equal to exactly  $\frac{1}{4}$  the wavelength in meters (3.28 ft. = 1 meter). One wire must be dead-ended at the last spreader, with sufficient wire allowed for tying through an insulator. To the other wire is added another piece of No. 14 enameled wire exactly equal to  $\frac{1}{2}$  the wavelength in meters. Some convenient bridle will be necessary at this connection, with care taken to keep sharp or square corners out of the circuit as far as possible.

Next comes the business of putting up the antenna. No doubt it would work best vertical, but if this is not possible, construct it as an inverted "L" with a single wire on top and a two wire lead-in. By all means stretch the wires tight and hold them from swaying in the wind. The writer, by taking particular care to do this, re-

liameter, in which case it will help as a check on operation.

It will also be found that besides being a good radiator on short waves at fundamental operation, it can also be used as a first harmonic system. The system as built for 40 meters works very well on 80 meters fundamental. For a receiving aerial, by connecting the two leads into the receiver as ground and aerial connections, using the short lead as a ground, most types of receivers can be made to work to perfection on this layout. Tuning the receiving set as the transmitting aerial was tuned, also helps. For this a 23-plate variable of any design may be used, provided it be "quiet."

Even yet there is much room for experiment with the whole thing. How about two or more wires fanned in the top? Who can tell what cages in the r. f. line would do. Try it on 20 or 5 meters. The writer would be very glad to give any further information he has about construction to any who write. All communications addressed to either 9AKT, 2620 Blaisdell Avenue, Minneapolis, Minn., or 9DKV, Rocky Ford, Colorado, will reach him.

## SOME FACTS ABOUT INDUCTIVE COUPLED TRANSMITTERS

By C. H. CAMPBELL, 11V

About a year has passed since inductively coupled transmitting circuits have come into universal use among the amateurs. The operation of these circuits is not difficult and for that reason, details which would greatly improved their operation are often overlooked.

Probably ninety per cent of the amateur transmitting stations use the Radio Corporation UL1008 inductance. A good way to adapt this to an inductively coupled circuit is to cut the inductance through the center with a hack saw and use one half for the primary and the other half for the secondary. There will be ample inductance in each half to permit operation on any of the amateur bands of wavelengths. Do not merely cut the copper ribbons and leave the rest of the inductance intact.

Many amateurs believe that the distance between the primary and secondary windings determine the amount of coupling. However this is only one of three factors. The others are the diameter of the coils and the number of turns in use. Therefore, the primary and secondary of equally sized coils would have to be further apart than where one is of smaller diameter than the other to give the same value of coupling. If the secondary were made sufficiently small in respect to the primary, it might be possible to place it inside the primary and still have fairly loose coupling between the circuits. This is not recommended, however, and for best results the primary and secondary should be of the same diameter, or very nearly so, and well separated to keep the coupling loose. If three turns were in use in the secondary circuit and then the clip moved to the fifth turn, the effective coupling would change and it would be necessary to increase the distance between the coils. Similarly, if the number of turns in the secondary were reduced to one, then the secondary would have to be moved closer to the primary in order to keep the value of coupling the same.

The proper value of coupling is usually the point at which the primary and secondary are closest together and still give stable operation right on the resonance peak. If the coupling is too tight there is a tendency

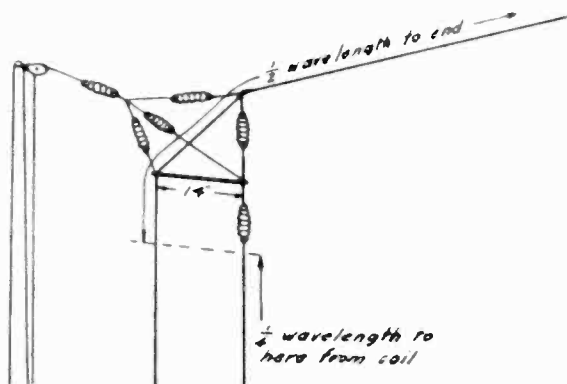
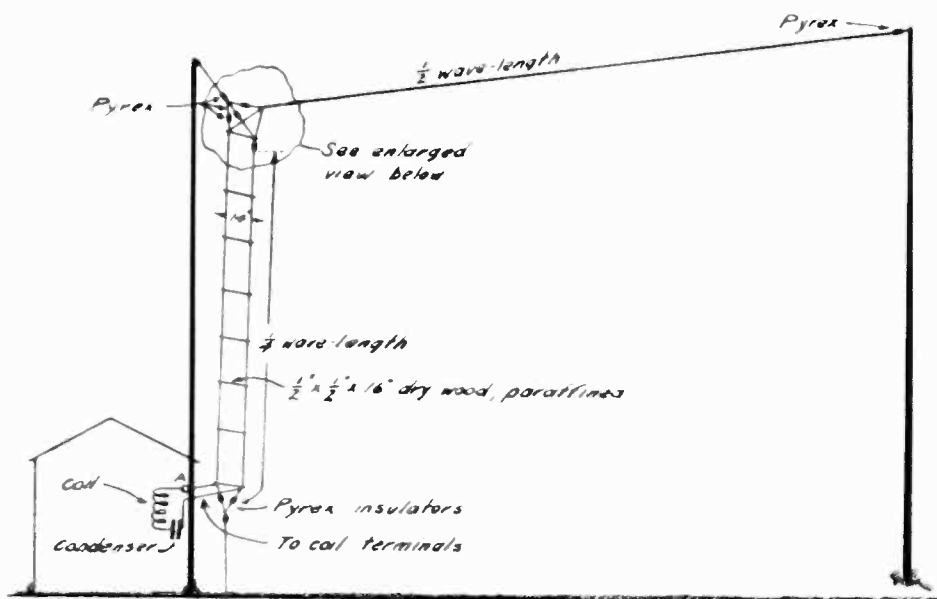

Details of Antenna.  
Enlarged View of Antenna Connections.

precious old poles of almost no use whatever. However, the radiator for which the following will give the construction, is one that can be used to good advantage where poles and masts from 30 to 100 ft. high are already in use.

The main, as well as the most advantageous feature in the Barrows antenna, is the non-radiating antenna feeder, or r. f. transmission line which reaches well up or out from the driver and surrounding building. This line is composed of two No. 14 enameled wires spaced uniformly at from 12 to 14 in. apart; with spreaders at intervals of 5 ft. These spreaders need be nothing more than dry stick  $\frac{1}{2} \times \frac{1}{2} \times 16$  in., soaked in hot paraffin. Where the lead goes into the building only porcelain tubes are necessary. This

received a report of a very steady wave and excellent signal strength when a regular hurricane, with both wind and rain, was raging at the station.

With reasonable care in measurements and the use of good insulators and well tied spreaders in this Barrows-Zeppelin type antenna there is little doubt that results will be well worth the effort expended.

If trouble is found in getting resonance with a driver on a certain wavelength, it is advisable to series a 23-plate variable in the long antenna lead. This condenser should be as close to the coupling coil as possible. If an antenna meter is used it should be just outside the condenser from the coupling coil. An ammeter is not necessary except in the absence of a plate mil-

# FROM THE RADIO MANUFACTURERS

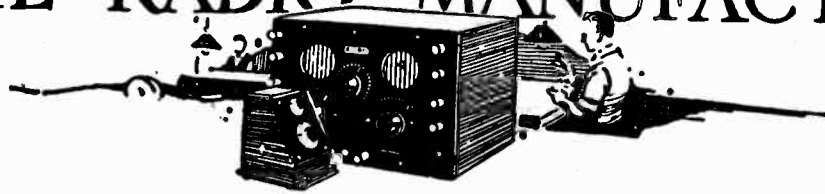

The new Amsco socket is designed to take all sizes of tubes using the UX or CX base without need for an adapter. It gives a positive wipe contact which locks the tube into place. It is exceedingly

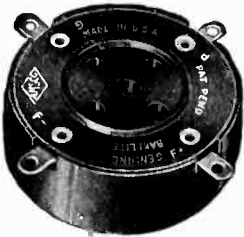

compact and light in weight and has a non-skid one-hole mounting. It is made of mottled green bakelite with metal parts of phosphor bronze, tinned where soldering is to be done.

The Victoreen superheterodyne transformer has been designed to have a very sharp resonance curve so as to give great selectivity even with an aperiodic primary and so as to prevent interstage oscillation. It is claimed to give satisfac-

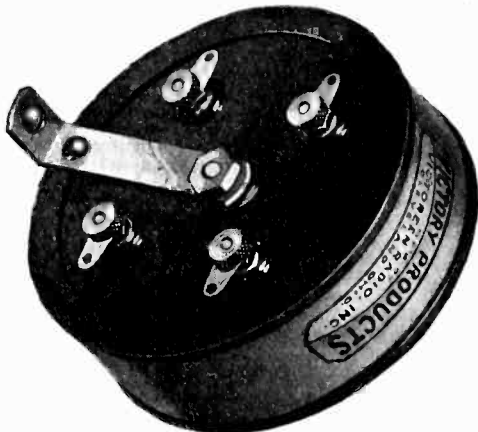

tory operation with unmatched tubes of either dry cell or storage battery type and with potentiometer control of volume. It is resonant at an intermediate frequency little affected by harmonics.

The Pacent superaudioformer is a 3 to 1 ratio transformer designed for power amplification with plate potentials up to 500 volts. It is claimed to give uniform amplification from 100 to 8000 cycles and

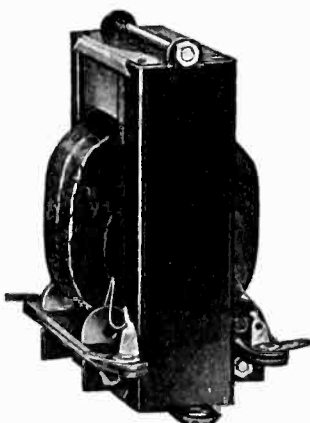

may be used in any stage. It has a high primary impedance, low secondary capacity, and a large laminated core of alloy steel.

Lastite is a simple means for making tight soldered connections. As may be seen in the sectional view it consists of a threaded nut, that can be screwed onto the binding post of a socket, trans-

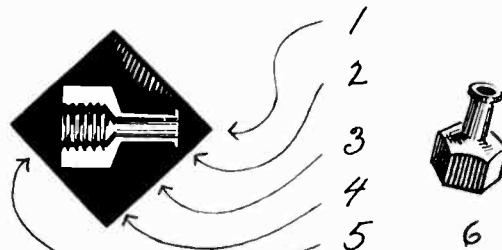

former or other radio part, and of a small tube into which a wire is put preparatory to soldering it to the flange on the end of the tube. This leaves both hands free for the soldering operation.

The socket tube reviver is a simple apparatus for reactivating thoriated filament tubes by the flash and aging principle. It can be attached without cord to

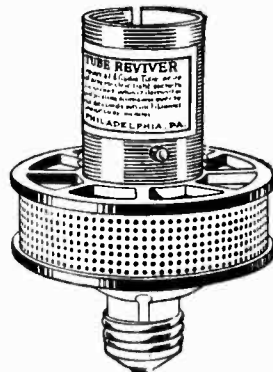

any 110 volt lighting socket. A small button of the side enables the tube to be "flashed" at high voltage for 45 seconds and then the tube is aged at low voltage for ten minutes.

The Pacent Isolantite adapter fits a small UX-base tube, such as the UX-120 or UX-199, to a standard Navy type of tube socket. The shell is provided with four holes, one larger than the other



three, to take the four prongs of the small UX base. A lock screw holds the tube in the adapter while a pin assures proper engagement with the bayonet slot of the usual socket.

The carborundum stabilizing detector unit has been especially designed for use with reflex sets using a. c. power. It uses a fixed carborundum crystal as a detector and a small dry cell and potentiometer which may be adjusted so as to give a "biasing" voltage which cuts down

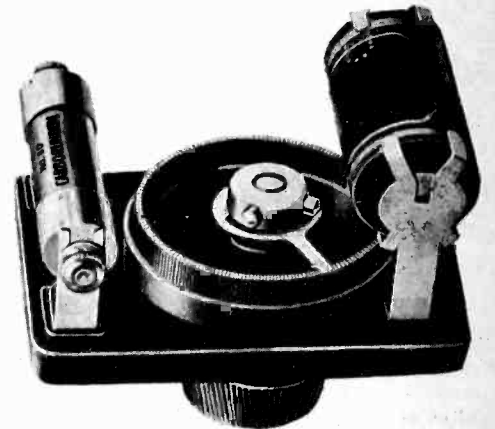

the effective resistance of the crystal and thus increases its sensitivity. By increasing the resistance slightly the selectivity is improved. Or this damping regulator may be used to control self-oscillation in a reflex set.

The Tune-Rite dial is a vernier dial geared so that when used with a semi-circular plate condenser the pointer gives a straight line frequency reading. The separation of the low wavelength

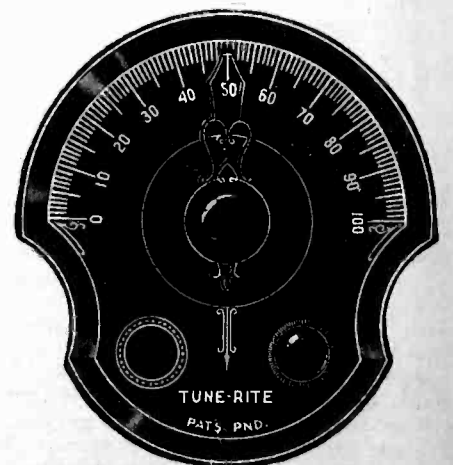

stations at the lower end of the dial is about the same as the high wavelength stations at the upper end. This dial is made in styles that readily convert any old condenser to a straight line frequency reading.

A piece of rubber hose, such as may be purchased from any druggist for a few cents, makes a good lead-in insulator, where the wire must be run under or on top of a window. The wire may be threaded through the hose, and the window closed as usual. A few tacks to hold the hose in place may be required.

# BUILD THE Camfield DUODYNE!

Nothing like it has ever  
been known before!

It is a Five Tube Tuned Radio Frequency Circuit using a new  
and Highly Efficient system of preventing oscillations.

*Sensitivity - Selectivity - Tone Quality*  
combined to give results  
never before obtainable!

*Build It Yourself with Camfield Parts*

at half the cost of a good five tube Receiving Set! The following Camfield Parts are essential for use in the Duodyne Circuit:

1 Type 22K Camfield Duoformer Kit.....	\$10.00
3 Type 886 Camfield Straight Line Variable Condenser, each.....	\$ 6.00
5 Type 11 Camfield Bull Dog Grip Socket, each .....	65c

**Write Direct to the Home Office for  
Complete *Free* Descriptive Literature**

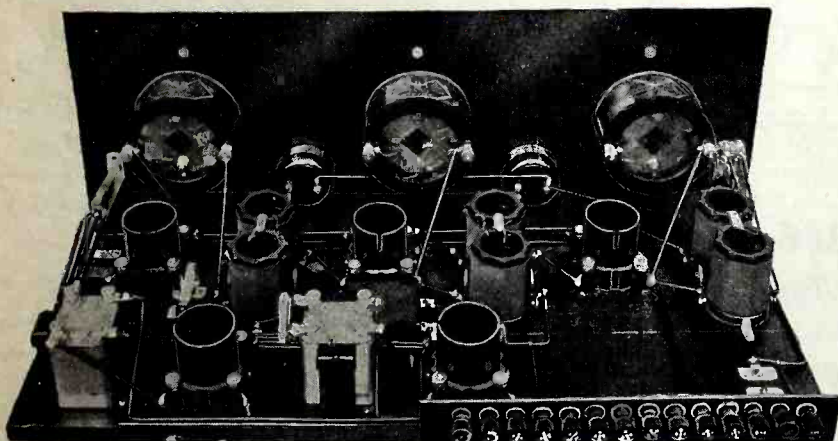

Rear Panel View, Showing Position of Parts and Wiring.

telling all about the Duodyne  
Circuit and Camfield Parts,  
giving us the name of your  
radio dealer.

#### DEALERS:

Our Sales Policies protect  
your profits and those of  
your jobber. Write us on  
your business letterhead for  
complete information about  
the Duodyne Circuit, Cam-  
field Parts and Dealers'  
Prices, giving us the name of  
your jobber.

## CAMFIELD RADIO MANUFACTURING COMPANY

Home Office

829 HARRISON ST., OAKLAND, CALIF.

Branch Office

1268 WEST 115th ST., CLEVELAND, OHIO



# With the Amateur Operators

## AN EFFECTIVE RADIATION SYSTEM

By T. C. GOODNER, 9DKV and 9AKT

In this day of radio, we are all ready to seize anything that seems to make for better transmission and reception. Especially is this true in short wave work where interference and static are at a minimum and where watts mean "countries rather than just states."

It happened to be the writer's luck, through the aid of a fellow ham, namely 9DFH, to hit upon the idea of the Barrows antenna as described in QST for June, 1925, and to adapt it to a "ham" layout.

The common failing of most short wave antennas is the impossibility of attaining a place free from trees, surrounding buildings, and wires. If the system is short all the wires are down so low as to make those

r. f. line is measured (by inches) from the coupling coil terminals to the out end and should be made equal to exactly  $\frac{1}{4}$  the wavelength in meters (3.28 ft.=1 meter). One wire must be dead-ended at the last spreader, with sufficient wire allowed for tying through an insulator. To the other wire is added another piece of No. 14 enameled wire exactly equal to  $\frac{1}{2}$  the wavelength in meters. Some convenient bridle will be necessary at this connection, with care taken to keep sharp or square corners out of the circuit as far as possible.

Next comes the business of putting up the antenna. No doubt it would work best vertical, but if this is not possible, construct it as an inverted "L" with a single wire on top and a two wire lead-in. By all means stretch the wires tight and hold them from swaying in the wind. The writer, by taking particular care to do this, re-

liameter, in which case it will help as a check on operation.

It will also be found that besides being a good radiator on short waves at fundamental operation, it can also be used as a first harmonic system. The system as built for 40 meters works very well on 80 meters fundamental. For a receiving aerial, by connecting the two leads into the receiver as ground and aerial connections, using the short lead as a ground, most types of receivers can be made to work to perfection on this layout. Tuning the receiving set as the transmitting aerial was tuned, also helps. For this a 23-plate variable of any design may be used, provided it be "quiet."

Even yet there is much room for experiment with the whole thing. How about two or more wires fanned in the top? Who can tell what cages in the r. f. line would do. Try it on 20 or 5 meters. The writer would be very glad to give any further information he has about construction to any who write. All communications addressed to either 9AKT, 2620 Blaisdell Avenue, Minneapolis, Minn., or 9DKV, Rocky Ford, Colorado, will reach him.

## SOME FACTS ABOUT INDUCTIVELY COUPLED TRANSMITTERS

By C. H. CAMPBELL, 11V

About a year has passed since inductively coupled transmitting circuits have come into universal use among the amateurs. The operation of these circuits is not difficult and for that reason, details which would greatly improved their operation are often overlooked.

Probably ninety per cent of the amateur transmitting stations use the Radio Corporation UL1008 inductance. A good way to adapt this to an inductively coupled circuit is to cut the inductance through the center with a hack saw and use one half for the primary and the other half for the secondary. There will be ample inductance in each half to permit operation on any of the amateur bands of wavelengths. Do not merely cut the copper ribbons and leave the rest of the inductance intact.

Many amateurs believe that the distance between the primary and secondary windings determine the amount of coupling. However this is only one of three factors. The others are the diameter of the coils and the number of turns in use. Therefore, the primary and secondary of equally sized coils would have to be further apart than where one is of smaller diameter than the other to give the same value of coupling. If the secondary were made sufficiently small in respect to the primary, it might be possible to place it inside the primary and still have fairly loose coupling between the circuits. This is not recommended, however, and for best results the primary and secondary should be of the same diameter, or very nearly so, and well separated to keep the coupling loose. If three turns were in use in the secondary circuit and then the clip moved to the fifth turn, the effective coupling would change and it would be necessary to increase the distance between the coils. Similarly, if the number of turns in the secondary were reduced to one, then the secondary would have to be moved closer to the primary in order to keep the value of coupling the same.

The proper value of coupling is usually the point at which the primary and secondary are closest together and still give stable operation right on the resonance peak. If the coupling is too tight there is a tendency

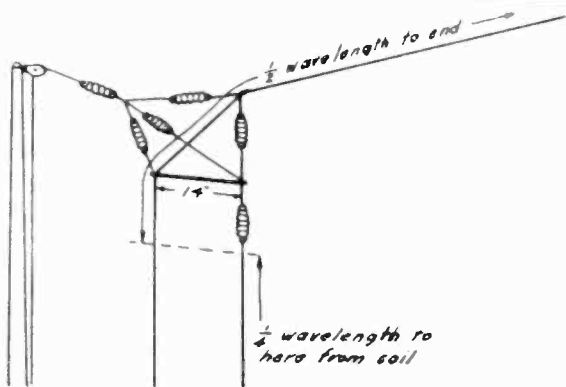
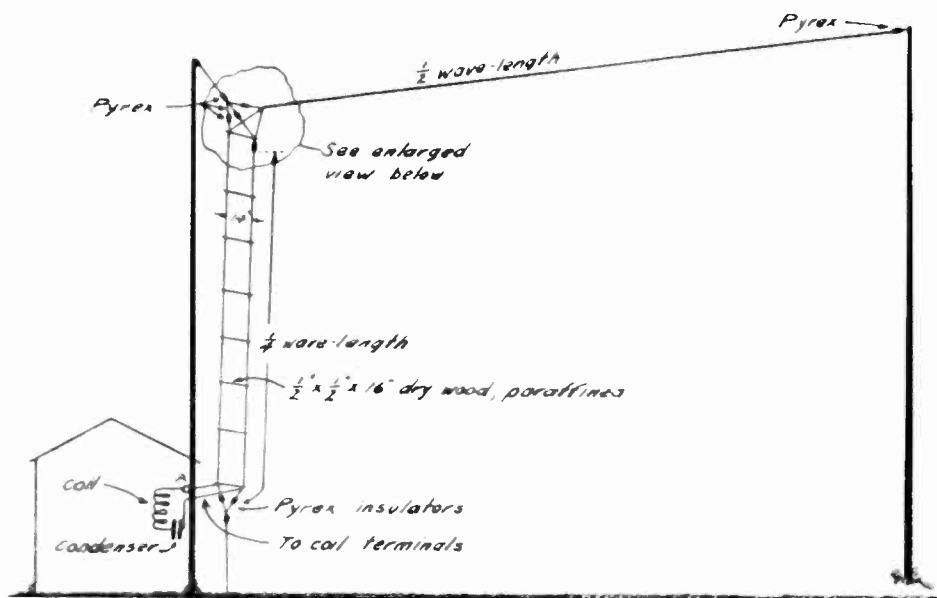

Details of Antenna.  
Enlarged View of Antenna Connections.

precious old poles of almost no use whatever. However, the radiator for which the following will give the construction, is one that can be used to good advantage where poles and masts from 30 to 100 ft. high are already in use.

The main, as well as the most advantageous feature in the Barrows antenna, is the non-radiating antenna feeder, or r. f. transmission line which reaches well up or out from the driver and surrounding building. This line is composed of two No. 14 enameled wires spaced uniformly at from 12 to 14 in. apart; with spreaders at intervals of 5 ft. These spreaders need be nothing more than dry stick  $\frac{1}{2} \times \frac{1}{2} \times 16$  in., soaked in hot paraffin. Where the lead goes into the building only porcelain tubes are necessary. This

ceived a report of a very steady wave and excellent signal strength when a regular hurricane, with both wind and rain, was raging at the station.

With reasonable care in measurements and the use of good insulators and well tied spreaders in this Barrows-Zeppelin type antenna there is little doubt that results will be well worth the effort expended.

If trouble is found in getting resonance with a driver on a certain wavelength, it is advisable to series a 23-plate variable in the long antenna lead. This condenser should be as close to the coupling coil as possible. If an antenna meter is used it should be just outside the condenser from the coupling coil. An ammeter is not necessary except in the absence of a plate mil-

for the tube not to draw its maximum input every time the key is pressed, especially when making dots. The result is that although good Continental characters are made at the key, it might sound like a Brasspounder of Nippon at the receiving end. Loosening the coupling to the proper value will rectify this difficulty. This value changes for every other adjustment of the circuit. Some stations are operated with tight coupling and the antenna slightly de-tuned from resonance. This will stop the paralyzing effect but when the coupling is too close, key clicks are apt to be radiated from the antenna.

There is a difference of opinion as to which end of the oscillator the antenna circuit should be coupled but the plate end is generally considered the best. The proper layout of a Hartley circuit is shown in Fig. 1.

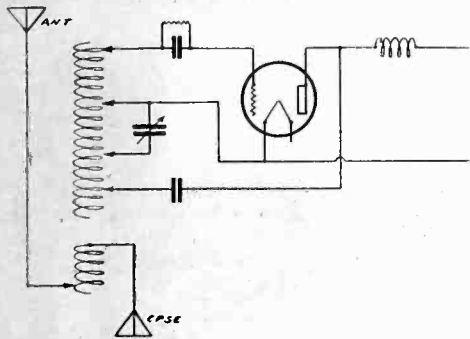

Fig. 1. Proper Layout of Hartley Circuit.

Be sure not to have any dead turns between the coils. Put the plate lead on the extreme end of the inductance and vary the space current with the filament clips. Put the counterpoise lead on the extreme end of the antenna inductance and vary the number of turns with the antenna clip. The primary tuning condenser should be shunted across the plate portion of the inductance rather than the grid portion as the electrical strain is not as great at that point. Sometimes when operating on very short wavelengths, the primary condenser is omitted and tuning is done entirely with the clips. This is rather clumsy and operation is not near so stable as when a smaller value of inductance is used with a primary tuning condenser.

### KEEPING FILAMENT VOLTAGE CONSTANT

By C. H. CAMPBELL, 11V

Since the description of Station 11V in December 1925 RADIO, I have had numerous requests for information about the extra winding on the plate transformer to keep the filament from "ducking" every time the key is pressed.

It is a well known fact that on transmitters, employing a plate potential greater than 500 volts, trouble is usually experienced in having the filament voltage vary as the key is operated, due to the additional power drawn by the plate. This constant flickering is a great strain on the tube and it will not stand that kind of treatment very long.

A few turns of flexible lampcord are wound on the plate transformer and connected in series with the primary of the filament transformer. The exact number of turns has to be found by experiment. At my station twelve turns are necessary to compensate for a drop of one-half a volt. With the right number of turns a voltage builds up in this winding which is just equal to the extra power drawn by the plate, and is fed into the filament transformer, thereby keeping the filament voltage at a constant value. If it does not work the first time reverse the polarity.

The QRA of Z-1AF is Gordon W. Smithson, 39 Surrey St., Ponsonby, Auckland, New Zealand. He is on 36 meters and any reports from American amateurs would be appreciated and promptly acknowledged.

# CALLS HEARD



By V. L. Rosso, Senatobia, Miss. from November 21 to November 29

1aci, 1ack, 1ajg, 1axo, 1bdm, 1bes, 1bs, 1bv, 1bv, 1ga, 1kw, 1yb, 2adk, 2adm, 2aey, 2ahk, 2ala, 2alt, 2apv, 2bir, 2box, 2bsc, 2buy, 2cd, 2cg, 2ci, 2ff, 2fo, 2gp, 2mu, 2aha, 2as, 2biw, 2bof, 2bwp, 2ckj, 2hu, 2im, 2ue, 2vx, 2yi, 2bk, 2cu, 2eo, 2eq, 2fa, 2fc, 2fp, 2jh, 2jr, 2jv, 2kw, 2oa, 2oy, 2ta, 2tx, 2vq, 2aar, 2aec, 2bh, 2bt, 2cco, 2che, 2dam, 2daq, 2vc, 2aij, 2jf, 2tuq. Canadian: 2au, 2dh, 2kp, 2xi, 2hp. Cuban: 2jo. Porto Rico: 4rl. Brazil: 1af, 1ib, 1rgt. Argentina: 1jz. Naval: nba, ncc, ndf, nkf, nvd. Commercial: wiz, wqo. Miscellaneous: fw.

By L. W. Bristol (6DN)

20 meters: 2ohm, 5atp, 7nx, 8er, 9cbb, 9sw, 9kv, nkf, wiz. 40 meters: 1aao, 1aap, 1off, 1aci, 1awe, 1axr, 1caw, 1cri, 1hs, 1rr, 1sk, 1sw, 1vc, 1wy, 1yb, 2acs, 2ahk, 2agu, 2agt, 2asa, 2aky, 2anm, 2apm, 2bir, 2cjo, 2cns, 2cbq, 2ds, 2ef, 2fo, 2kq, 2ku, 2kx, 2mu, 2zv, 3bw, 3cdv, 3ckl, 3dh, 3hs, 3jo, 3ld, 3lw, 4do, 4fo, 4gt, 4io, 4rm, 5acz, 5aph, 5aqu, 5ahs, 5afb, 5att, 5cc, 5ef, 5gn, 5gx, 5gj, 5he, 5hs, 5jf, 5ms, 5nj, 5jd, 5ph, 5qk, 5qw, 5uu, 5yd, 7af, 7eq, 7g, 7it, 7kg, 7li, 7ne, 7pz, 7tm, 7uj, 8avl, 8aly, 8bym, 8bqm, 8ban, 8baf, 8bpl, 8bcv, 8bkq, 8bzt, 8bqs, 8cjm, 8ckm, 8cau, 8ced, 8cct, 8cwk, 8ccl, 8dr, 8don, 8dpl, 8dbc, 8daa, 8dae, 8eq, 8ea, 8hb, 8jj, 8kc, 8jq, 8mc, 8pl, 9anz, 9awb, 9alt, 9ag, 9ang, 9aif, 9apm, 9adk, 9acq, 9acy, 9bz, 9bqa, 9bqb, 9bhp, 9bfp, 9bdw, 9bij, 9bkk, 9bvw, 9bcm, 9czz, 9cvm, 9che, 9cel, 9cep, 9ciw, 9cig, 9cw, 9ccj, 9civ, 9ckm, 9dpl, 9dat, (9dn), 9ddk, 9drz, 9dng, 9dl, 9ddh, 9dga, 9dx, 9elt, 9edz, 9efs, 9eel, 9gb, 9hp, 9ic, 9oo, 9ph, 9ql, 9mb, 9sg, 9tj, 9ua, 9wo, 9zt, c2bg, c4gt, c5ba, c5go, c5na, hu6aff, hu6buc, hu6dbl, egdvb, wiz, gd3, nkf, npg, nism, npo, npm.

By J. G. Tinney, 74 Kainui Road, Hataitai, New Zealand

1er, 1bg, 1ch, 1ka, 1sa, 1si, 1xu, 1yb, 1za, 1aao, 1hg, 1ahl, 1are, 1awe, 1axa, 1azl, 1bad, 1blu, 1cmx, 2ff, 2gy, 2mu, 2wr, 2xl, 2zb, 2ahm, 2aim, 2als, 2brb, 2cqq, 2cyw, 2xaf, 3cc, 3hg, 3ld, 3wn, 4cu, 4fl, 4iv, 4js, 4km, 4ku, 4rm, 4sb, 4si, 4tv, 4xe, 5ac, 5ak, 5ew, 5ft, 5gx, 5hy, 5jd, 5lg, 5ls, 5nj, 5nw, 5oq, 5uk, 5va, 5agn, 5aid, 5akl, 5akn, 5akz, 5ame, 5amf, 5amk, 5aph, 5asv, 5atv, 5aua, 5zai, 6bz, 6cd, 6ft, 6gu, 6hu, 6ji, 6jp, 6lj, 6ml, 6nw, 6tx, 6tz, 6ua, 6uf, 6vc, 6vr, 6wt, 6zb, 6zd, 6zh, 6zs, 6agk, 6ajl, 6ake, 6akm, 6akb, 6aum, 6bbv, 6bgb, 6bjd, 6bjj, 6buc, 6bvs, 6bvw, 6cah, 6ccv, 6che, 6cms, 6cmu, 6cuc, 6cqa, 6css, 6csw, 6dab, 6dah, 6dai, 6dam, 6dat, 6dax, 6xad, 7ek, 7it, 7lg, 7uj, 7uz, 7aek, 8ay, 8bg, 8eb, 8er, 8es, 8gz, 8pl, 8vt, 8adg, 8aly, 8bce, 8bgn, 8bnh, 8bpl, 8bqb, 8bwb, 8cau, 8ced, 8dn, 8dr, 8ek, 8hp, 8ic, 8uq, 8xn, 8zd, 8zt, 9ado, 9aj, 9akf, 9aod, 9bez, 9bbq, 9bwb, 9bwo, 9ccv, 9cd, 9cvm, 9cxx, 9czz, 9dac, 9dhk, 9djp, 9dlv, 9dmj, 9dng, 9dpx, 9drd, 9dvl, 9dvl, 9efs, 9ejj, 9eky, 9ets, 9kkv. Mexico: 1b, 1kix, 1af, 1aa, 9a, xda. England: 2cc, 2dx, 2kf, 2kz, 2lz, 2nm, 2od, 2sz, 5dh, 5lf, 5nn, 5qv, 6nn, 6rm, 6tm. Italy: 1au, 1co, 1er, 1mt, 1no, 1rt. Switzerland: 7de, 9ad. Dutch: o-ba, o-bq, o-sv. France: 8az, 8bf, 8co, 8et, 8ee, 8es, 8eu, 8fg, 8gm, 8hu, 8jbl, 8tok, 8weg, 8ca. Algiers: 8alg. Morocco: maroc. Belgium: 4yz. Japan: 1aa. China: npp. Sweden: smzs, smyy. Java: ane. Samoa: 6zac. Philippines: 1hr, nuqg. Porto Rico: 4rl, 4sa. Canada: 3aa, 4gt. Hawaii: fx1, 6ji, 6aff, 6ajl, 6cst. Argentina: aa8, afl, ah2, bal, bg8, cb8, db2, dd7, de3, dh5, fa3, fb5, ff9, fg4, ga2. Chile: 1eg, 1er, 2ld, 2re, 2rm, 9tc. Brazil: 1ab, 1ac, 1ad, 1gw, 2sp. Australia: 2ec, 2cm, 2cs, 2ds, 2gt, 2gw, 2jw, 2rd, 2rg, 2sw, 2yh, 2yl, 3ap, 3au, 3bd, 3bm, 3bq, 3kb, 3lp, 3qh, 3ul, 3yx, 4an, 4gd, 5aa, 5bg, 5da, 5lf, 5ww, 6cj, 7dx, 7gd, 7jb, 7om, 9dr (qra?) Log kept. Will qsl card with report sigs.

At U9DPX during November, 1925

a2BB, a2CM, a2CS, a2TM, (a2UI), a3AD, a3BD, a3KB, (a7JB), (a7PF), beBER, bz1AB, bz1AC, bz1AP, bz1IA, bzRGT, f8GI, fn2CO, g2KF, g5DH, hu6AJL, oA4Z, oA6N, p1HR, pr4SA, q2JT, rBA-1, rFA-3, rCB-8, rSGC, z1AO, z1AX, z2AC, z2XA, z4AL, ANE, f8Z, NISM, NISP, NISR, NTT, NVE, PB-3.

By Clarence Wolf, Jr.—3ABH, 1521 No. 16th Street, Philadelphia, Pa.

Detector only October 11th to Nov. 29th. 1aa, 1ai, 1ajk, 1are, (1awq), 1bfq, 1caa, (1cbg), (1chi), 1cjc, (1cot), 1pi, 1qv, (1ui), (1uu), (1zk), 2aav, (2acp), 2afo, (2afv), 2ahw, 2ajc, (2aje), 2akv, (2amk), 2amj, (2awq), 2bdi, (2bqb), 2bqq, 2bzz, 2ccl, (2cxl), (2cyh), 2av, 2bg, 2cp, (2cy), 2gp, (2ke), 2lm, (2od), 4bg, 4he, 4og, (4tg), 4vo, 4wg, (4wq), 5akn, 5apq, 5atp, 5bx, 5acz, 5ahc, (5amb), (5ane), 5aom, 5asi, 5ate, (5aul), 5azu, (5bay), 5bbl, 5bcz, (5bpd), (5bro), 5cap, (5cas), (5cgv), 5cjb, 5cju, (5cmw), (5cta), 5exp, 5dbn, (5dfo), (5dhh), (5dhx), 5dl, 5dpe, 5dqz, (5eu), (5eq), 5gi, (5iz), (5lp), (5wv), 9aai, (9ami), 9aub, (axb), 8bmm, 9bof, (9bvj), (9cax), (9clw), 9cxl, 9dew, 9dgv, 9dht, 9dlh, (9dxy), 9dy, (9ehg), (9eij), (9jo), 9kv, (9tv). Canadian: (3co), (AF2), 507 (Second character of this call fifteenth letter of alphabet and not zero). QRA of this station wanted. QRK mi 30 watts cw? A card goes out for every one that comes in.

By GRCS during Nov. 40-80

(1aci), (1ahl), (1ajo), (1azd), (1azr), 1axr, (1bes), (1blf), 1bqq, 1bvl, 1caw, (1cjl), (1cmf), 1af, 1fu, (1or), (1rd), (1pi), 1yb, (2ahk), (2anm), (2bkr), (2cvi), (2cvu), (2ev), (2cty), (2gp), (2kx), (2ll), 2mm, 2ak, 2zv, 3ad, (3aes), (3ash), (3afw), (3bit), (3bwt), (3blp), 3cdv, 3chg, 3ckp, (3cjm), 3hg, 3kg, (3jo), (3tr), 4cu, 4ch, 4fc, 4fl, (4ll), 4vo, 4tg, (8amd), 8bcj, (8bcu), (8bcv), (8bpa), (8aks), 8bbl, 8bcs, 8bau, 8bvw, 8bkm, (8bwr), (8bt), 8bzd, (8ccn), (8cgr), (8cgv), 8cjm, (8dr), 8dfr, (8psy), 8rh, 8rf, (8ry), 8aj, (8zk), (8tw), 8cbr, a-2yi, 2rg, 2ef, 2fo, 2kq, 2ku, 2cm, 2ds. New Zealand: 1ax, 2wa, 1ao, 4ac, 4af, 2ac. Misc.: (nq-2), nism, (m9a), 1-ier, g2sz, r-cb8, ch9tc. 50 watts here on 40 meters. Would appreciate any foreign reports of my sigs. All cards qsl'd. 6BCS, Route 1, Box 113, Gardena, Calif.

By U-6CHX during November

U. S.: 1vc, 1aao, 1biz, 1yb, 1caw, 1bqk, 1si, 1ana, 1ao, 1bhm, 1awl, 1cax, 1bdk, 1bad, 1hj, 1aae, 1bv, 1zq, 2agq, 2ajm, 2apm, 2bkr, 2br, 2bss, 2bsc, 2bl, 2cbg, 2cje, 2crp, 2ctq, 2cns, 2cvu, 2eo, 2co, 2mu, 2kx, 2kf, 2kr, 2pl, 2zv, 3ade, 3ckj, 3dh, 3ql, 3km, 4aa, 4fw, 4fl, 4iz, 4pz, 4rl, 4rm, 4rr, 4si, 4wl, 4we, 5ew, 5at, 5agz, 5agn, 5akl, 5alm, 5bn, 5kw, 5oq, 5uk, 5ph, 5zac, 6oa, 7ae, 7alk, 7ay, 7oy, 7mz, 7rl, 8aly, 8bgn, 8bgi, 8bkm, 8cvd, 8cjm, 8dgi, 8dfo, 8dno, 8gz, 8hw, 8xl, 8zz, 9ara, 9aim, 9akb, 9xj, 9bsa, 9bxq, 9bfp, 9bmt, 9bmv, 9cvm, 9cwo, 9cmo, 9cfn, 9ctq, 9ddh, 9dng, 9dms, 9dge, 9eez, 9ejj, 9elt, 9ecc, 9ef, 9gw, 9fj, 9bx, 9hp, 9ek. Australia: 1ax, 3ak, 2yi, 3ef, 3an, 3kb, 2cm, 2jw. New Zealand: 2ac, 2xa, 3ad, 3am, 4az, 4as, 4ac. Italian: 1as. Philippines: 1ar, 1cw, 1hr, nuqg. Ships and shore stations: gdyb, wyi, bam, fw, nuw, npm, npu, ngy, narj, wyd, neq, npz, nism. South Amer.: r-af1, r-b5f, r-db2, r-ga2. All heard between 35 and 45 meters.

By R. Lorain, October 24th to 31st between 3°30' S. and 8°31' S, long. 119 E. and 125°30' East. Distance for Americans between 8000 and 12000 miles.

American: 2zv, 4bu, 4iv, 4ku, 5ach, 5agl, 5agn, 5ahp, 5jd, 5gv, 5uk, 6am, 6alv, 6ajl, 6bg, 6bgc, 6bh, 6buc, 6dah, 6ea, 6ht, 6ol, 6rn, 6vr, 7ay, 7bg, 7jb, 7uj, 7ya, 8cgr, 8pl, 9ado, 9bdw, 9che, 9dhh, 9dng, 9drd, 9ek, 9zk, 9zt. Australian: 2ag, 2dj, 2gq, 2rg, 2sw, 2tm, 2ui, 2yh, 3bd, 3yx, 5ah. New Zealand: 1ao, 2xa, 4ac. Mexico: 1aa. Philippines: 1dl, 1rx, 1au.

At Macao and from Macao to Celebes Sea. Forty meters band.

American: 2bbg, 5ag, 5agu, 5aua, 5asv, 4gt, 6afa, 6ag, 6aff, 6ajm, 6ake, 6bj, 6bjk, 6bjd, 6bgv, 6bjx, 6bq, 6cgw, 6cto, 6che, 6rv, 6vc, 6nx, 6zac, 6zk, 6xhq, 9cfv, 9eae. Australian: 2bb, 2lo, 2tm, 2nqg (?) 2cm, 2yl, 2ay, 2kg, 3yx, 3bg, 3et, 3tm, 3em, 3ds, 3kb, 3gm, 5oq, 5aa, 5ah, 5kn. New Zealand: 1ax, 1ao, 2ac, 3am, 4ak. Canadian: 5bg. French: 8tk. Philippine Isl.: 1hr, 1cw, 1dl, 1rx.

By 9AGO, Joseph C. Fortelka, 2253 Marshall Blvd., Chicago, Ill.

1aae, 1aci, 1aol, 1alf, 1af, 1ajg, 1atv, 1awe, 1cal, 1caw, 1ckm, 1cre, 1cvf, 1ga, 1pl, 1xm, 1yb, 1yc, 1yd, 2aa, 2aau, 2ahm, 2akb, 2akg, 2akp, 2asp, 2cv, 2cuf, 2cxl, 2ff, 2fk, 2fo, 2kg, 3bzm, 3jw, 3ld, 4bu, 4cs, 4cu, 4dk, 4fl, 4gw, 4ib, 4rr, 4ua, 5acy, 5ado, 5agq, 5alm, 5aol, 5ary, 5atx, 5cc, 5dq, 5ew, 5gx, 5hy, 5jd, 5oq, 5ph, 5aj, 5rg, 5sh, 5sp, 6ajm, 6akm, 6bjd, 6bpm, 6bq, 6cco, 6cgw, 6clp, 6cqa, 6cvc, 6dag, 6das, 6dek, 6dgv, 6dps, 6ea, 6ec, 6hm, 6kb, 6rm, 6-w, 6sb, 6vc, 6wt, 7gb, 7if, 7ll, 7xa, 83ak, clar, c2ax, c3fc, faqr, mlj, mlaf. Sweden: sfd, z1ao, z2ad. Misc: 9s8, cv, fw, kes, nkf, wir, wiz, wqo.

(Continued on Page 68)

# FROM THE RADIO MANUFACTURERS

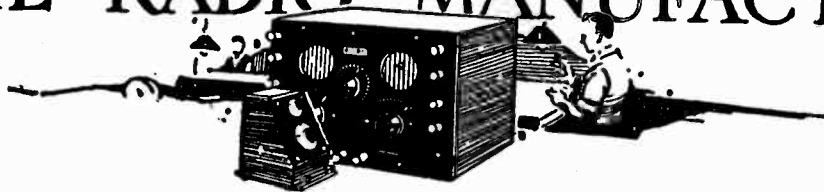

The new Amsco socket is designed to take all sizes of tubes using the UX or CX base without need for an adapter. It gives a positive wipe contact which locks the tube into place. It is exceedingly

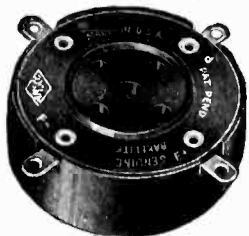

compact and light in weight and has a non-skid one-hole mounting. It is made of mottled green bakelite with metal parts of phosphor bronze, tinned where soldering is to be done.

The Victoreen superheterodyne transformer has been designed to have a very sharp resonance curve so as to give great selectivity even with an aperiodic primary and so as to prevent interstage oscillation. It is claimed to give satisfac-

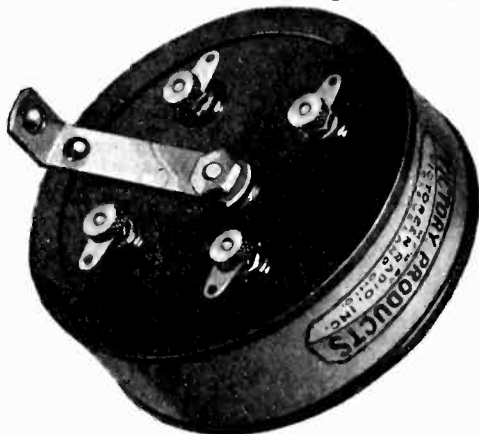

tory operation with unmatched tubes of either dry cell or storage battery type and with potentiometer control of volume. It is resonant at an intermediate frequency little affected by harmonics.

The Pacent superaudioformer is a 3 to 1 ratio transformer designed for power amplification with plate potentials up to 500 volts. It is claimed to give uniform amplification from 100 to 8000 cycles and

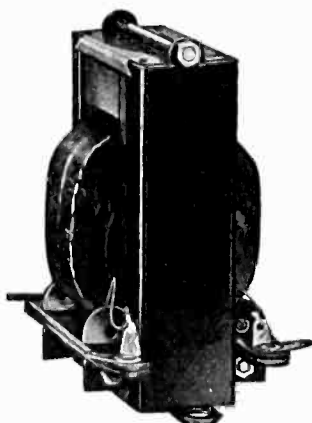

may be used in any stage. It has a high primary impedance, low secondary capacity, and a large laminated core of alloy steel.

Lastite is a simple means for making tight soldered connections. As may be seen in the sectional view it consists of a threaded nut, that can be screwed onto the binding post of a socket, trans-

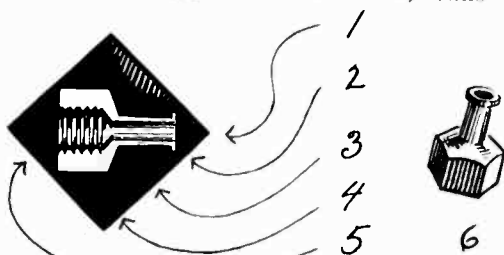

former or other radio part, and of a small tube into which a wire is put preparatory to soldering it to the flange on the end of the tube. This leaves both hands free for the soldering operation.

The socket tube reviver is a simple apparatus for reactivating thoriated filament tubes by the flash and aging principle. It can be attached without cord to

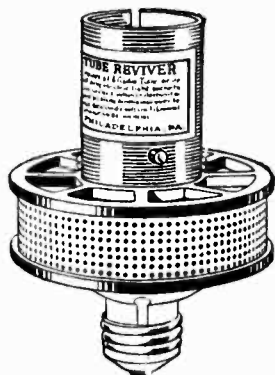

any 110 volt lighting socket. A small button of the side enables the tube to be "flashed" at high voltage for 45 seconds and then the tube is aged at low voltage for ten minutes.

The Pacent Isolantite adapter fits a small UX-base tube, such as the UX-120 or UX-199, to a standard Navy type of tube socket. The shell is provided with four holes, one larger than the other



three, to take the four prongs of the small UX base. A lock screw holds the tube in the adapter while a pin assures proper engagement with the bayonet slot of the usual socket.

The carborundum stabilizing detector unit has been especially designed for use with reflex sets using a. c. power. It uses a fixed carborundum crystal as a detector and a small dry cell and potentiometer which may be adjusted so as to give a "biasing" voltage which cuts down

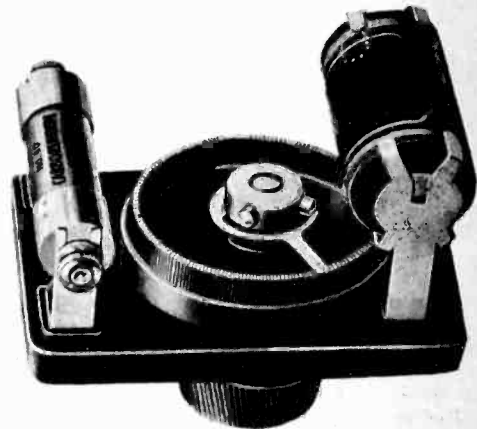

the effective resistance of the crystal and thus increases its sensitivity. By increasing the resistance slightly the selectivity is improved. Or this damping regulator may be used to control self-oscillation in a reflex set.

The Tune-Rite dial is a vernier dial geared so that when used with a semi-circular plate condenser the pointer gives a straight line frequency reading. The separation of the low wavelength

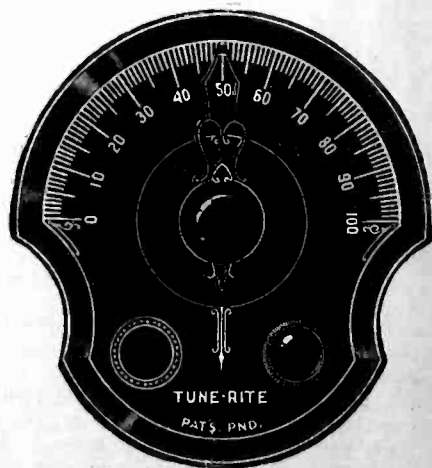

stations at the lower end of the dial is about the same as the high wavelength stations at the upper end. This dial is made in styles that readily convert any old condenser to a straight line frequency reading.

A piece of rubber hose, such as may be purchased from any druggist for a few cents, makes a good lead-in insulator, where the wire must be run under or on top of a window. The wire may be threaded through the hose, and the window closed as usual. A few tacks to hold the hose in place may be required.



# BUILD THE Camfield DUODYNE!

Nothing like it has ever  
been known before!

It is a Five Tube Tuned Radio Frequency Circuit using a new  
and Highly Efficient system of preventing oscillations.

*Sensitivity — Selectivity — Tone Quality*  
combined to give results  
never before obtainable!

*Build It Yourself with Camfield Parts*

at half the cost of a good five tube Receiving Set! The fol-  
lowing Camfield Parts are essential for use in the Duodyne  
Circuit:

1 Type 22K Camfield Duoformer Kit.....	\$10.00
3 Type 886 Camfield Straight Line Variable Condenser, each.....	\$ 6.00
5 Type 11 Camfield Bull Dog Grip Socket, each .....	.65c

**Write Direct to the Home Office for  
Complete *Free* Descriptive Literature**

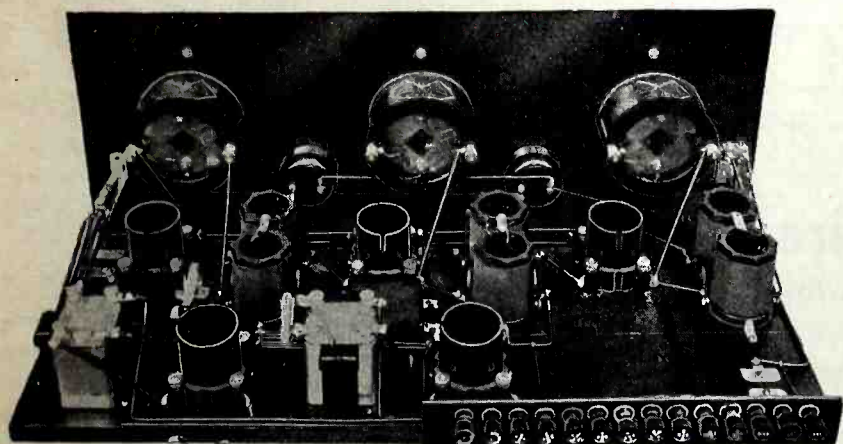

Rear Panel View, Showing Position of Parts and Wiring.

telling all about the Duodyne  
Circuit and Camfield Parts,  
giving us the name of your  
radio dealer.

#### DEALERS:

Our Sales Policies protect  
your profits and those of  
your jobber. Write us on  
your business letterhead for  
complete information about  
the Duodyne Circuit, Cam-  
field Parts and Dealers'  
Prices, giving us the name of  
your jobber.

## CAMFIELD RADIO MANUFACTURING COMPANY

Home Office

829 HARRISON ST., OAKLAND, CALIF.

Branch Office

1268 WEST 115th ST., CLEVELAND, OHIO

## HOW TO READ CIRCUIT DIAGRAMS

(Continued from Page 32)

circuit is shown leading to the *B* battery, by the thin black line. In the secondary of the 1st audio transformer is induced low frequency a.c. which is in turn amplified by the 1st audio tube and in a like manner passed through the next audio transformer and into the last amplifier tube, where the signal is heard in the plate circuit by the headphones or loud speaker. In each audio amplifier filament circuit the audio frequency path is shown in parallel with the d.c. filament lead, only one path being shown, in the negative lead.

The reflex set produces a very strange combination of the three forms of current, as is shown in Fig. 6, which is a diagram of a two tube reflex with crystal detector. The first vacuum tube acts as both radio and audio frequency amplifier, so that the alternating current paths are more complex than where the vacuum tube is used for only one purpose. The high frequency path is from the antenna circuit through the tuner to the first tube, where it is amplified and passed through the radio frequency transformer to the crystal detector circuit where most of it is rectified and converted into audio frequency. The latter pass through the audio frequency transformer shown in the dotted lines, and into the grid circuit of the first vacuum tube. In order that the radio frequencies will have a low resistance circuit, the .00025 and .002 mfd. by-pass condensers shown in red are placed in the circuit, as otherwise, the presence of the audio frequency transformer windings would retard the flow of radio frequency and impair the efficiency of the set. The first vacuum tube amplifies the audio frequency, which passes through the primary of the r.f. transformer to the primary of the 2nd audio transformer, from which it enters the grid circuit of the 2nd vacuum tube and is amplified to loud speaker or headphone volume.

Other radio circuits having more vacuum tubes with associated apparatus will represent elaborations of Figs. 5 and 6, but will be similar in principle and not difficult to analyze if the color charts are retained for ready reference, and the various parts of the circuit separated into the components.

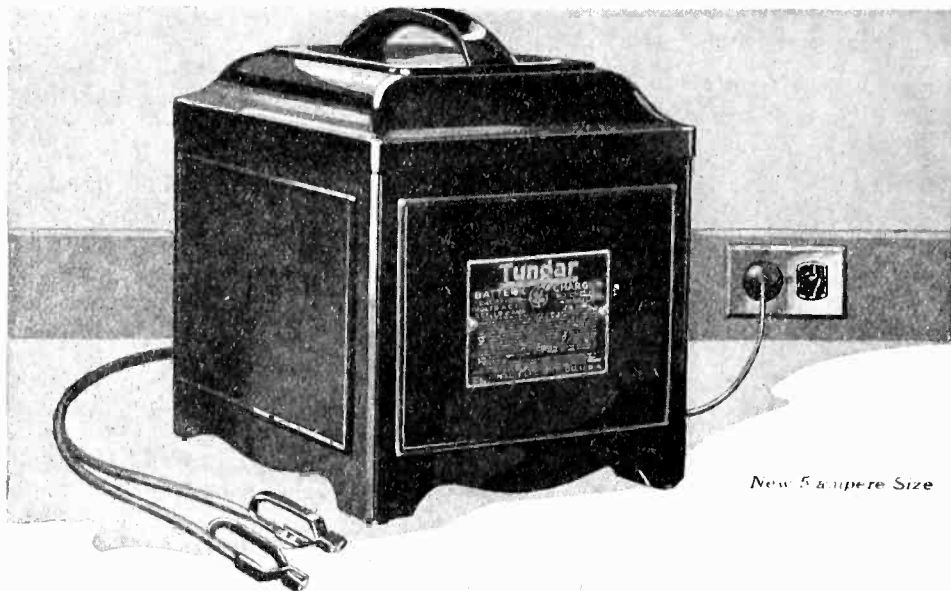

# Say Tungar

when you want the best battery charger



The Tungar is a G-E product, developed in the Research Laboratories of General Electric.

The new Tungar charges any make and size of storage battery: radio "A" and auto batteries, and "B" batteries as high as 96 volts in series.

East of Rockies

Two ampere size \$18.00  
Five ampere size \$28.00  
60 cycles . . . 110 volts

Merchandise Department  
General Electric Company  
Bridgeport, Connecticut

"Tungar" is fast becoming the word for battery charger. And no wonder!

Tungar is the trouble-proof, easy-to-use charger for *all* batteries. It's the original bulb charger. It's manufactured by General Electric. It makes no disturbing noise. It can't blow out Radiotrons.

## Tungar

REG. U.S. PAT. OFF.

**BATTERY CHARGER**

Tungar—a registered trademark—is found only on the genuine. Look for it on the name plate.

# GENERAL ELECTRIC

## The "Windham" Wire Former

A Handy Tool for

Electricians, Radio Fans and Mechanics

This rugged little tool not only makes accurate loops or eyes for No. 4, 6, 8 and 10 screws, but will make either sharp or easy radius right angle bends, and the sharp cutter will cut the toughest wire as well.

It is drop forged of the very best steel and carefully tempered in oil.

Retails for \$1.25

Dealers and Jobbers send for full information. Desirable territory still open.

## THE GOYER COMPANY

Willimantic, Conn., U. S. A.





# Modernize Your Radio Set



Type 365  
Rectifier Transformer  
Price \$10

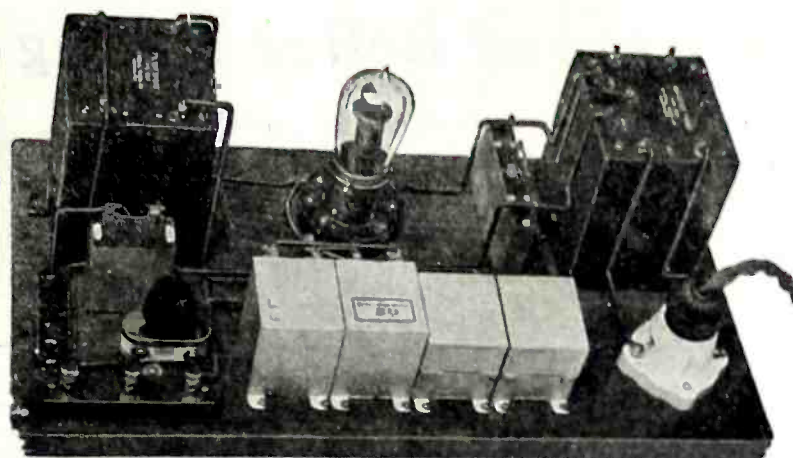

Type 366  
Filter Choke  
Price \$10

## Build a Practical "B" Eliminator

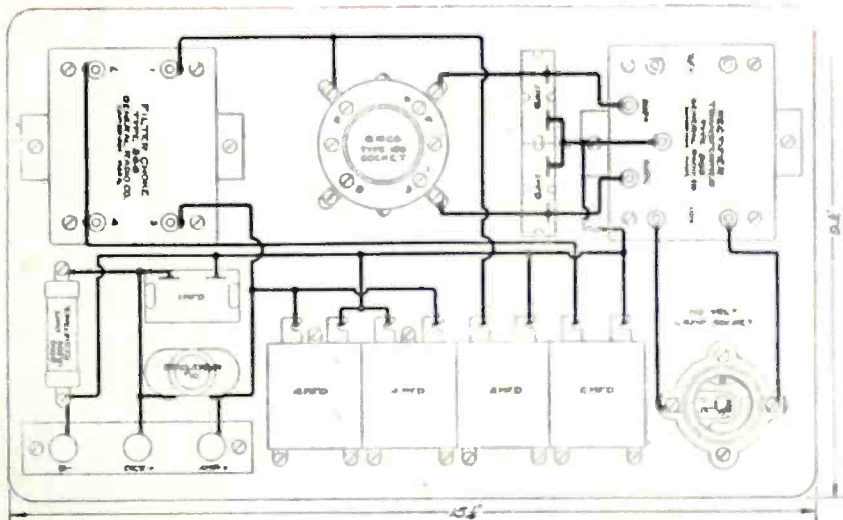

Raytheon  
Rectifier  
Tube  
Price \$6



Type 156  
Standard  
Socket  
Price \$1

The popular topic of discussion among set-builders today is "B" Battery Eliminators." Many set owners are anxious to modernize their receivers by the use of plate voltage supply units instead of "B" batteries.

The above diagram shows the arrangement of parts and connections for an efficient "B" battery eliminator using the new General Radio Type 365 Rectifier Transformer and Type 366 Filter Choke. These transformers give very satisfactory results in a plate voltage supply unit when used with the new Raytheon rectifier tube or other tubes of similar characteristics.

For further description refer to page 9158 of our new Bulletin 923-C, or write for our circular "Instruction for Building a 'B' Eliminator."

General Radio Co., Cambridge, 39, Mass.

# GENERAL RADIO

## INSTRUMENTS

*"Behind the Panels of Better Built Sets"*



# BREMER-TULLY

## Pioneers of Better Tuning

In every industry certain names stand out as synonyms for quality and reliability. It has been the good fortune of the Bremer-Tully Manufacturing Company to achieve that distinction in radio.

Jobbers of B-T Radio Apparatus coined the B-T slogan:

**"B-T never put out a radio part that was not an outstanding success."**

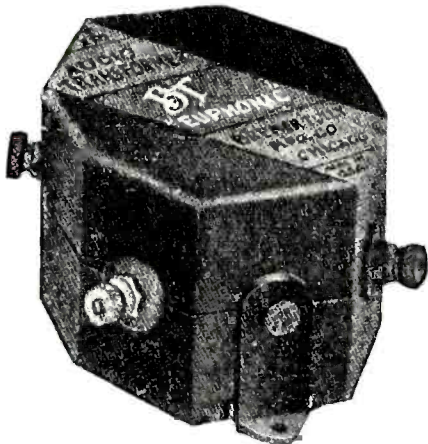

2.2 to 1 \$5.00 4.7 to 1 \$5.75

## "EUPHONIC" "Pleasing to the Ear"

No other product ever attained such instant approval as the Euphonic Audio Transformer. No other B-T product ever created an equal national demand, or grew so rapidly into national distribution. The only explanation lies in the faith of the Radio Public in B-T ability,—and the fact that the Euphonic Transformer demonstrated its quality on every test.

**The Euphonic is an entirely new conception in design.**

It is not over-size in iron, but amply proportioned, and with a scientific core distribution that is the result of 20 years of Radio and Wireless experience.

There is, however, a great increase in the much more expensive copper,—both primary and secondary being far in excess of ordinary practice.

Tonal quality over the full range and maximum amplification on both high and low notes make the Euphonic superior in our estimation to any other form of audio amplification. Try it and you'll agree.

The Euphonic offers the first remedy for distortion due to crossed wires. Movable legs permit mounting in almost any position, and the appearance is equally pleasing in any position.

## The B-T TUNING CONTROL

Says Mr. L. J. D. of Toronto:

*"I certainly like your new dial. Your goods don't need recommendations; they speak for themselves. One can buy them knowing they are getting the best."* L. J. D.

The B-T Tuning Control combines excellent appearance with the utmost in mechanical efficiency. It is the only dial that is good for either right-hand or left-hand condensers. It reads in degrees, station wavelengths, or station call letters. Ratio 12 to 1. The B-T is the original window dial.

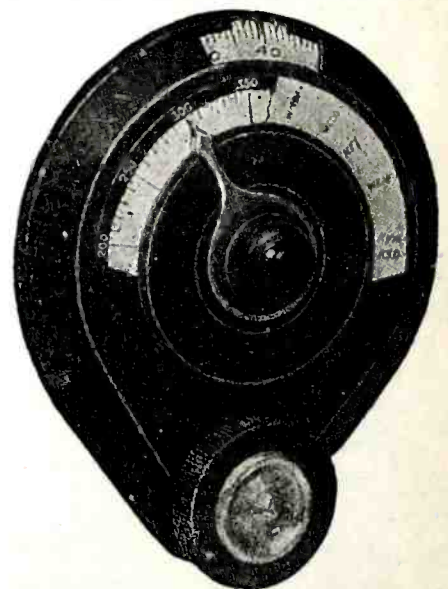

Black and Gold \$2.50

## B-T "LIFETIME" CONDENSERS ARE ACKNOWLEDGED LEADERS

Have You Read "Better Tuning?" Mr. A. F. B., Ft. Wayne, Ind., Says:

Ft. Wayne, Ind., Oct. 16, 1925.

*"I consider 'Better Tuning' one of the best and most sensible booklets ever issued by any radio manufacturer."*

A. F. B.

## Bremer-Tully Manufacturing Co.

532 South Canal St.

Chicago, Illinois



# THE B-T "SILENT" SOCKET

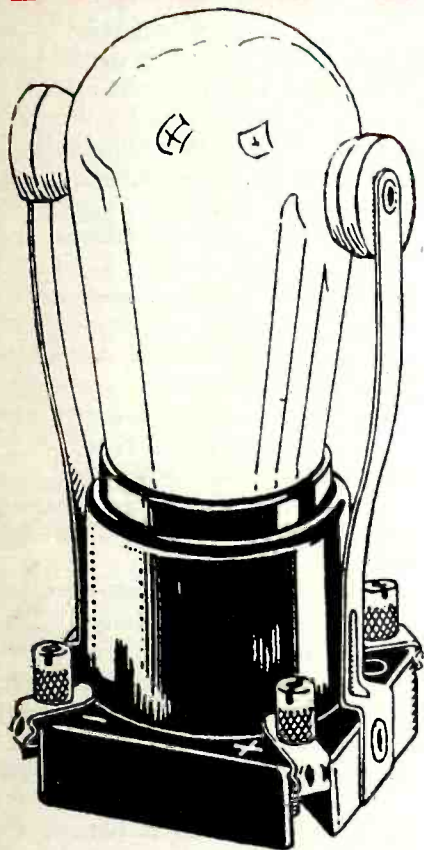

The "Silent Socket" includes a regular B-T Universal Socket. \$1.25

All radio has been searching for months for a remedy for microphonic noises.

B-T Laboratories had tried every conceivable means of springs, cushions, flexible mountings and even the complete suspension of the tube without success.

And then it was discovered that instead of floating the tube, what was needed was shock absorption of entirely different nature.

The "Silent" Socket is the result.

It has cured every case yet found, and the worst cases have been sought out for test.

Put one on your detector.

## The B-T TOROSTYLE TRANSFORMER

The B-T Torostyle Transformer,—heart of the unequalled "COUNTERPHASE"—the only new circuit of the season.

(Patented June 23, 1925.)

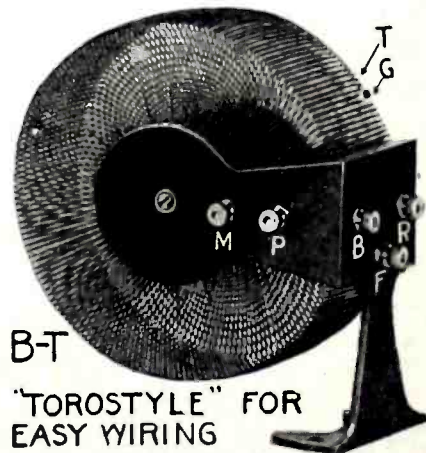

B-T "TOROSTYLE" FOR EASY WIRING

(Patented Nov. 20, 1925)

Torostyle Transformers in three styles: TA Antenna Coupler, TC Intermediate, T4 for one stage radio, each \$4.00

### Read what they say about Torostyle Transformers:

Kansas City.

"The Counterphase is in every particular by far the most efficient receiving set that I have owned or heard in operation. One stage of audio is quite sufficient for ample loud speaker reception in five rooms of all class B stations in the U. S., and many class A."

J. E. M.

Chicago.

"November 9th, outside of the usual run of distant stations the following were picked up from Chicago Heights: Miami Beach, New Orleans, New York, Denver, Springfield, and FOUR DIFFERENT STATIONS IN CALIFORNIA."

C. B. M.

Cincinnati.

"Summarizing tests on Counterphase Set I can safely say it has more volume, greater selectivity, greater sensitivity, and produces higher quality of reproduction than any receiving set I have ever heard."

A. C. H.

Kit No. 5 for the patented 5-tube Counterphase \$28.50.

Kit No. 6 for the 6-tube Counterphase \$38.00.

The 9-color wiring diagrams have never been approached in radio. They leave no room for error.

### B-T PRODUCTS INCLUDE:

Condensers, Tuners, Aircore Transformers, Sockets, Dials, Modulators, Variable High Resistances, Potentiometers, Choke Coils, Mikro-Mike Condensers, Audio Transformers, "Nameless" Kits, Counterphase Kits, and

**Complete Receivers**

## Bremer-Tully Manufacturing Co.

532 South Canal St.

Chicago, Illinois

## A Certified Check Against Distortion

As clear and mellow as chime sounds—let the "Electrad" Audiohm banish that stuttering, sputtering reception forever.

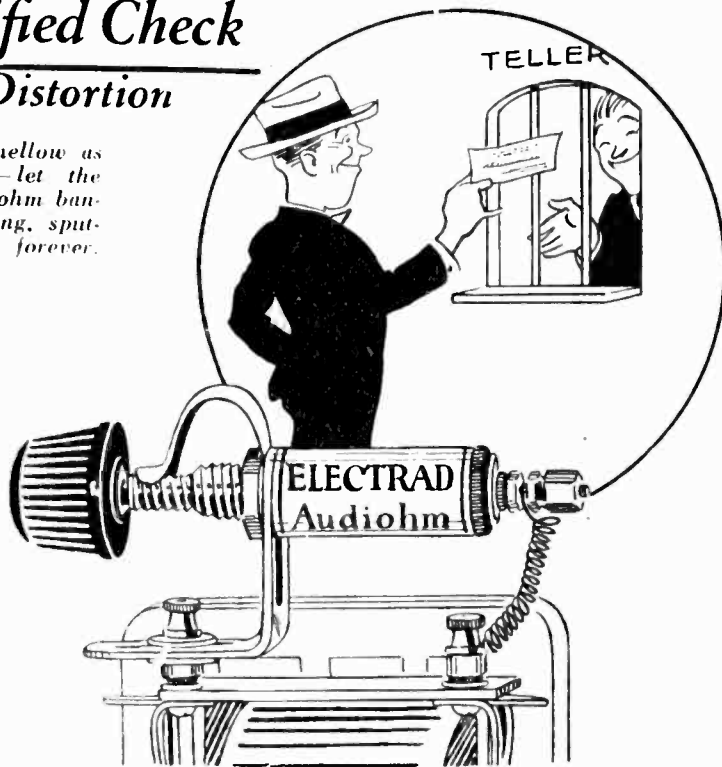

**I**F you want pure tones, clear and true, whether high, low or medium pitch, improve your set with the Audiohm. It insures reproduction that will equal in smoothness and richness the original tones of the instrument or voice—it makes any good set better.



"ELEGTRAD"  
LAMP  
SOCKET  
ANTENNA  
Price 75c

Plugs in on any light socket. Reduces static and other interference. No outdoor aerial needed.

Every receiving set with one or more audio transformers needs one of these tone, quality and volume controlling devices. Simply install it across the transformer secondaries.

Price \$1.50 at all good radio stores.

# ELECTRAD

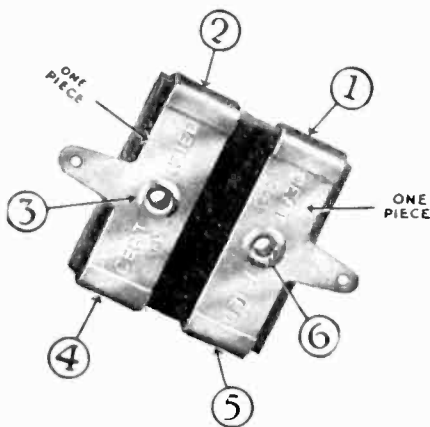

"The Six Point  
Pressure Condenser"

THE "Electrad" Certified Fixed Mica Condenser is a revelation in accuracy and design. Ingenious, rigid binding and firm riveting fastens parts securely at six different points insuring positive electrical contact. Impervious to temperature and climatic variations. Exerts even pressure upon the largest possible surface—can't work loose. Binding strap and soldering lug in one piece. Accuracy and quietness assured always. Value guaranteed to remain within 10% of calibration. Standard capacities, 3 types. Licensed under Pat. No. 1,181,623, May 2, 1916 and applications pending. Price 30c to 75c in sealed dust and moisture-proof packages.

Ask your dealer or write for **FREE**  
Descriptive Folder.

## ELECTRAD, INC.

428 Broadway  
New York City

Variohms, Audiohms, Lightning Arresters, Lead-Ins and many other "Electrad" radio products are on sale at your dealer's. Sent direct if he can't supply.

## EIFFEL TOWER SHORT WAVE TRANSMITTER

(Continued from Page 10)

It should be noted also that no oscillating currents are present in either the grid or plate wires, and these may therefore be placed as best suits the constructor, without fear of undesirable feedback effects, or other inconveniences which may be experienced in single valve oscillating circuits. Indeed, in the case of a single valve, it is necessary to use both the grid and plate connections from the filament if the circuit is to oscillate, which makes it almost imperative to use choke coils to cut out stray oscillations in the parts of the circuit where they are not desirable.

It is possible, when using two or more valves which have been previously matched as to characteristics, to obtain a transmitting circuit of remarkable stability, to which is coupled the radiating system.

At the Eiffel Tower station, six valves, rated approximately at 250 watts were disposed in two groups of three each, and connected according to the balanced method. The filament circuits were connected in parallel, and the plates and grids of one bank connected similarly to the corresponding elements of the other. The peculiar construction of the French tubes made this very easy, and the laboratory men designed a clever rack for quick change, in case of a burn-out.

Directly above the bank of valves, the frame on which had been wound all of the coils was mounted. Wood and hard rubber were used in its construction, and its main requirement is rigidity and good insulation.

Although either the plate or grid coils may be coupled to the antenna coil in this case it is the latter. Herewith are given the various values of the coils and windings:

The antenna coupling coil consists of two turns of stranded wire, about  $\frac{1}{2}$  in. apart and wound on a form of  $7\frac{3}{4}$  in. in diameter. For the grid coil, which is wound in two sections, each having the following: five turns, spaced  $\frac{3}{16}$  in. apart, on a form 15 in. in diameter. The grid coil is wound on the same form, and the winding spaced  $\frac{3}{8}$  in. apart, with five turns. The method used at the Eiffel Tower laboratory for the mounting of these coils can be seen in the pictures of the installation. All of the connections are made as direct and rigid as possible and in the Tower station, stranded wire, such as used in the antenna itself forms the inductances. It might be more efficient to use brass strips, either flat, or edge-wise wound.

The experimenter in order to follow the effects of the various changes in tuning the circuit, should have a plate milliammeter, a filament voltmeter, and an antenna hot-wire, or thermo-ammeter.

(Continued on Page 48)



# SM

# SILVER SIX

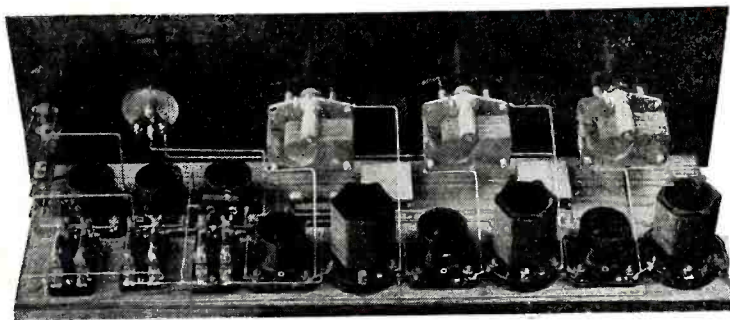

## FACTS THE "WHY OF THE SIX"

*As described in Radio Broadcast for January.*

**SELECTIVITY** is such that out of town stations may be brought to Chicago through twelve powerful local stations. Selectivity can be regulated at will, from a degree satisfactory for ordinary reception, up to the surprising limit where side-bands are cut.

**SENSITIVITY** is so great that nothing will surpass the "Six" except special laboratory-built super-heterodynes. Either coast may be brought in to Chicago during the summer months on a small antenna—in many cases on a loop.

**FLEXIBILITY** permits the use of antenna or loop with either detector, one or both stages of radio frequency amplification. Interchangeable R. F. Transformers, with adjustable antenna coupler, permit operation on all waves from 50 to 550—or higher if desired.

**VOLUME** is so great as to paralyze any but the best loud-speakers. Yet it may be adjusted to any degree by a single knob.

**QUALITY** cannot be excelled, due to resistance coupled amplification. It is the only receiver that will bring real appreciation of "cone" speakers.

**CIRCUIT** consists of two stages of R. F. amplification with special oscillation control uniformly effective at all wavelengths, grid-biased detector and three stage resistance coupled audio amplifier.

**EASE OF CONTROL** allows use of one, two or three dials at will.

**TUBES** may be either dry cell or storage battery, with UV201-A's recommended. "B" Battery Consumption at 135 volts is below 10 milliamperes—less than one-third that of other six-tube receivers.

**ASSEMBLY** requires but a few hours, using only parts supplied in kit.

The "SIX" has taken the storm. Thousands have built the "SIX" and thousands are building it today. Their letters say it is the marvel of Radio—and it is truly a great receiver. It has everything that makes for perfect reception, and still it is so simple that any novice can build it and get the same amazing results as an expert.

*Write for Mr. Silver's description of his new "SIX"*

TYPE 600 KIT, including all parts necessary to build the Complete "SIX"..... **\$53.00**

TYPE 610 KIT, essentials only, including 3 condensers, 3 inductances and 3 inductance sockets..... **\$27.75**

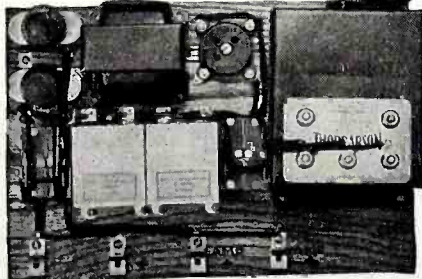

*See These and Other S-M Products at Your Dealer's*

### New Long Wave Coils

S-M Interchangeable Inductances for European wavelengths are now available. These new coils necessitate no circuit changes—they need merely be plugged in, in place of present sizes. Regular Type Numbers apply.

### For the "Silver Six"

The following coils are needed for the foreign wavelengths:

550-1200 Meters	1200-1800 Meters
2-112 D Coils	2-112 E Coils
1-110 D Coil	1-110 E Coil

### For the Improved "Silver Super"

Described in January "Radio News," the following coils are needed:

550-1200 Meters	1200-1800 Meters
1-110 D Coil	1-110 E Coil
1-111 D Coil	1-111 E Coil

### PRICE—ANY TYPE NUMBER

D Range	\$3.25
E Range	3.50

### The Improved Raytheon-Thordarson "B" Eliminator

This Eliminator will deliver from 20 to 200 volts at three different, adjustable voltages with maximum current of 50 milliamperes—more than enough for the largest receiver.

The S-M Type 650 Kit includes Thordarson Transformer, choke, Tobe Condensers, genuine Raytheon Tube, Bradleyohms and all necessary parts.....\$34.00  
Assembly Instructions by McMurdo Silver.....10c

### Thordarson Power Transformer

Endorsed by McMurdo Silver as the finest available. Its curve is a straight line—its quality cannot be improved on. Price each.....\$8.00

### Mail This Coupon

Silver-Marshall, Inc., Chicago, Ill.—106

Gentlemen: Please send me:

**A**—Complete building data on the Silver "Six," for which I am enclosing 50c.

**B**—Descriptive circulars on S-M Products.

**C**—Assembly instructions for S-M-Thordarson Raytheon "B" Eliminator, 10c.

Name.....

# Silver-Marshall, Inc.

106 South Wabash Avenue, Chicago

# SUPERADIO

\$56

5-Tubes

2-Dials

Individual  
R. F. Control



No "Crowding" on the  
Lower Wavelengths

Low Loss Straight Line Frequency Condensers in the tuning circuit provide a very pleasing separation of stations so that the usual "overcrowding" at certain points on the Dials and "dead spots" on other points is avoided. Further, the ingenious use of these Condensers makes possible EXTREME selectivity *without the usual critical adjustment*. This ease of tuning makes the Superadio the ideal Set for a woman to operate.

This is but ONE of many EXCLUSIVE Superadio features. Write for full descriptive literature. It will prove illuminating.

## SUPERADIO B-BATTERY ELIMINATOR

Another Superadio success by the manufacturers of the famous Superadio Dynamometer. Provided with taps for precise voltage adjustment, as follows: "B" Taps: Det.—4 to 35 volts variable; Amp.—45 volts; Amp.—67½ v.; Amp.—90 v.; Amp.—135 v. "C" Taps—4½ volts; 9 volts; 4 to 40 volts variable.

Type A for B and C Batteries.....\$35.00  
Type B for B Batteries.....\$25.00

DEALERS: Good Territory Open. Write

**De WITT-La FRANCE Co., Inc.**

54 Washburn Ave., Cambridge, Massachusetts

Boston Representative:

Martin, Hartley & Dewitt Sales Co., 99 Bedford St.

Chicago Representative:

William A. Welty & Co., 36 So. State St.

## Burns LOUD SPEAKER With Concert Unit

The large size of this Unit gives great range with tone of most pleasing quality, which, combined with the special amplifying properties of the Burns horn, produces remarkable results. A speaker that will add to the enjoyment of any receiving set. Pleases the eye as well as the ear.

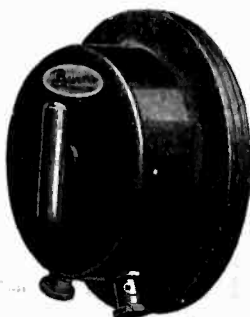

Horn is of a distinctive design with pyralin flare in several handsome finishes.

No. 205B—With Black Flare.....	\$22.50
No. 205D—Mahogany Tinted Flare.....	25.00
No. 205P—Mother-of-Pearl Flare.....	30.00
No. 100 —Medium Phonograph Unit.....	10.00
No. 120 —Concert Phonograph Unit.....	12.00

At your dealer's, or write direct to manufacturers

*American Electric Company*

State and Sixty-fourth Streets

CHICAGO, U. S. A.

(Continued from Page 46)

These instruments are the minimum required and for best results, each valve should be equipped with its individual rheostat, so that the filament current of each tube may be carefully regulated.

The method used for the keying is the so-called "grid resistance" control. In this case, the resistance is the grid to plate resistance of small vacuum tubes.

Four small 50-watt tubes, connected also in a balanced circuit, form the grid resistance. By varying the grid resistance through the negative battery of sixty volts which can be switched in the circuit by means of a relay and key, the oscillations of the main battery of oscillating valves can be controlled nicely, and the dots and dashes of the code formed.

The type, and number of valves to be used depends of course upon their characteristics, and their ability to handle the grid current of the oscillators. It will be found that a smaller valve than that required in the main oscillating circuit can be used successfully here. The method of connection is given in Figure 1.

It was found unnecessary in the Tower short wave transmitter to use a condenser, either fixed or variable, across either the plate or grid coils. A large variable condenser originally placed in the plate circuit was removed after tests. Variable condensers may be used when it is desired to increase the wavelength range of the transmitter. These instruments should be of very fine construction, and their insulation perfect.

The transmitter of the Eiffel Tower has been in daily use for many months, and repairs or changes have been hardly necessary. It has proven its reliability as a short-wave transmitter, a quality that recommends it particularly to the serious amateur. With a power of about ¾ kilowatts in the antenna, the station has a daylight range of several thousand kilometers. This range is fairly constant, and the signals are picked up regularly at the points mentioned above.

The wavelength range of the Eiffel Tower short wave outfit is from about 90 to 160 meters. Of course, by re-designing both the windings and the apparatus, wavelengths much shorter could be reached with equal ease, using the system of balanced circuits. Two tubes, one on each side, could be used for a lower-powered set.

Common cotton sleeving soaked in paraffine, and dried on a wire makes a very good substitute for "spaghetti" tubing. If no sleeving is available, the outer woven covering of shoe laces may sometimes be used.

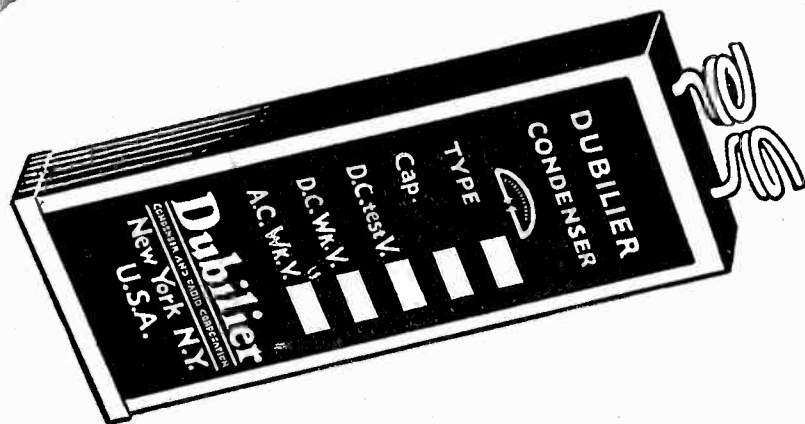

*Be sure to use the right condenser  
for the job*

**I**F YOU are building a "B" battery eliminator, be sure to use the right type of condenser in the filter circuits. The usual type of "By-Pass" condenser is not designed for the high voltages required.

Dubilier Filter Condensers are especially designed for use in the filter circuits of "B" battery eliminators. Their working voltage is very conservatively specified. That is why they give a permanent life of efficient service at voltages up to their maximum working ratings.

Remember that, with no load, the D.C. voltage impressed on the condenser in your filter circuit is 1.4 times the secondary terminal voltage of the A.C. transformer.

Use the right condenser for the job—made by the pioneer manufacturer of radio condensers.

**Dubilier**  
**CONDENSER AND RADIO CORPORATION**



# The Choice of Experts

**B**ANDED together in the membership of the American Radio Relay League, Inc., are men who have devoted themselves wholeheartedly and enthusiastically to the advancement of radio because of their love for the science and art. Among those who have gained world-wide recognition are: Gerald M. Best, Technical Editor of Radio; Lieutenant F. H. Schnell, Traffic Manager, A. R. R. L.; A. A. Hebert, Treasurer, A. R. R. L., and Don Wallace, winner of the Hoover Cup. They are not men who would use or recommend an unsuccessful thing. They believe in using equipment that is of highest quality. Quite naturally, therefore, we are proud of the fact that these experts use and endorse

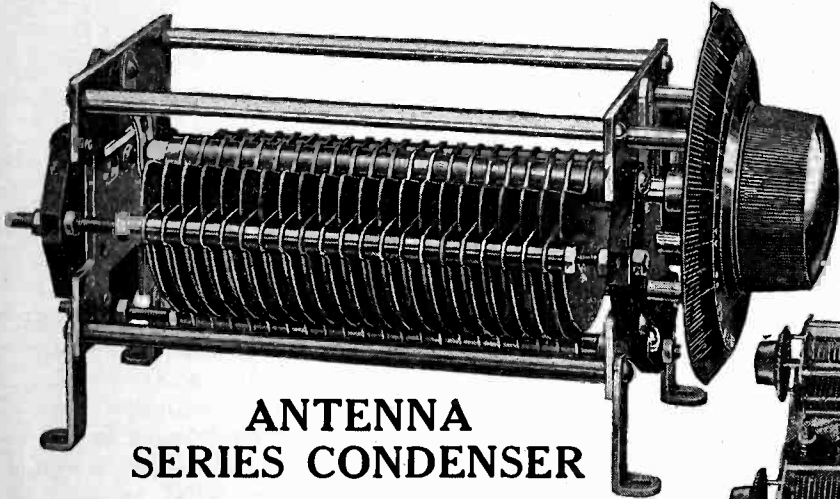

**ANTENNA  
SERIES CONDENSER**

## NATIONAL TRANSMITTING APPARATUS

The illustration shows Lieut. F. H. Schnell's short wave Transmitter using National Type D. X. T. transmitting condensers. These condensers are designed for continuous operation at 1500 volts—400 meters.

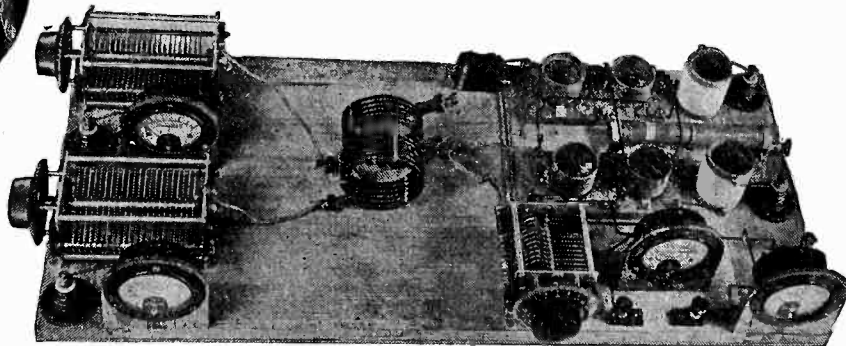

*These National Radio Products  
Have Also Achieved  
Leadership*

### NATIONAL TUNING UNITS

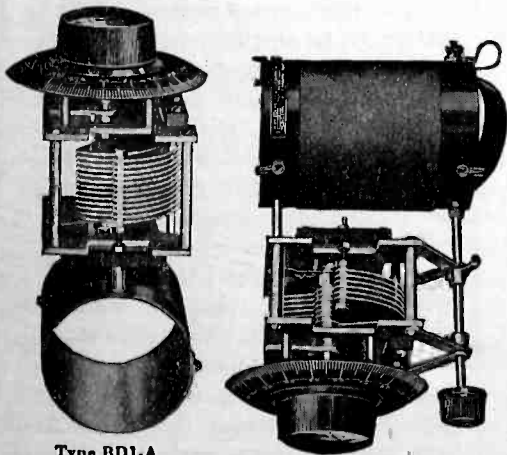

Type BD1-A

Embodying the Brown-  
ing-Drake Inductance  
Coil and National Con-  
denser.

Type BD2-A

Includes the Genuine Brown-  
ing-Drake Transformer and  
National Condenser.

### NATIONAL VELVET VERNIER DIALS

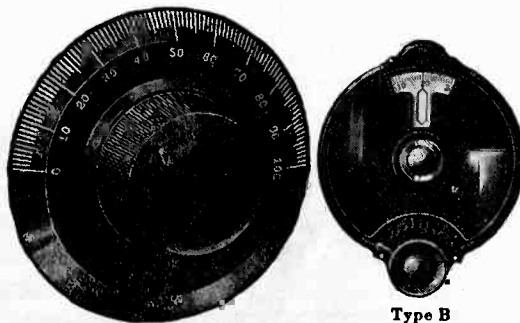

Type A

Noted for Its Velvety  
Smoothness.

Type B

(Patents Pending)  
Variable Ratio, Positive  
Control.

### NATIONAL CONDENSER

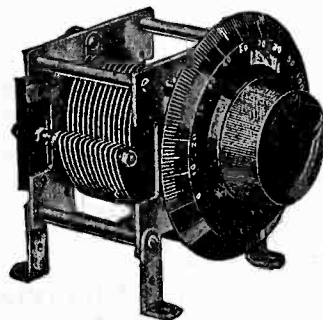

Straight Line Wave Length, Permits  
Spread of Stations Over 180° on the  
Dial.

*Get the Genuine*

**Insist upon NATIONAL COMPANY'S RADIO PRODUCTS**

*Your dealer appreciates your patronage and will gladly get them for you*

## NATIONAL COMPANY, Inc.

W. A. Ready, President

110 Brookline St.

Cambridge, Mass.

Tell them that you saw it in RADIO

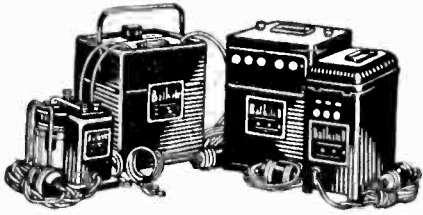

Equip your set with

FANSTEEL

# Balkite Radio Power Units

- Balkite Battery Charger
- Balkite Trickle Charger
- Balkite "B"
- Balkite "B" II

*the ideal radio  
power supply*

The Balkite Battery Charger for charging "A" batteries. The Balkite Trickle Charger for continuous charging. Balkite "B" replaces "B" batteries—designed for sets of 6 tubes or less. Balkite "B" II—for sets of 6 tubes or more.

FANSTEEL PRODUCTS CO., Inc.  
North Chicago, Illinois

PACIFIC COAST DISTRIBUTORS:  
Seattle, A. S. Lindstrom Co., 95 Connecticut St. San Francisco, A. S. Lindstrom Co., 274 Brannan St. Los Angeles, A. S. Lindstrom Co., 324 N. San Pedro St. Portland, A. S. Lindstrom Co., 146 1/2 N. 10th St. Salt Lake City, A. S. Lindstrom Co., 407 Dooly Bldg. Denver, Jack L. Hursch Co., 1641 Stout St.

## FANSTEEL Balkite Radio Power Units

BALKITE BATTERY CHARGER · BALKITE "B"  
BALKITE TRICKLE CHARGER · BALKITE "B" II

All Balkite Radio Power Units are Tested and Listed as Standard by the Underwriters' Laboratories

ARE YOU A SUBSCRIBER?

SEND FOR TRIAL SUBSCRIPTION

\$1.00 FOR SIX MONTHS

LATEST "COAST TO COAST" FULLY GUARANTEED

**RADIO'S 10 DAYS FREE TRIAL**

SAVE 1/3 TO 1/2

Uses everywhere report Miraco Radios get programs coast to coast on loud speaker output (sets three times as easily. Many hear foreign countries. Radio's most amazing feature is unconditional guarantee, factory built long distance sets—let testimony of users convince you.

**MIRACO RADIO GETS 'EM COAST TO COAST**

Powerful New Multi-tube Miraco gets long distance on loud speaker. Set, ONLY \$27.35 retail

FREE! Literature on latest improved 1 to 6 tube models, new low prices, testimony of users and SPECIAL OFFER. Write: **MIDWEST RADIO CORP.** Pioneer Builders of Sets 414 W. E. 9th St. Cincinnati, O.



**AGENT WANTED** Write for discounts.

*The Loud Speaker Sensation!*



## The KODEL MICROPHONE LOUD SPEAKER

You can't tell the KODEL MICROPHONE LOUD SPEAKER from the microphone the broadcasting stations use—they are exactly alike in size and appearance.

The efficient Kodel Sound Unit, with a ingenious new snail-shell horn, mounted inside the microphone case, produces a remarkably clear, full-toned volume. Non-vibrating tone chamber absolutely eliminates distortion.

\$15 model incorporates Kodel, Jr. unit; equipped with large Kodel unit \$20

**\$15.00**

Radio dealers everywhere have them.

THE KODEL RADIO CORP.  
507 E. Pearl St. Cincinnati, O.

RECEIVERS :: SPEAKERS  
HOMCHARGERS

**WKRC**

Owners of Kodel Broadcasting Station WKRC. Send for program

## Filter Condensers for "B" Supply Unit

All sizes—All specifications—Meet all requirements—Made in three voltage ranges. Full specifications and details at your dealer's or direct. **POTTER MANUFACTURING CO., North Chicago, Ill.**

**Potter**  
By-Pass and Filter  
**Condensers**  
(An American-Made Product)

## BRITISH BROADCASTING

(Continued from Page 11)

controlled. This enables listeners in areas which are not well served by the main station to obtain the programs given out by their area station.

The revenue of the B. B. C. is obtained from several sources. Firstly, anybody in possession of a radio receiver is bound by law to take out a receiving license from the government at a cost of \$2.00 per year. Half of this sum goes to the B. B. C. and the remainder to the government to cover incidental expenses incurred in the issuing of licenses and also for the inspection of the receiving stations, which is carried out periodically. As there are approximately a million and a half listeners it will be readily understood that the B. B. C. is in possession of ample funds and is therefore in the position to pay for the best artists obtainable.

The rate of interest payable on the capital invested in the B. B. C. is limited by the government to 7 1/2%, any earnings in excess of this amount being put aside for improving the system or are returned to the government for the reduction of taxation. In this connection it is interesting to note that the B. B. C. paid this maximum dividend at the end of the first period of twelve months, which goes to show how popular broadcasting is in the British Isles.

Owing to the lack of wealth in England today there are very few tube sets or loud speakers, and the broadcasting stations have consequently been so erected so that there is not one spot in the islands where a program cannot be picked up with a crystal receiver.

All the stations can be connected together by means of landlines which are the property of the state, and simultaneous broadcasting by all the stations is a regular feature of the organization. While this arrangement is beneficial for the broadcasting intelligence of a national character it nevertheless restricts the listener to only one program when such a feature is in progress.

Daventry, which is perhaps the first high power broadcasting station to be erected, is located in the center of the organization and it is believed that signals from this station can be picked up on a crystal set in any part of the country. This station employs a transmitter which works with a power of 25 kilowatts which can be increased to 50 if it is desired. The antenna is supported between two masts each 500 feet high. This station operates on a 1600 meter wave far removed from other stations so that interference is eliminated. This makes the design of a receiver to cover the complete range a difficult problem unless a change in inductance coils is resorted to.

The scarcity of dance music on the English programs is causing much com-

(Continued on Page 52)

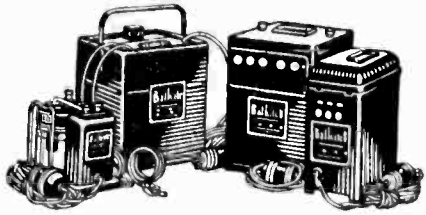

Equip your set with

FANSTEEL

# Balkite Radio Power Units

- Balkite Battery Charger
- Balkite Trickle Charger
- Balkite "B"
- Balkite "B" II

*the ideal radio  
power supply*

The Balkite Battery Charger for charging "A" batteries. The Balkite Trickle Charger for continuous charging. Balkite "B" replaces "B" batteries—designed for sets of 6 tubes or less. Balkite "B" II—for sets of 6 tubes or more.

FANSTEEL PRODUCTS CO., Inc.  
North Chicago, Illinois

PACIFIC COAST DISTRIBUTORS:  
Seattle, A. S. Lindstrom Co., 95 Connecticut St. San Francisco, A. S. Lindstrom Co., 274 Brannan St. Los Angeles, A. S. Lindstrom Co., 324 N. San Pedro St. Portland, A. S. Lindstrom Co., 146½ N. 10th St. Salt Lake City, A. S. Lindstrom Co., 407 Dooly Bldg. Denver, Jack L. Hursch Co., 1641 Stout St.

## FANSTEEL Balkite Radio Power Units

BALKITE BATTERY CHARGER · BALKITE "B"  
BALKITE TRICKLE CHARGER · BALKITE "B" II

All Balkite Radio Power Units are Tested and Listed as Standard by the Underwriters' Laboratories

ARE YOU A SUBSCRIBER?

SEND FOR TRIAL SUBSCRIPTION

\$1.00 FOR SIX MONTHS

LATEST "COAST TO COAST" FULLY GUARANTEED

**RADIO'S-10 DAYS FREE TRIAL**

Save 1/3 to 1/2

Users everywhere report that the program coast to coast on loud speaker (only sets three times as costly) Many hear foreign countries. Radio's most amazing value in unconditionally guaranteed, factory-built long distance sets—let testimony of users convince you.

**MIRACO RADIO GETS 'EM COAST TO COAST**

Powerful New Multi-tube Miraco gets long distance on loud speaker. Set, ONLY \$27.35

FREE! Literature on latest improved 1 to 6 tube models, low low prices, testimony of users and SPECIAL OFFER. Write:

**MIDWEST RADIO CORP'N**  
Former Builders of Sola  
614 W. 8th St. Cincinnati, O.



\$27.35 retail

AGENT WANTED Write for discounts.

*The Loud Speaker Sensation!*



## The KODEL MICROPHONE LOUD SPEAKER

You can't tell the KODEL MICROPHONE LOUD SPEAKER from the microphone the broadcasting stations use—they are exactly alike in size and appearance.

The efficient Kodel Sound Unit, with a ingenious new snail-shell horn, mounted inside the microphone case, produces a remarkably clear, full-toned volume. Non-vibrating tone chamber absolutely eliminates distortion.

\$15 model incorporates Kodel, Jr. unit; equipped with large Kodel unit \$20

**\$15.00**

Radio dealers everywhere have them.

THE KODEL RADIO CORP.  
507 E. Pearl St. Cincinnati, O.

RECEIVERS :: SPEAKERS  
HOMCHARGERS



## BRITISH BROADCASTING

(Continued from Page 11)

controlled. This enables listeners in areas which are not well served by the main station to obtain the programs given out by their area station.

The revenue of the B. B. C. is obtained from several sources. Firstly, anybody in possession of a radio receiver is bound by law to take out a receiving license from the government at a cost of \$2.00 per year. Half of this sum goes to the B. B. C. and the remainder to the government to cover incidental expenses incurred in the issuing of licenses and also for the inspection of the receiving stations, which is carried out periodically. As there are approximately a million and a half listeners it will be readily understood that the B. B. C. is in possession of ample funds and is therefore in the position to pay for the best artists obtainable.

The rate of interest payable on the capital invested in the B. B. C. is limited by the government to 7½%, any earnings in excess of this amount being put aside for improving the system or are returned to the government for the reduction of taxation. In this connection it is interesting to note that the B. B. C. paid this maximum dividend at the end of the first period of twelve months, which goes to show how popular broadcasting is in the British Isles.

Owing to the lack of wealth in England today there are very few tube sets or loud speakers, and the broadcasting stations have consequently been so erected so that there is not one spot in the islands where a program cannot be picked up with a crystal receiver.

All the stations can be connected together by means of landlines which are the property of the state, and simultaneous broadcasting by all the stations is a regular feature of the organization. While this arrangement is beneficial for the broadcasting intelligence of a national character it nevertheless restricts the listener to only one program when such a feature is in progress.

Daventry, which is perhaps the first high power broadcasting station to be erected, is located in the center of the organization and it is believed that signals from this station can be picked up on a crystal set in any part of the country. This station employs a transmitter which works with a power of 25 kilowatts which can be increased to 50 if it is desired. The antenna is supported between two masts each 500 feet high. This station operates on a 1600 meter wave far removed from other stations so that interference is eliminated. This makes the design of a receiver to cover the complete range a difficult problem unless a change in inductance coils is resorted to.

The scarcity of dance music on the English programs is causing much com-

(Continued on Page 52)

## Filter Condensers for "B" Supply Unit

All sizes—All specifications—Meet all requirements—Made in three voltage ranges. Full specifications and details at your dealer's or direct. POTTER MANUFACTURING CO., North Chicago, Ill.

**Potter**  
By-Pass and Filter  
**Condensers**  
(An American-Made Product)

Tell them that you saw it in RADIO



# The Choice of Experts

**B**ANDED together in the membership of the American Radio Relay League, Inc., are men who have devoted themselves wholeheartedly and enthusiastically to the advancement of radio because of their love for the science and art. Among those who have gained world-wide recognition are: Gerald M. Best, Technical Editor of Radio; Lieutenant F. H. Schnell, Traffic Manager, A. R. R. L.; A. A. Hebert, Treasurer, A. R. R. L., and Don Wallace, winner of the Hoover Cup. They are not men who would use or recommend an unsuccessful thing. They believe in using equipment that is of highest quality. Quite naturally, therefore, we are proud of the fact that these experts use and endorse

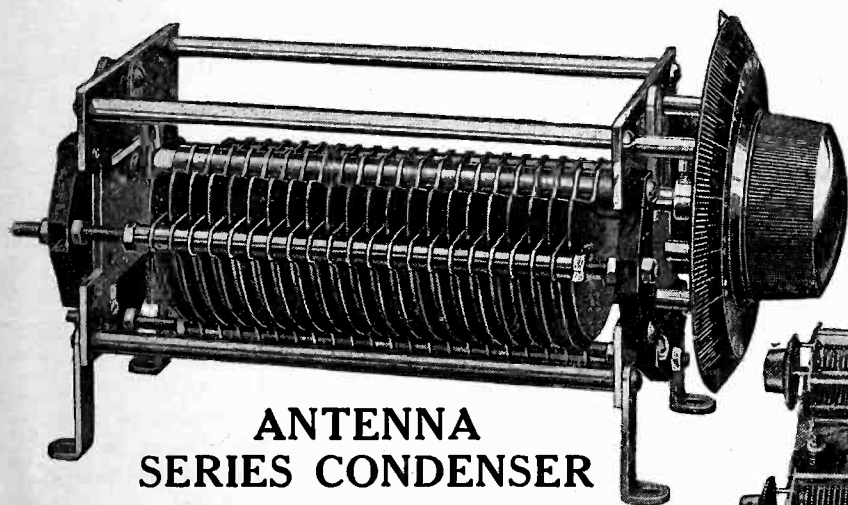

**ANTENNA  
SERIES CONDENSER**

## NATIONAL TRANSMITTING APPARATUS

The illustration shows Lieut. F. H. Schnell's short wave Transmitter using National Type D. X. T. transmitting condensers. These condensers are designed for continuous operation at 1500 volts—400 meters.

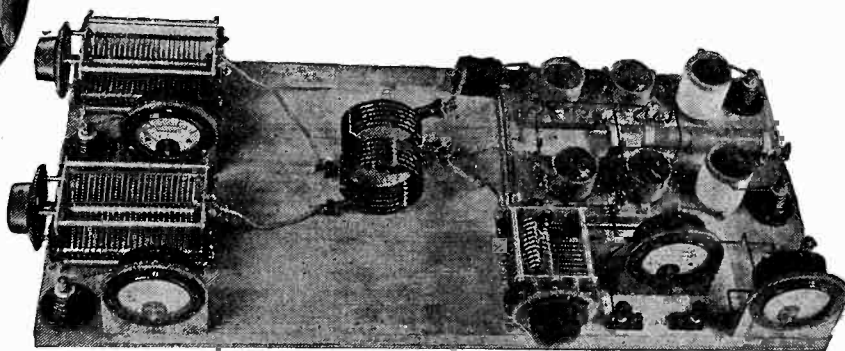

*These National Radio Products  
Have Also Achieved  
Leadership*

### NATIONAL TUNING UNITS

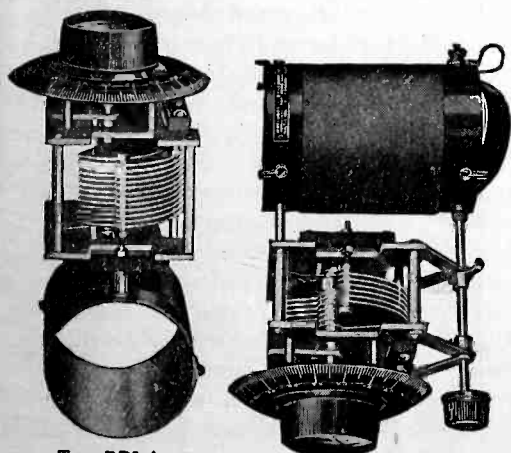

Type BD1-A

Embodying the Brown-  
ing-Drake Inductance  
Coil and National Con-  
denser.

Type BD2-A

Includes the Genuine Brown-  
ing-Drake Transformer and  
National Condenser.

### NATIONAL VELVET VERNIER DIALS

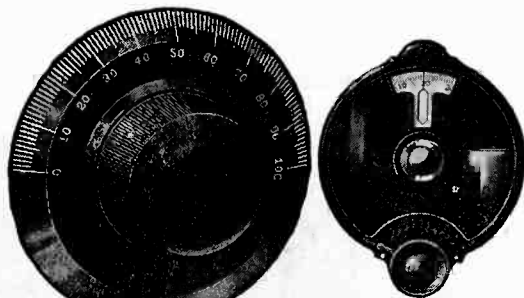

Type A

Noted for Its Velvety  
Smoothness.

Type B

(Patents Pending)  
Variable Ratio, Positive  
Control.

### NATIONAL CONDENSER

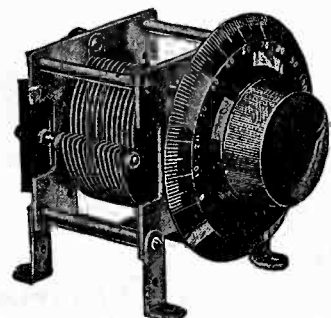

Straight Line Wave Length, Permits  
Spread of Stations Over 180° on the  
Dial.

*Get the Genuine*

**Insist upon NATIONAL COMPANY'S RADIO PRODUCTS**

*Your dealer appreciates your patronage and will gladly get them for you*

# NATIONAL COMPANY, Inc.

W. A. Ready, President

110 Brookline St.

Cambridge, Mass.

# The REMO TRUMPET CONCERT TYPE

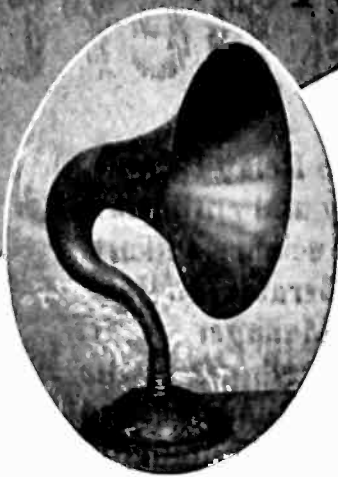

The Remo Trumpet  
(Concert Type)  
\$25.00

Dealer's Offer—both of these instruments will be sent to you on 10 days' free trial through your regular jobber. We are willing to do this so that you may hear them.

**THE REMO CORP. CONN.**

Local Representatives:  
FACTORY SALES AGENCIES CO.

Los Angeles

San Francisco

Seattle

## Have You Heard It?

*If Not, Read Offer Below!*

Every radio fan will be surprised and delighted with this loudspeaker. It produces the high and low notes without distortion with true and clear reproduction. It also has plenty of volume. Acknowledges no superior at any price. Handsomely finished in crystal black with grained mahogany bell and antique gold detail.

Price, \$25.00

## The Remola Concert Cabinet

Produces the same beautiful tone as the Trumpet. A fine mahogany finished cabinet of just the right size.

Remola Concert Cabinet  
\$25.00

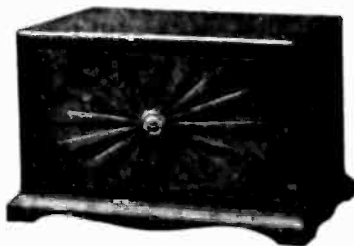

(Continued from Page 50)

plaint amongst the listeners who like their American cousins have come to regard dancing as part of their everyday life. Dance music at present is restricted to three periods a week, when the band of the Savoy Hotel, that resort which is so much favored by the American tourist, plays selections from its repertoire.

Announcing in the B. B. C. is not carried on to such an extent as it is in the States, and long intervals frequently elapse before the new listener can ascertain to which station he is listening.

This article would not be complete without a few words as to the possibility of Anglo-American broadcasting. The erection of the high power station at Daventry in England and the projected high power station at Bound Brook, New Jersey are undoubtedly the precursors to this form of broadcasting, and America may expect to hear some of the English programs during the winter months which will be rebroadcast through the American stations. This will aid in cementing the friendship between the two great English speaking nations.

## AN EFFICIENT TWO-TUBE SET

(Continued from Page 13)

small antenna it was possible to tune in on the loud speaker, without interference, station KFRC, a 50 watt station on 268 meters, fourteen miles away. It was further possible to tune in between these two stations and locate the wandering wavelength of KRE, which has a peak on about 256 meters. KRE was three miles away and using 50 watts.

This extreme selectivity cuts down the distance to some extent, but in localities which are not so congested, a large antenna can be used and this will bring in the distant stations with more power. To the writer's knowledge, there is nothing except a single circuit regenerative receiver that will do any better on distance using two tubes than circuit No. 2. A radio fan located at Modesto, California, recently reported that using Circuit No. 2 in combination with a Western Electric power amplifier he has logged 82 stations, among them being KDKA and several Chicago, Cincinnati, and Kansas City stations. This, however, is to be regarded as exceptional performance and can only be duplicated in the best of locations.

As stated before, the DX fans will have to wait another month for the set that really "brings 'em in with a roar," but it will be out in the March issue and the writer believes it will be a treat when the details are given.

National tests of radio reception to study the causes of fading are to be conducted by the Stewart-Warner Company in co-operation with Northwestern University on February 9, 10 and 11 from 8 to 11 p. m., central standard time.

# A NEW Radio Product by WESTON Pin-Jack Voltmeter

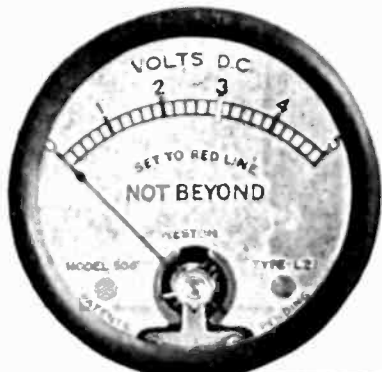

THIS instrument plugs directly into new Radiola, Victor and Brunswick models as shown by the illustration. No tools, no adjustments, no trouble—and it controls your radio operation so that you get the very best out of your set.

You simply turn your battery setting knob until the pointer on the voltmeter reaches the red mark at 3 volts on the dial. You have the exact point for the best reception, you prolong the life of your tubes, lengthen the use of batteries, get the best out of your set.

Don't fail to ask your dealer to show this new Pin-Jack Voltmeter to you or write us directly for full information.

## Pacific Coast Representatives

Western Electric Company  
Seattle, Wash.  
J. H. Southard  
San Francisco, Calif.  
A. A. Barbera  
Los Angeles, Calif.  
Repair Service Laboratory  
682 Mission St.  
San Francisco, Calif.

Weston Electrical  
Instrument Corporation  
136 Weston Avenue Newark, N. J.



STANDARD THE WORLD OVER

# WESTON

Pioneers since 1888

## AUGUST & SEPTEMBER

BACK COPIES OF "RADIO"  
With Best's Super-Het. Articles  
Both for 50c.  
"RADIO," SAN FRANCISCO

## FINANCIAL RETURNS ON RADIO

(Continued from Page 12)

getting started without further delay, such opportunities are surely within your grasp. Time spent in this phase of the game will be a schooling such as you cannot obtain elsewhere and will be of considerable value later on.

For those who have made special preparation, special lines of work will naturally be attractive. When a man has specialized in radio at the university, he is given an opportunity to associate himself with the various large manufacturing concerns upon graduation. The General Electric Company is such a concern. They send the young engineer to a school at their Schenectady plant for six months or longer, thus giving instruction that is to fit him for an important position in their radio organization. Or, a university graduate may enter the government service in any of the many available positions. Too, he may obtain employment with an engineering organization or with some inventive genius on special investigation and development work. It is in such branches of the service, such as I have mentioned above, that the individual has his choice of a large number of new subjects just lately attracting so wide attention. Among the outstanding ones, I might mention radio photography, wired wireless, high frequency transmission, beam transmission, world wide telephony and a host of other subjects of minor importance.

Summarizing, it is to be understood by the reader that the information given above is only a brief analysis of the opportunities to be found in the radio field and that the subjects discussed are perhaps only the high points of general interest. Remember, radio is yet in its infancy! This statement has been made upon countless of previous occasions and I find it is just as true today as it was five years ago, although the industry is now growing by leaps and bounds. Such being the case, there surely are a host of wonderful opportunities presenting themselves daily in the ever widening and new fields which are continually available. Those now entering the radio profession are reaping the present rewards and preparing themselves for responsible positions that the future surely has in store. Therefore, you will be wise if you no longer delay. Right now take an inventory of yourself and discover how you may organize your study and endeavors so as to ensure you a position of importance in the radio industry with financial returns in keeping with the effort expended.

A static eliminator in the form of a new metal, which separates the desired radio program from the undesired noise of static is announced by Prof. Dana J. Demorest of Ohio State University. This is important if true, but the burden of proof rests upon the professor.

## RADIO OWNERS

who can twist a dial can renew their old tubes without chance of error with this instrument. It is built so that it cannot be mis-operated.

YOU CAN DO IT YOURSELF  
WITH A

**BURTON & ROGERS  
TUBE  
FLASHER**

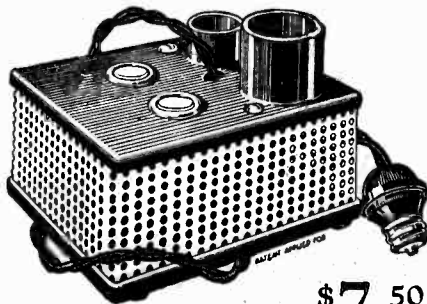

\$7.50

Send for pamphlet "Save a Life"

**Burton & Rogers Mfg. Co.**

755 Boylston St., Boston, Mass.



## PRECISION BI-PASS and Filter Condensers

Every good radio-set needs by-pass condensers. Use a TOBE .002 Mfd. around the primary of the first audio transformer, thus bypassing the radio frequency currents out of the audio end and improving the tone. You can put this in your set yourself.

On resistance or impedance-coupled amplifiers, the coupling condensers should be TOBE, not less than 0.1 Mfd., to pass all the low notes and secure really truthful reproduction.

TOBE Condensers are standard for smoothing and filter work in the Raytheon Plate Supply Unit.

TOBE Condensers are ACCURATE, durable, SILENT, dependable, and REASONABLE in price.

"A BETTER CONDENSER"

In the silver case and the silver carton

AT YOUR DEALERS

**Tobe Deutschmann Co.**

Cornhill, Boston, Mass.

## RADIOCAST WEEKLY

Sixty-four Pages of Programs, Photos, Humor, Musical Reviews, Schedules, Tables, Editorials, Etc.

5<sup>c</sup> Per Radiocast Weekly  
Copy 433 Pacific Bldg.,

SAN FRANCISCO

# STUDY RADIO!

Radio, the field of unlimited opportunity, calls for more trained men.

Prepare yourself for a high salaried position by using your spare time to study radio at home.

Radio Institute of America, the world's oldest radio school, has graduated more than 7,000 students. The value of RIA training is universally recognized—and graduates readily secure positions.

This coupon will bring you a wealth of important and interesting information.

## RADIO INSTITUTE OF AMERICA

Formerly Marconi Institute

Established in 1909

322 Broadway  
New York City

TEAR OUT

Radio Institute of America B  
322 Broadway, New York City

Please send me full information about your Home Study Course of radio instruction.

I am interested in the complete course, including code instruction, which qualifies for the U. S. Gov't Commercial or Amateur Radio License.

I am interested in the technical course for radio dealers, jobbers and salesmen.

Name .....

Address .....



"The enchantment of distance,  
the joy of clearness, with  
**FROST-FONES**"

# New! Better!

Two useful new items of **FROST-RADIO** now ready

## A new **FROST-RADIO** socket that fits all new type tubes

This new socket takes ALL tubes with the new type bases. Has perfect spring construction which grips each tube prong full length with self-cleaning, sliding contact. We believe this socket to have the most satisfactory contacts of any socket made. All terminals plainly marked. It is equipped with soldering lugs. Genuine black Bakelite in high lustre finish. Order from your dealer today.

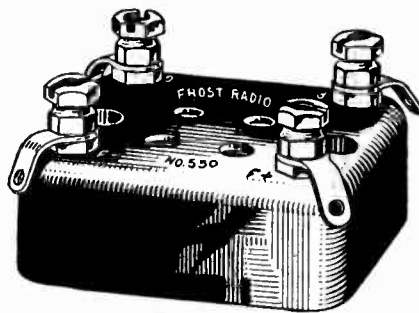

**FROST-RADIO**  
No. 530 **FROST-RADIO**  
SOCKET . . . 40c

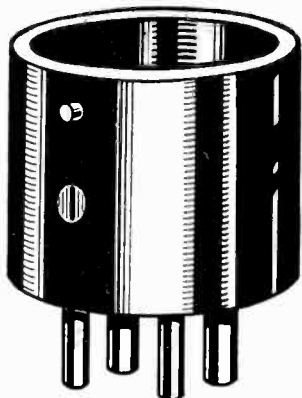

**FROST-RADIO**  
No. 540  
**FROST-RADIO**  
ADAPTER . . . 25c

## Convert your present stand- ard sockets to UX199—CX 299, or UX120—CX220 with this adapter

With this handy, inexpensive adapter you can instantly fit the new CX299 or UX199, and the CX220 or the UX120, into your present standard base sockets.

No need to rebuild your set to take the new tubes. Genuine black Bakelite—high lustre finish. Ask your dealer to supply you.

# HERBERT H. FROST, Inc.

314-324 WEST SUPERIOR STREET, CHICAGO  
NEW YORK CITY CLEVELAND KANSAS CITY LOS ANGELES

Export Office: 314 West Superior Street, Chicago

How to pass  
U.S. Gov't.  
Radio  
Examination



310  
Actual questions  
answered  
by E.E. Bucher

For a Short  
Time Only **60c**

RADIO INSTITUTE OF AMERICA  
322 Broadway, New York City

PASS the U. S.  
Government  
Commercial or Ama-  
teur Radio License  
examination! This  
book will help you  
do it! Send sixty  
cents in stamps or  
coin for your copy—  
postage prepaid to  
any point in the U.  
S., Canada or Mexico

## RADIO DEALERS

Get that new catalogue  
from Van Ashe!

New circuits—new parts—new sets.  
All the hard-to-get items—and  
extra good discounts!



**Van-Ashe Radio Co.**

210 North 10th St. ST. LOUIS, MO.

## POWER AMPLIFIER

(Continued from Page 18)

tained at a negative potential with respect to the filament, no d. c. current is flowing and therefore the insertion of this resistance does not cause a drop in the negative potential applied. The .5 mfd. condenser between this resistance and the filament winding of the power tube by-passes the a. c. in the grid circuit around this resistance, as well as the grid biasing resistance of 1500 ohms.

The parts shown in the bill of material are those used by the writer and are therefore known to operate satisfactorily. In some instances they are the only parts of their kind available; however, others may be on the market by the time construction is started. In any event, use only the best materials obtainable, as the amount of power handled is considerable and inferior articles may prove to be more expensive in the end. This warning applies particularly to the condensers used in the filter circuit and the coupling condensers.

A milliammeter may be placed in the plate circuit of the power tube between the output transformer and the point where it is connected to the 350 volt lead. It is not essential, but as the prime object of this amplifier is quality, it is advisable in that it provides a visual means of checking the quality. When an amplifier tube is operated with proper negative grid bias and is not overloaded, the milliammeter placed in the plate circuit should remain constant, registering the direct current flowing in the circuit. The natural period of the movement of the meter is so low that it will not be affected by the a. c. component of the plate current. If, however, this tube is overloaded, then the d. c. component will be subjected to more or less violent fluctuations, depending on the amount of overload. With the meter in the circuit, the overload point can be readily determined.

Fig. 2 shows the panel view of the amplifier, while Fig. 3 is a rear view and indicates the manner in which the apparatus is mounted on the baseboard. The baseboard should be of seasoned hardwood at least 5/8 in. thick and should be covered by a piece of No. 28 gauge sheet brass. Looking at the amplifier from the rear, the power transformer and filter system is all mounted to the left, while the amplifier itself is mounted at the right. The brass covering on the baseboard serves to connect together the cores and shields of all transformers, as well as the cases of all the condensers, thus individually and collectively shielding all the apparatus. The rectifier tube is mounted on the panel directly over the power transformer, the power tube in the center and the "high mu" tube at the left of the panel. All apparatus is mounted on the baseboard with the ex-

(Continued on Page 58)

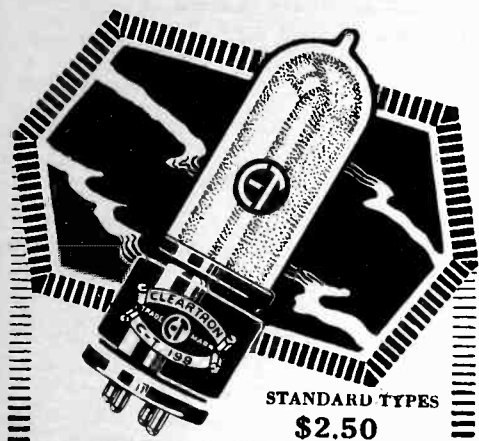

STANDARD TYPES  
\$2.50

## CLEARTRON

GUARANTEED  RADIO TUBES

Being unequalled for their long life and easy drain on batteries, Cleartrons are the most economical tubes you can buy. And—remember this, we guarantee perfect service or instant replacement. Buy quality—Cleartrons. At all reliable dealers. Write for free six page tube folder. CT-101A—A Hi-Mu tube for Resistance-Coupled Amplifiers \$3.00  
CLEARTRON VACUUM TUBE CO.  
28 West 44th Street New York City

Factories:  
West New York, N. J., Birmingham, Eng.

FOR BETTER RECEPTION

**BRACH**

### Radio and Home Demand Safeguards



ADD to the delights of your radio by giving it the protection that radio engineers demand and National Board of Fire Underwriters insists upon.

Carelessness is inexcusable when the dependable Brach Vacuum Arrester is available.

Millions in use throughout the world by principal railroad, telegraph and fire alarm systems.

Get yours today.

## BRACH VACUUM ARRESTER



L. S. BRACH MFG. COMPANY NEWARK, NEW JERSEY

## New Radio Log Book

and  
AIR LINE DISTANCE MAP

50c Money Refunded if you are not satisfied.

"RADIO," San Francisco

### Pure Quality

"Man!—of all the beautiful, round and full tones, this is the cat's pajamas! Well, folks, I'm Daven until death do us part!"

A Newspaper Radio Editor.

### For Neutrodyne Sets

"Your resistance coupled amplifier is certainly all that you claim for it. I would not hesitate a moment to recommend it to anyone who wants real quality without distortion. I did not find it necessary to use high voltage to get all the volume I wanted either, on a six tube Neutrodyne."

A Neutrodyne Fan.

### For a Super-Heterodyne

"I am using three steps of Daven amplification with wonderful results. The outstanding characteristic is large volume. This feature is very desirable when used on a Super-Heterodyne as I am using it."

A Professional Operator.

### Two Converts

"I followed your advice and put in another coupler instead of a transformer. I'm more than pleased. No more transformers for me! Your method of amplification is better, cheaper, and easier to assemble than any other."

From the Mid-West.

"Yesterday I got another Daven Unit and hooked it up. It would take some PULL to pry it away from me. Have a regular set now. I fail to see how anyone can stick to transformers after hearing music come through your way."

A Satisfied New Yorker.

### Quality Succeeds Distance

"After spending much money on sets trying to get DX, I gave up in disgust and concentrated my efforts to produce quality reception with freedom from distortion; and at last I've got it using your Resistance Coupled units."

From the Pacific Coast.

NAMES FURNISHED UPON REQUEST

**Daven**

Daven Radio Corp's  
gentlemen,  
amplifier & manual received. Made  
a few days before your letter came, I found  
my cause for its trouble I mentioned, and  
now that that is cleared up, I am very  
highly satisfied with my set.  
The volume is terrific and I am  
convinced that Quality and Daven are  
synonymous. Its Quality is a revelation.  
As I am an unskilled fan of Daven  
from now on, you can use my letter and  
name for any testimonials.  
I am through with experimenting.  
Very Sincerely,  
Earl James Johnston

### "QUALITY AND DAVEN ARE SYNONYMOUS"

"The Quality is a revelation." "Man!—of all the beautiful, round and full tones, this is the cat's pajamas." "The volume is terrific." Unnecessary to use high voltage to get all the volume I want." These are actual phrases Daven quality radio fans have written us.

Ask to see the Daven Super-Amplifier. It is for set owners who want more volume without distortion, and set builders who want Resistance Coupled Amplification without the labor of assembly. For greater amplification in resistance coupled amplifiers, use the new Daven Tube MU-20. Type MU-6 is for last or output stage of any set.

Daven products are sold only by good dealers

The Line of Music  
**DAVEN RADIO CORPORATION**  
Resistor Specialists  
NEWARK Reg. U. S. Pat. Off. NEW JERSEY



DAVEN RADIO CORPORATION  
151 Summit St., Newark, N. J.  
Please send me the following on  
Resistance Coupled Amplification:  
Check  Resistor Manual  
30c is enclosed.  
Here:  Complete Catalog (free).  
Name: \_\_\_\_\_  
Address: \_\_\_\_\_  
For Dealers:  
Send your letterhead or card,  
or this coupon and we will have  
our nearest distributor communi-  
cate with you.

Get the handbook of  
Resistance Coupled  
Amplification. At  
Dealer's 25c. By  
mail, postpaid, 30c.

## THE BIG LITTLE THINGS OF RADIO

22½ Volt  
Un-acid,  
Ever-  
lasting,  
Recharge-  
able  
"B"  
Storage  
Battery

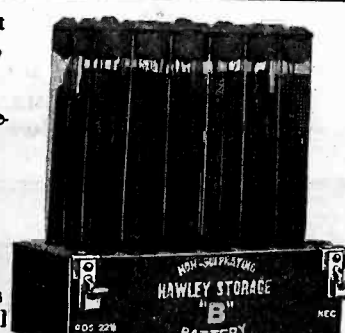

\$2.95  
Includes  
Chemical

45 volts \$5.25, 90 volts \$10.00, 112½ volts \$12.50,  
135 volts \$14.75, 157½ volts \$16.80. Truly the big-  
gest buy to day. Easily charged on any current, in-  
cluding 32 volt systems. Any special detector plate  
voltage had. Tested and approved by leading au-  
thorities such as Popular Radio laboratories. Over  
3 years sold on a non-red-tape 30 day trial offer  
with complete refund if not thoroughly satisfied.  
Further guaranteed 2 years. Knock-down kits at  
great savings. Complete "Hawley" "B" battery  
charger \$2.75. Sample cell 35c. Order direct—send  
no money—simply pay the expressman cost on de-  
livery. Or write for my free literature, testimonials  
and guarantee. Same day shipments.

**B. HAWLEY SMITH**  
316 Washington Avenue Danbury, Conn.

## The MOLLIFORMER "B" UNIT REPLACES "B" BATTERIES



SEND FOR complete description of this powerful "B" Unit that you can build in an hour at most reasonable cost. Uses the current from the light socket—Excellent for Supers and all TRF Sets—Assures greater Clarity—DX and Volume—Noiseless—No. Tubes nor Acids—Utilizes full wave rectification.

Guaranteed to Give Complete Satisfaction or Your Money Refunded

PRICE

Complete Kit	
60 Cycle Unit	\$22.50
Complete Kit	
25 Cycle Unit	\$24.50

Kits include Rectifiers.  
Parts sold separately if desired.  
DEALERS—Write for our proposition.

**C. E. JACOBS, Sole Mnfr.**  
2808 N. Kedzie Avenue CHICAGO

SEND FOR TRIAL SUBSCRIPTION  
\$1.00 FOR SIX MONTHS

*“Even the organ crescendo was perfect”*

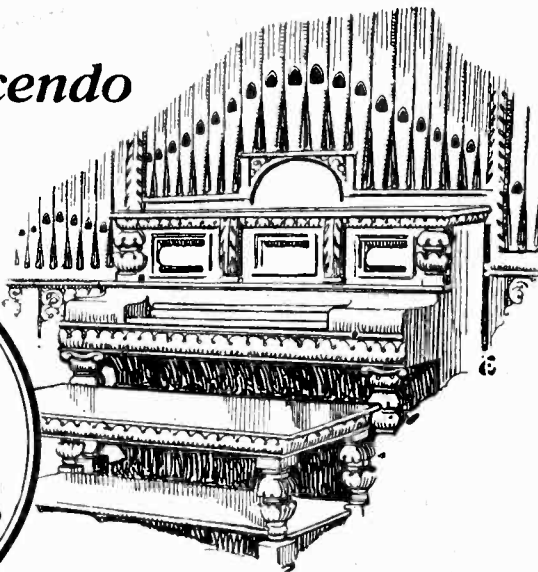
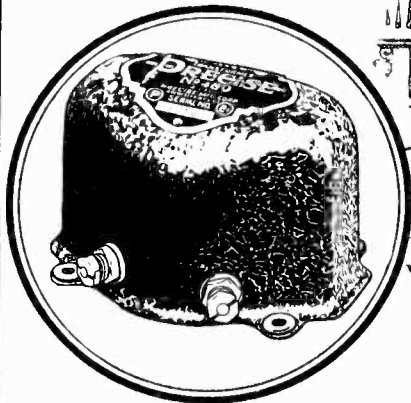

A VETERAN set-builder recently remarked about the purity of tone at tremendous volumes that he got through the Super-size Precise No. 480 Audio Transformer. In particular was he impressed with a recent organ recital which he had received. “Why,” he said, “even the organ crescendo was perfect.” The big Precise No. 480 (shown at the left) is truly a master transformer, designed for radio reception in a concert hall if necessary. It brings forth the deep rich tones or the high, clear tones with magnificent volume. The ratio of voltage amplification to frequency is practically a straight line, assuring uniform amplification over the entire range of useful audio frequencies.

Made in two ratios, 2½ to 1 and 5 to 1.  
Price, \$7.50, either ratio.

Ask your nearest radio dealer to show you the complete Precise Line.

**PRECISE MANUFACTURING CORPORATION**  
Rochester, N. Y.

**BRANCH OFFICES:**

- |  |   |
|--|---|
| 126 Liberty Street<br>New York City      | 1127 Pine Street<br>St. Louis, Mo.            |
| 205 W. Harrison St.<br>Chicago, Illinois | 701 A. O. U. W. Building<br>Little Rock, Ark. |
| 821 Market St.<br>San Francisco, Calif.  | 454 Builders' Exchange<br>Minneapolis, Minn.  |

**CANADIAN DISTRIBUTORS:**

Perkins Electric, Ltd.  
Toronto, Winnipeg, Montreal

**HOW TO TEST RADIO RECEIVERS**

(Continued from Page 22)

To keep the energy level the same, three conditions must be satisfied: (a) the audio-frequency e.m.f. (V) must be constant regardless of the frequency; (b) the amplitude of the carrier wave, as measured by the r.f. ammeter (A), must be constant throughout, and (c) the coupling between the receiving circuit and the output circuit of the r.f. oscillator must remain the same.

To measure the distortion introduced by a set at any definite wavelength, the r.f. oscillator is adjusted to the desired wavelength and the magnitude of the received signal measured for a series of audible frequencies (applied to the modulator grid) ranging from 200 to 3000 cycles.

To obtain the variation of signal strength with wavelength, readings are taken for a series of wavelengths ranging from 200 to 550 meters, all modulated to the same, say 1500 cycle note.

In the tests for volume, distortion and reception at different wavelengths it is of course understood that the set must be tuned in for the maximum signal in the phones before each reading, otherwise the results may prove erroneous.

To determine the selectivity, the carrier wave is adjusted to a definite wavelength, say 300 meters, and modulated by a definite audio frequency note, say 1500 cycles. The receiving set is then tuned in for maximum volume in the phones and the magnitude of this volume measured. Without further changing the tuning of the receiving circuit, the wavelength of the carrier wave is changed by ten meters to, say, 290 meters, the audio-frequency note remaining the same, and the signal strength again measured. The ratio of the second magnitude to the first is then a measure of the interference to be expected from a station of 290 meters wavelength when tuned in to 300 meters. This, of course, assumes that the desired and interfering stations are both equidistant from the receiver, which is not always true. A basis for comparison with other receivers is nevertheless established.

A little consideration will show that the tests outlined above have eliminated a number of the variables usually entering the problem. For example, referring to the matter of distortion, by keeping the voltage of the audio frequency note (impressed upon the modulator grid) constant, practically all the distortion due to the transmitting apparatus is eliminated. Furthermore, the distortion occurring in the transmitting medium is negligible since the distance from the transmitter to the receiving circuit is comparatively very small. All of the distortion measured may consequently be ascribed to the receiving set itself.

**RADIO AGENTS WANTED**  
**5 Tube Demonstrator FREE!**

Earn \$25 to \$100 a week, part or full time. Everyone a prospect. Complete line standard sets and accessories. \$5 to \$90. Write today for illustrated catalog and exclusive selling plan for live dealers and community agents. 20TH CENTURY RADIO CO., 1011 Coca Cola Bldg., Kansas City, Mo.

A Laboratory Product



**CRESCENT LAMP RESISTANCES**  
for Distortionless Amplification

As transmitting Grid leaks, they are made in special sizes and are not afraid of power. Dissipate 10 watts. Four standard sizes. \$1.50 each. Special resistances, \$2.50 each.

CRESCENT RADIO SUPPLY COMPANY  
3 Liberty Street, Jamaica, N. Y.

You Can Get Greater Reflex or Crystal Set Reception if you use the

**BROWNIE Vernier Detector**

\$2.00 at Your Dealer or Direct  
ROLAND BROWNIE & CO.,  
22 Saunders St. Medford, Mass.

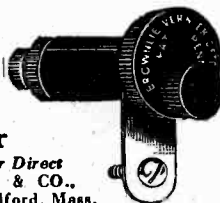

**ZENITH RADIO**  
LONG-DISTANCE  
Exclusive choice of MacMillan for his North Polar Expedition.  
ZENITH RADIO CORPORATION  
310 South Michigan Avenue, Chicago, Illinois



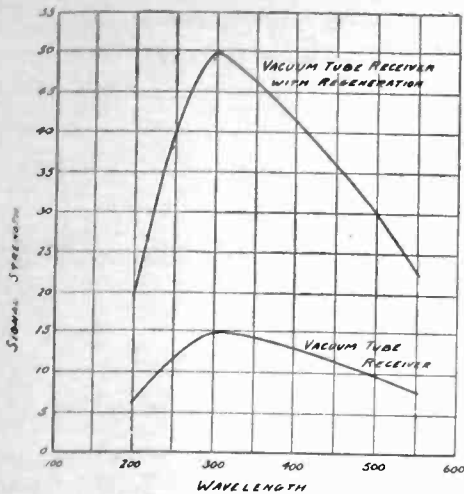

Fig. 3. Typical Curve Obtained With Test Equipment.

In Fig. 3 is shown a typical curve such as is obtainable with the test layout, and indicates the variation in signal strength with wavelength in a simple receiving circuit employing both a regenerative and non-regenerative vacuum tube. It is noted that the reception at 200 meters is only 40 percent of the optimum reception, which is at 360 meters.

### REBUILDING CONDENSERS (Continued from Page 35)

make a mark such as is shown by the dotted line. Make one plate as a pattern and trim all the plates to the required shape. Smooth the edges with a file and fine sand paper, then reassemble.

It will be found that the high to low ratio is now much greater than before as the minimum capacity is now but a fraction of what it was previously.

In my own experimental sets the following dial settings are noted:

	Meters	K. C. Frequency
WBBM	226	10° 1330
WREO	286	45° 1050
KDKA	309	55° 970
WGY	380	83° 790
WSB	428	105° 700
WCAP	469	125° 640
WJR	517	148° 580
KSD	546	155° 550

This is a combination of a 9-plate condenser altered as described and used in conjunction with a Lorentz type coil of 112 turns No. 22 D.C.C. wire on a 2¼-in. circle, wound over one and under two pegs. The coils are then sewed or laced with crochet cotton and mounted on strips of heavy fish paper. My dials are of the 180 degree type which accounts for the high readings.

### AIR LINE MAP AND LOG

**50c** The best log and map we have ever seen. Very handy and simple.

"RADIO"

Pacific Bldg. San Francisco

# AMPLION

ALFRED GRAHAM & CO.  
LONDON, ENGLAND  
Patentees

Product of Nearly  
40 Years' Experience

Bring in those distant  
programs clear and loud!

THE actual originators and world's oldest makers of loud speaking devices have created in The Amplion a long distance radio reproducer so clear and powerful that many users say it can be used instead of another tube in a set. Hear The Amplion—in comparison!—and you will understand the reason it leads in sales throughout the world—is the choice of the Royalty and Nobility abroad, and of the musically critical everywhere. Write for the "Amplion Pedigree."

THE AMPLION CORPORATION of AMERICA  
Executive Offices: Suite O, 280 Madison Ave., New York City  
Chicago Branch: 27-29 No. Morgan Street  
Canadian Distributors: Burndopt of Canada, Ltd., Toronto



Supreme clarity of tone caused Amplions to be chosen for use in St. Peter's, Rome, to reproduce important papal ceremonies.

All Amplions are completely equipped with cords and panel plugs.

Speakers and console units  
\$12 to \$4250

## -it's in the TUBE

YOUR receiving set can be no better than its tubes. CECO Tubes give maximum results in clarity of tone, rich volume and long life.

Our charted tests (results confirmed by laboratories of national reputation), PROVE CECO TUBES SUPERIORITY—as detectors, as amplifiers.

Buy CECO Tubes whether your set takes one tube or eight.

Now ready! CECO Tubes with new type long PRONG BASES. Also, power amplifier tubes, E (Dry Cell Type), F (Storage Battery), for last stage of Audio Frequency. Ask your radio dealer.

C. E. MFG. CO., Inc.  
702 Eddy St., Providence, R. I.



	"A"	"B"	"C"
Filament Volts	5.0	3.0	3.0
Filament Current	0.25	.06	.06
Plate Voltage	20 to 120	20 to 80	20 to 80



ARE YOU A SUBSCRIBER?  
Send \$1.00 for a Trial Subscription  
to "RADIO" for 6 Months.

## NA-ALD

Na-ald Deluxe Sockets are the only ones with these 3 exclusive features—lowest loss, lowest capacity and positive side-scraping contact. Send for booklet and laboratory test. Alden Mfg. Co., Dept. G12, Springfield, Mass.



### NO MORE LOOSE CONNECTIONS X-L PUSH POSTS

A binding post that really does excel, looks, action, service, and convenience. Push it down—insert wire—cannot jar loose from vibration. No screwing or danger of shearing off wires. Furnished attractively plated with soldering lug and necessary markings. Price, Each, 15c. X-L RADIO LABORATORIES  
2428 Lincoln Avenue Chicago

Tell them that you saw it in RADIO

**Build the Set That  
Holds 4 World's Records**



The receiver that brought in stations 6,000 to 8,000 miles distant with loud speaker volume night after night. All records fully verified.

**Holds World's Records For**

- (1) Longest distance ever received on a loop aerial — 8,375 miles.
- (2) Most consistent reception of stations 6,000 to 8,000 miles distant — 117 programs in three months.
- (3) Brought in 6 different stations in 2 1/4 hours—all over 6,000 miles.

**PRICE:**

Complete Set of Parts ..... \$89.00  
(Includes all parts necessary to make an exact duplicate of this wonderful receiver, together with book of instructions and complete blue prints.)

Story of development and proofs of records sent on receipt of stamped and addressed envelope.

**Scott Radio Laboratories**  
37 South Dearborn Street, Chicago  
*Dealers and Set Builders,*  
*Write for Discounts*

**NON-OSCILLATING R. F.  
CIRCUIT**

*(Continued from Page 16)*

far end to the set itself, be used. This antenna should be raised as high as possible, especially at the far end. It should be connected to the first antenna binding post on the set. If a long antenna is used, best results will probably be obtained by connecting it to the second antenna binding post on the set. After the set is in operation, the antenna should be tried on first one post and then the other, and left on the post that gives the best results.

The tuning of the set is similar to that of any five-tube neutrodyne or tuned radio frequency set. Readings on the

radio frequency tubes, and is placed in the circuit to be used as a volume control. When receiving local stations, it will only be necessary to turn this rheostat on a little way. It should never be turned on full except when the storage battery is run down. Neither one of the rheostats should be turned past the point necessary to give a filament voltage of five volts at the tube terminals. This can easily be checked if a voltmeter is available.

When dry battery tubes are being used, the filament voltage should never exceed three volts.

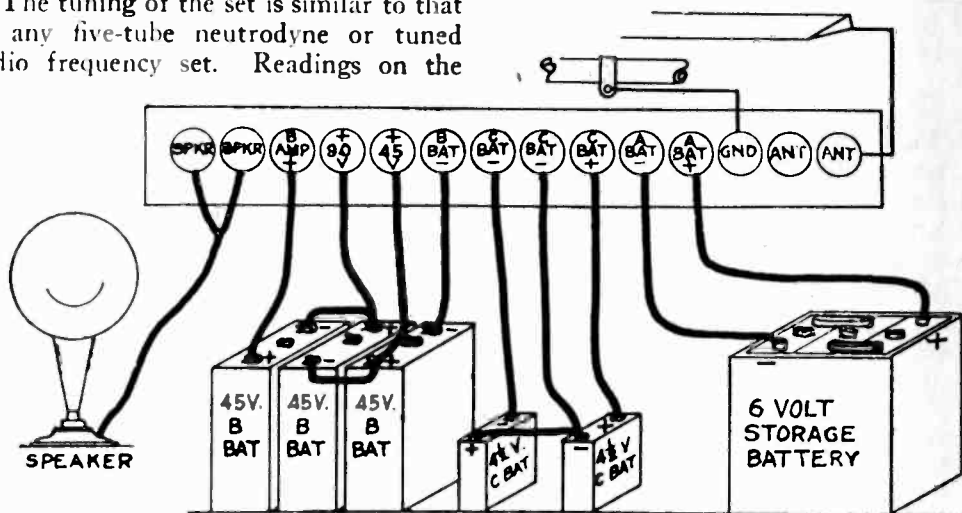

Fig. 6. Battery Connections to Set. Rear View.

center and right-hand dials will be practically the same for any given station. The reading of the left-hand dial may be the same or slightly above or below, depending upon the characteristics of the antenna and the position of the two-way switch on the lower left-hand corner of the panel. The position of this switch controls the relative selectivity and volume obtainable. When it is thrown to the right, the set will be more selective for cutting through the local stations, but will not have quite the volume on distant stations that it will when the switch is thrown to the left. In changing the positions of this switch, the left-hand dial will have to be reset to receive the same station. The position of any station will be slightly higher on the dial when the switch is thrown to the right.

It will be found easier to tune in distant stations for the first time if headphones are used. These may be plugged in to the jack on the lower right-hand corner of the set. Inserting the phones in this jack automatically shuts off the loud speaker and connects the phones to the output of the first audio frequency amplifier.

The right-hand rheostat in the set controls the filament current to the detector and the two audio frequency amplifier tubes. Its proper setting depends upon the degree of charge in the storage battery. It should never be turned on any further than necessary to give satisfactory signal strength. The left-hand rheostat controls the filament of the two

**POWER AMPLIFIER**

*(Continued from Page 54)*

ception of the tubes, sockets, gridleaks and the switches, which are on the panel.

In wiring the amplifier, use well insulated, flexible wire, such as No. 18 single fixture wire, or lampcord, as the voltages handled are considerable and bus bar wire will not do unless it is very well insulated with spaghetti. Keep the grid circuits away from the filament and plate voltage supply, as well as the 110 volt power wiring. A filament control jack for the output circuit lights the filament of the 1st stage, and any simple switch will do for the a. c. circuit. A Carter Jack Switch having two pairs of springs may be used to provide a convenient although not entirely fool-proof method of switching both the a. c. and storage battery circuits on and off, but unless the constructor is sure of his ability to handle 110 volt power circuits, it would be better to use separate switches for the two circuits and play safe.

When connected to any standard receiving set having a detector tube of either the 199 or 201-A variety, the volume obtainable with this amplifier when connected to a cone speaker is ample for a very large room, and the quality is beyond reproach. When used in connection with the shielded model Best Superheterodyne described in August 1925 RADIO, it furnishes an ideal combination, at a relatively small expense.

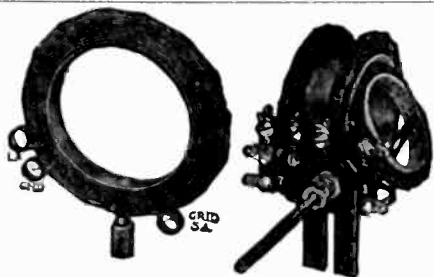

Coil Set No. 24 for Browning-Drake Circuit

**SICKLES  
DIAMOND WEAVE  
COILS**  
(Trade Mark Registered Aug. 4, 1925)

**For Browning-Drake  
Roberts, Craig and  
Hoyt Circuits**  
(Patented Aug. 21, 1923)

Sickles Coils for the famous Browning-Drake Circuit are the latest Sickles achievement in efficient design for a particular use. They are priced at \$7.50 a set.

The New No. 18A Coils for any Roberts Circuit are absolutely standard equipment. They are priced at \$8.00 per set.

Coil Set No. 20, at \$4.50, is for use specifically with the new Reflex Receiver designed by Albert G. Craig using the Sodian detector.

Coils for the Hoyt Circuit at \$10.00 a set, for the Knockout Reflex Circuit at \$4.00 a pair, and the Tuned Radio Frequency Coils at \$2.00 each, are other standard Sickles Coils. We manufacture also for manufacturers' special requirements.

*Send for descriptive catalog*

**The F. W. Sickles Co.**  
138 Union St. Springfield, Mass.

# The World's Greatest Radio Story

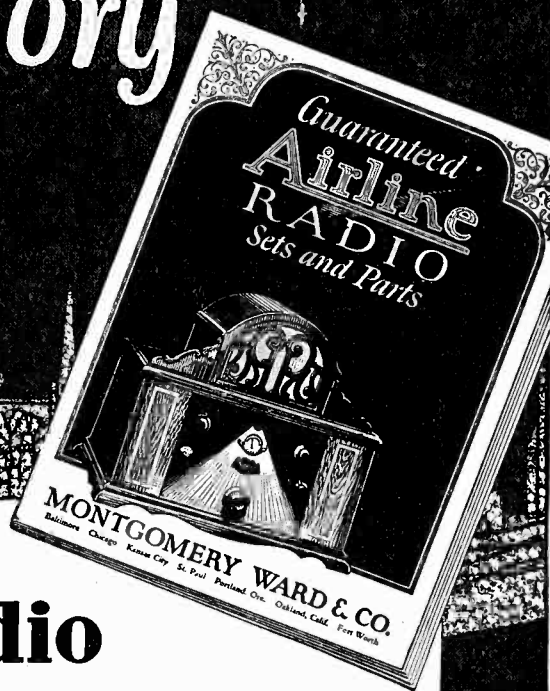

## Ward's New Radio Catalogue is Now Ready

Are you interested in seeing what is new in Radio— what is best and what has been approved?

And do you wish to know the lowest prices on tested sets, prices made without the usual "Radio profits?"

### This Catalogue is a Complete Guide to Radio

Ward's is headquarters for Radio, with probably the largest retail radio department in the whole world.

This new 52 page Radio Catalogue shows everything in parts, batteries, cabinets, contains a list of stations, a radio log for recording stations. It shows the best of the new sets. One tube sets that give amazing results.

Five tube sets with a single dial to turn. Think of tuning in one station after another by turning a single dial!

Every price quoted means a big saving to you. Everything offered is tested by our own Radio Experts. In fact, the best experts compiled this Catalogue for you.

Write for this 52 Page Book. It is yours free.

### Our 53 year old Policy

For 53 years we have sold only quality merchandise under a Golden Rule Policy. You can rely absolutely upon the quality of everything shown in this Radio Catalogue.

ESTABLISHED 1872  
**Montgomery Ward & Co.**

The Oldest Mail Order House is Today the Most Progressive  
 Baltimore Chicago Kansas City St. Paul Portland, Ore. Oakland, Calif. Ft. Worth

To Montgomery Ward & Co., Dept. 39-R

Baltimore Chicago Kansas City St. Paul  
 Portland, Ore. Oakland, Calif. Fort Worth

(Mail this coupon to our house nearest you.)

Please mail my free copy of Montgomery Ward's  
 New Radio Catalogue.

Name .....

Local address .....

Post office .....

State .....



# New "AMSCO" Products

*The choice of  
Leading Radio Engineers*

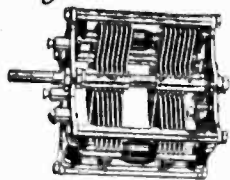

## AMSCO SIAMESE CONDENSERS

Used by William H. Preiss in his "Straight 8" Receiver, R. E. Lacault in his "Ultra-dyne," L. M. Cockaday in his "L. C. 26" Receiver, and specified by Lester L. Jones for single control receivers.

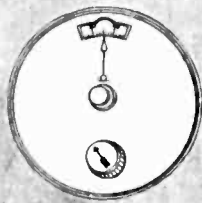

## DE LUXE MODEL AMSCO VERNIER DIALS

Now finished in gold, silver, and jet. Free acting forward or backward, fast or slow, without momentum or backlash. Gives finesse to fingers.

## FOR STRAIGHT-LINE AMPLIFICATION



## AMSCO RESISTANCE COUPLERS

The perfected instruments for straight-line amplification. All frequencies within the voice and music ranges, from the highest treble to the lowest bass, are augmented equally, giving true tone reproduction without distortion.

Investigate Amsco Resistance Couplers, Grid Gates and Resistors.

## It Clicks into Contact

## AMSCO UNIVERSAL SOCKET



All standard UX and CX radio tubes snap in with a click that assures positive contact.

Patented Amsco construction fully enclosed in genuine Bakelite. One hole mounting. They save space



**AMSCO PRODUCTS, INC.**  
Broome & Lafayette Sts., New York

# The Largest Net Paid Circulation

of any radio magazine on the Pacific Coast is being enjoyed by

## RADIOCAST WEEKLY

Send for a free sample copy

PACIFIC RADIO PUBLISHING CO.

Pacific Building - - - - San Francisco, Calif.

## FROM ARIEL TO GROUND

*(Continued from Page 24)*

every movement made by Dwyer with intense concentration. His look of puzzled bewilderment amused Dwyer, who had settled himself in the huge arm-chair in the center of the cabin.

"See something new?" he queried smiling.

"Something new!" answered the stranger, "Everything I see is new. Everything," he repeated, as the civilized food and now the civilized surroundings seemed to release the long disused methods of natural speech. "I thought I knew something about radio but all this is beyond me."

"How long have you been on the island?" Dwyer asked again.

"Seems like ten years," he answered, "but it may be less. What year is this?"

"1930," answered Dwyer.

"1930!" exclaimed the other, "then I've spent five years down there all alone on that little desert island. We were shipwrecked near there in November of 1925. I was chief operator of the *Admiral Sims* when she went on the rocks and I reached the island on a piece of wreckage after three days of drifting. Do you remember that ship?" he asked.

"Very well indeed," smiled Dwyer, "Who was your second operator?"

"A fresh guy named Dwyer," replied the castaway. "Whatever shark got him sure had indigestion!"

"Don't you recognize me, Mr. Joe Knapp?" asked Dwyer, turning the light to shine full on his own face.

"For the luv' o' mike! Denny Dwyer!" gasped Knapp, "If that doesn't beat the Dutch!"

But the unflattering reference to his former assistant by Joe caused Dwyer to respond a little coolly to the other's fervent expressions of delight at the astonishing reunion.

"We were picked up the next day after the wreck," Dwyer went on. "All the boats with all hands except you and the skipper. After searching for you two days we gave you up for lost and went on to San Francisco. When I saw you hopping around the fire down there a while ago there seemed something vaguely familiar about your antics! Remember you used to get a bit excited when the old sparks caused too much QRM?"

"There was more than that to drive a fellow crazy when you—" began Joe, but checked himself and asked in a more friendly tone, "Can you take me somewhere, Denny, where I can get cleaned up and look like a human being again?"

"I don't know about the last part," responded Dwyer, "but in my room you will find a razor and comb and so forth, and after a shower bath you can use some of my clothes for the present."

"Your room! Shower bath!" repeated Joe incredulously.

*(Continued on Page 62)*



Here Are  
Three Good Reasons  
Why You Should Use

**EBY**

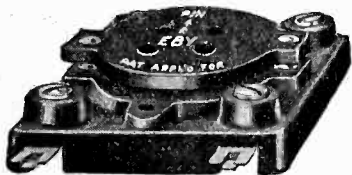

## SPRING SOCKETS

- 1** A three-point wiping contact that insures a positive contact at all times, regardless of the size of the prong or amount of solder on the prong tip.
- 2** Its ingenious design permits the tube to "float" when in service. This feature reduces microphonic noises to a minimum and prevents tube damage.
- 3** All the advantages of interchangeability of the new UX, CX, and UV tubes for 60c.

Don't take chances on twenty loose connections in a five-tube set. Use the new EBY positive contact sockets for better reception.

*If your dealer can't supply you, write to us, sending his name*

**H. H. Eby Manufacturing Co.**  
4710 STENTON AVENUE PHILADELPHIA, PA.



This is the EBY Binding Post that is standard equipment on eight out of ten of the radio receivers made in America—your dealer has all of the 27 different markings.

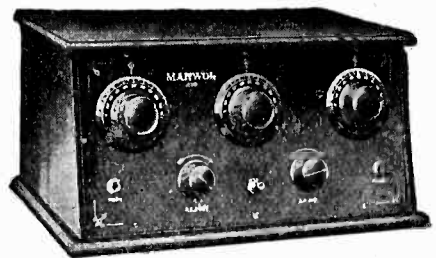

MARWOL JEWEL \$39.50  
5-Tube Tuned Radio Frequency

# MARWOL RECEIVERS

*The Buy-Word for Bigger Sales  
in 1926*

*The Greatest Line  
of Profit Makers for the Big  
Winter Radio Months*

Concentrate your efforts on Marwol, and 1926 will be your banner sales year for the following reasons:

1. Marwol Receivers give superb performance.
2. Marwols are moderately priced—which means a fast selling line with quick profits.

Send the coupon below for the Marwol story of sure profits and an outline of our plans to help Marwol dealers make 1926 a profitable radio year.

MARWOL RADIO CORPORATION  
546-548 Broadway, New York

Send us complete details about your merchandising plans to make 1926 the biggest Radio year for Marwol dealers.

Name .....

Address .....

City..... State.....

## MARWOL RADIO CORPORATION

546-548 Broadway, New York City

*Represented by these concerns:*

- |  |   |
|--|---|
| K. S. Byrd Co.<br>221 North 11th Street<br>Philadelphia, Pa.<br>Charles Saenger,<br>942 Prospect Avenue<br>Cleveland, Ohio<br>The Barsook Co.<br>53 West Jackson Blvd.<br>Chicago, Ill.<br>Dungan Sternfield Radio<br>Sales Co.<br>25 No. Dearborn St.<br>Chicago, Ill.<br>C. L. S. Holmes<br>502 Boston Block<br>Minneapolis, Minn. | Lane-Meyn & Company<br>Chemical Building<br>St. Louis, Mo.<br>C. E. Gay<br>166 Lowndale Street<br>Portland, Ore.<br>R. T. Carr<br>906 Sprague Street<br>Spokane, Wash.<br>Marshank Sales Co.<br>926 Insurance Exchange Bldg.<br>Los Angeles, Calif.<br>C. H. Wallis & Co.<br>1409 Syndicate Trust Bldg.<br>St. Louis, Mo. |
|--|---|



Better Quality Greater Volume  
More Economical to Operate  
Your Set With

## RAYTHEON TUBE B-ELIMINATORS

Using



## TRANSFORMERS



509  
Full Wave  
**\$7.00**  
List

## CHOKES



514  
20 Henry  
**\$5.00**  
List

Raytheon Tubes, \$6.00 List

Also Transformers and Chokes for R.C.A.  
and Cunningham Tubes

Practical in every respect the new Raytheon Tube B-Eliminators add more to the pleasure of radio than any achievement in two years. Performance is consistent and your B-Eliminator costs less to operate.

It is very easy to build your own B-Eliminator—and inexpensive compared with the cost of B-Batteries.

Order from your dealer or send check or money order direct to factory. C.O.D. deliveries made on request.

Built complete, including winding  
of coils, in Dongan plant

### MANUFACTURERS

Leading B-Eliminators today use Dongan Transformers and Chokes. One division of our big plant is equipped for large production for manufacturers. Special prices on request.

### JOBBERS

"Finest all-year radio merchandise on the market," said one of the country's leading jobbers. Dongan wishes new connections in certain territories.

Other Dongan Products—  
Audio Transformers  
Voltmeters.

**Dongan Electric Manufacturing Co.**  
2981-3001 Franklin Street, Detroit, Mich.

Pacific Coast Representatives:

San Francisco—  
Industrial Sales Co., 171 Second Street  
Los Angeles—  
W. A. Breniman, 443 South San Pedro Street  
Portland, Ore.—  
C. E. Gay, 166 Lowndale Street  
Seattle, Wash.—  
E. P. Denham, 2726 45th Avenue S. W.

TRANSFORMERS of MERIT for FIFTEEN YEARS

## Proved by Performance!



TRF Kit  
\$12.00

## AERO COILS

This season—thousands more fans found the answer to complete radio satisfaction thru Aero Coils.

Selectivity! Distance! Power! All these—to a degree not yet even approached by any other inductances. And simply because the Aero Coil is patented—both in principle and in construction. Any set—any circuit is greatly improved by substituting these wonder inductances for those you are now using. At your dealers.

Write for free Aero Booklet!

CT-80—Three Circuit Tuner.....	\$ 8.00
(Variable Primary)	
TRF-110—Radio Frequency Regenerative Kit.....	11.00
WT-40—Wave Trap Coil.....	4.00
OS-55—Oscillator.....	5.50
AX-45—Antenna Coupler.....	4.50
(Variable Primary)	

## AERO PRODUCTS, Inc.

217 N. Desplaines Street, CHICAGO

## Yours—free!



**WRS 96-PAGE  
Radio Guide Book**  
Profusely illustrated and "chockful" of interest for the radio fans.  
Trouble shooting chart.  
List of stations and Log Chart and hundreds of  
Radio Values on a  
**MONEY BACK  
GUARANTEE**

Your satisfaction is insured. Service and quality guaranteed or money refunded. Fill all your radio needs here—complete stock—24-hour service.

**FREE** A postal brings your copy. Write for it TODAY. Mention "Pacific Radio."

Wholesale Radio Service Company  
6 Church Street Dept. AR-12 New York City



## DON'T WAIT!

## Pep Up That Set Now With X-L VARIO DENSERS

Install them in your receiver and hear them speak for themselves

SPECIFIED BY

### GERALD M. BEST

Endorsed and Used by the Foremost  
Radio Engineers

SPECIAL FOR MODIFIED 45,000 CYCLE SUPERHETERODYNE

CAP. RANGE .00002 to .0001 M. F., \$1.50

MODEL N—Capacity range 1.8 to 20 micro-microfarads for balance in Roberts two tube, Browning-Drake, McMurdo Silver's Knockout, Neutrodyne and tuned radio frequency circuits. Price, \$1.00.

MODEL G—Two capacity ranges, .00016 to .00055 and .0003 to .001 Microfarads, for the Cockaday circuit, filter and intermediate frequency tuning in superheterodyne and positive grid bias in all sets. Price, \$1.50.

### X-L RADIO LABORATORIES

2426 Lincoln Avenue CHICAGO

**ARE YOU A SUBSCRIBER?**  
Send for Trial Subscription  
**\$1.00 for Six Months**

(Continued from Page 60)

"Right here," answered Dwyer, opening a door to a tiny sleeping compartment. "And here's the shower," he added swinging back another. "Help yourself. One of these suits of whites may fit you."

"Ought to," said Joe, "A lot of mine fitted you on the old *Admiral Sims*."

An hour later Joe re-entered the cabin, shaved, bathed and clothed in spotless linen. He relaxed into the comfortable seat with a sigh of utter content. He silently watched while Dwyer made various adjustments of the dials and switches on the control board, and as the latter seemed disinclined to volunteer any information Joe could no longer contain his curiosity.

"For Heaven's sake," he demanded, "Can't you tell me what you are doing now?"

"Just changing our direction," casually responded Dwyer, "Instead of stopping at Samoa we will go right on to Sydney."

"To Sydney!" repeated Joe, "You haven't enough gas to take us there, have you?"

"Only flitters use gas nowadays," explained Dwyer in a rather superior tone.

"Flitters?" said Joe.

"Yes. The small cheap monoplanes that were put on the market a few years ago. They are almost obsolete now. When I discovered the principle of energy transmission by radio—"

"When you discovered the which?" ejaculated Joe, but Dwyer continued, ignoring the interruption.

"—all the old methods of supplying power were quickly discarded. A chain of high power dynamiters now cover the entire surface of the globe, so that unlimited energy is always available by simply tuning one of my telemodynes to the nearest station."

"Dynamiters! Telemodynes!" gasped Joe.

"A dynamiter," Dwyer explained patiently, "is the machine that converts the enormous store of residual magnetism within the interior of the earth into radiated energy and the telemodyne is my perfected machine for changing this wave into useful power, which is then applied to a radimotor such as the thousand horse power one which is now driving us through the air at three hundred miles an hour."

Joe's jaw sagged and his eyes popped as he stared at the speedometer which Dwyer indicated.

"Three hundred miles an hour," he whispered, "and it's pitch dark! Suppose you meet head-on with somebody coming the other way?"

"That's impossible," snapped Dwyer. "The air is divided into levels for every type of flying machine, and for similar machines going in different directions."

(Continued on Page 64)



# LABORATORY SERVICE

By G. M. BEST

*"RADIO'S" New Calibration Laboratory Is Second to None*

THE complete laboratory of the Pacific Radio Publishing Company is at your service. We make tests—calculations—give you expert advice on your radio problems. Gerald M. Best is in charge of our own laboratory. We have an assortment of the finest testing equipment available.

Use this service. Let us answer your radio questions for you. We give you expert advice on your radio problems. Our service is most accurate—entirely dependable and PROMPT.

We will answer ten of your radio questions if you subscribe to "RADIO" for only one year. With your subscription to "RADIO" you will receive ten coupons, entitling you to answers to ten radio questions.

The regular cost for answering ten questions is \$2.50. Save this money! Subscribe to "RADIO" and get your answers without cost.

Use the coupon. Attach your remittance of \$2.50 to it and mail now. Your investment of \$2.50 will pay big dividends. The coming issues of "RADIO" will surprise you.

*This offer will shortly be withdrawn*

*Now is the time to act!*

-----COUPON-----

"RADIO," Pacific Building, San Francisco, Calif.

Here is \$2.50. Send me "RADIO" for one year and 10 free coupons entitling me to answers to ten radio questions.

Name .....

Address .....

City and State .....

# It's Easy to Build A Powerful Set

*Using the New and Improved FRESHMAN "TRF" Low Loss Kit*



## Straight Line Wave Length Condensers With Low Loss Self Balanced Coils

These are the identical units which have made the FRESHMAN MASTERPIECE factory built Receivers the World's Greatest Radio Sets

**\$ 9.50**

Complete instructions for building this powerful five tube receiver, written in plain everyday English, together with actual size schematic wiring diagram are furnished with every FRESHMAN "TRF" Kit.

**Sold by Authorized Freshman Dealers Only!**

**CHAS. FRESHMAN CO., INC.** Freshman Building, New York 2626 W. Washington Blvd., Chicago

## Read by 43,750 Families

—This leading Pacific Coast weekly program and schedule magazine contains 64 pages of the most reliable data in print.

**50 cents RADIO CAST WEEKLY**

for the next 12 issues—mailed to your home.

"The Recognized and Accepted Authority" Pacific Bldg. - - San Francisco

# Centralab Radiohm for Oscillation Control

THE Centralab Radiohm gives you perfect oscillation control—enables you to get full efficiency from your radio set.

By controlling oscillation with this little unit, you can hold that sensitive regenerative position which immediately precedes the oscillation point, without distortion or loss of selectivity. Think what a boon to clear, true-tone reception this is!

The Radiohm provides smooth variation of resistance from zero to 200,000 ohms. Ideal for plate circuit control of oscillation. Used as a standard unit in many leading commercial sets. Price: \$2.00.

# Centralab Modulator for Volume Control

This improved type of potentiometer takes the "rough spots" out of volume—smooths out powerful "locals" as well as difficult "DX." It provides noiseless control of tone volume without in any way affecting the tuning of your set. Has a maximum resistance of 500,000 ohms, specially tapered to give smooth, even control from a whisper to full volume—or vice versa—without de-tuning.

Can be used in audio circuits with any transformers or with Thordarson "Autoformers." Endorsed by Thordarson Electric Mfg. Co. Price: \$2.00.

Mail the coupon

**Central Radio Laboratories**  
14 Keefe Avenue, Milwaukee, Wis.

# Centralab

CENTRAL RADIO LABORATORIES, 14 Keefe Ave., Milwaukee, Wis.

Send me literature describing Centralab controls. Enclosed find \$\_\_\_\_\_ for which please send me the following:

Centralab Modulator, at \$2.00 each.  Centralab Radiohm, at \$2.00 each.

Name \_\_\_\_\_

Address \_\_\_\_\_

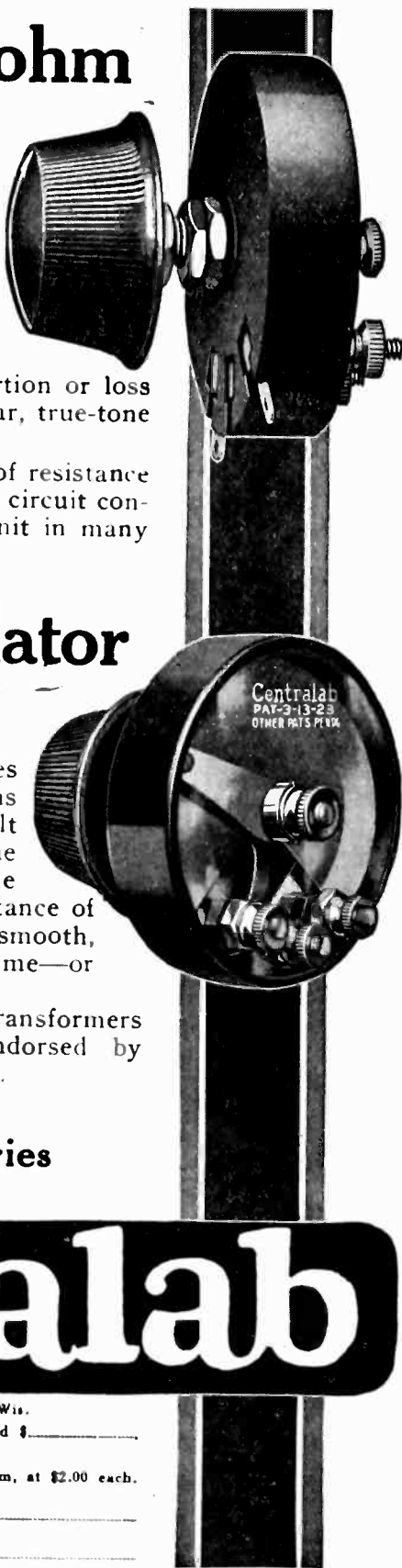

(Continued from Page 62)

"But we must be above the clouds," said Joe. "How are you going to know when you are over Sydney? Maybe you'll shoot straight across to Perth!"

"My automatic direction finder takes care of all that," Dwyer answered. "And in addition I can use this veerayscope which I developed especially for foggy localities where traffic is heavy."

"San Francisco?" queried Joe, but at the expression of irritation on the other's face he added hurriedly, "Oh! go ahead. How does it work?"

"It works on much the same principle as the fluoroscope which was used principally by the medical profession in connection with the X-ray machines of your time. Here, take a look!" he continued handing Joe the camera-like instrument and plugging in the cord from it to a jack on the control panel.

"It's black as the ace of spades," Joe reported, fitting the plush-lined openings to his eyes.

"Point it directly ahead," directed Dwyer, "and move it around a bit."

"The bottom is now a kind of greenish white," said Joe excitedly. "I see some kind of a mark and some figures. The mark looks like a cross in a circle. The number is 582."

"That's the insignia of Sydney," Dwyer explained. "The number refers to the latitude and longitude. Every station and every flying machine is equipped with a projector which sends out a powerful shortwave carrier and on this carrier is super-imposed the V-ray. This V-ray has the property of affecting a plate covered with crystals of balunium and making it glow in the dark. Any metal object placed in front of the projector will cast a distinct black shadow on the luminous plate of the scope, and it is those shadows you are now observing."

Joe was searching for and examining the marks of the various stations ahead. Newcastle to the right of Sydney, Melbourne away to the left, and Adelaide between the two but further west, were all easily identified by their distinctive insignia.

He turned the veerayscope downwards and picked up a large fast moving signal with a cluster of small signals speeding along behind it.

"What are they?" he asked, handing the instrument to Dwyer. "They look to me like a flock of whales chasing a seagull!" he added.

Dwyer looked for a moment and then switched on a powerful searchlight on the bottom of the *Ariel* and trained it on the objects cutting through the water nearly a mile below.

"That is a fleet of aquarines, or freight carriers," he told Joe. "The flyer in the lead is the radiductor's machine. He has complete control—by radio, of course—of the radimotors and steering equip-



## VEBY HIGH-MU TUBES

Will give your resistance-coupled amplifier greater volume of better quality than is possible with any other tube.

A. F. 20 High-Mu .....\$3.50  
A. F. 6 Power Tube.....\$4.50

VEBY RADIO CO.  
"Quality Resistors"

47-51 Morris Ave. Newark, N. J.

ment of all the twenty aquarines of the fleet."

Joe blinked stupidly and shook his head.

"Do you mean to tell me," he demanded, "that these things take the place of steamship freighters?"

"Of course, I do," answered Dwyer, "The old fashioned ships went to the junk pile years ago."

"Well, where are the masts and aerials? Where are the cargo booms? Where's the bridge? Where's the skipper and the crew?" Joe questioned plaintively.

"There isn't any more!" Dwyer explained, again with the superior smile. "A small loop of my own design replaces the aerial, and there is no necessity for any crew since the radioductor can maneuver the aquarine in any direction he wishes. Cargo booms are unnecessary because on arrival at San Francisco each unit is run into the great docking warehouses and the cover is removed. A battery of huge traveling cranes lifts out the cargo which is already stowed in large containers at the shipping port. Ten minutes is considered rather slow time for discharging one of those thirty thousand ton aquarines."

"Ten minutes to discharge a ship!" said Joe sarcastically, "That sure is slow! What makes them wiggle that way like a fish?" he added as the fleet disappeared over the horizon.

Dwyer switched off the searchlight and leaning back in his armchair answered his question.

"In the old days I was always greatly interested in the inefficient method of ship propulsion," he began, but Joe interrupted him heatedly.

"In the old days," he snapped, "to the best of my recollection you were never interested in anything but the dining saloon and your bunk!"

"Please don't interrupt me," said Dwyer languidly. "The propellor always seemed to me very wasteful of energy, so I devised the present method. This works exactly on the principle of a fish's tail. The entire aquarine is built like a large model shark, and a tail of semi-flexible metal is connected to a pivoted lever which extends inside the hull. A group of very powerful electromagnets on each side of the lever are energized alternately and pull the lever from side to side. This oscillating motion of the tail propels the vessel at a speed far in excess of anything possible with the old fashioned screws."

Dwyer stopped speaking and leaned over to a large dial, which was marked off into a great number of divisions and subdivisions. A section marked "music" was subdivided into vocal and instrumental, and these in turn into segments marked classical, dance, operatic and so on. A section marked "news" was divided into a group of smaller sections

# Now you can hear ALL notes!

A Thordarson Autoformer Amplifier built in accordance with instructions and diagrams furnished with each Autoformer

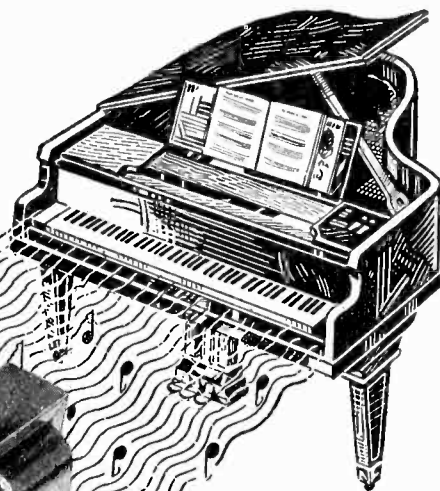
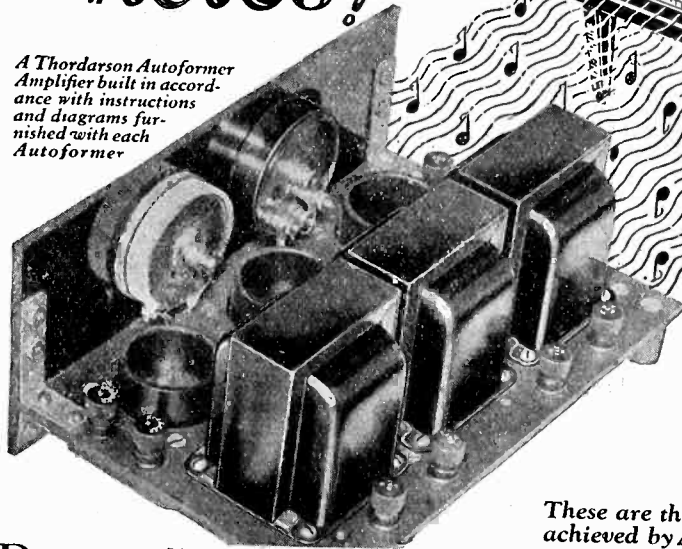

- 1 Full amplification of those bass notes hitherto largely "lost."
- 2 Greater clarity on all notes.
- 3 Improved reception of distant programs.
- 4 Better volume control.

These are the four great improvements achieved by Autoformer Amplification

## Deepest Bass to Highest Treble Brought Out Clearly

The Thordarson Autoformer is not "another transformer." It is an all-frequency amplifier, an entirely new instrument developed and built only by Thordarson. Autoformer Amplification is step-up impedance coupled with capacities and resistances. Write for fully descriptive literature. Autoformers, \$5 each. Dealers everywhere.

# THORDARSON

## Autoformer

Trade-Mark Registered

### All Frequency Amplifier

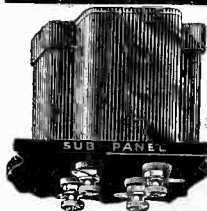

### Other Thordarsons

Thordarson Super Audio Frequency Transformers in either sub-panel or top mounting type. Three ratios: 2-1, \$5; 3 1/2-1, \$4; 6-1, \$4.50. Thordarson Power Amplifying Transformers, \$13 the pair. Thordarson Interstage Power Amplifying Transformers, \$8 each. All Thordarson products are unconditionally guaranteed.

**THORDARSON ELECTRIC MANUFACTURING CO.**  
*Transformer specialists since 1895*  
**WORLD'S OLDEST AND LARGEST EXCLUSIVE TRANSFORMER MAKERS**  
 Chicago, U.S.A.

**ZENITH**  
**KENNEDY**  
 Radiodyne  
 Planstiehl  
 Howard  
 Thermodyne  
**OZARKA**  
 Deresnadyne  
 ADLER-ROYAL  
 MURDOCK  
 MU-RAD  
 Valletone  
 LEICH  
 Silver-Marshall  
**GLOBE**  
 Newport  
 BUCKINGHAM  
 NUNN-LONDON  
 KUSTOMBILT and  
 many others  
 use Thordarson  
 Super-Amplifying  
 Transformers

Also choice of the MacMillan Arctic Expedition

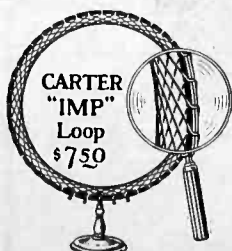

CARTER  
 "IMP"  
 Loop  
 \$7.50

See one at your dealer's.

Write for illustrated folder.

Coast Distributors:  
**A. S. LINDSTROM & CO.,**  
 274 Brannan St.  
 San Francisco, Calif.

Branch Offices at:  
 Los Angeles  
 Portland  
 Seattle  
 Salt Lake City

# CARTER

## New "IMP" LOOP

Again Carter leads with a loop that is compact, sturdy, yet highly efficient. No possibility of loose wires breaking. Weighs one pound, diameter 16 inches. Taps are provided for all loop circuits.

In Canada: Carter Radio Co., Ltd., Toronto





"We are about over Sydney," he remarked. "Look down. It's almost daylight and you can see it rather indistinctly. The power seems to be decreasing somehow," he added in a more worried tone.

Joe looked through the glass plate in the floor of the cabin, while Dwyer made some hurried changes in the controls.

"Sydney seems to be coming up to meet us pretty rapidly," Joe announced. "I can make out Circular Quay and George Street, and over there is the place where—"

"Something wrong!" shouted Dwyer. "We're falling! The power wave has been shut off. Must be another strike!" he yelled as he shifted switches frantically but to no effect.

"Guess there's another strike coming off right away too," answered Joe, "A regular walkout!" he added as he grabbed one of the parachutes which Dwyer had torn from their coverings.

Both jumped when the flying machine was still about a thousand feet above the water of the harbor, and both shot down at dizzy speed.

"They're not going to open!" Dwyer yelled in a panic as the parachutes failed to catch the terrific rush of air. "And I'm right over the Zoo on Turonga Island!"

His speed seemed to increase and he continued to drop sickeningly till within a bare few feet of the ground the parachute opened with a snap and he hung suspended directly over the open-air arena in which the lions of this famous zoo are allowed a sort of half-way liberty.

He twisted and struggled wildly only ten feet above the floor of the rocky den and when he saw a huge shaggy lion rush towards him with wide open jaws his limbs seemed to become suddenly paralyzed.

With a great bound the king of beasts fastened its massive paw on his shoulder and shook him violently. Close by a hoarse voice was shouting.

HE ceased his efforts to escape from the terrible animal and seemed to be dropping into pleasant unconsciousness when the shaking was repeated and the voice became more imperative. With a great effort of will he strove to concentrate on the insistent and very unpleasant voice and to ignore the claw that still held him in its mighty grasp.

"Hey you!" the absurd voice seemed to be addressing him, "Snap out of it now. You're half an hour late already!"

Dwyer struggled to a sitting position as the grip on his shoulder was released with a final violent shove. His head bumped against some hard unyielding object and he opened his eyes to find Joe Knapp regarding him with a hostile glare. He rubbed his eyes sleepily and passed his hand over the spot on his head which had come into sharp contact with

# AEROVOX

## FIXED CONDENSERS

have won an enviable  
**Reputation**  
among the foremost radio experts •  
~ there's a reason

\* Tested and approved by M. I. T., Yale, Radio News, Popular Radio and Popular Science. Used by over 200 of America's leading set manufacturers.

Made in all capacities. Also manufacturers of Grid Leaks, Resistors, Resistorformers and Rheostats.

AEROVOX WIRELESS CORP., 489 Broome Street, New York City

Chicago Office: 53 W. Jackson Boulevard

Western Representatives: RICE-HITT CO., SAN FRANCISCO-LOS ANGELES

**To-day-in every good set**



**Less wiring— Fewer losses**

Full, clear, rich tone depends on more than on just good apparatus. It depends, first of all, upon careful, compact wiring. AMPERITE eliminates complicated wiring, avoiding leaks and losses. Requires no attention. Controls the filament perfectly, bringing the utmost out of each individual tube. Permits use of any tubes or combination of tubes. Used in all popular construction sets. Price, \$1.10.

There is an AMPERITE for every tube  
Write for free hook-ups

**Radiall Company**  
Dept. R-2 50 Franklin St., N. Y. City

**AMPERITE**  
REG. U.S. PAT. OFF.

The "SELF-ADJUSTING" Rheostat

**HOYT "SUPER" CONTROL METER**



FOR PRECISION CONTROL of Radiola Superheterodynes No. 25 and No. 28. Instantly attached without any change in wiring to jacks already installed for this purpose. Permits setting rheostat for exact filament voltage for best reception and longest tube life.

A HOYT moving-coil voltmeter, type 17, with bronze rim, wood case to match set, non-scratch base and cord.

Price \$8.50

**BURTON-ROGERS CO.**  
26 Brighton Ave., Boston, Mass.

ARE YOU A SUBSCRIBER?  
SEND FOR TRIAL SUBSCRIPTION  
\$1.00 FOR SIX MONTHS

**Machine for Winding Honeycomb Coils**

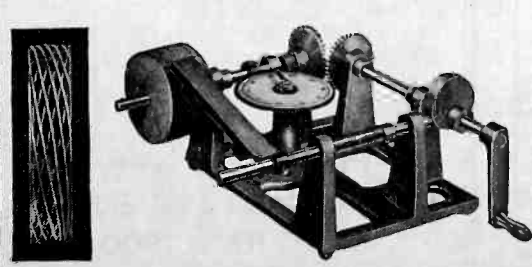

With this machine anyone can wind their own low-loss coils to suit their particular requirements. It will wind honeycomb type coils any width from one-half inch to one inch and the inside diameter of the coil can be arranged to suit by using various sizes of wooden spools on the winding spindle. It has a recorder with an adjustable pointer for counting the number of turns. Each machine is neatly finished in black enamel and packed in an individual carton. Price \$6.00

Get Our Agent's Proposition  
**MORRIS REGISTER COMPANY**  
Succeeding Morris Cash and Credit Register Company  
Factory: 29th and Broadway, Council Bluffs, Iowa.

Tell them that you saw it in RADIO

**You Can Depend on  
HAMMARLUND  
QUALITY**

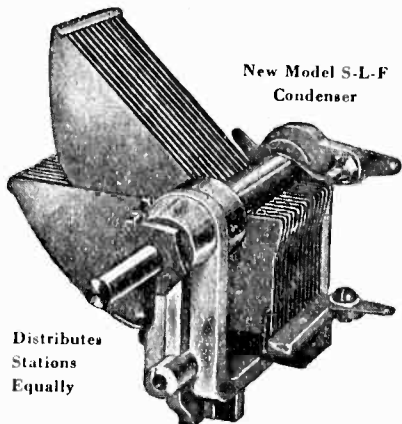

New Model S-L-F  
Condenser

Distributes  
Stations  
Equally

Hammarlund has manufactured precision instruments for telephone, telegraph and radio use for fifteen years. This new straight-line-frequency condenser is the culmination of that rich experience. It embodies every genuine low-loss feature known and is a mechanical and electrical masterpiece, providing the utmost in sharp tuning, equal distribution of stations over the dial and long, dependable service.

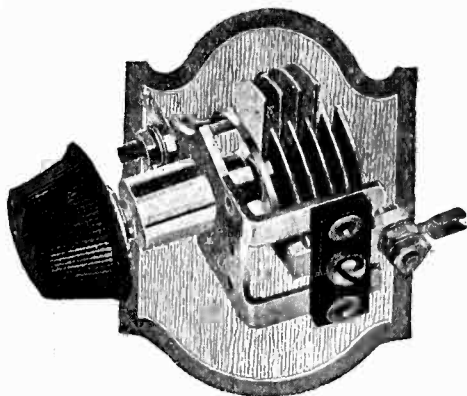

"Hammarlund  
Junior"

The  
Precision  
Midget

Here is a strongly-built shielded midget condenser, with soldered brass plates, clock-spring pigtail, minimum dielectric and one-hole mounting. An exceedingly efficient instrument for neutralizing, regeneration control and vernier use. Diagrams of uses sent on request.

Send 25 cents for illustrated book, giving complete instructions for assembling, wiring and operating the famous Hammarlund-Roberts Receiver.

**Hammarlund Mfg. Co.**  
124-438 W. 33rd Street, New York

Pacific Coast Representatives:

ATLANTIC & PACIFIC AGENCIES CORP.  
383 Brannan St., San Francisco

For Better Radio  
**Hammarlund**  
PRECISION  
PRODUCTS

# CHELSEA

Super  
five \$50.00

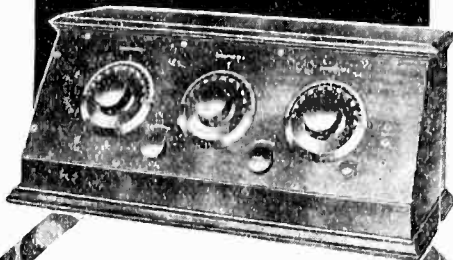

## The Set You Can Afford to Own

The new Chelsea offers the finest kind of service—consistently—regularly—without fuss or trouble.

Sweet, clear volume, and plenty of it, is obtained with but slight drain on the batteries and negligible wear on the tube filaments. Rugged bus-wiring, hand-soldered connections and a protective dust-proof, fool-proof inside panel are construction features insuring greater life and longer satisfaction. Fine mahogany piano finish Cabinet. Large over-size dials for positive selectivity make tuning a pleasure.

See this remarkable value at  
your Dealer's or write for  
illustrated folders

**Chelsea Radio Co.**  
CHELSEA, MASS.

## RADIOCAST WEEKLY

Sixty-four Pages of Programs,  
Photos, Humor, Musical Re-  
views, Schedules, Tables, Edi-  
torials, Etc.

5<sup>c</sup> Per Radiocast Weekly  
Copy 433 Pacific Bldg.,  
SAN FRANCISCO

the roof of the cabin over his bunk, and he gingerly felt of his shoulder.

"Where are we?" he grunted peevishly.

"Left Astoria an hour ago," answered Joe, "We're going out over the bar now, Shake a leg! The old man wants some bearings. There's a thick fog outside."

Dwyer was slowly climbing from his bunk and steadying himself on the pitching floor while he groped dazedly for his uniform. "Come on! Look alive!" insisted Joe, "I can't see what's the sense of you buying an alarm clock anyway. All you do is to set it and then shut it before it rings!"

He opened the door of the cabin and a rush of cold, fog-laden air swept in.

"For the luv' o' mike," he added, "try and stay awake long enough to get some press from NPL tonight."

He slammed the door and dashed below to the galley to get his midnight lunch before turning in, while Dwyer completed his hasty toilet and lurched unsteadily into the radio shack where he dropped heavily into the chair and picked up the headphones.

The old inferiority complex had squatted solidly again on the solar plexus of his subconscious ego!

Hi CUL GN.

### CALLS HEARD

(Continued from Page 39)

By KFUH

Heard and worked July 28th to August 8th, 1925, while anchored in lagoon at Fanning Island, 1000 miles south of Honolulu, 40 meters only.

(1pl), lux, lanq, 1cmf, 2gk, 2afn, 2mu, 2ij, 2bbx, 2agb, 2bum, (3bwj), 3bwf, 3ckg, (4sa), 4tn, 4km, (5uk), 5adz, 5ih, 5ng, 5agn, 5nj, 5ew, 5akz, 5zal, 5kc, 5cx, 5alj, (6awt), (6jp), (6dcf), (6cbb), (6aff), (6buc), (6zbn), (6cgo), (6zd), (6csi), (6aiv), (6csw), (6zac), (6cfi), 6uf, 6rm, 6bde, 6vc, 6clz, 6dh, 6bmw, 6js, 6ers, 6ur, 6ajl, 6dal, 6bh, 6rw, 6agk, 6bvy, 6bur, 6aij, 6ban, 6bsh, 6bcl, 6btm, 6bap, 6bgo, 6aol, 6cto, 6bkv, 6bjj, 6km, (7av), (7uz), (7uv), (7aek), 7fd, 7ay, 7gj, 7eh, 7nt, 7gb, 7it, (8ayy), 8aj, 8ckm, 8pl, 8nk, 8bf, (9uq), (9cxx), (9aon), 9bht, 9bpb, 9xn, 9ado, 9akf, 9dvl. Australian: 2yl, 2bb, 2ij, 3bd. New Zealand: (5ac), 1ax, 2ac, 4ar, 1ao, 4al, 2ae, 2xa. Chile: (1eg). Canadian: (9ck), 5ef, 4aa. Argentina: ba-1. Mexican: 1b, 1x. Navy: (nve), (npu), (npm), (naj), (nri), nki, npg, npn, nas, nirx, namg, npo, nsx, nedj. Commercial: (kdid), wap, wiz, wqn. Philippine Islands: 1hr.

(35 to 40 meters). August 8 to October 15, 1925. Stations heard and worked by KFUH while at Penrhyn Island; between Penrhyn Island and Papeete, Tahiti, and during time spent in Papeete Harbor, Papetoai Bay, Moorea and other islands of the Society group.

1cmp, 1bes, 1pl, lanq, 1yb, 1zi, 1ck, 1awe, 2lu, 2mm, 2xaf, 2mu, 2cpa, 2cvj, 2blm, 2ahm, 2bk, 2cxl, 2anm, 2aim, 2cjj, 3ckg, 3aao, 3lw, 3bva, 3hg, 3ckl, (4do), (4si), 4io, 4tv, 4rl, 4oa, 4fg, 4rm, 4bu, 4cu, 4il, (5ado), (5lg), (5aid), (5oq), 5ew, 5uk, 5zal, 5sd, 5akn, 5ox, 5bg, 5he, 5va, 5wi, 5amw, 5adz, 5ng, 5aj, 5aua, 5aab, 5agn, 5atv, 5amk, 5afn, 5alj, 5akz, 5ft, (6awt), (6jp), (6dcf), (6zac), (6cfi), (6zd), (6xad), (6ih), (6uf), (6cfe), (6aiv), (6aak), (6ea), (6che), (6ac), (6gk), (6amm), (6ahp), (6ol), (6bvs), (6sl), (6cmh), (6bzn), (6te), (6bip), (6cmq), (6cto), (6buc), (6asr), (6zbi), (6csw), 6chs, 6ct, 6vr, 6bjj, 6bmw, 6fa, 6km, 6abg, 6ajl, 6cix, 6cnc, 6bgv, 6btm, 6aqp, 6dah, 6bgb, 6apk, 6aff, 6bil, 6ccv, 6cor, 6afg, 6aum, 6nx, 6ase, 6ajm, 6qu, 6css, 6dab, 6wt, 6cah, 6ih, 6akc, 6dam, 6rw, 6aea, 6cw, 6zh, 6cz, 6alv, 6aaf, 6tq, 6ec, 6dax, 6ake, 6cgw, 6cqa, 6eb, 6cmd, 6ctf, 6bjd, 6ml, 6bkb, 6bbv, 6bon, (7de), (7ek), (7aek), 7ly, 7uz, 7ay, 7au, 7to, 7it, 7nx, 7df, 7uj, 7ot, 7eo, 7cs, (8bce), (8bnh), (8caz), (8pl), (8gz), (8rv), 8ac, 8eg, 8aly, 8cy, 8bf, 8er, 8tx, 8es, 8eq, 8bau, 8se, 8pk, 8xk, 8cau, (9ded), (9uq), (9efy), (9yav), (9zt), 9xn, 9bht, 9dvr.

(Continued on Page 70)

## THE MILLION-DOLLAR BEND

(Continued from Page 28)

tained; the judge would go half blind trying to see it; and the battling lawyers would lose it. And, far worse than this, the patent-owning company, in order to state their case, would have to lay before the court a great mass of jealously-guarded secret facts and formulas; which the gang on the other side of the fence would be writing down in their note-books so fast they would make their pencils smoke!

If the patent-holders could drag the defendant's wire-drawing machinery into court, they probably could prove their case; but these wire-making laboratories are mostly kept out of range of even the most high-powered legal rifle that can be brought into action against them. Either they are operated with such extreme secrecy that Sherlock Holmes himself could live and die over one of them and never suspect that it was around, or else they are located in Africa or Iceland, or some other equally inaccessible spot.

It appears rather improbable, therefore, that much of anything will be done by the owners of the tungsten wire patent toward trying to stop the manufacturing of infringing filament wire—especially in view of the fact that this patent has only four more years to live. There is one scandal-sheet published for the special edification and exasperation of persons engaged in the radio manufacturing and merchandising business that has been yapping and yelping and egging on the tungsten patent owners to come on out an' fight; but the only response from the elephant in the jungle is some ominous trumpeting and rumbling that occasionally grows loud and vexed enough to make all the little dogs turn and scoot in alarm.

A far more efficacious method of warfare favored by the holders of the big patents is being carried on today by deflecting the millions of dollars that might be wasted in fruitless litigation into costly and ceaseless advertising, which is marvellously potent, in time, to mold public opinion and confidence.

With the exception of the tungsten patent, there seems to be now hardly anything at all to prevent unlimited manufacture of radio tubes of the more popular types, by any one who cares to go into the expensive business of making them.

There does not appear to be any particularly important patents affecting the new high-mu tubes lately appearing on the market. The mechanical difference between a tube of high mu or high conductance and one of low mu or low conductance is merely that the high-mu tube has a much more closely wound grid than the other—with the result that the slight potentials applied to the grid have far greater choking effect on

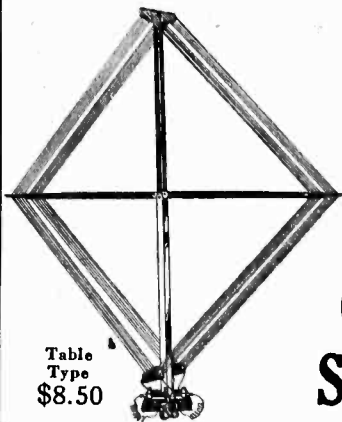
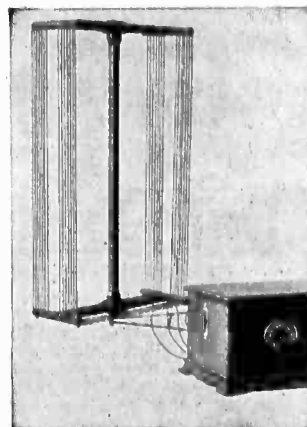

Table Type  
\$8.50

Take Your  
Choice!

## TWO GOOD SIGNAL LOOP AERIALS



Bracket Type, \$8.50

A bracket type that attaches right onto the end of your radio cabinet or a table type—you can't miss it on either one. When you buy a Signal Loop you're buying more than just good looks. You're buying an aerial backed by thirty years of experience in the manufacturing of electrical equipment.

Where quarters are close, remember the bracket type loop attaches right onto the end of your set and does away with that "extra piece of apparatus." It turns a complete 360° in the width of the standard cabinet.

Both aerials are beautifully constructed. The bracket type is of solid walnut. The table type is mahogany finished. All metal parts are heavily nickel plated. A third tap is provided for sets requiring it. Ask your favorite dealer to show you the Signal Loops—either type \$8.50. You will surely want one.

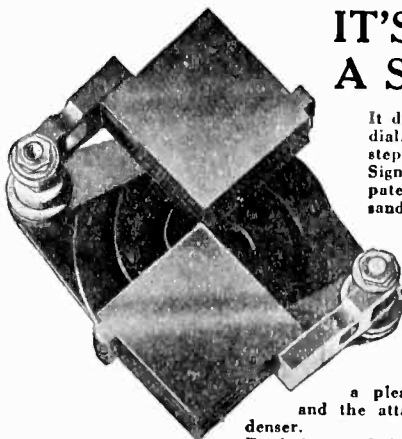

## IT'S EASY TUNING WITH A SIGNAL SPIRAL CAM

It distributes the wave lengths evenly over the 360° of the dial. Stations come in clearly without interference. Just step in at your dealer's and ask him to show you the Signal Spiral Cam Condenser—the condenser with the patented cam control. Then you will appreciate why thousands of fans have selected this condenser for their sets above hundreds of other condensers on the market today.

The Signal Spiral Cam Condenser is built for perfect control of high frequency as well as low frequency wave lengths. Results are uniform at all points on the dial—the scientifically designed cam takes care of that. There is absolutely no backlash and a balanced condition of the plate assemblies permits a smooth, velvety action that makes tuning a pleasure. Design permits single or three-hole mounting and the attaching of air core transformer directly onto the condenser.

Don't be satisfied with "just condensers." See the "Spiral Cam" before you buy. Three capacities, all one price—.00025, .00035 and .0005, \$4.00 and worth a lot more.

Jobbers and Dealers: If you are not fully acquainted with Signal Radio Products, we will be pleased to send you complete information. Write us at once for literature.

## SIGNAL ELECTRIC MANUFACTURING CO.

Dept. 3-B, Menominee, Mich.

1216 Hearst Building  
San Francisco

408 San Fernando Bldg.  
Los Angeles

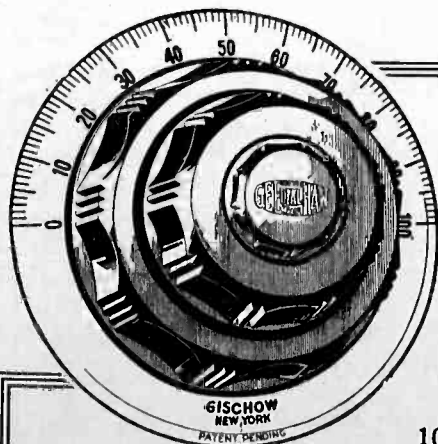

## GEE-HAW Micrometer TUNING DIAL

Ratio 100 to 1

A New Mechanical Principle  
Absolutely No Backlash

Manufactured by

OTTO R. GISCHOW CO., Inc.  
New York

For Sample Write to Pacific Coast Agents:

American Commercial Co.  
1067 Market Street, San Francisco, Calif.



**You Can Depend on  
HAMMARLUND  
QUALITY**

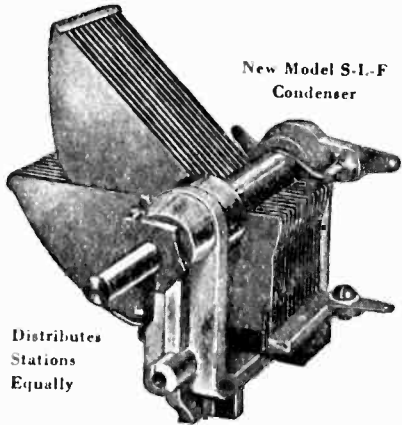

New Model S-L-F  
Condenser

Distributes  
Stations  
Equally

Hammarlund has manufactured precision instruments for telephone, telegraph and radio use for fifteen years. This new straight-line-frequency condenser is the culmination of that rich experience. It embodies every genuine low-loss feature known and is a mechanical and electrical masterpiece, providing the utmost in sharp tuning, equal distribution of stations over the dial and long, dependable service.

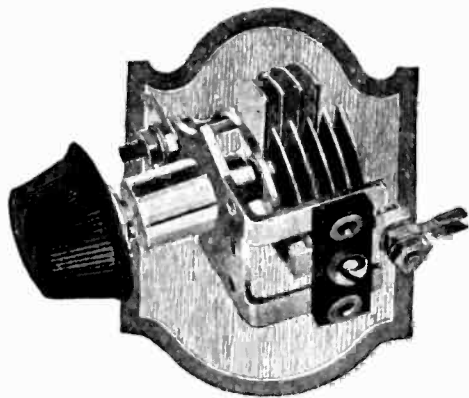

"Hammarlund  
Junior"

The  
Precision  
Midget

Here is a strongly-built shielded midget condenser, with soldered brass plates, clock-spring pigtail, minimum dielectric and one-hole mounting. An exceedingly efficient instrument for neutralizing, regeneration control and vernier use. Diagrams of uses sent on request.

Send 25 cents for illustrated book, giving complete instructions for assembling, wiring and operating the famous Hammarlund-Roberts Receiver.

**Hammarlund Mfg. Co.**  
124-438 W. 33rd Street, New York

Pacific Coast Representatives:

ATLANTIC & PACIFIC AGENCIES CORP.  
383 Brannan St., San Francisco

For Better Radio  
**Hammarlund**  
PRECISION  
PRODUCTS

# CHELSEA

Super  
Five \$50.00

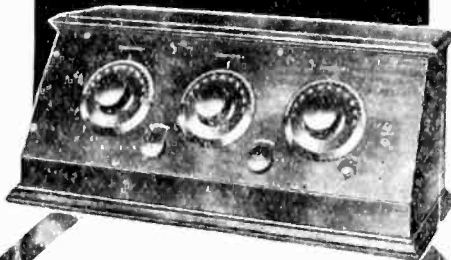

## The Set You Can Afford to Own

The new Chelsea offers the finest kind of service—consistently—regularly—without fuss or trouble.

Sweet, clear volume, and plenty of it, is obtained with but slight drain on the batteries and negligible wear on the tube filaments. Rugged bus-wiring, hand-soldered connections and a protective dust-proof, fool-proof inside panel are construction features insuring greater life and longer satisfaction. Fine mahogany piano finish Cabinet. Large over-size dials for positive selectivity make tuning a pleasure.

See this remarkable value at  
your Dealer's or write for  
illustrated folders

**Chelsea Radio Co.**  
CHELSEA, MASS.

the roof of the cabin over his bunk, and he gingerly felt of his shoulder.

"Where are we?" he grunted peevishly.

"Left Astoria an hour ago," answered Joe, "We're going out over the bar now. Shake a leg! The old man wants some bearings. There's a thick fog outside."

Dwyer was slowly climbing from his bunk and steadying himself on the pitching floor while he groped dazedly for his uniform. "Come on! Look alive!" insisted Joe, "I can't see what's the sense of you buying an alarm clock anyway. All you do is to set it and then shut it before it rings!"

He opened the door of the cabin and a rush of cold, fog-laden air swept in.

"For the luv' o' mike," he added, "try and stay awake long enough to get some press from NPL tonight."

He slammed the door and dashed below to the galley to get his midnight lunch before turning in, while Dwyer completed his hasty toilet and lurched unsteadily into the radio shack where he dropped heavily into the chair and picked up the headphones.

The old inferiority complex had squatted solidly again on the solar plexus of his subconscious ego!

Hi CUL GN.

## CALLS HEARD

(Continued from Page 39)

By KFUH

Heard and worked July 28th to August 8th, 1925, while anchored in lagoon at Fanning Island, 1000 miles south of Honolulu, 40 meters only.

(1pl), 1ux, 1anq, 1cmf, 2gk, 2afn, 2mu, 2lj, 2bbx, 2agb, 2bum, (3bwj), 3bwf, 3ckg, (4sa), 4tn, 4km, (5uk), 5adz, 5lh, 5nq, 5agn, 5nj, 5ew, 5akz, 5zal, 5kc, 5cx, 5alj, (6awt), (6jpp), (6dcf), (6cbb), (6aff), (6buc), (6zbn), (6cgo), (6zd), (6csl), (6ajv), (6csw), (6zac), (6cfl), 6uf, 6rm, 6bde, 6vc, 6clz, 6dh, 6bmw, 6js, 6crs, 6ur, 6ajl, 6dal, 6bhx, 6rw, 6agk, 6bvy, 6bur, 6alj, 6ban, 6bsh, 6bc, 6btm, 6bap, 6bgo, 6aol, 6cto, 6bkv, 6bjj, 6km, (7av), (7uz), (7uv), (7aek), 7fd, 7ay, 7gj, 7eh, 7nt, 7gb, 7it, (8ayy), 8aj, 8ckm, 8pl, 8nk, 8bf, (9uq), (9cxx), (9aon), 9bht, 9bpb, 9xn, 9ado, 9akf, 9dvl, Australian: 2yl, 2bb, 2lj, 3bd, New Zealand: (5ac), 1ax, 2ac, 4ar, 1ao, 4al, 2ae, 2xa, Chile: (1eg), Canadian: (9ck), 5ef, 4aa, Argentina: ba-1, Mexican: 1b, 1x, Navy: (nve), (npu), (npm), (naj), (nrri), nkf, npg, npn, nas, nlr, namg, npo, nsx, nedj, Commercial: (kdid), wap, wiz, wqn, Philippine Islands: 1hr.

(35 to 40 meters). August 8 to October 15, 1925. Stations heard and worked by KFUH while at Penrhyn Island; between Penrhyn Island and Papeete, Tahiti, and during time spent in Papeete Harbor, Papetoai Bay, Moorea and other islands of the Society group.

1cmp, 1bes, 1pl, 1anq, 1yb, 1zl, 1ck, 1awe, 2lu, 2mm, 2xaf, 2mu, 2cpa, 2cvj, 2blm, 2ahm, 2bk, 2cxl, 2anm, 2aim, 2cjj, 3ckg, 3aao, 3lw, 3bva, 3hg, 3ckl, (4do), (4si), 4lo, 4tv, 4rl, 4oa, 4fg, 4rm, 4bu, 4cu, 4ll, (5ado), (5lg), (5aid), (5oq), 5ew, 5uk, 5zal, 5sd, 5akn, 5ox, 5bg, 5he, 5va, 5wi, 5amw, 5adz, 5nq, 5aj, 5aua, 5aab, 5agn, 5atv, 5amk, 5afn, 5alj, 5akz, 5ft, (6awt), (6jpp), (6dcf), (6zac), (6cfl), (6zd), (6xad), (6lh), (6uf), (6cfe), (6alv), (6aak), (6ea), (6che), (6ac), (6gk), (6amm), (6ahp), (6ol), (6bvs), (6sl), (6cmh), (6bzn), (6te), (6blp), (6cmq), (6cto), (6buc), (6asr), (6zblj), (6csw), 6chs, 6ct, 6vr, 6bjj, 6bmw, 6fa, 6km, 6abg, 6alj, 6cix, 6cnc, 6bgv, 6btm, 6aqp, 6dah, 6gb, 6apk, 6aff, 6bil, 6ccv, 6cor, 6afg, 6aum, 6nx, 6ase, 6ajm, 6qu, 6css, 6dab, 6wt, 6cah, 6lh, 6akc, 6dam, 6rw, 6aea, 6cw, 6zh, 6cz, 6alv, 6aaf, 6tq, 6ec, 6dax, 6ake, 6ogw, 6cqa, 6eb, 6cmd, 6cft, 6bjj, 6ml, 6bkb, 6bbv, 6bon, (7de), (7ek), (7aek), 7ly, 7uz, 7ay, 7au, 7to, 7it, 7nx, 7df, 7uj, 7ot, 7eo, 7cs, (8bce), (8bnh), (8caz), (8pl), (8gz), (8rv), 8ac, 8eg, 8aly, 8cy, 8bf, 8er, 8tx, 8es, 8eq, 8bau, 8se, 8pk, 8xk, 8cau, (9ded), (9uq), (9efy), (9yav), (9zt), 9xn, 9bht, 9dvr.

(Continued on Page 70)

## RADIOCAST WEEKLY

Sixty-four Pages of Programs, Photos, Humor, Musical Reviews, Schedules, Tables, Editorials, Etc.

5<sup>c</sup> Per Radiocast Weekly  
Copy 433 Pacific Bldg.,  
SAN FRANCISCO

## THE MILLION-DOLLAR BEND

(Continued from Page 28)

tained; the judge would go half blind trying to see it; and the battling lawyers would lose it. And, far worse than this, the patent-owning company, in order to state their case, would have to lay before the court a great mass of jealously-guarded secret facts and formulas; which the gang on the other side of the fence would be writing down in their note-books so fast they would make their pencils smoke!

If the patent-holders could drag the defendant's wire-drawing machinery into court, they probably could prove their case; but these wire-making laboratories are mostly kept out of range of even the most high-powered legal rifle that can be brought into action against them. Either they are operated with such extreme secrecy that Sherlock Holmes himself could live and die over one of them and never suspect that it was around, or else they are located in Africa or Iceland, or some other equally inaccessible spot.

It appears rather improbable, therefore, that much of anything will be done by the owners of the tungsten wire patent toward trying to stop the manufacturing of infringing filament wire—especially in view of the fact that this patent has only four more years to live. There is one scandal-sheet published for the special edification and exasperation of persons engaged in the radio manufacturing and merchandising business that has been yapping and yelping and egging on the tungsten patent owners to come on out an' fight; but the only response from the elephant in the jungle is some ominous trumpeting and rumbling that occasionally grows loud and vexed enough to make all the little dogs turn and scoot in alarm.

A far more efficacious method of warfare favored by the holders of the big patents is being carried on today by deflecting the millions of dollars that might be wasted in fruitless litigation into costly and ceaseless advertising, which is marvellously potent, in time, to mold public opinion and confidence.

With the exception of the tungsten patent, there seems to be now hardly anything at all to prevent unlimited manufacture of radio tubes of the more popular types, by any one who cares to go into the expensive business of making them.

There does not appear to be any particularly important patents affecting the new high-mu tubes lately appearing on the market. The mechanical difference between a tube of high mu or high conductance and one of low mu or low conductance is merely that the high-mu tube has a much more closely wound grid than the other—with the result that the slight potentials applied to the grid have far greater choking effect on

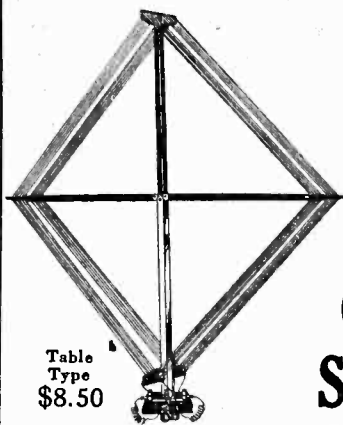
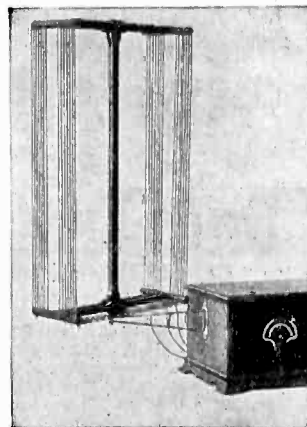

Table Type  
\$8.50

Take Your  
Choice!

## TWO GOOD SIGNAL LOOP AERIALS



Bracket Type, \$8.50

A bracket type that attaches right onto the end of your radio cabinet or a table type—you can't miss it on either one. When you buy a Signal Loop you're buying more than just good looks. You're buying an aerial backed by thirty years of experience in the manufacturing of electrical equipment.

Where quarters are close, remember the bracket type loop attaches right onto the end of your set and does away with that "extra piece of apparatus." It turns a complete 360° in the width of the standard cabinet.

Both aerials are beautifully constructed. The bracket type is of solid walnut. The table type is mahogany finished. All metal parts are heavily nickel plated. A third tap is provided for sets requiring it. Ask your favorite dealer to show you the Signal Loops—either type \$8.50. You will surely want one.

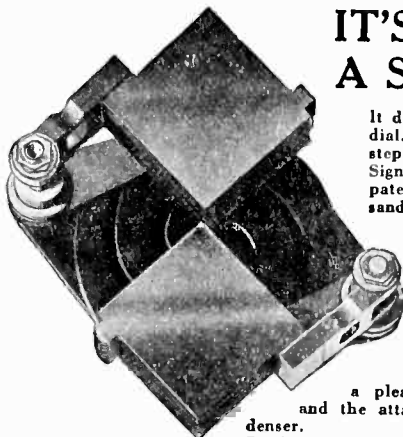

## IT'S EASY TUNING WITH A SIGNAL SPIRAL CAM

It distributes the wave lengths evenly over the 360° of the dial. Stations come in clearly without interference. Just step in at your dealer's and ask him to show you the Signal Spiral Cam Condenser—the condenser with the patented cam control. Then you will appreciate why thousands of fans have selected this condenser for their sets above hundreds of other condensers on the market today.

The Signal Spiral Cam Condenser is built for perfect control of high frequency as well as low frequency wave lengths. Results are uniform at all points on the dial—the scientifically designed cam takes care of that. There is absolutely no back lash and a balanced condition of the plate assemblies permits a smooth, velvety action that makes tuning a pleasure. Design permits single or three-hole mounting and the attaching of air core transformer directly onto the condenser.

Don't be satisfied with "just condensers." See the "Spiral Cam" before you buy. Three capacities, all one price—.00025, .00035 and .0005, \$4.00 and worth a lot more.

Jobbers and Dealers: If you are not fully acquainted with Signal Radio Products, we will be pleased to send you complete information. Write us at once for literature.

## SIGNAL ELECTRIC MANUFACTURING CO.

Dept. 3-B, Menominee, Mich.

1216 Hearst Building  
San Francisco

408 San Fernando Bldg.  
Los Angeles

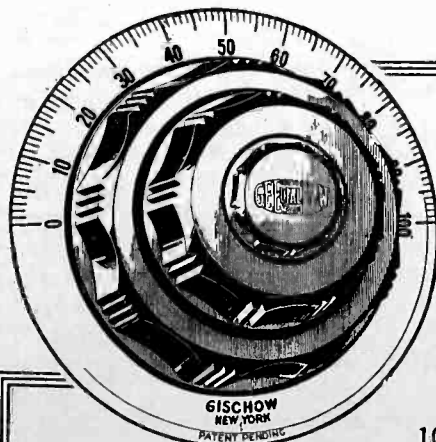

## GEE-HAW Micrometer TUNING DIAL

Ratio 100 to 1

A New Mechanical Principle  
Absolutely No Backlash

Manufactured by  
OTTO R. GISCHOW CO., Inc.  
New York

For Sample Write to Pacific Coast Agents:

American Commercial Co.  
1067 Market Street, San Francisco, Calif.



**No Back Panel Fussing**

Genuine Bakelite Throughout

**DeJUR RHEOSTATS**  
ONE HOLE MOUNT

Compare the DeJur Rheostat with any other on the market. You will find that the DeJur is different—better—more efficient. Fourteen exclusive features make the DeJur superior to all other rheostats on the market, and make it the ONLY RHEOSTAT WITH A POSITIVE CONNECTION PLATE. We guarantee them absolutely.

Sold by all dealers

Manufacturers—Write for sample and prices

**DeJUR PRODUCTS CO.**  
LAFAYETTE & BROOMESTS.  
NEW YORK

PATENTS APPLIED FOR

**ARE YOU A SUBSCRIBER?**  
Send for Trial Subscription  
\$1.00 for Six Months

**Filter Transformers**



Northern Electric Type Filter Coils adjusted to any specified frequency between 25 and 60 kilocycles, complete with calibrated condenser

**ONLY \$5.00**

Throw away that inefficient, unknown quantity in your set and replace it with a filter which won't distort.

**ARMY SALES COMPANY**  
1650 Jackson Street  
San Francisco, California

the electronic emission from the filament to the plate than they do in the case of a low- $\mu$  tube with a coarse grid. It is apparent, incidentally, that high- $\mu$  tubes are far easier on B-batteries than are the usual 201-A type.

It is becoming more and more needful, not only in the name of common fairness, but to avoid confusion in our own minds, that we should cease from referring to some radio tubes as bootlegs and to other tubes as not bootlegs. A bootleg tube, as has been often pointed out, is properly a deliberate counterfeit of some much-advertised make. There are at this moment large quantities of tubes, thousands indeed, being sold, falsely bearing a well-known trademark and packed in a well-known box. Sleuths in the employ of the Radio Corporation of America are reported to have run down a big outfit that was turning out such perfect counterfeits of Radiotrons, including the container, that the only immediately evident clue to their spuriousness was a slight difference in the shade of the red ink used to do the printing on the carton. These counterfeits, ninety-nine times out of a hundred, are foisted upon the unsuspecting public over the counters of the drastically cut-price radio stores.

The fact that a \$2.50 Radiotron or Cunningham tube is advertised by some store for \$1.69 or \$1.62 does not necessarily prove the tubes to be counterfeit; but it should interest the reader to be informed that no retail radio dealer anywhere in the entire United States today can himself buy these tubes for a cent less than \$1.72 apiece, spot cash. Some radio merchants do at times sell a few of their goods at cost price as leaders or trade-pullers; but when one of the biggest selling items of a radio store is continually offered at pretended cost price or less, then it is time to take that concern's advertisement with several grains of salt.

In concluding this story of radio tube patents, I may remark that there is a rumored possibility of further warfare over the big-production stem-machine patent that I have described; because of the fact that this glass-working patent mentions the use of compressed air in the course of the manufacturing process. The use of air in a process is a pretty broad specification; and under it even the new non-infringing machines may be attacked; but the Hungarian wizard in Newark, who builds practically all of the world's tube machinery, other than that used by one company, has still another revolutionary new airless machine in readiness, to be dragged out the moment the glass storm breaks around him again. The thicker the safe-makers build their doors, the hotter do the safe-busters make their oxy-acetylene flames; or, when that fails, sometimes they bring along a truck and a derrick, and carry away the darned safe entire.

**CALLS HEARD**

(Continued from Page 68)

9ek, 9qr, 9eay, 9eht, 9bpy, 9wo, 9fj, 9efs, 9zk, 9dpx, 9eky, 9ff, 9bib, 9cvn, 9cxx, 9bwb, 9dmj, 9co, 9ark, 9ejl, 9cfy, 9bwo, 9drd, 9dww, 9zd, 9akf, 9cid, 9eez, 9aod. Canadian: (5ba), (5go), (5bf, 5hp, 5ef, 4aa, 4gt, 3aa, 3kp, (9ck)). Mexican: (af, 1b, 1k, 1x, 9a. New Zealand: (1ao, 1ax, 1xa, 2ac, 2ae, 2bl, (3am), 3ao, (4ag), 4al, 4as, 4aa, 4ar, 4ak, 5da. Australian: (2ij), (2gq), 2hs, 2cm, 2ip, 2bb, 2xa, 2jw, 2sw, 2bk, 2im, 2yh, (3ef), 3lp, 3bq, 3bd, 4cm, 4an, 5bg, 5kn, 5da, 6ag. Argentina: (bal, afl, db2, de3, pa2, cb8, fg4, fb5, aa8. Brazil: (bzlab), bzlab. Philippine Islands: (pilhr). Chile: (leg). Cuba: q2mk. Japan: j1aa. England: g2cc, g2nm. U. S. Navy: (nrri), (nas), (numm), (nir), (nisv), (nqw), nedj, nkf, (nrm), nrg, npr, npo, npp, nve, naj, nsf, najd, nqg, (nqg-1), nqg-2, nijr, nisv, nirx. Commercial: (wap), (vmg), wiz, wir, wvy, idg, wqo, ftj, kel, wvz, fw, whw, kudg, (gdvb), vit, ane, aqe.

By Russ Shortman Jr., 6BWS, 717 West Jackson Street, Phoenix, Arizona.

1ah, 1are, 2bbx, 2cqx, 4oa, 4bu, 4io, 4we, 4ao, 5agn, 5ak, 5am, 5ef, 5eu, 5gl, 5hc, 5he, 5jd, 5ng, 5nj, 5oa, 5ox, 5qs, 5ry, 5uk, 5agu, 5asz, 5ad, 5atx, 5hy, 5aak, 5aea, 5ael, 5agc, 5ajj, 5aiv, 5ajm, 5ajo, 5arw, 5asg, 5ash, 5aw, 5bhc, 5bhz, 5bjh, 5bjd, 5bjh, 5bjx, 5bls, 5bq, 5btr, 5bvf, 5dah, 5bvz, 5bvy, 5cev, 5cgm, 5cgv, 5cgo, 5chm, 5ms, 5chl, 5chp, 5cia, 5cip, 5cix, 5cmq, 5cnf, 5erk, 5erx, 5csi, 5css, 5csz, 5cta, 5dh, 5eto, 5du, 5ea, 5eb, 5gn, 5gx, 5ia, 5jp, 5li, 5nx, 5rw, 5tx, 5bvs, 5ct, 5dag, 5dal, 5bwa, 5bwi, 5dak, 5ew, 5awt, 5asm, 5cin, 5cu, 5aj, 5bj, 5rl, 5ra, 5gj, 5si, 5anb, 5bse, 5bpl, 5bqi, 5dnf, 5bnh, 5ced, 5apm, 5apy, 5beq, 5bsp, 5bst, 5ek, 5elt, 5fz, 5dkr, 5bmd, 5dex, 5dij, 5dkh, 5dmj, 5ayp, 5zt, 5dac, 5daj, 5bwb, 5adi, 5cdv, 5ua, 5axb, 5ajl, 5nq, 5enn, 5aik. Others: wiz, wqo, wqn, nkf, numm, kfu, raa8, chieg, ch9tc, aabz, ??, qra??, pr4oi, z4aa, ane?? qra??

All of above stations were heard on a Schnell Tuner; detector only. Any of the above may have crds if they inform me as to their correct addresses. If anybody hears my low power CW I would appreciate a report. Crd for Crd.

**POLARIZATION OF RADIO WAVES**

(Continued from Page 34)

**Mechanical Model for Studying Wave Polarization**

I have a mechanical model, made up for studying wave polarization in the General Electric laboratory. The model consists of weights suspended in such a way that they are free to move in all directions. Twenty-two of these weights are arranged in a row and connected together by rubber bands. Each weight is suspended from a yoke and an equal weight hung on the other side of the yoke to serve as a counter weight. A screen is set up so as to hide the counter weight and avoid confusion in observing the wave motion. This model was set up especially to study the twisting of the plane of polarization and the experiment has strikingly confirmed the theory which it was intended to illustrate. This theory is briefly the following:

We will assume that the medium through which the radio waves pass has such characteristics that the velocity of propagation for a vertically polarized wave differs slightly from the velocity of the propagation for a horizontally polarized wave. It is not necessary for the present purpose to try to explain the reason for this difference in velocity. We may assume that the reason for it is due to the electrostatic and magnetic effects, to



the retarding effect of the velocity of the vertically polarized wave passing close to the earth, or, on the other hand, due to properties of free electrons in the upper atmosphere. Whatever the cause may be, we may assume that such a difference of velocity exists and the mechanical model has been constructed so as to reproduce such conditions. The weights on both sides are tied together with rubber bands. Wave motion in the horizontal or vertical planes can thus be studied independently, and these two wave motions may be adjusted for different velocities. A wave started in the vertical plane maintains itself vertically and a wave started horizontally maintains itself horizontally. If, however, a wave is started in a plane 45 degrees between the vertical and the horizontal, it is found that the wave motion proceeding therefrom assumes the shape of a cork screw. The straight line oscillation of the first weight is passed along as an elliptical motion which gradually widens into a circle. Then this circle narrowed down again to an ellipse and finally a straight line at right angles to the original line of oscillation. This is exactly in accordance with the theory. The point where the wave has shifted its plane of polarization 90 degrees is the point where the faster of the two waves is half a wavelength ahead of the slower wave. From this point on the wave proceeds repeating this peculiar cork screw motion.

The fact that the twisting of the wave is due to different velocities in the two planes of polarization can also be demonstrated by this model. For this purpose the rubber bands are added to the counter weights. The effect of this is to change the velocity of propagation in the vertical plane, whereas, the velocity in the horizontal plane has not been affected because only the vertical motion is transmitted to the counter weights by the suspension yokes. The system can thus be adjusted so that the velocities in the horizontal and the vertical planes are exactly equal. After this has been done it is found that the tendency to corkscrew motion disappears and the wave remains strictly in the plane in which it has been started.

While this mechanical experiment does not bring out any new facts that were not known from the classical theory of wave motion, it helps us to visualize the main phenomena in the radio wave propagation which we are trying to explain. The phenomena of a constantly shifting plane of polarization which we discovered experimentally in tests between Schenectady and Long Island can thus easily be explained.

USE OUR TESTING LABORATORY. SEE PAGE 63.

**Oh boy**  
**KESTER**  
*Rosin Core*  
**Radio SOLDER**  
*Sure is Safe and Simple*

Approved by  
**Radio Engineers**  
*A Genuine Solder*  
**CHICAGO SOLDER COMPANY**  
4254 Wrightwood Ave., Chicago, U.S.A.

Originators and  
World's Largest Manufacturers of  
*Self Fluxing Solder*  
**YOUR DEALER**  
CAN SUPPLY YOU

*The Reason*  
THE TUBE WITH A SENSIBLE GUARANTEE

**Quality!**  
**Performance**  
**Dependability**

*are the factors which made Supertron the foremost Independent Tube in America !!!*

The Public buy and enjoy Supertrons because they are assured of satisfaction by a serial numbered guarantee on each tube for their protection—at their own price; the public demand price—two dollars.

**All Types \$2.00**  
*Canada, \$2.75*

Try Supertron and Be Glad.  
At Good Dealers.

Branch offices in principal cities throughout the United States

**Supertron Mfg. Co.**  
Hoboken, N. J.

**SUPERTRON**  
A SERIAL NUMBER GUARANTEE

**5 TUBE GUARANTEED RADIO**  
Get Special Offer

**BIG POWERFUL MIRACO Ultra's**  
Users everywhere report it gets programs coast to coast, Canada to Gulf, loud and clear on speaker; outperforms \$100 to \$250 sets. Many \$59.50 value. Let users' testimony convince you. Retail

**FACTORY PRICES—SAVE 1/3 TO 1/2.**  
Sets \$13.75 up, retail. FREE Literature on latest 1 to 6 tube models, Agents new low prices and Dealers SPECIAL OFFER! Write to MIDWEST RADIO CORPORATION, Pioneer Builders of Sets, 414-B-E 8th St., Cincinnati, Ohio

**MIRACO RADIO GETS 'EM COAST TO COAST**

Tell them that you saw it in RADIO

## RADIOADS

A Classified Advertising Section Read by Better Buyers.

The rate per word is eight cents net. Remittance must accompany all advertisements. Include name and address when counting words.

Ads for the March Issue Must Reach Us by February Fifth

FREE BOOKLET. Interesting monthly payment Radio Magazine Subscriptions. Two-thirds publisher's price. Spencerlight Agencies, West Los Angeles, Calif.

10-WATT TRANSMITTER, voice, C W. Operates from AC. Acme transformer 500 volts, 2 filament. Two 5-watt tubes. Mounted on panel, complete. Write for information and prices. Will sell cheap. J. D. Brun, 1701 Franklin St., San Francisco.

TELEFUNKEN 200-WATT POWER TUBES \$70.—Filament 14 volts, 4 amperes, plate 3000 volts. Arthur Beyer, 106 Morningside Drive, New York. I enclose check for \$1.68, covering cost, viz. 21 words at \$0.08.

### AGENTS WANTED

AGENTS—Quick sales, big profits, outfit free. Cash or credit. Sales in every home for our high class line of Pure Food Products, Soaps, Perfumes, Toilet Articles, etc. Write today for money-making plans. American Products Co., 5792 American Bldg., Cincinnati, Ohio.

RADIO AMATEURS—Improve your set with a Faradon Mica Condenser, Model UC 1015, made expressly for Radio Corporation. Only \$1.00. Originally listed \$5.25. Capacity range .0002 to .001 mfd. All brand new and packed in original containers. Instruction sheet enclosed. Send your order in now! Utility Radio Co., 58 No. 6th St., Newark, N. J.

A LIFETIME EDISON will solve your "B" battery troubles. Good, live, large size elements connected with pure nickel wire, electrically welded 7c per pair. All parts for sale. Sample cell and "dope sheet" 10c. Paul Mills, Woodburn, Oregon. Successor to Chas. Snively.

WESTERN ELECTRIC 7-A POWER AMPLIFIER, hundred hours use, forty dollars with tubes. Lieut. Westrom, Fort Bliss, Texas.

SELL FIVE-TUBE RADIO SETS. Thirty days free trial. Three sales weekly pays \$90.00 profit. Experience unnecessary. DIRECT RADIO, 197B Fourteenth St., Milwaukee, Wis.

WANTED—More readers of "RADIO" to advertise their used equipment in these columns. RADIOADS bring quick and profitable sales. Turn your excess apparatus into profit. Some of our readers want just what you have to offer. Try the RADIOADS. You, too, will then be convinced that they PAY. Mail your copy now for the next issue.

KEEP station records in THE RADIO LOG BOOK, a handy pamphlet for recording stations heard, dial settings and other data. The price is only 10 cents per copy. For sale by Pacific Radio Pub. Co., Pacific Building, San Francisco.

MAKE \$100 WEEKLY in spare time. Sell what the public wants—long distance radio receiving sets. Two sales weekly pays \$100 profit. No big investment, no canvassing. Sharpe of Colorado made \$955 in one month. Representatives wanted at once. This plan is sweeping the country. Write today before your county is gone. OZARKA, INC., 126-E Austin Avenue, Chicago.

THE NEW square plate Ensign Variable Condensers. JUST OUT! Brass plates. Efficient on low waves. Get one of these condensers without cost in return for your subscription to "RADIO" for only two years. Five dollars brings you the condenser and the magazine. Send your check now. There are only a few of these condensers in our stock. "RADIO," Pacific Building, San Francisco.

FUNNY RADIO STORIES. Twelve of 'em in the "RADIOBUSTER," Volney G. Mathison's humorous thriller. 112 pages in bound form. Mathison knows how to write. You will enjoy his stories. Send \$1.00 today for a copy of the "RADIOBUSTER," or get it free with your subscription to "RADIO" for one year (\$2.50). Pacific Radio Publishing Co., Pacific Building, San Francisco.

YOUR RADIO QUESTIONS ANSWERED FREE.—Gerald M. Best, technical editor of "RADIO," will answer ten radio questions for you if you subscribe to "RADIO" for only one year at \$2.50. Get this wonderful technical service, together with a good, practical radio magazine. "RADIO," Pacific Bldg., San Francisco.

*A Safe Star to Steer by!*

*Samson TC Assembly*

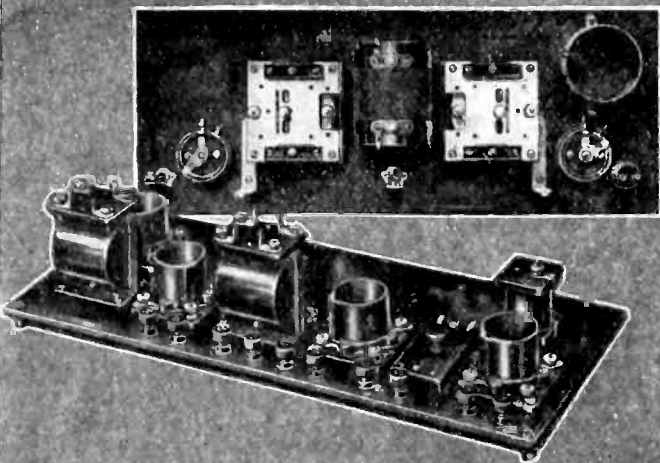

**O**F ALL stars in the heaven the good mariner most often uses the North Star. Because it is fixed—safe!

Steer your Radio Course for 1926 by the North Star of Radio Circuits as embodied in the Samson TC Assembly—a circuit that for a long time has been sponsored by Editors of Radio Periodicals because of its sterling performance.

The Samson TC Assembly will give you a startlingly real, surprisingly faithful reproduction of the selection as it is broadcast, variable selectivity to suit any owner and—distance.

In every respect it is a quality job throughout, from its design by nationally prominent engineers, its manufacture—the crowning achievement of nearly half a century experience—and the exclusive use of high-grade standard parts. There is no substitute for such quality.

The Samson TC Assembly, with all parts mounted on Formica engraved and drilled panels, ready to wire in a few hours—\$65.

For the man who builds his own it will not be necessary to discard the parts you have as the Samson Transcript Kit contains only the new essentials for building this remarkable circuit.....\$14.75

**SAMSON ELECTRIC COMPANY**

Manufacturers Since 1882

CANTON, MASS.

Sales Offices in Thirty Leading American Cities



# CHELSEA

*makes Home Sweet Home*

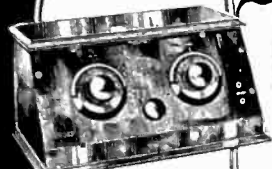

**Three Tube RECEIVER**  
\$26.00

Licensed Under  
Armstrong Patent  
No. 1113149

The only genuine Armstrong circuit 3-Tube Set, at this low price, with a dust-proof, fool-proof inside panel. Cord connections to batteries, no binding posts and many other refinements. Operates on all standard tubes. For distance and real tone quality, the equal of many \$100 sets.

### Added Features

Both of these New Chelseas possess performing features and refinements of design only found in the most expensive models. Each Chelsea is a manufactured product—not an assembled job—and is fully guaranteed.

Chelsea Branches  
New York, Philadelphia,  
Cleveland, Detroit,  
Chicago, Los Angeles

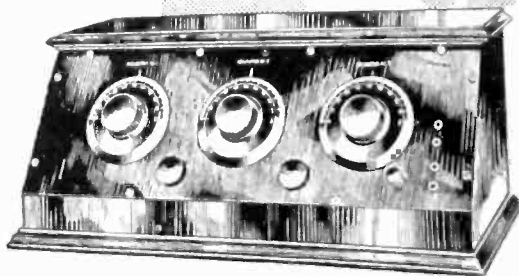

*The New Super-Five* \$50.00

There's no place like home with a Chelsea. After supper, dishes done, the family gathers round the living room to enjoy the radio wonders of the air—never more delightful and satisfying than with the New Super-Five. Here, power and perfect living tone quality are combined with easy operation. Dependable, enjoyable results are always assured.



Send for Folders  
Describing All  
Latest Chelseas

**CHELSEA RADIO COMPANY**  
179 SPRUCE STREET, CHELSEA, MASS.

## VACUUM TUBE

(Continued from Page 31)

of any circuit for generating oscillations, that during the portion of the cycle of the output current when the grid is positive with respect to the filament as a result of the voltage induced in the coil  $L_p$ , the voltage drop between the plate and filament connections (across the coil  $L_p$ ) is such as to oppose the voltage of the plate battery and hence to reduce the voltage across between filament and plate in the tube. During the other part of the cycle when the grid is negative with respect to the filament, the voltage acting between plate and filament is increased above that of the steady voltage of the plate battery. During the portion of the cycle when the grid is positive with respect to the filament, current flows within the tube between the grid and filament and this current increases as the grid becomes more positive. The direction of the current flow is in the direction of the emf, that is, from grid to filament inside the tube and from filament to grid outside of the tube.

Further, when the grid becomes positive with respect to the filament, there is a resultant increase in the current flow between the plate and filament of the tube, even though the plate voltage on the tube is being reduced. This increase is limited when the stable oscillating condition has been reached, by the saturation effect, which may occur at lower values of plate current than that corresponding to the total filament emission, owing to the loss of electrons to the grid.

The plate current wave is distorted at the other extreme of the cycle—that is, when the grid is negative—by rectification effects; moreover, the grid current is always pulsating, and may be zero for considerable part of the cycle while the grid is negative. Consequently, the waves of current supplied to the circuit between  $F$  and  $P$ , and  $F$  and  $G$ , Fig. 8, are each composed of a direct or average constituent, a fundamental constituent corresponding in frequency to that of the output current, and a number of higher frequency or harmonic constituents.

Speaking only in terms of the useful current constituents, a sinusoidal alternating current flows in the grid circuit in phase with the alternating voltage across the coil  $L_p$ , and therefore represents a withdrawal of power from the output circuit, which power is expended within the tube. On the other hand, a sinusoidal alternating constituent of plate current flows in opposition to the voltage across the coil  $L_p$ ; this means that power is being supplied to the output circuit from the plate circuit of the tube. The impedance of the output circuit to all frequencies that are harmonic multiples of the fundamental is

(Continued on Page 86)

## RADIO AGENTS WANTED

### 5 Tube Demonstrator FREE!

Earn \$25 to \$100 a week, part or full time. Everyone a prospect. Complete line standard sets and accessories, \$5 to \$90. Write today for illustrated catalog and exclusive selling plan for live dealers and community agents. 20TH CENTURY RADIO CO., 1011 Coors Bldg., Kansas City, Mo.

ARE YOU A SUBSCRIBER?

Send for Trial Subscription

\$1.00 for Six Months

## Potter

BY-PASS

### CONDENSERS

- Prevent "B" voltage fluctuation
- Allow undistorted amplification
- Make possible full bass tones
- Improve reception with "B" Supply Units.

Made in 1/2, 1, 1.5, 2, 3 and 4 Microfarad sizes

At Your Dealer's  
**POTTER MANUFACTURING COMPANY**  
North Chicago, Illinois





**NEW!**  
**Plug-in Coils**

**LOW REL LOSS  
LOW WAVE COILS**

In the Lead Again!—"REL" Basket Weave Coils now equipped with Plug-in Mountings—Quick, efficient coil changing—Five interchangeable units in each outfit—Triple cotton covered parafined wire—Chocolate color, won't soil—For any low-loss, low wave circuit—Covers 10 to 110 meters efficiently—Inexpensive—Rugged—No increase in Price!

Price \$4.50, including mounting.

At your dealer's, or order direct

**RADIO ENGINEERING  
LABORATORIES**

27 Thames Street New York, N. Y.  
"THE LOW LOSS COIL PIONEERS"

**You Can Make \$100  
Weekly Selling Radio**



Demonstrate once—results mean sure sales! Sell what everybody wants—radio at low prices. Coast to coast reception—4, 5 and 7-tube instruments.

**12 Selling FREE! Lessons**

Establish a business of your own. Start in spare time—evenings. Sales course in 12 lessons and 10 radio service lessons teach you everything.

**3100 Men Are Now Doing It!**

Success with over 3,100 men proves merit of our proposition. \$100 weekly not unusual—many Ozarka men make more in spare time!

**Free Book!** Write me personally—tell me about yourself. I'll see that my 64-page book, Ozarka plan No. 100, is sent you without cost. Please mention the name of your county. Mail the coupon!

**OZARKA INCORPORATED**  
120 Austin Avenue L. Chicago, Illinois

Gentlemen: 10-25

I am greatly interested in the FREE BOOK "The Ozarka Plan" whereby I can sell your radio instruments.

Name..... City.....

Address..... State.....

County.....

Radio Never Had a Tube  
Equal to

**EMPIRE-TRONS**



Type '99 also supplied with '01 base (all Bakelite).

Every tube is a model of perfection; finest mechanical construction, unequalled for clarity, sensitivity and perfect reception. Has been tested for 1200 hours' continuous operation.

Satisfactory Performance Guaranteed

Comparative tests invited—ask your dealer for an EMPIRE-TRON and hear the difference.

Superior Quality Priced Right

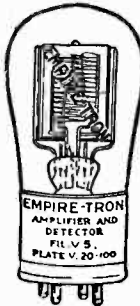

Made in U.S.A.

Tested in Our Factory

Distributors and Dealers Wanted  
Some Choice Territory Still Open  
Write for Circular and Particulars



MODEL A  
Bell 10 in.  
Height 22 in.



**EMPIRE  
SPEAKERS  
and  
UNITS**

A beautiful line of Speakers made of unbreakable composition finished in rich dark brown, crystalline effect. Very graceful and an ornament to any home. Brings out tone perfectly.

Model "A": Bell 10 in., height 22 in., fitted with EMPIRE Adjustable Unit—retails at \$13.50.

Model "C": Bell 14 in., height 22 in., fitted with EMPIRE Adjustable Unit—retails at \$16.50.

EMPIRE Adjustable Unit; constructed with greatest scientific care. Guaranteed to bring out the full volume of any set—true and clear-toned. Retail at \$6.50.

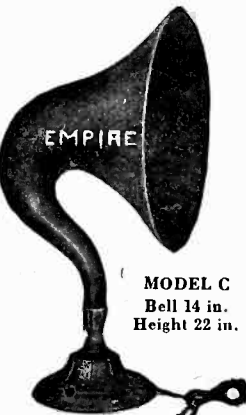

MODEL C  
Bell 14 in.  
Height 22 in.

"The Home of Empire Products"

They speak for themselves.  
Write for circulars and prices.

**American International Trading Co.**

59-61 Pearl Street, New York  
Cable Address: "Stanmarks, N. Y."

**RADIOCAST  
WEEKLY**

Forty-eight Pages of Programs, Photos, Humor, Musical Reviews, Schedules, Tables, Editorials, Etc.

**5c Per Radiocast Weekly Copy** 433 Pacific Bldg.,

**SAN FRANCISCO**

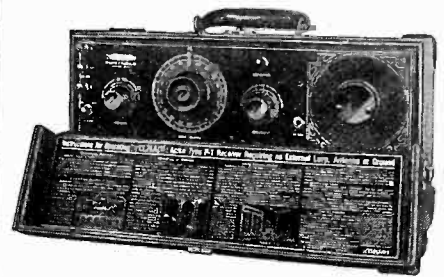

The Famous Truly Portable  
**TELMACO P-1 Receiver**  
Four Tubes Do the Work of Seven

The peer of portables in size, weight, ease of tuning, selectivity, distance, volume, workmanship and price. Aerial, loud speaker and batteries self contained. Complete with tubes and batteries. **\$125.00**  
\$141.50 Receiver only

**P-1 Kit Saves You Money!**

Our offer of the Telmaco P-1 Receiver in kit form has met with enthusiastic reception. This contains all parts, as built by us, including case, drilled and engraved panel, and illustrated instructions. **\$80.00** Complete kit  
Ask your dealer or write us. Descriptive folder free.

Radio Division:

**Telephone Maintenance Co.**  
20 So. Wells St. Dept. A Chicago, Ill.



Quality Radio Exclusively Established 1918

**CLARITY**

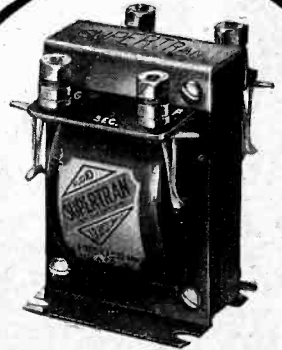

RATIOS 3 1/2 TO 1—5 TO 1

No set is better than its parts and no one part is more important than the Audio Transformer. That's why you should insist upon Supertrans in your set—they are by test, the best transformers on the market.

Distributed by

- L. W. Cleveland Co., Portland, Me.
- S. P. Denham, Seattle, Washington
- Waite Auto Supply Co., Providence, R. I.
- Gray Sales Co., Philadelphia, Pa.
- Rice-Hitt Co., San Francisco, Calif.
- B. Darmstadter, Chicago, Ill.
- Whiting Radio Co., Bridgeport, Conn.
- Paterson Radio Co., Paterson, N. J.
- Buffalo Radiophone Co. Inc., Buffalo, N. Y.
- The Jack L. Hursch Co., Denver, Colo.

**FORD RADIO & MICA CORP.**  
111-113 Bleecker St., N. Y.



REGISTERED U.S. PATENT OFFICE

**AUDIO TRANSFORMER**

ARE YOU A SUBSCRIBER?

SEND FOR TRIAL SUBSCRIPTION

\$1.00 FOR SIX MONTHS

Tell them that you saw it in RADIO

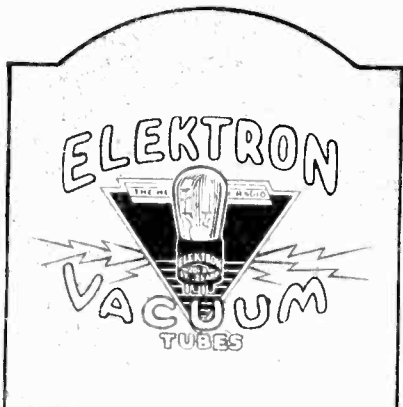

Elektron Tubes have proved to be the finest receiving amplifiers and detectors that money can buy. Reliable and highly efficient. Satisfaction guaranteed.

There's an Elektron (201-A, 199, or 199-A) for every type of circuit and battery equipment. DEALERS! Some excellent territory is open. Write for our proposition.



**Lectrodio Corp.**  
LYNN MASS

**SAVE MONEY**

Hot off the press—latest Radio Catalog & Guide brimful of new ideas, over 100 special hook-ups with information—all free. Shows savings as high as 50% on sets and supplies. Be sure to get this thrifty illustrated book before you buy. It means money in your pocket. Standard guaranteed goods. Write letters on postal note. Also please include name of radio friend.  
B. RAWIK CO., 103-124 S. Canal St., Chicago, U.S.A.

**BIG MONEY FOR RADIO**

Demand for high pay radio men is so great that a big Kansas City wholesale concern is now fitting men free to get into the radio business for themselves and make \$60 to \$200 a week without any capital invested. Select territory open. Send today for free catalog and amazing offer. Write direct to Mr. H. J. Salzw, Standard Radio Co., 1422 Walnut St., Kansas City, Mo.

*To-day  
-in every  
good set!*

**Tone Clarity  
Beyond Expectation**

Just pull the switch and note the clarity and richness of tone any Amperite-equipped set gives you. Amperite is the automatic rheostat which does away with hand rheostats and filament meters. No guessing. No uncertainty as to correct tube current. Tubes last longer. Makes any novice a master operator. Insist upon Amperite when you buy or build. Price \$1.10.

Write for free hook-ups

**RADIALL COMPANY**  
Dept. R-16, 50 Franklin St., N.Y. City

**AMPERITE**  
REG. U.S. PAT. OFF.

The "SELF-ADJUSTING" Rheostat

**RADIO MAPS**

POSTPAID  
ANYWHERE

**10c**

PACIFIC RADIO PUB. CO.  
Pacific Bldg., San Francisco

**Takes the mystery  
out of Radio**

JUST OUT—514 PAGES

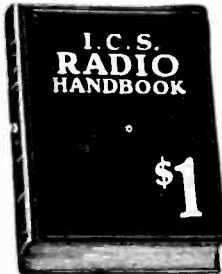

Compiled by  
**HARRY F. DART, E.E.**  
Formerly with the Western Electric Co., and U. S. Army Instructor of Radio.  
Technically edited by  
**F. H. Doane**

**NO MORE** need you turn from book to book, hoping to find what you want. It is all here, in 514 pages crammed full of every possible radio detail. Written in plain language, by engineers for laymen. 100,000 sold.

IT EXPLAINS: Electrical terms and circuits, antennas, batteries, generators and motors, electron (vacuum) tubes, many receiving hook-ups, radio and audio frequency amplification, broadcast and commercial transmitters and receivers, super-regeneration, codes, etc.  
Send \$1 today and get this 514-page I. C. S. Radio Handbook—the biggest value in radio today.

International Correspondence Schools  
Box 8262-D, Scranton, Penna.

I enclose One Dollar. Please send me—post-paid—the 514-page I. C. S. Radio Handbook. It is understood that if I am not entirely satisfied I may return this book within five days and you will refund my money.

Name.....

Address.....

Check here  and enclose \$1.50 if you wish the edition bound in Leatheroid.

(Continued from Page 84)

very great, hence there are no appreciable multiple frequency constituents of the current circulating in the output circuit, and the alternating voltages across the coils  $L_p$  and  $L_g$  are in all cases practically sinusoidal.

Consequently the useful power supplied by the tube can be determined in terms of the alternating voltage across  $L_p$  and the fundamental constituent of plate current. If we could neglect the grid current, this would be the power available for dissipation in the resistances. As the output current increases, the amplitudes of the alternating voltages across the plate and grid coils increase proportionately. The alternating grid current increases more and more rapidly, as the amplitude of the plate voltage becomes larger. On this account the power loss to the grid increases. The power supplied by the plate increases with increasing plate voltage, but as the grid voltage increases, the effective saturation current is reached when the grid is positive, and the plate current becomes zero for an appreciable part of the cycle when the grid is negative; consequently a continued increase in the amplitude of the output current results chiefly in an increase in the harmonic constituents of plate current without greatly increasing the fundamental. Obviously, then, a condition of stability ensues when the power supplied by the fundamental of plate current minus the power dissipated by the fundamental of grid current is just equal to the power dissipated by the output current in  $R_g$ ,  $R_p$ , and  $R_c$ .

**GRID POTENTIAL AND COUPLING.** In the Hartley circuit of Fig. 7 the instantaneous grid potential is determined by the potential across  $L_g$ . This potential is a function of  $L_g$  and the current flowing in this coil. Here,  $L_g$  and  $L_p$  are not mutually coupled. Referring to the circuit of Fig. 9, it will be seen that

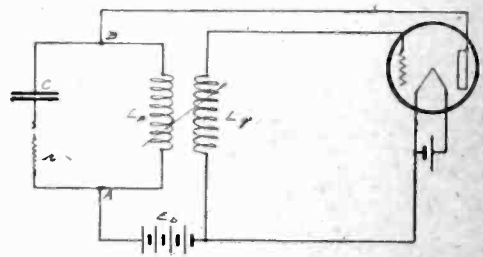

Fig. 9. Generating Circuit With Coupled Grid and Plate Inductances.

the operating grid potential is obtained by coupling  $L_g$  to  $L_p$ . Here,  $L_g$  is not a part of the oscillatory circuit.

By definition, the mutual inductance of two coils such as  $L_g$  and  $L_p$  of Fig. 9 is the number of interlinkages of magnetic flux from coil  $L_p$  with  $L_g$  per ab-

(Continued on Page 88)

THE TUBE WITH A SENSIBLE GUARANTEE

REGISTERED OFF.  
**SUPERTRON**  
A GOOD TUBE

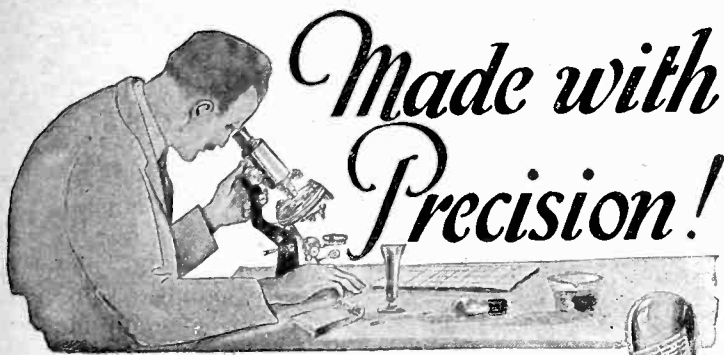

Made with  
Precision!

Right from the start at our factory each SUPERTRON is produced with PRECISION as the dominating factor.

The material, each process, the triple test, and the final inspection, are all guided by the most exacting PRECISION. The unit of PRECISION called SUPERTRON is serial numbered and wrapped in a certificate bearing a corresponding number.

*Thus giving you a means of identification to assure full satisfaction.*

Pacific Coast Offices:

LOS ANGELES—Pacific States Commercial Co., 3208 Glendale Blvd.  
SAN FRANCISCO—American Commercial Co., Rialto Bldg.

Branch Offices Thruout the United States

**SUPERTRON MFG. CO., Inc.**  
HOBOKEN, NEW JERSEY

Export Department, 220 Broadway, New York



All  
Types

**\$2.00**

Canada  
\$2.75

**SUPERTRON**

A SERIAL NUMBER GUARANTEE

**Oh boy**  
**KESTER**  
Rostin Core  
**Radio SOLDER**  
Sure is Safe and Simple

Approved by  
Radio Engineers  
A Genuine Solder  
CHICAGO SOLDER COMPANY  
254 Wrightwood Ave., Chicago, U.S.A.

Originators and  
World's Largest Manufacturers of  
Self-Fluxing Solder  
YOUR DEALER  
CAN SUPPLY YOU

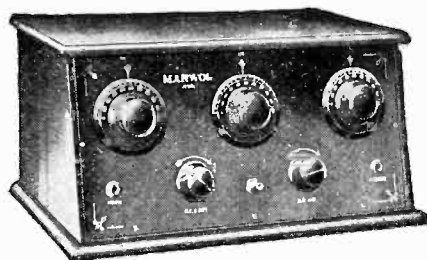

**\$39.50**

# MARWOL

The Line of

## MONEY MAKERS

FROM the MARWOL BABY GRAND at \$36.50 to the MARWOL CONSOLE GRAND at \$130, the MARWOL line holds the greatest sales and profit-making opportunities this year.

MARWOL is the outstanding line of the season, from every standpoint—quality, performance, appearance and range of models and price.

MARWOL Dealers know from past experience that MARWOL will not cut prices—that there is no Summer dumping of MARWOL—that MARWOL stands firmly behind its guarantee.

Our new Factory of twenty-five thousand square feet is in full production. This means that every MARWOL order will be shipped promptly—no delays or disappointments for dealers standardizing on MARWOL.

[ Write or wire today direct to us or to the Sales Branch nearest you for catalog of the complete line, discounts and full information. ]

**MARWOL RADIO CORP.**

546-548 BROADWAY

FACTORY No. 2

85 MERCER STREET, NEW YORK CITY

Pacific Coast Representatives:

In California:  
MARSHANK SALES COMPANY  
926 Insurance Exchange Bldg.,  
Los Angeles, California

In Oregon and Washington:  
C. E. GAY  
166 Lowndale Street,  
Portland, Oregon

In Idaho:  
R. T. CARR  
906 Sprague Street,  
Spokane, Washington



# The Sensation of the Season

MODEL 5-F-S

## New and Improved FRESHMAN MASTERPIECE

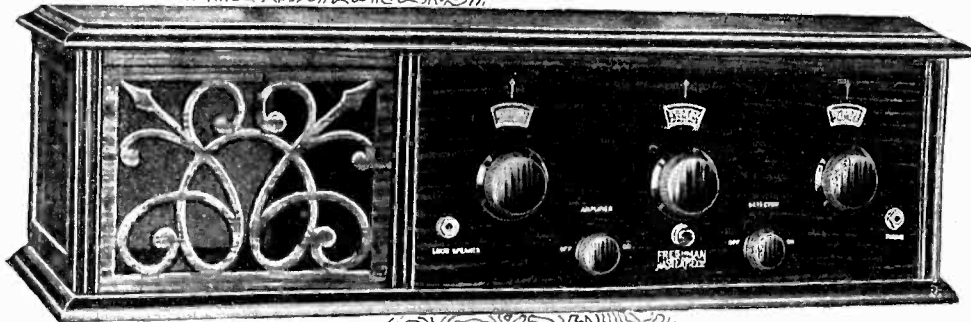

A five-tube tuned radio frequency receiver, encased in as fine a heavy 5-ply solid genuine mahogany cabinet as ever graced any radio set.

Every part embodied is newly constructed resulting in greater efficiency and finer tone quality. The illustration shows our new straight line wave length, low loss condenser and vernier device, permitting the reception of stations over a wave length from 190 to 550 meters.

For Sale By Authorized Freshman Dealers Only

**Chas. Freshman Co. Inc.**  
Radio Receivers and Parts  
FRESHMAN BUILDING  
240-248 WEST 40TH ST.—NEW YORK, N.Y.  
CHICAGO OFFICE — 327 S. LA SALLE ST.

# \$60.

Slightly Higher  
Denver and  
West

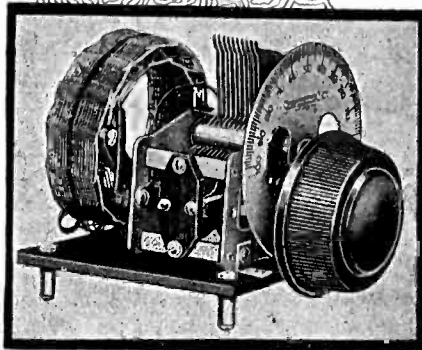

Vernier feature assures greater selectivity and sharper tuning.

ARE YOU A SUBSCRIBER?  
SEND \$1.00 FOR A TRIAL SUBSCRIPTION TO "RADIO" FOR 6 MONTHS

### "The Elixir of SET Life"

Just as the Heart is the most vital organ of the human body—the tube is the most vital part of the radio set. The SIMPLEX SUPER POWER TUBE performs its function in the radio set with the same sensitivity, accuracy and regularity as a healthy heart in the human body.

REJUVENATE YOUR SET WITH THE SIMPLEX SUPER POWER TUBE, IT MEANS LONGER LIFE AND BETTER RECEPTION.

GUARANTEE: Your dealer is authorized to exchange or return money for any defective S. S. P. Tube, within ten days.

PRICE: Silvered Tube . . . . . \$2.00  
Blue Tube . . . . . \$2.50

ASK YOUR DEALER FOR THE SIMPLEX SUPER POWER TUBE

TITANIA MANUFACTURING COMPANY, 105 West 40th St., New York



Types: S. S. P.  
201A, 199, S. S. P.  
12, Silvered and  
Blue.



(Continued from Page 86)

solute ampere change of current in coil  $L_p$ . The voltage set up in coil  $L_g$  is dependent directly upon this mutual inductance and the rate of change of current in coil  $L_p$ .

Suppose the circuit of Fig. 9 is generating oscillations of maximum strength. If the mutual inductance between  $L_p$  and  $L_g$  is decreased by separating the two coils the alternating potential induced in  $L_g$  is decreased. By virtue of the controlling action of the grid, this decrease in coupling results directly in a decrease in the amplitude of the plate current wave and a decrease in the variation of plate potential across  $L_p$ . This results further in a decrease in the strength of oscillations until a condition of stability ensues for the particular value of coupling between  $L_p$  and  $L_g$ . As the coupling is further decreased the oscillations will become weaker and weaker and finally stop at a particular value of coupling which is determined by the condition that for oscillations to exist, the mutual conductance of the tube must be at least equal in numerical value to a factor depending upon the constants of the external plate circuit and the particular value of mutual inductance between  $L_p$  and  $L_g$ . Once oscillations are stopped by decreasing the coupling, they will not again start until the coupling is increased appreciably beyond the previous stopping point.

The condition for strongest oscillations exists when the quantity involving the constants of the external plate circuit and coupling between  $L_p$  and  $L_g$  is such as to operate the tube over the portion of its characteristic corresponding to minimum mutual conductance for the tube itself. If the coupling is increased beyond this point, the oscillations will again decrease in strength. There is, therefore, an optimum value of coupling between  $L_p$  and  $L_g$  for most desirable operation.

CONDITION FOR MAXIMUM OUTPUT. The output of a tube and its circuit can be increased by increasing either the plate current or plate potential. We can increase the plate current by increasing the filament temperature. The detrimental effects of excessive filament temperature do not often make this a desirable method of increasing the output. We may, however, increase the plate potential providing at the same time we make the grid more negative by an amount equal to the quotient of the increase in plate potential and the amplification factor. Safety hinges upon adequate insulation and the maintenance of the necessary negative grid potential.

If output is plotted against external plate circuit resistance, other conditions remaining constant, it will be found that maximum output is obtained when the external plate resistance is equal to the internal plate resistance.



Precision  
Inducto  
Coupler  
Price, \$1.85

### McLaughlin Recommends It

James L. McLaughlin, the authority on superheterodyne design, recognizes the superiority of Precision Coils. He says: "The Precision Inducto Coupler is the only coil I recommend for use in my new One Control Superheterodyne.

The Inducto Coupler has been designed for use where a split winding coil is desired. Made of the best moulded hard rubber, which insures lowest losses.

The Cockaday 4-Circuit Coil is the only coil ever specified by Laurence M. Cockaday, inventor of the famous Cockaday Four-Circuit Tuner, for use in his set. Double silk covered copper wire results in increased volume and greater selectivity.

Cockaday  
4-Circuit  
Coil

Price, \$5.50

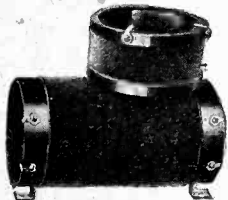

**PRECISION COIL CO., Inc.**  
209 Centre Street, New York, N. Y.

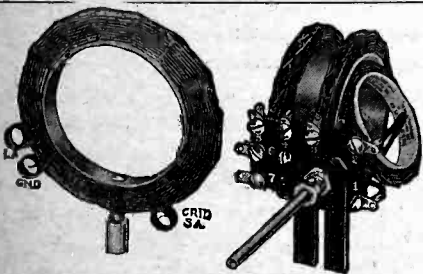

Coil Set No. 24 for Browning-Drake Circuit

### SICKLES DIAMOND WEAVE COILS

(Trade Mark Registered Aug. 4, 1925)

**For Browning-Drake  
Roberts, Craig and  
Hoyt Circuits**  
(Patented Aug. 21, 1923)

Sickles Coils for the famous Browning-Drake Circuit are the latest Sickles achievement in efficient design for a particular use. They are priced at \$7.50 a set.

The New No. 18A Coils for any Roberts Circuit are absolutely standard equipment. They are priced at \$8.00 per set.

Coil Set No. 20, at \$4.50, is for use specifically with the new Reflex Receiver designed by Albert C. Craig using the Sodian detector.

Coils for the Hoyt Circuit at \$10.00 a set for the Knockout Reflex Circuit at \$4.00 a pair, and the Tuned Radio Frequency coils at \$2.00 each are other standard Sickles Coils. We manufacture also for manufacturers' special requirements.

Send for descriptive catalog

**The F. W. Sickles Co.**  
138 Union St. Springfield, Mass.

## This Chart Tells the Success Story of the Signal Spiral Cam Condenser

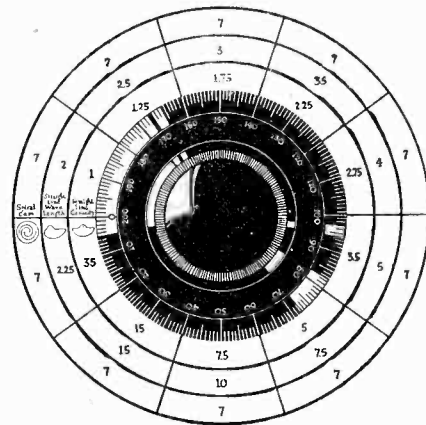

The Signal Spiral Cam Condenser is the only condenser on the market equipped with this unique and highly efficient control. The distinct advantage of its construction is best illustrated by the chart reproduced above. Note the even distribution of stations over the complete 360° of the dial as compared to typical condensers of other types. It's all in the cam!

### Other Important Features

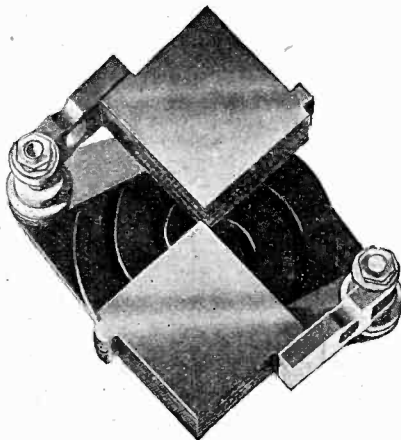

The Signal Spiral Cam Condenser operates with velvety smoothness and with a complete elimination of backlash, permitting easy and accurate tuning. The electrostatic field is concentrated within a small area and the dead dial shaft is not connected to either set of plates. It is compact, being no larger than the old semi-circular type. It is die cast throughout, insuring absolute uniformity. It is designed for either single or three-hole mounting, and air core transformers can in turn be mounted directly on the condenser. Signal Spiral Cam Condensers are built in three sizes with unusually low minimum capacities in all sizes, giving a high tuning ratio. One price for any capacity—.00035, .00025, .0005—\$4.00. See one at your dealer's.

### NOW—A BRACKET TYPE LOOP AERIAL

Cut out that extra piece of apparatus by attaching a Signal Bracket Type Loop Aerial right onto the end of your radio cabinet. This aerial will turn a complete 360° in a space no greater than the width of the average cabinet. This new aerial has all the advantages of the famous Signal Table Type Loop. Constructed of solid walnut with third tap for sets requiring them. See both types at your dealer's.

## SIGNAL ELECTRIC MANUFACTURING CO.

Dept. 3-K, Menominee, Michigan

Western Representatives:

**DON E. CAMPBELL**  
1216-17 Hearst Bldg., San Francisco, Calif.

**RADIO DISTRIBUTING CO.**  
408 San Fernando Bldg., Los Angeles, Calif.

Branches in all principal cities

## Get a Phonograph Unit FREE

With only one subscription to "RADIO" for one year—\$2.50. Unit is made by The Union Fabric Company.

SUBSCRIBE NOW

"RADIO"  
Pacific Building, San Francisco

## HEATH

RADIANT CONDENSERS  
For Real Radio Reception  
HEATH RADIO AND ELECTRIC MFG. CO.,  
208 First Street, Newark, N. J.



Na-ald DeLuxe Sockets are the only ones with these 3 exclusive features—lowest loss, lowest capacity and positive side-scraping contact. Send for booklet and laboratory test. Alden Mfg. Co., Dept. G9, Springfield, Mass.



## Vigilance

**Constant vigilance is the price of uniformity and constant vigilance is maintained over Magnatrons. That is why Magnatrons are uniform, and uniformly good.**

The Magnatron DC-201A, DC-199, and DC-199 (large base) now list for only \$2.50 each

Connewey Electric Laboratories  
Magnatron Building, - Hoboken, N. J.

Pacific Coast Representative:  
Pacific Radio Laboratory  
256 So. Los Angeles St., Los Angeles, Calif.

MAGNATRON  
**REX**  
the new  
tube for  
B battery  
eliminators



# MAGNATRONS

## Good Company

MAKE YOUR TUBES KEEP GOOD COMPANY

Bad tubes in your set spoil the good ones

REFORM your backsliding tubes with the

**\$7.50**

**BURTON & ROGERS  
TUBE  
FLASHER**

BRINGS BACK  
BAD TUBES

One model for  
D.C. or A.C.,  
all cycles.

Utmost simplic-  
ity of opera-  
tion.

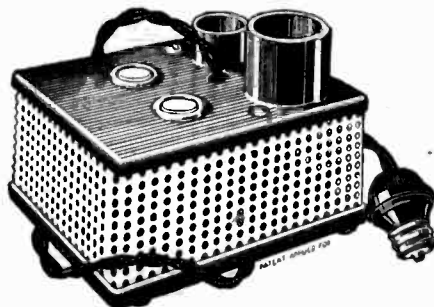

For tubes with  
thoriated fila-  
ments.

Results will  
exceed your ex-  
pectations.

Send for our booklet "Save a Life"

**BURTON & ROGERS MANUFACTURING CO.**

755 BOYLSTON STREET, BOSTON, MASS.

## STATIC MITIGATION

(Continued from Page 18)

ing different makes of a.f. transformers were used, and then a balance between the impulses would be difficult.

The antenna-ground circuit of each receiver must be coupled to the first tube circuit as in a neutrodyne receiver, and the connection which joins the A battery to ground must be removed to avoid the possibility of short circuiting any of the batteries through the common ground connection. Of course, separate A and B batteries must be used on each receiver. In case loop receivers are used, the two loops should be pointed in the same direction, since static from different directions is different in character.

The method of operating the two receivers is as follows: The outputs of the two are connected as shown in Fig. 2, using only a single loud speaker. They are then both adjusted to a station, the filaments of one being turned off while adjusting the other. Then both sets of filaments are turned on at once, and the intensity of static and signal adjusted by filament control until both are reduced to practically zero in the loud speaker. This is a test for the identity of characteristic of the two receivers. One receiver is then tuned sufficiently off of the station wavelength so that the signal is lost on it and only the static remains. The filaments of the other receiver should be turned off during this procedure. The detuned receiver should not be tuned so far off that it picks up some other station. It should have merely static on it and should be as close to the original signal wave as possible, without containing any of the signal energy. For this reason sharply tuned receivers such as the neutrodyne or super-heterodyne are desirable for this test.

After the condition of static on one receiver and static and signal on the second is obtained, it will probably be necessary to increase the static intensity on the first slightly, since it will not be quite as strong as on the second, in which the signal tends to accentuate the static impulses. By careful adjustment of the filament currents of the two receivers, the intensity of the static on the two can be equalized. Due to the fact that the two receivers are tuned to slightly different waves, only that type of static will be balanced which is substantially the same on all waves. The sudden sharp click variety is most nearly equal on all wavelengths, and it is this type on which this system is most effective.

It should be remembered that this is not a static "eliminator." If it did anything as final and definite as that, the author would be getting out a patent and selling stock. However, if sufficient care is taken in the adjustment of the receiver, a definite improvement in the ratio of the static to the station signal can be obtained.



**Introducing**  
**"SUPERUNIT JUNIOR"**

A little brother to the standard Type A and Type B "Superunits."

He measures 5x10" and he consists of a stage of tuned R.F., the detector and two stages of Thordarson audio.

He has plug-in coils and the standard set of coils which he uses will tune from 170 to 570 meters when used with the S-C Capacity Element to make a one dial set. Other coils for other wave lengths.

He makes the most efficient set for use with an aerial and there are just 11 connections to complete him.

**YOU SHOULD MAKE HIS ACQUAINTANCE!**

Price, complete with instructions . . . . . \$37.50

**MATERIALS NEEDED FOR A COMPLETE SET**

- 1 "Superunit, Jr."
- 1 S-C Capacity Element or 2 .0005 condensers.
- 1 Front panel, size 7x10 or larger.
- 2 Bradleystats.
- 1 Double circuit jack.
- 1 Single circuit jack.

Note: No baseboard is required.

**Hanscom Radio Devices**

Mfgs. of the S-C Capacity Element, the one dial control for two control sets.

Woonsocket, R. I., U. S. A.

Pacific Coast Representative:

**S. A. WINSOR**

1221 Venice Blvd., Los Angeles, Cal.

**RADIOCAST WEEKLY**

Forty-eight Pages of Programs, Photos, Humor, Musical Reviews, Schedules, Tables, Editorials, Etc.

**5c Per Copy** Radiocast Weekly  
 433 Pacific Bldg.,

**SAN FRANCISCO**



**FYNUR**  
**VERNIER CONTROL**

**NO BACKLASH Is Possible In This New Dial!**

In the new Fynur dial there are no gears to mesh, so there can be no lost motion; no backlash. Forward or backward, the movement is always smooth, free and without the slightest break or interruption.

Traction (beveled wheels) makes this new Vernier Control the most accurate tuning dial on the market. It is simple in construction and beautiful in appearance, and owing to a special automatic compensation adjustment for wear, it will outlast the set on which it is placed. If you want the utmost accuracy in reception, use Fynur Dials.

**\$3.50**

Ask your dealer or write to us

August Goertz & Co., Inc., 270-286 Morris Ave., Newark, N. J.

**ARE YOU A SUBSCRIBER?**

SEND \$1.00 FOR A TRIAL SUBSCRIPTION TO "RADIO" FOR 6 MONTHS

**POWERPEP!!!**

A brand new device for eliminating the antenna. Simply place POWERPEP under your telephone and listen-in. The results are amazing. Order one of these novel devices today. They are selling fast.

**ONLY 35 Cents--Postpaid**

Dealers and Jobbers' Prices on Request

**ATLANTUS MFG. CO.**

74 Front Street

Port Jervis, N. Y.

# Morrison

now offers the

## Mocking Bird Unit

Patented

\$7.50 List

All fans remember the pioneer of adjustment units—Morrison Model C. For 3 years this unit was a standard of comparison. In trend with radio's great growth, Morrison now offers the Mocking Bird Unit, the peer of all units.

You cannot equal the tone reproduction of the Mocking Bird Unit attached to the phonograph. Radio assumes new delights—purity of tone and the remarkable volume (adjustable) are marvelous.

The Handsome Mocking Bird Cabinet at \$30 list is a real musical masterpiece. Morrison Mocking Bird Cabinets and Units at most good dealers or send your order to factory. Absolute money-back guarantee if not satisfied.

### See Manufacturers:

Attractive quantity prices on Units to build into your Sets.

### Dealers:

Morrison has always been a merchandising leader. New schedule of discounts ready wire or write.

**Morrison Laboratories Inc.**

325 E. Jefferson Ave., Detroit, Mich.

### Pacific Coast Distributors:

**D. S. Spector Co.**

Rialto Building, San Francisco

# Morrison

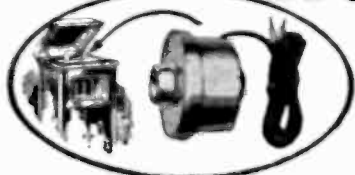

Loud Speaker

# B ELIMINATORS

Assured Success with New Type Tubes

and

# DONGAN

Transformers



Chokes

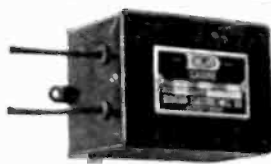

Designed especially for operation with the new Filament and Non-Filament Tubes, Dongan Transformers and Chokes are most essential parts of the remarkable new B-Eliminators. These new Eliminators are thoroughly endorsed by Corkaday and other authorities.

Names famous in the industry are found on these new type tubes. Likewise Dongan—long a leader in the production of quality transformers—shares in this achievement.

### Order by Number

PRICES AND SPECIFICATIONS:

No. 509 Full Wave	For Raytheon Tubes	List
No. 527 Full Wave UX213	For R. C. A. Tubes	\$7.00
No. 527 Full Wave CX313	For Cunningham Tubes	
No. 528 Half Wave UX216-B	For R. C. A. Tubes	
No. 528 Half Wave CX316-B	For Cunningham Tubes	

### CHOKES

No. 514	20 Henry	List
No. 506	30 Henry	\$5.00
No. 539	50 Henry	

Other Special Transformers and Chokes for Both A and B Eliminator Requirements

Build your B-Eliminator with Dongan Transformers and Chokes. See your dealer or send check or money order. New. Shipments made same day order received.

### Dealers!

Get your share of this business. Full details upon request.

### Manufacturers!

We can serve you in any quantity. Prices on request.

**DONGAN ELECTRIC MANUFACTURING CO.**

2981 Franklin St. Detroit, Mich.

Transformers of Merit for Fifteen Years

Pacific Coast Representatives:

- San Francisco—Industrial Sales Co., 171 Second Street
- Los Angeles—W. A. Brennan, 643 So. San Pedro Street
- Portland, Ore.—C. E. Gay, 166 Leewardale Street
- Seattle, Wash.—E. P. Denham, 2726 45th Avenue S. W.

## CALLS HEARD

(Continued from Page 44)

By 6CSW, 2330 Hillhurst Ave., Hollywood, Calif.

1aao, 1ac1, laep, 1ahg, 1alw, 1anq, 1bq1, 1bqt, 1ckp, 1cmx, 1ka, 1pl, 1uw, 1xu, 2afp, 2agw, 2bbx, 2buy, 2by, 2cty, 2dx, 2gu, 2gy, 2lu, 2nf, 2mk, 2qw, 2xaf, 3awh, 3bta, 3bva, 3cin, 3jw, 3kg, 3ot, 3vx, 4ac, 4av, 4fg, 4fl, 4jd, 4jr, 4oa, 4ol, 4rl, 4rm, 4sa, 4sl, 5aaq, 5adt, 5afd, 5ahw, 5aid, 5akl, 5amh, 5aph, 5asv, 5pu, 5qs, 5sd, 5uj, 5va, 5va, 5aff, 5buc, 5aji, 5cst, 5def, 5xl, 5bgn, 5biq, 5bkq, 5bqi, 5brc, 5byv, 5bzi, 5ced, 5ckm, 5cyl, 5dea, 5dme, 5eb, 5eq, 5jj, 5jq, 5sf, 5ul, 5zm, 5adr, 5aed, 5aef, 5afx, 5all, 5aon, 5aot, 5atq, 5aud, 5bcx, 5bdw, 5bck, 5bmv, 5brk, 5brq, 5ccb, 5ccs, 5cfy, 5cdo, 5cuo, 5daw, 5dbq, 5dkv, 5duc, 5dum, 5dwz, 5hp, 5pn, 5pz, 5se, 5zd, 5zk, 5zt. Canada: 3aa, 4aa, 4cr, 4gt, 4hz, 5ba, 5bf, 5ef, 5go, 5hp, 5ct, 5ek. Mexico: 1aa, 1af, 1ax, 1b, 1g, 1x, 9a. Australia: 2bb, 2bc, 2cm, 2ds, 2ij, 2xl, 3bd, 3bq, 3ef, 3ju. N. Z.: 1ao, 1ax, 2ac, 2ae, 2xa, 4ag, 4ak, 4al, 4ar, 5pl. Chile: 1eg, 2id, 9tc. Argentina: bal, aty. P. I.: 1hr, Misc.: nas, nedj, nkf, npu, nrri, numm, nuqg, wap, kfuh, jbc, 266? QRK? All cards answered.

By H. C. C. McCabe, 71 Holloway Road, New Zealand

U. S.—1xu, 1aep, 1aao, 1cx, 1bqc, 1my, 1anq, 1aa, 1are, 2xaf, 2aju, 3bva, 3hg, 4rr, 5oq, 5aav, 5atv, 6ea, 6eb, 6asv, 6rw, 6buc, 6xad, 6cso, 6css, 6jp, 6no, 6ts, 6aol, 6avj, 6awt, 6aff, 6bh, 6cdy, 6op, 6bel, 6eub, 6js, 6ajm, 6bge, 6bih, 6cnd, 6chs, 6bur, 6dah, 6bqb, 6bmw, 6chz, 6agk, 6ajj, 6awo, 6fa, 6ajl, 6ctn, 6qd, 6csw, 6bgo, 6cgo, 6bde, 7ay, 7aek, 7nt, 7gj, 7uz, 8che, 8apw, 8ced, 8adm, 8tx, 8bgn, 8gz, 9akf, 9bht, 9uq, 9ek, 9bn, 9wo, 9ado, 9xn, 9pl, 9ff. Miscellaneous: wiz, nkf, npg, nrm, nrrl, gbe, wap, nve, numm, cxl.

By 6ASD, 2347 Lucerne Ave., Los Angeles, California.

(40 meter band)

1anq, 1any, 1are, 1fx, 1nq6 (qra?), 1te, 1zm, 2act, 2bx1, 2afp, 2ahm, 2aim, 2bbx, 2bur, 2cgj, 2dx, 2gy, 2kr, 2la, 2np, 3bv, 3bee, 3btv, 3bva, 3chg, 3eu, 3ot, 3xb, 4ave, 4bv, 4eg, 4fg, 4gt, 4js, \*4km\*, 4rm, 4si, 4tn, 5aaq, 5ade, 5ado, 5agn, 5aid, 5all, 5akn, 5akz, 5alj, 5ame, 5apa, 5apm, 5aqa, 5arn, 5ary, 5ask, 5asy, 5ba, 5ce, 5co, 5ms, 5ox, 5pa, 5se, 5uk, 5ux, 5va, 5wa, 5xbh, 5zal, 7aek, 7ald, 7df, 7gj, 7it, 7kg, 7nx, 7uz, 7ya, 8alf, 8aly, 8by, 8ben, 8bhm, 8bpl, 8ced, 8cyl, 8dal, 8dkk, 8dno, 8eq, 8gl, 8gz, 8pl, 8rk, 8tk, 8tx, 8uk, 8zx, 9ado, 9aef, 9adr, 9aek, 9aep, 9aey, 9apn, 9atq, 9bcx, 9brg, 9bbp, 9bvn, 9bwo, 9cea, 9ccs, 9cju, 9eld, 9evn, 9czz, 9dac, 9dbb, 9occ, 9dkv, 9dp, 9ouc, 9dvr, 9dwn, 9dwz, 9dzn, 9ecc, 9efa, 9ehl, 9ek, 9ff, 9hp, 9oo, 9pn, 9tj, 9um, 9wo, 9xn, 9yav, 9zk. New Zealand: 4ak. Canada: 2aa, 4aa, 4gt. Hawaii: 6af. Mexico: 1b, 1k, 9a. Naval: nkf, npg, nrri. Com.: wir, wiz. Unknown: hjd, xa2, ya2.

By J. G. Tinney, 74 Kaimal Rd., Hattatol, New Zealand

(For July and August (20 to 45 meters) Detector only)

1ag, 1my, 1sf, 1te, 1za, 1anq, 1are, 1bgo, 1blu, 2gy, 2ha, 2lu, 2nf, 2xg, 2xl, 2yt, 2zv, 2afn, 2afp, 2bbx, 2bee, 2brb, 2bur, 2buy, 2cty, 2xaf, 3bg, 3hg, 3auv, 3bva, 3ckg, 4cu, 4fu, 4oa, 4ol, 4rl, 4rm, 4sa, 4vl, 4afu, 4ask, 5ef, 5ew, 5fh, 5kc, 5jd, 5nj, 5nq, 5oa, 5ox, 5uk, 5ael, 5akz, 5alj, 5atv, 5zas, 5ct, 5dh, 5dn, 5dq, 5ea, 5fa, 5jp, 5il, 5nx, 5ql, 5rm, 5rw, 5sb, 5tz, 5gx, 5zd, 5zh, 5agk, 5ajj, 5alv, 5ajl, 5ajm, 5akz, 5alf, 5apk, 5apw, 5asv, 5avj, 5awt, 5bap, 5bbw, 5bel, 5bhg, 5bih, 5bmw, 5buc, 5bur, 5bve, 5cbh, 5cdy, 5cgo, 5cgv, 5che, 5chs, 5cmu, 5cmq, 5cno, 5cra, 5cas, 5ost, 5cto, 5ovj, 5dab, 5dah, 5def, 5eta, 5mgk, 5xad, 7ay, 7nt, 7uf, 7uz, 7aek, 7xaf, 8eq, 8er, 8ea, 8gz, 8jj, 8ka, 8nk, 8pl, 8ry, 8sf, 8xn, 8adm, 8amb, 8apw, 8ayy, 8bgn, 8cak, 8cau, 8ces, 8chk, 8xyz, 9bn, 9dx, 9ed, 9ek, 9hp, 9nf, 9og, 9uq, 9zx, 9xn, 9ado, 9all, 9akf, 9aod, 9apm, 9bac, 9bak, 9bht, 9bbp, 9ccb, 9ced, 9dac, 9dpx, 9dqu, 9duc, 9dvw, 9dwj, 9ehl, 9yav, 9xq, 9dqu, 9duc, 9dvw, 9dwj, 9ehl, 9yav, 9xq. Alaska: 7de. Algeria: 8alg. Australia: 2bb, 2bc, 2bd, 2bq, 2cm, 2dj, 2ds, 2gq, 2ij, 2rg, 2so, 2as, 2tm, 2wa, 2yl, 2zn, 3ad, 3ef, 3bq, 3lm, 3lr, 3pm, 3ry, 3ul, 3yx, 4an, 4rb, 6am, 7gh, 7pl. Argentina: cbs. Brazil: 1ab, 2af, 2sp. Canada: 4gt. Chile: 1eg, 9tc. Cocos: 99x (qra?). England: 2cc, 2kf, 2la, 2nm, 2od, 2az, 5lf, 5nn, 6rm, 6tm; phone 2nm. France: 6co, 6ct, 6eg, 6fq, 6qq, 6tk, 6wg, 6yr. Hawaii: 6af, 1xi. Holland: o-ba, no-sv, pcuu. Italy: 1er, 1mt, 1no, 1rg, 1rt. Mexico: 1aa, 1b, 1x, 9a. Miscellaneous: aga, bbvp, cxi, f8z, kfuh, kfvm, m52, naj, nrj, nve, npg, nph, npm, npn, npo, npu, napp, naah, nedj, nrz, nrri, numm, pof, wir, wqn. North Polar Region: wap, wnp. Samoa: 6zac. Sweden: smyy.

(Continued on Page 96)

## The Wilson "B" Radiopower Unit

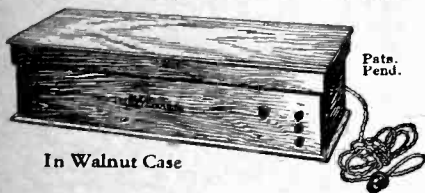

In Walnut Case

This new unit makes it possible to use a light socket for "B" voltage, without any troublesome hum from alternating current.

Supplies the constant voltage necessary for perfect reception. No acid to spill. No moving parts. Requires no attention. Semi-automatic in operation. The least expensive type of unit because of low first cost, minimum current consumption and long life. In handsome walnut case. Price \$35.

## The Andrews Paddlewheel Coil



Price \$3.00

For best results in home-built sets it is safer to use equipment employed in the best commercial receivers. Here is a superior coil used in such high grade receivers as the *Deresnadyne* and *Buckingham*. It can be used in any hook-up requiring a high type inductance.

Has exceptionally high ratio of inductance to resistance with minimum distributed capacity. Improves tone. Increases range, volume and selectivity. Blue prints of tested hook-ups employing this coil are available.

Our Technical Dept. will answer inquiries.

## Duo-Spiral Folding Loop

Handsomely finished in silver and mahogany to harmonize with the finest home furnishings.

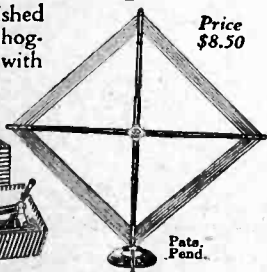

Price \$8.50

Easily portable. Has insulated handle and graduated dial. Reduces static and other interference. A special model for every circuit.

See these standard units at your dealers or write for complete information.

## Radio Units Inc.

1303 First Avenue Maywood, Illinois  
Perkins Elect. Ltd., Montreal, Toronto, Winnipeg

## Electric Soldering IRON--- FREE

Subscribe to "RADIO" for one year—\$2.50—and get a 110-volt MARVEL Soldering Iron FREE.

"RADIO," San Francisco

## Smallest Uniform Frequency Condensers made easily fit into present sets

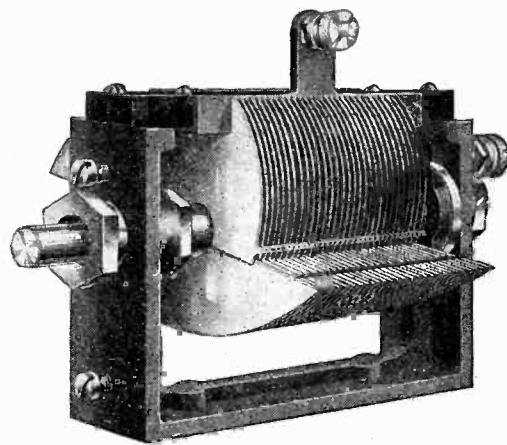

They are half to a third the size of others, are only 2¼" in diameter with plates fully extended, so will easily go into your set.

Do away with crowding of station readings—85 out of 100 come below 50 on dial with ordinary condensers—by using

## Samson Uniform Frequency Condensers

These condensers are built to 1/10,000 inch, silver plated all over and—in addition—have gold plated plates to prevent oxidization. Grounded rotor type—minimum capacity 12 mmf. losses lower than most laboratory standards. .500 mmf., \$7.00; 250 mmf., \$6.75; 250 mmf., \$6.50.

## SAMSON ELECTRIC COMPANY

CANTON, MASS.

Member RMA

Lombard J. Smith, 24 N. San Pedro St., Los Angeles, Calif.; A. S. Lindstrom, 274 Brannan St., San Francisco, Calif.; Mr. H. A. Killam, 146½ N. Tenth St., Portland, Oregon; Mr. G. H. Maire, 95 Connecticut St., Seattle, Washington; Jennings & McCollom Co., 407 Dooly Bldg., Salt Lake City, Utah; Jack L. Hirsch Co., 1641 Stout St., Denver, Colo.

Manufacturers of Quality Electrical Products Since 1882. Sales Representatives in Thirty Leading American Cities. Western Representative: A. S. Lindstrom Co., San Francisco, Los Angeles, Portland, Seattle, Salt Lake City.

Practically uniform high amplification over entire audible range with minimum distortion is obtained by using Samson Helical Wound Transformers. Ratios—6:1, 3:1. \$5.00.

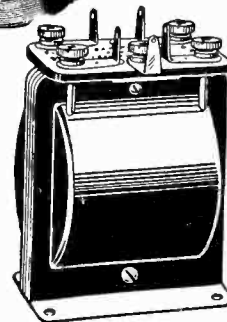
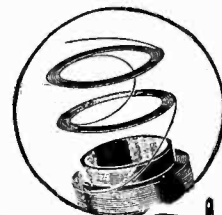

## RADIOCAST WEEKLY

Forty-eight Pages of Programs, Photos, Humor, Musical Reviews, Schedules, Tables, Editorials, Etc.

5¢ Per Radiocast Weekly Copy 433 Pacific Bldg.,

SAN FRANCISCO



SEND FOR TRIAL SUBSCRIPTION \$1.00 FOR SIX MONTHS

## LOOK!

Radio Mileage Chart, 10x16 inches. Not a map. No scale necessary to get your mileage. Mailed on receipt of 50 cents. Address:

Graph & Chart Service

P. O. Box 945

Waterbury, Conn.



# LABORATORY SERVICE

By G. M. BEST

THE complete laboratory of the Pacific Radio Publishing Company is at your service. We make tests --- calculations --- give you expert advice on your radio problems. Gerald M. Best is in charge of our own laboratory. We have an assortment of the finest testing equipment available.

Use this service. Let us answer your radio questions for you. We give you expert advice on your radio problems. Our service is most accurate---entirely dependable and PROMPT.

We will answer ten of your radio questions if you subscribe to "RADIO" for only one year. With your subscription to "RADIO" you will receive ten coupons, entitling you to answers to ten radio questions.

The regular cost for answering ten questions is \$2.50. Save this money! Subscribe to "RADIO" and get your answers without cost.

Use the coupon. Attach your remittance of \$2.50 to it and mail now. Your investment of \$2.50 will pay big dividends. The coming issues of "RADIO" will surprise you.

## COUPON

"RADIO," Pacific Building,  
San Francisco, Calif.

Here is \$2.50. Send me "RADIO" for one year and 10 free coupons entitling me to answers to ten radio questions.

Name.....

Address.....

City and State.....

## SHORT WAVE REFLECTORS

(Continued from Page 13)

$\frac{3}{4}$  meter is 29.51 in.,  $\frac{1}{4}$  of which is 7.38 in. This will be used later as the focal length. On a large sheet of paper draw line  $AB$  near one side. Line  $CD$  is drawn perpendicular to  $AB$  at its center  $E$ . On the line  $CD$  7.38 in. from  $E$  a point is located at  $G$ . This point is the vertex of the parabola. Another point 7.38 in. from  $G$  on line  $CD$  is located at  $X$ . This is the focus of the parabola. A number of lines,  $KK'$ ,  $LL'$ ,  $MM'$ ,  $NN'$ ,  $OO'$  are drawn perpendicular to  $CD$  as shown. They cross  $CD$  at points  $P$ ,  $H$ ,  $Q$ ,  $I$  and  $J$ . Take a compass and with distance  $EP$  as a radius strike an arc from  $X$  on  $KK'$  making points  $UU'$ . Then with the distance  $EH$  as a radius, from  $X$  strike arcs on  $LL'$  making points  $YY'$ , then taking the distance  $EQ$  do the same on  $CC'$ . Continue until the parabola is finished or in other words until the opening in the parabola is the right size, or in this case until the opening is 59 in. The distance from the vertex to the center and perpendicular to the line joining the sides of the opening or line  $GD$  is 30 inches.

The construction of the reflector needs little explanation. It is made of finished white pine. The top and bottom frame is made from 1 x 4 in. material. They are separated by posts 2 x 4 x 16  $\frac{3}{4}$  in. long. The whole frame is nailed together securely. A full sized drawing of the parabola is made on some wrapping paper. Nine equidistant points are located on the curve of the parabola on the drawing. By laying the drawing on the frame these points are transferred to it. These points are where the reflector wires are to be located.

The insulators shown in Fig. 3a consist of  $\frac{1}{8}$  in. bakelite, 1 x  $1\frac{1}{2}$  in., with  $\frac{1}{8}$  in. hole  $\frac{1}{8}$  in. from one end, which is screwed to a wooden block 1 x 1 x 2 in., which in turn is screwed to the

frame so the center of the bakelite insulator will be over the point for the reflector wires. The insulators for the aerial-counterpoise are the same except that they are 1 x 4  $\frac{1}{2}$  in. This allows for the coupling coil in the center. The reflector wires are cut from No. 14 bare copper wire. They are exactly 16  $\frac{1}{4}$  in. long and should be as straight as possible. The ends of the wires are slipped through holes in the insulators and twisted back around itself.

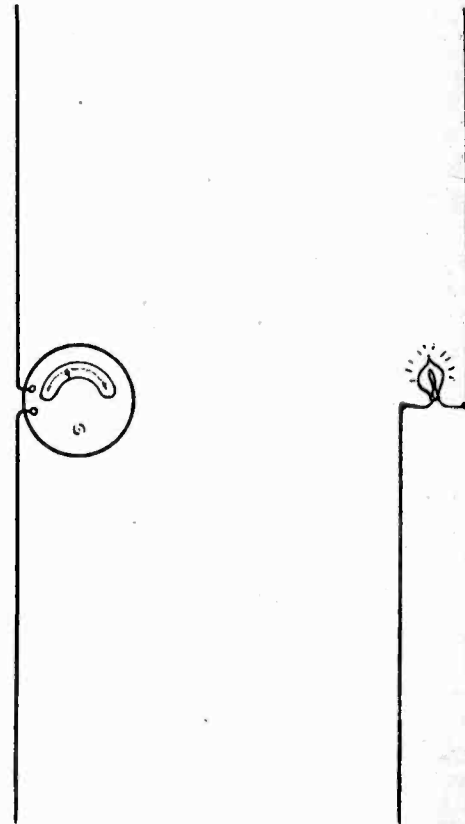

Fig. 4. Tuning Mechanism.

The transmitter is placed directly behind the reflector and is coupled to it by a link coil. The end coupled to the coil in the reflector is separated about  $\frac{1}{8}$  in. and held by two small insulators made like porcelain cleats, as shown in Fig. 3b.

(Continued on Page 96)

## The MOLLIFORMER "B" UNIT REPLACES "B" BATTERIES

SEND FOR complete description of this powerful "B" Unit that you can build in an hour at most reasonable cost. Uses the current from the light socket—Excellent for Supers and all TRF Sets—Assures greater Clarity—DX and Volume—Noiseless—No Tubes nor Acids—Utilizes full wave rectification.

Guaranteed to Give Complete Satisfaction or Your Money Refunded

Complete Kit— \$22.50  
60 Cycle Unit  
Complete Kit— 24.50  
25 Cycle Unit

Kits include Rectifiers.

Parts sold separately if desired.

DEALERS—Write for our proposition.

C. E. JACOBS, Sole Mnfr.

2808 N. Kedzie Avenue

CHICAGO

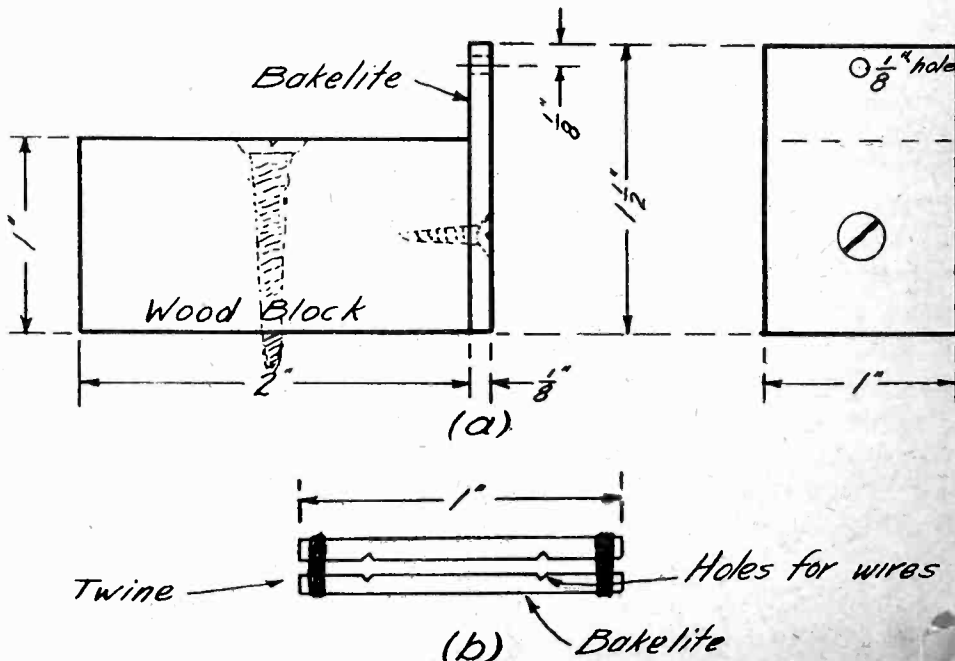

Fig. 3. Insulators.